

THE  
ANCIENT SECRET  
OF THE  
FLOWER OF LIFE

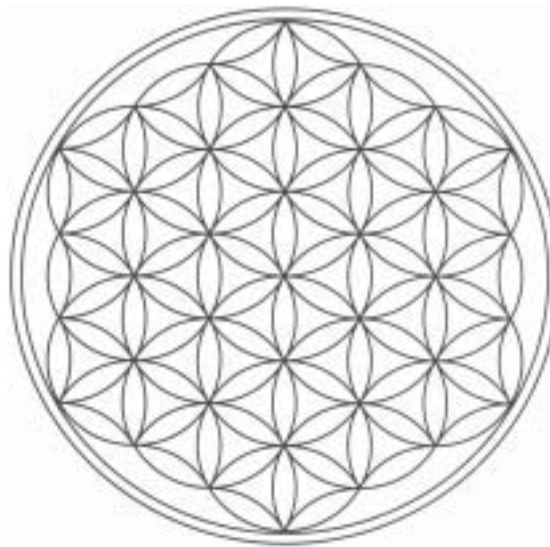

VOLUME 1

## **Acknowledgments**

There are so many beings—in the hundreds—who have helped bring this work to completion. I can't name them all, but I feel a need to recognize a few.

First of all, the two angels who entered my life long ago and who have lovingly guided my life, you are most honored. Thoth, the ascended master from Atlantis, Egypt and Greece, has given me a great deal of the information in this book. My family, my wife Claudette and my children, who have been my greatest love and inspiration in life. The 200 facilitators teaching this work of the Flower of Life in 33 countries, who have given me invaluable feedback, support and love that has kept me strong. The thousands of students who have written loving letters telling how this work has changed their lives; this has given me strength to continue. Livea Cherish, who put this work into book form from the video format, and Margaret Pinyan, whose fine editing ability allows this book to read so smoothly. Tim Stouse, who created about half the computer graphics, and Michael Tyree, who created the other half; they have made it possible to understand what was being said. And O'Ryin Swanson, the owner of Light Technology Publishing, who had the faith in me to publish this work.

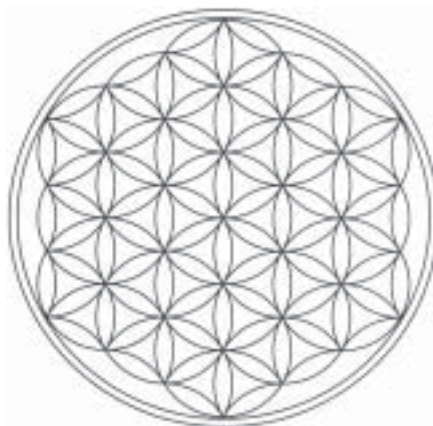

To the rest of you who are too numerous to name, I thank you all from my heart with the prayer that this work will actually help people understand who they really are so that together we can create a more loving world—and perhaps even a more loving universe. Thank you, dear ones.

## ***PREFACE***

Only one Spirit.

Long before Sumeria existed, before Egypt had built Saqqara, before the Indus Valley nourished, Spirit lived in human bodies, dancing in high culture. The Sphinx knows the truth. We are much more than we know. We have forgotten.

The Flower of Life was and is known by all life. All life, not only here but everywhere, knew it was the creation pattern — the way in, the way out. Spirit created us in this image. You know this is true; it is written in your body, in all your bodies.

Long ago we fell from a very high state of consciousness, and the memories are just now beginning to emerge. The birth of our new/old consciousness here on Earth will change us forever and return us to the awareness that there is truly only one Spirit.

What you're about to read is a journey of my life through this reality, how I learned about Great Spirit and about the relationships that each of us have with all life everywhere. I see Great Spirit in the eyes of everyone, and I know that He/She is within you. You already hold within your deepest being all the information I will be sharing with you. When you first read it, it may seem like something you've never heard before, but it isn't. This is ancient information. You can remember things that are deep inside you, and it's my hope that this book will trigger these things so you can remember who you are, why you came here, and what your purpose is for being here on Earth.

It is my prayer that this book will become a blessing in your life and give you a new awakening about yourself and something about you that is very, very old. Thank you for sharing this journey with me. I love you deeply, for in truth we are old friends. We are One.

Drunvalo

## INTRODUCTION

Part of my purpose in presenting this work is to assist people to be aware of certain events that have happened on this planet or are presently happening or are about to happen, events that are radically affecting our consciousness and the way we're living today. By understanding our present situation, we can open to the possibility of a new consciousness, a new humanity emerging on Earth. In addition, perhaps, my dearest purpose is to inspire you to remember who you really are and give you the courage to bring your gift to this world. For God has given each one of us a unique talent which, when truly lived, changes the physical world into a world of pure light.

I'll also be giving mathematical and scientific evidence to show how we got here, as spiritual beings in a physical world, in order to convince the left-brain analytical part of us that there is only one consciousness and one God, and that we are all part of that Oneness. This is important, for it brings both sides of the brain into balance. This balance opens the pineal gland and allows the prana, the life-force energy, to enter the innermost part of our physical being. Then and only then is the body of light called the Mer-Ka-Ba possible.

However, please understand that the evidence I originally learned this information from is in itself not important. The information could in most cases be completely changed to different information without affecting the outcome. In addition, I made many mistakes because I am now human. What is most interesting to me is that every time I made a mistake, it led into a deeper understanding of the Reality and a higher truth. So I say to you, if you find an error, look deeper. If you get hung up on

the information by overestimating its value, you will totally miss the point of the work. What I have just said is paramount to understanding this work.

I'll also be giving my personal experiences, many of which are, I admit, outrageous by the ordinary world's standards. Perhaps they are not so outrageous by the old world's standards, but it is you who must decide if they are true or are just stories — or if it even matters. Listen deeply with your heart, for your heart always knows the truth. Then I intend to share with you, as much as I can in the second volume, a specific breathing technique that will help you return to the vastly higher state of consciousness from which we all came. It is the remembrance of the breath connected to the lightbody of the Mer-Ka-Ba. This is one of the primary purposes of this work.

At this point a short story of how this book came about is in order. You will read about the angels, so I will not begin there, but rather with the later events. In 1985 the angels asked me to begin teaching the meditation of the Mer-Ka-Ba. I first learned it in 1971 and had been practicing it ever since, but I did not want to become a teacher. My life was easy and fulfilled. Basically, I was comfortable and didn't want to work so hard. The angels said that when someone is given spiritual knowledge, they must share it. They said it was a law of creation.

Knowing they were right, I opened my first class to the public in the spring of 1985. By 1991 my workshops were filled and overflowing, with hundreds of people on the waiting list. I didn't know how to reach everyone who wanted this information. In fact, I could not. So in 1992 I made a decision to release a video of one of my workshops and let it go out to the world.

Within less than a year it was exploding in sales, but there was one big problem. Most of the people who were watching the videos could not really understand what was presented because it was outside the context and content of their spiritual understanding. I gave a lecture to ninety people in Washington State, all of whom had seen the video tapes but had never been to one of my live workshops. It was there that I realized that only about 15 percent of the people actually knew how to live the meditation by using only the instructions on the video tapes. It was not working. Eighty-five percent were confused and unclear about the instructions.

Immediately I took the video tapes off the market. This, however, did not stop the video from continuing to be sold. People wanted the information, so they began to copy the existing tapes and give, sell or lease them to people worldwide. By 1993, it has been estimated that there were approximately 100,000 sets of these tapes in the world.

A decision was made. It was determined that the only way we could be responsible with this information was to have a trained person in the room when someone watched the video tapes. Trained means that we had carefully instructed a person to know and live the Mer-Ka-Ba. That person could then orally teach another. This is how the Flower of Life facilitator program was born. There are now over 200 trained facilitators in at least 33 countries. And the system has worked very well.

Now things are changing again. People are beginning to understand higher consciousness and its value and concepts. It is now time to release this book to the general public, which is now ready, we feel. A book has the advantage that people can take more time to study the drawings and photos carefully at leisure. And it will also have current updated information such as follows:

**Update: The times they are a-changing for sure! According to Dow Jones Company, Inc. in their magazine *American Demo' graphics*, February 1997, a ten-year scientific study has revealed that a brand-new culture is emerging in America and the Western world at this moment. Some have called this new culture the New Age, but it has had other names, depending on the country.**

**From our experience, we believe it is a worldwide emerging culture. It is a culture that deeply believes in God, family, children, spirit, Mother Earth and a healthy environment, femininity, honesty, meditation, life on other planets and the unity of all life everywhere. The members of this new culture believe, according to the study, that they are few and scattered. The survey revealed, however, to everyone's complete surprise, that "they" are one in every four adults in America — an amazing 44 million adults strong.' Something huge is happening here. Now that the money movers are aware of this enormous new market, you bet things will change. Everything from movie and TV content to the use of energy to the foods we eat and much more will be affected. Our very interpretation of the Reality may even eventually change. You are not alone, and it will not take long now for this fact to be apparent to everyone.**

Ever since the angels first appeared in 1971, I have been following their guidance. This is still true today. It was the angels who gave me the meditation of the Mer-Ka-Ba, and it is the meditation that is important here, not the information that is presented. The information is used just to bring us to a point of clarity so we can enter into a particular state of consciousness.

Understand that as I received the scientific information in the early years from 1971 to about 1985, I thought it was for my own personal growth. When I would read a scientific paper or magazine, I would discard it, not realizing that in the future I would have to prove what I was saying. Most of the articles have been located, but not all. Yet this information needs to go out. You, the reader, have strongly requested it. Therefore, wherever I can I will document my statements, but some proofs are lost, at least for the moment.

Also, part of the information is from nonscientific sources such as angels or interdimensional communications. We understand that "straight science" needs to be separated from a source who is considered psychic. Scientists are concerned about their credibility. As a side note, I would like to comment that this is similar to a male saying to a female that her feelings are not valid and that only logic is true or valid, that logic *must* be followed. Naturally, she knows another way; it is the way of life itself. It flows. It has no "male logic," but it is equally true. I believe in both, in balance.

If you can conceive of a person using both science and psychic abilities together to explore the Reality, you have come to the right place. Whenever possible I will differentiate between the two types of sources so that you are clear. This means that you must go within yourself to see if this information is true within your world. If something does not feel right, then discard it and go on. If it feels right, then live it and see if it is really true. But it is my understanding that the mind will never really know the Reality until it has joined with the heart. Male and female complete each other.

When you read this work you have two choices: You can come from your left brain, your male side, and take notes and carefully see the logic in each step, or you can come from your right brain, your female side, just let go and don't think — feel, watch it like a movie, expanded, not contracted. Either way will work. It is your choice.

Finally, as I prepared this book, I had to make another decision. Should the final stages of the meditation, the Mer-Ka-Ba itself, be released? I still feel that an oral teacher is best. Would you jump to the final stages of Tibetan Buddhism after reading one book? What has been decided is that everything will be given here up to the time of the 1993 video, with the precaution that you carefully enter the Mer-Ka-Ba and still seek out a Flower of Life facilitator. That information will be given at the end of the second volume. Much has been learned after and beyond these writings that can only be given orally and experientially.

The reason I am giving out the full information is that there are now at least seven other authors who have reprinted this work in one form or another. Some have taken it word for word, some have paraphrased me, and some have used my artwork and sacred geometry drawings. Some have asked and some have not. But the end result is that the information is out. Much of it has been distorted and sometimes it is just plain not true. Please know that it is not to protect myself, but to be responsible for the integrity of the work. This information belongs to the universe, not me. It is only the purity of the information that I am concerned with, and your clear understanding of it.

The exact instructions for the meditation are on the Internet [[www.floweroflife.com](http://www.floweroflife.com)], but of course not the hidden knowledge. That is experiential. You must live it. There is other information on the Net that states it is coming from me when it is not. There is also information out about the Flower of Life that is simply wrong or out of date. Hopefully, this work will make clear what has been veiled or distorted. I understand that these people were coming from their hearts, looking for the truth, but it is still my responsibility to you.

Therefore, in order to be clear and set the record straight, I am writing this book for all of you who wish to truly understand and know the truth.

In love and service, Drunvalo Melchizedek

# Remembering Our Ancient Past

## *How the Fall of Atlantis Changed Our Reality*

**A** little less than 13,000 years ago, something very dramatic happened in the history of our planet that we're going to explore in great detail, because what happened in the past is now affecting every aspect of our life today. Everything we experience in our daily living, including the particular technologies we use, the wars that erupt, the foods we eat and even the way we perceive our lives, is the direct result of a certain sequence of events that happened during the end of Atlantean times. The consequences of these ancient events have entirely changed the way we live and interpret reality.

Everything is connected! There is only one Reality and one God, but there are many, many ways that the one Reality can be interpreted. In fact, the number of ways to interpret the Reality are just about infinite. There are certain realities that many people have agreed on, and these realities are called levels of consciousness. For reasons we'll get into, there are specific realities that extremely large numbers of beings are focusing on, which include the one you and I are experiencing right now.

At one time we existed on Earth in a very high level of awareness that was far beyond anything we can even imagine right now. We hardly have even the capability to imagine where we once were, because who we were then is so out of context with who we are now. Because of the particular events that happened between 16,000 and 13,000 years ago, humanity fell from that very high place through many dimensions and overtones, ever increasing in density, until we reached this particular place, which we call the third dimension on planet Earth, the modern world.

When we fell—and it was like a fall—we were in an uncontrolled spiral of consciousness moving down through the dimensions of consciousness. We were out of control, and it was very much like falling through space. When we arrived here in the third dimension, certain specific changes took place, both physiologically and in the way we functioned in the Reality. The most important change was in the way we





Fig. 1-1. The star tetrahedral field that surrounds each of us.



breathed prana, a Hindu word for the life-force energy of this universe. Prana is more critical to our survival than air, water, food or any other substance, and the manner in which we take this energy into our bodies radically affects how we perceive the Reality.

In Atlantean times and earlier, the way we breathed prana was directly related to the electromagnetic energy fields that surround our bodies. All the energy forms in our fields are geometric, and the one we will be working with is a star tetrahedron, which consists of two interlocked tetrahedrons [Fig. 1-1]. Another way of thinking of it is as a three-dimensional Star of David.

The apex of the upward-pointing tetrahedron terminates one hand's length above the head, and the apex of the downward-pointing tetrahedron terminates one hand's length below the feet. A connecting tube runs from the upper apex to the lower point through the body's main energy centers, or chakras. This tube, for *your* body, has the diameter of the circle you make when you touch your longest finger to your thumb. It looks like a glass fluorescent tube, except it has a crystalline structure at the ends that fit into the two apexes of the star tetrahedron.

Before the fall of Atlantis, we used to bring prana simultaneously up and down this tube, and the two prana flows would meet inside one of our chakras. Specifically how and where the prana meets has always been an important aspect of this ancient science, which today is still being studied throughout the universe.

Another major point in the human body is the pineal gland, located almost in the center of the head, which is a huge factor in consciousness. This gland has degenerated from its original size, comparable to a ping-pong ball, to its present size, that of a dried pea, because we forgot how to use it a long time ago—and if you don't use it, you lose it.

Pranic energy used to flow through the center of the pineal gland. This gland, according to Jacob Liberman, author of *Light, the Medicine of the Future*, looks like an eye, and in some respects it is literally an eyeball. It's round and has an opening on one portion; in that opening is a lens for focusing light. It's hollow and has color receptors inside. Its primary field of view—though this has not been determined scientifically—is upward, toward the heavens. Just as our eyes can look up to 90 degrees to the side from the direction they face, the pineal gland can also “look” as much as 90 degrees away from its set direction. Just as we cannot look out the back of our heads, the pineal gland cannot look down toward the Earth.

Held inside the pineal gland—even in its shrunken size—are all the sacred geometries and understandings of exactly how the Reality was created. It's all there, in every single person. But these understandings are not accessible to us now because we lost our memories during the Fall, and without our memories we started to breathe differently. Instead of taking in prana through the pineal gland and circulating it up and down our central tube, we started breathing it in through the nose and mouth. This caused the prana to bypass the pineal gland, which resulted in our seeing things in a totally different way, through a different interpretation (called good and evil or polarity consciousness) of the One Reality. The result of this polarity consciousness has us thinking that we're inside a body looking out, somehow separated from what's “out there.” *This is pure illusion.* It feels real, but there is no truth at all to this perception. It's merely the view of reality we have from this fallen state.



For example, there is nothing wrong with anything that happens, for God is in control of the creation. But from one point of view, a polarity view, looking at the planet and how it evolves, we should not have fallen down here. In a normal curve of evolution, we should not be here. Something happened to us that was not supposed to happen. We went through a mutation—we had a chromosome breakage, you might say. So the Earth has been on red alert for almost 13,000 years, and many beings and levels of consciousness have been working together to figure out how to get us back onto the path (DNA) where we were before.

The effect of this “mistaken” fall in consciousness and the ensuing efforts to get us back on track is that something *really good*—something unexpected, something amazing—has resulted. Beings from all over the universe who have been trying to help us with our problem have initiated various experiments on us in an effort to assist, some legally and some without license. One particular experiment is resulting in a scenario that no one anywhere had ever dreamed would become a reality, except one person in a single culture from a long-distant past.

### **The Mer-Ka-Ba**

There’s another major factor that we’re going to focus on in this story. Thirteen thousand years ago we were aware of something about ourselves that we’ve since completely forgotten: The geometric energy fields around our bodies can be turned on in a particular way, which is also connected to our breath. These fields used to spin at close to the speed of light around our bodies, but they slowed down and stopped spinning after the Fall. When this field is turned back on and spins, it’s called a Mer-Ka-Ba, and its usefulness in this Reality is unparalleled. It gives us an expanded awareness of who we are, connects us with higher levels of consciousness and restores the memory of the infinite possibilities of our being.

A healthy spinning Mer-Ka-Ba is fifty to sixty feet in diameter, proportionate to one’s height. The rotation of a spinning Mer-Ka-Ba can be displayed on a computer monitor using the appropriate instruments, and its appearance is identical with the infrared heat envelope of the galaxy [Fig. 1-2]—the same basic shape as the traditional flying saucer.

The word Mer-Ka-Ba is made up of three smaller words, Mer, Ka and Ba, which, as we are using them, came from ancient Egyptian. It is seen in other cultures as *merkabah*, *merkaba* and *merkavah*. There are several pronunciations, but generally you pronounce it as if the three syllables are separate, with equal accents on each. Mer refers to a specific kind of light that was understood in Egypt only during the



Fig. 1-2. Infrared photo of a galaxy, called the Sombrero galaxy, showing its heat envelope.

Eighteenth Dynasty. It was seen as two counterrotating fields of light spinning in the same space, which are generated by certain breathing patterns. *Ka* refers to the individual spirit and *Ba* refers to the spirit's interpretation of its particular reality. In *our* particular reality, *Ba* is usually defined as the body or physical reality. In other realities where spirits don't have bodies, it refers to their concepts or interpretation of the reality they bring with them.

So the Mer-Ka-Ba is a counterrotating field of light that affects spirit and body simultaneously. It is a vehicle that can take spirit *and* body (or one's interpretation of reality) from one world or dimension into another. In fact, the Mer-Ka-Ba is much more than this, because it can *create* reality as well as move through realities. For our purposes here, however, we will focus mainly on its aspect as an interdimensional vehicle (Mer-Ka-Vah means *chariot* in Hebrew) that will help us return to our original higher state of consciousness.

### *Returning to Our Original State*

To be clear, returning to our original state is a natural process that can be easy or difficult according to our belief patterns. However, simply be' coming involved with the technical relationships of the Mer-Ka-Ba, such as correcting our breathing patterns or mentally realizing the infinite connections to all patterns of life, for example, is not enough. At least one other factor is even more important than the Mer-Ka-Ba itself, and that is the understanding, realization and living of divine love. For it is divine love, sometimes referred to as unconditional love, that is the primary factor that allows the Mer-Ka-Ba to become a living field of light. Without divine love, the Mer-Ka-Ba is just a machine, and this machine will have limitations that will never allow the spirit that created it to return home and reach the highest levels of consciousness—the place where there are no levels.

We must be experiencing and expressing unconditional love in order to move beyond a certain dimension, and the world is fast heading toward that higher place. We are heading away from the place of separatism where we see ourselves inside the body looking out. That view will be gone soon, to be replaced with a different view of reality where we'll have the sense and knowledge of absolute unity with all life; and that sense will grow more and more as we continue to move upward through each level on our journey home.

Later we will explore special ways of opening the heart—to kindle compassionate, unconditional love so that you can have a direct experience. If you can just let this happen, you may discover things about yourself that you didn't know before.

*Dear reader: There are procedures in the workshops that cannot be reproduced on the tapes or in this book because they are totally experiential. They are just as important as the knowledge, for without them the knowledge is worthless. The only way we can give these experiences now is through oral tradition through a living workshop. But that may change in the future.*

### *A Higher, Inclusive Reality*

Another component we're going to focus on has many names, but in present-day terms it's usually referred to as the higher self. In the higher-self reality, we literally exist in other worlds besides this one. There are so many dimensions and worlds that it almost surpasses human capability to conceive of it. These levels



are very specific and mathematical, and the spacing and the wavelengths in and between these levels are identical to the relationships within musical octaves and other aspects of life. But right now your third-dimensional consciousness has probably been severed from your higher aspect, so you're aware only of what's going on here on Earth. This is not the norm for beings existing in a natural unfallen state. The norm is that beings first become aware of several levels at once, like chords in music, until finally, as they grow, they become aware of everything everywhere at once. The following example is unusual, but it demonstrates what is being talked about.

I'm in communication with someone right now who is aware of many levels at once. The scientists who are studying her are speechless; they cannot understand how she does what she's doing. She might be sitting in a room, yet she claims to be watching from outer space. NASA checked her out by asking her to "see" a specific satellite and give specific information that could be known only if someone were actually there. She gave them readings off their instruments, which I'm sure seemed impossible to the scientists. She said she was flying alongside the satellite and simply read them. Her name is Mary Ann Schinfield. She is legally blind, yet she can walk around a room and no one would know that she cannot see. How does she do it?

Recently she called me, and while we were talking she asked if I would like to see through her eyes. Of course I said yes. Within a few breaths, my field of vision opened up, and I was looking at or through what looked like a huge television screen *chac filled my field of vision*. What I saw was astounding. It seemed that I was moving very fast through space without a body. I could see the stars, and at that moment Mary Ann and I, seeing through her eyes, were moving alongside a string of comets. She was very close to one of them.

It was one of the most real out-of-body experiences I have ever had. Around the perimeter of this "TV screen" there were about twelve or fourteen smaller TV screens, each one giving extremely fast images. One of them up in the upper right-hand corner was flashing rapidly moving images such as triangles, light bulbs, circles, wavy lines, trees, squares etc. It was this screen that told her what was in the immediate space where her body was located. She could "see" through these seemingly unrelated images. There was another screen in the bottom left-hand corner where she communicated with other extraterrestrial life that was within this solar system.

Here is a person who is in a three-dimensional body on Earth, but has full memory and experience of living in other dimensions. This manner of interrupting the Reality is unusual. People do not normally see inner TV screens, but we do exist in many other worlds even though most of us are not aware of it.

You presently exist on probably five or more levels. Though there is a break between this dimension and others, when you connect with your higher self you mend that break, after which you start becoming aware of the higher levels and the higher levels start paying more attention to you— communication begins! This connection to the higher self is probably the most important thing that could happen in your life—more important than understanding any of the information I'll be giving. Connecting with the higher self is more important than learning to activate the Mer-Ka-Ba, because if you connect yourself to your Self, you will get absolutely clear information on how to proceed step by step through *any* reality and how to lead yourself back home into the full consciousness of God. When you connect with your higher self, the rest will happen automatically. You will still have

to live your life, but everything you do will have great power and wisdom within your actions, thoughts and emotions.

Exactly *how* to connect with one's higher self is what many people, including myself, have been trying to understand. Many people who have somehow made this connection often don't know how it happened. In this course I'll attempt to explain exactly how to connect with your higher self. I'll do my best.

### *Left- and Right-Brain Realities*

There's one more component to this picture. I'll be spending perhaps half of our time on left-brain information like geometries and facts and all kinds of information that to many spiritual people would seem totally unimportant. I'm doing this because when we fell, we divided ourselves into two—really three, but primarily into two—main components, which we call male and female. The right brain, which controls the left side of our body, is our feminine component, though it's truly neither male nor female. This is where our psychic and emotional aspect lives. This component knows that there's only one God and that oneness is all there is. Though it can't really explain it, it just knows the truth. So there are not a lot of problems with the female component.

The problem is on the left side of the brain—the male component. Because of the nature of how the male brain is oriented—a mirror image of the female—it has its logical component forward (more dominant), while the female has its logical component toward the back (less dominant). The left brain does not experience oneness when it looks out into the Reality; all it sees is division and separation. For that reason, the male aspect of us is having a difficult time down here on Earth. Even our major sacred books such as the Koran, the Hebrew Bible and the Christian Bible have divided everything into opposites. The left brain experiences that there is God, but then there's also the devil—perhaps not quite as strong as God, but a huge influence. So even God is seen in terms of duality, as one pole of the opposing forces of dark and light. (This is not true in all sects of these religions. A few of them see that there is only God.)

Until the left brain is able to see the unity running through everything, to know that there is truly one spirit, one force, one consciousness moving through absolutely everything in existence—until it knows that unity beyond any doubt—then the mind is going to stay separated from itself, from its wholeness and from the fullness of its potential. Even if there's the *slightest* doubt at all about unity, the left-brain aspect will hold us back, and we can no longer walk on water. Remember, even Thomas walked on water for a short moment when Jesus asked him to, but one little cell in his big toe said, "Wait a minute, I can't do this," and Thomas sank into the cold water of polarity reality.

### *Where We're Going with This Information*

I'm dedicating a lot of our time to showing you beyond any shadow of a doubt that there is only one *image* in everything. There is one and only one image that created all that exists, and that image is the same image that has formed the electromagnetic field around your body. The same geometries that are in your field can be found around everything—planets and galaxies and atoms and everything else. We will examine this image in great detail.



We're also going to go into the history of the Earth, because it is very important to our present situation. We cannot really understand how we got here if we don't know the process that led us to this point. So we'll spend a considerable length of time talking about what happened a long time ago; then slowly we'll come forward until we get to what's going on today. It's all tied together. The same old thing has been going on all along, and it's still going on—in fact, it has never stopped.

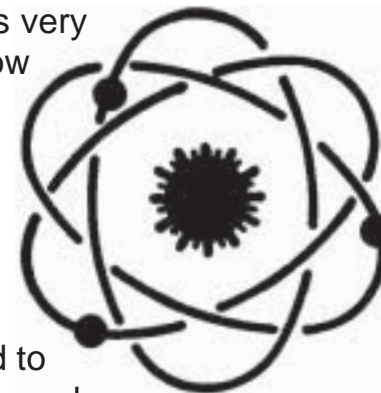

Those of you who are predominantly right-brained may feel inclined to

skip this left-brained material, yet it is most important for you to hang in there. It is through balance that spiritual health returns.

When the left brain sees absolute unity, it begins to relax and the corpus callosum (the band of fibers joining the two hemispheres) opens in a new way, allowing an integration between the two sides. The link between the left and right brain widens, a flow starts, information is passed back and forth, and the opposing sides of the brain begin to integrate and synchronize with each other. If you're hooked up for biofeedback, you can actually see this happening. This action turns on the pineal gland in a different manner and makes it possible for your meditation to activate the lightbody of the Mer-Ka-Ba. Then the whole process of regeneration and recovery of our previous higher levels of consciousness can proceed. It is a growth process.

If you are studying any other spiritual practice, you do not need to stop in order to begin the work with the Mer-Ka-Ba—unless, of course, your teacher does not want to mix traditions. Other meditations that are based on truth can be extremely useful once the Mer-Ka-Ba is spinning, because then noticeable results can evolve very, very quickly. I will repeat myself just so you know for sure: The lightbody of the Mer-Ka-Ba does not contradict or inhibit any other meditation or religion that upholds the belief that there is only one God.

So far we've talked only about the ABCs of spirituality. These are just the beginning steps. But these first steps are the most important ones I know.

Your left brain may love all this information and file it away in neatly labeled pigeonholes; this is fine. Or you can just relax and read this like an adventure story, a mind-stretcher, a fantasy. However you read it, the fact that you *are* reading this book is what matters, and you will receive whatever you're meant to receive.

In the spirit of oneness, then, let us embark upon this journey of exploration together.

## Challenging the Belief Patterns of Our Parents

Many ideas we believe today and “facts” we’ve been taught in school are just not true, and people are now beginning to realize this worldwide. Of course, usually these patterns were believed to be true at the time they were taught, but then concepts and ideas changed, and the next generation was taught different truths.

For example, the concept of the atom has changed dramatically so many times over the last ninety years that at this point they don’t really adhere to a concept. They use one, but with the understanding that it may be wrong.

At one time the atom was thought to be like a watermelon and the electrons were like seeds inside the watermelon. We really know very little about the Reality that exists around us. Quantum physics has now shown us that the person performing the experiment influences the outcome. In other words, consciousness can change the outcome of an experiment, depending on its belief patterns.

There are other aspects of ourselves we hold true that may not be true at all. One idea that has been held for a long time is that we’re the only planet in existence with life on it. In our heart of hearts we know this is not true, but this planet will not admit this truth in modern times even though there is powerful evidence of UFO sightings that have been coming from all over the world nonstop for over fifty years. Any subject other than UFOs would have been believed and accepted by the world had this subject not been so threatening. Therefore, we’re going to look at evidence that suggests there is a higher consciousness in the universe, not only in the stars, but perhaps right here on the Earth.

As a side note, I suggest that you see two videos aired on *NBC* Television as a special, hosted by *Charlton Heston*: “The Mysterious Origins of Man” and “The Mystery of the Sphinx.” Both are distributed by BC Video at 1-800-508-0558.

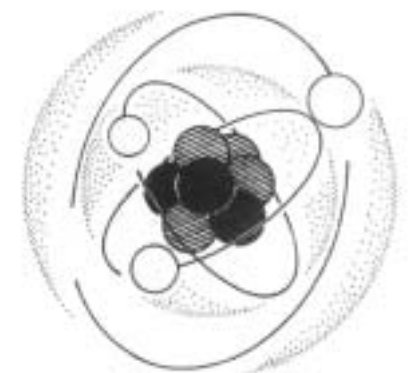
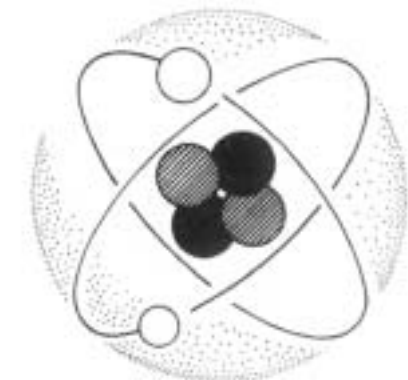
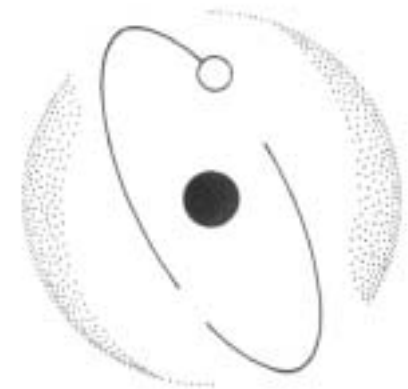

## Gathering the Anomalies

### The Dogon Tribe, Sirius B and Dolphin Beings

This drawing [Fig. 1-3] is truly remarkable. The information in it came from a book about Sirius, *The Sirius Mystery* by Robert Temple. He had, I was told, between ten and twelve different subjects to choose from, each one of which would lead to the same conclusion but from a totally different point of view. I'm glad he chose the one he did, because it happens to relate to another aspect of what we will be talking about.

Robert Temple was one of the first people to reveal certain facts— though scientists have known for a long time—about an African tribe near Timbuktu called the Dogons. This tribe holds information that is simply impossible for them to have by any standards in our view of the world today. Their information destroys everything we think we know about ourselves in regard to being alone.

You see, the Dogons have a cave on their land that stretches way back into a mountain, and in this cave are wall drawings over 700 years old. One particular man, the holy man of their tribe, sits at the front of this cave to protect it. This is his lifetime job. They feed him and take care of him, but no one can touch him or get close to him. When he dies, another holy man takes his place. In this cave are amazing drawings and bits of information.

I'm going to tell you about two of these bits—and these are only two of many.

First of all, we're referring to the brightest star in the sky (with an apparent magnitude of -1.4)—Sirius, now called Sirius A. If you look at Orion's Belt, those three stars in a row, and follow the line downward to your left, you see a very bright star, which is Sirius A. If you follow them upward about twice the distance, you see the Pleiades. The information in the Dogon cave specifically showed another star rotating around Sirius. The

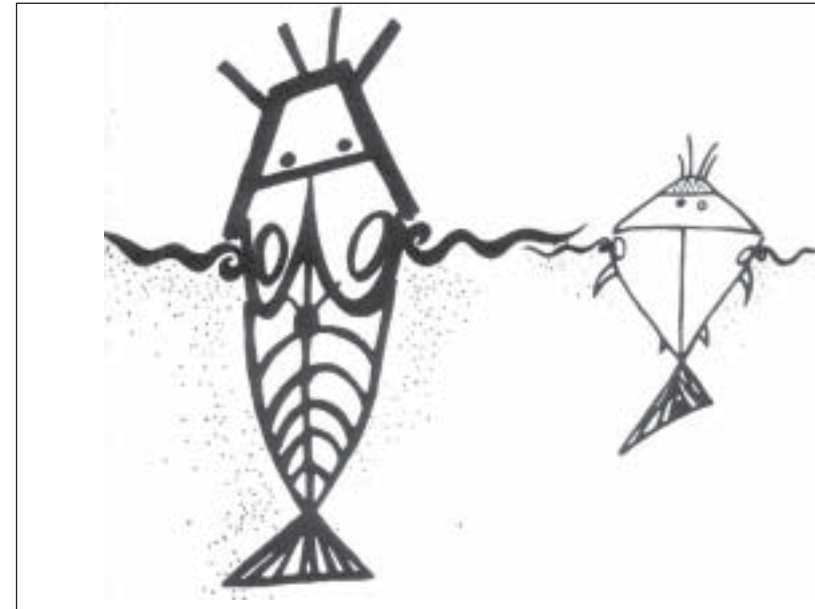

Fig. 1-3. Dogon drawing or Nommo, the great culture hero who brought civilization to Earth. Because both eyes are shown in the drawings, they are presumed to be plan views, which means the tail is opposed (like a dolphin) rather than lateral, as it is with a fish. The waterline is clearly indicated, implying that the Nommo is air-breathing. This drawing came out of the Australian magazine *Simply Living*.

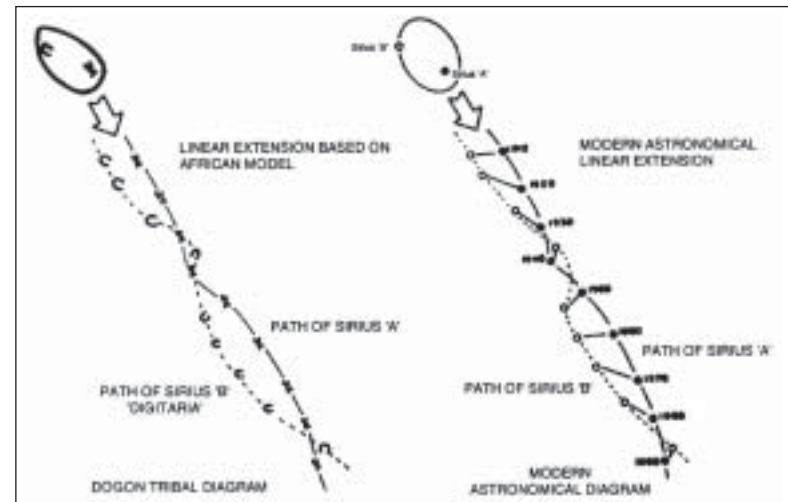

Fig. 1-4. Two linear extensions, representing the revolution of Sirius B around Sirius A. The diagram on the left is based on Dogon drawings; the projection of the right was calculated by Robert Temple.



Dogons are very specific about this star. They say it's very, very old and very small, and that it's made out of what they called the "heaviest matter in the universe" (which is close, but not actually correct). And they say that it takes "close to fifty years" for this small star to rotate around Sirius. This is detailed stuff. Astronomers were able to validate the existence of Sirius B, a white dwarf, in 1862, and only about fifteen or twenty years ago could they validate the other information.

Now, stars are very much like people, as you will begin to see. They're alive, and they have personalities and many qualities like we have. On a scientific level, they have growth stages. They start out as hydrogen suns, like ours, where two hydrogen atoms come together in a fusion reaction to form helium. This process creates all the life and light that's on this planet.

As a star further matures, another fusion process begins—the helium process—where three helium atoms come together to form carbon. This growth process continues through various stages until it gets all the way up through a particular level of the atomic table, at which point the star has reached the length of its life span. At the end of its life, as far as we know, there are two primary things a star can do. New data on pulsars and magnetars give other options. One, it can explode and become a supernova, a huge hydrogen cloud that becomes the womb for hundreds of new baby stars. Two, it can rapidly expand into what's called a red giant, a huge explosion that engulfs all its planets—burns them up and destroys the whole system, then stays expanded for a long time. Then slowly it will collapse into a tiny old star called a white dwarf.

What the scientists found rotating around Sirius was a white dwarf, which corresponded exactly to what the Dogons say. Then science checked to see how much it weighed, to see if it really was the "heaviest matter in the universe." The original computations—made about twenty years ago—determined that it weighed about 2000 pounds per cubic inch. That would certainly qualify for heavy matter, but science now knows that this was an extremely conservative estimate. The newest estimate is approximately 1.5 million tons per cubic inch! Black holes aside, that would surely seem to be the heaviest matter in the universe. This means that if you had a cubic inch of this white dwarf, which is now called Sirius B, it would weigh about one and a half million tons, which would go right through anything you set it on. It would head toward the center of the Earth and actually oscillate back and forth across the core for a long time until friction finally stopped it in the very center.

In addition, when they checked the rotational pattern of Sirius B around the larger Sirius A, they found it to be 50.1 years. Now, that absolutely could not be a coincidence! It's just too close, too factual. Yet how did an ancient primitive tribe know such detailed information about a star that could be measured only in this century?

But that is only part of their information. They also knew about all the other planets in our solar system, including Neptune, Pluto and Uranus, which we have discovered more recently. They knew exactly what these planets look like when you approach them *from space*, which we have also only recently learned. They also knew about red and white blood cells, and had all kinds of physiological information about the human body that we've recently learned. All this from a "primitive" tribe!

Naturally, a scientific team was sent over to ask the Dogons how they knew all this. Well, that was probably a big mistake for these researchers, because if they accepted that the Dogons really have this information, then ^by default they must accept how they got it. When they asked, "How did you learn this?" the Dogons replied that the drawings on the walls of their cave showed them. These drawings show a flying saucer—it looks just like that very familiar shape—coming out of the sky and

landing on three legs; then it shows the beings in the ship making a big hole in the ground, filling it with water, jumping out of the ship into the water, and coming up to the edge of the water. These beings look very much like dolphins; in fact, maybe they *were* dolphins, but we don't know for certain. Then they started communicating to the Dogons. They described where they came from and gave the Dogon tribe all this information.

That's what the Dogons said. The scientists just sat there. Eventually they said, "Nooo, we didn't hear that." Because it didn't fit into anything they thought they knew, they just kind of hid the information somewhere under a carpet in their minds. Most people, scientists included, just do not know what to do with these kinds of facts. There has been a lot of information like this that we just don't know what to do with. Since we can't find a way to integrate this unusual information with what we already think we know, we just stick it away somewhere—because the theories don't work, you know, if we keep it.

Here's another thing the Dogons knew. This little drawing was on the walls [Fig. 1 -4], but the scientists didn't know what the heck it was ... until computers calculated the orbits of Sirius A and Sirius B. As seen from Earth, this pattern shown in the Dogon cave is identical to the pattern made by Sirius B moving around Sirius A—in a specific time frame, which happens to be from the year 1912 to the year 1990. The dolphins, or whoever those beings were, gave this present-day diagram/time pattern to the Dogons at least 700 years ago!

Now, as this has unfolded in my life, I've discovered that both 1912 and 1990 were very important years. In fact, the period between these two years was probably one of the most important periods ever in the history of the Earth. I'll explain more about this as we go on, but briefly, in 1912 time-travel experiments began, as did experiments between the extraterrestrial Grays and humans. (We will explain later.) And 1990 was the first year that the ascension grid for our planet was completed. And many other events happened during this period. The fact that the Dogon wall drawings pinpointed this period could be considered clearly prophetic.

### *A Trip to Peru and More Dogon Evidence*

I first came upon this Dogon information in 1982 or '83. I found myself around a group of people who were working with the Dogon tribe, who were actually going there and communicating with them. Then in 1985 I took a group of people to Peru, including one of these Dogon researchers. We checked into a plush hotel in Cuzco called the Hotel San Agustin, intending to go walking the following day on the Inca Trail, about forty miles over the mountain tops. You walk up to about 14,000 feet, then drop down to Machu Picchu about 5000 feet below. It's beautiful.

Our hotel was a Spanish adobe palace hidden behind high walls in the center of town. We were paired off so we could get cheaper rates. I was with the Dogon researcher, and he was constantly telling me about what they were learning, including a lot more than we're discussing here. We got a room, and the room number was 23. He got all excited and exclaimed, "Room 23!—a very auspicious number!" From Africa, where the Dogons live, the star Sirius disappears below the horizon and is out of sight for a couple of months; then it appears again on the morning of July 23, when it rises about one minute before the Sun. It appears, bright ruby-red, just above the horizon, almost exactly due east. Sixty seconds later the Sun emerges. So you can see

Sirius for just a moment, then it's gone. This is called the heliacal rising of Sirius, which was a very important moment for most of the ancient world, not just for the Dogons and Egypt.

This is the moment when Sirius and the Sun and the Earth are in a straight line across space. In Egypt, almost all the temples were aligned with this line, including the gaze of the Sphinx. Many of the temples had a tiny hole in the wall somewhere; then there would be another tiny hole through another wall, then through another wall and another, going into some dim inner chamber. In that chamber there would be something like a cube or Golden Mean rectangle of granite sitting in the middle of the room with a little mark on it. At the moment of the heliacal rising of Sirius, a ruby-red light would strike the altar for a few seconds, which would begin their new year and the first day of the ancient Sothic calendar of Egypt.

Anyway, here we were in Peru, getting the room and remarking about the number 23. We walked into the room and set our things down; then we both looked at the bed, and on the bedspread we saw this image [Fig. 1-5].

We just stood there in amazement, looking at it for about five minutes before we could even speak, because the wheels in our heads were going around so fast, trying to figure out how this could be.

If you look again at the image of the beings who got out of the flying saucer, they looked very similar. They were half in and half out of water—air-breathing mammals—and their tail fins were horizontal, not vertical like fish. The only sea creatures with such fins are cetaceans such as dolphins and whales.

But the Dogon image is from Africa ... and here we were in Peru, staring at a very similar-looking mammal. This just didn't compute. So we asked the hotel personnel, "What do you know about this emblem?" They didn't know much. They were mostly of Spanish descent and weren't tied much into Indian legends. They didn't know the old stories of creation, so they had no idea what it meant. Here's a picture of the whole insignia [Fig. 1-6]:

In order to find out more, we rented a little car and drove around the area asking other people. We finally ended up at Lake Titicaca, talking to some Uros Indians. At one point I asked, "What do you know about this?" They said, "Oh, yeah," and proceeded to tell me a story that sounded very much like what the Dogons had told! This is their creation story: A flying saucer came out of the sky and landed in Lake Titicaca on the Island of the Sun. These dolphinlike creatures jumped into



Fig. 1-5. Logo on bedspread in Cuzco hotel.



Fig. 1-6. Logo of Hotel San Augustin, Cuzco.

the water, came up to the people, told them where they came from, and in the beginning, began an intimate relationship with the pre-Inca peoples. It was this connection with the Sky People, according to the story, that launched the Incan empire.

I just sat there with my mouth open. Afterward, *Simply Living* magazine out of Australia published a whole series of articles on this subject. When people started investigating, they found that cultures all over the world have similar stories. There are *twelve different cultures* in the Mediterranean alone that tell a similar story.

We'll come back to the dolphins a lot in this work because it seems they played a huge role in the unfoldment of consciousness on this planet.

### A Sanskrit Poem and Pi

Let's look at something totally different now to suggest that the ancient beings of this world were perhaps more evolved than we give them credit for. Figure 1-7 is a phonetic translation of a Sanskrit poem. It was shown in an article published in *Clarion Call* magazine, in the early eighties, I believe. The English translation is shown below the Sanskrit.

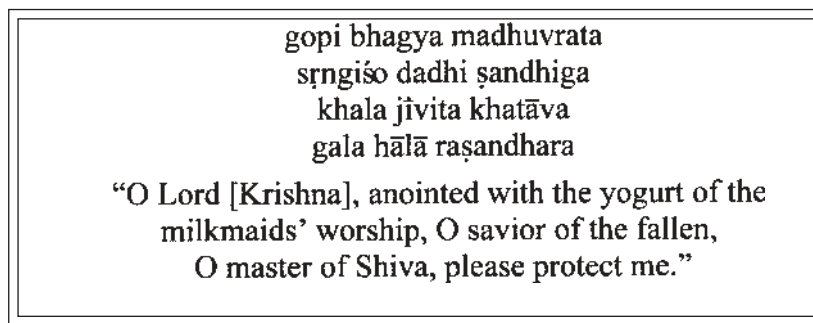

Fig. 1-7. From *Clarion Call* magazine:  
 “Mathematics and the Spiritual Dimension” by David Osborn.

Over many years researchers have discovered that each one of these Sanskrit sounds corresponds to a numerical value. It took them a long time to figure this out. Figure 1-8 shows all the various sounds that are possible in Sanskrit. Each sound has a numerical value from zero to nine, and some syllables have two number values. For instance, *ka*, a primary sound, translates as *spirit* and corresponds to either zero or one, depending on its usage, I assume.

When researchers took these different sound values and applied them to this particular poem, a mathematical figure came up that is extremely significant: 0.3141592653589 . . . continuing out to thirty-two digits. This is the exact number of *pi* divided by ten carried to thirty-two digits! No one has ever figured out how to calculate

ka				=	0
ka	ṭa	pa	ya	=	1
kha	ṭha	pha	ra	=	2
ga	ḍa	ba	la	=	3
gha	ḍha	bha	va	=	4
gna	ṇa	ma	sa	=	5
ca	ta	śa		=	6
cha	tha	ṣa		=	7
ja	da	ha		=	8
jha	dha			=	9

$pi/10 = 0.3141592653589793238462643383279$

Fig. 1-8. All Sanscrit sounds, with their numerical values.

for the decimal point, which is why this is pi over ten. If you move the decimal point one digit to the right, then it would be 3.1415 etc., the diameter of a circle divided into its circumference. Well, they might have known about the diameter of a circle divided into its circumference, but in our culture's understanding of who these ancients were, there is no possibility that they could have calculated it with that kind of accuracy. Yet here is undeniable evidence.

There are many, many of these poems and many, many other writings in Sanskrit. I don't know how far they've come in deciphering all of it, but I think that when all is said and done, it's going to be pretty remarkable.

How did they do that? Who were these people, really? Is it possible that our understanding of them is not exactly correct? Were they maybe a little more advanced than we thought? This poem definitely suggests this.

### *How Old Is the Sphinx?*

The following is also probably one of the most important discoveries on the planet ever. It's happening right now at this moment. However, it began about forty years ago with R.A. Schwaller de Lubicz. He's a famous self-educated Egyptian archaeologist who has written many books. He and his stepdaughter, Lucie Lamy, have demonstrated a profound understanding of sacred geometry and the Egyptian culture.

While observing the Sphinx, Schwaller de Lubicz became especially interested in the tremendous wear on its surface. Toward the back of the Sphinx there are wear patterns that cut twelve feet deep into its surface, and this type of wear pattern is totally different from the patterns on other buildings in Egypt [Fig. 1-9]. The wear patterns on other buildings, supposedly built at the same time, are textured by sand and wind, which is consistent if the buildings are, as believed, around 4000 years old. But the wear patterns on the Sphinx look like they've been smoothed with water. According to mainstream thought, the Sphinx, the Great Pyramid and other associated



Fig. 1-9. Sphinx

buildings were built about 4500 years ago in the Fourth Dynasty under Cheops.

When this discrepancy was brought up to Egyptian archaeologists, they refused to listen. This went on for about forty years. Other people noticed it, but the Egyptians simply would not admit the obvious. Then a man named John Anthony West became interested. He has written many books on Egypt, including *Serpent in the Sky* and a fine Egyptian guidebook. When he heard about the Sphinx dispute, he went to look for himself. He could see that the wear was incredibly excessive and that it did look like water had caused the wear. He also found, like Schwaller de Lubicz, that he could not get the accredited archaeologists to listen to his beliefs about the Sphinx.

There's a reason for this denial, I believe. Please understand, I am not trying to discredit a major religion. I am merely reporting. You see, there are around 5000 Egyptian archaeologists in the world, and they all pretty much agree with each other in most ways. This agreement has become a tradition. They make little changes, but not too many (and not too fast, either), and most agree on the age of the pyramids. All of these archaeologists are Muslim, with a few exceptions, and their holy book is the Koran. The Koran, in its traditional interpretation, says that creation began about 6000 years ago. So if a Muslim were to say that a building is 8000 years old, he would be disputing their bible. They cannot do that, they simply cannot, so they won't even talk about it, won't even discuss it.

If you say that anything is more than 6000 years old, they will not agree. They will do anything to protect their belief, making sure that no one knows about any man-made objects that might be more than 6000 years old. For instance, they've enclosed the pyramids of the First Dynasty, which are older than Saqqara, and built military fortifications around and within the walls so nobody can get to them. Why? Because they are older than or close to 6000 years. So John Anthony West stepped outside the Egyptian archaeology world and brought in an American geologist named Robert Schoch, who did a computer analysis that gave a totally different, scientific point of view. Lo and behold, beyond any doubt at all, the Sphinx *does* have water wear patterns—and in a desert that's at least 7000 years old, it puts it well over the age of 6000 years.

On top of that, computers have calculated that it would take a minimum of 1000 years of continuous, torrential rains dumped on the Sphinx— nonstop for twenty-four hours a day—to cause that kind wear. This means the Sphinx has to be at least 8000 years old minimum. Because it's not likely that it bucketed rain nonstop for 1000 years, they figured that it's got to be at least 10- to 15,000 years old, maybe a lot older. When this evidence gets out to the world, it will be one of the most powerful revelations on this planet in a very, very long time. It's going to have a bigger effect on the world's view of itself than probably any other discovery. This evidence has not entered the schools or general knowledge yet, though it has gone all around the planet. It has been looked at and checked out and thought about and argued over, and in the end most scientists have agreed

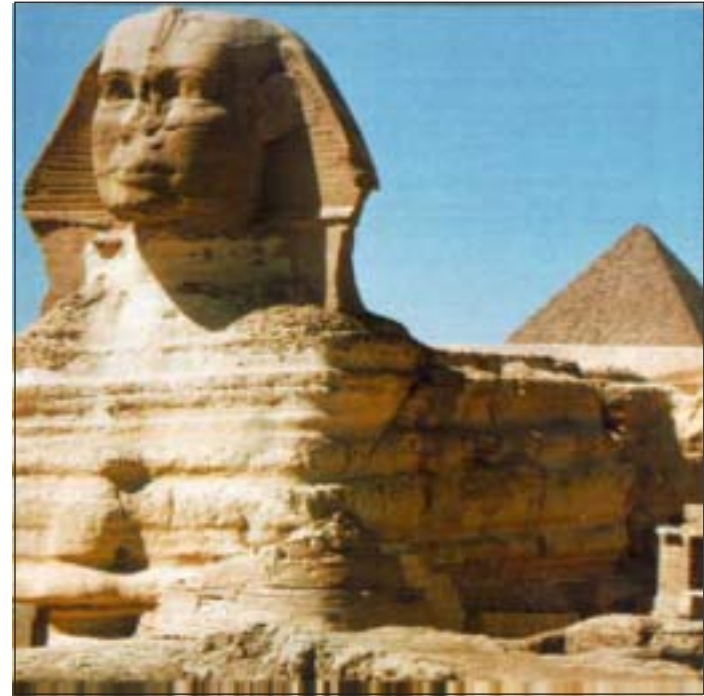

that it cannot be doubted.

So the age of the Sphinx has now been put back to at least 10,000 years, maybe 15,000 or a lot more, and it's already changing the entire worldview of the people on the cutting edge of archaeology. You see, judging by everything we presently think we know, the oldest civilized people in the world were the Sumerians, and they go back to approximately 3800 B.C. Before that, conventional knowledge says there was nothing but hairy barbarians—no civilization at all anywhere on the whole planet. But now we have something man-made and civilized that's 10,000 to 15,000 years old. That changes everything!

In the past, when something new like this is discovered that has a major influence on the viewpoint of the world, it takes about a hundred years for it to get to the people, for the average person to say, "Oh, yes, that is true!" But this time it'll happen a lot quicker because of television, computers, the Internet and the way things are today. Now scientific circles, for the first time ever, are actually beginning to look at the words of Plato in a new light when he talked about another culture, another continent, from a dim past called Atlantis.

The Sphinx is the largest sculpture on the planet. It was not done by hairy barbarians, but by a very sophisticated culture. And it was not done by anybody we now know here on Earth. From a scientific point of view, this is the first solid evidence to be accepted about the true age of civilization. There has been lots of other evidence, but people just kept putting it under the table. This information on the Sphinx has made a crack in our worldview. This took place about 1990, and the crack is now widening. We now have the accepted evidence that there absolutely *had* to have been someone on Earth who was highly civilized as early as 10,000 years ago. You can see how that's going to completely change our view of who we think we are.

### *Edgar Cayce, the Sphinx and the Hall of Records*

I find it extremely interesting that the Sphinx is causing this change, especially in view of what the A.R.E. [Association for Research and Enlightenment] has been saying. The A.R.E., a foundation based on teachings of "the sleeping prophet," Edgar Cayce, says that the Sphinx contains the opening to the Hall of Records. The Hall of Records is an alleged underground chamber containing physical proof of superior ancient civilizations on Earth.

Cayce is a very interesting prophet. He made about 14,000 predictions in his lifetime, and by 1970, 12,000 of those predictions had come true and 2,000 were still in the future. And in all those predictions, he made only one tiny mistake. Out of 12,000 predictions, that's incredible. You can almost forgive him for that one mistake: He received a letter from a man in France asking for a health reading, but Cayce mistakenly gave a reading on the inquirer's twin brother. That was his only mistake. Every other thing came true exactly as Cayce had predicted—up until 1972. However, after 1972 mistakes began to happen, and I'll explain why at the right time. (For those who think Cayce's prediction that Atlantis would rise to the surface before 1970 did not come true, check out the January 1970 issue of *Life* magazine. Islands *did* come to the surface in the area where Cayce said Atlantis was located; some sank again



Fig. 1-10 Hieroglyphs for Thoth

and some are still above water today.)

According to Cayce, the right paw of the Sphinx is the opening to the Hall of Records. Both Thoth and Cayce have said that there are physical objects hidden in a room underground near the Sphinx that absolutely prove that there were advanced cultures on this planet long before us. Thoth says that these objects will prove the existence of these advanced cultures as far back as five and a half million years. In comparison, our level of culture is but a child to these ancient cultures.

In fact, according to Thoth, civilization on this planet actually extends back 500 *million* years, and our very first culture originally came from the stars. But something colossal happened five and a half million years ago that affected the akashic records. I cannot understand how that could even take place, because of what I understand the akashic records to be. According to what I know, anything that occurs, occurs forever in vibrational form. So I don't understand how the akashic records can be destroyed; yet I'm told this is true.

### *Introducing Thoth*

Who is Thoth? What you're seeing in this illustration [Fig. 1-10] is Egyptian hieroglyphics. Everything in the picture is hieroglyph, not just the images at the top. "Hieroglyph" means *holy writings*. These hieroglyphs are drawn on papyrus, which was supposedly the first paper in the world. The person depicted here is a man named Thoth, pronounced with a long o. (Some day people say Thawth, but he pronounces it Thoth.) The hieroglyph shows his head as an ibis, a bird. So whenever you see this man with wide shoulders and a strange-looking bird head, it's a hieroglyph depicting this particular being, Thoth. He's holding papyrus reeds because he was the person who introduced writing to the world. The introduction of writing was a profoundly important event, probably the most influential act that has ever occurred on this planet in this cycle. It made more changes in our evolution and consciousness than any other single act in our known history.

Thoth is also holding in his left hand something called the ankh, which is the symbol for eternal life. The ankh is an extremely significant symbol in this work, just as it was one of the primary symbols in Egyptian times. There is an electromagnetic energy field surrounding our bodies shaped like the ankh. The remembrance of it, ac-





Fig. 1-13. Thoth writing (figure on right, an original wall carving)



Fig. 1-12. As Thoth is said to have invented writing, he is often depicted with a papyrus roll and stylus. Copy of a wall sculpture.

According to the Egyptian point of view, is the beginning of our returning home to eternal life and true freedom, so the ankh is a primary key.

All these things are an introduction. I'll be skipping all over the place, talking about many different subjects that won't seemingly be tied together; then slowly, as we proceed, I'll bring them all together in one coherent picture.

On my second trip to Egypt, I went everywhere looking for this little bird called an ibis. They supposedly lived in the reeds, so I looked through the reeds with my camera. I kept looking for one the whole time I was there. I looked from one end of Egypt to the other but never saw a single ibis. I had to wait until I got back to the Albuquerque Zoo to take this picture [Fig. 1-11]. They look kind of like short-legged storks with bright pink feathers.

Here is Thoth writing [Fig. 1-12]. This is a copy off a wall, and this next photo [Fig. 1-13] is an actual wall sculpture. He's kneeling here, holding the pen and writing.



Fig. 1-11. White Ibis

This was a revolutionary act that had never been attempted before in this cycle. According to the conventional version of history, this act took place in Egypt during the time of Saqqara, but I have my doubts. I personally believe that it took place about 500 years earlier. Saqqara was built during the First Dynasty, approximately 3300 B.C. When we talk about the pyramids older than Saqqara, you will understand why I believe this.

## **My Story**

### ***Berkeley Beginnings***

Some of you may not accept the possibility of communication with beings on other dimensional levels, but this is what took place in my life. I didn't ask for it, it just happened. As it turned out, I had almost daily communication on interdimensional levels for a number of years with this man Thoth. Now that I understand it more, my personal relationship with Thoth really began when I was in college at Berkeley.

I majored in physics and minored in mathematics until I was just about to receive my diploma. I needed only one more quarter to graduate. I decided I didn't want the degree, because I had discovered something about physicists that turned me off to the idea of becoming involved in a science that I believed was no science at all. This is all changing now. This in itself could be a book, but the why of it is related to the same thing I said about archaeologists. Physicists, just like archaeologists, will turn their heads away from the truth if it means too much of a change too fast. Perhaps the real truth is that this is human nature. So I switched to the other side of my brain and started majoring in fine arts. My counselors thought I was nuts. "You're going to give up a physics degree?" they asked. But I didn't need it, didn't want it. Then to graduate I had to go for two more years majoring in fine arts and art history.

Changing majors makes sense now, because when you study the ancient writings, you find out that the ancients perceived art, science and religion as interwoven, interconnected. So the programming I was putting myself through was appropriate for what I'm doing now.

### ***Dropping Out to Canada***

I got my degree in 1970. After going through Vietnam and looking at what was happening in our country at that time, I finally said, "I've had it! This is it! I don't know how long I'm going to live or what's going to happen, but I'm just going to be happy and do what I've always wanted to do." I decided to get away from everything and go live in the mountains like I had always wanted. So I left the United States and went to Canada, not knowing there would be thousands of Vietnam War protesters following me a year later. I married a woman named Renee, and the two of us went into the middle of nowhere and found a little house on Kootenay Lake. We were a long way away from anything. You had to walk four miles from the nearest road to get to my house,

so we were really isolated.

I began to live my life exactly like I had always wanted to live. I had always wanted to see if I could live on nothing, so I gave it a try. It was a little scary at first, but it got easier as time went on, and pretty soon I became adept at natural living. I lived a wonderful and full life on basically no money. After a while I realized, Hey, this is a lot easier than holding a job in a city! I had to work hard for only about three hours a day, then I had the rest of the day off. It was great. I could play music and run around and have a good old time. And that's exactly what I did. I had fun. I played music about ten hours a day, with lots of friends who came from miles around. Our place had gained quite a reputation by then. We just had fun. In doing this, which is very important to my understanding now, I discovered something about myself. It was from this—"returning to my inner child" is how I phrase it these days—that my inner child was released, and in that releasing, something happened to me that was the catalyst that led into my life as it is today.

### *The Two Angels and Where They Led Me*

While in Vancouver, Canada, we decided that we wanted to know about meditation, so we started studying with a Hindu teacher who lived in the area. My wife and I were very serious about wanting to understand what meditation was about. We had made hooded white silk robes to show respect. Then one day, after practicing meditation for about four or five months, two tall angels about ten feet high appeared in our room! They were right there—one was green and one was purple. We could see through their transparent bodies, but they were definitely there. We did not expect this to take place, nor did we ask for it. We were just following the instructions that our Hindu teacher was giving us. I don't believe he fully understood either, as he kept asking us many questions. From that moment on my life was never the same. It wasn't even close.

The first words the angels said were, "We are you." I had no idea what they meant. I said, "You're me?" Then slowly they began to teach me various things about myself and the world and about the nature of consciousness. Finally my heart completely opened to them. I could feel tremendous love from them, which totally changed my life. Over a period of many years they led me to about seventy different teachers. They would actually tell me in meditation the address and the phone number of the teacher I was to go see. They would tell me either to call first or just show up at his or her house. So I would do this—and it would always be the right person! Then I would be instructed to stay with that person for a certain length of time. Sometimes, right in the middle of a particular teaching, the angels would say, "Okay, you're done. Leave."

I remember when they sent me to Ram Dass. I hung out in his house for about three days wondering what the heck I was doing there; then one day I went to touch him on the shoulder to see something, and I got a zap that practically knocked me to the floor. The angels said, "That's it. You can leave now." And I said, "Okay." Ram Dass and I became friends, but whatever I was supposed to learn from him was over within that one second.



The teachings of Neem Karoli Baba, Ram Dass's teacher, are very important to me. It was his belief that "the best form to see God is in every form." I've also been exposed to Yogananda's work and cherish who he was. Later we'll be talking about Sri Yukteswar and some of his work. I've been intensely involved in almost all the major religions. I've resisted the Sikhs because I do not believe that military preparation is necessary, but I've studied and practiced almost all the rest of them—Muslim, Jewish, Christian, Taoist, Sufi, Hindu, Tibetan Buddhist. I've deeply studied Tao-ism and Sufism—I spent eleven years with Sufism. However, through all this study, the most powerful teachers for me have been the Native Americans. It was the Indians who opened the doorway for all my spiritual growth to take place. They've been a very powerful influence in my life. But that's another story, some of which I'll give in time.

All the world's religions are speaking of the same Reality. They have different words, different concepts and ideas, but there's really only one Reality, and there's only one Spirit moving through all life. There might be different techniques to get to different states of consciousness, but there's only what is real, and when you're there you know it. Whatever you want to call it—you can give it different names—it's all the same thing.

### *Alchemy and the First Appearance of Thoth*

At one point the angels led me to a Canadian man who was an alchemist and who, amongst other things, was actually turning mercury into gold (though it can also be done from lead, which is more difficult). I studied alchemy for two years with him and watched this process with my own eyes. He had a sphere of glass about 18" in diameter filled with a liquid, and little bubbles of mercury would rise into it. They would go through a series of fluorescent colors and changes, rise to the top, turn into little balls of solid gold, then sink down to the bottom. Then he would collect all these little balls of gold to use for his spiritual work. He owned an ordinary-looking little house in Burnaby, British Columbia, on an ordinary-looking street. If you drove down the street, his house would look like any of the others. But *under* his house was a hidden laboratory. He had taken the millions of dollars in gold and dug straight down, building a huge complex filled with everything from electron balances to you-name-it so that he could further his work. He didn't care about money at all. And of course the purpose in alchemy is not to make gold or money, but to *understand the process* of how mercury or lead changes into gold.

It's the process that's important. Because the process of going from mercury to gold is identical to the process that a human follows going from this level of consciousness into Christ consciousness; there is an exact correlation. As a matter of fact, if you were to study all of alchemy, you would have to study every single chemical reaction in existence, because every reaction has a corresponding *experiential* aspect to something in life. It's the old "as above, so below" saying. (By the way, Thoth is the man who originally spoke those words when he was known as Hermes in Greece.)

At one point I was sitting in front of this alchemist teacher, and we were doing a particular kind of open-eyed meditation where we were locking breaths and breathing a certain way. He was sitting about three feet away from me, and we had been in this meditation for maybe an hour or two, a pretty fair length of time. Then something happened—something

I had never seen before, ever! He kind of went fuzzy, then disappeared right before my eyes! He was just gone. I'll never forget it. I sat there for a moment and didn't know what to do. Then I hesitantly reached over and felt for him. There was nobody there. I thought, Wow! I was totally in astonishment. It blew my mind (as we would say in the '60s and '70s), it definitely did! I didn't know what to do, so I just continued to sit there. Then pretty soon a different person appeared in front of me, somebody completely and absolutely different! It wasn't even close. My alchemist teacher was about thirty-five years old and this guy was maybe sixty or seventy, and a lot shorter—maybe five feet three or four.

He was a little guy, and he looked Egyptian. He had dark skin and his hair was kind of long, but pulled back. He had a clean-shaven face except for a thick beard growing from his chin that was perhaps six inches long and tied in five places. He was dressed in simple tan-colored cotton clothing with long sleeves and pants and sat cross-legged facing me. After my shock wore off, I just looked into this person's eyes. There I saw something I hadn't seen before except in babies' eyes. When you look into a little baby's eyes, you know how easy it is because there's nothing going on, no judgment, no nothing. You can just fall into their eyes, and they'll fall into yours. Well, that's what it was like to look at this man. There were just these big baby eyes in this old body. He didn't have anything going on. I had an instant connection with this person, and there were no barriers. He touched my heart like no one had ever done before.

Then he asked me a question. He said there were three missing atoms in the universe, and did I know where they were? I had no idea what he meant, so I said, "Well, no." Then he gave me an experience, which I'm not going to describe, that sent me way back in time to the beginning of creation and brought me forward again. It was a very interesting out-of-body experience. When I came back, I understood what he meant about the three missing atoms—at least I thought I did. And I said, "Well, I think what you mean is this," and proceeded to tell him what I thought. When I finished, he just smiled, bowed and disappeared. A little later my alchemist teacher reappeared. My teacher didn't know the change had taken place. Everything that happened seemed to be only in my experience.

I went away from that totally preoccupied with the experience. At the time, the angels had me working with four other teachers, so I was going from one to the next to the next, and my life was really full. But I couldn't think about anything except this little man who had appeared to me. I never asked him who he was, and he didn't return. Time went on, and finally the experience started to fade away. But I always carried the question, who was that guy? Why did he have me go look for those three atoms, and what was this all about? I had a longing to see him again, because he was the purest person I had ever met—ever. Twelve years later I found out who he was. It was Thoth. On November 1, 1984, he reappeared in my life ... and taught me so much. But again, that's another story for later.

### ***Thoth the Atlantean***

This man, Thoth of Egypt, goes almost all the way back to the beginning of Atlantis. He figured out, 52,000 years ago, how to stay conscious in one body continuously without dying, and he has remained in his original body since then—until 1991, when he moved into a new way of being far beyond our understanding. He lived through most of the period of

Atlantis and even became king of Atlantis for a period of 16,000 years. During those times he was called Chiquetet Arlich Vomalites. His name was actually Arlich Vomalites, and Chiquetet was a title that meant “the seeker of wisdom,” because he really wanted to *be* what wisdom was. After Atlantis sank (we will discuss this subject in great detail soon), Arlich Vomalites and other advanced beings had to wait for about 6000 years before they could begin to reestablish civilization.

When Egypt began to come to life, he stepped forward and called himself Thoth, keeping that name all through the time of Egypt. When Egypt died, it was Thoth who started the next major culture, which was Greece. Our history books say that Pythagoras was the father of Greece and that it was from and through the Pythagorean school that Greece unfolded and from Greece that our present civilization emerged. Pythagoras says in his own writings that Thoth took him by the hand, led him under the Great Pyramid and taught him all the geometries and the nature of the Reality. Once Greece was born through Pythagoras, Thoth then stepped into that culture in the same body he had during the time of Atlantis and called himself Hermes. So it is written, Arlich Vomalites, Thoth and Hermes are the same person. True story? Read *The Emerald Tablets*, written 2000 years ago by Hermes.

Since that time he’s had many other names, but I still call him Thoth. He came back into my life in 1984 and worked with me just about every day until 1991. He’d come in and spend maybe four to eight hours a day teaching me about so many things. This is where the largest body of the information I’ll be sharing with you came from, though it correlates with other information and has been substantiated by many other teachers.

The history of the world, especially, came from him. You see, while in Egypt, where he was called the Scribe, he wrote down everything that took place. He was the perfect person for it, right? He was constantly alive, so as a scribe he would just sit there and watch life go by. He was a good impartial witness, as that was a major part of his understanding of wisdom. He seldom talked or acted except when he knew that it was in divine order. Eventually Thoth discovered how to leave Earth. He would go to another planet where there was life and just sit there and watch. He would never interfere, wouldn’t say a single word. He’d be absolutely silent and just watch—just to see how they lived their lives, to get wisdom, to understand—for maybe a hundred years on each planet. Then he would go somewhere else and watch.

Altogether, Thoth was gone from Earth for about 2000 years studying other life forms. But he considers himself an Earth person. Of course, we have all come from somewhere else at one point or another in the game of life, because the Earth is not that old. It’s only about five billion years old, and spirit is forever, always has been and always will be. You always have been and always will be.



Fig. 1-14. Shesat, Thoth's wife

Spirit cannot die, and any other understanding is just an illusion. But Thoth considers himself from here because it was here that he made the first step that led him into immortality.

This is Thoth's wife, Shesat [Fig. 1-14]. She's a most extraordinary person—in some ways at least as extraordinary as Thoth, if not more so. She was the first person to bring me consciously to Earth, which was in, roughly, 1500 B.C. I was not physically here, but we had made a conscious link across the dimensions. She connected with me because of problems the Egyptians were having within their country that, from her point of view, would eventually affect the whole world and the outcome of humanity. We worked very closely together. I still have a very deep love for her and a really close connection, though she's no longer here. Neither is Thoth. In 1991, together they left this entire octave of universes and stepped over into a completely different kind of experience of life. Their actions are important to us, as you will see.

In 1984, Thoth came back into my life, twelve years after my first experience with him while meditating with my alchemy teacher. The first thing he did was to lead me through an initiation in Egypt. He had me travel all over Egypt and perform ceremonies and accept initiations at certain temples. I was asked to enter a particular space under the Great Pyramid, repeat long phrases in the original Atlantean language and enter a state of consciousness where my body was only light. I'll tell that story when it's time, I promise.

### *Thoth, Geometries and the Flower of Life*

After I had been back from Egypt for three or four months, Thoth came in and said, "I want to see the geometries that were given to you by the angels." The angels had given me the basic information/geometries of how reality is related to spirit, and the angels had taught me the meditation I'm going to give to you. This meditation was one of the first things Thoth wanted from me. That was the exchange: I received all of his memories and he received the meditation. He wanted the meditation because it was a lot easier than the method he was using. His way of staying alive for 52,000 years was very tenuous—it was like hanging on by a thread. It required him to spend two hours every day in meditation or he would die. He had to spend one hour with his head to the north and his feet to the south, in a very specific meditation; then he had to spend another hour in the reverse position doing a different meditation. Then once every fifty years, in order to keep his body regenerated, he had to go into what's called the Halls of Amenti and sit for ten years or so before the Flower of Life. (This is a pure flame of consciousness that resides deep in the womb of the Earth and to which humanity's level of consciousness is completely dependent for its very existence. More later on this subject.)

Thoth was very interested in this new meditation because what took him two hours to accomplish takes only six breaths with the Mer-Ka-Ba meditation. It's quick, efficient and far more accurate; and its potential is much greater, as it leads into a permanent form of awareness. So Thoth began to give me vast amounts of what he knew. When he would appear in my room, we would not speak with words like we're doing now. We would speak using a combination of telepathy and holographic images. His thoughts to me were holographic, I guess you would say. But there was even more going on than that. If he wanted to describe something to me, I would taste, feel, smell, hear and see his thoughts.

He said he wanted to see what the angels had given me in terms of geometries, so I gave it to him telepathically, with a little ball of light, third eye to third eye. Then he looked at the whole thing, and about five seconds later said that I was missing many levels of interconnected information. So for many hours of every day I would sit there making drawings and figuring out what all this stuff was that we now call sacred geometry.

At that time I had no words for this way of seeing. I didn't know what it was, and in the beginning I had no idea what it really meant. And I didn't know anybody else who was aware of it except in the past. I thought I was the only one in the whole world. But the more I became involved, the more I realized that it's been going on forever and it's everywhere throughout the Earth's history and throughout the universe. He taught me in this way for a long time. Finally we came up with a single drawing [Fig. 1-15], which he said contains everything—all knowledge, both male and female, no exceptions. This is the one:

I know this is an outrageous statement to make this early in this writing, but this one drawing, according to Thoth, contains within its proportions every single aspect of life there is. It contains every single mathematical formula, every law of physics, every harmony in music, every biological life form right down to your specific body. It contains every atom, every dimensional level, absolutely everything that's within waveform universes. (I'll explain in just a moment about waveform universes.) After he taught me, I understood the above statement; but to just throw out that statement right now sounds incredible. God willing, I will prove what I'm saying. Obviously, I cannot prove that this drawing contains every single aspect of creation, because there are too many things that exist to do that in one book. But I can show you enough proofs so that you'll be able to see that you can carry it over to everything.

Thoth then told me that I would find this image of the Flower of Life in Egypt. There were two times that I doubted him in all the years I worked with him, and this was one of those times. My little mind went, "No way!" because I had by now read almost every book there was on Egypt, and I had never seen this anywhere. In my mind I scanned through everything I could think of. No, I thought, that symbol is not anywhere in Egypt. But he said I would find it, and then he left. I didn't even know where to begin to look for it.

About two weeks later, I saw my friend Katrina Raphaell, who has written, I believe, three books on crystals. She had just returned from Egypt and was in a grocery store in Taos, New Mexico, when I walked in. She was standing at the film counter and had just gotten back the photographs from her most recent trip to Egypt. She had a stack about ten inches high sitting on the counter and was taking them out, thirty-six at a

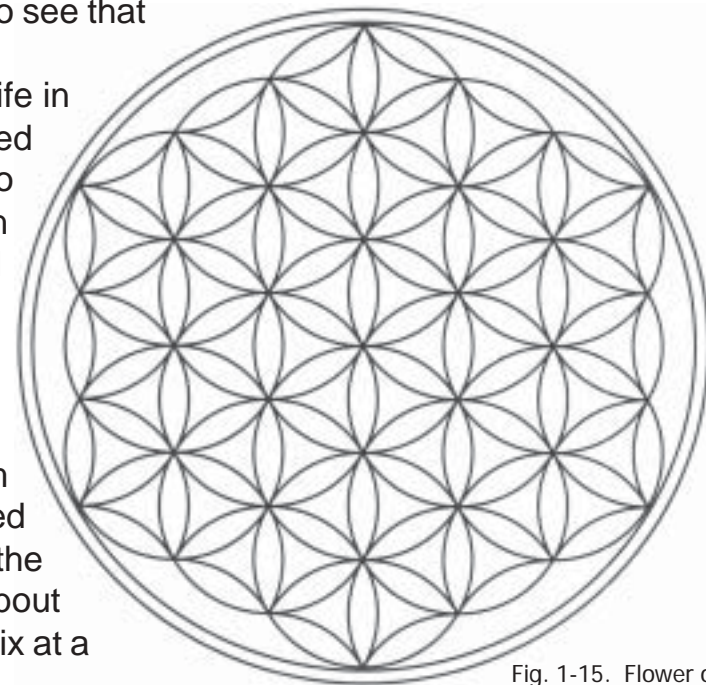

Fig. 1-15. Flower of Life



time, and stacking them. We started talking, and at one point she said to me, “Oh, by the way, my guiding angel told me that I’m supposed to give you a photograph as soon as I see you.” I said, “Okay, what is it?” She said, “I don’t know.” She turned away from the pile and went through it behind her back, pulled one out at random, handed it to me and said, “This is the one I’m supposed to give you.”

Now, Katrina had no idea of the work I was doing, though we had been friends for a couple years, because I didn’t talk to many people in those days about my work—and I definitely had not talked to her. The picture she pulled out was this one—the Flower of Life on a wall in Egypt [Fig. 1-16]!

That particular wall is probably one of the oldest walls in Egypt, in a temple that’s almost 6000 years old, one of the oldest temples on the planet. When I saw the Flower of Life in that photo, I couldn’t say anything but “woooooowww.” Katrina asked, “What is that thing, anyway?” All I could say was, “You don’t understand, but wooooowww!”

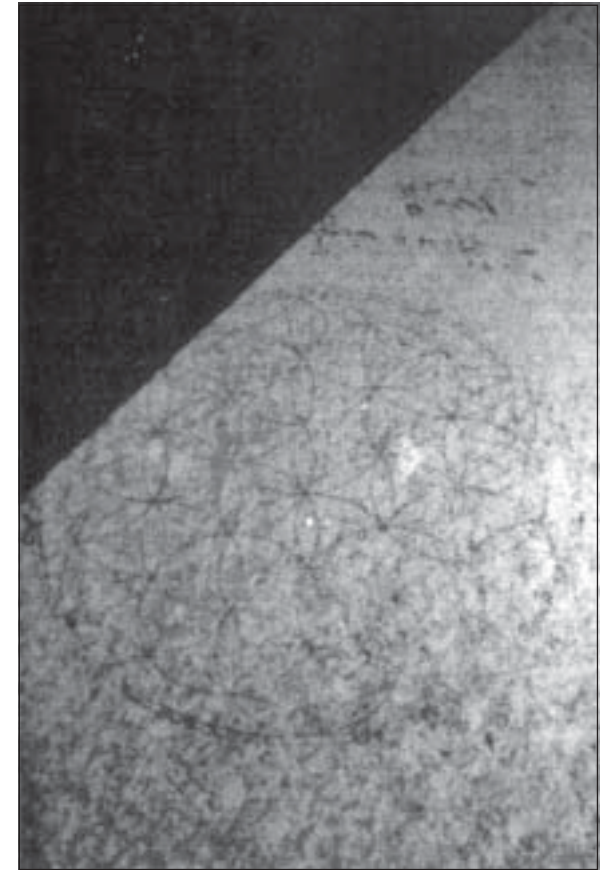

Fig. 1-16. Flower of Life on wall in Abydos, photo by Katrina Raphaell.

# The Secret of the Flower Unfolds

## The Three Osirian Temples in Abydos

This temple is in Abydos [Fig. 2-1]. It was built by Seti the First and dedicated to Osiris. Behind it is another very old temple called the 1 Osirian Temple, where the wall carving of the Flower of Life was found by Katrina Raphaell. There is still a third temple, also dedicated to Osiris and also called the Osirian Temple. Figure 2-2 is what the plan looks like.

Evidently, when they were digging back into the mountain to build the Seti I temple, with full knowledge that the third Osirian temple was there, they found the older, second Osirian temple between the two. Seti I changed the plan for the newer temple into an L shape to avoid destroying the more ancient temple. It's the only L-shaped temple in all of Egypt, which strengthens this idea.

Some people say that Seti I built the older temple, too. However, the older one is a completely different construction design and has much larger stone blocks. Most Egyptian archaeologists agree that it is a much older temple. It is also lower in elevation than the Seti temple, which gives credence to its age. When Seti I began construction of his new temple, the second one looked like a hill. The third temple, the long, rectangular one in the back, is also dedicated to Osiris, and it is one of the oldest temples in Egypt. Seti I was building his temple on this site because the other (third) temple was very old and he wanted to dedicate a new temple to Osiris. We'll look at the Seti I temple, then the third one, then the second and oldest one.



Fig 2-1. Temple of Seti the First. This view is of the small projection at far right of the L-shaped building in Fig. 2-2

Fig 2-2. Plan of the three adjacent Osirian temples at Abydos.

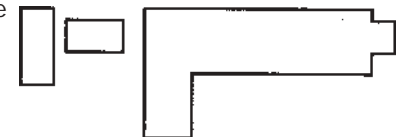

## *Carved Bands of Time*

In recent times archaeologists have discovered something very interesting about the wall carvings in Egyptian temples. Tourists usually notice that there appears to be a great deal of vandalism on the walls, where a lot of the hieroglyphs, especially ones of the immortals, had been chipped off and destroyed. What they might not notice is that the chipping is in a specific horizontal band, from about eye height up to about twelve to fifteen feet. There is no chipping above or below that. I didn't even notice that when I was there; it just didn't click. It didn't click for a lot of Egyptian archaeologists either for hundreds of years, until somebody finally said, "Hey, the destruction is always in this very specific region." From that realization, they began to understand that there was a difference between the region below the destruction and the one above.

They finally figured out that there are time bands on the walls. The band from about eye height down to floor level would represent the past; the band from eye height up to about fifteen feet or so would represent the present (the time the temple was built); and higher than that (these temples sometimes go up forty feet and more) would tell about what will occur in the future.

The archaeologists then realized that the only people who could have understood this relationship and actually chipped the hieroglyphs was the priesthood of the temple. The priests were the only ones who would have known that they were chipping out only the present. An ordinary vandal would not have been so precise in selecting only the band representing the present. Besides, the destroyers did not come in with a sledgehammer; they actually chipped certain things out very carefully. It has taken all these centuries to figure this out.

## *The Seti I Temple*

This is the front of the Seti I temple at Abydos [Fig. 2-3]. This is a small portion of a huge, huge temple.

I know now of at least two proofs that the Egyptians could see into the future. I have a picture of one of these: Way up high on one of the beams in this portion of the first temple at Abydos is something that, if you've never seen it before,



Fig. 2-3 Front of the Seti I temple at Abydos, looking down the length of the temple facade in Fig. 2-1

is hard to believe, but it's there. I'm going to get a picture of the other one the next time I visit Egypt, because I know exactly where it is.

I think these two pictures are absolute proof, beyond any doubt at all, that they were able to see the future. *How* they did it I don't know; that's up to you to figure out. But the fact is, they did. At the very end I'll show the picture that proves this.

### *The "Third" Temple*

This is the third temple of the three—a long, open temple [Fig. 2-4]. This temple was considered the most sacred spot in all of Egypt by the ancient kings and pharaohs, because they believed that this was where Osiris had experienced resurrection and become immortal. King Zoser, who built the beautiful funerary complex at Saqqara with its famous Step Pyramid, supposedly for his burial, did not bury himself there. Instead, he buried himself at this little unpretentious back temple.

They don't allow anyone into this third temple. But I couldn't stand to just look down into it. There was nobody around that I could see, so I dropped down over the wall into a courtyard. I managed to get about five minutes of space before the Egyptians began yelling at me to get out.

I thought they were going to arrest me, but they didn't. The hieroglyphics in there are extraordinary—nothing like you would see anywhere else. The simplicity and perfection of the drawings is remarkable.

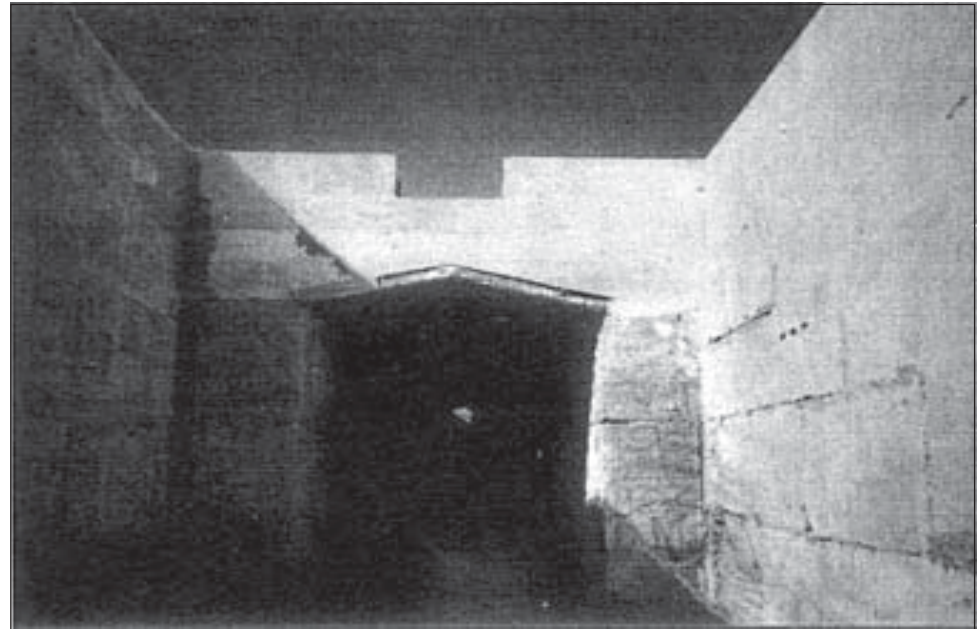

Fig. 2-4 The Osirian "third" temple at Abydos. Top of the wall is as ground level.



Fig. 2-5. Second (middle) temple at Abydos. Reeds are growing in the water covering the floor. The arrow at right indicates the wall where the Flower of Life is inscribed.

## *The "Second" Temple's Sacred Geometry and Flower of Life*

This is the second temple of the three [Fig. 2-5], which is lower than the other two. It was buried under the earth before they dug it out. (The ramp, seen at the right edge, was built to allow access from the higher ground level.) I took this picture from the third temple, looking toward the Sen I temple, whose back wall can be seen in the background. The second temple is where the Flower of Life drawings in Katrina's photo were found.

They allow you to go into only one place in the second temple, which happened to be the perfect place. The second temple is mostly filled with water now because the Nile has risen, but when it was first found, it was open and dry.

Here are two inside views [Fig. 2-6] of the center of the temple before it filled with water. There are three distinct areas: (1) the steps that come in from below to the center of the temple, where there is an altarlike stone; (2) the altarlike stone itself; and (3) the steps that go back down on the other side of the altar, which can't be seen here. You will see these

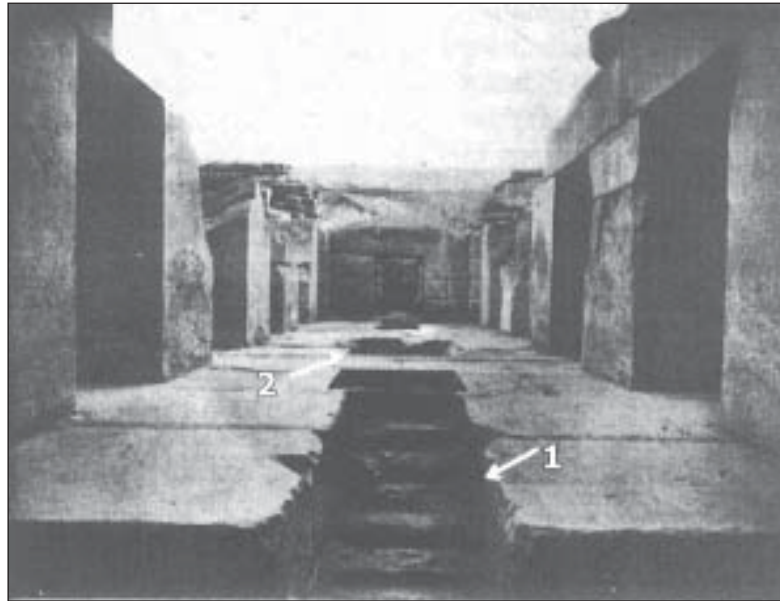

They allow you to go into only one place in the second temple, which happened to be the perfect place. The second temple is mostly filled with water now because the Nile has risen, but when it was first found, it was open and dry.

Here are two inside views [Fig. 2-6] of the center of the temple before it filled with water. There are three distinct areas: (1) the steps that come in from below to the center of the temple, where there is an altarlike stone; (2) the altarlike stone itself; and (3) the steps that go back down on the other side of the altar, which can't be seen here. You will see these three levels represented in the three phases of the Osiris religion. You can see the two sets of steps in the plan of the Osirian "second" temple on the next page [Fig. 2-7].



Fig. 2-6. Steps inside the second temple, before it became partly filled with water. [From Robert Lawlor's Sacred Geometry]

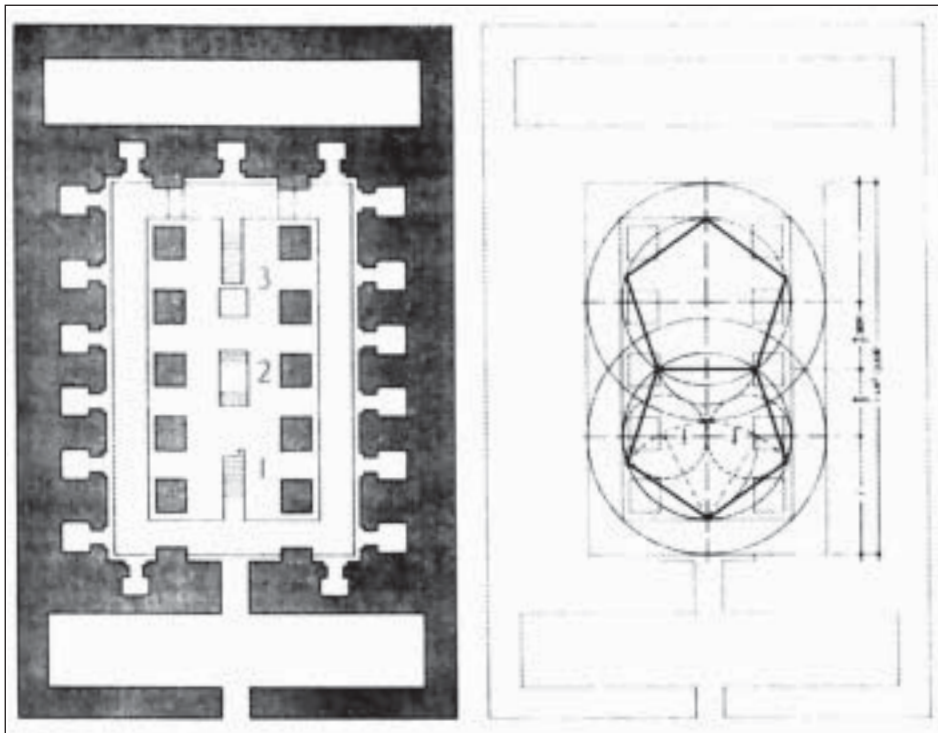

Fig. 2-7. Plan of the Osirian second temple (from *Sacret Geometry — "Philosophy and Practice"* by Robert Lawlor).

them onto each surface of a dodecahedron (twelve pentagons put together as at C), the resulting shape happens to be the stellated dodecahedron D, of the specific proportions of the Christ consciousness grid around the Earth. Without this grid there would not be a new consciousness emerging on this planet. You will understand before the end of this work.

Two of these icosahedral caps hinged together are like clamshells, indicated at E. These caps are the key, as they demonstrate the geometry used in the Christ-consciousness grid. And that's what, I feel, they're depicting

three levels represented in the three phases of the Osiris religion. You can see the two sets of steps in the plan of the Osirian "second" temple on the next page [Fig. 2-7].

Lucie Lamy shows here what the original plan of the temple looked like. The two back-to-back pentagons show the sacred geometry that was hidden in its plan. Now I need to give you some background on this geometry.

The shape shown at A [Fig. 2-8] is an icosahedron. The surface of an icosahedron is made up of equilateral triangles arranged into five-sided pentagonal shapes, shown at B, which are called icosahedral caps in sacred geometry. Here the triangles are equilateral. If you were to take the icosahedral caps off the icosahedron and fit

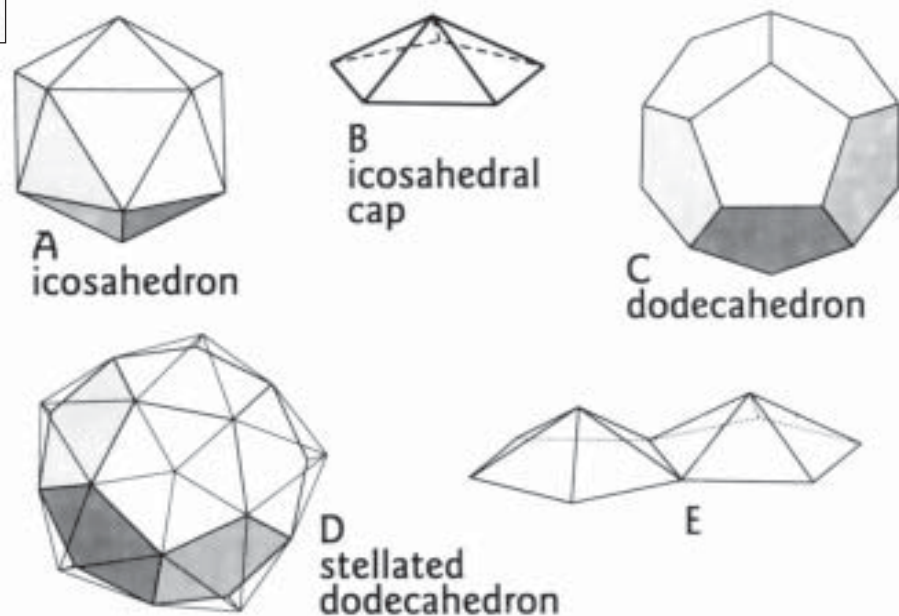

Fig. 2-8. Shapes. D is the Christ consciousness grid.

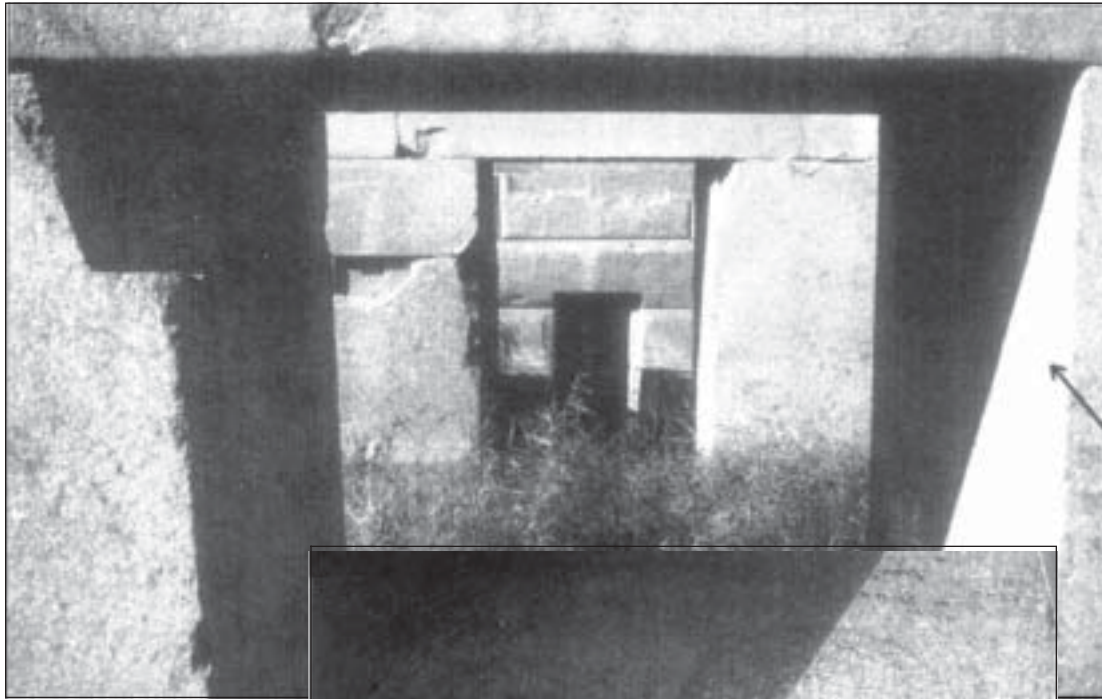

Fig. 2-9 Looking through the second temple. Arros shows where Katrina took photo.

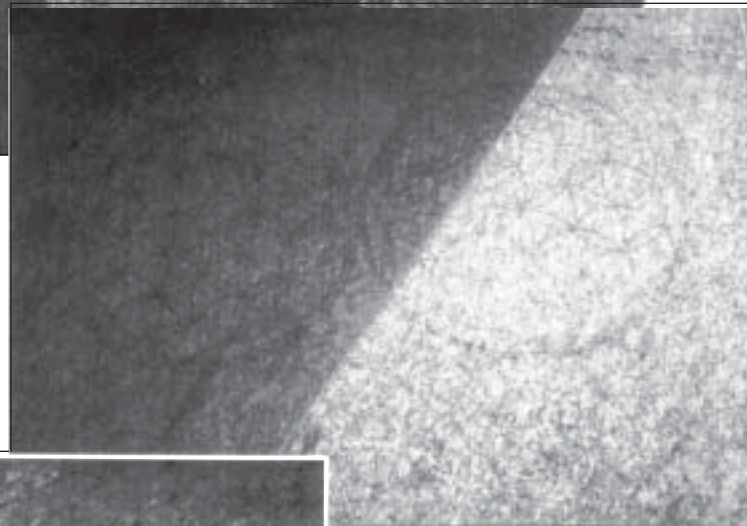

Fig. 2-10. The same Flower of Life that was in Katrina's photo. [Fig. -16]



Fig. 2-11. Seed of Life on left. This is the same stone wall as above, but farther to the left.

in the geometry and plan of this ancient temple. I find it very appropriate that they used back-to-back pentagons in the plan for a temple dedicated to Osiris and resurrection. Resurrection and ascension lead into Christ consciousness.

Figure 2-9 is down in the second temple. The arrow indicates the place where Katrina unknowingly took a photograph of the Flower of Life. Here's the same picture taken with my camera [Fig. 2-10]. My photo came out better than hers, and you can see in the shade that there's another Flower of Life pattern on the same stone, side by side. To the left of these two Flower of Life patterns, on the same stone, are other related figures. The stones that were used to build this temple, including the one in these figures, are huge. I would say they weigh at least 70 to 100 tons. It makes you wonder how those hairy barbarians moved all those hundred-ton stones around.

There are many related patterns on these walls. The left one in this photo [Fig. 2-11] is called the Seed of Life, which comes directly out of the Flower of Life pattern, as shown in Figure 2-12.

There was water at the bottom of this wall, so I couldn't get in there. But I was wondering what was on the other side of the stone, so I leaned around, put the camera on automatic and took a picture to see what would come out. This is what I got [Fig. 2-13]. You can barely see it in this photograph, but it shows many of the components that are aspects of what we're going to be studying in this course.

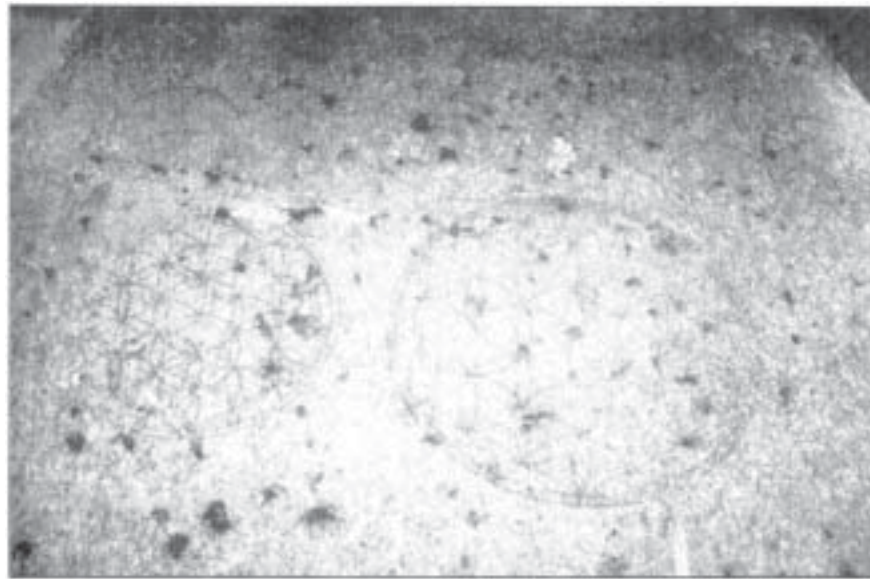

Fig. 2-13. Flower of Life, with other components at top.

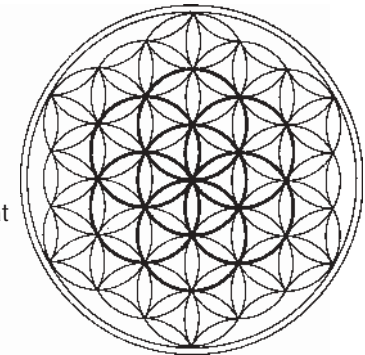

Fig. 2-12. Seed of Life in middle of Flower of Life

It was an amazing feeling to look at these drawings because they were so familiar to me, and I knew what they meant. And here they were, arranged on an Egyptian wall thousands of years old. The drawings were ancient, yet I knew exactly what they were.

### *Carvings of the Copts*

This next shot shows a wall in the second temple taken from a long way away using an 80mm lens. On this wall is a drawing, which you can barely see in this photo [Fig. 2-14], though we could see it clearly when we were there. It looks like Figure 2-15.



Fig. 2-14. Coptic sign.

It's a symbol for Christianity, but it originated with a group of Egyptians called Copts, who lived at the time when the Egyptian empire was dying. They later became the very first Christians, if we include two other Egyptian groups who were connected with them—the Essenes and the Druids. You might not think that these two other groups had Egyptian roots, but we believe they did.

This is a Coptic symbol, and when I saw it, I realized it was probably the Copts who made these drawings related to the Flower of Life, not the original builders. The Copts came much later, but

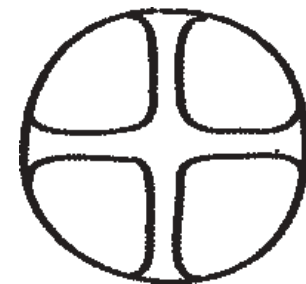

Fig. 2-15. Coptic symbol





Fig. 2-16. Coptic design #1



Fig. 2-17. Coptic design #2

they probably knew this was a place for resurrection and used it for the same purpose. The building would have been several thousand years old when they made these drawings. In this case the drawings would have been no older than 500 B.C., which is when the Copts began.

This is the actual Coptic symbol, a cross and the circle [Fig. 2-16], sometimes found inside a triangle.



Fig. 2-18. Another Coptic design.



Fig. 2-19. Fish breathing air.

This is another one, in which you see the cross and the circle, though it's very worn [Fig. 2-17]. At the top you see the six loops of the center of the Flower of Life. In Egyptian drawings, whenever you see a sphere over a head, it means that the focus is whatever is inside the sphere. That's what they're thinking about or what the purpose is at that moment.

Figure 2-18 is another way this symbol is sometimes used—four intersecting arcs with an outer circle around them.

I find this photo very interesting [Fig. 2-19]. You see the fish breathing air. This was done *before* Christ. It's Coptic. It has thirteen little notches, or scales, if you want to call them that, and it's breathing air. We've seen a fish breathing air before, with the Dogons and in Peru. Now here it is in Egypt—and it is seen in other places around the world as well.

### ***The Early Church Changes Christian Symbolism***

When you go back and really study some of the older writings, you find that there was a big change in the Christian religion about 200 years after Christ died. In fact, he wasn't very well known for about 200 years, at which time the Greek Orthodox Church, which was the most influential church of the day, made many changes in the Christian religion. They discarded many beliefs, added others, and changed things around to fit their needs. One thing they changed was an

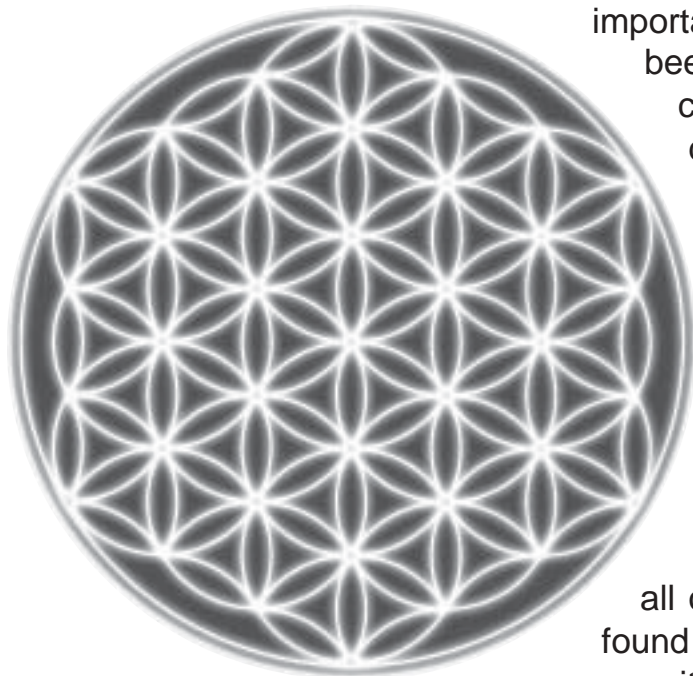

Fig. 2-20. Flower of Life

Update: In recent times we have found the Flower of Life image in eighteen more places, including Sweden, Lapland, Iceland and the Yucatan.



Fig. 2-21. Seed of Life, extracted from flower.

Fig. 2-21.  
Tree of Life

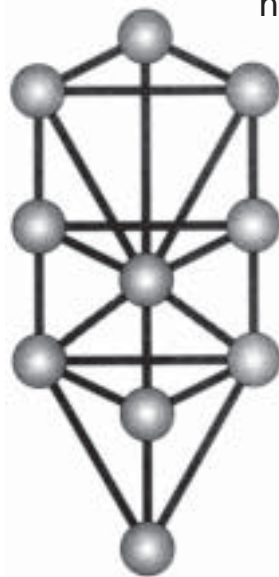

important symbol. All the way back to the time of Christ, from everything we've been able to read, Christ was not known as the fish, but as the dolphin. It was changed from the dolphin to the fish during the Greek Orthodox editing. Today Jesus is referred to as the fish, and even modern Christians use the fish to represent Christianity. What this means exactly, I don't know. I can only speculate when we talk about dolphins. In addition, the Greek Orthodox Church also removed from the Bible all references to reincarnation, which previously had been fully accepted as part of the Christian religion.

## The Flower of Life: Sacred Geometry

This image of the Flower of Life [Fig. 2-20] is not only found in Egypt, but all over the world. I'll show you photographs of it worldwide in volume 2. It's found in Ireland, Turkey, England, Israel, Egypt, China, Tibet, Greece and Japan—it's found everywhere.

Almost everywhere around the world it has the same name, which is the Flower of Life, though elsewhere around the cosmos it has other names. Two of the main names would be translated as the Language of Silence and the Language of Light. It's the source of all language. It's the primal language of the universe, pure shape and proportion.

It's called a flower, not just because it looks like a flower, but because it represents the cycle of a fruit tree. The fruit tree makes a little flower, which goes through a metamorphosis and turns into a fruit—a cherry or an apple or something. The fruit contains within it the seed, which falls to the ground, then grows into another tree. So there's a cycle of tree to flower to fruit to seed and back to a tree again, in these five steps. This is an absolute miracle. But you know, it just goes right over our heads. It's so normal that we simply accept it and don't think much about it. The five simple, miraculous steps in this cycle of life actually parallel the geometries of life, which we'll continue to see all through this work.

## The Seed of Life

As I was showing earlier [Fig. 2-12], in the middle of the Flower of Life are seven interconnected circles which, if you take them out and draw a circle around them, would create the image called the Seed of Life [Fig. 2-21].

## The Tree of Life Connection

Another image in this pattern, which you're probably more familiar with, is called the Tree of Life [Fig. 2-22]. Many people have thought that the Tree of Life originated with the Jews or Hebrews, but it did not. The kabbalah did not originate the Tree of Life, and there is proof. The Tree of Life does not belong to any culture—not even the Egyptians, who carved the Tree of Life on two sets of three pillars in Egypt at both Kamak and Luxor around 5000 years ago. It's outside any race or religion. It is a pattern that is intimately part of nature. If you go to distant planets where there is consciousness, I'm sure you'll find the same image.

So if we have a tree, then a flower, then a seed, and if these geometries do in fact parallel the five cycles of a fruit tree that we see on Earth, then the source of the tree would have to be perfectly contained within the seed. If we take the images of the Seed of Life and the Tree of Life and superimpose them, we can see this relationship [Fig. 2-23].

See how perfectly they fit? They become like a key, one fitting directly over the other. In addition, if you look at the Tree of Life that was found on Egyptian pillars, you'll see one more circle above and one below [Fig. 2-24]. This means there were originally twelve components, and the twelve-component version also fits perfectly over the whole Flower of Life image. (There is a thirteenth circle to the Tree that can either be there or not.)

I'm approaching sacred geometry as though you never heard the words in your life. We're starting from the very bottom, and we'll slowly build on this until we get to the place where it makes sense. First you can see the synchronicity of the way sacred geometry forms move together and fit perfectly into each other. This is a right-brain way of understanding the special nature of this geometry. As we study more and more complex patterns, you'll keep seeing the same kind of amazing relationships moving through everything. The odds of some of these geometrical relationships happening at all is probably a zillion to one, yet you will consistently see these mind-boggling relationships unfold.

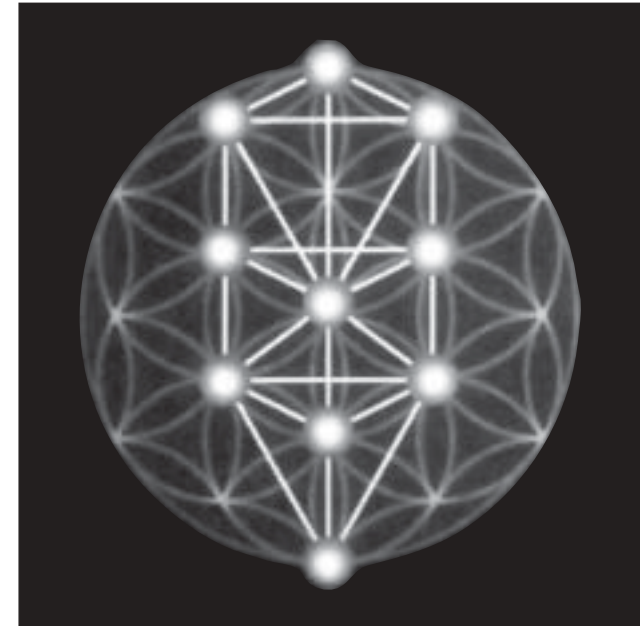

Fig. 2-23. Superimposed Tree and Seed of Life

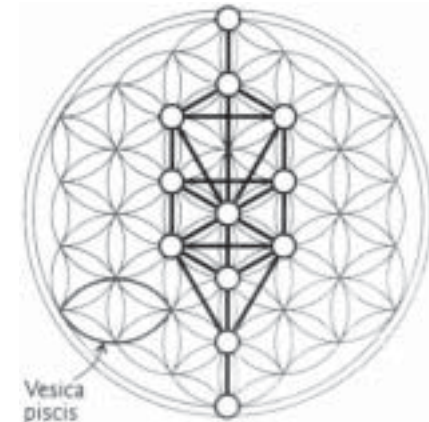

Fig. 2-24. Tree of Life with two extra circles.

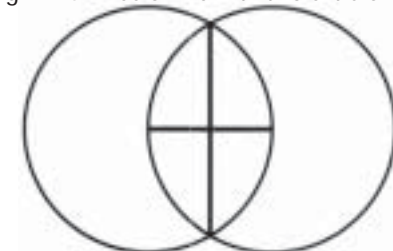

Fig. 2-25. Vesica piscis with key axes.

## The Vesica Piscis

In sacred geometry there's a pattern that looks like this [Fig. 2-25]. It's formed when the centers of two equal-radius circles are placed on each other's circumferences. The area where the two circles intersect forms what's called a *vesica piscis*. This configuration is one of the most predominant and important of all relationships in sacred geometry, as you'll begin to see.

There are two measurements in the vesica piscis—one that runs through the center across the narrow width, and one that connects one point to the opposite point through the center—that are keys to a great knowledge within this information. What many people don't know is that every line in the Tree of Life, whether it has 10 or 12 circles, measures out to either the length or the width of a vesica piscis in the Flower of Life. And they *all* have Golden Mean proportions. If you look carefully at the superimposed Tree of Life, you'll see that *every line* corresponds exactly to either the length or the width of a vesica piscis. This is the first relationship that became visible as we came out of the Great Void. (The Great Void is another key that will be discussed soon.)

## Egyptian Wheels and Dimensional Travel

These wheels [Fig. 2-26] are some of the oldest symbols known. So far they've been found only on the ceilings of certain very old Egyptian tombs. They're always found in sets of four or eight, and nobody knows what they are. The world's most famous Egyptian archaeologists don't have the vaguest idea what they mean. But to me they're proof that the Egyptians knew that the Flower of Life was more than just a pretty design and that they knew most, perhaps even more, of the information that will be shared here. In order to understand where the wheels are in the Flower of Life, you have to

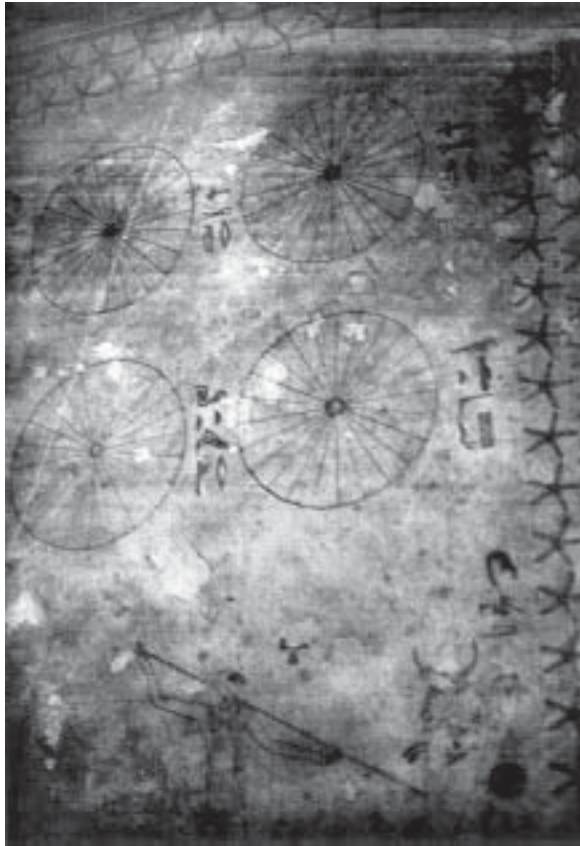

Fig. 2-26. Wheel on an Egyptian wall.

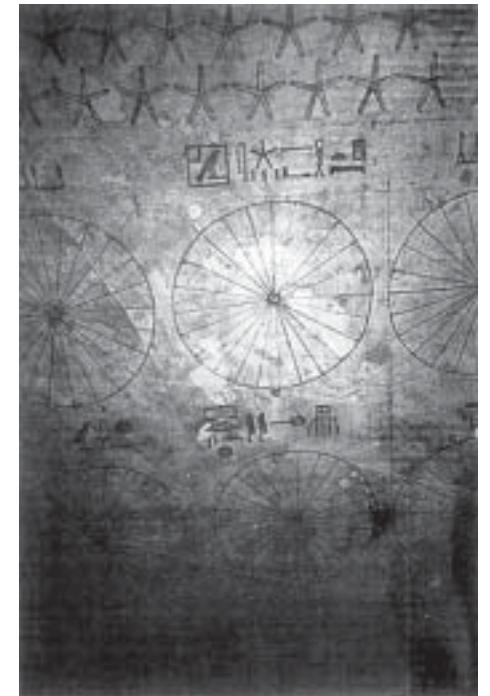
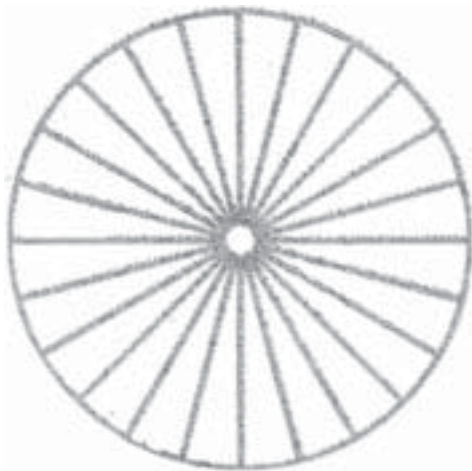

Fig. 2-27. Wheels; not all eight are visible here.

study the tremendous levels of knowledge contained within it. You would never get there by just looking at designs. It's nothing that you could just happen on—you'd have to know the *ancient secret of the Flower of Life*.

This photo shows most of a set of eight of these wheels [Fig. 2-27]. The next picture [Fig. 2-28] is very dark and hard to see details. This is a ceiling, and it was pitch black where I took the picture. Walking toward the right along the bottom of the drawing are seven people with animal heads. They're called neters, or gods, and each of them has an orangish red oval above its head, which Thoth called the *egg of metamorphosis*. The neters are concentrated on the time when we go through a certain stage of resurrection, which is a rapid biological change into a different life form. They're holding an image of that transition as they're walking along the line, then suddenly the line comes to an end and there's a 90-degree shift upward, and they're walking perpendicular to their first direction.

This 90 degrees is a very important part of this work. The 90-degree turn is crucial to understanding how to make resurrection or ascension real. The dimensional levels are separated by 90 degrees; musical notes are separated by 90 degrees; the chakras are separated by 90 degrees—90 degrees keeps coming up over and over again. In fact, in order for us to enter into the fourth dimension (or any dimension, for that matter), we must make a 90-degree turn.

Probably at this point I need to make sure we have a common understanding about what dimensions are—like third dimension, fourth dimension, fifth dimension and so forth. What are we talking about? I'm not talking about dimensions in a normal mathematical sense, as in the three axes or so-called dimensions of space: the x, y and z axes—front to back, left to right and up and down. Some people call these three axes the third dimension and say that time becomes the fourth dimension. This is not what I'm talking about.

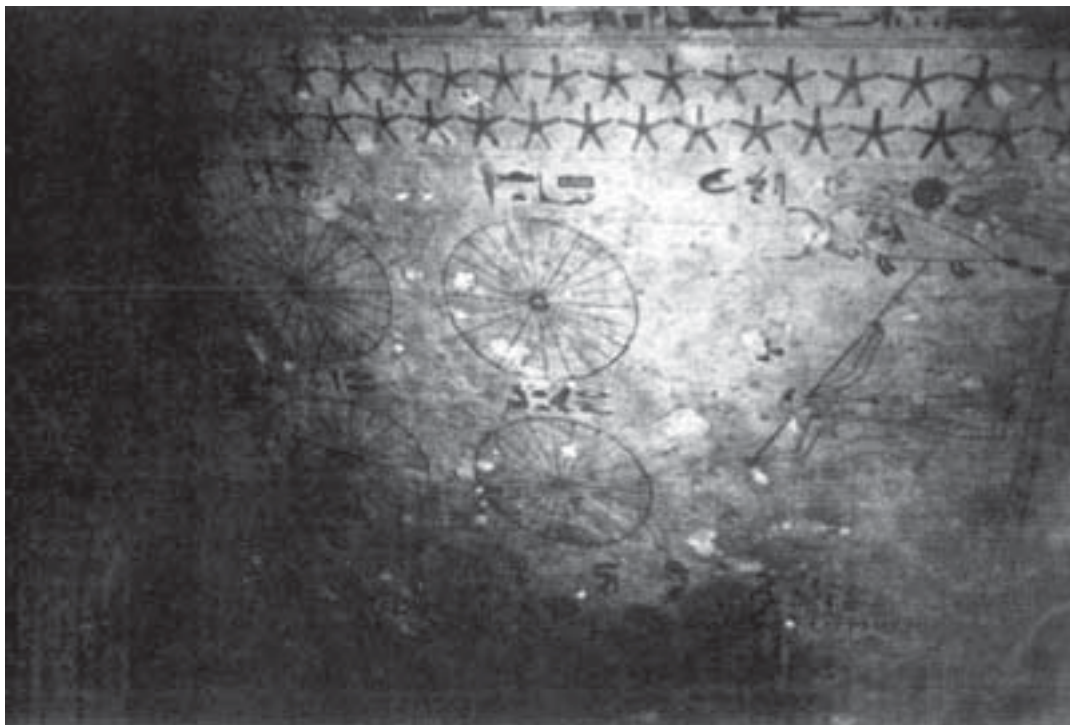

Fig. 2-28. Wheels, neters and 90-degree turn at right. The dark circles are above the heads of figures, the seven at the bottom having animal heads.

## Dimensions, Harmonics and the Waveform Universe

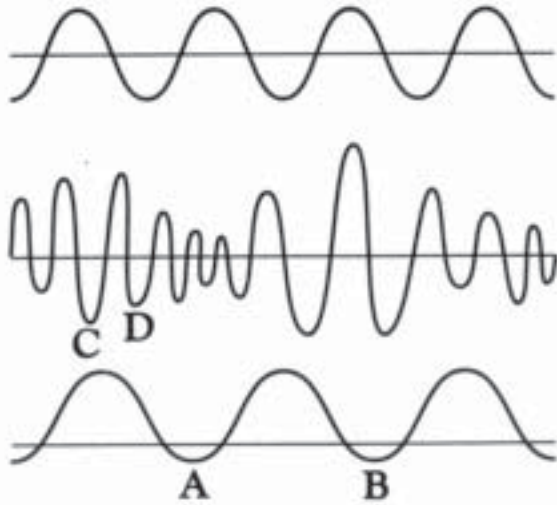

Fig. 2-29. Sample sine waves.

What I'm seeing as the various dimensional levels has to do more with music and harmonics than anything else. There are probably different connotations of what I'm talking about too, though most people who study this pretty much agree. A piano has eight white keys from C to C, which is the familiar octave, and in between those are the five black keys. The eight white keys and the five black keys produce all the sharps and flats in what's called the chromatic scale, which is thirteen notes (actually twelve notes, with the thirteenth beginning the next octave). So from one C to the next is really thirteen steps, not just eight.

Keeping that in mind, I want to show you the concept of a sine wave. Sine waves correspond to light (and the electromagnetic spectrum) and the vibration of sound. Figure 2-29 shows some samples. We're all probably familiar with this. In the entire Reality we're in, every single thing is based on sine waves. There are no exceptions I know of except the Void itself and perhaps spirit.

Everything in this Reality is sine wave, or cosine, if you want to look at it like that. What makes one thing different from another is wavelength and pattern. A wavelength extends from any point on the curve to the point where the entire curve starts over, as from A to B on the longer wavelength, or from C to D on the shorter wavelengths. If you get into a really long wavelength, they look almost like straight lines. For example, your brain waves are about ten to the tenth power centimeters, and they're almost like straight lines coming out of your head. Quantum physics or quantum mechanics looks at everything in the Reality in one of two ways. They don't know why they can't look at it in both ways at once, though the geometries tell why if you study them very carefully. You can consider any object, such as this book, as being made up of tiny particles like atoms; or you can forget that idea and just look at it as a vibration, a waveform, such as electromagnetic fields or even sound, if you like. If you look at it as atoms, the laws can be seen to fit that model; if you look at it as waveforms, the laws can be seen to fit *that* model.

Everything in our world is a waveform (sometimes called pattern, or sine-wave signature) or could even be seen as sound. All things—your bodies, planets, absolutely everything—are waveforms. If you choose this particular way of looking at Reality and superimpose that view over the reality of the harmonics of music (an aspect of sound), we can begin to talk about different dimensions.

## *Wavelength Determines Dimension*

The dimensional levels are nothing but differing base-rate wavelengths. The only difference between this dimension and any other is the length of its basic waveform. It's just like a television or radio set. When you turn the dial, you pick up a different wavelength. Then you get a different image on your TV screen or a different station on your radio. It's exactly the same for dimensional levels. If you were to change the wavelength of your consciousness, and in so doing change all your body patterns to a wavelength different from this universe, you would literally disappear out of this world and reappear in the one to which you were tuned.

This is exactly what the UFOs do when you see them shooting across the sky, if you've ever seen one. They shoot across at unbelievable speeds, then make a 90-degree turn and disappear. The people onboard those ships are not being carried through space like we are on airplanes. Spaceship passengers are consciously connected psychically to the vehicle itself, and when they get ready to go into another world, they go into meditation and link all aspects of themselves into oneness. Then they make either a 90-degree shift or two 45-degree shifts all at once in their minds, actually taking the whole ship, along with its passengers, into another dimension.

This universe—and by that I mean all the stars and atoms going infinitely out and infinitely in forever—has a base wavelength of about 7.23 centimeters. You can pick any spot in this room and go infinitely in or infinitely out forever within this particular universe. In a spiritual sense this 7.23-cm wavelength is Om, the Hindu sound of the universe. Every object in this universe produces a sound according to its construction. Each object makes a unique sound. If you average the sounds of all the objects in this universe, this third dimension, you would get this 7.23-cm wavelength, and it would be the true sound of Om for this dimension.

This wavelength is also the exact average distance between our eyes, from the center of one pupil to the other—that is, if you take a hundred people and average them. It's also the exact average distance from the tip of our chins to the tip of our noses, the distance across our palms and the distance between our chakras, to give a few more examples. This 7.23-cm length is located throughout our bodies in various ways because we are emerged within this particular universe, and it is embedded within us.

It was Bell Laboratories that discovered this wavelength, not some spiritual person sitting in a cave somewhere. When they first put up the microwave system that went around the United States and pulled the on switch, they found static in their system. You see, Bell Labs just happened to pick for the system's sending frequency one slightly longer than seven centimeters. Why they chose that wavelength, I don't know. They tried to find the static, looked through their equipment, tried everything they could. First they thought it was coming from inside the Earth. Eventually they looked into the heavens and found it, and said, "Oh, no, it's coming from *everywhere!*" In order to get rid of the static, they did something that we as a nation and a planet are *still* suffering from: They upped the power 50,000 times over what they would normally need, which created a very powerful field, so that the 7.23-cm wavelength coming from everywhere would not interfere.



## Dimensions and the Musical Scale

For reasons such as the above, I believe that 7.23 centimeters is the wavelength of our universe, this third dimension. As you go up into dimensional levels, the wavelength gets shorter and shorter, with higher and higher energy. As you go down in dimensional levels, the wavelength gets longer and longer, with lower and lower energy, more and more dense. Just as with a piano, there's a space between the notes, so that when you hit one note, there's a very definite place where the next note is. In this waveform universe we exist in, there is a very definite place where the next dimensional level exists. It's a specific wavelength relative to this one. Most cultures in the cosmos have this basic understanding of the universe, and they know how to move between dimensions. We've forgotten it all. God willing, we will remember.

Musicians, music theorists and physicists discovered long ago that there are places between the notes called overtones. Between each step of the chromatic scale there are twelve major overtones. (A group in California has discovered over 200 minor overtones between each note.)

If we show each note in the chromatic scale as a circle, we have thirteen circles [Fig. 2-30]. Each circle represents a white or black key and the shaded circle at the end would be the thirteenth note that begins the next octave. The black circle on this illustration represents the third dimension, our known universe, and the fourth circle, the fourth dimension. The twelve major overtones between any two notes, or dimensions, are a replica of the larger pattern. It's holographic. If you carry it further, between each overtone you'll find another twelve overtones that replicate the whole pattern. It goes down and up literally forever. This is called a geometrical progression, only in harmonics. If you continue to study it, you'll

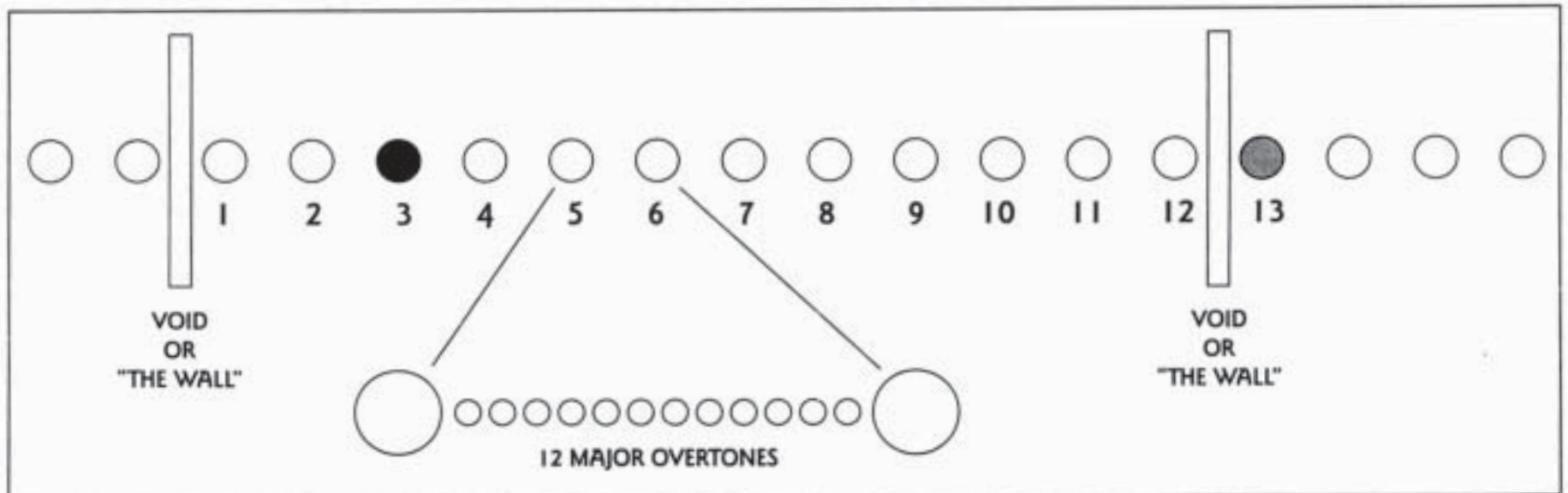

Fig. 2-30. An octave between the walls. The black circle represents the third dimension; the shaded circle ends one octave and begins the next.

find that each of the unique musical scales that have been discovered *produces a different octave of experience*—more universes to explore! (This is another subject we will come back to.)

You've probably heard people talk about the 144 dimensions and how the number 144 relates to other spiritual subjects. This is because there are twelve notes in an octave and twelve overtones between each note; and  $12 \times 12 = 144$  dimensional levels between each octave. To be specific, there are 12 major dimensions and 132 minor dimensions within each octave (though in truth the progression goes on forever). This diagram represents one octave. The thirteenth note repeats, then there's another octave above that one. There's an octave of universes below this and an octave above, and it stretches on theoretically forever. So as big and as infinite as *this* universe seems (which is just an illusion anyway), there are still an infinite number of other ways to express the one Reality, and each dimension is *experientially* completely different from any other.

That's what much of this teaching is about—reminding us that we here on Earth are sitting in the third dimension on a planet that is in the process *right now* of becoming fourth-dimensional and beyond. The third-dimensional component of this planet is about to be nonexistent for us after a while—we're going to be aware of this dimension for only a short time longer. First we'll go into certain overtones of the fourth dimension. Most people in the higher dimensions who are watching and helping with this process now believe that we're going to keep moving on up through higher dimensions quite rapidly.

### ***The Wall between Octaves***

Between each whole-note universe and between each subspace or overtone universe, there is nothing—no thing, absolutely zip. Each of these spaces is called a *void*. The void between each dimension is called the *duat* by Egyptians or the *bardo* by Tibetans. Each time you pass from one dimension or overtone into the next, you pass through a void or blackness that's in between. But certain voids are “blacker” than others, and the blackest of these exist between the octaves. They're more powerful than the voids that exist within an octave. Please understand that we are using words that cannot fully explain this concept. This void that exists between octaves can be called the Great Void or the Wall. It's like a wall you have to pass through to get to a higher octave. God put these voids there in a particular way for certain reasons that will soon become apparent.

All of these dimensions are superimposed over each other, and every *point in space/time contains them all*. The doorway to any of them is anywhere. That makes it convenient—you don't have to go looking for it, you just have to know how to access it. Although there are certain sacred places in the geometries of our reality here on Earth where it's easier to become aware of the various dimensions and overtones—sacred sites, which are nodal points connected to the Earth and the heavens (we'll also talk about them later)—there are also specific places in space that are tied to the geometries of space. These places are sometimes referred to by explorers as stargates, openings to other dimensional levels where it's easier to get through. But in truth, you can be anywhere to go anywhere. It really

doesn't matter where you are if you truly understand the dimensions and, of course, are capable of divine love.

## *Changing Dimensions*

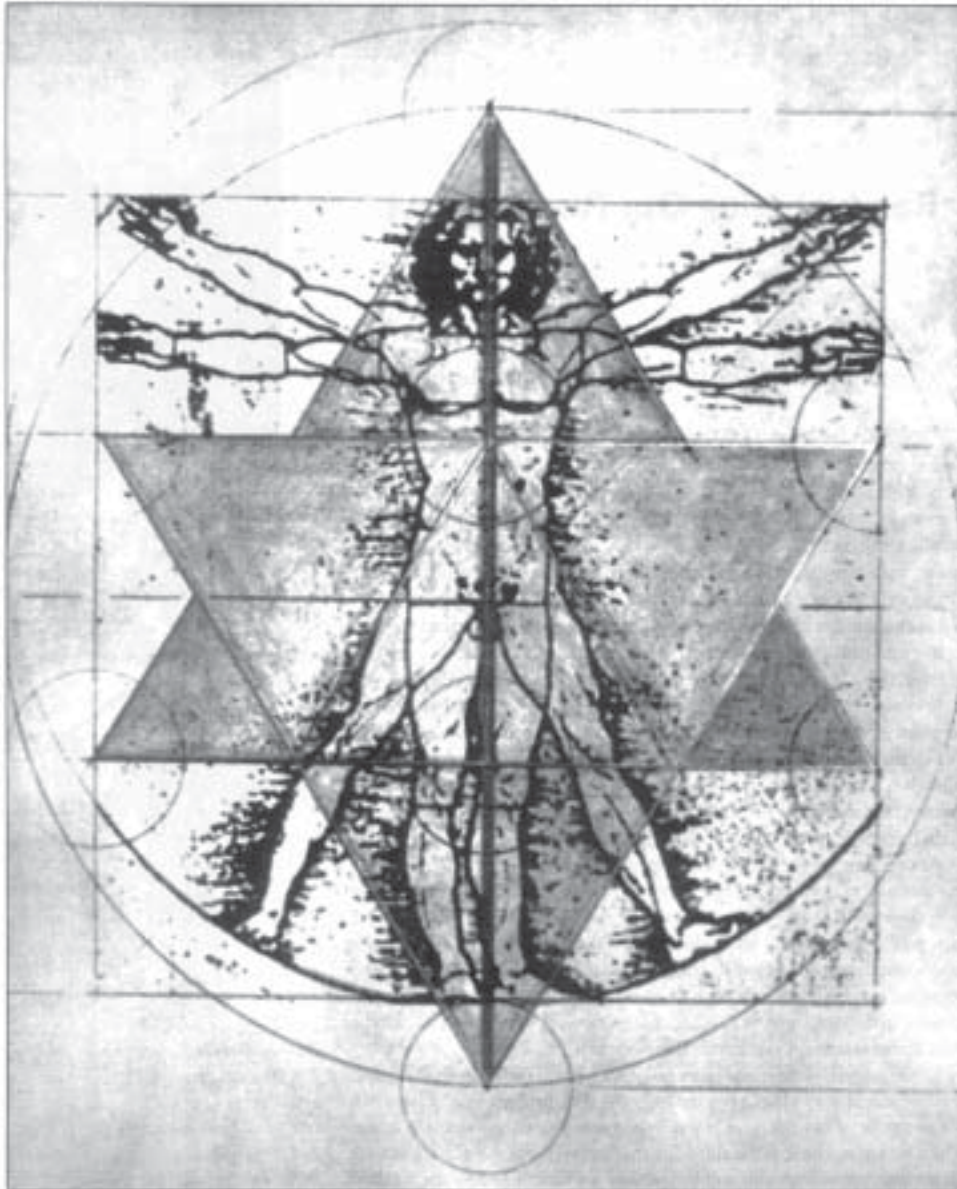

Going back to those guys on the temple ceiling (a few pages ago), they're changing dimensions. They're making a 90-degree turn and changing their wavelength. And those wheels, as you're going to see later, are connected to the harmonics of music—and you now know that the harmonics of music are connected to the dimensional levels. Since the people on the ceiling are making this change while thinking about metamorphosis and resurrection, I believe these wheels are actually telling us exactly where they went, into which dimension. By the time we finish, you'll understand what I'm talking about.

## **The Star Tetrahedron**

This star tetrahedron with Leonardo's image behind it [Fig. 2-31 ] is going to become one of the most important drawings for this work. What you're looking at is two-dimensional, but think of it in three dimensions. A star tetrahedron, just as shown here, happens to exist around each human body. We're going to spend a great deal of time to get you to the point where you can see that you do have this image around your body. Notice especially that there's a tube running down the center of the body through which we can breathe life-force energy, and the two apices at the top and bottom of this tube connect the third dimension to the fourth dimension. You can inhale fourth-dimensional prana directly through the tube. You could be in a vacuum, a total void, with no air to breathe, and completely survive if you could live the principles of this understanding. 51

As Richard Hoagland has shown the United Nations and NASA, we are now beginning to scientifically rediscover this field. Just as it is shown around Leonardo, it is also around planets, suns and even larger bodies. This could become the standard explanation of how some of these outer planets survive. Why? The planets are radiating off the surface far more energy than they're receiving from the Sun, a lot more. Where is it coming from? With this new understanding, if Leonardo were a planet instead of a person, the points at the north and south poles would be bringing in huge amounts of energy from another dimension (or dimensions). Planets literally exist in more than one dimension, and if you could see the whole Earth in all its glory—the various fields and energies around a planet—you'd be astounded. Mother Earth is far more intricate and complex than we at this dense level can perceive. This channeling of energy is actually how it works for people, too. And the particular dimension (or dimensions) that this energy comes from depends on how we breathe.

On Leonardo's drawing, the tetrahedron pointing up to the Sun is male. The one pointing down toward the Earth is female.

We're going to call the male one a Sun tetrahedron and the female one an *Earth* tetrahedron. There are only two symmetrical ways that a human being can look out of this star-tetrahedral form with one point of the star above the head and one point below the feet and with the alignment of the human body looking toward the horizon: For a male body looking out of his form, his Sun tetrahedron has a point facing forward, and the opposite flat face is behind him; his Earth tetrahedron has a point facing out the back, and the opposite flat face is in front [Fig. 2-3 2a].

For a female body looking out other form, her Sun tetrahedron has a flat face forward, and a point facing out the back; and her Earth tetrahedron has a point facing forward, and the opposite flat face is behind her [Fig. 2-320]. We'll explain the Mer-Ka-Ba meditation through the fourteenth breath in volume 2. First I would like to introduce other aspects so that you can begin to remember and prepare yourself for the eventual reactivation of your lightbody, the Mer-Ka-Ba. Beginning soon, we'll start talking about yogic breathing, which probably many of you are already familiar with. Then we'll learn about mudras after that. We're going to keep going step by step until we are ready to experience spherical breathing, the state of being from which your Mer-Ka-Ba can come to life.

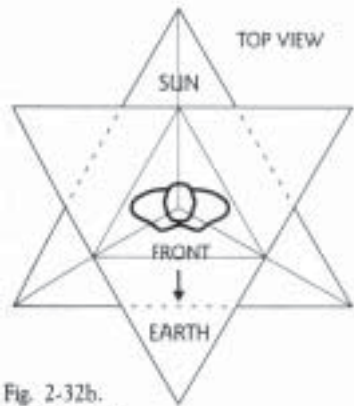

Fig. 2-32b. Female in her star tetrahedron.

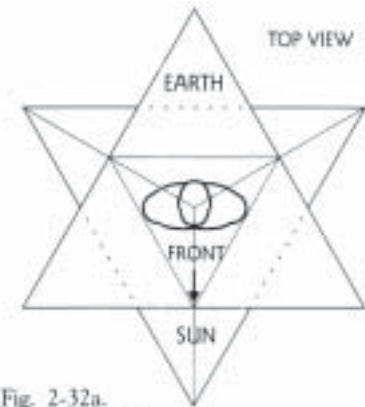
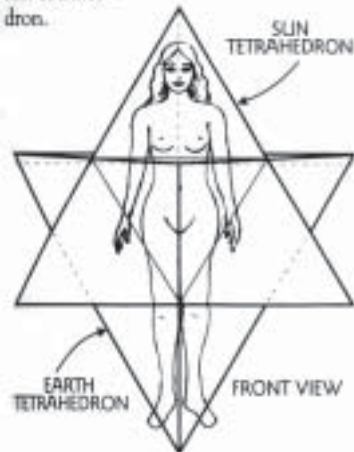
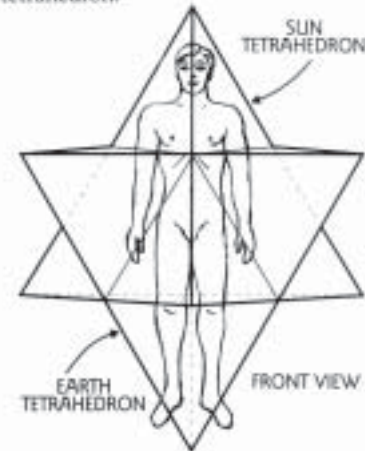

Fig. 2-32a. Male in his star tetrahedron.



## *Threeness in Duality: The Holy Trinity*

To understand the situation here on Earth, we will offer another piece of information to refer to as we proceed. In nature, the law of opposites appears to be manifesting throughout our reality, such as male and female or hot and cold. In truth, this is incomplete. Actually, every manifestation in our reality has *three* components. You hear people talk about male and female polarity and about polarity consciousness; that isn't the full truth. There has never been a polarity in this reality without a third component, with one rare exception we will talk about in a moment.

There is a trinity in almost every situation. Let's think of some exam' pies of what we usually call polarity. How about black and white, hot and cold, up and down, male and female and Sun and Earth? For black and white, there's gray; for hot and cold, there's warm; for up and down, there's the middle; for male and female, there's a child, for the Sun and the Earth (male and female), there's the Moon (child). Time is also in three components: past, present and future. The mental relationship of how we see space is with the x, y, z axes—front and back, left and right, up and down. Even in each of these three directions there's a middle or neutral point, creating three parts.

Probably the best example is the fabric of matter itself in this third dimension. Matter is made of three basic particles: protons, electrons and neutrons. On the next higher level of organization from the three basic particles you will find atoms, and on the next lower level, finer particle divisions. In a similar manner, consciousness perceives itself in the middle between the macrocosm and the microcosm. If you look closely into either level, you will *always find threeness*.

There is a special exception, as there almost always is. It relates to the beginning of things. Primal aspects usually do have twoness, but they are extremely rare. An example is found in number sequences. Sequences such as 123456789.... or 2-4-8-16-32..., or 1-1-2-3-5-8-13-21... —and in fact all sequences known—strangely enough need a minimum of three successive numbers of the sequence in order to calculate the entire sequence, with one exception: the Golden Mean logarithmic spiral, which needs only two. This is because that spiral is the source of all other sequences. In the same manner, atoms all have three parts, as mentioned before, with the single exception of the first atom: hydrogen. Hydrogen has only one proton and one electron; it has no neutron. If it has a neutron, which is the next step up, it is called heavy hydrogen, but the very beginning of matter has only two components.

Since we mentioned numbers exhibiting threeness, we might as well bring up *color*. *There are three* primary colors from which the three secondary colors are created. This means that the universe as we now know it—all created things—is composed of three primary parts except in its rare primal areas. In addition, the very nature of how the universe is perceived by human consciousness is through the three major ways we just spoke of: time, space and matter, all of which are reflections of the sacred holy trinity.

## *An Avalanche of Knowledge*

Most people by now are aware that something unusual is going on here on Earth. We are in extremely accelerated time, and many events are happening that have never been seen before. There are more people on the planet than have ever been known before, and if we continue at the same rate, in a few more years we will double our population to about eleven or twelve billion people.

Regarding our human evolutionary learning curve, the supply of information on the planet is growing far faster than the population. Here's a fact according to the *Encyclopedia Britannica*. From the time of our oldest known human civilization, the ancient Sumerians (circa 3800 B.C.), continuing for almost 5800 years until about A.D. 1900, a certain number of bits of information had been collected, a certain number of so-called facts that were added up to determine precisely how many things we knew. Fifty years later, from 1900 to 1950, our knowledge had doubled. That means it took 5800 years to learn a certain amount, then it took fifty years to double it—amazing! But then in the next twenty years, by about 1970, we doubled it again. It took only ten more years, to about 1980, to double *that!* Now it's doubling every few years.

Knowledge is coming in like an avalanche. The information was coming so fast in the mid-eighties that NASA couldn't put it into their computers fast enough. I heard that in approximately 1988 they were eight or nine years behind in simply entering the incoming data. At the same time this avalanche of knowledge is building up, the computers themselves, which are boosting the acceleration, are about to make a huge change. Approximately every eighteen months computers are doubling both speed and memory. First we came out with the 286, then the 386; then we had the 486, and now the 586 is out [this was 1993], which makes the 486 obsolete. We didn't even know how to use the 486 yet, and here's the 586. And we've already got the 686 planned. By the turn of the century or soon after-ward, a home computer will be so powerful and fast that it will surpass all of the present (1993) computers of NASA and the Pentagon combined.

A single computer will be so fast and powerful that it can actually watch the whole Earth and give constant weather data for every square inch of the planet. It will do things that now seem absolutely impossible. And we're beginning to speed up our ability to enter the data: Now huge amounts of information are entered directly from other computers and scanners and direct voice. So with this incredible amount of knowledge entering into human consciousness, it becomes obvious that a major change for humankind is being birthed.

For thousands of years spiritual information was kept secret. Priests and priestesses of various religions or cults would give their lives to keep the rest of the world from knowing about one of their secret documents or piece of spiritual knowledge, making sure it remained secret. All the various spiritual groups and religions around the world had their secret information. Then suddenly, in the mid-sixties, the veil of secrecy was lifted. In unison, almost all the spiritual groups of the world opened their archives at the same moment in history. You can browse through books in your neighborhood bookstore and see information that has been sealed and guarded for thousands of years. Why? Why now?

Life on this planet is accelerating faster and faster and faster, obviously culminating in something new and different, perhaps just out of the reach of our normal imagination. We are always changing. What does this mean for the world? Why is it happening? Better yet, why is it happening now? Why didn't it happen a thousand years ago? Or why didn't it wait to happen 100, 1000 or 10,000 years from now? It's really important to understand the answer to this question,

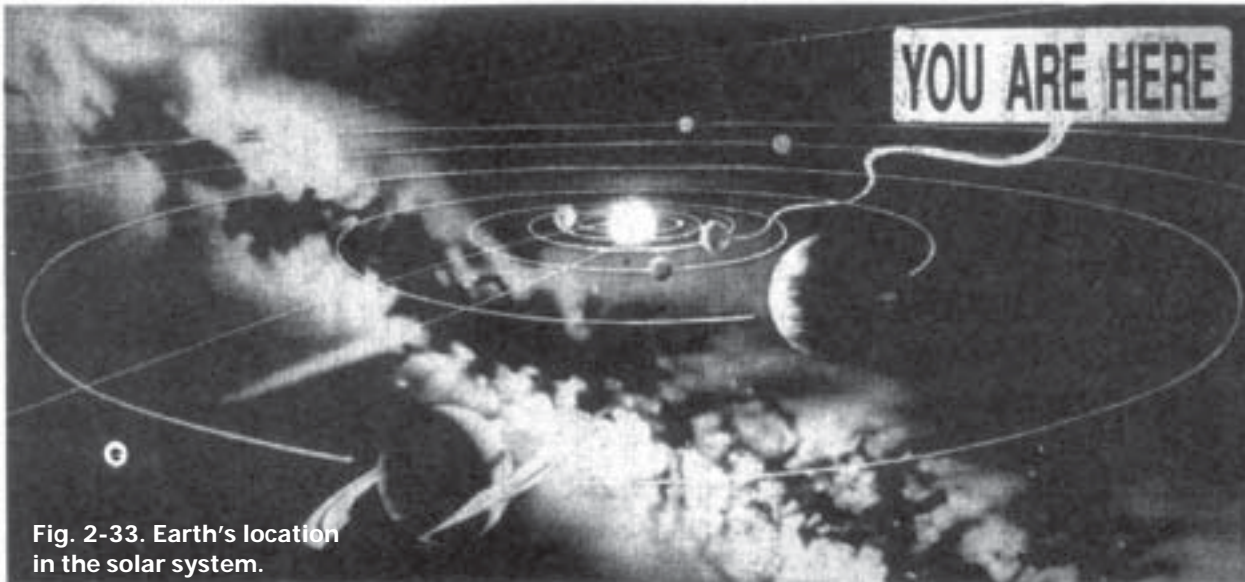

Fig. 2-33. Earth's location in the solar system.



Fig. 2-34. Quasar (quasi-stellar radio source) believed to be the most distant and luminous objects in the universe.

because if you don't know why this is happening now, then you probably will not understand what's happening to you in *your* life or be prepared for the coming changes.

Though I don't want to get into the real meaning of what this is about right now, one of the answers lies in the fact that the computer is made out of silicon and we're made out of carbon. It's tied into the relationship of silicon and carbon, but I'll leave that for a while and continue with the unusual nature of what's happening here on Earth.

## Earth's Relation to the Cosmos

Let's talk about Sirius and the Earth again. You are here [Fig. 2-33], and this is where we begin in the big picture. From where we are on this third planet out from the Sun, Earth's intimate connection to Sirius cannot be understood very easily. You have to go out into deep space to things like this [Fig. 2-34], which you might not recognize—at least most people don't. This is a quasar, and it's enormous. It defies all the laws of physics, and we don't know what the heck it's doing. But that's not really what I want you to notice.

## Spirals in Space

This next photo is a little closer and more familiar to us [Fig. 2-35]. This is a galaxy, obviously not us, because it's pretty hard to take a picture of yourself from within yourself. (The cluster at the bottom right is a nebula, and it is almost certainly much, much closer than the galaxy; they are not connected.) Notice the stars coming out of the galaxy in a white spiral. At exactly 180 degrees opposite one of the spirals is another emerging spiral. I believe there are eight known forms of galaxies—though all of them are functions of each other—and this is the primary model.

For a long time astronomers pretty much thought that what you saw out there was it; if you could see it, it was there. They were either totally oblivious to the invisible side of Reality, or they didn't feel it was that important. But the invisible side of our Reality is actually much greater than the visible side, and probably more important. In fact, if the full electromagnetic spectrum were a line about two yards long, then visible light, with which we see objects, would be a band about 1/32 of an inch wide. In other words, the visible part of the Reality is far less than one percent of the total—almost nothing. The invisible universe is really our true home.

There's much more. There are things even beyond the electromagnetic spectrum that we're just beginning to understand. For example, they've discovered that when an old sun explodes and dies, like the one in the bottom right of the picture, it seems to occur only in the dark area of the spiral (shown by arrow A), indicating that there is a difference between deep space (arrow B) and the inner space between the light spirals. So they're beginning to realize there's a distinct difference between the two areas of space as well as between the dark and the light areas of the galaxy. There's something different about the dark areas of the spiral that seems to be related to the light areas.

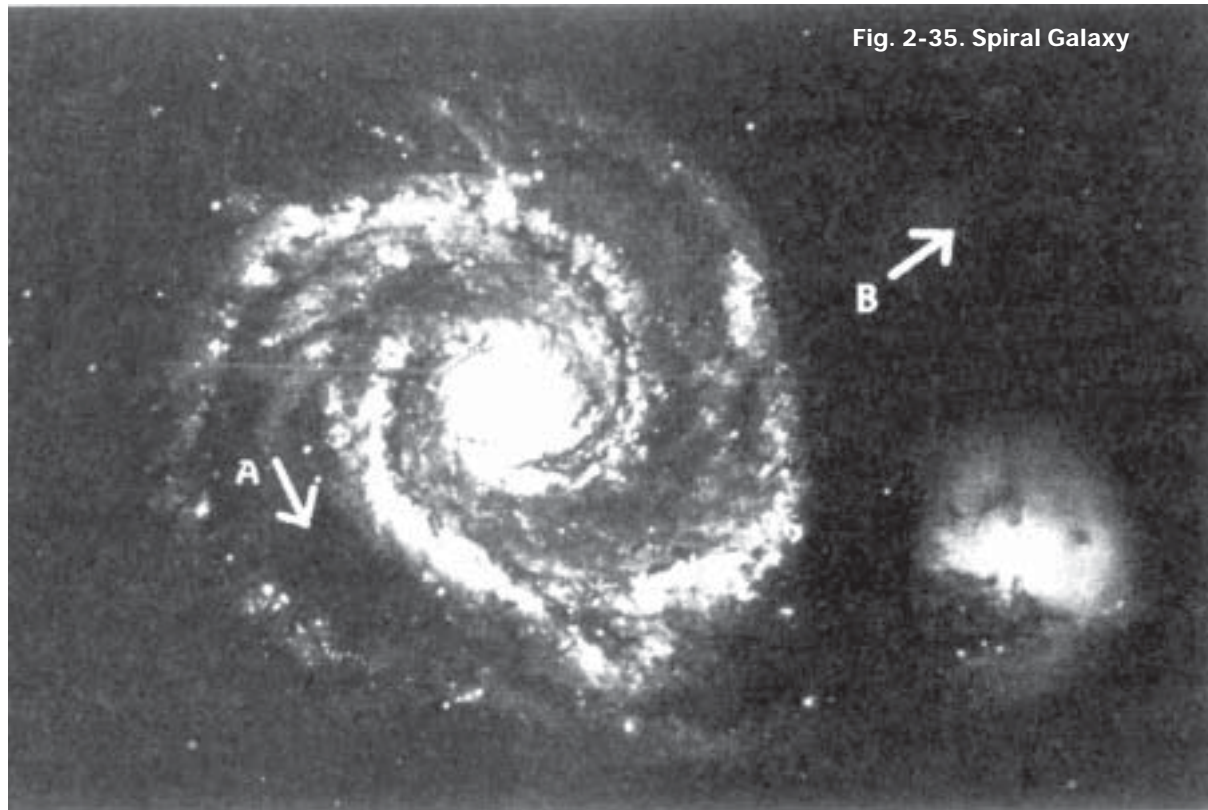

Fig. 2-35. Spiral Galaxy



## Our Sirius Connection

Observing these characteristics of a galactic spiral led to another discovery. Other scientists noticed that as our solar system moves through space, it's not moving in a straight line, but in a helical pattern, a spiral. Well, such a spiral is not possible unless we are gravitationally connected to an other large body, such as another solar system or something larger. For example, many people think the Moon rotates around the Earth, right? It does not. It never has. The Earth and the Moon rotate *around each other*, and there's a third component between them approximately one-third of the distance from the Earth to the Moon, which is the pivotal point, and the Earth and Moon rotate around this point in a helical pattern as they also move around the Sun. This happens because the Earth is connected with a very large body, which is the Moon. Our moon is huge, and it's causing the Earth to move in a particular pattern. And since the entire solar system is spiraling in the same manner through space, then the whole solar system must be gravitationally connected with some *other* very large body.

So astronomers started searching for this body that was pulling on our solar system. They first narrowed it down to a certain area of the sky that we were linked with, then they narrowed it down further and further, until just a few years ago they finally pinned it down to a specific solar system. We are linked with the star Sirius—with Sirius A and Sirius B. Our solar system and the Sirius system are intimately connected through gravitation. We move through space together, spiraling around a common center. Our fate and the fate of Sirius are intimately connected. *We are one system!*

Ever since scientists have known about the dark area inside a spiraling galaxy being different, they have discovered that stars don't just move *out* along the curved arm of a spiral. If someone spun a water hose over his head and you viewed the scene from above, you would see droplets that appeared to move in spirals. Can you envision that? Each individual drop though, is not moving in a spiral, but is moving radially away in a straight line from the center; it only *appears* to be moving in spirals. It's the same way in a galaxy. Each of these stars is actually moving radially away.

At the same time the stars are moving radially away from the center, they are also moving, independent of the system as a whole, from one arm through the dark light into the white light, orbiting the whole galactic system. It probably takes billions of years—I don't know—for one cycle to complete itself.

Imagine that Figure 2-36 is a galaxy viewed from above and that the dark color represents the black-light spirals and the light color represents the white-light spirals. From the edge it looks like a flying saucer. The orbit we make around the center of the galaxy has within it a spiral motion similar to a coiled spring. In addition to our solar system, the same spiral motion is seen between Sirius A and Sirius B [see Fig. 1-4 in chapter 1]. The spiral of the Earth and the Moon, I believe, is different. This spiraling motion of the two Sirian stars just happens to be identical to the geometries of the DNA molecule, according to an Australian scientist. This makes you suspect that perhaps there's a relationship in the unfolding of things, that events happen according to some kind of larger plan, similar to the unfolding of a human body guided by the information within the DNA. Of course, it's only speculation, but because of the principle "as above, so

*Update: This update will not make complete sense until you fully understand the Mer-Ka-Ba, but this is the most appropriate place to put it. Astrophysicist William Purcell has just discovered (reported May 12, 1997, in Time magazine) that "a colossus of antimatter," a tube at 90 degrees to the plane of the galaxy, "is spewing out from the center of our galaxy and reaching trillions of kilometers into space." This resembles the same geometries of the Mer-Ka-Ba on a galactic level.*

*At the same time, Cornell astronomers have discovered that about 80 percent of the stars in the galaxy NGC 4138 (mostly older stars) are rotating in one direction, whereas about 20 percent of the stars (mostly younger stars) are rotating in the opposite direction along with a huge cloud of hydrogen gas. Their findings were presented on January 18, 1997, at the American Astronomical Society. This is a counterrotating field. Not only do galaxies look like Mer-Ka-ba fields, but they appear to have the same internal dynamics! (Of course, I personally believe that galaxies are living beings, and that they are really nothing but a huge living Mer-Ka-Ba field.) In addition, physicists*



Fig. 2-36. Spiral Galaxy, overhead view (top) and edge (bottom).

below," this is highly probable.

So we have two related questions to answer. One is why Sirius is so important, which has been explained by our gravitational connection to it, Another is, why is this extremely rapid pattern of evolution we are experi-

encing on Earth today taking place at this moment in history? Let's keep looking in the heavens. First, here are two incidental pieces of information to share.

A Galaxy's Spiral Arms, Surrounding Sphere and Heat Envelope

Figure 2-37 is out of *National Geographic*, showing what they've now discovered. They've found that spheres of energy surround galaxies. Notice the tiny galaxy with its spiraling arms, along with a bunch of loose stars, all enveloped in the sphere of energy. Then outside that sphere is another enormous sphere of energy, shown here as a hexagonal grid. So there's a huge sphere inside a smaller sphere, with a tiny galaxy inside it. As we progress, you're going to see that you have exactly the same field around *you*.

Figure 2-38 is a picture of the heat envelope of a galaxy, slightly tilted,

Sun, and as the Earth orbits the Sun, the angle that the light hits the

*at the University of Rochester and the University of Kansas have found evidence that changes the long-held belief that space is the same in all directions. Researcher John Ralston reported that "there seems to be an absolute axis, a kind of cosmological North Star that orients the universe." This work is published in the April 21, 1997, issue of Physical Review Letters.*

*They have also discovered that light travels differently along this axis than anywhere else. There are now two known different speeds of light! The **axis is the key to the living Mer-Ka-Ba field, and this finding may eventually prove that the entire universe is really just a giant living Mer-Ka-Ba field. After you are aware of your own Mer-Ka-Ba field, reread this section and you will understand.***



Fig. 2-37. Galactic energy spheres.



Fig. 2-38. Galactic heat envelope.

surface of the Earth changes, depending on where it is in its orbit. This is why we have four seasons.

Within this yearly rotation there's another very slow wobble, which most people know as the precession of the equinoxes, which takes almost 26,000 years to complete. To be more accurate, it's about 25,920 years—it depends on who you read, because everybody comes up with a few years' difference. There are other wobbles, too. For example, that +23-degree angle to the Sun is not fixed; there's a wobble of about 40,000 years where it changes about three degrees—from about 23 to about 26 degrees. Then there's another wobble inside the little three-degree wobble that completes a cycle about every fourteen months. And they've discovered another one that completes about every fourteen years. Now they say they've discovered yet another one. If you read the ancient Sanskrit writings, *all* these wobbles are profoundly important for consciousness on the planet. They're tied directly to specific events and to the time these events happen on the planet—just as our DNA is tied to the various phases in the growth of the human body.

For now I just want to look at the main wobble, which is called the *precession of the equinoxes* [Fig. 2-39]. This wobble moves in an oval pattern, and the large oval in Figure 2-40 is the wobble itself. The right end, on the long axis of the oval, is called the apogee, which points toward the center of the galaxy. The bottom half of the oval shows when the planet is heading *toward* the center of the galaxy, and the top half shows when the planet has come back around and is heading *away* from the center. This movement away from the center of the galaxy is also called *going with the galactic wind*. The Sanskrit writings say that the ancient beings—who somehow knew about the precession—say that it's not at the far ends of this oval when great change takes place, but slightly *after* these extreme points are passed—at the points indicated by the two small ovals at A and C. Great change takes place at those two points. There are two other points

Fig. 2-39. Precession of the equinoxes (the point at which the Earth's celestial equator intersects its ecliptic) is due to the slow rotation of the Earth's axis around a perpendicular to the ecliptic.

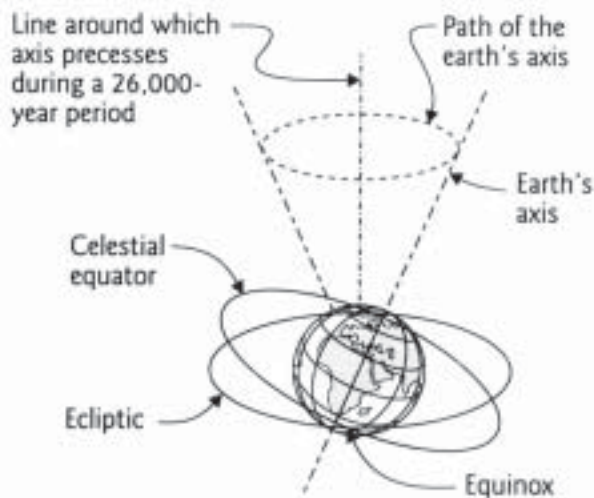
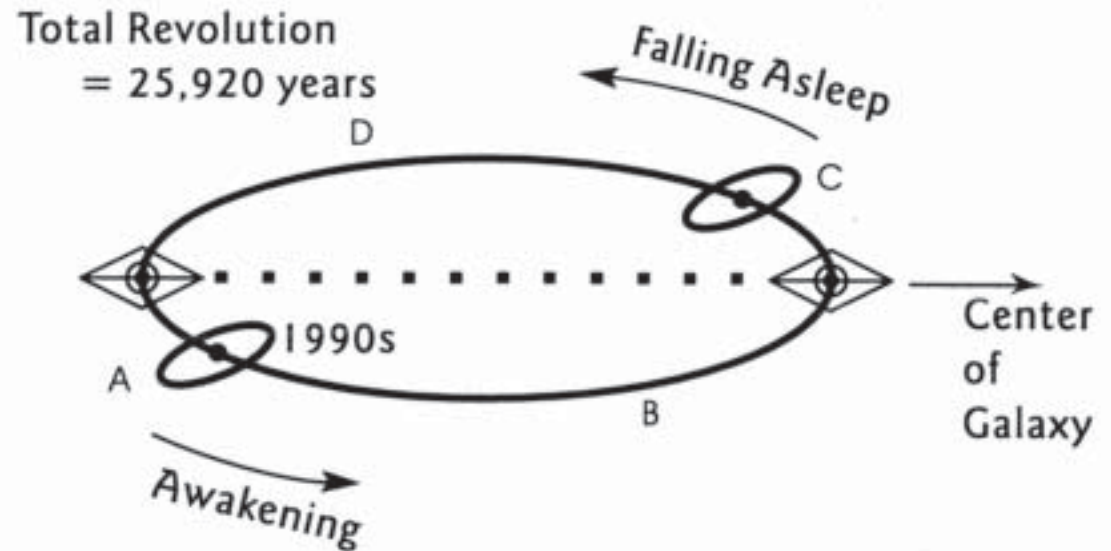

Fig. 2-40. Traveling through the time period marked by the cycles of the precession of the equinoxes. The large oval is the path of the Earth's axis.



sitting halfway between the small ovals, shown at B and D, which are also very important places, though change is not as likely as at A and C. Right now in the 1990s we are positioned at A, the lower small oval, which indicates that this is a time of tremendous change.

According to the ancient writings, when we reach the upper small oval at C [Fig. 2-41], moving away from the center of the galaxy, we begin to fall asleep and keep losing consciousness and falling through the dimensional levels until we come to the place at the lower small oval, when we start to wake up and begin to move up through the dimensional levels.

We wake up in definite stages until we get to the upper oval again, when we fall asleep again. But this is not a closed pattern, because we're moving through space. It's a helical, open-ended pattern like a spring, not a repeating cycle as within a circle. Because of that, each time around we fall asleep a little less than the time before and wake up a little more. A similar cycle occurs on Earth each day. If you look at the Earth from space, it is half dark and half light at any moment, and the people on the dark side are pretty much asleep and the people on the light side are pretty much awake. Even though we have day and night, we don't repeat the same things over and over, but hopefully we wake up and become more conscious each day. Even though we fall asleep and wake up, we keep going further each rime. This *precession of the equinoxes is just the same*, only it's a much longer cycle.

### Yugas

The Tibetans and the Hindus called these particular time periods *yugas*, which are simply ages. Each yuga has both a descending and ascending phase, so if you use the Hindu system, the age around the top oval at C is called the descending satya yuga. Then comes the descending treta yuga, dwapara yuga, and kali yuga at the other end. In the kali yuga you have both descending and ascending. Then you enter the ascending dwapara and so on. We're now in the ascending dwapara yuga. We're out of the kali yuga by about 900 years, and right now is the time when amazing things are predicted to happen. The world is now rediscovering for itself that these are periods of enormous changes on Earth. This diagram [Fig. 2-42] was made by Sri Yukteswar, Yogananda's guru. He did this in the late 1800s. Though he did not know the true time duration of the precession of the equinoxes, he put it at 24,000 years. That was very close, because most Hindus had no idea of what they were doing when working with the yugas. (I don't mean to put them down, but they

didn't.) You see, when we were coming through the kali yuga, we were in the darkest most-asleep times. Most of the books written in the last 2000 years were written by people who were asleep, relatively speaking, and were trying to interpret books written by people who were much more awake. They didn't understand what the older books were

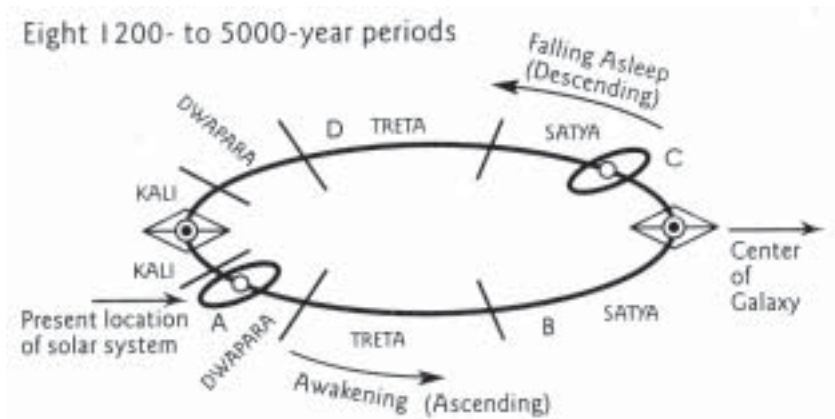
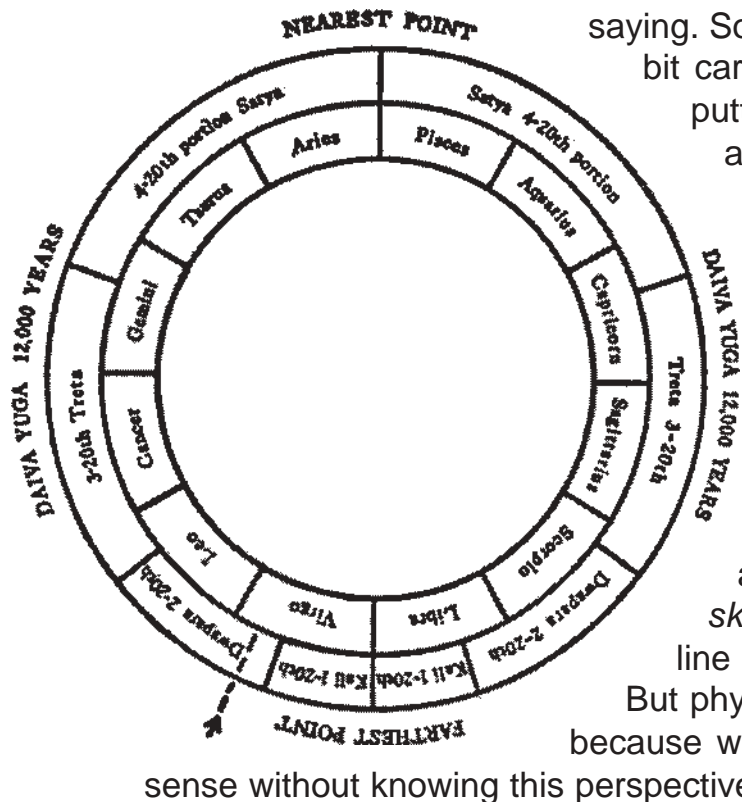

Fig. 2-41. The four Hindu yugas, ascending and descending.



saying. So, as with any book written in the last 2000 years, you've got to be a little bit careful because of the time it was written in. Many Hindu scholars were putting the precession of the equinoxes at hundreds of thousands of years, and some said one yuga is around 150,000 years. They were wrong and just did not understand.

Yuktswar knew better, but he wasn't quite right either. What he did in this diagram was to put the different yugas around the outer edge, and on the inside he put the twelve signs of the zodiac, thus showing which yugas corresponded with what sign. When he made this chart we were in Virgo, shown in the bottom left quadrant. At the moment we're between Virgo and Leo. Depending on what astrologer you talk to, we're close to the third eye of the virgin right now and passing into Leo—that's physically. That means the planet physically is between Virgo and Leo. But if you look 180 degrees across the heavens, you see the sky moving from Pisces into Aquarius. At this moment we're right on the line between Pisces and Aquarius, about to head into the Age of Aquarius. But physically it's a whole different point of view. You need to understand that, because when we look at the works in Egypt, some of their writings don't make sense without knowing this perspective.

## Modern Views on Pole Shifts

In the 1930s, Edgar Cayce was channeling answers for a geologist when, in the middle of a question, Cayce stopped and said something like, "You know, there's something a little more important going on with the Earth that maybe you should know about," and started talking about how the poles of the Earth are going to shift soon. He said the year it would happen would be the winter of 1998, but things have changed since then in a psychically unpredictable manner. The poles still may shift, but then again, they may do it in a way slightly different from Cayce's prediction. We do have free will, and we can change the fate of the world simply through our being.

Edgar Cayce was an extraordinary human. He was a man people listened to when he spoke. The statement by Cayce that the poles were going to shift in the near future was almost unbelievable by most of the world. But because it was Edgar Cayce predicting this outrageous event, scientists and other interested persons began to study the possibility.

Geologists would not believe his statement because they thought it would probably be millions or hundreds of millions of years between pole shifts, that this kind of change took a very long time. But because of Cayce's prediction, certain scientists began to search anyway. A string of major pieces of evidence came forth that lent tremendous weight to what Cayce was saying, and they have now changed the world's view on this subject. The scientists suspected that if there were a change in the physical poles, then there would also be a change in the *magnetic* poles. One of the ways they decided to study this possibility was to examine the ancient lava beds of the world. This started taking place, I believe, in the 1950s or early '60s. They wanted to study lava beds because (1) they figured there would be tremendous volcanic action if such a shift took place, and (2) lava has a characteristic that could verify and date previous magnetic pole shifts.

### *Iron Pilings and Core Samples*

Iron pilings are found in most lava, and these pilings have a different melting point than the lava itself. The pilings harden while the lava is still flowing and, being iron, line up with the magnetic poles. Through this observation, geologists can see exactly where the magnetic poles were at the time the lava hardened. They needed to get samples from only three locations to be able to triangulate and know exactly where the magnetic north pole was at the time the pilings hardened. Then, of course, they could radiocarbon-date it, which was the best they could do back in those days. There were other approaches to this problem, which we will look at in a moment.

So they discovered an earlier magnetic north pole that was not where it is now but a long way away, centered in Hawaii. That last shift took place right at the upper oval—a little less than 13,000 years ago. They then did ; another test and found that the poles had shifted before *that* at the lower oval. This opened up a whole new area of investigation into the Earth's magnetics.

The Geological Society of America published a summary of findings gathered from ocean-floor core samples (*Geology* 11:9, September 1983). The samples were six inches in diameter and eleven feet long, and the researchers analyzed the sediment. They discovered that sometimes the poles simply reverse themselves. The north becomes the south and the south becomes the north. This was another thing Edgar Cayce talked about that people had a hard time believing. But when they analyzed these core samples, they found it was true. Going back hundreds of millions of years, they discovered a cycle where the magnetic north pole would remain in place for a long time—then in a single day, less than 24 hours, magnetic north switched to the south. It stayed that way for a long time, then switched again. But toward the ends of these long cycles were shorter periods where the magnetic poles would reverse themselves again. This flip happened every once in a while. And as we come closer into present times, the flips are starting to happen closer together—from north to south, south to north, and at the same time moving to new locations. This has happened hundreds of times over the last several hundred million years. A whole new viewpoint of the Earth's magnetics, called *geomagnetics*, is beginning to be understood. From space, would this not appear as a pulse?

## *Pole-Shift Triggers*

By now there have been many people trying to figure out what could cause a pole shift. What are the dynamics? What's the trigger that makes it happen? There's a book by John White—who's also an Edgar Cayce advocate—who has compiled almost all the information in the world on this subject, though he does not mention, I believe, the particular information on the last magnetic shift being in Hawaii. His book is called *Pole Shift*, of course. It's a very scientific and interesting book. If you read it, you'll get an excellent understanding of this subject, which is vast and amazing.

There are two main theories right now about what the trigger could be that would cause the poles to move. One of them is obvious and the other more subtle. The obvious one is called the Brown theory, named after Hugh Auchincloss Brown, who conceived this idea. His theory is that for some reason the south pole begins to form off-center (which is exactly what's happening now), then it builds up quite rapidly toward the end of the cycle (which is also exactly what's happening now), until one day it breaks free from the centrifugal force of the Earth's rotation. It's just like any spinning object: When something is off-center, it throws the whole object off-center and forces it to find a new equilibrium. If the weight of the ice keeps building and building, eventually something's going to happen. The Earth can't keep spinning in the same rotational position. It will find a new pole that is centered. Yet there are some scientists who believe that the mass of ice at the South Pole is not enough to trigger a pole shift.

As a matter of fact, the ice at the South Pole in some places is over three miles deep and building, especially rapidly over the last 20 years, faster than ever expected, probably because of the greenhouse effect. And today there are three enormous volcanoes underneath the icecap that can be seen from our satellites. It's melting the underside of the icecap, and huge rivers are flowing out from beneath it at this very moment. Perhaps this fact was not entered into the equation by the doubting scientists. If that icecap, which is twice the size of the United States, were to break free, it's been calculated that it would move toward the equator at 1700 miles an hour to find balance, according to John White. That would obviously cause some problems here and there. Brown's theory appears to be happening, but it is not a certainty.

However, someone has offered another theory, one which even Albert Einstein considered seriously, that holds a possible answer to the equations that unbelieving scientists have used. His name is Charles Hapgood. He, and other scientists who worked with him, discovered at least two layers of unusual rock underneath the Earth's crust which liquefy under certain conditions. Other scientists have demonstrated this in laboratories where they've put the same kind of rock into a miniature Earth and duplicated the conditions of the inner earth. From this experiment, they found that the surface or crust of the Earth can slip over the main mass of the Earth, which continues its rotation as if nothing had happened. It's a fact. It *can* happen, but of course we do not know if it will actually happen in real time. They don't know the specifics of how this would work—such as what trigger could cause this slippage. Charles Hapgood wrote two books, *Earth's Shifting Crust* and *The Path of the Pole*, that will probably eventually change our view of our world dramatically.

Albert Einstein wrote the foreword to Charles Hapgood's first book, *Earth's Shifting Crust*. I feel it is important enough to reprint here directly:

*I frequently receive communications from people who wish to consult me concerning their unpublished ideas. It goes without saying that these ideas are very seldom possessed of scientific validity. The very first communication, however, that I received from Mr. Hapgood electrified me. His idea is original, of great simplicity, and ; if it continues to prove itself ; of great importance to everything that is related to the history of the earth's surface.*

*The author has not confined himself to a simple presentation of this idea. He has also set forth, cautiously and comprehensively, the extraordinarily rich material that supports his displacement theory. I think that this rather astonishing, even fascinating, idea deserves the serious attention of anyone who concerns himself with the theory of the earth's development.*

It is a given that Albert Einstein was one of the most brilliant humans who has ever lived, yet few geologists even yet believe such an outrageous theory. Only in more recent times has proof begun to accumulate that such things could be true. The same scientific world didn't believe Mr. Einstein either when he said how much energy was contained within a very small amount of matter.

It is my belief that the trigger to the pole shift is connected with the geo-magnetism of the Earth. This would take a long time to explain, which I am not prepared to do here at this time. What is known is that for the last 500 years the Earth's magnetic field has been continually weakening, and in the last few years it has been doing absolutely bizarre things. According to Gregg Braden in *Awakening to Zero Point: The Collective Initiation*, the Earth's magnetic field actually began to weaken about 2000 years ago. Then around 500 years ago, the weakening really began to accelerate. (Could it be 520 years? This would match the Mayan Calendar, which predicted a huge change at that time.) In recent times the magnetic field is making unheard of changes.

### *Magnetic Flow Changes*



Fig. 2-43. Magnetic flow around the Earth

The idealized lines of magnetic flow [Fig. 2-43] you see coming out in a torus around the Earth are not what geologists have found. The reality is that the magnetic lines look rather like straight weaving patterns [Fig. 2-44]. They're fixed, but they're not precise in that idealized kind of way. And there are certain areas where they're stronger and other areas where they're weaker. These lines normally do not move, but because the field is getting so weak, they are beginning to move and change. The birds, animals and fish, and the dolphins and whales and other creatures use these magnetic lines for their migration patterns. So if the magnetic lines change, their migration patterns go off, which is what we're seeing all over the world right now. Birds are flying to places they're not supposed to be, and whales are beaching themselves on land, where it's supposed to be water as far as they're



concerned. They're simply following the magnetic line they've followed for centuries, and they're running into land that wasn't on that line before.

When these magnetic fields pass through zero point and completely change—which they may do very soon—we'll have another subject to talk about, about what happens then. You see, we believe your very memory is tied to those fields. You can't remember anything without these magnetic fields. In addition, your emotional body is tied powerfully to the magnetic fields, and if they change, your emotional body is radically affected. It's easy to understand that the Moon affects the tides of the world through the pull of gravity. We also know that the magnetic fields of the Earth are slightly affected by the phases of the Moon. When the Moon is full and passes overhead, we get a slight bulge and change in the magnetic field of the Earth. Just

look at what happens in big cities during a full moon. The day before, the day of, and the day after the full moon, we have more rapes and murders and killings and weirdness of this nature than we do for the rest of the entire month. The police blotter of any major city will verify that. Why? Because these fields especially affect people who are right on the edge of emotional instability, who are barely able to cope during normal times. They're right on the edge, then the Moon comes along and moves the magnetic field just a little bit, and the person experiences an emotional dip and does things he or she normally wouldn't do.

So imagine what would happen if the geomagnetic field of the Earth starts destabilizing. I heard in October 1993 from someone who's involved in aviation that in the last two weeks of September, major landing strips had to recalibrate their guidance systems because the magnetic fields made a unilateral shift all over the planet. It seemed to be temporary, lasting about two weeks. At that time you might have remembered an incredible emotional outburst within yourself and people around you. In my world I'm on the phone with people from all over the world. People were freaking out everywhere. That's why I suspected that maybe what I heard might really be true. If it is true, then we are beginning to proceed almost certainly into the next phase of this work. These breakdowns in the magnetic field of the Earth will begin to come closer and closer together until there is a total collapse of the field and a shifting of the poles. This is one of the signs of

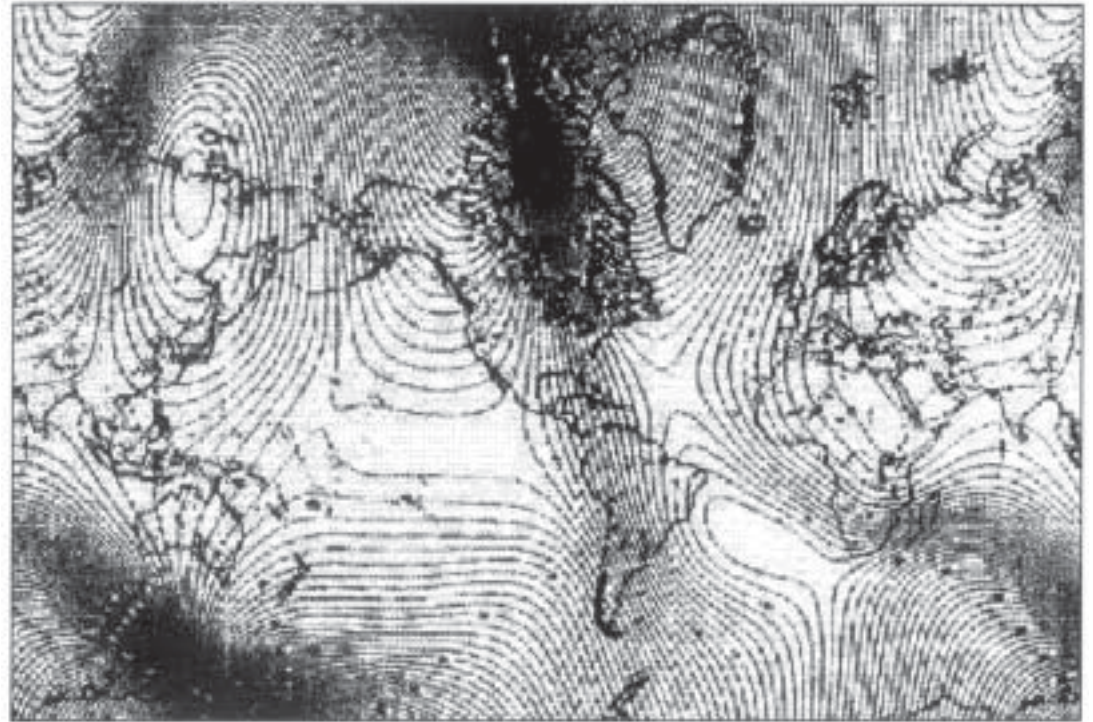

Fig. 2-44. Sample of complex model of Earth's main magnetic field, generated by the USGS for the year 1995.

the very end times.

There's no reason to get into fear about any of this. Even though what's happening is unusual, we've all been through these kinds of things many, many times before. This is not unusual for you, though most of you have very little memory of it. When you actually start going through the dimensional shift and get into the feel of it, you'll say, "Oh, yeah, I remember this now. Here we are, going through this birthing again." So it's not a big deal, yet it is.

You came from somewhere else when you were born as a baby, right? You came from some other dimension and you passed through a void and came out through the womb to Earth. You traveled this path before, and we're about to do a similar kind of thing, only it's a really unusual one this time. There's no reason to fear it when you know all of it and remember who you are. In fact, what's occurring is extremely positive. It's very, very beautiful.

### *Harmonic and Disharmonic Levels of Consciousness*

The Sanskrit literature talks about how when we approach the lower oval at A [in Fig. 2-40] in the precession, we become aware of electrical energies. We can fly in the sky. We can do many unusual things. The world becomes extremely unstable, and in a single *day* we get rid of the old way of viewing the world and make a huge transformation in consciousness. But as we approach this transformation, given the particular level of consciousness we have, we tend to destroy everything we touch. It's a natural part of who we are. We're not doing anything wrong; it's just the way we are. We're doing it exactly right. We destroy everything, we cause everything to go into disharmony. I'll be talking about this later, but I think it would be appropriate to tell you this much now:

On Earth, according to Thoth, there are five totally different steps or levels of life that each human is going to pass through. When we reach the fifth level, we will make a transformation that transcends known life itself. That's the normal pattern. Each one of these levels of consciousness has many aspects that are different from the other levels. First, they have different chromosome levels. The first level of human consciousness has 42 + 2 chromosomes; the second level has 44+2 chromosomes; the third one has 46 + 2; the fourth, 48 + 2; and finally 50 + 2. Each level of human consciousness has a different body height associated with it. (This might sound kind of funny if you've never heard it before.)

The first level of 42 + 2 has a range of height somewhere between four and maybe six feet. The people who fall into that category specifically are the Aborigines in Australia, and I believe that certain tribes in Africa and South America also do.

The second level of consciousness has 44+2 chromosomes, and that's us. Our band of height is about five to seven feet. We're a little taller than the first group. The third level's height goes up considerably. The 46+2 chromosome level interrupts the Reality through what you could term unity or Christ consciousness. That range of height is from about ten to sixteen feet tall.

Then there's another range for the fourth level of consciousness—the 48 + 2s—who have a height of about 30 to 35 feet.

The final band, the perfected human, is between 50 and 60 feet tall. They have 52 chromosomes. I suspect that the reason there are 52 cards in a deck is related to those 52 chromosomes of the potential of man. For those of you who are Hebrew, you might remember that Metatron, the perfect man—that which we will become—was blue and 55 feet tall. (We'll talk about this again when we get into the subject of Egypt)

There are states between the consciousness levels, like Down syndrome, for example. Down syndrome happens when a person transitions from this second level of consciousness, which we are on, into the third level, but didn't quite make it. The person didn't get all the instructions right, and where he almost always fails is in the left-brain instructional aspect of the chromosomes. A Down syndrome person has 45+2 chromosomes—he got one of them, but not the other. He or she got the emotional one—the heart one—all right. If you know any Down syndrome children, they are pure love, but they don't understand how to make the transition into the third level of human consciousness. They are still learning.

The second and fourth levels of consciousness are disharmonic, and the first, third and fifth levels are harmonic. You'll understand this when we see it in the geometries. When you look at human consciousness from a geometrical point of view, you can see the harmonic levels, and you can see that the disharmonic levels are simply out of balance. That's where we are right now—out of balance. These disharmonic levels are absolutely necessary. You can't get from level one to level three without passing through level two. But two is a totally disharmonic consciousness. Does not chaos bring change?

Whenever a consciousness gets into the second or fourth level, it knows it can be there for only a short time. These levels are used as stepping stones—like a stone in the middle of a river, one you jump on and get off of as soon as you can to get to the other side. You don't hang out there, because if you do, you fall in. If we were to hang out here on Earth even just a little bit longer, we would destroy our planet. We would destroy it by just *being* who we are. Yet we are a sacred and necessary step in evolution. We are a bridge to another world. And we are living this bridge by just being alive in this incredible time.

### THREE

## The Darker Side of Our Present and Past

We are about to enter negative subjects for a bit. You could say, “There he goes getting into that fear stuff just after he said not to get into fear,” but I want us to observe all the facets, both positive and negative, of life here on planet Earth. I don’t want to look at only the positive ones; I want you to see the whole picture. And when you look at the whole picture, both the good and the bad, you’ll see that the chaos is just part of the truth and part of the birth. A phenomenal change in human consciousness is occurring at this moment, though if you take any tiny segment of what’s happening or look out in the world and see all the wars, famines and human emotional garbage that’s filling our newspapers, the future does not look good. But when you get the whole image of life, you’ll see that beyond all the negative, there’s something much greater and vast and sacred and holy occurring at this moment in history. It becomes clear: Life is whole, complete and perfect now!

### Our Endangered Earth

However, the most conservative scientists in the world that I can find don’t give our planet more than 50 years—50! The most conservative scientists on the planet say there will be no life or almost none on this planet within 50 years if we continue the way we’re going. Many scientists give us only three or more years; some of them give us ten. Most don’t give us more than fifteen years. It depends on who you read. Even if it were a hundred or a thousand years, would that be acceptable?

You would not be hearing any of this information today if it were not for some changes in our government that have taken place in the last eight years that have *allowed* this information to be presented. Although they’re not allowing you to know everything, there has been a change in the powers that be

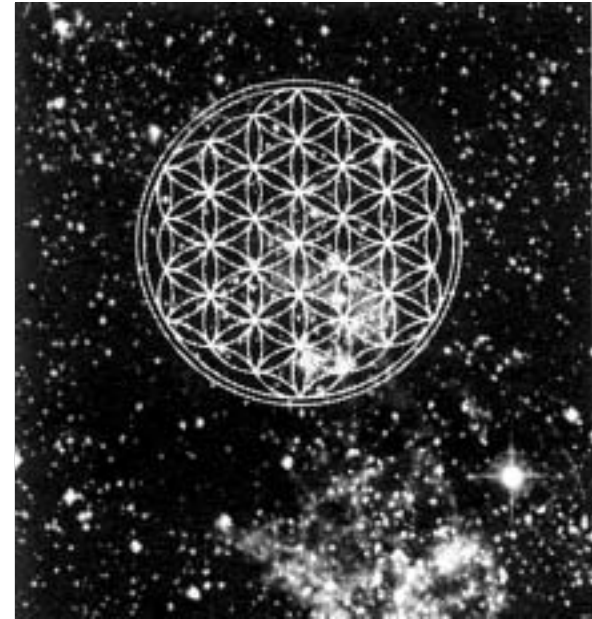

*In 1992 the world nations met at an “Earth Summit” in Rio de Janeiro to discuss Earth’s environmental problems. The largest gathering of heads of state in the history of the world was called because of the danger of losing our planet. Most of the world came, but the United States, the largest polluter in the world [fig. 3], didn’t even want to participate. It was obvious that the political administration felt that money, jobs and the economy were more important than whether the Earth survived.*

*Five months later, on November 18, 1992, a document titled “World Scientists’ Warning to Humanity” was released. More than 1600 senior scientists from 71 countries, including over half of all living Nobel Prize winners, signed this document. It was the most alarming warning the world has ever received from such a powerful body of researchers. You would think that this document would hold*

where they're beginning to cooperate with *life*. They simply can't let you know the full extent of the situation, because they believe that most of the world would just quit their jobs and say, the heck with everything, leading to complete chaos. Instead of quitting, is not this the time to focus? Human consciousness is powerful. We will know what to do. We are more than the ordinary world knows. Do you remember?

Okay, now let's talk about the dark side. This is a January 2, 1989, issue of *Time* magazine [Fig. 3-1]. In 1988 the secret government of the world decided to allow us to know some of what was going on around environmental problems. This was the first major publication on the subject in the world. *Time* magazine declared the Earth to be the "planet of the year." Instead of featuring a man or woman of the year, they broke away from their tradition. The entire magazine was devoted to our endangered Earth and its problems. If you were to read the problems as they were presented in 1989 and then read the problems as they're being presented in articles today, you'll realize that what they gave us in 1989

was a ultra-watered-down version of the truth. It wasn't even close. But at least it was a beginning for our world to see the truth about what we have done to Mother Earth.

We're going to discuss only four or five different problems



Fig. 3 U.S. is by far the biggest polluter on the planet.

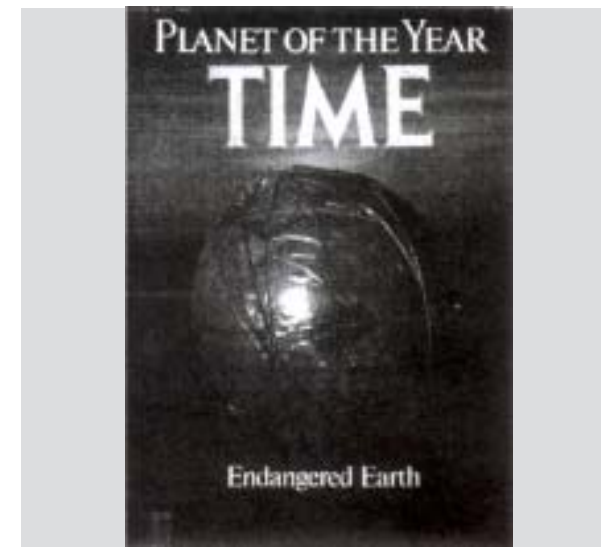

Fig. 3-1. Allowing the truth to be known

*great credibility and that the world would carefully listen. It began:*

*"Human beings and the natural world are on a collision course. Human activities inflict harsh and often irreversible damage on the environment and on critical resources. If not checked, many of our current practices put at serious risk the future that we wish for human society and the plant and animal kingdoms, and may so alter the living world that it will be unable to sustain life in the manner that we know. Fundamental changes are urgent if we are to avoid the collision our present course will bring about."*

*The warning document then began to list the crises: polluted water, oceans, soil, atmosphere, diminishing plant and animal species and human overpopulation. (More than half of the life on this planet is now extinct and continuing to die.) The words became stern:*

*"No more than one or a few decades remain before the chance to avert the threats we now confront will be lost and the prospects*

the Earth has, though there are multiple different scenarios going on. If *any one* of these scenarios were to break down, all life on the planet would eventually die. And at the moment they're *all* about to break down—it's just a matter of which one breaks down first. And whenever one system goes, then all the rest of them will go eventually, and that's it, there won't be any more human life. It will be over with, and we'll end up just like Mars or the dinosaurs.

A few years ago, around the turn of this century, there were 30 million species of life forms on Earth—30 million *different* species of life. In 1993 there were about 15 million. It took billions of years to create these life forms, and in less than a blink of an eye, a mere hundred years, half of the life on this dear Earth is dead. Around thirty species a minute are now becoming extinct somewhere. If you were to watch this planet from space, it would appear to be dying very, very rapidly. Yet we're going on as though nothing's happening and everything's great. We're sticking money in the bank and driving our cars and just wiggling right on. Yet from an honest point of view, we have a real life-and-death problem going on here on Earth, and few people seem to be really serious about it.

When they tried to get the entire world to come together in Rio in the early '90s to discuss the worldwide environmental problem, our president didn't even want to go. Why not? Because the problems are so serious that if we were to fix them, another problem would happen that would be an even more serious problem, from the president's point of view: We would be plunged into a worldwide financial breakdown, after which a large portion of the Earth's population would die from starvation and other problems. In essence, we cannot afford to repair the environment. On the other side of the coin, can we afford not to?

### *Dying Oceans*

It was in the August 1, 1988, issue [Fig. 3-2] that Time magazine focused its attention on the oceans and what was happening there. Jacques Cousteau wrote a book about this around 1978. He was a very respected person, but when he wrote this book, he lost credibility in scientific circles because he made a statement that nobody could believe. He founded his statements on pure science, but people simply could not or would not accept the truth. Specifically,



Fig. 3-2. Divulging the status of our seas.

*for humanity immeasurably diminished. We the undersigned, senior members of the world's scientific community, hereby warn all humanity of what lies ahead. A great change in our stewardship of the Earth and life on it is required if vast human misery is to be avoided and our global home on this planet is not to be irretrievably mutilated."*

*Yet most of the world rejected this statement even though it was created by one of the most respected scientific bodies ever assembled on Earth. You would think we would pause and say, "If this is true, what can we do? Let's drop everything and do whatever is necessary." But the governments know that if we are to avert this crisis, we must change the way we live, and that would not be politically comfortable. No politician wants to be the one to introduce this unpopular change. To the governments, the economy would suffer and*

he said that the Mediterranean Sea would be a dead body of water by the end of 1990 and that the Atlantic Ocean would also be dead by the turn of the century. People thought, “This guy’s nuts. It’s never going to happen.”

Well, it is happening. The Mediterranean Sea is now somewhere around 95 percent dead. It’s not 100 percent, so he was not exactly right. Nevertheless, it’s still going to be a dead sea if people continue to live the way they do. And the Atlantic Ocean is rapidly doing the same. Maybe it won’t happen in the year 2000, but it will happen very soon after that. Unless something changes dramatically, it will die—no fish, no dolphins, no life in the Atlantic.

We can’t live without the oceans. The bottom of the food chain, the plankton, will be gone, and if they go, we go. When we don’t take this seriously, it’s like saying, “Well, I don’t really need my heart.” This is a major component in the ecosystem on Earth, and it’s going fast. This is not debatable, this is scientific fact. The only part that is debatable is when. It is *really happening*. Nobody believed it would happen because they just couldn’t accept this truth.

New York City, for instance, has pipes that go twenty miles out and dump all their human feces into the oceans. They figured, Well, the oceans will take care of it. But for the last 60 years or so it’s been building up into a huge mountain. Now, there’s a mountain range of shit out in the ocean that is moving toward New York City. It’s now up against and actually coming into the harbor, and they don’t know what to do about it. It would take more money than New York has to fix it. This is the kind of foresight that we as humans have demonstrated.

The human manure approaching New York is an Atlantic Ocean problem. However, the problem is not limited to the Atlantic or the Mediterranean. The Pacific Ocean is Earth’s largest body of water, and it will probably take longer, but it is also having tremendous problems, especially in certain areas.

The red tide [Fig. 3-3] is the first deadly sign of the pollution. It’s an algae that destroys everything that lives underneath it—it kills everything. And these red tides are beginning to sweep all over, especially around Japan where there’s so much pollution. We’ve made lots of mistakes all over the Earth because we don’t have the consciousness to know how to live in harmony with our own body, Mother Earth. This is like a symptom of cancer or some other dreaded disease.



Fig. 3-3. Red tide.

*perhaps even collapse if we were to stop polluting. So it has become a war of money against life—terrible but true.*

*The New York Times and the Washington Post, two of our most respected leaders in reporting the news, rejected this document as not newsworthy. This gives you a good idea of the importance we place on the planet itself. (You can read about all this and much more in *The Sacred Balance, Rediscovering Our Place in Nature* by David Suzuki.*

*Think for a moment: This warning document gives us “one or a few more decades” to avert this crisis—and it was written seven years ago. This Earth is billions of years old. It has taken millions of years for mankind to reach this level of awareness, yet in a mere 10 to 30 years, a geological blink of an eye, if we do not act in a positive manner, we may become “irretrievably mutilated.” The word “extinct” was avoided, but we all know it is a possibility.*

*Update: Since June 1996 a new possibility has been given to us. Perhaps we have found*

## Ozone

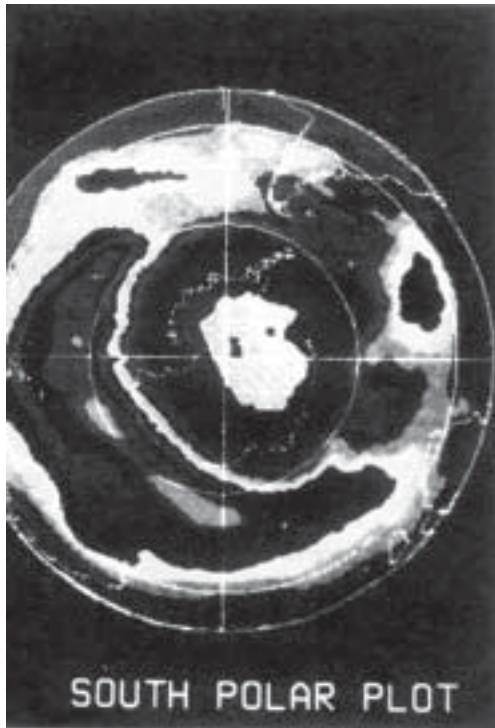
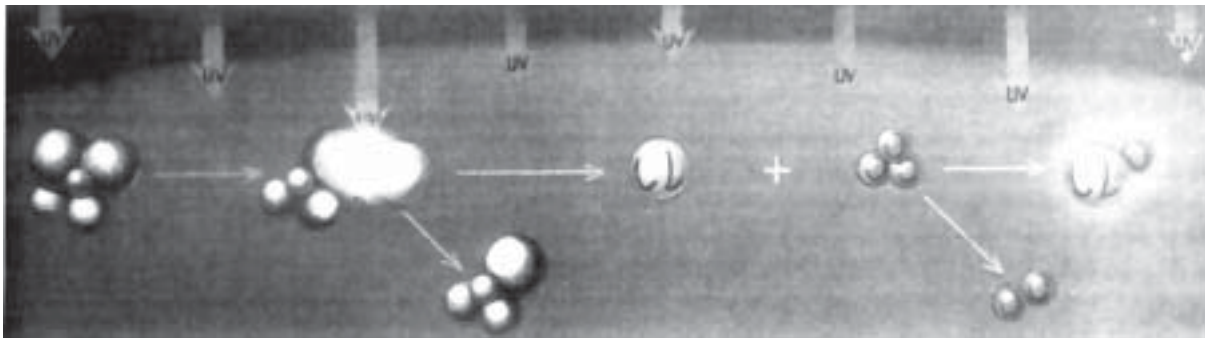

Fig. 3-4. Ozone hole above the South Pole.

Here's another problem. Figure 3-4 shows the ozone hole above the South Pole. Ozone forms a thin layer about six feet thick. It's a really thin, fragile layer, a living layer that's constantly being rebuilt. We know very little about it, though we know more than we would if it weren't for the UVC light (ultraviolet light, band C) that's coming through the holes right now. When they began to detect huge amounts of UVC, especially as shown here coming into the South Pole, they couldn't understand how there got to be so much, because their computers didn't show it. Then they found out that their software programming was set up in such a way as to override this sort of thing. After they reprogrammed their software, they found out the hole was really there. This was some years ago.

What they actually were looking for was chlorine monoxide, the molecule shown in the far right of Figure 3-5. They figured that the ozone hole is caused by various chemicals, one of which are CFCs. CFCs react with the ozone in such a way that when the chlorine connects with the ozone, the ozone molecule breaks apart, thus forming oxygen and chlorine monoxide. Scientists fig-

Fig. 3-5. Ozone reaction in molecules.



*a way to heal the Earth of her environmental problems. This is the work of the new workshop we call the Earth-Sky. As much as I would love to tell you where the work of the Flower of Life has taken us, this is not the time. A new book will have to be written because this new information is too vast to discuss in a simple update. All I can say is that I am very optimistic for the 3D survival of Mother Earth at this time.*

*Update: Since June 1996 a new possibility has been given to us. Perhaps we have found a way to heal the Earth of her environmental problems. This is the work of the new workshop we call the Earth-Sky. As much as I would love to tell you where the work of the Flower of Life has taken us, this is not the time. A new book will have to be written because this new information is too vast to discuss in a simple update. All I can say is that I am very optimistic for the 3D survival of Mother Earth at this time.*

***Update: Remember that Professor Einstein did not know for sure that when the first atomic bomb was ignited, the nuclear chain reaction would stop when the original fuel sample was expended. Our government knew that when this first bomb exploded, it might be the end of the world—all life over in a matter of minutes. But we did it anyway! This is spiritual incompetence!***

*We are faced with another moment in history where our government has decided to take another chance with our lives. When HAARP was turned on in the spring of 1997, they did not know for sure if the atmosphere was going to be destroyed. They still do not know for sure what the long-range effects will be, just as they did not know during World War II with the Manhattan Project.*



ured, given the speed they thought the CFCs were moving toward the ozone, that the chlorine monoxide up there would be about 30 times over normal, and they were very worried about it. So the world governments tried to get the companies that were producing the CFCs—Freon and various other chemicals that cause this problem—to stop producing those products and find other answers. In reply, the companies all said in unison, “We’re not doing it. That’s a natural phenomenon. We have nothing to do with it.”

So the world governments had to prove in court that the companies were at fault, which they did. To get the proof they needed, for the first time in the history of the Earth every single country on the planet cooperated in a single venture. This had never happened before. They flew high-altitude planes over the South Pole for about two years collecting data, and they finally came up with something that *really* scared them. The destructive ingredient, chlorine monoxide, wasn’t 30 times over normal—it was 500 times over normal and moving much faster than they had believed.

This article came out in 1992,<sup>1</sup> I believe [Fig. 3-6]. It first says that the EPA predicts 200,000 more skin cancer deaths from the ozone hole. But up in the



Fig. 3-6. Upping the ante.

*What is HAARP? You need to know. HAARP stands for High-Frequency Active Auroral Research Project. It is a weapon massively more powerful than the atomic bomb. They intend to beam more than 1.7 gigawatts (billion watts) of radiated power into the ionosphere and actually boil the upper atmosphere in order to create a mirror and/ or an artificial antenna to transmit huge amounts of power to any specific area on the Earth. This energy would be used to manipulate global weather, hurt or destroy ecosystems, knock out electronic communication, and change our moods and mental states. Not to mention that it could be used to try to destroy or manipulate the new Christ grid around the world. Read Angels Don't Play This HAARP by Jeane Manning and Dr. Nick Begich. You will learn more.*

**Update:** In 1995 and 1996, the secret government exploded six atomic bombs in an area near Moorea Island, part of the French Tahitian Islands. France, along with several other countries, placed these bombs into a sacred physical place of Mother Earth's body. If they had done this to your mom, you would have called it violent rape. They were neutron bombs, which do not destroy structures, but "merely" destroy all life in the region.

*If the Earth were a woman, the area where they deliberately placed the bomb would be her perineum. Going straight through the Earth from there would be Earth's crown chak-ra, which just happens to be the Great Pyramid region in Egypt. This became the focus of attention, for the secret government shut down the entire Great Pyramid, not allowing anyone to come near for three days so they could test the results in the consciousness of the planet. They were trying to destroy a specific field of energy that has grown to enclose the Earth.*

right column they have a tiny section reporting that the EPA says that the *fatality* estimates they had originally given were incorrect, and are 21 times worse than they had estimated. Twenty-one times—now, that’s a lot. It’s not like saying, “Well, it’s a little bit more.”

This is what the government has been doing; they give out little bits of information in little articles that don’t tell you much. They don’t make it a big deal. By law they *have* to announce it, so they announce it in little articles and then let it go. Then they up the ante in another insignificant article—as in this article here, for example, where they said the danger was 21 times higher than their first estimate; then two weeks later the same paper comes back and says, “Oh, by the way, we were off two weeks ago, it’s actually double that.” Well, double doesn’t sound like much—except that means it went from 21 times to 42 times worse than their first report, which is an incredible amount. If the truth had’ been told in the first place, it would have sounded terrible and created fear.

This is what’s been going on all over the world for a long time. The only way the world governments know how to deal with the situation is by letting it out little by little, admitting to more and more and more. They know they have to tell you the truth (for reasons you’ll learn later), but they’re afraid to say we’re in real trouble. They just say, “Well, it’s not so bad, but it’s getting worse,” and statements like this.

Well, not only is there an ozone hole at the South Pole, but there’s one at the North Pole now, and the rest of the ozone is swiss cheese. In 1991 or 1992 there was a major television production on the ozone hole. It brought together all the major people who were involved in studying this, and they discussed all the pros and cons. They interviewed a particular husband-and-wife team—I don’t have their names, but they also wrote a book on this very subject several years ago, predicting that the ozone hole was going to happen. Before we even knew about it, they had studied it all, according to this program. And the ozone is now undergoing changes exactly like they said it would and at exactly the rate they predicted.

This couple was brought on TV as the experts, and the interviewer asked, “Well, what do you think?” This interviewer was kind of puppylike, asking, “What are we going to do? You guys know everything about it, so what are we going to

*You could call it one of Earth’s memory banks. You and I call it Christ consciousness. They, the secret government (which is still you and me), were fearful of this new consciousness, but I believe now it has been mostly resolved.*

*The polarities of the Earth are slowly merging. At the time of this transcript in 1993 we were living in a period of planetary insight. Now, in 1997, we are on the edge of planetary unity based on understanding. The great test is still ahead, especially if the secret government decides to use HAARP to try to destroy the Christ grid.*

***Update:*** *On the positive side, doctors at UCLA began about five years ago examining a young boy who had been born with AIDS. He had been checked at birth, at six months and again at one year. He still had AIDS. He wasn’t checked again until he was about five. When they checked him this time, all traces of the AIDS virus were gone. It was as though he had never contracted AIDS. They didn’t know how his system became immune; all they knew was that it did. They checked everything they could think of, including his DNA. It was here where they found a change. This young boy did not have human DNA!*

*We have 64 codons in our DNA, but in normal humans only 20 of these codons are turned on. The rest are inert or not working, except for three, which are the stop and start programs. This young boy had 24 codons turned on—he had found a way to mutate that made him immune to AIDS. In fact, when they were testing him, they found that he was immune to everything. They found that his immune system was 3000 times stronger than a normal human’s.*

do about the ozone?” The husband said, “There’s nothing we can do.” I don’t believe they like to hear statements like that on major channels. The interviewer asked, “What do you mean, there’s nothing we can do?” The authors said, “Well, suppose we get the entire world to cooperate?”—which is the first thing that would have to happen, and we can’t even do that now, some fifteen years later! “Suppose we do get the entire planet to say, ‘Okay, we’ll stop it all today. No more of these chemicals that are destroying the ozone will ever be used again.’”

The author said, “Okay, suppose we did it. Suppose we got the whole world to stop. That still doesn’t solve the problem.” And the interviewer said, “What do you mean? Wouldn’t it just heal itself?” The author answered, “No, because the spray can that you sprayed yesterday sits on the surface of the ground and the CFCs take 15 to 20 years to rise to the ozone layer. This layer that’s slowly rising and eating the ozone will continue for 15 to 20 years even if we stop everything today. And it will continue to eat it faster and faster, because we’ve used more and more of these chemicals in recent years.” He said, “There won’t even be an ozone layer”—I think he said in ten years. “I see no solution at all.”

If we lose our ozone, we’re in big trouble. All the animals of the world will go blind. You won’t be able to go out during daytime without a space-suit on, meaning every square inch of your body will have to be covered—special UVC goggles and everything. In a short time the UVC light would eventually kill you. And we’re rapidly approaching that. If you don’t think so, read what the *Wall Street Journal* reported in January 1993.

*The Journal* was reporting what’s happening in southern Chile, which is close to the ozone hole at the South Pole. The animals are starting to go blind. The people who live there have thick, dark skin, and they’ve spent all their lives outside, but now they’re getting burned in the course of everyday living. And it’s spreading north from Chile and starting to happen everywhere. Because of the Swiss cheese aspect of the entire ozone layer, places all over the Earth are becoming unsafe. You never know where these spots are going to be because they move over the face of the Earth from year to year. This ozone problem is happening now, not tomorrow or later or maybe someday. It’s occurring at this very minute. Given another few years, we’re going to be in really serious trouble.

*Then they found another child with the same situation, coming out of AIDS and turning on the same 24 codons, becoming immune to AIDS and other diseases. They found 100, then 10,000. UCLA now believes that 1% of the world has made this change. They now believe that 55 million children and adults are no longer human, by DNA definition. There are so many people doing this now that science believes that a new human race is being born at this time and that it seems to have come out of AIDS. It is almost impossible for these people to become sick.*

*It is also interesting that in November 1998, it was announced that in 1997, AIDS dropped off by 47%, which is the biggest drop in history for any major disease. Could this be one of the reasons?*

*Further, in **Cracking the Bible Code** by Jeffrey Satinover, when they ran the word “AIDS” into the code, they found all the usual associated words. They saw the words in the blood, death, annihilation, in the form of a virus, the immunity, the HIV, destroyed, and many more. However, there were certain other words that did not make sense to those researchers but that only now can be understood in the light of the previous information. They found the words, “the end to all diseases.”*

*This is perhaps the single most important event in the world today.*

They knew about the ozone problem at least as far back as when Reagan was president. When the environmental agencies asked him, "What will we do about this ozone problem?", Reagan was really flippant about it. He said something like, "Aw, we'll just issue raincoats and dark sunglasses to solve the problem." Just like that, what the heck? We're talking about our very lives here, our very existence, and the governments are continuing as though it doesn't even matter.

### *The Greenhouse Ice Age*

In the first seven days in office, President Bush was approached by 700 environmental groups—700 of them in unity and agreement. They said to Bush, "We have an even bigger problem than the ozone and the oceans; the biggest problem that we know of is the greenhouse effect. If the greenhouse effect is not checked very soon, it's going to destroy the planet." This is what they had agreed on and what they believed was the truth. For a while Gorbachev and the world's governments were talking about how they were going to put space stations up there to monitor the environment and move with responsible action, Gorbachev was gung ho on the whole thing. Then I guess they gave up on it, just quit, though they're still watching these things very carefully. It's a pretty hopeless situation.

Figure 3-7 is a satellite photograph of the oceans taken from above Australia. That dark blotch above Australia and New Guinea reached the hottest ocean temperature in recorded history in 1992. It was 86 degrees Fahrenheit in that spot. That's 86-degree ocean water. If that continues to spread across the equator, it's going to do exactly what John Hamaker has predicted. If you're familiar with Hamaker and his theories, he has powerful evidence that as this water heats up, something very different from a hot planet will happen: it's going to be a *cold* one—very, very cold. Dr. Hamaker predicts an ice age descending upon us within a few short years.

Fig. 3-7. Hottest ocean in history.



I won't go fully into the dynamics of the so-called greenhouse effect, but an intimate part of it is tied to rocks, minerals and trees. One average acre of trees holds within it 50,000 tons of carbon dioxide. When trees are cut down, burned or just die, all that carbon dioxide gets released into the atmosphere, and when the atmosphere contains a certain level of carbon dioxide, it activates the beginning of an ice age. Hamaker found proof that this is what triggered the last few ice ages on this planet. He found his evidence primarily from studying core samples taken from ancient lake beds. The core samples show, by simply looking at the pollen count, that the Earth for millions of years had a cycle of 90,000 years of ice followed by a temperate period of 10,000 years, followed by 90,000 years of ice, followed by 10,000 temperate years. That particular cycle has been going on for a long, long time.

In addition, Hamaker has discovered—and other people have verified it—that the length of time it takes to go from a warm age into an ice age is a mere 20 years! People who have been studying this for a long time believe that we're possibly now around 16 or 17 years into that 20-year cycle, but of course no one really knows. And they say that when the end of the 20 years or so is reached, [snaps fingers] in a *single day*, less than 24 hours, it'll all be over. The clouds will back up over the Earth, the average temperature will drop to about 50 below zero, and most areas of the world won't see the Sun again for 90,000 years. If those guys are right, we've got only a few more years of sunshine. It'll keep getting warmer and warmer and hotter and hotter until that day hits, then snap! it'll be all over. I'm not going to give all the details of Hamaker's work, but I suggest you do the research yourself if you want to know about it. He has powerful evidence. Study what he has to say. His book is called *The Survival of Civilization*.

### *Ice Age to Warmth, a Quick Switch*

Scientists have just discovered another surprise, which has some of them shocked and barely able to believe it. They thought that when an ice age recedes, it would take thousands of years to warm back up again. But they now have evidence that it takes only *three days*, says an article written in Time magazine. It takes 20 years to go from warm to cold and three days to go from cold to warm. So the greenhouse effect is a major and serious problem. No one knows the answer, but what's scary is that they're trying to instigate supposed answers that are totally untested. They're all fighting about whose answer is the best and who wants to do what—but nobody *knows*. It's like the ozone—they've got maybe 15 different ideas about what to do to fix the ozone, and any one of them might make it better—or worse. No one knows what these things are going to do, because we have never done them before. We seem to be willing to experiment on ourselves to find out if we're going to make it or not.

### *Underground Atomic Bombs and CFCs*

On top of that, all kinds of other problems are occurring. Some things are so scary that governments are afraid to tell you anything at all. They won't tell you about one thing that I simply have to talk about, because it's so important that somebody *has to* say something! I know they don't want me to talk about this, but I don't think they'll stop me.

We're finding CFCs in the upper atmosphere. Now, "authorities" in the government have been saying that CFC products like Freon will float up there because they're lighter than air. But guess what—and you scientist types can check this out: CFCs are not lighter than air, they're *four times heavier than air*. They *sink*, they don't rise! So how did they get up there? It might have been the 212 *aboveground* atomic bombs that our governments have blown off in the world. Many people suspect that's how all those CFCs got up there in the first place, and that it really wasn't *us* who caused most of the problem with our air conditioners. It was the atomic governments o/the world.

At one point they all went underground with their bombs, and we thought, That's okay, they're bombing underground; nothing will happen now. It's not okay, folks. It's probably the most dangerous thing that's going on in the world today, even more than HAARP, and they're still doing it. I cannot prove what I am about to say, so do not believe it until you can prove it.

Adam Trombly, a famous scientist who has accomplished important work in science, has been monitoring the underground atomic bombing around the world. He probably knows more about this than any other person in the world—even the governments recognize this. Trombly explains what happens when these atomic bombs are exploded underground. The energy doesn't just sit there; it has to go somewhere, so it goes shooting through the Earth, bouncing off its insides, ripping apart the plates and doing incredible damage as it goes bouncing around like a ping-pong ball. This bouncing effect inside the Earth continues for about 30 days after the explosion.

Trombly, much like Jacques Cousteau and others, now has a theory that predicts all kinds of things that will happen—and they're *all happening Mm!* Things like the Indian Ocean dropping 23 feet over a very short period of time was predicted by Trombly at least ten years ago—just as Jacques Cousteau had predicted the death of the Mediterranean Sea in ten years. Many brilliant people are speaking out their truth, but few people are listening. If Trombly is correct, we're only a few more atomic bombs away from the whole planet literally splitting apart in little pieces. The governments around the world have been on red alert since about 1991 over the changes happening to the Earth that were predicted by Trombly. They're scared to death. Yet I believe China just blew up another one—and the U.S. is talking about blowing one up just because China did!

Anyway, life goes on. It's a good thing there are other levels to our spirit than just the physical. If it weren't for the ascended masters and our higher aspect, we would be in a hopeless situation. But because of the work of other great souls, you and humanity are just beginning to live. You will soon be birthed into another new, clean and beautiful world, thank God, and there's no one else to thank but God. We're going to be okay through all of this. And yet I will continue .

..

### ***The Strecker Memorandum on AIDS***

Here's one last drama. Actually, there are many other perilous situations (I could go on for hours), but I'll just give you this last one about AIDS. I suggest you try to find the Strecker Memorandum material if you haven't read it or watched the

video. The governments are really trying to suppress it. Dr. Strecker made a video memorandum of what he believed happened around AIDS. He is a brilliant person. He has worked with retroviruses and is an expert on this subject. He showed the video on television, and the governments threatened him. They allegedly killed his brother and the senator who was sponsoring it. But they didn't get Strecker—that would have been too obvious, I guess. Dr. Strecker has distributed many of his videos. He got them out to the world, though you don't hear about it anymore.

Dr. Strecker shows on his film how the United Nations was trying to solve an environmental problem. They knew that the biggest environmental problem in the entire world was the human population, and at the rate it was going, the world would double its population by 2010 or 2012. But because of what the Chinese did, allowing only one child per couple, and other strenuous work around the world, they slowed it down. But they believe that it's still going to happen. It is now estimated that somewhere around 2014 the world population will have doubled. If that happens, computer models have shown that all life on Earth will die or wish they were dead, according to the United Nations, because we can barely keep it together with almost six billion people. Can you imagine what it would be like with 11 to 12 billion people in the world? There's just no way, at least under the present system.

So, *if you* were in the United Nations and knew this potential disaster was going to take place and had to make a decision, what would you do? I'm not judging the people who did this—just put yourself in their position of great power. You see that the Earth is coming to a solid wall, that it's going to be totally destroyed if something is not changed. So they made a decision—and Dr. Strecker showed the memorandum right on television. The United Nations decided that, rather than hit that wall of 11 billion people, right then and there they were going to create a virus or a disease that would kill specifically three-quarters of the people on Earth. In other words, instead of increasing to 11 billion, they wanted to *reduce* the current population by three-quarters. He showed the actual U.N. document that planned to eliminate three-quarters of the world's population.

Dr. Strecker showed scientifically exactly how the U.N. did it. They took a virus from a sheep and a virus from a cow and blended them together in a certain way to make the AIDS virus. But before they ever distributed it, they also made a cure for it. The governments have the cure right now, according to Dr. Strecker. The people who were doing this—and history will verify this—were obviously prejudiced, because they singled out two groups: the Blacks and the homosexuals.

In Haiti there was an epidemic of hepatitis B moving through the homosexual community, and they all needed to be injected with the hepatitis B vaccine. So U.N. agents took the AIDS virus, put it in the hepatitis B vaccine and injected it into everyone. That's how the virus started, according to Dr. Strecker. The other evidence that this is true is that throughout the rest of the world, the virus was not given exclusively to homosexuals. In Africa, where at least 75 million people have AIDS, the ratio of male to female infection is almost exactly 50-50, from the beginning until now. Only in Haiti, and eventually in the United States, did it spread almost exclusively through the homosexual population. If you look at the figures for this country, females are now getting AIDS faster than anyone else. Soon nature will balance it out, and you'll see exactly the same thing you see everywhere else around the world, which is that equal numbers of males and females

have AIDS. It isn't a gay disease at all—it has nothing to do with it. It has to do with the prejudice of the people who created it.

According to Dr. Strecker, the World Health Organization, which has been instrumental in creating this disease, has also been concerned about other diseases—and so have doctors pretty much everywhere. For instance, let's take cancer: Doctors have been concerned that someday cancer will become contagious, not by pollution or foods or things like this, but that it will become airborne or waterborne, like a cold. You'd just walk by somebody with cancer and you'd get it. But the number of different kinds of cancer viruses is so small that the likelihood of that ever happening is pretty slim. It still could happen, but it's not likely. But for AIDS, *there are 9000 to the 4th power or 6,561,000,000,000,000 totally different kinds of AIDS viruses*—that's a huge number. And every time someone gets AIDS, a brand-new virus is created, one that has never been seen before, ever. This means that it's *inevitable*, mathematically speaking—it's just a matter of time— that AIDS will spread rapidly, just like a cold, throughout the world.

There is a story going around that the World Health Organization believes that this rapidly spreading form of AIDS may have already begun. Around 1990 or 1991 the WHO checked an African tribe of 1400 members, including everyone from little babies to old people, who obviously had all different kinds of sexual practices (you know, little babies aren't into sexual things), and they found that every *single member*, without exception, had AIDS. That's when the WHO announced secretly that the virus was probably now airborne or waterborne, and that it might eventually spread like wildfire, like a common cold. There would be a few years' lag as with any other new disease. If this were to happen, would you know that you are safe? You need to know the truth—you *are more than you know!*

### *A Perspective on Earthly Problems*

If we were not multidimensional beings, if we were only physical bodies connected to the Earth and had nowhere to go, we would be in a very serious situation. But because of who we are, what is about to happen on Earth could become a vehicle for enormous growth. Remember, life is a school. Maya is maya!

But still, if we realize the incredibly dangerous situation we're in, we might awaken to who we are. The only reason I'm even saying these words and not keeping it secret is because we're like a group of people in a sinking boat. It's got a big hole in it and the water's pouring in. It's not *time to sit there and play games and do business as usual and think along the normal ways of thinking*. If you didn't know the truth about our environment, you might just go along with your life and not act.

I'm not suggesting to act environmentally, though that is not wrong, What I'm much more concerned with is an internal form of acting, a meditation, a meditation that consciously reconnects you to all life everywhere, It is what the Taoists say: *The way to do is to be*. There's nothing wrong with acting externally, but there's another kind of acting that's required here, I believe. It requires a state of mind where we realize the situation, we begin to take it seriously and work in a way where we can make some real changes in our consciousness. This inner thing we need to focus on and understand will slowly unfold as we continue. Whoever understands the other side of this coin of life will realize that these



environmental issues are not a real problem when higher consciousness enters into the 3D world, though from a 3D point of view, it does look like the end of life.

## The History of the World

We're going to open a new subject: the history of the world and how it relates to the present. Each one of these pieces of the puzzle widens the view. The situation in which we find ourselves in this world didn't develop at random. Events occurred that we need to remember. Many of us were here in past lives, and we have these memories within us. But that's beside the point. We need to know exactly what occurred in order to understand how it developed into this situation today. This history, of course, will not be found in history books, because history books of human "civilization" go back only 6000 years, and we need to go back about 450,000 years to begin.

This information was first given to me by Thoth around 1985. Then after Thoth left in 1991,<sup>1</sup> I became aware of Zecharia Sitchin, read his works, and found out that Sitchin's and Thoth's information were almost *perfect* fits—so perfect it just couldn't be a coincidence. It was amazing how close they were. Many things that Thoth had mentioned—such as giants in Atlantis, which he didn't explain further—were explained in Sitchin's books. And many things that Sitchin appears to have overlooked were deeply explained by Thoth. So the combination of these two sources gives a very interesting viewpoint. You don't have to accept this viewpoint; you can just listen to it like a legend, think about it and see if it's workable for you. If something doesn't feel true to you, then of course don't accept it. But I believe this is as close as I can get to the truth, and I offer it to you. Remember, I had to translate the geometrical and hieroglyphic images of Thoth into English. Something is bound to get lost, but I do feel it is close enough to trigger your memories.

First you must realize something about written history. Somebody has to hold the pen and write it down, so written history is always the viewpoint of the person or people who wrote it. Written history began only in the last 6000 years, but would that history be the same if it had been written by different people? Consider that in most cases it was the winners of the wars who wrote the history books. Whoever won a war said, "This is what happened." The losers didn't get to put in their two cents. Look at any of the major wars, especially World War II, which was a very emotional war. If Hitler had won World War II, our history books would be completely different. We'd be examining a totally different set of "facts." We would be the bad guys, and they would have shown good reason for doing in the Jews etc. But we won, so we wrote it from our perspective.

Well, everything's like that all the way through history. Nobody ever talks about this subject, yet it's obvious. Even Thoth was very aware of this; he said, "I'm giving you my viewpoint. I have watched the centuries go by, but I'm only one person. This is what I believe is true, but you must realize that other people may hold different viewpoints on history." So

even he was not saying, “This is it—take it or leave it.” So with that observation, we’ll proceed.

### *Sitchin and Sumeria*

I’m going to begin first with Zecharia Sitchin’s work. If you haven’t read his books yet, you have a great treat in store if you want to read about this firsthand. His primary book is called *The 12th Planet*, though I recommend two others, *The Lost Realms* and *Genesis Revisited* (in that order). He writes about many cities that were described in the Christian Bible, such as Babylon, Akkad and Erech, which for a long time people thought were myths because nobody could prove their existence. There wasn’t even the slightest sign that they existed. Then they finally found one city, which led to another, which led to another, which led to another. They eventually found all of the cities mentioned in the Bible.

Realize that all these ancient cities have been discovered in the last 120 years or so, most of them more or less recently. As they’ve dug down into the layers of these ancient cities, they’ve pulled out thousands of cylindrical clay tablets upon which the history of Sumer *and* the history of the Earth is recorded in great detail, going back hundreds of thousands of years. Their written language is called cuneiform. What I’ll be telling you is not just Sitchin’s interpretation. Many other scholars now know how to read cuneiform, and as they translate these works, it’s changing our whole viewpoint of the world, of what we think is true—just as John Anthony West’s work with the Sphinx is also influencing modern thinking about human history.



We’ll come back around full circle later to explain how the Sumerians received their information. The Sumerian records are the oldest written records on the planet, 5800 years old, but they describe things that happened billions of years ago, and in great detail things that happened after 450,000 years ago. Whether you’re using scientific knowledge or Thoth’s, our race is about 200,000 years old. Sitchin says that we’re older than that, maybe 300,000 years or so, but the records and Thoth do not say that—and neither do the Melchizedeks. We’ve been here slightly more than 200,000 years, but there were civilizations on the Earth—long before this cycle and long before the Nefilim—that were far more advanced than the Nefilim or anything we’ve seen since. They left without a trace. By the end of this book you’ll understand why there was nothing left when they departed. This is the planet’s past. It’s part of who we are, in a way. We have access to all that information. There’s a component within each one of us that has all this information recorded. It’s easily accessible, but most of us are just not aware of it.



Normally we give greatest credence to the oldest source of an historical event because it is closer in time than a scribe further removed from the event. These are the oldest writings we have, with the possible exception of the geometrical language that predates Egyptian

hieroglyphics. The ancient Sumerians were telling us a story of history that's very difficult to accept because of our certainty that what we now know about the past is correct. The story is so outrageous on so many levels that scientists are having a very difficult time accepting it even though they know it must be true. It *is* the oldest source! If it weren't so outrageous, we would have accepted it at face value long ago because it came from such an ancient source.

On the other hand, if they were crazy, making up stories without any real knowledge, how do we explain that they knew so many facts about nature that, from our point of view of history, would have been impossible for them to know? For example, not only did the Dogons know about all the outer planets, but so did the Sumerians—from the very beginning of their culture! The oldest known culture in the world, the Sumerians, extending back to around 3800 B.C., knew exactly what it looked like to approach our solar system from outer space. They knew about all the outer planets, and counted them from outer to inner, as though coming in from outside the solar system. Just as the Dogons showed on the cave wall, the Sumerians described the relative sizes of different planets and described them in detail, as if they were actually passing them in space—what they looked like, the water on them, the color of the clouds. The whole experience was described in detail 3800 years B.C.! This is fact. How is this possible? Or is the truth of our beginning unknown to us?

Before NASA sent our space probe into outer space past the outer planets, Sitchin sent them a Sumerian description of all the planets viewed from space. And when the satellite reached them one by one, sure enough, the Sumerian descriptions were exactly right. Another example: They *knew of the precession of the equinoxes from the very beginning of their existence as a culture*. They knew that the Earth was tilted on its axis at 23 degrees to its orbital plane around the Sun and that it rotated in a circle that took approximately 25,920 years to complete. Now, that's a tough one for a straight historian to understand, especially a scientific type who knows that it takes 2160 years of continuous observation of the night skies to even know that the Earth wobbles. The minimum length of time is 2160 years, yet the Sumerians knew about it on day one of their civilization.

How did they know it? There is so much extraordinary evidence coming out of these clay tablets that it's not being absorbed into the general thinking very quickly. As I was taught in school and understood it, Moses wrote Genesis around 1250 B.C., which is about 3250 years ago. That's what I've always read. Yet Sumerian tablets exist that were written at least 2000 years before Moses lived, and they have the same account as the first chapter of the Bible almost word for word. These tablets even have Adam and Eve and the names of all their sons and daughters, the whole spectrum of events described in Genesis. It *was all written down before Moses ever received it*. This proves that Moses was not the author of Genesis. Obviously, this truth will be hard to accept by the Christian community, but it is true. I can understand why this knowledge is taking so long to sink into our modern culture, because it's a huge deviation from the accepted history of the Earth, and this minor/major truth about Moses is only a tiny part of the whole truth.

### ***Tiamat and Nibiru***

Even deeper than any of these exceptional and impossible bits of information they knew (and there is much more) is the actual story the Sumerians wrote about the beginnings of the human race before Adam and Eve. They're talking

about a time that goes way, way, way back. The story begins several billion years ago when Earth was very young. It was then a large planet called Tiamat, and it rotated around the Sun between Mars and Jupiter. Ancient Earth had a large moon, which their records say was destined to become a planet itself someday in the future.

According to the records, there was one more planet in our solar system that we are only vaguely aware of in these modern times. The Babylonians called this planet Marduk, and this name has sort of stuck, but the Sumerian name for it was Nibiru. It was a huge planet that spun retrograde compared to the other planets. The other planets are in a more or less flat plane moving in one direction, but Nibiru moves in the other direction, and when it comes close to the other planets, it passes through the orbit of Mars and Jupiter [Fig. 3-8].

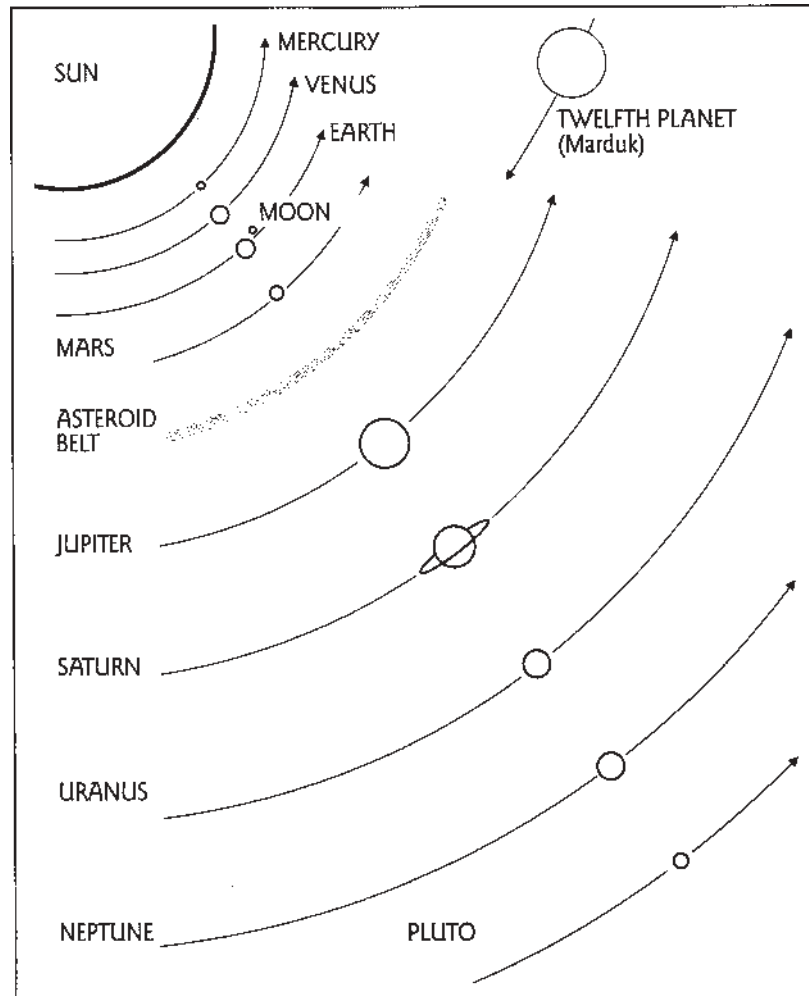

Fig. 3-8. Solar system including Marduk/Nibiru and the remains of Tiamat (asteroid belt and Earth)

They said that it passes through our solar system every 3600 years, and when it came, it was usually a big event in our solar system. Then it would go way out past the outer planets and disappear from our sight. NASA, by the way, has probably found this planet. At least it is the most probable possibility. They used two satellites and located it at an enormous distance from the Sun. It's definitely there, but the Sumerians knew about it thousands of years ago! Then, according to the records, as fate would have it, on one orbital pass Nibiru came in so close that one of its moons struck Tiamat (our Earth) and tore about half of it off—just ripped this planet right in half. According to the Sumerian records, this big chunk of Tiamat, along with her major moon, got knocked off course, went into orbit between Venus and Mars, and became Earth as we now know it. The other chunk broke into a million pieces and became what the Sumerian records call “the hammered bracelet,” which we call the asteroid belt between Mars and Jupiter. This is another point astronomers have marveled at. How did they know about the asteroid belt, because you can't see it with the naked eye?

This is how far back the Sumerian records go. The records continue to talk about earlier events, until at one point they tell more about Nibiru. It was inhabited by conscious beings called the Nefilim. The Nefilim are very tall: the females are about 10 to 12 feet and the males are about 14 to 16 feet. They're not immortal, but their lifetime is about 360,000 Earth years, according to the Sumerian records. Then they die.

## *Nibiru's Atmosphere Problem*

According to the Sumerian records, approximately 430,000—perhaps as much as 450,000—years ago the Nefilim started having a problem with their planet. It was an atmospheric problem very much like the ozone problem we're having right now. And their scientists decided on a solution similar to what our scientists have considered. Our scientists have considered putting dust particles into the ozone layer to filter out the Sun's damaging rays. Nibiru's orbit takes it so far away from the Sun that they needed to hold in the heat, so they decided to put gold particles into their higher atmosphere, which would reflect the light and temperature back like a mirror. They planned to get large quantities of gold, pulverize it and suspend it in space above their planet. Yes, it is true that they talked about subjects that seem contemporary—ancient humans talking about ETs and sophisticated science. This is not *Star Trek* or science fiction; it is real. What they said is pretty amazing, and that's why it's been so slow coming out into the general public's knowledge.

The Nefilim had the capability of space travel, though they weren't at that time much further advanced than we are right now, it appears. The Sumerian records show them in their spaceships with flames coming out the back—rocket ships. This is beginning space travel, not sophisticated. In fact, they were so primitive that they had to wait until Nibiru got near enough to Earth before they could even make the trip between the two planets. They couldn't just take off any old time, but had to wait until they were close. I believe that since the Nefilim weren't able to leave the solar system, they searched through all the planets that were here and found that Earth had large quantities of gold. So they sent a team here over 400,000 years ago for one purpose only—to mine gold. The Nefilim who came to Earth were headed by twelve members who were like bosses, about 600 workers who were to actually dig the gold, and about 300 who stayed in orbit in their mothership. They first went into the area of present-day Iraq and began to establish themselves and build their cities, but that's not where they mined the gold [Fig. 3-9]. For the gold, they went to a specific valley in south-east Africa. One of the twelve, whose name was Enlil, was the leader of the miners. They went deep into the Earth and dug large quantities of gold. Then every 3600 years, when Nibiru/Marduk came around, they would shuttle the gold to their home

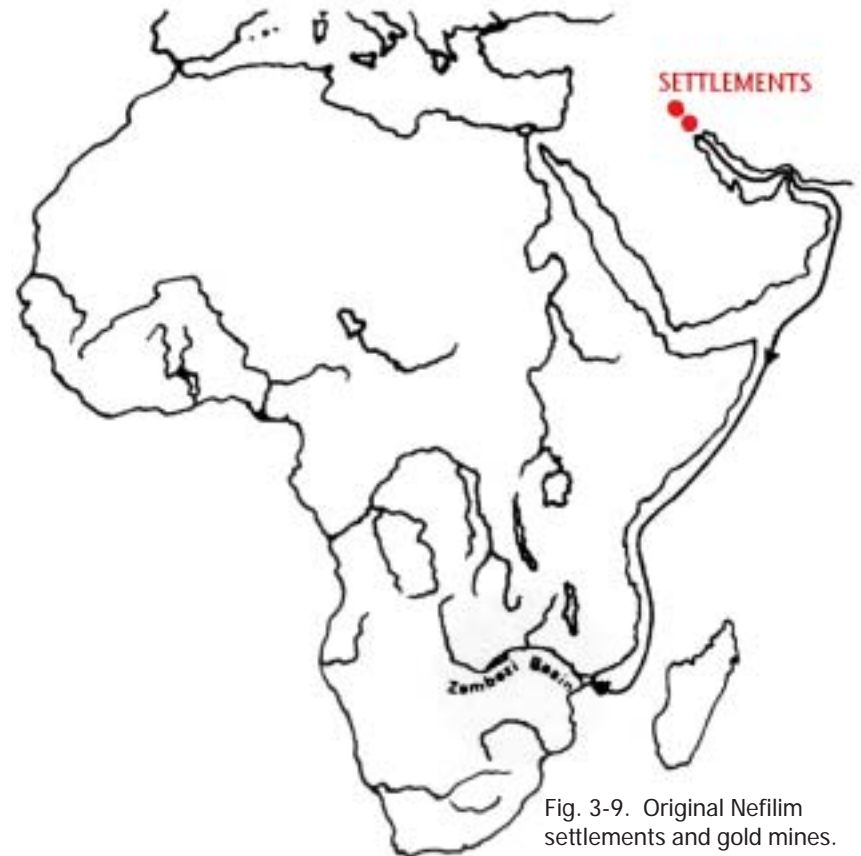

Fig. 3-9. Original Nefilim settlements and gold mines.

planet. Then they'd continue their digging while Nibiru traveled its orbit again. According to the Sumerian records, they dug for a very long time, about 100,000 to 150,000 years, and then the Nefilim rebellion took place.

I don't quite agree with Sitchin's dating on when this happened. He got it, not directly through the Sumerian records, but by calculating how long he thought it should be. He came up with the time of about 300,000 years ago when the rebellion took place. I believe it was closer to 200,000 years ago.

### *The Nefilim Rebellion and the Origin of Our Race*

Somewhere between 300,000 and 200,000 years ago the Nefilim workers rebelled. The Sumerian records wrote about this rebellion in great detail. The workers rebelled against their bosses; they did not want to keep digging in the mines. You can imagine the workers saying, "We've been digging this gold for 150,000 years, and we're tired of it. We're not going to do this anymore." I would probably have lasted about one month.

The rebellion presented a problem for the bosses, so the twelve leaders came together to decide what to do. They decided to take a certain life form that already existed on this planet, which was, as I understand it, one of the primates. Then they would take the blood of the primates, mix it with clay, then take the sperm of one of the young male Nefilim and mix these elements together. The tablet actually shows them with what looks like chemical flasks, pouring something from one flask to another to create this new life form. Their plan was to use the DNA of the primates and their own DNA to create a more advanced race than Earth had at that time so that the Nefilim could control this new race for the sole purpose of mining gold.

According to the original Sumerian records, we were created to be miners, as slaves to mine gold. That was our only purpose. And when they mined all the gold they needed to save their own planet, their intention was to destroy our race and leave. They weren't even going to allow us to live. Now, most people hearing that would think, That can't be us; we're too noble for something like that. But that is what the oldest written records on Earth state to be the truth. Remember, Sumerian is the oldest known language in the world, older by far than works such as the Holy Bible and the Koran. It now appears that the Holy Bible was birthed out of the ashes of Sumer.

What science has discovered is almost as interesting. In the exact place where the Sumerian records say we mined gold, archaeologists have found gold mines. These ancient gold mines are dated back as far as 100,000 years. What is really incredible is that *Homo sapiens* (that's us) were mining gold in these mines. Our bones were found there. Those gold mines had been worked at least 100,000 years ago, and they have dated humans in these mines as early as 20,000 years ago. Now, what the heck were we doing mining gold 100,000 years ago? Why did we need gold? It's a soft metal, not something you could use like certain other metals. It wasn't found very often in ancient artifacts. So why were we doing this, and where was it going?

### *Did Eve Come from the Gold Mines?*

Then there's the so-called Eve theory that people have been trying to put down for a long time.

Scientists took a certain component in the DNA molecule and overlapped it to show which one came first, and they figured out that the first person of humanity lived somewhere between 150- and 250,000 years ago. And that first person, whom they called Eve, happened to come from the exact valley the Sumerians claim that we were mining gold [Fig. 3-10]! Since then one scientist has discarded this theory because there are many other ways to look at the DNA origins. But I still find it remarkable that this theory just happened to point at the same valley where the Sumerian records say it all started.

### *Thoth's Version of the Origin of Our Race*

Now, let's see how similar Thoth's version is. He agrees with the Melchizedek tradition that our particular race didn't start 350,000 years ago as Sitchin says, but exactly 200,207 years ago (from 1993), or 198,214 years B.C. He said that the original people of our race were placed on an island located off the coast of southern Africa, called Gondwanaland.

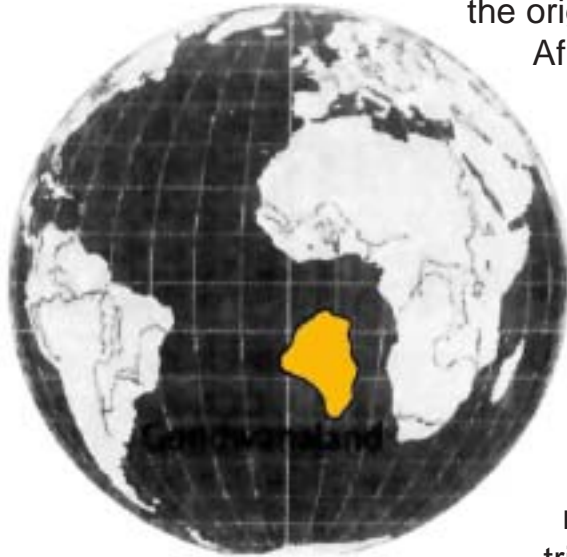

Fig. 3-11. Gondwanaland

I don't know if this is the right shape for Gondwanaland [Fig. 3-11]; it's not important, but it was in that area. They were placed here primarily so that they could be contained and not leave. When they evolved enough to be useful to the Nefilim, they were transported to the mining area in Africa and to various other places where they were used to mine gold and perform other services. So this original race, our ancestors, developed and evolved there on the island of Gondwanaland for about 50- to 70,000 years.

You can see on this map how the various landmasses could have fit together at one time, and this is what scientists now suspect is true. They call this one landmass, before it divided, Gondwanaland. They got the name from the creation stories of the tribes in western Africa. If you read the various creation stories of these tribes, they all have different ideas about how creation took place, but one thread runs through all of them exactly the same. They all say they came from the west, from an island off the western shore of Africa, and that it was called Gondwana. They all agree on that one piece of information, with the one known exception of the Zulus, who claim to have come from space.

The Sumerian records actually picture humans as about one-third the height of the Nefilim. The Nefilim were definitely giants compared to us. They were 10 to 16 feet tall, if you believe the records. I don't see any reason for them to lie. Thoth said that there were giants on the Earth, but he didn't say who they were or anything more about them. The Bible

says the same thing. Here it is in chapter six of Genesis:

“And it came to pass, when men began to multiply on the face of the earth, and daughters were born unto them”—that’s an important statement, “when men *began* to multiply” (I’ll talk about that in a moment)—“that the sons of God” (think about that one for a moment; it’s saying the “sons of God” plural) “saw the daughters of men, that they were fair; and they” (the 50m of God) “took them wives of all which they chose. And the Lord said, ‘My spirit shall not always strive with man, for that he also is flesh’ “ (this indicates that “the Lord” is also flesh), “yet his days shall be an hundred and twenty years. There were *giants* in the earth in those days and also after that; when the sons of God came in to the daughters of men and they bare children to them, the same became mighty men which were of old, men of renown.”

That part of the Bible has been interpreted in a lot of ways. But when you see it in the light of what the Sumerian records are saying, it takes on a completely different aspect, especially when you read the older Bibles that tell what the giants were called. They were called the “Nephilim” in the Christian Bible, exactly the same-sounding word as the Sumerian records give. There are over 900 versions of the Bible in the world, and almost all of them talk about giants, a large percentage of them specifically calling them the Nefilim.

### ***Conceiving the Human Race: The Sirian Role***

Toth says there were giants here on Earth. That’s all he said. He didn’t say how they got here or where they came from. He said that when our race was created, these giants became our mother. He said that seven of them came together, dropped their bodies by consciously dying, and formed a pattern of seven interlocking spheres of consciousness, exactly like the Genesis pattern (which you’ll learn about in chapter 5). This merging created a white-blue flame, which the ancients called the Flower of Life, and they placed this flame into the womb of the Earth.

The Egyptians call this womb the Halls of Amenti, which is a fourth-dimensional space that’s located third-dimensionally about a thousand miles under the surface of the Earth and is connected to the Great Pyramid through a fourth-dimensional passageway. One of the primary uses of the Halls of Amenti is for the creation of new races or species. Inside it is a room, based on Fibonacci proportions, made from what appears to be stone, In the middle of the room sits a cube, and on top of the cube is the flame the Nefilim created. This flame, which is four or five feet tall and about three feet in diameter, has a whitish blue light. This light is pure prana, pure consciousness, which is the planetary “ovum” created for us to begin this new evolutionary path that we call human.

Toth says that if there’s a mother, there’s got to be a father somewhere. And the nature of the father—the father’s sperm—must come from outside the system or body. So when the Nefilim were setting up their flasks and preparing for this new race to develop, another race of beings from a far-distant star—from the third planet out from Sirius B—were preparing to travel to Earth. There were 32 members of this race, 16 males and 16 females who were married into a single family. They were also giants of the same height as the Nefilim. Though the Nefilim were primarily third-dimensional beings, the Sirians were primarily fourth-dimensional.



Thirty-two people marrying each other probably sounds strange, too. On Earth, one male and one female marry because we're reflecting the light of our sun. Our sun is a hydrogen sun, which has one proton and one electron. We duplicate that process of hydrogen, and that's why we marry the way we do, one on one. If you were to visit planets that have helium suns, which have two protons, two electrons and two neutrons, then you would find two males and two females joining together to make children. When you go to an old sun like Sirius B, which is a white dwarf and highly evolved, it has a system of 32 (germanium).

So the Sirians came here and knew exactly what to do. They entered directly into the womb of the Halls of Amenti, right into the pyramid and before the flame. These beings had the understanding that all things are light. They understood the connection between thought and feeling. So they simply created 32 rose-quartz slabs that were about 30 inches high, 3 or 4 feet wide and roughly 18 to 20 feet long. They created them out of nothing—absolutely nothing at all—around the flame. Then they lay down on these slabs, alternating male and female, facing upward with their heads toward the center around this flame. The Sirians conceived, or merged with the flame or ovum of the Nefilim. On the third-dimensional level, the Nefilim scientists placed the laboratory-created human eggs in the wombs of seven Nefilim women, from which the first human being was eventually born. Conception in human terms happens in less than 24 hours—the basic process through the first eight cells. But conception on a planetary level is very different. According to Thoth, they lay there without moving for approximately 2000 years, conceiving with the Earth this new race. Finally, after 2000 years, the first human beings were born in Gondwanaland, off the western shores of southern Africa.

### *Enlil's Arrival*

Now, the part of the story where the Sirians are the father doesn't seem to completely correlate with what the Sumerian records say, at least according to the story given by Zecharia Sitchin, until you look at a sequence of events that Sitchin didn't seem to understand. Enlil, who was the first one to come to Earth and was the boss in southern Africa—did not land on

*land* when he arrived on Earth. He landed in the waters. Why did he go into the waters? Because that's where the dolphins and the whales were. The dolphins and whales were the highest level of consciousness on this planet, and still are. In simple galactic terms, Enlil had to go into the ocean to get permission to live and mine gold on Earth. Why? Because this planet belonged to the dolphins and whales, and it is galactic law that permission must be granted before an off-planet race can enter into a different consciousness system. According to the Sumerian records, Enlil stayed with them a very long time, and when he finally decided to come onto land, he was *half human and half fish!* At one point Enlil became all human. This was described in the Sumerian records.

You see, the third planet out from Sirius B that some call Oceana happens to be the home planet of the dolphins and whales. Peter Shenstone, leader of the dolphin movement in Australia, has channeled an unusual book, *The Legend of the Golden Dolphin*, which came from the dolphins and describes exactly how they came from another galaxy, how they

came to be on the little star around Sirius B, and how they traveled to Earth. The entire planet there is almost completely water; there's an island about the size of Australia and another about the size of California, and that's all. On those two landmasses there are human-type beings, but not very many. The rest of the planet, which is all water, is cetacean. There's a direct connection between the human-type beings and the cetaceans, so when Enlil (a Nefilim) came here, he first connected with the dolphins (Sirians) to receive their blessing. *Then* he went onto the land and began the process that led to the creation of our race.

### *Nefilim Mothers*

To recapitulate and clarify: After the rebellion, when it was decided to create a new race here on Earth, it was the Nefilim who became the mother aspect. The Sumerian record says seven females stepped forward. Then the Nefilim took clay from the earth, blood from the primate and sperm from the young Nefilim male, mixed this together and put it into the wombs of the young female Nefilim who were chosen for this. They gave birth to human babies. So seven of us were birthed at once, not just one Adam and Eve, according to the original stories—*and we were sterile*. We could not reproduce. The Nefilim continued procreating little humans, making an army of little beings—us—putting them on the island of Gondwanaland. If you want to believe this story, which is part Sumerian record and part Thoth, our race's mother is Nefilim and our father is Sirian. Now, if it were not for the Sumerian records concerning the Nefilim, this would all seem absolutely outrageous—and it still does. But there's a tremendous amount of scientific evidence that this is true if you read the archaeological records—not about the Sirian father, but definitely about the Nefilim mother.

Science doesn't understand how we got here. You are aware that there's a "missing link" between the last primate and us. We seem to come out of nowhere. They do know that we're somewhere between 150- and 250,000 years old, but they have no idea where we came from or how we developed. We just stepped through some mystical doorway and arrived.

### *Adam and Eve*

Another interesting part of the Sumerian records was that after they mined gold for a while in Africa, the cities in the north, near modern-day Iraq, became quite elaborate and extremely beautiful. They were in rain forests and had huge gardens around them. It was finally decided, according to the Sumerian records, to bring some of the slaves from the southern mines to the cities to have them work the gardens. Evidently we made great slaves. One day Enlil's younger brother, Enki (whose name means *snake*), went to Eve—and the records used that name, Eve—and told her that the reason his brother didn't want the humans to eat of that tree in the center of the garden was because it would make them like the Nefilim. Enki was trying to get even with his brother for a dispute they were having. (The whole story is much more involved than this, but you can read it in the records.) So Enki convinced Eve to eat of the apple tree, the tree of the

knowledge of good and evil, which, according to the records, included more than just a dualistic point of view. It gave her the power to procreate, to give birth.

So Eve found Adam and they ate of this tree and had children, each of which was listed by name on the Sumerian tablets. Now, think about the Adam and Eve story from here on—both stories: the one in Sumerian records and the one in the Bible. God walks through the garden—he’s *walking*, he’s in a body, in flesh, which was suggested in Genesis. He’s walking through the garden calling for Adam and Eve. He doesn’t know where they are. He’s God, but he doesn’t know where Adam and Eve are. He calls for them and they come. He doesn’t know that they ate of the tree until he sees them trying to hide themselves because they’re ashamed. Then he realizes what they’ve done.

Here’s another thing: The word for God, *elohim*, in the original Bible—intact, in all the bibles—was not singular but plural. Was the God who created humanity a race of beings? When Enlil found out that Adam and Eve had done this, he was furious. He especially didn’t want them to eat of the other tree, the tree of life, because then not only would they be able to procreate, but they would become immortal. (We don’t know if these are really trees or not. It might have been symbolic for something bound to consciousness.) Therefore, at that point Enlil removed Adam and Eve from his garden. He put them somewhere else and monitored them. He had to have monitored them because he wrote down the names of all the sons and daughters; he knew everything that was going on in the whole family. It was all written down over 2000 years before the Bible was ever written.

From the time of Adam and Eve, our race developed in two strains: one that could procreate and were free (though monitored), and the other that could not have children and were slaves. According to modern scientists, this latter strain continued to mine gold until at least 20,000 years ago. The bones of this second strain that were found in the mines were identical to ours; the only difference is that they couldn’t have children. This strain was completely destroyed at the time of the Great Flood, roughly 12,500 years ago. (There is much more to this subject, which we will give to you at the right moment.)

We will be talking about four Earth pole shifts in this work—when Gondwanaland sank, when Lemuria sank, when Atlantis sank (which is the Great Flood) and the one that is now about to happen. This side note is important to understand: According to Thoth, the degree of tilt of the Earth’s axis and the degree of the pole shift—which happens on a pretty regular basis, according to science—have a direct relationship to the change in consciousness on the planet. For example, the last time the pole shifted at the time of the Great Flood, the North Pole was in Hawaii (I realize this is debatable)—at least that’s where the magnetic pole was—and now it’s practically 90 degrees from there. That’s a big change. It was not a positive change, but a negative one—we went down in consciousness, not up.

### *The Rising of Lemuria*

According to Thoth, after Adam and Eve there was a major shift of the axis, which submerged Gondwanaland. Thoth says that when Gondwanaland went down, another landmass came up in the Pacific Ocean, which we call Lemuria, and

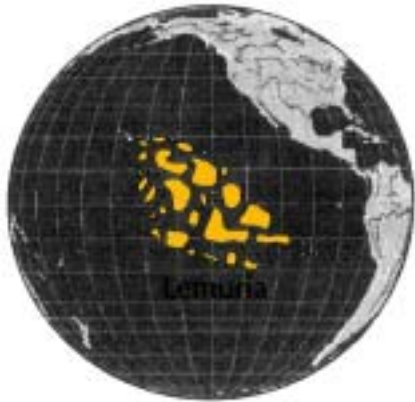

Fig. 3-12. Lemuria.

the descendants of Adam and Eve were taken from their homeland and brought to Lemuria.

Figure 3-12 is not exactly what Lemuria looked like, but it's close in a certain way. It extended from the Hawaiian Islands all the way down to Easter Island. It was not a solid mass, but a series of thousands of islands that were closely linked. Some of them were big, some of them little, and there were a whole lot more than this picture shows. It was like a continent that was barely above water—a water continent.

Adam's race was brought there and allowed to develop on its own without the Nefilim interfering, as far as I know. We remained on Lemuria for 65- to 70,000 years. While we were on Lemuria, we were very happy. We had few problems. We were accelerating through our evolutionary path and moving very well. We did lots of experiments on ourselves and implemented many physical changes to our bodies. We were changing our skeletal structure, working on the base of our spine a great deal, working on our skull size and shape.

We were mostly right-brained, feminine in nature. An evolutionary cycle has to choose whether it's going to be male or female, just like you did when you came to Earth. You've got to make that decision. So our race was becoming female. By the time Lemuria sank, as a race we were equivalent to about a 12-year-old girl.

### *Explorations of Lemuria in 1910*

The fact that Lemuria probably existed was established in our society as far back as 1910. We don't remember much about this knowledge, because in 1912 something happened to change our course of evolution. In 1912 experiments took place that were similar to the Philadelphia Experiment of 1942 and '43, which we'll talk about later. They actually did the experiment in 1913, but it turned out to be a huge catastrophe, and I personally believe that this experiment is what caused World War I in 1914. After that we were never the same.

Before World War I the spiritual growth pattern of the United States was similar to what's happening right now. People were extremely interested in spiritual and psychic work, in meditation, in understanding the ancient past and in everything else of that nature. People like Colonel James Churchward and Augustus Le Plongeon from France were studying Atlantis and Lemuria, and there were many similar thought patterns compared to the present. Then when World War I came along, we fell asleep and didn't start waking up again until the 1960s. But the proof they had in 1910 about the existence of Lemuria was pretty remarkable, and it had to do with coral. Coral can grow underneath the surface of water only to a depth of 150 feet. In 1910 I suspect the Pacific floor was higher than it is now, because they were able to see coral rings on the surface of the ocean floor heading away from Easter Island for a great distance.

By the way, the ocean floor *does* rise and fall. You might not know it, but the Atlantic Ocean floor rose over two miles in December 1969; you can look this up in the January 1970 issue of *Life* magazine. In the Bermuda area many islands suddenly began to break the surface. Some are still there, but most of them sank again. The ocean floor had been over

two miles deep prior to that time.

At the time that Plato described Atlantis and the Atlantic Ocean, the Greeks were having a difficult time navigating their ships into the Atlantic Ocean outside the Straits of Gibraltar because the water in that area was only 10 or 15 feet deep, sometimes even less. Now the water is deep again.

The coral rings they discovered in the Pacific were estimated at 1800 feet deep. This meant that the rings originally had islands inside, because the coral had to be close to the surface in order to grow. If the rings were 1800 feet deep, it meant that since coral cannot grow below 150 feet, the rings sank very, very slowly. In 1910 people could see these rings going off into the distance, so they knew there had to be a lot of islands there at one time. Probably more important, if you follow the fauna and flora from the Hawaiian Islands, you find the same features on a whole series of islands moving along an arc from Hawaii all the way to Easter Island. These islands are separated by long distances, but if you look on a map, you'll see a long string. That string used to run along the western shores of Lemuria. All those islands, including Tahiti and Borea, were part of Lemuria. All the islands in this string have exactly the same fauna and flora—not on any of the other islands, just this one string—the same trees, same birds, same bees, same bugs, same bacteria, same everything. Science can explain this phenomenon only if there were at one time much closer land bridges between these islands.

### *Ay and Tiya and the Beginning of Tantra*

This new civilization in Lemuria was developing quite well; everything was going along just great. But most of Lemuria eventually sank. About a thousand years before it sank, two people were there whose names were Ay and Tiya. This couple did something that no one else had ever done before, at least in our evolutionary cycle. They discovered that if you make love in a certain way and breathe in a certain way, you get different results when you have a child. Through the conception of that different kind of birth, all three of them—the mother, the father and the child—would become immortal. In other words, by having a baby in a certain way, the experience changes you forever.

Ay and Tiya suspected that they had become immortal, I'm sure, because of their experience. As time went on and everybody else started dying but they remained alive, people began to realize that they really did have something. So they finally set up a school. As far as I know, it was the first mystery school on the Earth in this cycle. It was called the Naacal, or Naakal (rhymes with McCall), Mystery School, where they simply tried to teach how to do this thing we call resurrection or ascension through tantra. Tantra is a Hindu word for yoga or union with God through sexual practices. (We have a lot to go over before we can understand exactly what they were doing.) Anyway, they did this and then they began to teach other people.

Before Lemuria sank, they had instructed approximately a thousand people, which means that about 333 families of three each were able to understand what they were doing and demonstrate it. They were able to make love in this unusual way. They didn't touch each other, actually. In fact, they didn't even need to be in the same room. It was

interdimensional love-making. They taught others how to do it, and it was getting to a place where in another few thousand years they would probably have translated the whole race into a new consciousness.

But God evidently said no, it was not the right time. They had just gotten started when Lemuria sank. Lemuria, like I said, was female, and the Lemurians were very psychic. They knew that Lemuria was going to sink a long time beforehand. They knew with absolute certainty; it wasn't even a matter of discussion. So they prepared a long time in advance. They took all their artifacts to Lake Titicaca, Mount Shasta and other places. Even the great golden disk of Lemuria was removed. They got everything of value out of the country and prepared for the end. When Lemuria finally sank, they were totally off the islands. They had resettled from Lake Titicaca through Central America and Mexico to as far north as Mount Shasta.

### *Lemuria Sinks and Atlantis Rises*

According to what Thoth says, the sinking of Lemuria and the rising of Atlantis occurred at the same time, during another shift of the axis. Lemuria went down, and what would be called Atlantis rose.

Atlantis was a pretty large continent, as shown here [Fig. 3-13]. The southeastern part of the United States wasn't there; Florida, Louisiana, Alabama, Georgia, South Carolina, North Carolina and parts of Texas were under water. I don't know if Atlantis was quite this big or not, but it was pretty big. It actually consisted of this continent plus nine islands: one to the north, one to the east, one to the south and six to the west, which extended to where the Florida Keys are now.



Fig. 3-13. Atlantis.

*Update: On May 23, 1998, Aaron Du Val, president of the Egyptology Society in Miami, Florida, announced that ancient Atlantis has been found near Bimini, and that it can be scientifically proven beyond any doubt. They have found a huge underwater pyramid and have open hermetically sealed chambers to expose records that confirm what Plato said about Atlantis during the time of ancient Greece. Mr. Du Val said they will present their evidence to the world before the end of 1998 or soon afterward.*

## The Aborted Evolution of Consciousness and the Creation of the Christ Grid

### How the Lemurians Evolved Human Consciousness

The immortal beings of Lemuria “flew” from their homeland to a little island north of the newly risen continent of Atlantis. They waited for a long time on the island they named Udal, then they began to recreate their spiritual science. If you had watched them, you wouldn’t have known what the heck they were doing; you’d have thought they were nuts. In order to describe what they were doing, I have to describe something else first

#### *The Structure of the Human Brain*

This circle [Fig. 4-1] represents a human head, looking down from above. There’s the nose (N). The human brain is divided into two components, the left side and the right side.

In Figure 4-2, the left side is male and the right side is female, and they are linked by the corpus callosum. According to Thoth, this is the nature of these two hemispheres: The left, male component sees everything absolutely logically—as it is, you might say. The right, female component is much more concerned with *experiencing* something than understanding it. The female and male perceptions are mirror images of each other—as if you had a mirror between them. If you had the word LOVE written into the male component, he would see it as shown. But the female sees its mirror image, also as shown. When the male looks at her way of perceiving, he says, “There’s no logic here.” She looks at him and says, “Where is the feeling?”

The brain is further divided into four lobes by another thin division. The male side of the brain has a component behind it that reflects, or mirrors the front, as shown in Figure 4-3. There’s another mirror image behind the female side that reflects what’s in front of it. The male logical component has a totally experiential component behind it and the female experiential component has totally logical component behind it. It’s as if there are four mirrors reflecting each other in these four possible ways. When we look at the geometries later, you’ll see that the forward part in the male brain, the logical component, is based on the triangle and the square (in two dimensions) or the tetrahedron and the cube (in three

dimensions). The forward part in the female brain, the experiential component, is based on the triangle and the pentagon (in two dimensions) or the tetrahedron, the icosahedron and the dodecahedron (in three dimensions). There are also diagonal pathways connecting the left-front logical to the back-right logical, and the right-front experiential to the back-left experiential. Thus the mirror quality reflects side to side, front to back, and diagonal to diagonal. This is the way we're made up, according to Thoth.

### *The Attempt to Birth a New Consciousness on Atlantis*

When the time was right, the Naacals from Lemuria created a spiritual representation of a human brain on the surface of their Atlantean island. Their purpose was to birth a new consciousness based on what they had learned during Lemuria. They believed the brain had to come first before the body of the new consciousness of Atlantis was to emerge. With Thoth's image of the human brain in mind, you can begin to make sense of their actions. First they made a wall down the middle of the island about 40 feet high and 20 feet wide, which sealed off one side of the island from the other. Literally, you had to go into the water to get to the other side. Then they ran a minor wall across at 90 degrees to the first wall, which divided the island into four parts.

Then half of these thousand people, who were of the Naacal Mystery School, went on one side and half stayed on the other, depending on their nature. That could mean that all the women stayed on one side and all the men went to the other side, but as I understand it, where a person went did not depend on the physical body, but his or her dependency on one side of the brain or the other. In this way, approximately half became the male component of the brain and the other half became the female component.

They spent thousands of years in this physical state until they believed they were ready for the next step. Three people were selected to represent the corpus callosum, the part of the brain that links the left and right hemispheres together. Thoth's father, Thome, was one of these. He and two other people were the only ones allowed to go everywhere on the island. Otherwise, the two sides had to remain completely separate from each other. Then the three began to align their energies and thoughts and feelings and all aspects

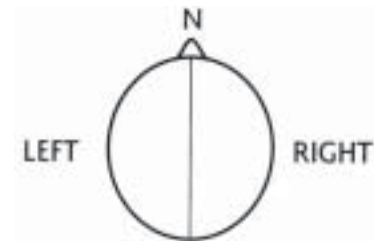
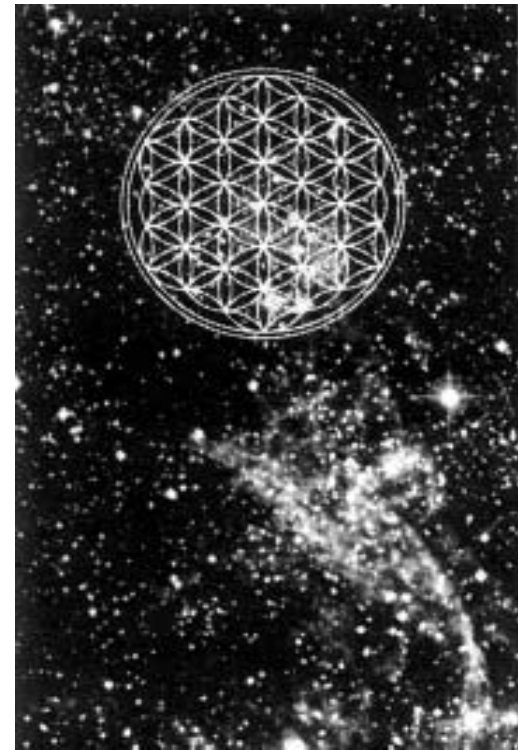

Fig. 4-1. The two hemispheres of the human brain.

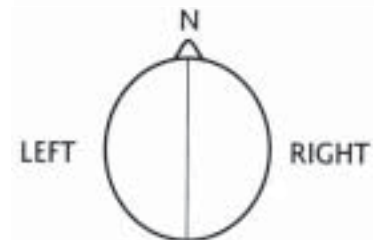
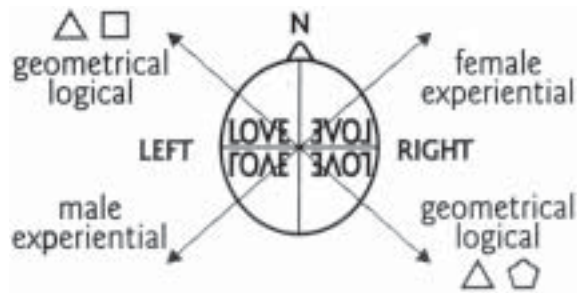

Fig. 4-2. Dynamics of the two hemispheres, reflecting side to side.





of humanness into an integrated human brain, not with human cells, but rather with human bodies.

The next step was to project onto the surface of Atlantis the form of the Tree of Life. They used the form here [Fig. 4-4] with 12 circles on it instead of 10, but the 11th and 12th circles were off the mainland; one of the points was on Udal and one was in the water to the south. So there were ten components on the mainland, which is the configuration we're familiar with. Even though it extended over hundreds of miles on the surface of this land, they projected it to the accuracy of a single atom, according to

Toth. There is an indication that even the spheres of the Tree of Life were used to designate the size and shape of the cities of Atlantis. Plato says in his book Critia<sup>5</sup> that the main city of Atlantis was made of three rings of land separated by water, as shown in this drawing [Fig. 4-5]. He also says the city was constructed of red, black and white stones. This last statement will make sense as soon as we talk about the Great Pyramid.

### *The Children of Lemuria Are Called Forth*

Suddenly, in a single day, the brain of Atlantis, the Naacal Mystery School, breathed life into the Tree of Life on the surface of Atlantis. This created vortexes of energy rotating out of each of the circles on the Tree of Life. Once the vortexes were established, then the brain of Atlantis psychically called forth the children of Lemuria. Millions and millions of Lemurians, who by then had settled along the west coast of North and South America and in other places, began to be pulled to Atlantis. A great migration began, and the ordinary people of the sunken Lemuria started moving toward Atlantis. Remember, they were feminine right-brained beings and inner communication was easy. However, the Lemurian body of consciousness had reached only the age of twelve as a planetary consciousness. It was still a child, and some of its centers weren't functioning yet; they had worked with those energies and had mastered only eight of the ten. So each migrating Lemurian was attracted to one of these eight centers on Atlantis, depending on the nature of the individual. There they settled and began to build cities.

That left two vortexes with nobody using them, not a single person. These two vortexes were pulling life toward them, and in life you just can't have an empty place. Life will find a way to fill it. For instance, if you're driving along the freeway following another car and you drop too far behind it, somebody will fill in the gap, right? If you leave a place empty, life will step in and fill it. That's exactly what happened on Atlantis.

Though Lemurians settled into only eight of the vortex areas, Mayan records state clearly that there were ten cities in Atlantis when it fell. In fact, you can see those records in the Troano document, which is now located in the British Museum. This document is estimated to be at least 3500 years old, and it describes in detail the sinking of Atlantis. It's Mayan, and it contains an authentic account of the cataclysm, according to Le Plongeon, the French historian who translated it. Here is what it says:

*In the year 6 Kan on the 11th Muluc in the month Zak, there occurred terrible earthquakes which continued without interruption until the 13th Chin. The country of the hills of Mud, the land of Mu, was sacrificed, being twice upheaved. It suddenly disappeared during one night, the basin being continually shaken by volcanic forces. Being confined, these caused the land to sink and to rise several times and in various places. At last the surface gave way, and ten countries were torn asunder and scattered, unable to stand the forces of the convulsions. They sank with their 64 million inhabitants.*

The ten countries mentioned were referring to the ten points on the Tree of Life. When you see this document, it shows an extremely sophisticated city with volcanoes going off inside and all around it, pyramids and everything else being destroyed and people getting in boats and trying to escape. It describes the incident in the Mayan language, which uses pictures.

## The Aborted Evolution

### *Two Empty Vortexes Drew Extraterrestrial Races*

To fill those two empty vortexes, according to Thoth, two extraterrestrial races stepped in—not one, but two completely different races. The first race was the Hebrews, coming from our future. Thoth says they came from off the planet, but I don't know specifically where. The Hebrews were kind of like a kid who went through the fifth grade and didn't make it and had to do that grade over again. They hadn't graduated to the next level of evolution, so they had to repeat that grade. In other words, they were like a child who had already been through the math stuff. They knew a lot of things that we didn't know yet. They had legal permission from the Galactic Command to step into our evolutionary path at that time. They brought with them, according to Thoth, many concepts and ideas that we had no idea about yet because we hadn't entered into those levels of awareness. This interaction actually benefited our evolution, I believe. There was no problem with their coming to Earth and settling. There probably would have

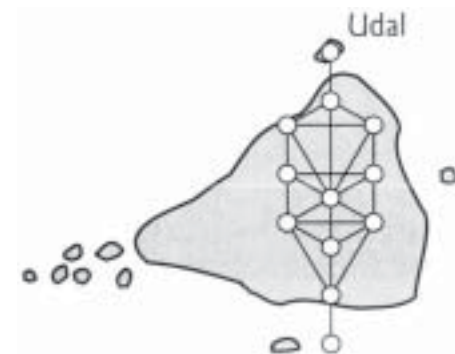

Fig. 4-4. Tree of Life on Atlantis.

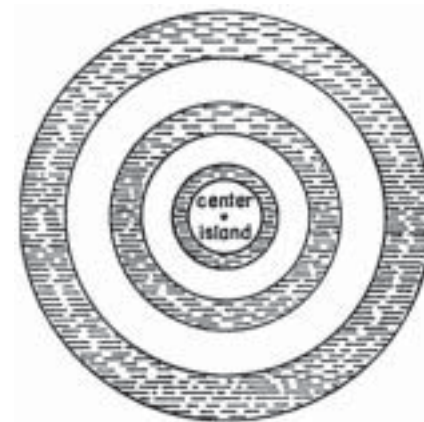

Fig. 4-5. Atlantean city of Poseidon.

been no problem at all if just this one race had come here.

The other race that stepped in at that time caused big problems. These beings came from the nearby planet of Mars. (I know this may sound strange, but it sounded even stranger when I was saying this back in 1985 before people like Richard Hoagland began to speak up.) It has become evident, because of the situation that has developed in the world, that this same race is still causing major problems. The secret government and the trillionaires of the world are of Mars extraction or have mostly Martian genes and little or no emotional/feeling body.



### *Mars after the Lucifer Rebellion*

According to Thoth, Mars looked much like Earth a little less than a million years ago. It was beautiful. It had oceans and water and trees and was just fantastic. But then something happened to them, and it had to do with a past “Lucifer rebellion.”

From the very beginning of this experiment we are in—and all of God’s creation is an experiment—experiments similar to the Lucifer rebellion (if you want to call them rebellions) have been attempted four times. In other words, three other beings besides Lucifer attempted to do the same thing, and each time it resulted in utter chaos throughout the universe.

More than a million years ago, the Martians had joined the third rebellion, the third time that life decided to try this experiment. And the experiment failed dramatically. Planets everywhere were destroyed, and Mars was one of them. Life attempted to create a separate reality from God, which is the same thing that’s going on now. In other words, a portion of life attempted to separate itself from all other life and create its own separate reality. Since everyone is God anyway, this is okay—you can do that. The only thing is, it never has worked so far. Nevertheless, they tried it again.

When someone tries to separate from God, they sever their love connection with Reality. So when the Martians (and many others) created a separate reality, they cut the love bond—they disconnected the emotional body—and in so doing they became pure male, with little or no female within them. They were purely logical beings with no emotions. Like Mr. Spock in Star Trek, they were pure logic. What happened in Mars, and in thousands and thousands of other places, was that they ended up fighting all the time because there was no compassion, no love. Mars became a bat-tieground that just kept going on and on and on, until finally it became clear that Mars was not going to survive. Eventually they blew their atmosphere away and destroyed the surface of their planet.

Before Mars was destroyed, they built huge tetrahedral pyramids, which you’re going to see in photographs in the second volume. Then they built three-sided, four-sided, and five-sided pyramids, eventually building a complex that was able to create a synthetic Mer-Ka-Ba. You see, you can have a space-time vehicle that looks like a spaceship, or you can

have certain other structures that do the same thing. They built a structure from which they were able to look ahead and behind in time and space to tremendous distances and time periods.

A small group of Martians tried to get away from Mars before it was destroyed, so they translated themselves into the future and found a perfect place to resettle before Mars was destroyed. That place was Earth, but it was about 65,000 years in our past. They saw that little vortex sitting there on Atlantis with nobody in it. They didn't ask permission. Being part of the rebellion, they didn't go through the normal procedure. They just said, "All right, let's do it." They stepped right into that vortex, and in so doing, they joined our evolutionary path.

### *Martians Rape the Human Child Consciousness and Take Over*

There were only a few thousand of these Martians who actually used the time-space-dimension consciousness machine, or building. The very first thing they did when they arrived here on Earth was try to take control of Atlantis. They wanted to declare war and take over. However, they were vulnerable because of their small numbers and perhaps other reasons, so they couldn't do it. They were finally subdued by the Atlanteans/ Lemurians. We were able to stop them from conquering us, but we could not send them back. By the time this took place in our evolutionary path, we were about the age of a 14-year-old girl. So what you had here was similar to a 14-year-old girl being taken over by a much older man, a 60- or 70-year-old man who simply forced himself on her. In other words, it was rape. We were raped, we had no choice. The Martians just stepped in and said, "Like it or not, we're here." They didn't care what we thought or felt about it. It was really no different from what we in America did to the Native Americans.

Once the initial conflict was over, it was agreed that the Martians would try to understand this female thing they lacked, this emotional feeling, of which they had none at all. Things more or less settled down for a long time. But the Martians slowly began to implement their left-brain technology, which the Lemurians didn't know anything about. All the Lemurians knew was right-brain technology, which today we know very little about. Psychotronic machines, dowsing rods and those kinds of things are right-brain technologies. Many right-brain feminine technologies would astound you if you saw them in action. You can do absolutely anything that you can imagine with right-brain technology, just as you can with left-brain technology, if they are brought to their full potential. But then we really do not need either one—this is the great secret that we have forgotten!

The Martians kept putting out these left-brain inventions, one after another after another, until finally they changed the polarity of our evolutionary path because we began to "see" through the left brain, and we changed from female to male. We changed the nature of who we were. The Martians gained control bit by bit, until eventually they controlled everything without a battle. They had all the money and all the power. The animosity between the Martians and the Lemurians—and I'm putting the Hebrews in with the Lemurians—never subsided, not even to the very end of Atlantis. They hated each other. The Lemurians, the feminine aspect, were basically shoved down and treated like inferiors. It was not a very loving situation. It was a marriage that the female component did not like, but I don't think the Martian males

really cared if she liked it or not. It remained this way for a very long time, until approximately 26,000 years ago, when the next phase slowly began.

### *Minor Pole Shift and the Subsequent Debate*

It was about 26,000 years ago when we had another minor pole shift and a small change in consciousness. This pole shift took place at the same point on the polar wobble called the precession of the equinoxes that we have now returned to (see the lower small oval at A in Fig. 4-6). It wasn't much, though it has been recorded by science. The two small ovals on the cycle are where these changes always take place, and right now we're back at point A again.

At the time of this pole shift, a piece of Atlantis, probably about half the size of Rhode Island, sank into the ocean. That caused a tremendous amount of fear in Atlantis, because they thought they were going to lose the whole continent, like what happened to Lemuria. By this time they had lost most of their ability to see into the future. They were shaking in their boots for a long time simply because they didn't know for sure what was going to happen. They were still afraid a hundred years later, then slowly this fear began to subside. It took over 200 years for them to feel safe again.

Atlantis was a little beyond the lower oval at A when they finally relaxed their fear about Earth changes. But the memory was still there. They were going along nicely for a while, then out of the blue approximately 13,000 to 16,000 years ago, a comet approached Earth. When this comet was still in deep space, the Atlanteans knew about it because they were more technologically advanced than we are now. They witnessed its approach.

A great conflict began to occur in Atlantis. The Martians, who were in the minority even though they were in control, wanted to blow it out of the sky with their laser technology. But there was a huge movement amongst the Lemurian population against using the Martian left-brained technology. The feminine aspect said, "This comet is in divine order, and we should allow this to take place naturally. Let it hit the Earth. That is what's supposed to take place."

Of course, the Martians replied, "No! Let's blow it out of the sky. We have very little time, or we all will be killed." After lots of arguing, the Martians finally and reluctantly agreed to allow the comet to hit the Earth. When it arrived, it came screaming into the atmosphere, plunging into the Atlantic Ocean just off the western shore of Atlantis near where Charleston, South Carolina, is now, only it was on the bottom of the ocean then. The remnants of that comet are now scattered over four states. Science has definitely determined that it did hit there somewhere between 13,000 and 16,000 years ago. They're still finding pieces. Although most of the fragments were centered near Charleston, one of the two largest pieces actually struck the main body of Atlantis in its southwestern area. These left two huge holes in the floor of the Atlantic Ocean and could have been the true cause of the sinking of Atlantis. The actual sinking did not happen at that time, but took place at least several hundred years later.

## *The Martians' Fateful Decision*

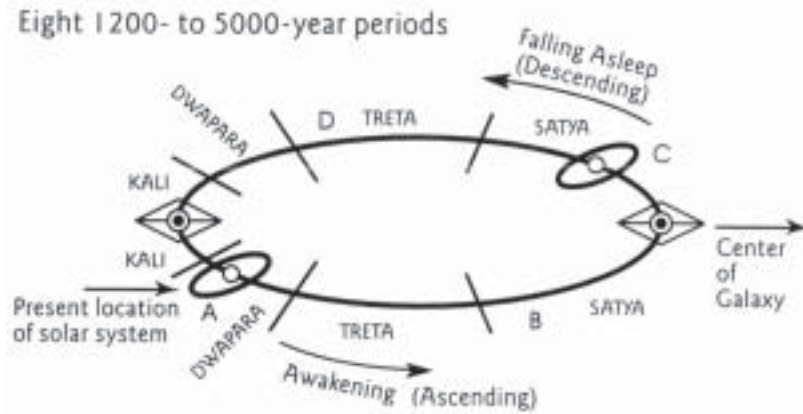

The pieces of the comet that crashed into the southwestern area of Atlantis happened to be right where the Martians were living, killing a huge portion of their population. The Martians got hurt the worst by consenting to allow the comet to come in. Well, that was too humiliating and painful for them. This was the beginning of a great loss of consciousness for Earth. What was about to take place was the seed for a bitter tree, the same tree we live by today. The Martians said, "It's all over. We are divorcing you. We're going to do whatever we want from now on. You can do whatever you want, but we're going to lead our own lives and try to control our own fate. And we're not going to

listen to you ever again." You know this whole number. We've seen it in divorced families throughout the world. And the children? Look at our world! We are the children!

The Martians decided to take over the Earth, of course. Control, the Martian's primary interface with the Reality, rose to meet their anger. They began to create a building complex like the one they had constructed on Mars a long time earlier, in order to create a synthetic Mer-Ka-Ba once again. The only thing is, around 50,000 Earth years had passed since they had created one, and they didn't remember exactly how to do it—but they thought they did. So they built the buildings and began the experiment. That experiment is directly tied to a chain of Mer-Ka-Bas that began with the Mars experiments a little less than a million years before. Later, one was done here on Earth in 1913, another one in 1943 (called the Philadelphia Experiment), another one in 1983 (called the Montauk Experiment), and another one that, I believe, they're attempting to do this year (1993) near Bimini Island. These dates are windows of time that open up and are tied to the harmonics of the situation. The experiments must be timed to these windows in order to succeed.

If the Martians had succeeded in setting up a synthetic harmonic Mer-Ka-Ba, they would have had absolute control of the planet, if that was their intention. They would have been able to make anybody on the planet do anything they wanted, though eventually it would have meant their own demise. No higher-order being would place this kind of control on another if they truly understood the Reality.

## *Failure of the Martian Mer-Ka-Ba Attempt*

The Martians built the buildings in Atlantis, set up the whole experiment, then threw their switch to begin the energy flow. Almost immediately they lost control of the experiment, like falling through space and time. The degree of destruction was more horrible and sinful than I care to describe. In this Reality, you can hardly make a greater error than to create an out-of-control synthetic Mer-Ka-Ba. What the experiment did was begin to rip open the lower-dimensional levels of the

Earth—not the higher ones, but the lower ones. To give an analogy, the human body has membranes between different parts, such as in the heart, the stomach, the liver, the eyes and so on. If you took a knife and slit open your stomach, that's would be like ripping open the dimensional levels of the Earth. Various aspects are separated from other aspects of spirit by these dimensional membranes, and they're not meant to mix. You're not supposed to have blood in your stomach, but in your arteries. The purpose of a blood cell is different from that of a stomach cell.

These Martians did something that almost killed the Earth. The environmental disaster we are experiencing today is nothing in comparison, though the problems we are having are a direct result of what we did long ago. With the right understanding and enough love, the environment could be repaired in a single day. But had this Martian experiment continued, it would have destroyed the Earth forever. We would never have been able to use the Earth as a seed base again.

The Martians made a very, very serious mistake. This out-of-control Mer-Ka-Ba field, first of all, released a huge number of lower-dimensional spirits into the Earth's higher-dimensional planes. These spirits were forced into a world they did not understand or know, and were in total fear. They had to live—they had to have bodies—so they went right into people, hundreds of them into each person in Atlantis. The Atlanteans could not stop them from entering their bodies. Finally, almost every person in the world was totally possessed by these beings from another dimension. These spirits were really Earthlings like us, but very different, not coming from this dimensional level. It was a total catastrophe—the biggest catastrophe the Earth has probably ever seen.

### *A Disruptive Heritage: The Bermuda Triangle*

The Martians' attempt to control the world took place near one of the Atlantean islands in the area we now call the Bermuda Triangle. There's an actual building sitting on the ocean floor down there that contains three rotating star-tetrahedral electromagnetic fields superimposed on each other, creating a huge synthetic Mer-Ka-Ba that stretches out over the ocean and into deep space. This Mer-Ka-Ba is completely out of control. It's called the Bermuda *Triangle* because the apex of one of the tetrahedrons—the stationary one—is sticking up out of the water there. The other two fields, are counterrotating—and the faster-rotating field sometimes moves clockwise, which is a very dangerous situation. (When we say clockwise, we mean the *source* of the field, not the field itself. The field itself would appear to be rotating counterclockwise.) You'll understand this when you learn more about the Mer-Ka-Ba. When the faster field rotates counterclockwise (from its source), everything's okay; but when the faster one moves clockwise (from its source), that's when time and space distortions happen. Many of the airplanes and ships that have disappeared in the Bermuda Triangle have literally gone into other dimensional levels because of the out-of-control field there.

A primary cause of much of the distortion in the world—the distortion between humans such as wars, marital problems, emotional disturbances etc.—is that imbalanced field. That field is not only causing distortions on Earth, it's causing distortions way, way, way out in remote areas of space because of the way Reality is constructed. That's one of the reasons why this race of beings called the Grays, and other ET beings we'll talk about at the appropriate time, are trying to correct what happened here long ago. This is a big problem that extends way beyond Earth. What they did back 00

Atlantis was against all galactic law. It was illegal, but they did it anyway. It will be solved, but not until the year 2012. There's not much the ETs can do in the meantime, but they'll probably keep trying. Eventually they'll succeed.

## The Solution: A Christ Consciousness Grid

### *Ascended Masters Assist the Earth*

At the time of the synthetic Mer-Ka-Ba failure, there were about 1600 ascended masters on Earth, and they did everything they could to try to heal the situation. They tried to seal the dimensional levels and get as many of these spirits as they could out of people and back into their own worlds. They did everything on every level they could. They eventually got most of the spirits out and healed about 90 to 95 percent or more of the situation, but people still found many of these unusual beings living in their bodies.

The situation at that time began to deteriorate extremely rapidly. All the systems on Atlantis—financial, social and all the concepts of how life ought to be—degenerated and collapsed. The continent of Atlantis and all its people became sick. They started getting weird diseases. The entire continent went into a state of survival just trying to live through each day. The situation grew continually worse. For a long period of time it was hell on Earth, horrible. If it had not been slowed down by the ascended masters, it would truly have been the end of this world.

The ascended masters (the highest levels of our consciousness at that time) didn't know what to do to help bring us back into a state of grace. I mean they *really* didn't know what to do. They were children compared to the events that had been forced upon them, and they had no idea how to handle it. So they prayed. They called in higher levels of consciousness. They called in everybody who could hear their plea, including the great Galactic Command. They prayed and prayed. So the problem was reviewed on many high levels of life.

Similar kinds of events have happened before on other planets; this wasn't the first time. So before it actually happened, our ascended masters and galactic friends knew that we were going to fall out of grace, out of the high level of awareness we were experiencing at the time. They knew that we were going to fall way down the spectrum of life. Their concern was to figure out some way to get us back up on track after the fall, and they knew it had to be done quickly. They were looking for a solution that would heal the whole Earth, both the dark and the light. They weren't concerned with a solution where only the Martians would be healed, or only the Lemurians or only *part* of the Earth. They were looking for a situation that would heal the whole Earth and all of its inhabitants.

Higher levels of consciousness don't go along with this "us and them" point of view. There's only one consciousness moving through all life, and they were trying to get everybody to come back into a state of love and respect for each other.



They knew that the only way they could do it was to get us back into Christ consciousness, a level of beingness where we can see the unity, and they knew we would proceed from there with love and compassion. They knew that if we were going to get back on track, we would have to be in Christ consciousness as a planet by the end of the 13,000-year cycle—which is now. If we were not in Christ consciousness by then, we wouldn't make it at all. We would destroy ourselves. Although spirit is eternal, life interruptions can be temporally lost.

The only problem was that we couldn't get back to Christ consciousness by ourselves, at least in a short time. Once we had fallen to this level it would be a very, very long time before we would be able to come back up naturally. So the problem was really one of time. We were part of a greater consciousness that

loved us, and out of love it wished to assist us back into conscious immortality as soon as possible. It would be much like having a child who hit his head real hard, resulting in a concussion. You would want him to return to consciousness quickly.

It was finally decided to try a kind of standard operating procedure that usually works in these situations, though not always. In other words, it was an experiment. Earth's people were about to be subjects of a galactic experimental project in the hope of helping us. We would experiment on ourselves. It wasn't done by extraterrestrials or anything like that; they simply showed us how to do it. We were given instructions on how to proceed with this experiment, and we actually carried it out. . . . successfully.

What about the Sirians? Our helpers honestly believed that we would make it, though they knew it would be close. In fact, they wouldn't have gotten permission from the Galactic Command to do the experiment if they hadn't honestly believed we would make it. You can't lie to the Galactic Command.

### ***A Planetary Grid***

At this point, so that you'll understand the procedure they decided on, I need to talk about grids. A planetary grid is an etheric crystalline structure that envelops the planet and holds the consciousness of any one species of life. Yes, it does have an electromagnetic component associated with the third dimension, but it also has an appropriate higher-dimensional component for each dimension. Science will eventually discover that there's a grid for every single species in the world. There were originally 30 million grids around the Earth, but now there are about 13 to 15 million, and they're decreasing rapidly. If there are just two bugs on the planet, and they're just sitting somewhere in Iowa, they have a grid that stretches around the entire planet, or they couldn't exist. It's just the nature of the game.

*Note: For those of you who believe that we will be out of this dimension before 2012, you are probably right. The correction to this Atlantean field, even though the Earth will probably be in at least the fourth dimension by then, will be completed in that third-dimensional year, according to Thoth.*

Each of these grids has its own geometry and is unique; there's not another one like it. Just as a species' body is unique, its point of view of interpreting the Reality is also unique. The Christ consciousness grid holds the Christ consciousness for the planet, and if that grid isn't there, we can't reach Christ consciousness. This grid was there during Atlantean times, though we were very young, and it was beginning to function at certain times during the precession of the equinoxes. They knew it would be placed into a passive state by the Martians' actions, so they decided to synthetically activate the Christ consciousness grid around the Earth. It would be a living grid, but it would be synthetically made—like creating a synthetic crystal from a living cell of a live crystal. Then at the right time, hopefully before we killed ourselves off, the new grid would be complete, and we could ascend to our previous level once again. One example of the effect of a grid is shown in the hundredth monkey theory.

### *The Hundredth-Monkey Concept*

You have probably read the book, *The Hundredth Monkey* by Ken Keyes, Jr., or perhaps the earlier book of Lyall Watson, *Lifetide: The Biology of the Unconscious*, who describe a 30-year scientific research project on the Japanese monkey, *Macaco fuscata*. The island of Koshima, Japan, has a wild colony and the scientists were providing them with sweet potatoes dropped in the sand. The monkeys liked the sweet potatoes, but not the sand and dirt. An eighteen-month-old female they named Imo found she could solve the problem by washing the potatoes. She taught this trick to her mother. Her playmates also learned this new way, and they taught their mothers, too. Soon all the young monkeys washed their sweet potatoes, but only the adults who imitated their children learned this behavior. The scientists recorded these events between the years 1952 and 1958.

Then suddenly, in the autumn of 1958, the few monkeys doing this on the island of Koshima reached a critical mass, which Dr. Watson arbitrarily placed at 100, and bingo!—almost every monkey on the island started washing its potatoes without any further influence. If it had happened on only that one island, they probably would have figured there was some form of communication and looked for it. But simultaneously the monkeys on the surrounding islands also started washing their potatoes. Even on the mainland of Japan in Takasakiyama the monkeys were washing their potatoes. There was no possible way these monkeys could have communicated by any way we know. It was the first time that scientists had ever observed anything like this. They postulated that there must have been some kind of morphogenetic structure or field that stretched across these islands through which the monkeys were able to communicate.

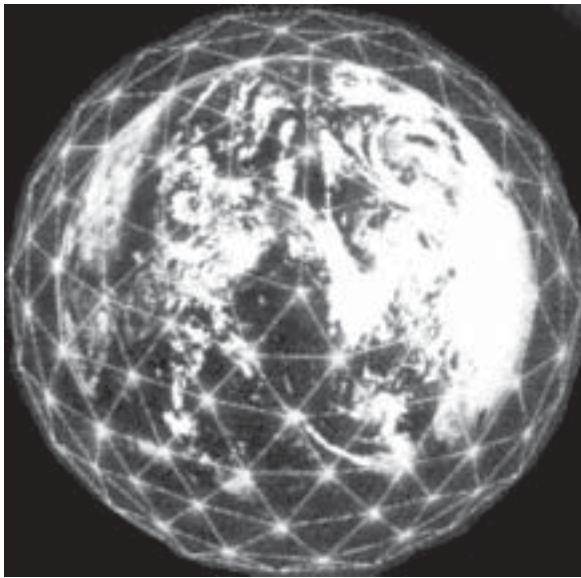

## ***The Hundredth Human***

Many people thought a lot about the hundredth monkey phenomenon. Then a few years later a scientific team from Australia and Britain wondered if human beings possessed a grid similar to the monkeys. They did an experiment. They made a photograph that had hundreds of human faces in it, little ones and big ones, faces in the eyes. Everything was made up of these faces, but when you first looked at it, you could see only about six or seven. It took training to see the other ones. Usually someone had to first point out where they were.

These people took their picture to Australia and conducted a study there. They selected a certain number of people from a spectrum of the population, then showed each of them the picture, giving them a certain length of time to look at it. They held the photograph up to someone and said, “How many faces do you see in this photo?” During the time the subjects were given, they would generally come up with six, seven, eight, nine or maybe ten faces. Few people saw more. When they had gotten a few hundred people as their basic sampling and recorded accurately what had been observed, some of the researchers went to England—on the other side of the planet—and showed the picture on a closed-cable BBC television station that broadcasts only to England. They carefully showed where all the faces were, every single face. Then *a few minutes later* other researchers repeated the original experiment with new subjects in Australia. Suddenly people could easily see most of the faces.

From that moment, they knew for certain that there was something about humans that had not been known. Now, the Aborigines in Australia had known about this “unknown” part of us for a long time. They knew that there was an energy field connecting people. Even in our society, we’ve observed that somebody on one side of the planet would invent something very complex at the same moment that someone on the other side of the Earth invented the same thing, with the same principles and ideas. Each inventor would say, “You stole it from me. It was mine. I did it first.” This has happened many, many times, stretching back for a long time. So after this Australian experiment, they began to realize that *something* very definitely connects us all.

## ***The Government’s Discovery of the Grid and the Race for Control***

As far back as the early 1960s, the American and Russian governments had discovered these electromagnetic fields, or grids, that stretched around the world. Human grids—yes, there are more than one—are high above the Earth, about 60 miles or more.

Remember, I told you about the five levels of consciousness on Earth that correspond to different numbers of genes and different heights? Well, there are only three levels of consciousness that Earth is actually experiencing right now. Two others are way beyond us at this time. The first level is primal, the second level is our present consciousness, and the third level is the Christ or unity consciousness, the one we’re about to enter. After the Fall, about 13,000 years ago, there were only two active human grids around the Earth, the first and the second levels. The Aborigines in Australia were

on the first level, for example, and we, the mutants, were on the second level. (That's what they call us—mutants—because we mutated to where we are now.) Science has done very little research on the Australian Aborigines, so our countries haven't become aware of their grid. But the governments did a lot of research on us, and they discovered exactly what our grid looks like: It's based on triangles and squares. It's a very male grid that stretches around the whole planet. Now, we have a third grid up there, which we will call the unity-consciousness grid, or simply "the next step." It's been there, completed, since February 4, 1989. Without that grid, it would be all over for us, folks. But it is there. The governments became originally aware of our second-level grid maybe as far back as the 1940s. I realize that this statement is in contradiction to what was said above. But nevertheless I believe that the grid was discovered even before the hundredth monkey theory came out. Because of World War II, the governments were beginning to place military bases all over the world in little out-of-the-way places, on obscure islands like Guam. Why did they select these particular places for their bases? It probably wasn't for the reasons they said. When you lay out the grid and the military bases all over the world, especially those of Russia and the United States, well, son-of-a-gun, the bases are almost always located right on the nodal points of the grid—exactly over the top or on little spirals that come off of the nodal points. It could not possibly have been a coincidence that they just happened to spread out their empire of military bases in these precise places. They were trying to take control of this grid, because if they could control it, they knew they could control what we think and feel. A subtle war was going on between these two governments. However, the war changed its nature considerably in 1970, though I'll have to explain that later. Of course, behind both the United States and Russia was the secret government, which controlled the outer appearance and timing of this conflict.

### *How the Grid Was Constructed, and Where*

Now that we have the necessary background, we can continue with the drama in Atlantis. The project to rebuild the grid was begun by three men: Thoth, a being named Ra and a being named Araragat. These men flew to a place in what is now Egypt, to the area now called the Giza plateau. At that time it was not a desert, but a tropical rain forest, and it was called the Land of Khem, which means the land of the hairy barbarians. The three men went to that particular place because the axis of the old unity-consciousness grid extended out of the Earth from that point. They were going to rebuild a new grid on the old axis, according to instructions given by higher consciousness.

They had to wait until the right moment—until the precession of the equinoxes passed the low ebb in consciousness—before they could act, and this low ebb was still far into their future. After that they would have a little less than half a cycle, about 12,900 years or so, to complete everything by the end of the twentieth century. We couldn't go any longer than this or we would destroy ourselves and our planet.

First they had to complete the grid on the higher dimensions, then they had to physically build the temples in this dimension before the new unity grid would manifest. Once manifested and balanced, they were to help us begin to consciously move into the higher worlds of being and begin anew our path home to God.

So Thoth and friends went to the very spot where the unity-consciousness vortex exited the Earth. This point was about a mile away from where the Great Pyramid sits in the desert today, but then it was out in the middle of nowhere, in the middle of a rain forest. Centered right over the axis of this vortex on the Earth, they created a hole extending approximately one mile into the Earth, lining it with bricks. It took only a few minutes or so, because they were sixth-dimensional beings, and whatever they thought always happened. It was that simple.

Once the hole aligned with the unity axis was created, they mapped the ten Golden Mean spirals that emerged from the hole and located where they moved above the Earth. They used the hole as the axis, starting far down, and mapped the spirals of energy as they moved up out of the hole and extended into space. One of the spirals exited the Earth not far from the present Great Pyramid. Once they found it, they built a little stone building in front of the hole; that building is the key to the entire Giza complex. Then they built the Great Pyramid.

According to Thoth, the Great Pyramid was built by himself, not Cheops. Thoth says that it was completed about 200 years prior to the shifting of the axis. The apex of the Great Pyramid, if the capstone were in place, sat exactly on the curve of the spiral. They lined up the center of the hole with the south face of the stone building and the north face of the Great Pyramid. It has amazed surveyors who have looked at this. Though these structures are a mile away from each other, the south face of the stone building and the north face of the Great Pyramid are in perfect alignment. They do not believe that we could do it any better today even with our modern technology.

Later the other two pyramids were also built directly on that spiral. In fact, that's how the hole was discovered, through aerial photography. They noticed that the three pyramids were laid out on a logarithmic spiral. Then they traced the spiral back to its source and went to that spot, and there was the hole and the stone building. That discovery was made, I believe, in the early 1980s. It was recorded in the McCollum survey that was completed in 1984 by Rocky McCollum.

I've seen the axis hole and the building with my own eyes. I consider it to be the most important place in all of Egypt and so does the Edgar Cayce A.R.E. There's also another hole about a city block away from the first spiral, and this spiral starts out a little differently, but then slowly, asymptotically, superimposes itself over the first spiral. To be able to build around this hole in this spiral pattern, the planners had to have a very sophisticated understanding of life. (I'll explain this understanding later also.) So these two completed spirals defined the axis of what would eventually become the unity-consciousness grid around the Earth.

### *Sacred Sites*

After starting the new grid over the existing collapsed grid and putting one pyramid on the line of the spiral, Thoth, Ra and Araragat mapped where these two energy lines curved and crossed each other in over 83,000 places on the surface of the Earth. Fourth-dimensionally, one dimension higher than this one, they constructed an entire network of buildings and structures over the whole planet, placing them on the nodes of this energy matrix. All of these structures were laid out

with the proportions of either the Golden Mean or Fibonacci spirals, and all were mathematically referred back to that single point in Egypt now called the Solar Cross.

The location of the sacred sites of the world are no accident. It was a single consciousness that created every single one of them—from Machu Picchu to Stonehenge to Zaghuan—you name it, to anywhere. Almost all of them (with a few exceptions) were created by a single awareness. We're becoming more aware of this now. Richard Hoagland's work brings this forth, though he wasn't the first one. They show how one sacred site is extrapolated from another one, then another and still another. These sites go beyond time, in that they were all built at different times, and they go beyond any particular culture or geographical location. They were obviously done by one consciousness who coordinated the whole enterprise. Eventually researchers will see that this spot in Egypt is the point from which all the other sacred sites were calculated.

This Egyptian area is the north pole of the unity-consciousness grid. On the other side of the planet, out in the South Pacific in the Tahitian Islands, is a little island called Moorea, where the south pole of the grid is located. For those of you who have been on top of Wayna Picchu for a birds-eye view, Machu Picchu, at about 9000 feet in the Peruvian mountains, seems to be surrounded in a perfect circle by mountains. It's like a female circle surrounding a phallus rising in the middle. Well, the island of Moorea is similar to this, only it's shaped like a heart. Each house on Moorea has a heart with the house number on it. The phallic Moorean mountain in the center of the heart is much bigger than Wayna Picchu in Peru, but you will still see the same ring of mountains surrounding this earthen pole. This is the precise south pole of the entire unity-consciousness grid. If you go straight through the Earth at Moorea, you come out in Egypt. It's off only an ever so tiny bit—there's a very slight curve, which is natural. The Moorean pole is negative, or female, and the Egyptian pole is positive, or male. All the sacred sites are connected to the Egyptian pole, and they're all interlinked through the central axis leading to Moorea. It's a torus, of course.

### *The Pyramid's Landing Platform and the Ship beneath the Sphinx*

This is the Great Pyramid [Fig. 4-7]. It has a so-called "missing capstone," and there have been all kinds of speculations about it. According to Thoth, the actual missing capstone is  $5^{1/2}$  inches high and solid gold; it is a holographic image of the entire pyramid. In other words, it has all the little rooms in it and everything in proportion, and it's sitting in the Hall of Records. The other two pyramids go up to a sharp point; only the Great Pyramid has a flat surface on top. That missing piece is not little—it's about 24 feet square at the base. If you get on top, it's a huge platform. This flat area is actually a landing platform for a very special airship that exists on Earth.

The Sphinx is not far away from the Great Pyramid. According to *The Emerald Tablets* and Thoth, the Sphinx is much, much older than the 10- to 15,000 years estimated by John Anthony West. One factor that many present researchers have neglected to consider is that the Sphinx has been under sand during most of its recent existence. In fact, when Napoleon went to see the Sphinx, he didn't even know it was there because all he saw was its head. It was completely buried, and it has

been buried for most of the last few hundred years at least. Taking that factor into consideration, which could be a major one, the wear caused by rain and wind would have taken a lot longer than they're presently figuring.

According to Thoth, the Sphinx goes back at least five and a half *million* years. I guess eventually that will be brought forth, because he hasn't been wrong about anything yet. Even John Anthony West secretly suspects that it is a great deal older than 10- to 15,000 years. He wasn't concerned with making speculations into the millions of years; he just wanted to get it well past the 6000-year mark, because that will crack our previously accepted Earth history. He and his team have now done that, and later, I believe, they'll try to push the date back further as they introduce more evidence.

According to Thoth, approximately one mile under the Sphinx there is a round room with a flat floor and a flat ceiling. Inside this room is the oldest synthetic object in the world—older than any other consciously assembled matter on Earth. According to Thoth, though even he can't prove it, this object goes back 500 million years when "that which led to human life" began. The object is about two city blocks in size; it's round like a disk and has a flat bottom and top. It's unusual in that its skin is only three to five atoms thick. Its top and bottom surfaces have a certain pattern that's shown in Figure 4-8.

The pattern itself is five atoms thick; everywhere else it's only three atoms thick. And it's transparent—you can see right through it—almost like it's not there. This is a ship, but it has no motors or visible form of power. Even though Doreal's interpretation of *The Emerald Tablets* states that this ship had atomic motors in it, according to Thoth it does not. Doreal translated *The Emerald Tablets* in the Yucatan in 1925 and could not understand the description of how the ship was powered. The idea of atomic motors was the farthest-out idea he could think of for a power source. But it is actually propelled by thoughts and feelings, and is designed to connect with and extend your own living Mer-Ka-Ba. This ship is connected directly to the spirit of the Earth, and in *The Emerald Tablets* it's called a warship. It was the protector for the Earth.





Fig. 4-7. The Great Pyramid.

### *The Vulnerability of This Period and the Appearance of the Heroine*

Every single time we reach that vulnerable point in the precession of the equinoxes when our poles make these little shifts, extraterrestrials have tried to take over the planet, according to *The Emerald Tablets*. This has been going on for millions and millions of years, and it's still going on. When I

read that in the Tablets, I didn't yet know about the Grays or any of these beings, and I thought, "Someone coming from somewhere else to take over the Earth? Naw, this is silly!" But even today, this same thing's going on. It never stops, it just keeps on. It's called, simply, the battle of the dark and the light.

Every single time a takeover seems imminent, there has always been one very pure person who figures out how to get into the next level of consciousness, then finds the ship and raises it into the air. The Earth and the Sun connect within that person and give him or her great power, then whatever that person thinks and feels will happen. That's how this airship is a warship: Whatever races are trying to take over Earth, this person just thinks them away—thinks up a situation that forces them to leave. This keeps our evolutionary process going without any kind of outside interference or influence. At least that's what is *supposed* to happen.

By now we have definitely been tampered with. That pure person has appeared, and that event has already happened here on Earth. This is why the Grays are leaving. The problems they're having is because of one single woman—one 23-year-old female from Peru (she was 23 in 1989 when she did this). She made the first ascension

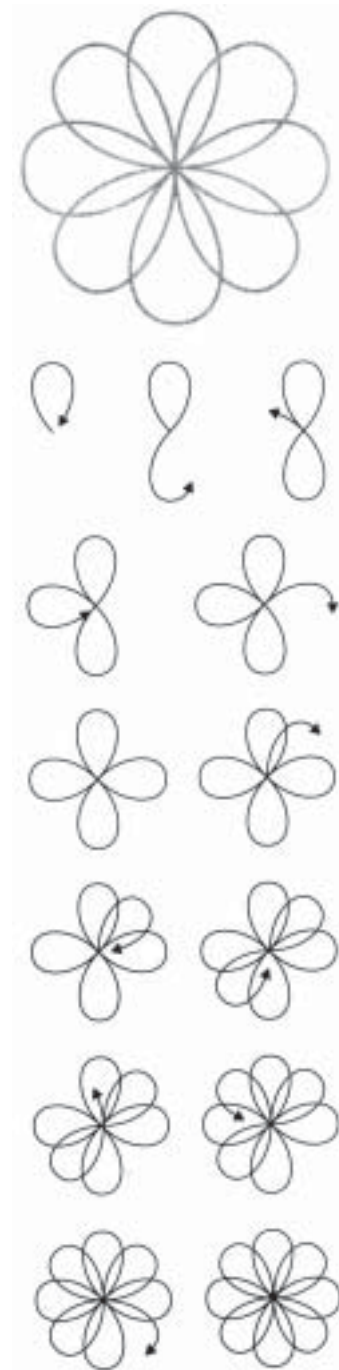

Fig. 4-8. The pattern on the disk beneath the Sphinx.



process up to the new grid and connected with it, connected with the Earth, found the ship and raised it into the air. First she made some basic connections that had to be done with crystals on the Earth, then performed the programming that had to be recalculated. The very next thing she did was to *think* that the Grays and others related to this attempted takeover of Earth were going to become sick if they remained here, and there would be no cure.

Within one month, all the Grays started getting sick, and the whole process she envisioned began to happen. The Grays have been forced to leave the Earth now. Their bases have been abandoned, and they have been forced to alter their plans. The presence of this entire army of beings from space has now been reduced to almost nothing, all because of one small but holy woman. It's amazing [chuckles]. We guys know what that's like—I've been reduced to nothing lots of times by my wife.

### *Awaiting the Atlantean Catastrophe*

Toth and his partners finished the complex in Egypt to help rebuild the grid. Then they abandoned it in the middle of the rain forest and went back to Atlantis to prepare. It sat alone for 200 years, because they knew that at that critical point in the precession of the equinoxes, the poles would shift. They knew that Atlantis would sink, so they waited.

One day it finally happened. The catastrophe actually took only one night. Science has proven that when poles shift, it takes about 20 hours. It happens just like that [snaps fingers]. You wake up one normal day, and that evening it's a totally different world. The whole process is about three and a half days long, but the pole shift happens in about 20 hours. We're all going to experience this enormous change when we see big chunks of the United States start to drop off into the water—then you'll know it's for sure. There are other early signs that will tip you off that the change is about to happen. When enough information has been given, I'll remind you of what you already hold in your memories.

When they saw the very first signs of the shift coming on, Toth, Ra and Ararat returned to the Sphinx and raised the warship into the sky. All they did was raise the vibration of the molecules only one overtone higher than the Earth exists on. This allowed them and the ship to pass right through the Earth into the sky. Then they moved to Atlantis, lowered the ship to the surface, and picked up the people of the Naacal Mystery School, which included the original immortals from Lemuria as well as those who became enlightened during the time of Atlantis (by that time about another 600 people had ascended). So the original thousand from Lemuria and the 600 from Atlantis had increased the number of ascended masters to about 1600, the only occupants of the ancient airship.

Now, the people on this ship were not only passengers, they were creating a living group Mer-Ka-Ba that surrounded the ship with a very large field in the shape of a flying saucer—the same shape that's around the galaxy and around your body when your Mer-Ka-Ba is spinning. They had a very powerful protective field around themselves as they headed for Khem, soon to be the new Egypt. Toth said that they had risen about a quarter mile off the planet with the members of the mystery school on board when they watched the island of Udal sink. This was the last piece of Atlantis to disappear into the water, with the exception of a few small islands. Then they flew the ship to Egypt and landed it on top of the Great Pyramid. From the side it

looked like the middle drawing in Figure 4-9.

If you were to extend the Great Pyramid up to where the capstone would naturally terminate, you would find that the ship and the pyramid were built for each other. If you were to look at this from the top, it would look like the right-hand view in the figure. The circle is the ship and the square is the Great Pyramid. The perimeter of the Great Pyramid and the circumference of the ship are the same. It's debatable if that's possible or not, but they can get very, very close. Whenever that mathematical relationship happens, life appears. It's the basic relationship of life throughout the universe. (We'll describe this geometrically soon.) If the ascended masters had not had spinning Mer-Ka-Ba fields around them, they wouldn't be here today (and probably neither would we), because their Mer-Ka-Bas protected them from all that happened next.

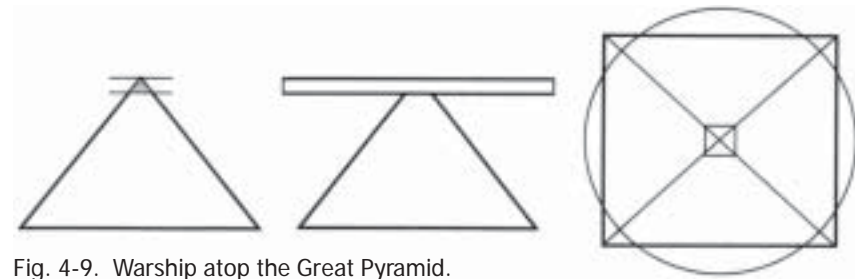

Fig. 4-9. Warship atop the Great Pyramid.

After they landed on the pyramid, the poles began to shift and the human consciousness of the Earth began to plummet. Simultaneously, the electromagnetic and magnetic fields of the Earth collapsed, and all life on this planet went into the Great Void, the three and a half days of absolute blackness described by many cultures around the world.

### ***The Three and a Half Days of the Void***

*The Emerald Tablets* say that every single time we go around the precession of the equinoxes and our poles go through these changes, we go through a void space for about three and a half days. The Mayas described the Void in the Troano document. At one point in the story, three and a half stones are painted black. This refers to the time when we go into what we now call the *electromagnetic null zone*. As the poles shift, a phenomenon

takes place (we'll go into great detail about this later) where for about three and a half days we're in darkness (it could actually be anywhere from two or two and a half days to a little over four days). The last time, it was evidently three and a half days. It's more than just blackness; it's nothing, it's void. And, by the way, when you are in the Void, you will realize that you and God are one, that there is no difference at all. We'll talk about the Void again at the right moment.

### ***Memory, Magnetic Fields and Mer-Ka-Bas***

If the people on the warship hadn't been protected by the Mer-Ka-Ba during that change, they would have completely lost their memories. You see, our memory is held together primarily by a magnetic field that exists around the brain—inside the skull and around the head. That field is further connected to every cell in the brain by individualized magnetic fields within each cell. Science first found the internal magnetic particles within each cell and then found the larger outer field. This was the first new find in human physiology in the last 300 years. Memory is dependent on a steady,

living magnetic field, very much like a computer. Its connection to the Earth's magnetic field is not understood by science at this time. If you don't have a means of protecting your memory, it will be erased, gone. It'll be like unplugging a computer in the middle of a file. It's just gone. That's exactly what happened to the Atlanteans and others who survived the catastrophe but who didn't have spinning Mer-Ka-Bas. Those very sophisticated people, who were more advanced than you and I, suddenly found themselves in a situation where they didn't know anything. They had high-tech bodies and high-tech minds, but it was like having a great PC sitting on the table with no software, nothing there.

So the population that survived, and there were a few, had to start all over again. They had to begin at square one to figure out how to stay warm, how to make fire and so on. This loss of memory was the result of their forgetting how to breathe, forgetting their Mer-Ka-Bas, forgetting everything—falling down through the dimensions, going into a totally unprotected state and ending up in this very dense world—having to eat food again, doing all kinds of things that hadn't been part of our experience for a very long time. They were slammed into a very dense aspect of the planet and had to learn to survive all over again. This was all a result of the synthetic Mer-Ka-Ba experiment that had taken place on Atlantis.

Without that small group of ascended masters, we would not have survived at all—we definitely would all have left human experience. The whole Earth experiment would have been over forever. But they kept the field alive, just barely, while everything else crashed around them. Besides the ascended masters, there were also two other groups on Earth who had Mer-Ka-Ba fields intact at the time. The Nefilim and the Sirians, our mother and father, kept their fields alive. I don't know where the Nefilim retreated to within this planet's dimensional worlds, but the Sirians remained in the Halls of Amend, inside the inner earth. Both of these groups are still here on the planet, hidden within the dimensional worlds.

### *What the Thoth Group Did after Light Returned*

After the three and a half days of darkness, the Earth reappeared, light reappeared, the fields stabilized themselves, and we were down in this third-dimensional world where we are now. Everything was new and different—everything. It had totally changed experientially. When we consider the landmass of Atlantis, the Atlanteans had really been on a much higher level of interpreting that landmass. They didn't experience it like we do. It was experienced in a totally different way that's pretty hard to explain from our third-dimensional point of view.

After they landed on top of the Great Pyramid, Ra and about a third of the people from the ship went down through a tunnel that goes into a room at the two-thirds level, which will someday be discovered. (They've discovered four new rooms in the Great Pyramid in only the last few years.) When this room is discovered, they'll find that it's made with red, black and white stones, which were the primary architectural colors of Atlantis. This is what Thoth told me to say. From this room is a channel they used to descend to a city or a temple far below the pyramid, which Thoth and friends built when they built the pyramid. It was designed to hold approximately 10,000 people because they knew a large number would ascend over the next 13,000 years, until the Day of Purification.

After the fields stabilized and a third of the people followed Ra into the room made of red, black and white stones, from there they entered the underground city and began the root of our present civilization. Another part of the root was being formed at the same time in Sumer (another story). At the same moment in time, the remaining 1067 or so ascended masters lifted the warship off the Great Pyramid and flew to the place now called Lake Titicaca, where they

landed on the Island of the Sun (in Bolivia). Thoth got off there, along with about a third of the people. Then they took off again and flew to the Himalayan mountains, where Araragat got off with the remaining third of the people. Seven people, however, remained with the ship, flew it back to the Sphinx and lowered it into that room, where it has remained for the last 13,000 years—until recently when the young woman from Peru raised it again into the open blue skies of Mother Earth's atmosphere.

### *Sacred Sites on the Grid*

Egypt became the male component of the grid. That is where the male structures were laid out. There's hardly any femaleness there compared to female areas of the world. Of course, the polarity to maleness does exist— Isis is that counterpart—but the overall energy flow is male. South America, especially Peru, Central America and also parts of Mexico became the female component of the grid. However, ultimately the entire female aspect of the grid became centered at the complex in Uxmal, in the Yucatan, where many survivors from Atlantis had found refuge.

Starting at Uxmal, seven temples are laid out in a spiral, probably a Fibonacci spiral, and they are the seven primary temples of the female component of the grid. These are chakra centers, just like the chakra centers that are laid out down the length of the Nile. These feminine centers begin with Uxmal, then go to Labna, then to Kabah, then over to Chichen Itza, then over to Tulum near the ocean, then way down near Belize to Kohunlich, curving back inland to Palenque. Those seven places created the primary spiral of the feminine aspect of the grid being created for our new Christ consciousness, which we are only now able to access.

From Palenque the feminine aspect of the grid splits north and south. Here we see another polarization of the energy. The feminine component of the female spiral of the grid heads south and jumps over to Tikal in Guatemala, and that begins a new octave. When we relate it to music, the seventh site bridges to the eighth note, or the beginning of the next octave of the next spiral. And the spiral keeps going south through the feminine component of the grid. Eventually it moves through places like Machu Picchu and Sacsayhuaman near Cuzco, Peru. One of the main spirals ends in a place called Chavin, in Peru, which was the primary religious center of the Incan empire. From there it goes to Lake Titicaca to a place about a half a mile off the Island of the Sun in Bolivia. Then it makes a 90-degree turn and heads out toward Easter Island and finally to Moorea, where it anchors into the Earth.

Heading north from Palenque is the male component of the female aspect of the grid. It goes through the Aztec ruins and up through the American Indian pyramids. (The American Indians made physical pyramids, some remains of which can be seen in and around Albuquerque, New Mexico.) Then the spiral continues to Blue Lake near Taos, New Mexico, which is the counterpart of Lake Titicaca. This is one of the most important areas in the United States, protected for a long time by the Taos Indians. Again, there's a 90-degree turn at Blue Lake. From there the spiral heads out across the mountains, going through Ute Mountain (on the New Mexico side of the Colorado border) and through many mountains and structures that have been built.

In conjunction with the sacred sites, the creators also used mountains because of their vortex energy. Finally, before the spiral leaves the coast of California, it passes through Lake Tahoe, Donner Lake and Pyramid Lake. From there it goes through underwater mountain complexes until it reaches the Hawaiian Islands, where Haleakala Crater is one of the primary components, then heads south again. It goes through the Hawaiian Island chain that connects for thousands of miles all the way back to Moorea.

So it's a huge open circle that comes around the Earth, starting at Uxmal and connecting at the south pole of the Christ grid. The feminine component of the grid is a massive circle of complexes. Understand that in between each of the major sites mentioned above are literally hundreds of smaller sites—churches and temples of many religions, sacred sites of nature such as mountain peaks and ranges, lakes, canyons and so on. If you could see the greater plan, you would see how they form perfect spirals, first moving clockwise, then moving counterclockwise until they reach their destination, Moorea, in the South Pacific.

The pyramids built in the Himalayan mountains were primarily crystalline in nature, meaning they were constructed by using third-dimensional crystals at the corners, aimed to form a pyramid. They built physical pyramids there, too—lots of them. Most of them are not known, though some are. The largest known pyramid in the world so far is in the western mountains of Tibet. It's a solid-white pyramid that's in almost perfect condition, with a huge, solid-crystal capstone. At least two teams of scientists have been there, and it has also been photographed from the air. It's visible only three weeks out of the year when its crystal capstone peers out of the deep snow to view a valley long deserted from human endeavor.

I talked with the leader of the team that went into this pyramid. He said it looks like a brand-new pyramid and that there's nothing written on the walls. It's white, smooth and hard, like marble. When they entered it, they went down a long tunnel, where they found a large room in the center. There's no writing anywhere, no designs, no nothing—except that in the middle, high up on a wall, there is one inscription—the Flower of Life! That's it. If you want to say everything, all you have to do is put that on a wall. That says it all. By the end of this book you'll understand why.

All the sacred sites on Earth, with a few exceptions, were planned on a fourth-dimensional level by higher consciousness, and by now most have third-dimensional counterparts connected to them—in other words, real buildings on



real sites. However, there are still some very important sites that have *only* fourth-dimensional structures. Those fourth-dimensional pyramids primarily represent the neutral or child energy of the Christ grid. Altogether there are three aspects of the Christ grid that surround the Earth—Mother, Father and Child. The Father is in Egypt, the Mother is in Peru-Yucatan-South Pacific and the Child is in Tibet.

### *The Five Levels of Human Consciousness and Their Chromosomal Differences*

According to Thoth, there are five different levels of human consciousness possible here on Earth. These are people who have different DNA, completely different bodies and different ways of perceiving the Reality. Each level of consciousness grows from the last one, until finally on the fifth level humanity learns how to translate into a whole new manner of expressing life, leaving Earth forever.

The primary visual difference between these types is their height. The first-level people are about 4 to 6 feet tall. The second-level people are about 5 to 7 feet tall, where we are at now. Third-level people are about 10 to 16 feet tall, which we are about to translate to. The fourth-level being is about 30 to 35 feet tall, and the last is about 50 to 60 feet. These last two levels are for the distant future.

This may seem strange at first, but do we not begin as a microscopic egg and get larger and larger until we are born? Then we continue to grow taller and taller until we are adults. According to this theory, the human adult is not the end of our growth pattern. We continue through DNA steps until we are 50 to 60 feet tall. Metatron, the Hebrew archangel who is the perfection of what humanity is supposed to become, is 55 feet tall! Remember the giants who lived here on Earth referred to in chapter 6 of Genesis? According to the Sumerian records, they were about 10 to 16 feet tall. When we look at a three-year-old and a ten-year-old, we know that they have different levels of consciousness, and it is primarily by their height that we make this judgment.

According to Thoth, each level of consciousness has different DNA; however, the primary difference is the number of chromosomes. Using this theory, we are now on the second level and have 44+2 chromosomes. An example of the first level is certain aboriginal tribes in Australia where they have 42+2 chromosomes. On the third level, which we are about to move to, people have 46+2 chromosomes. The next two levels have 48+2 and 50 + 2, respectively.

We will discuss this in depth in the second volume of this book and show the sacred geometry around this understanding, which will make it clear.

### *The Evidence in Egypt for a New Look at History*

We're now going to focus on Egypt because Egypt happens to be where the main mystery school was located and where evidence of the different-sized humans, and levels of consciousness, still remain, though generally unrecognized. Egypt was the area they chose where they would ultimately restore our consciousness, and the primary area where survivors from Atlantis and the ascended masters were in one place. We could discuss the history of those other areas, and we will a little, but the focus for this work will be on the Father, because it is through the Father that the primary information of the Mer-Ka-Ba must be remembered.



Fig. 4-11. Abu Simbel.



Fig. 4-10. Bust of Tiya.

This is an Egyptian statue of Tiya [Fig. 4-10]. Tiya and her husband Ay were the first two to create a baby by interdimensionally connecting through the sacred tantra, which

led to immortality for all three, the father, the mother and the child. You can get a pretty good idea what Lemurians looked like from looking at her. She and her husband are still alive, and they're still on the planet today even after tens of thousands of years. They're two of the oldest beings in the world and two of the most respected of all the ascended masters because of all they've done for human consciousness.

### *Giants in the Land*

This is Abu Simbel [Fig. 4-11] in Egypt, which is located at the base of the spine in the chakra system of the masculine aspect of the Christ grid. Notice how very tall these statues are; this was the *actual height* of these beings! Compare it to the size of the tourists near the bottom right in the photo. If these stone folks were to stand up, they would be in that 60-foot range, which indicates that they were at the fifth level of consciousness.

These beings [Fig. 4-12], on a different wall at Abu Simbel, would be about 35 feet tall, representing the fourth level of consciousness. They built rooms for these different heights. This doorway is made for the Venusians—the Hathor race—who are on the third level of consciousness. I'll tell you more about the Hathors later.

These third-level beings [Fig. 4-13] are about 16 feet tall, indicating they are male, as the females of this race are about 10 to 12 feet tall. In their section of the building the rooms are around 20 feet high, with ceilings and beams in proportion to 10- to 16-foot-tall beings. Next to that room, through a little door-



Fig. 4-12. Abu Simbel and Hathor doorway.



Fig. 4-13. Inside abu Simtel; third-level beings.

way (you can't see it here) that looks like it's made for us, is a little room with a much lower ceiling. The Egyptians didn't make these statues arbitrarily—they never did *anything* arbitrarily. There isn't a single scratch on a single stone; there is not even one, I believe, that was done unconsciously. There was a reason and a purpose for everything. And usually it was created on many, many different levels. The *Emerald Tablets*, for example, are written on one hundred levels of consciousness. Depending on who you are, you'll understand something utterly and completely different from other people. If you should go through a consciousness change, go back and reread *The Emerald Tablets* again. You won't believe it's the same book, because it'll talk to you in a different way, depending on your



understanding.

These are Earth beings [Fig. 4-14] passing through the various levels of consciousness. In this photo you see a huge 55-foot-tall being with a statue our size standing by his leg. This is the king and queen. Archaeologists don't know how to interpret this, so they just say that the kings were more important than the queens, and that's why they made her little. But it didn't have anything to do with that. The statues are showing the five levels of consciousness. Every king and pharaoh who ever lived in Egypt had five names, representing the five levels of consciousness.

Some of the kings and queens were able to translate between the different levels in order to guide the population into the spiritual realms. One special example of this still exists. In Egypt there's an ancient round house. I didn't get to see it, but it was described to me by the famous archaeologist, Ahmed Fayhed, so I know it's real. This was Ay and Tiya's house for a long time (though they're obviously not using it now). This round house has a wall down the middle. You can't get from one side of the house to the other without going outside, walking around, and coming in the other side. Does this sound like the island of Udal in Atlantis? On one side of the middle wall is a picture of Ay, who looks very Egyptian with his angled skirt, beard and various Egyptian paraphernalia. He appears of normal height. On the other side of the wall Ay's image is about 15 feet tall. He looks very different, but you can see that his face is the same. He has a huge skull going way back like the higher-level races do (I'll show you some soon). These two pictures of Ay show that he could go back and forth between these two different levels of awareness by changing consciousness.



Fig. 4-14. King and queen on different levels of consciousness.

### ***Stair-Step Evolution***

According to Melchizedek knowledge, both the Sumerians and the Egyptians emerged onto the surface of the Earth at almost the same moment, complete, whole and perfect, with their language totally intact, with all their skills and understanding and knowledge, with almost no evolution prior to that time (at least none that science knows of). They simply appeared at one moment in history in their most perfect state. The writing that came out at that moment was extremely sophisticated and clear, and has never been improved on since. After that initial impulse, these cultures became less and less clear, until finally these advanced civilizations degenerated away. You would think they would get better and more sophisticated as time advanced, but that's not what happened. This is scientific fact. No one in conven-

tional archaeology knows how this happened or can even explain how it *could* have happened. It's a great mystery.

Egypt and Sumer are placed into a special category called *stair-step evolution* by archaeologists. They were given this classification because of how they seemed to gain information and knowledge. What happened was, one day Egypt got its language, full and complete, then that knowledge leveled off; then a little while later they would know everything you could possibly imagine about, perhaps, building a certain kind of moat or water system. A little more time would go by, and then they would suddenly know everything about hydraulics. It would keep going on and on like that. How did the Egyptians and the Sumerians get this information? How did they suddenly, in one day, know everything? I'll give you Thoth's answer.

First I need to make this clear on the precession drawing, repeated below [Fig. 4-15]: Point A is where we are now, and point C is when the fall of Atlantis happened. Point C is also when the poles shifted; science has determined that's when it happened. That's also when the Great Flood of Noah happened, and the melting of the icecaps because of all the changes that were occurring on Earth. Point C is when the destruction occurred. Remember, I mentioned earlier that there were two other points, B and D, when change could also take place and be assimilated most easily. For a 6000-year time span, from point C where the destruction happened to point D where new teachings could be given, the ascended masters had to sit and wait while the Atlanteans, who were now hairy barbarians in Egypt, slowly returned to the state where they could accept this new, yet ancient, knowledge. These approximately 1600 ascended masters had been living under the Great Pyramid since the Fall, and they had to wait 6000 years before they could start teaching and building the new culture.

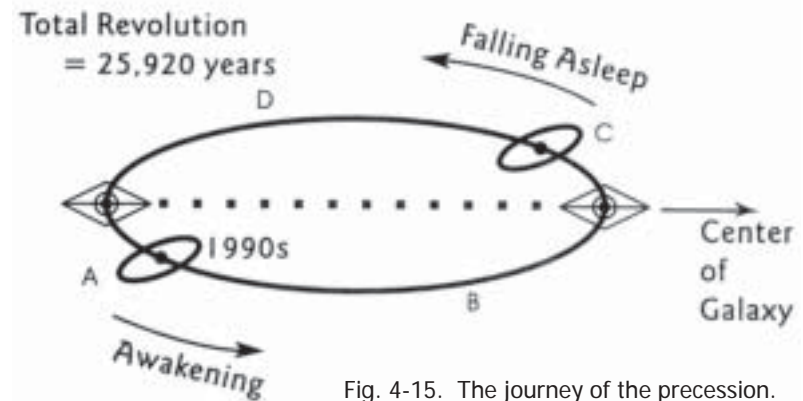

Fig. 4-15. The journey of the precession.

### **The Tat Brotherhood**

Thoth's son Tat remained in Egypt with Ra after the Fall. Later this group became known as the Tat Brotherhood. Even today there's an external brotherhood in Egypt called the Tat Brotherhood, physical people who are the protectors and keepers of the sacred temples. Hidden behind the current Tat Brotherhood are the ascended masters.

So the immortal aspect of the Tat Brotherhood sat there waiting and waiting, observing and waiting, until the time when the Egyptians could receive their teachings. When that day finally came, which was the birth of Sumer and Egypt, the Tat Brotherhood watched until they found either a person or a group of Egyptians who were ready for the ancient knowledge. Then one, two or three members of the Brotherhood appeared in bodies looking just like the people they were about to teach. They would go up to the surface, approach the person or group and give them the information

outright. They flat-out said, “Hey, look at this. Did you know that if you did this and this and this, that this is what will happen?” The Egyptians would say, “Wow, look at that!” They would use the knowledge, thus creating a new “step” in their evolution.

Then the men and women from the Brotherhood would go back under the pyramid, the Egyptians who were given these teachings would give it to the rest of the culture, and the culture would quickly ascend to the next step. The Egyptians would assimilate that for a while; then the Brotherhood would look for another group that was ready for the next subject. They’d go to the surface again and say, “Look, here’s everything you want to know about this.” They simply gave it to them. The ascended masters gave the people this information over a short period of time and their evolution simply shot up and up in stair steps.

### *The Parallel Evolution in Sumer*

This same evolutionary pattern was also occurring in Sumer. Though the present historical line says that Egypt began in approximately 3300 B.C. and Sumer began 500 years earlier, in about 3800 B.C., I believe they both started at almost the same moment. I think that if historians would get their dates accurate, they’d discover that both Sumer and Egypt started only a few years apart. However, the evolution in Sumer was led by the Nefilim, the mother aspect, and the one in Egypt was led by the Sirians, the father aspect. That’s the primary difference. I think the mother and the father agreed, “Now is the time for our children to remember.” I believe it was a parental decision, and that when researchers look very carefully, they’ll find that both countries started to blossom at the same moment in time, which was tied to the point in the precessional orbit (point D) when it was most likely to be successful.

This is also how the Sumerians knew about the precession of the equinoxes. It takes 2160 years to recognize that there is a precession of the equinoxes, but the reason the Sumerians knew about it was because the Nefilim said, “Do you know there’s a precession of the equinoxes?” Very simple. It’s not a complicated thing. They just explained it all and the people wrote it down. The Sumerians knew about events that went back 450,000 years because they were given the information. They simply wrote it down and applied it.

But after these ancient cultures got all this brilliant information, they degenerated. Why would they degenerate instead of going higher? Because they were in the *sleep* cycle, the “falling asleep” portion of the precession. They were falling more and more asleep with each breath, right into the kali yuga, the most asleep moment of the cycle. In the middle of the kali yuga—2000 years ago—was the time of Jesus, and humans were sound asleep and snoring. People in the kali yuga who read books and other studies written in the earlier, more-awake period had a difficult time fully understanding what was being written about. Why? Because they were relatively unconscious. This is why cultures all over the world, not just in Egypt and Sumer, degenerated until they ceased. Right now we are about to awaken fully and know the truth of our beingness.

## Well-Kept Secrets in Egypt, Key to a New View of History

This is Saqqara [Fig. 4-16]. According to the linear archaeological belief, this is where the Egyptian culture began. This pyramid was the first to be built in Egypt, by their way of thinking. When it was first created, it was covered with beautiful white stones. In fact, this whole city stretches for miles and miles and into the Earth hundreds of feet, including buildings and complexes *under* the ground. This would have been amazing if you could have seen it when it was brand new—especially since only a short time in history before it was built, we were supposedly all hairy barbarians. There was a jump from hairy barbarians to this supersophisticated culture in only a second of archaeological time.

This is a pyramid [Fig. 4-17] that I think destroys the belief that Saqqara is where it all began. This pyramid is at least 500 years older than Saqqara. If this is true, the time when the Egyptians emerged on the Earth is identical to the time the Sumerians emerged—which I believe is exactly what happened. This pyramid is called Lehirit (a phonetic spelling), and it's one of the few unguarded pyramids in this category. There are quite a few of these stepped pyramids, called *mastabas*. The Egyptians have taken almost all these pyramids that approach or exceed 6000 years of age and put military bases and huge electrical fences around them. In some cases they've got soldiers on guard with machine guns. If you try to approach these pyramids, they would probably try to kill you. They don't want anyone to know about these pyramids, and they especially don't want you to examine them. If you try to talk to an Egyptian about them or ask to see them, they play it down.

I went through this. They would say, "Aw, it's not important. They're just made out of little adobe bricks by primitive people. They're nothing, nothing to them." And I'd say, "Well,

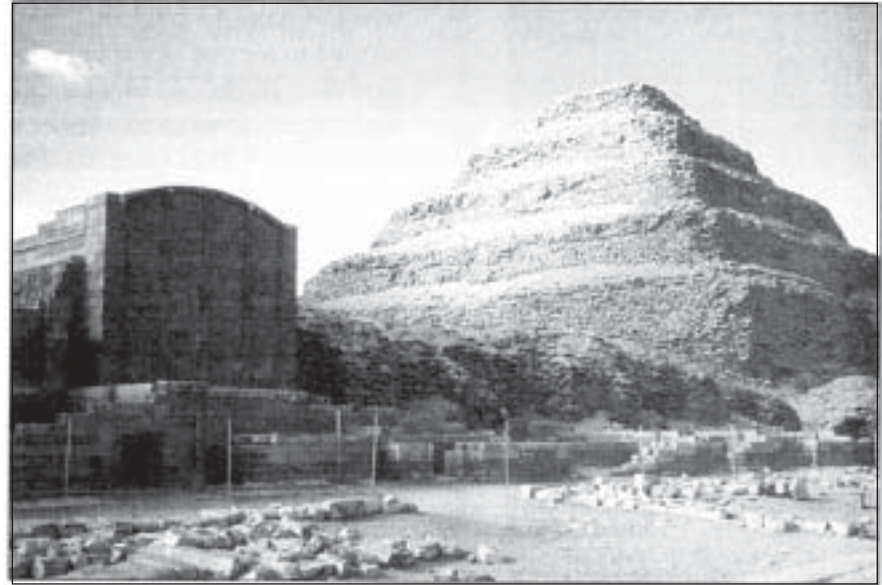

Fig. 4-16. The pyramid at Saqqara.



Fig. 4-17. The pyramid that destroys the Saqqara theory. One of the two flat blocks in foreground has a carved star of David inside a circle (☉)

can I go see one?” “Nah, it’s just a waste of time. Don’t do it.” I had to keep pushing and pushing because I wanted to see one. I was brought in to various governmental offices, and I kept saying, “Please, can I just go see one?” And they would say, “No, no, no.” Finally I had to give bribes to get into these places. One government official wanted \$8,000 to sneak me in there at night without any cameras, just to look at it for fifteen minutes, then get away. This is how closely they protect these structures.

Finally, after a long ordeal, I found out about one of these pyramids that was not on a military base because there was a little village around it about a half an hour from Saqqara. Once I realized that I didn’t have to go through any government red tape, I finally found a person who was connected with that village. I had to pay him a lot of money—it wasn’t thousands, but it was hundreds—to go there. So we drove into the little village; I had to go to the leader to ask permission and pay *him* money, too. Then I was allowed to go there for thirty minutes but not take any pictures. I managed to get this one photograph, and that was all.

Not only was this pyramid there, but *there were pyramids all over the place everywhere*, for what I estimated to be ten miles around! At one time this was a major complex. They’re not doing anything to take care of it because they know that this pyramid is probably older than 6000 years. So I found out that these “unimportant” pyramids were not so unimportant after all. The stones that covered this pyramid, like the slanting ones shown in Figure 4-17, probably weigh 60 to 80 tons apiece. They were very sophisticated even though the internal part of the pyramid was made with adobe bricks.

On top of a block beside the base was a circle with a Star of David —the key to the Mer-Ka-Ba experience. A ramp goes down maybe 200 feet to the river below, and the pyramid is still working, still functioning—it’s pumping water. Pyramids pump water; they’ve demonstrated this in the United States now. If you build a pyramid right, it’ll pump water with no moving parts. So this pyramid fills up with water and has to be pumped dry before anyone can enter.

To top all this off, I just happened to sit next to an American linguistics team when I was flying back home (pure luck, of course), who happened to have just entered this pyramid! Very few people can go in there, but this was a team of 30. He told me about the writing inside that was definitely older than Saqqara. There is geometrical writing all over the walls. I would *love* to see that. This guy was very excited as he told me that this team of 30 linguistics experts who got to see the inside now believe that *the key to all languages in the world is* in that pyramid. I believe he’s probably correct. He understood sacred geometry, and as you will soon discover, sacred geometry is the root of all language in the universe.

# Egypt's Role in the Evolution of Consciousness

## Introduction to Some Basic Concepts

### *Egyptian Tools and Symbols of Resurrection*

The ancients used certain symbols to represent the three aspects of consciousness we use for our sojourn here on Earth. You'll see representations of these symbols all over the world. These depictions have one animal that lives underground, one that walks on the Earth, and one that flies over the Earth. The animal that lives under the ground represents the microcosm; the one who flies through the air represents the macrocosm; and the one who walks the Earth represents the middle level between the two—like us. The same symbols are everywhere. In Egypt you'll see a vulture on the left, the right eye of Horus in the middle, then a cobra on the right [Fig. 5-1]. In Peru it's the condor, the puma and the rattlesnake. For the American Indians it's the eagle, the mountain lion and the rattlesnake. In Tibet it's a chicken, a pig and a snake.

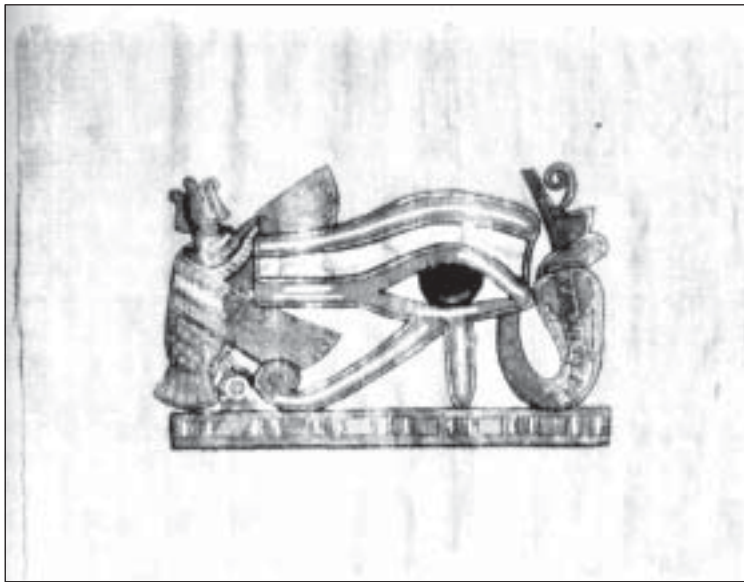

Fig. 5-1. Symbols representing the three aspects of consciousness.

This photo [Fig. 5-2] shows the tools and symbols





Fig. 5-2. Tools of resurrection.

of resurrection the Egyptians used. The object at point A is a shortened form of a rod that's usually about four feet long and has a little tuning fork on one end and a 45-degree angle on the other end. This was used at the back of the head to transfer vibration into the body. Along with that they used the hook and the flail, which we'll see in just a moment. Arrow B points to the oval, which is usually a red-orange color, that you see over the initiates' heads. This was the symbol for the metamorphosis that happens when we go through resurrection or ascension, when we literally change the shape and chemistry of our body.

Arrow C shows a power generator they sometimes use to increase the vibration. Unfortunately, Thoth left before I could fully understand the use of this object. Arrow D indicates the ankh, which I understand more, and I'll give you my understanding. It's the most important tool of understanding they possessed. From an Egyptian point of view, it's the key to eternal life. Arrow E points to a triangle within a triangle, which is the Egyptian hieroglyphic for the star Sirius, the symbol for Sirius A and Sirius B. Point F is just a name, called a cartouche. The bird at the top right is a vulture, which is sacred to the Egyptians and associated with the movement from one level of consciousness to another. I'm not going to go into the other things in the picture, but these are some of the tools the early Egyptians used.

### *The Difference between Dying, Resurrection and Ascension*

These geometric images [Fig. 5-3] come from the Old Kingdom. The little Flower of Life patterns are associated with Lehirit—the pyramid that I believe destroys the Saqqara theory.

Figure 5-4 is a picture of Osiris (on the left). He's holding a crook (A); a 45-degree rod with a tuning fork on the end (B); and a flail (C), which are the three primary instruments used

of resurrection the Egyptians used. The object at point A is a shortened form of a rod that's usually about four feet long and has a little tuning fork on one end and a 45-degree angle on the other end. This was used at the back of the head to transfer vibration into the body. Along with that they used the hook and the flail, which we'll see in just a moment. Arrow B points to the oval, which is usually a red-orange color, that you see over the initiates' heads. This was the symbol for the metamorphosis that happens when we go through resurrection or ascension, when we literally change the shape and chemistry of our body.

Arrow C shows a power generator they sometimes use to increase the vibration. Unfortunately, Thoth left before I could fully understand the use of this object. Arrow D indicates the ankh, which I understand more, and I'll give you my understanding. It's the most important tool of understanding they possessed. From an Egyptian point of view, it's the key to eternal life. Arrow E points to a triangle within a triangle, which is the Egyptian hieroglyphic for the star Sirius, the symbol for Sirius A and Sirius B. Point F is just a name, called a cartouche. The bird at the top right is a vulture, which is sacred to the Egyptians and associated with the movement from one level of consciousness to another. I'm not going to go into the other things in the picture, but these are some of the tools the early Egyptians used.

of resurrection the Egyptians used. The object at point A is a shortened form of a rod that's usually about four feet long and has a little tuning fork on one end and a 45-degree angle on the other end. This was used at the back of the head to transfer vibration into the body. Along with that they used the hook and the flail, which we'll see in just a moment. Arrow B points to the oval, which is usually a red-orange color, that you see over the initiates' heads. This was the symbol for the metamorphosis that happens when we go through resurrection or ascension, when we literally change the shape and chemistry of our body.

Arrow C shows a power generator they sometimes use to increase the vibration. Unfortunately, Thoth left before I could fully understand the use of this object. Arrow D indicates the ankh, which I understand more, and I'll give you my understanding. It's the most important tool of understanding they possessed. From an Egyptian point of view, it's the key to eternal life. Arrow E points to a triangle within a triangle, which is the Egyptian hieroglyphic for the star Sirius, the symbol for Sirius A and Sirius B. Point F is just a name, called a cartouche. The bird at the top right is a vulture, which is sacred to the Egyptians and associated with the movement from one level of consciousness to another. I'm not going to go into the other things in the picture, but these are some of the tools the early Egyptians used.



Fig. 5-3. Geometric images from the Old Kingdom.



Fig. 5-4. Resurrecting Osiris.

for resurrection. These tools were connected with resurrection, not ascension. There's a difference between the two. What is the difference? First of all, there's dying, a process where you go into the void state immediately after death. You're unconscious, unaware of the dying process to the degree that you have no control over the images. This way of dying takes you into the third overtone of the fourth dimension, which results in your cycling back into this Earth existence again and again—reincarnation. Because you're unconscious in this cycle, you're not using your Mer-Ka-Ba except unconsciously, so once you get to the other side, you don't have any memories of this side. When you reincarnate back to Earth again, you don't have any memories of where you just came from, either. So the reincarnating just keeps going on and on. It's a lot of energy moving very slowly. You eventually get through it, but it's a very slow process.

When you go through resurrection, you're aware and conscious of your Mer-Ka-Ba, though usually you don't become fully aware of it until after you die. You die, you drop the body and *then* you become aware of your Mer-Ka-Ba. Then you re-create your body and go through a process that leads you into either the tenth, eleventh or twelfth overtone of the fourth dimension. From there you don't go through reincarnation anymore. Your memory is never blocked again and you continue on into eternal life.

There's a big difference between dying and resurrection, but there's an even greater difference in ascension—which is now possible, since the grid was completed in 1989. Ascension was highly unlikely until this grid was complete. In as-

ension you don't die at all; there's no death process involved as we know it. Of course, it is true that you no longer are on Earth, and from that point of view, you die. What happens is, you simply become aware of your Mer-Ka-Ba one way or another—either remembering it on your own, being taught it or however it happens to you. This means you become aware of your body as light. Then you're able to pass through the Void totally consciously—from the Earth side through the Void to the higher dimensions, aware the whole time. In this way you simply walk out of this life without going through the death process, which involves reconstructing your human body. When a person ascends, he/she simply disappears from this dimension and reappears in the next, passing through the Void.

Ascension is now completely possible, and this book is one possible set of instructions on exactly how to accomplish this process. You personally might not pass through ascension; you might actually die or go through resurrection. It doesn't make much difference at this point in the game of life on planet Earth, because if you die in the normal manner, you'll go into the third overtone and into a holding pattern for a while. Then when the rest of the Earth cycles through this



coming change, all people on that third overtone will also rise to the same dimensional level as those who resurrected or ascended. Even the Bible refers to this, saying that at this time the dead will rise. There is no such thing as death; there are just different states of being. It's a little like water, which can be a liquid, solid (ice) or gas (fog), but it is still water.

Right now very few human incarnations are occurring on Earth except under certain conditions. This is probably your last life, folks—this is it! Of course, there are exceptions to almost all rules, so there may be a few on this Earth who have decided to reincarnate. Time is running out. If we make it to the end of this century, I'll be amazed. I seriously doubt if the third dimension will still be available for human life by that time. Only God knows for certain. Where are the people coming from who are being born on Earth today? Not from here! I'll explain when I talk about the new children.

### *When the Sun Rose in the West*

As Egypt began to evolve, it developed into two countries, Upper Egypt and Lower Egypt. Upper Egypt was south and Lower Egypt was north. Egyptians named Upper and Lower Egypt in this sort of reverse way of thinking because in their earlier life as a country during Atlantis, the Earth was rotating in the opposite direction and the magnetic poles were reversed. Our present north was then south and vice versa. Not only did the poles shift their position after Atlantis, but the Earth actually rotated in the opposite direction. Thoth said that he's gone through five pole shifts:

He's seen the Sun rise in the east and he's seen it rise in the west, then in the east, the west and again the east—five times!

On the ceiling of the temple at Dendera, which is the heart chakra of the male aspect of the Christ grid, is an astrological zodiac that demonstrates this reversed polarity. The zodiac rotates in the opposite direction, as if the Sun rose in the west instead of the east [Fig. 5-5]. The River Nile flows from south to north, whereas almost all the other rivers in the world flow from north to south. This indicates to me that the Egyptians held onto the older energy flow even in the Earth.

We are the creators of our universe. People involved in Sufism may remember Sufi Sam, also known as Murshid Sam Lewis. He was buried—in the early '70s, I believe—at the Lama Foundation in New Mexico. There's a plaque over his grave that reads: "On that day the sun will rise in the west, and all men seeing will believe." He was referring to the time that's coming. When the poles shift this next time, there will be a reversal of the Earth's rotation, thus the way we move in relation to the Sun.



Fig. 5-5. The Egyptian zodiac, shown flowing in the opposite direction even though this depiction was done in the present age.

## *Osiris, the First Immortal*

Prior to Egypt, during Atlantis, existed the Naacal Mystery School headed by Ay and Tiya and a thousand members from Lemuria. It was located on the island of Udal, north of the mainland. They were trying to teach the Atlanteans how to become immortal. The only thing is, either they weren't very good teachers then, or the people just couldn't get it, because it took 20- to 30,000 years before one person finally achieved the immortal state of being. The first person to make it was Osiris, who was not Egyptian, but Atlantean. The story of Osiris didn't happen in Egypt, even though it talks about the Nile, but in Atlantis. Though most of you know this story, I'll tell it anyway, in a condensed form.

There were two brothers and two sisters from the same family. Their names were Isis, Osiris, Nephthys (or Nefus) and Set. Isis married Osiris and Nephthys married Set. At the point where this story begins, Set killed Osiris. He put Osiris' body in a box and floated it down the Nile, though it was really another river in Atlantis. This killing disturbed Isis, and she and her sister, Set's wife, went out to look for Osiris. They found his body and brought it back, intending to bring Osiris back to life. When Set found out, he cut Osiris' body into fourteen pieces and spread them all over the world so that his sisters could not bring him back to life. Isis and Nephthys then went out looking for these pieces to put him back together. They found thirteen of the fourteen and assembled the pieces, but they never found the phallus, the fourteenth piece. It was Thoth (who was in Atlantis as well as Egypt) who, through magic, restored the fourteenth piece. This restored the creative energy flow, brought Osiris back to life and, in addition, gave him immortality.

From the Egyptian point of view, it was through sexual energy that immortality was reached. (Remember, it was through sexual energy, tantra, that immortality took root in Lemuria.) I'm going to leave the last element of this story until another appropriate moment, because a certain understanding needs to come first. But notice that Osiris was first alive, walking around in a body in the first level of consciousness. Then he was killed and his body was cut into pieces. He was separated from himself—this was consciousness level two, our level. Then his pieces were brought back together and he was made whole again, which put him into the third level of consciousness, which is immortality.

He went through three levels of consciousness. The first one was whole, the second one was separated from itself, and in the third level all the components were brought back together. This made him whole again and also made him immortal; he would no longer die. When Osiris finally got through all this, he came back as an immortal being, the first resurrected master of Atlantis. So they used Osiris's understanding of how he became immortal as the template for how other people could reach the same state of consciousness. This became the religion of Atlantis and later on the religion of Egypt.

## *The Transpersonal Holographic Memory of the First Level of Consciousness*

Atlanteans, because of the way their brains functioned, had complete memory. They remembered everything that had ever happened to them. And their memory was *transpersonal*, which means that anything one person remembered,

the others in their race could remember. The Aborigines in Australia have this type of memory right now. When anything happens to one Aborigine, any other can reexperience it anytime he or she wants. If an Aborigine were to walk into this room right now, he or she would in effect be giving the experience to all of their race anywhere on the planet.

You see, they're on the first level of consciousness where they're not separated from themselves. We're on the second level and are very separated from ourselves. Like the Atlanteans, Aborigines don't have memory like our vague kind of recollection; they have full-tilt 3D holographic memory. They could reconstruct this room moment by moment through the entire workshop, and all the rest of them could walk around in here and look at it. They could walk up to your table and look into your eyes. It wouldn't be real time; it's what they call Dreamtime, like in a dream, but it's an absolute replica of the Reality. Their memory is perfect; they don't have any mistakes or flaws. Obviously, in that kind of culture the Atlanteans had no reason to write anything down. Why try to describe something with words when you've got the real thing?

They didn't need it; however, the Martian aspect did need it, so they had a written language. Even after the Fall, the Egyptians (and others) had an amazing ability to remember. At that point they had lost their holographic and transpersonal memory, but they still had *photographic* memory. When the mystery school students were doing the complicated kind of training we'll be doing soon, they could do it all in their head. With our less efficient memory, we cannot do this in the same way they did; we have to struggle just to remember someone's name. The complexity will increase as we progress, making it difficult to remember from photo to photo, but the ancient ones could do this completely in their head. There is something about doing this in your head that's important, so later I'm going to show you some illustrations that will assist you to do this yourself.

This experience holds a primary key for understanding the nature of creation. Re-create the illustrations that follow as if you were actually in the Void moving through the geometrical movements. Experiencing it gives you the understanding that the circles on the page represent actual movements, and that these geometrical movements of spirit in the Void are the beginning and end of creation.

### *The Introduction of Writing, Which Created the Second Level of Consciousness*

*The Forty-Two Books of Thoth* record that after the Fall, when the Atlanteans got into Egypt and were no longer experiencing full memory, writing was introduced. In fact, it's written right in the Egyptian records that it was Thoth who introduced writing to the world. This one act completed the "fall" and threw us out of the first level of consciousness and fully into the second, because it changed the way we accessed memory. It sealed our fate.

This act of learning how to write caused us to grow the top half of our skull from our eyebrows up. The simple act of introducing writing changed many factors in the way we perceive our Reality. To get at our memory now, we have to go in and pull out the desired information with a code. We go in with a word or a concept to bring back the memory of whatever it is. In fact, we can't even remember something without having certain eye movements. Our eyes have to

move in certain ways in order for the memories to flow out. The Egyptian memory system was vastly different from the way it was before the Fall. Comparing this change of memory to the Osiris saga, the Egyptians had entered the stage where they were in separate pieces, where they were inside their bodies, thinking they were separate from the rest of Reality. This feeling of being separate was, of course, destined to change many aspects of how human beings live.

### *The Roadblock of Polytheism: Chromosomes and Neters*

Now the plot thickens. Things were going well with the stair-step evolution plan. After a while Upper and Lower Egypt combined into one country under King Menes and the First Dynasty began. But as time went on, a serious problem developed which, if it had not been solved, would have caused major catastrophes for us in the twentieth century—in fact, we would not have survived as a planet. We wouldn't have had a chance. It seems like a not-so-important thing, but it was very important for some who watch over this planet. It had to do with the religious beliefs of the Egyptians.

As I said, the Egyptians no longer had full holographic transpersonal memory anymore, so they had to write down what their religion was. This writing is called *The Forty-Two Books of Thoth*. Donald Beaman, who lives in Boston, is the man who reconstructed this book. There were 42 books, with two more books set aside from the main body. Forty-two plus two represents the number of chromosomes of the first level of consciousness. Your chromosomes, as you are about to see, are geometric images and patterns that describe the entire Reality—not just your body, but *everything* in the Reality, from the most distant planet to the smallest plant and every single atom.

Inside his book you'll see what are called *neters*. Neters are gods, with a small *g*. This is one of the neters—Anubis [Fig. 5-6]. They are mythical human beings with animal heads, and each one represents a different chromosome, a different aspect and characteristic of life. Neters represent the pathway of how to go from the first to the second level of consciousness. The ascended masters used Osiris' particular genetic coding to help other people learn how to ascend. In other words, Osiris had lived the experience of ascension, and now the pathway was in his DNA, specifically the chromosomes. The genetic keys were then opened to the initiate through the neters, who represented Osiris' chromosomes.

But a problem developed from this way of representing their religion, especially as Upper and Lower Egypt again became more separated. Both Lower *and* Upper Egypt had 42+2 gods, or neters, representing these stages. But Upper Egypt had images slightly different from those of Lower Egypt; the images had changed over time when the two countries were separate. When Menes put the two countries together as a single country called Egypt, in order to



Fig. 5-6. The neter Anubis.

be politically correct he adopted all these images. So now they had 84 + 4 gods representing the same religious ideas. That was probably a big mistake, because it got very confusing. For instance, in one area they would take one of the neters like Anubis and say, "This is God," with a big G. Another area would say, "Isis is God," and another area would claim Sekhmet to be their God.

So then there were 88 different ideas of God in the country. They would say, "My God is *the* God, and your gods are wrong." It became very separated and occult, and after a while no one had any idea that there really was only one God. They didn't understand what the Tat Brotherhood was trying to tell them. From our American point of view, this would be like a chromosome breakage; it was a mutation, and it was not correct. Even with all the help from the Tat Brotherhood, they just couldn't get it right, and it got worse and worse.

All the evidence I've seen indicates that the Christian religion came directly out of the Egyptian religion. If you study both of them, they're parallel in every single way *except* for the Egyptians' understanding of God. The Christian religion came back later and totally discounted the Egyptian religion, even though Egypt is the probable source of the origins of Christianity. The Christians saw the Egyptians as being occult. And they were, but it was because their religious belief had become corrupted, with the clear exception of 17<sup>1/2</sup> years during the Eighteenth Dynasty.

## The Rescue of Human Consciousness

### *Akhenaten's Life: A Brilliant Flash of Light*

For a very short period of 17<sup>1/2</sup> years, a brilliant flash of light appeared, then disappeared again. And that brilliant flash of white light is what saved our spiritual lives. It began in approximately 1500 B.C., when the worshiping and arguing over so many gods was prevalent. The ascended masters finally decided that something must be done. Finally they chose a plan. Thoth told me the following story.

As the first step, they decided to bring in an actual Christ-conscious being in an actual Christ-conscious body so we could put back into the akashic records the memory of what Christ consciousness was all about. It had been lost in the Fall. This Christ-conscious body would be much taller than those on the planet at the time. This would be an example for the Earth people to see. That was the first part of the plan. It was a very bold step, and they did it.

The ascended masters had decided that the Christ-conscious person should become king of Egypt. In order to do this, they had to break all the rules, and I mean all of them. What they did was approach the king of that period, Amenhotep II, and ask him for a favor. Thoth simply walked into the room physically, went right up to him and said, "Look, I'm Thoth," which I'm sure was difficult for the king to believe. By that time the Egyptians probably thought that all those neters in their

stories were mythical. Yet here's a real person standing there who was one of the neters. Thoth said, "We have a serious problem here in Egypt, and I need your help."

Thoth somehow got Amenhotep II to do something that no Egyptian king would ever do. Amenhotep's son was about to become king, and Thoth said, "I want your son to *not* become king; I want to put an outside lineage onto the Egyptian throne." Amenhotep II agreed to it. It must have been a pretty profound experience, I don't know what Thoth did—he probably came in glowing or levitating or something like that. But he did something to convince the king that it was necessary. Once they received the king's permission, they had to actually create the living body, which was not easy.

### *Creating the Bodies of Akhenaten, then Nefertiti*

So how did they do this? They went to Ay and Tiya—who were very, very old, no matter how you look at it—and said, "We would like you to have a baby." They had to go to someone who was immortal to get the immortal genes, because they have a different chromosome count—46 + 2 instead of 44 + 2. Ay and Tiya agreed, and they had a little baby. The baby was given to Amenhotep II to become the next king.

So the little baby grew up and became king. He became Amenhotep III, who then mated; I am not sure if it was physically or interdimensionally, and I don't know who it was, but he would almost have *had* to mate with someone who had the higher chromosome levels. Anyway, their baby boy became known as Amenhotep IV, and that baby was the one they had special plans for. That baby, Amenhotep IV, has a more popular name, which you know as Akhenaten.

Meanwhile Ay and Tiya waited a generation and then had another baby. That baby was a little girl whose name was Nefertiti. Nefertiti grew up with Akhenaten, and then they married. They were really brother and sister because they had the same bloodline. The Osiris story is similar—brother and sister marrying and becoming a new possibility in life. So these two people grew up and became the king and queen of Egypt.

### *The New Rulership and the One God*

For a while Amenhotep III and his son Akhenaten ruled the country together—two kings at the same time, again breaking the rules. Meanwhile they built a brand new city called Tel el Amarna in the exact center of Egypt. We still don't know how they got it in the exact center. Akhenaten put a stone there that says, "This is the center of the country." Today we could not have done it better from a satellite. It makes you wonder who these people were who could locate right down to the square inch the center of a country hundreds of miles long. It's pretty amazing. They built an entire city out of white stones. It was beautiful—it was space-age.



Akhenaten and his father ruled the country simultaneously from two places for a while—from Thebes and from Tel el Amarna. The father resigned the throne while he was still alive—which again breaks the rules—and gave the country to Akhenaten, who then became the first pharaoh of Egypt. There were no pharaohs before Akhenaten, only kings. Pharaoh means *that which you will become*. In other words, they were showing the people what they would literally become in the future. Akhenaten, Nefertiti and their children were not exactly human.

This tall figure [Fig. 5-7] is Akhenaten. I'm going to talk about this picture for a moment. Akhenaten's main purpose was to break up all the occult religions and bring the country back to a single religion where they believed that there was simply one God. At that time all the people were worshiping statues, so they were used to believing in things. Akhenaten had to give them something to see to believe in, so he gave them the image of the Sun as God, because this image was something they couldn't stick on their altars again.

There was another reason he gave them the image of the Sun. He told them that the breath of life, the prana field, came from the Sun. This is true in terms of third-dimensional thinking, though prana is really anywhere and everywhere—there are infinite amounts of it at any point. Since prana also comes from the Sun, this image shows the Sun's rays coming down; and on two of the rays are little ankhs, which the rays are holding up to the nose, to the breath, showing that eternal life is through the breath.

In this same picture you also see the lotus, the national flower of Atlantis. It was the Naacals who brought the lotus to India. The Naacals are written about in Indian Sanskrit writings and are talked about even in modern times. They came long before Buddha and were there during Buddhist times. In Egypt the lotus flower represented Atlantis, and in this picture you see them out of the vases. Everyone knew that Atlantis was dead, but they were still paying homage to it by having the lotuses out



Fig. 5-7. Akhenaten teaching about God, a copy of the carving in Fig. 5-8.



Fig. 5-8. Akhenaten teaching about God, original carving.

before. You see ducks that look like ducks [Fig. 5-9], just like we see in modern art. This is important to remember when you're looking at art of the Eighteenth Dynasty, because that means that whatever you see is exactly what the artist saw. They were not allowed to lie.

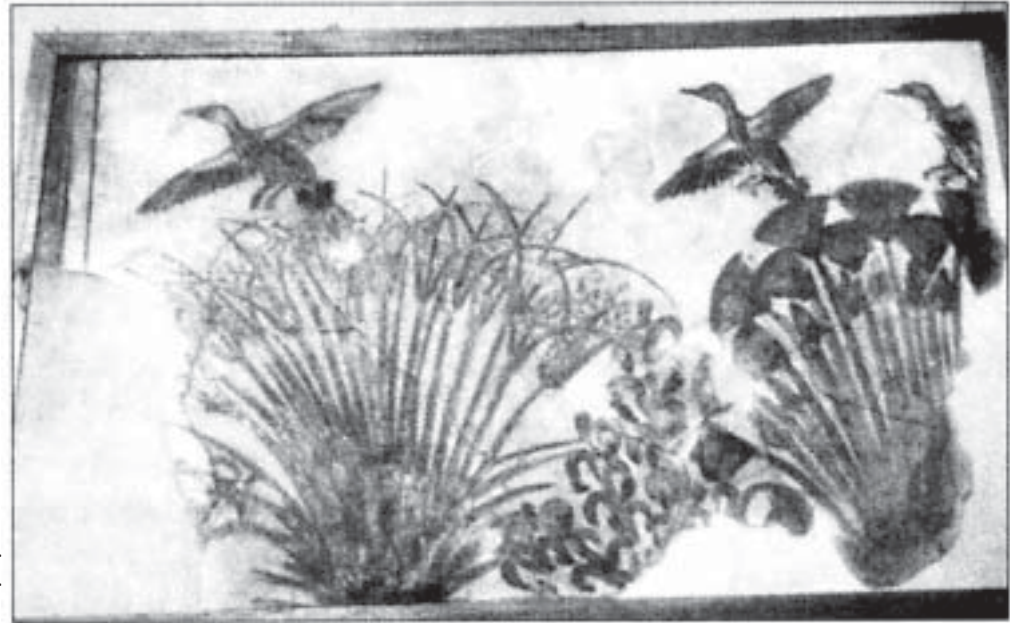

Fig. 5-9.  
Truth in ducks.

of the vase. Figure 5-8 is the original wall carving.

Notice that Akhenaten, the main figure, has a long, skinny neck, skinny hands, a high waist, wide thighs and skinny legs. The usual Egyptian explanation is that he had a disease and was deformed—of course, so was Nefertiti and all their daughters. (Evidently they all had the same disease.) I believe something very different.

### *The Reign of Truth, Which Depicts a Different Genetics*

Besides making the religions monotheistic again, Akhenaten also said, "In this new religion we're not going to have any more lying, no more untruthfulness. And we're going to change our art so that it reflects the total truth." So during the Eighteenth Dynasty— never before nor after—there was a totally unique art form. The artists were instructed to sculpt or paint things just as their eyes saw it, like a photograph. So began an art that looked realistic instead of stylized, as it had been





Fig. 5-10. Maat, the neter of truthfulness.

allowed to wear clothes during the Eighteenth Dynasty except for ceremonial and other special purposes.

This neter's name is Maat [Fig. 5-10]. That's a feather on top other head. She became one of the most important neters in this new religion because of her name, which translates as truth or *truthfulness*. She was the important issue in everything. Everything was to be absolutely truthful, and there were to be no distortions, no lies, so that everything could get back into focus. This was an important part of Akhenaten's teachings.

One of the caskets had the Flower of Life etched directly over the head of the mummy inside, and the second casket held the bones of a seven-year-old boy—but he was eight feet tall! That casket is sitting in the basement of the Cairo Museum at this moment—at least it probably is. It's the only real proof so far of what these bodies looked like. From Thoth's teachings, this statue of Akhenaten is exactly what he looked like, just as if you took a photograph of him.

This is a statue of Akhenaten in the Cairo Museum [Fig. 5-11]. Akhenaten was 14<sup>1/2</sup> feet tall, not counting his headdress. When I stood next to this, the top of my head came up to the widest part of his hips. Nefertiti was ten feet-something. She was actually small for her race. The daughters were also very tall. This is according to Thoth. Hard evidence of this has recently come into official hands, and they don't know what to think about it. They found two caskets in Tel el Amarna, Akhenaten's city.

This issue about truth was taken to such an extreme that they were not even allowed to wear clothes, because wearing clothes was hiding, and that was a form of lying. No one was al-



Fig. 5-11. Statue of Akhenaten in the Egyptian Museum, Cairo.



Fig. 5-12. Bust of Nefertiti, State Museum, Berlin.

This is a bust of Nefertiti [Fig. 5-12] that was found in Tel el Amarna. There is almost nothing left of that city. At one point the city was dismantled brick by brick and spread all over the world. The Egyptians did not want you to know that Akhenaten and Nefertiti had ever lived. The only reason we do know is because they had buried some things in rooms deep underneath the ground that earlier people didn't find. This bust



Fig. 5-13. Nefertiti in the nude.

was found there. Many people think of Nefertiti as a very beautiful woman, but they don't realize that she was extremely tall and that her body was very unusual in certain ways.

Figure 5-13 is a little-known statue of Nefertiti found in the same room as the bust. She's not wearing clothes because they didn't believe in that at the time. She had a huge head, large ears, a long, skinny neck and a high waist. She also has a kind of bulging tummy. And if you could see the rest other, she has skinny legs and wide thighs.



Fig. 5-14. Two of Nefertiti's and Akhenaten's daughters.



Fig. 5-15. Another daughter.

These are two of their daughters [Fig. 5-14]. Their skulls are enormous and they have high waists, skinny calves and huge ears. This is another one of the daughters. [Fig. 5-15] I feel certain that it is exactly what she looked like. If you could see that head from the back, you would see its size. It was big. It's hard to see the size of these ears until you actually get right next to it.

Figure 5-16 is another daughter, younger than the last one — little neck, huge skull extending back.

Fig. 5-16. A younger daughter.

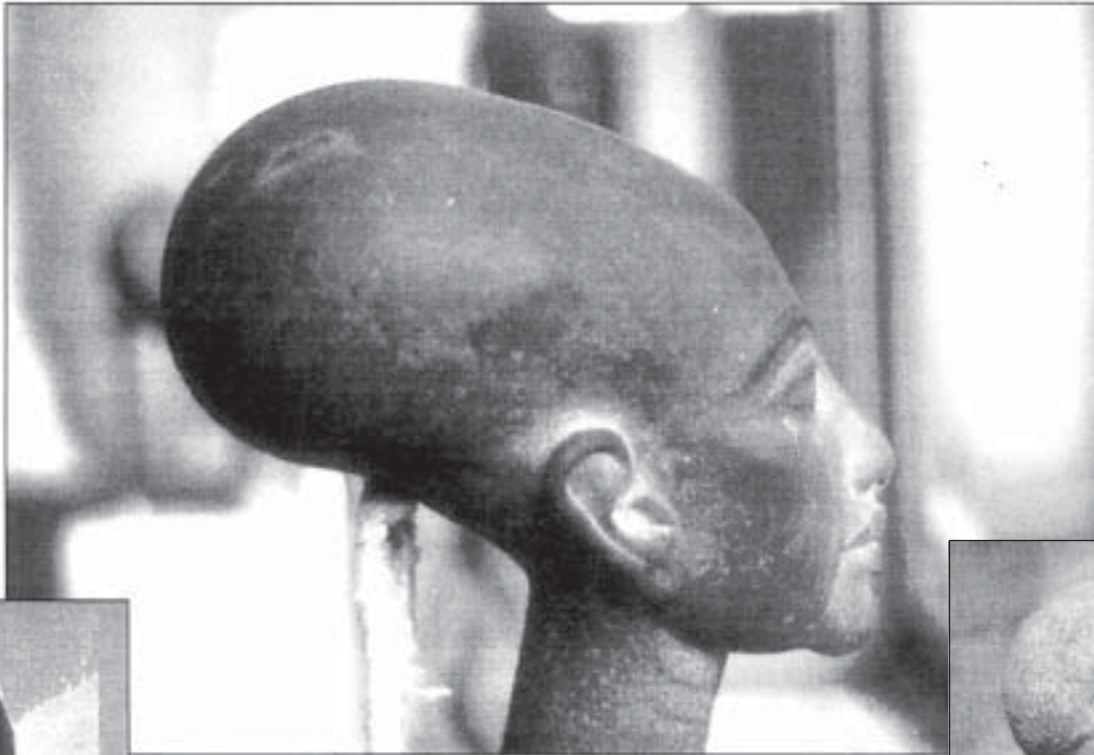

Fig. 5-17. Teenager of one of the daughters.



Fig. 5-18. Another young daughter.



This is an image of one of the daughters as a teenager. [Fig. 5-17]

This is another [Fig. 5-18]. You can see how big the head is relative to the body.

This is a baby [Fig. 5-19]. Again, the skull goes way up and around. The ears are about half the size of the head.

Physiologically these bodies are vastly different from human bodies. There are all kinds of differences—brain differences and other unusual things. For example, they have two hearts. The only reason we have one heart is because we have one sun. But these are Sirian beings—actually, they were members of the 32 beings who were sitting around the original flame—and their bodies are from the star Sirius. The Sirian star system has two stars, Sirius A and Sirius B. It's a binary system, as are a vast majority of the star systems. And in those systems life forms have two hearts. If there's only one sun, life forms have one heart. (If there are more stars than two in the system, there will still be two hearts.)



Fig. 5-20. Bust of King Tut.

### *King Tut—and Other Elongated Skulls*

This is King Tut [Fig. 5-20], who took over directly after Akhenaten was disposed of. King Tut was only eighteen years old when he became king. Nobody knows for certain where he came from. The slide says he was a son-in-law of Nefertiti and Akhenaten, married to their daughter. He was obviously part of this lineage, though his skull doesn't appear as big. But he does have the big ears. According to Thoth, King Tut was allowed to take over for only one year. He ruled during the transition between Akhenaten and the next phase. King Tut was in telepathic communication with Nefertiti while she ran the country through him for that one year. She was in hiding.

This is the museum at Lima, Peru [Fig. 5-21]. I just want to note that they also have some pretty amazing skulls there. Peru is another of the places Thoth went to. They found these skulls [Fig. 5-22] in Peru, just like those in Egypt. These large skulls are



Fig. 5-19. A baby in Akhenaten's family.



Fig. 5-22. Skulls found in Peru.



Fig. 5-21. Museum in Lima.

found in three areas of the world: in and around Egypt, Peru and Tibet—nowhere else, at least that I know of. Remember, these are the primary areas where these beings went.

This was one of my teachers [Fig. 5-23], who is now dead. His name was Kalu Rinpoche, a Tibetan lama. I've had many teachers, but I feel especially close to this one; I really love him a lot. Notice the shape of his skull.

### *Memory: The Key to Immortality*

You might wonder, If Akhenaten and others were immortal, then why are they dead? I'll give you the definition of immortality from a Melchizedek point of view,

which hopefully will help. Somebody else may have a different definition, but this is what we feel. Immortality has nothing to do with living in the same body forever. You're going to live forever anyway; you have always been alive and you always will be, but you might not be conscious during all that time. The definition from our point of view has to do with memory. When you become immortal, you reach the point where your memory remains intact from then on. In other words, you're conscious from then on, with no unconsciousness coming in. It means you stay in the body as long as you want to, and when you want to leave it, you leave. To have to stay in a single body forever would be a jail or a trap, because it means you couldn't leave. There might be a reason for leaving that body, and you will eventually find that you want to go beyond wherever you are. This is the definition of eternal life: Simply put, you have continuous, unbroken memory.

Back now to what happened after Akhenaten was dethroned. In order to let things get back to the old ways, which they wanted to do, the country went into a transitional state. The people who became king and queen directly after him are almost comical—they let Ay and Tiya take over the country. We have a long time lag here, then they became king and queen. It's written right in the records. They took over for around thirty years, and then they gave it to Seti I, who became the first king of the Nineteenth Dynasty. He immediately changed everything back to the old way, erased everything and called Akhenaten the same name they called Jesus—"the criminal." He called him the worst king who ever lived because of his teaching that there was only one God.



Fig. 5-23. Kalu Rinpoche.

## *What Really Happened to Akhenaten?*

Most of Egypt hated Akhenaten, except for a small group. The priesthood hated him most of all because Egyptian religious beliefs were centered on the priests. They controlled the people, their way of life and the economy. They became rich and were more powerful than anybody else. Then Akhenaten came along and said, “You don’t need priests; God is within you. There is only one God, and you can access God from within your own self.” The priests reacted to protect themselves and their vested interests. Also, Egypt had the most powerful military in the world, and when Akhenaten became pharaoh, they were chomping at the bit, ready to go out and take over the world. Akhenaten said no. He was a complete pacifist and said, “Come back onto our soil. Do not attack anyone unless you’re attacked.” He made the military come back and sit by idly, and they didn’t like that.

So he had not only the priesthood, but the military against him. On top of that, the people themselves were into their little religions, and they loved worshiping their little gods. This wouldn’t ultimately do them any good—it wouldn’t get them where they needed to go according to the DNA plan of the universe—which was back home to God, to the one God—but nevertheless they were really into what they were doing.

When the people were forcefully told that they could no longer do certain religious acts, this caused great animosity toward Akhenaten. It would be like our president saying, “Okay, there are no more religions in the United States; there’s just the president’s religion.” And if the president brought all the military back onto American soil with an isolationist point of view, he wouldn’t be very popular. Neither was Akhenaten. But he knew that he had to do it no matter what, even if it meant his own death. He had to do it to correct the pathway that our collective DNA had encoded into the Reality. In addition, he needed to put into the akashic records the memory of the sacred purpose that Christ consciousness held.

So what happened then? According to the accepted history, the priesthood and the military got together and gave Akhenaten a poison that killed him. According to Thoth, that is not exactly what happened, because they *couldn’t* kill him. He could drink the poison, but it wouldn’t hurt him. They did something much more exotic. Thoth says that the priesthood hired three black Nubian sorcerers, who made a concoction similar to what is used in Haiti today to make someone *look* dead. It was given to Akhenaten at a public meeting called by the priesthood and the military. After Akhenaten drank the liquid, all life signs appeared to stop. As soon as the royal doctor pronounced him dead, they rushed him off to a special room where they had a sarcophagus waiting. They placed him in the sarcophagus, put on the lid with a magical seal and buried it in a hidden place. Thoth said that Akhenaten had to wait inside the sarcophagus for almost 2000 years before a piece of the seal broke away and the magic was broken. He then returned to the Halls of Amenti. This was not a problem for Akhenaten. Thoth said that to an immortal being like Akhenaten, it was more like a nap. My question is, did he really allow this to happen to him?



## *Akhenaten's Mystery School*

What's important here is one fact: Akhenaten developed a mystery school. The school was called the Egyptian Mystery School of Akhenaten, the Law of One. As it turned out, he had only 17<sup>1/2</sup> years to produce results. He brought students from the Left Eye of Horus (the feminine side) Mystery School, which I'll talk about later—graduates who were at least 45 years old—into the Right Eye of Horus Mystery School. This right-eye information had never been taught before in Egypt. He taught them for twelve years, after which he had only five and a half years to see if he could get them to live immortality. And he did it! He got about 300 people into immortality. I believe they were all, or almost all, women.

Someone once asked, "Why didn't Akhenaten work with the population in a different way so as to not get himself into such a dangerous situation?" But can you think of a way to change a whole population in such a short time without causing strife? Could you do that in the United States right now—in one year bring all religions into one? I don't think there is a way except to just do it, even if it means getting "killed." Besides, the only thing he really needed to do was simply live his life. It would get into the akashic records and be a memory that we all have in our DNA. One day alone would get it encoded, then afterward they could do whatever they wanted with him. He wasn't really concerned about it. He knew that the country, the society and the customs would all go back to the old way. But he did have these 300 immortal people who would go on beyond him and Egypt. .

## *The Essene Brotherhood and Jesus, Mary and Joseph*

After Akhenaten was gone, the 300 immortal Egyptians joined the Tat Brotherhood and waited from roughly 1350 B.C. to about 500 B.C.—about 850 years or so. Then they migrated to a place called Masada, Israel, and formed the Essene Brotherhood. Even today Masada is known as a capital of the Essene Brotherhood. These 300 people became the inner circle, and mostly ordinary people formed an outer circle, which became very large.

Mary, the mother of Jesus, was one of the members of the inner circle of the Essene Brotherhood. She was immortal even before Jesus became immortal. Joseph came from the outer circle. This is according to Thoth; it's not written in the records. It was part of the Egyptian plan that the next step would be to bring in someone who would demonstrate *exactly how* to become immortal when starting as an ordinary human, put the experience into the akashic records and make it real. Somebody had to do it. According to Thoth, Mary and Joseph came together and mated interdimensionally (which we'll talk about later) to create the body for Jesus, which would allow his consciousness to come in from a very, very high level. When Jesus first came in, he began life on Earth as human as any of us. He was totally human. And through his own work he transformed himself to the immortal state through resurrection, not through ascension, and put into the akashic records the process of exactly how to do it. This is according to Thoth, and it was planned a long, long time before it ever took place.

## The Two Mystery Schools and the 48 Chromosomal Images

We're now changing direction again and beginning a new system of knowledge that will continue for a while until you see this symbol again a long way down the line. This was the symbol for the Egyptian Mystery School of Akhenaten, the Law of One [Fig. 5-24]. It's the Right Eye of Horus. The right eye is controlled by the left brain; it's male knowledge. Although the right eye "sees" directly to the right brain, this is not what the Egyptians were communicating. It is not the "seeing" but rather the *interrupting* of the "seeing" information that was important here. It is the left brain that makes this interruption of what is seen; it controls the right side of the body, and vice versa. In the same manner, the Left Eye of Horus, controlled by the right brain, is female knowledge, which was taught in the twelve primary Egyptian temples along the Nile. The thirteenth temple was the Great Pyramid itself. It took twelve years of initiation, spending a year, one cycle, in each of these temples learning all the feminine components of consciousness.



Fig. 5-24. Symbol for the Right Eye of Horus Mystery School.

But the male component, the Right Eye of Horus, was taught only once, and it was not written down anywhere. It was purely an oral tradition, though its primary components are etched on a single wall under the Great Pyramid that leads into the Hall of Records. As you go down that hall, you get almost to the bottom, and just before it makes a 90-degree turn, high up on the wall you see an image about four feet in diameter, which is the Flower of Life. Beside it you would see 47 other images, one after another, which are the images of the chromosomes of Christ consciousness, the level of consciousness we're

moving into now. After these two volumes are published, we may publish a book of these images.

These images will be given throughout this book, mixed up and in slightly different form. This is what the Great Pyramid is all about. Its primary purpose, beyond anything else, is to take someone from our level of consciousness into the next level. There are lots of other reasons why it's in existence, but ascension and resurrection are the absolute purpose.

## Genesis, the Creation Story

### *Egyptian and Christian Versions*

We're going to begin with a realization that the Christian and the Egyptian understandings of Reality are almost identical. The Christian understanding is derived from the Egyptian. Here are the first three sentences of the Christian Bible: "In the beginning God created the heaven and the earth. And the earth was without form and void, and darkness was upon the face of the deep, and the spirit of God moved upon the face of the waters. And God said, 'Let there be light,' and there was light."

To begin with, this statement that the Earth was without form until it came out of the Void, out of nothing, is exactly what the Egyptians believed. It's also what many other religions believe. Both Egyptian and Christian religions believe that all that's needed to start the process of creation is *nothing* and spirit, and when those two concepts are brought together, then all things can be created. They believe that creation begins by the *movement* of spirit. In the second sentence it says, "The earth was without form and void" and that the spirit of God *moved* upon the face of the waters. Then in the very next sentence, God says, "Let there be light." The movement happened first, then the light happened immediately after.

According to the Egyptian belief, one tiny detail was left out of the current Christian Bibles. It isn't necessarily wrong in the older Bibles, though. There are 900 versions of the Bible in the world, and in many of the older ones the first sentence says, "In the beginning there were six." It starts out in other ways too; it's been changed many times over the years.

The ancient Egyptians would say that the way our modern Bibles begin creation is impossible, especially if you think about it from a physics point of view. Imagine a dark, infinite space that goes on forever and ever in all directions. There's nothing in it—just infinite space with nothing in it. Imagine yourself—not your body, but your consciousness—being in the middle of that. You're just floating there with nothing. You can't really fall, because where would you fall to? You wouldn't know if you're falling down or going up or off to the side; in fact, there's no way to experience any motion at all.

From a purely physics or mathematical point of view, motion itself, or kinetic energy, is absolutely impossible in a void. You can't even rotate, because motion cannot become real until there's at least one other object in the space around you. There has to be something to move *relative* to. If you don't have something relative to move to, how would you know you're moving? I mean, if you went up thirty feet, how would you know that? There's no change. With no change, there's no movement. So the ancient Egyptians would say that before God "moved upon the face of the waters," He/She had to first create something to move relative to.

## *How God and the Mystery Schools Did It*

Now, think of yourself standing in a dark room, near the door to a second room. You are ready to go into the second room, which is very, very dark. You can barely see the door leading into it. You go into the second room, close the door behind you, and it's pitch black.

When you're faced with that situation, you have the ability to project a sensing beam from your third-eye area, and you can also sense from your hands. (You can actually sense from any chakra, but people usually do it from their third eye or their hands.) You can project a beam of consciousness into that dark room for a certain distance. It might go only an inch, or maybe you can feel outward a foot or two, and you just know that nothing (or something) is in that space. Your consciousness goes out this distance and then it stops. Your knowingness quits, and you don't know what's beyond that. You probably all know what I'm talking about, though a lot of us have allowed that sense to retreat because we rely on our eyes so much.

But some people, especially the ancient Egyptians, were really good at this. They could go into a dark room and feel all around and know if anything was there even though they couldn't see a thing with their eyes. There are blind people who can also demonstrate this ability.

We actually have six of these sensing rays—not just one, but six. They all come from the center of our heads, the pineal gland. One ray comes out the front of our head at the third eye and another goes out the back; one goes out of the left and another out of the right side of our brain; and another goes straight up through the crown chakra and the sixth straight down through our neck—the six directions. These are the same directions of the x-y-z axes of geometry. The Egyptians believed that this innate aspect of consciousness is what allows creation to begin. They believed that if we didn't have this ability, creation would never have happened.

In order to understand this process of creation on the deepest level, Egyptian students were told to imagine and enact the process we are about to go through. The following description is how they explained and practiced it in their mystery schools. The way they learned isn't the only way it could have been done, but this is how they were trained.

The dark background in this picture represents the Great Void, and the little eye represents the spirit of God [Fig. 5-25]. So here's the spirit of God existing in the Void, out in nothing. Imagine that you're that little spirit in the middle of the Void. (When you're in the Great Void, by the way, you will realize that you and God are one, that there is no difference at all.) After hanging out in the Void for a long time, you probably would get bored or curious or lonely, and you would want to try something new, to have some new adventure in your life.



Fig. 5-25. Spirit of God in the great Void.

### *First Create a Space*

So spirit, the single Eye, shoots a beam of consciousness out into the Void. It shoots this beam first to the front, then to the back, then to the left, then the right, then straight up and straight down [Fig. 5-26]. Realize that whatever distance you project out front, you project the same distance out back, also to the left, the right and up and down. The consciousness beam projects the same distance in all six directions for any one individual. Even though each one of us is different in how far we can project this beam (one of us might project an inch, another two feet and another fifty feet), there is equality in all six directions. So spirit projects those beams outward in those six directions, defining space: north, south, east, west, up and down.

This might be why the American Indians and native people all around the world find the six directions so important. Have you ever noticed this in their ceremonies, how important it is that they define the directions? It's also important in the Kabala, in some of the meditations they do.

### *Next, Enclose the Space*

In the mystery schools, after they've projected these six beams in the six directions, the next thing they do is connect the ends of these projections. This forms a diamond, or square, around them [Fig. 5-27]. Of course, when it's at the angle shown in this diagram, it looks like a rectangle, but you can see that it would actually be a square. So they make a little square around their point of consciousness. Then from the square they send a beam up to the top, forming a pyramid around the base of the square [Fig. 5-28].

After they create the pyramid on top, they then send a beam down to the bottom point, forming a pyramid below [Fig. 5-29]. If you look at this in actual 3D space, the two back-to-back pyramids form an octahedron. Here's another rendition of the octahedron [Fig. 5-30].

Remember that this is just spirit. You don't have a body in the Great Void; you're just spirit. So you're in the Great Void, and you've created this field around you. Now, once you've defined the space by mapping out the Fig. 5-30. Octahedron around spirit, octahedron with two back-to-back pyramids, you have an object. Kinetic energy or movement is now possible; something is now possible that was not possible before. Spirit can move outside the shape and move around it. It can go in any

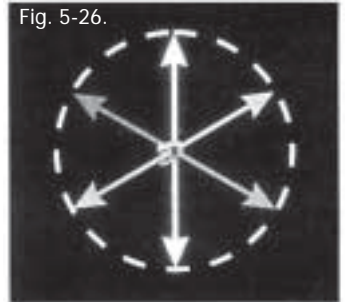

Fig. 5-26.

Spirit projecting consciousness into six directions.

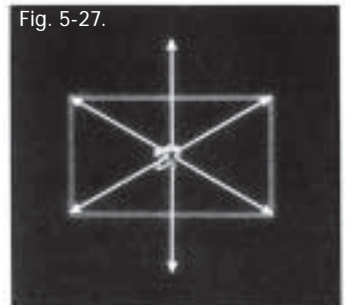

Fig. 5-27.

Spirit in its first created diamond.

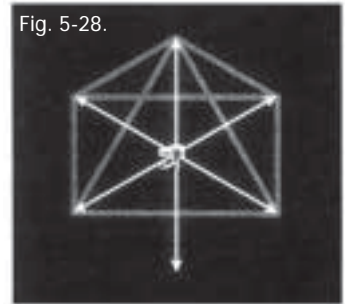

Fig. 5-28.

Projecting a pyramid above.

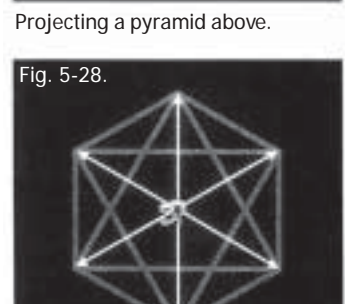

Fig. 5-28.

Projecting a pyramid below.



Fig. 5-30. Octahedron around spirit.

direction for miles and miles, then come back and have a center place for everything. The other thing spirit can do is remain stationary in the middle of the shape, letting the shape move instead. The shape can rotate or wobble or move in all possible ways. So relative movements are now possible.

### ***Then Spin the Shape to Create a Sphere***

The octahedron the students created this way had three axes—front to back, left to right, and up and down. They were told to spin the shape around one of the axes—it didn't matter which, and it didn't matter which direction. They would spin it one way or the other, then they would spin the shape once around another axis, and once around the third axis. With just one spin around each of the three axes, they traced the parameters of a perfect sphere. Before the students were allowed to move their own point of consciousness, they were taught to spin this octahedral form and create a sphere around themselves.

It has been agreed upon by everyone involved in sacred geometry that I know of, that a straight line is male and any curved line is female. Thus one of the most male forms is a square or a cube, and one of the most female forms is a circle or a sphere. Since the octahedron that spirit projected is made up of only straight lines, it's a male shape; and since the sphere is made of only curved lines, it's a female shape. What the Egyptians did was to create a male form and then convert it to a female form. They went from maleness to femaleness.

This same story is related through the Bible where Adam was created first, and then from Adam, or out of Adam's rib, was created the female. Of course, the image of spirit inside the sphere is also the image of the school.

Sacred geometry started when spirit made its first projection into the Void and created the first octahedron around itself. The Void is infinite—nothing in it—and these forms being created are also nothing. They're just imaginary lines created out of consciousness. This gives you an indication of what Reality is—nothing. The Hindus call Reality *maya*, which means illusion.

Spirit can sit in the middle of its first creation for a long time [Fig. 5-31], but eventually it'll make a decision to do something. To re-create this process, mystery school students were given instructions to reenact the same motions that spirit took. *Two simple instructions* are all that's required to create and complete everything in the entire universe.

### ***The First Motion in Genesis***

Remember that spirit is now sitting in a sphere. The instructions are to move to that which is *newly created*, then *project another sphere exactly like the first*. That does something very special and unique. This is an absolutely foolproof system for creating Reality. You cannot make a mistake no matter what you do. All you do is move to what is newly created and project another sphere the same size as the first one. In this system, since



Fig. 5-31. Spirit in the middle of its first creation.

nothing exists except this bubble in the Void, and the inside of the bubble is the same as the outside, the only thing that's new or different is the membrane itself, the *surface* of the sphere.

So consciousness decides to go to the surface. It makes no difference where it goes on the surface; it can go anywhere. It doesn't make any difference *how* it gets there either, whether it goes in a straight line or curves or spirals out or explores every speck of space in between. It can be really creative; it doesn't make any difference. But somehow or another it will end up somewhere on the surface of the sphere.

For purposes of this example we'll say spirit went up to the top (just to be symmetrical and easier to deal with). Anyway, spirit, this little single eye, lands on the surface [Fig. 5-32]. It has just made the first motion in Genesis: "And the spirit of God moved upon the face of the waters." And the very next thing was: "God said, 'Let there be light,' and there was light."

At this point spirit knows how to do only one thing—actually, it knows how to do two things, but the end result is one. It knows (1) how to project the little octahedron and create a sphere and (2) how to move to what's newly created. That's it, a very simple Reality. So once it arrives on the surface, it makes another octahedron, spins it through the three axes and forms another sphere identical in size to the first one. It's identical in size because its ability to project into the Void is the same. Nothing has changed in that respect. So it creates a second sphere exactly the same size as the first.

### ***The Vesica Piscis, through Which Light Is Created***

When it does that, it has done something that, in terms of sacred geometry, is very special. It has formed a vesica piscis at the intersection of the two spheres [Fig. 5-33]. Have you ever seen two soap bubbles together? When two soap bubbles intersect, a line or a circle goes around their linkage. If you were looking at the two bubbles from the side, the newly formed section would look like a line, but if you were looking down at the two bubbles from the top, you would see the newly created form's circumference *inside* the larger spheres.

The vesica piscis circumference is symmetrical to, and smaller than, the circumference of the larger spheres. In other words, it would appear from the side like a straight line [Fig. 5-34, center], and from the top like a



Fig. 5-32. Spirit's first motion.

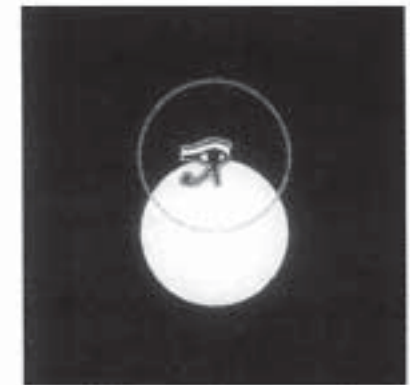

Fig. 5-33. First motion/day; the first two spheres of creation take a vesica piscis.

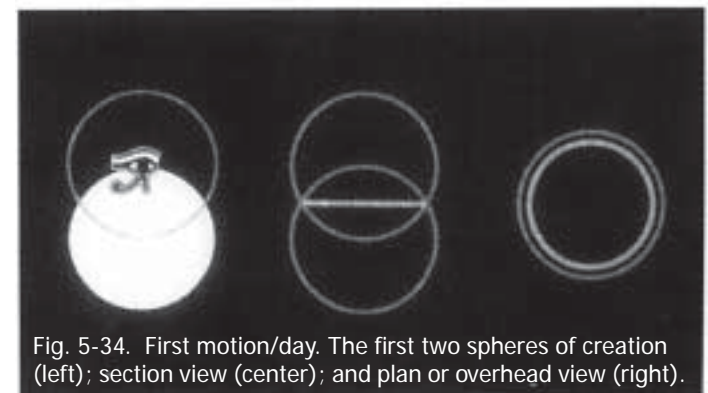

Fig. 5-34. First motion/day. The first two spheres of creation (left); section view (center); and plan or overhead view (right).

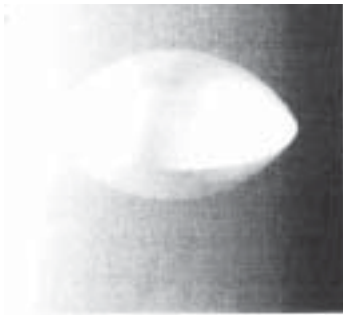

Fig. 5-35. A 3D vesica piscis, a three-dimensional solid shape taken out from the two spheres that made it.



Fig. 5-36. Third sphere, second motion/day of Genesis. When sitting in the center of uppermost circle/sphere and looking down, the horizontal line is seen as a circle.

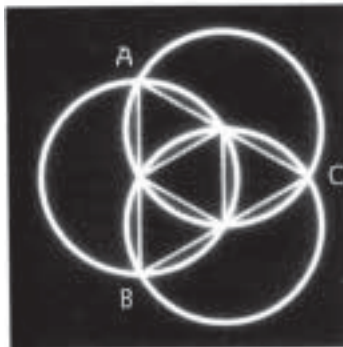

Fig. 5-37. Small and large tetrahedrons in three spheres.

circle [right]. Even though the vesica piscis is usually two-dimensional like a coin, its three-dimensional aspect is just as valid. If you were to take it out of the middle of the two spheres, it would look similar to a football, like Figure 5-35.

I cannot prove this to you now, but later in this book I'll be able to prove that this image is light. It's the geometric image through which light was created. It's also the geometric image through which your eyes were created, which receive light. Besides light, it's also the image of the patterns that are connected to your emotions and many, many other aspects of life. This is the basic geometry of the electromagnetic field. It's too simple to understand here. I have to wait until things get more complex; then I can explain it. I'll show you that the first motion of Genesis creates the pattern that is life. That's the reason why God said, "Let there be light." He couldn't say that until He had projected the second sphere and made the vesica piscis.

### *The Second Motion Creates the Star Tetrahedron*

When spirit is in the center of its second sphere and looking down at the vesica piscis, it's looking upon a newly formed circle, the circle of the vesica piscis. This circle is the only thing that's new, and spirit's instructions are to go to what's newly created. It doesn't make any difference where it goes on the new circle. It cannot make a mistake; it just moves to somewhere on that circle and projects a new sphere as in Figure 5-36.

No matter where spirit lands, we can rotate the spheres to look like this drawing. So I'm going to say that it moved on the circle to point A, on the left. At that moment a *huge* amount of information was created (in every motion of Genesis, vast amounts of knowledge come out). The first *creation* produced the sphere. The first *motion/day* produced the vesica piscis, which is the basis of light. The second motion/day produced, in the interpenetrating relationship between the three spheres, the basic geometries of the star tetrahedron [Fig. 5-37], which you will soon see is one of the most important shapes for life.

We're not going to get into all the information that was formed at this time, but each time a new sphere is formed, more and more information unfolds and more and more creative patterns become visible. After the first and second motions have taken place—from anywhere on the sphere to anywhere on the circle (no matter how spirit moved, no matter where it went on the circle/sphere, it will always be perfect)—it will begin to move exactly on the equator of the original sphere. There are an infinite number of equators on that sphere, but it will choose a perfect one.



## *“Move to That Which is Newly Created” until Completion*

After that pattern is created, there’s only one instruction left to follow—forever. The only other action to be taken until the end of time is always to move to the innermost *circle point(s)* and project another sphere.

For the sake of clarity, let’s define what we mean by “innermost circle point.” Look at Figure 5-36. In this case there are three innermost circle points. If your eye were to trace the outside perimeter of this pattern, it would come to three places that are the closest places to center. It is these “closest places to center” that we are calling the innermost circle points. In the case of the Genesis pattern that this movement of spirit is creating, there are six innermost circle points.

So with this in mind, spirit starts moving exactly around the equator of the original or central sphere. When it has traversed the full 360 degrees and reaches the point at which it started (which will be six points or movements), it begins to follow its second impulse (or instruction, for the mystery school students): Move to *the* innermost *circle points*, which are now located on the circumference of the original sphere where two vesica pisces intersect. Simply put, they are the points as close as possible to the outside of the pattern. That continual movement begins to form a vortex. This vortex motion creates different types of three-dimensional forms, one after another, which are the building blocks or blueprints of the entire Reality.

Once spirit has created the third sphere, it now moves to the innermost circle point and projects another sphere [Fig. 5-38]. There is information here, but it is too complex to discuss at this time.

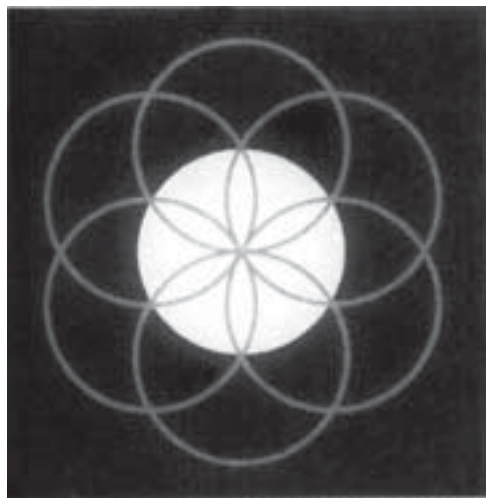

Fig. 5-41. Sixth sphere, fifth day of Genesis.



Fig. 5-41a. Showing a 3D view of this.

This is very interesting; it is the fourth motion/day [Fig. 5-39]. It says in many Bibles in the world that on the fourth day of Genesis exactly one half of creation was completed. Starting from the first motion, exactly one half of the circle was formed [Fig. 5-39a]. We have moved exactly 180 degrees from the point of the first motion.

Figure 5-40 is the fifth day of Genesis—more information.

And then on the sixth day [Fig. 5-41] a geometric miracle takes place:

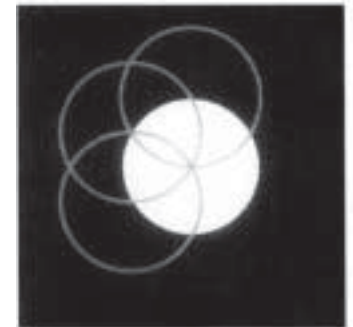

Fig. 5-38. Fourth sphere, third day of Genesis.



Fig. 5-39. Fifth sphere, fourth day of Genesis.

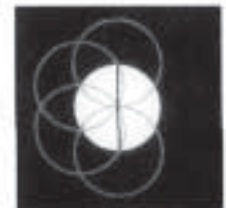

Fig. 5-39a. Half of creation

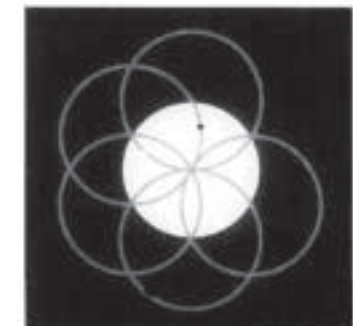

Fig. 5-40. Sixth sphere, fifth day of Genesis.

the last circle forms a complete six-petaled flower. This is what many of the earlier Bibles meant when they said, “In the beginning there were six.” Our Bible now says that creation was formed in six days, and this fits exactly. This is the pattern of Genesis, so we refer to it as the Genesis pattern. It’s the beginning of the creation of this universe we live in.

These original movements of spirit are really important. This is why I spend so much time going through this near the beginning of this course. Later on we’ll get more complex, but for now this is just the beginning of how the manifestation of Reality is created.

We’ll pull these 3D shapes off the page in a minute, one by one. If they could be made solid, you could look at them and hold them in your hands. We will begin to ground this abstract information into Reality for you. Then we’re going to take them further to show you how they actually create the Reality we live in. If you study this on your own, you’ll be seeing some extremely elaborate aspects of creation come from this explanation of the Reality. If you were constructing these geometries yourself, you would draw a line somewhere in the sacred geometry that spirit makes as it moves through the Void, and it’ll mean something amazing; then another line will mean something else even more amazing. Life began simply, then created the complex world we live in.

This is not just mathematics, and it’s not just circles or geometries. *This is the living map of the creation of all Reality.* You must understand this or you’ll get lost and won’t understand what this book is leading to. The reason we’re doing all this is so that your left brain can understand the unity of all creation so that polarity consciousness can be transcended.

## The Significance of Shape and Structure

### Developing the Genesis Pattern

#### *The Torus, the First Shape*

Let's look at the first object that comes off the page—the Genesis pattern itself (see Fig. 5-41). If you look at a math book, this Genesis pattern has the minimal amount of lines that can be drawn on a flat surface to delineate the three-dimensional form called a torus. A torus is formed when you rotate the Genesis pattern around its central axis, creating a shape that looks like a doughnut, but the hole in the middle is infinitely small.

A torus, here called a tube torus because this particular one is shaped like an inner tube [Fig. 6-1 ], is unique in that it's able to fold in on itself, turning either inward or outward. No other shape in existence can do this or anything similar. A torus is the first shape that comes out of the completed Genesis pattern and is absolutely unique among all forms in existence.

It was Arthur Young who discovered that there are seven regions on this shape, which are collectively called *the seven-color map*. You can pick up almost any mathematics book, and if you go to the torus, it'll talk about the seven-color map. There are seven regions, all the same size, that will exactly fit in the tube torus with nothing left over. Just like on the Genesis pattern, six circles going around the seventh, central one take up the entire sur-

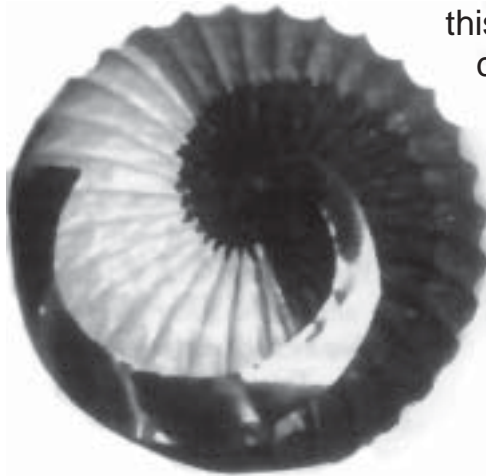

Fig. 6-1. The colorful tube torus.



face. It's perfect, flawless.

In sacred geometry there's something called ratcheting. You take a circle or a line and ratchet it, like when you take a ratchet tool in car mechanics and use it to rotate something a certain distance. For instance, imagine two Genesis patterns superimposed on each other. One pattern is fixed; if you rotate the other pattern 30 degrees, you would have twelve spheres around the central one. It would look like this [Fig. 6-2] in two dimensions. In three dimensions it would look like a tube torus. Then if you connect all possible lines in the middle, you get this pattern [Fig. 6-3].

Ratcheting the twelve spheres once more, this time 15 degrees, so that there are 24 spheres, you would get this pattern [Fig. 6-4]. This pattern has what is called a transcendental pattern associated with it. What is a transcendental pattern? A transcendental number in mathematics, from my way of looking at it, is a number that comes from another dimension. In that dimension it is probably whole, but when it gets here it does not completely translate into this world. We have a lot of those. One of them, for example, is the *phi ratio*, which I'm going to talk about later.

It's a mathematical proportion that starts out with 1.6180339 and continues forever, meaning you never know what the next digit is going to be, and it never ends: people have let computers run for months without coming to an end. As a simple explanation, that's what a transcendental number is.

The shape of the torus is what governs many aspects of our lives. For example, the human heart has seven muscles that form a torus, and it pumps in the seven regions shown in the map of the torus. We have embodied all knowledge. The torus is literally around *all* life forms, all atoms, and all cosmic bodies such as planets, stars, galaxies and so on. It is the primary shape in existence.

"In the beginning was the Word." I believe that time will reveal that language/conscious sound/the word will all be revealed in the torus. There are those who believe this to be true now, but only time will tell.

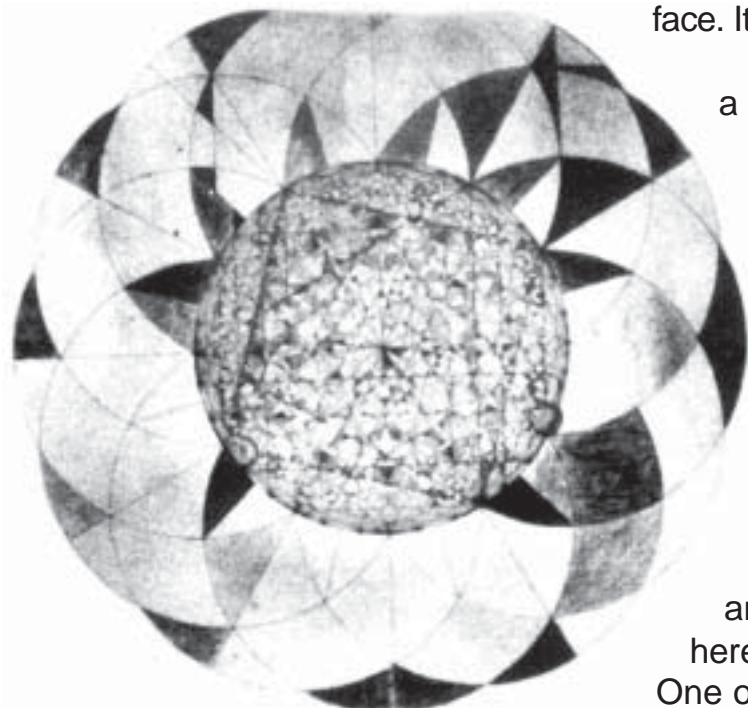

Fig. 6-2. Genesis pattern ratcheted once.

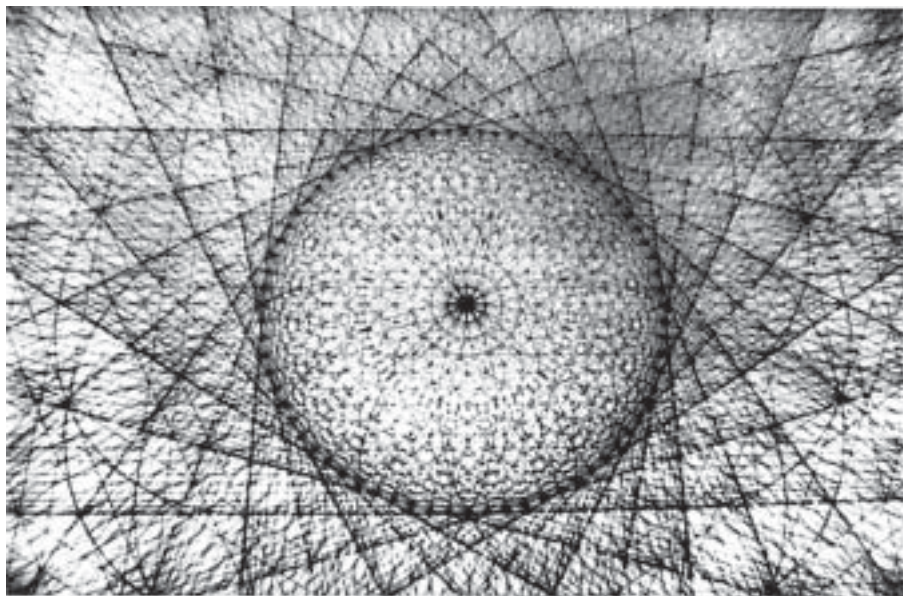

Fig. 6-3. Ratcheted Genesis pattern with all possible connected lines.

## The Labyrinth As a Movement of Life-Force Energy

Figure 6-5 is a sevenfold labyrinth. This is found all over the world—everywhere from China to Tibet to England to Ireland to Peru to the American Indians.

One was just found in Egypt. You'll find this labyrinth on the floors of many of the churches in Europe. The same form is on stone walls everywhere. It must have been of great importance to ancient mankind. There are seven regions in it, which relates to the torus and to the beating of the human heart. Later on I'll be talking about the ancient Druid mystery school on the Island of Avalon in England. To get to the top of the hill there, you have to walk through this same labyrinth, going back and forth through this motion.

While I was in England, I spoke to Richard Feather Anderson, who is an author and an expert on labyrinths, and I learned something. As part of his research, he has people walk through the labyrinth. He's discovered that when you walk through it, you are forced to move through different states of consciousness, giving you a very specific experience. It causes the life-force energy to move through the chakras in the following pattern: three, two, one, four, seven, six, five. The energy starts in the third chakra, then goes to the second, then to the first; then it jumps up to the heart (fourth), then into the center of the head to the pineal gland (seventh), then to the front of the head to the pituitary gland (sixth), and then down into the throat (fifth).

When you walk this labyrinth, unless you block the experience, you will automatically move through these changes. Even if you don't know about these things, you will go through the experiences anyway. People all over the world have found this to be true. Mr. Anderson believes that if you draw lines (the number of lines indicating which of the seven paths it is) in the order you walk the path—three, two, one, four, seven, six, five—it forms what looks like a cup [Fig. 6-6]. He feels that this particular labyrinth is re-

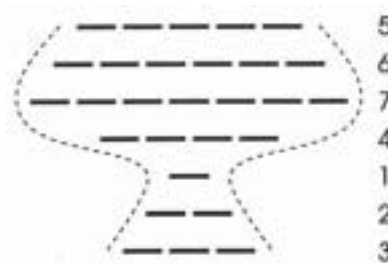

Fig. 6-6. The labyrinth sequence creates a cup.

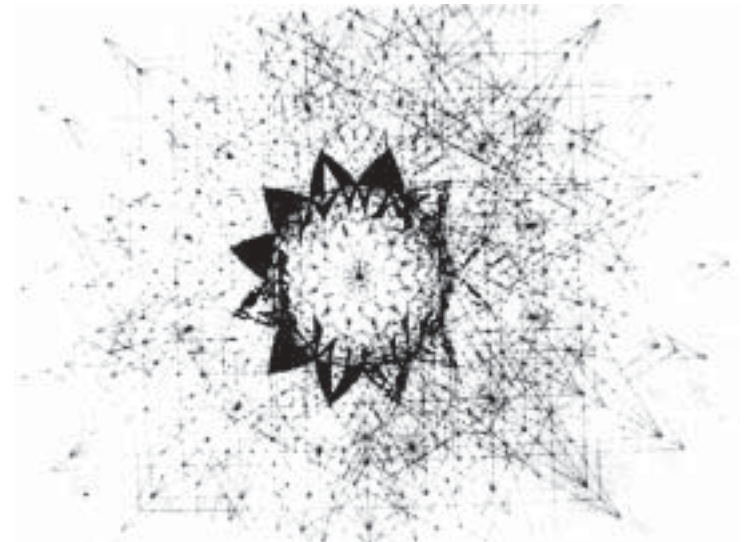

Fig. 6-4. Twice-ratcheted Genesis pattern with all possible connected lines.

*Update: I have just seen a picture from Europe [1998, see below] of the biblical Melchizedek, in which he is holding the key to the labyrinth inside a bowl.*



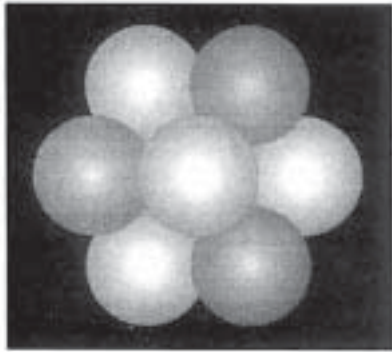

Fig. 6-8. 3D spheres/balls.

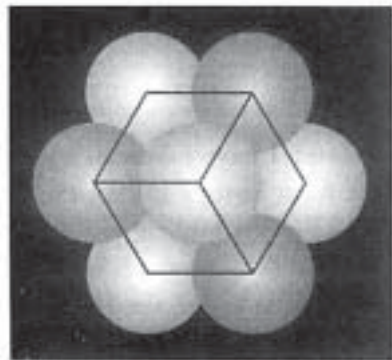

Fig. 6-8a. Connecting centers to form a cube

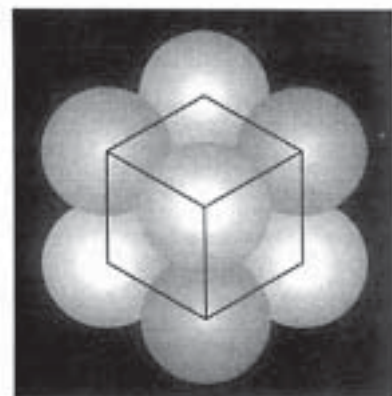

Fig. 6-8b. A different view.

lated to the shape of the Holy Grail and to its secret knowledge. From my experience, this feels right, but I am keeping an open mind. I don't know about this yet; it may be true.

I experimented with this labyrinth on myself, and it is true that those changes did happen for me. However, I was also able to experience these same changes in a different way. I was able to walk a straight line toward the center of the labyrinth and simply make the changes within myself as I reached each place where the turn would be in the labyrinth. I was able to reach the same state without walking through the whole pattern. Remember the labyrinth; I'll come back to it after a while.

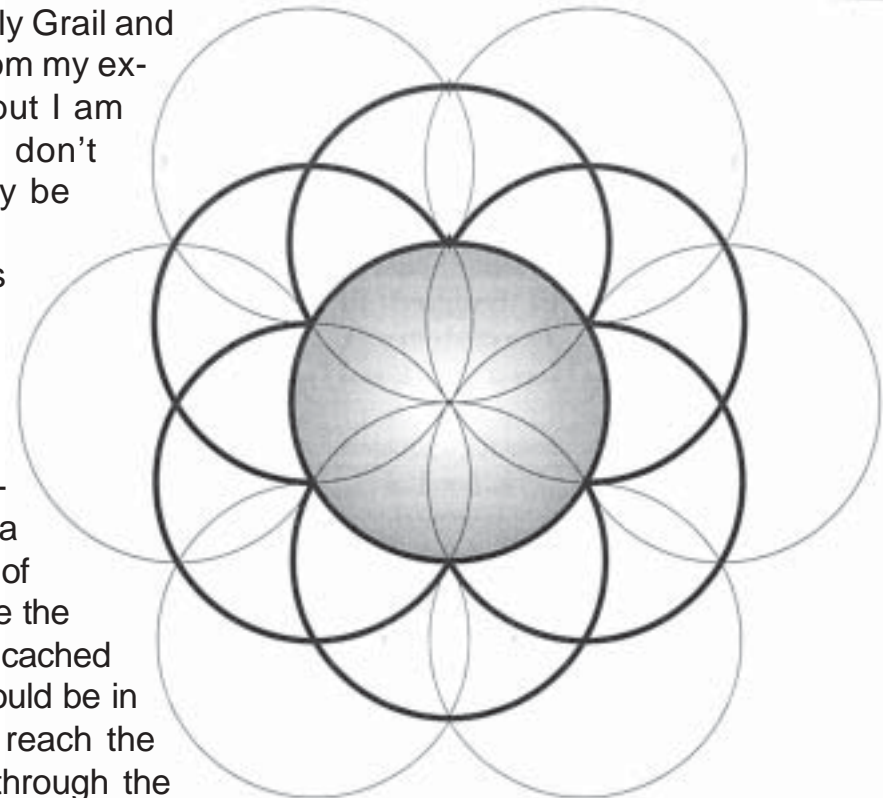

Fig. 6-7. Vortex beyond the Genesis patterns.

### *The Egg of Life, the Second Shape beyond Genesis*

The dark innermost circles show the six days of Genesis [Fig. 6-7]. Once the consciousness projects the first seven spheres and completes this Genesis pattern, it then continues moving in a rotational pattern from each consecutive innermost place until it completes its second vortex motion as seen by the light outermost circles. That motion in turn completes a three-dimensional shape you can hold in your hand, which looks like Figure 6-8. If you were to take Figure 6-7 and erase all the lines in the middle and certain other lines, you would see this pattern. The pattern of spheres is like what spirit would have seen had it moved outside its creation and said, "Aha, I see this thing! It looks like that" [Fig. 6-8].

The eighth sphere is actually behind these visible spheres. If you were to connect their centers, you would see a cube [Figs. 6-8a and 6-8b].

So what? Who cares? Well, the ancients did, because they were concerned with creation, life and death. They called this cluster of spheres the Egg of Life. I'll soon show you how the Egg of Life is the morphogenetic structure that created your body. Your entire physical existence is dependent on the Egg of Life structure. Everything about you was created through the Egg of Life form, right down to the color of your eyes, the shape of your nose, how long your fingers are and everything else. It's all based on this one *form*.

### *The Third Rotation/Shape: The Fruit of Life*

The next vortex is the third rotation [Fig. 6-9]. The spheres in this vortex are centered at the innermost places in the perimeter of the previous round, as shown by the six arrows here. So when spirit rotates in this third vortex, you get the gray rings shown here. Then you notice a new relationship where the six circles touch the center one and each other. If you took seven pennies and pushed them together on a table, they would look like that. This third rotation is an extremely important relationship in the creation of our Reality. When you look carefully at the Flower of Life, you see these seven circles that touch each other.

There are nineteen circles in the Flower of Life [Fig. 6-10], and they're surrounded by two concentric circles. For some reason, that image is found all over the world. The question is, why did they do that all over the world and stop at nineteen circles? It's an infinite grid and could have been stopped anywhere. The only place on the whole planet where I've seen them go out beyond those nineteen circles was in China, where they made room-divider screens [Fig. 6-11]. One of the most famous patterns they used on those screens was the Flower of Life. They made it in a rectangular shape, carrying it all the way out to the edge.

But in all others that were found, you would usually see just the Flower of Life pattern. This is because when the ancient beings realized what the other component was and how important it was, they decided to make it secret. They didn't want people to see this relationship I'm about to show you. It was so sacred and important that they just could not allow it to become common knowledge. It was appropriate at that time; however, now we either use the informa-

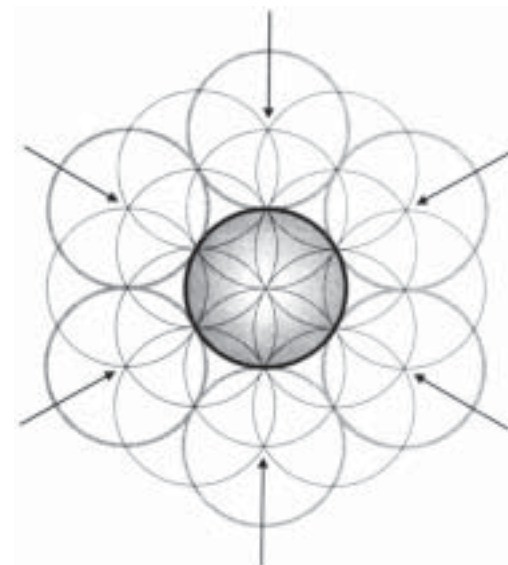

Fig. 6-9. The third rotation.

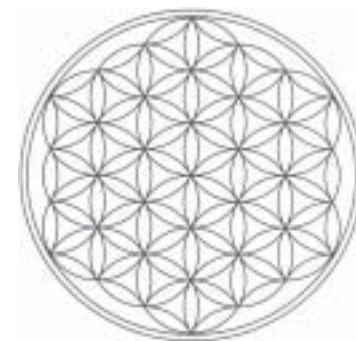

Fig. 6-10. Flower of Life.

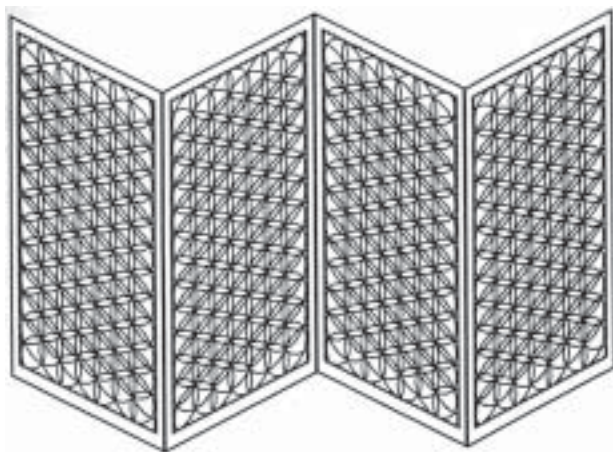

Fig. 6-11. Chinese screen, stylized Flower of Life.

tion or fall further into the darkness.

Notice that in the Flower of Life pattern you see many incomplete circles, which, of course, can also be spheres. Look all around the outer edge of Figure 6-10. If all you did was complete all of these circles, then the secret would unfold. This was the ancient's way of coding the information.

The additional circles/spheres that extend beyond the original Flower of Life pattern inside the large gray ring in Figure 6-12 complete all the incomplete circles at the edge of that pattern.

As soon as you complete these spheres, with one more step you'll have the secret: Go to the innermost places of the perimeter, shown by the arrows, and rotate the next vortex. When you do, you get the pattern of thirteen circles, shown here by the smaller gray circles, including the center. When it's extracted from the rest of the pattern, it looks like Figure 6-13.

This pattern of thirteen circles is one of the holiest, most sacred forms in existence. On Earth it's called the Fruit of Life. It is called the fruit because it is the result, the fruit, from which the fabric of the details of the Reality were created.

Combining Male and Female to Create Metatron's Cube, the First Informational System Now, all the circles in this pattern are female. And there are thirteen ways, with these thirteen circles, that you can superimpose male energy—in other words, straight lines. If you superimpose straight lines over this in all thirteen ways, you'll come up with thirteen patterns that, along with the Egg of Life and the torus, create everything in existence. The Egg of Life, the torus, and this Fruit of Life, a total of three patterns, create everything in existence without exception—at least I have not been able to find an exception. I'll give you what I've learned; obviously I cannot show you everything, but I'll show you enough to convince you this is true. I'm going to call these *informational systems*. There are thirteen informational systems associated with the Fruit of Life pattern. Each system produces a vast and diversified amount of knowledge. I'm going to show you only four of those. I think that's enough.

The simplest system comes forth by simply connecting all the centers of the circles with straight lines. If you decided to put straight lines on this pattern, probably about 90 percent of you would think first of connecting all ters. If you do that, you end up with this pattern [Fig. 6-14], which is known through-

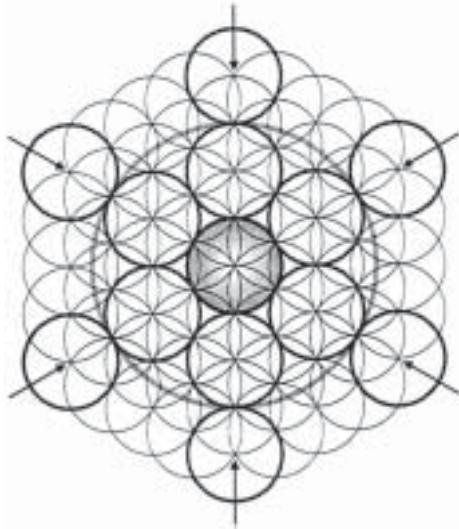

Fig. 6-12. Completing the incomplete circles.

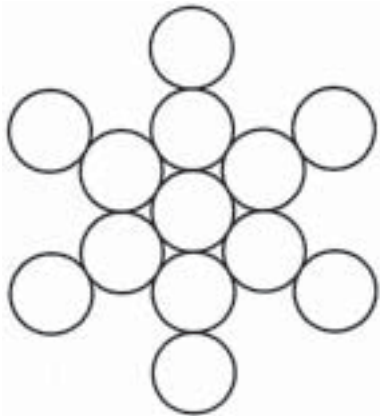

Fig. 6-13. The Fruit of Life.

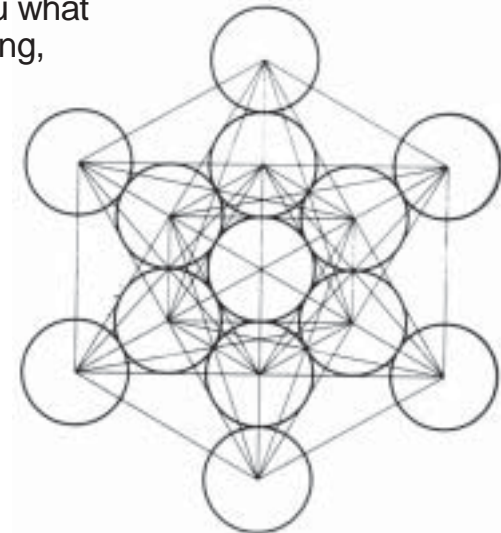

Fig. 6-14. Metatron's Cube



out the universe—everywhere—as Metatron’s Cube. It is one of the most important informational systems in the universe, one of the basic creation patterns of existence.

## The Platonic Solids

Anyone who has studied sacred geometry or even regular geometry knows that there are five unique shapes, and they are crucial to understanding both sacred and regular geometry. They’re called the Platonic solids [Fig. 6-15].

A Platonic solid has certain characteristics by definition. First of all, its faces are all the same size. For instance, a cube, the most well-known of the Platonic solids, has a square on every face, so all its faces are the same size. Second, the edges of a Platonic solid are all the same length; all edges of a cube are the same length. Third, it has only one size of interior angles between faces. In the case of a cube, this angle is 90 degrees. And fourth, if a Platonic solid is put inside a sphere (of the right size), all the points will touch the surface of the sphere. With that definition, there are only four shapes besides the cube (A) that have all of those characteristics. Second (B) is the *tetrahedron* (tetra means four), a polyhedron that has four faces, all equilateral triangles, one edge length and one angle, and all points touch the surface of a sphere. The other simple one is (C) an *octahedron* (octa means eight), whose eight faces are equilateral triangles of the same size, edge length and angle, and all points touch the surface of a sphere.

The other two Platonic solids are a little more complicated. One (D) is called an icosahedron, which means it has 20 faces, made of equilateral triangles with the same edge length and angle, and all points touch the surface of a sphere. The last one (E) is called a *pentagonal dodecahedron* (dodeca is 12), whose faces are 12 pentagons (five sides), with the same edge length and angle, and whose points all touch the surface of a sphere.

If you’re an engineer or an architect, you have studied these five shapes in college, at least cursorily, because they’re the basis of structures.

### Their Source: Metatron’s Cube

If you study sacred geometry, no matter what book you pick up, it shows the five Platonic solids, because they are the ABCs of sacred geometry. *But* when you read all these books—and I’ve read almost all of them—and ask the experts, “Where do the Platonic solids come from? What is their source?” almost everyone says they don’t know. Well, the five Platonic solids come from the first informational system of the Fruit of Life. Hidden within the lines of Metatron’s Cube [see Fig. 6-14] are all five of these shapes. When you look at Metatron’s Cube, you’re looking at all five Platonic solids at once. In order to see each one better, you have to do that trick again where you erase some of the lines. If you erase all the lines except certain ones, you get this cube [Fig. 6-16].

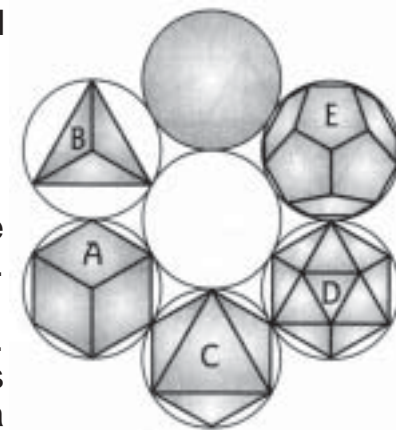

Fig. 6-15. The five Platonic solids.

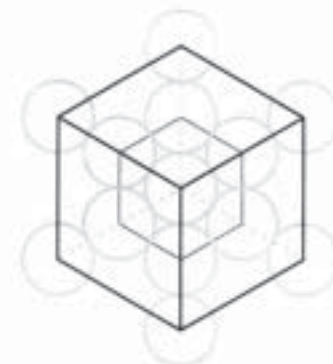

Fig. 6-16. Here are the two cubes extracted from Metatron’s Cube.

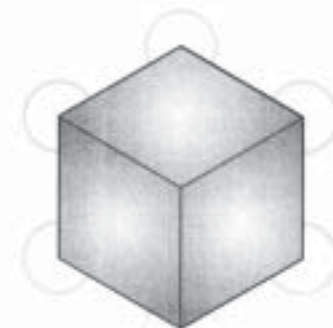

Fig. 6-16a. Solid larger cube from previous figure.



Fig. 6-17. The star tetrahedrons extracted from Metatron's Cube.



Fig. 6-18. Two octahedrons extracted from Metatron's Cube.



Fig. 6-19. Two icosahedrons extracted from Metatron's Cube.



Fig. 6-17a. Solid larger star tetrahedron in Fig. 6-17.



Fig. 6-18a. Solid larger octahedron.

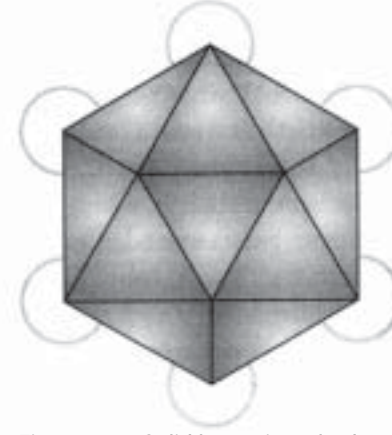

Fig. 6-19a. Solid larger icosahedron.

Can you see the cube? It's actually a cube within a cube. Some of the lines are dotted because they would be behind the front faces. They are invisible when the cube becomes solid. Here's the solid form of the larger cube [Fig. 6-16a]. (Make sure you see this one, because they get harder and harder to see as we go.)

By erasing certain lines and connecting other centers [Fig. 6-17], you get two superimposed tetrahedrons, which form a star tetrahedron. Like this cube, you actually get two star tetrahedrons, one inside the other. Here's the solid form of the larger star tetrahedron [Fig. 6-17a].

Figure 6-18 is an octahedron inside another octahedron, though you're looking at them from a special angle. Figure 6-18a is the solid version of this larger octahedron.

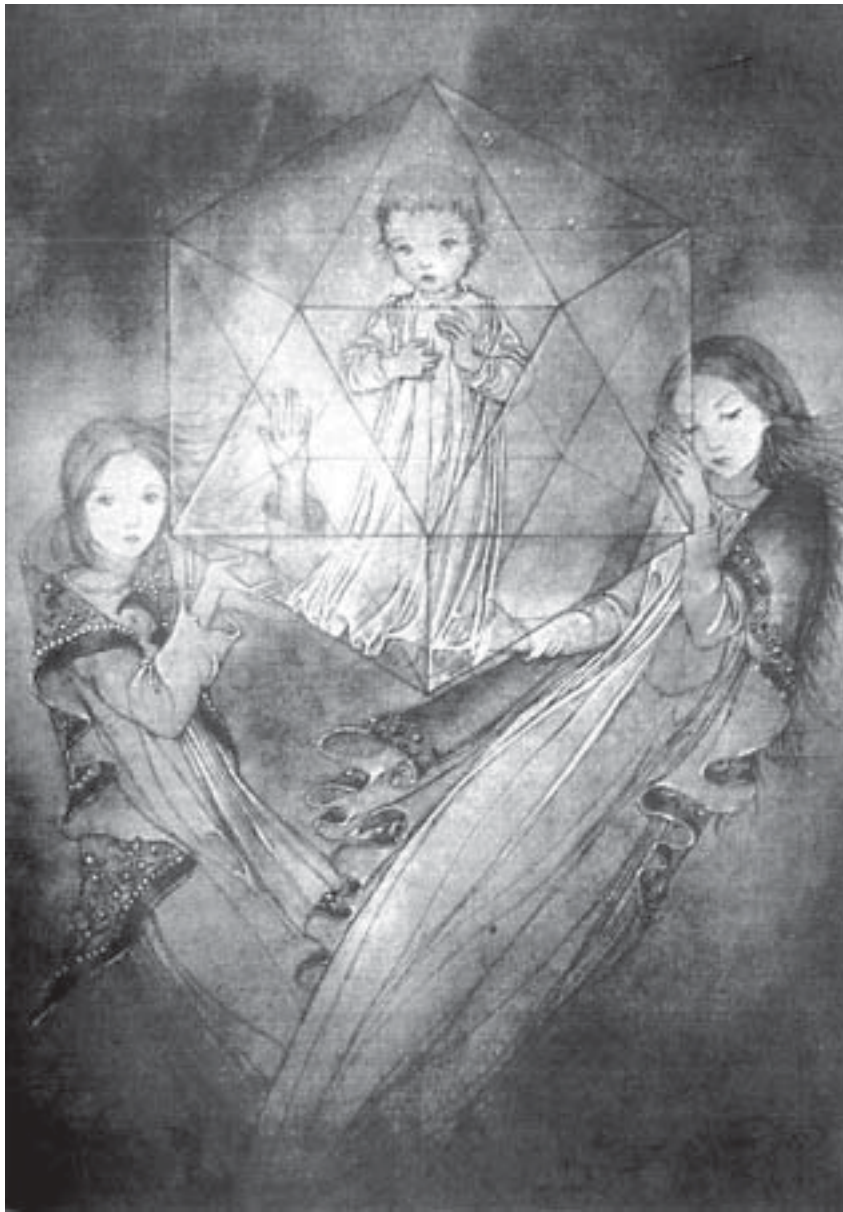

Fig. 6-20. Sulamith Wulfing's painting of the Crist Child.

Figure 6-19 is one icosahedron inside another, and Figure 6-19a is this solid version of the larger one. It somehow becomes easier if you see it this way.

These are three-dimensional objects coming out of the thirteen circle of the Fruit of Life.

This is Sulamith Wulfing's painting of the Christ Child inside an icosahedron [Fig. 6-20], which is very appropriate, because the icosahedron represents water, as you will see in a moment, and the Christ was baptized in water, the beginning of the new consciousness.

This is the fifth and last shape—two pentagonal dodecahedrons, one inside the other [Fig. 6-21] (here showing only the inner dodecahedron for simplicity).

Figure 21a is the solid version.

As we have seen, all five of the Platonic solids can be found in Metatron's Cube [Fig. 6-22].

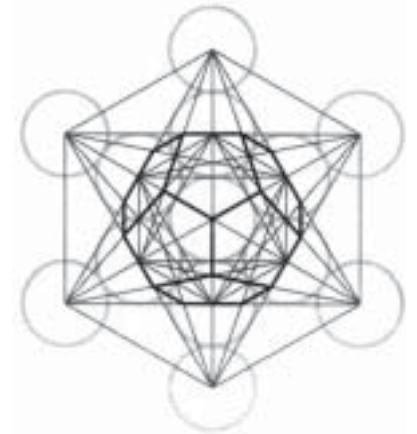

Fig. 6-21. Pentagonal dodecahedron in Metatron's Cube.

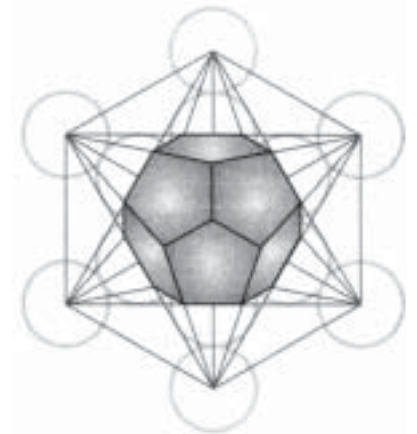

Fig. 6-21a. Solid dodecahedron.

## The Missing Lines

When I was looking for the final Platonic solid in Metatron's Cube, the dodecahedron, it took me over twenty years. After the angels had said, "They're all in there," I started to look, but I could never find the dodecahedron. Finally one day a student said, "Hey, Drunvalo, you forgot some of the lines in Metatron's Cube." When he pointed them out, I looked and said, "You're right, I did!" I thought I had connected all the centers together, but I had forgotten some of them. No wonder I couldn't find that dodecahedron, because those missing lines defined it! For over twenty years I'd assumed that I had all the lines when I hadn't.

This is one of the great problems in science, believing you have solved a problem, then moving on and using that information to build on. Science is now having to deal with the same kind of problem around falling bodies in a vacuum, for example. It has always been assumed that they fell at the same rate, and much of our higher science is based on this fundamental "law."

It has been proven wrong, yet science continues using it. A spinning ball falls much faster than a nonspinning one. Someday there will be a scientific day of reckoning.

When I was married to Macki, she was also deeply involved in sacred geometry. Her work is very interesting to me because it's female—right-brained pentagonal energies. She shows how emotions and colors and shapes are all interrelated. Actually, she found the dodecahedron in Metatron's Cube before I did. She took it and did something I never would have thought of doing. Metatron's cube, you know, is usually drawn on a flat surface, but it's really a three-dimensional shape. So one day I was holding the three-dimensional shape and trying to find the dodecahedron in there, and Macki said, "Let me look at that thing." She took the three-dimensional shape and rotated it by the phi ratio. (Something we've not talked about yet is that the Golden Mean ratio, also called the phi ratio, is approximately 1.618.) Rotating the shape like that was something I would never have thought of doing. After she did that, she cast a shadow through it and got this image [Fig. 6-23].

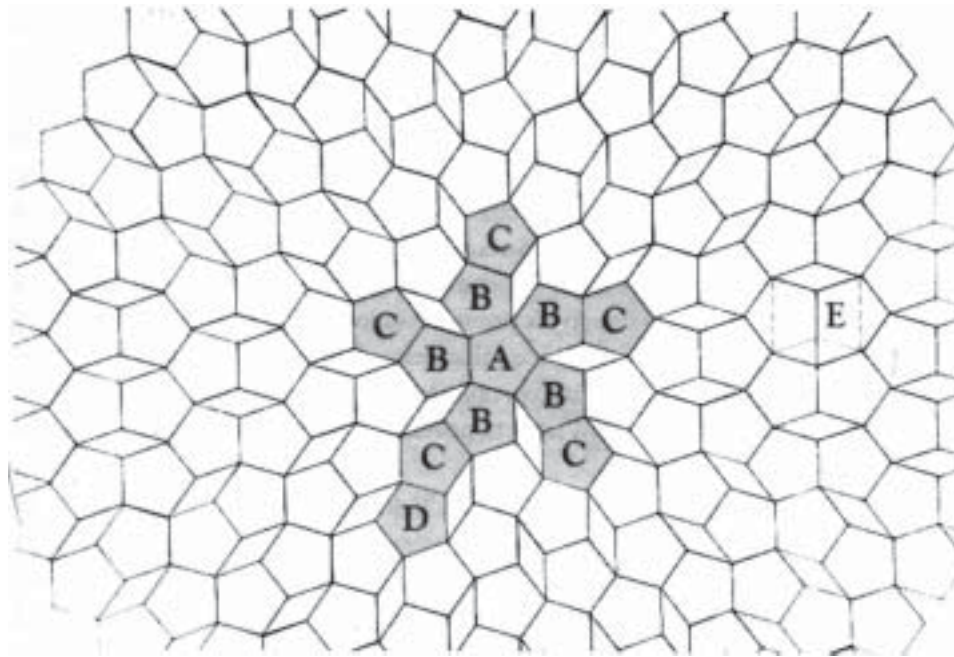

Fig. 6-23. Macki's pentagon design from Metatron's Cube. When cut out and folded, it makes a three-dimensional pentagonal dodecahedron.

*Update: According to David Adair, NASA has just made a metal in space that is 500 times stronger than titanium, as light as foam and as clear as glass. Is it based on these principles?*

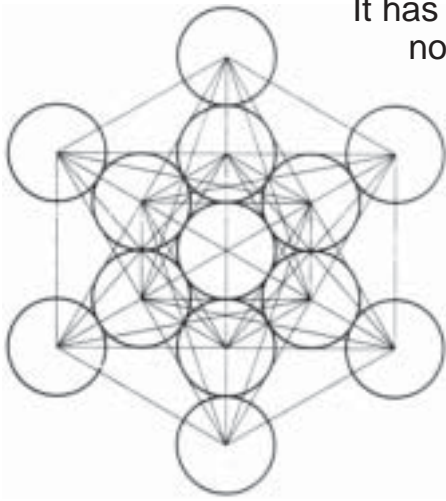

Fig. 6-22. Metatron's Cube.

Macki originally created this, then gave it to me. It has a center at pentagon A. Then if you take the five pentagons coming off of A (pentagons B) and one more pentagon coming off of each of those five (pentagons C). you have an *unfolded* dodecahedron. I thought, Wow, this is the first time I've ever found *any* kind of dodecahedron in there. She did that in three days. I'd never found it in twenty years.

We once spent almost a whole day looking at this drawing. It was exciting, because *every single line* in this drawing is in a Golden Mean ratio. And there are three-dimensional Golden Mean rectangles all over. There's one at point E, where the two diamonds above and below are the top and bottom of a three-dimensional Golden Mean rectangle, and the dotted lines are the sides. It's amazing stuff. I said, "I don't know what this is, but it's probably important." So we put it aside to consider at another time.

### *Quasi Crystals*

Later I found out about a brand-new science. This new science is going to change the technological world dramatically. Using this new technology, metallurgists believe they will be able to make metal ten times harder than diamonds, if you can imagine that. That would be incredibly hard.

For a long time when they looked into metals, they were using what's called x-ray diffraction to see where the atoms were. I'll show an x-ray diffraction photograph of this shortly. Certain specific patterns came up that revealed there were only certain kinds of atomic structures. They thought it was all there was to learn because that was all they could find. This limited their ability to make metals.

Then there was a game going on in *Scientific American* which was based on Penrose patterns. Roger Penrose was a British mathematician and relativist who wanted to figure out how to lay pentagon-shaped tiles and fully cover a flat surface. You cannot lay only pentagon-shaped tiles on a flat surface—there's no way to make it work. So he came up with two diamond shapes that are derivatives of a pentagon, and with those two shapes he was able to form lots of different patterns that would fit on a flat surface. It became a game in *Scientific American* back in the eighties to put these patterns together in new forms, which then led some metallurgical scientists who were watching this game to suspect something new in physics.

Ultimately they discovered a new kind of atomic grid pattern. It was always there; they merely discovered it. These grid patterns are now called quasi crystals; it's a new thing (1991). They're unraveling what shapes and patterns are possible through metals. Scientists are finding ways to use these shapes and patterns to produce new metal products. And I'll bet that the pattern Macki got out of Metatron's Cube is the grand master of all, and that any Penrose pattern in existence is derived from it. Why? Because it's all Golden Mean, it's basic—it came straight out of the basic pattern in Metatron's Cube. Though it's not my business, at one point I will probably determine if it's really true. I see that instead of using the two Penrose patterns and the pentagon,

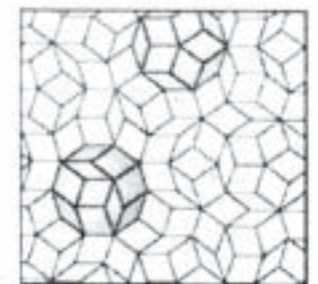
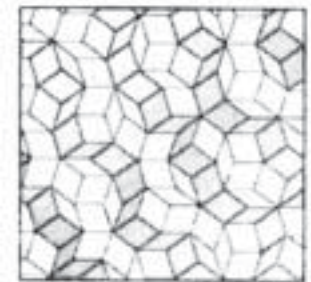

*UPDATE: In 1998 we are beginning to open up another new science: nanotech.nology, We have created microscopic "machines" that can go into a metal or crystal matrix and rearrange the atoms. In 1996 or 1997 in Europe a diamond was created out of graphite using nanotechnology. This diamond was about three feet across, and it is real. As the science of quasi crystals and nanotechnology merge, our experience of life will also change. Look at the late 1800s compared to now.*

it uses only one of them and a pentagon. (I just thought I'd offer that.) What's happening in this new science right now is interesting.

As this book begins to unfold, you'll discover that sacred geometry can describe in detail any subject whatsoever. There is not one thing you can pronounce with your mouth that cannot be *completely, utterly and totally described, with all possible knowledge*, by sacred geometry. (And we are making the distinction between knowledge and wisdom: Wisdom needs experience.) Yet a more important purpose of this work is to remind you that *you* have the potential of a living Mer-Ka-Ba field around your body and to teach you how to use it. I'll continually come to places where I digress into all kinds of roots and branches and talk about every subject you can think of. But I'm going to keep coming back on track, because I'm heading in one particular direction, toward the Mer-Ka-Ba, the human light body.

I've spent many years studying sacred geometry, and I believe you can know everything there is to be known about any subject whatsoever just by focusing on the geometries behind it. All you need is a compass and a ruler—you don't even need a computer, though it does help. You have all knowledge in you already, and all you have to do is unfold it. You simply learn the map of how spirit moves in the Great Void, and that's it. You can unravel the mystery of any subject.

To summarize, the first informational system comes out of the Fruit of Life through Metatron's Cube. By connecting the centers of all the spheres, you have five shapes—really six, because you have the central sphere, which started the whole thing. So you have six primal shapes—the tetrahedron, the cube, octahedron, icosahedron, dodecahedron and the sphere.

### **The Platonic Solids and the Elements**

These six shapes were considered by the ancient alchemists and great souls like Pythagoras, the father of Greece, to have had an *element* aspect to them [Fig. 6-24].

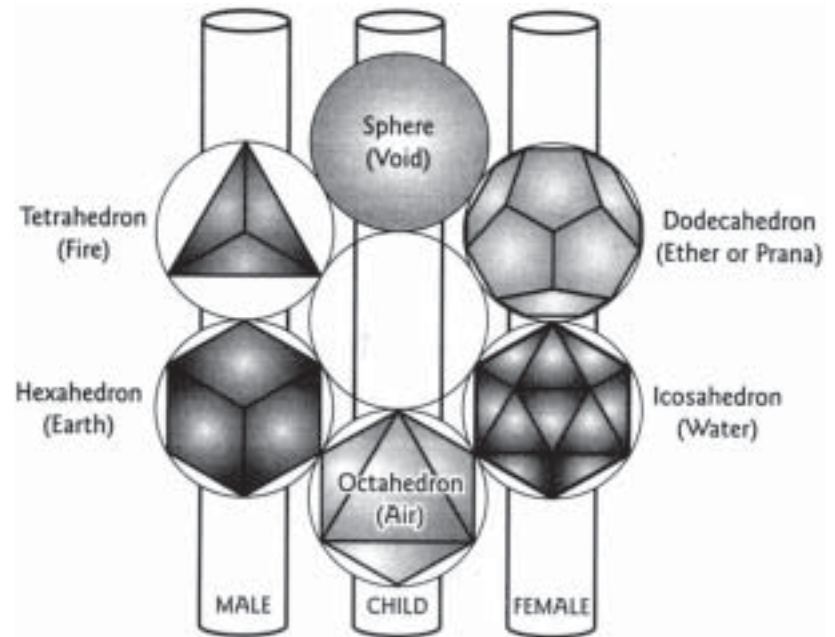

Fig. 6-24. Relating the six elements to the six primal shapes, shown in three columns that depict the trinity of polarity. The left (male) column represents the left brain and the proton and includes 3- and 4-sided faces; the center (child) column represents the corpus callosum and the neutron. The right (female) column represents the right brain and the electron and includes 3- and 5-sided faces. The ether is the basic form of the Christ consciousness grid.

The tetrahedron was considered fire, the cube was earth, the octahedron was air, the icosahedron was water and the dodecahedron was ether. (Ether, prana and tachyon energy are the same thing; they extend everywhere and are accessible at any point in space/time/dimension. This is the great secret of zero-point technology.) And the sphere is voidness. These six elements are the building blocks of the universe. They create the qualities of the universe.

In alchemy, they usually talk only about fire, earth, air and water; they seldom discuss ether or prana because it's so sacred. In the Pythagorean school, if you even uttered the word "dodecahedron" outside the school, they would kill you on the spot. That was how sacred the shape was. They wouldn't even discuss it. Two hundred years later when Plato was alive, he would discuss it, but only very carefully.

Why? Because the dodecahedron is near the outer edge in your energy field and is the highest form of consciousness. When you get to the 55-foot limit of your energy field, it's a sphere. But the very next shape inside the sphere is the dodecahedron (actually, the dodecahedron/ icosahedral relationship). In addition, we live in a big dodecahedron that contains the universe. When your mind reaches out to the end of space—and there *is* an end—there's a dodecahedron enclosed in a sphere. I can say this because the human body is a hologram of the universe and contains the same principles. The twelve constellations of the zodiac fit inside it. The dodecahedron is the terminating point of the geometries, and it's very important. On a microscopic level, the dodecahedron and the icosahedron are the relational parameters of the DNA, the blueprint of all life.

You can relate the three columns in this figure to the Tree of Life and to the three primary energies of the universe: male (on the left), female (right) and child (center). Or if you go right down to the fabric of the universe, you have the proton on the left, electron on the right and neutron in the center. This central column, which is the creating one, is the child. Remember, we went from an octahedron to a sphere to begin the process out of the Void. It is the beginning process of creation, and it is found in the child, or central column.

The left column, holding the tetrahedron and the cube, is the male component of consciousness, the left side of the brain. The faces of these polygons are triangles or squares. The center column is the corpus callosum, which links the left and the right sides. The right column, holding the dodecahedron and the icosahedron, is the female component of consciousness, the right side of the brain, and the polygon faces are made up of triangles and pentagons. Thus the polygons on the left have three- and four-sided faces and the shapes on the right have three- and five-sided faces.

In terms of the Earth's consciousness, the right column is the missing component. We have created the male (left) side of Earth's consciousness, and what we are doing now is completing the female component for wholeness and balance. The right side is also associated with Christ or unity consciousness. The dodecahedron is the basic form of the Christ consciousness grid around the Earth. The two shapes in the right column are what are called duals of each other, meaning if you connect the centers of the faces of a dodecahedron with straight lines, you get an icosahedron; and if you connect the centers of an icosahedron, you again get a dodecahedron. Many polyhedrons have duals.

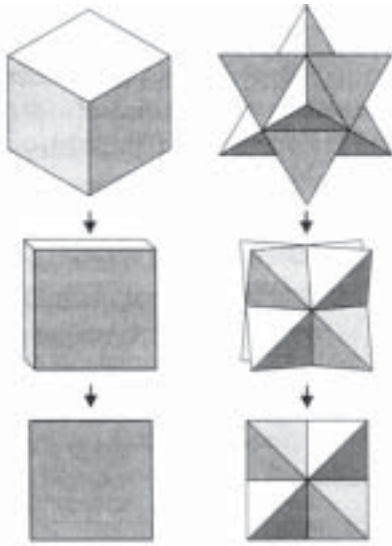

Fig. 6-25. Cube and star tetrahedron sitting next to each other so you can see the squareness of the star tetrahedron.



Fig. 6-26. An icosahedral cap.

In Dan Winter's book, *Heartmath*, the DNA molecule is shown to be constructed by the dual relationship of dodecahedrons and icosahedrons. One can also see the DNA molecule as a rotating cube. When you rotate a cube through 72 degrees in a particular pattern, it makes an icosahedron, which is in turn a dual with the dodecahedron. So there's a reciprocal pattern going up the DNA strands: the icosahedron, then the dodecahedron, the icosahedron, continuing back and forth. This rotation through the cube creates the DNA molecule. It has been determined that this is the exact sacred geometry behind the DNA, although there may be further hidden relationships.

This 72-degree angle rotating in our DNA connects with the blueprint/ purpose of the Great White Brotherhood. As you may know, 72 orders are associated with the Great White Brotherhood. Many people speak of the 72 orders of angels and the Hebrews speak of the 72 names of God. The reason for 72 has to do with the way the Platonic solids are constructed, which is also related to the Christ consciousness grid around the Earth.

If you take two tetrahedrons and superimpose them (though in different positions), you get a star tetrahedron, which, from a different view, is nothing but a cube [Fig. 6-25]. You can see how they're interrelated. In a similar manner, you can also put five tetrahedrons together and make an icosahedral cap [Fig. 6-26].

If you make twelve icosahedral caps and put one on each face of the dodecahedron (it would require 5 x 12, or 60 tetrahedrons to create a dodecahedron), it would be a *stellated* dodecahedron because a point comes out of the center of each face. Its dual is the 12 points in the center of each face of the dodecahedron, which forms an icosahedron. The 60 tetrahedrons plus the 12 points of the centers equal 72—again, the number of orders associated with the Great White Brotherhood. The Brotherhood actually functions through the physical relationships of this stellated dodecahedron/icosahedron form, which is the basis of the Christ consciousness grid around the world. In other words, the Brotherhood is attempting to bring out the consciousness of the planet's right brain,

The original order was the Alpha and Omega Order of Melchizedek, which was formed by Machiventa Melchizedek about 200,200 years ago. Since then 71 other orders have been created. The youngest one is the Brotherhood of the Seven Rays in Peru/Bolivia, the seventy-second order.

Each of the 72 orders has a life pattern like a sine-wave curve, where some of them come into existence for a certain length of time and then disappear for a while. They have biorhythms just as a human body does. The Rosicrucians, for example, are on a hundred-year cycle. They come out for a hundred years and then disappear totally for a hundred years—they literally disappear off the face of the Earth. Then a hundred years later they're back in the world and function-



ing for another hundred years.

They're all on different cycles, and they're all functioning together for one purpose—to return Christ consciousness back to this planet, to set up this lost feminine aspect of consciousness and bring balance between the left and the right side of the planet's brain. There's another way to look at this that is really extraordinary. When v/e talk about England, I will get to it.

### *Using Bombs, and Understanding the Basic Pattern of Creation*

*Question: When they detonate an atomic bomb, what happens to the elements!*

As far as the elements are concerned, they are converted into energy and other elements. But there is more to the picture. You have two kinds of bombs: fission and fusion. Fission is splitting matter apart and fusion is putting it together. It's okay to put it together—nobody complains about that. All the known suns in the universe are fusion reactors. I realize what I am about to say is not accepted by science yet, but when you rip matter apart through fission, there's a corresponding outer-space location associated with it that is affected—as above, so below. In other words, inner space (the microcosm) and outer space (the macrocosm) are connected. This is the reason that fission is illegal throughout the universe.

Detonating atomic bombs also creates an enormous imbalance on Earth. For example, when you consider that creation balances earth, air, fire, water and ether, an atomic bomb causes a massive amount of fire in one place. That's an out-of-balance sequence and the Earth must respond.

If you dumped 80 zillion tons of water on a city, that would also be an out-of-balance situation. Anywhere you have too much air, too much water, too much of anything, it's out of balance. Alchemy is the knowledge of how to keep all these things in balance. If you understand these geometries and know what their relationships are, you can create what you want. The whole idea is to understand the *map* underneath it all. Remember, the map is the way spirit moves in the Void. If you know the underlying map, then you have the

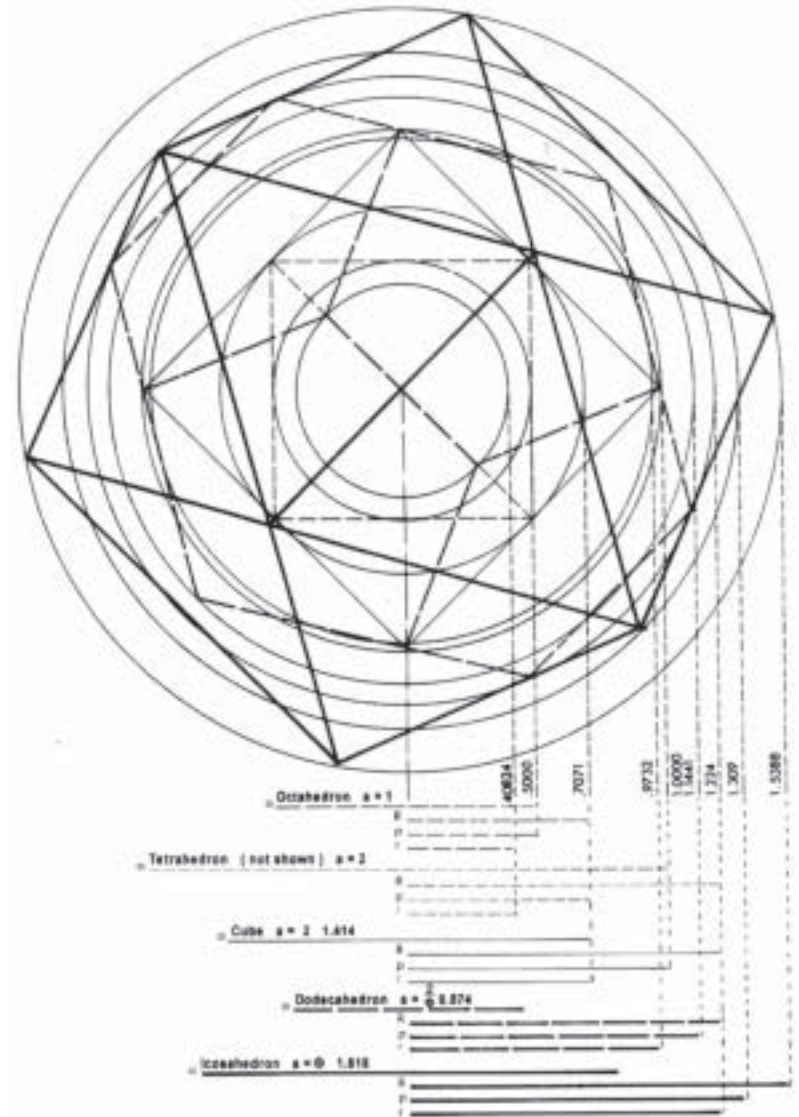

knowledge and understanding to cocreate with God.

Figure 6-27 shows the interrelationship of all these shapes. Each point connects to the next one, and they all have certain mathematical relationships related to phi ratios. The more you study this, the more these five shapes become one. We've only recently begun to remember this ancient science, though they fully understood everything in Egypt, Tibet and India a long time ago. They understood it in Greece, then they forgot for a long time. They remembered it again during the Italian Renaissance, then forgot again. The modern world has almost completely forgotten what shape really means, and we are just now remembering.

## Crystals

### Grounding Our Learning

Now we're going to take this abstract information that doesn't really seem to apply to us in our everyday lives, and we're going to tie it to our everyday experience. Some of this is not in everyday experience, but we can more or less understand and connect with the subjects.

First I'm going to ground this information to crystals. There are lots of other areas of nature I could use, but it's so obvious in crystals that anybody can see it. I could use viruses or diatomaceous earth. I could show it in a lot of things, but crystals are good because people like them.

To begin looking at these crystals, let's first examine this x-ray diffraction pattern [Fig. 6-28]. When you shoot x-rays down the C axis of the atomic matrix of a crystal or metal, you'll get these little dots showing you exactly where the atoms are located. In this case, this is a beryl crystal that actually displays the Flower of Life pattern. The beryl crystal uses the pattern to arrange its atoms and form this specific crystal. It's really amazing that these little atoms simply line themselves up in space, often with enormous distances between them. These microscopic spaces are relatively vast, like between the stars in the night sky. The atoms perfectly align themselves in cubes and tetrahedrons and all kinds of geometric shapes. Why?

This is an x-ray diffraction pattern of a crystal [Fig. 6-29]. You can see how the atoms have arranged themselves in a cubical design. It's interesting that in all the various forms manifested in the Reality, the atoms themselves are spheres. This simple fact has been overlooked by most researchers, but the sphere is the

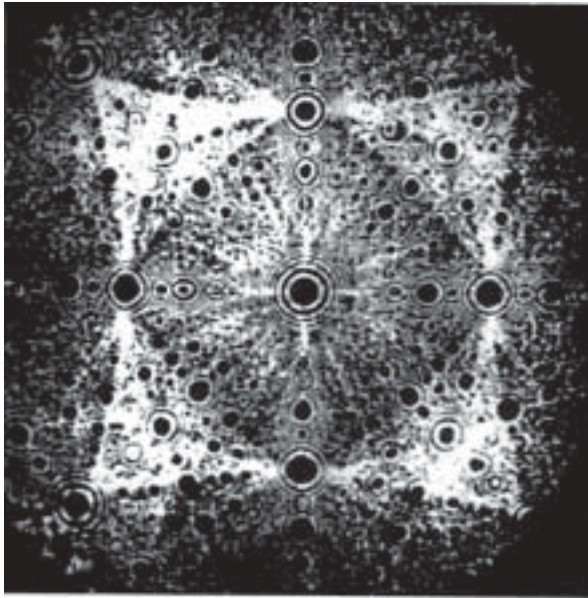

Fig. 6-29. Atomic pattern of a crystal matrix.

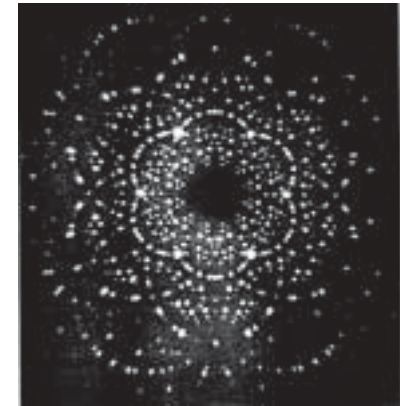

Fig. 6-28. Atomic pattern of a beryl crystal.

main form that everything came from in the beginning. It is important in understanding creation.

The entire fabric of everything in our existence is made up of “marbles” —all different sizes of spheres. We’re sitting on a sphere, the Earth, and spheres are rotating around us. The Moon, Sun and stars are all spheres. The whole universe, from macrocosm to microcosm, is made up of little spheres in one way or the other. The light waves moving through space are all spheres. We think of a light wave as making waves through space, but it’s much more complex. An electrical field spins one way around it and a magnetic field rotates at 90 degrees to the electrical field, and they expand in spherical patterns.

Imagine a cube in deep space, and see a bright light flashing from it, going out in all directions, 360 degrees. What do you have? Do you have a cubical light-wave energy field moving away from it? At first thought you might say it would be an expanding cube, getting bigger and bigger and bigger. But that’s not what happens. Light waves move radially away from their source at 186,200 miles a second, so when a light wave moves from the surface of a cube I hold in my hand, in one second the light from the face of the cube is already 186,200 miles away. And the wave that moved off a *corner* of the cube, which is a little farther away from the center than the face, is, in one second, 186,200 miles away from the center plus maybe a fraction of an inch. If you could see a fraction of an inch at 186,200 miles, you’d have super vision. And that’s only in one second; two seconds later the form has expanded twice that far, and a minute later it’s enormous.

So you have a *sphere* moving away from something that originated as a *cube*. If the object happens to be really big, then the light wave first tends to take the shape of the object, but it slowly turns into a sphere as it moves away and the object becomes smaller and smaller relative to that light field. So what you have out there is a bunch of light spheres, moving away in all directions and interconnecting with each other.

When you see light coming directly toward you, it’s white. But if it’s not moving directly toward you, it’s black. In fact, the entire night sky is filled with brilliant white light, but we see the light only when it’s coming toward us. We don’t see the light waves that move sideways from us; we just see black. If we could see it all, it would be blinding. Light is everywhere, and there is no place in space where it is not, as far as I know. The sphere is literally everywhere.

### ***Electron Clouds and Molecules***

Atoms are also made up of spheres. If you look at the hydrogen atom, the proton is compacted in the center and the electron is way out there orbiting the proton. If the proton were the size of a golf ball, the electron would be about a football field away—and that electron is moving *real fast!* I remember that when I was studying physics, I could not believe that the little electron, *which is a pinpoint you cannot even see*, is moving around and around in some microscopic space *at nine-tenths the speed of light*. This means that the electron travels around the proton about *170,000 miles every second, around something you can’t even see!* My mind was totally boggled! I went home and lay on the bed and stared at the ceiling for a long time. That was just inconceivable to me.

The little electron moves around so fast that it appears as a cloud. In fact, they call it an electron cloud. There’s only one electron, but it’s moving so fast that it appears to make a sphere around the central proton. It’s like a television

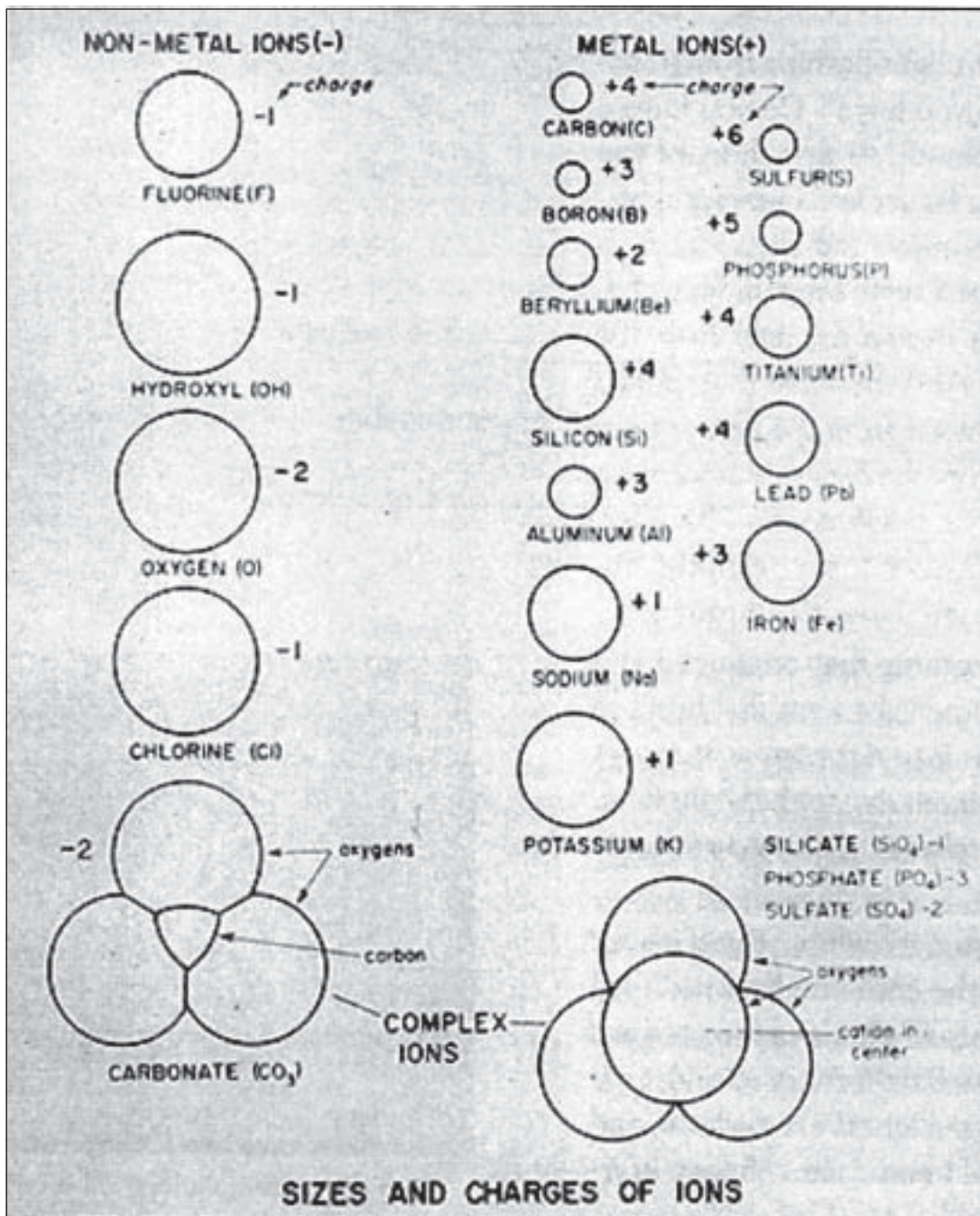

Fig. 6-30. Sizes and charges of ions.

screen, where there's only one electron beam moving across that screen at any one moment, moving carefully and intentionally down the screen, zigzagging back and forth until it gets all the way down to the bottom, then starts all over again. It's doing this so fast that you see a very believable image.

So spheres are the primary component of the Reality we're experiencing. Although an electron orbit describes a sphere, it can also describe other patterns, such as a figure eight. Physicists have been able to calculate this only for hydrogen, and so far they're just guessing about the rest. An atom is called an ion if it has too many or too few electrons and has either a positive or a negative charge. So the primary characteristics of an atom are how big it is and what its charge is [Fig. 6-30]. These two main factors determine whether or not different atoms will fit together into molecules. There are other subtle factors involved, but size and charge are primary.

Figure 6-31 shows how atoms combine. These were the primary patterns known for a long time, until they figured out about quasi crystals. The atoms on this chart have several varieties. A shows a linear pattern with a smaller atom in the middle. B shows a triangular pattern of three with a little atom in the middle. The little atom can literally either be there or not be there. C shows a tetrahedral pattern, with one atom in the middle, or not. D shows an octahedral pattern, and E shows a cubical pattern. Now, because of new scientific information, we can add icosahedral and dodecahedral patterns.

Atoms always line up in specific ways when they crystallize [Fig. 6-32]. They form into, say, a cube, and then that cube puts another cube next to itself and another cube next to it, and soon you get one cube connected to another, connected in turn to another cube and so on, forming what is called a lattice. There are all kinds of ways that atoms can join. The resulting molecules are always associated with sacred geometry and the five Platonic solids. It makes you wonder how those little atoms know to go only into those certain places, especially when they get very, very complex!

Even when you get into this complicated molecule [Fig. 6-33] and break it down, you see the shapes in it, and they *always* revert to one of the five Platonic solids—it doesn't matter what the structure is. No matter what you call it—metal, crystal, anything else—it will always come down to one of these original five shapes. I'll show you more examples as we get further into this.

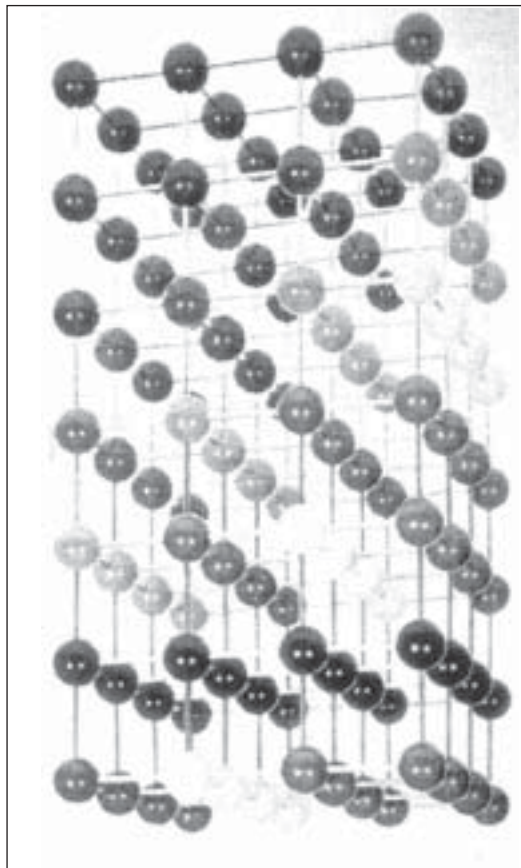

Fig. 6-32. Simple lattice formation of atoms.

### The Six Categories of Crystals

Now we'll get into crystals. There are at least a hundred thousand different

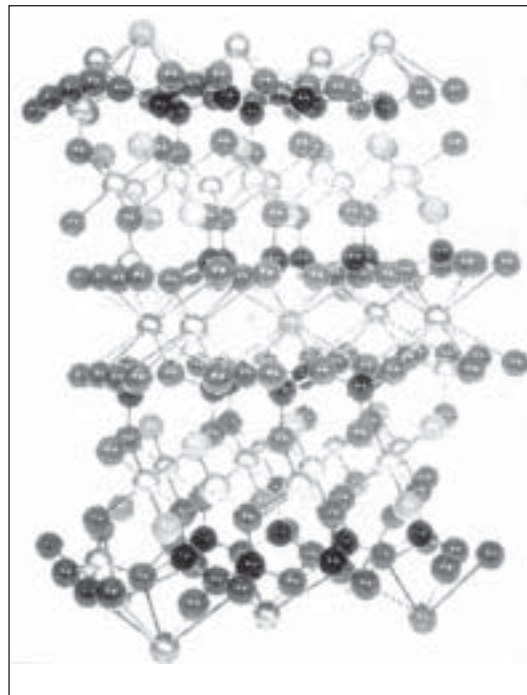

Fig. 6-33. Complex molecular formation.

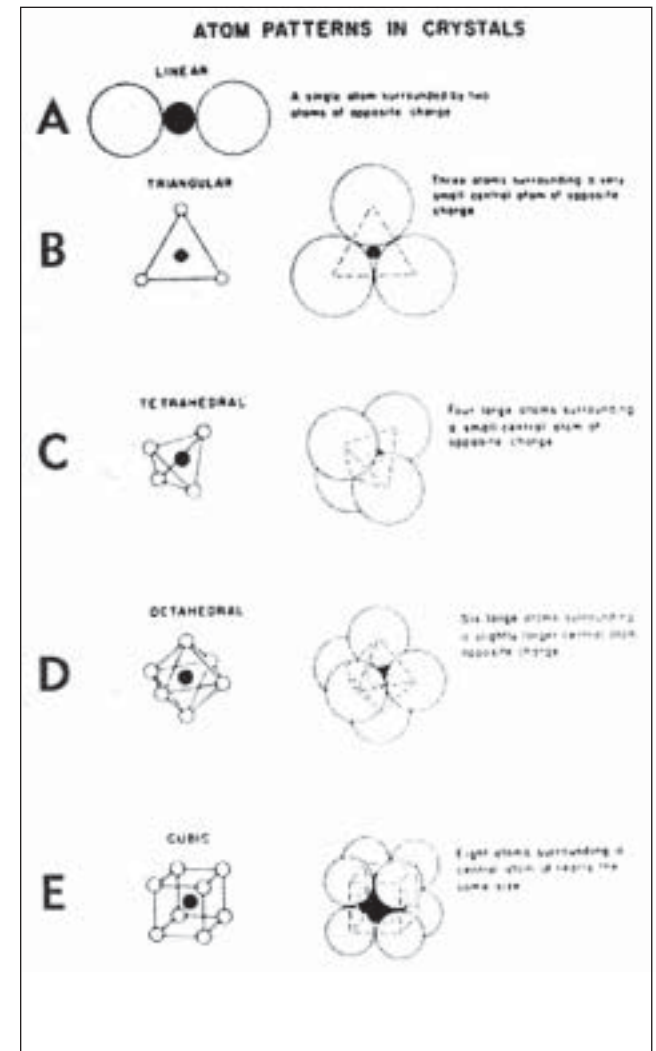

Fig. 6-31. Atom patterns in crystals.

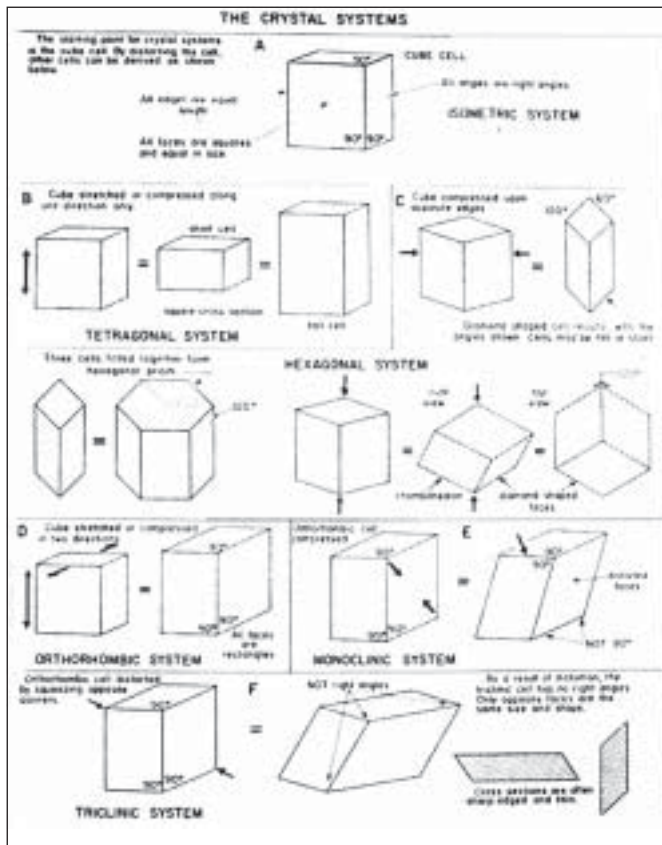

Fig. 6-34. Crystal systems.

kinds of crystals. If you've ever been to the Tucson Gem and Mineral Show, you know exactly what I'm talking about. This show takes over eight or ten hotels, with every room in the multistory hotels filled with crystals. In the auditorium you'll see all the gems. There are lots and lots *and lots of* different kinds of crystals. And more are being found; almost every year there are eight, nine, ten brand-new crystals never known before. But no matter how many crystals there are, they can all be put into six categories: isometric, tetragonal, hexagonal, orthorhombic, monoclinic and triclinic [Fig. 6-34]. And all six of those systems used for organizing all known crystals are derived from the cube, one of the Platonic solids. It's a matter of which angle you are viewing the cube from—the square, hexagonal or rectangular view as opposed to the normal 90° cubic angle. Now, this is where it starts to get interesting, at least for me— hopefully, for you, too.

These are fluorite crystals [Fig. 6-35a and b]. Fluorite is found in just about any conceivable color you can think of, including clear. There are two primary fluorite mines in the world: one is in the United States and the other in China. Fluorite is found with two totally different atomic structures: one is octahedral and the other cubical. This purple fluorite crystal is made up of tiny cubes all clumped together. They were not cut that way, they

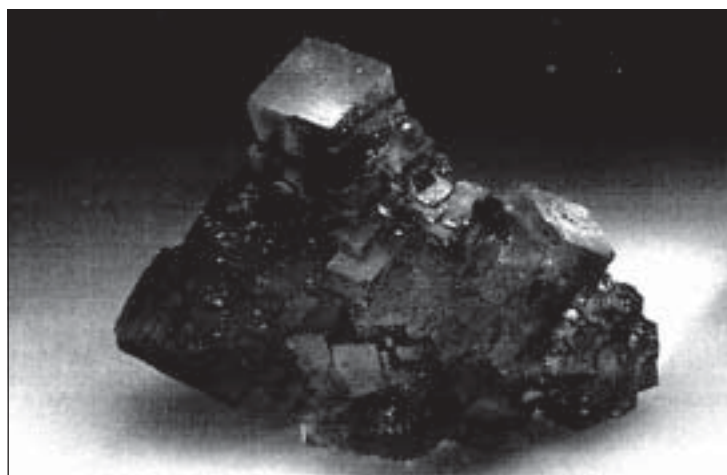

Fig. 6-35a. Fluorite crystal with a cubical structure.

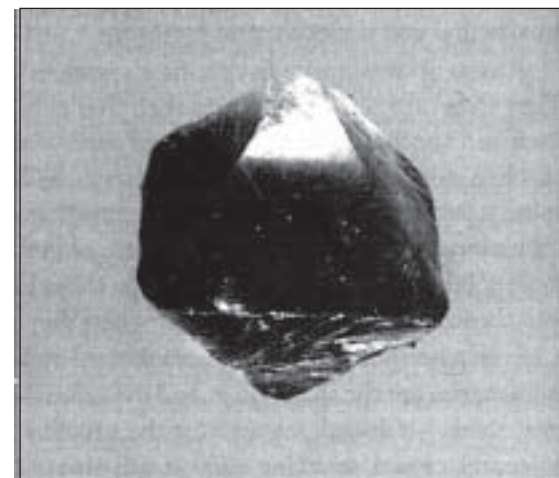

Fig. 6-35b. Fluorite crystal with an octahedral structure

grew that way. The clear fluorite crystal is an actual octahedron. It was not cut that way, but in this case it didn't grow that way, either. It usually comes in sheets, and if you drop it or strike it, it breaks along the weakest bonds, which happen to be octahedral, because the atoms are in an octahedral lattice. If I were to drop it onto a hard surface, it would break into a whole bunch of baby octahedrons.

But what's especially interesting is that it's been discovered that fluorite will grow from one shape to the other—from cubical to octahedral and back again. In its natural state, given enough time, a cubical crystal will someday become octahedral. And given enough time, an octahedral fluorite crystal will become cubical. They oscillate over time, first becoming one, then the other, back and forth over very long periods of time. Geologists have found some fluorite crystals in the process of change, but they could not understand how they oscillated like that.

### Truncating Polyhedrons

One geology book tried to explain how fluorite changes like this [Fig. 6-36]. At the bottom right you see a cube. If you were to cut off its corners by the same amount, it's called truncating. You can truncate any polyhedron, meaning any of these many-sided shapes. When you do that (in this case a cube), you can cut off either the corners, the edges or the faces, as long as you cut them all the same.

If you truncate this cube by cutting the corners at 45 degrees all the way around, you get the next shape to its left. If you truncate it again in exactly the same way, you come up with the next shape to the left. If you do it once more, you get an octahedron (on the far left). You can go back the other way, truncating the corners of the octahedron, and come back through the whole procedure until it turns back into a cube. This was the geology book's attempt to explain how in the heck fluorite changes shapes like that. The book actually explains only how this change *could* take place geometrically.

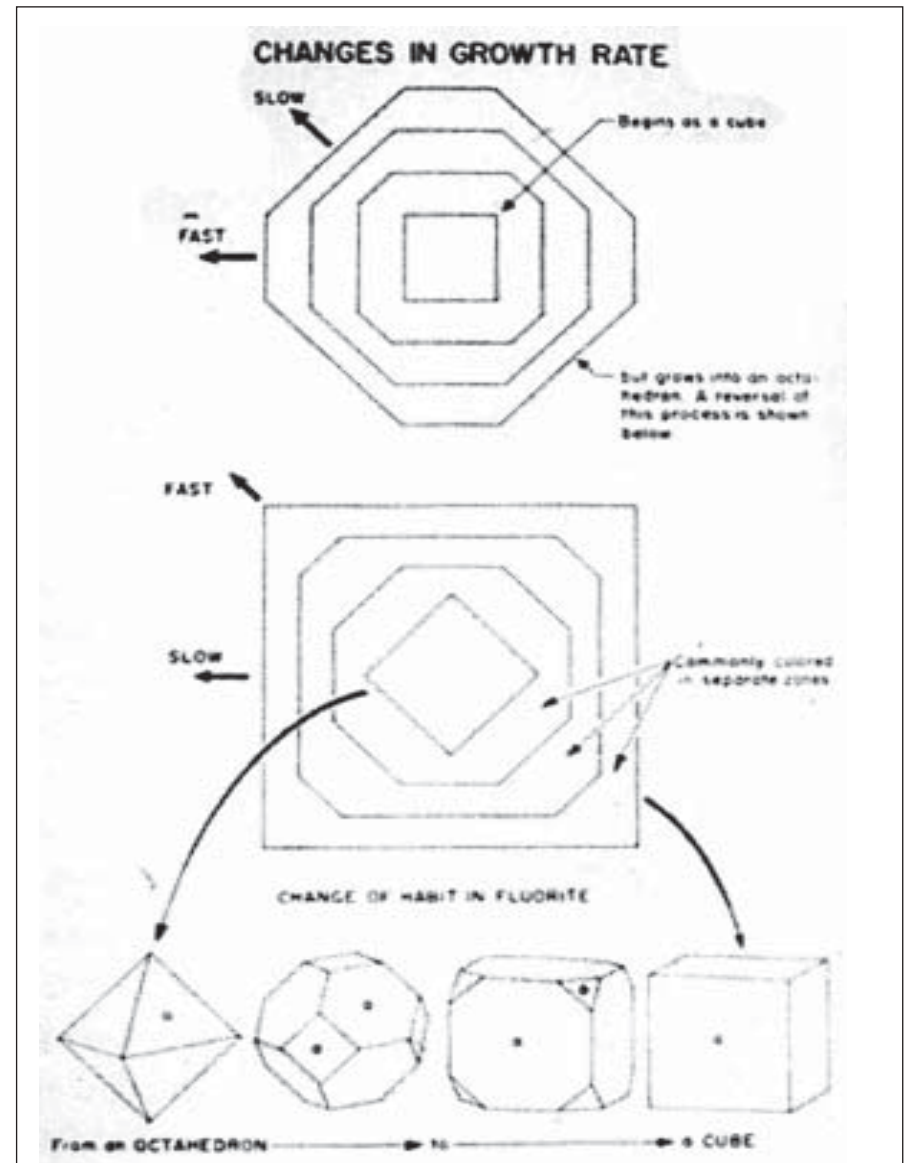

Fig. 6-36. A fluorite crystal.

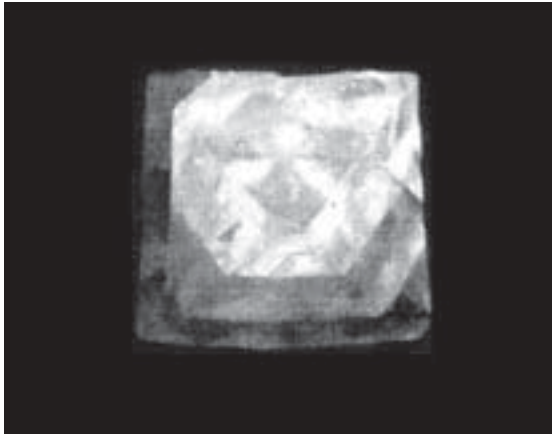

Fig. 6-37. My own fluorite crystal.

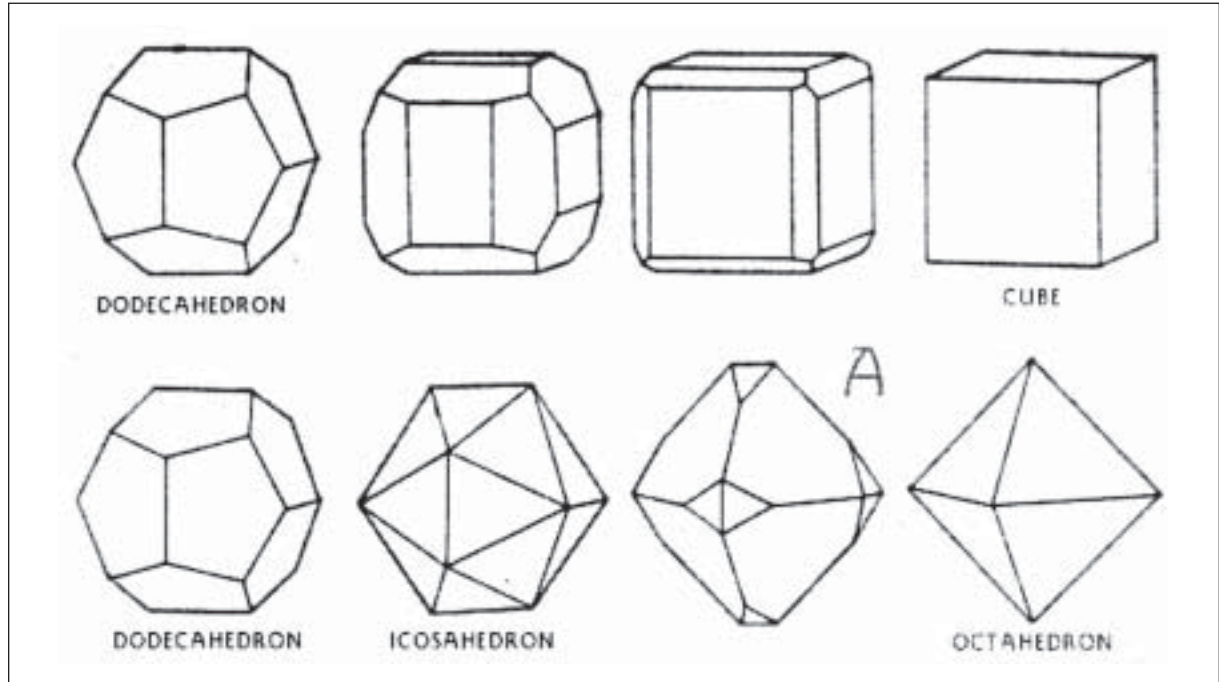

Fig. 6-38. Different truncating possibilities. Top line: truncating edges; bottom line: truncating points.

But in truth, something far more amazing takes place when fluorite changes. The ions actually *rotate and expand or contract* to become a different lattice! It's much more complex than the book shows.

This is another fluorite crystal [Fig. 6-37], one of my own. It's very big, about four inches on a side. You don't often see them this big anymore. In case you can't quite see it, it comes up to a point in the center.

Somebody put this in a window where the sunlight hit it, and because the bonds in fluorite are so weak, when the sunlight struck it, it cracked along the octahedral atomic lines, of course.

In the upper right corner of Figure 6-38 is a cube. The cube to its left is truncated along its edges. Truncated twice more, the darn thing turned into a dodecahedron. This is an example of the cube/dodecahedron in crystals.

In Figure 6-39 the upper crystal is a pyrite cube. It grew that way, no one cut it. There's a huge one like this in Silverado, Colorado, about six feet square, I believe. They simply took it out of the earth as a perfect cube. This little pyrite is square on two ends, rectangular on the sides. The lower crystal is a tiny pyrite

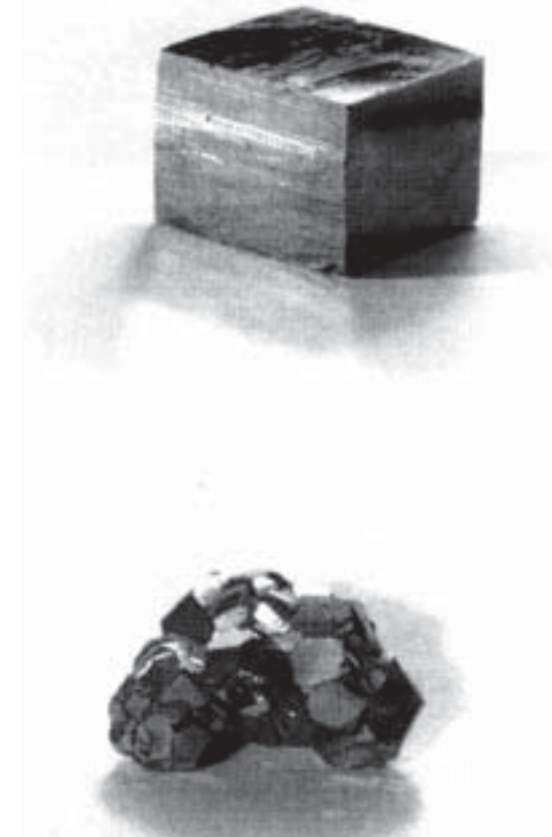

Fig. 6-39. Pyrites: a cube (top) and a cluster of pentagonal dodecahedrons (bottom).



dodecahedron cluster. Some of them are almost perfect—and it grew this way in Peru. If this little slab had been left in the earth long enough, those little dodecahedrons would turn into cubes; and over enough time after that, they would turn back into dodecahedrons. If you take the dodecahedron [bottom left in Fig. 6-38] and truncate its points, it turns into an icosahedron [next to it on the right]. If you keep truncating the points, it turns into an octahedron. I could go on with this truncating business for a long time. There are thousands of ways to do it. Each pattern and crystal, no matter how complex it gets, will turn into one of the five Platonic solids if you truncate it just right, showing the innate nature of the five Platonic solids in crystal structure.

A little side note: If you look inside a point-truncated tetrahedron made of glass or crystal or even mirrors, it will reflect the light. The mirrored reflection inside it is a perfect icosahedron. Check it out.

You can go on and on with this. You'll see some that look really strange, like they couldn't possibly be based on anything logical, but all you have to do is a little geometry, and *every time* you will find out that it's derived from one of the five Platonic solids. There are no known exceptions. No matter what the crystal pattern is, it's always based on a Platonic solid. Crystal structures are a function of the five Platonic solids that came out of the Fruit of Life, out of Metatron's Cube. If you want to see more of these crystals, you can find plenty in the *Rocks and Minerals* book by Charles A. Sorrell.

There's one more set I want to talk about that refers back to Figure 6-38, "Different truncating possibilities." When you truncate an octahedron by cutting off all the corners so that they are 90° to each other (shown at A on the figure), it makes the shape on its left. If you were to draw it on a flat surface, it would be a square with a diamond in the middle [Fig. 6-40]. This pattern happens to be related to our consciousness, to the very nature of who we are.

### *Buckminster Fuller's Cube Equilibrium*

This is what that shape looks like three-dimensionally [Fig. 6-41]. It's called a cuboctahedron or vector equilibrium. You can see that it's originally a cube, but if the angle at point A were continued upward, it would form an octahedron. It's both at once, an octahedron and a cube. It doesn't know which one it is; it's somewhere in the middle. When Buckminster Fuller found this polyhedron, he became almost preoccupied with it. He thought that the cuboctahedron was paramount, the greatest shape that ever was in creation, because it does something that no other known shape does. It was so important to him that he gave it a brand-new name: the vector equilibrium. He discovered that this shape, through different rotational patterns, turns into *all five* of the Platonic solids! This one shape seems to have them all contained within itself [Fig. 6-42].

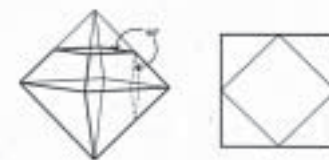

Fig. 6-40. Looking at the face (right) created by truncating all 6 points of an octahedron (left, shown with one point truncated and another at 90°)



Fig. 6-41. Views of a vector equilibrium (cuboctahedron)



Fig. 6-42. Vector of cube equilibrium toy called Vector Flexor.

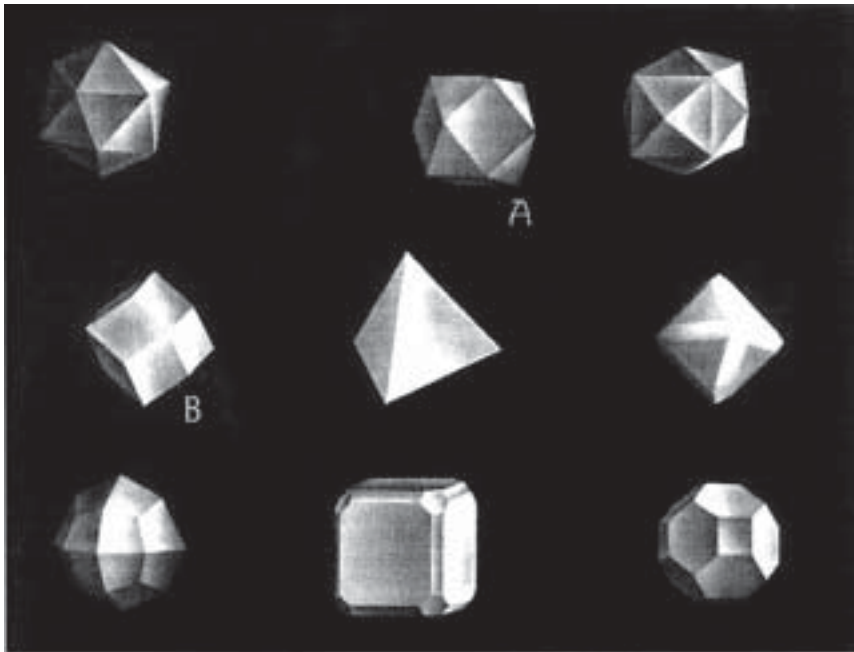

Fig. 6-43. A variety of polyhedrons. A is cuboctahedron and B is rhombic dodecahedron.

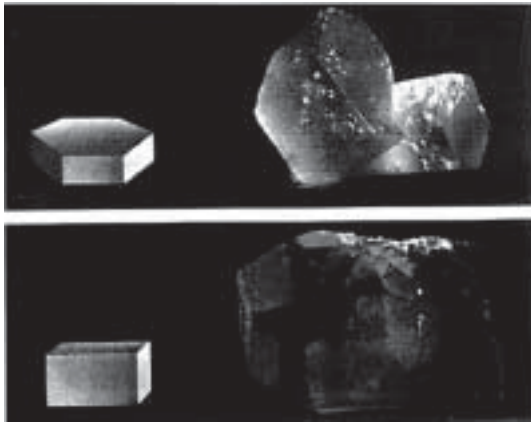

Fig. 6-44. Comparing atoms and crystals, hexagonal (beryl) and orthorhombic (topaz) systems.

The one at A is the cuboctahedron we just discussed; the one at B is the rhombic dodecahedron. The latter is important because it's the dual of the cuboctahedron. If you connect the centers of the cuboctahedron, you get the rhombic dodecahedron, and vice versa. Figure 6-44 shows how the internal geometries of the atoms are reflected in the angles of these crystals. We've seen that already, in terms of the crystals being cubes, octahedrons and other forms.

If you find this interesting, buy this toy [see the reference section] and play with it. It will answer all your questions if you let it.

### *Deep inside a Sesame Seed*

Other people have also studied the cuboctahedron. Is anybody familiar with a man named Derald Langham? Not too many people know of him. He has been pretty quiet during his life. His work is called *Genesa*, if you want to study it. I really respect him. First of all, he was a botanist who single-handedly saved South America during World War II. They were starving to death, and he created a corn that grew like a weed. You just threw it on the ground, and it grew almost without water. It was a great service to the South American continent. Later he studied the sesame seed, and when he explored deep inside it, he found a cube. In fact, when you get inside any seed, you'll find little geometrical shapes that are associated with the Platonic solids, primarily the cube.

Derald Langham found thirteen rays that came out of the sesame seed's cube. Carrying those studies further, he discovered that the same energy fields that are in plant seeds also exist around the human body—which is what we will eventually talk about. But he focused on the cuboctahedron, which is interconnected with the fields around the body. We will be discussing that, though my instructions are to focus on another shape: the star tetrahedron. We have a star tetrahedral field around our bodies, which is also around seeds, but which makes a series of geometrical progressions that are different from the cuboctahedron/vector equilibrium. Langham made a series of what you might call sacred dances (in Sufi talk) in which you move and connect with all the points in your field in such a way that you become aware of them. It's really good information.

Figure 6-43 shows some of the three-dimensional forms of the polyhedrons we have been talking about.

## The 26 Shapes

From my way of thinking, the first five Platonic solids are the first five notes of the pentatonic scale. The octave has seven notes, the last two corresponding to the cuboctahedron (A) and the rhombic dodecahedron (B) shown in Figure 6-43. Five additional shapes form the chromatic scale, and there's a thirteenth one, the return. Thus there are 13 polyhedrons that form the chromatic scale of music. From those 13, 13 more are formed that are the same, only stellated, to total 26 shapes—two octaves within each other. In terms of form, those 26 shapes are the key to all the harmonics of the Reality. We don't need to get into such complexity here, but it just goes on and on and on.

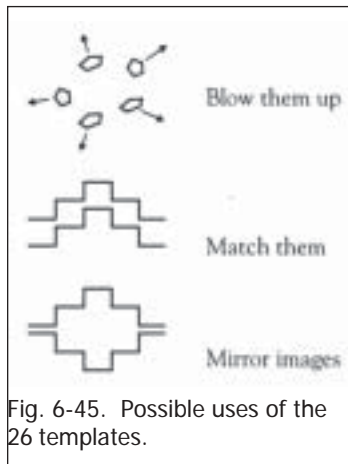

Fig. 6-45. Possible uses of the 26 templates.

Some of you may know of Royal Rife, the man who was trying to cure cancer through electromagnetic fields (EMF) such as light, which I believe is absolutely possible and has been done. Rife knew of 7 of the 13 (or possibly 26) frequencies. The ones he published were incorrect, but he purposely did that. Those he published cause cancer, though if they're shifted slightly in a certain mathematical way, they return to the original frequencies, and each frequency destroys most or all of a specific virus or bacterium.

However, Rife only knew part of the equation. If he had known the sacred geometry we now know, he could have come up with all 26 forms and eliminated any virus in existence. It doesn't matter how many AIDS viruses there are, there's nothing to finding a solution. There are a maximum of 26 templates, and the right frequencies will eliminate every single virus (or bacterium). Because every virus is a polyhedron—structurally, they look just like the polyhedrons in Figure 6-43—there are various ways you can deal with them. You can either blow them up through certain harmonics of EMF, or you can match them [Fig. 6-45]. If you can match them, you can couple with them, much like an antivirus does. Or you can simply make them nonexistent by creating a waveform that's a mirror image of what they are. There are lots of ways to work with AIDS, but one primary key is understanding that there are a maximum of 26 geometries associated with it.

Crystallized water—ice crystals—form these hexagonal patterns we call snowflakes [Fig. 6-46]. You can see the relationship to the Flower of Life. Over and over and over again you will find this relationship of 3D patterns to the geometries that come out of this one central Flower of Life pattern.

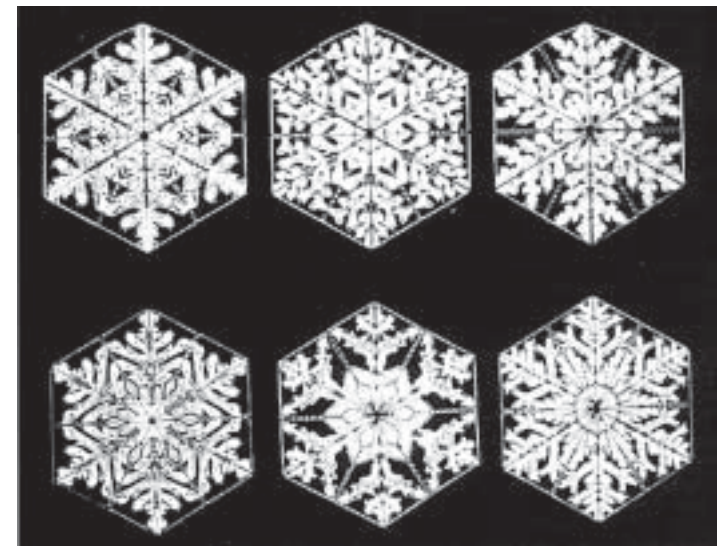

Fig. 6-46. Ice crystals, or snowflakes.

## The Periodic Table

This is an interesting version of the Periodic Table of the Elements [Fig. 6-47], because it shows that every element, with a few exceptions that cannot be determined because they will not crystallize, is related to the cube. One of these few exceptions is fluorine, because fluorine reacts with almost nothing. It's one of the most inert gases. But on almost all the other elements we find this cubical relationship, except the fourth-dimensional atoms that fall outside the natural Table of Elements and those that are synthetic or man-made. They don't happen naturally in nature.

Each atomic element has an associated crystalline structure. In every single case scientists have found that the different crystalline structures associated with atoms can be reduced to the structure of a cube. You might have noticed that the cube seems to be more important than the other polygons. For example, crystals are divided into six different categories, but the cube is the basis of all of them. In the Bible it says that the throne of God is so many cubits in different directions. When you make one, it's a cube. The pharaohs in Egypt sat on a cube. What the heck is it about the cube?

### The Key: The Cube and the Sphere

Well, the cube is different from the other Platonic solids because it has one characteristic the others do not—except for the sphere, which also has the same characteristic. Both the sphere and the cube can perfectly contain the other four Platonic solids and each other symmetrically, by their surface, assuming you have the right sizes. The cube is the only Platonic solid with this special characteristic: You can take a sphere, slip it inside a cube, and it will touch the six faces perfectly and symmetrically. And a tetrahedron will slide right down one of the axes and become the diagonals of the cube, fitting perfectly and symmetrically. A star tetrahedron will also fit perfectly inside a cube. The octahedron is actually the dual of the cube; if you connect the centers of the adjacent cube faces, you get an octahedron. That one is easy.

When you get to the last two Platonic solids, it doesn't look like they could fit symmetrically into the cube and the sphere, but they do. It is a little difficult to show here, but you can see for yourself. Using a real model, just find where both the icosahedron and the dodecahedron have six edges in

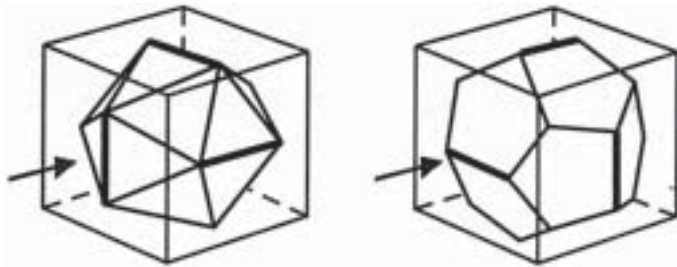

Fig. 6-48. Icosahedron and dodecahedron fitting exactly into a cube.

the planes of the cube, and you have it. You will see how they slide into the faces of the cube [Fig. 6-48].

You can see how the other four Platonic solids fit symmetrically into the cube and the sphere. What is important here is that only the sphere and the cube have this capability. The cube is the father, the most important male form. The sphere is the mother, the most important female form. So in the entire Reality, the sphere and the cube are the two most important forms and will almost always dominate when it comes to primary relationships in creation.

It was for this reason that a man named Walter Russell did some work long ago that was absolutely phenomenal. I don't believe he knew anything about sacred geometry—he was sacred-geometry illiterate, to my knowledge. Yet he intuitively grasped it in his mind. And when the images were happening in his mind, he chose the cube and the sphere as the main geometries to talk about what he understood. And *because* he chose those two forms and not others, he was able to go far. If he had selected any others, he would have made a big mistake and would have been unable to do the work he did.

### *Crystals Are Alive!*

This amplifies my thoughts about crystals being alive. Before I taught this course I used to give courses on crystals, back in the early or mid '80s, I guess. And I discovered—not through giving the courses, but through my actual interaction with the crystals themselves—that *these crystals are alive*. They are living and conscious. I was able to communicate with them, and they communicated with me. Through these interchanges I found out all kinds of things. The more I lived with them and learned how to connect with them, the more I discovered just how conscious they were. It was one of the most interesting awakenings in my life.

One time I was in San Francisco giving a course to about thirty people, and I was saying this very thing, “These guys are alive.” Everybody was listening and saying, “Yeah, yeah, yeah.” Then one person said, “Prove it.” I said, “Okay,” then I quickly thought up something to do. I gave everybody a piece of paper and a pencil, and said, “We’re going to grab a crystal at random.” I selected a crystal that nobody had seen—actually took one and kept it hidden. We didn’t let anybody see it. Then I said, “Now, nobody gets to examine this crystal or even see what it is. You’re just going to put it on your forehead, and you have one second—that’s it. You’re going to ask the question, Where are you from? The very first word that comes in, write it on a piece of paper and fold it up so no one sees it. Just take the crystal, ask the question, hand it to the next person, then write down what you get.” That was the only way I could think of to prove it.

We passed that crystal around to thirty people, and everybody wrote down an answer. Then we looked to see what we received. And *every single person* had “Brazil” written down! What are the odds of that?

Crystals have phenomenal abilities. They affect people in all kinds of ways. Katrina Raphaell has written a lot about this in her books, but many other people have also

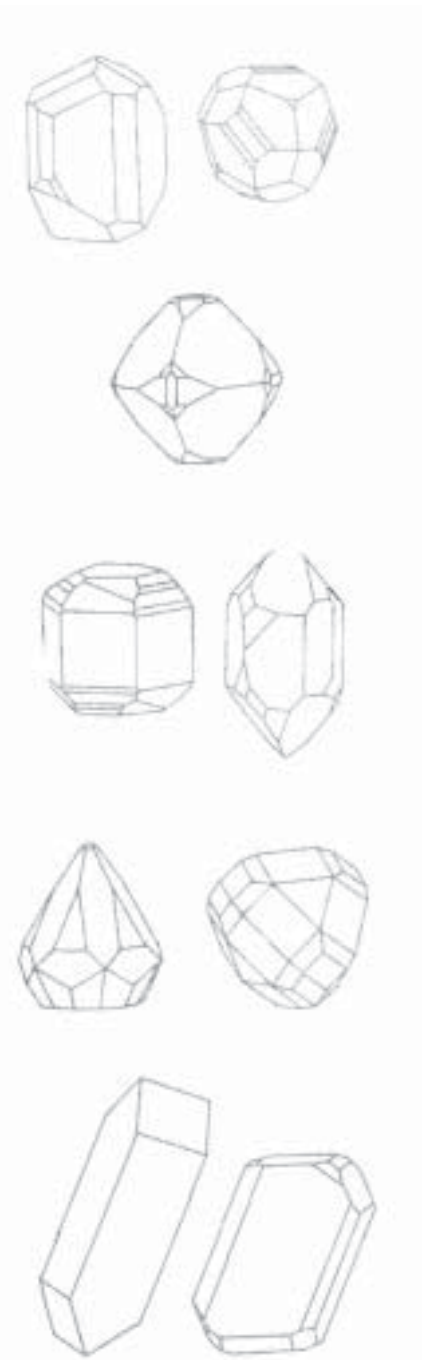

learned about the abilities of crystals over the years. Many ancient beings and civilizations were also well aware of this. Crystals don't just happen as the result of a chemical reaction either; they grow. When you study how crystals are formed, they grow very much like people in lots of ways.

An aerial view of your energy field (shown back in Fig. 2-32) is in part simply the Flower of Life pattern, which is hexagonal in nature. Our fields grow hexagonally, just as crystals do. Though the silicon molecule is a tetrahedron, when it forms quartz it links with another silicon tetrahedron to form a cube. Then it throws out a long line of little star tetrahedrons or cubes to form a row. Then the row begins to spin, changing direction exactly at 60 degrees to form a hexagon, the same structure seen around the human body from above.

Crystals have genders. They're either male or female or both. If you know what to look for, you can look at a crystal and see which way it's rotating. Find the lowest window or face and look to see where the next face is. If it is on the left, then it is rotating clockwise, and that crystal is female. If it is on the right, then it is rotating counterclockwise, and it is male. If there are faces on both sides at just about the same height, you should see two spirals moving around this crystal in opposite directions, and that crystal would be bisexual.

Often two crystals are joined at the base and wrap somewhat around each other. These are called twinned crystals, and these are almost always male and female. It's rare for them to do it differently.

### *The Future Silicon/Carbon Evolutionary Leap*

Here's an image I love to talk about. The sixth element on the Periodic Table is carbon. It is the most important element as far as we're concerned, because it's us. It makes up organic chemistry; it is the element that makes our bodies possible. We have been told that carbon is the only living atom on the Periodic Table, that only organic chemistry produces life, nothing else. But that's definitely not true. They suspected this as far back as the '50s when scientists began to study these things.

They realized that silicon, which is directly below carbon on the chart (one octave apart) also exhibits the principles of life. There appears to be no difference. Figure 6-49 shows how silicon forms certain chains and patterns. These are only a few. Silicon makes endless patterns, and

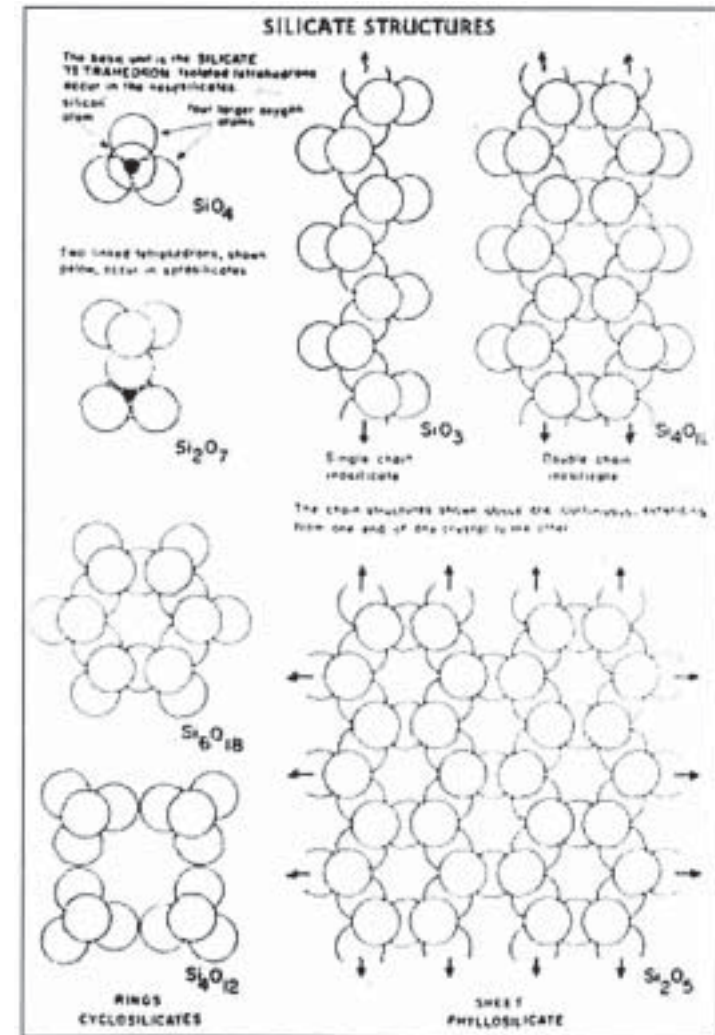

Fig. 6-49. Silicon makes forms and relationships.

it will react chemically with almost anything that comes near and form something with it. Carbon has the same ability, making endless forms and chains and patterns and reacting chemically with almost anything nearby. This is the primary characteristic that makes carbon a living atom.

On a chemical level, it appears that there should also be silicon life forms. After this was discovered, several science fiction movies were made in the '50s based on the belief that there might be silicon life forms on other planets. There were a bunch of scary movies about living crystalline structures. They didn't know when they were making those movies that there really are silicon life forms right here on this planet. Some of these were recently found several miles deep in crevices in the ocean. Silicon sponges were found—live sponges that grow and reproduce, demonstrating all the principles of life, and with not a single carbon atom in their bodies!

Here we are, sitting on Earth, which is over 7000 miles in diameter. Its crust, 30 to 50 miles thick, is, like an eggshell, made up of 25 percent silicon, but because silicon reacts with just about anything, the crust is actually 87 percent silicon compounds. That means that the Earth's crust is almost pure crystal, 30 to 50 miles deep. So we're on this huge crystal ball floating through space at seventeen miles a second, totally oblivious of the connectedness of carbon life with silicon life. It would seem that silicon and carbon must have a very special relationship. We carbon-based beings are living on a crystal ball made of silicon, our crystal planet, looking for life outside ourselves in outer space. Perhaps we should look toward our feet.

Now, think about computers and the modern world. We're making computers that are performing all kinds of incredible things. The computer is rapidly moving humankind into a new experience of life on Earth. What are computers made of? Silicon. And what is the computer industry trying to do as fast as it can? Make self-aware computers. We're very close to accomplishing this, if we haven't already. I feel sure that very soon we will have self-aware computers. So here we are, carbon-based life forms creating silicon-based life forms, and we're interacting with each other.

When we have self-aware silicon-based computers, nothing will ever be the same again. We're going to have two different life forms/components of the Earth connecting with each other, and the speed with which we will evolve at that point, aside from everything else, is going to be very, very fast—faster than anything we would normally expect. I believe that this will come true in this lifetime.

# The Measuring Stick of the Universe:

## The Human Body and Its Geometries

### *Geometry within the Human Body*

It's easy to see how the five Platonic solids influence the structural patterns of crystals and metals. Metals also have atomic lattices. It's simple to see the geometrical relationship of these types of molecules, but when you look at yourself or at a baby being formed, it's much more difficult to see how this kind of geometry could have anything to do with us at all. Yet *it does*. In the beginning of your life in the

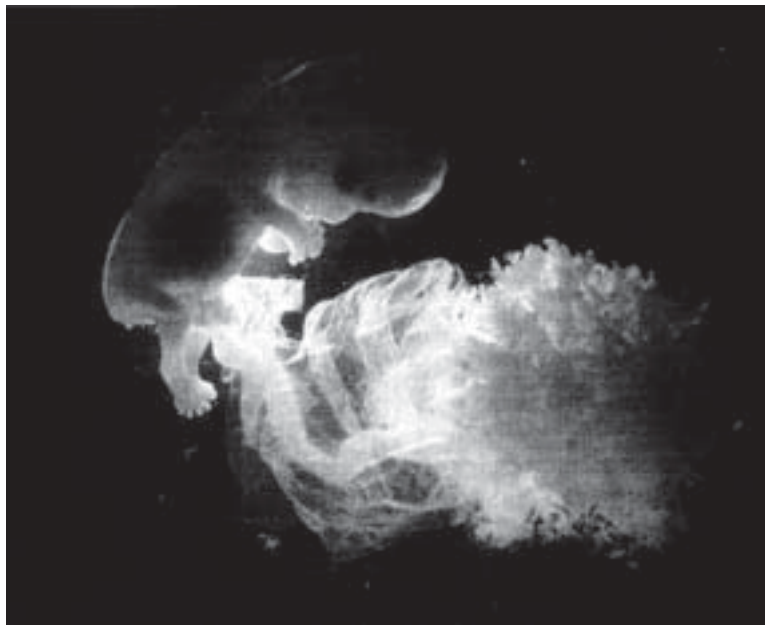

Fig. 7-1. The human fetus.

womb, you were nothing but geometrical forms [Fig. 7-1]. In fact, all life forms—trees, plants, dogs, cats, everything—have the same geometrical and structural patterns running through them that ran through you when you were microscopic. Their very life and structural support depend on the forms. In fact, all life forms *are* these geometrical patterns, but it is not apparent to the casual eye. The geometrical relationships are important to perceive, not only so the If brain can realize the unity of all life, but for





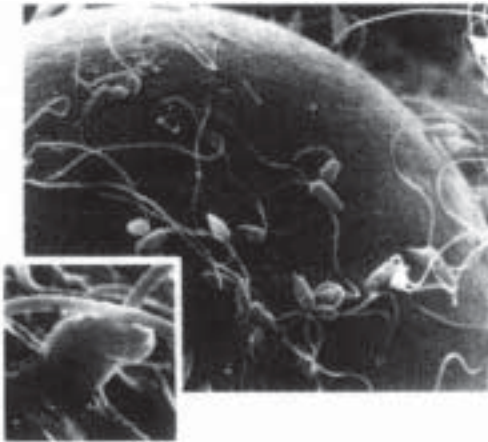

Fig. 7-2. Sea urchin swarm around egg; one penetrates (inset).

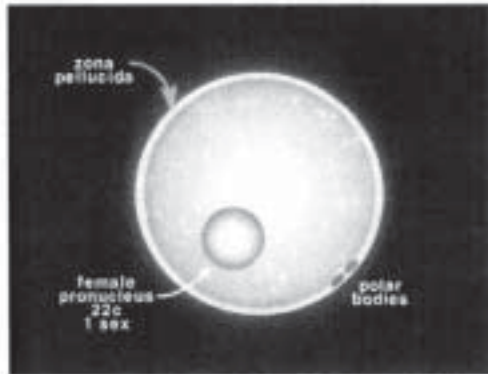

Fig. 7-3. The human ovum.

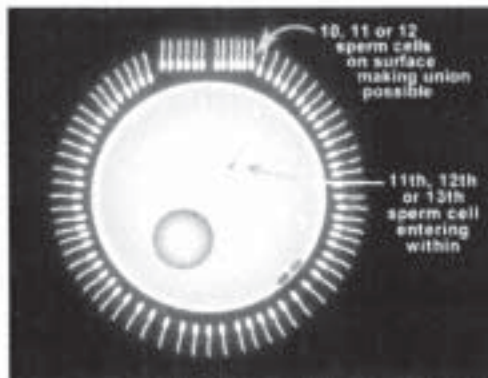

Fig. 7-4. Twelve sperm allowing the thirteenth to penetrate the ovum.

another reason: so that we can understand these electromagnetic structural patterns around our body and beg to re-create the living Mer-Ka-Ba around us.

### *In the Beginning Is the Sphere, the Ovum*

Figure 7-2 is a sea urchin egg with sperm swarming around it. I'm going to be talking primarily about human beings and human conception, but I'm actually discussing *all* life forms known on Earth, because the procedure illustrated in the next few figures is identical for every life form known—not just humans, but everything.

Every known life form begins as a sphere. It's the most female form there is, so it makes perfect sense that the female would choose that shape to form the ovum [Fig. 7-3]. The ovum is a perfect round ball. Another example of a round ovum is inside a chicken egg. When you remove the yolk from a hard-boiled egg, you can see how perfectly round it is. All of us begin as a sphere.

I would like you to notice some simple things about this ovum. First, there's a membrane around it called the *zona pellucida*. Remember this, because I will refer to it over and over again; it has to do with why the ancients put two circles around the Flower of Life instead just one or none.

Inside the membrane is a liquid, and inside that, just like the chicken egg, there's another perfectly round sphere called the female pronucleus, which contains 22+1 chromosomes—half the chromosomes necessary to create a human body. The number of chromosomes changes, depending on the life form, and those particular chromosomes are different in every life form. Inside the *zona pellucida* are two polar bodies. I'll explain those in a moment.

### *The Number Twelve*

When you were first learning about human biology, you were probably told that it takes one sperm for conception to occur. That isn't true, according to *Time* magazine, even though most textbooks still state this. It is now known that the ovum must be absolutely saturated with hundreds of sperm, or conception is not even possible. Second, out of those hundreds, ten, eleven or twelve must come together in some kind of pattern on the surface—a pattern they're still trying to figure out—that allows the eleventh, twelfth or thirteenth sperm to enter the ovum [Fig. 7-4]. One

sperm cannot get through the membrane without the other ten, eleven or twelve. It's not possible except under unnatural conditions, where a human manipulates the conception.

This image brings up what was possibly hidden in the life of Jesus. Jesus came here to a round ball called Earth, which was saturated with people. The first thing he did was gather twelve males together, no females. Jesus—from my point of view and from his, I'm sure, because he did it—could not have done what he did without the twelve disciples. Seldom does anyone wonder why he gathered those twelve disciples together. He absolutely *had* to have them. If we are right, he could have done it with ten or eleven, but he chose twelve. I believe that the *number* of sperm that join to allow the one sperm to enter the egg determines the sex—and Jesus chose twelve. Prior to Jesus' time, in Greece, near the area of his ministry, people saw the Earth as a sphere. Right after that they began to see the Earth as a cube and flat. Then 400 years ago, Copernicus came along and changed it back to a sphere. So people's perception of the Earth went from a sphere to a cube and back to a sphere. Exactly the same thing (sphere to cube to sphere) goes on during conception, only at a much faster rate. I don't know if this analogy is true or not, but it sure does look like it.

### ***The Sperm Becomes a Sphere***

Anyway, the little sperm gets in through the zona pellucida with the help of the other sperm and then starts swimming toward the female pronucleus [Fig. 7-5].

The first thing that happens is that the sperm's tail breaks off and disappears—it's just gone. Next, the tiny sperm head expands and becomes a perfect sphere, which is the male pronucleus. It becomes *exactly* the same size as the female pronucleus, and it contains the other half of the necessary information. The words "exactly the same size," I believe, are very important when you look at the next figure.

Next, they pass through each other and form a geometrical relationship called the vesica piscis [Fig. 7-6]. It's not possible for two spheres to pass through each other and perfectly coincide without forming a vesica piscis. This means that at that exact moment, the male and female pronuclei form the image of the first motion of the first day of Genesis, and literally all the information of the Reality (and light) is contained in that geometry. It's so simple. That image could not be formed unless *these two pronuclei were the same size*. It's for that reason I believe that the female determines which sperm will enter. Science proved around 1992 that the determining factor for which sperm will enter is the female. She selects the one to allow in.

Just as everybody in this room has a different projection length into a dark space or into the Void, each little sperm also has a different-size sphere around it. She's not going to let him in unless his size is identical to hers. If it's a matching key, okay; if it's not, forget it. This could explain why many people who have tried to have babies cannot have them; there's no explanation that anybody can see. This might be at least one explanation.

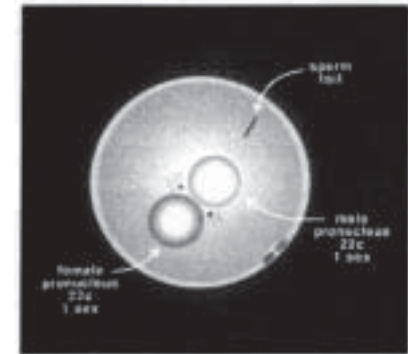

Fig. 7-5. The sperm's breakthrough.

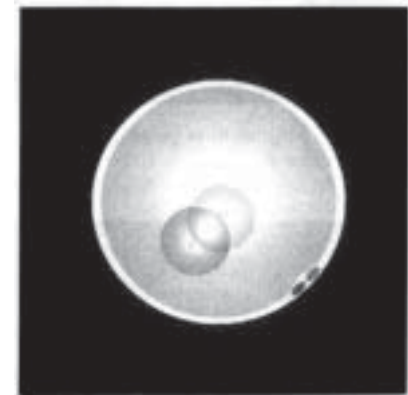

Fig. 7-6. Union of male and female pronuclei.

## The First Human Cell

After the two pronuclei make a vesica piscis, the male pronucleus continues to permeate the female pronucleus until they are one [Fig. 7-7]. At this time it's called a human zygote, the first cell of the human body. So you began as a sphere before you created your familiar human body. Actually, you were a sphere within a sphere.

The next thing you need to know is that the human zygote will not change size during the first nine cell divisions. It's fixed, as is the size of the outer membrane. The human zygote is about 200 times bigger than the average cell in the human body, so big you can actually see it with your naked eye. When it divides into two, each of those two cells are half the original size; and when those two cells divide into four, each cell is a quarter of the original size. The cells keep dividing like this, getting littler and littler, until they've divided eight times and number 512. At that point the average cell size of the human body is reached. When that happens, mitosis continues, and the dividing cells expand beyond the boundaries of the original zona pellucida.

So, first the growth goes into itself, then out beyond itself. When the first growth goes inward, it's as if it's trying to figure out how to do it. Once it figures that out, it goes beyond itself. All life uses this process. I use that same understanding to figure out some of the geometries, which you'll see later.

Figure 7-8 is an electron microscope photograph of the first cell of a mouse egg.



Fig. 7-7. Oneness in the human zygote.

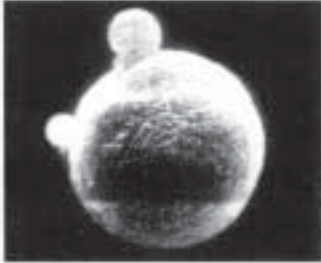

Fig. 7-8. First cell of a mouse egg.

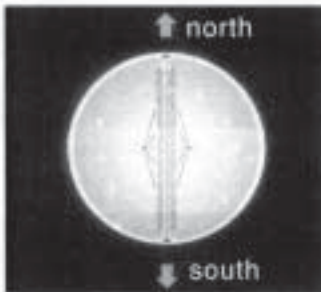

Fig. 7-9. Migration of polar bodies to form a central tube.

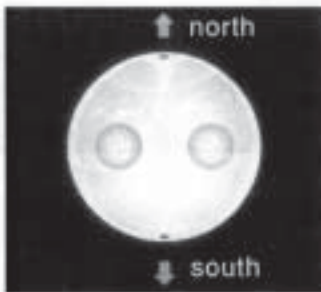

Fig. 7-10. Chromosomes forming the first two cells.

## Forming a Central Tube

The next thing that happens in the conception process is that those little polar bodies begin to migrate through the zona pellucida. One goes down and becomes the south pole and the other becomes the north pole. Then out of nowhere a tube appears, running right down through the center of the cell. Then the chromosomes break in half, and half of them line up along one side of the tube and half along the other [Fig. 7-9].

This is a familiar image in human energy fields—it's very much like the energetics of an adult human being. As you study this further, you'll see that you have a similar sphere of energy around you. You have a north pole and a south pole, and you have a tube running right down through your body. Half of you is on one side of that tube and half is on the other. So this picture is very much like the energy field of an adult human being, though the human energy field is much, much more defined than that. But we've got to wait until we get further along to see how true this is.

After the chromosomes have lined up along the two sides of the tube, they form into two cells, one on each side of the tube, and each cell contains 44+2 chromosomes [Fig. 7-10].

Here are the first two cells in a mouse egg [Fig. 7-11]. The zona pellucida has been taken away so you can see the inner part.

An important piece of information came up around 1992. Many books said that the female gave  $22 + 1$  chromosomes and the male gave  $22+1$ . That was flat-out true, according to them; it wasn't even considered that it could be anything else. But that has now been found to be untrue. The female can give any *number whatsoever*. She can give  $22 + 1$  or all  $44 + 2$  or any number in between. This new information has completely changed the field of genetics. They've thrown almost everything they knew out the window and started over.

Scientists used to depend on electron microscopes for photographs. Now they have laser microscopes that can take movies, so they can watch these things happening. They're gaining information very rapidly. I'm sure they're a lot further now than we are showing you. Science is in the midst of mapping every one of the 100,000 chromosomes in the DNA of the human body. Within just a few more years we'll know what every single chromosome is and what it does, which means that we'll be able to

engineer any kind of human being you can imagine, create any appearance or intelligence or emotional body—anything we want. We'll be able to do it and know exactly what we will get. Are we God? This is a question that must be answered.

### **The First Four Cells Form a Tetrahedron**

The next step is that the cells divide again, going from two to four—a binary sequence—1, 2, 4, 8, 16 etc. Most textbooks show the first four cells forming a little square, but that's not what happens. They actually form a tetrahedron—one of the Platonic solids—and the apex of the first tetrahedron points either to the north pole or the south pole [Fig. 7-12]. (The tetrahedron is formed by linking the centers of the spheres together.) I believe that whether it points north or south probably determines which sex it is. They haven't discovered that yet, but they'll probably figure it out, based on the polarities of the tetrahedron. If the tetrahedron forms with an apex pointing to the south pole, toward the feet of the newly forming fetus, it should be female; if it forms with an apex pointing to the north

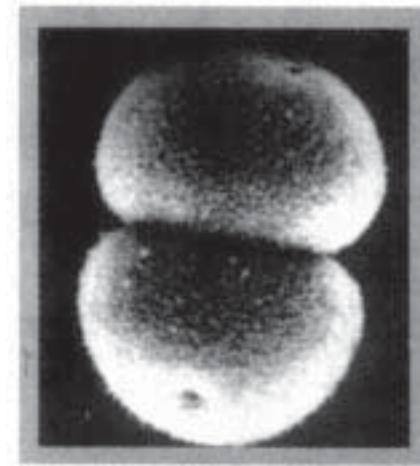

Fig. 7-11. First two cells in a mouse egg.

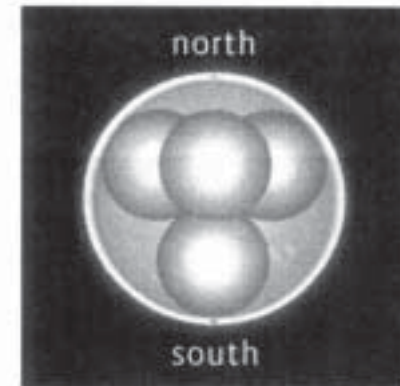

Fig. 7-12. The first four cells form a tetrahedron.

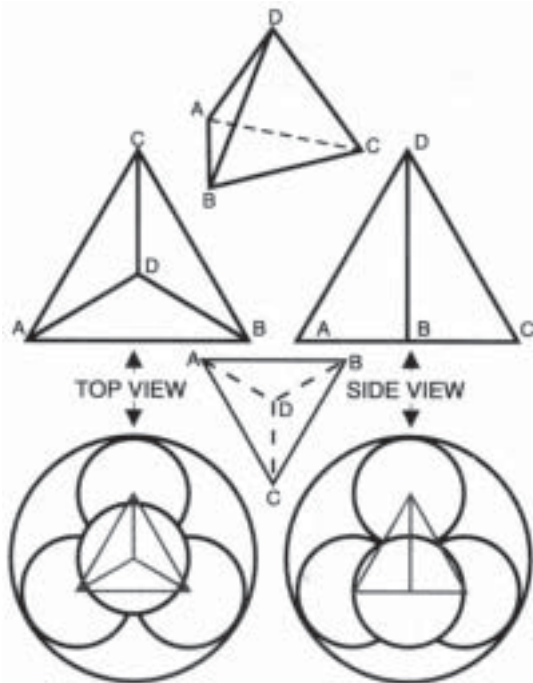

Fig. 7-13. Geometries of the first tetrahedron.

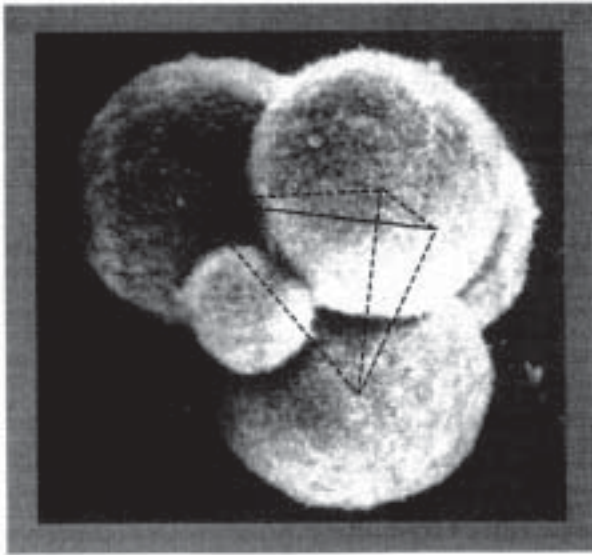

Fig. 7-14. The four cell tetrahedron in a mouse egg.

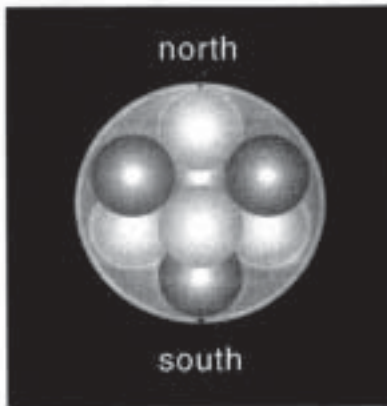

Fig. 7-15. Egg of Life in the first eight cells.

pole, toward the head, it should be male. If this is true, they'll be able to determine immediately what the sex is. Since they'd have to do that within about an hour or so after conception, it would be fairly inconvenient.

These are the geometries of the first tetrahedron [Fig. 7-13]. The side view is on the right and the top view is on the left.

Figure 7-14 is an electron microscope view of a mouse egg. In this picture it's growing really fast, but it's still aligned through the north-south pole. That tiny cell is beginning to form beyond the original tetrahedron. The fourth point of the tetrahedron is in the center of the large cell in the background.

Next, the cells divide into eight; they form one tetrahedron facing up and one tetrahedron facing down, and you get the star tetrahedron. Here it is—the Egg of Life [Fig. 7-15]. This form came out of Genesis, remember? It came out of spirit's second rotation. Every single life known—on Earth anyway, and probably everywhere—must pass through the Egg of Life. According to the angels, this point where the original eight cells form a star tetrahedron—or a cube, depending on how you look at it—is one of the most important points in the creation of the body.

Science has also recognized that this particular stage of development is different from any other, and it has many unique qualities that don't occur at any other time in its development.

The most important quality of these original eight cells is that they appear to be identical—there appears to be nothing different about them at all. Usually it's easy to see the difference between one cell and another, but here they all appear to be the same. Researchers have tried to find differences, but they couldn't. It would be as though there were eight identical twins in this room, dressed exactly alike, with their hair combed exactly the same way. Scientists have found that they can split the egg in two at this point, through the middle of the cube, with four cells in one part and four in the other, and two identical people—or rabbits or dogs or anything else—will be created. They've also been able to sever it once more, making four identical life forms. I don't know if anybody has been able to go further than that and make eight life forms, but they've definitely gone as far as four.

### *Our True Nature Is in Our Original Eight Cells*

According to the angels, these original eight cells are closer to who you really are than your physical body is, closer to your true nature. That sounds odd, I know, because we're used to identifying with our human bodies. But these eight

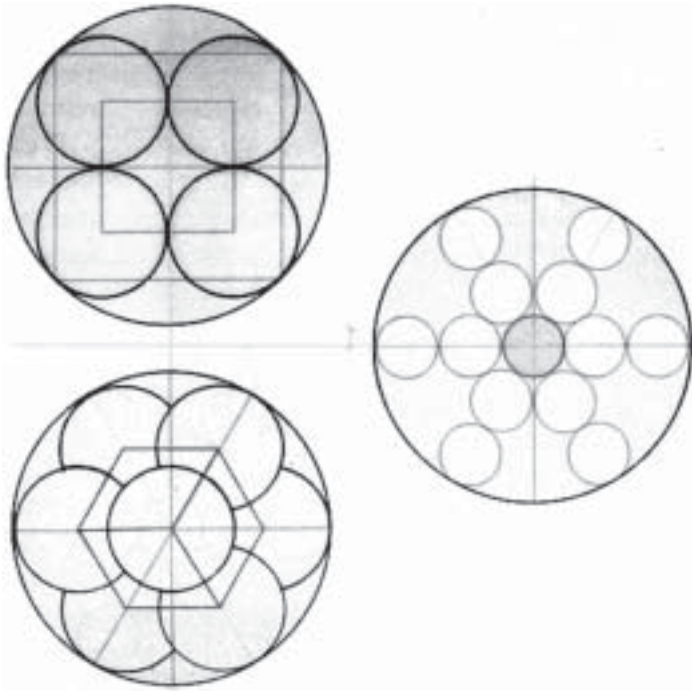

Fig. 7-16. Geometries of the first eight cells, 2 views.

cells are closer to who we *really* are. The angels say these eight cells are immortal relative to your body. You get a brand-new body every five to seven years; every single cell in your body dies within a five- to seven-year period and is replaced with a new one, except for the original eight cells. They remain alive from the time you're conceived until the time you die and leave the body. All the rest go through their life cycles, but not these eight.

These cells are centered in the precise geometric center of your body, which is slightly above the perineum. For the female the perineum is located between the anus and the vagina. For the male it's between the anus and the scrotum. There's a little piece of skin there, and even though there's not a physical opening, there is actually an energetic opening. That's where the central tube runs through your body, coming out the top through the crown chakra at the top of your head. If you look at a newborn baby during the first few weeks, you'll see the top of its head pulsing. If you were to look at the bottom of the baby, at its perineum, you'd see the same pulsing. That's because the baby is breathing in the proper way.

Both ends are pulsing because

the energy is flowing from the two poles—coming not only from the top down, but from the bottom up—and meeting. This is the basic understanding of the Mer-Ka-Ba. From the point where the original eight cells are located, it's the same distance to the top of your head as it is to the bottom of your feet. And the cells are arranged just as they were when they first came into existence—in the Egg of Life pattern—north up, south down.

If you notice in the previous illustration, when the Egg of Life is oriented to the north and south, you can actually see through the middle to the light-colored sphere on the back side. That's very different than when you look at it as a hexagon—you can't see through a hexagonal pattern. I want you to notice this difference for later, when we talk about doing the meditation to activate the Mer-Ka-Ba.

Figure 7-16 and the next are two views of the first eight cells. These original eight cells are the key, because according to the angels, we don't grow like a

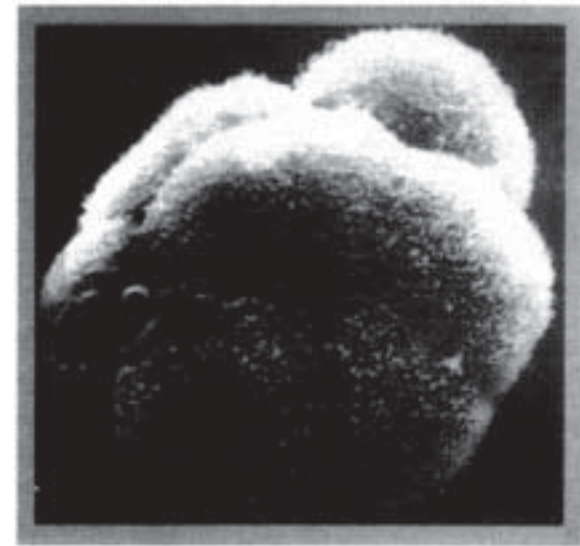

Fig. 7-17. Mouse egg starting to divide beyond the first eight cells.



Fig. 7-18. Becoming a blob.

string bean, getting longer and longer. We actually grow radially in 360 degrees, from the original eight cells.

This picture of the mouse egg was taken just as the eight cells started to divide again [Fig. 7-17]. It's not a great photograph, as these pictures are difficult to get; the cells are dividing very quickly. They have to strip off the zona pellucida, have the cells stop at the right place, then take the photograph.

### *The Star Tetrahedron/Cube of 16 Cells Becomes a Hollow Sphere/Torus*

After the eight-cell division, it divides into 16 cells, whereupon it forms another cube or star tetrahedron on the end. This is the last time it will be symmetrical. When it divides into 32, 16 cells are in the middle and 16 on the outside. If you take the 16 on the outside and try to fill in the empty spaces to keep it symmetrical, you will find it is not possible. (I've actually done this. You end up with two open spaces no matter how you do it.) It needs 18 cells to be symmetrical. You wonder why. At the

next division there are 32 more cells, but it gets worse [Fig. 7-18]. You wonder, What's going on here? It's getting weird. Where did all the symmetry go?

Well, it was meant to do that. It starts turning into a blob. We become a blob for a while. But the blob has consciousness in its blobness. Then it stretches and the inside starts turning out, becoming a hollow ball like this photo [Fig. 7-19].

Once it gets to this stage, it becomes a perfect hollow sphere. Then the north pole starts dropping through the space inside, going down toward the south pole,

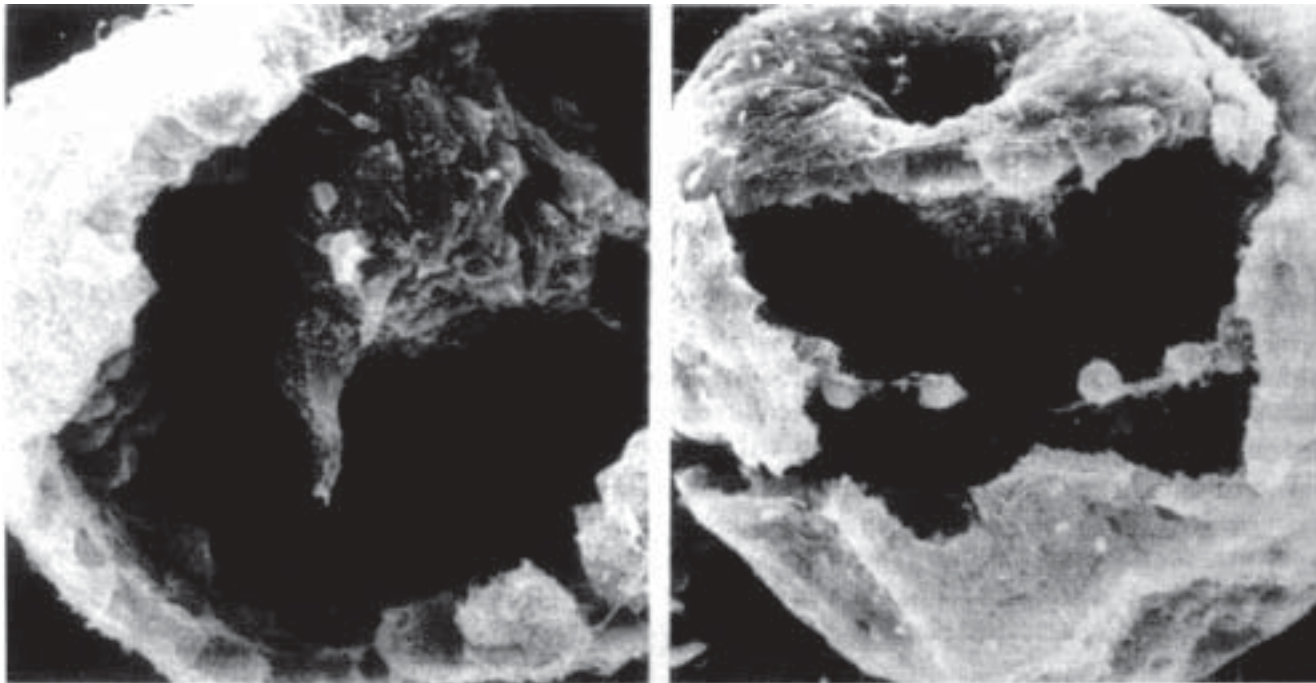

Fig. 7-19. Original cells forming into a torus (see the photo at right). A sea urchin embryo, magnified 2000 times, begins as a hollow ball of cells. It forms a gut by folding inward (left) until its cells reach the opposite side.

and the south pole comes up through the space to meet the north pole. The embryo in this photo has been broken apart so the center could be photographed. If you could see this in its completeness, it looks just like an apple cored through the middle. The hollow sphere then becomes a torus—a spherical torus like the photo on the right.

Every single known life form goes through this torus stage. This formation in the apple/torus shape is called the *morula*.

After this the expansion goes beyond the zona pellicuda and the cells begin to differentiate. The hollow space inside the torus becomes the lungs, the north pole becomes the mouth, the south pole becomes the anus, and all the internal organs from inside the tube that runs through the middle. If it's a frog it begins to get little legs, or if it's a horse a little tail grows. For a fly, little wings develop, and a human starts to look like a human. But before this differentiation, we all look like a torus. I suspect this is why, though I don't have any proof, biblical tradition says that the tree of knowledge of good and evil is an apple tree. We really *do* turn into something that looks very much like an apple at one stage.

### *Progression of Life Forms through the Platonic Solids*

To summarize, we start out as a sphere, the ovum. We then move to a tetrahedron at four cells, then on to two interlocked tetrahedrons (a star tetrahedron or a cube) at eight cells. From two cubes at sixteen cells we turn back into a sphere beginning at 32 cells, and from the sphere we become a torus at 512 cells. Planet Earth and its magnetic field is also a torus. All of these forms are sacred shapes that come out of the first informational system of the Fruit of Life, which is based on Metatron's Cube.

We could go on for probably another seven or eight months talking about this subject, showing how more and more and more things are connected to these five shapes—the Platonic solids. But I think you can see exactly what I mean. By the way, modern mathematicians say that the Platonic solids have been known only since civilization began about 6000 years ago, but this is not true. Some put their discovery during the time of Greece. Archaeologists have recently found some perfect models in the earth—perfectly cut in stone—that were found to be 20,000 years old. Those hairy barbarians obviously knew more than we give them credit for.

### *Underwater Birthing and Dolphin Midwives*

I would like to take a quick digression from the geometries of birth to something slightly different. A Russian named Igor Charkovsky has been involved in underwater birthing for a long time. He has probably assisted with at least 20,000 underwater births. His daughter, one of the first to be born underwater, was in her twenties, I think, when the following incident took place. Charkovsky and his team had taken a woman to the Black Sea for an underwater birth. They were sitting there prepared for the birth, with the woman lying in water about two feet deep.

As I remember, three dolphins approached, pushed everybody away and took over. The dolphins did something that looked like scanning up and down her body—something I have experienced, and which does something to the human system. The woman gave birth with almost no pain or fear. It was a phenomenal experience. That experience with underwater birthing began a new practice of using dolphins as midwives, which has now spread all over the world. There's something about the sonar that dolphins project at the time of birth that seems to really relax the mother.



Dolphins have preferences with humans. This is not an absolute rule, but is usually true. If you go swimming with dolphins and there are children around, the dolphins go to the children first. If there are no children, they go to the women. If there are no women, they go to the men. And if there's a woman who's pregnant, everyone else can forget it—she gets their total attention. That little incoming baby is the greatest thing of all. The dolphins become very excited when they see a human giving birth. They just love it.

Dolphins can do things that are really amazing. Babies who were born with midwifing dolphins, at least as it's going in Russia, are extraordinary children. From everything I've read so far, not one of those babies has an IQ under 150, and they all have extremely stable emotional bodies and extremely strong physical bodies. They seem to be superior in one way or another.

France has also had underwater births—over 20,000. They give birth in big tanks. When they first started doing this, they had all the instruments laid out on tables and all the emergency supplies ready, with a doctor standing by in case there was a problem. But they didn't have a problem for a long time; a year went by and they still hadn't had a problem. Still another year went by, and finally 20,000 births went by without one *single complication!* Now they just have the instruments and equipment stuck in a corner somewhere because there simply aren't any problems. I don't know if they know why, but for some reason, when a woman is floating in water, it seems like most complications solve themselves.

I got to spend some time with a woman who was an assistant with Charkovsky in Russia. She had brought back many films that were taken during the births. I watched two movies of two different women giving birth who not only were not in pain, but they were having orgasms while having their babies—long, extended orgasms lasting about twenty minutes. It was total pleasure. I know that's the way it's supposed to be. It simply makes sense, and these women were proving it.

I've also seen some Russian movies where babies and children two or three years and older sleep on the bottom of swimming pools. They literally sleep underwater on the bottom of the pool, and about every ten minutes they come up while they're asleep, roll their faces over the surface, take a breath, go back down and settle on the bottom again. These kids live in water—that's their home. They're being given a name, almost like they're a different species. People are calling them *homodolphinus*. They seem to be a blend between humans and dolphins. Water is becoming their natural medium, and they're extremely intelligent.

So I have a great deal of respect for underwater birthing. And the possibility of having dolphins there at the same time is truly a gift. I think it's a healthy trend the way many countries are allowing this new way to birth, though in the United States there's a lot of pressure against it. Lately in the U.S., the pressure seems to have subsided, and I think you can do this legally now in Florida and California. Around the world, in New Zealand, Australia and other places, there are lots of centers. And, of course, the more women see other women not in pain, obviously they're going to want to do it, too.

### *Geometries That Surround the Body*

Here we go with the next adventure. We've now seen how the geometries unfold in conception. We saw how we started with a little cube of eight cells, which became the center of our bodies. Now I want to look at the geometries outside the body. The way the angels explained it to me is the way I'm going to give it to you.

This began when I was in Boulder, Colorado, sometime between 1976 and 1978; I can't pinpoint it for sure. I was living in a communal home with a bunch of friends and had my own bedroom. One night the angels came in with a new teaching for me. They showed me the geometries by projecting glowing forms in space. It would be like holographic images that would appear maybe seven or eight feet away from me, and I'd work with them from there. In my room the angels showed me this image of a circle and a square [Fig. 7-20]. They said they wanted me to find this image in Metatron's Cube [Fig. 7-21]. Then they said good-bye and left, leaving me with no real instructions on how to proceed.

After they left, I figured this wouldn't be too hard, because they were always giving me little things to do. I'd do them, wait for them to come back, then they'd give me something else to do. I figured it wouldn't take long. But as I found out, it wasn't that easy. At least four months went by and I still couldn't figure it out. The way I see it, the angels intervened directly to help me with this.

I was sitting there in my room one night around nine, the floor covered with drawings. (I used my floor as a table because I had so many drawings.) My door was closed, and I was sitting there studying my drawings, trying to solve the problem the angels had given me. I had so many drawings you wouldn't believe it, trying to figure out where the circle and the square were in Metatron's Cube.

In those days I didn't tell anybody what I was doing; I didn't tell people for a long, long time because it was a very personal experience for me. And quite frankly, nobody was interested anyway. Nobody cared about geometry back then, because it had not emerged into most people's consciousness as it has now.

### *The Masonic Key to Squaring the Circle*

Someone knocked on the door. I opened my bedroom door, and here's this tall guy standing there. I had never seen him before in my life. He looked kind of sheepish, and he said, "I was supposed to come here to tell you some things." I asked his name and more about what he wanted.

"Well," he said, "I was sent here by the Masons to tell you about the circle and the square."

This really jolted me. I sort of froze in my tracks and just looked at him for a moment, try-to understand how this was in happening. Then I figured I didn't really care *how* it was happening, only that it was. I just grabbed him by the

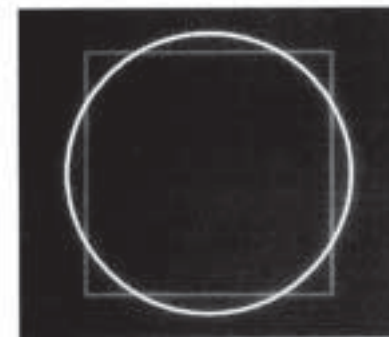

Fig. 7-20. The circle and the square.

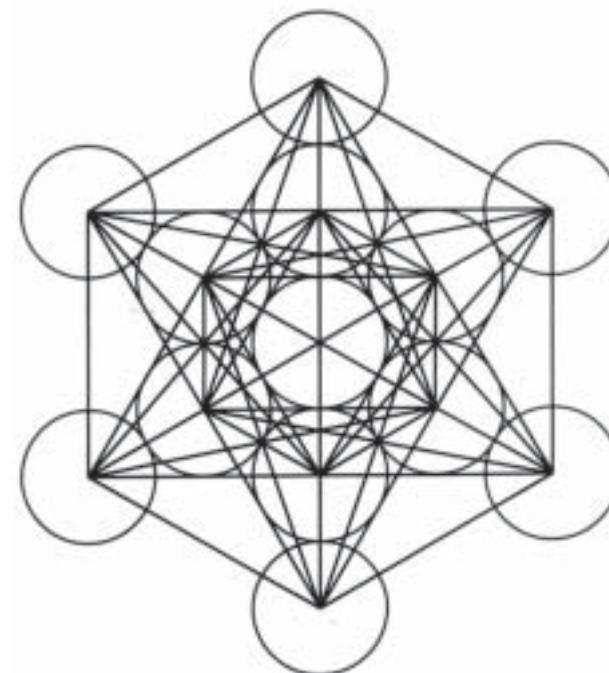

Fig. 7-21. Metatron's Cube.

hand and said, “Get in here,” pulling him in and closing the door. I said, “Anything you have to tell me, I want to know what it is.” So he drew this drawing [Fig. 7-22].

First he drew the square, then he drew the circle around the square in a particular way—and there was the image I had seen glowing in the room! I thought, This is going to be good. He divided the square into four sections, then he drew diagonals from the corners through the middle to the opposite corners. Then he drew diagonals through the four smaller squares. Then he drew lines from I to E and E to J. Next he drew lines from I to H and H to J (E and H being the points on the circle’s circumference where the vertical center line intersects it).

Up to this point I’d had no problem, but then he drew a line from A to nowhere (G) and back to B, and from D to nowhere (F) and back to C. I said, “Wait a minute, that isn’t in the rules I was given. That doesn’t fit—there’s nothing there.” And he said, “It’s okay, because this line (A-G) is parallel with that line (I-H), and this line (D-F) is parallel to this line (J-E).”

“Well,” I said, “that’s a new rule. I didn’t have that one before. I mean, there’s nothing there. Parallel lines?—well, okay I’ll listen.”

Then he began to tell me all kinds of things. He said that the first key is that the circumference of the circle and the perimeter of the square are equal, which is what I told you before. This circle and square is the same image seen from the air as that of the Great Pyramid with the ship sitting on top.

### **The Phi Ratio**

He began to tell me about the phi ratio of 1.618 (rounded here to three decimal points). The phi ratio is a very simple relationship. If you had a rod and you were going to put a mark on it somewhere, only two places would mark the phi ratio, shown as points A and B in his illustration [Fig. 7-23].

There are only two places, depending on which end you’re coming from. Shown on the lower drawing, it’s a relationship such that if you divide D by C and E by D, the two answers will be the same— 1.618 .... So you divide the longer portion by the shorter portion, and that gives you the ratio 1.618. When you divide the whole length of E by the next

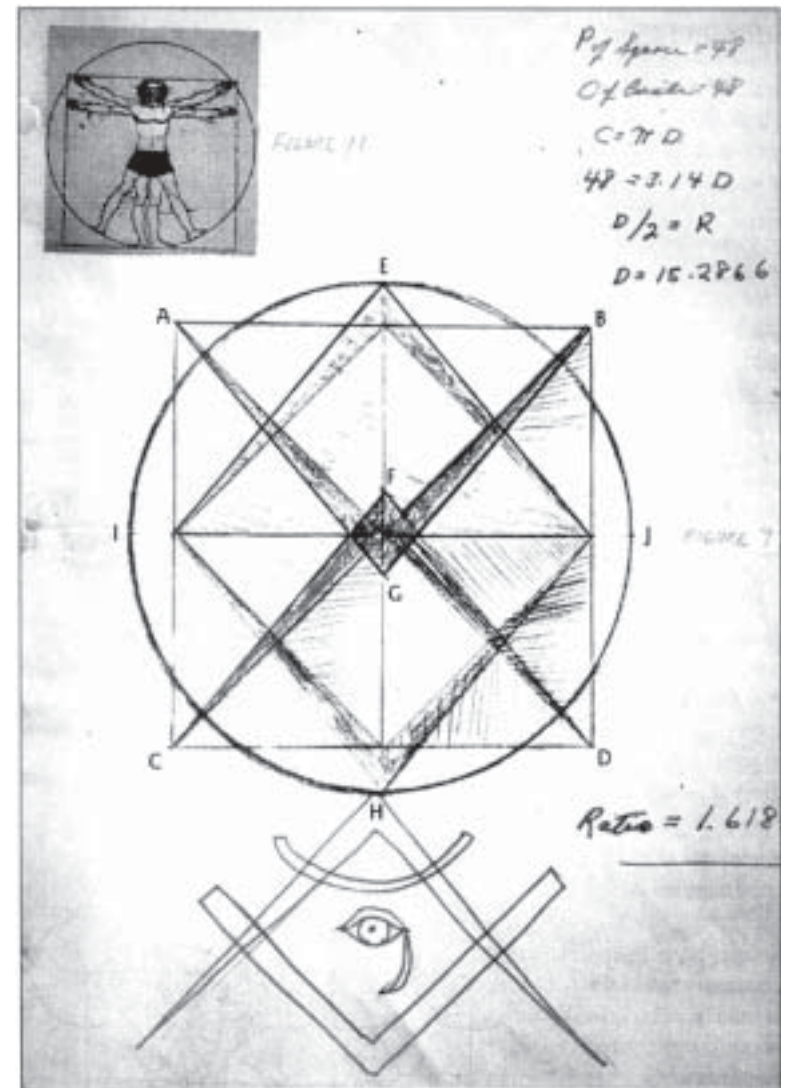

Fig. 7-22. The Mason's drawing.

shorter portion, which is D, you'll get the same ratio. It's a magical place. Even though I was studying mathematics in college when this incident took place, the phi ratio somehow had gone over my head. I didn't get it. I had to go back and restudy all this stuff.

This guy also brought up Leonardo's drawing with the circle and the square around it, giving me more information, which I'll tell you later. I asked him many questions, and about half the time he didn't know the answer. He'd just say, "That's the way it goes," or "I don't know; we don't know that." Though I can't say this for certain, I suspect the Masons have lost a great deal of their information. I think that they once had a brilliant knowledge that was very much like the Egyptians', and both of those disciplines have gone downhill.

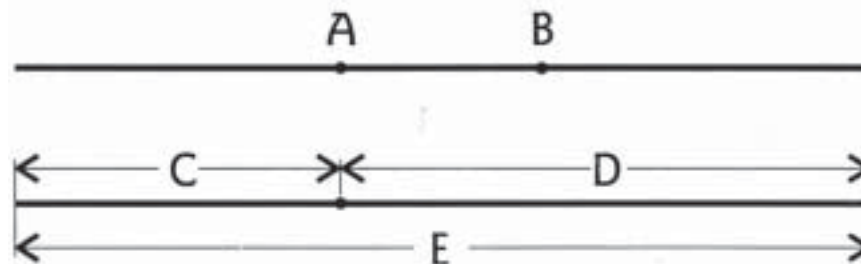

Fig. 7-23. Phi-ratio points.

Before he left, he drew the sketch at the bottom of his diagram [see Fig. 7-22], with a square and the right eye of somebody—I can't say Horus because I don't know who it is—and then left. I've never seen him since. I don't even remember his name.

### *Applying the Key to Metatron's Cube*

This gentleman from the Masons didn't answer the question specifically—how the circle and the square fit into Metatron's Cube. In fact, I don't think he'd ever seen Metatron's Cube. But something he said triggered something in me so that I understood what it was. Right after he left I knew the answer. As you know, Metatron's Cube is really a three-dimensional object, not a flat object. Three-dimensionally, Metatron's Cube looks like this [Fig. 7-24]. It's a cube within a cube, three-dimensionally. Then if you rotate it to this view [Fig. 7-25], you have its square aspect.

Once you do that, you have Figure 7-26. At this point you can drop the outer aspect; all you need are just the original eight cells. Around those eight cells there's already a sphere, the zona pellucida. The cells are in the shape of a cube, so if you draw both a circle and straight lines around it, you get the image of the circle and the square the angels showed me. I was happy!

### *The Two Concentric Circles/Spheres*

But then I calculated the perimeter of the square and the circumference of the circle—and they were not equal. I was bummed out for a long time because I figured I hadn't found

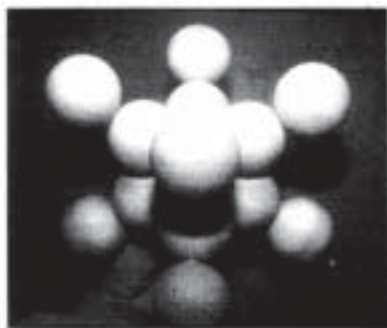

Fig. 7-24. Three-dimensional Metatron's Cube, end view.



Fig. 7-25. Three-dimensional Metatron's Cube, squared view.

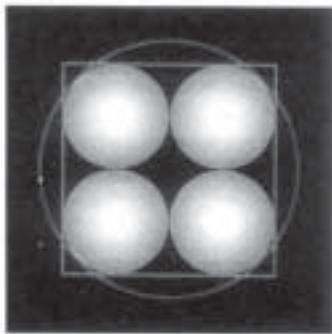

Fig. 7-26. The Circle and the square in Metatron's Cube.



Fig. 7-27. The Mason's lines drawn over the Egg of Life.

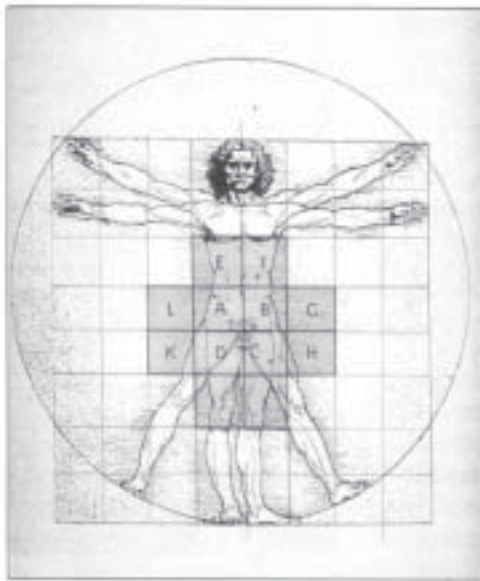

Fig. 7-28. Leonard's famous man (canon)

it. About three years later I discovered that I *had* found it, but had just not understood. In sacred geometry, when you find something that appears incorrect or breaks the idea you're trying to form, you have to keep going deeper, because often you just don't have the whole picture yet.

What I discovered was that the zona pellucida has a thickness to it; there's an inner surface and an outer surface. Every membrane has an outer and an inner surface, and when you use the outer surface of the zona pellucida, the proportions go into a near-perfect phi ratio. The amount of imperfection is actually part of the equation. (You'll know what that means in a while.) This is why there are two lines around the Flower of Life—the inner and the outer circle of the zona pellucida. So from now on, whenever you see four circles in a square, we're talking about the Egg of Life, the original eight cells. Just take it for granted.

So in this drawing [Fig. 7-27] I drew in all the lines that the Mason drew just to see how they would line up and what would happen, comparing the Mason's drawing to the eight cells. Nothing appeared to be happening in the middle of the drawing that I could see, though I suspected something at this point, which had to do with a circle that would just fit in the middle of the four spheres. But I did discover that the corners of the square (a cube, actually) define the exact centers of the outer layer of cells in the 16-cell division, as at point A. This was an interesting observation. So I began to doodle and study further to see what they meant. Obviously, the angels wanted me to go down this road, but I had no idea where this road led.

### *Studying da Vinci's Canon*

I decided to look deeper at this drawing of Leonardo's [Fig. 7-28]. I had also majored in art, so I had studied much of Leonardo's work, but I didn't realize until later how much artwork he had done. This drawing has become probably one of his most famous works. It's perhaps even more important to us than the Mona Lisa or any other famous work of his. This kind of drawing, a standard for something (in this case, a standard for human beings), is called a canon, a human canon.

The first thing that struck me about this drawing is how amazingly we all attune to it. For instance, because there are 30 frames per second that come across on a video, you could flash this drawing of Leonardo's for just an instant, yet people would immediately recognize it. We know something there is important; perhaps we don't know exactly what it is, but we still retain the image. There is a tremendous amount of information about us in this drawing. But as it turns out, it's not really about us. It's about who we used to be, not about who we are now.

To begin this analysis, notice first that there are lines drawn over the arms and the trunk, across the chest and over the legs and neck. The head is divided into another

series of lines. Notice that the feet are drawn at both 90 degrees and 45 degrees—subtle things. Also notice that if you were to stand with your arms straight out and your legs straight down, a square or cube forms around your body, as in Leonardo’s drawing. The center of that square is located exactly where the original eight cells are, which is also a square or cube, in the center of your body. Notice the small cube around your original cells and the bigger cube around your adult body.

When you are standing with your arms outstretched like Leonardo’s man, there is a difference between the height and the width of your square. Computers have shown by measuring a hundred people or more that there is one ten-thousandth of an inch difference between the width of your outstretched arms and your height. Though I couldn’t understand for a long time why that difference was there, I think I know now. It has to do with the Fibonacci series, which life is based on. You will see this shortly.

If you put your legs out to the side, like the outer legs on Leonardo’s drawing and stretch out your arms like the upper arms, a perfect circle or sphere fits around your body, and its center is located exactly at the navel. When you do that, the circle and the square exactly touch at the bottom. If you were to move the center of the circle down to the center of the square, the circle and the square would synchronize just like they do in the Mason’s drawing and the drawing that shows the warship superimposed over the top of the Great Pyramid. It is a major secret of life.

When you measure almost all the copies of Leonardo’s drawings, you find that the circle is really an oval and the square is really a rectangle. It’s different in all of them because they’ve been copied and folded so many times. But in the original, accurate drawing, the hand length from the wrist line to the longest finger equals the distance from the top of the head to the top of the circle when the two centers are aligned; this same length shows up between the navel and the center of the square. So when you bring the two centers together, everything aligns.

### *Phi Ratios in the Human Body*

As I was discovering this, I thought, We have these geometrical forms that appear to be outside the body as well as inside it. One of the things the angels said, which really stuck with me, was that the human body is the measuring stick of the universe—that absolutely everything in the universe can be measured and determined from our bodies and from the energy fields around them. Since the phi ratio seemed to be such an important aspect to the Mason, and since he went on and on about it, I wanted to see where it was in the human body.

I discovered it—and of course other people have also discovered it. Realize that in Figure 7-29 the square shown is the square around the body as in

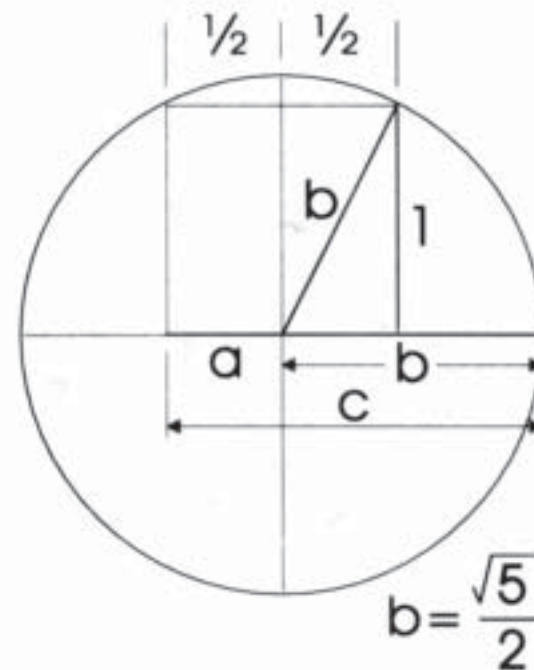

Fig. 7-29. Phi-ratio diagram for the human body.

Leonardo's drawing. And that the line dividing the square in half is the center line of the human body. Also notice that the line  $b$  is not only the diagonal of one-half of the square, but is also the radius of the circle.

Now, if you are interested in the math, see Figure 7-30, which proves that the phi ratio is found in the geometrical energy fields around the body in at least this one relationship. There are many, many other phi relationships in and around the body.

As you can see, the phi ratio =  $\frac{1}{2} + \frac{\sqrt{5}}{2}$ . If you put this into your computer, you will see the transcendental number of phi continue until your computer runs out of memory. I know most of you out there don't care, but I've presented this information for the few.

By the way, I'll just throw this out to you: When you're studying sacred geometry, you'll find that diagonals are one of the major keys for extracting information from your forms (in addition to shadows, expanding from two to three dimensions, comparing male to female and so on). It never fails.

I believe it was Buddha who asked his disciples to contemplate their navels. Whoever it was, I began to realize as I studied that there was more to the navel than meets the eye. Then I found a medical book, whose authors must have also listened to Buddha, because they did a tremendous amount of research on navels. What the geometries show is that in the ideal, the navel sits at the phi ratio between the top of the head and the bottom of the feet. This is what most books indicate.

The authors found out that when a baby is born, its navel is in the exact geometrical center of the body. Both male and female babies start out this way, and as they grow, the navel starts to move toward the head. It moves up to the phi ratio, then continues upward. Then it comes back down to below the phi ratio, oscillating during the formative years. I don't know what the ages are, but these movements and locations happen at specific ages. It never actually stops at the perfect phi ratio in either males or females, but if I remember correctly, the male navel ends up slightly above the phi ratio and the female navel just below it. If you average the male and female points, you get the perfect phi ratio. So even though Leonardo's drawing is of a male, it assumes that it is at the phi ratio, but of course in nature it would not be.

Da Vinci figured out that if you draw a square around the body, then a diagonal from foot to extended fingertip, then draw a parallel line (another one of those parallel lines) from the navel horizontally over to the side of the square,

$$\frac{b}{a} = \frac{b+a}{b} = \frac{c}{b}$$

$$b^2 = a^2 + 1^2 = (\frac{1}{2})^2 + 1 = \frac{1}{4} + 1 = \frac{5}{4}$$

$$b = \frac{\sqrt{5}}{2}$$

$$c = a + b = \frac{1}{2} + \frac{\sqrt{5}}{2} = \Phi$$

$$\Phi = 1.6180339...$$

Fig. 7-30. Equation for the phi ratio.

that horizontal line intercepts the diagonal line exactly at its phi ratio [Fig. 7-31] as well as that of the vertical line from head to feet. Assuming it's at that perfect point, not slightly above for females or slightly below for males, this means that the human body is divided into phi ratios from top to bottom, which we stated earlier. If these lines were the only places in the human body where the phi ratio is located, it would probably be just an interesting fact. But the truth is, the phi ratio is located in thousands of places throughout the body, and it is not just a coincidence.

Here are some obvious phi-ratio locations in the human body [Fig. 7-32]. The length of each bone in the finger has a phi ratio to the next bone, as shown in the lower drawing. That same ratio occurs with all your fingers and toes. This is a somewhat unusual relationship because one finger is longer than the other in what appears to be an arbitrary fashion, but it's not arbitrary—nothing in the human body is. The distances on the fingers marked A to B to C to D to E are all in a phi ratio, as well as the lengths of the phalanges, F to G to H.

If you compare the length of the hand to the length of the lower arm bone, it has a phi ratio, just like the length of the lower arm bone compared to the upper arm bone. Or take the length of the foot to the lower leg bone, or that bone to the thigh bone and so on. This phi ratio is found throughout the entire bone structure in all kinds of places and ways. It's usually at places where something bends or changes direction. The body also does it through proportionate sizes of one part to another. If you study this, you will be continually amazed.

Figure 7-33 is another way of showing the phi ratio. You make a curve so that you can see how one curve is linked with another, and you can see all the cascading phi ratios of the human body. This is from *The Power of Limits* by Gyorgy Doczi. I highly recommend this book. Notice that on this male he drew the line for the navel slightly above where the actual phi ratio is located. He knew about that, and very few people I have read understand it.

I want to talk about this Greek statue. The Greeks were well aware of this understanding of phi ratios. So were the Egyptians and many, many other people in ancient times. When they created a piece of art like this, they were actually using both sides of the brain simultaneously. They were using their left brain to very carefully measure everything—I mean *really* carefully, not kind of or sort of. They were measuring to make sure that everything was exactly mathematically correct according to the phi proportion. To be as creative as they wanted, they were also using their right brain. They could put any expression on the face and have the statue hold anything or do anything they wanted. The Greeks combined the left and right brain.



Fig. 7-31. Leonardo's drawing with more lines, one of which (the horizontal line) divides both the vertical and diagonal.

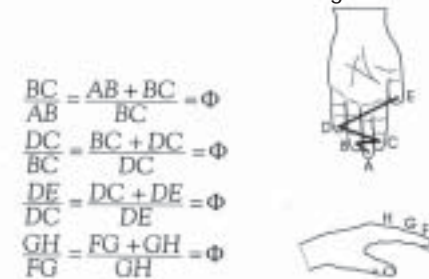
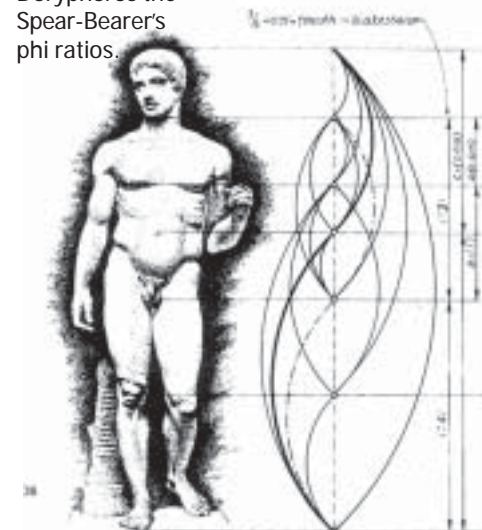

Fig. 7-33. Doryphoros the Spear-Bearer's phi ratios.

Fig. 7-32. Phi ratios on human body.





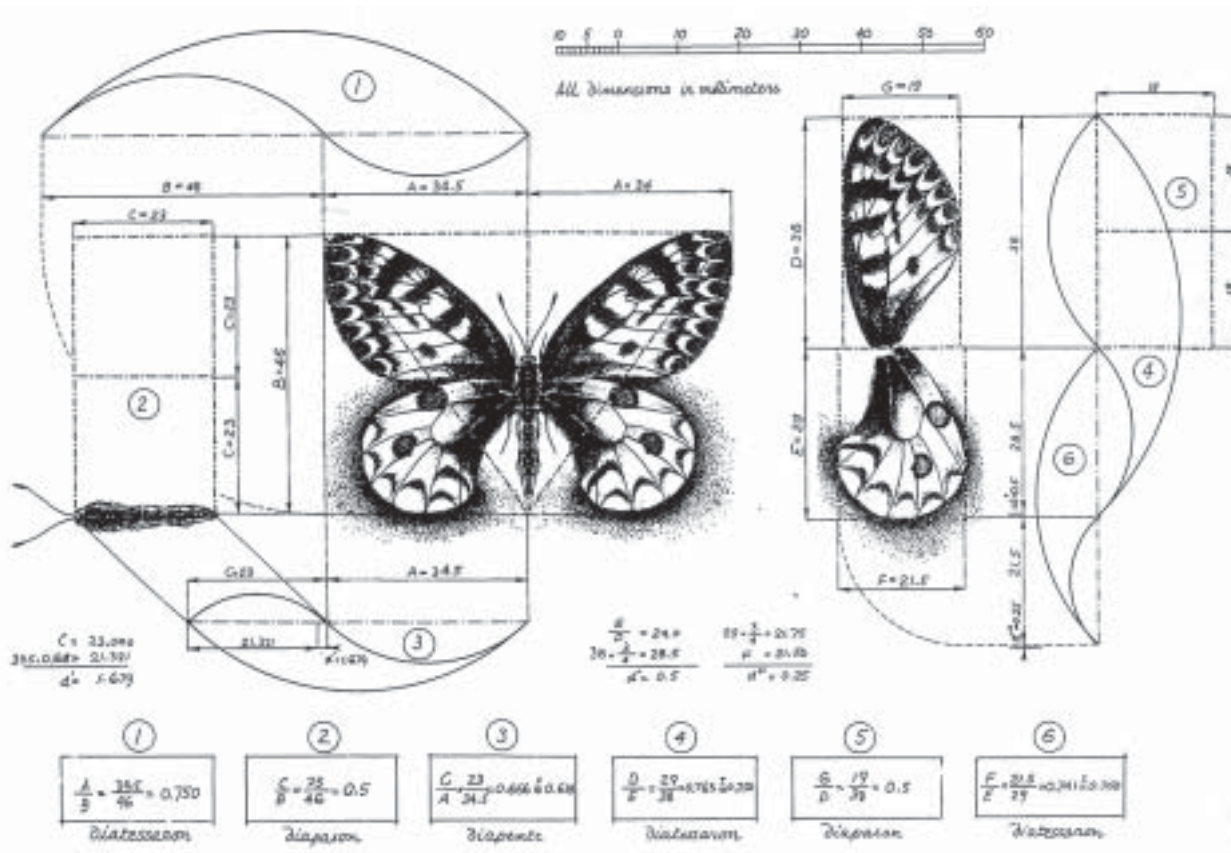

Fig. 7-34. Phi ratios in butterflies.

When the Romans came in and took over Greece, the Romans knew absolutely nothing about sacred geometry. They saw the Greeks incredible art and tried to duplicate it, but if you compare Greek art to Roman art after they conquered Greece, Roman art looks like it was done by amateurs. Even though Roman artists were really good at what they did, they just didn't know they were supposed to measure everything—that there had to be this kind of perfection for the body to look real.

### *The Phi Ratio in All Known Organic Structures*

Phi-ratio mathematics goes not only through human life, but through the entire spectrum of all known organic structure. You can find this in butterflies [Fig. 7-34] or dragonflies [Fig. 7-35], where each little rail section is proportioned to

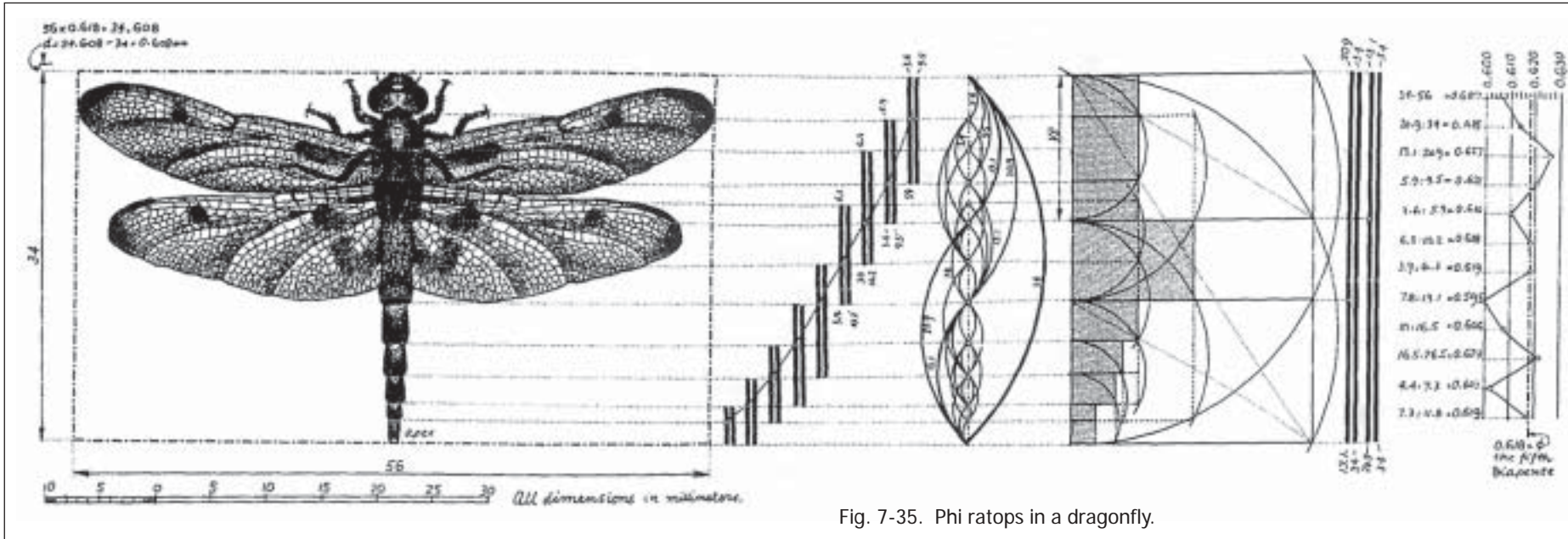

Fig. 7-35. Phi ratios in a dragonfly.

the phi ratio. The lengths of the sections of the dragonfly form phi ratios. This illustrator was focusing on one thing, but you can also look where every little bend is in the legs, the length and width of the wings, the size of the head compared to its width and length—everything. You can go on and on and on, and you'll keep finding the phi ratio everywhere you look.

Fig. 7-36. Pfi ratios in a frog skeleton.

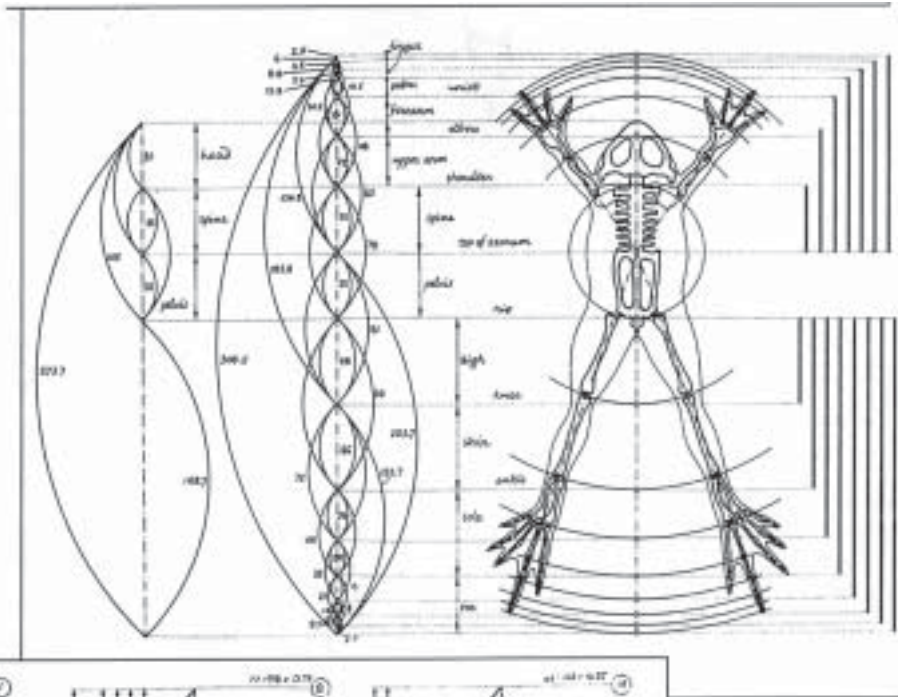
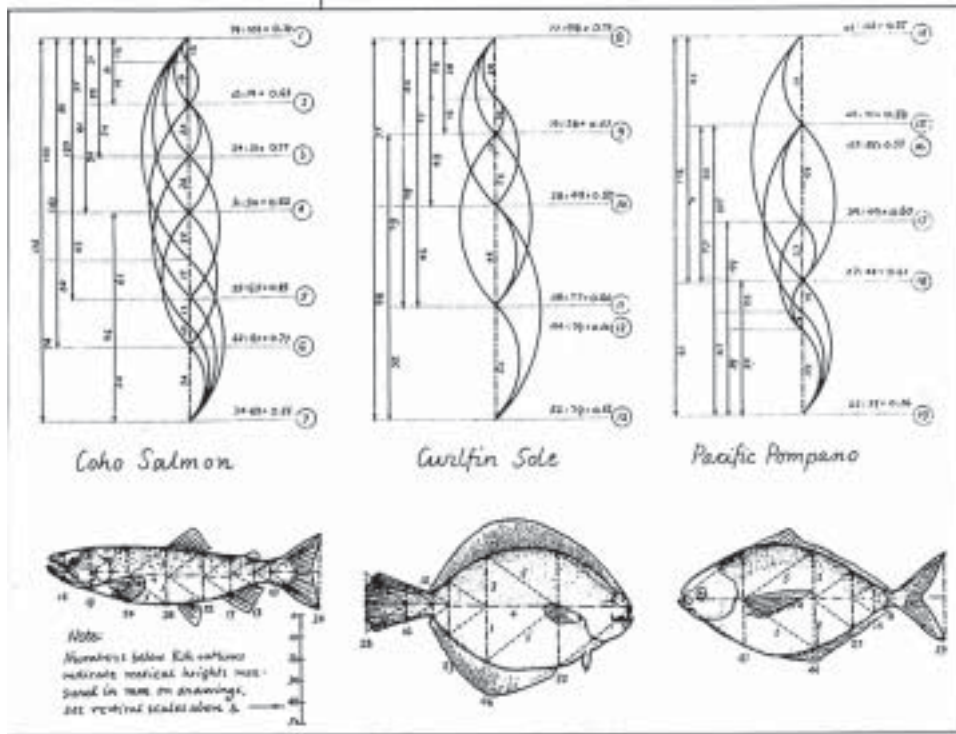

Fig. 7-37. Phi ratios in fish.



Look at this frog skeleton [Fig. 7-36] and see how every single bone is in phi-ratio patterns, just like in the human body.

Fish, I think, are really incredible, because fish don't look like they have any phi-ratio stuff going on—and there are so many different kinds. But when you analyze them, the phi ratio is there as well [Fig. 7-37].

The other universal measurement you'll find, one I talked about before, is 7.23 centimeters, the wavelength of the universe. You'll find this wavelength scattered through the body, such as the distance between your eyes; but the phi ratio occurs more often than any other.

Once a measurement of any species has been determined, then every other measurement in that species follows in the phi-ratio proportion. To put it another way, there are only certain possibilities in human structure, and once the size of one part of the body is determined, that determines the size of the next, and on and on. Soon I'll show you the Egyptian building that Lucy Lamy reconstructed just by measuring one little piece of rubble. This is how she did it: Once she knew the size of the first piece, she knew that every shape after that would relate to it in phi ratios.

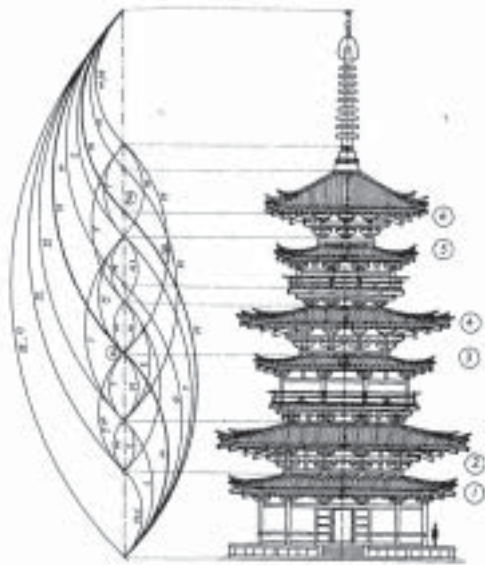

Fig. 7-38. Pagoda of Yakushiji Temple

The phi proportions are built into this Japanese pagoda architecture [Fig. 7-38]. This illustrates another point about creativity that I want to make. When they designed and built this structure, they carefully measured *every single distance* to match the various lines shown, and they carefully measured where to put each board—right down to that little ball on the very top, so that it could correspond with and form these relationships we have been studying. I'm sure if someone ever checks, they'll find that the size of the doors, the windows and probably every small detail are all based on phi proportions or other sacred geometry.

Other classical architecture around the world used the same principles. The Greek Parthenon looks really different from this Japanese structure, but the Parthenon embodies the same mathematics. And the Great Pyramid looks very different from either of those two buildings, but it also embodies the same mathematics—only a lot more. What I'm saying is, your left brain can understand and use these mathematics, and it doesn't hinder creativity at all. It can even enhance it.

### **Golden Mean Rectangles and Spirals around the Body**

Another sacred form we have in life is the spiral. You may wonder where it came from. We're living in a spiral—the galaxy, which has spiral-ing arms. You're using spirals to listen to the sounds around you because the little apparatus in your ears is in a spiral form. There are spirals all over nature. The more you look, the more you find. Spirals are found in pine cones, sunflowers, a few animal horns, deer antlers, seashells, daisies and lots of plants. If you put your open hand vertically in front of you, thumb toward your face, notice the movement as you roll your fingers into a fist, starting with your little finger. They trace out a Fibonacci spiral. This is a very special spiral, as you will see.

Where do spirals come from? They have to come from somewhere, and they have to be generated out of the dynamics of the original system, the Flower of Life, if what we believe is true. Well, all you have to do is go back to the human body—to the same pattern we came up with for the phi ratio [see Fig. 7-30]. If you simply take the diagonal line, lay it down flat, then complete the rectangle formed with that new extension—you have a Golden Mean



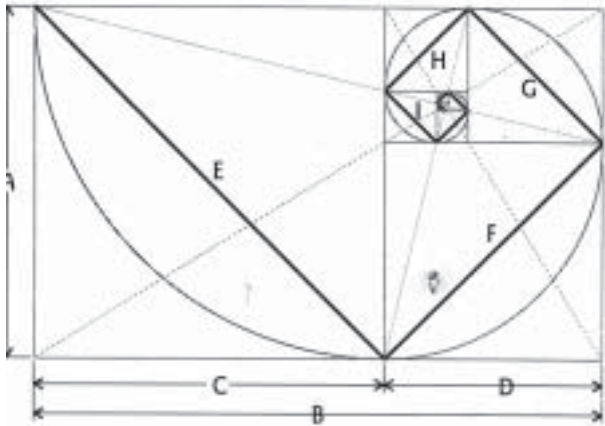

Fig. 7-39. The Golden Mean rectangle and male and female spirals.

rectangle, the source of the Golden Mean spiral.

The outer rectangle of this drawing [Fig. 7-39] is called a Golden Mean rectangle, the same as above. To get another Golden Mean rectangle, all you have to do is measure the rectangle's shorter edge (side A) and plot that distance along the longer side (side B), which makes a square (with equal sides;  $A = C$ ). The area that's left over (D) is another Golden Mean rectangle. Then you can take the shorter edge again and plot that distance along the longer edge to make another square, and what's left over is still another Golden Mean rectangle. This can continue forever. Notice that each newly formed rectangle is turned 90 degrees. If you run diagonals across each rectangle, their crossing locates the exact center of the spiral they form. You can see how the diagonals become a key for more information: Line F has a Golden Mean ratio to line E, continuing inward. We can say that F is to E what G is to F and H is to G and I is to H and so on. There are other kinds of spirals, but the Golden Mean spiral is paramount in creation.

### *Male and Female Spirals*

Fig. 7-40. Leonardo's canon and spiral.

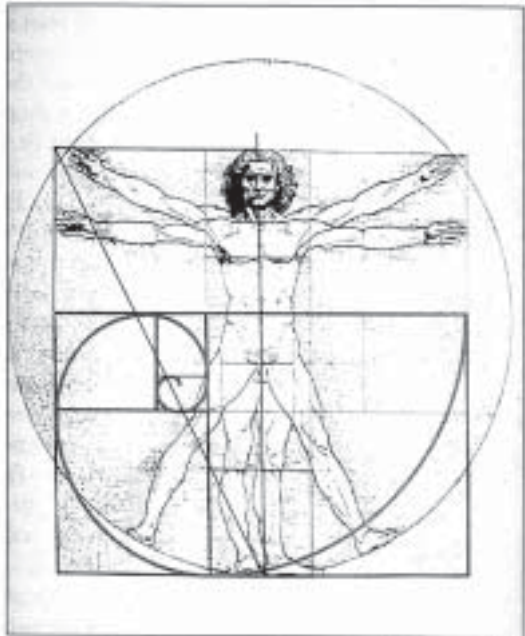

There are two kinds of energies that move through Golden Mean rectangles. One energy is the diagonals that cross the squares, moving at 90-degree turns, shown in black. That's the male energy. The female energy is the line that keeps curving in toward the center, shown in gray. So you have a female Golden Mean logarithmic spiral, along with a male spiral that uses straight lines with 90-degree turns at the phi ratio. In much of the work I will show you, we'll be looking only at the male aspect, but you must remember that the female aspect is always there.

Some books say that if you draw a horizontal line through the navel in da Vinci's man [Fig. 7-40], what's left over in the lower portion is a Golden Mean rectangle; and that if you draw a line from the top corner of the large square to the middle point at his feet (the center of the opposite side of the square), that semi-diagonal will pass through the exact center of a Golden Mean spiral as shown in the figure. You can create a spiral if you draw in the consecutively smaller Golden Mean rectangles like we did in Figure 7-39. I've read several books about this, and I believe it's *almost* true. But something else is actually

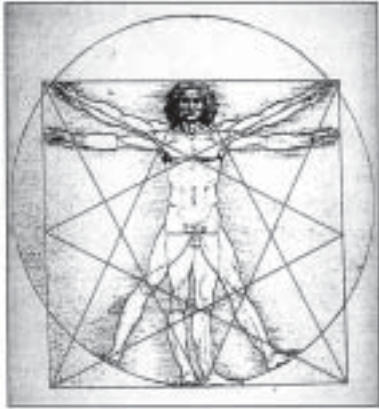

Fig. 7-41. Diagonal lines made by connecting corner to the center of the opposite side of the square.

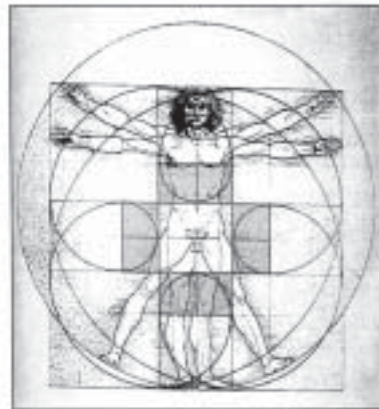

Fig. 7-42. Spirals and the original eight squares.

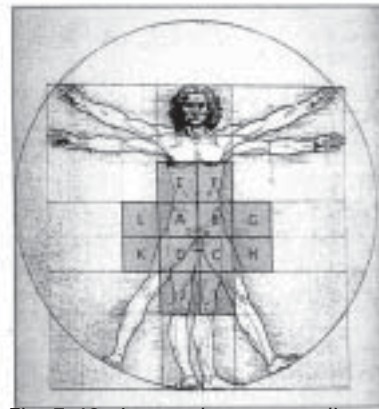

Fig. 7-43. Leonardo's surrounding grid.

happening that is important to understand if one really wants to know about Mother Nature.

In fact, I'm convinced that there are no Golden Mean rectangles or spirals in existence unless they're synthetically made. Nature does not use Golden Mean rectangles or spirals—it doesn't know how. The reason nature doesn't know how is because a Golden Mean spiral will literally go inward forever—maybe not with a pencil and paper, but technically it will go on forever and ever. It will also go outward forever too, because you can take the longest line of any Golden Mean rectangle, make a square to get a larger Golden Mean rectangle and continue to do this forever. So a Golden Mean rectangle has no beginning and no end. It will go inward and outward forever.

This is a problem for Mother Nature. Life doesn't know how to deal with something that has no beginning and no end. We can sort of deal with something that has no end, but if you think about it, it's difficult to think of something having no beginning. Just try to get that in your mind—something that has no beginning. This is hard for us because we are geometric beings, and geometry has centers, beginnings.

Since life doesn't know how to deal with this, it has found a way to cheat. It has found another spiral to create with. Life figured out a system of mathematics that approximates this so well that you can hardly tell the difference. The books say that this spiral on Leonardo's drawing in Figure 7-40 is a Golden Mean spiral, which I say can't be true. Also, there is not just one little spiral here; there are eight spirals rotating around the body— one for each Golden Mean rectangle, connected to the eight possible semi-diagonals around the human body [Fig. 7-41]. This drawing shows the eight that intersect the human body.

Figure 7-42 shows the eight spirals with their eight centers located around the center of the body, in the same pattern and with the same center as the original eight cells inside the body—right?

Leonardo drew these little lines that make a grid over and around the body [Fig. 7-43]: There are four squares in the center (A, B, C and D, clockwise) and eight squares surrounding them (E through L). Those outer eight squares happen to be where the eight semi-diagonals of Figure 7-41 intersect the body and where the eight spirals of Figure 7-42 begin. So we have eight places around the body and a central pattern of four squares in the middle, centered exactly around the original eight cells. Life is amazing, is it not?

When I noticed this about Leonardo's drawing, I figured there must be something important about this relationship. But when I realized that there's no such thing as a Golden Mean rectangle or spiral in nature, I began to suspect that these spirals were probably something slightly different. And that's what they turned out to be—slightly different.

It turns out that these spirals are Fibonacci in nature, which we will explore in the next chapter. Understanding the difference between the Golden Mean and Fibonacci spirals may seem simple and unimportant, until the bigger picture of nature unfolds to reveal something astonishing about this relationship. No one can ever understand why the 83,000 sacred sites on the Earth were built or what their purpose was without knowing this difference.

# Reconciling the Fibonacci-Binary Polarity

## The Fibonacci Sequence and Spiral

In order to understand why those eight spirals around da Vinci's canon are not Golden Mean spirals and to find out what they are, we have to go to another person—not Leonardo da Vinci, but Leonardo Fibonacci. Fibonacci preceded da Vinci by over 250 years. From what I've read about him, he was a monastic, often in a meditative state. He loved to walk through wooded forests and meditate as he was walking. But evidently his left brain was simultaneously active, because he started to notice that plants and flowers had number associations [Fig. 8-1].

Flower petals and leaf and seed patterns correspond to definite numbers, and the flowers on this list are the ones I think he saw, if I've got it right. He noticed that lilies and irises have three petals and that buttercups, larkspurs and columbines (the flower at the top right in Fig. 8-1) have five. Some delphiniums have 8 petals, corn marigolds have 13 and some asters have 21. Daisies almost always have either 34, 55 or 89 petals. He began to see these same numbers over and over again throughout nature.

This little plant [Fig. 8-2] doesn't actually exist; we created it with computer graphics, shuffling it around like a deck of cards. The original plant on which this illustration is based is called the sneezewort; we simply made the computer graphics fit that plant.

Fibonacci noticed that when the sneezewort plant first came out of the ground, it grew only one leaf, just one little leaf. As it grew taller, farther up on its stem it grew one more leaf; then a little bit farther it grew two leaves, then three, then five, then eight; then it had thirteen flowers. He probably said, "Gee, those are the same numbers I keep seeing in the petals of other flowers—3, 5, 8, 13."

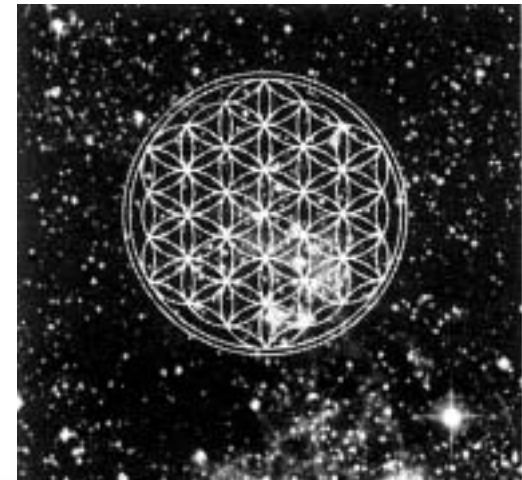

Leonardo Fibonacci & Plant Growth	
Number of Petals	Samples
3	lilies & irises
5	buttercups, larkspurs & columbines
8	some delphiniums
13	corn marigolds
21	some asters
34, 55 & 89	daisies

Fig. 8-1. Fibonacci sequence in plant growth.

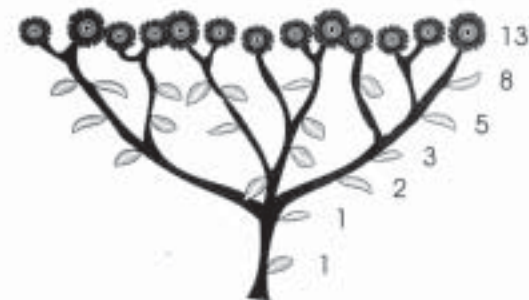

Fig. 8-2. The computerized sneezewort.





Fig. 8-3. Hibiscus flower.

Eventually this sequence of 1, 1, 2, 3, 5, 8, 13, 21, 34, 55, 89 and so on became known as the *Fibonacci sequence*. If you are given any three consecutive numbers in this sequence, you can recognize the pattern: you simply add two consecutive numbers to get the next number. See how it works? This is a very special sequence. It's crucial in life. Why is it important? This is perhaps my interpretation of why, but I'll do my best to show you.

This is a hibiscus flower with five petals [Fig. 8-3]. The stamen inside has five terminating buds, and the direction of those two geometric forms are reversed to each other one set pointing up and one pointing down. When most people look at this flower, they don't think, "Let's see, it has five petals." They simply look at it, notice its beautiful smell and experience it from their right brain. They're not thinking about the geometry or mathematics going on in the other side of the brain.

### *Life's Solution to the Infinite Golden Mean (Phi) Spiral*

Remember that I said how the Golden Mean spiral has no beginning and no end, and that life has a hard time with that? It can cope with no end, but it has a difficult time grokking something that has no beginning. I have a really hard time doing it, and I think we all wrestle with that situation.

What nature did was create the Fibonacci sequence to get around the problem. It's like God said, "Okay, go out there and create with the Golden Mean spiral," and we said, "We don't know how." So we made up something that is not the Golden Mean spiral, but it rapidly comes so close that you can hardly tell the difference [Fig. 8-4].

For example, the phi ratio associated with the Golden Mean is approximated by 1.6180339. Look what happens when you divide each number in the Fibonacci sequence into the next higher number. Here's the sequence in the left column: 1, 2, 3, 5, 8, 13, 21, 34, 55, 89. In the second column I've shifted the sequence by one so we can divide the number in the first column by the number in the second column (see column 3). Notice what happens when you divide a column-two num-

$$\Phi = 1.6180339\dots$$

(Fibonacci Sequence)

Current Term	Previous Term	Division	Ratio
1	1	1 / 1	1.0
2	1	2 / 1	2.0
3	2	3 / 2	1.5
5	3	5 / 3	1.6666
8	5	8 / 5	1.600
13	8	13 / 8	1.625
21	13	21 / 13	1.615384
34	21	34 / 21	1.619048
55	34	55 / 34	1.617647
89	55	89 / 55	1.618182
144	89	144 / 89	1.617978
233	144	233 / 144	1.618056

Fig. 8-4. Fibonacci sequence.

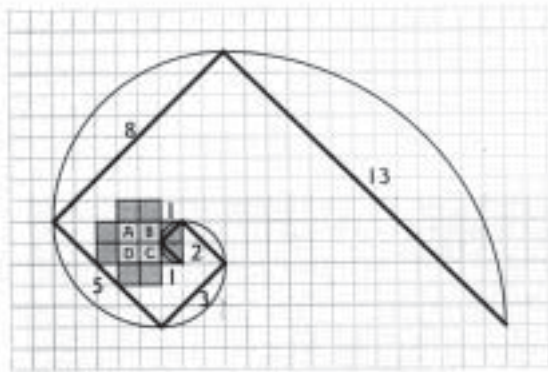

Fig. 8-5. Fibonacci female (curved) and male (angled) spirals on an expanded grid.

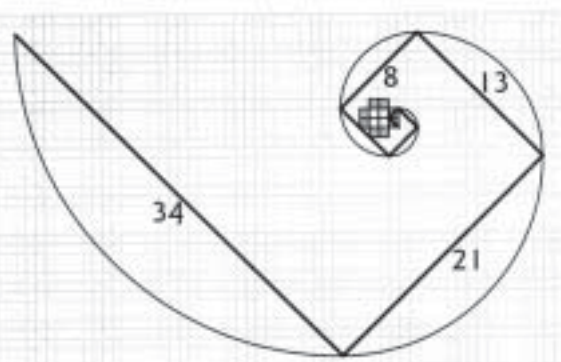

Fig. 8-6. A view of the Fibonacci spiral, both male (straight line) and female (curved).

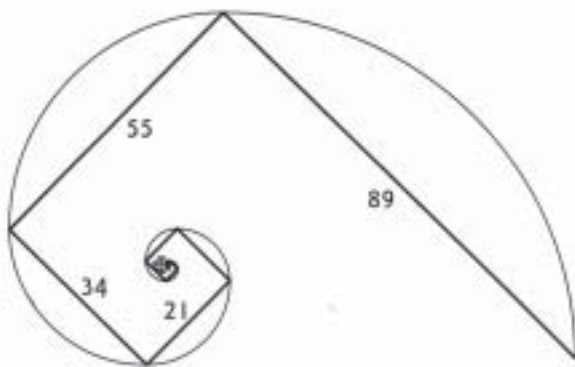

Fig. 8-7. A more distant view.

ber into the one in column one. When we divide 1 into 1, we get 1.0. Now, 1.0 is a lot less than the phi ratio. But when we go to the next line and divide 1 into 2, we get 2, which is greater than phi, but closer than 1 is. When we divide 2 into 3 we get 1.5, which is a lot closer to phi than either of the previous two answers, but it's under.

Three into 5 is 1.6666, which is over, but a lot closer. Five into 8 is 1.60, and it's under. Eight into 13 is 1.625, which is over. Thirteen into 21 is 1.615, under. Twenty-one into 34 is 1.619, over. Thirty-four into 55, 1.617, under. Fifty-five into 89, 1.6181, over. The next one goes under, then over, each time getting closer and closer to the actual phi ratio. This is called asymptotically reaching a limit. It can never ever reach the actual number, but practically speaking, you wouldn't be able to tell the difference after a few divisions. You can see this graphically in Figure 8-5.

The light gray squares are the four central squares of the human body where the original eight cells are located. The eight dark gray squares around these central squares are where the spirals begin. Does everybody get that?

Rather than having them spiraling in forever and ever, we're going to do something different—because this is what life does, I believe. I'm going to use one of the outer squares as my starting point, and this will be true for all eight. I'm choosing one of them as an example.

Using a diagonal across just one of the tiny background squares as our measure, we'll call this diagonal line one unit. Then we move according to the Fibonacci numbers: 1, 1, 2, 3, 5, 8, 13, 21, 34, 55, 89, with a 90-degree turn after each number. In our first step we go one length, then turn 90 degrees and go one again. Then we turn 90 degrees and go two lengths, turn another 90 degrees and go three lengths. Between each step we take a 90-degree turn. The next step is 5 units long, then 8. So we have 1, 1, 2, 3, 5, 8, 13.

Then we diagonally cross 21 squares, then 34 [Fig. 8-6]. Then 55, then 89 [Fig. 8-7]. As we do this, the spiral unfolds and gets closer and closer to phi, the Golden Mean spiral, until very rapidly there's no way to tell the difference in life, at least visually.

Comparing the two spirals must have been a very important feature if one studied life, because the ancient Egyptians displayed both the Fibonacci and the Golden Mean spirals at the Great Pyramid. Even though the spirals have two different origins, by the time they get out to steps 55 and 89, the two lines are practically identical. When people who studied Egypt saw the three pyramids lined up on the spiral, they thought it was the Golden Mean, not the Fibonacci spiral. Then they came back and found one of the holes (refer to



Fig. 8-8. Slice of a nautilus shell.



Fig. 8-9. Pine cone.

page 109). Several years later they realized that just a little ways away, maybe a hundred yards or so, was another marker. They hadn't realized there were *two* spirals. I don't know whether the people working with this understand its significance even yet.

### *Spirals in Nature*

Here is sacred geometry in nature [Fig. 8-8], the real thing. It's a nautilus shell cut in half. It's an unwritten rule that every good sacred geometry book has to have a nautilus shell in it. Many books say this is a Golden Mean spiral, but it's not—it's a Fibonacci spiral.

You can see the perfection of the arms of the spiral, but if you look at the center or beginning, it doesn't look so perfect. You can't really see this detail here. I suggest that you look at a real one. This innermost end actually hits the other side and bends, because its value is 1.0, which is a long ways from

phi. The second and third ones bend also, but not as much because they are coming closer to phi. Then they start fitting better and better, until you see this perfectly graceful form developing. You could think that the little nautilus made a mistake in the beginning; it looks like he didn't know what he was doing. But he's doing it perfectly, it's not a mistake. He's simply following exactly the mathematics of the Fibonacci sequence.

On this pine cone [Fig. 8-9] you see a double spiral, one going one way and one going the other. If you were to count the number of spirals rotating one direction and those going the other direction, you'd find that they're always two consecutive Fibonacci numbers. There are perhaps 8 going one way and 13 the other, or 13 going one way and 21 the other. The many other double-spiral patterns found throughout nature correspond to this in all cases that I know. For instance, the sunflower spirals are always related

to the Fibonacci sequence.

Figure 8-10 shows the difference between the two. The Golden Mean spiral is the ideal. It's like God, the Source. As you can see, the top four squares on both drawings are the same size. The difference is in the areas where they originate (the bottom sec-

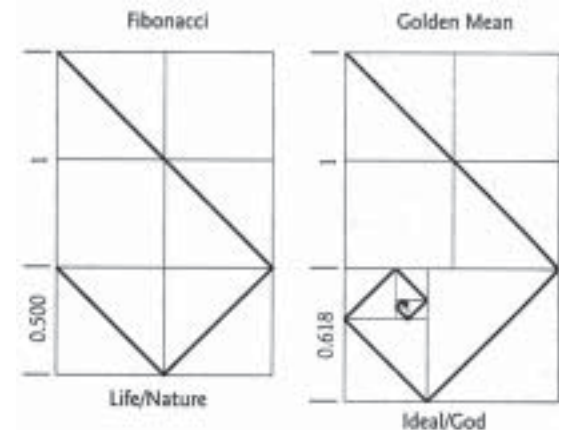

Fig. 8-10. Comparing Fibonacci and Golden mean spirals

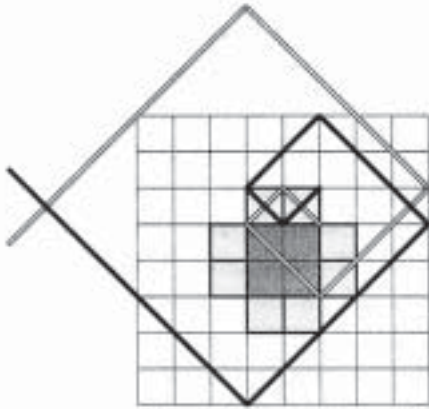
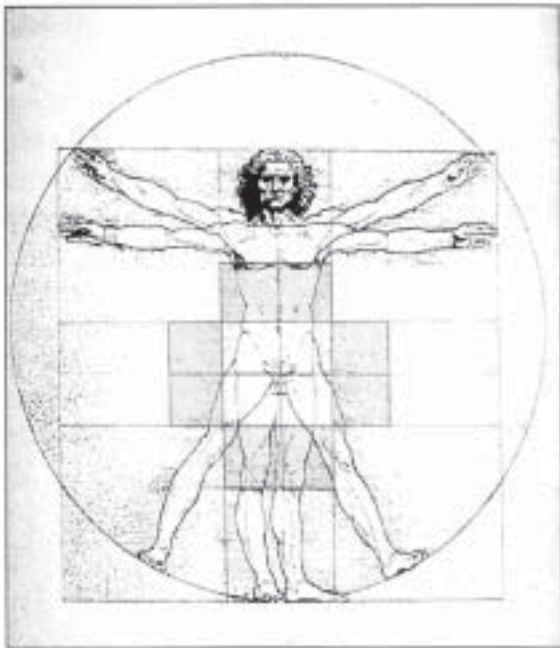

Fig. 8-11. Grid without canon, showing two mirroring Fibonacci spirals, male (dark line) and female (light line).

Fig. 8-12. Grid with da Vinci canon.



tions of the two diagrams). The bottom of the Fibonacci spiral has an area half the size (0.5) of the area above; the Golden Mean spiral has an area 0.618 the size of the area above. The Fibonacci spiral shown at near right is constructed using six equal squares, whereas the Golden Mean spiral starts deeper inside (actually, it never starts—it has been going on forever like God). Even though the originating point is different, they very quickly approximate each other.

Another example: Many books state that the King's Chamber is a Golden Mean rectangle, but it's not. It's also tied to Fibonacci.

### *Fibonacci Spirals around Humans*

When we draw a 64-square grid and incorporate this spiral pattern, we get Figure 8-11. Superimposing da Vinci's canon over this 8-by-8 grid [Fig. 8-12], the eight squares (shaded) seem to have a unique attribute. There are four possible ways to move a Fibonacci spiral out of one of the four double squares. Returning to Figure 8-11, let's use the upper double square as an example. One way to start is from the upper right corner, as shown by the darker line. It crosses one square (1), turns right to cross one more square (1), turns right again to cross two squares (2)—interestingly enough, it reaches the top of the grid at this point. Continuing to turn right, it crosses 3 (the next number in the sequence)—and, son-of-a-gun, it has now reached the right side of the grid! The next number is 5, which takes the line to the bottom of the grid. The following number, 8, takes the line across three squares before it leaves the grid. There's a perfect reflective quality as this spiral moves out from the beginning square.

Another way you could start in this double square is from the lower right corner, as shown by the lighter line (this forms a little pyramid in the top two squares. In this case your 90-degree turns will be to the left. So you cross one square (1), then one again (1), then 2—this time passing through the center four squares of the grid (where the original eight cells reside). After turning left again to cross 3 squares, the line touches the right side of the grid. The next number, 5, will leave the grid after crossing two squares. It's a perfect synchronicity of movement. Whenever you see this kind of perfection, you know you're almost surely hitting on really basic geometries.

**UPDATE:** *Since the time of Tesla, governments have not allowed the knowledge of zero point to come forth. Why? Tesla wanted to give free, unlimited energy to the world, which he knew would come from zero-point technology. But J.P. Morgan, who owned many copper mines, did not want electricity to be free. Instead, he wanted to force electricity to pass through copper wires so he could meter it, charge the public and make money. Tesla was stopped, and the world has been controlled ever since.*

*Since that time in the 1940s, any person who researched zero-point technology and talked publicly about it was killed or disappeared—until just recently. In 1997 a video company called Lightworks secretly brought together a few of these scientists and filmed their works.*

*They gave the history of what had happened since the 1940s and showed clear working models of the inventions. They showed machines that, once running, give off more electricity than it takes to run them. They showed batteries that never need charging. They showed how an ordinary gasoline motor can be converted to run on ordinary water with more power than gas. They showed panels that will produce boiling water forever as long as the outside temperature is above 40 degrees below zero Fahrenheit. They showed many other scientific inventions considered impossible by today's standards. When Lightworks was done, on a single day the video was released and the information put on a Web site ["Free Energy: The Race to Zero Point." 105-minute video by Lightworks (800) 795-8273, \$40.45 ppd; www.lightworks.com]. This has forced the world to change direction. Two*

All this is crucial to understand, if you care to know, how the Egyptians achieved resurrection. They were doing it scientifically, you might say. They were using science to create a synthetic state of awareness that would lead to immortality. We're not going to achieve our awareness synthetically; we're going to do it naturally, but you might find it useful to understand how an ancient civilization was attempting to achieve this.

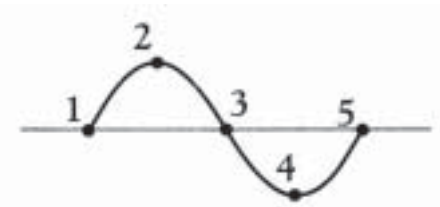

Fig. 8-13. Waveform showing 5 zero points.

### **The Human Grid and Zero-Point Technology**

This basic sacred geometry of a 64-square grid around humans is becoming understood in science. In fact, there's an entirely new science happening around it, though it's having a hard time getting out because of politics. This new science is called zero-point technology. This grid is, I believe, the geometry of zero-point technology, though most scientists see it in a different way.

Most people involved in zero-point technology think of it in terms of waveforms or energy. They talk about the five places in a waveform, as shown here [Fig. 8-13]. Or they think of zero point as the amount of energy that matter has when (and if) it reaches zero degrees Kelvin, or absolute zero. To me, both of these ways are valid, but the way based on sacred geometry will eventually become the cornerstone of this new science because it is so fundamental.

These points associated with the waveform are also related to breathing. These points are where the zero point is accessed. They are like doorways into another world. Yogic pranayama is usually talked about in terms of two or three places (depending on whether you count the beginning of the next cycle), which are between the inbreath and the outbreath. That's also zero-point technology if you focus it on human breathing.

This new zero-point understanding has a geometry behind it, and that geometry is around the human body. The human body is always the measuring stick of creation.

weeks later both Japan and England announced that they are very close to solving the cold-fusion problem. The world began to change.

On February 13, 1998, Germany issued a world patent on a free-energy machine based on carbon, a thin sheet of material that will produce 400 watts of electricity forever. This means that all small appliances such as computers, hair dryers, blenders, flashlights etc. will not need to be plugged into the system. It is the end of the old way and the birth of unlimited free energy.

## Male- and Female-Originating Spirals

To begin with we must understand that there are two kinds of spirals, depending on whether they are straight lines (male) or curved lines (female). We talked about this before. However, now we are going to introduce a new concept. The *originating point* of the spiral in this geometric pattern will further determine if it is male or female in a different way. In a double square there are four corners where a spiral can originate: top left, top right, bottom left and bottom right [see Fig. 8-14]. The two top positions produce male spirals, the two bottom positions, female spirals. The male spiral lines never pass through the center four squares; the female lines always do.

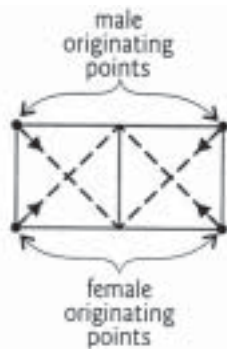

Fig. 8-14. The originating points.

Figure 8-15 shows the two kinds of male and female spirals and how they joints move through this geometric pattern.

To make it clear, we will give an example. If the spiral begins at the top right point, it will be a male spiral relative to this geometrical pattern. In addition, the curved aspect of this male spiral would be female, and the straight-line aspect would be male. Every polarity always has another polarity within it, and within that new polarity there is always still another polarity. This division process will continue theoretically forever.

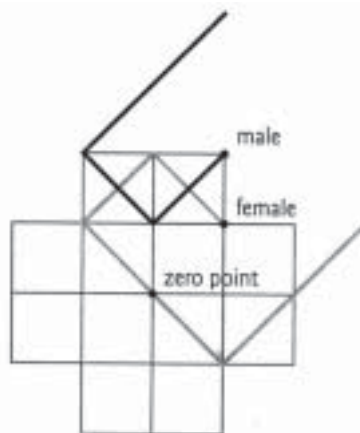

Fig. 8-15. The two kinds of spirals.

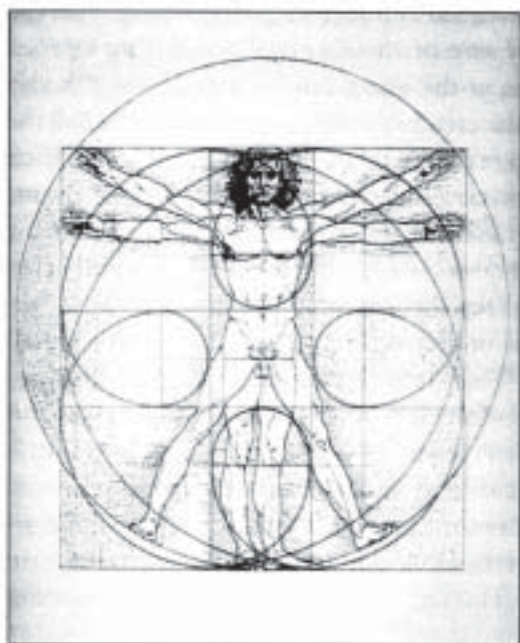

Fig. 8-16. The male-originating spirals with female curved lines

Figure 8-16 is an example of the male-originating spirals that begin at the top (meaning the greatest distance from center), but showing only their female (curved) aspect. This drawing shows all eight possible male-originating spirals that exist around the body, from a Fibonacci perspective, in their female (curved) form. They carry the Fibonacci sequence only as far as 5 (1-1-2-3-5). In this limited arrangement it's interesting to note how the curved spirals do a sort of loop-to-loop. The energy could actually become each other and

recirculate. This Fibonacci movement is what I believe is really going on around the human body, not the Golden Mean that most books claim.

In Figure 8-17 we see male-originating spirals around the human body. Here we show the male (straight-line) aspect but only two with female curved lines.

In Figure 8-18 we see the female spirals around the human body, which originate at the bottom, or closest points to center. Here we show primarily the male (straight-line) aspect of these female spirals. The female (curved) aspect of only two female spirals are shown (not all eight), which form a heart. Notice the pattern they create. One heart faces one way, and after it has been extended 180 degrees, a bigger heart faces the other way. Every one of these curved female lines passes through zero point at the exact center of the human body. This zero point is the creation point, or what we would call the womb. It is for this reason that females have the womb in their bodies and males do not. Males never pass through zero point. Later you'll see these heart-shaped relationships tied to many other natural phenomena such as light, eyes and emotions, to mention a few, so keep them in mind.

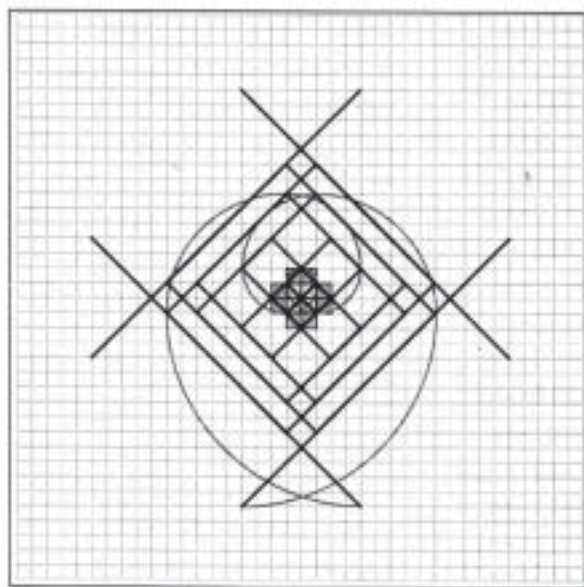
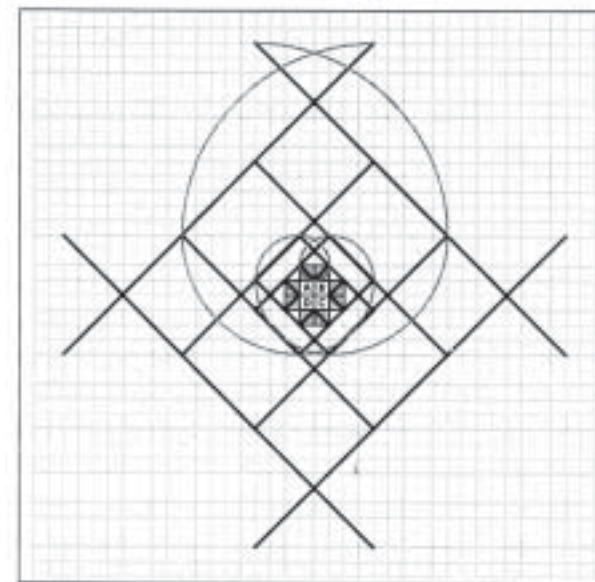

Fig. 8-18. The female-originating spirals with male straight lines.

Fig. 8-17. The male-originating spirals with male straight lines.



Now, with that understanding we're going to look at another sequence. There are thousands of mathematical sequences; I suppose on one level you could even say an infinite number. But in useful terms, there are many. A sequence can simply be 1, 2, 3, 4, 5, 6, 7, 8. In every one of the thousands and thousands of sequences known to man, three numbers are required to identify the pattern, the whole sequence—with the exception of the Golden Mean logarithmic sequence, in which case you need only two. This implies that it is probably the source of all other sequences.

According to my guidance, two sequences besides the Golden Mean are of major importance to nature and life. They are the Fibonacci sequence, which we just looked at, and the binary sequence we are about to look at. Here we will see the Fibonacci as female and the binary as male. They are really more than just female and male; they act more as mother and father. They are both primary, coming straight from the Golden Mean, just as the two primary colors that come from white light are red and blue.

## Binary Sequencing in Cell Division and Computers

The binary sequence [Fig. 8-19] is a mitosis that simply doubles each time, such as from 1 to 2 to 4 to 8 to 16 to 32. Instead of adding to the last number like we do in the Fibonacci sequence, we double it.

Let's look at the binary sequence for a moment. It goes 1, 2, 4, 8, 16, 32, doubling at each jump. In order to determine the characteristic of the sequence, all you need to do is take any three consecutive numbers in the sequence—like 2, 4 and 8. You double the 2 and get 4, and double the 4 to get 8. It takes three consecutive numbers to positively identify the doubling process.

In terms of a pronucleus's mitotic cell division, by the time the first cells form into the apple shape, there have been nine cell divisions, totaling 512 cells. Holding that in mind, look at these two facts:

Fact one (shown in Fig. 8-19): There are  $10^{14}$  cells in the average human body. That's 100 trillion cells in the average person. That's a lot of zeroes. Fact two (in the same figure): An adult human body has to replace two and a half million red blood cells in every second of life. That definitely sounds like a lot. It would take you about two and a half months just to count to two and a half million if you were doing it day and night, 24 hours a day, seven days a week. Yet if we are to stay

**BINARY SEQUENCE**

1, 2, 4, 8, 16, 32, 64, 128, 256, 512, . . . (first 10 mitotic cell divisions)

1. There are  $10^{14}$  (100,000,000,000,000) cells in the average human body.
2. When the human body is complete (adult), it must replace 2½ million red blood cells every second of its life.

Fig. 8-19. The binary sequence in mitotic cell division.

alive, our bodies have to create millions of new red blood cells every second to replace the dead ones. And the only way this can be achieved is through mitotic cell division.

You look at it and say, "Well, it's become 512 with only nine divisions, so it's going to have to really go for it to get up to this 100 trillion." But there's something almost magical that happens. Anyone who has studied mathematics knows this, but if you have never studied this before, it feels almost like magic. This is what happens [Fig. 8-20]: After the next ten divisions, cells have multiplied to over half a million. When it divides ten more times, there are 536 million.

According to Anna C. Pai and Helen Marcus Roberts in their book, *Genetics, Its Concepts and Implications*, it takes exactly 46 mitotic cell divisions to reach the  $10^{14}$  cells of the human body. It takes *only 46 divisions!* It's magical to me that this number—46—happens to be the number of chro-

Next 10 mitotic cell divisions	Next 10 mitotic cell divisions
1024	1,048,576
2048	2,097,152
4096	4,194,304
8192	8,388,608
16,384	16,777,216
32,768	33,554,432
65,536	67,108,864
131,072	134,217,728
262,144	268,435,456
524,288	536,870,912

(From 512 cells in the first 10 mitotic divisions to over a half-million in the second 10 divisions)

(From a half-million cells to a half-billion cells at the end of 30 mitotic divisions)

Fig. 8-20. Next 20 mitotic cell divisions.



mosomes we have in the average cell. Chance or coincidence?

These numbers are amazing. It's not amazing if you've studied it, because by then you're often immune to it. But it still amazes me.

I would like to talk about how computers work. I started to mention how we've got carbon and silicon arcing back and forth between each other. And who's making the silicon computers? We are—carbon-based beings. Out of all the various mathematical possibilities, we chose the binary sequence as the basis of how the computer works. It's the basis of the whole computer system, and it's also one of the primary bases of life itself. I feel sure it was not an accident that we chose the binary sequence, because we are life, and deep inside we know the importance of this sequence.

I know most of you probably know this, but nevertheless I want to show how a computer works. Imagine little light switches called computer chips, and when you turn on one of these lights, you see the number designated for that chip. If you turn on the 1 chip, you see 1. If you have five computer chips in your computer, they're designated 1, 2, 4, 8 and 16. You can turn these five chips on or off to get any number between 1 and 31. If you turn on just the 1 chip, you see the number 1. If you turn on the second chip, designated as 2, you see the number 2. The same for chip 4, chip 8 and chip 16.

By turning on every *combination* of those five chips and adding them up, you can come up with any number between 1 and 31. In other words, if you turn on the first chip, you get 1. Turn the second one on and get 2. And if you turn the first two on at the same time, you get 3. The next one you turn on is 4; 4 and 1 is 5; 4 and 2 is 6; 4 and 2 and 1 is 7. Then for 8, you turn on the 8 chip. Eight and 1 is 9; 8 and 2 is 10; 8 and 2 and 1 is 11; 8 and 4 is 12; 8 and 4 and 1 is 13; 8 and 4 and 2 is 14; and 8 and 4 and 2 and 1 is 15. Then for 16, you turn on the 16 chip. Adding the fifth chip gives you all numbers through 31 when they are combined in every possible way.

If you add just one more chip and call it 32, now you can get every number between 1 and 63. If you add another chip and call it 64, you can get every number between 1 and 127 and so on. If you have a computer that has 46 chips, *you can get every single number between 1 and 100 trillion*—just by turning 46 little chips on and off! This is what has enabled the unfoldment of knowledge that's happening so rapidly on the planet right now. And your body has been using this technology for millions of years!

### *Searching for the Form behind Polarity*

I studied the Fibonacci and binary sequences with the guidance of the angels, who were constantly leading me through it. The more I studied them, the more I personally believed that there must be geometry behind them, a secret form that created these number sequences. Since the angels said that the human body and geometry fields are the measuring stick of the universe, I suspected strongly that if these two sequences were like two mother/father, male/female components, then there must be a single geometric form hidden behind them, a form that generated both. I searched for a way to wed them.

I looked for this secret for years. For a long time I was very serious about it, then I gave up because I couldn't figure out what it was. But I always kept one eye open for an answer, always looking for a little clue that would maybe do it. And one day I got it.

## The Polar-Graph Solution

### *A Sixth-Grade Math Book*

A little boy I was taking care of was in the sixth grade, and he wanted to know about a particular mathematical problem. It was a relatively simple problem, but I didn't remember how to do it. I looked through his book to remember how it went so I could explain it. As I was going through his book, I saw the geometry I needed—in a sixth-grade math book! The author of the book didn't understand what I was seeing, because he was thinking along a totally different line. But I saw in the mathematics of it something I'd been looking for, and it was the key that tied these two primary sequences together.

I'm sorry that I don't remember the name of the book or the author—it was a long time ago—but it showed a polar graph and its relationship to a Golden Mean spiral. Figure 8-21 is a map of the South Pole on a polar graph. Notice the cross through the center, one line following the  $x$  axis and the other the  $y$ . Every circle does in fact have these lines crossing it. We demonstrated this by taking a flat disk about half an inch thick, randomly scattering sand all over it. We held it by a handle underneath and hit it with a wooden mallet. The sand would rearrange itself into a perfectly square cross like you see in this illustration. If we used a sound generator on the disk, the sand would change into many other geometrical patterns. But the very first pattern that emerges by striking a round disk

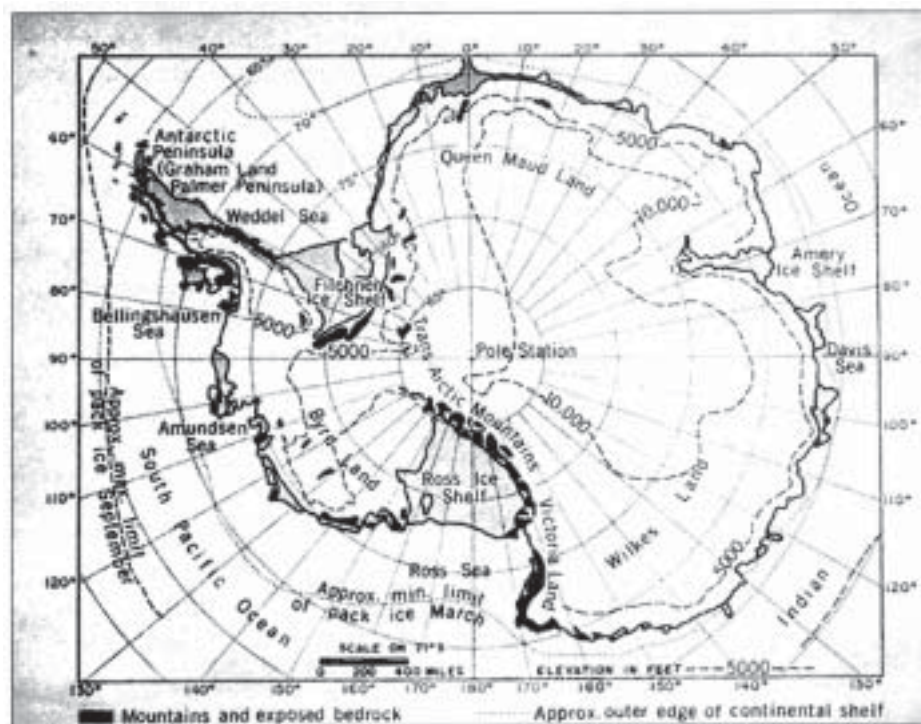

Fig. 8-21. Polar graph and map [from *World Atlas of Geomorphic Features* by Rodman E. Sneed].

at a low rate will be a perfectly square cross.

When you have a circle with a square cross over it, you take the radius of the circle as your measuring stick and call it 1 (that makes the calculations very easy). Drawing concentric circles the same distance outward from that first radius gives you a polar graph.

### *Spirals on a Polar Graph*

This is how a polar graph usually looks [Fig. 8-22], with 36 radial lines including the vertical and horizontal lines. These lines indicate 360 degrees in 10-degree increments. Then concentric circles are drawn, each one the same distance as the one before, creating eight equal demarcations along each radius, counting the inside circle as one. There's a great deal of reasoning behind a polar graph. Think first about what it represents. It is a

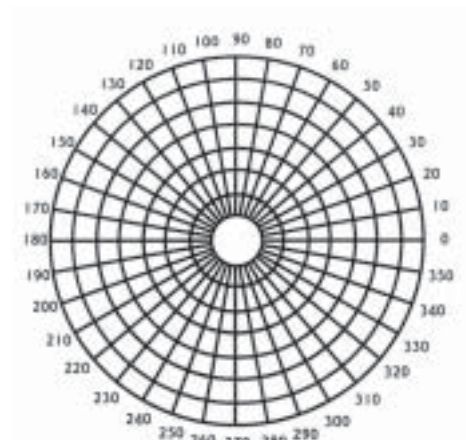

Fig. 8-22. Polar graph.

two-dimensional drawing that attempts to show a three-dimensional sphere, one of the sacred forms, by projecting it onto a flat surface. It is the shadow form. Casting shadows is one of the sacred ways of obtaining information. Also, a polar graph has both straight lines (male) and circular lines (female) superimposed over each other—both male and female energies at once.

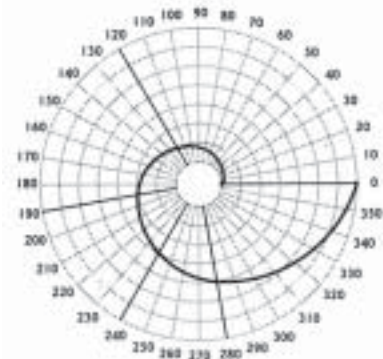

Fig. 8-23. Golden Mean spiral plotted on a polar graph.

Think of the small central circle as a planet in space. From the surface of the planet, the author of the math book plotted a Golden Mean spiral— not Fibonacci, but Golden Mean. It starts at the zero radius on the circumference of the little “planet” in the center, and it is plotted one time around, from zero to 360°, or back to zero [Fig. 8-23].

Now, to figure out the value of any point, you would use the middle circle as a value of one (since it represents the distance from the center to the first circle, which we are calling the “planet”), then count outward to wherever the spiral crosses a radius. Thus on the radius at 260° (between the fourth and fifth rings) you would have counted outward to roughly 4.5. (Of course, on a computer you could be more accurate.) On the radial line at 210°, the spiral would have reached about 3.3. Does everybody understand that?

Now, look what happens to the actual data from zero to 360°. At zero degrees the spiral is exactly one circle (radial increment) away from center, because it's on the surface of that little sphere or planet. Then it goes around through different changes until it gets to 120°, where the spiral crosses the second circle. The spiral continues outward to the fourth circle, exactly where the 240° radial line sits. And it reaches the eighth (outer) circle precisely at the 360° (also 0°) radius. The radial increments have doubled (a binary sequence of 1, 2,4,8) at exactly 0°. 120°, 240° and 360°.

Notice Figure 8-24, which shows the crossing points of the spiral. The white stars to the left of the radial-increment column show where the binary sequence crosses a radius. The black stars show how the spiral advances, in a Fibonacci sequence (1, 2, 3, 5, 8), crossing radials at 120°, 190°, 280° and 360°. Both sequences *simultaneously reach full circle (360°), though in differing increments*, following this

Golden Mean spiral. This spiral, shown on a polar graph, has integrated the binary and Fibonacci sequences!

I was so excited, I was doing cartwheels for a few days. I knew I had found something really extraordinary, even though I didn't fully know what it was. (This is another one of my weaknesses I have to admit to here. Once I saw it, I knew that if I decoded one of the patterns, it would be true for the other one, and I've never gone back even to look at the other pattern, which is probably equally as interesting.)

But I did analyze what a binary sequence does. The spiral crosses at 0, 120, 240 and 360 degrees. As you can see, that forms an equilateral triangle [Fig. 8-25]. If this binary spiral kept going outward, it would cross radii at further increments of 16, 32, 64 and so on, yet always hit those three 120-, 240-, and 360-degree radial lines as they too are extended.

You not only have a triangle, but you're actually looking at a three-dimensional tetrahedron, because the 120-, 240- and 360-degree radii extend to the center forming the top view of a tetrahedron as well as a side view.

### ***Keith Critchlow's Triangles and Their Musical Significance***

Another image on this drawing is an equilateral triangle with the horizontal line running straight through the middle from 0 to 180 degrees. This is the side view of the tetrahedron. Now, you might not think that's important, and I probably would have never picked up on it, but another person did—Keith Critchlow. We don't know what he was thinking or how he arrived at this. He didn't know what you know right now when he did it. (He may know it now after he's seen this work, but he didn't when he wrote his book.)

Figure 8-26 is Critchlow's work. He drew an equilateral triangle with a line through the middle; then he measured to the middle of the center line (see black dot) and drew a line down to the corner and up to the top edge and then vertically down to the center line, as shown. Who knows why? Where that first diagonal line crossed the center line, he then drew

Angle	Radial increment from center	Angle	Radial increment from center	Angle	Radial increment from center	Angle	Radial increment from center
0° ★	1.0 ★	100°	1.8	190°	3.0 ★	280°	5.0 ★
10°	1.1	110°	1.9	200°	3.2	290°	5.3
20°	1.1	120° ★	2.0 ★	210°	3.4	300°	5.6
30°	1.2	130°	2.1	220°	3.6	310°	6.0
40°	1.3	140°	2.2	230°	3.8	320°	6.3
50°	1.3	150°	2.4	240° ★	4.0	330°	6.7
60°	1.4	160°	2.5	250°	4.2	340°	7.1
70°	1.5	170°	2.7	260°	4.5	350°	7.5
80°	1.6	180°	2.8	270°	4.7	360° ★	8.0 ★
90°	1.7						

Angle	0°	120°	240°	360°	a binary sequence!	
Distance from pole	1.0	2.0	4.0	8.0		
Angle	0°	120°	190°	280°	360°	a Fibonacci sequence!
Distance from pole	1.0	2.0	3.0	5.0	8.0	

Fig. 8-24. Table showing distance of spiral from pole, measured in radial increments.

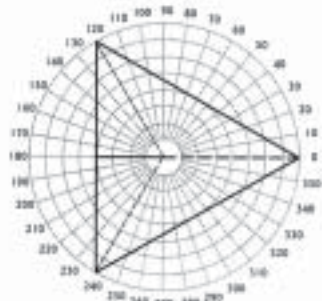

Fig. 8-25. Binary spiral forming a tetrahedron on polar graph.

a vertical line to the upper edge, then down to the same lower corner. Using the point where it crossed the center line, he repeated what he had done before, then did it once more to the left. You could keep going in both directions from your first line. By drawing this funny little form, he discovered something of great importance.

He says, "Continuing in this way" (in that pattern of construction), "each successive proportion will be the harmonic mean between the previous proportion and the total length, and all these proportions will be musically significant,  $1/2$  being the octave,  $2/3$  being the fifth,  $4/5$ , being the major third,  $8/9$  being the major tone [step] and  $16/17$  being the half tone [half step]. In other words, he's comparing the measurement of these lines to musical tones.

He then tried measuring it in a different way, starting at a different point [Fig. 8-27] of the center line, at three-fourths (see black dot), and found that the measurements were  $1/7$ ,  $1/4$ ,  $2/5$ ,  $4/7$ ,  $8/11$  and  $16/19$ —and all these numbers are musically significant.

This is very, very interesting. It means that the harmonics of music are somehow related to the proportions of this central line moving through a tetrahedron. But he had to measure first to begin, and if you have to use a measuring stick, you're not at the core of sacred geometry; something's missing. If you're right in sacred geometry, you *never* have to use anything to measure. The measuring apparatus is built in so that you can calculate everything without having any kind of calculus or ruler or anything else. It's always built right into the system.

I experimented with his drawings and discovered that if I put the polar graph behind his pattern, I could reproduce his first pattern, which showed the octave—the halfway mark—without any measuring [Fig. 8-28].

All I had to do was draw over a line that was already there from the lowest apex of the triangle through the center of the sphere to the opposite side of the triangle; when I dropped the line straight down, it divided the center line *exactly* in half, which was the octave point Critchlow had found. Then the other three lines could automatically be drawn.

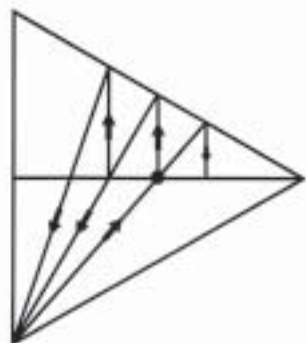

Fig. 8-26. Keith Critchlow's triangles.

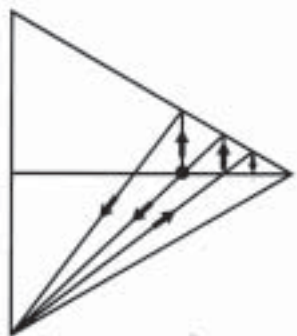

Fig. 8-27. Keith's work.

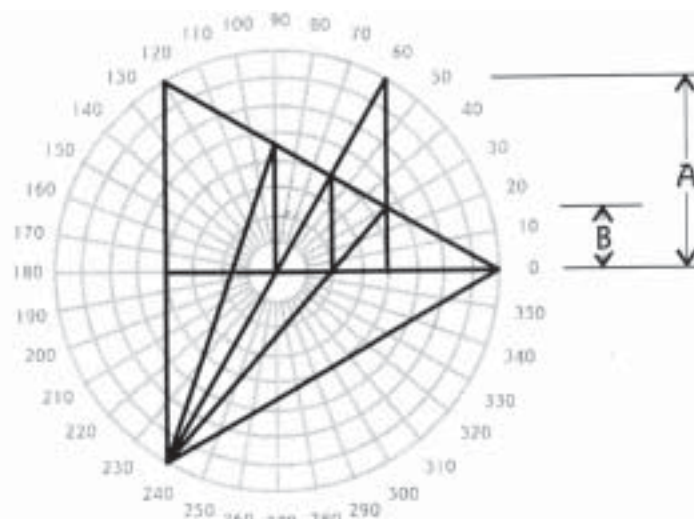

Fig. 8-28. Critchlow's triangles on the polar graph.

I then discovered that the outermost circle of the polar graph, which circumscribes the equilateral triangle, was also harmonic to the central line: the vertical line at 60 degrees (line A) exactly overlies line B. There is a correspondence between the male (straight lines) and the female (curved lines) components inside and outside the triangle, and these proportions were all musically significant. *And I didn't have to measure anything!*

We have now taken this light-years beyond the above. A research team has found that you can draw these lines not only from the center, but from *any* of the nodal points inside the upper half of the triangle, and you will come up with all known harmonics in existence. In other words, if you draw a line from any of the points where the straight and curved lines cross; from 0 to 120 degrees, then down to the corner of the primary triangle and start making your patterns, you'll come up with all the harmonic systems not only the Western keyboard, but the Eastern systems as well—in fact, all known harmonic systems and many unknown ones that have never been used.

People who have done this research now believe that *all* the laws of physics can be derived from musical harmonics, now that the full system of harmonics has been revealed. I personally believe that the harmonics of music and the laws of physics are interrelated, and we now believe we've proven this mathematically and geometrically, though it is not fully shown here.

I was very excited at the time I was gathering this information, because the implications are incredible. It means that the harmonics of music are located inside a tetrahedron, and that these harmonics are now determinable. Since then we've discovered another geometric pattern behind the one shown in this illustration that reveals all the keys, and it has opened up all the inner meanings of what Egypt was about.

The Egyptians reduced their entire philosophy to the square roots of 2, 3, and 5 and the 3-4-5 triangle. Many people have given explanations for it, but there's another explanation hidden behind the geometry of the tetrahedron. That idea probably went over almost everybody's head, including mine, in a way. But it's there and we're working on it now.

### *Black- and White-Light Spirals*

While I was working on the harmonics of music, I got a postcard in the mail. The postcard was a polar graph with reflective surfaces [Fig. 8-29]. It had little reflectors in each component. I want you to see how light reflects off a polar graph. It reflects off what appears to be a Golden Mean or Fibonacci spiral.

There are two arms of the spiral, one opposite the other, exactly 180 degrees apart. Notice that between the reflecting arms the light goes very dark. The black-light spirals are rotating at 180 degrees to each other and 90 degrees to the white light. (We've seen that before in the swirling galaxy.) If you look right in the center, you can see that the two opposite arms are exactly 180 degrees to each other.

This is where we've seen it before [Fig. 8-30]. Here a white-light spiral comes out in one direction, and 180 degrees from it another white-light spiral goes out in the opposite direction. The dark arms—the feminine ones—come out between the light ones. That explains why the black light between the light arms of the spiral is different from the blackness

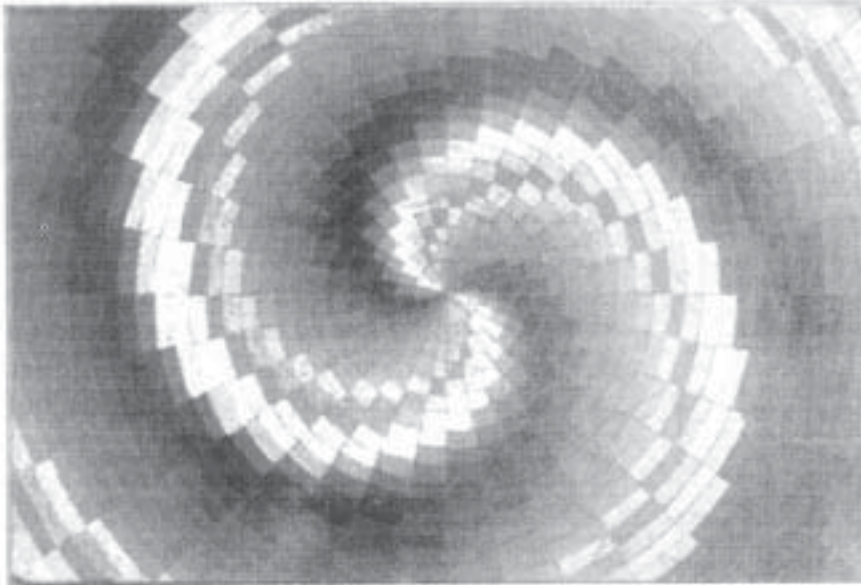

Fig. 8-29. Postcard with spiral.

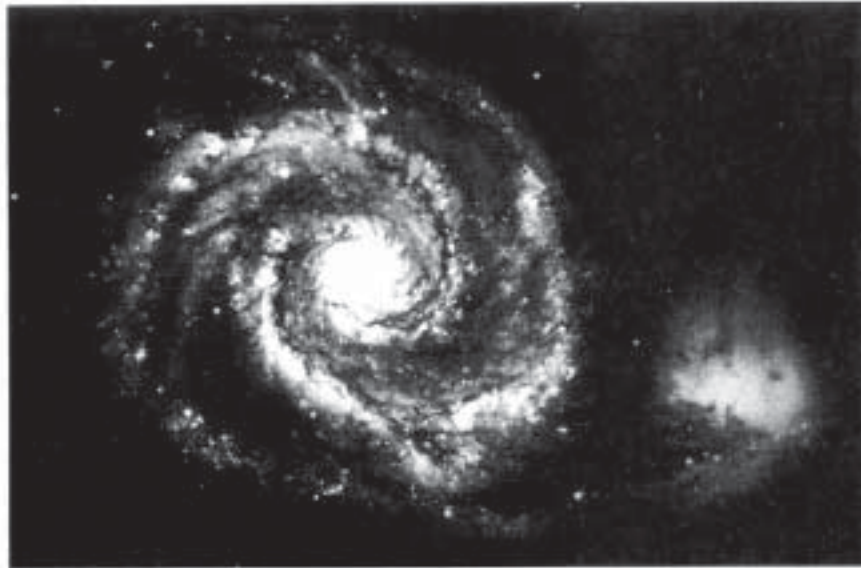

Fig. 8-30. Swirling galaxy.

in the rest of space [see Fig. 2-35], as scientists have discovered, because the black light within a spiral is the feminine energy, and the darkness out in space is Void, not the same. The scientists couldn't quite understand why it was different.

### *Maps for the Left Brain and Their Emotional Component*

There's one more simple teaching I would like to give here. Drawing the tetrahedron over the polar graph geometrically represents the harmonics of music. That drawing and the information I've given you on this subject comes into your understanding through your left brain. But do you remember how we went through those visualizations, where I was saying that every line on a page is not a line on a page, but a map of how spirit moves through the Void? So these drawings are maps—for the left brain.

But there's another component that's equally important to understand: Besides being a map of how Spirit moves in the Void, the lines on any sacred-geometry drawing also represent something else. For *every line in sacred geometry, there is always an associated emotional and experiential aspect*. There is not only a mental component, but an emotional component that can also be experienced. A sacred-geometry drawing can enter human consciousness through the left brain, but there is a way that it can also enter experientially through the right brain. Sometimes this emotional/experiential component is not obvious.

What does this mean? Let's use music as an example. Music can come into human experience as sound and be heard and felt inside us, or it can be understood by the left brain as proportion and mathematics. As you study sacred geometry, remember that both sides of the brain use the same information differently.

*[Here Drunvalo played a Sioux Lakota flute to give students a direct experience. He asked them to close their eyes and experience the music instead of mentally studying or thinking about it.]*

Form and the sacred geometry associated with it are the source, but the way this information enters the human experience is different. It's usually a lot easier to take in information experientially through the right brain than through the logical left brain, but they're equivalent. It's hard to see that they're equivalent, but they are. Throughout all this geometry, as you look at these triangles and squares around the body and the relating spheres and shapes, some kind of experience is associated with each geometry. Maybe you don't know what the particular experience is. It might take a whole lifetime to figure out what it relates to, but it's my belief that there is always an experiential aspect associated with every sacred geometrical form.

### *Arriving Back at the Fruit of Life through the Second Informational System*

Now I'm going to give a kind of bottom line for all this. Remember that we plotted this triangle, and its apexes hit at 0, 120 and 240 degrees, then we added these lines [see Fig. 8-28 on p. 224] ? But in nature, like in the galaxy, there's not just one spiral, but two, going out from the center in opposite ways (see Figs. 8-29 and 8-30). So if you copy nature, you would have to plot two spirals, which will produce two opposing triangles on the polar graph [Fig. 8-31]. If you look carefully, it actually produces two tetrahedrons—more specifically, it's a star tetrahedron inscribed inside the sphere.

If you've seen Richard Hoagland's work, do you remember what the message on Mars at Cydonia was? It was a star tetrahedron inside a sphere. If you haven't seen Richard Hoagland's work, I suggest you look at what he showed the United Nations. Though science is just beginning to understand what this is about, what Mr. Hoagland showed them will probably make a lot of sense to you now.

Inside the star tetrahedron in the sphere, there's another star tetrahedron [Fig. 8-32]. And inside the smaller tetrahedron a sphere fits perfectly . If you take that size sphere and center it on each one of the points of the tetrahedrons, you end up with the Fruit of Life. If I rotate this drawing 30 degrees and get rid of some of the lines, you can see the result more clearly [Fig. 8-33].

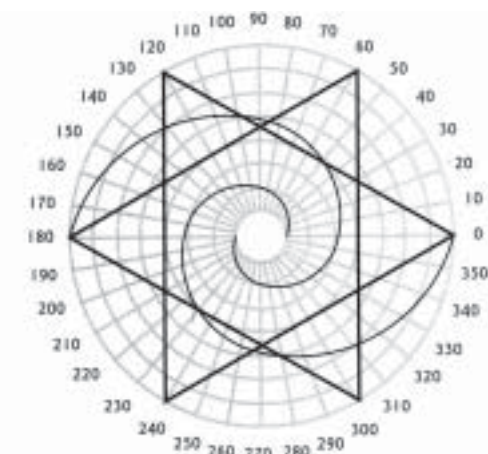

Fig. 8-31. Two spirals forming a star tetrahedron on a polar graph.

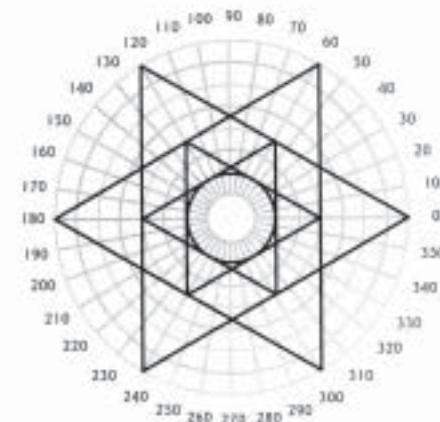

Fig. 8-32. A star in a star.

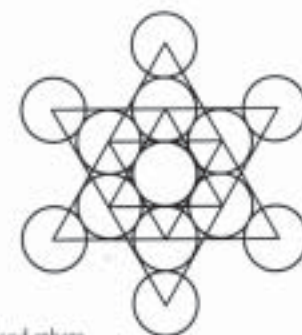

Fig. 8-33. Fruit over stars and sphere.



What you just saw, only in reverse image, was the second informational system of the Fruit of Life. All the information above with the star tetrahedron, Golden Mean spirals, light, sound and the harmonics of music and so on came from this second information system.

I could have started with the Fruit of Life and gone back the other way, but it isn't how it happened to me. I wanted to show you that the second information system is accessed by connecting the concentric circles of the Fruit of Life with *radial* lines coming out from *the center*, rather than connecting all the centers together as we did to find the Platonic solids and the information on crystals. It is just a different way to superimpose male lines over the female lines of the Fruit of Life.

In the first system of information—Metatron's Cube—we came up with the structural patterns of the universe based on the five Platonic solids. These appear in lattice structures of metals and crystals and in many other patterns in nature that we didn't talk about. The diatoms that make up diatomaceous earth were one of the first life forms in the world, and diatoms are nothing but little geometric patterns, or functions of the patterns. What you have just been shown is how light, sound and the harmonics of music are interrelated through a star tetrahedral field inscribed inside a sphere that came directly out of the Fruit of Life, the third rotational pattern of Genesis [Fig. 8-34].

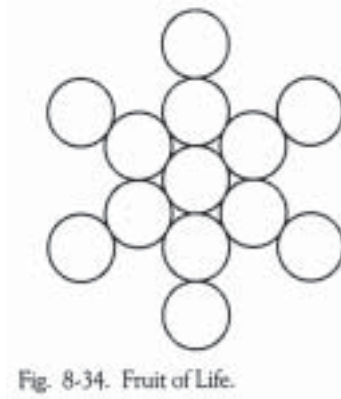

## AFTERWORD

It is now becoming clear that geometry—and thereby proportion—is the hidden law of nature. It is even more fundamental than mathematics, for all the laws of nature can be derived directly from sacred geometry.

In the second part of this work we will show you more of nature's secrets. We believe it will begin to change the way you see the world you live in. It will become clear that your body is the measuring stick or the holographic image of the universe, and that you, the spirit, play a more important role in life than society has taught us.

Finally (and this will be paramount in this work), you will begin to see how the geometries are located in the electromagnetic fields around your body that are about 55 feet in diameter. Remembering these fields is the beginning of human awakening, like a baby bird breaking into the light and out of the darkness inside its eggshell. The sacred and holy human lightbody, called the Mer-Ka-Ba by the ancients, becomes a reality. This Mer-Ka-Ba is the “wheels within wheels” of Ezekiel in the Bible. The pathway home through the stars becomes evident as the blueprint of creation emerges.

We are intimately connected to the Source of all life. In the remembering of this information will come an awakening that will dispel the myth of separation and bring you into the very presence of God. This is my prayer.

Until we meet again in volume two, In love and service, Drunvalo

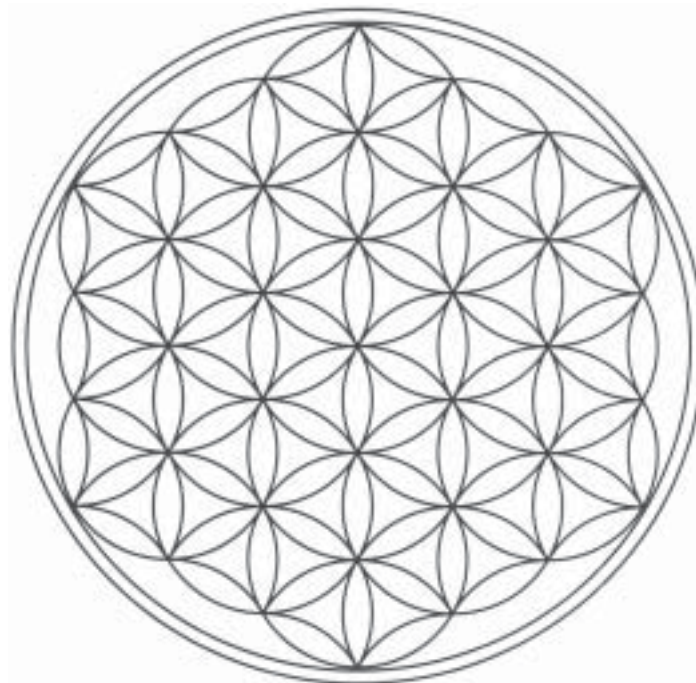

# REFERENCES

## Chapter 1

Lieberman, Jacob, Light, *the Medicine of the Future*, Bear & Co., Santa Fe, NM, 1992. Temple, Robert K.G., *The Sirius Mystery*, Destiny Books, Rochester, VT ([www.gotoit.com](http://www.gotoit.com)). Satinover, Jeffrey, M.D., *Cracking the Bible Code*, William Morrow, New York, 1997. West, John Anthony, *Serpent in the Sky*, Julian Press, New York, 1979, 1987. Cayce, Edgar: many books have been written about him; the Association for Research and Enlightenment in Virginia Beach, VA, is a source of an enormous amount of material. Perhaps the most well-known book is *The Sleeping Prophet* by Jess Stearn.

## Chapter 2

Lawlor, Robert, *Sacred Geometry: Philosophy and Practice*, Thames & Hudson, London, 1982. Hoagland, Richard C.; see [www.enterprisemission.com/](http://www.enterprisemission.com/). White, John, *Pole Shift*, 3rd ed., ARE Press, Virginia Beach, VA, 1988. Hapgood, Charles, *Earth's Shifting Crust and The Path of the Pole* (out of print). Braden, Gregg, *Awakening to Zero Point: The Collective Initiation*, Sacred Spaces/Ancient Wisdom Pub., Questa, NM; also on video tape (Lee Productions, Bellevue, WA).

## Chapter 3

Hamaker, John and Donald A. Weaver, *The Survival of Civilization*, Hamaker-Weaver Pub., 1982. Sitchin, Zecharia, *The 12th Planet* (1978), *The Lost Realms* (1996), *Genesis Revisited* (1990), Avon Books. Begich, Nick and Jeanne Manning, *Angels Don't Play This HAARP*, Earthpulse Press, Anchorage, AK, 1995.

## Chapter 4

Keyes, Ken, Jr., *The Hundredth Monkey*, out of print. Watson, Lyall, *Lifetide*, Simon and Schuster, New York, 1979. Strecker, Robert, M.D., "The Strecker Memorandum" (video), The Strecker Group, 1501 Colorado Blvd., Eagle Rock, CA 90041 (203) 344-8039.

*The Emerald Tablets of Thoth the Atlantean*, translated by Doreal, Brotherhood of the White Temple, Castle Rock, CO , 1939. Obtainable from Light Technology Publishing.

### **Chapter 6**

Anderson, Richard Feather (labyrinths); see [www.gracecom.org/veriditas/](http://www.gracecom.org/veriditas/). Penrose, Roger; see <http://galaxy.cau.edu/tsmith/KW/goldenpenrose.html>

<http://turing.mathcs.carleton.edu/penroseindex.html> ;

[www.nr.infi.net/~drmatrix/progchal.htm](http://www.nr.infi.net/~drmatrix/progchal.htm) . Adair, David; see [www.flyingsaucers.com/adairl.htm](http://www.flyingsaucers.com/adairl.htm) . Winter, Dan, *Heartmath*; see [www.danwinter.com](http://www.danwinter.com) . Sorrell, Charles A., *Rocks and Minerals: A Guide to Field Identification*, Golden Press, 1973.

Vector Flexor toy, available from Source Books (see below). Langham, Derald, *Circle Gardening: Producing Food by Genesa Principles*, Devin-Adair Pub., 1978.

### **Chapter 7**

Charkovsky, Igor; see [www.earthportals.com](http://www.earthportals.com); [www.vol.it/](http://www.vol.it/); [www.well.com](http://www.well.com). Doczi, Gyorgy, *The Power of Limits: Proportional Harmonies in Nature, Art and Architecture*, Shambhala, Boston, MA, 1981, 1994.

### **Chapter 8**

“Free Energy: The Race to Zero Point” (video), available from Lightworks, (800) 795-8273, \$40.45 ppd., [www.lightworks.com](http://www.lightworks.com) .

Pai, Anna C. and Helen Marcus Roberts, *Genetics, Its Concepts and Implications*, Prentice Hall, 1981.

Critchlow, Keith, *Order in Space: A Design Source Book*, Viking Press, 1965, 1969 and other books are out of print; see [www.wwnorton.com/thames/aut.ttl/at03940.hrm](http://www.wwnorton.com/thames/aut.ttl/at03940.hrm) .

Most of the books and sacred geometry tools, in addition to posters, kits, videos, tapes and CDs recommended in this workshop, are available from Source Books, P.O. Box 292231, Nashville, TN 37229-2231, (800) 637-5222 (in U.S.) or (615) 773-7652. Catalog available.

# Contents

PREFACE .....	2
INTRODUCTION .....	3
<b>Remembering Our Ancient Past .....</b>	<b>7</b>
How the Fall of Atlantis Changed Our Reality .....	7
The Mer-Ka-Ba .....	10
Returning to Our Original State .....	11
A Higher, Inclusive Reality .....	11
Left- and Right-Brain Realities .....	13
Where We're Going with This Information .....	13
Challenging the Belief Patterns of Our Parents .....	15
Gathering the Anomalies .....	16
The Dogon Tribe, Sirius B and Dolphin Beings .....	16
A Trip to Peru and More Dogon Evidence .....	18
A Sanskrit Poem and Pi .....	20
How Old Is the Sphinx? .....	21
Edgar Cayce, the Sphinx and the Hall of Records .....	23
Introducing Thoth .....	24
My Story .....	26
Berkeley Beginnings .....	26
Dropping Out to Canada .....	26
The Two Angels and Where They Led Me .....	27
Alchemy and the First Appearance of Thoth .....	28
Thoth the Atlantean .....	29
Thoth, Geometries and the Flower of Life .....	31
<b>The Secret of the Flower Unfolds .....</b>	<b>34</b>

The Three Osirian Temples in Abydos .....	34
Carved Bands of Time .....	35
The Seti I Temple .....	35
The “Third” Temple .....	36
The “Second” Temple’s Sacred Geometry and Flower of Life .....	37
Carvings of the Copts .....	40
The Early Church Changes Christian Symbolism .....	42
<b>The Flower of Life: Sacred Geometry .....</b>	<b>43</b>
The Seed of Life .....	44
The Tree of Life Connection .....	44
The Vesica Piscis .....	45
Egyptian Wheels and Dimensional Travel .....	45
Dimensions, Harmonics and the Waveform Universe .....	47
Wavelength Determines Dimension .....	48
Dimensions and the Musical Scale .....	49
The Wall between Octaves .....	50
Changing Dimensions .....	51
<b>The Star Tetrahedron .....</b>	<b>51</b>
Threeness in Duality: The Holy Trinity .....	53
An Avalanche of Knowledge .....	54
<b>Earth’s Relation to the Cosmos .....</b>	<b>55</b>
Spirals in Space .....	56
Our Sirius Connection .....	57
Yugas .....	60
<b>Modern Views on Pole Shifts .....</b>	<b>61</b>
Iron Pilings and Core Samples .....	62
Pole-Shift Triggers .....	63
Magnetic Flow Changes .....	64
Harmonic and Disharmonic Levels of Consciousness .....	66
<b>The Darker Side of Our Present and Past .....</b>	<b>68</b>

Our Endangered Earth .....	68
Dying Oceans .....	70
Ozone .....	72
The Greenhouse Ice Age .....	76
Ice Age to Warmth, a Quick Switch .....	77
Underground Atomic Bombs and CFCs .....	77
The Strecker Memorandum on AIDS .....	78
A Perspective on Earthly Problems .....	80

The History of the World .....	81
Sitchin and Sumeria .....	82
Tiamat and Nibiru .....	83
Nibiru's Atmosphere Problem .....	85
The Nefilim Rebellion and the Origin of Our Race .....	86
Did Eve Come from the Gold Mines? .....	87
Thoth's Version of the Origin of Our Race .....	87
Conceiving the Human Race: The Sirian Role .....	88
Enlil's Arrival .....	89
Nefilim Mothers .....	90
Adam and Eve .....	90
The Rising of Lemuria .....	91
Explorations of Lemuria in 1910 .....	92
Ay and Tiya and the Beginning of Tantra .....	93
Lemuria Sinks and Atlantis Rises .....	94

**The Aborted Evolution of Consciousness  
and the Creation of the Christ Grid .....** **95**

How the Lemurians Evolved Human Consciousness .....	95
The Structure of the Human Brain .....	95
The Attempt to Birth a New Consciousness on Atlantis .....	96
The Children of Lemuria Are Called Forth .....	97

The Aborted Evolution .....	98
Two Empty Vortexes Drew Extraterrestrial Races .....	98
Mars after the Lucifer Rebellion .....	99

Martians Rape the Human Child Consciousness and Take Over .....	100
Minor Pole Shift and the Subsequent Debate .....	101
The Martians' Fateful Decision .....	102
Failure of the Martian Mer-Ka-Ba Attempt .....	102
A Disruptive Heritage: The Bermuda Triangle .....	103
<b>The Solution: A Christ Consciousness Grid .....</b>	<b>104</b>
Ascended Masters Assist the Earth .....	104
A Planetary Grid .....	105
The Hundredth-Monkey Concept .....	106
The Hundredth Human .....	107
The Government's Discovery of the Grid and the Race for Control .....	107
How the Grid Was Constructed, and Where .....	108
Sacred Sites .....	109
The Pyramid's Landing Platform and the Ship beneath the Sphinx .....	110
The Vulnerability of This Period and the Appearance of the Heroine .....	112
Awaiting the Atlantean Catastrophe .....	113
The Three and a Half Days of the Void .....	114
Memory, Magnetic Fields and Mer-Ka-Bas .....	114
What the Thoth Group Did after Light Returned .....	115
Sacred Sites on the Grid .....	116
The Five Levels of Human Consciousness and Their Chromosomal Differences .....	118
The Evidence in Egypt for a New Look at History .....	118
Giants in the Land .....	119
Stair-Step Evolution .....	121
The Tat Brotherhood .....	122
The Parallel Evolution in Sumer .....	123
Well-Kept Secrets in Egypt, Key to a New View of History .....	124
<b>Egypt's Role in the Evolution of Consciousness .....</b>	<b>126</b>



Introduction to Some Basic Concepts .....	126
Egyptian Tools and Symbols of Resurrection .....	126
The Difference between Dying, Resurrection and Ascension .....	127
When the Sun Rose in the West .....	129
Osiris, the First Immortal .....	130
The Transpersonal Holographic Memory of the First Level of Consciousness .....	130
The Introduction of Writing, Which Created the Second Level of Consciousness .....	131
The Roadblock of Polytheism: Chromosomes and Neters .....	132
<b>The Rescue of Human Consciousness .....</b>	<b>133</b>
Akhenaten's Life: A Brilliant Flash of Light .....	133
Creating the Bodies of Akhenaten, then Nefertiti .....	134
The New Rulership and the One God .....	134
The Reign of Truth, Which Depicts a Different Genetics .....	136
King Tut—and Other Elongated Skulls .....	141
Memory: The Key to Immortality .....	143
What Really Happened to Akhenaten? .....	144
Akhenaten's Mystery School .....	145
The Essene Brotherhood and Jesus, Mary and Joseph .....	145
The Two Mystery Schools and the 48 Chromosomal Images .....	146
<b>Genesis, the Creation Story .....</b>	<b>147</b>
Egyptian and Christian Versions .....	147
How God and the Mystery Schools Did It .....	148
First Create a Space .....	149
Next, Enclose the Space .....	149
Then Spin the Shape to Create a Sphere .....	150
The First Motion in Genesis .....	150
The Vesica Piscis, through Which Light Is Created .....	151
The Second Motion Creates the Star Tetrahedron .....	152
"Move to That Which is Newly Created" until Completion .....	153
<b>The Significance of Shape and Structure .....</b>	<b>155</b>
<b>Developing the Genesis Pattern .....</b>	<b>155</b>
The Torus, the First Shape .....	155

The Labyrinth As a Movement of Life-Force Energy .....	157
The Egg of Life, the Second Shape beyond Genesis .....	158
The Third Rotation/Shape: The Fruit of Life .....	159
<b>The Platonic Solids .....</b>	<b>161</b>
Their Source: Metatron's Cube .....	161
The Missing Lines .....	164
Quasi Crystals .....	165
The Platonic Solids and the Elements .....	166
The Sacred 72 .....	168
Using Bombs, and Understanding the Basic Pattern of Creation .....	169
<b>Crystals .....</b>	<b>170</b>
Grounding Our Learning .....	170
Electron Clouds and Molecules .....	171
The Six Categories of Crystals .....	173
Truncating Polyhedrons .....	175
Buckminster Fuller's Cube Equilibrium .....	177
Deep inside a Sesame Seed .....	178
The 26 Shapes .....	179
The Periodic Table .....	180
The Key: The Cube and the Sphere .....	180
Crystals Are Alive! .....	181
The Future Silicon/Carbon Evolutionary Leap .....	182
<b>The Measuring Stick of the Universe: .....</b>	<b>184</b>
<b>The Human Body and Its Geometries .....</b>	<b>184</b>
Geometry within the Human Body .....	184
In the Beginning Is the Sphere, the Ovum .....	185
The Number Twelve .....	185
The Sperm Becomes a Sphere .....	186
The First Human Cell .....	187
Forming a Central Tube .....	187
The First Four Cells Form a Tetrahedron .....	188
Our True Nature Is in Our Original Eight Cells .....	189

The Star Tetrahedron/Cube of 16 Cells Becomes a Hollow Sphere/Torus .....	191
Progression of Life Forms through the Platonic Solids .....	192
Underwater Birthing and Dolphin Midwives .....	192
Geometries That Surround the Body .....	193
The Masonic Key to Squaring the Circle .....	194
The Phi Ratio .....	195
Applying the Key to Metatron's Cube .....	196
The Two Concentric Circles/Spheres .....	196
Studying da Vinci's Canon .....	197
Phi Ratios in the Human Body .....	198
The Phi Ratio in All Known Organic Structures .....	201
Golden Mean Rectangles and Spirals around the Body .....	204
Male and Female Spirals .....	205
<b>Reconciling the Fibonacci-Binary Polarity .....</b>	<b>208</b>
The Fibonacci Sequence and Spiral .....	208
Life's Solution to the Infinite Golden Mean (Phi) Spiral .....	209
Spirals in Nature .....	211
Fibonacci Spirals around Humans .....	212
The Human Grid and Zero-Point Technology .....	213
Male- and Female-Originating Spirals .....	214
Binary Sequencing in Cell Division and Computers .....	216
Searching for the Form behind Polarity .....	217
The Polar-Graph Solution .....	218
A Sixth-Grade Math Book .....	218
Spirals on a Polar Graph .....	219
Keith Critchlow's Triangles and Their Musical Significance .....	220
Black- and White-Light Spirals .....	222
Maps for the Left Brain and Their Emotional Component .....	223
Arriving Back at the Fruit of Life through the Second Informational System .....	224
<b>AFTERWORD .....</b>	<b>226</b>
<b>REFERENCES .....</b>	<b>227</b>

THE  
ANCIENT SECRET  
OF THE  
FLOWER OF LIFE

VOLUME 2

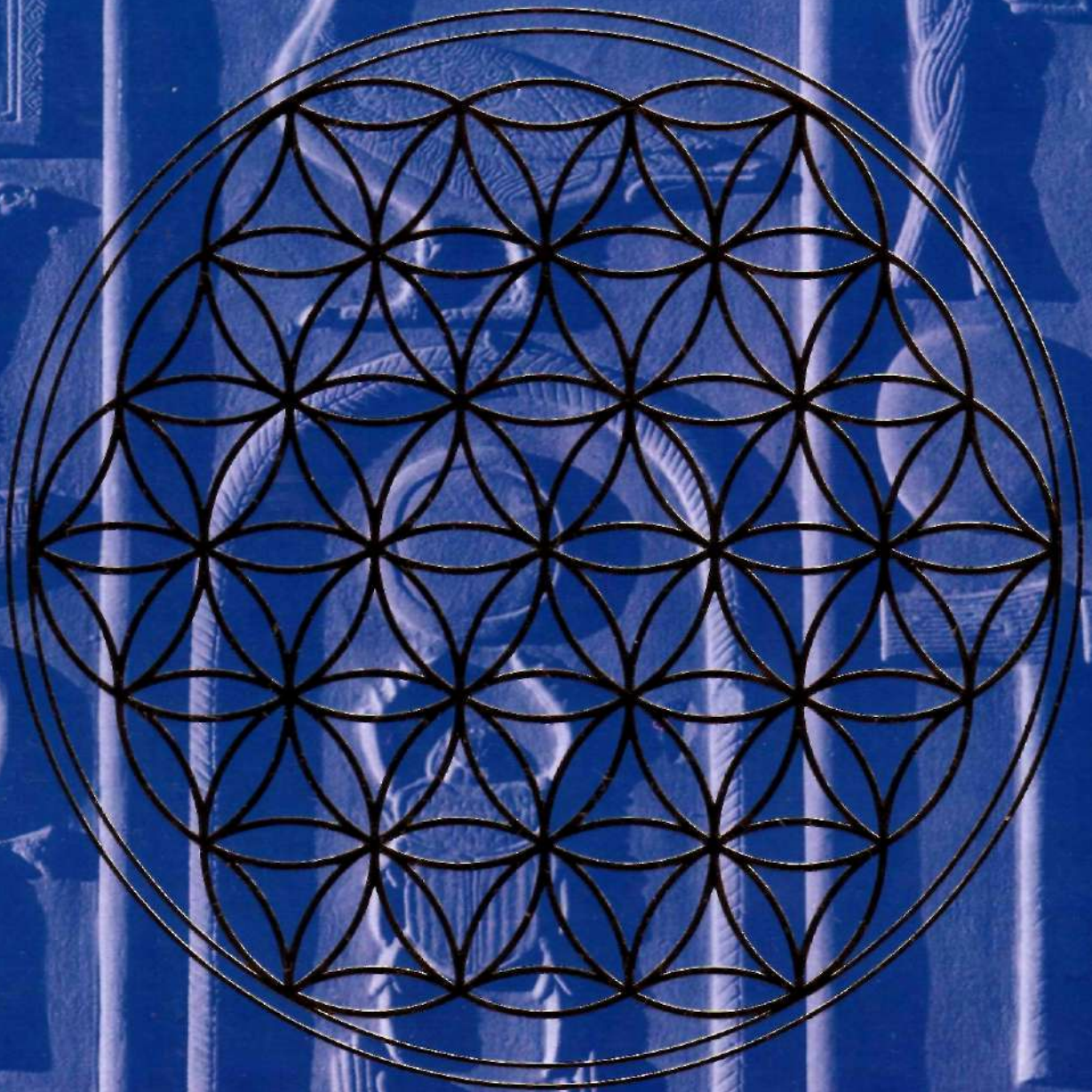

*by Drunvalo Melchizedek*

Copyright © 2000  
by CLEAR LIGHT TRUST  
All rights reserved.

No part of this book may be used  
or reproduced in any manner without  
prior written permission from the publisher,  
except in the case of brief quotations  
embodied in critical reviews  
and articles.

Book editor, Margaret Pinyan

Computer graphics originated by  
Tim Stouse and Michael Tyree

ISBN 1-891824-21-X



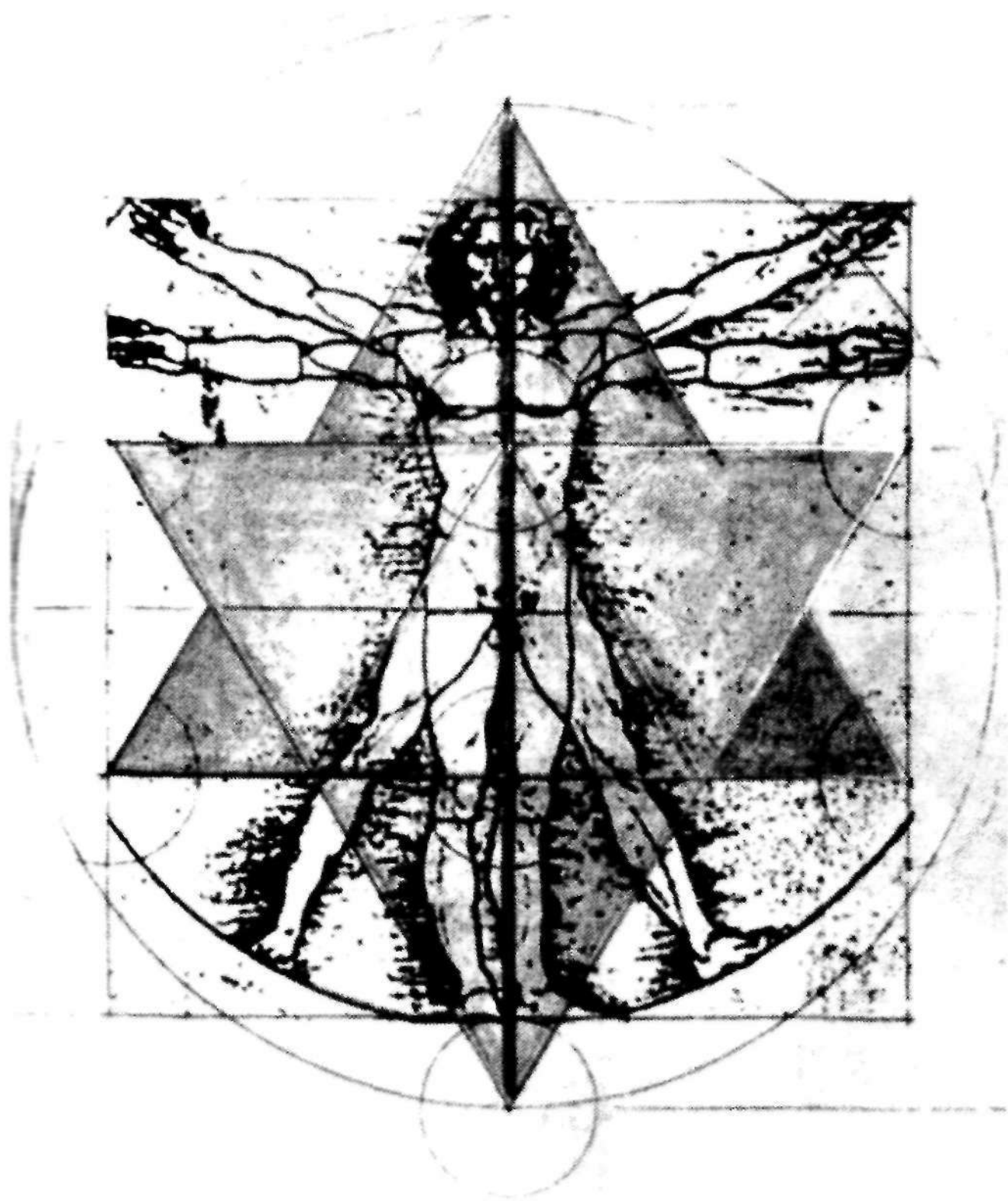

## **Dedication**

This book, volume 2, is dedicated to the child within you  
and to all the new children as they emerge upon the face of the Earth  
to bring us home into the higher light.

## CONTENTS

Introduction . . . . .	xi
<b>NINE Spirit and Sacred Geometry</b>	<b>225</b>
<i>The Third Informational System</i>	
<i>in the Fruit of Life</i> .....	225
The Circles and Squares of Human Consciousness.....	225
Finding Near-Perfect Phi Ratios. . . . .	226
The First and Third Levels of Consciousness.....	227
Locating the Second Level. . . . .	228
Geometric Lenses to Interpret Reality. . . . .	229
Superimposing the Fruit of Life. . . . .	230
Lucie's Genius. . . . .	230
Lucie's Ladder. . . . .	231
Side Note: Sacred Geometry Is a Do-It-Yourself Project.....	233
A Snag in the Ladder. . . . .	234
<i>The Three Lenses. . . . .</i>	235
Square Roots and 3-4-5 Triangles. . . . .	236
Leonardo's and CBS's Eye. . . . .	237
Vitruvius" 10 by 12. . . . .	238
10,000 Years to Figure Out. . . . .	239
<i>Vitruvius and the Great Pyramid. . . . .</i>	240
The Search for a 14 by 18. . . . .	241
<i>The Unknown Leonardo. . . . .</i>	242
<i>A Great Synchronicity. . . . .</i>	245
Earth-Moon Proportions. . . . .	246
Earth, Moon and Pyramid Proportions. . . . .	248
<i>Rooms in the Great Pyramid. . . . .</i>	248
More Rooms. . . . .	250
The Initiation Process. . . . .	250
Light Reflectors and Absorbers above the King's Chamber. . . . .	251
<i>Comparing the Levels of Consciousness</i> .....	252
Catching the White Light . . . . .	252
Proof of the Initiation Chamber.....	254
Catching the Dark Light . . . . .	255
The Halls of Amend and the Face of Jesus.....	256
<i>Summary of the Initiation Process. . . . .</i>	256



<b>TEN The Left Eye of Horus Mystery School</b>	<b>259</b>
Egyptian Initiations . . . . .	262
Crocodile Initiation at Kom Ombo. . . . .	262
The Well under the Great Pyramid. . . . .	267
The Tunnel beneath the Pyramid. . . . .	268
TheHathors. . . . .	278
Dendera . . . . .	280
An Immaculate Conception . . . . .	282
The World's Virgin Births. . . . .	282
Parthenogenesis. . . . .	283
Conception on a Different Dimension. . . . .	284
Thoth's Genesis and FamilyTree. . . . .	285
An Earth Lineage Travels into Space. . . . .	285
The Flower of Life Seen from the Feminine Side_____	287
Wheels on the Ceiling. . . . .	292
The Geometry of the Egyptian Wheels.....	293
<b>ELEVEN Ancient Influences on Our Modern World</b>	<b>297</b>
The Heliacal Rising of Sirius.....	303
Virgo and Leo, Aquarius and Pisces. . . . .	304
The Four Comers Implication. . . . .	304
The Philadelphia Experiment . . . . .	305
<b>TWELVE The Mer-Ka-Ba, the Human Lightbody</b>	<b>309</b>
The Geometries of the Human Chakra System.....	310
The Unfolded Egg of Life and the Musical Scale. . . . .	311
The Human Chakras and the Musical Scale. . . . .	314
The Wall with a Hidden Doorway. . . . .	315
Ways to Find the Doorway. . . . .	317
Chakras on Our Star Tetrahedrons. . . . .	319
The Egyptian 13-Chakra System. . . . .	320
Discovering the True Chakra Locations. . . . .	321
A Body-Surface Chakra Map. . . . .	322
A Different Movement on the Star Tetrahedron. . . . .	323
The Five Spiraling Light Channels. . . . .	324
Let There Be Light . . . . .	324
Egyptian Sexual Energy and the Orgasm . . . . .	330
The 64 Sexual/Personality Configurations. . . . .	332
Instructions for the Orgasm. . . . .	333
Beyond the Fifth Chakra. . . . .	334
Through the Final Half Step.....	335
The Energy Fields around theBody. . . . .	337
How to See Auras. . . . .	338
The Rest of the Human Lightbody.....	340

From My Old Writings—Living as a Child . . . . .	399
How Life Works When You're Connected with the Higher Self...401	
Communicating with Everything Everywhere.....403	
Foretelling the Future. . . . .	404
The Lessons of the Seven Angels.....406	
Testing the Reality of Your Connection with Your Higher Self...407	
<b>SEVENTEEN Duality Transcended</b>	<b>411</b>
<i>Judging</i> . . . . .	411
<i>The Lucifer Experiment: Duality</i> . . . . .	411
The Bright and Shining One . . . . .	412
Creating a Dualistic Reality. . . . .	414
Earth Humans as the Focus of the Experiment . . . . .	417
Using the Intellect without Love. . . . .	418
The Third, Integrated Way. . . . .	419
<i>The Sirian Experiment</i> . . . . .	419
My Three Days in Space. . . . .	419
Technology Reconsidered. . . . .	421
The History of the Sirian Experiment . . . . .	422
August 7, 1972, and the Successful Aftermath. . . . .	425
The Return of Free Will and Unexpected Positive Consequences . . . . .	426
<b>EIGHTEEN The Dimensional Shift</b>	<b>429</b>
<i>The Great Change</i> . . . . .	429
<i>An Overview of a Dimensional Shift</i> .....429	
The First Signs. . . . .	430
The Phase before the Shift . . . . .	431
Five to Six Hours before the Shift. . . . .	432
Synthetic Objects and Lucifer-Reality Thought Forms. . . . .	433
<i>Planetary Shifts</i> .....434	
The Experience of an Actual Planetary Shift . . . . .	435
Six Hours before the Shift . . . . .	435
The Void—Three Days of Blackness. . . . .	436
The New Birth . . . . .	437
Your Thoughts and Survival. . . . .	438
<i>How to Prepare: The Secret of Everyday Life</i> —440	
<i>This Unique Transition</i> . . . . .	442
<b>NINETEEN The New Children</b>	<b>443</b>
<i>The Current Growth of Knowledge</i> .....443	
<i>Human Mutations, Historical and Recent</i> .....445	
DNA Changes in Blood Types. . . . .	445
The Indigo Children . . . . .	446
The Children of AIDS.....448	

The Bible Code and AIDS.....	449
The Superpsychic Children.....	450
The Fourth-Dimensional Shift and the Superkids.....	454
Life Is Great, an Epilogue.....	455
References.....	459
Index.....	463
<i>Template for a Star Tetrahedron (see back of book)</i>	

## INTRODUCTION

We meet again, together exploring the vastness of who we are, and again dreaming the same ancient secret that life is a beautiful mystery leading to wherever we envision.

Volume 2 contains the meditation instructions that were originally taught to me by the angels for entering the consciousness state called the Mer-Ka-Ba—in modern terms called the human lightbody. Our lightbody holds the possibility for the human potential to transcend into a new translation of the universe we find so familiar. Within a specific state of consciousness, all things can begin anew and life will change in ways that appear miraculous.

These words speak more of remembrance than of learning or teaching. You already know what is in these pages because it is written in every cell of your body, but it is also hidden deep inside your heart and your mind, where all that is really needed is just a simple nudge.

Out of the love that I have for you and all life everywhere, I offer these images and this vision to you so that they will be useful; so that they will bring you closer to the self-realization that Great Spirit is intimately and lovingly connected to your essence; and with the prayer that these words be the catalyst that opens the way for you into the higher worlds.

You and I live in a pivotal moment in Earth's history. The world is dramatically metamorphosing as computers and humans enter into a symbiotic relationship, giving Mother Earth two ways to see and interpret world events. She is using this new sight to alter and open the pathways into the higher worlds of light so that even a child can understand. Our Mother loves us so much.

We, her children, are now walking between the two worlds, our ordinary everyday life and a world that surpasses the dreams of even our oldest ancestors. With our Mother's love and our Father's help, we will find a way to heal the hearts of the people and transform this world back into unity consciousness once again.

May you enjoy what you are about to read, and may it truly be a blessing in your life.

In love and service,  
Drunvalo

## Spirit and Sacred Geometry

### The Third Informational System in the Fruit of Life

**W**hat you are about to read is a subject outside most human thought. I ask you to read this with a little faith, and to carefully begin *to see in a new way*. It may not make *sense until you* are deep into the subject. It revolves around the idea that *all consciousness, including human, is solely based on sacred geometry*. Because it is, we can begin to see and understand where we have come from, where we are now and where we are going.

Remember that the Fruit of Life is the basis of all thirteen informational systems, and that it is by superimposing male straight lines in unique ways over the female circles of the Fruit of Life that these systems are created. In the first eight chapters we investigated two of these systems. The first system created Metatron's Cube, which generated the five Platonic solids. These forms created structure throughout the universe.

The second system, which we touched on lightly, was created by straight lines coming from the center of the Fruit of Life *and* concentric circles, thus creating the polar graph. This in turn created the star tetrahedron inscribed in a sphere, which is the basis of how vibration, sound, harmonics, music and matter are interrelated in all of creation.

#### The Circles and Squares of Human Consciousness

We will approach this third informational system indirectly. The source, the Fruit of Life, will reveal itself as we proceed. We'll call this new system *circles and squares of human consciousness*. It's what the Chinese called circling the square and squaring the circle.

According to Thoth, all levels of consciousness in the universe are integrated by a single image in sacred geometry. It is the key to time, space and dimension as well as consciousness itself. Thoth also said that even emotions and thoughts are based on sacred geometry, but that subject will have to wait until later in this book.

For each level of consciousness there is an associated geometry that



completely defines how that specific level of consciousness will interpret the one Reality. Each level is a geometrical image or lens that spirit looks through to see the one Reality, resulting in a completely unique experience. Even the spiritual hierarchy of the universe is geometrical in its structure, copying nature.

According to Thoth, there are nine crystal balls beneath the Sphinx, one inside the other. Archaeologists and psychics have been searching for these crystal balls for a long time—it's an ancient legend. It is said that these crystal balls are somehow connected to the consciousness of the Earth and to the three levels of consciousness that humans are now experiencing.

Various seekers have searched for the nine spheres, spending a great deal of time and money, but according to Thoth, you don't need the crystal balls; you just need to draw nine concentric circles, because it's just as revealing. If they'd known it was geometry and consciousness they were seeking and not necessarily an object, the knowledge would have come easier.

According to Thoth, if you were to approach a planet you've never seen before and wanted to know the different levels of consciousness experienced on that planet, you would take some of the little beings on that planet and measure them, assuming you can get them to hold still long enough. From those measurements you can determine the square-and-circle sacred ratios connected with their bodies, and from this information determine their exact level of consciousness.

Other ratios, always derived from the cube, are used to determine the

levels of consciousness in other than the human form, such as animals, insects and ETs, but in the case of humans, it's the circle and the square. By seeing if the square that fits around the body is bigger or littler than the circle that goes around the body, and by exactly how much, you can determine how they interpret the Reality and exactly what level of consciousness they're on. There are quicker ways, actually, but this way is fundamental to existence itself.

Thoth said to draw nine concentric circles and put a square around each one so that it fits perfectly (one side of the square and the diameter of the circle inside it will be equal), as in Figure 9-1. In this way you have equal male and female energies. Then see how die squares interact with the circles—how the

male energy interacts with the female energy. The key, according to Thoth, is how closely the perimeter of the square and the circumference of the circle approximate the phi ratio. This is the key to human life.

### Finding Near-Perfect Phi Ratios

Looking at the innermost square, no circles cross it; the same is true for the second square. The third square begins to penetrate the fourth circle,

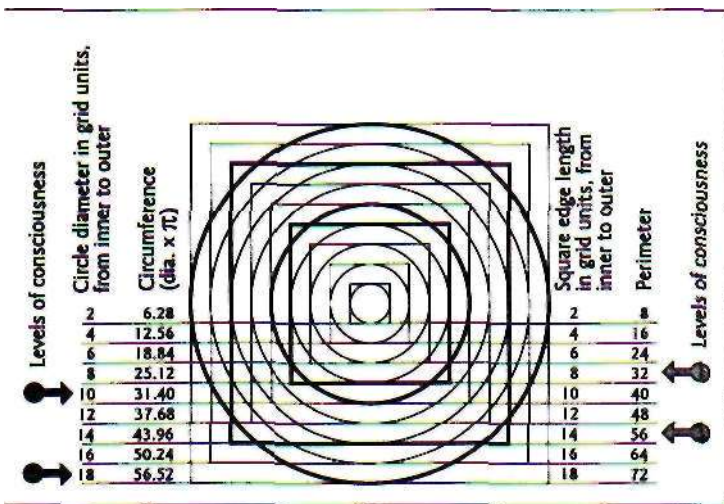

Fig. 9-1. Concentric circles and squares. The darker circles and squares are the pairs that approximate the phi ratio. They also locate the first and third levels of human consciousness. (One grid unit equals one radius of the center circle or *one-half side* of the square that surrounds it. One can see that the diameter of the center circle and one edge of its surrounding square are the same length.)

though it's obviously not a phi ratio. However, the fourth square penetrates the fifth circle in what *appears* to be a near-perfect phi ratio. Then it comes out of phi ratio again on the fifth and sixth squares. Then, unexpectedly, the seventh square penetrates the ninth circle again in what *appears* to be near-perfect phi ratio—not *one* circle beyond, as it did on the fourth square and fifth circle, but *two* circles beyond. And it is even closer to the Golden Mean, the phi ratio of 1.6180339..., than the first one.

This is the beginning of a geometrical progression that could go on forever, a progression in which we humans are only the second possible step. (And we thought so highly of ourselves!) Using the full life of a human as the yardstick, in human history we are now at the level of consciousness represented by the development of the human zygote just after the completion of the first cell. Life in the universe is beyond anything we can image, yet we are a seed that contains the beginning as well as the end.

Coming back to the practical, you can measure these things without a measuring stick by calling the radius of the innermost circle one unit; thus the first circle and first square are two radii across. (This unit makes up an accused grid.) And when you expand to the fourth square, it will be 8 radii across. To know how many radii there are around all four sides of the square, you simply multiply by 4 to see that 32 radii compose the perimeter if the fourth square. We need to know the perimeter because when it equals or approximates the circumference of the circle, we have the phi ratio. (Check chapter 7.)

We wish to see if the fifth circle's circumference is equal to (or close to) the perimeter of the fourth square (32 radii), so we calculate its circumference by multiplying its diameter times pi (3.14). Since there are 10 units radii across the fifth circle, if you multiply that times pi (3.14), the circumference equals 31.40 radii. The square's perimeter is exactly 32, so they are very close; the circle is slightly smaller. According to Thoth, this represents the first time that human consciousness becomes self-aware.

Now let's calculate this for the seventh square and ninth circle. There are 14 radii across the seventh square; multiplying by 4 gives us 56 radii for the perimeter of the seventh square. The ninth circle has a diameter of 18 radii, and that times pi is 56.52. In this case the circle is slightly larger, whereas before, it was slightly smaller. If you keep making circles beyond the otigis was nine, you'll see the same pattern: slightly larger, slightly smaller, slightly larger, slightly smaller—getting closer and closer to the perfection we noted on the Fibonacci sequence approaching the phi ratio [see chapter 8].

### The First and Third Levels of Consciousness

In Figure 9-2 we are looking at the very beginning of consciousness in these first two phi-ratio places. This indicates that consciousness will probably continue forever to expand

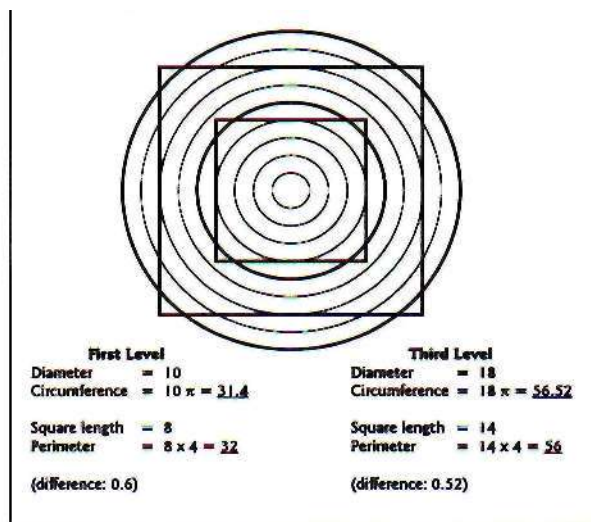

Fig 9-2 The  $\wedge \wedge \wedge$  levels

of human consciousness, near-perfect phi ratios.

and approximate the perfection of the phi ratio or the Golden Mean. So the fourth square relative to the fifth circle and the seventh square relative to the ninth circle form near-perfect phi ratios. Those happen to be, according to Thoth, the first and third levels of consciousness. They are very, very close to being harmonic consciousness, which makes them self-aware. Remember the nautilus shell (page 210)? In the beginning it was not even harmonically close, compared to several steps further down the geometrical path. It is the same here. But what happened to the second level of human consciousness?

According to Thoth, no one has ever figured out how to go from the first level, which is where the Aborigines are, straight into the third level, which is Christ or unity consciousness. We needed to have a stepping stone or a bridge between the two—which is us, the second level. The question now is, where is our level of consciousness in this drawing?

### Locating the Second Level

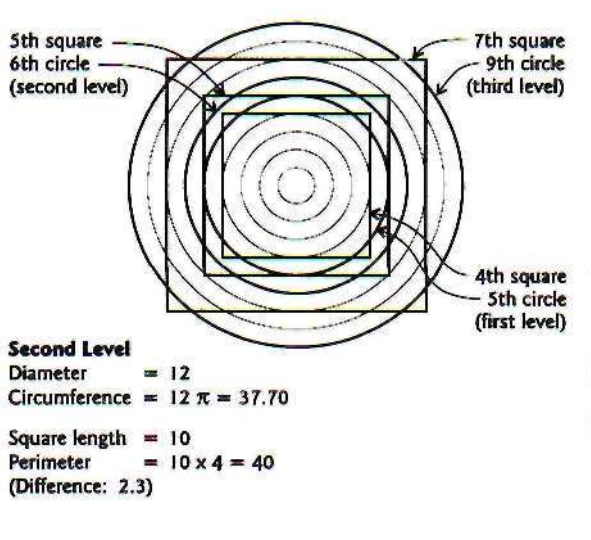

Fig. 9-3. The three geometric levels of human consciousness on Earth: square 4 and circle 5 = first (aboriginal) level; square 5 and circle 7 = second (present) level; and square 7 and circle 9 = third (Christ) level.

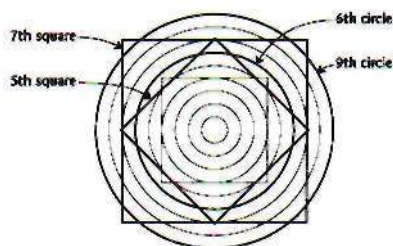

Fig. 9-4- Rotating the second-level square 45 degrees bridges the second and third levels of consciousness.

There are two places where we (ordinary humanity) could be on this circle/square system: on the fifth or the sixth square relative to some other circle. There are only two squares between the first and third levels in Figure 9-1. From my way of seeing, I didn't know what difference it would make which square we were on, and Thoth wouldn't tell me. He just said, "It's the fifth square relative to the sixth circle" without explaining why. So for two or three years I was wondering why it was the fifth square relative to the sixth circle and not the sixth square relative to the seventh circle. Still he wouldn't tell me. He simply said, "You figure it out." It took me a long time to understand why. When I finally figured out why, Thoth simply gave me a nod, meaning I was correct. Here are the three levels of consciousness with the other nonharmonic squares removed [see Fig. 9-3].

If we rotate the square by 45 degrees [see Fig. 9-4] into a diamond, the secret purpose of our existence becomes apparent. In this view the rotated fifth square very closely approximates the location of the seventh square. It is not perfect because we are not harmonic ourselves, and we do not have a perfect Christ love, but we show the way to Christ consciousness by our human love. And further, we are still connected to the first level because our geometry perfectly touches the fourth circle of the first level of consciousness. We contain the Aboriginal consciousness perfectly, and we imperfectly contain the Christ love. This is what we are—a connecting bridge.

This is the key to why human consciousness is found in this particular geometric relationship and why it is necessary. Without our present way of seeing the one Reality, the first level of consciousness would never be able to evolve into the higher light. We are like a rock in the middle of a small stream. One jumps to it, but immediately continues on to the other side.



As you're going to see later in this chapter, this diamond view is the key to our second level of consciousness. You'll see this in the Great Pyramid and also in other works I'll be showing you. The square with the diamond inside is very important to humanity. Buckminster Fuller also thought it was very important. This form, when in 3D, is called the *cuboctahedron*. Bucky gave it a special name: the *vector equilibrium*. Bucky observed that the cuboctahedron has the amazing ability, through rotation, to become all five Platonic solids, giving a clue to its paramount position in sacred geometry. Why is it important to humanity? Because the square with the diamond inside it is connected to one of the primary reasons for human existence—the role of moving from Aboriginal, the first level of consciousness, to Christ consciousness, the third level.

When you measure the human geometries using this system, we humans are on by about three and a half radii. We're not even close to being harmonic (You could measure this yourself if you wish.) We're a disharmonic consciousness, though we are necessary to complete life. So when life gets to where we are, it gets in and out as fast as possible, like jumping on the rock in the middle of the stream. Why? Because when we are disharmonic, we destroy anything and everything around us. If we stay there too long, our lack of wisdom will destroy even ourselves. If you look at the world's environment and our continual wars, you can understand. Yet we are essential to life.

#### Geometric Lenses to Interpret Reality

The next thing Thoth wanted me to do was look at these three different levels of consciousness geometrically so I could see what these geometrical lenses looked like. Remember, there's only one God, only one Reality. But there are lots of ways to interpret the Reality.

The innermost square (the fourth) in Figure 9-5 represents the first level: the middle square (the fifth) the second level; and the outer one (the seventh) the third level. I'm going to call the inner square an 8 by 10, meaning that it has eight radii per side and its relating circle (the fifth) has a diameter of ten. The middle square is 10 across and the sixth circle 12, so I'm calling it a 10 by 12. This is the middle or second level, which we exist on now. For the Christ-consciousness level, there are 14 radii across the square (the seventh) and 18 radii across the ninth circle, so we'll call that a 14 by 18. So we have an 8 by 10, a 10 by 12 and a 14 by 18.

So, there's always a reason for everything in sacred geometry. Nothing—absolutely nothing—occurs without a reason. You might ask why, out of the whole spectrum of possibilities, did self-aware consciousness *begin* when the fourth square went into harmony with the fifth circle?

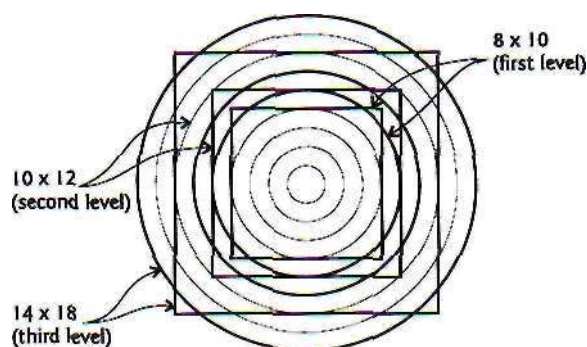

Fig. 9-5. The three levels of human consciousness in terms of units or radii in their circle-square pairs.

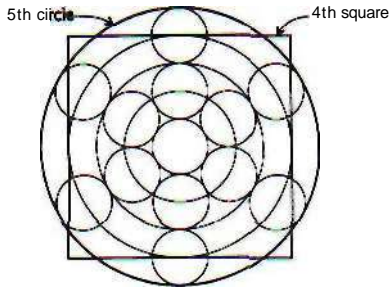

Fig. 9-6. Fruit of Life overlaid upon the first level of consciousness.

## Superimposing the Fruit of Life

To understand why, let's try superimposing the Fruit of Life on this drawing of the first level of consciousness [see Fig. 9-6]. Look at that! It exactly fits the fourth square and the fifth circle, our 8 by 10! This center circle is the same as the center circle of the previous drawing, as are all five concentric circles here. This drawing shows only, the fourth square, which forms a near-perfect phi ratio with the fifth circle, as we saw before.

Do you see the perfection of life? The Fruit of Life pattern was hidden beneath this pattern all along; they're precisely superimposed over one another. In a right-brain way, that's how to explain why consciousness first became self-aware between the fourth and the fifth circle—because that sacred image was hidden behind that part of the pattern. The Fruit of Life was completed at that precise moment and the phi ratio first appeared. When the phi ratio appeared, it was the first time that consciousness actually had a way to manifest.

## Lucie's Genius

There's one more thing before we get into those three different images of consciousness. When I discovered that the concentric circles-and-squares drawing could be superimposed perfectly over the Fruit of Life pattern, I wanted to see if anything had been written about it. At the time, I was sitting in my room listening to this man Thoth, whom nobody else could see but me, and he was telling me that the Egyptians perceived three different levels of human consciousness. I wanted to know if this idea existed in Egyptian history outside his account.

When I tried to find it in the writings, to my surprise, I did. At least I found it in the writings of Lucie Lamy, the stepdaughter of Schwaller de Lubicz. Nobody else I could find knew anything about this idea of three levels of human consciousness. Schwaller and Lucie understood deeply about Egypt's relationship to sacred geometry. Most Egyptologists didn't understand that *at all* until recently. In my estimation, after studying Lucie's work, she is one of the greatest people ever involved in sacred geometry. She has absolutely amazed me with her work. I always wanted to meet her, but I never did. She died a few years ago, about 1989 or so, in Abydos, Egypt. I want to show you something about Lucie Lamy so you can see what caliber of person she was.



Fig. 9-7. A side view of the temple at Kamak that Lucie put together.

This small temple [see Fig. 9-7] is inside the Karnak temple complex. Karnak is connected to the Temple of Luxor by a wide walkway about two miles long. It has human-headed sphinxes on both sides at the Luxor end, which gradually turn into sheep-headed sphinxes as it gets closer to Karnak. The Karnak temple

complex is huge, and the pool where the ancient priests cleansed themselves would amaze you by its sheer size.

To give you a sense of the scale of this small temple, a person standing in front of it would come up to about the lower edge of the slanted windowsill. Before: Lucie found the stones of this temple, they were literally just a big pile of rocks. The archaeologists knew that they belonged together because they were unique; there was nothing else around like them. But they didn't know what the building had looked like, so they left them in a big pile, hoping that someday someone would figure it out. Then they found another big Pile of unique stones. They had no idea about them, either. What do you do with a bunch of broken-up stones? It's hard to say what the original building looked like, right?

But Lucie looked at the rocks, took some measurements, and then went home and drew plans that looked just like this photograph. She said, "That's what it's going to look like." And when they put it together, every single stone fit together and formed what you see there! She understood sacred geometry, and she had made the blueprint by examining the stones and measuring them. She put another building together in a similar way. I think that's really exceptional. The more I study this woman, the more I'm amazed by her.

#### Lucie's Ladder

Before Lucie died, she put all her understanding of the Egyptians' knowledge of these three levels of consciousness into one drawing. She said this was the key to understanding Egypt's consciousness levels. Therefore I

attempted to analyze what she was saying through her own drawing on this subject.

This is her drawing Fig. 9-8L. I redrew it in this next photo [Fig.9-9J] and later added the outer broken-line circle so I can show you something else. It was not copied clearly and had to be redrawn.

The first thing I noticed about her drawing was that there was a Star of David within a Star of David and a circle in

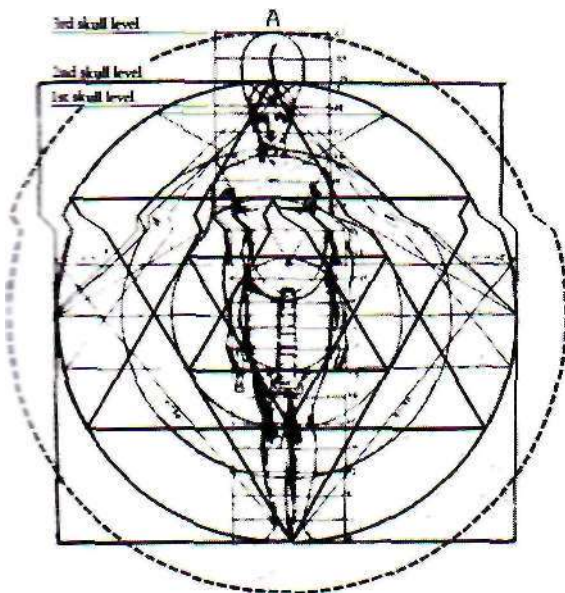

fig. 9-9. Lucie's drawing with a new outer circle at the top of the head of the third level of consciousness and a small and large Star of David. The new circle's circumference matches the perimeter of the square.

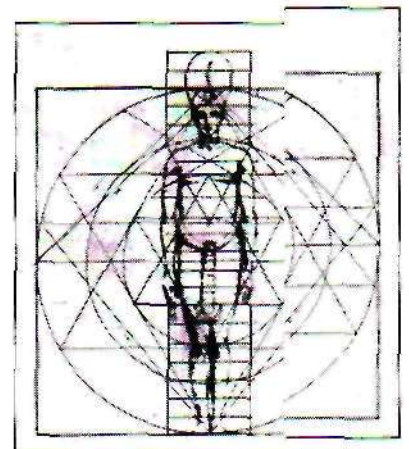
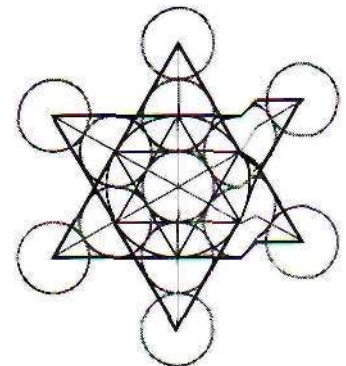
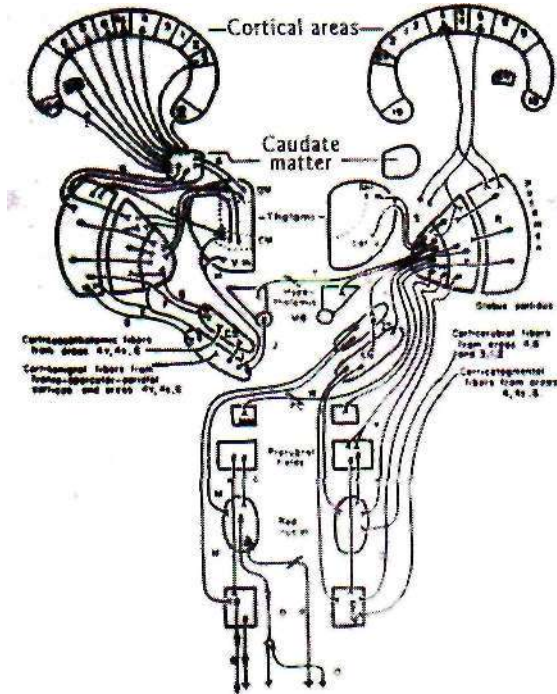

Fig. 9-8. Lucie Lamy's original drawing.





Schematic diagram of the computing centers and communications pathways of the extrapyramidal system in the human brain. Removal of the upper cortical areas, where conscious thinking takes place, has little effect on the circuit of information required for the equally complex computations needed for walking and maintaining equilibrium. The pathways show the routes of chemical reactions and electric-like impulses. (From *Brains, Behavior and Robotics* by James S. Albus, Byte Books, 1981.)

Fig. 9-10. Schematic of human brain showing that a lobotomy would not affect complex motor functions.

the middle. (We've seen that before in the Fruit of Life [see page 162] and we'll see it again shortly.) Also, there's a ladder going up the middle, from zero to 19 steps inside the square, then two more steps above, a total of 21.

According to Lucie, the numbers 18, 19 and 21 are directly connected to Egyptian thought concerning the three levels of consciousness. Eighteen symbolizes the Aborigines, and she wrote that the ancient Egyptians believed that humans then didn't have the top half of the skull. Apparently the skull used to slope to the back. When we moved into the second level, we "added" a higher skull, and when we physically move into the third level, as we are about to do, we'll grow a huge skull that will extend to the phi-ratio point of the circle that would relate to the square—to 21. If you draw a phi-ratio circle around the square, indicated at point A, it exactly reaches the center of line 21. Therefore, each of the skull levels are actually contained in the geometry of this drawing, according to Lucie.

Figure 9-10 is a schematic of the human brain from *Brains, Behavior and Robotics* by James S. Albus. This shows that you

can perform a lobotomy, removing the entire top half of the skull with everything in it, and it won't kill a person—which to me is astounding in itself. This is circumstantial evidence that what the Egyptians

were saying was true: that the top half of our skull was added, that it is not an absolutely essential component for life and is something separate from what we used to be.

Figure 9-11 is the floor plan of the Temple of Luxor. This temple was dedicated to mankind and is also called the Temple of Man, which means *us*—not any man, not just any level of consciousness, but the second level we're on now. This plan is laid out in 19 divisions. You can see the human skeleton behind the drawing. Every room, everything in this drawing, was designed to represent all the various parts of the human being. Coming off from the

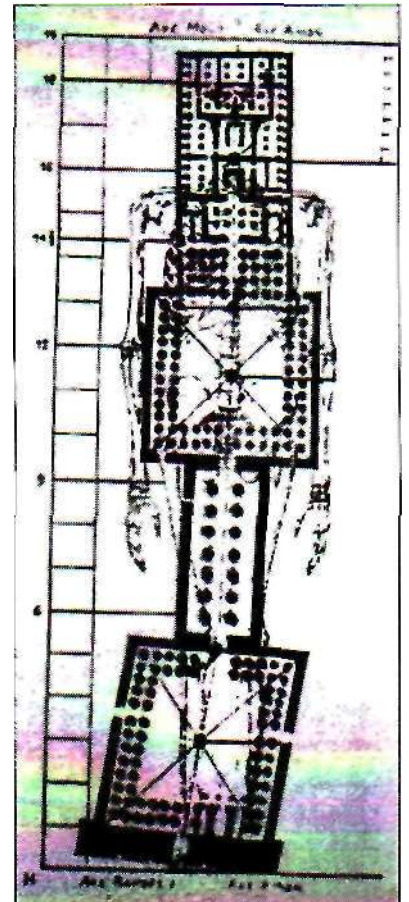

Fig. 9-11. Plan of the Temple of Luxor.

feet was a long pathway that led several miles to the temple complex at Xarnak.

I had first noticed that the Fruit of Life [Fig. 9-12] was definitely contained in Lucie's drawing [Fig. 9-]. This fact alone impresses me because I hadn't seen the Fruit of Life anywhere else in

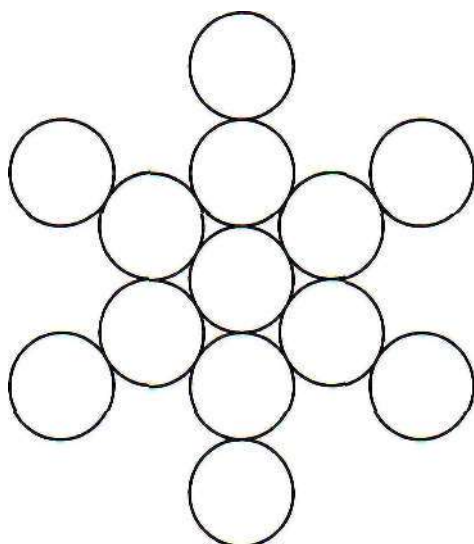

Fig. 9-12. The Fruit of Life.

But I wanted to understand more about the ladder that goes to the top to 19 and 21. I

knew that a ladder like this is another way of making concentric circles, so I decided to study what Lucie was doing with this ladder. I began to redraw every one of her lines to see what she was trying to convey [Fig. 9-13]. So I took these two drawings [Figs. 9-12 and 9-13], which were obviously both out of her original drawing, and combined them. I reconstructed her drawing, superimposing the lines very accurately [Fig. 9-13a].

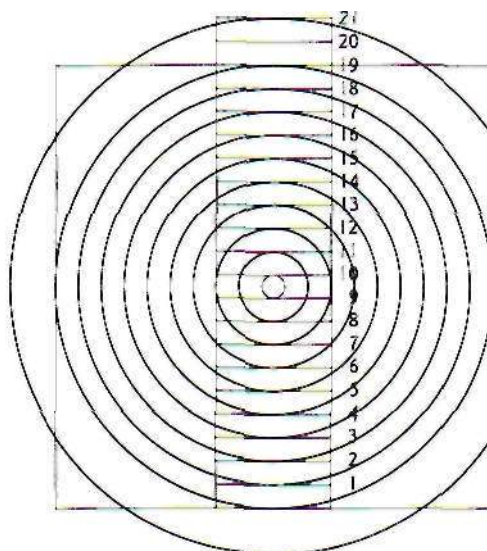

Fig. 9-13. Lucie's ladder, with concentric circles drawn to step 19 and again at step 21.

Side Note: Sacred Geometry Is a Do-It-Yourself Project

This might be the right time to take a little side trip and express something about sacred geometry that is very important to understand if you decide to become a student of the subject. When you sit in an audience and look at sacred geometry forms or read about it in this or any other book, receiving the information passively, you're absorbing a very small amount of the information coming off these drawings. However, if you were to sit down and *draw* them yourself, actually construct them, something happens to you, something far beyond what happens if you simply look at them. Anyone who has ever done this will tell you the same thing. This is one of the basic premises of the Masons. When you actually sit down and line things up and physically draw the lines, something seems to happen that is akin to a revelation. You draw the circle and you start understanding. Something happens inside. You start understanding on very, very deep levels why things are done the way they are. I believe there is no substitute for personally reconstructing these drawings.

I can *tell* you about how important this is, but what I've found is that few people actually take the time. It took me over twenty years to do these drawings, but it doesn't have to take you that long. For many of these draw-

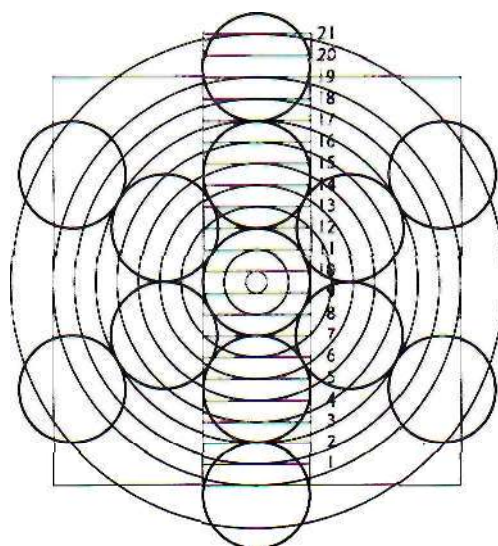

Fig. 9-13a. Lucie's basic geometry, with the temple plan and the Fruit of Life superimposed over it.

ings, I would spend two or three weeks in front of one, like a meditation, just gazing at the image. I might spend half a day and make only one line to fully understand the implications that line has for nature.

### A Snag in the Ladder

Before I combined the two drawings, Figures 9-12 and 9-13, extracted from Lucie Lamy's original drawing, I started by drawing a concentric circle for every line on the ladder except 20, shown in Figure 9-13a.

Notice that on the original drawing [Fig. 9-8], the central circle was divided into exactly five horizontal components, or rungs on the ladder (don't count the horizontal line running through the middle of the circle). You can clearly see that on the original drawing. Therefore I assumed that the other circles of the Fruit of Life pattern would *also* be divided into exactly five components. Pretty straightforward. I did that. Here it is [Fig. 9-14], but only the top three vertical circles, leaving out the rest for simplicity's sake.

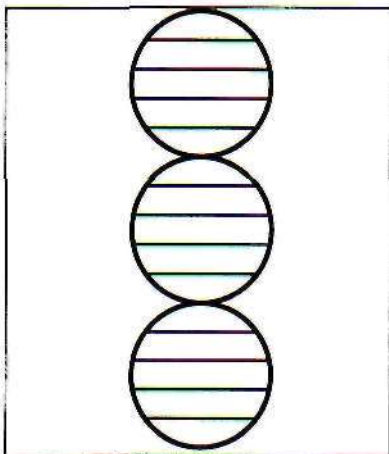

Fig. 9-14. Dividing the circles into five equal components.

Each circle has five equal components. The only problem is that it didn't fit, it didn't work. I couldn't believe it! I'd thought it was going to be a simple thing, and I would go on from there, but it didn't fit. It just simply didn't work geometrically. So I went back and checked the two drawings, thinking, *I can't be wrong here. There it is, plain as day.* But when I put them back together again, they still would not superimpose.

After many, many hours I went back and studied Lucie's original drawing again. There were definitely five divisions in the middle circle and seven divisions on either side of it. Then I got a special little instrument to measure the *size of the steps* of the ladder. I discovered that the seven divisions below and the seven divisions above the central circle were smaller than those *inside* the central circle! She had changed the sizes to make them fit! Lucie *knew* that we're on a disharmonic level of consciousness; she knew the ladder wouldn't fit without changing some of the measurements, but she wanted to put it all into one drawing. So she *made* it fit, knowing that if people would just study it, they would understand that the level she was drawing with—the 19 divisions, was a disharmonic level of consciousness.

It was subtle in a manner similar to Leonardo's canon of man, where he wrote in a mirror image on the top of his drawing so that you would have to hold up a mirror to read it. In the same way, the original drawing of Lucie's is the male aspect, and the female component of it is a mirror image. Many of the ancients were constantly changing things to hide knowledge. It's like a little game to hide what you don't want to be known by the outer world. When I realized that, I really began to understand that this is truly a disharmonic level of consciousness, and I knew then that the Egyptians also understood this. After that I began to spend a lot more time studying Lucie's drawings.

## The Three Lenses

At this point, now that we know that the three levels of consciousness were known by the Egyptians, we'll go back to those three geometric drawings and study them carefully. They are the lenses that each level of human consciousness uses to interpret Reality: the 8 by 10, the 10 by 12 and the 14 by 18. We'll begin by drawing the 8 by 10, the first level of consciousness.

Thoth showed me an ingenious way of constructing this drawing without measuring or calculations. You need only a straightedge and a compass. He showed me directly, saying that this would save me a lot of time [see instructions at bottom right for Fig. 9-15].

When *the* last step is completed, you have a grid of 64 small squares inside the large square, with *exactly one* additional grid square's width between the large square's perimeter and the large circle's circumference [Fig. 9-16]. The large square measures 8 grid squares across and the large circle measures 10 across—a perfect 8 by 10. And you didn't need a ruler to measure it!

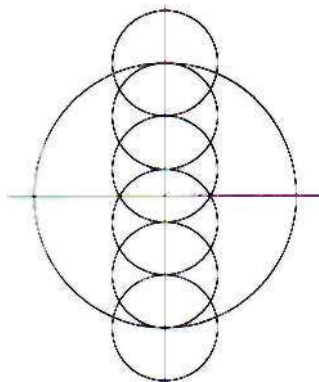

Fig. 9-15c. Step 3.

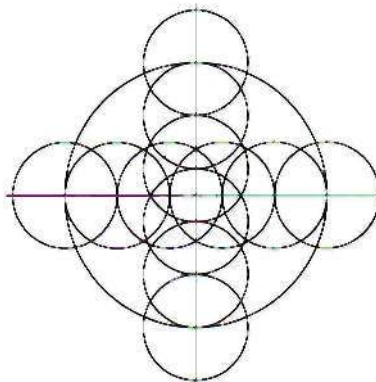

Fig. 9-15d. Step 4.

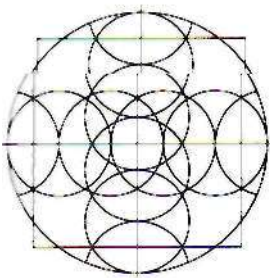

Fig. 9-15e. Step 5.

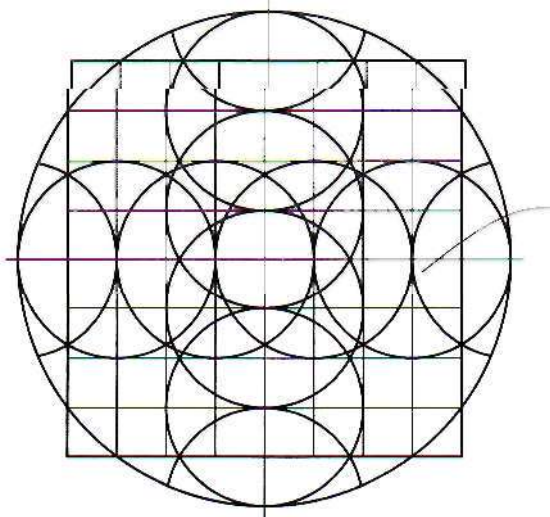

Fig. 9-16. Step 6: An 8-by-10 grid of the first level of consciousness.

Fig. 9-15a. Step 1.

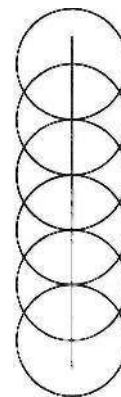

Fig. 9-15b. Step 2.

1. Draw a vertical line, then draw a circle on the line [Fig. 9-15a].
2. Draw five more identical circles centered on the points where the vertical line crosses the circumference of the previous circle [Fig. 9-15b].
3. Draw a horizontal line through the points of the middle vesica piscis. Centered where the horizontal and vertical lines cross, draw a large circle around the four middle circles [Fig. 9-15c].
4. Draw the same size circle as in Fig. 9-15b centered over the horizontal line starting at the edge of the large circle. Create five more circles in the same manner as step 2, only horizontally [Fig. 9-15d].
5. Construct a phi-ratio square with sides passing through the long axes of the four outer vesica piscis.
6. Within the square, draw parallel lines through each tangency point (where circles touch but don't cross) and also through the long axes of each of the remaining vesica piscis [Fig. 9-16]. This gives you an 8-by-10 grid.

## Square Roots and 3-4-5 Triangles

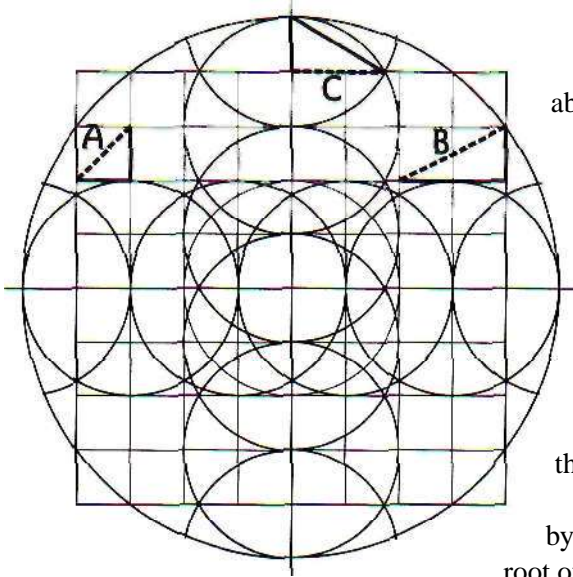

Fig. 9-17a. The square root of 2 (the triangle at A), the square root of 5\* (the triangle at B) and the square root of 3 (the triangle at C).

Note: The Pythagorean theorem relates the hypotenuse of a triangle to its sides:

$$h^2 = a^2 + b^2 \text{ or } h = \text{sqrt}(a^2 + b^2)$$

where  $h$  is the hypotenuse and  $a$  and  $b$  represent the length of the sides.

\*Thus when  $a = 2$  and  $b = 1$  (as in the triangle at B),  $a^2 + b^2 = 5$ , so  $h = \text{sqrt}(5)$ .

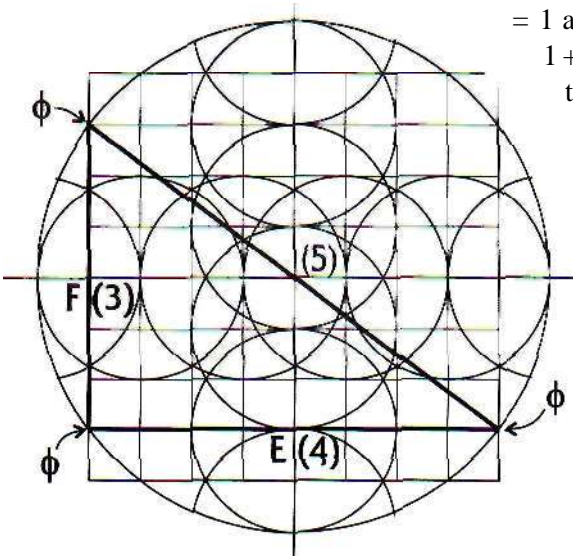

Fig. 9-17c. One of the eight 3-4-5 triangles inscribed in the circle in this grid. Here one unit is 2 grid-square lengths.

There's another aspect of this 8-by-10 grid that I sometimes talk about, but I'll touch it lightly now.

Some of you may know that the Egyptians reduced their entire philosophy to the square root of 2, the square root of 3, the square root of 5 and the 3-4-5 triangle. It just so happens that all those components are in this drawing of the first level of consciousness, and it's extremely rare that such a thing would happen in the way it is occurring. In Figure 9-17a, if the length of the sides of the small squares is taken as 1, then the diagonal line A is the square root of 2; the diagonal B is the square root of 5, and line C is the square root of 3, from the vesica piscis.

For example, by the square root of 5, 1 mean that *if four* grid squares are a unit (1) [Fig. 9-17b], then line D would be 1 and line E would be 2.

The Pythagorean rule states that the diagonal (hypotenuse) of a right triangle is derived by adding the squares of the two sides of a right triangle, then taking the square root of the result. Thus,  $1^2 = 1$  and  $2^2 = 4$ ; then  $1 + 4 = 5$ , making the diagonal the

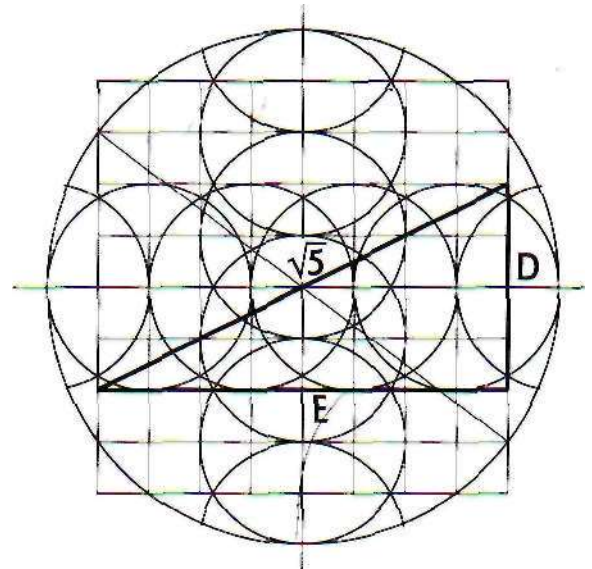

Fig. 9-17b. The square-root-of-five ( $\sqrt{5}$ ) triangle shown another way, using *four* grid squares instead of one as equal to 1.0.

square root of 5 ( $\text{sqrt}5$ ). That's what they mean by the square root of 5. See Figure 9-17b, where four grid squares equal one unit.

A 3-4-5 triangle is perfectly inscribed in Figure 9-17c. If you count the length of two squares as one unit for your yardstick, then line F is exactly 3 units (6 squares) and line E will be 4 (8 squares). Since these sides measure 3 and 4, then the diagonal *has* to be 5, making a 3-4-5 triangle. In fact, there are eight of them in this figure that are perfectly inscribed, whirling around the center. What is so rare is that the 3-4-5 triangles are inscribed *exactly* at the points where the circle crosses the square to form the phi ratio. These are amazing synchronicities that you wouldn't happen upon by pure coincidence. Now let's do this drawing a little differently.



### Leonardo's and CBS's Eye

We now superimpose two Fibonacci spirals, a female spiral (broken line) and a male spiral (solid line) [Fig. 9-18]. We saw a perfect reflection before [see Fig. 8-11]. The male spiral (A) touches the top of the "eye" and spirals up and around clockwise. The female spiral (B) passes through zero point (C), the center of the eye, then up and around counterclockwise. (This eye in the middle, by the way, happens to be the CBS eye, which makes me wonder who those guys were who designed their corporate image.) This eye is a lens, though Thoth sees it as an eye. It's the geometry through which the mind of the first level of consciousness interprets Reality. This drawing represents the Aboriginal level of consciousness with 42 + 2 chromosomes (the author regrets that he has lost the scientific reference paper from Australia to prove this fact). It's the first level of human consciousness on Earth, and it's the first time human consciousness becomes self-aware.

Notice that this figure and the next two (out of Leonardo's canon, which we used before) have the same geometries [Figs. 9-19 and 9-20]. Both patterns have a 64-square grid and the same inner structure, although the circle and square are differently positioned in the Leonardo drawings. They're interrelated, making me wonder who Leonardo really was and what he was really studying!

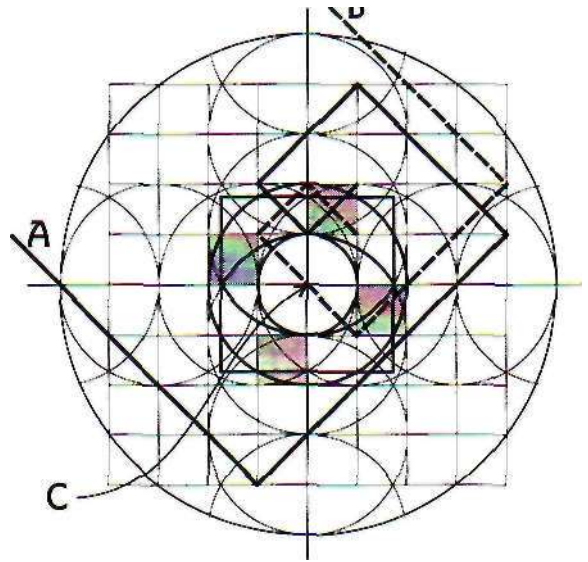

Fig. 9-18. A different perspective, showing the CBS eye in the center, at zero point (C).

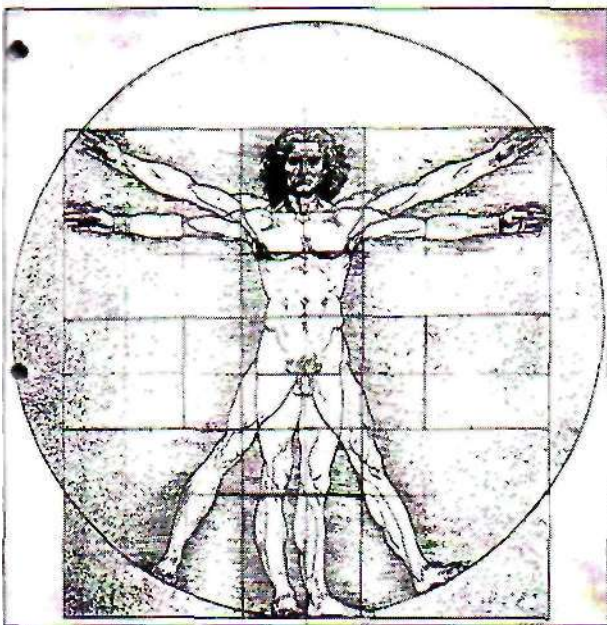

Fig. 9-19. Leonardo's original grid.

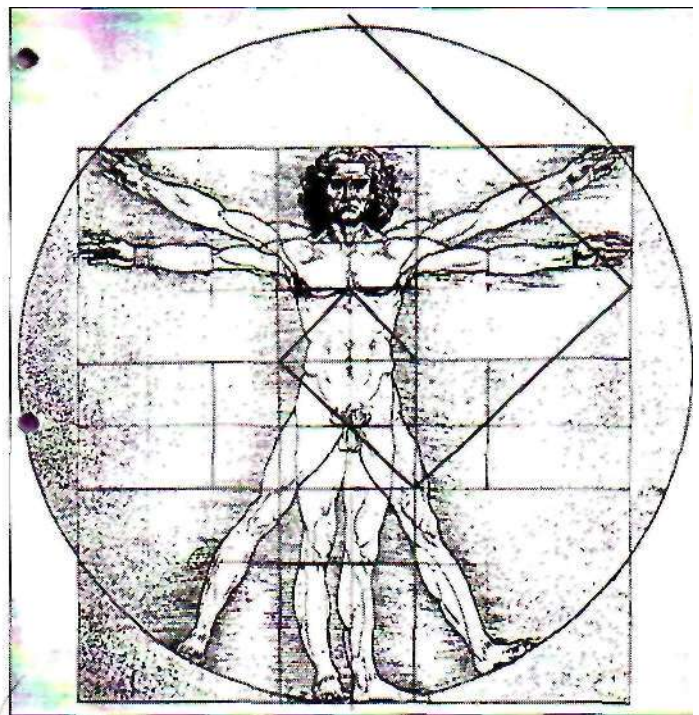

Fig. 9-20. A female spiral superimposed on Leonardo's human grid.

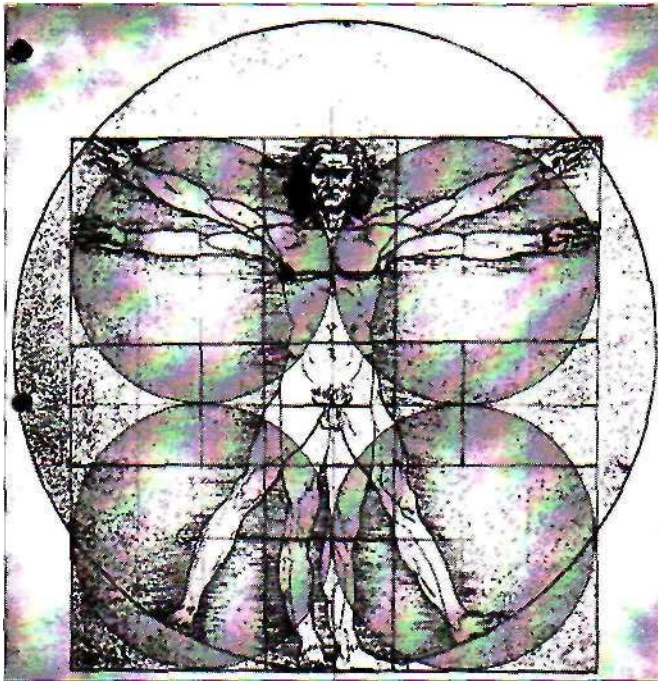

Fig. 9-21. The Leonardo canon superimposed over the eight-cell division (the other four cells hidden behind the visible four).

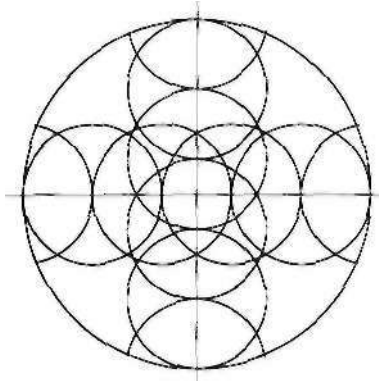

Fig. 9-22. Four circles that will create the 8 by 10 grid.

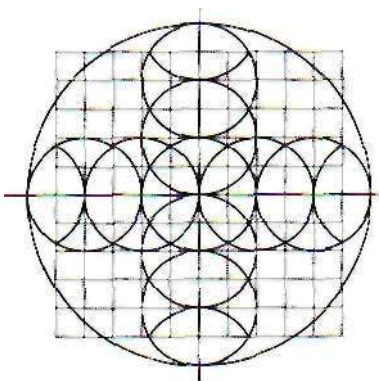

Fig. 9-23. The 10 by 12.

In Figure 9-21 you see the eight-cell division [see the Egg of Life in Fig. 7-26] and the human body underneath; you can begin to see the actual proportions of the adult human being contained in that eight-cell division. (Later in this chapter we will discuss in more detail the relationship between Leonardo's canon and the Egg of Life.) This also means that if Leonardo actually understood this information, if it wasn't just a coincidence, he was not talking about us, but about the first level of consciousness—the Aborigines, the first peoples of the world. Of course, I don't *know* if he knew this or not, because this one piece of information is not enough to base that kind of judgment on.

Because Leonardo did create an 8 by 10 around his canon—and since there are lots of grid possibilities—this was enough for me to suspect that maybe he *did* understand these levels of consciousness based on geometry. So I began to search all of Leonardo's works to see if he had a human canon with a 10 by 12 or a 14 by 18. I searched and searched and looked and looked, but I couldn't find it. I mean I really looked, but after a while I gave up. Later, at another time

when I was restudying Leonardo, I noticed that this drawing of the canon of man based on the 8 by 10 wasn't really Leonardo's work, because the proportions were drawn from his teacher, Vitruvius. Vitruvius actually lived about 1400 years before him, but Leonardo considered him his most important mentor.

#### Vitruvius' 10 by 12

Once I found out that this was really Vitruvius' proportions, I began to go through *his* works to see if I could find a 10 by 12 or a 14 by 18—and I did! I found a 10 by 12. This gave me two of the three levels of consciousness, which then made me suspect strongly that these men, Vitruvius and Leonardo, were following exactly the same line of thought that Thoth was teaching me. To top this off, Vitruvius was a Roman engineer whose writings, when revived and printed in the 1400s, were responsible for the architecture of some of the magnificent churches in Europe. Leonardo was a master mason.

If you draw *five* circles of the same diameter along the axes (as in Fig. 9-23) instead of four (as in Fig. 9-22) and draw lines through the lengths and conjunctions of all the vesica pisces, you come up with this grid of 100 squares—a 10 by 12.

You know that it's exactly a 10 by 12 because there are 10 squares across the big square and 12 squares across the diameter of the large circle. As we saw in Figure 9-16, the vesica pisces around the four sides are half inside and half outside the square, and because half the width of a vesica piscis determines the square sizes (you've drawn lines through the lengths of all 12 vesica pisces and parallel lines at all 10 conjunctions), you know you have the perfect ratios.

### 1 0.000 Years to Figure Out

However... when I started my (female-originating) Fibonacci spiral from the upper right corner of the central four squares (point A in Fig. 9-24), it didn't seem to be hitting in the right places as it did in the 8 by 10; it didn't seem to have synchronicity.

I remember that I was doing this while Thoth was watching. He watched me for a long time and then he said, "I think I'm just going to tell you this one." I said, "Well, I'll get it." He said, "No, I think I'll just tell you." I said, "How come?" He replied, "You probably won't get it for a while. It took us 10,000 years to figure this out, and I don't have the time."

This is what Thoth told me: For the first level of consciousness (8 by 10, Fig. 9-16), for those four grid squares in the middle, the number 1 we arrived at as our measuring stick was not 1. It was 1 *squared*—that was its actual value—and 1 squared equals 1. But how do you know the difference when you're looking at it? And when you come to the second level of consciousness, the 10 by 12, it's not 2, but 2 *squared*, which equals 4. So you have to take the diagonal of four squares as your unit of measure, which means it takes two diagonal lengths now instead of one to equal the 1 of our measuring stick [see Fig. 9-24a].

When you use this new measuring stick of two diagonals, then everything begins to move in synchrony again. I'm not gone to tell you what this is about yet except that this is the second level of consciousness. This is us. And this drawing is the geometrical lens that we interpret the one Reality through.

Figure 9-25 is Vitruvius' canon, which is a 10 by 12. When you first look at it, it doesn't look like a 10 anything, because there are 30 squares on a side—900 squares in all. However, when you look carefully, you'll see a dot counting off every third square. And when you count from dot to dot, counting every three squares as one, you get exactly ten units on a side. So there are 100 bigger squares hidden within this grid.

I believe that Vitruvius' canon is a 10 by 12, though it's difficult to prove that, since Vitruvius did not draw the phi-ratio circle. If he had, the circle would create a 10 by 12 for certain [see fig. 9-26]. However, the other thing you see in the drawing is this diamond (apex at A, B, M and N), which doesn't seem to fit anything. But this is also an indication of the second level of consciousness, referred to earlier in this chapter [see Fig. 9-4 and

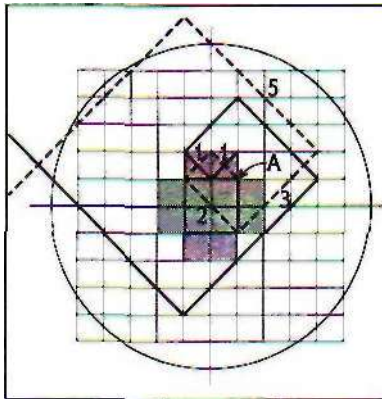

Fig. 9-24. Grid of consciousness level two; unsynchronized spiral. Here a unit is a diagonal of one grid square; you can follow the Fibonacci sequence.

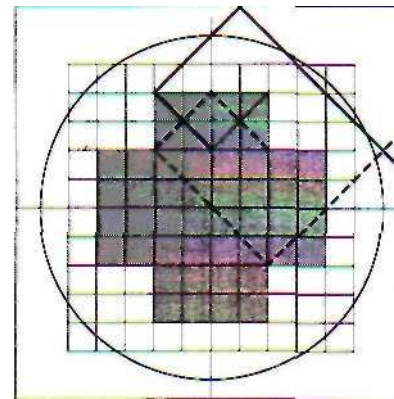

Fig. 9-24a. Grid of consciousness level two; synchronized spiral. Here a unit is a diagonal of two grid squares, so that only the first three numbers in the Fibonacci sequence are inside the grid. Can you find the difference in synchronicities between Fig. 9-24 and Fig. 9-24a, where there is an imbalance between the two in two ways? (The secret lies in the secret pyramid in Fig. 9-39.).

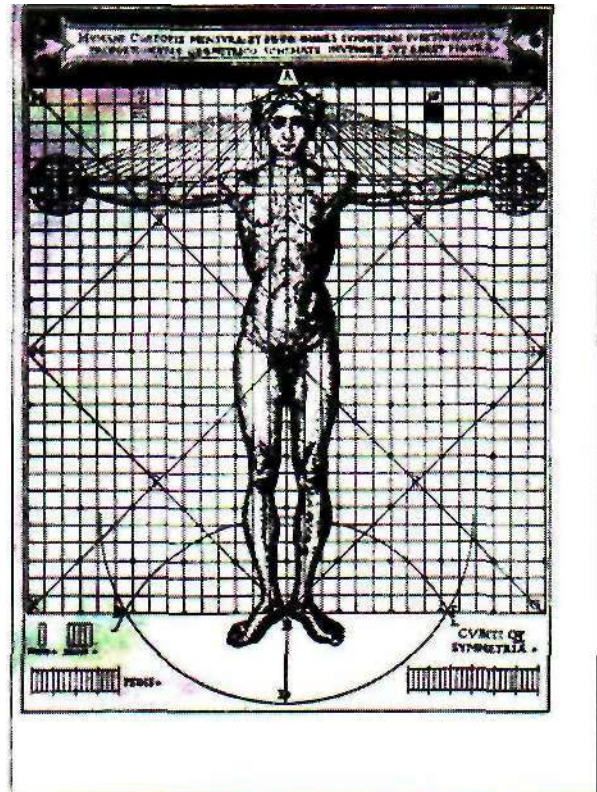

Fig. 9-25. Vitruvius' canon.

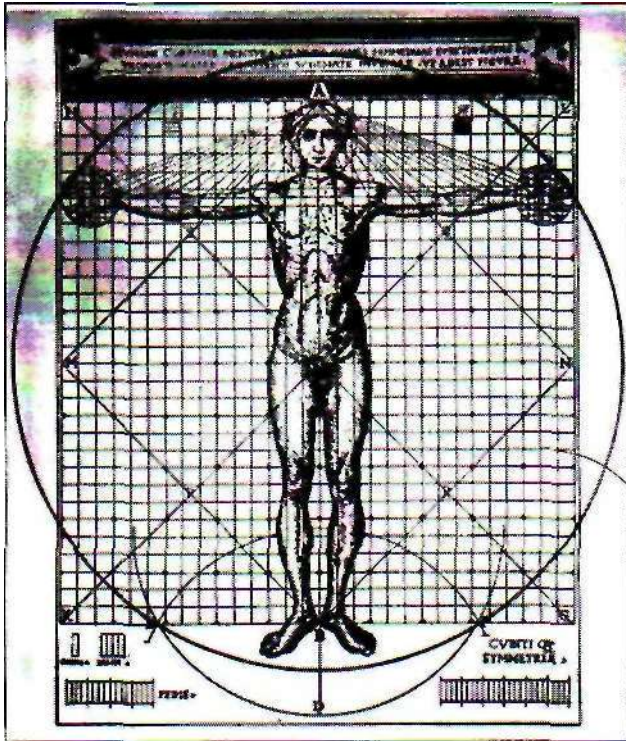

Fig. 9-26. New circle around Vitruvius' canon.

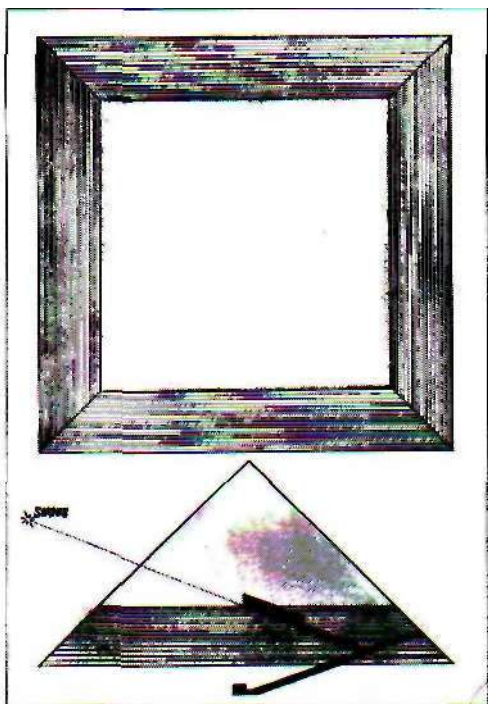

Fig. 9-27. Pyramid cut off at the level of the King's Chamber.

text] as the basis for the selection of the 10 by 12 in the first place. To me, the fact that Vitruvius drew this diamond over his canon is proof he understood that this was the second level of human consciousness.

Another thing about this canon is that inside each square delineated by the dots are nine little squares. Now, the nine-square pattern happens to be the key to the inner grid of the next level—Christ consciousness—because the next level doesn't use 1 squared or 2 squared—it uses 3 squared, and 3 squared equals 9. We have to take 9 squares to create the harmonics in the next level, which is the number of stones in the roof of the King's Chamber.

### Vitruvius and the Great Pyramid

To say it again, Figure 9-26 shows the diamond shape around the second level of consciousness—the shape that ties the first and third levels of consciousness together. When we rotated the square of the second-level consciousness 45 degrees [see Fig. 9-4], it geometrically approximates where the Christ consciousness is and actually touches the seventh square of Christ consciousness. This square-and-

diamond pattern is also found, subtly, in the plan of the Great Pyramid, which can be seen as further proof that the pyramid was meant to be used by the second level of consciousness to enter the third level.

If you cut the pyramid off at the floor level of the King's Chamber, the square on top [see Fig. 9-27] is exactly one-half the area of the base. The Egyptian government figured that one out. You don't need a measuring stick to see this. If you take the top square and rotate it 45 degrees as shown in Figure 9-28, its corners touch the base perimeter exactly. By drawing diagonals to connect opposite corners of the inner diamond-square, you make 8 equal triangles (four inside and four outside the diamond-square). Because the inner triangles are the same size as the outer ones (see the two darkened triangles), the area of the inner square is pearly exactly one-half the area of the base.

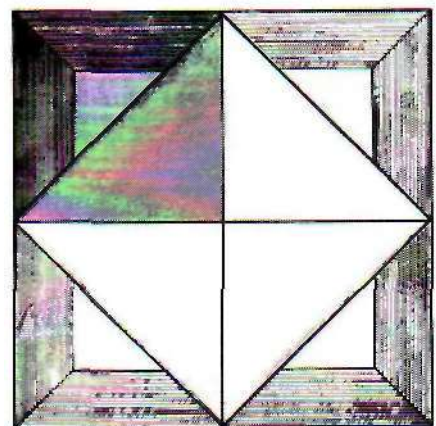

Fig. 9-28. Squares and diamonds that illustrate the fact that the "upper" square (see previous figure) has exactly half the area of the "lower" square. **Calculating it.**

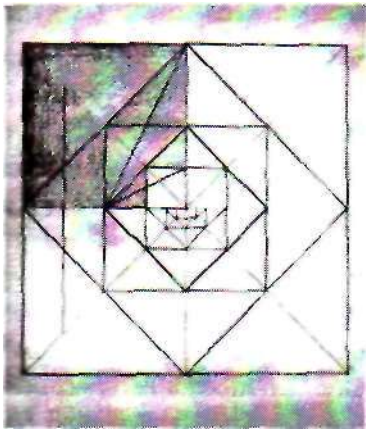

Fig. 9-29. Outer square with successive inner squares rotated by 45 degrees.

The King's Chamber—whose floor level determined the size of the upper square in both these figures—was built for us, for our level of consciousness, to go through the initiation into the next level of Christ consciousness. This becomes obvious as the information becomes known and understood.

In Figure 9-29 you can see the actual geometry of an outer square with successive inner squares of half the size rotated by 45 degrees. We could get into a deep discussion on the esoteric meaning of this geometrical progression, because the sacred square roots of 2 and 5 geometrically oscillate forever, but I believe you will understand on your own as we continue.

### The Search for a 14 by 18

At this point I had drawings of two of the three levels of consciousness from the lineage of Leonardo and Vitruvius, and I was really excited. I started looking through everything I could find of Vitruvius, trying to find a 14 by 18. I looked and looked, then all of a sudden it dawned on me. The 14 by 18 is Christ consciousness. My logic said that if he did have such a drawing, it would be the most holy drawing he had, and it would probably be inside some gold container hidden deep under a sacred altar somewhere. It wouldn't be thrown around on a table and probably wouldn't emerge at all into public knowledge. I kept looking, but I've never found anything. I don't know if I ever will.

Figure 9-30 is the drawing of us, with added lines that are mine. It may become very important for you. In fact, it's so important to me that it is the frontispiece for the first eight chapters. It is of immediate importance because it shows the exact proportions of the star tetrahedron around your body; the tube running through the middle, which we will use for our breathing in the meditation that leads to the knowledge of the Mer-Ka-Ba, the human lightbody; and the phi-ratio circle. Figure 9-30a shows a sphere we haven't talked about yet—the sphere of consciousness that will develop around your universal heart chakra when you breathe in the ancient way. My prayer is that by the end of this book, this knowledge will have deep meaning for you and help you in your spiritual growth.

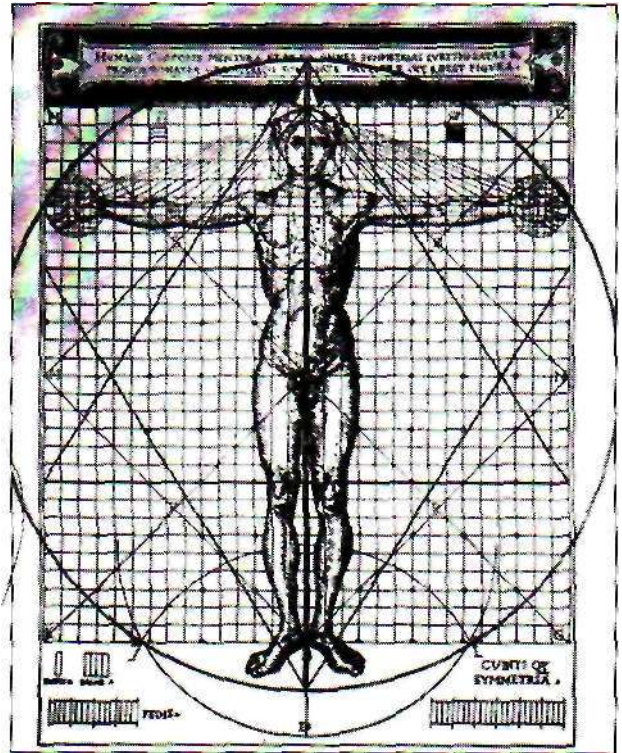

Fig. 9-30. Vitruvius's second level of consciousness. Added: the phi-ratio circle, the central ptana tube and the star tetrahedrons that represent the basis of the Mer-Ka-Ba.

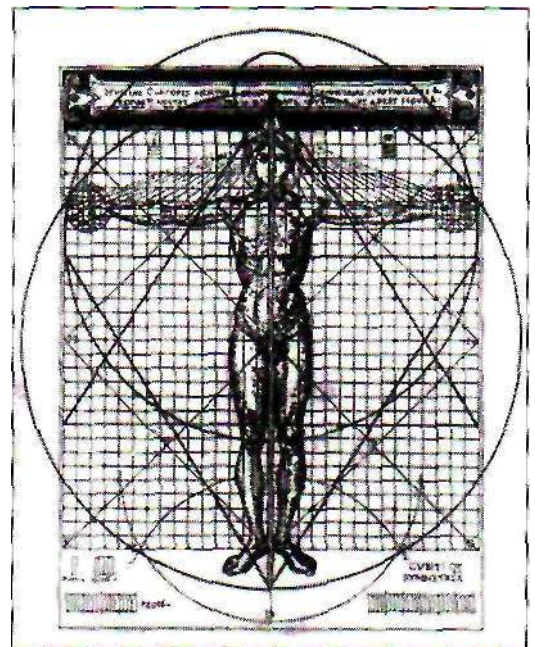

Fig. 9-30a. Added: the new sphere of consciousness centered at the heart chakra, which results from a different way of breathing.

## The Unknown Leonardo

Now I had two of the three pieces. I suspected strongly that Leonardo and Vitruvius were working along the same lines that Thoth was teaching me, but I still couldn't say absolutely. In my heart I was pretty sure, but it was still circumstantial evidence. Then one day I was in New York City; I had given a workshop there. I was sitting in the home of the woman who had sponsored this workshop and who had an excellent library. I noticed a book on Leonardo I had never seen before. It was called *The Unknown Leonardo*. It was composed of works by da Vinci that everybody considered unimportant. These sketches weren't included in the beautiful manuals because they were seen as just doodles and preliminary sketches.

As I leafed through this book I'd never seen before, I suddenly saw this [Fig. 9-31]. Leonardo had drawn the Flower of Life! And it wasn't just a doodle—he was actually calculat-

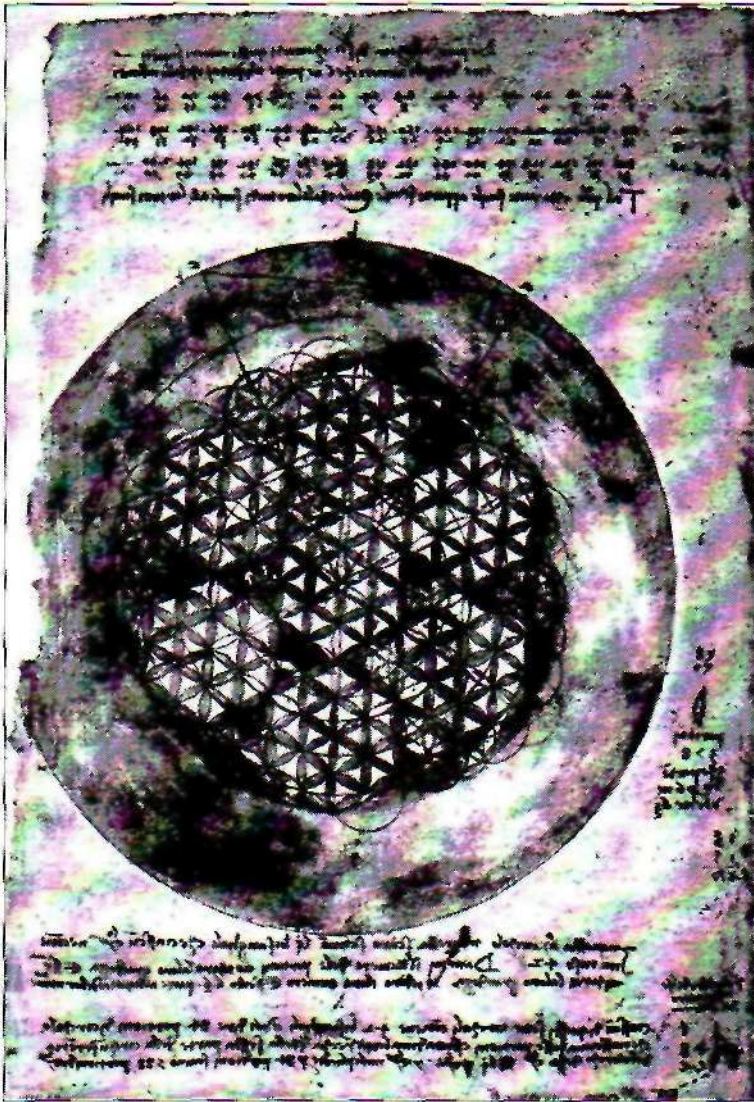
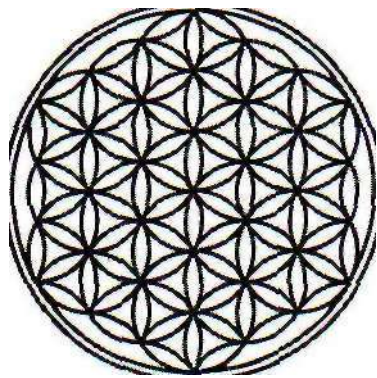

Fig. 9-31. Leonardo's Flower of Life- From *The Unknown Leonardo* (Ladislav Red, ed., Abradale Press, Harry Abrams, Inc., Publishers, New York, 1990 edition).



ing angles and studying and understanding the geometries associated with the Flower of Life.

Figure 9-32 is on another page of the book and shows how he drew various geometric patterns found in the Flower of Life. The flower design at point A is one of the

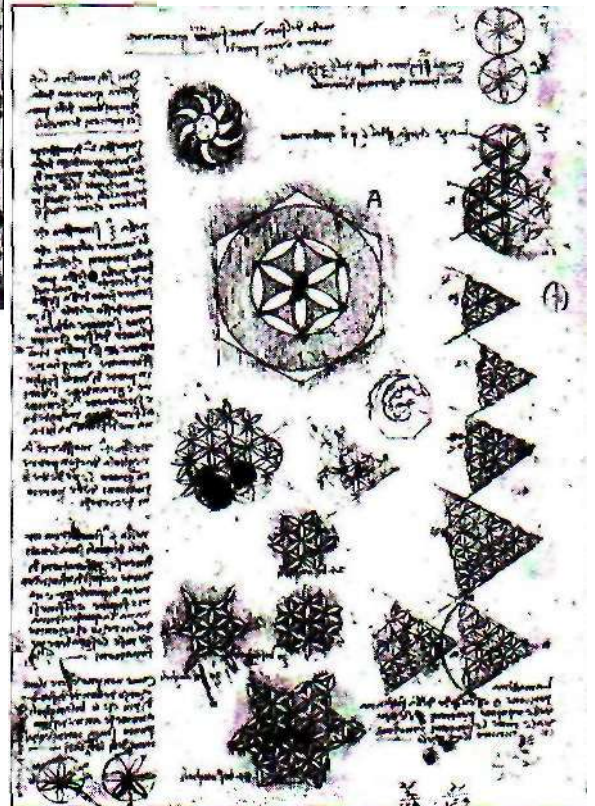

Fig. 9-32. More of Leonardo's Flower of Life sketches. A: the core of the Flower of Life. (From *the Unknown Leonardo*, page 64-)

leys you'll find all over the world—it's the central core of the Flower of Life. You'll find this —age in churches, monasteries and places all rrer the planet, relating back to this core information about creation that we've forgotten.

He went on working with all the possible relationships and calculating angles he could find. As tar as I know, Leonardo was the first person to figure all these ratios and apply diem to physical inventions. He invented amazing things *based* on these ratios [Fig. 9-33a]—things such as the helicopter, which he first envisioned, and gear relationships as seen today in automobile transmissions. And they all came out of his drawings studying the Flower of Life! The editor of the book didn't recognize what all this was. He just said, "This is where his gear inventions came from." Leonardo went on and on, figuring as many ratios as possible. Here's another page of his work [Fig. 9-33b].

Now I can say quite confidently that Leonardo definitely was moving, or had already

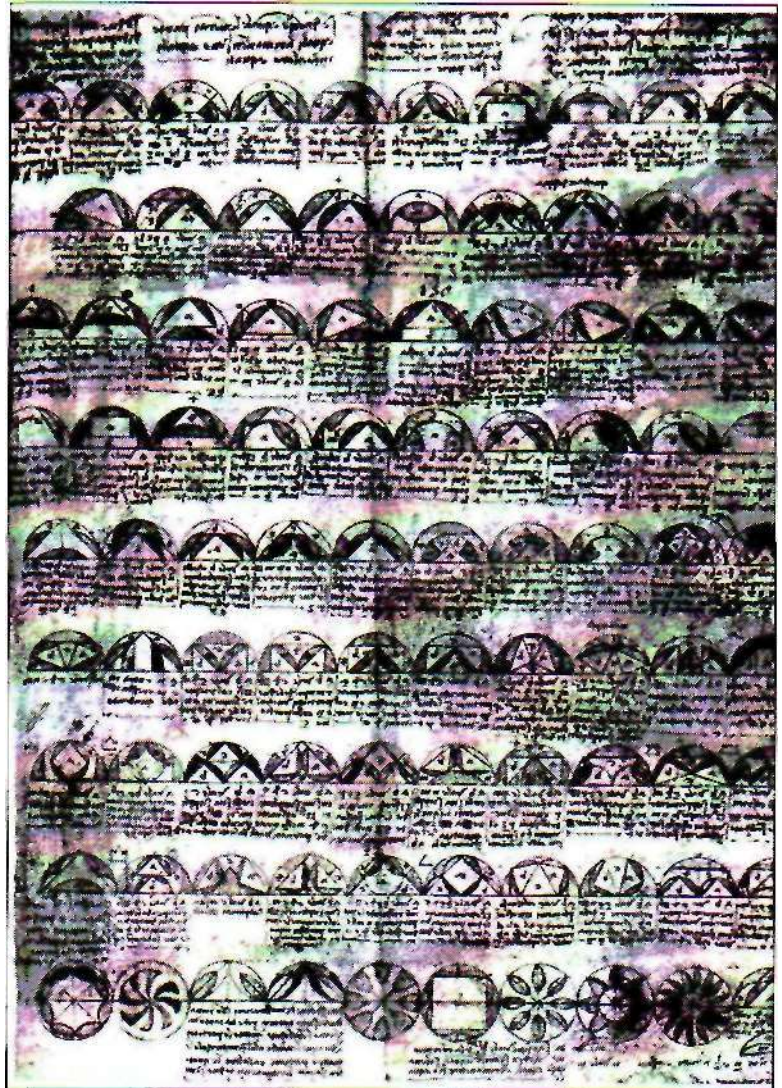

Fig. 9-33a. Leonardo's gear ratios applied to his inventions. (From *The Unknown Leonardo*, page 78.)

moved, in the same way geometrically that Thoth had taught me and I'm showing you. I believe Thoth's teachings and Leonardo's study were based on the same understanding of the Flower of Life.

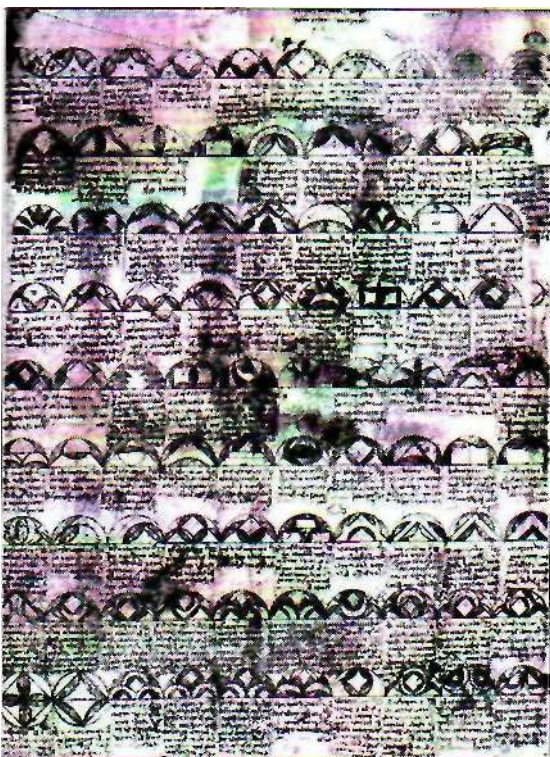

Fig. 9-33b. More ratios and proportions. (From *The Unknown Leonardo*, page 79.)

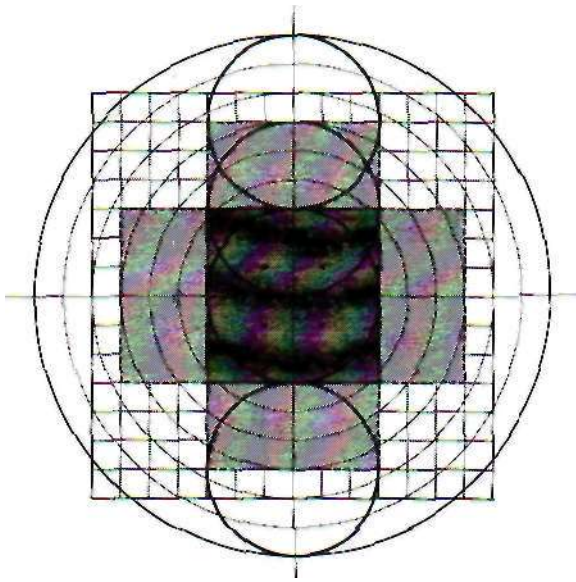

Fig. 9-34. **The Christ consciousness;** the 14 by 18 square-circle relationship of the third level of consciousness.

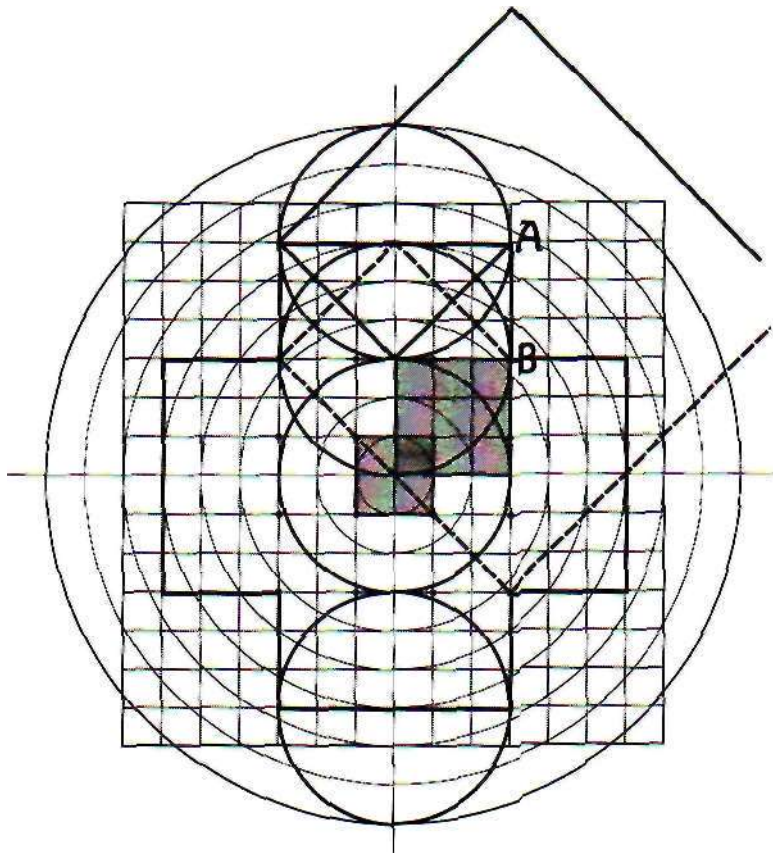

Fig. 9-34a. The Christ consciousness, 14 by 18, showing the basic unit (4 dark center squares) and the 3-square diagonal unit of the spiral (larger shaded square).

There is another famous man who was moving in the same manner—Pythagoras. When you work with sacred geometry and make the drawings—which forces you to know angles and geometrical proportions—you have to prove your actions. Every time I came up with something to prove, rather than going through all the trouble of actually creating the proof myself, I could find it in existing geometry books. And in almost every single case, the proof had come from Pythagoras.

Every proof that Pythagoras worked out—almost the whole spectrum of his school—was not just a random proof of some geometry. Each one was a living proof on the same path we're on right now. He *had* to prove each step in order to keep going. He couldn't just guess at something; he had to prove it, and he had to do it geometrically before continuing. After a while I got all of his drawings and proofs together because I knew I would need them. It had taken him his whole life to figure out these things, and of course I wanted to move faster.

So now we know that at least two *of* the great ones of the past, Leonardo da Vinci, one of the greatest men to ever live, and Pythagoras, the father of the modern world, both realized the significance of the Flower of Life and applied this knowledge to everyday life.

Let's examine the last geometrical drawing of consciousness, the 14 by 18, Christ consciousness [Fig. 9-34]. All you need is nine concentric circles as before, a square around the seventh circle, and you have the basic drawing of Christ consciousness—a 14 by 18. But when you come to the middle four squares, you cannot base them as 1 squared or 2 squared; you must use 3 squared as your basic unit. Three squared equals 9, so now you use nine squares as your basic unit to equal four center squares, and you draw a square around the nine as shown (shaded). Your measuring unit is now three diagonals. So the male-originating spiral [see Fig. 9-34a] would start at point A and go down, over and out, and the female spiral (broken line) would start at point B and go up, down, then precisely through the center or zero point and leave the grid. You have synchronicity happening again on this drawing, but only if you know to use three diagonals or nine squares (shaded), which was already in Vitruvius' drawing of the second



*level of consciousness. This was his way of saying the same thing Thoth said: The second level of consciousness contains the basic information of the third level, Christ consciousness.*

What is the synchronicity? Look how the female exactly passes through the female zero point and the male exactly passes over the center line and the outer circle. The same thing can be seen in Figure 9-24a. This is the key. In a few pages you will see what these points actually represent, the base and apex of the Great Pyramid.

### A Great Synchronicity

Now I'm going to show you a series of drawings to illustrate a great synchronicity.

In Figure 9-35 you can see the original eight cells (shaded circles) surrounded by the inner surface of the zona pellucida [compare with Fig. 7-26]. (The other four cells are directly behind these four.) The outer circle forms the phi ratio with the square surrounding the human figure, and the adult human being fits the combined geometries perfectly. Even the star tetrahedron is there [Fig. 9-35a].

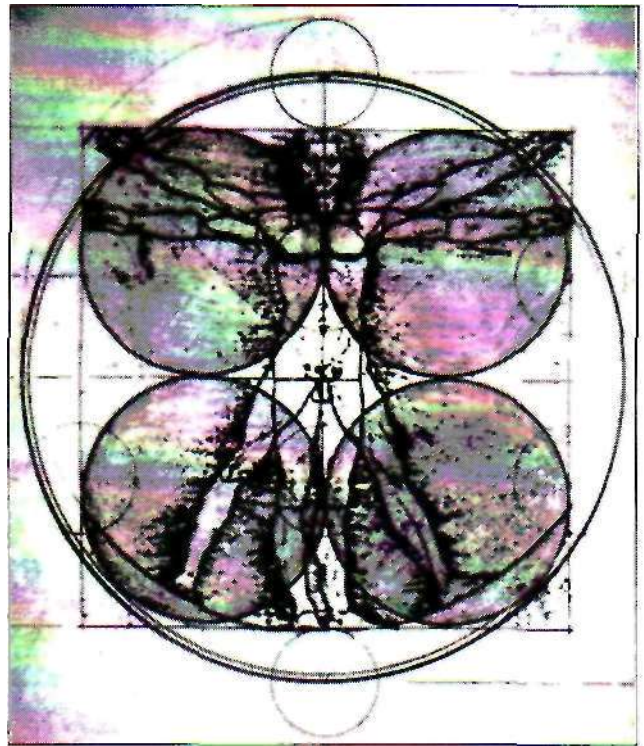

Fig. 9-35. Leonardo's canon superimposed over the eight original cells (shaded circles; four are behind the four you see).

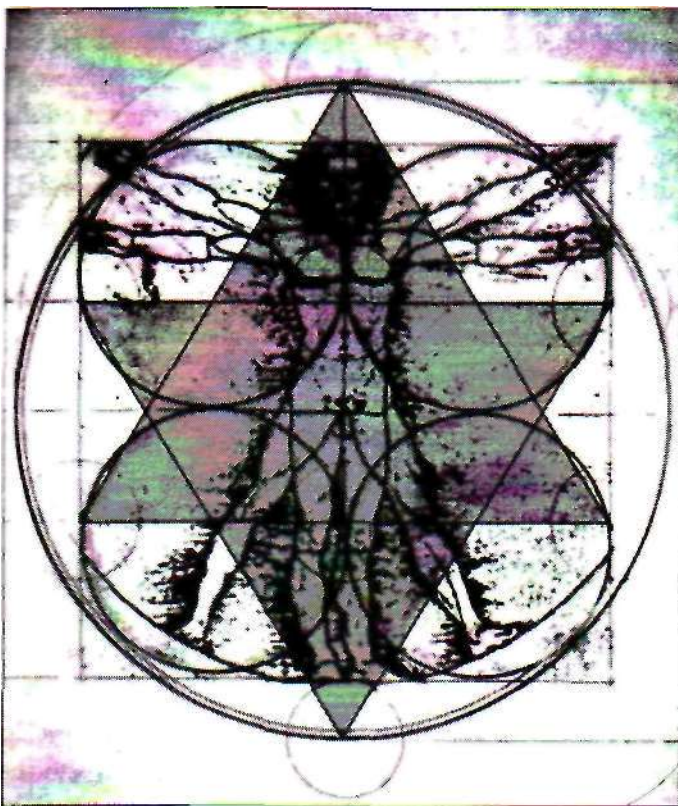

Fig. 9-35a. Fitting the star tetrahedron into both the canon and the original eight cells.

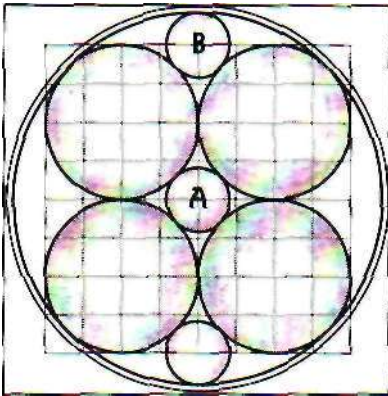

Fig. 9-36. The eight original cells without Leonardo's canon, adding three circles.

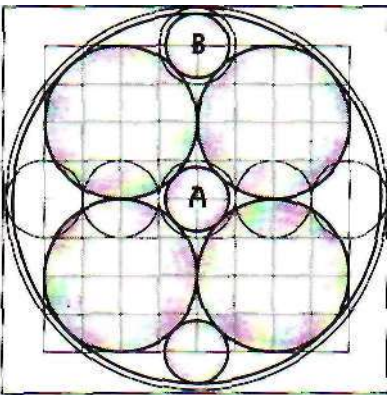

Fig. 9-36a. Showing how the slightly larger circle that fits into the grid square precisely fits *inside* the three-dimensional original cells and how this circle, on the outside, touches the outer surface of the zona pellucida.

If you were to draw three equal circles along the vertical axis (Fig. 9-36)—and they would fit perfectly because, the star tetrahedron is divided into thirds—it would show that the original eight cells and the adult human being are interrelated. The microcosm is linked to the everyday world.

This is a two-dimensional drawing of the eight original cells. In a three-dimensional form, if you were to put a sphere in the middle that would pass through to the center—like a marble that would just fit between these spheres and enter the center—that sphere is represented by the circle at point A. If you take that same size circle and put it at the top (B), it would just touch the inner surface of the zona pellucida, showing you its location.

Then take the circle that fits *behind* the smaller central circle—the slightly larger one that fits into the 64-square grid [see Fig. 9-36a]. When you put this size circle at point B, it shows you the exact *outer* surface of the zone pellucida. So the smaller circle that fits through and the slightly larger one that fits perfectly inside are the keys to the inner arid outer surface of the zona pellucida, and they indicate where these elements go in the phi ratio. My way to calculate this is the only way I know, though there may be others.

Now back to Leonardo's drawing superimposed over the original eight cells. On Figure 9-37 we superimpose over da Vinci's canon a different geometry that shows a further relationship to the macrocosm as well as the microcosm. Notice the large shaded sphere that fits perfectly around the human body from head to foot and also inside the square around the human body. Now notice the smaller shaded circle directly over the man's head. This small circle is created by putting the point of a compass on the top of the phi-ratio circle around the human body and extending the compass arm to the top of the human head. This same circle on Figure 9-35 would have a radius from the outer surface of the zona pellucida to the top of the head or the square. The smaller circle just touches the larger shaded circle. (As a side note, the center of the smaller circle is exactly where the thirteenth chakra is located.)

So what does all this mean?

### Earth-Moon Proportions

Many people have claimed this next piece of information as their own, but none of them were the actual originators, because I found an even earlier person who was involved in this and was supposedly the originator. The earliest written work I can find is by Lawrence Blair [*Rhythms of Vision*], but he doesn't claim it; he says he got it from older works. I don't know who originally came up with this idea, but it's truly remarkable information, especially if you've never heard it before.

Consider: The size of the two shaded spheres on this drawing [Fig. 9-37] "happen" to have exactly the same ratio as that of the Earth and the Moon. This ratio is located in the human body and in the original eight cells of all life. In addition, not only do the spheres in this drawing possess

the same relative sizes as the Earth and the Moon, but just as in this drawing, a square that would fit around the Earth and a circle that would pass through the center of the Moon (if the Moon were touching the Earth would have a phi ratio. This can be proven, which also proves that the size of the Earth and the Moon are as stated.

To prove it, you have to know the diameter of the Earth, which is equal to one edge of a square that would fit around it, just like the same square that fits around the human body. Multiply that by 4 to find out how many miles it would take to go around the square. Once you determine that, you need to know how many miles go around the circle that would pass through the center of the Moon if the Moon were touching the Earth.

So let's look at this.

The average diameter of the Earth is 7920 miles. The average diameter of the Moon is 2160 miles. The perimeter of the square that would fit around the Earth equals the diameter of the Earth times 4, or 31,680 miles. To figure the miles in the circumference of the circle that passes through the center of the Moon, you need to know the diameter of the Earth and the radius of the Moon at both the top and the bottom of Figure 9-37—which is the diameter of both the Earth and the Moon—added together, times pi. If those numbers are the same or very close, then that would prove it. The circumference of the circle equals the diameter of the Earth (7920 miles) plus the diameter of the Moon (2160), which equals 10,080. If you multiply 10,080 times pi (3.1416), it is 31,667 miles [see Fig. 9-38]—*only 13 miles difference!* Considering that the ocean is 27 miles higher at the equator than it is anywhere else (the ocean is pulled outward in a 27-mile ridge), 13 miles is nothing. However, if you multiply 10,080 miles times 22/7 (a number often used to approximate pi), it comes out to the exact *same number* as the perimeter of the square—31,680 miles!

Thus the size of the Earth is in harmonics with (in phi ratio to) the Moon, and these ratios are found in the proportions of our human energy fields and even in the very Egg of Life itself.

I spent weeks thinking about this paradox. The human energy field contains the size of the Earth we live on and the Moon that moves around her! It was like the thought about electrons traveling at 9/10 the speed of light. What does it signify? Does it mean that only certain sizes of planets are possible? And that there's no randomness at all, in any way? If our bodies are a measuring stick for the universe, does it mean that we contain within us, somehow or somewhere, all sizes of all possible planets? Does it mean the sizes of all suns are located in us somewhere?

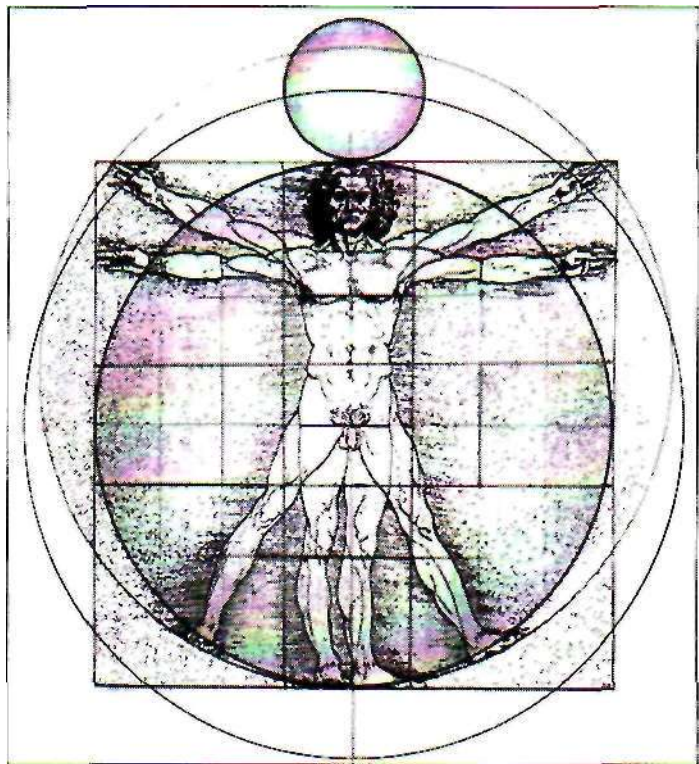

**Fig. 9-37. Leonardo's canon with the square and the circle inside.** The small shaded circle above the head is centered on the outer surface of the zona pellucida, which is the phi-ratio circle to the square.

$$7920 \times 4 = 31,680$$

$$D = 7920 + 2160 = 10,080$$

$$10,080 \times \pi = 31,667$$

**Fig. 9-38. Earth and Moon calculations.**

This information has come up in a few books in recent times, but the authors pass over it like it's nothing. But it's not nothing; this is serious stuff. I'm still deeply amazed by the perfection of creation. This knowledge definitely supports the idea that "man is the measuring stick of the universe."

### Earth, Moon and Pyramid Proportions

If this is not enough, check out what some of these other lines mean. If you were to draw a horizontal line through the center of the Earth to its circumference, then lines from those two points up to the center of the Moon,

and from the center of the Moon a line back to the center of the Earth [Fig. 9-39, these are the *precise* proportions of the Great Pyramid in Egypt! That angle at A is 51 degrees 51 minutes, 24 seconds, exactly the same as that of the Great Pyramid [Figs. 9-40 and 41].

Thoth, when he was Hermes in Greece, says in *The Emerald Tablets* that he was the one who made *die* Great Pyramid, and that he did it from the proportions of the Earth. The above proof gives credence to his claim.

Since the Earth, the Moon (and the entire solar system), the physical human body and the Egg of Life are all related geometrically and the Great Pyramid ties them all together; and since we have these three different consciousness levels that happen to have pyramids inside each one, we can superimpose these drawings over the Great Pyramid and know what the rooms are all about and where they are located within the pyramid. The Great Pyramid is really the great map for the level of consciousness we are all on. No wonder why (why from a subconscious level) 18,000 people visit the Great Pyramid every day!

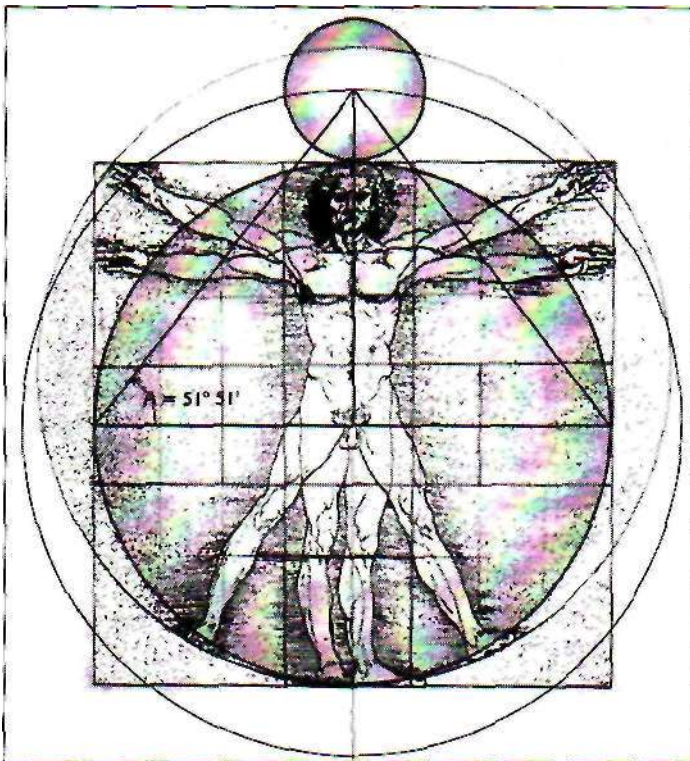

Fig. 9-39. Earth-Moon proportions. Angle A is the angle found in the Great Pyramid-

### Rooms in the Great Pyramid

Until around 1990 almost everyone thought the Great Pyramid [see Fig. 9-41] contained only the King's Chamber (K), the Queen's Chamber (Q), the Grand Gallery (G), the Pit or Grotto (E)—which is a very strange place—and the Well (W) (called that because there was a "well" in the room). However, they've found four more rooms in just the last several years (since 1994). Three more rooms off three walls of the Queen's Chamber have been found. One room had nothing in it, another was filled from floor to ceiling with radioactive sand, and the third had nothing in it but a solid gold statue, which the Japanese allegedly removed. (Incidentally, the King's Chamber and Queen's Chamber don't have anything to do with male/female. The names were given to those rooms by the Muslims because the Muslims buried men under flat roofs and women under pitched roofs. It has nothing to do with kings and queens.)

This theft was followed by a silent alarm around the world. It caused the Egyptian Antiquities Minister to be fired and all the foreign archaeologists to be kicked out of the country during the crisis. There was a worldwide hunt for the gold statue, but they never found it, as far as I know, and they never found the people responsible. The statue is absolutely priceless. The solid gold alone would be worth a lot, but there's no amount of money that could match the value of the statue itself. The Japanese scientists were present when I was there in January 1990, and the statue was taken right after that.

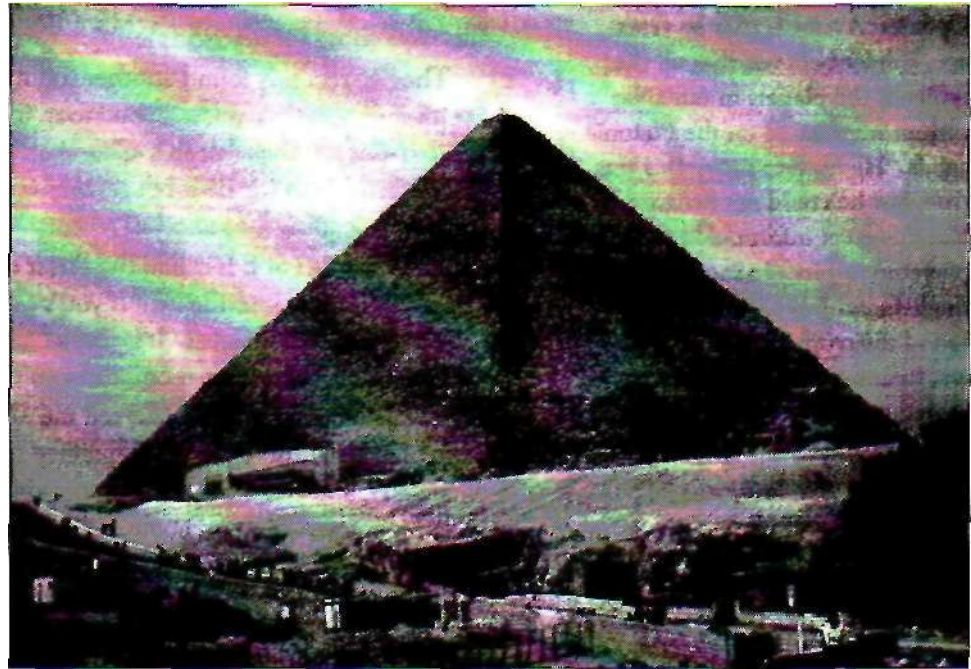

Fig. 9-40. The Great Pyramid.

You see, the Japanese had made some instruments that could see into the Earth, and with these they found a brand-new room beneath the Sphinx. Through 60 feet of rock they could look into the room so well that they could see a coil of nape and a clay pot in a corner. They also found a tunnel leading from the room under the Sphinx to the Great Pyramid. This tunnel has been mentioned in many of the ancient writings, though the ancient writings say there are actually three tunnels.

The statue was located where the Japanese were investigating. According to my sources who were there, the Japanese imaged the gold statue inside the room next to the Queen's Chamber, then went to the Egyptian Minister of Antiquities and asked permission to remove it, but he refused them on every level. I think the Japanese thought there would be no problem. The entire Queen's Chamber -as filled with their scaffolding at the time, and no one was allowed inside. So the Japanese had full access to this wall and the room behind it. About a month or so after they were denied permission, they gathered up their scaffolding and left the country. Only after they left Egypt did the Minister of Antiquities notice the new mortar in the bricks on die wall facing the hidden room where the gold statue was located, and realized what they (allegedly) had done. But it was too late. He got fired for it; it was quite a big deal.

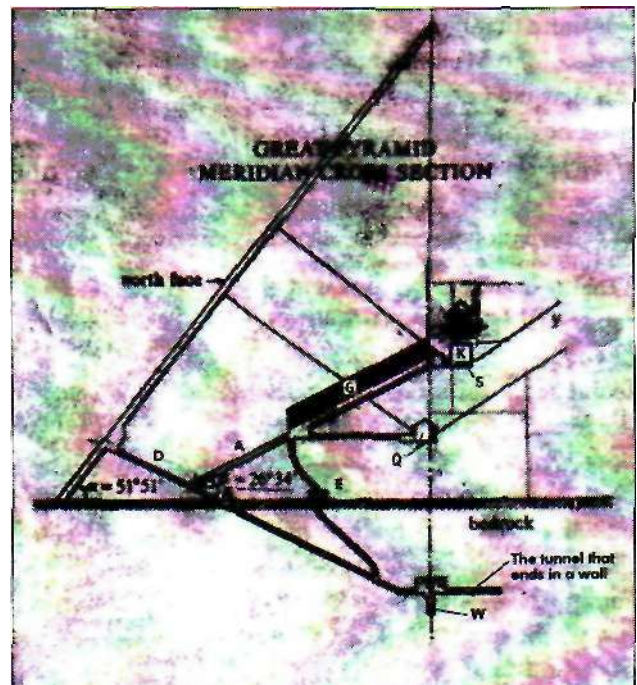

Fig. 9-41. Cross section of the Great Pyramid.

- |                                 |                         |
|---------------------------------|-------------------------|
| A: Ascending Passage            | K King's Chamber        |
| D: Descending Passage           | Q Queen's Chamber       |
| E: excavation called the Pit    | S Sarcophagus           |
| G: seven-corbeled Grand Gallery | W shaft called the Well |

Update: About 300 or so years ago, Kepler believed that all the orbits of the planets in our solar system were based on the Platonic solids. He tried to prove this was true, but he could not because he had incorrect information for the planetary orbits. In modern times Englishman John Martineau has found the truth- Using computers, he input most of the known sacred geometry relationships and the precise information of the maximum, minimum and mean orbits of the planets as determined by NASA for the computer to compare. What he found is astounding.

It was found that simple sacred geometry determined the orbital relationships between the planets, and that *nothing* was random. Kepler was right, except that it was more than just the Platonic solids. John Martineau put all this new/old information into a book published in 1995, *A Book of Coincidence: New Perspectives on an Old Chestnut* [currently out of print, Wooden Books, Wales].

What is important to us is that all the sacred geometry relationships discovered by Martineau are found in the human energy field, the Mer-Ka-Ba. This means that not only is the relationship of the Earth and her moon found in the human energy field, but that of the entire solar system. It is becoming increasingly clear that man is truly the measuring stick of the universe.

## More Rooms

They've recently found another room off the Queen's Chamber. There are two ventilation ducts about four to six inches in diameter that go upward out of the Queen's Chamber. A German researcher [Rudolf Gantenhrink] ran a little robot camera way up one of those ducts and found a doorway leading into another room.

The chamber at E is called the Pit; it's a really strange room. They usually won't let you into the Pit. If you've been there, it probably means you have friends in high places. It is just a big hole in the ground. Thoth never told me much about this room, so I can't tell you.

The three places Thoth *did* tell me about are the King's Chamber (toward the top), the Queen's Chamber (almost halfway up to the King's Chamber), and the Well (below ground level at the very bottom). I'll give you as much information about these three places as I can as they relate to the three levels of consciousness.

## The Initiation Process

The initiation process of a person who moves from the second level of consciousness to the third begins in the Well. If you read *The Emerald Tablets*, it tells you that the initiation begins at the end of a tunnel that goes nowhere. It's a tunnel that seemingly has no purpose, and the Well is the only room we know of in the Pyramid that fits that description. This tunnel goes horizontally deep into the Earth about 80 to 100 feet and simply ends. The usual Egyptian archaeologist has no idea why the ancient Egyptians dug this tunnel. I've looked carefully at it, and it looks like when they were carving it out, they got to a certain place and decided, "Let's do something else," because the end is rough, like they simply decided to quit.

Now let's leave this tunnel for a while and look at the initiation process in the King's Chamber. First, the King's Chamber was made for you and me to move into Christ consciousness; this is its primary purpose. It's a room of initiation. I'm going to give you a concept of the particular technique the Egyptians used for resurrection. It was a rather synthetic way, because it required physical instruments and the knowledge of how to use them. We, you and I, are not going to be using this method at this time in history, but it is extremely educational to see how the Egyptians did it. Later I will tell you in detail what I believe humanity will be using to move into the third level of consciousness.

First we'll try to understand why these three rooms are placed where they are inside the Great Pyramid. This information will illuminate many questions you may have. The King's Chamber is not a Golden Mean rectangle, though you may have read that in several books. It's something a lot more interesting: It's a square-root-of-5 room—a perfect 1 by 2 by square-root-of-5 room. Remember the human body with that line down the middle and a diagonal, which were bisected at the center of the circle by a line that created a phi ratio [see Fig. 7-31]? Well, this room is like that. The

floor plan is a perfect 1 by 2, and the height of the room is exactly one-half the diagonal of the floor.

See how the King's Chamber is off center in Figure 9-41? But it's off center in a very special way. When you enter it, having climbed the Grand Gallery and ducked to go through the tiny anteroom, the sarcophagus is off to your right. In its original placement, the exact center of the pyramid ran right through the sarcophagus, but it has been moved. The apex of the pyramid is shown at the top. You need to know this first.

Two initiations actually took place in the King's Chamber. The first one was in the sarcophagus. The second one, which usually happens many years later, sometimes even thousands of years later, happens precisely in the center of the room, marked by half the diagonal. There's a fourth-dimensional object you can't see physically that sits in the middle of the room. The room is made up of precisely 100 stones on the walls and ceiling. It was created for the second level of consciousness, and we have exactly 100 squares around our bodies geometrically.

### Light Reflectors and Absorbers above the King's Chamber

Here's another aspect of this picture you need to see as we put the pieces of the puzzle together.

Figure 9-42 is a section drawing of the King's Chamber and the five layers above the room. The immediate ceiling of the King's Chamber is made of nine huge stones (remember that nine is the key to Christ consciousness), and over it is a series of stone layers, as shown in the drawing, with an air space between each layer. The usual explanation is that this was built to relieve the pressure on the flat roof of the King's Chamber so that it doesn't cave in. Well, it's true that it *does* that, but I don't believe that's the only reason for the layers. The standard explanation is that the Queen's Chamber doesn't need one of these pressure-relievers because it has a pitched roof. But there's at least one other room in the pyramid—the Well—without a pitched roof, and you could ask, why they didn't put one of these so-called pressure relievers over it, since it is beneath the Pyramid and has millions of tons more pressure? (There are two and a half million blocks in this pyramid, and their weight is tremendous.) So something else is obviously going on concerning these five spaces.

When you look carefully at those layers, it becomes pretty clear that they are more than just air space to relieve pressure. The bottom sides of the blocks are polished like glass. The top sides are totally irregular and covered with about a quarter inch of black foam. Yes, *foam!* It looks like somebody sprayed it on with a spray can. I don't know what it is, but that's what it looks like. When you think about it, you've got these mirrorlike surfaces facing downward and these irregular, foam-covered surfaces facing upward. It looks to me like it's designed to reflect energy coming from underneath and absorb energy coming from above. It's a separator, which we will explain in just a moment.

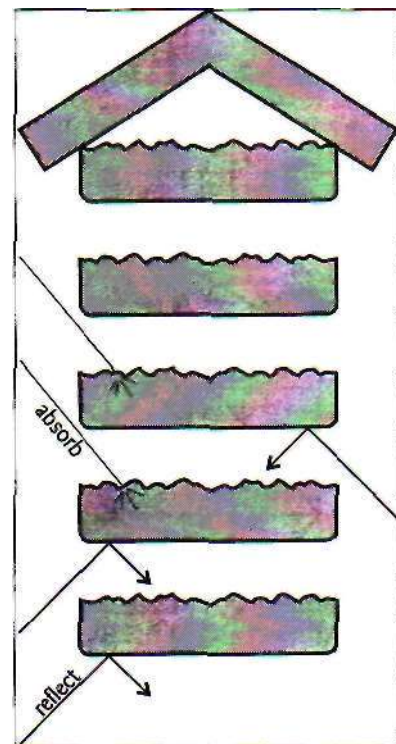

Fig. 9-42. The five open spaces above the King's Chamber.

It has still another function (almost everything the Egyptians did has more than one purpose): It's also a sound generator. When we look carefully at this room relative to the superimposed geometric images of human consciousness, this will become clear.

I want to repeat that this is Thoth's information, what he said to me. Most of this information is not written down anywhere.

### Comparing the Levels of Consciousness

The Great Pyramid is definitely not made for first-level Aboriginal types with  $42 + 2$  chromosomes. It has nothing to do with them. The Great Pyramid is primarily based on thirds, which synchronizes with our level and the Christ-consciousness level of consciousness, but not the first level.

Figure 9-43 is the drawing of the first level of consciousness, showing the pyramid. There are 5 grid units from its base to the apex; you see that the first level of consciousness is based on fifths, which is divisible only by 1 and 5.

Here's the second-level drawing with the pyramid [Fig. 9-44] and the 100-unit grid for this level of human consciousness. Counting from its base to the top are 6 units, divisible by 3.

The pyramid in the third-level drawing [Fig. 9-45] is 9 units high, also divisible by 3, and this is the Christ-consciousness level. The reason thirds were chosen as the basis for the Great Pyramid is because 3 is the common denominator between the two levels of consciousness connected to its ultimate purpose.

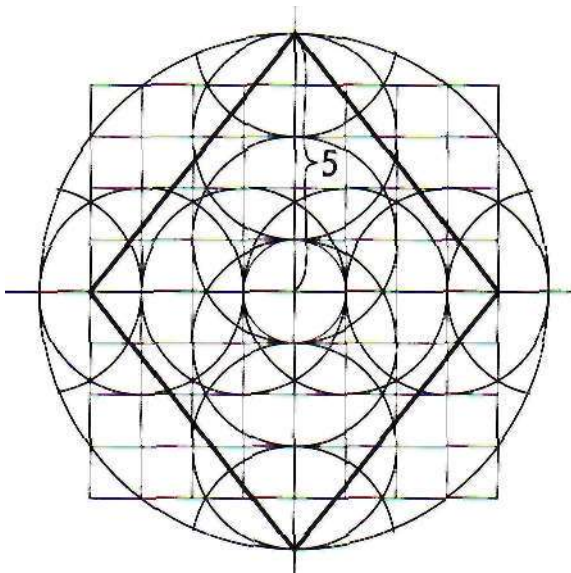

Fig. 9-43. Schematic of the first level of consciousness, 8 by 10.

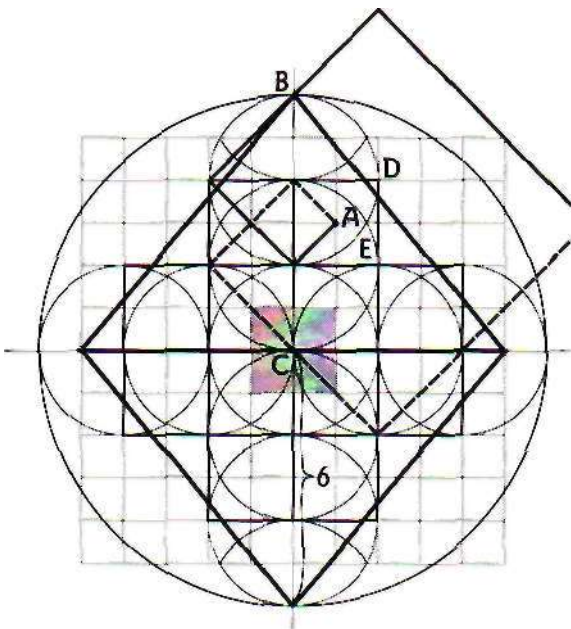

Fig. 9-44. Schematic of the second level of consciousness, 10 by 12, with a 100-unit grid. Dark-light spiral (broken line) goes through center (zero point) to the center of the Earth. White-light spiral (solid line) travels to the center of the galaxy.

### Catching the White Light

Look at the second-level (10 by 12) drawing, Figure 9-44- Here you have the white-light energy [solid line] starting at point A and going down first, then spiraling around to exactly hit the apex of the pyramid at point B (if the capstone were there). And you have the dark-light energy [broken line], also starting at A but going up first, then spiraling around to pass through zero point, the center point of the base of the pyramid at C. According to Thoth, because of the placement of the Great Pyramid on the Earth connecting into the Earth's huge geometrical field—specifically the octahedral field of the Earth, which is equivalent to our own fields—and because of the pyramid's mass and the geometries used in it, the white-light energy field spirals upward and becomes extremely strong, stretching all the way out to the center of the galaxy. The dark-light energy comes in from above,



spirals through zero point and connects with the center of the Earth. In this way the Great Pyramid connects the center of the Earth to the center of our galaxy.

Suppose you want to connect with only the white-light energy, get just that energy, and get *it at its source*. (In the Egyptian initiation this *is* necessary for experiencing Christ consciousness.) The white-light energy actually starts at point D and comes down one diagonal to cross the diagonal I've drawn starting at point A. And the dark-light spiral starts at point E and goes up across one square to meet its connection at point A. But if you start at points D and E, the energies will cross near their point of origin; the problem with that is that the energies tend to switch polarities.

Thoth tried to explain it to me. The female can come in and become the male, or the male can come in and become the female only when they are returning to the source, or beginning, and only at point A. The Egyptians wanted to use the white-light energy just after it crossed point A but *before* it made the 90-degree turn, which is precisely where the King's Chamber is located. But if they were to put the initiation room in that area, they would have another problem to solve, because just above that area is the black-light, or female, energy.

*That's* the reason for the separators, the five spaces above the King's Chamber. The spaces absorb the black-light energy coming from above and reflect the white-light energy coming from below. In this way they separate the two from each other. When you're lying in the sarcophagus, the male energy comes down, rises off the floor at a 45-degree angle and passes right through your head. That beam, about two inches in diameter, comes up through the back of your head and passes through your pineal gland, which is the hidden secret to all this work. (At the right time we will explain.)

Getting to this point in the Egyptian experience took *twelve* years of training in the Left Eye of Horus school and twelve years in the Right Eye of Horus. If they thought you were ready after twenty-four years, at the right time they would place you in that sarcophagus, put the lid on and leave you between two and a half to four days.

You would lie down in the sarcophagus, connect with that white-energy beam with your pineal gland, then (using your twenty-four years of training) you would go out on the spiral 1, 1, 2, 3, 5, 8, 13, making very specific turns, following the male straight-line, 90-degree energy (not the female curved energy, which cannot be followed), going *way* out to have the awesome experience of becoming all of creation—synthetically experiencing Christ consciousness.

After you'd been out in the cosmos for a few days, you would return. Because of your training, you knew you were supposed to return, and you would return by using the Fibonacci mathematics, which was the key to your being *able* to return.

According to Thoth, they did lose people occasionally. He said they lost about one out of every 200 initiates. When you're out there *being* the uni-

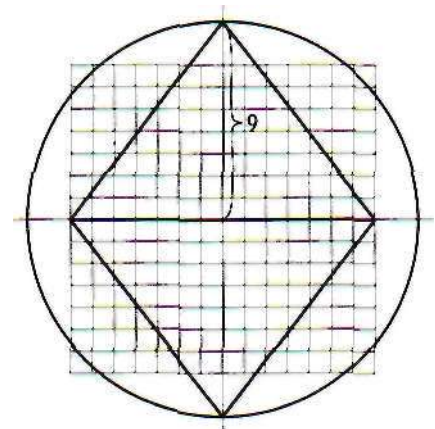

Fig. 9-45. Schematic of the third level of consciousness, 14 by 18.

verse, it's so beautiful that the thought of coming back to Earth is not exactly the greatest thought in your mind. You don't really want to. It takes great discipline. When they trained you, the ancient Egyptians drilled this "returning" into your mind, because all you have to do is say no, and you remain there in that state of consciousness. If you do stay, then your body dies in the sarcophagus and you no longer live on Earth. But most of them did come back, because the reason for doing this in the first place was to evolve the human consciousness. If you did not come back, the Earth would not have that experience.

In the next chapter we will show how the Egyptians placed both the Fibonacci and Golden Mean spirals dramatically around the Great Pyramid. Why? Because they wanted you to know the important difference between these two mathematical relationships. Relating to what we just talked about with the dark and light energies, if the Egyptians went out of a Golden Mean spiral, they would never know where to begining was, since a Golden Mean spiral has no beginning and no end. Therefore they would never know where their body was located relative to the universe. But because it's a Fibonacci spiral, they could count down, moving down the Fibonacci numbers such as 5, 3, 2, 1 and 1, locating their body exactly, then center into it. They would step out of this experience onto Earth inside the sarcophagus in the King's Chamber where their body was located. But they would be a completely altered person, never again the same, having had the direct experience of what it is like to be in Christ consciousness.

#### Proof of the Initiation Chamber

The fact that this is an initiation chamber and not a burial chamber is pretty obvious for two reasons. The first has to do with the mummification process used in Egypt. Throughout early Egyptian history—for every known king, queen, pharaoh, doctor, lawyer or other special person who was ever mummified—the process was carried out the same way. They had a ceremony, took out the organs and placed them in four clay jars, then wrapped the body, now in the process of mummification, and placed it in the sarcophagus, sealing the lid. Then they carried the sarcophagus and the four jars to wherever they were going to bury them.

There have been no known exceptions to this procedure that I am aware of; yet in the King's Chamber the sarcophagus is larger than the doorway. They couldn't have carried it into the room because they can't even get it out. It's one enormous piece of granite. It had to have been placed in the King's Chamber during the construction of the pyramid. That's the only reason it's still there—otherwise it would have been stolen a long time ago and put in the British Museum or somewhere. The lid's gone because it could be taken out, but they can't remove the sarcophagus.

The doorway into this chamber is small, and the tunnel you have to go through to get there is even smaller, smaller than the sarcophagus itself. It's

clear that no one was buried in this sarcophagus. Further, a mummy was not found in this sarcophagus when the King's Chamber was first opened. This is circumstantial evidence, but it's pretty powerful.

The other indication that this is an initiation chamber is that there are air shafts going into it. If it were meant to be a tomb, they wouldn't need air facts. Egyptian burial chambers are as airtight as possible to protect the — *mummy*, and none have air ducts. But both the King's Chamber and the Queen's Chamber have them. Why? To make sure there is air circulating for the people who use the room for their ceremonies.

Here's another little piece of circumstantial evidence indicating what the King's Chamber was used for. When they first examined it, they noticed white powder inside the end of the sarcophagus facing the center of the pyramid, the very place where your head would be if you were being initiated as described above. They didn't know what it was, but they scooped it up and put it into a little glass vial, which is now sitting in the British Museum. Only recently did they figure out what it was. You see, when you are in meditation and you go into the theta state, the corpus callosum fully links the left and right brains and the pituitary gland begins to excrete a liquid through the forehead. When that liquid dries up, it becomes little white crystals, which flake off. That's what this was on the bottom of the sarcophagus in the King's Chamber. There was far more powder than a single person would produce. This probably meant that lots of people went through that initiation.

After you've returned to your body in the King's Chamber, they immediately take you down the Grand Gallery and into the Queen's Chamber. Thoth didn't describe exactly what they did there, but he said it was designed to stabilize you and your memory when you came back from that super cosmic experience so you wouldn't forget, wouldn't lose the experience. This was and still is the primary purpose of the Queen's Chamber.

### Catching the Dark Light

The chamber below ground level called the Well is actually where initiation begins. Nobody I've studied in the conventional world knows why this room is there. But when you superimpose the cross section of the pyramid over the drawing of the second level of consciousness [see Fig. 9-44], you can see what it is.

Suppose you wanted to get only the black-light spiral, which is actually the beginning of the pyramid initiation. Logically, you would think you'd do it at the area *above* the King's Chamber (following the logic of its location—unless you know what's involved here. If you *did* do it in the higher area, you would have to go through zero point at the base, and going through the Great Void is not exactly desirable. There are too many variables in that state, according to Thoth. So they chose a place immediately after the energy beam left zero point, which is in the area of the tunnel.

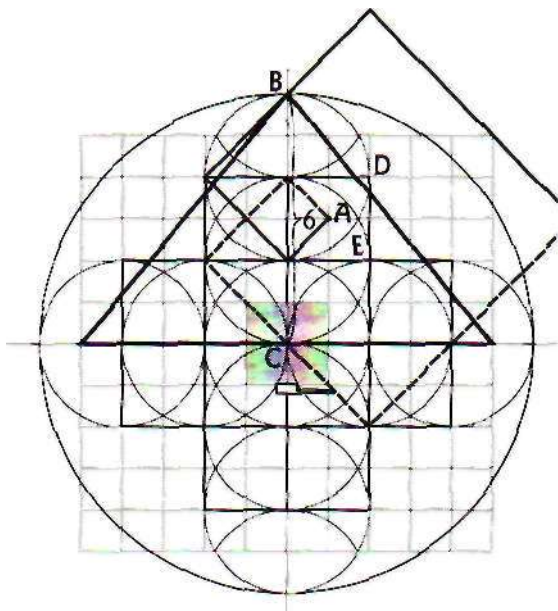

Fig. 9-46. The Great Pyramid, showing the black-light beam, angling downward to cross the end of the tunnel below the pyramid.

Now, think about this for a moment. This drawing [Fig. 9-46] is not perfect, but if it were, you would see the black-light beam coming down at a 45-degree angle and actually crossing the end of this tunnel. The Egyptians continued *to* dig until they reached the dark-light beam, then they went about a foot farther and stopped. That beam is real, because I've been there and I've experienced it. If you lie down there, a powerful beam of energy comes in and locks onto you—and you *will* have an incredible experience.

### The Halls of Amenti and the Face of Jesus

After the initiation process is completed in this tunnel, the initiates go through a training that teaches them how to go toward the center of the Earth to the Halls of Amenti, the womb of the Earth. This space is located about a thousand miles inside the Earth, not in the center. The Halls of Amenti is a space as vast as all of outer space. I've been there; some of you have heard me tell that story. And so have all Egyptian initiates, before they entered the King's Chamber to experience the third level of human consciousness.

There's another little fact about the Great Pyramid that has recently been discovered and it is very, very interesting. Leading into the Queen's Chamber, on the right-hand side way up high, they discovered something about three or four inches in size. You all probably know about the Shroud of Turin, on which is imprinted what some people suspect is the actual face of Jesus. Scientific analysis couldn't determine how the image of the face was put on the cloth, but it *has* shown that it was somehow created through an intense blast of heat. That's all they can say about it, at least from everything I've read. Leading into the Queen's Chamber, there's an image of a person on what looks like a photograph on stone, and they don't know how it was created. Scientific analysis indicates that it was made by an intense blast of heat. And the image appears to be the same face that's on the Shroud of Turin. It looks like the face of Jesus, if you accept that, and it leads into the Queen's Chamber, a chamber that was used to stabilize Christ consciousness.

### Summary of the Initiation Process

First you go to the Well, to the initiation at the far end of the tunnel, and experience the dark-light energy that leads to the Halls of Amenti, or the womb of the Earth. Then you go to the King's Chamber, where you experience while white-light energy that gives the experience of being all of creation. Finally you go to the Queen's Chamber, where you are stabilized in the experience of creation so that you can return to everyday life to help others find their way. Then you wait a long time. At a certain moment, which could even be in a future life, you go back into the King's Chamber

for the final initiation, which is a four- or five-minute ceremony that happens in the center of the room. In this ceremony an ankh is drawn on the third eye of the initiate to verify that you are still on the path and have stabilized over a long period of time. Those are the steps of initiation as described to me by Thoth.

What we have now seen is one of the major keys to knowledge in the universe: the geometry of the consciousness levels of human origins. We have only begun to explore this science. We have examined only the first three levels, but this knowledge gives us the understanding of where we have been, where we are now and where we are going. Without this understanding we could not know **the** basic blueprint and map to human consciousness.

## The Left Eye of Horus Mystery School

**T**here are three mystery schools in Egypt. The male school is the Right Eye of Horus. The female school is the Left Eye of Horus. And the third school is the child, the Middle or Third Eye of Horus, which is simply life—but the Egyptians considered life the most important school of all. From the Egyptian point of view, everything that happens in this life is a lesson, part of a school preparing for higher levels of existence, which the normal world calls death. Life is all about teaching and learning, and what we call everyday normal life has, to the Egyptians, a deep, secret meaning. This wall mural [Fig. 10-1] shows the right eye, the left eye and the middle eye. This mural is the symbol for not only all three schools, but also the meaning and purpose of life itself. The right eye is male, the left eye is



Fig. 10-1. Top center: Right eye, middle eye and left eye.

female and the middle eye is the child, the source of both the other two eyes, for we all begin life as a child.

The Left Eye of Horus, the feminine pathway, explores the human nature of emotions and feeling, **both** positive and negative, sexual energy and birthing, death, certain psychic energy, and everything that is not logical.

We've been looking at the male Right Eye Mystery School since chapter 5. Now I'd like to explore the other side of the brain, the feminine side. I'm probably not the best person to teach this subject since I am male, but I'm going to give it my best effort. What we are about to give to you is information that can help you today in life and ascension if you understand the subtle nature of what is discussed.

Figure 10-2 is another depiction of the different schools. You can see the two eyes with the sphere in the middle.

Figure 10-3 is a pyramid capstone that's now in the Cairo Museum. First of all, you Sitchin (see chapter 3) fans may remember that the symbol of the oval with the wings and the two cobras coming out of it is the symbol for Marduk, the tenth planet. Notice again the two eyes with the center component, symbolizing the three schools.

Another symbol for the Right Eye of Horus school is the ibis and the oval, shown underneath the right eye (left of center). To the left of those symbols is a name—a cartouche. And farther to the left you see the triangular symbol for the star Sirius and the ankh,



Fig. 10-2. Another wall mural of the three schools.



Fig. 10-3. Capstone from a pyramid.



Fig. 10-4. Isis, Osiris and the resurrection tools.

a symbol of eternal life. In the middle of that row of symbols is the egg of metamorphosis, representing the actual physical change that one goes through in life to reach immortality. Then going toward the right, another symbol for the

Left Eye of Horus school is a flower stalk with a bee next to it. Then there's another cartouche, and farther to the right you see the star Sirius, eternal life and the snake, which represents kundalini energy.

Here you see Isis and Osiris [Fig. 10-4], and he's holding the tools of resurrection: from left to right, the hook, a 45-degree endpiece of the rod that has a tuning fork at the other end, and a flail. Isis has the ankh, and she's giving it to him from behind. According to Thoth, the only way you can initiate the ankh is from behind. If you initiate it from the front, it will destroy you. The ankh is *very* important, and we will be giving the sexual breathing instructions associated with the ankh later (all things at the right time).

The hook and the flail are actual tools, and these [Fig. 10-5] are King Tutankhamun's.



Fig. 10-5. King Tutankhamun's hook and flail





Fig. 10-6. Isis, Horus and Osiris at Abu Simbel.

This mural is on a wall at Abu Simbel [Fig. 10-6], and you see the family here—Isis, Horus and Osiris. This is the only place I've seen in all of Egypt where they actually show the physical use of these tools of resurrection. I couldn't believe it when I saw it. Horus is holding the rod to the back of Osiris's head, right at the chakra point that is the primary doorway into the eighth chakra. The hook is not shown here, but they actually slide the hook up and down this main rod to tune it. Evidently they got it tuned just right without it. Here Osiris is holding his arm up and one finger is holding the tuning fork, which is an angled piece with which you can fine-tune your body to get the exact vibration running up your spine. As you can see, he has an erection. Sexual energy was and still is a paramount component in their concept of resurrection. The sexual energy was running up his spine. It was at the moment of orgasm that they were able to make this transition. This subject will require a book of its own because it is so complex, so we will not address the subject of Egyptian tantra fully at this time.

In Figure 10-7 you see Isis placing the ankh to Osiris' nose and mouth, showing that the ankh, or the key to eternal life, was linked to breath. Thus far the ankh is linked to both the sexual energy and to the breath.

In Figure 10-8 you see it again in another place. Instead of the usual sphere over the top of her head, you see the red oval of metamorphosis, meaning that she's giving him instructions about how to go through metamorphosis and about breathing, which is what you'll be receiving here. She's gently holding his hand, and she has a kind of Mona Lisa smile, a very gentle, loving smile, as she teaches him the breathing that will take him from ordinary consciousness into Christ consciousness.

## Egyptian Initiations

### Crocodile Initiation at Kom Ombo

In the feminine world of emotions and feelings, if they are not in balance within the initiate, this imbalance will stop us from evolving. Until the emotional balance is achieved, we can proceed on the path of enlightenment only a certain distance, then all will stop. For without love and compassion and a healthy emotional body, the mind will fool itself into thinking all is well. It will create the sensation that the initiate is reaching enlightenment when in truth he or she is not.

We are bringing the following ceremony to light because it is a perfect example of the importance that the Egyptians placed on overcoming fear,

one of the negative emotions. Fear was and still is the primary force that stops a person from growing into the light. As we move into the higher worlds of light, we manifest our thoughts and feelings directly. This fact of nature becomes a tremendous problem, since we will almost always manifest our fears first. And in manifesting our fears in a new world, a new dimension of existence, we destroy ourselves and are forced to leave the higher worlds. Therefore, what all the ancient races have discovered, and what we are rediscovering now in modern times, is that in order to survive in the higher worlds, we must first overcome our fears here on Earth. To reach this goal, the Egyptians built special temples along the Nile.



Fig. 10-7. Isis offering ankh to Osiris.



Fig. 10-8. Another offering of the ankh.



Fig. 10-9. Temple at Kom Ombo.



Fig. 10-10. Two left eyes.

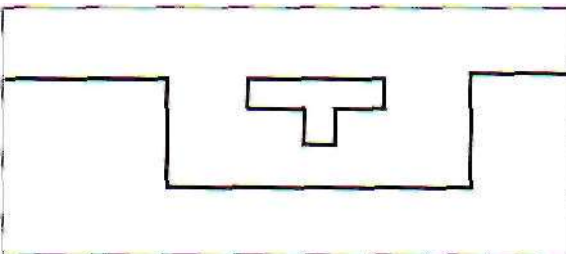

Fig. 10-11. Cross section of ceremonial hole in next figure.

Figure 10-9 is the temple at Kom Ombo. It represents the second chakra, the sexual chakra, of twelve chakras that run up the Nile—thirteen if you wish to count the Great Pyramid. Kom Ombo is the only temple that's dedicated to polarity, or duality, which is the basis of sexuality, and two gods are associated with it. In fact, it is the only temple dedicated to two gods in all of Egypt: Sobek, the crocodile god, and Horus. As you face the temple, the right half of this temple is dedicated to darkness and the left side to the light.

An interesting event recently happened in this temple—sort of a sign of the times. There was a major earthquake in Egypt in 1992, and Gregg Braden told me that he was sitting in this temple when the earthquake hit. Practically everything on the dark side fell, but the light side didn't lose a brick. As you will see in this work we do, the light is now stronger than the dark.

The carving in Figure 10-10 is on the rear wall of that temple at Kom Ombo. Two left eyes of Horus show that this is the emotional-body school, the feminine school, and that it's really two schools dedicated to two gods. On the left you see the 45-degree rod of resurrection.

The first time I went there I took a friend, and the second time she took me. This was my second trip in 1990, and we went through a beautiful ceremony that my friend had set up in Kom Ombo. For part of the ceremony we climbed down in a hole, and Figure 10-11 is a cross section of that hole.

A big granite slab comes down in the middle, allowing only a little space between the bottom of it and the ground. So we squeezed underneath the low part and came back out the other side. That was the physical part of this ceremony. Here's a photo of somebody going down into it [Fig.10-12].

But I could see that there must have been more to it than that in the ancient past. My friend was working with a large group of people, so I mostly watched that day. I was conscious of Thoth's presence the whole time I was in Egypt, so I asked him, "Is that it?" He said, "No, there's more than that." So I asked, "Well,

would you tell me?" He replied, "All right. This knowledge might be helpful to you."

Thoth told me to climb up high onto a wall at the back side of the temple and look back. So I climbed up on that wall, looked back and took this picture [Fig. 10-13]. The entrance to the ceremony hole was at point B, just off the picture. You can see the Nile in the background to the left of the large structure. The river ran along the front and the water from the Nile came right up into the temple. This was a temple where water and crocodiles were used in the teachings.

On the previous photo [Fig. 10-12], you can see the little wedge-shaped pegs at points A [Fig. 10-12b]. They use pieces of metal shaped like that to lock two stones together so that they don't move around during earthquakes; that makes it more stable. Those wedges actually hold walls in place at these points. Where the man is going down into the hole there used to be walls on both sides. When you are up high on the other side (where I took this picture), you can see the little wedge holes going all the way to the top at C. Walls at D and E had originally extended forward to where I took this picture, and you can see a secret hollow space in the middle. In this view from the back of the temple, the left side of this hollow center was the side of the "dark," and the right side was the side of the "light." If you were on either side of this wall, you wouldn't know there was a hollow place in the middle. It would be pretty hard to tell because you'd think that the other side of that wall was the other side of the temple.

At each of the temples in Egypt, they would create situations to force you to have experiences you would not normally bring on yourself, so that when you had similar experiences you would become stronger and less fearful. You would be put in extremely fearful situations to overcome your fears. That's what this secret hollow space was all about—an exercise to overcome fear, a specific kind of fear.



Fig. 10-12. Entrance to the ceremony hole. You can see the right hand and top of head of the man descending into it.

Fig. 10-12b. Shape of wedge at points A.

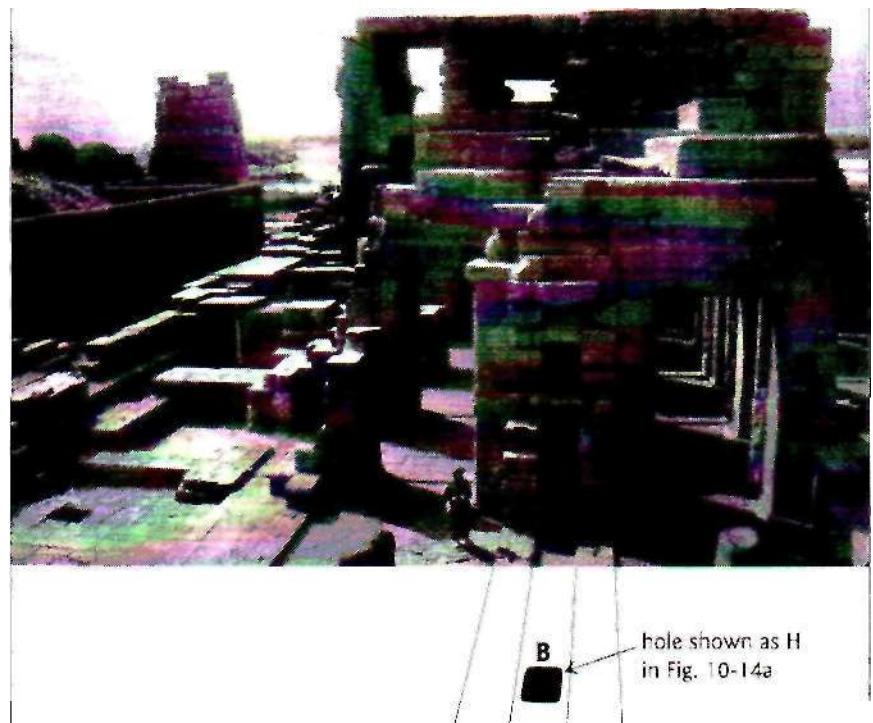

Fig. 10-13. What's left of the initiation site in Kom Ombo.

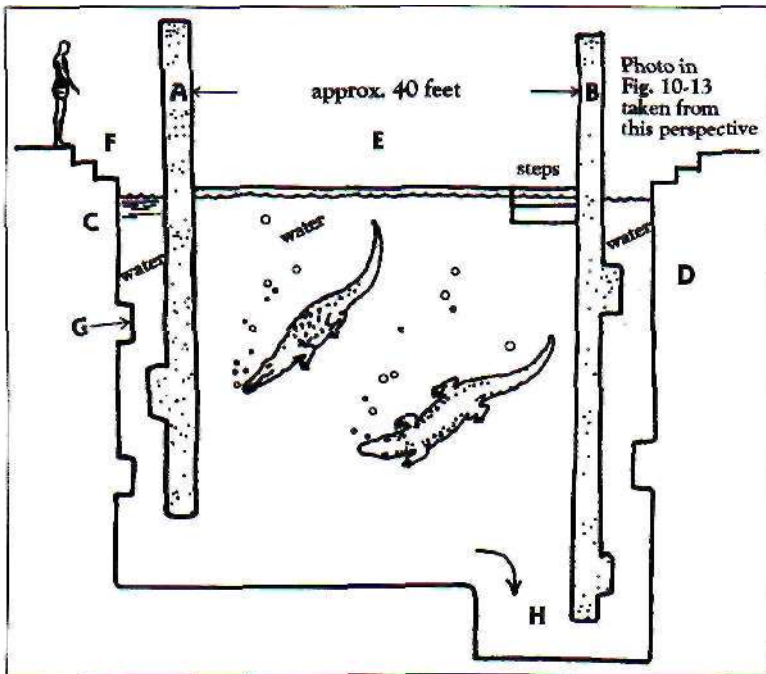

Fig. 10-14a. Crocodile pool used for initiatory experience.

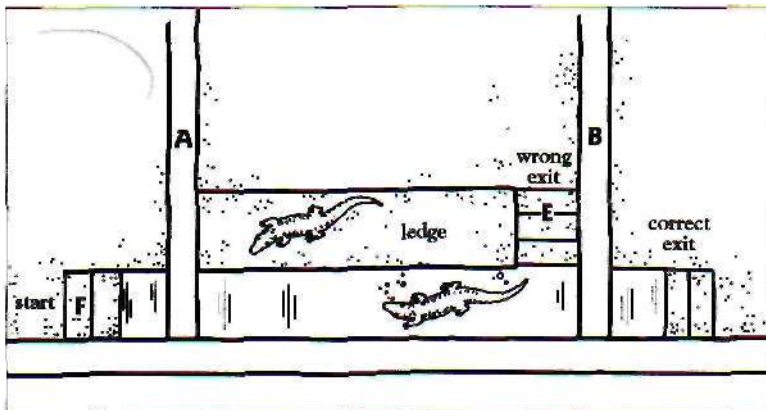

Fig. 10-14b. Top view of the crocodile pool.

That was more or less the function of the complex as Thoth explained it to me. Figure 10-14a is a section, viewed from the side, of the hollow place between the walls. The walls at A and B spanned the short distance to walls C and D, and this formed a sort of mazelike channel going from one visible opening to the other. Inside this channel was water—and crocodiles—maybe one trying on the ledge in the center, having a good ol' time waiting for some human to enter the water. Light came in through the opening at E.

Imagine yourself as a neophyte about to undertake this test. After much preparation and meditation, you would stand on the steps at F, look down and see a little square of water at your feet no bigger than about one square yard. You would not have any idea what was in the water or where it led to. Then you were told to go into the water and not come out the way you went in. You, the neophyte, had only one breath—and you had to be careful, because if you hurried to jump in without caution, you would hit the granite slab at point G. But your training would have taught you to be careful in all unknown situations. So at first you had to move around this granite slab. When you got to the bottom, which is about 20 feet deep and under wall A, you would emerge out of the darkness of the channel and look up toward the light. Then you would see the crocodiles. You can imagine the fear that would come up in such a situation. There was not much the initiate could do at this point except swim upward, squeeze by these fearful life forms and get out. That's what happened with almost everyone the first time around, according to Thoth.

What you didn't know was that these crocodiles were fully fed so they would not hurt you. But that hardly makes a difference to initiates down in that channel holding their breath and looking up at them. They didn't lose anybody to the crocs, but nevertheless . . .

When you, the initiate, stepped out of the water at E [see top view, Fig. 10-14b], you were told that you had just failed. Then you would have to go through more and more and more training. When your teachers thought you were ready, they would put you through this ceremony a second time. This time you knew about the crocodiles, that you had only one

breath, and that the way out was not past the crocs toward the light. So you would go down to the bottom again, and at the moment of your greatest fear. when you could actually see the crocodiles, you had to search for another way out. The opening at H is where we went down and came up for my friend's ceremony. So if you found the opening at H, you had to go far---- down and under wall B before you could swim up and out another pitch-black channel, not knowing for sure that it was even the way out.

This was the kind of initiation the Egyptians performed in these schools very calculated experiences. And these experiences were many and varied. This building had all kinds of special rooms designed to overcome fear. This temple also had a positive side, where they studied tantra—not just sexual pleasures, but understanding the sexual currents and other sexual energies and their relationship to resurrection. They also studied breathing and its relationship to all things that are human. The mundane ability to simply stay under water that long was quite a feat.

Now that we understand the importance of fear, I will talk about direct experience and the secret of the Well.

#### The Well under the Great Pyramid

The room in the Great Pyramid called the Well was closed off in about 1983 for safety reasons. They installed an iron door at the opening to the descending passage up at the main level, and kept a guard there for a long time. This was because many people had died in the Well, so many that they finally closed off the room to tourists. They had died of unbelievable things—for example, poisonous snakes and spiders that don't even *exist* in Egypt! The last incident happened just before they closed the Well. Some kind of poisonous gas appeared in the air and killed a group of people who were doing ceremony in the room. Nobody knows what it was.

This space has a very unusual nature, especially toward the end of the tunnel, where it ends at a wall. In this tunnel there is a connection between the third and the fourth dimensions. Whatever you think and feel happens, for real. If you've got any fears, they will become real. They will manifest and will not allow you to survive in the new world. If you are fearless, then you are free to manifest in the positive, which opens the door to the higher worlds. As you will see, this is the nature of the fourth dimension: whatever you think and feel happens.

This is why the Egyptian mystery schools took students through twelve years of training where they were faced with every fear known to man. Kom Ombo held only fears associated with the second chakra. Each chakra has its associated fears. They took initiates through every fear you can imagine, so that by the end of twelve years they were absolutely fearless because they had overcome all fear. All the mystery schools and training schools around the world did exactly the same thing in various ways.

The Incas were incredible. The things they did to get you into a fear state and then overcome it were unmentionable. In contrast to the Egyp-

tians, they didn't care if they lost a high percentage of their people. They were intense. The Mayans did the same thing. Remember the Mayan ball games where two teams would practice all year long to play a game that was like basketball, but it is believed that the *winners* had their *heads* cut off? They believed it was an honor to die this way, but it was really all part of a higher-dimensional training program.

Another interesting thing that's happened many times down in the tunnel below the Pyramid is that people would lie down, close their eyes and have an awesome experience, then wake up in the sarcophagus in *the King's Chamber!* They'd ask, "How did that happen?" This has been written about many times, and the present-day Egyptians haven't a clue how this could take place. What happened was that the people who experience this phenomenon didn't have the right training, so they were pulled back along the black-light energy vortex, traveled through the Great Void and came to the beginning of the black-light vortex. Then they reversed polarities and went down the white-light spiral into the sarcophagus.' It brought the whole being, body and all, right back through into this other reality. j

There were many, many problems with people lying down in the sarcophagus in the King's Chamber and having experiences that were irrational by modern standards. For that reason they moved the sarcophagus a long time ago. They pulled it askew and pushed it back so it doesn't line up with the field at all. When you lie down in it now, you can't get your head in the beam. It's not even possible now. The Egyptians know. They understand; they're not dumb. And they've been there for a long, long time. Of course, they have a story about why the sarcophagus was moved, but they are silent about why they have not moved it back to its original position.

They understand about the sarcophagus, though they didn't understand about the tunnel beside the Well. So in 1984, after this group of people died down in the Well tunnel, they sealed the whole area off and wouldn't allow anyone else into it. When we went there in 1985 and explained to them that it was only the *end* of the tunnel where the problem was, they opened up the rest of the area to the public. Now it's open except for the tunnel. The entire area was closed off for a period of only about a year.

### The Tunnel beneath the Great Pyramid

In the original Flower of Life workshop I used to tell stories each day, because it is one of the best methods I know to give and receive information. The story I am about to tell is my personal experience in the tunnel so that you can understand the nature of the initiation the Egyptians went through and the nature of the fourth dimension, which will become more and more important as this book unfolds. This happened exactly as I perceived it, and I hope this story opens an insight within you. You do not have to believe it. You can take it as just a story if you wish.

What follows has been edited because it is too long in its entirety, but the most important points have been retained.

In 1984 Thoth appeared to me and said that I was to prepare for an initiation in Egypt. He said it was necessary for me to go through this initiation in order *to* connect with the Earth's energies and move with the Earth's changes in the future. Thoth told me that for this initiation I had to arrive in Egypt without any help from myself. I could not buy a ticket or make any arrangements on my own. I also could not even tell anyone that I wanted to go to Egypt. Somehow the events in my life had to naturally take me there without any effort on my part. If they did, then the initiation would begin. If they did not, then the initiation would not happen. The beginning rules were simple.

About two weeks later I visited my sister, Nita Page, in California. I had not seen her in a very long time. She had just gotten back from China, so it seemed like a perfect chance to meet. Nita is always traveling. She has been to almost every major city and country in the world many times over. She loves to travel so much that she eventually bought a travel agency to blend her love with her job.

As I was sitting with her in her home, I was careful not to talk about what Thoth had requested of me. But without any words on my part, it just happened. It was late at night around 1:30 A.M. and we were talking about China. There was a book on her coffee table called *The Secret Teachings of All Ages* by Manley P. Hall. As she was talking, she casually flipped open the book to a page that showed the Great Pyramid, and the conversation changed to Egypt. After a while, she looked me in the eye and said, "You have never been to Egypt, have you?" I said no, and she said, "If you ever want to go, I will pay for everything. Just let me know."

I had to bite my tongue not to talk about what Thoth had requested of me, but I did. I did not say a word. I simply told her thanks, and that if I ever wanted to go, I would call her.

My sister had been to Egypt twenty-two times and had probably been to every temple in Egypt. I was glad she wanted to take me, but I didn't really know what this would mean in terms of the initiation. However, as soon as I arrived home, that same night Thoth appeared and told me that my sister *was* the way I would go to Egypt. I just sat there and listened to him. He then said that I was to call her in the morning and tell her that I wanted to go between January 10 to 19 in 1985. He said that this period was the only time this initiation could be given. Then he left. This was a day in early December 1984, which meant that we would have about a month to prepare.

The next morning I sat by my phone to call her, but I was feeling a little strange. When my sister had offered this trip and said that she would take me, I knew that what she really meant was someday, not immediately. So I sat by my phone thinking how I would ask her. I must have sat there for over twenty minutes before I finally got up the courage to call.

When she answered, I told her about Thoth and what he had asked of me. Then I told her we would have to leave in about a month. She immediately told me to hold on. She said it would not be possible for at least nine months, which was about what I expected her to say. Nita, as I said, ran a



travel agency, and she was booked solid until the middle of September. She loved me and tried to soften to blow by saying that she was about to go to work, and she would check her schedule and call me in a few hours. When she hung up I assumed it was over, but I didn't understand it, since Thoth has never been wrong on anything, ever, and he had said, "This is how you will go to Egypt."

Shortly after, my sister called me back; she sounded strange. She said, "I am booked even longer than I remembered this morning. I am booked solid through October. But when I looked in the time period you gave me, there was not even one booking. It was completely blank! I am booked on the ninth and on the twenty-first, but nothing in between. Drunvalo, I believe that Thoth was right. We are supposed to go."

Not only that, Nita called me the next day to tell me further interesting news. She said, "When I phoned to buy the tickets for us at United Airlines, I talked to my friend in ticketing who does most of the ticketing for my travel agency, and when he found out that the tickets were for me and my brother, he gave them to me for free." To me, this just emphasized the perfection of this initiation. It truly was effortless.

Thoth then began to appear every day to teach me different information pertaining to the work I would need to do in Egypt. First he gave me an itinerary we were to follow. The order of which temples we would enter could not be broken for any reason. We had to visit them in this exact order or the initiation would not be completed.

Then he began to teach me to talk in Atlantean. There were certain phrases and statements that had to be spoken aloud in perfect Atlantean in order for this to work. Every day Thoth would come and instruct me how to say them. He would have me repeat them over and over until they were perfect for his ears. Then he would have me write them down phonetically in English so that I could remember them when I got to Egypt. In each temple I had certain words to say in Atlantean to begin the initiation.

Finally Thoth taught me how to work with fear. He taught me certain techniques to identify whether the fear was real or imaginary. He had me imagine electric-blue rings that would move up and down the outside of my body like hula hoops. If the fear was imaginary, the rings would move in one way, and if the fear was real, the rings would move in another way. I took this training very seriously. He told me my very life could depend on my knowing this meditation. I did as he said and studied everything he taught me as though my very existence depended on it.

As we came closer to the time we were to leave, other people became interested in this trip. Thoth knew before they even asked that they would want to go. He said it had been written down long ago. Finally there were five of us—myself and my sister, another woman and her husband and his brother. I remember as we arrived in Egypt, we flew over the Giza complex and circled once. All five of us were like children waiting to go out and play, we were so excited.

We were met at the airport by Ahmed Fayhed, the most renowned Egyptian archaeologist in the world, next to his father Mohammed. Mohammed was famous all over Egypt, and both of them were good friends of my sister Nita. Ahmed led us out of the passport lines and took the stamp out of the hands of one of the officials, stamped our passports and immediately guided us out into the street and into a taxicab without anyone so much as asking us about our luggage. He took us to his home, which was more of an apartment building several stories high. His large family lived in different "apartments" in this building. From his home we looked straight into the eyes of the Sphinx.

Ahmed's father, Mohammed, was an interesting man. When he was a small child he had had a dream that there was a huge wooden boat next to the Great Pyramid. The next day he drew the boat, which included hieroglyphics. He also wrote down the exact location of the boat in his dream. Somehow the Egyptian officials saw this drawing and noticed that the hieroglyphics were real, so they drilled a hole in the location where the child said the boat would be. And it was really there!

The Egyptian government took the boat out of the ground but found that it was dismantled, so they tried to put it together. After two years of trying, they gave up. Then Mohammed had another dream. In this dream he saw the blueprints showing how to put the boat together. By now the Egyptian government listened to him. They took the blueprints and with them, the boat went together perfectly. They then built a special beautiful room next to the Great Pyramid to house the boat. It is still there today, and you can see it for yourself if you wish.

Mohammed found almost the entire buried city of Memphis by simply telling them exactly where to dig. He provided the Egyptians with a drawing of the building or temple before they dug it up, and he was right in every single detail.

The middle pyramid at Giza was also opened through Mohammed's psychic powers. The government asked him if it would be all right to open this pyramid. Mohammed meditated and finally said yes. The government said they would move only one block (out of over two million), so Mohammed meditated for five hours in front of this pyramid. He finally said, "Move that block." As it turned out, that was the exact block that hid the doorway, and the Egyptians entered the second pyramid for the first time. He is the father of Ahmed Fayhed, our guide and my sister's friend.

When we arrived at Ahmed's house, he gave us rooms and let us relax for a couple of hours. Then he met with my sister and me and asked us where we wanted to go. I gave him the itinerary that Thoth had given me. He looked at it and said, "This is no good. You have only ten days here, and the French train that goes to Luxor does not leave until 6:00 P.M. tomorrow tonight. You will lose almost two days. I feel we should go to Saqqara first, then immediately go to the Great Pyramid." This, of course, was exactly what Thoth said we could *not* do; he was emphatic that we must move exactly as the original itinerary indicated.

But Ahmed was even more emphatic that we *not* use this itinerary. Ahmed would not take no for an answer, and he set up everything for us to go into the Great Pyramid early the next morning. On top of that, he did not want us to go into the tunnel beside the room called the Well. It took a great deal of convincing him that we absolutely had to enter the tunnel. This was the primary reason for coming to Egypt. He told us how dangerous it was, that many people had died in that part of the pyramid, and that if we insisted on this part of the itinerary, he would not go there with us.

I didn't know what to do. Thoht said that we *had* to move according to his itinerary, and now it looked like we were not going to/I knew that if we didn't, the initiation would not happen. I decided to go to the Great Pyramid in the morning as Ahmed wanted, fully realizing that if I did, it would be all over.

The next morning I was sitting in Ahmed's living room along with the others in the group. We all had our little daypacks set up with everything we thought we might need, like flashlights, candles, water and so on. Finally the hour came for us to leave and Ahmed opened the front door and said, "Let's go." My sister went out and behind her were the other three members. I just stood there for a moment, then threw on my daypack and started to move toward the door.

Then something happened truly out of the blue. I felt absolutely perfectly healthy and happy that morning, but a little worried about this itinerary thing. As I took a step toward the door where Ahmed was waiting, I suddenly felt a wave of energy come over me. It stopped me in my tracks. Then a second very strong and powerful wave of energy went through my body. I couldn't figure out what was happening to me. Then these waves of energy came faster and faster. The next thing I knew, I had fallen to the floor and was throwing up. Every system in my body seemed to be breaking down before my eyes. Within ten to fifteen seconds, I was so sick I could hardly respond to my circumstances.

It's strange. When a person gets sick this fast, the spirit inside the body doesn't have time to get sick. I remember lying on the floor trying to figure out what was happening to me. It was almost like watching a movie of myself getting sick.

They carried me into a bedroom, where my condition quickly degenerated into total paralysis. I could not move any part of my body. It was an amazing experience. I lay there for about three hours, and it seemed that whatever it was, it was getting worse. There was not much anyone could do. The next thing I remember is waking up the next morning.

For most of the day I could do nothing but lie there. Finally around three in the afternoon I began to feel a little stronger. I tried to do the Mer-Ka-Ba meditation to heal myself, but at that time I didn't know how to do it lying on my side. I tried for a while, but to no avail. Finally I called my friend and her brother into the room and asked them to prop me up into a sitting position. They helped me to get into the familiar position for doing the meditation.

As soon as I got the prana flowing through my body again, I began to feel stronger. After only about thirty minutes, I was walking around the room—a little dizzy, but walking. Ahmed came into the room and saw me standing. He asked me if I was better, and I said yes, but I was still sick. He then reached into his pocket and pulled out the original itinerary and looked at it. He said that if I could travel in an hour and a half, we could get on the French train to Luxor. Then he said, "This should make you happy. We can now do your original itinerary as you planned."

I have always wondered if I made myself sick so that we could return to the original itinerary or if Thoth did it. Either way, the "sickness" was not normal. At least I have never felt anything like it in my entire life. So now, finally, the true initiation could begin. As I rode on the train to Luxor, the thoughts and feelings of the sickness kept trying to return, but I kept my pranic breathing going, filling my body with life-force energy, and by the time we reached Luxor the next morning, I was back to my old self again, excited for what might come.

We checked into a hotel in Luxor before we began the initiation at the first temple, the Temple of Luxor, the temple dedicated to Amun. Ahmed handed me my room key. It was room 444, the number of initiation into spirit. I knew then that everything was back on track and moving perfectly. In fact, all movements in Egypt flowed perfectly from then on. We arrived at each temple in the exact order that Thoth wanted. I had my little piece of paper so that I could remember the Atlantean words, and each ceremony was also performed in the manner that he wanted. Life flowed like the river Nile.

Finally, on January 17 we arrived back at Ahmed's house, ready to complete the final initiation in the tunnel. This had not been planned, as I had little control over the events in Egypt, but we went into the Great Pyramid on January 18, my birthday. In fact, the second time I went to Egypt, in 1990, I was following my friend's plans, and I ended up in the Great Pyramid on my birthday again. I feel sure there is a cosmic reason for everything that happens.

We arrived on the seventeenth, but we couldn't get into the Great Pyramid until Ahmed received written permission from the government, which didn't come until late that night. So early in the morning of the eighteenth we headed for the tunnel.

When we arrived at the steel gate leading to the Well, Ahmed and his people stopped the flow of tourists at two points so the tourists could not see that we were going into this off-limits area. Realize that there were 18,000 people a day going into this pyramid, so it was like stopping cattle heading for their feed. The guard who let us in then said, "You have one hour and a half, exactly. Set your watch with your alarm. If you are not here on the dot, we will come and get you, and we will not be happy. Do not be late." Then he let us through, and as soon as we were out of sight, he let the tourists continue.

So here we were standing at the top of a long, sloping tunnel at an angle of 23 degrees, the same tilt as the Earth's axis, that led about 400 feet downward into an underground room.

None of us knew what to do. How do you move down a tunnel only about a yard high and a yard wide that slopes at a steep angle? You can't walk, you can't crawl. We laughed and thought maybe we could roll down. We had to remove our daypacks because they hit the ceiling of the tunnel, so we finally decided that we had to walk like a duck, with our daypacks in our laps. It seemed to work. Everyone else went first, and I was last.

As I proceeded down the tunnel, my mind was blank. I seemed to not be thinking but only observing. Then something happened that awoke me. There is a vibration in the Great Pyramid that is very deep and intensely masculine. It never seems to end. I was very aware of this vibration from the moment I entered the pyramid and I was concentrating on it as I descended. Suddenly I noticed these two red squares [see Fig. 10-15] embedded in the walls of the tunnel, one on each side. They were about two inches square. As I passed them, the vibration seemed to drop about one full octave, and at the same moment a feeling of fear went through me.

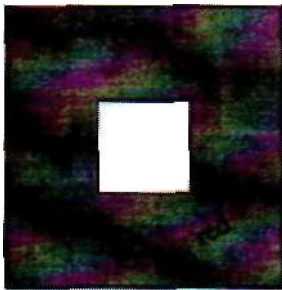

Fig. 10-15. The red square.

I was so involved with this vibration and this new feeling of fear (which is very unusual for me) that I forgot everything Thoth had taught me. He said that fear would be most important to overcome once I entered this space, but still I forgot everything. I was just reacting to my feelings.

As I proceeded deeper into the tunnel, I was simply feeling the fear, but then I came to another set of red squares. As I passed them, the vibration dropped another octave and the feeling of fear became even more intense. I started talking to myself. I asked, "What am I afraid of?" Then I heard a voice inside me say, "Well, you are afraid of poisonous snakes." I replied, "Yes, that is true, but there are no snakes in this tunnel." The inner voice said, "How can you be sure? There may be snakes in this tunnel."

As I arrived at the bottom, I was still having this internal dialogue and feeling this intense fear now over snakes. I mean, yes, I have a fear of snakes, but it isn't something that comes up very often in my *life*. Thoth seemed to be a million miles away. I forgot he existed. I forgot the electric-blue rings that could take the fear away. All that training for nothing.

We passed through the first room, which is seldom in any of the books on Egypt, into the main room where the tunnel we'd come to Egypt to visit branched off. There in the middle of the room was the "well" the room was named after. We looked into it, but it is filled with debris about 30 feet down. This room has no particular shape. It is totally female, with no straight lines. It looks more like a cave than a room. At last we were standing in front of the tiny tunnel that was the reason we came all this way.

An interesting side note: When I talked with Thoth about this area, he said that this room was not built by the Egyptians. It was so old that even he did not know who built it. He said that protecting this room was the primary reason why he placed the Great Pyramid in this exact location. He

said it was the opening to the Halls of Amenti, the womb of the Eardi and a fourth-dimensional space, one of the most important sites in the world.

Whenever I can, I check what Thoth says, which he encourages. Especially things that can easily be checked. So when I was with Ahmed on the French train going to Luxor, I had asked him about this room and who built it. He confirmed what Thoth had said, that it was not built by the Egyptians, and he didn't know who'd built it, either. Yet no book on Egypt that I am aware of speaks of this.

On with the story. This tunnel is very small. I'm not sure of the exact dimensions, but it is smaller than the one we came down in. The only way you can get inside this tunnel is by crawling on your belly. I believe it goes back into the Earth for about 80 to 100 feet, but people who are returning from there lately say that it goes back only about 25 feet. This cannot be, so the Egyptians have now probably sealed the tunnel. The floor was made of silica sand and was soft. The walls and the ceiling were covered with tiny quartz crystals and shone like diamonds. It was beautiful. When we pointed our flashlights inside, the light seemed to spiral, traveling just a few feet into the tunnel, then there was darkness. I have never seen anything like it.

One by one we each aimed our flashlights into the tunnel to assess the situation. After each person had done this, they all turned and looked at me and said, "You brought us here; you go first." I had no choice.

I tucked my backpack up against my chest and began to crawl, with my tiny flashlight pointing the way. Of course, I was still feeling the fear of snakes and was looking for them, hoping not to find them. After what seemed hours, I reached the end of the tunnel, with no sight of snakes. I breathed easier and relaxed. But then I noticed something—a small round hole near the **right-hand side** of the tunnel's end. It looked like a snake hole.

My fear jumped into high gear. I took my flashlight and pointed it into the hole to see if something was looking back. There wasn't. I didn't like it, but what could I do?

I shifted my attention to the immediate problem. It was then I realized that the Egyptian hieroglyphs that showed the way Osiris led initiates in this tunnel could not be performed in modern times because our bodies are bigger [see Fig. 10-16].

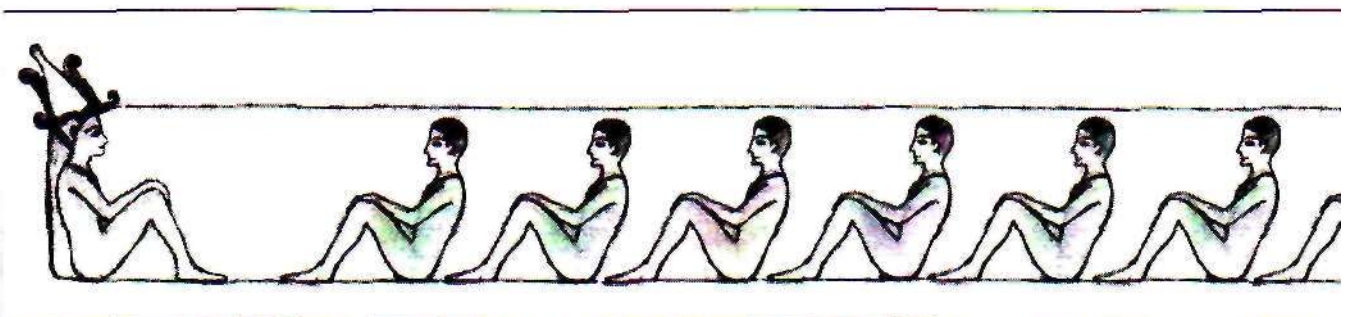

Fig. 10-16. Osiris and initiates in the tunnel.

According to the hieroglyphs, Osiris and his initiates sat. This was impossible for me, so I finally remembered Thoth again and asked him to come in. He told me to lie on my back with my head toward the end of the tunnel and for the rest of the group to do the same. I made this suggestion to the group, and they all complied.

As I lay there on my back, immediately several things happened. First I noticed overwhelmingly that this was the darkest place I had ever been. I held my hand up to my eyes, but it was so black that I couldn't even begin to see my hand. I do not believe that there was even one light photon in that space.

The next experience I had was the incredible sense of mass and gravity. I could feel the mountainous mass that was on top of me. It was like being buried alive. I had solid rock in every direction except out the tunnel, and that was clogged with human bodies. It was a very good thing that I am not claustrophobic. If I were, the feat of small, tight spaces would have ended the initiation for sure. Actually, for me this all felt great, no problem.

Thoth then came in very clearly and told me to begin my Mer-Ka-Ba meditation. I started to, but then the fear of snakes began to come back. I remembered that there was a tiny "snake" hole that was now just off to the left of my head behind me, but I couldn't see it. My imagination went wild. I could see snakes coming out of this hole and beginning to cover my body. It felt so real. I *knew* that if I continued with this fear, it *would* become real, and I would be covered with rattlesnakes. This knowing made it even worse. I knew this was how so many people had died in this tunnel. And *still* I forgot my training on fear that Thoth had taught me.

What I did was probably an American reaction. I grabbed my shirt like John Wayne and began to "talk sense" into myself. I said that I had come all the way to Egypt from America, and "so what if I died? Life would still go on." I told myself, "Get a hold of yourself. Forget the snakes and remember God" and "Even if my whole body is covered with snakes, I am going to continue."

Lucky for me, it worked, and I was able to shift my attention to completing the Mer-Ka-Ba meditation. The beautiful flying-saucer disk extended out to about 55 feet around my body, and a sense of well-being came over me. I completely forgot about the snakes. Although it did not occur to me at the time, not until I arrived home in America, it was interesting that I'd been unable to do the meditation lying down when I was sick a few days earlier, yet it happened naturally in this tunnel. I have thought about this; perhaps it was because there was almost no sense of up or down. It was like floating in outer space. Whatever the reason, thank God I was able to meditate lying on my back in that tunnel.

Thoth was now always in my field of view. He first requested of me the Atlantean words that would allow permission from the seven lords of the Halls of Amenti. He asked that I say these words with power, so I did as he said. There was a space after that. I can't really explain it, but it seemed

like years went by. Thoth then asked me if I knew that when I had been in the Mer-Ka-Ba I'd been sending light out in all directions like the Sun. I told him, "Yes, I know that." He asked me again, "Do you *really* know?" I told him again that yes, I knew that. He then spoke a third time, saying, "If you really know, then open your eyes and see." I opened my eyes, and I could see in the tunnel. Everything was lit up with a soft glow, much like moonlight. It did not seem to come from a source. It was almost like the air was glowing.

Then my mind engaged, and I thought it was someone in the group with a light on. I leaned up on my elbows and looked down the tunnel at the other four initiates, but they were lying still with no flashlights turned on. I could see them clearly. I lay back and looked around; it was amazing. I could see perfectly every detail around me. I thought to myself that it was bright enough to read, then I closed my eyes again. Every so often I would open my eyes again, and the light was still there.

At one point when my eyes were closed, I asked Thoth what was next. He looked at me and said, "Isn't lighting up a tunnel enough?" What could I say? So for about one hour I lit up the tunnel and watched this incredible phenomenon. I remember that when my alarm went off to tell us to return to the top, I had my eyes closed. I opened my eyes, expecting the tunnel to be lit, but it was pitch black. That surprised me. The initiation was over.

We went to the top and the guards were there with the gate open. My sister went outside the pyramid, since she had been there so many times, but the rest of us became tourists and went into the King's Chamber and other rooms. We exchanged stories later, and it was clear that each person had a different experience—depending on what they needed, we assumed. My sister's story was extremely interesting to me. She talked about how she stood up in this little tunnel and was greeted by these very tall beings who took her into a special room for her initiation. Life is more than we know.

When I exited the pyramid, I could hardly believe my eyes. From the height of the doorway's location up the pyramid, I could see an enormous crowd that I estimated to be about 60 to 70 thousand people. As I looked closer, I realized that they were almost all children. Upon even closer examination, the children were from about five to twelve years old. There were very few adults. I don't know why they were there, but there they were.

As I looked down at the bottom step of the pyramid, I noticed that the children were holding hands in a line as far as I could see along one edge. I walked to the step just above them, around one of the adjacent sides, and the children were holding hands there, too. My curiosity was so great, I ended up walking around the entire Great Pyramid to see if it was true, and it was! The children were holding hands in a complete circle around the Great Pyramid. I even went to the second and the third pyramids to see if it was true there too, and it was. The children had circled all three pyramids while we were inside. I asked myself, What does this mean?



When I got back to my room at Ahmed's house, I went into meditation and brought the angels in. I asked them the question, "What do all those children mean?" They asked me if I remembered what they had said twelve years before. I didn't know what they were talking about, so I asked them to explain. They said that twelve years before, I had been asked to be the father of a child that they said had come from the Central Sun. They said that he would be the apex of a pyramid of millions of children who would come to Earth to help us during our transition into *the* next dimension. The angels said that these children would be almost like ordinary children until twelve years passed, then a quickening would begin and they would slowly emerge upon the face of the Earth as a force that could not be stopped. They said that these children were connected together by spirit, and at the right moment in history they would lead the way into the new world.

After the meditation, I calculated the years between my son Zachary's birth and that day. Zachary was born on January 10, 1972, and the day of this initiation was January 18, 1985. It had been thirteen years and one week. I had forgotten, but the children had not.

In the final chapter you will learn what science now knows about these children. You will see the great hope that is emerging on Earth from these beautiful beings from space, our children.

Remember, children are the Middle Eye of Horus; they are life itself.

## The Hathors

The Hathors were the main or primary mentors within the Left Eye of Horus Mystery School. Though they were not from Earth, in the ancient days they were always here to assist us in unfolding our consciousness. They loved us dearly, and they still do. As our consciousness became more and more third-dimensional, we eventually could no longer see them or respond to their teachings. Only now, as we grow, are we beginning to see and communicate with them again.

Figure 10-17 is the likeness of a member of the Hathor race, a race of fourth-dimensional beings who come from Venus. You don't see them on the third-dimensional world of Venus, but if you tune to Venus on the fourth dimension, especially on the higher overtones, you'll find a vast culture there. They are the most intelligent consciousness in this solar system, and they function as the headquarters or central office for all life under our Sun. If you come into our solar system from the outside, you must check with Venus before proceeding.

The Hathors are beings of tremendous love. Their love is on a level of Christ consciousness. They use vocal sounds as their means of communicating and performing feats within their environment. They have amazing ears. They have almost no darkness to them at all; they're just light—pure, loving beings.

Hathors are very much like dolphins. Dolphins use sonar to do almost

everything, and Hathors use their voices to do almost everything. We create machines to light or heat our houses, but the Hathors simply use sound through their voices.

There aren't many of these Hathor-face statues left because the Romans thought they were some sort of evil spirits and perpetrated great destruction upon their images. This carving is found in Memphis, and it's at the top of a 40-foot pillar, though the present ground level is just above the top of the pillar [what you see here is excavated]. They had recently discovered this temple when I was there in 1985.

The Hathors are about 10 to 16 feet tall, the same height as the Nefilim, mentioned in chapter 3. For a very, very long time they have **helped** people on Earth, almost always through their love and their incredible knowledge of sound. There's an initiation in Egypt where the sound of the ankh is created—this is one of the initiations in the Great Pyramid. It's a continuous sound that a Hathor makes, without stopping, for somewhere between half an hour to an hour. It is used primarily for healing the body or restoring balance in nature. It's like when we sound On and have to breathe at the same time. The Hathors learned how to make a sound without stopping, breathing in through their nose, into their lungs and back out through their mouth continuously. Conducting this sound-of-the-ankh initiation ceremony was only one of the many things they would do for us to create balance. The Hathors were here on Earth helping mankind for thousands of years.

Breathing in and out at the same time and making a continuous sound without stopping is not unheard-of today. An Aborigine playing the didgeridoo uses circular breathing. He can make one tone nonstop for an hour by controlling the air flow into and out of his body. It's not that hard to learn, actually.

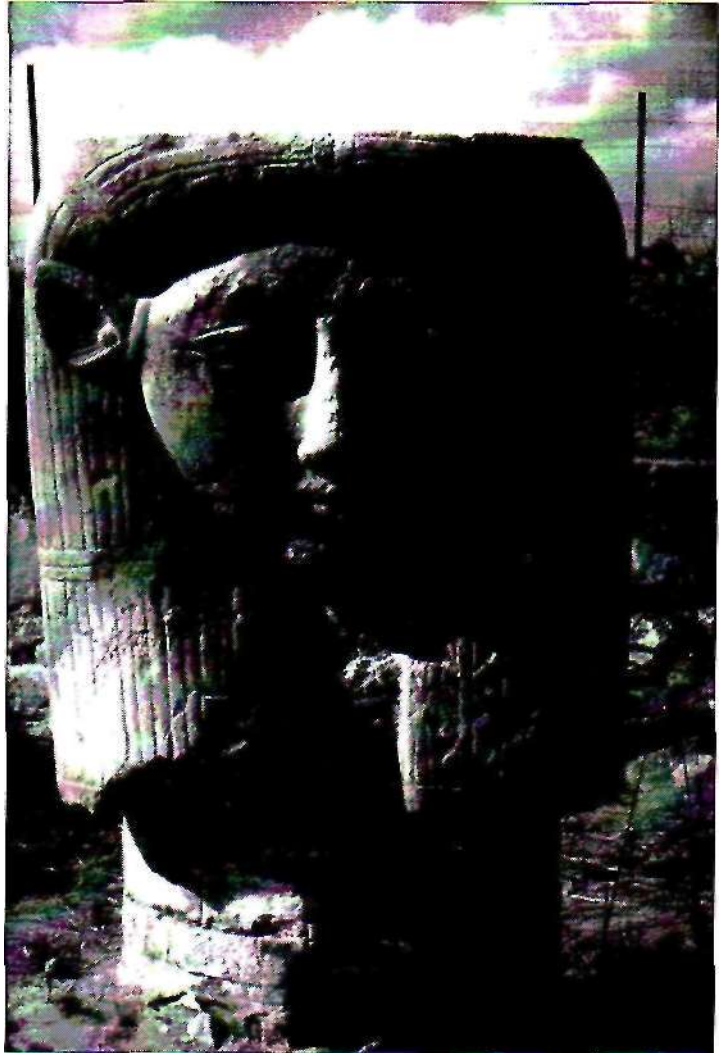

Fig. 10-17. A Hathor.

## Dendera



Fig. 10-18. Dendera.

Figure 10-18 shows you Dendera, and this temple was dedicated to the Hathors, the great mentors of the human race. There used to be Hathor faces on all those columns, but someone in the past tried to destroy them. There are huge pillars inside this temple that extend to the back of the temple. This temple is enormous; you can't *believe* the size of this place! It stretches back a quarter mile or so.

Dendera has two primary places I would like to mention. Inside this temple you will find the astrological chart that I've referred to a couple of times. Here also you

will find a room that I have seldom talked about because I have not personally seen it. If you enter the temple and turn right, beneath the front panel in the floor is a small room, as I understand it. In this room is something that is impossible by all of today's standards. There is a carving of the Earth from space, perfectly proportioned, with an extension cord coming out of the Earth that has a modern electrical plug on the end of it. Next to the plug is a wall outlet exactly like we have today. It is unplugged. How can this be? How could the Egyptians know that in the future the Earth would be electrified.<sup>7</sup>

Let me tell you a story and show you the photo I promised in an earlier chapter. When I was in Abydos at the Seti the First Temple [Fig. 10-19a; see chapter 2] one of the guards who was working with me told me to wait



Fig. 10-19a. Seti the First Temple at Abydos.

until all the people were out of this area of the temple. He then told me to aim my camera and take a picture of a particular place on one of the ceiling beams. It was dark and I could not really see what I was photographing. It was not until I returned home and developed the picture that I could see what it was.

This photo was also impossible by all known ideas of what the past, present and nature means [see Fig. 10-19b]. As we talked about the "carved bands of time" on page 32, anything about 15 feet from the floor level were about the future. This photo shows a section about 40 feet from the floor feed up against the ceiling.

What is it? It is a picture of an attack helicopter with what looks like stacked oil barrels below and a half sphere with an eagle stand--- on top facing an ar----- tank. There appear to be two other kinds of airplanes facing the same direction. Facing this "en-say" is an armored tank.



Fig. 10-19b. The carvings in Seti the First Temple at Abydos.

Then I first showed this photo in 1986 it didn't make sense. But in 1991 there was a retired military officer in my workshop who identified the helicopter as a very specific U.S. military helicopter and said that the entire series of hieroglyphics fits the parameters of the Desert Storm war. This was the only war where this helicopter and tanks were present at the same time.

It is hard to say that the Egyptians could *not* see the future when they made these hieroglyphics thousands of years before the helicopter was even invented. Many people and Web sites around the world have been looking at this photo ever since I took it, and there is still no explanation.

This photo [Fig. 10-20] shows the top of a doorway to a small room up high in the back of the Temple of Dendera. In the center of the upper lintel stone is the symbol for Marduk, the planet of the giant Nefilim. Beneath that is a circle with the Left Eye of Horus inside, which is difficult to see here. And to its left is the hieroglyph for Thoth, who is pointing to the circle [see detail in Fig. 10-20a).

Beyond this portal and on the walls of the room is a beautiful rendition of the story of Isis and Osiris, which I retold in chapter 5, volume 1. I regret that the officials would not let me take photographs to show you. The story depicted on the wall is the basis of the Egyptian religion. In an extremely simplified form, it is told in this way.

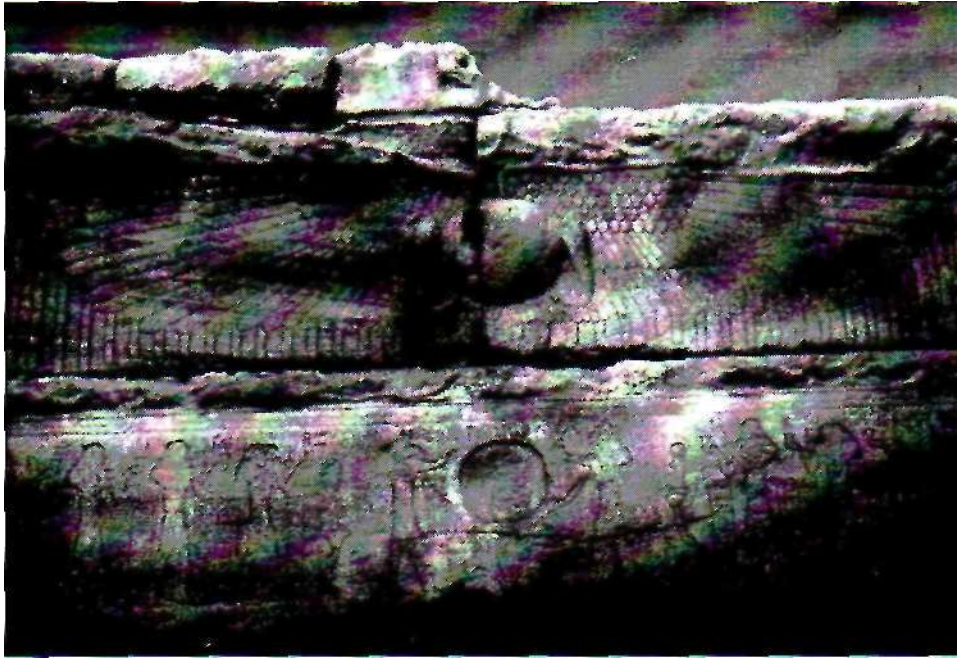

Fig. 10-20. The lintel of the doorway to a room inside the Temple of Dendera. Top center is the symbol for the planet Marduk. Below it is the Left Eye of Horus in a circle, and to its left is the hieroglyph for Thoth. The room itself contains the story of Isis and Osiris in hieroglyphs.

### An Immaculate Conception

Osiris and Set, and Isis and Nephthys, were brothers and sisters. Osiris married Isis and Set married Nephthys. At one point Set killed Osiris, put his body in a wooden casket and floated him down the Nile (really a river in Atlantis). Isis and Nephthys began to search the world to find Osiris' body. When they found it, they brought it back, but Set found out and cut Osiris' body into fourteen pieces. He sent the pieces all over the world to make sure Osiris would never return. Isis and Nephthys then searched for the pieces and found thirteen of them. The fourteenth was Osiris' phallus.

The story on the wall shows that the thirteen pieces were found and put together without the missing phallus. Then Thoth does some magic, the phallus comes alive and the creative energy flows through Osiris' body. It shows that Isis then turns into a hawk, flies through the air and comes down and wraps her wings around her husband's penis. Then she flies away, becoming pregnant. She has a hawk-headed baby, Horus, only he's not really hawk-headed—that's just the hieroglyph for his name. Horus then avenges his father's death and the pain that Set put Osiris through.

Thoth says that what they're depicting here is an immaculate conception, or virgin birth. Since the woman doesn't have to be a virgin, he called it immaculate conception. Thoth described the birth as an interdimensional one. Isis flew to Osiris interdimensionally; it was not a *physical* mating that took place.

### The World's Virgin Births

What I'm about to present to you is information I was told to tell you. I didn't know what to think about it myself for a long time, and you'll have to draw your own conclusions. I'm telling you what I now know to be true, but when they first told me this, I thought it was pure myth. Most people think it's pure myth, that the story about Mary and Joseph and the



Fig. 10-20a. Detail of circle at lower part of Fig. 10-21.

virgin birth could happen only to Jesus and couldn't possibly happen to the average person. But I've learned that there's hard evidence that immaculate conception is absolutely true and is a part of everyday life.

Many of the religious leaders and founders of the world's religions, like Krishna, for example, or Jesus, are said to have been born of a virgin birth—of a mother and father who did not physically mate. As I said, we think of that as something that couldn't possibly be true in everyday life. On levels of life on Earth other than human, virgin births occur every minute of the day all around us, all over the world, all the time. Insects, plants, trees, almost every level of life, use immaculate conception as one means of reproduction. I'll give you an example.

Figure 10-21 is the family tree of a male bee. A female bee can birth a male bee anytime she wants. She doesn't have to ask permission from the male and doesn't need a male to create a new male. She can just do it. If she wants to make a female bee, however, she must mate with a male. In this family tree, the *male* needs only a mother, but the female *needs* both father and mother. Any bee father needs only a mother, and the generation follow in this particular way. The column of numbers at the left of the figure show the number of members at each level of this family tree. When you look at these numbers, you'll see the sequence 1, 1, 2, 3, 5, 8 and 13—the Fibonacci sequence—unfolding here.

This indicates that *immaculate conception*—or at least this one—is based on a Fibonacci sequence. But if people mate in the normal way, what sequence is that? First there's the baby, then the two parents, the four grandparents, the eight great grandparents—1, 2, 4, 8, 16, 32, the binary sequence. These two birth processes emulate the two primary sequences of life: the Fibonacci sequence is female and the binary sequence is male. So according to this theory, immaculate conception is female and physical copulation is male.

### Parthenogenesis

Figure 10-22 is a photo of a gecko, a little lizardlike being [the clipping, from the Tacoma, Washington, *Morning News Tribune* on January 15, 1993, comments on an article in the then-current issue of *Science*]. These geckos live in the Pacific islands, and this particular one is called the mourning gecko. They are about three inches long and are *only* female. There are no male mourning geckos—ever—on the planet, only female

The entire culture of mourning geckos are exclusively female, yet they keep having babies without any males around. The article says that they're all female, and they reproduce asexually by laying and hatching eggs without male help. How do they do that?

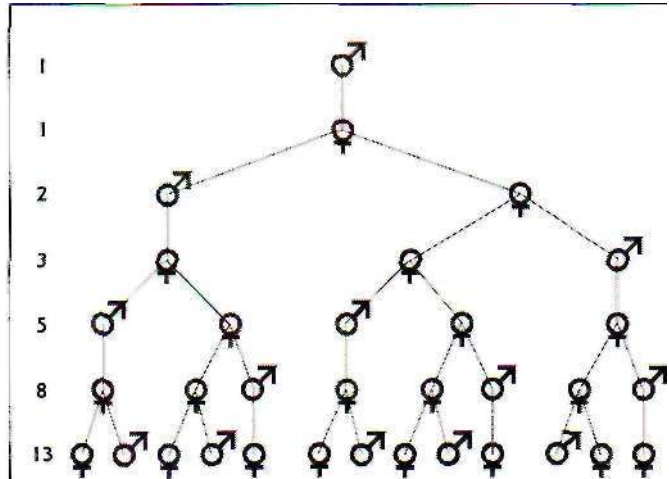

Fig. 10-21. Family tree of a male bee.

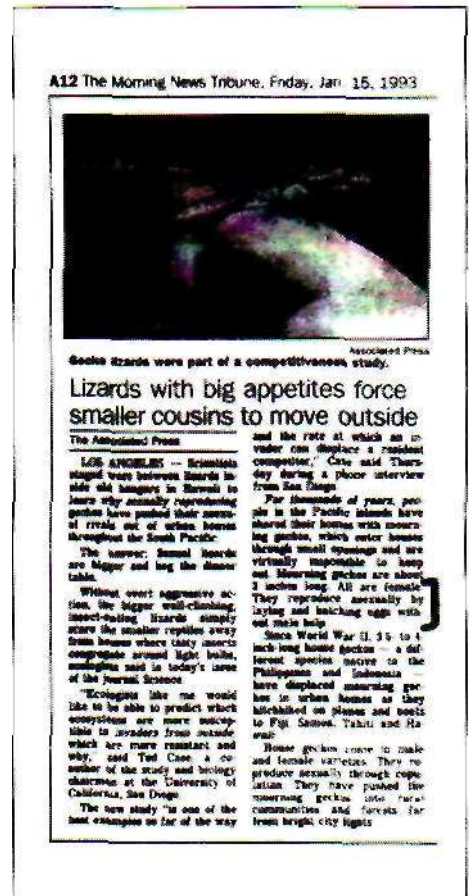

Fig. 10-22. Gecko in the news; an exclusively female species. Perhaps some readers can do more research on this subject.

Peter C. Hoppe and Karl Illmenser announced in 1977 the successful birth at the Jackson Laboratory in Bar Harbor, Maine, of seven "single-parent mice." The process was called parthenogenesis or virgin birth. However, "immaculate conception" would be a more accurate term, since the female does not have to be a virgin. In other words, they were able to take mice and, without a male, induce conception. How did they do that?

I had the good fortune to have a doctor in one of my workshops who had researched parthenogenesis and who had accomplished it in human beings. I was able to sit down and talk with him about it. According to this doctor, all a scientist needs to do is simply break the zona pellucida with a little pin. As soon as that happens, mitosis begins and soon a baby is born. It seems that breaking the surface is all that's necessary!

As I stated on page 189, the male does not necessarily contribute 50 percent of the chromosomes in a conception, which was always thought to be true. The female can contribute anywhere from 50 to 100 percent. Science has definitely established this as a fact. They've also found out something new about genes. Scientists had always thought that the function of each gene was fixed, that a certain gene did a certain thing. But now they've found that that's not true, either. A specific gene will do something totally different, depending on whether it comes from the mother or father. This has thrown another curve ball into the understanding of biology.

Since 1977, researchers have tried breaking the surface of the egg of all kinds of living forms. When they did it with female human beings, the woman would give birth to female babies—at least they've always been female so far—without male sperm. So it's now been established absolutely that this can happen.

Two other things: (1) These female children born through parthenogenesis are absolutely identical to their mothers and (2) in all cases the female children have been sterile. It seems to me that there's a lot more going on around this subject than we probably ever thought. This is true of many subjects we *thought* we knew so much about.

### Conception on a Different Dimension

After thinking about this idea of virgin birth for a long time, I came up with this question: When scientists induced parthenogenesis, is it possible that they might have created a baby that is based on a different principle? Is it possible that the female child isn't really sterile, but that she is no longer in a binary sequence, but the Fibonacci sequence? And is it possible that she can conceive *only* interdimensionally? They haven't thought about that because they've been watching to see if she can conceive *physically*. Interdimensionally means you don't even have to be on the same side of the planet—or even on the same planet, for that matter. You connect on another level of existence. This way of conceiving still has the sexual energy and the orgasm, but it does not require physically being together.

Here's another thing: When conception is created synthetically through parthenogenesis, when a sharp object is used to break the surface, it always ends up being a girl. I believe now that when mating is done interdimensionally, it will be a boy every time. Of course, just because Mary and Joseph had Jesus, a boy, and Krishna was a boy and *so on is not enough* proof to say it will always be a boy, but it looks like it. There has never been an exception that I am aware of.

## Thoth's Genesis and Family Tree

My attention to immaculate conception began a long time ago. I was doing geometry one day and Thoth was watching me. I was trying *to* figure out something he was trying to explain to me. Of course, the last thing in the world I was thinking about was immaculate conception, especially parthenogenesis. He asked me if I would I like to hear the story about his mother. I said, "Yeah, sure"—you know, while I was figuring out the geometry, not really too interested in his story. Then he told me a very unusual story. I didn't know what to think about it. He simply told me the story and left. After he left I wondered, What was *that* about?

He said his mother's name is Sekutet. I had the opportunity to *meet* her once, only once. She's an exceptionally beautiful woman, and she's about 100,000 years old, in the same body. Thoth said that after the time of Adam and Eve, when humans were learning to mate physically and go through the binary sequence, his mother did it in a different way. She found a man and *fell* in love with him, but they learned to mate interdimensionally. They had a baby boy—not a girl, but a boy. And in the process of having this baby, very much like Ay and Tiya [see chapters 3, 4 and 5), they understood immortality and became immortal.

This happened a long, long time ago, near the beginning of our race. Thoth's mother and her husband were part of the newly created race that was developed to mine gold. I don't know if they came from the Adam and Eve lineage or from the part of the human lineage that was supposedly sterile. At any rate, they figured out how to mate interdimensionally almost at the very beginning of our evolution. They might actually have been the very first ones to use this way to give birth.

## An Earth Lineage Travels into Space

When their baby grew up and became a man, his father, Sekutet's first husband, left Earth and went to the fourth-dimensional level of Venus, merged with their evolution and became a Hathor. This is referred to in Egyptian stories and myths. Over and over again their stories tell about how they would die and ascend to the level of Venusian consciousness.

After the father had left for Venus, Sekutet mated with her son interdimensionally and became pregnant again. She had a second baby boy, and when he grew up, her first son (the second son's father) went to join *his* father on Venus. After the first son arrived on Venus, his father



went to Sinus. Later, when the second baby was grown, Sekutet mated with *him* interdimensionally and had still a third son. When her third son was mature, the second son (the third son's father) joined *his* brother/father (the first son) on Venus. After the second son got settled on Venus, the first son left for Sirius. And after the first son got settled in Sirius, then his father (the *original* father) went on to the Pleiades. But the Pleiades was just the beginning.

This began a living lineage that traveled deeper and deeper into space, each son following his father out farther and farther. It's an interesting story. Thoth said that this has continued all the way from shortly after the Adam and Eve period in history up to the time of Atlantis.

Thoth's father, Thome, was one of the three who acted as the corpus callosum connecting the two sides of the island of Udal in Atlantis [see page 96]. At one point Thome left Atlantis—he simply disappeared off the Earth and went to Venus, leaving Sekutet and Thoth here on Earth.

But then Thoth broke the lineage. He married a woman, Shesat, and according to Egyptian legend, they had a baby, whose name was Tat [see page 123ff]. But Thoth said, "That's not true. It's more complex than that." He said that before he met Shesat, he mated with his mother interdimensionally, and that's who conceived Tat—his mother. He and Shesat did have a baby, which was *not* in the records; it was conceived in Peru and was a baby girl. She was physically conceived. So he says that he has the Fibonacci sequence, in his children with his mother, and also the binary sequence, simultaneously. According to Thoth, that's never happened before.

After telling me about his mother, he said, "That's that," and left. I wondered what that was all about. It was weird. Why did he tell me that? Later on he came back and said, "You really need to know more about virgin birth," and he told me to study it. So I started reading everything I could find on the subject. The more I read, the more amazing it became.

If you want to take the subject further, go ahead. You may find that having a baby can be a doorway into immortality. If you really do love someone and that person really loves you—if the love between you is true love—then you may have another option available, in terms of ascension through sacred marriage and interdimensional conception. Through your union you re-create the living holy trinity on Earth.

The experience that Ay and Tiya had with sacred marriage and birth on Lemuria now becomes clear. Perhaps there really is more to life than we know.

In the preceding pages we have explored parts of the feminine pathway, the Left Eye of Horus Mystery School. Realize that your emotions and feelings need to be balanced and that you simply must overcome your fears before you can truly work with the lightbody's energy field, the Mer-Ka-Ba.

## The Flower of Life Seen from the Feminine Side

We will now examine one more aspect of Egyptian philosophy from a purely feminine point of view, from the way the Left Eye of Horus Mystery School would see it. What follows can also be seen as proof that the Egyptians knew about the Flower of Life and *lived* it.

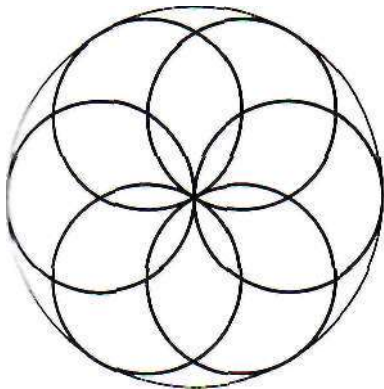

rs- 10-24. Genesis pattern within a circle (turned 30 degrees).

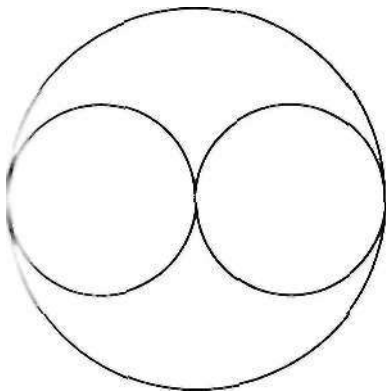

r~4- 10-25. Two circles circumscribed by a large circle.

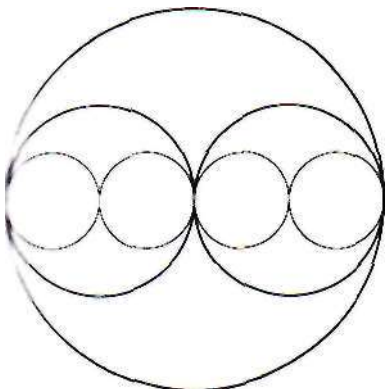

Fig. 10-26. Doubling the circles.

We're going to unfold the Flower of Life in a completely different way than we did before. We're going to look at it in a right-brain feminine way rather than a left-brain masculine way as we did earlier. It will not have a male logic as it did before, but a female logic.

We will begin, as we did earlier, with the Flower of Life [Fig. 10-23]. There's a certain image inside the Flower of Life that we will bring out. If you remove the Genesis pattern and put a circle around it, you get this image [Fig. 10-24]

Then after you take out the four circles on the top and bottom of the large circle, you get this image [Fig. 10-25]. As you can see, this image is derived from the Flower of Life.

Now, once we have this new image, we're going to use it over and over. We'll take the image of the two circles and make half-size circles inside the medium-size circles [Fig. 10-26]. We keep making half-size circles in each of the smallest circles, until we have Figure 10-27.

Remember the zona pellucida and the egg? Remember how the egg first went within itself to understand how life works, then when it got to the morula stage, or the apple shape [see page 192], it



Fig. 10-23. The Flower of Life

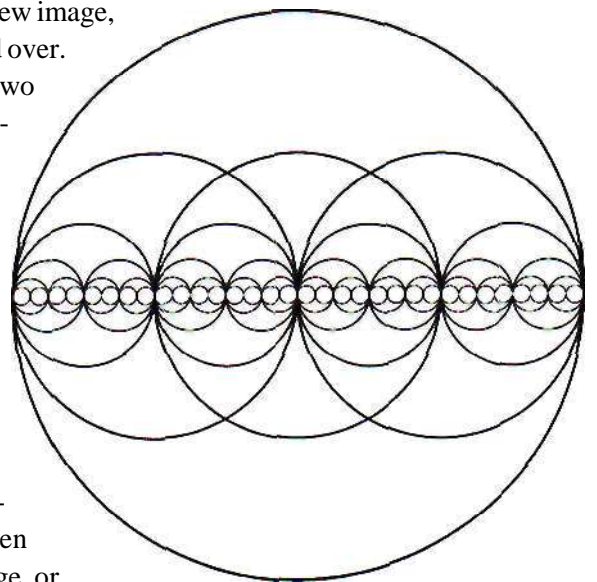

Fig. 10-27. A string of circles.

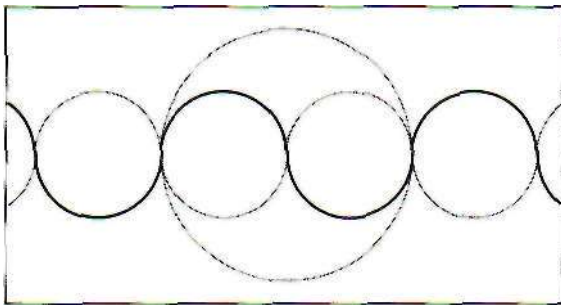

Fig. 10-28. Sine wave going beyond itself.

went out beyond itself? I would like to show you this same idea geometrically. This pattern you see in Figure 10-27 is in a binary sequence; you have 2 circles, then 4, 8, 16, 32 and so on. When the egg first went within, it did so geometrically. So geometrically, you can go *into* a pattern to discover how it can go *beyond* the pattern. You can go within a pattern to see how the sine wave works in order to go beyond the original pattern [Fig. 10-28]. The dark line here shows the sine wave of the pattern in Figure 10-25 continuing beyond the original pattern. Once this is understood, life can go beyond itself. Life simply needs to know how something

works geometrically in order to use it in larger patterns. As above, so below. So with this understanding, we will look at the Flower of Life again, but in a different way.

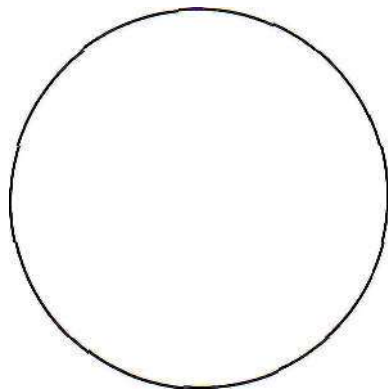

Fig. 10-29. A circle, the basic pattern.

The basic principle of the Flower of Life is a circle, or a sphere [Fig. 10-29]. And in every circle, no matter what its size, seven smaller circles can fit exactly inside it in this pattern [Fig. 10-30]. This is an eternal truth.

You see this in the Flower of Life, where there are seven primary circles hidden inside the larger circle. This relationship of 7 in 1 is also the basis of the Fruit of Life pattern. In the Flower of Life the Fruit is hidden in such a way that when you finish all the unfinished circles around the outside edge, one more vortex rotation *beyond* that leads to the Fruit of Life—*outside* the pattern [see Fig. 6-12].

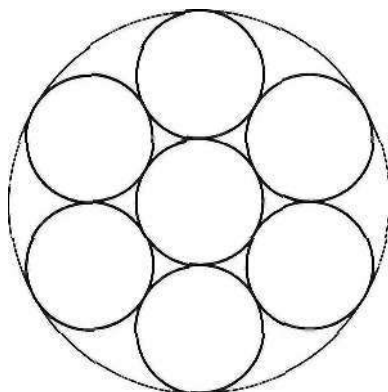

Fig. 10-30. Seven circles in one.

But there is a way the Fruit of Life can be obtained *within* the system. All you do is use the *radius* of the middle circle (or any of the seven) as the *diameter* of your new circles, starting the first new circle in the center of the original seven-circle pattern. Then you line them up, and when you've drawn twelve circles beyond and around the center one, you have the Fruit of Life *inside* the pattern [see Fig. 10-31].

You can see that you come directly to the Fruit of Life by going *within* rather than without as we did in earlier chapters. You can see the incredible harmony that moves in this geometry. Is this not the same with music? Seven notes are in the octave, and *within* the octave are the five additional notes of the chromatic scale.

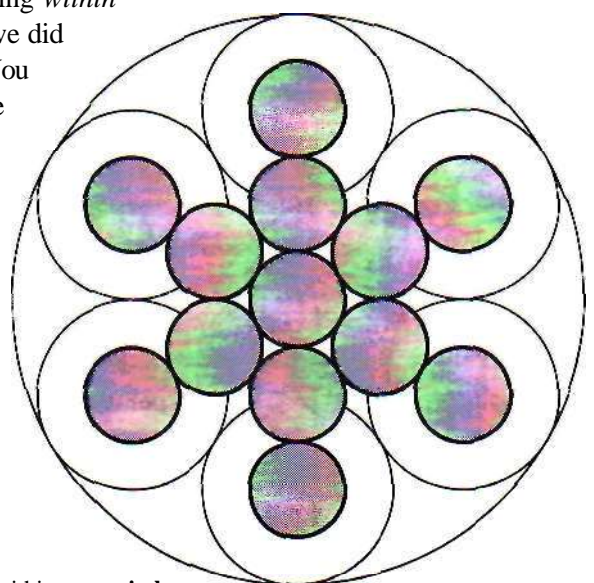

Fig. 10-31. Thirteen circles within seven circles.

I was next instructed to continue that process, so in Figure 10-32, I used the radius of the mailer circles as the diameter of an even smaller series of circles and expanded them out over the page.

You begin to see something that isn't certain set, but it looks like the Fruit of Life is holographic. In other words, you see 13 circles connected to 13 circles connected to 13 circles connected to 13 circles and so on—little Fruits of Life all around, perfectly and harmonically arranged on the page.

Once again, if we draw a series of even smaller circles using the radius-to-diameter proportion, we get the grid of circles in Figure 10-33.

I deliberately did not extend the grid over the whole pattern so that you don't get lost in the maze. You can see again that it keeps repeating, 13 circles connected to 13 circles and on and on. If you keep doing this, the grid will continue forever, yet inside, perfectly harmonic within each pattern and fully holographic, in what is called a geometric progression. You can go *inward* forever and you can go *outward* forever, because a circle around the whole drawing would simply be the central circle of a still larger grid.

This geometric progression is *similar to the Golden Mean* ratio—it has no beginning and no end. And when you have these no-beginning-and-no-end situations, you're looking at something very primal. It was this understanding that enabled us to do certain things in science, such as theorizing the creation of an infinite storage bank for a computer that would be considered impossible by conventional mathematical thinking.

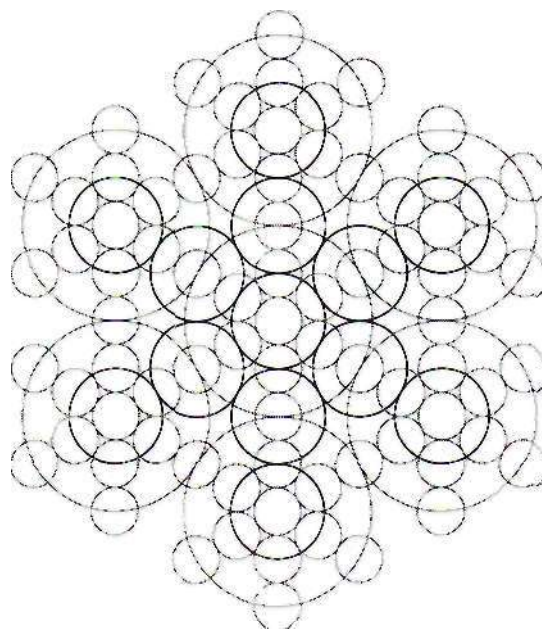

Fig. 10-32. Going one more **radius within**, or reproducing at half size.

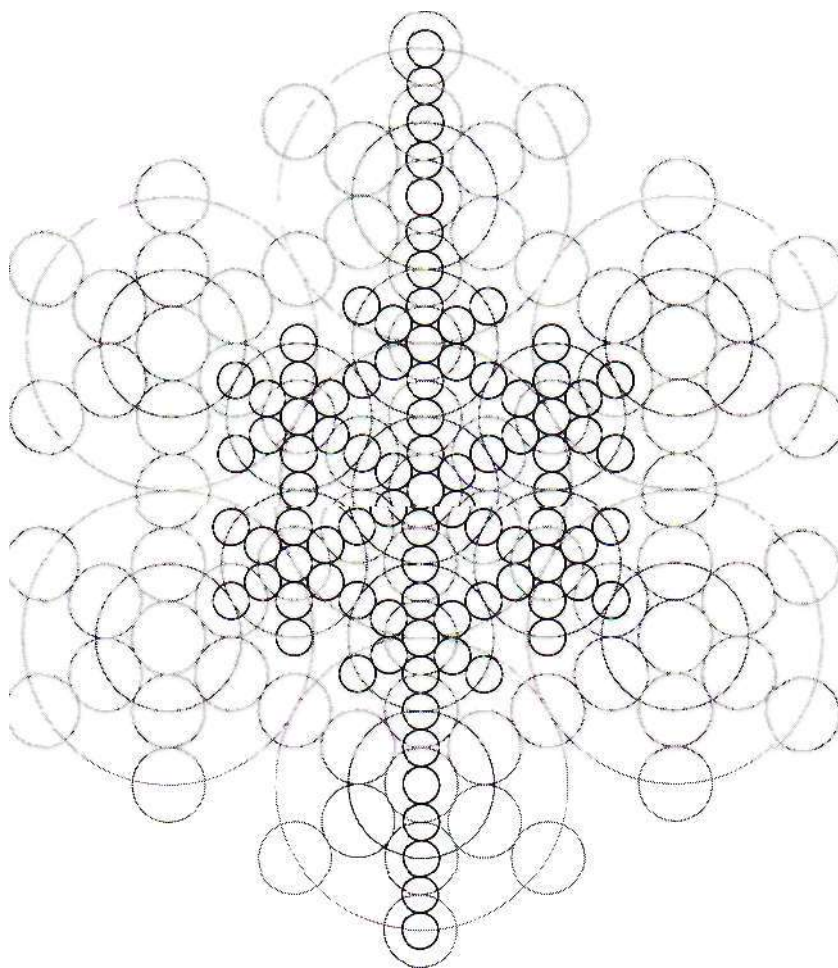

Fig. 10-33. Going inward one more radius.

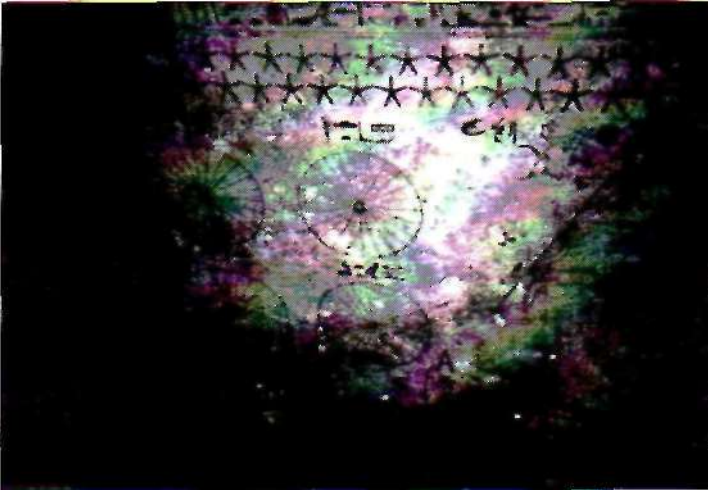

Fig. 10-34a. Egyptian wheels on ceiling.

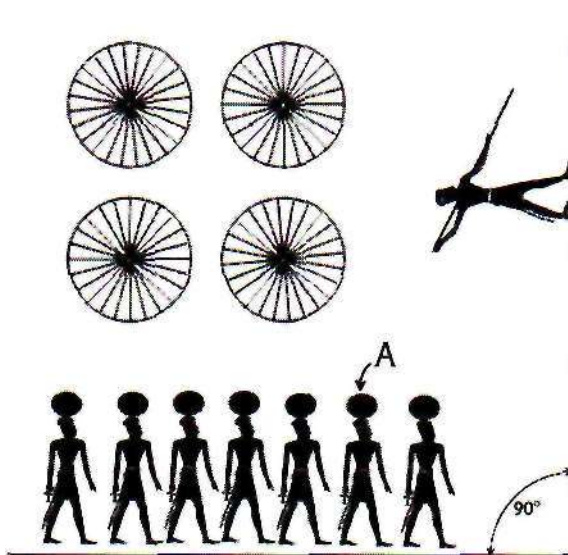

Fig. 10-34c. Simplified schematic of the wheels on the ceiling.

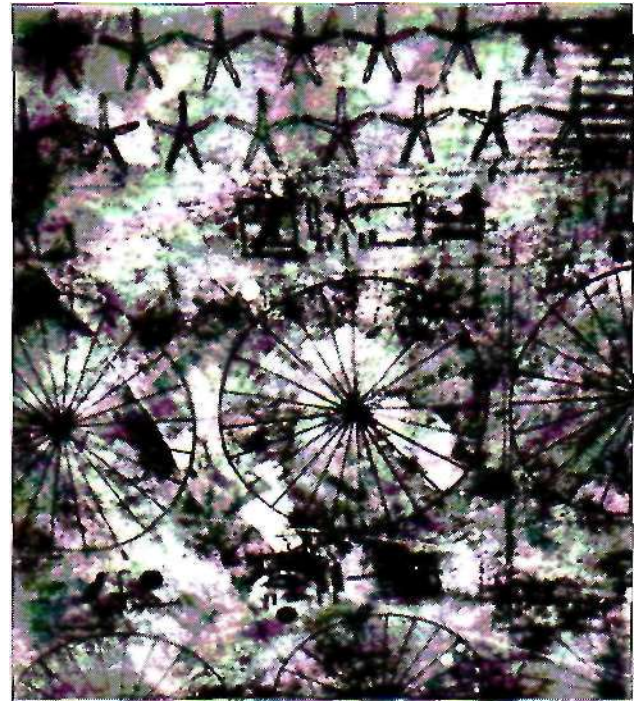

Fig. 10-34b. Detail of wheels on a different ceiling.

Now that we understand how this new grid works, let's see what those wheels represent that were found on the ceilings of Egyptian tombs **that** we showed you in chapter 2 [pages 42 and 43]. Here are two of those photos [Figs. 10-34a and b] and a simplified schematic [10-34c]. No one knows what they are. Perhaps what follows will give one answer. [See descriptive text later, on page 293.]

First, observe in Figure 10-35 the beautiful geometric harmony of this circular grid from Figure 10-32 over the Flower of Life. See how this flows with perfection. See how this proves its source—the Flower of Life!

Now see how the star within the star of the Fruit of Life moves harmonically over this grid [Fig. 10-36]. In Figure 10-36b I have rotated the star within the star and the entire grid 30 degrees. You can still see the star tetrahedron inscribed in the sphere, but now you see it lying on its side. Figure 10-37 is a polar grid from chapter 8. See or sense how these two inner Fruit of Life patterns could be overlaid and that they would be harmonic.

As a side note, these two drawings, if superimposed, would be a partial top view of your personal energy field, which is about 55 feet across, about 27 feet from your center to the circumference. You contain all these geometries around you. When you look carefully at these various drawings, you'll see

that they can all be overlaid, superimposed one over the other, over the other, over the other. As you study these drawings, you begin to see a single image emerging, all from the Flower of Life.

We have already seen how the image in Figure 10-38 is limited to the harmonies of music [see page 222]. And we have seen how the harmonies of music and the dimensional levels are interrelated, and that the differences in the cycles per second between musical notes and the wavelengths of successive dimensions or universes are proportionally exactly the same [see pages 45-47]. Since you know that this drawing is linked with

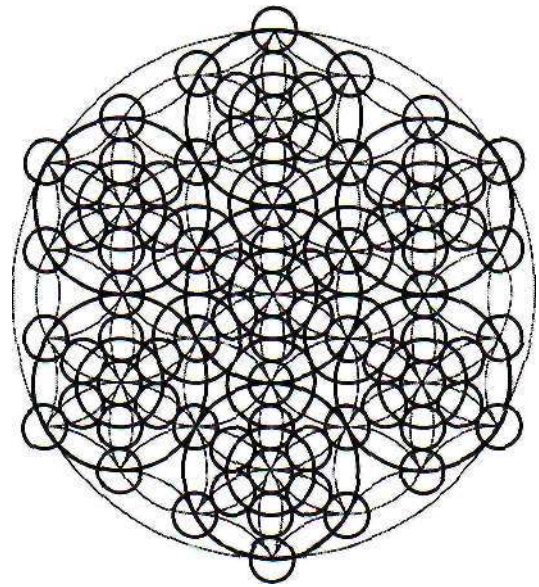
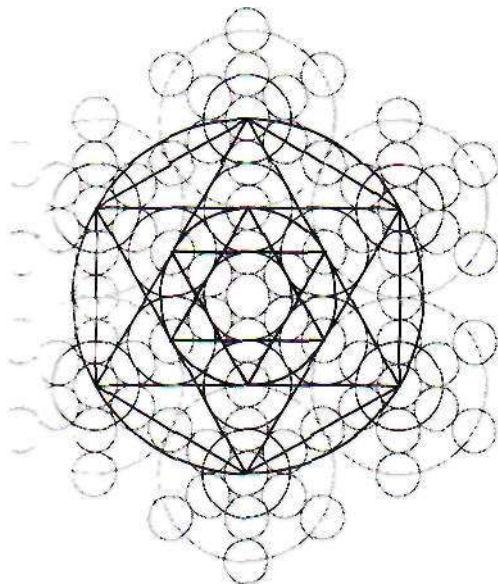

Fig. 10-35. The Flower of Life and the new grid.



I ~36. The star within the star of the Fruit of Life.

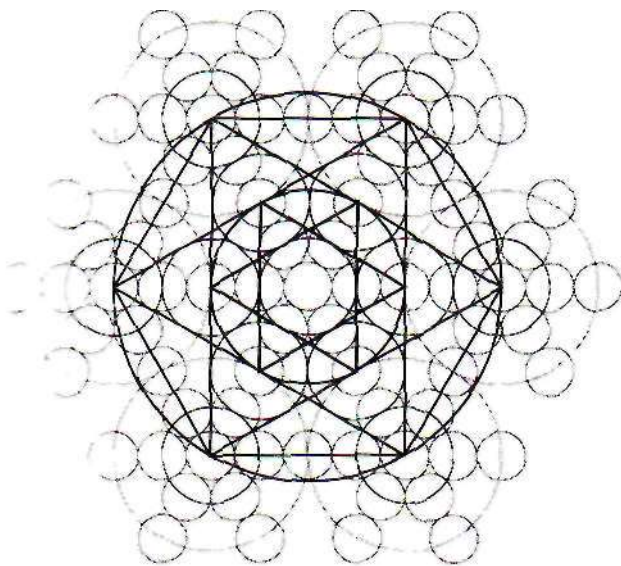

Fig. 10-36b. The star within the star of the Fruit of Life rotated 90 degrees.

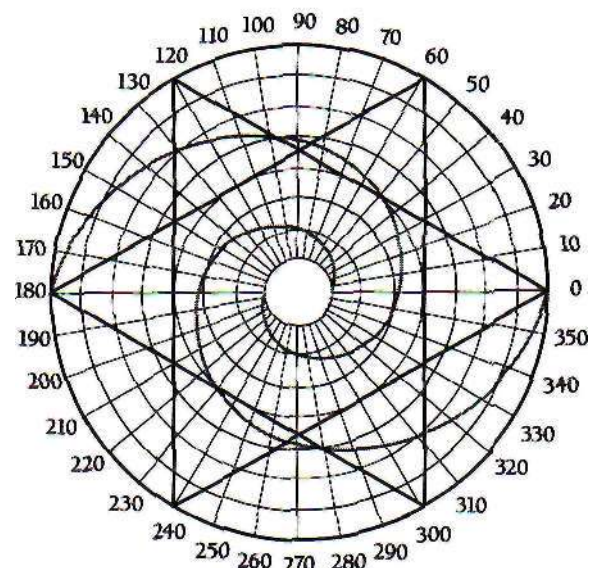

Fig. 10-37. The star tetrahedron inscribed in a circle and over a polar grid, from chapter 8, page 223.

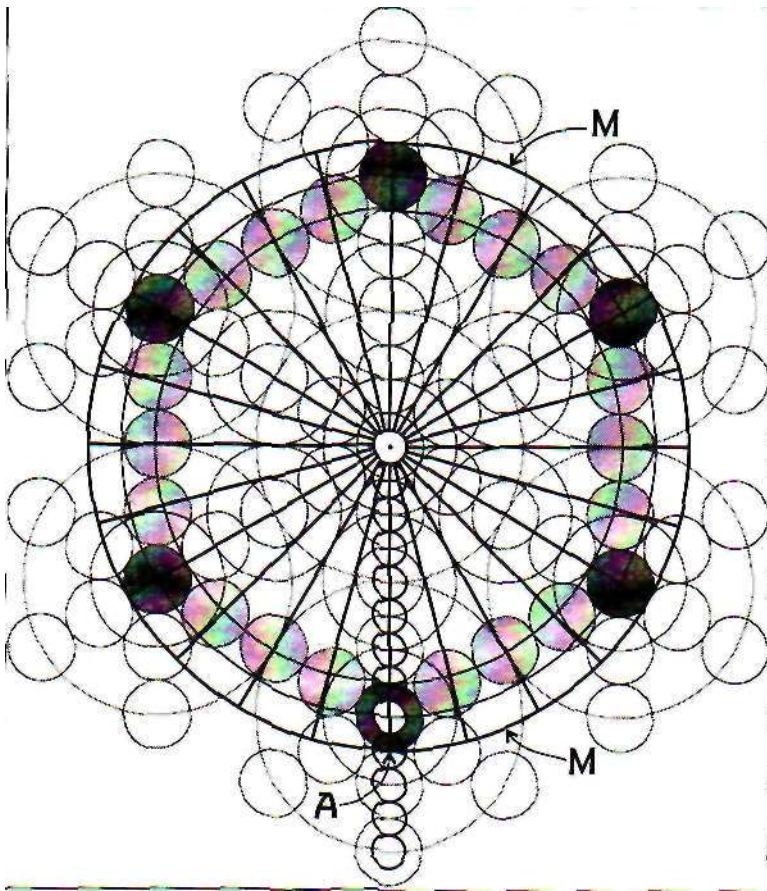

Fig. 10-38. The secret key.

the harmonies of music and sound, you can study this figure [10-38] to gain more understanding about the wheels on the ceilings of tombs in Egypt.

Notice first that there is a series of shaded circles in this grid that go around the center in a hexagonal pattern and that they are connected to each other. Exactly 24 of these little spheres are *couching each other*. If you scaled downward one more level to the next smaller-size circle, like the little one in the middle of the drawing, you would discover that there are exactly nine diameters of these smaller circles between the center and the edge of the outer circle at M, which contains the 24 connecting circles. The outermost of these nine circles is indicated by arrow A, and the count of nine includes the radius of both the central circle and the outer circle as one diameter. You can see these nine diameters; you don't need to measure them. Now notice the dark outer circle, shown by arrows M, that fits around all those 24 spheres perfectly, and the 24 radial lines that cross only 12 of the centers of those circles. The other 12 radial lines are at the circumference of the next larger size circles.

### Wheels on the Ceiling

That circle M and the 24 radial lines produce an image that is identical to the wheels on this Egyptian ceiling [Fig. 10-39] shown again here.

Do you remember near the beginning when you saw a picture of those wheels on the ceiling? It was among the first photos I showed you [page 42], and I said that those were proof that the Egyptians understood the information that was in the Flower of Life, and that this wasn't just some funny little design on an Egyptian ceiling. Now I'm going to show you what I believe they are, at least in a right-brain way, so you'll be able to understand the way the ancients thought.

I've had every part of these wheels in Egypt carefully measured. If you measure the diameter of the little hub in the middle and line up the same-size circles going from the center to the

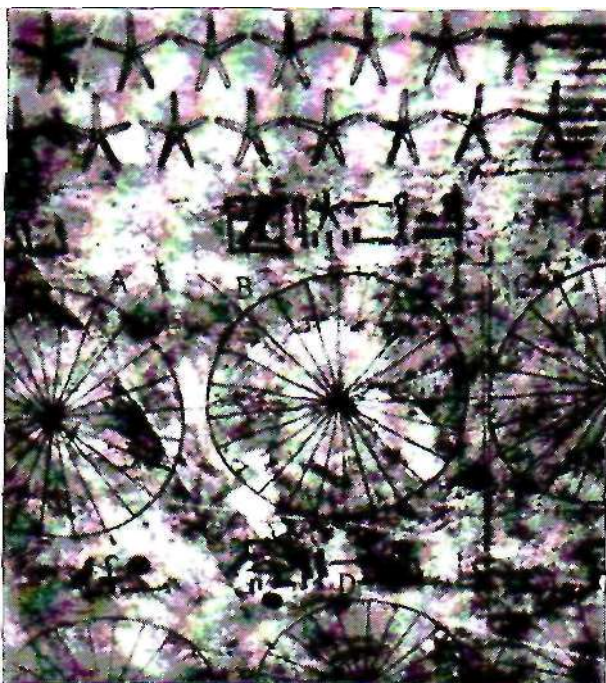

Fig. 10-39. The wheels A, B, C and D illustrate how the spokes do or do not line up with each other.

edge of the wheel, there would be exactly nine diagrams, showing that the proportions between the little circle in the middle, the outer circle and the 24 spokes are identical to the previous two images [Figs. 10-37 and 38].

Arrow A [Fig. 10-34a, more clearly in 10-34c] points out the Egg of Metamorphosis over the heads of the figures, who are making a 90-degree turn and are showing the progression of resurrection, I believe, based on the above geometries. These wheels are keys. They exhibit the proportions that indicate and precisely locate the dimensional level where these an----- Egyptians went. They left a map on these ancient ceilings.

You'll notice that each wheel is rotated differently [Fig 10-39], so that the spokes in one are not always lined up with those of the next. The lines between wheels B and C look like they're precisely lined up, but between wheels A and B and wheels B and D the lines are off center. They're all slightly turned to a different angle. I feel sure they're indicating the dimensional level or world where they went.

But no matter how you look at it, whatever these wheels are, the fact that they painted them on the walls means that they understand the deeper geometry within the Flower of Life. It took tremendous knowledge to arrive at these designs; it could not have been an accident. So from my point of view, we *know* they knew about the Flower of Life. The Egyptians knew at *the* very least what we're talking about here, and more than likely they understood the Flower of Life on levels of life that we in modern times are just now beginning to remember and understand.

### The Geometry of the Egyptian Wheels

Now, in order to complete the geometrical understanding of these wheels on the ceiling and other Egyptian hieroglyphs, I offer the following. There are two other Egyptian hieroglyphs that are equally important coming from these same drawings, and it is clear to me that they must be integrated if we wish to truly understand more about what the Egyptians were expressing.

In Figure 10-40 I revert back to an older drawing that shows the Fruit of Life pattern in a deeper progression. Notice that these six dimensions separate the drawing into exactly six parts, each at precisely 60 degrees.

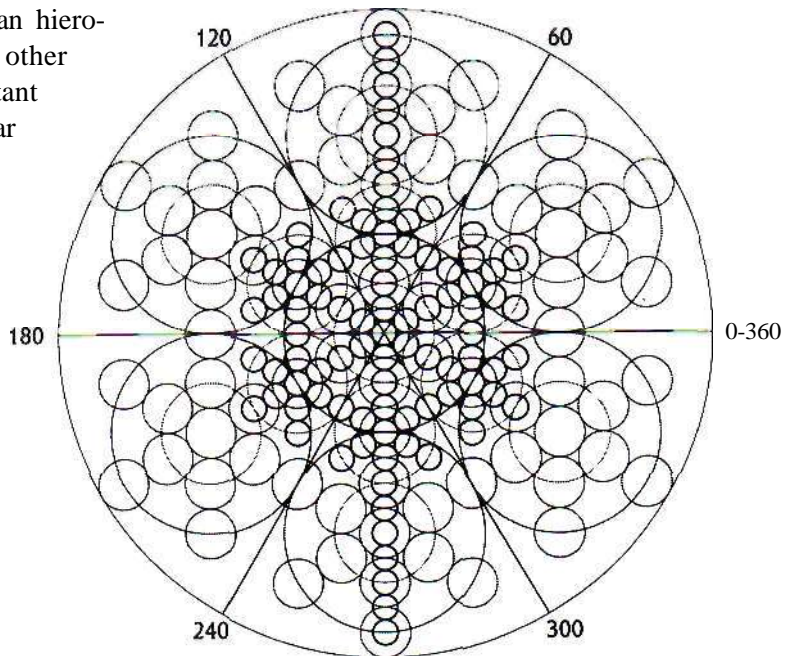

Fig. 10-40. Fruit of Life with 6 divisions.



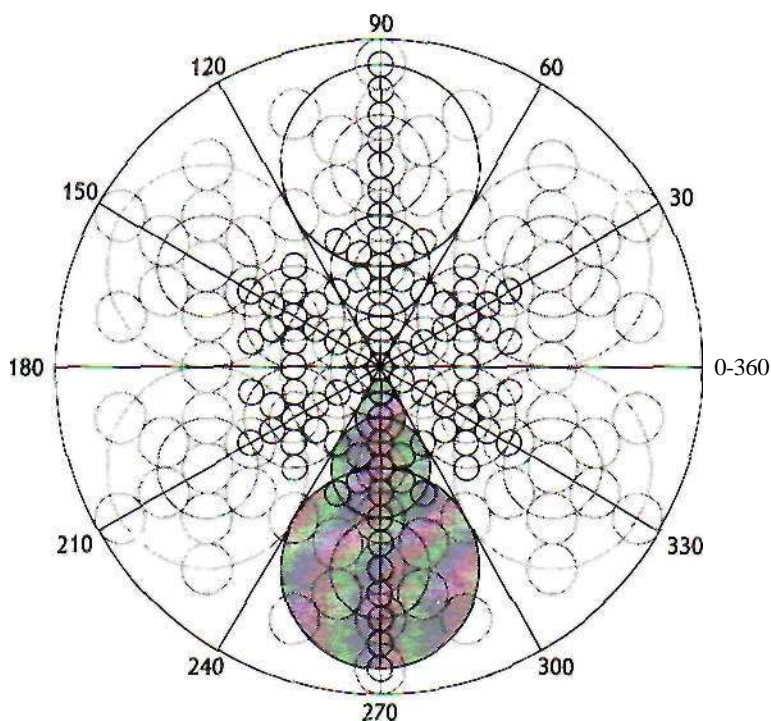

Fig. 10-41. The shaded circles show the 60-degree angle, and the lines running through the center of the Fruit of Life show the 30-degree angle.

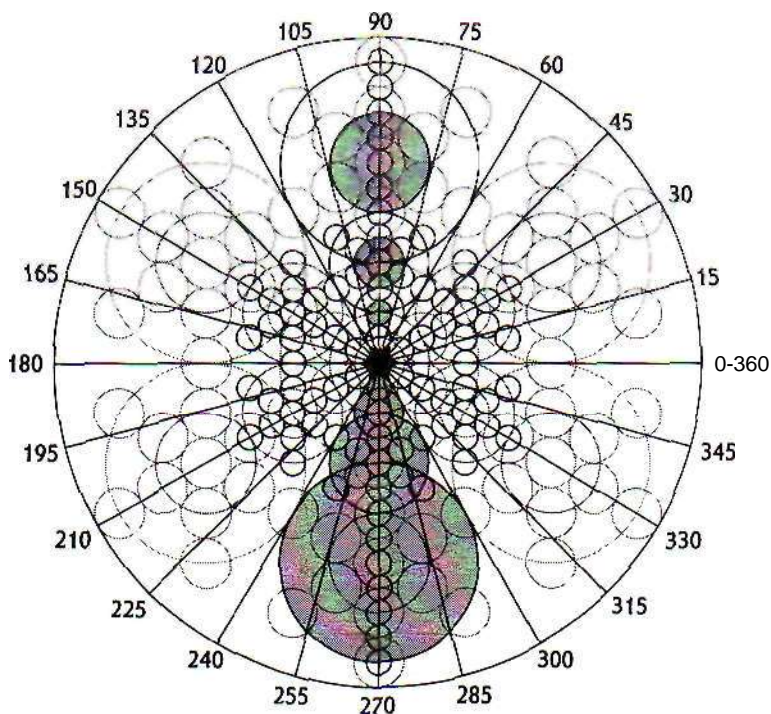

Fig. 10-42. The circles between 75 and 105 degrees at the top of the wheel also show the 30-degree angle.

In Figure 10-41 in the bottom and top 60-degree arc you can see the circles that exactly define this arc. If you then draw the lines down the middle of each arc defined by the center of each Fruit of Life pattern, you arrive at the next six secondary divisions, resulting in 30-degree divisions on the outer wheel. This divides the outer circle into 12 divisions, and is, of course, the wheel the ancient Egyptians used at the Temple of Dendera to define the astrological chart, divide the heavens and group the star patterns.

Continuing in Figure 10-42, the shaded circles in the upper 60-degree arc define the 15-degree arc on either side of the central line at 90 degrees, from 75 to 105 degrees. What is left over in this upper 60-degree arc is exactly two 15-degree arcs, dividing the outer wheel into exactly 24 divisions—the precise geometry found in the burial ceilings in Egypt.

Since these 24-division wheels were also found on the ceilings with five-pointed stars that represent the stars, it would only make sense that they were related to the astrological chart at Dendera, by which the Egyptians were plotting their way into the heavens. More proof of this idea can be seen directly from the astrological chart at Dendera [Fig. 10-43]. Notice that there are eight males and four females on the outside of the "wheel," supporting it. This represents the 12 divisions of the heavens. But also notice that they have 24 hands actually holding this wheel. Then notice that directly inside the wheel are 36 images. All three primary divisions of the wheel are in this image at Dendera: 12, 24 and 36.

Further, if you examine Figure 10-44, you will see something pretty amazing. At first this drawing will seem a little confusing, but it will unfold clearly. Look first at the 30-degree line and see the seven circles (starting with the number zero) moving from the central one out to number 6. The white circle number 1 was used to define the six divisions of 60 degrees. The white number 2 circle was used

to define the 30-degree arc of the 24-division outer wheel. The third circle will break the outer wheel into 20-degree arcs and, when split in half, create 10-degree arcs, the same 10-degrees of the polar graph that is believed to come from Egypt. (If it didn't, it could have.) Look at the 150-degree line with its shaded number 3 circle. Finally, the two shaded circles on either side of that dark circle number 3 define the same 10-degree angle, splitting the entire 60-degree arc into six 10-degree divisions, which, when completed in all six divisions, results in the 36-division outer circle of the polar graph.

Notice the math. The first circle is a full 60 degrees. The second circle is 60 degrees times one-half = 30 degrees (the 24 outer circles). The third circle is 60 degrees times one-third = 20 degrees (the 36-division circle). If we were to continue, the next circle, the fourth, is 60 degrees times one-fourth = 15 degrees (48-division circle). The fifth circle is 60 degrees times one-fifth = 12 degrees (60-division circle). Finally, the sixth circle is 60 degrees times one-sixth = 10 degrees (72-division circle).

The last one would create the polar graph directly, and it must be noted that dividing the outer circle into 72 divisions creates the platform to move into pentagonal geometry, since the angle of the pentagon is 72 degrees. Now female geometry would begin to form.

This subject has hardly been touched, but it seems very interesting. The 12-division wheel defines the heavens; the 36-division wheel defines the Earth, and the 24-division wheel is between the Earth and the heavens.

Update: Days before printing this book, an anomaly was discovered as we were checking the math on the final diagram. At first I was going to completely rewrite this section, but then I decided that future researchers may need this example and understanding of how a mistake can lead in even greater discoveries. So I have left it as *it* is because the essence is correct, and simply present the evidence.

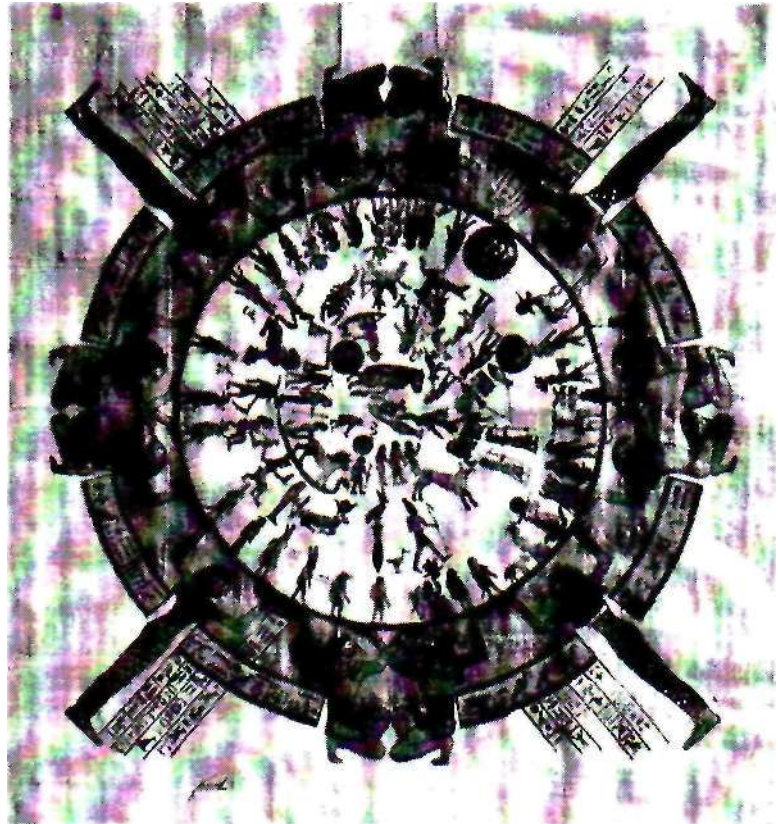

Fig. 10-43. Astrological chart at Dendera.

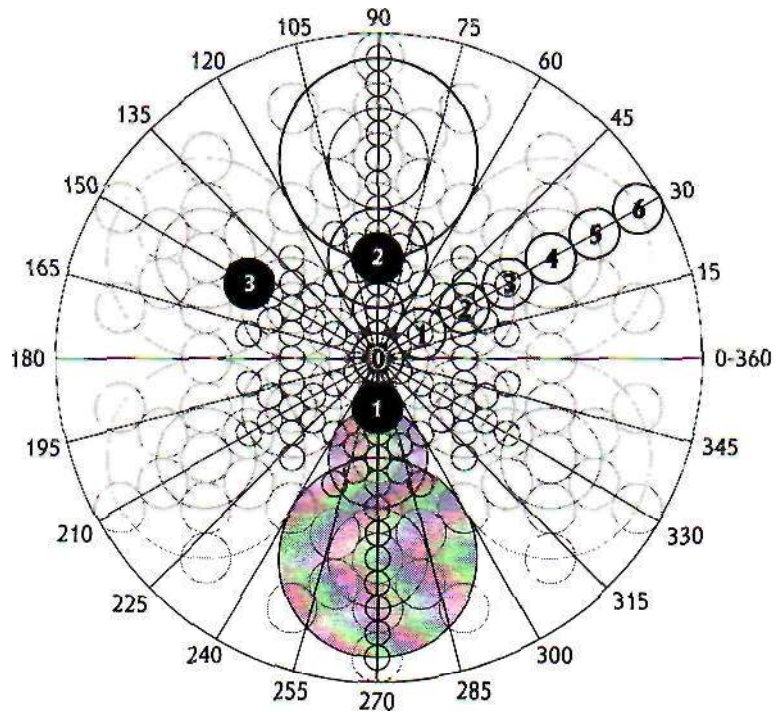

Fig. 10-44. The circles, 0 through 6, show the different angles of the different wheels.

First of all, sacred geometry is an exact science. There are no mistakes whatsoever. In all of sacred geometry I have noticed that whenever something "looks right," it probably is—but not always. However, whenever something is proven to exist in a geometric progression within a specific drawing, all related progressions within that first progression should also be true. I have never seen this not to be true.

So what is the problem?

In the progress of the first six divisions of the outer circle at 0, 60, 120, 180, 240 and 300 degrees in Fig. 10-40, they are absolutely perfect. The second set of six lines, creating the 12 divisions in Fig. 10-41, are also perfect. It is clear that the circular progression, as emphasized at 90 and 270 degrees, separates these lines at exactly 60 degrees and the central line into two exact 30-degree divisions. This is positive.

But when looking at Fig. 10-42, the internal circular progression inside the original progression does not apparently continue in further progressions. The math shows that the lines at 75 and 105 degrees do not perfectly fit the circle. Each line is off by about one-half of one degree—such a small amount you can barely see. So what does this mean?

When the wheels were measured, it was assumed that the divisions were equal, but perhaps this is not the case. If the ancient Egyptians were using these wheels to map space and the Earth, what is important? Is it more important that the divisions are equal or that they conform to the actual geometries? If they were using this pattern out of the Flower of Life, then the actual geometric progression would be important, since no matter how far the progression expanded into space, the map would be perfect.

This means that someone must go to Egypt and with extreme accuracy measure these wheels to know the truth. If 12 of the lines are perfect and 12 are off this tiny bit and they conform to these geometries, then a deeper understanding of ancient Egypt would become apparent. We could re-create the map.

There are other possibilities, but this is up to you to discover.

At the end of this book will be a short message to announce a new Internet Web service to the world that will enable us to find the truth not only of something like the above, but the truth of almost any subject.

My prayer is that you will become a spiritual researcher seeking the truth. For in the truth we will not only discover what wheels on ancient Egyptian ceilings mean, we will find our true selves. ^

## Ancient Influences on Our Modern World

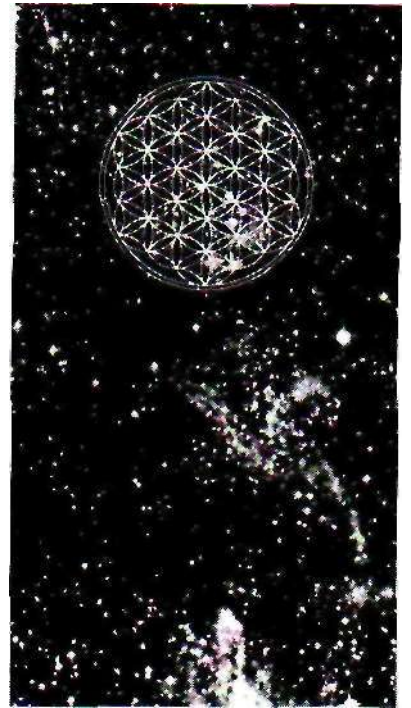

This is the Golden Mean rectangle [Fig. 11-1; see also chapter 7] derived from the pyramids, which can be recognized only when seen from the air. This Golden Mean spiral approaches the pyramid complex from over a mile away (at A) and passes over the center or apex of each of the three pyramids in the Giza complex. The Fibonacci spiral appears almost identical as it passes over the pyramids. As we saw in chapter 8, the Fibonacci sequence approximates the Golden Mean. What this means is that its source is in a slightly different place from that of the Golden Mean. They start out differently but soon become almost identical.

The Golden Mean spiral's connection with the Giza complex was discovered more or less recently, around 1985, whereas the source of the Fibonacci spiral was discovered about ten years earlier and given the name, the Solar Cross. No name has been given to the source of the Golden Mean spiral as far as I know.

This Golden Mean spiral at Giza is very interesting. The Egyptians put a stone pillar over the exact center or source of this spiral as well as one on either side—three pillars. I haven't physically seen this one yet. (I actually walked right by it the first time I was in Egypt but didn't know it was there.) According to the McCollum survey [*Giza Survey: 1984*], which was done in 1984, there are three pillars there. When John Anthony West went there, he said there were *four*, so I don't know—they're either growing or somebody was mistaken. Not only do these pillars mark the center of the vortex, but they also mark the diagonal line B very, very carefully; they wanted us to know about this line. Why? We will have to give some background information before we answer this question.

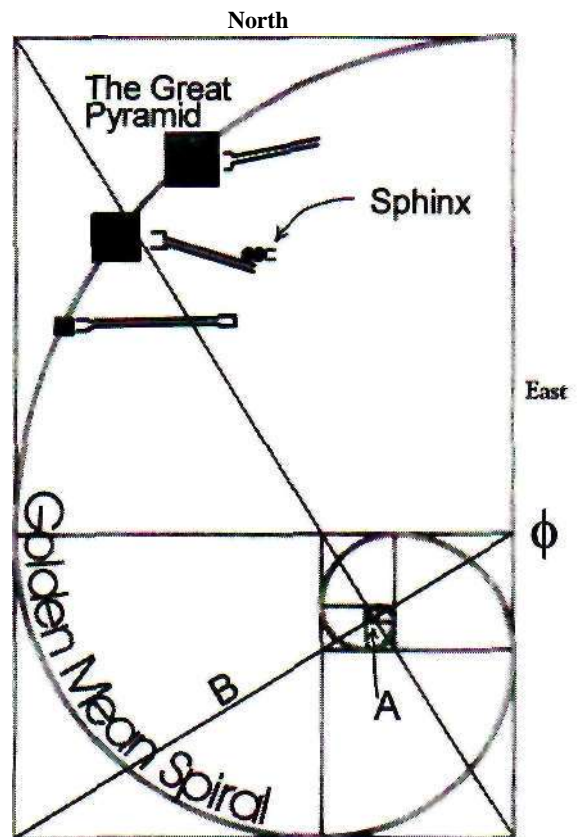

Fig. 11-1. The Golden Mean spiral. The phi symbol indicates one of the two places where the right vertical edge is bisected at a phi ratio of its length.

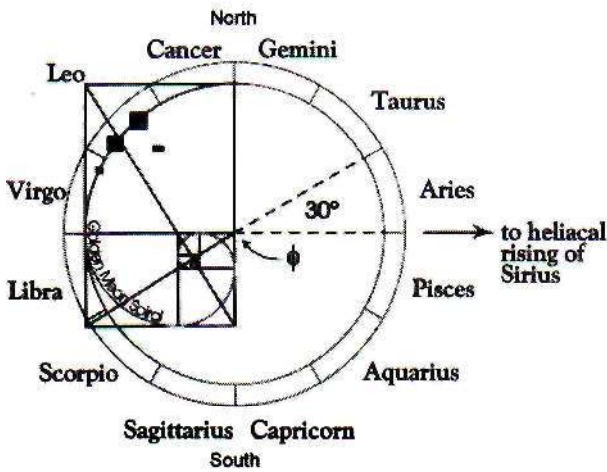

Fig. 11-2. Egyptian astrological wheel, Fig. 11-1 seen from farther away.

There's an enormous astrological wheel connected with the Great Pyramid complex that can be calculated only from the air [Fig. 11-2]. Making such astrological wheels that you can see only from the air is not unusual for the Egyptians if you follow the Druids, who came out of Egypt. The Druids went to Glastonbury, England, and created exactly the same kind of aerial view of the astrological wheel as in Egypt, except that it was more graphic. The one in England clearly shows the different signs on the ground, but it can be seen only from the air. Approximately five or six other Druid-made astrological wheels have been found in England that can be seen only from the air. So it seems to have been an Egyptian-Druid trait to create these wheels.

There is further proof located at the Dendera Temple in Egypt. High on a ceiling is a full astrological wheel similar to what we are used to. So we know the Egyptians knew about and used the astrological wheel. The only thing that was really different was the direction of movement of the heavens. The wheel was moving backward relative to modern observations.

The other bit of information shown on this drawing is that the angle between the ramp that comes off the Great Pyramid and the ramp that comes off the second pyramid is a precise 30 degrees [Fig. 11-3]. That's an important bit of information, which we will use in a minute.

From the McCollum survey we see that the ramp in Figure 11-3 that comes off the third pyramid points exactly to the other phi-ratio point on the long side of the Golden Mean rectangle that contains all these geometries. This is further proof that the Egyptians understood the geometric implications of the spirals moving out of these strange holes in the desert.

The placement of the Sphinx appears to be random, just sitting there out in the middle of nowhere, who knows why and what for? But now you know about the Golden Mean rectangle around the Giza complex that can only be known from the air. If you bisect that rectan-

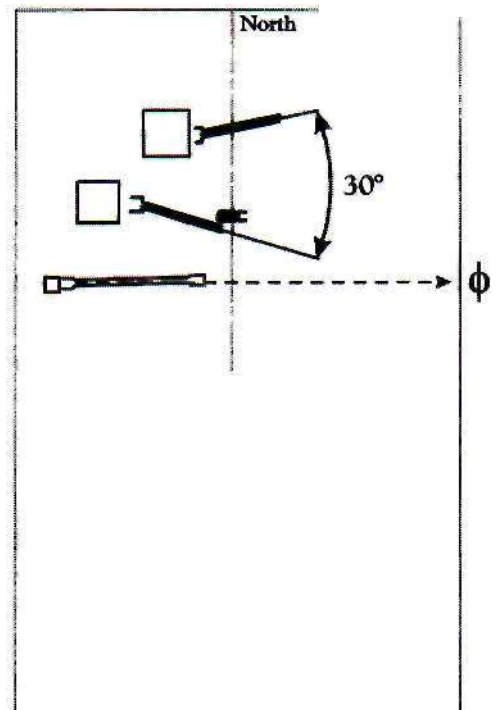

Fig. 11-3. The two ramps, showing the 30-degree angle.

Update: About two years ago we discovered the great secret to the entire layout of the Giza complex. It was the building that was located beside the "hole" from which we first thought the spirals arose. Since then we have discovered much more.

I originally said that the building next to the hole was a Golden Mean rectangle because this is what other Egyptian reports have said. But because of certain research we were doing, it became obvious that this could not be true. So I sent someone to Egypt to measure this building and tell me what it really was.

It was found to be a square with four outer chambers around it. It was in the exact proportions as

gle vertically [Fig. 11-4]—put your compass on the right edge and draw a little arc in the middle, then do the same from the left edge (like the compass lines at A show)—and draw a line down the middle, that line passes exactly through, and parallel to, the plane of the vertical front of the flat headdress of the Sphinx. Simultaneously, if you extend the line of the southern base of the second pyramid, it skims the right shoulder of the Sphinx, marking a specific spot [Fig. 11-5].

Figure 11-6 shows the flat headdress of the Sphinx. And the center of the long edge of that Golden Mean rectangle passes exactly through the front edge of the headdress. To put it another way, *the headdress* marks the precise center of the long direction of the Golden Mean rectangle, proving that the Sphinx was not placed in the sand at random. And the line of the south face of the second pyramid skims right along the surface of the shoulder of the Sphinx.

These two lines that mark this spot on the Sphinx are evidential, not perchance. For those of you who are involved in Edgar Cayce's work, you'll remember that about 60 years ago he said that someday we would find a room associated with the Sphinx that would lead to the records that were proof of superadvanced civilizations on Earth going back for millions of years, and that the opening to this room would be located in the right paw of the Sphinx. To be more precise, the pyramids' placement relative to the Sphinx is not random, since the Sphinx is older than the pyramids.

While we were in Egypt, we were told by Thoth that there would be 144 people—48 sets of three people each—who would come from the West to

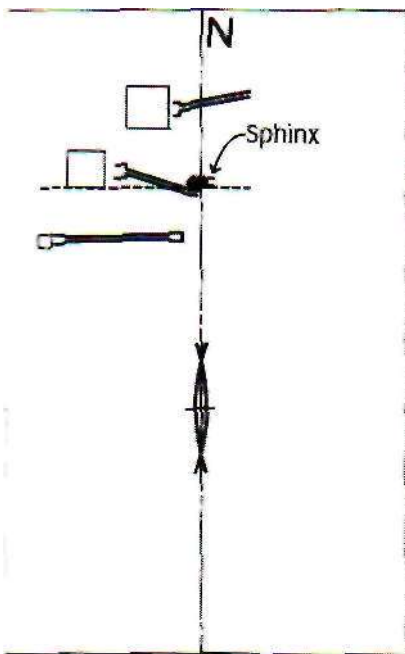

FIG. 11-5. The alignment of the Sphinx's right shoulder/paw and the second pyramid is shown in the horizontal dashed line within this Golden Mean rectangle.

Egypt. And that these sets of three would each have some thing specific to do there. Eventually one particular set of these sets of three would walk up to the Sphinx and enter this special room containing what Edgar Cayce called the Hall of Records. Thoth said their voices would open the way to one of three hallways deep under the sand that would lead to the Hall of Records. This room Japanese scientists have already found; Thoth said there would be a clay pot in the corner with some hieroglyphics on it that would tell them which of the tunnels they were supposed to move through. Even the clay pot has been found by the Japanese instruments, along with a coil of rope.

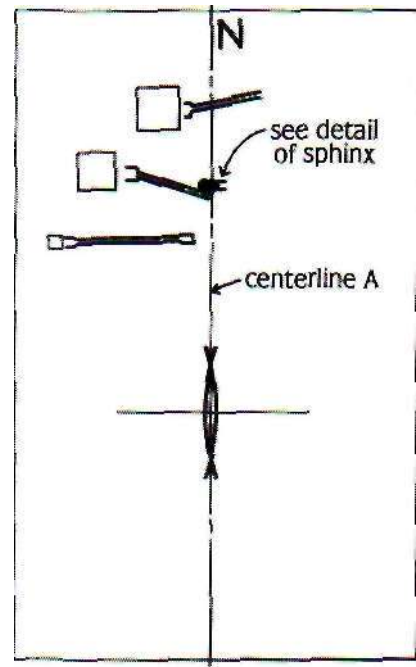

Fig. 11-4. The placement of the Sphinx. See the vertical bisecting line, created by finding the center of the Golden Mean rectangle (see curved lines made by a compass from each side). This line marks the vertical front of the Sphinx's headdress.

the drawing around Leonardo's body.

In this building were four pillars. Two were at the exact beginning of two Fibonacci spirals. One passed exactly over the top of the three pyramids and was no doubt the source of the Fibonacci spiral that had been previously discovered. The other one spiraled out into the desert in the opposite direction. This design was a square lattice pattern, the same as that around Leonardo's body. From this grid everything in the Giza complex was defined. It was the key to everything in Giza and possibly every major sacred site in the world.

The other two pillars seemed to be placed in a completely arbitrary position, but they were not. These two pillars were the source



Fig. 11-6. Sphinx with flat headdress. Scaffolding shows that reconstruction/stabilization were taking place.

of a series of pentagonal geometric progressions that defined the position of the Great Pyramid itself and everything in the Giza complex, but used a different system than the one above. A double check, perhaps?

We showed the Egyptian government this information. They responded by removing this building and destroying all signs of its original placement! It is as though it never existed. The ancient Egyptian building that is the key to all of Egypt has now been destroyed. Only God knows why. I guess they did not want people to know where everything was. -^

When I went there in 1985 with two other people, the Sphinx was sitting nice and flat and perfect, with no problems. We were instructed by Thoth to put a particular kind of sound down a tunnel that sat directly behind the Sphinx, about a quarter mile back. We were to make a specific sound for a certain length of time and then stop and leave, which we did.

I won't say that we were responsible for what happened, but when we went back there in 1990, the Sphinx was slanted toward its right shoulder. The Sphinx began to rotate, not a little bit, but a lot, and the right shoulder/paw kept breaking open. The Egyptians did everything they could to keep it patched up, as you can see by the scaffolding in Figure 11-6. The other thing is that the head of the Sphinx seems to be trying to fall off. Thoth said it *would* fall off someday, and when it does, it will expose a golden sphere in its neck that is some kind of time capsule. He didn't go into it very much. So those were two things the Egyptians were having a difficult time with—trying to keep the head on the Sphinx and trying to keep its right paw from breaking open.

Now, one final piece of information: Thoth said that under the Giza complex there was a city that would hold 10,000 people. He said this around 1985, and I talked about it publicly as early as 1987. The people who lived in this city would be people who had reached immortal status and had become part of what we call the ascended masters. They were what the ancient Egyptians called the Tat Brotherhood. About six years ago their numbers had reached just over 8000. This underground city is the place where the Tat Brotherhood lived in isolation while the rest of humanity continued to evolve. We mentioned this in chapter 4. Now I would like to give you an update on what is happening around this city in the past five years. It is important to know, but because it cannot be proven, please hold your judgment until the truth is finally revealed.

What I am about to say about the underground city in Egypt is highly controversial, and most Egyptian officials will not admit to any of it. They say it is all just somebody's imagination. History will tell. From what I know and have seen, they are not telling the truth. Egypt has a very good reason for you to not know about this city, at least not yet.

What I am about to say about the underground city in Egypt is highly controversial, and most Egyptian officials will not admit to any of it. They say it is all just somebody's imagination. History will tell. From what I know and have seen, they are not telling the truth. Egypt has a very good reason for you to not know about this city, at least not yet.

Update: Thoth came to me in about 1992 and said that he was going to have to leave the Earth and that his work with me was finished, at least for now. He said he was sorry, but the events on Earth had accelerated, and the ascended masters, the Tat Brotherhood and what many call the Great White Brotherhood (which are all the same) were about to venture into a new area of consciousness, an area no human being has ever entered before. He said that whatever happened would determine the outcome of human evolution forever. I have not seen him since. (See the update at the end of this section, because he has now returned.)

Thoth explained that in the summer of 1990, he and the rest of the ascended masters had decided that the consciousness of the Earth was about to reach a critical mass in January 1991 during the Egyptian window of January 10 through 19. He said that it would begin in August 1990, and at the following month the outcome would be determined. He said that the human population was still highly polarized, but that a special "moment" had arrived where great change could take place.

*They* saw that it was possible at this moment that we, the Earth, could become one in spirit and ascend to a higher level of consciousness exactly in the middle of the Egyptian window. Thoth made it clear that the ascended masters were not really sure what was going to happen. It depended on the hearts of the people of the Earth. The ascended masters had all decided to leave at once as a ball of living light, giving the Earth a tremendous burst into the new level of consciousness. Their leaving for a higher level of life was to be a decision for the good of all mankind.

However, when August 1990 came, Thoth said that the ascended masters

were not sure if we were going to make the shift (at that time), and that there would not be another window of opportunity for some time. They held back on their plan to leave. Later in August, Iraq and her assistants were the only energy in the entire world to evade unity on an outer level. By September 1990 the world had declared war on Iraq. And on exactly January 15, 1991, the moment in the middle of the Egyptian window when the ascended masters were hoping that the world would come together, we came together as an entire planet, except for Iraq, to wage war instead of peace. We missed the opportunity for unity by only one nation. This unity, however, was not just nations, but primarily the people of the world.

Instead, we went to war on that day—January 15, 1991—and the Egyptian window of opportunity moved us deeper into the darkness instead of the light.

Thoth and the ascended masters responded by setting up another plan where only 32 masters at a time would leave the Earth and attempt to find the place in the universe to which humanity was supposed to eventually translate. Leaving in small groups would be timed to certain events in human experience to (again) give power to these events. Thoth and his wife Shesat were part of the first group to leave. On an almost daily or weekly basis, the masters traveled in small groups into higher dimensions and a new way of being, a way that someday the rest of humanity would follow. As they left the city under the Great Pyramid, slowly the city became deserted. By the end of 1995 only a small group of seven beings remained behind to protect the city.

As this city emptied, it then could be used for another purpose—to prove



to the modern world that there is more to life than we know and that there is great hope for humanity.

Now let's talk about rumors. There is very little proof of what I am about to say, so hold it only as a possibility until the world knows the real truth.

In November 1996 I was contacted by a source in Egypt who said that something had just been discovered that was beyond anything that had ever been found in Egypt. The person said that a stone stele (a flat stone rock with writing on it) came out of the ground between the paws of the Sphinx into the daylight. This stele spoke of the Hall of Records and a room under the Sphinx.

The Egyptian government immediately removed the stele so that no one would see what it said. Then they dug into the earth between the paws and opened the room under the Sphinx that the Japanese had found in 1989. There was the clay pot and the coil of rope. The person said that the government traveled down a tunnel coming off this room into a round room that had three more tunnels coming off it. In one of these tunnels that headed toward the Great Pyramid, the government found two things they had never seen before.

First they found a light field, a sheet of light that blocked entry past this



point. When the government tried to pass anything through this light field, it could not penetrate it. Not even a bullet could pass through it.

In addition, if one of the government officials tried to physically approach this light field, at about 30 feet from the light he/she would get sick and throw up. If he tried to press forward, he would feel like he was going to die. No one, to my knowledge, was able to touch the field.

From aboveground, the government found something just past this light field that was also extremely unusual. They found an underground twelve story building at that point—twelve stories deep in the Earth!

The combination of these two things—the light field and the twelve-story building—were more than the Egyptian government could handle. They asked for foreign help. The Egyptian government decided that a particular man (whom I will not name) was the person who could turn the light field off and enter the tunnel. He would do this with two other people. One of these people was a friend I knew very well, so I was able to follow closely what was happening. My friend brought in Paramount Studios, which would be allowed to film the opening of this unique tunnel. Paramount had filmed the opening of King Tut's tomb, so they had a very good relationship with Egypt

They planned to enter, or at least attempt to enter, this tunnel on January 23, 1997. The government wanted several million dollars from Paramount, which they agreed on. However, the day before they were to enter, the Egyptians decided they wanted more money and asked for one and a half million dollars under the table, which outraged Paramount. Paramount said no, so everything was off. For about three months there was silence.

Then one day I heard that a different group of three people had entered the tunnel. I heard that they had entered and shut off the light field by using their voices and the holy names of God. The primary person in this group, who is famous and does not want his name mentioned, went to Australia and showed a video of the trip into the tunnel and the twelve-story building, which proved to be much more than just a building. The building went on and on for miles under the ground and was really the edge of a city. I had three good friends in Australia who watched this film.

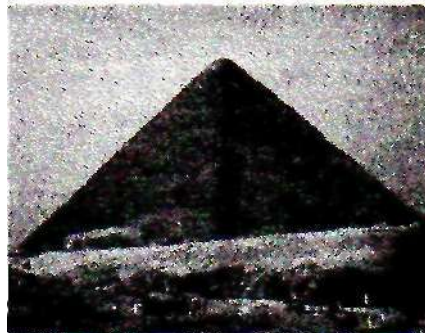

Then entered another person, Larry Hunter, who has been an Egyptian archaeologist for over 20 years. Mr. Hunter contacted me and began to tell me a story almost identical to what I had been receiving through my sources in Egypt, except that it was more detailed. He said that the city is six and a half miles by eight miles on the surface and twelve stories deep, and that the city perimeters are outlined by special and unique Egyptian temples.

What follows next overlaps the work of Graham Hancock and Robert Bauval in their book *Message of the Sphinx*. Graham and Robert had guessed that the three pyramids of Giza were placed on the ground in the exact arrangement of the three stars of Orion's Belt. In fact, they be-

lieved that all the major stars of the Orion constellation should be found in the placement of temples in Egypt but they were never able to completely prove this theory.

Mr. Hunter, however, has proven the truth of this, and I've seen the evidence. Using the knowledge of star navigation that he obtained when he was in the Navy, Mr. Hunter found a temple at every single location that corresponds to every major star in the Orion constellation. He used the GPS system to locate these spots on the Earth with a 50-foot accuracy, and physically went to each place where a temple should mark a star. Thus it was verified. In each place there *was* a temple—which was surprising—and each temple was made of a unique substance not found in any other temple in all of Egypt. This substance is also what was used to create the foundation stones of the three Giza pyramids, including the Great Pyramid. It is called *coin in stone*. It is limestone that looks like it has coins stirred into it. It is unique, found only in these temples that span an area on the surface of six and a half by eight miles.

To be clear, this is a theory that has not been accepted by the Egyptian government but the underground city that Thoth said was there that would hold 10,000 people is, according to Mr. Hunter, marked by temples made of a unique substance, and the temples match the star pattern of the constellation of Orion.

From what I have seen, I believe this to be true, but the Egyptian officials say this is fantasy. I am keeping an open mind. Eventually the truth will be known. I do believe that if this *is* true, this archaeological find will have an uplifting effect on human consciousness when the underground city is revealed. Now let's return to the discourse on Egypt. v

## The Heliacal Rising of Sirius

Here are the pyramids and the Golden Mean rectangle that surrounds the whole complex [Fig. 11-7]

Notice the two main lines that pass right through the center of the circle at  $\phi$  ( ). If we completed that circle on the ground, it would have a diameter of about two and a half miles. The McCollum surveyors who discovered this relationship, along with almost everyone who has ever written about the Giza complex, chose east as the direction the pyramids and the Sphinx were facing. But we now know that this is not correct. People have always believed that the pyramids were lined up to magnetic north-south, but computers have now show that the three pyramids were never aligned this way. They're off a tiny, tiny bit. People have said that the reason they were off this litde bit is because of continental drift.

But this "off a little bit" is not off at all—it's exactly correct. The three eastern-oriented pyramid faces are in a line that converges at a single point on the horizon—in other words, an arc. The point on the horizon happens to be the point of the heliacal rising of Sirius, which is not true east. This is the moment we talked about in chapter 1 (page 14), when on July 23 the star Sirius rises about one minute before sunrise, appearing as a bright red star. It is the moment when the Earth, our Sun and Sirius form a straight line.

Even more amazing is that the *eyeballs* of the Sphinx are looking at the same exact spot. This is what comput--- have shown. This makes sense because the ancient Egyptian religion and the Egyptian Sothic calendar were based on the heliacal rising of Sirius. Sirius was paramount to their very existence. So let's align this drawing to the heliacal rising of Sirius rather than to the east.

Because of the two ramps that were aimed exactly 30 degrees apart, let's divide the circle into 30-degree sections, which creates the twelve segments of the astrological chart ( $30 \times 12 = 360$  degrees). We already know that they totally understood astrology, because an entire astrological wheel was on the ceiling of the temple at Dendera [see Fig. 11-8], so it's completely logical to put those twelve segments in the circle. If you do, you have a very possible time wheel. The McCollum survey, for example, shows that when using this theory, the Great Pyramid sits in Leo and the time line of the point relative to 0 iegrees Aries is at 10,800 B.C. (This is exacdy the time when Edgar Cayce said it had been built.)

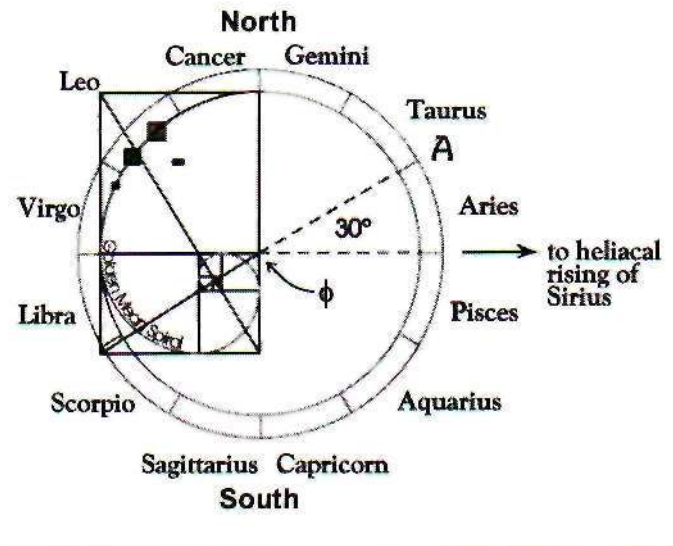

Fig. 11-7. Circular layout of the pyramid/Sphinx complex. Notice how the Golden Mean rectangle and spiral of the Giza complex touch the center of the astrological wheel at  $\phi$  ( ).

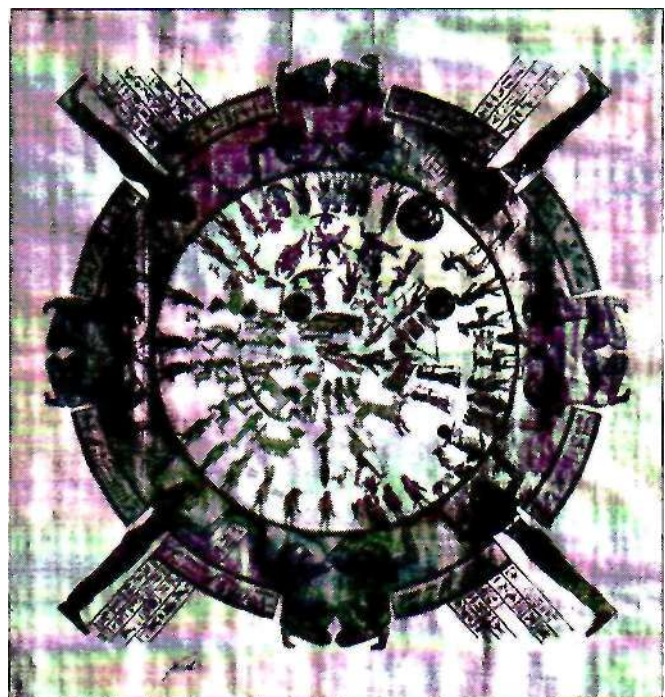

Fig. 11-8. A copy of the Egyptian astrological wheel from the ceiling of the temple at Dendera.

Update: In January 1999, the angels came and said that the ascended masters would begin to return to Earth during the Egyptian window, January 10 to 19, 1999. They told me they would bring with them knowledge of a new and completely different universe. The angels said that the Earth would soon begin to receive brand-new knowledge, knowledge that humankind had never even imagined before.

Then in November 1999, Thoth came to me for the first time in many years. He said he was back, and that at the right time we would work together again. It was interesting that a few days later, while at a lecture I was giving, a young man came up to me with a gift. He handed me an orange ibis feather, the ibis being a symbol of Thoth.

Shesat came in at the same time as her husband Thoth, and she began to communicate with me also. She stayed with me for two weeks. What she had to say was about my primary purpose for coming into this octave of dimensions. I am still learning about this lesson, so I will wait to talk about what she brought to me.

## Virgo and Leo, Aquarius and Pisces

Looking at the aerial view of the pyramids with a superimposed astrological wheel [Fig. 11-7], it places the three pyramids physically in Leo and Virgo on the wheel. This just happens to be where we are physically at this moment in our orbit in the precession of the equinoxes. More than that, the Sphinx was originally half lion and half human female, and it is believed that during the Fourth Dynasty the Sphinx's face was recarved into that of a man with a beard—which fell off. Now it has a kind of male face without a beard, but originally it was female, and combined Leo (the lion) and Virgo (the virgin)—further confirmation that this astrological drawing is accurate.

Further, McCollum's survey map shows that if you were to draw lines from the pyramids, the apexes, corners etc. across the circle of the wheel to the opposite side, it would throw a spectrum of accurate dates between Aquarius and Pisces, which is the time period we are in now—the Age of Pisces moving into the Age of Aquarius. So that's another consideration. But no one I know of has done enough research yet to be able to calculate this. With today's computers, we should be able to do this extremely accurately. Possibly one of you out there will do this work?

## The Four Corners Implication

In the beginning of this chapter we asked why the ancient Egyptians had marked a certain line [see line B in Fig. 11-1] connected to the Golden Mean rectangle that encloses the Great Pyramid. Then we said we needed to give you more information first. Perhaps the following may be one answer.

There was an astrologer who had an amazing idea about this diagonal, which has to do with the stars and a specific area of the United States. Once the astrologer saw that there was an astrological chart in the sand around the Great Pyramid, she wanted to know about the diagonal line at A [see Fig. 11-7] that seemed to be so important to the ancient Egyptians. I can't quite explain what she did because I'm not an astrologer, but she took the astrological wheel and related it to the North Pole and aligned it somehow to Cairo. Then she looked to see where the other end of the line would point. It marked a specific spot on planet Earth. In her understanding, it was the Four Corners area of the United States, where Utah, Colorado, New Mexico and Arizona meet. To the Hopi and other native peoples, the Four Corners area is marked by four mountains, which create a much smaller area.

For years I sat on this information, waiting to see what would unfold, waiting to see if anything emerged that would somehow associate Egypt with the Four Corners. Then a few years ago a young man came to me and had an amazing story to tell. I listened because the story was saying that something Egyptian was connected to the Four Corners [see update next page].

## The Philadelphia Experiment

Now we switch to a seemingly completely different and unrelated subject—but *in fact it is related to* everything in this book.

Most of you have at least heard of the Philadelphia Experiment. This experiment was performed by the Navy in 1943 near the end of World War II. An interesting fact is that in the beginning it was headed by Nicola Tesla, who died shortly before the actual experiment was completed. Tesla's part in this experiment, I feel, was paramount, but we will never know, since it has been so tightly hidden by *the* government. He was replaced by John von Neumann, who is usually known as the person who set up and oversaw this experiment.

The experiment tried to make a U.S. Navy ship invisible. This, of course, would give an incredible edge in warfare. In essence, the ship would be taken to another dimension and returned back to this one. It is my belief that Tesla had been communicating with the Grays and had learned the secret of interdimensional travel from them. It has been reported that Tesla was once asked where he got these ideas for this experiment, and he himself said that he got them from ETs. I'm sure that people in the '40s just thought he was kidding.

I realize that many people think that this information *comes* from the imagination of unstable people. But if you want to (and I have), you can get a copy of the original (then-top-secret) paperwork that the government still has. However, most of the paperwork has been blacked out for reasons of "national security." There is still enough that is visible to prove that the experiment did happen and to show much of its nature.

From what I have learned from this document and from many people studying it—and mostly from meditation with angels—is that the Philadelphia Experiment was energetically connected to other experiments through time, space and dimension. The first experiment was performed on Mars almost a million years ago when the Martians first came to Earth at the beginning of Atlantis. The next experiment was completed at the end of Atlantis about 13,000 years ago, which created the Bermuda Triangle and has caused major problems in many far-distant areas of deep space. That experiment, as I have said in the first book, was completely out of control, because in trying to create a synthetic Mer-Ka-Ba to control Atlantis, the Martians did not remember exactly how to do it.

This out-of-control synthetic Mer-Ka-Ba in the Bermuda Triangle, which is located near Bimini, has been causing real problems in deep outer space ever since. The primary reason the Grays first came to Earth was to solve this problem. They were the ones who were being affected most by this illegal experiment. Many of their planets were being destroyed. Later the Grays tried to use us to create a hybrid race to save themselves, but their experiments on us were completely unrelated to the original problem.

The Grays, trying to solve this problem of the out-of-control Mer-Ka-Ba near Bimini, *assisted* humans to do the first modern experiment to solve the

Update: What I am about to tell you is highly controversial. It may be true and possibly it is not. But it is worth it if some of you search out the truth.

A young man came to me and began to tell me this story. He said there is a mountain inside the Grand Canyon called the Temple of Isis. You might wonder why they called it that. In 1925 a great discovery was found in and around this mountain. It was written about in the *Arizona Gazette*, I believe, in 1925, and in a book published, as I recall, in 1926. He went to the still-existing newspaper and found the microfiche on file that shows what they found in this mountain. There are about six pages dedicated to the subject. I have seen it with my own eyes. [Perhaps readers can assist us to give exact references for both the article and the book, which had "Egypt" as part of its title and a picture of a flying saucer on its cover.]

The newspaper says that they found Egyptian mummies and Egyptian hieroglyphs on the walls "inside" the mountain called the Temple of Isis. I saw the photos where they were bringing out the mummies, and I saw the hieroglyphs. The newspaper said that the Smithsonian Institute was doing the fieldwork and quoted them as saying that this was the biggest find in North American history. A book was written about this about a year later, but I don't remember its name. Then there was silence for about 68 years, until 1994.

This young man said that he first found the 1926 book telling of this find, then researched the newspaper article of 1925. He told me the following *story* about hiking

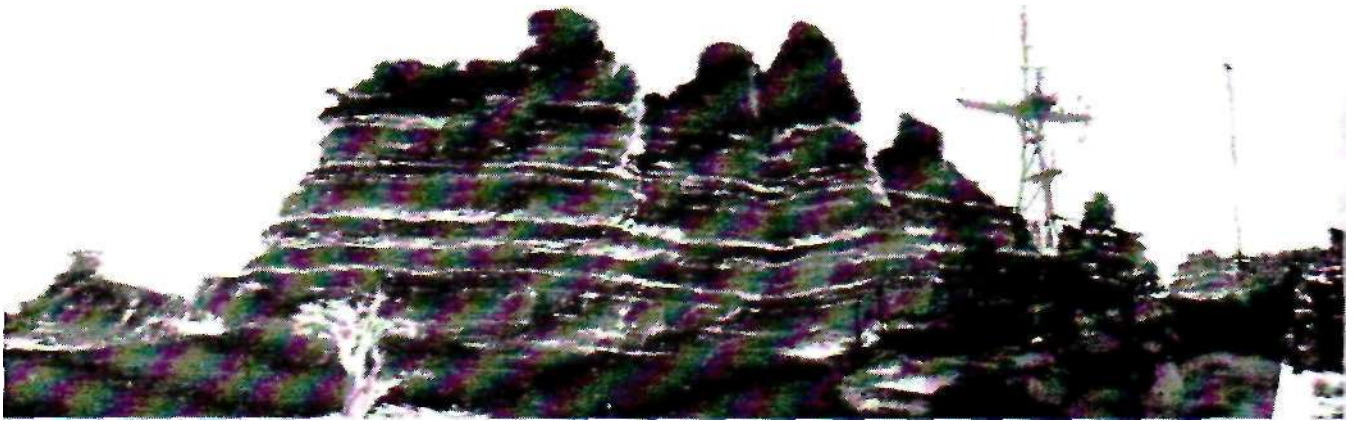

into the Grand Canyon to find this place. It is important to know that this Temple of Isis mountain is located in the Grand Canyon in an area now closed off to the public, except that a permit can be obtained under certain conditions. Even then only a small group of people at a time are allowed into this area. There is no water there except for one or two springs that are far apart. Water has to be carried with you, which limits how long you can stay there. Also, it is so hot there that people have a difficult time staying alive unless they are trained-

He told me that he and a friend went into this area. They were both expert mountain climbers trained in survival. He says that as he and his teammate approached the mountain, they found an actual stone pyramid made by human hands not far from the mountain. It was large enough to be impressive to these two researchers. To reach the Isis Temple, they had to climb a rock face that went straight up about 800 feet. Since they were professional mountain climbers, this did not stop them, as they were prepared.

According to the original article in the *Arizona Gazette*, there were 32 large doorways entering the

problem at the Bermuda Triangle. It was performed in 1913, but it didn't work. In fact, I believe it made things worse and probably was the source of the First World War in 1914. Exactly forty years later (this time period is critical), the U.S. military performed the Philadelphia Experiment in 1943 during the Second World War. Again, in 1983 (40 years later) the Montauk experiment was performed, trying to solve the problems caused by the Philadelphia Experiment. A small experiment was finally completed in 1993 (a harmonic of the 40 cycle) to speed up the male component of the original problem caused by the Atlanteans.

All these experiments are connected. They are important to understand because they were all higher-dimensional experiments based on Mer-Ka-Ba science. The Philadelphia Experiment was based on the counter-rotating fields of the star tetrahedron, very similar to what we are teaching here. The Montauk Experiment was based on the counterrotating fields of the octahedron, another possibility.

One day I gave a workshop on Long Island, New York, and while I was in the workshop I talked about the Philadelphia Experiment. Directly after that workshop I was scheduled to give another one on the next weekend, so I was hanging out for a few days at the home of the woman who sponsored the, first workshop-

The next morning she said, "Have you seen the movie, *The Philadelphia Experiment*?" I didn't even know there was such a movie, so we watched the video. That night or the next morning, a man named Peter Carroll called me—he was then the coach for the New York Jets. He said that he had gotten my name from someone and had heard that I was talking about the Philadelphia Experiment. He wanted to know if I wanted to meet one of the survivors of this experiment.

I had already connected with one of the original engineers of the Philadelphia Experiment, and this engineer couldn't believe that I actually knew and understood what they had been doing. He was so excited about it that he had given us a few pieces of the original equipment and showed us exactly how it was done. It was all based on the star tetrahedron. So now someone was inviting me to meet a survivor.

I went to Peter's house, and there I met two people—Duncan Cameron, who was one of the people who allegedly survived the Philadelphia Experiment, and Preston Nichols, who has since written a book about this experience. I had a very enlightening moment there.

They had used Duncan and his human spine in 1943 to do this experiment, putting a synthetic Mer-Ka-Ba field around him. Later, when the experiment was tried again in 1983, it was called the Montauk Experiment, of which Preston claims to be one of the original engineers. When he said that, I said, "Okay, if you are who you say you are, then would you tell me exactly how you did it?" He described in detail how he did it. It was real stuff, I believe, based on his very high-level understanding of the geometry of the Mer-Ka-Ba. So I suspect that Preston is who he says he is.

Then Duncan came into the room. He had the strangest thing going on around him. He had two Mer-Ka-Ba fields rotating around him, and they were both out of control. They were wobbling and constantly changing positions relative to each other. They were rotating way too slowly, and they weren't phase-locked to make them work together.

When Duncan came into the room and entered *my* field, he stopped and couldn't get any closer. He seemed to be repelled almost like two magnets repelling each other. He tried to come closer, but he was so out of balance that he could not come into my field. He was forced backward. He finally ended up walking about 35 feet down the hallway until he felt comfortable, and we held our conversation from this distance. He was standing just a few feet outside my Mer-Ka-Ba field. We would sort of shout down the hall. I didn't have any problem getting closer to *him*, but when I did, he became very uncomfortable and asked me to move.

I am within my living Mer-Ka-Ba field all the time, and the first thing he wanted to know was, "What's that black ring around your field?" Approximately 55 feet in diameter, a spinning Mer-Ka-Ba has a thin black ring where the field rotates at nine-tenths the speed of light. (See again that photograph of the Sombrero galaxy from chapter 2 [Fig. 11-9] ?)

Notice the black ring out where the galaxy is moving the fastest. When things start reaching the speed of light, you don't see the light. There's light there, but it starts turning black relative to where you are. What this told me is that Duncan could actually see my Mer-Ka-Ba, and that in itself is very rare.

The next observation I made was that Duncan had no emotional body. I asked him about that, and he said that the government gave him LSD and used his sexual energy to strip him of any emotions. I had never seen anyone in this state before. This, of course, was the problem he was having with his two Mer-Ka-Bas. He had two because he was linked to both the Philadelphia and the Montauk experiments. Neither of them were created with and by love, so they were completely out of balance.

Preston was sitting next to me, and I noticed that he was sweating and chewing his fingernails as if he were very afraid. I asked him about this, and

temple high above ground level. My friend said that they were still there, but looked like someone had attempted to destroy them. They picked one of the "doorways" that looked in the best condition and climbed up to it.

When they reached it, they found that the opening went into the mountain about 40 feet, where rubble blocked their way. However, above this doorway was a perfectly round cutout about six feet in diameter and several inches deep that had been created by human hands. Human beings had definitely been there to make this cutout. They found no hieroglyphics.

Their water was running out, and they made it back just in time. He said that staying another day might have been fatal, as the spring that should have given them more water was dry.

The other interesting part of this story is that another "mountain" in the Grand Canyon, on the same latitude and only a mile or so away, is being excavated by the U.S. government. This site is so important to the government that they have made it illegal to fly over the area under 10,000 feet! The entire mountain is surrounded by the military, which keeps everyone out of the area. What have they found?

Actually, the only reason I listened to this person about this possible Egyptian site was because of what we had learned about the diagonal line on the Giza Plateau that pointed to the "Four Corners area in the United States," indicating that something Egyptian and important seemed to be located there.

Why am I telling you this? Because I believe that Egypt will



Fig. 11-9. The Sombrero galaxy.

eventually play a role in the unfolding of the consciousness of Earth, and I do not want what I know about this to be lost. -^

he said that yes, he was very concerned at this time. It seems that the Mer-Ka-Bas that created the Philadelphia and Montauk experiments were now linked, and because of some information they had, they were worried about these Mer-Ka-Bas returning to Earth and causing great harm. He was worried about his life and the lives of others.

After leaving, I talked with the angels. I could see exactly what was wrong with Duncan's Mer-Ka-Bas, and I thought it would be very easy to fix them. But the angels would not let me interfere. They said that in the year 2012, on December 12 a pretest on a

new experiment would take place for twelve days that would solve all the problems and bring everything back into balance. They told me not to help.

However, Al Bielek, another survivor of the Philadelphia Experiment and Duncan's brother, called me a couple days later trying to get me to help Duncan. I could not help. They have to wait a few more years and all will be well.

I have brought up this subject because of the nature of these experiments. As I said, they are based on Mer-Ka-Ba science. At this point our government is using this information for purposes other than making invisible weapons of war. They have discovered that they can affect human emotions and control human minds. It is important for you to know, because you, in your Mer-Ka-Ba, can be immune to what they are doing by using the knowledge in this book.

There are many experiments that the governments of this world are doing on their populations, not to mention the problems with the Earth's environment. Knowing and using the power of the human lightbody, you can bring balance not only to yourself, but also to the whole world. It is this subject—learning to use your lightbody and how this can change everything—that I am bringing to your attention. You are more than you know. Great Spirit lives within you, and under the right circumstances, through you all things are possible. You can heal yourself and the world and assist in the ascension of Mother Earth into the next world if your love is great enough.

## The Mer-Ka-Ba, the Human Lightbody

**T**he Egyptian Mystery School studied all the varied aspects of the human experience, more than we could possibly speak of here. But the one aspect that was central to the entire Egyptian training in the mysteries was the Mer-Ka-Ba. The Mer-Ka-Ba, the human Lightbody, was everything! Without this knowledge and experience, the other worlds were impossible to reach, from their way of seeing.

"Mer-Ka-Ba" has the same meaning in several languages. In Zulu it is pronounced just like in English. The spiritual leader of the Zulus, Credo Mutwa, says his people arrived here from space on a Mer-Ka-Ba. In Hebrew it is *Mer-Ka-Vah*, and means both the throne of God and a chariot, a vehicle that carries the human body and spirit from one place to another.

In Egyptian, the word "Mer-Ka-Ba" is actually three words: *Mer* is a special kind of light, a counterrotating field of light; *Ka* means spirit (at least here on Earth it has the connotation of the human spirit); and *Ba* means the interpretation of the Reality," which here on Earth usually means the human body. When you add these words together, my understanding of Mer-Ka-Ba is "a counterrotating field of light that will interact and translate the spirit and the body from one world into another," though it is really much, much more. It is the creation pattern itself through which all that exists has originated.

You know this. It's nothing really new to you. You just forgot for a moment in time. You have used the Mer-Ka-Ba a zillion times as your lives have unfolded throughout the creation of space/time/dimension. And you will remember again just as you need it.

This chapter will speak indirectly of the human lightbody, or the Mer-Ka-Ba. We will talk about the internal mechanics and energy flows of the lightbody, whereas in the next chapter we will give the understanding of the Mer-Ka-Ba meditation itself—a way to actually experience it, then remember. It will probably help you to know this internal structure first in order to work with your Lightbody. If you don't feel it is necessary, then of





course go on to the next chapter.

Let it be known that you can re-create or activate your lightbody with' out this knowledge. You can re-create it with love and faith alone, and for some people, that is the only way. I acknowledge this possibility, but my assignment here on Earth is to bring forth this pathway, using male knowledge, because some of you can understand only through the left brain. The female pathway is more intact within the Earth's biosphere, and it is the male that now needs the balance so desperately.

We will begin with the innermost points of energy called the chakras and slowly move outward to explain the entire human energy field. This is a lot of information; there is only so much I can do to simplify such a complicated subject.

Before we begin, there is one last image that must be seen, or you will never understand. No matter how much you try to know and understand the Mer-Ka-Ba through the sacred geometry, it will never be enough. There is the missing half that is experiential, and it can only be experienced while you are immersed in love. Love is more than just necessary; love is the very life of the Mer-Ka-Ba. Yes, the Mer-Ka-Ba is alive. It is nothing less than you, and you are alive. The Mer-Ka-Ba is not something separate from you; it is you. It is the energy lines that allow the life-force energy, the prana, the chi, to flow into you and from you back to God. It is your very connection to God. It is that which links you and God together as one. Love is half of the light that is swirling around you, knowledge is the other half. When love and knowledge become one, the Christ will be present, always.

If you think that within these pages you may find something useful to help you in one of the projects of your mind, you will never know the truth. It can only be experienced. If you are searching for the mechanics to have the Mer-Ka-Ba experience, I offer you the following.

## The Geometries of the Human Chakra System

If the male pathway is your choice, then the human chakra system is imperative to know and understand when working with the subtle energies within and around the human body. These are often lumped together and called the human lightbody.

A *chakra* is an energy point within and sometimes outside the body that has a specific quality. When a person is focused in one particular chakra, their whole world is colored by the energy of that chakra. It is like a lens through which everything in existence is interpreted.

Although each chakra is different, both energetically and experientially, they all have certain aspects that are the same. There also is an underlying energy flowing through the chakra system and connecting them that is extremely helpful to comprehend.

The human chakra system is based on eight chakras along the spine. There is a more integral system of thirteen chakras, which we will examine

later. Realize that there are many minor chakras we will not talk about at all, such as the ones in the hands and feet.

We are first going to focus on the flow of energy up the spine area, then branch off to many related subjects. In the next chapter we will see the sacred geometric fields of light that surround your body and are the basis of the living Mer-Ka-Ba.

We will explore the geometric source of the 8-chakra system, which is based on the structure of the Egg of Life, the same energy pattern as the original eight cells of the human body discussed in chapter 7. Note also that the original eight cells, the 8-chakra system and the eight internal electric circuits of the human body seen in Chinese medicine are all related to the cube or to the star tetrahedron, depending on one's point of view. The electric circuits have many conduits connecting to every cell in the body. In Chinese medicine these circuits are called meridians. A full study of the chakra system must include this knowledge, but not here, because it is so complex and not really necessary for our purpose. Here we will introduce only what is necessary to activate your Mer-Ka-Ba.

### The Unfolded Egg of Life and the Musical Scale

Visualize the Egg of Life, the form with the eight spheres in the shape of a star tetrahedron [Fig. 12-1]. Now disconnect all the spheres and open it up into a chain [Fig. 12-2]. But it must be done in a specific sequence, keeping the half steps in place. What you have is the human 8-chakra system - the primary chakras running up and through the body. Human energy, from sexual to electrical, moves in the pattern you see here.

You have the same change-in-direction half steps between the third and fourth chakras and the seventh and eighth chakras. And there's still that special change between the fourth and fifth chakras, the heart and the sound chakras. These movements are also found in the harmonics of music. Seeing the structure of the musical scale will help you apply that structure to the human chakra system. Let's look at music to understand what was just said.



Fig. 12-1. The Egg of Life.

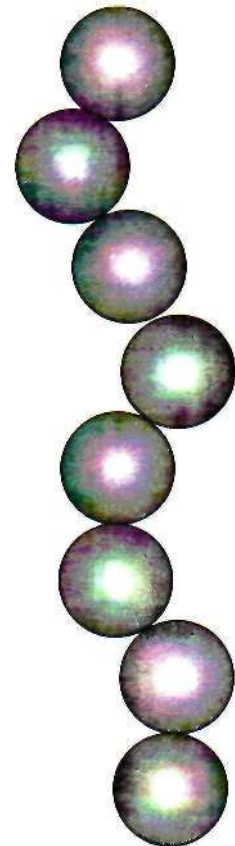

Fig. 12-2. Unfolding the Egg of Life.

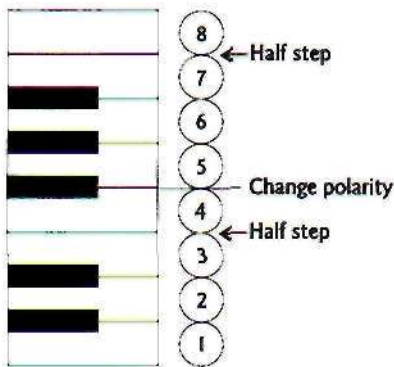

Fig. 12-3. The Egg of Life musically unfolded. On the left is an octave on a keyboard. The scale of C uses the white keys, making it easy to visualize the half steps (in relation to the black keys) and visually see the two tetrachords that make up a major scale. A major scale has half steps between 3 and 4 and between 7 and 8.

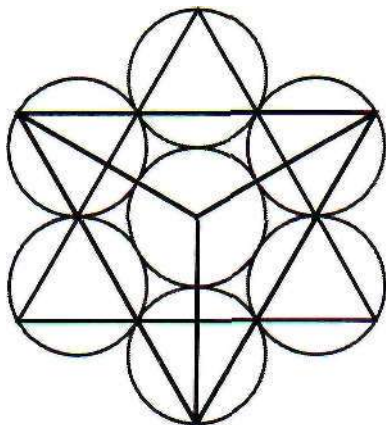

Fig. 12-4. The 3D tetrahedron within the Egg of Life.

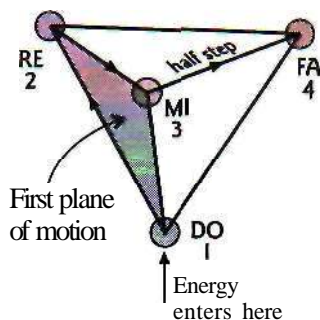

Fig. 12-5. The female tetrahedron. From the bottom point, *do*, a plane is chosen to reach *re* and *mi*; a change in direction (half step) is necessary to reach *fa* on the last vertex of the tetrahedron, completing the first tetrachord of the scale.

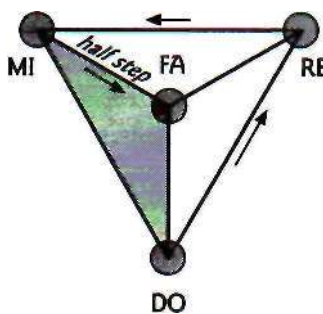

Fig. 12-6. The base of the tetrahedron is chosen for the plane of motion. The final vertex of the tetrahedron must then be *fa*, here seen at the "top" center.

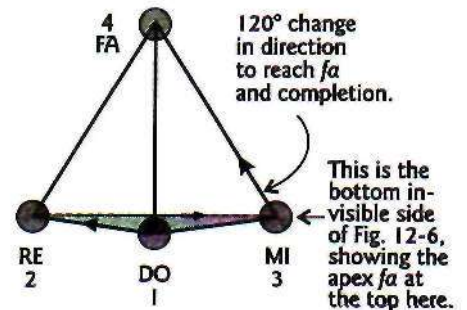

Fig. 12-7. The half step between the third and fourth notes. A 120-degree change in direction is necessary in order to move to another plane to reach *fa* at the last remaining vertex.

In the musical scale of any major key, there is a half step between the third and fourth notes and the seventh and eighth notes [Fig. 12-3]. These half steps are built into wind instruments such as the flute by the positioning of the holes. Likewise, there is a special place between the fourth and fifth notes that Gurdjieff talks about. It is the place where the polarity reverses, changing from female to male. Using the unfolded Egg of Life, we show how energy moves through music and through this shape, which is the same in the body chakras.

The energy of the Mer-Ka-Ba, the two tetrahedrons embedded in a human life form [Fig. 12-4], moves in the following way [Fig. 12-5]: 1 (*do*) goes to 2, 3 or 4, then to one of the other two vertexes, moving in a flat plane to do so. To reach the remaining vertex, it must now change direction—the half step.

Using the classical Western system of the octave as shown on the piano, the note *do* enters the star tetrahedron of the Egg of Life at the bottom point (vertex) of the female tetrahedron. The energy is male as it comes in from the previous octave, but it must change to female because it has just entered a new, "female" tetrahedron. The polarity reverses again when moving to the next tetrachord or tetrahedron [see Figs. 12-6 and 7]. The energy coming into a vertex has three planes (A, B or C) to move along [see Fig. 12-6]. To show the energy flow here we'll start in the middle/top. Once a plane has been chosen (C), it must move in that triangular plane, which gives it the next two notes, *re* and *mi*, at the other two points on that plane.

The movement takes place on one triangular plane and the distance between the notes is exactly the same. However, to reach the fourth and last note, *fa*, and complete this female tetrahedron, it must change to a new plane (half step), thus change its direction [see also Fig. 12-7].

Remember the movements of Genesis and the creation out of nothing [chapter 5, beginning page 147] ? Spirit's projections in the Void—shadow forms—are the same concept. When spirit is in the Void, or nothing, the forms it creates are really nothing, too. The rules that spirit has chosen are

that everything can be seen as either 2D or 3D but must be in 2D first. Two-dimensional reality is primary, before the 3D world.

When spirit looks at the movement on one plane of the tetrahedron and a change of direction occurs, the shadow form of the 2D world (the distance traveled is seen as a shadow) appears about half the distance of the first two movements on the triangular plane. Geometrically, the shadow is slightly longer than half, and I believe this is the actual experience. It is labeled a half step. In truth, it is the same distance as the other three notes, but experientially for spirit, it seems like a half movement, which results in this world as a half step between *mi* and *fa*, because, as we said, the 2D world is the source. Now the first female tetrahedron is complete.

At this point the energy must change from the female to the male tetrahedron [see Fig. 12-8]. It does this by moving from *fa* directly through the center of the star tetrahedron (the interpenetrating male and female tetrahedrons), or the "void," to reach *sol*, the first note of the male tetrahedron. In so doing, it changes polarity from female to male.

The energy will move just as it did in the female tetrahedron, but the plane on which it must move is restricted to the horizontal plane at the bottom of the male tetrahedron (*sol*, *la*, *ti*). After choosing one of the three available vertexes for *sol* (5 on the left), it chooses *la* and *ti* to complete that plane.

The energy must now change direction again to complete itself, just as it did in female tetrahedron. It makes this directional change [Fig. 12-9] to reach the last note, *do*, which becomes the first note of the next tetrahedron. Death becomes birth, transition from one form into another. Male becomes female and the procedure begins anew.

Anew? Yes, because there is a complex of star tetrahedrons—at the very least a chain of star tetrahedrons—in all the systems we are discussing. just as in music, there are octaves above and below this one, which theoretically continue forever. It is the same in music as it is for consciousness and even the dimensional levels we spoke of in chapter 2. As for the energy moving up the chakras, it is the same, too. There are chakra systems above and below the system you experience. This can be seen as the geometrical basis for immortality. Spirit just keeps moving up or down as it wishes, leaving one world (body) only to enter another.

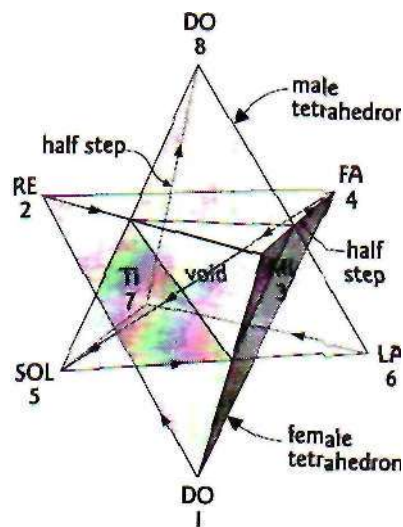

Fig. 12-8. Energy moving between tetrahedrons.

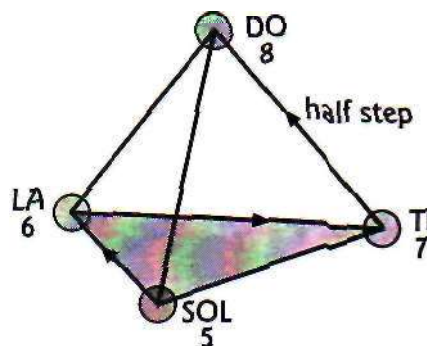

Fig. 12-9. The male tetrahedron, making its directional change to *do*, the first[ note/ vertex of the next (female) tetrahedron.

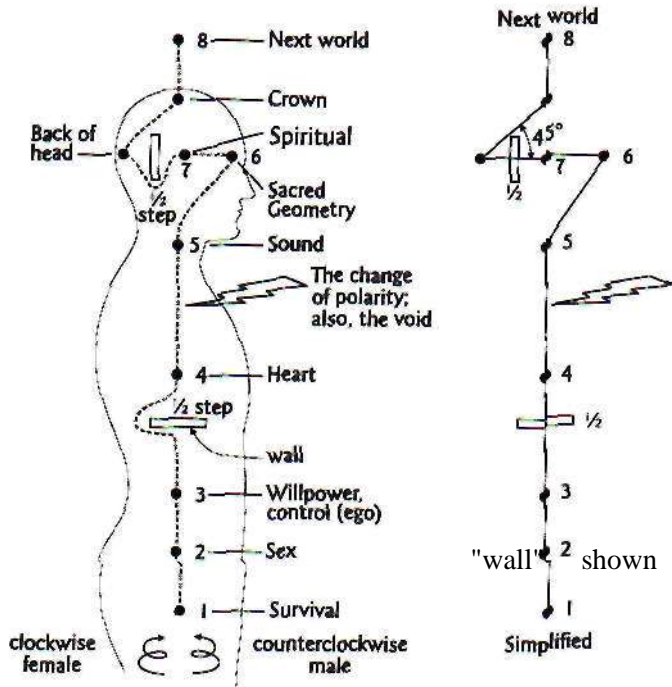

Fig. 12-10. The human 8-chakra system.

### The Human Chakras and the Musical Scale

Let's look at the human chakras [Fig. 12-10] and see how they move in exactly the same way as the musical scale. (The chakra placement is not perfect on this drawing.)

Moving topographically on the surface of the body, notice the three lower chakra points. The first one is near the base of the spine, the second one is 7.23 centimeters higher, topographically, and the third one is 7.23 centimeters higher than that. This is an average for full humans, and it's the same as the average distance between our eyes, although you personally might be different. After the third chakra, there is a change in direction at the "wall" shown above it, which we'll call a half step.

This half step is crucial to human evolution, and it is revealed only when the spirit is ready and has mastered its position in this new world. To the spirit in the body, this half step is hidden, not apparent-

The spirit simply cannot see it until the time is right.

Once this half step is found and passed, the energy flows to the heart, the throat, the pituitary gland and *the* pineal gland before it encounters another wall/half step that again stops the flow. This "wall" is located between the back of the head and the pituitary gland and is perpendicular to the plane of the first wall. Once the energy has moved past this second half step, it reaches the eighth and final chakra of this octave. This eighth chakra is, in Hindi, called the Godhead, for it is the goal of all life. It is located exactly one hand-length above your head.

The eighth chakra is just the beginning, or first note, of another set of chakras above the head. There is also another set of chakras below the ones in your body, and from which you have come.

There are two primary ways the energy can move up through the body, one triple and the other female. First, the energy always moves in a spiral, and when it spirals counterclockwise relative to the body, it's male; when it spirals the other way, it's female, which is clockwise relative to the body. The human spirit's main focus starts at the bottom of the chakra system when you're born, then moves up during your life through the various stages.

Each chakra has a quality, which is noted on the above drawing. The first is survival, the second is sex, the third is willpower, the fourth is the heart or emotions, the fifth is sound, the sixth is the sacred geometry of creation, the seventh is spiritual and the eighth is the next world of existence.

When beings come into a brand-new reality where they've never been before—babies coming to Earth, for example—they have one thing on their mind and one thing only. They want to be able to survive and stay here; their whole focus is on being able to survive this new world, so they do

everything they can to stay. As we mentioned, the first chakra becomes like a lens through which you interpret this new reality, and the interpretation requires your whole focus, just trying to stay in this new world.

The moment survival has been achieved, it becomes apparent to the spirit that one or two more chakras are available. (It's actually two, but spirit may see only one.) The rest of the chakras are not apparent because of the half-step wall. The half step hides the higher chakras from spirit, at least until spirit has learned to master the lower chakras and wisdom shows the way into the higher understanding.

Once survival has been achieved, you desire to make contact with the beings in that reality—this is instinctual. When you're a baby, that's usually interpreted as making contact with your mother, especially her breast - this reality, but in fact it is sexual in nature.

As you get older, the desire for contact becomes purely sexual; you want physical contact with the beings in this world. In higher worlds it takes on different connotations, but basically you locate and make contact with the life in that new world. So we call that chakra the sexual one. After you've survived and made contact with the beings, you now have the third chakra available, which has to do with wanting to learn how to manipulate and control the new reality, or what you might call willpower. You want to know how things work, what the laws are in this new world. How do you do it?<sup>3</sup> You spend all your time trying to figure out physical things. Using your willpower, you begin to try to control the physical world. In higher worlds, physical is different from physical in the third dimension, but there is still a correspondence between the worlds.

Your efforts to understand the reality are interpreted in many ways as time goes on. When you're a baby there's a particularly interesting time, often called the terrible twos, where you want to know *everything* about the world around you and test to see what you can and cannot do. You pick up everything, break it, throw it in the air, look for something else—in short, do everything you're not supposed to do. This child will continue until he/she is satisfied in her understanding of the physical world.

When you're a baby, you don't know that there's a change in direction after the third chakra; there's something like a wall obscuring the next four chakras. The child is not aware of the many more chakra lessons to come. There's more to life, but the child is totally oblivious to it. On Earth, even when we become an adult, we may not know there are higher centers in the body. Much of the world is still living in the first three chakras. But that is changing fast, because Mother Earth is waking up.

#### The Wall with a Hidden Doorway

God put this wall or half step or change in direction there so that you won't know it until you've mastered all the lower centers to a certain degree. So when you're growing up, you're in only the three lower chakras. You may be in all of them at once or maybe mostly in one and partly in the

others; or it could be a balanced blend or combination of all three.

This pattern is true of a person, a country, a planet, a galaxy or anything alive; at any level of existence, this same pattern of movement occurs. Let's take a country like the United States. We're a brand-new country in an old world; we're young relative to countries in Europe or elsewhere; we're just a baby. Until the 1950s, the vast majority of people in this country were in one of the three lower chakras—not everybody, of course, but most people. They were concerned with control, money, materialism, houses, cars, sex, food, especially with survival aspects, making sure they stored up enough money to feel secure. That was a really materialistic world. Then in the '60s changing consciousness began to rapidly alter what was thought to be normal. People began to meditate and enter the higher chakras.

If you go to an old country like India, Tibet and parts of China, places that have been around a long, long time and, as a country, have found their way through the wall with a hidden doorway *to* the next level, they moved up into the fourth, fifth, sixth and seventh chakras. And as they moved through these higher four centers, they eventually came to another block after the seventh chakra, stopping further progress.

The lower part of our body has three centers and the upper part has four. Once a country or a person goes beyond the first half step, they're never the same again. Once they *know* there's something more, they'll spend the rest of their life trying to figure out how to get back to the upper centers, even if they had just a fleeting experience of the higher worlds.

In terms of a person or a country, though, once it gets above the first half step, moving up into the heart, the sound currents, the geometries and the spiritual nature of things, what sometimes happens is that they lose their concern about the lower centers of consciousness. They don't really care about their physical side very much—whether their house is nice or anything like that. They're more concerned about the information and experiences they're learning about the nature of these higher centers. So sometimes when you look at these older countries, they seem to be physically almost devastated because their whole focus is toward trying to find out what this Reality is about on the higher levels. An example of this kind of country is India.

Once a country has actually reached and focused on the seventh chakra, which is very difficult, its only concern is what happens after death, the next level of life. This was the case in ancient Egypt.

The doorway or half step between these two chakra groups is in a place (direction) where, under normal conditions, you would never find it; you wouldn't even know it existed. You might have to go through quite a few lifetimes before you even learned of the existence of a doorway to these upper chakras—especially if you lead a simple, conventional life. But inevitably, especially in a country or person that's spiritually focused, the doorway will be found.

## Ways to Find the Secret Doorway

I feel that in the beginning—in the *new* beginning, after the fall during the end times of Atlantis—humans first started experiencing this higher level of consciousness that had been lost. It was through near-death experiences, because death was something that everyone experienced. When someone dies, he goes through the first doorway and finds other worlds, other interpretations of Reality. They may experience another reality for only a short time, then something happens. Instead of totally dying, they come back into their body. But they still have that *memory*. *People who go* through this kind of experience are completely changed, and they're probably going to do everything they can to find out what happened to them. They'll really question this other aspect of life, which is related to the higher chakras.

Possibly the next group of humans who found their way through to a higher level were those who took psychedelics. Psychedelics have been used all *over* the world and throughout history by almost every religious culture I know of. Psychedelics are not drugs in the normal sense. They're very different from pleasure drugs like opium, heroin, crack and similar substances, which can actually do exactly the opposite of psychedelics. The pleasure drugs tend to enhance the lower centers and make you feel good, but they trap you in those lower centers. Gurdjieff felt that in terms of the spiritual path, cocaine was the worse drug of all. I'm not judging anybody about this, but that was his opinion of cocaine, because it causes a particular delusion and increases the sense of ego. It heads you in the opposite direction that spirituality normally takes.

But the psychedelics do something different, and they are not usually physically addicting like the pleasure drugs. The Incas used San Pedro cactus mixed with a little bit of the coca leaf. (Coca leaf is completely different from cocaine.) Some of the Native Americans (Indians) use a psychedelic called peyote, which is legal for them since it is part of their religion. All over the world in Egypt, in about 200 locations, you'll find images of the *Amanita muscaria mushroom*, a big white mushroom with red dots. At least one book has been written solely about this subject [*The Sacred Mushroom* by Andrija Puharich].

In the United States in the 1960s, LSD took people through this doorway to the higher chakras—specifically, LSD-25. Over twenty million Americans took LSD-25 and were blasted through into the upper centers or chakras. Most of them were totally out of control, with no initiation. The ancient cultures made significant preparations before they used these kinds of psychedelics, but there was no preparation for most of these Americans in the '60s, and there were a lot of casualties. They were blasted through into the higher chakras. In most cases they landed in the heart; they had a major sense of expansion and of becoming love and all of creation.

However, they could have landed in the fifth chakra of the sound currents if they began their experience with music. There would have been



nothing to stop them. Music automatically leads you into the fifth chakra, and many times that was the case. The fifth chakra is a totally different experience from the heart chakra, just as the sex chakra is extremely different from the survival chakra.

If the person experimenting went up far enough to reach the sixth chakra, he would have found the sacred geometries that created the universe. A person who went into this chakra would have had incredible geometrical experiences, where all of life would appear geometrical.

A few rare people may have found their way into the seventh chakra, which is spiritual. At this level there is really only one concern: how to find the way to become one with God, how to connect directly with God. It's the only interest a person in that center would have. Nothing else would matter.

But the problem with psychedelics is that the person is always thrown back down to the lower centers and the 3D reality when the drug wears off. They are changed forever by the experience, and usually they continue to seek a way to return to these higher worlds, and it is usually not through psychedelics.

The psychedelic era did one permanent thing for sure—it opened the doorway or the half step for the consciousness of the United States as a country. It gave people an experience that showed them the higher worlds really existed. Since then, millions of those people have been spending their lives trying to get back to those higher sacred places, and in so doing, they are changing the country and the world.

I think the next stage of evolution came along when people were trying to figure out how to get back to that higher state of consciousness without having to use drugs. We had our gurus and yogis, meditations and various spiritual practices, religious and spiritual experiences seeking the way. In the late '60s and '70s we were fixated with spiritual teachers. There are all kinds of meditations and spiritual paths that will lead you into a place calm enough for you to find the doorway and go through this wall. One way is not better than another; the concern is only about which one will work for you.

Eventually, after you've been dwelling in the fourth through seventh chakras and have mastered them, you'll come to another wall, which is at 90 degrees to the lower one. The angles you must negotiate to get through the top wall are different—and tricky. But if you can find your way through, you can actually transcend this third-dimensional world and go into next world, which all of life here on Earth will follow someday. You die here and you're born somewhere else. You leave this place and enter a new place. Spirit is eternal and always has been. We'll talk about this new place soon. It is not somewhere to go, it is really more a state of being.

In Egypt, after initiates had twenty-four years of training, they were given an appropriate psychedelic and put in the sarcophagus in the King's Chamber for three days and two nights (sometimes up to an extra day).

The primary experience they sought was to find this doorway and enter the higher worlds, then return to Earth to help others. This becomes apparent to almost everyone who reaches for these higher levels: There is only one thing *to* do when you return *to* Earth—serve all life, for it *becomes* very apparent through this experience that you *are* all life.

Eventually most seekers around the world search for a way different from a near-death experience or drugs. They search for a way that comes from nature, a way that is contained within themselves before they were even born. The search is always the same. No matter what religion or spiritual discipline, no matter what technique or form of meditation, no matter what words are used to describe their experiences, it is the doorway, either the first or the second one, that will always be the focus of their seeking.

### Chakras on Our Star Tetrahedrons

Those eight chakras that run up through our bodies have duplicates in the space around our bodies [Fig. 12-11 J. They are spheres of energy that vary in size, depending on the person's size. The radius of these spheres is the same length as a person's hand, measured from *the* tip of the longest finger to the first wrinkle on the wrist. (My sphere has about a 9-inch radius, or 18-inch diameter.)

They are actual spheres of energy that *sit on the* points of the star tetrahedral field that's around your body in space. They are, in fact, your chakras. "duplicated" in the space around your body. You can detect or feel the spheres when you enter the spherical area, but the actual chakra is like a pinpoint—it's very little and in the exact center—located at the apex of each point of your star tetrahedron.

When I had access to a molecular emissions scanner (MES), we were able to see these things. Days before I quit working in the field of technology, we measured our bodies and focused on the centers of our chakra points located at the tps of our star tetrahedrons. First we searched with the sensor-head of the MES, but the machine didn't sense a thing. But *when we went through the center point, the computer screen would light up.* Once we found it, we had to lock in on it; then we could take a microwave "photograph," which looked like a chakra inside die body. We found out that each inner chakra has a living pulse associated with each external chakra and the system as a whole. I was preparing to figure but what this pulse was tied to when I left, so I don't know the answer. Of course, the first thing we would have checked was the heartbeat. But the body produces other rhythms, and at this time we do not know.

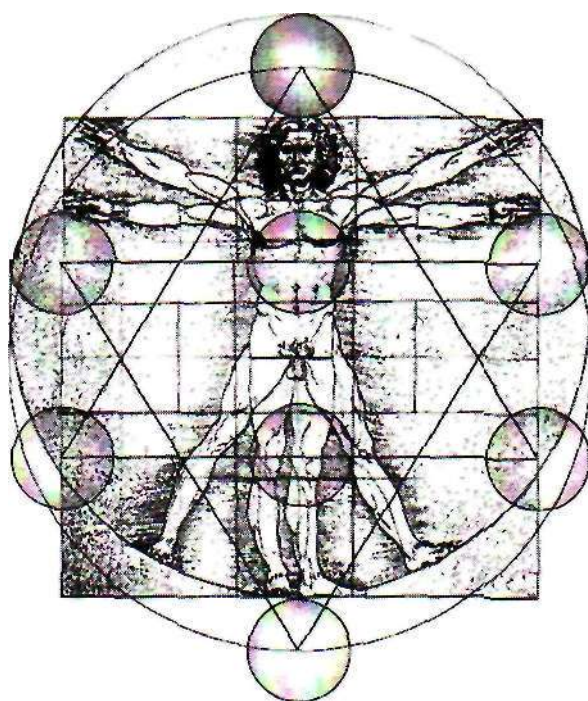

Fig. 12-11. Leonardo's canon with eight spheres.

## The Egyptian 13-Chakra System

Now we will explore the expanded energies of the chromatic chakra system, the system with thirteen chakras. I would like to preface this section with the acknowledgment that this information is not necessary for most of you to know. It is very complex, and for some of you *it will* only make it harder to understand the energy flows within the body. Either skip this section or read it with an "information only" attitude if you feel you need to.

When a person uses the 13-chakra system instead of the 8, there is something that needs to be understood, or great confusion will occur. From what I have learned, you cannot use both systems at once. You must use one or the other, but not both simultaneously. It is a mystery, except to say that the very same thing happens in quantum physics: You can see the Reality as made up of either particles (atoms) or vibration (waveform), but if you try to superimpose both systems at once, neither will work.

For example the "void" step between the fourth and the fifth note of a scale happens between the heart and the throat chakras in the 8-chakra system. But in the 13-chakra system it happens between the two hearts, between the sixth and the seventh chakras. The reason is that spirit is using two entirely different views or systems of movement in the star tetrahedron. We will try to make it as simple as possible.

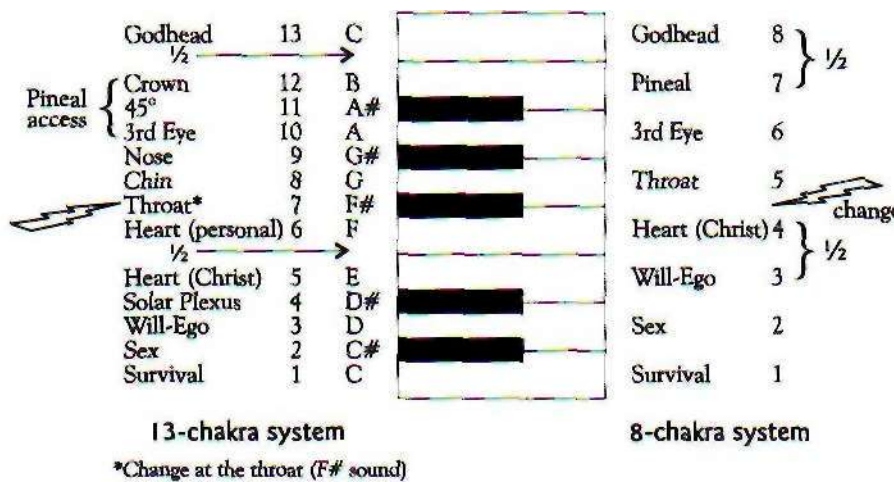

Fig. 12-12. The piano scale and the 13-chakra (chromatic) and 8-chakra (major scale) systems.

In the chromatic scale, best seen on piano keys, adding the five black keys to the eight white keys that make up the C major scale totals thirteen notes [Fig. 12-12]. In other words, when you add the pentatonic scale of the five black keys (C# D# F# G# A#) to the C major scale (the white keys C D E F G A B C), you get the chromatic scale. All other scales on the piano are similar, but they with use sharps or flats. Beginning with do (or C, since the C scale is easiest to see on a keyboard), we have the following chromatic scale:

C, C#, D, D#, E, F, F#, G, G#, A, A#, B, C

The half steps are between E and F and between B and C (bolded). Notice that there is no sharp (black) note in between these pairs. The special void between the fourth and fifth note of an octave is between F and G, where the second tetrachord begins [see the lightning bolt On the right in Fig. 12-12]. In the chromatic scale it is different, because the *How* is based on a different view of the star tetrahedron. We will first look at how the chromatic scale is laid out, then talk about the flow.

The chromatic scale has twelve notes, and the thirteenth is the return, or the first note of the next scale. In every octave there are *seven notes*, and the eighth is the return. This means that the eighth chakra of the octave and the thirteenth chakra of the chromatic scale are the same note and have the same role.

Fining these two harmonic systems together in the chakra system gives us the *chromatic* 13-chakra system, which is far more complete than the 8 system. Many questions that will arise are answered when using the extended chromatic chakra system. For instance, it is only with this system that you will find the topographical (body surface) distance of 7.23 cm between, chakras.

So some things are possible using the 13 system that are not possible in the 8 system and vice versa. Therefore, sometimes we will use the 8 system and sometimes the 13 system. We will always tell you which one we are us-

There are many other systems of harmonics and scales, all of which are used in various ways by nature *to* arrange the harmonic relationships around us. I say, however, that *all* harmonic systems of music are derived from a single sacred geometric form, but this is not necessary to know now for the work we are doing. This single sacred geometric form is related to the tetrahedron, but is too complex to bring up here.

One of the systems we talked about is the dimensional levels of creation (chapter 2, page 43). If you reread this section now, it will begin *to* make much more sense.

#### Discovering the True Chakra Locations

We were able to look into the body with the molecular emissions scanner, and we could see the microwaves coming from each chakra and locate them precisely. But we found that the images coming off these chakras were not always located where some of the books said they were. For one thing, many books I read said that the thirteenth chakra was anywhere from four to six finger-widths above the head—but there's nothing there! We searched and searched this area, because that's what the books said, but still there was nothing there. But when we went where the geometries were indicating, which is one hand-length above the top of the head, bingo, there it was! We could see the screen light up with activity.

Another obvious difference was the third chakra of the 8 system. According to most martial arts teachings and many Hindu philosophies, the third chakra is either one or two finger-widths below the navel. But there's nothing there, either—nothing! We searched and searched that area, but we found it in the most obvious place, also predicted by the geometries. When you look at the absolute geometrical center of the navel, you find the third chakra.

I suspect that somebody along the line told a white lie. They tried to make it secret because they knew that this chakra was a very important

place, and I think they purposely distorted the information. Secrecy through distortion in the sciences and in religious and spiritual matters, especially in the last 2000 years, has been rampant.

#### A Body-Surface Chakra Map

The other thing the Egyptians say about the 13-chakra system is that the centers are found topographically—on the surface of your body—and evenly spaced. The actual chakras are not evenly spaced inside the breathing tube, but the entry *points* are evenly spaced over the surface of your body. And they're separated by exactly the distance between the centers of your eyes. The distance between your eyes is the same as the distance between the tip of your nose and the tip of your chin and several other pertinent places on your body. If you are overweight, this will not work, but you can try.

Make that distance your measuring unit, then lie down on a flat, hard surface, like a floor, and put one finger at your perineum. This locates the survival chakra, the first chakra. (The perineum is the piece of skin located between the anus and the vagina in females, and between the anus and the scrotum in males.) When you measure from there one length over the surface of your body, it will mark the second chakra, the sexual chakra, which is on or just past your pubic bone.

Measuring upward from the sexual chakra, you'll find that your thumb goes right inside your navel, locating the third chakra.

One measure beyond your navel, your thumb will go exactly inside the mouth of the solar plexus, the fourth chakra of the 13-chakra system.

When you come up one more measure, you'll come to the fifth chakra, the Christ chakra, the first heart chakra. It's located a little above the sternum bone.

When you take the next measure, it will exactly mark the sixth chakra, which is the second heart chakra. The first heart chakra, which is more primal, is universal unconditional love for all life. It is love for God, whereas the sixth chakra is love for *part* of life. If you fall in love with a person, you feel it in this upper center. Even if you fall in love with a planet, as long as it's only a portion of the Reality, no matter how big it is, you'll feel it in the upper heart.

Both heart chakras are on white keys in the chromatic scale. This is very interesting, because that happens to be exactly where the half step is located—between them on the 13-chakra system [see Fig. 12-12].

When you measure once again (remember, you have to be lying on a flat surface), you'll find that your thumb will hit the Adam's apple, if you're male. Of course, if you're female, you don't have one, so it's harder to tell. This is the seventh chakra of the chromatic scale.

When you take the next measure, it will touch your chin, which is chakra number eight. The chakra point on the chin is a really powerful one. It's seldom talked about, though Yogi Bhanjan has talked about it in his dis-

courses to his pupils. He considers it one of the most important chakras.

Measuring again, you'll reach the nose, which is the ninth chakra point. And when you take the next measure, you'll touch your third eye, the tenth chakra.

Measure once again, and it marks just above the top of your forehead to the eleventh chakra, a place we call the 45-degree chakra, which I'll tell you about below.

One more measure to the top of your head will touch the crown chakra, which is chakra number twelve. Then one hand-length above your head you will find your thirteenth chakra, the end of this system and the beginning of the next one.

The reason we call the eleventh chakra the 45-degree chakra has to do with how the tenth, eleventh and twelfth centers are connected to the pineal [Fig. 12-13]. Remember when I talked about the pineal gland as an eye? Well, it seems that when the pineal gland "looks" or projects energy to the pituitary gland, it produces the third-eye perception. There's another line of energy that projects from the pineal to where the eleventh chakra is located; this sits at a 45-degree angle (average) from the pituitary projection. I believe it is exactly 45 degrees, but I can't prove it. Then there's another projection, which goes straight up and out of the crown. All these last three chakras are focusing in on or projecting out from the pineal gland.

Here is another contradiction between the two chakra systems. The 8 system sees the pineal as the chakra from which one moves into the next world. In the 13 system, this chakra has three access points and has ways of working with this energy that are different from the simple 8 system.

Another interesting note: In the 8 system, the first half step is found between the universal heart and the throat (sound). However, the first half step in the 13 system is located between the *universal* heart (the love for all life everywhere) and the personal heart (the love for someone or something). This is between the fifth and the sixth chakras in this system. This difference between the Christ consciousness and the personal love of human consciousness is one of the most important areas of understanding in spiritual work; and that happens to be exactly where the change in direction takes place. The next half step above, between the twelfth and thirteenth chakras, is also a crucial place, and this again is different from the 8 system. It's a crucial place, because that's when you move from one world or dimension to another. But both half steps (and the individual chakras themselves) provide the essential lessons of life.

### A Different Movement on the Star Tetrahedron

It seems as though spirit decided that there was more than one way to move through the star tetrahedron. When we use the 8-chakra system, it is -retry simple, but in using the 13-chakra system, spirit becomes far more complex. I was going to offer a possible way that spirit could move through

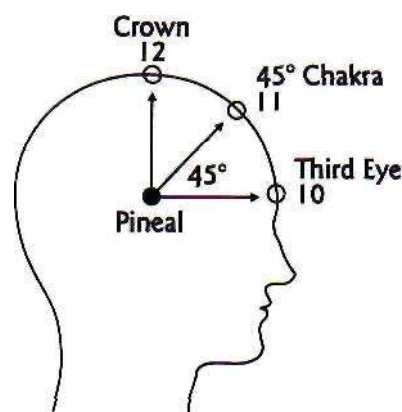

Fig. 12-13. Three chakras of the pineal gland.

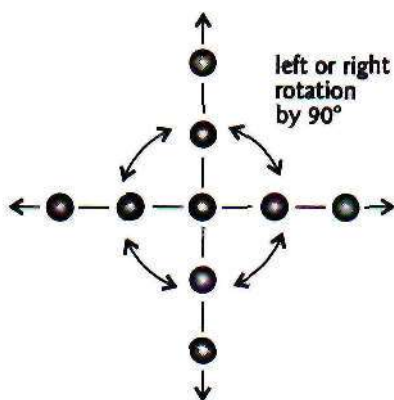

Fig. 12-14a. Top view of the five channels, seen as a horizontal line that rotates up the spinal column.

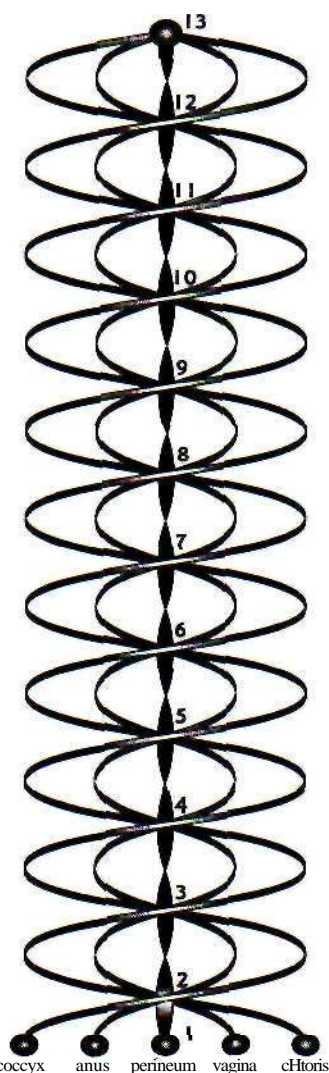

Fig. 12-14b. Rotation of the spiral of light up the chakras, a female seen from the side.

the star tetrahedron and still meet the requirements of the Reality perfectly, but after looking at it, I decided that it would probably cause more confusion than help. So if you really want to know, do it yourself. Try the top or bottom view of the tetrahedron first. Clue: One tetrahedron will give only the white keys and the other only the black keys (sharps or flats).

### The Five Spiraling Light Channels

Both of the previous two chakra systems show a very simplified understanding of the full chakra system, which is really much more complex than what has been presented so far. Although we have been talking about one channel that connects all the chakras that the energy flows through, there are actually *five different channels* and four additional chakras associated with each major chakra. They are set out in a horizontal line, 90 degrees to the vertical [Fig. 12-14a], and they rotate in 90-degree increments as they rise up the central column [Fig. 12-14b].

Three of these channels are primary, the outside two and the central one, and the two others are secondary. This relates to the five different kinds of human consciousness that Thoth talked about in chapter 9. Remember, the first, third and fifth are unity consciousness and the second and fourth are disharmonic consciousnesses. It further relates to the five senses and the five Platonic solids, but in order to keep it simple, we will not elaborate further.

Before we can discuss these five channels, we must talk about light. By understanding the way light moves in deep space, it will be easier to understand the movement of prana up these chakras. All forms of energy have a single source, and that source is prana or chi or life-force energy. It is consciousness itself, awareness, spirit—spirit, which began its journey in the Void, creating imaginary circles and lines.

To study light is to study the movements of spirit through its sacred dance into nature. Spirit made it so. We have been studying the movements of spirit, but now we will become more specific in our discussion. We will study light first, then return later to this discussion of chakras.

### Let There Be Light

This simple drawing in Figure 12-15 is the most important one I've ever done for my understanding of the Reality. Do you remember that when I talked about the first day of Genesis—which probably seems like a thousand years ago—we went from the Void to the top of the first sphere? And when we got to the top and formed the second sphere, we formed a vesica piscis? In the Bible, after the first motion of God upon "the face of the waters," He immediately said, "Let there be light." Remember that I said I would show you that the vesica piscis is light? Well, Figure 12-15 shows the energies of a vesica piscis. It's much more complex than this, but this is enough to show the relationship between it and light.

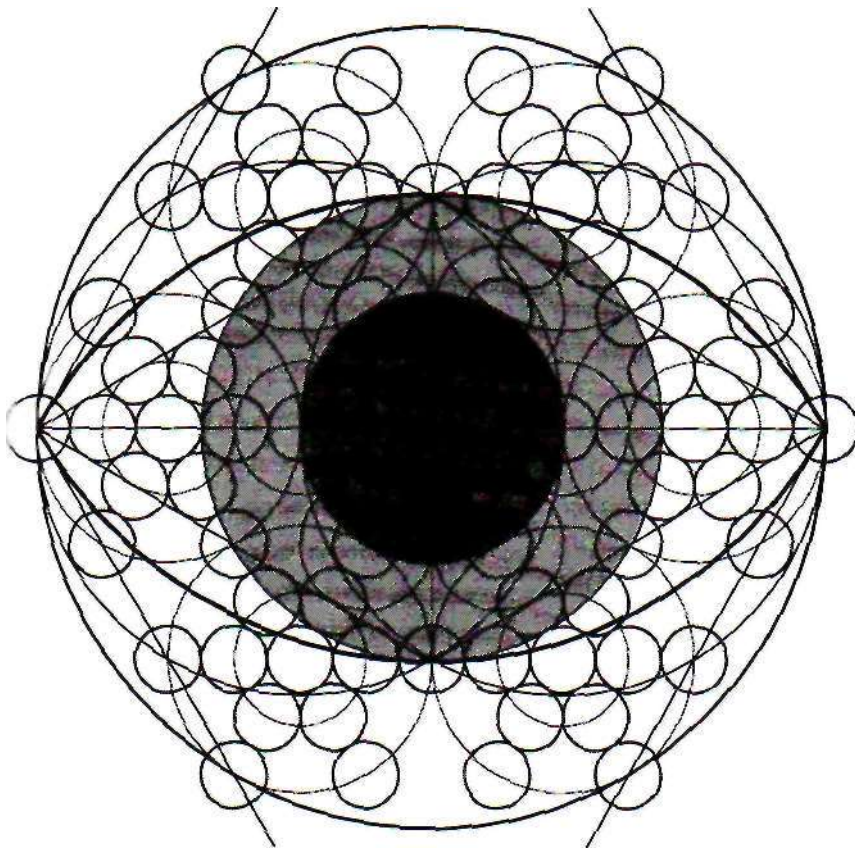

Fig. 12-15. "The Eye," a sacred geometry drawing.

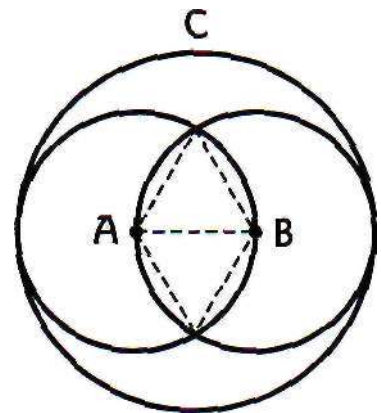

Fig. 12-16a. Vesica piscis created by two circles, here enclosed within a larger circle.

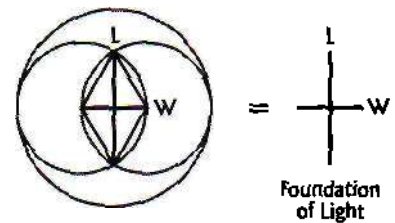

Fig. 12-16b. Same drawing with diamond and cross inside the vesica piscis.

In Figure 12-16a circles A and B pass through each other's centers, forming a vesica piscis, and both fit perfectly inside circle C. This vesica piscis is further delineated by the lines inside it, which form two equilateral triangles. The length (L) and width (W) of these two triangles together form a cross [see 12-16b]. This cross is the foundation of light.

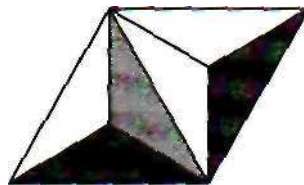

Fig. 12-17a. Top view of two 3D tetrahedrons with edges touching.

Notice now that these two triangles are really two edge-to-edge 3D tetrahedrons [Fig. 12-17a] (imagine two tetrahedrons sitting on a table with their edges touching, viewed from above), fully visible and contained perfectly inside the vesica piscis in Figure 12-17b. L is the length of a vesica piscis and W is the width. Every time the vesica piscis rotates by 90 degrees, a new one is created [see the smaller and larger crosses in the figure], and the length of the smaller one becomes the width of the larger. The drawing begins to form a shape that looks like an eye. This progression can continue forever, moving both toward and away from the center. This is a geometrical progression of relationships within the vesica

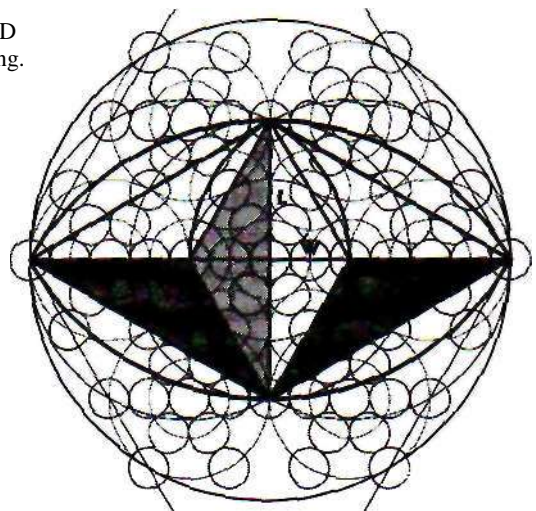

Fig. 12-17b. Two edge-to-edge 3D tetrahedrons.



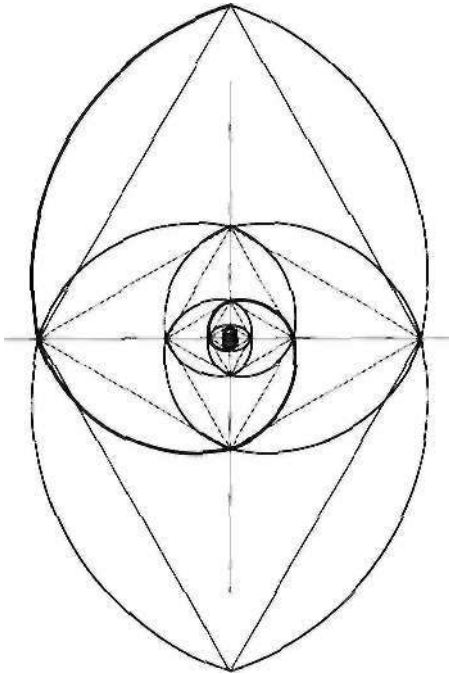

Fig. 12-18. Spirals of light.

piscis that identifies the blueprint of light based on the square root of 3. As you will see below in Figure 12-18, light moves in exactly this way.

When I was giving this workshop many years ago, there was a certain man present. I don't think I'll mention his name because I don't know whether he would want me to. He is considered one of the three greatest experts on light in the world. He is also one of the most brilliant people in the world. This guy's incredible. When he got out of college, he was 23 years old and Martin-Marietta signed him up and gave him a massive amount of money and a large team of scientists. They said, "Do anything you want. We don't care." That's how brilliant this person is. So with this money he studied light. One of the first things he did was study eyes, because eyes are the receivers of light.

If you want to study something in nature, you get to the components—in this case, the light wave and the instrument that receives the light wave, the organic eye—because one will reflect the other in its geometrical makeup. There should be a similarity between the eye and the light wave, and in their movements as well. If you're trying to build an instrument to receive something, the closer you can duplicate what you're receiving, the better you can receive it.

This gentleman discovered, after studying just about all types of eyes on the planet, that there are six categories, just like crystals. There are six different types of eyes on planet Earth, and each living thing within a type has geometric as well as physical similarities with every other living thing in that category.

I met this gentleman when he came to one of my first workshops, and when I flipped this picture on the screen [Fig. 12-18], he nearly fell out of his chair. He started to get a little angry, and he explained why. You see, after all his research—studying and typing eyes and study in related fields—this is the drawing *he* had come up with as the common thread between all eyes. This was how he had categorized them. At first he thought I must have stolen it from him. He knows now that I simply received it from Thoth. But as you know, this information doesn't and cannot belong to anybody. It belongs to all of us, and it's accessible to anybody who asks the right questions. It's embedded in every cell of every living thing.



Fig. 12-19. The human eye.

If we look at someone's eyes, we see ovals, but the eye is actually round. It's a ball, a sphere, and there's a lens on one part of the surface (Fig. 12-19). In Figure 12-15, you can see the round sphere, the oval shape of the vesica piscis and the smaller circle of the iris. You can almost *feel* the correctness of the geometries there with your right brain.

But that eye drawing is much, *much* more than just a drawing. It really shows the geometries behind the eyeball and the geometries of light itself, because they are one and the same. The geometries that create all eyes and the geometries of the entire electromagnetic spectrum, including light, are identical. When the spirit of God made the very first move in Genesis, it created a vesica piscis and immediately said, "Let there be light." It was not a coincidence that light came first.

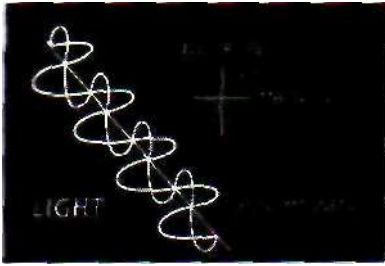

Fig. 12-20. A light wave's movement.

A light wave moves as shown in Figure 12-20. Here you can clearly see the relationship between the vesica piscis and light. An electrical component is moving in a sine wave on one axis at the same time a magnetic component is moving at 90 degrees to it, also in a sine-wave pattern. Simultaneously the entire pattern is rotating in

90-degree segments.

If you look at Figure 12-21, you will see the geometry of light. The long axis, or length, of the vesica piscis is the electrical component and the short axis, or width, is the magnetic component, and they are in the square-root-of-3 ratio to each other. In chapter 2 [page 41] I mistakenly said that the length and width of a vesica piscis was in the Golden Mean proportion. Actually, they are related through one of the sacred numbers of the Egyptians, the square root of 3. However, when you look at the pattern created by two vesica piscis at 90 degrees from each other that are set to the Golden Mean and at the square-root-of-3 pattern, it becomes obvious that they are extremely similar. Perhaps nature is trying to duplicate the Golden Mean again, as it has done with the Fibonacci series.

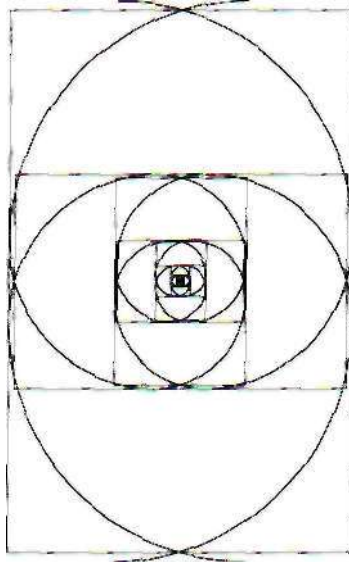

Fig. 12-22a. The geometry of light in Golden Mean spirals.

As light flows in 90-degree turns, it can be seen geometrically by examining how the vesica piscis turns 90 degrees as it moves in or out of the progression. If you can see this, then you will understand the geometry of light in Figure 12-18.

The Golden Mean spirals appear very close to the square-root-of-3 spirals of the vesica piscis, but notice that the rectangles in Figure 12-22a do not quite touch each other as they do in a true vesica piscis.

Interestingly, Figure 12-22b, a drawing of a true vesica piscis, is both the geometry of eyes and light. It is also the geometry of many other natural living things, such as the leaves in Figure 12-23. Leaves are designed by nature to receive light for photosynthesis. In these leaves you can see the same geometry that was in Figure 12-18, the spirals of light.

Now we will see how the movement of energy up the chakras is similar to the movement of light. (I repeat that this information is for certain people who feel it essential, and that if you wish to skip or just scan this section if it feels too complicated, you can, because you really need only the information about the basic energy flows of the 8- or 13-chakra systems.)

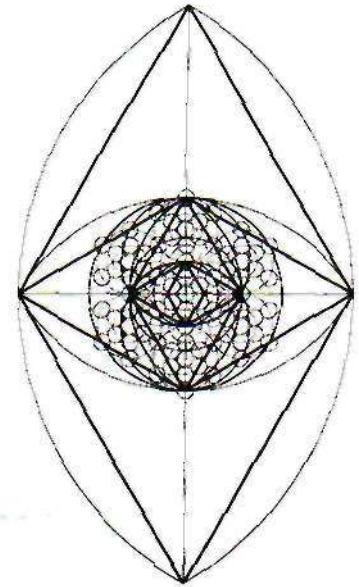

Fig. 12-21. The geometry of light.

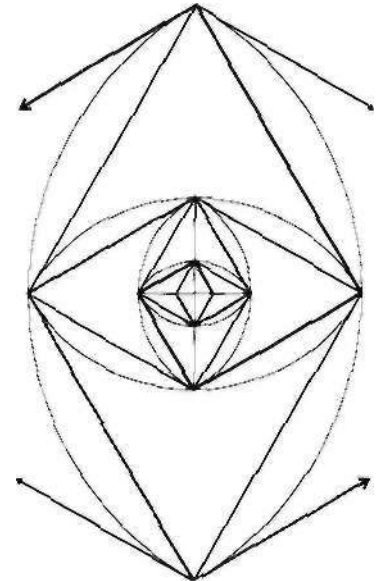

Fig. 12-22b. Four male square-root-of-three spirals coming out of a vesica piscis.

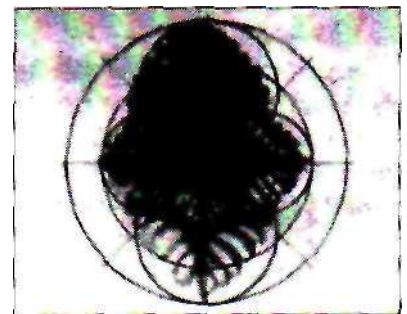

Fig. 12-23. Leaves and light.

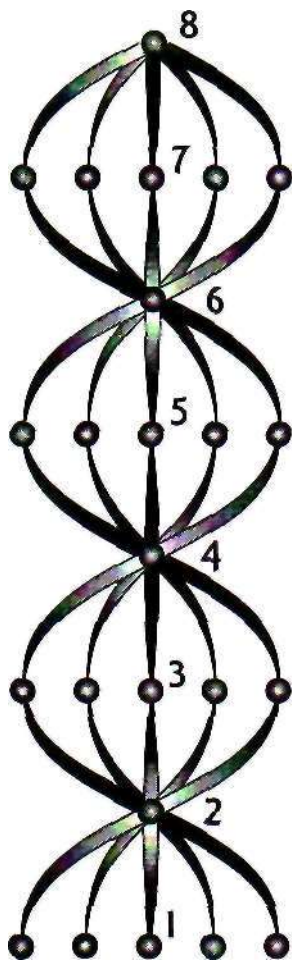

Fig. 12-24a. Spiral of light moving up the eight chakras.

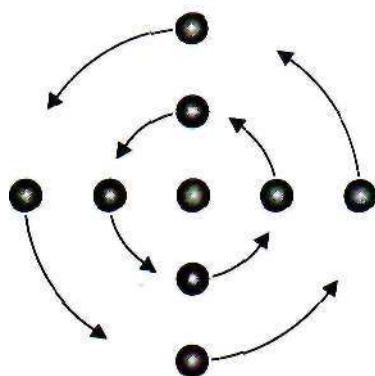

Fig. 12-24b. The male spiral as viewed from above. The female is reversed, or clockwise as seen from above.

Figure 12-24a is an image of light or energy, of how light spirals as it moves up the spine, just as it moves in deep space, except that in space it continually expands. Figure 12-24b shows how it looks from above.

Now let's see the energy flow. There are five channels where energy ascends the chakras. These five channels spiral up through the body in one of two ways, male or female. The male energy spirals counterclockwise and the female clockwise, as seen from the center of the body.

I'm going to have to be graphic to describe these five channels. There's no way to get around it. If you were beneath a person looking up at their subtle-energy channels (at the genital area), you'd see five channels of energy flowing up through the spine. There are very special connections and openings that appear on a horizontal line, 90 degrees to the vertical tube running through the chakra points. These openings are shown at the bottom of the diagram. That's at the base of a person's trunk at the perineum.

As we have said, the perineum is located between a woman's anus and vagina and a man's anus and scrotum. In that little bit of soft skin at the perineum, there's actually an internal opening, though it cannot be seen. In at least one body therapy, when pressure is placed on the perineum, the finger can actually move about two inches into a person's body. The perineum is the opening to the central tube in which the primary chakras are located. But there are four more openings and energy channels, two on each side [see Fig. 12-25].

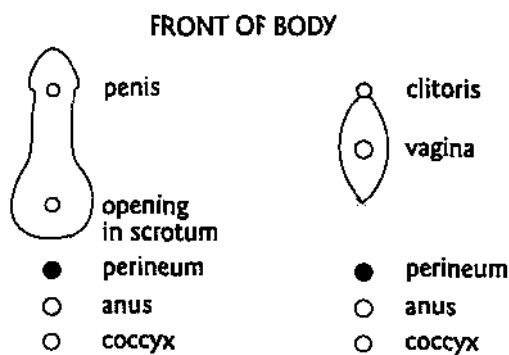

Fig. 12-25. The five openings to the five channels.

Behind the perineum is another opening, the anus, which has an energy flow that spirals upward as shown in the diagram; and behind the anus is another energy flow. The flow originates below the triangular-shaped sacrum, at the tip of the coccyx. This point lines up horizontally with the anus and perineum. The swing is much wider from there (shown graphically in Fig. 12-24a) and it has a more powerful flow of energy than the anus. In front of the perineum is the vagina in females or the opening inside the scrotum in males, where the energy level is similar to that of the anus. In front of that is a more powerful energy flow that is similar in strength to the spine; this originates at the clitoris in females or the penis in males and swings wide, as shown in Figure 12-24a.

Looking at the five channels at the bottom of the trunk, notice that they are laid out in a straight line from front to back. Everything about them flows from back to front with the exception of the male testicles, which are side to side but placed close together. This exception makes sense when you see the fifth chakra in a few minutes. The opening to the vagina is a vesica piscis whose orientation is front to back. The opening to the penis is also a vesica piscis, also oriented front to back. The first-chakra flow itself is laid out front to back, with the single exception mentioned.

We reach the second chakra, rotating 90 degrees either clockwise (female) or counterclockwise (male). Life always tries to conform to these natural energies, and you can see that in many cases these directional energies conform to the physical body parts. Actually, the body parts conform to the directional flow of the internal chakras.

At the level of the second (sexual) chakra, the female fallopian tubes are located to the sides—at 90 degrees to the direction of the first chakra, which is front to back. Spiraling up one more time, we reach the third chakra and the navel. Think of the umbilical cord coming out in a front-to-back direction. As we spiral up to the fourth chakra, the solar plexus, it is shaped like a vesica piscis and is oriented from side to side, 90 degrees to the third chakra.

One more rotation brings us to just above the sternum, where we will see something different from anything below—except, perhaps, the first chakra. That difference can be seen when you look at the rotational pattern.

Figure 12-26a is an overhead view of a person who is facing the top of the page. When we begin this spiral up the spine, the first-chakra energy races the front (the top of the page). To illustrate, let's say it rotates counterclockwise [shown by arrows at 26a and 26b]. When it comes to the second chakra (2), its rotation would face toward the left. At the third chakra (3), it would face the back (or bottom of the page). At the fourth chakra (4), the solar plexus, it would face to the right. And when it spirals upward to the sternum, the lower heart chakra (5), it has returned to its original direction, facing front again.

So the heart chakra is different because it knows the whole pattern; the energy has made one full circle of 360 degrees. This also happens with a sine-wave curve or a light wave [see 26c]; it has five places to complete itself. At the lower heart chakra, where the cycle completes itself, we find both front-to-back and side-to-side energies. It has made a cross in this very special place. The Egyptians felt that this was one of the most important centers in the body. It's the place of completeness, where we experience our love for God. At this center you see the breasts facing front-to-back in depth but side to side in placement; both directions are happening simultaneously, which we also saw at the testicles in the first chakra, which is the same point on the circle [1 and 5 in Figs. 12-26a or 12-26b].

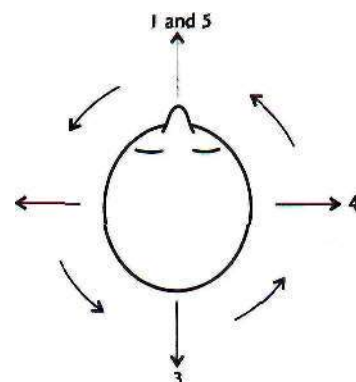

Fig. 12-26a. Looking at the head from above. One complete cycle goes up the spine in five movements, shown by the arrows facing each direction.

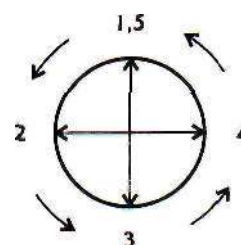

Fig. 12-26b. One complete cycle as a circle.

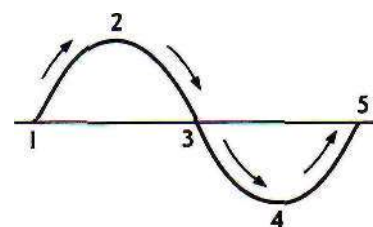

Fig. 12-26c. One complete cycle as a sine wave or light wave.

## Egyptian Sexual Energy and the Orgasm

Here we will take a small sidestep to discuss an immense subject—the importance of sexual energy and the human organism. It was believed in ancient Egypt that the orgasm was the key to eternal life, and that it was intimately connected with the fifth chakra. First we will explain the connection to eternal life.

When humans today practice sexual energy and orgasm, little concern is given to what happens to this energy when it is released. Most people in the world are ignorant about what happens to their sexual energy after they have an orgasm. Usually the energy moves up the spine and out the top of the head directly into the eighth or thirteenth chakra. In a few rare cases, the sexual energy is released down the spine into the hidden center below the feet, the point opposite the one above the head. In either case, the sexual energy, the concentrated life-force energy, is dissipated and lost. It is similar to discharging a battery into a ground wire. It is no longer in the battery; it is gone forever. This is what all the world's tantric systems I am aware of believe: that orgasm brings one a little closer to death because a person loses his or her life-force energy in the orgasm. But the Egyptians have found long ago that it does not have to be this way.

It is for this reason that the Hindu and Tibetan tantra systems ask the male to avoid ejaculating. Instead, they speak of these tiny invisible tubes where the sperm migrates up to the higher centers when a student learns to control the orgasm.

Both of these systems and the Chinese Taoist tantra system are all primarily concerned with the sexual energy flow, sometimes referred to as sexual currents. They are primarily concerned with what happens when the sexual energy is moved before the orgasm, but they all have entirely different views of this energy compared to the Egyptians.

The Egyptians believed that orgasm is healthy and necessary, but that the sexual energy currents must be controlled in a deeply esoteric procedure that is unlike any other system. They believed that if this energy is controlled, the human orgasm becomes a source of infinite pranic energy that is not lost. They believe that the entire Mer-Ka-Ba or lightbody benefits from this sexual release, that under the right conditions the orgasm will directly lead to eternal life—and that the ankh is the key.

What has the ankh to do with sexual energy? It is complicated to explain, but I will take the time. In order to see what took thousands of years for the Egyptians to grasp, we will begin with the fifth chakra— You can see from the section above that the fifth chakra is the first place where the rotating chakra system returns full circle. This is the first chakra that has the energies of both front-to-back and left-to-right. If you could see these energies from the top, they would look like this [Fig. 12-27a].

If you could see these energies from the front view of a human, they would look like this [Fig. 12-27b]

Notice that both of the above examples are Christian symbols. How-

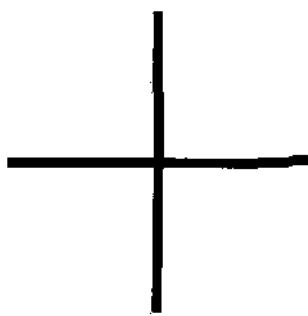

Fig. 12-27a. Top view of the upward-spiraling energies at the fifth chakra.

ever if you could see the same energies; from the side of a human being, they would appear different than you would expect. There is another energy-flow "tube" there that the Egyptians discovered from their discourses with the Tat brotherhood under the Great Pyramid. This information comes straight from ancient Atlantis. From the side, this is what a human being's energy field as----- with the fifth chakra looks like Fig. 12-27c],

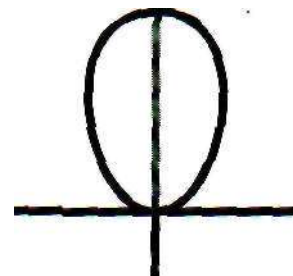

Fig. 12-27c. Side view at the fifth chakra—the Egyptian ankh.

I find it very interesting that the Christians must have understood this at: one time, for on the robes of many [Christian priests, at certain times of the year that are usually associated with resurrection, you will see the following symbol [Fig 12-27d]. This symbol shows all three views—the top,

Fig. 12-27b. Front view of these energies at the fifth chakra.

front and side at once. I believe the Christians omitted the complete loop of the ankh so that they would not show a connection with the old Egyptian religion. But it is obvious that they knew.

Now that you know that this "ankh" energy conduit is located in the human energy field, you will be able to understand the reasons for the Egyptian's sexual conduct.

Let me explain something about the ankh before I speak about its relationship to sexual energy. When I toured the museums in Egypt, I personally observed over 200 Egyptian rods. These rods were mostly made of wood, although other materials were sometimes used. They had a tuning fork on the bottom end, and the top end had four different types of devices that could be attached.

The 45-degree attachment that is used in the actual experience of resurrection is mentioned in chapter 5, but we didn't really discuss the ankh. This end piece is amazing. As the tuning fork at the bottom end vibrates, this energy is normally dissipated very quickly. But if you place an ankh at the top end, the energy seems to wrap around back into the rod, moving downward as it returns, thereby sustaining the energy.

I was in Holland a couple of years ago, and there some people had made many rods *out of* copper with a high-quality tuning fork at the bottom and a threaded end at the top, *so* that different end pieces *could be screwed* on. I experimented with this rod. Using it without a top piece, I struck the tuning fork and timed how long it would vibrate. Then I screwed on the ankh and struck the tuning fork again. With the ankh on top, the rod vibrated almost three times longer.

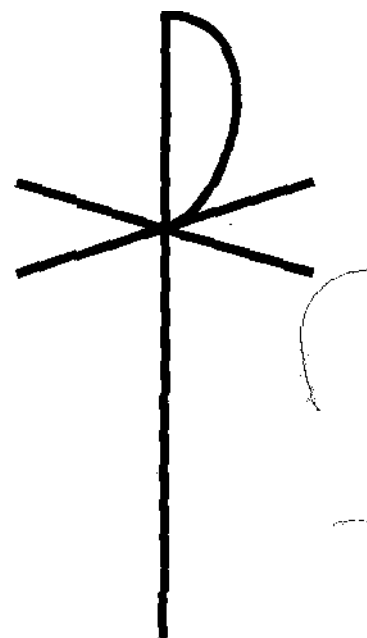

Fig. 12-27d. The Christian symbol that incorporates all three of the above

This is the key to why the Egyptians performed the particular sexual practices we are about to explain. They found that if they had an orgasm and let it go out the top or bottom *of* the spine, the sexual energy was lost. But if the sexual energy were guided by consciousness to move into the "ankh" conduit, it would come back into the spine and continue to resonate and vibrate. The life-force energy was not lost. In actual experience, it seems to increase the energy.

You can talk about it all day, but if you try it one time, you will understand. However, it is not easy to do in one test. For the first few times the sexual energy will often shoot past the point of the fifth chakra and continue on up and out of the body. So it takes practice. Once it is learned, I doubt seriously if you would ever have an orgasm any other way. It's too powerful and feels too good. Once your body remembers this experience, it is not likely to revert back to the old way.

### The 64 Sexual/Personality Configurations

Once you have experienced what I am saying, you may change it slightly to fit your needs. I will begin by explaining the basic sexual practices of the ancient Egyptians as told to me by Thoth. It is hard to believe from a modern view how complex and intricate their system was.

First of all, they did not see just two sexual polarities, but 64 *entirely separate* sexual polarities. I am not going to go into great depth here, but I will lay out the simple pattern. This pattern was copied from the human DNA molecule and the 64 codons.

They see four basic sexual patterns: male, female, bisexual and neutral. These were further broken down into polarities. Male: Male-heterosexual and Male-homosexual. Female: Female-heterosexual and Female-homosexual. Bisexual: Male body and Female body. Neutral: Neutral-male body and Neutral-female body. This makes eight primary sexual patterns.

What I am about to say is, again, outside of normal human knowledge. The Egyptians did not see us in our body all alone. They perceived and identified eight completely separate personalities. All eight personalities are directly related to the original eight cells, which make the eight electrical circuits that lead to the eight primary chakras, which is the basis of the eight points of the tetrahedron around the body.

When a spirit comes to Earth for the first time, it arranges the tetrahedrons around the body in such a way as to be male or female. The personality that emerges is the first one. At the second lifetime, the spirit usually arranges the tetrahedrons in the gender opposite to the first lifetime. The spirit will continue to choose a different point of the tetrahedron to face forward until all eight points and all eight personalities have experienced life on Earth. After the first eight lifetimes, usually the spirit will choose a rhythm that keeps a sexual balance during its lifetimes on Earth. An example would be to choose three male lifetimes followed by three female life-

times, then continue in that pattern. The rhythm could be almost anything *the* spirit chooses.

What happens in almost all cases is that spirit likes one of both the male and female personalities more than the others and uses it more often. The result is that one male and one female personality become dominant, like a grandfather and grandmother to the other six. Then there is a slightly younger one, equivalent to a middle-aged person. Next is a still younger one that would be about in the late twenties or early thirties. Finally, there is one that is seldom used and is like a teenager. It is the same for both sexes. These eight personalities together make up the entire personality complex of the spirit that first came to Earth.

The ancient Egyptians combined the eight primary sexual modes and the eight personalities to create the 64 sexual/personality configurations associated with Egyptian tantra. We are not able to work within this arena at this time. It is a fascinating subject, one that requires many years to master. The Egyptians took twelve years to pass through each of the sexual/personality configurations, resulting in a person who has great wisdom and understanding of life.

At the end of this training the student would have a "conference" with all eight personalities conscious at the same moment in order to bring the wisdom of the grandfather/grandmother to the younger personalities.

#### *Instructions for the Orgasm*

Here is exactly how to achieve the "ankhing" associated with the human orgasm. Whatever you do sexually before the orgasm is completely up to you. I am not here to judge you—and definitely the Egyptians would not, since they believe in knowing all 64 sexual modes before you enter the King's Chamber to ascend to the next level of consciousness. This is *their* idea, but it is important to know that it is not necessary. You can reach the next level of consciousness without knowing this information. However, from their point of view, the idea of anking is of paramount importance in achieving eternal life. You will have to decide for yourself if it is something you wish to practice.

1. The moment you feel the sexual energy about to rise up your spine, take a very deep breath, filling your lungs about 9/10 full, then hold your breath.

2. Allow the sexual energy of the orgasm to come up your spine, but at the moment it reaches the fifth chakra, with your willpower you must turn the flow of sexual energy 90 degrees out the back of the body. It will then automatically continue inside the ankh tube. It will slowly turn until it passes exactly through the eighth or thirteenth chakra one hand-length above the head at 90 degrees to the vertical. It will then continue to curve around until it returns to the fifth chakra, where it began. It will often slow down as *it* approaches its point of origin. If you can see the energy, it comes to a sharp point. When it approaches the fifth chakra from the front of the



body, there is sometimes a tremendous jolt as it connects with this chakra—All this takes place while you are holding your breath.

3. The instant the sexual energy reconnects with its source, take in the full breath. You had filled your lungs only 9/10 full, so now you fill them as completely as you can.

4. Now exhale very, very slowly. The sexual energy will continue on around the ankh channel as long as you are exhaling. When you reach the bottom of this breath, you will continue to breathe very deeply, but a change happens here.

5. At this point, continue to breathe a deep, full breath, but instantly see the sexual energy as prana coming from the two poles and meeting in your fifth chakra as before. Be aware of your entire Mer-Ka-Ba and feel this energy radiate into and throughout your entire lightbody. Let this energy also reach down into the deepest physical levels of your body structure, even past the cellular level. Feel every cell becoming rejuvenated by this life-force energy. Feel how this beautiful energy surrounds your very being and brings health to your body, mind and heart.

6. Continue to breathe deeply until you feel the relaxation begin to spread throughout your body; then relax your breath to your normal rate.

7. If possible, allow yourself to completely relax or even sleep for a while afterward.

If this is practiced for even one week, I believe you will more than understand. If it is continually practiced, it will begin to give health and strength to your mental, emotional and physical bodies. It will give great strength and power to your lightbody as well. If it does not feel right for some reason, then don't do it.

### Beyond the Fifth Chakra

Physiologically, you can't see the next chakras as clearly as the five below, but we will see the same phenomenon in the upper part of the body [see Fig. 12-28]. After the spiral exits the fifth chakra, it rotates to the left, to the sixth chakra, which is the personal heart chakra. The physical heart is off center on our left side and at 90 degrees to the fifth, Christ chakra.

Then the spiral rotates to the rear as it rises to the throat chakra. The Adam's apple of the male protrudes along this front-to-back plane.

But when it comes to the eighth chakra, the chin, the system seems to break down. It's clearly a front-to-back flow also, like the throat—no 90-degree change. Why? At this point the energy enters into a new configuration, perhaps because it is the eighth chakra, which usually completes the cycle in the 8-chakra system. A new, smaller chakra system emerges inside the head alone that defines the 13-chakra system, yet is separate from it.

What is going on? If you study Leonardo's canon [Fig. 12-29], you'll see that the head is drawn inside one of the 64 squares that is further broken up into a 4 x 4 grid of 16 squares. In this drawing you can barely see what I am talking about, but if you can find a good copy, you will see. A 16-square grid

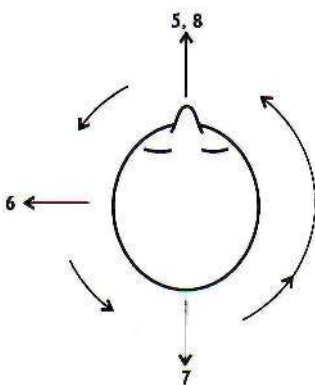

Fig. 12-28. The upward spiral from the fifth chakra.

is a function of a 64-square grid in which the head is exactly the size of one of the 64 squares. So the head is 1/64th of the square around the entire body.

The chakra system goes all the way up through the body and through the head, but in the head there's a separate mini chakra system that runs from the tip of the chin to the top of the head. It seems to be an 8-chakra system, but I am not positive that the 13 system is not there also. Realize that this mini chakra system is in addition to and inside the 13-chakra system we have begun to study.

The chakra points are located at the tip of the chin, the mouth, the tip of the nose, the eyes and the third eye. The other three are inside the head and cannot be seen unless we study the internal parts of the brain.

Again you can see the rotational pattern in the shape of the body part. First, the tip of the chin extends outward, facing straight ahead, then the mouth, a vesica piscis, is 90 degrees, extending left and right. The nose faces front to back at 90 degrees to the mouth, then the eyes, also vesica pisces, extend to the sides at 90 degrees to the nose. Finally, the third eye is the place of completion, the fifth point, just like the Christ chakra. It is for this reason that both places, the Christ chakra and the third-eye chakra, are so important-and unique. They both are the fifth and completing chakra within their respective systems.

This was the work I was involved with when Thoth left the Earth. I wish I had had more time with him on this subject, because it's not in any books. The Egyptians never wrote any of this down. None of the Right Eye of Horns information was written down anywhere except in the Hall of Records. It was all transmitted orally.

#### Through the Final Half Step

Figure 12-30 shows the head, the pineal gland and the thirteenth chakra. Eventually our consciousness is going to be located at the pineal gland, and we're going to want to get up to the thirteenth chakra. The most obvious way is to go straight up, but God made sure that that was *not* the way because it's the most obvious. He changed the angle so that you can't find it, so that you will stay in the pineal until you really master it. just as on the 8-chakra-system drawing [Fig. 12-10]—where there's a block after the third chakra so you can't get into the upper chakras—there's another block toward the back of the head, where the half step is. Experientially, it is very difficult to figure it out. The Tibetans say that you can't go up to the thirteenth chakra unless you go to the back of the head first. You have to find the doorway, and once you do, you can step through it.

There are actually five chakras in a straight line running from front to

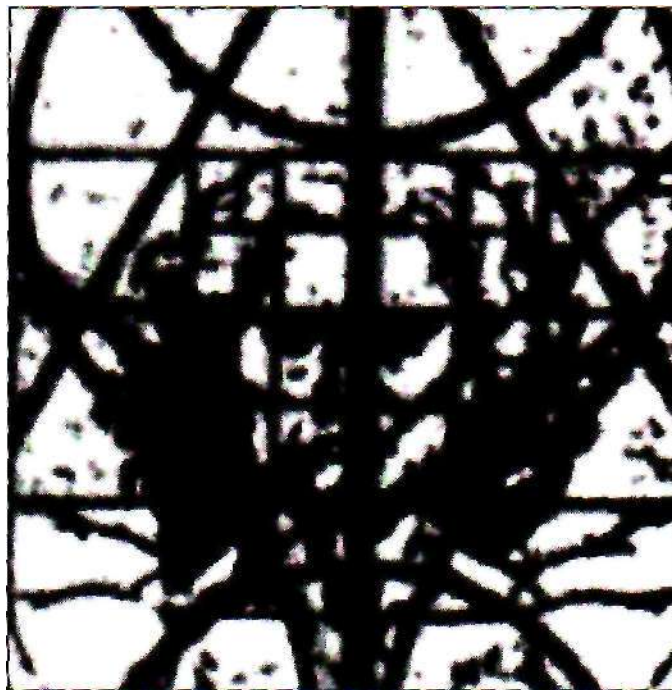

Fig. 12-29. Leonardo's human canon.

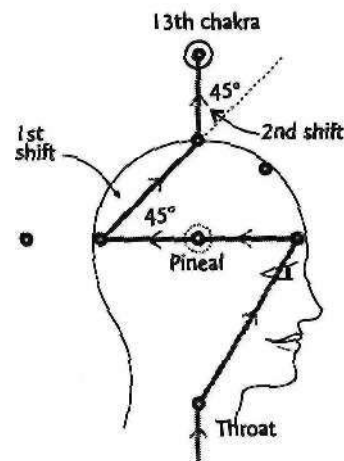

Fig. 12-30. Ascension in modern times.

back, as shown. Three are inside the head, one is in space behind the head, and the other in space in front of the head. Most of us are familiar with only the pineal and the pituitary.

The Nefilim originally figured out how to get from the twelfth to the thirteenth chakra and change dimensional levels, but their secret was different from the way we're going to do it. The Nefilim went to the pineal gland first, then shot their consciousness forward to the pituitary gland and continued it out into space to the chakra that sits in front of the head. Once they entered that front chakra, they made a 90-degree turn and went straight up. That put them in another world. Because of this rapid-change technique they used, which is shaped like an L, the Nefilim became known as the L's or Els. It became their nickname. Later, when the Nefilim were becoming rare on Earth, they became known as the Elders, or the old ones.

I believe the Earth is going to do it another way—unless you *ward* to go the way of the Nefilim. But I'm going along with the rest of the planet. The way I will describe now is how Thoth and Shesat left. The reason we're using this method of leaving is because it's the easiest way known. These were some of the instructions Thoth told me on his last day here.

We will find our way from the pineal to the point at the back of the head. We have to pass through the crown chakra to get out, so from that back point, we make a 45-degree turn to get to the crown. When we reach the crown, we make another 45-degree turn to move up to the thirteenth chakra. You may find the Mer-Ka-Ba becoming unstable because of the rapid 45-degree turn. Don't worry, it will stabilize.

Prior to the Fall in Adantis, we made one 90-degree turn; but it's difficult that way—it's a real shock. It's easier to make two 45-degree turns. When you make that first 45-degree turn, you'll find that your Mer-Ka-Ba field will sort of wobble, and you may feel really strange. You've got to sit there and center until your Mer-Ka-Ba field restabilizes itself. You will make two shifts separated by about a minute to a minute and a half. When you feel it stabilize again, make another 45-degree turn to connect to the thirteenth chakra.

This is what many of the ascended masters have done during their ascension. They make the first shift, wait till everything settles down, and immediately make another shift. For just a moment you're in a kind of no-man's-land, and it's not very stable; you can't stay there. If you stayed there too long, I don't know what would happen. But you stay there for only a moment and then whoosh, you make the second shift, which puts you into the next dimensional level, in this case the fourth dimension.

- I'm telling you this again so you will remember; you might find this useful at some point. There are lots of ways to directly experience other dimensions, but it requires a more mature soul to make that rapid 90-degree turn. Making these two 45-degree turns is like using training wheels. It's easier, and it's not as likely to throw you off balance.

## The Energy Fields around the Body

Now we're going to look at the energy fields around the human body that are created by the movement of energy and consciousness *within* the chakras.

The first energy field that comes off the body is the prana or chi field, sometimes called the etheric field. Although it comes out of the whole body, it's seen primarily around your hands, your feet, your head and on your shoulders a little bit, *too*. Usually *it's* a soft, white-blue light. Immediately next to the skin is a black field, and just beyond it begins a light bluish light. This bluish light is the prana or the life-force energy of your body. If it's around your hands, it'll show up anywhere from a quarter inch to maybe 3 or 4 inches away. But around the rest of your body it usually extends less than an inch from the skin.

Even if you don't believe in it and have never seen it before, you can see it easily. I'm going *to* describe how *to do it* if you wish *to* try it. All you do is take a piece of black construction paper and get directly under an incandescent light with a dimmer switch. Hold your hand about an inch away from the paper and slowly turn down the dimmer switch until you can't see your hand. Wait 11 seconds. Your eyes will adjust, and when they do, you'll see your hand again. When your hand reappears, you should see the prana aura. You may have to do it a second time.

Then look at, say, the last section of your middle finger, with the black paper maybe an inch behind it. Lock your eyes on it and don't blink. Now wait. Within 10 or 15 seconds you'll begin to see this soft blue glowing light around your fingers.

Once you see the field, you can do different things. You can put the tips of two fingers on opposite hands together, whereupon the flames that shoot out the tips of the fingers will lock. Then move your fingers apart and you'll see the flames stretch out like bubble gum. When your fingers get about five inches or so away from each other, the flames will snap back. You can do this over and over. Most people can see this.

Then you can take a crystal—it doesn't have to be a fantastic one—and hold it against your wrist. Start doing yogic breathing deeply and rhythmically—really deep and really long—to bring in prana. You'll see the flames at the tips of your fingers begin to grow. Sometimes these flames can go out four to six inches. (You can actually see this.) Then you'll notice that it's connected to your breath. As you inhale, the field will slightly contract; as you exhale, *it* will expand. You can see with your own eyes how the breath and the prana field interrelate.

Kirlian photography is done by placing your hand or finger or a leaf on a charged plate, then exposing it electrically on a special film. You can see these fields in the photograph. Figure 12-31 is from the Human Dimensions Institute, and the pictures are from the finger of a well-known local healer. On the top, when the healer is sitting there doing nothing, you can see the whitish blue light coming off the tip *of* her finger and around the edges. The photo on the bottom shows what happens after she begins to

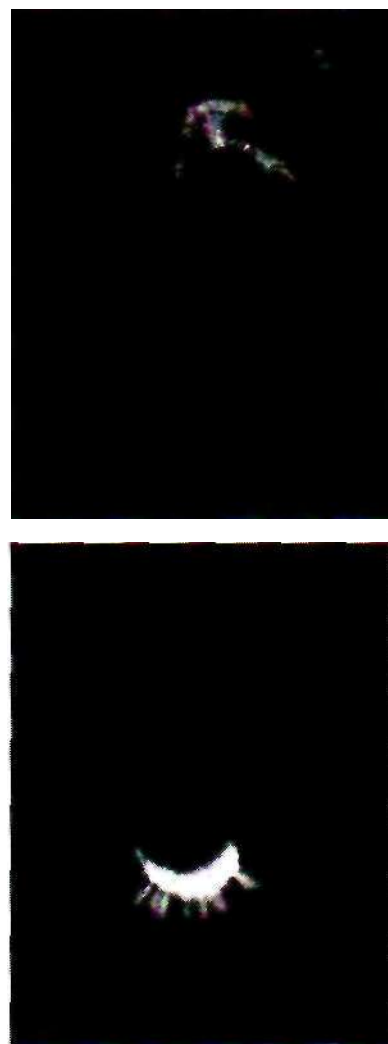

Fig. 12-31. Kirlian photos of fingertips, pointing downward.

breathe and focuses on healing. Whitish blue flames are coming out the tip of her finger. In this case, it's not just the breath that's doing this—it's also which chakra she's centered in, which I will talk about in the chapter on healing-

Beyond the prana field, as it radiates away from the body, is another field of energy that is not associated directly with your breath, but with your thoughts and emotions. Your thoughts emit electromagnetic fields from your brain. And your emotions also put out electromagnetic fields. You can see them, they're visible. However, most people have tuned them out, so we don't know they're there. Cameras have now been connected to computers that can photograph the aura, so it is no longer guesswork, but a scientific fact. Look into the work of Dr. Valorie Hunt to see how far science has opened up the secrets of the human aura.

Tuning out incoming information is an interesting subject. It's like living in a big city where all kinds of horns are going off, fire engines and police sirens, auto crashes, people screaming—everything imaginable. All this loud noise is going on all the time, and in the human experience, it is heard as a low drone, although it's really loud. There's a continual drone going on in every city, but if you live there all the time, you don't hear it. You tune it out. For most people it's just not there. Yet if someone comes from the woods or a little town into a big city, it seems deafening. But that's only because he or she is so sensitive to it. If that same person stayed in the city long enough, he would do the same thing, just tune it out. Then it's gone for him, too. We have done the same thing with human auras, for whatever reason. Perhaps because it has been too painful to see the truth of another person's thoughts and feelings, most of us have turned off our ability to see auras.

### How to See Auras

If you wish to really see and know the aura, I suggest that you first read a couple of books on color therapy. This will give you the meaning of different colors, but as I have found, this meaning is within all of us, and we all understand color on a subconscious level. I have read 22 books on color therapy and found that they all say the same thing. There is hardly any difference between their definitions, so if you read two or three, I feel sure you will get the message. The book by Edgar Cayce [*Auras: An Essay on the Meanings of Colors*] is excellent, simple and to the point.

The military trains some of their special forces to see auras because they can then look at someone and know exactly what they're thinking and feeling—which obviously could be very advantageous to the military. They have a special training technique, which I'm going to give you.

Get some construction paper with many colors, then a big piece of white paper, maybe 2 feet by 3 feet. You'll see a phenomenon of vision that has nothing whatsoever to do with auras, but through this technique you can learn to see the real human aura.

Put the white paper on *the* floor under a lamp that has a dimmer switch.

In the middle put a piece of colored construction paper. Use red the first time. Now lock your eyes in the middle of the colored paper and don't think. Wait for 30 seconds. Keeping your eyes locked on the colored paper, quickly pull it away and keep staring at the same place on the white paper. Within less than a second you'll see the *complementary* color of the color you stared at. If you used red, you'll see green. The afterimage will always be different from the original color, but always the same shape.

The afterimage will be glowing and transparent and appear to float above the surface. If you do this experiment with four or five different colors in a row, which would take just a few minutes, by the time you get done you'll have a certain sensitivity to being able to see this type of color image—glowing, transparent and floating in space. These colors are very much like auric fields, except that they are more ideal, because few people save auric colors that are quite so clean and clear.

For the next part of the training you need a partner; preferably both of you will wear white clothing. That's the easiest way to see the colors. Clothing certainly won't block an aura, but the color you wear could make the aura harder or easier to see. Have your partner stand against a white wall, then take the light with a dimmer switch, turn it up to its brightest and shine it on your partner. Now take one sheet of colored paper and put it an inch or so in front of your partner from the nose down, letting your partner hold it there. Get back and look at the color in the same way as before; lock your eyes on it, count to 30, then have your partner remove it. Now you'll see the complementary color floating in space in front of your partner. In this way you can get used to colors floating in space around a person and your mind can adjust to this idea.

After that you might put a colored paper behind the head or the shoulder, maybe a foot or two in front of your partner. Do that four or five times, until you get used to seeing colors floating around the body. Then remove the colored paper and continue watching your partner while you turn the dimmer switch down very, very slowly. You will come to a magical place where the person's body will start to get very dark—then bingo!—all the colors will pop out and you'll see the aura.

You'll see it *all*. You'll know that these are the real colors of the aura, not the complementary colors you were seeing earlier, because you'll see a variety of *changing* colors. Whatever that person is thinking and feeling at the time will be projected at that moment. Usually you'll find that the colors around the head and shoulders will primarily be what the person is thinking. The colors around the chest and the body, wrapping around the back, are going to be primarily your partner's feelings and emotions, though there can be a slight overlap sometimes.

In addition to the aura showing the person's thoughts and emotions, there's a third possibility. Sometimes a physical problem in the body shows up in the aura. If something inside your body is hurting, it'll often show up as a colored shape in your aura. The colors emitted from your thoughts will

glow and change as your thoughts change, and the colors that are your emotions usually tend to float or move. But the ones associated with an illness will be fixed and generally have angles or a shape, and the shape won't change. As the body moves around, it will be fixed at a certain place. Sometimes you might not see an illness at all because the light of that illness is totally inside the body and there's nothing emerging outside. But usually something will stick out.

There's a physician at the Human Dimensions Institute who teaches courses about diagnosing human illnesses by reading human auras. He discovered a long time ago that once you know how to read auras, you can simply look at someone and see all their fixed auric patterns to know exactly what's wrong with that person. You don't need to go through MRIs or anything. Just look, and you know exactly. Most people can do this, and he teaches it. All people are capable of seeing auras, I believe, unless there is some real physical or emotional problem.

Here's how you can tell if these fields are real or not. In a class I would say to the person we are looking at, "Okay, think about your car." (People have all kinds of mixed feelings about their cars.) And immediately you'll see the auric colors change around their head where they're thinking. And then you can say, "Think about someone you don't like." You'll probably see a muddy red color, the color for anger, because we usually have anger associated with someone we don't like. That will come out around the head and shoulders, perhaps even all the way down around the body. Then you can say, "Think about someone you really love. Get into it. Find one person you really love and think about that person." You'll usually see pink colors coming out around the chest area and gold or white colors coming out around the top of the head. If you have the person think about spiritual matters and God, you'll usually get lots of golds and violets. These colors will change the moment a person changes his/her thoughts. That's how you know it's real.

Once you have this ability, you can turn it on and off at will. I leave it off all the time unless I'm asked to do it. But it's real easy. It's kind of like a stereogram; you can just look at the paper normally if you want, or you can focus softly and go into the other level, which is what you do when you see auras. You can either look at the surface of the body, or you can focus softly and look around the body. Looking at the space around the body is similar to looking at stereograms. You can do either one.

### The Rest of the Human Lightbody

The human aura is contained in an egg-shaped field that encloses the body. Out from that are hundreds of geometric images that are very, very specific. They're electromagnetic in nature (at least in this dimension), and you can pick them up on a computer screen and see them if you have the instruments. They're very hard to see without instruments. You can sense them with the mind, you can feel them, but they're difficult to see be-

caouse die energy is so subtle. Once you get the Mer-Ka-Ba field going, it's easier because the Mer-Ka-Ba has so much power.

In che next chapter we will investigate these geometric fields and make them clear. Once seen, they offer the possibility of ascension into worlds of light, which will resuk in immortality and the direct knowledge of God.



## The Mer-Ka-Ba Geometries and Meditation

**T**o summarize the last chapter: First there is the energy flow through the chakras, and from the chakras the meridians reach each cell in the body. Then there is the prana field close to the body, generated by the chakra/meridian energy flow. Next there is the auric field that extends out a few feet off the surface, generated by the thoughts and feelings/emotions and surrounded by an egg-shaped energy field. Out past that we begin to see the geometric fields of light that make up the bulk of the human lightbody. The Mer-Ka-Ba is a potential of the geometric fields of light and is created through consciousness. It does not happen automatically except over a very long period of evolution, and at this moment in history less than 0.1 percent of humanity has a living Mer-Ka-Ba. I believe that will change dramatically over the next few years.

The human being is surrounded by numerous geometric fields of energy that are electromagnetic in nature within this dimension [Fig. 13-1]. The Mer-Ka-Ba extends into all possible dimensions, and in each dimension uses the laws of that dimension to manifest. In the figure above, you are seeing only one of hundreds of other possibilities that exist around the body. You are looking at the star-tetrahedral field that is the first geometric field off the surface of the body, sometimes referred to as the "opening" to the Mer-Ka-Ba. This field will be the one we will use (at least most of us) here on Earth at this time in history, but we are going to show you the more . complete geometric lightbody, because for some of you this information will become very important. For the vast majority of you, this first star tetrahedral field is all that is necessary to know. Once you reach the next world, the fourth dimension of this planet, you will receive all the additional information you will need at that time.

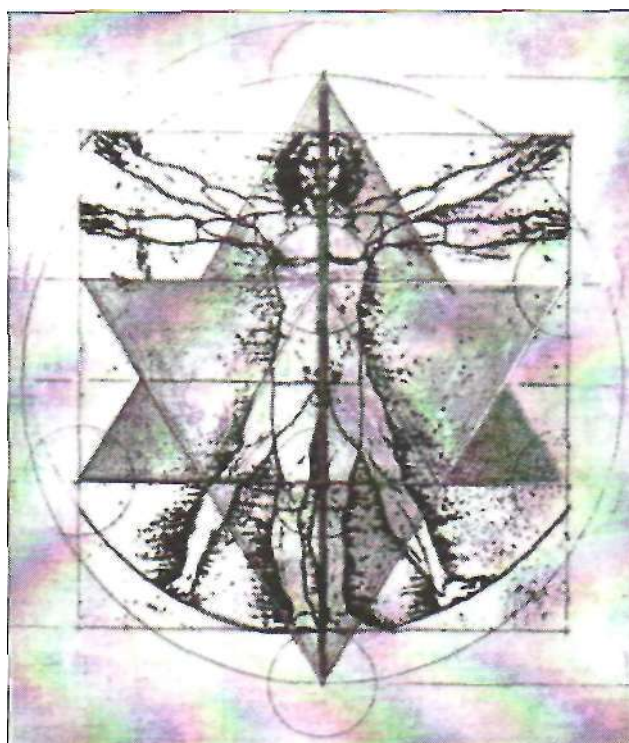

Fig. 13-1. The human star-tetrahedral geometry.

Why do I keep giving information that is only for a few? I am speaking to an audience that is on many levels of evolution. All of you are important to life. In fact, if even one spirit were to become nonexistent, the entire universe would cease to exist. In order to reach the whole audience, I must go beyond what most people need.

## The Star Tetrahedron, Source of All Geometric Fields around the Body

If you were to follow these energy lines of this star-tetrahedral field to their source within the body, you would be looking at the tiny star-tetrahedral field of the original eight cells—the Egg of Life, located in the exact geometric center of the body. As you saw in chapter 7, the creation of life is geometric. Mitosis moves through sphere to tetrahedron to star tetrahedron to cube to sphere again, and finally to torus. This geometric beginning of life does not stop there. It continues out to a distance of about 55 feet around the body, creating an amazingly intricate array of interconnected and interrelated geometric energy bodies that will be used over time by life as it evolves.

Now that you understand the source of these geometric fields around the body, let's take a look at them. We will begin with the star tetrahedron. First we will repeat part of the information on pages 48 and 49 to save you from having to look it up. It is the beginning.

The work that is to follow is sacred and will result in your being changed forever. If it does not feel like the right path for you to follow at this time, then don't. Wait until you feel sure. Once you have entered upon this path, there is no turning back. You will know and will have experienced too much in the higher chakras. You can read this chapter, but that is not what I am talking about. It is the actual *experience* of the Mer-Ka-Ba that will change you and your life. It will alert your higher self that you are becoming aware, and your higher self, which is you on a higher level of consciousness, will begin to alter your life here on Earth and you will rapidly begin to grow spiritually.

You may find major changes in your life begin within days or weeks of beginning this practice. Friends and relationships that have been in your way spiritually will recede, and new friends and relationships will appear. Whatever has stopped you from growing spiritually will disappear and whatever you need will appear. It is a spiritual law, as you will soon see if you choose to enter this path within the higher chakras and the Mer-Ka-Ba. I say this to you so that you will know and not be surprised. Once life is aware of your awakening, it will assist you; then once you have begun to awaken, life will use you to further unfold it. Do you remember? This is, of course, not the first time you have entered this path. In truth, you do know. So let us begin.

This star tetrahedron with the human image within it [Fig. 13-2] is going to become one of the most important drawings for understanding and

working with the Mer-Ka-Ba as taught here in this book. What you're looking at is two-dimensional, but think of it in three dimensions. In three dimensions it is two interlocked tetrahedrons that are perfectly contained within a cube. It would really help if you were to make or buy one of these forms so that you can get the image perfectly in your mind. [In the back of this volume is a template that can be copied, cut out and taped to form the star tetrahedron.]

One of the first things the angels did when they were teaching me was ask me to make a star tetrahedron out of cardboard. Somehow, holding this form in your hands really helps your understanding. In fact, it is almost essential, for a misunderstanding at this point could completely stop your further: growth.

One simple way to construct a star tetrahedron is to first construct an octahedron with eight identical equilateral triangles. (You see, there is an octahedron inside the center of a star tetrahedron). Then make eight identical tetrahedrons that exactly fit over each face of the octahedron. Now glue the eight tetrahedrons onto each face, and you have a star tetrahedron-. There are other ways [see the pattern in back of this book], but this way is easy. I highly recommend that you somehow obtain a star.

The next thing is to understand how your body fits into this star tetrahedron, or how the star is arranged around your body. By carefully studying this 3D star tetrahedron you have obtained or constructed and by studying Figure 13-1, your mind will begin to remember. Please do this first.

On Leonardo's drawing, the tetrahedron pointing upward to the Sun is male. The one pointing down toward the Earth is female. We're going to call the male one a Sun tetrahedron and the female one an *Earth* tetrahedron. There are only two symmetrical ways that a human being can look out of this star tetrahedral form with one point of the star above the head and one point below the feet and with the alignment of the human body looking toward the horizon.

For a male body looking out of his form, his Sun tetrahedron has a point on the bottom plane facing forward and the opposite flat face is behind him; his Earth tetrahedron has a point on its top plane facing backward and the opposite flat face is in front [see Fig. 13-2, left].

For a female body looking out of her form, her Sun tetrahedron has a flat face forward and a point facing the back; her Earth tetrahedron has a point facing forward and the opposite flat face is behind her [see Fig. 13-2, right]. Fur-

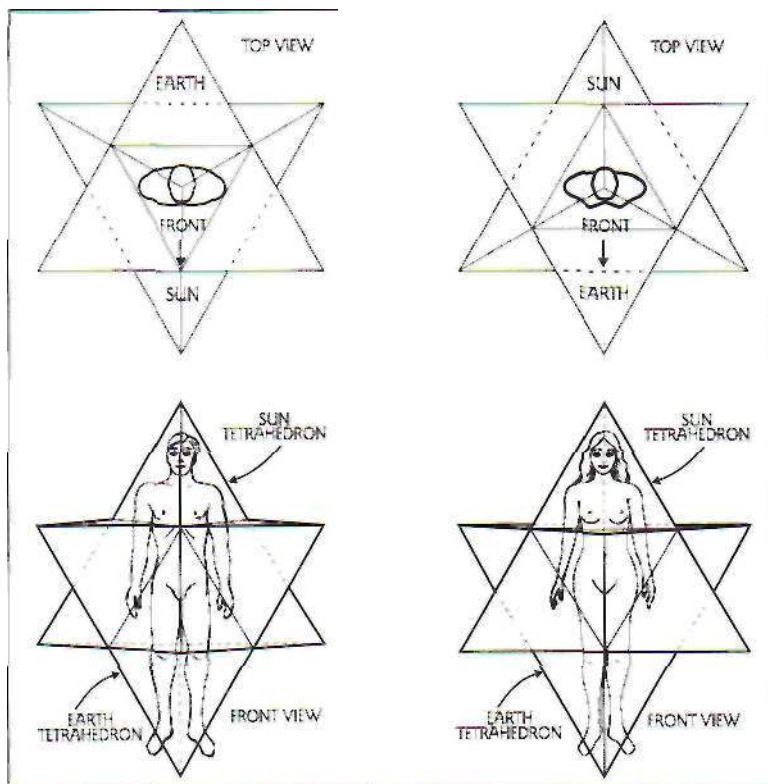

Fig. 13-2. The male and female orientation within the star tetrahedron.

Update 1: If you have been on Earth and did not recently come from somewhere else, your Mer-Ka-Ba has been dormant for 13,000 years. So it has been a very long time since your body has sensed this experience. This breathing practice will reestablish the living Mer-Ka-Ba around your body. The practice functions much like a spinning wheel that has to be spun every so often to keep it spinning. In a Mer-Ka-Ba, however, eventually the repeated spinning begins to take on a life of its own, and at one point in the practice the spinning will continue indefinitely. But it takes time. This state of the Mer-Ka-Ba is now being called a "permanent" Mer-Ka-Ba, which means a person is what is called a *conscious* breather. A conscious breather is someone with a permanent Mer-Ka-Ba who is consciously aware of the Mer-Ka-Ba breath. To be clear, the daily practice that follows is a method to construct a living Mer-Ka-Ba field around your body, but the practice will someday be stopped and replaced by conscious breathing.

However, there are very definite problems that can occur if you stop doing the practice before your Mer-Ka-Ba is really permanent. Your ego may say to you, "Oh yes, I am sure that *my* Mer-Ka-Ba is permanent" when in fact it is not. If you stop doing the practice too early, then your Mer-Ka-Ba will stop living (or spinning) after about 47 to 48 hours. So how can you tell if it is permanent?

This is very difficult for some people because when you are beginning, the energy of the Mer-Ka-Ba is very subtle. If you have been doing the Mer-Ka-Ba for

ther, there are actually three complete star tetrahedrons around the body all the exact same size and superimposed over each other along the same axis. If you could see them, they would appear as only one, but there are really three. We will explain in breath fifteen.

Now we are going to give the actual ancient Mer-Ka-Ba meditation and special updated information to help you solve most of the problems that people have encountered in the past when attempting to activate their Mer-Ka-Ba using these or similar instructions. These instructions, which I have slightly edited here, were originally used by the Flower of Life facilitators and have been posted on Web sites around the world, but most people have not been able to do this work from these instructions because of problems that have been hidden until recently. Read these updates as referenced to avoid the earlier problems.

The problems that people have had in understanding these instructions have been identified over the last five years by direct experience in workshops, and they will be clearly noted in the updates format in the margin in a special section. I believe this new way will work, but the best possible way is still to seek out a Flower of Life facilitator to teach you. These FOL facilitators are in over 33 countries and can be located on the Internet at [www.floweroflife.org](http://www.floweroflife.org). Or you can call the Flower of Life office in Phoenix, Arizona, USA, direct at (602) 996-0900. They have been carefully trained not only to teach the Mer-Ka-Ba instructions, but also to teach the oral instructions of the heart that cannot be taught from a book. And the lessons of the heart are more important than the knowledge itself. It is, of course, up to you how you proceed, but once you begin to understand the Mer-Ka-Ba, the FOL facilitator could become indispensable. With this preface, we will begin the instructions. These instructions will be in four parts.

## Spherical Breathing and the Remembrance of the Mer-Ka-Ba

*Like the Sun, we must breathe, radiating out to all life. And from all life we will receive our manna.*

Begin by creating a place in your home that is used only for this meditation. Make a space where no one will walk through or disturb you, such as in a corner of your bedroom. A small altar with a candle and a cushion or pillow to sit on may be helpful. Make this place holy. It is here that you will learn to create the living Mer-Ka-Ba around your body and make conscious contact with your higher self.

Enter into this meditation once each day until the time comes when you are a conscious breather, remembering with each breath your intimate connection with God. [Read Update 1.]

To begin the meditation, first sit down and relax. Any human position is possible for doing the meditation, but sitting lotus style or on a chair is probably best. You decide. Begin by letting the worries of the day go. Breathe rhythmically and shallowly in a relaxed manner. Be aware of your

breath and feel your body relax. When you feel the tension begin to fade, place your attention on your Christ chakra, which is located just about one centimeter above your sternum, and begin to open your heart. Feel love. feel love for God and all life everywhere. Continue to breathe rhythmically (the same length of time in and out), being aware of your breath, and feel the love moving through your spirit. When the feeling of love is in your beingness, you are ready to move toward the experience of the Mer-Ka-Ba. The degree you are able to love will be the degree to which you will be able to experience the living Mer-Ka-Ba.

## An Overview of the Meditation

There are seventeen breaths to reach completion. The first six are for the balancing of the polarities within your eight electrical circuits and for the cleansing of these circuits. The next seven, which are quite different, are to reestablish the proper pranic flow through your chakra system and to create what is called *spherical breathing* within your body. The fourteenth breath is unique. It changes the balance of pranic energy in your body from third-dimensional to fourth-dimensional awareness. The last three breaths re-create the counterrotating fields of the living Mer-Ka-Ba within and around your body.

### Part 1: The First Six Breaths

The following instructions are broken into four areas: mind, body, breath and heart.

#### **FIRST BREATH: Inbreath**

**Heart::** Open your heart and feel love for all life. If you cannot do this you must at least open to this love as much as is possible for you. This is the most important instruction of all.

**Mind:** Become aware of the Sun (male) tetrahedron (the apex facing upward to the Sun, with a point facing to the front for males and for females a point facing to the back). See this Sun tetrahedron filled with brilliant white light surrounding your body. (The color of this brilliant white light is the color of lightning as you see it coming from a thundercloud. It is not only the color of lightning, it is the energy of lightning.) Visualize it the best you can. If you cannot visualize it, sense or feel it surrounding you. Feel the Sun Tetrahedron filled with this energy. [Read Update 2.]

**Body:** At the same moment of inhalation, place your hands in a mudra where your thumb and first finger in both hands are touching. Lightly touch the tips of the two fingers, not allowing the sides of your fingers to touch each other or any other object. Keep your palms facing up. [Read Update 3.]

**Breath:** At this same moment, with your lungs empty, begin to breathe in a complete yogic breath. Breathe through your nostrils only, except at certain places, which will be described. Simply breathe from your stomach

more than one year *and* you find that you are aware of your Mer-Ka-Ba many times a day, then it is fairly certain that it is permanent. If you are in contact with your higher self and you are sure of it, then simply ask. However, one thing is also for certain: If you stop doing your practice and you find that you have not even thought of or remembered your Mer-Ka-Ba for several days, you must begin again. Once you are a conscious breather, you will remember your Mer-Ka-Ba every day.

Update 2: You will need to have a small three-dimensional physical star tetrahedron to look at. Realize that each edge of this star tetrahedron is the width of your outstretched arms from the middle finger of one hand to the middle finger of the other hand (or your height, if you prefer). So the star around you is very big. You can draw a triangle on the floor or use strings to see with your mind the actual size of your tetrahedrons. This will help tremendously. In the Flower of Life classes they often use a full-size 3D star tetrahedron and get inside it. This really works.

When you visualize your tetrahedrons, do not see them outside yourself. Do not see a small star out in front of you with you inside it. This will disconnect you from the actual field and will not create the Mer-Ka-Ba. Your mind needs to connect with the real field, so see the tetrahedrons *around your body* with you inside.

Second, you have different options to connect your mind with your tetrahedrons. Some people can visualize them; their ability to visualize is amazing. Other peo-

ple cannot visualize them, but they can feel them. Both ways are equal. To see is left-brained and male, and to feel is right-brained and female. Either way works; it really does not matter. Some people use both ways at once, which is also okay.

Update 3: A mudra is a hand position. Many spiritual practices use mudras. The Tibetans and the Hindus both use them in their practices. What this does is connect your body consciously with a specific electrical circuit within your body. As you change mudras, it will connect you with a different electrical circuit.

There are eight electrical circuits in the body, coming from the eight original cells. It is hard to explain here, but it is necessary to balance only six circuits to achieve balance in all eight. It is similar to the global positioning system (GPS) system that locates a specific spot on the surface of the Earth. This system is based on the tetrahedron. If three points of the tetrahedron are known, then the fourth can be located. In the same way, if three electrical circuits are balanced, it will balance the fourth. Therefore, if six points of the star tetrahedron are balanced, the last two, located above the head and below the feet, will automatically become balanced. That is why there are only six balancing (and cleansing) breaths for the eight electrical circuits.

first, then your diaphragm and finally your chest. Do this in one movement not three. The exhalation is completed either by holding the chest firm and relaxing the stomach, slowly releasing the air, or by holding the stomach firm and relaxing the chest. The most important point is that this breathing becomes rhythmic, meaning the same time duration in and out. Begin by using seven seconds in and seven seconds out, which is what the Tibetans use. As you become familiar with this meditation, find your own rhythm. The breaths can be as long as you are comfortable with, but should not be less than five seconds unless you have a physical problem and cannot do it that long. Then, of course, do the best you can.

The following instructions for a complete yogic breath are from *Science of Breath: A Complete Manual of the Oriental Breathing Philosophy of Physical, Mental, Psychic and Spiritual Development* by Yogi Ramacharaka [Yoga Publishers Society, 1904]. Perhaps this description from his book will be helpful:

Breathing through the nostrils, inhale steadily, first filling the lower part of the lungs, which is accomplished by bringing into play the diaphragm while descending exerts a gentle pressure on the abdominal organs pushing forward the front walls of the abdomen. Then fill the middle part of the lungs, pushing out the lower ribs, breastbone and chest. Then fill the higher portion of the lungs, protruding the upper chest thus lifting the chest, including the upper six or seven pairs of ribs.

At first reading it may appear that this breath consists of three distinct movements. This, however, is not the correct idea. The inhalation is continuous, the entire chest cavity from the lowered diaphragm to the highest point of the chest in the region of the collarbone being expanded with a uniform movement. Avoid a jerky series of inhalation and strive to attain a steady, continuous action. Practice will soon overcome the tendency to divide the inhalation into three movements and will result in a uniform, continuous breath. You will be able to complete the inhalation in a few seconds after a little practice.

Exhale quite slowly, holding the chest in a firm position and drawing the abdomen in a little and lifting it upward slowly as the air leaves the lungs. [Author's Note: Some teachers reverse this part by holding the abdomen in a firm position and relaxing the chest. Most teachers use the first method. Either way is fine.] When the air is entirely exhaled, relax the chest and abdomen. A little practice will render this part of the exercise easy, and the movement, once acquired, will be afterward performed almost automatically.

#### **FIRST BREATH: Outbreath**

**Heart:** Love.

**Mind:** Become aware of the Earth (female) tetrahedron (apex pointing up the Earth, with a point facing to the back for males, and for females a point

facing to the front). See this tetrahedron also filled with brilliant white light.

Body: Keep the same mudra.

**Breath:** Do not hesitate at the top of the inhalation to begin the exhalation. Exhale quite slowly for approximately seven seconds, in the yogic manner. When the air is out of the lungs, without forcing, relax the chest and abdomen and hold the breath. When you feel pressure to breathe again after five seconds or so, then do the following:

**Mind:** Be aware of the flat equilateral triangle at the top of the Earth tetrahedron located in the horizontal plane that passes through your chest at approximately 3 inches below the Christ chakra, or approximately at the solar plexus [see Vitruvius' canon on the frontispiece before chapter 1]. In a flash, and with a pulselike energy, send that triangular plane down through the Earth tetrahedron. It gets smaller as it goes down because it conforms to the shape of the tetrahedron and pushes all the negative energy of the mudra or electrical circuit out the tip or apex of the tetrahedron. A light will shoot out of the apex toward the center of Earth. This light, if you can see it, will usually be a muddy or dark color. The mind exercise is performed simultaneously with the following body movements. [Read Update 4.]

**Body:** This following exercise can be achieved with your eyes either open or closed. Move your eyes slightly toward each other; in other words, slightly cross your eyes. Now bring them up to the top of their sockets (by looking upward). This motion of looking up should not be extreme. You may feel a tingling sensation between your eyes in the area of your third eye. Now look down to the lowest point you can, as fast as you can. You may feel an electrical sensation move down your spine. The mind and the body must coordinate the above mental exercise with the eye movements. The eyes look down from their uppermost position at the same time the mind sees the horizontal triangular plane of the Earth tetrahedron move down to the apex of the Earth tetrahedron. It will naturally return to its normal position.

This combined exercise will clean out the negative thoughts and feelings that have entered your electrical system in this particular circuit. Specifically, it will clean out the part of your electrical system associated with the particular mudra you are using. Immediately upon pulsing the energy down your spine, change mudras to the next one and begin the entire cycle over again for the second breath.

The next five breaths repeat the first, with the following mudra changes:

SECOND BREATH Mudra: Thumb and second [middle ] finger together.

THIRD BREATH Mudra: Thumb and third finger together.

FOURTH BREATH Mudra: Thumb and little finger together.

FIFTH BREATH Mudra: Thumb and first finger together (same as first breath)

SIXTH BREATH Mudra: Thumb and second finger together (same as second breath)

Part one, the first six breaths (balancing the polarities and cleansing your electrical system), is now complete. You are now ready for part two.

Update 4: Do not worry about this negative energy entering Mother Earth. She is fully able to assimilate this energy with no problem. However, if you live in a two-story building or higher, it may be necessary to do one more thing in order to be responsible. When passing through a building into a lower floor, if this energy comes in contact with other people, it will contaminate them. In order not to cause harm, the following is necessary:

We have not explained psychic energy yet, so you must go on faith if you do not understand it. You must see and *know* that this negative energy you have emitted will not become attached to another person and will completely enter Mother Earth without causing harm. By simply *thinking this thought*, it will be so.

## Part 2: The Next Seven Breaths, Re-creating Spherical Breathing

Here an entirely new breathing pattern begins. You do not need to visualize the star tetrahedron at this time. You only need to see and work with the breathing tube that runs through the star, from the apex of the Sun (male) tetrahedron above your head to the apex of the Earth (female) tetrahedron below your feet. The tube extends from one hand-length above your head to one hand-length below your feet. The diameter of *your* tube will be the size of the circle formed by touching your own thumb and middle finger together. (Because all people are different, each person must be his, her own measuring stick.) The tube is like a fluorescent tube with a crystalline tip at each end that fits into the top and bottom apexes of the two tetrahedrons. Prana enters the tube through an infinitely small hole at the tip.

### SEVENTH BREATH: *Inbreath*

Update 5: The following refinement is optional. If it does not feel necessary, then don't do it, and continue to use only love. Use this refinement only after you are comfortable with this practice and are no longer concentrating on how to do it. It is as follows: Replace the feeling of love that is held for all seven breaths with the following seven feelings or qualities of mind, holding them during the entire breath.

- Breath 7 Love
- Breath 8 Truth
- Breath 9 Beauty
- Breath 10 Trust
- Breath 11 Harmony
- Breath 12 Peace
- Breath 13 Reverence for God

This pattern is necessary for entering a stargate such as the one found in Orion in the middle of the Crab Nebula. Only a person (or spirit) who is living these qualities can enter such a stargate. This pattern has a subtle field that will help you in the future. If you do not understand now, you will later. -S\*

Heart: Love. There is another refinement that can be used after you have first perfected this meditation. [Read Update 5.]

Mind: Visualize or sense the tube running through your body. The instant you begin the seventh inbreath, see the brilliant white light of prana moving up and down the tube simultaneously. This movement is almost instantaneous. The point where these two prana beams meet within your body is controlled by the mind; this is a vast science known throughout the universe. In this teaching, however, you will be shown only what is necessary to take you from the third- to the fourth-dimensional awareness and move with the Earth as she ascends.

In this case you will direct the two beams of prana inside the tube to meet at your navel—or more correctly, within your body at the navel level. The moment the two beams of prana meet, which is just as the inbreath begins, a grapefruit-sized sphere of white light/prana is formed at the meeting point centered within the tube exactly at this chakra. It all happens in an instant. As you continue to take the seventh inbreath, the sphere of prana begins to concentrate and grow slowly larger.

Body: For the next seven breaths, use the same mudra for both inbreath and outbreath: the thumb, first and second fingers touching together, palms up.

Breath: Deep, rhythmic yogic breathing, seven seconds in and seven seconds out, or whatever is best for you. There is no holding your breath from now on. The flow of prana from the two poles will not stop or change in any way when you switch from inbreath to outbreath. It will be a continuous flow that will not stop as long as you breathe in this manner—even after death, resurrection or ascension,

### SEVENTH BREATH: *Outbreath*

Mind: The prana sphere centered at the navel continues to grow. By the



time of the full exhalation, the prana sphere will be approximately eight or nine inches in diameter.

**Breath:** Do not force the air out of your lungs. When your lungs empty naturally, immediately begin the next breath.

EIGHT BREATH: *Inbreath*

**Hearth:** Love

**Mind:** The prana sphere continues to concentrate life-force energy and grow in size.

NINTH BREATH: *Outbreath*

**Mind:** The prana sphere continues to grow and will reach maximum size at the end of this breath. The maximum size is different for each person. If you put your longest finger at the edge of your navel, the line on your wrist that defines your hand will show you the radius of the maximum size of this sphere for you. This sphere of prana cannot grow larger; it will remain this size intact even when we expand another sphere beyond this one later.

NINTH BREATH: *Inbreath*

**Mind:** sphere cannot grow larger, so the prana begins to concentrate within the sphere, causing it to grow brighter.

**Breath:** The sphere grows brighter and brighter as you inhale.

NINTH BREATH: *Outbreath*

**Hearth:** As you exhale, the sphere continues to grow brighter and brighter.

TENTH BREATH: *Inbreath*

**Mind:** As you inhale the tenth breath, the sphere of light in your stomach and will reach maximum concentration. Approximately halfway into the tenth inbreath, at the moment of maximum possible concentration, the sphere will ignite and change color and quality. The electric blue-white color of prana will turn into the golden color of the Sun. The sphere will become a golden sun of brilliant light. As you complete the tenth inbreath, this new golden sphere of light will rapidly reach a new and higher concentration. At the moment you reach full inhalation, the golden sphere of light in your body is ready for a transformation.

TENTH BREATH: *Outbreath*

**MIND:** At the moment of exhalation, the small sphere of golden light, two hand-lengths in diameter, bulges to expand. In one second, combined with the breath described below, the sphere expands quickly to the size of Leonardo's sphere (the fingertips of your extended arms). Your body is now completely enclosed in a huge sphere of brilliant golden light. You have re-

turned to the ancient form of spherical breathing. However, at this point the sphere is not stable. You must breathe three more times (breaths 11,12 and 13) to stabilize the new golden sphere.

**Breath:** At the moment of exhalation, make a small hole with your lips and blow out your air with pressure. Notice how your stomach muscles contract and your throat seems to open. In the first moment of this breath, you will feel the sphere begin to bulge as you force the air through your lips. Then at the right moment (usually within a second or two), relax and let all the remaining air out through your lips. At that moment the sphere will immediately expand to the size of the Leonardo sphere. Notice that the original smaller sphere is also still there. There are two spheres, one within the other.

#### **ELEVENTH, TWELFTH AND THIRTEENTH BREATHS: Inbreath and Outbreath**

**Mind:** Relax and drop your visualization. Simply *feel* the flow of the prana flowing from the two poles, meeting at the navel and expanding outward to the large sphere.

**Breath:** Deep, rhythmic yogic breathing. At the end of the thirteenth breath you have stabilized the large sphere and are ready for the important fourteenth breath.

It is important to note here that the original small sphere is still inside the larger sphere. In fact, the small sphere is actually brighter and more concentrated than the larger one. It is from this inner sphere that prana is drawn for various purposes such as healing.

### **Part 3: The Fourteenth Breath**

#### ***FOURTEENTH BREATH: Inbreath***

**Heart:** Love.

**Mind:** At the beginning of the fourteenth inbreath, using your mind and your thoughts, move the point where the two beams of prana meet from your navel to about two or three finger widths above the bottom of the sternum, the fourth-dimensional chakra of Christ consciousness. The entire large sphere, along with the original small sphere, still contained within the large sphere, moves up to the new meeting point within the tube. Though this is very easy to do, it is an extremely powerful movement. Breathing from this new point within the tube will inevitably change your awareness from third- to fourth-dimensional consciousness, or from Earth consciousness to Christ consciousness. It will take awhile to have this effect on you, but as I have said, it is inevitable if you continue this practice.

**Body:** The following mudra will be used for the rest of the meditation. Males will place the left palm on top of the right palm, both faced upward, and females will place the right palm on top of the left palm. Let the thumbs lightly touch each other. It is a relaxing mudra. [Read Update 6.]

Update 6: Because there is a sexual change taking place on Earth at this time triggered by the new light from our Sun, many people have found that their sexual polarity has changed. Since this mudra is not really important except to relax the meditator, it is now suggested that you use whichever mudra feels right for you. And if it seems to change sometimes, then change with it. <-

**Breath:** Deep, rhythmic yogic breathing. However, if you continue to breathe from your Christ center without moving on to the Mer-Ka-Ba (this is recommended until you have made contact with your higher self), then shift to a shallow, comfortable rhythmic breath. In other words, breathe rhythmically but in a comfortable manner where your attention is more on the flow of energy moving up and down the tube, meeting at the sternum and expanding to the large sphere. Just feel the flow. Use your feminine side to just be. At this point don't think; just breathe, feel and be. Feel your connection to all life through the Christ breath. Remember your intimate connection with God. [Read Update 7.]

#### **Part 4: The Last Three Breaths, Creating the Vehicle of Ascension**

It used to be taught that you not attempt this fourth part until you had made contact with your higher self and your higher self has given you permission to proceed. We are now giving you permission to proceed, but continue to be open to communication with your higher self. This part is to be taken seriously. The energies that will come into and around your body and spirit have tremendous power.

#### **FIFTEENTH BREATH: Inbreath**

**Heart:** Unconditional love for all life.

**Mind:** Be aware of the whole star tetrahedron. Each is composed of one Sun (male) tetrahedron interlocked with one Earth (female) tetrahedron. These two, the Sun and Earth tetrahedrons together, form the whole star tetrahedron (the three-dimensional Star of David). Now, realize that there *are three separate star tetrahedrons superimposed over each other*—three complete sets of double (star) tetrahedrons that are exactly the same size and appear as one but are actually separate. Each star tetrahedron is exactly the same size, and each star tetrahedron has a polarity of its own, either male, female or neutral. Each star tetrahedron will turn or spin on the same axis.

The first star tetrahedron is neutral in nature. It is literally the *body itself*, and it is locked in place at the base of the spine. It never changes its orientation, except under certain rare conditions that have not been discussed. It is placed around the body according to the sex of the body.

The second star tetrahedron is male in nature and electrical. It is literally *the human mind*, and it can rotate counterclockwise relative to your body, looking outward. To put it another way, it rotates toward your left, beginning from a point in front of you.

The third star tetrahedron is female in nature and magnetic. It is literally the *human emotional body*, and it can rotate clockwise relative to your body, looking outward. Put another way, it rotates toward your right, beginning from a point in front of you. [Read Update 8.]

On the inhalation of the fifteenth breath, as you are inhaling, say to

Update 7: For many years it was recommended that people breathe only from the spherical breath until they had made conscious contact with their higher self. Because the Earth has moved into a higher consciousness in the last few years, it is now recommended that you immediately continue to part four of the living Mer-Ka-Ba.

Update 8: This is one of the biggest misunderstandings people have. Not being clear that there are really three *sets* of tetrahedrons around the body, they simply rotate the Sun tetrahedron counterclockwise and the Earth tetrahedron clockwise. This is a

mistake that does not cause any real harm, but it stops further spiritual growth.

This type of Mer-Ka-Ba will take you into an overtone of the third dimension of this planet, which has been used by medicine men and women and shamans for thousands of years to gain power and to heal. It has been used even for warfare. But it leads nowhere, and it definitely will not allow you to ascend into the higher worlds that the Earth is taking us to. If you are doing this now, begin anew and start the practice as described here.

Update 9: You can also use the mudra of the interlaced fingers: Interlace your fingers, thumbs lightly touching.

Update 10: After you have created the Mer-Ka-Ba and have been doing it for about two weeks, you can do this blowing out more symbolically because your mind knows exactly what your intentions are and can achieve this step with or without this blowing out. (But if you like to do it, that is okay.)

Update 11: This is why the numbers 34/21 are used: As you know from chapter 8, these are Fibonacci numbers. All counterrotating fields in nature, such as pine cones, sunflowers etc., that have different speeds, are Fibonacci numbers. (There may be exceptions, but I am not aware of them.) That explains it on one level, but why 34/21?

Without going into a long dissertation, each chakra has a different

yourself in your mind the code words, "equal speed." This will start the two rotatable star tetrahedrons spinning in opposite directions at equal speeds. Your mind knows exactly what your intentions are and will do as you say. This means there will be a complete rotation of the *mind* tetrahedrons for every complete rotation of the *emotional* tetrahedrons. If one set goes around 10 times, the other set will also go around 10 times, only in the opposite direction.

Body: Continue the mudra of the cupped hands from now on. [Read Update 9.]

Breath: Deep, rhythmic yogic breathing again, but only for the next three breaths. After that, return to shallow, rhythmic breathing. We will mention this again.

#### **FIFTEENTH BREATH: Outbreath**

Mind: The two sets of tetrahedrons take off spinning. In an instant they will be moving at exactly one-third the speed of light at their outermost tips. You will probably not be able to see this because of their tremendous speed, but you can feel it. What you have just done is to start the "motor" of the Mer-Ka-Ba. You will not go anywhere or have any exciting experience. It is just like starting the motor of a car but keeping the transmission in neutral. It is an essential step in creating the Mer-Ka-a.

Breath: Make a small hole with your lips just like you did for breath number ten. Blow out in the same manner, and as you do, feel the two sets of tetrahedrons take off spinning. [Read Update 10.]

#### **SIXTEENTH BREATH: Inbreath**

Mind: This is the most amazing breath. On the inbreath, as you are inhaling, say to yourself in your mind, "34/21." This is the code for your mind to spin the two sets of tetrahedrons at a ratio of 34 to 21, meaning that the *mind* tetrahedrons will spin to the left 34 times while the *emotional* tetrahedrons will spin to the right 21 times. As the two sets speed up, the ratio will remain constant.

Breath: Deep, rhythmic yogic breathing. [Read Update 11.]

#### **SIXTEENTH BREATH: Outbreath**

Mind: As you let out the breath, the two sets of tetrahedrons take off in an instant from their setting at one-third the speed of light to two-thirds the speed of light. As they approach two-thirds light speed, a phenomenon occurs: A flat disk quickly extends from the original eight cells within the body (at the level of the base of the spine) to a distance of about 55 feet in diameter. And the sphere of energy centered around the two sets of tetrahedrons creates, with the disk, a shape that looks like a flying saucer around the body. This energy matrix is called the Mer-Ka-Ba. However, this field is not stable. If you see or sense the Mer-Ka-Ba around you at this point,

you will know it to be unstable. It will be slowly wobbling. Therefore, breath number seventeen is necessary to speed it **up**.

**Breath:** Same as breath number fifteen. Make a small hole with your lips and blow out with pressure. It is at this point that the speed increases. As you will feel the speed increasing, let out all your breath with force. This action will cause the higher speed to be fully obtained and the Mer-Ka-Ba to be formed in a stable position.

#### ***SEVENTEENTH BREATH: Inbreath***

**Heart:** Remember, unconditional love for all of life must be felt throughout this meditation or no results will be realized.

**Mind:** As you breathe in, say to yourself the code "**nine-tenths the speed of light**." This tells your mind to increase the speed of the Mer-Ka-Ba to 0/10 the speed of light, which will stabilize the rotating field of energy. It will also do something else. The third-dimensional universe we live in is tuned to 9/10 the speed of light. Every electron in your body is rotating around every atom in your body at 9/10 the speed of light. This is the reason this particular speed is selected. It will enable you to understand and work with the Mer-Ka-Ba in this third dimension without having to have fourth or higher-dimensional experiences. This is very important in the beginning. [Read Update 12.]

**Breath:** Deep, rhythmic yogic breathing.

#### ***SEVENTEENTH BREATH: Outbreath***

---

**Mind:** The speed increases to 9/10 the speed of light and stabilizes the Mer-Ka-Ba.

**Breath:** Same as breaths fifteen and sixteen. Make a small hole in your lips and blow out with pressure. As you feel the speed take off, let all your breath out with force. You are now in your stable, third-dimensionally-tuned Mer-Ka-Ba. With the help of your higher self, you will understand what this really means.

After you are finished with the breathing exercise, technically you can immediately get up and return to your everyday life. If you do, try to remember your breathing and the flow through your body as long as you can and you can realize that life is an open-eyes meditation and everything is

However, it would be desirable to remain in the meditation for a while longer, perhaps fifteen minutes to an hour. While you are in this meditation state, your thoughts and emotions are amplified tremendously. This is a great time for positive affirmations. Talk to your higher self to discover the possibilities of this special meditative time. We will talk about this in detail in the chapter on psychic energy.

speed ratio associated with it in this dimension. The chakra we have moved into with the fourteenth breath and are breathing from is the Christ chakra, and that is the speed ratio of that chakra. The chakra above this one is 55/34, and the one below it, the solar plexus, has a ratio of 21/13. It is not important for us to know this now, for when we reach the fourth dimension we will be given full knowledge about this subject.

**Update 12:** Many teachers in the world have decided to teach people to move faster than the speed of light with their Mer-Ka-Bas. This is their decision, but I feel it is extremely dangerous. Most of the higher selves of these people will not allow this to happen even if the person commands it to take place. If a person really did have the Mer-Ka-Ba moving faster than the speed of light, that person would not be visible in this world and would exist somewhere else in the universe. They would no longer live on 3D Earth.

There will come a time when this will become appropriate, and it is called the 18<sup>th</sup> breath. We will talk about this in a moment.

### **EIGHTEENTH BREATH:**

This very special breath will not be taught here. You must receive it from your higher self. It is the breath that will take you through the speed of light into the fourth dimension (or higher, if higher self directs it). It is based on whole-number fractions, just as in music. You will disappear from this world and reappear in another one that will be your new home for a while. This is not the end, but the beginning of an ever-expanding consciousness returning you to the Source. I ask that you do not experiment with this breath. It can be very dangerous.

When the time is right, your higher self will cause you to remember how to do this breath. Do not be concerned about it; it will come when needed-

There are many people teaching how to do this 18<sup>th</sup> breath now, especially on the Internet. I can't tell you what to do, but please be careful. Many of these teachers are saying that they know how and that they can take you there and have you return to Earth. But just remember, if you really take this breath, you will no longer exist in this dimension. The idea that you can go to a higher dimension and return to Earth is highly unlikely. Not that it is impossible, simply highly unlikely. If you were to truly experience the higher worlds, you would not want to come back. So please be careful. As I said, when the time is right, you will remember what to do without any outside help whatsoever.

### **Additional Information, and Problems That People Sometimes Experience**

All the problems or misunderstandings will be placed in this section for convenience. Some may be repeated from above and some will be new. We already mentioned the number-one problem associated with the creation of the human Mer-Ka-Ba with the spinning of the male and female (Sun and Earth) tetrahedrons in opposite directions instead of spinning the Sun and Earth *star tetrahedrons* (the set) in opposite directions. We are going to re-print this update here again since it is so important. Below are other related problems and additional information, but they use different terms to help your understanding.

#### **1. Spinning the tetrahedrons, top and bottom only.**

This is one of the biggest mistakes people make. They are not clear that there are really three sets of star tetrahedrons around the body, and they simply rotate the Sun tetrahedron counterclockwise and the Earth tetrahedron clockwise. This is a mistake that does not really cause any harm, but it stops further spiritual growth.

This type of Mer-Ka-Ba will take you into an overtone of the third dimension of this planet, used by medicine men and women and shamans for thousands of years to gain power and to heal. It has been used even for warfare. But it leads nowhere, and it will definitely not allow you to ascend into the higher worlds that the Earth is taking us to. If you are doing this now, begin anew and start the practice as described.

## **2. Experiencing the tetrahedrons as either too small or too big, or one bigger or smaller than the other.**

Sometimes when people examine their tetrahedrons, they find that they are either too big or too small or that one is bigger or smaller than the other. These instructions also apply to a crooked or unaligned field. What does this mean?

Your tetrahedrons are an exact measure of the polarity balance within your body. The first and primary polarity within your body comes from your parents. The Sun tetrahedron is your father's energies as given to you at conception; the Earth tetrahedron is your mother's energies as given to you at conception. If you experience a trauma originating from your parents during your childhood, especially from conception to about three years of age, your tetrahedrons will mirror this trauma.

For instance, if your father spanked or hit you in such a way as to cause real tear, almost for sure your Sun tetrahedron will contract and become smaller than normal. If this happened only once, perhaps it will heal and return to normal if the father is truly loving. But if this hitting continues, the Sun tetrahedron will remain distorted and smaller than normal, which will affect the child's life as long as he/she lives unless a healing is received in some manner.

The tetrahedrons should be the same size, and each edge-length should be the length of your outstretched arms. But this is seldom the case. Almost every human being on Earth has had trauma during childhood and beyond. What can we do? This is where emotional healing or therapy becomes necessary.

In the ancient schools, such as in Egypt, the female or right-brained aspect of the mystery school (the Left Eye of Horus) always came first. The student began there, and after the emotional healing took place, then the left-brained aspect was taught (the Right Eye of Horus). Here in the United States and in other left-brained countries, we have introduced the left-brained studies first because these countries are having a difficult time understanding the female pathway. In many cases they have simply rejected this sample pathway. Therefore we have introduced this male pathway first just to get their attention. But now that we have your attention and you are beginning to study this pathway, I find it necessary to tell you that you must now, or at least at some point on this path, begin to study the female way.

Emotional healing is essential if you really wish to find enlightenment in this world. There is no way around it. Once you begin to find out about the higher worlds, you yourself will stop your growth past a certain point until this emotional healing has taken place. I am sorry, but that is the way it is.

The good news is that there has been a great success in refining techniques to assist the human to heal the emotional body in the last 70 years. From the time of Freud until now, an incredible understanding has come to humanity around the human emotions. Wilhelm Reich was the primary

person, more than perhaps any other, who opened the door to this great understanding. It was Reich who realized that as children, not wanting to feel the pain of an emotional experience, we stored these painful emotions within our muscles, our nervous system and in the space around our bodies, our lightbody. We now know it is not just anywhere in our lightbody, but specifically in our tetrahedrons.

Since the time of Reich, Dr. Ida P. Rolf decided that if this emotional pain was stored in our muscles, then let's go in and get it. So Rolfing was born. Then many great souls came to this idea of Reich's, such as Fritz Perl and Sandy Goodman with the related ideas of Gestalt therapy and psychodrama. In more recent times, hypnotherapy was born, which opened even newer doors of understanding, including our past (and future) lives and their effect on our present lives. The existence of entities or dysfunctional spirits and energies such as found in witchcraft, voodoo and so on have become more understood with an easy method of release.

My suggestion is that you trust yourself and open to the possibility of someone coming into your life who can help you with your emotional imbalances (even if you are not aware of them). It almost always requires help from the outside. We usually cannot see our own problems, so this is one area of human experience where outside help is just about the only way.

Only when a person is in a relatively healthy emotional balance can he or she successfully function through the Mer-Ka-Ba.

### **3. When the disk that extends from the Mer-Ka-Ba is in the wrong location.**

The 55-foot disk that extends from the body comes from the original eight cells, and this disk is in that exact location. It passes through the area of the perineum, near the base of the spine. It is fixed at that location, or should be.

Sometimes it is mistakenly seen emerging from other chakras or other locations in the body. It is very important to move this disk with your mind to the correct location, as this will change the nature of the whole chakra system. This is one mistake that will distort the entire Mer-Ka-Ba experience, yet is easily corrected. You simply "see" it returning to its proper place, then hold it there for a while to stabilize. Make sure each day, as you do the steps of the Mer-Ka-Ba, that this disk is in the proper place, and after about a week it will remain there.

### **4. A reversed-spin field.**

Various mistaken understandings could cause a reversed-spin field for the Mer-Ka-Ba. In other words, instead of the *mind* tetrahedrons spinning to the left (from within the body) at the rate of 34 and the *emotional* tetrahedrons spinning to the right (from within the body) at the rate of 21, the speed ratio is reversed. By this we mean, the mind moves at 21 and the emotional at 34. No matter how you arrive at this state, it is very dangerous. A reversed field is antilife. If you do this long enough, it will almost surely result in sickness or even death.



The solution is simple—just correct it. But when you correct the field, it is like starting all over again to create a permanent field.

To be very clear, since this is extremely important, we will give these instructions again: From within the body looking out, and from a point in front of the body as the point of reference, the *mind* tetrahedron moves to the left 34 times while the *emotional* tetrahedron moves to the right 21 times.

**5. Seeing yourself in a set of small star tetrahedrons in front of and outside of your body.**

If you see yourself in a small star tetrahedron in the space in front of your body, this will not create the Mer-Ka-Ba. Your mind *must* connect with the *real* energy field of the star tetrahedrons. You must see yourself *inside the center* of the real field that exists around your body. You can see this field or you can sense or feel it. It does not matter, for either way will connect the mind to the lightbody.

### Minor Problems and Misunderstandings

**6. Perfect use of the mudras.**

For the first two weeks, the exact use of the mudras is very important. However, once the mind and body know what you are attempting to do, then the mudras can be relaxed or even not used at all. The body needs to know that you are attempting to connect to a particular electrical system within it. Once the body knows which system it is, it can go there simply by your intention. It's kind of like riding a bicycle. At first your attention must be placed on keeping your balance. Once your body knows how to keep this balance, your attention is no longer necessary; it happens automatically.

**7. Blowing outward—the tenth, fifteenth, sixteenth and seventeenth breaths.**

This is similar to #6. The blowing out is very important in the first two weeks, but after that it can be done very lightly or not at all. Once the mind and body understand, they will perform this function purely from intention.

**8. Colors.**

For the first two weeks to perhaps a month, we ask that you use the color of lightning in the tetrahedrons and the breathing tube. Many of you may find or have found that color(s) have entered your Mer-Ka-Ba experience, and you are not sure if this is all right.

We are asking you to use the color of lightning because that is the truest nature and color of pure prana. But many people will find that they cannot help color from coming into their Mer-Ka-Ba. First the tetrahedrons will fill with color and finally the entire Mer-Ka-Ba. This is not wrong, but normal.

After about one month, we ask that you allow color to enter your Mer-Ka-Ba without using intention. In other words, simply allow whatever happens to happen. Feel what happens within your body when these colors begin to emerge. See within your mind if images begin to appear. What these colors and images are is communication from your higher self. It is the beginning of direct communication, and it connects with the rest of life.

person, more than perhaps any other, who opened the door to this great understanding. It was Reich who realized that as children, not wanting to feel the pain of an emotional experience, we stored these painful emotions within our muscles, our nervous system and in the space around our bodies, our lightbody. We now know it is not just anywhere in our lightbody, but specifically in our tetrahedrons.

Since the time of Reich, Dr. Ida P. Rolf decided that if this emotional pain was stored in our muscles, then let's go in and get it. So Rolfing was born. Then many great souls came to this idea of Reich's, such as Fritz Perl and Sandy Goodman with the related ideas of Gestalt therapy and psychodrama. In more recent times, hypnotherapy was born, which opened even newer doors of understanding, including our past (and future) lives and their effect on our present lives. The existence of entities or dysfunctional spirits and energies such as found in witchcraft, voodoo and so on have become more understood with an easy method of release.

My suggestion is that you trust yourself and open to the possibility of someone coming into your life who can help you with your emotional imbalances (even if you are not aware of them). It almost always requires help from the outside. We usually cannot see our own problems, so this is one area of human experience where outside help is just about the only way.

Only when a person is in a relatively healthy emotional balance can he or she successfully function through the Mer-Ka-Ba.

3. When the disk that extends from the Mer-Ka-Ba is in the wrong location.

The 55-foot disk that extends from the body comes from the original eight cells, and this disk is in that exact location. It passes through the area of the perineum, near the base of the spine. It is fixed at that location, or should be.

Sometimes it is mistakenly seen emerging from other chakras or other locations in the body. It is very important to move this disk with your mini to the correct location, as this will change the nature of the whole chakra system. This is one mistake that will distort the entire Mer-Ka-Ba experience, yet is easily corrected. You simply "see" it returning to its proper place, then hold it there for a while to stabilize. Make sure each day, as you do the steps of the Mer-Ka-Ba, that this disk is in the proper place, and after about a week it will remain there.

4. A reversed-spin field.

Various mistaken understandings could cause a reversed-spin field for the Mer-Ka-Ba. In other words, instead of the *mind* tetrahedrons spinning to the left (from within the body) at the rate of 34 and the *emotional* tetrahedrons spinning to the right (from within the body) at the rate of 21, the speed ratio is reversed. By this we mean, the mind moves at 21 and the emotional at 34- No matter how you arrive at this state, it is very dangerous. A reversed field is antilife. If you do this long enough, it will almost surely result in sickness or even death.

The solution is simple—just correct it. But when you correct the field, it is like scarring all over again to create a permanent field.

To be very clear, since this is extremely important, we will give these instructions again: From within the body looking out, and from a point in front of the body as the point of reference, the mind tetrahedron moves to the left 34 times while the *emotional* tetrahedron moves to the right 21 times.

5. Seeing **yourself in a set of small star tetrahedrons in front of and outside** of your body.

If you see yourself in a small star tetrahedron in the space in front of your body, this will not create the Mer-Ka-Ba. Your mind *must* connect with the real energy field of the star tetrahedrons. You must see yourself inside *the* center of the real field that exists around your body. You can see this field or you can sense or feel it. It does not matter, for either way will connect the mind to the lightbody.

### Minor Problems and Misunderstandings

- Perfect **use of the mudras.**

For the first two weeks, the exact use of the mudras is very important. However, once the mind and body know what you are attempting to do, then the mudras can be relaxed or even not used at all. The body needs to know that you are attempting to connect to a particular electrical system within it. Once the body knows which *system* it is, it can go there simply by your intention. It's kind of like riding a bicycle. At first your attention must be placed on keeping your balance. Once your body knows how to keep this balance, your attention is no longer necessary; it happens automatically.

**7. Blowing outward—the tenth, fifteenth, sixteenth and seventeenth** breaths.

This is similar to #6. The blowing out is very important in the first two weeks, but after that it can be done very lightly or not at all. Once the mind and body understand, they will perform this function purely from intention.

8. Colors.

For the first two weeks to perhaps a month, we ask that you use the color of lightning in the tetrahedrons and the breathing tube. Many of you may find or have found that color(s) have entered your Mer-Ka-Ba experience, and you are not sure if this is at all right.

We are asking you to use the color of lightning because that is the truest nature and color of pure prana. But many people will find that they cannot help color from coming into their Mer-Ka-Ba. First the tetrahedrons will fill with color and finally the entire Mer-Ka-Ba. This is not wrong, but normal.

After about one month, we ask that you allow color to enter your Mer-Ka-Ba without using intention. In other words, simply allow whatever happens to happen. Feel what happens within your body when these colors begin to emerge. See within your mind if images begin to appear. What these colors and images are is communication from your higher self. It is the beginning of direct communication, and it connects with the rest of life.

## **9. The other senses.**

To be clear, it is not only color or sight, but all the five human senses (eventually some senses that you may now not be aware of) that will begin to interact within your Mer-Ka-Ba. Do not be afraid, just relax and allow it to happen. It is completely healthy.

Beyond the colors and images, you may begin to hear sounds, voices or even music or harmonics. You may smell fragrances, feel touches or sensations from somewhere or someone and even experience tastes in your mouth. You may even begin to see in a new and unexpected way that does not seem to be coming from your eyes. You are awakening to life! Have fun, for this is a new world beginning to emerge, and you are a child.

## **10. Feelings and emotions.**

Feelings and emotions play an enormous role in the experience of the Mer-Ka-Ba. It is the female emotional body that brings the Mer-Ka-Ba to life, not just the male knowledge of how to create it. To begin to understand what is being said, study the stargate breath pattern in update 5, page 350 and also Figures 18-1 and 18-2 on page 441, and live it within your Mer-Ka-Ba. Just so you know, there are many other stargate patterns, but every one I know of all have *love* and truth as part of their pattern. You know this information. As you live and feel how emotions and feelings engage within the Mer-Ka-Ba field, you will remember. Experiment.

## **11. Sexual energy.**

Sexual energy is primary to the Mer-Ka-Ba on this level and within human consciousness. The full knowledge of Egyptian tantra is too complex to transmit at this time and is not necessary. The only aspect of Egyptian tantra that is necessary to understand is what is called *ankhing*, which is described in chapter 12 [page 333]. If you no longer use sexual energy, then do not be concerned with that section, and continue.

## **The Acceleration of Spirit in Matter**

The following is a very important issue that must be discussed. Because of the nature of the subjects we have talked about in this book, many of you may experience emotional releases after experiencing the Mer-Ka-Ba. If you do, it is normal.

I know that we talked about this before, but I would like to say it again since it is so important. When you start the breathing, and the prana flow begins again after 13,000 years of not functioning, higher self may begin to take control of your life and purify it. By this I mean that persons, places and things in your life that were blocking spiritual development will often leave you. At first this seems like a loss or a negative. But when your new life comes into focus, you will see why certain things had to change. Do not be afraid during this transitional period. God and your higher self are watching over you.

The degree to which you experience this transition will depend on how clean and unattached your life is now. It's like when you take a medicine.

At first you may appear to be getting more unhealthy as the disease comes out of your body. How long the transition takes depends on how sick you were in the first place. Of course, once it is out, you feel and live a much healthier life.

## An Overview of the Human Energy Field beyond the Mer-Ka-Ba

The following information is, again, needed only for certain people. You can read this section, but if it is not seen as something important or necessary, then simply skip it or read it for information only. A day may come when it will be important to you.

The energy field of the human being is far more complex than was taught through the Flower of Life workshop. As we have said before, the star tetrahedron is the opening to higher consciousness, but there is much more.

Every possible level of consciousness in the universe is within the human energy field now, but it is only a potential. There is only one Reality. There is a nearly infinite number of ways that these energy fields can interact to create different Mer-Ka-Bas, which interrupt the one Reality and make it seem different. Depending on the Mer-Ka-Ba, the whole universe will experientially be entirely different and even seem to have unique laws. Most of the conscious universe is working on all possible solutions to this problem." One thing is for certain: All the possibilities are based on geometry and the knowledge of how to combine these geometries.

To assist humanity and the future of humanity, I will offer the following geometrical possibilities. I in no way claim that this information is complete, only that it is a possibility. We will begin with the star tetrahedron and give a pictorial view of the basic complete field beyond the Mer-Ka-Ba. We will present this in steps until we have reached the full field.

First there are the original eight cells, and from there the adult human body. Of course, the human body can be replaced with any kind of body and may vary depending on the environment and the needs of spirit, but the geometries will always be the same. In many cases there is no body, simply spirit. Then around the body or spirit there is the star-tetrahedral field, which always begins the geometry shown in Figure 13-3.

Next is the star-tetrahedral Mer-Ka-Ba field, which looks like this when it is alive [Fig. 13-4].

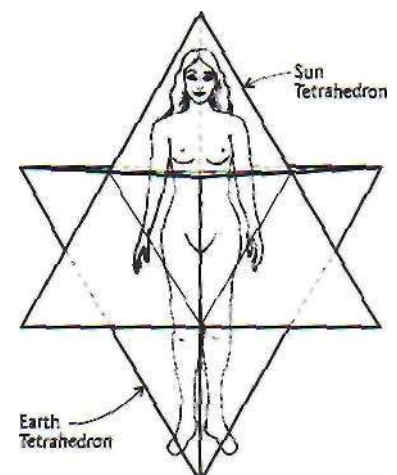

Fig. 13-3. The body and star, front view.

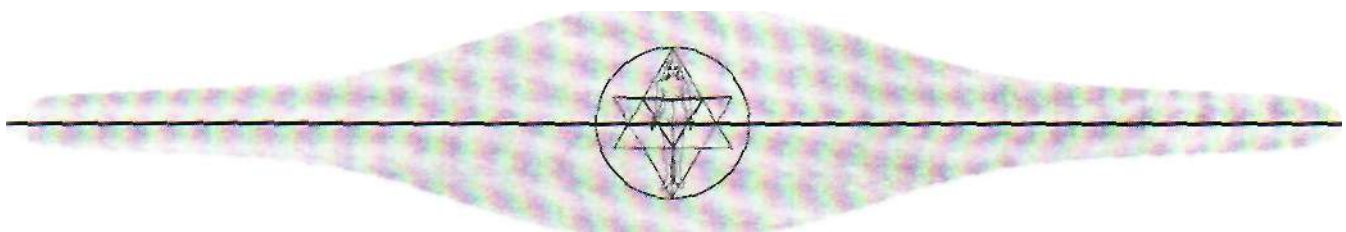

Fig. 13-4. Body, star and Mer-Ka-Ba.

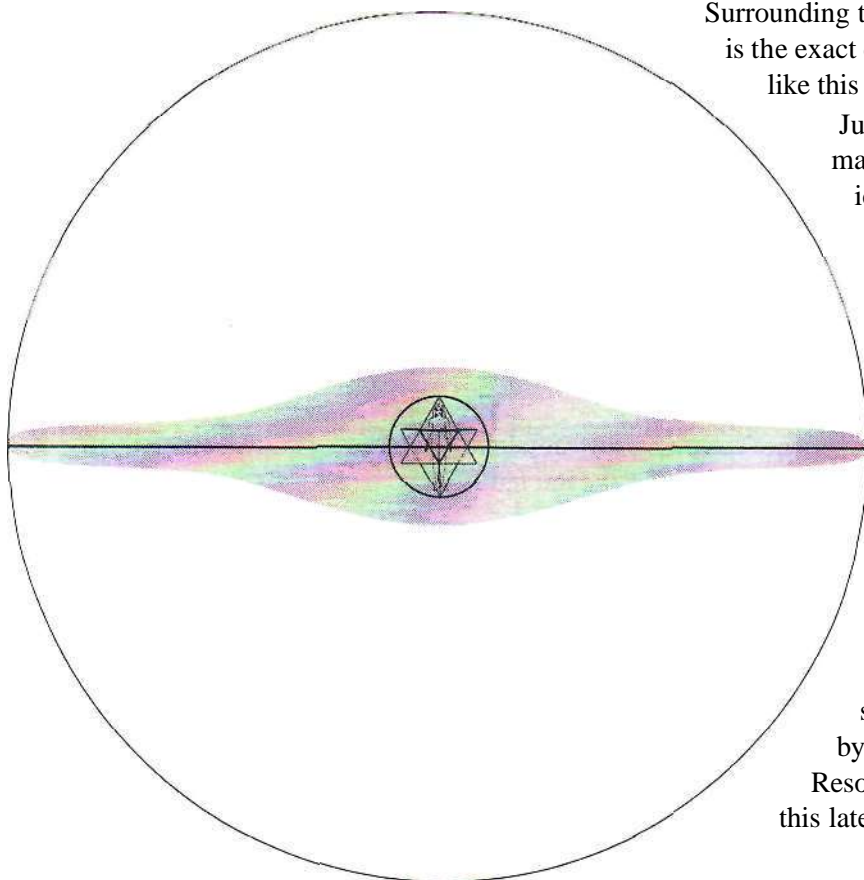

Fig. 13-5. The outer sphere.

Surrounding the Mer-Ka-Ba is a sphere of energy that is the exact diameter of the Mer-Ka-Ba disk. It looks like this [Fig. 13-5].

Just inside this outer sphere is an electromagnetic field in the shape of an icosahedron. Immediately inside that is the dual of the icosahedron, the pentagonal dodecahedron. The icosahedron is actually created by a stellation of the dodecahedron, where one edge-length of the dodecahedron is used to determine the length of the stellation. All the edge-lengths of the stellated icosahedron are the same.

This energy field is the same as the Christ grid that now surrounds the Earth. This is important, since it gives us a direct possibility of consciously connecting with this Earth grid by connecting with our own outer grid. Resonance is the answer. We will talk about this later. This is what it looks like [Fig. 13-6].

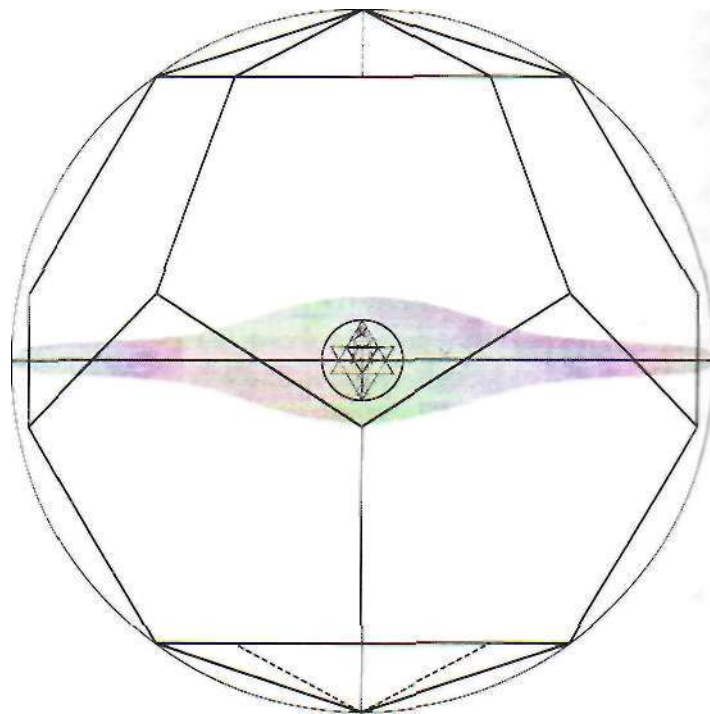

Fig. 13-6. The stellated dodecahedron with the icosahedron.

Next, the breathing tube that we were taught that ended at the tips of the star tetrahedron actually continues both up and down to connect with the stellated dodecahedron. It looks like this [Fig. 13-7].

In between the Alpha (the star tetrahedron) and the Omega (the stellated dodecahedron) are many other geometric energy fields, all symmetrically centered on this breathing tube. There are so many of them, including the internal lines of force, that if you could see the complete geometric field, you could hardly find a place to see through it. We will not draw all of them in now for two reasons; One, it would be impossible to distinguish between them here without making hundreds of special drawings. Two, it is not necessary for ascension in the immediate future. We will give one example and talk about that. This information will be the same for all the other geometric forms.

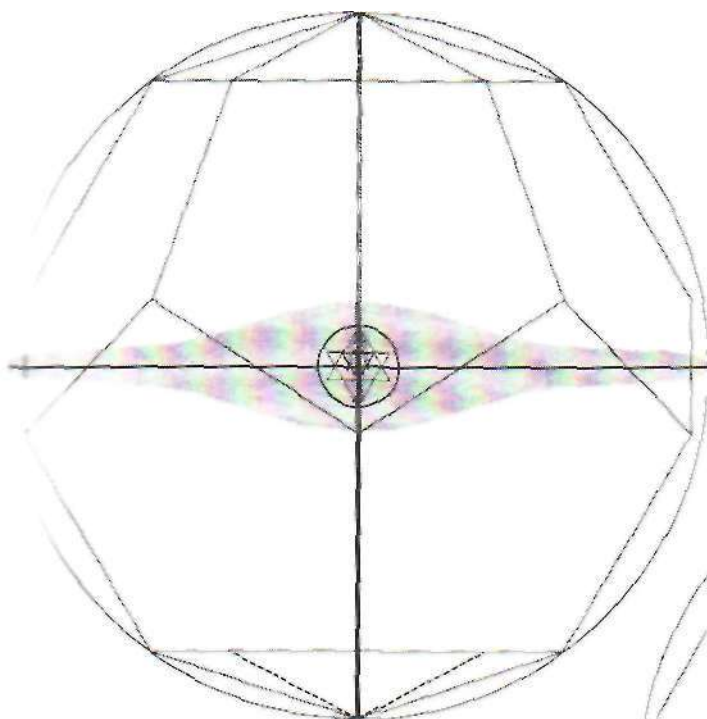

Fig. 13-7. The extended breathing tube.

Here we are going to add a hypothetical geometric form. This polyhedron is not actually in this location, but it will serve as the example. In between the Alpha and the Omega we will add an octahedron as shown [Fig. 13-8]. Realize that not only in the star tetrahedron but in every geometric form that composes the human lightbody, there are three completely different superimposed and identical polyhedral or geometric forms, although you see only one.

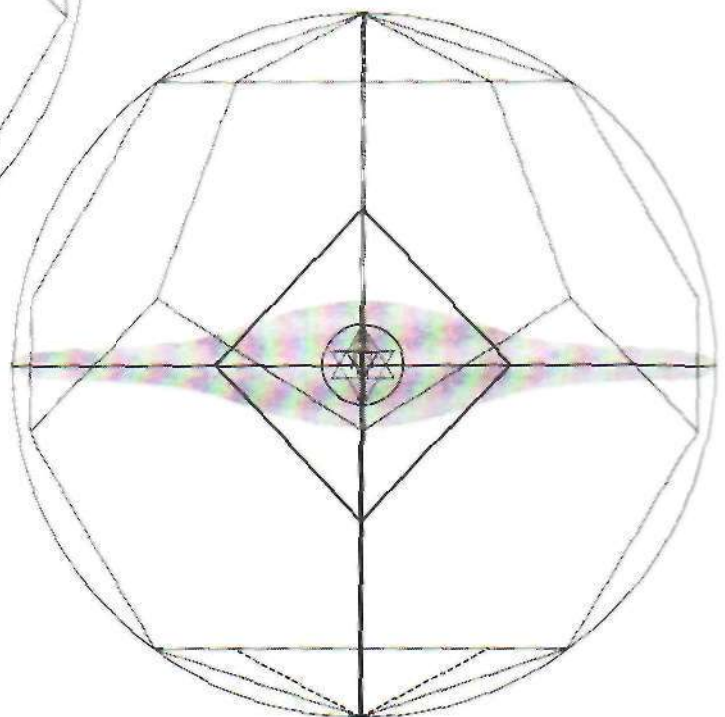

Fig. 13-8. The hypothetical octahedron (visualize the fluorite octahedral crystal from Fig. 6-35h in the center).

Remember that with the star tetrahedron there are three sets, one that is fixed, one that will rotate to the right and one that will rotate to the left. This is true with every single geometric *form* around the *body*.

We will say this again in the chapter on psychic energy: All psychic energy comes down to two parts, *attention* and intention. Where the mind places its attention and whatever intention the mind has, that is what will happen. Of course, one's belief systems control the possibilities.

Therefore, the breathing tube passes through many geometric energy fields with many extended possibilities. How do you select which one to use? You simply place your attention on a specific field (first you must know it is there) and with your intention open the field. The breathing tube will now work, but only from that place and through those geometries.

The breathing tube has a special geometric or crystalline cap that fits perfectly into the new energy field and allows the new prana to enter your breathing tube. Yes, prana has different qualities that come from different worlds and that change consciousness in addition to the Mer-Ka-Ba. Figure 13-9 shows three possibilities.

Finally, there is a toroidal field (a doughnut shape) that is centered on each Mer-Ka-Ba the spirit is using. Sometimes spirits will be running many Mer-Ka-Bas in the same moment, which usually results in "wheels within wheels." The geometric forms are so close together that the possible toruses look almost like onion skins. These toroidal fields extend beyond the actual Mer-Ka-Ba and enclose it. See Figure 13-10.

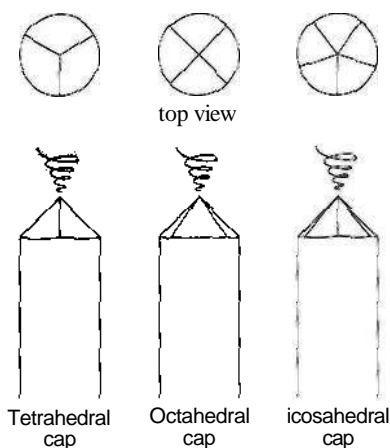

Fig. 13-9. Three possible breathing-tube caps. They will always have the same number of faces that the polyhedron has.

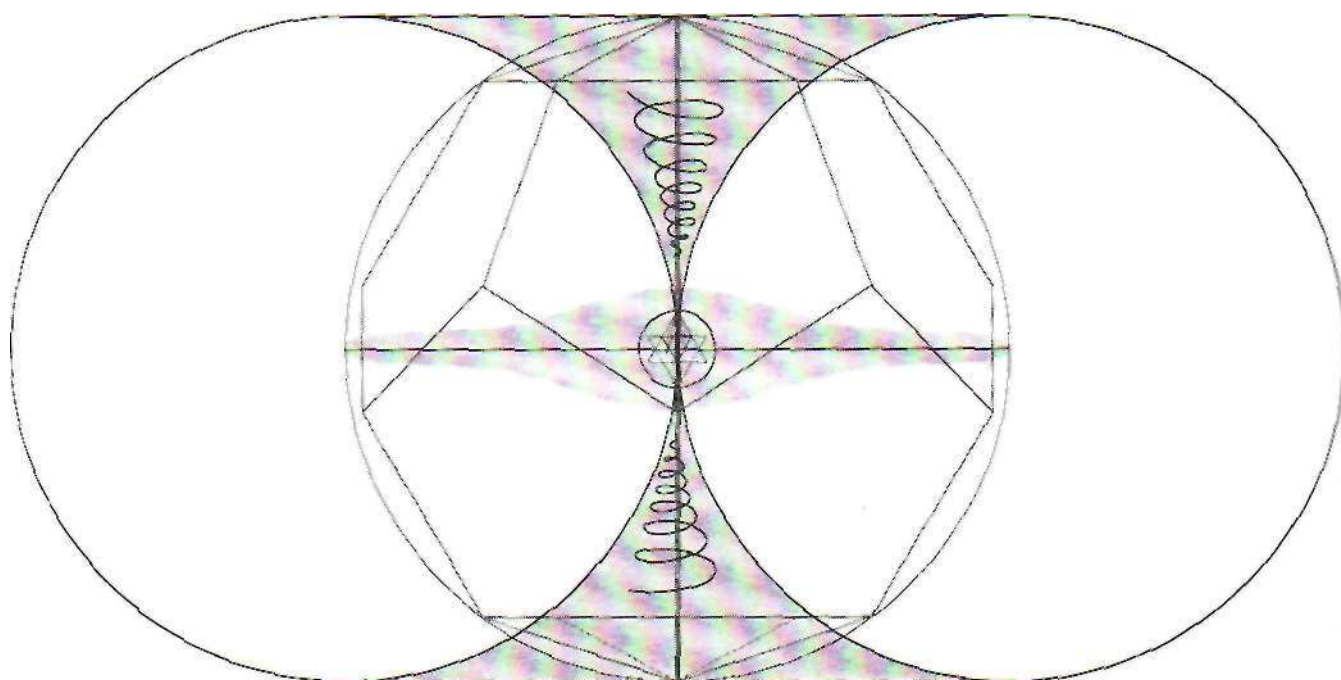

Fig. 13-10. The toroidal field of the inner star tetrahedron. (Visualize a doughnut cut in half.)



In this last drawing we will put everything together except the middle geometries between the Alpha and the Omega. This will at least give you a better image and understanding of the extended nature of your lightbody [Fig. 13-11].

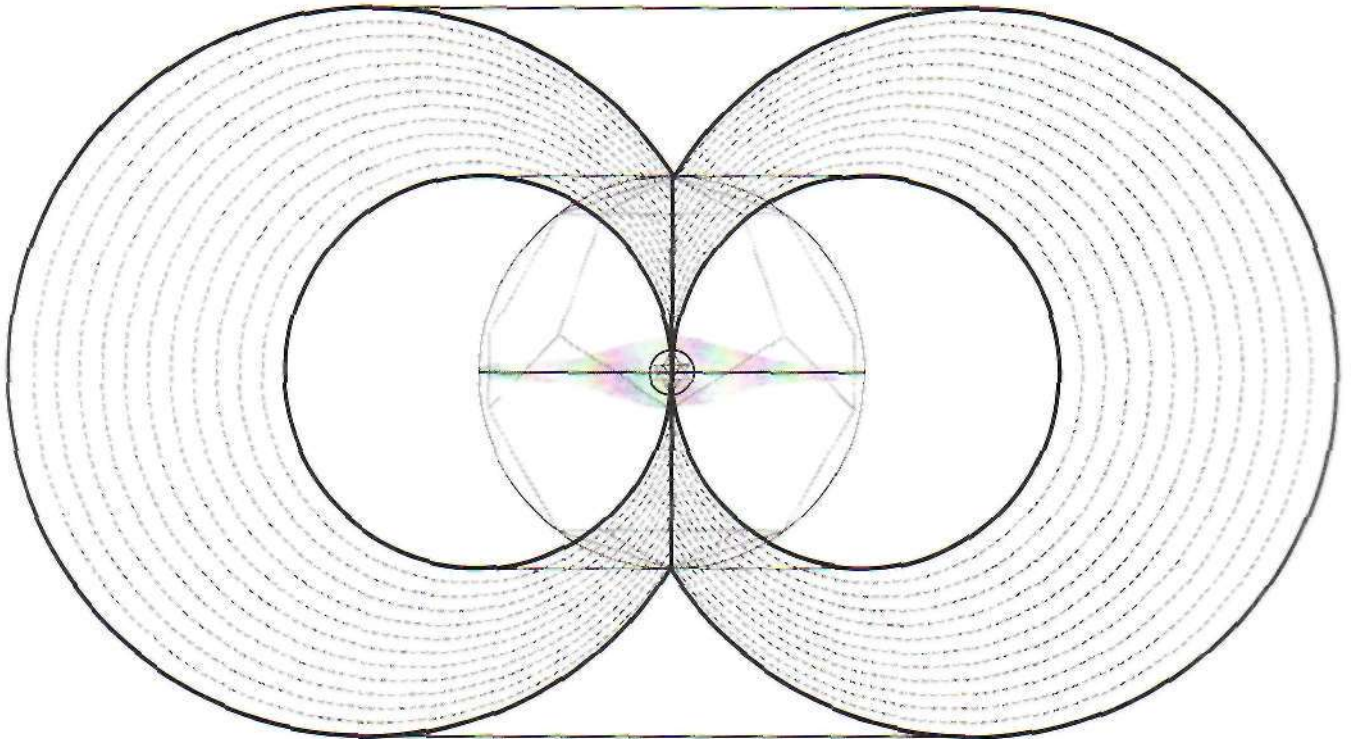

Fig. 13-11. The full lightbody surrounding all life forms—and all forms are alive.

The full lightbody surrounds all life forms—and all forms are living.

Although Figure 13-11 is an almost complete image of the energy field around the human being, the following image is what primarily manifests in the Reality as the Mer-Ka-Ba or human lightbody [Fig. 13-12].

This is an infrared photograph of the heat envelope of the Sombrero galaxy, slightly tilted. It looks like a flying saucer. It has a huge ring around the outer edge, which is dark because the outer edge is moving very, very fast. *This heat envelope is in the exact proportions of the Mer-Ka-Ba around your body when it's activated through breathing and meditation.* With the proper equipment, you can see it on a computer screen, since it has an electromagnetic aspect that is partially within the microwave range.

It is now up to you. Having come this far, you hold the basic knowledge to activate your lightbody. If in your meditation and in your heart you know that this is the right thing to do, then begin. But perhaps you should wait until you have read the next chapter, for there is a great deal more than just turning on your Mer-Ka-Ba. This achievement is only the beginning.



Fig. 13-12. The Sombrero galaxy.

## The Mer-Ka-Ba and the Siddhis

In the last two chapters we have defined the energy flow and field of the human lightbody. We have also given instructions for activating the human Mer-Ka-Ba. When this information was first given in the Flower of Life workshop, it was assumed that the students would find their way to their higher self, and their higher self would instruct them on the content of this chapter (and of course much more). This did happen with some students, but only a small percentage. The majority never really understood what the Mer-Ka-Ba was or how to use it—in other words, how to meditate inside it.

For this reason, the subsequent Earth/Sky workshop was created to assist students in further understanding and living the meaning and purpose of the Mer-Ka-Ba. In this chapter we will give you the basics to help you begin, but it is still essential that you consciously connect with your higher self at some point to really unfold your purpose in life.

In the Flower of Life we taught only how to activate the Mer-Ka-Ba, and many students thought that was all there was to it. They thought that *was* the meditation, but they simply did not understand. The Mer-Ka-Ba is the pattern that all things visible and invisible were created through. There are no exceptions. Thus the Mer-Ka-Ba has infinite possibilities.

### Further Uses for the Mer-Ka-Ba

It is generally believed that the Mer-Ka-Ba is the vehicle for ascension, and yes, that is true. But it is much more. It is *everything* more. The Mer-Ka-Ba can be anything whatsoever, depending on what the consciousness within the Mer-Ka-Ba decides. The only limitation it has depends on the memory, imagination and limits (belief patterns) held in consciousness. In its purest form, this tetrahedral Mer-Ka-Ba's only limitation is that it cannot take the spirit through the Great Void or past the "Great Wall" into the next octave of dimensions. This act requires a person to give up individuality and merge with at least one other spirit to form a special kind of Mer-Ka-Ba, which is definitely not necessary to know at this time.

If a human ego decides that it is going to use the Mer-Ka-Ba in a nega-



tive way, to cause harm or control others or profit personally or do anything that is not in integrity and not based on the purest images of love, then that ego will learn a hard lesson. Many have tried, including Lucifer. God knew this would happen and arranged the universe in such a way that this cannot happen, for the Mer-Ka-Ba needs love to be alive. As soon as the Mer-Ka-Ba is misused, it begins to die. Very quickly, the higher self enters and that person is "arrested" or stopped, and they must wait *to* continue the upward climb in consciousness until the lesson of love is learned. Do not underestimate what I have just said or you will simply waste your time.

In chapter 17 we will talk about what happened when Lucifer found that he could not manipulate the Mer-Ka-Ba.

The Mer-Ka-Ba is very much like a computer. If a person simply activates his or her Mer-Ka-Ba and does nothing else, then this is like buying a new high-tech computer with superadvanced potential without loading any software. The computer just sits on the desk humming away, but nothing is accomplished. It is not until the software is loaded that the purpose *of* the computer can be accessed. And the software you choose will determine the nature of the possible uses of the computer.

It is not a perfect analogy, but it is close. It is true that just by activating your Mer-Ka-Ba, it alerts your higher self and the awakening process begins. But eventually *you* must consciously connect with your higher self to download the higher meaning and purpose in order to fulfill your purpose on Earth. This chapter's purpose is to help you in that process.

### Meditation

We usually think that meditation is when we close our eyes and go within, which ultimately leads us to self-realization. This is a way, but meditation can also happen when your eyes are open. With a wider perspective we can see that all of life is meditation. Life is a school of remembrance.

If you connect with your higher self, its instructions will lead into meaningful meditation and self-realization. This is the ideal way. However, if you do not connect, then you can use the traditional forms of meditation, techniques such as Kriya Yoga, V'apasana meditation, Tibetan, Taoist etc You can use these forms of meditation and practice the Mer-Ka-Ba at the same time without problems as long as the teacher you are learning from does not mind. If your teacher says that you cannot use another method such as the Mer-Ka-Ba, then you must either follow their instructions or find another teacher if you wish to continue with the Mer-Ka-Ba.

Now, while one is learning meditation, whatever the method, a particular level of consciousness will emerge. It *is* inevitable. It has *to do with the* relationship between the inner and the outer worlds. One begins to realize that all is light, and the miraculous phase begins. The siddhis begin to manifest. It is this stage of development that we are going to discuss here, because it is the stage that, when mastered, is closely followed by an understanding of the meaning and purpose of life. It is also a stage that the whole

world is now beginning to enter. We must understand, and we will.

### Siddhis, or Psychic Powers

What is a siddhi? This is a Hindu term that means "power"—more accurately, it means psychic power. The siddhis are considered by many Hindu teachers to be an aspect of consciousness we must pass through, but they are usually considered dangerous. Why? Because it is very easy to get spiritually lost in this area of consciousness when the ego has not been transcended by the time this area is reached. The ego can become so charged by the siddhi experience that it forgets it is God that it is returning to; it may even think that it (the ego) *is* God. Still, it cannot be overlooked or avoided. This level *of* consciousness must be mastered.

So when I talk about the siddhis, please remember that I speak about them so that you can master them, not use them for personal gain or to enhance the ego.

When the angels first taught me how to do the Mer-Ka-Ba in 1971, I began to have some strange experiences that I could not explain. Very often when I was around electrical equipment (especially when the Mer-Ka-Ba disk popped out on the sixteenth breath), I would blow up or burn out electrical equipment close by. This experience went on for almost fifteen years. I thought it was just a side effect and there was nothing I could do about it. It also became very expensive over time. I lost many TVs, radios and other electrical equipment.

One day in about 1986 I was working with Thoth in my meditations. I happened to be visiting Hawaii. I sat down in a circle with a few friends to meditate with them, and I was sitting next to a wall that had a light switch directly above my head. At the very instant that I popped out the disk on the sixteenth breath, the light switch blew up in the wall behind me and started a fire. We had to quickly dig a hole in the wall and squirt it with a fire extinguisher.

I felt embarrassed. It had plagued me for many years, so after the fire was out, I went into the other room and brought Thoth into my meditation. I felt that perhaps he could explain what I was doing wrong. I asked him what I could do. He simply said, "Don't do it. Tell your Mer-Ka-Ba that it will no longer affect electrical fields." My first thought was, "Is it really that simple?"

So right then and there I "told" my Mer-Ka-Ba not to affect electrical fields anymore, and that was the end of my electrical problems and the beginning of my understanding of the siddhis associated with the Mer-Ka-Ba.

The siddhis are no more than commands to do something, and *if done right*, that thing will happen. If the commands are given to your Mer-Ka-Ba, your Mer-Ka-Ba will continue forever to fulfill that command until you stop, change or alter that command with your intention. I realize this is simple to say but more difficult to truly understand. I will do my best to explain.

## Programming Crystals

Computers are made of crystals, and both computers and crystals have traits similar to the Mer-Ka-Ba. The programming of crystals is extremely similar to what could be called the programming of the Mer-Ka-Ba. Many books have been written about the possibilities and techniques of programming crystals.

As I have said before in this work, everything in psychic energy is based on two things: attention and intention. I have also said that crystals are living beings. They can receive and send frequencies and even complicated waveforms anywhere within the electromagnetic field (EMF), and this includes our human thoughts, emotions and feelings. Remember the first radio, a crystal set? It was nothing but a wire touching a natural quartz crystal in a certain place. The crystal would pick up the signal, and we could hear sound through the radio speaker.

Marcel Vogel was a great scientist working for Bell Labs. He held over a hundred important patents, including the invention of the floppy disk. This was a man who knew crystals and computers from a deep scientific understanding. At one point in his life, just before he died, he referred to the number of programs that a natural crystal could hold at one time. He said that the crystal could hold only as many programs as there were faces on the end of the crystal. At the time, I thought this was incredible, and I sought to prove or disprove this statement.

I contacted a scientist I knew, Bob Dratch, and we did a simple experiment to see if this was true. We placed a quartz crystal on a lab bench with the sensor head of his molecular emission scanner (MES) aimed at the crystal to pick up the microwave emissions and send them through special homemade software into the computer to be analyzed.

Bob watched the screen as I programmed the crystal with my thoughts. Our thoughts are long EM waves that transmit into space and can be received by scientific equipment, so why not put them into a crystal to be received just like a radio signal?

Of course, Bob did not know what I was thinking, so seemingly he would have to rely on my telling him when I did it. But this was not the case. The instant I programmed the crystal with a thought (the idea of love), Bob noticed an immediate change in the sine-wave signature on the screen in the shorter wavelengths. It was not long before Bob could tell me instantly when I had programmed the crystal and when I" erased one of the programs. (You erase a program or remove it simply by telling the crystal to do so.)

I could not fool him. I would put three programs in and take out two, and Bob could see the three added blips on the sine-wave signature, then he would see two blips being removed. He could track me perfectly. We were also able to confirm Mr. Vogel's statement that a crystal could hold only as many programs as there were faces on the tip of the crystal. As soon as I exceeded the number of faces on this crystal, the blips would no longer

show up on the sine-wave signature. The crystal simply could not or would not accept them. I was amazed.

From this experiment I believe we can see that crystals hold thoughts (and emotions and feelings), and that they can send them back out. Your Mer-Ka-Ba is no different. In fact, it is even crystalline in nature in that it uses the same geometries that crystals use to structure their atoms. Whatever thoughts, emotions or feelings you emit, with your *attention* on the Mer-Ka-Ba and your *intention* to place them into the Mer-Ka-Ba, they will be received by your Mer-Ka-Ba, which will continue to send them out forever until you stop them. And no one, not even Lucifer, can stop or alter your Mer-Ka-Ba programs except you. Unless, of course, you have a program that says they can.

One difference between crystals and the Mer-Ka-Ba is that the Mer-Ka-Ba *has no limit* on how many programs it can hold. It seems like this is true, anyway. I have put vast patterns of programs in my Mer-Ka-Ba and it works perfectly. If there is a limit, I know for sure it is not a low number such as six or eight as is found in crystals.

## Mer-Ka-Ba Programs

The programming of the Mer-Ka-Ba and all psychic energy is very interesting. It happens to us every day, but few people see it for what it is. I would like to tell you a couple of stories before I begin this section. I feel they will help explain the nature of this subject. However, I will begin with a definition.

### Ways to Manifest Wine

Let's say you wanted a particular kind of French wine or some specific thing like that. It's your favorite wine, and you think, "I really wish I had this particular bottle of wine here." You see it in your head, your mouth is watering and your desire is strong. You want it but you don't know where to get some.

Well, you could create the wine on a 3D level. You could grow the grapes, wait several years for them to fruit, pick them and press them, then wait ten years or so to age the wine before you have your favorite bottle of wine. It might be a little trouble and a little slow, but if that's what you accept as your reality, then you can do that.

Or you could run down to the store and buy a bottle of the wine you desire.

Or you could just sit there thinking about the wine, and somebody walks into the room with a bottle of it and says, "I've got an extra one of these. Do you want one?" and sets it on your table.

If that happened just once, you'd say, "Boy, that was a fantastic coincidence!" But if every time you think of something the coincidence happens, after a while you're bound to start thinking, "Hey, this is weird. Whenever I think of something, I want something or I need something, it just happens."

Eventually the coincidences will lead you to the realization that there is definitely a connection between what you're thinking and feeling and these "coincidences." Many of you on the path know exactly what I am talking about, for it is the beginning of the spiritual path.

This then leads you to the next step of the siddhis, when you begin to explore exactly how you make these things happen and how you can make them happen on purpose instead of seemingly accidentally. And that leads to performing acts like Jesus did when he converted water into wine. In this instance you're taking one element and changing it into another. Thus you prove to yourself and to others that what you believe about this Reality is real. You've established it and made it real. This is the area that is dangerous, however, because usually the ego has not yet been transcended.

Then you may go another step beyond that, which would be to actually make the wine from nothing—not just converting the elements, but creating it directly from the Void. At this stage your higher self and you have merged.

A step beyond that is not even having the desire for the wine in the first place—to not have a need or want at all, knowing that all things are whole, complete and perfect as they are. You are now outside of polarity. The pathway home becomes clear.

#### The Gas Can

When I was living out in the woods in Canada, I began to first realize this idea of coincidence. The angels had already appeared to my wife and me and we were being guided by their words. They had told us not to worry about money while we were in this beginning stage with them. They said that they would give us everything we needed. They said that there was a "natural law" that God had made with man. Mankind could either rely on God to give them substance, or mankind could rely on themselves. If they relied on God, everything needed would always be "within reach," but if they relied on themselves, He would not help them as they requested.

My wife was getting very upset with me because we needed a gas can for our car. She had run out of gas several times, and we were over 20 miles from the nearest gas station. She had just run out again the day before and had to walk several miles, so she was very upset at me for not buying her this gas can. She was going on and on and on about it, making a big deal out of this little gas can. I kept saying, "You've got to trust in God." She said, "God? I need a gas can!" And I said, "You know the angels said we aren't to work at this time, and they'll supply everything for us. Yes, we are really low on money, but please have faith." Actually, they did supply us with everything; we already had absolutely everything we would ever need—except a gas can.

We took a walk down to the lake where we were living, and all the was down to the lake she was going on and on and on, "We have to go back to

the city. We have to quit this living by faith. This is too hard. We need money." We sat down on a rock and looked out onto this beautiful lake surrounded by majestic mountains that God had given us, and she continued to complain to me, to the angels and to God.

I kind of glanced over to the side as she was talking, and there, about 20 feet away, was a gas can just sitting there between two rocks. Somebody had evidently pulled a boat up there and left it. But it wasn't just any old gas can. It must have been the most incredible gas can on the planet! I didn't even know they made such things. It was a beautiful red can made of thick, solid brass trimmed with a heavy, solid brass handle. This gas can must have cost \$100 or more!

So I said, "Just a minute," and went over and picked it up, came back and set it down next to her, saying, "How about this one.<sup>7</sup>" It kept her quiet for about two weeks.

### The Stack of Money

This little house out in the woods we were living in was located in one of the most beautiful places on Earth. It had been given to us by the Catholic church to stay in as long as we wanted to for free. We had nothing... but we had everything—even a gas can. But at one point, as we mentioned, we were starting to run out of money. Because the angels asked us not to work during the time we were out in the woods and only continue with our meditation, our supply of money kept dwindling.

And as the money got lower and lower, I could see my wife getting more and more nervous. Finally we were down to \$16 and no way in sight for us to get more. As the money supply shrank, you could see her patience shrink with it. Her fear grew. That was it, she was ready to leave me. We had to make a payment of about \$125 on our car the next day or we would lose it. We didn't have it, and that was that. She complained all day and all that evening. Finally we went to bed. She rolled over as far on her side of the bed as possible and drifted off to sleep.

About midnight there was a knock on the door. Now, we were out in the middle of a deep forest. There was a four-mile walk just to get to the house from the closest road, and our nearest neighbor was two miles away. So we were surprised by this rare nighttime visitor.

I rolled out of bed, threw on a robe and opened the door. Standing there was an old friend I hadn't seen for about two years with a big smile on his face. He came in and said, "Oh man, I've been looking for you everywhere. You are really isolated. Are you trying to hide from someone or something?" I said, "Well, no. I just like nature. Come on in. What are you done here in the middle of the night?"

Well, I'd loaned him a bunch of money a long time ago. I basically just gave it to him and had actually forgotten about it. He said, "I felt really compelled to come here and pay you this money! I couldn't think of anything else." And he put a huge stack of twenty-dollar bills on the table,



amounting to \$3500. To my wife and me, living as simply as we were, this might as well have been a million dollars!

### The Second Stack

My wife was dumbfounded. That shut her up for about six months or so. Not a word.

As this money began to dwindle, her faith became weaker. This time we were down to about \$12 to our name and her faith began to be shaken again. She went on and on and on; she was going to leave me and the family and return to the States. Hours went by, the Sun went down and she continued to complain. Then we went to bed after a long stressful day arguing about money and about having faith in God. Then again in the middle of the night came another knock on the door.

This time it was another friend, one who went *way* back, all the way back to Berkeley to my beginning days in college. I couldn't believe it! I don't know how he found me. He came in, and the same thing happened, only it wasn't quite as much this time. It was only \$1800. But he said, "Here's this money you gave me once when I was in need. I hope it helps you."

My wife went through the same exact changes. First she was very happy and didn't complain for a few months, but as that money began to run out, she lost all faith. She just could not believe that the angels—who were appearing to her as well as me—could really supply us with "everything we needed" as they said they would, even though they had demonstrated it for almost two years.

When this money ran out, she forced the issue and returned to Berkeley to get a job. It was the beginning of the end of her spiritual life. Soon she could no longer see the angels anymore. Then she had to rely on herself to live. She got a job, and for her, life returned to its normal state before the angels appeared to us. Life became solid and the magic faded from her life.

The angels have never left my side. To this day I leave my substance up to them and give my life energy to God. I have faith and trust in the unseen. As my faith became stronger with each stack of money, my wife's became weaker. It is like the story of the glass that is either half full or half empty depending on how you see it. Remember this story, for we will all be tested when it comes to the siddhis and the natural laws of God.

During this time my wife and I experienced firsthand many, many miracles. We saw these miracles almost every week, sometimes every day, for about two years. Most of them were way beyond just someone giving us money. They were truly impossible happenings that anyone would call a miracle. Yet it was a great lesson for me to watch how a miracle could cause one person to become deeper in love with God and another to move deeper into fear.

There is a great spiritual danger with the siddhis in more ways than one. It is not just that the ego may become enhanced and attempt to use the

siddhis for personal power and gain, but also that the ego may enter fear and stop meditating. Either way, it stops further spiritual growth until the time is right. No one is truly lost, only delayed.

## Four Ways to Program the Mer-Ka-Ba

Now that we have introduced you to the siddhis and the possible pitfalls, let's see exactly how the Mer-Ka-Ba can be programmed.

First of all, there are four ways the Mer-Ka-Ba can be programmed. These four ways correspond to the four primary sexual pathways, which are male, female, both and neither. Each of these four sexual pathways also have a polarity, so under "male" there is "male-male" (heterosexual male) and "male-female" (homosexual male). Under "female" there is "female-female" (heterosexual female) and "female-male" (lesbian female). "Both" is bisexual, and under that category is "bisexual male" and "bisexual female." Finally there is "neither," which also has the polarity "asexual male" and "asexual female." These eight polarity breakdowns have further polarity breakdowns that are unnecessary to unfold at this time.

The four ways to program the Mer-Ka-Ba follow this same sexual classification: male, female, both and neither.

### Male Programming

In the Shiva religion there are 113 ways to meditate. They believe that there are exactly 113 ways and no more. They feel that no matter what way you meditate or what you call it, even if you invent a new form, your way will fit into one of these 113 ways.

The first 112 ways are male, and the last (or first) way is female. The male ways are pathways that can be written down or verbally described to another person. Exact descriptions are possible and logic is the rule. You are told that if you do this, this and this, then a particular result can be expected.

But the single female way has no rules. It is never done the same way twice (it could be, but that would not be known beforehand). The female pathway has no logic in the normal male way of thinking about things. The pathway moves according to feelings and intuition. It is like water in its movements, following the path of least resistance.

Thus male programming in the Mer-Ka-Ba is very specific and logical. One example is the following:

When I began the Tri-Phased Mer-Ka-Ba workshop in between the Flower of Life and the Earth/Sky workshops, I experienced a particular problem. The Tri-Phased Mer-Ka-Ba was a huge Mer-Ka-Ba field with a distance across the disc of 1.6 million miles. It required two or more people co create it. The energy release at the time the disk popped out was enormous. It was picked up on military computers, and they sent four black helicopters to investigate this new phenomenon. They would not leave, and they interfered with my teaching program.

The angels told me that I would do nine of these workshops, then never again. This Tri-Phased workshop became one of the most misunderstood and misused information ever. About thirty international teachers and untold Internet sites, without asking permission, began to use this information, but no one knew what its true purpose was. They thought it was for the evolution of people, but it was not. It was only for the awakening of the spirit of Mother Earth and for the activation of the Earth's Mer-Ka-Ba. This has now been accomplished, along with the misuse of this information by many teachers and the spiritual misguidance of many of their students.

At any rate, groups of three or four black helicopters continued through each of the first six workshops. Within fifteen minutes after the group entered the Tri-Phased Mer-Ka-Ba, the black helicopters would arrive, and they would stay for about one or two hours, using their instruments to run tests on us.

In the sixth workshop the FBI sent a man, who fully identified himself, and three other FBI agents who did not, and it was through their interaction with the group that I decided to use the siddhis of the Mer-Ka-Ba to protect the group from further harassment. The angels gave me permission to do this.

All I did was set up a surrogate Mer-Ka-Ba. I will explain this idea completely toward the end of this chapter, but briefly, a surrogate Mer-Ka-Ba is a field created by a person separate from the person's own Mer-Ka-Ba. This Mer-Ka-Ba can remain in a fixed area, such as your house or land. It can have completely separate programming from your personal Mer-Ka-Ba, though it remains alive through your life-force energy.

This surrogate Mer-Ka-Ba I created was placed in a spot on the land where the Tri-Phased workshop was taking place. It was big enough to surround the entire area so that when the group entered into the Tri-Phase, my special "male" programming would protect them from the black helicopters. The male programming I used was simple: It simply stated that the internal area within the Mer-Ka-Ba and the external effects of the Mer-Ka-Ba would be "invisible and undetectable" by anyone, and it was.

When the group created their Tri-Phased Mer-Ka-Ba, for the first time in seven workshops, no black helicopters appeared. They could no longer see us. It was that simple. And as you might have noticed, it was the same method that stopped the electrical disturbances.

However, we made a human mistake, and this shows the problems of male programming. This same group, on the last day of the workshop, decided that they wanted to go to Sedona, about 50 miles away, to do the last part of the workshop. In traveling to this spot, we were outside the surrogate Mer-Ka-Ba with the "invisible and undetectable" programming, and we all forgot about it. We were miles out in the forest with no one around, but about fifteen minutes after this group popped out their Tri-Phased Mer-Ka-Ba, six black helicopters arrived and would not leave. They just continued to swarm around us like flies for almost an hour.

In the last two Tri-Phased workshops, we used the "invisible and undetectable" programming and stayed inside this Mer-Ka-Ba. Not one helicopter of any color appeared to harass us. This is the nature of the male programming—the need to be specific.

I am not here to tell you what to do or what to program into your Mer-Ka-Ba. I am here only to tell you how. The rest is up to you and your higher self. But when we talk about healing yourself and others or about healing the world's environment, for example, this information will begin to make more sense.

### Female Programming

As we just said, female programming has no logic. Any man in a relationship with most women knows exactly what I am saying. (Just kidding.)

Female programming is formless, and an example would be difficult even to explain. But I will try. Thinking of psychic protection, one may come up with many male programming ideas on how to do that. For example, to reflect psychic energy back to its source or into the Earth or convert it from negative to positive. There are many, many male ways to do this. But a female would do something like program her Mer-Ka-Ba to choose whatever possibility that is appropriate without being specific. In other words, *all possibilities*. Therefore, she has no idea how the Mer-Ka-Ba is going to respond to a psychic attack, but it will, and it will always be successful.

Another way is to put your fate into the hands of God. It is very similar, except that it accepts the possibility that might mean the psychic attack appears to be working. God has a greater wisdom when it comes to these matters. Remember, even the idea of psychic attack falls within the area of polarity. It is thinking of an us and a them.

### Both Programming

This is pretty simple to explain. It is a spirit in either a male or a female body that uses both ways at the same time. It will run a female program for whatever it is doing, and at the same time it will run specific male programs to accomplish a particular purpose.

### Neither Programming

The idea of "neither" programming is paradoxical. A neither person (extremely rare on Earth but major in the cosmos) does not program at all. They are persons who are outside polarity and do not respond to it. Even the Taoist idea that "nakedness is the greatest defense" would never cross their minds. They see life and the Reality in a completely different perspective that would be almost unimaginable to us.

Since almost no "neither" persons exist on Earth, there is little point in discussing this type of person. Besides, if you are one of those persons, you don't need to do this work. You are already living the Way.

## The Surrogate Mer-Ka-Ba

As we said, a surrogate Mer-Ka-Ba is a living Mer-Ka-Ba field separate from the Mer-Ka-Ba that is around the person who creates it. It is a Mer-Ka-Ba field that can remain in a fixed area, such as your house or land. It can have completely separate programming from your personal Mer-Ka-Ba, though it remains alive solely through your life-force energy.

It is simple to create:

1. Pick a spot where the "breathing tube" will be.
2. Decide where the outer limits *of* the Mer-Ka-Ba will be—in other words, where the radius of the disk will end. For example, the edge of your property. The size of this surrogate Mer-Ka-Ba can be very big. (We are still experimenting with this. At the moment I have one 228 miles in diameter that is helping with the environment in the area where I live. It took me several years to learn how to use one *of* this size.)
3. Do not be concerned with the sex of the Mer-Ka-Ba or which way the tetrahedrons are facing. It will work anyway.
4. The size of the tetrahedrons will automatically adjust to the size you set for the disk, so you do not have to think about that, either.
5. As you do your personal meditation with your Mer-Ka-Ba, "see" the same thing happening to your new surrogate Mer-Ka-Ba. Each step *of* the meditation 1 through 17 you "see" it happening to your surrogate while you see it happening to your personal one.
6. You must remember your surrogate Mer-Ka-Ba every day, just as you must remember your personal Mer-Ka-Ba. This means that every day as you do your Mer-Ka-Ba meditation, you see the same thing happening with your surrogate, step by step, breath by breath. When the disk pops out for your personal Mer-Ka-Ba, then the surrogate's disk pops out, too.
7. You can have more than one surrogate, but it becomes complex, since you must remember them to give them life energy.
8. Program your new surrogate to whatever you set immediately after completion. Once programmed, it will stay until you remove it.

One last thought. I/you have a permanent Mer-Ka-Ba, then you will find that you can create a surrogate Mer-Ka-Ba instantly with a single breath. And it requires less attention to stay alive.

### Conclusion

We have *discussed* the subject of the siddhis and some of the pitfalls *of* higher meditation with the Mer-Ka-Ba. However, we have not discussed the real purpose of meditating within the Mer-Ka-Ba. We will say again that it is through the conscious connection with your higher self that you will realize who you really are—self-realization. This primary realization is the beginning of all meditation that leads to fulfilling your purpose for existing. We will discuss this in another chapter.

## Love and Healing

### Love Is Creation

Love is the source of all of creation. It is the consciousness that actually forms the created universes, dimensions and worlds that we live within. As we look into the other worlds with our dualistic minds, we always see everything in threes, as we have said before. We see time as the past, present and future. We see space as the x, y and z axes. And we see size in the microcosm, the everyday world and the macrocosm. We will call this the trinity of the Reality.

Everything in this trinity of the Reality, from atomic particles to the *grand* galaxies, is held together by forces that we have given different names, seeing these forces as separate and unrelated. The atoms are held together by atomic forces that seemingly are different from the forces of gravity that hold planets *to* suns and suns *to* other suns, but are they really different? Perhaps the only real difference is the dimensional level they manifest in.

Love is a particular vibration of *consciousness* that, when it *is* between humans, holds people to people in all our relationships. Without love, marriage is just a shell and will usually break apart. Sometimes a marriage will stay together only *to* save the children, but *is it not still love that holds the marriage together, love for the children?* We may have other reasons to continue a relationship without love, but it is never the same as true love, love is the bond that is stronger than any other. People will die for love.

I believe that everything in the universe is a mirror of consciousness. From what I have seen, all energy is consciousness no matter what the name of it is, whether *it is called* electricity, magnetism, electromagnetic fields, heat, kinetics, atomic forces, gravity and so on. And from this belief we can see that according to  $e = mc^2$ , energy is related to matter—and to the speed of light squared, a number. Therefore, matter *is also* consciousness, only crystallized. From this view of the world, everything is consciousness. And consciousness is the light that reflects off the matter of the outer world and creates the entire outer world, breath by breath. The inner world of *consciousness*—the dreams, visions, feelings, emotions, sexual energy, kundalini, and even our



interpretations of the outer reality—are all the source of matter and how this matter is arranged,  $e = mc^2$ . And love is the binding agent within this equation. Love is the exact vibration that matter responds to. We have a great power to create. We have forgotten, but now is the time to remember.

This is why the living Mer-Ka-Ba needs love to become alive. Without love the Mer-Ka-Ba is lifeless and will soon die. The female aspect must be present in love to balance the male, or life will not be.

It is love that can change water into wine. It is love that can bring a person back from the dead. It is love that can heal yourself and others. It is love and love alone that will heal this world. So to speak of healing without speaking of love is not speaking with truth. In medicine only certain things are possible. But with love all things are possible. With love, the incurable disease is nothing but light, and the atoms of the body can be re-formed into perfect health. The absence of love is the source of all disease, for it is love that binds matter into order out of chaos, and without love, chaos will always ensue.

### **Healing takes place only when love is present.**

In the late '80s we did research to see if all healers might have something in common. We looked at many healers, most of whom used different forms or techniques. Just about every technique of healing known was present. Hands-on healers, psychic surgeons, Reiki masters, prana healers, medicine men and women, shamans, practitioners of witchcraft, psychic healers and so on were all present. We studied the energies coming off their bodies and found that they all had an almost identical sine-wave signature, the same pattern of three high waves and one low wave that continuously repeated—and that the source of this pattern was located in the universal heart chakra.

This was very interesting from a geometric point of view, because the length of the breathing tube above and below the heart chakra was exactly one part male to three parts female. This was the one aspect that was the same in each of these healers, at least while they were healing. They were centered in the Christ chakra just above the sternum at the moment they were healing—the primary chakra of universal unconditional love!

From this research and other experiences I have had, I now believe that whatever healing technique(s) a person uses is of little importance. The technique simply gives the healer a structure for the mind of that person to focus on, but the *real* healing comes from the love that healer is giving to the person being healed. The healer's love for that person heals, not their knowledge. So speaking of healing without speaking of love will always evade the truth.

Healing people, healing villages or healing the entire planet is all the same. The only difference is simply the greater degree of love.

The mind has the knowledge to manipulate matter, but love has the power to not only manipulate matter, but to effortlessly create matter from nothing. No matter what the problem is that needs to be healed, love can

always find a way. *True love has no limits.*

What is the veil that keeps us from seeing and living this great truth? It is the belief patterns we hold that limit us. What we believe to be true is always our limitation. If our doctors tell us that a certain disease is incurable and we believe them, we cannot heal ourselves. We are frozen in that belief. We must then live out that belief even if it means living in great pain and discomfort for the rest of our lives. Only a miracle, something much greater than ourselves, can overcome a frozen belief. So it is our minds that can arrest a healing. When our minds are in control and not our hearts, we will almost always suffer.

Let me tell you a true story about one woman's triumph over her mind and her belief patterns. Her name is Doris Davidson.

Doris contracted polio and was restricted to a wheelchair for about twelve years before I met her. Her doctor had told her that she would never walk again, and she had resigned herself to this "fact." She lived alone with her son, who sacrificed his life to take care of her.

One day she began to read some books on healing through crystals. She became excited by the author's words, which spoke of how any and all diseases are curable. Through these words she began to have hope again for the first time in many years. She called the author to ask her for advice, but for whatever reason, the author asked her to call me.

When Doris called me and asked for help, I told her that I would have to ask permission before I could help her, and that I would call her back. (We will talk about the importance of asking permission later in this chapter.) I spoke to the angels, and all the channels opened up for this healing to begin. They told me not to do any of the healing work that I usually do, but to work *only* on her belief patterns. They said that as soon as she *really* believed it was possible to be healed, she would do it herself.

So I called her back and all we did was talk. Once a week for many months we would talk, always leading the conversation to allow her to believe that she could heal herself. For all these months nothing happened.

Then one day she called me, and it was obvious by her voice and commitment that she had changed. She told me how she had made certain decisions. First, she had decided that she was never going to sit in her wheelchair again. So she sold it and had her doctor rig her up with special braces that confined her hips and legs. Her legs had deteriorated from sitting for so many years and were very weak. Along with this, she needed a four-legged walker to keep her from falling over. Many months went by with these restrictions.

Then one day she felt that her legs were getting strong enough and she switched to regular crutches. This began to work, and Doris became even more certain that she could heal herself.

Her legs became so strong that the hip braces were no longer necessary, and she switched to braces that held only her knee joints in place. She was walking so well and feeling so confident that she asked her son to leave



home so that he could have a life. She was now able to take care of herself without any outside help.

Then the big day came. Doris was able to walk without the crutches using only the braces. She became so excited, I could hardly talk to her on the phone. A few days later she went to the California Department of Motor Vehicles and managed to get a drivers license. Immediately after that she sold her house and bought a brand new RV and drove to Taos, New Mexico, where I was living, and attended one of my Flower of Life workshops. She walked into the workshop without help and with a smile so big that she looked like she was going to lift off the ground. She was a changed woman.

Nine months later I was walking down the street in Taos, and I saw Doris come running up to me. It was the first time I had seen or talked to her since the workshop. She had gotten a job and had disappeared for a while. She whirled around in a circle to show me that all her braces were gone. She looked at me and said, "Drunvalo, I am completely healed, 100 percent. I am so happy. I love you." And she danced away. I watched her as she skipped down the street with not even a trace that she'd ever had polio or had ever spent twelve years in a wheelchair.

Every year for about five or six years she would send me a Christmas card out of gratitude. But I hadn't done anything; she had healed herself. She understood the problem, and believed from the depth of her heart that it was really possible to heal herself—and of course she did.

Remember the lady who simply touched the garment of Jesus to heal herself, to whom Jesus said, "Daughter, be of good comfort; thy faith hath made thee whole."

What you believe to be true is always your limitation. If you do not believe in limitations, you are free.

## "Heal Thyself"

First of all, there's healing yourself and healing others. You always begin with yourself. If you cannot heal yourself, how can you truly heal others.<sup>1</sup> So let's begin with your own energy field, your Mer-Ka-Ba.

As far as the breathing and the Mer-Ka-Ba meditation is concerned, I believe that if you do the breathing daily and *get* the prana moving through your body, you will eventually find health. However, "eventually" can be shortened considerably with the understanding that the Mer-Ka-Ba is alive and responds only to the conscious intentions of the spirit within the field.

Because *of* the perfectly balanced male and female prana one receives by breathing within the Mer-Ka-Ba, *some* diseases are going *to go* away just from the breath. You should feel a tremendous change quickly in some health problems, but not all. There are other problems that can be healed only with a deeper understanding of the nature of what disease is.

This story will emphasize the nature of disease. In about 1972 I was living in the forest in Canada with my wife and children. My wife and I had been studying hypnotism. We had learned that we could leave our bodies

and fly from room to room in our house. We even set up tests to see if our perceptions were real.

One of the tests was simple. When my wife was in a trance state, I left the room and went into another room, changing the room in a certain way that only I knew. When I came back I had her fly into the other room and tell me what she saw. She described it perfectly- It was then that I began to understand that life on Earth was different from what I believed.

We did many tests, some of which became more complex. One was when she would fly (astral-project or remote-view) down to a bookstore and pick out a book that neither of us had read. Then she would pick a certain page in the book and read it to me. I would write it down, including the page number. Then the next day we would check this book to see what was on that page. It was always perfect. As time went on, we became more and more confident of the nature of what the Reality was and how consciousness fit into the big picture.

Then one day I was drying a cast-iron pan on the stove. I had forgotten it for about fifteen minutes and it was practically orange-red. My wife walked into the room and without thinking, picked up the pan. I tried to speak, but it happened so fast I couldn't. She picked the pan up with her left hand and moved about three feet before her body responded with pain. She dropped the pan and began to scream and went into instantaneous shock.

Immediately, without thinking, I ran over to her and looked at her hand. She had really burned it badly, and I didn't know what to do but put it in cold running water. I did that for a few minutes, but then something else took over within me. I looked at her and told her that I was going to put her under. She agreed. The first thing I did was tell her that all her pain was going away. Immediately the pain stopped. Her eyes were closed now and she was relaxed. I decided to go one step further.

I watched her palm as I held her burned hand. I told her, under hypnosis, that her hand was going to go back to absolute normal on the count of three. The moment I said the word "three"—about two or three seconds later—the hand returned to normal. I saw this with my own eyes, and it changed my life. I knew in that moment that everything society and my parents had ever told me about the Reality was not true. The body was light, and it responded to consciousness. It responded to whatever the person truly believed.

After that day we performed many experiments that proved beyond any doubt that the Reality is light, meaning like light, not solid, held in place by consciousness. It was the first important lesson in healing in my life. It took me many more years to understand that what had happened with my wife's hand could be applied to all healing situations in this Reality. A diseased organ, for example, that is almost destroyed can be returned to health simply through consciousness alone.

I had a friend named Diana Gazes who did a TV show in New York for a

while, called "Gazes into the Future." She used to film all kinds of spectacular healings to put on her show. She stopped her show after many years, but one of the last shows she was going to put on (though it never made *it*) was one about an incredible healing with an eleven-year-old boy. She had been taping on video this boy's progress over about a year, and it was almost done when her show was canceled.

When this boy was very young, he used to collect salamanders. You know, you can pull off a salamander's leg or tail, and it'll just grow another one. Well, the parents hadn't told him that that applied only to salamanders and not people. Because they hadn't told him, he didn't know. He believed that all living things did that, including people. When he was about ten years old he lost his leg above the knee. So what did he do? He just grew another leg.

It's all on Diana's video. In the last part of the video he was growing his toes. It took about a year or so for him to do it. What's possible? It all depends on your belief systems, what you believe is possible and the limitations you put on yourself.

Once you have healed yourself and know the nature of what I am talking about, spirit may ask you to heal others. If you are asked to be a healer, then there is more to understand.

## Healing Others

You don't have the right to heal anybody you want, even if you could go around and touch everybody and they'd be absolutely healed. It's illegal. This is a school we live in, and everybody's experience is their own experience, and they need it. You can't heal someone just because you want to or they need or deserve it. *You have to get permission first.*

Why get permission? We cannot see very well from this position within the third dimension. We do not know what our actions are really going to do in the bigger picture. We may think that we are doing this person great good by healing him when in fact we are harming him. We all live in a cosmic school of remembering. An illness may be just what that person came to Earth for. Through this illness this person may learn compassion, and by healing him you take away that possibility. Keep your ego out of the way, and healing will come naturally.

This is how I proceed. First I ask permission from my own higher self, asking whether this is in divine order. (I will talk about what the higher self is in chapters 16-18.) If I get a yes, then I must verbally ask the person (if possible) if he wants me to heal him. If I get a yes, then I must now bring in his higher self and ask it if this healing is in divine order. Sometimes I will get permission and sometimes not. If I do not get permission, then I simply say I am sorry that I cannot help them, and allow nature to move the way it will. If I get a yes, then this is what I do.

To be clear, when I say, "This is what I do," I do not mean that this is necessarily what *you* should do. I am using myself as a guideline to help you

understand, but I am in no way saying this is dogma.

The person's higher self knows exactly what is wrong down to the most minute detail, so continuing to talk to the person's higher self after you have permission will give you great knowledge about this illness. I have found that the person's higher self, if I ask, will even tell me exactly what to do to heal this person. Sometimes it is a traditional pathway, but sometimes it will not make sense to the mind at all. The higher self may tell you to paint a red star (for example) on your forehead while you are working with this person. Your mind will not understand, but the person will see the red star and suddenly it triggers something inside, and an immediate healing takes place. Use the person's higher self, for it knows everything.

The following ideas may be different from what you have learned about healing. Just keep an open mind. First of all, I realize that people have many concepts about what disease is, but as I have said above, to me the body is simply light and can be changed easily once the mind can accept the healing. Coming from that place, I see the whole body as just energy, including the disease. To me it does not matter what the story is around the disease—what the person thinks caused this disease. To me, both the body and the disease are just energy.

I have found that it is easiest to heal if the old negative, "diseased" energy is removed before one attempts to put positive energy into the body. I have found that energy, negative or positive, responds to human intention very well. Let's say a person has cataracts on both eyes and can't see at all. Medical doctors would say there is nothing that can be done except to have cataract surgery.

From my view, it is only energy. I would reach down to the eyes with my fingers, and with my intention, I would get hold of the energy with my fingers and pull this old diseased energy out of their body. Different healers around the world have many different ideas about what to do with this diseased energy once it is out of the body. Obviously, you can't just leave it sitting around for it to become connected to someone else.

The prana healers of the Philippines visualize a bowl of violet light that burns and consumes the diseased energy. Everyone has different instructions. The angels told me to just send it toward the center of the Earth and that Mother Earth would take it and convert it into useful positive energy. It has worked perfectly for me.

Everyone has different ideas about how to generate the healing prana or positive energy to put back into the body. Chi Gung masters pull the energy from nature. The Philippine pranic healers pull it from the Sun. You have a special advantage, since you are learning the Mer-Ka-Ba, and you will be able to pull unlimited pure prana from the fourth dimension for this purpose. As you were shown in chapter 13, there is a sphere of prana two hand-lengths in diameter that surrounds the heart chakra, where the two pranic flows meet. On the tenth breath this sphere expands to enclose the human body, but the original smaller sphere is still there. It is from this

source that one can get this prana for healing.

So from this sphere around your heart chakra, you simply visualize *with* intention that this energy move from around your heart into the person who needs healing. It is unlimited, so as fast as you use it, it is replaced. You can see this energy moving down your arms into your hands and then into the person to wherever the person needs it. And it does not actually matter where this person is located in the world. You can send your energy to him with your intention, and it will be received.

Once you have removed the diseased energy and replaced it with pranic energy, the last step is to see the person becoming healed in your own mind—and also (extremely important) see them healthy about three months in the future. You know it will be so.

This form of healing is very simple, but it works. Remember, it is really love that allows the healing to come to pass.

Now, there is a slightly new subject that I will address here. Most healings that do not take place no matter what the healer does, are because there is something within the person that is stopping the healing. We are talking about something other than belief patterns. This is something that many healers wish to avoid, but it is *absolutely necessary to address* if the person has this problem.

This brings up the subject of entities and dysfunctional thought forms that are not part of a person, yet live within that person. These entities act as parasites. They are not the person, but that person has, by his thoughts, emotions/feelings or actions, attracted these entities. By their presence these entities can keep a healing from taking place as well as directly cause major diseases.

What is an entity? It is a living being who has come from another dimension but somehow entered this world. In the world from which they came, they are useful and necessary to the universe as a whole. But here they are a problem.

There is another kind of entity that is simply a human spirit who, out of fear, has not left the third dimension and has chosen to reside within another person. And there are other possibilities, such as ET spirits who may or may not be from this dimension but are in the wrong place at the wrong time.

The understanding is similar to the cellular levels within your body. Each cell in your body is unique and lives in a particular body part. It has a job to perform for the body as a whole. They appear different; brain cells look different from heart cells, which are different from liver cells and so on. As long as the cells are in the right place, there is no problem. But if we were to cut your stomach open, blood cells would pour into your stomach. They should not be there, so a healing would be necessary to remove these blood cells and stop this influx of alien cells.

What is a dysfunctional thought form? It is the thought of a human or other being that has arrived within a person, usually by intention. A spell, a

curse, directed hatred and so on can all come to life within a person. Once within someone, it will usually take on a form, which might have almost any shape, and a life-force energy. It will appear to be alive. It is removed in the same way that spirits are.

All these possibilities have a detrimental effect on human health, with the exception of the "good" entity. Yes, rarely there is a spirit of a highly evolved nature who is good for the person. When one is discovered, I usually do nothing to remove it. At the right time it will leave on its own.

Hypnotherapists deal with these issues all the time. It is usually the first thing they do. And I agree with them. After you get permission from a person's higher self, the first thing you do is check to see if he has any of these entities or dysfunctional thought forms. I have found that about half the people I have seen have them. The source of these entities is often from the time period when the Mer-Ka-Ba was misused on Atlantis and the dimensions were ripped open, about 13,000 years ago. And very often these entities have remained with a particular soul for all this time.

Ask your higher self if you are to become involved with this part of healing. If not, then forget it, but be prepared that sometimes there will be nothing you can do as long as an entity lives within the one to be healed.

I will explain what I do to remove them, but please remember that it is not the technique, but love that is so important. And my path is definitely not the only way or technique to assist in healing. If you are just beginning, some of what I say may not make sense. I will do my best.

In the past, the Catholic Church and others have used exorcism to evict the entity out of the person's body. This was usually done with very little understanding on a spiritual level and mostly by brute psychic force. The priest just wanted to remove the entity and didn't care what happened to it. Little did he know that this spirit is simply going *to move* into someone else's body as soon as possible, which is usually the first person the entity sees. The entity *must* live within someone's body. It is not capable of living long outside some form.

So what good is this form of exorcism? The disease, the entity, still stays alive within humanity. It is in a world that is not its own. It is afraid and very unhappy. These entities are similar to little children, but in order to protect themselves in this alien world, they have learned to take on frightful appearances and noises to keep humans away. If they are approached in love, honesty and integrity and you can convince them that you really are going to send them back home, they will not resist but will usually even help. So my suggestion is that you treat these entities like children, no matter what they do.

Now let's see what they might do. [If you understand the Reality, that it is just light and that it conforms to your intentions, then you know that you can remember and create the intentions that will heal all things. Do not be afraid of these entities or dysfunctional thought forms. They can do nothing to you as long as you connect to them only through love. In this particu-

lar state of consciousness, you are immune. If you connect to them through fear, sexual energy, drug-related experiences or any experience that brings them into your internal world, they can possess you.

With love, I begin by asking the person's higher self if there are any entities or dysfunctional energies within that person. If it says yes, I immediately put up a mind field in the shape of an octahedron (two back-to-back pyramids) that surrounds the person and usually myself, too. This is done for two reasons: It will not allow the spirit to escape and move into someone else's body, and it provides a dimensional window at the tip of the octahedron to move the spirit back into its home world.

Then I personally invoke Archangel Michael to assist me. He loves to do this work because it brings the universe just a little bit closer into order. He stands behind me and watches over my shoulders. We work together as one. He will work with you if you just ask.

Then I place my hand over the person's navel and ask the entity to come forth to me. I then go into telepathic communication with the spirit(s). I have found it is not necessary to have the entity talk out of the person's mouth. (This just makes matters more complex and can produce fear in the person.) Once I am in telepathic communication with the spirit, I send it love so it knows that I am not there just to "get it," but that I am interested in its well-being, too.

Every spirit in existence was created by God for a reason and serves a sacred purpose in the overall scheme of life. Nothing has ever been done at random. I tell the entity that my purpose is to return it to the world from which it came. And I mean it. Once the spirit is convinced that I will really do this, it is easy.

Then I feel and internally see this spirit. These entities have many shapes and forms, which will seem very strange to a novice. Often they are shaped like a snake or insect, but they can appear in almost any form. At the right time I begin to pull this spirit out of the body. Once the spirit is out about three feet, I hand it over to Michael, and he brings the spirit up to the apex of the octahedron and sends it through the dimensions back to its home. Michael knows exactly what to do.

This becomes a win-win situation for both the person and the spirit. The spirit returns home, which to it is like going to heaven. There it can fulfill its sacred purpose in life and be happy. And the person being healed is inside his own body all alone, sometimes for the first time in thousands of years, and he is able to function in a new and healthy way. Many diseases will often simply go away all by themselves, since it was the spirit that was causing the problem in the first place.

A little side note: The reason I put my hand over the navel is because I have found that that is the easiest place from which to remove spirits. They usually enter a body from a specific chakra at the base of the skull, at what is called the occiput. Usually a person has entities because he has used heavy drugs or alcohol and become vulnerable to them or because entities may

have found an opening from the person's use of sexual energy or because the person has entered extreme fear and become helpless. There are other ways, but these are the three major reasons I have found.

Once one spirit leaves and demonstrates that going home is real, almost always, if there are other spirits, the others will line up and help you, without a fight, so that they too can go home.

I know this is a strange subject, but it is real. I have observed the results in thousands of people and seen how this has helped them become whole and healthy again

I'll give a couple of examples. Last year in Mexico a young man I didn't know came up to me after a workshop, saying that he needed help. He said that for about a year, he had not been able to control himself in many ways. He felt like a spirit was inside him, and asked me if this was true.

After getting permission, I talked to his higher self, who said that there was only one spirit inside him and to proceed in my normal way. The spirit came forth and began to speak in English, but with a thick Italian accent. I giggled inside, since I had never heard a spirit that had an Italian accent before. We talked for about fifteen minutes. Finally he told me he would leave, and in a few more minutes it was over.

The young man felt much better, and we began to talk. I asked him how he thought he had opened up to this spirit. He said he didn't know that for sure, but he did know where it happened. I asked where. He said, "Italy." Inside I said, "Of course." This spirit was human and was simply afraid to eave until now.

Another example was from Europe. A woman and her husband came to my workshop. They had been married for years and loved each other very much, but as they began to get older, she began to sexually fantasize about this "imaginary" man. It was not because the sex between her and her husband was not good. The fantasies simply began.

As time went on, this imaginary man began to take more and more of her sexual energy until one day she could not have an orgasm *except* with this imaginary man. So she stopped making love with her husband, and from her point of view, she couldn't help it. This imaginary man made her have sex at least two or three times a day, whenever *he* wanted, not her. She had no control.

This could have been an emotional or mental problem, but in this case it wasn't. This was a real "imaginary" man from another dimension. She had opened the doorway through drugs. She had stopped taking the drugs, which she had done only twice, but it was too late. The man was inside her.

After getting permission, I talked with her higher self for a long time. The spirit inside her was a highly intelligent being. There was no fooling this one. When I contacted him, he already knew what I was going to do. He held a deep conversation with me for about twenty minutes and then wanted to see Archangel Michael. So I invited him to stick his head out of this woman's stomach and look for himself. When he saw Michael, I knew



by the expression on his face that he was impressed- He immediately popped back into her body, looked at me and said that he needed more time to think about it. He told me to contact him the next day.

The next day, the lady told me that she had talked with him almost all night. He said he loved her and didn't really want to go, but he had decided that it would be best for both of them. And then, of course, they had sex again.

That evening I held my hand over her stomach and contacted him again, as he had asked. He simply said, "Good evening. I want to tell you that I like you very much, and I want to thank you for assisting in this manner." Then he said that he was ready to go. I lifted him out and Michael held onto his shoulder and took him into the world from which he came. No resistance whatsoever.

When I told the woman it was over, she was amazed. She said she hadn't felt anything. Then she looked at me and said, "He wanted me to tell you that he likes you."

That evening she and her husband made love together for the first time in a long time. The next morning they were so happy that they decided to have a second honeymoon. Life was to begin again.

Details: Make sure you get *all the debris* out of the body. Many of these entities will lay eggs or leave behind some kind of debris. Ask where it is, or feel it and pull it out and let it go back with them. If you leave this debris, the person could get sick from it or even keep the diseases caused by the spirit.

One last statement. Personally, if I get sick or something begins to go wrong, which is seldom, I wait a little bit before I heal the situation. Why.' Because I want to know why I caused this unbalanced experience in my life. I examine my life. I want to know what I thought, felt, said or did or how I lived that created this disease so that I can correct it so that it does not come up in some other form. I wait for the wisdom.

## A Final Message and a Story

I'm sure you've heard this one: "There are no limitations in this world except the ones you place on yourself,"

Diana Gazes, from the above story, left her TV show and went to Hawaii to learn about herself. She took a leave of absence from the whole film world. She could look at spoons and bend them with her thoughts, and she taught people, mainly in corporations, how to work with psychic energies. She's a very psychic person, and she wanted to explore this part of herself more. Anyway, she was in Hawaii and we decided to do this psychic experiment she wanted to do. The details of the experiment are not important, but we were going to do it for ten days, and each day after it was done, I would call her and we would verify our results.

I did it the first day and called her, then I did it the second day and called her. On the third day I decided, "I think I'll not do the experiment today

And see what'U happen." After the experiment was supposed to be completed, I called her up, but there was no answer. Something had happened. She wasn't there. I didn't know what to do, so I asked the angels, "Well, what do I do with this." They said, "Here's her phone number. Call her up."

So this phone number came out of the blue and I called it, wondering what was going to happen. To my sort-of surprise (the angels are never wrong), Diana picked up the phone. I said, "Hi Diana," and she said, "Who's this?"

"It's me, Drunvalo."

"Drunvalo?"

I said, "Yeah, how're you doing? You sound funny."

She said, "Drunvalo? How ... ?" She was quiet for a moment, and then she said, "How can this be? Drunvalo, I was just, walking by this phone booth, and the phone rang. How did you do this."

Soooo, just have faith in yourself, trust yourself. God is within you, definitely. You can heal anything. You can bring your body and your world into perfect balance with love. Life flows and becomes easy, not diseasy.

## The Three Levels of the Self

**W**e think of ourselves as living on Earth in this human body, but have you ever considered that you may exist on another level, or even levels, of life at the same time you are here? This is the belief of many of the Earth's indigenous peoples, such as the Maya and the kahunas of Hawaii. They see us as multidimensional beings literally living other lives in other worlds, which is the truth, from everything I know.

Under normal conditions we humans are consciously connected to these other parts of ourselves, but because of the Fall during the time of Atlantis, we are separated from our higher selves. When we do connect and it becomes a reality, we live life in a manner that would seem impossible to us now. We can see the past and future clearly and are able to make decisions based on higher knowledge, which affects our spiritual growth in positive ways. This we have lost due to our actions long ago.

These higher levels of ourselves that exist in other dimensions are called our higher self or higher selves if we consider it from the bigger picture—though to think of our higher self as a single being is right and wrong at the same time. There is only One Being in the universe, yet there are many levels that exist within this One Being. Remember the way we spoke of the levels of consciousness in chapter 9?

Your higher self is connected to even higher selves. So there are higher selves connected to higher selves connected to higher selves. Each higher self is on a different level of consciousness that is still larger and more encompassing, until finally the ultimate level is reached before transcending this waveform universe of dimensions altogether. Each person has the *capability* of existing within every possible level of consciousness at the same moment, but this is rare.

So it is similar to a lineage or a family tree that grows upward until finally it connects with God and all life. But we were separated from our multidimensional self at one point when we, as the human race, fell to this present third-dimensional consciousness. There was a division that took place. We fell so far down in consciousness that the other aspects of ourselves could no longer communicate. Although we are not, for the most part,



aware of our higher selves, they have always been aware of us.

As time has progressed since the "Fall," communication has been sporadic and rare. Our higher selves have mostly waited for us to awake. They have been waiting for the right moment in time. It's been kind of a one-way separation—they are aware of us, but we are not aware of them.

If the kahunas of Hawaii are correct, our higher selves have placed us on hold and are out there playing and communicating with each other, preparing for the day when we will wake up to the rest of life. Most of us have not truly connected with our higher selves for almost 13,000 years, except for short periods of grace and light.

This reconnection with your higher self is not channeling or anything *of* that nature. It is just a reconnecting of your own essence and spirit to itself. Perhaps, more accurately, it is a remembering—a remembering, bringing the various members of spirit back together. Some people call it the soul. For me, I see only spirit. I see Great Spirit, and all spirits that come from that source are just a portion of Great Spirit. In this view we are all related to Great Spirit, or God. Some of the connotations of the word "soul" imply that souls are different from each other and are somehow unrelated. To me, all souls or spirits are from the same source. If you want to see God as our Father/Mother, then we are all brothers and sisters in the entire universe.

What I have found—and it has been found by almost all native tribes in the world—is that we have this higher aspect within us. If we can make the connection with conscious communication, we then get clear guidance from within us about how to move moment by moment in life. The movements become filled with grace and power, with little or no effort. This guidance comes from only you, and it cares about you in the same way you care about yourself. And it's a guidance that you could never figure out or understand from this third-dimensional level.

A side note: Superimposed over the levels of life and the higher selves is what many people call the Spiritual Hierarchy. The Spiritual Hierarchy is composed of beings who have been given responsibility for organizing and running the government of the universe. The Spiritual Hierarchy is interwoven with our higher selves and is not directly related to us. Just because you connect with your higher self does not mean that you have connected with the Spiritual Hierarchy. I bring this subject up only as a reference, to answer the question before it is asked.

Following is the example that the angels originally gave me when I was trying to understand how the higher self could see so clearly. Suppose you were rowing down a river in a canoe. Let's say you're in a jungle and it's the blue skies and green water of the Amazon. There's foliage all over. You're having a good time, just row, row, rowing your boat down the stream of life. And when you look behind you, you can see only a little way. The trees are so high on each side of the river that you can't see outward or beyond the bend.

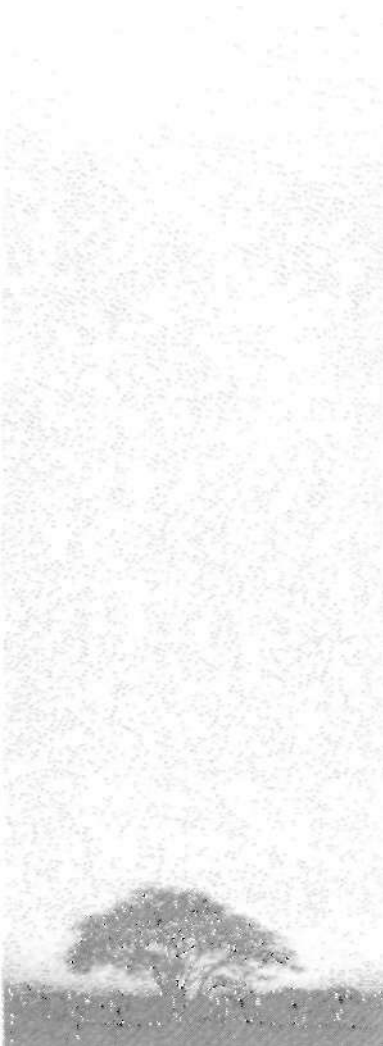

Your memory of the river goes back only a little, and that's all you can see. As you pass the bend into the next area of the river, you kind of forget the past. You can remember a little bit, but the farther you go down the river, the more unclear it gets in your memory. You can look ahead and see the next bend, so you can see ahead into the future up to the next bend in the river, but after that you don't have any idea what's coming up. You've never been on this river before.

Your higher self is like a huge eagle flying high over your head. Your higher self is in another dimension and perceives time spherically. It sees the past, the present and the future all occurring simultaneously. It can see way back along the river, way, way, way back, much farther than you can, and it has a good memory. It can see far into the future, too. It has limitations, but they're expanded.. It's a fantastic view compared to yours on the river, so it can see things as they're about to happen. It can also see relationships in the reality that you, from this human place, just simply can't see because of your position. Let's say you're following the instructions of your higher self, and your higher self, a great bird, comes down to you and says, "Hey, take your canoe over to the side of the stream here and get out now."

If I didn't follow my inner guidance very well, I might say, "Oh, I don't want to do that. It's beautiful, you know. No, let's wait awhile, and then I will leave." But if I were following the guidance of my higher self, I would simply do it and ask few questions. Then the higher self might say, "Carry your boat through the jungle." So you carry your canoe over logs and tree roots and red-ant hills, and you're thinking, "Oh man, these higher selves!"

If you have been following your inner guidance, you know what I mean. You're going through all these changes, moving this heavy canoe through the jungle, wondering why the higher self has asked you to do this seemingly crazy act. You might go for half a mile through this dense jungle before you reach the river again and can look back up the river. From there you see that around that last bend was a 500-foot waterfall crashing onto massive rocks. Had you continued as your ego had wanted, you would have been killed. But because you changed your path and went another way, you continue to live on Earth. You avoided a disaster by following an invisible inner guidance that has an ancient wisdom.

I used to give a technique for reconnecting with higher self. I now realize that this technique works only under certain conditions. It worked for me, but I didn't realize that it actually didn't work for me in the way I originally thought it did. Why doesn't it work for someone else? I tried to understand, but at first I couldn't.

I had tried for many years, but I just could not understand it. I finally just asked my higher self. (I usually wait until I can't figure it out any other way.) I asked the angels, "Please, just tell me. Show me what it is." A whole series of events happened after that, one after another, each leading to a better understanding.

The first thing that happened right after I asked for help was at a work-



shop I was giving in the state of Washington in Olympia. A man there was in his sixties, a native Hawaiian. When I saw him, I could not understand why he was at this workshop, because I could see that he didn't need to be there.

I waited awhile before I approached him, and I finally said, "What are you doing here?" He said, "I don't know."

"Oh, okay. Neither one of us knows why you're here." So I went back to teaching and waited a long time.

A couple *of days* later I was talking with him and said, "What do you do?" He said that he was a kahuna from Hawaii.

"What do you teach?"

He said, "I teach only one thing, and that's how to connect with higher self."

"Oh..." So when it came time for me to talk about the higher self at the workshop, I said, "Just a minute." I sat down in the audience after asking the kahuna from Hawaii to talk about the higher self. He talked for an hour and a half to two hours about connecting to higher self from a Huna point of view. It was perfect for me.

This talk changed my understanding. From the way I had understood it through my experience, there was me and there was higher self, because that's what my life seemed to tell me. But the kahuna made it clear that we are divided into *three* parts—the higher self, the middle self and the lower self. I should have known, since everything is broken up into thirds.

Since that time with the kahuna, I have had many experiences that have made the following clear. If we are the middle self in our duality consciousness, then what are the other two selves, the higher and lower selves? We will slowly explain who and what they are, but it is most important to understand that one cannot reach or connect with the higher self until one has first reached and connected with the lower self. Spirit must first move downward before it can reach to the heavens. This teaching has been verified in so many ways in my life. So we will begin by explaining what the lower self is.

## The Lower Self—Mother Earth

In the most straightforward terms, the lower self is your unconscious mind. But contrary to the popular thought that the unconscious mind is connected only with yourself and your personal unconscious thoughts, this unconscious mind of the lower self is connected with all other human beings on Earth (Jung's collective unconscious), and it intimately knows every individual person's unconscious mind also. Further, it knows the unconscious minds of not only every human alive, but also everyone who has ever lived on Earth in the past as well as everyone who will live on Earth in the future. Yes, your subconscious mind knows the past and the future in detail, at least relative to the Earth. In addition to that, your lower self knows everything associated with *all life on* this planet, not just human—in other words, the entire living biosphere. It is a perfect record. And this

lower self is alive and comes across as a single being communicating with you. It is Mother Earth *herself*. She is your lower self.

To be clear, the lower self is the Earth and all life on, in and above her. I am not sure at this time if the Moon is included with the lower self. It probably is, but I am not certain.

According to the Hawaiian kahunas, and really to most other indigenous peoples of the world, Mother Earth is a young child about two to six years old, depending on who you talk to. She is always a child, because she is a child.

To connect with your lower self, it is believed by indigenous peoples worldwide that you must begin by loving her and playing with her. Adult sophistication and all its technological thinking and trappings will not work to connect with the Mother. She is usually not interested. You could meditate for hours every day, you could spend all your time doing nothing but trying to connect with the Mother, but usually it is a waste of time. The harder you try, the less likely that anything will happen. Why? Because she will connect only with the innocent child within you. And of course most of us have lost our childhood innocence. We have lost the pathway to know and consciously connect with the Mother. Your inner child must be remembered and lived if you wish to proceed. Even Jesus said it: "Except ye become as little children, ye shall not enter into the kingdom of heaven."

Let's look at ourselves, our adult side that thinks it knows so much. You may have a master's or doctor's degree from one of the great universities of the world; you may be considered an expert in your field; you may even be famous and very highly respected. But if you wish to know Mother Earth, you must put all that aside and completely *forget* it. She is *not* impressed. Mother Earth loves children, and if your childlike nature and your innocence are allowed to emerge from the muck of your adulthood, then something real can begin in your spiritual life.

When the kahunas want to find fish, for example, they ask Mother Earth for substance. And she will answer them. The answer might very well come from within the reality itself. The clouds might turn into a human hand and point to the place where the fish are. The kahunas get in their boat and when they reach the spot that the Mother told them about, there the fish are. This is a way of living with nature that civilized mankind has completely lost, although a few indigenous tribes and Earth keepers still live that way.

Now let's look at you. You are at work or school, say, and you decide to go home. You reach in your pocket for your keys. Immediately your thoughts are in the future. You are already thinking about your car and going home. *Once you get to your car* and start it up, you are thinking in the future again. You are thinking about the drive home *or* your lover or perhaps even your cat *or* dog, but you are more than likely not thinking about what is right before your eyes. You are still in the future or the past. But *only from the present* can we truly experience anything. The present is usu-

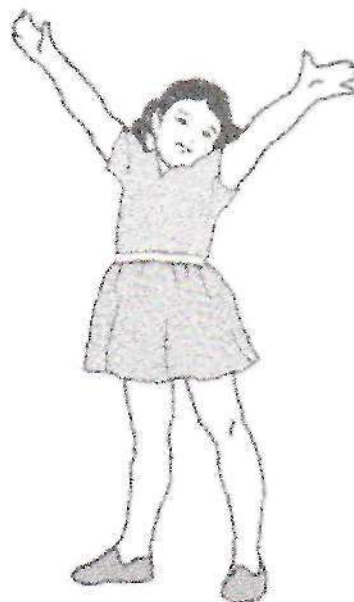

ally too painful for most people to participate in.

Did you really look at the beauty all around you? Did you see the sunset? Did you see the billowing white clouds in the sky? Did you smell the air, or did you decide not to because it was filled with pollution? Did you see the incredible beauty of the colors of nature? Did you feel love for Mother Earth? Did any of your senses function except what was necessary *to* drive home? This is the problem. Our adult lives are deadened, and we are only living a shadow of what *is* humanly possible.

Have you ever noticed children when they are experiencing nature? They become lost in sensing the great beauty all around them, so much so that they sometimes are seemingly in another world. Do you remember?

If you wish to connect with your lower self, with Mother Earth, you must find your inner child and become a child again. Play with the Mother, have fun, really enjoy life. It means living a life that is joyous. It does not mean play-acting like a child and making silly sounds and faces—unless, of course, that is what is really coming from your heart. It means living your life in the way you really want to, not in the way that someone else feels you should. It means caring about people and about animals and other life, because you can feel the connection, not because it will profit you somehow.

I didn't understand what had happened to me at the time the angels appeared. All I knew was that I had given up on living life according to the rules that seemed to have no meaning. I had begun to live a life that I really loved. I had moved to the mountains of Canada, where I had always wanted to live. I moved deep into the forest because I had always wanted to do that. I wanted to see if I could live on nothing, and I became very close to nature. I had no fear. As I watched the sunrise, every day was like a new birth into life for me. Each day was special. I played music most of the day, which was my dream. I had *to* work hard for about three hours a day, but the rest of the time was mine. I loved life, and I still do. The seeds that were *sown* in those early years are still gnning in my life today.

It was then, at the peak of this Canadian experience, when the angels appeared to me and my wife. It was the beginning of a lifelong love of life. It was a silent key to higher consciousness, but at the time I didn't understand. As I have found, in order to begin a true spiritual life, one begins in nature as a child. Once a true connection with your lower self has happened—and only then, according *co* the kahunas—you may connect with the higher self. It will be Mother Earth who decides if you are ready, and when she feels you are, she will introduce you *to* this grand part of yourself that we call the higher self. No amount of force or determination, no amount *of* begging *or* crying or feeling sorry *for* yourself, will bring this *to* you. Only love, innocence and a great deal of patience will allow you to find your way. You have *to forget* about trying. You even have *to forget* that you are connecting to Mother Earth. You simply must live life from your heart and not your mind. Your mind will function, but under the control of the heart.



## The Higher Self—All That Is

Okay, if the Earth is the lower self, then what is the higher self? It is simple. The higher self is everything else in existence. All the planets, the stars/suns, the galaxies, the other dimensions—everything is your higher self. It is you. This is why there are higher selves to the higher selves as you expand into the infinite. The experience of the higher self is very different from the experience of Mother Earth.

Consider this for what it may be: Mother Earth will often play with you and tell you that *she* is your higher self, using the words that she knows will get your attention. She may come to you in your meditation and tell you she is your higher self and that you must listen to her. She may instruct you to do all kinds of earthly things, like run all over the world doing projects for her. But she is just playing, and you are taking her seriously, not realizing that it is just a game.

If you ask her to tell the truth, whether she is really your higher self, she will never lie. She will laugh and tell you the truth. At this point you are supposed to laugh also and begin to play with her. But most adults will simply get mad and think they are being used. Then the connection is lost. This is why the kahunas always ask, when they connect with the higher self, if it is really the higher self. The Mother is a funny girl, but she is wonderful to know when your heart is pure. And what escapes most meditators' understanding is that Mother Earth *is you*.

The higher self knows everything that has ever been known by any life form anywhere, and everything is alive. And it knows everything that will ever happen in the future, just like Mother Earth, except that it is for all the rest of creation.

Once you are connected consciously to the lower and higher self, life becomes a completely different experience from anything you have known before. Life works through you, and your words and actions have great power because they are not from your little limited middle self. They are from *all life*, from all of creation. Nothing is outside you, everything is within you. And the truth of who you really are will begin to unfold.

## From My Old Writings—Living as a Child

I had been living in the forest for about a year. I had no plan and nowhere to go. I was just being. I was just simply playing, just like I played when I was a kid. I would go outside and look at tall pine trees and feel and see their great spirits. I could talk to them, and they would talk back to me. I would find animals and walk up to them with no fear. I became so in tune with my surroundings that I could walk right up to deer only three feet away and look them in the eyes, and they wouldn't even think of running. They would just look back with their open and innocent eyes. I could feel them connect with me in my heart. All the animals knew that my home was theirs and that it was safe.

As time passed, life became very simple, and I was really enjoying each

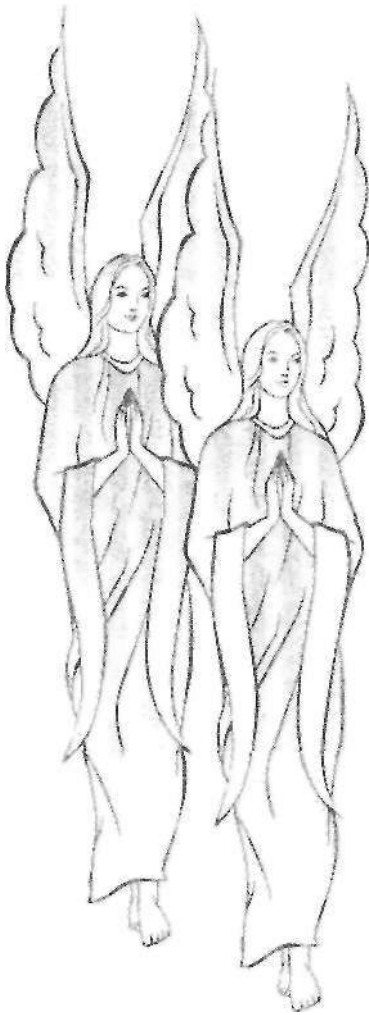

moment. I felt like I could spend eternity here amongst the life that seemed to cuddle me in its arms. It was at that moment, when I least expected anything spiritual to happen, that the angels appeared, these two beautiful angels, one green and one purple. I really didn't know what was going on. I started following their direction because I could feel their immense love for me. And once the angels appeared, all these things started happening in my life. The coincidences began . . .

First they were just little ones, then incredible ones. Then more incredible, and then ridiculously incredible. And then it went beyond ridiculously incredible—it went into flat-out, plain, total miracle. I began to see things that were absolutely impossible according to my logical mind. I just watched these impossible happenings all around me and I would think, "Oh boy, this is really fun! I like this a lot!"

In that entire time I never really understood what was happening to me. I never understood when the angels came and told me that the green angel was the spirit of the Earth and the purple angel was the spirit of the Sun. I didn't get it. I didn't know what that meant. When they told me, "We are you," I understood even less.

Mother Earth is connected to all of us in the whole world; our subconscious mind *is* the subconscious mind of the planet. When I would start thinking about the nature religions such as the Druids and the Shintos and how they were connecting with the Earth, the Moon and the Sun, it began to make sense. It all started falling into place. I began to understand.

You see, we've lost this truth so much that we've severed our bond with the Earth. We don't have it anymore. We're sophisticated now. We're adults, we're civilized. Did anybody see the Peter Pan movie? You know, the one with Robin Williams called Hook? That movie is exactly what we're talking about, exactly. If you haven't seen it, do so, and if you have, look at it again with new eyes. It might surprise you.

There was always a third angel in the background, a huge presence of a gold angel. It was always silent and was simply a witness whenever the two angels and I would communicate. Almost a year went by and never a word from the gold angel. One day the two angels came to my wife and me and said that the gold angel wanted to speak to us. They said he would speak on a specific day, which was about a week in the future.

My wife and I were so excited. We fasted and prepared for this wondrous event. We could only imagine what the gold angel would say. On the appointed day we went into meditation, and there he was, front and center. The two other angels were in the background. We had very high expectations. We thought he was going to lead us in some new way. Then he spoke the words, "It is only light." He looked at us for about a minute in silence and then disappeared. We had no idea what this message meant. We thought it was too simple. We wanted more.

The green angel, the Earth, was our lower self, and the purple angel, the

Sun, was our higher self. Over the years we began to understand that the gold angel was the next level of our higher self. In about 1991 I was teaching a class, sitting in a medicine wheel on a hill on Orcas Island in the San Juans. I called in the angels during our opening circle.

The green and purple angel came in and looked straight into my eyes. Then the gold angel came in directly behind them. The gold angel then passed right through the other two and turned around, facing the same direction I was, toward the center of the circle. He then slowly moved back into the space of my body and merged with my being. The sensation was electrical, and I went, "Wwwwoowwus." I felt an immediate change in my spirit, a huge surge of energy. I knew something really big had just happened, but I had no idea what it was.

I slowly began to understand. That was my first physically direct connection with my higher self. And the work with the purple angel, though it was also my higher self, seemed distant. This was somehow very different and straightforward. I began to notice that as I saw the angels from then on, they would not tell me in detail what to do, which I had become used to. After that they would tell me to find the answer within myself. They would say that I was older now and must find my own way. If I made a mistake, they would wait as long as possible before they instructed me to make a change.

From 1970 until about 1991, approximately 21 years, I was working with my lower self, although I didn't know what I was working with. You can know almost *anything* from the lower self because you have the entire knowledge of the planet. All the practices with dowsing rods, pendulums and psychotronic instruments I am convinced is just your lower self.

What I've found is that the connection with your lower self becomes a spiritual growth process during which you start slowly, then grow faster and faster. You can almost watch yourself becoming something new.

A question was once asked at one of my workshops, "Is there a particular sensation or emotion you get when you connect with your higher self?" I replied, "I always feel like I'm in the presence of God. Other than that, I don't know. It isn't God as religions define God, but it's such a higher aspect of us that it feels like it."

## How Life Works When You're Connected with the Higher Self

Here's another story from the past. Directly after the angels entered my life, they led me to a school called the Alpha and Omega Order of Melchizedek. In a meditation with the angels, they gave me an address, 111-444 Fourth Avenue, Vancouver, Canada, and a man's name, David Livingstone. They instructed me to go to that address and talk to this man. I finally found the place, which was in an old industrial section of the city where there were warehouses and the like. The address itself was in an alley attached to an old rusty door with a freshly painted, colorful sign just above

the door that read: *Alpha and Omega, Order of Melchizedek*. David Livingstone was a real person, and I met him under very unusual conditions. He allowed me to learn in this school, where about 400 people were studying meditation. I learned many valuable lessons there, of which the following is but one. If you understand the meaning of this story, you will know the importance of the higher self in your spiritual growth.

There was a young man who lived in Japan, and he was communicating with his higher self through a form of automatic writing. This in itself is not unusual, but the language was not from this planet. It was composed of all these weird symbols and shapes with lines and dots placed seemingly at random. He acknowledged that this language was not human, yet he could both read it and speak it. But he knew no one to speak it with.

All instructions from his higher self came to him in this language, and he guided his life by them. He did whatever his higher self suggested, for the truth of this being had been shown to him. He believed it completely.

One day in 1972 his higher self told him to get in an airplane and fly to Vancouver, British Columbia, on a certain day at a certain time, then stand on a certain street corner and wait there. That's all the higher self said to do; he didn't know what was to happen after that. Because he believed it completely and always did whatever it said, like a child would with its parents (as long as it was morally right, of course), he bought the ticket, flew to Vancouver and found the street corner and waited. He had total *faith*.

On that day I was studying at the school, and David was in the same room. He looked down at his watch and said, "Oh yeah, he's going to be there soon." He told another man, "Go to this location," handing him a piece of paper, "to the southeast corner. There will be a Japanese man waiting there." He told the student the man's name and asked him to bring the Japanese man back to the school.

So the student went to this corner, walked up to the young Japanese man, calling him by name. All he said was, "Come with me, please," and led him back to the school. The Japanese man spoke English, but not very well. He was taken to this little room that was only about 10 feet square, where he was asked *to wait*. David told me that he wanted me *to watch* what was about to happen, so he brought me into that same room and said to me, "Okay, you stand there," pointing to a corner of the room.

After a while, David entered the room and addressed the Japanese man by his name. They had never met each other in their lives. David asked him a few simple everyday questions, such as what city are you from in Japan and the like. When he finished his small talk with him, David told him, "Wait here. I'll be back in a few minutes." He asked me to stay with him, then he left. We just looked at each other.

A little while later a tall, beautiful woman quietly entered the room. I didn't know who she was. There were a lot of people in this organization, and I didn't know them all. She set up an easel up in front of the *two of us*, and over it was draped a piece of dark purple velvet that hid whatever was

underneath. The easel was probably about four feet square.

Then four young men silently walked in the door. Two stood on one side of the easel and two stood on the other. There was another long wait, with the six of us just standing there. Finally David came in. The Japanese man looked genuinely curious, showing no fear or confusion, but he asked, "Okay, what's this all about? What's going to happen here?" David didn't answer him, but just looked at him and lifted the piece of purple velvet off the easel. The Japanese man's eyes widened. Written all over the board was this young man's secret language—which, as far as he knew, no one in the world knew but himself.

Now, the Japanese man had not shown this language to anyone since his arrival in Canada. David hadn't seen the language, yet there it was, all over the easel. I don't know what it said, but the guy's eyes got about as big as pies, and all he could say was, "Ooohhh." Then, as if to increase the shock of seeing his secret language written by someone else, the four men standing on either side of the easel began speaking to him in that language. When the first man spoke, the Japanese man looked as though he had gone into shock. He collapsed emotionally and began to cry and sob uncontrollably. The four men began to assure him that everything was all right—in his secret language, of course.

I'll bet there was a little piece of him that thought he might be nuts, you know, after these words had come from nowhere in a language that no one knew. Suddenly here was an incredible confirmation of the truth of his inner meditations. They were all from a particular planet somewhere, and they all knew exactly where. All of them went crazy with joy, particularly this Japanese man. He was so happy he could barely stand it. It was the beginning of an amazing adventure of life for him. I can't tell you what happened after that because they asked me not to.

Anything is possible, absolutely anything. But you have to believe in yourself, you have to trust yourself and open up this innocent childlike quality within yourself. And if you do, it's a process that will reconnect all of you back into this wholeness, from which this kind of direct connection to God is very obtainable, I feel. It's an in-between step, I would say, in what is in the transcendental meditation aspect of things.

## Communicating with Everything Everywhere

Eventually, when you're completely connected to the lower and higher -elves, it becomes clear that everything is alive. Once that realization becomes your life, then everything becomes communication and everything has meaning. The higher and the lower selves can communicate with you in all kinds of ways, not just in a vision as angels or as a voice that speaks in secret tongues in your head. Once connected, the entire Reality becomes alive and fully conscious, and everything is communicating at all times.

Your inner world is alive and directly connected to the outer world. The outer world can speak to your inner world. The shape of trees, the color of a

car at the right moment, even the license plates on the car, can communicate to you. The movement of the wind, the flight of bird in a certain direction—everything. Everything becomes alive and communicates. This world is much more than we were taught by our parents. The truth is, they didn't know, though long ago their ancestors did.

I remember years ago when I asked the lower self for a sign to show me that: what I was about to do was in divine order. If a sign did not appear that I could understand, I was not going to perform this particular ceremony I was contemplating. This was in the very beginning days when the angels first appeared and after I had made my first trip back to California.

I was driving up 1-5 in California heading back toward Canada at that moment. Only seconds later I saw something I could hardly believe, so I stopped the car and backed up to see if my eyes were telling me the truth. I got out of the car and walked over to an old barbed wire fence and peered into a large, flat grassy field. And there they were: At least two hundred large black ravens were all standing facing each other in what appeared to be an absolutely perfect circle. It looked like someone had drawn a ring on the ground and asked them all to stand on it and face the center. It had the most amazing effect on my faith. Mother Earth sure knows how to get to your heart!

Now, you "know" those things don't happen—but they do, at least when you can see that Mother Earth lives. She has the greatest sense of humor!

## Foretelling the Future

One last story. When I first met the angels, I was somewhat preoccupied about knowing the future. I would use the I Ching and the tarot cards to try to understand what was coming. I practically wore out my I Ching. In the beginning the angels knew my desire to know the future. Whenever I would ask for future information, they would seldom cooperate. Then in a single day it all changed.

The angels came to me and said that from now on they were going to tell me everything that was going to happen the following day. They said that because the time difference between when they told me and the time it happened was so quick, I would be able to see the truth about the future. And they actually did it.

They gave me a synopsis of the following day, then at their discretion, certain moments or events in great detail. They would tell me every phone call, who it would be, the basic nature of what would be said and the exact minute it would occur. They would list every piece of mail I would receive and, in certain cases, exactly what was said in the letter. They would also tell me the name of each person who would come to my door and what they wanted. They also would tell me exactly when I would leave my house and when I would return and the primary events in between. During this time we always knew where we were going the next day, so that many times we would prepare, because it would always happen.

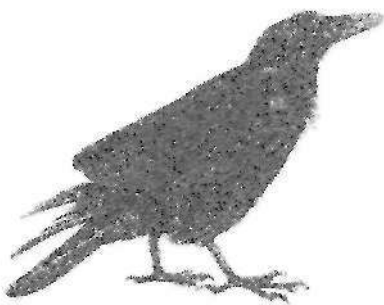

On the first day I waited minute by minute for each event to happen, And everything happened exactly as they said. I was so happy, because I finally knew for sure that the future could really be known. My confidence in the angels increased even more, for now I saw them as having real powers. fromn my ego point *of view*. I remember after *a* while how I would pick up the phone and say, "Hi, John. I knew you would call." Of course, in the days before Caller ID, this was impressive—at (east my ego thought so. f was so happy with myself.

One day I asked the angels about my papers to immigrate to Canada. I wanted to know if the government was going to allow me to stay. Instead of telling me, they gave my wife a vision. She described the vision as it was happening) and I carefully wrote it down. She saw us driving home in a silver car heading into the countryside. She opened the glove compartment and reached inside to get the mail. She leafed through about six letters and round the one from the Canadian government. She opened it and read it to me. I wrote down every word.

When she came out of this vision, we examined what was said, but nothing made any sense. First of all, we did not have a silver car, and second, our mail was dropped through our *front* door. Why would it be in our car? The letter would say that I had been approved and would give me all my scores in detail. We talked about this letter for a while, but when ic hadn't happened within a month or so, we soon forgot about it because it seemed to be a mistake. It worried me, because the angels had never made a mistake.

A few months later we moved from our house in Burnaby to a farmhouse put in the countryside. We had bought a new silver car, and one day I was driving home from the post office, where we had *to go to* pick up our mail. I had thrown it into the glove compartment and was heading home with my wife, who was in the passenger's seat. By this time we had both completely forgotten the vision the angels had given us some months before. As she reached into the glove compartment, she shrieked, remembering the vision. She leafed through the mail, and the sixth letter was from the government. We opened it and later compared it with the vision we had written down. It was the same, word for word, even down to the scores that no one could have made up.

Meanwhile the angels' daily forecast of the following day continued. I remember how it put me thtough so many changes. In the beginning I rhought it was the greatest thing that had ever happened to me. Then as time went on, I began to take it for granted as part of my life. As time continued, I became bored with it. I remember how I began to not want to take down the notes when the angels would give me the details of the future. You know what it is like? It is like seeing a movie for the second or third rime. You know what is going to happen, and it lacks the surprise and impact. Life became boring.

Finally I couldn't take it anymore, and during my meditation with the

angels I asked them to please stop telling me what was going to happen in the future. I might outwardly look now like I am pushing for the future; I might fight tooth and nail for a cause because I believe in doing my best in life. But inside, I am still. I know it will all be fine. From this experience I now believe that everything that happens in life is whole, complete and perfect. I know the wisdom of not knowing.

## The Lessons of the Seven Angels

When the angels first arrived in my world, I listened *to* their every word. I followed them because I could feel their love and because they showed me their deep understanding of the Reality. As J told you, eventually the green and purple angels were replaced by the gold angel. When this happened, there was a change in how I related to all of them. They quit instructing me in my everyday and spiritual affairs and began to see if I could find my own way.

Slowly over time, my work with the gold angel became one of learning how to know the answer from within myself without asking the angels. When I found this knowingness, I also found that I attained it through certainty. It was a knowingness that did not require asking for an answer. It came from within, and it came from within the heart, not the mind. There was a certainty without a doubt, like knowing your own name, and it was this certainty that allowed knowingness to emerge from the heart. Along with this knowingness I found there was a loss of wanting to know.

It was clear they wanted me to become more independent. Is this not similar to how parents treat their children? In the beginning parents take almost complete control over their children's lives. But as the children get older, they begin to teach them to do things for themselves. Weaning a child from its parents is necessary if the child is to become an adult. I think it is the same here on this level of life, too.

What surprised me completely was that one day another angel entered my world. This angel was pure white and had the quality of uncomplicated form or simplicity about it. The gold angel receded into the background with the other two angels, but remained visible, and for about a year the white angel taught me. What it taught me I am not sure. It was about letting go, not feeling attached to anything, living perfection and knowing that all is well. Even though my life was now becoming increasingly complicated from the teaching I was giving around the world, everything seemed to slow down. I understood what was inside, but I found it difficult to put into words.

Then in the midst of this fuzzy experience, the white angel joined the other three, and a fifth angel appeared. This angel had no color or form. It was what I call the clear angel. It is an angel of completion. It brought *to* me lessons of bringing all things together. It was an angel of my higher self that I have never talked about before. I am still working with this angel, and someday I may talk about it.



This angel pointed out to me how the angels related to music, and how this angel and the other four were connected to the notes of the pentatonic scale—five angels and five notes of the pentatonic scale. The clear angel suggested to me that someday two more angels would come, and that they would complete the knowledge of the octave—seven notes and seven angels. I waited.

About a year ago, at the beginning of 1999, two new angels appeared together to me while I was about to give an Earth/Sky workshop. It was none other than archangels Michael and Lucifer. They were holding hands. Since that time new lessons about duality have been filling my days on Earth, lessons I will talk about in the next chapter.

After working awhile with your lower and higher selves, there is a transformation that takes place inside you. I don't know when that stops, if ever. I keep finding myself changing all the time, yet I am beginning to see that the patterns are repeating, and I am simply that I am.

People look at me and say, "You can't do that. That will never work." But it works. Why? It is not me doing it. As the gold angel said, "It's just light." Everything, all the stuff we think we need, is only light.

There's no problem with creating it. There's plenty of energy, there's so much of everything. You know, there are tons of places to go, infinite space and dimensions. Everything is in abundance. There's no reason for these limitations, but we place them on ourselves because of our fears.

If you have a hard time believing that you could play all the time, well, that's your limitation. Doesn't playing mean doing something you really enjoy doing? I always like to try to create my life in such a way that I am giving to someone, because if I create giving to someone, it automatically comes back so that I can keep on giving. This makes me happy. It will come back, whatever it is that you do. It could be anything. It doesn't really matter as long as it brings joy. Keep your little child happy.

## Testing the Reality of Your Connection with Your Higher Self

This test will not work for all of you who read this, at least not at this moment, but it will at some time in your future. If you have not connected to your lower self, with Mother Earth, then do that first. If you are now connected to your lower self, then this might really work for you. If you are already connected to your higher self, then it could be an interesting and useful proof. But if you are just beginning, then just hold this idea for the future.

Once you feel that you are connected to your lower self and you feel and know that you have permission to connect with your higher self, this is a simple test you can do to prove your connection to yourself. This proof helps build confidence and leads to a stronger spiritual understanding. Not everyone needs this proof, but some of you may. So if after reading this test, if it does not seem necessary, then go on to the next chapter.

Begin by asking your lower self, Mother Earth, if this test is okay for you to do. If she says yes, then have fun.

Once you feel that you are ready to make this connection with higher self, then get a pencil, paper and a clipboard and write down a statement that you've got to put in your own words. Basically you're going to ask your higher self for a test to prove to yourself that this connection is real. Again, you may not need this test to prove their existence to yourself, and if you don't, then don't do it. You want the higher self to prove to you that it *is* the higher self and at the same time (which is important), you want this test to be spiritually healthy for your evolution.

If you get a green light to go ahead, then begin by making sure that the room is set so that you will not be disturbed by anyone or anything such as a telephone or visitors. Then write down on your paper exactly what you are going to say to your higher self. You are asking for a test, so something like "What can I do, a physical act, in this reality that will prove to me that I've really made this connection with you? It will prove to me in my heart and mind that I've made this connection, and it will be for the greatest good of my spiritual growth at the same time."

Put it in your own words and write it down exactly the way you want to say it to your higher self. Then put the paper and the pencil down in front of you. Next, enter into meditation with your lower self, Mother Earth, and go into the point where you're breathing through the fourteenth breath and have prana moving through you. Then remain in the meditation for at least 30 minutes or more, until you've reached a state where you're very, very still inside.

Just sit with Mother Earth with no expectations. At the right moment, ask your higher self to come forth. The kahunas say you must ask, or the higher self will probably not come. When you feel or sense its presence, speak to your higher self in your own words, coming from your heart, the request that you made on paper. Then you simply listen and wait. Feel the flow of the prana moving through your body. Feel the connection you have with the Mother, and listen for the Father to respond.

The kahunas say it won't always happen the first time. And sometimes the lower self doesn't feel you're ready yet, so she blocks your pathway. But you must ask anyway, and then wait for the higher self to enter into your awareness. When it does, the experience could be anything, just about anything at all that your imagination could think of. In my case these two angels appeared in the room. But that does not set a standard. Anything can happen.

I'm very visual, but you might not be. It does not matter. It doesn't mean that one way is better than another. You might simply have a voice appear in your head and say, "I'm the higher self. What do you want?" Who knows, it might sound like your voice or it might not. Maybe colors start appearing to you and you know what they mean. There's somehow a great meaning in *whatever* occurs. It could just be a feeling or sensation, but

The instructions from God at the beginning of the Lucifer experiment were for humans to live free will. But what does free will mean? Does it not mean *all possibilities*, both good and evil? Does it not mean that we would be allowed to do *anything* we wanted, with the idea, from a biblical point of view, that we would learn discrimination for the good?

Life was given the ability to do anything it wanted, all possibilities; it was given free will. Therefore, how could free will exist unless consciousness created the format for this way of being? And who creates consciousness? The one and only God. Lucifer did not create free will, but it was through his actions and decisions that free will became a reality. It was God who created Lucifer so that free will would exist. Before the Lucifer experiment, there was no free will except during the three other attempts. All life moved according to the will of God, according to the cosmic DMA. There were no deviations, and free will was only a potential that life could someday try.

At one point, because free will was possible, we realized that there was a particular way we could experience this reality that had not been tried before. So we tried it. We actually tried three versions of it, and each time it failed. They were absolute disasters. The latest experiment and fourth attempt, with Lucifer heading it, used a different approach to create free will. This time God chose an area of consciousness that was just above human existence: This experiment began with the angels. So it was the angels who brought this new freewill consciousness to mankind to be lived here in these dense worlds, and life everywhere watched to see how it would fare.

With great respect between two brothers, the battle between good and evil began. It was a battle to the death, yet neither could die. It was a battle that had to be, for it was the will of God. For the overall sake of the universe, Michael supported the side of the light and the good and Lucifer backed the side of darkness and evil. A new possibility was about to be lived. And we humans thought it was a great idea, this idea of free will.

### The Bright and Shining One

It becomes clear in the study of sacred geometry that nothing was created without intention and reason. It wasn't just a mistake; in fact, there *are* no mistakes. And when God created Lucifer, as you can read in the Bible, he was the most magnificent angel God had ever created. He was the most intelligent, the most beautiful, the most amazing of all angels. So he had no peer; he was the top-of-the-line model of the angelic worlds. God gave him the name Lucifer, meaning "the bright and shining one." God gave him this name, so do you think God made a mistake?

If you think back to our own human nature, we always tend to look to our heroes as that which we want to become. We look up to those people who have gone before us, who have blazed the trail in the direction we feel we want to go, and we model much of our behavior after our heroes. Because of the understanding of "As above, so below," it is the same for Luci-

lutely did not contact your higher self, for sure, guaranteed. Your higher self will never tell you to do something that is wrong or harmful. If you understand what the higher self is, it is self-evident. If you received a message supposedly from your higher self that is morally wrong, then burn the paper and forget it. Forget about the higher self and go back to playing some mote with your lower self. Definitely wait awhile before you try it again. But this distortion almost certainly will not happen.

However, if you get it on paper and it says to do something inconvenient or something you don't really want to do or that you think is silly—anything your ego doesn't really like or thinks is stupid to do—that does not matter. If you're going to follow this path, then the next thing you must do is *do it*, whatever it is. Then wait and see what happens.

In the act of doing it, look to see what happens in the Reality, which you are not in control of. The Reality itself will react to that act and should show you and prove to you, beyond any doubt in your mind, that you have reached your higher self. It might not prove a thing in anybody else's mind, but it will be very specific with you.

We have just entered a world where everything is light, meaning conscious, alive and a *function of* your thoughts and feelings. If it feels *too* strange or if you feel fear, wait. Everything is in the timing. If you have just connected with your lower and/or higher self, life is going to become beautiful, interesting and a lot of fun.

## Duality Transcended

### Judging

**W**hat I am about to say is a view of what we call evil that is different from what most of the religions of the world believe. I am in no way attempting to protect Lucifer or sanction his acts. I am simply giving a new/old perspective on what is behind what Lucifer is doing in the universe that, once understood, allows the possibility of transcending good and evil and entering pure oneness with God. The possibility of ending duality is impossible as long as we remain in the consciousness of good and evil. We have to transcend it and enter a different consciousness, but we cannot do that if we continue to judge.

As long as we continue to judge the events in our lives, we give power to them as either good or bad, which determines the course of our lives. To end it and then transcend it, we must step outside this polarity. We must change, and this change has to come in some way from our not judging this world. For it is in judging that we decide that something is good or bad. That is the basis of good and evil, or duality consciousness. The key seems to be viewing all the worlds in our universe and all events within them as whole, complete and perfect, knowing that the cosmic DNA, the cosmic plan, is proceeding exactly as directed by the Creator.

### The Lucifer Experiment: Duality

The words "the Lucifer rebellion" carry a stigma that has haunted mankind for at least since the Bible has been on Earth. Many of us humans, especially Christians, believe that Lucifer is the cause of all evil and darkness that has ever transpired on this planet. We call what Lucifer did a rebellion, projecting an image that Lucifer is somehow going against the universal cosmic plan. But unity consciousness sees Lucifer's work in a slightly different light. His work is not known as a rebellion, but as the Lucifer experiment.

Why would it be called an experiment? Because that is exactly what it is, a test to see if certain parameters of life will work. *Life is an experiment!*



The instructions from God at the beginning of the Lucifer experiment were for humans to live free will. But what does free will mean? Does it not mean *all possibilities*, both good and evil? Does it not mean that we would be allowed to do *anything* we wanted, with the idea, from a biblical point of view, that we would learn discrimination for the good?

Life was given the ability to do anything it wanted, all possibilities; it was given free will. Therefore, how could free will exist unless consciousness created the format for this way of being? And who creates consciousness? The one and only God. Lucifer did not create free will, but it was through his actions and decisions that free will became a reality. It was God who created Lucifer so that free will would exist. Before the Lucifer experiment, there was no free will except during the three other attempts. All life moved according to the will of God, according to the cosmic DMA. There were no deviations, and free will was only a potential that life could someday try.

At one point, because free will was possible, we realized that there was a particular way we could experience this reality that had not been tried before. So we tried it. We actually tried three versions of it, and each time it failed. They were absolute disasters. The latest experiment and fourth attempt, with Lucifer heading it, used a different approach to create free will. This time God chose an area of consciousness that was just above human existence: This experiment began with the angels. So it was the angels who brought this new freewill consciousness to mankind to be lived here in these dense worlds, and life everywhere watched to see how it would fare.

With great respect between two brothers, the battle between good and evil began. It was a battle to the death, yet neither could die. It was a battle that had to be, for it was the will of God. For the overall sake of the universe, Michael supported the side of the light and the good and Lucifer backed the side of darkness and evil. A new possibility was about to be lived. And we humans thought it was a great idea, this idea of free will.

### The Bright and Shining One

It becomes clear in the study of sacred geometry that nothing was created without intention and reason. It wasn't just a mistake; in fact, there *are* no mistakes. And when God created Lucifer, as you can read in the Bible, he was the most magnificent angel God had ever created. He was the most intelligent, the most beautiful, the most amazing of all angels. So he had no peer; he was the top-of-the-line model of the angelic worlds. God gave him the name Lucifer, meaning "the bright and shining one." God gave him this name, so do you think God made a mistake?

If you think back to our own human nature, we always tend to look to our heroes as that which we want to become. We look up to those people who have gone before us, who have blazed the trail in the direction we feel we want to go, and we model much of our behavior after our heroes. Because of the understanding of "As above, so below," it is the same for Luci-

fer. He wanted to be like his heroes, but he didn't have anyone higher than himself in his realm. He didn't have any heroes.

He was the greatest archangel in creation. There was no one greater than he. Rather, the only hero he had was God, who was the only being beyond him, from where he could see. So Lucifer did something very natural—and I feel sure that God was aware that this would take place when he created him. He wanted to be as good as God—to actually *be* God—from a *creation* level. There's nothing wrong with merging with God, but that isn't exactly what he wanted to do. He wanted to be *just like* God. In fact, he wanted to be even better than God. Lucifer wanted to surpass his hero.

Lucifer was so intelligent that he knew how the universe was created. He knew the images, the patterns and the codes that had created the universe. But in order to be greater than God, he decided that he would have to separate from God. As long as he was part of God, he could not go beyond Him. So, evidently with God's blessing (since He created him), Lucifer started on a great experiment to see what could be learned by creating in a different way from how God/Spirit had made the original creation. He severed the love bonds between himself and God and created a Mer-Ka-Ba field that was not based on love, because once he severed the love between himself and God, he could no longer make a living Mer-Ka-Ba.

Archangel Lucifer and many other angels started on this great experiment to see what could be learned in this new way. As we said, similar experiments had actually been tried three times before by other beings, but those experiments had ended in massive destruction and pain for everyone involved. Many planets had been completely destroyed, including one in our own solar system—Mars. But Lucifer was retrying this old experiment with a new method.

So he severed the love bonds between himself and God (at least it outwardly appears this way) and created a Mer-Ka-Ba field that was not based on love. What he did was make an interdimensional time-space machine that we call a spaceship. This flying object—sometimes seen as a flying saucer but also many other shapes—was more than just a vehicle as we think of it, much more. It could not only move throughout the spectrum of this multidimensional Reality, but it could create realities that seemed to be just as real as the original creation. It is similar to what we are now calling virtual reality, only this was a virtual reality that could not be distinguished from the real thing.

So Lucifer made this synthetic Mer-Ka-Ba to create a reality separate from God so that he could ascend to the heights and be just as good as God, at least in his own mind. He couldn't *be* God, but he could be *like* God, his hero.

In order to convince other angels that this experiment was necessary, he chose a different pathway out of the Great Void to create his synthetic reality that was unique unto itself. To explain this in detail, we will move to the Garden of Eden.

In the Garden of Eden there were two trees: the tree of life, which led to eternal life, and the tree of the knowledge of good and evil. In the Genesis pattern of creation as seen in the Flower of Life, the pathway the little spirit took, coming up to the top of the original sphere of creation, was associated with the first tree, the Tree of Life [see chapter 5, page 151]. The spirit came from a single point in the center of the first sphere and began to rotate in a vortex, creating the images that created the reality that leads to eternal life. The Tree of Life and the Flower of Life are of the same creation.

But there is another way that spirit can exit the Great Void, and it is associated with the tree of the knowledge of good and evil. It is actually the same geometry, except that it has a different view of the geometry. In other words, there's another path to follow in sacred geometry to exit the Great Void and create a reality that appears the same but is geometrically and *experientially* different. Lucifer knew this, and he chose that pathway to create a new kind of reality he could control. At least controlling this new reality was part of his original intention. Archangel Michael's original intention was to simply create free will. Their *inneT* agendas were different.

#### Creating a Dualistic Reality

Lucifer convinced a third of the angels in heaven to go with him to support him in this new reality. He convinced them because his particular pathway out of the Great Void resulted in a unique viewpoint that had not yet been lived or explored. From their angelic viewpoint of reality, it was a possibility of life and someone needed to live it.

Important to at least the angels who followed Lucifer, this new pathway also contained a system of knowledge that was able to give an experience that had never been fully lived before in the original Reality of God. This experience centered around two pieces of geometric knowledge—rather simple pieces too, it would seem. These two geometric forms were primal knowledge about the Egg of Life and the source of all living forms.

The first sphere they were seeking fits in the center of the Egg of Life and touches all eight spheres [see A in Fig. 9-36a]. The second sphere fits perfectly inside any of the six holes in the center of each face of the Egg of Life (just visualize the eight spheres of the Egg of Life inside a cube, which has six faces). This knowledge had always been known, but from within the original Reality it was not possible to actually live and experience it. Remember, all sacred geometry has an experiential aspect. For your information, see Figure 17-1. The diamond view—a square turned 45 degrees—shows the Luciferian geometry of these two spheres.

Lucifer told the angelic worlds that we needed to do this experiment because the universe had missing information, and the only way to get the information was to live it. So he chose this particular view of geometry in which to start his new, separate reality creation. Through this new geometry he interpreted his creation in a new way. This gave the experience of being *inside* a life form separate from the rest of reality. Many believe it was



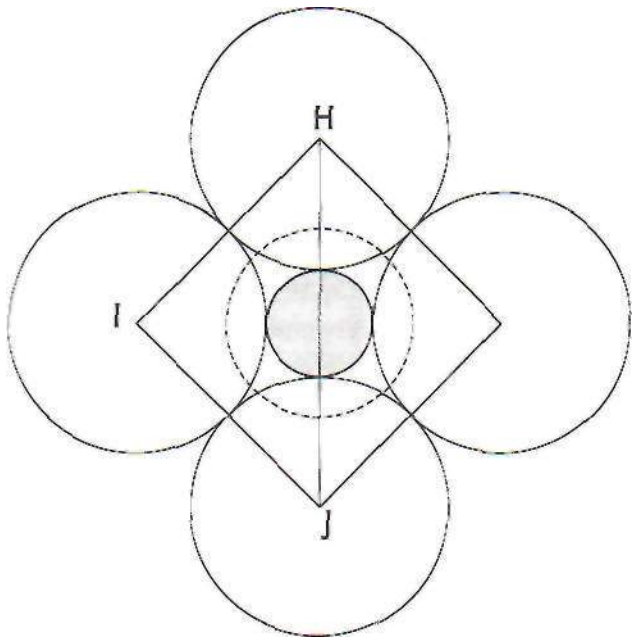

**Egg of Life, diamond view**

Large sphere diameter = 1

$$HI = 1$$

$$IJ = 1$$

$$HJ^2 = HI^2 + IJ^2$$

$$\therefore HJ = \sqrt{2}$$

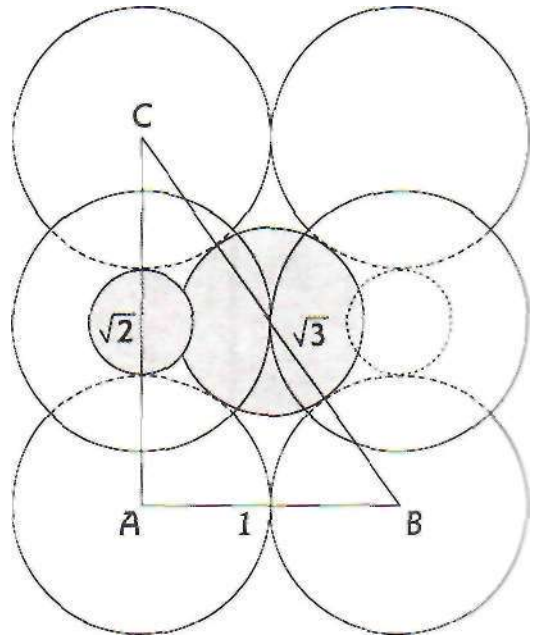

**Egg of Life, turned on edge 90°**

$$AB = IJ = HI = 1$$

$$AC = HJ = \sqrt{2}$$

$$BC^2 = AC^2 + AB^2$$

$$BC^2 = 2 + 1$$

$$\therefore BC = \sqrt{3}$$

Fig. 17-1. Quest for the experience of two primal spheres. On the left: The sphere that touches only 4 is related to matter (the square of 2). On the right: The sphere that touches all 8 is related to light (the square root of 3).

great and, most important, that it was new. There was hardly ever anything new in creation.

The way of Lucifer was the diamond view of the Egg of Life, the same dimensional view that humanity happens to be living at this moment in history. Yes, we did follow Lucifer.

Remember the ninth chapter, "Spirit and Sacred Geometry," where we were at the second level of consciousness? Remember how the Earth is now living the three levels of consciousness (out of five possible levels) and how we had to rotate the second level of consciousness 45 degrees to the diamond view to get it to point to the next level, Christ consciousness [see Fig. 9-4, page 228] ?

Lucifer chose the square view, then turned it 45 degrees to the diamond view, the view in Figure 17-1. It was this view of the Egg of Life he wanted to obtain, because this view was the one that was needed to experience both the inner and outer spheres that would fit into those openings we spoke of above. The seemingly innocent need for this information from this view (remember, on an experiential level) was a huge deal to the angels

whose purpose was to create free will and live all possibilities. This was a possibility that might work. And it was a possibility that had never been lived before, or at least never been lived successfully.

So these are the details of how Lucifer did it. Again, I am merely reporting this information so that you can transcend the dualistic view of life into the next higher level, Christ consciousness, and "get thee behind me," Lucifer, as Jesus would say.

The trick to this new reality was that spirit can separate itself; it can be in two or more places at one time. It is very much like cell division, or mitosis, except without form. It is what makes mitosis possible in the first place.

So the new reality was created with the same sacred geometry as the Flower of Life, except that spirit divided itself into two and began to rotate out of the Great Void in a double helix pattern from *two completely different centers*. This created the new reality. In addition, Lucifer used the diamond view of the Egg of Life, turning it 90 degrees to the rectangular view in order to focus the new, untried consciousness through it. It became the lens through which we interpreted the new reality. This was revolutionary.

In creating the original Reality, on the *first* day of creation at the first motion of the spirit of God, spirit moved itself to the top of the first sphere [see chapter 5, Fig. 5-32]. Then we started the rotating pattern, which began creation. But there's another way to enter creation, where spirit would leave part of itself at the very first center. In other words, at the very first instant of the motion away from center, which is the very first moment that creation begins, spirit would divide itself in two and leave part of itself in the center and move the other part of itself to the top of the first sphere. Then it would create the next sphere at the top of the first sphere, the same way as in the other creations [Fig. 17-2].

But from then on, the *next* motion, on the second day of Genesis, spirit begins a *double* rotation motion, where the center half of spirit rotates over one way and the top half of spirit rotates over the other way and forms the two spheres, which make this pattern [Fig. 17-3].

From there it divides itself again, to create this pattern [Fig. 17-4].

It then begins a pattern of dividing and coming together. But it is primarily division, separating from one's self. It expands into this pattern [Fig. 17-5], then continues outward.

This can keep going on and on and on . . . and eventually you end up with exactly the same grid as the Flower of Life—the same laws, the same apparent reality, the same planets and suns and trees and bodies. Everything's the same except for one *huge* difference. The Flower of Life pattern has a single geometric center—one eye, and a being who enters creation this way is connected directly to all life and to God. But Lucifer's pattern has not a *single* geometric center, but *two* specific centers—two eyes. No matter how big the grid is, when you come back to its center, you'll find two centers or eyes. And it has been separated from God. There is no love. These angels of Lucifer have almost forgotten what love is. Remember

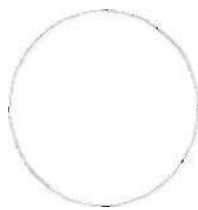

First creation

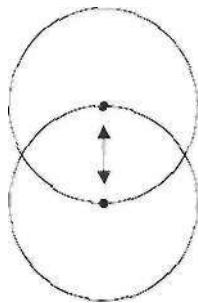

Day one

Fig. 17-2. First day of Lucifer's creation. Spirit resides in both centers at once.

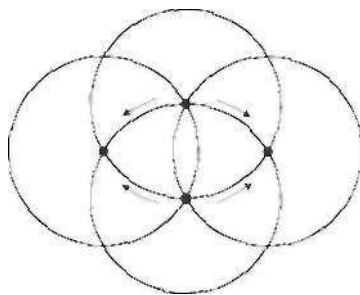

Fig. 17-3. Second day of Lucifer's creation.

what Jesus said, "If thine eye be single, thy whole body shall be full of light"? [See Fig. 17-6.]

But again, who is in control here? *God is.* And God created this situation. It wasn't Lucifer who created this situation—it was God, one step before Lucifer. God created Lucifer and knew what Lucifer was going to do. So there must be a reason for creating this separate reality.

### Earth Humans as the Focus of the Experiment

Lucifer began this new reality shortly before we humans came into existence as a race—a little over 200,000 years ago. And we have become the key players. There must be a reason why all these things have happened. I think that the purpose behind this Luciferian experiment, which has been going on for these millions and millions of years, is now coming to fruition on Earth, and that Earth has been chosen as the place to give life new birth. This is what it looks like.

Whatever the ultimate purpose for creating this new reality is I do not know, but it has become clear throughout the cosmos that the Earth has become the focus of this intense drama. And it appears as though the fruition of this experiment is about to unfold before our eyes. You and I are the players who take this new reality and transform it in the direction of the ultimate purpose. We are to go beyond anything archangels Lucifer and Michael had imagined. We are to be the children of the third way, a new reality born from the first two.

We here on Earth are all part of this Luciferian experiment. All of us have chosen this path. Every one of us on this planet has chosen this way, whether you like it or not, whether you want to be identified with it or not. You chose this, because you're here. And our physical mother, the Nefilim, are also part of the Lucifer experiment, and so is our physical father, the Sirians, though the Sirians have almost totally extracted themselves. The race from Sirius B, the dolphins, were also part of the Lucifer experiment. If you remember, the dolphins came down in a *spaceship* to the Dogons. They were also involved in technology. They had little hard-shelled vehicles for a long time too, but they gave it up about 200 years ago and now they're making an incredible transformation back to unity.

I don't know if reverting back to a no-technology world as found in the original Reality is actually the answer. I'm not certain. I think that we here on Earth are going to discover the answer. The answer is on this planet, whatever it is, and the people on this planet have become the grand catalyst of the ex-

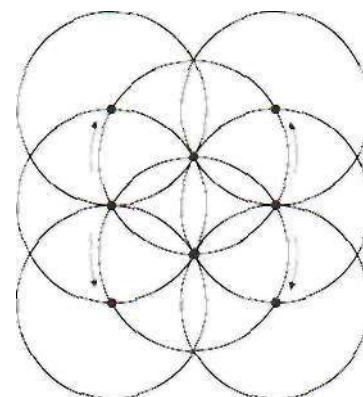

Fig. 17-4. Third day of Lucifer's creation.

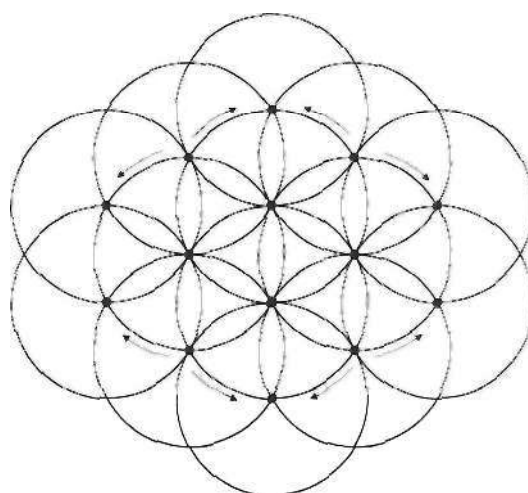

Fig. 17-5. Fourth day in Lucifer's creation.

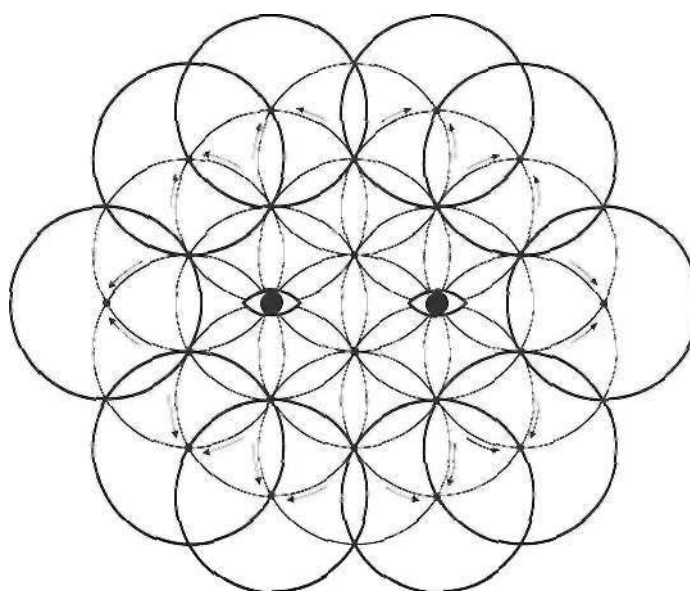

Fig. 17-6- As the days continue, the two eyes of Lucifer become clear. There is no "single" geometrical center, or "eye."

periment—the experiment upon which all life is now breathlessly focused to see what happens. Why? Because what happens here on Earth is going to affect everyone everywhere. And I believe that this answer is coming through our hearts.

### Using the Intellect without Love

This is how Lucifer convinced all these angels that we really needed to experience this new way. What happened to these angels? They severed their love connection with God, with all life, and functioned on one side of their brain, not on both—they functioned only with intelligence, not love. This has created races of beings that were incredibly intelligent but had no experience of love or compassion—like the Grays and the Martians, for example. In the past this always resulted in their fighting each other, sending life into chaos.

This is where Mars comes in. Mars was one of those races (not of the Lucifer experiment, but the one before that) that was terminating almost a million years ago. At that time life was destroying itself everywhere. Mars destroyed itself. It was constantly warring, constantly fighting, because there was no love or compassion. Then at one point they just blew their atmosphere away and destroyed everything. But right before they did, there were certain people who knew that destruction was inevitable, and some of them were the Martians who came to Earth and settled in Atlantis, causing all the Mer-Ka-Ba troubles here on Earth.

This is the focus. The result of this Lucifer experiment was that the Lucifer beings created physical ships and focused on technology, creating an entire technologically based system and a separate reality from the original Reality, whereas the beings who did not separate from God had absolutely no technology whatsoever. They were led by Archangel Michael. Then the war of opposites began. Archangel Michael, the angel of light, and Archangel Lucifer, the angel of darkness, began the cosmic war of duality that created our good-and-evil, dualistic consciousness.

Archangel Michael and the angels of light have living Mer-Ka-Ba fields that can do anything that Luciferian technology can do, and even more. And Archangel Lucifer and his angels of darkness have their technological Mer-Ka-Bas and their synthetic reality. So we have two totally different approaches to life. Look at archangels Michael or Gabriel or Raphael—they don't have technology and spaceships. They live in lightbodies, and their reality, the original Reality, is based on light. It is what could be called light technology based on love. Then there's this other way, Lucifer's way, where you have all this material stuff to be concerned with. We have our houses and cars and all the things we feel we need. The whole web we're in is Luciferian technology. You can look out at the world and see the difference between nature, the original Reality, and what mankind has done with its separate reality created by the knowledge of Lucifer.

Of course, you can take this to the extreme—anybody, any life form

whatsoever, no matter where they are, if they're flying around in technological crafts, they are part of the Lucifer experiment, flat out, I don't care who they are. But there's an entire spectrum of engagement with this experiment. There are some beings who are so far into it, who are so addicted to it, that they're helpless in a certain way. They cannot live without it. There's a spectrum of addiction to it all the way to and including people like us. We're addicted to it also, but we still have one foot in the original Reality, too.

It would be very difficult for us to take off all our clothes, which are now technological because they are made with machines, and walk into the woods again with nothing but our bodies. We're definitely addicted to our technologies. On the other hand, we do have love. We have a tiny spark of love; we haven't completely severed our love from life. Thus we're some of the beings in the universe who have somehow not completely severed our connection with God. We have technology, but we still sense and know what love is. It's weak, not powerful; it's not a blazing, blinding light. But we still have it. We have both aspects. We have the original Reality potential still within us.

### The Third, integrated **Way**

An important understanding is that we Earthlings are finding the universal answer in a totally unique way that's never been seen before. This whole thing between the original Reality and the Luciferian reality seems to be leading to a third way that is some kind of combination of the first two.

If you cross your eyes when you look at the two-eyes drawing [Fig. 17-6], you may see the third way when you see *three* eyes. Then the middle path becomes a combination of both. You're actually seeing both of them superimposed over each other. View this figure as a stereogram, and you'll see that it creates a third, unique pattern. This new third way is the hope of all life everywhere. The universe has been at "war" for 200,000 years—the battle between the dark and the light with no apparent solution. Now it appears this struggle is going to culminate in a new birth, a third reality.

## The Sirian Experiment

Within the Luciferian experiment there was a second experiment that is changing everything here on Earth and is expected to change everything everywhere. Perhaps this second experiment will ultimately create a reality where both ways can be integrated. It does seem to the ascended masters that this is what God is doing. This next experiment was created and directed by the Sirians, who fathered our human race.

The story that follows is outrageous. Believe it only after you have found within yourself that it is true.

### **My Three Days in Space**

More than 25 years ago, around 1972, not too long after the angels first

appeared to me, one day I was sitting with my family and another couple who were living with us at the time. The two angels came in and told me that they wanted me to go into a room by myself and enter a meditation that would not be disturbed. (This was long before Thoth appeared on the scene.) I asked my family to leave me alone for a while, went to a separate room, sat down and went into the Mer-Ka-Ba meditation.

The next thing I knew, the angels had me lift out of my body, and we headed into outer space. That was the first time I saw the formation of the golden human grid around the Earth. I literally passed through it. I remember closely examining many geometrical parts being formed within this living space. Then the angels said, "We want to take you into deeper space." They communicated that I should not be worried or concerned about going so far away from Earth.

The angels and I together literally started moving away from the planet. I watched Earth recede, and the angels were right with me. We moved past the Moon—I will never forget watching as we quickly moved first toward it, then slowly past it. We silently moved out deeper and deeper into space, and I could see the Moon becoming much smaller. Then we flew outside a membrane that surrounds and contains both the Earth and the Moon. This spherical membrane is about 440,000 miles away from the Earth, though our scientists are not aware of it yet. On the other side of that energetic membrane sat motionless a huge vehicle that was about 50 miles long. It could not be detected from Earth because of the technology they were using. It was cigar-shaped, black and seamless. On one end was a huge opening covered with a clear material, and as I approached it, I was pulled toward the opening, where bright light streamed from the inside.

I felt sucked right into the opening and through the glass, or whatever it was, into a room where there were many people. They were very tall compared to me, and there were both males and females. Immediately as I asked the question, *Who are these people?*, within myself came the answer: "We are Sirians." They showed me instantly how they, the Sirians, are actually two humanoid races, one very dark and one very light, and they became brothers a long time ago. This was the white race I now found myself being curious about. There were about 350 members on this vehicle, and they wore white clothing with little gold insignias on their left arms. I sat down with three of them, two females and a male, who talked to me telepathically for a long time. Then they guided me through their entire ship. I ended up spending three days on this vehicle while my body sat at home in my room. They seemed to want to teach me as much as possible about how their ship was run and how they lived.

Everything in the inside of this ship was white, no other color. The rooms were seamless and had forms that came out of the floors and walls and ceilings—mostly the floors and walls—that looked like art forms, shapes like beautiful futuristic sculptures. It felt like you were in an art gallery everywhere you went. And these shapes *were* their technology. They had no mov-

ing parts in the ship, nothing except shapes. They had reduced their entire technology to shape, form and proportion, and all they had to do was connect with the shapes with their minds and hearts and they could do anything.

Those of you who have been to Peru have probably noticed that in the middle of the old Incan temples there would often be a large beautiful rock with many angles and shapes and sacred proportions cut and formed on its surface. Well, those rocks are not just rocks—those "rocks" were and still are ancient Incan libraries. They contain the entire records of their civilization. If you know how to connect with them, you can read every second of what happened during the entire Inca period. But the Sirians on this ship had taken it way beyond just record-keeping, so that anything you could think of could be done by this unbelievably simple and beautiful technology, even space travel. We on Earth today are just beginning to understand this technology. We call it psychotronics. It is a technology that requires human (or other than human) contact for the technology to work.

When I came back into my body, the angels began to tell me why they had taken me there. They weren't using words but were telepathically projecting images to me to explain what was happening to me. I expressed to them, "Wow, that was incredible! Their technology is amazing!" I went on and on, saying how great it was. They watched me for a bit, then said, "No, you don't understand. That's not the understanding we want you to have." I said, "What do you mean?"

### Technology Reconsidered

My angels told me this: "Suppose your body gets cold in this room, and you decide that you're going to go out and make something to heat the room. So you invent a heater, a really good heater, and some kind of energy source, whatever you need to heat the room. Then you put the heater in the room, it heats up the room and you get warm. From the angels' point of view, if you did that, you just became spiritually weaker. Why? Because you were forgetting your connection to God. You could have heated the room or your body by your own inner essence, but instead you gave your power away to an object,

The angels projected to me that as civilizations make more and more advanced technology, if that is the choice they have made, they are separating further and further from the source of life and are becoming weaker and weaker because they have become addicted to the technology. They need it to survive. The angels were saying that the beings in that ship were spiritually very weak. In other words, I was not to look at them as a superadvanced race, but as people who needed spiritual help.

The bottom line of this experience was that the angels wanted me to give up technology and concentrate on pure consciousness as the way to remember God. I heard all that. I really thought I understood the lesson they were giving me. Then as time went on I completely forgot it. It's such a human thing to do!

Anyway, I knew I'd been in their ship for about three of our days, but when I got back in my body, my mind immediately said to myself, "I've been out for about two hours," because that was my middle-self mind rationalizing what had just happened. (That's what we do, rationalize unusual experiences.) So I stood up and walked into the other room where my family and friends were.

When my wife first saw me, she looked at me, pale-faced and fearful. Everybody came up to look at me with worried expressions. I asked, "What's wrong with you guys?" My wife answered and said, "Well, you've been sitting in that room for three days without moving. We couldn't get your attention, and we were just about to call the hospital for help." Then my mind realized that I really *had* been in space for three days. Even though I knew in my heart that it was true, I had to look at a newspaper to make sure. And sure enough, it was true.

### The History of the Sirian Experiment

After this experience with the angels and the Sirian spaceship, I thought the reason the angels wanted me to know about this black cigar-shaped craft was to become aware of their technology and its technological relationship to Lucifer. I didn't know then that there was another reason, one that would have equally great importance.

On April 10, 1972, my spirit walked into the body of Bernard Perona, the person who was in this body before I entered. It is clear why I chose that particular time when I look at the timing of events in my past. For something would happen later that year that would forever change the course of history for this planet. It would actually change the course of history for all life everywhere, it now appears.

What I am about to say must be understood as higher-dimensional knowledge and history. The story you are about *to* read, from a normal human perspective, will seem absolutely outrageous and impossible, probably as impossible as the idea of going to the Moon would have been to people in 1899. From a cosmic perspective, it is business as usual, except that what has come out of this experiment is truly unique and of paramount importance to the entire creation. *I know* that by telling this Story *I will* be pushing my credibility, whatever I have, to the max. But the angels have insisted that this story be told.

The reason that this Sirian experiment was undertaken in the first place goes back to Atlantis. In chapter 4, I wrote that because of the misuse of Mer-Ka-Ba knowledge by the Martians [page 98ff], the dimensional worlds of the Earth were cut open, causing us to fall in consciousness. And because of this misuse of energy, the human race fell deep into this dense third-dimensional world. As we said before, the Galactic Command, a body of 48 members, approved the rebuilding of the Christ consciousness grid around the Earth, using the system of sacred temples and special sites to re-create this grid geomantically so that humanity could regain its right-



ful place in the universe. It was a plan that had been used before by countless other planets in a similar position, and it had almost always worked. But when it hadn't, the consciousness of that particular race was lost.

It was calculated by those who know these things that we would be back into Christ consciousness before a particular cosmic event would occur in August 1972. This cosmic event was to be huge relative to this solar system, and if we were not back into Christ consciousness by that time, we would be destroyed, including planet Earth.

Thoth and the ascended masters of this human race, in conjunction with the Great White Brotherhood and the Spiritual Hierarchy of this galaxy, planned everything down to the last detail. This experiment by galactic consciousness was to be completed before August 1972 no matter what.

What was this cosmic event? In August 1972 our Sun was going to expand into a helium sun, a natural event. You see, it was then a hydrogen sun. All the light that comes to Earth and creates all life on this planet comes from the fusion of two hydrogen atoms to make helium. But as this helium builds up over billions of years, a new reaction begins, with three helium atoms coming together in a fusion reaction to form carbon. It was known that this reaction would take place in August 1972, which would mean that if humanity was not in the right state of consciousness at that moment, we would be burned to a crisp. If we were in the right state, namely Christ consciousness, we would be able to protect ourselves and life would go on. We absolutely *had* to be complete with the consciousness change before this date.

In the middle of the 1700s, after almost 13,000 years of this experiment to re-create the Christ-consciousness grid, it became clear to our physical rather, the Sirians, that we were not going to make it. What was so sad was that we were not going to make it by only a few years. The Sirians and the Nefilim, our father and mother, both wanted to help, but our father was much further advanced in knowledge and understanding and was more prepared to actually do something. So the Sirians took the initiative to find a way to save humanity. The problem was, there was no solution known in the whole galaxy.

The Sirians loved us so much—we were their little child, and they did not want to lose us. So about 250 years ago they began to search the akashic records of the galaxy to see what other races had thought of concerning this problem. There was no known answer that worked. But because their love was so strong, they continued to search even though there was almost zero chance. Then one day as they were searching a distant galaxy, they found a single being who had proposed a possible solution to this human problem. It had never been tried or tested, it had only been conceived. But the idea was brilliant and could really work.

The Sirians went to the Galactic Command and asked permission to perform this unusual experiment on Earth humanity in order to save us. The Sirian council presented all the knowledge they had learned. You see,

the problem was that our Sun was going to physically expand past the Earth and engulf the Earth in its flames in August 1972. This expansion would be only a pulse, returning to almost normal after a few years. But as far as humanity was concerned, five minutes would destroy us.

In order to make this experiment work, the Sirians first had to protect the Earth and humanity from the Sun's heat, but in order not to completely destroy our evolutionary DNA, we could not know they were doing it. It was much like the Star Trek mission statement of not interfering with a planet's indigenous cultures. But there really *is* a powerful reason for not interfering: This kind of ET interference would alter the human DNA forever, and the original human instructions would be lost. If we knew what they were doing, we would not be human anymore! As you may have surmised, this information is only for a few, not for mass consciousness.

The Sirians had to accelerate our evolutionary path so we could catch up with the cycle of the new reality and finish the 13,000-year experiment and return to Christ consciousness. Then we had to relive what we had missed because of the expansion of the Sun in order to put us back in sync with the new Luciferian reality. This was a very complex situation to manipulate.

The Galactic Command asked the Sirians if they expected anyone to survive if they *didn't* do the experiment- If the Sirians had said yes, even if it were only one man and one woman, they would not have been allowed the experiment. But since every last human was expected to be destroyed, then there was nothing to lose, so they agreed to it. Besides, this experiment had never ever been done before, not since the beginning of life. They too wanted to know if it would work.

The Sirians returned and, locked into position, just outside the membrane the huge, black cigar-shaped ship- They built this ship exclusively for this experiment. They then went to the Earth in the fourth dimension and placed objects at the remote corners of the star tetrahedral field of the Earth's lightbody and locked them in place. These were out in space over a thousand miles from the surface, one object at each of the eight points.

Then a special laser beam, unlike anything we know, transmitting unbelievable amounts of data, was fourth-dimensionally beamed down to the north or south pole of the Earth to one of the remote objects, which then sent a beam that was either red, blue or green to each of three of the other seven objects. The beam was relayed until it reached all eight remote objects. From the remote object opposite the one that received the initial beam, it penetrated the Earth to its center and from there outward to the surface into each human being on the planet. The animals and the rest of life on Earth were also inside this energy field, although they were not manipulated. It entered into the original eight cells at the center of each human, and from there outward to each human's star tetrahedral field. This last step created a unique holographic field around each human being, giving the Sirians a means to alter human consciousness. They could both

protect and change consciousness without the humans' knowing about it.

This created a holographic field around the Earth that re-created the outer reality of space. It placed us in a holographic replica of the universe, twice removed from the original Reality. This same field was used to protect the Earth from the deadly expansion of the Sun. The Earth would be engulfed with fire, but we would not know it.

At the same time, they could gain control of human thoughts and feelings and project images into our immediate surroundings. This would give them the ability to influence the evolutionary patterns of every person on Earth. The overall system would allow complete protection while this change was taking place without the humans knowing it, and allow the complete alteration of our DNA if and when it became necessary.

The plan was to take away our free will for a short time in order to make rapid changes in our DNA, then slowly restore our free will to the point where *we* would begin to control the patterns—all this to lead humanity as fast as possible into Christ consciousness. Would a complicated, untried plan such as this work? No one knew. But the universe was about to find out.

### August 7, 1972, and the Successful Aftermath

The big day came—August 7, 1972. The peak of the event actually occurred over a period of about seven days, but the seventh of August was its greatest expansion. What really happened on that day we humans will not know until we reach Christ consciousness, and no one on Earth would believe me if I put it into words. The real event was almost completely hidden from us through holographic means, but what did happen or what we were allowed to see was still the most powerful emission of energy from the Sun on record. The solar wind reached around 2,500,000 miles per hour for three days and continued at record output for 30 days. It was a truly spectacular cosmic event.

The experiment was incredibly successful. It did work, and we, the innocent humans, were still alive. We made it through the most crucial minutes without any problems. What the Sirians did was keep the programs running that would look to humans like there was little change, then continue the events in the exact way they would have unfolded without the holographic field. They didn't want to change anything until they knew that the system worked perfectly. After about three months they began their real work, rapidly changing consciousness.

For two years, from about June or July 1972 (just prior to the Sun's expansion) until about the end of 1974, we had no free will. All events were programmed, and our reactions to the events were also programmed to force rapid spiritual growth. This worked amazingly well. The Sirians were filled with glee. It looked like we were really going to make it.

## The Return of Free Will and Unexpected Positive Consequences

Finally, as progress became apparent, the Sirians began to allow freewill choices. However, if we did not respond with the right choice, the Sirians would continue to give us a similar set of reality choices over and over again until we learned the spiritual lesson. The outer circumstances would change, but the same spiritual lessons would be applied. At one point we became adept and the Sirians allowed us to take back our free will completely.

All this was timed to another event, which was the completion of the Christ grid around the world that the Great White Brotherhood was focusing on. It was completed in 1989, which then made it possible for humans to actually ascend into the next dimensional world. Without this grid there could not be ascension to any level. There were a few minor adjustments in the immediate years that followed, but the grid was functional.

Since the early 1990s humankind has been in a most-remarkable position in the universe, and we don't even know it.

Within the first three years of this Sirian experiment, it became apparent that something very unusual was beginning to happen, something that no one anywhere had ever seen or expected. As this strange phenomenon began, people from all parts of the galaxy became very interested in us. Before this time we were just another speck in the worlds of light. As the experiment continued, even other galaxies began to watch us. And on dimensional levels, all of life shifted its attention to our humble little planet. We became a superstar in the universe—and everyone knew but us!

What was causing the attention was the speed with which we were evolving. From where we are, inside the holographic experiment, we can't tell how fast we are evolving, but from outside the system it is clear. We are evolving so fast that no life form ever known anywhere has ever even come close to achieving what we are doing naturally. And it is increasing exponentially, just as it is inside the experiment if we are observant. What this all means is not really clear to the Spiritual Hierarchy. It's hard to tell what any experiment is going to do when there is no history, no precedent.

The story we told about Thoth and Shesat leaving with 32 members to move into the higher-dimensional worlds and go past the Great Void [chapter 11, page 301] will begin to make sense now. The ascended masters were attempting to find out what this all meant. They began to follow and enter the dimensional windows that had been opened by our expanded consciousness. It now is clear that they lead all the way past the Great Void into the next dimensional octave. This is all so absolutely astounding, by normal galactic understanding of the universe, that few are willing to speak out about where this is all leading to. What is clear is that this is new.

Further, upon close examination, this tiny seed of information that came from a single life form in a distant galaxy (who had an idea that triggered the Sirian experiment) was contained within the original Reality. God put it there, not Lucifer. Of course, God knew what would happen,

and only He knows where this will lead.

The reason for telling you this information so that you know the hidden reality behind the events of the day is simple: You are now, or about to become, one of the new ascended masters who will inherit the Earth. You, and those who work with you, will soon be responsible for awakening the rest of humanity. The primary information necessary to open your minds and hearts to the original Reality is within you. Within you is a wisdom older than time. May all that you do be a blessing for all life everywhere. God will always be with you.

May you transcend the good-and-evil, dualistic consciousness and open to the oneness of the One God and the original Reality. From this ancient perspective, the birth of something brand new will surely emerge into the light of this new day.

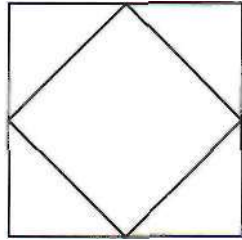

## The Dimensional Shift

### The Great Change

**M**ost of the prophets and the indigenous peoples of the world see a "great change" coming to Earth and to mankind. We see this change, ultimately and specifically, as a planetary dimensional shift into a new level of existence associated with a change of consciousness into Christ or unity consciousness. In the final chapter we will look closely at the great change itself and what may be understood from it. In this chapter we will peer into the nature of the dimensional shift associated with this change to find wisdom that can now be lived here on Earth to bring balance to these changes. Understanding the nature of the dimensional shift is a way to speed one's spiritual growth and utilize to the greatest potential the time we have left on this beautiful planet.

A dimensional shift is when a planet or any cosmic body moves from one dimensional level into another. In our case it will be from the third to the fourth dimension. The whole planet and everyone on it will experience this translation from one dimension to another. The Native Americans believe that we are about to move from the fourth world into the fifth world, a change preceded by a day they call the Day of Purification. The difference in the numbers is because they see the Void as a world and begin counting from that point. So the third dimension of the Melchizedeks and the fourth world of the Native Americans are the same.

If you choose, you can understand the nature of this transformation into the next dimensional level, or next world. Even though it's probably going to be a very quick transformation, we can see the nature of it and understand what the changes are that we must enter. It also lifts the veil from the events of this world and explains why they are happening, which allows clarity of mind and heart about this transformation as we pass through it.

### An Overview of a Dimensional Shift

On planets in this galaxy, normally the geomagnetic fields first begin to weaken and then become erratic, the civilization on the planet begins to



break down and finally the last phase is entered. The final phase lasts usually no more than two years but nearly always at least three months. In this phase the civilization begins to dissolve, and it becomes extremely dangerous just to be alive. All the systems that keep civilization in place disintegrate and chaos rules. This is the period that most religions, such as the Mormon religion, have prepared for. It is the period when we are still on Earth in the third dimension before we actually make the transition into the fourth dimension.

Then there is a period of five or six hours before the dimensional shift begins. This is a very strange time, when the fourth dimension begins to leak into the third dimension. It really helps to know this is coming.

When the shift actually begins, there will be no doubt. There are specific changes of color and form that are outside of most human consciousness. From this point forward, we have left the Earth's third dimension. Usually the axis of the planet will shift at this time, but we will not know it because we will literally be in a new space-time dimension. There are always other possibilities for how this might happen, but this is the normal course.

Passing through the Void, we will enter into the Earth's fourth dimension. Life will be altered dramatically. Ascension, resurrection and final death will all take place before this phase. Birth into the new world will have begun.

The following scenario details the way a dimensional shift generally happens in the universe, but Earth is an exceptional case. I will first talk about a normal transition as though that is what will happen, but our own transition could and almost certainly will lead to something more anomalous. The course of history may turn into something very different from what I am about to tell you. It depends on the love we have for each other as a planetary race of beings. At the end of this discussion I will present another theory. It is too early to know for sure that it is happening, but it seems to be.

### The First Signs

The first sign of a planetary dimensional shift is a sharp weakening of the geomagnetic field, which science knows has been dropping on Earth for the last 2000 years, since Jesus appeared. In the last 500 years, the Earth's geomagnetic field has been dropping more dramatically. As we approach the dimensional shift, the geomagnetic field will begin to go crazy, which has already happened. The world's airports have had to alter the magnetic error corrections for north for their airport maps in order to use automatic instruments. The last thirty years has seen very peculiar magnetic field changes. The birds are not migrating to their usual locations. Birds use magnetic lines to navigate their migratory routes home, and these lines have changed dramatically. I believe this is what is causing the whales and dolphins to beach themselves, because they too use these lines to migrate. Many mag-

netic lines that have always followed the coast have now moved inland. As the cetaceans follow them, they run into land and are beached. Eventually the geomagnetic field will probably collapse and fall to zero. It has happened many times in Earth's history.

If this happens, several scenarios might take place. The field could reverse itself and the poles would switch. Or it might return to the same polar configuration after it reaches zero, but with a completely different axis. There are various ways it could move, but it doesn't really matter to you and your ascension. You will not be here on this level of Earth's dimensions, so you won't have a direct experience of this change.

There are other more subtle energy changes, such as the Schumann frequency (the basic resonant frequency of planet Earth), which will change before the dimensional shift occurs, but the geomagnetic change is the biggest. I am not going to speak about the Schumann frequency, since the United States government has gone to great lengths to deny that this change is occurring. If you really want to know the truth, check with Germany and Russia, because both nations have information on this subject that utterly conflicts with our government's position. You can also study Gregg Braden's work. His work is more enlightened and honest.

The importance of the geomagnetic field lies in the effect it has on the human mind when and if it moves to zero *and* stays there for more than about two weeks. According to the Russians, in the early days when they put people into space and they were mostly out of the Earth's geomagnetic field for more than two weeks, their cosmonauts literally went crazy. This is exactly what happened after the Fall when Atlantis sank—people lost their memories and went nuts. It seems that Earth magnetism holds our memories intact, much like a cassette tape, and this is tied to our emotional bodies. So the Russians invented a small appliance to be worn on a belt that cosmonauts wear to maintain a normal geomagnetic field around the body when in space. I'm sure that NASA has done the same thing.

It may seem strange that geomagnetics would affect our emotions, but just think what happens during a full moon. The full moon makes only slight changes in the geomagnetics, but the effect is obvious. In any major city in the world, check out the police records on the day before, the day of, and the day after the full moon. There are more murders, rapes and general crime on those three days than at any other time. However, when the geomagnetic field moves to zero, it becomes a much greater problem. Even the fluctuations of the world stock market are based on human emotions, so you can see how major fluctuations in the Earth's geomagnetic fields that last for longer than two weeks can cause havoc in the world.

### The Phase before the Shift

This is the period that usually lasts from three months to two years. It is triggered mostly by the geomagnetics driving people crazy. This is what causes the collapse of the social systems of the world. The stock market



crashes, the governments become nonfunctional and martial law is invoked but doesn't work because the military is having the same problem. This is followed by the lack of food and other supplies and no help. On top of this, most people become paranoid and reach for their guns. Nowhere is safe on the Earth's surface.

However, because of the tremendous help that our spiritual ET brothers have given us and because of the dramatic changes in consciousness that we have accomplished ourselves, there is an excellent chance that we will not go through this dangerous period, and if we do, it will be very quick. In fact, I would not be surprised if we had *no warning at all*, except the five to six hours that we speak of below.

If we were to prepare for this phase on a *physical* level, we would put food and supplies in a hole in the ground to last at least two years. However, if we entered this underground fort when the shift began, we would not come out. Why? Because the dimensional shift will take us into a new dimension of the Earth's consciousness, a place where the third dimension, our normal world, will not exist. Once the shift begins, the third-dimensional world will pass away, so it is unfeasible to put food and supplies in a hole and expect to emerge after everything is over and resume life as usual.

A large portion of our population have recently done this in anticipation of a Y2K problem. There is nothing wrong about doing it, but it must be understood that it cannot save you. No *physical* preparation will help you in the higher dimensional levels. Success there depends on your spiritual awareness and mostly on your character. Yes, character. I will explain soon.

#### Five to Six Hours before the Shift

This phase is a weird one, from a human point of view. The Native Americans in the tribe I was first born to when I arrived on Earth, the Taos Pueblo, are told to enter the pueblo, pull the curtains, not look outside, and pray. To look outside would only cause fear, which is the last thing you need.

A strange phenomenon begins at this stage. The two dimensions begin to overlap. You may be sitting in your room when suddenly something appears out of nowhere that will not be explainable to your mind. It will be a fourth-dimensional object that will not fit into your understanding of reality. You will see colors that you have never seen before in your life. These colors will be exceedingly bright, and they'll seem to have their own light source. The color will seem to be emitted rather than reflected. And they have a shape your mind will not be able to explain. These objects will be the strangest things you have ever seen. It is okay; it's a natural phenomenon.

My strong suggestion to you is, *don't touch* one of these objects. If you do, it will instantly pull you into the fourth dimension at an accelerated rate. It would be easiest and best if you avoid moving that fast. If it is unavoidable, then it is the will of God.

## Synthetic Objects and Lucifer-Reality Thought Forms

The other phenomenon that almost certainly will occur has to do with the nature of the reality that Lucifer created and that we live within. The original Reality is created in such a way that everything is in divine order with everything else. But in Lucifer's reality, technology has made synthetic materials. These materials, which are not found in nature, will not be able to pass into the fourth dimension. They will return into the elements they were created from. It is possible to send a synthetic material into the next dimension, but it requires a special energy field to keep it intact.

Further, these synthetic materials have a spectrum of stability. Some of them, like glass, are not far removed from nature. Glass is just melted sand. But other materials are far removed, thus far more unstable, such as our modern plastics. This means that some synthetic objects, depending on their stability, will melt or disintegrate quicker than others during this five-to six-hour period. Your car is made of plastics and other highly unstable materials, so it will definitely be unserviceable. Even your house is probably made of many unstable materials and will, for the most part, break down and partly disintegrate. Most modern homes will be unsafe during this phase.

Knowing that this time would come and what would happen when it did, the Taos Pueblo long ago made it illegal to use modern building materials inside the pueblo. The Taos people do make summer homes of synthetic materials away from the pueblo, but they know that when the Day of Purification comes, they are to head for their ancient homes on the pueblo. Sometimes they put windows in their pueblo buildings, but because the openings didn't have glass before, if they lose a window, it won't be a big loss. Other than that, their pueblo is made only of mud, straw, sand, stones and trees. They will not experience this problem.

Therefore, it would be best to be in nature when this happens, but if you cannot be, then it is the will of God. I would not worry about this. I am only informing you so that you will understand as the shift begins.

I will explain this a little further. Synthetic objects are really just thoughts created by and through the Luciferian experiment. They don't exist in the original Reality. It might be hard to understand that they're only thoughts. "Thought forms" would be a better term. They come from what the Hindus call the mental plane, from a higher-level dimension, and slowly filter down through the dimensions until they get here in the third dimension.

In human terms, a person thinks of something, imagines it, then figures how to do it. People create it in one way or another and manifest the object on the Earth. It can be an individual or a group of people, it doesn't matter. The person (or persons) who creates it does not hold the object here on the Earth plane even if they created it. It's held in place by our third-dimensional human grid around the planet. That's the consciousness grid of all

the people on this level. It's an agreed reality held in place by the grid, so if someone dies who created an object, the object remains. But if the grid that holds these objects were *to* break down, the *object* would turn into the materials it came from, leaving no trace. And this grid will break down before or during the shift.

Obviously, the people who are already going crazy because of the collapse of the geomagnetic field will become much worse when they see the Luciferian reality collapsing, when objects begin to disappear or disintegrate. The good side is that it lasts for less than six hours.

According to Edgar Cayce and other psychics, there have been many extremely advanced civilizations here on Earth before, but there is little or no trace of them. This is because of what we have just described. Their synthetic materials did not make it through the last dimensional shift 13,000 years ago or through other prior shifts. God cleans up the original Reality environment every time there is a dimensional shift.

If an advanced ET culture *comes* here and wants *to* make a *structure* (like a pyramid, for example) last for tens of thousands of years, they don't make it out of a sophisticated metal like stainless steel. They use natural materials from the planet that are very hard and durable. This way they know that the pyramid will last through all these natural dimensional changes that every planet experiences. It's not a Stone Age limitation, it's just an intelligent thing to do, that's all.

Furthermore, these advanced ET cultures are also very careful not to leave any trace of themselves. They either take their bodies with them or vaporize them in order not to break the galactic law of noninterference.

## Planetary Shifts

Every person who has ever lived on Earth has already experienced the shift. They had to in order to get here on Earth. It's just a cosmic fact. Unless we came from close by, wherever we came from before we came to Earth, we had to have passed through the Void to get here, so we had to change dimensions. On the day you were born on Earth as a baby, you experienced a dimensional shift. You moved from one world into another. It's only because of our poor human memory that we don't remember.

By not remembering the experience of being born or of the other dimensions, we have placed enormous limitations on ourselves. For one, we can't overcome the reality of great distance. The distances in our reality are so great that we can't cross them. We can't even leave our solar system, for in this present state of awareness we are prisoners in our own home.

Is it not true? Traveling great distances by spaceship in the conventional way of perceiving time and space is not possible. Scientific minds have come *to that* conclusion already. But *of course it* is a disheartening suggestion that we can never leave our own solar system. Reaching the nearest star (Alpha Centauri, about four light-years away) would take about 115 million years using current space technology. Humans *do not*

live that long, and besides, that is only the closest star. To reach deep into space would simply be impossible. We would have to change our understanding of time and space to be successful.

As we have said, our problem is that we know about only time and space; the reality of dimension has been mostly lost. Because all things are perfect, we are remembering *now*, just when we need to. We first remember in our dreams, then in our movies. Movies like *Star Trek*, *Contact*, *Sphere* and many others all explore ideas about dimension. *We will remember*, for God is with us.

So let's do it. I'll tell you exactly what normal!} happens in a dimensional shift. I will give this description from my direct experience, but what really comes to pass may be slightly different, for the universe is always experimenting. Some of you would probably prefer that I tell this in story form, but I feel that a straight shot may be more appropriate.

### The Experience of an Actual Planetary Shift

Remember that what I am about to say is what a galactic textbook would reveal. It is just the normal scenario. There can be many different details because life is flexible, but by knowing the norm, you can imagine the differences.

As we enter this new millennium, the ascended masters feel that there will be very little violence approaching this shift, for we have come a long way on the path. We have done a great job in helping to birth the new human consciousness! So I am going to say it now—relax, don't worry. Enjoy this transition. As you witness the perfection of life, you can be that little baby you may have wanted to revert back to. Know that you are going to be taken care of and that pure love is guiding the events. This energy wave is so much bigger than you that you might as well surrender to life and just be.

We have probably altered the possibility of the two years to three months of chaos. It is now believed that the period before the shift will probably be very short and with almost no disruption. They expect little or no warning except for the five- or six-hour shift. More than likely you will wake up one morning, and before sunset find yourself a baby in a brand-new world.

### Six Hours before the Shift

Let's begin six hours before the shift. You wake up on a clear, cool morning feeling great. As you stand up, you realize that you are feeling very light and a little strange. You decide to take a bath. As you're watching the water, you sense something behind you. You turn and see a large, brightly glowing object of strange colors floating about three feet off the floor next to the wall. As you try to figure out what this is, a smaller one appears out of nowhere a few feet away. They begin to float around the room.

You jump up and run into the bedroom, only to see the whole room filled with these strange, unimaginable things. You might think you are

having a mental breakdown or that maybe a brain tumor is affecting your perception, but neither is the case. Suddenly the floor begins to break apart and the whole house begins to distort. You run outside into nature, where everything seems normal except that there are many of these strange things everywhere.

You decide to sit down and not move. You remember your Mer-Ka-Ba and begin to breathe with awareness. You relax into the prana flow that moves through your body. The great spinning Mer-Ka-Ba has enclosed you in its warmth and safety. You become centered and wait, because what's about to happen is God's grace. There really is nowhere to go. It's the greatest ride you can imagine. It is ancient, yet it is brand new. It is beautiful and you feel fantastic. You feel more alive than you ever did when you were in the normal Earth reality. Each breath seems to be exciting.

You look across the meadow, where a red, glowing fog begins to slide into the space all around you. Soon you are surrounded by this red fog, which seems to have its own source of light. It's a fog, but it doesn't actually look like any fog you have ever seen before. It seems to be everywhere now. You are even breathing it.

An odd feeling comes over your body. It isn't really bad, just unusual. You notice that the red fog is slowly changing to orange. You no sooner see it is orange than it turns yellow. The yellow quickly changes into green, then blue, then purple, then violet, then ultraviolet. Then a powerful flash of pure white light explodes into your consciousness. You are not only surrounded by this white light, but it seems that you *are* this light. For you, there is nothing else in existence.

This last feeling seems to continue for a long time. Slowly, very slowly, the white light changes into clear light and the place where you are sitting becomes visible again. Only it looks like everything is metallic and made of pure gold—the trees, the clouds, the animals, the houses, other people—except your body, which may or may not appear like gold.

Almost imperceptibly, the gold, metallic reality becomes transparent. Slowly everything begins to look like golden glass. You'll be able to see right through walls; you can even see people walking behind them.

### The Void—Three Days of Blackness

Finally, the gold, metal reality begins to dim and fade away. The bright gold becomes dull and keeps losing its light until your entire world is dark and black. A blackness engulfs you, and your old world is gone forever. You can't see anything now, not even your body. You realize that you are stable, but at the same time you seem to be floating. Your familiar world is gone. Do not feel fear here. There is nothing to be afraid of. It is completely natural. You have entered the Void between the third and the fourth dimensions, the Void that all things came from and must always pass back into. You have entered the doorway between the worlds. There's no sound and no light. It's total sensory deprivation in every imaginable way.

There is nothing to do but wait and feel gratitude for your connection with God. You will probably dream at this point. It is okay. If you don't dream, it will seem like a long, long time is passing. In truth, it will be only about three days.

To be concise, this period may last from two and a quarter days (the shortest ever known) to about four days (the longest ever experienced). Normally it is between three and three and a half days. These days are Earth days, of course, and this time is experiential, not real, because time as we know it does not exist. You have now reached the "end of time" that the Maya and other religions and spiritual people have spoken *of*.

### The New Birth

The next experience is rather shocking. After floating in nothing and blackness for three days or so, on one level of your being it may seem like a thousand years has gone by. Then, totally unexpected and in an instant, your entire world will explode with a brilliant white light. It will be blinding. It will be the brightest light you have ever known, and it will take a long time before your eyes can adjust and handle the intensity of this new light.

More than likely the experience will seem brand new, and what you have just become is a baby in a new reality. You're a little baby. Just like when you were born here on Earth, you came from a very dark place into a very light place; you were somewhat blinded and didn't know what the heck was going on. The experience is similar in many ways. Congratulations! You were just born into a brilliant new world!

When you start adjusting to this intensity of light, which might take awhile, you'll begin to see colors you've never seen before and never knew existed. Everything, the whole configuration, the whole experience of the reality, will be bizarre and unknown to you except for the short time with the floating objects right before the shift.

In truth, it is more of a second birth. On Earth when you are born, you begin small and continue to grow until you are an adult. We usually think of human adulthood as the end of growth. What may sound strange until you see it is that a human adult body in the next world is a baby. Exactly as happens here, you begin to grow and get taller until you reach adulthood in this new world. Adulthood in this new fourth-dimensional world is surprisingly taller than here. An adult male is about 14 to 16 feet tall, and an adult female is about 10 to 12 feet.

Your body will seem solid, just as on Earth, but compared to third-dimensional Earth, it isn't. In fact, if you were to go back to Earth, no one could see you. You still have an atomic structure, but the atoms will have mostly converted into energy. You have become a great deal of energy and very little matter. You can walk right through a solid wall on Earth, but here you are solid. This new birth will be your last life in structure as you know it. In the fifth dimension, which will be coming soon after the fourth,

there are no life forms. It is a formless state of consciousness. You will have no body, but will be everywhere at once.

Time is extremely different in the fourth dimension. A few minutes on Earth is several hours in 4D, so in what will seem like about two years, you will reach adulthood. But simply growing up is not what life is all about, just as here on Earth. There are levels of knowledge and existence that would be hard to imagine from where you will be when you first enter the fourth dimension, just as a baby here on Earth could not comprehend astrophysics.

### Your Thoughts and Survival

Here you are, a baby in a new world. Yet in this new world you are far from helpless. You are a powerful spirit that can control the entire reality with your thoughts. Whatever you think, happens instantly! Yet at first you normally don't recognize this connection. Most people don't put the two together for several days, and those few days are crucial. They *could* keep you from surviving in this *new world* if you don't understand.

Here you are, only a few minutes old, and the first big test in life begins. When the fourth-dimensional window is opened, anyone can go through, but generally not everyone can stay.

What we have found is that there are three types of people at this stage. First, there are people who pass over who are ready. They have prepared themselves in this life by the life they lived. Then there are people who aren't ready, who are filled with so much fear that they cannot allow themselves to leave this third dimension past the Void, and they immediately return to Earth. Finally, there's a third group that passes over but isn't really quite ready for this experience.

They were ready enough to transition into the fourth dimension, but they weren't really prepared to stay there. Jesus spoke of these people when he said at the end of a parable that "many are called, but few are chosen."

There was another parable about a wheat farmer whose servants reported that many weeds were growing in his wheat fields and asked what to do. The farmer told them to let the weeds grow with the wheat, and when it was harvest time, *to* gather them both up and then to separate the chaff from the wheat. A farmer would normally attempt to get rid of the weeds before they got big, but that's not what he said *to do*. What Jesus was referring to is these two different kinds of people—the ones who are ready and the ones who aren't.

When people are not quite ready, it means they are bringing all their fears and hatred with them. When they find themselves in this very bizarre world, all their fears and anger arise. Because they don't know that whatever they think will take shape around them, their fears begin to manifest.

Because they don't understand what is happening, in the beginning most people reproduce familiar images of their old world, things they can recognize. They do this to make sense of what is happening. They are not

doing this consciously, but from their survival instinct. They start creating the old images and emotional patterns. But this new world is so bizarre that all their fears come up. They say, "Holy cow, what's going on? This is crazy, insane!" They see people who had died long ago. They might begin to see scenes from their past, even their childhood. Nothing makes sense. The mind searches for some way to create order.

They think they're hallucinating, and this brings up more fear. Thinking in their Earthly way, they might feel that someone is doing this to them, so they need to protect themselves. The ego thinks it needs a gun. Manifestation follows thought, and when they look down, there's a rifle with a scope, just what they wanted. They pick up the gun and think, "I need ammunition." They look to their left and there are huge boxes of it. They load up and begin looking for bad guys who they think are trying to kill them. So who instantly appears? The bad guys, fully armed.

Now their worst fears start manifesting, whatever they are, so they start shooting. Everywhere they turn, other people are trying to kill them. Finally their biggest fear manifests, and they are fatally shot.

A scenario of some sort will happen that will remove them from this higher world back to the world from which they came. This is what Jesus meant when he said, "For all they that take the sword shall perish with the sword." But Jesus also said, "Blessed are the meek, for they shall inherit the earth," which means that if you're sitting in this new world thinking simple thoughts of love, harmony and peace, trusting in God and yourself, then that is exactly what will manifest in your world. You will manifest a harmonious, beautiful world. If you are "meek," you allow yourself to remain in this higher world by your thoughts, feelings and actions. You survive.

That's just the beginning, of course. So you are born into a new world and you survive. From this point on there are various possibilities. One that will invariably occur is that after a while you'll start to explore this reality, and at one point you will realize that whatever you think, happens.

At this point people often look down at their bodies and say, "Wow," and, with their thoughts, perfect their bodies and physically become what they always wanted to be. They will heal everything, grow back arms and legs. Why not? It's like a toy to a child. Because ego often still functions a little bit at this stage, you might make yourself really beautiful or handsome or taller. But you will soon get bored with perfecting your body. You will begin to explore the rest of your new reality.

One thing will almost certainly happen. You'll suddenly notice large moving lights around the area you are in. They're called mother and father. Yes, you will have parents in the fourth dimension. It is, however, the last time, for in the next higher world you will not.

In the area of the fourth dimension where you arrive, the family problems we have experienced here on Earth don't exist. Your mother and father there will love you in ways you probably have only dreamed of on Earth. They will completely love and take care of you. They will not allow



anything to happen to you in a bad way once you have survived. You have absolutely nothing to worry about. It is a time of tremendous joy if you simply surrender and allow this love to guide you. You may realize that you've just won the big game of life.

All the pain and suffering you have experienced in life is over, and another beautiful and sacred level of life is emerging. Now the purpose and meaning of life begins to return consciously. You begin to experience another ancient, yet new way of being, and it's yours. It has always been yours, but you gave it up. So now you are returning to the state of awareness where God is apparent in all of life. He is apparent with every breath that enters your shining body of light.

## How to Prepare: The Secret of Everyday Life

You ask, what can we do here on Earth that will prepare us for this experience of the higher worlds?

It's definitely not collecting food and making a hole, in the ground or anything else like that. Not that this is wrong action, only that physical preparation has its limits. In heaven, in the higher worlds, you are what you create. It is true here too, but most of us don't know it. From the fourth dimension on, it becomes obvious.

Since we are what we create, then it becomes important and necessary that our emissions are in harmony with all life everywhere. We come to understand that everything we think, feel and do creates the world we must live in. Therefore, ordinary life here on Earth can be seen as a school, a place where each moment of life gives us lessons that can be directly translated into the next world. No wonder Egypt and most of the ancient civilizations regarded death with such reverence. Death, no matter how it comes, is the doorway of darkness into the Void that leads into the brilliant light of the higher worlds of life. If mastered, it leads directly into a conscious connection with all life everywhere—eternal life!

So what about these Earthly lessons? The truth is that the Source of all life is in the eyes of every person created. So even here on Earth, great intelligence and wisdom and love are present in every moment inside each person. Once this is seen, then it becomes clear that your thoughts, feelings and actions are the key. You know exactly what to do. In simple words, it's perfecting your character. The shining diamonds in your character become the survival tools of ascension.

Buddha, Mother Mary, Lao-tsu, Mohammed, Jesus, Abraham, Krishna, Babaji, Sister Teresa and about 8000 other great masters of the eternal light—these are your schoolteachers and the heroes of life. By their examples they show you how to build your character. All of them feel that loving your neighbor is the primary key. It brings order into the world you create. It gives you eternal life. Do you see?

In the Melchizedek transition, as you pass through what are called stargates and go from one area of existence to another, the only way you

can get through is by thinking, feeling and being very specific emotional and mental patterns. These patterns generally come in sets of five or six [see chapter 13, update 5]. The pattern I used to enter this dimension was *love, truth and beauty, trust, harmony and peace*. There are many others. They are like codes or keys that allow you to pass the guardians. If the guardians sense that you are ready for the world they guard, they will let you through. If they do not, they will chase you back to the world from which you came. It's just their job—and you set it up that way.

If you can just sit there and keep chanting those patterns of love, truth and beauty, trust, harmony and peace, you don't have to worry about a thing. That's the female pattern [see Fig. 18-1]. There are other patterns. There's a male pattern [see Fig. 18-2], which is *compassion, humility and wisdom, unity, love and truth*. All stargate patterns have love and truth.

Wherever there is compassion and humility, there is wisdom; that's the male component. And wherever there is love and truth, there is unity; that's the female component. On the first stargate pattern, which is arranged differently, wherever there is love and truth, there is beauty, which is the male component. And wherever there is trust and harmony, there is peace, the female component.

So these mental/emotional states or stargate patterns become the most important possessions you could have when you enter the higher worlds. They'll become even more essential each time you pass higher. Where does this process lead?

When you reach the fourth dimension and see and understand your situation and begin to demonstrate your ability to control events, a funny thing begins to happen. Remember the painting on the Egyptian ceiling called the egg of metamorphosis [see chapter 10, Fig. 10-34a], the one with the red-orange oval over the heads of the Egyptians as they were making the 90-degree turn into the next world? Like them, you will begin to go through a metamorphosis. Like the butterfly, your body will rapidly change into something similar but uniquely different.

"Pharaoh" means "that which you will become." The first king given the name pharaoh was Akhenaten, with his lovely wife Nefertiti. If you want to know what you will become, there they are to see. The race they came from, the Sirians, are our father, and we carry the genes they have given us. At the right moment we will change into their race. It is a race designed for the fourth dimension. When it happens, you will say to yourself, "Of course, I remember." The changes taking place in your body will feel so natural that you won't even think about it.

Life in the next world will seem normal and ordinary once growth begins. You will have entered one of the three highest overtones of the fourth dimension—the tenth, eleventh or twelfth overtones. In one or more of these three worlds you will gain the knowledge and wisdom to move into the fifth dimension, the beginning of a return trip straight back to God, ever changing as the truth unfolds.

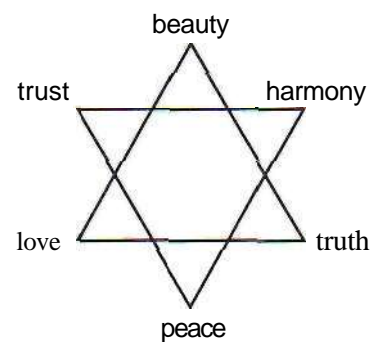

Fig. 18-1. The female stargate pattern.

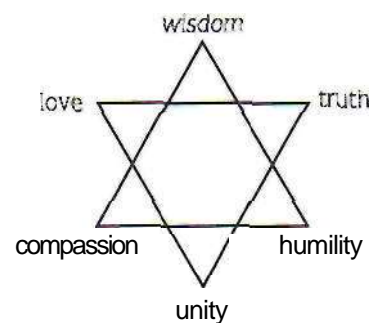

Fig. 18-2. The male stargate pattern.

The eyes of the universe are upon us, the great souls of the universe are following us closely. We are the children of God who offer the possibility of new life to life. In deepest gratitude, I thank you for being alive.

## This Unique Transition

We have told you what normally happens when a planet transitions into the fourth dimension. Now we will propose a new theory of what may be happening here in the beginning of the 21<sup>st</sup> century of the third millennium on Earth. Occasionally a planet may enter into an anomaly in order to make the transition easier. It transits into the next dimension, but it re-creates the old dimension in such a way as to complete the old karma and make a smoother transition into the next world. It is rare on a planetary basis, but possible. It usually requires a very high level of consciousness to initiate it, though, and this is almost always lacking.

Edgar Cayce said that the axis of the Earth would change in the "winter of 1998," but it did not. Other predictions suggested that by August 11, 1999, we would have entered a higher dimension or destroyed ourselves, and it seems that we have not done that, either. Could it be that we already transitioned into the fourth dimension and don't know it? It is possible.

This is a subject so vast that I can hardly contain it. Perhaps the best way is to discuss where this higher level of consciousness could be coming from that would be making this kind of change. It just may be that the new children of Earth, the leading edge of consciousness, are here just for this reason. Vast numbers of our children today are high spiritual beings who have come to Earth to help us with this transition into a new world.

These new children have the ability to initiate the transition of this world into a new world through extraordinary means. We may be witnessing this miracle at this very moment in history. With their high level of universal understanding, they could re-create this world in the next world in such a way as to not lose a single soul—which is their desire, I believe. We would have to change Jesus' saying into "Many are called, and *all* are chosen." I believe he would be overjoyed. It has been the dream of the universe to transition every last soul, but it has never been possible before.

How could children save a planet in such an extraordinary way? A child's pure innocence and love in the higher worlds is the source of harmonic creation itself. If these children are real, and they appear to be, then anything whatsoever is possible now. God may have just blessed us with His perfect grace.

## The New Children

**W**e humans are so funny. Exciting, earth-shaking miracles could be happening all around us, and we would rationalize them away so that our old world continues to be comfortable and unchanged. No one wants to rock the boat. Actually, most of us would just like to keep sleeping and hiding from the awesome changes that are everywhere in our daily lives. In the last hundred years the Earth has changed so much that no one, and I mean *no one*, would have believed the present if you had described it in 1899.

Y2K, the "year 2000." How did we get here to this supertechnological world so quickly? It's exponential, that's why.

### The Current Growth of Knowledge

In the fall of 1999 I talked with Edgar Mitchell while we were in the Yucatan. We were both speaking at a Mayan conference during the time the shaman and Mayan priest Hunbatz Men performed the ceremonies for the "New Light of the Sun." This was a beautiful and important series of ceremonies, which had not been allowed for hundreds of years, that ushered in the beginning of a new light from the Sun and, as a result, a new Earth.

Dr. Mitchell said that NASA was in the middle of the greatest renaissance in the history of science, surpassing even the understandings of relativity and quantum physics. These theories had never quite fit together, and there were anomalies. Einstein had searched for the unified field theory that would bring all forces together in a single mathematical formula. Since Einstein's time, the scientific world has been searching for this theoretical holy grail.

Now, according to Dr. Mitchell, NASA has found the answer. He said that NASA has learned as many facts about our physical environment in the last five years (as of September 1999) as civilization has learned in the last 6000 years. Further, he said that they have learned as much in the last six months as in the previous five years! It is definitely exponential. Only a mere one hundred years ago the idea of going to the Moon, as Dr. Mitchell



has so eloquently demonstrated, would have been considered absolutely impossible.

NASA has found the unified field theory. They feel that a great understanding has been born. In a nutshell, they have discovered that the Reality is holographic, that just as in a hologram, where you can take a small piece of the picture from anywhere on the image and retrieve the whole image, any physical piece of this Reality contains the image of the whole universe. Distant star patterns can be found in a piece of your fingernail.

Even more interesting is that the inverse is also true. That piece of fingernail can be located not only where we find it, but also anywhere in space. The Reality is not what we thought it was. The Eastern Indians called our reality *maya*, which means "illusion." They were right. It *is* a hologram. It is only light!

Thought follows attention. Attention follows intention.

Computers are changing everything—this special love affair between the two living atoms, carbon and silicon. The Earth has *two* eyes and can see in a new way. She can now see much better and farther. If only we can learn to live in peace, if only we can learn not to destroy our environment, I believe, I *really believe*, that Great Spirit will give us another chance with this Earth. In fact, perhaps it has already happened, this second chance.

The indigenous peoples of North, South and Central America performed the ceremony that brings together the condor and the eagle, acknowledging that the next 13 years are the last cycle of this Earth. Many teachers of the Mayan calendar have said that the last cycle ends on either December 22 or December 24, 2012. But the elder brothers, the Kogi, and the Maya themselves say no, that the last 13-year cycle begins on February 19, 2000, and ends on February 18/19, 2013.

What is so important is that the elder brothers believe that we, the younger brothers, are changing to remember the ways of Great Spirit. Joy sings in the jungle and old hearts are moved. We are learning quickly. We are waking up from a 500-year-old dream that was closer to a nightmare. The eyes of a child are blinking open.

And why would not the great change happen now? Were you not warned over and over long ago? Almost every prophet who has ever lived (speaking about the end of time) has placed it at this exact moment that you are reading this book. This period, different from the last 13-year cycle above, is from February 26, 1998 (an eclipse of the Sun) to February 18/19, 2013, and this is the time of the Great Change. Notice that this end-time date is different from the traditional date of December 24, 2012.

Edgar Cayce ("the sleeping prophet"), Nostradamus, the Holy Bible, Mother Mary, Yogananda and many others of the civilized world predicted that this time we live in is the time of the great change. Some saw this time as one of great destruction and pain, with huge Earth changes and a world altered beyond recognition; others saw a time of rapid spiritual growth, a time of ascension into a new world. Some saw both.

The indigenous peoples of the world—the Maori of New Zealand, the Zulus of Africa, the kahunas of Hawaii, the Eskimos of Alaska, the Maya of Mexico and Guatemala, the Kogi of Colombia, the Native Americans of North America, the Shintos of Japan and many others—all feel and predict that a great change is about to happen or, in some cases, is now happening.

Why would so many great people over such a long period of time point their finger at this particular moment in history? So I say again, why would not the great change happen now? And *is* it happening now?

In 1899 there were 30 million species of life on this planet. It took Mother Earth billions of years to reach this teeming variety of life forms from the one-celled amoebas to the magnificent humans and dolphins. It took mankind and his misuse of energy and his unconscious actions to reduce the number of life forms to less than half in a mere hundred years. Over 15 million species are now gone forever. How can we go so far up in consciousness and stoop so low at the same time?

If we can control our greed, if we can live from our hearts, we may make it. It is clear to me that Mother Earth has found a way to save us, the uncaring humans. Assuming this is true, do you know where this new hope is coming from? Not our great scientists or our greatest minds; it is coming from our innocent children. They are leading the way, just as the Holy Bible said would happen.

## Human Mutations, Historical and Recent

The renaissance taking place in NASA is mirrored by what is happening inside our bodies. Deep in our DNA we are becoming new and very different. What appear to be genetic changes in our human DNA are showing up all over the world. What many scientists would call mutation has already occurred and, like it or not, the birthing of at least *three* new human races appears to be occurring at this very moment on the Earth—three very different kinds of races, filling the needs of a new humanity. The great change is definitely happening inside us, and hardly anyone knows. It is quiet, but it is getting louder with the first breath of each newborn baby.

### DNA Changes in Blood Types

DNA changes are rare, but they do happen. One of the most documented cases is associated with human blood. Mankind had only one blood type from the dawn of humanity until relatively recently. No matter what the outer skin appearance was—black, yellow, red, white, brown—the blood was the same. Everybody had type O blood flowing through their veins and everybody killed animals for their food. It was universal until a mere 15,000 years ago, the time when the great comet struck the Earth off the coast of Atlantis.

What happened? Most of the world, other than Atlantis, quit moving from place to place to hunt and eat animals; we became farmers. Our diets changed. We began to eat vegetables and grains in combinations that had

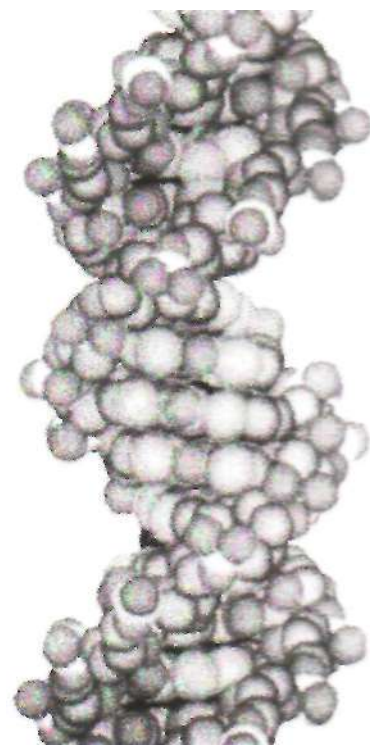

never entered the human body before. The body responded to these dietary changes by mutating the human DNA and making a new, unheard-of blood type, type A. Besides this new blood, there were other DNA changes that affected the stomach acids and enzymes and other body functions to assimilate these new foods. Some scientists suggest that climate changes may also have had an effect on this mutation.

As time went on, twice more the human blood changed, each time in response to changes in diet and possible climate changes. Types B and AB were born. At the moment there are four types, but will this continue? Toward the end of the 20<sup>th</sup> century, foods from all over the world became available to almost anyone anywhere on Earth. Humanity for the first time began to eat all the foods of the world. You can go into almost any major market in the civilized world and get anything you want from anywhere—papayas from Mexico, avocados from California, olives from Greece, vodka from Russia and on and on. You can go into almost any American city and eat Chinese food or Mexican, Italian, Japanese, American, German and so on. Will a new blood type emerge to accommodate this unprecedented shuffle of foods?

As you can see, DNA changes do take place with seemingly innocuous changes in diet and climate. The changes happening on Earth today are astounding by anyone's standards. They are so huge that one would expect a human genetic response, and beyond doubt, humanity has responded.

A new change has taken place in human genetics that has such far-reaching implications to the future of mankind that I simply must discuss it. Most of the people who have made these DNA changes are children. There are three distinct categories, each with very different, exciting new powers. There might be more than three, but to date this is all we can see. I believe these children are leading us into a new future unlike what has been experienced in the last few million years. In addition, as I suggested before, these children may have altered the fourth-dimensional shift to complete the karma of the third dimension in such a way as to allow *all* humans to make this translation into the fourth dimension. Yet with or without this dimensional shift, the new human genetic change will alter us forever.

It was from China in 1974 that the first newly mutated child was noticed by the world. It was a young boy who was able to "see" with his ears. Yes, he could see with his ears in the same way you can see with your eyes—actually, even better. Do you think it is impossible? If you do, then you are in for a life-shaking surprise.

Perhaps I am getting ahead of myself. Let's start here in the United States with a completely different race of new children. These children are called the Indigo children.

### The Indigo Children

The Indigo children, as they are now called by science, were first traced back to the year 1984. This was the year when suddenly a child appeared

with very different human traits, and since that time this new type of human being has spread rapidly. As of 1999, science has suggested that approximately 80 to 90 percent of all the children born in the United States are Indigo children. I believe it probably will rise to nearly 100 percent in the future. You and I are obviously being phased out. These children are being born not only in the U.S., but also in many other areas of the world that seem to be connected with the wide use of computers.

Lee Carroll and Jan Tober have written a book called *The Indigo Children: The New Kids Have Arrived*. It is a book of compiled scientific studies, letters and notes written by medical doctors, psychologists and scientists who have been studying these new children since they were first discovered. It is the first book in the world, I believe, to discuss these new children. I have been aware of these children for the last ten years or more, and I have been discussing them with hundreds of people and children's groups that have also noticed the change. Yet no one officially recognized them until this book appeared. So I thank Lee and Jan for this timely edition. Please read this book if you wish to know more of the details.

Now, how are these children different? Science has not yet figured out exactly what the specific DNA change is that has taken place in this new race, but it is obvious that one has happened. First of all, these children have a different liver than ours, which means there has to be a DNA change. This liver change is, naturally, a response to the new foods we are eating. The new liver is designed to eat, of all things, *junk food!*

Sound funny? Why? We would all become increasingly unhealthy or even die if we continue to eat these kinds of foods on a long-term basis. What happens to cockroaches when you feed them poison? At first they get sick and die, *but then they* mutate, change their DNA and end up loving our poisons. We have to keep changing our poisons because they keep adapting to them. Do you think that human beings are any different? We continue to feed our kids poisonous junk food, so they have to adapt to survive.

But this liver change is nothing compared to the other revisions in human nature and genetics. First of all, these Indigo children are brilliant. They have an IQ that averages around 130, and I do mean average, as many of these kids are way up in the genius range of 160 or higher. A 130 IQ is not a genius, but it used to be that only one person in 10,000 had it. Now it is becoming normal. The intelligence of the human race has just jumped into a new range.

Doctors and psychologists studying these children have found that the computer seems to be an extension of these kids' brains. They are far more able to function within the parameters of computer software than anyone ever before. Where this will lead we can only speculate.

What I find fascinating about these brilliant new kids is that our teachers and the educational system found them defective when judging this new human race. In the beginning our educational system didn't realize they were so intelligent. They have actually thought they were problematic.



They diagnosed them with attention deficit disorder (ADD) because they thought they could not stay focused. The problem is now becoming clear: It is not the children; it is the educational system itself that is not prepared to educate these gifted children. The children are simply bored with the speed and nature of the delivery and the content of the information. We need to adapt to this exciting new race of children. Give an Indigo child who has been tagged as ADD or ADHD something to study that he or she *is interested in*, and you will see the brilliance unfold before your eyes. There is so much we need to learn in order to allow the great potential of these kids to come to light.

It is clear to people studying these children that they also have very heightened psychic abilities. They can literally read their parents' minds. They know what you are thinking. These and other differences you can read about in *The Indigo Children* have led researchers to realize that a new way of raising these children is mandatory. If you have had a child or are raising a child born after 1984, you need to read this book.

Who the Indigo children are, of course, is in great debate. Many psychics are saying that they are coming from the indigo ray, a very high level of consciousness not of this Earth. I also feel this is true, for when I first met the angels in 1971 they began talking about these new children that would come in the future and change the world. They told me many details about them that are coming true at this time.

Also, many psychics I have discussed this subject with feel that there are actually two different cosmic sources for these children. One is the indigo ray and the other is the deep-blue ray, similar but different. Wherever they come from, it definitely is a diversion from the normal human evolutionary track. And the Indigo children are not the only ones who have changed their DNA.

### The Children of AIDS

The children of AIDS are a special grouping of mostly children who have made their DNA change because of a different problem. It was not food (if that *is* a cause) that changed them, but AIDS/HIV.

I recommend that you read a book by Gregg Braden called *Walking between the Worlds: The Science of Compassion*. Mr. Braden was the first one to report this new race in a popular publication. I quote from him: "If we define ourselves genetically, this new species looks different in terms of specific DNA, though their bodies may appear as the familiar bodies of friends and loved ones. On a molecular level, beyond the seeing of the naked eye, they have allowed themselves to become genetic possibilities that were not available just a few short years ago. In the open literature there are reports of a phenomenon that scientists have named *spontaneous genetic mutation*. They are called spontaneous because they appear to have developed during the course of an individual's lifetime in response to a life challenge rather than appear as a new form of the code detected at birth. In these instances,

the genetic code has learned to express itself in a new way that serves the individual's survival."

There is a report of a young boy in kindergarten who was born with HIV. As quoted from Mr. Braden's book [page 81], "Researchers at the University of California, Los Angeles, School of Medicine report unambiguous evidence of a boy who tested positive for HIV twice—at 19 days of age and one month later. Yet by every measure, this kindergartner appears to have been HIV-free for at least 4 years' [in a quote from an article in the April 1995 *Science News*]. The study was reported by Yvonne J. Bryson and her colleagues in the March 30, 1996, *New England Journal of Medicine*.... The virus is not lying dormant within the body, opportunistically awaiting an external cue to become active; it is eradicated from the body!"

This new resistance to HIV infection is so strong that in a few of the cases it was 3000 times more resistant than what it would take to infect a normal person. In all cases their resistance to HIV is noticeably higher. If this were just one small boy showing these changes, it would simply be an interesting phenomenon, but this is not the case. From *Walking between the Worlds*: "A study released in the August 17, 1996, issue of *Science News* reports that about 1 percent of the population tested now have developed genetic mutations that make them resistant to HIV infection!" In October 1999, the United Nations reported that the six-billionth person was born, which means that 1 percent of the population (60,000,000 children and adults worldwide) have altered their DNA to become resistant to HIV.

Exactly what has changed in the DNA of these children is known. It has to do with codons\*. In the human DNA there are four nucleic acids, which combine in sets of three to form 64 codons. Normal human DNA has 20 of these codons turned on, plus three others that act much like the stop-and-start codes in software programming. The rest of these codons are inactive. Science has always thought that these unused codons were from our genetic past, but now that theory is changing. Perhaps they are actually from our future. These children have turned on four more of these "unused" codons, giving them 24, which has completely altered their resistance to HIV infection.

The potential of what this means is staggering. These children appear to have superheightened immune systems. As they are being tested for other diseases, it is becoming clear that they very well may be disease-resistant or even immune to many other, if not all, diseases. Testing in this last area is not yet conclusive.

### The Bible Code and AIDS

I would also like to bring your attention to something taking place in another arena of investigation. This one has to do with the Bible code, the

\* Codon: A sequence of three adjacent nucleotides constituting the genetic code that specifies the insertion of an amino acid in a specific structural position in a polypeptide chain during protein synthesis.

computer code found in the Torah. Some researchers of the Bible code at the Hebrew University in Israel plugged the acronym AIDS into the computer program to see what would happen. You can read in *Cracking the Bible Code* by Jeffrey Satinover, M.D., on page 164, the amazing supportive revelation. "AIDS" brought forth the following words in the matrix: *death, in the blood, from apes, annihilation, in the form of a virus, the HIV, the immunity, destroyed*—all words you would expect from the search term AIDS. But in the matrix was also a phrase that made no sense to the Bible code researchers in Israel, because they didn't know what was happening with AIDS research here in America. In the matrix of AIDS it was clearly stated, "the *end to all diseases*"! I believe this new race of children will eventually make its mark on humanity in a way that will change forever the experience of being alive on Earth.

In the beginning of this section, Mr. Braden mentioned the phrase "spontaneous genetic mutation"—spontaneous because it takes place during a person's lifetime, not before birth. What does this mean to you? When this mutation was first discovered, it was always in children, but over time science has found more and more adults who have followed these children and mutated in exactly the same manner. This is exciting, because it means that you and I, even if we don't have AIDS, might possibly alter our DNA to superstrengthen our immune system just as they have. How is this possible?

You are all aware of the hundredth-monkey theory. (We mentioned this in chapter 4, page 106.) It was first a young female monkey, a child, that began to wash the sand off her potatoes. Then her friends, who were also children, imitated her. Soon the mothers began to imitate their children, and finally the fathers. At one point the potato-washing phenomenon, in a single day, expanded to the other monkey-inhabited islands, even to the mainland of Japan. In the same way, it may be possible that you and I can change our DNA to give us a superstrong immune system.

We are researching this exciting possibility ourselves at this moment, using the Mer-Ka-Ba and meditation. In the same way that attention and intention are the key to psychic abilities, placing your attention on your DNA and having the intention for it to change in the same way as these kids' DNA is a definite possibility for evolutionary change. What is happening with the following third new race of children will present further possibilities.

### The Superpsychic Children

The superpsychic children are perhaps the most unusual and charismatic race being born today. Their dramatic abilities distinguish them from the other two races with their sensational demonstrations. These children are able to do things that most people thought could be done only in movies with computer graphics. What is so amazing of all is that it is real. If these children don't change our world, nothing will. Notice how some of the

abilities of these children resemble the manifestations of consciousness we talked about in chapter 18, during the dimensional shift. What you think is what you get! These children are able to demonstrate that whatever they think becomes reality.

Paul Dong and Thomas E. Raffill wrote *China's Super Psychics*. It reports what has been transpiring in China around these new psychic children who have begun to emerge since 1974 with the young boy who could see with his ears. Actually, the Chinese government claims that these children, when blindfolded, could see either with their ears, nose, mouth, tongue, armpits, hands or feet. Each child was different and their vision from these unheard-of areas was perfect. These tests were not just a percentage right some of the time; they were flawless.

I first spoke about these children in 1985 when I mentioned the article about them in *Omni* magazine. *Omni* was invited to come to China to observe some of these children and write an article about them. *Omni* assumed that there might be cheating involved, so when they were given some of these children to test, they conducted their examinations in a way that ruled out any possible cheating. They left nothing to chance.

One of the tests began this way: With the children present, *Omni* took a stack of books and at random selected one of them, then opened the book at random and ripped out a page, crumpling it up into a small ball. *Omni* then placed it in the armpit of one of these children—and this child could read every word on the page perfectly! After many varied tests, *Omni* became convinced that the phenomenon was real, but they could not explain how these kids were doing it. Their report was released in their January 1985 issue.

But *Omni* was not the only one to send researchers to observe these children. Several other world magazines and also papers in respected journals such as *Nature*, a prestigious science magazine, have also agreed that this phenomenon is real.

In Mexico City we found exactly the same new human traits emerging in the children there. There may be more, but we found over 1000 children able to see with various parts of their bodies. What is noticeable is that these Mexican children can see with the very same parts of the body as the Chinese children do. It sounds like this DNA mutation has jumped across the ocean just as in the hundredth-monkey phenomenon. Soon I will come back to one of these children, now nineteen, to give my direct experience of the abilities she demonstrated to us.

According to Paul Dong in *China's Super Psychics*, seeing with various parts of the body was the psychic ability that caught the attention of the Chinese government, but this ability was quickly understood to be only the tip of the iceberg. These children began to demonstrate other psychic abilities that are truly difficult to accept inside this "normal" reality.

Mr. Dong reports how several times a large audience of a thousand people or more would enter *the* auditorium and *be* handed a live rosebud. When everyone was seated and quiet, the demonstration would begin with

a young Chinese girl, about six years old, who would come on stage all by herself and stand in the center facing the audience. Then with a silent wave of her hand, the thousand rosebuds would slowly open into full-blown, beautiful roses before the eyes of the astonished audience.

Mr. Dong also speaks of how over 5000 young children have demonstrated in public another amazing feat. Realize here that the Chinese government has carefully tested these children to see if what I am about to say is real or not. The government is convinced it is true.

One child would take a sealed bottle of pills off a shelf at random, like vitamin pills, for example. The bottle would be sealed with the original plastic wrap and have a tightly screwed metal or plastic top. The bottle would then be placed in the center of a large bare table. Then a video camera would observe what happened next.

The child would say to the audience that he/she was beginning, but nothing was visible to the audience. Suddenly, the pills inside the sealed bottle would pass right through the glass and appear on the table. In many cases, the child would then take another object, such as a coin, set it on the table, and it would pass into the sealed bottle. This demonstration and others like it are definitely approaching what I would call fourth-dimensional consciousness. What you think and what happens are connected.

There are several other psychic abilities that have been demonstrated in China, according to this book. If you are interested, read what has been reported. You may think that this is just magic tricks, but when you see these things in person, it is very hard to explain. For the first ten years the Chinese government would not believe it either, until the number of these children who could do these things kept growing. By the time *China's Super Psychics* was released in 1997, the Chinese government had identified over 100,000 of these children. In fact, by about 1985, the government and the Chinese scientific community simply had to admit it was true.

Because they realized what this could mean, the government set up training schools to assist these children in their psychic abilities. Whenever a psychic child is found now, he or she is sent to one of these schools. Important is the fact that they have found that they can even take children who are not known to be psychics and in the presence of the naturally psychic kids, the trained children can perform the same wonderful feats.

This brings forth the memory of Uri Geller, the famous psychic from Israel who could bend metal objects just by looking at them. In his book, *Uri Geller, My Story*, he talks about when he demonstrated his psychic abilities on television throughout Europe. He went on TV and asked people to get knives, spoons and forks and place them in front of the television set. With millions of witnesses, he then bent tableware before their eyes *and* tableware in the homes in Europe who were watching the show. This single act had an interesting side effect. From the phone calls immediately after the show and the following days, it was discovered that over 1500 children were able to do the same thing *just by seeing it happen one time*. They could all

bend the metal tableware with their minds.

People, especially scientists, were convinced that Mr. Geller was a magician and that everything he did was a trick of some kind. Stanford Research Institute asked if he would submit his magic to scientific scrutiny. Mr. Geller agreed. For a period of time Mr. Geller did whatever Stanford asked him to do to prove once and for all that his psychic ability was not a trick.

Just to give you an idea of how tight the testing at Stanford was, one of the tests placed Mr. Geller in a sealed steel room, which was also a Faraday cage (a room where electromagnetic fields, such as radio waves and even brain waves or thoughts, could not pass through the walls). He was sealed in physically as well as energywise. The Stanford researchers placed outside the test chamber a sealed, hand-blown glass tube that was twisted on each end so that it could not be opened without breaking it. Inside it was a piece of the hardest metal known to man. Then they told Mr. Geller to bend it. With all their scientific instruments recording the test, Stanford scientists watched in total amazement as the piece of superhard metal bent as if it were Jell-O. Mr. Geller could in no way have cheated.

What is so impressive is that besides Mr. Geller, there were about 15 children from Europe who could also do these things, and they were tested along with him. Everything that Stanford did to test Mr. Geller they also did with the children, and these kids could do everything he could do. So if this was a trick, then 15 children were also "advanced magicians," and Stanford Research Institute, with all their scientific magic, could not detect fraud.

This test and the rest of the research from Stanford was printed in *Nature* magazine in its October 1974 issue. The *New York Times* immediately came out with an editorial that said: "The scientific community has been put on notice 'that there is something worthy of their attention and scrutiny' in the possibilities of extrasensory perception." Yet here we are in the next millennium, and science still will not seriously admit that the human potential for psychic abilities is real. I believe that these new children appearing around the world will soon force science into accepting what has always been true. The old paradigm has nowhere to go and must dissolve.

In Denver, Colorado, in July 1999, I spoke about these new children to a large audience. I asked a young woman named Inge Bardor from Mexico to demonstrate directly to this audience her ability to see with her hands and feet. At that time she was eighteen years old. For about an hour, Inge placed a blindfold around her eyes and accepted photographs at random from the audience. She would hold the photograph and lightly touch it with the fingertips of her other hand.

First she would describe the picture perfectly, as though she was looking at it, but then she would become more specific, giving information that would be impossible for her to know even from a photo. She could tell everything about the people or place in the photo. She could tell exactly

where the photo was taken and what was around the area outside the view, such as a lake or buildings.

Inge could even describe the person who took the photograph and what he/she was wearing that day. She could tell you what everyone in the photo was thinking at the moment the picture was taken. In one photo of the inside of a house, Inge went into the house psychically and described exactly what was down the hallway. She even described what was on the bedside table.

Finally someone placed a newspaper under Inge's feet, and with her high-heeled shoes on, she was able to read the paper as if it was in her hands and she wasn't blindfolded. (If you are interested in this video, please call Lightworks Video at 1-800-795-TAPE and ask for "Through the Eyes of a Child.")

Under the strict discipline of scientific research, the Chinese government has observed these children changing the human DNA molecule in a petri dish before cameras and scientific equipment necessary to record this supposedly impossible feat. If this is true, which the Chinese government claims, would *we* not be able to change our own DNA with just the right understanding? I think so. Just follow the children.

How is it possible that 60 million people in the world have already changed their DNA to drastically improve their immune systems against HIV infection through spontaneous genetic mutation, if not through a process similar to what our new children of China have demonstrated? This is a grand time in the history of the Earth—and you are alive to experience this extraordinary world change!

I was recently in Russia, in September 1999, and there I spoke with many Russian scientists about these new children. I talked with people who asked me not to print their names, but some were on boards of directors that controlled over 60 Russian scientific communities, including the Russian space program. They told me personally that what was happening in China was also happening in Russia. Thousands of Russian children were exhibiting the same kinds of psychic abilities. I am convinced that these three new races of children are truly a worldwide phenomenon, one that is altering the human experience on Earth forevermore.

## The Fourth-Dimensional Shift and the Superkids

The question is, have we actually entered the fourth dimension and recreated it to appear like the third dimension? It does seem this way as I observe these new children. But the truth will come out of its own accord. Now that you know the nature of the original Reality mingled with the Lucifer reality, search your own heart. Is it true? Look inside yourself. Are *you* changing? Are you even remotely the same person you were just a few years ago? And now that you are exploring, or about to explore, your higher consciousness with your lightbody, the Mer-Ka-Ba, will your life ever be the same? Birth has its way of making everything new again.

## Life Is Great

We live in a world that exists only in the mind of God. It is only light. Using sacred geometry, the Mother/Father spirit of life has created a universe of light for us to play in and love each other. We are the children of God. Great Spirit expresses through each one of us and speaks of worlds of consciousness far above the ordinary life of humanity. We hold within us a potential so great that if all the adjectives in the dictionary were compressed into one word, it would still not fully describe the innate greatness shining out of the eyes of a single ordinary, everyday child.

You have a choice. You can continue to live life from the normal human perspective, where the only reason for being alive is to become comfortable through material things or to gain control over other human beings through force—or realize that the outer world is not something you appropriate, but rather an opportunity to express joy and love in your life. The outer world and our inner world are one.

Breathe deeply the pure life force into your glowing chakras and let your Mer-Ka-Ba live. Open your heart fearlessly to the unknown and look with the eyes of a child into the eyes of God in each person who stands before you. It is all so simple.

I love you.  
Drunvalo



## NOTE TO THE READER

The Flower of Life Workshop was presented internationally by Drunvalo from 1985 until 1994. This book is based on a transcript of the third official videotaped version of the Flower of Life Workshop, which was presented in Fairfield, Iowa, in October 1993. Each chapter of this book corresponds more or less to the same-numbered videotape of that workshop. However, we have changed the written format where necessary to make the meaning as clear as possible. Hence, we've shuffled paragraphs and sentences and occasionally even whole sections to their ideal locations so that you, the reader, can glide through this with the greatest of ease.

Please note that we have added current updates throughout the book, which are in boldface. These updates begin in the margin alongside the old information. Since so much information was presented in the workshop, we have divided the material into two parts, each with its own table of contents. This is volume 2.

For those who wish to locate a facilitator in their area, see the Flower of Life Web site [www.floweroflife.org](http://www.floweroflife.org) or call the Flower of Life Headquarters in Phoenix, Arizona (English only) at (602) 996-0900 or fax (602) 996-4970. Or call the Latin American division office at 52-5-846-0007 in Mexico City (Spanish and English available).



# MAAT RESEARCH

## The Way of Truth



*Maat is the ancient Egyptian goddess of Truth. She is still alive  
in the hearts of those who love the Mother.*

In the summer of 2000, a new Web site will open that seeks to find integrity in the world's information. This is important, for we believe that the Internet is forming a global brain and birthing a new type of planetary communication. At the moment, there is so much distortion of information moving through the Web that it is akin to being mentally unbalanced, not knowing what is reality and what is not. The truth would bring clarity. Most important, truth might just find the answer (s) to save ourselves from ourselves. We might even find peace.

How will this be accomplished? This site will report the truth on a specific subject as it is known and give all supporting documentation. It will not merely refer to a specific source, but actually show the documentation whenever possible or tell you how to get it so that everyone can make their own interpretation of what is being claimed.

Once all known documents are released, the site will ask the public to respond with what they personally know. Anything that anyone in the world knows that can be proven will be checked out and posted on the site, providing a data bank of reliable knowledge and a search engine to find what is needed.

Whereas most news agencies report on a subject only once and perhaps never talk about it again, we will maintain the subject and keep building the database until the truth reveals itself.

Nine months in the birthing, Maat Research will soon open just for you and for Mother Earth.

[www.maatresearch.com](http://www.maatresearch.com)

*If you really want to know.*

## REFERENCES

### Chapter I

- Liberman, Jacob, *Light, the Medicine of the Future*, Bear & Co., Santa Fe, NM, 1992.
- Temple, Robert K.G., *The Sirius Mystery*, Destiny Books, Rochester, VT ([www.gotoit.com](http://www.gotoit.com)).
- Satinover, Jeffrey, M.D., *Cracking the Bible Code*, William Morrow, New York, 1997.
- West, John Anthony, *Serpent in the Sky*, Julian Press, New York, 1979, 1987.
- Cayce, Edgar: many books have been written about him; the Association for Research and Enlightenment in Virginia Beach, VA, is a source of an enormous amount of material. Perhaps the most well-known book is *The Sleeping Prophet* by Jess Stearn.

### Chapter 2

- Lawlor, Robert, *Sacred Geometry: Philosophy and Practice*, Thames & Hudson, London, 1982.
- Hoagland, Richard C; see [www.enterprisemission.com/](http://www.enterprisemission.com/).
- White, John, *Pole Shift*, 3rd ed., ARE Press, Virginia Beach, VA, 1988.
- Hapgood, Charles, *Earth's Shifting Crust* and *The Path of the Pole* (out of print).
- Braden, Gregg, *Awakening to Zero Point: The Collective Initiation*, Sacred Spaces/Ancient Wisdom Pub., Questa, NM; also on video tape (Lee Productions, Bellevue, WA).

### Chapter 3

- Hamaker, John and Donald A. Weaver, *The Survival of Civilization*, Hamaker-Weaver Pub., 1982.
- Sitchin, Zecharia, *The 12th Planet* (1978), *The Lost Realms* (1996), *Genesis Revisited* (1990), Avon Books.
- Begich, Nick and Jeanne Manning, *Angels Don't Play This HAARP*, Earthpulse Press, Anchorage, AK, 1995.

### Chapter 4

- Keyes, Ken, Jr., *The Hundredth Monkey*, Vision Books, 1982, not copyrighted. Obtainable [www.testament.org/testament/100thmonkey.html](http://www.testament.org/testament/100thmonkey.html) and other Web sites.
- Watson, Lyall, *Lifetide*, Simon and Schuster, New York, 1979.
- Strecker, Robert, M.D., "The Strecker Memorandum" (video), The Strecker Group, 1501 Colorado Blvd., Eagle Rock, CA 90041 (203) 344-8039.

The *Emerald Tablets of Thoth the Atlantean*, translated by Doreal, Brotherhood of the White Temple, Castle Rock, CO, 1939. Obtainable from Light Technology Publishing.

### Chapter 6

Anderson, Richard Feather (labyrinths); see [www.gracecom.org/veriditas/](http://www.gracecom.org/veriditas/).  
Penrose, Roger; see <http://galaxy.cau.edu/tsmith/KW/goldenpenrose.html>  
<http://turing.mathcs.carleton.edu/penroseindex.html>; [www.nr.infi.net/~drmatrix/progchal.htm](http://www.nr.infi.net/~drmatrix/progchal.htm).

Adair, David; see [www.flyingsaucers.com/adairl.htm](http://www.flyingsaucers.com/adairl.htm).

Winter, Dan, *Heartmath*; see [www.danwinter.com](http://www.danwinter.com).

Sorrell, Charles A., *Rocks and Minerals: A Guide to Field Identification*, Golden Press, 1973.

Vector Flexor toy, available from Source Books (see below).

Langham, Derald, *Circle Gardening: Producing Food by Genesa Principles*, DevhvAdair Pub., 1978.

### Chapter 7

Charkovsky, Igor; see [www.earthportals.com](http://www.earthportals.com); [www.vol.it/](http://www.vol.it/); [www.well.com](http://www.well.com).  
Doczi, Gyorgy, *The Power of Limits: Proportional Harmonies in Nature, Art and Architecture*, Shambhala, Boston, MA, 1981, 1994.

### Chapter 8

"Free Energy: The Race to Zero Point" (video), available from Lightworks, (800) 795-8273, \$40.45 ppd., [www.lightworks.com](http://www.lightworks.com).

Pai, Anna C. and Helen Marcus Roberts, *Generics, Its Concepts and Implications*, Prentice Hall, 1981.

Critchlow, Keith, *Order in Space: A Design Source Book*, Viking Press, 1965, 1969 and other books are out of print; see [www.wwnorton.com/thames/aut.td/at03940.htm](http://www.wwnorton.com/thames/aut.td/at03940.htm).

### Chapter 9

Lamy, Lucie, *Egyptian Mysteries: New Light on Ancient Knowledge*, Thames and Hudson, London, 1981.

Albus, James S., *Brains, Behavior and Robotics*, Byte books, 1981 (out of print).

The *Unknown Leonardo*, Ladislav Reti, ed., Abradale Press, Harry Abrams, Inc., Publishers, New York, 1990 ed.

Blair, Lawrence, *Rhythms of Vision: The Changing Patterns of Myth and Consciousness*, Destiny Books, 1991 (out of print).

Martineau, John, *A Book of Coincidence: New Perspectives on an Old Chestnut*, Wooden Books, Wales, 1995 (out of print).

### Chapter 10

Hall, Manley P., *The Secret Teachings of All Ages*, Philosophical Research Society of Los Angeles, 1978.

### **Chapter 11**

Hancock, Graham and Robert Bauval, *The Message of the Sphinx: A Quest for the Hidden Legacy of Mankind*, Crown Publishers, Inc., 1996.

### **Chapter 12**

Puharich, Andrija, *The Sacred Mushroom*, Doubleday, 1959 (out of print).  
Cayce, Edgar, *Auras: An Essay on the Meaning of Color*, A.R.E. Press, Virginia Beach, VA, 1989.

### **Chapter 13**

Ramacharaka, Yogi, *Science of Breath: A Complete Manual of the Oriental Breathing Philosophy of Physical, Mental, Psychic and Spiritual Development*, Yoga Publishers Society, 1904.

### **Chapter 19**

Carroll, Lee, and Jan Tober, *The Indigo Children: The New Kids Have Arrived*, Hay House, Carlsbad, CA, 1999.  
Braden, Gregg, *Walking between the Worlds: The Science of Compassion*, Radio Bookstore Press, Bellevue, WA, 1997.  
Satinover, Jeffrey, M.D., *Cracking the Bible Code*, William Morrow, New York, 1997.  
Dong, Paul, and Thomas E. Raffill, *China's Super Psychics*, Marlowe & Co., New York, 1997.  
Geller, Uri, *Uri Geller, My Story*, Praeger Press, New York, 1975 (out of print).  
"Through the Eyes of a Child," 2-video set from Lightworks, (800) 795-TAPE (795-8273).

Most of the books and sacred geometry tools, in addition to posters, kits, videos, tapes and CDs recommended in this workshop, are available from Source Books, P.O. Box 292231, Nashville, TN 37229-2231, (800) 637-5222 (in U.S.) or (615) 773-7652. Catalog available.

**Template for a  
STAR TETRAHEDRON**

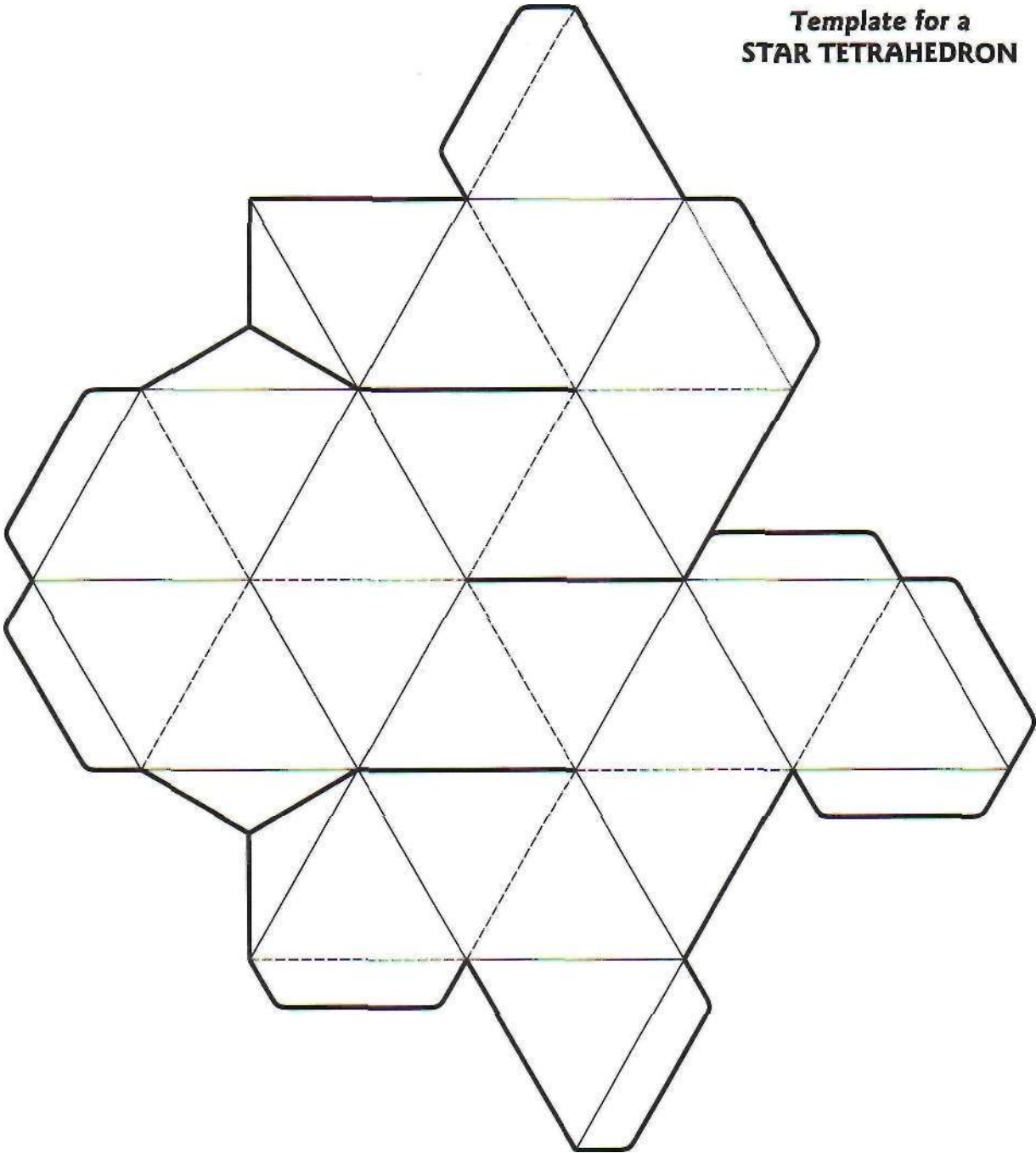

**Instructions:**

1. Cut out the outline.
2. Cut along all heavy lines.
3. Score plain lines on the front.
4. Score dotted lines on the back.
5. Fold triangles upward along plain lines.
6. Fold triangles downward along dotted lines.
7. Glue or tape tabs to form small tetrahedrons.
8. Continue until you have a star tetrahedron.

Note: This will take concentration, so don't be discouraged. (It might be helpful to make several copies.)

## CONTENTS

Introduction . . . . .	xi
<b>NINE Spirit and Sacred Geometry</b>	<b>225</b>
<i>The Third Informational System</i>	
<i>in the Fruit of Life-</i> .....	225
The Circles and Squares of Human Consciousness. . . . .	225
Finding Near-Perfect Phi Ratios. . . . .	226
The First and Third Levels of Consciousness. . . . .	227
Locating the Second Level. . . . .	228
Geometric Lenses to Interpret Reality. . . . .	229
Superimposing the Fruit of Life. . . . .	230
Lucie's Genius. . . . .	230
Lucie's Ladder. . . . .	231
Side Note: Sacred Geometry Is a Do-It-Yourself Project. . . . .	233
A Snag in the Ladder. . . . .	234
<i>The Three Lenses.</i> . . . .	235
Square Roots and 3-4-5 Triangles. . . . .	236
Leonardo's and CBS's Eye. . . . .	237
Vitruvius' 10 by 12. . . . .	238
10,000 Years to Figure Out. . . . .	239
<i>Vitruvius and the Qreat Pyramid.</i> . . . .	240
The Search for a 14 by 18. . . . .	241
<i>The Unknown Leonardo.</i> . . . .	242
<i>A Qreat Synchronicity.</i> . . . .	245
Earth-Moon Proportions. . . . .	246
Earth, Moon and Pyramid Proportions. . . . .	248
<i>Rooms in the Qreat Pyramid.</i> . . . .	248
More Rooms. . . . .	250
The Initiation Process. . . . .	250
Light Reflectors and Absorbers above the King's Chamber. . . . .	251
<i>Comparing the Levels of Consciousness</i> .....	252
Catching the White Light. . . . .	252
Proof of the Initiation Chamber. . . . .	254
Catching the Dark Light. . . . .	255
The Halls of Amenti and the Face of Jesus____	256
<i>Summary of the Initiation Process</i> .....	256