

*Fallout Shelter Surveys:*

**GUIDE FOR  
ARCHITECTS AND ENGINEERS**

**NP-10-2**

**National Plan Appendix Series**



**Executive Office of the President**

**OFFICE OF CIVIL AND DEFENSE MOBILIZATION**

*Fallout Shelter Surveys:*

**GUIDE FOR  
ARCHITECTS AND ENGINEERS**



(NP-10-2 National Plan Appendix Series)

May 1960

(Reprinted July 1960)

Executive Office of the President

OFFICE OF CIVIL AND DEFENSE MOBILIZATION.

# CONTENTS

	Page
INTRODUCTION.....	iv
I. SHIELDING FUNDAMENTALS.....	1
Fallout.....	1
Fallout gamma radiation.....	2
Shielding terminology.....	3
Barrier effects.....	4
Geometry effects.....	4
II. SHIELDING CALCULATIONS.....	6
Roof contribution.....	6
Skyshine contribution.....	6
Ground contribution (aboveground areas).....	7
Ground contribution (belowground areas).....	7
Height effects.....	8
Mutual shielding.....	8
Apertures.....	8
Perimeter ratio.....	9
III. SPACE AND VENTILATION.....	10
General.....	10
Area and volume requirements.....	10
Ventilation requirements.....	11
Filter requirements.....	12
IV. WATER SUPPLY AND SANITATION.....	13
General.....	13
Water supply requirements.....	13
Sanitary requirements.....	13
V. POWER SUPPLY AND OTHER FACTORS.....	15
Electric power requirements.....	15
Entrances and exits.....	15
Hazards.....	16
VI. COMMUNITY SURVEY PROCEDURES.....	17
Data collection.....	18
Data analysis.....	19
Reports.....	20

## SUPPLEMENTS

	Page
<b>SUPP. A—SAMPLE FORMS</b>	
Part 1—Data collection form.....	23
Part 2—Shielding analysis outline (roof contribution).....	26
Part 3—Shielding analysis outline (ground contribution—above-ground areas).....	27
Part 4—Shielding analysis outline (ground contribution—below-ground areas).....	28
Part 5—Shielding analysis outline (summary).....	29
Part 6—Data summary form.....	31
<b>SUPP. B—SHIELDING ANALYSIS CHARTS AND EXAMPLES OF CALCULATIONS</b>	
Chart 1—Barrier shielding effects.....	33
Chart 2—Reduction factors for combined shielding effects (roof contribution).....	35
Chart 3—Reduction factors for combined shielding effects (ground contribution—aboveground areas).....	37
Chart 4—Reduction factors for combined shielding effects (ground contribution—belowground areas).....	39
Chart 5—Shielding effects of height.....	41
Chart 6—Reduction factors for apertures, ground floor.....	43
<b>TABLES OF CORRECTION FACTORS</b>	
Table CF-1—Aperture correction to ground contribution.....	44
Table CF-2—Skyshine correction to roof contribution.....	44
Table CF-3—Mutual shielding correction to ground contribution.....	44
<b>SUPP. C—BRIEF TABLE OF MASS THICKNESSES</b> .....	45
<b>SUPP. D—ASSUMPTIONS USED IN DEVELOPMENT OF PROCEDURES FOR SHIELDING CALCULATIONS</b> .....	47
<b>SUPP. E—COMPUTATIONAL FORMS</b>	
Part 1—Condensed shielding analysis (aboveground areas).....	49
Part 2—Condensed shielding analysis (belowground areas).....	50
Part 3—Wall-by-wall shielding analysis (aboveground areas).....	51
Part 4—Wall-by-wall shielding analysis (belowground areas).....	52

## INTRODUCTION

The purpose of this guide is to provide architects and engineers with procedures and standards for (1) evaluating the fallout shelter potential of existing structures, and (2) modifying structures from the standpoint of radiation shielding and habitability to improve their worth as fallout shelters. These same procedures and standards may be used for preliminary design to incorporate shelter into new structures.

The standards suggested in this guide are not meant to obviate the sound professional judgment that individual cases will require. However, it is important when considering fallout shelter standards to keep in mind that *survival* is the paramount issue and that comfort is secondary. Therefore, engineering practices that have been proved sound for peacetime purposes may be somewhat unrealistic if followed to the letter in designing fallout protection. For example, local building codes and zoning regulations may require over-design of shelters as far as survival requirements are concerned. In such cases, exceptions to the local regulations should be sought.

Emphasis in this guide is on procedures for collecting, analyzing, and summarizing information on potential shelter areas. A suggested Data Collection Form and a Data Summary Form are shown in supplement A. Detailed analysis procedural forms, intended primarily for informa-

tional and instructional purposes, also are shown in supplement A. Condensed analysis forms are in supplement E.

Explanation of the various symbols used is given in the shielding analysis outlines, parts 2, 3, and 4, supplement A.

Six charts in supplement B are used in making shielding calculations.

The methods of evaluating radiation protection used in this guide were developed from radiation penetration studies sponsored by the Office of Civil and Defense Mobilization and the Department of Defense since 1956 at the National Bureau of Standards of the Department of Commerce. The Atomic Energy Commission cooperated with OCDM in testing the theories developed from these studies. In addition, members of a subcommittee on radiation shielding of the Committee on Civil Defense, National Academy of Sciences, aided in the development of procedures described in this guide.

Architects and engineers, to whom this guide is addressed, should also read the first publication in this OCDM series, NP-10-1, *Fallout Shelter Surveys: Guide for Executives*. NP-10-1 provides background guidance for the executive—in government, industry, or other large facility—responsible for planning and directing a fallout shelter survey.

# I. SHIELDING FUNDAMENTALS

## FALLOUT

The detonation of a nuclear weapon near the ground causes large quantities of earth and debris to be forced up into the fireball and the resulting mushroom-shaped cloud—a cloud which may reach an altitude of 15 miles or more before leveling off. The earth and debris particles in the cloud vary in size from fine powder to large grains, and it is these particles which act as the sources of radiation that can damage living cells.

Most of the particles fall back to the earth's surface within 2 days—"early fallout"—but some remain aloft far longer—"delayed fallout." (See fig. 1.) In a nuclear attack the immediate and most serious danger would be from early fallout. Therefore, the term fallout as used in this manual refers to early fallout only.

Significant amounts of fallout do not arrive outside the blast area earlier than about one-half hour after an explosion. From then on, it begins to cover an increasingly large area and may eventually blanket thousands of square miles. At any given location, however, the elapsed

time between the arrival of fallout and the cessation of deposition may be a matter of hours.

The distribution of fallout over large regions, and possible coverage of much of the Nation, is discussed in the first publication of this OCDM series, NP-10-1, *Fallout Shelter Surveys: Guide for Executives*.

In this guide, attention is given to the distribution of fallout particles around and on specific types of structures. It is probable that flat, builtup roofs with parapet walls would collect and retain more fallout than other roof types; and that smooth, sloping roofs without dormers or monitors would collect and retain the least. However, in the case of sloping roofs, fallout may collect in the eavestroughs and remain for some time. Effects of wind, rain, and snow on fallout deposition on various roof types are only qualitatively known. Therefore, except for special conditions indicated in part II of this guide, "Shielding Calculations," fallout will be assumed to cover roof surfaces uniformly—according to their horizontal projections (fig. 2). Further, it will be assumed that no significant amounts of fallout enter the structure itself.

Fallout deposition in the area around a structure may be of equal or greater importance than that on the structure itself. Among the factors affecting local distribution of fallout around a structure are the type, and relative location and height, of nearby buildings; position of the structure relative to geographic features, such as hills, depressions, and bodies of water; and the nature of surrounding surfaces and grounds, such as paved or unpaved, wooded or cleared. The effects of the more important factors will be discussed in part II of this guide. In general, it will be assumed that fallout covers the area surrounding the structure uniformly.

Once fallout is on the ground it may be further redistributed by the action of wind, rain, and snow. This is termed "weathering." The effects of weathering are so variable and complex they will not be considered in this guide.

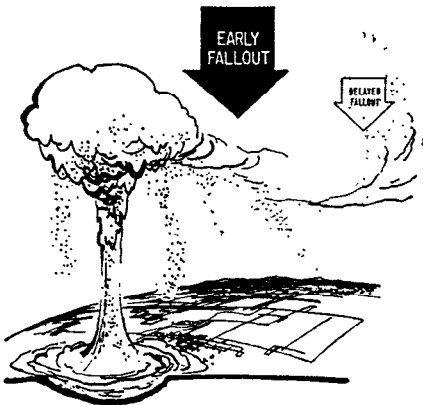

FIGURE 1.—Formation of fallout.

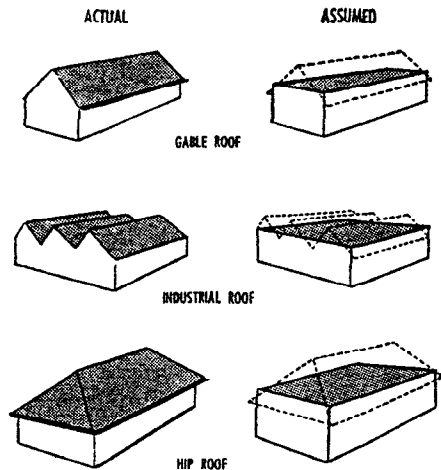

FIGURE 2.—Fallout on roofs.

Early fallout particles are generally assumed to be mostly within a range of 50 to 500 microns in size.

Three different kinds of radiation are associated with fallout—alpha and beta particles, and gamma rays. Radioactive materials that give off alpha and beta particles may be dangerous if they are ingested through contaminated food, water, or air, but from the shelter standpoint they present no problem. Alpha particles cannot penetrate the external layer of skin, and beta particles cannot penetrate heavy clothing. However, *gamma rays, like X-rays, are highly penetrating, and can cause serious damage to living tissue. The primary aim of fallout shelter is to provide a shield against gamma radiation.*

## FALLOUT GAMMA RADIATION

Exposure doses of fallout gamma radiation are measured in units called roentgens (r). Indications of the physiological effects of various acute exposure doses are given in figure 3.

The radioactivity of fallout decreases with time—rather rapidly at first, but more slowly as time passes. A convenient rule to remember for this decay process is that for every sevenfold increase in time after detonation, the dose rate decreases by a factor of 10. For example, 3 hours

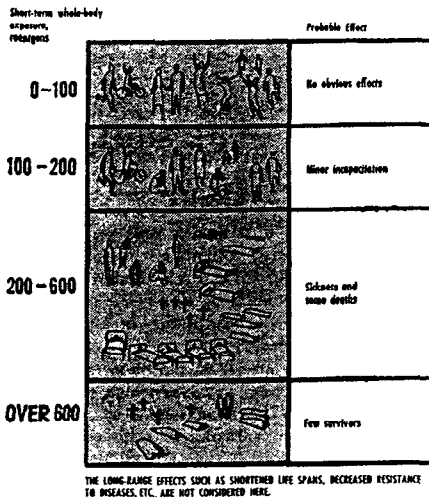

FIGURE 3.—Acute effects of gamma radiation.

after a nuclear explosion, measurements taken in an area where fallout is no longer accumulating on the ground indicate a dose rate of 50 roentgens per hour (r/hr). Assuming no weathering effects, the dose rate 18 hours later (21 hours after the explosion) would be 5 r/hr. (The quotient of the elapsed time ratio (21/3) is 7, and the predicted dose rate, 5 r/hr, is  $\frac{1}{7}$ th the 3-hour dose rate.)

Gamma radiation striking a barrier can be (1) absorbed by the barrier, (2) scattered within the barrier, or (3) passed through the barrier unchanged in direction. (See fig. 4.) What happens in any given case is largely determined by the thickness of the barrier and the penetrating power of the radiation. See page 4 for a discussion of "Barrier Effects."

The penetrating power of gamma radiation is related to its energy. A convenient unit of measure for this energy is "Mev" (million electron volts). Generally, the higher the energy of gamma radiation striking a barrier, the thicker the barrier must be to reduce the amount of radiation passing through it by a given factor. For example, 12 inches of concrete is required to reduce gamma radiation of  $\frac{1}{2}$  Mev by a factor of 100; 15 inches if the energy is 1 Mev; and about 20 inches if the energy is 2 Mev.

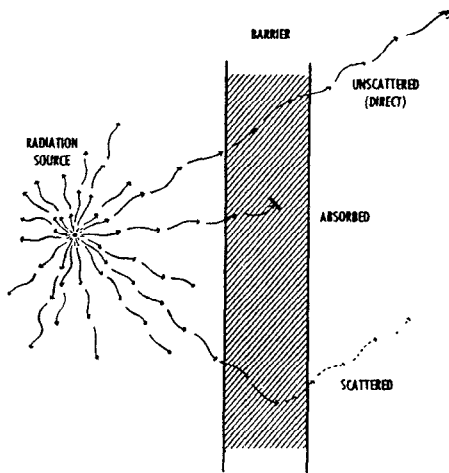

FIGURE 4.—Gamma radiation paths.

Gamma radiation from fallout consists of many energy components. These may vary up to about 3 Mev. All of the charts in this guide take into consideration the spectrum of energies associated with fission products about 1 hour after an assumed detonation. The net penetrating effect of this spectrum of energy is roughly equivalent to that of cobalt-60, for which the average energy is about  $1\frac{1}{4}$  Mev.

## SHIELDING TERMINOLOGY

Protection from the effects of fallout gamma radiation may be achieved in two ways. One method is to place a barrier between the fallout field and the individual. This is termed "barrier shielding." The second method is to increase the distance of the individual from the fallout field and/or reduce the extent of the fallout field contributing to the individual's dose. This is termed "geometry shielding."

In most analyses it is necessary to consider the effects of both barrier and geometry shielding. This is termed "combined shielding."

The location of the position in the structure to be analyzed for shelter is termed the "detector position" or simply the "detector."

The term "protection factor" expresses the relative reduction in the amount of radiation that would be received by a detector in a protected

location compared to the amount it would receive if it were unprotected. For convenience of calculation, the reciprocal of the protection factor, called the "reduction factor," is used. Reduction factors, expressed as decimals, can be added when combining the effects of fallout on the roof over the detector (roof contribution) and fallout on the ground surrounding the detector (ground contribution). For example, the roof contribution at a given detector position may be 0.015, and the ground contribution at this point 0.010. The sum of these, 0.025, would be the total reduction factor. The protection factor in this case would be the reciprocal of 0.025, or 40.

Table 1 relates shelter categories to corresponding protection factors. It is intended to provide

TABLE 1.—Description of shelter categories

Shelter category	Protection factor <sup>1</sup>	Common examples <sup>2</sup>
A.....	1,000 or greater.	OCDM underground shelters. Subbasements of multistory buildings. Underground installations (mines, tunnels, etc.).
B.....	250 to 1,000.	OCDM basement fallout shelters (heavy masonry residences). Basements (without exposed walls) of multistory buildings. Central areas of upper floors (excluding top 3 floors) of high-rise buildings <sup>3</sup> with heavy floors and exterior walls.
C.....	50 to 250....	OCDM basement fallout shelters (frame and brick veneer residences). Central areas of basements (with partially exposed walls) of multistory buildings. Central areas of upper floors (excluding top floor) of multistory buildings with heavy floors and exterior walls.
D.....	10 to 50....	Basements (without exposed walls) of small 1- or 2-story buildings. Central areas of upper floors (excluding top floor) of multistory buildings with light floors and exterior walls.
E.....	2 to 10....	Basements (partially exposed) of small 1- or 2-story buildings. Central areas on ground floors in 1- or 2-story buildings with heavy masonry walls.
F.....	2 or less....	Aboveground areas of light residential structures.

<sup>1</sup> This term expresses the relative reduction in the amount of radiation that would be received by a person in a protected location, compared to the amount he would receive if he were unprotected.

<sup>2</sup> These examples refer to isolated structures.  
<sup>3</sup> For the purposes of this example, "high-rise" buildings are those greater than about 10 stories; multistory buildings are those from 3 up to about 10 stories.



(1) a general idea of the relative amounts of protection offered by common types of buildings, and (2) a preliminary estimate of potential shelter areas for survey programing purposes. These protection factors may be conservative in many cases since they are based on isolated structures. For example, in the case of a building surrounded by taller buildings, the protection factor might be increased sufficiently to raise it to a higher category. In any case, on-site examination and practical judgment must be used before a protection factor is assigned to any given structure.

## BARRIER EFFECTS

If a shield is placed between a radiation source and a detector, there will be a reduction in the detector reading. It is convenient to evaluate the attenuation of a given shield by its "mass thickness," which is expressed as the weight, in pounds per square foot (psf), of a solid barrier. A table of mass thicknesses for various common building materials is presented as supplement C. It may be assumed that the weights given for the various types of roof, floor, and wall construction, as found in standard engineering tables, are equivalent to the mass thickness of the construction.<sup>1</sup>

When analyzing the shielding effectiveness of a given barrier, it is essential to consider the relative positions of the barrier, the contamination, and the detector. For simplicity, this guide considers three cases, as follows:

1. In case 1 (fig. 5) the fallout is deposited on top of the barrier and the detector is located immediately under the barrier. This is termed "fallout on a barrier."

2. In case 2 (fig. 5) the barrier is perpendicular to the contaminated plane, which is located on one side of the barrier only, and the detector is located 3 feet above the contaminated plane on the opposite side of the barrier. This is termed "fallout adjacent to a vertical barrier."

3. In case 3 (fig. 5) the contamination and the barrier lie in the same plane. However, the fallout surrounds the barrier and does not lie directly on it. The detector is located just under the barrier. This is termed "fallout adjacent to a horizontal barrier."

Chart 1<sup>2</sup> shows how reduction factors vary with

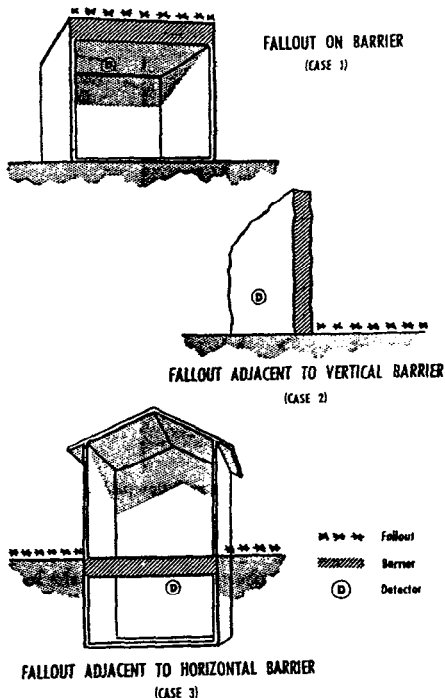

FIGURE 5.—Barrier shielding effects.

mass thickness for the three cases cited above. (See also examples 1, 2, and 3 for chart 1, p. 32.)

## GEOMETRY EFFECTS

The concepts involved in geometry shielding may be visualized by considering a cleared circular area in a smooth contaminated plane, with a detector located over its center (fig. 6a). The dose rate measured at the detector will decrease as the size of the cleared area increases. Likewise, as the detector is raised vertically above the center of the cleared area, the dose rate decreases.

If, as in figure 6b, the contamination covers the circular area and the rest of the area is clear, the dose rate would decrease as the detector is raised or lowered vertically from the center of the contaminated circle.

<sup>1</sup> A convenient reference is *Minimum Design Loads in Buildings and Other Structures* (A 58.1-1965), published by the American Standards Association, Inc., 70 East 45th St., New York 17, N.Y.; Price \$1.50.

<sup>2</sup> "Barrier Shielding Effects." (See p. 33, supp. B.)

The higher the detector, the smaller the ground contribution to the detector.

The larger the cleared area, the smaller the ground contribution to the detector.

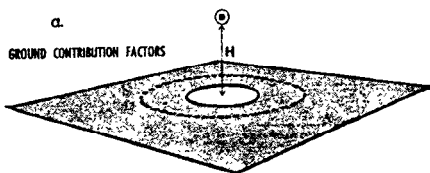

The smaller the contaminated area, the smaller the roof contribution to the detector.

The greater the distance below the contamination, the smaller the roof contribution to the detector.

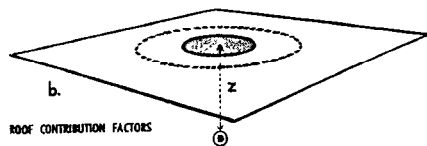

FIGURE 6.—Geometry shielding effects.

Two examples may be given from these generalizations:

1. First, if two buildings are of the same height and similar construction, but of different area, the dose rate measured at the center of the ground floor would be less in the larger building, provided the contamination of the roof is not considered. Thus, the larger the area of a structure, the less the ground contribution at the center of the ground floor.

2. In the second example, if two buildings are of equal area and similar construction, but differ in height, the dose rate measured at the center of the ground floor would be less for the higher building provided the contamination on the ground is not considered. Thus, the higher the structure, the less the roof contribution at the center of the ground floor.

The interrelationship of barrier and geometry shielding may be seen in the fact that in both of the above cases the mass thicknesses of the walls, floors, etc., also affect the dose rate at the detector.

## II. SHIELDING CALCULATIONS

### ROOF CONTRIBUTION

As stated earlier (p. 1), for the purposes of this guide, fallout is generally assumed to cover roof surfaces uniformly—according to their horizontal projections (fig. 2).

In a building that has relatively thin interior wall partitions ( $X_1$  less than about 20 psf), only three factors are necessary to determine the combined shielding effects for the roof contribution (fig. 7a). First, it is necessary to know the total mass thickness ( $X_o$ ) of the roof and all the floors between the contamination and the detector; second, the total area of the roof ( $A_r$ ) over the detector; and third, the distance from the detector to the roof.<sup>3</sup> The combined shielding effect for the roof contribution, expressed as a reduction factor, is found from chart 2.<sup>4</sup> (See example 1 for chart 2, p. 34.)

When interior wall partitions are relatively thick ( $X_1$  greater than about 60 psf), the actual area of the roof contamination contributing to the detector is that enclosed by the interior walls (fig. 7b). In finding the reduction factor from chart 2, the central roof area ( $A_c$ ) is used instead of total roof area ( $A_r$ ). (See example 2 for chart 2, p. 34.)

For buildings (fig. 7c) with interior wall partitions of intermediate thicknesses ( $X_1$  20 to 60 psf), the contribution from the central roof area and the contribution from the remainder of the roof must be added.<sup>5</sup> This is done as follows:

1. Calculate the contribution from the central roof area.
2. Calculate the contribution from the total roof area, but use as a mass thickness the total overhead mass thickness ( $X_o$ ) and that of the interior wall ( $X_1$ ).
3. Repeat calculation 2, but use the central roof area ( $A_c$ ) instead of the total roof area ( $A_r$ ).
4. By subtracting the result of calculation 3 from that of 2, the roof contribution from outside the central area is obtained.

<sup>3</sup> For convenience, chart 2, p. 35, assumes the detector is 10 ft. below the roof ( $Z=10$  ft.). For other  $Z$ 's, the roof area is adjusted by a  $K$  factor on the same chart.

<sup>4</sup> "Reduction Factors for Combined Shielding Effects: Roof Contribution." (See p. 25, supp. B.)

<sup>5</sup> See example 3 for chart 2, p. 34.

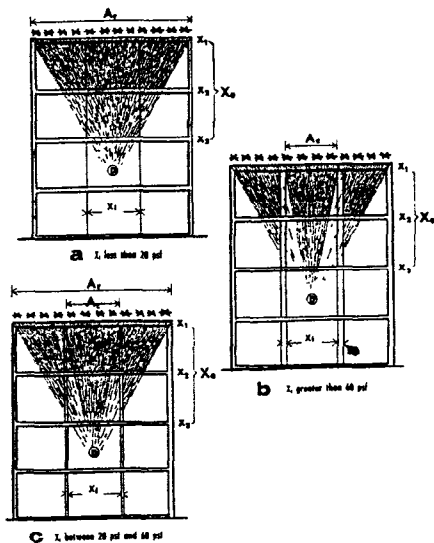

FIGURE 7.—Roof contribution.

5. The total roof contribution is the sum of items 1 and 4.

### Skyshine Contribution

"Skyshine"—an effect produced by scattering of radiation by the air—is another factor that should be considered in relation to roof contribution. The effect is roughly analogous to the "sky glow" caused by scattering of light over cities on misty nights.

To account for skyshine, use is made of table CF-2 (p. 44). As will be noted, if  $X_o$  is very large, the skyshine contribution is negligible. (See example 4 for chart 2, p. 34.)

Even if a roof is decontaminated, either by weathering or by a washdown system, skyshine might still be a factor to be considered.

For skyshine correction to roof contribution—with comparisons for a contaminated and a

decontaminated roof—see table CF-2 in supplement B (p. 44). Also see examples 4 and 5 for chart 2 (p. 34).

## GROUND CONTRIBUTION (Aboveground Areas)

Radiation from the ground surrounding a building must reach the detector inside by penetrating walls, windows, and doors. (See fig. 8.) Generally, a distinction is made between the radiation passing through walls and that passing through apertures. The latter case is discussed under Apertures, page 8.

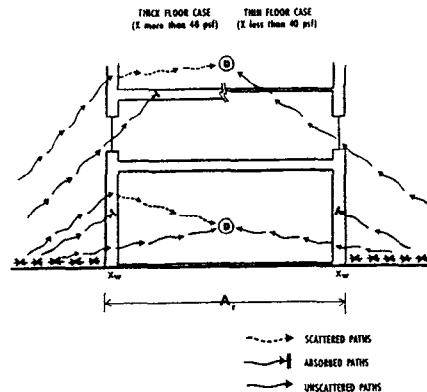

FIGURE 8.—Ground contribution (aboveground areas).

In a windowless structure, radiation reaches the detector both directly and by scattering from within the walls. These barrier effects are accounted for in the wall mass thickness ( $X_w$ ) factor in chart 3.<sup>6</sup> The geometry effects are related to the cleared area around the detector, which is given as the ordinate on this same chart. (See example 1 for chart 3, p. 36.) If the building has no interior partitions, the wall mass thickness ( $X_w$ ) equals the exterior wall mass thickness ( $X_e$ ); however, when interior partitions exist, the wall mass thickness used as the abscissa in chart 3 should be the sum of the exterior and interior walls, i.e.,  $X_w = X_e + X_i$ . (See example 2 for chart 3, p. 36.)

<sup>6</sup> "Reduction Factors for Combined Shielding Effects: Ground Contribution—Aboveground Areas" (See p. 37, supp. B.)

Note that for very small areas (less than 100 sq. ft.) geometry effects are no longer important, and the curve for wall barriers (case 2, chart 1), may be used to obtain the reduction factor directly.

## GROUND CONTRIBUTION (Belowground Areas)

In basement areas with virtually none of their walls exposed above grade (fig. 9), the only radiation reaching a detector from ground contamination would be that scattered by the walls on the ground floor, or skyshine through openings in these walls. All of this radiation must pass through the floor slab located immediately above the basement.

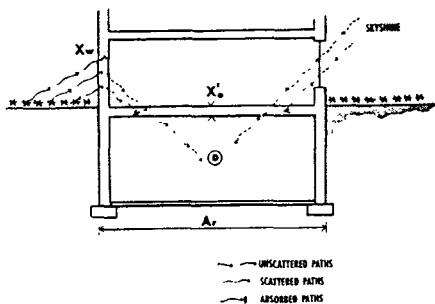

FIGURE 9.—Ground contribution (belowground areas).

For the simplest case, with windowless walls on the ground floor, chart 4<sup>7</sup> gives the reduction factor for radiation scattered into a detector at the center of a basement, 5 feet below the ground floor slab. To account for the mass thickness of the overhead floor slab,  $X'_f$ , it is necessary to multiply the reduction factor from chart 4 by the one obtained from the case 3 curve in chart 1. (See examples 1, 2, and 3 for chart 4, p. 38.)

Exposed portions of basement walls are computed as aboveground areas and adjusted by the percentage exposed. This adjusted ground contribution is added to ground contribution as calculated with the assumption of no exposed walls. When making the exposed-wall calculation from chart 3, the mass thickness of the basement wall,  $X_b$ , is used in lieu of  $X_w$ . (See example 4 for chart 4, p. 38.) Partitions in the basement are added

<sup>7</sup> "Reduction Factors for Combined Shielding Effects: Ground Contribution—Belowground Areas." (See p. 39, supp. B.)

to the basement wall, and this total mass thickness is the  $X_s$  to be used in chart 3.

To simplify belowground calculations, use is made of an "adjusted" mass thickness for the wall on the ground floor,  $X'_w$ . This is merely the product of the mass thickness of the ground floor wall and the percentage of wall without apertures. For example, if  $X_w$  equals 60 psf and windows cover 25 percent of the wall area, the proportion of wall without apertures would be 75 percent and  $X'_w$  would equal 60 psf times 0.75, or 45 psf. This last number would be the one to use in making the belowground calculation from chart 4. (See example 2 for chart 4, p. 38.)

## HEIGHT EFFECTS

Upper floors of multistory buildings may offer substantial shielding and should be considered for shelter areas. (See fig. 10.) An indication of the protection afforded by such an area can be cal-

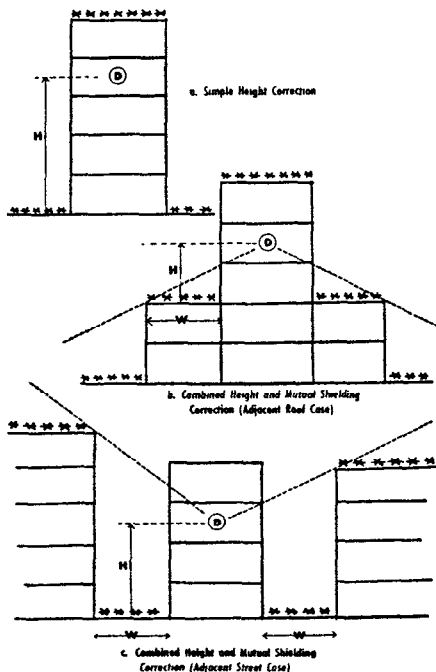

FIGURE 10.—Height and mutual-shielding effects.

culated by applying a height correction (chart 5<sup>a</sup>) to the reduction factor for ground contribution as calculated with the assumption that the floor under consideration is a ground floor. (See example 1 for chart 5, p. 40.)

Discretion must be used when selecting the appropriate height of the detector above the contamination, because adjacent roofs can complicate matters (fig. 10b and c). The shielding effects of adjacent buildings must also be considered (fig. 10c).

## MUTUAL SHIELDING

Adjacent buildings may effectively reduce the amount of radiation reaching a detector from ground contamination (fig. 10b and c). To account for this, a correction factor is applied to the ground contribution. This factor is a function of the width of the contaminated strip surrounding the shelter area. The value of the factor may be obtained from table CF-3, page 44. (See example 2 for chart 6, p. 42.)

## APERTURES

Condensed shielding calculations are made with a detector located at the center of a floor area. In these cases, aperture computations are of two types: those for a detector located above sill level and those for a detector located below (fig. 11a).

In either case, the calculation for ground contribution is made on the assumption that the exterior wall has no mass thickness ( $X_w = X_s = 0$  psf); or when appropriate, the windows are assumed to be shielded by the interior partitions ( $X_w = X_i$ ) and the applicable aperture correction from table CF-1, page 44, is applied to the value obtained from chart 3. Further adjustment is made for the actual percentage of openings in the wall. (See example 3 for chart 3, p. 36.)

Note that table CF-1 is divided into a "thick floor" case and a "thin floor" case. With thick floors, it is assumed that no radiation from below reaches the detector. With thin floors, some of the radiation passing through the windows of the story below may reach the detector, because thin floors provide virtually no shielding (fig. 8).

For practical purposes, a floor of mass thickness greater than 40 psf may be assumed to be "thick", and less than that, "thin". Normally, this means

<sup>a</sup>"Shielding Effects of Height." (See p. 41, supp. B.)

## PERIMETER RATIO

Reduction factors for ground contribution may be calculated on a wall-by-wall basis, providing adjustments are made for the relative length of the sides. In general, the ground contribution is calculated as if all the walls of a building are of the same construction as the wall under consideration. The final reduction factor from this computation is multiplied by the perimeter ratio of this wall. The perimeter ratio for a given wall is the quotient of its length and the total perimeter of the building. (See fig. 12.)

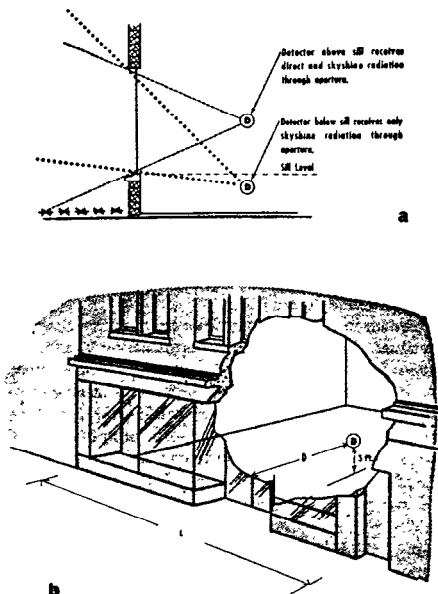

FIGURE 11.—Aperture contribution.

that concrete floor slabs are considered to be thick floors and wooden floors are considered to be thin.

An illustration of an aperture calculation is given in example 2 for chart 5, p. 40.

Many large buildings, which are otherwise rather massive, have windows extending entirely across one wall (fig. 11b). To determine the reduction factor at a given distance from an aperture that extends virtually to the ground, use chart 6.<sup>9</sup> It is necessary to know only the length of the aperture and the distance from it. (See examples 1 and 2 for chart 6, p. 42.) Chart 6 should be used only when considering areas on the ground floor.

To calculate the ground contribution through apertures in a basement wall, it is necessary either to assume that (1) the exposure is large enough to warrant a separate "aboveground" calculation or (2) the exposure is small enough to follow the "belowground" analysis. In general, a basement wall exposure of up to about 3 feet can be reasonably calculated using the belowground analysis.

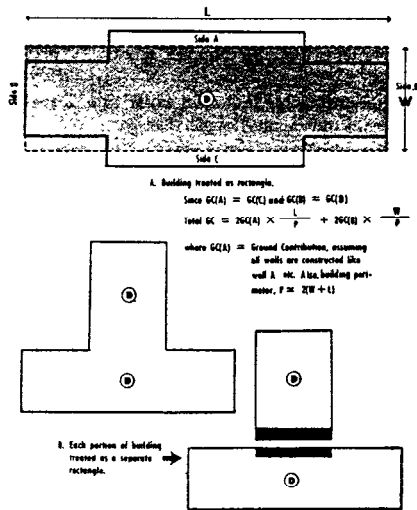

FIGURE 12.—Perimeter effects.

To find the total reduction factor for ground contribution, it is necessary to add the contribution from each wall. The wall-by-wall shielding analysis forms on pages 51 and 52 provide space for calculations for a building in which each of four walls have different shielding characteristics. (Note: The sum of all the perimeter ratios is 1.0.)

Care must be taken in applying the perimeter ratio technique to irregularly shaped buildings. Small irregularities generally can be overlooked, but simple adjustments are sometimes necessary, as in figure 12a.

Major irregularities, as exemplified by buildings of T, U, L, or H design, require handling of each wing as a separate building.

<sup>9</sup> "Reduction Factors for Apertures, Ground Floor." (See p. 43, supp. B.)

### III. SPACE AND VENTILATION

#### GENERAL

Although a potential shelter area may provide excellent shielding from fallout radiation, its worth as a shelter is limited if it is poorly ventilated, deficient in sanitary facilities, or too small for the number of occupants. Sanitation is discussed in connection with water supplies, in part IV of this guide.

Another limiting factor on capacity of a shelter area is the anticipated length of stay.

Because fallout decays rapidly during the first few days after the explosion (p. 2), this would be the critical period of shelter occupancy. In view of this, there are many structures that lend themselves to a "core" concept (fig. 13). The "core" shelter is a relatively small area with a high protection factor, surrounded by or adjacent to a larger area that has a lower protection factor. During the critical period of stay-time, occupants would remain in the "core" shelter, with minimum, or "survival", space and ventilation. Later, the larger shelter area, with better living conditions, could be used.

#### AREA AND VOLUME REQUIREMENTS

The term "capacity", as used in shelter surveys, refers to the number of persons that can be accommodated in a shelter.

Assuming dual-purpose usage, capacity may be estimated by allowing approximately 15 sq. ft. of gross floor area per shelter occupant. Gross floor area includes such items as columns, fixed equipment, and storage space for shelter supplies. The minimum net floor area allowance per person is 10 sq. ft. except when using the core shelter principle. In that case, the net area may be reduced to 8 sq. ft. per person for short-term occupancy.

Optimum use of shelter requires detailed planning. Table 2 is designed to aid in this planning.

TABLE 2.—Factors for shelter capacity planning

Activity	Floor space required	Remarks
	<i>Sq. ft.</i>	
Sleeping in cots.....	30	Includes aisle space.
Sleeping in double bunks.....	15	Includes aisle space.
Sleeping in triple bunks, <sup>1</sup> .....	10	Includes aisle space.
Sitting.....	8	Includes aisle space.
Walking.....	Use aisle space.	Use aisle space.
Storage.....	2	Includes space for food, bunks, etc.
Fixed equipment....	As required.	

<sup>1</sup> Specially constructed emergency bunks.

In general, it may be assumed that at any given time one-half of the occupants are in bunks and the other half are sitting, standing, or walking. When evaluating or designing shelters based on the "core" concept, it may be desirable to consider all occupants as sitting, and therefore allocate 8 sq. ft. per person.

Shelter capacity or occupancy time may be limited by the volume of the room and not by its area. This is particularly true if mechanical ventilation is inadequate. For rough estimating,

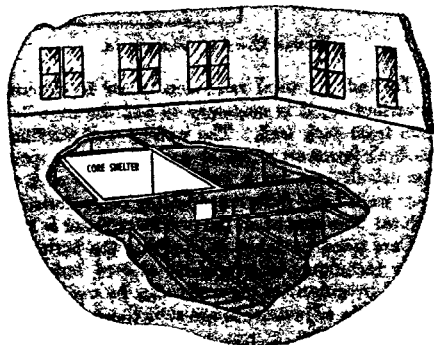

FIGURE 13.—"Core" concept.

each shelter occupant should be allowed at least 500 cu. ft., where no mechanical ventilation is available. This would permit shelter occupancy for about a day before conditions become intolerable. In many cases, however, interior stairwells, shafts, and ducts would create enough natural ventilation to extend stay-time markedly.

## VENTILATION REQUIREMENTS

The basic requirement for a shelter ventilation system is that it provide a safe and tolerable environment for a specified shelter occupancy time. In areas of very light fallout, occupancy time may be as little as one day. In areas of heavy fallout, it may be as much as 2 weeks or more, but occupants probably could spend some time outside the shelter after the first few days.

The following are important considerations in the ventilation of shelters:

1. Oxygen supply is generally not a critical factor. Carbon dioxide is. The carbon dioxide concentration should not exceed 3 percent by volume, and preferably should be maintained below 2 percent by volume. Three cfm per person of fresh air will maintain acceptable concentrations of both oxygen and carbon dioxide.

2. A combination of high temperature and high humidity in a shelter may be hazardous. An effective temperature of 85° F. should not be exceeded.

3. If recommended sanitation and ventilation standards are followed, odors within a shelter should not be unacceptable under the short-term emergency situation.

Based upon the above factors, the following minimum standards for ventilation may be used as guidance in making shelter surveys and for preliminary design purposes:

1. If no mechanical ventilation is available, a net volume of 500 cu. ft. per person may be used for estimating shelter capacity.

2. If mechanical ventilation is used, at least 3 cfm of fresh air per person should be provided to permit full shelter occupancy. If there is no provision for cooling the air, provision should be made for increasing the fresh air supply during hot or humid weather.

3. If equipment is available for mechanical ventilation at rates of less than 3 cfm of fresh air per person, with occupancy estimated on the basis of floor area, the net volume of space required per person may be determined from table 3.

4. The installation of equipment for the artificial cooling of air for shelter purposes only should be avoided if possible.

5. A heating system generally is not essential. Use of blankets, heavy clothing, etc., for warmth usually will suffice when outside air temperatures are low.

TABLE 3.—Relation of space requirements to ventilation

Rate of air change (minutes) <sup>1</sup>	Volume of space required per person
	<i>Cu. ft.</i>
1,000+-----	500
600-----	450
400-----	400
200-----	300
100-----	200
60-----	150
35-----	100
22-----	65

<sup>1</sup> Computed as the ratio,  $\frac{\text{Net volume of space (cu. ft.)}}{\text{Fresh air supply (cfm)}}$

EXAMPLE for table 3, "Relation of Space Requirements to Ventilation"

Given:

A potential shelter area with clear floor dimensions of 60 by 90 ft., and a ceiling height of 10 ft.

Find:

1. The capacity: based upon adequate ventilation (3 cfm or more of fresh air per person), at least 15 sq. ft. of floor area per person, and at least 65 cu. ft. of space per person.
2. The capacity: based upon no ventilation ( $\frac{1}{2}$  cfm or less of fresh air per person) and 500 cu. ft. of space per person.
3. The capacity: based upon ventilation with 270 cfm of fresh air supplied by a blower.

Solution:

1. Floor area = 60 × 90 = 5,400 sq. ft.  
Volume = 5,400 × 10 = 54,000 cu. ft.

$$\text{Capacity} = \frac{54,000}{15} = 360 \text{ persons}$$

or

$$\text{Capacity} = \frac{54,000}{65} = 830 \text{ persons}$$

(The smaller capacity, 360 persons, governs.)

2. Volume = 54,000 cu. ft.  
Capacity =  $\frac{54,000}{500} = 108$  persons
3. Volume, V = 54,000 cu. ft.  
Fresh air, Q = 270 cfm

$$\text{Ratio, } \frac{V}{Q} = 200 \text{ min. for air change}$$

From table 3, when  $\frac{V}{Q} = 200$ , the required space per person = 300 cu. ft.

$$\text{Capacity} = \frac{54,000}{300} = 180 \text{ persons}$$



## FILTER REQUIREMENTS

Weatherproof air intakes should be provided for the ventilation systems of all shelters to keep out rain and fallout particles. For home shelters with hand-operated blowers, a simple hooded intake is considered sufficient. For larger shelters, however, fresh-air intake velocities of mechanical ventilation systems may be high enough to draw fallout particles into the shelters. Therefore, good quality commercial air filters should be installed. High-efficiency filters that would remove sub-

micron sizes of particles are not required for fallout shelter.

If filters or plenum chambers where radioactive particles can accumulate are in or adjacent to a shelter area, they should be shielded. The following is a guide for sizing the filter shields, which may be walls, or floors above or below the filter:

<i>Intake (cfm)</i>	<i>Mass thickness (pcf)</i>
100	40- 60
1,000	80-120
10,000	160-240

## IV. WATER SUPPLY AND SANITATION

### GENERAL

As in the case of space and ventilation, shelter occupancy time is an important factor in water supply and sanitary requirements. However, a distinction should be made between occupancy time within the designated shelter area and within the building itself. (See discussion of the "core" concept on page 10.)

This means that water sources and sanitary facilities available to the entire building—both inside and outside the main shelter area—should be considered in evaluating a structure for shelter.

### WATER SUPPLY REQUIREMENTS

A supply of potable water is essential. At least one-half gallon per day must be readily available to each occupant. In addition, it is highly desirable to have another one-half gallon of water per day per person for hygienic purposes.

Of the available water supply, at least 1 gallon per person should be stored *inside the shelter* (e.g., 100 gallons for a 100-person shelter). A storage tank connected to an existing waterline in regular use would insure that the stored water would be fresh when needed.

A reliable well in or adjacent to the shelter area is the best source of supply. However, if it can be assumed that the normal public water supply will be available under war-emergency conditions, consideration may be given to its use. Before relying on this source for drinking water, it should be ascertained that the water would be uncontaminated and that the treatment and pumping plant would be in operation. This requires fallout shelter for the operators and an auxiliary power source if there is likelihood that normal power would be disrupted. If the public water supply is from wells, there would be less danger of contamination by radioactive particles.

Colloidal and soluble radioactive isotopes could be hazardous if sufficient quantities of fallout contaminate a water source. Exposed surface sources such as reservoirs of public water systems are the most vulnerable to this type of contam-

ination. Use of water from these sources may be dangerous for drinking, but not dangerous for such uses as washing or flushing.

To determine the overall water supply available to a shelter area, both outside sources and those within the building should be considered. A most desirable type of outside source would be a large covered water tower or reservoir which is connected to the building by a gravity piping system. To determine actually how much water would be available to a given shelter area, a general analysis must be made of all potential users that would be dependent upon this outside source during an emergency.

In larger buildings, water in hot water tanks, fire reserve tanks, house storage tanks, or in the piping systems, may be a good resource. However, water from each source should be checked to see if it is potable. In residences, hot water tanks are excellent sources of potable water; and if ample warning is received, bathtubs and sinks could be filled before the arrival of fallout.

### SANITARY REQUIREMENTS

Because of the confined and crowded living conditions that sheltering might require, sanitation could be a major problem.

Personal cleanliness would have to be encouraged. Metal or plastic hand basins, with buckets for water distribution, would be adequate.

In family shelters, human waste may be disposed of through use of newspapers, plastic bags, or other disposable containers. These would then be deposited in tightly covered containers. A suitable type of chemical toilet may also be used.

In the larger group shelters, regular or austere flush-type toilets, or chemical toilets, should be available on the basis of 1 per 70 occupants. Half of these may be outside the shelter area if readily available in other parts of the building.

A suggestion for austere demountable manual flush-type toilet facilities is the use of long, wall-hung galvanized sheet metal urinals, and long, wall-hung and leg-supported galvanized sheet metal toilets with smooth board edge seats. The

urinals and toilets should be provided with outlets designed for quick coupling to Y's and traps in the soil stacks. Water supply should be available at the flushing end of the urinals and toilets. Tapped wall inserts and bolts should be provided for quick fastening of the urinals and toilets. Fixtures of this type would be stored in a manner similar to that for bunks and bedding, for installation immediately upon occupation of the area for shelter purposes.

In-shelter storage of wastes would take up valuable space. Therefore, for long stay-times, installation of sewage pumps or ejectors should be considered—for use with either chemical or flush-type toilets.

Trash and garbage should not be allowed to accumulate. While inside the shelter, it should be kept in tightly covered containers; and it should be deposited outside the shelter area as often as necessary.

## V. POWER SUPPLY AND OTHER FACTORS

### ELECTRIC POWER REQUIREMENTS

In all but family and small group shelters, electric power will be needed to operate motors and to provide light. The greatest load probably would be for the ventilation system. If a special emergency ventilation system is installed, fan motor power requirements may be kept to a minimum. In many cases, it may be more desirable to modify an existing ventilation system. In this case, the minimum power requirement must be determined by the size of the existing fan motors. This may be far more than the basic emergency system requirements.

Other electrical motors that may be required for larger group shelters include those for a water well pump and a sewage ejector pump.

Lighting is not a critical factor in electrical power requirements. A minimum illumination level of only 5 foot-candles should be sufficient for most of the shelter area. Higher levels may be needed in "activity" areas, but power required for light should still constitute only a small part of the total electric load.

The best source of emergency electric power is an engine-generator set with an adequate supply of fuel—preferably a 2-week supply. The relative merits of gasoline, diesel, and liquefied petroleum gas engines should be carefully considered. Initial cost is important, but so are local code requirements, ease of maintenance, dependability, safety of operation, and storage characteristics of fuels.

The capacity of emergency engine-generator sets may range from 1 to 10 kilowatts per 100 shelter occupants, depending upon lighting and equipment requirements, and dependability of outside power. Normally, the requirement would be in the lower half of this range.

If the power station has fallout protection, and operational plans provide for the continued operation of the station under fallout conditions, it may be assumed that electric power would be available. Under such circumstances the capacity of the shelter emergency generator set may be

limited to the lighting and ventilation loads, or to the lighting load alone, if such a calculated risk is acceptable.

### ENTRANCES AND EXITS

Entrances, exits, and other openings can markedly affect shelter category and capacity—for example, large garage-type doors in the basement walls of many commercial buildings. Doors of this type, used for belowground shipping service and parking areas, have low mass thicknesses and are in exposed positions. This can result in a low protection factor for basement areas where the factor might otherwise be high.

Baffle walls can be used to shield entryways and other openings (fig. 14). In any given instance the baffle wall should be of a mass thickness that will provide the category of protection desired for the shelter. In most cases this mass thickness should be equivalent to  $X_w$  or  $X_b$ , whichever is appropriate. Exceptions to this will be those cases where the mass thickness of  $X_w$  or  $X_b$  is extremely high (e.g., a granite wall 3 feet thick).

In some cases, stairwells entering shelter areas have open sides and it may be necessary to provide shielding walls to enclose them. In general, the mass thickness of these walls need not be greater than 100 psf.

Accessibility may affect fill-time of a shelter. As an example, the basements of some large buildings may in themselves have high capacity. However, these same areas may be served chiefly by elevators and may have only one or two narrow stairways for entry. In an emergency, the elevators may not function, and fill-time would be lengthened appreciably.

Local fire codes may be useful in determining accessibility and fill-time. In regard to these two factors, however, it should be kept in mind that a heavy concentration of fallout is not likely to occur immediately following the explosion of a nuclear weapon some distance away.

## HAZARDS

Sometimes areas that offer good protection from radiation are used for storage of dangerous materials or have other dangerous conditions.

Architects and engineers should carefully consider all types of hazards before designating areas as suitable for use as shelters.

Some of the hazards to look for are storage of

explosives, or highly combustible materials such as paints, varnishes, and cleaning fluids; or exposed high-voltage equipment.

If the amount of dangerous material in storage is small and readily movable, or the hazard can be isolated, the capacity rating of the shelter should not be affected.

Local fire codes should be consulted to determine which materials are hazardous.

## VI. COMMUNITY SURVEY PROCEDURES

Administrative information on programing and planning a community fallout shelter survey, and general guidance on making the survey, is presented in the first of this OCDM series, NP-10-1, *Fallout Shelter Surveys: Guide for Executives*.

As pointed out in that guide, the overall management of a community shelter survey is the responsibility of the chief executive of the community or his designee, such as his civil defense director. However, a professional architect or engineer, preferably from local government, should direct the details of the actual survey, on a full-time basis.

It is important that the survey director thoroughly understand the nature of fallout radiation and how shielding factors relate to the problem. This, and an efficient survey organization, will help keep survey costs at a minimum. Other factors that will help keep costs down are: Complete, up-to-date, and readily available local records on existing buildings; and a cooperative spirit within local government, among civic associations, and on the part of the public.

Good public relations is essential to a successful survey. This point should be emphasized to all those who take part in the work. Another thing to remember is that the survey will be news. It is important that the survey director and the local chief executive who is administering the project be in agreement on procedures for keeping local news media fully informed on the purpose of the survey, on progress, and on results.

The survey director should be thoroughly familiar with the objectives of the survey and the benefits to be expected. He should know that fallout shelter surveys implement the *National Policy on Shelters*,<sup>10</sup> and broaden the base of information used to make policy decisions at local, State, and national level. Locally, this information is a prerequisite to: A shelter utilization program, a shelter improvement program, or a shelter construction program. Such information is useful also in progressive city planning.

<sup>10</sup> Announced May 7, 1958, by Leo A. Hoegh, Director, OCDM, at the direction of the President.

The survey director will need to determine the probable cost of the survey; the time, skills, and manpower required; the best available sources of information; and the type of task force organization best suited to the local situation. Following are some guidelines concerning these factors:

1. From experience on pilot surveys, an estimate of cost may be obtained by multiplying the peak population of an area by 10 cents, multiplying the number of individual structures in the area by 50 cents, and taking the higher of these two figures as the estimate.

2. Generally three-fourths of the total estimated cost may be allocated for salaries. Sufficient personnel should then be obtained to complete the project in the shortest period of time consistent with the available manpower.

3. Personnel with the required skills, such as engineers, inspectors, computers, draftsmen, and clerks, are usually available within local government. Such personnel may often be obtained on a loan basis to establish a short-term task force to conduct the fallout shelter survey. This staff might be augmented by temporary personnel obtained through established local civil service rosters. Local government may also be able to provide office space, equipment, and furnishings, and administrative, accounting, and printing or other reproduction services. Use of regular personnel, facilities, and services of local government has other important advantages; for example, indoctrination and retention of "know-how" within the local government organization.

4. Before extensive field work is started, a check should be made for pertinent records and other informational sources of local government, business, and industry. Table 4 lists some of the more important of these sources.

5. The type of organization to be used in any given survey is largely dependent upon the size and nature of the area to be surveyed, the manpower available, and the method of collecting and recording pertinent data.

Engineers and inspectors should be trained in the methods and techniques to be used in the

TABLE 4.—Sources of information useful in fallout shelter surveys

Sources	Remarks
<i>Publications, maps, and photos</i>	
Operational Survival Plans.....	These plans have been completed for every State in the United States and contain much useful information for shelter surveys.
Sanborn maps.....	These maps can be obtained for almost every urban area in the United States with a population of 2,000 or more. They show location and construction characteristics of every building in a given area. Information on basements, type of occupancy, etc., is included.
Bureau of Census publications.....	Statistical abstracts, county and city data books, etc., contain detailed population information.
Topographic and geologic maps and air photos.....	Location of underground installations such as mines, tunnels, caves, etc.
<i>Local government offices</i>	
Building Department.....	Plans may be on file for each public building and most private buildings.
Tax Assessor's Office.....	Records may give summaries of construction type, size, and location of all types of buildings.
Planning Commission.....	Land-use maps, population studies, and general information on building types for certain areas may be available.
Department of Education.....	Information on schools, including student populations and possibly building plans.
Police and Fire Departments.....	Location and possibly building plans of all stations in the area.
Department of Public Health.....	Location and possibly building plans of medical facilities in the area.
<i>Private businesses and associations</i>	
Electric power, telephone, and gas companies.....	Location and possibly building plans of their office buildings, generating stations, etc.
Chamber of Commerce.....	Location and description of commercial and industrial establishments.
Architects, engineers, and building contractors.....	As-built drawings of buildings designed by their firms.
Building materials suppliers.....	Information on materials used in local building construction.
Trade associations.....	Information on buildings constructed using their products.
Individual building owners or managers.....	As-built drawings and up-to-date information on alterations.

particular survey area before field operations are undertaken. These personnel should be given a short course on general use of this guide, and they should practice by making sample calculations on the various types of dwellings and other structures common to the particular area under consideration.

### DATA COLLECTION

Where accurate and complete data is available from existing records such as may be found in a tax assessor's office, or from sources such as "as-built" plans or Sanborn maps, it may be possible to have clerical personnel or draftsmen transfer or copy this information onto the data collection form. (See part 1, supp. A.)

In most metropolitan areas, the above procedure should be confined to structures other than dwellings, because the category of dwellings usually can be determined in cruising (windshield) surveys.

In this type of survey, a preliminary analysis can be made of the various types of dwellings in the entire survey area to determine which dwellings may be considered typical of each class. For example, every residence in a given subdivision

may be so similar that an analysis of one could reasonably be assumed to apply to all.

A cruising (windshield) survey team is a driver and an inspector. As they go down a street, the inspector looks at the various dwellings and enters on previously prepared data sheets his estimates of the shelter category and capacity, according to street address. Visual inspection in this manner is sufficient to classify each dwelling. Often a cruising team can readily designate an entire slab-on-grade subdivision as "F" category for shelter purposes.

Where records are not available, up-to-date, or reliable, inspectors would then make on-site inspections to obtain the basic data required to analyze the major structures.

In any case, it usually is necessary to survey each major structure individually. This is because of structural complexities, and because the best of plans will not show the disposition and nature of many items, such as equipment, stored goods, and furniture; nor do they usually indicate the state of repair or other factors that may have a marked effect on the area's worth as shelter, or on the cost of improvement.

Field personnel should carry identity cards and explanatory letters signed by an executive of the local government. The letters should introduce the bearer, briefly explain the purpose of his work, and urge cooperation on the part of building owners or tenants.

If an inspector finds no one available to admit him to a building, he should leave a "call-back" card. The card should give the inspector's name and survey office address and telephone number, tell the purpose of the visit, and ask that the inspector be called to arrange a convenient time for his return.

For shelter survey purposes, "districts" should be chosen to coincide with well-established areas such as census tracts, political precincts, or land-use areas as determined by local planning commissions.

Several engineer-inspector teams may be assigned to one supervising engineer to do a particular district of a city or to specialize by type of structure, such as public, commercial, or industrial buildings. There will be fewer correlation problems if assignments are made by districts.

Critical structures, such as electric power stations and waterworks, should be analyzed first to determine whether or not they may be operable in a war emergency. Special attention should be given to public structures, such as schools, hospitals, and government buildings. These structures usually are strategically located in respect to population distribution, and often offer good shelter areas.

Information obtained on individual structures should be entered on the fallout shelter survey data collection form. (See part 1, supp. A.)

The latest available data on the population and its distribution may be obtained from updated census data which should be available from either the Bureau of the Census, the local Chamber of Commerce, or some other reliable source.

## DATA ANALYSIS

The data and information collected in fallout shelter surveys is used to (1) analyze each structure and determine the existing protection afforded (protection factor and category) against fallout radiation; (2) determine the number of persons that can be sheltered in a structure; (3) estimate the possible shielding improvements that could be made at reasonable cost to belowground areas to raise the category of protection; (4) estimate

the possible habitability improvements (ventilation, sanitation, and water supplies) that could be made at reasonable cost to increase the number of shelter spaces; and (5) estimate the total cost.

Comprehensive step-by-step shielding analysis procedures are outlined in supplement A for three general cases; that is, Roof Contribution (part 2), Ground Contribution—Aboveground Areas (part 3), and Ground Contribution—Belowground Areas (part 4). Roof and ground contributions are combined in a separate outline (part 5), which also compares existing and modified protection factors. These shielding analysis outlines are intended for instructional purposes.

To facilitate the survey analysis procedure, several steps have been combined and the outlines simplified so that aboveground or belowground areas may be analyzed on a single page.

For community fallout shelter surveys, single-family residences and one-story buildings with light interior partitions should be analyzed through use of the "condensed" forms shown in parts 1 and 2 of supplement E. For analysis of other structures, the comprehensive wall-by-wall procedures shown in parts 3 and 4 of supplement E should be used. Many structures have several potential shelter areas. Because each area may have a different protection factor, each should be analyzed separately.

A summary form for recording the results of an analysis is presented as part 6 of supplement A.

After an architect, engineer, or inspector has analyzed a few structures, he will find that once the "input" data is assembled, even a complex structure can be analyzed in a short time.

Charts 1 through 6 and tables of correction factors are provided in supplement B for use in shielding analysis. For reference, a "Brief Table of Mass Thicknesses" is included as supplement C.

For planning purposes in shelter surveys, shelter habitability standards may be based on a maximum floor-space requirement of 15 sq. ft. per person, and a maximum shelter-occupancy time of 2 weeks.<sup>14</sup> It may be assumed that basement windows of dwellings would be filled in by the occupants with readily available materials.

Analysis of the ventilation problem should be confined initially to a comparison of the capacity of the existing equipment, if any, and the number of persons this equipment can accommodate.

<sup>14</sup> See part 1, "Ventilation Requirements," p. 11.



Pilot surveys indicate that \$25 per occupant of improved shelter may be used in estimating the cost of habitability improvements—ventilation, sanitation, water supply, and power supply—in order to develop the full shelter capacity. A more detailed cost analysis should be made when improvements are actually contemplated.

Standard items selected for shielding improvements should be costed according to local prices for materials and labor. Examples of these standard items are shown in figure 14.

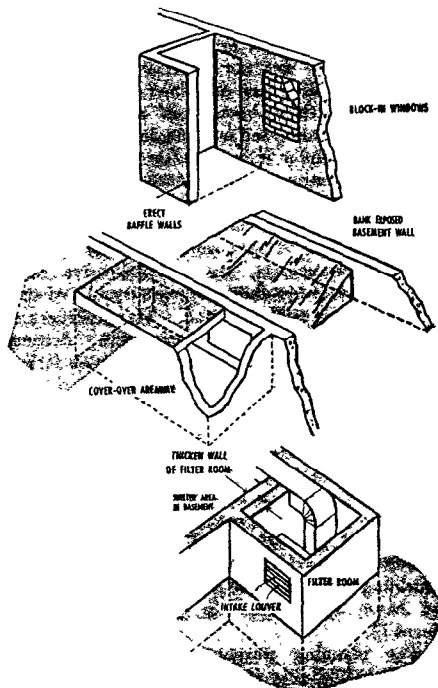

FIGURE 14.—Examples of shielding improvements.

Following are some of the things that can be done to improve shielding:

1. Block-in windows or raise sill level.
2. Cover areaways.
3. Erect baffle walls at entrances and exits.

(NOTE.—4, 5, and 6 are generally not feasible for above-ground areas.)

4. Increase mass thickness of wall construction.
5. Increase mass thickness of roof construction.
6. Increase mass thickness of floor construction.
7. Reduce exposure of basement walls.
8. Shield filter room or plenum chamber. (See p. 12.)

## REPORTS

The following outline may be useful in preparing the final fallout shelter survey report:

1. Description of survey area.
2. Procedures used in the survey.
3. Summary of survey results.
4. Discussion of survey results.
5. Conclusions and recommendations.

The detailed tabulation sheets and supplementary maps should be included as appendixes or as companion publications.

Because of the voluminous nature of the collated shelter survey information, concise methods of presentation must be used. (See fig. 15.) One method is a three-part sequence of symbols that denote shelter category, shelter capacity, and cost

D		WILMINGTON DISTRICT 1960-1961				SHELTER DISTRICT 12		
SHELTER SPACES FOUND IN SHELTER CATEGORIES								
CATEGORY	NUMBER	EXISTING SPACES						TOTAL
		IMPROVED SPACES BY COST OF IMPROVEMENT	a	b	c	d		
A	276	44	416				416	
B	299	46	400			368	726	
C	191	23	232	140	236		608	
D	385	53	516	282	366	20	1,354	
E	5,340	82.2	5,446	44			5,890	
TOTAL	6,490	100	10,610	424	822	388	12,044	
POPULATION—NIGHT TIME							28,131	
SURPLUS OR DEFICIENCY							-16,787	
DAY TIME							19,438	
SURPLUS OR DEFICIENCY							-7,324	

Tabulation of Survey District

Map of Survey District

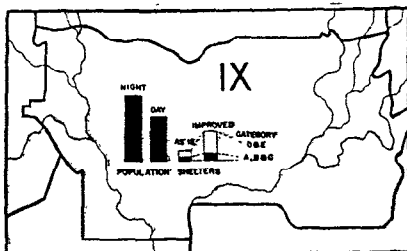

FIGURE 15.—Sample data records.

per person for required improvements. Shelter category letter symbols are given in table 1, and

TABLE 5.—*Cost symbols for improvement of shelters*

Symbol	Estimated cost per shelter occupant
	<i>Dollars</i>
a.....	Less than 25.
b.....	25 to 50.
c.....	50 to 75.
d.....	75 to 100.
e.....	More than 100.

the cost of improvements (exclusive of supplies) may be reported using the symbols given in table 5.

As an example, in the concise, three-part presentation "C75b." "C" denotes shelter category (with a protection factor of 50 to 250); "75" indicates a shelter capacity of 75 persons; and "b" relates to a per capita cost estimate of \$25 to \$50 for improvement of category, habitability, or both.

These same symbols may also be used for entry of data on tabulation sheets or maps.



DATA COLLECTION FORM <sup>1</sup>

- (1) Survey No. \_\_\_\_\_ (2) By \_\_\_\_\_ (3) Date \_\_\_\_\_
- (4) Location \_\_\_\_\_
- (5) Description of surroundings \_\_\_\_\_  
\_\_\_\_\_
- (6) Description of structure:
- |                                  |                             |
|----------------------------------|-----------------------------|
| a. General dimensions _____      | b. Number of floors _____   |
| c. Floor heights _____           | d. Sill heights _____       |
| e. Basement floor level _____    | f. Ground floor level _____ |
| g. % basement wall exposed _____ | h. % areaways _____         |
- (7) Structural information: *Apertures*
- |                         |   |
|-------------------------|---|
| a. Roof _____           | % |
| b. Ground floor _____   | % |
| c. Higher floors _____  | % |
| d. Exterior walls _____ | % |
| e. Interior walls _____ | % |
| f. Basement walls _____ | % |
- (8) Nonstructural information:
- |                           |                       |                   |
|---------------------------|-----------------------|-------------------|
| a. Occupancy _____        | Business hours _____  | Other times _____ |
| b. Entrances, exits _____ | c. Ventilation _____  |                   |
| d. Sanitation _____       | e. Water supply _____ |                   |
| f. Power supply _____     | g. Hazards _____      |                   |
- (9) Adaptability for fallout shelter \_\_\_\_\_
- (10) Remarks \_\_\_\_\_  
\_\_\_\_\_

<sup>1</sup> See Part 1-A, following, for instructions on filling out this form.

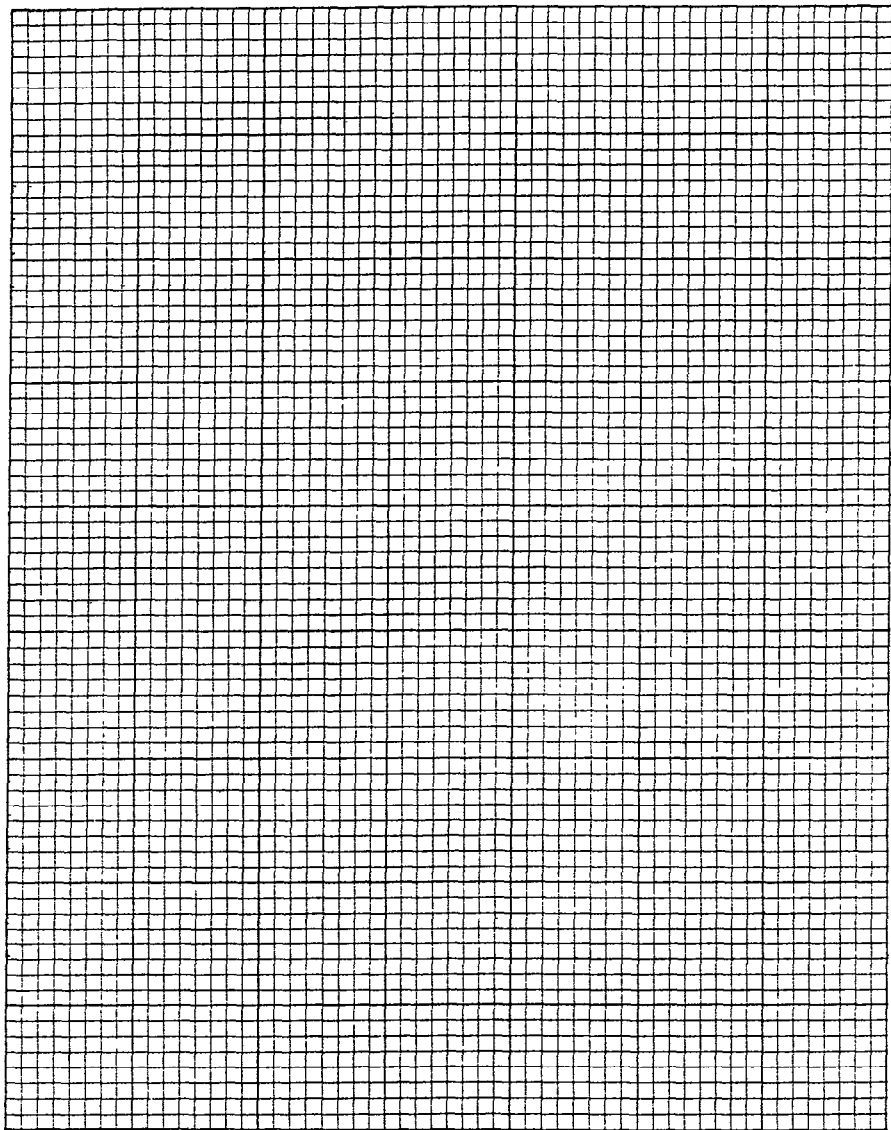

**Instructions for Completing the Fallout Shelter Survey Data Collection Form <sup>1</sup>**

1. Appropriate file number. This may be keyed to shelter district number, census tract number, etc.
2. Name of inspector.
3. Date data was collected.
4. Street address and shelter district, or name of subdivision, tract, precinct, etc.
5. Land use (industrial, commercial, residential, etc.). Height and general description of adjacent buildings; e.g., four-story brick loft building and two-story brick residence. In urban areas, include distances to adjacent buildings.
- 6a. Overall length, width, and height; L-shaped, T-shaped, U-shaped, etc. Make sketch on graph paper on reverse side of Data Collection Form.
- 6b. Self-explanatory.
- 6c. Give basement floor height as, e.g., B10½ ft.; ground floor height as, e.g., G15 ft.; and upper floor heights as, e.g., U9½ ft.
- 6d. Self-explanatory.
- 6e. Distance from basement floor to average ground line outside (level lot). Distance from basement floor to highest and lowest ground line (sloping lot).
- 6f. Distance from ground floor to average ground line outside.
- 6g. Estimate percent of basement wall above grade.
- 6h. Estimate percent of basement wall in areaways.
- 7a. State type of roof construction and estimate percent of roof area with skylights, hatches, etc.
- 7b and 7c. State type of floor construction and estimate percent of floor area with stairwells, elevator shafts, etc.
- 7d, 7e, and 7f. State type of wall construction and estimate percent of wall area with windows, doors, or duct openings.
- 8a. After "Occupancy" state whether residential, commercial, industrial, storage, public building, etc. After "Business hours," state number of employees and transients normally in building. After "Other times," state number of employees and transients in building after the normal business hours of the community.
- 8b, 8c, 8d, 8e, 8f, and 8g. To explain these conditions, use the graph paper on reverse side of the Data Collection Form for notes and sketches.
9. Indicate area(s) in building with fallout shelter potential.
10. Sources of information may be noted here.

NOTE.—Photographs may be useful in identifying a particular problem or structure. Attach to form.

<sup>1</sup> See Part 1, preceding.

Shielding Analysis Outline

ROOF CONTRIBUTION

- (1) Total roof area,  $A_r$ .....
- (2) Central roof area,  $A_c$ .....
- (3) Distance, roof to detector,  $Z$ .....
- (4) Distance correction factor,  $K$  (chart 2).....
- (5) Adjusted total area,  $A'_r = A_r \times K$ .....
- (6) Adjusted central area,  $A'_c = A_c \times K$ .....
- (7) Total overhead mass thickness,  $X_o$ .....
- (8) Interior wall mass thickness,  $X_i$ .....
- (9) Combined overhead mass thickness,  $X_c = X_o + X_i$ .....

---

- (10)<sup>1</sup> Chart 2, [(5) or (6)] and (7).....
- (11) Chart 2, (5) and (9).....
- (12) Chart 2, (6) and (9).....
- (13) Subtract (12) from (11).....
- (14) Roof contribution, (10) + (13).....
- (15) Skyshine correction (table CF-2, p. 44).....
- (16) Total roof contribution (14)  $\times$  (15).....

<sup>1</sup> When  $X_i$  is less than 20 pcf, use items (5) and (7); and delete steps (11), (12), and (13). When  $X_i$  is greater than 60 pcf, use items (6) and (7); and delete steps (11), (12), and (13). When  $X_i$  is greater than 20 pcf, but less than 60 pcf, use items (6) and (7); and also complete steps (11), (12), and (13).

## Shielding Analysis Outline

## GROUND CONTRIBUTION

(Aboveground Areas)

- |  |       |
|--|-------|
| (1) Ground floor area, $A_r$ .....   | _____ |
| (2) Exterior wall mass thickness, $X_e$ .....                                      | _____ |
| (3) Interior wall mass thickness, $X_i$ .....                                      | _____ |
| (4) Total wall mass thickness, $X_w = X_e + X_i$ .....                             | _____ |
| (5) Percent apertures in wall, $Ap\%$ .....  | _____ |
| (6) Percent of wall which is solid, $100 - Ap\%$ .....                             | _____ |
| (7) Aperture correction (table CF-1, p. 44).....                                   | _____ |
| (8) Height of detector above contamination, $H$ .....                              | _____ |
| (9) Height correction: $H_s$ (chart 5, p. 41).....                                 | _____ |
| (10) Width of contaminated plane, $W_c$ .....                                      | _____ |
| (11) Mutual shielding correction: $M_s$ (table CF-3, p. 44).....                   | _____ |
| (12) Perimeter, $P = 2(W + L)$ .....   | _____ |
| (13) Length of wall, $W$ or $L$ .....  | _____ |
| (14) Perimeter ratio, $P_r = W/P$ or $L/P$ .....                                   | _____ |
| <hr/>  |       |
| (15) Chart 3, (1) and (4).....   | _____ |
| (16) Chart 3, (1) and (3).....   | _____ |
| (17) $(15) \times (6)$ .....   | _____ |
| (18) $(16) \times (5) \times (7)$ .....  | _____ |
| (19) Uncorrected ground contribution $[(17) + (18)]$ or (15).....                  | _____ |
| (20) Corrected ground contribution $(19) \times (9) \times (11) \times (14)$ ..... | _____ |



Shielding Analysis Outline

GROUND CONTRIBUTION

(Belowground Areas)

- (1) Ground floor area,  $A_f$ .....
  - (2) Ground floor exterior wall mass thickness,  $X_e$ .....
  - (3) Percent apertures in ground floor wall,  $Ap\%$ .....
  - (4) Adjusted wall mass thickness,  $X_w' = X_e \times (100\% - Ap\%)$ .....
  - (5) Immediate overhead mass thickness,  $X_o'$ .....
  - (6) Basement wall mass thickness,  $X_b$ .....
  - (7) Percent of basement wall exposed,  $Ex\%$ .....
  - (8) Width of contaminated plane,  $W_e$ .....
  - (9) Mutual shielding correction:  $M_s$  (table CF-3, p. 44).....
  - (10) Perimeter,  $P=2(W+L)$ .....
  - (11) Length of wall,  $W$  or  $L$ .....
  - (12) Perimeter ratio,  $P_r = W/P$  or  $L/P$ .....
- 
- (13) Chart 4, (1) and (4).....
  - (14) Chart 1, case 3, (5).....
  - (15) Ground contribution through overhead, (13) $\times$ (14).....
  - (16) Chart 3, (1) and (6).....
  - (17) Ground contribution through basement walls, (16) $\times$ (7).....
  - (18) Uncorrected ground contribution (15) $+$ (17).....
  - (19) Corrected ground contribution, (18) $\times$ (9) $\times$ (12).....





DATA SUMMARY FORM

(1) Survey No. \_\_\_\_\_ (2) By \_\_\_\_\_ (3) On \_\_\_\_\_

(4) Location \_\_\_\_\_

(5) Description of shelter area:

a. Location within building \_\_\_\_\_

b. General dimensions \_\_\_\_\_

c. Space use \_\_\_\_\_

d. Unimproved shelter area:<sup>1</sup>                      Category \_\_\_\_\_                      Capacity \_\_\_\_\_

e. Improved shelter area:                      Category \_\_\_\_\_                      Capacity \_\_\_\_\_

(6) Required improvements:

*Item*

*Cost*

a. Shielding ..... \_\_\_\_\_

b. Entrances, exits ..... \_\_\_\_\_

c. Ventilation ..... \_\_\_\_\_

d. Sanitation ..... \_\_\_\_\_

e. Water supply ..... \_\_\_\_\_

f. Power supply ..... \_\_\_\_\_

g. Storage ..... \_\_\_\_\_

h. Miscellaneous ..... \_\_\_\_\_

i. Total cost ..... \_\_\_\_\_

(7) Unit costs:

a. Cost per occupant (shielding) ..... \_\_\_\_\_

b. Cost per occupant (habitability) ..... \_\_\_\_\_

c. Cost per occupant (total) ..... \_\_\_\_\_

(8) Shelter area symbol ..... \_\_\_\_\_

<sup>1</sup> Stay-time generally limited by habitability requirements.

## SUPPLEMENT B

(Part 1)

### Examples for Chart 1, "Barrier Shielding Effects"<sup>1</sup>

1. From the standpoint of roof contamination, when  $A_r'$  is very large (greater than 5,000 sq. ft.), and/or  $X_o$  is very large, geometry shielding effects are unimportant. In these situations, reduction factors for roof contribution can be taken directly from the curve for case 1.

*Example:* If total overhead mass thickness ( $X_o$ )=300 psf, then

$$\text{Roof contribution} = \underline{\underline{0.00019}}$$

2. From the standpoint of ground contamination, when  $A$  is very small (less than 100 sq. ft.), geometry shielding effects are unimportant. In these situations, reduction factors for ground contribution can be taken directly from the curve for case 2.

*Example:* If wall mass thickness ( $X_w$ )=60 psf, then

$$\text{Ground contribution} = \underline{\underline{0.22}}$$

3. The curve for case 3 is used in conjunction with chart 4, page 39, to determine ground contribution into basement areas.

*Example:* From chart 4, a value of 0.03 has been determined as the ground contribution into a basement area with a "weightless" floor overhead. If the actual floor slab has  $X'_o=40$  psf, then the reduction factor derived from the overhead slab is 0.14, and

$$\text{Ground contribution} = 0.03 \times 0.14 = \underline{\underline{0.0042}}$$

---

<sup>1</sup> Chart 1 follows.

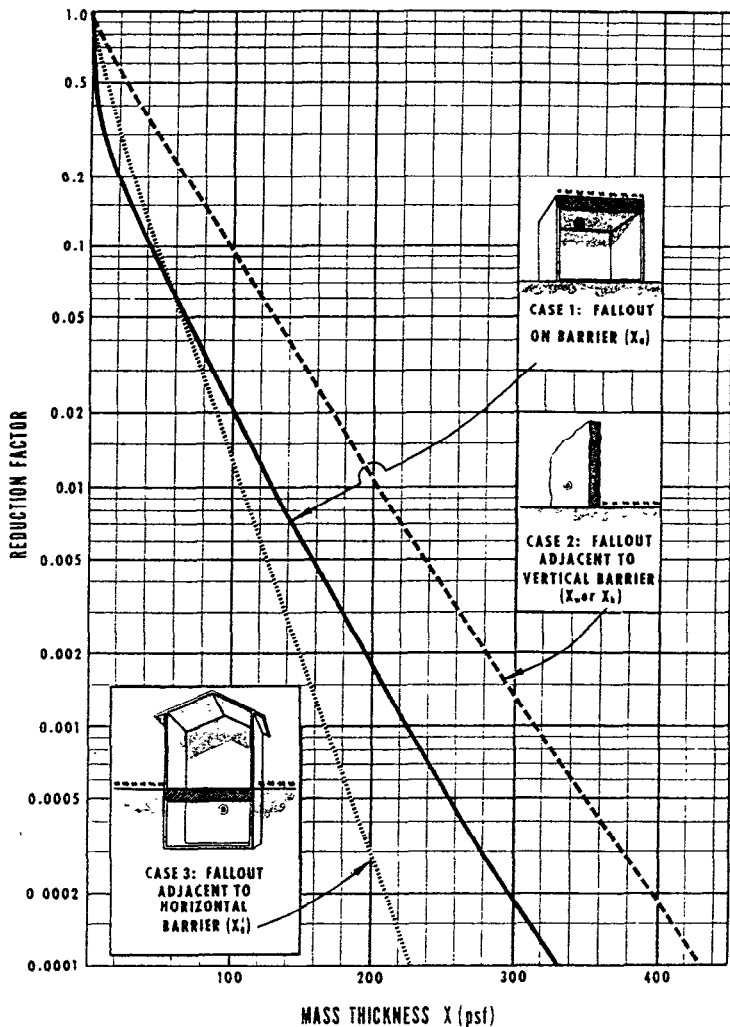

## BARRIER SHIELDING EFFECTS

CHART 1

**SUPPLEMENT B**

(Part 2)

**Examples for Chart 2, "Roof Contribution"<sup>1, 2</sup>**

1. For buildings with "thin" interior partitions ( $X_1$  is less than 20 psf), use adjusted total roof area,  $A'_r$  and  $X_o$ , which equals the sum of the roof and floor slabs between the detector and the roof contamination.

*Example:* Detector at center of 2nd floor of 5-story building with  
 $A_r=5,000$  sf,  $Z=35$  ft., and  $X_1=10$  psf.  
 For  $Z=35$  ft.,  $k=0.082$ ; and  $A'_r=5,000 \times 0.082=410$  sf  
 $X_o=30$  psf (roof) +  $3 \times 50$  psf (floor slabs) = 180 psf  
 Roof contribution ( $A'_r=410$  sf and  $X_o=180$  psf) = 0.0024

2. For buildings with "thick" interior partitions ( $X_1$  is greater than 60 psf), use adjusted central roof area,  $A'_c$  in lieu of  $A'_r$ .

*Example:* Data same as above, except  $A_c=2,000$  sf and  $X_1=70$  psf.  
 $A'_c=2,000 \times 0.082=164$  sf  
 Roof contribution ( $A'_c=164$  sf and  $X_o=180$  psf) = 0.0016

3. For buildings with interior partitions of  $X_1=20$  psf to 60 psf, the roof contribution from outside the central area must be added to the roof contribution from inside the central area.

*Example:* Data same as for example 2 above, except  $X_1=40$  psf.  
 Then  $X_o=180$  psf + 40 psf = 220 psf  
 Reduction factor ( $A'_c=410$  sf and  $X_o=220$  psf) = 0.0010  
 Reduction factor ( $A'_c=164$  sf and  $X_o=220$  psf) = 0.0008  
 Roof contribution from outside central area = 0.0002  
 Roof contribution from inside central area = 0.0016  
 Total roof contribution = 0.0018

4. In preliminary design of shelter in individual structures, skyshine contribution should be considered, as in examples a and b, below.

*Example:* a. Data same as for example 3 above.  
 Total roof contribution (excluding skyshine) = 0.0018  
 Total roof contribution (including skyshine) =  $0.0018 \times 1.01 = 0.00182$  or 0.0018

NOTE: The value 1.01 is from table CF-2, page 44.

*Example:* b. Data same as for example 1 above, except assume detector is on fifth floor: that is,  $Z=6$  ft.  
 ( $K=2.8$ ) and  $X_o=30$  psf  
 $A'_r=5,000 \times 2.8=14,000$  sf  
 Roof contribution (including skyshine) =  $0.15 \times 1.11 = 0.16$

NOTE: The value 0.15 is from chart 2; and the value 1.11 from table CF-2, page 44.

5. When it can be assumed that contamination is completely removed from the roof, only skyshine need be considered as roof contribution.

*Example:* Same data as for example 4b above, except contamination is completely removed from roof.  
 Roof contribution (skyshine only) =  $0.15 \times 0.11 = 0.016$

NOTE: The value 0.11 is from table CF-2, page 44.

<sup>1</sup> Chart 2 follows.

<sup>2</sup> See "Shielding Analysis Outline, Roof Contribution" (p. 20).

# Reduction Factors for Combined Shielding Effects

## ROOF CONTRIBUTION

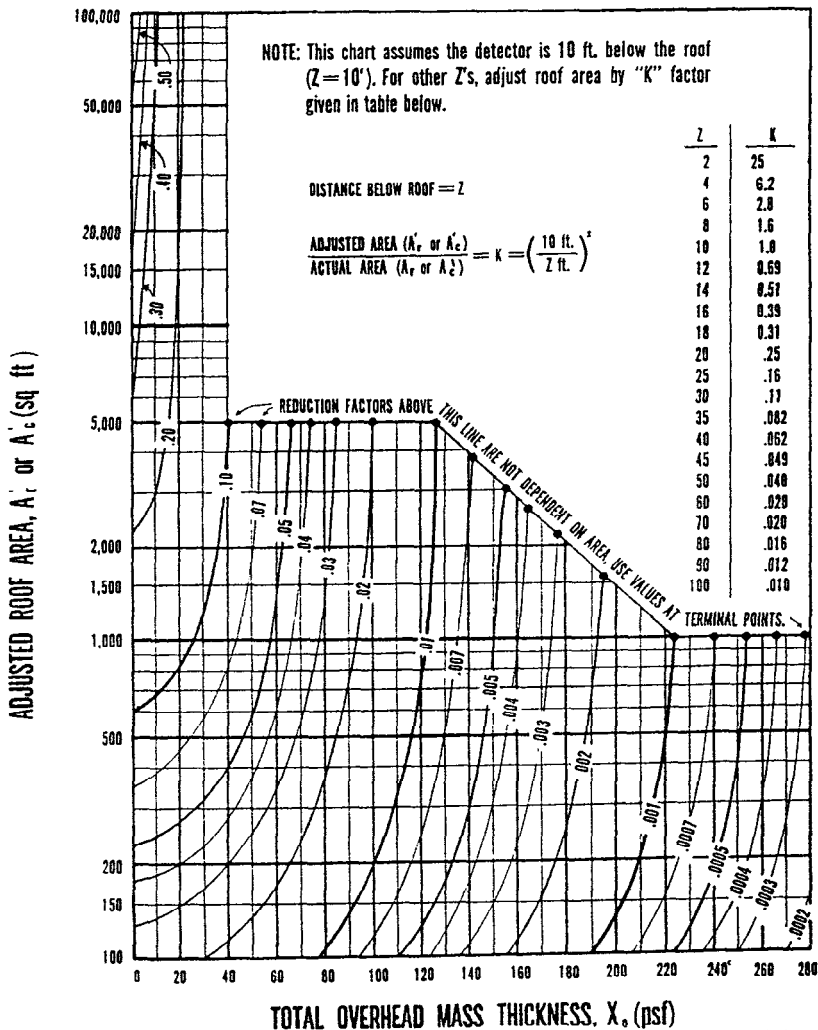

CHART 2



**SUPPLEMENT B**

(Part 3)

**Examples for Chart 3, "Ground Contribution—Aboveground Areas"<sup>1,2</sup>**

1. For buildings with 0% apertures or 100% apertures, only the area of the building,  $A_r$ , and the wall mass thickness,  $X_w$  ( $=X_e$ ), need be known to determine ground contribution at center of first floor.

*Example:* a.  $A_r=5000$  sf       $X_w=X_e=60$  psf       $Ap\%=0\%$

Ground contribution=0.096

b.  $A_r=5000$  sf       $X_w=X_e=3$  psf       $Ap\%=100\%$

Ground contribution=0.39

NOTE: For convenience, window glass is often assumed to have  $X=0$  psf.

2. For buildings with interior partitions,  $X_w=X_i+X_e$  should be used for the wall mass thickness.

*Example:* a.  $A_r=5000$  sf       $X_e=60$  psf       $X_i=20$  psf       $Ap\%=0\%$

Then  $X_w=60$  psf + 20 psf = 80 psf

Ground contribution=0.060

b.  $A_r=5000$  sf       $X_e=3$  psf       $X_i=20$  psf       $Ap\%=100\%$

Then  $X_w=3$  psf + 20 psf = 23 psf

Ground contribution=0.22

3. For buildings with intermediate values of  $Ap\%$ , the contribution through the solid portion of the wall is added to the contribution through the apertures.

*Example:* Same data as for example 2 above, except  $Ap\%=25\%$ .

Contribution through apertures =  $0.25 \times 0.22 = 0.055$

Contribution through solid portion of wall =

$(1.00 - 0.25) \times 0.060 = 0.045$

Ground contribution = 0.10

NOTE: Example 3 above assumes the detector is above sill level. Therefore, the aperture correction is 1.0 for the first floor. See table CF-1, page 44, and example 2 for chart 5, page 40.

<sup>1</sup> Chart 3 follows.

<sup>2</sup> See "Shielding Analysis Outline, Ground Contribution (Aboveground Areas)" (p. 27).

# Reduction Factors for Combined Shielding Effects

## GROUND CONTRIBUTION - ABOVEGROUND AREAS

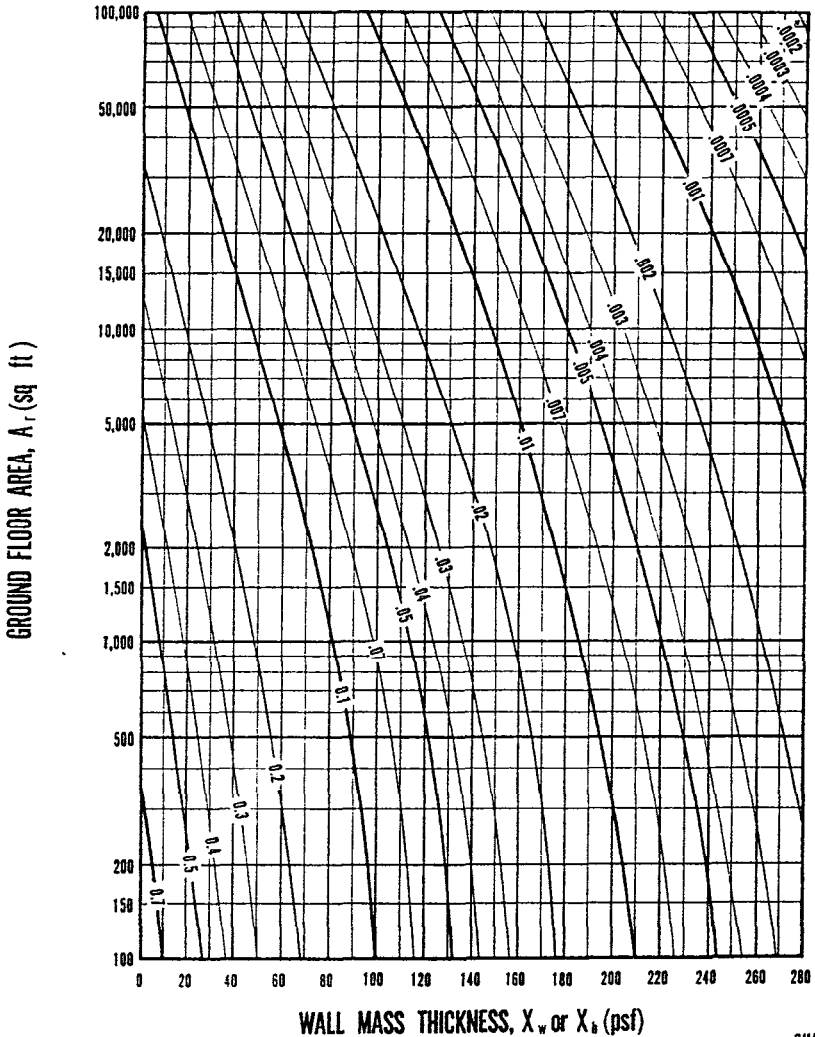

CHART 3

**SUPPLEMENT B****(Part 4)****Examples for Chart 4, "Ground Contribution—Belowground Areas"<sup>1, 2</sup>**

1. For buildings with  $A_p\% = 0\%$  on the first floor, use the total floor area,  $A_t$ , and the mass thickness of the wall,  $X_w (= X_s)$ , to determine the ground contribution at the center of a basement which is entirely below grade ( $Ex\% = 0\%$ ) and has a very light floor overhead ( $X'_s = 0$  psf).

*Example:*  $A_t = 5000$  psf       $X_w = X_s = 60$  psf       $X'_s = 0$  psf  
 $A_p\% = 0\%$        $Ex\% = 0\%$   
 Ground contribution = 0.034

2. For buildings with apertures in the wall of the first floor, use an adjusted wall mass thickness,  $X'_w = (100\% - A_p\%) X_w$ .

*Example:* Same data as for example 1 above, except  $A_p\% = 25\%$ .  
 $X'_w = (100\% - 25\%) \times 60$  psf = 45 psf  
 Ground contribution = 0.045

3. To account for the shielding afforded by the floor over the basement, use case 3, chart 1 (p. 33).

*Example:* Same data as for example 2 above, except  $X'_s = 40$  psf.  
 Ground contribution =  $0.045 \times 0.14 =$ 0.0063

4. To account for basements that have walls partially above grade, assume  $Ex\% = 0\%$  and find ground contribution. Assume  $Ex\% = 100\%$  and find ground contribution. Then add to the ground contribution for  $Ex\% = 0\%$ , the ground contribution through the exposed portion of the wall.

*Example:* Same data as for example 3 above, except  $Ex\% = 20\%$  and  $X_b = 60$  psf.  
 Ground contribution ( $Ex\% = 0\%$ ) = 0.0063  
 Ground contribution ( $Ex\% = 100\%$ )  $\times 20\% = 0.096 \times 0.2 =$ 0.019  
 Total ground contribution = 0.025

**NOTE:** The value 0.0063 ( $Ex\% = 0\%$ ) is from example 3 above. The value 0.096 ( $Ex\% = 100\%$ ) is from example 1a for chart 3 (p. 36).

<sup>1</sup> Chart 4 follows.

<sup>2</sup> See "Shielding Analysis Outline, Ground Contribution (Belowground Areas)" (p. 26).

Reduction Factors for Combined Shielding Effects  
**GROUND CONTRIBUTION-BELOWGROUND AREAS**

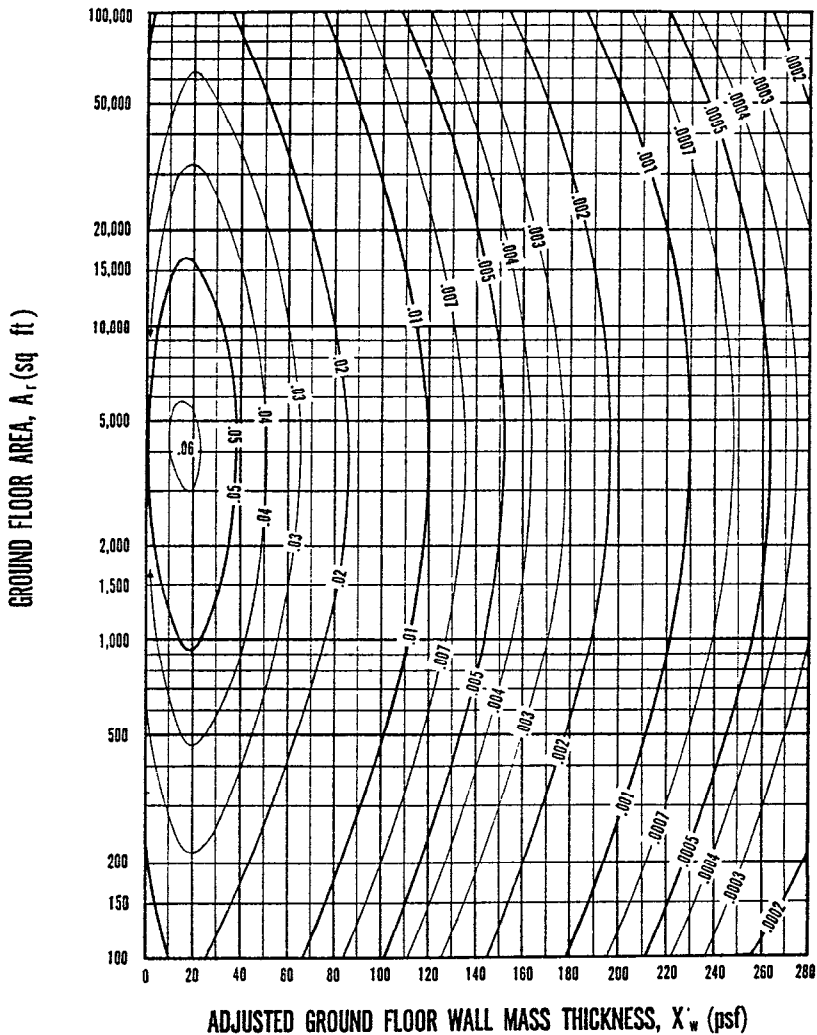

CHART 4

## SUPPLEMENT B

(Part 5)

### Examples for Chart 5, "Shielding Effects of Height"<sup>1, 2</sup>

1. In upper stories of buildings, the ground contribution is decreased by the effect of height. For convenience, an area is calculated as if it were on the ground floor, and then adjusted by a height correction factor,  $H_c$ .

*Example:* Assume same data as in example 1a for chart 3, except the shelter area is located on the fifth floor of the building; i.e., the detector is about 55 feet above the ground.

Then from chart 5,  $H_c=0.48$ , and

$$\text{Ground contribution} = 0.096 \times 0.48 = \underline{0.046}$$

**NOTE:** The value 0.096 is from example 1a for chart 3, which is for a windowless building.

2. To correct for apertures, use table CF-1, page 44.

*Example:* Same data as for example 1 above, except  $A_p\% = 25\%$  (floors are "thick").

$$\text{Ground contribution through apertures (detector above sill level)} = 0.39 \times 0.48 \times 0.25 \times 0.4 = \underline{0.019}$$

$$\text{Ground contribution through apertures (detector below sill level)} = 0.39 \times 0.48 \times 0.25 \times 0.2 = \underline{0.0094}$$

**NOTE:** The value 0.39 is from example 1b for chart 3. The values 0.4 and 0.2 are from table CF-1, page 44. To obtain the total ground contribution, the contribution through solid portion of wall should be added to contribution through aperture. (See example 3 for chart 3, p. 36.)

<sup>1</sup> Chart 5 follows.

<sup>2</sup> See "Shielding Analysis Outline, Ground Contribution (Aboveground Areas)" (p. 27).

# SHIELDING EFFECTS OF HEIGHT

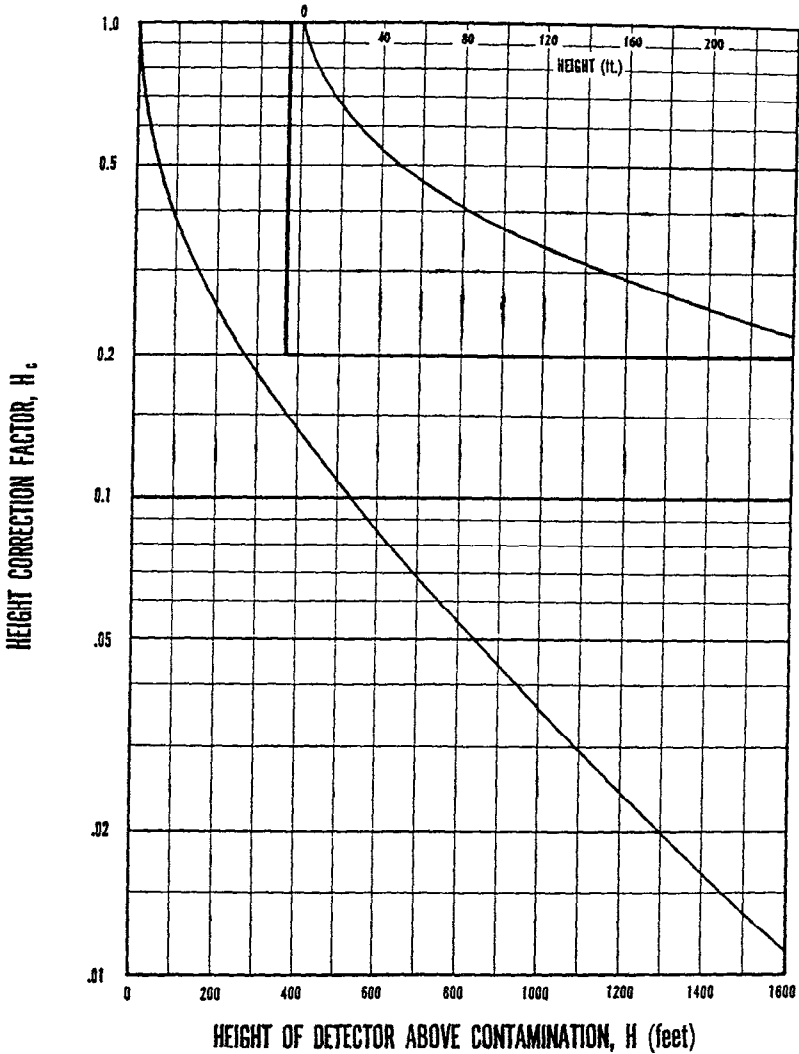

CHART 5

## SUPPLEMENT B

(Part 6)

### Examples for Chart 6, "Reduction Factors for Apertures, Ground Floor" <sup>1</sup>

1. On the ground floor of a multistory building surrounded on three sides by other buildings and with the remaining wall covered by windows, the reduction factor from ground contribution decreases as distance from the aperture increases.

*Example:* Length of aperture,  $L=50$  ft.

$$\text{Ground contribution (detector 20 ft. from aperture)} = 0.19 + \text{or, } \underline{0.20}$$

$$\text{Ground contribution (detector 60 ft. from aperture)} = \underline{0.06}$$

2. Buildings across the street provide some shielding. To account for this, use table CF-3, page 44.

*Example:* Same data as for example 1 above, except there are commercial buildings across the street, which is 100 ft. wide.

$$\text{Ground contribution (detector 20 ft. from aperture)} = 0.20 \times 0.4 = \underline{0.08}$$

$$\text{Ground contribution (detector 60 ft. from aperture)} = 0.06 \times 0.4 = \underline{0.024}$$

**NOTE:** The value 0.4 ( $W_s = 100$  ft.) is from table CF-3, page 44.

---

<sup>1</sup> Chart 6 follows.

Note: Detector is assumed to be 3' above the floor.

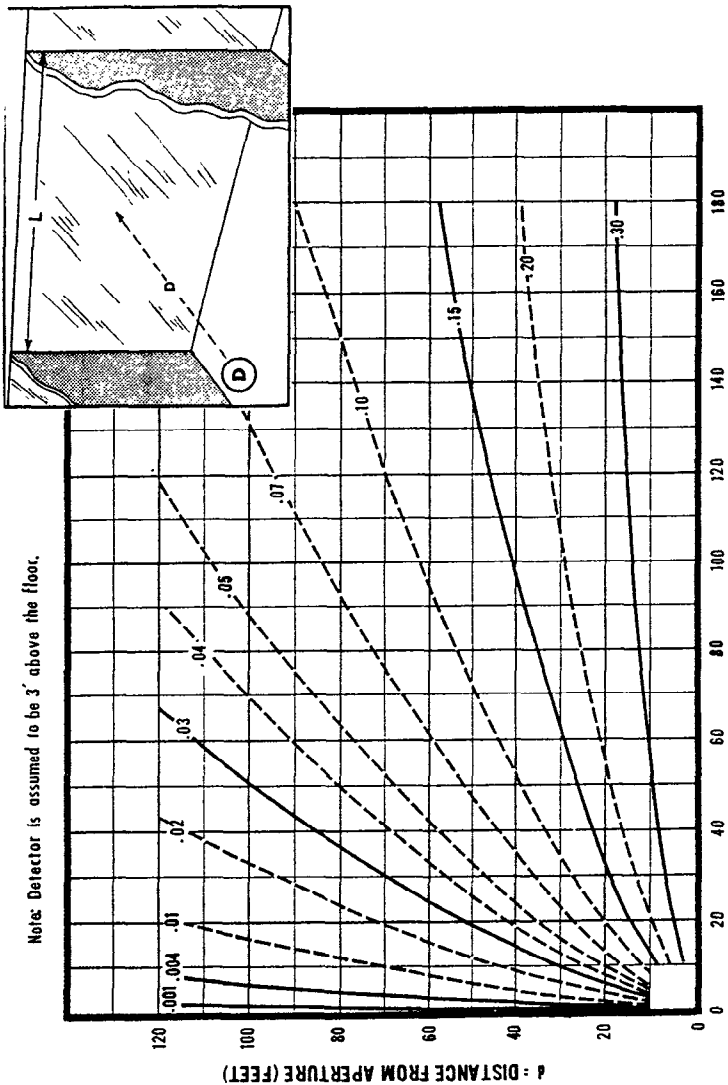

## REDUCTION FACTORS FOR APERTURES, GROUND FLOOR

CHART 6



## TABLES OF CORRECTION FACTORS

TABLE CF-1.—Aperture correction to ground contribution<sup>1</sup>

Floor No.	Thick floors ( <i>X</i> greater than 40 psf)		Thin floors ( <i>X</i> less than 40 psf)	
	Above sill	Below sill	Above sill	Below sill
1	1.0	0.2	1.0	0.2
2	.7	.2	1.0	.7
3	.6	.2	1.0	.6
4	.5	.2	1.0	.5
5	.4	.2	1.0	.4
6	.3	.2	1.0	.3
6+	.2	.2	1.0	.2

<sup>1</sup> Table CF-1 may be used for either simple or complex (wall-by-wall) cases. See example 2 for chart 5 for use of this table.

TABLE CF-2.—Skyshine correction to roof contribution<sup>1, 2</sup>

Total overhead mass thickness, <i>X</i> .	Contaminated roof	Decontaminated roof
0	1.15	0.15
50	1.08	.08
100	1.04	.04
200	1.01	.01

<sup>1</sup> Applied to reduction factor from chart 2 (p. 35).

<sup>2</sup> Table CF-2 is generally used for cursory checks only. However, it is also used to evaluate the efficacy of roof decontamination. See examples 4 and 5 for chart 2 for use of this table.

TABLE CF-3.—Mutual shielding correction to ground contribution<sup>1</sup>

Width of field ( <i>W</i> <sub>s</sub> )	Correction factor ( <i>M</i> <sub>s</sub> )
feet 0	0.00
10	.08
20	.10
50	.20
100	.40
200	.60
500	.80
1000	.90
Infinite	1.00

<sup>1</sup> Table CF-3 is for wall-by-wall calculations. See example 2 for chart 6 for use of this table. When a condensed computational form (supp. E) is used, make the following adjustments in tabular values in the case of urban buildings (those in areas of predominantly multistory commercial buildings): Streets on one side,  $\times \frac{1}{2}$ ; on two sides,  $\times \frac{1}{2}$ ; on three sides,  $\times \frac{1}{4}$ . (Streets on all sides, use values "as is.")

BRIEF TABLE OF MASS THICKNESSES

This brief table of mass thicknesses is presented as guidance only. In general, it may be assumed that the weights given for the various types of roof, floor, and wall construction as found in standard engineering tables are equivalent to the mass thickness of the construction. Publications of the American Standards Association, the American Institute of Steel Construction, the American Concrete Institute, and others may be used for this purpose.

Item	Thickness	Weight (mass thickness)	Item	Thickness	Weight (mass thickness)
	<i>Inches</i>	<i>lb./sq. ft.</i>		<i>Inches</i>	<i>lb./sq. ft.</i>
Asbestos:			Concrete—Continued		
Board.....	3/16.....	2	Cinder.....	4.....	22
Corrugated.....	.....	4	.....	6.....	30
Shingles.....	1/2.....	2	.....	8.....	39
Asphalt:			.....	12.....	61
Roofing (3 ply).....	.....	1	Lightweight.....	4.....	20
Roofing (4 ply and gravel).....	.....	6	.....	6.....	28
Roofing (5 ply and gravel).....	.....	7	.....	8.....	39
Shingles.....	.....	2	.....	12.....	61
Clay:			Fiberboard or sheathing.....	1/2.....	1
Brick.....	1.....	8-10	Glass panes.....	1/4.....	3 1/2
Tile:			Gypsum:		
Facing.....	2.....	15	Block.....	2.....	8-10
Facing.....	4.....	25	Block.....	4.....	10-12
Facing.....	6.....	38	Board or sheathing.....	1/2.....	2
Partition.....	4.....	18	Plaster:		
Partition.....	6.....	29	Applied directly or on lath.....	1/2-3/4.....	5-6
Partition.....	8.....	34	Solid.....	1.....	8-10
Partition.....	10.....	40	Plywood sheathing.....	3/4.....	1
Shingles.....	8.....	10-20	Slate.....	3/16.....	7
Structural.....	8.....	42	Soil:		
Structural.....	12.....	58	Clay.....	1.....	6-9
Concrete:			Loam.....	1.....	7-10
Cinder.....	1.....	9	Sand and gravel.....	1.....	8-11
Flavite.....	1.....	8	Steel:		
Lightweight.....	1.....	6-8	Plate.....	1.....	41
Reinforced.....	1.....	12 1/2	Corrugated sheet.....	20 Ga.....	2
Slag.....	1.....	10-11	Panels.....	18 Ga.....	3
Stone or gravel (std. wt.).....	1.....	12-12 1/4	Stone masonry.....	1.....	10-14
Block (hollow).....	.....	.....	Stucco.....	3/4.....	5
Stone or gravel (std. wt.).....	4.....	30	Terra cotta.....	1.....	5
.....	6.....	42	Wood:		
.....	8.....	55	Sheathing.....	1.....	2 1/4
.....	12.....	85	Shingles.....	.....	2 1/4
			Siding.....	1.....	1-2 1/4



## Assumptions Used in Development of Procedures for Shielding Calculations

### FALLOUT DISTRIBUTION

Fallout is assumed to be uniformly distributed over exposed surfaces according to their horizontal projections. Fallout on vertical surfaces is not considered.

### ENERGY OF GAMMA RADIATION

The energy spectrum of gamma radiation is assumed to be that from fission products at one hour after weapon burst.

### BARRIER ATTENUATION

It is assumed that the amount of attenuation by a given barrier depends only on its mass thickness and not on the chemical composition of the barrier material.

### SCHEMATIZATION

The basic schematization consists of replacing a structure by another with the same height but with a square cross-sectional area equal to that of the original structure. The roof is replaced by a circular disk with area equal to that of the building.

### CONTRIBUTION FROM SOURCES ON THE ROOF

#### *Barrier Effect*

Calculations are for the attenuation of radiation from an infinite plane isotropic source through an overhead barrier, using the moments method.

#### *Geometry Effect*

This factor gives the ratio of dose rate from a finite disk source to that from an infinite plane source. The barrier is assumed to be uniformly distributed between source and detector. The geometry factor depends on the source geometry and the angular distribution of radiation at the detector. Since the angular distribution is dependent on the barrier thickness, the geometry factor is also dependent on barrier thickness.

#### *Reduction Factor from Roof Contribution*

The product of the reduction factor from the roof barrier effect and the roof geometry effect is the reduction factor for the roof contribution.

### CONTRIBUTION FROM SOURCES ON THE GROUND

#### *Barrier Effect*

Calculations are for the penetration of radiation from a semi-infinite plane isotropic source on one side of a vertical wall to a detector on the other side. Solutions were obtained by the moments method.

#### *Geometry Effect*

*Thin walls* (mass thickness much less than 40 psf).—This factor gives the ratio of the dose rate above a cleared circular area to the dose rate at the same height above an infinite plane source.

*Thick walls* (mass thickness much greater than 40 psf).—This factor, which depends upon the angular distribution of the radiation emerging from the inner surfaces of the wall, gives the ratio of the dose rate inside a square building of finite height to that between two infinitely long and infinitely high vertical slabs of the same wall mass thickness.

*Walls of intermediate thickness*.—A weighted average of the thin wall and thick wall geometry factors is used. The weighting factors are determined by the relative amounts of scattered and unscattered radiation emerging from the inner surface of the walls. The weighting factors vary with wall thickness.

#### *Reduction Factor from Ground Contribution*

The product of the reduction factors from the wall barrier effect and the ground geometry effect gives the reduction factor for the ground contribution.

### CONTRIBUTION FROM RADIATION SCATTERED FROM AIR AND GROUND

A correction for scattered radiation, which varies with the mass thickness of the walls, is included in the ground geometry factors for detector position below grade. A fraction of 20 percent, scattered to total radiation, is assumed at 3 feet above an infinite plane isotropic source

## NORMALIZATION OF REDUCTION FACTORS

The *total reduction factor* is the ratio of the dose rate at the detector to that 3 feet above an infinite smooth plane. It is the sum of roof and ground reduction factors.

### CORRECTION FACTORS

The correction factors presented in the tables on page 44 are intended to correct for several

effects in a qualitative way. More accurate estimates would involve a complicated dependence on other variables.

### DETECTOR POSITIONS

For ground floor areas, the detector position is assumed to be 3 feet *above* ground level at the geometric center of the structure. For basement areas, the detector position is assumed to be 5 feet *below* the level of the ground floor at the geometric center of the structure.

## CONDENSED SHIELDING ANALYSIS

(Aboveground Areas) <sup>1</sup>

Survey No. \_\_\_\_\_ By \_\_\_\_\_ Date \_\_\_\_\_

(1) Roof area \_\_\_\_\_ sf (2) Distance, roof to detector \_\_\_\_\_ ft.

(3) Total overhead mass thickness \_\_\_\_\_ psf

(4) Wall mass thickness \_\_\_\_\_ psf (5) Apertures \_\_\_\_\_ %

(6) Roof contribution: (1), (2), and (3), chart 2..... \_\_\_\_\_

(7) (1) and (4), chart 3..... \_\_\_\_\_

(8) (1) and 0 psf, chart 3..... \_\_\_\_\_

(9)  $(7) \times (100\% - (5))$ ..... \_\_\_\_\_(10)  $(8) \times (5)$ ..... \_\_\_\_\_(11)  $(9) + (10)$ ..... \_\_\_\_\_(12) Ground contribution:  $(11) \times \text{table CF-3 } (M_s)$ ..... \_\_\_\_\_(13) Reduction factor:  $(6) + (12)$ ..... \_\_\_\_\_

(14) Protection factor: reciprocal of (13)..... \_\_\_\_\_

(15) Category of shelter area..... \_\_\_\_\_

<sup>1</sup> This form should be used only for analyses of ground floor areas of buildings with light interior partitions.

## CONDENSED SHIELDING ANALYSIS

(Belowground Areas)<sup>1</sup>

Survey No. \_\_\_\_\_ By \_\_\_\_\_ Date \_\_\_\_\_

- 
- 
- (1) Roof area \_\_\_\_\_ sf      (2) Distance, roof to detector \_\_\_\_\_ ft.  
(3) Total overhead mass thickness \_\_\_\_\_ psf  
(4) Wall mass thickness \_\_\_\_\_ psf      (5) Apertures \_\_\_\_\_ %  
(6) Ceiling mass thickness \_\_\_\_\_ psf  
(7) Basement wall mass thickness \_\_\_\_\_ psf      (8) Exposure \_\_\_\_\_ %
- 
- 

- (9) Roof contribution: (1), (2), and (3), chart 2..... \_\_\_\_\_  
(10)  $(4) \times (100\% - (5))$ ..... \_\_\_\_\_  
(11) (1) and (10), chart 4..... \_\_\_\_\_  
(12) (6), case 3, chart 1..... \_\_\_\_\_  
(13)  $(11) \times (12)$ ..... \_\_\_\_\_  
(14) (1) and (7), chart 3..... \_\_\_\_\_  
(15)  $(14) \times (8)$ ..... \_\_\_\_\_  
(16)  $(13) + (15)$ ..... \_\_\_\_\_  
(17) Ground contribution:  $(16) \times$  table CF-3 ( $M_s$ )..... \_\_\_\_\_  
(18) Reduction factor:  $(9) + (17)$ ..... \_\_\_\_\_  
(19) Protection factor: reciprocal of (18)..... \_\_\_\_\_  
(20) Category of shelter area..... \_\_\_\_\_
- 

<sup>1</sup> This form should be used only for analyses of basement areas of buildings with light interior partitions.





