

Praise for

# Rainwater Harvesting for Drylands and Beyond Volume 2

"Harvesting rainwater was once a worldwide technology, but was replaced by pipes, canals, and sprinklers: an inefficient and wasteful strategy that results in running dry. In *Rainwater Harvesting for Drylands and Beyond, Volume 2*, Brad uses the concept of 'planting water' as a guiding principle in designing landscapes that passively harvest resources to grow more resources. Such brilliant, low-tech, regenerative systems are vital to hydrating the land and maximizing the benefit that water brings to plants, animals, and people. Thus, this book is an excellent and comprehensive tool for all bucket-and-shovel 'engineers' to maximize the hydrological resource, reduce energy use, and transform their once-erosive landscapes into ones of stability, botanical diversity, and abundance."

—Arty Mangan, Bioneers Food and Farming Program Director

"This volume should be on the bookshelf of every conscientious homeowner in the desert Southwest. Rainfall truly becomes something to celebrate when we can use it to fill up the soil banks in our property instead of watching it rush down the street into a storm sewer."

—Nancy R. Laney, Executive Director, Tucson Botanical Gardens

"The cheapest—and sanest—way to meet our growing need for water is to squeeze more out of the water we already have, especially rainwater and used household water. Lancaster approaches these unsung streams as a farmer might, cultivating them in order to nourish dry landscapes. He has produced a water-farming guide that will inspire both the casual gardener and the card-carrying permaculturalist. With step-by-step instructions and clear illustrations, he guides the reader through simple techniques—berms, curbscuts, greywater plumbing—which in turn guide water into your soil and landscape. Lancaster is clearly determined to save the world.

And he's determined to make it easy for the rest of us to help.

—Hannah Holmes, author of *Suburban Safari: A Year on the Lawn*

## Awards

- Winner, *DIY Book Festival – How-To Category*
- Gold Medal, *Living Now Book Awards – Gardening/Landscaping*
- Silver Award, *Nautilus Book Awards – Ecology/Environment/Sustainability*
- Silver Award of Achievement, *Garden Writers Association Media Awards*
- Finalist, *Arizona Book Publishers Association Glyph Award – Reference*
- Pick, *Southwest Book of the Year by the Pima County Public Library*
- Finalist, *USA Book News National Best Book Awards – Gardening*
- Finalist, *Foreword Magazine Book of the Year Award – Home and Garden*

For inside cover figure captions see last page of book.

"Brad's book is a treasure. It brings much-needed clarity to a timely subject and what's more it inspires, motivates, and lifts the spirit. It's a resource that no steward of the land should ignore."

—Owen Dell, landscape architect and contractor, author and educator, Santa Barbara, California

"The level of detail that Brad provides is unmatched in the water-harvesting industry. This is one of the seminal books of our time."

—Nate Downey, author of *Harvest the Rain* and *Rooftop Water Harvesting in New Mexico*

"Water has been identified as a global crisis in the making and Arizona is fast becoming ground zero for this issue in the U.S. Fortunately people like Brad Lancaster are working to change our illogical, wasteful approach to water use.

Brad is one of those outstanding teachers who communicate passion and excitement while bringing an amazing wealth of knowledge to water conservation. This second encyclopedic volume is a distillation of his many years of study, experience, and experimentation and gathers together in one volume a vast number of resources.

The information is thorough, well-documented, clearly explained, and eminently useful. Every civil engineer, landscape architect, planner, and architect should read this book and implement its strategies. If they did, our coming water crisis could be averted and our cities could become far more productive and pleasant places to live."

—Antony Brown, Director, Ecosa Institute

"This is a fascinating book, full of real-life examples and lots of inspiring ideas for a variety of sites and soil types. Anyone who wants to live and garden more sustainably will enjoy it."

—Elizabeth Davison, Director, University of Arizona Campus Arboretum;  
Lecturer, Division of Horticultural/Crop Sciences, University of Arizona

"The prescription for water sustainability Brad has painstakingly drawn up in this very informative book is based on real-life successes, has a very wide application even across the seas, and is simple and reliable. What touches us most are his friendly narration and the 'tell-tale' illustrations that have an eye for detail."

—Shree Padre, Messenger of Rainwater Harvesting, India

"Brad is an earth and water sculptor. Practical, easy to follow, well researched and logical, *Rainwater Harvesting for Drylands and Beyond, Volume 2*, is destined to be one of my more dog-eared resource books. It's probably going to get a little muddy too!"

—Cado Daily, University of Arizona Cooperative Extension, Water Wise Program

"The book is a wonder of practical and progressive strategies for anyone interested in preserving our precious surface-water resources and putting them to good use. Brad Lancaster has outlined how to use earthworks to capture rainwater and to use it to foster productive plant life. Volume 2 of this three-volume work builds on the conceptual framework of Volume 1 and introduces easy-to-understand definitions, diagrams, and photographs to implement these water-harvesting ideas."

—Corky Poster, architect and planner; Director, Drachman Institute; Distinguished Professor of Outreach, University of Arizona, College of Architecture and Landscape Architecture

"As a permaculture teacher and designer, *Rainwater Harvesting for Drylands and Beyond* is my 'go to' source for how to design a sustainable water system."

—Dan Dorsey, Sonoran Permaculture Guild

"Those who apply the lessons Brad Lancaster describes so clearly in this one-of-a-kind book can dramatically lower their consumption of water from conventional sources, yet live in a virtual oasis, even in the driest climates! Buy a copy today and put it to good use."

—Dan Chiras; author of *The Homeowner's Guide to Renewable Energy*, *The Solar House*, *The New Ecological Home*, *The Natural Plaster Book*, and other books

"After guiding us to see the world of water harvesting as he does in Volume 1, Brad Lancaster now gives us the details on how to shape our landscape to capture as much water as possible in Volume 2.

Volume 1 provided us with the principles for water harvesting and Volume 2 gives us the blueprints, methods, and tools for applying those principles to our own or neighborhood landscape. Details abound. While others say the devil is in the details, Brad shows us that success is in the details—along with doing it yourself. When I first became interested in water harvesting it was sufficient for me to be satisfied with understanding water harvesting as the process of applying hydrology to small watersheds. But, the students have shown me that that is not enough! You must do it to really understand it. Volume 2 gives us the details for catching the water on our land and putting it to use, thereby reducing consumption of utility-provided water; and if we can get whole neighborhoods to follow, also reducing the magnitude of street flooding.

You need to understand and apply the Eight Principles of Water Harvesting given in Volume 1 in analyzing your site. Once you know what you want to do, you can select the appropriate practices, and then with Volume 2 you can do it. I don't think you'll find yourself reading Volume 2 cover to cover as you need to do with Volume 1, but Volume 2 is a practical engineering guide where you can look up the details you need for a given project."

—James J. Riley, Ph.D., Soil, Water, and Environmental Science Department, University of Arizona

"Brad has outdone himself with this volume. I think it will be an even more valuable reference and resource for the thoughtful public than the first volume. Thank you Brad for making the effort to do justice to that most precious of water sources—our rainfall."

—Val Little, Director, Water Conservation Alliance of Southern Arizona

"Whether you have years of experience or are just beginning to explore a greener way of living; whether you're a do-it-yourselfer, an educator, a client, or a consultant/designer of regenerative systems, this book (and these three volumes) is for you. You will love the ease of reading, clarity, and beauty of illustrations. And it will get you off your buns and out into the land you love."

—Barbara Rose, Dancing Rocks Community; education, integrated design, consulting, and local/native foods and herbs, Tucson, Arizona

"Many of us have been involved with rainwater harvesting from roofs using gutters and cisterns for years, but not until I read Brad Lancaster's Volume 2 did I realize that we have been missing most of the rainwater harvesting opportunities! This incredibly important book provides the tools for anyone to collect and direct rainwater using simple, natural, affordable, aesthetically pleasing strategies based on appropriately sculpting the earth."

—Gayle Borst, architect and Executive Director of Design-Build-Live, Austin, Texas

"The information presented in Volume 2 is crucial for healing our relationship with the planet. The book's accessible style and format makes it an important reference guide for anyone who works on the land. Amidst instruction on the fine art of digging ditches and the subtle science of placing rocks and sticks, Brad weaves in essential wisdom about relationship with our resources and invites us all to become stewards of the Earth.

—Amanda Bramble, Director of Ampersand Project, Madrid, New Mexico

See [www.HarvestingRainwater.com](http://www.HarvestingRainwater.com) for more testimonials and book reviews



Rainsource Press is committed to preserving ancient forests and natural resources. We elected to print this title on 100% post consumer recycled paper, processed chlorine free. As a result, for this printing, we have saved:

160 Trees (40' tall and 6-8" diameter)  
73,447 Gallons of Wastewater  
51 million BTU's of Total Energy  
4,459 Pounds of Solid Waste  
15,250 Pounds of Greenhouse Gases

Rainsource Press made this paper choice because our printer, Thomson-Shore, Inc., is a member of Green Press Initiative, a nonprofit program dedicated to supporting authors, publishers, and suppliers in their efforts to reduce their use of fiber obtained from endangered forests.

For more information, visit [www.greenpressinitiative.org](http://www.greenpressinitiative.org)

Environmental impact estimates were made using the Environmental Defense Paper Calculator. For more information visit: [www.papercalculator.org](http://www.papercalculator.org).

## THE REGENERATIVE FUND

Once production costs are recovered, 10% of the profits from each book sold will go to the "Regenerative Fund." This money will help fund projects, presentations, and publications that promote rainwater harvesting and other sustainable living strategies. The fund will also be used to help distribute these resources to libraries and schools.

# Rainwater Harvesting for Drylands and Beyond Volume 2

WATER-HARVESTING EARTHWORKS

Brad Lancaster

Illustrated by  
Joe Marshall  
Silvia Rayces  
Ann Audrey  
Gavin Troy  
Kay Sather  
April Baisan  
David Harnish



RAINSOURCE PRESS

Tucson, Arizona  
[www.HarvestingRainwater.com](http://www.HarvestingRainwater.com)

Copyright © 2008, 2010 by Brad Lancaster  
All rights reserved.

Published by:  
Rainsource Press  
813 N. 9th Ave.  
Tucson, AZ 85705  
U.S.A.  
[www.HarvestingRainwater.com](http://www.HarvestingRainwater.com)

First Printing 2008  
Second Printing 2010, Revised  
Printed and bound in the United States of America on acid-  
and chlorine-free, 100% post-consumer recycled paper

Cover design: Kay Sather  
Front cover art: Gavin Troy  
Back cover illustration: Kay Sather  
Back cover photo: Josephine Thomason  
Book design: Teri Reindl Bingham  
Illustrations: Joe Marshall ([www.planetnameddesire.com](http://www.planetnameddesire.com)),  
Silvia Rayces, Ann Audrey, April Baisan, David Harnish  
Photographs: Unless otherwise noted, all photographs are by Brad Lancaster

Lancaster, Brad

Rainwater Harvesting for Drylands and Beyond, Volume 2:  
Water-Harvesting Earthworks/Brad Lancaster.

p. cm.

Includes bibliographical references and index.

ISBN 978-0-9772464-1-0

1. Rainwater harvesting. 2. Water harvesting. 3. Landscape design. 4. Ecology.  
5. Sustainable development. 6. Do-it-yourself technology. 7. Sustainable  
Stormwater Management. 8. Erosion control

Library of Congress Control Number (LCCN): 2007943019

This book is for information purposes only. It is not intended to promote any  
violation of the law, and is true and complete to the best of the author's knowledge.

The author disclaims any liability arising from use of this information.

To

*Everyone featured in this book, the volume preceding it,  
and the one to follow, for inspiring and teaching me  
by sharing your exemplary, caring lives and actions*

*All I have connected with, and been hosted by,  
on my daily and worldly travels in search of lives  
and strategies in balance with nature and community.  
You may not be mentioned directly within these pages,  
but the teachings from your shared passions  
and practices are infused throughout.*

*All who are actively living the change  
they want to see in the world*

# The Eight Principles of Successful Rainwater Harvesting

---

## **1. Begin with long and thoughtful observation.**

Use all your senses to see where the water flows and how. What is working, what is not? Build on what works.

## **2. Start at the top (highpoint) of your watershed and work your way down.**

Water travels downhill, so collect water at your high points for more immediate infiltration and easy gravity-fed distribution. Start at the top where there is less volume and velocity of water, and it is easier to manage.

## **3. Start small and simple.**

Work at the human scale so you can build and repair everything. Many small strategies are far more efficient than one big one when you are trying to infiltrate water into the soil.

## **4. Spread and infiltrate the flow of water.**

Rather than having water erosively run off the land's surface, encourage it to stick around, "walk" around, and infiltrate into the soil. Slow it, spread it, sink it.

## **5. Always plan an overflow route, and manage that overflow as a resource.**

Always have an overflow route for the water in times of extra heavy rains and, where possible, use that overflow as a resource.

## **6. Create a living sponge.**

Maximize living and organic groundcover to create a living sponge so the harvested water is used to grow more resources, while the soil's ability to infiltrate and hold water steadily improves.

## **7. Do more than just harvest water.**

Maximize beneficial relationships and efficiency by "stacking functions." For example, berms can double as high and dry raised paths. Plantings can be placed to cool buildings in summer. Vegetation can be selected to provide food.

## **8. Continually reassess your system: the "feedback loop."**

Observe how your work affects the site—beginning again with the first principle. Make any needed changes, using the principles to guide you.

*Principles 2, 4, 5, and 6 are based on those developed and promoted by PELUM—the Participatory Ecological Land-Use Management association of east and southern Africa. Principles 1, 3, 7, and 8 are based on my own experiences and the insights gained from other water harvesters.*



# Contents

|  |       |  |    |
|--|-------|--|----|
| List of Illustrations  | xiii  | Chapter 1. Assessing Your Site, Choosing Your Earthworks, and Tips on Implementation | 35 |
| Tabled and Boxed Information   | xix   | Part 1: Understanding Patterns of Water Flow and Reading Slope                       | 35 |
| Acknowledgments  | xxi   | Part 2: Summary of Water-Harvesting Earthworks                                       | 41 |
| Foreword by Andy Lipkis  | xxiii | Part 3: Twenty-Six Water-Harvesting Earthwork Tips                                   | 44 |
| Preface  | 1     | Chapter 2. Berm 'n Basins  | 65 |
| The Eight Principles of Successful Rainwater Harvesting                    | 4     | What Is a Berm 'n Basin?   | 65 |
| Water-Harvesting Ethics  | 8     | Where Is a Berm 'n Basin Used?   | 66 |
| Who This Book Is For   | 8     | Tools and Materials  | 66 |
| How to Use This Book and Volumes 1 and 3                                   | 9     | Steps to Build a Berm 'n Basin   | 67 |
| Deciding How Best to Harvest Your Water                                    | 10    | Variations of Berm 'n Basins   | 78 |
| Introduction. Earthworks Defined, Their Advantages, and a Story of Success | 13    | Multiple Functions of Berm 'n Basins   | 80 |
| What Is Rainwater Harvesting with Earthworks?                              | 13    | Real-Life Examples   | 82 |
| Earthworks—A Resurging Ancient Strategy                                    | 16    | The Grandmother Approach   | 82 |
| Earthworks Plant the Rain to Turn Water Scarcity Into Water Abundance      | 17    | Using Trees Killed by Fire   | 82 |
| Earthworks Are the Foundation Strategy of Sustainable Landscapes           | 17    | Harvesting Windswept Snow  | 83 |
| Additional Benefits of Earthworks  | 19    |  |    |
| I Give Thee Thy Shovel   | 25    |  |    |
| Real-Life Example  | 25    |  |    |
| Water Scarcity Into Water Abundance  | 25    |  |    |

|   |            |  |            |
|---|------------|--|------------|
| <b>Chapter 3. Terraces</b>                | <b>87</b>  | <b>Chapter 6. Imprinting</b>             | <b>143</b> |
| What Is a Terrace?                        | 87         | What Is Imprinting?                      | 143        |
| Where Is a Terrace Used?                  | 88         | Where Is Imprinting Used?                | 144        |
| Tools and Materials                       | 89         | Tools and Materials                      | 145        |
| Implementation Steps to Build a Terrace   | 89         | Implementation Steps                     | 145        |
| Multiple Functions of Terraces            | 99         | Variations for Special Imprinters        | 149        |
| Real-Life Examples                        | 100        | Multiple Functions of Imprinting         | 150        |
| Terrace Building, Tarahumara Indians      | 100        | Real-Life Example of Imprinting          | 150        |
| Terraced Cistern Steps, Gardens           | 102        | Restoring Bladed Land                    | 150        |
| <br>                                      |            |  |            |
| <b>Chapter 4. French Drains</b>           | <b>105</b> | <b>Chapter 7. Mulching</b>               | <b>153</b> |
| What Is a French Drain?                   | 105        | What Is Mulching?                        | 153        |
| Where Is a French Drain Used?             | 106        | Where Is Mulch Used?                     | 155        |
| Tools and Materials                       | 106        | Tools and Materials                      | 156        |
| Steps to Build a French Drain             | 107        | Implementation Steps                     | 160        |
| Variations of a French Drain              | 115        | Variation of Mulching                    | 163        |
| Multiple Functions of French Drains       | 116        | Mulching as More Than a Water-           |            |
| Real-Life Examples                        | 116        | Harvesting Strategy                      | 163        |
| Pumice Wick Turns Stormwater into Asset   | 116        | Real-Life Examples                       | 166        |
| French Drain Helps Eroding Driveway       | 116        | Ancient Hohokam Rock Mulching            | 166        |
|   |            | Junk Mail as Productive Vertical Mulch   | 167        |
|   |            | Mulching Thinned and Dead Trees          |            |
|   |            | on Contour                               | 169        |
|   |            | Mulching in Wet Lands                    | 171        |
|   |            | Concrete Drainageway into                |            |
|   |            | Cobble Infiltrationway                   | 172        |
| <br>                                      |            |  |            |
| <b>Chapter 5. Infiltration Basins</b>     | <b>119</b> | <b>Chapter 8. Reducing Hardscape and</b> |            |
| What Is an Infiltration Basin?            | 119        | <b>Creating Permeable Paving</b>         | <b>173</b> |
| Where Are Infiltration Basins Used?       | 120        | What Is the Reduction of Hardscape?      | 174        |
| Tools and Materials                       | 122        | Where Is Hardscape Reduction Used?       | 175        |
| Steps to Build Infiltration Basins        | 122        | Hardscape Removal, Tools, and Materials  | 179        |
| Variations of Infiltration Basins         | 132        | What Is Permeable Paving?                | 180        |
| Multiple Functions of Infiltration Basins | 135        | Where Is Permeable Paving Used?          | 180        |
| Real-Life Examples                        | 136        | Permeable Paving Tools and Materials     | 182        |
| Turning Flood Control Structures into     |            | Steps to Install Permeable Paving        | 188        |
| Beautiful Amenities                       | 136        | Multiple Functions of Reduced            |            |
| Planting Water in Pots                    | 138        | Hardscape and Permeable Paving           | 190        |
| Abundance in a Community Garden           | 138        | Real-Life Examples                       | 191        |
| Rain Gardens—Infiltration Basins of       |            | Driveway Gardens                         | 191        |
| Wetter Lands                              | 140        | A Multipurpose Alternative to Curb       |            |
|   |            | and Gutter Drainages                     | 192        |
|   |            | Green Streets and Green Parking Lots     | 193        |
|   |            | Watering Street Trees with Street Runoff | 194        |

|  |     |   |     |
|--|-----|---|-----|
| Chapter 9. Diversion Swales  | 205 | Chapter 12. Greywater Harvesting:<br>Making the Most of Your Recycled<br>Water and Earthworks       | 289 |
| What Is a Diversion Swale?   | 205 | What Is Greywater Harvesting?   | 291 |
| Where Is a Diversion Swale Used?                                     | 205 | Where Greywater Is Used   | 295 |
| Tools and Materials  | 206 | My Preferred Greywater Systems  | 302 |
| Implementation Steps to Build a<br>Diversion Swale                   | 207 | Developing a Gravity-fed Greywater System   | 307 |
| Variation of a Diversion Swale                                       | 216 | Variations  | 308 |
| Multiple Functions of Diversion Swales                               | 218 | Real-Life Examples  | 317 |
| Real-Life Examples   | 219 | An Outdoor Shower   | 317 |
| Diversion Swales Irrigating Landscapes<br>and Controlling Stormwater | 219 | Composting Toilets and Greywater<br>Disposal Versus Septic Tanks and Sewers                         | 317 |
| Spreader Drain Turning Stormwater<br>Liability into Asset            | 221 | Greywater Harvesting Helps Create<br>Fire-Resistant Oasis   | 320 |
| Chapter 10. Check Dams   | 227 | Backyard Greywater System Became<br>a Neighborhood Laundromat                                       | 320 |
| What Is a Check Dam?   | 228 | Pooling and Conserving Resources<br>to Build Community  | 321 |
| Where Is a Check Dam Used?   | 228 | Epilogue  | 323 |
| Tools and Materials  | 229 | The Fun and Easy Path to Abundance  | 323 |
| Implementation Steps to Build a<br>Check Dam                         | 230 | A Drop in the Bucket of Abundance   | 325 |
| Variations of Check Dams   | 245 | Start Now   | 325 |
| Multiple Functions of Check Dams                                     | 250 | Choosing to Be a Hero   | 326 |
| Real-Life Examples   | 252 | Real-Life Examples  | 326 |
| Gabions That Created a Spring  | 252 | Turning a Flooding Backyard into a<br>Neighborhood Oasis  | 326 |
| Check Dams Building Community  | 252 | Working Together to Create Public<br>Water-Harvesting Demonstration Sites                           | 327 |
| Where Rocks Have Made the Water Flow                                 | 253 | A Community Helping Itself to Attain<br>Water Sustainability  | 328 |
| Chapter 11. Vegetation   | 257 | Working to Bring Back the River<br>of Their Childhood   | 328 |
| What Role Does Vegetation Play in<br>Water Harvesting?               | 257 | Appendix 1. Patterns of Water Flow<br>and Erosion with Their Potential<br>Water-Harvesting Response | 331 |
| Where Is Vegetation Used?  | 258 | Appendix 2. Bunyip Water Levels<br>and A-frame Levels   | 339 |
| Steps to Vegetate an Area  | 260 | Appendix 3. Water-Harvesting<br>Earthworks Calculations   | 348 |
| Tools and Materials for Planting                                     | 274 |   |     |
| Multiple Functions of Vegetation                                     | 284 |   |     |
| Real-Life Examples   | 285 |   |     |
| Street-Tree Orchards   | 285 |   |     |
| Native Living Christmas Trees  | 288 |   |     |
| Planting an Urban Forest to Manage<br>a City as an Ecosystem         | 288 |   |     |

|  |     |                       |     |
|--|-----|-----------------------|-----|
| Appendix 4. Example Plant Lists<br>and Water Requirement Calculations<br>for Tucson, Arizona | 365 | Appendix 6. Resources | 378 |
|  |     | References            | 379 |
| Appendix 5. Sizing and Implementation<br>of the Kitchen Resource Drain<br>(KRD) in Arizona   | 371 | Glossary              | 385 |
|  |     | Index                 | 393 |

# List of Illustrations

|       |  |    |        |  |    |
|-------|--|----|--------|--|----|
| P.1.  | Mr. Phiri in hand-dug "immigration center" reservoir               | 1  | I.13A. | Natural native plant density without earthworks                                  | 24 |
| P.2.  | Mr. Phiri tending his tree nursery                                 | 1  | I.13B. | Increased natural native plant density with earthworks                           | 24 |
| P.3.  | Kayaking flooded street, Tucson                                    | 2  | I.14.  | Concrete shade structure, built before now-mature trees planted, Laporiya, India | 27 |
| P.4A. | Santa Cruz River, Tucson, early 1900s                              | 3  | I.15.  | Y. Kumar, L. Singh, R. Poar, J. Singh, of GVNML                                  | 27 |
| P.4B. | Same stretch of Santa Cruz River, Tucson, 2006                     | 3  | I.16.  | Map of Laporiya, India   | 29 |
| P.5.  | Begin with long and thoughtful observation                         | 4  | I.17.  | Goats browsing in pasture of choukas, Sahalsagar                                 | 30 |
| P.6.  | Start at the top (highpoint) of your watershed                     | 4  | I.18.  | Sahalsagar choukas   | 30 |
| P.7.  | Start small and simple   | 5  | I.19.  | Phool Sagar earthen tank, Laporiya   | 31 |
| P.8.  | Slow, spread, and infiltrate                                       | 5  | I.20.  | Tree-lined road entering Laporiya  | 32 |
| P.9.  | Always plan an overflow route                                      | 6  | I.21.  | Intensive, sunken, water-harvesting garden, berms as raised paths                | 32 |
| P.10. | Create a living sponge   | 6  | I.22.  | R. Poar, J. Singh in front of map of Laporiya village                            | 33 |
| P.11. | Do more than just harvest water                                    | 7  | 1.1.   | Water-harvesting mooning   | 37 |
| P.12. | Continually reassess your system: the "feedback loop"              | 7  | 1.2.   | Dendritic pattern of branching watercourses, Cienega Creek                       | 38 |
| I.1.  | Rain-fed bounty  | 13 | 1.3.   | Four different slopes: proportions, degrees from horizontal, percentages         | 39 |
| I.2A. | Landscape actively wasting and consuming resources                 | 14 | 1.4.   | Range of slopes from 0 to 90 degrees   | 39 |
| I.2B. | Landscape passively harvesting resources                           | 14 | 1.5.   | Using line level to measure slope  | 40 |
| I.3A. | Landscape draining its resources away                              | 15 | 1.6.   | Using bunyip water level to measure slope  | 41 |
| I.3B. | Sustainable landscape harvesting, recycling on-site resources      | 15 | 1.7.   | Solar arc of trees and shrubs  | 45 |
| I.4.  | Living sponge of organic matter, healthy soil, vegetation          | 17 | 1.8.   | Infiltration basins, new plantings within wetter oasis zone                      | 46 |
| I.5A. | Poor soil supporting limited life                                  | 19 | 1.9.   | Runoff from raised pathways and road drains to sunken basins                     | 46 |
| I.5B. | Healthy and diverse soil life supporting diversity                 | 19 | 1.10.  | Integrated landscape site plan for urban lot                                     | 48 |
| I.6.  | Nutrient flows whereby soil life transforms wastes and nutrients   | 20 | 1.11.  | Integrated landscape site plan for suburban or rural lot                         | 49 |
| I.7A. | Depleting the living sponge by vacuuming fallen-leaf resources     | 20 | 1.12.  | Three important elevations   | 50 |
| I.7B. | Enhancing by recycling nutrients and organic matter                | 20 | 1.13A. | Runoff from commercial/industrial site to one single-purpose basin               | 51 |
| I.8.  | Salt buildup at base of four plants irrigated with municipal water | 21 | 1.13B. | Runoff directed to many multipurpose basins                                      | 51 |
| I.9.  | Well and field abandoned, Rajasthan, India                         | 22 | 1.14A. | Too much runoff to one earthwork   | 52 |
| I.10. | Water-harvesting field, Rajasthan, India                           | 22 | 1.14B. | Runoff turned into soak-in with multiple earthworks                              | 52 |
| I.11. | Check dam seeping flow weeks after last rain                       | 23 |        |  |    |
| I.12. | Trees along highway, runoff-enhanced                               | 24 |        |  |    |

|        |   |    |        |   |     |
|--------|---|----|--------|---|-----|
| 1.15.  | Downspout directing water to high point   | 53 | 2.28.  | Plan view of windberms, contour berms, young trees                                  | 84  |
| 1.16A. | Piped overflow from one basin to another  | 54 | 2.29.  | Side view of windberms, young trees, harvested snow                                 | 84  |
| 1.16B. | Overland diversion swale overflows from one basin to another                          | 54 | 3.1.   | Terraces stabilized with dry-laid salvaged concrete walls                           | 87  |
| 1.17.  | Earthworks and plantings emphasized on periphery of small yards                       | 55 | 3.2.   | Terraces with dry-laid stone walls  | 88  |
| 1.18A. | House set low in landscape and prone to flooding                                      | 56 | 3.3.   | Different strategies for different steepness of slope                               | 89  |
| 1.18B. | House with landscape regraded to prevent flooding                                     | 56 | 3.4A.  | Side view of terraces showing components and measurements                           | 91  |
| 1.19.  | Lush native-plant landscape not disturbed when homes built                            | 57 | 3.4B.  | Earthen terrace without retaining wall, with measurements                           | 91  |
| 1.20.  | Site map of property and rainfall income  | 61 | 3.5.   | Height of terrace retaining wall and depth of cut into slope                        | 92  |
| 1.21.  | Site map, with estimated runoff and runoff volumes for each type of catchment surface | 63 | 3.6.   | Narrow terraces on steep slope  | 92  |
| 2.1.   | Berm and basin  | 65 | 3.7.   | Terrace without retaining walls   | 93  |
| 2.2.   | Boomerang berms and contour berms   | 66 | 3.8.   | Terraces with sandstone retaining walls   | 93  |
| 2.3.   | Berm 'n basins and terraces with retaining walls at varying slopes                    | 67 | 3.9.   | Elevation view of two retaining walls and associated terraces, showing "tie stones" | 95  |
| 2.4A.  | Contour line identified and marked  | 68 | 3.10A. | Tampers, homemade and purchased   | 95  |
| 2.4B.  | Digging of berm 'n basin on contour   | 68 | 3.10B. | Tamping with tamper   | 95  |
| 2.5A.  | Cut-away (side) view of berm 'n basin   | 69 | 3.11.  | Building terraces starting at bottom of slope and working up                        | 97  |
| 2.5B.  | Overhead (top) view of berm 'n basin  | 69 | 3.12.  | Terraces with dry-laid retaining walls, zig-zagging overflows                       | 97  |
| 2.6.   | Berm thickness and height ratio   | 70 | 3.13.  | Rock-stabilized diversion swale overflows from one terrace to another               | 98  |
| 2.7.   | Raised path with rock-stabilized edges  | 70 | 3.14.  | Earthen terrace overflow directed to natural and constructed drainageways           | 98  |
| 2.8.   | Cross section, b'n'b depth and width measurement locations                            | 73 | 3.15.  | Vegetation between retaining-wall rocks   | 99  |
| 2.9.   | Perspective view, b'n'b length measurement  | 73 | 3.16.  | Path repaired with terrace-like railroad tie steps                                  | 99  |
| 2.10.  | Berm 'n basins spacing  | 73 | 3.17.  | Terraced fields, Peru   | 100 |
| 2.11.  | Contour berm and rototiller   | 73 | 3.18.  | New trinchera and field, Chihuahua, Mexico  | 101 |
| 2.12A. | Speeding up revegetation by leaving undisturbed strip                                 | 74 | 3.19.  | Old trinchera and field, Chihuahua, Mexico  | 101 |
| 2.12B. | Vegetation in undisturbed strips seed adjacent bare area                              | 74 | 3.20.  | Looking down Vine Street, Seattle, gardens, watercourse, cistern steps              | 102 |
| 2.13.  | Speeding up revegetation with undisturbed strip between multiple basin sections       | 74 | 3.21.  | The Beckoning Cistern and terraced planters, Seattle                                | 103 |
| 2.14A. | Failed unlevel berm   | 75 | 3.22.  | Beckoning Cistern, second view  | 103 |
| 2.14B. | Successful level berm   | 75 | 4.1.   | Pipeless French drain beside driveway   | 105 |
| 2.15.  | Line of folks stomping berm   | 75 | 4.2.   | French drain for runoff from roof and patio   | 105 |
| 2.16.  | Boomerang berms stabilized on downslope with rock                                     | 75 | 4.3.   | Canale roof drain, drain box, pipe to French drain                                  | 107 |
| 2.17.  | Zig-zagging spillways   | 76 | 4.4.   | Berms upslope of French drain   | 108 |
| 2.18A. | Poorly planned berm 'n basin, backing water up against house                          | 77 | 4.5.   | French drain without pipe; overflow to infiltration basin                           | 108 |
| 2.18B. | Well-planned berm 'n basin  | 77 | 4.6A.  | Round mixed-sized particles, dense-graded aggregate                                 | 110 |
| 2.19.  | One-rock check dams placed within berm 'n basin placed off contour                    | 77 | 4.6B.  | Angular same-sized particles, open-graded aggregate                                 | 110 |
| 2.20.  | Contour berms   | 78 | 4.7A.  | Pond liner and drain box  | 111 |
| 2.21A. | Unfinished contour berm   | 78 | 4.7B.  | Canale and drain below  | 111 |
| 2.21B. | Finished contour berm   | 78 | 4.8.   | French drain with pipe connected to downspout                                       | 112 |
| 2.22.  | Boomerang berm with one end stabilized with rock overflow                             | 79 | 4.9A.  | Perforated pipe laid within French drain  | 112 |
| 2.23.  | Series of boomerang berms overflowing one into another                                | 79 | 4.9B.  | Cut-away view, perforated pipe in French drain                                      | 112 |
| 2.24.  | Net-and-pan system of berms   | 80 | 4.10.  | French drain with infiltration chamber  | 114 |
| 2.25A. | Berm as a raised path   | 80 | 4.11A. | Deep-pipe irrigation  | 115 |
| 2.25B. | Berm as a raised driveway   | 81 | 4.11B. | Rock-tube irrigation  | 115 |
| 2.26.  | Brush berms anchored with downslope stakes  | 81 |        |   |     |
| 2.27.  | Burned trees felled on contour as log erosion barriers                                | 82 |        |   |     |

|        |   |     |        |   |     |
|--------|---|-----|--------|---|-----|
| 4.12.  | Driveway sloped toward French drain, Haggard residence                | 117 | 6.11.  | Post-imprinting.  | 151 |
| 5.1.   | Series of infiltration basins along curbless street                   | 119 | 7.1A.  | Bare earth, high evaporation, small tree                              | 153 |
| 5.2.   | Lancaster side yard and winter garden                                 | 120 | 7.1B.  | Mulched earth, low evaporation, large tree                            | 153 |
| 5.3.   | Trees: atop mound, in circular berm, in infiltration basin            | 121 | 7.2.   | Bladed building pads versus healthy sponge-like watershed             | 154 |
| 5.4A.  | Infiltration basins and solar arc of young trees                      | 122 | 7.3A.  | Strip-mining leaves and nutrients, higher maintenance                 | 156 |
| 5.4B.  | Trees at full size forming solar arc                                  | 122 | 7.3B.  | Maintenance, cost increase with purchased fertilizer                  | 156 |
| 5.5.   | Terraced or stepped basins with overflows                             | 123 | 7.3C.  | Harvesting leaf-drop and nutrients, less maintenance                  | 156 |
| 5.6.   | Raised path between basins  | 123 | 7.3D.  | Let nature do the work  | 156 |
| 5.7A.  | Basin diameter bigger than tree canopy                                | 124 | 7.4.   | Free mulch delivered  | 157 |
| 5.7B.  | Percentage of water absorbed by tree roots, distance from tree center | 124 | 7.5.   | Recycling prunings, cutting up prunings for mulch                     | 158 |
| 5.8.   | Large basin divided into small basins                                 | 124 | 7.6.   | Layered mulch   | 159 |
| 5.9A.  | Circular-basin measurements   | 127 | 7.7A.  | Unanchored mulch washed off slope                                     | 160 |
| 5.9B.  | Rectangular-basin measurements  | 127 | 7.7B.  | Mulch anchored within basins  | 160 |
| 5.10.  | Infiltration basin spillway and depth                                 | 127 | 7.8A.  | Mulching between seedlings  | 162 |
| 5.11.  | Basins constrained by narrow right-of-way                             | 128 | 7.8B.  | Mulched garden with mature vegetables                                 | 162 |
| 5.12.  | Space tight: steep-sided basin edge stabilized with rock              | 128 | 7.9.   | Vertical mulch  | 163 |
| 5.13.  | Water from roof drains away from building                             | 128 | 7.10.  | Bermuda grass uncontrolled versus mulched, eaten by chickens          | 164 |
| 5.14.  | Infiltration basins in small urban yard                               | 129 | 7.11.  | Fruit-tree urinal   | 165 |
| 5.15A. | Stabilized spillways connecting terraced basins, sloped site          | 130 | 7.12A. | Newly planted tree beside hole for junk mail                          | 167 |
| 5.15B. | Stabilized spillways connecting basins, flat site                     | 130 | 7.12B. | Hole filled with junk mail  | 167 |
| 5.16.  | Spillway with stone stabilization                                     | 130 | 7.12C. | Junk mail and hole topped with straw                                  | 167 |
| 5.17.  | Planting for water needs and tolerance                                | 131 | 7.13.  | Contour berms of pinyon pine brush                                    | 169 |
| 5.18A. | Erosive runoff over slope from downspout                              | 133 | 7.14.  | Contour berms of woodchips  | 170 |
| 5.18B. | Stone-stabilized downspout spillway                                   | 133 | 7.15.  | Abundant growth of new grass around woodchip berms                    | 171 |
| 5.18C. | Calm outlet of downspout above basin mulch                            | 133 | 7.16A. | Concrete drainageway  | 172 |
| 5.19.  | Basin between two young trees, ready for mulch                        | 133 | 7.16B. | Cobble infiltrationway  | 172 |
| 5.20A. | Yard with vegetation losing runoff in storms                          | 134 | 8.1A.  | Impervious landscape  | 173 |
| 5.20B. | Same yard with perimeter berm, raised pathway                         | 134 | 8.1B.  | Mountain Avenue as a river of runoff                                  | 173 |
| 5.21.  | Beneficial microclimate of sunken garden basin                        | 135 | 8.2.   | Highway runoff grows bigger trees                                     | 174 |
| 5.22.  | Sunken garden beds  | 135 | 8.3.   | Two-track (wheel-track) driveway paves 60% less area                  | 175 |
| 5.23.  | Milagro Cohousing site plan   | 136 | 8.4.   | Narrow street and mesquite trees                                      | 175 |
| 5.24A. | Milagro, newly constructed basins                                     | 137 | 8.5A.  | Traffic circle in concave road with raised curb and curb cuts         | 176 |
| 5.24B. | Milagro basins mulched and vegetated                                  | 137 | 8.5B.  | Traffic circle in concave road with flush curbs                       | 176 |
| 5.25.  | Low-tech subsurface clay-pot irrigation                               | 138 | 8.5C.  | Traffic circle on raised crown of road with raised curb, no curb cuts | 176 |
| 5.26A. | Garden site fenced and pre-garden                                     | 138 | 8.6.   | Chicanes or pullouts with flush curbs                                 | 177 |
| 5.26B. | Volunteers digging sunken garden beds                                 | 138 | 8.7.   | Sunken planting basin in cul-de-sac                                   | 177 |
| 5.27.  | Recently completed sunken garden beds after rain                      | 139 | 8.8.   | Hammerhead turnaround   | 178 |
| 5.28.  | Established garden beds   | 140 | 8.9A.  | Sidewalk draining to street   | 178 |
| 5.29.  | Salmon on downspout, rain garden, Portland                            | 141 | 8.9B.  | Sidewalk draining runoff to tree basin                                | 178 |
| 5.30.  | Dancing sculpted figure, rain garden, Portland                        | 141 | 8.10.  | Opening in curb directs street runoff to landscape                    | 179 |
| 6.1.   | Bulldozer pulling imprinter roller                                    | 143 | 8.11.  | Shade trees in contour basin cut into parking lot                     | 180 |
| 6.2A.  | Exposed, compacted soil   | 144 | 8.12.  | Permeably paved parking lot   | 181 |
| 6.2B.  | Imprinted soil encourages infiltration                                | 144 | 8.13.  | Shaded grass horse-and-buggy parking                                  | 181 |
| 6.3.   | Fresh imprints  | 144 | 8.14.  | Garden path mulched with woodchips                                    | 183 |
| 6.4.   | Imprinting steep slope  | 145 | 8.15A. | Porous parking lot, salvaged-concrete walkway                         | 183 |
| 6.5.   | Bulldozer with self-cleaning tracks                                   | 146 | 8.15B. | Porous aggregate bicycle parking                                      | 183 |
| 6.6.   | Roller core of imprinter and alternating star rings                   | 147 |        |   |     |
| 6.7.   | Imprinter teeth, standard and steep-slope                             | 149 |        |   |     |
| 6.8.   | Imprinter squashing tumbleweed  | 150 |        |   |     |
| 6.9.   | Dust storm on denuded land, Marana, AZ                                | 150 |        |   |     |
| 6.10.  | Imprinting and seeding  | 151 |        |   |     |

|        |   |     |         |   |     |
|--------|---|-----|---------|---|-----|
| 8.16A. | Round mixed-sized, dense-graded aggregate                                 | 184 | 9.11.   | Berm thickness and height   | 215 |
| 8.16B. | Angular same-sized particles, open-graded aggregate                       | 184 | 9.12.   | Water pooling in basin at swale's end                               | 215 |
| 8.17A. | Gravelpave <sup>2</sup> geocells installation, Milagro Cohousing          | 185 | 9.13.   | One-rock-high check dams within diversion swale                     | 217 |
| 8.17B. | Completed Gravelpave <sup>2</sup> parking lot                             | 185 | 9.14.   | Bottom length of spreader drain, and overflow                       | 217 |
| 8.18.  | UNI Eco-Stone open-jointed paving blocks                                  | 186 | 9.15.   | Diversion swale speed humps   | 218 |
| 8.19.  | Salvaged concrete sidewalk patio  | 187 | 9.16.   | Raised berm accessways and sunken basins                            | 218 |
| 8.20.  | Open-jointed paving block construction components                         | 187 | 9.17A.  | Strawberry Creek, Berkeley, pre-daylighting                         | 219 |
| 8.21A. | Runoff and sediment misdirected over pavement                             | 189 | 9.17B.  | Portion of post-daylighted Strawberry Creek                         | 219 |
| 8.21B. | Runoff directed to sunken basins  | 189 | 9.18A.  | Elevation view, Village Homes                                       | 220 |
| 8.22.  | Layered courses of pavement   | 189 | 9.18B.  | Plan view of Village Homes, diversion swales                        | 220 |
| 8.23.  | Stabilized edging for porous pavement                                     | 189 | 9.19.   | Laying out spreader drain, contour line                             | 221 |
| 8.24.  | Zemachs in garden, where driveway used to be                              | 191 | 9.20.   | Marking spreader drain route  | 222 |
| 8.25.  | Zemachs' and neighbor's yard  | 192 | 9.21.   | Grader cutting diversion swale                                      | 223 |
| 8.26A. | Seattle street before Street Edge Alternatives (SEA) Project              | 193 | 9.22A.  | Original slope  | 223 |
| 8.26B. | Seattle street after SEA renovation                                       | 193 | 9.22B.  | Early passes with road grader                                       | 223 |
| 8.26C. | Same SEA street, with maturing vegetation                                 | 193 | 9.22C.  | Drain with basin (latter passes with grader)                        | 223 |
| 8.27.  | Curb cuts along residential street, sidewalk strip and scuppers           | 193 | 9.22D.  | Completed drain   | 223 |
| 8.28.  | Curb cuts along arterial street, Portland                                 | 194 | 9.23.   | Diversion swale harvesting runoff                                   | 225 |
| 8.29.  | Water-harvesting parking lot  | 194 | 9.24.   | Completed swale, surge basin, windbreak                             | 225 |
| 8.30A. | Tucson right-of-way, 1994, before rainwater harvesting                    | 196 | 10.1.   | Check dam stabilizing road crossing drainage                        | 227 |
| 8.30B. | Tucson right-of-way, 2006, path, basins, plantings                        | 196 | 10.2.   | Gabion as a wire-wrapped check dam                                  | 227 |
| 8.31.  | Basins extending to existing driveway curb cut                            | 196 | 10.3.   | Gabion stabilizing erosion below culvert                            | 228 |
| 8.32A. | Tucson right-of-way, 1994, before trees                                   | 197 | 10.4.   | Check dam locations, good and poor, plan view                       | 231 |
| 8.32B. | Tucson right-of-way, 2004, after trees                                    | 197 | 10.5.   | Check dam locations, elevation view                                 | 231 |
| 8.33.  | Curb cut and raised paths   | 199 | 10.6.   | Well-anchored check dams upslope of trees                           | 232 |
| 8.34A. | Curb-cut detail drawing, plan view  | 201 | 10.7A.  | Check dam set diagonally across channel                             | 232 |
| 8.34B. | Curb-cut detail drawing, elevation views                                  | 201 | 10.7B.  | Check dam set perpendicularly to flow                               | 232 |
| 8.35A. | Concrete cutting, beginning horizontal curb cut                           | 202 | 10.8A.  | Check dams too close together                                       | 233 |
| 8.35B. | Concrete cutting, angled curb cut   | 202 | 10.8B.  | Check dams heel-to-toe  | 233 |
| 8.36.  | Smoothing cuts and edges with grinder                                     | 202 | 10.9.   | Series of check dams, positioning relative to headcut erosion       | 233 |
| 8.37.  | Finished curb cuts, basins, trees   | 203 | 10.10.  | Gabion in channel with well-defined banks; height and channel depth | 234 |
| 9.1.   | Diversion swale   | 205 | 10.11.  | Cut back unstabilized slopes  | 235 |
| 9.2.   | Water flow from culvert spread out by diversion swale                     | 206 | 10.12A. | Unstable check dam  | 235 |
| 9.3.   | Diversion swales as overflows from one basin to another                   | 206 | 10.12B. | Stable check dam  | 235 |
| 9.4.   | Diversion swales as inlet and outlet channels                             | 207 | 10.13.  | Banana check-dam shape  | 236 |
| 9.5A.  | Break point and key point   | 208 | 10.14.  | Gabion baskets with landscape fabric                                | 237 |
| 9.5B.  | Break line and keyline  | 208 | 10.15.  | Poorly built gabion with flat top                                   | 237 |
| 9.6A.  | Marking contour line, placing level distance markers                      | 209 | 10.16.  | Bending fencing into gabion basket                                  | 238 |
| 9.6B.  | Using water level to mark diversion swale's path                          | 209 | 10.17.  | Reinforcing gabion basket with cross bracing                        | 238 |
| 9.7.   | Diversion berm, speed hump directing runoff to basin                      | 211 | 10.18.  | Setting rock in homemade gabion basket                              | 239 |
| 9.8.   | Diversion swale diverts runoff from drainage ditch                        | 212 | 10.19.  | Bucket brigade rock delivery  | 239 |
| 9.9.   | Earthen diversion swale directing runoff from slope, and gabion           | 212 | 10.20.  | Hog-ring pliers fastening basket seam                               | 240 |
| 9.10A. | Stabilized diversion swale to collect hillside runoff, Jaipur Fort, India | 213 | 10.21.  | Fold top of basket in direction of water flow                       | 240 |
| 9.10B. | Diversion swale entering Jaipur Fort                                      | 213 | 10.22.  | Finished gabion, and apron downstream                               | 241 |
| 9.10C. | Diversion swale directs water to Fort's cistern                           | 214 | 10.23.  | Gabion steps crossing drainage                                      | 241 |
|        |   |     | 10.24.  | Apron of gabion diffuses force of falling water                     | 242 |
|        |   |     | 10.25A. | Unstable check dam without apron                                    | 243 |
|        |   |     | 10.25B. | Stable check dam with apron   | 243 |
|        |   |     | 10.26.  | Gabion apron length 1.75 times dam height                           | 243 |
|        |   |     | 10.27.  | Quilting gabion apron   | 244 |
|        |   |     | 10.28.  | Attaching fencing to basket to create gabion apron                  | 244 |
|        |   |     | 10.29A. | One-rock check dam before rain                                      | 246 |
|        |   |     | 10.29B. | One-rock check dam after summer rains                               | 246 |



|         |  |     |         |  |     |
|---------|--|-----|---------|--|-----|
| 10.30.  | Brush rill-repair  | 246 | 11.24A. | Pruning a young dryland tree   | 282 |
| 10.31.  | Zuni brush check dams  | 247 | 11.24B. | Tree after pruning and growth  | 282 |
| 10.32.  | Straw-bale check dam with rock apron   | 248 | 11.25.  | Three-step technique for pruning large limb                                  | 282 |
| 10.33A. | Single-fence gabion, perspective view  | 249 | 11.26.  | Rain-irrigated cactus fruit  | 284 |
| 10.33B. | Plan, cross-section, and side views of single-fence gabion                     | 249 | 11.27.  | Girl Scouts planting a neighborhood tree, 1996                               | 286 |
| 10.34A. | Deep crossing without check dam  | 250 | 11.28.  | Same velvet mesquite tree, 2006  | 286 |
| 10.34B. | Shallower crossing with check dam  | 250 | 11.29.  | Mesquite pancakes  | 287 |
| 10.35.  | Check dam, multiple flows, main drainage, side ditches                         | 250 | 11.30.  | Mobile hammermill grinding mesquite pods                                     | 287 |
| 10.36A. | Poorly built series of check dams  | 251 | 12.1.   | A bathroom-sink-greywater "spring" irrigating tree, shrubs                   | 289 |
| 10.36B. | Well-built series of small gabions   | 251 | 12.2.   | Evaporative-cooler-drain "spring" irrigating salt-tolerant tree, shrubs      | 290 |
| 10.37.  | Check dam, Teran watershed   | 253 | 12.3.   | Air-conditioner condensate drains to bare dirt                               | 291 |
| 10.38.  | Carpet of soil and grass upstream of check dam                                 | 254 | 12.4A.  | Greywater stub-out not yet connected   | 292 |
| 10.39.  | Turkey Pen watershed check dam   | 254 | 12.4B.  | Greywater stub-out connected   | 292 |
| 10.40.  | Check dam work began at top of watershed                                       | 255 | 12.5.   | Three-way diverter valve under sink retrofit installation                    | 293 |
| 10.41.  | Check dam, running water, and trees  | 256 | 12.6.   | Three-way diverter valve between toilet and sink, Ecohood                    | 293 |
| 11.1.   | Tree selected to provide multiple resources                                    | 258 | 12.7A.  | Bathtub installed higher to access tub's diverter valve                      | 293 |
| 11.2A.  | Hot, bleak environment hinders community interaction                           | 259 | 12.7B.  | Closeup of bathtub diverter valve  | 293 |
| 11.2B.  | Sheltered environment inviting community interaction                           | 259 | 12.8.   | Greenhouse greywater harvesting in cold climate                              | 297 |
| 11.3.   | Planting for cold and warmth needs   | 261 | 12.9A.  | Branched-drain greywater system for low water use                            | 302 |
| 11.4.   | Solar arc and windbreak of trees   | 262 | 12.9B.  | Branched-drain greywater system for higher water use                         | 302 |
| 11.5.   | Wind harvester of trees and shrubs   | 262 | 12.10.  | Discharge of greywater into mulched basin (above mulch)                      | 303 |
| 11.6A.  | Plants placed too close together   | 264 | 12.11.  | Greywater drain discharging into mulched basin via subsurface outlet shield  | 305 |
| 11.6B.  | Plants well-placed, based on expected mature size                              | 264 | 12.12A. | Infiltrator Systems outlet chamber before covering with soil, exterior view  | 306 |
| 11.7A.  | Evergreen tree misplaced, winter sun exposure lost                             | 265 | 12.12B. | Same outlet chamber and greywater pipe covered with soil, exterior view      | 306 |
| 11.7B.  | Deciduous tree misplaced, so 50% winter sun exposure lost                      | 265 | 12.12C. | Interior of three Infiltrator Systems infiltration chambers linked together  | 306 |
| 11.7C.  | Tree selected, placed to retain winter sun exposure                            | 265 | 12.13.  | Sample site plan, greywater discharge for water-conserving household of four | 308 |
| 11.7D.  | Trees planted outside "no major trees" zone, to retain winter sun exposure     | 265 | 12.14.  | Four options for diverting and distributing greywater flow                   | 309 |
| 11.8.   | Section of two-tiered berm 'n basin at Occidental Arts and Ecology Center      | 267 | 12.15A. | Outdoor tree shower  | 310 |
| 11.9.   | Annual irrigation demand of three native trees                                 | 269 | 12.15B. | Hose adapter Y-connector with dual shut-off for shower, garden hoses         | 310 |
| 11.10.  | Annual irrigation demand of one citrus tree                                    | 269 | 12.16A. | Vinyl tube accesses bathtub greywater  | 311 |
| 11.11.  | Annual irrigation demand of turf   | 269 | 12.16B. | Exterior siphon hand pump for tub greywater                                  | 311 |
| 11.12.  | Planting for water needs and tolerance   | 270 | 12.17A. | Hand pump siphons tub's greywater from tub to exterior                       | 312 |
| 11.13.  | Tree needing better drainage beside basin                                      | 271 | 12.17B. | Exterior pipe: Vertical pipe conveys greywater siphoned from bathtub         | 312 |
| 11.14.  | Food grown with harvested water  | 271 | 12.18.  | Bathtub drain screens: unaltered, altered                                    | 313 |
| 11.15.  | Mesquite guild   | 273 | 12.19.  | Vinyl tubing zip-tied against siphon-pump intake pipe                        | 314 |
| 11.16.  | Tree planted within a basin without hardpan                                    | 275 | 12.20A. | Multi-drain greywater system for exterior washing machine                    | 314 |
| 11.17.  | Tree growing at an angle planted straight                                      | 276 | 12.20B. | Multi-drain greywater system distributing greywater to landscape             | 315 |
| 11.18A. | Planting and pedestaling within a basin for better drainage                    | 277 | 12.21.  | Multi-drain greywater system for interior washing machine                    | 315 |
| 11.18B. | Planting on a basin-side terrace   | 277 |         |  |     |
| 11.19.  | Protection from browsing animals, fenced tree                                  | 277 |         |  |     |
| 11.20.  | Fencing protects base of vegetation from animals                               | 278 |         |  |     |
| 11.21.  | Staked young tree  | 278 |         |  |     |
| 11.22A. | Bucket drip-irrigation   | 280 |         |  |     |
| 11.22B. | Bucket with emitter hole in side   | 280 |         |  |     |
| 11.23A. | Small basin and drip irrigation emitters, with stunted root growth             | 281 |         |  |     |
| 11.23B. | Expansive, drought-resistant roots with wide basin, emitters moved farther out | 281 |         |  |     |

|         |  |     |        |   |     |
|---------|--|-----|--------|---|-----|
| 12.22.  | Food caught in wire screen for kitchen sink              | 315 | A1.9B. | With added berm 'n basins                                 | 336 |
| 12.23.  | Kitchen Resource Drain (KRD), elevation view             | 316 | A1.10. | Break line and keyline                                    | 337 |
| 12.24.  | Deluxe outdoor shower                                    | 317 | A1.11. | High-water-flow detritus on young cottonwood              | 337 |
| 12.25.  | Multi-drain system for outdoor shower                    | 317 | A1.12. | Scour hole  | 338 |
| 12.26.  | Garden watered with KRD and harvested rainwater          | 318 | A2.1.  | Bunyip water level  | 339 |
| 12.27.  | Sapote fruit grown with rainwater and greywater          | 321 | A2.2.  | Testing the bunyip level; water is level                  | 340 |
| 12.28A. | Wash and Well (Sitting Tree), front view                 | 322 | A2.3.  | Removing air bubbles from tubing                          | 341 |
| 12.28B. | Wash and Well, back view                                 | 322 | A2.4A. | Non-vertical bunyip stake gives incorrect reading         | 342 |
| 12.29.  | Multi-drain greywater system for washer and water filter | 322 | A2.4B. | Bunyip stake vertical for correct reading                 | 342 |
| E.1.    | Wasteful path to scarcity                                | 324 | A2.5.  | Leapfrogging the bunyip to mark contour line              | 342 |
| E.2.    | Stewardship path to abundance                            | 325 | A2.6.  | Bunyip shows land slopes toward house                     | 343 |
| A1.1    | Erosion triangle   | 331 | A2.7.  | Using a bunyip, confirming slope drains away from house   | 344 |
| A1.2.   | Microdetritus berms and sheet flow                       | 332 | A2.8.  | Celebrating completion of water-harvesting landscape      | 345 |
| A1.3A.  | Pedestals and sheet flow                                 | 333 | A2.9.  | A-frame level   | 345 |
| A1.3B.  | With added contour berm and imprints                     | 333 | A2.10. | Calibrating A-frame, step one                             | 346 |
| A1.4A.  | Nick point at head of rill                               | 333 | A2.11. | Calibrating A-frame, step two                             | 346 |
| A1.4B.  | With added contour berm, boomerang berm, brush weirs     | 333 | A2.12. | Calibrating A-frame, final step                           | 346 |
| A1.5A.  | Rills on roadcut   | 334 | A2.13. | Using A-frame level, finding and marking contour line     | 346 |
| A1.5B.  | With added boomerang berms, contour berms, brush weirs   | 334 | A2.14. | Line-level A-frame  | 347 |
| A1.6A.  | Gully  | 334 | A5.1   | Plan view of KRD, composting toilet, and greywater system | 372 |
| A1.6B.  | With added contour berm and gabion                       | 334 | A5.2.  | KRD with inspection pipe doubling as auxiliary vent       | 373 |
| A1.7.   | Bank cutting at curves                                   | 335 | A5.3.  | Percolation test  | 375 |
| A1.8.   | Different sizes of sediment                              | 335 | A6.1.  | Children on a PlayPumps merry-go-round                    | 394 |
| A1.9A.  | Exposed roots  | 336 |        |   |     |

# Tabled and Boxed Information

## TABLE

|      |  |    |
|------|--|----|
| 1.1. | Quick Reference Guide to Water-Harvesting Earthworks | 42 |
|------|--|----|

## BOXES

|      |   |    |
|------|---|----|
|      | The Eight Principles of Successful Rainwater Harvesting   | vi |
| P.1. | Drylands: A Definition  | 9  |
| P.2. | Advantages of Rainwater and Its Harvest with Earthworks   | 10 |
| P.3. | Comparing Earthworks and Tanks  | 11 |
| I.1. | The Abundance of Rainwater  | 16 |
| I.2. | Manual Awareness Saves More Water Than Automatic Convenience  | 18 |
| I.3. | Material and Practice Choices That Can Increase or Decrease Our Fossil Fuel Consumption and Its Negative Side Effects | 26 |
| 1.1. | Creating Regenerative Systems   | 36 |
| 1.2. | How to Take a Measurement of a Slope  | 40 |
| 1.3. | Calculating Rainfall Volumes  | 59 |
| 1.4. | Calculating Runoff and Runon Volumes  | 60 |
| 2.1. | Berm 'n Basin Synonyms, Terminology   | 66 |
| 2.2. | Calculating Approximate Water-Holding Capacity or Volume of Berm 'n Basins  | 71 |
| 2.3. | Calculating Berm 'n Basin Spacing Distance  | 72 |
| 2.4. | A Water-Harvesting Plant Nursery Laid Out in Contour Berms  | 78 |
| 2.5. | Boomerang Berms Revegetate Degraded Land  | 79 |
| 2.6. | A Net-and-Pan Orchard System in the Negev Desert  | 80 |
| 3.1. | Calculating Approximate Water-Holding Capacity (Volume) and Spacing of Terraces                                       | 90 |
| 3.2. | Calculating Optimum Terrace Width   | 91 |
| 3.3. | Landscape Fabric: An Optional Net Between a Terrace Wall and Its Backfill   | 96 |

|        |  |     |
|--------|--|-----|
| 3.4.   | Considerations for Terrace Walls in Cold Climates  | 96  |
| 3.5.   | Tire Retaining Walls   | 97  |
| 4.1.   | Using Cardboard to Encourage More Lateral Infiltration of Harvested Water into the Root Zone of Plants | 110 |
| 4.2.   | Cautions   | 113 |
| 5.1.   | What an Infiltration Basin is Not  | 120 |
| 5.2.   | Calculating Infiltration-Basin Capacity or Volume  | 125 |
| 7.1.   | What Mulch is Not  | 155 |
| 7.2.   | Mulch in the Vegetable Garden  | 162 |
| 8.1.   | Gasoline and Oil Facts   | 179 |
| 8.2.   | Where Can You Recycle Asphalt and Concrete?  | 180 |
| 8.3.   | Tapping Into the Rivers of Runoff Along Our Streets  | 195 |
|        | How to Cut Curbs and Harvest Street Runoff   | 198 |
| 9.1.   | Marking the Route of a Diversion Swale with a 1:300 Slope: An Example                                  | 210 |
| 9.2.   | Ponds  | 210 |
| 9.3.   | Tips on Pond Construction  | 211 |
| 10.1.  | Inducing a Meandering Flow   | 231 |
| 10.2.  | Look Above the Drainage and Its Check Dams   | 231 |
| 10.3.  | Potential Legal Cautions   | 233 |
| 10.4.  | Other Precautions  | 233 |
| 10.5.  | Homemade Wire-Fencing Gabion Baskets Versus Pre-Manufactured Gabion Baskets                            | 237 |
| 10.6.  | Making Your Own Gabion Baskets   | 238 |
| 10.7.  | Filling the Homemade Gabion Basket, Attaching Cross Braces, and Finishing                              | 240 |
| 10.8.  | Wrapping Your Gabion Apron in Fencing  | 244 |
| 10.9.  | Do Not Underestimate the Value of the Apron  | 245 |
| 10.10. | Placing a Check Dam to Stabilize Multiple Flows  | 250 |
| 11.1.  | Noontime Winter Solstice Shadow Ratios   | 263 |
| 11.2.  | Tracking and Restoring Native Plants in a Disturbed Urban or Suburban Core                             | 266 |

|        |  |     |        |   |     |
|--------|--|-----|--------|---|-----|
| 11.3.  | Planting for Wind-, Gravity-, and Water-Distribution of Seed   | 268 | A3.1.  | Abbreviations, Conversions, and Constants for English and Metric Measurement Units  | 349 |
| 11.4.  | A Mesquite Guild   | 273 | A3.2.  | Estimating Maximum Rainfall Runoff Using Rules of Thumb   | 352 |
| 11.5.  | Moving Plants After They've Been Planted   | 274 | A3.3.  | Meteorological and Climate Resources  | 352 |
| 11.6.  | Planting Study Saves Our Backs and Wallets   | 275 | A4.1.  | Approximate Annual Water Requirements for Mulched Vegetable Gardens in Tucson, Arizona, Planted in Sunken Basins  | 365 |
| 11.7.  | Size Matters When It Comes to Water Needs  | 279 | A4.2.  | Native Multiuse Trees for the Tucson, Arizona, Area   | 366 |
| 12.1.  | How Much Greywater Does a Household Produce?   | 294 | A4.3.  | Native Multiuse Shrubs, Cacti, and Groundcover for the Tucson, Arizona, Area  | 367 |
| 12.2.  | The Legality of Greywater  | 294 | A4.4.  | Exotic Multiuse Fruit Trees, Vines, and Cacti for the Tucson, Arizona, Area   | 368 |
| 12.3.  | Greywater-Harvesting Tax Incentives in Arizona   | 295 | A4.5A. | Monthly Water Requirements in Inches—Evergreen Plants   | 369 |
| 12.4.  | Soaps, Detergents, and Greywater   | 298 | A4.5B. | Monthly Water Requirements in Inches—Deciduous Plants   | 369 |
| 12.5.  | Per-Capita Indoor Water Use for Average (Non-Conserving) American  | 299 | A4.5C. | Conversion Table: Canopy Diameter vs. Gallons/Inch under Canopy   | 370 |
| 12.6.  | Estimates of Personal Indoor Water Use with Efficient Fixtures and Water-Conserving Habits                       | 300 | A5.1.  | A Potential Variance for the Chamber's Inspection Port  | 373 |
| 12.7.  | Estimates of Discharge Volumes from Household Evaporative Coolers, Air Conditioners, and Reverse-Osmosis Filters | 301 | A5.2.  | How To Do a Simple Percolation Test of Your Soil  | 375 |
| 12.8.  | Advantages of the Greywater Systems Described in this Chapter  | 304 | A5.3.  | Steps for Determining the Number of Leaching Chambers Needed for a Residence with Composting Toilet, and No Sewer or Septic Hook Up, Using ADEQ Regulations | 376 |
| 12.9.  | Automatic Dishwashers and the KRD  | 319 |        |   |     |
| 12.10. | The Influence of Time and Temperature on the Composting Process  | 320 |        |   |     |
| E.1.   | Important Tips for Those Doing Community Work  | 329 |        |   |     |
| A2.1.  | Getting Rid of Air Bubbles in Bunyip Tubing  | 341 |        |   |     |

# Acknowledgments

**T**hese acknowledgments build on, and duplicate, many of those from Volume 1, because once upon a time there was just one BIG water-harvesting book, before it was refined to a more accessible and focused three-volume set, none of which could've been done without the incredible community of passionate souls who helped me along the way. Here I attempt to give well-deserved recognition to you all, though I apologize for its brevity and incompleteness. The community is much larger, its deeds far deeper, and my gratitude much more heartfelt than these words express.

Thank you to my gracious hosts and teachers in India: Laxman and Jagveer Singh, Yogesh Kumar, and the villagers of Laporiya; Shree Padre; Anupam Mishra; the staff of GRAVIS; and S. Vishwanath for your inspirational examples and sharing. For your teachings, input, encouragement, guiding examples, and ideas, thanks to Chris Meuli; Art Ludwig of Oasis Design; David Omick and Pearl Mast; Eric Shepp and Mike Henrie; Bill Cunningham of Southwest Solar; Barbara Rose of Dancing Rocks Permaculture Community; Matt Weber; Jeff Blau; Nate Downey and Melissa McDonald of Santa Fe Permaculture; Ben Haggard, Joel Glanzberg, Tim Murphy, and Vicki Marvick of Regenes Group; Jeremiah Kidd of San Isidro Permaculture; Richard Jennings of Earthwrights Designs; Dave Elkin and Portland, Oregon's, Green Streets staff; Seattle, Washington's, SEA Streets staff;

Blue Agave Landscape Design and the Amado family; Christian Nys, Jay Johnson, and the other residents of the Pierson Street Ecohood; Greg Peterson of the Phoenix Urban Farm; Dan Dorsey; the pioneering students of PARASOL; daylighters Robert Pinkham and Wolfe Mason Associates; Carlson Architects, Buster Simpson, and Peggy Gaynor of Growing Vine Street; Justine Willie and the other staff of the Black Mesa Permaculture Project; Kevin Moore Koch of Technicians for Sustainability; Barbara Clark, Chet Phillips, and Debbie Hawkins of the Teran Project; Joe and Valer Austin; Van Clothier of Stream Dynamics; Craig Sponholtz of Dryland Solutions; Bill Zeedyk of Zeedyk Ecological Consulting; Jay Norton; David Cleveland; Bill Hoffman of the Austin, Texas, Water Utility Commercial and Industrial Water Conservation Programs; Michael Corbett and Judy Corbett of Village Homes; David Bainbridge; Owen Dell and the Fossil Fuel-Free Landscaping Group; Dan and Karen Howell of the Running Rain Society; Allegra Ahlquist; Ann Chanecka; Toby Hemenway; Mary and Charles Zemach; Hunter McGee; Juan Daniel Villalobos and Barney Burns of K'etami Wasar'a and Native Seeds/SEARCH; Kathy Moore; George Montgomery; Brock Dolman; the pioneering residents of Stone Curves and Milagro Cohousing pushing for greener living; Bob Dixon and Ann Carr; Tom Brightman and the Sitting Tree Community; Meg Keoppen and the AWET stewards; and Carlos

Ochoa and Richard Martinez. Thank you Bill Mollison and David Holmgren for permaculture—a potential-expanding tool of integration.

Kudos to all peer reviewers of the draft manuscripts for your invaluable feedback and insight. You often pulled me out of a writer's tunnel vision, and showed me the light. To those who provided me with testimonials, I am indebted to you. I sought out your thoughts because of how much I value your impressions and great work in the world.

This book would not work without beautiful, vibrant illustrations, so here's to artists Joe Marshall, Silvia Rayces, Ann Audrey, Gavin Troy, Kay Sather, David Harnish, and April Baisan for making the ideas and concepts of this book pop from the pages. I'm grateful for Andy Lipkis' inspiring foreword and the story of his visionary, world-changing work.

The many wonderful people I used as sounding boards for this book were essential—especially those who doubled as editors. Thanks to the foundational assistance of Eileen Alduenda, the latter help of book-midwife extraordinaire June Fritchman, and the dedication of Ann Audrey from the earliest, nebulous stages right up to this book's birth. You three were an absolute joy to work with, and you were indispensable due to your amazing organizational skills, editing, understanding, management, and support. I consider you all the core co-creators of this book. In addition,

the editing and feedback of Rose Houk, Karen McCombe, David Confer, Eric Wagner, Kimi Eisele, and Kay Sather (with illustrations and photos) were essential. Teri Bingham thank you for your patience and beautiful book design and layout. Bob Bingham thank you for your hawk eyes and able assistance to Teri.

I am incredibly lucky to have a very supportive, loving family. That base of support has been crucial. In particular, thanks to Mom and Dad for your continual encouragement and feedback; and Rodd and Chi for going with, living with, and helping refine our site's viability—and for wonderful food when work would've otherwise consumed me.

I'm also thankful for my family, friends, and neighbors who are helping spread the ideas and implementation of sustainable living far and wide. But it goes well beyond those I know. For example, these days I'm seeing water harvesting pop up all over my community and in the communities I travel through. Along with new sites, old water-harvesting sites are being rediscovered or seen with new understanding and appreciation. Critical mass has not yet been achieved, but the rate of this "waterspread's" growth is staggering. Seeing water planted rehydrates my soul. Hope soars as I see there are people who care, people who are aware, and people who are willing to manifest a better way. To you all—*thank you*.

# Foreword

By Andy Lipkis

*“G’day! How yur tanks?”*

**T**his four-word greeting changed my life. Twenty-one years ago while traveling up the east coast of Australia with my wife and infant daughter, I noticed that nearly every conversation between rural Australians began with this question.

Instead of the automatic, “How are you?” or “Nice weather,” it was a specific question that—once I figured out what it meant—spoke volumes about these people’s connections: to the land, to each other, and to the environment.

Tanks, also known as cisterns, are the very large containers that store captured rainwater and provide rural Australians with their life support: vital water for drinking, bathing, and gardening. Many rely exclusively on captured rainwater for all their needs.

This one question bundled and abbreviated a collection of concerns: How is your water supply holding out? How has the rain treated you? How are you doing in managing your land and water? How is your family holding up? At what state of readiness do we need to be for our community today?

Having spent much of my life working to awaken people’s awareness and inspire them to take personal responsibility for the environment, I was flabbergasted at the advanced state of consciousness being expressed by these Aussies, and I saw in that awareness an answer to the water crisis facing cities both in my native Los Angeles as well as in arid and non-arid lands around the world.

And for that same reason, I congratulate and thank you for picking up this book. You wouldn’t be reading this if you didn’t have an awareness of the need to take responsibility and action either to secure your own water supply or help solve the larger looming problems. Whether you are in it for selfish or selfless reasons, you are a pioneer and taking on the role of environmental healer. You are an early adapter—because of climate change and other issues—to a world that is already experiencing ever-increasing water and energy issues.

Your experience, persistence, and success in this new wave of rainwater harvesting may lead the way to wide-scale systemic adoption and implementation in cities around the world.

Rainwater capture is transitioning from an individual act of personal survival and self-reliance, to one that is replanting seeds of community, interdependence, resilience, and sustainability.

The local and global world water situation is becoming urgent. As humans in first-world nations, our consumption and waste of natural resources is generating sufficient pollution and depletion to damage and impair the healthy functioning of nearly every natural system on earth. These ecosystems are our life-support infrastructure for clean, abundant, and safe water, as well as food, oxygen, and a stable climate. Reversing the degradation requires a profound transformation of individual and communal perspective and behavior.

Instead of believing that government and centralized systems are in charge of the environment, we must shift to the other end of the spectrum where individuals, families, households, neighborhoods, villages, and towns take personal and collective responsibility and see that they are the managers of the ecosystem and their natural life support systems. In this emerging paradigm, government can and must provide information, guidance, feedback, resources, incentives, and systems that enable people to utilize their passion, compassion, creativity, and other energies to help out on an ongoing basis.

If the issues above aren't reason enough, it is important to realize that harvesting rainwater is a crucial means of fighting global warming and preparing our homes, families, neighborhoods, and communities for the coming consequences.

As you read this book, you'll find that rainwater harvesting practiced as prescribed herein is really watershed and ecosystem stewardship. In sculpting your landscape and creating water-capture systems, you will be restoring, revitalizing, or mimicking natural systems such as forest watersheds; as such, you'll be repairing the ecosystem and laying the foundations of your community's sustainability. And you will be a leader. Any change you make on your home can become a demonstration and model that others—your neighbors, elected officials, or government agency staff—will be able to study and copy.

As president of TreePeople, a nonprofit organization I founded 37 years ago, I like to say that we are helping nature heal our cities. Our work is to inspire people to take personal responsibility and participate in making their cities sustainable urban environments. Our prime focus is to support people in designing, planting, and caring for *functioning community forests* in every neighborhood in Los Angeles (at the time of this writing, one of the world's least sustainable megacities).

Forests are natural sustainability infrastructure. Trees are THE basic earthwork. Trees and forests, and the highly porous and mulched soil beneath them, capture, slow, filter, store, and recycle rainwater, and thereby recharge streams, groundwater aquifers, and springs. They provide protection from droughts, floods, and pollution—cleaning the water so it's

drinkable and usable. Trees and forests sustain life. Unfortunately, when most cities were created, the land's original watershed functionality was unwittingly destroyed. The idea behind *functioning* community forests is to plant trees and manage the land in cities in a way that mimics natural forests, bringing water, protection, and resources back to urban residents. However, since urbanization has sealed so much of the land with buildings, roads, and parking lots, simply planting trees and creating green spaces often isn't enough to make up for the lost watershed. By adding additional rainwater-harvesting technologies that are designed to mimic nature, such as earthworks—infiltration pits, swales, and cisterns—it is possible to replace the watershed and ecosystem functions that were lost.

The magnitude of the water crisis—and the opportunity—became clear to me in 1992, when the U.S. Army Corps of Engineers proposed to spend half a billion dollars to increase the capacity of the Los Angeles River by raising the height of its concrete walls. The Corps determined that the Los Angeles area had been so overpaved that, instead of soaking into the ground, rainwater from a 100-year storm event would rush off all the paved and sealed surfaces so quickly that it would overwhelm the river and flood the nearby cities of southern L.A. County.

It was at that moment that the “How Yur Tanks?” lessons clicked for me. I wondered how much of our 14.7 inches (373 mm) of average annual rainfall we were throwing away each year, and whether we could use that half-billion dollars for cisterns to capture and use that precious rainwater, just like the Australians. I asked the county's flood control engineers and they dismissed the idea, stating that replacing the river walls would require installing a 20,000-gallon (75,700-liter) tank at each of one million homes—an expensive and impossible task. The local water supply and stormwater quality agencies had similar responses to my questions. The idea was too expensive for their individual missions and budgets and would require what they all considered to be completely unacceptable lifestyle changes on the part of the public. In the process of these discussions, however, I learned that our average rainfall, if harvested and used appropriately, could replace the portion of our imported water



that we use for landscape irrigation—roughly half of the one billion dollars’ worth of water the city of Los Angeles IMPORTED every year.

What seemed impossible to the agencies was perfectly logical to me. Having participated in design and deployment of L.A. City’s extraordinarily successful curbside recycling program that now serves 750,000 households, the magnitude of the task didn’t worry me. I researched and found out that the separate water-related agencies had separate, unconnected plans to spend a combined \$20 billion in the next decade or so to upgrade or repair their respective systems, yielding only “band-aids” with no overall improvement in sustainability of the region.

So, I began designing a 20,000-gallon (75,700-liter) cistern that could safely fit in a small urban yard without compromising anyone’s lifestyle or posing any threat during our occasional earthquakes. It turned out to be a modular 2-foot-wide, linear, recycled food-grade plastic tank that could replace the fence or wall that separates most urban and suburban residential properties. Further, I proposed to outfit all the tanks with wireless remote-controlled valves and pumps that would enable flood-control, water-supply, and stormwater-quality officials to centrally manage the multitude of independent tanks as one highly adaptable storage network.

The networked mini-reservoirs could thereby perform at least triple service for potentially less money than all the agencies’ separate projects. By adapting all the areas’ landscapes to become functioning community forest watersheds, my system was intended to produce multiple additional benefits such as creating tens of thousands of new *green-collar* jobs, saving copious amounts of electricity (by reducing air-conditioning needs with well-placed shade trees AND reducing the pumping required to import water over the mountains into Los Angeles), reusing all garden and landscape biomass and prunings on site as mulch, creating a new local plastic recycling industry product and market, and creating a disaster-resilient backup local water supply.

This was a lovely and compelling vision, but no one in an official capacity took it seriously. I realized I’d need to do something to prove that the idea was feasible, both technically and economically. That

notion turned into a six-year program of design, feasibility, and cost-benefit analysis that became known as the T.R.E.E.S. Project (Transagency Resources for Environmental and Economic Sustainability). It involved hundreds of engineers, landscape and building architects, foresters, scientists, and economists who collaborated to create a book full of designs and specifications (*Second Nature*, TreePeople, 2000) to retrofit or adapt every major land use in Los Angeles to function as urban forest watersheds. Other team members spent two years conducting a rigorous cost-benefit analysis. And finally, we built a demonstration project, adapting a single-family home in South Los Angeles. The story of the T.R.E.E.S. Project, including all of its major partners and participants, is told at [www.TreePeople.org/trees](http://www.TreePeople.org/trees).

The demonstration site, known as the Hall House (named for its owner, Rozella Hall), had a relatively simple set of interconnected earthworks designed to capture, clean, store, and use rainwater from a massive storm event, and prevent any of the rainwater or biomass from leaving the property and thus being wasted. We built berms around the lawns, installed a mulched swale, put in a diversion drain to pick up driveway runoff and carry it to a sand filter under the lawn, fabricated and installed two modular 1,800-gallon (6,800-liter) fence-cisterns which were fed by rooftop rain gutters through a filter, then connected to the irrigation system, and finally, planted a trellis “green wall” of climbing roses to shade and cool the house’s sun-heated south-facing wall. We also removed 30% of the lawn and replaced the remaining turf area with drought-tolerant grass.

Then, on a hot August day in 1998, we invited our agency partners, numerous public-works officials, and the news media to see the demonstration house. We handed them umbrellas and unleashed a 1,500-year flood event, pumping and spraying on that one house 4,000 gallons (15,100 liters) of water in ten minutes. Officials huddled in stunned silence as they watched the water fall and flow, pooling in the bermed lawns and cistern. They saw that none of the water flowed to the street and stormdrain system. They saw how, in that one instant, their annual billion-dollar burden of separate infrastructure systems and needs were elegantly bundled and handled. The result: no stormwater pollu-

tion, no street flooding, no greenwaste, dramatic water and energy savings, more attractive landscape, and potentially thousands of new jobs.

The head of L.A. County Public Works' flood control division couldn't contain his enthusiasm and proclaimed that the simple elegance meant this demonstration could be easily replicated. A day later, after he and his staff reviewed both our engineered designs and cost-benefit analysis, he called me: "I'm sorry. We didn't understand. We think you've cracked it. Your idea needs to be deployed throughout the whole county, but it's going to cost more and take more time than you think. But despite that, we need to begin scaling this up immediately. We'd like to try this idea to solve one of the county's most persistent urban flooding problems."

That was the beginning of the Sun Valley Watershed project, located in the City of Los Angeles' San Fernando Valley. After a successful two-year feasibility study, the County Public Works Department launched a thorough "stakeholder-led" watershed-management-planning and environmental-impact analysis. Six years later, both the plan and environmental report were approved; construction of the first project began within a few weeks. The plan calls for the retrofit of 20% to 40% of the watershed's 8,000 homes, and installation of a diverse network of earthworks. The earthworks mix ranges from simple to complex, beginning with tree planting, pavement removal, mulching, and berming. On the more complex end, the projects will include installing street swales, and school watershed parks that replace asphalt play yards with permeable greenspaces above large underground infiltration systems and cisterns. Details of the Sun Valley Watershed Plan, progress and planning process are available at [www.SunValleyWatershed.org](http://www.SunValleyWatershed.org).

The Sun Valley Watershed planning process informed and transformed many of the participating agencies and organizations and inspired others who followed the process. For example, Los Angeles County Public Works formed a new, integrated Watershed Management Division. The City of Los Angeles Bureau of Sanitation launched and completed its first ever Integrated Resources Plan for Water. And among several cities outside the Los Angeles area, the

City of Seattle initiated its Salmon Friendly Seattle program, which seeks to restore viable salmon habitat throughout the metropolitan area by revitalizing watershed and forest functionality in all the city's neighborhoods.

There are several keys to the projects' successes so far:

- 1) we demonstrated that these adaptations represented *acceptable and attractive* lifestyle changes that would be politically palatable;
- 2) we demonstrated with rigorous engineering that they were technically feasible, safe, and capable of solving pressing problems;
- 3) we demonstrated that they were economically feasible by identifying multiple outcomes and benefits that altogether would over time save money for the assembled funding partners; and
- 4) we engaged and educated all the stakeholders from both the community (including children) and relevant agencies.

This story is far from over. As it continues to unfold it presents a variety of political, jurisdictional, and regulatory issues and problems that we work to resolve. My initial vision was that so much water and money could be saved by local governments that agencies would help individuals and businesses cover the costs of installing and maintaining the systems on their properties. That is now happening in some cities, such as Santa Monica, Seattle, and Houston, that are giving grants for cisterns and water-saving landscapes.

As we confront growing water-quality and supply issues, plus the increased threat of flooding and weather-related calamities, it is increasingly urgent that we find ways of adapting our homes, neighborhoods, towns, and cities to become climate-change and disaster resilient. You have a huge role to play in protecting your household and region by personally implementing some of the water-harvesting practices detailed in this book. If you do this, and make yours a *demonstration* project, you will help prove that it is feasible and attractive for your region. You will make it more

politically palatable, so your local politicians can pass laws, change ordinances and codes, and make resources available to help others implement on a wide scale. And then, collectively, we just might tip the balance and put our nation on the road to a healthy, just, and sustainable future.

Dig in and have fun.

—*Andy Lipkis*

*Andy Lipkis is president of TreePeople, a Los Angeles-based social-profit organization that he founded in 1973. Andy collaborates with leaders, cities, businesses, and agencies to identify and implement natural-systems-based solutions to human, social, and infrastructure problems. He co-wrote, with his wife and partner Kate, The Simple Act of Planting A Tree: A Citizen Foresters' Guide to Healing Your Neighborhood, Your City and Your World, and has been recognized and honored as one of the founders of the Citizen Forestry movement.*



# Preface

*We ain't dry. We just leakin'.*

—Janet Millington, Australian permaculture teacher referring to a lack of water harvesting and conservation compounding droughts in Australia

**Y**ou've got to plant the water before you plant the trees." An African water-farmer named Mr. Zephaniah Phiri Maseko told me this. "Create a water plantation by planting the rain," he said. "Plant it here, there, over there, everywhere, so it will germinate everywhere!"

I looked across a diversely vegetated landscape. It was something of a miracle. This area in the dry region of Zvishavane, Zimbabwe, (average annual rainfall 22 inches, or 559 mm) was once highly degraded and eroded. But Mr. Phiri had turned a wasteland into an oasis by controlling erosive runoff, harvesting the rain, and planting it within the soil. He and his family did it by creating a diverse array of water-harvesting earth-



Fig. P.1. Mr. Phiri in the hand-dug reservoir he calls his "immigration center" located on the highest point of his site, where he has a good amount of soil. "Rain, welcome to my country!" he shouts during storms. "Now I will tell you where you will live: in the soil!"

works such as infiltration basins, terraces, berm 'n basins, check dams, diversion swales, and contour plantings throughout their 7.4-acre (3-hectare) site.

Following the simple principles of water-harvesting, they began at the top of their watershed and continued all the way to the bottom. Now more water



Fig. P.2. Mr. Phiri tending his tree nursery. He gives hundreds of trees a year to fellow community members to vegetate the watersheds, build water-absorbing soil, and grow more resources. "People must plant the water before they plant the trees," he says. Water is planted with water-harvesting earthworks.

was harvested within their soils than was extracted from them by pumping out groundwater, or by evaporation and plant uptake. They gave the land more than they took. As a result, Mr. Phiri's well levels and those of his immediate neighbors began to rise slowly. Erosion was in check, soil was accumulating, fertility was increasing, and the family's farm could now support the family for the long-term. Scarcity had been turned into abundance.

As I walked around Mr. Phiri's land, I felt excited and hopeful. Here was a living, thriving example of a site, stewarded by people, that was improving with time! Progress was happening without degrading the lives or environments of others! For too long I had observed too many gardens, yards, farms, neighborhoods, ranches, and communities degrading with time. Many appeared to be doing great on the surface, but when I looked more closely I realized they were consuming more resources (water, energy, time, money, soil fertility) than they were producing. They were taking more resources from their local economies, ecosystems, and communities than they gave back.

So it was in my hometown of Tucson, Arizona. Growth was booming but we had contaminated our aquifer, depleted groundwater supplies, run our rivers dry, and killed countless springs and wells. Then we took water from other regions using elaborate canal, pump, and water-right buyout schemes at great financial and environmental cost to feed our constantly growing demand for water. Tucson was killing itself—or at least its water resources and those of others. And everyone who lived in Tucson—everyone who drank, irrigated, built, bathed, and washed with water—was part of that problem. But I didn't want to contribute to the problem. I wanted to leave. I wanted to run.

"If we run from our problems, they follow us," Mr. Phiri said, when I told him of my dilemma. "But if we root ourselves and face our problems we solve them."

I then realized the concepts and the strategies Mr. Phiri had used could easily be replicated or adapted elsewhere, such as my hometown. I excitedly returned home, rooted myself, and adapted Mr. Phiri's concepts and strategies in my yard, at my clients' sites, and in neighborhood projects, all with wonderful results.

At our Tucson, Arizona, home (receiving 12 inches or 305 mm of average annual rainfall), each year my



**Fig. P.3. Matt Weber kayaking his flooded neighborhood street in Tucson, Arizona. The bulk of the rain falling on the city's private and public landscapes (where it would be a free resource) is quickly drained to the streets and stormdrains, where flooding is a costly liability.**

brother, sister-in-law, and I now typically harvest over 100,000 gallons (378,500 liters) of rain and runoff in the soil of our 1/8-acre (0.05 ha) urban oasis and surrounding public right-of-way. We consume just 20,000 gallons (75,700 liters) of municipal water a year to meet our household needs and provide water to our washing machine, which serves as a community greywater-harvesting laundromat (see our story in Real-Life Examples in chapters 8 and 12). Ninety-five percent of the landscape's, orchard's, and garden's water needs are supplied by a combination of harvested rainwater and greywater, which consists of recycled "wastewater" from all household drains except the toilet. Our once-barren lot is now a lush landscape that produces 15% to 25% of our food, passively heats and cools the home, enhances urban wildlife habitat, and has won numerous awards for water conservation and artistry.

This book documents a diverse array of successful sites where passive water-harvesting earthworks serve as the foundation of thriving landscapes. You can accomplish similar successes at home and beyond by simply building on the skills you already have and using common sense. Mr. Phiri had only a 6th grade education when he taught himself to harvest the rain. Now his work at home, in his community, and throughout southern Africa inspires a new generation of water harvesters. The key to Mr. Phiri's success (and mine) was following eight principles of successful rainwater harvesting, and three ethics.



Fig. P.4A. The Santa Cruz River in Tucson, Arizona, looking southeast from Sentinel Peak in the early 1900s. Note the meandering, flowing river and the rich sponge of vegetation throughout the watershed (especially where the native tree forests have not yet been replaced by agricultural fields). Such a watershed absorbs more rainfall than it drains. Water moves more slowly and consistently through the forested watershed and the meandering waterway.  
Courtesy of Arizona Historical Society/Tucson BN 203, 274

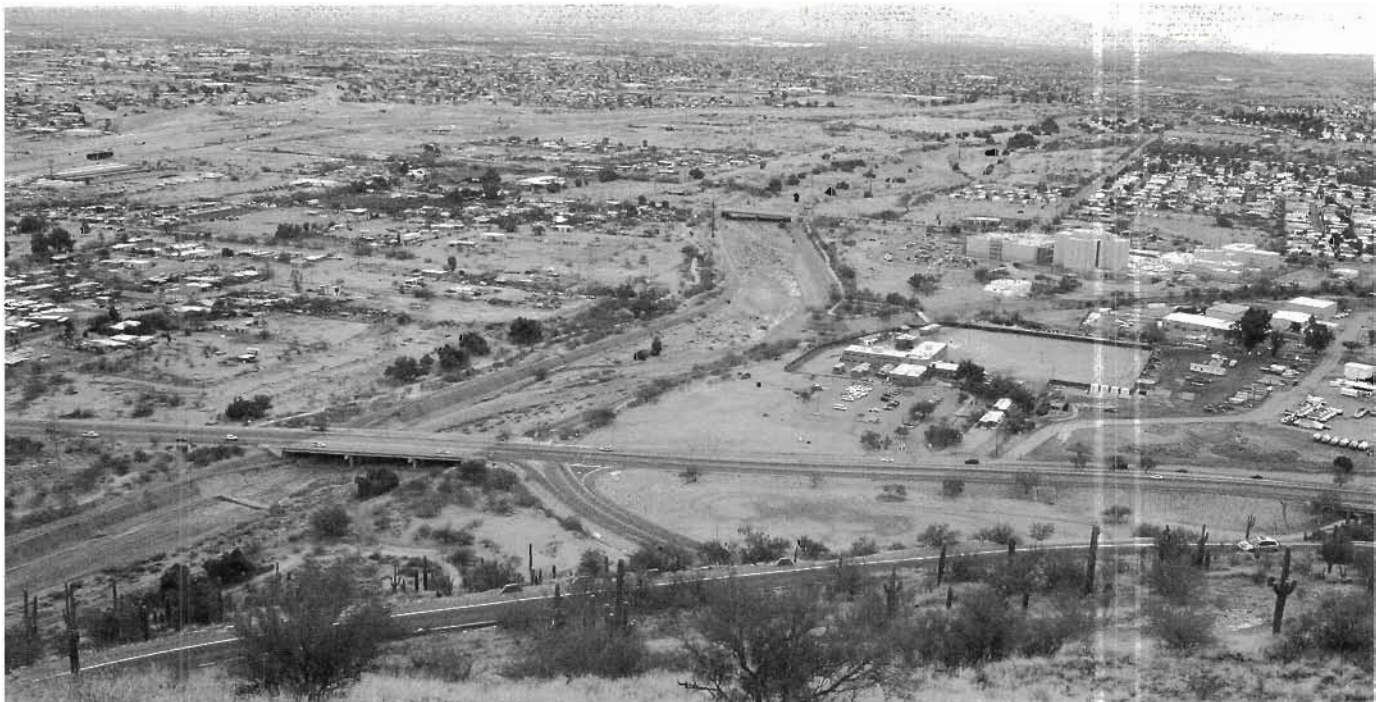

Fig. P.4B. The same stretch of the Santa Cruz River in 2006. Note the dry, channelized riverbed and how much of the watershed's vegetative sponge has been replaced with pavement, buildings, or bare compacted earth. The watershed now drains more rainfall than it absorbs. During storms, flooding water erosively rips through the watershed and straightened river channel unchecked to cause flooding problems downstream. And summer temperatures are rising due to the heat absorbed within the exposed pavement.

# THE EIGHT PRINCIPLES OF SUCCESSFUL RAINWATER HARVESTING

## 1. BEGIN WITH LONG AND THOUGHTFUL OBSERVATION



Fig. P.5. Observe where the water flows, where it collects, where it drains away, and where it drains from. This informs you of your resources and challenges. What is working? Build on that. What is not working? Change it.

## 2. START AT THE TOP (HIGHPOINT) OF YOUR WATERSHED AND WORK YOUR WAY DOWN

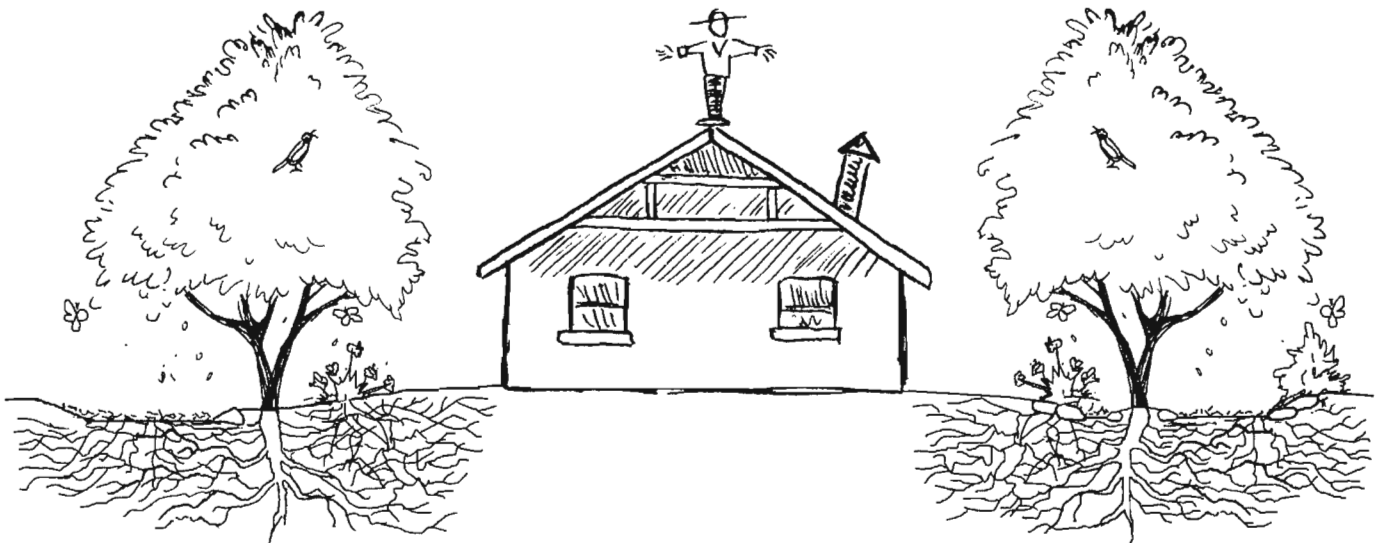

Fig. P.6. It is easier to harvest water high in the watershed than low in the watershed because the volume and velocity of flow is less, and more manageable, at the top. And you can then use the free power of gravity to distribute the harvested water to areas downslope.



### 3. START SMALL AND SIMPLE



Fig. P.7. Small, simple systems of appropriate scale are easier to create and maintain than complex, extensive systems so starting small and simple makes it all more fun. As an added benefit, large numbers of small earthwork structures distributed throughout a watershed will be far more effective at hydrating the land than a small number of large-scale earthwork structures in just a few areas of the watershed.

### 4. SLOW, SPREAD, AND INFILTRATE THE FLOW OF WATER

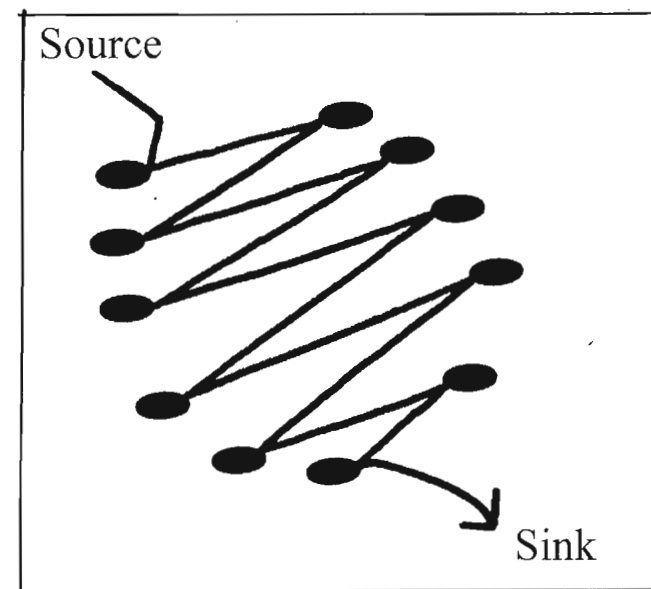

Fig. P.8. Zig-zag and calm the flowpath of water to reduce destructive erosion and increase the time and distance the water flows. This will increase infiltration into the soil from source (high point) to sink (low point). This practice achieves waterspread throughout the watershed.

## 5. ALWAYS PLAN AN OVERFLOW ROUTE, AND MANAGE THAT OVERFLOW AS A RESOURCE

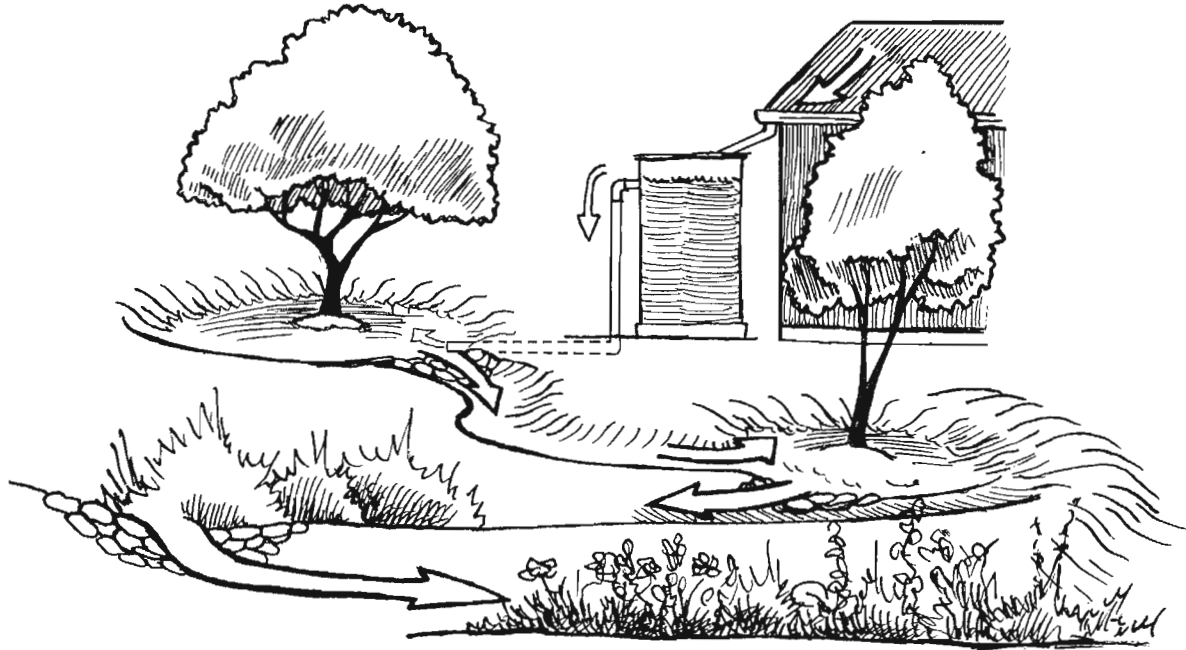

Fig. P.9. You can't turn off the rain once your water-harvesting earthworks and cisterns are filled up, so always be prepared for overflow. In this case, cistern overflow water is designed to fill a nearby, vegetated earthwork, then overflow to the next earthwork, and the next, as it passively irrigates sheltering vegetation. The zig-zagging flowpath also follows the fourth principle—slow, spread, and sink. Arrows denote runoff flow.

## 6. CREATE A LIVING SPONGE

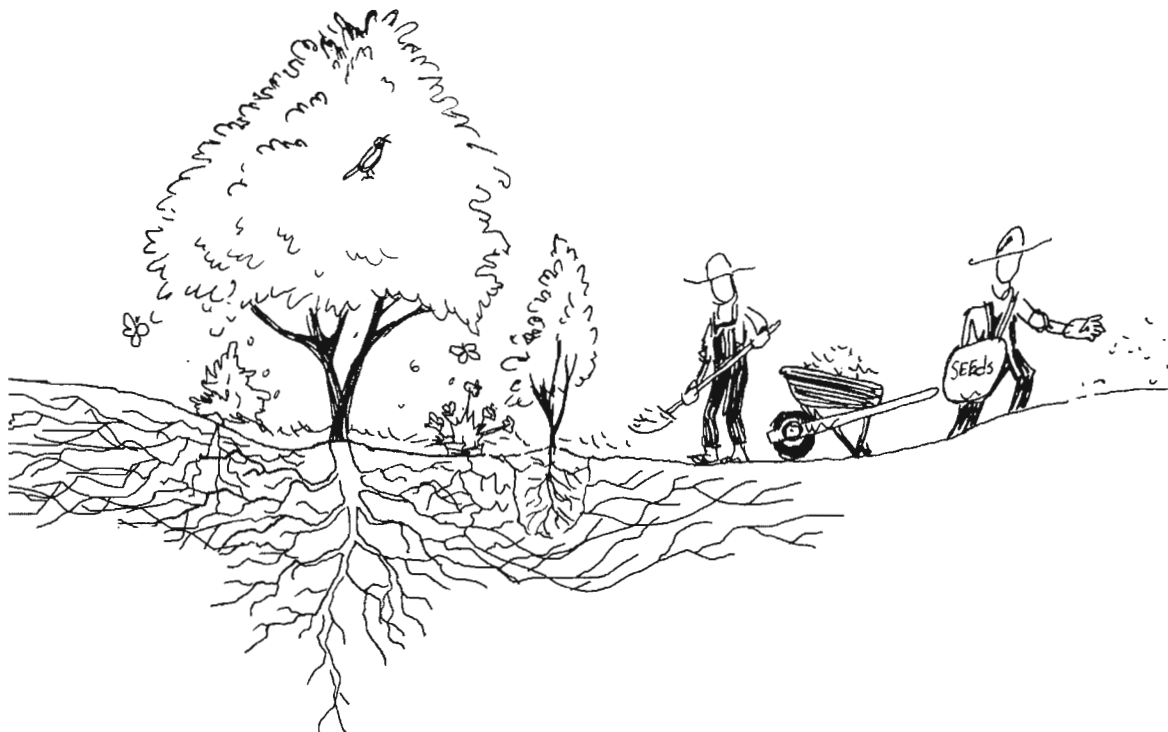

Fig. P.10. Maximize planting of climate-appropriate vegetative groundcover and spread organic mulch over the surface of the soil to create a "living sponge" that uses harvested water to grow more resources. As roots expand and soil life increases, the soil's ability to infiltrate and hold water steadily improves.

## 7. DO MORE THAN JUST HARVEST WATER

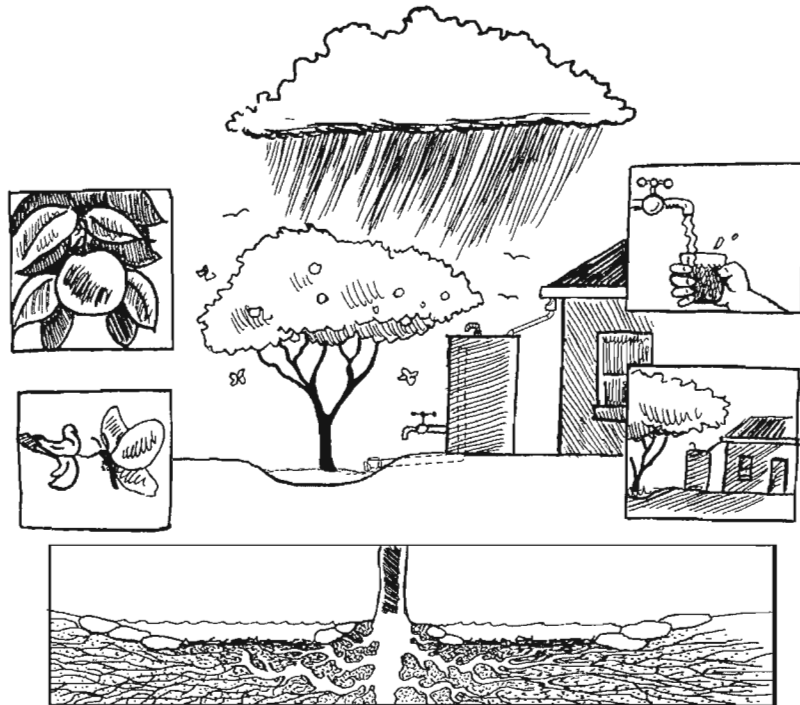

Fig. P.11. Maximize beneficial relationships and efficiency by “stacking functions.” For example, cisterns and earthworks provide high quality irrigation water and serve as on-site stormwater control strategies. In turn, rain-irrigated vegetation and above-ground cisterns can passively shade and cool the east and west sides of buildings in summer, while the plants also clean our air, produce food, create wildlife habitat, and add beauty to our lives.

## 8. CONTINUALLY REASSESS YOUR SYSTEM: THE “FEEDBACK LOOP”



Fig. P.12. The value of long and thoughtful observation extends throughout the life of your system. How is the land responding to your work? How are your strategies performing? What still needs to be addressed? Make any needed changes using all the principles to guide you.

## WATER-HARVESTING ETHICS

The following three ethics further increase the benefits of water harvesting on your site and well beyond. They are the ethics of permaculture,<sup>1</sup> a methodology of integrated, sustainable design based on natural systems.

1. The CARE OF THE EARTH<sup>2</sup> ethic reminds us to care for all things living and nonliving, including soil, water, air, plants, animals, and entire ecosystems. As Bill Mollison states in *An Introduction to Permaculture*, “It implies harmless and rehabilitative activities, active conservation, ethical and frugal use of resources, and ‘right livelihood’ (working for useful and beneficial systems).”<sup>3</sup>
2. CARE OF PEOPLE<sup>4</sup> directs us to strive to meet our basic needs for air, water, food, shelter, education, fulfilling employment, and amiable human contact in ways that do not hamper or prevent others from doing the same. We do not exploit or disregard others for our own gain. Nor do we destroy the environment that supports us all. Instead, we sustain a basic quality of life that improves our environment while enabling others to do the same.
3. REINVESTMENT OF SURPLUS TIME, MONEY, AND ENERGY<sup>5</sup> to achieve the aims of people and earth care encourages us to extend our influence and surplus energies to help others attain the ethics in their own life and work. This helps us all because it strengthens the greater communities in which we all live.

These principles and the ethics are the core of successful water harvesting. They apply equally to the conceptualization, design, and implementation of all water-harvesting landscapes. You must integrate *all* the principles and ethics—not just your favorites—to realize a site’s full potential. Used together, they greatly enhance success, dramatically reduce mistakes, and enable you to adapt and integrate a range of strategies to meet site needs. While the principles and ethics remain constant, the strategies you use to achieve them will vary with each unique site.

For a thorough introductory description of water-harvesting principles and ethics and to read Mr. Phiri’s full story, see volume 1, chapter 1 of *Rainwater Harvesting for Drylands and Beyond* (Rainsource Press, 2006).

## WHO THIS BOOK IS FOR

This volume (the second of a 3-volume set) guides you to harvest water in earthworks in a safe, productive, sustainable way in new and existing landscapes. You will learn how to harvest rainwater, stormwater runoff, and greywater within landscape and garden soil using simple earthworks. Earthworks are simple earthen structures that help reduce outdoor water consumption, decrease water bills, control erosion, enhance soil fertility, grow living air conditioners, support regenerative local resource production, and create a system that gets better with time as it helps enrich the larger ecosystem. Earthworks help you achieve maximum effectiveness for the least effort and cost while adapting strategies to your site, whether it’s urban, suburban, or rural, big or small.

You can choose the best combination of earthworks and variations described here to address the unique conditions of your site, and you can develop new strategies based on what you learn. This book tells and shows you *how to do it* and provides inspiring case studies to teach you and motivate you so you *will do it*. The descriptions are detailed and well-illustrated, so they’re easy to follow, and will be useful to backyard gardeners, do-it-yourself and professional landscapers, landscape architects, planners, designers, students, farmers, ranchers, engineers, teachers, community activists, and others.

Dryland-appropriate strategies are emphasized because that’s where the need is greatest (see box P.1). Many strategies are based on indigenous traditions that allowed people to survive and thrive in drylands for thousands of years. Yet water-harvesting principles are universally applicable—both wet and dry climates experience drought and flooding. Rainwater harvesting reduces the impacts of dry seasons, droughts, and floods, buffering our lands from changing climates and climatic extremes by making the land more resilient.

### Box P.1. Drylands: A Definition

Drylands are typically defined as areas of the world where **potential** average yearly moisture loss (evapotranspiration) exceeds average yearly moisture gain (precipitation). Evapotranspiration is the combined **measurement** of water loss to evaporation and **transpiration**.<sup>6</sup> Transpiration is the loss of moisture from plants to the air via the stomata within their leaves.

More than **16 billion acres** (6 billion ha), 47.2% of the Earth's land surface, is dryland. A fifth of the world's population lives in dryland habitat.<sup>7</sup> Normal dry seasons can last six months or more. Droughts can last for years.

Industrial and conventional agricultural sectors consume and contaminate the bulk of our fresh water resources.<sup>8</sup> In contrast, this book focuses on intensive, small-scale strategies ideal for homes, neighborhoods and communities in urban, suburban, and rural settings. We begin work at the top of our “watershed of influence” where we can more easily influence what happens and directly observe and benefit from the results. This makes it easier to implement and maintain the strategies and to more quickly realize their potential. It also leads to less dependence on consumptive industry and agriculture. As you gain experience and success you will become an example, and your watershed of influence will naturally grow. You begin to plant *seeds of abundance*—rather than scarcity—well beyond your site.

## HOW TO USE THIS BOOK AND VOLUMES 1 AND 3

The three volumes of *Rainwater Harvesting for Drylands and Beyond* create a series on how to conceptualize, design, and implement integrated and sustainable rainwater-harvesting systems. I strongly recommend everyone read Volume 1 to get a detailed understanding of water harvesting principles and ethics in the context of integrated sustainable design. Volume 1 puts all three volumes in context. It shows you how to assess your site so you can conceptualize and design truly efficient and productive *integrated*

systems that do far more than harvest rainwater. Volumes 2 and 3 describe the specific techniques you need to undertake the general strategies presented in Volume 1. Volume 2 focuses on earthwork techniques that passively harvest rainwater and greywater within the landscape. Volume 3 will focus on roof catchment and cistern systems.

Real-Life stories of people creating, implementing, maintaining, and living with water-harvesting landscapes and systems frame all three volumes. The scale and context varies, but they all illustrate principles in action. You can adapt these ideas to the scale and context your site requires.

## VOLUME 2: WATER-HARVESTING EARTHWORKS

The *Introduction* to this volume defines earthworks, explains why you should use them, and shares an inspiring story of how water harvesting brought abundance to a once-dying community.

*Chapter 1* is a quick reference guide providing tips on assessing a site's water flow and slope. A comprehensive table summarizes and compares all the earthwork strategies described in later chapters. Use this table to find the right earthworks for your needs, then jump to the appropriate chapters to learn more. Be sure to read the important cautions contained in this chapter. Go on to further tips on earthwork placement and selection including information on bountifully efficient oasis zones and how to live within your site's water budget.

*Chapters 2 through 11* address individual earthwork strategies, defining them, and outlining where to use them and how to implement and maintain them. Tips and examples help you integrate these earthworks into your site so they do more than harvest water. All of these chapters end with stories illustrating how real people in real places have used these techniques—so if you love stories go to the end of each chapter first!

*Chapter 12* illustrates how to integrate greywater harvesting within rainwater-harvesting earthworks to keep the landscape thriving in dry seasons and turn “waste” water into a resource.

The *Epilogue* ties together what you have learned, and tells four more water-harvesting stories.

Separate appendices at the end of this book provide specific information about waterflow patterns, simple tools for measuring slope and placing earthworks, calculations for sizing earthworks, appropriate vegetation, and additional resources for rainwater harvesting and permaculture.

Case studies illustrate how real people have transformed their sites using both specific water-harvesting strategies and combinations of techniques. Read the case studies to learn about:

- Homesteading grandmothers restoring their land using simple earthworks made on their daily walks, and water-harvesting berms and brush that are sustaining windbreaks of trees with harvested runoff and wind-driven snow (chapter 2)
- Tarahumara Indians checking erosion and hydrating their steep canyon lands with stone terraces (chapter 3)
- New housing developments irrigating their thriving landscapes with rainwater- and greywater-harvesting earthworks that double as their on-site stormwater control (chapter 5)
- People who plant junk mail to hydrate the soil and revegetate the land (chapter 7)
- Curb cuts and infiltration basins redirecting street runoff to passively irrigate flourishing greenbelts of street-side shade trees, and water-draining driveways that have been converted into water-absorbing gardens (chapter 8)
- Check dams that helped create springs and perennial flows in previously dry creek beds (chapter 10)
- Neighbors who have created greywater-harvesting laundromats to sustainably irrigate fruit trees (chapter 12)

### Box P.2. Advantages of Rainwater and Its Harvest with Earthworks

- Rainwater (and hail, sleet, and snowfall) is delivered to us free of charge, eliminating the need for costly distribution systems
- Rainwater is the highest-quality source of irrigation water
- Rainwater is salt-free and can help flush plant-damaging salts from the root zone in alkaline soils
- Rainwater is a natural fertilizer containing sulfur, beneficial microorganisms, mineral nutrients, and nitrogen
- Rainwater harvesting reduces utility bills
- Rainwater harvesting reduces flooding by reducing flow to streets and storm drains
- Rainwater harvesting reduces nonpoint-source pollution of stormwater
- Rainwater harvesting provides a water source when well, surface, or municipal water is contaminated or unreliable
- Water harvesting helps utilities reduce summer peak demands for water and reduces the volume of wastewater that needs to be treated at water treatment plants
- Water harvesting is fun, and it'll get you dancing in the rain!

## DECIDING HOW BEST TO HARVEST YOUR WATER

Despite the many advantages of water-harvesting earthworks (box P.2), they may not be the only water-harvesting strategy to meet your site needs. Tanks/cisterns may also be desirable. How you plan to use your harvested water determines how best to harvest your water (box P.3).

### Box P.3. Comparing Earthworks and Tanks

| CHARACTERISTICS                              | EARTHWORKS  | TANKS   |
|--|---|---|
| Water uses                                   | Provide large quantities of high-quality rainwater to garden and landscape  | Provide water for drinking, washing, fire control, and supplemental irrigation. Water quality will vary with catchment surface, tank construction, screening, and maintenance. Rainwater has very low hardness. |
| Water collection areas                       | Can collect water from roofs, streets, vegetation, bare dirt, greywater drains, air conditioner condensate, etc.                            | Need a relatively clean collection surface (typically a metal, tiled, or slate roof) located higher than the tank.  |
| Water storage capacity                       | Very large potential to store water in the soil   | Storage capacity limited by the size of the tank  |
| Cost   | Inexpensive to construct and maintain. Can build with hand tools, though earthmoving equipment can speed up the process.                    | Much more expensive than earthworks to construct and maintain. Cost varies with size, construction material, above- or below-ground placement, self-built or prefab, etc.                                       |
| Location                                     | Do not locate within 10 feet (3 m) of wall or building foundation. May be difficult to use in very small yards with adjacent large roofs.   | Can locate within 10 feet (3 m) of wall or building foundation, but you should be able to walk around entire tank to check for, and repair, leaks. Tanks increase water-storage potential in very small yards.  |
| Time period water is available               | Water available for limited periods after rainfall depending on soil type, mulch, climate, and plant uptake                                 | Water available for extended periods after rainfall   |
| Maintenance                                  | Earthworks work passively; require some maintenance after large rainfalls   | Maintenance required, must turn valve to access water and may need pump to deliver water  |
| Erosion control                              | Very effective for erosion control  | Can assist with erosion control   |
| Greywater collection                         | Very effective at harvesting greywater from household drains  | Not appropriate to harvest greywater in tanks due to water-quality issues. Never store greywater in a rainwater tank.   |
| Water quality impacts to environment         | Pollutants in greywater and street runoff intercepted in the soil stay out of regional waterways  | Less impact than earthworks to the broad environment  |
| Impacts on urban infrastructure and flooding | Can capture large volumes of water, reducing need for municipal water, stormwater drains, and stormwater treatment, and decreasing flooding | Can capture low to moderate volumes of water, reducing demand for municipal water, stormwater drains, and stormwater treatment, and decreasing flooding   |
| Groundwater recharge                         | Can sometimes recharge very shallow groundwater tables  | Not an efficient use of tank water  |

## LANDSCAPE OR GARDEN USE

If you plan to use harvested water (including rainwater, runoff, *and* greywater) for landscape or garden use, begin harvesting water in the soil using *earthworks*. Landscapes that harvest water in soil and are planted with low-water-use native perennials can typically subsist on rainfall alone once vegetation is established. However, storing water in cisterns gives you the option of applying supplementary irrigation in dry times, especially if a vegetable garden or less hardy non-native vegetation is planned.

## POTABLE USE AND WASHING

If you plan to harvest water for potable use and washing, harvest rainwater in tanks, but do not forget the soil. (See Volume 1 for overall guidance, and Volume 3 for specific cistern information.) Direct overflow from the tank, greywater from your house, and runoff from the general landscape into water-harvesting earthworks. The more water you can effectively harvest and hold in the soil, the less supplemental cistern irrigation will be needed.

## MATCH THE QUALITY OF WATER BEING HARVESTED TO THE STRATEGY USED TO HARVEST IT

Runoff from clean roofs constructed of metal, slate, or tile, or coated with elastomeric paints approved for rainwater collection systems, is the cleanest and most appropriate water to store in cisterns for domestic consumption and watering vegetable gardens. This runoff can also be harvested directly within earthworks. Stormwater from dirtier surfaces such as earthen slopes, streets, or sidewalks should be directed not to tanks, but to trees and shrubs in earthworks. Household greywater should be directed to and utilized within mulched basins planted with trees and shrubs. Do not store greywater in tanks. Instead, direct greywater directly to mulched and vegetated earthworks.

Keep in mind the question, “How do I plan to use my harvested water?” as you read the comparisons of these water-harvesting approaches in box P.3.

If water-harvesting with earthworks is appropriate for your site and needs, read on; the rest of this book shows you how.



# Introduction

## Earthworks Defined, Their Advantages, and a Story of Success

### WHAT IS RAINWATER HARVESTING WITH EARTHWORKS?

The next time it rains, run outside and cup your hands to capture the water falling freely from the sky. Drink it and taste the sweetness. Share it.

Grab a shovel to make cup-like shapes in the soil, so plant roots, earthworms, fungi, and myriad other life forms can also drink the sweetness. These grow and share the bounty of food, oxygen, shelter, fertility, medicine, building materials, wildlife habitat, and beauty. This is rainwater harvesting with earthworks.

Water-harvesting earthworks or “rain gardens” are the simple strategies and landforms that capture and “plant” rain and localized runoff, our *highest-quality* sources of irrigation water,<sup>1</sup> which come to us *free of charge*.

Earthworks function as easy and convenient passive-irrigation and erosion-control systems. There are no manufactured tanks, no mechanical pumps, and no plumbed irrigation systems with associated maintenance requirements, though such systems can be used in conjunction with earthworks. Earthworks store water in the soil—our largest and least expensive “tank”—with the force of gravity and the living pumps of plants moving water through the system. Earthworks function whenever rain falls and water flows, whether you are there or not. Water-harvesting tanks and mechanical irrigation setups are active



Fig. I.1. Rain-fed bounty

systems that require you or your valve and timer system (ultimately you) to turn the water on and off. Mechanical irrigation systems require regular maintenance and are prone to wasteful leaks. While earthworks take effort to install, over time they typically cost less and require less maintenance than active systems.

Earthworks are appropriate for use in landscapes, gardens, farms, ranches, parks, schoolyards, street

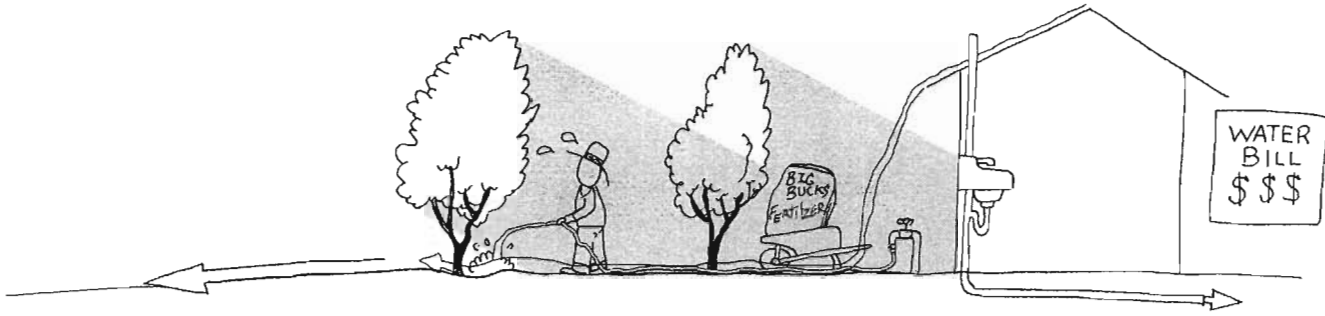

Fig. I.2A. A landscape actively wasting and consuming resources. Rainwater, greywater, and organic matter are drained away. Homeowner must purchase/import resources to replace those lost. Arrows denote stormwater runoff and sink-drain-greywater flow.

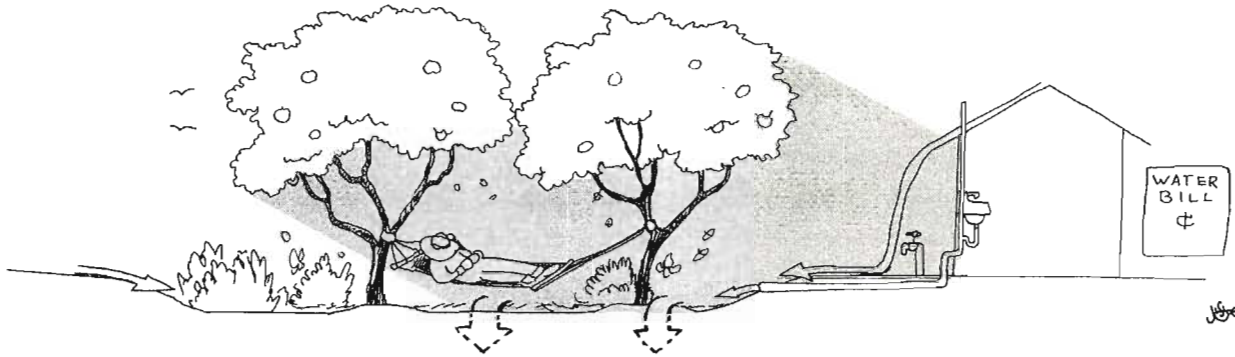

Fig. I.2B. A landscape passively harvesting resources. Rainwater, greywater, and organic matter are freely harvested in the soil to naturally grow more on-site resources. Arrows denote stormwater runoff and sink-drain-greywater flow.

medians, public rights-of-way, restoration sites, and lots of other places. Their specific shapes are based on the unique topography and needs of each site. From bowl-like depressions in flat soil, to serpentine contour berms cutting across slopes, to a course of rocks laid across the bottom of an ephemeral drainage, they all act as nets, slowing, capturing, and infiltrating water into the soil and healing erosion at the same time.

Earthworks *hydrate* rather than dehydrate the land. They can cost as little as the price of a shovel or as much as the cost to utilize an operator and large earth-moving equipment. They *maximize the potential* of available rainfall, concentrating it to create thriving

landscapes that slash water bills, reduce use of nonrenewable water supplies (such as depleting groundwater), decrease downslope flooding, and improve water quality.

Compare a landscape that drains rainwater and other resources (figs. I.2A, I.3A) to a landscape that harvests rainwater and other resources (figs. I.2B, I.3B).

## A DRAINING LANDSCAPE

A draining landscape drains and dehydrates the land.

Plants sit on top of a convex landform, often on burial-like mounds that drain water, topsoil, and

organic matter away, stunting plant growth over the long term. These mounds of imported soil are often created to make small plants appear larger or to avoid digging into hard soil, but they require expensive long-term watering and fertilizing to replace the rain-water and soil fertility drained away. It is a system reminiscent of a hospitalized patient on an intravenous drip.

In a draining landscape, roof runoff is directed past plants into streets and storm drains via gutters, downspouts, and landscaped “stream beds.” This ejected water can become a flooding liability in the street and other downstream areas. Hardscape (sidewalks, driveways, and patios) slopes away from the landscape into streets and storm drains, adding to flooding problems.

If 12 inches (305 mm) of rain falls on this parched site in a year, as little as 1 inch (25 mm) may actually infiltrate the soil. So, automatic irrigation systems in these landscapes frequently turn on just hours after a downpour or even while rain is pouring from the sky.

This waste leads to water scarcity.

## A HARVESTING LANDSCAPE

A harvesting landscape collects and generates multiple resources while hydrating the land.

In a harvesting landscape, climate-appropriate plants are placed within or beside mulched concave earthworks that function like sponges, retaining water, topsoil, and organic matter. This way you enhance rather than deplete local resources.

Digging earthworks may take more work in the short run, but there is far less work, cost, and maintenance in the long run. The “need” to import water and fertilizer is offset or eliminated along with your contribution to the over-consumption of local groundwater or potable water supplies. A harvesting landscape mimics thriving natural systems where life thrives when water lingers.

Earthworks direct roof runoff to plant roots in the soil where it is a resource. Hardscape raised and sloped to direct its runoff into the landscape, further enhances on-site water resources, while reducing street flooding and sediment dumping downslope.

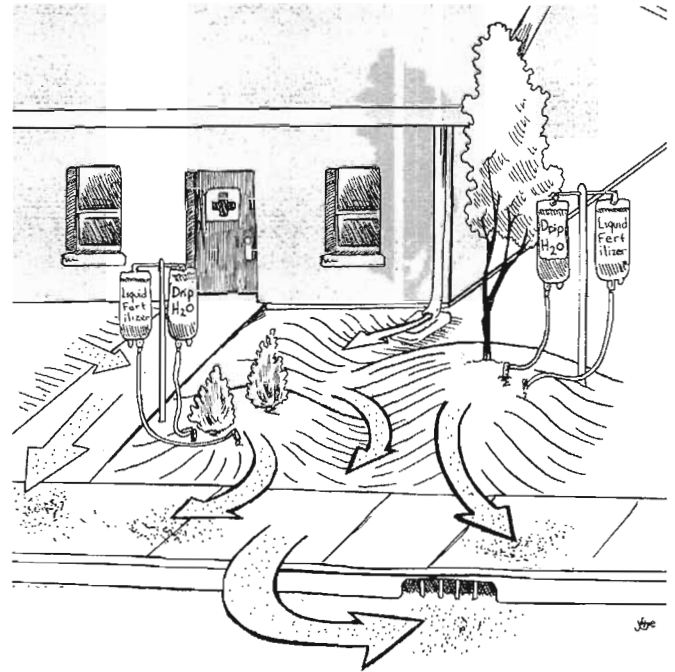

Fig. 1.3A. A landscape on life support draining its resources away. Note the mounded planting areas and the hardscape and landscape draining *all* run off to the street.

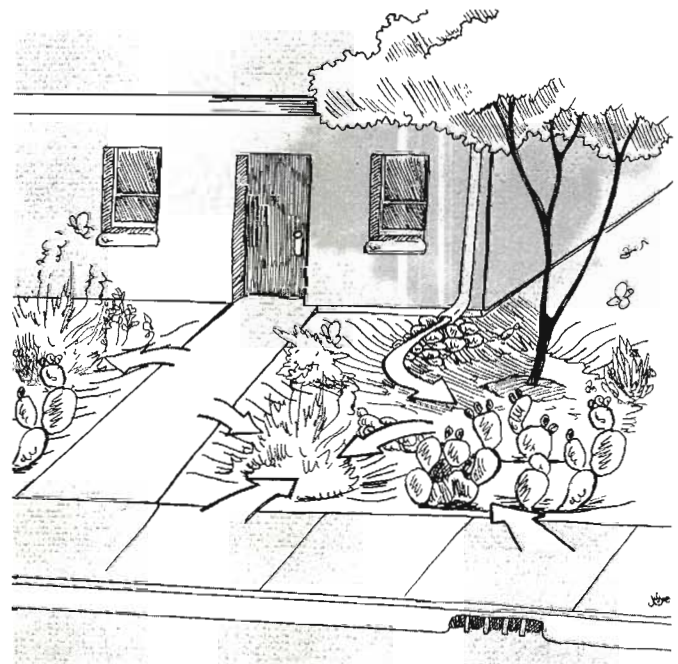

Fig. 1.3B. A sustainable landscape harvesting and recycling on-site resources. Note the water-harvesting sunken, mulched planted areas, the native vegetation, and how the hardscape (sidewalks and roof) beneficially drains into the soil. The earthworks overflow from one to another, until only the *surplus* water—not all the flow—overflows to the street.

### Box I.1. The Abundance of Rainwater

One inch of rain equals 0.623 gallons per square foot of catchment surface.

One inch of rain falling on a 1,000-square-foot catchment surface equals 623 gallons of water.

One inch of rain falling on 1 acre of catchment surface equals 27,121 gallons of water.

Ten millimeters of rain falling on 100 square meters of catchment surface equals 1,000 liters of water.

Ten millimeters of rain falling on one hectare of catchment surface equals 100,000 liters of water.

Every locality had its own system. Almost everyone did it.”<sup>5</sup> Water- and soil-harvesting terraced fields and other earthworks have been used throughout wet and dry areas of Asia, North and South America, Africa, and Europe for generations (see volume 1, appendix 2 for traditional Native American techniques in the U.S.). There is a 4,000-year-old tradition of harvesting water in soils of the Indian subcontinent.<sup>6</sup>

For centuries past, and again in the present, earthworks allow dry-farmed production of pomegranates, almonds, figs, peaches, carob, and grapes in the Negev desert of Israel on just 4 inches (102 mm) of annual rainfall.<sup>7</sup> Use of earthwork strategies likely spread quickly because they are effective and can readily be made with materials on hand such as soil and rock. Dryfarmed fields that harvest rain typically have yields 2 to 7 times higher than those that do not.<sup>8</sup>

When mechanical pumps, piped water, and large-scale dams and river-diverting canal systems were introduced from the early 1900s on, the use of earthworks went into decline. Piping in water from elsewhere was perceived to be more convenient than using water harvested on site. The availability of the water no longer seemed to depend on rains and rainfall harvesting. We grew accustomed to water coming from pipes, canals, sprinklers, and irrigation tubing rather than the sky. But now the pipes, canals, sprinklers, and tubes are starting to run dry.

Across the globe, we are extracting water from rivers and aquifers more rapidly than natural recharge replenishes it, causing groundwater levels to drop and flows in the majority of our rivers to dwindle.<sup>9</sup> In addition, much of this water has been contaminated by agricultural, urban, and suburban nonpoint-source pollution (contaminants collected and carried within our unchecked or unharvested runoff).

The water scarcity we have created is now bringing about a resurgence of interest in water harvesting. These techniques efficiently use the water we have, reduce the water we extract, and can enhance recharge of aquifers and rivers by putting more rain in the soil than we take out. Around the world more and more individuals, groups, and communities are again harvesting the rain. The result is more verdant landscapes, rising well levels, new springs, and even the revival of once-dead rivers. The more people who do it, the

In addition, this decreases the risk of slipping on winter ice in cold climates.

If 12 inches (305 mm) of rain fall directly on this spongy landscape in a year and the roof and sidewalk areas are each equal to the soil area, 12 inches of rain will fall on the landscape directly, another 12 inches of rain will run off the roof to the landscape, and an additional 12 inches of rain falling on the sidewalks will be directed into the landscape, tripling available rainfall for a total of 36 inches (914 mm) of rain that year! Using this harvested water will offset or even eliminate the need for municipal or well water for landscape irrigation once plants are established, especially low-water-use native plants. Flooding is averted because overflow is routed and managed as a resource (the fifth water-harvesting principle).

This stewardship of the landscape and water leads to abundance.

## EARTHWORKS – A RESURGING ANCIENT STRATEGY

Before the advent of modern irrigation and pumping technology, people used a diverse array of water-harvesting and water-conserving earthworks in all populated dryland environments and many wetter climates to recharge wells, grow food and other vegetative resources, and control flooding and erosion.<sup>2,3,4</sup> As Fred Pearce states in *When the Rivers Run Dry*, “Harvesting the rain was once a worldwide technology on which millions of people depended.

greater the effect. You will read about such successes at the end of each chapter in this book.

*“If you quench Mother Earth’s thirst,  
she will quench yours.”*

—Pandurang Shastri Athavale, Vedic scholar and water-harvesting advocate,  
*When the Rivers Run Dry*

## EARTHWORKS PLANT THE RAIN TO TURN WATER SCARCITY INTO WATER ABUNDANCE

All the earthworks presented in this book harvest and plant the rain in the earth and vegetation, so the water moves slowly and productively through the soil of the watershed, rather than quickly and erosively running over and off the soil’s surface. The earthworks described here do not store water on top of the soil like a puddle or a pond where water would be lost to evaporation or mosquitoes could breed. Since mosquitoes need at least three days of standing water to evolve from eggs to adults,<sup>10</sup> properly constructed water-harvesting earthworks never have standing water for more than 12 hours and typically not more than one hour. Earthworks should be porous sponges that quickly pull water beneath the surface. Pervious surface mulches of organic material such as woodchips, bark, straw and/or compost are key to creating this sponge. Vegetation is just as important. The plants’ roots create thousands of micro-channels throughout the soil, speeding up infiltration of water into the soil and steadily increasing the soil’s storage capacity as plant and soil life grows and diversifies.

As a “living pump,” vegetation accesses the moisture harvested within the soil and distributes it throughout the plant, enabling you to eat harvested water in the form of a peach, pomegranate, olive, or mesquite pod. Water in the form of shade trees cools you. Water pumped into windbreak trees shelters you. This “tree water” reduces erosion and improves air quality. You enjoy the water in the form of flowers and the hummingbirds and butterflies they attract. With



**Fig. I.4. A living sponge of organic matter, healthy soil, and diverse vegetation quickly infiltrating water then pumping it back out in the form of fruit, shade, fertility, erosion control, wood, beauty, and wildlife**

rain-irrigated plants you sustainably grow and produce resources, rather than wastefully buy and consume resources.

In some (but not all) hydrologic environments, rain and snow harvested in soil can make their way to springs, creeks, rivers, and wells. Surface runoff can supply quick, high-volume infusions of water (sometimes in the form of destructive floods), but the slow path water takes from soil to springs, creeks, rivers and wells provides more consistent and productive flows throughout the year, including dry times. The more water harvested in wet seasons, the more water there is to feed the springs, creeks, rivers, and wells that yield water throughout the year.

## EARTHWORKS ARE THE FOUNDATION STRATEGY OF SUSTAINABLE LANDSCAPES

Earthworks, not drip-irrigation systems, are the foundational strategy of water-conserving, sustainable landscapes, because earthworks that harvest direct rainfall can also harvest greywater, air-conditioning condensate, runoff, rainwater distributed from

### Box I.2. Manual Awareness Saves More Water Than Automatic Convenience

According to a report by the American Water Works Foundation:

- Households that employ an automatic timer to control their irrigation systems use 47% more water outdoors than those that do not. This is because timer settings often are neither changed with seasons nor once plants are established, so automated systems irrigate whether plants needed water or not, and even if it is raining. In addition, leaks are seldom noticed or repaired.
- Households with drip-irrigation systems use 16% more water outdoors than those without drip-irrigation systems. Landscapes and gardens typically have a diverse array of plants with differing water needs, yet all plants on a drip system are watered, even if only a few plants actually need the water.
- Households who water with a *hand-held* hose use 33% less water outdoors than other households.<sup>11</sup> You won't water any more than you have to, because there are other things you'd rather be doing. Note: For this to work, you must hold the hose when watering. Leaving the hose running on a plant unattended does not conserve water.

Earthworks reduce or eliminate our need to apply supplemental irrigation whether via drip irrigation, hand-held hose, or other means. Using earthworks, we can achieve a more sustainable hierarchy in household and community water management in which:

- Rainwater and localized runoff, our on-site water resources, are the *primary* water source for our landscapes and gardens.
- Greywater is the *secondary* water source for our landscapes. Greywater is household “wastewater” that drains from sinks, clothes washers, showers, bathtubs, reverse-osmosis water filters, and the condensate from air conditioners.
- Municipal water or groundwater from private wells is strictly a *supplemental* source for landscapes used *only* in times of need such as drought. This is water pumped onto, or pumped up to, our site.

By embracing this sustainable water-use hierarchy and using a climate-appropriate plant palette, you can sustainably support a lush landscape year round using only harvested rainwater and greywater, even in times of no rain. This spares the use of precious and expensive potable water for irrigation. As a society we spend vast resources purifying water to drinking water standards, as well as building and maintaining pipes and pumps, and using fossil fuels to deliver water throughout the community while keeping it safe to drink. It is a waste of all these resources to cast this potable water into our dirt and toilets.

About 30% of the potable water consumed at single-family residences in the U.S. is used for outdoor irrigation.<sup>12</sup> In hot dry climates potable water consumption for irrigation can be much higher. In Albuquerque, NM 40% of potable water goes to irrigation.<sup>13</sup> In San Diego, CA, Denver, CO, and Phoenix, AZ, well over half the drinking water consumed at single-family residences is used for irrigation.<sup>14</sup>

In a typical U.S. household, the flushing of toilets accounts for up to 30% of all indoor potable water use.<sup>15</sup> Most people are not conscious that their commodes are filled with drinking water (which they soil

cisterns, and municipal water used in the landscape. No matter what type of water is harvested, earthworks reduce erosion, decrease downstream flooding, enhance stormwater quality, and retain organic matter falling from plants, which increases soil fertility. Drip-irrigation systems harvest nothing. Their only purpose is to distribute pressurized water (usually pumped in from off site) via plastic pipe and drip emitters to individual plants.

Yet drip-irrigation systems are promoted as the pinnacle strategy for achieving water-efficient landscape. Studies prove otherwise: While drip irrigation can be more efficient than flood or sprinkler irrigation of agricultural fields of same plants, diversely planted drip-irrigated landscapes and gardens often use more water than those without these systems (see box I.2).

daily), but dogs are. Perhaps that's why they drink from the toilet bowl!

The potential of water harvesting is great—even in dry communities. A recent study found that average rainfall in the average urbanized sections of the desert city of Tucson, Arizona, (12 inches or 305 mm of rain per year) is equivalent to 74% of the total water supplied to those sections by the local water utility.<sup>16</sup> Thus, just by utilizing this rainfall instead of potable water to irrigate landscapes, water consumption could be reduced by 30% to 50%.

## ADDITIONAL BENEFITS OF EARTHWORKS

Earthworks create living water-harvesting systems that can improve with time.

Soil—the “earth” of earthworks—is alive. The more vegetation and other life there is within it, the more life it can support, for life builds on life (figs. I.5A, B). As Toby Hemenway explains in *Gaia's Garden*, “An acre of good pasture may support a horse or two, say about a half-ton of aboveground animals. But living in the soil of that acre may be 2 tons of worms and another 2 tons of bacteria, fungi, and soil animals such as millipedes and mites. That one-horse-per-acre soil may contain eight or ten horses' worth of

animals below ground.”<sup>17</sup> That soil life is what makes the horse's life and ours possible.

Soil animals, plants, fungi, and microorganisms are the ultimate transformers and recyclers converting the solar energy, rocks, animal and insect waste, and dead matter into food, fertility, and other energies. Plant and soil life transforms things we cannot readily use into resources that we can use (fig. I.6). The more healthy soil life that exists, the more resources it can produce. Yet the health of soil and plants depends not just on soil life and nutrients, but the depth and speed of their flows and interconnections.<sup>18</sup> Water lubricates these flows and interconnections. Water carries plant nutrients from the roots upward, and food from the leaves downward, and plays an important role in photosynthesis—the solar-powered production of vegetation. Water also speeds the decomposition process and the transfer of energy between life forms, while speeding the growth of vegetation, earthworms, and other soil life.

This life, and the resulting harvest of leaf-drop and humus within the earthworks, then moderates extreme conditions, both dry *and* wet. In dry, fast-draining sandy soils, plants, surface mulch, and other organic matter in the soil help absorb and hold onto more water. Toby Hemenway reports that, “soil with as little

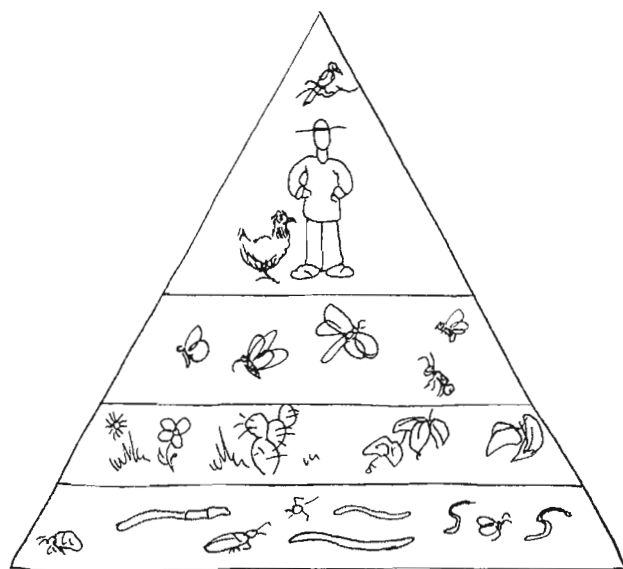

Fig. I.5A. Poor soil supporting a limited amount and diversity of life. Adapted from *Gaia's Garden*, Chelsea Green Publishing, 2001

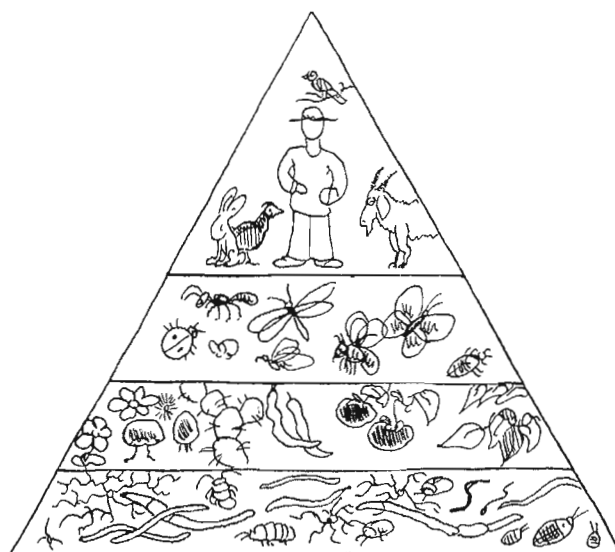

Fig. I.5B. Healthy and diverse soil life supporting a greater amount and diversity of life and resources. Adapted from *Gaia's Garden*, Chelsea Green Publishing, 2001

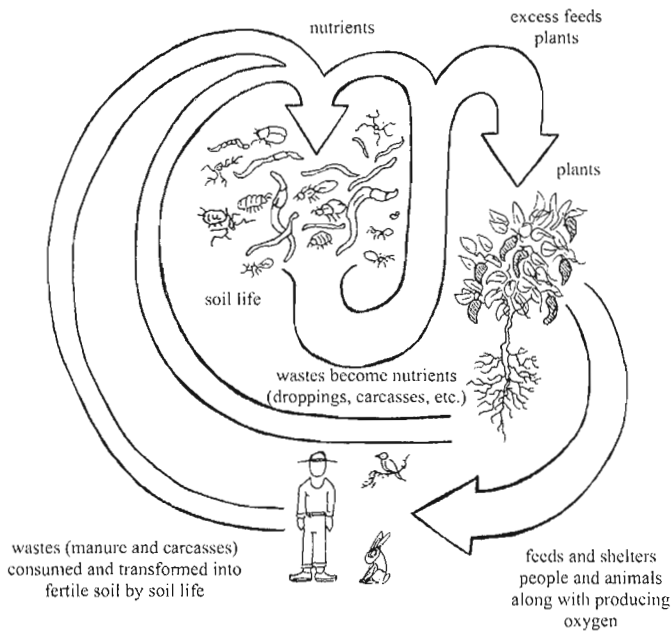
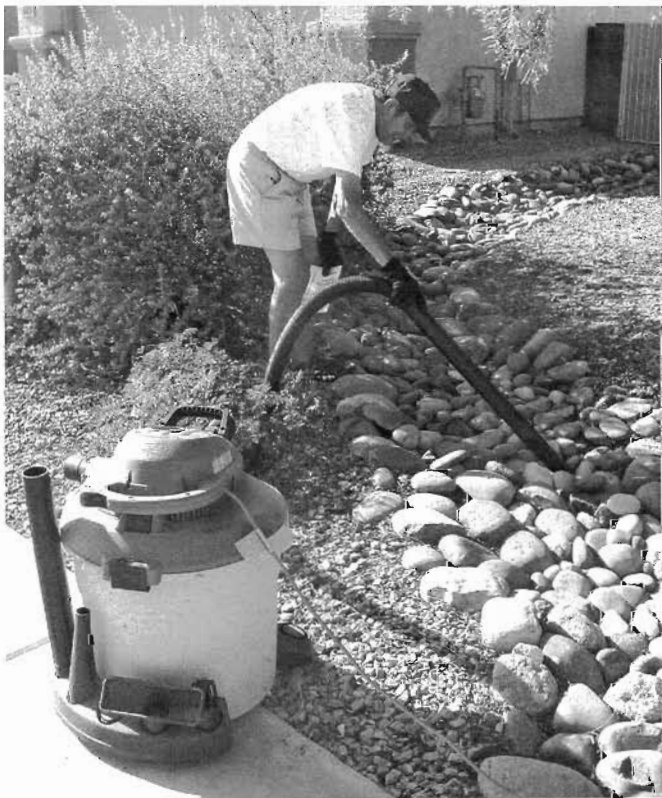

Fig. I.6. Nutrient flows whereby soil life transforms “wastes” and nutrients into more life and resources. Adapted from *Gaia’s Garden*, Chelsea Green Publishing, 2001

as 2% organic matter can reduce the irrigation needed by 75% when compared to poor soils with less than 1% organic matter,” and “shading soil [with mulch and plants] has been shown to reduce evaporation loss by over 60%.”<sup>19</sup> In wet, poorly draining clayey soils, plants, mulch, and organic matter help increase the soil’s porosity, enabling vast amounts of water to be absorbed without losing the soil’s ability to hold air, since it is the lack of air that drowns waterlogged plants.<sup>20</sup> Whatever the climate, growing roots, burrowing earthworms, and branching fungi thriving in the sheltered environment of vegetated earthworks continually expand subsurface microchannels through which water can quickly infiltrate and nutrients can rapidly be exchanged; life building on life.



I.7A. Depleting the living sponge by vacuuming a site’s nutrient-rich “waste” of fallen leaves and organic matter. Credit: Jenny Leis



I.7B. Enhancing the living sponge by recycling nutrients and organic matter. Prunings are cut up and used as mulch, along with fallen leaves, for the plant from which they came. In a healthy system there is no such thing as waste.



## EARTHWORKS HELP THE GOOD FLUSH OUT THE BAD

Soil fertility degrades over time on dryland farms and landscapes dependent on imported ground or surface water for irrigation due to the continual buildup of the salts introduced with the imported water (fig. I.8). High-sodium soils crust up or lose their structure, reducing the ability of water and roots to penetrate the soil and the ability of vegetation to take up water and conduct photosynthesis.<sup>21</sup> Such salt accumulation results in the loss of 25 million acres (10 million ha) of farmland around the world every year.<sup>22</sup>



Fig. I.8. Salt buildup at the base of four plants irrigated with municipal water. See the white circular salt deposits around the base of each plant irrigated with drip irrigation emitters. Note how the irrigation emitters, the water they emit, and the salt do not extend much beyond the plant, thus roots are not encouraged to extend further, which would better stabilize and support the plants. Tucson, Arizona.

Yet soils on dryland farms and landscapes irrigated primarily with harvested rainwater steadily increase in fertility and their ability to hold water, because salt-free rain steadily flushes the salts of alkaline soils out of the plant-root zones. Researcher Michael Evenari found that rain harvesting on fields in the Negev desert continually decreased previously severe soil salinity to the point that moderately salt-sensitive crops including apricots, almonds, and carob could be grown.<sup>23</sup>

All of this became dramatically apparent to me during a recent trip to Rajasthan, India, where I visited farm after farm with salt-crustured soils abandoned after less than 30 years of groundwater and canal irrigation (fig. I.9). I also visited many thriving farms in the same area that had been irrigated with harvested rainwater for generations, and none showed signs of salt buildup in the soil (fig. I.10).

## EARTHWORKS CAN CREATE LONG- LIVED, SELF-MAINTAINING OASES

Earthworks always perform better when maintained, though a well-designed and -built system can operate as a “beneficial ruin” once established since it can be largely self-maintaining. Long-abandoned earthworks located throughout the world still function and help support pocket oases of vegetation. Examples in the southwest U.S. include check dams, terraces, contour berms, and stone mulches constructed by prehistoric Native Americans (see Real-Life Examples in chapter 7, and appendix 2 in Volume 1) and more recently by 1930s Civil Conservation Corps projects.

Each time I come across one of these old earthworks I find a lost world full of life. These unexpected treasures lure me to find more old sites and to create new ones—both in the wild and the city. I create a simple earthwork at the beginning of the rainy season, toss in some locally collected native seed or seedling followed by one good shot of water, then I’m gone. When I return months or years later I typically find more life than was there before, especially with urban tree planting projects. For these projects I advocate planting trees and spreading native wildflower seed in mulched water-harvesting earthworks. On average the trees planted within earthworks have about a 50%



Fig. I.9. This well and the field in background were abandoned after groundwater was depleted and irrigation with pumped groundwater raised salt levels in the soil to the point that plants would no longer grow. Jaisalmer District, Rajasthan, India.



Fig. I.10. This water-harvesting field has been productive for generations without any signs of salt buildup in the soil. A khadin, or large berm at the low end of the field, captures and backs up runoff to the point that it spreads over and infiltrates within the entire field. A winter crop of mustard green seedlings is being grown. Jaisalmer District, Rajasthan, India.



Fig. I.11. A check dam built long ago atop bare bedrock has accumulated, upslope of the dam, a level terrace of soil and organic matter in which vegetation now thrives. The harvested soil and organic matter act as a sand tank that quickly infiltrates stormwater flow, then slowly releases it to the plants' roots, and as a seeping flow over the bedrock that continues to run for weeks after the last rain. Anastasia Rabin enjoys a drink of this tasty water. Pima Canyon, Tucson, Arizona.  
For color photo see inside front cover.

higher survival rate than conventionally planted trees without such earthworks. All trees benefit from initial supplemental irrigation, but those without earthworks often die when the person doing the watering quits or the irrigation system breaks down. In contrast, trees and wildflowers planted in earthworks live on even when supplemental irrigation stops because earth-worked soils hold water longer, and the basins receive additional water each time it rains.

## EARTHWORKS UTILIZE AND ENHANCE WHAT YOU HAVE ON SITE TO SAVE COSTS AND INCREASE POTENTIAL

Earthworks are best built using on-site materials such as soil, rock, and organic matter that naturally

blend into the landscape. Salvaged materials, including chunks of old concrete, can look great when carefully formed into dry-stacked walls, porous paving, and check dams. Existing native vegetation is planted in earthworks to the greatest extent possible because it is genetically programmed to burst into life exactly when seasonal rains fill basins. In areas where native vegetation is stunted due to lack of water, the addition of earthworks beside the plants can spur their growth from shrub-sized trees into shade-producing canopy trees. This can keep material and plant costs low to nonexistent.



Fig. I.12. Trees can grow along this highway where the runoff from the road boosts the available water. Beyond reach of the road runoff, only creosote bush grows. Southeastern Arizona.

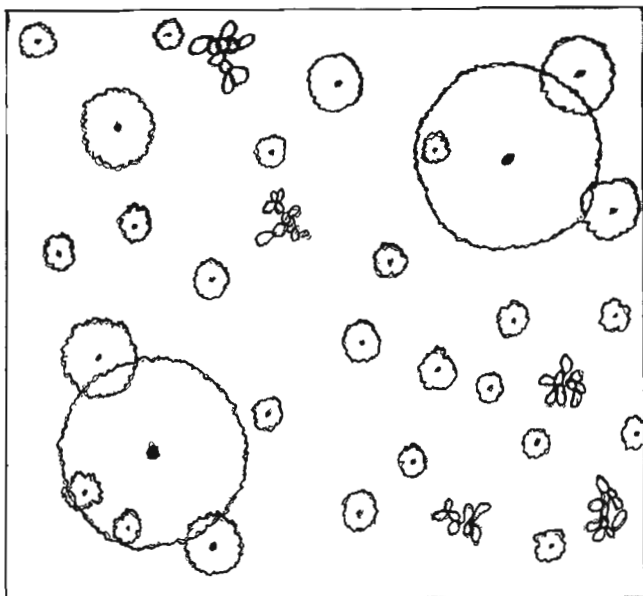

Fig. I.13A. Natural native-plant density *without* water-harvesting earthworks, when watered only by rainfall. Based on average annual rainfall of 12 inches (305 mm) on 1,000 ft<sup>2</sup> (92.9 m<sup>2</sup>) of yard space, and estimates of plants' water needs from appendix 4 in Tucson, Arizona.

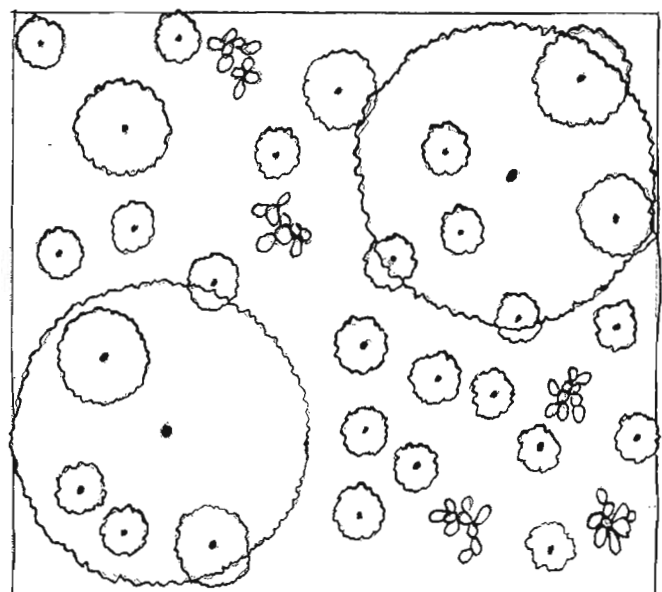

Fig. I.13B. Increased natural native-plant density *with* water-harvesting earthworks when watered only by rainfall. Based on average annual rainfall of 12 inches (305 mm) on 1,000 ft<sup>2</sup> (92.9 m<sup>2</sup>) of yard space, and estimates of plants' water needs in Tucson, Arizona, from appendix 4. Greater plant size and density achieved by water-harvesting earthworks that increase the availability of rainfall to plants by reducing water loss to runoff and evaporation. Plant size and density could be increased further if runoff from an adjoining surface, such as a roof, street, or patio, and/or household grey-water, were also harvested within the landscape's soil.

## EARTHWORKS HELP CREATE MORE SUSTAINABLE, FOSSIL-FUEL-FREE LANDSCAPES

Fully using on-site resources reduces or eliminates our need to import resources from off site. Not only is this less expensive and more efficient, but it reduces our on-site consumption of dwindling fossil-fuel supplies and the pollution and global warming that threaten our future survival. According to scientists, we must reduce our carbon dioxide emissions by 70% (from 1990 levels) by the middle of this century to stabilize the Earth's climate. If we do not do this, we run the risk of disaster, as the rate of climate change will outpace the ability of ecosystems, food production systems, and economic development to adapt.<sup>24</sup>

While water-harvesting earthworks add abundance to the landscape by helping trees and plants survive, they also help reduce energy costs and the use of fossil fuels, artificial fertilizers, and pesticides. Currently 5% of the electricity consumed in the U.S. is used to move water.<sup>25</sup> Earthworks decrease the consumption of fossil fuels (and the corresponding generation of CO<sub>2</sub>) otherwise needed to pump water, fuel trucks, pipe water, and build the associated infrastructure. Earthworks combined with greywater harvesting also help reduce the energy-related costs of collecting, treating, and disposing sewage. Synthetic fertilizers, pesticides, herbicides, and “green waste” hauling are not needed when earthworks harvest on-site nutrient-rich organic matter and weed-suppressing mulch. Passive solar design in combination with growing earthwork-supported shade plants reduces energy consumption for conventional heating and cooling (see how to do this in Volume 1, chapter 4). This is sorely needed. According to *The Weather Makers*, 55% percent of the total United States domestic energy budget is devoted to home heating and air conditioning. Home heating alone costs Americans \$44 billion a year.<sup>26</sup> Yet, I've repeatedly found that common-sense design strategies can reduce costs to a fraction of what they are now.

See box I.3 for easy fossil-fuel-free landscape/garden choices (and see appendix 6 for additional resources promoting fossil-fuel-free strategies, and resources proactively addressing local and global

climate change). Remember: Thriving gardens and landscapes existed long before we started using fossil fuels.

## I GIVE THEE THY SHOVEL

Ready to harvest water? Go for it! The following chapters show you how to do it, whether you are doing the work or hiring someone to help. I advise my clients to begin harvesting water with earthworks because it is doable, fun, and effective. Just planting several native, low-water-use shade trees on the east and west sides of your home within or beside water-harvesting earthworks is a great start. The trees can grow to beautify, shade, and cool (by up to 20°F or 11°C) the area around your home in summer, while still letting the free light and heat of winter sun come in! Trees are natural, solar-powered air conditioners and heaters—and thanks to the earthworks, those trees, once established, will be watered just from the rain falling freely from the sky. Plant the rain. Plant life. And live within the constraints of your watershed. By doing so, you will give back more than you take. Over time your own landscape and the world around you will improve rather than become worse. When the mechanical irrigation system fails, the passive water-harvesting systems and the life that they support will live on. Move off the wasteful path to scarcity, and onto the stewardship path to abundance. And soon you'll be *dancing* in the rain!

Need still more inspiration? Read the following story.

## REAL-LIFE EXAMPLE

### EARTHWORKS TURNING WATER SCARCITY INTO WATER ABUNDANCE - RAJASTHAN, INDIA

I end this introduction with a story of how the Indian village of Laporiya turned wastelands into oases through water-harvesting earthworks, common watershed stewardship, and realization of the Eight Principles of Successful Rainwater Harvesting (see Preface for further description of the principles). While the scale and context may be very different

### Box 1.3. Material and Practice Choices That Can Increase or Decrease Our Fossil Fuel Consumption and Its Negative Side Effects

| Fossil-fuel-consuming material or practice  | Fossil-fuel-free alternatives   |
|---|---|
| Municipal or well-water irrigation  | Harvested rainwater, localized runoff, and greywater irrigation   |
| Accessing and transporting irrigation water with plastic pipe   | Accessing and transporting irrigation water with earthworks   |
| Moving water with a mechanized pump powered by imported electrical energy or fossil fuels   | Moving water with the free power of gravity, a ram pump, or alternative on-site energy source such as solar, wind, or micro-hydro   |
| Virgin concrete patios and paths; groundcover or "paving" with decomposed granite or gravel groundcover that has been mined elsewhere and transported to the site | Raised and compacted patios and paths of on-site earth or mosaics of salvaged concrete chunks used as pavers; groundcover or "paving" of organic mulch, preferably from local "green waste" or prunings cut up on site      |
| Chemical fertilizers  | Compost, organic fertilizers, local manure  |
| Pesticides  | Integrated pest management, beneficial insects, organic gardening practices   |
| Herbicides  | Mulch   |
| Imported materials such as soil mixes, exotic stone or fired brick, wood from distant forests, and newly manufactured products                                    | Local materials such as on-site amended soil, native stone or earthen building materials such as sun-dried adobe brick and cob, wood from urban/local trees, and used manufactured products reclaimed from the waste stream |
| Water-intensive plantings   | Native and low-water-use climate-appropriate plants   |
| Lawn  | Drought-tolerant groundcovers   |
| Ornamental plants   | Multiuse food and medicinal plants  |
| Power mower or weed whacker   | Hand mower, grazing animals, getting rid of or greatly reducing lawn, hand weeding tools, mulch to keep weeds down  |
| Power blower  | Rake, broom   |
| Power pruners   | Hand pruning saw and hand shears  |
| Home spa or hot tub   | Cistern storing non-potable water, or go to beach, river, local water hole, or community pool or hot tub  |
| Landscape lighting  | Moon and star light; or dark-sky compliant, low-level, solar-powered lights   |
| Hired labor driving to your site  | Creating a more efficient landscape you can care for yourself   |
| Driving to exercise in a distant mechanically heated and cooled gym and purchasing off-site resources   | Exercising as you transport yourself by foot, bicycle, skateboard, etc.; exercising outdoors to maintain home and neighborhood, public landscapes, and gardens that generate on-site resources                              |

*This box was adapted from and inspired by "How To Go Fossil-Free in Your Garden" by the Fossil-Free Landscaping Group, Santa Barbara, California, Owen Dell ([www.owendell.com](http://www.owendell.com)), and the Fossil-Free Landscaping Group (<http://groups.google.com/group/Fossil-Free-Landscaping>).*

from your site, this story illustrates the universality of the principles and how one person's local vision can be hugely magnified as ideas and efforts spread and infiltrate throughout our watersheds—like rain into the soil. For more water-harvesting success stories, urban and rural, big and small, in the U.S. and beyond, see the Real-Life Examples section at the end of chapters 2 through 12, and the epilogue.

## A VILLAGE THAT PLANTED ITS RAIN AND WATERSHED

*The water of the pastures is in the pasture  
The water of the farms is in the fields  
The water of the village is in the village*

—A Sahalsagar village song touting the importance of harvesting the rain as close as possible to where it falls, by the people living closest to where it falls

After attending an international water-harvesting conference in Delhi, India, friends and I set out for the Thar Desert of Rajasthan to learn how people harvested water in the world's most populated desert. Our first destination was the village of Laporiya, but the drive there was unnerving. We saw a moonscape of bare soil and sometimes pavement. Our guide, Jagveer Singh, explained that the land was stripped of trees to make charcoal, denuded of grass by overgrazing, and encroached on by illegal mining and the building of houses and temples. On the horizon we saw farm fields of exposed windblown dirt. Some farms had been productive for a short time after bore wells were dug, but most wells had since dried up. The crumbling soil was eroded and salt-encrusted.

We drove farther, and thankfully the land dramatically started to green. We stopped at an odd concrete platform atop four 8-foot (2.4-m) posts seemingly placed in the middle of nowhere (fig. I.14). Nearby were numerous shade trees. We were now among the water-harvesting earthworks the villagers of Laporiya had built in their common pastureland. "What is that concrete structure for?" I asked. "A shady place for people to gather," replied Singh. "Why not just gather

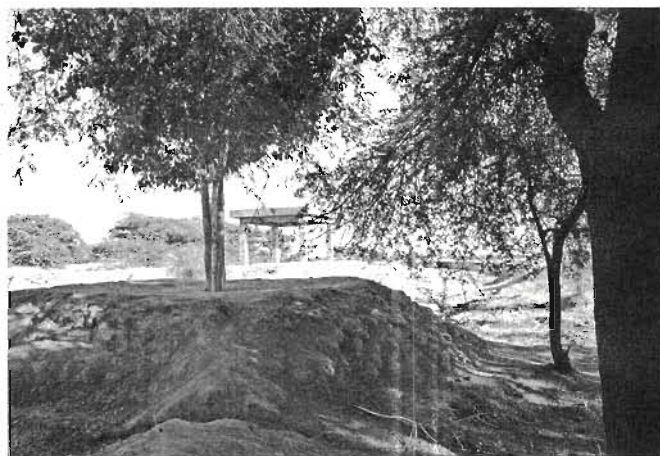

Fig. I.14. In the background sits a concrete shade structure built for the villagers to gather and rest while they planned and built their earthworks. The earthworks now support the shade trees in the foreground.



Fig I.15. Yogesh Kumar, Laxman Singh, Ramkaran Poar, and Jagveer Singh of GVNML

under the trees?" I asked. "Because when we started this work there were no trees."

In the 1970s the village of Laporiya was a drought-prone area of barren, saline soil, denuded pasturelands, and starving livestock. While summer rains once averaged 20–24 inches (508–610 mm) per year, a drought has kept annual rainfall below 8 inches (203 mm) since 1999. Nonetheless, Laporiya today is a relative oasis thanks to indigenous water-harvesting earthworks and communal stewardship of the local watershed.

Laxman Singh (elder brother of our guide) initiated the work. The nongovernment organization he organized, Gram Vikas Navyuak Mandal Laporiya (GVNML), and the village took it to completion.

Singh was born in 1956 when Laporiya was desolate. Though the son of the village chief, he had

a rather impoverished childhood due to poor village land and water. At age 12 Laxman left for school in Jaipur, the capital of Rajasthan. Throughout his late teens he was troubled whenever he returned to his poor village. Families and animals were continually migrating away from the dismal conditions. At age 20 Singh decided to remain in Laporiya and work to improve it. He began farming 12 acres (5 hectares) of his father's land. It was tough work, and he often slept only two or three hours a night atop bullock carts to keep the animals from eating his crops.

After years of farming he became frustrated at the lack of improvement in the community's economic conditions and backward social practices. Laporiya comes from the local word *lapod*, meaning "mad." And Singh was determined the village would be known for more laudable reasons.

So, with a group of friends, Singh started a school, and taught the village youth in the evenings. This began to empower the youths who came to believe change was possible. This was the beginning of what would later become Singh's nongovernment organization, GVNML.

Singh wanted to reinvigorate the land. He spoke at length with village elders asking them what could improve the land, particularly the denuded common pastures. "Grass," they replied. But to grow grass there had to be water. The dying wells could not provide it, and most of the rain and soil washed away. He watched the government build trenches and contour berms to harvest runoff, but these trenches concentrated water in local areas of pasture land rather than spreading it out to support widespread growth of grass. This initial *long and thoughtful observation* phase of Singh's learning showed him what was not working, and he set out to find and build examples that did work.

In the 1980s Singh traveled around India to visit traditional and revived water-harvesting and land-conservation projects, both large and small. One of these was an extensive project in the Alwar District of Rajasthan where five dry rivers were revived with perennial water flow after 650 villages built or rejuvenated 3,000 small earthen check dams and implemented community-led forestry projects that revegetated and "re-sponged" the rivers' watersheds.

The successes inspired Laxman Singh to return to his village determined to create water-harvesting strategies well suited to Laporiya's gradually sloping, degraded pasture lands. Based on his long and thoughtful observation of the land, consultation with village elders about monsoonal water flow, and his own observations of rain, soil erosion and soil deposition, Singh devised the chouka (square) system. This variation of boomerang berms (see chapter 2) consisted of a series of rectangular sections of pasture bounded on three sides with earthen berms about 3 to 5 feet (0.9 to 1.5 m) in height. The upslope, open side invites runoff in, while the berm retains this water, gradually spreading it throughout the whole chouka area, and cumulatively over the entire pasture encouraging water to *slow, spread, and infiltrate* into the soil where it is less prone to evaporation. Surplus water exits around the upper end of one of the side berms, then flows into an adjoining chouka slightly down-slope. Overflow water flows from one chouka to the next until it is caught by an ephemeral watercourse that takes the extra water down to a natural monsoonal arroyo and a series of more distant earthen tanks or reservoirs. Every chouka has *an overflow route, and overflow from one chouka to the next is managed as a resource* ensuring each earthwork is filled before surplus water leaves the system.

It took Singh three years of trial and error to get the chouka system working right, and he and the villagers continue to perfect the choukas as they repeatedly work with and observe them—the eighth principle: *Continually reassess your system: the "feedback loop."* If berms were made too tall and long, too much water covered the land and drowned the grass. If berms were too short and low, they harvested too little water and grass dried out. He found a 9-inch (23-cm) depth of harvested water to be ideal for local soils and native grass. Many of the choukas on land with a 1% (0.6° or 100:1) slope are 656 feet (200 m) wide with side berms about 328 feet (100 m) long. The steeper the slope, the shorter the length of the side berms. The more gradual the slope, the longer the length of the side berms. To fix choukas that were too far apart, that collected too much water too deep, an extra chouka was placed between the two resulting in water being spread out to shallower depths in all choukas.



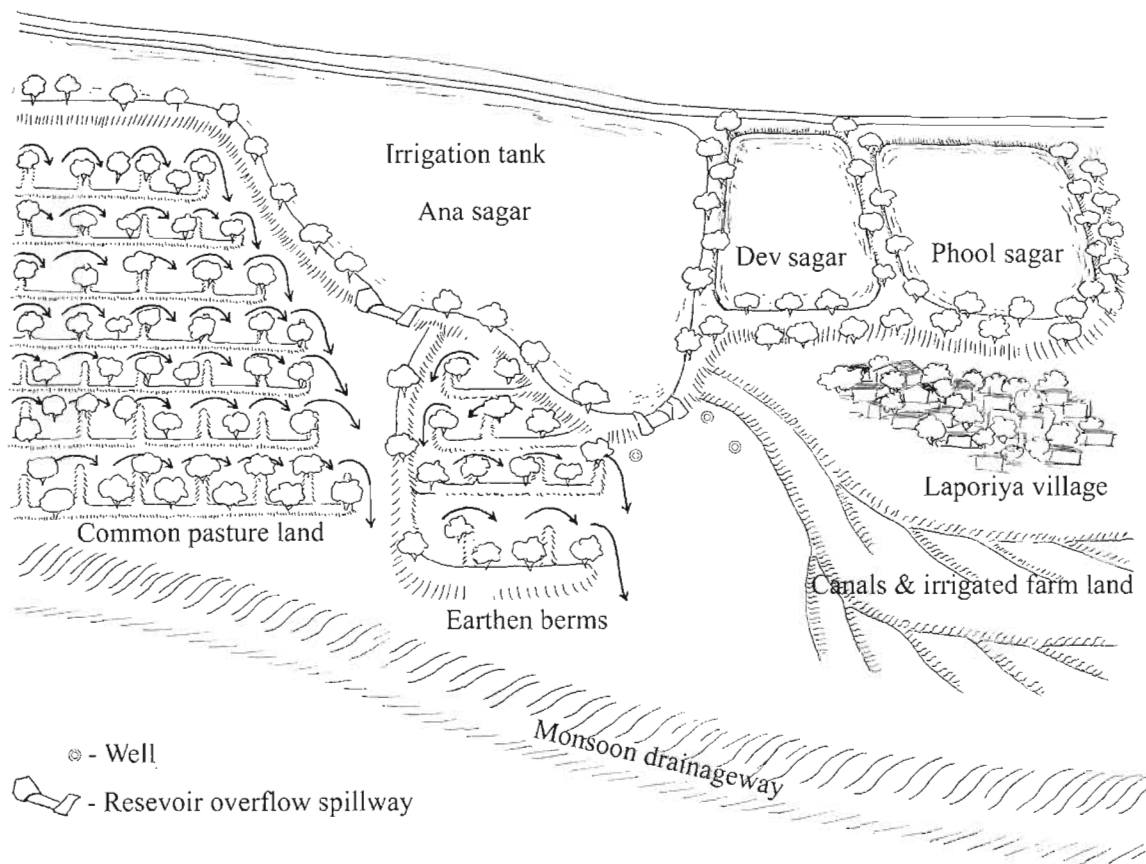

Fig. I.16. Map of Laporiya. The choukas are the square berms in the common pastoral land seen at left side and center of figure. Arrows show overflow route of water.

Singh started at the top (highpoint) of the pasture's watershed and worked his way down. It was easier to manage smaller volumes and velocities of runoff, and he was able to start relatively small and simple with his experiments.

The choukas spread shallow water over a larger area than the government-built trenches, promoting the growth of more grass (over 30 different species recorded thus far) and helping recharge the groundwater. Laxman got the soil for the berms by digging a series of level-bottomed, 1-foot (30-cm)-deep basins (for even infiltration of water caught within it) upslope of the berms. This created three distinct microclimates and moisture zones: the drier berms, the wetter basins, and the flat areas in between. These supported a greater diversity of vegetation. Water-loving grasses for cattle and edible mushrooms for people grew in the basins. Camels go for the leaves of the trees that grow on and stabilize the berms, while acting as windbreaks. Goats roam the flat areas browsing

on shrubs that also provide fruit for villagers. The diverse microclimates and growth created by the choukas' topography has helped maximize beneficial relationships and efficiency by "stacking functions"—the act of selecting and designing every element so it does at least three different things.

But before Laxman Singh could get village support for the choukas, he had to focus his efforts on the earthen tanks or *sagars* high in the village watershed. The tanks are the village reservoirs, and they harvest runoff from areas upslope of the village to supply accessible surface water for livestock and irrigation while recharging the adjoining wells that supply domestic drinking water. Hand dug by the villagers generations earlier, they had since silted up and parts of the embankments had broken. Their capacity had been reduced to a fraction of what it once was, thus less water infiltrated the soil and more water erosively ran out of the watershed, contributing to sinking groundwater levels. Some villagers thought the government



Fig. I.17. Goats browsing in pasture of choukas in the neighboring village of Sahalsagar. Runoff flows in from right side of photo. Chouka berm on left stops the runoff and spreads the water back over the pasture to the right. The square basins upslope of the berm were dug out to obtain soil for the berm.



Fig. I.18. Sahalsagar choukas. Slope is from right to left. Chouka in the background overflows to the chouka in the foreground, which overflows to another series of choukas downslope to the left.



Fig. I.19. The Phool Sagar earthen tank in Laporiya. Though full just after the summer monsoon rains, in the winter season of 2005, a drought year, the bulk of the surface water has disappeared. Nonetheless, drinking water is available from the adjoining well year round thanks to monsoon rainwater, harvested and infiltrated into the soil.

would fix the tanks, while others thought it was their destiny that the reservoirs be broken. So, in 1991 Laxman began to spread and sink the potential of proactive water harvesting in the minds of the people with a small and simple gesture. He began to repair the reservoirs himself, by hand, along with two youths from his GVNML village youth group. His example stirred the people. Seeing Laxman return each day to make tank repairs, more villagers began to join the work until, in the end, the entire village worked together to help repair the tanks.

With this success the villagers were motivated to do more. Laxman then introduced them to the *choukas*. Using volunteer labor, he initiated *chouka* construction on a 123-acre (50-ha) area of pasture land to assimilate the degraded land into a single protected unit. Existing paths used by people and animals were integrated into the *chouka*'s layout to enhance pasture use rather than impede it—*stacking functions*. Once the *choukas* were made, the compacted soil was plowed, and seed was broadcast just before the rains. Grazing was not allowed until the new seedlings were well established. When the villagers saw what they had done, they became believers. “Initially, we could not understand the *chouka* method,” said villager Chotu Guzar, “but when the process was initiated we could visualize the result of the innovative plan.”

However, the water-harvesting earthworks alone were not enough in Laporiya. The watershed had to be stewarded rather than exploited. The villagers needed to *maximize the living and organic groundcover—the living sponge of the watershed*. The village met to decide how the land would be managed. They decided to ban the collection of manure from the pastures (dried manure is a preferred cooking fuel) so the land's nutrients could instead be recycled back into the soil. Hunting was prohibited. Cutting down native trees was banned, though coppicing, the selective pruning for wood, was allowed. If someone felled a tree, they needed to plant another, tender a written apology, and pay 11 pounds (5 kg) of grain. The villagers put up signs to notify outsiders of the work and the rules of the land. Every family is now required to plant five trees per year. Shepherds tending their animals among the *choukas* continually plant trees, shrubs, grasses, and other groundcover, the seed of which they collect year round to broadcast just before the rains.

Laporiya is now a village of diverse trees that provide shade, clean air, food, livestock fodder, wildlife habitat, medicinal herbs, fuelwood, and beauty. I found Laporiya to be the most vibrant of all the Rajasthani villages we visited over a four-week period. I loved walking the winding dirt roads and footpaths bursting with laughing children and healthy animals beneath a continual canopy of branches. Trees atop water-harvesting berms surround the fields and gardens. During my stay, I was continually invited to drink tea and sweet buffalo milk beneath family neem trees beside the homes. Babui, keekar, tamarind, and amla trees, which have become rare elsewhere in Rajasthan, are abundant in Laporiya. Birds are everywhere. And, even in drought, shepherds surrounded by browsing goats showed off over a foot of soft, edible new growth in the shrubs and trees of *chouka* pastures. The villagers now produce a surplus of food, including 240,000 rupees' worth of milk sold each year by 200 families. Two crops a year, rather than one, can now be grown in rain-fed, rain-harvesting fields. Water levels in wells have risen from 60 feet (18 m) deep in 1991 to just 15 feet (4.5 m) beneath the surface now. Migration of families and animals out of the village has ceased.



Fig. I.20. The tree-lined road entering Laporiya. Dev Sagar tank is to the right and Phool Sagar tank is to the left of the road (both just out of the picture frame).

Another of our guides, the enthusiastic Yogesh Kumar, pointed out deer in the pastures and the wild birds gathering in the center of the town explaining, “This is an open zoo—everyone, people and animals, can come and go as they choose. They are not sad in a cage, but happy and free.” Villagers are encouraged to put water and seed out for wild birds. The reservoirs allow animals to drink and they can graze in the choukas’ abundant vegetation. In return, wildlife provides fertilizing manure complete with a diversity of seeds that grow into plants—nature as gardener.

In the center of town across the road from the gathering birds, you can view a map of this open zoo and its watershed. It is a mural of the village’s master plan delineating common land, private land, tanks, fields, and choukas. Another mural delineates the village and who will manage what. It took 13 years to complete this planning process and get the whole village to agree. The plan is the culmination of the village taking ownership and stewardship over its resources and its future. It is the foundation of



Fig. I.21. An intensive, sunken, water-harvesting food garden surrounded by multiuse trees planted atop berms that also double as raised paths

Laporiya's long-term success. As Singh explained, "Social work must come before technological work because people can make or break any strategy."

The story and strategies of Laporiya's success have now spread to more than 172 villages, and are benefiting over 330,000 people. How? Through celebration. Every year on the eleventh day after Diwali, the Devuthni Festival takes place in and around Laporiya. For several days Laporiya's 3,000 villagers march through neighboring villages promoting water harvesting, conservation of common lands, tree planting, and empowerment of the people. The number of marchers grows each year, as villagers from some 50 other Laporiya-inspired villages now participate. After marching there is a day of worship when people bless the water bodies they have dug themselves, anoint trees with the holy symbol tilak, and tie sacred threads or *rachis* around each other's wrists and the trees, connecting them all and signifying the brotherhood of the villagers, their neighbors, the trees, and the watershed that supports and unifies them all.

Next follows a day of *shramdan*, voluntary labor to repair water-harvesting systems or create new ones. On the last day, 10 people are awarded the Diamond of the Land in recognition of their exemplary work creating or maintaining community water-harvesting strategies and vegetation in their village. The festival is a wonderful realization of the Eighth Principle: the "feedback loop" as people review the previous year's work and discuss future plans for forestation and enhancement of the local ecology. Of course, the celebration includes feasting, dancing and song. "It is a rhythm of joy-discuss-joy-discuss-joy-discuss..." guide Yogesh explained.

Laxman Singh calls this work the "road to livelihood." And the feedback loop shows this work is a success. Each of the 103 wells in the village can now annually irrigate 2.5 to 5 acres (1-2 ha) even in drought. They no longer go dry as wells in neighbor-

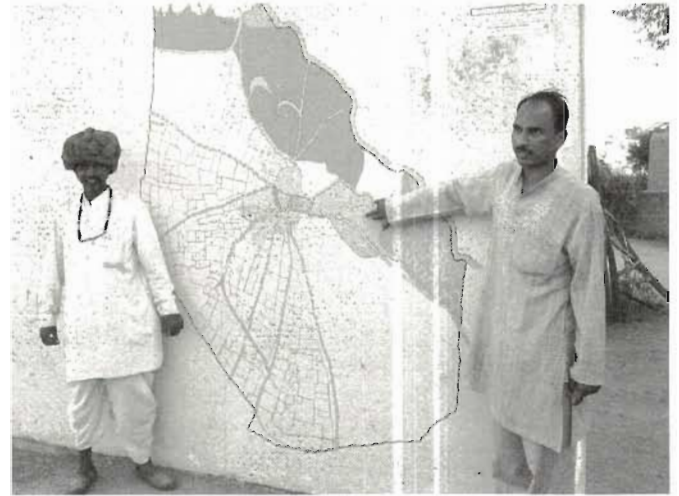

Fig. 1.22. Ramkaran Poar and Jagveer Singh in front of a map of Laporiya's water, tanks, pastures, fields, and village. Jagveer points to Ana Sagar, the town's earthen irrigation tank; beneath his arm are the common pastures treated with choukas.

ing villages without water harvesting still do. White salty soil and black sodic soils have been replaced with fertile soils supporting abundant vegetative growth. Local control of water and the watershed has returned. Rainwater harvesting vision and technology has "spread and sunk" among rural youth and citizens in the Laporiya-inspired villages, where more water is now put back into the land than is taken out. Government-supported green-revolution agriculture, dependent on deep wells, trucked-in water, and canal systems drawing from distant dying rivers, has been replaced with sustainable self-reliance, local pride, and ecological revival. It is the local ecosystem first and foremost that is the basis of Laporiya's economy, quality of life, health, and happiness—the foundation on which we all ultimately depend.

*For more information on the work of GVNML and Laporiya, see [www.gvnml.org](http://www.gvnml.org).*



# 1

CHAPTER

## Assessing Your Site, Choosing Your Earthworks, and Tips on Implementation

*The simplicity and complexity of harvesting water is it must be site specific.*

—Shree Padre, Indian water harvester, farmer, journalist

This three-part chapter shows you how to work with, build on, and enhance the natural, free, living systems on your site to create a sustainable system of water-harvesting earthworks.

Part 1 builds on the water-harvesting principle of *long and thoughtful observation* and the site assessment tools described in Volume 1, chapter 2, by helping you understand basic patterns of water flow over land and techniques used to use “read” land slope. Both are key to getting to know your site. With this information you can select the earthwork strategies best suited to your site’s needs.

Part 2 provides a quick go-to guide describing earthworks featured in this book. Scan the listed earthworks and their appropriate uses to see which might suit your site. Next, read the four important cautions applicable to all earthworks. When you are ready to hit the dirt, use the go-to guide (table 1.1) to direct you to the appropriate chapter that describes how to construct your selected earthwork(s) and provides case studies illustrating their successful use.

Part 3 provides 26 helpful tips to help you create regenerative rather than degenerative systems (see box 1.1). Building regenerative, integrated, multifunctional earthworks will help ensure that your site gets better naturally as time passes, not worse.

### PART 1: UNDERSTANDING PATTERNS OF WATER FLOW AND READING SLOPE

Water flows downhill and takes the path of least resistance. Therefore, the steepness and condition of a site’s slope greatly affects the speed and volume of water that runs off the slope. The steeper and more bare the slope, the faster and more erosive the runoff. The more gradual and vegetated a slope is, the slower the runoff and the greater the infiltration. The more slowly the water runs off, the easier it is to manage. The more runoff infiltrates into the soil, the more the landscape is hydrated.

Natural drainages are low places in the unaltered landscape where the water collects and flows downhill. They function as “overflows” for the broad landscape. Whatever water and soil the landscape cannot hold, the drainages carry away.

Without a doubt, the best and most fun way to observe patterns of water flow and to read slope is to get out in the pouring rain and watch it flow across the land! But since dryland environments have relatively few rainy days, I offer three fun and effective techniques to understand water flow even when it’s dry:

## Box 1.1. Creating Regenerative Systems

By following the eight principles of water harvesting, passively irrigating your landscape with water-harvesting earthworks, and living within your site's water budget, you can create regenerative landscapes. Regenerative landscapes recreate themselves without depending on piped-in fuel or pumped-in water. Once established, they do most of the work so you don't have to.

Regenerative landscapes maximize the return on your water-harvesting investment. Anytime we invest effort, time, money, material, or labor we basically do so in one of three ways: degeneratively, generatively, or regeneratively.

A degenerative investment:

- Starts to degrade or break down as soon as it is made
- Requires ongoing investments of energy and outside inputs to keep it functional
- Consumes more resources than it produces
- Typically serves only one function
- *Examples include:* ornamental lawns and landscapes dependent on chemical pesticides, fertilizers, and irrigation water imported from deep wells or municipal utilities; mechanically heated and cooled buildings powered by imported energy; and conventional single-use parking lots

A generative investment:

- Starts to degrade as soon as it is made
- Requires ongoing investments of energy and outside inputs to keep it functional
- Produces more resources than it consumes
- Typically serves multiple functions
- *Examples include:* multiuse landscapes (producing multiple resources such as food, beauty, and wildlife habitat); passively heated, cooled, and lighted buildings; durable renewable-energy products such as solar, micro-hydro, and wind-power systems; parking lots that grow a carport orchard of food-producing shade trees using harvested stormwater; and built rainwater-harvesting structures that increase the use and accessibility of on-site water resources

A regenerative investment:

- Can repair and recreate or regenerate itself
- Starts to grow or improve once it is made
- Does not require ongoing investments of energy and outside inputs to keep it functional
- Produces more resources than it consumes
- Typically serves multiple functions
- Can reproduce itself
- *Examples include:* multiuse landscapes living solely off natural rainfall and requiring no additional outside resources after establishment, self-regenerating natural forests and ecosystems, revolving community loan funds, a culture and education system that mentors or passes the knowledge and wisdom of the older generations to the younger, and vegetative rainwater-harvesting structures that build and repair themselves after establishment

Strive to make all your water-harvesting systems regenerative by working with, not against, the natural world. If you simply harvest rainwater passively, the way this book suggests, you'll rise from the degenerative to the generative level. Then keep developing and refining your system to bring it ever closer to the regenerative level.





Fig. 1.1. Water-harvesting mooning. Altering your perspective by looking at the landscape upside down sometimes makes subtle slopes more obvious.

- Bend over and look at the landscape through your legs. This altered perspective gets your eyes closer to the ground and sometimes makes subtle slopes more obvious. And it gives onlookers something to wonder about!
- Use simple, inexpensive tools such as “A-frames” and/or water levels called “bunyips” to measure elevation differences and land slope. See figure 1.6 later and appendix 2 for details.
- Hone your observation skills for “tracking” water flow.

## TRACKING WATER FLOW

Water leaves tracks. Generally, life thrives where water lingers. Vegetation is denser and topsoil is thicker and healthier in areas where rainwater runoff flows

slowly and soaks into the ground. Erosion occurs in places where runoff flows rapidly over the landscape, washing away soil and leaving vegetation stunted.

To learn to track water, carefully observe water flowing, pooling, and infiltrating during and immediately after a heavy rainstorm. Return after the water stops flowing and pooled water has soaked into the soil. Examine these same areas. Notice whether organic matter, clay, sand, and rocks have accumulated or have been washed away. Re-envision water flowing in these places to directly compare erosion and the tracks left by flowing water to your observations of active water flow noted minutes or hours before.

Water flow over the landscape often takes the form of a branched system, similar to the branched circulatory system of our bodies. At the top of all watersheds are very small branches not easily recognized, like the microscopic capillaries within our skin. They are the tiny air spaces within the soil, rock, organic matter, and

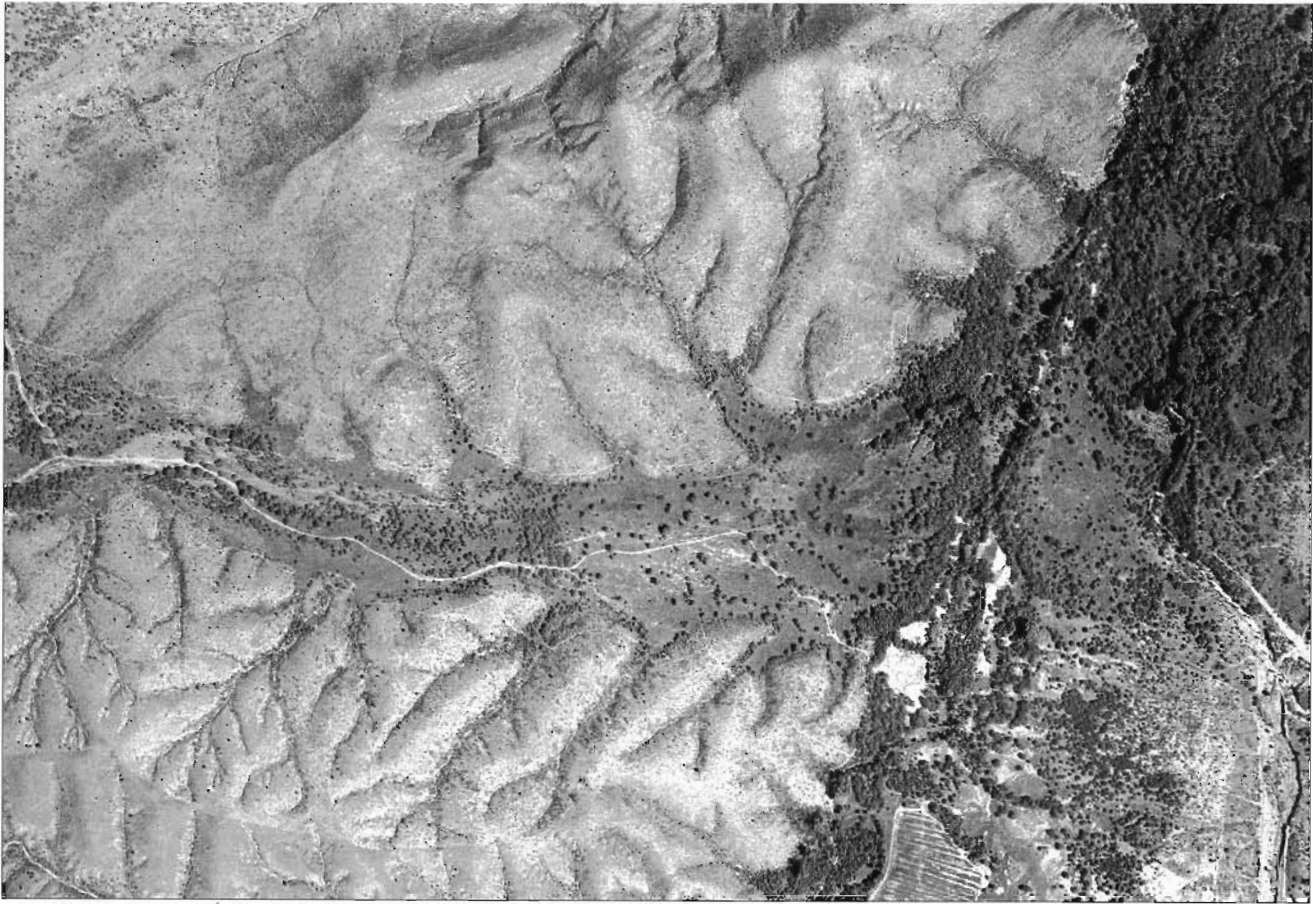

### Cienega Creek, Arizona

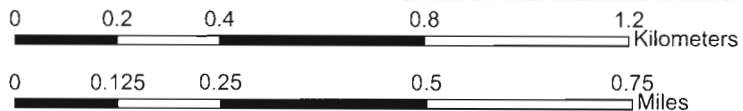

Fig. 1.2. Aerial photo of dendritic pattern of branching watercourses at Cienega Creek, Pima County, Arizona. Note how water drains off the dry, sparsely vegetated ridges into small drainages that combine with others as they move downslope, eventually merging into the larger, densely vegetated Cienega Creek below. Map provided by Pima Association of Governments

vegetation covering the watershed. Runoff forms when these tiny “capillaries” of soil and vegetation are saturated, and water begins to flow over the surface. As water runs farther down a slope more surface runoff collects, and the upper branches of the watershed become noticeable. You see slight depressions and small drainages where more of the runoff begins to concentrate and flow downhill. Continuing downhill, these small drainages merge to become washes, wadis, arroyos, or creeks. These larger branches combine with others, eventually merging into rivers. The larger the

branch (or vein), the higher the volume and velocity of water moving through the system.

Identify the capillaries of your watershed, then follow the first principle of water harvesting: *Start at the top (highpoint) of your watershed and work your way down.* The capillaries are the headwaters—or top—of our watersheds where the lower volume and velocity of runoff is easily managed. The capillaries of a community watershed are very often the small drainages and small subwatersheds of our backyards, school grounds, and work places. Many small efforts made

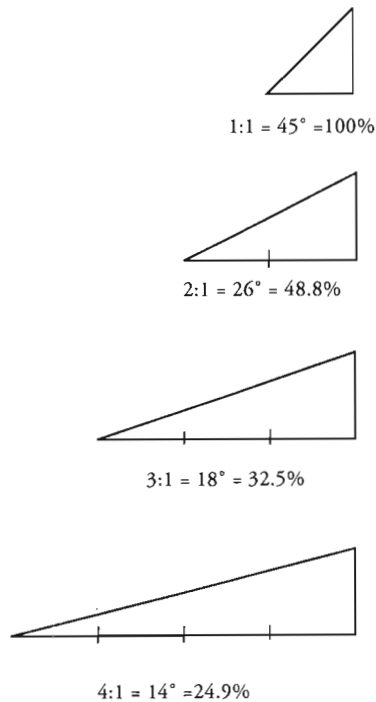

Fig. 1.3. Four different slopes measured by proportions, degrees from horizontal, and percentages

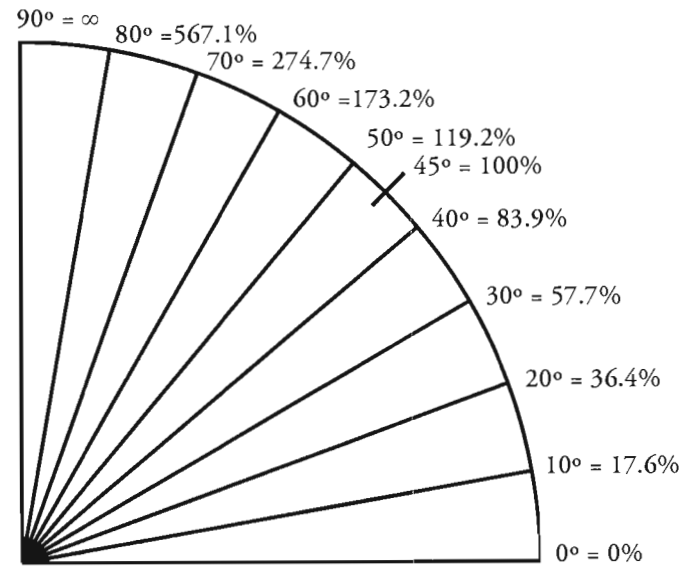

Fig. 1.4. A range of slopes from 0° or 0% up to 90° or infinity

here—a branch or pile of rocks laid across a slope, infiltration basins for trees—can cumulatively make a big difference. It's easy and we can all do it!

See appendix 1 for illustrations of a number of water and erosion tracks and options for water-harvesting strategies to address them. The section below will help you identify slope steepness to further guide you in selecting site-appropriate earthworks. Table 1.1 summarizes a range of water-harvesting earthworks to choose from. These strategies are described in detail in later chapters of this volume.

## HOW TO MEASURE AND DESCRIBE SLOPE

Because proper earthwork selection and placement depends on the slope of a site, it is helpful to know how to measure and describe a slope. Three common methods of measuring and describing slopes are described here: proportions, degrees from horizontal, and percentages. Choose the method that is most useful for you.

**Proportion** is the ratio of a slope's horizontal distance to its vertical distance. This is my favorite way of measuring slope, since I find it intuitively gives people a mental image of the slope. A 3:1 slope extends out a horizontal distance of 3 units, while rising a vertical distance of 1 unit. You choose which unit of measurement to use for your proportions (English or metric). For this example let's use feet, so the slope extends horizontally 3 feet for every 1 foot of vertical rise. Note: When using proportions, it is important to be clear which unit represents the vertical and which represents the horizontal, since some folks list the horizontal first, as I do, and some list the vertical first. See figure 1.3.

**Degrees from horizontal** is a measurement civil engineers often use to represent the angle of a slope from horizontal. A site that is 0° from horizontal is a flat level site. A site that is 90° from horizontal is a vertical cliff. All sites lie somewhere between the 0° to 90° range. A slope with a vertical drop of 1 foot over a horizontal distance of 3 feet is 18.4° from horizontal. See figures 1.3 and 1.4.

**Slopes expressed as percents** are calculated by multiplying the distance of vertical rise of a slope by 100, then dividing that figure by the horizontal distance covered by the slope. For example, a slope with a rise of 1 foot over a horizontal distance of 3 feet is a 33% slope ( $1 \times 100 \div 3 = 33\%$ ). A slope with a rise of 1 foot over a horizontal distance of 1 foot is a 100% slope ( $1 \times 100 \div 1 = 100\%$  slope). Slopes measured in percentages range from 0% for a horizontal line to infinity ( $\infty$ ) for a vertical line projecting straight up. See figures 1.3 and 1.4.

### Box 1.2. How to Take a Measurement of a Slope

To take a measurement of a slope, you measure the vertical rise of the slope as it relates to horizontal distance of the slope. Two easy ways to do this are to use a string, a line level or carpenter's level, and a yard stick or tape measure (fig. 1.5); or to use a bunyip water level (fig. 1.6).

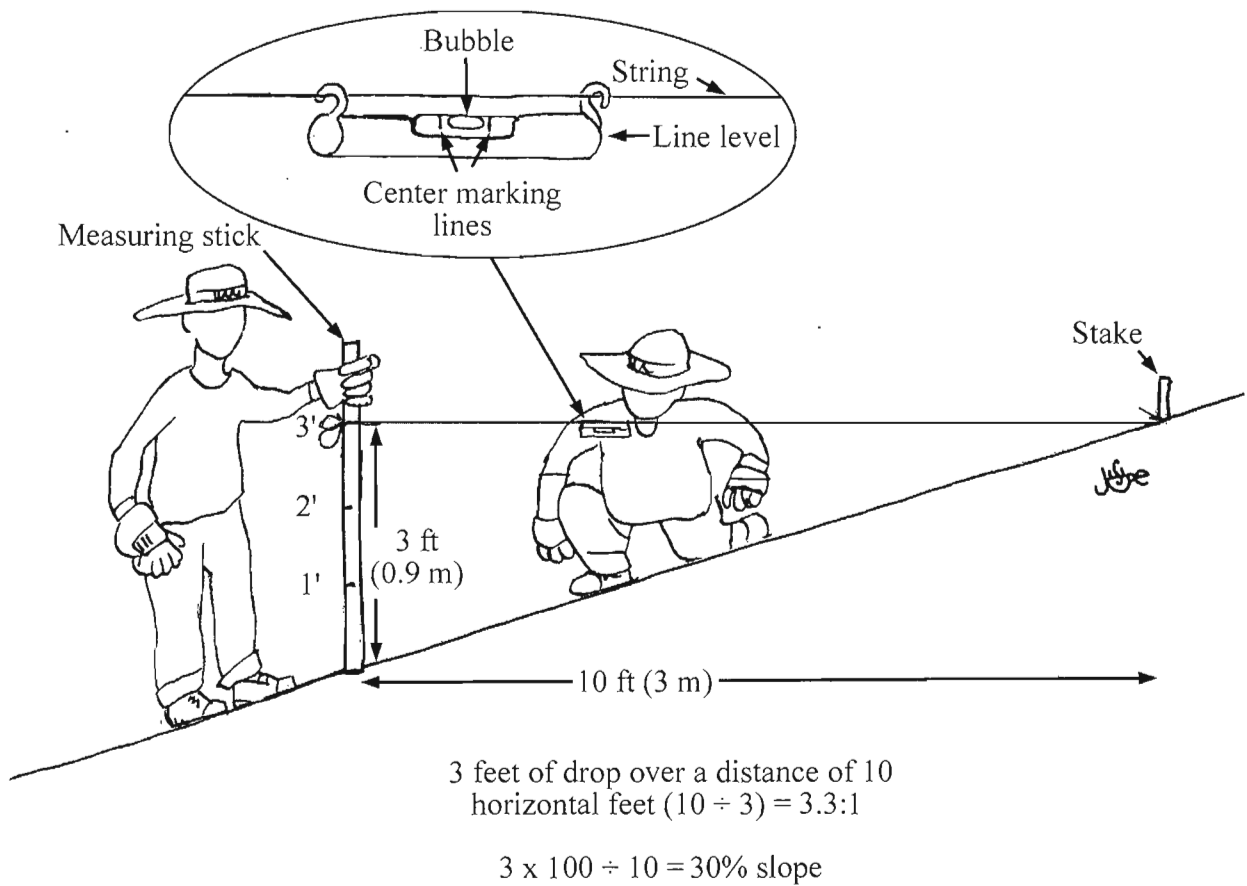

Fig. 1.5. Using a line level to measure slope. Hold or stake one end of a string on a slope. Pull the string tight to a set length (such as 10 feet or 3 meters), and place a line level in the center of the string. Raise or lower your end of the string until the line level's bubble is centered between its center marking lines, indicating the string is level. (You could also use a carpenter's level to check the level of the string.) Then use a tape measure or measuring stick to measure the vertical rise of the slope. Adapted from *Food from Dryland Gardens* by David Cleveland and Daniela Soleri, Center for People, Food, and Environment, 1991

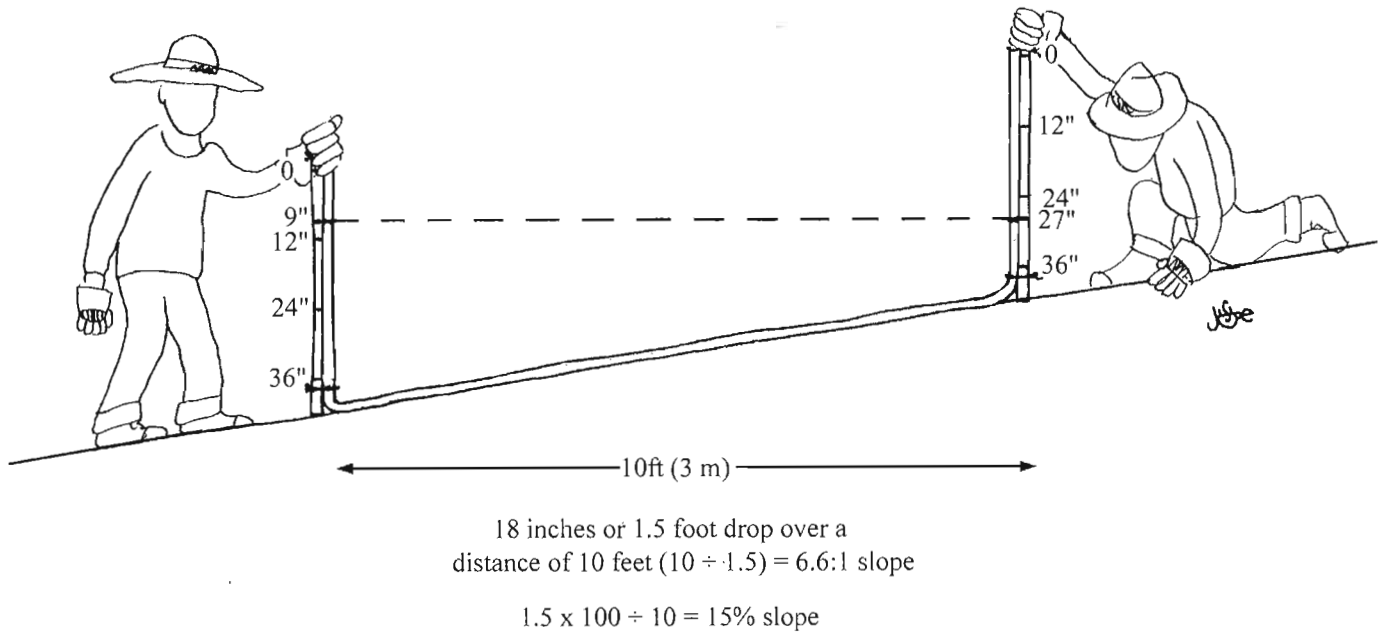

Fig. 1.6. Using a bunyip water level to measure slope. The difference in *water level* between the two stakes is the vertical measurement. The bunyip reads 21 inches on one stake and 9 inches on the other.  $27 - 9 = 18$  inches or 1.5 feet. The distance between the *two stakes* is the horizontal measurement. See appendix 2 for more information.

## PART 2: SUMMARY OF WATER-HARVESTING EARTHWORKS

What follows is a quick reference guide. Table 1.1 briefly describes all water-harvesting strategies featured here and leads you to the chapters that cover them in detail. Chapter 2 contains a detailed discussion of design, calculations, and construction of water-harvesting earthworks, describing the berm 'n basin technique. Chapter 2 also provides an important foundation for understanding all the other water-harvesting earthwork techniques. Read it thoroughly, and go back to it as you read about and implement other earthwork strategies.

Note that there are many more water-harvesting earthworks than those featured here, but most can be

classified as variations of those I feature. In fact all the separate earthworks described here could be classified as variations of one another because they all strive to check runoff and harvest rain, snow, and runoff in the soil. I provide many earthwork strategies and case studies to help you to choose what is best for your site's unique conditions and to empower you to create your own variations.

Note: *Green roofs or eco-roofs* (roofs covered with soil in which vegetation is grown) are not covered in this book. They can be a great strategy, especially in urban environments short on unpaved soil, but because they are constructed on top of buildings rather than within soil at land surface, I do not consider them a typical earthwork.

**Table 1.1. Quick Reference Guide to Water-Harvesting Earthworks**

| EARTHWORK STRATEGY and CHAPTER  | WHAT IT IS   | GOALS  | WHERE TO USE   | CAUTIONS SPECIFIC TO STRATEGY   | VARIATIONS   |
|---------------------------------|--|--|--|---|--|
| Berm 'n Basin<br>Chapter 2      | Berm set perpendicular to slope, typically made of earth excavated to form adjoining upslope basin                         | Intercepts and infiltrates runoff in localized area  | Use on land sloped up to 3:1, 18 degrees, or 32.5% grade. Size for maximum stormwater event. Do not use in drainageways.   | Try to preserve what existing perennial vegetation you can.   | <ul style="list-style-type: none"> <li>- Contour berm</li> <li>- Boomerang berm</li> <li>- Net and Pan</li> </ul>  |
| Terrace<br>Chapter 3            | Relatively flat "shelf" of soil built parallel to contour on slope   | Creates level planting area to intercept direct rainfall and some runoff from slope  | Slopes up to 2:1, 26 degrees, or 48.8% grade. Size for maximum storm event. Do not use in drainageways.  | NOT appropriate in soils prone to waterlogging or areas with perched aquifers   | <ul style="list-style-type: none"> <li>- Terrace with a retaining wall</li> <li>- Terrace without a retaining wall</li> </ul>  |
| French Drain<br>Chapter 4       | Trench or basin filled with porous rock, organic material, or bottomless infiltration chamber                              | Infiltrates intercepted rainwater quickly into subsurface while maintaining flat walking surface   | Flat to gently sloped land where deep infiltration is needed. Intercept only sediment-free runoff water (e.g., runoff from roof, paved patio, driveway, etc.). Do not use in drainageways.   | NOT appropriate in areas with sediment-laden water or beneath or across roadways. Internal perforated pipe can become root-clogged. | <ul style="list-style-type: none"> <li>- French drain without pipe</li> <li>- French drain with pipe</li> <li>- French drain with infiltration chamber</li> <li>- Deep pipe irrigation</li> <li>- Rock tube irrigation clogged.</li> </ul>               |
| Infiltration Basin<br>Chapter 5 | Shallow level-bottomed depression dug into earth   | Intercepts and infiltrates rainfall, runoff, and greywater   | Flat to gently sloped land. Intercept runoff from multiple or all directions. Size for maximum storm event and peak surge of greywater. Do not use in drainageways.  | NOT appropriate in areas of shallow groundwater where it might result in standing water, or over septic drain fields                | <ul style="list-style-type: none"> <li>- Basins around existing vegetation</li> <li>- Berms forming basins around existing vegetation</li> <li>- Sidewalks creating basins</li> <li>- Sunken garden beds</li> <li>- Raised sunken garden beds</li> </ul> |
| Imprinting<br>Chapter 6         | Revegetation strategy using numerous micro-imprints/depressions  | Collect seed, rainwater, sediment, and plant litter to create favorable microclimates for seed germination and growth                              | Flat to sloped land up to 2:1; 26 degrees, or 48.8% grade. Use on abandoned fields, building sites, rangeland, soils with rock up to one foot in diameter. Need > 1 acre to justify mechanical imprinting. Do not use in drainageways. |   | Imprinter equipment varies for steep slopes and rocky soils. Can imprint without mechanical equipment.   |
| Mulch<br>Chapter 7              | Application of porous organic or mineral materials to soil surface (e.g., compost, aged manure, straw, wood chips, gravel) | Increase infiltration rate, improve soil fertility, reduce evaporation loss, limit soil erosion, suppress weed growth, delineate basins from paths | Mulch soil inside water-harvesting earthworks. Do not use in drainageways.   | Slow or stop runoff before it comes in contact with mulch on slopes. Keep mulch light right around buildings.                       | <ul style="list-style-type: none"> <li>-Surface mulch</li> <li>-Vertical mulch</li> </ul>  |

Table 1.1. Quick Reference Guide to Water-Harvesting Earthworks

| EARTHWORK STRATEGY and CHAPTER                               | WHAT IT IS  | GOALS   | WHERE TO USE  | CAUTIONS SPECIFIC TO STRATEGY   | VARIATIONS  |
|--|---|---|---|---|---|
| Hardscape Reduction and Use of Permeable Paving<br>Chapter 8 | Planning and design strategy to increase water infiltration by reducing nonpermeable hardscape and replacing with porous or non-contiguous paving materials | Minimizes areas of impermeable paving over soil to reduce heat island effect, increase water infiltration, contain and filter pollutants on site  | Use permeable paving where impervious paving would otherwise be used and where you want to increase water infiltration. Useful on densely developed sites with little unpaved surface. Most effective when harvesting rainwater that falls directly on it, not runoff from upslope areas. Do not use in drainageways.                     | Raise permeable paving above the surrounding landscape to prevent settling or pavement displacement due to poorly draining subsoil. NOT appropriate in areas receiving sediment-laden runoff. | <ul style="list-style-type: none"> <li>- Pavement reduction &amp; shading</li> <li>- Broken pavers</li> <li>- Grid-stabilized soil or gravel</li> <li>- Permeable concrete pavers</li> <li>- Porous concrete</li> <li>- Stabilized earth or crushed rock</li> </ul> |
| Diversion Swale<br>Chapter 9                                 | Curvilinear basin or swale constructed slightly off land contour  | Gently and gradually move water downhill and across a landscape, while promoting infiltration into the soil   | Diversion swales direct runoff to water-harvesting earthworks, or tame the force of water from culvert or roadside bar ditch. Can use diversion swales as water inlet and drain channel bookending agricultural irrigation bays. Direct overflow water from one water-harvesting earthwork to another. Do not use in drainageways.        | Do not use in alkaline soils prone to salt buildup or water-logging.  | <ul style="list-style-type: none"> <li>-Diversion swale</li> <li>-Spreader drain</li> </ul>   |
| Check Dam<br>Chapter 10                                      | Small pervious dam used to slow, spread, and infiltrate more of the water's flow into the drainage bed and banks  | Slow and spread flow in ephemeral watercourses, to increase infiltration, reduce flooding, reduce erosion, stabilize land   | Use loose rock check dams in small, low volume, low velocity watercourses. Use wire-encased rock gabions in small drainages with sandy soil, and in larger watercourses. Can address eroding arroyos or gullies, stabilize roads or paths across drainages, reduce erosion below culverts. Use in ephemeral, NOT perennial, watercourses. | May need regulatory approval to work in watercourses. Placement and correct construction is critical to avoid damage.   | <ul style="list-style-type: none"> <li>- Loose-rock check dam</li> <li>- One-rock check dam</li> <li>- Brush check dam</li> <li>- Straw bale check dam</li> <li>- Gabion</li> <li>- Fence gabion</li> </ul>   |
| Vegetation<br>Chapter 11                                     | The living element of all earthworks that anchors, builds, and shelters soil while regeneratively producing resources                                       | Increase infiltration, support or produce new plant life, soil microorganisms, wildlife habitat, food, fiber, forage, building materials, shelter, medicine, erosion and dust control, water storage, and much more | Plant within or beside all earthworks, throughout watersheds, from flats to slopes. Plant climate-appropriate species at densities that can primarily subsist on the harvested rainfall, runoff, and greywater. Can plant within drainages if stabilizing banks and bed without detrimentally impacting flow                              | Locate and space plants based on expected mature size, water needs, water sources, and tolerance to inundation. Keep root crops away from greywater. Beware of invasive exotics.              | <ul style="list-style-type: none"> <li>- Planting within basin</li> <li>- Planting on a slight pedestal within basin</li> <li>- Planting beside basin</li> </ul>  |

## FOUR IMPORTANT POINTS OF CAUTION FOR ALL EARTHWORKS

1. A good general rule, and a recommendation in the International Building Code, is to *not* infiltrate water in the soil within 10 feet (3 m) of a building's foundation. (This does not include sealed cisterns.)<sup>1</sup> This ensures that you do not weaken the structure by disturbing soil within the 45° angle of compressive force emanating from the footing. Staying this distance from the structure also reduces the risk of saturating the soil under the building and avoids creating a habitat right at the base of the building where moisture-loving termites would thrive. Instead, provide moisture for termites out in the landscape where these “earthworms of the drylands” will expertly turn fallen leaves and dead plant matter (not your house) into fertile, porous soil.
2. Always check for underground utility lines before you dig and strictly avoid any areas where these do, or might, exist. Rupturing a gas line will ruin your day, guaranteed. In Arizona, there is a free service called “Blue Stake” that will mark all utility lines running from the street to the meter at your site. Call them at least four days before you dig.
  - In Arizona and New Mexico call 811.
  - In southern California, call Dig Alert 811 or 1-800-422-4133.
  - In northern California and Nevada, call 1-800-227-2600.Elsewhere, call your local utility company to find out if a similar service exists for your area. The utility lines running from the meter to the house *will not* be marked by these free utility-locator services, but they can be located by a private locator service for a fee. It is very important that you locate all underground utility lines at your site. Also, to avoid future problems, do not plant trees where they could grow into overhead utility lines.
3. The water-harvesting strategies presented here can generally be designed and implemented without having a registered engineer analyze the situation and prepare the design. However, if any of the following conditions exist, you need to hire a registered engineer and/or consult with a geologist:

- You are working in a regulated drainage
- An expensive asset (like your house) could be affected by the design
- The work might affect neighboring properties
- You are dealing with steep or unstable slopes
- You are in an area prone to mudslides
- Any other circumstance you feel uncomfortable with, or situations that might be creating a risk for yourself or others

If hiring these professionals is not an option, then reduce, simplify, or modify your project so such help is not required. You are ultimately responsible for the work you do on your site.

4. Follow *all* rainwater-harvesting principles and ethics summarized in this volume's preface, and thoroughly described in Volume 1, chapter 1.

Note that the principle of “start small and simple” can expand with knowledge, experience, and the scale of a project. For example, in a master-planned community a well-designed and implemented series of street-side runoff-harvesting basins and plantings (“natural drainage systems”—see chapter 8) could be utilized throughout the development and its watershed. While individually the strategies are small, cumulatively they are large, and are much more effective than a large retention/detention basin(s) focused at the bottom of the site's watershed.

## PART 3: TWENTY-SIX WATER-HARVESTING EARTHWORK TIPS

### 1. FOLLOW ALL OF THE “EIGHT PRINCIPLES OF SUCCESSFUL WATER HARVESTING.”

See this volume's preface or Volume 1 for these principles.

### 2. FOLLOW THE “FOUR IMPORTANT CAUTIONS.”

See the cautions on this page.



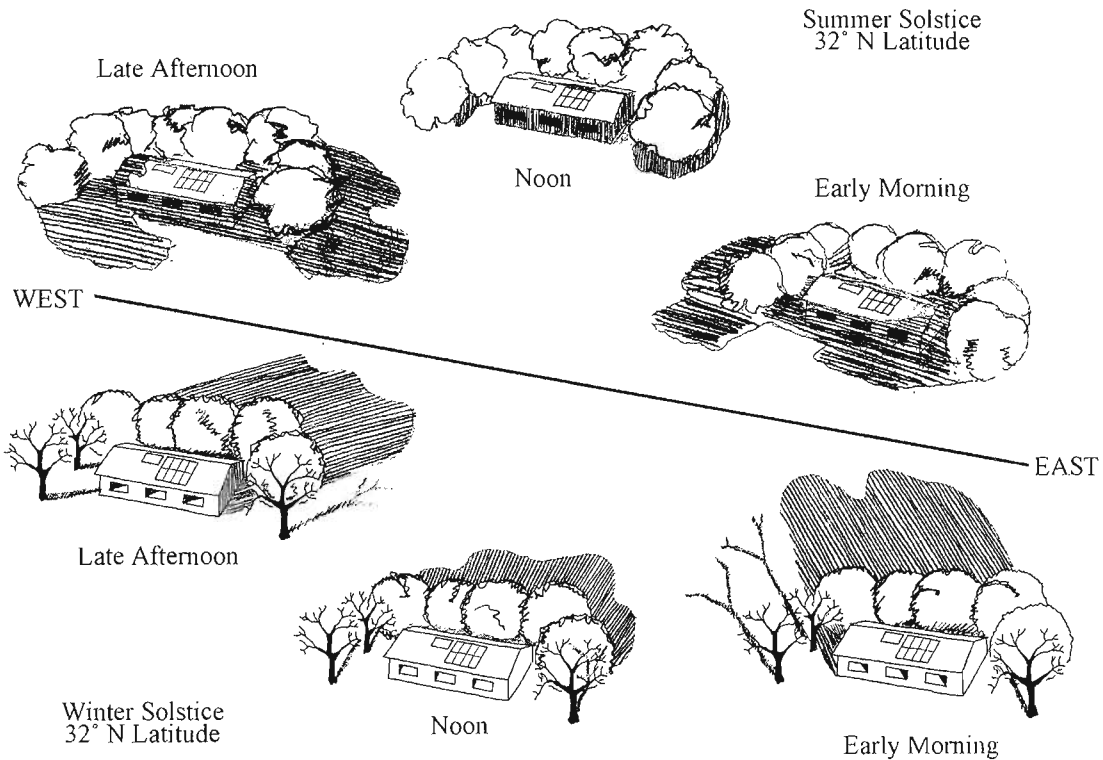

Fig. 1.7. Solar arc of trees and shrubs at 32° N latitude works with the changing angles of the sun's rays throughout the year. In summer, the arcs shade buildings, gathering areas, and gardens from rising and setting sun in summer, cooling temperatures by up to 20°F (11°C). In winter, the arc retains full exposure to the winter sun for maximum free solar heating, solar power, and light during the cold months of the year. Properly sized roof overhangs or window awnings shade south-side windows in summer, while letting in winter sun (see Volume 1, chapter 4 for sizing calculations). And it really gets dynamic when the arc is set up to be passively irrigated by the runoff (and greywater if available) from the building or gathering area it shelters! See the planting section of chapter 5 for more details. Note: In the southern hemisphere, trees would be planted on the south rather than the north side of building.

### 3. START WITH JUST ONE OR TWO SMALL SIMPLE EARTHWORKS.

Watch to see how small-scale earthworks function in the next big rain. Use lessons learned at this scale to guide your work with more extensive water-harvesting earthworks.

### 4. PLACE YOUR EARTHWORKS WHERE THEY, AND THE VEGETATION THEY SUPPORT, WILL CREATE THE GREATEST NUMBER OF BENEFICIAL FUNCTIONS AND RESOURCES.

For ideas, see the integrated design patterns from Volume 1, chapter 4: the solar arc, maintaining solar

access, and raised paths and sunken basins (see figs. 1.7, 1.8, 1.9). And refer to the multiple functions sections of chapters 2 through 12 in this volume.

### 5. BEGIN HARVESTING WATER WITHIN YOUR SITE'S OASIS ZONES TO MAXIMIZE CONVENIENT, CONCENTRATED ABUNDANCE, WHILE REDUCING WASTEFUL, SPRAWLING RESOURCE CONSUMPTION.

While following the water-harvesting principles, focus much of your initial earthworks and plantings where convenience, efficiency, and your chances of success are the greatest, i.e., in the oasis zones. Oasis zones are the areas of your site with both conveniently accessi-

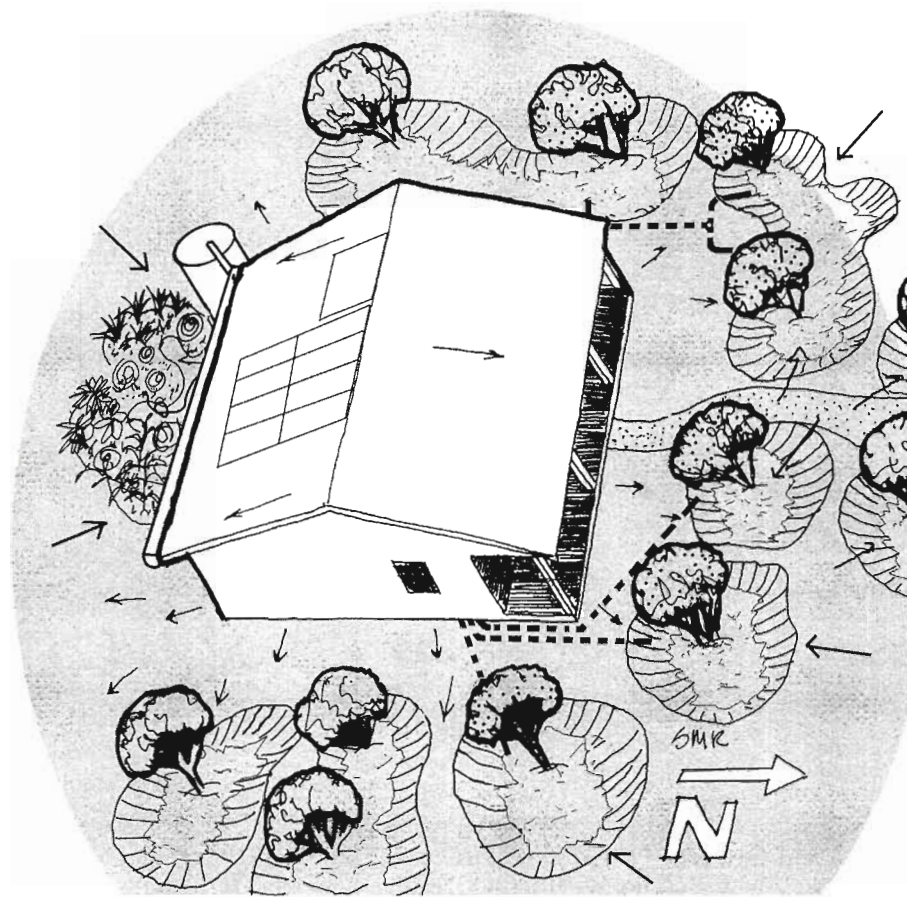

Fig. 1.8. Infiltration basins and new plantings within the wetter oasis zone 30 to 50 feet (9 to 15 m) from house, though at least 10 feet (3 m) from the building's foundation. Newly planted shade trees on the east, west, and north sides of a home in the northern hemisphere are irrigated with harvested runoff from roof and surrounding landscape, along with household greywater (distributed with below-ground pipe—see dotted lines). Low-growing garden is planted in basin on south, or winter-sun side of home. Plantings within and beside basins will create a solar arc as they grow to mature size, shading and cooling building from rising and setting sun in summer, while letting in free winter sunlight and heat from south, and maintaining solar exposure to solar panels and solar water heater on roof. Winter-deciduous trees on the east and west side of home let in even more winter light and heat. In fire-prone areas, vegetation can be placed farther from home, while still within the oasis zone, and should be pruned up to prevent low ground fires from migrating up low-growing branches. See chapter 5, figure 5.4, for view of the arc's vegetation at mature size.

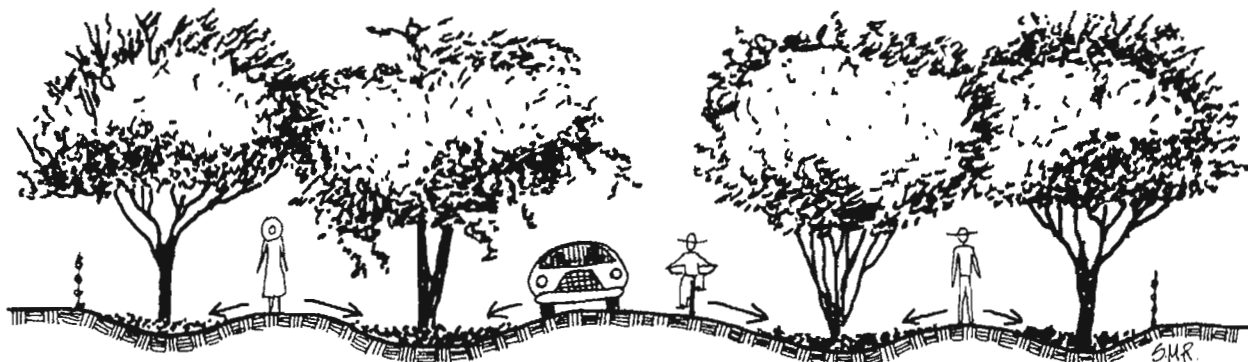

Fig. 1.9. Runoff from raised pathways and road drains to adjoining water-harvesting basins that are well mulched and vegetated to create living sponges within the drier oasis zones.

ble on-site water (rainfall, runoff or runoff, and potentially cistern water and household greywater as well) *plus* intense human use (where you have the greatest impact and spend the greatest amount of time outdoors).

The *primary*, or *wetter, oasis zone* is usually within 30 to 50 feet (9 to 15 m) of homes and buildings—the area where roof runoff, household greywater, and people can be most efficiently engaged to support plantings. As this is the wetter oasis zone, it typically contains the more water-needy vegetation on the site, and often the *only* more water-needy vegetation on the site. Earthworks themselves should typically not be constructed within 10 feet (3 m) of a building because it is important to avoid saturating the soil beneath the foundation.

*Secondary, drier* oasis zones are areas within 10 to 20 feet (3 to 6 m) of frequently used paths, driveways, and roads. These lack greywater access, but they have human presence, and runoff from the adjoining accessway hardscape is easily captured.

These oasis zones characteristically suffer from the most human disturbance. Vegetation and topsoil are removed to build houses, patios, driveways and roads; soil is compacted by vehicle, foot, and pet traffic; and erosion occurs due to a lack of vegetation and mulch anchoring soil in place. Yet these areas can also benefit from the greatest available resources: the attention of you and other people; on-site harvestable water; and compost, prunings, and mulch from the house and yard. Use these resources to quickly and conveniently heal disturbances, to sustainably generate more on-site resources, and to reduce excessive maintenance. Follow the principle of “stacking functions” to create cooling shade trees arrayed in a solar arc, food-producing windbreaks, gardens, infiltration sponges, erosion control, bird and butterfly habitat, and beauty.

Concentrating your initial earthworks in areas with intense human attention is especially important in dryland environments where disturbed soil is naturally slow to revegetate and heal due to the lack of water. Constructing earthworks disturbs the soil and creates a temporary wound on the bare earth. Design these “wounds” so that they speed their own healing by harvesting water, soil, seeds, and fertility. Over time these earthworks enhance the land’s ability to sustain more life. Nonetheless, any such abrasion is prone to

erosion until stabilized with vegetation. Water-harvesting earthworks located in the broad landscape can remain bare for years if they happen to be created at the beginning of a drought cycle, especially if they do not receive mulch, supplemental water, and human care to jump-start the revegetation process.

Starting your initial work in the oasis zone also reins you in, keeps you from spreading yourself too thin by doing too much too fast, and reduces “back-yard sprawl”—haphazardly starting projects throughout a site without efficiently and thoughtfully integrating them with one another. Focusing first on the wetter oasis zone, then the drier oasis zone(s) encourages steady growth that radiates out from a stable core, like lichen radiating out from its center. Your home and wetter oasis zone form your site’s nuclei. Your water-harvesting efforts should radiate out as your experience, learning, and thoughtful integration of on-site resources (rainwater, greywater, winter sun, vegetation) grow to sustainably meet on-site needs (water, shelter, food, aesthetics) (figs. 1.10 and 1.11).

## 6. CONSTRUCT INITIAL EARTHWORKS IN DISTURBED AREAS, NOT HEALTHY, INTACT ECOSYSTEMS.

When possible, build earthworks just after adjacent buildings and hardscapes are built or before new landscapes are planted. This will not result in any additional disturbance, and the newly created landforms will help heal the land more quickly and reduce the need for resource inputs and long-term maintenance. If you are retrofitting an existing landscape with water-harvesting earthworks, be careful to minimize damage to existing vegetation during implementation.

## 7. INVESTIGATE YOUR AREA'S INDIGENOUS, HISTORICAL, AND CONTEMPORARY WATER-HARVESTING STRATEGIES TO SEE WHAT HAS PROVEN TO WORK IN YOUR CLIMATE AND CONDITIONS.

This research will expose you to previous successes and failures, and give you ideas about what is possible and what is successful. Search water-harvesting literature,

*continues on page 50*

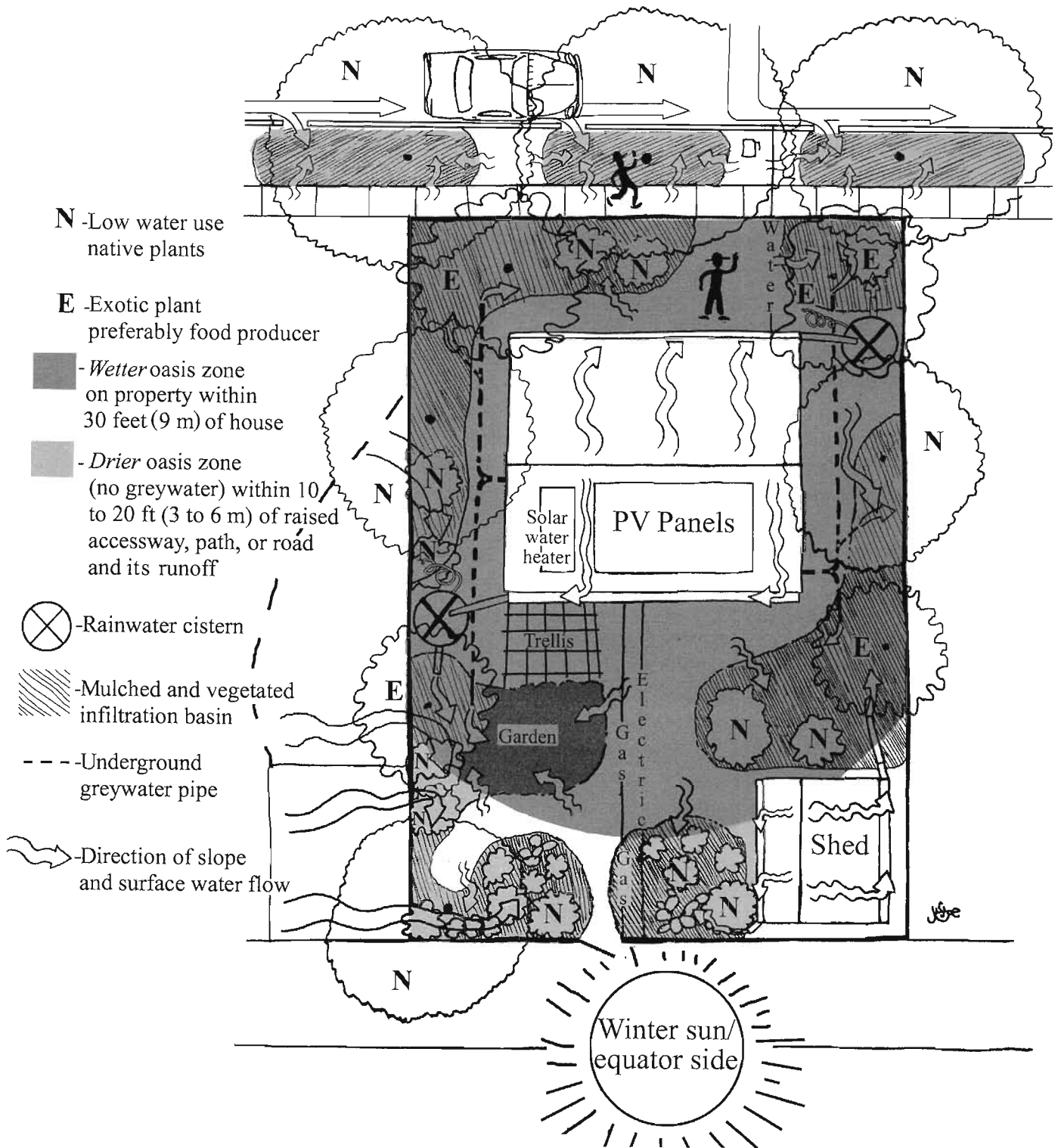

Fig. 1.10. Integrated rainwater- and greywater-harvesting landscape site plan for an urban lot (plan view). Higher water-use plants (typically exotic fruit trees or larger native plants) are planted inside the wetter oasis zone, receiving roof and hardscape runoff and household greywater. Here vegetation passively shades and cools the home and people, produces food, gives beauty, and provides other benefits. Only lower water-use plants—ideally natives—are planted beyond the wetter oasis zone. Compare to the similar figure in Volume 1, chapter 4, to see how this site’s integrated design works with the resources and challenges of sun, noise, wind, neighbors, and more.

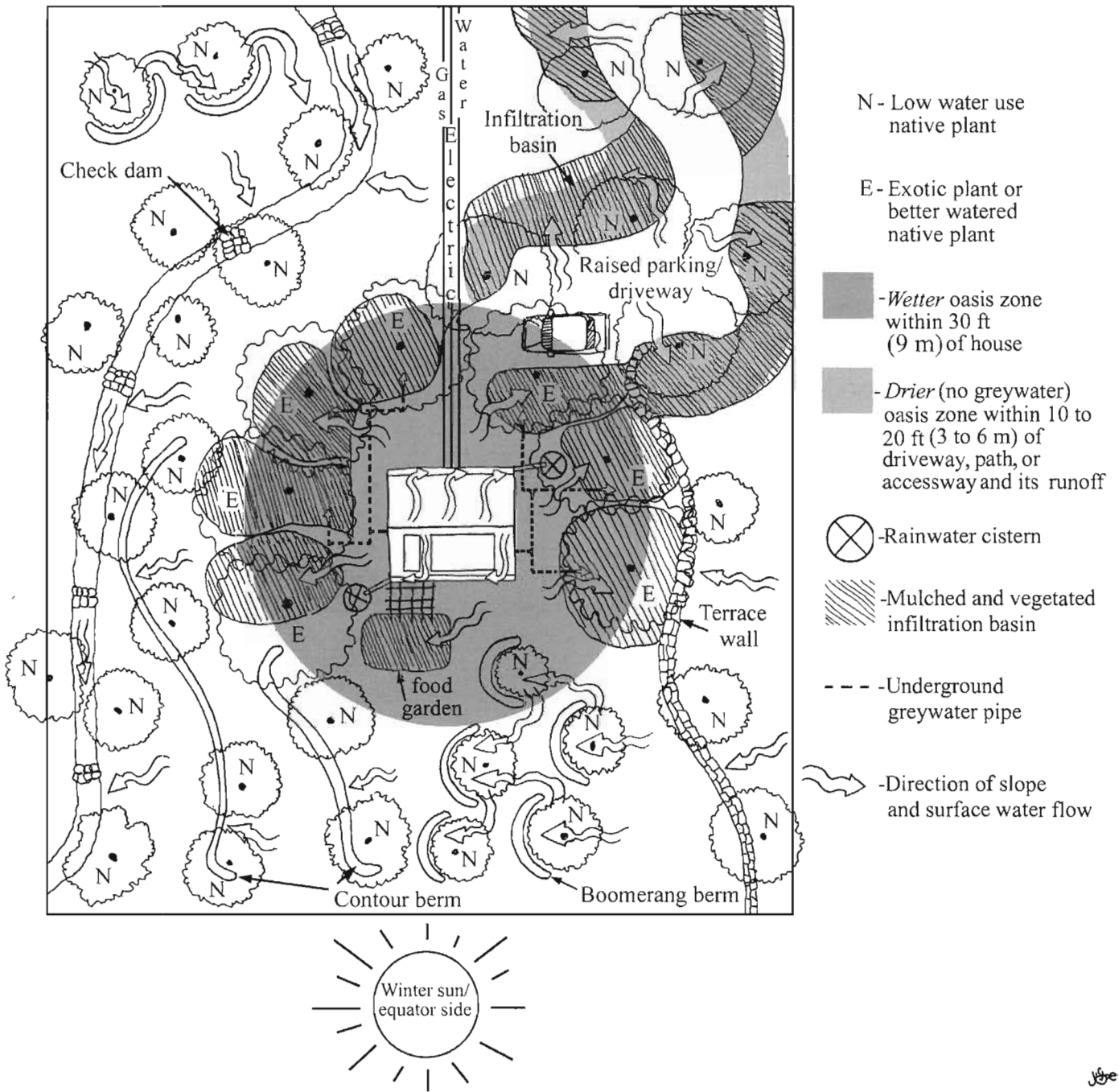

Fig 1.11. Integrated rainwater- and greywater-harvesting landscape site plan for a suburban or rural lot (plan view). As in figure 1.10, higher water-use plants (typically exotic fruit trees or larger native plants) are planted exclusively within or beside mulched basins or other earthworks inside the wetter oasis zone. A secondary drier oasis zone, lacking greywater, enhances the growth of lower water-use vegetation planted within 10 to 20 feet (3 to 6 m) of the raised driveway within reach of its runoff. Only low-water-use plants—ideally natives—are planted beyond the oasis zones. Better yet, leave existing native plants in place. A lower maintenance landscape might consist entirely of low-water-use natives.

the Internet, the press, and local permaculture and water-harvesting organizations. See appendix 6 for a list of water-harvesting resources.

## 8. MAKE EARTHWORK BASINS DEEPER AND BERMS BIGGER THAN YOU MIGHT INITIALLY THINK NECESSARY.

Over time, basins fill with sediment and organic matter, and berms erode. Making basins deeper and berms bigger initially will increase their lifespan and effectiveness. Specific details on earthwork sizing and erosion prevention are provided in respective earthwork technique chapters later in this volume.

## 9. PAY SPECIAL ATTENTION TO THREE IMPORTANT ELEVATIONS AS YOU CREATE YOUR EARTHWORKS: THE SPILLWAY, THE SURROUNDING LAND AREA, AND THE BOTTOM OF THE BASIN.

Elevation 1 – Make sure the bottom of the earthwork or its basin is sufficiently lower than the elevation of the spillway to ensure the earthwork holds water rather than draining it all through the spillway.

Elevation 2 – Make sure the earthwork's overflow spillway is truly the low point of the earthwork's perimeter or edge. This is important for guaranteeing that the overflow spillway, and not another inadvertently low point, acts as the overflow point.

Elevation 3 – Make sure the perimeter or edge of the earthwork is low enough in relation to the elevation of the surrounding area so harvested water will not back up against or flood anything you don't want flooded.

The *minimum* elevation difference between each of these three points should be 4 inches (10 cm), but a larger difference is typically much preferred. See appendix 2 for information and tools on how to measure these points.

## 10. MAKE SURE YOUR EARTHWORKS PERCOLATE OR INFILTRATE WATER.

Do not create mosquito-breeding puddles! Make sure water does not stand for more than 12 hours. Mulching and planting earthworks is typically the best remedy for addressing long-standing water. The more roots and burrowing soil life you have, the more quickly water will infiltrate. Dropping the level of overflow spillways can also help by releasing water that can't infiltrate quickly. Chapter 12 gives you more strategies for infiltrating water fast, and shows you a

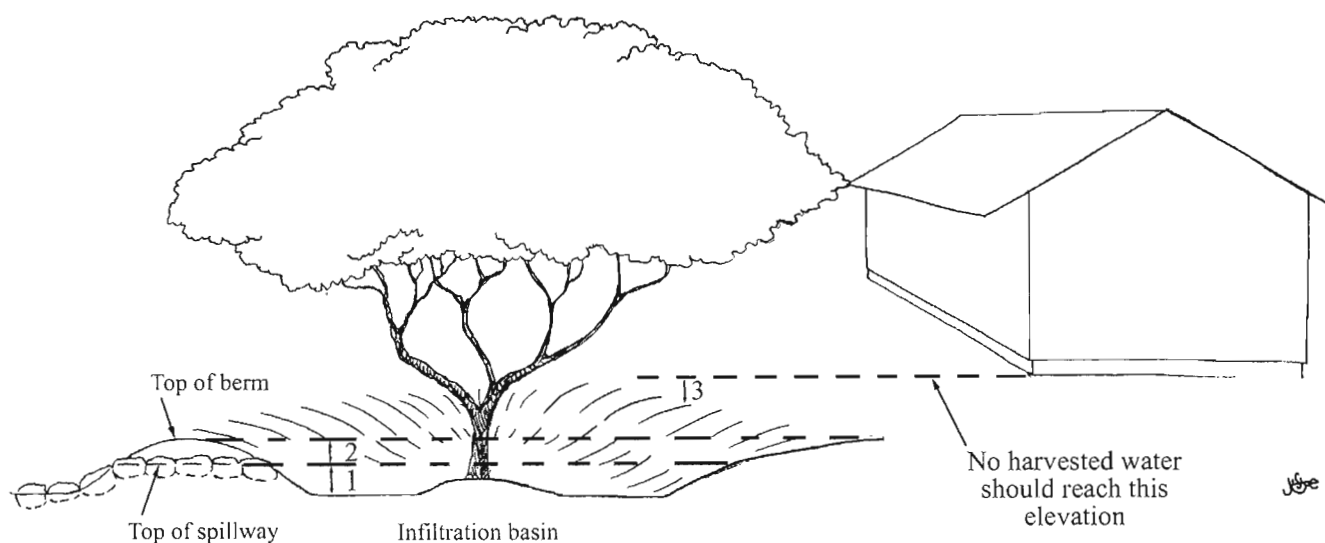

Fig. 1.12. Three important elevations: Elevation 1: Earthwork bottom or basin is lower than elevation of spillway to ensure water is harvested, rather than drained. Elevation 2: Overflow spillway is the low point of earthwork's perimeter. Elevation 3: Perimeter or edge of earthwork is below anything you don't want water to back up against or flood.

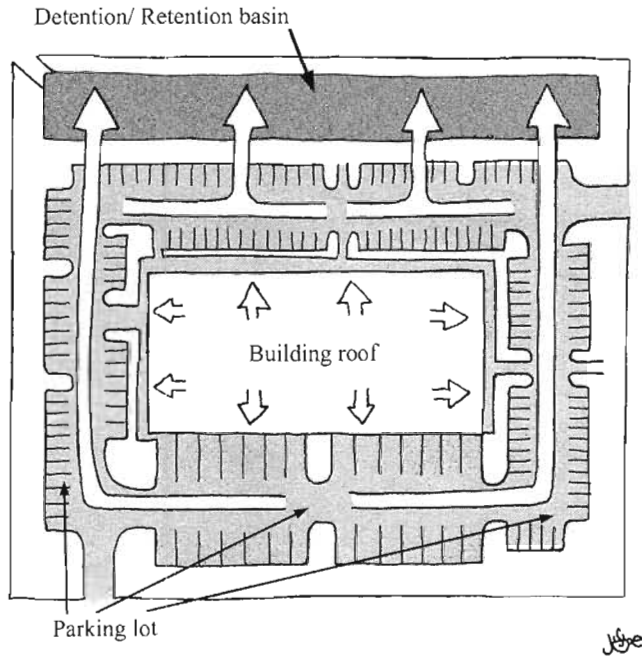

Fig. 1.13A. Runoff from commercial/industrial site's entire watershed is directed to *one* flooded detention/retention basin at site's lowest elevation. This concentrated water turns into a problem, while leaving the rest of the site drained and dehydrated. Arrows denote water flow.

way to test the percolation rate of your soils. The next tip will also help you promote infiltration.

## 11. DIVIDE LARGE WATERSHEDS INTO SMALLER SUBWATERSHEDS.

Conventional stormwater management designs typically place a large detention/retention basin at the bottom of a site to accept all the runoff from the site's watershed. These basins hold so much water in big storms that the vegetation in them drowns while the rest of the site is drained and dehydrated (fig. 1.13A).

I advocate collecting site runoff at multiple points throughout the site's watershed, starting at the top and continuing all the way to the bottom. This divides the site watershed into multiple smaller subwatersheds, each with its own water-harvesting earthwork(s). Each subwatershed yields an easily managed volume of harvested water that quickly infiltrates to passively irrigate associated plantings. In addition, this multi-subwatershed water harvesting approach controls flooding and

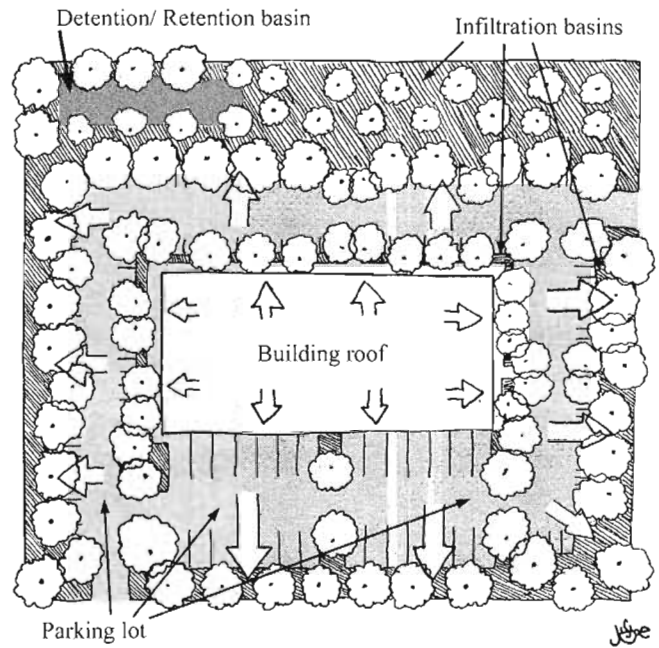

Fig. 1.13B. Site runoff is directed to *multiple* water-harvesting infiltration basins, dividing the site watershed into multiple subwatersheds. All water quickly infiltrates to passively irrigate landscape and grow native shade trees in mulched basins. These trees act as living air conditioners, living carports, and living water and air filters. Spreading out harvested water spreads the resource around to hydrate more of the site and generate more on-site resources. The retention basin size at bottom of site can be greatly reduced; furthermore, more beneficial vegetation can be grown within it due to lower, more easily managed water volumes.

hydrates the entire site. Figure 1.13B illustrates this approach for a commercial development. The Real-Life Examples section of chapter 5 shows how this was done for a 28-unit cohousing development. Chapter 8 shows examples along streets and public rights-of-way, and within parking lots. Chapter 12 has examples for single-family residences, urban and rural.

If after dividing a site into smaller subwatersheds you still have too much water collecting within an area or earthwork, consider dividing the contributing watershed up even more. Installing more earthworks, cisterns, and/or plantings above the inundated area will reduce the volume of contributing runoff, while further increasing a more expansive slowing, spreading, and sinking of water throughout its watershed (fig. 1.14).

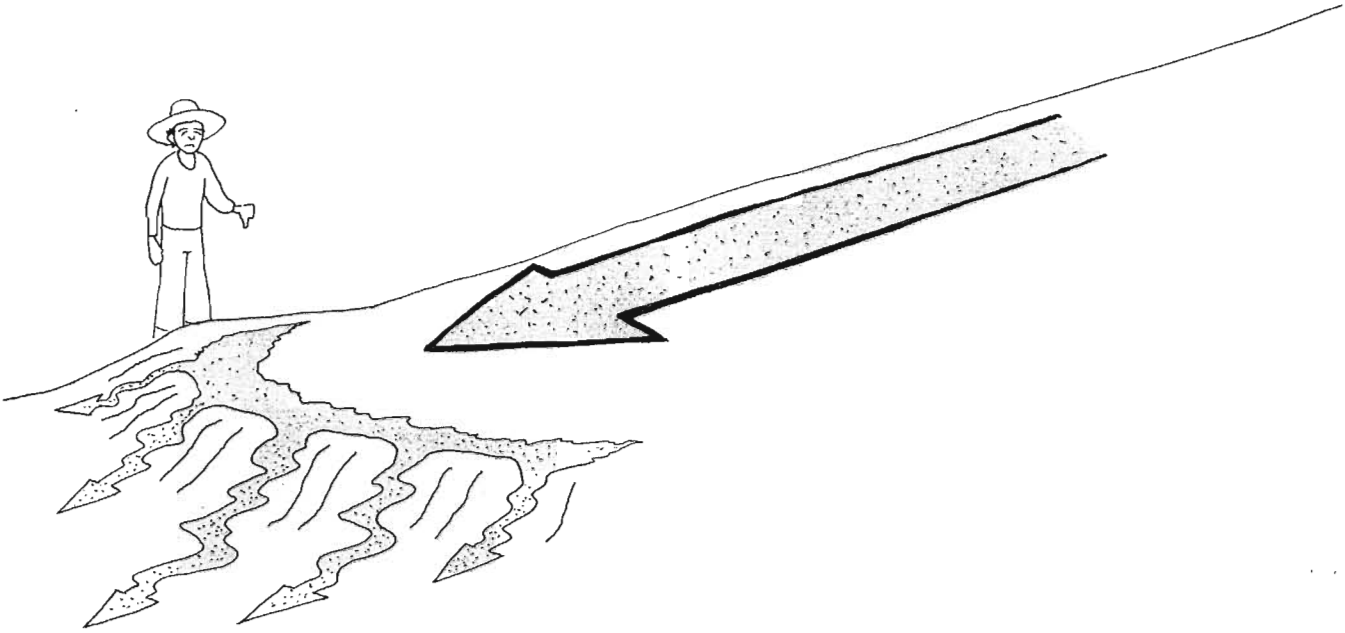

Fig. 1.14A. Too much runoff contributing to, and inundating a water-harvesting earthwork

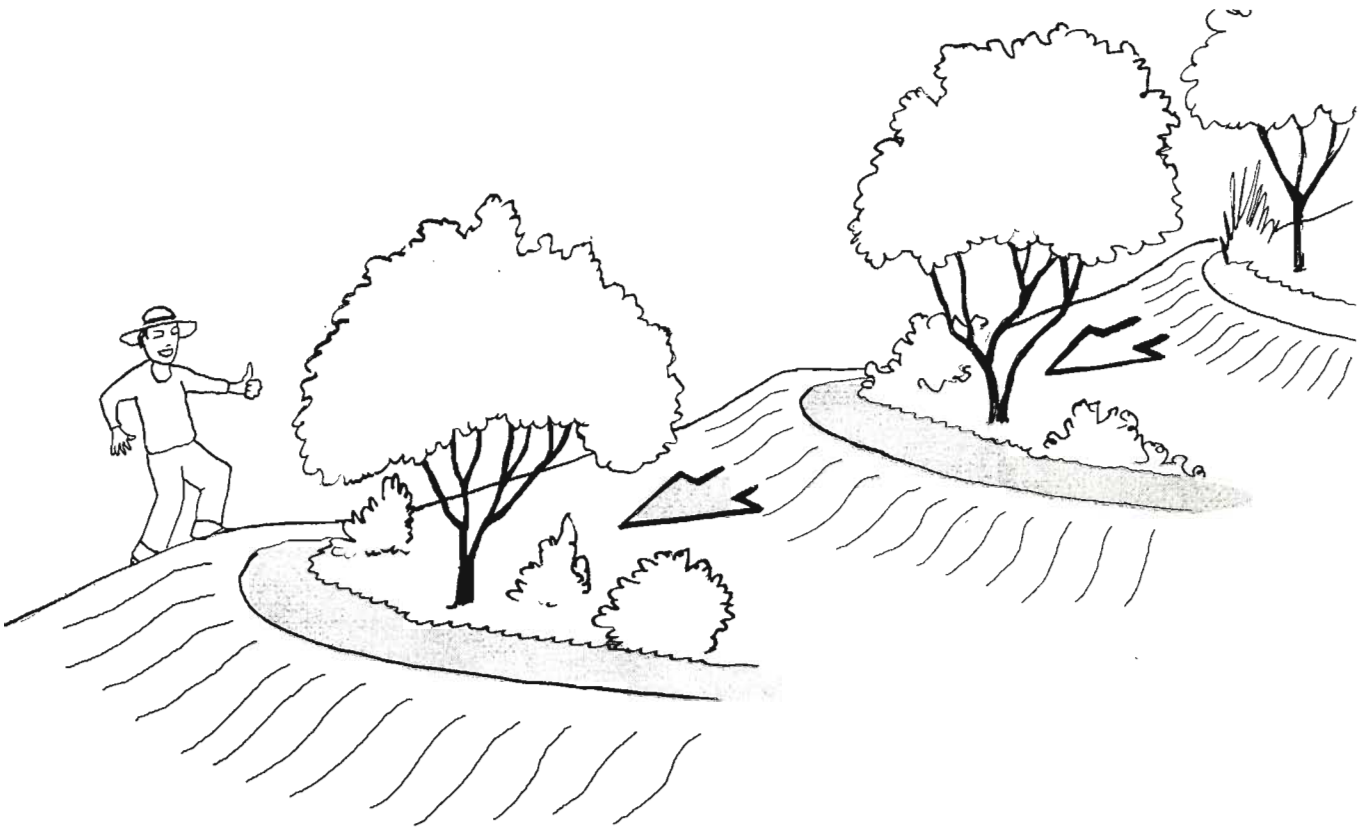

Fig. 1.14B. More runoff turned into soak-in higher in the watershed with more earthworks, so all structures work well and none are inundated





Fig. 1.15. Downspout directing water to a high point at the site to passively spread and infiltrate water over more of the site. Water from cistern faucet and overflow pipe is gravity-distributed to all areas downslope.  
 Note: Terraced basins are at least 10 feet (3 m) from building foundation.

**12. DIRECT DOWNSPOUTS, CISTERNS, AND GREYWATER DRAINS TO HIGH POINTS AT THE SITE SO GRAVITY CAN BE USED TO DISTRIBUTE WATER THROUGHOUT THE SITE VIA A SERIES OF EARTHWORKS.**

See figure 1.15.

**13. HARVEST WATER THROUGHOUT A WATERSHED BEFORE HARVESTING WATER WITHIN THE WATERCOURSE THAT DRAINS IT.**

Often people are mesmerized by the amount of water flowing down their site's watercourses—the site's natural ephemeral or perennial drainageways—and they want to harvest that water first. But remember the second water-harvesting principle: *Start at the top (highpoint) of your watershed and work down* to make work easier and more efficient while hydrating the whole site, not just the bottom.

**14. DO NOT CUT OFF AN EXISTING, HEALTHY, NATURAL WATERCOURSE.**

Natural watercourses are important wildlife habitats and corridors that should be maintained. While you can harvest water above a natural watercourse, do not cut off all water flow to the watercourse. Direct overflow from earthworks above to natural drainages below to keep existing, erosion-controlling vegetation in the watercourse healthy while managing surplus water.

**15. UTILIZE OVERLAND FLOW OF WATER, RATHER THAN PIPED FLOW.**

I advocate using pipes to direct relatively clean water from rooftops, downspouts, cisterns, or household greywater systems to earthworks. But once water has flowed over a paved or earthen surface, it is best to continue the flow of the water using earthworks rather than pipes (figs. 1.16A, B).

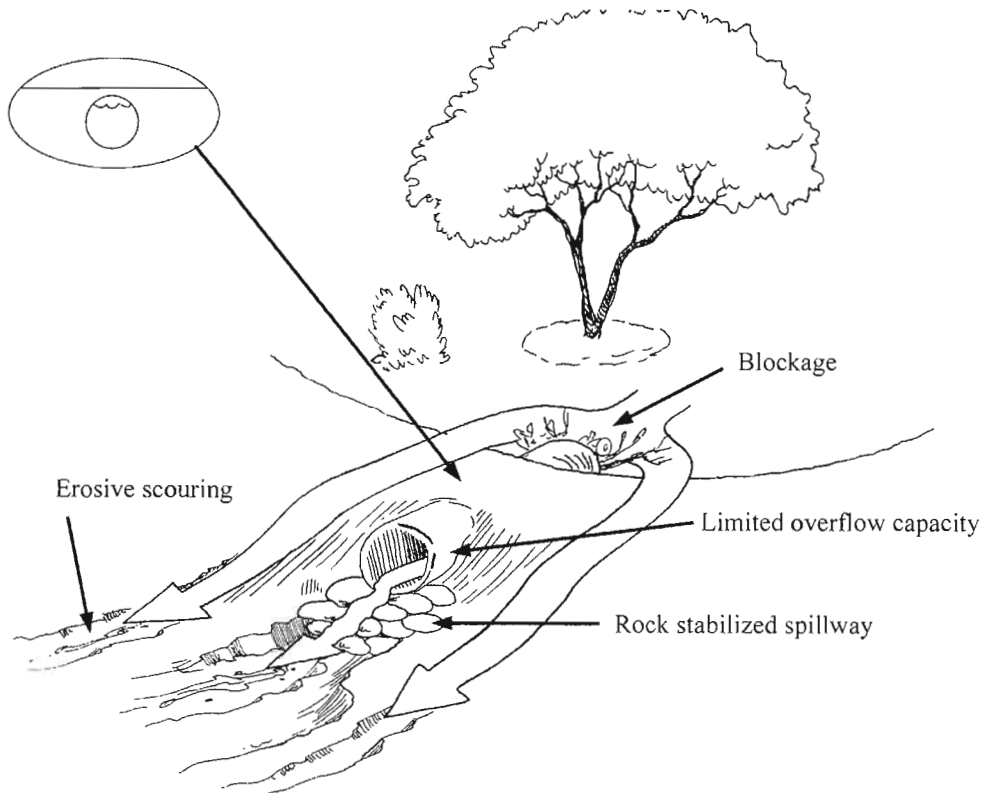

Fig. 1.16A. A piped overflow from one basin to another. The pipe has a limited flow capacity and is likely to clog with debris on the inlet end, while concentrating water into a more erosive force on the outlet end. Oval shows cross section of water flow through pipe.

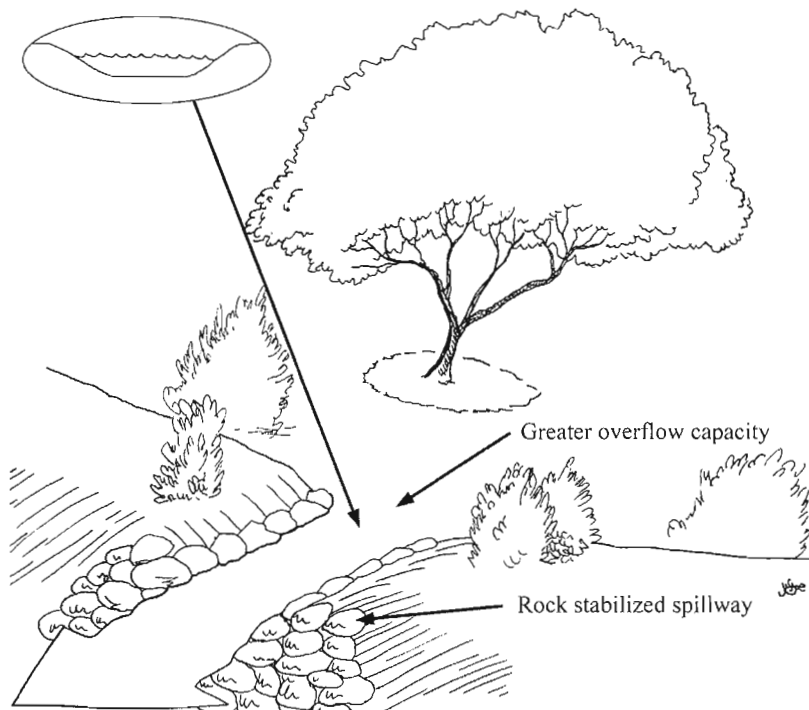

Fig. 1.16B. An overland diversion swale overflows from one basin to another. The swale has a greater flow capacity that increases as more water moves through it and rises to the widening upper banks. It is unlikely to clog due to the larger area, and because debris can flow with the water without obstruction. The swale also concentrates the flow less than a pipe so the potential for erosion is less. Oval shows cross section of water flow through diversion swale.

Pipes can clog with dirt, debris, roots, and critters. They cost money. And they concentrate water, increasing its erosive force as it exits the pipe. Directing water overland via depressions, spillways, diversion swales, and natural watercourses eliminates the maintenance needs of piping. There is nothing to buy. And overland strategies slow, spread, and infiltrate water flow more easily.

**16. DO NOT IMPORT DIRT ONTO, OR EXPORT DIRT OFF, A SITE UNTIL YOU'VE EXHAUSTED YOUR EXISTING ON-SITE RESOURCES AND NEEDS.**

To save time, money, and the inconvenience of transporting dirt, get the dirt you need to raise a path or construct berms by digging new infiltration basins or enlarging existing basins on site. If you need to get rid of surplus soil, raise the elevation of building pads, patios, and driveways or construct earthen adobe, rammed earth, or cob walls, benches, or other structures.

**17. IN NEW CONSTRUCTION, RUN ALL UNDERGROUND UTILITY LINES (GAS, WATER, ELECTRIC, CABLE, PHONE, MAIN DRIP IRRIGATION PIPE) UNDER RAISED PATHWAYS OR ACCESS WAYS, NOT BENEATH YOUR EARTHWORKS.**

Using this strategy, you will always know where the utility lines are, and they will always be accessible. In addition, roots are less likely to disturb the utility lines and you won't need to disrupt plants to access the lines.

**18. IN SMALL YARDS FOCUS EARTHWORKS AND PLANTINGS AROUND THE PERIPHERY.**

Make your small yards feel big, not claustrophobic. Basins and plants placed in the middle of a small yard fill it up. Basins, shrubs, and trees placed on the yard's periphery leave nice open space in the center while softening and masking boundary fences and walls (fig. 1.17). Peripheral trees cast shade over much of the yard, but their trunks are out of the way.

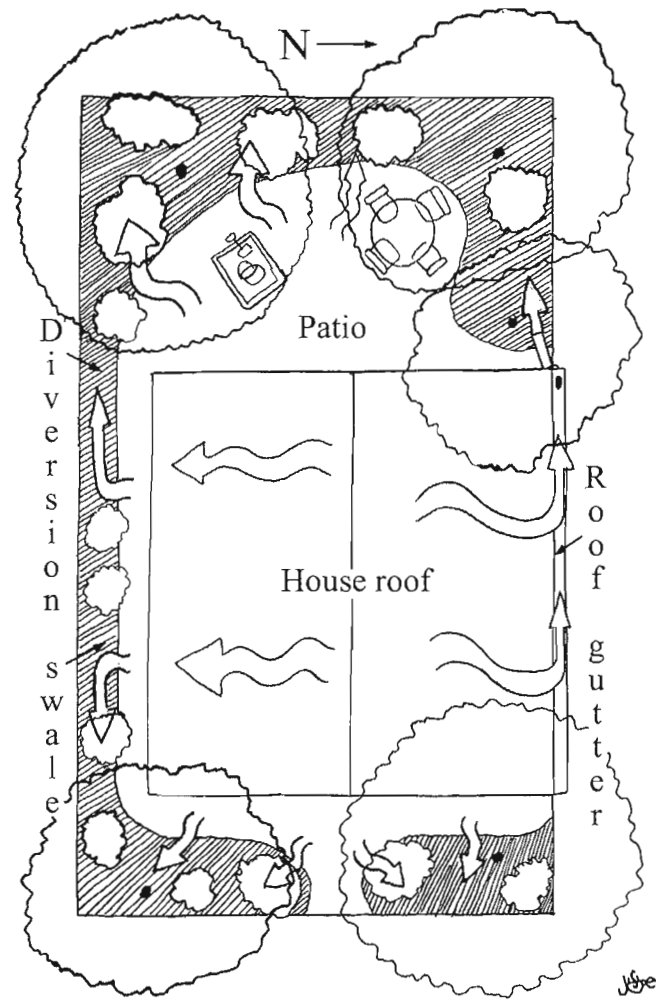

Fig. 1.17. Water-harvesting earthworks and plantings are emphasized on the periphery of small yards to shelter them, while making them feel bigger. Diversion swale in narrow side yard infiltrates water for plantings, while directing overflow to larger earthworks in front and back yards. Trees shade out summer rising and setting sun, while low-growing plants let in winter sun and light on the south side of this northern hemisphere home. See Volume 1, chapter 4, for more on passive-solar landscape design.

**19. DRAIN WATER FROM NARROW SIDE YARDS USING GRADUALLY SLOPED DIVERSION SWALES.**

Very gradually sloped diversion swales placed along the property line will allow some water infiltration in the side yard to irrigate perimeter plantings while moving surplus water away to prevent soil saturation against the house. Design the diversion swales

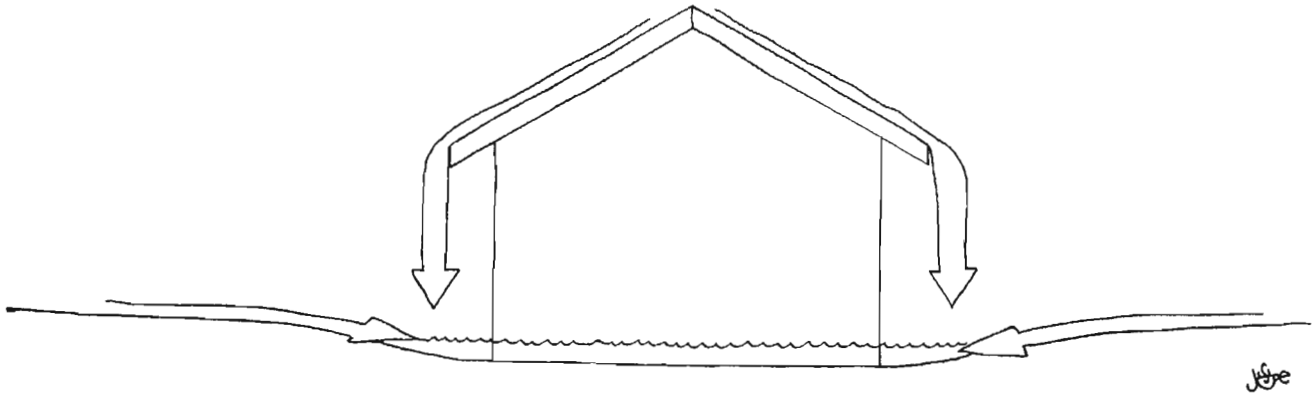

Fig. 1.18A. A house set low in the landscape and prone to flooding

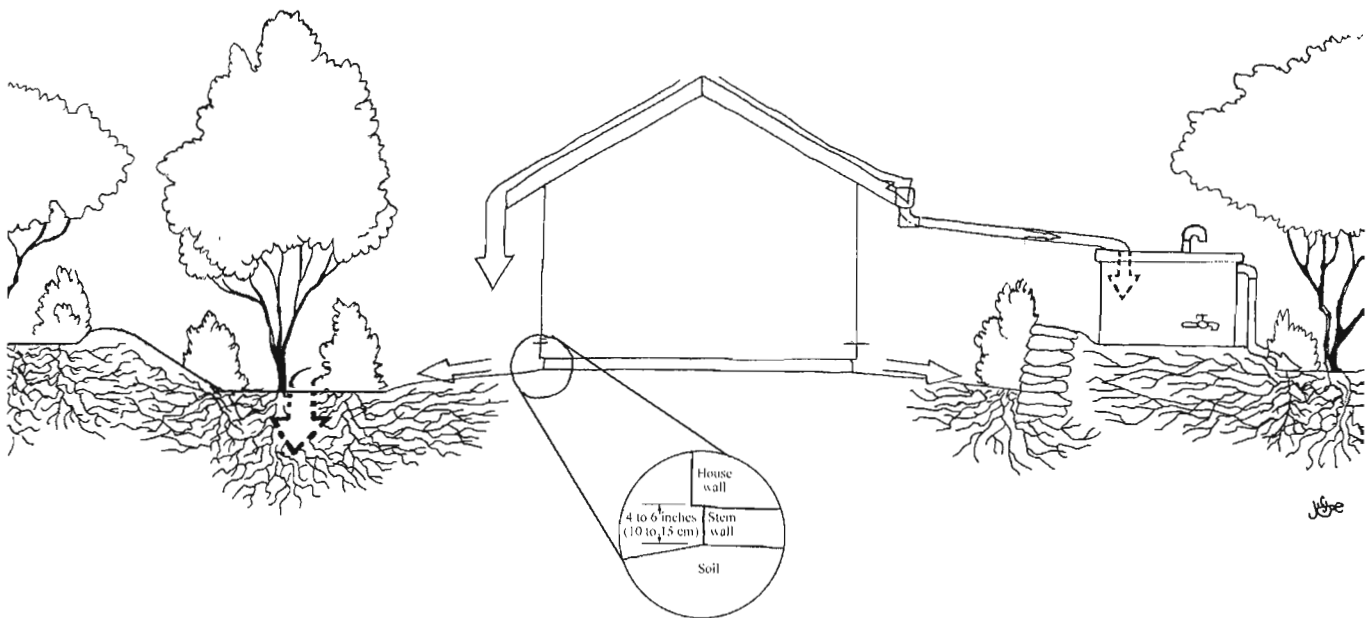

Fig. 1.18B. The house with the landscape regraded to drain and harvest water away from the house to eliminate flooding and passively irrigate the vegetation. Note: A space between the top of the building's stem wall and the wall of the house is kept free of soil to prevent moisture and subterranean termites from entering the wall.

to route surplus runoff to larger front and back yards where water can infiltrate in multiple earthworks to support plantings (fig. 1.17).

## 20. DRAIN WATER AWAY FROM BUILDINGS SET LOW IN THE LANDSCAPE BY RE-GRADING THE LAND AROUND THEM.

If runoff water flows toward your home, regrade the land slope around the building so water flows away and fills earthworks set 10 feet (3 m) or more

from the foundation. When regrading, make sure any soil in contact with the building is at least 4 to 6 inches (10 to 15 cm) below the top of the foundation or stem wall to prevent moisture and/or termites in the soil from making contact with your walls, where they might cause damage (see fig. 1.18B). In addition to regrading around the house, place earthworks high in the site's watershed to intercept water and create overflow routes that direct overflow from these earthworks away from the building.



Fig. 1.19. Lush native plant landscape was not disturbed when these homes were built. It naturally survived just on rainfall for decades, and continues to do so today, while the vegetation within 30 feet (9 m) of the homes thrives with the roofs' runoff and household greywater also directed to its roots. This photo was taken two years after the homes were built. Dancing Rocks Permaculture Community, Tucson, Arizona

## 21. UTILIZE NATIVE VEGETATION WITHIN YOUR LANDSCAPES.

The easiest way to create a water-sustainable landscape is to leave all existing native vegetation in place. It is already established, and can survive on rainfall alone.

The next easiest way is to revegetate a site exclusively with native vegetation. Ideally use low-water-use indigenous plants typically found within a 25-mile (40-km) radius of the site and 500 feet (150 m) above or below the site's elevation. Though some sites may require using native species from farther away to bring in more diversity, start with species within the small radius to ensure you do not overlook superior local species. Native vegetation is typically the most beneficial for native wildlife and creates a "sense of place," rooting us to the local bioregion. Having evolved over millennia within the local climate, soils, and natural

rainfall regimes, these plants are very well adapted to your site. Plant natives within or beside water-harvesting earthworks and they'll *thrive*.

## 22. LIMIT EXOTIC PLANTS TO THE OASIS ZONE.

Exotic vegetation such as fruit trees and vegetables typically need more water and care than plants native to your site's drier microclimates. If used, plant these exotics exclusively in the oasis zone where runoff and greywater are readily available and can meet their higher water needs. You will also be there to provide additional attention and harvest the bounty. Plant tough drought-tolerant natives in earthworks beyond the oasis zone, where they can thrive on rainfall alone once established, while creating a shelter belt that protects the tender

exotics from excess sun and wind. However, keep in mind that not all natives are equal. Those naturally found in wetter areas are more water-needy, while those found in drier areas are more drought-tolerant. Plant accordingly, depending on site needs and water availability. Chapter 11 expands on this.

## 23. TO DETERMINE WHAT PLANTS TO PLACE WITHIN OR BESIDE YOUR EARTHWORKS, TAKE A HIKE!

Go into nearby wild natural areas with elevation, microclimate, and rainfall similar to your site, and see what grows naturally in depressions or along ephemeral waterways. These are the plants that will grow well within the basins of your earthworks. Observe the plants that grow naturally in higher, well-drained areas. Place these plant species atop berms or beside earthwork basins, but not in the basins. Mimic nature.

For placement of fruit trees and other exotic species, read plant books and ask knowledgeable plant nursery staff about what such trees require. If they need good drainage, plant them beside, not within, earthworks so their roots can access harvested water but their root crowns remain high and well drained.

## 24. LIVE WITHIN YOUR SITE'S WATER BUDGET.

To truly turn water scarcity into abundance we must work to give the watershed more than we take from it. This goes beyond maintaining current degraded conditions; we need to improve them. Building earthworks and establishing vegetation to capture rainwater previously lost to runoff and evaporation is a primary way to improve conditions. But earthworks and plantings alone are not enough. We must make sure we don't overconsume or overspend the site's limited water budget. To achieve this goal I give you the following challenge:

*Consume less water on site than falls on your site in an average year of rainfall.*

Your total average annual on-site water consumption (domestic/interior and landscape/exterior) should be less

than the total average annual rainfall at your site. You can estimate the income of your site's water budget by estimating how much rain falls on your site in an average year using the equations in box 1.3 and the example illustration in figure 1.20. Then estimate how much additional income or rainfall you gain through "runon" (i.e. runoff running *onto* the site), and how much income or rainfall you lose to runoff running off the site in box 1.3 and figure 1.21. Consult local climate records and your rain gauge for local rainfall.

For more thorough descriptions and illustrations of these calculations, see Volume 1, chapter 2. For additional calculations see appendix 3 of this volume.

At a minimum, plan for landscape/exterior water consumption to be less than your average on-site rainfall. Use no more water from municipal sources or private wells than falls on, runs onto, and is harvested and infiltrated at your site. If you have a well, regularly monitor the water level within it. If the water level stays the same or rises things are likely going fine, but if the level is dropping changes need to be made to reduce the groundwater depletion.

To live within a site's rainfall budget-determine your sustainable water income (on-site rainfall and runon), and your water expenses (check your water bill or the meter on your well). Boxes 12.5 and 12.6 in chapter 12 provide water use rates for household water fixtures and appliances. The website [www.h2ouse.org](http://www.h2ouse.org) expands on this, and provides additional conservation strategies. Estimated water needs of plants can be obtained from the local agricultural extension office (or see appendix 4 for example plant lists and water requirement calculations for Tucson, Arizona). Chapter 11 gives you many tips on estimating plants' water needs through observation, and strategies to minimize their water needs, while boosting plant health and on-site resource production. Native perennial plants will likely use less water than exotics. The goal is to hydrate rather than dehydrate our watersheds, and to infiltrate and enhance more resources than we extract.

Can you do it? Absolutely! It happens naturally all the time. Get out to the wild natural areas and you'll see all kinds of life living in balance without irrigation or human intervention. The wild site's natural water budget will largely determine plant density, with

*continues on page 62*

### Box 1.3. Calculating Rainfall Volumes

#### CALCULATING RAINFALL VOLUMES IN ENGLISH UNITS:

To calculate the volume of rainfall in cubic feet that falls in an average year on a specific catchment area, such as your roof, yard, section of street, neighborhood, or other subwatershed:

CATCHMENT AREA (in square feet) multiplied by the AVERAGE ANNUAL RAINFALL (in feet) equals the TOTAL RAINWATER FALLING ON THAT CATCHMENT IN AN AVERAGE YEAR (in cubic feet)

(or)

CATCHMENT AREA (ft<sup>2</sup>) × AVERAGE RAINFALL (ft) = TOTAL RAINWATER (ft<sup>3</sup>)

If you normally measure annual rainfall in inches, simply divide inches of rain by 12 to get annual rainfall in feet. For example, folks in Phoenix, Arizona, get about 7 inches of annual rainfall, so they would divide 7 by 12 to get 0.58 feet of annual rain.

Once you get your answer in cubic feet of annual average rainfall, convert cubic feet to gallons by multiplying your cubic-foot figure by 7.48 gallons per cubic foot. The whole calculation looks like this:

CATCHMENT AREA (ft<sup>2</sup>) × RAINFALL (ft) × 7.48 gal/ft<sup>3</sup> = TOTAL RAINWATER (gal)

For example, if you want to calculate how much rainwater in gallons falls on your 55-by-80-foot (4,400-square-foot) lot (fig. 1.20) in a normal year where annual rainfall averages 12 inches, the calculation would look like this:

4,400-square-foot catchment area × 1 foot of average annual rainfall × 7.48 gallons per cubic foot = 32,912 gallons of rain falling on the site in an average year

#### CALCULATING RAINFALL VOLUMES IN METRIC UNITS:

To calculate the volume of rainfall falling on a specific catchment area in liters:

CATCHMENT AREA (in square meters) × AVERAGE ANNUAL RAINFALL (in millimeters) = TOTAL RAINWATER FALLING ON A CATCHMENT AREA IN AN AVERAGE YEAR (in liters)

For example, if you want to calculate how much rainwater in liters falls on your 24-by-16.5-meter (396-square-meter) lot in a normal year where annual rainfall averages 304 millimeters, the calculation would look like this:

396-square-meter catchment area × 304 millimeters annual rainfall = 120,384 liters of rain falling on site in an average year

#### CALCULATING RAINFALL VOLUMES FOR A GIVEN RAIN EVENT IN ENGLISH OR METRIC UNITS:

To calculate the volume of rainfall on a specific catchment for a given rain event:

Use the calculations above, but enter the amount of "rainfall from a given rain" in place of "average annual rainfall."

Note: Appendix 3 provides more detailed information on conversions, constants, and calculations for water harvesting.

## Box 1.4. Calculating Runoff and Runon Volumes

You can get a ballpark estimate of runoff volume from any sloped surface by multiplying the volume of rain that falls on that surface by its "runoff coefficient"—the average percentage of rainwater that runs off that type of surface. For example, a rooftop with a runoff coefficient of 0.95 estimates that 95% of the rain falling on that roof will run off.

The runoff coefficient for any given surface depends on what the surface is composed of. Rainfall intensity also affects the coefficient: the higher the rainfall intensity, the higher the runoff coefficient. Ranges and averages of various runoff coefficients I use in the southwest US are as follows:

- A roof or impervious paving (such as concrete patio or an asphalt street): 0.80-0.95
- Sonoran Desert uplands (healthy indigenous landscape): range 0.20-0.70, average 0.30-0.50
- Bare earth: range 0.20-0.75, average 0.35-0.55
- Grass/lawn: range 0.05-0.35, average 0.10-0.25
- For gravel use the coefficient of the ground below the gravel.

The runoff coefficient for earthen surfaces is greatly influenced by soil type and vegetation density. Large-grained porous sandy soils tend to have lower runoff coefficients while fine-grained clayey soils allow less water to infiltrate and therefore have higher runoff coefficients. Whatever your soil type, the more vegetation the better, since plants enable more water to infiltrate the soil.

### CALCULATING YARD RUNOFF/RUNON: AN EXAMPLE

#### CALCULATING RUNOFF/RUNON VOLUMES IN ENGLISH UNITS:

Let's say we are on a site receiving 18 inches of rain in an average year, and the neighbor has about a 25-by-12-foot bare section of his yard that drains onto our example property. The soil is clayey and compacted.

Determine the available rainwater running off that section of the neighbor's yard, and running on to our land by multiplying its catchment area (300 square feet) by the average annual rainfall in feet (1.5) by 7.48 (to convert the answer to gallons):

$$\text{CATCHMENT AREA (ft}^2\text{)} \times \text{RAINFALL (ft)} \times 7.48 \text{ gal/ft}^3 = \text{TOTAL RAINWATER (gal)}$$

$$300 \times 1.5 \times 7.48 = 3,366 \text{ gallons of rain falling on that section of the neighbor's yard in an average year.}$$

Multiply that figure by the soil surface's runoff coefficient of 0.60:

$$3,366 \times 0.60 = 2,019 \text{ gallons annually running off the neighbor's compacted yard into ours. Add that to our site's annual rainwater budget.}$$

#### CALCULATING RUNOFF/RUNON VOLUMES IN METRIC UNITS:

Let's say we are on a site receiving 457 mm of rain in an average year, and the neighbor has about a 7.5-m-by-3.6-m bare section of his yard that drains onto our example property. The soil is clayey and compacted.

Determine the available rainwater running off that section of the neighbor's yard and running on to our land by multiplying its catchment area (27 m<sup>2</sup>) by the average annual rainfall in millimeters (457) to get liters of runoff in an average year of rain:

$$\text{CATCHMENT AREA (m}^2\text{)} \times \text{RAINFALL (mm)} = \text{TOTAL RAINWATER (liters)}$$

$$27 \times 457 = 12,339 \text{ liters of rain falling on that section of the neighbor's yard in an average year.}$$

Multiply that figure by the soil surface's runoff coefficient of 0.60:

$$12,339 \times 0.60 = 7,403 \text{ liters annually running off the neighbor's compacted yard into ours. Add that to our site's annual rainwater budget.}$$



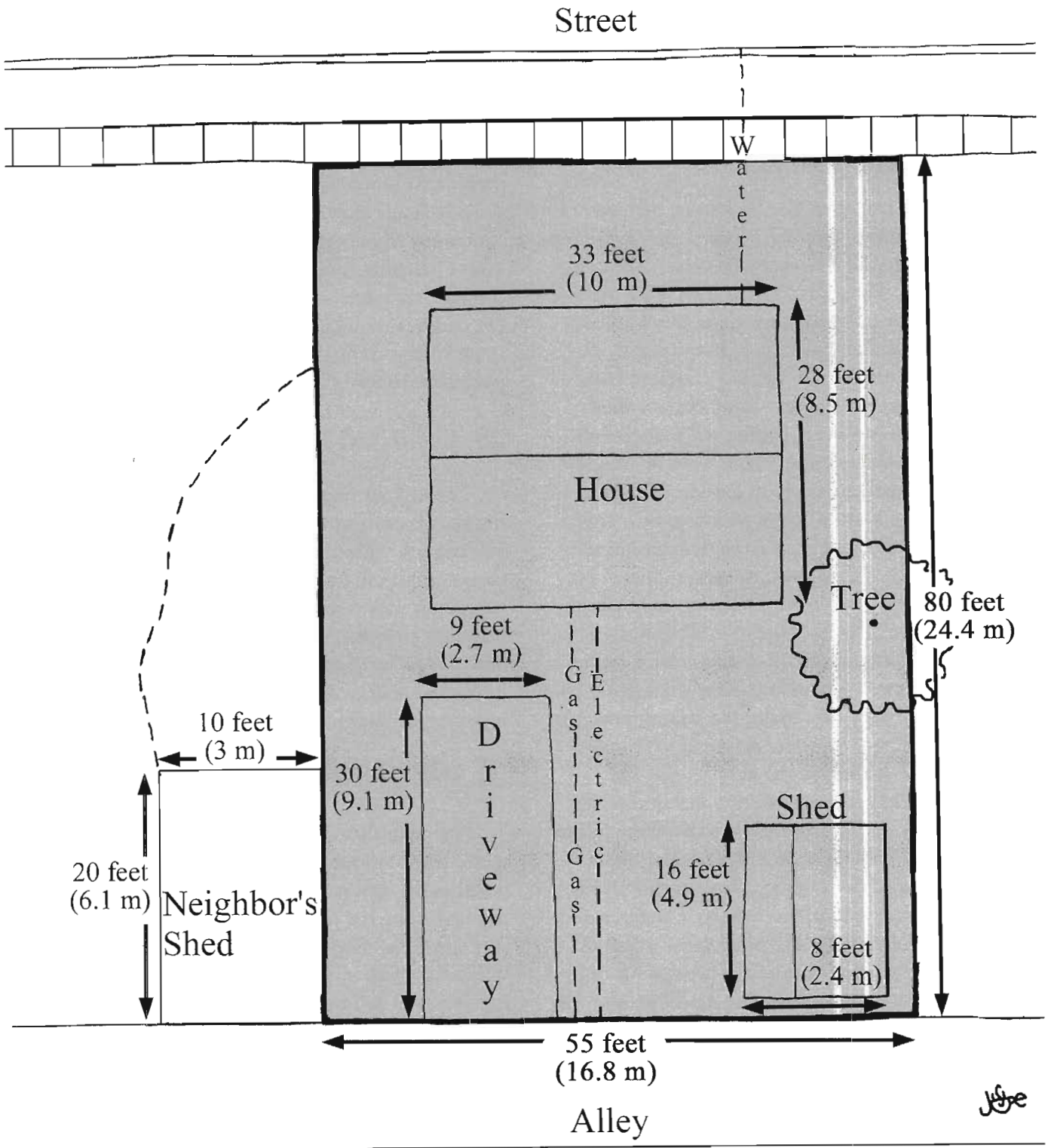

Fig. 1.20. Site map (overhead/plan view) of a 4,400-square-foot (409-m<sup>2</sup>) property. In an average year of 12 inches (304 mm) of precipitation the site receives 32,912 gallons (124,585 liters) of rainfall "income." See box 1.3 for how to calculate a site's rainfall "income." Compare to figure 1.21.

higher density in areas with more rainfall and infiltration, and lower density in areas with less rainfall and more water loss to runoff.

## Giving Back More Than You Take: A Goal Leveraging You to Greater Creativity and Dynamism

The idea of having to give back more than you take irritates some people. They see it as a constraint *limiting* what they can do. I see it as a constraint *enhancing* what we can do. The goal of giving back more than we take pushes us to attain a greater good, which directly benefits us, while also spreading its benefits and resources (not harm) to a maximum of others, both now and in future generations. More lives are then empowered to do the same, cycling still more benefits and resources back to us and others. Thus life steadily *improves* for all, rather than getting worse. This idea inspires us to think more before we act, to be more creative, which in turn enables us to be more productive and efficient for less total resource consumption, cost, and physical effort. Rather than allowing us to take the quick, poorly thought-out route of inefficient short-term ease and waste for instant gratification, it pushes us to take a smarter route of long-term efficiency, gratification, and vibrancy that attains the seventh principle of water harvesting—*maximize beneficial relationships and efficiency by “stacking functions.”*

The idea is to get every strategy, and in this case, every earthwork and its vegetation, to perform at least three functions, while sustainably producing more than it consumes. For example, placed and built right, an earthwork alone can passively harvest water, reduce flooding, control erosion, and provide the irrigation water for the vegetation within it. Those plants can be selected to provide food and herbal medicine, provide summer shade for an adjoining building or patio, allow for warming winter-sun exposure, enhance wildlife habitat, and provide fragrant flowers—all the while consuming no more water than is naturally

available on site. The more functions your design freely provides the richer it all becomes, all the while offering a deeper, more-layered beauty.

I can be initially lured to the surface beauty of an ornamental garden, but if the ornamentation is the extent of its use, and it depends on continual inputs/imports of water, fertilizer, and maintenance, I see that its beauty is only skin deep. The attraction quickly fades. However, when I enter into a multi-functional regenerative garden I discover layer after layer of creative integration freely cycling and building multiple resources such as water, fertility, food, habitat, and beauty. This beauty continually grows the more I learn about, and benefit from, the regenerative garden's expanding dynamism.

## 25. BEGIN WITH CONSERVATION.

Lessen your need for water so your water-harvesting system can provide for more of your needs and you can live within your site's water budget. Such conservation can be achieved by using low-water-use vegetation within or beside earthworks, mulching, recycling greywater within the landscape, using low-flow showerheads and appliances, and practicing integrated design. Always *reduce* before reusing, recycling, or designing anew.

## 26. HAVE FUN!

Play with these ideas and earthworks as you adapt them to the unique conditions of your site. Each site is distinctive and requires choosing and creatively implementing the techniques that are appropriate for its slope, soils, rainfall characteristics, those living and interacting with it, and the vegetation. Combine existing strategies and invent new ones. Follow the principles, be dynamic, and make a party out of it. Invite friends over to help with your earthwork creation, celebrate its completion, and watch it soak up the rain when it pours from the sky!

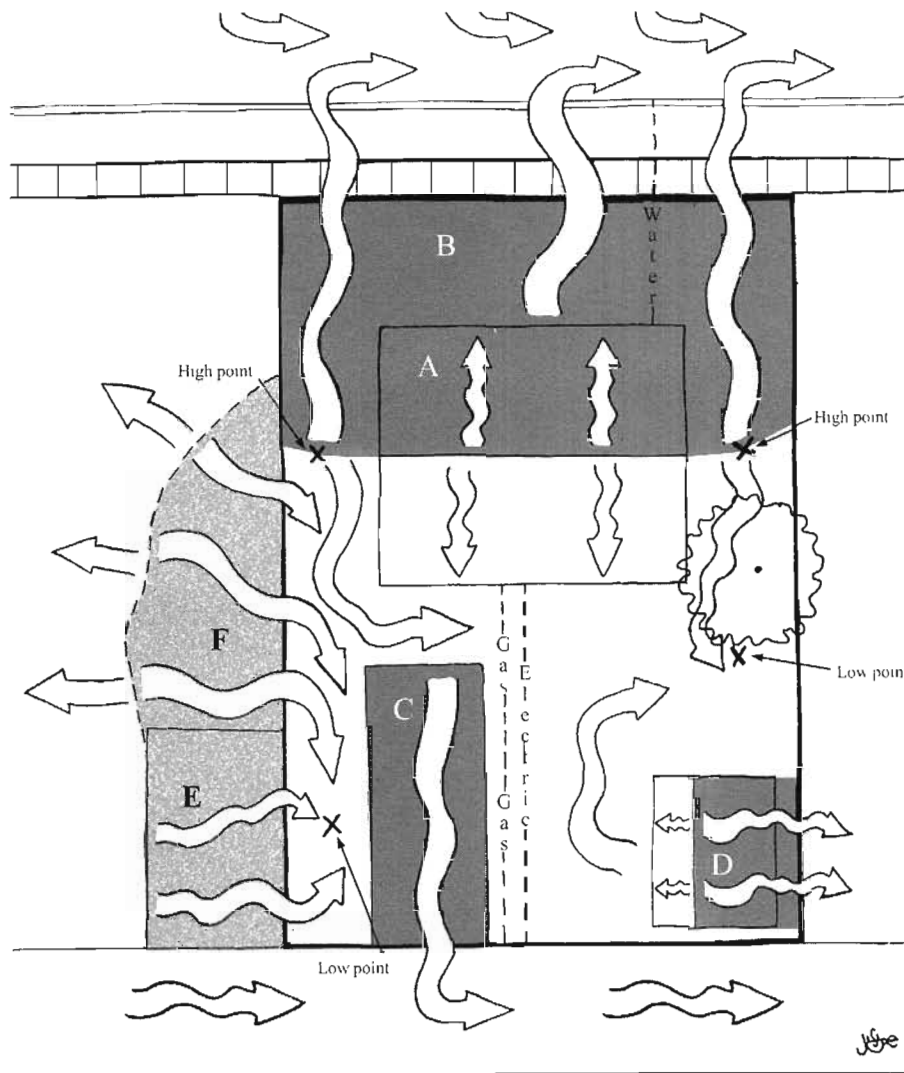

### RUNOFF LOST

- A. 3,282 gallons (12,424 liters) runoff lost from 462 ft<sup>2</sup> (42.9 m<sup>2</sup>) half of metal roof having a 0.95 runoff coefficient.
- B. 2,246 gallons (8,502 liters) of runoff lost from 858 ft<sup>2</sup> (79.7 m<sup>2</sup>) section of gravel yard having a 0.35 runoff coefficient.
- C. 1,818 gallons (6,878 liters) of runoff lost from a 270 ft<sup>2</sup> (25.1 m<sup>2</sup>) concrete driveway having a 0.90 runoff coefficient.
- D. 539 gallons (2,037 liters) runoff lost from 80 ft<sup>2</sup> (7.4 m<sup>2</sup>) section of shed's asphalt shingle roof having a 0.90 runoff coefficient.

### RUNON GAINED

- E. 1,421 gallons (5,379 liters) runoff gained from neighbor's 200 ft<sup>2</sup> (18.6 m<sup>2</sup>) metal shed roof having a runoff coefficient of 0.95.
- F. 1,571 gallons (5,943 liters) runoff gained from 350 ft<sup>2</sup> (32.5 m<sup>2</sup>) section of neighbor's compacted dirt yard having a runoff coefficient of 0.60.

Fig. 1.21. In an average year of 12 inches (305 mm) of rainfall this site receives 32,912 gallons (124,572 liters) of rainfall, gains 2,992 gallons (11,325 liters) of runoff from the neighbor's yard and shed roof, and loses about 7,885 gallons (29,845 liters) of runoff for a total site rainwater budget of 28,019 gallons (106,052 liters). If the landscape were changed to harvest both runoff and runon, the site's annual rainwater resources could increase up to a total of 35,904 gallons (135,897 liters). Estimated annual runoff and runon volumes off each type of catchment surface are listed with surface material and runoff coefficient. Still more runoff from sidewalk, street, and alley could be harvested within the public right-of-way to grow public street and alley trees (see chapter 8 for strategies on harvesting street runoff). See box 1.4 for calculations of runoff and runon volumes.



# Berm 'n Basins

**B**erm 'n basins simply cast a net across slopes to catch runoff and encourage it to infiltrate into the soil to grow soil-stabilizing and erosion-checking vegetation (fig. 2.1). There are many variations of this strategy and you can tweak their placement and use to make more. In this chapter you'll see how potted plants set along a contour line have created a water-harvesting plant nursery on a sloped lot, how smile-shaped berms are boosting the growth of trees beside which they are placed, and how a net and pan system of berms has harvested enough rainwater to grow fruit trees in the Negev desert on just 4.1 inches (104 mm) of annual rainfall. You'll also see how raised paths and roads built on contour become water-harvesting strategies, how burned trees felled on contour are helping rehydrate and revegetate burned forests, and how the berm 'n basin concept can be suited and oriented to the wind to harvest windblown snow.

## WHAT IS A BERM 'N BASIN?

The berm 'n basin (b'nb) creates a net that is perpendicular to sloping land in order to *slow*, *spread*, and *infiltrate* runoff that would otherwise flow unchecked downhill (fig. 2.1). Thus the b'nb helps accumulate resources (water, soil, seeds, organic matter) where they would otherwise readily and erosively drain away. A b'nb usually consists of two parts: an excavated

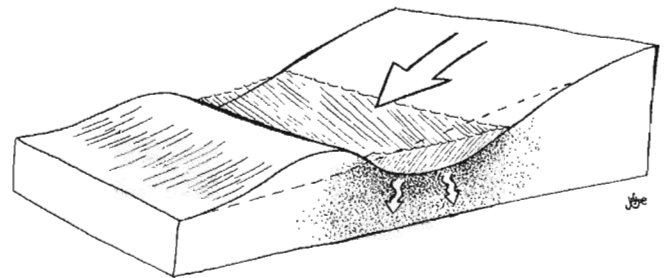

Fig. 2.1. A berm and basin holding runoff water and infiltrating it into the soil

basin and a raised berm located just downslope of the basin. The berm can be made of the earth excavated to form the basin or it can be made from brush, rock, or additional earth. The basin holds water; adding the berm enables you to harvest even more water. This water then grows soil-stabilizing, resource-producing vegetation to maximize living and organic ground-cover.

Berm 'n basins only work on slopes—not flat ground. Also berm 'n basins generally have a sloped basin, as a level-bottomed basin would mean more earth moving than necessary on a slope.

The berm can wind serpentine-like along a contour line, catching and infiltrating runoff all along its length; it can be made boomerang-like to focus its harvested water around select plantings; or it can literally look like a net of berms draped around an orchard of trees—each tree placed within a different square of

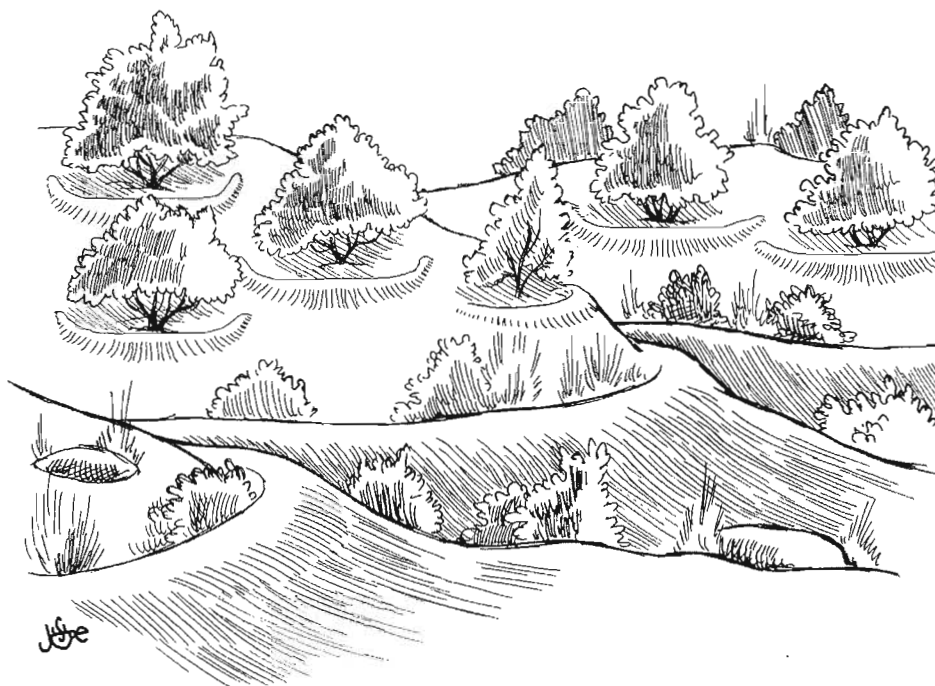

Fig. 2.2. Boomerang berms to focus water around trees and contour berms below on hillsides

the rain-catching net (fig. 2.2 shows two variations). In many instances the berm, or a section of it, can double as a raised path.

Other earthworks may be used above or below berm 'n basins depending on the landform of the watershed. Study your watershed, and start at the top with the appropriate strategy. This strategy and its variations is just one of your options.

See appendix 6 for more resources related to berm-'n-basin-type earthworks and their use in permaculture and other contexts.

### Box 2.1. Berm 'n Basin Synonyms, Terminology

Within the permaculture community,<sup>1</sup> what I call a "berm 'n basin" is known as a "swale" cut on contour. Outside the permaculture community, the term "swale" usually refers to a gradual drainageway cut off contour. Confusion is common. So I use "berm 'n basin" as a general term for contour swales and similar earthworks that stop and infiltrate runoff. I use the term "diversion swale" for a gradually draining swale. It's my hope these terms will be more readily understood by all.

## WHERE IS A BERM 'N BASIN USED?

Berm 'n basins are used across gently- to moderately-sloped land where they intercept and infiltrate runoff water into the soil. This technique should never be used in or across drainages. B'nbs are generally used on slopes with less than 3:1 pitch, where for every three units of horizontal length, a slope drops less than one unit in height.

Earthworks on steeper slopes (of 3:1 or more) will most likely need the stabilization of a retaining wall (see chapter 3 on terraces). Figure 2.3 illustrates different slopes and different berm 'n basin and terrace options.

## TOOLS AND MATERIALS

**Siting tools:** a bunyip water level, A-frame level (appendix 2 in this volume gives instructions for both these homemade levels), or transit.

**Excavation tools:** pointed shovel, pick, and rake. Optional equipment for larger jobs can include a Ditch Witch (gas powered ditch digger) operated by one person walking and wrestling behind it, backhoes,

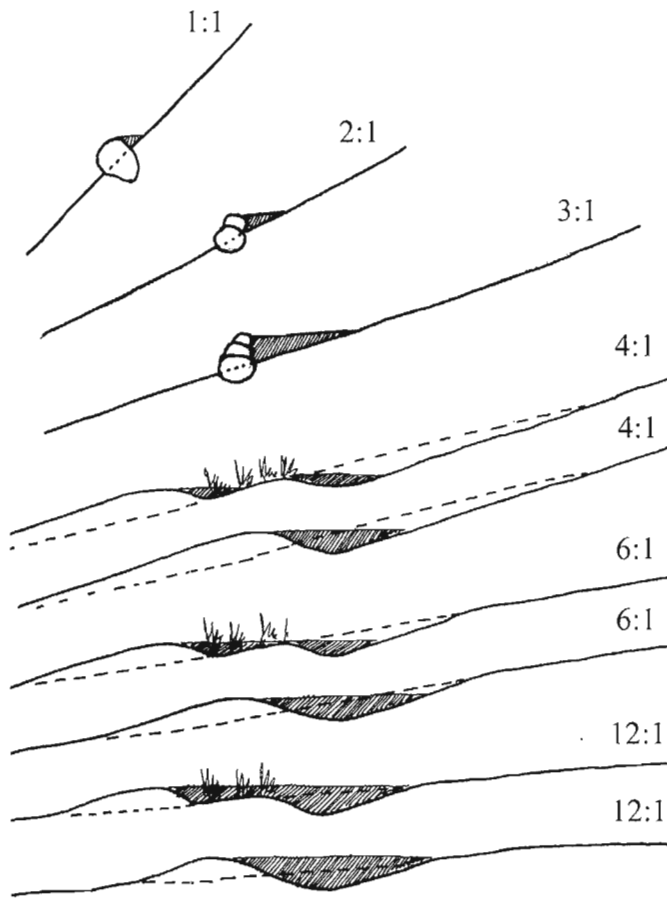

Fig. 2.3. Berm 'n basins and terraces with stone retaining walls at varying slopes. Dotted lines indicate original grade. Shaded areas indicate water-holding capacity of berm 'n basins, and soil-holding capacity of terraces. With the slopes showing berm 'n basins, note the options of one large deep basin versus two shallower basins made by placing the berm farther downslope to leave a strip of undisturbed and vegetated soil between berm and basin. The sides of the berms and basins themselves are constructed so they do not slope more steeply than 2:1. Terraces are appropriate for slopes 3:1 or greater.

bulldozers with a six-way blade, or earth graders in areas where the topography is not irregular or too steep.

**Construction materials:** Try to responsibly use materials at hand rather than purchasing them. Berms can be made of stone, brush, logs, living vegetation, or other nontoxic local materials.

## STEPS TO BUILD A BERM 'N BASIN

### SITING

Assess the slope, water flow, and potential for various water-harvesting strategies throughout your site. Note if and where a berm 'n basin would be appropriate to meet your site needs, and which variation. Take into account the land slope and the condition of the watershed. On steep overgrazed or disturbed land, you will be confronted with large volumes of fast-moving sediment-laden water in intense rainfalls. To manage this water, successive lines of berm 'n basins may be needed, placed at close intervals going down the slope. On gentle slopes covered with thick native grass, the watershed can absorb more rainfall before significant runoff begins, and fewer, more widely spaced berm 'n basins may be sufficient, while causing less disturbance to the intact fabric of the land. Remember the important principle of harvesting water: *Start at the top of the watershed, or as close to the top as you have control over, and work your way down.* If other water-harvesting strategies are better suited above the area you want to make berm 'n basins—start with them, then make your b'nbs if still needed.

Use a bunyip water level or A-frame level to work your way along the contour of the land, staking the location of the berm 'n basin to ensure it will hold runoff water rather than drain it. Mark your berm locations with stakes, flagging, surveyor's spray paint, or a line scratched deeply into soil (fig. 2.4A shows identifying the contour line; fig. 2.4B shows digging along the contour line).

Mark on site all the potential berm 'n basins you plan to build *now* to integrate them with one another. For example, through integration you can ensure that each earthwork overflows to the next below, berms are laid out where you need raised paths, and all looks good too (you can adjust the curves of the berms or the distance between berms so all looks and functions well). On-site markings are key, because they enable you to see and make needed changes to the b'nb placement based on how it relates to other on-site elements such as fence lines, vegetation, pathways, etc. However, consult your site plan to make sure your

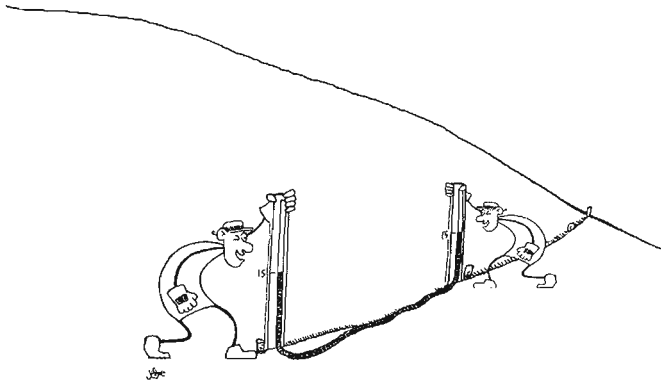

Fig. 2.4A. A contour line identified with a bunyip water level and marked with stakes and a line scratched into the soil for the construction of a contour berm

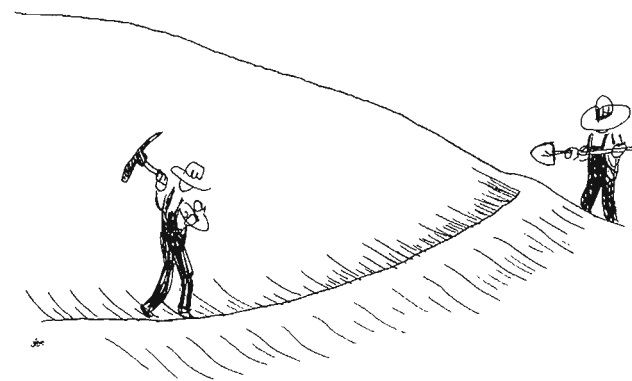

Fig. 2.4B. Digging of the berm 'n basin along the contour line

b'nb placement also works with planned future plantings or other design elements.

Carefully recheck layout and markings *before* you move any earth, since your markings are much easier to change than constructed berm 'n basins. If you hire an equipment operator, complete all preparation work beforehand so s/he doesn't sit around charging you for the time while you scramble to mark the work site.

## APPROPRIATE SIZE

See figures 2.5 A and B for a schematization and the terms that will be used for the various components of your berm 'n basin.

## Berms

Make bigger berms than you need rather than smaller ones. You'll reduce the chance of a berm blowing out (being breached) in a big storm or eroding too quickly. As a rule of thumb, make the base of the berm portion of your b'nb structure at least four times as thick or wide as the height of the b'nb, measured from the bottom of the basin to the top of the berm (fig. 2.6). This will give you a berm with a 2:1 slope, though a more gradual slope of 3:1 will create a still more stable berm.

For example, the berm portion of a 6-inch (15-cm) tall dirt b'nb would be about 24 inches (61 cm) thick at its base. This also gives your berm 'n basins a gradual slope, reducing tripping hazards. The distance from the bottom of the basin, its height, to the top of the berm typically ranges from 6 inches (15 cm) to 3 feet (0.9 m).

In sandy soil, make berms thicker. In clayey soil you can make berms a bit higher and narrower because this soil generally holds together well. In gopher country, regardless of soil type, always go thicker so critter holes will be less likely to blow out the berms. And berms should always be wider/thicker where they double as raised accessways such as foot and wheelbarrow paths (3-6 feet or 0.9-1.8 m; fig. 2.7), a tractor trail (8 feet or 2.4 m), or driveway (slightly wider than vehicle).

Berm spillways will be discussed later. Spillways are indented about 1/3 to 1/2 down from the top of the berm.

## Basins

The basin created by the digging of your berm, on the other hand, because it is dug into a slope, will be considered to be approximately triangular in shape (the point of the triangle being the curve of the berm). Its *length* is the distance that the b'nb runs along the land contour; its *width* is determined by finding a *level* line from the top of the berm's spillway to the back of the slope. *Depth* is the vertical distance from the bottom of the basin to the top of the berm's spillway. For specific calculations determining b'nb water-storage capacity see box 2.2.



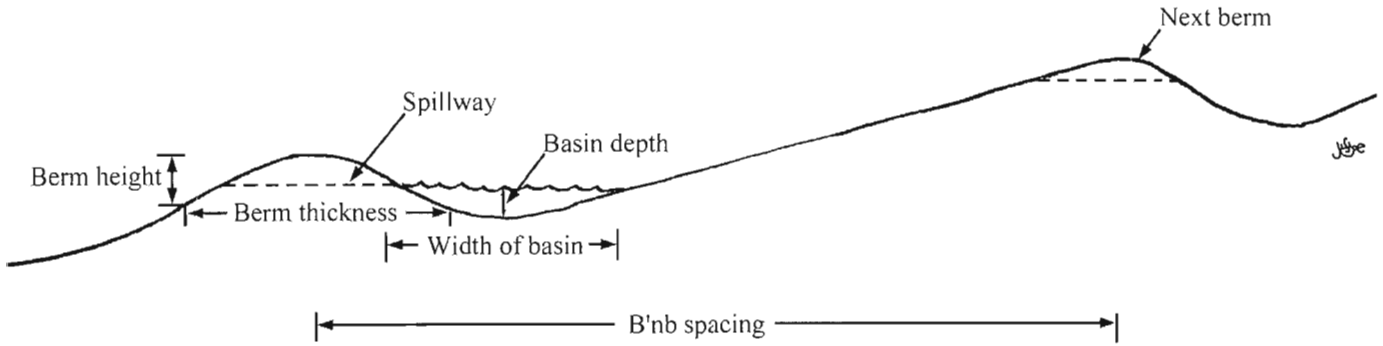

Fig. 2.5A. Cut-away (side) view of berm 'n basin, with measurements

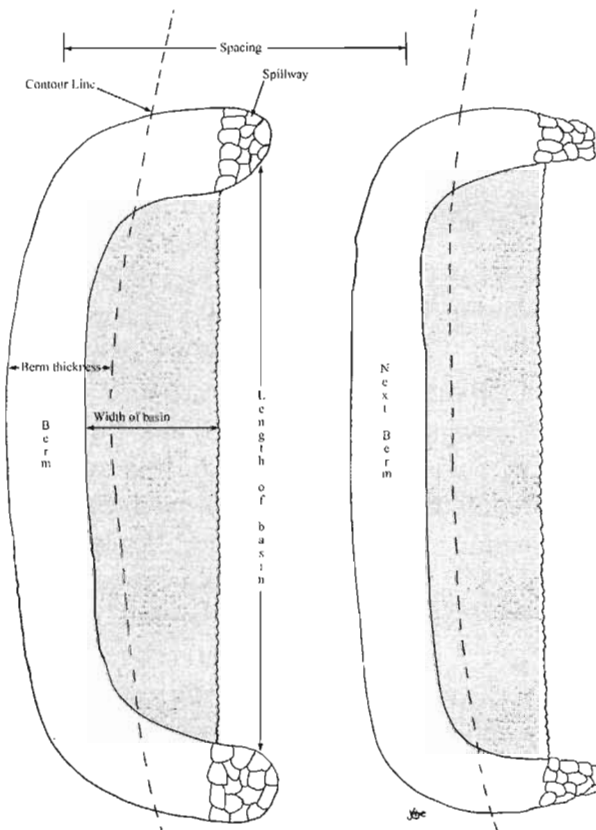

Fig. 2.5B. Overhead (top) view of berm 'n basin

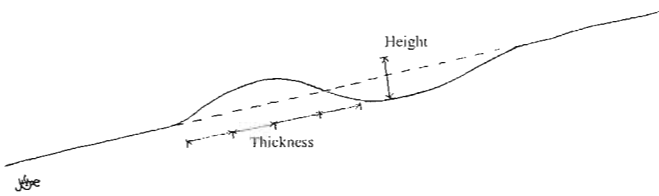

Fig. 2.6. Recommended minimum thickness:height ratio of a berm is 4:1



Fig. 2.7. Raised path with rock-stabilized edges, Lady Bird Johnson Wildflower Center, Austin, Texas

Ideally, the finished “footprint” of a b’nb should eventually be sheltered by the vegetation growing on/within it or canoping over it. The vegetation shelters the berm ’n basin, increases water infiltration, and decreases soil moisture loss to evaporation.

## SPACING

The berm ’n basin is a localized area where a certain volume of water can be caught to be infiltrated into the earth. But, while some of that water is the rain that falls directly on the b’nb, most of the harvested water is from a much larger area, a subwatershed determined by b’nb *spacing*.

Base the berm ’n basin size and spacing on your site goals and rainfall and runoff conditions. You can harvest the same amount of water by building many small b’nbs close together or building two large b’nbs far apart. In the first case, a little bit of water will infiltrate in lots of places throughout your landscape; in the second case, a lot of water will infiltrate in just two places in the landscape. If you want to cover a slope with drought-tolerant plants for erosion control, build many small b’nbs to serve vegetation planted throughout your landscape. If you want to grow water-hungry fruit trees in the desert, build two large b’nbs and plant climate-appropriate fruit trees along them to get a greater concentration of water.

Space berm ’n basins according to their water-holding capacity and the expected volume of runoff. The lower the water-holding capacity of the b’nb, and the greater the volume of expected runoff, the closer together b’nbs should be, resulting in a smaller “microwatershed” serving each. The greater the water-holding capacity of the b’nb and the lower the volume of expected runoff, the farther apart berm ’n basins should be, so a larger microwatershed serves each one. Generally, place and size your structures to hold all the runoff that will drain into them in a typical large storm. In Tucson, at a minimum I strive to hold all the runoff from a 2-inch (51-mm) rainfall. But holding all the runoff from a 3-inch (76-mm) storm is preferable, and hydrates the landscape even more.

You don’t have to build all your berm ’n basins at once. Start with one at the top of your site and add more downslope as you are able. See how the first one performs in a storm. How might you refine your approach? If so much water overflows your berm ’n basin that your berm is eroding away or breached (known as blowing out), make your b’nb bigger or build future ones closer together. If little or no water backs up behind your berm ’n basin, you can probably build future ones smaller and space them farther apart.

As you gain experience, the size and spacing of your berm ’n basins and other water-harvesting earthworks will become more intuitive. For specific calculations to determine spacing of b’nbs, see box 2.3. Appendix 3 includes additional handy calculations for catchment area, etc.

## Box 2.2. Calculating Approximate Water-Holding Capacity or Volume of Berm 'n Basins

### A. MAXIMUM B'NB CAPACITY

To calculate the maximum volume of water your berm 'n basins could hold at one time, you will need to know the depth, width, and length of your b'nb.

- **Depth** is the vertical distance from the bottom of the basin to the top of the berm's spillway.
- **Width** is the horizontal distance from the top of the lip of the berm's spillway to the point upslope where water will back up to.
- **Length** is the distance that the b'nb runs along the land contour.

Figures 2.5, 2.8, and 2.9 show where depth, width, and length measurements are taken; figures 2.8 and 2.9 show dimensions for an example b'nb. Since the water will be held within a rounded triangular space (in cross-section view, as in figure 2.5A) rather than a rectangular space, you will use the equation for the area of a triangle, which in this case is:

$$\text{AREA} = 1/2 \times \text{WIDTH} \times \text{DEPTH}$$

$$\text{VOLUME OF WATER-HOLDING CAPACITY} = \text{AREA} \times \text{LENGTH}$$

$$\text{VOLUME} = 1/2 \times \text{WIDTH} \times \text{DEPTH} \times \text{LENGTH}$$

Plugging in the numbers from our example berm 'n basin:

$$\text{Volume in cubic feet} = 0.5 \times 10 \text{ ft} \times 2 \text{ ft} \times 40 \text{ ft} = 400 \text{ ft}^3$$

Multiply the 400 ft<sup>3</sup> volume by 7.48 gal/ft<sup>3</sup> to convert to gallons:

$$\text{Volume in gallons} = 400 \text{ ft}^3 \times 7.48 \text{ gal/ft}^3 = 2,992 \text{ gallons}$$

That's a lot of water for one small b'nb! And it's much cheaper to build than a tank that holds the same volume.

### B. B'NB CAPACITY PER FOOT OF LENGTH

You can also calculate the water-holding capacity for each 1 foot length of b'nb instead of for a specific length:

$$\text{Volume in cubic feet per 1 foot of berm} = 0.5 \times 10 \text{ ft} \times 2 \text{ ft} \times 1 \text{ ft length} = 10 \text{ ft}^3 \text{ per foot of length}$$

Again, to get gallons, multiply by 7.48 gal/ft<sup>3</sup>

$$\text{Volume in gallons} = 10 \text{ ft}^3 \times 7.48 \text{ gal/ft}^3 = 74.8 \text{ gal/ per foot length of b'nb}$$

*Note that these calculations do not take into account any water infiltrating into the soil, only water collected on the surface, and runoff from upslope.*

See Equations 6B and 7B in appendix 3 for these calculations and examples in metric units.

### Box 2.3. Calculating Berm 'n Basin Spacing Distance

To figure out the spacing distance between b'nbs, i.e., the distance between one berm and the next berm above it (see fig. 2.5), you need to know the typical percentage of total rainwater that will run off a slope. This is known as the runoff coefficient. The runoff coefficient for any given slope depends on what the surface is composed of and whether it has vegetation. Here are suggested *runoff coefficients* for different surfaces expressed as decimals (for example, a runoff coefficient of 85% is equal to 0.85 when expressed as a decimal). Runoff coefficients will be lower for light rains and higher for heavy rains:

- Impervious paving or a building's roof: range 0.85–0.95
- Healthy Sonoran Desert Uplands: range 0.20–0.70, average 0.30–0.50
- Bare earth: range 0.20–0.75, average 0.35–0.55
- Grass/lawn: range 0.05–0.35, average 0.10–0.25
- For gravel, use the coefficient of the ground below the gravel.

The runoff coefficient is greatly influenced by soil type, so there is a broad range of potential runoff values. Large-grained sandy soils have lower runoff coefficients, while fine-grained clayey soils have higher runoff coefficients.

Now, we'll figure out how far apart to put b'nbs. The example site has bare earth with clayey soils, so we'll use the high end of the average runoff coefficient for bare earth, 0.55. We want to harvest most of the rainfall runoff from a large storm; in Tucson, Arizona, this is a 2-inch rainfall event. We want rainfall to be expressed in units of feet instead of inches, so:

$$2 \text{ inches} \div \text{by } 12 \text{ inches/foot} = 0.17 \text{ feet of rainfall.}$$

Then, we use the water-holding capacity of the b'nb calculated in box 2.2 (section B), expressed in units of cubic feet of volume *per linear foot* of berm 'n basin (this was 10 ft<sup>3</sup> per foot of length).

Now, to figure out the spacing distance between b'nbs:

$$\text{SPACING DISTANCE} = \text{B'NB WATER-HOLDING CAPACITY (per unit length)} \div (\text{RUNOFF COEFFICIENT} \times \text{RAINFALL FROM A LARGE STORM})$$

Plugging in the numbers of our example above:

$$\text{Spacing distance} = (10 \text{ ft}^3 / 1 \text{ ft length of b'nb}) \div (0.55 \times 0.17 \text{ ft}) = 106 \text{ ft spacing}$$

This means if you construct your b'nbs about 100 feet apart on the landscape, you will capture most of the rainfall runoff from a large storm in Tucson, Arizona, most of the time (see figure 2.10).

To capture all of the water from even huge rainfalls in Tucson, we use the highest runoff coefficient for bare dirt, 0.75, and use a rainfall of 3 inches, or 0.25 feet (the chance of a 3-inch rain storm happening in any given year in Tucson is 1 in a 100) and calculate spacing distance:

$$\text{Spacing distance} = (10 \text{ ft}^3 / 1 \text{ ft length of b'nb}) \div 0.75 \times 0.25 \text{ ft} = 53 \text{ ft spacing}$$

So b'nbs spaced about 50 feet apart in Tucson would catch every drop of runoff water in a rain event not exceeding 3 inches of precipitation. Remember b'nbs *collect silt and detritus over time*, plus they lose some volume when mulch is thick, so always err on the side of making b'nbs closer together and larger.

See Equation 8B in appendix 3 for this calculation and an example in metric units.

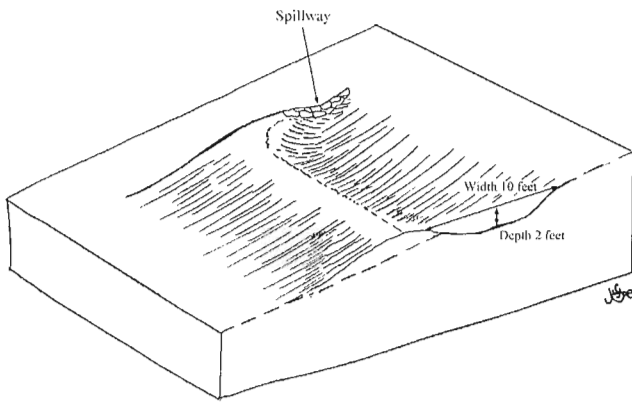

Fig. 2.8. Cross section showing depth and width measurement locations; the depth is 2 feet and the width is 10 feet.

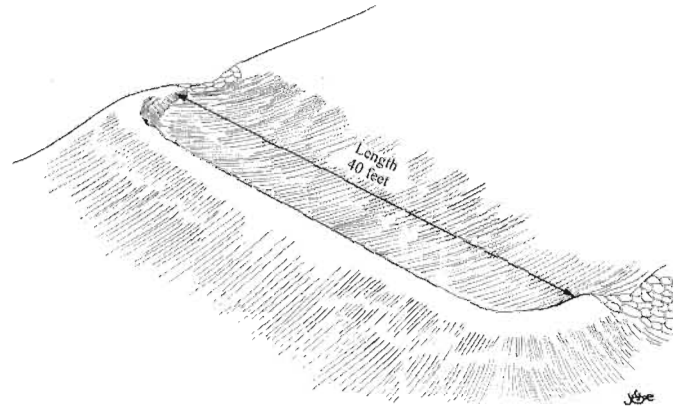

Fig. 2.9. Perspective view showing length measurement; the length is 40 feet.

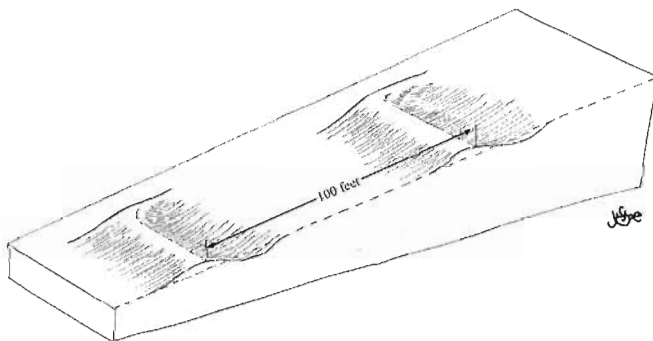

Fig. 2.10. Berm 'n basins 100 feet apart. Not to scale

## CONSTRUCTION

To construct a b'nb, dig a basin just upslope from where you marked its location, then use the excavated dirt to build your dirt berm downslope (fig. 2.11). When digging basins, leave established shrubs and trees in place by digging around them—you want to encourage that vegetation. It doesn't matter if the basin's bottom undulates or is a bit irregular; it is the top of the berm that needs to be level. When building up the berm, go ahead and pile the dirt around smaller existing plants along your marked line. But try not to cover the base of larger trees and shrubs since the soil against the trunk may harm them.

## Hastening revegetation

If working in a well-vegetated area, you can speed up revegetation of the land you disturb with three methods I learned from Dan and Karen Howell of the Running Rain Society:

1. Leave a 1-foot (30-cm) wide undisturbed vegetated strip of land between your berm and basin (figs 2.12A, B).
2. Break up the basin into a series of smaller basins separated by undisturbed, vegetated strips of land (fig. 2.13).



Fig. 2.11. Contour berm dug with rototiller, with dirt from basin becoming the downslope berm. Credit: Tim Murphy

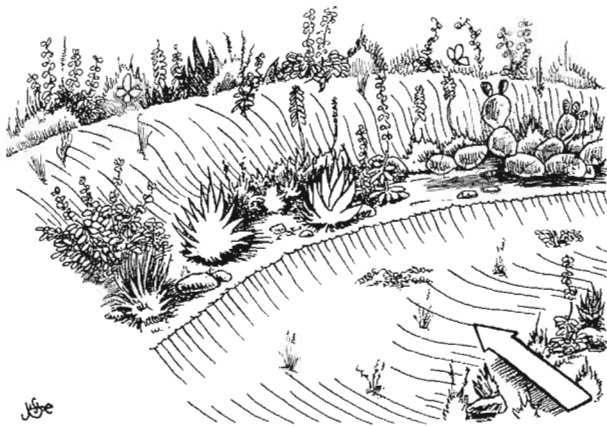

Fig. 2.12A. Speeding up revegetation of earthworks by leaving a strip of undisturbed soil and vegetation between berm and basin

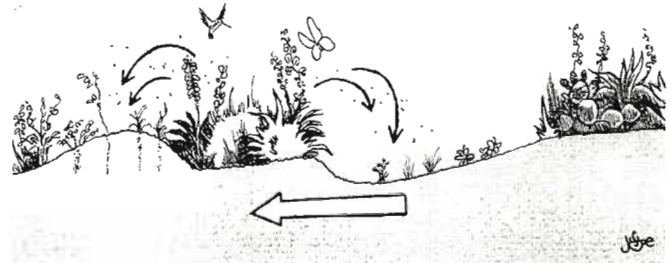

Fig. 2.12B. The vegetation in the undisturbed strips will seed the adjacent bare areas.

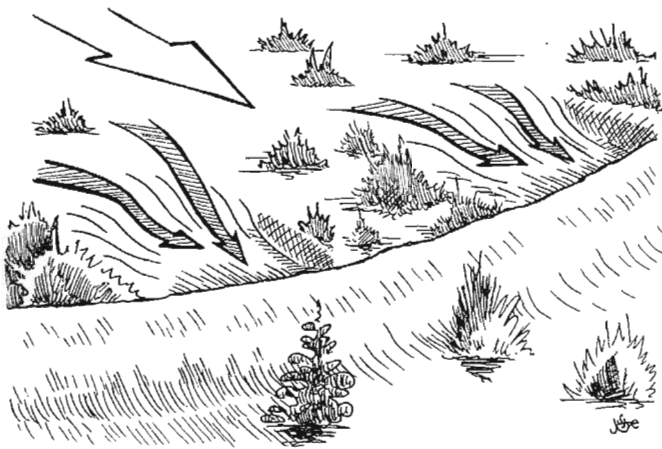

Fig. 2.13. Speeding up revegetation of earthworks by leaving a strip of undisturbed soil and vegetation between sections of basin, in effect creating smaller basins

3. Bring in soil to create berms without the basins. This method works especially well in landscapes with established vegetation, so you don't disturb its roots with digging.

With these methods the established plants will cast seed and provide some shelter over the newly dug or deposited earth.

## Level and tamp your berms

Make the top of the berm level so you won't have any unplanned low points that become unexpected erosive spillways (compare figs. 2.14A and 2.14B). Check the level with a bunyip or A-frame level.

Compact your berms, but not your basins. To make berms safer and stronger, walk on them and tamp them down evenly with your feet (fig. 2.15). A mechanical tamper should be used only where the berm is a path or road, because it will compact the soil so much that nothing to very little will grow on it.

Basins are never tamped, compacted, or sealed. Instead, they are ideally covered with mulch, and can be ripped, graveled, or loosened to increase water infiltration. Note that in wetter climates larger perennial vegetation is often planted atop the berms for better drainage, and on farms the basin becomes a grassed accessory in dry times—sometimes made level and wide enough for a tractor.

If you have ample rocks on hand, lay them on the *downslope* side of the berm for additional stabilization (though this is often unnecessary). Place the rocks carefully and as close together as you can to prevent rainwater from creating concentrated rivulets between the rocks and eroding the berm (fig. 2.16).

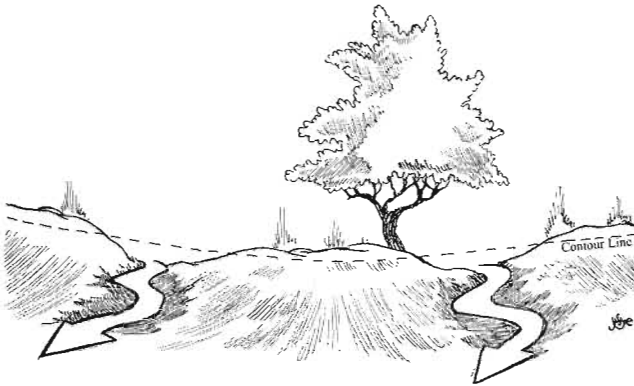

Fig. 2.14A. A failed unlevel berm with low spots that have become unplanned, unstabilized drainages (erosively cut to the bottom of the basin), which drain the berm 'n basin of all its water



Fig. 2.14B. A successful level berm with a planned, stabilized overflow (above the bottom of the basin) allows surplus water to exit the berm 'n basin, while the majority of the water is harvested within the earthwork.

## LOCATION AND CONSTRUCTION OF APPROPRIATE SPILLWAY(S) FOR OVERFLOW

A spillway is a low point in the berm. Locate spillways where slopes are gradual, vegetation is well established, and soil has had little disturbance so you can easily control and utilize the overflow. Avoid steep, disturbed, or sparsely vegetated slopes prone to erosion.

Zig-zag, i.e., stagger, your overflow spillways. When you have a series of berm 'n basins, one above the other, offset the spillways from one b'nb to the next rather than placing one spillway directly above another. Overflow will then zig-zag across the landscape slowly, spreading and infiltrating into the soil, instead of draining straight downhill (fig. 2.17).

In principle, if you start at the top of your watershed and have enough berm 'n basins, they shouldn't completely fill with water except during particularly large storms. Such storms will eventually come. This does not mean you should over-prepare by building



Fig. 2.15. A line of folks stomping/tamping the berm with their feet



Fig. 2.16. Boomerang berms stabilized on their downslope side with rock

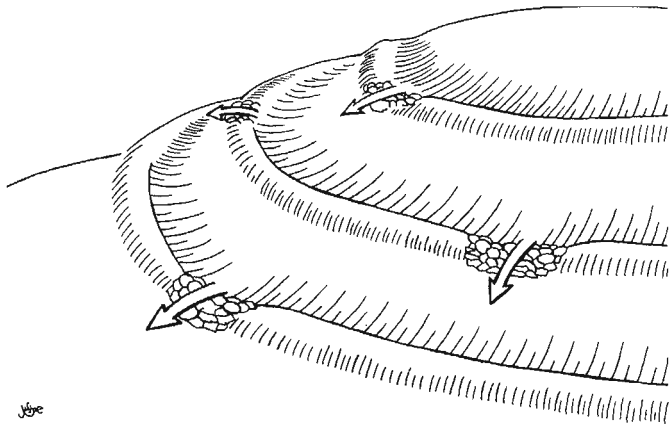

Fig. 2.17. Zig-zagging overflow spillways to spread and infiltrate more of the water's flow

the Hoover Berm. Rather, incorporate a series of spillways into your berms so when they do overflow, it occurs where you've planned for it. That way the long-term effect of your work is productive not destructive—the goal of the fifth water-harvesting principle, *always plan an overflow route*.

Spillways should be indented to around 1/3 the height of the berm in your b'nb. Using this rule of thumb, a small berm that is 12 inches in height would have a modest spillway indented 4 inches below the top of the berm. A 3-foot-tall berm would have a spillway that was 12 inches below the top of the berm. This creates a safe, effective spillway while keeping as much storage capacity as possible in your b'nb.

Build your spillway wide—at least twice as wide as your berm height, measuring from the bottom of the basin to the top of the berm. The spillway will then be less likely to clog with debris, and the water flowing through it will be less constricted and erosive.

If you have a large watershed draining into your berm 'n basin you may need more than one overflow spillway to ensure that you have adequate overflow capacity to handle the incoming water. Ideally you will start implementing water-harvesting earthworks at the top of your watershed and work your way down slope, breaking the larger watershed up into a series of smaller watersheds spaced between earthworks.

Spillways should be stabilized with rock, dense vegetation, or other durable materials, so fast-flowing water won't erode the berms and land downslope. Establish vegetation such as native grass as soon as possible to anchor everything in place. Rocks can be undercut if big storms hit before plants become established. This is called piping. To prevent this, place erosion-control fabrics or a layer of organic mulch under the rocks.

### **Caution:** Keep your berms from flooding what you don't want flooded

To avoid unwanted flooding, examine the area upslope of your desired berm location to see if anything is located there that will be harmed by standing water. If so, relocate the proposed berm downslope to prevent harmful flooding.

Once you've built a berm, double check it with your water level tool (appendix 2). Place one stake of the water level on top of the berm's spillway. Place the other stake upslope of the b'nb at a spot level with the top of the spillway. Mark that spot—it is the highest point water can pool upslope of the berm (contrast figs. 2.18A and 2.18B). To be extra safe, use the top of the berm rather than the top of the spillway as the highest point behind which water can back up.

If there is still a threat of unwanted flooding, lower the height of the spillway or berm, or move the whole b'nb downslope.

## PLANTING YOUR BERM 'N BASIN

Grow a maintenance team within your b'nb. Vegetation's roots aerate and stabilize the soil. Leaf drop decomposes, creating more fertile soil, encouraging the infiltration of water and promoting life and growth. Plants store water in their roots, stems, and leaves; reduce erosion; produce oxygen; attract wildlife; and provide food and shade. Bare earthen berm 'n basins erode, but *living* b'nbs covered in vegetation grow and strengthen themselves.

I prefer to plant right in the basins where water concentrates, especially when planting desert trees that typically grow at or near drainageways, so they're tolerant of temporary flooding. Some folks in wetter



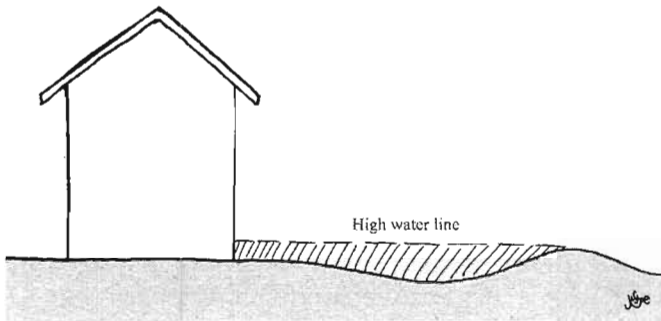

Fig. 2.18A. A poorly planned and located berm 'n basin backing water up against the house

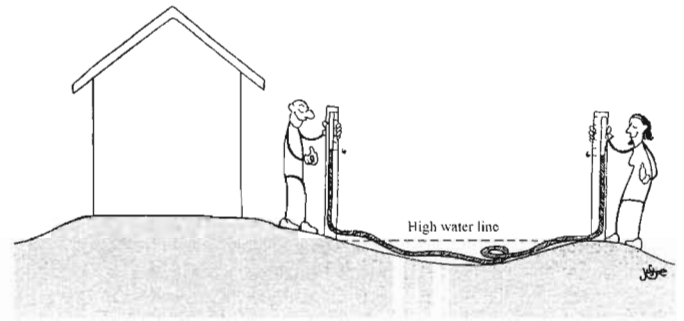

Fig. 2.18B. A well-planned berm 'n basin that won't back water up against the house

climates prefer to place plants downhill of the berms, on top of the berms, or uphill of the basins so plants are outside the basins and won't be temporarily flooded during rains. See what works best for your situation. So that your earthen berm won't erode away in heavy rains, you will also want to scatter native low-water-use groundcover or grass seeds on the berm itself. Select the seed of local plants that naturally grow on exposed dry areas like your berm. Rake the seeds in a bit, then let the rain germinate them, though supplemental irrigation can dramatically speed up the revegetation of the berm.

If you don't buy seed or nursery-grown plants, then collect seed from desirable plants found on site or nearby and scatter these seeds across your b'nbs. Gather organic matter for mulch and put that in the basin too. This will conserve moisture, improve soil, and further enhance microclimates for plants. Some seeds may like to germinate in mulch while others might be suppressed by mulch. So scatter seeds both inside and outside your b'nb to give seeds a chance to germinate in their preferred microhabitat.

For more information on how to plant, see chapter 11 on vegetation; for more specific information on mulch, see chapter 7.

## MAINTENANCE

Check your berm 'n basins often, especially during and after storms. If spillways are eroding, reinforce them. If berms are blowing out, make them bigger, or

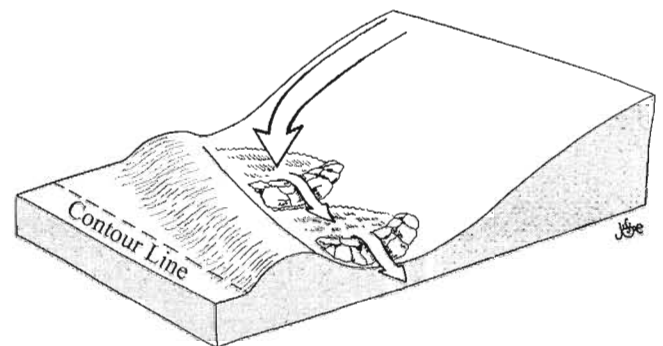

Fig. 2.19. One-rock check dams placed within a berm 'n basin mistakenly placed off contour

see if other water-harvesting structures can be made above them. If a b'nb was misplaced off contour and acts as a water drain, then build small internal berms or one-rock check dams within the basin area, positioned perpendicular to the main berm to intercept the water before it drains away. These internal berms or check dams should be no taller than  $2/3$  the height of the main berm so they don't divert overflow water out of the earthwork (fig. 2.19).

## VARIATIONS OF BERM 'N BASINS

### CONTOUR BERM 'N BASIN

A *contour berm 'n basin* is perhaps the most common variation. It is constructed along a contour line, which is a level line perpendicular to the slope of the land. This strategy can retain runoff water across an entire slope. The length of a contour b'nb is up to you and the site; it could be from 2 feet to 2 miles long (fig. 2.20). Curve both ends of your berm uphill and taper the ends into the slope. This way when it rains, water will be retained by the contour b'nb and will infiltrate into the soil, rather than running erosively

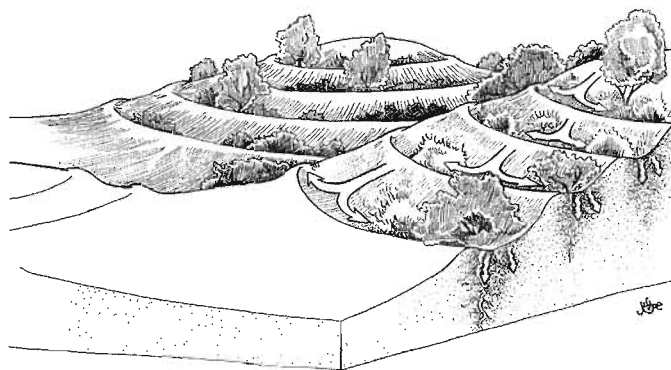

Fig. 2.20. Contour berms

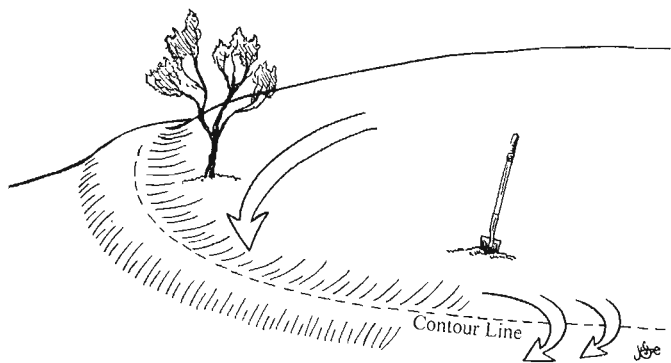

Fig. 2.21A. An unfinished contour berm draining water out its incomplete end

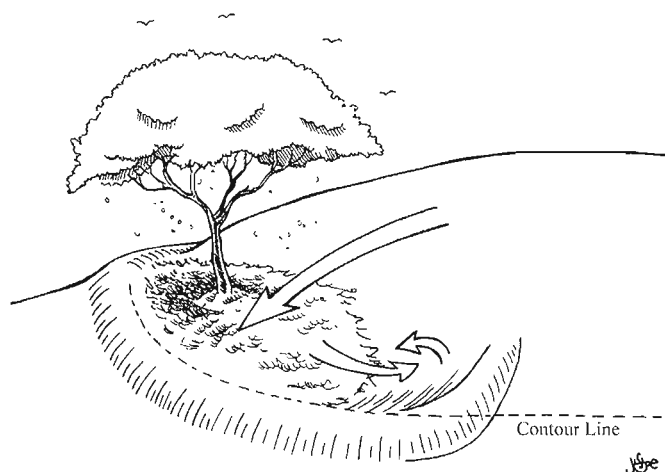

Fig. 2.21B. A finished berm harvesting water, organic matter, and soil

#### Box 2.4. A Water-Harvesting Plant Nursery Laid Out in Contour Berms

For years, friend and permaculturalist Chris Meuli has harvested water successfully in the soil to grow hundreds of trees he plants after growing them out in pots (see his Real Life story in chapter 7 on mulch). Now, he uses these trees, while they are still growing in their nursery pots, to harvest even more rainwater. The pots are set along the contour of his sloping land in rows three pots deep, creating "nursery-pot contour berms" nestled in a mature stand of sheltering pinyon and juniper trees. Chris covers the sides and tops of the pots with mulch to reduce soil temperature and evaporation loss. This strategy reduces Chris' irrigation needs and acts as a form of erosion control. A hose connected to a rainwater cistern upslope of the nursery provides irrigation water. When irrigation water drains through a pot, the excess water is now caught or slowed by the berm made of pots and mulch, so more infiltrates into the soil and waters the surrounding pinyon and juniper trees. And when it rains the contour pots catch stormwater.

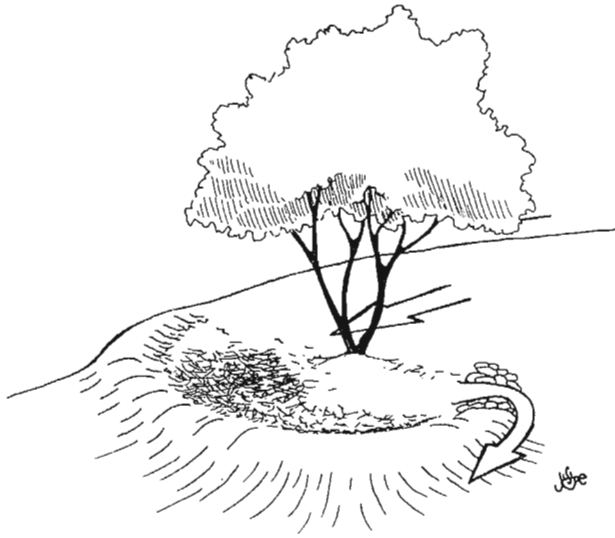

Fig. 2.22. A boomerang berm with one end stabilized with rock and made slightly lower than the other end to act as an overflow spillway



Fig. 2.23. A series of boomerang berms overflowing one into the other

out the ends of the b'nb (see fig. 2.21; see box 2.4 for an example). In areas with a lot of rock, stone berms can be built with or without soil.

Build contour berms only in the more gradually sloping areas above the break line or below the keyline (see appendix !).

## BOOMERANG, FISHSCALE, AND SMILING BERMS

*Boomerang*, *fishscale*, and *smiling berms* are different names for the same type of b'nb (see box 2.5 for an example). From here on, we'll call them boomerangs. They are semicircular in shape with the curved ends facing upslope, like someone opening their arms to the upslope water as if to give it a big welcoming hug: "'Cause we love that water!" Boomerangs concentrate water around an existing or proposed plant. You can create just one or a whole array of them. A hillside of native trees or a fruit orchard planted in boomerangs resembles "miles of smiles."

The two ends of a boomerang berm are typically level with one another, while the rest of the berm dips downslope to create a cuplike shape. However, the top of the berm is made level, so the height of the berm will be shorter at the ends of the berm and taller in the middle of the berm. Mark the two level ends of

the boomerang with a water level or A-frame level, then mark the location of the dipped berm from end to end. That done, dig out the basin and make the berm. Or, just make the berm by bringing in soil.

Stabilized spillways can be situated at one or both of the curved ends of a boomerang (figs. 2.22 and 2.23). To direct overflow around just one end, make that end a little lower than the other. Use an A-frame or bunyip water level to check your work. When

### Box 2.5. Boomerang Berms Revegetate Degraded Land

At the Tucson Audubon Society's Santa Cruz River Habitat Site northwest of Tucson, boomerang berms are helping revegetate sloping sandy flood-control dikes, while reducing the need for irrigation. Project manager Ann Audrey reports that, "In a test-plot area, native vegetation was planted with and without boomerang berms to compare the results. After the first significant summer rain of the season, the soil moisture only reached a depth of 4 inches (10 cm) where no boomerang berm existed. Yet, where there were boomerang berms, soil moisture reached a depth of over 20 inches (50 cm). A year later, plantings within berms are noticeably bigger and healthier than those without such earthworks."<sup>2</sup>

### Box 2.6. A Net-and-Pan Orchard System in the Negev Desert

In the Negev desert of Israel, botanist Michael Evenari successfully grew an orchard of olives, apricots, pomegranates, almonds, grapes, and saltbush for pasture on a scant 4.1 inches (105 mm) of average annual rainfall without supplemental water. He planted each tree, vine, or shrub within its own microcatchment—a separate microwatershed ranging in size from 168 ft<sup>2</sup> (15.6 m<sup>2</sup>) to 10,760 ft<sup>2</sup> (1,000 m<sup>2</sup>). Each microcatchment or “pan” in Evenari’s orchard was surrounded by an earthen berm or “net” about 8 inches (200 mm) high. These berms captured the rainfall and concentrated its moisture within the broad root zone of the planted tree or vine. Microcatchment size was based on the **water needs** of the plants and the amount of rainwater expected to fall within the earthwork (appendix 3 gives you the calculations to do the same; appendix 4 provides water needs and calculations for sample plants for Tucson, Arizona.)

The greater a plant’s water needs, the greater the size of its microcatchment—up to a point. Evenari found that if a microcatchment was too big it actually provided less benefit to the plant than a smaller microcatchment, because a significant amount of water was lost to evaporation, and much of the moisture that did infiltrate into the soil did so beyond the plants’ root systems.

When sized correctly, no supplemental irrigation was needed within the net-and-pan orchard. The rainwater was simply used where it was harvested.<sup>3</sup>

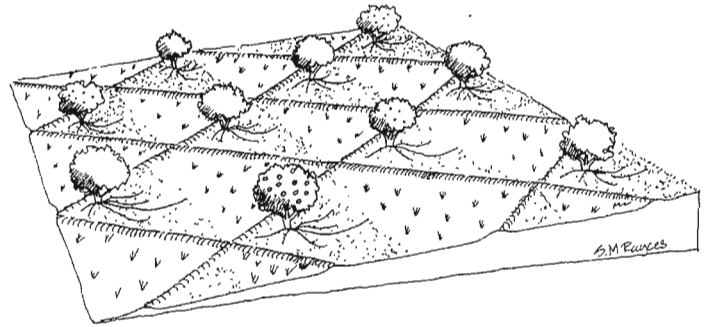

Fig. 2.24. A net-and-pan system of berms. The upper half of the pan is a catchment surface draining water to the lower half where the water infiltrates into the root zone of the tree.

height of a berm in a net-and-pan system is consistent from one part of the berm to another, but since the berm runs up and down hill, the elevation of the top of the berm is not level, as it would be with a boomerang berm. See box 2.6 for an example.

Appendix 6 lists further resources on various kinds of berms.

## MULTIPLE FUNCTIONS OF BERM 'N BASINS

### BERMS AS PATHS, DRIVEWAYS, AND ROADS

The berms of b'nbs can often double as raised accessways. This keeps the paths high and dry, and the adjacent basins and plant roots sunken and moist



Fig. 2.25A. A berm as a raised path

creating a series of boomerangs always direct overflow from one to the next to attain the spread and sink principle.

## NET-AND-PAN SYSTEM

A net-and-pan system is a modified series of boomerang berms connected directly to one another, concentrating harvested runoff at multiple points in the landscape. A completed system looks like a “net” of berms draped over a hillside with “pans” or basins inside each segment of the “net” (fig. 2.24). The



Fig. 2.25B. A berm as a raised driveway/road, Dancing Rocks Permaculture Community, Tucson, Arizona. The driveway runs along the contour, halting runoff from the land upslope. Mulched basins along the road then infiltrate the water to establish and enhance soil-stabilizing vegetation. The road surface is stabilized with stone and gravel collected on site when four building pads were excavated. The banks of the raised driveway could be further stabilized with larger rock if the need arises. Note that the driveway was kept as narrow as possible to reduce the negative impact to the landscape.

(figs. 2.25 A,B). See chapter 8 on permeable paving as well as appendix 6 for road construction guide resources.

### BERM 'N BASINS AS EROSION CONTROL: BRUSH BERMS

Since berm 'n basins slow the overland flow of runoff, they simultaneously reduce soil erosion. Brush berms can be used high in the watershed where sheet flow of runoff is light. Lay enough brush in direct contact with the soil so you don't have big openings that would let concentrated water quickly escape and cause more erosion. You can anchor the brush in place with downslope stakes, the mass of large branches, or by partly buried branches (fig. 2.26).

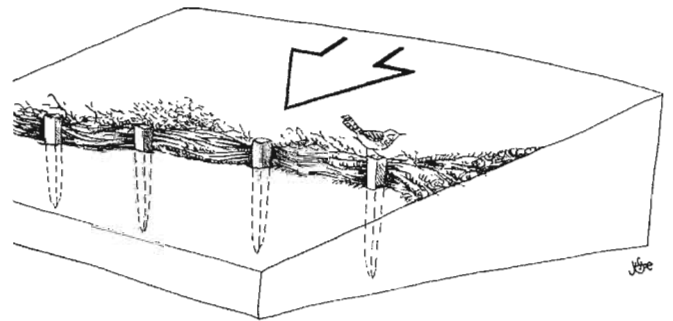

Fig. 2.26. Brush berms anchored with downslope stakes

## BERM 'N BASINS AS FIREBREAKS

Vegetation planted around water-harvesting earthworks has more available moisture than vegetation in the general landscape, so it can be more resistant to drought and fire. To enhance this effect, plant drought-hardy, fire-resistant vegetation such as saltbush (*Atriplex* spp.), thornless nopal cactus (*Opuntia ficus-indica*), or aloe (*Aloe* spp.) within contour berms, and situate them on fire-prone slopes or in the path of prevailing winds that could carry a fire. See appendix 6 for more information on designing for fire protection.

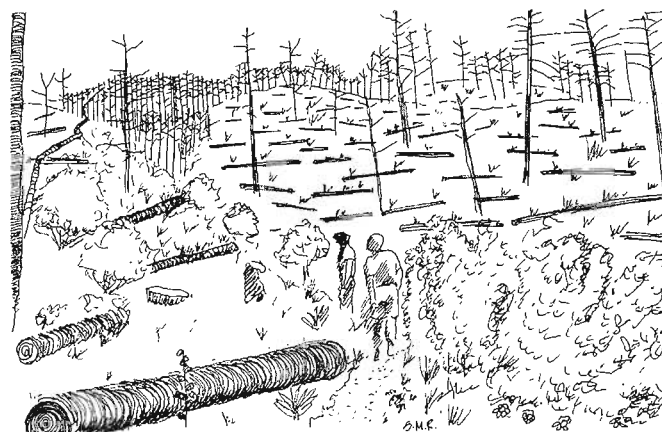

Fig. 2.27. Sketch of burned trees felled on contour to act as log erosion barriers stabilize the landscape at Lama, New Mexico

## REAL-LIFE EXAMPLES OF BERM 'N BASINS

### THE GRANDMOTHER APPROACH — DRAGOON, ARIZONA

Two senior homesteaders in rural southeast Arizona stroll their rolling land every day. As they walk, they reposition small, fallen branches or agave stalks so they lie perpendicular to the slope. They roll small rocks with their feet to create terrace-like berms, and pile prunings and brush into serpentine contour lines. They do just a little bit each day, in a relaxed, meditative way. Though slow, it *is* making a difference. New plant growth has germinated in the water-and-soil net of their simple earthworks, and this in turn is attracting ever more beneficial wildlife.

### USING TREES KILLED BY FIRE TO BRING BACK THE FOREST—LAMA, NEW MEXICO

In 1996, a 7,000-acre (2,828 ha) forest fire ravaged most of Lama Mountain north of Taos, New Mexico. The Lama Foundation, a spiritual community nestled on the mountain, found itself surrounded by a scorched landscape spotted with a standing forest of dead and charred ponderosa pines. The dead trees were weak and some snapped and fell in the wind. With the land burned bare, erosion promised to be severe with coming rains.

The Lama residents decided to act. They cut the weakest trees so they would land perpendicular to the slopes, a common forestry practice called *log erosion barriers*.

The logs didn't have adequate contact with the ground so the community lopped their branches and piled them on the upslope side of the logs, then covered everything with loose straw, creating a sturdy barrier to trap sediment. Vast networks of these log-and-branch berms were created across the land. In addition, the community built check dams of logs, branches, straw bales, and rock within the drainages (fig. 2.27).

While the community had done extensive work, it wasn't enough to prevent a devastating flow when the first big storm hit. The lack of material and vegetation to absorb rainfall and brake runoff, in combination with the high mobility of loose ash and fire-scorched soil, led to sediment and stormwater pouring down the slopes.

However, the check dams and most of the log-and-branch berms held firm. These structures trapped soils, sediments, and seeds, creating a foothold where revegetation could begin. Millions of small plants popped up around the berms, creating "living berms" of new vegetation. With the help of these plants and the earthworks constructed by the community, the land recovered faster here than other areas affected by the fire.<sup>4</sup>

## HARVESTING WINDSWEPT SNOW WITH WINDBERMS—MORIARTY, NEW MEXICO

*By Chris Meuli*

During the severe drought of spring 1996, the Lama Foundation wildfire north of Taos, New Mexico, made me look at my semirural land through new eyes. Convinced that such a disaster could also happen in Edgewood, I thinned pinyon pine and juniper trees that were crowded, diseased, or too close to buildings. (Later, I was surprised how many microclimates this tree thinning would create. Around the remaining trees, a circle of shade shifted daily where there had previously been a deep darkness under the crowded crowns of the trees. These circles of sunshade interface created a great diversity of sites suitable for a variety of planting.) Then the question was, “Where can I use this biomass that I’ve thinned with the least amount of work for the greatest benefit?”

Nearby, on the windswept, treeless high plains desert near Moriarty, New Mexico, I have been working for over a decade to establish windbreaks. But the versatile honey locusts I planted in the 1980s had stopped growing vertically and started growing horizontally in the persistent wind of this site. More recent plantings of hardier evergreens paired with contour berms were faring better, but to improve success, the drying effect of the harsh wind needed to be addressed. So I hauled the thinnings (“slash”) from Edgewood over to Moriarty to construct windberms for the young windbreak trees. Windberms are built structures that serve the same purpose as traditional windbreaks, which are typically “grown.” The idea was to slow the wind down, deflect it off the ground, and attenuate its strong mechanical forces. Perhaps the windberms would also harvest moisture during the blowing winter snows.

At this 20-acre (8-ha) site a relentless westerly wind blows virtually parallel to the contour, and annual precipitation averages 14.5 inches or 368 mm at an elevation of 6,217 feet or 1,894 m. During most days, the wind is a constant 5 to 15 miles (8–24 km) per hour with regular gusts to 15 to 45 miles

(24–72 km) per hour in the spring. By feeling, hearing, and seeing the patterns of blowing sand and debris, I knew that the wind direction varied 30–45 degrees from moment to moment. Berms curved with their “backs” into the wind, so to speak, could address this constant variation.

Based on traditional windbreak design, windberms should be semipermeable so that they can filter and slow the wind. In contrast, a solid wall of material can cause scouring and actually amplify wind effects. A windbreak will calm the wind to a distance 3 to 5 times the height of the windbreak on the windward side and to a distance 10 to 15 times the height of the windbreak on the leeward side. Berms can be placed to complement or alter the existing patterns created by water flows, roads, fences, structures, windbreaks, and human and animal paths.

Tree slash, cactus cuttings, prunings, discarded lumber scraps, and many other “waste” products prove useful in constructing a windberm. Established trees, shrubs, and cacti can anchor the berm to the ground.

Fifteen pick-up loads of slash were sufficient to construct five windberms, each 3–4 feet (0.9–1.2 m) high and 40–120 feet (12–36 m) long. Stacked in interlocking patterns, the slash did not blow apart in gusts of wind. Overlapping the ends of the windberms prevented wind from funneling between two adjacent windberms while allowing room for walking and pulling a cart between them (fig. 2.28).

By the end of the summer, the slash had dropped most of its needles, mulching the ground beneath it and adding much-needed organic matter to this recovering former cattle range. The berms also enhanced the habitat for reptiles and small mammals.

The effect that the windberms had on a snowfall the following January was dramatic. Severe winds blew the 16 inches (40 cm) of snow off of my neighbors’ land into drifts that were 2 to 3 feet (0.6–0.9 m) deep on both the windward and lee sides of the windberms (fig. 2.29).

Two years later, there is a dramatic increase in the size and health of the trees on both sides of the windberms compared to trees further away. A great diversity of vigorous groundcover and grass has grown up in and alongside the berms. These enhance the wind-

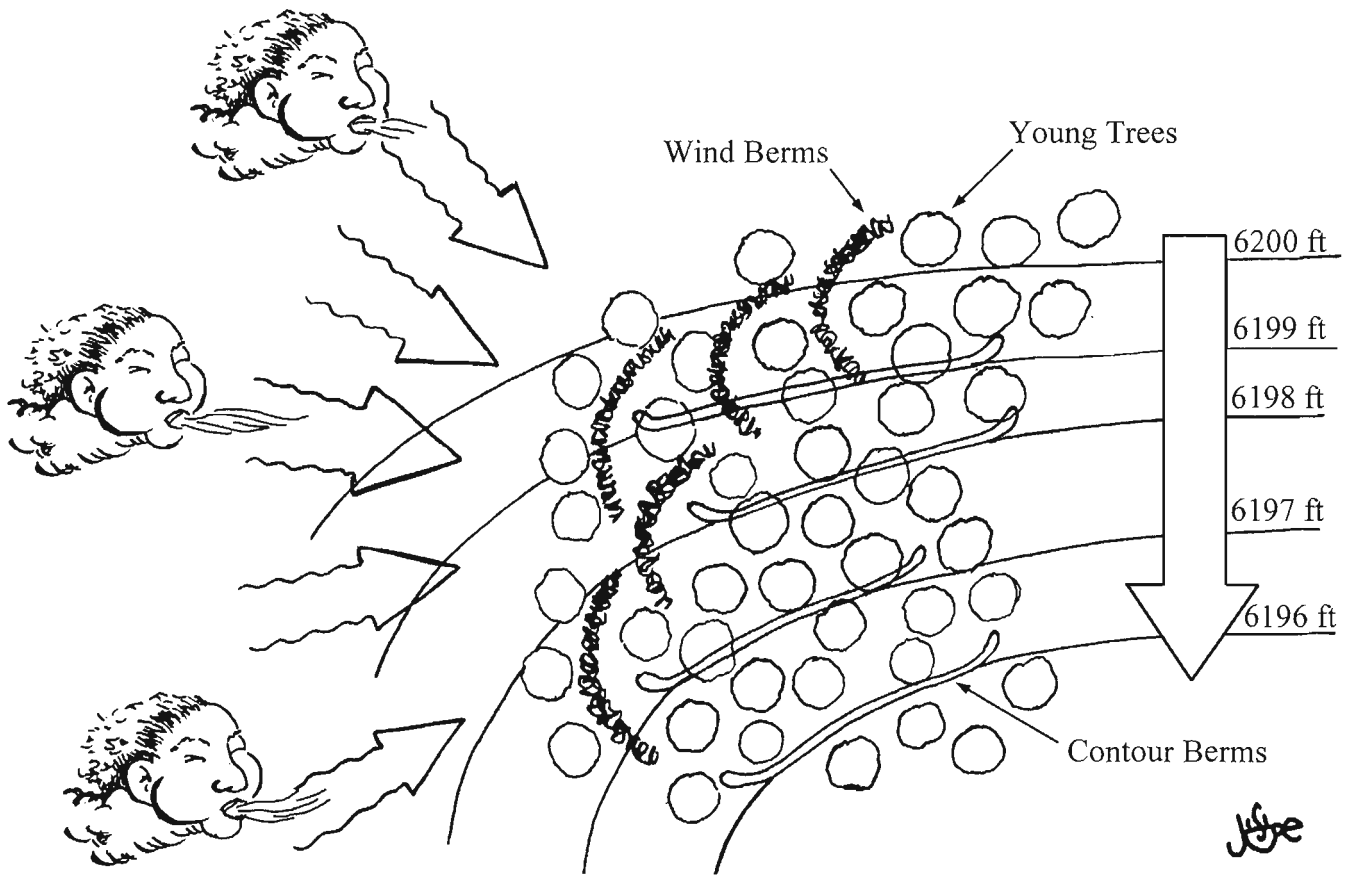

Fig. 2.28. Plan view of Chris Meuli's windberms, contour berms, and young tree plantings

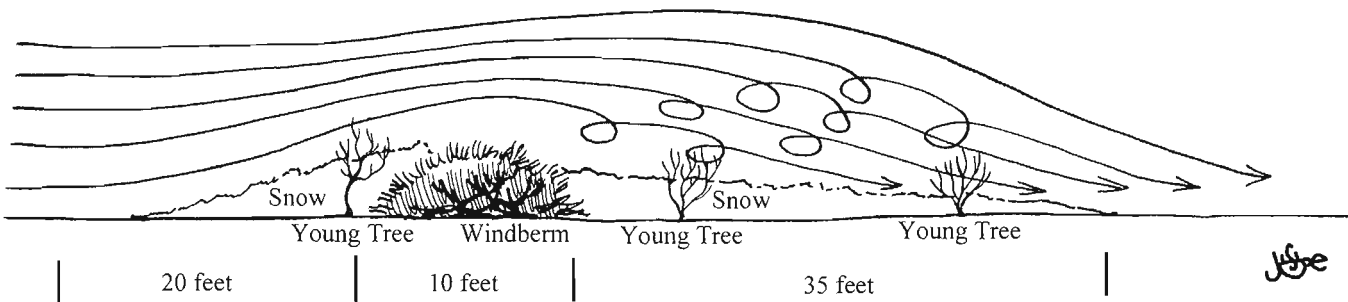

Fig. 2.29. Side view of windberms, young trees, and harvested snow



modifying, shading, mulching, and water-retention effects.

*Chris Meuli experiments with simple techniques that enable humans to live sustainably in New Mexico. You can contact him by leaving a voice message on his phone at 505-281-4871 or by email at mpermadr@aol.com.*

*This story is adapted from an article that first appeared in the Permaculture Drylands Journal, Number 31, Winter, 1998. Used with permission.*

See the resources in appendix 6 for more information on windbreak and snowbreak design.

## BERM 'N BASINS IN WET LANDS— OREGON

Toby Hemenway, author of the wonderfully integrated gardening guide *Gaiá's Garden*, is an avid fan of berm 'n basins, which he calls “swales.” In his south-

ern Oregon climate rain falls all winter but can cease for months at a time in summer. On the slope just below his home, Toby dug an 80-foot (24-m) long, 3-foot (0.9-m) wide berm 'n basin. As Toby states (in which he refers to b'nbs as swales), “It's made a tremendous difference, holding moisture long after the rains have gone. Come summer, above the swale the grass shrivels and browns within days after the rains stop. Below it, not only does the greenery remain verdant for weeks longer, but many new wildflower species have spontaneously appeared in the welcoming microclimate. Humus is building, diversity is growing. I've found that letting water concentrate and soak in via swales will store it in the soil deeper and longer than if the water simply spreads across level ground. I'm sold on swales.”<sup>5</sup>



# Terraces

## WHAT IS A TERRACE?

A terrace, sometimes called a bench, is a relatively flat “shelf” of soil built parallel to the contour of a slope (fig. 3.1). This is not to be confused with a retaining wall that may support the terrace of soil. Terracing creates *flat* planting areas for gardens, orchards, or native vegetation that will utilize the harvested water and stabilize the slope. And as you will see in the Tarahumaran Indian example at the end of this chapter, terracing can also check erosion, harvest soil, and recharge wells. This is an energy-intensive strategy requiring a good deal of soil and rock movement, so it is typically reserved for use on smaller



Fig. 3.1. Terraces stabilized with dry-laid walls made from salvaged concrete sidewalk or “urbanite” in the sloped backyard of the Zemach residence, Los Alamos, New Mexico

sloped lots where space is limited, and the need for planting space will justify the work. A series of terraces creates a steplike effect that encourages more water to infiltrate into the soil than run down the slope, while helping control erosion. Terraces can be used on steeper slopes than berm ’n basins if stabilized with a retaining wall on their downslope side. The walls can be beautifully simple, using only natural or salvaged stone, gravity, and the right angle and care in their installation to hold them in place—no mortar is needed. And the retaining wall, if no taller than 18 inches (45 cm) high, can double as a seating bench.

Unlike berm ’n basins, terraces do not have depressions built into them, so in order to retain more rainwater and accumulate organic material, they need to be bordered by the top of such a wall or a berm. The terrace also spreads the water out more over the wider level surface so everything within is more evenly watered and less likely to drown.

This chapter discusses three kinds of terraces: a) earthen terraces without retaining walls, b) dry-wall stone or concrete-chunk retaining-wall-stabilized terraces, c) masonry-wall-stabilized terraces. I prefer the first two kinds of terraces, and provide instructions for building them. I do give a reference for masonry terraces, but am not really promoting them—especially if mortar is used, as I feel it’s better to use porous dry-laid retaining walls, preferably with native, salvaged, or at-hand materials (fig. 3.2).



Fig. 3.2. Terraces stabilized with dry-laid stone walls and accessed via a whimsical stairway. Stonework by Goettling McGee, Inc., Seattle, Washington

How would you know which type of terrace to build? The slope and the look you want determine it. Only gradual slopes can handle terraces without retaining walls, and these terraces act a lot like stepped basins. Terraces with retaining walls are for steeper slopes; they are more work up front, but can be less maintenance down the road due to the stability of the retaining wall (it doesn't erode).

## WHERE IS A TERRACE USED?

Of all the strategies in this book, this is the water-harvesting approach that *needs the most caution*. While terraces are used successfully throughout many parts of the world, the progressive failure of poorly built or poorly maintained terraces breaking down in a domino effect can cause severe land damage, probably worse than if they not been built at all.<sup>1</sup> For this reason, this book limits its scope to backyard-scale terrace construction within backyard-scale watersheds. Here your chances of success are increased and your chances of failure (and consequences of failure) decreased.

I'm defining a *backyard application and scale* as one where:

- You are in control of your entire watershed and you have implemented strategies to harvest or divert all potential upslope runoff before it enters your planned terrace area.

Reason: You do not want to risk unchecked or unforeseen flows from upslope blowing out your terraces. Clearing vegetation, diverting water, wildfires, and construction can all create or magnify erosive runoff.

- Both the slope on which you are constructing the terraces, and the slopes above and below the terrace work, do not exceed 2:1.

Reason: Steeper slopes are far more challenging and risky locations to construct terraces, and should be left to experienced terrace builders, or those under the supervision of knowledgeable engineers.

- There are no sublayers of clay beneath the area where you plan to construct your terraces.

Reason: Clay is soil's natural grease. If soil on a slope above a clay layer becomes supersaturated with moisture, you risk the chance of a localized landslide.

- Terraces are built at a scale that you can do yourself.

Reason: You want structures that you can easily manage and maintain yourself.

If you want to tackle larger or more challenging sites, do so only with the supervision of an engineer and/or experienced stone mason familiar with local conditions and the utilization of terraces for harvesting rain in the soil.

Terracing is an energy-intensive strategy, and will cause much disturbance to the land when the work is being done. This disturbance will be slow to revegetate in drylands. So, this strategy is only recommended in areas of intensive use, such as back- or frontyard gardens or actively maintained agricultural land, that will provide the needed inputs to quickly vegetate/stabilize the terraces and maintain them.

A terrace is most effective when constructed on a gradual slope that has stable soil. The ratio of the amount of earth moved to the amount of terrace created decreases as slopes get steeper, making the work less practical and efficient. Terracing for agriculture is preferable at slopes of 10–18° (18 to 33% grade).<sup>2</sup> Nonetheless, in many parts of the world where arable land or space is limited, such as Cape Verde, the

Andes of Peru, and parts of Southeast Asia, terraces are common on slopes much steeper than 22° (40% grade).<sup>3</sup> In such systems rainfall is harvested within the terraces, and often creek or runoff water is directed through them for supplemental irrigation. I reference sources that cover such uses of terraces but the information I present here deals *only* with harvesting rain that falls directly on the terrace and the minor slope between terraces that are built in a series.

Terraces are not appropriate in soils prone to waterlogging where rainwater infiltration could lead to saturated subsurface conditions due to the presence of layers—such as clay—that impede the movement of water down through the soil.

## TOOLS AND MATERIALS

**Tools:** For earthen terraces you'll need: an A-frame or bunyip water level (appendix 2 provides instructions for making these simple tools), a pointed shovel, and a pick or mattock. A backhoe comes in handy for larger-scale terrace projects where you have adequate access.

If constructing retaining walls for your terrace you will also need a hand tamper (see fig. 3.10 later), wheelbarrow, pry bar, stone mason's hammer, and sledgehammer.

**Materials:** Mulch to cover the surface of the terrace and its berm, seeds and/or live plants to vegetate the terrace, berm, and any areas of disturbance.

If you are constructing retaining walls, you will need angular stone or broken-up chunks of concrete sidewalks ranging in size from 12 to 24 inches (31–61 cm) long. Ready-made stone for dry-stacked retaining walls is usually available for purchase at your local mega-home-project store, but try to find at-hand alternatives.

## IMPLEMENTATION STEPS TO BUILD A TERRACE

### SITING

Determine if and where terraces will meet your needs and if a retaining wall will be needed (fig. 3.3). As a general rule, the added support of retaining walls will probably not be needed if the terraces are located on well-vegetated slopes with stable soils, and they are constructed in locations with a slope of 3:1 (18° or 33% grade) or less, both above and below the terrace itself. It is your responsibility to assess whether the slope you are working on is stable. If you have any doubts about its stability, consult an engineer.

If slopes are steeper than 3:1, build retaining walls.

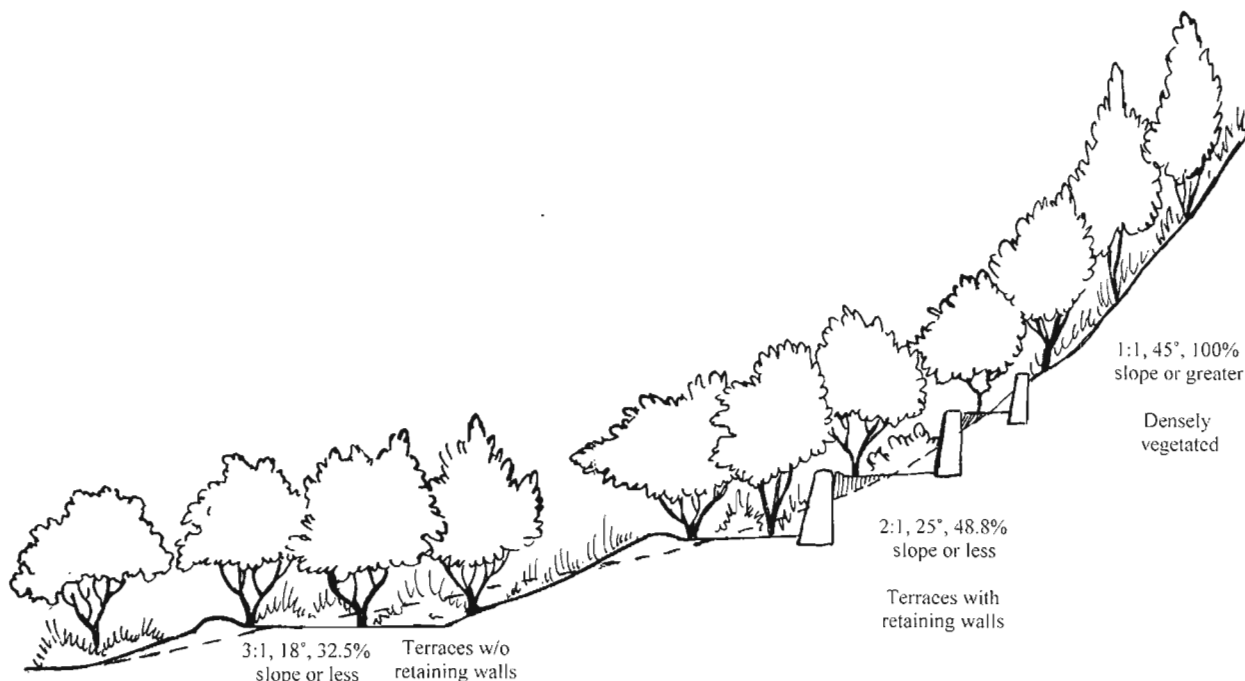

Fig. 3.3. Different strategies for different steepness of slope. Note that the retaining walls drawn in this illustration would likely need to be designed/constructed by experienced professionals due to steepness of slope drawn. Note that slopes described in text are appropriate for backyard applications.

### Box 3.1. Calculating Approximate Water-Holding Capacity (Volume) and Spacing of Terraces

#### WATER-HOLDING CAPACITY OR VOLUME

The calculation process for terraces is generally the same as that used for berm 'n basins (see the previous chapter on berm 'n basins, boxes 2.2 and 2.3). The one difference, because the terrace is flat, is that the terrace calculation is adjusted to reflect the more rectangular shape (in cross-section) of the terrace. Therefore you calculate the size, or water-holding capacity, of a rectangular terrace with the following calculation for volume:

$$\text{VOLUME OF WATER-HOLDING CAPACITY (ft}^3\text{)} = \text{LENGTH (ft)} \times \text{WIDTH (ft)} \times \text{DEPTH (ft)}$$

For example, you're planning to build a terrace that is 24 feet long, 8 feet wide, and 4 inches or 1/3 (0.33) foot in depth below the spillway.

$$\text{Volume in cubic feet} = 24 \text{ ft} \times 8 \text{ ft} \times 0.33 \text{ ft} = 63.36 \text{ ft}^3 \text{ (rounded up to } 64 \text{ ft}^3\text{)}$$

Multiply by 7.48 gal/ft<sup>3</sup> to convert to gallons:

$$\text{Volume in gallons} = 64 \text{ ft}^3 \times 7.48 \text{ gal/ft}^3 = 478.7 \text{ gallons}$$

You may also want to calculate the per-foot volume of your terrace. In some cases, you may not need this, as the constraints of a small backyard may determine the size of your terrace. However, in terracing a larger area with catchment area upslope, it will be useful for calculating spacing between terraces.

$$\text{VOLUME IN CUBIC FEET PER 1 FOOT OF TERRACE} = 1 \text{ (ft) LENGTH} \times \text{WIDTH (ft)} \times \text{DEPTH (ft)}$$

$$\text{Volume in cubic feet per 1 foot of terrace} = 1 \text{ ft} \times 8 \text{ ft} \times 0.33 \text{ ft} = 2.64 \text{ ft}^3 \text{ per 1 foot of length}$$

#### SPACING

If it seems possible to use terracing for water harvesting over a large area, with multiple terraces or other earthworks catching rainfall from a large slope, you may find this calculation useful. Once you've calculated the water-holding capacity of your terrace per foot of length, calculate its spacing related to the catchment area above the terrace.

$$\text{SPACING DISTANCE (ft)} = \text{TERRACE WATER HOLDING CAPACITY (ft}^3 \text{ per 1 ft length)} \div (\text{RUNOFF COEFFICIENT} \times \text{RAINFALL FROM A LARGE STORM (ft)})$$

Using the figure of 2.64 ft<sup>3</sup> per 1 ft length, assuming a runoff coefficient of 0.40 for a healthy Sonoran desert indigenous landscape (see runoff coefficients in box 2.3), and wanting to capture all the runoff from a 3-inch or 0.25 ft storm (3 inches ÷ 12 inches/ft = 0.25 ft):

$$\text{Spacing distance} = (2.64 \text{ ft}^3 / 1 \text{ ft length of terrace}) \div (0.40 \times 0.25 \text{ ft}) = 26.4 \text{ ft spacing}$$

See appendix 3 for metric calculations.

Choose the general locations for your proposed terraces based on your site goals. Water-harvesting terraces are often used on smaller, sloped lots to maximize the amount of gardening and planting space. Use an A-frame or bunyip water level (see appendix 2) to find the land contour in these locations, then mark the terrace locations with stakes, flagging, surveyor's spray paint, or a line scratched deeply into the soil.

Mark all the potential terraces you are planning to build now, in order to integrate them with one another. Unlike a series of berm 'n basins, a series of terraces should be constructed *starting from the bottom of a slope and moving up*. This is helpful because once you build the first terrace at the bottom, you will have a level terrace from which to work as you move upslope. Each terrace then helps stabilize the base of the terrace built above it. In addition, the topsoil removed during the construction of a higher terrace can be spread out on the terrace below to help build its soil layer.

Remember, however, to follow the overriding water-harvesting principle of starting at the top of the slope when you *plan* your work. While it is best to build terraces from the bottom up, all other water-harvesting strategies planned for areas upslope of your terraces should be constructed before constructing your terraces.

## SPACING AND APPROPRIATE SIZE

Determine the spacing and size of your terrace according to the type of terrace you decide to build, the steepness of the slope, and the depth of your soil.

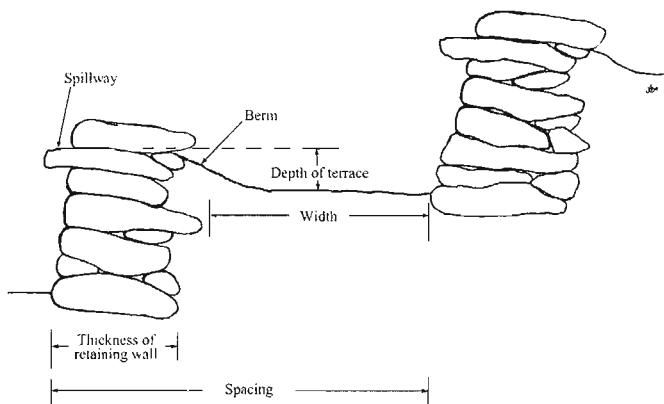

Fig. 3.4A. Side view of terraces showing components and basic features and measurements

### Box 3.2. Calculating Optimum Terrace Width

In dryland areas, you can calculate the optimum width of a terrace with the following calculation from Herman J. Finkel's *Semiarid Soil and Water Conservation*<sup>4</sup>:

$$\text{WIDTH OF TERRACE} = \frac{\text{MAXIMUM DEPTH OF CUT IN THE SOIL}}{\text{THE DEGREE OF THE SLOPE}}$$

For example, on a 10% or 0.10 slope, if the maximum allowable cut is 1.5 feet, the width of the terrace would be 15 feet (see fig. 3.5). The width is calculated as follows:

$$15 \text{ ft} = 1.5 \text{ ft} \div 0.10$$

The terraces should be spaced and sized to harvest both direct rainfall on the terrace and runoff from the slope above, while ensuring the harvested water will not sit on the soil surface longer than 12 hours. If you want to calculate approximate size and spacing for a series of such terraces see box 3.1. See box 3.2 for calculating optimal terrace width based on slope. See figure 3.4A, B to see where depth, width, and length measurements are taken.

## Retaining wall height

As shown in figure 3.5, when building terraces with retaining walls, the height of the wall should not

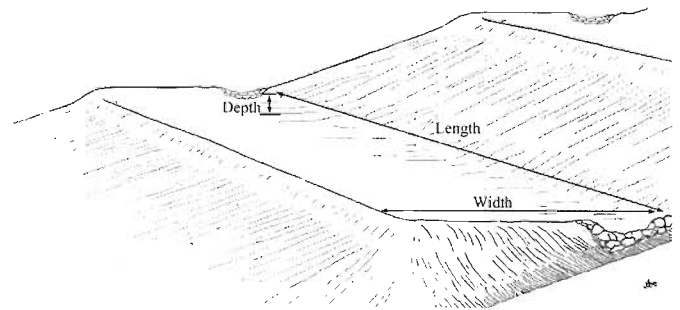
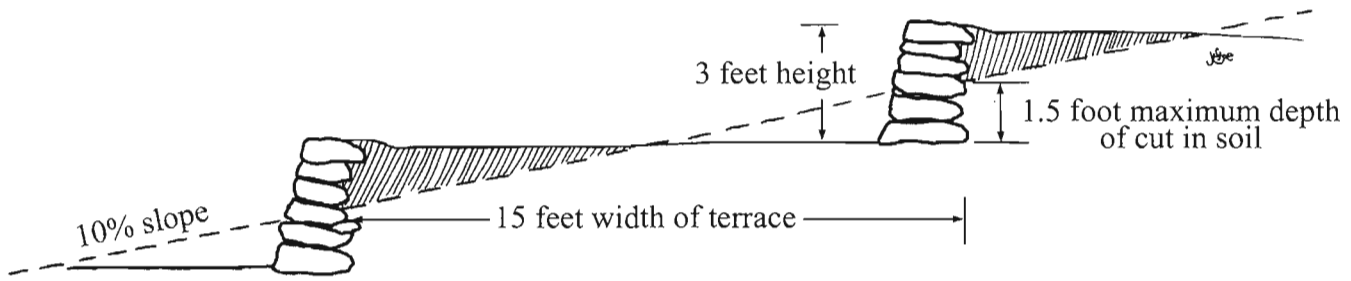

Fig. 3.4B. Earthen terrace without retaining wall showing depth (measured from level terrace surface to the top of the overflow spillway), width, and length measurements. Notice the berm and the stone spillways at the sides of the terrace's basin.



$$\text{width of terrace} = \text{maximum depth of cut in soil} \div \text{degree of slope}$$

Fig. 3.5. The height of a terrace retaining wall should not exceed twice the depth of the cut made into the slope at the base of the wall. Here the cut is 1.5 feet, so the wall height does not exceed 3 feet.

be more than twice the depth of the cut into the slope. The depth of the cut is limited by the depth of the soil, which is often shallow on steep slopes. In addition, follow the principle of starting small and playing it safe. The taller the wall, the more difficult the work, since you must use larger stones and lift them higher. Walls 2 feet (60 cm) or less in height are the easiest to build and also the safest. Do not exceed a wall height of 4 feet (120 cm) without the supervision of an experienced engineer or mason familiar with water-harvesting terraces.

Whichever style of terrace you build, you'll find the steeper the slope, the narrower the width of each terrace will be and the closer together a series of

terraces will be (fig. 3.6). Box 3.2 gives a calculation for optimal terrace width based on slope.

Note: The heavier your rainfall and runoff, the more you should limit the size of a terrace and the extent of a terrace system to prevent it from being overwhelmed with too much water.<sup>5</sup>

## CONSTRUCTION

*This section is broken into two parts: terraces without, and terraces with, retaining walls.*

### Terraces without retaining walls

To construct a terrace without a retaining wall, dig into the slope to create the inner surface of the terrace and place the excavated topsoil to the side. (You want to eventually spread this fertile topsoil over the surface of your terrace, not bury it.) Continue digging, placing the excavated subsoil downslope to build up the outer surface of a level terrace bed. The deeper into the slope you cut and the farther out you fill, the wider the terrace will be. But make sure neither your digging nor the placement of your dirt results in slopes steeper than 3:1 above or below your terrace. Once you've made the terrace to the desired size, spread the topsoil that you placed off to the side back over the surface.

Use a bunyip or A-frame level to make sure the bed of your terrace is level. Construct a raised, level berm along the outer edge of your terrace to help retain rainfall within the terrace, since the terrace itself

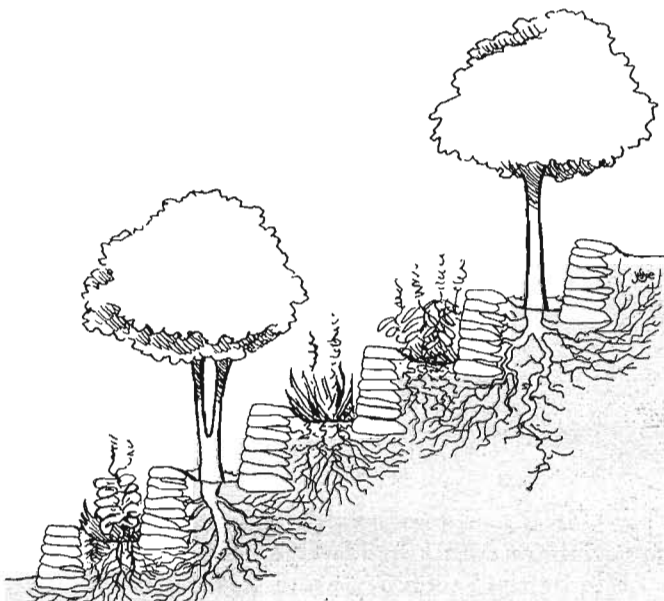

Fig. 3.6. Narrow terraces on a steep slope



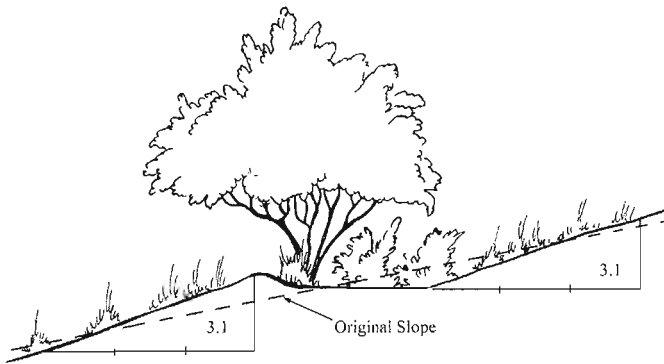

Fig. 3.7. A terrace without retaining walls. Such a strategy can be used on gradual slopes less than 3:1, 18°, 32.5%. However, care must be taken to ensure that the steeper slopes, created between the terraces by their construction, will not exceed a 3:1 slope; otherwise retaining walls will need to be constructed to stabilize the slope and structure.

will be level rather than concave (see fig. 3.7). Without a berm, there is little water-harvesting capacity and no control of overflow, without which the terrace will erode. Compact the berm by tamping it with your feet. It can double its purpose by making it wide enough to use as a path. Unless it is stabilized with rock, vegetation, or another material, I typically make the berm three to four times as thick as it is tall, ensuring good strength, a gradual slope, and a thicker girth less susceptible to an erosive blow out. The surface of the flat, finished terrace bed area should be leveled but not compacted; you want rainwater to be able to infiltrate here.

Due to the sloping land present between the terraces, this style of terrace can harvest runoff from this slope and magnify the natural rainfall available to the terrace itself.<sup>6</sup> The slope must be well stabilized with vegetation to prevent excessive runoff and erosion of both the slope and the terrace. In addition, you must make sure terraces are properly spaced (using the calculations for terraces in box 3.1) so that the volume of anticipated runoff flowing from this intermediate slope will not exceed the capacity of the terrace, and potentially blow through your earthworks rather than infiltrate the soil.



Fig. 3.8. Terraces with sandstone retaining walls built by Raincatcher and San Isidro Permaculture harvest direct rainfall in Santa Fe, New Mexico. Although unseen, there is beneficial water-harvesting redundancy here. Roof runoff from canales (roof drains) is stored in an underground cistern and distributed via an automatic drip system to irrigate vegetation in dry times. A greywater system (shower, sinks, and clothes washer) adds additional irrigation water via French drains with perforated pipe.

## Terraces *with* retaining walls

Before building retaining walls, check with local building authorities about guidelines or limits regarding their construction in your area. Different climates, soils, and seismic conditions can necessitate different requirements. See figure 3.8 for an example.

Most municipalities require a permit for retaining walls over 2 feet (60 cm) high. Many also stipulate that walls over 4 feet (120 cm) high must be designed and their construction supervised by a licensed engineer.<sup>7</sup> This wisely encourages construction of a series of smaller terraces with low retaining walls, rather than one big terrace with a tall wall. At minimum you must meet local standards and codes.

Retaining walls are often built with a very wide foundation or footer, steel-reinforced masonry mortared in place, and weep holes or pipes that permeate the wall to allow drainage. For more information on steel-reinforced masonry retaining walls, check *Basic Masonry* by the editors of Sunset Books, Sunset Publishing Corporation, 1995.

However, I find retaining walls constructed of dry-laid stone (no cement mortar) or broken slabs of

salvaged concrete sidewalks often work better. Unlike a rigid wall, the loose rock structure is somewhat flexible, reducing horizontal pressure on the wall and absorbing some frost heave.<sup>8,9</sup> As a result, dry-stacked stone walls do not require as wide a foundation as would a conventional retaining wall. They save you the cost of cement and the negative environmental impact of its manufacture. Drainpipes are not needed since the dry-laid stone is naturally porous through the joints between the stones. This porosity is essential for the wall to work because it allows the release of excess soil moisture and hydrostatic pressure caused by water accumulating in the soil behind the wall. If this soil moisture and pressure were not released, the wall would fail. Since dry-laid stone retaining walls are my preference, the remainder of this section describes their construction.

Pick angular rock for retaining walls, not round river cobble. Angular rocks can better lock into each other, while round rock tends to want to roll or pivot. The rock should be durable. If it easily flakes or crumbles when struck with a hammer, it is too weak. More or less block-shaped stones with flat tops and bottoms make for easier, quicker setting. Rock size primarily ranges from 12 to 20 inches (31–51 cm) long for walls 2 feet (60 cm) tall or less, and from 20 to 24 inches (51–61 cm) for walls from 2 feet to 4 feet (60–120 cm) tall. These lengths enable the rock to set deep enough into the slope and backfill to firmly anchor or lock in place. Smaller, flat shim and thicker wedge stones will be needed beneath or between the front or back of larger stones to level them in place. Small chinking stones will be needed to fill the gaps in wide joints between the larger stones. And smaller rock or rubble may also be needed to fill in some of the gaps between stones behind your wall before you backfill with soil.

You should begin at the base of your slope or along a section of the slope that is relatively gradual, allowing both a stable base for your wall and about a 4- to 6-foot (120–180 cm)-wide area you can clear for access, piling stone and tools, and maneuvering while you work. Create the “pad” or “platform” on which the retaining wall will be placed. To do this, dig out a level platform into the subsoil of the slope. Subsoil is the naturally compacted soil beneath the less com-

packed, more organic-rich topsoil. It is important to recognize the difference because if you do not build the base of your wall on well-compacted earth, the soil will later compress or settle and your wall will sink.

You want your platform to be about 4 to 12 inches (10–30 cm) wider than the planned thickness of the retaining wall—not the planned width of the terrace. The thickness of the wall should be from 12 to 20 inches (31–51 cm) for walls 2 feet (60 cm) tall or less, and from 20 to 24 inches (51–61 cm) for walls from 2 feet to 4 feet (60–120 cm) tall.<sup>10</sup> The taller the wall, the wider its base, and the larger its “batter” will be. A batter is a deliberately constructed lean of the wall back toward the slope to prevent shifting soil from eventually toppling the wall. Dry-stacked walls up to 2 feet in height should have a 5° to 10° batter into the slope. Walls from 2 to 4 feet in height must increase their batter to 15°.<sup>11</sup> (Fig. 3.9 shows a schematization of dry-laid stone retaining walls.)

With your platform established, dig an anchoring trench for the wall. This means digging down an additional 6 inches (15 cm). The trench will hold both a 2-inch (5-cm)-thick base layer of open-graded, angular gravel and your wall’s first course of stone, so the gravel and the bottom part of the stones will be beneath grade. If the soil drains poorly due to heavy clay soils or for some other reason, you can improve drainage and stability by digging the trench deeper and adding proportionately more gravel in the bottom of the trench.

Stockpile your excavated dirt and rubble to the side to use later to fill in behind your retaining wall, and *save topsoil in a separate pile* to use later for the upper layer of the terrace.

Compact the gravel within your anchoring trench by tamping it with your feet or a tamper (fig. 3.10A, B), then carefully lay and set the first course of stone *firmly* in place on the gravel. Use your heaviest stones for the base of your wall. The upper surfaces of all the stones should be pitched slightly toward the rear of the wall, further reinforcing the wall’s batter or lean into the slope.<sup>12</sup> Add or remove gravel beneath the stone to set it to the desired angle. Lay the stones of your wall as close against one another as possible, *plugging any holes between them with smaller rocks to hold back the soil.*

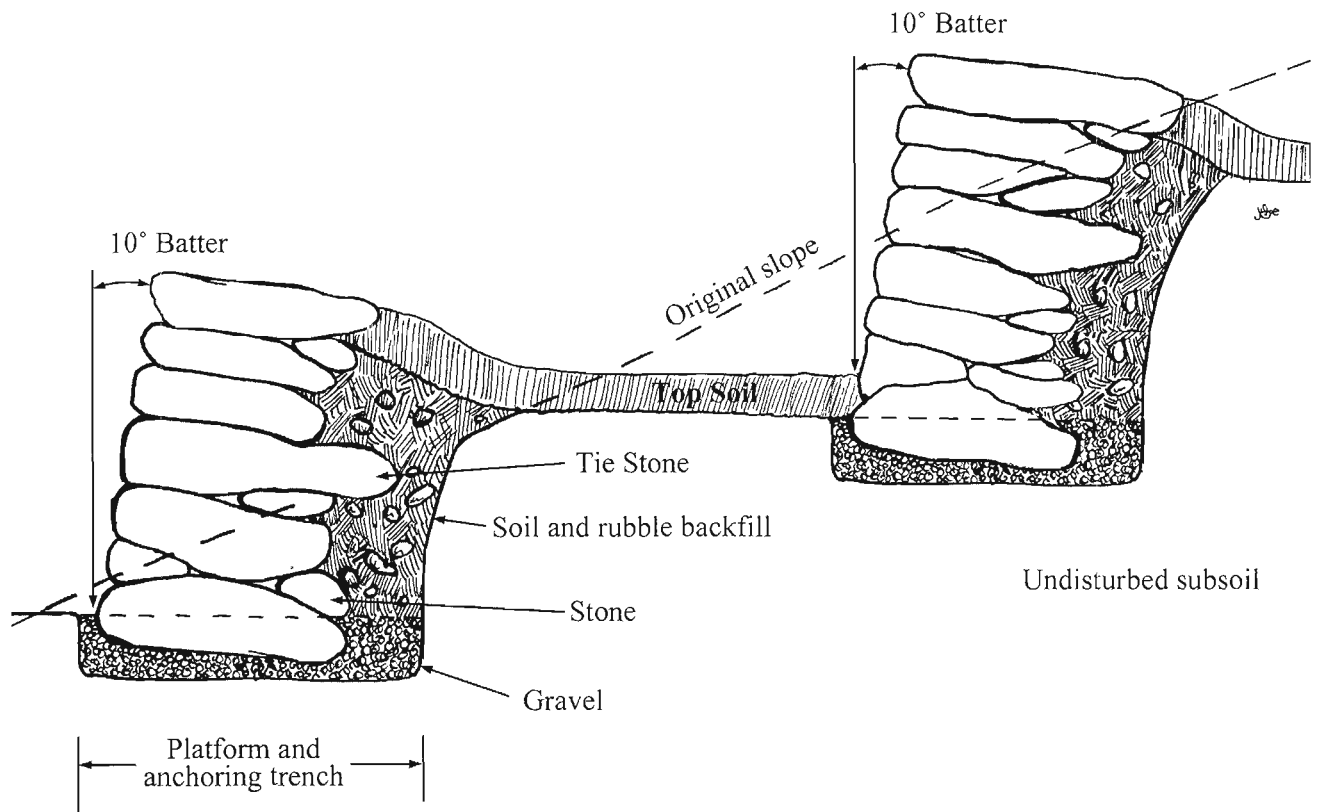

Fig. 3.9. Elevation view of two dry-laid stone retaining walls and associated terraces. The “tie” stones or “deadmen” are long stones randomly placed in the wall to reach further back into the backfill to better tie or anchor the wall in place.

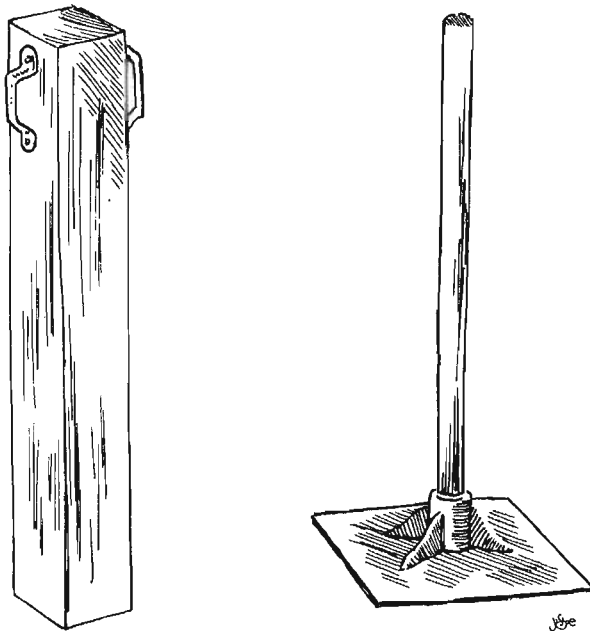

Fig. 3.10A. A homemade 4 x 4 tamper and a purchased hand tamper

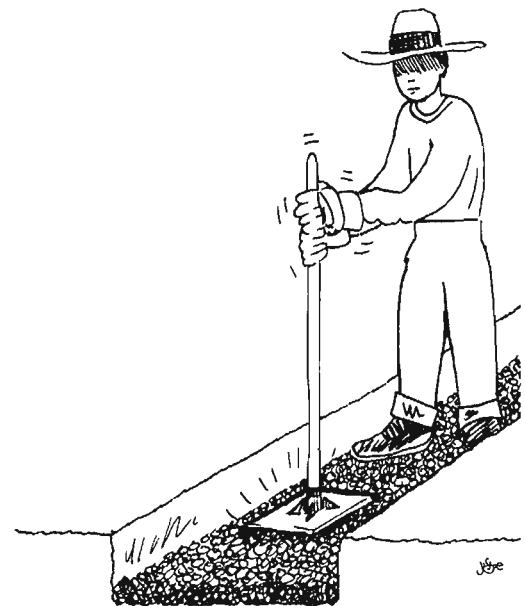

Fig. 3.10B. You hold the handle or handles and tamp the earth or gravel with the flat bottom of the tamper.

### Box 3.3. Landscape Fabric: An Optional Net Between a Terrace Wall and Its Backfill

Some builders of water-harvesting terraces such as San Isidoro Permaculture in Santa Fe take the additional precaution of laying either landscape fabric, a mat of coconut fiber, or three layers of burlap between their terrace walls and the compacted soil backfill. The fabric acts as a water-porous net, which, along with the small rocks used to plug holes between terrace wall stones, helps ensure backfilled soil will not erode through the terrace wall.

### Box 3.4. Considerations for Terrace Walls in Cold Climates

I do not have any terrace-building experience in cold regions, and have used only soil as a backfill. Soil is also the chosen backfill among my water-harvesting, terrace-building friends in colder Santa Fe, New Mexico (7,000 feet elevation with average January high temperatures of 40°F (4°C) and lows of 19°F (-7°C)). But for still-colder regions, references on building dry-stacked retaining walls recommend a backfill of gravel with landscape fabric first laid against the cut dug into the slope.<sup>13,14</sup> The gravel improves drainage and the landscape fabric prevents the gravel from becoming clogged with sediment and soil. Together, the gravel and fabric form a protective layer that prevents frost-heaved soil from pushing through your backfill and shoving out your wall.<sup>15</sup>

Note: The resources I've consulted for cold-region retaining-wall construction do not specifically address retaining walls for water-harvesting terraces. Thus I worry that a gravel backfill, if not adequately covered with a compacted berm of soil, may too quickly drain water harvested within the water-harvesting terrace, leading to erosion of the structure. Therefore, anyone considering constructing this strategy in a cold region should first consult with local experts.

Next, backfill between the inside of the wall and the cut in the slope. I live in a warm climate and always use compacted subsoil as my backfill material (see box 3.4 for cold climate considerations). Compaction of the backfill material is key, because

you do not want a loose backfill that will too quickly drain harvested water through the backfill and out the terrace wall. Such rapid draining would result in erosive pipelike holes forming through the backfill and even the soil beneath your terrace's basin, converting your terrace from a water harvester into an erosive and leaky sieve. Compact the backfill using a hand tamper and then a metal rod or the handle of a mini sledgehammer to fill any hidden voids and compact the soil between, behind, and under your stones. Nontoxic rubble, such as broken up concrete, pieces of brick, and rock fragments can be added to the backfill mix behind your terrace wall for convenient on-site use of these "waste" materials.

Sweep soil or gravel off the top surface of the first course so the next course will rest directly on stone. Then repeat the process for your next layer of rock. And remember:

- Offset vertical joints with every new course of rock by placing a whole rock over the joint between the two rocks below it. This greatly adds to the strength and stability of the wall.
- Maintain your batter.

If your terrace wall needs to rise above the level of the cut you made into the slope, use your stockpiled earth to create a higher mound on the slope against which you can build your wall. Thus, the terrace surface is built up in layers as each course of stone wall is laid to retain it. Then, use your stockpiled topsoil to construct the uppermost layer of your terrace and make it level.

If building a series of terraces, remember that you are working from the bottom up and you want to work with gravity. So when you cut a new platform into the subsoil of the slope for your next higher retaining wall, use the dirt you excavate to build up the soil level in the preceding terrace below (fig. 3.11).

Course by course, build your terrace wall to the level you want your terrace to be, and then above.

Now, construct your *terrace berm*. The top course of the stone wall will act as the outer edge of your berm, so it should rise at least 5 inches (12.5 cm) above the level of your terrace, and more if this terrace



Fig. 3.11. Building terraces starting at the bottom of the slope and working up

wall will include a spillway (see next subsection). Use large, flat-topped capstones for stability and a potential foot path. Then add and compact dirt along the inside edge of the wall to create the earthen portion of the berm. Without a berm there's no control of overflow, and the terrace will erode.

If in making your terrace you created a slope steeper than 3:1 above it, stabilize that slope with another retaining wall.

And don't forget to make your terraces accessible. Build in steps for an access path or create a ramp at the end of your terrace for wheelbarrows and other equipment, making sure the top of the ramp is high enough to prevent it from becoming a drainageway for the terrace.

For more detail on dry-stacked stone retaining walls and step-by-step photos I highly recommend you consult David Reed's comprehensive and thoroughly illustrated guide *The Art and Craft of Stonescaping: Setting and Stacking Stone*.

## LOCATION AND CONSTRUCTION OF APPROPRIATE SPILLWAY(S) FOR OVERFLOW

*Directions from this point on apply to terraces both with and without retaining walls.*

The spillway is the planned overflow route for excess water to safely flow over the terrace berm. A spillway is a low point in the berm, dipping down to about half the berm's height. For a typical backyard terrace, the berm might be 10 inches tall, so in that case the spillway would be 5 inches (12.5 cm) below the berm's top. I recommend designing for no more

### Box 3.5. Tire Retaining Walls

If you want to investigate the use of salvaged tires rammed with earth as a retaining wall material see the how-to guide, *Earthship, Volume III: Evolution Beyond Economics* by Michael E. Reynolds, Solar Survival Press, 1993. Website: [www.earthship.net](http://www.earthship.net). Tel.: 800-841-9249.

than a 5-inch (12.5-cm) depth of water storage capacity on the surface of a terrace. This maximum 5-inch depth helps ensure that the terrace does not retain too much water, which could supersaturate the soil, leading to failure of the terrace.

Make your spillway and overflow route large enough to handle all surplus water. A berm's spillway should be at least twice as wide as the berm is tall, with a minimum spillway width of 12 inches (30 cm). Narrower spillways are more likely to clog with debris.

If you have a series of terraces, align the spillways from one terrace to the next in a zig-zag or staggered pattern. This will help spread overflow more evenly across the terraces rather than shortcutting the flow of water straight through them (fig. 3.12).

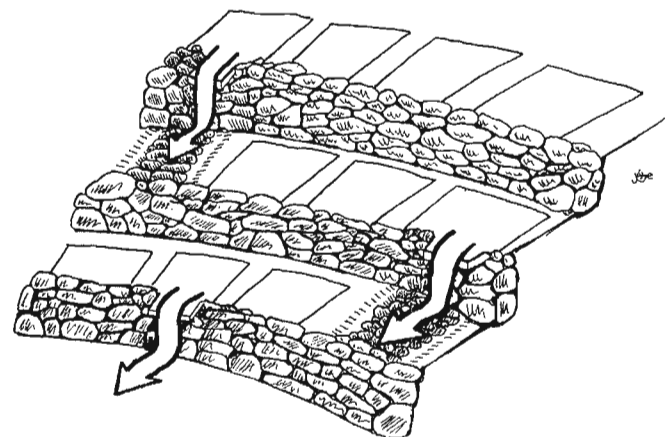

Fig. 3.12. Terraces with dry-laid stone retaining walls and zig-zagging overflows spreading and infiltrating more of the water's flow. Note that these terraces are divided into sunken planting beds.

Between terraces that are built without retaining walls, a spillway from the upper terrace can be extended diagonally downward to become a diversion swale (see chapter 9) to connect the upper terrace to the next lower one (fig. 3.13). This will lessen the slope of the channel and reduce the speed of flowing water. Overflow can also be directed to a stabilized central drainageway (fig. 3.14).

Whichever terrace system you use, all spillways and the drainageways they flow into should be *stabilized*. Christopher Barrow, in his book *Alternative Irrigation: The Promise of Runoff Irrigation*, recommends using:

- Dense grass to stabilize spillways and drainageways on slopes of less than 15% (9°) as long as the grass is protected from drought, brushfires, and livestock damage
- Rock for slopes between 15 and 20% (9–11°)
- Stepped concrete and masonry if slopes are greater than 35% (19°) to prevent erosion<sup>16</sup>

At the base of your spillway, place a stabilized apron or platform to disperse the force of the outflow. Make your apron at least as wide and as long as the width of your spillway channel. See figure 10.26 in chapter 10 on check dams; the principle is the same.

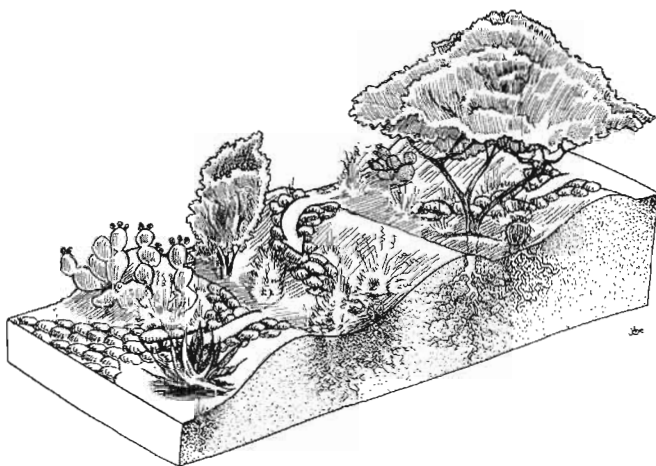

Fig. 3.13. Rock-stabilized diversion swale overflows from one earthen terrace to another

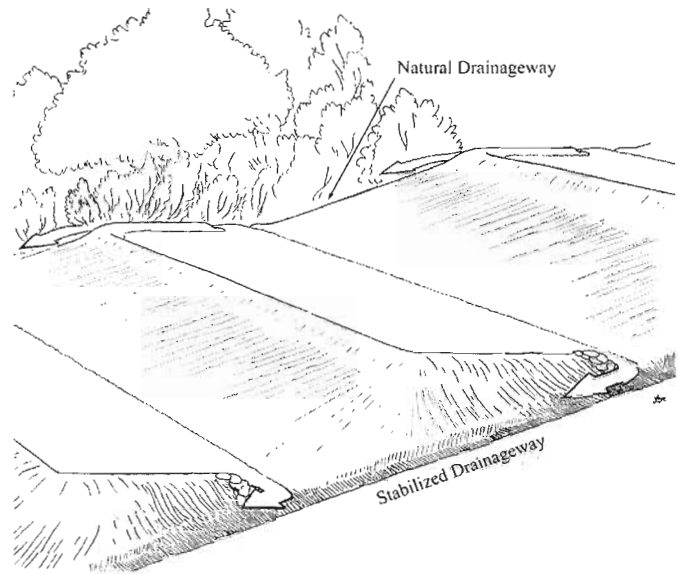

Fig. 3.14. Earthen terrace overflow directed to both a natural drainageway stabilized with vegetation, and a constructed stabilized drainageway

## PLANTING YOUR TERRACE

Vegetation is a key element of any terrace system. Roots hold and stabilize the soil. Fallen leaves act as a green manure increasing humus and fertility. Transpiring plants utilize the harvested water, reducing the hydraulic pressure infiltrating water exerts on hill slopes and retaining walls. Plant stabilizing perennial species to cover the slopes between terraces, spillways, areas abutting the retaining wall, the area just down-slope from the flat terrace, and the berm itself. Maintain these stabilizing perennial plantings even if your primary use of the terrace is as a garden of annual plants. Limit your annual plantings to the level area within the terrace.

Focus on growing sheltering, low-water-use trees. Avoid planting water-demanding vegetation in dryland environments in general, and in areas of less stable soils in particular. By sticking to low-water-use species, you ensure that the rain falling naturally on the slope will be sufficient to support a well-established plant. This reduces water use and avoids the need for supplemental irrigation, which could destabilize the slope. See chapter 11 on vegetation for more tips.

Where your climate permits, tuck moss and other plantings between the rock of your retaining walls for



Fig. 3.15. Vegetation between retaining-wall rocks. Stonework by Goettling McGee, Inc., Seattle, Washington.

more anchoring effect and a wonderful flow of vegetation springing over and from the rock (fig. 3.15).

## MAINTENANCE

Check your terraces periodically, especially during and after storms, to make timely repairs, learn what works, and see how vegetation responds.

Make necessary repairs and adjustments, which could include: resetting loose or fallen rock, stabilizing eroding spillways, reinforcing berms, clearing debris from spillways, adding mulch to terrace basins, and replanting.

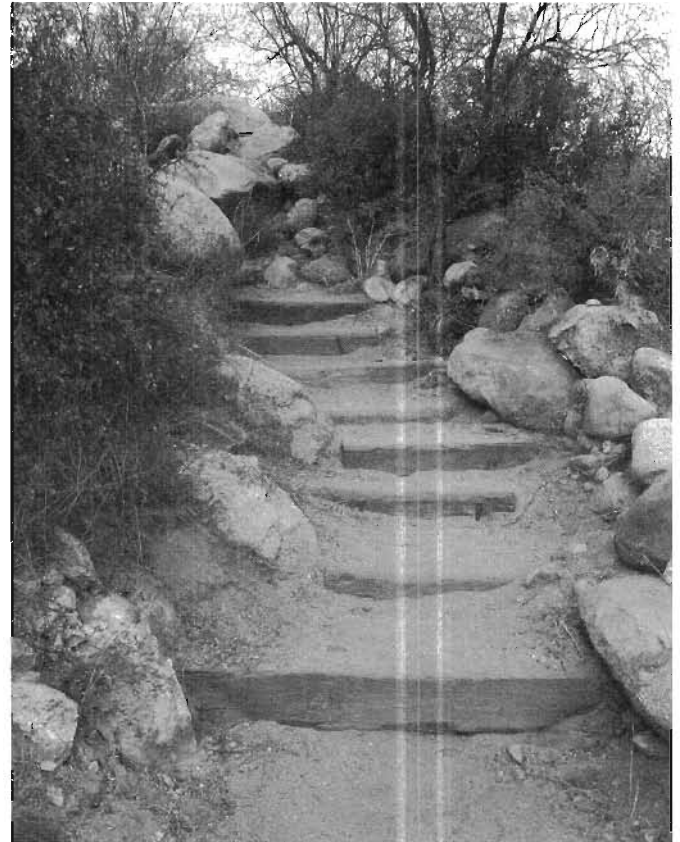

Fig. 3.16. A once-eroded path repaired with terrace-like steps stabilized with railroad ties. Catalina State Park, Tucson, Arizona.

Good maintenance is vital, as the progressive failure of a series of unmaintained terraces can cause severe land damage. Watersheds above terraces must also be maintained to prevent unchecked and excessive runoff from blowing out the structures below. Keep watersheds well vegetated.

## MULTIPLE FUNCTIONS OF TERRACES

### LOW TERRACE WALLS AND TERRACES AS STEPS

Pathways that run up and down slopes typically become eroded drainage-ways. Creating terrace-like steps within these pathways, either by placing check-dam-like stone terrace steps or wooden railroad-tie-steps across the path can help stabilize the trail and reduce erosive runoff (fig. 3.16).



Fig. 3.17. Terraced fields in Peru. Credit: Windsor Cousins

## LOW TERRACE RETAINING WALLS AS BENCHES

Terrace walls 16 to 18 inches (41–46 cm) high double as seating benches.

## TERRACING AS INFRASTRUCTURE FOR COMMUNITY WATER MANAGEMENT

In the mountain village of Huaynacotas, Peru, an intricate system of interlinking terraces, dating back to the time of the Incan Empire, still functions as a communally managed water-distribution system based on equitable distribution of resources (fig. 3.17). For an inspiring account of how it all works, read Paul Trawick’s “Trickle-Down Theory, Andean Style: Traditional Irrigation Practices Provide a Lesson in Sharing,” *Natural History*, October, 2002, pages 60–65, or his book *The Struggle for Water in Peru*.

## REAL-LIFE EXAMPLES OF TERRACES

### TERRACE BUILDING OF THE TARAHUMARA INDIANS—SIERRA MADRE, MEXICO

In 2002, while seeking examples of indigenous water-harvesting traditions, I visited the Tarahumara village of Wajurana, high in Mexico’s Sierra Madre overlooking majestic Copper Canyon. I was guided by Juan Daniel Villalobos, the local director of *K’etami Wasar’a*, which means “our sustainable farmland” in Tarahumara. On these beautiful though marginal lands, erosion is often severe and water is scarce. Overgrazing and excessive timber cutting in growing pastoral communities compounds land and water problems.

Juan Daniel showed me a community practice that was reducing erosion and enhancing local water



resources: numerous stone “*trincheras*” built throughout the village. *Trinchera* is a Spanish term for both stone-wall-reinforced terraces and check dams. Averaging 5 feet (1.5 m) high and ranging from 30 feet (9 m) to over 300 feet (91 m) long, their construction has helped the villagers reclaim a hectare of eroding land and annually harvest a significant amount of stormwater runoff in the soil. These simple structures have made it possible for many households to set up subsistence gardens, heirloom-fruit-tree orchards, and stands of native timber trees (see figs. 3.18 and 3.19).

Whether used as a terrace or a check dam, the construction of *trincheras* is virtually the same. What differs is placement. Terraces are built on eroding slopes outside of drainageways. Check dams are constructed within eroding drainageways. These *trincheras* are hand-built during traditional communal work parties. All participants are paid with food as they improve existing structures and create new public infrastructure. Each household builds an equal section of the *trinchera*. The combined hands can accomplish in two hours what one person would need eight days to complete. Once built, it takes one to three years for *trincheras* to naturally collect a level bed of soil upslope, converting eroded land into fertile gardens. *Trincheras* built in the Sierra Madre have remained intact for over 500 years.

For over 10 years, Juan Daniel has worked with *K’etami Wasar’a* helping plan and construct *trincheras* and plant gardens in villages. Village leaders determine where and when they want to build. Juan Daniel works with Native Seeds/SEARCH and the Catholic Church to provide food for work parties, transport rock, and purchase vegetation-protecting fencing.

Juan Daniel started small, helping establish one *trinchera* garden in the village of Roguerrachi. Interest spread. Soon there were 15 gardens, then other communities came forward. Two hundred gardens have since been created. Where water is abundant, gardens grow annual vegetables. Where water is scarce, deeper-rooted fruit trees are the predominant crop. Most receive supplemental water from nearby springs, but in the drier areas some gardens and orchards subsist entirely on rainfall.



Fig. 3.18. New *trinchera* and field at Rowerachi, Chihuahua, Mexico in 2002. Note the batter or lean of the wall into the slope. Credit: Barney Burns.



Fig. 3.19. Old *trinchera* and field at Rancho Newatabo, Chihuahua, Mexico in 2002. Apple trees to left of photo are planted among another series of lower *trincheras*. Credit: Barney Burns.

The *trinchera* gardens have improved the health of both land and people. A few years ago a 100-foot (30-m) deep well dug in Wajurana yielded no water. After *trincheras* were built, water appeared in the well. Though not enough to pump, there was enough soil moisture for the roots of vegetables and fruit trees to tap. Some families produced enough food and crafts to give up their jobs outside the villages and meet most needs within their communities.

This pattern can be replicated anywhere—plant local rains in local soils so more life and livelihoods can grow.

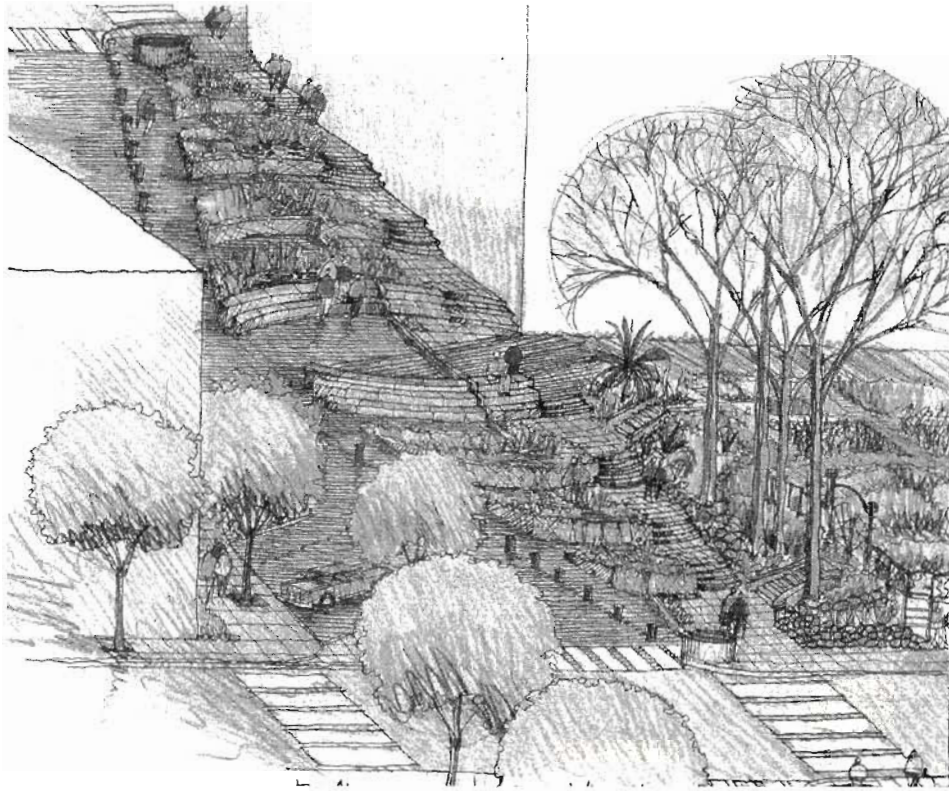

Fig. 3.20. Bird's eye view looking down Vine Street from Fourth Ave. to Third Ave., in Seattle, Washington, showing the gardens, watercourse, narrowed street, and cisterns

See "Trinchera Tradition in the Sierra Madre" by Barney Burns, *Seedhead News*, Fall Equinox, 2002, Native Seeds/SEARCH newsletter.

## TERRACED CISTERN STEPS, GARDENS, AND MORE – SEATTLE, WASHINGTON

Residents of the densely populated, urban neighborhood of Belltown in downtown Seattle (average annual rainfall of 36 inches or 914 mm) have long been surrounded by concrete and glass. But a transformation is occurring. The residents came together in the mid 1990s to organize under the name of Growing Vine Street. Their goal: to turn the entire eight-block length of Vine Street into a street park—a parade of art and nature that reintroduces the hydrologic cycle to the urban core.

Their plan is to direct stormwater runoff from surrounding buildings to fanciful cisterns and a new urban stream meandering through various earthworks

running the street's entire length (fig. 3.20). The cisterns and stream then passively irrigate numerous plantings along the watercourse. And these plantings naturally biofilter many of the water's impurities so it can be released directly into Elliot Bay below without passing wastefully through the city's conventional water treatment facilities, as was the case with the old below-ground stormwater pipes.

Terraced planters are ideal here due to the slope of the street, the urban public space, and the canyonlike effect from the buildings. The terraces create level planting areas where before there were none, and they meander into the street, causing traffic to slow down. Along walkways, the terrace walls double as seating benches, decorated with colorful mosaics and sheltered with canopy trees. And gravity pulls the water from the mesalike rooftops to springlike cisterns, an old-fashioned hand pump within the garden, terraced planters, and the abundant plantings, until the overflow water empties into a small jade pool before merging with the waters of Elliot Bay.



Fig. 3.21. The Beckoning Cistern and terraced planters. This 10-foot (3-m) high, 6-foot (1.8-m) diameter metal culvert cistern/sleeve reaches upward, capturing roof runoff through the hand's index finger and sending overflow out its thumb. The overflow water is then caught by a series of terraced planters. Terrace walls double as seating benches.

A thriving community garden; historic cottages housing artists in residence; hand-shaped cistern; air-cleaning and noise-buffering “acoustic” trees, shrubs, and vines; and a series of large terraced planters called the Cistern Steps are already in place with more to follow (figs. 3.20, 3.21, and 3.22). The result is a dynamic community green space where slowing the flow of traffic, water, and people has resulted in the area bursting with life and its celebration.

For the complete Growing Vine Street story and many more images see [www.growingvinestreet.org](http://www.growingvinestreet.org).



Fig. 3.22. View of the Beckoning Cistern from across the street. A faucet enables neighborhood gardeners to utilize the cistern water to irrigate the adjoining plantings.



# 4 French Drains

## WHAT IS A FRENCH DRAIN?

Sometimes called a soakaway, dry well, or a pumice wick, a French drain is a trench or basin filled with porous materials including open-graded, angular gravel; pumice stone; or rough organic matter such as straw or bark. These materials have ample air spaces between them that allow water to infiltrate quickly into the drain and percolate into the root zone of the surrounding soil, while creating a stable surface you

can walk on, run across, or ride over with a bicycle. (See figs. 4.1 and 4.2.) Thus, French drains can be placed alongside impervious driveways and patios to harvest their runoff while simultaneously extending the pedestrian-accessible space along such hardscapes. French drains can address the problem of “too much water in too small an area” and are especially useful for redirecting, holding, and subsequently infiltrating runoff from roofs and other hardscape in small yards.

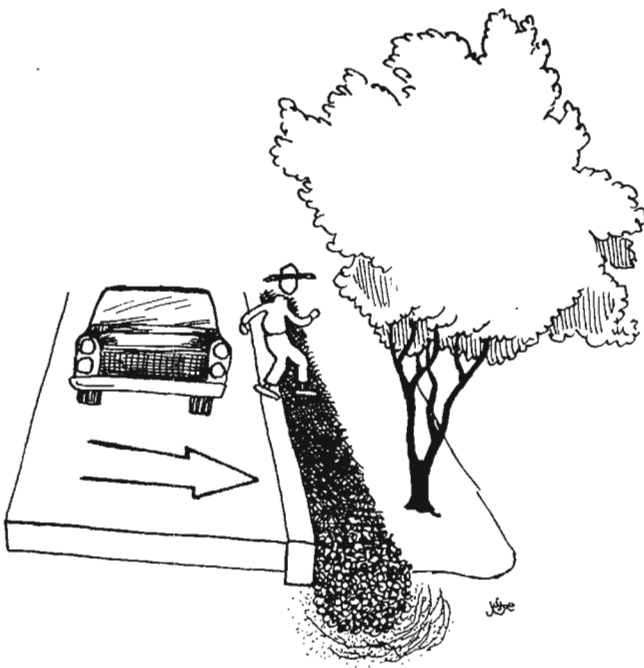

Fig. 4.1. A pipeless French drain beside a driveway

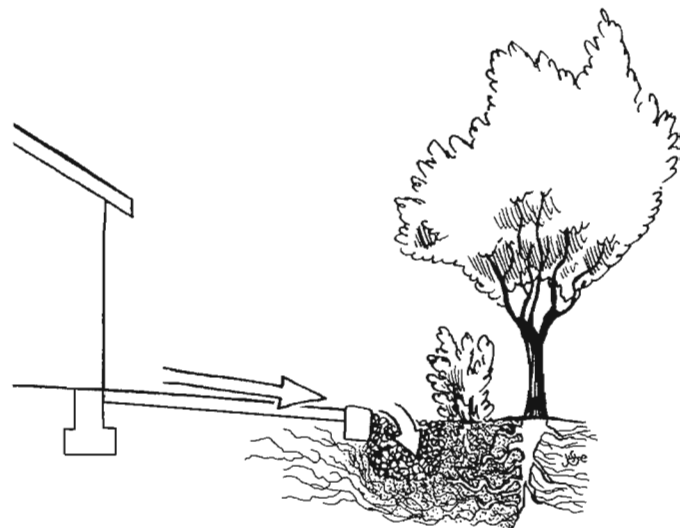

Fig. 4.2. French drain infiltrating intercepted runoff from a roof and patio

French drains can be used for localized watering of adjacent plants to encourage deeper, more drought-tolerant root growth—these include deep-pipe irrigation and rock-tube irrigation. And, the source of that water can be rainwater or high quality air-conditioning condensate, which can be of considerable volume in humid climates, as explained in the section on multiple uses of French drains.

A French drain can be constructed with or without pipe placed horizontally within the porous material that fills the drain. Pipe or infiltration chambers are not needed for short drains or when a drain is constructed parallel to the surface from which it is harvesting runoff, such as along the edge of a patio. Perforated pipe or chambers are used to distribute water more evenly within trenches exceeding 20 feet (6 m) in length.

Caution: I typically construct French drains without pipe to reduce the expense and environmental impact of plastic pipe, and because roots can enter and clog pipe over time. However, there are strategies that can lessen root intrusion into pipe, such as wrapping a French drain with landscape fabric, or better yet, using infiltration chambers instead of perforated pipe.

Note: Gravel-, pumice-, or mulch-filled French drains hold only about one-third to one-half as much water as open berm 'n basins, trenches, or infiltration basins hold. However, the water harvested in a French drain is less prone to evaporation due to the fill material.

## WHERE IS A FRENCH DRAIN USED?

French drains are used on gently sloped or flat land where you want the water-harvesting potential of a berm 'n basin or infiltration basin, but not the obstacle that a berm or open basin might create. For example, they are suitable adjacent to paved parking areas, driveways, or patios. Placed there, they immediately intercept the runoff from the paved surfaces, while giving folks more room to safely run or walk around cars, patio furniture, or other people (fig. 4.1). Do not place a French drain across a driveway used by cars, as their weight could sink them into water-saturated soil.

Place a French drain only where it will intercept relatively sediment-free water, such as at the end of a

rain gutter's downspout pipe or at the edge of a paved surface. Do not use French drains to capture runoff from dirt catchment surfaces or within natural drainages where they would quickly fill up with the sediment carried by the runoff. Once this sedimentation happens most of the original water-holding capacity of a French drain is lost.

French drains with pipe are used extensively to capture water falling from canale roof drains of Santa Fe-style homes. The drain gets the water away from the foundation of the house and into the landscape where it can passively irrigate plants (fig. 4.3).

## TOOLS AND MATERIALS

**Basic tools:** a pointed shovel, flat shovel, pick or digging bar, and water level (see appendix 2 which describes simple tools for measuring slope).

**Helpful machinery:** Ditch Witch or backhoe.

**Materials** include porous fill such as open-graded, angular gravel or aggregate; pumice; escoria; rocks; straw; or bark. Pumice and basalt enable you to hold more water than other gravel due to their more porous nature. (Use basalt rather than pumice if the drain will be regularly walked on or if you live in a cold climate, since pumice is softer and breaks down more readily from disturbance and freeze-thaw cycles). Small, broken pieces of concrete and brick, or large prunings can be placed in the bottoms of French drains before covering them with gravel. Turn such nontoxic “wastes” into resources.

If you use perforated pipe within your drains, wrap landscape fabric around the fill material to help keep roots from growing into the pipe. Use non-perforated rigid plastic pipe to move water from one point to another. Use perforated 4-inch-diameter (100-mm-diameter) rigid pipe in the length of the drain where you want infiltration to occur. Rigid pipe is less likely to sag than flex pipe, reducing clogs from accumulated debris and distributing water more evenly.

Infiltration chambers (no taller than 13 inches or 33 cm) from [infiltratorsystems.com](http://infiltratorsystems.com) or [hancor.com](http://hancor.com) can be used instead of perforated pipe, and landscape fabric is not needed since roots are far less likely to grow into the large air space within the chambers.

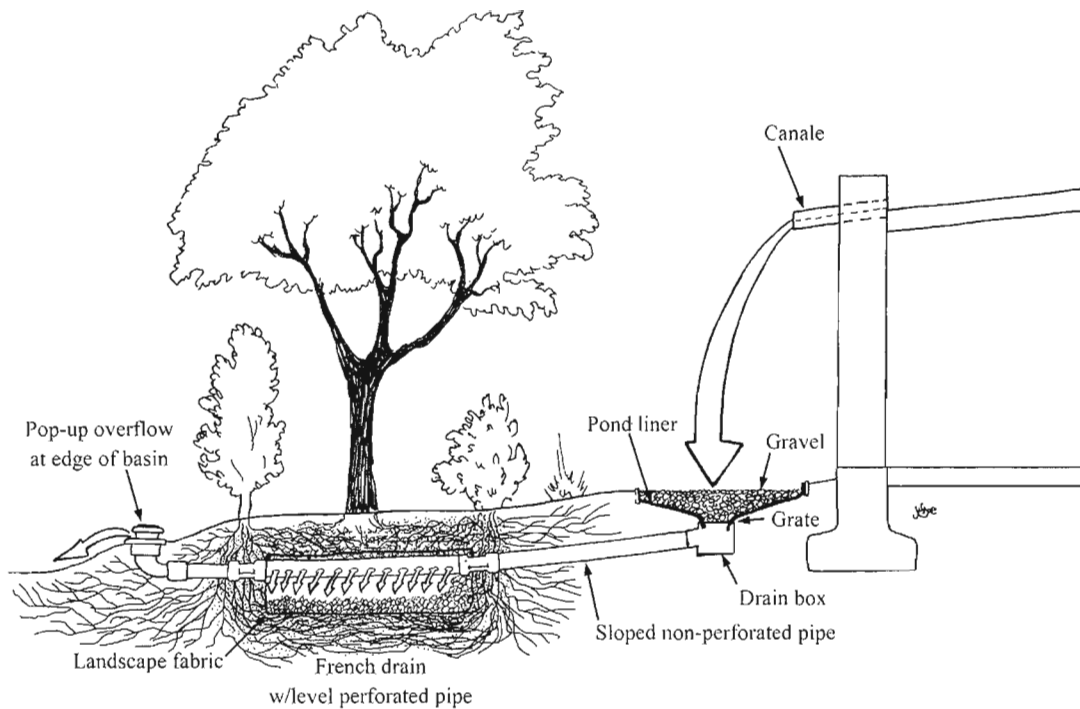

Fig. 4.3. A canale roof drain, drain box, and pipe directing roof runoff away from the house to a French drain within the landscape. Note: While the illustration's perspective may be misleading, the vegetation is planted adjacent to the French drain, not on top of it. See fig. 4.10 for the option of using infiltration chambers instead of perforated pipe and gravel.

## STEPS TO BUILD A FRENCH DRAIN

### SITING

I typically limit French drains to areas of heavy foot traffic where I want to harvest runoff from relatively sediment-free surfaces without creating a tripping hazard.

Site the French drains where you want to increase infiltration of water into the soil in the root zone of plants, which grow adjacent to, but not in, or on top of, the French drain. Do not place French drains where you don't want plants or their roots to grow, such as across or beneath roads, driveways, or paths. If placing a French drain on a gradual slope, try to lay it on contour. An A-frame or bunyip water level, or transit will help you get it right.

To prevent French drains from prematurely silting up, place berm 'n basins or infiltration basins upslope

of French drains in the unpaved sections of landscapes that would otherwise shed sediment-laden runoff into the French drain (fig. 4.4).

### SPACING

A pipeless French drain should be placed close to the paved surface from which it is harvesting runoff. A stabilizing curb or spillway placed between pavement and drain will prevent the pavement from being undercut by water flowing into the French drain. (See fig. 4.5.)

French drains can be placed farther away from their water source if non-perforated pipe transports the water to the drain.

As with all water-harvesting earthworks, a French drain should be at least 10 feet (3 m) from the foundation of any building.

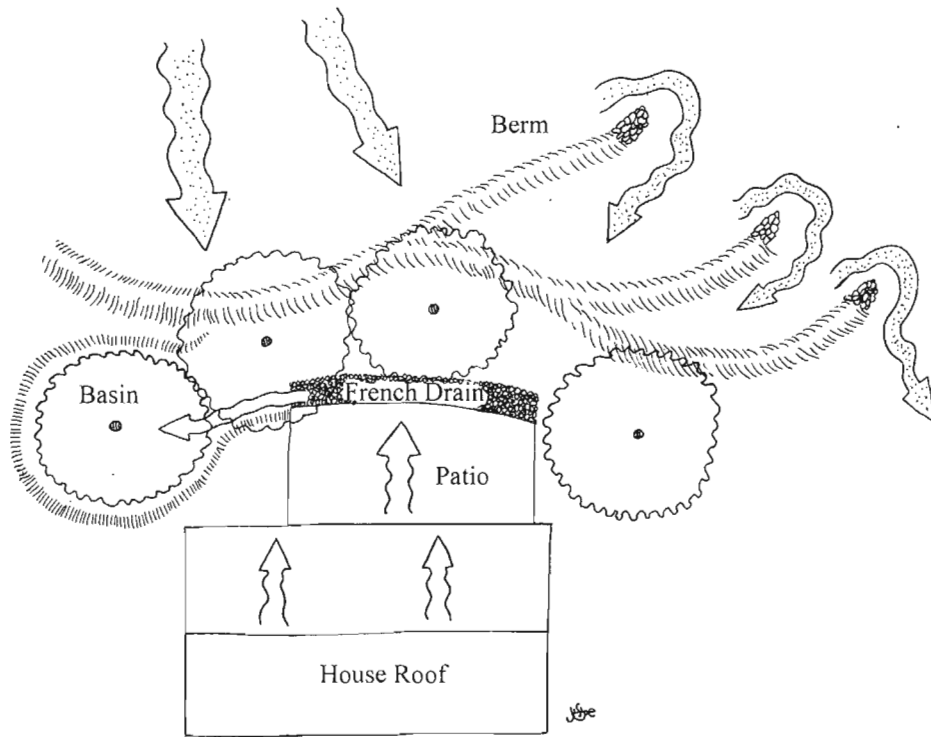

Fig. 4.4. Berms upslope of a French drain intercept and infiltrate sediment-laden runoff with overflow directed to other berms and away from the French drain. The French drain intercepts sediment-free runoff from roof and patio with overflow directed to a tree within an infiltration basin.

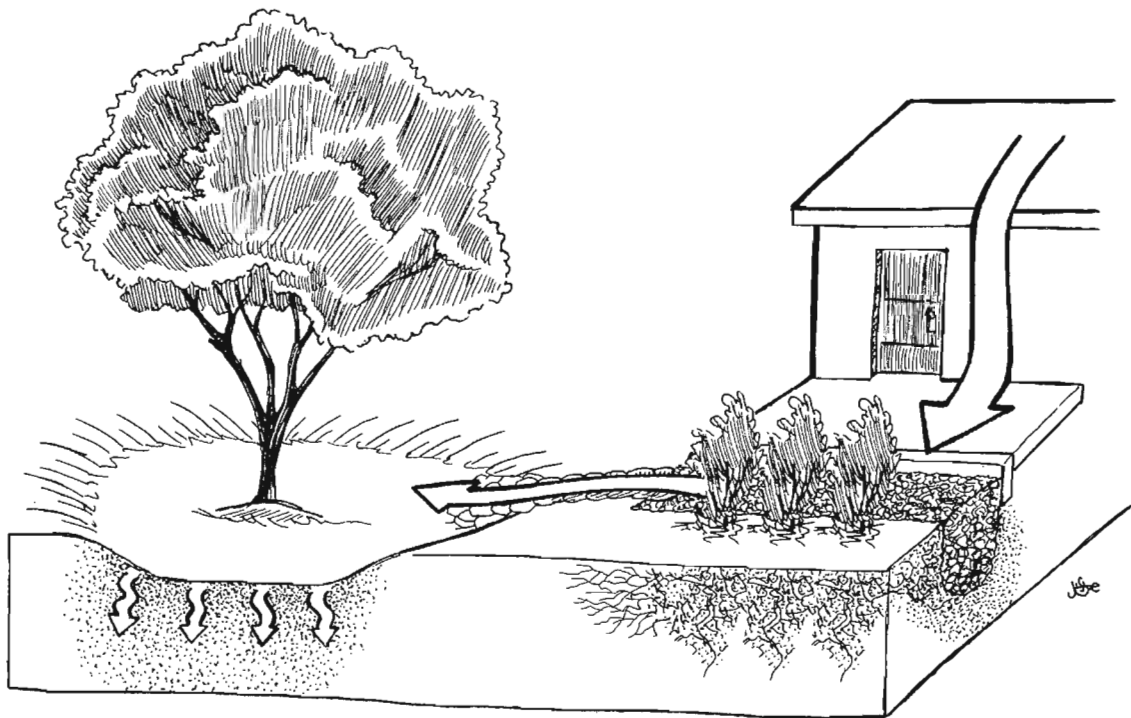

Fig. 4.5. French drain without pipe; overflow directed to an infiltration basin. Notice the stabilizing curb between the patio and French drain.



## APPROPRIATE SIZE

Use the catchment calculations found in appendix 3 to estimate how much water you expect to flow into your French drain at one time. Remember, the presence of porous fill material will reduce the water-holding capacity to about one-third to one-half of the trench's total volume. Either make your French drain large enough to take all the expected flow or plan to route the extra flow to other earthworks.

Make your French drain a minimum of 15 inches (38 cm) wide and 15 inches deep. My experience is that anything shallower or narrower collects too little water to justify the work. The length will vary depending on the water-holding capacity you need, where runoff originates, and where you want the runoff to support plants.

## CONSTRUCTION

To attain maximum water infiltration, dig a hole or trench on contour, the same as you would dig a basin for a contour berm 'n basin on contour, but you don't have to make a berm. The soil dug from the trench can be used to raise the level of a nearby pathway or patio so that it will shed water to adjoining French drains or basins. If you do make a berm, place it on the downslope side of the French drain. Make the bottom of your basin or trench level to encourage even infiltration of water.

Rake and rough up the bottom and sides of your trench if they were compacted or smeared smooth during excavation to improve the permeability of the soil lining your trench. Also, remove large stones or other debris from the bottom of the trench. Verify that the trench is still level.

The next sections describe, first, a French drain without pipe, and then, a French drain with pipe.

### French drain *without* pipe

After digging your trench, and, if desired, placing cardboard at its bottom (see box 4.1), fill it with gravel, stones, coarse organic mulch, or other appropriate material that leaves large pores for water to move quickly through and infiltrate into the adjoining soil.

To be porous, permeable, and stable under a load, aggregate or gravel particles must be angular in shape so their flat faces interlock with each other and resist rotating and shifting. "Crushed stone" or "crushed gravel" are appropriately angular materials, as opposed to smooth round "river stone" or "pea gravel," which rotate and slip past each other and "give" under a load (fig. 4.6A). The aggregate must also be open-graded or single-sized, which results in the aggregate having a narrow range of particle sizes and open void spaces that improve interlocking between particles (fig. 4.6B).

Make sure the open-graded gravel you select is durable enough not to wear down to finer material. Before delivery have it washed clean of fine particles that could clog the pores between the aggregate. While aggregate with particle sizes up to 1 inch (2.5 cm) drain rapidly, 1/2-inch (1.25-cm) particles are easier to walk on. If filling with pumice or basalt/volcanic stone, use 5/8-inch (1.5-cm) diameter or larger so your French drain won't plug with smaller pieces of the pumice, called "fines." Tamp the upper layer of gravel by stomping on it with your feet or tamping it with a hand tamper to get the gravel to better interlock with itself and stay put.

Avoid gravel fill in trenches in garden settings, because the gravel is horrible to dig into or till. Instead use coarse, dig-friendly, organic mulch. Organic matter such as straw bales, loose straw, and good-sized chunks of bark work well as fill, but these materials will need to be replenished as they break down. This decomposition creates great soil but as it does the air spaces become smaller and water infiltration is reduced. Nevertheless, infiltration rates will still be better than they were before making the French drain.

**OVERFLOW:** Since the top of a pipeless French drain is typically "at grade" (level with the surrounding soil), excess runoff that fills the drain will overflow and continue along its original path. One way to direct overflow to other water-harvesting earthworks is to construct the lowest point of the rim of the French drain in the direction where you want the water to overflow. Then use a diversion swale to direct the water to a specific location. (See chapter 9 on diversion swales).

#### Box 4.1. Using Cardboard to Encourage More Lateral Infiltration of Harvested Water into the Root Zone of Plants

Water-harvesting systems designer Richard Jennings of Earthwrights Designs puts a layer of cardboard on the bottom of his French drain trenches to create a less permeable bio-mat of decomposing material, which pushes more of the water infiltration to the sides of the trench. This keeps more of the water in the top 2 feet (0.6 m) of the soil, and the densest root zone of associated plants. Old magazines or layers of newspaper could also be used.

### French drain *with* pipe

#### HARVESTING WATER FROM A CANALE:

Create a funnel drain to capture the water falling from the canale by digging a 3- to 4-foot (90–120 cm)-diameter hole beneath the end of the canale (refer to fig. 4.3).

Place a 12-inch (30-cm) plastic drain box in the center of the hole, with the drain box's outflow hole facing toward your future French drain. The top of your drain box should be about 6 inches (15 cm) below grade with the grate facing up. Then, dig a trench for, and install, non-perforated 4-inch (100 mm)-diameter plastic pipe from the drain box to the area of the landscape where you want to infiltrate the water (should be a minimum 10 feet from building foundation). The non-perforated pipe must drop at least 1/2 inch per 10 horizontal feet (13 mm drop per 3 m horizontal).

Now go back to the drain box to finish making your funnel. Backfill around the drain box with soil up to the top of the box, then add more backfill creating a gradual slope from grade to drain box grate. Remove the grate atop the drain box. Place a 4- to 5-foot (120–150 cm)-wide piece of 20- to 40-mil plastic pond liner over the drain box (pond liner is available from building, pond, and plumbing supply stores, and while less expensive shower liner can be used in

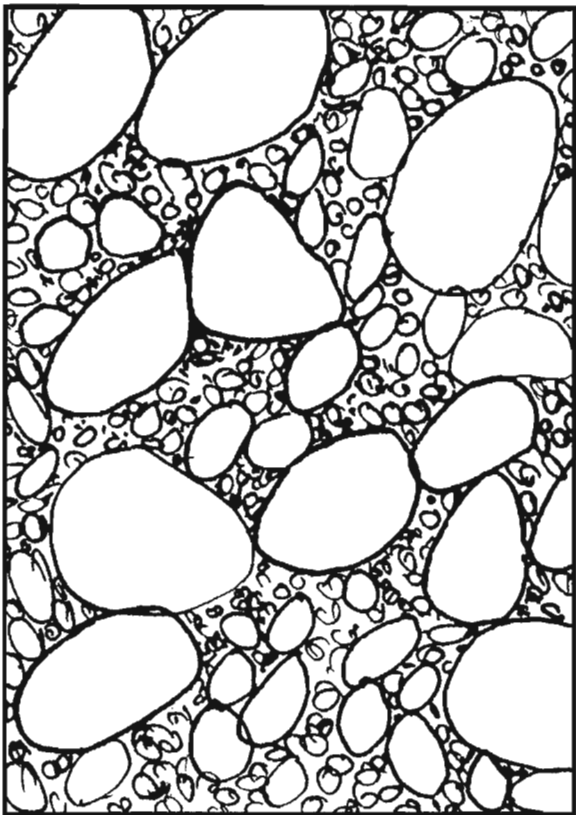

Fig. 4.6A. Round mixed-size particles packed in dense gradations

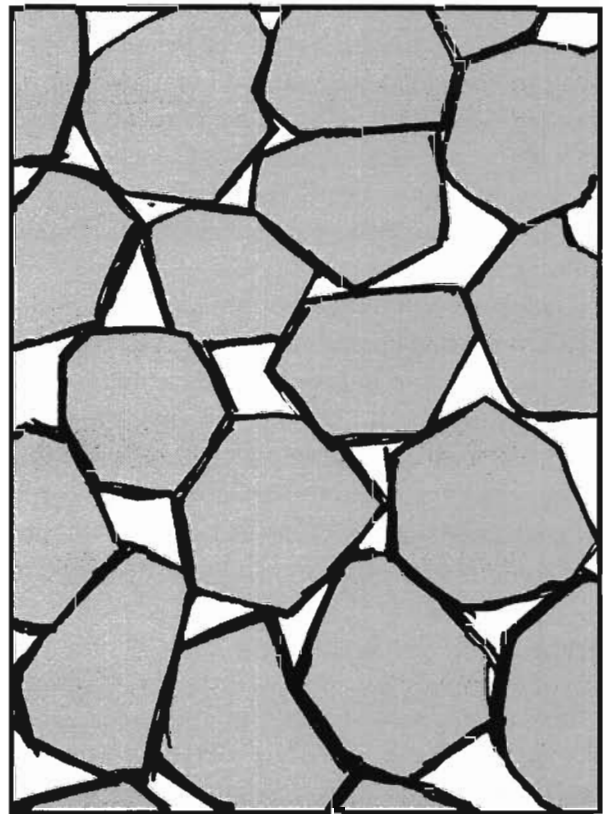

Fig. 4.6B. Angular particles packed in open-graded gradation. Angular, open-graded aggregate is far more porous.



Fig. 4.7A. Pond liner and drain box with the X-cut in the plastic beneath the grate so water can freely drain into the drain box. Credit: Jeremiah Kidd

warmer climates, it often disintegrates in cold ones). Cut the center of the plastic with two cuts in the shape of an X—make sure these cuts are less than the width of your drain box so all water will be directed into the box (fig. 4.7A). Put the grate back on the drain box over the hole you cut in the plastic to hold everything in place. Then cover the drain box with rock or gravel larger than the hole size of the grate so you don't fill the box with rock. Install a ring of large rock or steel edging around the border of your drain box's funnel to further reduce sediment from entering the drain and make a neater appearance (fig. 4.7B).

Now go back to the end of your non-perforated pipe to connect and lay the perforated pipe.

**HARVESTING WATER FROM A DOWNSPOUT PIPE:** Connect non-perforated plastic pipe to the base of your downspout. The pipe diameter must not be less than the downspout's diameter; 3 inch (75 mm) to 4 inch (100 mm) is typical. Dig a trench and run the pipe to the area of the landscape where you want to infiltrate the water (should be at least 10 feet [3 m] from the building foundation). Slope the pipe run so there is at least a 1/2-inch (13 mm) drop for every 10 feet (3 m) of horizontal length. Then connect the non-perforated pipe to the perforated pipe (fig. 4.8).

**LAYING PERFORATED PIPE:** Perforated drainpipe should be installed level within a level trench about 15 inches (38 cm) wide and 15 inches deep. You want to

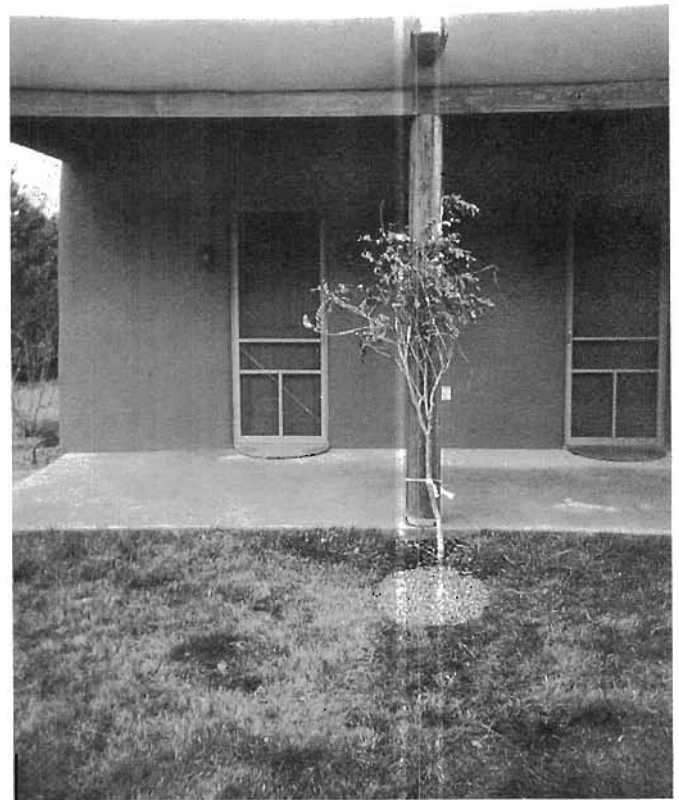

Fig. 4.7B. Canale and drain below. Drain box is now covered with gravel larger than the drain box grate, and the gravel is ringed with steel edging to keep gravel in place and sediment out. Credit: Jeremiah Kidd

infiltrate the water into the root zone of plants, so avoid trenches deeper than 24 inches (61 cm).

Line the trench with landscape fabric if you want to deter root growth into the French drain. Fill the bottom of the trench with 8 inches (20 cm) of pumice or gravel and tamp it with your feet or a hand tamper. Connect your perforated pipe to the non-perforated pipe from the canale or downspout. Lay the rigid perforated pipe level on top of the gravel, aiming the pipe holes to the sides of the trench. This allows a 1/2 inch (1.25 cm) of water to fill the entire length of pipe before it spills out all the holes—more evenly distributing the water. (See figs. 4.9A and 4.9B).

**OVERFLOW:** Install an overflow outlet at the end of your pipe run. This could be a pop-up overflow (see fig. 4.3) allowing surplus water to surface at an elevation below the downspout inlet, or a grated opening

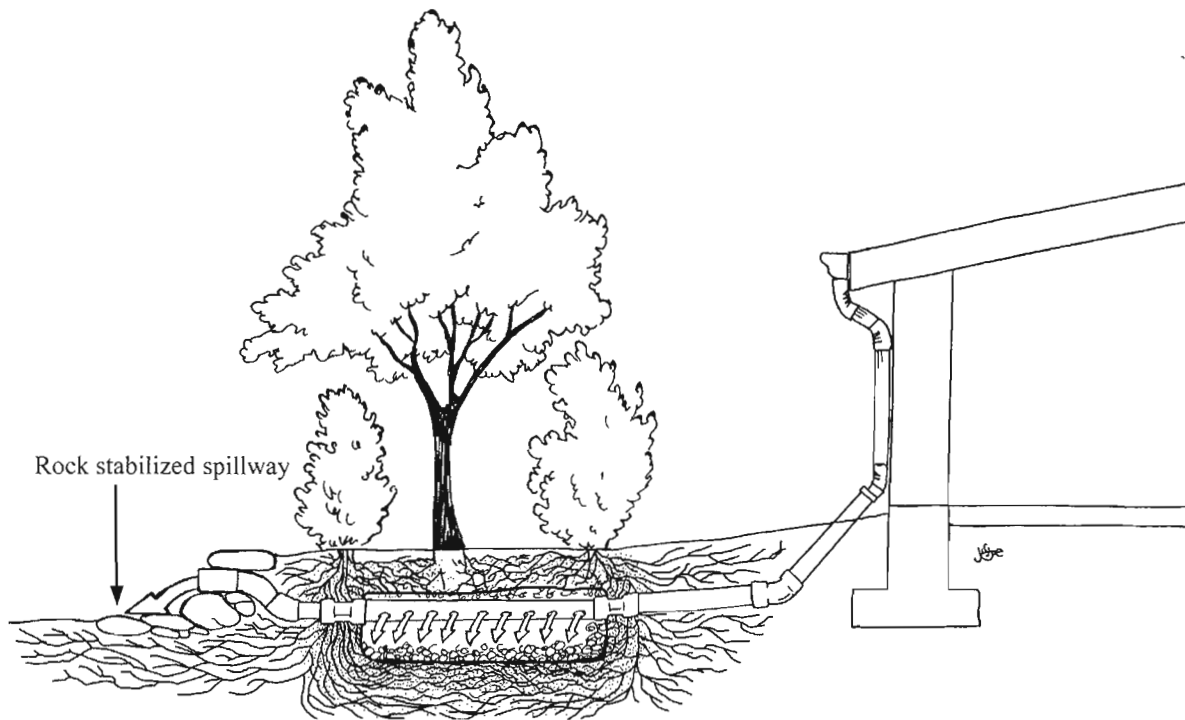

Fig. 4.8. French drain with pipe connected to downspout. Note the overflow (exiting a dry-laid retaining wall) is higher than the perforated pipe in the French drain, so most of the water infiltrates into the drain, while the overflow is lower than the inflow elevation where the downspout enters the pipe, so no water backs up against the house. A rock apron diffuses the falling overflow water. Note: While the illustration's perspective may be misleading, the vegetation is planted adjacent to the French drain, not on top of it. Compare to figure 4.3 which shows overflow from a canale.



Fig. 4.9A. Perforated pipe being laid level within a French drain of gravel wrapped in landscape fabric. The French drain will direct roof runoff to passively irrigate a windbreak of trees. Credit: Jeremiah Kidd

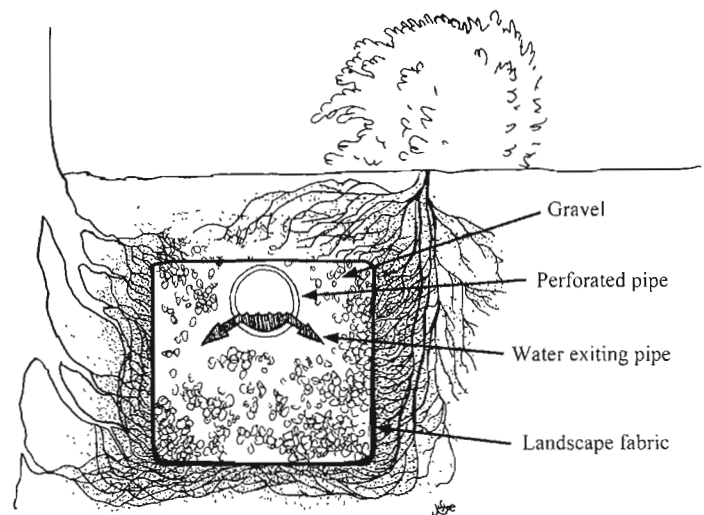

Fig. 4.9B. Cut-away view, looking into perforated pipe within a French drain

## Box 4.2. Cautions

1. In some instances the installation of French drains may require permits from the U.S. Environmental Protection Agency (EPA). According to the EPA, French drains could be considered Class V stormwater drainage wells if they are lined with drain tile or installed with piping for subsurface distribution of fluids. Such wells are regulated by EPA and by primacy states (states that have primary enforcement responsibility for their Public Water System Supervision programs). Regulations through the Underground Injection Control (UIC) program protect underground sources of drinking water (USDWs), from runoff that enters stormwater drainage wells, which may be contaminated with sediments, nutrients, metals, salts, fertilizers, pesticides, and microorganisms. A USDW is defined as an aquifer that contains less than 10,000 mg/liter total dissolved solids and is capable of supplying water to a public drinking water system.<sup>1</sup>

French drains are not considered stormwater drainage wells if they are excavated trenches filled with stone or coarse organic matter and do not include piping or drain tile. In such instances, they are usually wider than they are deep.

For more information see [www.epa.gov/npdes/pubs/sw\\_class\\_v\\_wells\\_fs.pdf](http://www.epa.gov/npdes/pubs/sw_class_v_wells_fs.pdf).

2. French drains collecting runoff from a potentially polluted surface such as a parking lot or driveway may carry pollutants along with the infiltrating water into the soil. As a result, French drains and other underground infiltration structures may require a Discharge Permit from your state environment department. Check with officials in your area to determine if a permit is needed.

releasing surplus water through a terrace wall or into an infiltration basin (fig. 4.8). Either way, make sure your overflow outlet is above the perforated pipe so most of the water will infiltrate the French drain, and below the drain box or downspout inlet so no water will back up against your house. Direct overflow water to another water-harvesting earthwork, a natural drainage, or (if no other option) a stormwater drain.

**COVER UP:** Once all pipe is laid within the trench, check to make sure the perforated pipe is level and all solid pipe slopes at least 1/2 inch per 10 linear feet (1.25 cm per 3 m). Then cover the pipe with more pumice or gravel. To prevent dirt from prematurely silting up the drain, either wrap the top of the gravel-filled trench with landscape fabric or place 20 to 24 sheets of newspaper atop the gravel. Cover the landscape fabric or newspaper with 2 to 10 inches (5–25 cm) of soil and tamp it in place.

### French drain with infiltration chambers

For water-harvesting French drains with “pipe,” I prefer using bottomless, louvered-sided infiltration chambers instead of more commonly known perforated pipe. Because the chambers have such a large air

space within them, roots rarely grow into and clog the chamber as they typically do with smaller interior perforated pipe. Instead, roots grow to form a beneficial root mat under the chamber, but they are not likely to grow into and clog the chamber (see fig. 12.12C in chapter 12 for an interior view of a chamber used in a greywater-harvesting application). In addition, the chambers provide for a greater water-holding and water-distribution capacity due to their larger interior void space, which does not plug with sediment as can eventually happen with gravel- or crushed-stone-filled trenches. Thus, no landscape fabric is needed, and native soil can be used rather than gravel to backfill around the chambers, allowing you to plant or seed directly on top of, or beside, the chamber. Don't plant trees or large shrubs directly on top of the chambers because they will collapse the chambers with their weight.

Infiltration chambers were originally designed for septic leach fields, though they work great for water-harvesting French drains and greywater-harvesting systems too. They can be purchased from septic system suppliers, and are manufactured by Infiltrator Systems Inc. ([www.infiltratorsystems.com](http://www.infiltratorsystems.com)) and Hancor ([www.hancor.com](http://www.hancor.com)). Both companies provide detailed installation instructions. And for installations within

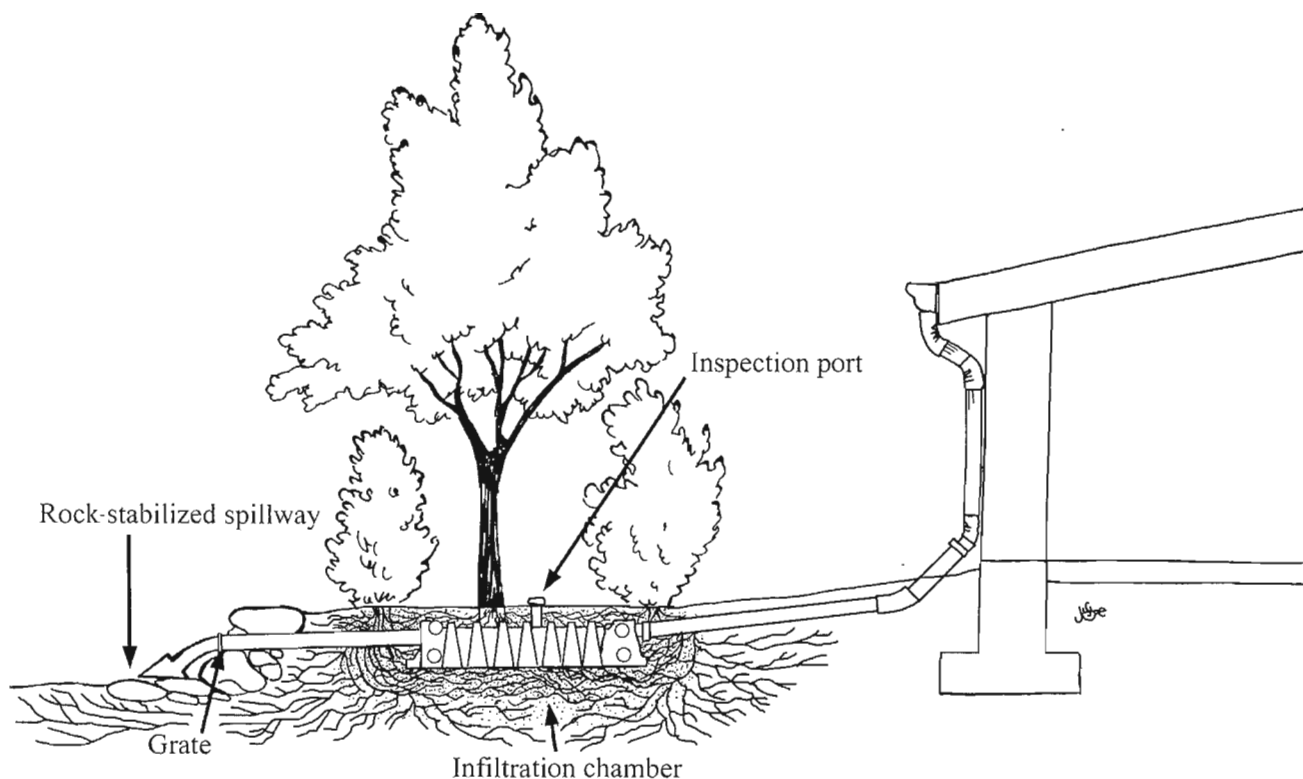

Fig. 4.10. French drain with infiltration chamber. Non-perforated pipe brings the water to the chamber and takes surplus away via the overflow pipe. The large void space in the bottomless, louvered-sided chamber will not clog with roots so no landscape fabric is needed, and the chamber can be covered with native soil rather than gravel. The chamber could also be used instead of perforated pipe and gravel with a canale installation (fig. 4.3).  
 Note: A plastic drain grate covers the overflow opening so rodents don't enter the pipe.

trenches curving along contour lines, Infiltrator Systems offers angled connection joints called “contour swivel connections” that link up their “Quick4” chambers in a curvilinear pattern. Hancor offers a similar system.

Whether your trenches are straight or gradually curved, place the chambers atop the level bottom of your trench, connect as many chambers as needed to attain the desired capacity of your system, and cap the two ends with end caps. Incoming non-perforated pipe is connected to one end, and a non-perforated overflow pipe is connected to the other end. Add an inspection port or two, and cover the chamber(s) with native soil dug from your trench (see fig. 4.10). You will likely want to cover the chamber(s) with a slight mound of soil at first, because the soil will settle as it recompacts into place.

Be sure you obtain chambers that do not exceed 13 inches (33 cm) in height. This way you can dig a

shallower trench and more easily distribute the incoming water into the top 2 feet (0.6 m) of the soil where the bulk of the soil life and roots will utilize the water. The Infiltrator Systems’ “Quick4 Standard Chamber” or Hancor’s “EnviroChamber ProArc Standard Chamber” are ideal.

## PLANTING YOUR FRENCH DRAIN

Plant around, rather than in, a French drain. Perennial plants are best (see chapter 11 in this volume on vegetation). Vegetation prolongs the life of French drains by stabilizing soil and acting as a living filter that catches sediment before it reaches the drain. Native grasses and indigenous groundcovers work well. They can be planted beneath sheltering trees that use the water harvested in the drain. If leaf drop is allowed to accumulate and the plants are allowed to grow, the soil underneath will be loose, porous, and

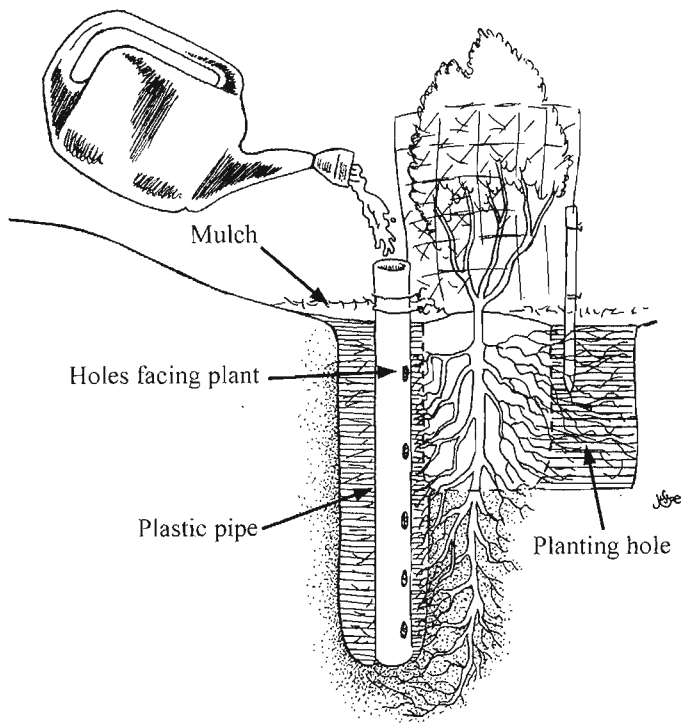

Fig. 4.11A. Deep-pipe irrigation within an infiltration basin

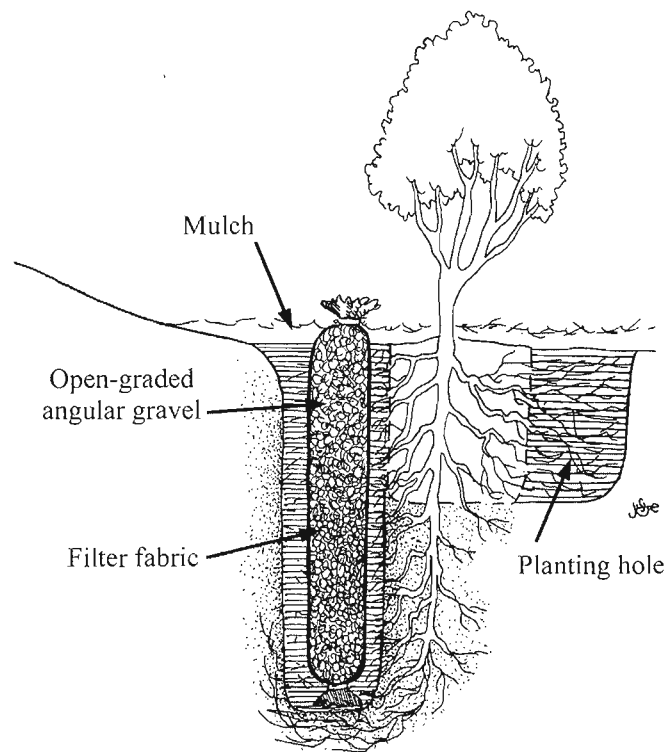

Fig. 4.11B. Rock-tube irrigation within an infiltration basin

fertile with organic matter, creating a natural sponge for rainwater infiltration. French drains might eventually silt up, but the vegetation and healthier soil they help establish create a “living French drain.”

## MAINTENANCE

Check your French drains periodically, especially during or following big rains, and make repairs or adjustments as needed. Add fill material after the original fill has settled.

## VARIATIONS OF A FRENCH DRAIN

### DEEP-PIPE IRRIGATION

David Bainbridge, author of *A Guide for Desert and Dryland Restoration*, developed deep-pipe irrigation to direct irrigation water deep into the root zone of associated plantings. He accomplishes this deep irrigation by inserting a plastic pipe or bamboo tube vertically into the soil. Deep-pipe irrigation encourages

deep root growth, producing more drought-tolerant plants than surface irrigation produces. In addition, less irrigation water is lost to evaporation and there is less weed growth (fig. 4.11A).

Using 3/4- to 2-inch (19- to 50-mm)-diameter plastic pipe for drip-irrigation emitters or hand watering, and 4-inch (100-mm)-diameter pipe for water-truck watering, cut the pipe in 18- to 24-inch (45–60 cm)-long sections. Starting 6 inches (15 cm) down from one end of each pipe section, cut or drill holes on one side of the pipe at 3-inch (7-cm) intervals.

Dig a hole within a water-harvesting earthwork that is large enough to hold a perennial plant and the pipe. Place the plant against one side of the hole; then set the pipe vertically against the plant’s root ball. The holes or slits in the pipe should be facing the plant. Leave 3 to 6 inches of pipe sticking up above grade so sediment does not flow into and clog the voids between the gravel. Backfill around the plant and pipe, then mulch the surface of the soil. Fill the pipe with 1/2-inch (1.25-cm)-diameter gravel or rock. If installing drip irrigation place an emitter in the end of the pipe. If you need fencing to

keep critters from nibbling on your plant, you can use the end of the pipe as a stake to hold the fencing in place.

After plant establishment, the pipes can be pulled and reused.

## ROCK-TUBE IRRIGATION

Rock-tube irrigation uses a gravel-filled tube of landscape fabric instead of pipe to accomplish deep irrigation. The porous fabric filters out sediment, while allowing harvested runoff and irrigation water to seep into the tube and quickly infiltrate deep into the soil (fig. 4.11B).

The San Isidro Permaculture crew of Santa Fe describes the construction process as follows: Cut a piece of 4-inch (10-cm)-diameter plastic pipe that is 6 to 12 inches (15–30 cm) longer than the depth of the root ball of the plant you are planting. Wrap the pipe with landscape fabric, overlapping the fabric 6 inches (15 cm), and pinning it together with long nails, wire, or landscape pins. Tie off the bottom end like a sausage. Dig a hole for your plant and tube as you would for a deep-irrigation pipe. Tubes are typically planted 6 to 12 inches (15–30 cm) deeper than the plant's rootball to encourage roots to grow down deep. The top of the tube is at or just above grade. Set the plant and tube in place, then backfill around them both. Fill the pipe within the tube with 1/2-inch (1.25-cm) or larger-diameter gravel, then pull out the pipe to use on another rock tube. Tie off the top of the tube and cut off any excess fabric. Mulch the surface of the basin around your plant and tube.

For a similar strategy using only mulch (no pipe or landscape fabric) see the vertical mulch variation in chapter 7.

## MULTIPLE FUNCTIONS OF FRENCH DRAINS

### FRENCH DRAINS AS AN AIR-CONDITIONING CONDENSATE-DISTRIBUTION SYSTEM

Air-conditioning condensate is atmospheric water that condenses on the cold evaporator or coil of an air-conditioning unit. Condensate is minimal when air is

very dry, but can be substantial when air is humid. In the relatively humid climate of Austin, Texas, as a rule of thumb you can collect from 0.1 to 0.2 gallons (0.37 to 0.75 liters) of condensate per ton-hour of actual air-conditioner run time.<sup>2</sup> This can add up to 2,000 gallons (7,580 liters) of condensate per day at a large commercial air-conditioning unit in Austin.<sup>3</sup> A growing number of commercial sites in Texas use this water along with harvested rainwater to irrigate their landscapes.

Condensate can be directed to any water-harvesting earthwork, and works particularly well with a French drain if local ordinances require the condensate to be drained subsurface.

## REAL-LIFE EXAMPLES OF FRENCH DRAINS

### PUMICE WICK TURNS STORMWATER LIABILITY INTO AN ASSET—NORTHERN NEW MEXICO

Too much water in too small an area—that was the problem Jeremiah Kidd of San Isidro Permaculture was hired to solve. He was shown a small north-facing courtyard that would get flooded with runoff from the adjacent home's roof, creating a mud pit in summer and an ice rink in winter. French drains with pipe were the answer. Drain boxes were installed at the base of each canale draining into the courtyard, then covered with cobble and gravel (figs. 4.7A, B). Non-perforated pipes were installed to direct the roof runoff from the drain boxes through the courtyard's perimeter garden wall to a French drain irrigating a row of young cottonwood trees acting as a windbreak for the home (fig. 4.9A). The courtyard no longer floods or freezes, and the stormwater liability is now an on-site resource that grows with the trees.

### FRENCH DRAIN HELPS TRANSFORM AN ERODING DRIVEWAY INTO A PERMEABLE GREEN SPACE—SANTA FE, NEW MEXICO

Ben Haggard once had a long, sloping, dirt driveway that acted like a drainageway. It was bleak to look at, took up half his yard, and in storms it drained both





Fig. 4.12. The driveway has been cut down to the length of a car and the width of two. It is paved with porous open-graded aggregate, and sloped toward the base of the terrace retaining wall where a French drain infiltrates any runoff. The terraces, rain- and greywater-irrigated vegetation, and metal trellis help screen out headlights at night. Ben Haggard residence, Santa Fe, New Mexico

the driveway's surface, and the yard's runoff and topsoil to the street (fig. 4.12).

Now Ben has converted the driveway into an alluring sponge that infiltrates water, grows plants, builds soil, and adds value to his home. The driveway has been reduced to a two-car parking area the length of an average car. The graveled parking area slopes not to the street, but to a pipeless French drain on the other side of two railway ties that act as wheel stops. There the French drain doubles as a permeable path people can use as they walk around the front of the parked cars. A dry-stacked terrace wall made from salvaged pieces of concrete sidewalk rises from the house side of the French drain to a mulched basin in which a young oak tree has been planted. The terrace eliminates the old slope of the driveway and, along with newly planted vegetation, blocks the house from headlights and increases privacy. The terrace basin, French

drain, gravel parking surface, and a contour berm placed above the terrace work together to infiltrate runoff throughout the front yard. This passive irrigation supports low-water-use, wildlife-attracting native plants including oak, rabbit brush, sage, datura, native grasses, and penstemon on 15 inches (381 mm) of average annual precipitation at 7,000 feet (2,133 m) elevation. It's a landscape that creates a sense of place unique to Santa Fe.

Closer to the house, apricot, crabapple, and Chinese jujube trees planted in mulched basins increase diversity and grow food. Household greywater augments their irrigation. This simple utilization of on-site water has softened and enriched the house by bringing life and appeal to its surroundings, and it joyfully lures visitors up the winding mulched path through it all.



# Infiltration Basins

## WHAT IS AN INFILTRATION BASIN?

An infiltration basin is a relatively shallow, *level-bottomed* depression dug into the earth (fig. 5.1). This is a primary rainwater-harvesting technique for flat to very gradually sloping land, and is the one people often think of for irrigating trees and other plantings. Among the variations discussed in this chapter are infiltration basins around existing vegetation, and those used to make sunken gardens. Basin planting is particularly appropriate for drylands gardens, reducing water needs by up to 50% compared to raised bed gardens often found in areas of more plentiful rainfall. Among the Real-Life Examples you'll see how infiltration basins are used as a highly productive and less-invasive alternative to costly retention/detention basins in developments. There's also an intriguing, traditional, very-low-water-use technique of "planting water in pots"—then planting seedlings around the water-filled porous clay pots to tap the gradually seeping water. In the wetter climates of the Northeast, Northwest, and Midwest U.S., landscaped infiltration basins are promoted under the name *rain gardens*.

The infiltration basin's diameter can extend well beyond the canopy of a mature tree's branches, or it can be one of many smaller basins whose combined surface areas far exceed that of the single large basin. Like a bowl or a catcher's mitt, it collects, infiltrates, and utilizes the rain and leaf-drop that falls within it, while also catching the runoff from the surrounding area, and

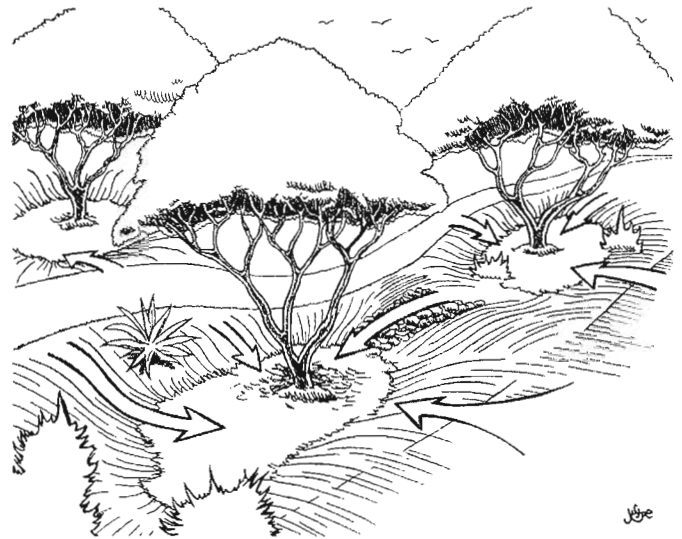

Fig. 5.1. A series of infiltration basins intercepting and infiltrating rainfall and runoff from adjoining curbless street and raised walkway (footpath). Designed correctly, these basins can act as the sole irrigation system for the associated vegetation (once the plants are established), while doubling as a flood control system.

potentially household greywater too (see chapter 12 for more on greywater). A layer of mulch covers the surface of the basin to soften it, increase infiltration rates, improve soil fertility, and reduce water loss to evaporation. Vegetation is planted within and beside the basin to utilize the harvested water and grow more resources, while further increasing its infiltration.



Fig. 5.2. Overhead view of my brother's and my side yard and winter garden. All plantings are located in infiltration basins. All pathways and gathering areas (such as under the ramada) are raised to drain their runoff to the adjoining basins. Rocks stabilize the basins' edge. The 1,200-gallon ferrocement cistern in bottom right of picture captures roof runoff for later use in the garden, while its overflow is directed to the citrus tree's basin.

Dig the basins where you want the water to infiltrate and grow sheltering vegetation close to the water's source, then use the excavated soil to create meandering raised pathways or patios that beneficially drain their runoff into the basins and roots of the associated plants. Any surplus water is directed via spillways from one basin to the next, spreading and infiltrating water throughout the site. On gradually sloping sites the basins can act as a series of stepped basins, much like terraces without retaining walls. The result: transformation of what was once a rather dull and dehydrated flat site to a dynamic one with a wonderful variety of topography—that *harvests* resources rather than draining them.

Compared to other earthworks, infiltration basins have far greater water storage capacity than similarly sized French drains because they are open, not full of aggregate or mulch. The flat-bottomed infiltration basins are also typically wider than the rounder-bottomed basins of b'nbs, whose size and shape are hemmed in by the slope on which they are built. And infiltration basins on flatter sites usually have no berms, so they can draw in the runoff from all directions of the land immediately surrounding them. (Fig. 5.2 shows infiltration basins in a backyard.)

## WHERE ARE INFILTRATION BASINS USED?

Infiltration basins work best on relatively flat landscapes or gradual slopes, and do a great job of concentrating water around the plants within the basins. Thus, they are often built as sunken garden beds, water-harvesting tree wells, household greywater drains irrigating an oasis of fruit trees, and interconnected mosaics of vegetated basins throughout a landscape. However, different contexts lead to different approaches.

Land disturbance is slow to heal in the dryland environment so it is best to minimize it—especially in areas where there are few resources such as people to do maintenance, runoff water to boost direct rainfall, or supplemental irrigation to get vegetation established and more quickly heal the scar. So, in broadscale dryland restoration projects it is often wise to focus revegetation plantings in natural basins or depressions rather than removing existing vegetation through the creation of new basins. The only dirt moved is that from the digging of a planting hole, and that dirt is cast to the downslope edge of the depression to increase its water-holding capacity. If more invasive basin creation is to happen, try to focus it in areas already disturbed and lacking in vegetation. Along roadways this can work well, since adjoining basins can harvest the road's runoff, delineate what is road and what is not, curb erosion, and perhaps grow a

### Box 5.1. What an Infiltration Basin Is Not

An inefficient landscaping practice is planting vegetation on the tops or sides of mounds that are positioned within flat or convex landscapes. Mounds drain rain, irrigation water, soil, and organic matter away from the plants and off site, diminishing soil fertility and increasing maintenance needs and water bills.

A slightly less inefficient practice is planting vegetation inside circular berms or earth rings. This practice retains irrigation water and some rainwater and leaf drop, but deflects upslope runoff and leaves dropping beyond the encircling berm, thus reducing the harvested rainwater and organic matter available to plants. See figure 5.3.



Fig. 5.3. From left to right, a tree planted atop a mound from which water and soil drain away; within a circular berm which diverts area runoff and any leaf drop falling outside the berm away from the tree; and within an infiltration basin toward which the surrounding area is sloped so all direct rainfall, surrounding runoff, and leaf drop is harvested. These trees could've all been the same size at planting, and planted at the same time, though their current size reflects how the vegetation will respond to the degree to which different landforms drain or harvest resources.

sheltering shade tree. Dirt excavated to form the basin can further beef up or raise the road base so it stays high, dry, and accessible. And, the easy access to the basins makes it more likely that the structures and plantings will be monitored and maintained when people come through the site.

Around new construction and areas of intense human use—such as homes, schools, and businesses—land disturbance is extreme, but the amount of available resources to mitigate that disturbance is high, thus this is where the creation of infiltration basins makes the most sense, and it is where the basins can best work as multipurpose on-site flood control as well. Basins made in these often compacted and denuded areas can focus roof, patio, and driveway runoff to areas that can infiltrate that water and grow a solar arc (figs. 5.4A, B) of shade trees. This solar arc blocks out the hot summer sun on the east, west, and north sides of the building (in the northern hemisphere), while welcoming in the sun's free source of heat and light in winter, as long as you limit plantings to low vegetation in basins on the south (winter-sun) side of the building that won't shade the windows. (See Volume 1, chapter 4 for more on solar arcs, and see the "Planting Your Infiltration Basin" section of

this chapter for tips on tree species and spacing from buildings.) Greywater from household drains can also be directed to the basins to carry associated plantings through the dry seasons lacking rain, and people can care for new plantings until they are established and able to thrive on harvested rainwater and greywater alone.

Infiltration basins should not be constructed within 10 feet (3 m) of buildings or in drainages. Nor are they appropriate for use in places where groundwater is very close to the surface, which might prevent complete drainage and result in prolonged periods of standing water. Similarly, do not locate infiltration basins over septic drain fields since they could overflow the fields with harvested rainwater.

Mr. Zephaniah Phiri's use of infiltration basins within drainages, which he calls "fruition pits," (see Volume 1, chapter 1, for the story of Mr. Phiri's reclamation of eroded land in Zimbabwe) is an exception to the rule of avoiding drainages. These fruition pits were placed within the confines of large human-made drainage swales having a 1:1,200 slope. Mr. Phiri took extreme care to stabilize the edges of the fruition pits placed within drainages, to make sure they did not get washed out due to unstable soils or heavy runoff.

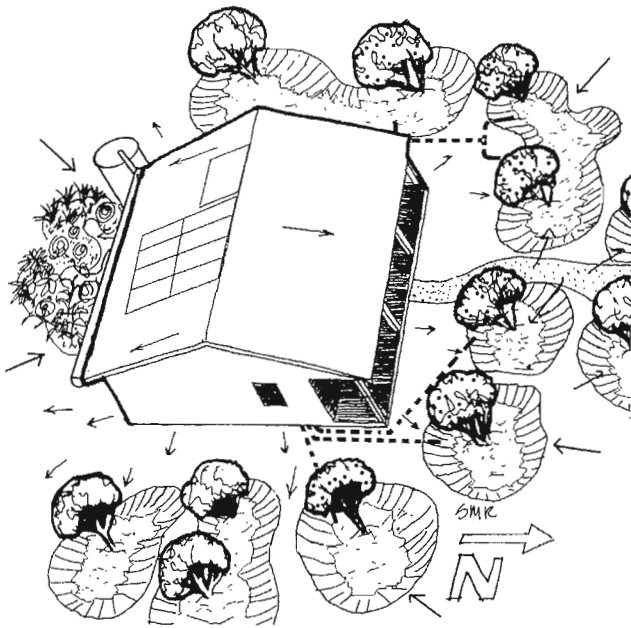

Fig. 5.4A. Water-harvesting infiltration basins placed to help grow a solar arc of trees at 32°N latitude. Basin on the winter-sun side of the house grows a sunken garden. Young trees planted within the basins are irrigated with harvested roof runoff. Greywater (dotted lines) is directed to fruit trees where people gather for convenient irrigation and fruit harvest.

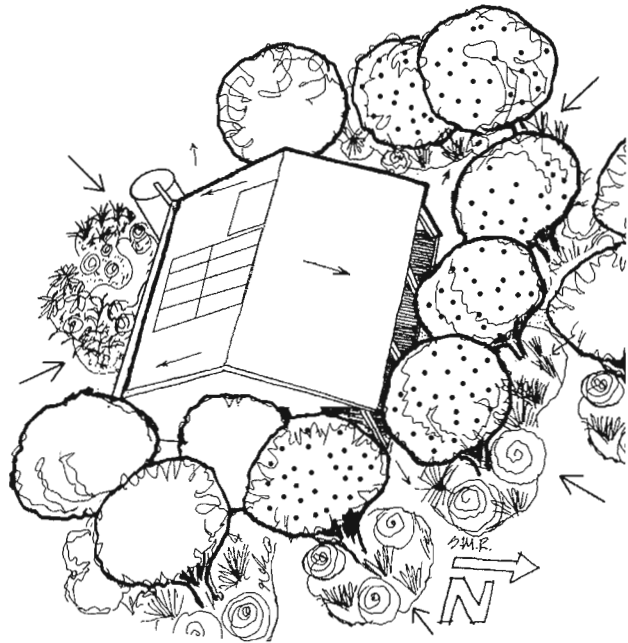

Fig. 5.4B. Trees at full size forming a living solar arc “cool” outdoor summer temperatures by 10 to 20°F (5.5–11°C), while maintaining full winter sun access for free heat, light, and a thriving winter garden. Note how solar panels and solar hot water heater are centered on the south-facing side of roof by the ridgeline to minimize shading by trees in morning and afternoon.

## TOOLS AND MATERIALS

**Tools:** Infiltration basins have to do with digging, so you’ll want a shovel, pick, rake, work gloves, and a wheelbarrow. A Ditch Witch, small skip loader, or backhoe add mechanical muscle when soil is hard or work is more extensive.

**Materials:** Once your basin is dug, you will need organic matter for mulch, and seeds or plants to bring it to life.

## STEPS TO BUILD INFILTRATION BASINS

### SITING

Infiltration basins are placed where you want to grow vegetation. They work great near pathways, driveways, alleys, patios, gathering areas, and buildings if they are positioned lower than these hardscapes. That way they harvest rainwater that runs off these

paved, compacted, or sealed surfaces. Trees planted in the basins utilize that runoff water and grow to shelter the area.

Mark the outline of your basins with stakes, flagging, surveyor’s spray paint, flour (it’s nontoxic), or lines scratched deeply into the soil. Borders can be round, oval, curved, or crescent—whatever shape meets your aesthetic needs and works around existing or planned vegetation and structures. I find curves more appealing than straight lines, and I prefer basins of varying sizes and shapes for interest.

If you plan other water-harvesting earthworks, mark these at the same time, so all water-harvesting earthworks are integrated. For example, you could construct a series of earthworks that overflow from one to another. For interconnected basins, position the first basin at the source of runoff (perhaps beneath a roof gutter’s downspout or at the top of a slope), and position subsequent basins in a series with the first flowing into the next, and so on. On gradual slopes, terraced basins can step downhill. This distributes rainwater in



Fig. 5.5. Terraced or stepped basins from which overflow water will flow down a stabilized spillway to the next basin below. The bottom of each basin is lower than the height of its spillway so water infiltrates throughout the landscape—each stepped basin of the way.

manageable volumes to multiple locations throughout the landscape, and keeps erosion in check (fig. 5.5).

If you need paths, raise the pathways and position them between or along the sides of basins so they act

as partial borders for your earthworks (fig. 5.6). This can also reduce your digging, because as you cast excavated dirt on the path bordering the basin, this raised basin edge deepens the basin.

## APPROPRIATE SIZE AND SPACING

Infiltration basins for perennial plantings should be at least 9 inches (23 cm) deep. Don't start any shallower because you'll be adding mulch and over time additional organic matter and silt will accumulate, raising the bottom of the basin. Where I have the space, and the incoming runoff, I may dig basins 18 to 24 inches (45–60 cm) deep. I don't go any deeper because I want to avoid basins that hold more water than will infiltrate into the soil within 12 hours. If berms are created on the downslope side of the basin, they should be at least 2 feet (60 cm) wide to make them durable, and as much as 3 to 5 feet (90–150 cm) wide to double as raised pathways suitable for wheelbarrows, wheelchairs, and easy walking (fig. 5.6). Plan your basins' size to handle the expected amount of direct rainfall and runoff, and size according to the *mature* size of plants you want to grow within the basins. Ideally,



Fig. 5.6. A raised path between basins

the boundary of a basin should extend at least 1.5 times the width of the mature plant's canopy. This is because most of the plant's roots spread 1.5 to 3 times the width of the canopy, within the top 2 feet (60 cm) of soil, and most of the water used by a plant comes from outside the canopy drip line (figs. 5.7A, B).<sup>1</sup>

In addition, most of the plants' leaf-drop is then collected within the depression, and the basin's surface is sheltered by the plants and accumulated organic matter.

In urban areas and smaller yards it may not be possible to create a basin 1.5 to 3 times the width of a mature tree's canopy. The desire for patio space, paths, and such must also be incorporated into the layout. In such instances, make the basin as close as you can to the ideal size, and settle for that. A smaller basin is better than no basin. It's also fine to break up a single larger basin into smaller basins with a raised path or section of a raised patio. The roots will find the water accumulating in the low spots (fig 5.8).

In landscapes mixing plantings of trees and shrubs, I limit the size of individual basins to no more than 40 feet (12 m) across, yet it's fine to have an area divided into a number of smaller sub-basins that amount to a cumulative basin area much larger than 40 feet across (fig. 5.8). Dividing large basins into sub-basins also helps ensure that harvested rainwater more evenly infiltrates throughout the whole area of each basin. In larger undivided basins water may concentrate in just a few low spots too distant for some of the associated plants to reach with their roots.

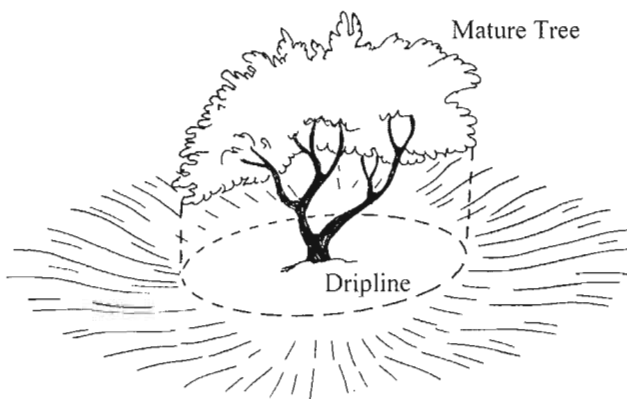

Fig. 5.7A. Ideally, the infiltration basin diameter is at least 1.5 times (and up to 3 times) the diameter of the associated mature plant's canopy drip line, since roots spread, and most water used by many desert plants is drawn from the root zone outside the canopy drip line.<sup>2</sup> However, even one undersized basin or a series of them is better than no basin.

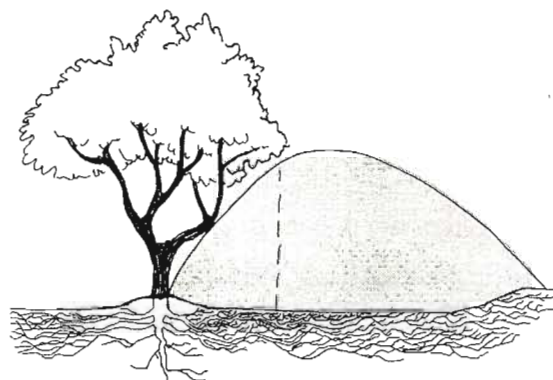

Fig. 5.7B. The shaded area indicates the percent of the water absorbed by the tree roots at a given distance from the tree's center. Adapted from: *Water Requirements of Landscape Trees*<sup>3</sup>



Fig. 5.8. Large basin divided into smaller basins



## Box 5.2. Calculating Infiltration-Basin Capacity or Volume

To calculate the maximum volume of a surge of water your infiltration basin could hold at one time, you need to know the depth, and the bottom and top diameters of a circular basin (from which it's easy to calculate these radii) or the bottom and top widths and lengths of a rectangular basin (see figs. 5.9A, B). For the rectangular basin; I will provide an additional alternative "ballpark" equation, essentially using an average extent of the basin area multiplied by its depth. Keep in mind that because it's so difficult to measure large basins accurately, all your calculations will in any case give approximate volumes. In the calculations below, all numbers, including  $\pi$ , have been rounded off to 2 decimal places, and the results have been rounded off to whole numbers.

- **Depth** is the distance from the bottom of the basin to the top of its rim (or the lip of the spillway if you have one). See figure 5.10.
- **Diameters** (circular basin). Because the edges of the basin are sloped, two different diameter measurements are used: one ( $D_1$ ) measured at the bottom of the basin, and the second ( $D_2$ ) measured at the top of the basin. Diameter is easier to measure than radius, but the radius of each circle is 1/2 its diameter: Hence  $R_1$  and  $R_2$  are each half of  $D_1$  and  $D_2$ , respectively.
- **Widths** (rectangular basin). Because the edges of the basin are sloped, two different width measurements are used: one measured at the bottom of the basin ( $W_1$ ), and the second measured at the top of the basin ( $W_2$ ).
- **Lengths** (rectangular basin). Because the edges of the basin are sloped, two different length measurements are used: one measured at the bottom of the basin ( $L_1$ ), and the second measured at the top of the basin ( $L_2$ ).

### CIRCULAR-BASIN CAPACITY CALCULATION (FIG. 5.9A):

$$\text{VOLUME} = 1/3 \times \pi \times \text{DEPTH} \times (R_1^2 + \{R_1 \times R_2\} + R_2^2)$$

or

$$\text{VOLUME} = (\pi \times \text{DEPTH} \times (R_1^2 + \{R_1 \times R_2\} + R_2^2)) \div 3$$

where  $R_1$  and  $R_2$  are the radii of the bottom and top circles  
( $R_1$  equals half of  $D_1$ , and  $R_2$  equals half of  $D_2$ ).

Figure 5.9A shows where depth and diameter measurements are taken for the calculation. Use the same units for all measurements. For example, all English measurements should be in feet. Using the example basin (with a depth of 2 feet, bottom radius of 6.5 feet, and top radius of 12.5 feet), the calculation is as follows:

$$\text{Basin capacity/Volume (ft}^3\text{)} = (\pi \times 2 \times (6.5^2 + \{6.5 \times 12.5\} + 12.5^2)) \div 3$$

$$\text{Basin capacity/Volume (ft}^3\text{)} = (\pi \times 2 \times (\{6.5 \times 6.5\} + \{6.5 \times 12.5\} + \{12.5 \times 12.5\})) \div 3$$

$$\text{Basin capacity/Volume (ft}^3\text{)} = (\pi \times 2 \times (42.25 + 81.25 + 156.25)) \div 3$$

$$\text{Basin capacity/Volume (ft}^3\text{)} = (3.14 \times 2 \times 279.75) \div 3$$

$$\text{Basin capacity/Volume (ft}^3\text{)} = 1,756.83 \div 3$$

$$\text{BASIN CAPACITY/VOLUME} = 586 \text{ ft}^3$$

Then, to convert cubic feet to gallons:

Multiply  $586 \text{ ft}^3$  by 7.48 gallons/cubic foot to convert to 4,383 gallons of basin capacity.

continued on next page

## Box 5.2. Calculating Infiltration-Basin Capacity or Volume (continued)

SQUARE-OR RECTANGULAR-BASIN CAPACITY CALCULATION (FIG. 5.9B):

$$\text{VOLUME} = 1/3 \times \text{DEPTH} \times (\{L_1 \times W_1\} + \{L_2 \times W_2\} + (\text{sqrt } \{L_1 \times W_1 \times L_2 \times W_2\}))$$

or

$$\text{VOLUME} = (\text{DEPTH} \times (\{L_1 \times W_1\} + \{L_2 \times W_2\} + (\text{sqrt } \{L_1 \times W_1 \times L_2 \times W_2\}))) \div 3$$

with the sqrt being the square root, which is a function found on most calculators.

Figure 5.9B shows where depth, width, and length measurements are taken for the calculation. Use the same units for all measurements. For example, all English measurements should be in feet. Using the example basin (with a depth of 1.5 feet, bottom length of 16.5 feet, bottom width of 14 feet, top length of 20 feet, and top width of 17 feet), the calculation is as follows:

$$\text{Basin capacity/Volume (ft}^3\text{)} = (1.5 \times (\{16.5 \times 14\} + \{20 \times 17\}) + (\text{sqrt } \{16.5 \times 14 \times 20 \times 17\})) \div 3$$

$$\text{Basin capacity/Volume (ft}^3\text{)} = (1.5 \times (\{16.5 \times 14\} + \{20 \times 17\}) + (\text{sqrt } \{78,540\})) \div 3$$

$$\text{Basin capacity/Volume (ft}^3\text{)} = (1.5 \times (\{16.5 \times 14\} + \{20 \times 17\}) + 280.25) \div 3$$

$$\text{Basin capacity/Volume (ft}^3\text{)} = (1.5 \times [231 + 340 + 280.25]) \div 3$$

$$\text{Basin capacity/Volume (ft}^3\text{)} = (1.5 \times 851.25) \div 3$$

$$\text{Basin capacity/Volume (ft}^3\text{)} = (1,267.86) \div 3$$

$$\text{BASIN CAPACITY/VOLUME} = 426 \text{ ft}^3$$

Then, to convert cubic feet to gallons:

Multiply 426 ft<sup>3</sup> by 7.48 gallons/cubic foot to convert to 3,186 gallons of basin capacity.

Easy average-depth ballpark calculation for rectangular basins, in case you don't have a calculator to do square roots.

$$\text{VOLUME/BASIN CAPACITY} = \text{DEPTH} \times (\{L_1 \times W_1\} + \{L_2 \times W_2\}) \div 2$$

Both basins hold a lot of water! And they are much cheaper to build than tanks that hold these same volumes.

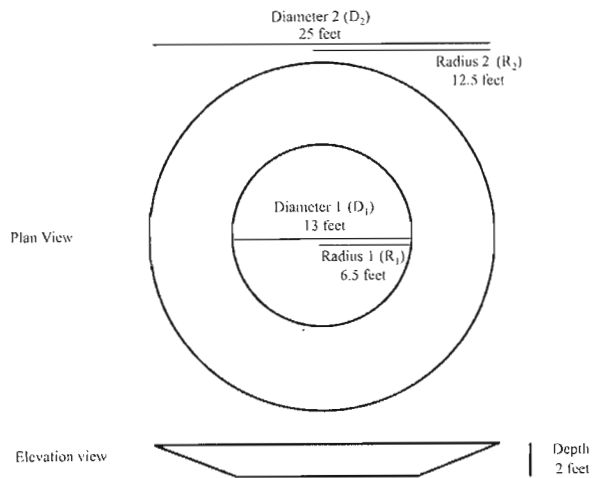

Fig. 5.9A. Circular-basin depth and diameter measurements, plan view and elevation view

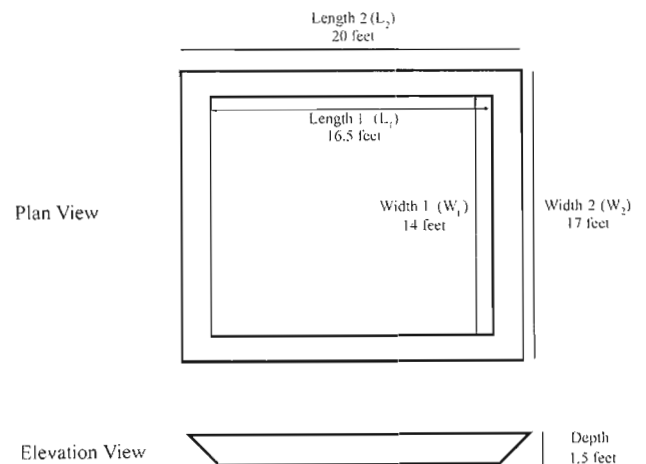

Fig. 5.9B. Rectangular-basin depth, width, and length measurements, plan view and elevation view

## CONSTRUCTION

Dig your infiltration basin and grade the surrounding earth so it slopes into the basin and captures runoff water from a large area. The deeper the basin, the more storage capacity and the longer it will last before filling with organic matter and migrating soils. However, I don't recommend more than a 2-foot (60-cm) depth for a basin, since you don't want to hold more water than can infiltrate within 12 hours.

Make the slopes of the infiltration basin's edge gradual and stable for a more welcoming appearance, a safer edge for pedestrians, and less erosion. A 3:1 or more gradual slope (for every 3 units of horizontal length the slope drops 1 unit in vertical height) is typically used around heavy foot traffic areas like sidewalks and patios. However, such slopes of your basin may constrain its depth. For example, if you dig a 6-foot-diameter basin beside a sidewalk, with a 3:1 slope around the basin's edge, you probably can't go any deeper than 12 inches (30 cm) with the basin because of the limitation of your slope (fig. 5.11).

A steeper slope can be used in areas short on space if stabilized with vegetation or rock (fig. 5.12).

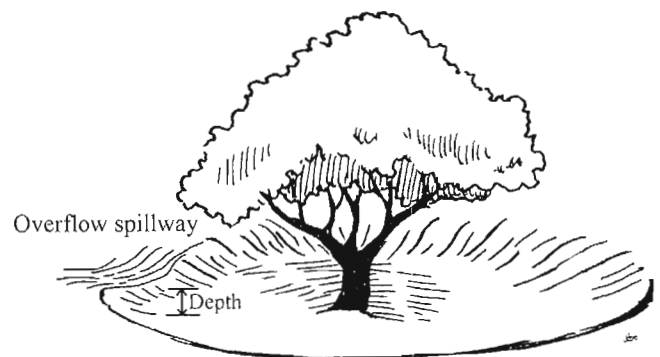

Fig. 5.10. Infiltration basin with spillway, showing depth measurement

Whenever possible, make the bottom of your infiltration basin *level*. This speeds up and more evenly distributes the infiltration of water throughout the whole basin.

Avoid compacting the bottom of a water-harvesting basin, since that decreases the rate at which water can infiltrate into the soil. Reverse the compaction of the basin that occurs when you excavate it by loosening the soil with a rake. In poorly draining soils, you may need to increase infiltration rates further by

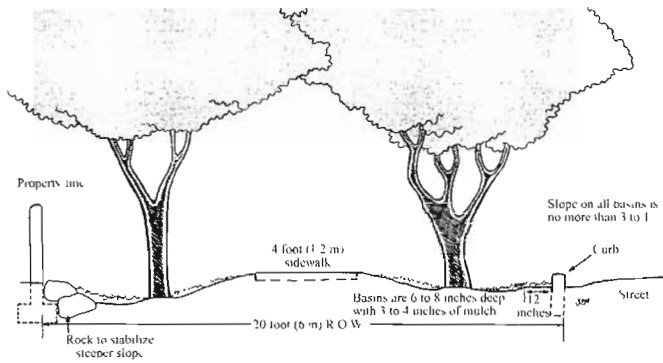

Fig. 5.11. Basin depths constrained by their gradual slopes in a confined space, in this case a 20-foot (6-m) right-of-way with two trees and 4-foot (1.2-m) wide sidewalk. The steepest section of earthen slope between sidewalk and tree is a 3:1 slope. Note the deepest part of the basin is away from the curb to lessen root heave of infrastructure.



Fig. 5.12. Space was tight along this public right-of-way, so the resulting steep-sided edge between path and basin was stabilized and delineated with rock. Mulch and vegetation within the basins further discourage folks from stepping off the path. Note: Basin to left is low enough to capture street runoff, while higher basin to the right harvests runoff from the path.

graveling, ripping, or aerating the bottom of a basin before planting vegetation and applying mulch.

Use the dirt dug from an infiltration basin to help water flow into, or stay within, the basin. One way to do this is to place the extra dirt on the downslope side of the basin to form a boomerang-shaped berm that increases the basin's storage capacity. Excavated dirt can also create raised paths or patios that drain into the basins. Do not construct a complete ring of dirt around a basin because that would keep additional upslope runoff from flowing into the basin.

Ensure that water drains *away* from nearby buildings (fig. 5.13). Placing dirt dug from a basin around the base of a building can sometimes help. However, keep a minimum distance of 4 inches (10 cm) between the level of the dirt and the top of a building's stem wall (typically the level of the floor or the bottom of an exterior stucco plaster). This helps prevent damage to walls caused by direct contact with soil moisture, rainfall splash, or easy entry of subterranean termites.

Stabilize basin edges to reduce erosion. Stone or brick can be placed around the edge of your basins, if they do not rise above the uphill side of the basin's edge, which would keep precious runoff water out. Smaller perennial plants can also be placed around basin perimeters to beautify and define their edge.

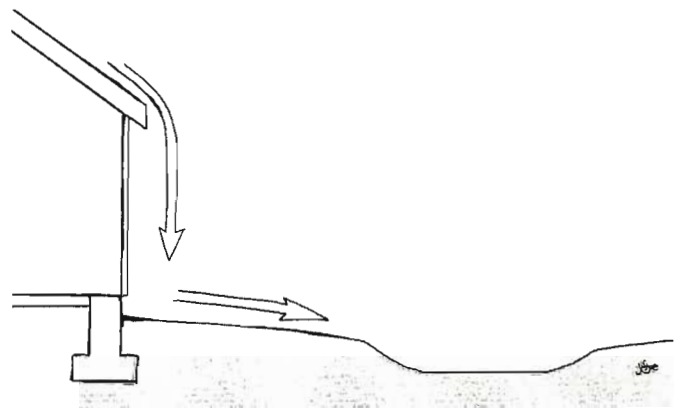

Fig. 5.13. Water from roof should drain away from the building to the basin.

(Fig. 5.14 is an example of an infiltration basin in a small yard.)

## LOCATION AND CONSTRUCTION OF OVERFLOW SPILLWAYS

Allow excess water to flow out of a basin to other water-harvesting earthworks by carefully positioning the lowest edge of the basin so it directs overflow

water where you want it to go. You can use a diversion swale—a gradually sloping drain described in chapter 9—or a stabilized spillway to lead overflow from one basin to another earthwork (figs. 5.15A,B and 5.16).

The final overflow of your system—at the lowest end of your water-harvesting earthworks and the bottom of your watershed—should always be directed to an existing drainage. Ideally, this would be a natural vegetated arroyo, wash, or creek, though in the urban setting it may simply be a storm drain or the street.

## PLANTING YOUR INFILTRATION BASIN

When planting your infiltration basins, hardy native species are an excellent choice because they are already adapted to the extremes of local climate and

geology, and don't need fertilizers or pesticides. Exotics typically need more care, though those appropriate for your area can also work well.

Select and place vegetation according to both a plant's water needs and how much water you expect to harvest within the basin. This approach results in four distinct planting strategies or placements (fig. 5.17):

1. Place vegetation with higher water needs and a higher water tolerance in the bottom of your basin. Such plants naturally grow in drainages or floodplains and are accustomed to periodic inundation by water and sediment. Velvet mesquite, canyon hackberry, blue palo verde, and desert willow are indigenous examples in southern Arizona. Date palms are an exotic example.



Fig. 5.14. Planted infiltration basins (right side of photo) in small yard. Area between house and basin slopes and drains into the basin. Roots of low-water-use plants against house are drawn to the basin for water by irrigating them only on the side closest to the basin, then moving drip-irrigation emitter or hose a foot closer to the basin every few months in the growing season, until roots have reached the basin. Roof runoff is also directed to the basins via a downspout (out of view) then a pipe beneath the path. Greywater from a sink and washing machine is also directed to the basin as explained in chapter 12. The basin edge is stabilized and delineated with stone.

For color photo see inside back cover.



Fig. 5.15A. Stabilized spillways connecting terraced basins on a gentle slope. Note that the bottom of each basin is lower than the top of its spillway so only surplus water overflows the basins, while the majority of the water sticks around and infiltrates. Finished basins are also vegetated and mulched to enhance the infiltration.



Fig. 5.15B. Stabilized spillways connecting basins on a flat site. Basin depths are the same here, though they can vary randomly. Spillway elevations on such flat sites can all be the same, whatever the basin depth.



Fig. 5.16. Spillway with stone stabilization. The center must be the low point with raised banks similarly stabilized with stone so the water does not cut a new, more-erosive path. The bottom of the slope where the soil becomes level is also stabilized to calm the faster-moving water that flows down the slope.

2. Plants with lower water needs, a lower tolerance for inundation, or preference for good drainage are suitable for the sloping sides of the basin. These are naturally found growing in areas unlikely to be periodically inundated with water or sediment. The poorer your soil drainage (heavy clay soils drain poorly), the higher you should plant this vegetation in relation to the bottom of the basin.

These plants can also be planted in *gradually* sloping dirt pedestals raised 4 to 10 inches (10–25 cm) above the bottom of the basin. This helps prevent disease by keeping water, soil, and mulch from standing against the base of the vegetation. The elevations of these pedestals should *not* exceed the ele-

vation of the basin's edge or you'll begin to get more of a water-draining system than a water-harvesting system. No pedestal should have a steep or even moderate slope or it will quickly erode away. Foothills palo verde, stone-fruit trees, and citrus trees are climate-appropriate examples for my area.

3. Vegetation that is drought-hardy or water- and rot-sensitive is planted on the periphery of basins. The base of the plant remains high and dry, while the roots can grow underneath and around the bottom of the basin to access the water as needed. Avocados, carob trees, edible nopal cactus cultivars (*Opuntia ficus-indica*), and native cacti are examples.

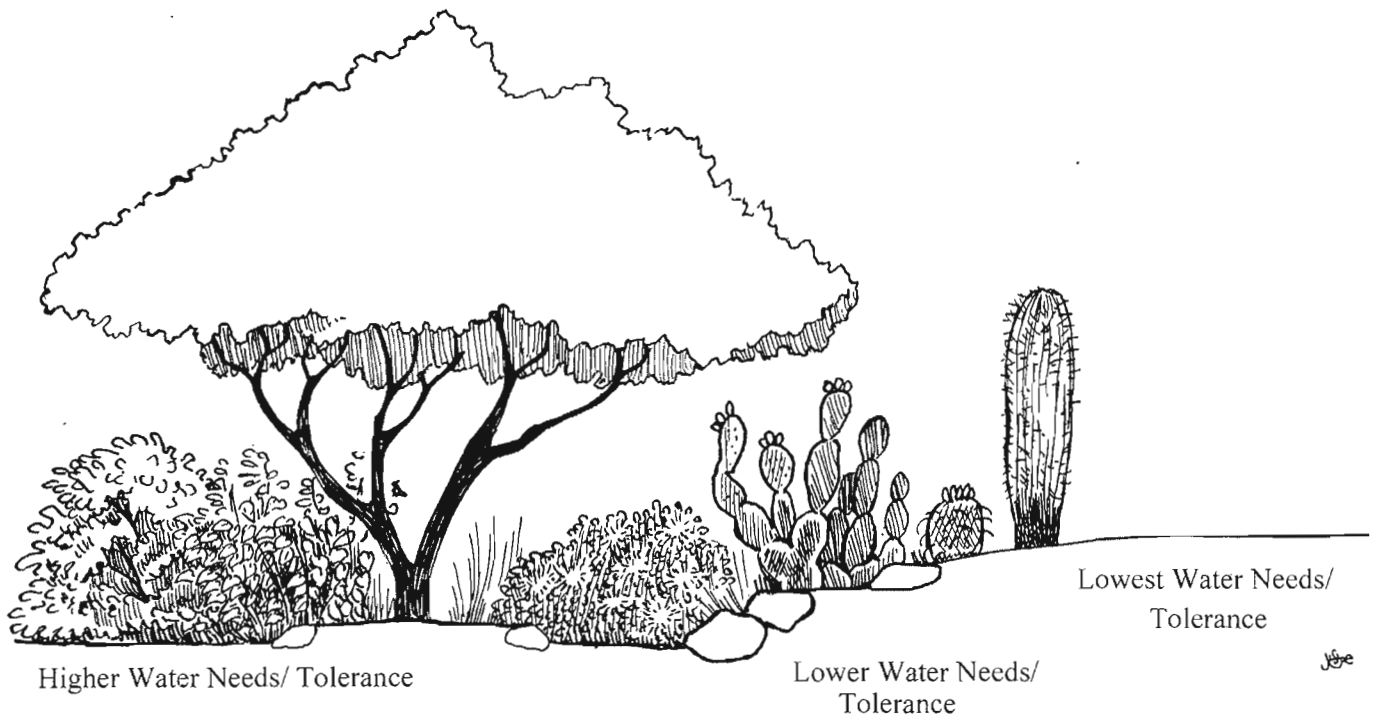

Fig. 5.17. Planting according to water needs and tolerance. Note: Cold air pools in low spots so cold-intolerant plants may need to be planted outside of basins.

4. If planting by seed, scatter a diverse seed mix of native annual and perennial wildflowers, grasses, shrubs, and trees with desirable growing characteristics throughout the basin, and rake it into the top 1/4 inch (0.6 cm) of soil. Various plants will germinate within their preferred microclimates in the basin. Moisture-loving species germinate more readily in bottoms, while drought-tolerant plants succeed on drier slopes. If you are seeding, avoid mulch or limit it to a very sparse application and depth of 1 inch (2.5 cm) or less. A thick layer of mulch inhibits germination of both weed seed *and* the seed you want to germinate. Once your plants are at least 6 inches (15 cm) tall you can thicken the mulch.

For further information on appropriate plantings and how to plant, see chapter 11 on vegetation.

While it's important to construct the outer boundary of the basin to accommodate the adult plants or

tree, it's equally important to make an additional shallow internal depression in a 2-foot radius (0.6-m) around new plantings to ensure that in small rainfall events, or during irrigation, the water is concentrated around the small plant during the critical period of initial establishment. Deep-pipe irrigation or rock tube irrigation (see chapter 4, Variations section) can also work well for plant establishment in place of such a shallow depression.

After planting, lay a 2- to 4-inch (5–10 cm) layer of mulch over the entire surface of your basin, except right around the base of your plants where only a very thin layer of mulch should be applied. Wet mulch against the base of a plant may encourage crown rot, but within the basin it increases water infiltration, reduces water loss to evaporation, and makes a basin appear shallower while delineating its edge. A thinner layer of mulch works better where the basin only receives direct rainfall, as you don't want the mulch to prevent water from a light rain to reach the soil. A thicker layer of mulch works well where the basin

harvests greywater or additional runoff such as from a roof's downspout or a patio, where enhanced infiltration is a greater need. (See chapter 7 on mulch.)

## Notes on planting a solar arc of basins around a building

Trees with a mature canopy 25 feet (7.5 m) in diameter should be planted 10 to 15 feet (3–4.5 m) from the east and west sides of buildings to provide maximum passive cooling in hot months<sup>4</sup> (see figs. 5.4A, B). The taller the tree will grow, the farther from the house it can be—and should be—if you don't want to excessively shade solar panels and solar water heaters on the roof.

Spacing of the vegetation from a building will vary from site to site. The higher the fire threat or the taller the vegetation, the farther the plants will be placed from a building. The lower the on-site water resources, the more sparse the planting density will be, and the plants will be selected for lower water use.

To avoid damage to the house, do not use trees with shallow or invasive root systems or those susceptible to storm damage, such as eucalyptus, Chilean mesquites (*Prosopis chilensis*), African sumac (*Rhus lancea*), cottonwoods (*Populus fremontii*), or pepper trees (*Schinus* spp.).

## MAINTENANCE

Check your infiltration basins periodically, especially during or just after heavy rain. You may need to stabilize basin edges, especially along curving paths where folks like to cut corners. Boulders, rock, and bulky vegetation stabilize soil and deflect shortcuts.

If basins are quickly filling with sediments carried by runoff from upslope areas, construct additional water-harvesting earthworks to capture and filter that runoff before it gets to your basins. If you can't access the upper watershed because it's a neighbor's property or for some other reason, plant vegetation on contour just above your basins to sift and slow the incoming sediment-rich runoff.

If a downspout erosively pours water over the slope of a basin's edge (fig. 5.18A), stabilize the spillway with either rock (fig. 5.18B) or black plastic corrugated

drain pipe that daylights an inch or two above the mulch covering the bottom of the basin (fig. 5.18C).

Reapply mulch as it decomposes. This is easily done for free just by letting leaf and fruit drop accumulate in the basin, along with prunings cut up with hand pruners to 4-inch (10-cm) or shorter lengths.

If the tree canopy grows beyond the boundary of your basins, and you have lots of energy, you might want to enlarge the basins beyond the expanding drip line of the tree. Rake up the mulch, enlarge your basins, and reapply the mulch. But first assess if the effort is really needed.

## VARIATIONS OF INFILTRATION BASINS

### BASINS AROUND EXISTING VEGETATION

You can dig infiltration basins beside existing young trees and shrubs (fig. 5.19)—beyond the drip edge of their canopy—where their roots will grow to access the harvested water. I emphasize young plants, because there is no need to dig basins around a healthy mature tree or shrub that is doing fine without them. In addition, some sensitive trees, such as the desert ironwood (*Olneya tesota*) in my area, can be easily damaged or killed by disturbing their surface roots.

On sloping land, rather than a basin construct a boomerang berm (see chapter 2 on berm 'n basins) on top of the soil on the downslope side of the plant, since this will disturb fewer roots.

### BERMS FORMING BASINS AROUND EXISTING VEGETATION

On densely planted flat ground, you likely will not want to do any digging of basins to avoid disturbing existing plant roots, but you may want to bring in dirt to make a perimeter berm that holds all on-site rainwater and perhaps runoff from a nearby roof. Just make sure your earthworks won't hold enough water to flood anything you don't want flooded such as a house. Use a water level to make sure the top of your berm is lower than the threshold of your doorway or any vent openings beneath the floor (figs. 5.20A, B).



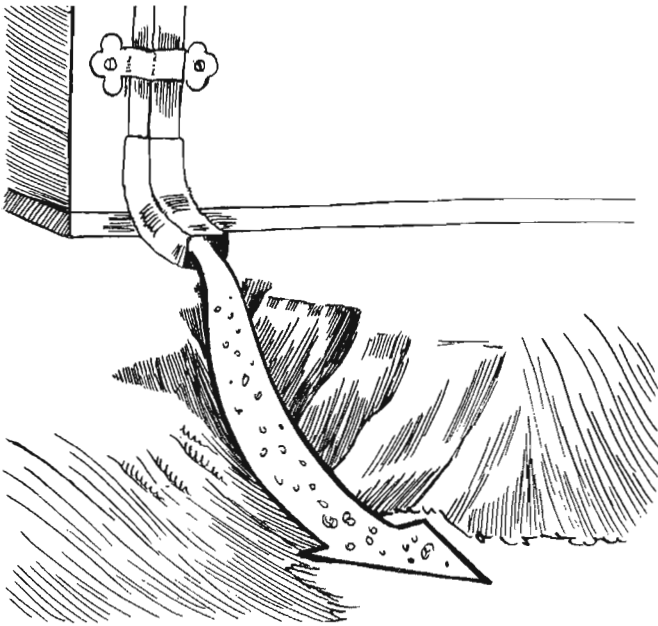

Fig. 5.18A. Runoff erosively flowing over a steep slope

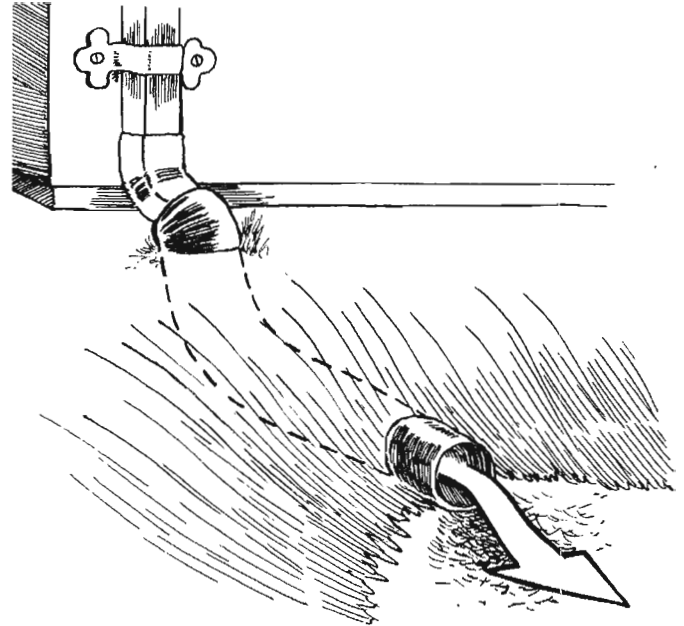

Fig. 5.18C. Calmly outletting downspout flow above the mulch within a level basin so debris does not back up in the pipe. Ensure the pipe slopes into basin so no water sits in the pipe where mosquitoes could breed.



Fig. 5.18B. Stone-stabilized downspout spillway



Fig. 5.19. A basin made between two young trees, and ready for a surface mulch to be applied

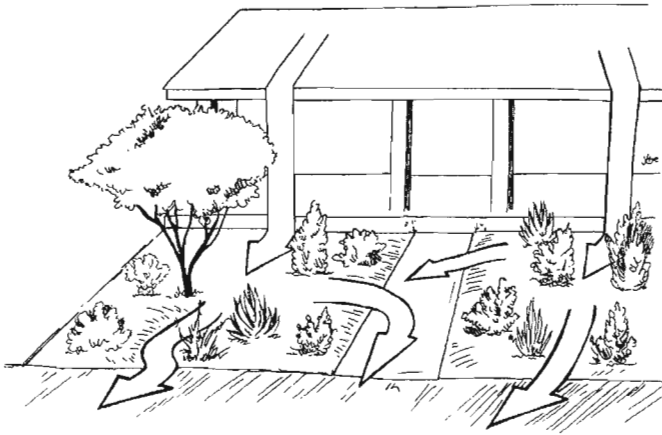

Fig. 5.20A. A yard with existing vegetation that loses runoff in big storm events

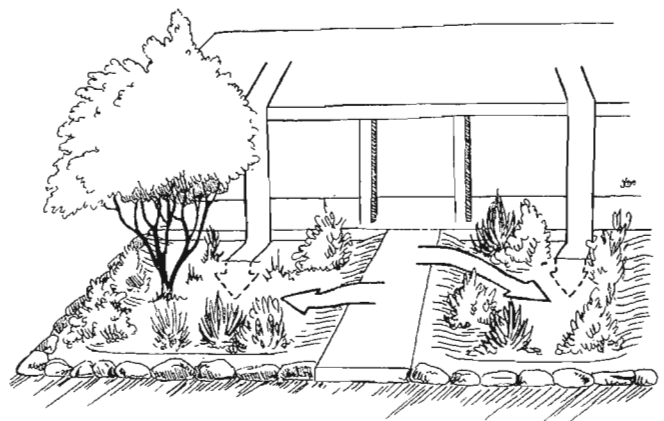

Fig. 5.20B. The same yard after dirt was brought in to create a perimeter berm. Now runoff sticks around and infiltrates the soil. The berm must not be made so high that harvested water could flood the house or anything else you don't want flooded. Existing pathways within the berm may need to be raised to keep them high and dry, and may then double as part of the berm.

Note how the now-raised walkway creates a berm dividing the yard into two subbasins.

## SIDEWALKS CREATING BASINS

In the urban setting where concrete is ubiquitous, basins can be created by sidewalks, especially in denser apartment and condominium complexes where sidewalks leading to multiple doorways crisscross the landscape. The key is to plan for this before construction with three elevations in mind—1) the threshold of the doorways (and top of the building's stem wall), 2) the elevation of the surrounding soil, and 3) the top of the sidewalk—and to ensure that the planned elevations are realized every step of the way.

First, the final grading of the soil around the buildings is done to ensure the soil slopes, and stormwater drains, away from the structures. The elevation of the soil should be at least 4 inches (10 cm) below the elevation of the doorway thresholds, against the building, while dropping to a level at least 8 inches (20 cm) below the elevation of the doorway thresholds as you get farther from the buildings. Then 4-inch (10-cm)-thick sidewalks can be poured atop the soil, not dug down into the soil. This results in a number of 4-inch (10-cm)-deep basins created and surrounded by the 4-inch (10-cm)-tall bermlike sidewalks, which slope away from the doorways and porches to a point where the top of the sidewalk is at least 4 inches (10

cm) below the threshold elevation. So if the basins fill with water they will overflow over the stable concrete sidewalks—away from the buildings and with no threat of flooding over the threshold into the indoor space.

The basins can then be planted (ideally removing excavated soil so you don't fill your basins) and mulched no higher than within 2 inches (5 cm) of the top of the sidewalk, so sidewalk runoff will definitely run into the basins, and mulch will not run over the sidewalk.

Note: If applying this concept, first check with local building authorities in your area to see if they require different elevation ratios.

## SUNKEN GARDEN BEDS

I've found sunken vegetable garden beds 25 to 50% more water-efficient than raised beds. Sunken beds hold both the rain that falls into the planting area and the runoff that drains into them from surrounding areas. Raised beds often do the opposite.

As the guide *Food from Dryland Gardens* points out, the raised earth around sunken basins provides protection from the drying winds and sun for the moist soil, young seedlings, and transplants (fig. 5.21). Conversely, in hot dry conditions, raised beds expose a lot of surface area to the sun, which increases soil temperatures, accelerates evaporation, and leads to salt buildup in the growing area.<sup>5</sup>

Dig sunken beds no wider than 4 feet (1.2 m) so you can reach all plantings without stepping into and compacting the bed. Dig down about 18 inches (46 cm) to break up the soil, and amend the loosened native soil with aged compost or manure at a ratio of 1 part soil to 1 part aged or composted manure (I amend the soil as such only for the planting of annuals; perennial plantings get amendments only in the form of an organic surface mulch). Excess soil can be used to make a raised path around the bed (fig. 5.22).

## SEASONALLY ROTATING AMONG SUNKEN, GROUND LEVEL, AND RAISED SUNKEN GARDEN BEDS

In some climates, it's wise to rotate the growing of your vegetables between garden beds of varying topography based on seasonal rainfall and temperature swings. In the temperate coastal areas of the western U.S., with heavy winter rains and little summer rain, sunken beds can work great for annual summer crops. Level mulched garden beds at the same elevation as the surrounding landscape are better for annual winter crops since they help avoid oversaturation—especially with clayey soils. Raised or ground-level perimeter pathways of mulch further help sponge up excessive moisture in wet times and reduce its loss from the garden beds' soil in dry times.

In cold climates, a raised form of the garden bed enables dark soils to more quickly warm up for quicker germination of seed and faster plant growth in the spring. Raised beds are made of a raised section of earth on which annual garden plants are planted. A sunken garden bed can be made atop this by making a perimeter berm of earth to hold, and maximize the potential of, direct rainfall or irrigation water. In the wet season, the perimeter berm of the raised bed can be smeared off for better drainage if needed.

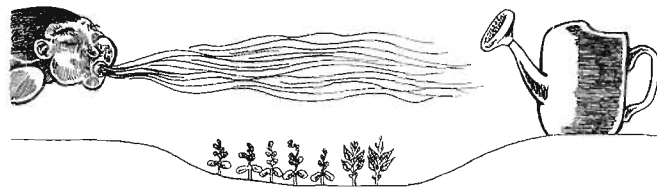

Fig. 5.21. The beneficial microclimate of a sunken garden basin

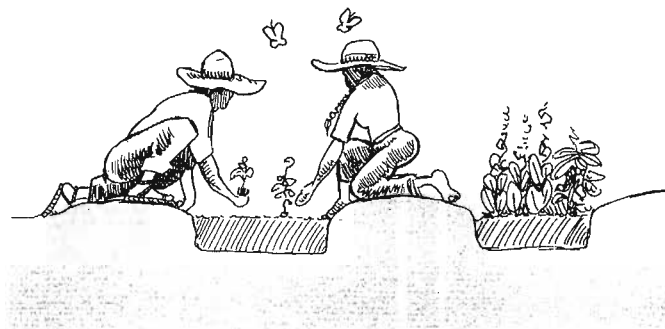

Fig. 5.22. Sunken garden beds

Play with these strategies and see what works best for you. Experiment with modifications and share your results.

## MULTIPLE FUNCTIONS OF INFILTRATION BASINS

### INFILTRATION BASINS GROWING A "LIVING FENCE"

Infiltration basins can be located along or near property lines and planted with appropriate vegetation to create living screens of plants. Refer to figure 5.14 for such an example of an integrated use of infiltration basins in a small urban yard.

### INFILTRATION BASINS AS ALTERNATIVES TO FLOOD-CONTROL DETENTION AND RETENTION BASINS

New developments are required to create on-site structures to mitigate their potential contribution to

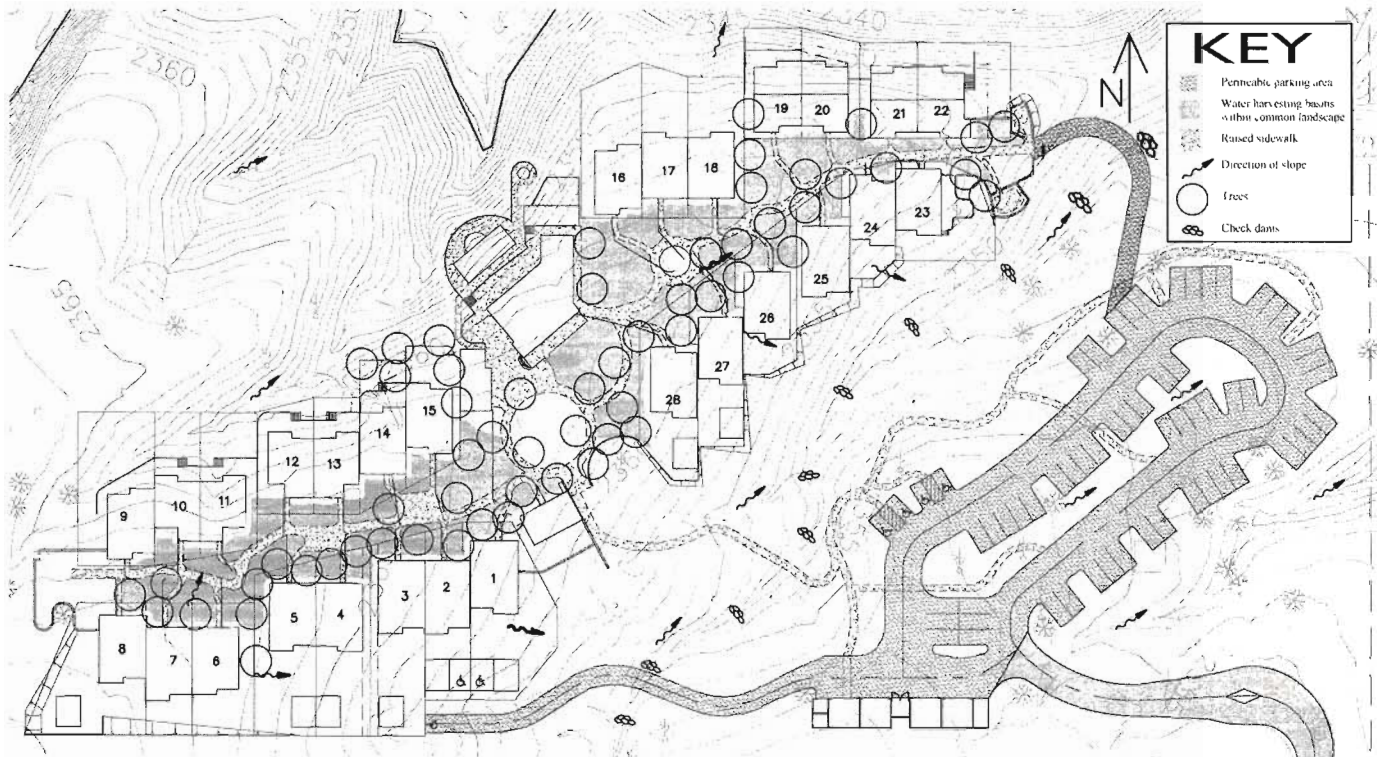

Fig. 5.23. Milagro Cohousing Site Plan. There is no large stormwater-detention/retention basin(s) at the bottom of this site because dozens of small, landscaped, infiltration basins infiltrate and utilize all the runoff beginning at the top, and continuing throughout, the development. Although unmarked, there are also infiltration basins in many residents' back yards. Trees are selected and placed to maintain winter solar access to south-facing windows. Reproduced with permission of Tomas Guido Jr., TnT Engineering

downstream flooding and water contamination. This is typically done by constructing large detention/retention basins at the lowest elevations of the site to hold on-site runoff and associated contaminants by “detaining” a portion of the water before allowing it to slowly flow offsite, and permanently “retaining” another portion of the water on site by infiltrating it into the ground. This works to a degree, but leaves the majority of the site drained and dry.

Integrating rainwater-harvesting basins with landscape plantings *throughout* a site’s watershed, rather than just at the bottom, is a more efficient and productive approach, since it hydrates the whole site, offsets the need for irrigation, controls downstream flooding and contamination, and utilizes stormwater as an on-site asset rather than a liability. *See the following story for more.*

## REAL-LIFE EXAMPLES OF INFILTRATION BASINS

### TURNING FLOOD-CONTROL STRUCTURES INTO BEAUTIFUL WATER-HARVESTING AMENITIES—TUCSON, ARIZONA

The 28-home Milagro Cohousing development in Tucson illustrates the effectiveness of integrating infiltration basins throughout a site. There are no conventional detention or retention basins at the bottom of the Milagro development. Instead dozens of small infiltration basins are grouped and scattered throughout the site’s landscape. They are the dominant landform throughout the common area landscape, and in the majority of backyards (figs. 5.23, 5.24).

Raised pathways break the landscape into an integrated series of large basins. Small earthen berms divide these large basins into groups of smaller



Fig. 5.24A. Rainfall collected in newly constructed infiltration basins minutes after a large summer storm. The basins have not yet been mulched or planted. Milagro Cohousing, Tucson, Arizona. Credit: Natalie Hill.



Fig. 5.24B. Same basins mulched and vegetated. Basins are designed to infiltrate water quickly so there are no problems with mosquitoes or anaerobic soils. These basins, with their spongy mulch and soil-burrowing plant roots, infiltrate all water within 20 minutes.

infiltration basins, which hold both the rain that falls within them and roof runoff. Diverse arrays of food-producing, wildlife-attracting plants are planted within the basins to utilize this rainwater. Mulch then covers the soil's surface to make that rainwater go further.

Some of the homes direct their roof runoff to above-ground cisterns first, which then direct their overflow to the basins. The cistern water is then doled out in the dry seasons to irrigate more water-needy vegetables and such.

In the unlikely event the basin system overflows, each basin overflows to the next to manage the excess water. The concrete sidewalks of the raised paths act as stabilized spillways between basins and dip slightly where surplus water is meant to pass. The final overflow exits from the lowest basins into a natural drainage, which is alive with undisturbed, established vegetation that is enhanced by a series of small water-harvesting check dams. Just that rainwater and wastewater are enough to enable the designed landscape to produce 100 pounds (45 kg) of organic produce per resident per year.

This system of infiltration basins holds approximately seven times more stormwater than a conventional system of retention basins, though it does far more than control flooding. By integrating basins throughout the landscape, flood-control strategies

double as a passive rainwater-irrigation system that nurtures a community orchard, gardens, native-wildlife habitat, and living air conditioners in the form of shade trees.

Household greywater could also be directed to these basins (as illustrated in chapter 12) to act as a supplemental irrigation source. However, at the time of construction, such a greywater system was not legal. Instead, Milagro treats all its wastewater on site via a constructed wetlands at the bottom of the site, then pumps the water back up to subsurface irrigation lines 8 inches (20 cm) beneath the bottom of the basins. This recycled water is a great boon for the landscape, but it does introduce unwanted salts to the soil, as would greywater. But the rainwater again saves the day, since it flushes the salts from the root zone of the plants each time it fills the basins.

This system has received a government permit and can be duplicated with help from a progressive civil engineer. David Confer and I designed the layout of basins and landscaping to maximize rainwater use in the landscape, provide shade trees for passive cooling, and maintain winter solar gain for south-facing windows. Civil Engineer Tomas E. Guido Jr. of TnT did the engineering.

For more information visit Milagro's website at [www.milagrocohousing.org](http://www.milagrocohousing.org).

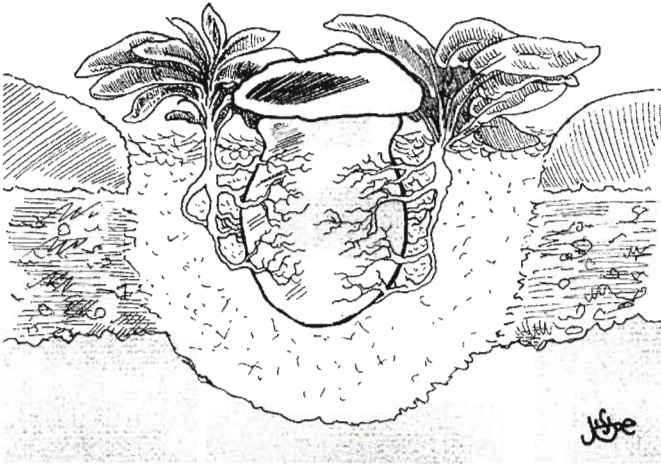

Fig. 5.25. Low-tech subsurface irrigation system of a partially buried clay pot filled with water

## PLANTING WATER IN POTS— INDIA AND ARIZONA

The next step beyond planting in bowl-like basins is actually planting pots (fig 5.25). Unglazed, fired earthen pots, or ollas, can be buried to their necks in a planting area (ideally a basin) and filled with clean water (preferably salt-free rainwater from a cistern) to irrigate adjacent plants. If your pot has a drainage hole at the bottom, this can be sealed with silicone caulk (check to make sure it does not leak before you bury it). Once buried, a small plate or flat rock is placed over the pot opening to reduce evaporation, and to prevent mosquito breeding and lizard drownings.

Seeds are planted within an inch or two of the pot where the soil is wetted by the pot. Depending on your soil and seed, you may be able to then water just

the pot, or you may need to directly water the soil around the seeds for a couple of weeks until the seedling roots extend to the water slowly wicking through the ceramic walls of the pot. The pot is refilled to the top as needed. Sustainability researcher David A. Bainbridge reports that efficiency of the clay pot method is much better than drip irrigation and as much as ten times more efficient than conventional surface irrigation.<sup>6</sup>

A study in India found this method grew melons and pumpkins to maturity with very little water (less than 2 cm of water over a hectare of land for the entire 88-day growing period).<sup>7</sup> In my Tucson garden, 1.5- to 2-gallon (5.6–7.5-liter) pots irrigating established perennial herbs (oregano, garden sage, chives, marjoram, thyme, fennel, and lemon grass) needed to be refilled twice a week in the summer months and once a week in winter.

## INFILTRATION BASINS PRODUCE ABUNDANCE IN A COMMUNITY GARDEN—DOWNTOWN TUCSON, ARIZONA

Within inner-city Tucson, Arizona, water-harvesting infiltration basins are pumping out produce where there was once a parking lot. It all started in 1998 when neighborhood volunteers reclaimed an abandoned softball-field-turned-dirt-parking-lot and created the Dunbar/Spring Organic Community Garden. Grant money paid for a 3-foot (1-m) high fence to keep dogs and cars out of the area, and neighborhood

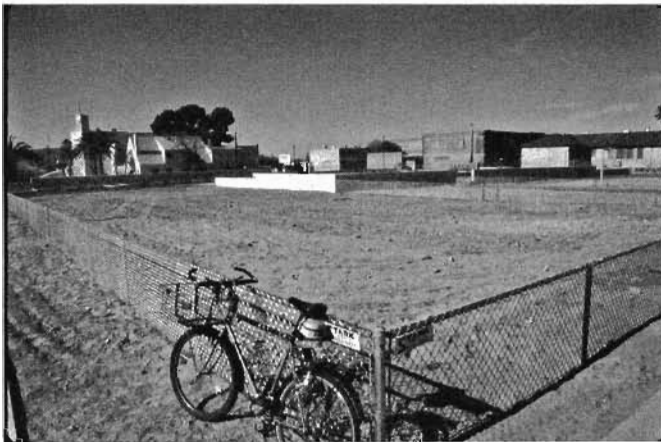

Fig. 5.26A. Garden site fenced and ready for digging



Fig. 5.26B. Volunteers digging sunken garden beds in 1998



Fig. 5.27. Recently completed sunken garden beds minutes after a downpour. Summer 1998



Fig. 5.28. The garden in winter 2005

volunteers drew up plans for garden plots, an orchard, a shade ramada and tool shed, playground area, and a mini-ethnobotanical park of native vegetation.

Infiltration basins were dug to create all the planting areas. The sunken garden beds were dug by hand to forever connect the community volunteers to the garden via their sweat and effort, and to spread the hands-on knowledge of how to create such basins. Upon completion, the top of the sunken beds' prepared soil was about 6 inches (15 cm) below grade. Basins for the orchard and mini-ethnobotanical park were made 18 to 24 inches (45 cm to 60 cm) deep with a donated backhoe and operator from Tucson Water. Winding, raised pathways were created from the excavated dirt to access the plantings and shed runoff to the vegetation. (Figs. 5.26A, B and 5.27).

Three raised garden beds were also built to act as benches and provide easy gardening for people unable to bend over. Yet it was soon discovered that the raised beds dried out more quickly than the sunken beds. So, even the older and less able gardeners now typically choose to garden the sunken beds over the raised ones.

The success of the infiltration basins was apparent even before the garden was finished. Just after the basins were dug, but before they were planted or mulched, summer storms dumped 2 inches (51 mm) of rain on them within a few hours. The basins captured all the rainfall and on-site runoff, while the raised dirt paths remained firm and dry enough for wheelchair and wheelbarrow access (fig. 5.27).

It took two days for the collected water to infiltrate into the soil or evaporate into the air. Then seeds and plants were put into the moist earth, and a layer of mulch (compost, aged manure, straw, and salvaged woodchips) was spread over all the basins but not tilled in. More mulch accumulated as gardeners allowed falling leaves to remain in the basins. Prunings were cut up on site to 4-inch (10-cm) lengths, and laid beneath the plants.

The following year summer storms again dropped 2 inches of rain within several hours. As before, the basins harvested all runoff. But this time—thanks to the mulch, vegetation, and a booming earthworm population—the harvested water infiltrated into the soil in 20 minutes, as opposed to two days. Far less was lost to evaporation this time. And mosquitoes

were never an issue, because the water was in the soil and plants, not on the surface.

The garden is watered by rain (averaging 12 inches or 305 mm per year) and an automatic drip-irrigation system hooked up to the municipal water supply. An inexpensive rain sensor (Mini-клик II) is connected to the irrigation timer and shuts the system off when it rains and does not turn it back on until the soil begins to dry. Thanks to the basins and mulch, the garden's irrigation system can remain off for up to two weeks at a time. That saves thousands of gallons of groundwater annually and helps reduce damaging salt buildup from the application of salt-containing municipal water.

To save even more water, the timer is set to come on only at night or very early in the morning when evaporation rates are lower. The timer is also manually reset with the seasons, watering far less in the cooler months, then increasing waterings in the hot dry months. All these strategies cost little or no money, save water and maintenance, and best of all, they help produce an abundance of tasty organic fruits and vegetables in a beautiful garden (fig. 5.28).<sup>8</sup>

## RAIN GARDENS—THE INFILTRATION BASINS OF WETTER LANDS

Rain gardens are popping up all over wetter states such as Maryland, Virginia, Wisconsin, Michigan, and Minnesota, and in the Northwest U.S., as a positive response to growing problems of groundwater depletion and water pollution. They are basically water-harvesting infiltration basins planted with colorful shows of flowering native vegetation, and some add artful downspouts and sculpture to celebrate the rain and its harvest (figs. 5.29 and 5.30). Their primary purpose is to replenish or recharge near-surface groundwater supplies with rain that would otherwise run off paved, compacted, or convex surfaces. In addition, rain gardens using hardy native vegetation improve water quality by eschewing chemical pesticides and fertilizers, while using the plants, mulch, and microorganisms to naturally filter pollutants carried in the captured runoff.

Rain gardens are a wonderful yard-scale strategy for irrigating landscapes naturally and cleaning up water-





5.29. Celebrate the rain! Steelhead trout swim up a steel downspout directing roof runoff to a rain garden below. Portland, Oregon.  
For color photo see inside front cover



5.30. Celebrate the rain! Roof runoff from the New Seasons Market showers down from a cloudlike downspout onto a sculpted figure within a rain garden. As the falling water hits and moves the figure's propeller umbrella, the figure also starts to move and dance in the rain. Portland, Oregon

sheds locally. As RainGardens.org states, "Government studies have shown that up to 70% of the pollution in our streams, rivers, and lakes is carried there by stormwater. Although most people never think about stormwater, about half the pollution that stormwater carries comes from things we do in our yards and gardens!"<sup>9</sup>

There are many great resources on rain gardens, with more appearing all the time. I invite you to plug "rain gardens" into a web search, starting with RainGardens.org. Look for resources applicable to your area and ecosystem, since most offer plant lists and planting instructions for specific climates and regions (primarily non-dryland).



# 6 Imprinting

## WHAT IS IMPRINTING?

Imprinting is a water-harvesting technique used to accelerate the revegetation of disturbed and denuded land by creating numerous small, firm, and well-formed imprints or depressions in the soil that collect seed, rainwater, sediment, and plant litter, and provide sheltered microclimates for germinating seed and establishing seedlings (fig. 6.1). Ideally, each imprint captures enough water to germinate one or more seeds and sustain their growth. Imprints have enough water-storage capacity to increase infiltration to levels above most dryland rainfall rates, thus eliminating nearly all runoff and associated erosion (fig. 6.2A, B). As vegetation grows in imprinted areas, the plants themselves become the permanent water-harvesting solution by



Fig. 6.1. Bulldozer pulling an imprinting roller. Imprints are in the foreground.

further increasing infiltration, decreasing erosion, and continually reseeding themselves.

Of all the strategies described in this book, imprinting is the only one intended specifically for large, *already degraded and denuded*, areas of 1 acre (0.4 ha) or more, not the urban backyard. However, many rural drylands homeowners, ranchers, and farmers could benefit from knowing this strategy, which has also been used to restore land in and near housing developments, as the Real-Life Example demonstrates. Besides restoration of vegetation, imprinting can be used for dust control or suppression of weeds, in particular tumbleweed.

Unlike more invasive practices such as disking, tilling, or pitting, imprints are created with downward force, like footprints. This process does not invert the soil's surface, uproot or cover plants, or destroy beneficial soil life such as cryptogamic crusts and mycorrhizae. The best imprints are V-shaped and are made with an imprinter roller, though hoofprints, slow-moving deep-knobbed wheels, or bulldozer tracks can create somewhat similar effects.

Imprinting works simultaneously on two scales. On the very small scale, a single imprint is a tiny microbasin approximately 1-foot-square in size and shape. On the very large scale, multiple imprints combine to create a water-harvesting surface over a considerable area; one imprinted acre contains 43,560 imprints (107,637 imprints/ha) (fig. 6.3).

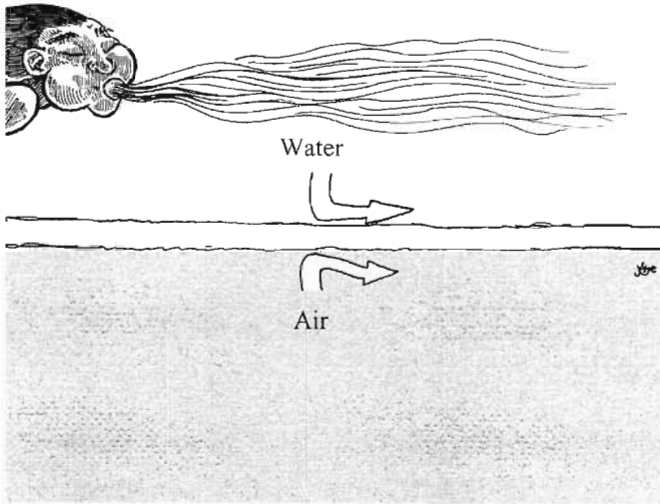

Fig. 6.2A. Exposed, compacted soil encourages erosive runoff and exposes soil and seedlings to the full force of drying winds.

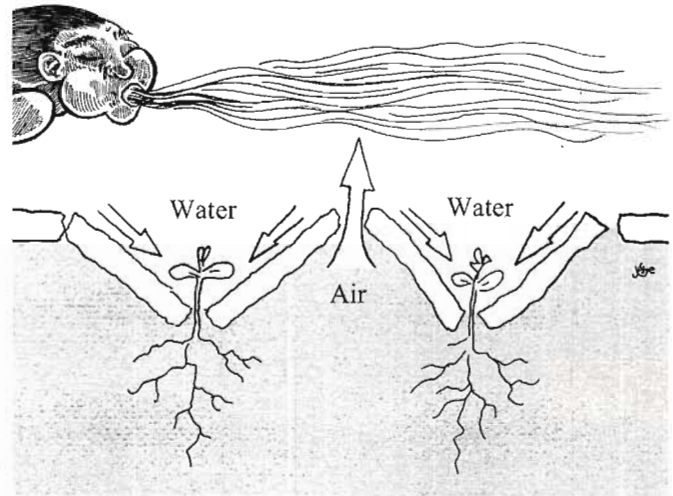

Fig. 6.2B. Imprinted soil encourages infiltration of water and shelters seedlings.

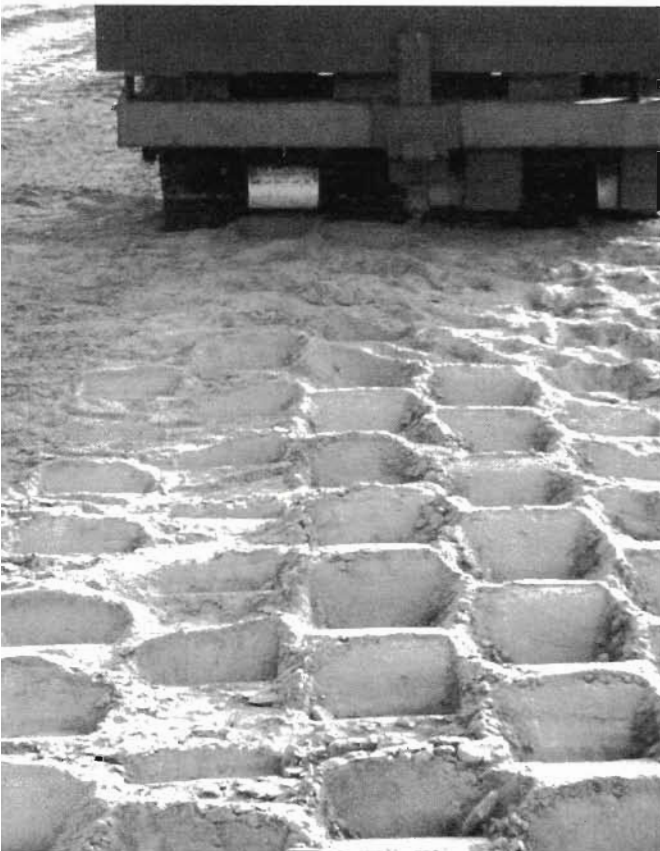

Fig. 6.3. Fresh imprints

Research soil scientist Bob Dixon invented imprinting in 1976, and with his coworker, restoration ecologist Ann Carr, continues to enhance its effectiveness as a no-till method of seeding and restoring degraded drylands. Since Bob and Ann are the experts on this strategy, most of this chapter is based on their consultations and publications.<sup>1,2,3</sup>

## WHERE IS IMPRINTING USED?

Imprinting is appropriate for use on abandoned farm fields and building sites, overgrazed rangeland, soils with rock up to 1 foot (30 cm) in diameter, and slopes as steep as 2:1. This technique is particularly useful for establishing vegetation on degraded lands with annual precipitation ranging from 3 to 14 inches (76 mm to 356 mm).

Imprinting is typically used in rural areas, not urban backyards. Sites should be at least an acre (0.4 ha) in size to justify the expense of bringing in the imprinting equipment. Thus, imprinting is typically used by ranchers, transportation departments, developers revegetating excessively eroded land, and

those trying to revegetate abandoned farm land or larger denuded acreage.

## TOOLS AND MATERIALS

**Basic tools:** an imprinter roller and a tractor to pull it. Some areas may have commercial imprinting services. A later section in this chapter describes the construction of imprinter rollers. If an imprinter roller is not available, large hooved animals or a bulldozer with deep tracks could be used instead.

**Materials:** native plant seeds mixed half and half by volume with wheat bran to evenly distribute the seeds throughout the mix.

## IMPLEMENTATION STEPS

### SITING

After you've determined that your site may be suitable for imprinting, there may be additional strategies to implement to make your investment of time and money worthwhile. Walk your site; survey it.

Consider the slope and the condition of the watershed. You may be confronted with large volumes of fast-moving, sediment-laden water washing across the site during intense rainstorms, especially if land above your site is sparsely vegetated or steeply sloped. If land slope, soil texture, and access are suitable for imprinting, start at the top of the watershed. This may be sufficient to stop erosion and revegetate the land. However, imprints can be washed out by heavy runoff flowing from upslope.

Therefore, if imprinting is not feasible for use at the *top* of your watershed, first create a series of contour terraces, berm 'n basins, or diversion swales that intercept runoff, then conduct imprinting lower in the watershed. It may also be possible to intersperse terraces and contour berms between sections of imprinting to further slow runoff, increase infiltration, and decrease premature erosion of imprints. Survey the site and mark where each strategy is to be implemented.

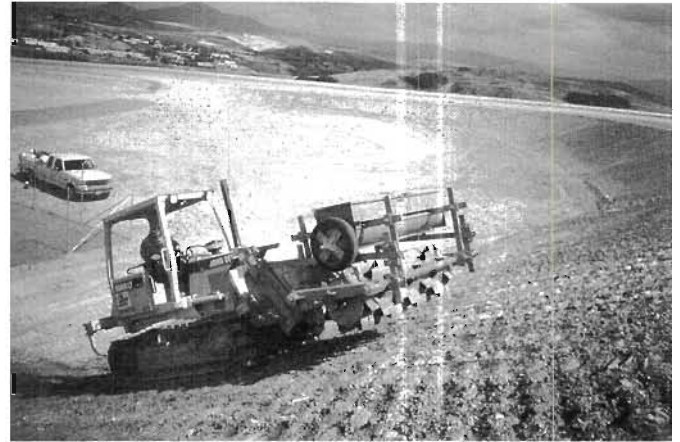

Fig. 6.4. Imprinting a steep slope

### SPACING AND APPROPRIATE SIZE

Each imprint can hold about 1 gallon (3.8 liters) of water on level land. They are created by the protruding angle irons welded to an imprinter roller, which are called their "teeth." These imprinting teeth are staggered about 1 foot apart from center to center throughout the roller. The individual imprints they create are about 4 to 7 inches (10 to 18 cm) deep, 10 inches (25 cm) long, and 8 inches (20 cm) wide.

### CREATING IMPRINTS

To undertake imprinting, you will need to obtain an imprinting device or contract with a commercial imprinting service. Information on the availability of imprinters and their manufacture is available at The Imprinting Foundation's website: [www.imprinting.org](http://www.imprinting.org). See appendix 6 for further contact information.

For treating large acreages, an imprinting roller with a seeding attachment is the tool of choice since it evenly distributes seed as it creates long-lasting imprints. Imprinting rollers equipped with staggered 1-foot-square (30 cm) imprinting teeth are designed to be non-directional with respect to slope. However, on steep slopes it's best to pull the imprinter up and downslope rather than across slope for the safety and comfort of the operator (fig. 6.4). This also reduces wear and tear on equipment.

The growers or cleats on bulldozer tracks can imprint soil if you do not have access to an imprinter roller. But imprinting with a bulldozer requires traveling



Fig. 6.5. A bulldozer with self-cleaning tracks

back and forth across the land many times because of the narrow bulldozer tracks. Run the bulldozer up and down slope so the imprints made by the grousers are aligned on land contour. A standard bulldozer track makes a small, less than adequate imprint; however, a bulldozer equipped with self-cleaning tracks makes imprints that are comparable in size and capacity to imprinting rollers (fig. 6.5). They work well on steep slopes and in wetlands; however the availability of this special purpose track is limited.

Cattle can sometimes be used to create imprints, though hoofprints may be shallow unless the soil is soft or moist. Temporarily fence off the area to be imprinted, bring in the cattle, then promptly remove them once the soil is thoroughly imprinted by their hoofs.

Whatever your imprinting device, make your imprints deep enough to intercept substantial runoff

and hold sufficient water for seed germination. Shallow imprints disturb the land without creating sufficient water storage capacity to assist much with seed germination. In addition, the roller core of an imprinter should be at least 20 inches (50 cm) in diameter. Smaller diameter imprinters generate more of a shearing force than a downward force, rounding off and obscuring imprints rather than making them deep and firm. This creates excessive soil disturbance, a condition favoring germination of annual weed seeds.

Each of the resultant *imprinted* microwatersheds is about 1 foot (30 cm) square, and can hold 3 to 5 liters of water per imprint on level ground—this will retain all the water from a 2- to 3.5-inch (50 to 88 mm) rainfall.

## CONSTRUCTING AN IMPRINTER ROLLER

If a local imprinting service is not available, you may want to build a community imprinter roller. Ranchers using homemade imprinters have seeded perennial grasses on some 50,000 acres (20,000 ha) of degraded rangeland in southern Arizona alone.<sup>4</sup>

An imprinter roller can be fabricated from a used 10- to 20-foot (300–600 cm) long, 20- or 24-inch (50–60 cm) diameter smooth roller, which can be purchased at farm auctions for around \$200. Weld 10-inch (25 cm) lengths of 6 X 6 inch (15 cm) to 8 X 8 inch (20 cm) angle iron onto the roller in a pattern of staggered star rings (fig. 6.6). Leave a 2-inch (5-cm) gap between the rings and between each piece of angle iron. This 2-inch (5-cm) gap around the base of each angle iron tooth improves penetration into the soil while providing a berm around each imprint to hold rainwater in place until the water infiltrates into the soil.

By staggering the imprints you prevent the formation of rills and gullies. Additionally, alternating imprints reduces ant predation since there is no continuous rill or furrow they can follow like a highway to the seed buffet.

Fabricate a rectangular tow frame to allow you to pull your imprinter roller with a tractor. The tow frame should be built from square tool bars that permit the use of commercial tool clamps to attach hitches and accessories. Make the front and rear of the tow frame identical so hitches can be attached to either front or rear to reverse the direction of rotation of the imprinter roller. This doubles the life of the imprinting teeth because they wear on their leading edges.

As mentioned in the planting/seeding section, weights can be temporarily added to the tow frame at the axle level or slightly below the axle level to create sufficient weight to increase the depth of imprinting in more compact soils. This is similar to the way suitcase weights are used to add ballast to the front end of farm tractors.

Install a seed box at the top of the imprinter roller in such a way that a well-mixed and controlled amount of seed drops onto the roller as it rolls

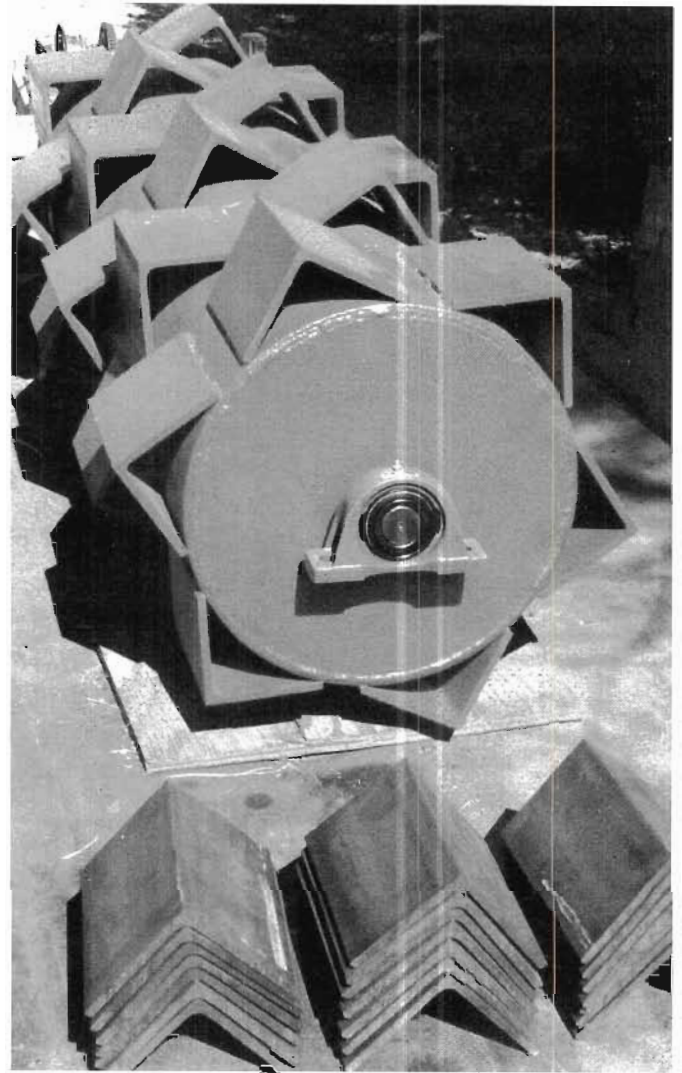

Fig. 6.6. The roller core of an imprinter with alternating star rings of angle iron

forward, allowing it to imbed seeds into the soil at the same time it forms the imprints.

Some variations for special imprinters are described later. Contact The Imprinting Foundation for further specifications for constructing and using an imprinter and tow frame (appendix 6).

## LOCATION AND CONSTRUCTION OF APPROPRIATE SPILLWAY(S) FOR OVERFLOW

Imprinting makes many small depressions in a slope, but does not change the overall slope of the

landscape. The direction excess water flows after imprinting is the same as before imprinting, thus spillways are not needed.

## PLANTING/SEEDING

Select a seed mix of species adapted to the site's climate and degraded soil. Native plant species are best adapted to thrive in the natural conditions of your area. Avoid the use of any invasive exotic species such as buffelgrass (*Pennisetum ciliare*). Diversify your seed mix by incorporating species that germinate in different seasons and under different conditions. About one-fourth of your seed species should be fast-growing hardy pioneers that prefer exposed, disturbed soils. They provide quick shade and create conditions for the germination of seed from plants preferring less exposed soils. In severely degraded sites and areas where grazing is a land management goal, Bob Dixon often recommends incorporating exotic annual barley and ryegrass since the seeds are cheap, readily available, and germinate quickly to stabilize the imprints and increase soil fertility. The remaining three-quarters of your seed mix should be hardy perennial plants. On average, 10 to 15 pounds (4 to 6 kg) of seed is used per acre (0.4 ha) of imprinted land.

To uniformly mix and discharge seeds of diverse size and shape, Bob mixes his seed half and half with wheat bran—an inexpensive by-product of white flour milling. The flaky bran prevents fluffy low-density seeds from migrating upward in the seeder box, and keeps the smooth high-density seeds from moving downward, thus ensuring a vertically uniform mix. Bob's seeder box is attached to the frame of the imprinting roller, just before the roller. Thus, the imprinter presses the seeds into the soil, lessening predation by insects, rodents, and birds before germination. A seeder could also be rigged to a bulldozer. If seeders are not attached to either the imprinter or bulldozer, seeding can be done with a seeder mounted on a tractor that runs in front of a second tractor pulling the imprinter. If you are using cattle to do the imprinting, broadcast seed by hand or with a hand-cranked seeder strapped to your body after the cattle have created the imprints and have been removed from the land.

Note that farm seeders and planters are designed for uniformly shaped seeds that flow evenly through discharge ports, like sand through an hourglass. Native seed mixes with their diverse sizes and shapes do not flow evenly, therefore a mechanical device called a seed agitator is needed to push the seed mix through the discharge ports. Because of this, commercial seeders often need to be modified to uniformly scatter native seed mixes.

For seed sources in your area, check with your regional or state native plant society for reputable distributors. You can also inquire with the Plant Material Centers of the Natural Resource Conservation Service (NRCS), United States Department of Agriculture, which maintain lists of seed sources. Or look in the yellow pages under "Seed." In my area Wildlands Restoration (tel: 520-882-0969) is often my preferred supplier.

Time your imprinting and seeding so seeds are in place before local rain and germination seasons. Here in the Sonoran Desert, Bob prefers to seed in the fall to capitalize on the gentle winter rains that soak into the soil, rather than the violent summer rains that might erode or flatten imprints and run off the soil's surface. Fall seeding also lets Bob use native cool-season-germinating species such as perennial four-wing saltbush (*Atriplex canescens*), annual Indian wheat (*Plantago purshii*), and exotic annual barley and ryegrass that sprout quickly and rob light and soil moisture from fall-germinating Russian thistle (*Salsola iberica*) and exotic warm-season-germinating weeds. Saltbush continues to grow as temperatures rise, while Indian wheat, barley, and ryegrass complete their life cycles in the spring, allowing warm season natives to colonize the improved soil within the decomposing plant material. With this approach, desirable native vegetation has a good chance of becoming dominant and stabilizing the imprints.

The odds of getting good germination rates of native seeds and survival of seedlings is improved by imprinting, but ultimately success depends on the timing and volume of rainfall and the duration of conditions that promote germination and seedling growth. It is important to be patient when seeding, and to take heart in the small triumphs until conditions are ideal for good germination. Some portion of the seeds will



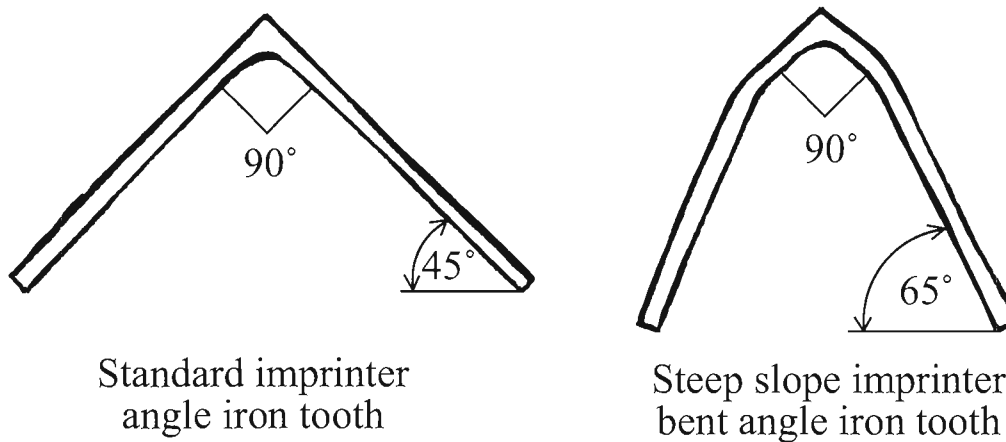

Fig. 6.7. A standard imprinter angle iron tooth, left. A steep-slope imprinter angle iron tooth made by pressing the legs of the angle iron together, right

survive in the soil until that particular year when conditions are finally ideal. In the meantime, imprinting will reduce erosion, increase soil stability, and provide competition for nonnative invasive plants such as tumbleweed. Imprints and seeds are designed to wait for up to five years for good rains to occur.

If soil is so compacted the imprinter cannot make adequate depressions, you may want to delay imprinting until a week after a good rain has penetrated the soil. Adhering to this sequence will make imprinting more effective because the soil will be soft enough to create deep imprints, but not so soft the surface is unsuitable to bear the weight of heavy equipment. On sandy sites where the wind could erode unstabilized imprints, you may want to wait until the soil is damp to conduct imprinting so the imprints will form a slight crust and hold their form once they dry. Alternatively, if you imprint right before the onset of a rainy season, even imprints made in very dry sandy or silty soil will consolidate once the first good rain falls on them.

The pressure exerted by a standard imprinting roller can be adjusted between 15 and 30 pounds per square inch (psi). The 15 psi (1.05 kilogram-force/cm<sup>2</sup>) is created by the basic weight of the imprinter, which is 500 pounds (225 kilograms) per foot (30 cm) of roller length. Additional weight, up to 500 pounds per foot, can be loaded on the

imprinter frame to achieve up to 30 psi (2.10 kilogram-force/cm<sup>2</sup>).

Most hard, dry soils can be imprinted with 30 psi of imprinting force; however, some especially hard soils may require softening by ripping or rain first.

## MAINTENANCE

Keep cattle, all-terrain vehicles, and other disturbances off imprinted areas until vegetation has become well established. Then manage the land carefully to prevent it from becoming degraded again.

Check your imprints periodically, especially during or just after big rains. You may need to create contour terraces or berm 'n basins to manage runoff on slopes if heavy runoff washes imprints away. Once you have added these earthworks to manage large volumes of runoff water, re-imprint the land between them.

## VARIATIONS FOR SPECIAL IMPRINTERS

**Imprinters for steep slopes** should be made with angle iron bent to a narrower angle to create a more effective microbasin shape (fig. 6.7).

**Imprinters for rocky land** should be made with steel that is at least 1/2 inch (1.25 cm) thick for the



Fig. 6.8. An early style of imprinter squashing tumbleweed so it acts as a mulch for the imprints

roller core and angular imprinting teeth to reduce the potential for bending on impact with large rocks.

## MULTIPLE FUNCTIONS OF IMPRINTING

### IMPRINTING FOR DUST CONTROL AND RESTORATION OF DESERT SAVANNAS

Areas denuded by blading, overgrazing, or conventional farming often suffer from dust pollution and soil erosion due to the destabilization of the soil and resulting increase in runoff. These problems are compounded when lands are abandoned in a debilitated state. Imprinting and seeding speeds the restoration process of the degraded watershed.

### IMPRINTING AS WEED SUPPRESSION

An imprinter can be rolled over invasive weeds such as tumbleweed or Russian thistle (*Salsola iberica*), flattening and partially imbedding the plants into the imprints to create a water-saving, soil-enriching mulch. Ideally imprinting should occur while the weeds are still immature and do not have viable seeds on them (this depends on rainfall, sometimes in spring).

Mulch is very helpful for promoting water infiltration because it supports surface feeders such as pill bugs, solitary bees, termites, and ants that bore holes

into the soil. Mulching weeds with an imprinter turns a problem into a resource (fig. 6.8).

Most weeds such as Russian thistle thrive in disturbed and exposed soils. Imprinting minimizes further soil disturbance and turns weeds into soil-sheltering mulch, where “late successional” plants, such as perennial grasses, shrubs, and trees, can germinate in the shelter of the imprints and mulch. Russian thistle will continue to grow, but as long as the soil is not disturbed again, other plants from the imprinted seed mix will begin to dominate. It may take five years to notice much change, but once you’ve seeded and imprinted, you need do little more than wait.

## REAL-LIFE EXAMPLE OF IMPRINTING

### RESTORING BLADED LAND—MARANA, ARIZONA

In the mid 1980s, the developers of the Continental Ranch housing development leveled, straightened, and walled a 5-mile (8-km) stretch (592 acres or 240 ha) of floodplain along the Santa Cruz River in Marana, Arizona. Such severe disturbance accelerated storm runoff, erosion, and downstream sedimentation, while greatly increasing dust pollution (fig. 6.9).

The entire area was imprinted and seeded with a complex native-seed mix of early-, mid-, and late-successional species to accelerate establishment of a



Fig. 6.9. Dust storm caused by denuded land, Marana, Arizona



Fig. 6.10. Imprinting and seeding



Fig. 6.11. Post-imprinting

stable plant community with biodiversity equal to or greater than relatively undisturbed areas nearby (fig. 6.10).

Within one year a mat of vegetation started to reestablish on below-normal rainfall. Three years later the soil was well vegetated, fully resolving the on-site dust pollution problem (fig. 6.11). Today, a dense

groundcover of shrubs and trees is established on nothing more than 10 inches (254 mm) of average annual rainfall infiltrated into the soil imprints.

See video footage of a similar imprinting project in the drylands section of the four-part *Global Gardener* video (Bullfrog Films, [www.bullfrogfilms.com](http://www.bullfrogfilms.com); more information in appendix 6).



# 7

CHAPTER

## Mulching

### WHAT IS MULCHING?

Mulching is the application of porous materials such as compost, aged manure, straw, woodchips, or gravel onto the *surface* of the soil. These mulch materials, and others, are described under Tools and Materials, for mulch need not be the purchased bagged “bark chips” synonymous with mulch for so many people. Mulch can be creative! And, mulch is especially appropriate for small urban and suburban lots.

Mulch is both a spongy welcome mat luring water into the soil and a sheltering cover reducing soil-moisture loss to evaporation, and thus it's great when placed in the basins of earthworks (figs. 7.1A, B). Mulch also limits soil erosion and weed growth, delineates planting areas, can act as a deodorizer for livestock pens and fruit-tree urinals, and improves soil fertility. (See the “Mulching As More Than a Water-Harvesting Strategy” section later in this chapter for more on these applications.)

Where I want vegetation, I prefer mulches of organic material, such as tree bark or compost, that will more quickly break down and build soil than more permanent mulches, such as rock or gravel. This is very important in home landscapes, especially those of new homes where the topsoil has been entirely bladed away to create a compact building pad devoid of any organic material (fig. 7.2). The application of organic mulches speeds up the rate at which water-absorbing topsoil and fertility are brought back to a

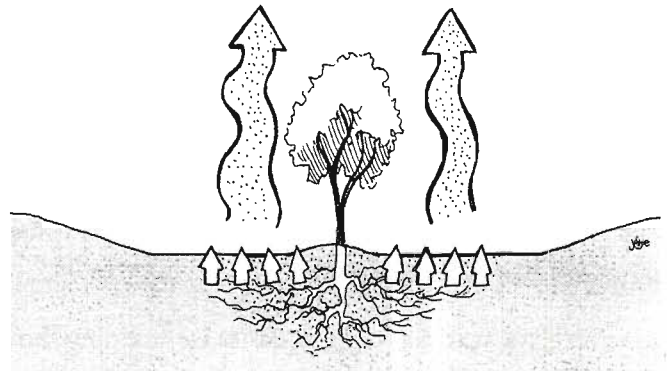

Fig. 7.1A. Bare earth, high evaporation, small tree. A basin without mulch losing most of its soil moisture to capillary action and evaporation.

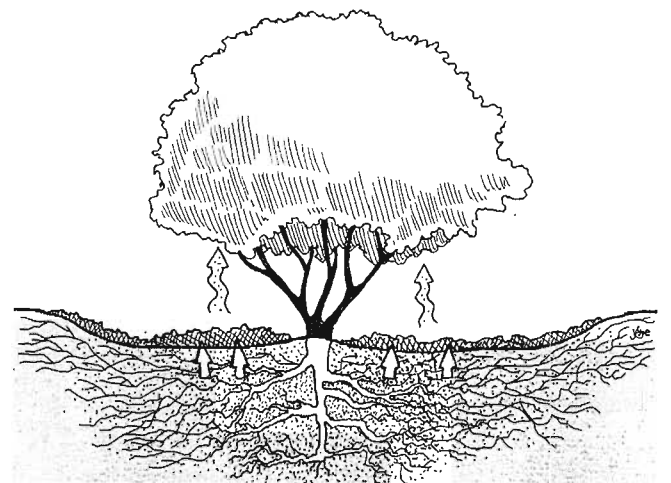

Fig. 7.1B. Mulched earth, low evaporation, large tree. The basin mulched for improved infiltration and retention of water in the soil.

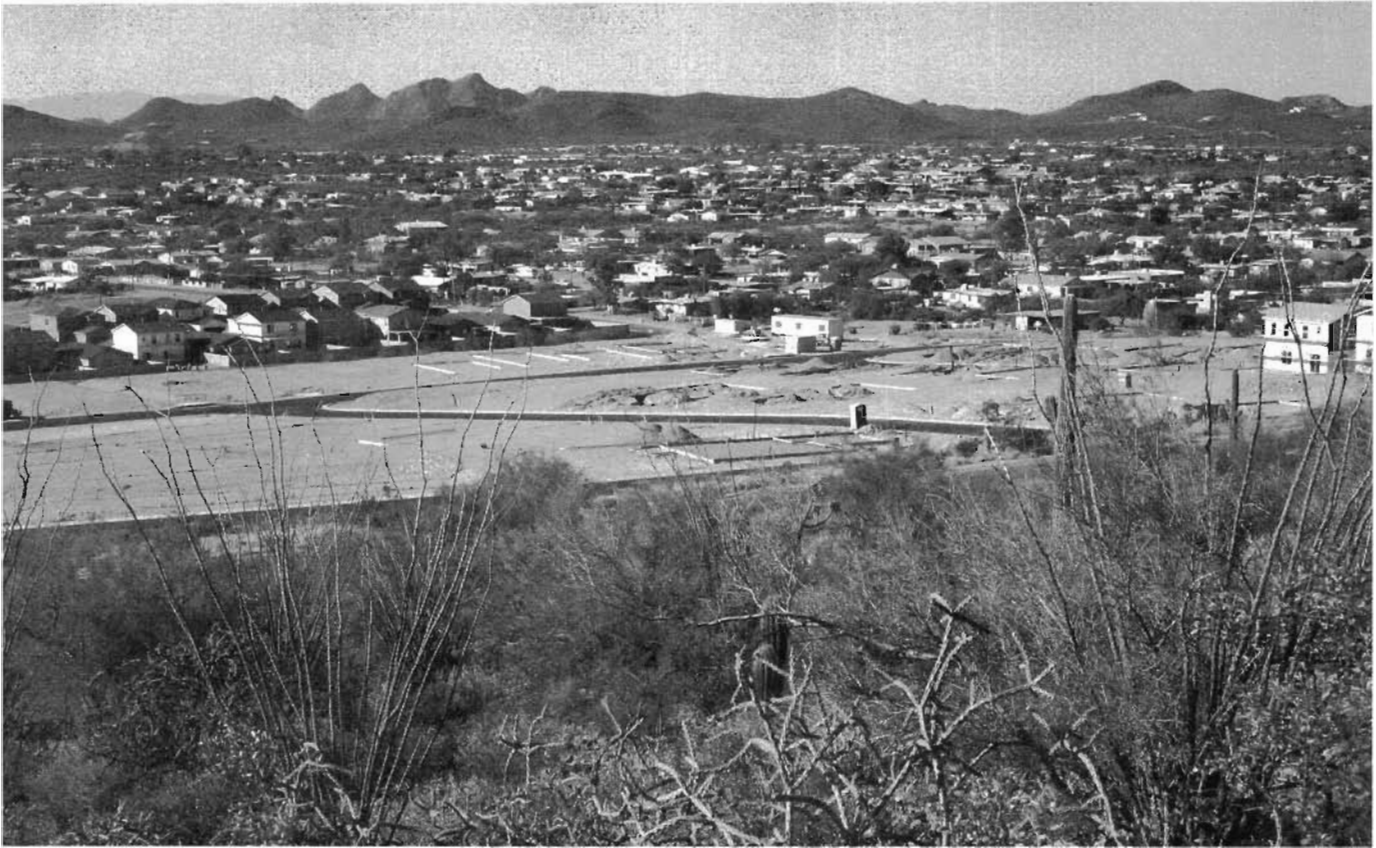

Fig. 7.2. Bladed building pads. The relatively healthy, sponge-like watershed of established vegetation and topsoil, in the foreground, has been bladed and compacted below (background) to create a sterile and water-phobic watershed.

disturbed site, it makes digging easier by lessening the compaction and dryness of the soil, and it encourages you to allow fallen leaves to remain on site, under and around vegetation, as a naturally renewing source of more mulch.

Gravel or rock mulches create a more permeable surface than bare earth but, by themselves, do not add fertility to the soil in our lifetime. What's more, gravel mulches seem to encourage people to rake up any fallen leaves or organic matter to keep the gravel in full view. Thus the site is continually strip-mined of its fertility. Nonetheless, gravel mulches can benefit plants by reducing water loss to runoff, catching organic matter between their aggregate, reducing the digging of rodents, and heating up the soil in colder climates (see the Ancient Hohokam Rock Mulching example at the end of this chapter, and appendix 2 in Volume 1 "Water Harvesting Traditions in the Desert Southwest"). But I prefer to limit the use of this durable gravel to access ways and gathering areas such

as paths, driveways, and patios where its durability is a plus. (For more on gravel specifications, see the Tools and Materials section.)

Mulch is placed on the *surface* of the soil. It is not mixed or dug into the soil, since its porosity would be greatly reduced with soil between its particles. In addition, most organic mulch materials are rich in carbon and, if mixed in the soil, could deplete nitrogen in the soil as they decompose. Nitrogen depletion occurs because microorganisms assisting decomposition need nitrogen to break down carbon, which they get from the surrounding soil. Carbon-rich mulch applied on the soil's surface decomposes more slowly than if it's mixed into the soil, so soil nitrogen is consumed at a slower rate that does not adversely affect vegetation.

*Vertical mulching* is an exception to the surface application of mulch. It is a technique that packs organic mulch into open holes or trenches without mixing the mulch into the soil or covering it with earth. Like French drains, vertical mulching encour-

ages quick penetration and storage of moisture deeper below the soil's surface. What differs from French drains is the use of organic matter, rather than gravel, as the fill material for the hole. The organic matter itself becomes a storage medium of water along with the soil, and it slowly releases it over time—to the extent that the mulch can still be moist three months after the last big rain event. So vertical mulch is used where you want to concentrate soil moisture beside a plant, and encourage deeper root growth that will utilize the slow release of water harvested within the mulch. Vertical mulching is used only where there is enough water to saturate the mulch, such as where incoming runoff water adds to the volume of direct rainfall a planting area receives, or where supplemental irrigation water is applied to the vertical mulch. See the Variations section of this chapter for more.

Among the other techniques discussed in the Real-Life Examples section are recycling dead trees as mulch, and Ruth Stout's "no work" gardens using heavy straw mulch.

Mulch *happens*. See it. Understand it. Mimic it. Benefit from it. Under trees and shrubs in a healthy forest you always find a rich humus created from accumulated leaves, bark, and twigs: mulch. The particles comprising mulch protect the soil from the compacting force of raindrops. They act as countless tiny water-harvesting sponges intercepting those drops before they have a chance to become erosive runoff, and they allow the moisture to infiltrate into adjacent soils.

Once rainwater has infiltrated into the soil, the mulch layer helps retain that precious moisture by greatly reducing the loss of water to evaporation. In drylands, evaporation from the upper 4 inches (10 cm) of soil is typically very rapid. High temperatures, drying winds, and capillary action move water quickly upward within the soil to the surface where liquid water changes to water vapor and moves out of the soil into the atmosphere.<sup>1</sup> Mulch shelters soil and shallow roots, lowering their temperatures in hot climates. This enables earthworms and other beneficial soil life to thrive. These life forms and the mulch build soil as it gradually decomposes into humus. This nutrient-rich humus feeds trees and other plants. Birds and other animals come for the food and shelter offered

### Box 7.1. What Mulch Is Not

A harmful practice in the dryland environment is laying plastic over the soil to discourage weed growth, then covering the plastic with a layer of gravel. Plastic is not porous. It dehydrates the landscape by preventing rainfall from infiltrating into the soil. Ironically, it encourages the growth of molds beneath its surface, which coupled with the dehydrated soils can lead to the death of landscape plants it surrounds. Plastic does discourage weeds, but it also discourages many beneficial life forms. It is not a true mulch.

by the vegetation, and leave little fertilizing packets of their own in the form of manure. Everything falls to the ground and decomposes to be taken up again by flourishing plant and animal life, creating a wonderfully sustainable nutrient loop.

In the human-built environment, fallen leaves are often snatched up with a rake or hit by a gust from a gas blower, then bagged in plastic, and carted off to the dump. The resulting bare earth is scorched in summer, frozen in winter, and prone to erosion and high evaporation year round. In addition, far less water is absorbed into the soil, and water is more likely to wastefully puddle, because exposed soil often forms a cap-like layer of more compacted, less permeable earth. Advertisers and landscape companies then turn around and sell manufactured fertilizer and imported mulch to replace the free, local nutrients that are routinely removed. You can save work and expense by letting leaves fall and naturally decompose under your plants. Leaves on paths and patios can be raked or swept into sunken basins nearby (compare figs. 7.3A,C with 7.3B,D).

### WHERE IS MULCH USED?

Mulch is the key to getting more of your harvested water to infiltrate into the soil rather than puddle on top of it. So use it—especially an organic mulch—where you want water to infiltrate into the soil around vegetation and within all basins. More

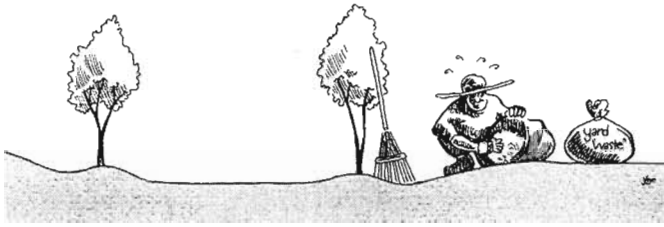

Fig. 7.3A. Strip mining leaves and nutrients results in higher maintenance, higher costs, and smaller trees.



Fig. 7.3B. Maintenance and costs increase with purchased fertilizer used to replace removed nutrients.

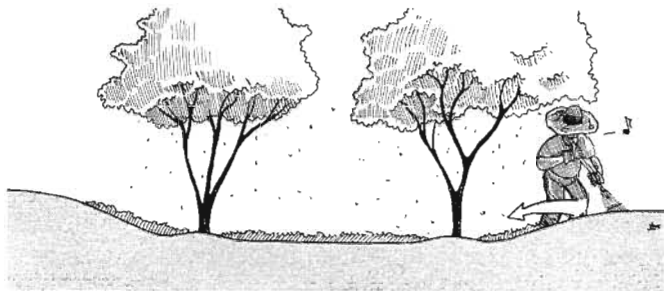

Fig. 7.3C. Harvesting leaf-drop and nutrients results in less maintenance, lower costs, and larger trees.

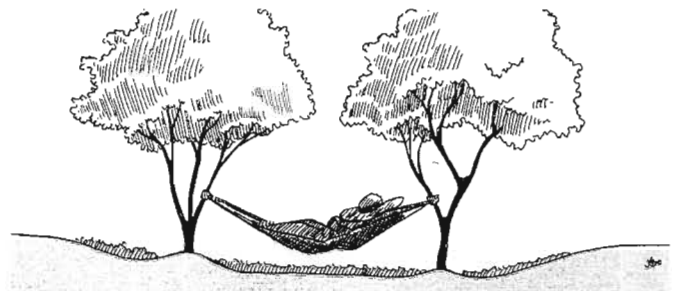

Fig. 7.3D. Relax, and let nature do the work.

durable gravel mulches can be used to cover paths, driveways, and gathering areas.

To save material costs and maximize efficiency, prioritize the use of mulch to the more water-rich, intensively used sections of a landscape, within basins or terraces harvesting runoff and/or greywater, rather than spreading it over the whole landscape. But if you have the materials on hand to cover more surface area with mulch—go for it.

Do not place mulch within drainages or on steep slopes where it will wash away with runoff. However, if the runoff on steep slopes is first checked with vegetation and/or earthworks, mulch might then be used.

## TOOLS AND MATERIALS

**Tools:** work gloves, wheelbarrow, shovel, rake, and pitchfork. A truck, front loader (such as a Bobcat), or backhoe can be used to move mulch materials around large sites.

**Materials:** Typically the easiest and cheapest way to mulch is to use whatever organic material is at hand. By organic I mean natural, primarily carbon-

based materials that break down and improve the soil, such as dead plant material, manure, or compost. Though natural, more-durable rock and gravel don't meet my definition of organic mulch.

Common mulching materials are listed below, with notes on their characteristics and availability. This list is not comprehensive; it's just to give you inspiration as to what else you could use. Note that while any of these mulches can be beneficial on their own, high carbon mulches (straw, paper, cardboard, dry leaves) will give you greater benefit if mixed with a nitrogen source (manure, fresh green prunings, compost, grass clippings). This keeps the soil's ratio in balance and provides a greater range of nutrients.

- **Finished compost** can be made at home, purchased at garden supply stores, or found at composting facilities (look up "compost" in the yellow pages). To learn how to make your own, contact your local organic-gardening club or read a composting book. Finished compost is the best mulch for vegetable gardens.



- **Aged manure** is often free from livestock stables. Make sure it is sufficiently aged and composted so it won't burn your plants or smell like the fresh stuff. If you want your manure poison-free, avoid suppliers who spray insecticides at their sites to discourage flies. To avoid propagating Bermuda grass (*Cynodon dactylon*) or field bindweed (*Convolvulus arvensis*), avoid manure originating from animals that eat feed containing these two plants. Politely ask livestock owners and commercial suppliers about their product and they'll tell you what you need to know. Aged manure is a good nitrogen-rich material to bring fertility back to disturbed sites. Place the manure as the bottom layer of mulch and carbon-rich tree bark or wood chips above as the top layer.

- **Tree bark and woodchips** can often be obtained free from local firewood distributors who consider them waste products, municipal dumps in well-wooded areas, or tree-trimming companies, particularly those that cut trees from conflicting power lines for the local power company. Flag down the driver of the tree-trimming truck, and give him or her a map to your site and where you want their chipped trimmings dumped (saving them a trip to the more-distant dump) (fig 7.4). Make your own mulch by renting a heavy-duty chipper for a day when you can mulch all the accumulated prunings from your site and your neighbors'. Since the bark and chips are generally bigger and heavier than manure and compost particles, they work well as an anchoring top layer—especially in areas of strong winds. Two inches (5 cm) of aged manure or homemade compost topped with 2 inches (5 cm) of dry tree bark is my favorite combination of mulch. I don't go far to get it, it works great, and it costs nothing but time and transportation.

- **Straw** can frequently be obtained free at the conclusion of straw-bale wall raisings. Water-damaged or broken bales are available from feed stores for close to nothing. After spreading straw over the soil, spray it with water to compress and lock it into itself, reducing the chance of it blowing away. Straw makes a good general mulch for use in vegetable



Fig. 7.4. Free mulch delivered!

gardens or around trees, but it will need more reapplications due its rapid decomposition.

- **Discarded paper products** such as cardboard, newspaper, junk mail, and office paper can all be mulch, and will eventually decompose into soil. Remove staples to reduce hazards. Cover these materials with straw, manure, compost, fallen leaves, or bark so your landscape looks fertile rather than trashy. By covering paper products, you'll also keep them from blowing away.
- **Discarded natural fibers** such as old cotton clothing, wool rugs, and damaged basketry can also be used as mulch since they will eventually break down into the soil. Again, cover them with straw, compost, or bark for a cleaner appearance.
- **Grass clippings** can be recycled right back into your lawn. Called *grasscycling*, this is a faster, cheaper, and easier way to maintain a healthy lawn than conventional management that tosses grass clippings into the garbage. See the resources in appendix 6 for more information.
- **Fallen leaves** decompose into fertile soil that produces more plants that produce more leaves that decompose, contributing to the next mulch layer. Assist this natural cycle by raking or sweeping fallen leaves toward your plants. Consider bagged leaves sitting on street curbs as gift-wrapped mulch to take home and use.



Fig. 7.5. Recycling prunings. Cutting up prunings for mulch as they are pruned, and letting them lie beneath the plant from which they came, cycles the nutrients from the plants back into the soil and keeps this valuable biomass on site. Hand pruning shears easily cut up small branches under 3/4 inch (1.9 cm) in diameter.

- **Prunings** from your plants smaller than 3/4 inch (1.8 cm) in diameter should be cut up to about 4-inch (10-cm) or shorter pieces and laid beneath the plants from which they came. All plant parts work as mulch so help your plants mulch themselves (fig. 7.5).
- **Vegetation** is the “living mulch” that shelters soil, moderates temperature, and creates beneficial microclimates for more vegetation. Desert trees tend to grow with their branches draped down to the ground, where they shade the soil, protect the bark from sunburn, and create habitat for wildlife. Avoid the temptation to prune desert trees to create single tall trunks, and instead allow them to take on their natural, stronger, multi-trunked shape.
- **Rock and gravel** make long-lasting surface mulches that don’t break down. Light-colored gravel reflects sunlight and can cool the soil surface in hot climates,

although the air above the rock will still be hot. Dark-colored gravel absorbs, stores, and re-radiates heat—often an advantage in colder climates. Rock and gravel can be used below grade for French drains, but while they encourage rapid infiltration of water into the soil, they lack the water-holding capacity of organic matter used as a vertical mulch.

Do not use decomposed granite where you want to infiltrate water, such as in basins, since the clay fines in the material can seal the surface. If decomposed granite is used, limit its use to raised pathways, accessways, and gathering areas.

If using the gravel as a surface mulch to cover a path, driveway, or gathering area it must be both open-graded (aggregate particles of one size) for good porosity, and angular (not round) aggregate so the gravel interlocks into itself and stays in place, rather than rolling around like pea gravel does. Note that aggregate 1/2 inch (13 mm) or smaller in size is

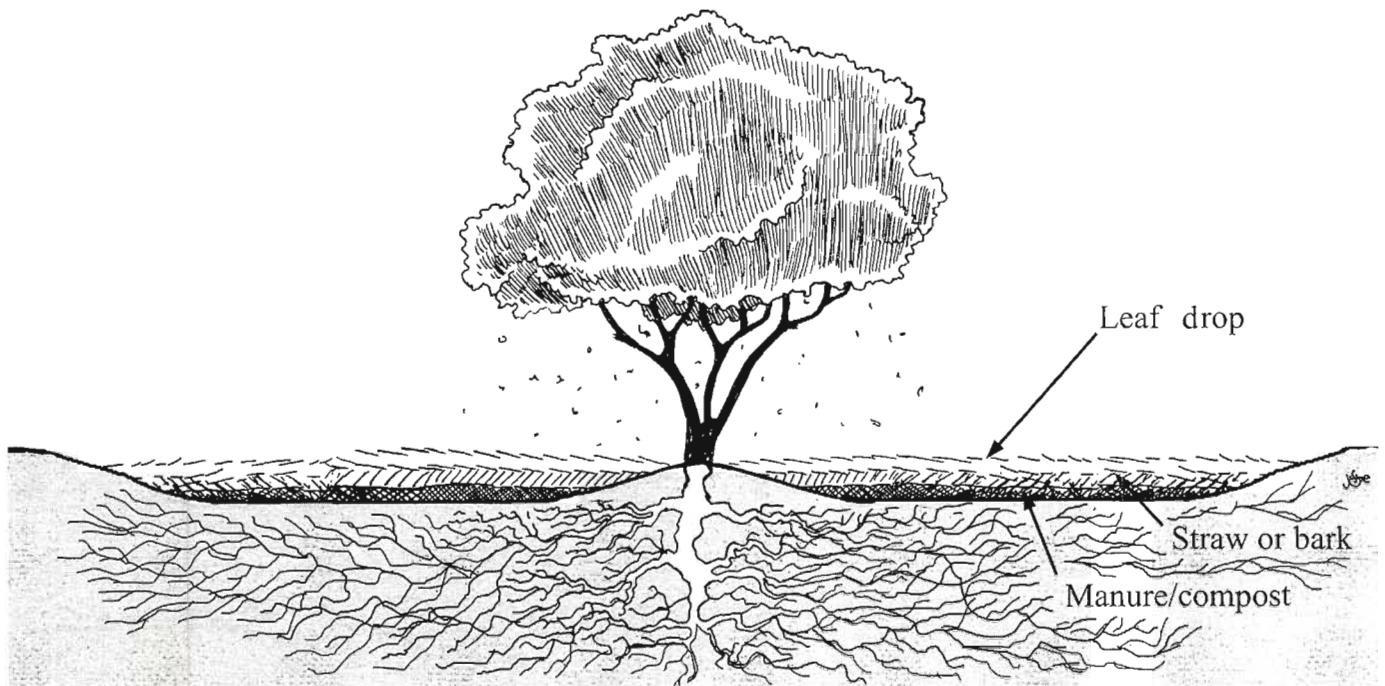

Fig. 7.6. Layered mulch: manure or compost on the bottom for nitrogen-rich fertility, straw or bark above as a top dressing, and accumulated leaf drop and cut-up prunings as the self-regenerating mulch material

much easier to walk on or to roll a wheelchair or baby carriage over than larger aggregate. (See the discussion of porous aggregate in chapter 8 for more.) Rock and gravel are not used for vertical mulches because they lack the water-holding capacity of organic matter.

- **Sand** is a mulch traditionally used on lands farmed by Native Americans such as the Hopi and Navajo, where it naturally overlays clay soils. Dry-farmed gardens are planted by temporarily moving a section of sand aside to expose a small area of moist clayey soil below. The clay is punctured using a digging stick, a few seeds are dropped in, the hole is covered with moist clay, then sand is put back over the clay soil.

## MULCH LAYERING

Different mulch materials often work together, sometimes with two or more materials working better than one.

You can layer mulch by topping unaesthetic organic mulch materials, such as newspapers, junk mail, and old cotton rags, with your tree bark or shredded straw mulch. Lightweight materials that can blow away can be topped with some aged manure or compost, then topped with bark. Junk mail and the high-carbon trashy stuff has little nutrient value, but as it decomposes it will provide the spongy blanket effect so important in drylands for absorbing water and slowing its loss to evaporation. Note: I apply thicker layered mulch only within earthworks harvesting additional runoff and/or greywater. The added moisture then enables the beneficial decomposition of the mulch. See figure 7.6 of layered mulches in an infiltration basin.

My favorite layered mix is to place the more nitrogen-rich compost or aged manure on the bottom, then big carbon-rich stuff like bark on top, since this mix provides a nutrient boost from the compost and aged manure, and an insulative spongy blanket of the coarser mulch. But when available materials call for heavier, nitrogen-rich materials to be layered atop lighter, carbon-rich materials that can work too.

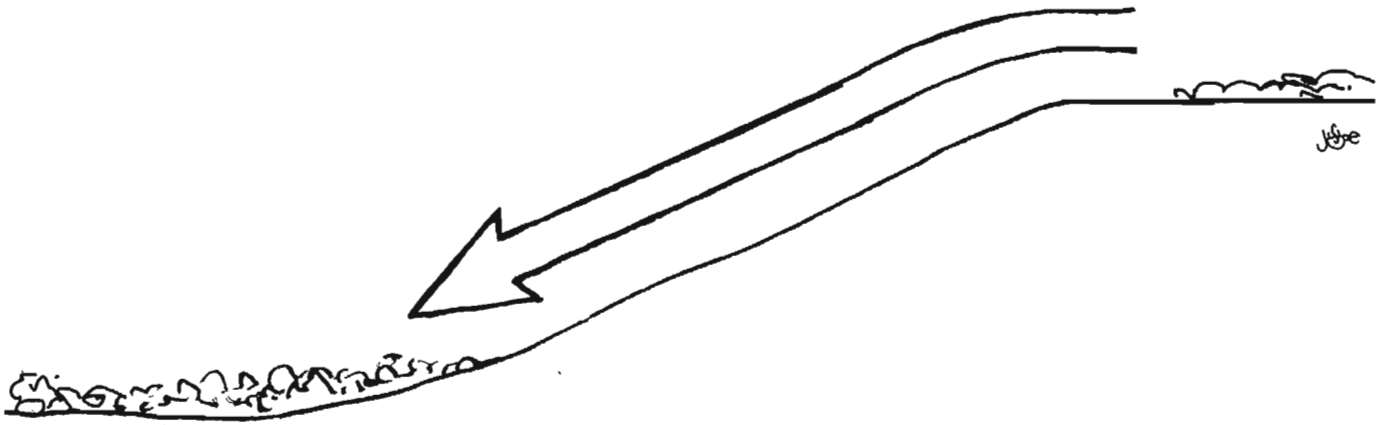

Fig. 7.7A. Unanchored mulch washed off slope. Arrow denotes unchecked runoff.

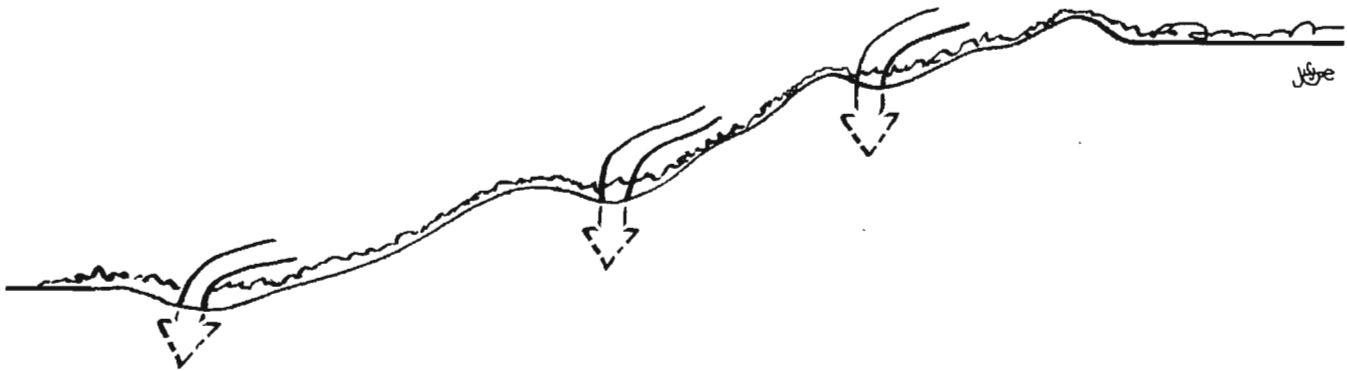

Fig. 7.7B. Mulch anchored within basins of earthworks and where runoff has been checked. Arrows denote runoff infiltrated into the soil.

And on top of any layered mulch goes the leaf litter naturally falling from above.

## IMPLEMENTATION STEPS

### SITING

To determine the feasibility and type of mulch, consider the slope and condition of your site's watershed. Significant runoff will wash mulch away, so mulch is nearly always used in combination with other water-harvesting earthworks and placed within their anchoring depressions. However, if ample materials exist, mulch can also be applied between earthworks, or atop raised earthen pathways, or on berms where it slows erosion (figs. 7.7A, B).

Mulching can be widely used on small lots, since the amount of material needed to cover the area is relatively low. Be more selective in its use on larger sites to keep material needs from getting out of hand. For example, you might apply mulch only to lush areas and earthworks around buildings and within gardens, while leaving hardier vegetation and more-remote earthworks to provide their own mulch.

In fire-prone areas, use organic mulch only in depressions around vegetation where moisture lingers; this mulch can help make plants more resilient in droughts. Keep organic mulch light right around buildings, and break up your property with organic-mulch-free firebreaks of rock and gravel mulch, raised paths, or wide berms.

## PLACING AND THICKNESS (SPACING) OF MULCH

A thicker layer of mulch works well where the basin harvests greywater or additional runoff such as from a roof's downspout or a patio, where enhanced infiltration is a greater need. However, a thinner layer of mulch works better where the basin receives only direct rainfall, and you don't want the mulch to prevent water from a light rain from reaching the soil. A thicker mulch also makes deeper basins appear shallower—a good thing beside paths and patios where you may want the greater waterholding capacity of a deeper basin, along with a shallower, gradual, and safer topography.

In dryland climates I find an initial application of a 4-inch (10-cm) thickness of *organic* mulch to be optimum within earthworks receiving runoff and/or greywater. But I use only an initial 2-inch (5-cm) thickness of mulch in areas receiving only direct rainfall. Less mulch breaks down too quickly and weeds are more likely to grow up through it. Thicker applications may reduce rather than increase soil moisture by soaking up all the water from a light rain, and leaving the soil below dry. However, it's fine if naturally occurring mulch exceeds 2 inches (5 cm)—the build-up is not too sudden, and roots grow through it.

That initial layer of organic mulch will likely decompose to half its thickness or less in a few months. Whether I rebuild the mulch depends on how much water the mulched area receives. For areas that get only direct rainfall, I typically let the mulch decompose, while encouraging the natural accumulation of leaf-drop. For areas that receive direct rainfall, plus additional water as runoff, greywater, or supplemental irrigation with well/municipal water, I add mulch to maintain at least a 2-inch (5-cm) thickness until leaf-drop from the plants does it for me. The additional water ensures the moisture will reach the soil, and the thicker mulch enables the area to more quickly absorb the water.

Mulch the entire basins of water-harvesting earthworks, but use only a very thin layer or no mulch within 4 inches (10 cm) of the trunks of plants; here limit organic mulch depth to 1/2 inch (13 mm). This ensures you don't retain moisture against the above-

ground portions of the plant that might induce rot or diseases or attract insects.

Thicker organic mulch can be used in areas with greater concentrations of water and wetter climates. Ruth Stout, the Connecticut “Queen of Mulch Gardening” and author of *How to Have a Green Thumb without an Aching Back*, found that in her climate you need a minimum of 8 inches (20 cm) to keep weeds at bay. She calculated that 25 50-pound (22 kg) straw bales would be needed to cover a 50- × 50-foot (15- × 15-m) space with 8 inches (20 cm) of straw.<sup>2</sup>

A gravel mulch should not exceed 2 inches (5 cm) in depth when used around plantings, but if used as a porous paving material on paths or driveways it can be as deep as 6 inches (15 cm) (see chapter 8). In areas where you are trying to establish wildflowers, use a very light layer of gravel or decomposed granite mulch no thicker than 1 inch (2.5 cm) to help anchor seeds and provide tiny microclimates of moisture, but avoid using organic mulch. Many wildflowers are pioneer species that prefer barren, disturbed soils.

Remember to keep mulch 5 feet (1.5 m) away from a building's foundation to avoid excessive moisture buildup in wet times and the accumulation of fire-prone material in dry times.

## APPLICATION AND DRESSING UP OF MULCH

I'm a laid-back gardener and allow my mulch to have a wild, natural appearance. I'm also thrifty and love turning waste into resources, so I use materials that are on hand or can be freely salvaged. I spread mulch to the desired thickness on the surface of the soil and that's it. However, if you want a more manicured appearance you can spend a little more time and money to get the look you want. Uniformly screened mulches are available for purchase from local composting facilities, landscaping companies, or garden-supply stores. You can get the same result with salvaged materials if you do the screening or processing yourself. For example, straw run through a chipper/shredder comes out in fairly uniform pieces 2 inches (5-cm) long or shorter, while manure ground

## Box 7.2. Mulch in the Vegetable Garden

Three to four inches (7.5–10 cm) of mulch seems ideal for my southern Arizona vegetable garden—but not right around seedlings. Mulch creates a moist and fertile microclimate atop the soil, so it attracts a number of beneficial burrowing insects and worms that eat decomposing organic matter and turn it into still more fertile soil. Most don't bother live plants, but some, such as sow and pill bugs, eat very small plants or seedlings. Therefore, I spread vegetable seeds and transplant seedlings in 4- to 6-inch (10–15 cm) wide rows of temporarily bare earth, then lay mulch between the rows. This way the mulch reduces some evaporation of soil moisture, sow and pill bugs stay under the mulch, and seedlings are not eaten (fig. 7.8A). When plants reach 8 inches (20 cm) in height the threat of being eaten is gone. I then spread the mulch right up to the base of annual plants and throughout the garden up to a depth of 3 to 4 inches (fig. 7.8B). However, see what works in your area and climate by experimenting. In the wetter climate of upstate New York, mulch against lettuce can create a slug-fest.

With the mulch now in place, I can reduce watering by about 25%, or even more if I irrigate under the mulch (the soil then absorbs most of the water directly, rather than the mulch absorbing it first). As a bonus, the mulch dramatically suppresses weed growth.

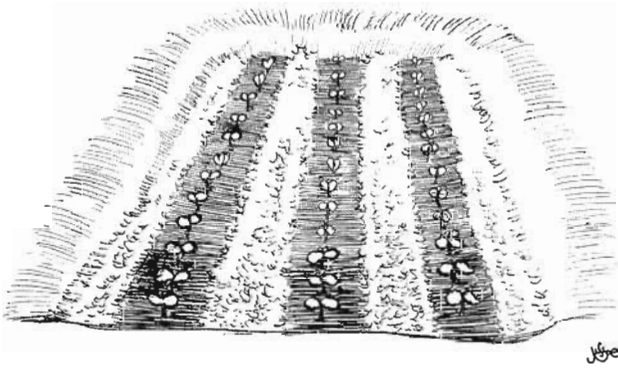

Fig. 7.8A. Mulching between seedlings



Fig. 7.8B. Mulched garden with mature vegetables

up with a rototiller turns cow patties and dung balls into a fluffy top dressing.

### MULCH, DRAINAGE, AND OVERFLOW SPILLWAYS

Mulch should mimic the drainage pattern of the soil it covers so apply it evenly over the general landscape to maintain the existing drainage pattern. If you need to change the drainage pattern, regrade the underlying soil prior to mulching.

Within water-harvesting earthworks, cover the surface of basins and depressions, while keeping the spillway clear to allow the unhindered outflow of excess water.

### MULCH AND PLANTS

Vegetation is the key to getting your water-harvesting earthworks to regenerate their own mulch. If you are planting from seed, do not apply more than a sparse 1/4-inch (0.6-cm) thick layer of mulch or you will hamper germination. Once your plants have grown taller than 6 to 8 inches (15–20 cm), you can apply a thicker layer of mulch.

But desert plants that are prone to rot, such as cacti, should *not* be mulched with organic material that will hold moisture around the base of the plant. These plants are typically not planted in basins where more water gathers and organic mulches work best. Instead these plants are typically placed outside of basins where there is better drainage; gravel and rock mulches work fine around the cacti.

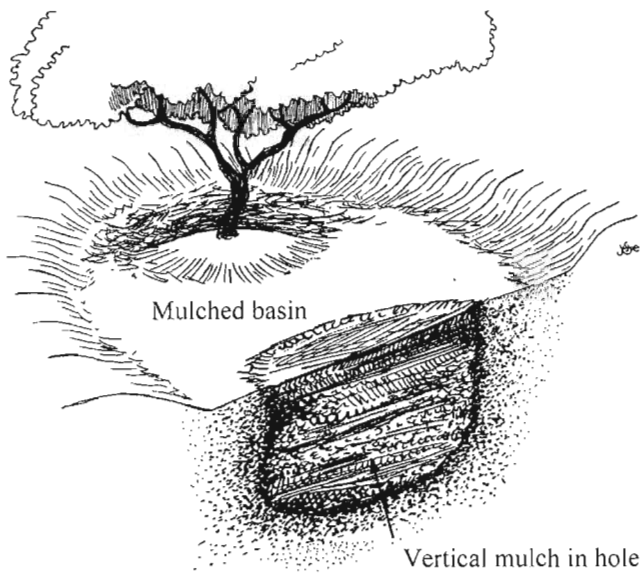

Fig. 7.9. Vertical mulch variation (mulch-filled hole or trench) encouraging infiltration and retention of water deeper into the root zone of the soil

For more information on mulch and plants, see chapter 11 on vegetation.

## MAINTENANCE

Check your mulch periodically, especially during or just after big rains, and replenish it as needed. To recharge nutrients, place compost or aged manure on top of the old mulch, then place straw, bark, or wood-chips on top of it all. Using this layered strategy, as the carbon-rich mulch breaks down it utilizes nutrients from the compost or manure rather than the soil. As decomposition continues, nutrients are slowly time-released into the soil.

Let mulch naturally accumulate in your earth-works; this is often the only mulch replenishment/recharge needed. Rake in leaves from nearby patios. Cut prunings that are smaller than 3/4-inch (1.8-cm) diameter into 4-inch (10-cm) or shorter sections, and drop them under the plants from which they came. Larger diameter prunings make good firewood.

## VARIATION OF MULCHING

## VERTICAL MULCHING

Vertical mulching is the technique of filling holes or trenches with porous organic matter, without mixing mulch *into* the soil or covering the holes with dirt. Vertical mulching creates spongy conduits leading water quickly down to the root zones of adjoining plants where the moisture is released over an extended period of time (fig. 7.9). Holes or trenches should be constructed 6 to 18 inches (15–45 cm) away from the base of newly planted trees, 12 to 15 inches (30–38 cm) deep, and 1 to 2 feet (0.3–0.6 m) wide. Trenches can range from 2 to 20 feet (60–600 cm) long, with the longer trenches used when you have a lot of mulch material to dispose of and localized runoff you want to harvest. The trench is always laid on contour.

David Cleveland and Daniela Soleri report in *Food from Dryland Gardens* that “In semiarid India vertical mulch of sorghum stubble in trenches 12 inches (30 cm) deep and 6.5 feet (2 m) apart gave 25 times more grain yield and 2 times more straw yield than the areas without vertical mulches in a very dry year.”<sup>3</sup>

## MULCHING AS MORE THAN A WATER-HARVESTING STRATEGY

### MULCH FOR DELINEATING PATHS, PATIOS, AND PLANTINGS

A change in surface materials can be used to delineate different areas of a site. Well-mulched surfaces clearly distinguish planting areas and gardens from patios and earthen paths, and can prevent people and animals from mistakenly disturbing these “green areas.” If by accident someone does walk into a planted area, the mulch helps protect the surface and reduce soil compaction.

### MULCH FOR STABILIZING CAMPSITES

Sleeping on cold bare ground will suck the heat out of your body and make your hips and shoulders ache. Camp on that bare spot repeatedly, and you’ll hasten erosion. However, if you sleep on a thick bed of mulch, you’ll be insulated from the cold ground and padded from pain. The mulch can help curtail

erosion too. Outfitters, outdoor enthusiasts, and camp managers can make a positive impact on people and environment by mulching their campsites. Large-sized organic mulch, like bark and woodchips, works well on paths where feet will slowly break it down, while finer mulches like straw, pine needles, or fallen broad-leaves work well in sleeping areas over which tents are set up or sleeping bags laid down. Earthworks such as terraces can create level sleeping areas, hold mulch in place, improve rainfall infiltration into the soil, and encourage the growth of the surrounding vegetation that regenerates the mulch, stabilizes the soil, and makes for beautiful surroundings.

For fire safety, keep organic mulch away from campfires.

## MULCH AS WEED CONTROL

Mulch retards weed growth if it is spread at least 4 inches (10 cm) deep. Bare, disturbed earth attracts the germination and growth of “pioneer species.” These tough plants with a preference for disturbed soil anchor and protect the exposed soil, but too often these days many of these pioneers turn out to be nonnative invasive plants that are detrimental to native-plant and ani-

mal communities. If thick mulch covers the soil, the establishment of seeds of all kinds is reduced.

Likewise, I’ve found mulch reduces troublesome Bermuda grass (*Cynodon dactylon*) or large crabgrass (*Digitaria sanguinalis*). Cover this grass with 2 to 3 inches (5–7.5 cm) of manure (fresh or “hot” manure is best since it burns the grass). Next, lay down large pieces of cardboard with edges overlapped 18 inches to 2 feet (45–60 cm) so the grass is deprived of sunlight. Bicycle or furniture boxes with staples removed are best since they are large and freely available from dumpsters. Then, spread 2 to 4 inches of topsoil, aged manure, or compost over the cardboard to hold everything down. Finish with an appealing top-dressing of mulch, such as straw or salvaged bark. The Bermuda grass dies out when it no longer receives energy from the sun. As it decomposes it too becomes mulch and improves the soil—Bermuda grass as a soil builder! The cardboard breaks down in a year or two, but by then the Bermuda is soil.

This method works with an isolated patch of Bermuda grass, if you cover it all and *promptly* pull the few shoots that will grow through or around it to reach daylight. In cases where Bermuda is invading your yard from your neighbor’s yard and you can

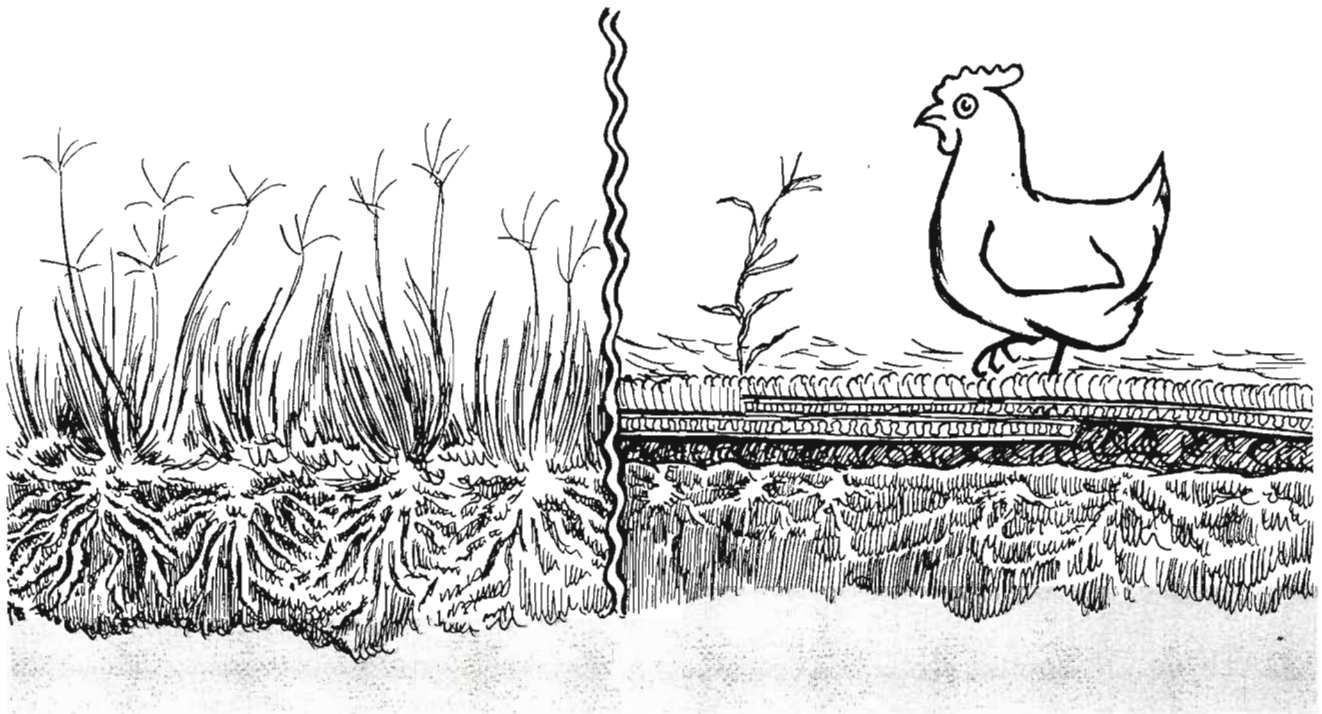

Fig. 7.10. Rampant Bermuda grass versus grass mulched and hunted



cover only part of the patch, it is much less effective and the grass will eventually come back. Still, this method will improve soil, conserve water, and at least slow the spread of the Bermuda grass.

You can also employ some friendly, manure-producing animals. Both chickens and desert tortoises eat Bermuda grass. I located my chicken run on a pasture of Bermuda; within months all the grass was gone (fig. 7.10).

## MULCH AS A MULTIPURPOSE DEODORIZER FOR LIVESTOCK PENS

I keep a 4-inch (10-cm) layer of dry straw and wood chips spread over my backyard chicken run and the floor of my chicken coop. This eliminates odors from chicken droppings and greatly improves the drought-tolerance and health of the dense, chicken-friendly vegetation planted throughout. Odors are eliminated through an aerobic decomposition process. The beneficial microorganisms that make this happen need a carbon source (dead plant material), a nitrogen source (fresh manure, urine), moisture, and oxygen to grow and multiply.

In my chicken run, carbon-rich mulch counterbalances the nitrogen-rich droppings from the birds. With too little nitrogen, decomposition slows down. With too much nitrogen, the excess is released as a smelly ammonia gas.<sup>4</sup> I don't mind decomposition taking a while but I do mind bad odors, so I go heavy on the organic mulch. That leaves my chicken yard smellin' pretty.

In addition, all this mulch and manure fertilizes the soil, increasing soil moisture and soil life, thereby providing the chickens with more food in the form of many more earthworms and beneficial insects, which the birds love to scratch up and eat. The healthier soil also benefits forage-producing plants located in and around the pen. Indigenous plants with berries and leaves consumed by poultry include wolfberry (*Lycium* spp.) and desert hackberry (*Celtis spinosa*), which are mixed with edible cacti, barberry (*Berberis trifoliolata*), pomegranate (*Punica granatum*), quailbush (*Atriplex lentiformis*), and others.



Fig. 7.11. Fruit-tree urinal

## MULCH AS A MULTIPURPOSE DEODORIZER FOR FRUIT-TREE URINALS

Just as carbon-rich mulch counters the odor of livestock urine, it does the same for human urine. I've been to numerous gatherings where screened mulch beds are temporarily set up to give men and women the option of using a safe, effective, waterless urinal. The beds conserve a tremendous amount of water compared to flush toilets—which can use 1 to 8 gallons (3.8–30 liters) per flush—and greatly reduce the strain on septic systems (fig. 7.11).

A temporary privacy screen is erected beside a fruit or native tree located away from any water sources into which urine might accidentally drain. Behind the screen, a thick bed (8 inches [20 cm] or more) of dry high-carbon mulch, such as straw, sawdust, or woodchips, is laid down. People then urinate directly on the mulch. Stepping blocks are set up for women. There are no bad odors, and the tree gets a dose of nitrogen oxidized by the mulch. If odors arise, that is a sign for maintenance. More dry mulch must be added, or the urinal is moved to another mulch bed beside another tree. The urine beds are relocated every two days or so at large gatherings (over 150 people). Used mulch

either stays with the original tree as is, or is mixed into a compost pile for further decomposition before it is returned to the tree. Ideally, the urine beds are located in water-harvesting infiltration basins where concentrated salt-free rainwater can dilute the salts introduced by the urine.

Folks get so excited by this simple system that many set up their own, saving water and generating fertilizer at home. As Swedish university studies found, one adult produces enough fertilizer in urine to grow 50 to 100% of the food required by an adult.<sup>5</sup>

A mulched urinal must be well managed to keep it odorless. While urine is usually sterile in healthy populations,<sup>6</sup> it can act as a vector for some diseases and parasites such as typhoid and schistosomiasis.<sup>7</sup>

For more resources on using urine in gardens and information on composting toilets see the resources listed in appendix 6.

## MULCH AS A GARDEN AND SOIL AMENDMENT

According to the comprehensive guide, *Food from Dryland Gardens*,

Organic matter from many different local sources is a high-quality, low-cost resource for maintaining dryland garden soil fertility. It provides the following benefits to garden soils as it decomposes to humus:

- Organic matter is the source of 90–95% of soil nitrogen, including that which is cycled through microorganisms.
- When organic matter makes up more than 2% of soil, it can be the major source of available phosphorus and sulfur.
- Organic matter is a major source of the cements necessary for aggregate formation to create strong soil structure with a higher proportion of larger pores, which improves water-holding capacity and water and air movement.

- Organic matter may supply 30–70% of the negatively charged [ion] sites that hold nutrient cations plants can use. This electrical property also gives organic matter the ability to act as a *buffering agent*, moderating the tendency of the soil to change pH when acid or alkaline substances are added to the soil.
- Organic matter acts as a chelate: it forms compounds with metal nutrients (usually iron, zinc, copper, or manganese), increasing their solubility and availability to plants.
- Organic matter supplies carbon for energy to many soil microorganisms that perform beneficial functions such as nitrogen fixation.
- In cities where garden soils contain lead from exhaust fumes of vehicles or lead-based paints, soils containing 25% or more organic matter significantly reduce the uptake of the poisonous lead by garden crops.
- Organic matter acts as mulch on the soil surface.<sup>8</sup>

## REAL-LIFE EXAMPLES OF MULCHING

### ANCIENT HOHOKAM ROCK MULCHING—SOUTHERN ARIZONA

Throughout southern Arizona one can find remains of cultivated plots of agave, a major food and fiber plant among the Hohokam. The Hohokam lived here before A.D. 1400 and knew the value of mulch. They piled a mulch of rocks around the bases of their cultivated agave plants. Remains of these piles can still be found today, less than 29 inches (75 cm) high, and averaging about 1.6 yards (1.5 m) in diameter.

A study by Suzanne and Paul Fish, Charles Miksicek, and John Madsen entitled “Prehistoric Agave Cultivation in Southern Arizona” reports that vegetation today usually favors the microclimates of the rock piles over adjacent non-mulched areas.<sup>9</sup> Excavations found root biomass directly beneath the rock piles averages 2.7 times the weight of roots in adjacent



Fig. 7.12A. Newly planted tree beside hole for junk mail



Fig. 7.12B. Tree with adjacent hole filled with phone books, magazines, and junk mail

unmulched areas. The plants were most likely responding to greater soil moisture below the piles and nutrients from organic matter caught between the rocks.

During the same study, an experimental planting of agaves in prehistoric Tucson fields revealed additional benefits from rock mulch. During dry months, rodents damaged agaves planted without rock mulch as they searched for food. Agaves in rock piles were left untouched.

Within the 135-square-mile (350-km<sup>2</sup>) study area northwest of Tucson, the researchers discovered numerous rock pile fields—including over 1.9 square miles (5 km<sup>2</sup>) of fields in the upper bajada section alone. Within this latter section, there are an estimated 42,000 rock piles and 1,173,000 linear feet (120,000 m) of terraces and check dams harvesting water and soil. Utilizing these numbers they calculated that the agave harvest could support the caloric requirements of 155 people each year, while producing an additional crop of 4.1 tons (3.72 metric-tons) of fiber.

Using rock mulch, terraces, check dams, and appropriate crops, the Hohokam maintained a productive system of agriculture that depended entirely on harvested rainfall. The downside may have been the large amount of wood needed to roast and process the harvested agave, resulting in severe deforestation of

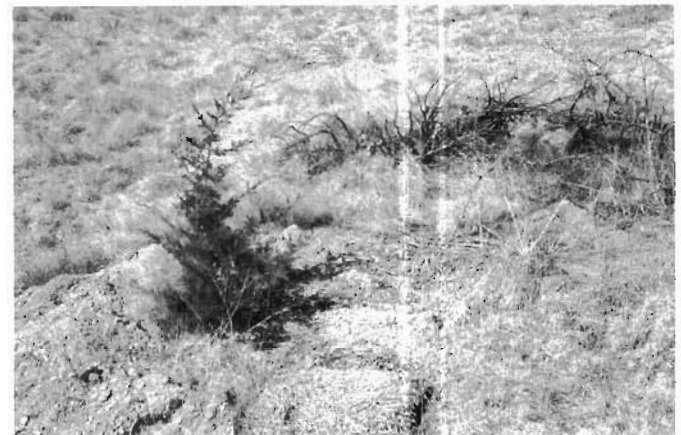

Fig. 7.12C. Junk mail topped with pretty straw. Straw is packed down in place to prevent its blowing away. Roots of adjacent tree will tap the moisture held in the junk mail mulch.

the area that may have made the local climate drier—but we'll leave that for another discussion.

## JUNK MAIL AS PRODUCTIVE VERTICAL MULCH—ALBUQUERQUE, NEW MEXICO

Whenever Chris Meuli plants a tree on his land in the high plains east of Albuquerque, New Mexico, he digs a hole and a trench. The hole is for the tree and the trench is for junk mail (fig. 7.12A, B).

Like most desert soils, those on Chris' site have an organic matter content of only 1 to 1.5%, and store significant water for only a few days after a rainfall. So

Chris packs 2 to 6 cubic feet (0.05–0.16 cubic meters) of junk mail and other organic matter into the trench next to the new tree. Everything he has on hand is thrown in whole. Chipping and shredding are jobs left to the termites and earthworms. Any biodegradable matter that absorbs water, such as straw, newspaper, phone books, or old love letters, can be used as a “mulch sponge.” As for concerns about potential heavy metals emanating from the inks used on junk mail, Chris feels the amounts are minuscule and are quickly diluted in a sea of humus, virtually inactivating them. Just to be safe he avoids using junk mail around edible root crops.

“Junk mail is not attractive,” admits Chris, “so I always mulch over it with a thick layer of straw (expensive!), grass clippings (free!), or leaves (free!). Each fall I harvest leaves off of the sidewalks of Albuquerque, which are otherwise destined for the dump, and carry them out to Edgewood. I try to never drive empty. I’m able to collect between 500 and 800 bags every year!”

Chris constructs his mulch sponges on contour, 12 inches (30 cm) to 14 inches (35 cm) wide (standard newspaper width) and 4 to 20 feet (120–610 cm) long on contour. He digs them only 12 to 15 inches (30–38 cm) deep since ample tree roots live in this upper layer. He positions these sponge trenches 6 to 10 inches (15–25 cm) away from his tree holes with undisturbed dirt in between (refer to fig. 7.9, illustration of vertical mulch).

While digging his holes and trenches, Chris deposits the soil dug from the trenches downslope to create berms to help slow runoff and direct it around the newly planted trees and into the mulch trenches. If enough time and energy are available, he extends the berms into a more expansive series of boomerang berms to guide even more runoff to the trees and sponges.

Once a tree is planted, the adjoining trench is full of mulch, the berm is complete, and a thick layer of mulch is spread over the basin, Chris gives the tree a deep watering. If it has been particularly dry and Chris has the time and energy, he may also water the vertical mulch sponge. This will be the only time he ever waters the tree or the sponge.

The sponges absorb enough moisture from winter snows to maintain the trees until the July rains, which sustain them until the following winter. The sponges are moisture banks providing a very slow release of water over a long period. After months of drought, Chris has dug his hands deep into the mulch to find the junk mail moist to the touch. Mats of native tree and native grass roots invade the sponges for this moisture.

After years of monitoring, the plants beside the sponges have never shown any signs of nitrogen deficiency (chlorosis), despite the high carbon content of the sponge’s mulch. Ecologist friends Jim Brooks and Scott Jackson have found the same results in sandy soil sites around Albuquerque, receiving about 8 inches (203 mm) of rain a year at its 5,000 foot (1,500-m) elevation.

Chris has planted hundreds of trees this way, creating about 300 mulch sponges within the alkaline clay soils of his 8-acre (3.2-ha) site, where rainfall averages 14 to 16 inches (355–406 mm) per year at an elevation of 6,700 feet (2,042 m). The sponges are scattered amidst additional earthworks such as five long earthen contour berms, dozens of smaller earthen contour berms, over a hundred boomerang and contour berms made of brush and prunings, and about a dozen small check dams in the drainages.

His earthworks are his irrigation system. Chris relates, “On my land I have well over a mile and a half (2.4 km) of drip irrigation, laid in the mid-1980s. It was way too expensive, took a lot of time to maintain, and delivered very hard aquifer water to the trees. I no longer use any of it! The trees grow much better with the sponges, probably for a variety of reasons, including the clean rain water, more organic matter nearby with more worms and soil life, and less interference from gophers and ground squirrels who seemed attracted to the underground moisture plumes created by the drip systems.”

The mulch sponges are not permanent. After four to five years they decompose into a rich porous soil, but by that time trees are well established and survive without sponges.

Over the past five years, Chris has made sponges from most of the newspapers, magazines, and cardboard “produced” from 5 to 10 households, which



Fig. 7.13. Contour berms of pinyon pine brush. Richard Jennings's land, Santa Fe, New Mexico

amounts to at least 3 to 5 tons (2,700–4,535 kg) of organic matter per year. Chris says, “It seems to have an amazing effect on the people who donate the materials to me; they seem much more aware of the amount of material they use in their lives and more thoughtful about where their ‘waste products’ end up. They really enjoy visiting the trees that have been nourished by their household wastes, discarded documents, and old love letters.”

In the upper portion of his land, where there's a great view, Chris and friends planted three ponderosa pines of similar size in a burial ceremony for their dear friend Don Byrd, the man who originally introduced Chris to this place in the 1970s. The tree planted atop a sponge mixed with Don's ashes has soared, growing twice as fast as the other two.

## MULCHING THINNED AND DEAD TREES ON CONTOUR—SANTA FE AND ALBUQUERQUE, NEW MEXICO

During successive years of drought in the pinyon-juniper forests of northern New Mexico, huge swaths of pines succumbed to an infestation of bark beetles. The standing dead trees left behind pose a serious fire threat. Interestingly, this fire threat, and potentially the bark beetle infestation itself, were exacerbated by over 100 years of fire suppression.

In the past, natural wildfires occurred every 5 to 15 years. These 300° to 400°F (165–225°C) fires prowled beneath the forest canopy in the high desert forest, burning grasses and culling small weak trees without harming tall mature trees. In the absence of frequent moderate fires, small trees grow thick in the forest. Here they compete for nutrients and water, increasing the susceptibility of large trees to disease and creating fire ladders that feed raging fires (up to 2,000°F or 1,100°C), which kill young and old trees alike.



Fig. 7.14. Contour berms of woodchips. Chris Meuli's land, Edgewood, New Mexico. Credit: Chris Meuli

These problems became the solution using one of two strategies.

Strategy one: Thin young trees from the forest, cut down diseased trees, cover cut trees with clear plastic for six weeks to solar cook the beetles, then cut up and spread the treated wood over the landscape as brush contour berms (fig. 7.13).

Strategy two: Thin young trees and cut and chip dead trees for firewood and mulch. Dead trees can be cut anytime of year, but the resulting firewood must be covered in clear plastic for at least six weeks, tucking the plastic around the bottom of the wood pile with soil to create an airtight, solar-cooked bag of wood. Woodchips are spread to create raised mulched paths and contour berms, but only in winter when bark beetles are dormant (fig. 7.14). This way the cambium of the woodchips, and its scent, dries out before temperatures rise in spring, and does not attract more bark beetles.

Chris Meuli finds woodchip berms to be the easiest and most useful water harvesting-strategy at his site. They require no digging and virtually disappear into the landscape as they mature, plus they hold back more water than brush berms. At his 12-acre (4.8-ha) site east of Albuquerque, Chris has used over 70 cubic yards (53 m<sup>3</sup>) of woodchips to create raised mud-free footpaths and over two dozen contour berms 10 inches (25 cm) high and 15 to 100 feet long (4.5–30 m). The woodchips were free, obtained from on-site thinning projects and municipal green “waste” mulching programs.

The effect has been wonderful. After receiving only 0.75 inch (19 mm) of precipitation over a seven-month period in 2005 to 2006, an incredible 17 inches (432 mm) of rain fell in summer 2006, including two 2.5-inch (63-mm) rainfall events. Even though the soil was already saturated, the mulch quickly swelled with rainfall and runoff, becoming dense and heavy and staying anchored in place.



Fig. 7.15. Abundant growth of new grasses above and below woodchip berms. Chris Meuli's land, 2006, post rains. Credit: Chris Meuli.

Water collected behind the 10-inch (25-cm) berms before spilling evenly over 5- to 20-foot (1.5- to 6-m)-wide, level-topped sections of saturated woodchips. Soil and nutrient-rich detritus collected behind the 10-inch berms to a quarter of their height. As Chris exclaimed, "I now have the densest stands of native blue grama grass growing above the berms that I've ever seen!" (fig. 7.15).

Because Chris placed his two dozen woodchip berms close enough to one another to check runoff, beginning at the top of his slope, only two berms had overflow issues. Both had minor "washouts" less than a foot (0.3 m) wide and 2 inches (5 cm) deep, after which the wide dense berms became self-stabilizing. It took Chris less than a minute to repair the washouts by raking chips up onto the overflow area. To get ready for the next rainy season Chris will lay more woodchips atop the mature berms to bring their settled height of 6 inches (15 cm) back up to the original 10 inches (25 cm). Even without renewing the berms, the flush of newly established grasses would act as living, regenerative grass berms.

## MULCHING IN WET LANDS—CONNECTICUT

Ruth Stout has passed on, but during her life she wrote many humorous and informative articles and books about her extensive use of mulch. At her Reddings, Connecticut, home (average annual rainfall of 51 inches or 1,295 mm) she raised abundant crops with no more than the rain falling directly onto her large garden—even in drought years. She called it "No Work Gardening." She planted the seeds, mulched, and then came back later to harvest. No watering was needed due to soil-building and evaporation-reducing mulch, and very little weeding was needed since the mulch suppressed the weeds. It was so easy and she enjoyed it so much she still productively gardened this way at 100 years of age!

Check out some of Ruth Stout's books such as *Gardening Without Work* and *How to Have a Green Thumb without an Aching Back*.

Her video, "Ruth Stout's Garden," is a gem. See appendix 6 for more information on her books and videos.

## CONCRETE DRAINAGEWAY TO COBBLE INFILTRATIONWAY— TUCSON, ARIZONA

The Architecture building at the University of Arizona used to be bounded by a sterile, impervious concrete drainageway (fig. 7.16A), but life has now broken through. The concrete was jackhammered and turned to urbanite, or broken-up concrete chunks, then left in place to form a heavy cobble mulch. Heavy cobble is what you want in drainages where water flows through the earthwork rather than just settling into it. The cobble does not float away as organic mulch would.

A few native boulders and rocks were mixed in with the urbanite to improve and “naturalize”

appearances. The result is a beautiful porous infiltrationway that slows, spreads, and sinks the flow of water like a natural cobbled waterway would (fig. 7.16B). Vibrant native trees and flowering shrubs then utilize that water. In fact, no city or potable water is now needed to irrigate these established plants. Roof runoff and air conditioning condensate from the adjoining buildings are the primary irrigation sources.

This example of turning a drain into a sponge and the waste of jackhammered concrete into a resource of recycled cobble is my favorite part of this project, but it is only the overflow of a much larger potable-water-free landscape – the Underwood Family Laboratory designed by Christy Ten Eyck at the new College of Architecture and Landscape Architecture building. A must-see when in Tucson.



Fig. 7.16A. Before - *impervious concrete drainageway*. South of Architecture building, University of Arizona, Tucson, AZ. For color photo see inside back cover.



Fig. 7.16B. After - *porous cobble infiltrationway* after the concrete was jackhammered and left in place. The infiltrating water passively irrigates the native vegetation growing through the cobble. For color photo see inside back cover.



# Reducing Hardscape and Creating Permeable Paving

*Pavement now covers over 60,000 square miles in the U.S.—2 percent of the total surface area, and 10 percent of all arable land.*

—[www.culturechange.org/factsheet1.html](http://www.culturechange.org/factsheet1.html)

**W**hy reduce pavement and make it permeable? According to the Natural Resources Defense Council, “Worldwide, at least one-third of all developed urban land is devoted to roads, parking lots, and other motor vehicle infrastructure (fig. 8.1A). In the urban United States, the automobile consumes close to half the land area of cities; in Los Angeles the figure approaches two-thirds ... Typical total imperviousness in medium-density, single-family home residential areas ranges from 25% to nearly 60%. Total imperviousness at strip malls or other commercial sites can approach 100%.<sup>1</sup> At what cost? When impervious cover reaches 10 to 20% of a watershed’s area, ecological stress becomes apparent,<sup>2</sup> with pavement often making the effects of drought worse. For example, according to a report by American Rivers, the rapid expansion of paved-over and developed land in Atlanta, Georgia and surrounding counties contributes to a yearly loss of rainwater infiltration ranging from 57 to 133 billion gallons. If managed on site, this rainwater—which could support annual household needs of 1.5 to 3.6 million people—would filter through the soil to recharge aquifers and increase underground flows to replenish rivers, streams, and lakes.<sup>3</sup> Watersheds are dehydrated as less water infiltrates into the soil and groundwater, and eroded as the volume and velocity of runoff increases, causing flooding and property damage (fig. 8.1B).



Fig. 8.1A. Impervious landscape, a “sea of pavement” dehydrates the site and floods downstream areas.



Fig. 8.1B. Mountain Avenue as a river of runoff. Tucson, Arizona. Photo Credit: Ann Audrey

The buildup of silt and pollution in waterways harms aquatic life and fishing, causes illness, and leads to shortages of drinking water.<sup>4</sup> And in the hot, dry days between rains, exposed pavement and

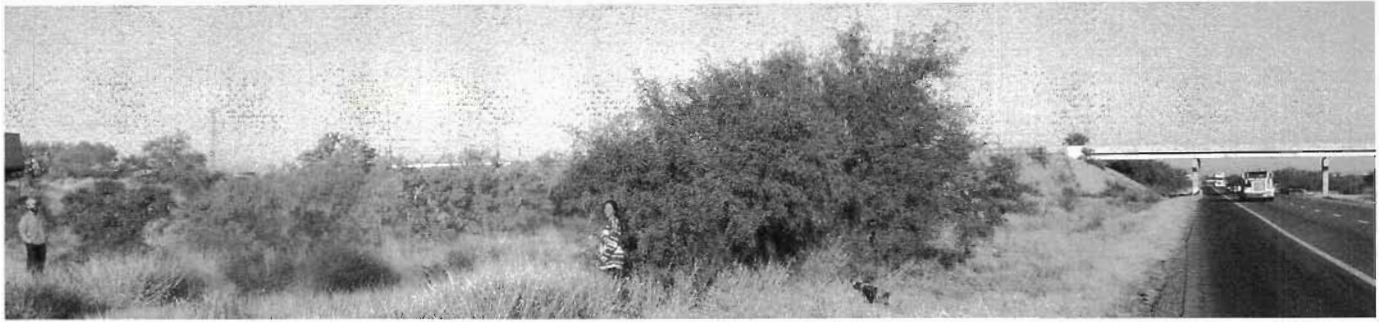

Fig. 8.2. Highway I-10, near Benson, Arizona. Impervious pavement can be used as a catchment surface from which the runoff can be harvested—if there is enough adjoining plantable space that can infiltrate and utilize that runoff. Note how the trees beside the roadway (middle of photo) utilize runoff to grow larger than the trees (left) beyond reach of the runoff (compare tree heights to persons standing beside them). However, if there is typically more runoff than can be harvested locally, hardscape reduction and permeable paving should be considered.

buildings store heat like a battery, then release it in the late afternoon and evening, raising temperatures by up to 10°F—this is called the *heat-island effect*.<sup>5</sup>

But—there’s an alternative.

We can *reduce pavement* by creative planning and design, and where pavement remains we can consider the use of permeable paving instead of conventional impermeable pavement. *Permeable paving* is a broad term for water-harvesting techniques that use porous paving materials to enable water to pass through the pavement and infiltrate into soil. Permeable paving allows passive irrigation of adjoining plantings, decreases the need for expensive drainage infrastructure, and reduces soil compaction. The permeable paving allows roots to breathe, since it does not seal and close off the soil’s surface and source of oxygen—they would not be able to do so if the surface were sealed. Permeability allows bacteria to set up home in the paving’s pores—these life forms bioremediate many of the toxins imported from car oil and the like; tree roots and organic matter further enhance the bioremediation.<sup>6</sup>

Among the many ideas and case studies presented in this chapter, you’ll see:

- How excessive impervious driveways and other paved areas can be made porous, reduced in size, converted to gardens, or done away with entirely
- How neighborhood streets and rights-of-way are being transformed to function more like the watershed of a healthy forest than a street

- How communities are slowing traffic, controlling flooding, reducing the heat-island effect, and creating beauty in neighborhoods by planting trees in and along the streets where they are irrigated by runoff harvested from the streets
- And how parking lots can become parking orchards

At the very least, we can try to be observant of open-ground space between impermeable surfaces, where the direct rainfall and runoff could be harvested (fig. 8.2), as well as try to actively reduce unnecessary impermeable surfaces (fig. 8.1), and use permeable pavement whenever possible, so that rainwater falling upon these surfaces can be utilized by plants and infiltrate the ground.

Reduction of hardscape is explored first, and then permeable paving.

## WHAT IS THE REDUCTION OF HARDSCAPE?

Hardscape reduction is a strategy to minimize the need for pavement through creative planning and design, and to remove impervious pavement, where possible. By reducing hardscape (and sloping it toward adjoining earthworks), you can increase the adjoining pervious areas to enhance on-site water infiltration of the hardscape’s runoff, reduce runoff leaving the site that would otherwise contribute to downstream flooding and contamination, and decrease the heat-island

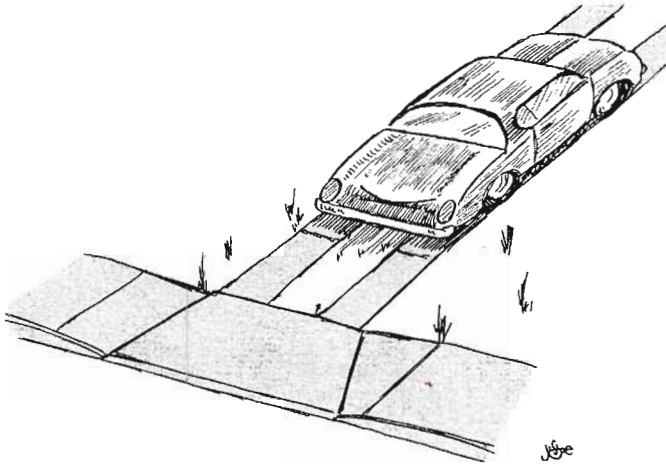

Fig. 8.3. A two-track (wheel-track) driveway paves 60% less area than a conventional driveway.

effect caused by excessive, exposed hardscape. Considering how to decrease hardscape should be the first step in planning any paving projects.

## WHERE IS HARDSCAPE REDUCTION USED?

It is used wherever there is excessive pavement. Here are some strategies to consider:

### Reduce driveway paving to parallel wheel tracks

A “wheel-track” driveway can reduce impermeable surface area by 60% compared to conventional concrete driveways.<sup>7</sup> Just leave the center strip of the driveway unpaved, and if you like, cover it with vegetation or gravel (fig. 8.3). Go further still and limit the driveway’s length to that of your vehicle so the shortened driveway simply becomes a park-way.

### Eliminate the need for a driveway

Use the street as a city-maintained driveway and parking space by parking along the curb. Then eliminate your driveway and use this area for other purposes.



Fig. 8.4. Narrower streets and young native food-producing mesquite trees irrigated by harvested street runoff. Civano neighborhood, Tucson, Arizona

## Eliminate the need for a car and associated paved surfaces

Use your feet, a bicycle, friends with cars, a community car-share program, and public transportation to reduce or eliminate your household’s need to own motorized vehicles. This could save you \$7,000 or more a year in costs for car insurance, maintenance, fuel, and payments.<sup>8,9,10</sup> Lobby your local government to provide public transportation, integrated infrastructure, and land-use plans that maximize the convenience, safety, and comfort of bicycle and foot traffic linked to public transport.

Information sources for alternatives to car ownership and land uses that require paving can be found in appendix 6.

## Plant along sidewalks and within medians

Public rights-of-way, street medians, and sidewalks can all be made more beautiful, pervious, comfortable, and healthy by planting indigenous shade trees (fig. 8.4). According to the National Wildlife Federation, “There are about 60 to 200 million spaces along our city streets where trees could be planted. This translates to the potential to absorb 33 million more tons of CO<sub>2</sub> every year, and saving \$4 billion in energy costs [from reduced mechanical cooling and flood control infrastructure].”<sup>11</sup> Food-producing trees

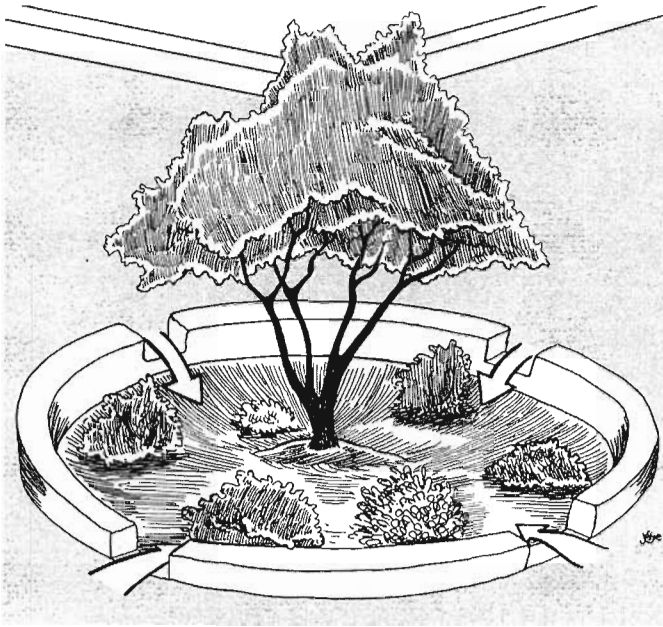

Fig. 8.5A. Traffic circle with raised curb and curb cuts. Used where runoff flows through concave intersections. Raised curb keeps cars out; cut lets water in.

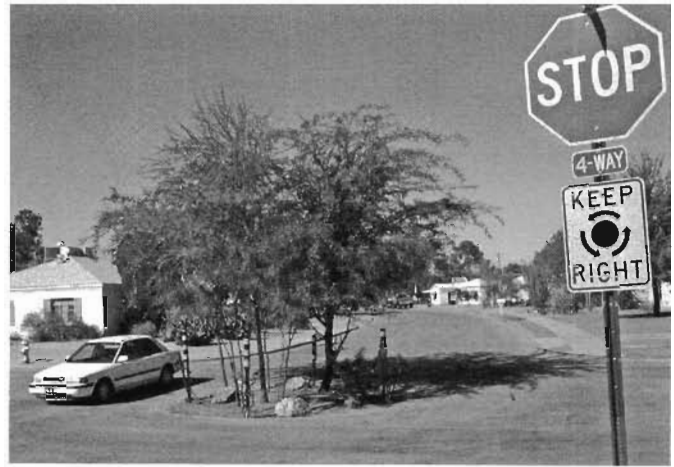

Fig. 8.5B. Traffic circle with curbs flush with street. Used where center of intersection/road is the low point and runoff can flow across the curb and into the planting area. Boulders and bollards keep cars out.



Fig. 8.5C. New traffic circle with raised curb, but no curb cuts. Used where center of road or intersection is raised or crowned to drain water to side of road. Raised curb (and sunken, mulched basin within) retain rainfall that would otherwise run off. Note: The construction of this circle reduced the paved area of the intersection by 26%!

can enhance local food security at the same time. Vines can be planted where space is limited.

For a multipurpose alternative to curb and gutter drainages, see the Real-Life Example in this chapter from Seattle, Washington, and resources related to it in appendix 6. In Tucson, Desert Harvesters is promoting street-grown food; see [www.DesertHarvesters.org](http://www.DesertHarvesters.org).

## Reduce width and shade streets

Plant trees in the streets; it's legal! Construct traffic-calming circles, chicanes, chokers, and pullouts within residential streets. See [www.trafficcalming.org](http://www.trafficcalming.org) and [www.walkinginfo.org](http://www.walkinginfo.org) for examples. Talk to your local traffic engineering department for information on the design and approval process, and potential funding. Enhance these traffic-calming strategies by incorporating water harvesting. If devices are placed at the high point of a crowned road from which water drains *away*, circle them with a raised curb, while the soil within is lower than the curb—to keep the water around. If the traffic-calming strategies are placed in low areas that water drains *toward*, set the curbs of

these structures flush with the pavement or make cuts in the curbs to allow runoff to flow into the circles and pullouts. Depress the earth within planting areas and plant climate-appropriate shade trees (figs. 8.5A, B, C shows various styles of traffic circles; fig. 8.6 shows a chicane or pullout). All this makes neighborhoods safer, cooler, and more beautiful.



Fig. 8.6. Chicanes or pullouts with flush curbs. Used where road is crowned or raised in the center and drains runoff to streetside curb. Flush curb allows runoff to infiltrate soil of planting area, while surplus runoff can continue down the street. These pullouts calm traffic by forcing it to meander. Speed humps in the area constricted by pullouts could calm traffic even more if needed.

### Promote smaller cul-de-sacs

Reducing the turning radius of a cul-de-sac (a turnaround or dead end) from 40 feet (12 m) to 30 feet (9 m) reduces impervious paving by about 50%.<sup>12</sup>

According to the Best Management Practices of the Metropolitan Council's Environmental Services website, a 40-foot (12-m) turning radius works for most emergency, maintenance, and service vehicles, while a 30-foot (9-m) radius requires the largest of these vehicles to make one backing movement to turn around.<sup>13</sup>

### Promote landscaped islands within cul-de-sacs

Depressed water-harvesting landscapes can be created in the untraveled center of cul-de-sacs. A flat concrete curb flush with the level of the street stabilizes the pavement and allows runoff to flow into the cul-de-sac's open center (fig. 8.7).

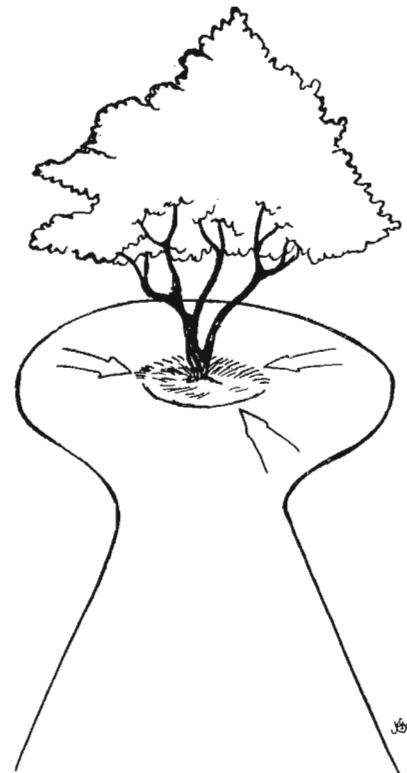

Fig. 8.7. Sunken planting island in a cul-de-sac

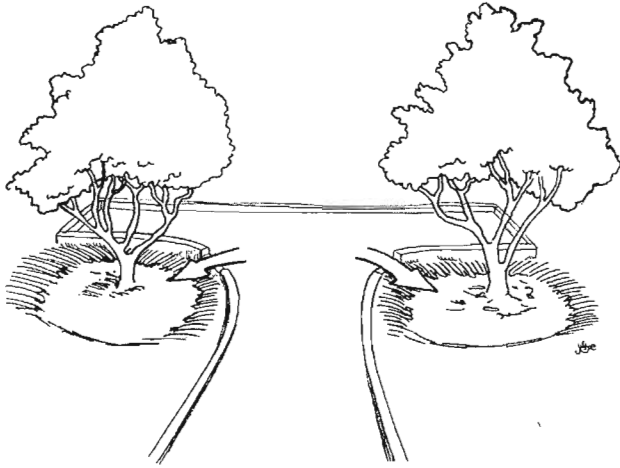

Fig. 8.8. A hammerhead turnaround with runoff directed to trees in basins

### Use a T-shaped ("hammerhead") turnaround rather than a cul-de-sac

T-shaped turnarounds take up less than half the space of 30-foot (9-m)-radius cul-de-sacs. Vehicles need to make three-point turns, however, so these are most appropriate on streets with ten or fewer homes (fig. 8.8).<sup>14</sup>

### Encourage automobile alternatives

Advocate for the installation of convenient, shaded bike racks, bike paths, foot paths, and bus stop shelters to encourage less resource-consuming modes of transportation and reduce the number of required parking spaces.

### Reduce parking space dimensions

Position compact car spaces close to building entryways while placing parking areas for larger vehicles a little farther away. This rewards folks who are minimizing resource consumption. Determine the most space-efficient parking design for each site, which may include angled parking to reduce driving lane width.<sup>15</sup> Create triangular tree basins at the end of the angled parking spaces.

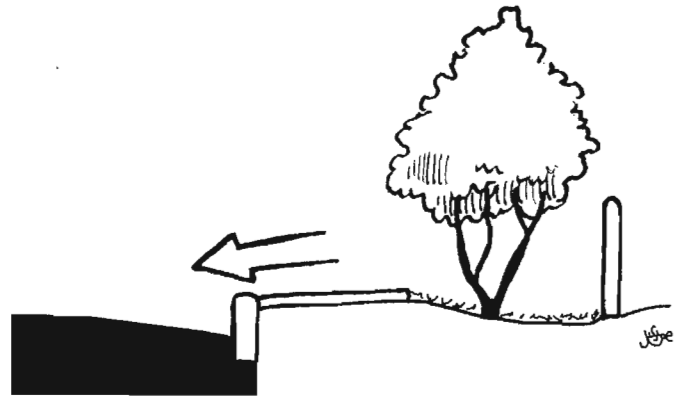

Fig. 8.9A. Sidewalk wastefully sloped to drain its runoff to the street. Note: Sidewalk slope is exaggerated.

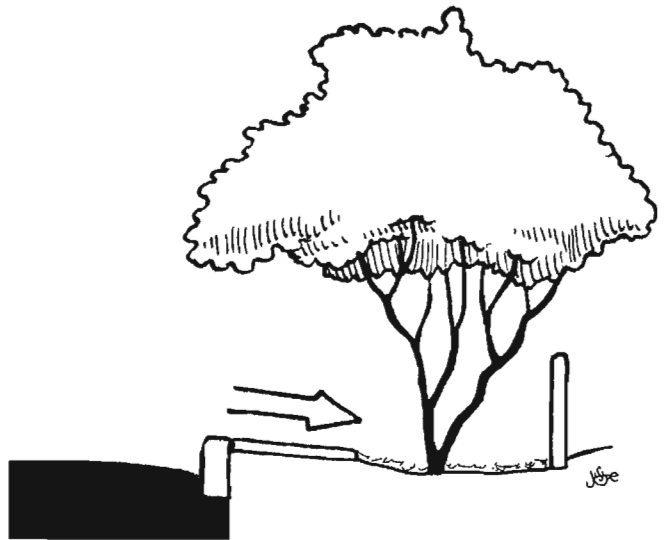

Fig. 8.9B. Sidewalk wisely sloped to drain its runoff to adjoining tree basin. Slope sidewalk at least 1/8 inch (3 mm) per linear foot (30 cm), but never more than 1/4 inch (6 mm) per foot.

### Promote shared parking lots

Parking lots can be shared by businesses and organizations whose peak parking demands occur at different times, such as offices needing weekday parking and restaurants needing primarily evening and weekend parking.<sup>16</sup>

### Slope pavement to drain into landscapes

Any paved surface can be designed to drain toward sunken landscaped areas rather than straight to the street or storm drain (figs. 8.9A, B). Openings can

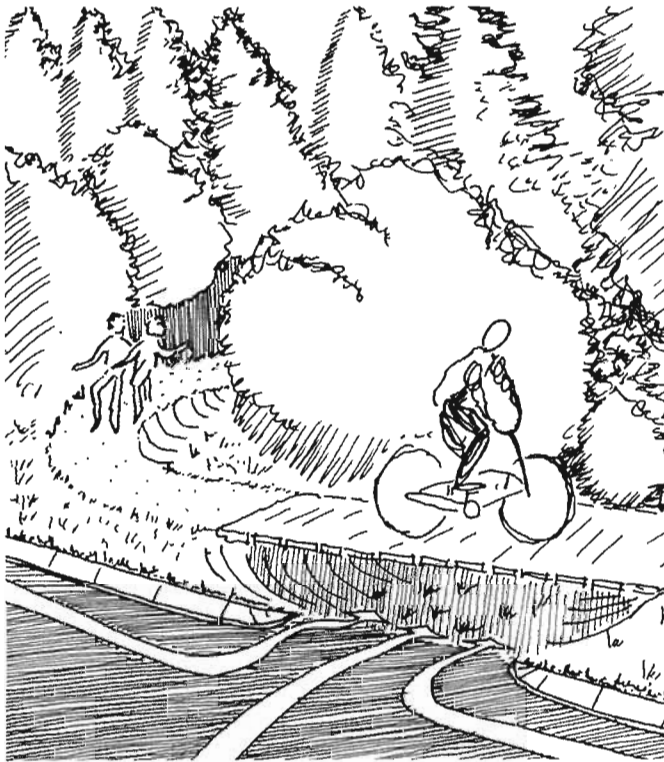

Fig. 8.10. Opening in curb directs street runoff to diversion swale (shaded area under bridge) in the landscape, Village Homes, Davis, California

be placed in raised curbs bordering paved surfaces to allow street runoff to flow into the basins to passively irrigate trees that shade the pavement (fig. 8.10).

In the next chapter, figure 9.16 provides a schematization of this concept.

## Reduce building footprints

We can design and construct more efficient and elegant buildings by building smaller and smarter. This saves material costs, and less energy is needed for heating, cooling, and maintenance. *Cohousing* homes share exterior walls with one another, and residents sharing community pools, common rooms, the use of a common clubhouse with an entertainment center, and laundry facility—this way these single shared facilities can take the place of many in each individual home. *Clustered developments* and garden cities limit development to one or several dense areas, leaving the rest of the site open for green space, wildlife habitat, and/or agricultural land supporting the community.

### Box 8.1. Gasoline and Oil Facts

- Approximately 10 gallons (or 10 liters) of water are required to manufacture 1 gallon (or 1 liter) of gasoline.<sup>17</sup>
- One gallon (or 1 liter) of oil can contaminate up to a million gallons (or a million liters) of water.<sup>18</sup>
- 20 pounds (9 kg) of carbon dioxide (CO<sub>2</sub>) emissions are generated from 1 gallon (3.8 liters) of gasoline.<sup>19</sup>
- An average tree stores 13 pounds (5.8 kg) of carbon every year and a community forest can absorb enough carbon dioxide to compensate for driving a car 26,000 miles (41,600 km). At this time in history, the burning of coal, gasoline, and other fossil fuels has added more carbon dioxide to the atmosphere than trees and oceans can absorb, and this is the principal cause of global warming.<sup>20</sup> Conversely, reducing our production of carbon, while growing more trees, leads to less global warming.

See appendix 6 for cohousing, garden-city, and small-house resources.

The automobile dominates much of our lives, resulting in our homes, communities, and quality of life taking second place. This can be seen where closed garage doors rather than front porches greet visitors to our dwellings, where driving to the neighbor's or the local store is perceived to be safer or easier than walking or riding a bicycle, and where air and water quality are worsening (see box 8.1). See appendix 6 for more sources of information for alternatives to car ownership, excessive automobile use, and paving.

## HARDSCAPE REMOVAL, TOOLS, AND MATERIALS

**Basic tools to remove impervious pavement:** include a pick-axe, 10-pound sledgehammer, shovels, and wheelbarrow. Jackhammers and backhoes make big jobs easier.

**Hardscape Removal:** Asphalt-driveway removal can usually be done by hand, and it feels great when



Fig. 8.11. Shade trees planted in a basin cut on contour in a once-solid asphalt parking lot. A bunyip water level was used to find the contour, and spray paint marked it before cutting. Parking bay strips were repainted to align with the basin. The speed hump (at the far end of the basin) acts as a diversion berm directing additional runoff into the basin. After one year, the trees could survive entirely on runoff from the building and remaining asphalt. This photo was taken three years after the trees were planted. Old Community Food Bank site, Tucson, Arizona. Note: Mulch would further enhance the water infiltration and storage capacity of the basin. Photo and design credit: Dan Dorsey

you uncover the soil (fig. 8.11)! Drive a pick-axe under the edge of the paving and pry it up to crack the surface. When you see the dirt below you'll literally feel the earth take a big breath—or at least I do. If you are just cutting a hole in the asphalt, a concrete saw can be rented or hired to do the job to make nice clean cuts.

The weak (and potentially toxic) asphalt should be recycled (see box 8.2). For breaking up thicker asphalt or concrete, use a sledgehammer, jackhammer, or even a backhoe to peel it up and drop it—which will break it.

If you work carefully breaking up concrete you can use the larger chunks as permeable paving (fig. 8.19),

### Box 8.2. Where Can You Recycle Asphalt and Concrete?

Great question! For asphalt and concrete recycling, contact your city and state transportation departments. Better yet, try to beneficially reuse that heavy, nontoxic concrete on site. Also, check Recycler's World at [www.recycle.net](http://www.recycle.net).

or to build check dams or terraces (fig. 3.1 in the terrace chapter). And this leads to the next part of this chapter: Permeable Paving.

## WHAT IS PERMEABLE PAVING?

Permeable paving is a term for water-harvesting techniques using porous or non-contiguous paving materials to enable water to pass through and beneath the pavement and infiltrate into the soil. Among its advantages, permeable paving allows passive irrigation of adjoining plantings and lessens soil compaction under and around such paving. Tree roots beneath permeable paving can breathe, and—along with the porous pavement—filter pollutants. The huge surface area of the well-aerated and occasionally moistened porous pavement structure helps support a diverse ecosystem of life similar to that of natural soils, and this life can help biodegrade oils into carbon dioxide and water.<sup>21</sup>

Permeable paving also decreases the need for additional and expensive drainage and flood-control infrastructure, because water infiltrates it rather than runs off it. Thus, the porous paving is its own drainage and flood-control infrastructure.

## WHERE IS PERMEABLE PAVING USED?

Permeable paving enhances water infiltration in locations where conventional, impervious paving would otherwise be used. It is most useful on densely developed sites where there's not enough unpaved surface to capture on-site runoff within earthworks alone (fig. 8.12). Permeable paving is most effective when it



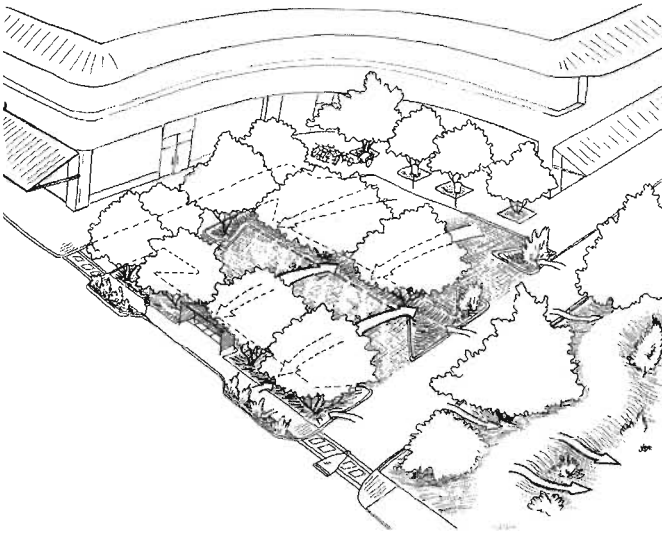

Fig. 8.12. Permeably paved parking lot, and impermeably paved raised road and path directing runoff to sunken vegetated basins. Planting of food-producing shade trees, such as velvet mesquite (*Prosopis velutina*) creates a rain-irrigated parking orchard. Note: Pattern of raised pavement and adjoining sunken planting area works with both permeable and impermeable pavements.

harvests only the rainwater that falls directly upon it, without additional runoff from upslope areas. Raise the paving above the surrounding landscape to prevent settling or pavement displacement due to poor-draining subsoil, and prevent sediment-laden stormwater runoff from washing over and into the permeable pavement, plugging its pores.

Porous pavement materials are best suited for areas of light traffic such as paths, driveways, parking stalls, and parking lanes, which can amount to approximately half of the built cover in most urban land uses.<sup>22</sup> Permeable paving is ideal for use near or around shade trees, since it mimics a less compacted, healthy natural soil surface allowing the exchange of air and moisture throughout the tree's root zone (see fig. 8.13 for horse-and-buggy parking).

## WHERE NOT TO USE PERMEABLE PAVING

However, as Bruce K. Ferguson in his book *Porous Pavements*<sup>23</sup> recommends, the following types of settings should ordinarily be *avoided* when considering the use of permeable paving to infiltrate stormwater:

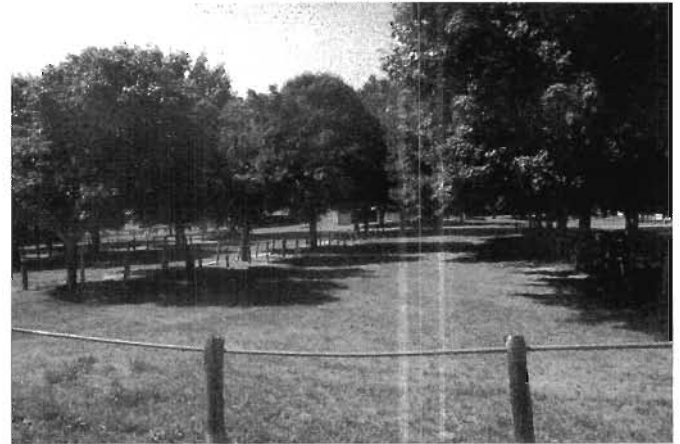

Fig. 8.13. Shaded grass parking lot for horses and buggies at an Amish church in Pennsylvania

- Where slopes exceed 5% (3° or 19:1), and the subgrade could erode from water moving in the pavement
- On steep unstable hillsides where extra moisture could further destabilize the slope
- Over septic tank leaching fields where excess moisture could compromise the septic system
- Over toxic soil deposits such as industrial *brownfields* that could leach contaminants into the environment
- Where soil is so grossly permeable that it becomes a conduit for untreated water into the groundwater
- Where a building's basement is within 20 feet (6 m) of the pavement, and could flood from infiltrating water
- Where runoff is already being harvested from an impervious surface for direct use, such as harvested runoff in adjoining earthworks that passively irrigate shade trees
- Where fill soil supporting heavy traffic could be weakened by excess moisture
- Where road crews spread pore-clogging sand or cinders for winter traction

- Where over-swelling soil could displace rigid concrete, paving blocks, or asphalt (though this is typically not a problem for porous aggregate or soft porous paving such as mulch)<sup>24</sup>

In addition, avoid:

- Drainageways
- Underlying soils that can't drain infiltrated water within 48 hours, or where water tables are 3 or 4 feet (0.9–1.2 m) below the surface, hindering drainage<sup>25</sup>

they hold up, what worked, and what did not work. This is very important, because if you use a standard product or use the paving in the wrong context you may need to replace it at great cost. Speak to those who install and use the material to get installation tips, learn about product performance, avoid costly mistakes, and get advice on obtaining permits (these may need to be experimental permits).

**Tools:** Refer to the instructions given in the options (below), and if applicable, manufacturers' installation instructions.

**Materials:** Some options for permeable paving materials and products:

### Soft porous pavement or "mulch"

A mulched surface of woodchips, bark, and crushed shells (in coastal areas) is often the lightest-weight porous pavement. It provides a natural appearance and is easy to install and maintain. It biodegrades to help build soil, though it will need to be reapplied more often than more durable materials. The light weight of these materials reduces delivery costs but potentially negates their use in exposed areas with high winds.

**INSTALLATION TIP:** Lay mulch at least 3 to 4 inches (7.5–10 cm) thick and lightly compact or tamp it to hold it in place. Contain the loose mulch material by placing it within a fixed border such as large rocks or tree branches anchored into the soil. A shovel, rake, and wheelbarrow are the basic tools needed.

**APPROPRIATE USE:** Mulch can be used along light traffic footpaths, within gardens (fig. 8.14), and on playgrounds if it meets ASTM F 2075 criteria to lessen the impact of a child falling onto the surface. Use mulch only in areas with less than a 3% slope. Mulched surfaces are not ADA-accessible.

### Porous aggregate

Porous aggregate (gravel) has the "highest permeability and the lowest cost of almost any permeable

## WHEELCHAIR ACCESSIBILITY

All permeable paving materials discussed here can be made wheelchair accessible if properly installed, though not necessarily American Disabilities Act (ADA)-compliant. With some, particularly the open-jointed paving blocks, there may be vibration issues due to wheels traveling over open pore spaces or joints between the pavers. Porous aggregate, and especially soft porous paving, can be the most challenging for wheelchair access. At this time there are no specific ADA guidelines for permeable paving materials, though the porous paving industry often recommends that parking spaces for the handicapped be made of conventional materials, while the rest of the lot be made of permeable paving.<sup>26</sup> Similarly, 3-foot-wide (0.9 m) sections of pedestrian paths can be made of ADA-compliant materials, while using permeable paving as a peripheral material where more pavement is desired. For commercial products, see manufacturers' websites for updated information on ADA compliance.

## PERMEABLE PAVING TOOLS AND MATERIALS

A number of material options are described in this section. Before buying permeable paving, research the applicability of different materials for your unique site and refer to manufacturers' instructions and information about material options and guidance on the tools needed for permeable pavement installation. Ask for references and verify the products' quality. Visit sites where the materials have been installed to see how



Fig. 8.14. Garden path mulched with small woodchips

paving material,”<sup>27</sup> and is more durable than soft porous pavement (figs. 8.15A, B). To be porous, permeable, and stable under a load, the aggregate particles must be angular in shape so their flat faces interlock with each other and resist rotating and shifting. “Crushed stone” or “crushed gravel” are appropriately angular materials, as opposed to smooth round “river stone” or “pea gravel,” which rotate and slip past each other and “give” under a load (fig. 8.16A).<sup>28</sup> The aggregate must also be *open-graded* or *single-sized*, which results in the aggregate having a narrow range of particle sizes and open void spaces that improve interlocking between particles (fig. 8.16B).

Make sure the open-graded gravel you select is durable enough not to wear down to finer material. Before delivery have it washed clean of fine particles that could clog the pores between the aggregate. While aggregate with particle sizes up to 1 inch (2.5 cm) drains rapidly, 1/2-inch (1.25-cm) particles are easier to walk on, and still smaller sizes should be used where wheelchair accessibility is needed.<sup>29</sup>

**INSTALLATION TIPS:** Porous aggregate is very easy to install and maintain with a shovel, wheelbarrow, rake, and hand tamper (see fig. 3.10 in the terrace chapter). Porous aggregate can be placed on uncompacted subgrade soil, though the aggregate itself should be slightly tamped and compacted to reduce settling or shifting. In some cases it may be necessary to place a porous *geotextile* or *landscape fabric* on the subsoil before the aggregate is put in place to prevent



Fig. 8.15A. Porous-aggregate parking lot and salvaged-concrete walkway, Tucson, Arizona. Note: The system could be improved if walkways directed their runoff to vegetated basins rather than the parking lot.



Fig. 8.15B. Porous aggregate under bike racks and trees in heavy pedestrian zone, University of Arizona, Tucson. Runoff from concrete sidewalk is harvested in porous aggregate, while sidewalk and curb help keep aggregate in place. Trees would benefit even more if the section of impervious concrete between pillars and palm tree were replaced with an extension of pervious pavement.

underlying soil from mixing with, and filling in pores between, the aggregate. Aggregate should be applied in a layer at least 3 inches (7.5 cm) thick where it will be driven upon. A 6-inch (15-cm) application improves drainage and minimizes soil compaction when the aggregate is tamped in place.

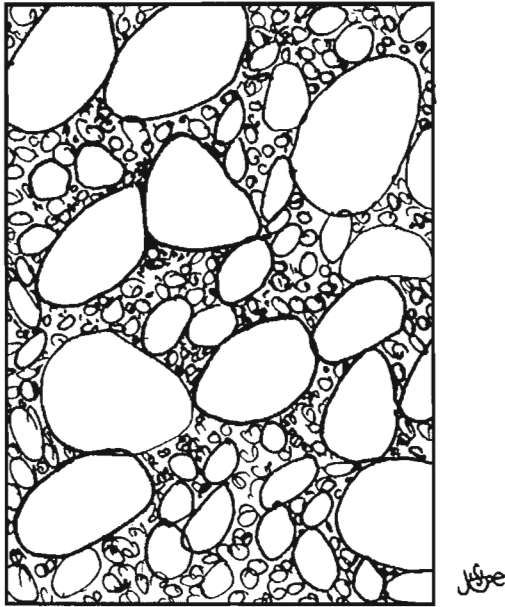

Fig. 8.16A. Round mixed-size particles packed in dense gradations

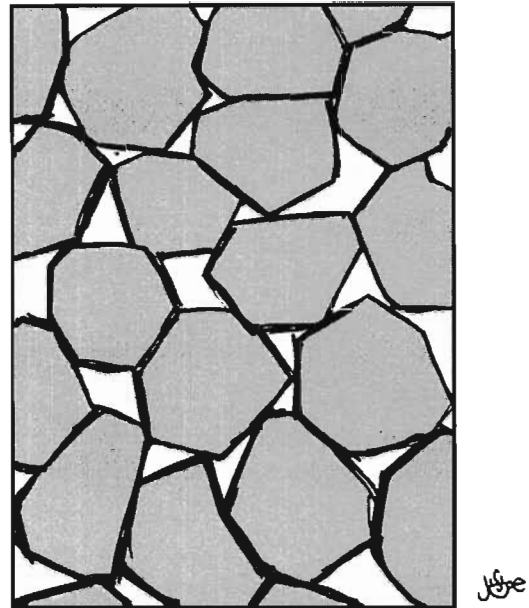

Fig. 8.16B. Angular particles packed in open-graded gradation. Angular, open-graded aggregate is far more porous and stable.

**APPROPRIATE USE:** Because porous aggregate can be displaced, do not use it on slopes steeper than 3%, and confine its use to very-low traffic areas such as pathways, residential driveways, lightly used parking stalls, long-term RV parking, and the grounds of plant nurseries. Contain the aggregate with a firm border such as concrete curbing, large rock, or strips of plastic or metal *structural edging*. Because of its flexible nature, aggregate works well over swelling soil, uncompacted soil, and tree roots, and in areas where soil heaving results from deep-freezing weather.<sup>30</sup>

## Plastic geocells

These manufactured products are designed specifically as a permeable paving material. The geocells are a connected matrix of open, plastic cells that can be filled with aggregate, soil, or turf. Some brands also include a backing of geotextile fabric. The geocell matrices come in panels or rolls that are laid on firm native soil or on a compacted porous base material of engineered soil, depending on the model and application (fig. 8.17A, B).

**INSTALLATION TIPS FOR THE GRAVELPAVE<sup>2</sup> BRAND OF GEOCELL:** Create a firm base course of

porous engineered fill, similar in depth to what would be placed under asphalt. Roll the plastic matrix flat into place over the base course and secure it with long landscaping nails hammered into the soil at a rate of 4 nails per square meter. Using rakes and brooms, spread washed, open-graded, angular gravel over the matrix until it thoroughly fills the plastic rings and covers them with 1/4 inch of gravel. Compact the aggregate into place with a hand-pulled lawn roller. The matrix reinforces the gravel material, reducing rutting, mud accumulation, and root-zone compaction. Acting somewhat like a snowshoe, it also spreads weight more evenly so heavy machinery such as fire trucks and garbage trucks can travel over the surface (when saturated with moisture) without it sinking. The erosion-control fabric reduces weed growth and keeps gravel from subsiding past the matrix into the potentially large open-graded aggregate sub-base. Volunteers led by a knowledgeable supervisor can typically do the installation once the underlying soil or base course is graded and in place. The matrix is easy to install around obstructions by cutting it with ordinary hand or power tools, and it doesn't require special fasteners or connectors.



Fig. 8.17A. Gravelpave<sup>2</sup> geocells with landscape fabric backing being installed at Milagro Cohousing parking lot, Tucson, Arizona. Flush concrete curb will strengthen the edge between the geocell surface and the incoming stabilized-earth road.



Fig. 8.17B. Completed Gravelpave<sup>2</sup> parking lot with geocells filled with gravel. There is no runoff from this parking lot, so no detention basin or other drainage infrastructure was required. See the first Real Life Example in chapter 5 and figure 5.23 of the Milagro plan for more.

**APPROPRIATE USE:** Use Gravelpave<sup>2</sup> or another brand of plastic geocells for trails, horse paths, high-use pedestrian areas, residential driveways, light-traffic parking lots, commercial parking lots, and storage yards. The heavy duty Geoblock brand has been used successfully for ATV trails in Alaska and on mountain bike paths with slopes steeper than 25% (14°) in Wisconsin.<sup>31</sup> The use of geocells expands the use of aggregate and turf to more demanding traffic settings than these materials could bear alone, such as emergency vehicle accessways.<sup>32</sup> See the resources appendix 6 for Gravelpave<sup>2</sup> and Geoblock contact information.

## Open-jointed paving blocks

These paving blocks are solid units installed with at least a 1/4-inch (6-mm) space or joint between them. The joint is filled with a quick-draining, open-graded angular aggregate or vegetated soil, or are left open for infiltration of water into a porous base course beneath the blocks. The blocks can be manufactured specifically for porous paving (fig. 8.18), such as open-jointed, interlocking concrete pavers, or can be bricks, stone, or salvaged chunks of concrete installed with open joints (fig. 8.19).

**INSTALLATION TIPS FOR OPEN-JOINTED, INTERLOCKING CONCRETE PAVERS:** It's best to have the installation done by a contractor experienced with interlocking concrete paving systems.<sup>33</sup> The contractor will first spread geotextile fabric over the subgrade. Next, the contractor will spread and compact a base course of open-graded (commonly No. 57 gradation<sup>34</sup>) angular aggregate over the fabric. The aggregate acts as the filtering and storage medium for runoff, minimizing damage from soils that heave when frozen. The geotextile fabric keeps the aggregate from mixing with, and having pore spaces clogged by, the soil below. Next, the contractor will lay down a maximum 1-inch (2.5-cm) thick layer of smaller open-graded aggregate as a level bed for the interlocking concrete pavers.<sup>35</sup> The pavers are then laid, the joints are filled with an angular porous aggregate (typically with a No. 8 gradation from ASTM D 448),<sup>36</sup> and a vibratory plate compactor is used to seat and level



Fig. 8.18. UNI Eco-Stone open-jointed paving blocks. Courtesy of UNI-GROUP U.S.A.

everything in place. Note: *Firm edging must be provided around the paved area to hold the paving block and aggregate base course in place.* See figure 8.20.

**INSTALLATION TIPS FOR STANDARD BRICK, STONE, OR SALVAGED CONCRETE PAVERS:** Grade the area to be paved to the desired slope and elevation, allowing for the thickness of the paving material, plus a 3- to 6-inch (7.5- to 15-cm) thick base course of washed, open-graded 3/8- to 1/2-inch (9- to 12-mm) diameter angular gravel. Lay the pavers with at least a 3/4-inch open joint between them, then fill the joint with open-graded, washed angular gravel. If using salvaged concrete, choose flat “paving stone” pieces with a roughly uniform thickness of 4 inches (10 cm) or more to provide strength, a neat appearance, and easy installation. For step-by-step instructions and photographs on laying the concrete, bricks, or stone see David Reed’s comprehensive book *The Art and Craft of Stonescaping: Setting and Stacking Stone*.



Fig. 8.19. Salvaged chunks of concrete sidewalks are decoratively laid as a porous patio in the award-winning landscape of the Amado residence, Tucson, Arizona. Designed by Blue Agave Landscape Design

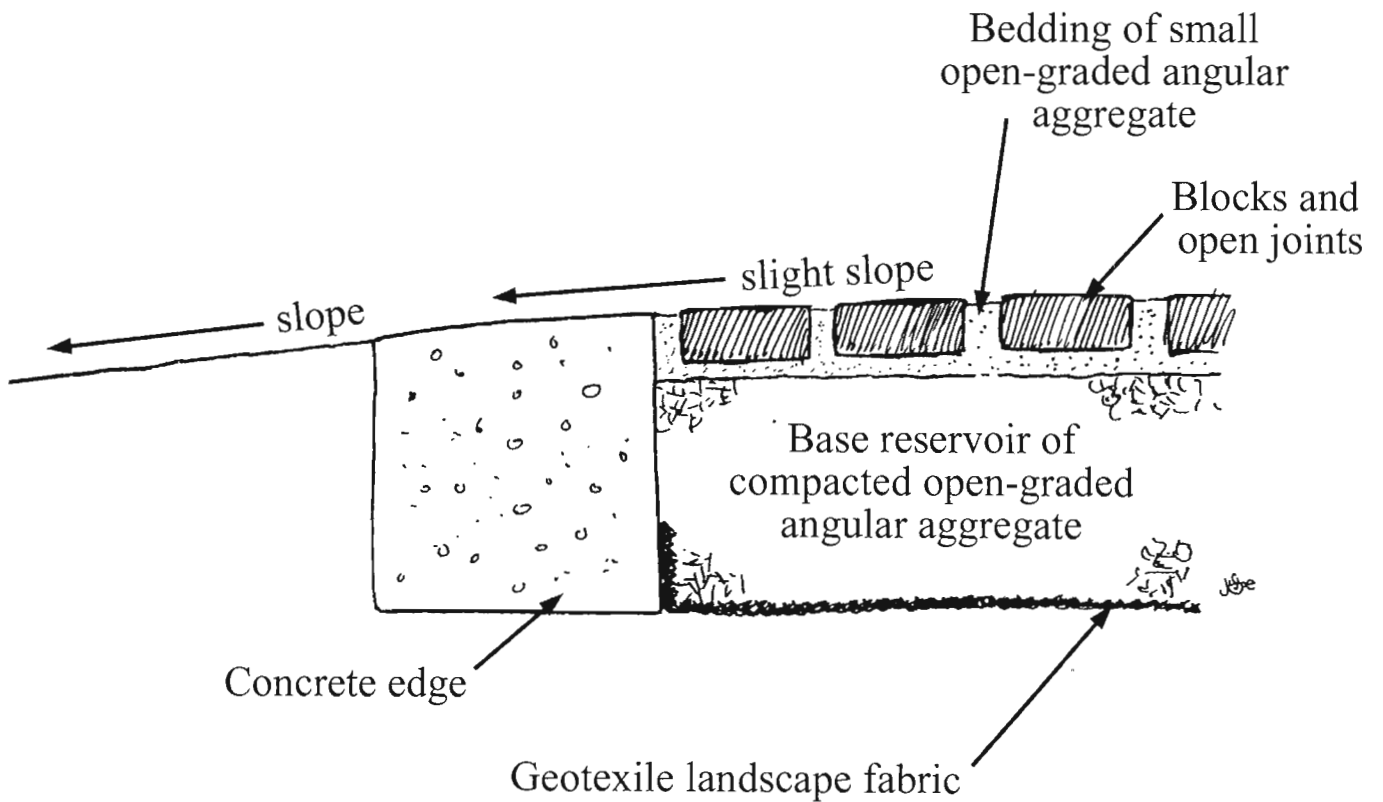

Fig. 8.20. Typical open-jointed paving block construction components. Adapted from *Porous Pavements*<sup>37</sup>

**APPROPRIATE USE:** Use open-jointed, interlocking concrete pavers for paths, patios, entryways, plazas, driveways, parking lots, cul-de-sacs, light-traffic residential streets, and loading docks. They are a durable material with a long service life, and the stable, interlocking concrete pavers can handle heavy loads such as water-laden fire trucks in a variety of climates. Use standard brick, stone, or salvaged concrete pavers laid with an open joint for light-traffic paths, patios, and residential driveways. All open-jointed paving blocks provide access to underground utilities, and the paving material can be put back in place when utility work is complete.

See the resources appendix 6 for suppliers of open-jointed, interlocking concrete pavers. For a more thorough description of the permeable paving options listed above; additional options including porous concrete, porous asphalt, and others; products; performance; cost; installation; maintenance; and case studies, I highly recommend the comprehensive book *Porous Pavements* by Bruce K. Ferguson, CRC Press, 2005.

## STEPS TO INSTALL PERMEABLE PAVING

As reported in the *Stormwater Journal*, porous paving expert Bruce Ferguson stresses three things must be done with each porous pavement installation:

- 1) Select for location
- 2) Make sure the design is correct
- 3) Build properly

“If you do all these things right, there is no reason to expect failure,” Ferguson adds, “If you do any one of them wrong, it probably will fail.”<sup>38</sup>

## SITING

Plan for, and grade, the surface of the paved area and the subsurface beneath to drain surplus water away from adjacent buildings and downward and away from the paved area toward vegetated water-harvesting earthworks placed at least 10 feet (3 m) from buildings. Standard pavement slopes range from a 1/8-inch

(3-mm) to a 1/4-inch (6-mm) drop per horizontal foot (30 cm). Permeable paving is most effective when it harvests only the rainwater falling directly on it, without receiving additional runoff from upslope areas, though a limited amount of sediment-free runoff from impervious roofs and pavements is acceptable.<sup>39</sup>

Sections of permeable paving may settle or become displaced if too much water infiltrates and the subsoil doesn't drain sufficiently. In addition, silts flowing onto the paving clog the small spaces between the porous pavement, so all permeable paving surfaces should be raised above the immediately surrounding landscape. Permeable paving may be paired with water-harvesting earthworks such as berm 'n basins or infiltration basins that are placed upslope to catch sediment-laden runoff before it reaches the paving, and infiltration basins or boomerang berms placed downslope of the paving to receive excess water running off the paving. (Compare figs. 8.21A and 8.21B.)

## SPACING

If locating the paving beside a wall or building, place its top surface at least 6 inches (15 cm) below the top of the adjacent stem wall or floor level to reduce rainwater splash and potential wall damage.

## CONSTRUCTION

Installation of permeable pavement will vary depending on materials used. Refer to the manufacturer's specifications and the requirements of your local building authority.

Multilayered pavements should have each successive lower layer extend beyond the edge of the layer above (fig. 8.22).<sup>40</sup>

## LOCATION AND CONSTRUCTION OF OVERFLOW SPILLWAYS

Overflow from porous paving should be directed to adjacent water-harvesting earthworks such as infiltration berms, berm 'n basins, or diversion swales. The edges of the paving are often stabilized with concrete curbs or brick or stone mortared in place so that overflow will not undermine the paving (fig. 8.23).



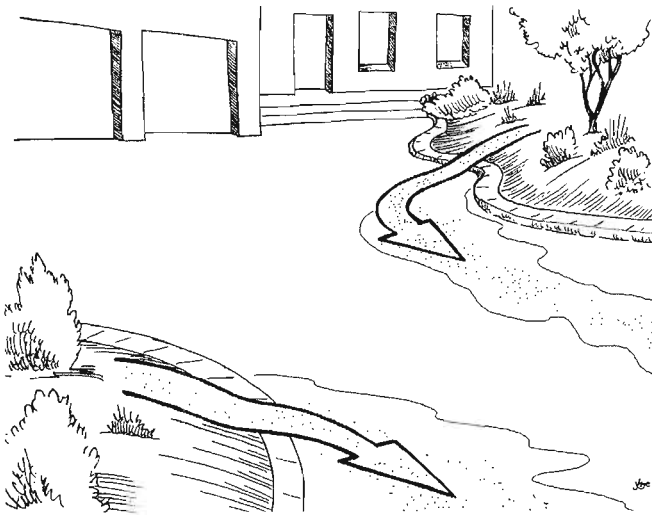

Fig. 8.21A. Runoff and sediment misdirected over pavement

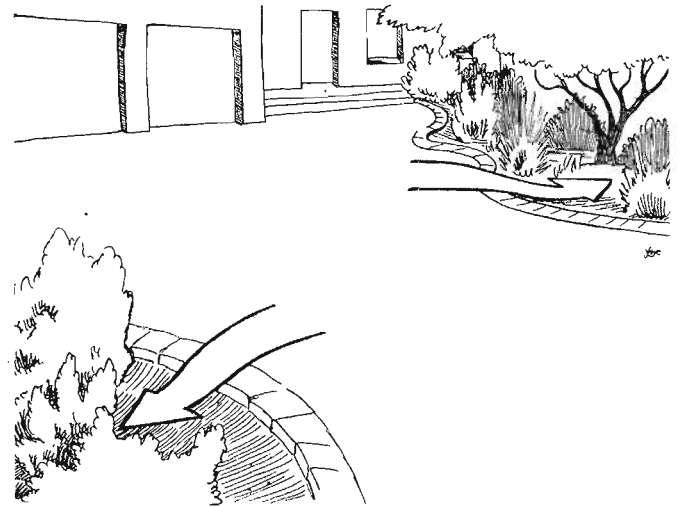

Fig. 8.21B. Runoff beneficially directed to sunken vegetated basins

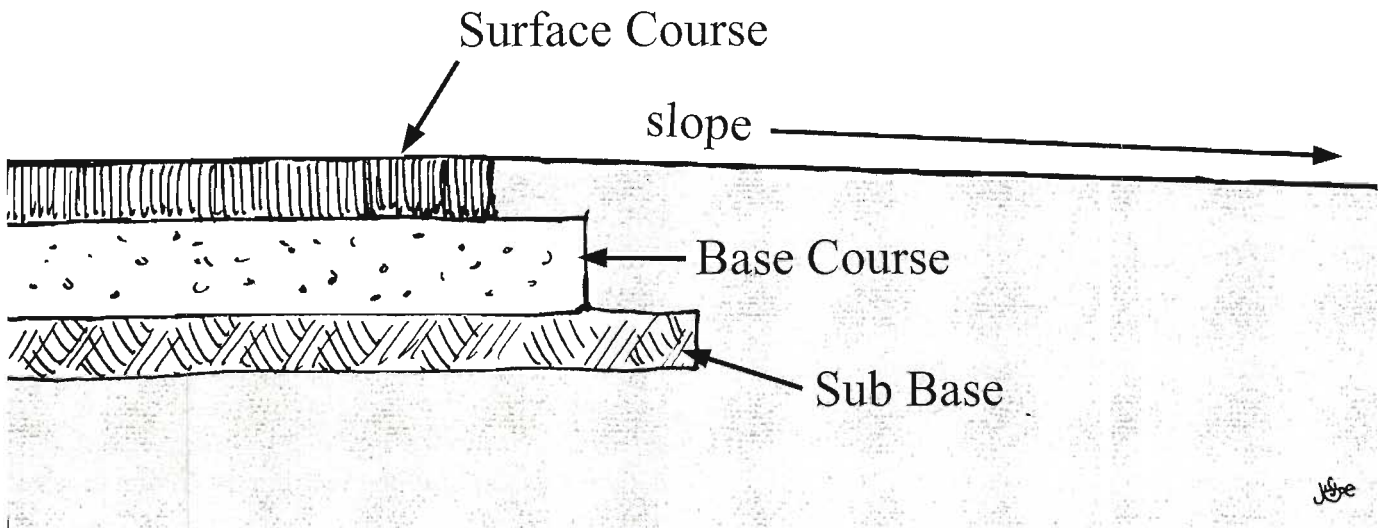

Fig. 8.22. Lower layers extend beyond upper layers. Adapted from *Porous Pavements*<sup>41</sup>

## PLANTING PERMEABLE PAVING

In wet climates, grass is often planted in the joints between some permeable paving, such as Grasspave<sup>2</sup> (these porous pavements with grass are intended for alleys and parking spaces, not sidewalks, and the grass is supposed to cover the pavement or matrix that supports heavy loads of big trucks). I don't recommend this in drylands because the harsh microclimate of the pavement would necessitate regular watering. Instead, I recommend porous pavements that are not planted, such as porous aggregate or Gravelpave<sup>2</sup>. The planting is then focused adjacent to—not in—the paving. For

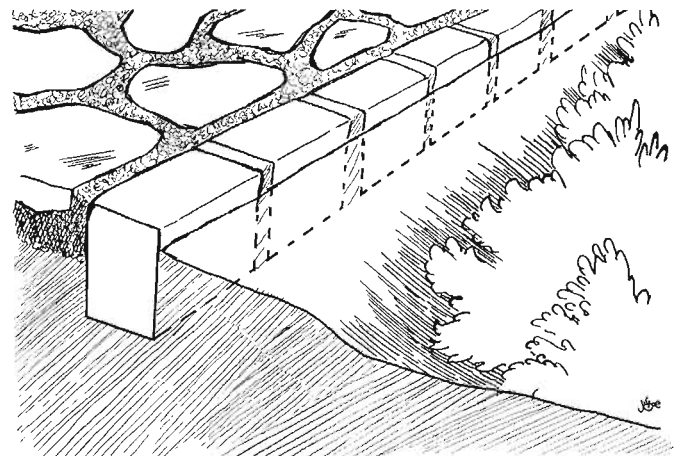

Fig. 8.23. Stabilized edging (curb) for a porous pavement of salvaged concrete set in gravel

instance, low-water-use native vegetation could be planted in adjoining water-harvesting infiltration basins. Vegetation anchors soil, uses the harvested water (that has percolated below the paving surface), shades the paving, cleans the air, reduces glare and noise pollution, provides wildlife habitat, and adds beauty and comfort.

Trees and permeable paving are very compatible. For a tree to grow to its natural mature size and live a full life, its root zone (at a 24-inch or 61-cm depth) should be at least as large as the area expected under the tree's canopy at full maturity.<sup>42</sup> This is not possible when the tree's roots are unduly surrounded and confined by impervious paving and its compacted subsoil, since the sealed and compressed soil can no longer provide the needed storage and transfer of air, water, and nutrients. However, less compacted, non-sealed soil covered with porous pavement can still act like natural soil, allowing roots to extend as far as they need. There are also special subsoil mixes that can be utilized beneath porous paving to further enhance root growth (see Bruce K. Ferguson's *Porous Pavements*).

## MAINTENANCE

Keep paved areas relatively free of debris that could clog the pore spaces between paving materials. Sweep leaves and other plant litter into adjacent basins where it can serve as mulch. If excess runoff and sediment washes over the pavement, construct other water-harvesting earthworks upslope to capture and infiltrate that runoff before it gets to the pavement.

## MULTIPLE FUNCTIONS OF REDUCED HARDSCAPE AND PERMEABLE PAVING

### REDUCING THE HEAT-ISLAND EFFECT

The heat-island effect occurs in heavily paved and developed areas when the full power of the sun heats up, and becomes stored in, the thermal mass of exposed sidewalks, pavement, and buildings with little or no sheltering vegetation. That stored heat is released in late afternoon and evening, keeping sum-

mer evening temperatures as much as 10°F higher than normal.<sup>43,44</sup>

In urban and suburban areas the best strategy to reduce the heat-island effect is to reduce hardscape and plant shade trees and other vegetation that will canopy over and shade the hardscape. Note that trees use less water and provide more cooling than turf.<sup>45</sup> Enabling the planting of more sheltering trees throughout a paved area, and enhancing their growth potential through the use of permeable paving, works where paving must be maintained.

## CONTROLLING FLOODS AND POLLUTION

Impervious cover increases the speed at which watersheds drain, leading to downslope flooding. For example, in 1886, when agricultural and urban development covered only 10% of a portion of the Des Plaines River watershed in Illinois, the river's median annual discharge was 4 cubic feet (0.11 cubic meters) per second. Today, with development covering 70 to 80% of that area, the median annual discharge is 700 to 800 cubic feet (19.8 to 22.6 cubic meters) per second—175 to 200 times the earlier discharge level.<sup>46</sup> And, much of that runoff is contaminated. The U.S. Environmental Protection Agency ranks urban runoff and storm-sewer discharges as the second most widespread source of water quality impairment in our nation's estuaries, and the fourth most common source in our lakes.<sup>47</sup>

It doesn't need to be this way. Studies in Ontario, Canada, found that permeable pavement can reduce runoff volume by 90% and yield significantly cleaner runoff water when compared to impermeable paving surfaces.<sup>48</sup> But pollutants don't just vanish, so our ultimate strategy should be to keep contaminants out of our air, soil, and water in the first place. Minimize car use, and fix leaks that could drip chemicals through permeable paving into soil or water. Minimize or avoid using herbicides, pesticides, and other chemicals, and dispose of them properly.

Web links to photos and publications of integrated sustainable stormwater projects are in appendix 6.

## REDUCING COST

According to porous pavement expert Bruce K. Ferguson, “A porous pavement with little or no drainage structures is commonly less expensive than a dense pavement with the large drainage and treatment systems it requires.”<sup>49</sup>

## IMPROVING SAFETY

Vehicles and pedestrians have better traction on a porous pavement in wet weather than impervious pavement with a sheet of water on it. Thus all interstate highways in Georgia and Oregon are repaved with an overlay of porous asphalt, which increases the carrying capacity of the roads in wet weather by reducing the risk of vehicle hydroplaning.<sup>50</sup>

## REAL-LIFE EXAMPLES OF REDUCING HARDSCAPE AND CREATING PERMEABLE PAVING

## DRIVEWAY GARDENS—LOS ALAMOS, NEW MEXICO

A radical change has occurred at the suburban home of Mary and Charles Zemach in Los Alamos, New Mexico (where average annual precipitation is 18.9 inches or 480 mm at 7,200 feet or 2,194 m elevation). Workers removed half of a four-car-wide concrete driveway, a lawn, a cement walkway, front steps, and brick planters that used to dominate the front yard (fig. 8.24). The broken-up concrete was then reused to create water-harvesting terrace walls throughout the sloping back yard (see fig. 3.1 in the terracing chapter). But more was needed, so another 35 tons of broken concrete were salvaged from the landfill to complete terraces and line garden paths. Admiring the uniform thickness of the salvaged concrete, Mary remarked, “Just stack them up like bricks. They’re much easier to use than odd-shaped rocks.” The terrace walls support a permeable patio of flagstone and numerous well-vegetated infiltration basins.

The result is a productive outdoor gathering area and verdant landscape designed by Ben Haggard and implemented by permaculture landscaping firms.



Fig. 8.24. The Zemachs in the garden where their driveway used to be



Fig. 8.25. The Zemach yard planted with food-producing shrubs and fruit trees (on the left) is watered less often and with less supplemental water than neighbor's lawn on the right.

Well-mulched infiltration basins and contour berms have replaced a driveway section and lawn. Runoff from the remaining section of driveway is directed into two French drains and a diversion swale.

Dryland-adapted perennial plantings burst with color, fruit, and fragrance. A permeable flagstone ramp meanders through the plantings, making the garden wheelchair accessible. Abundant veggies and 30 fruit trees sprout from terraces and from the edges of French drains and rock wicks filled with rubble from the demolished brick planters and driveway. The old lawn became mulch.

Mary's garden provides fresh organically grown food for her family all year long, and she freely gives away the surplus. Thanks to the water-harvesting earthworks, she has never watered her productive yard more than ten times a year, applying an inch of water per watering. Yet her neighbor's lawn is often watered daily in summer. Summing up her strategy, Mary says, "The cheapest way to store water is to get it into the soil as fast as possible." (See fig. 8.25.)

Chapter 5 in *Gai'a's Garden: A Guide to Home-Scale Permaculture* by Toby Hemenway is about the Zemachs, and the cover photo features Mary's yard.

## A MULTIPURPOSE ALTERNATIVE TO CURB AND GUTTER DRAINAGES—SEATTLE, WASHINGTON

The Street Edge Alternatives (SEA) and Green Grid projects in Seattle, Washington, (average annual rainfall of 36 inches or 914 mm) have created 20 blocks of an alternative neighborhood-street design that uses pavement reduction, water-harvesting earthworks, and native salmon-friendly plantings in combination with traditional drainage infrastructure. The result is an area that functions more like the watershed of a healthy forest than a suburban street.

Within the project sites, existing linear streets, with open drainage ditches and culverts to either side, are realigned to a curvilinear path narrowed to 14 feet (4.3 m) (18 feet or 5.5 m at intersections), wide



Fig. 8.26A. Seattle, Washington, street before the Seattle Street Edge Project. Courtesy of Seattle Public Utilities



Fig. 8.26B. Seattle street right after Seattle Street Edge Project. Courtesy of Seattle Public Utilities



Fig. 8.26C. Same street in summer 2005

enough for two standard cars to pass each other slowly. A concrete sidewalk mirrors the curvilinear street on one side only, to further minimize impervious paving. All remaining areas within the right-of-way are used to detain and infiltrate stormwater. The old drainage ditches have become meandering diver-

sion swales and rain gardens that lengthen the flow path of runoff, while mulch and native plantings welcome the water into the soil. This reduces downstream flooding, filters contaminants, enhances wildlife habitat, and provides the landscape with most of its irrigation needs.

The impervious surfaces along the street have been reduced 11%, and over 100 trees and 1,100 shrubs have been planted. Rain infiltrates on site and is utilized by the vegetation, eliminating over 98% of the once-problematic stormwater runoff. People enjoy the beautiful landscapes so much there is now big public demand for such work to extend into other streets and neighborhoods. Salmon benefit from the reduction of pollutants and sediments flowing into streams. The rewards of this project are diverse and the cost was comparable to traditional curb, gutter, and sidewalk street improvements.<sup>51</sup> (Compare figs. 8.26A, 8.26B, and 8.26C.)

For more on the Seattle SEA project and similar projects elsewhere, see appendix 6.

## GREEN STREETS AND GREEN PARKING LOTS—PORTLAND, OREGON

The Green Streets projects in Portland, Oregon (average annual rainfall of 36 inches or 914 mm) is using Natural Drainage Systems design (figs 8.27–8.29)



Fig. 8.27. Curb cuts along a residential street beside the People's Co-op, Portland, Oregon. Sidewalk strip beside curb allows for easy access of people entering and exiting cars parked along curb, while steel scupper directs runoff water to vegetated infiltration basin. Raised curb alerts pedestrians to edge of basin.

For color photo see inside front cover



Fig. 8.28. Curb cuts along an arterial street beside the New Seasons Market direct runoff into adjoining mulched and vegetated basins. Portland, Oregon



Fig. 8.29. Water-harvesting parking lot, New Seasons Market, Portland, Oregon. Parking area drains to adjoining sunken, mulched planting areas. Wheel stops keep cars out, but let water pass by. Trees are planted on slope so their roots can access the harvested water, while their root crown is well drained. As trees grow, they will canopy over the asphalt.

## WATERING STREET TREES WITH STREET RUNOFF—TUCSON, ARIZONA

Rainwater harvesting can lead to dramatic change. When my brother Rodd and I purchased our Tucson home in 1994, it was bordered on two sides by a 20-foot- (6-m) wide bare dirt public right-of-way acting as a haphazard neighborhood parking lot. Then we began harvesting water in the soil. Now we are bordered by beautiful native shade trees that arch over a meandering footpath and the adjacent street. Native birds nest and sing in the branches. Neighbors smile and wave as they stroll by.

Before we started, the land between our property and the street was heavily compacted and all runoff drained into the street, which in turn drained stormwater out of the neighborhood. In big storms the section of the street along the curb became a strong flowing stream, and properties downstream risked being flooded.

Rodd and I banned cars from the right-of-way with well-placed boulders and delineated a curving earthen footpath. I sold my car and fitted my bicycle with a large basket and saddlebags. Rodd parked his truck on the street. To shade pedestrians, bicyclists, and cars, we organized our neighborhood's first annual

to recognize and capitalize on what urban roadways often are—ephemeral waterways. Thus, they are designing curb cuts into both new and retrofitted street-side curbs to direct street runoff into mulched street-side infiltration basins in which native shade trees and other plantings are planted to filter, infiltrate, and utilize the water to then grow a canopy of summer shade over the street and sidewalk. And it doesn't stop there. They are also calming traffic and increasing plantable green space by narrowing residential streets with pullouts and median plantings, creating water-harvesting parking lots and parking garages growing a living carport of adjacent shade trees, and more. See appendix 6 for additional information, including web links to their downloadable self-guided bicycle and car tours of sustainable stormwater strategies throughout the city.

### Box 8.3. Tapping Into the Rivers of Runoff Along Our Streets

In an average year of rainfall (12 inches or 304 mm), the runoff from rain falling on my neighborhood's streets equals over 1.25 million gallons per mile (or 3.46 million liters per kilometer)!

In my climate, that's enough runoff to provide all the irrigation needs of 422 established 20-foot (6-m)-tall trees per mile (1.6 km), or a tree every 25 feet (7.5 m) lining both sides of the street.

So we've started to tap that runoff to passively and sustainably irrigate street-side shade trees, which will turn hot and sterile strips of asphalt into cool and beautiful greenways that solve flooding and water quality problems instead of creating them. You can do the same.

See the estimates below or box 1.4 in chapter 1 to calculate the runoff volumes in your streets. The estimates above are based on 12 inches (304 mm) of rainfall, an average residential street width of 38 feet (11.4 m), a 0.85 runoff coefficient for the impervious asphalt street surface, trees with 20 foot (6 m) heights and canopy diameters—each needing 3,000 gallons (11,370 liters) of water per year, and spacing the trees 25 feet (7.5 m) apart. The water needs of the trees were calculated with the information and tables in appendix 4. Trees' water needs will vary with tree type, tree size, and climate.

Note: The calculations do not take into account the additional rainfall within the public right-of-way adjoining the street. This additional rainfall could provide additional water for the trees in drought years, and/or supply water needs of additional plantings such as shrubs or groundcover plants.

The rain and runoff can be harvested by mulched street-side basins at least 6 inches (15 cm) deep, 6 feet (1.8 m) wide, and 10 feet (3 m) long, in which the trees are planted. If the street has curbs, curb cuts may be needed to access the runoff. See box 5.2 for calculating basin capacities.

For every inch of rainfall...

- A 10-foot wide paved street will drain 27,800 gallons of runoff per mile
- A 20-foot wide paved street will drain 55,700 gallons of runoff per mile
- A 30-foot wide paved street will drain 83,500 gallons of runoff per mile

For every 100 mm of rainfall...

- A 3-m wide paved street will drain 300,000 liters of runoff per kilometer
- A 6-m wide paved street will drain 600,000 liters of runoff per kilometer
- A 9-m wide paved street will drain 900,000 liters of runoff per kilometer

tree-planting event, planting 280 trees, 19 in the right-of-way adjoining our property.

We selected low-water-use natives including the velvet mesquite with its sweet-tasting seedpods, the desert ironwood with peanut-flavored seeds, and blue and foothills palo verdes with edible flowers and seeds.

We also planted water. We called Bluestake to mark existing underground utility lines for free (call your local utility for a similar service), and applied for a city permit to allow us to plant in the right-of-way. A city traffic engineer came by to ensure our earthwork and tree locations met standard setback requirements from utilities and did not block footpaths or views of stop signs. Infiltration basins and trees were positioned along the curb to shade the right-of-way

and street. Dirt from the sunken basins was used to build up the adjacent meandering footpath. Rain falling on the right-of-way now flows into infiltration basins where it waters trees. The land has been made pervious and is no longer compacted (compare figs. 8.30A and 8.30B).

We wanted rainwater to be the trees' primary water source during their establishment and the only water source when they matured. So we figured out our rainwater budget. With 12 inches (305 mm) of average annual precipitation, the microcatchments serving our infiltration basins could harvest 29,700 gallons (112,266 liters) of rain a year—enough to sustain the vegetation, but not to grow it to the desired size. For our 19 trees to reach a desired mature height



Fig. 8.30A. Public right-of-way 1994, Tucson, Arizona



Fig. 8.30B. Public right-of-way 2006, Tucson, Arizona

of 20 feet (6 m) they would each need 3,000 gallons (11,349 liters) of water per year (see appendix 4 for Example Plant Lists and Water Requirement Calculations).<sup>52</sup> We would need another 27,000 gallons (102,060 liters), so we turned to the street and found the water we needed and more!

Our street is crowned (raised) in the middle so water drains toward the curbs where it concentrates and flows when it rains. Using the following, we calculated that our part of the street's catchment area would yield about 30,000 gallons (113,400 liters) of water per year:

Our part of the street's catchment surface was 19 feet wide  $\times$  256 feet long, which, when multiplied by 1 foot annual rainfall = 4,864 cubic feet of water. To convert cubic feet to gallons and take into account the runoff coefficient for the street, we multiplied 4,864 cubic feet  $\times$  7.48 gallons/cubic foot  $\times$  85% runoff = 30,000 gallons (113,400 liters), street runoff available to our section of public right-of-way each year. (The 85% runoff coefficient is the estimated net water runoff from pavement; the other 15% is lost to infiltration, evaporation, etc. See appendix 3, equation 5.)

We directed street runoff into street side infiltration basins via curb cuts, and mulched the basins to increase water infiltration and help delineate the basins from the footpath (fig. 8.31).

The *overflow for the earthworks occurs at their inflow point*. When the basins reach capacity, water backs up into the street, preventing additional street runoff from entering the system. Mulch floats up on the rising water then settles back down as the moisture

sinks into the earth. Our raised footpath acts as a dike keeping street runoff from flooding our property.

We could have stopped supplemental watering after three years, but we continued monthly watering in summer for another three years to increase the trees' growth, and then slowly weaned them from supplemental water. Today the trees arch over our heads, and water-harvesting earthworks are their prime water source providing 95% of the irrigation needs—we apply supplemental water only in extreme drought.

The vegetated right-of-way shades and cools the street and path. Runoff from the right-of-way now drains into the mulched basins, and there have been no ill effects to the plants from the pollutants collected with the stormwater. Life abounds where before there was none. (Compare figs. 8.32A and 8.32B.)

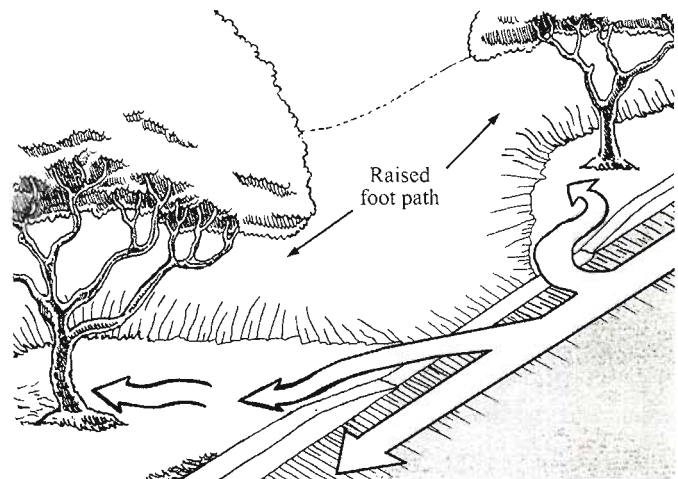

Fig. 8.31. Basins extend to existing driveway curb cut. Surplus water continues down the street after basins fill with water.





Fig. 8.32A. Public right-of-way 1994. This is the same right-of-way as in figure 8.30A, but taken from across the street.



Fig. 8.32B. Public right-of-way 2004. This is the same right-of-way as in figure 8.30B, but taken from across the street.

## HOW TO CUT CURBS AND HARVEST STREET RUNOFF

The strategy described below reduces street flooding, decreases the need for flood-control infrastructure, beautifies neighborhoods, creates wildlife habitat, and naturally filters pollutants from soil and air. Use this information as a template for creating curb cuts (fig. 8.33) where they are legal, or as the basis for obtaining an experimental permit.

### Siting

#### 1. Observe the flow of street runoff during a heavy downpour.

Note the flow's direction, location (in the middle of the street or along the curb), speed, volume, and the size of the watershed contributing runoff to the flow. Consider curb cuts only in locations where the following conditions exist: a) water flows along the curb, b) you are confident you can manage the flow, and c) there is sufficient space to harvest water in the public right-of-way—typically you need *at least* 4 feet (1.2 m) between the sidewalk/path and curb. Do not make curb cuts where water regularly goes over the tops of the curb, or where the street slope is steep, resulting in a very fast flow.

#### 2. Check for the location of existing utilities.

Call Bluestake or a similar service to mark utility locations. Contact the landscape architect in your municipal traffic engineering department to find out the set-backs required from utilities, curbs, walkways, and stop signs when digging and planting trees.

#### 3. Mark infiltration basin locations.

Take into account required utility and traffic-sign setbacks and the locations where shade trees can shade both the street and footpaths, yet not block traffic signs or pedestrian view of oncoming cars.

#### 4. Maintain pedestrian access.

Connect the street to the right-of-way via sidewalks or pathways constructed between basins. These accessways should be at least 4 feet (1.2 m) wide and at the same elevation as the top of the curb. Space the accessways an average car length apart from one another so that cars parked along the curb can open their doors to the paths—not dense vegetation in basins.

#### 5. Dig your water-harvesting infiltration basins.

Leave a flat, compacted 18- to 24-inch-wide (45-60-cm) platform of earth running along the right-of-way side of the curb for people to step onto as they exit vehicles parked along the curb (some folks may not think to park with their car doors accessing a path rather than a basin). This platform of earth should be level with the top of the curb at the curb, then slope very slightly toward the basin. This earthen platform also ensures the deepest section of the basin is at least 18 inches (45 cm) away from the curb, lessening the chances of roots heaving the curb. Near walkways and the street any slopes you create should not exceed a

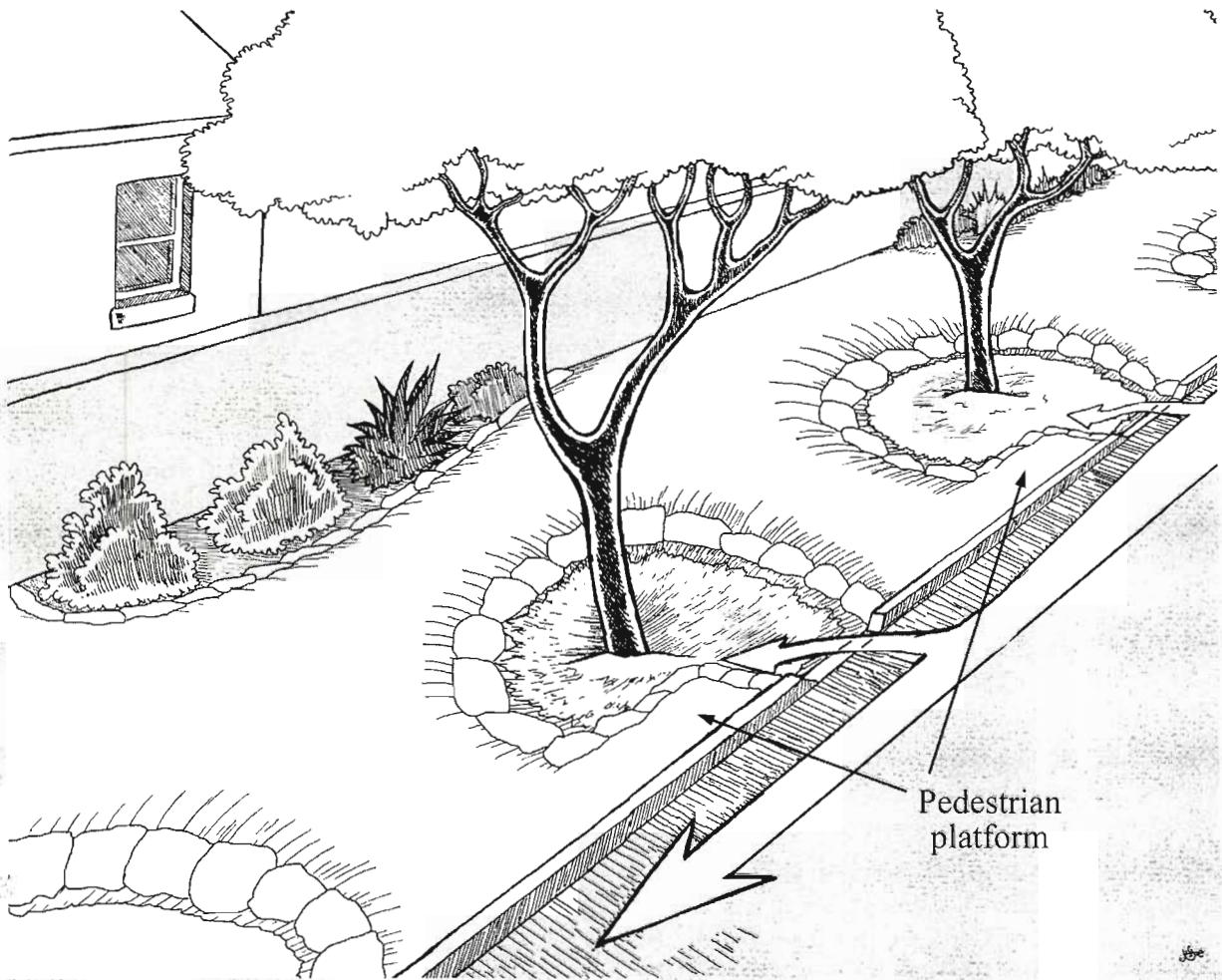

**Fig. 8.33. Curb cut.** Raised paths surrounding the basin ensure overflow is directed back to street. Two-foot (0.6-m)-wide pedestrian platform along curb makes it easier to exit cars parked on street. Street runoff is directed into basins via curb cuts. Once the basins are full, surplus water just continues down the street.

3:1 grade, unless delineated and stabilized with rock, while not exceeding a drop of 20 inches (50 cm) (see fig. 5.11 in the infiltration-basin chapter).

#### 6. Mark curb cut locations.

Place one curb cut per basin or per series of interconnected basins, so surplus water will exit from the same place where it enters. This way, water will pool and infiltrate *into* the basins, rather than erosively running *through* them. Locate the curb cut on the upslope side of your basin to increase water storage capacity. The curb cuts should be angled 45° on either side for safer, more gradual edges. Some concrete cutting services may have to make 30° cuts due to the limitations of their equipment. Make the base of the cut no wider than 18 inches (45 cm)—you want to let water in, not cars.

Plant your trees now if it will be awhile before you make your curb cuts; otherwise plant the trees after you make the cuts (see step 10).

## APPLY FOR A CURB-CUT PERMIT

Call your local transportation department officials to inquire on their public right-of-way curb-cut permitting process. This may require a couple drawings describing what you intend to do (figs. 8.34A, B). Note: See the “Public Right-of-Way Water Harvesting” page of my website [www.HarvestingRainwater.com](http://www.HarvestingRainwater.com) for additional curb-cut details.

## MAKE THE CUTS

I recommend that novices make only one curb cut to start. See how it works in the next big rain, and if all is well you can make the rest of the cuts. If things go wrong—fix them and reconsider making more cuts.

7. **Call a concrete-cutting service** (about \$300 for one complete curb cut, though the per-cut cost drops significantly with more cuts, since much of the cost is getting the equipment and operator to and from the site) **or rent a concrete-cutting circular saw with minimum 14-inch (35-cm) diameter blade along with an industrial hand-held grinder\*** (about \$200 per day) if allowed.

\*While some communities may allow citizens to make their own permitted curb cuts, mine currently does not. Instead, our transportation department requires licensed contractors/concrete cutting companies to make the cuts. Thus, the rest of the steps apply to a licensed concrete cutting company making the cuts.

A note on cost: You can determine a rough estimate of the stormwater-holding capacity of infiltration basins fed by curb cuts using the calculations in box 5.2 or equations 13 and 14 in appendix 3. Then divide the total storage capacity in gallons or liters by the total cost for a \$-per-gallon or \$-per-liter cost for basins and curb cuts. The two basins and curb cuts permitted with the drawings in figures 8.34A, B came out to rough cost of \$150 per 200 gallons (758 liters) of stormwater capacity (I did not count the labor cost of the basin digging, rock work, and tree planting as I did it myself with salvaged rock and mulch). Note that the basins' capacity can increase with time as the roots of the trees and shrubs planted in the basins grow, break up the ground with their roots, and increase water infiltration rates into the soil. This cost is a good deal when compared to a typical cistern cost of \$1 per gallon (\$0.27 per liter) of storage capacity, especially since these structures and their trees also contribute to flood control; improved air, soil, and stormwater quality; passive summer cooling; neighborhood beautification; local food production; wildlife habitat enhancement and more.

### 8. Cut the curb.

Measure and mark all cut lines before the concrete-cutting service arrives. Ensure the street is clear for the large equipment (fig. 8.35A). And be on hand to observe and document the cutting service's quality of work (fig. 8.35B). After cutting, a good company will smooth out the cuts and their edges with a concrete grinder for a nicer appearance (fig. 8.36).

### 9. Make sure your curb cut acts as both your inflow location and overflow location for street runoff water.

Make the bottom of the infiltration basin deeper than the level of the street so water flows into it. Make sure the non-curb edge of the basin is the same elevation as, or higher than, the top of the street curb. This

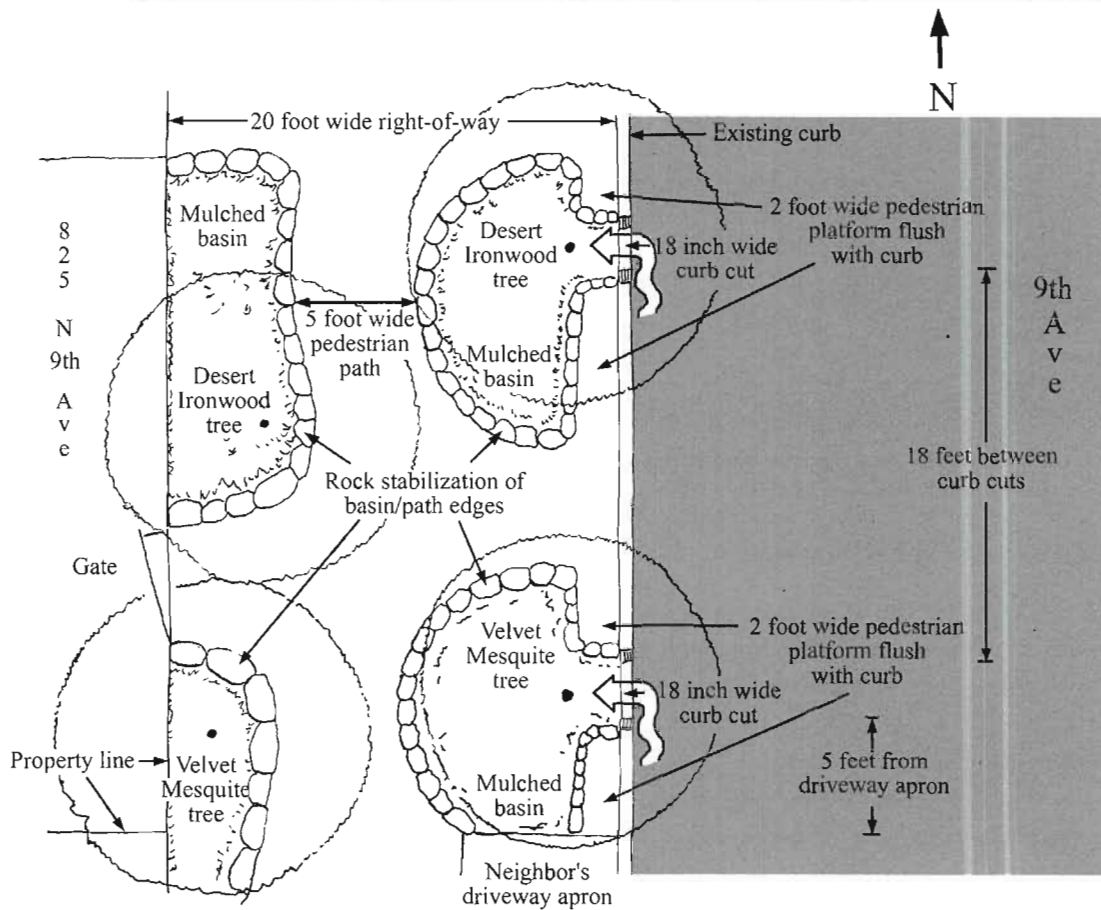

Fig. 8.34A. Curb-cut detail drawing for curb-cutting permit, plan view

forces excess water to flow back into the street, not into the adjoining property where it could create flooding problems, for which you do *not* want to be the cause. *This also avoids legal problems relating to surface-water rights by keeping the water harvested from the public street in the public right-of-way.*

If the top edge of a basin is an earthen path, compact it to an elevation 2 inches (5 cm) above the level of the curb to compensate for additional compaction and settling that will occur with use. Concrete sidewalks don't settle so they can be built at the level of the top of the curb.

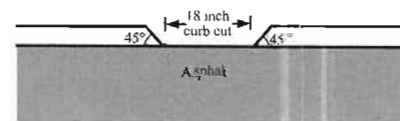
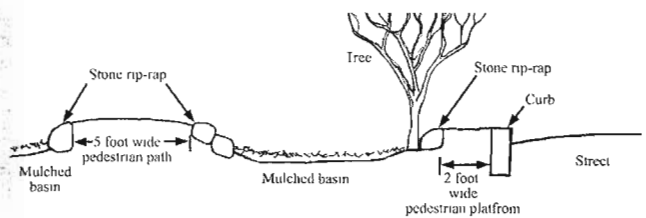

Fig. 8.34B. Curb-cut detail drawing for curb-cutting permit, elevation views



Fig. 8.35A. Concrete-cutting service beginning to make the horizontal cut of the curb cut

#### 10. Plant a tree in each infiltration basin.

Plant trees 24 inches (60 cm) in from the curb, keeping them clear of cars, and allowing shade to be cast over both the street and footpath. The top of your trees' root balls should be set at the level of the street or just two inches (5 cm) above it. If there is sufficient space in the basin, deepen the basin around the trees outside the perimeter of the root ball, leaving the trees on a slight pedestal or terrace inside the basin. This will help prevent the base of your trees from getting too saturated with water (see chapter 11 on vegetation for more details on tree planting).

#### 11. Mulch your basins.

Organic mulch such as straw, bark, or compost distinguishes your basins from paths, reducing the chance of people walking through them. I prefer bark since the larger size lasts longer than smaller particle mulch. The mulch helps partially fill the basins with porous material, reducing the severity of their slopes, while increasing the rate that water infiltrates into the soil. In addition, the mulch creates habitat for soil microorganisms that filter toxins in water running off the street. Place mulch to a minimum depth of 4 inches (10 cm) throughout the basins leaving a mulch-free area 4 inches (10 cm) around the base of each tree. See figure 8.37 for finished curb cuts and basins.

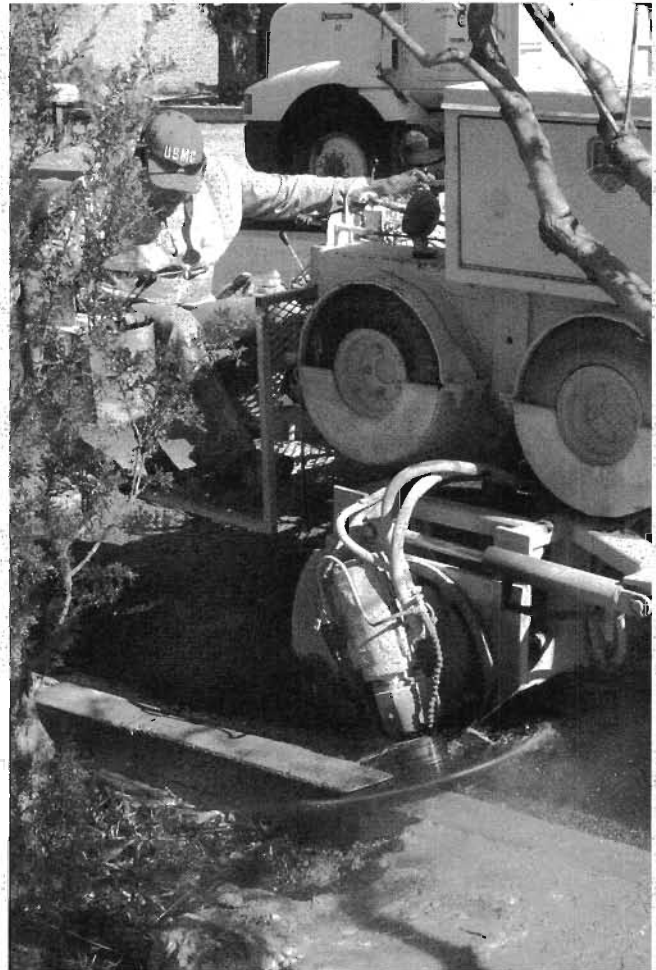

Fig. 8.35B. Concrete-cutting service making an angled cut



Fig. 8.36. Smoothing out the cuts and edges with an industrial hand-held grinder

Note 1: See figures 8.26B, C for a flush curb that spreads, rather than concentrates runoff, making street-side water harvesting easier while eliminating the need for curb cuts.

Note 2: Larger, wider, pedestrian-oriented, water-harvesting, tree-lined public rights-of-way should become the standard in urban and suburban environments to offset the mass paving of the watershed and shrinking yard sizes. As private outdoor space shrinks, public outdoor space must increase. Place underground utilities in the street instead of in the public right-of-way so more trees and understory vegetation can be planted to utilize the harvested runoff without utility conflicts. See Terraced Cistern Steps, Gardens, and more in the Real-Life Examples section of chapter 3 for a dynamic urban right-of-way example.



Fig. 8.37. The finished curb cuts, basins, and trees permitted with the drawings from figs. 8.34A, B. Note that the less drought-tolerant tree between the basins will be removed once the two food-producing native trees in basins grow to a larger size.





# 9 Diversion Swales

## WHAT IS A DIVERSION SWALE?

A diversion swale is a gently sloping drainageway that moves water slowly downslope across a landscape, while simultaneously allowing some of it to infiltrate into the soil. Like a berm 'n basin, it usually consists of a generally curvilinear basin with the excavated earth placed downslope to form a berm. Unlike a berm 'n basin, which is constructed on-contour to contain and allow all water to soak into the earth locally, a diversion swale is built *slightly* off-contour, allowing a portion of the water to soak into the soil locally while moving surplus water slowly downhill from one place to another, infiltrating water all along the way (fig. 9.1). A diversion swale is sometimes called a *diversion drain*,<sup>1</sup> with a variation known as a *spreader drain*. Landscape architects may refer to a diversion swale as a *bioswale*.

This chapter also discusses *ponds*, which can be the large “infiltration basin” or collection endpoint of diversion swales.

## WHERE IS A DIVERSION SWALE USED?

Diversion swales are used to intercept, infiltrate and redirect both sheet flow and channelized water. Diversion swales can tame the force of water that rushes out from a culvert or roadside bar ditch, transforming the concentrated fast-moving water into a

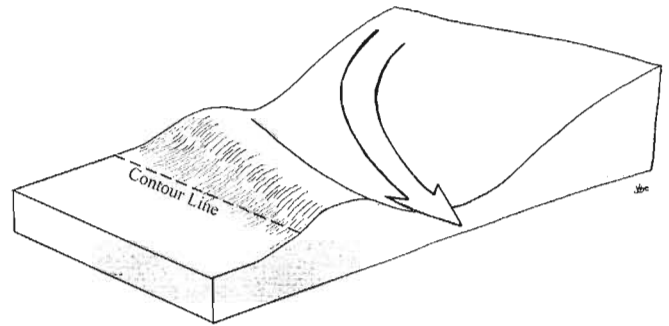

Fig. 9.1. Diversion swale

valuable resource by spreading out and calming the flow. Diversion swales can direct runoff to a water-harvesting berm 'n basin, infiltration basin, pond, or other final destination (fig. 9.2).

Diversion swales can integrate multiple water-harvesting earthworks by diverting overflow water from one earthwork to another. For example, a series of diversion swales can transport overflow from one infiltration basin to another until the final diversion swale directs remaining overflow to a natural drainage way (fig. 9.3). In agricultural irrigation applications, diversion swales can act as both water inlet channels and drain channels removing surplus water (fig. 9.4).

Diversion swales can be multifunctional. Their berms can function as raised roads or paths, as well as water-harvesting speed humps directing street runoff to vegetated basins. They can be used for beautifully land-

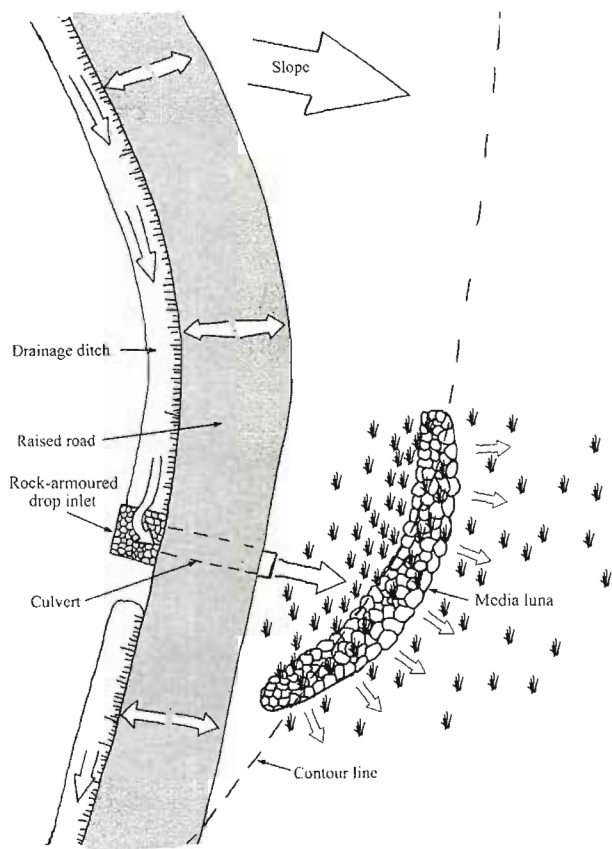

Fig. 9.2. Media luna slowing, spreading, and sinking flow from culvert to transform erosive channelized flow into productive sheet flow. Here the one-rock-high media luna acts like a one-rock check dam/diversion swale hybrid.

scaped stormwater control in developments, as well as to “daylight” formerly buried or culverted streams. The final Real-Life Example shows how a spreader drain harvests “unwanted” water from an upslope property to sustain a thriving windbreak of trees.

Diversion swales should not be used in situations where alkaline soils are prone to waterlogging and salt buildup. Waterlogging occurs when soil moisture collects atop subsurface hardpan or clay layers, saturating the topmost layer of soil. The accumulating runoff introduces more salts to the soil, and the poor drainage keeps it around. In such instances, a combination of water-harvesting earthworks and *interceptor drains* may be needed to infiltrate rainfall higher in the watershed to reduce runoff, then drain excess runoff water from the site. See appendix 6 for more on interceptor drains.

## TOOLS AND MATERIALS

**Tools:** You will need a bunyip water level (see appendix 2) or other surveying device, flagging or survey stakes, shovels, and pick axes. For large projects consider using a road grader, backhoe, or similar large machinery to do the earthmoving.

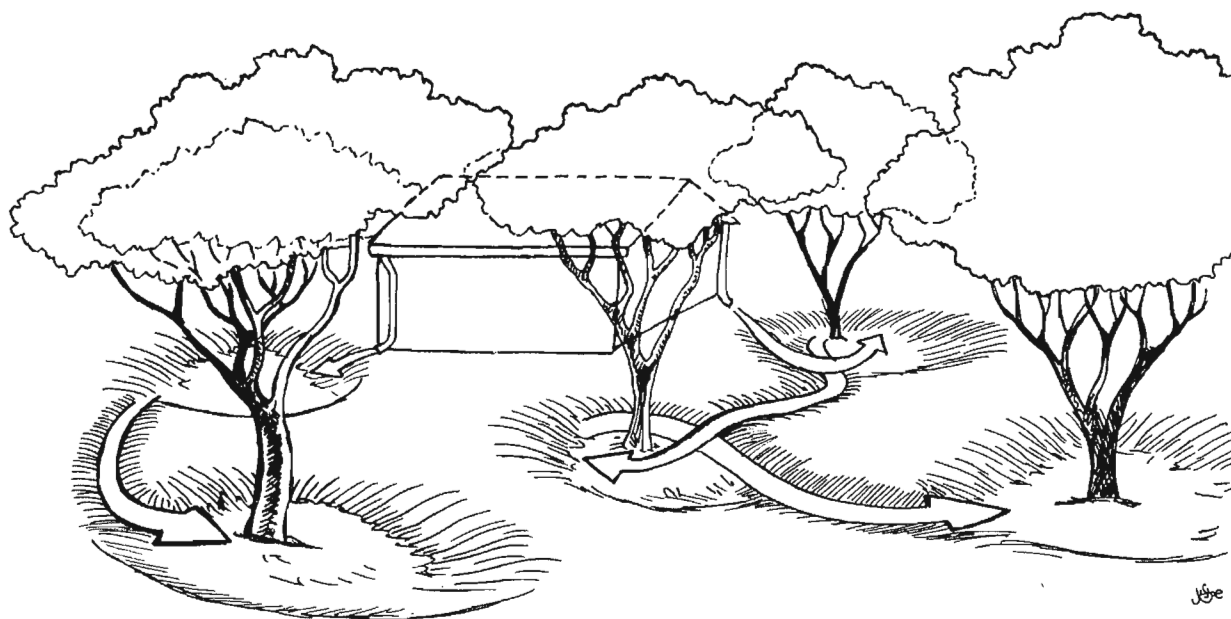

Fig. 9.3. Diversion swales as the overflow route from one basin to another

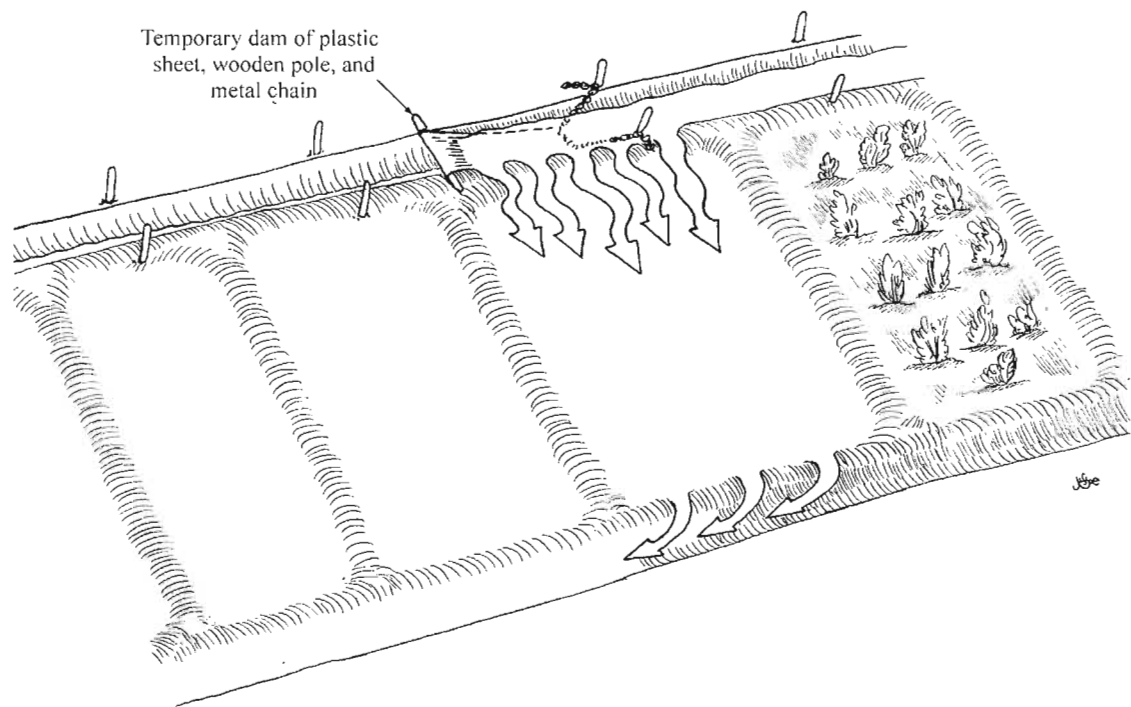

Fig. 9.4. Diversion swales as inlet (head drain) and outlet (tail drain) channels for irrigation and overflow of agricultural fields

**Materials:** Seeds, and/or live plants to vegetate the berm and spillway of your diversion swale.

## IMPLEMENTATION STEPS TO BUILD A DIVERSION SWALE

### SITING

#### The *keyline*<sup>®</sup> concept

After carefully studying the condition of the watershed, decide if and where you may want to place a diversion swale and associated water-harvesting earthworks. In landscapes of varied topography, especially undulating hills and valleys, I find the *keyline*<sup>®</sup> concept of Australian water harvester P. A. Yeomans helpful when reading the slope of the land and siting diversion swales.<sup>3</sup> The keyline is that contour line across a landscape where the slope changes from convex to concave. (See figs. 9.5A, B.)

*Break lines* are places or contour lines in the landscape where slopes change from gentle grades where sediments settle out of slow-moving runoff, to steep

grades where sediments are picked up and carried away by faster-moving runoff. *Keylines* are the contour lines where slopes change from steep grades where sediments are picked up and carried away by fast-moving runoff, to gentler grades where sediments settle out of slower-moving runoff. On a micro-level, you may see a break line where a slope covered with leaves and silts changes to a steeper patch of naked sloping dirt. The keyline would be downhill where that naked slope changes to a more gradual slope where collected fines, silts, and organic matter accumulate. The land below that keyline could be a good location for planting, since it is not eroding, but instead is receiving water and organic matter. On a macro-level, a mountain or hilltop slopes down to a break line where it steepens and erosion increases, then comes the keyline where the slope lessens at the top of an alluvial fan composed of depositing sediments.

Concentrate water-harvesting and revegetation efforts where less effort is required—above break lines first (but be very careful if in areas prone to mudslides), then below keylines second. Diversion swales should be only used on depositional slopes, preferably

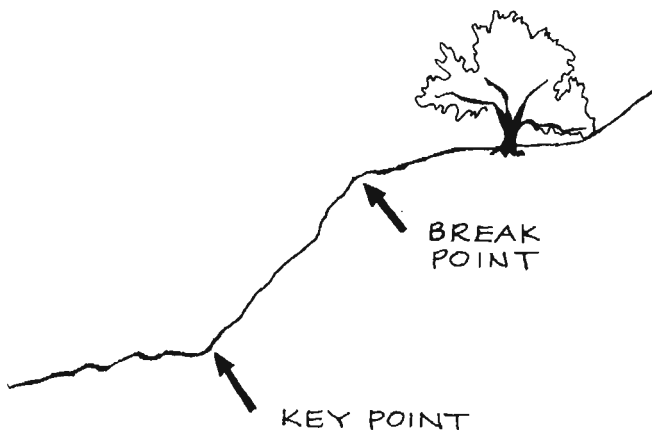

Fig. 9.5A. Break point and key point, side view

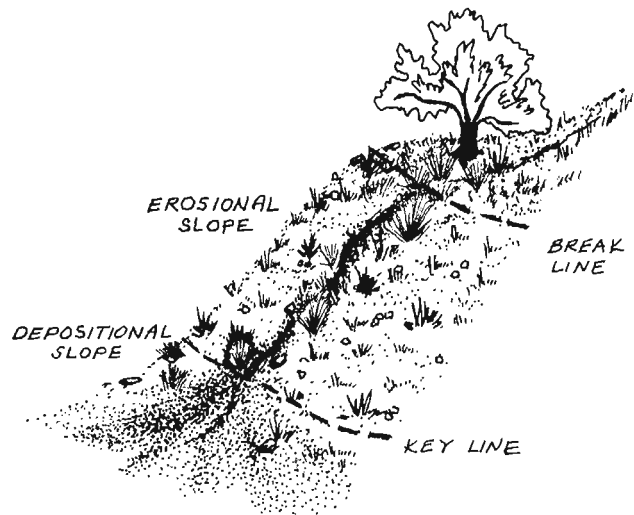

Fig. 9.5B. Break line and keyline, perspective view

those at or below the keyline. In this location they are easier to build because less soil needs to be moved, they are more stable, and they function more efficiently diverting surplus water from one location to another. Be wary of the slope between the break line and the keyline as it may be too steep or challenging to do more than seed the area, plant vegetation on-contour, or carefully lay out contour berms or terraces made of brush or single courses of rock.

If you are building a small earthen dam or pond, make sure you will not back up water above a keyline. You need to keep the water level below the keyline, so you can direct your overflow across gentler, more easily managed slopes.

See appendix 6 for a listing of P. A. Yeoman's books.

## The path of the diversion swale

To lay out a diversion swale, stand where you'd like your swale to begin (at a water's source which you want to slow, spread, and sink—such as at a culvert's downstream opening or where unchecked runoff is about to become erosive), where you want the berm of the swale

to act as a raised path, or where there are no conflicts with infrastructure or landforms (trees and rock outcroppings). Then mark off a contour line, using your preferred tool (see appendix 2), in the direction you want the swale to go. (Refer to fig. 9.6A). Every 25 to 100 feet (or every 10 to 30 meters) along the contour put a stake or flag in the ground to act as a distance marker (placing stakes at closer intervals enables you to use a bunyip water level with a shorter tube, and makes it easier to see subtleties in the slope of the landscape). The contour line will act as a reference point from which you will mark the slope of your diversion swale, and the distance markers will be where you will measure the drop in slope.

Once you have the contour line marked out to the distance you want, you are then ready to mark off the gradually sloping path you want the diversion swale to take across the natural decline (see fig. 9.6B). A bunyip water level is my tool of choice to mark the path of the swale. The drop in the swale's slope can range from as little as 1:6,000 (0.016%) in fine sands (0.2-inch drop in elevation for every 100 linear feet of the swale)<sup>4</sup> to as much as 1:300 (0.33%) in more stable soils (a 4-inch drop in elevation for every 100 linear

*continues on page 211*

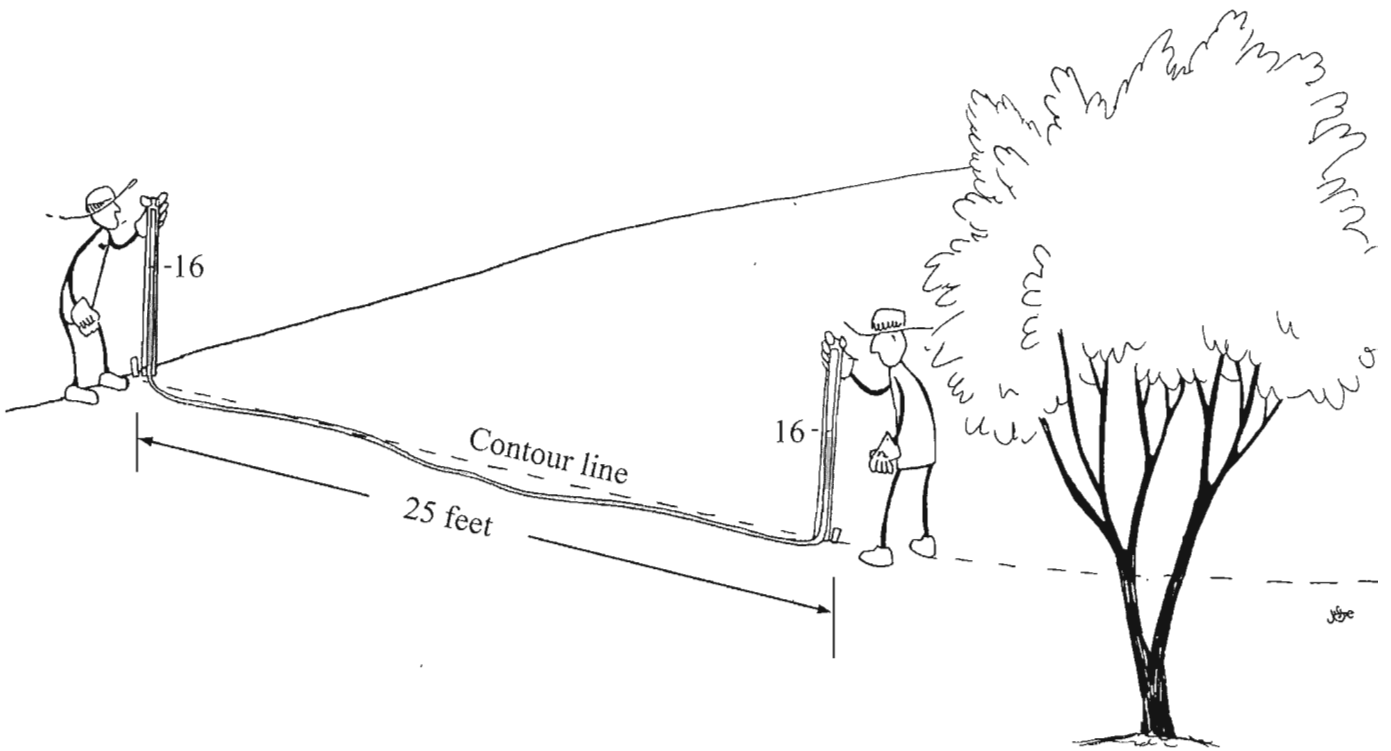

Fig. 9.6A. Marking a contour line, and placing distance markers along it every 25 feet

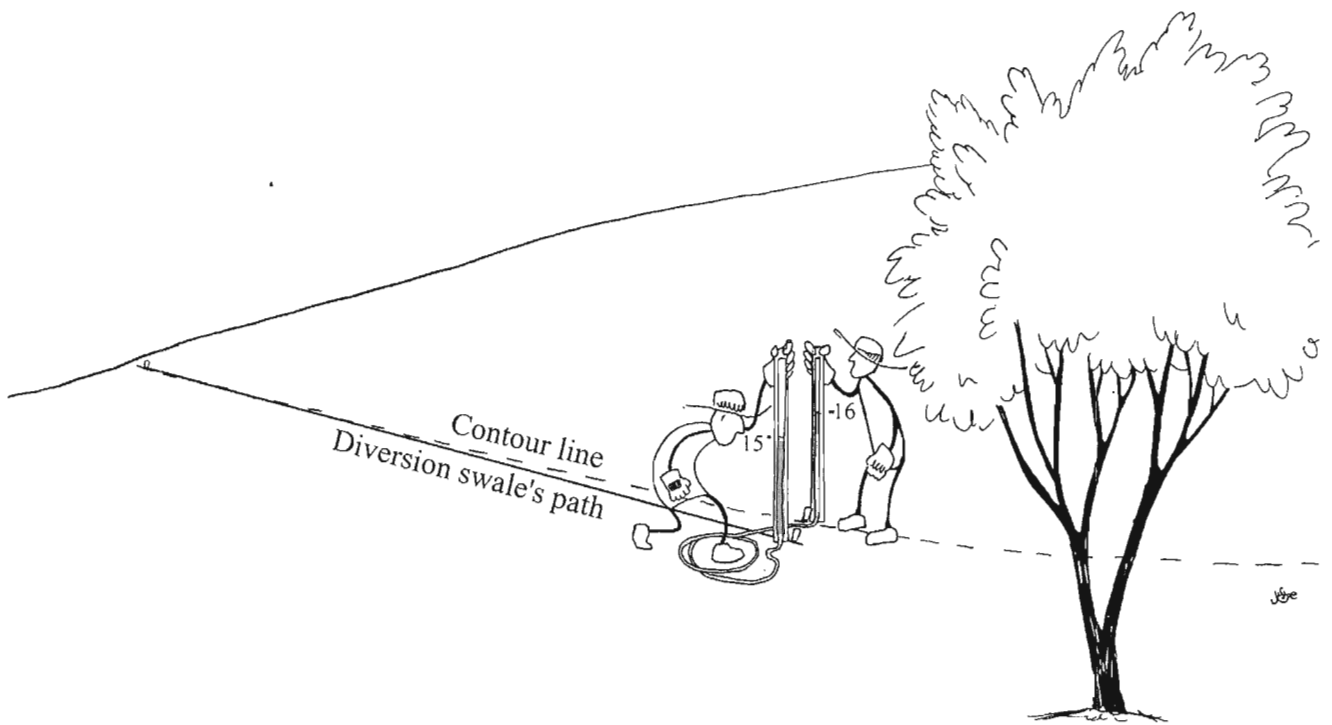

Fig. 9.6B. Using a water level to mark a progressive 1-inch drop off the contour line at every 25-foot interval to lay the swale's path at a 1:300 slope off-contour

### Box 9.1. Marking the Route of a Diversion Swale with a 1:300 Slope: An Example

Step 1. Mark off a contour line in the area you want your swale to be placed (see fig. 9.6A, marking contour line). Then, figure out how much you want your swale to slope. This can range from 1:6,000 (gradual) to 1:300 (steep). In this case, a 1:300 slope is permissible because of very stable soil. The desired swale slope will determine the next step.

Step 2. Place distance markers (flags or stakes) along your contour line at even lengths—based on your slope ratio—from which you will mark the sloping path of the swale (step 3). For example, this swale will slope 1:300—that equals a drop of 1 inch for every 300 linear inches, or 1 foot for every 300 linear feet. So, you could place distance markers at 300-inch intervals along your contour line. But, most likely you'll find it easier to deal in feet with longer lengths, so divide the 300 inches side of the slope ratio by 12 (12 inches in a foot) to get the slope ratio of a drop of 1 inch for every 25 linear feet. That done, place distance markers every 25 feet along your contour line, instead of every 300 feet (fig. 9.6A). (If you wanted a 1:600 slope, you'd divide 600 by 12, to get 50, so you'd place distance markers every 50 feet.)

Step 3. Mark your swale's sloping path. At the first 25-foot distance marker along the contour line, measure a drop of 1 inch (fig. 9.6B) below the contour line. Mark this elevation with a flag or stake. Make a line from the beginning of the contour line to your new marker (1 inch below the contour's 25-foot mark). Then go to the next 25-foot distance marker along the contour line and mark a drop of 2 inches—every 25 feet the swale's path progressively drops another inch off contour. Continue the line of the swale's path from the last marker to this latest one. And keep going as such until you get to the desired end of the swale.

If dealing in metric measurements a 1:300 slope would equal a drop of 1 centimeter every 300 centimeters, or a drop of 1 centimeter every 3 meters.

### Box 9.2. Ponds

Ponds can be an effective water-harvesting strategy or a wasteful water-consuming strategy. If you use rainwater as the *sole* water source, then you have a "water-harvester." If you design a pond that uses piped-in well or municipal water as its water source, then you have a "water consumer." Always avoid water-consuming ponds and fountains. This is especially true in drylands! (A possible compromise, using harvested water only, would be fountains running on rainwater harvested within a cistern, and when the cistern water dries up the fountain stops running until rains once again fill the fountain cistern. The cistern water, however, would likely be more efficiently used to irrigate a canopy of cooling, food-producing, and wildlife-attracting shade trees).

The decision to use water-harvesting ponds should be considered with caution and care. In the dryland environment, high evaporation rates can rob large amounts of water stored above rather than within the soil or closed cisterns.

The higher the rainfall and the lower the evaporation rate, the more sense it makes to use a pond. In the cool climate of northern California where 60 inches (1,524 mm) of rain can fall in a winter, followed by a bone dry spring, summer, and fall, ponds can hold very large volumes of winter runoff for a fraction of the cost of a cistern of similar volume. Placed high in the landscape, gravity can distribute pond water around a site for irrigation, fire control, and domestic water supply.

Is a pond appropriate for your site? Perhaps so, if you have sufficient rainwater runoff to fill and maintain it through dry seasons and droughts, or else you are fine with letting it run dry during the dry seasons. A pond is probably not appropriate if you plan to supplement your pond with piped-in well or municipal water. For information on assessing pond location and building one, contact your local Natural Resources Conservation Service (NRCS) agent (found under U.S. Department of Agriculture).

### Box 9.3. Tips on Pond Construction

- Make your pond deep rather than wide and shallow to reduce the surface area exposed to heat and evaporation. However, ensure pond slopes are gradual enough for animals to climb out should they accidentally fall in.
- Plant deep-tap-rooted, low-water-use shade trees or tall shrubs around your pond to deflect the sun's heat and moisture-robbing winds. In southwestern Arizona, avoid thirsty cottonwoods and instead plant hardier native velvet mesquites.
- Stock your pond with *native* mosquito-eating fish to help prevent your pond from becoming a major breeding ground for mosquitoes. If these native fish get loose, they boost native fish populations rather than hurt them as exotic fish often do. Contact your local Game and Fish agent for help.
- Set your pond high enough in the landscape so you can distribute water by gravity.
- As with any water-harvesting strategy, your pond must have an adequately sized and stabilized overflow route.
- Temporarily pooling water behind new check dams (chapter 10): Remember that my emphasis in this book is strategies for storing water in the soil not atop it—for instance, properly built check dams should not create ponds, and any water temporarily backing up behind them will overflow over the center of the check dam and through its porous structure—the overflows of the check dam.

See appendix 6 for more pond resources.

feet of swale).<sup>5</sup> The steeper the slope of the diversion swale the more quickly water will flow downhill, the less infiltration will occur along the path of the water, and the more potential increases for erosion to occur along the water's path. The more gradual the slope, the more water can infiltrate, and the less likely erosion will occur. (See box 9.1 and the Spreader Drain story in the Real-Life Examples section of this chapter for more details on determining your swale's slope and marking your swale's route.)

### Termination of diversion swales (and ponds)

Ideally, each diversion swale should terminate at another water-harvesting earthwork such as an infiltration basin or pond, in order to maximize on-site infiltration of water. Even these terminal earthworks must have overflows, which could consist of another diversion swale leading surplus water to yet another earthwork downslope, while further spreading and sinking the water's flow across the landscape (fig. 9.3 shows basins overflowing one into another).



Fig. 9.7. A diversion berm/speed hump directing parking lot runoff into a vegetated basin. Arizona-Sonora Desert Museum, Tucson, Arizona

Besides infiltration basins (fig. 9.7) what are some other overflow/termination options? One, but to be used with extreme caution *especially in drylands*, is a pond or reservoir (see boxes 9.2 and 9.3). A diversion swale can direct runoff directly to vegetation (fig. 9.8). It can redirect runoff to a check-dam-stabilized waterway instead of a steep erosive slope (the steep area between break line and keyline; see fig. 9.9 and also



Fig. 9.8. A diversion swale that diverts runoff from a driveway-side drainage ditch into existing vegetation. The swale bends and levels, terminating as a contour berm. Work by San Isidro Permaculture and Raincatcher. Santa Fe, NM.



Fig. 9.9. An earthen diversion swale redirecting runoff away from an eroding steep slope, to a drainageway stabilized with a gabion. Note: A series of contour berms were first placed upslope of the diversion swale to start harvesting water at the top of the watershed. Santa Fe, New Mexico.





Fig. 9.10A. A stabilized diversion swale built to collect hillside runoff and redirect it to a cistern in the Jaipur Fort built in 1726, Jaipur, India. This diversion swale and the cistern are still in use. The Maharaja opened the fort to the public in 1983, and it is now a tourist attraction.



Fig. 9.10B. Diversion swale entering the Jaipur Fort (foreground), and the 2.4-mile (4-km) catchment in the background

refer to 9.5B). It can also flow to cisterns (especially when the catchment is relatively sediment free, and silt traps divert sediment before it gets to the cistern)—see figures 9.10A, B, and C, three photos of a water-harvesting diversion swale in India that captures water from a hill above an old fort in Jaipur, then directs the runoff into a huge underground cistern.

If using a diversion swale to move excess water from one water-harvesting earthwork to another, begin marking the diversion swale’s location at the overflow spillway of the highest earthwork, then mark the swale’s route at the appropriate slope to the planned inflow point for your next earthwork. If you find the slope of the diversion swale is too steep or too gradual, you may need to move the lower earthwork or its inflow point higher or lower to correct or adjust the slope.

Mark the diversion swale’s route with stakes, flagging, surveyor’s spray paint, or a line scratched deeply into soil. Do the same for the outline of any other water-harvesting earthworks with which the swale interconnects. If you are considering a pond or small earthen dam, please read boxes 9.2 and 9.3.

## SPACING

As you would with a berm ’n basin, space your diversion swales according to their size and the expected volume of runoff. The smaller (meaning

lower water-holding capacity) the swale, and the higher the expected runoff, the closer together swales or other water-harvesting earthworks should be, which results in a smaller “microwatershed” serving each swale. The larger the swale and the lower the expected runoff, the farther the distance between swales should be, which gives each swale a larger microwatershed. See appendix 3, runoff calculations: Equations 1–3 are for calculating surfaces; equation 5 gives net runoff examples using an outdoor area with the surface’s runoff coefficient.

## APPROPRIATE SIZE

Diversion swales can range from a small furrow leading roof-downspout water to a vegetated infiltration basin, to a huge swale cut across acres of sloping land. Design your earthworks to handle the peak flow of runoff from large storm events (see Volume 1, chapter 2 on assessing your site, and the example of a 3-inch rainfall event for equation 5 in calculations appendix 3).

The diversion swale does not need to be sized like a holding basin because it moves rather than holds water. But it does need to be large enough to handle the peak flow of the incoming water. For example, if it is taking water from a culvert or downspout, the rule of thumb is to build the swale bottom width equal to 2 to 4 times the diameter of the culvert or downspout



Fig. 9.10C. Diversion swale (channel entering from lower left corner) directs water to enter a covered cistern in Jaipur Fort, India. Uncovered cells or square tanks (see people sitting at edge of the tank) capture the silt in the runoff, and the slope of the diversion swale itself is greatly reduced so silts settle out and relatively silt-free water enters the massive cistern (beneath square plaza-like cover with raised octagon in its center).

with a depth equal to the diameter—this applies to the recommended swale slopes ranging from 0.17% to 0.33%. The more vegetation within the swale the wider the swale, since the plants will slow the water's flow. That way the channel of the diversion swale does not adversely constrict the flow of water coming into it. For example, in determining the depth and width of a diversion swale to direct overflow water from one backyard-scale water-harvesting earthwork to another, make all the diversion swales the same ample size so the inflow and outflow capacity for each swale will be equally large and will be able to transport all water safely. I don't use any exact calculation, but instead play on the intuitive level, making sure my diversion swale width exceeds the diameter or width of the incoming channel; however, equation 15 in calculation appendix 3 provides further information on sizing

your diversion swale. If using a series of diversion swales to collect runoff from a large catchment area plus direct overflow water from one large-scale water-harvesting earthwork to another (such as from one earth dam to another), you may need to increase the size of the swale as you move down the watershed, since the swale will be collecting both overflow water and a significant amount of runoff from the land above the swale.

Err on the side of making the berms and basins of your diversion swales bigger to reduce the chance of a berm eroding too quickly or blowing out in a big storm. As a rule of thumb, make the base of the berm around 4 times as wide as the height of the swale. See figure 9.11. In gopher country (regardless of soil type), go wider with your berms so the critters' holes will be less likely to

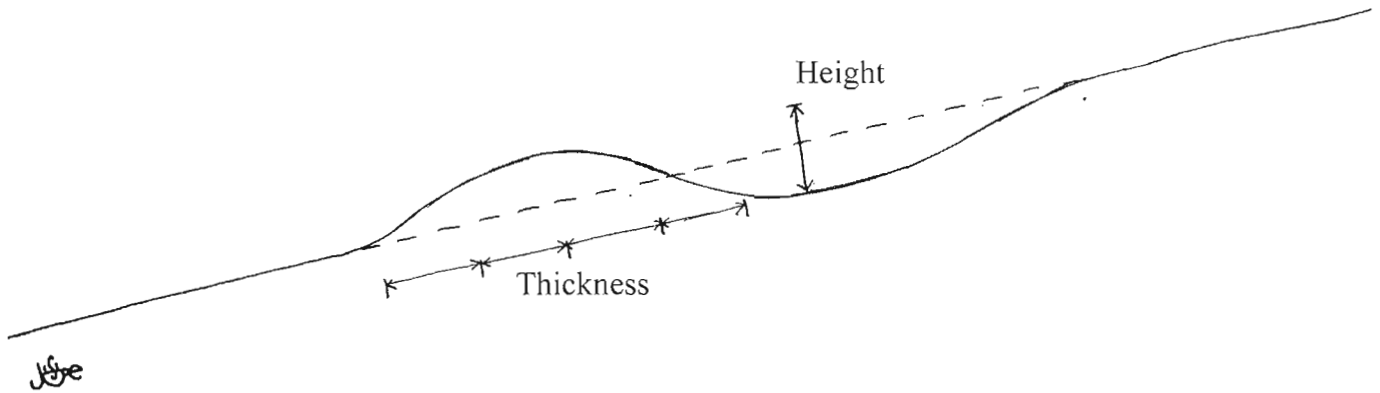

Fig. 9.11. Berm base 4 times as wide as berm height

blow them out. Make your berms wide enough to double as accessways wherever the potential exists.

## CONSTRUCTION

To construct a diversion swale, dig a basin just upslope of the markings you made delineating the planned route of your swale, then use the excavated dirt to build your dirt berm downslope. When creating the berm, go ahead and pile the dirt around existing plants along your marked line. Smaller plants may get completely covered, but larger, only partially covered plants should recover.

Give the berms and basins of your swales a gradual slope for more erosion resistance and to make revegetation easier. A 2:1 slope works, but a more gradual 3:1 slope is more stable.

To firm up your berms, compact them by walking on them and tamping them down evenly along their length with your feet. Berms built by graders and backhoes can likewise be compacted by the machine.

Do not compact the basin where you want water to infiltrate along its course.

## LOCATION AND CONSTRUCTION OF APPROPRIATE SPILLWAYS FOR OVERFLOW

The “overflow spillway” of a diversion swale is the lower end of that swale. To control and utilize overflow water, the swale should terminate at a point in the landscape where land slope is gradual to level, vegetation is well established, and soil has not been

greatly disturbed. Surplus water can be discharged to a water-harvesting earthwork, a stable natural waterway (preferably one that is shallow and well vegetated), or a storm drain.

If the final destination of the water is an earthwork such as an infiltration basin, the lower end of the diversion swale should have a gradual slope right up to the point that it meets the level bottom of this final basin. Water pooling in the basin will diffuse the force of incoming water from the diversion swale, which will temporarily back up along the lowest section of the swale (fig. 9.12).

Any sudden drop in grade where the lower portion of a swale meets an earthwork must be stabilized. A combination of stone rip-rap with vegetation usually works well. The rip-rap should be either heavy enough that it does not get washed away, or anchored in place by a wire gabion mattress or apron (see chapter 10 on check dams, section on gabions).

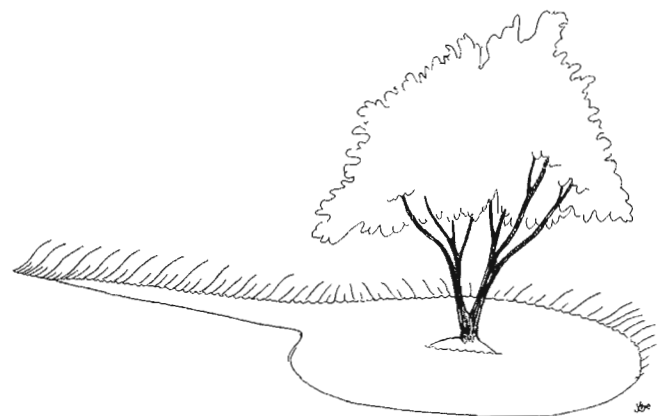

Fig. 9.12. Water pooling in basin at the base of diversion swale

## PLANTING YOUR DIVERSION SWALE

Planting strategies depend on the intended use of your swale. If it's primarily to divert water, planting in the basin would impede the flow of water, so instead plant the berm, the area just downslope of the berm, and the spillway. If the goal is to infiltrate water along the length of the diversion swale, and divert only excess water, then you may be able to seed the basin with low-growing vegetation like native grass that will increase infiltration rates along the length of the swale. But, the banks of your swale must be high enough to ensure that water slowed by, and backing up behind, the vegetation will not erosively breach the swale's banks.

## MAINTENANCE

Check on your diversion swales periodically, especially during or just after big rains. Make any needed repairs or adjustments. Berms may need to be built higher or wider, or blockages in the channel may need to be cleared. If an excessive amount of runoff is entering or eroding the swale, create more water-harvesting earthworks upslope of the swale within its watershed. Check the condition of the bottom of the basin to see if there is evidence that soil is being carried away along with the water flowing through it. This may indicate the slope of the diversion swale is too steep. Water flow can be slowed down by constructing small one-rock-high check dams (see chapter 10) periodically within the confines of the swale channel. Be sure the check dams do not rise above the banks of the swale and inadvertently divert water out of it. You can plant trees on the downslope side of check dams to utilize the harvested water (fig. 9.13).

## VARIATION OF A DIVERSION SWALE

### SPREADER DRAINS

Spreader drains are designed with the upper and middle portion of their basin to slope gradually like a typical diversion swale, but the bottom length is constructed dead level on contour without a downslope berm to create a very wide overflow spillway. Water

flowing down the swale slows to a crawl along the level bottom section, then stops at the end of the drain's basin. Water slowly collects, backs up, and rises within the bottom end of the swale's basin until the water crests and evenly overflows the level downslope edge as a shallow spread-out sheet flow, rather than a deep constricted flow. The overflow area must have a *gradual* slope and be well stabilized with vegetation to prevent erosion and increase water infiltration. However, in degraded land, or devegetated areas, compaction or even concrete stabilization of the spillway might be appropriate, while simultaneous efforts quicken the revegetation of the area just downslope of the stabilized spillway (fig. 9.14).

Spreader drains slow and diffuse the force of incoming water, encourage its infiltration along their gradually sloping furrow, and finally spill and spread any overflow water as slow, wide sheet flow. They help prevent erosion and gully formation by diverting, diffusing, and infiltrating the channelized water from roadside drainage ditches or small earthen dams. In wetter areas spreader drains can be used to irrigate fields or pastures with sheet flow. Spreader drains should be sized to handle peak storm flows from their catchment.

Spreader drains can be constructed with a berm on the up- or downslope side of the sloping sections of their basin. Although there is no berm on the downslope side of the level end section of the basin, there can be one on the upslope side. This ensures a more gradual overflow spillway along the swale's downslope edge than would be the case with a mounded berm. Sometimes the excavated dirt is placed in mounds on the upslope side of the basin to allow some additional infiltration of runoff from upslope areas into the drain,<sup>6</sup> though as you will see in the spreader-drain case study in the Real-Life Examples section, the excavated dirt can create a nice raised road or path in the form of a continuous berm upslope of the basin. Either way, additional water-harvesting earthworks, such as berm 'n basins, may be needed upslope of the drain to prevent excessive overtopping of the drain's upslope bank or berm and keep fast-moving or sediment-rich runoff from entering the spreader drain and causing erosion.

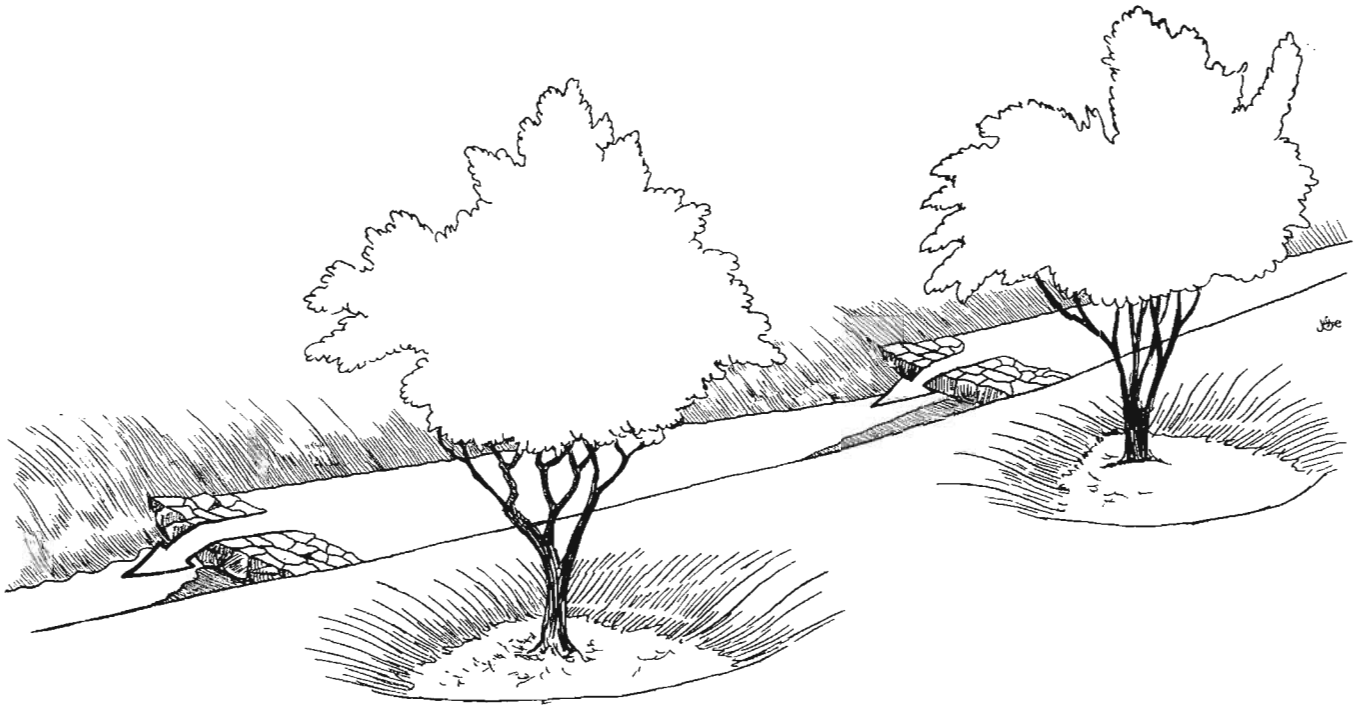

Fig. 9.13. Low one-rock-high check dams slowing the flow within a diversion swale

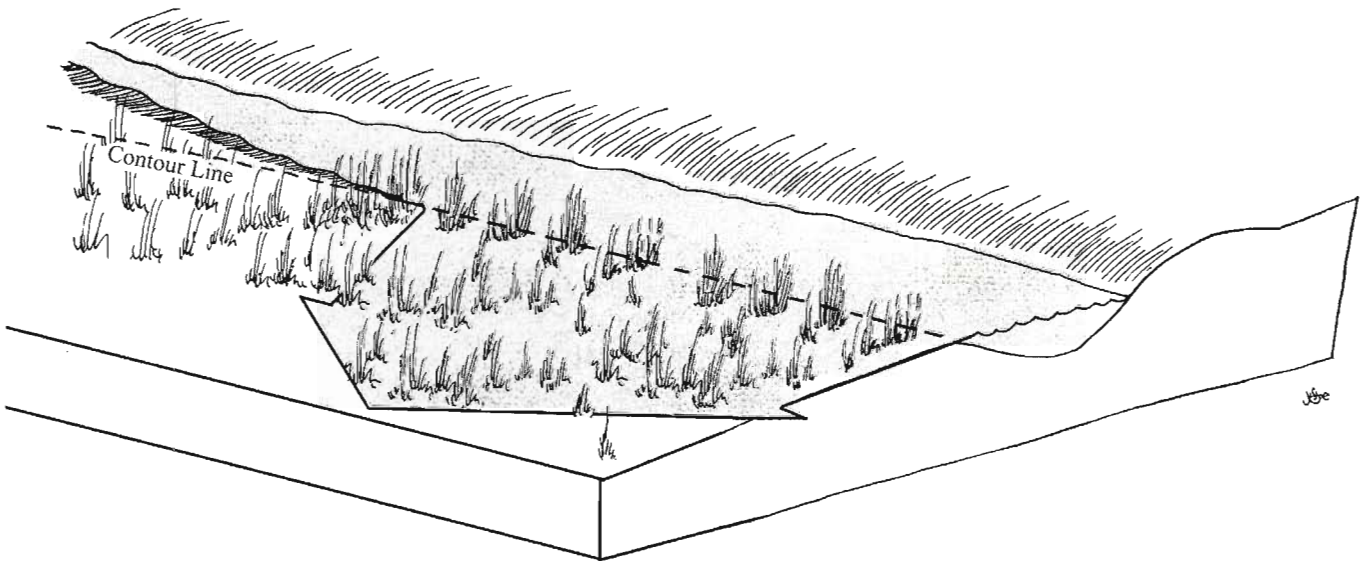

Fig. 9.14. The bottom length of the spreader drain is level so backed-up water overflows as a thin sheet of water. Water pools in bottom level section of basin first. Once full, the pooled water overflows evenly as sheet flow over the level downstream edge of the drain.

# MULTIPLE FUNCTIONS OF DIVERSION SWALES

## DIVERSION SWALES AS WATER-HARVESTING SPEED HUMPS

Diversion swales can help remedy erosion of existing pathways, driveways, or roads that run parallel with a slope and are prone to acting as unplanned waterways. Constructed in a series, gradually sloping diversion berms (minus the basins) are placed across the path to create water-harvesting “speed humps.” The berm intercepts water flowing down the road or path and diverts it to adjoining basins supporting vegetation. For best effect, don’t stop the diversion berm once it has directed water off the path. Continue the diversion berm as a contour berm around a patch of existing or planned vegetation to form a water-harvesting “J” shape that closes off the very end of the swale by curving the berm upslope. This ensures the diverted runoff water will slow down and infiltrate into the soil, rather than continuing to flow over the surface possibly creating erosion off the path. These water-harvesting earthworks can help support trees and other vegetation to stabilize the land and shade the road (fig. 9.15; see also fig 9.8 earlier).

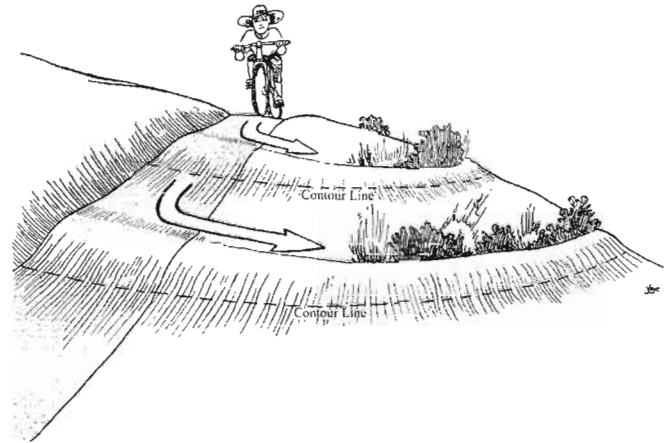

Fig. 9.15. Diversion swale speed humps

## THE BERMS OF DIVERSION SWALES AS ROADS OR PATHS

The berms of small-scale diversion swales can be constructed to function as paths. The berms of large-scale diversion swales can be constructed to function as roads. To ensure the roadway/berm does not become saturated with infiltrated water, it should be constructed with a well-compacted base of good draining soil (engineered fill dirt composed of gravel and sand, or appropriate local materials). Figure 9.16 shows driving, biking, and pedestrian accessways on

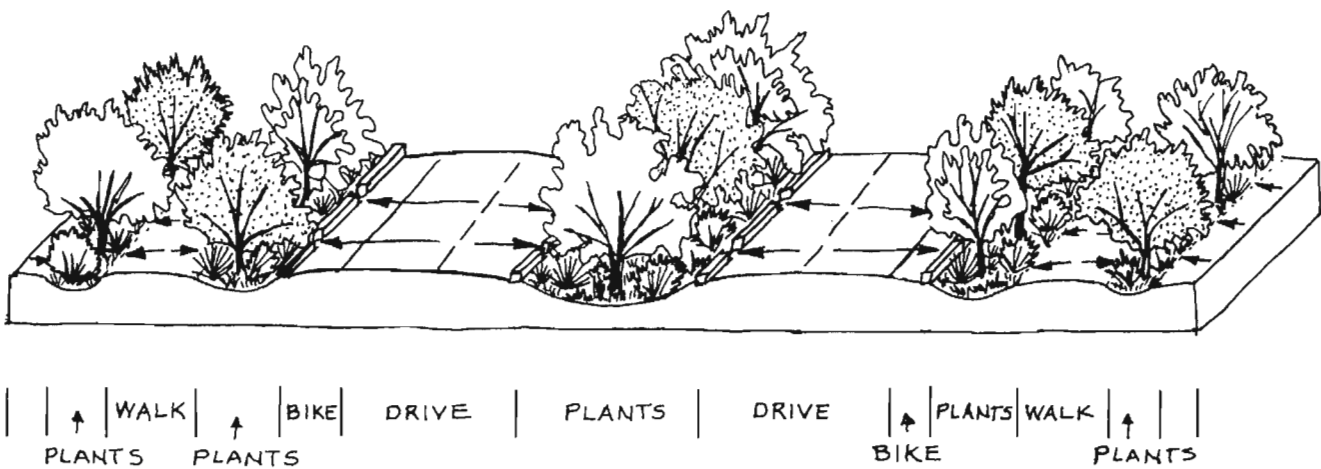

Fig. 9.16. Raised berm accessways and sunken basin planting areas

raised diversion-swale berms, with plants in the basins harvesting runoff. For further information on road construction, see appendix 6.

## DIVERSION SWALES AS RAIN GUTTERS IN THE LANDSCAPE

Bill Mollison reports that in the Canary Islands diversion swales made of concrete or stone walls gather runoff from large rock faces, then lead the water to underground caves or large open tanks.<sup>7</sup> See figure 9.10 for the Jaipur Fort example in India.

## DIVERSION SWALES USED TO “DAYLIGHT” OR BRING BACK TO THE SURFACE FORMERLY CULVERTED OR BURIED WATERWAYS

“Daylighting” is the act of uncovering a piped or buried waterway and restructuring and revegetating it to make it a healthy, meandering, more natural watercourse. Daylighting reverses the pattern of channelizing and burying our natural waterways, a practice common in the built environment. The success of the 1984 daylighting of Strawberry Creek at a park in Berkeley, California, inspired numerous daylighting projects in other communities.<sup>8</sup> The benefits include flood control, reduced downstream erosion, improved

water quality, enhanced wildlife habitat, and increased neighborhood livability. Compare figures 9.17A and 9.17B. For more information on daylighting techniques and restoring waterways in urban environments see the resources in appendix 6.

## REAL-LIFE EXAMPLES OF DIVERSION SWALES

### DIVERSION SWALES IRRIGATING LANDSCAPES AND CONTROLLING STORMWATER—DAVIS, CALIFORNIA

At Village Homes in Davis, California (average annual rainfall of 19 inches or 482 mm), residential lots and streets are graded to slope toward meandering, creeklike swales that run through the development. Runoff caught within these swales passively irrigates a beautiful landscape of shrubs and trees planted among boulders. Small check dams are placed across these drainages to help slow the flow of water, harvest runoff in the soil, and prevent surges downstream (fig. 9.18). The effect is amazing. As developers Judy and Michael Corbett report, “In light rains, this surface drainage system allows all the water that falls on site to be absorbed into the ground. In heavier rains, the system empties some water into the city’s storm drains, but not nearly the amount a typical



Fig. 9.17A. Strawberry Creek Park was an abandoned railyard prior to daylighting the creek in 1984. Courtesy of Wolfe Mason Associates. Reprinted with permission from *Daylighting: New Life for Buried Streams*.



Fig. 9.17B. A portion of the daylighted section of Strawberry Creek after construction. The vegetation has since grown into tall trees that now overhang and shade the stream. Courtesy of Wolfe Mason Associates. Reprinted with permission from *Daylighting: New Life for Buried Streams*.



Fig. 9.18A. Elevation view of Village Homes houses and diversion swale. Note how homes front or face the pedestrian/bike/water corridor *not* the street. From *Designing Sustainable Communities* by Judy Corbett and Michael Corbett © 2000 by Island Press. Reproduced by permission of Island Press, Washington, D.C.

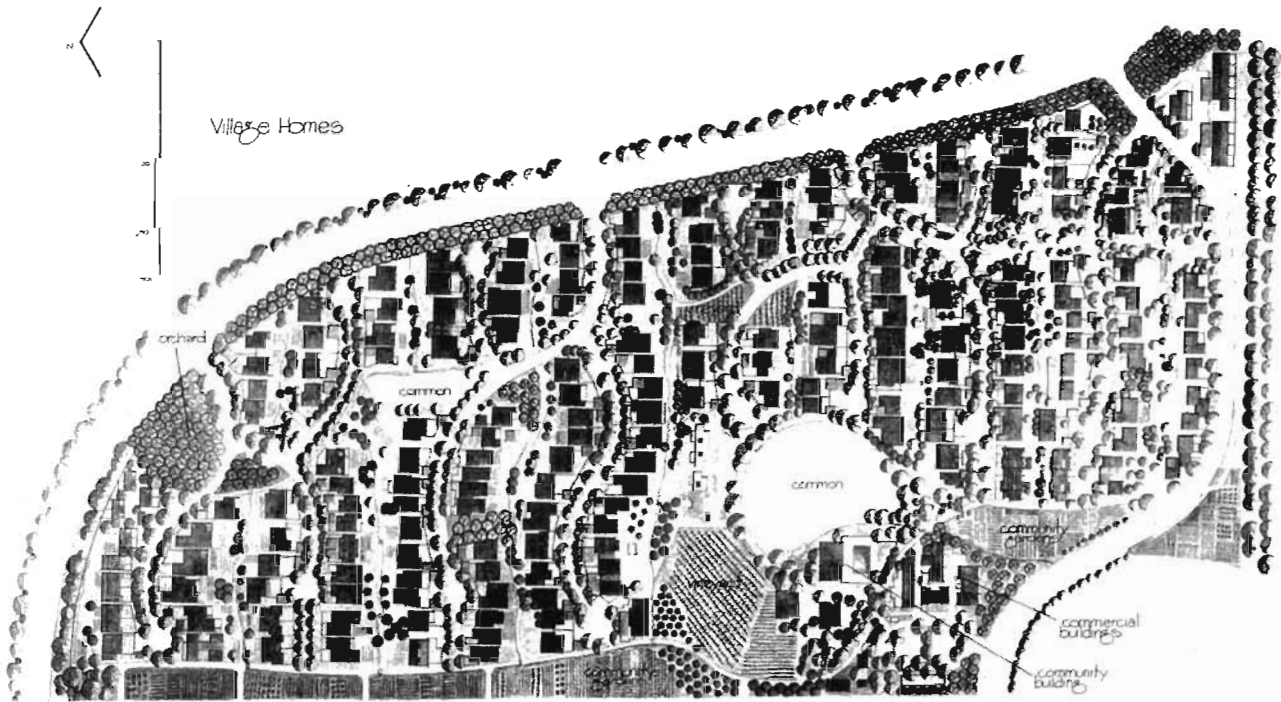

Fig. 9.18B. Plan view of Village Homes. Diversion swales intercept runoff from streets and meander along with bicycle/pedestrian paths past homes' backyards. All homes oriented to maximize passive solar heating and cooling. From *Designing Sustainable Communities* by Judy Corbett and Michael Corbett © 2000 by Island Press. Reproduced by permission of Island Press, Washington, D.C.



subdivision would. Currently, at least 90 percent of on-site runoff is kept on site. And as the trees continue to make the soil more porous, the land's capacity to hold and absorb runoff increases.” See appendix 6 for a resource.

## SPREADER DRAIN TURNING A STORMWATER LIABILITY INTO AN ASSET—MORIARTY, NEW MEXICO

By Chris Meuli

In 1996 an opportunity arose to create a spreader drain on my gently sloped (1–3% slope) and undeveloped 20-acre (8-ha) site in Moriarty, New Mexico (where annual precipitation averages 14.5 inches or 368 mm at 6,217 feet or 1,894 m elevation). One day after a heavy summer rain, I almost got stuck in this high-plains desert while driving on what previously had been very dry soil. A neighbor had started developing a subdivision uphill from my site. The bar ditch next to his new gravel road had collected the surface water from over 50 acres (20 ha) of land and concentrated it on my site, creating a quagmire.

Seeing this over-concentration of a resource (the “pollution” of water in the desert!), I began considering ways to spread it over a much larger area, rather than allowing it to concentrate in a useless mud-hole or cause an eventual washout. I learned that the county engineer was requiring my neighbor to put a 24-inch (60-cm) culvert under the future road that would connect to this new gravel road. I approached my neighbor to see if he would place a culvert where it would benefit both of us. He agreed. I located a spot where the bar ditch water could be directed easily into a culvert and delivered onto a corner of my property as high as possible in the landscape. This would become the head of the spreader drain.

Since I didn't know how to slope this drain, I read up on Bill Mollison's *Permaculture: A Designer's Manual* and found more than a page on spreader drains and related earthworks. He suggested swale slopes, ranging from 1:600 to 1:1,500 (a drop of 0.8 to 2 inches in 100 feet) on most soils and up to 1:6,000 (a 0.2-inch drop in 100 feet) in areas with fine sands.<sup>10</sup> I guessed that a slope of 1:1,200 (a 1-inch drop in 100

feet or 1-cm drop in 12 meters) on my heavy caliche-clay soil would suffice.

### Siting the spreader drain

I began the work by hiring two neighborhood boys, 10 and 13 years old, to help do the bunyip work (see appendix 1). They marked a 700-foot (213-m) long level contour line starting at the outflow point of the future culvert, and placed pink highway flags every 25 feet (7.6 m) along its length, making a nice pink curve that could be seen easily from a distance. I knew we had an accurate contour because the flags formed a curving line that matched the subtle topographical variations in the landscape. We reset several flags that didn't fit into the general curve due to minor local



Fig. 9.19. The first step in laying out a spreader drain: Chris Meuli's young neighbors (and their dog) bunyip a contour line across a 3% slope on Chris' property.  
Credit: Chris Meuli

variations, so that the curves became broad and gentle (fig. 9.19).

Next we used the bunyip water level to mark the sloping line of the diversion swale just downslope of the contour line. Starting from the 100-foot (30.5 m) contour flag, we used the water level to mark a point 1 inch (2.5 cm) lower than the contour line and placed a sentinel flag there. At the 200-foot (61 m) contour flag we found where the slope dropped 2 inches (5 cm) and placed another sentinel flag, and so on—marking the spreader swale's sloping path with a

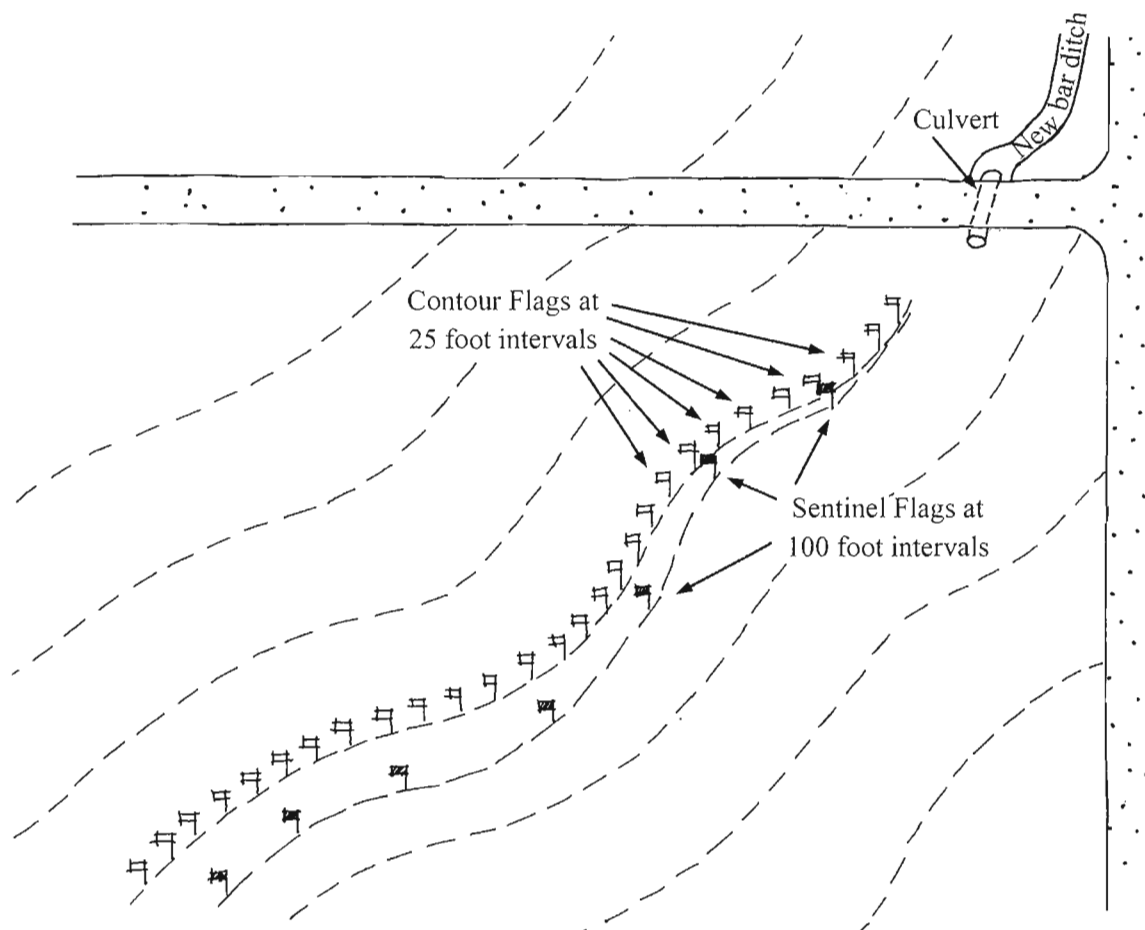

Fig. 9.20. Marking the spreader-drain route

progressive drop in elevation of 1 inch every 100 feet or 1:1,200. We could see that the row of sentinel flags pulled away gradually from the contour flags, going imperceptibly downhill just as we would expect the 1:1,200 slope to pull away gradually from the level contour. Then we eyeballed both curving lines and placed flags every 25 feet between the sentinel flags so they mirrored the gentle curves of the contour flags uphill (see fig. 9.20). The last 200 feet of the drain were marked level. That done, we pulled out all the flags that were on contour.

## Building the drain

To move the dirt, I hired my neighbor's road-grader operator, who was doing excellent, but conventional, work on the new gravel road. When I

described the plan, he knew "exactly" what I wanted, and would have been happy to do the work without my being present! When I met him the next week to supervise the project, he was totally surprised at what I really planned to do. He had been doing excavation work for over 20 years and didn't believe you could move water without having a big ditch somewhere.

We began by grading deeply into the soil upslope from the flags, throwing the dirt uphill with the grader blade. On the return trip, we would throw that dirt farther uphill creating a V-shaped furrow almost 16 feet (4.8 m) wide. After 5 hours, we had thrown over 300 cubic yards (228 m<sup>3</sup>) of dirt uphill! (See fig. 9.21.) This created a drain with a center 11 inches (27.9 cm) lower than its overflow edge. We also had a fairly flat berm above the drain that was almost 1 foot (30 cm) high and over 12 feet (3.6 m) wide. Figures 9.22A, B, C,



Fig. 9.21. Grader cutting diversion swale on Chris' land. Note: The operator was not allowed to drive grader on the downslope side of swale in order to retain all soil-stabilizing vegetation over which swale overflow water would flow. Credit: Chris Meuli

and D is an elevation view of the slope before and after Chris' spreader-drain construction. Arrows denote slope.

With a spreader drain, there is a tradeoff between how much capacity the drain should have so the water may soak into the earth locally, and how much water is allowed to overflow the apron at the low end of the drain on the downslope side. This is determined by the slope of the land (the steeper the land, the greater the volume of water the spreader drain should hold),



Fig. 9.22A. Original slope. Drain location marked with flagging pre-construction.



Fig. 9.22B. Early passes with roadgrader. Digging commenced, dirt cast upslope.



Fig. 9.22C. Drain with basin dug upslope of flagging and dirt cast upslope of basin to form berm. Final drain size 11 inches (30 cm) deep, 16 feet (4.8 m) wide.



Fig. 9.22D. Completed drain. Uphill berm graded to form road, downhill overflow apron is undisturbed.

and the area of land being serviced (the larger the area, the more water should overflow the apron).

Ideally, the overflow apron downslope from the flags (marking the spreader drain's route) is grassed, remains undisturbed, and is not compacted. All this greatly reduces the chance of erosion. I carefully supervised the roadgrader operator, making sure that he made his turnarounds upslope from the spreader drain to minimize disturbance of the intact vegetation.

The spreader drain was an enormous and beautiful piece of meandering earthwork, wandering through the landscape like a fat brown snake lying in the gray buffalo-grass. Its natural appearance amazed even the grader operator. He later commented that the dirt thrown uphill would "make a dandy road" that would never get muddy.

## Working with watershed neighbors

The magnitude of the work alarmed my neighbor, who immediately called in several civil engineers, who all told him it was going uphill and would never work anyway because it wasn't deep enough. He had his lawyer draw up a contract absolving him of all liability regarding the spreader drain. Whenever the document referred to "accepted civil engineering practices" I added "and sound permaculture design." We both signed it and he filed it with the county clerk. It was a thoughtful design that optimized natural patterns, utilized a "waste

product” in a beneficial way, and incorporated features to prevent disaster. I was surprised to realize that conventional “earthworkers” didn’t use these common sense principles in their work.

The next week I checked out the promised 24-inch culvert. I was aghast to discover that its crown was 36 inches (91 cm) below grade! It took me two weeks to calm my disbelief before calling my neighbor to learn his rationale. He stated that the civil engineer recommended 18 inches (46 cm) of packed dirt and 18 inches of gravel above the culvert. The process of planning a road from the top down, rather than considering gravity, water, and landform as primary, puzzled me. I told my neighbor that it was a matter of time before the culvert would silt in and need to be replaced. He listened skeptically.

Then I created a simple surge basin below the culvert to absorb the energy of the incoming water before it entered the spreader drain. A surge basin is a pond, often 12 to 18 inches (30 to 45 cm) deep that utilizes the standing water in the pond to diffuse the kinetic force of the incoming water. This prevents the scouring so often seen in arroyos and below culverts. A surge basin has an overflow sill that should be level with the inflow of the channelized water or the bottom of the culvert. Optimally the surge basin turns the water 30° or more before allowing it to enter the head of the spreader drain in an even and controlled manner. The water is turned by building the spillway of the surge basin at an angle 30° or more from the channeled inflow to the basin.

## The spreader drain in action

The first spring after the swale’s construction, over an inch (25 mm) of rain fell on a soil saturated by unusually heavy snows. The spreader drain worked beautifully, gently distributing a tremendous amount of surface runoff in a thin film of water along its entire 700-foot (213-m) edge, soaking areas 300 feet (91 m) downhill (nearly 5 acres or 2 ha). I was able to document this marvelous event with photographs, capturing this remarkable apparition of a sinuous

body of water in the high-plains desert (fig. 9.23). Three years later the culvert under the road silted in and only these pictures would finally convince my neighbor that the water was really not running from the spreader drain back up into the culvert. He paid for a new culvert and replaced it, again at the same depth (he still didn’t get it!), and I paid to have it reset 18 inches (45 cm) higher.

The next year I planted a crenulated windbreak downhill from the spreader drain. Due to water harvested in the soil of the spreader drain from the previous spring, I found the ground 70 feet (21 m) downslope to be easy digging and still moist at a depth of 2 feet (0.6 m), an unbelievable change from the previous 12 years. The windbreak’s trees are thriving, and I have not had to water them since planting, despite increasingly dry weather over the past several years in New Mexico. Grasses and weeds have sprung up in the drain itself. I had wondered if they would impede the flow of water and cause damming and excessive silting, but the flows are so slow and broad that this has not occurred. And the road above the drain is an excellent road indeed (fig. 9.24).

## The feedback loop

*Despite the swale working well, Chris would make the slope of his diversion swale more gradual if he were to do it again. He has noticed that water runs quickly within the first 200 feet of the structure, where signs of erosive channelization are just beginning to show. If the swale sloped more gradually, 1:2,000 to 1:3,000, this likely would not have occurred. To remedy the situation, Chris plans to enlarge the surge basin and reduce the slope of the first 200 feet of the swale.*

*The above was written by my friend Chris Meuli, with much of it based on his article “Capturing and Using Wild Water: The Well-Built Spreader Drain” published in the Permaculture Activist, Nov. 2000 issue.*

*See chapter 2, Real-Life Examples, Windberm Story, for contact information for Chris Meuli.*



Fig. 9.23. Diversion swale harvesting runoff

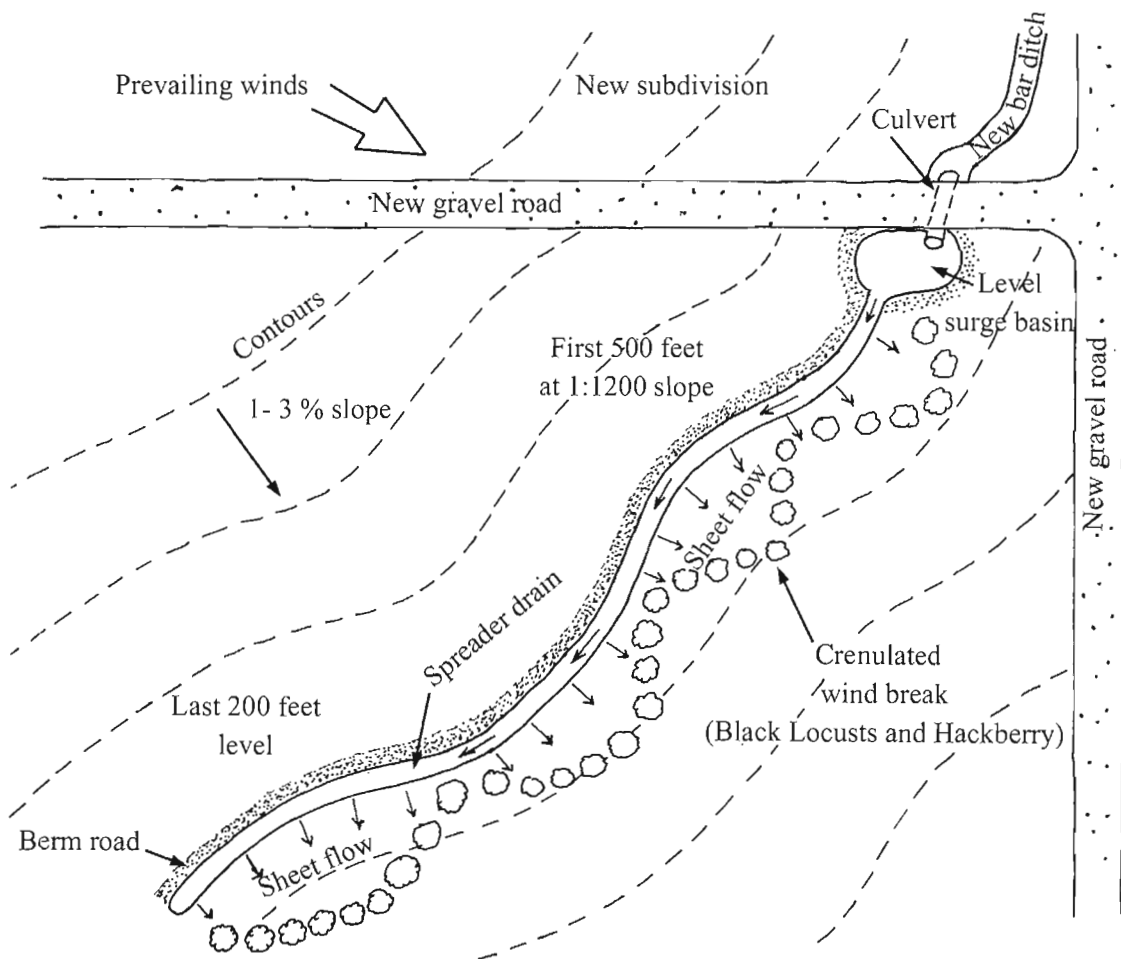

Fig. 9.24. Completed swale, surge basin, and windbreak layout



# 10

## CHAPTER

# Check Dams

Check dams and gabions, their wire-wrapped kin, are the water-harvesting earthworks specifically meant for use within drainages—the area of the landscape where water naturally concentrates and flows. These pervious dams slow and spread this flow so more water can infiltrate the soil, more fertile soil can settle out behind the dam to absorb more water, and more vegetation can get established and grow to become the longer-term living element of the structure. As such, check dams can help stabilize eroding drainages and enhance wildlife corridors. They can also create safer, more shallow crossings of waterways or a stepped pathway

up and down a channel's banks. Just one on bedrock may be enough to create an ephemeral spring, whereas hundreds coupled with other earthworks and good land stewardship can enable dry creeks to flow again, help heal whole watersheds, and empower the communities of those living within the healed land. Read on—this chapter describes it all.

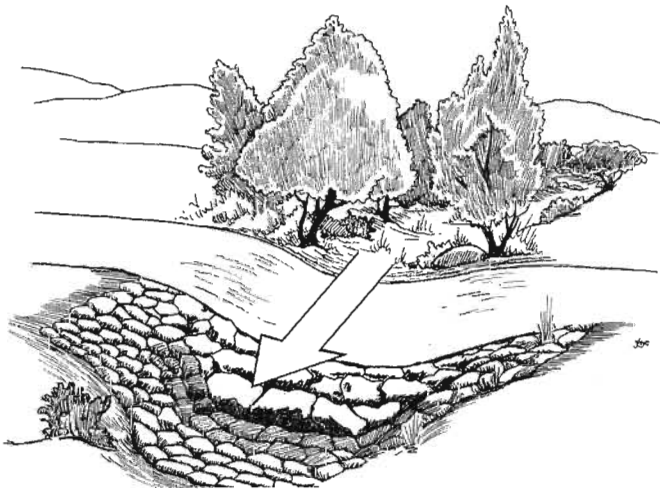

Fig. 10.1. A loose-rock check dam stabilizing a road crossing a drainage

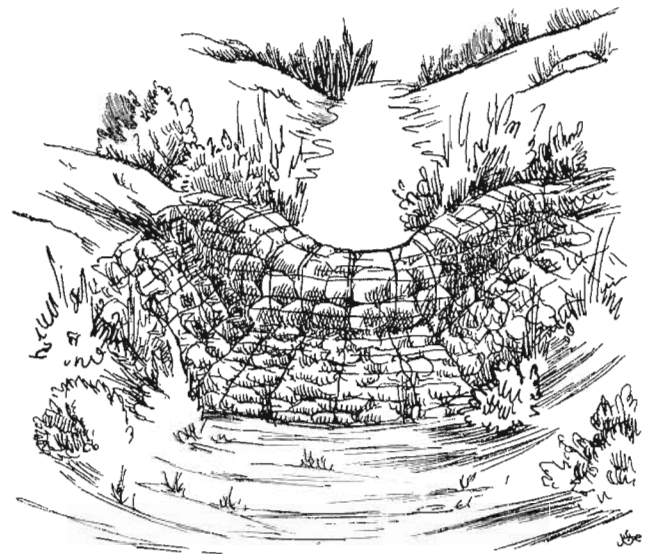

Fig. 10.2. A gabion is a wire-wrapped stone check dam. A wire-wrapped downstream apron prevents erosion at the base of the check dam and dam failure.

## WHAT IS A CHECK DAM?

A water-harvesting check dam (fig. 10.1) is a low barrier that is *permeable* or “leaky,” and placed perpendicular to the flow of water within a drainage. The check dam does not stop, but rather slows the flow of water. As it does so, running water temporarily backs up behind the dam and spreads out over more of the drainage’s surface before flowing through and over the dam. By slowing and spreading the flow of water, check dams help moisture infiltrate into the soil, reduce downstream flooding by moderating the peak flow of water, retain soil and organic matter on the upslope side of the dam, reduce erosion, and stabilize a section of the landscape. The porosity of the dams also dissipates the hydrostatic forces of the water flow hitting the structure, making them easier to effectively construct than nonporous dams.<sup>1</sup>

Typically a check dam is made of rocks, though construction materials can vary. *Loose-rock* check dams are made from rocks carefully placed against one

another. They can be made in tightly packed rows of rock laid across the drainage just one rock high or they can be made a few courses high like dry-stacked stonewalls. *Gabions* (figs. 10.2, 10.3) are check dams in which the rocks are encased in a wrapping of wire fencing or a wire basket that holds everything together—sort of a rock burrito in a wire tortilla. Other styles of check dams use other materials such as brush and straw bales. Whatever style you choose, water should always be able to pass through the small spaces between the material making up the check dam, as well as flow over the top of the dam.

## WHERE IS A CHECK DAM USED?

This book covers the use of check dams across drainages that flow only in response to rainfall events (an ephemeral drainage), not across a perennial drainage that flows at all times. Check dams are often placed across eroding arroyos or gullies where they retain soil and detritus, and increase soil moisture,



Fig. 10.3. Gabion stabilizing erosion caused by upstream culvert. Work by Santa Fe Permaculture



creating conditions favorable for vegetation growth. They work well to stabilize roads or paths crossing ephemeral drainages (fig. 10.1), and also can be placed downstream of culverts to reduce erosion (fig. 10.3). Built atop bedrock, check dams can often create ephemeral seeps or springs as water captured in the porous soil and organic matter held upstream of the check dam will slowly release the harvested moisture over the more impervious bedrock (fig. I.11).

Check dams made of loose rock, straw bale, or brush are appropriate for use at the top of an erosive rill or within small drainages that have low volume and low-velocity water flows. The watersheds serving these small drainages are usually less than 200 acres (80.9 ha), though you will see an example of loose-rock check dams in larger watersheds in the “Where Rocks Have Made the Water Flow” story at the end of this chapter.

Wire-encased rock gabions are sometimes used further down a drainage where water flows are larger and velocities higher. Wire-encased rock gabions have also been used higher up in the watershed when working with small sized rocks, or when working in sandy soils, which can be unstable. The wire fencing or baskets hold numerous individual rocks, combining them into one continuous, permeable structure that can be stable even under the force of large volumes of fast-moving water. In addition, wire-wrapped rock gabions hold up better than loose rocks under the heavy feet of roaming cattle, and resist sinking into wet sand or loose soils. However, due to the disadvantages of gabion's wire wrapping it is often more appropriate to use *wireless* check dams—see below.

### Keeping it simple: Advantages of wireless check dams over gabions:

- Loose-rock or brush check dams don't require any wire, fencing, or gabion baskets, so you can use on-site materials, rather than buying or importing supplies.
- If you mess up and the loose rock or brush check dam fails, no one will know. Rock and brush will be strewn about, but it will look natural since you used only natural materials. If you mess up a gabion and it fails, foreign litter will result. Sharp sections of

wire fencing or gabion baskets could be strewn about the drainage.

- The use of loose-rock or brush check dams is most appropriate when we start high in the watershed, and their effective size is limited. Thus they push us to follow the principles of starting at the top of our watershed, and starting small and simple. This then helps keep us working at the scale where we are most effective.
- The structural integrity of gabions relies upon the wire. And while the wire can last a hundred years in drylands, when the wire eventually rusts and fails, the gabion will likely also *fail*, except for the unlikely occurrence when dense vegetation and its roots have become well enough established to take the place of the wire.

## TOOLS AND MATERIALS

**Basic check dam tools:** You will be digging, moving rocks and other materials, and checking contour levels. So you'll need a shovel, digging bar or pry bar, pick-ax, wheelbarrow, and bunyip (water level). Brush check dam construction will require pruning saws, pruning shears, post-hole diggers, and perhaps a mini-sledgehammer to drive wooden posts into drainage bottoms. A backhoe can dig large anchoring trenches if needed. A pickup truck may be useful for transporting rocks. You'll want protective clothing, heavy gloves, and boots.

**Additional gabion tools:** Bolt cutters, lineman's pliers, hog ring pliers (available from feed stores), and rib-joint (or channel lock) pliers.

### Common check dam materials:

- **Rock**, when available, is my favorite material because of its durability. This is especially important in dry climates with slow vegetation growth, where the check dam must last long enough to help establish a living check dam of plants. Use angular rock, as its angled edges lock into one another, making it a better choice than round rock. Rocks should be at least 12 to 24 inches (30–60 cm) in diameter or at least 20 pounds (9 kg) in weight for a loose-rock check dam to give it sufficient anchoring weight and

mass. However, a wire-wrapped gabion can sometimes use rock as small as 6 to 9 inches (15–22 cm) in diameter. The heavier the water flow, the larger the rocks. Boulders may be needed in some cases.

To minimize soil disturbance, loss, and erosion, collect rocks laying on the surface rather than digging out partially buried rock. And, take rock from gradual slopes or flat areas, upslope of where you plan to build the check dam. The check dam just below the area of disturbance will catch eroding soil and keep it in the landscape.

- **Salvaged chunks of concrete** can be used in place of rock. Concrete is a durable material readily available in the urban environment, often found in 4-inch-thick pieces of broken sidewalk. Laid skillfully, salvaged concrete looks great.
- **Brush, branches, and pole cuttings** can be used to make vegetative check dams, but should not be used to make wire-wrapped gabions. Use dead wood and brush, or carefully prune or coppice appropriate plants to obtain living material. Cutting poles (thin limbs) from native willow and poplar works well in areas where these trees are commonly available since they readily recover from pruning or coppicing. Seep willow (*Baccharis salicifolia*) can be used in drier areas of the Southwest. The fresh cuttings from poplar and willow can grow into new plants if the cut end is placed deep into moist soil—speeding vegetation enhancement in the drainage.<sup>2</sup> Dead wood and brush will not come back to life, but their biomass can help harvest rain and soil to help establish new native vegetation. Even dry, dead brush from invasive plants such as tamarisk (*Tamarix ramosissima*) can be used for this purpose—though make sure it does not contain viable seed. In areas where brush is sparse you can obtain material by carefully pruning lower branches from nearby trees (see chapter 11 for pruning tips).

Thick, woody material will last longer than thin material. Wooden posts or cut poles should be 3 to 6 inches (7–15 cm) in diameter, and 4 to 6 feet

(1.2–1.8 m) long, depending on the height of your check dam.

- **Straw bales** can be used for a less durable, but quickly installed check dam, but not in a wire-wrapped gabion. Straw bale check dams are not as permeable as those made of the other materials and are more prone to blowing out under the pressure of flowing water, so take extra care to anchor them securely in place, and to establish a good overflow spillway.

**Additional gabion materials:** You can purchase pre-manufactured gabion and spillway-apron baskets. To make your own baskets you'll need 11- to 14-gauge galvanized wire field fencing. This field fencing should be at least 4 to 6 feet (1.2–1.8 m) tall, and have wrapped joints, not welded, because welded joints are more prone to break with rust or wear. The spacing of the fence grid should be no larger than 4 inches (10 cm) wide, and must be smaller than the diameter of the rock used to fill the gabion. Galvanized hog or cage rings and 14-gauge galvanized wire are used to tie gabion and apron baskets.

You may also want **indigenous seeds and plants** to revegetate the area when you're done.

## IMPLEMENTATION STEPS TO BUILD A CHECK DAM

### SITING

Assess if check dam materials such as rock are readily at hand. If not, is there access to bring in materials? Is the cost justified?

Locate a check dam in a straight section of a drainage. Do not place it in, or just after, a curve where meandering water currents and erosion are likely to cut around the check dam. Scouring often occurs in the outer bends of curves, where water can then pool. However, straight sections of a drainage are where you find crossover riffles where sediments naturally deposit in areas of slower moving water—so placing dams here will speed up their beneficial accumulation of sediment (fig. 10.4).

Check dams work best in sloping drainages that are already naturally stepped—water flow occasionally drops or falls slightly from one level to the next. Thus, the stepped terracing created by the check dams builds on an existing pattern. In very gradually sloping drainages where there is no natural stepping you may want to consider induced meandering rather than check dams (see box 10.1).

Place check dams in gradually sloping sections of a stepped drainage rather than steep sections where water flow is faster and more aggressive (fig. 10.5). This will lessen the chance of the dam blowing out. Also, a longer terrace can build up on the upslope side of a check dam built on a gradual slope, holding more soil, organic matter, and water.

Help anchor a check dam in place by locating it on the upslope side of a tree or boulder (fig. 10.6). If there is a constriction in a drainage, place a check dam *upstream* of the narrowest point of the constriction so the water flow will help wedge the check dam in place. Do not place the check dam in the narrowest point or just downstream of the constriction because it will be subjected to the increased speed and force of the constricted water.

*Water flows perpendicularly to an object it flows over.* So, build a check dam perpendicular to the channel you are placing it in; consequently water passing over and through the check dam will continue straight down the channel (fig. 10.7B). A check

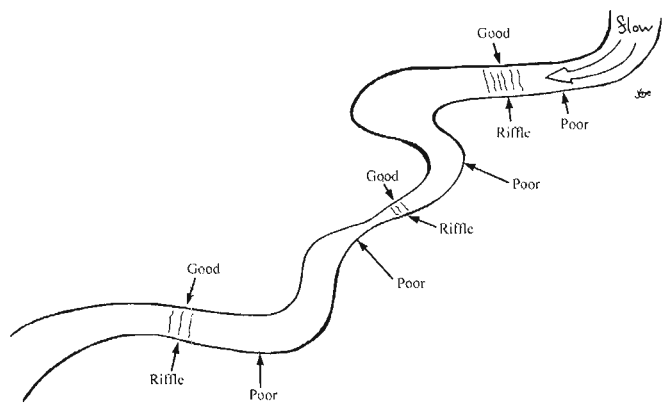

Fig. 10.4. Hypothetical check dam locations, good and poor (plan view)

### Box 10.1. Inducing a Meandering Flow

In appropriate settings, structures called *vanes* or *baffles* are placed diagonally across a drainage to direct water flow into the banks of a straight waterway and induce a more meandering flow. This lengthens the distance the water must travel and slows its velocity, helping to spread and sink the flow. This strategy is beyond the scope of this book, but you can learn more in *An Introduction to Induced Meandering: A Method for Restoring Stability to Incised Storm Channels* by Bill Zeedyk and/or *Let the Water Do the Work* by Bill Zeedyk and Van Clothier. Additional induced meandering resources can be found in appendix 6.

### Box 10.2. Look Above the Drainage and Its Check Dams

Check dams should be *part of a whole* water-harvesting approach for a catchment area. A severely eroding watershed can yield runoff volumes that could wash out even the best-built check dams. Mitigate watershed destabilization such as overgrazing, clearcutting, or all-terrain vehicle use. Infiltration basins, berm 'n basins, imprinting, revegetation, and other techniques might then be needed to stabilize soil and increase infiltration high in the watershed.

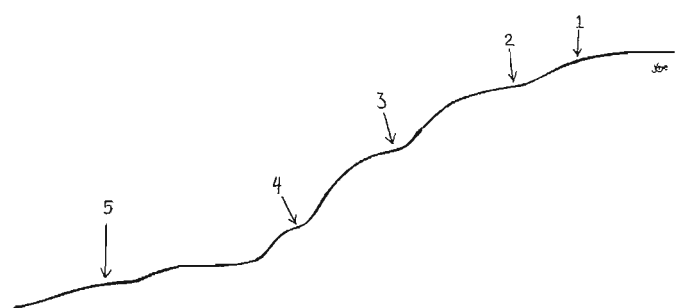

Fig. 10.5. Hypothetical check dam locations (elevation view). 1. Ideal location: Start here high on slope, low water energy. 2. Good location: For second dam, moderate slope. 3. Poor location: Steep slope, high water energy. 4. Very poor location: Maximum slope and water energy. 5. Good location: If other check dams are built first higher up slope. Adapted from Teran Watershed Project and Rock Wedge Workshop (webpage: [www.saguaro-juniper.com](http://www.saguaro-juniper.com))

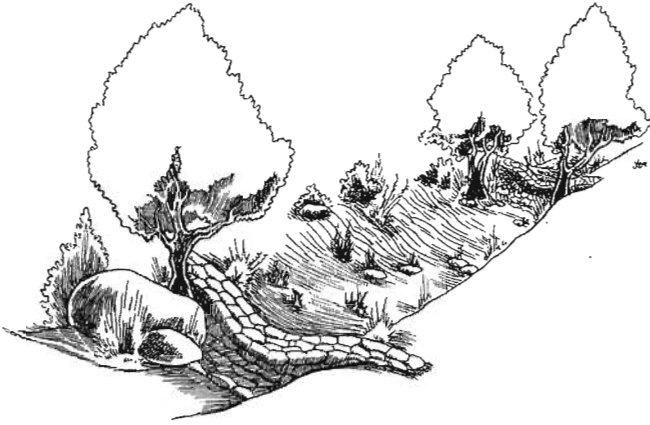

Fig. 10.6. Well-anchored check dams upslope of trees and boulders

dam built at an angle to the channel will redirect the water's flow into a bank of the drainage, causing erosion (fig. 10.7A).

Avoid small drainages where there is not sufficient bank definition and channel depth to contain the bulky check dam and the backing up of water, causing the system to overflow outside the channel.

Continually observe water flow to enhance your understanding of it. The better you comprehend it the better you will be able to place, build/plant, and maintain structures or plantings within and along it. See appendices 1 and 6 for additional resources aiding you in this effort, but above all else just get out there and look—*especially when it's raining*.

You can then build on truth, not lies. For example, check dam clients have mistakenly told me their small ephemeral watercourse had not flowed in years, let alone had a heavy flow. But observation of the watercourse told the truth of a recent heavy flow of water when I spotted relatively fresh water-deposited detritus caught two feet or higher within the branches of the vegetation lining the drainage. To succeed we need to design for what truly happens, not lazy assumptions.

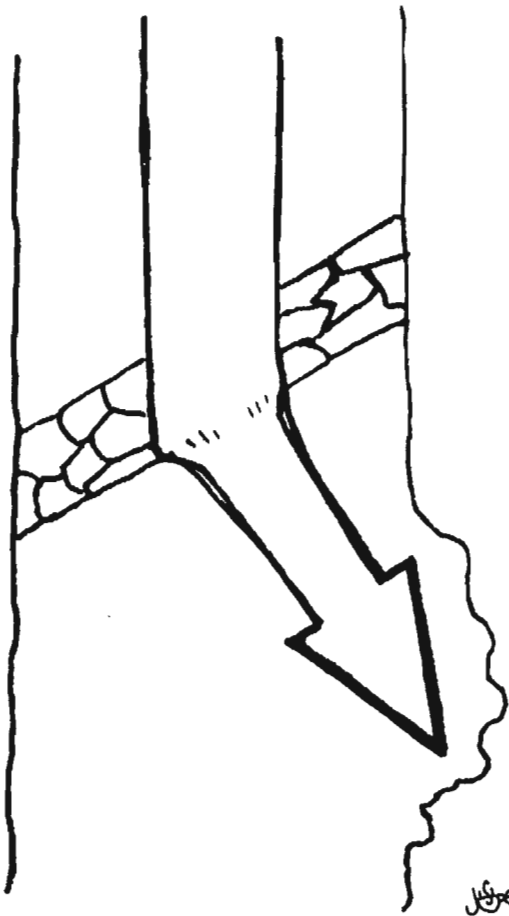

Fig. 10.7A. Check dam set diagonally across the channel causes water flowing over the check dam to flow perpendicularly to the dam into the channel bank

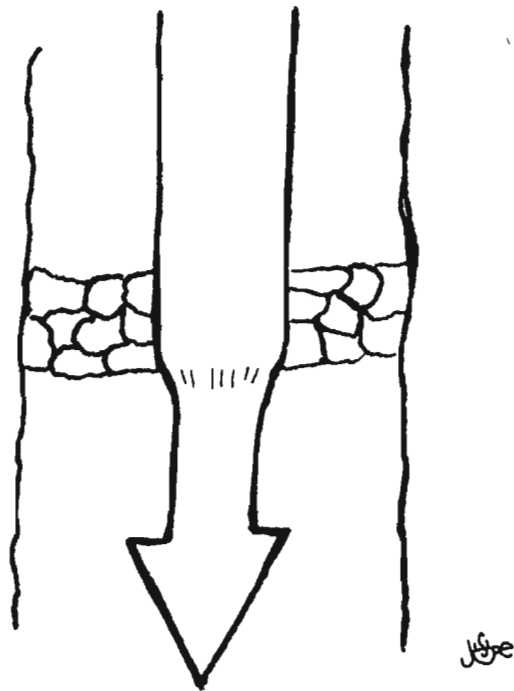

Fig. 10.7B. Check dam set perpendicularly to the channel so water flowing over the check dam will flow perpendicularly to the dam straight down the channel

### Box 10.3. Potential Legal Cautions

Check dam construction in a U.S. drainage that originates upslope of, or that is located off your land, may require a permit, depending upon how many of acres of land are affected and how the regulatory branch of your local Army Corps of Engineers (ACOE) interprets the permitting process. Consult the Clean Water Act, Section 404 permits from the Army Corps of Engineers: <http://www.epa.gov/region5/water/cwa.htm>, and your local ACOE office.

### Box 10.4. Other Precautions

- Check the weather and do not build check dams on days when rain is expected. If water flows through a drainage midway through check dam construction, all your work might be destroyed.
- Wear a hat, gloves, long-sleeve shirt, and closed toe shoes to protect yourself from the sun and rough rocks.
- Do not throw rocks, since someone could be hit accidentally and injured.
- Don't strain yourself. Lift with your legs, not your back. Roll rather than lift heavy rocks. And work with others, rather than doing too much yourself and ending up with a hernia.

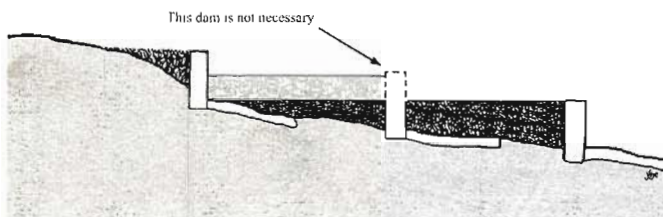

Fig. 10.8A. Poorly placed check dams too close together

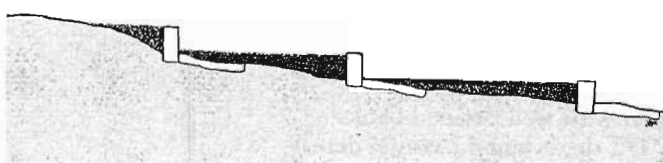

Fig. 10.8B. Well-placed check dams set heel-to-toe

## SPACING

The placement and number of check dams you build will depend on the terrain, the materials you have available, and your energy level (this ain't couch potato work).

Ideally, a series of check dams should be placed *heel-to-toe*, where the *toe* of the level terrace of accumulated soil and sediment behind each downstream dam extends to the *heel* of the downstream-facing base of the next upstream dam. The terrace of soil then stabilizes the upstream dam, but does not bury it. Thus, when siting and spacing check dams, a bunyip water level or laser level can be helpful. Once you've constructed the upper check dam, use the tool to make sure the planned elevation of the top of the next lower check dam will not rise above the base of the constructed check dam above. You can drive a stake into the drainage bed where the lower check dam will be constructed, and mark on the stake the elevation you don't want to exceed when building the lower check dam (compare figs. 10.8A and 10.8B).

Remember that the height of the check dams will also determine their spacing using this scheme—see the "Appropriate Size" section below.

Typically you begin constructing check dams at the top of the drainage and work your way down. However, if a drainage is experiencing rapid headcut erosion (see appendix 1 on erosion patterns), you may need to begin with the construction of a check dam 5 to 30 feet (1.5–9 m) downstream of the headcut as well. The lower check dam will act as a bandage helping stabilize and fill in the headcut, while upper drainage check dams and/or other earthworks will help calm the flow of water contributing to the headcutting (fig. 10.9).

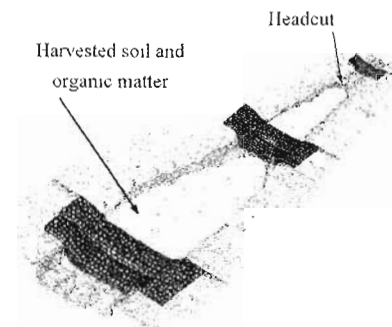

Fig. 10.9. Series of check dams, showing positioning relative to headcut erosion

## APPROPRIATE SIZE

Build check dams no taller than 2 to 3 feet (0.6–0.9 m), and no taller than 1/3 to 1/2 the depth of the channel at the dam's center point in the middle of the drainage (fig. 10.10). Staying within this size limitation will make your check dams easier to build, more stable, and will lessen the chance of water erosively overflowing the channel's banks. This also embodies the rainwater-harvesting principle of starting small, and it is better to place many small check dams throughout the landscape than to build a few large ones that benefit only a small section of the watershed. Smaller check dams are far less likely to blow out or become undercut than large ones.

This book covers check-dam and gabion construction up to a 3-foot (0.9-m)-tall gabion in a 20-foot (6-m)-wide drainage. For larger applications consult with your local Natural Resource Conservation Service agent.

## CONSTRUCTION

This section is broken into two parts: loose-rock check dams and gabions. We begin with loose-rock check dams.

### Loose-rock check dams

Dig down into the bed and the banks of a drainage to create an anchoring trench, locking your check dam into a base of firm soil. Dig the anchoring trench to a depth half the width of the rock you are using to construct your dam. The larger the potential water flow and the less stable the soil, the larger the rock and thus the deeper the trench should be. The trench should be dug *both* into the drainage bed and laterally into the *stabilized* portion of the banks. Stabilized banks have attained a flatter, permanent angle of repose compared to the unstabilized banks, which have an abrupt edge cut by erosion. First: Unstabilized banks should be cut

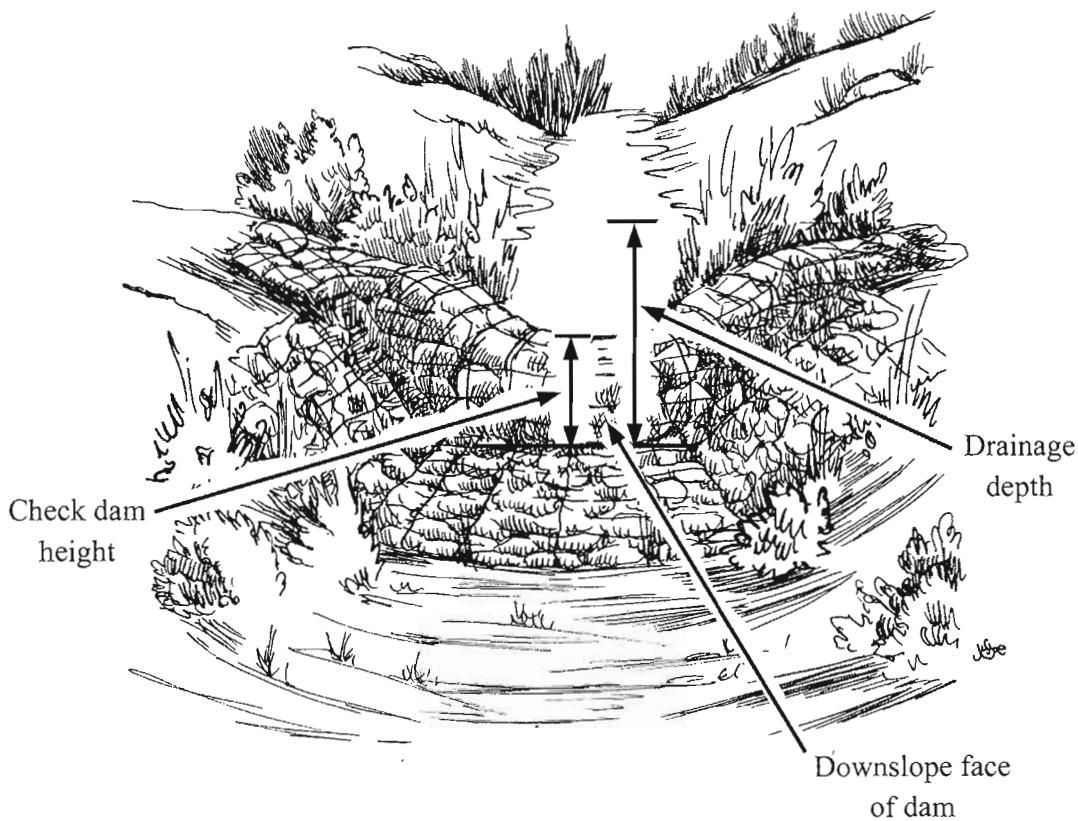

Fig. 10.10. Gabion placed in channel with well-defined banks. Gabion height does not exceed 1/3 to 1/2 the original channel depth.

back to a 1:1 slope or more gradual slope—where your anchoring trench will be dug. *Then* dig your anchoring trench into the more gradual slope (fig. 10.11). Cast all dirt from the trench to the channel upslope of the check dam so it can help jump-start the silting-in of the dam.

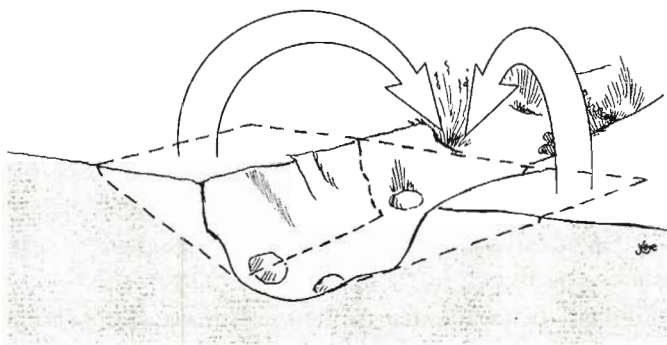

Fig. 10.11. Cut back steep unstabilized slopes before digging anchoring trench, and cast the dirt to the upslope side of the dam.

Carefully lay the larger heavier rocks on the downstream face of the check dam's anchoring trench to secure the rest of the rock in place. These rocks are the foundation stones of your check dam—it is of utmost importance that you set them firmly in position. Place smaller stones in spaces between the larger rocks to prevent water from erosively piping or jetting through unfilled openings. If large voids are not plugged within the check dam, sediment will not accumulate above the structure. The sediment accumulation is needed to increase the stability of the check dam and to stabilize the drainage.

Carefully place the rocks so their weight and placement hold them against and on top of one another. The rock cannot be set at an angle steeper than the angle of rest (or repose) the rock takes, which depends on the type, weight, size, and shape of the individual stones, and how well you set them in place. This angle of repose determines the slope of the upstream and downstream faces of the check dam. Angular rocks or boulders that are large enough to hold their position in the flow of water can be used to build a downstream check dam face ranging in slope from as steep as 1:1 to a more gradual 1.5:1. The upstream face should be ramped at 1.5:1 or more gradual slope to divert a portion of

flowing water over the check dam rather than absorbing the full force of flowing water into a more vertical dam face. Lay or ramp individual rocks so flowing water will press them into place rather than pull them apart. Smaller or round rock does not hold together well and necessitates a more gradual slope on both sides of the dam. (Compare figs. 10.12A and 10.12B, unstable and stable check dams.)

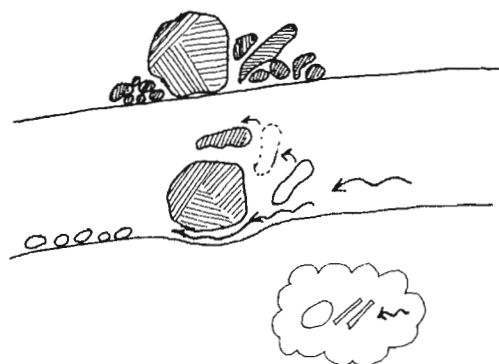

Fig. 10.12A. Unstable check dam. The bottom course of rock is not keyed into the soil, so is undercut by flowing water. Other rocks are randomly and loosely placed, with no attention paid to their angle in relation to water flow, so are displaced by flowing water. The apron rocks are too small, and wash away.

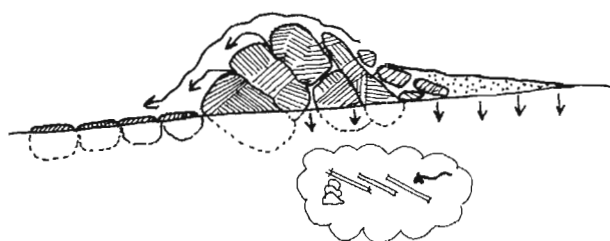

Fig. 10.12B. Stable check dam. The bottom course of rock is keyed into the soil. Rocks are carefully fitted tightly against one another, like roof shingles in relation to the water flow, so water will press the rock in place. An apron of keyed-in-place rock on the downslope side then diffuses the force of water flowing over the structure.

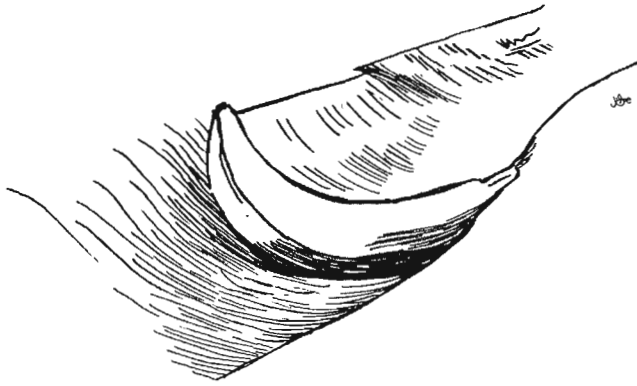

Fig. 10.13. Banana check dam shape. The check dam cuts straight across the channel, while the banana curve creates a dipped spillway in the center of the dam.

Build the top of the check dam in the shape of a banana with the low point of the check dam at its center (fig. 10.13). The center elevation should be significantly lower than the ends of the dam, which should extend upward to the top of each bank, preventing water from cutting around the ends of the dam, and acting as a spillway of sorts. This shape directs overflow water down the center of the drainage, away from the sides of the channel where it could cause erosion or jump the banks. In addition, the gradual slopes of the banana-shaped check dam are less likely to collect clogging debris in heavy flows than check dams having a more constricted and rectangular spillway.

You want to make sure the water backing up behind the dam doesn't cut into the banks or around the ends of the dam. So, create a banana-shaped anchoring trench to create a banana-shaped dam that is tightly anchored into the bottom of the drainage and the banks. When all rocks are laid, filling the trench and rising up to create the dam, the dirt dug out from the trench is packed back in and around the rocks wherever there is a gap between the rocks laid and the edge of the anchoring trench.

When it's built correctly, you should be able to walk across your dam without the rocks moving or slipping. To use the check dam as a stable crossing over the drainage, lay the top layer of rock with the flatter rock surfaces facing up. Do the job well now, and it will last for decades.

A slow, steady, and stable approach is to build a course or layer of a check dam, let it silt up in a storm(s), then build another course or layer, let it silt up, and so on.

## Gabions

A gabion is a check dam in which rocks are held by a wire basket; the text in this section describes gabions constructed with prefabricated gabion baskets and apron mattresses (boxes 10.5–10.8 describe construction and additional details for use of homemade gabion baskets and aprons).

To construct a gabion, begin by digging an anchoring trench into the bed and banks of the drainage, perpendicular to the direction of water flow. A trench 12 to 18 inches (30–45 cm) deep and 18 to 24 inches (45–60 cm) wide will typically anchor a rock gabion with a finished height of up to 2 feet (60 cm) above the original level of the drainage bed. Make the trench 24 inches wide for a gabion up to 3 feet (0.9 m) tall. If you are using prefabricated gabion baskets, make the trench just a tad wider than the gabion basket so it fits in easily. Dig the trench 18 to 24 inches (45–60 cm) into the *stabilized* bank on both sides (stabilized banks have a more gradual, permanent angle of repose than banks that are being rapidly cut by erosion). If you find the banks are unstabilized, *before* you dig the anchoring trench cut unstabilized banks back to a slope of 1:1 or more gradual to improve stability—then dig the anchoring trench (see fig. 10.11). Cast the dirt from the trench you dig to the upslope side of the gabion to jump-start the silting-in process.

Prefabricated gabion baskets will take on the form of a *gradually* sloping trench in which they are laid, so dig the trench in the form of a banana. Make the low point of the trench and the gabion at the center of the drainage, significantly lower than the top of either bank. Make the ends of the trench and the gabion extend upward, in a banana-like curve, to the tops of the banks (fig. 10.14; fig. 10.22 shows the finished gabion). Water backing up behind the gabion will overflow over the low center point without eroding the banks (fig. 10.15 shows a gabion “blow out” where water backing up behind the straight-topped





Fig. 10.14. Gabion baskets lined with landscape fabric being laid in a trench sloping up the banks. Landscape fabric and excavated dirt are on the upslope side of the basket. Note that the basket top is folded open to the upslope side, so when it is folded closed it will be folded in the direction of water flow. Compare to figure 10.22, which shows the finished gabion.

gabion lacking adequate bank protection has eroded a new channel on one side of the gabion). The low center point can also be attained by installing additional shorter gabion baskets against the banks of the drainage and atop the bottom basket.

Line the excavated trench with 2 inches (5 cm) of mulch or fine brush; or, attach landscape fabric (a permeable geotextile available from suppliers of erosion control products) to both the *underside* and *upstream* side of the gabion basket (fig. 10.14). The mulch, brush, or fabric will reduce the chance that water moving through the rocks of the gabion will loosen or “pipe” through the soil below. The more tightly you



Fig. 10.15. Poorly built gabion with a flat top and no low center or bank protection. Flowing water was spread to the banks where it cut around the gabion at the left, so the soil has eroded.

#### Box 10.5. Homemade Wire-Fencing Gabion Baskets Versus Premanufactured Gabion Baskets

For projects with just a few small gabions, I get woven-joint wire fencing (welded joints come loose with rust) from a hardware or feed store, and custom build each gabion to the size and shape I need.

For projects that need a large number of gabions or larger gabions, using pre-manufactured gabion baskets can save you time, and they are stout enough to be loaded full of rock with a backhoe or front loader. They come in rectangular shapes typically 3 feet (0.9 m) tall, 3 feet wide, and 6 feet (1.8 m) long, and need to be special ordered from companies such as Maccaferri Gabions ([www.maccaferri-usa.com](http://www.maccaferri-usa.com)).

pack the rocks together and thoroughly fill large voids with smaller rock, the less mulch, brush, or fabric will be needed, if at all.

If you are using premanufactured gabion baskets, assemble them according to the manufacturer’s directions. If you are constructing your own gabion baskets using wire fencing, follow the instructions in boxes 10.6–10.7. In either case, place your baskets in the trench, then tamp the bottom of the structure firmly in place.

### Box 10.6. Making Your Own Gabion Baskets

To make a gabion basket, cut a length of field fencing the same length as your trench. If the soil of your trench is firm, center the length of fencing over the full length of the trench. Walk on the fencing, compressing it into the trench and forming it to the trench's shape.

If the soil of your trench is loose and collapses when disturbed, bend and form your fencing to the dimensions of your trench before you place it in the trench. To do this, lay the fencing out on the ground, and place your foot, or a wooden 2 × 4 held in place by your foot, along the line where you want to make a 90° bend. Then, bend the fencing up against the edge of your foot or the wood (fig. 10.16). Continue along the full length of the cut section of fencing until it is in the shape of an "L." Make another 90° bend barely less than the width of the trench from the first bend. The fencing should now be in the shape of a "U." Place the "U" right side up in the trench. Walk into the "U" and tamp the fencing flush with the bottom and sides of your trench. You've got the foundation of your homemade basket in place and ready for reinforcement.

Now cut additional pieces of fencing to the width and planned height of your gabion to act as end pieces and reinforcing cross braces that will break up your continuous basket into 2- to 3-foot (60–90 cm) wide cells or compartments. Wire or hog-ring the braces to the bottom and each side of the basket, up to the top of the trench (fig. 10.17). Cut your cross braces to the height at which you plan to build the gabion. These braces help hold the vertical-walled shape of the basket while you fill it, and help to strengthen it when complete. (Cross braces installed to the planned height of a gabion can be seen in figure 10.18.)

Fold open the sides of your basket for easy access, and weigh down the basket with rocks. The cross braces should be sticking up vertically. You are now ready to begin filling your basket with rock.



Fig. 10.16. Bending fencing into a gabion basket. Two lengths of fencing were first overlapped and hog-ringed together to make a larger basket. The longer side of the basket will go on the upstream side of the trench so it can later be folded downstream to cover the top of the rock that will be placed within the gabion basket. Excess fencing can be cut off once the rocks are placed within, and fully wrapped by, the basket.

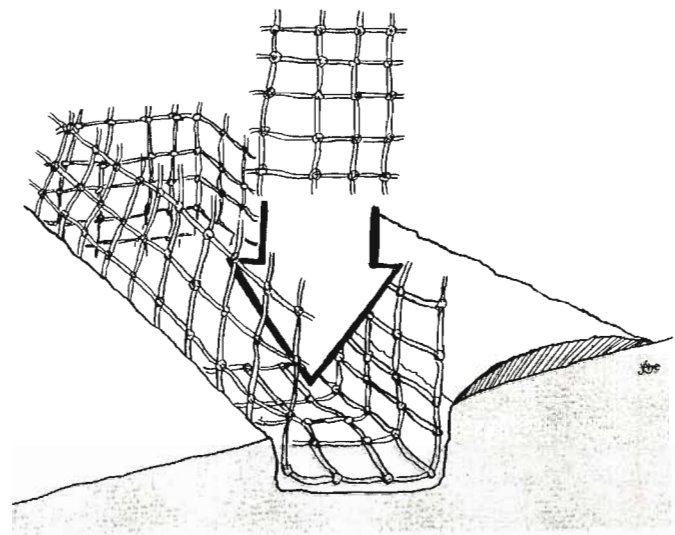

Fig. 10.17. Reinforcing the gabion basket by inserting cross bracing

Set rock in the gabion basket, using rock larger than the openings in the wire (fig. 10.18). Carefully set rocks in place so the rock fill is as firm, stable, and dense as possible. Fill large spaces between rocks with smaller stones to prevent water from piping or riffing through any big openings.



Fig. 10.18. Setting rock within a homemade gabion basket. Angled rocks are set firmly in place, with the larger rocks placed at the bottom, and the flat faces of large rocks facing outward for a neater appearance. Smaller rocks can then fill the core of the gabion. The basket lid is temporarily weighted down with rock so gabion builders can walk over it as they step in and out of basket. Direction of water flow is from left to right, so gabion will help stabilize once-eroding road. The entire pile of rock will be used within the gabion basket and its apron.

If you have a large group of people, one person per gabion compartment should be a builder. Other people bring materials to each builder, who then sets rock in place. Organize a “bucket brigade” of folks to move rock from a distant pile to the structure (fig. 10.19). *Do not throw any rocks—the potential of someone getting hit by a thrown rock is too severe a danger to risk.*

Fill the basket to the top with carefully laid rock. Lay the top course of rock with relatively flat sides facing up. Pull the gabion lid tightly over the rock, and fasten the seam at least every 6 inches (15 cm) with wire or hog rings (see figs. 10.20 and 10.21). When finished, your rock fill should have vertical sides set tight within the gabion basket, and a relatively flat top curving like a banana up the banks of the drainage. The top of a well-made gabion can be an attractive, functional footpath (see figs. 10.22 and 10.23).



Fig. 10.19. Bucket-brigade rock delivery

### Box 10.7. Filling the Homemade Gabion Basket, Attaching Cross Braces, and Finishing

Carefully set your rock within the basket until the rock is level with the top of your trench. The largest rocks should be at the bottom as a heavy base.

Unfold the sides of your basket that are lying on the ground, and set them vertical. Using wire or cage rings, fasten the cross braces to the sides of the basket every 2 to 4 inches so they are tight and secure all the way up to the top of the basket.

Now fill the basket up to your planned height, beginning at the gabion's lowest point—the bottom of the banana curve at the center of the drainage. Once the elevation of the gabion is set at the center, continue laying rock to either side, raising the level as you move toward either bank.

Note: If your trench has a substantial banana bend you may find your gabion basket gets looser the higher you stack your rock. If this is the case, stack your rock to the desired height of the gabion. Then make occasional folds in the loose fencing to take up the slack. Compress these folds against the rock face of the gabion and wire or hog-ring the fold in place. Rib-joint pliers, sometimes known as channel lock pliers, are handy to pull sections or folds of the basket tightly together before wiring or hog-ringing them in place.

Tightly fold the remaining sections of the basket over the top of your finished rockwork, with the downstream side of the basket beneath the upstream side (so flowing water will press your seam closed rather than pry it open; refer to figure 10.21). Make sure you have a minimum overlap of 4 inches (10 cm) for strength. Pull the basket tight against the rock. Rib-joint pliers work great to pull the basket tight when the pliers squeeze two different sections of the basket together. Fasten the basket shut with hog rings or wire, every 6 inches (15 cm) along the seam (see figure 10.20).

If your basket sides are not long enough to cover the top of your gabion, or they do not extend as tall as you'd like to build your gabion, add another length of fencing to the upstream side or both sides of your basket (depending on how much is needed). Do this after most of the existing basket is filled with rock and anchored in place. (The additional length(s) of fencing can get in the way of workers bringing in and laying rocks, so try to postpone adding it until it is needed.) Overlap the new section of fencing 4 inches (10 cm) over the old, fastening the seam every 6 inches (15 cm). Tie your basket cross braces to the extended sides of your basket and continue to build your gabion.

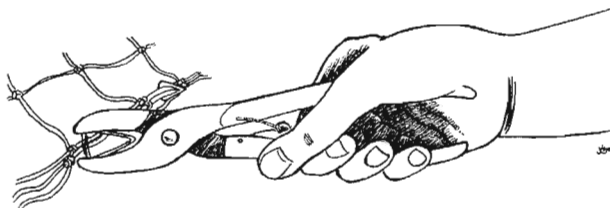

Fig. 10.20. Hog-ring pliers fastening basket seam with a hog ring

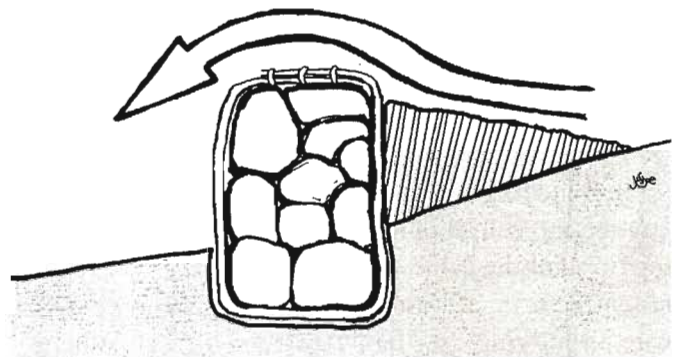

Fig. 10.21. Fold top of basket in direction of water flow.

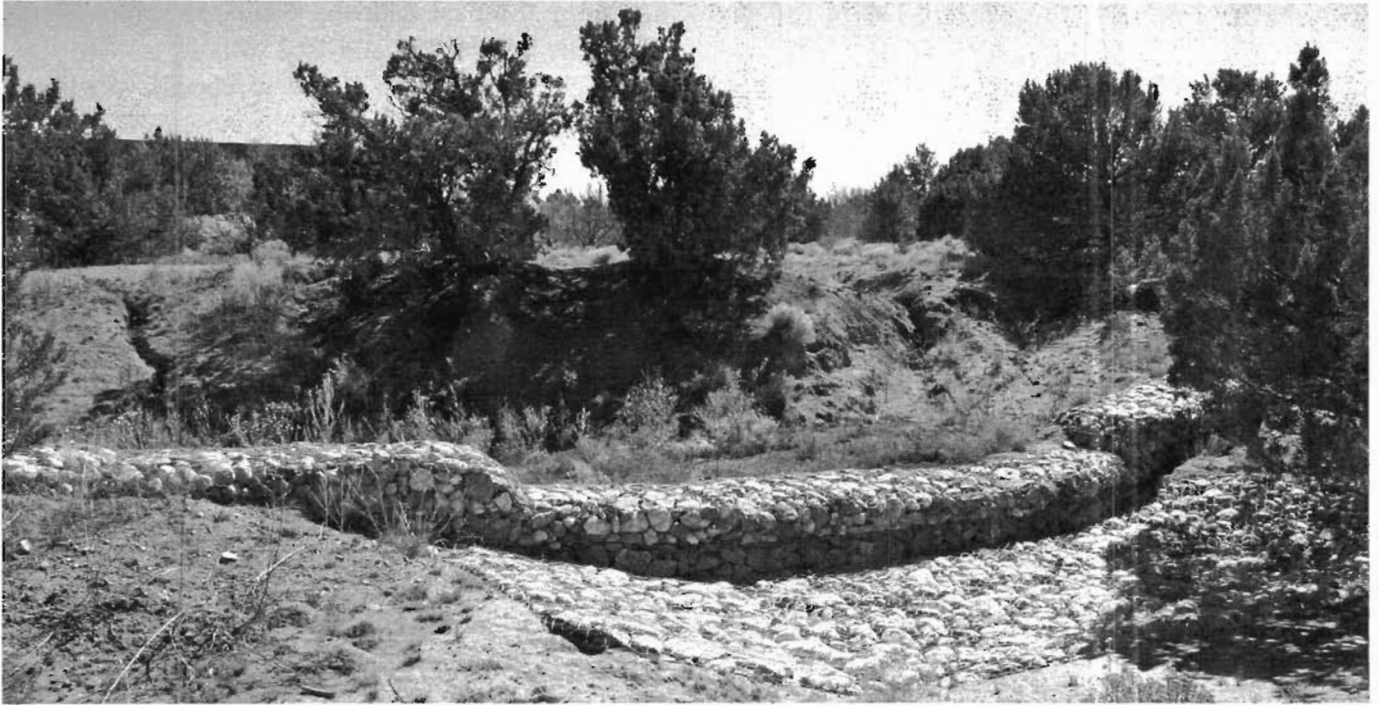

Fig. 10.22. Finished gabion (from fig. 10.14 earlier) with a flat enough top and gradual enough slope to work as a footpath. Note the wire-wrapped apron downstream. Work of San Isidro Permaculture. Museum Hill complex, Santa Fe, New Mexico



Fig. 10.23. Gabion steps crossing a drainage. Work by Santa Fe Permaculture

## LOCATION AND CONSTRUCTION OF APPROPRIATE SPILLWAYS FOR OVERFLOW: THE "APRON"

If the bottom and sides of the channel in which you are building a loose-rock check dam or gabion is bedrock, your work is done. If not, there is one last step: Create an "apron." The apron is a platform of large (preferably flat) rocks set on the bottom and sides of the channel along the entire length of the downstream side of the check dam or gabion. The apron begins where the downslope side of the check dam stops. Like a kitchen apron, it keeps things from getting too messy. The rock apron absorbs and breaks up the erosive force of water spilling over the dam in heavy storm flows (fig. 10.24). If this force were not abated, the falling water would eventually erode soil

out from under the dam and destroy all your work (compare figs. 10.25A and 10.25B).

A check dam apron can be wrapped in wire like a gabion apron. However, often the loose-rock check dam apron is just rock, large enough that it won't wash away, set level with the natural bed and banks of the drainage. A gabion apron is wrapped in a wire apron basket or mattress, similar to the gabion basket, and is also set so the top of the apron is at the level of the natural bed and banks of the drainage. You don't want the top of the apron to rise above the level of the natural bed or it will create another erosive waterfall of flow. Check dam aprons should be at least 1.75 times as long from front to back as the check dam or gabion is tall.<sup>3</sup> Thus a 2.5-foot (75-cm) high check dam should have at least a 4.3-foot (129-cm) wide apron (fig. 10.26).

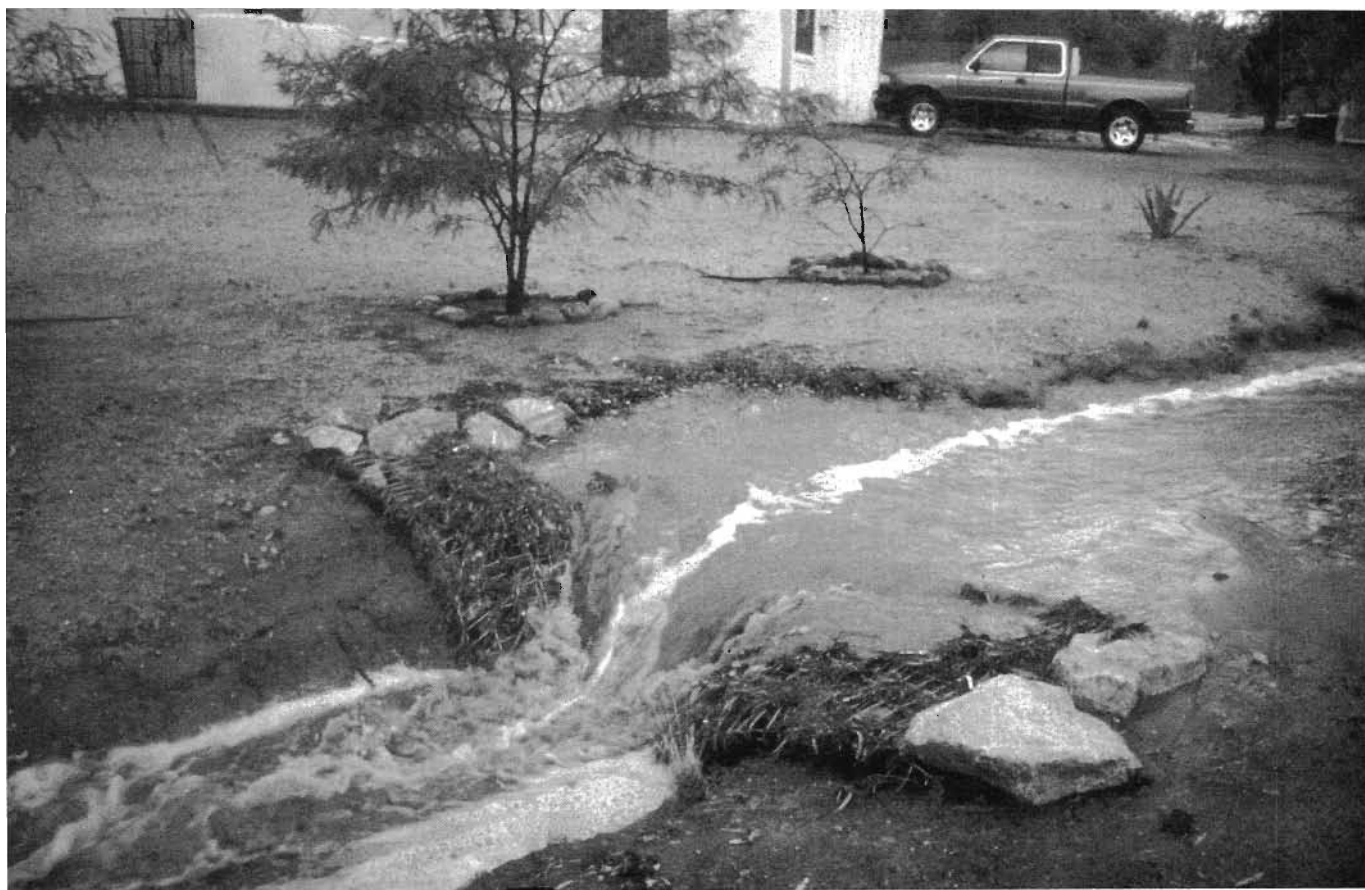

Fig. 10.24. The apron of a small gabion diffuses force of falling water, and captures fertile organic matter. Note: While the check dam is currently working, more of the runoff needs to be harvested higher in the watershed. Drainlike landscapes such as the one in the background need to harvest the rain on site instead of draining excessive runoff and topsoil to the ditch. Credit: Ann Audrey

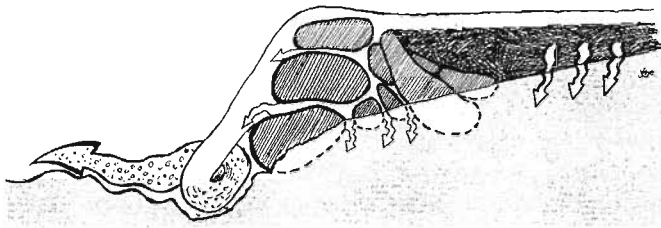

Fig. 10.25A. Unstable check dam without apron

If you are building a loose-rock apron, excavate a trench of sufficient depth to anchor the rocks of the apron while leaving the top of the finished apron roughly level with the natural bed and banks of the drainage. As always, toss the spill dirt on the upslope side of the check dam to speed up the silting in process.

If you are building an apron for a gabion, you will need to encase the apron in a wire basket similar to the kind used for the gabion itself. You can purchase premanufactured apron baskets (sometimes called

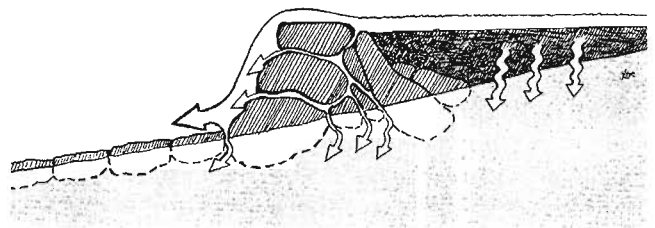

Fig. 10.25B. Stable check dam with apron. Note that a bedrock apron is far superior to loose rock for a check dam multiple rocks high due to “waterfall effect”

“mattresses”), or make them out of field fencing (box 10.8). Either way, line the apron trench with 2 inches (5 cm) of mulch or fine brush, then set the apron mattress over the brush. As an alternative, you can attach landscape fabric to the underside of the apron mattress. The brush or landscape fabric liner will reduce the force of water flowing through the rocks. Fasten the apron mattress to the base of the gabion every 6 inches (15 cm).

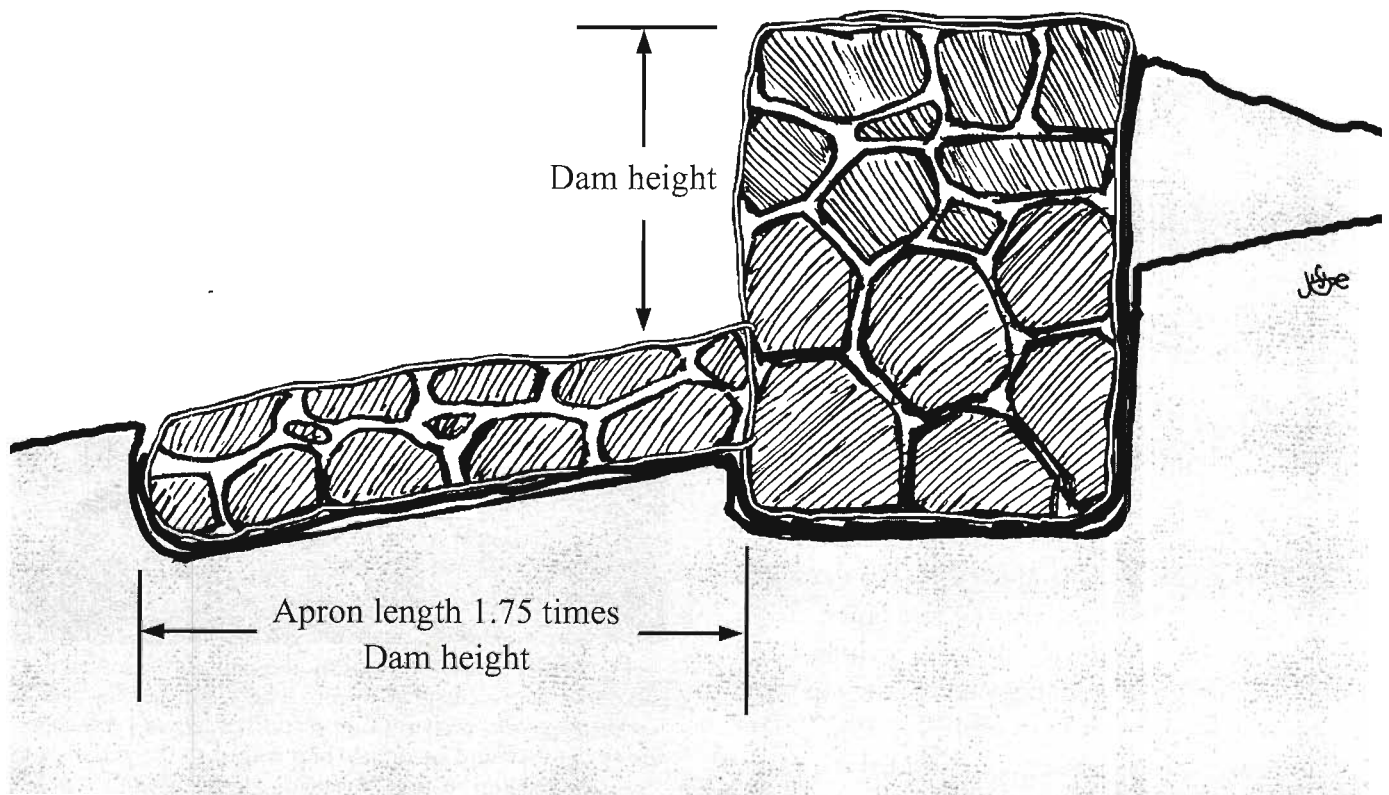

Fig. 10.26. Gabion apron at least 1.75 times as long as check dam is tall. Note how the top of the apron is flush with the drainage bottom.

## Box 10.8. Wrapping Your Gabion Apron in Fencing

First dig a shallow trench the depth, width, and length of your planned apron. Then lay a length of fencing within the apron trench from one end of the gabion to the other on the downslope side. Fasten the fencing to the gabion's base every 6 inches (15 cm). If needed, lay another length of fencing along the first. Overlap the two at least 4 inches, and fasten them together every 2 to 4 inches (5–10 cm). Keep attaching more lengths of fencing until you have enough to cover the bottom of the apron trench and to fold back up and over to cover the top of the apron (fig. 10.28).

Lay your rock on top of the fencing within the trench. The apron basket should be tightly filled with enough rock so that you cannot see the soil below.

When the trench is filled, tightly fold the fencing over the top of the laid rock, and fasten it securely to the base of the gabion every 6 inches. Quilt the apron tight as needed (fig. 10.27).

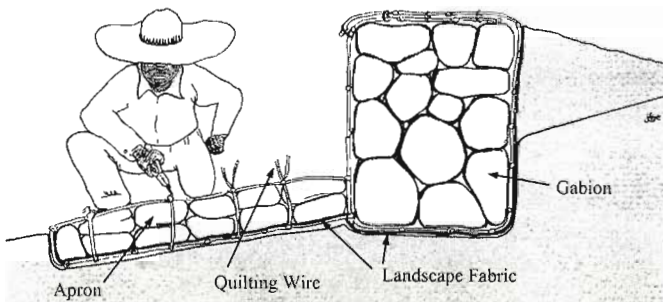

Fig. 10.27. Quilting a gabion apron

You will need to “quilt” all homemade gabion aprons to make sure the apron rocks don’t get pushed to one end by a heavy flow of water. To “quilt the apron,” tie lengths of 14-gauge wire every 12 inches or so to the underside of the apron mattress. Fill the mattress *tightly* and *densely* with rock while bringing the lengths of wire up between the rocks—pack the rocks densely enough so you cannot see the soil beneath the rock apron. The finished top of the apron should be level with the natural bed and banks of the drainage. Close the top of the apron mattress and fasten the closure every 2 to 4 inches (5–10 cm). Securely tie the free ends of your “quilting wires” to the top of the apron locking the rocks in place (fig. 10.27). Pre-manufactured apron mattresses are divided into basket cells so you can quilt the apron basket by hog-ringing or wiring the cross braces of the cells to the top or lid of the apron mattress.

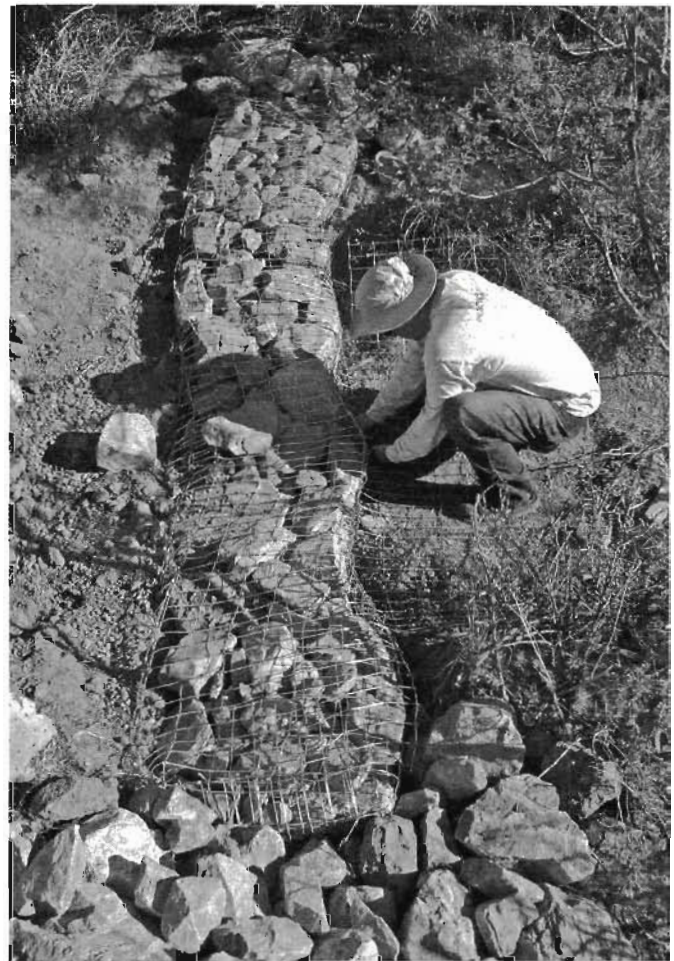

Fig. 10.28. Attaching section of fencing to completed gabion basket to create an apron. The apron fencing will be covered in rock, then another section of fencing will cover the apron rock and be tightly hog-ringed to the gabion and bottom section of fencing, encasing the rock in fencing. Notice the dirt excavated to create the gabion’s anchoring trench has already been packed around the gabion basket on the upslope side. Also, apron is worked around existing, soil-stabilizing vegetation.



### Box 10.9. Do Not Underestimate the Value of the Apron

Near Patagonia, Arizona, I observed a series of 2- to 3-foot (60–90 cm)-high gabions without aprons scattered within a badly eroding drainage of clayey soil. Four years after construction, erosion was being checked and a tremendous amount of soil was being held just *upstream* of the gabions, but directly *downstream* of each apron-less gabion the storm water running over the gabions had cut pits up to 3 feet (90 cm) deep that were threatening to destroy all the work! New gabions (with aprons) were needed downstream of the pits to help fill them in with harvested soil. However, if the original gabions had had aprons in the first place, the extra work would not have been necessary.

Tamp the soil around the base and all edges of the loose-rock check dam or gabion and the associated apron with the end of a shovel handle (best for tight spots), your feet, or a hand tamper. This will make it harder for flowing water to dig out and carry away soil otherwise loosened and disturbed by your work.

## PLANTING YOUR CHECK DAM

Once a check dam or gabion has silted in, you can distribute seeds of plants native to the area around the dam, though some seeds will distribute themselves by flowing in with runoff water. Native grasses are well suited to filter fine clay particles from muddy water and build soil in gully bottoms. *Asparagus* (*Asparagus* spp.), Apache plume (*Fallugia paradoxa*), and seep willow (*Baccharis salicifolia*) can be planted within the terrace of a check dam in appropriate climates. These plants are drought tolerant, yet have the ability to lie down in periodic heavy water flows, get covered in soil, and sprout back out of the soil in more places than before the water flow. Look for plants in your area that will do the same.

## MAINTENANCE

Check on your structure regularly, especially during or just after big rains. This is an important step

with check dams, since they are more susceptible to damage or failure due to their placement in water-courses. If any rocks from a dam, gabion, or apron have migrated downstream, replace them with larger, heavier rocks, or reinforce the structure with wire wrap. Add rock and increase the quilt points in a loose gabion mattress. If water is flowing around a check dam, adjust, lengthen, or reinforce it so water is directed over and through the dam in the center of the drainage instead. If scouring is occurring on the downslope side of your check dam, install or reinforce an apron. Did you start high enough in the watershed? Did you consider strategies other than just check dams? If not, get on it now.

## VARIATIONS OF CHECK DAMS

### ONE-ROCK DAMS

One-rock dams are the easiest check dams to build, and due to their low profile are very stable and prone to minimal scouring. They are just one rock high (no stacking of rock) and placed in three to five parallel rows packed tightly together across the drainage. There is no apron. The low elevation and horizontal orientation of the one-rock dams encourages the recruitment of vegetation directly within the structure, and the plants then further roughen the basin bottom, slow the flow of water, hold more soil, and anchor the structure with their roots. These structures don't necessarily raise the elevation of a drainage bottom, rather they stabilize the existing grade.

One-rock dams are best suited to rocky, ephemeral drainages.<sup>4</sup> Select and place your rock so the structure is more or less level from bank to bank, and ensure the height of the dam does not exceed 1/3 the bankfull depth of the channel so water will not be diverted out of the drainage. As is specified in the excellent booklet *An Introduction to Erosion Control* by Bill Zeedyk and Jan-Willem Jansens, "size rocks proportionately to the 1/3 bankfull depth of the channel, 20–40 pound (9–18 kg) rocks for a channel one foot (0.30 m) deep, 60–80 (27–36 kg) pounds for streams one and a half feet (0.45 m) deep."<sup>5</sup> Do not use greatly oversized rock that will cause excessive turbulence that could undermine the structure.<sup>6</sup> See figures 10.29A, B.



Fig. 10.29A. One-rock dam, Red Windmill Draw, Malpai Ranch, near Douglas, Arizona. Reproduced with permission from *An Introduction to Erosion Control* by Bill Zeedyk and Jan-Willem Jansens. Photo credit: Van Clothier



Fig. 10.29B. Two months later, after summer rains, new vegetation has grown upstream of the stabilizing dam. Reproduced with permission from *An Introduction to Erosion Control* by Bill Zeedyk and Jan-Willem Jansens. Photo credit: Van Clothier

Maintenance requires replacing rocks scoured away by flood flows or widening the structure with additional rock if flows begin to cut around it.<sup>7</sup>

For more informational resources on one-rock check dams, see appendix 6.

## BRUSH CHECK DAMS

Brush check dams are a traditional method used in alluvial fans of the arid southwest U.S. and the Negev desert. They reverse the concentrated and ero-

sive flow of runoff in deepening channels by dissipating the water's flow with fine mats of woody material that slow, spread, and sink runoff, sediments, and the nutrients they carry over more area—and often into channel-side, dry-farmed agriculture. They typically do not exceed 3 feet (1 m) in height, and last three to five years under unfavorable conditions.<sup>8</sup> They are less durable than rock check dams and may require more maintenance, but they are quick to build, maintain, and replace and do not require an anchoring trench or stone apron when constructed. And when placed higher in the watershed (fig. 10.30), and in drier climates where water flow is more variable and unpredictable, they can be very effective (fig. 10.31).

Monitoring traditional Zuni brush dam construction in northern Arizona and New Mexico, researchers Jay Norton and S.F. Siebert; with Zuni farmers F. Bwannie, P. Peynetsa, and W. Quandelacy found the dams respond differently to a wide range of flow. For example, in small flows (a yearly recurrence), the



Fig. 10.30. Brush rill-repair, Occidental Arts and Ecology Center, Occidental, California. This photo was taken a while after the work, so soil disturbance is no longer visible.



Figure 10.31. Brush check dams with punjie posts immediately upstream in the lower part of the Lallo arroyo on the Zuni Indian Reservation, Arizona. Note the waterlines behind the structures and the effect of brush clearing along banks. Reproduced with permission from “Native American Methods for Conservation and Restoration of Semiarid Ephemeral Streams.” Credit: Jay Norton

brush accumulates some water and sediment, while slowing—not stopping—its flow down the channel. In moderate flows (1.5- to 10-year recurrence), the brush accumulates more resources, slows the flow down the channel, and protects the channel from additional incision (especially when the dams are constructed heel-to-toe or fill the channel) (fig. 10.31). And in large flood flows (a rarer occurrence), the structures act as a pressure-relief valve, giving way and avoiding major bank and channel erosion as occurs when rigid structures breach. Debris jams then form farther downstream where the brush accumulates and diverts some of the bankfull flows over the channel’s banks to deposit water and sediment over a much larger area, while also filling in much of the incised channel.<sup>9</sup> It’s an elastic strategy where once the woody material is in the channel, Zuni brush-dam builders say, “Mother Nature will move it to where she wants

it.” Thus it is believed that over-strengthening of the brush dams with anchoring trenches and the like would cause more damage when larger floods take the structures out.<sup>10</sup>

To construct a Zuni-style brush check dam, as with any water-harvesting strategy, understand the land and flows you are working with by beginning, and continuing, with long and thoughtful observation. This method is based on the Zunis’ understanding of their particular environment, and it’s constantly evolving as they encounter new conditions. Start at the top of the watershed in an area where brush is naturally abundant. This will prevent additional erosion and costs from vehicular transport of materials. In addition, the gathering/clearing of the abundant brush and pruning of the lower branches of trees (for punjie posts and larger, heavier material) can encourage more native-grass growth and improve sightlines for livestock in

areas that are grazed. Put as much brush as possible in the channel, stomping it down as you do so. The less brush that is available the more important it is to carefully lay, weave, and anchor the brush into the drainage, via existing outcroppings of rock, exposed roots, vegetation, posts driven into the soil, or the brush weighed down with occasional large rocks or logs—basically making do with what's at hand. Make a tight, dense net of brush that will truly slow the water flow, not a loose net with gaping holes that will too easily float away or concentrate and speed water flow rather than slowing it.

Brush piles are one of the simplest Zuni methods. Simply stomp down the brush and layer it sparingly with rock and larger logs, but only if such materials are readily available. Pack, weave, and interlock the material into shallow rills of the upper drainages with the goal of putting as much woody material as possible into the channel. If you are using fresh cuttings of willow (*Salix* spp.), poplar (*Populus* spp.), or the more drought-tolerant Apache plume (*Fallugia paradoxa*), mulberry (*Morus* spp.) or seep willow (*Baccharis salicifolia*), and there is adequate soil moisture for rooting, shove the butt ends of the brush into the banks so they can take root and grow.

Another traditional Zuni method uses pungie posts. As described in “Native American Methods for Conservation and Restoration of Semiarid Ephemeral Streams,” “pungie posts” consist of clusters of pinyon and juniper limbs and stems set into the arroyo bed to form comb-like structures that capture woody debris and create reinforced debris jams during flow events. The posts were set at least 2 feet (60 cm) into the ground, angled upstream. Placement was downstream from brush-pile structures and upstream from other types to protect and reinforce them. Some of the pungies were reinforced with post-and-wire braces. Part way through the season, the workers decided to alter this method by leaving the fine branches on the posts so that, if posts washed out, they would function as woody debris.”<sup>11</sup> Smaller branches can also be woven around the posts, across the drainage. Whether weaving branches or not, the pungie-post method also avoids the need for anchoring trenches (fig. 10.31).

For more information on these and other brush check dams, see the resources in appendix 6.

## STRAW-BALE CHECK DAMS

Straw-bale check dams are similar to brush check dams. They are just as short-lived, with the bales taking the place of the brush running perpendicular to the drainage. You must plan and plant or seed for revegetation of the straw-bale check dam to occur before it decomposes. The spongelike nature of the straw bales will hold moisture for extended periods and help support the growth of new vegetation.

Do not place this type of dam in large drainageways or those with heavy flows. To keep you “in check” do not make a straw-bale dam larger than three bales long, until you are familiar with the strategy and have observed the effect of a three-bale dam in the landscape.

To construct a straw bale check dam, dig a trench the length of your dam, the width of your straw bales, and  $\frac{3}{4}$  the depth of your straw bales. Burying the bales to at least  $\frac{3}{4}$  their depth helps keep them from floating away, and lessens end cutting around the bales or undercutting below them caused by impounding too much water. Place dirt on the upstream side of the trench. The trench should be banana-shaped with the low spot of your dam in the center of the drainage, and the two ends rising up the banks (fig. 10.32).

Place your bales firmly next to each other, one bale high. Jump on them to bend them into the slightly curved shape of the trench. When the bales are in place, the low point of the dam must be in the center of the drainage to act as a spillway, and the banks must be protected by the rising ends of the dam. This

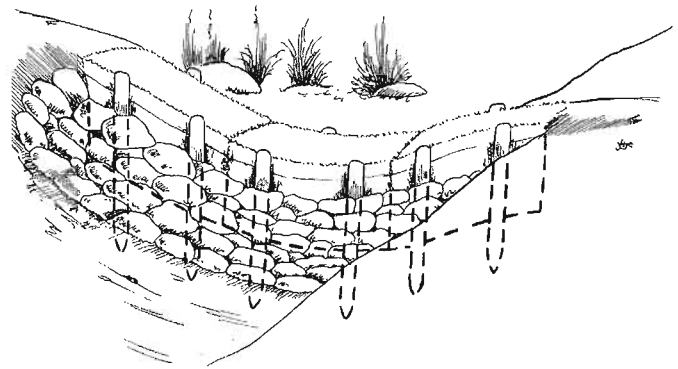

Fig. 10.32. A straw-bale check dam with rock apron. The stone apron prevents erosion from water flowing over the straw bales.

will prevent water from cutting around the sides of the bales and eroding the banks of the drainage.

If needed, drive three vertical wooden posts either right next to each straw bale (one upslope and two downslope), or drive the posts through the middle of each bale. Create an apron with rock or brush. Pack excavated dirt against the upslope side of the dam and fill any holes, openings, or low spots around the bales.

Note: In some areas of the United States, bales of shredded tires are used as damlike structures. I do not advocate this. The bales of shredded tires are not pervious enough, and they will litter the watercourse as they decompose.

## FENCE GABIONS

Gabion variations include single- or double-fence gabions. Fence gabions often entail constructing one vertical section of 32-inch (80-cm)-tall, or shorter, woven wire fence perpendicular to the flow of an ephemeral drainage. The bottom of the fence is anchored within a narrow trench. Once the trench is backfilled, attach another section of the woven wire fence to the base of

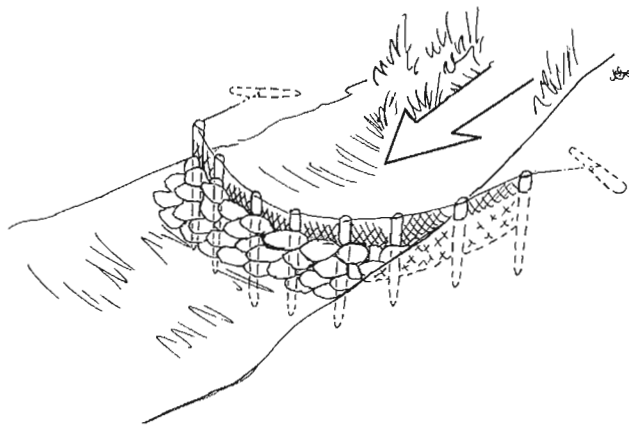

Fig. 10.33A. A single-fence gabion, perspective view. The bottom of the woven wire fencing is buried in the anchoring trench. Posts are placed 2.5 to 3 feet (0.75 to 0.9 m) apart on the downslope side of fencing. Connecting 9-gauge wire is wrapped around the top of all posts along the top of the fencing, and is then anchored into the banks via buried anchors or “dead men.” Rock or brush apron stabilizes overflow. Fencing is put in like a banana, and bowed somewhat downstream. The dip in the center of the gabion could also be a “V” made by running two sections of fencing from either bank, or by cutting and folding one section of fence.

the first and lay it on the bottom of the drainage (upslope side of structure), and stake in place. Loose rock or a thick layer of mulch covered with some soil is then stacked on the upslope side of the vertical fence, and atop the horizontal section of fence (figs. 10.33A, B). This technique uses less rock than a loose-rock check dam, and is easier to key into the banks and drainage bed than a typical gabion due to the much narrower key trench. It is an alternative to a gabion basket in ephemeral drainages with light water flow.

For further information on these and other styles of gabions see appendix 6.

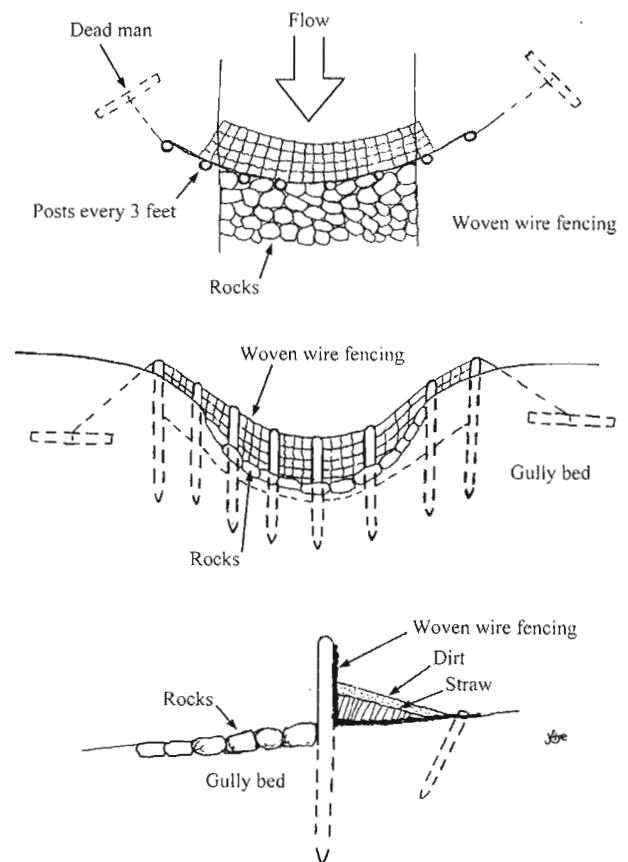

Fig. 10.33B. Plan, cross-section, and side views of single-fence gabion. Adapted from “Recommendations for the Control and Reclamation of Gullies.” Note: Dead-man anchors are often unnecessary in smaller drainages.

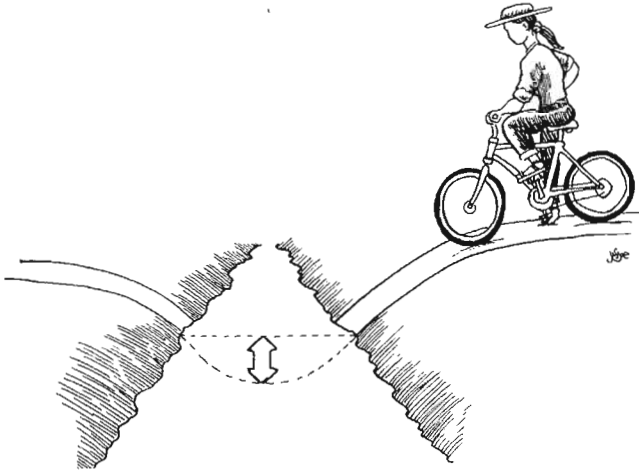

Fig. 10.34A. Deep unpassable flow without a check dam. Arrow denotes deepest depth of water.



Fig. 10.34B. Spread-out, shallow, and passable flow with check dam. Arrow denotes deepest depth of water. The gabion itself is just downstream of the road, so that the road is on the silted-up terrace behind the gabion, not on the gabion itself.

## MULTIPLE FUNCTIONS OF CHECK DAMS

### CHECK DAMS AS "BRIDGES"

The gabion and the level terrace of soil that accumulates behind it make the dip between banks less severe and more easily passable. For example, while a car or bicycle cannot pass through 2 feet (60 cm) of flowing water in a deepening gully (fig. 10.34A), an 18-inch (45 cm)-high gabion placed in that same gully—and the adjoining terrace of accumulated soil behind it—can spread out the water flow, reducing the water's depth to a passable 6 inches (15 cm) or less of gentle flow (fig. 10.34B). Warning: Never cross running water unless you are sure it is passable, particularly after storms. To ensure that the terrace of

soil (when wet) can support a vehicle's weight, build the terrace with engineered fill to the width of a vehicle. This strategy can be superior to using a culvert, since the gabion spreads and slows the flow of water while reducing erosion. A culvert will often constrict and speed up the downstream flow of water, contributing to more erosion downstream.

### CHECK DAMS AS STEPS ON A PATH

Where existing paths move downslope, mini check dams serving as steps of rocks or railroad ties can be placed in a series moving down the path to reduce

#### Box 10.10. Placing a Check Dam to Stabilize Multiple Flows

When a check dam is used to stabilize a road that crosses a waterway in hilly terrain, the check dam must be placed far enough downstream of the road to ensure that the water flowing down the drainage ditches to either side of the road will enter the waterway upstream of the check dam. This water will then flow over the check dam, rather than erosively cut around it (fig. 10.35).

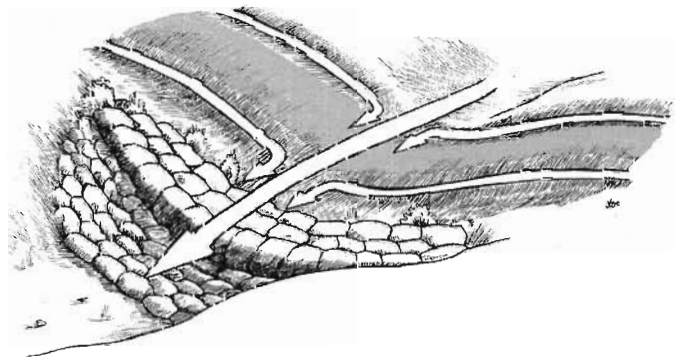

Fig. 10.35. Check dam checking the flow of main drainage and roadside drainage ditches

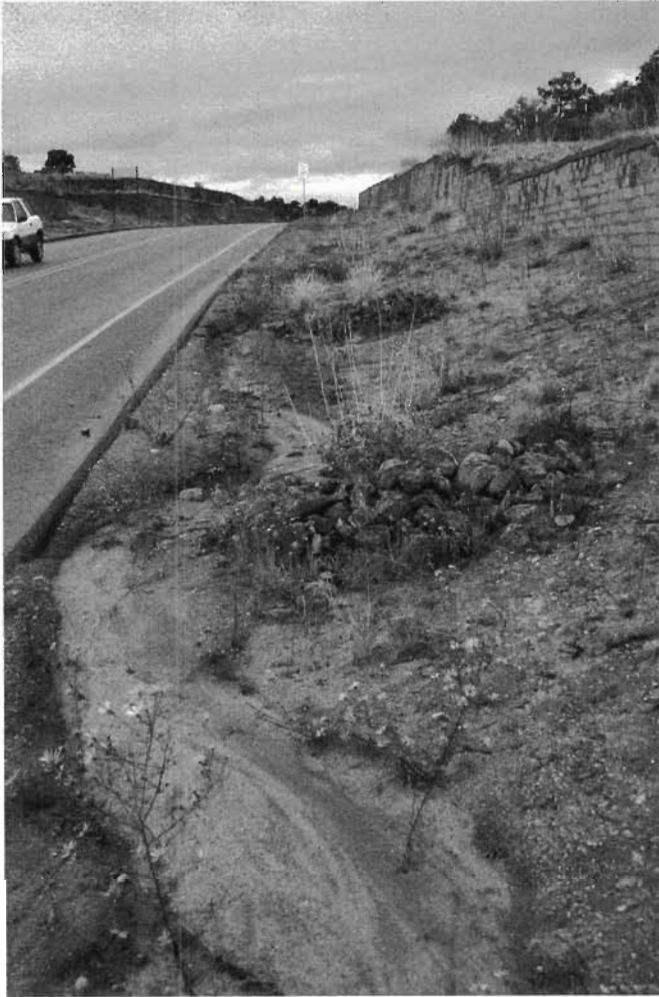

Fig. 10.36A. A poorly-built series of check dams with the low point at the edge of the rock piles harvests nothing and moves erosion closer to road.

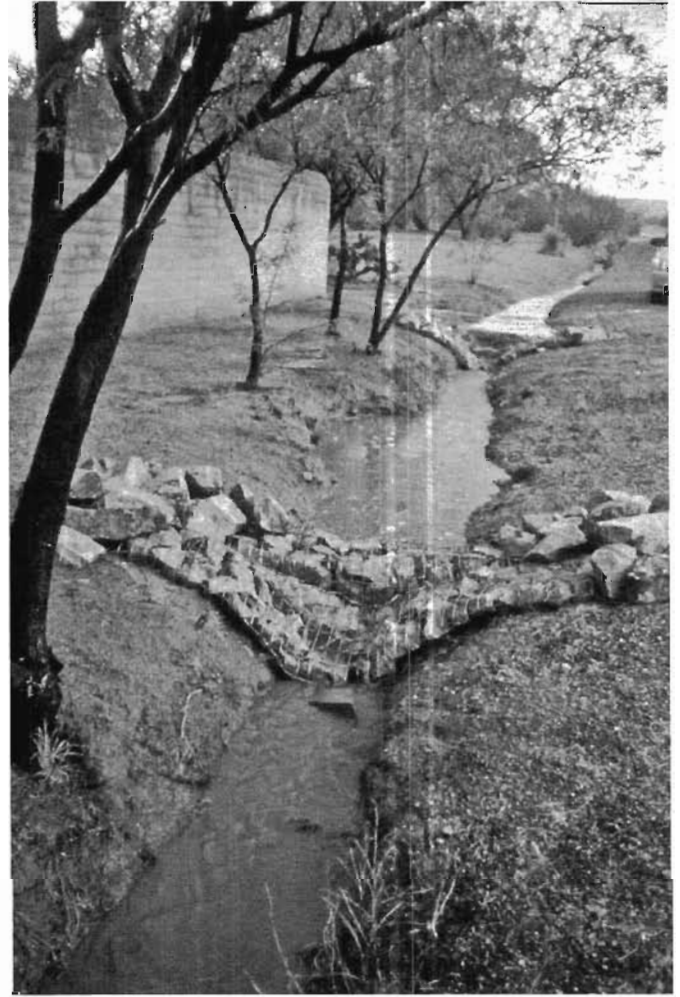

Fig. 10.36B. A well-built series of small gabions with their low point in the middle of the channel harvest water and check erosion in a roadside drainage ditch. The road is to the right of picture frame.  
Credit: Ann Audrey

erosion and stabilize the trail (see fig. 10.23 earlier and fig. 3.16 in the terrace chapter).

### CHECK DAMS AS DRAINAGE-DITCH STABILIZATION

Roads traveling downslope, and crowned to drain water to bare dirt drainage ditches on either side, quickly erode the ditches with unchecked runoff. Check dams can stabilize these drainages and encourage anchoring vegetation. Compare figures 10.36A and 10.36B.

### CHECK DAMS HELP REDUCE THE RISK OF FIRE

Fire typically travels uphill, frequently within drainages. Yet, vegetation planted near and along check dams is naturally more resistant to drought and fire because it has access to more soil moisture than vegetation in the general landscape. To enhance this effect, drought-hardy, fire-resistant vegetation such as California poppy (*Eschscholzia californica*), agave (*Agave* spp.), jojoba (*Simmondsia chinensis*), or pomegranate (*Punica granatum*) could be planted beside the dams.

For information on fire-prone and fire-resistant plants see the chapter-2 section of appendix 6.

## CHECK DAMS AS WILDLIFE— CORRIDOR ENHANCEMENT

Check dams set up the conditions to support a higher density and diversity of vegetation than would otherwise be supported in an unstabilized drainage. This in turn enhances conditions for wildlife traveling up and down the drainage.

## REAL-LIFE EXAMPLES OF CHECK DAMS

### THE GABIONS THAT CREATED A SPRING—BLACK MESA, ARIZONA

Ancient springs had been drying up on the Four-Corners-area reservation lands of Black Mesa as the Peabody coal mining operation consumed 3,800 acre-feet of local groundwater each year to form a slurry of coal and water piped off to a massive power plant in Laughlin, Nevada.<sup>12</sup> Against this backdrop of extraction, local Indigenous People have been trying to put more resources *into* the land. They've formed the Black Mesa Permaculture Project (BMPP) to help build more self-reliant and sustainable skills through workshops, demonstrations, and assistance in local food production, traditional uses of native plants, land restoration, and water harvesting. Most project materials are salvaged since there is almost no funding. So check dams are built with mattress springs, local stone, old tires, and concrete chunks. It's working.

In a very erosive part of the reservation receiving less than 10 inches (254 mm) of rain a year, a 3-foot (0.9-m)-high gabion was built. It caught enough eroding soil from the runoff of one massive storm to create a level terrace as high as the gabion itself. Another gabion was built 2 feet (0.6 m) high atop that harvested soil. Storms and floodwaters returned, forming a second terrace of silt behind the latest dam. The rain stopped, but three weeks later and 30 feet (9 m) downslope of the gabions, water began trickling out of the arroyo bed. The stormwater caught in the silt terraces behind the gabions had infiltrated deep into the soil, hit sandstone bedrock, then ran along the bedrock to where it surfaced 30 feet (9 m) downstream. The trickle continued for three months! See

figure I.11 in the introduction for a similar result in southern Arizona.

The gabions had not stopped the flow of water through the landscape, but had slowed it down. Instead of rushing through in a matter of hours, the water took months to move on, allowing the water to further cycle through local people, plants, and wildlife. It has shifted things in the right direction for a few, and shows others how to do the same.

### CHECK DAMS BUILDING COMMUNITY—CASCABEL, ARIZONA

In 1996 residents of the rural community of Cascabel, along with Natural Resource Conservation Service employees, local Nature Conservancy personnel, and Americorps volunteers, came together to create a conservation program for their 11,000-acre (4,450-ha) Teran watershed, a subwatershed of the San Pedro River (where annual precipitation averages 14.3 inches or 363 mm). Their conservation district was awarded a \$151,000 Arizona Department of Water Resources grant, which they used to fund the construction of over 5,300 loose-rock check dams throughout 1,330 acres (538 ha) of the watershed. The grant also funded a monitoring program to document changes resulting from the improvements, installation of 53,000 feet (16,154 m) of fencing to improve cattle rotation, and community workshops on watershed-restoration strategies.

All improvements aimed to increase groundcover on upland slopes with the goal of improving the health of the watershed and the effectiveness of the water cycle. To that end, the check dams collected an estimated 2,400 tons (2,177,232 kg) of soil that previously would have been washed away (fig. 10.37). But the project went further. Bringing together such a diverse group of concerned individuals strengthened community ties. Local people did all the work, cycling the money through, and strengthening, the local economy. And the skill base and watershed awareness of all participants was increased. Project manager/ceramic artist Barbara Clark and work crew leader/rancher Debbie Hawkins add, "Community backyard conservation projects promote good land stewardship. A community that actively participates in conserving local





Fig. 10.37. Chet Phillips inspects a check dam holding a level terrace of soil high in the Teran watershed.

natural resources builds an economically, ecologically, and culturally sustainable future.”

See appendix 6 for Teran Watershed Project resources.

## WHERE ROCKS HAVE MADE THE WATER FLOW—CHIRICAHUA MOUNTAINS, SOUTHERN ARIZONA

Nestled in the western foothills of the Chiricahua Mountains of southeastern Arizona at about 6,000 feet (1,800 m) elevation sits El Coronado Ranch. The surrounding grasslands are mottled with oak, juniper, and pinyon pines. Rainfall varies from 7 to 30 inches (177–762 mm) per year yet El Coronado Ranch is a lush oasis in this high desert, with flowing streams, thick grasslands, and abundant wildlife. But things weren’t always so.

When Joe and Valer Austin bought El Coronado Ranch over 20 years ago erosion was severe on the 2,000 deeded acres. Water flowed in the drainages only during the rainy season, and many of the creekbeds were eroded down to bedrock. Surveying the land just after purchase they wondered, “What do the cattle eat?” Barren outcrops of reddish soil and rock were more prominent than grassy areas.

Today, if you look across the land following rains you’ll see water flowing and seeping in and around most of the washes. In some streams water now flows year round. Once bare bedrock is now blanketed with a thick, spongy carpet of fertile soil and grass (fig. 10.38). Water bugs, fish, ducks, and turtles have

returned along with the water to the streams.

Cottonwood and willow trees are volunteering where previously there were none. No hunting is allowed on the ranch, yet local hunters complain that all the deer live here. “Well,” Joe explains, “where you have water, you’ve got life.”

What has brought on this dramatic and bountiful change? Simply put, the Austins laid rocks perpendicular to the slope. Specifically, they built loose-rock check dams, lots of them.

## Slowing the water's flow

Joe and Valer built their first check dam to stop their driveway from washing out where it crossed a small drainage. They used materials at hand—rocks, old concrete footing, and broken bricks. Soil was trapped and held in place by the check dam, the road stopped washing out, and a seep formed downslope lingering long after the rains, supporting a lush growth of grass.

“Hey,” they thought, “if this check dam can do this much here where it’s relatively dry, let’s see what others can do where more water flows!”

## Thinking broadly

Over the next 10 years they put in more than 20,000 loose-rock check dams on their 2,000 deeded acres plus still more on the 14,000 acres they lease. Two watersheds have been treated with check dams running from the top to the bottom of the main drainages, and many more are scattered over the minor drainages, dips, and slopes leading into the main waterways. The results are impressive.

The 180-acre Bedrock watershed used to run one month of the year but has now run 34 months straight. The 2,000-acre Turkey Pen watershed would run three months of the year, but now pools of water linger where before there were none, and water flows almost year round (fig. 10.39). The system quietly works and builds on itself with almost no additional input or cost.

Runoff is calmed as flow is dispersed in a widened drainage made shallower by spreading check dams, accumulating soil, and plants. It’s a wonderfully



Fig. 10.38. Joe Austin pulls back a carpet of soil and grass just upstream of a check dam.



Fig. 10.39. Turkey Pen watershed check dam. There is no apron since the dam was built atop bedrock. Note the flat top of the dam. This has led to end cutting on some of the dams, which could be avoided if the center of the dam were made lower and the ends higher to direct overflow down the middle of the drainage while protecting the banks.

For color photo see inside front cover.

regenerative strategy, because once in place it “grows” its own replacement. The fertile soil gathering behind the check dams supports vegetation that eventually creates living check dams. “Set up the right conditions,” Valer says, “and both the plants and the soil will volunteer.”

## Working small

When asked how big he makes his check dams, Joe replied, “I’d rather make them smaller and put in more total check dams than make them bigger and put in fewer.” He starts at the top of the watershed explaining, “The bottom of the watershed is just the tip of the watershed iceberg. Start at the top and you can keep all the work you do at the bottom.” (See fig. 10.40.)

Water-harvesting structures placed at the bottom of the watershed with nothing upslope necessitate huge, engineered, machine-built structures, which can bring on disaster if they fail. The Austins’ check dams are too small to cause much trouble if they fail, ranging from 6 inches to 3 feet in height and built by hand. However, of 200 check dams observed, researcher Craig Sponholtz noted that “approximately 30% had been compromised by end-cutting or significant plunge pool scouring.”<sup>13</sup> The end-cutting could have been avoided if the flat-topped dams had been built more banana-like in shape with a low spot in the middle of the drainage. The plunge pool scouring could have been avoided if aprons had been constructed on the downslope side of the dams where the dams were built atop soil rather than bedrock.

Small check dams are safe, and cheap. The Austins didn’t spend a cent on materials; instead they used local stone and debris with no added wire or baskets. Skilled workers were hired to build the dams, with a four-person team putting in 10 structures a day. Some may say that labor costs make such work unaffordable. Valer argues that you can’t afford not to do the work. If you don’t do anything you *lose* topsoil, organic matter, water, and productivity each year. If you put in small water-harvesting systems you *gain* soil, organic matter, water, vegetation, and greater productivity each year. These strategies don’t drain the system, they feed it.

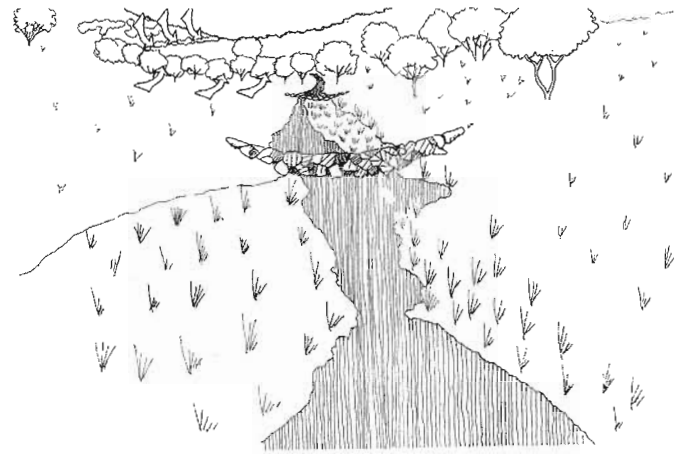

Fig. 10.40. Check dam work began at the top of watershed. Arrows indicate other dams.

The Austins run 200 to 300 head of cattle under an efficient system of rotation that has helped heal the land. Animals are allowed in riparian areas only during the vegetation’s dormant season. Young trees are fenced to ensure they will grow into large trees. Water and grass are now more widely available so cattle use less energy searching for food and water, maintain good weight and health, and return higher profits.

No less valuable is the growing diversity and density of wildlife, which improves the ecosystem and furthers its potential to achieve still-higher levels of health and succession. Yaqui chub, an endangered native fish, has been reintroduced to the watershed and can be seen darting around the rare Sonoran mud turtles that thrive at El Coronado. Thick-billed parrots perch on cottonwood and willow trees spreading the seed they eat throughout their range (fig. 10.41).

## Calm the flow, but don’t stop it

When the Austins began, folks said the ponds below their check dam work would never fill again, but they filled the first year after dam construction and have maintained their water levels better than before. Downstream neighbors have benefited from rising well levels. With check dams in place, and a healthier watershed, water now meanders gently through the land over a period of weeks and months, rather than ripping through in a matter of hours.

As Joe sat on a thick cushion of vegetation with water bubbling by he reflected. “Had I been told I



Fig. 10.41. Valer beside check dam, running water, and the trees they support

needed to put in 20,000 stone structures I'd still be thinking about that. You just have to start."

The good news is that even one well-built check dam near the top of the watershed can begin the healing process. At El Coronado they just kept going.

For more resources on the El Coronado Ranch, see appendix 6.

# 11

CHAPTER

## Vegetation

*The Forests are the mothers of the rivers.*

—Plaque beneath the Save Our Trees statue at Brand Library in Glendale, CA, honoring the connection between the health of our water and the living watersheds that cleanse and moderate its flow

### WHAT ROLE DOES VEGETATION PLAY IN WATER HARVESTING?

Vegetation is the key component of all water-harvesting earthworks. When vegetation is not present in a watershed, stormwater can become a destructive liability, flowing erosively away or pooling to breed mosquitoes before evaporating. In contrast, vegetation is a spongy living welcome mat that induces rain to quickly infiltrate into soil. Vegetation turns stormwater into a productive resource that irrigates plants for free, supports springs and creeks, and assists in groundwater recharge.

Vegetation brings water-harvesting earthworks to life. Plants anchor, build, and shelter soil—reducing erosion and controlling dust. Plants create the beneficial microclimates that support soil microorganisms and even more plant life. Vegetation provides wildlife habitat, food, fiber, livestock forage, building materials, medicine, oxygen, water-storage capacity, beauty, and more. Plants are *living pumps* that access and draw soil water up into fruits and seeds. We in turn “eat” this water in the form of a peach, pomegranate, olive, or mesquite pod. We are cooled by the water taking the form of shade trees, which can reduce summer temperatures by as much as 20°F (11°C) beneath their canopies.<sup>1</sup> We enjoy water in the beauty of flowers, and the hummingbirds and butterflies they attract. The plant-based web of life—with the benefits

it creates and the resources it generates—steadily matures into greater size, productivity, and diversity. This web is the regenerative element of the system (see box 1.1, chapter 1).

A water-harvesting earthwork without associated vegetation is dead. It can quickly erode, clog with silt, breed mosquitos, and excessively evaporate water. The addition of vegetation turns a dead system into a living system because it creates the conditions to sustainably support more abundant life than would otherwise appear. The addition of vegetation improves the function of water-harvesting earthworks. Roots expand, canopies grow, leaves fall and collect, and earthworms burrow, dramatically increasing the water-holding capacity and infiltration rate of earthworks while checking erosion. Insect-eating birds are lured in to provide nutrient-rich droppings, outside seeds, and mosquito control. Cleaner air and cleaner water are products of these enlivened systems.

In this chapter I encourage the liberal use of trees because the coverage and shelter of their canopies, and the extension of their soil-stabilizing roots, far exceeds their comparatively small footprint on the ground (their trunk). A pruned-up tree can provide plenty of space beneath its branches for gathering, planting, and playing. Shrubs can be useful where gathering or annual planting is not a priority, but trees typically provide more shelter from sun and wind than shrubs do.

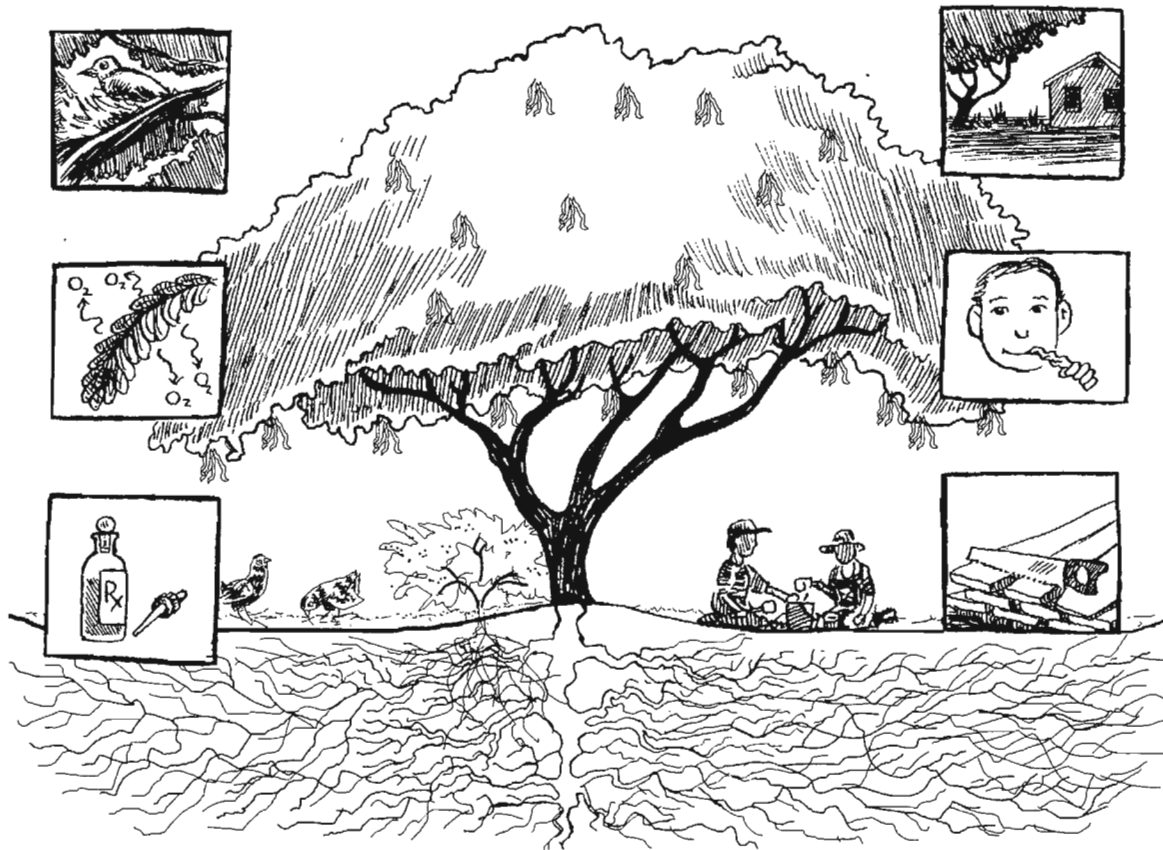

Fig. 11.1. A tree selected and placed to provide multiple resources

Select vegetation appropriate to your site by getting to know the native vegetation in your area. Take a hike in undisturbed, nonirrigated natural areas. Better yet, take many hikes. Observe the native plants growing in a range of microclimates (moist depressions, hot dry slopes, canyons, and many others). Replicate these patterns at home by understanding existing microclimates, creating new ones, and planting appropriately. Trees can be planted within or beside earthworks. Shrubs, grasses, and groundcover are placed beneath or outside the shelter of tree canopies depending on their microclimate preferences. Cacti—in warmer climates—are planted in well-drained areas of the landscape.

## WHERE IS VEGETATION USED?

Vegetation is planted within or beside every water-harvesting earthwork throughout all watersheds. Maximize vegetation's potential and functions using integrated design patterns detailed in chapter 4 of

Volume 1, and using additional tips in this chapter. Follow these patterns to maximize the beneficial functions of plants as they guide you to thoughtfully select and place them in complimentary relationships with other site elements. For example:

- Enhance community by planting trees that beautify and shade natural gathering areas such as community mailbox clusters, post offices, playgrounds, bus stops, schools, libraries, and sidewalks/benches outside cafes. Shade invites folks to linger, talk, joke, and connect, while reducing exposed hardscape that creates the withering heat-island effect. Harvest runoff from the hardscape to support the adjacent plantings as discussed in chapter 8.
- Extend, enhance, and soften fences and walls with perimeter plantings. Newly planted vegetation located next to fences and walls is at reduced risk of being run over or weeded out. As perimeter plant-

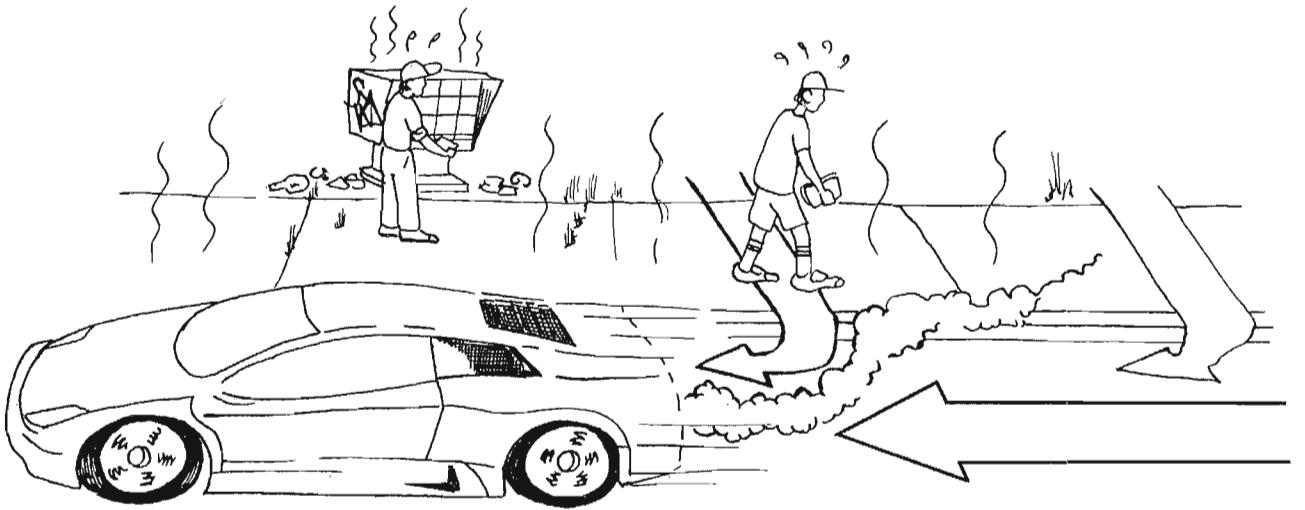

Fig. 11.2A. A hot, bleak environment that hinders community interaction due to its uncomfortable exposure

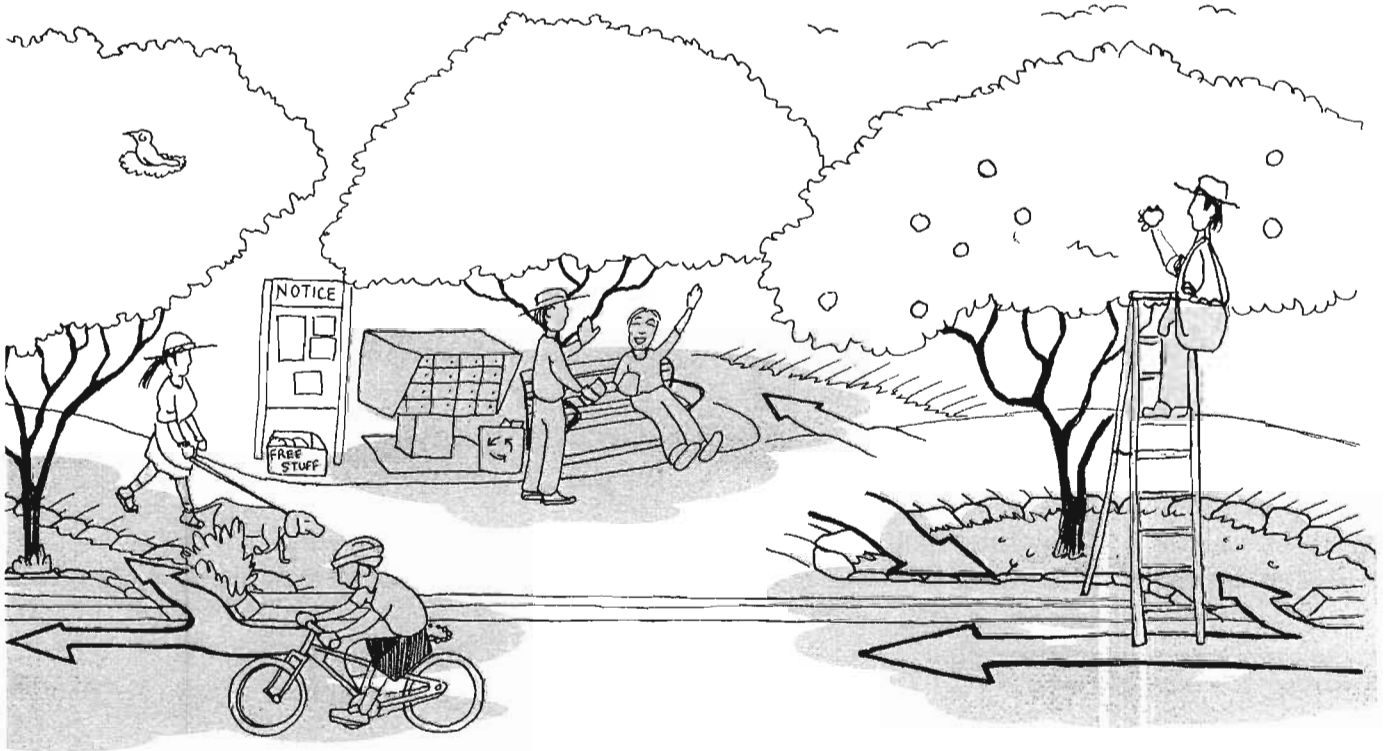

Fig. 11.2B. A sheltered environment inviting community interaction due to its comfort, life, and beauty

ings grow, they can shelter added plantings tucked below. See figure. 5.14 for a small-yard example.

- Grow food-producing plants within easy reach of site water sources and the people who will pick and eat the produce. This plant placement enhances local food security, improves health with fresh food, and results in better care for the plants.

## STEPS TO VEGETATE AN AREA

### SITING PLANTS AND EARTHWORKS

Zimbabwean water harvester Mr. Zephaniah Phiri Maseko, whose simple earthworks and watershed management has turned wastelands into oases, once said, “The land must harvest water to give to the trees, so before you plant trees you must plant water.” Start work at your site by creating water-harvesting earthworks to plant water within the soil. *Then* plant trees and other vegetation within or beside these earthworks.

#### Siting plants and earthworks by zones of available resources

Focus initial earthwork construction within your site’s oasis zones where rainwater runoff and greywater are concentrated, and where you—the site steward—spend much of your time (chapter 1, water harvesting tip number 5; and chapter 12, site considerations section). This will increase the speed of revegetation, and provide the maximum benefits in the location where you spend the bulk of your time—right around your home, in gathering and activity areas, and along well-used paths. Oasis zones can have dense, diverse mini-forests of exotic/native food plants, or just more robust native plantings than the less water-rich zones of your site can support. It all depends on what you and your water supply can sustainably support.

#### Selecting plants according to their comfort range

Select vegetation well-suited to the climate and soils of your site so plants will naturally and passively

thrive without imported water and nutrients, or excessive time and labor to make up for what the plants lack. Get to know your area’s native vegetation through observation and through books on regional ecology, plants, and gardening. Talking with local gardeners, native plant enthusiasts, and locally owned plant nursery staff can help in identifying suitable plants and learning about their preferences. In this volume, see subsections on “Perennial Native Plants,” “Selecting Plants to Keep Their Water Needs Within the Bounds of On-Site Water,” and box 11.2 later.

Select herbs, vegetables, fruit trees, and nut trees well-suited to your climate. Citrus thrive best in warm to hot, frost-free climates, while apples are generally better-suited for cool climates with average temperatures of 65° to 75°F (19° to 24°C).<sup>2</sup> Focus on cultivars or varieties appropriate for your specific locality and soils, and that have flavors and textures you prefer. Cultivars are varieties of domesticated plants cultivated for adaptation to specific soil types, climate extremes, local pests, or with preferred flavors, colors, fragrance, texture, and fruiting times. Cultivars are typically created by farmers and gardeners through careful selection, seed saving, and grafting of plant stock from their favored specimens. Well-adapted varieties or cultivars will thrive and produce an abundance of fruit in your climate and soils, while those better-suited to other climates and soil types will suffer and produce little to nothing at your site. For example, heat-adapted Anna and Ein Shemer apple varieties do well in my low desert region. Empire and McIntosh apple varieties do well in cooler climates. See appendix 6.

#### Selecting sites and microclimates for plants’ comfort range

Select the plant types and cultivars best suited at your site, and place them in their preferred microclimates.

### SOLAR ORIENTATION

Plant heat-tolerant and heat-loving plants in hotter microclimates on the west-facing and winter-sun sides (south-facing side in northern hemisphere, or the north-facing side in southern hemisphere) of



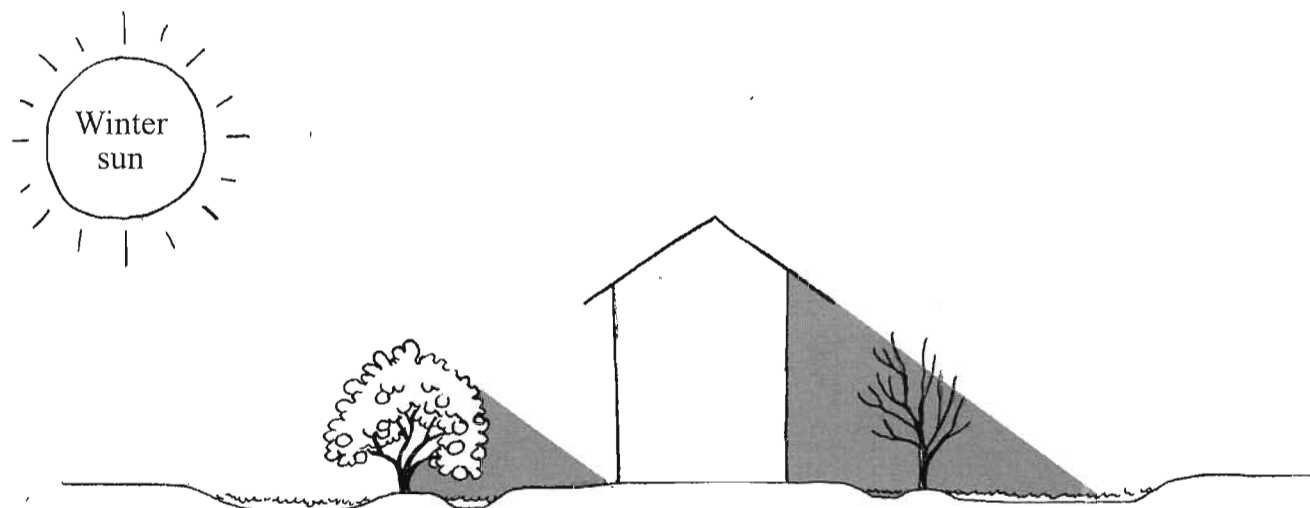

Fig. 11.3. Planting for cold and warmth needs. A cold-sensitive evergreen citrus tree on the warm winter-sun side of house, and a cold-needy winter deciduous fruit tree on the cold winter-shade side of house. Note: Citrus tree is placed so it will not shade winter-sun-facing windows of house in winter.

hillsides, buildings, fences, and other vegetation. Plant cold-tolerant and cold-loving vegetation on the colder winter-shade side (north-facing side in the northern hemisphere, or south-facing side in southern hemisphere).

Many deciduous fruiting plants have a *chilling* requirement of 100 to 1,000 hours of temperatures below 45°F (7°C) to break their winter rest period.<sup>3</sup> Without sufficient cold, buds won't open or will open unevenly in the spring. Blossom buds often require less cold than leaf buds, so in temperate latitudes blossom buds frequently open before leaf buds begin to grow. Fruit may fail to set if leaves do not develop soon enough to provide food shortly after the blossoms open. In my warm climate, I place such plants in colder microclimates with more winter shade to help get the needed chill. Placement in colder microclimates also reduces the chance of fruit trees warming up and flowering too early in the spring, resulting in late frosts killing off early blooms. Using late-blooming varieties also helps avoid spring frost damage. Receiving less solar heating also aids in maintaining higher soil moisture since water loss to evaporation and evapotranspiration increases with a rise in temperature.

Citrus trees and vegetable gardens don't like either cold or excessive heat, so in my region I place them in

warm east-facing and winter-sun facing locations, while avoiding hotter west-facing exposures. In cooler regions, west-facing exposures for citrus trees and gardens may be fine.

## WIND

Wind increases water lost to evaporation and evapotranspiration, intensifies cold, and can break limbs, damage fruit, and carry fire. But wind can also cool in summer or provide renewable energy through wind power. Research and observe how prevailing winds change through the seasons in both force and direction at your site and in your region. At your site, use screening strategies to deflect or divert unwanted wind, or to harvest wind that is useful. Porous windbreaks are preferable to solid windbreaks and barriers (e.g. walls and buildings), which induce destructive turbulence as the wind tumbles, swirls, and continues over and around them. Porous windbreaks such as latticed fencing, trellised vines, and tough native shrubs and trees *slow* wind rather than blocking it completely. In wet climates, porous windbreaks also allow good ventilation to help prevent mildew.<sup>4</sup> Evergreens fare best as winter wind windbreaks since they don't drop their leaves.

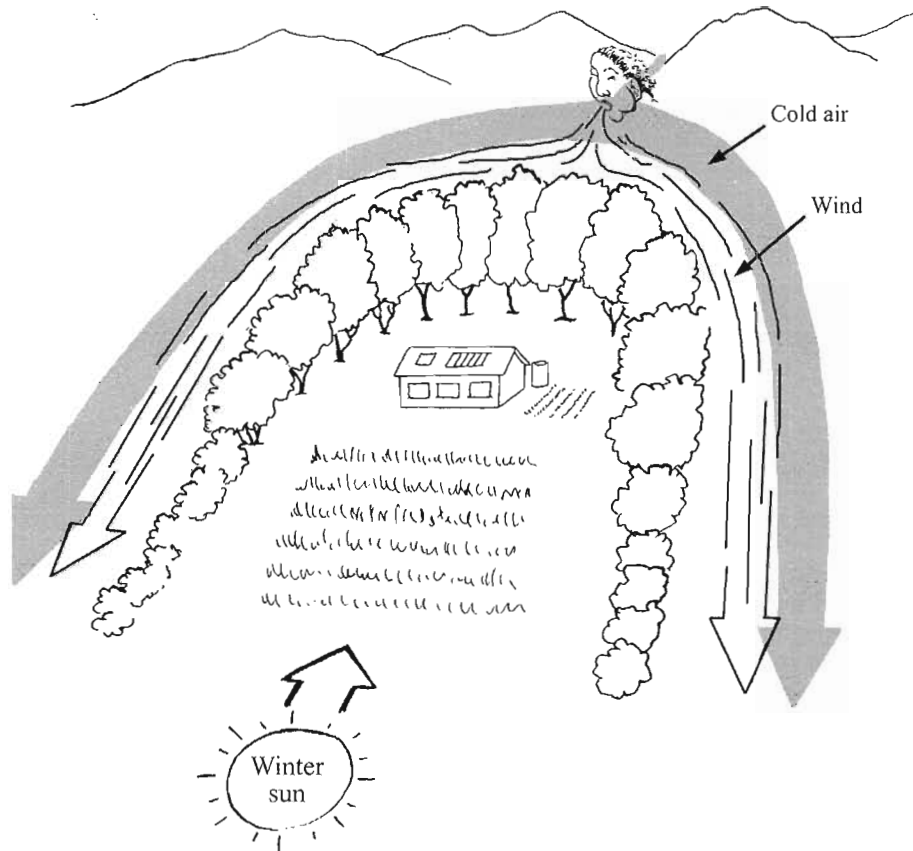

Fig. 11.4. A solar arc and windbreak of trees and shrubs harvesting winter sun, while diverting and deflecting cold winter northerly winds and cold air drainage around a home

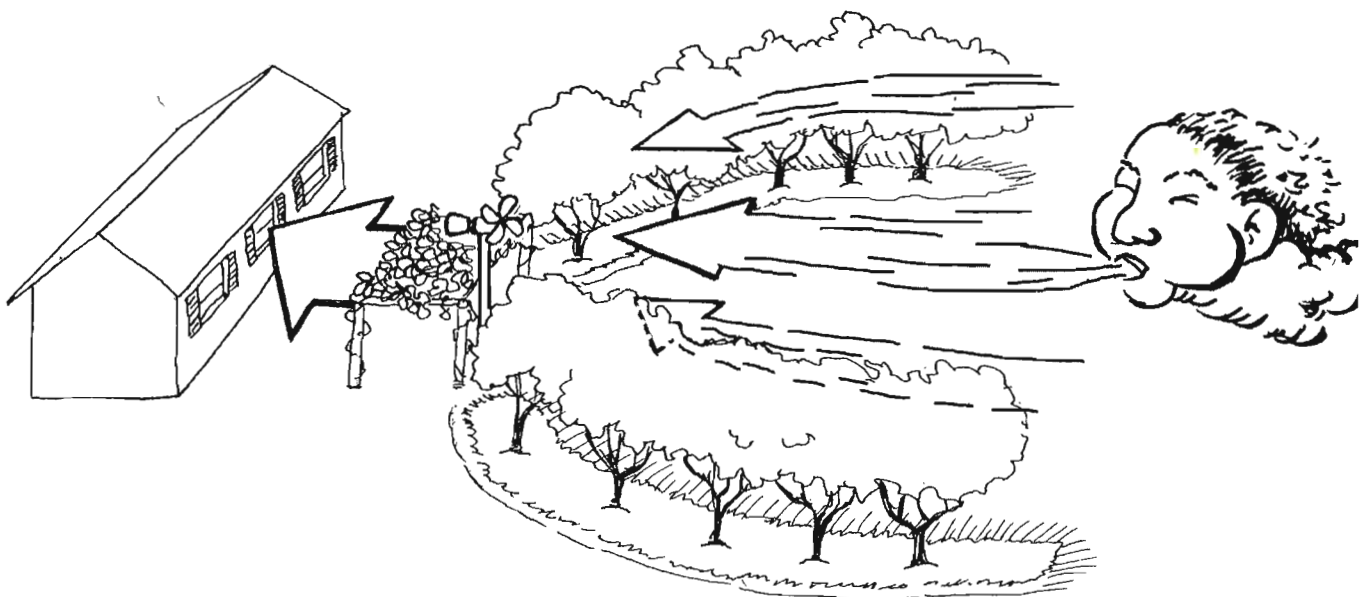

Fig. 11.5. A wind harvester of trees and shrubs directing and concentrating wind toward a house for passive cooling and wind power. Adapted from *The Solar House: Passive Heating and Cooling* by Daniel D. Chiras, Chelsea Green Publishing, 2002

## COLD AIR

Cold air flows downhill like syrup, often damming up behind obstacles and pooling in low spots. Place cold-tender plants on slopes or place them beside—not within—basins in flat yards, so plants do not sit in the low spots where cold air pools. If cold air pools behind a solid fence or wall where you don't want it, a section of permeable wire fencing or an open gate can drain it away. Frost-free *thermal belts* are often located at least 100 feet (30 m) above the nearest low ground or valley bottom, and below colder high elevations. To avoid frost damage, hillside planting strategies might consist of placing early-blooming varieties in the thermal belt near the top of a hill where cold air will quickly drain past them, and late-blooming varieties at the bottom of the hill.

Plantings can deflect or harvest cold air. An arc of vegetation placed upslope of buildings, gathering areas, and gardens, with the ends of the arc facing downward deflects cold air around these sites (fig. 11.4). An arc of vegetation placed just downslope of these sites, with the ends of the arc facing upwards harvests the cold. A screen of tall, dense vegetation placed on the downslope bank of a pond will retain the evening's cold air and cool water temperature, thus reducing water lost to evaporation—which increases as temperature increases. See appendix 6 for more resources on microclimate assessment; see appendix 6, section X for firebreak and windbreak resources.

## Trees

*Begin with trees.* Trees are the pillars of the vegetative framework of your landscape. Play with an array of potential locations for trees and earthworks. Mark potential locations on the ground by scuffing lines in the dirt representing the full diameter of the mature canopy of each tree placed beside the water-harvesting earthwork supporting it (fig. 11.6A, B). Now sit outside with a tall glass of iced tea and imagine what things would look and feel like with *full-grown* trees in the areas you marked. Walk around these imaginary trees. If you plan for any size less than the trees' eventual full sizes, you will waste time and money planting too many trees, too close together. Make sure there are

no conflicts with overhead or underground utility lines. Make sure trees will not shade out solar panels, solar water heaters, winter gardens, or winter-sun-facing windows (see figs. 11.7A, B, C, D for examples). Determine the longest shadow a mature tree or other object will cast on the winter solstice (December 21 in the northern hemisphere, June 21 in the southern) by looking up your latitude in box 11.1 and multiplying the tree's height by the associated factor of the shadow ratio (fig. 11.7C).

If your imaginary placement has trees too close together or in the wrong spot, move your marks and imagine the new design. Determine how rainfall runoff and greywater could be directed to the earthworks supporting the trees. Make room among the trees for gradually meandering raised pathways and gathering and play areas. Keep playing with your tree layout until you find the optimal design for your site.

### Box 11.1. Noontime Winter Solstice Shadow Ratios

Adapted from: "Effective Shading with Landscape Trees," by William B. Miller and Charles M. Sacamano, University of Arizona College of Agriculture, Cooperative Extension Bulletin 188035/8835, March 1990

| North or South Latitude | Object Height: Length of Shadow Cast at Noon |
|-------------------------|--|
| 28°                     | 1:1.28                                       |
| 32°                     | 1:1.49                                       |
| 34°                     | 1:1.55                                       |
| 36°                     | 1:1.75                                       |
| 40°                     | 1:2.04                                       |
| 44°                     | 1:2.50                                       |
| 48°                     | 1:3.13                                       |
| 52°                     | 1:3.70                                       |
| 56°                     | 1:5.26                                       |

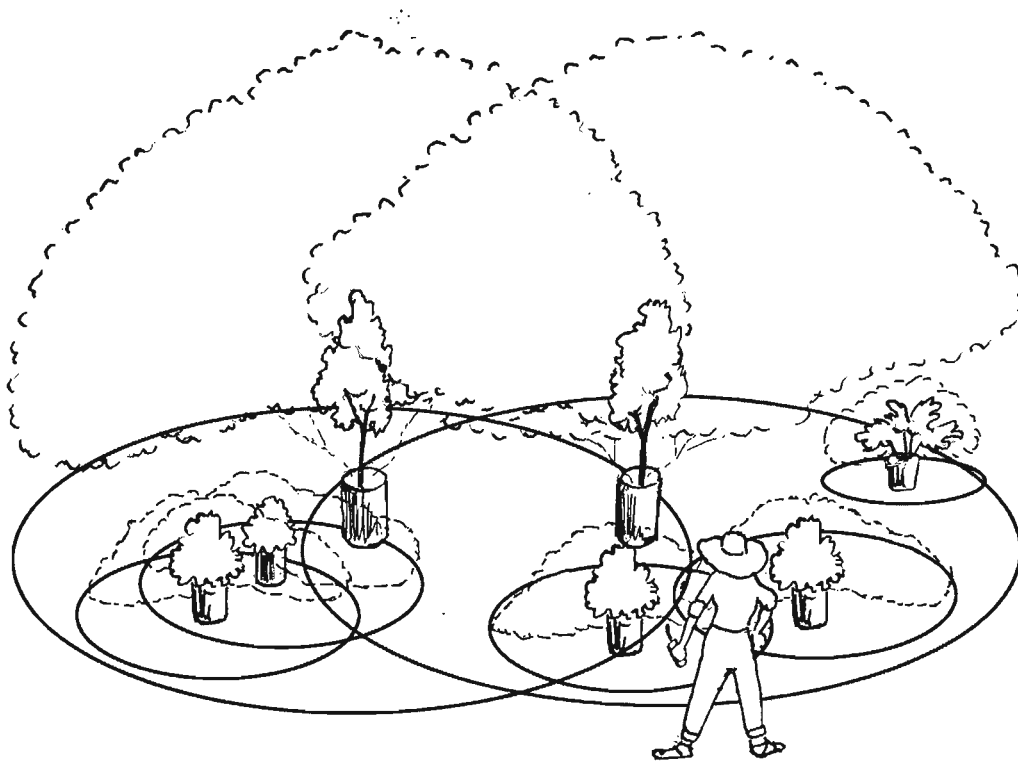

Fig. 11.6A. Plants placed too close together as illustrated by circles drawn in the dirt to represent the new plants' expected size at maturity. Move and reassess the plants' placement as needed.

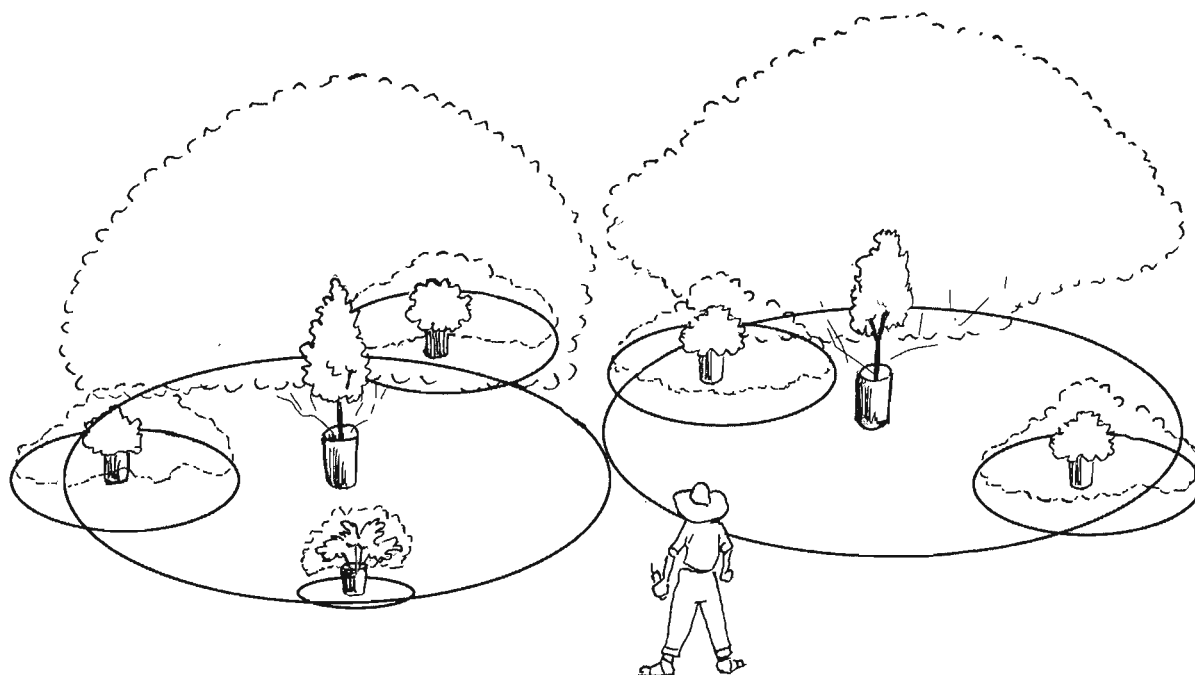

Fig. 11.6B. Plants well-placed and spaced based on their expected mature size. The plants can now be planted.

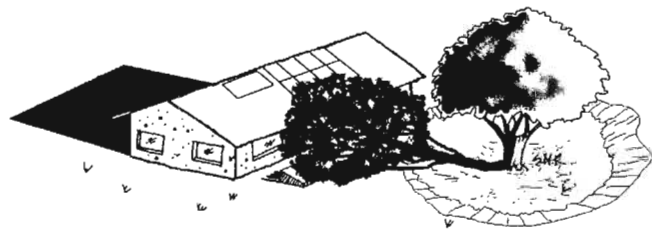

Fig. 11.7A. At 32° latitude an evergreen tree misplaced, such that at mature size the winter-sun exposure at noon on winter solstice is lost for the winter-sun facing windows, winter garden, solar water heater, solar panels, and solar oven. See box 11.1; Volume 1, chapter 4 provides simple ratios and calculation information to determine winter shadows and sun angles throughout the year for better placement of shadow-casting trees and structures.

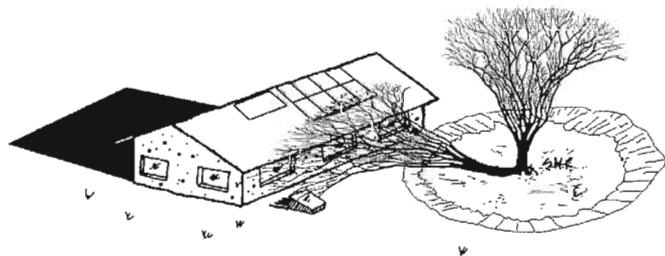

Fig. 11.7B. At 32° latitude a deciduous tree misplaced, so at mature size, about 50% of winter-sun exposure at noon on winter solstice is shaded out by bare branches, increasing heating costs and severely hampering solar power production.

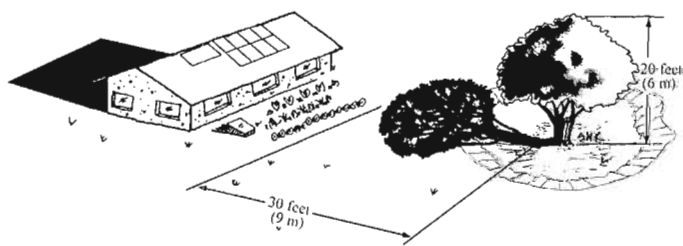

Fig. 11.7C. At 32° latitude a tree correctly selected and placed, such that at mature size, exposure on the winter solstice at noon will be maintained for a home's winter-sun facing windows, winter garden, solar water heater, solar panels, and solar oven. As noted in box 11.1, at this latitude the noontime winter solstice shadow ratio is 1:1.49. So for every foot (or meter) of its height, an object will cast a shadow 1.49 feet (meters) in length.

## Perennial Native Plants

Perennial drought-tolerant native plants can be placed anywhere at your site. As true local survivors, these plants are the best choice for areas distant from convenient human access, household runoff, and grey-water. Perennial plants act as long-lived anchors in the landscape. They grow extensive root systems to access soil moisture in dry seasons and drought years. I define native plants as vegetation indigenous to a 25-mile (40-km) radius of a site, found within 500 feet (150 m) of the site's elevation, and in a similar microclimate to that of the site's. So if you have a dry site, a high-water-use cottonwood (*Populus* spp.) tree found along a perennially flowing creek 20 miles (32 km) away wouldn't really be native to your site's dry conditions. But a lower-water-use acacia (*Acacia* spp.) tree

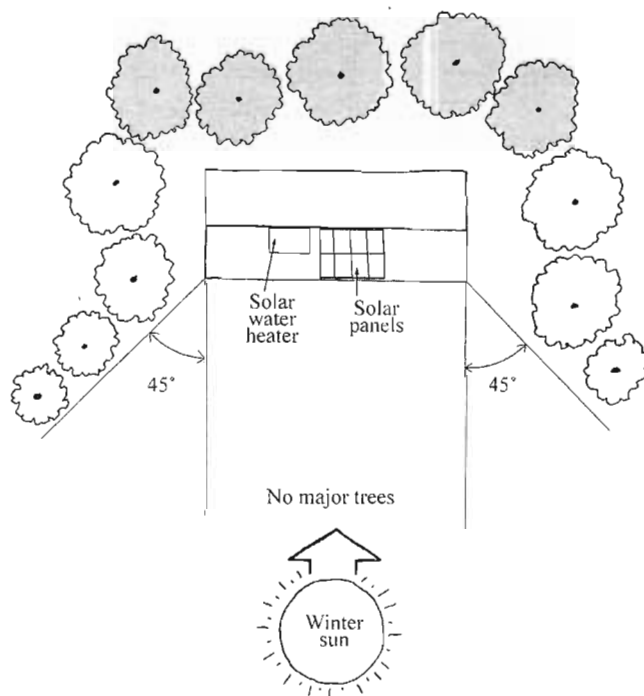

Fig. 11.7D. Trees planted only outside the area marked "no major trees" to retain winter solar gain for winter-sun facing windows, solar panels, and solar water heater. Winter-deciduous trees planted on the east and west sides of building shade out rising and setting sun in hot months, while letting in some light and heat in winter. Evergreen trees planted on winter-shade-side of house (north-facing in northern hemisphere, south-facing in southern hemisphere) further shade home from rising and setting summer sun. Adapted from *Designing and Maintaining Your Edible Landscape Naturally* by Robert Kourik, Metamorphic Press, 1986.

### Box 11.2. Tracking and Restoring Native Plants in a Disturbed Urban or Suburban Core

Finding native plants in built-up areas is becoming more challenging as “development” covers more land. But look closely and you will find pockets of undisturbed land and vacant lots that have never been bladed. Walk these sites with good native plant identification books and observe everything up close. To see bigger swaths of intact native ecosystems you may need to look within a 50- or a 100-mile (80- to 160-km) radius of your site. Track down historic native plant lists from university herbariums or local native plant societies. Purchase native plants that naturally grow near your site, or that historically grew there. These are the species best adapted to the local subtleties of your site's climate and soils. You can collect seed to grow out plants yourself, or contract with a nursery to grow them for you, but do not collect wild plants.

Then bring the natives back! Plant them in yards and neighborhoods in the urban and suburban core. As the native plants grow, native birds will follow and carry seeds to new pockets in the city. The diversity of plants, nesting birds, and visiting butterflies in my inner-city yard and neighborhood has soared since we reintroduced native plants like the delicious-seeded foothills palo verde (*Parkinsonia microphyllum*), the edible-flowered, hummingbird-attracting chuparosa (*Justicia californica*), and the colorful pollinator-friendly snapdragon vine (*Maurandya antirrhiniflora*). I planted the living seed bank in my yard—the wind and wildlife planted the neighborhood.

found growing along an ephemeral arroyo 20 miles (32 km) away would be native to your site's conditions—especially in a spot receiving additional seasonal roof or road runoff.

Some sites may require defining *native* with a larger radius to bring in more diversity, but start with the small radius to ensure you do not overlook superior local species. Native plants have spent millennia coevolving with local soils, climate, and wildlife so they require no fertilizers or pesticides, they support the greatest density and diversity of native wildlife,

and they can live on natural rainfall alone. Native plants can be minimally pruned, but do not require it.

### Perennial and annual climate-appropriate exotics

Although I promote the use of low-maintenance, low-water-use native plantings, I'm not against exotic plants. I love them if they meet three criteria:

- They are non-invasive
- Their water consumption does not contribute to exceeding the site's water budget
- They increase rather than deplete on-site resources. Climate-appropriate, food-bearing, exotic perennials are my favorite

Exotic plants typically need more water and care than low-water-use natives, especially if you want them to produce fruit. If under-watered, some fruit trees may look fine but never produce fruit, and what's the point in that? Appropriate selection and placement of exotics is key. I place them in wetter oasis zones within 30 feet (9 m) of buildings to get more roof runoff, greywater, and care, which in turn increases production and success (see tip 5 in chapter 1 and illustrations in chapter 12). More drought-tolerant exotics can be placed in drier oasis zones that lack greywater.

Pomegranates (*Punica granatum*), fruiting olives (*Olea europaea*), and cultivars of non-native edible fruiting cactus (*Opuntia ficus-indica*) have relatively low water needs. They do not thrive and produce on direct rainfall alone in my town (average 12 inches or 304 mm per year), but can flourish with additional rainfall runoff without added greywater. I planted these species beside basins in the public right-of-way in front of my house where harvested runoff from the street and footpath boosts their growth and fruit production. Move up about 1,000 feet (300 m) in elevation to the community of Oracle, Arizona, where additional rainfall (average 19 inches or 482 mm per year) and cooler north-facing microclimates increase the diversity of exotic food plants that can be grown



Fig. 11.8. A section of a 60-foot (18-m)-long, 2.5-foot (0.75-m)-wide, 1.5-foot (0.45-m)-deep, two-tiered berm 'n basin full of rain at Occidental Arts and Ecology Center in northern California. In 2006, 96 inches (2,438 mm) of rain fell, resulting in this b'n'b harvesting over 600,000 gallons (2,274,000 liters) of runoff. Most of the water comes from a 4-inch (100-mm)-diameter drainpipe from a diversion drain installed upslope to dewater a 1/3-acre (0.13-ha) area above a septic leach field. This pipe used to daylight onto a forested slope forming a gully 5 feet (1.5m) wide and 4 feet (1.2 m) deep, from which erosive sediment flowed down to contaminate a stream of spawning salmon. Now the gully has been stabilized, and the b'n'b intercepts the runoff to help recharge groundwater while improving the stream's water quality for the salmon. Such b'n'bs, typically with smaller catchments, are also used on the site to passively irrigate apple, apricot, peach, and plum trees. The trees are planted beside, but not within, the basins, so the root crown is better drained in this wetter climate. Credit: Brock Dolman.

on harvested rainfall and runoff to include grapes, apricots, peaches, and pistachios. (On average, temperatures drop about 3.5°F or 2°C with every 1,000-foot or 300-meter gain in elevation).<sup>5</sup> In other communities with wetter or cooler climates, apples, plums, walnuts, and more can produce solely on rain and runoff harvested in the soil.

To find appropriate multiuse perennial exotics for your area, seek out local abandoned orchards to see what plants are surviving without care. Seek out active orchards too—especially ones that are dry-farmed. Mimic the microclimates and cultivars too, if you like the fruit. If you can't find local cultivars in local plant

nurseries, investigate mail-order sources or take cuttings from local trees and graft them to root stock to create your own nursery stock plants.

For exotic annuals such as vegetables choose *heirloom* or *open-pollinated* varieties. This way you can select, save, and replant seeds from your most healthy, productive, tasty plants—creating new subvarieties especially well-adapted to your climate, soils, tastes, resistance to local pests, and gardening style. Avoid hybrid and genetically modified (GMO) seed. As Suzanne Ashworth's great seed saving resource *Seed to Seed* states, "Standard [open-pollinated] varieties will come "true-to-type (produce plants like their parents) if

not allowed to cross with similar varieties growing nearby. In contrast, hybrids are the result of deliberately crossing two different parent varieties, usually inbreds. Hybrids should be avoided for seed-saving purposes, because they are incapable of producing plants like the previous generation. Seed saved from hybrids will either be sterile or will begin reverting to one of the parent varieties during succeeding generations.”

Plant exotic annuals in the best seasons for your area. In lower latitudes cabbage, broccoli, cauliflower, onions, garlic, spinach, lettuce, chard, beets, and carrots prefer cool weather and will produce in winter or spring when supplemental-irrigation needs are lower than in hot summers. If you plant in locations convenient to the user, produce is much more likely to be used. Culinary herb gardens work great when placed just outside kitchen doors, if solar exposure in that location is appropriate.

For additional resources including books, organizations, nurseries, and seed catalogs see appendix 6.

## Native grasses and annuals

Native annual grasses and wildflowers work great as rain-activated accents that flesh out perennial landscapes in years of good rain. Their seeds lay dormant in the soil in dry years. To establish them, roughen soil with a hard rake just before the rainy season, broadcast the seeds, and rake soil to cover so birds, rodents, and ants do not immediately eat them. Keep at least a 10-foot (3-m)-wide grass-free perimeter around buildings to reduce fire risk when the grass dries out.

## SELECTING PLANTS TO KEEP THEIR WATER NEEDS WITHIN THE BOUNDS OF ON-SITE WATER

Strive to create a vibrant landscape that, once established, will be sustained by a hierarchy of water use where:

- Rainwater is the primary water source
- Greywater is the secondary water source

### Box 11.3. Planting for Wind-, Gravity-, and Water-Distribution of Seed

Use your observational skills to get natural forces to help you plant for free. This is particularly useful on large sites needing major revegetation, but can also be useful on small sites. Plant low-water-use natives where the seeds they produce will be carried naturally to needed germination sites. For example, observe the direction of seasonal prevailing winds and plant species that produce light, wind-blown seeds upwind of areas needing revegetation. Planting on high points and ridges can help broadcast seed farther. Plant species producing heavier seed high in the watershed where seed will flow downslope with runoff and gravity. In the urban environment, establish street-side plantings to distribute seed via stormwater in the street. Seeds from species planted along natural drainages can be carried both upslope and downslope by wildlife picking up seed in their coats, mouths, and guts. As animals move up and down these transportation corridors, they will distribute seeds. This service is enhanced when you plant species whose fruit is particularly relished by local wildlife.

- Well or municipal water is a supplemental source used only during times of need, such as drought

With this water-use hierarchy you can create a beautiful landscape that produces more resources than it consumes and is in balance with your on-site rain-water budget. The supply side of this budget includes rain and snow falling directly on your site and “runon,” runoff running onto, and harvested within, your site from offsite sources. A landscape irrigated only with these water sources is sometimes called a *rain-only landscape* or a *precipitation-only landscape*.

Augment this water supply using your personal “waste water” transformed into your personal “recycled resource” by properly distributing greywater from household drains (but not the toilet) to the landscape (see chapter 12). Such a landscape is sometimes called a *free-water landscape*, since the precipitation and runoff comes to you free of charge, and the gravity-fed distribution of the greywater to your plants and soil freely turns an on-site “waste” into an additional water resource.



Use the calculations shown in chapter 1, boxes 1.3 and 1.4, and figures 1.20 and 1.21, to determine the supply side of the water budget for your site. See boxes 12.5, 12.6, and 12.7 in chapter 12 to estimate volumes of supplementary on-site greywater. Select potential plantings by adding their water needs and comparing that total to the total volume of water available on site. Then weigh the trade offs between the water demand of different species and your preference for the species you want at your site. For example, in southern Arizona a series of infiltration basins receiving 9,000 gallons (34,000 liters) of annual rainfall and runoff can support three mature 20-foot (6-m)-tall, low-water-use native velvet mesquite trees, each needing about 3,000 gallons (11,300 liters) of water a year (fig. 11.9). This same amount of water can instead support one mature orange tree needing about 8,000 gallons (30,300 liters) of water a year (fig. 11.10).<sup>6</sup> Or this same amount of water can support a 225-square-foot (20.7-m<sup>2</sup>) section of turf (fig. 11.11).<sup>7</sup>

However, the drought-intolerant citrus tree will require water from a cistern or household greywater to provide dry-season waterings, which low-water-use native mesquites will not require. Delivering household greywater to the citrus tree boosts the volume and frequency of watering without increasing household water demand, and could prevent the need to install a cistern. To keep the water-hungry turf green year round, it will need a large cistern to provide enough rainwater for dry-season waterings. Surface greywater irrigation is not recommended for lawns, in order to prevent those playing on lawn from coming into direct contact with the greywater. And while subsurface greywater irrigation of lawns is possible,<sup>8</sup> I typically don't recommend it either, due to the high costs and complexity of such a system irrigating thousands of tiny root systems throughout the lawn, rather than a cheaper, simpler system irrigating one large root system of a tree.

The water, soil, and microclimate conditions plants are exposed to vary from site to site in the same region, and vary even more between regions. You can get information about plant needs relevant to your area from local gardeners, local irrigation publications, plant books, agricultural cooperative extension agencies, and (in Arizona) the Arizona Department of Water

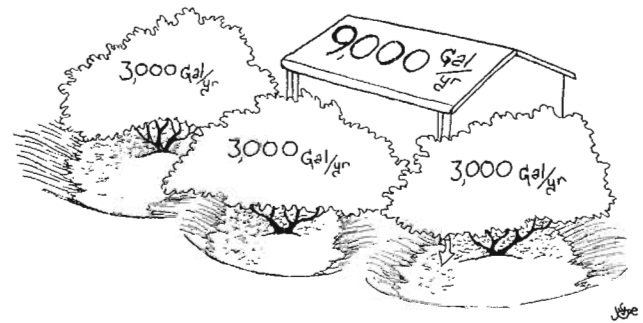

Fig. 11.9. Annual irrigation demand in Tucson, Arizona, of low-water-use, dry-season-adapted, native mesquite trees met by rainwater supply from roof runoff

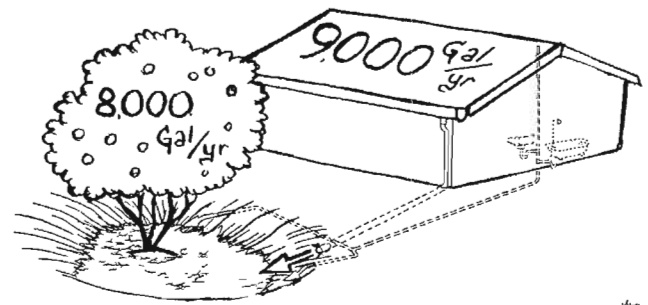

Fig. 11.10. Annual irrigation demand in Tucson, Arizona, of higher-water-use, dry-season-susceptible, exotic citrus tree met by rainwater supply from roof runoff, and supplemented with greywater in dry times

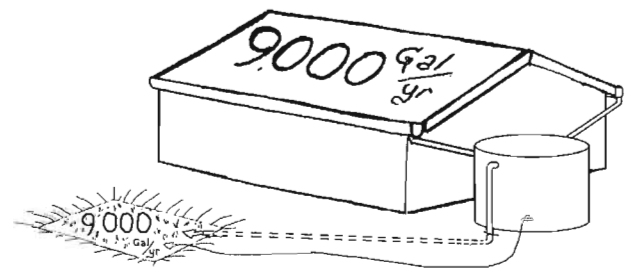

Fig. 11.11 Annual irrigation demand in Tucson, Arizona, of 225-ft<sup>2</sup> (20.7-m<sup>2</sup>) section of water-hungry turf met by rainwater supply from roof runoff. Tank stores water in times of plenty to slowly dole it out in the dry seasons' times of need. Note: It is much more difficult and costly to use greywater to irrigate the relatively small root networks of thousands of individual grass plants, than it is to irrigate the relatively large and expansive root network of a few trees and shrubs.

Resources' *Low Water Use/Drought Tolerant Plant List*. (See the resources in appendix 6 for plant list sources.)

But the most fun way to learn about plant needs is to TAKE A HIKE! Estimate the needs of plants by observing the natural conditions under which they grow *without irrigation*. Walk wild areas where seeds sprout and grow to maturity on rainfall alone. Walk feral areas like abandoned orchards and once-nurtured landscapes that are now supported solely by rain. Get to know local species using good plant identification books and taking walks with enthusiastic plant experts. Look around and ask yourself: What lives? What dies? What thrives? What struggles? Where? Why? And at what densities?

Drought-tolerant plants grow in exposed areas where they survive on the rain that falls directly on them. Water-needy plants are found along drainages, waterways, and roadside ditches where runoff is concentrated. Plants you find growing in depressions ought to grow in infiltration basins. Plants you find growing in drainages should do well near check dams. Observe plant species naturally growing near one another. Which plants like full sun? Which grow under a canopy of shade? What planting densities can be naturally sustained? What excessive planting densities with excessive water needs lead to plant stress and death? Mimic what you observe working in the natural environment when you select species and decide their planting locations at your own site. If your site is on a well-drained, dry, south-facing slope, look for examples of wild vegetation growing on similar slopes. Replicate this native plant palette and plant distribution pattern on your land. You should have success as long as you do not try to replicate plant palettes and patterns growing in microclimates very different from your own. However, you can introduce plants from a slightly wetter microclimate if you first create a wetter microclimate by converting a landscape that drains water into one that harvests water.

When planting water-harvesting earthworks, place more water-tolerant vegetation in the bottom of infiltration basins and beside French drains or check dams where soil moisture is relatively high. The more poorly soil drains, the more important it is to choose water-tolerant plants. Less water-needy plants and less water-tolerant plants should be placed on the well-drained

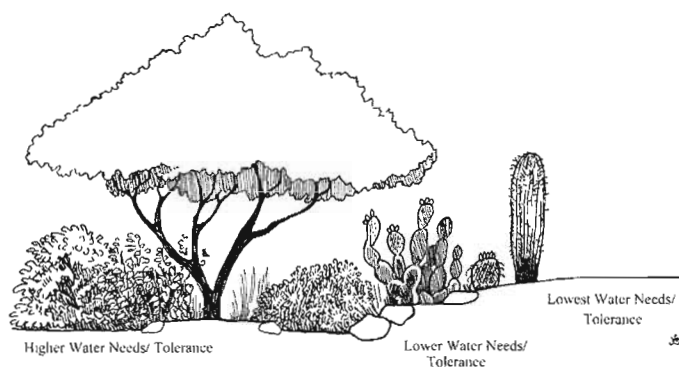

Fig. 11.12. Planting according to water needs and tolerance. Tucson, Arizona, low-water-use native plant arrangement could include a blue palo verde (*Parkinsonia floridum*) tree and understory plantings of wolfberry (*Lycium fremontii*), chuparosa (*Justicia californica*), penstemon (*Penstemon parryi*), oreganillo (*Aloysia wrightii*), yerba de venado (*Porophyllum gracile*), and limberbush (*Jatropha cardiophylla*). Cacti include Englemann's prickly pear (*Opuntia engelmannii*), barrel cactus (*Ferocactus wislizenii*), and saguaro (*Carnegiea gigantea*).

slopes of basins and berms. Drought-tolerant plants, like cacti, and species with a low tolerance for standing water, like many fruit trees, are planted on the periphery of water-harvesting earthworks where roots can access harvested water, but the base of the plant stays high and dry (fig. 11.12).

Refer to plant books and knowledgeable folks at your local agricultural extension office for water needs, plant culture requirements, and climate requirements of exotic plants. Plant nursery staff may not be the best resource if they are more interested in selling plants than giving you accurate information. Exotic plants are typically grown with irrigation water and are harder to find growing in natural conditions without irrigation and care. To play it safe, put fruit trees on gradual pedestals or terraces within basins, or beside basins where roots can access harvested water while avoiding crown rot due to having too much water against their base (fig. 11.13).

See my website, [www.HarvestingRainwater.com](http://www.HarvestingRainwater.com), and appendix 4 for water requirements of some multi-use native and exotic plants in Tucson, Arizona.



Fig. 11.13. A tree needing better drainage planted beside a basin where its roots can easily tap the harvested water, while leaving the base of the tree (root crown) well drained and dry to reduce the chance of crown rot

## MAXIMIZING RESOURCES

Strive to turn your landscape into a producer rather than a consumer of resources by selecting plants that thrive within your rainwater budget while producing food, medicine, wildlife habitat, shade, soil-building nitrogen, beauty, a sense of place, craft materials, or fragrance.

Look first to the native plant palette to meet your needs. Using natives gives you an immediate sense of place—a tangible connection to your site's ecosystem, seasons, and traditional cultures who made use of native plants. The columnar saguaro cactus is a symbol of the Sonoran desert, and one of the many living calendars (living seasonal almanacs) and food plants that blanket the landscape. Saguaro blooms welcome spring's migrating white-winged doves, the lesser long-nosed bat, and the Mexican long-tongued bat. Its delectable fruit is the focus of the summer harvests and feasts of traditional Tohono O'odham, and the end of the saguaro harvest signals the arrival of the summer's monsoon storms. Native food plants are particularly rich in the Sonoran desert, with over 500 known edible plants representing approximately one-fifth of the desert's flora.<sup>9</sup> Not all bioregions enjoy such edible abundance, but all have their own native resource-producing plants providing food, medicine, dyes, wood, and fiber.



Fig. 11.14. Food grown and processed at Tucson, Arizona, site that was watered entirely by harvested rainwater, and in some cases supplemented with household greywater

If you have a need that cannot be met by a native plant, consider planting an exotic species that can meet that need while thriving within your site's microclimates and rainwater budget. Planting an ill-suited exotic will gobble up resources, and is unlikely to produce the fruit or grow to the size you desire if it does not get needed water and care. Do not plant exotic species that can become invasive pests. Deciduous salt cedars (*Tamarix ramosissima*) were brought into Arizona to control erosion on stream banks, but now aggressively dominate riparian areas all over the state. Huge resources are now spent to get rid of them.

Plant a diversity of species rather than just a few to see what works and what doesn't. You'll learn which plantings are worth replicating and which to avoid, and you can share this information with friends and neighbors. Even plants that die are resources in the form of knowledge and mulched organic matter.

Greater diversity extends your harvest and enjoyment. I love the wave of yellow flowers that covers blue palo verde (*Parkinsonia floridum*) and foothills palo verde (*Parkinsonia microphyllum*) trees in spring.

The harvest of their barley-flavored seeds soon follows (pick green but full-sized, peel off the seed pod and eat the seeds or blanch and dry them for storage; you can soak the dried seeds in water to rehydrate and eat them later). These two related palo verdes set flowers and produce seed three weeks apart. Planting both varieties extends the show of flowers, the wildlife they attract, and the seed harvest. This principle applies to exotic vegetation too. For example, Valencia orange trees are harvested in my area from February through May. By adding an earlier-fruiting Marrs orange tree the harvest is extended from October to May.<sup>10</sup>

## CREATING PLANT GUILDS

A *guild* is a harmonious assembly of living species and nonliving elements such as rocks or buildings that perform better through their cooperative interrelationships than they would as individuals. Many simple guilds are well known, like the corn-bean-squash combination used by Native American farmers. The nitrogen-needy corn creates a living trellis on which the nitrogen-fixing bean vine grows. The squash sprawls out over the soil benefiting from the nitrogen-enriched soil and the diffuse shade cast by tall corn plants. The broad-leafed squash casts a deep shadow on the soil that acts as mulch, retaining moisture in the soil, preventing erosion, and deterring weed growth. A nonliving element such as a building can enhance this guild by directing its roof runoff to the garden, and if placed to the west of the garden, by acting as an afternoon sunscreen, lowering ambient temperatures at the hottest time of the day and reducing water loss to evapotranspiration. The guild benefits the inhabitants of the buildings with food, beauty, and passive cooling, especially if the squash vine grows up a trellis on the side of the home.

Guilds occur naturally in all intact ecosystems, making it easy for you to observe, replicate and experiment with them on your own site. An example from the Sonoran desert is the mesquite guild (box 11.4).

So how do you re-create an existing guild or create a new one?

Mimic one. I'm always looking to see what plants naturally grow with other plants, especially in wild areas. If I find a group of healthy vibrant plants, I

know that I've found a successful guild. I may not know why those plants are grouped together, I just know they are likely to grow well together if I plant this guild in similar soils and microclimates.

Becoming familiar with botany and plant families expands guild-creation skills. It can help you create an entirely new guild based on one you have observed in nature. For example, if I have sufficient on-site water resources, I can create a new guild producing different resources (though likely requiring more water) by incorporating low-water-use natives and climate-appropriate exotics based on the mesquite guild. I could substitute the leguminous mesquite tree with a leguminous tree from the same botanical family (*Fagaceae*, Pea Family) such as a higher-water-use exotic carob tree (*Ceratonia siliqua*) or a low-water-use native desert ironwood tree (*Olneya tesota*). I could switch the native greythorn (*Ziziphus obtusifolia*) with a somewhat more water-needy sweet-fruited Chinese jujube (*Ziziphus jujuba*), spaced further to the perimeter of the guild due to its taller growth habit. The saguaro (*Cactaceae*—Cactus family) could be exchanged for another cactus such as the edible and thornless nopal (*Opuntia ficus-indica*) or a cholla, (*Opuntia* spp.) with its tasty flower buds. I could replace a small-fruited native wolfberry (*Lycium andersonii*), with a larger-fruited native variety (*Lycium fremontii*). The native chiltepine (*Solanaceae*, nightshade family) could be switched with a related nightshade such as a domesticated Anaheim chile (*Capsicum annuum*) or the beautifully flowering datura (*Datura wrightii*)—careful—it is poisonous if consumed.

New guild creations work most of the time. Replications of observed native plant guilds almost always work. Seek out guilds in your area. Learn about the plants that form them, then invite them to grow in your yard. Before you plant your guild, create the water-harvesting earthworks that will support it—plant the water before you plant the plants. For more on guilds see appendix 6.

## SPACING YOUR PLANTS, AND PLANT SIZE

Locate and space all your plantings based on their size and water needs when full grown, not their size

## Box 11.4. A Mesquite Guild

The velvet mesquite tree (*Prosopis velutina*) is the central pillar of many Sonoran desert guilds. Flowers cover the tree in spring and summer attracting over 60 native pollinators.<sup>11</sup> Sweet and nutritious seedpods then form. Javelina, coyote, birds, and other wildlife consume the pods and leave manure behind. This improves the soil, as does decomposition of remaining seedpods, accumulation of fallen leaves, and the nitrogen-fixing action of beneficial bacteria living within root nodules on the leguminous tree.

This self-fertilizing island provides excellent wildlife habitat and a farmers' market of food plants. Beneath the mesquite, desert hackberry (*Celtis pallida*), greythorn (*Ziziphus obtusifolia*), and wolfberry (*Lycium* spp.) form an intertwining canopy of thorny foliage, with edible berries that birds love. A young saguaro (*Carnegiea gigantea*), and even a chiltepine (*Capsium annuum* var. *aviculare*), may grow underneath the mesquite, gaining protection from excessive sun and cold. The young saguaro will harden to the elements and eventually rise high above the mesquite, its flowers attracting insects, bats, and birds whose pollination services will help produce heavenly fruits. The **chiltepine** is a wild chile with a devilishly hot taste. The birds feast on this fruit, along with that of the wolfberry, hackberry, and greythorn, and feed the soil with their phosphate-rich droppings.

Digested seed from the fruit of the guild is dispersed as birds fly off and deposit manure in other areas. In fact, some seeds, such as the wild chile, need to pass through a bird's gut to enhance their germination. As naturalist and chile-addict Gary Paul Nabhan notes, chiltepines are so keenly associated with birds that many of the common names refer to this relationship: bird pepper, *pico pajaro*, *pajaro pequeno*, and so on.<sup>12</sup>

The plants and animals of this guild act as a living community, sustaining and improving itself through many beneficial relationships among its varied life forms. Wildlife is the mobile planter, expanding the community's territory. Vegetation works the soil, its roots breaking up and aerating the earth to allow more moisture infiltration when it rains. Plant leaves drop and collect, creating organic mulch, which stabilizes, protects, and ultimately becomes the soil. This mulch also creates conditions in which beneficial mycelium or fungi can thrive and expand the guild within the soil. The fungi sends out branching networks of root like growth, further permeating and stabilizing the soil as it helps break down the mulch. Some of this mycelium also attaches itself to the roots of the plants, in effect increasing the plants' root network. The fungi then help provide the plants with essential nutrients and additional moisture, while the plants provide the fungi with sugars.<sup>13</sup>

Beneficial microclimates within the broad landscape enhance the guilds. Greater diversity of life forms and larger specimens can be sustained where more water collects, such as along drainages or within depressions; or where more water is conserved by shelter, such as within canyons or forests.

By encouraging or creating such beneficial guild relationships we can minimize long-term maintenance and costly inputs, and increase the potential of our landscape designs. Humans have regularly consumed fruits of the mesquite, greythorn, wolfberry, hackberry, and chiltepine, and many of the guild's plants are used as traditional herbal remedies. In certain markets, mesquite pods are ground into flour that sells for \$14 per pound and the hot little chiltepines, once dried, command a price as high as \$50 a pound. The saguaro fruit is too good to sell, you just eat it or turn it into wine.

Once you observe one guild, you'll see the basic pattern and start recognizing guilds throughout various landscapes. Master permaculture designer and teacher Tim Murphy originally introduced me to the mesquite guild through his teachings and "Hackberry/Walnut Guilds" article<sup>14</sup> on which much of this information is based. I went looking for the guild, found a version of it, and then saw guilds everywhere. I invite you to do the same.

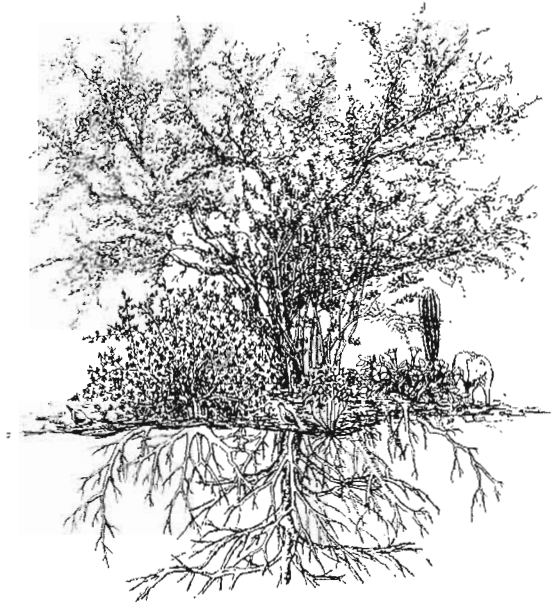

Fig. 11.15. A mesquite guild.  
Credit: April Baisan and David Harnish

### Box 11.5. Moving Plants After They've Been Planted

If in the first year after planting you realize you made a mistake in the placement of a tree or shrub, you can dig it up and replant it elsewhere. Try to keep the soil around the root intact and, if possible, move the plant when it is dormant (usually in the winter season). Move the plant when the soil is not saturated with water.

when planted. This will keep you from planting too densely, exceeding on-site water supply, or blocking a path with an overgrown shrub. A nursery plant that is 1 foot (30 cm) tall today could be a 10-foot (3-m)-tall and-wide shrub in the not too distant future. Landscaping books, knowledgeable plant nursery staff, and cooperative-extension master gardeners are great sources of mature-plant-size information.

Place large tree and shrub species in the middle of a planting area or along a fence or wall where they do not create a new barrier, but build off an existing one. Surround them with smaller-growing species placed around the edge of their water-harvesting basin so you can see and appreciate the beauty of all the plants.

## TIMING YOUR PLANTING

Plant with the seasons. In southern Arizona, I plant nursery-grown perennials in late summer and early fall after summer rains bring moisture and when the heat of summer starts to subside. This way the plant has fall, winter, and spring to send roots into the soil and get ready for June's dry heat. With cold-intolerant plants like citrus I wait until just after the last spring frost to plant. This gets the citrus in the ground before the furnace heat of summer, but puts off exposure to the bite of cold until the plant is a little older and hardier. Ask local cooperative-extension master gardeners for recommended planting times in your area. Observe when plants flower, set seed, and germinate in your yard and in the wild. Plants whose seeds germinate with winter rains, such as four-wing saltbush and California poppies, should be seeded in late fall. Species that germinate with the summer rains,

such as mesquite and devil's claws, are seeded just before or after the first summer rain.

The time when you plant is not as important if you irrigate, but planting with the seasons can reduce the need to irrigate and increase plant survival.

## TOOLS AND MATERIALS FOR PLANTING

**Tools:** to plant trees and shrubs: a pointed shovel or hoedad, pick, and wheelbarrow. A mechanical ditch digger, trackhoe, or backhoe are helpful for digging multiple large holes.

To plant grass or wildflower seeds you need a hard bow rake or field rake (leaf rakes are too flimsy) to loosen the soil's surface; seed is then sown and a thin layer of soil raked over them.

To irrigate new plantings, a garden hose, soaker hose, drip-irrigation bucket (a 5-gallon or 19-liter bucket with a 1/8th-inch or 4-mm hole drilled in the bucket's side just above its base to slowly drip water), or conventional drip-irrigation lines are typically used to get the plants established before supplemental irrigation is ceased.

**Materials:** nursery-grown plants, seed, organic mulch, and optional fencing.

## PLANTING

When you are ready to plant, set plants in their pots (or without pots if bare-root plants are used) on the ground where you will later be planting them. Again, imagine how big they will be when mature. Readjust their locations if needed, then plant.

When you put in a 5- to 15-gallon (19- to 57-liter) plant, use the following steps (see fig. 11.16):

- Dig a hole up to twice as wide (though I typically dig only as wide) as, and as deep as (but no deeper than) the root ball contained in the planting pot (see box 11.6). Water-tolerant plants can be placed within water-harvesting basins. If the plant is not tolerant to temporary soil saturation, place it beside the basin (fig. 11.13); or place it on a gradually sloping pedestal within a basin.

### Box 11.6. Planting Study Saves Our Backs and Wallets

Two experiments in Tucson, Arizona tested the long-held belief that trees planted in desert soils need to be planted in back-breakingly deep holes backfilled with costly imported soil and amendments. Argentine mesquite trees (*Prosopis alba*) transplanted from 24-inch (60-cm) box containers, and oaks (*Quercus virginiana*) transplanted from 5-gallon (19-liter) containers, were planted under a variety of conditions. Some were planted in holes 5 feet (1.5 m) deep and wide, while others had holes no deeper than the root ball of the trees. Some holes were backfilled with amended soil, some just with native soil, and some with native soil capped with a surface mulch of composted yard waste.

The findings are cause for celebration! The study concludes by saying, "Organic amendments *in* the backfill do not improve and may reduce shoot and root growth. A shallow, wide hole with unamended backfill and a surface mulch is an acceptable, if not superior, planting standard for trees and shrubs."<sup>15</sup>

Interestingly, researchers found that trees planted in deep holes tended to settle and sink into the uncompacted soil beneath them. In addition, caliche (a hardpan composed of calcium carbonate) was not the impenetrable barrier it was typically thought to be, since roots from the trees frequently penetrated it, even if the shovel did not.

For more see "Effect of Planting Practices on Tree Performance" by Jimmy L. Tipton, Elizabeth Davison, and Juan Barba in Series P-107, Cooperative Extension Station, The University of Arizona, Tucson, U.S. Department of Agriculture.

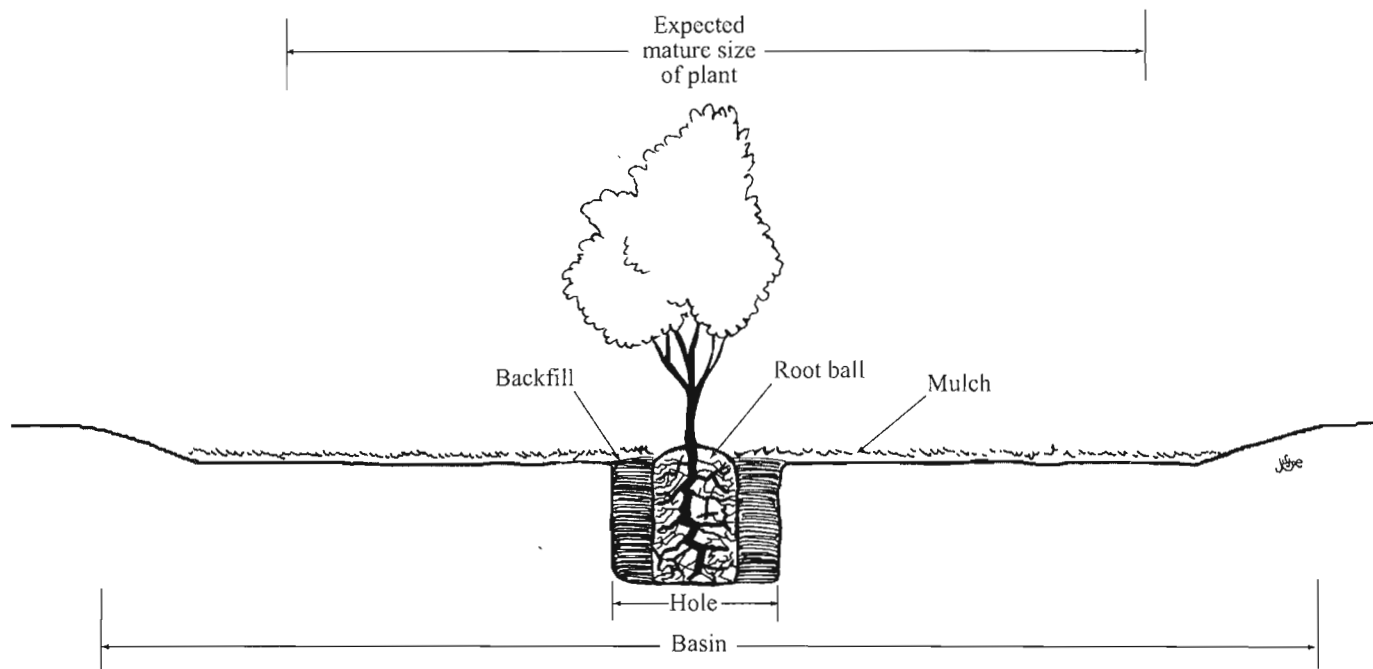

Fig. 11.16. A tree planted within a basin without hardpan. Ideally the basin (or the cumulative area of a number of adjoining basins) should be 1.5 to 3 times the expected canopy diameter of the plant at maturity (if space allows), since most water used by plant is from the root zone outside the canopy drip line (see fig. 5.7B). However, even one small basin is better than no basin.

- Check for correct hole depth by placing the plant—still in its pot—into the hole. The top of the dirt within the pot should be level with, or slightly above, the top of the surrounding grade. Do not place the root crown (the point where the base/trunk of the plant enters the soil and root growth begins) at the lowest point within a basin because the root crown of some species could rot if water sits in the basin too long. Take the pot back out of the hole and make any needed adjustments to hole depth.

- Loosen the plant root ball from the sides of the pot by carefully laying the potted plant on its side and pressing the side of the pot as you gently roll the potted plant 360°. Do not press so hard that you break up the root ball, which breaks more roots and root hairs and reduces the plant's chance of success. Tap the bottom of the pot to loosen the base of the root ball. Pick up the pot, place a hand on top of the root ball, and tilt the pot so the root ball slides into your waiting hand(s). A friend can lift and tilt while you catch. If some of the dirt falls off the root ball during this operation, you may need to put some backfill in the bottom of the hole before placing the plant in to maintain the right elevation in the hole.

- Check to see if the root ball is rootbound or pot-bound, a condition where the roots are tightly wound in circles within the pot, resulting in stunted growth. If the plant is potbound, take it back to the nursery and exchange it for one that is not.

- Having removed the plant from the pot, *carefully* place (do not drop) it in the hole, centering it and setting it upright. Tilt the root ball in the hole if necessary to make the trunk stand up straight (fig. 11.17). Backfill with the same soil you dug out of the hole. Typically you should not amend this soil, though if the majority of the soil you dig out is caliche hardpan, you may want to replace some of the caliche with a better-draining soil. Compact the backfill with your hands, feet, or the tip of your shovel's handle so there are no large air spaces around the root ball.



Fig. 11.17. Tree growing from its root ball at an angle is planted with the root ball at an angle so the tree is set vertically in the ground. Planter is compacting the soil around the root ball with the heel of her boot.

- Do not prune newly planted trees or shrubs as this will deter root growth; however, some grasses will transplant more successfully if they are trimmed 25% once planted.
- If you are putting out seed for wildflowers or native grass in the water-harvesting basin, spread the seed out and rake it into the top 1/4 inch (6 mm) of the basin soil.
- Mulch the soil's surface starting about 4 inches (10 cm) away from the trunk of the plant—do not place mulch next to the plant's base—and extend it at least 2 feet (0.6 m) beyond the drip edge of the plant's canopy. Better yet, mulch beyond the drip line to the entire basin (see chapter 7 for more). Seeded areas should have only a very light mulch, otherwise germination will be inhibited.
- Give your plants a thorough watering.
- Reuse plant containers or recycle them at a plant nursery that grows out plants.

For less water-tolerant plants or within basins with hardpan and poorer drainage, create a well-drained pedestal or terrace within, or on the edge of, the basins. Plant in a hole dug shallow enough so the top



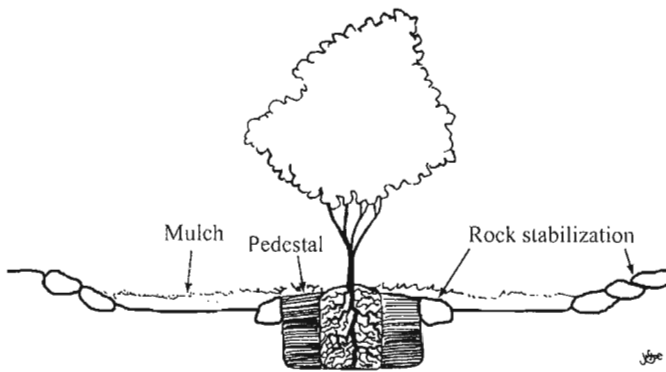

Fig. 11.18A. Planting and pedestaling within a basin for better drainage around the base of the tree (its root crown). Note: Stabilizing the slope of pedestals and terraces will greatly reduce their erosion.

third of the root ball is above the bottom of the basin, then backfill with dirt compacted with foot and shovel to create a slight, gradually sloped pedestal around the plant. Do not place the top of the pedestal higher than the upper edge of the basin. The pedestal will keep any temporarily standing water away from the base of the plant, so it drains better, and reduces chance of disease (figs. 11.18A, B).

*Broadcasting seed* in water-harvesting earthworks, rather than planting nursery stock, is often a less expensive way to revegetate a broad area. Perennial plants grown in place from seed have deeper and wider root growth, and are more drought tolerant and vigorous, than similar plants transplanted from potted stock since they were never hemmed in by a pot.

## FENCING

If animals might eat or trample tender young plants or seeded areas, fence each plant individually or place them in a protected yard. A two-foot-high wrapping of chicken wire held in place with two stakes keeps rabbits, chipmunks, chickens, and pack rats at bay (fig. 11.19). (The inconvenience of the fencing usually deflects them to hardier, established, unfenced vegetation.) Protection against javelina or destructive dogs requires 3-foot (0.9-m) tall hardware cloth or field fencing staked with two to four posts. Keep out deer and goats with 6- to 8-foot (1.8- to 2.4-m)-tall,

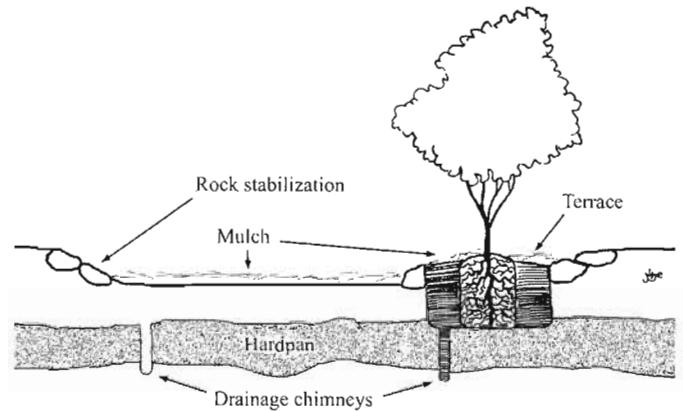

Fig. 11.18B. Planting on a basin-side terrace for better drainage around the base of a tree. Due to the presence of poorly draining hardpan, chimney holes have also been dug through hardpan beside, but not beneath, root ball to avoid root rot due to excessive water. Fill these chimney holes with soil.

well-staked field fencing. Keep goats, horses, and mules entirely away from the main branches and trunks of plants they could kill by eating them to the ground or stripping all bark. Trees with *well-protected, out-of-reach bases* can eventually grow a shade canopy

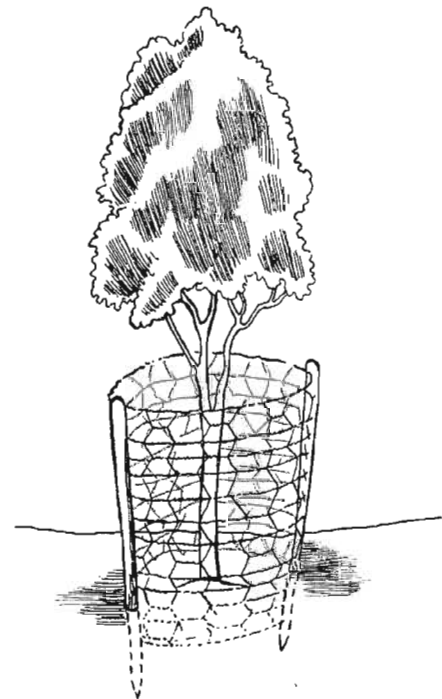

Fig. 11.19. Protection from browsing small animals. Can bury lower part of fencing if necessary.

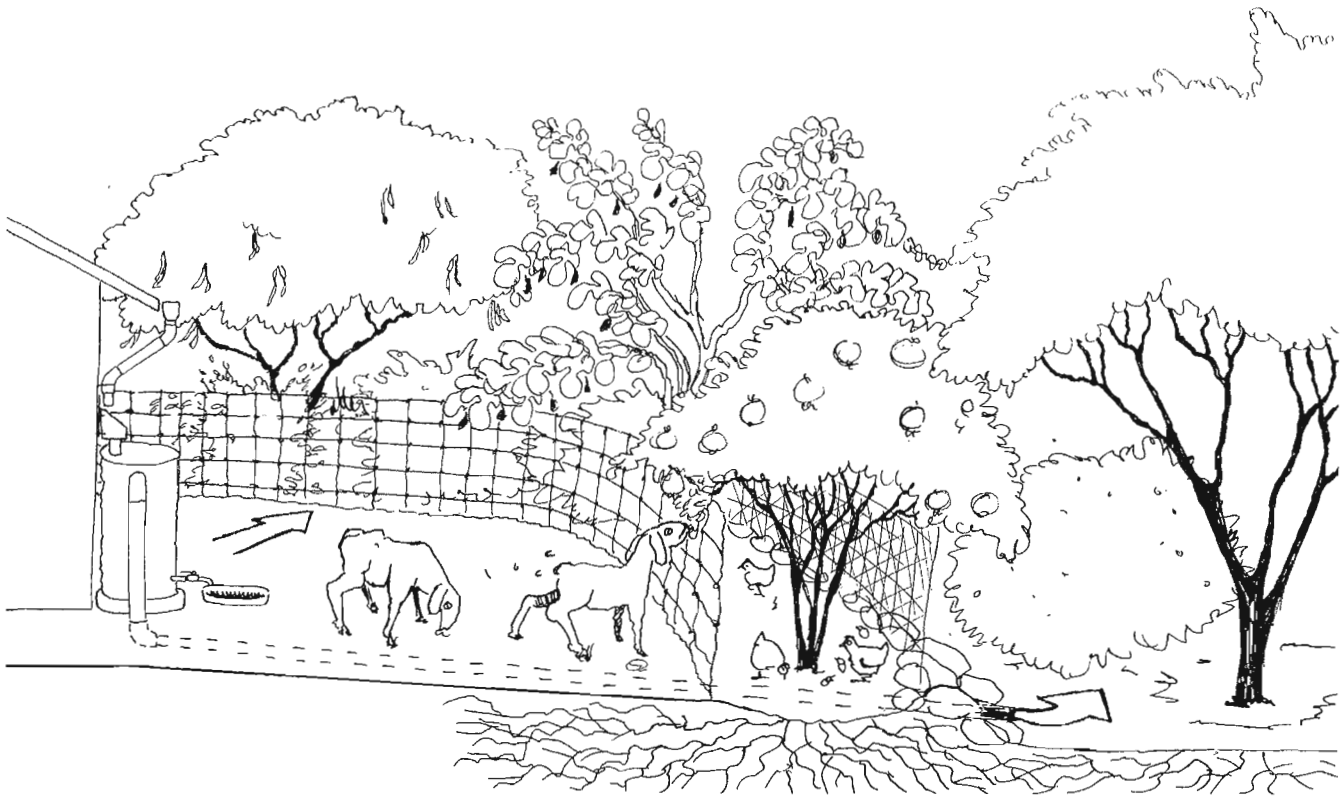

Fig. 11.20. Fencing protects the base of vegetation from browsing animals, so the plants can provide a protective canopy of shade, while the lower portions are sustainably browsed and pruned by the animals. Adapted from *Living Together: A Permaculture Site Assessment for the Phoenix Zoo Children's Trail Farm* by the Phoenix Permaculture Team, 1997

over animals with just the lower branches being pruned/chewed.

## STAKING

Do not stake trees unless they cannot support themselves. If you must stake a tree, stake it loosely so it can bend and sway in the wind, moving like an exercising muscle, developing strength and flexibility (fig. 11.21). Remove stakes as soon as the tree can support itself. An alternative to staking is carefully thinning a tree's canopy to reduce its size until it can support its own weight and mass. I avoid having to stake by purchasing nursery trees that are not staked in the first place.

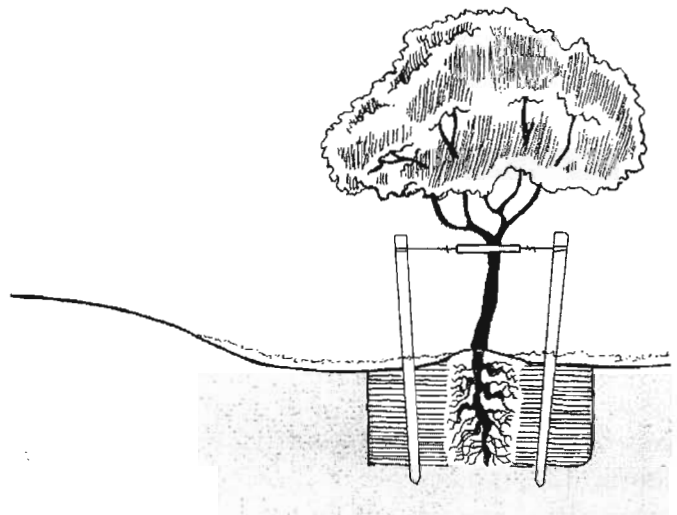

Fig. 11.21. Staked young tree. Stake trees if necessary, because the more plants can bend and sway with the wind, the stronger and more flexible they will become.

## MAINTENANCE

Check your plants regularly, making sure they get the watering, fencing, pruning, and weeding they need.

## WATERING

Watering schedules will vary depending on climate and plant species. Local landscaping books, and cooperative extension and nursery staff can advise how much and how often to irrigate plants, though you'll find your water-harvesting earthworks can reduce or eliminate the need for irrigation once the plants are established. In my climate, I water newly planted low-water-use *native* vegetation (transplanted from 1- to 5-gallon or 4-to 19-liter-sized pots) for the first two to three years to get them established. Larger plants and some exotic plants will need longer supplemental watering. I water heaviest the first year, giving most low-water-use trees and shrubs a good soaking every other day for the first three weeks, making sure the entire root ball is watered. Then I back off to one good soaking per week until winter, when I cut back to watering once every two weeks. When the weather warms up, I boost the frequency back to once a week.

By the second year I begin to gently wean plants off supplemental irrigation, reducing waterings to once a month. By year three, I limit monthly watering to summer, though I'll give one or two extra waterings in a drought. From that point on, if I've selected and planted vegetation well and rains are reliable, plants grow well on rain and supplemental greywater alone. But, if I want certain plants to grow more quickly, I continue supplemental watering until they've reached the desired size, then gradually wean them off. Directly observing plants, and adjusting watering to their condition, is always superior to unchecked automatic waterings. During summer, irrigate at night or early morning when temperatures and evaporation rates are lower.

Observe plants in your yard and in the wild to learn about their health and habits through different seasons. Native, low-water-use, dryland plants have many adaptations that sustain them through dry seasons and droughts. Some drop their leaves and go dormant, then burst with green leaves and colorful

### Box 11.7. Size Matters When It Comes to Water Needs

According to George Montgomery, Curator of Botany at the Arizona-Sonora Desert Museum in Tucson, a nursery-grown, low-water-use native tree planted from a 5-gallon (19-liter) nursery pot needs about two years of supplemental watering before it can survive on rainfall alone. However, trees planted from 24- to 36-inch (60- to 91-cm) containers can take up to ten years of supplemental watering to become established.<sup>16</sup>

Large containerized plants are utilized to get a big plant *now*, but interestingly, smaller nursery stock planted in the ground can grow faster than bigger stock. I have found that 5-gallon trees planted at the same time as 15-gallon (56-liter) trees outgrow the 15-gallon trees in 3 to 5 years.

blooms when rains arrive. During drought dormancy, the stems remain flexible when bent, as long as they are healthy. Expect and appreciate these seasonal changes. But in drought years, if your established plants show signs of drought stress as opposed to drought dormancy, give them a boost with supplemental water to carry them through until it rains. Do not water so much that they respond with the abundant growth characteristic of wet seasons. Signs of drought stress can include abnormal leaf drop, curling or yellowing of leaves, and shriveling of cacti. Keep taking hikes and carefully observing native plants to detect the differences between healthy adaptation to drought and excessive suffering from drought stress.

Native and non-native plants that are not well established cannot tolerate water stress, so water them accordingly. Poorly adapted non-native plants or high-water-use natives may be dependent on supplemental irrigation throughout their lives. If you are using an automatic drip irrigation system, consider resetting it to come on only when you turn it on when plants actually need it, saving water and money. At the very least, change automatic timer settings to correspond with the seasons—cut back in cool and wet seasons and install a rain sensor that shuts off the system when it rains. If most plants are doing fine, do not turn on drip irrigation systems to water just one or two plants

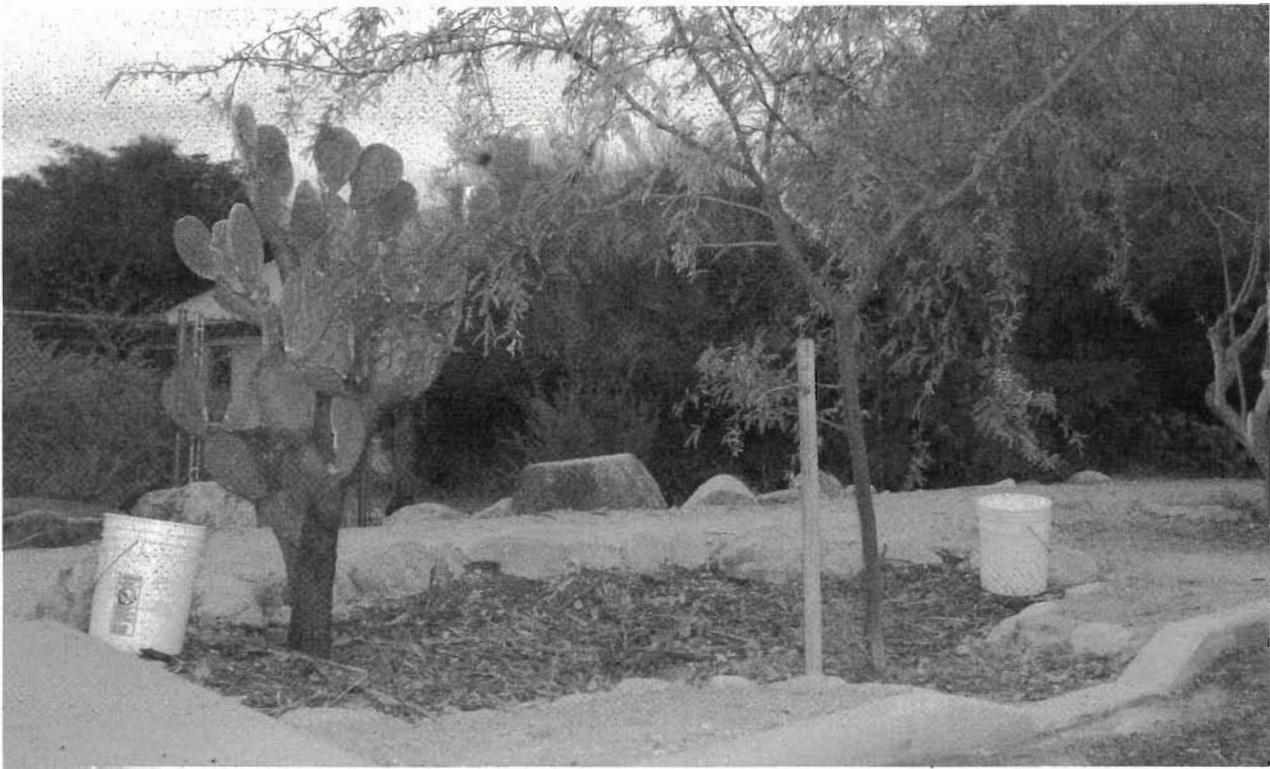

**Fig. 11.22A.** Bucket drip irrigation. More expansive root growth is encouraged by placing a drip-irrigation bucket on either side of the tree, and just beyond the drip edge of the tree's canopy.  
 Note: The curb cut directs street runoff to the tree's basin (see chapter 8 for more).



**Fig. 11.22B.** 1/8-inch (3-mm)-diameter hole in the side of the bucket, just above bucket's bottom, discharges the water like a drip-irrigation emitter.

in the landscape; water those few plants with a hose instead. See box I.2 for statistics on the efficiencies of automatic drip versus manual hose irrigation.

Use a plastic 5-gallon (19-liter) bucket with a 1/8-inch (3 mm)-diameter hole drilled in its side for an efficient, inexpensive, and mobile manual drip-irrigation system. Fill the bucket with water, carry it to where it is needed, and the water will empty through the hole in about an hour. Place the bucket farther from the base of plants as their roots grow, and use it only when the plants need supplemental water, typically when they are becoming established and perhaps during drought (figs. 11.22A, B). Don't buy a new bucket. Get a used one, and turn a waste into a resource. Donut shops sell used buckets cheap.

Encourage vegetation to extend roots deep and wide so plants will be less likely to blow over in strong winds and have increased access to residual soil moisture in dry seasons and droughts. Applying water only near the base of the plant will result in a stunted ball of roots. Instead, spread water out so roots will follow.

Multiple earthworks surrounding plants will lure roots in many directions. Once plants on drip systems are established, move the emitters about 6 inches (15 cm) farther from the base of the plant each month during the growing season to encourage more extensive root growth. Many dryland plants draw most of the water they use from the root zone *outside* the plant's canopy drip line.<sup>17</sup> Mimic the philosophy of Zimbabwean water farmer, Zephaniah Phiri, who says to his plants as he puts them in the ground, "There is the water; now go and get it!"

## PRUNING

Pruning can open up a space, help transform shrub trees into canopy trees, and regain winter solar access otherwise shaded out by low-growing branches (see drawing of tree pruned for optimal winter sun and summer shade in chapter 4, Volume 1).

But such pruning should not occur until a plant is well established, three years or more after planting. This is because auxins (which are made in the tips of branches) travel to the roots to assist in root establishment. The more root growth there is, the more drought-tolerant a plant will be, and the better it will be anchored against strong winds. Pruning removes the sources of auxin, thus root establishment is slowed. The only pruning I recommend early in a tree's life is to prune off broken branches at their point of origin.

If you prune plants after their establishment, minimize cuts and nurture the natural growth form of the plant. Many dryland trees and shrubs are naturally multitrunked, with a draping, well-balanced canopy that provides cover for wildlife, shades the bark of the plant, and keeps the ground surface cool. Do not prune such plants into a single trunk or they will become top-heavy, requiring staking and continuous maintenance.

A good pruning cut consists of a direct line from the outside edge of the branch bark ridge (a raised furrow of bark on top of a branch) to the outside edge of the branch collar (a raised furrow of bark on the underside of a branch). The meristematic tissue in these raised furrows will grow over the edges of the cut to heal the cut. Make clean—not jagged—cuts so they

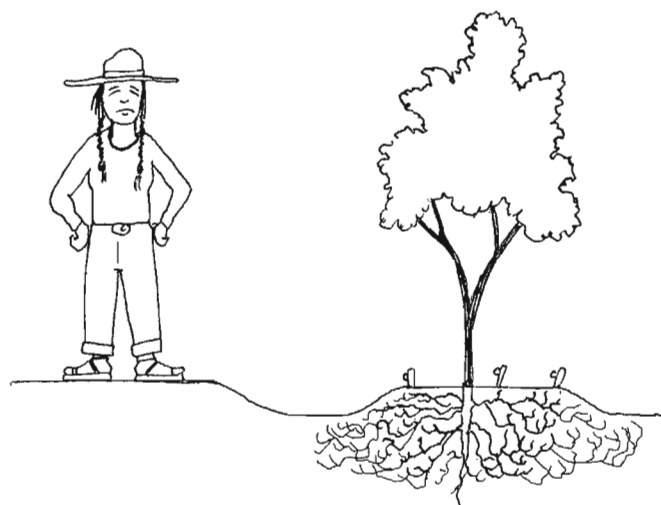

Fig. 11.23A. Small basin and drip-irrigation emitters installed and left at the base of a tree grow a stunted, concentrated pivot ball of roots. Such root growth makes the plant more susceptible to drought stress and to being blown over in strong winds.

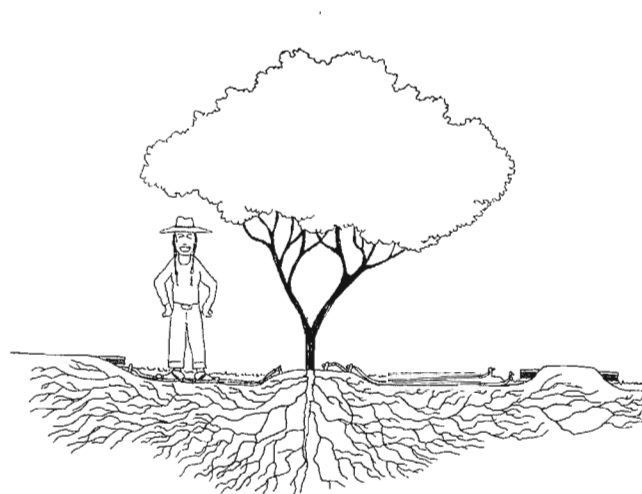

Fig. 11.23B. Expansive, stable, and drought-resistant growth of roots can be stimulated by using wide basins, multiple basins, or drip-irrigation emitters initially installed at the tree base, then periodically moved farther out to encourage root growth. Note: If greywater is distributed to the tree, branching or splitting its flow so greywater discharges on both sides of the tree helps encourage extended root growth.

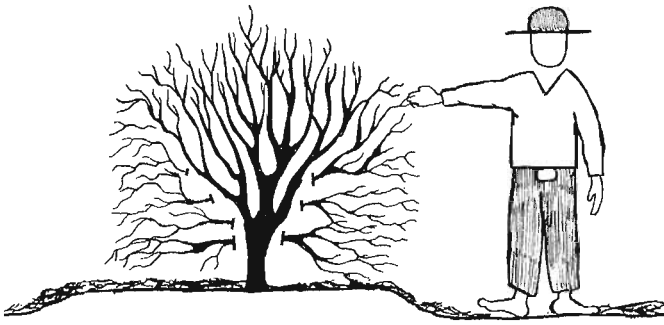

Fig. 11.24A. Pruning a young dryland tree to encourage upward growth, while retaining natural, multitrunked shape. Note: Such pruning is necessary only if you are trying to create a shade canopy you can get under. Never prune more than 25% of the plant. And never “top” or prune the upward growing branches.

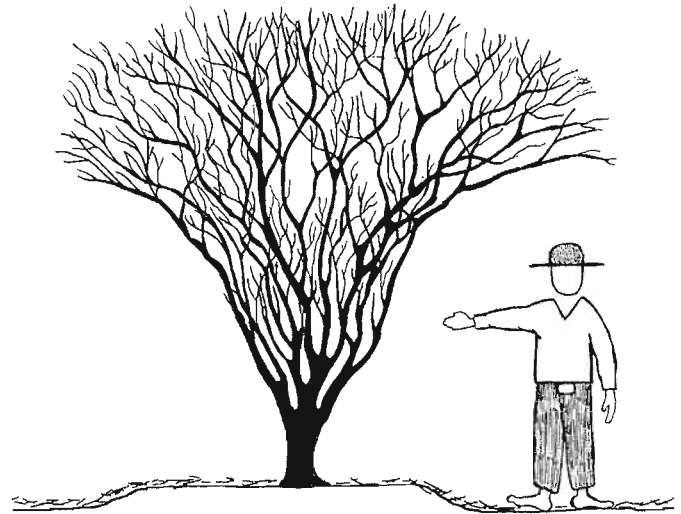

Fig. 11.24B. Tree after pruning and growth. Note recycling of cut-up prunings as mulch.

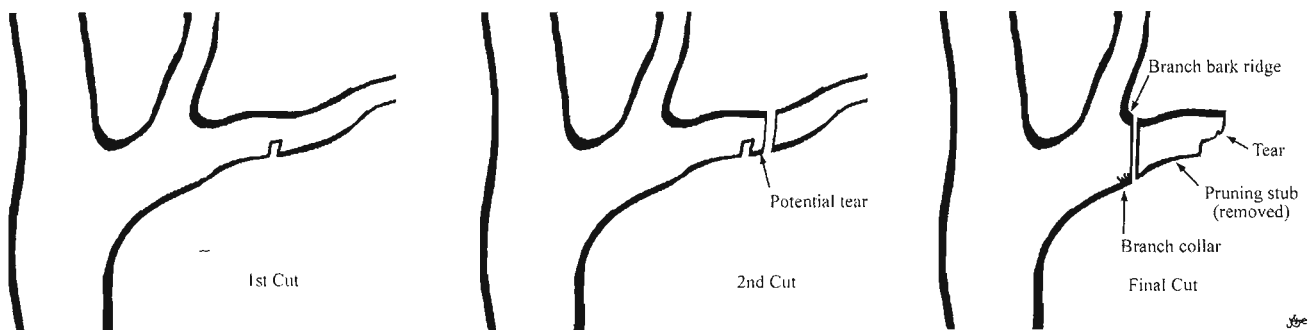

Fig. 11.25. A three-step technique for pruning a large limb: First, cut from the underside of limb, upwards one quarter to one third of the way through the branch. Second, cut from the top of the limb downwards, sawing the branch completely off. Third, cut from top to bottom to remove the stub. Cut from the outside edge of the branch bark ridge to the outside edge of the branch collar, so the meristematic tissue can heal the cut.

heal quickly. Sharp saws or pruning shears are far better than hatchets for making clean cuts. Scissor-action *by-pass* hand-pruning shears (see fig. 7.5) can be used to cut branches under 3/4 inch (2 cm) in diameter. Avoid using *anvil-type* pruning shears or loppers that work by directing a cutting blade against a flat surface, crushing plant tissue as it cuts. For larger cuts, use a sharp pruning saw and the three-step saw method shown in figure 11.25 to prevent the weight of large branches from splitting or tearing the plant at the cut location.

Do not leave the dreaded “bad-pruning stubs” on plants (see final cut on fig. 11.25). These pose hazards to people and they create entry points for insects and disease. Leave the cut surfaces dry—do not apply tree wound treatments, paints, or pruning compounds. Such compounds may seal in harmful bacteria and interfere with the plant’s ability to naturally seal wounds.<sup>18</sup>

Cut or shred pruned plant materials into 4-inch (10-cm) or shorter pieces, and use these resources onsite by laying them on the ground as a water-conserving mulch around the plants they came from

(fig. 7.5). As the prunings decompose, their nutrients are recycled back into the soil and eventually back into the plant. Large branches can be used for building projects or firewood.

## WEEDING

*What is a weed? A plant whose virtues  
have not yet been discovered.*

—Ralph Waldo Emerson

You can dig out or pull *unwanted* weeds, especially if they are invasive non-native species. Pull them before they flower and seed, and drop them in place to beneficially decompose into the soil.

“Weeds” that are desired are no longer weeds at all. For example, I once pulled invasive Bermuda grass (*Cynodon dactylon*) until I noticed my chickens loved to eat it. Now I let it grow, but only where my chickens can pull it for me. Purslane (*Portulaca oleracea*) is a succulent, low-growing “weed” that I find delicious and nutritious. I used to kill purslane, now I encourage it and even plant “improved” larger-leaved varieties, and eat them both.

For more information on the virtues of certain weeds see appendix 6.

## GOING ORGANIC: NATURALLY ENHANCING THE HEALTH OF THE SOIL, THE PLANTS, AND THE SYSTEM AS A WHOLE

In *The Soil and Health: A Study of Organic Agriculture*, Sir Albert Howard describes how the health of plants and those who eat the plants—people and animals—ultimately depend on the health of the soil plants grow in. The system’s health also depends on the quality of water that travels over and through the soil, and then is taken up into plants, animals, and people. We are what we eat and drink. Some of us eat animals, and all of us—including animals—eat plants, so we should be concerned about what the plants “eat and drink.” Studies show that organic foods are healthier and higher in nutrients than nonorganically grown foods.<sup>19</sup> I recommend practicing organic methods of gardening, farming, and landscaping in which no non-

natural pesticides, herbicides, or fertilizers are used. Organic methods improve our foodsheds, watersheds, and airsheds, which are all interconnected. See appendix 6 for resources on growing and eating organic foods.

## THINNING: OBSERVE YOUR PLANTS AND SPACING

Thinning is needed when plants’ water demands begin to exceed your landscape’s water supply. This can happen as landscapes grow and mature and as volunteer plants increase. In wet years, densely spaced plants look great since there is plenty of water to go around. But when drought hits, you will see signs of stress such as drooping plants, leaf drop, or even dieback of parts or all of some plants. Thinning reduces competition for water. It also reduces the threat of fire since higher soil moisture will keep remaining plants green, and dead fuel wood will be removed and turned into mulch.

When thinning, begin in densely crowded areas and take out short-lived, fast-growing pioneer plants before you take out long-lived, slow-growing, higher order plants. In Tucson I remove fast-growing, weak-wooded four-wing salt bush (*Atriplex canescens*) before removing slower-growing, medicinal Mormon tea (*Ephedra trifurca*), or the dense-wooded, fruit-producing desert hackberry (*Celtis spinosa*). When deciding what to thin, try to preserve higher value plants such as food producers. Cut up or chip the thinned plants, and use them to mulch land surfaces to recycle nutrients back into the soil, increase rainwater infiltration, and reduce loss of soil moisture to evaporation.

You may need to remove or transplant high-water-use plants that have been misplaced in areas with insufficient water supply. This becomes more apparent as plants grow and water needs increase. I planted an orange tree on the periphery of my property before I understood the concept of oasis zones. This plant received plenty of harvested runoff in wet seasons but not enough in dry seasons, so it was stunted and never bore fruit. Once transplanted into the wetter oasis zone beside my home, the orange tree received more rooftop runoff in the wet season and household grey-water year round. Now it grows well and bears fruit.



Fig. 11.26. Rodd Lancaster enjoying rain-irrigated, neighborhood-grown cactus fruit. In addition, the cactus pads can be cooked as a vegetable.

Consider thinning vegetation if your site needs more direct sunlight. An ornamental palm tree on the south side of our home prevented winter sun from reaching our south-facing windows, leaving the home frigid. We removed the ill-placed tree, and now the winter sun coming through the windows passively heats our home. See chapter 4, Volume 1 for more information on designing with the sun.

## MULTIPLE FUNCTIONS OF VEGETATION

### VEGETATION AS LOCAL SOURCE OF FOOD AND FOOD SECURITY

Astonishingly, in the United States, food typically travels from 1,500 to 2,500 miles (2,414 to 4,023 km) from a farm to your table.<sup>20</sup> Yet, plants in your landscape can produce food right outside your door (figs. 11.26 and 11.28). One hundred fruit trees scattered throughout a thousand-home neighborhood are just as productive as a hundred trees planted in a 1-acre (0.4-ha) irrigated orchard. A thousand such neighborhoods could produce as much as a thousand acres (404 ha) of orchard.<sup>21</sup> Besides food, orchards integrated with homes and neighborhoods provide passive cooling, living playgrounds, windbreaks, erosion control, beauty, and stronger local economies.

Watering these trees and other food-producing plants with harvested rainwater and on-site greywater drastically reduces the strain a groundwater-irrigated orchard puts on community water resources. In addition, it simultaneously eliminates the fossil fuel consumption needed to harvest, package, transport, and sell the distant orchard's produce to you.

## VEGETATION AS OUR PLANET'S LUNGS

According to the *Citizen Forester's Guide: The Simple Act of Planting a Tree*, a big tree can provide a day's worth of oxygen for up to four people.<sup>22</sup> According to the U.S. Department of Agriculture, "One acre of forest absorbs six tons of carbon dioxide and puts out four tons of oxygen. This is enough to meet the annual needs of 18 people."<sup>23</sup>

## VEGETATION AS AN ENERGY SAVER

U.S. Forest Service meteorologist Gordon Heisler estimates that well positioned trees arrayed around conventional houses can lead to energy savings of 20-25% when compared to the same house located in an unvegetated open area.<sup>24</sup>

## VEGETATION AS AN ECONOMIC FACTOR

The American Forests organization ([www.americanforests.org](http://www.americanforests.org)) has created modeling software to help communities analyze the effects of their urban forests. Results from this model showed that tree cover in Garland, Texas, was saving the city \$5.3 million a year through residential energy savings, runoff reduction, and air pollution removal.<sup>25</sup> In 1985, the American Forestry Association estimated that over the course of a year, an average 50-year-old urban tree would supply air conditioning worth \$73, soil-erosion and stormwater control worth \$75, wildlife shelter worth \$75, and air-pollution control valued at \$50, for a total value of \$273 (in 1985 dollars). The lifetime value of the tree, compounded by 5% for 50 years was estimated at \$57,151.<sup>26</sup> The U.S. Forest Service estimates that market values for homes are increased from 7 to 20% by the presence of trees.<sup>27</sup> And calculations of monetary



value do not begin to address the trees' true value for enhancing quality of life in addition to property value.

## VEGETATION AS STORMWATER MANAGEMENT

The resource guide *Shading our Cities* reports that USDA scientist Rowan Rowntree found vegetated areas intercept and transpire enough water to significantly modify the water budget of urban regions. He states, "in a one-inch (25-mm) rainstorm over twelve hours, the interception of rain by the canopy of the urban forest in Salt Lake City reduces surface runoff by about 11.3 million gallons (42,827,000 liters), or 17%. Most cities could count a like reduction, with the values increasing as the canopy increases. That [vegetation] allows surface-water recharge, cuts the cost of wastewater disposal, and averts the flooding and sedimentation of city streams or rivers."<sup>28</sup>

## TREES AS AIR CONDITIONERS

The Cool Communities website quotes the USDA as saying, "The net cooling effect of a young, healthy tree is equivalent to ten, room-size air conditioners operating 20 hours a day."<sup>29</sup> The National Wildlife Federation notes "There are about 60 million to 200 million spaces along our city streets where trees could be planted. This translates to the potential to absorb 33 million more tons of CO<sub>2</sub> every year, saving \$4 billion in energy costs,"<sup>30</sup> and helping mitigate the effect of global climate change caused by our excessive discharge of carbon dioxide into the atmosphere.

## VEGETATION AS A FACTOR IN COUNTERACTING GLOBAL WARMING

Around 80% of global warming has been caused by carbon dioxide liberated by humans burning fossil fuels, especially coal. Due to the very long life of CO<sub>2</sub> in the atmosphere, around 56% of all CO<sub>2</sub> ever released by human activity is still aloft. It is too late to avoid changes being brought on by global warming, but we still have time to implement strategies to avoid disaster.<sup>31</sup> The primary action must be to reduce the 1990 level of CO<sub>2</sub> emissions by 70% by 2050.<sup>32</sup>

The sooner we accomplish this, the more positive the outcome. You as an individual could achieve a 70% reduction in greenhouse gas emissions almost instantly by replacing a four-wheel-drive vehicle with a hybrid fuel car and, when possible, by carpooling, walking, and bicycling instead of driving. You can do your part to reduce greenhouse gas emissions at power plants by using less power; using more energy-efficient appliances; installing a solar-, wind-, or microhydro-power system at home; or calling your local energy provider to purchase *renewable energy* from a green energy program.

At the same time we can plant perennial vegetation—especially trees—to draw existing carbon from the air, and sequester or bind it within their tissue. Forest and scrub vegetation across the continental 48 states can take up half a billion tons of carbon, balancing out more than a third of the emissions from U.S. cars and factories.<sup>33</sup> That's a huge gift, but we need to shift the balance so carbon sequestration exceeds carbon emissions. See appendix 6, section VII (Introduction) for resources to reduce climate change.

## VEGETATION AS A LIVING TOTEM, HISTORICAL MARKER OR MONUMENT

Plant a climate-appropriate, long-lived tree to mark a birth, wedding, graduation, or the passing of a life. Long-lived species include the native oak on the west coast of the U.S. and the desert ironwood tree or saguaro cactus in the Sonoran desert. These plants will grow with the child, relationship, career, or memories, improving life in the present and providing for the future. A marble tombstone or monument is static. A living tombtree or monument steadily grows into a more useable and enjoyable form. Any time is a good time to plant a tree, though the best time is 20 years ago, or today. See appendix 6 for more information about living monuments and green burials.

## REAL-LIFE EXAMPLES

### STREET TREE ORCHARDS—TUCSON, ARIZONA

In my hometown (average annual rainfall of 12 inches or 304 mm at elevation of 2,500 feet or 762 m)



Fig. 11.27. Girl Scouts planting a neighborhood street tree in 1996



Fig. 11.28. In 2006, Chi Lancaster stands beside the velvet mesquite tree planted ten years before in fig. 11.27. It now produces shade, beauty, wildlife habitat, edible seed pods, and nectar for our honey bees. Seed pods harvested from the tree are tasty to chew on and can be ground into flour. Neighborhood cholla buds, olives, chiltepinas, mesquite flour, prickly pear jam, and honey sit on the ground near the curb cut that allows street runoff to passively irrigate food-bearing plants in the right-of-way.

there is a collaborative effort to promote, celebrate, and enhance local food production by planting indigenous, food-bearing shade trees, then showing folks how to harvest and process the bounty. Annual events include neighborhood tree plantings, mesquite-pod grinding, and native-food feasts.

Neighborhood tree plantings focus on low-water-use, food-producing native shade trees that provide nest sites to draw native song birds back into the urban and suburban core. Neighbors can purchase 5-gallon (19-liter) trees for \$8 each thanks to generous subsidies from Trees for Tucson and Tucson Electric Power Company. Volunteer crews of neighborhood residents receive instruction on planting trees in water-harvesting earthworks, then plant trees along streets and sidewalks and in private yards (fig. 11.27).

Within hours of planting, the neighborhood is changed for the better. More neighbors know each other, newly planted trees demonstrate community commitment, and water-harvesting earthworks are ready to fill in the next rainfall.

Six years later, trees are full and beautiful, native songbirds flourish, and the flora and fauna of the local ecosystem anchor the community's sense of place (fig. 11.28). Within eight years of planting, tree-shaded neighborhoods are noticeably cooler than

unplanted areas as tree shade starts to offset the heat-island effect caused by excessive pavement and buildings exposed to the sun.

In the Tucson area, indigenous food trees include velvet mesquite (*Prosopis velutina*), foothills palo verde (*Parkinsonia microphyllum*), blue palo verde (*Parkinsonia floridum*), and desert ironwood (*Olneya tesota*). Once established, these trees can survive on rainfall alone and will thrive within water-harvesting earthworks. Native food trees in other regions might include oak, pinyon pine, sugar maple, walnut, or date palm.

Mesquite-milling days and mesquite-pancake feasts are organized in October and November at community gardens, farmers' markets, and the community food bank. October marks the harvest period for summer gardens and the end of the mesquite-harvest season. Mesquite pancakes served with syrup made from the fruits of prickly pear and saguaro cacti "plant the seeds" of native foods' delicious tastes and potential within the minds and palate of the hungry public (fig. 11.29).

The feast is enriched by the sale and consumption of local garden-produced corn, squash, tomatoes, and tepary beans, and cultural foods including tamales, sweet-potato pie, and pickled cholla buds. Local musicians play as folks eat and the mobile community hammermill is fired up to grind the mesquite pods brought by neighbors who harvested over the summer (fig. 11.30). Flour goes home with the harvesters so mesquite breads, cookies, and sauces can be cooked up in their kitchens.

By planting and harvesting the produce of the native ecosystem and backyard gardens, we make these foods sustainable parts of our daily experience, community/cultural identity, and food security. Mesquite pods were once a major food of the indigenous peoples of this area. Perhaps they will be a major food

again, both for the indigenous people and more recent arrivals. See [www.DesertHarvesters.org](http://www.DesertHarvesters.org) for more.

Note: See the "Watering Street Trees with Street Runoff" in the Real-Life Examples section of chapter 8 for more before-and-after photos of neighborhood tree planting. And see "Turning Flood-Control Structures Into Beautiful Water-Harvesting Amenities"

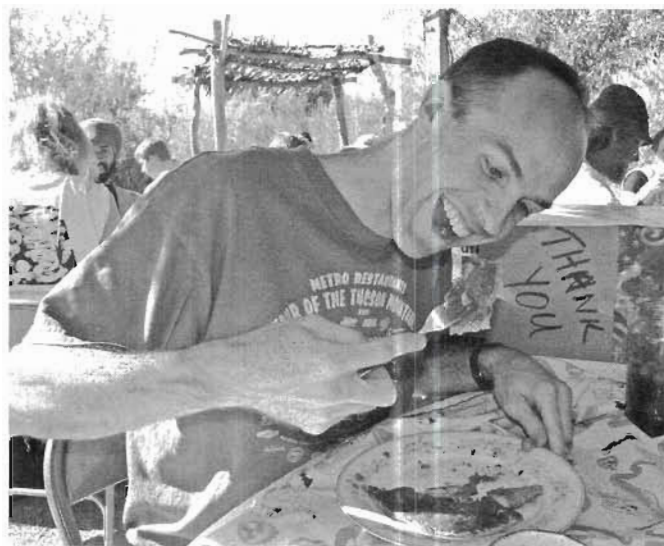

Fig. 11.29. Garth Mackzum feasting on mesquite pancakes with prickly pear syrup

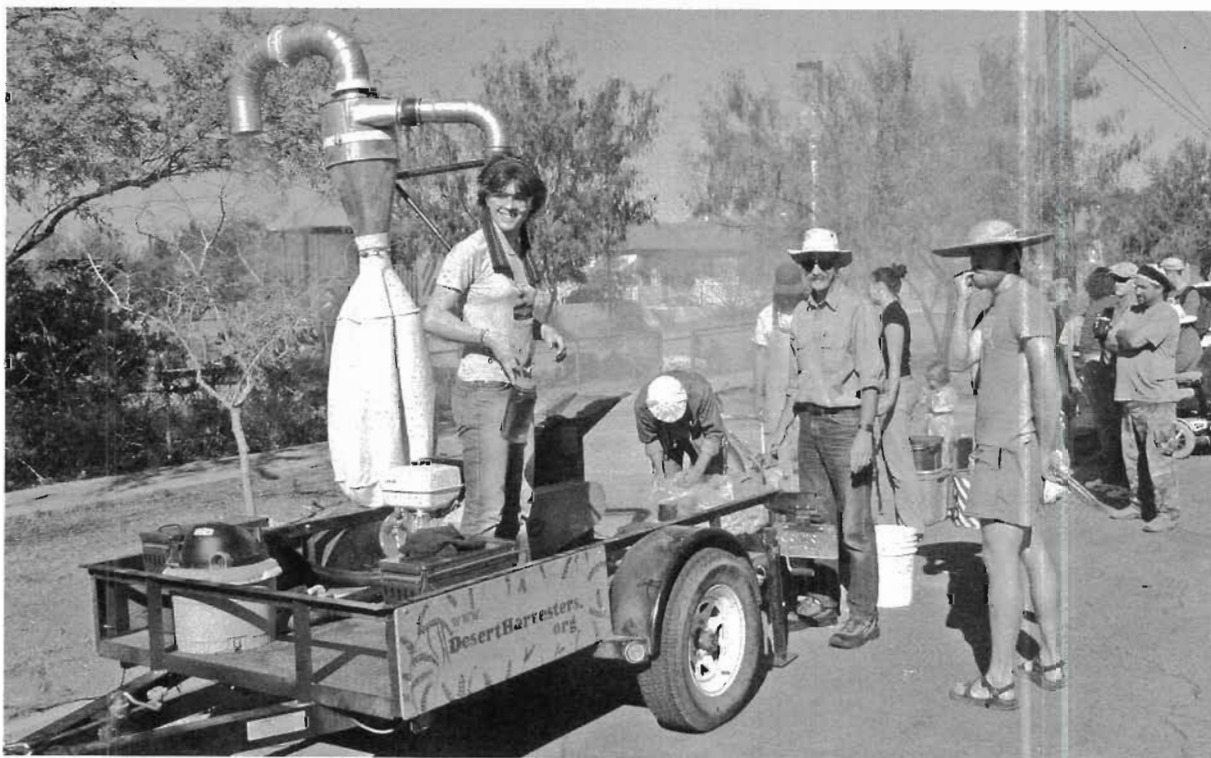

Fig. 11.30. Mobile hammermill grinding mesquite pods into edible flour

in the Real Life Examples section of chapter 5 for planting strategies appropriate for common landscapes of cohousing, condominium, and apartment complexes.

## NATIVE LIVING CHRISTMAS TREES

A new place-based holiday tradition is growing in the Southwest as folks forgo exotic, water-needy, living coniferous Christmas trees and instead use living, low-water-use native plants. In the low deserts, evergreen desert ironwood trees, saguaro cactus, and creosote bushes are purchased from local nurseries and decorated for the holidays with dried ornaments from the desert such as devil's claws, yucca seed pods, and the orchid-like skins of saguaro fruit. In the high deserts, potted indigenous pinyon-nut-producing pines replace non-native pines. After the holidays these native, low-water-use plants are planted in water-harvesting earthworks in the yard or right-of-way and become long-term gifts to the community and ecosystem.

## PLANTING AN URBAN FOREST TO MANAGE A CITY AS AN ECOSYSTEM – LOS ANGELES, CALIFORNIA

At age 15, Andy Lipkis felt the power of tree planting. During summer camp, he helped plant smog-resistant cedar and pine trees in dying sections of the Santa Monica Mountain forests. The forests surrounded by Los Angeles were dying from excessive air pollution. The plantings succeeded and life again flourished. Seeing the forest's transformation, thanks in part to his efforts, gave Andy great strength. He wanted other kids to experience this too. So, three years later, in 1973, Andy founded the nonprofit organization TreePeople to undertake tree planting to save more of the Santa Monica Mountain forests, and to green the city of Los Angeles as well. Just over 1,000 trees were planted in the first project Andy organized.

Since then, Tree-People has grown to 55 employees and thousands of citizen-volunteers who have planted over two million trees in 30 years. And they

plan to plant a million more, potentially increasing the city's existing tree canopy by nearly 60%. People of all ages are trained to plant and care for trees as part of myriad programs. These include distributing free fruit trees to low-income neighborhoods; replacing large swaths of paved school campuses with trees and turf planted by students, teachers, and parents; and putting on free workshops preparing citizen-volunteer foresters to plant in yards, neighborhoods, parks, and forests. These efforts have led to cleaner air, increased shade, reduced flooding, energy savings, a more livable city, and a populace engaged as stewards of their homesites, community lands, and watershed.

And now, as you can read in this book's foreword, the efforts of Andy, TreePeople, and the city of Los Angeles have extended to "planting the rain" as they plant the trees. Andy and TreePeople did so by leveraging the reallocation of money earmarked for multimillion-dollar flood-control projects and sewage treatment plants designed to drain the city's watershed of much of its 14.7 inches (373 mm) of average annual rainfall, to instead create a diverse array of multiuse *greeninfrastructure* that hydrates the watershed. The greeninfrastructure consists of water-harvesting strategies combined with urban-forestry projects on private property, in parks, on school grounds, along streets, and within parking lots to naturally capture, filter, infiltrate, and reuse stormwater throughout the city's watersheds.

With each example and each success the city moves closer to sustainability, the health of its ecosystem improves, and the community is strengthened as people get to know one another and work together. It's a biologically based, integrated approach that began with Andy's teenage vision sparked by planting trees.

Perhaps that's why TreePeople focuses so much energy on kids' programs. They've resulted in tens of thousands of L.A.'s kids planting trees and participating in the water-harvesting transformation of their schools and neighborhoods—empowering them to envision and realize whole new acts of positive change that will inspire tens of thousands more.

For more information see [www.TreePeople.org](http://www.TreePeople.org).

# 12

CHAPTER

## Greywater Harvesting: Making the Most of Your Recycled Water and Earthworks

*The society which scorns excellence in plumbing as a humble activity and tolerates shoddiness in philosophy because it is an exalted activity will have neither good plumbing nor good philosophy; Neither its pipes nor its theories will hold water.*

—Jerry Warsaw

The previous chapters illustrated how to create and plant water-harvesting earthworks. These *foundations* of sustainable landscapes passively harvest our primary water source—direct rainfall and resultant runoff—into bowl-like shapes in soil to help support multiuse plants. This chapter shows how to

maximize the potential of earthworks near homes and buildings by harvesting and recycling secondary water sources within those earthworks—especially in times of no rain. Secondary water sources include greywater from the drains of clothes washers, bathtubs, showers, and sinks (fig. 12.1); clearwater discharge water from

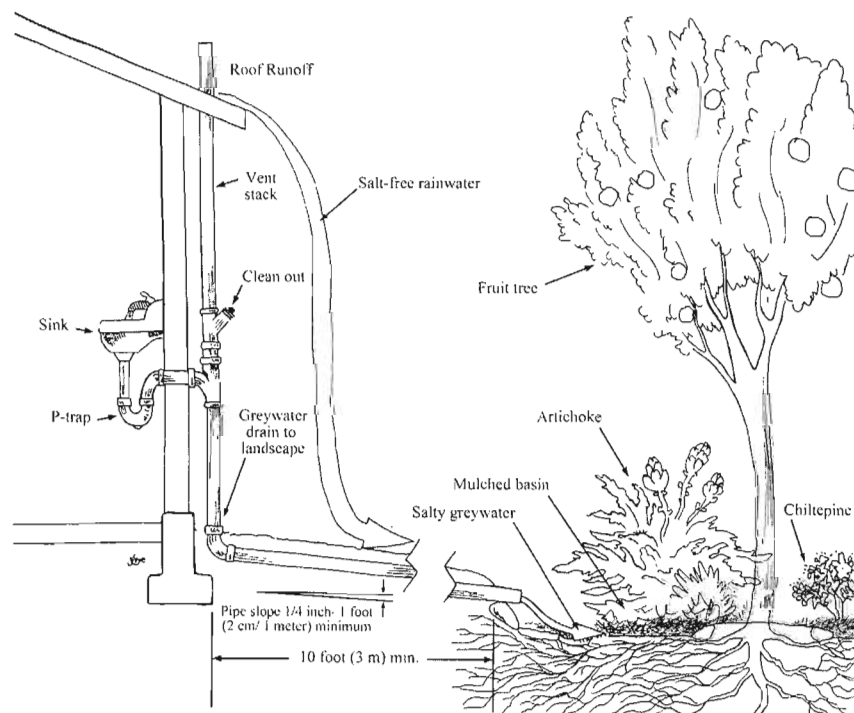

Fig 12.1. A bathroom sink greywater “spring” irrigating shade tree and shrubs. End of greywater pipe discharges a few inches above the mulch within the basin to prevent solids from backing up within the pipe and clogging it. End of pipe can be left visible or concealed by large rocks as long as they do not block flow. Note: The vent stack, clean out, and a section of the drainpipe above the soil are installed on the exterior of the wall for easy access, but could instead be installed conventionally within the wall.

Adapted from *The New Create an Oasis with Greywater*, by Art Ludwig

reverse-osmosis water filters; bleed-off water from evaporative coolers (fig. 12.2); and air conditioning condensate i.e., atmospheric water that condenses on the cold coil of an air conditioning unit (fig. 12.3). Recycling secondary water sources within earthworks will enable you to support a lush landscape year-round, while reducing or eliminating irrigation with potable drinking water delivered from municipal supplies or wells. You'll turn "waste" water into a vegetation-growing resource producing shade, food, cleaner air, wildlife habitat, and other benefits around homes and other buildings.

The volume of fresh water available on this planet is finite, but we can increase the productivity of this water by using it again and again—or "cycling it"—to support multiple life forms, uses, and resources. Read on to see how the combined cycling of rainwater and "waste" water has created fire-resistant landscapes within fire-ravaged land, how neighbors forming "greywater laundromats" build community and grow fruit, and how homes built with greywater systems and com-

posting toilets productively harvest and recycle "waste" and "wastewater" within thriving landscapes.

All greywater harvesting options discussed or referenced in this chapter are safe, easy, convenient, and affordable. Incorporating greywater harvesting at the time of construction or major renovation is generally the easiest and least expensive approach when stub-outs are installed (fig. 12.4A). Stub-outs for greywater plumbing are built-in connections that allow easy future access to the drain water stream. Ideally the upper end is located for easy access at the greywater source, such as inside the bathroom beneath the sink, rather than an inconvenient placement outside or under the floor. The lower downstream end of the stub-out pipe is routed to sections of yard that have ample space to place harvesting basins. Stub-outs remain capped until a greywater distribution system is set up in the landscape, then they can be connected to the drain plumbing and the greywater can be put to use.<sup>1</sup> Often it is ideal if the stub-outs are connected with a three-way valve (figs. 12.4B, 12.5, 12.6 and 12.7) or a multi-drain

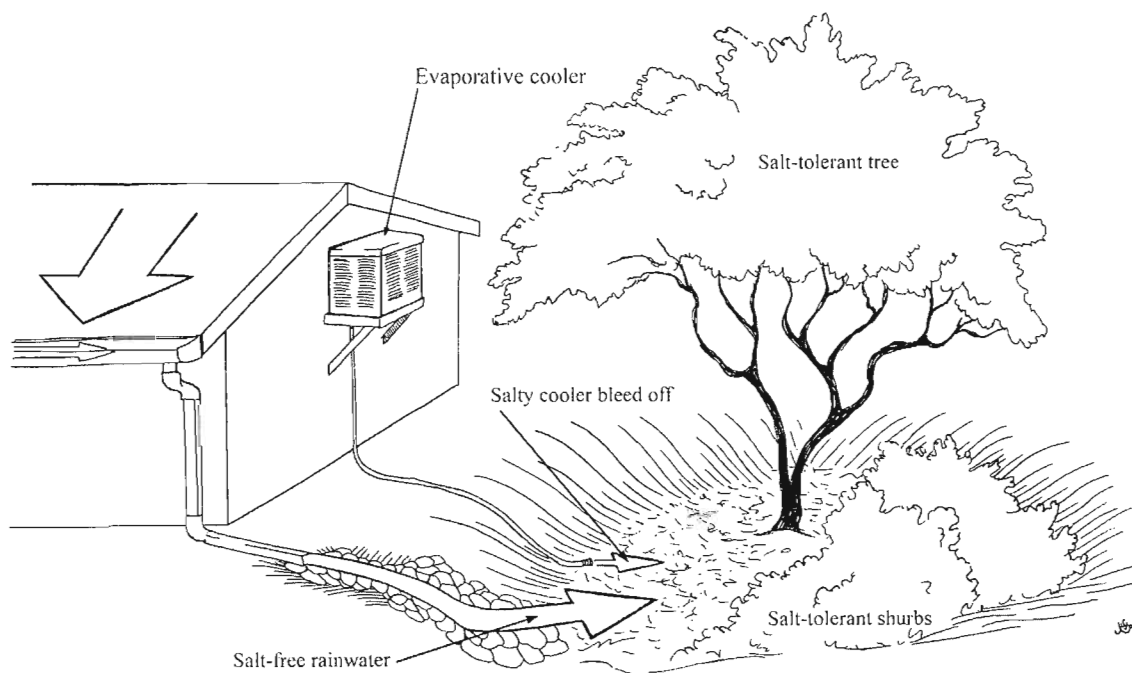

Fig. 12.2. An evaporative cooler "spring" irrigating salt-tolerant tree and shrubs. The overflow drain hose from an evaporative cooler directs bleed-off water to sunken, mulched basin. Household cooler bleed-off discharge rate can range from 1gal/hour (3.7 liters/hour) to 5 gal/hour (18.9 liters/hour). Cooler bleed-off water is high in salt, so associated plantings must be salt-tolerant and occasionally flushed with salt-free rainwater to remove accumulated salts from the root zone of the plants. Screwbean mesquite tree (*Prosopis pubescens*), four-wing saltbush (*Atriplex canescens*), and native wolfberry (*Lycium fremontii*) are used here. As the tree grows to shade the cooler, the cooler's efficiency increases.

system (figs. 12.20A, B, and 12.21) enabling the user to direct the greywater to the landscape or the sewer/septic depending on what goes down the drain, the weather, or the saturation of the soil in the landscape. Greywater lines originating inside a home should be diverted downstream from P-traps and vents to inhibit the entry of insects, vermin, or odors into the house via greywater lines. Three-way diverter valves can often be installed as high in the system's flow as the vent/sewer stack, downstream of the P-trap. See [www.OasisDesign.net](http://www.OasisDesign.net) for more on stub-outs.

Existing homes can typically be retrofitted with simple techniques such as stub-outs to sinks against exterior walls, cooler-bleed-off harvesting, or the multi-drain system for washing machines and outdoor showers (both described in the Variations section). See what works for you, your site, and your lifestyle. You don't have to do it all, just start somewhere. Anything is an improvement, and the more you do, the better!

Note: This chapter includes enough information on greywater systems to understand conceptually what they can do, and how you can combine them synergistically with rainwater harvesting. It includes real-world examples, and some greywater-design innovations of friends and mine. These are covered in more detail, as they cannot be found elsewhere. Other systems, such as the branched-drain system, which I also favor, have already been clearly published, and are just summarized with their sources referenced. Yet there are still many more systems than I feature here. For complete information on greywater-system design, construction details, use, and maintenance, see Art Ludwig's *The New Create an Oasis with Greywater*. For information on dealing with permits, larger systems, or making greywater systems for others, see his *Builder's Greywater Guide*. Much of the material in this chapter is drawn from or inspired by these books. Both are available from [www.OasisDesign.net](http://www.OasisDesign.net), which also includes over 100 pages of free greywater information.

## WHAT IS GREYWATER HARVESTING?

*Greywater* is wastewater that originates from a clothes washer, bathtub, shower, or sink. Wastewater from flushing toilets is called *blackwater*. Wastewater that originates from a kitchen sink and dishwasher

*continues on page 294*

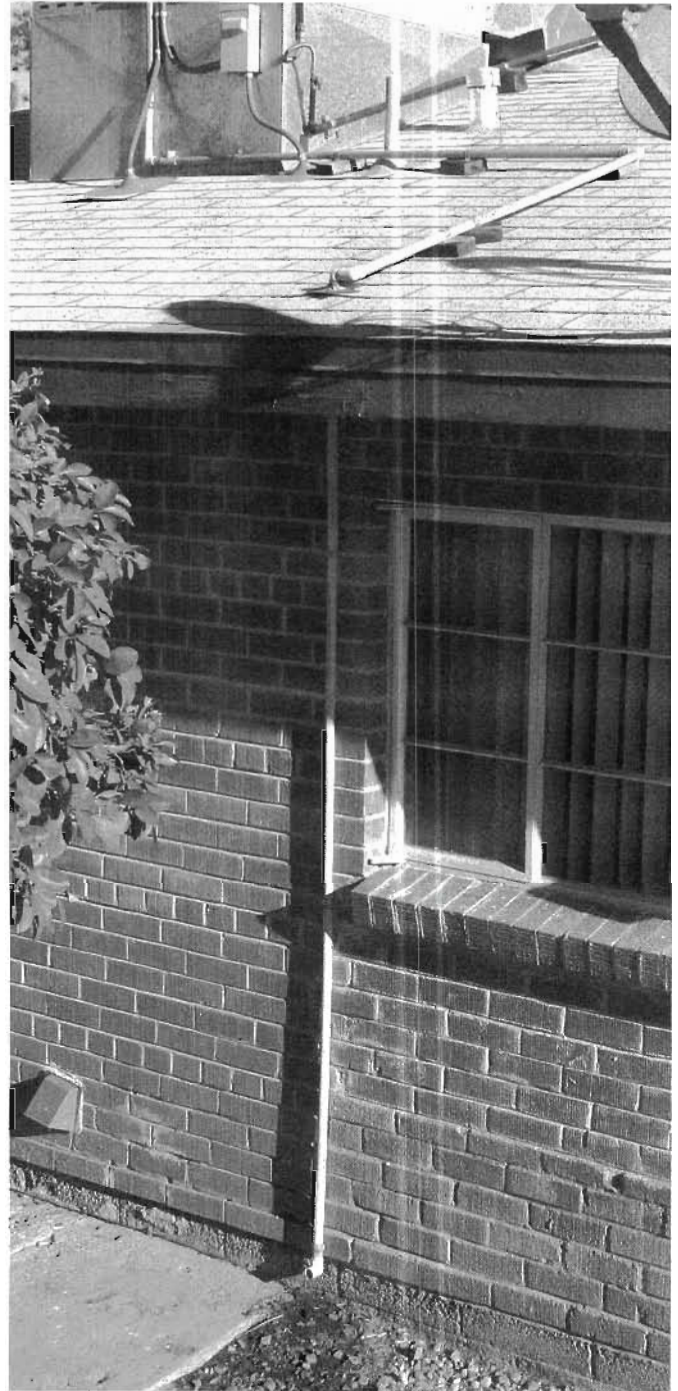
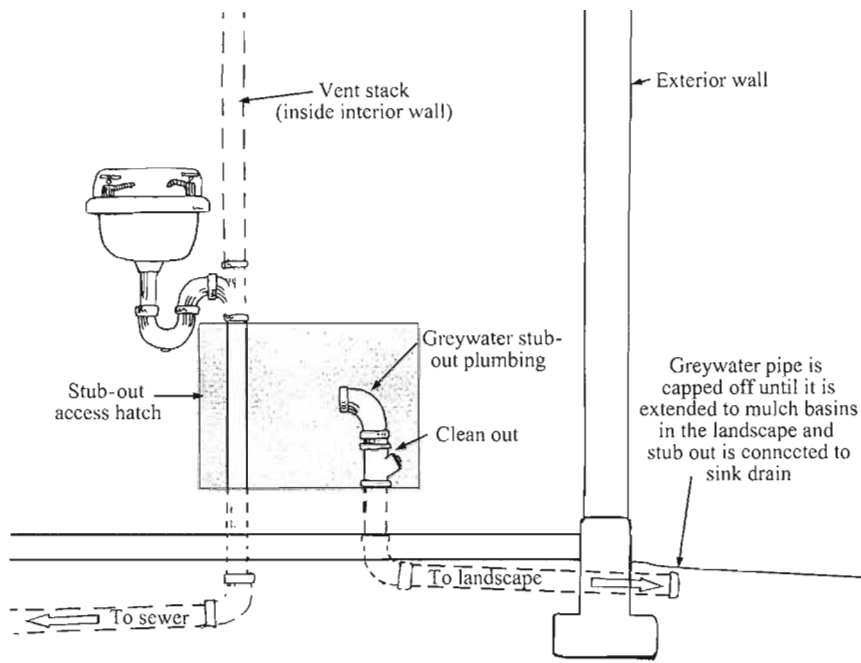
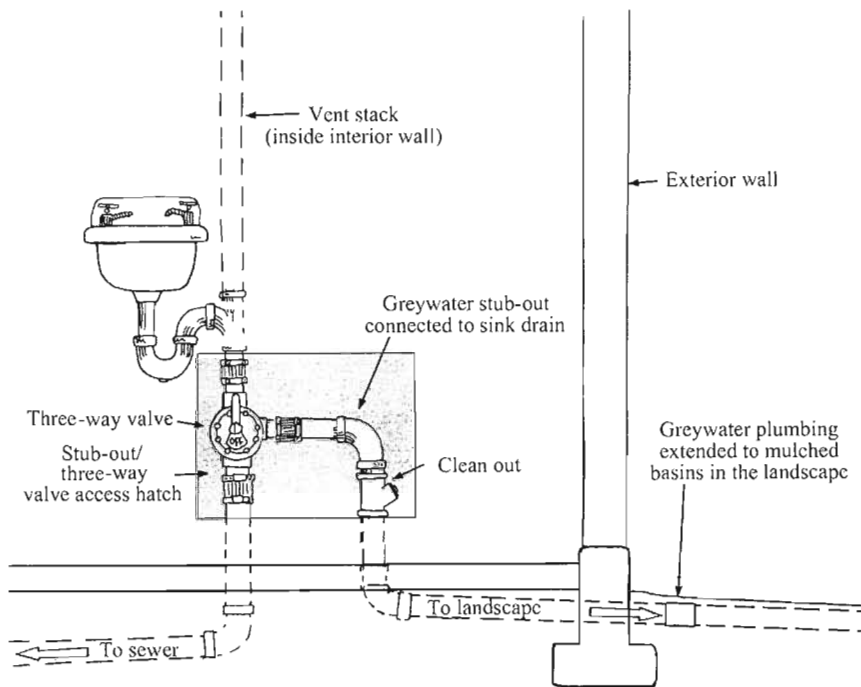

Fig. 12.3. A home air conditioner's condensate wastefully drains to bare dirt. Instead, direct the flow of condensate water to mulched and vegetated basins where this high-quality, salt-free water can help dilute salts that accumulate from harvested greywater and evaporative-cooler bleed off. In hot dry times condensate volume is low, but condensate volume can be significant in humid climates or humid seasons. Commercial and industrial air conditioners create a vast untapped source of high quality water that too often flows wastefully to the sewer.



Joe

Fig. 12.4A. Stub-out not yet connected. A bathroom sink and drain with a greywater stub-out which is capped off and waiting to be hooked up to the greywater flow. The stub-out can be made accessible for later hookup by installing a removable section of drywall or latched door, or by leaving it exposed within a below-sink cabinet. Note: the stub-out should exit the building as high as possible (even above grade) for the maximum number of gravity-fed distribution options within the landscape



Joe

Fig. 12.4B. Stub-out connected. The bathroom sink and drain hooked up to the greywater stub-out via a three-way diverter valve. Before the sink is hooked up to the greywater line, the landscape end of this greywater line must be connected to an outlet point in a mulched and vegetated basin. Whenever possible, make greywater use convenient by putting the three-way diverter valve in an easy-to-reach place in the same room as the greywater source. If it's not convenient, it won't be used. Note that the three-way valve was installed with "no hub rubber couplings" for easy replacement, though it could be permanently glued to the plastic drainpipe instead.



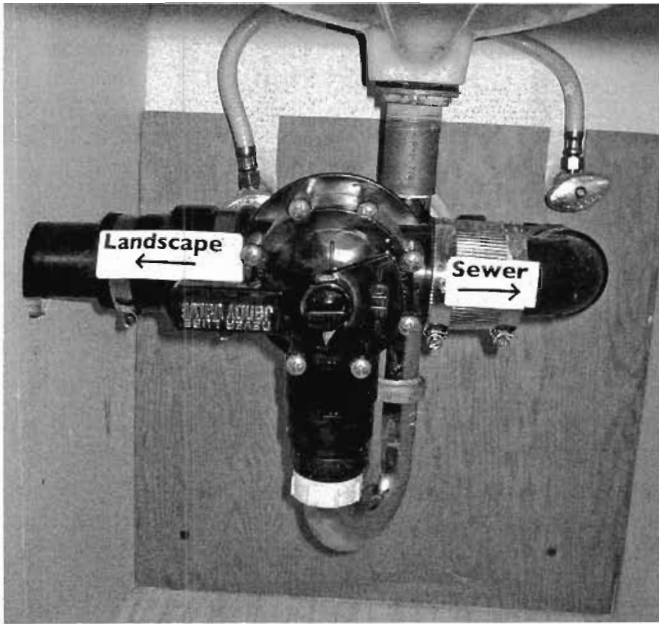

Fig. 12.5. Three-way diverter valve under bathroom sink provides the convenient option of sending greywater to the landscape or the sewer depending on what goes down the drain, how saturated the soil is, and weather and soil conditions. Greywater pipe is directed under bathroom counter top within the existing cabinetry and through the adjoining exterior wall to access the landscape. Sewer pipe is connected to the existing sewer/vent stack within the interior wall.  
 Credit: Greg Peterson of Phoenix Urban Farm.  
 Jandy-Valve brand valves are available from pool and spa suppliers and OasisDesign.net.



Fig. 12.6. Three-way diverter valve conveniently located between toilet and sink directs sink greywater to landscape or sewer at the Eco Hood in Phoenix, Arizona



Fig. 12.7A. This bathtub was installed higher than normal to enable easy access to the tub's three-way diverter valve via a beautiful hidden door.  
 Credit: Sonya Norman



Fig. 12.7B. Closeup of bathtub diverter valve.  
 Credit: Sonya Norman. For more stub-out examples see the *Images* page at [www.HarvestingRainwater.com](http://www.HarvestingRainwater.com)

contains higher levels of organic solids and coliform bacteria than other greywater sources, so some regulators consider these water streams blackwater as well, but I prefer Art Ludwig's classification of *dark grey water*.<sup>2</sup> *Clearwater* is wastewater without added solids such as discharge water from reverse-osmosis water filters and the condensate from air-conditioning and refrigerator units. Clearwater can be harvested as greywater, or managed separately using simpler runs of small diameter tubing. The original source of water, which after initial use becomes greywater, could be harvested rainwater, municipal/well water, or a combination of these.

Greywater can be safely treated and recycled on site rather than discharged into the sewer. *Greywater harvesting* is the practice of directing greywater to the primary root zone (top 2 feet or 0.6 m of the soil) of perennial plants to help grow beautiful and productive landscapes while achieving wastewater treatment without using energy or chemicals.<sup>3</sup> Plants and microorganisms in the soil consume and filter the organic nutrients and bacteria found in greywater, treating it naturally and returning clean water to the water cycle. Greywater harvesting is a great way to reduce potable-water use and implement the sustainable hierarchy of water use, where:

- rainwater is your landscape's primary water source,
- greywater is the secondary water source, and
- municipal/well water is strictly a supplementary source used in times of need.

Greywater reuse keeps "waste" water on site, treats it on site, and reuses it on site as a resource. Reclaimed water consists of greywater, blackwater, and other materials put down drains that are *drained off site, treated off site to meet nonpotable standards, and then pumped to selected destinations for reuse*. Reclaimed water is typically used for irrigation at ball fields, golf courses, and parks, but has been expanded to residential areas in some cities.<sup>4</sup> For home- and office-scale landscape irrigation, on-site greywater reuse is far more economical and energy efficient than reclaimed water use. Greywater flows by gravity straight to

### Box 12.1. How Much Greywater Does a Household Produce?

Based on typical water consumption in the United States, a single person produces up to 40 gallons (152 liters) of greywater per day, while a family produces around 140 gallons (532 liters) per day. If all sources of residential greywater were recycled on site, this family would have 51,000 gallons (193,800 liters) of water per year to irrigate plants in their landscape.<sup>5</sup>

*Note: Typical water consumption in the U.S. is very high compared to the rest of the world, so practicing conservation measures in addition to greywater reuse would be wise. (See boxes 12.5 and 12.6 for more information on water usage and conservation.)*

### Box 12.2. The Legality of Greywater

Regulations in Arizona and New Mexico currently set the standard for encouraging greywater use in the United States. No permit or fee is required for household systems that follow basic guidelines and have greywater flows that do not exceed 400 gallons (1,512 liters) per day in Arizona<sup>6</sup> or 250 gallons (947 liters) per day in New Mexico.<sup>7</sup> Call local authorities for regulations in your area. The Greywater Policy Center, [www.oasisdesign.net/greywater/law](http://www.oasisdesign.net/greywater/law), lists regulations for many states in the U.S.

mulched basins where soil, soil life, and multiuse vegetation naturally filter the water. Individuals save money managing their own systems while reducing the community's "need" to unsustainably overpump aquifers or import water. The key is to start *treating and harvesting greywater at the top of the watershed* just as with rainwater.

Greywater harvesting is legal in many parts of the U.S. and elsewhere, and is being actively promoted with financial incentives in some locations (see box 12.2, box 12.3, and the greywater harvesting page at [www.HarvestingRainwater.com](http://www.HarvestingRainwater.com) for more information).

### Box 12.3. Greywater Harvesting Tax Incentives in Arizona

Effective January 1, 2007, Arizona taxpayers who install a "water conservation system" in their residence (defined as a system to collect residential greywater), may take a one-time tax credit of 25% of the cost of the system up to a maximum of \$1,000. Builders are eligible for an income tax credit of up to \$200 per residential unit constructed with a water conservation system installed.

For more information go to [www.azdor.gov](http://www.azdor.gov). Click on "credit pre-certification" on the left side of the home page. Click on "gray water conservation tax credit" for general information, and applications for corporations and individuals.

Wear gloves when working in greywater-irrigated soils, and wash your hands when work is done.<sup>9</sup>

- *Greywater may contaminate the surface of fruits or vegetables it comes in contact with.*

**SOLUTION:** Do not allow greywater to come into contact with edible portions of food crops. Do not distribute greywater through sprinklers. Avoid using greywater to irrigate root crops or low-growing salad greens that touch irrigated soil.<sup>10</sup> Though a plant's roots and stem are in contact with greywater, if the fruits or vegetables growing on that plant do not come into contact with greywater they will be fine to eat (e.g., oranges on a tree, tomatoes on a trellised vine, and artichokes cut well above ground). Do not consume fallen fruits or vegetables that come into direct contact with greywater-irrigated soil.

- *Greywater tanks smell.*

**SOLUTION:** Do not store greywater, in any case, not for more than 24 hours. Microorganisms can grow and reproduce in the undigested organic matter within it.<sup>11,12</sup> Instead, discharge greywater directly into healthy topsoil where the water and nutrients will be used before bacteria multiply.

- *Soil waterlogged with greywater can smell, attract mosquitoes, and suffocate plants.*

**SOLUTION:** Do not concentrate greywater in an area where it could pool and waterlog soil for more than 24 hours. Instead, disperse greywater intermittently to different areas in the landscape so each area fully drains and aerates between waterings.<sup>13</sup> Maximize quick infiltration of greywater by mulching basins. Plant with water-tolerant perennial vegetation placed beside basins or on well-drained mounds within basins so the root crown at the base of plants is kept relatively high and dry.

## WHERE GREYWATER IS USED

Greywater can be safely and effectively used if a few basic rules are followed. The best approach to safe greywater use will depend on your site's characteristics and the quality and quantity of greywater available. An overview of these considerations is provided below, and more in-depth information is provided later in this chapter.

## GREYWATER CAUTIONS AND SOLUTIONS

There has never been a documented case of greywater-transmitted illness in the United States.<sup>8</sup> Nonetheless, for safety, success, and aesthetics, be aware of the following cautions and simple solutions (and see *The New Create an Oasis with Greywater* for more):

- *Greywater may contain infectious organisms washed from your body, clothes, or food.*

**SOLUTION:** Do not drink greywater. Avoid direct contact with greywater by conveying it below land surface in pipes and discharging it under mulch or soil within infiltration basins. Label all greywater lines.

- *Greywater irrigation could seal clayey fine-grained soils with soaps or fats and increase salt buildup in soil, adversely affecting plants.*

SOLUTION: Mulch soil to create a coarse filter that prevents soil clogging with soaps or fats. The mulch also minimizes evaporation that would otherwise leave salts behind, and reduces the erosive impact of greywater surges. Compost kitchen food scraps, fats, and oils to keep them out of greywater streams (see figure 12.22 later). Use low-salt, greywater-compatible soaps and detergents (see box 12.4). Plant areas irrigated with greywater with salt-tolerant vegetation. Flush greywater-irrigated areas with a good dose of salt-free rainwater at least once a year.

- *Insects or vermin may try to enter a home through a greywater pipe.*

SOLUTION: Install a conventional P-trap and vent between your house drains and greywater pipe outlets. Hire a plumber and/or see a plumbing book, such as Sunset's *Basic Plumbing Illustrated* for P-trap and vent installation. Just as P-traps and vents keep gases and vermin from entering your home from sewer pipes, they will also keep them from entering your home through greywater pipes in your yard. Avoid attracting vermin into your greywater pipes in the first place by composting food scraps, fats, and oils instead of disposing of them in a sink garbage disposal.

- *Chemicals sent down the drain may contaminate plants and soil.*

SOLUTION: Do not use household drains as waste disposal systems to "throw something away." There is no "away." Instead, consider drains as conduits to the natural world. Don't buy or use toxic chemicals. Avoid products containing boron, chlorine bleach, and paint thinner. Do not clean car parts, wash oily rags, or dispose of waste solutions from home photo labs in greywater systems. Use environmentally benign cleaning agents (box 12.4; and the greywater harvesting page at [www.HarvestingRainwater.com](http://www.HarvestingRainwater.com)). If you can't avoid contaminating water, divert the contaminated water to the sewer or septic system (figs. 12.4B, 12.5, 12.6,

12.7, and 12.20 and 12.21 later) and reevaluate your lifestyle to prevent such contamination in the future.

- *A massive week-long family gathering could overload a system designed for just a few people.*

SOLUTION: Size your system to handle larger-than-average volumes or divert the greywater to the sewer or septic system for the week.<sup>14</sup>

- *Greywater could mingle with, and contaminate, surface water.*

SOLUTION: Do not allow greywater to run off your property or to mingle with surface water. Discharge greywater on site below ground or within mulched infiltration basins, and contain it at these discharge points. Do not apply greywater to saturated soils.<sup>15</sup>

## SITE CONSIDERATIONS

The systems described here use gravity flow to irrigate areas of the site that are lower in elevation than the home's greywater sources. To make gravity feed possible, the greywater drainpipe must have a 2% slope, dropping 1/4 inch per linear foot (2 cm drop per linear meter) from its source to its outlet in the top 2 feet (0.6 m) of soil—the primary root zone of plants. Pipe can slope more than 2%, but not less. The higher the elevation where greywater exits the house the better, so gravity can direct greywater to lower and more distant land areas while maintaining the minimum pipe slope necessary for gravity-fed distribution. To irrigate areas that are higher in elevation than your greywater source, see *The New Create an Oasis with Greywater* for options.

Soil drainage is an important consideration in designing greywater systems. Harvesting greywater in soils with insufficient drainage to prevent greywater from excessively pooling on the surface requires special adaptations (see the *New Create an Oasis with Greywater*). Extremely porous soils through which greywater could rapidly drain past the plant root zone also require special adaptations, though extremely porous soils are much less of a problem than soils with poor drainage.

I recommend discharging greywater into mulched, rainwater-harvesting earthworks within the site's wetter oasis zone, as described in chapter 1 (figs. 1.10 and 1.11). This zone is positioned around gathering spots like patios, front porches, and paths, generally within 30 feet (9 m) of your home, though at some sites the slope and greywater volume may make it necessary to discharge greywater beyond this distance. In most cases, greywater infiltration basins should be no closer than 10 feet (3 m) from a building to prevent soil saturation around the building's foundation. Concentrating greywater in this oasis zone minimizes greywater pipe length and keeps plants that need more water and care closer to people, where the plants can be easily tended and used. The wetter oasis zone provides three water sources to serve the plants: 1) the primary source consists of direct rainfall, rainwater runoff from roofs and hardscape, and rainwater stored in cisterns; 2) the secondary source consists of greywater from household drains; and 3) the supplemental source consists of municipal/well water from the hose bib used only in driest times.

Discharging greywater into water-harvesting earthworks allows salt-free rainwater to leach from the soil potentially plant-harming salts from soaps in greywater and municipal/well water. At the same time, reliable greywater supplies augment intermittent rainwater supplies to sustain plants through dry spells.

Limit the planting of high- and medium-water-use plants such as exotic fruit-bearing trees, shrubs, and vines to the wetter oasis zone, with some plantings in the drier oasis zone if there is sufficient water. Only low-water-use plants should be placed outside oasis zones. Using this planting pattern, exotic plants get convenient access of "exotic" greywater and supplemental municipal/well water plus "native" rainwater and runoff. Low-water-use plants—primarily natives—located outside the oasis zone are the only plants that subsist entirely on native rainwater and runoff, once the plants are established. These native plantings can be enhanced with additional water-harvesting earthworks where appropriate.

Use appropriate design strategies at sites with very small yards to avoid overloading the soil with infiltrating greywater. Strategies include limiting the number of greywater sources that drain to the yard and/or



**Fig 12.8. Greenhouse greywater harvesting in cold climates. Sink water drains to the adjoining planting bed to irrigate bananas and more at the Earthship Visitors Center in Taos, New Mexico.**

installing a diverter valve to rotate greywater flow through multiple endpoints. For example, use a three-way diverter valve on sink, shower, or tub drains (figs. 12.4B, 12.5, 12.6, and 12.7A, B) and/or create multiple drain options for the washing machine (see figs. 12.20 and 12.21 in the Variations section). These valve and drain options allow you to direct greywater flow to different basins within the yard or to the sewer or septic system if soil becomes saturated.

Infiltration basins for greywater and rainwater should not be constructed in drainages, above septic leachfields, or within 5 feet (1.5 m) of the top of seasonally high water tables. If you have a well, do not discharge greywater any closer to the well than county regulations would allow a septic tank leachfield to be installed.<sup>16</sup>

Greywater use is not recommended during very wet or very cold seasons or where water-logged or frozen soil may prevent the use of the system for that part of the year (see "My Preferred Greywater Systems" section later in this chapter for greywater resources addressing cold climate options within greenhouses, fig. 12.8, and fig. 12.5 for diversion option).

## Box 12.4. Soaps, Detergents, and Greywater

Cleaning products labeled “biodegradable” or “natural” or even “eco-friendly” may not be greywater-compatible—meaning suitable for the plants and soils of your greywater-irrigated landscape.

### GREYWATER-COMPATIBLE PRODUCTS

I prefer to use Oasis brand or Bio-Pac concentrated liquid laundry detergent and dishwashing soap; both are greywater compatible (see [www.bio-pac.com](http://www.bio-pac.com)). I dilute 1 part Oasis brand dishwashing soap with 8 parts water to use as a hand and body soap. For shampoo, I use Aubrey Organics brand shampoos after scanning labels to be sure there are no sodium products in the ingredients.

Traditional *liquid* soaps made from potassium-based ingredients such as Dr. Bronner’s liquid soaps and handcrafted liquid soaps are greywater compatible as long as they don’t contain harmful additives such as sodium salts. You can contact soapmakers and ask about their ingredients.

### PRODUCTS AND INGREDIENTS TO AVOID

- harsh chemicals such as chlorine and drain cleaners
- bleaches and fabric softeners
- detergents with whiteners, softeners, and enzymes
- bar soaps and powdered laundry detergents that typically use sodium-based products as filler material. Sodium salts can harm plants and soils. Accumulation of salts is of special concern in drylands where soils tend to be alkaline and naturally high in salts. It is wise to occasionally flush dryland soils with rainwater or other non-salty water.
- borax and other cleansers and products made with boron. Boron is needed by plants, but only in extremely small amounts
- soaps and detergents with the following ingredients: peroxygen, sodium perborate, sodium tryptochlorite, petroleum distillate, alkylbenzene, salt
- disinfectants

The above list of products and ingredients was compiled from State of California, Department of Water Resources ([www.owue.water.ca.gov](http://www.owue.water.ca.gov)) publication *Graywater Guide: Using Graywater in Your Landscape*.

My website includes a page on greywater harvesting with more information on soaps and detergents, recommended brands, and laundry and cleaning tips ([www.HarvestingRainwater.com](http://www.HarvestingRainwater.com)). Also see appendix 6 for a list of related resources and websites.

## GREYWATER QUALITY AND QUANTITY CONSIDERATIONS

In most households, the highest quality greywater is from bathroom sinks, showers, bathtubs, and air conditioners. The quality of greywater discharged from washing machines varies with the type of soaps, detergents, and other chemicals used (see box 12.4). Evaporative cooler-bleedoff water is particularly high in salts, but salt-tolerant vegetation can use this water if soil is occasionally flushed with salt-free rainwater. Greywater harvested from kitchen sinks and dishwash-

ers requires special treatment due to the presence of food scraps, oils, and grease (see the “Kitchen Resource Drains” in Variations section). Use of dishwasher greywater is especially challenging due to the presence of strong dishwashing detergents. As a result, low-quality dishwasher greywater is the last greywater source I consider tapping, while high-volume washing machine and shower or bathtub greywater, along with low-volume, but high-quality bathroom sink greywater, are the first greywater sources I tap. See boxes

**Box 12.5. Per Capita Indoor Water Use for Average (Non-Conserving) American**

| Fixture         | Average Volume/Use  | Average Frequency  | Average Use/Person/Day     | Average Use/Person/Week     | Average Use/Person/Year           |
|-----------------|---|--|----------------------------|-----------------------------|-----------------------------------|
| Washing Machine | 40.9 gal/load<br>(155.0 liters/load)  | 0.37 loads/day<br>(2.52 loads/week)                                  | 15.0 gal<br>(56.8 liters)  | 105.0 gal<br>(398.0 liters) | 5,475.0 gal<br>(20,750.0 liters)  |
| Shower          | 17.2 gal<br>(65.2 liters)<br><br>The average shower was 8.2 minutes with a flow rate of 2.22 gal/minute (8.4 liters/minute) | 0.67 showers/day<br>(4.69 showers/week)                              | 11.6 gal<br>(44.0 liters)  | 81.2 gal<br>(307.7 liters)  | 4,234.0 gal<br>(16,046.9 liters)  |
| Bathroom Faucet | Data Not Available  | Data Not Available   | 3.4 gal*<br>(12.9 liters)  | 23.8 gal<br>(90.2 liters)   | 1,241.0 gal<br>(4,703.4 liters)   |
| Bathtub         | 24.0 gal<br>(91.0 liters)   | 0.05 baths/day<br><br>(Most Americans take showers instead of baths) | 1.2 gal<br>(4.5 liters)    | 8.4 gal<br>(31.8 liters)    | 438.0 gal<br>(1,660.0 liters)     |
| <b>TOTALS</b>   |   |  | 31.2 gal<br>(118.2 liters) | 218.4 gal<br>(827.7 liters) | 11,388.0 gal<br>(43,160.5 liters) |

Figures for average volume/use, average frequency, and average use/person/day are from [www.h2ouse.org/tour](http://www.h2ouse.org/tour), except for bathroom faucets. The original source of data is *Residential End Uses of Water* by P.W. Mayer, W.B. DeOreo, E. Opitz, J. Kiefer, B. Dziegielewski, W. Davis, and J.O. Nelson, a study sponsored and published by the American Water Works Association Research Foundation, Denver, Colorado in 1999. Water use was measured in 1,200 households in ten U.S. and two Canadian cities.

\*Source of average American daily use estimate for bathroom faucet: [http://www.watersavertech.com/Aquacraft\\_Savings\\_Report.pdf](http://www.watersavertech.com/Aquacraft_Savings_Report.pdf).

12.5, 12.6, and 12.7 for estimates of greywater volumes produced by these sources.

When you use your own greywater, you become very aware of the effects of products you put down the drain, and wonderfully conscious of the fact that there is no “away.” If you sent toxins down your greywater drain they would kill your plants, so you simply stop using toxic substances, which makes for a clear conscience and a healthier life and environment. It becomes obvious that we cannot throw any toxic materials “away” because they all stay on the planet with us. We may temporarily move toxins off site, but they invariably return via contamination of piped-in water, food grown off site that we purchase and eat, and the air we breathe. Thankfully the fewer toxic materials we use the fewer will be discharged as waste on the planet.

Three-way valves for sinks, tubs, and showers (figs. 12.4B, 12.5, 12.6, and 12.7A and B), and multiple-drain options for washing machines (figs. 12.20 and 12.21 later), make greywater recycling alluring for more people because they don’t have to immediately give up the occasional use of non-landscape-friendly soaps or cleansers containing boron, sodium, or chlorine. When such products are used, people can temporarily direct greywater to the sewer or septic system—though the sewer/septic route does eventually deposit cleansers in a diluted form into fresh waterways, groundwater, lakes, or ocean bays.

Do not harvest greywater from a water softener using sodium-based products such as sodium chloride, though potassium chloride is okay. Sodium-softened water backwash is extremely high in salt, which is harmful to plants.<sup>17</sup> Households using harvested

*continues on page 302*

### Box 12.6. Estimates of Personal Indoor Water Use with Efficient Fixtures and Water-Conserving Habits

| Fixture                   | Factors Affecting Volume/Use  | Frequency and Volume Assumptions   | Use/Person/Day                | Use/Person/Week                 | Use/Person/Year                    |
|---------------------------|---|--|-------------------------------|---------------------------------|------------------------------------|
| Efficient Washing Machine | Volume per use affected by washer efficiency, washer capacity, and adjustability of water levels. Efficient washers available in U.S. generally use 18 to 25 gal/load* (68 to 95 liters/load). Some use only 10 gal/load (37.9 liters/load). Capacities range from 1.6 to 3.8 ft <sup>3</sup> * (0.045 to 0.108 m <sup>3</sup> ). | Average U.S. frequency: 0.37 loads/day (2.52 loads/week) (see box 12.5).<br>Volume per load: 20 gal (75.8 liters/load)   | 7.4 gal (25.0 liters)         | 51.8 gal (175.1 liters)         | 2,701.0 gal (9,130.1 liters)       |
| Shower                    | Volume per use affected by shower-head type, shower length, water line pressure, and the size valve is opened to. Low flow showerheads range from 1.5 to 2.5 gal/min* (5.7 to 9.5 liters/min). Ultra low flow showerheads range from 0.8 to 1.5 gal/min (3.0 to 5.7 liters/min).  | Assumed average U.S. frequency: 0.67 showers/day (4.69 showers per week) (see box 12.5)<br>Volume per use: 5 minutes/shower assuming flow rate 1.8 gal/min (6.8 liters/min) for total 9 gal/shower (34.1 liters) | 6.0 gal (22.7 liters)         | 42.0 gal (159.2 liters)         | 2,190.0 gal (8,300.1 liters)       |
| Bathroom Sink             | Volume per minute affected by aerator type at faucet outlet, size valve is opened to, and length of time faucet is on during sink use. Faucets with an attached low flow aerator range between 0.5 to 1.5 gal/min (1.9 to 5.7 liters/min).  | Assumptions: faucet turned off part of time during sink use; low flow aerator is installed. (Assuming 8 uses/day, 15 sec/use, and 1.0 gal/min (3.8 liter/min) aerator  | 2.0 gal (7.6 liters)          | 14.0 gal (53.1 liters)          | 730.0 gal (2,766.7 liters)         |
| Bath                      | Americans typically take showers instead of baths. This estimate assumes baths typically used for washing children use low volume of water for safety reasons, and occasional use by adults who want full bath for therapeutic value.   | Assumed average U.S. frequency 0.05 baths/day; volume 24 gal/use (91.0 liters) (see box 12.5)  | 1.2 gal (4.5 liters)          | 8.4 gal (31.8 liters)           | 438.0 gal (1,660.0 liters)         |
| <b>TOTALS</b>             |   |  | <b>15.8 gal (59.9 liters)</b> | <b>110.6 gal (419.2 liters)</b> | <b>6,059 gal (21,856.9 liters)</b> |

\* gal = gallons, ft<sup>3</sup> = cubic feet, gal/min = gallons per minute

Use rates estimates based on the following sources:

[www.fypower.org/res/tools/products\\_results.html?id=100122](http://www.fypower.org/res/tools/products_results.html?id=100122); [www.energystar.gov/index.cfm?c=clotheswash.pr\\_clothes\\_washers](http://www.energystar.gov/index.cfm?c=clotheswash.pr_clothes_washers);  
[www.cee1.org/resid/seha/rwsh/rwsh-main.php3](http://www.cee1.org/resid/seha/rwsh/rwsh-main.php3); [www.fypower.org/res/tools/products\\_results.html?id=100160](http://www.fypower.org/res/tools/products_results.html?id=100160);  
[www.watersavertech.com/Aquacraft\\_Savings\\_Report.pdf](http://www.watersavertech.com/Aquacraft_Savings_Report.pdf); [www.watersaver.org/indoorwateruse.asp](http://www.watersaver.org/indoorwateruse.asp);  
[www.eere.energy.gov/consumer/your\\_home/water\\_heating/index.cfm/mytopic=13050](http://www.eere.energy.gov/consumer/your_home/water_heating/index.cfm/mytopic=13050)

- High efficiency washing machines cut energy and water use by half or more. Efficient machines use very little detergent (e.g.: 2 Tablespoons [14.8 mm] of liquid detergent for a washer with a 2.65 ft<sup>3</sup> [0.105 m<sup>3</sup>] capacity). Horizontal axis (front loaders) are the most efficient.
- To estimate your showerhead's flow rate hold a gallon container under the showerhead and record the time it takes to fill in seconds. The bucket will get heavy (8.5 lbs or 3.8 kg) so you may want to put it on a step ladder. Then divide 60 by the seconds of fill time to calculate flow rate in units of gallons/minute. Example: If it takes 30 seconds to fill: 60 ÷ 30 = 2 gallons per minute (9.5 liters per minute). Since 1992, flow rates for faucets and showerheads made in the U.S. must be 2.5 gallons per minute or less at 80 pounds per square inch (9.5 liters per minute or less at 552 kilopascals).



### Box 12.7 Estimates of Discharge Volumes from Household Evaporative Coolers, Air Conditioners, and Reverse-Osmosis Filters

| Water Source                                | Example Discharge Rates  | Factors Affecting Discharge Volume   | Water Quality  | Compatible Vegetation  |
|---|--|--|--|--|
| Evaporative-Cooler Bleed-off                | Evaporative coolers are most effective in high-temperature, low-relative-humidity conditions. Example discharge in dry conditions of Phoenix, Arizona: Cooler bleed-off discharge is 1 to 5 gal/hour* (3.7 to 18.9 liters/hour) <sup>a</sup> for estimated average single-family residential cooler use.   | <ul style="list-style-type: none"> <li>- Relative humidity</li> <li>- Temperature</li> <li>- Number of hours of run time</li> </ul>  | Typical bleed-off water has high salts ranging from 375 to 4,043 mg/L, with average 1,580 mg/L. <sup>b</sup> Some evaporative coolers have a "sump dump" discharge, which often contains higher levels of total dissolved solids (TDS) than bleed-off. | Use bleed-off only on salt-tolerant vegetation. If TDS is < 5,000 mg/L, can irrigate salt-tolerant Bermuda and salt grass. If TDS < 2,000 mg/L can use on low-salt-tolerant plants such as citrus trees and almond, apple, peach, and pear trees. <sup>b</sup> |
| Air-Conditioner Condensate                  | <p>Example discharge in dry conditions of Phoenix, Arizona:<sup>c</sup> 0.01 to 0.02 gal (0.04 to 0.09 liters) of condensate/hour for estimated average single-family air conditioner, 2-3 ton capacity. Condensate from a large commercial unit can reach 500 gallons (1,895 liters)/day.<sup>c</sup></p> <p>Example discharge in humid conditions of Austin, Texas:<sup>d</sup> 0.1 to 0.2 gallons (0.3 to 0.7 liters) of condensate/hour for estimated average single-family air conditioner, 2-3 ton capacity. Condensate from a large commercial unit can add up to 2,000 gallons (7,580 liters)/day.<sup>d</sup></p> | <ul style="list-style-type: none"> <li>- Relative humidity</li> <li>- Temperature</li> <li>- Ton-hours of run time: typical 2 – 3 ton capacity residential air conditioner may run 60% to 70% of the time on hottest, most humid days.<sup>d</sup></li> <li>- Frequency of air exchange within building. Commercial buildings typically exchange air more frequently than similar sized residential units, so can produce more condensate.</li> <li>- Amount of humidity produced inside the building by various activities</li> </ul> | AC condensate is typically high-quality water produced when humid air condenses on the cold evaporator or coil of an air conditioning unit.  | Use salt-free condensate as irrigation source throughout landscape and garden in both humid and dry landscapes. Can use condensate to help leach accumulating salts from primary root zone in top 2 feet (0.6 m) of soil.                                      |
| Reverse-Osmosis (RO) Water-Filter Discharge | Discharge of 2 to 5 gal (7.58 to 18.95 liters) per gallon of water purified. Assuming 1 gal/person/day (3.79 liters) drinking and cooking water needed, discharge would be 2 to 5 gal (7.58 to 18.95 liters)/person/day.   |  | RO filter discharge water has about 25% higher concentration of TDS than the tapwater it is filtering. <sup>e</sup> It has no suspended solids.  | Use as irrigation source on landscape and garden.  |

\* gal = gallons

<sup>a</sup> Roy Otterbein, "Installing and Maintaining Evaporative Coolers," *Home Energy* magazine online, May/June 1996. <http://www.homeenergy.org/archive/hem.dis.anl.gov.eehem/96/960511.htm>

<sup>b</sup> Martin M. Karpisak, Thomas M. Babcock, Glenn W. France, Jeffrey Zauderer, Susan B. Hopf, and Kenneth E. Foster, "Evaporative Cooler Water Use in Phoenix," *Journal AWWA*, Volume 90, Issue 4, April 1998

<sup>c</sup> Personal communication with Bill Hoffman, Austin Water Utility Commercial and Industrial Water Conservation Program Coordinator, 27 July, 2006

<sup>d</sup> Bill Hoffman, "Combining Storm and Rainwater Harvesting at Commercial Sites," First American Rainwater Harvesting Conference, August 21-23, 2003 Proceedings

<sup>e</sup> Ludwig, Art, *Create an Oasis with Greywater*, Oasis Design, 2006

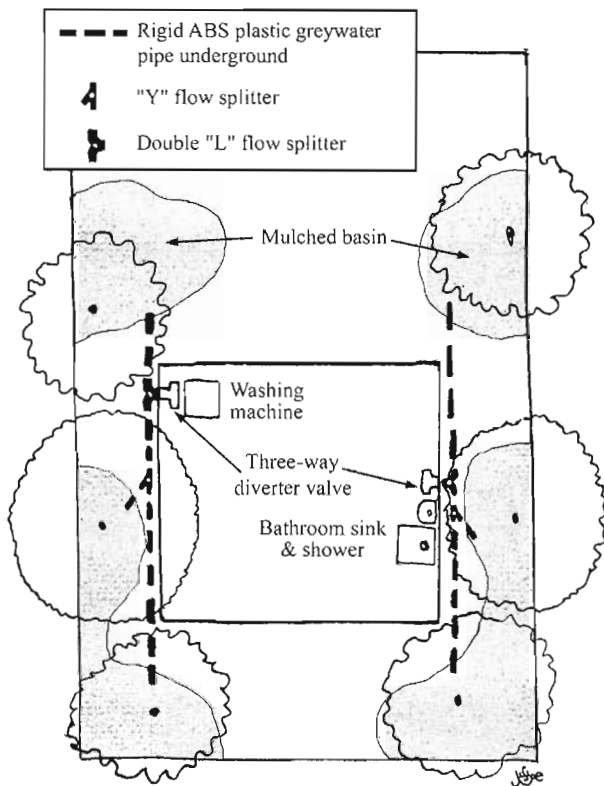

Fig. 12.9A. A branched-drain greywater system for a low-water-use household. Flow splitters and underground pipes direct greywater to six outlets within mulched basins (plan view). Note greywater pipe under raised paths for easy access and more drop potential

rainwater as their primary water source *do not* need water softeners, since rain is naturally soft.

My website includes a page on greywater harvesting with more information on soaps and detergents, recommended brands, and laundry and cleaning tips ([www.HarvestingRainwater.com](http://www.HarvestingRainwater.com)). See also appendix 6 for a list of related resources and websites.

## MY PREFERRED GREYWATER SYSTEMS

There are many different ways to harvest greywater. Review your options to see what is most appropriate for the unique characteristics of your site, lifestyle, skills, and budget. Useful greywater resources in addition to those already mentioned include [www.greywater.com](http://www.greywater.com); *Water from the Sky* by Michael Reynolds found at [www.earthship.net](http://www.earthship.net) (especially good for those recycling greywater within household greenhouses); and *The*

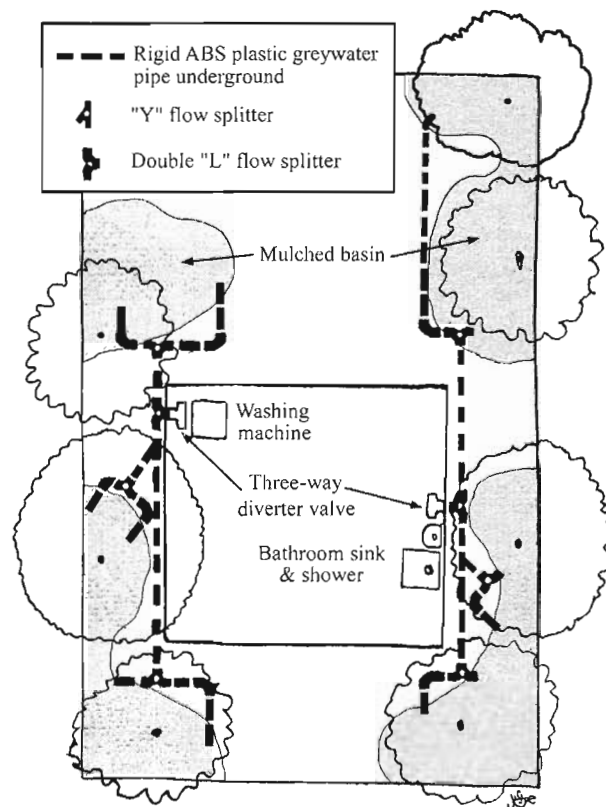

Fig. 12.9B. A branched-drain greywater system for a higher-water-use household. Flow splitters and underground pipe direct greywater to 12 outlets within mulched basins.

*Composting Toilet System Book* by Carol Steinfeld and David Del Porto, available at [www.ecowaters.org](http://www.ecowaters.org).

I prefer systems that disperse greywater via mulched and vegetated basins (figs. 12.9A, B). Mulched basins do triple duty—they harvest rainwater, treat the greywater, and grow plants. Greywater is discharged from the ends of non-perforated pipes either a few inches above the mulch or into subsurface outlet shields so pipe clogging does not occur (figs. 12.10 and 12.11). The systems described in this chapter do not incorporate drip irrigation or perforated pipes to disperse greywater because such systems typically add unnecessary complexity, costs and maintenance. Drip-irrigation systems require pretreatment of the greywater to prevent clogging of emitters, and perforated pipe tends to clog with roots.

The seven greywater systems described in this chapter are relatively low maintenance and work compatibly with discharge to mulched basins. These systems are:

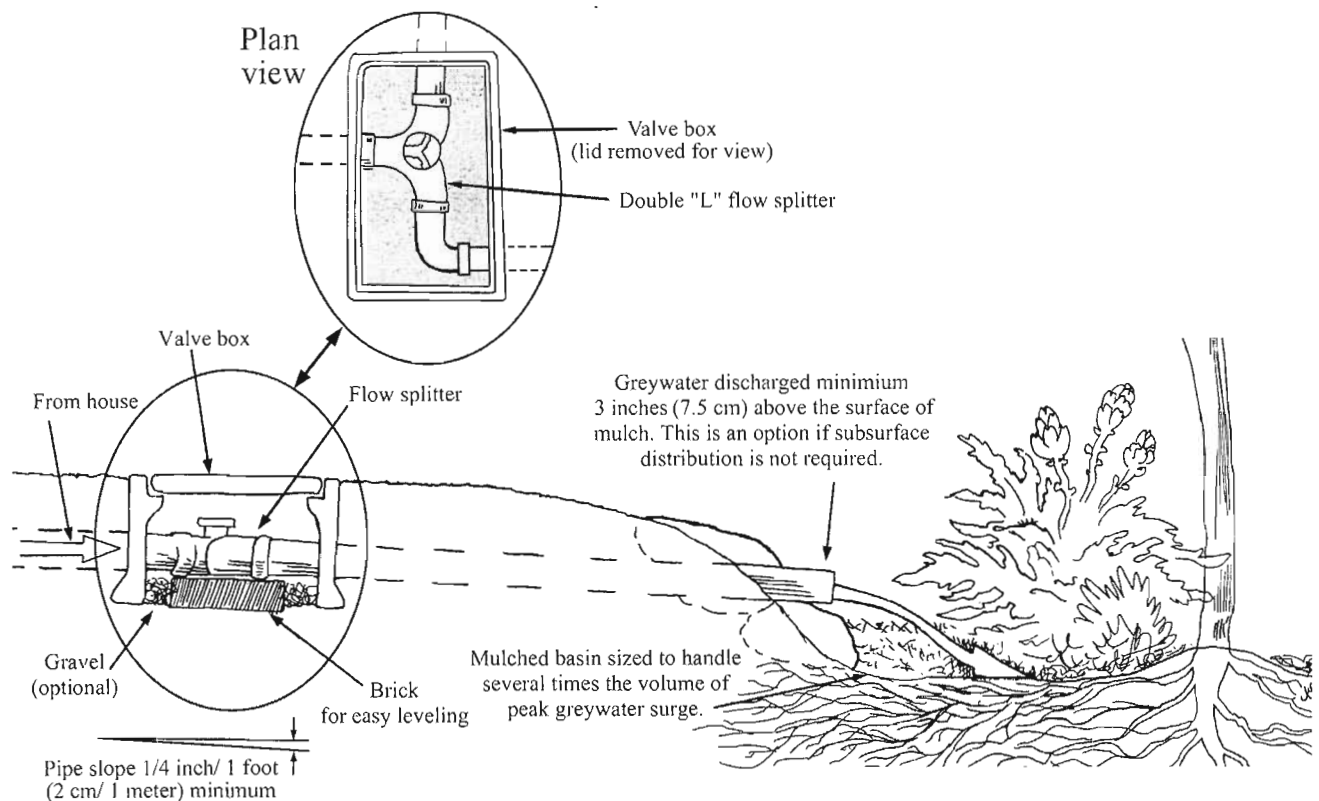

Fig. 12.10. Discharge of greywater into a mulched and level-bottomed basin for even infiltration of water throughout the basin (elevation view). Maintaining a clear space between the end of the pipe and mulch is key to keeping solids from backing up in the pipe and keeping roots from growing into and clogging the pipe. Note placement of flow splitter in valve box for easy access. Adapted from the *The New Create an Oasis with Greywater*

- **Branched-drain greywater system** (see below)
- **Outdoor hose shower** that is quick, simple, inexpensive, and great for summer (see Variations section)
- **Siphon-tube system** that allows inexpensive access to greywater from bathtubs or shower stalls whose drainpipes are inaccessible (see Variations section)
- **An interior-siphon, hand-pump-powered greywater drain** that does the same as the siphon tube system, but far more conveniently (see Variations section)
- **Multi-drain system for washing machines** that conveniently sends greywater to a different part of the landscape with each load of wash (see Variations and Real-Life Examples sections)
- **Kitchen Resource Drain (KRD)** that allows the legal reuse of kitchen sink water in Arizona (see Variations section)
- **Permitted household greywater and composting toilet combination** that enables home construction without a sewer or septic hook up (see Real-Life Examples section)

## BRANCHED-DRAIN GREYWATER SYSTEM

To meet most needs, my favorite system is Art Ludwig's *branched-drain greywater system*. It is very easy and convenient to use, with little maintenance, and can be incorporated into many greywater systems. However, it is fairly involved to design and install, so you'll need Art's detailed instructions in *The New Create An Oasis with Greywater*. What follows here is

### Box 12.8. Advantages of the Greywater Systems Described in this Chapter

- *There are no storage tanks or pumps* adding excess complexity, maintenance, and cost. Gravity moves the water directly to the infiltration basin, which contains the surge of water and quickly absorbs it in the soil. The two siphon systems (Variations section) are an exception. They rely on the siphon effect that is kick-started with a hand pump.
- *These greywater systems are ideal for creating a supplementary dryland-appropriate irrigation source.* Select greywater-associated plantings from among low- to high-water-use non-riparian perennial species that can endure periods of time without greywater and be alive and well when you come home from vacation. Alternative wastewater-treatment systems that require continual applications of water—such as constructed wetlands with high-water-use riparian vegetation continually immersed in the greywater or black-water—cannot function unless you leave the water running while away.
- *There are no bad smells in these greywater systems* because there is no standing water. All water is quickly absorbed by the mulch, the soil, beneficial organisms within the soil, and the vegetation, all of which act as natural filters. The Kitchen Resource Drain in the Variations section is an exception, since some water is “stored” in the grease trap. In this case odors are vented through the household vent stack.
- *There are no manufactured filters* to complicate the system and require more maintenance.
- *These systems do not clog with roots.* Unlike French drains with pipes, or septic leach pipes buried in gravel, these greywater systems discharge water well above mulch and soil, or discharge water within empty subsurface outlet chambers. Roots would have to grow through a large volume of air to get to the pipes. The outdoor hose shower (Variations section) has no pipes or tubing.
- *Greywater systems relieve strain on septic tank systems and municipal sewage treatment plants.* By reducing the volume of water discharged into septic tanks or municipal sewer treatment infrastructure, their lifespan and capacity are increased.

an introduction enabling you to conceptualize how to integrate the branched-drain system with your rainwater-harvesting earthworks.

Branched drains use gravity to passively distribute greywater from household drains to multiple mulched, vegetated infiltration basins. Greywater flow is split (or “branched”) using 1.5- to 2-inch (40- to 50-mm)-diameter pipes, valves, or “double L” or “Y” fittings. Flow can subsequently be split multiple times until as many as 16 outlets distribute greywater among landscape basins (fig. 12.9).

This system conveniently spreads greywater around, reducing the chance any one area becomes overwatered. This is further enhanced when greywater lines from different sources are directed to different areas of the landscape to more easily distribute greywater over a larger area. For example, greywater lines from the laundry are kept separate from bathroom-greywater lines. And if there are multiple bathrooms, the greywater from each is directed to different areas. Nonetheless, greywater lines from different sources can be combined, but then more pipe is needed to redisperse and distribute the combined greywater flow to a large area.

See the “greywater harvesting” page at [www.HarvestingRainwater.com](http://www.HarvestingRainwater.com) for information on how to make your own flow splitters.

### Discharge of greywater into mulched basins

Discharge of greywater into mulched basins is the simplest system to design and install, and is legal in Arizona and New Mexico. The basins are sized to contain and infiltrate several times the peak surge of greywater that will be discharged in a short period of time. Thus greywater adequately infiltrates the soil, while preventing oversaturation even when the soil is already moist from rainfall or previous greywater discharges. Trees and other perennial vegetation are planted in association with these basins to increase the rate of infiltration and use of the greywater and rainwater they collect (fig. 12.10). Greywater never overflows out of the basins and does not puddle on the surface of the soil. Instead greywater infiltrates into the soil beneath the surface of the mulch.



Fig. 12.11. A greywater drain discharging into a mulched basin via a subsurface outlet shield made from an upside down 5-gallon (19-liter) plastic bucket with holes drilled into its sides. An unused bucket outlet shield sits beside the basin to illustrate what the bucket within the basin looks like. Note: The hole cut in the bottom of the bucket (which is the top of the shield) is smaller in diameter than the bucket bottom, leaving a rim of plastic that keeps the bucket firm and strong. **WARNING:** The outlet shield must be placed within a much larger mulched basin sized to handle the peak surge of greywater entering it. That way greywater flowing out of the shield is fully contained and quickly infiltrates, as seen here. A bucket shield without an associated mulched basin is too small to adequately infiltrate greywater surge, and will lead to smelly anaerobic soil conditions. The flat rock seen here sitting beside the drain outlet is placed over the chamber to prevent the plastic from degrading in the sun, to improve appearances, and to keep the greywater below the surface of the rock and mulch. The mulched basin also harvests rainwater from the surrounding area. The rock that lines the basin banks stabilizes the basin's edge.

## Discharge of greywater into mulched basins through a subsurface outlet shield

You may need to add a *subsurface outlet shield* if your greywater pipes have an outlet within a mulched basin below the mulch. This sometimes occurs when greywater pipes exit buildings at a lower than ideal elevation, or when dealing with a very flat site, while maintaining the minimum 2% drop in the greywater pipe. The shield is an empty, porous chamber of air whose sole purpose is to enable any solids in the greywater to easily drop clear of the end of the pipe, while

also preventing roots under the mulch from growing through the air and into the pipe. I typically use a 5-gallon (19-liter) plastic bucket with 1-inch (2.5 cm) holes drilled into its sides (fig. 12.11). Bottomless plastic irrigation valve boxes can be used instead of buckets if desired, though no shield should be less than 5 gallons (19 liters) in capacity or deeper than a standard bucket height of 14 inches (35 cm).

The outlet shield must be placed within a mulched basin sized to contain and infiltrate several times the peak surge of greywater flowing out of the shield in a short period of time (fig. 12.11). The area around the

shield is backfilled with mulch, not soil, so the greywater entering the shield can quickly drain out into the surrounding mulched basin, while remaining beneath the surface of the mulch.

### Discharge of greywater into subsurface outlet chambers

The branched-drain greywater system gets a little more complex if you add installation of *outlet chambers or subsurface outlet chambers*—also called *leaching chambers or infiltration chambers*—to the ends of greywater drainpipes. These empty, bottomless, plastic chambers have a larger capacity than the 5-gallon (19-liter) bucket outlet shield, and help ensure that greywater always remains beneath the surface of the soil, mulch, and chamber, reducing the potential for people or animals directly contacting greywater. This enables you to get your system permitted in areas with more restrictive requirements (figs. 12.12A, B, C).



Fig. 12.12A. A premanufactured Infiltrator Systems outlet chamber sized to handle the peak surge of greywater entering the system from a bathroom sink. The soil percolation rate is slow due to high-clay soils. Urban Farm, Phoenix, Arizona. Note: These infiltration chambers also work great for septic leach fields, since you can plant trees beside them to utilize the “waste water.”

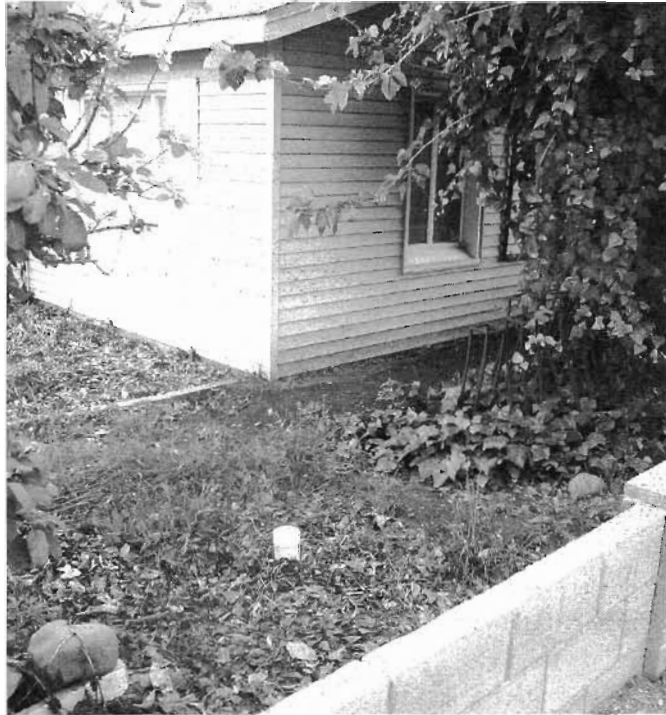

Fig. 12.12B. The Infiltrator Systems outlet chamber and greywater pipe covered with soil and fallen leaves. Note: The inspection pipe can be hidden under decorative rock if desired.



Fig. 12.12C. The interior of three Infiltrator Systems infiltration chambers linked together, Lama, New Mexico.

Unlike outlet shields, outlet chambers can be covered in soil *if* sized to handle the entire peak surge of greywater when there is no associated basin to absorb overflow. See *The New Create an Oasis with Greywater* for details on subsurface-outlet- and infiltration-chamber sizing and installation.

Chamber sizes can be reduced by branching or splitting the greywater flow to multiple points—reducing the flow to each point, and/or by placing the chambers within larger mulched infiltration basins. Each basin greatly expands the capacity of each chamber, when covered with the basin’s mulch rather than soil. The greywater can then quickly overflow from the chamber to the larger capacity basin, while remaining beneath the surface of the mulch. Diversion options, such as three-way valves or multi-drains for washing machines make the system even more fail-safe, since they enable you to temporarily direct the greywater elsewhere if the chamber or basin becomes too saturated.

Subsurface outlet chambers can be bought from manufacturers, often from suppliers of septic systems, or can be made from reused materials. Large, bottomless premanufactured outlet/leaching chambers are inexpensive, durable, and come ready to install with louvered sides to enhance water infiltration. They are unlikely to clog with roots due to their large void space, which is a great deal larger than the bucket outlet shield or perforated pipe typically used in French drains and septic leach fields. See [www.Hancor.com](http://www.Hancor.com) or [www.InfiltratorSystems.com](http://www.InfiltratorSystems.com) for outlet-chamber suppliers; see a product example in figures 12.12A, B, C. Do not use chambers taller than 13 inches (33 cm), in order to discharge more of the greywater higher in the soil profile where more roots and soil life can utilize and filter the water.

## DEVELOPING A GRAVITY-FED GREYWATER SYSTEM

### CONCEPTUALIZING AND PLANNING

To develop a greywater system, start by gathering site information and sketching potential locations of greywater sources, piping, and basins with which to support existing and planned vegetation. Follow the

rainwater-harvesting principle of *maximizing beneficial relationships and efficiency by ‘stacking functions’* to design a flourishing oasis zone close to your home. Consider sun angles in different seasons and how trees and shrubs grown with greywater could either shade out or let in sunlight. See chapter 4 of *Rainwater Harvesting for Drylands and Beyond: Volume 1* for guidelines on incorporating a winter-heating and summer-cooling “solar arc” of vegetation east, west, and north of buildings in the northern hemisphere and east, west, and south of buildings in the southern hemisphere (see figs. 1.7 and 1.8 in chapter 1).

Follow the steps below to develop your greywater plan. Record the data you gather on the site plan you prepare (see fig. 12.13).

1. *Estimate your greywater discharge* (fig. 12.13 and boxes 12.5, 12.6, and 12.7).
2. *Determine where greywater is accessible, and where you can easily distribute it* (fig. 12.13).
3. *Determine where you need greywater for existing or planned vegetation* (fig. 12.13).
4. *Determine your options for diverting greywater flow to multiple destinations* (fig. 12.14):
5. *Draw a plan of your greywater distribution system from source to outlets* (fig. 12.14).
6. *Size basins based on the soil’s percolation rate and the expected greywater flow* (see box A5.2 in appendix 5 for how to do a soil percolation test).
7. *If you use subsurface chambers covered with soil and therefore there is no basin, size the chambers to handle the maximum potential surge of greywater.*

### DESIGN AND INSTALLATION

To design and install a branched-drain greywater system or twenty other system options, use Art Ludwig’s *The New Create An Oasis With Greywater* as your guide. It includes key tips and strategies you don’t want to be without.

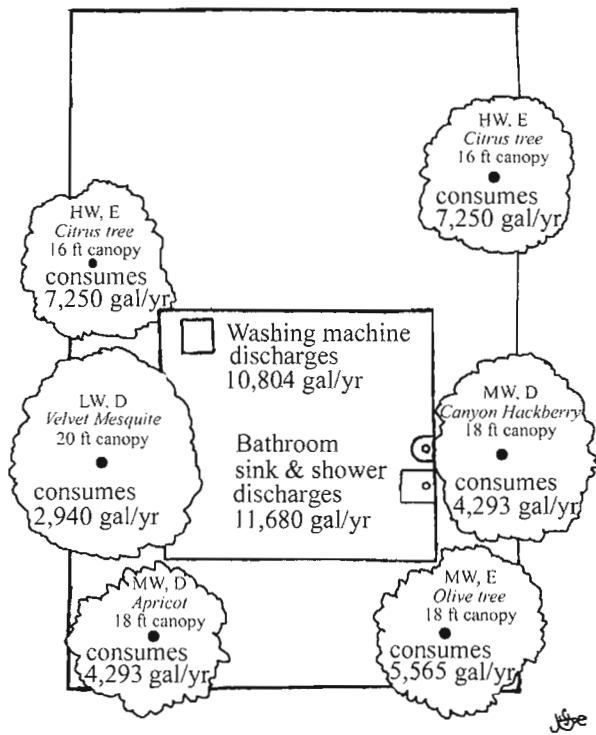

Fig. 12.13. Sample site plan showing average annual greywater discharge for a water-conserving household of four people (based on box 12.6), and annual water needs of trees downslope, and within reach, of household greywater sources. Water needs based on Example Plant List appendix 4. Harvested rainwater makes up the difference of the plants' water needs. At sites with higher rainfall and higher greywater production, you can increase planting density. At sites with low available water, reduce planting density or switch to lower-water-use plants. (LW = Low-water-use tree, MW = medium-water-use tree, HW = high-water-use tree, D = deciduous, E = evergreen)

With Art's guide you can do the work outside the house yourself, and effectively monitor the work of a plumber inside the house. Plumbers are experts with vents, P-traps, and interior or "collection" plumbing that links fixtures in the house to one or more outside distribution points. But their utility ends once the greywater pipe enters the yard. Most plumbers do not realize the need to discharge greywater in the top two feet (0.6 m) of soil where most root growth and soil life flourish. Explain this to them, along with the need to tap existing drain lines as *high as necessary* in the home to give you the maximum potential distance for gravity-fed distribution of greywater throughout the yard, while maintaining a minimum pipe slope of 1/4

inch per foot (2 cm per meter). If you don't take into account the needed change in elevation and drop of your pipe, if you try to irrigate plants too far away from your fixture, or if your yard slopes up a bit, the outlet pipe could end up too deep for effective irrigation and greywater treatment. To determine the slope of your site and pipe see bunyip section, appendix 2.

## MAINTENANCE

The systems described in this book are specifically designed for low maintenance. However, remember the rainwater-harvesting principles of "*Long and thoughtful observation*" and "*Continual assessment of your system: the feedback loop.*" Always pay attention to the health of plants being irrigated by greywater, and discontinue greywater irrigation if plants appear stressed. Then give them fresh water or harvested rainwater until they recover from the stress. In dryland areas with less than 20 inches (508 mm) of annual rainfall, periodically apply harvested rainwater (or fresh water if harvested rainwater isn't available) to all plantings to leach out accumulated salts.<sup>18</sup>

Soils should drain quickly enough so there is no standing water around plants that could lead to harmful anaerobic conditions. Make sure the root crown at the base of each plant is above the expected level of incoming rainwater and greywater to reduce the chance of rot.

For more specifics of system maintenance see *The New Create an Oasis with Greywater*.

## VARIATIONS

### OUTDOOR HOSE SHOWER

Outdoor showers can provide easily accessible greywater right where it is needed. Sling a hose with a spray nozzle over a branch that overhangs a mulched basin, and you've got a low-cost, easy-to-install outdoor shower. It's refreshing to use in the summer when the water needs of the plants, and your need for a shower, are the greatest. Many modern garden nozzles have a convenient shut off valve and as many spray options as a massaging showerhead at less cost. You can bathe in a swimsuit or install a screen to bathe in



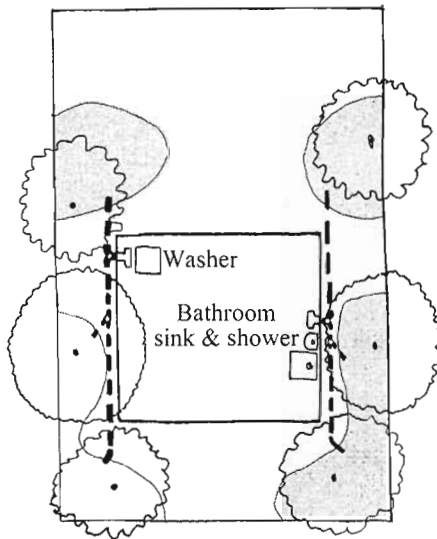

1. Greywater sources stay separated, and flows are passively split with flow splitters. Three-way diverter valves conveniently located inside house provide the option of directing greywater to landscape or sewer/septic.

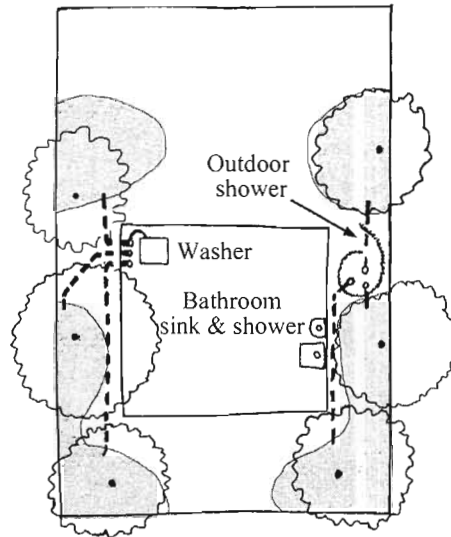

2. Flows at each source actively split by multiple drains so greywater distribution can be easily rotated to different basins. Outdoor shower's accessible greywater drains make shower water available to landscape when indoor shower's drain is inaccessible.

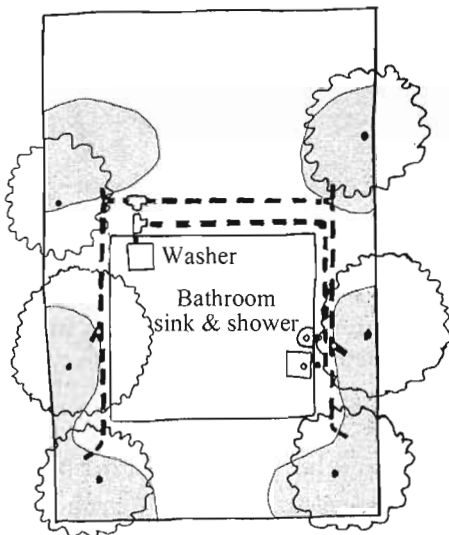

3. Combined flows actively split with an exterior three-way diverter valve located within an irrigation valve box.

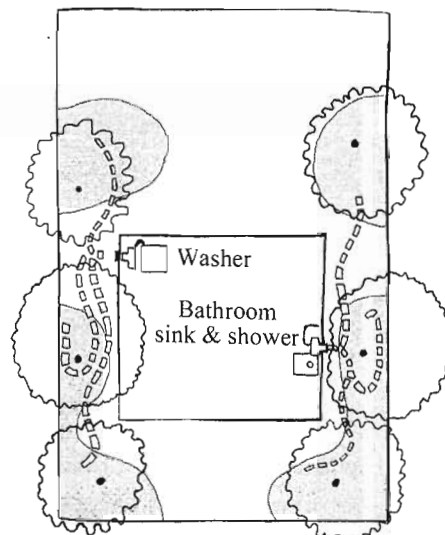

4. Flows actively split by rotating an above-ground flexible 1-inch (30-mm) minimum diameter spa-flex PVC greywater hose among different basins. Spa-flex will not kink and clog like garden hose. It is available in different colors.





-  Mulched basin
-  Three-way diverter valve
-  Rigid ABS plastic greywater pipe underground
-  Flexible and moveable PVC spa-flex greywater hose above ground

Fig. 12.14. Four different options for diverting and distributing greywater flow around a yard. Adapted from *The New Create an Oasis with Greywater*



Fig. 12.15A. A low-cost outdoor tree shower. If your water pressure is high, you may need to wire or tie the hose to the branch.

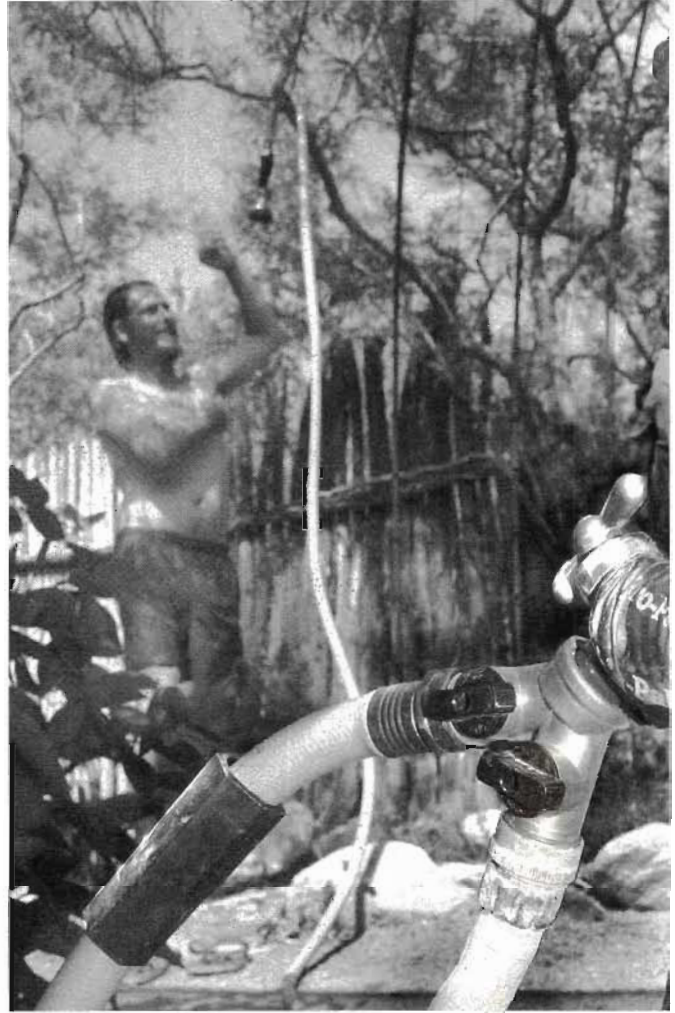

Fig. 12.15B. A hose adapter Y-connector with dual shut-off valves makes it convenient to keep your tree shower hooked up to its own hose all summer, while a second hose is available for other hose use.

privacy. Place a stake or pole as the hose stand until newly planted trees grow, and create an optional porous deck to stand on using a wooden pallet or paving stones. Thoroughly applied mulch—along with the deck—will eliminate muddy feet. In cold climates this could be installed in a greenhouse. See figs. 12.15A, B for a hose shower and convenient hookup, and figures 12.24 and 12.25 (later) for a more permanent outdoor shower plumbed into a hot-water line for multiseason use.

## A SIPHON-TUBE GREYWATER DRAIN

To inexpensively access otherwise inaccessible greywater from interior bathtubs or shower stalls, use a

siphon tube. It works best for bathrooms located against an exterior wall. Attach one end of a vinyl tube to the bottom of a water-filled bathtub or shower stall using a suction cup wired to the tube. From a hardware store you can get the tubing and suction cups, which come with a wire hook in place. The other end of the tube runs through a hole drilled in the bathroom wall to a mulched basin just outside. Use a hand pump (available at auto-parts stores) to draw water through the tube and get the siphon effect going, then pull the pump off the tube and let the water drain out into a mulched basin. The outdoor basin receiving the water must be lower in elevation than the bottom of the bathtub or shower stall. The downside of this sys-

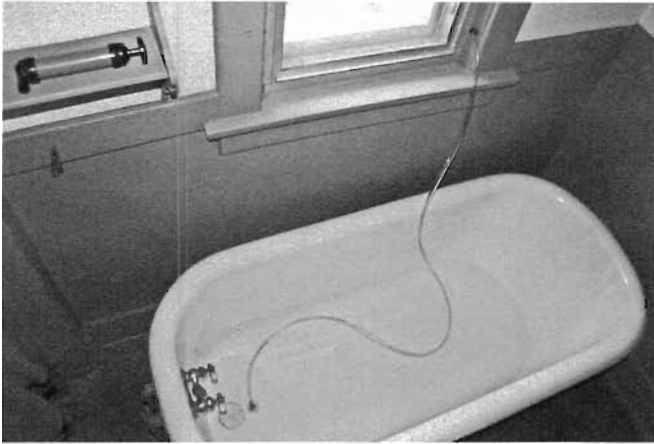

**Fig. 12.16A.** Vinyl tube suction-cupped to bottom of tub and run through window frame transports greywater from tub to landscape, overcoming inaccessible tub-drain plumbing.

tem is it is not as convenient as a branched-drain system or outdoor shower since you need to go outside to get the siphon going (figs. 12.16A, B).

### AN INTERIOR SIPHON, HAND-PUMP-POWERED GREYwater DRAIN

This is my favorite system for obtaining greywater access from an existing interior bathtub or shower that is located against an exterior wall. It is slightly more complex than the siphon-tube greywater drain, but far more convenient, because the pump is located inside the bathroom where you and the greywater are (figs. 12.17A, B). You pump the hand pump a few times, the siphon effect kicks in, and all the water from a five-minute shower can be drained out to the landscape in about ten minutes. It was designed by Christian Nys and Jay Johnson of the Pierson Street Ecohood in Phoenix, Arizona.

### Materials

To get ready to construct an interior-siphon, hand-pump-powered greywater drain, first obtain a siphon hand pump that is made to attach to—and drain—a 55-gallon (208 liter) drum. These pumps are available from Grainger ([www.grainger.com](http://www.grainger.com)). In addition, obtain about 1 foot (30 cm) of braided vinyl tubing. The interior diameter of the vinyl tubing



**Fig. 12.16B.** Exterior siphon hand pump (from auto parts store) pulls tub greywater through tube. Once water is flowing, the pump is pulled off, the tube is placed in a mulched basin with fig tree, and the siphon effect continues to draw the water. Purchase the hand pump first so you can select the correct tube diameter to fit the pump.

should be the same as the exterior diameter of the pump's rigid pipe (usually one inch or 25 mm). Also get a rubber drain screen with depressed cup, white silicone caulk, some 1.5-inch (40-mm)-diameter rigid ABS plastic drainpipe, about a foot (30 cm) length of schedule-20 PVC pipe with an interior diameter of 1 3/16-inch (30-mm), two 6-inch-long (150 mm) 3/8-inch (10 mm)-diameter eye-bolts, a toggle nut, hex nut, and lock washer to thread onto each eye-bolt, and a 2-inch (5-cm)-wide steel plate (see installation notes to determine its length). All these materials are available at the hardware store (except perhaps the



Figure 12.17A. The hand pump siphons the tub's greywater through a rigid intake pipe, up to the pump, then through a hole bored in the exterior bathroom wall, carrying greywater out to mulched and vegetated basins located outdoors. The type of rubber drain screen that has a depressed cup to catch hair, but allows water to pass through, is adapted for use as the intake point for the pump pipe by sealing the screen holes with white silicone caulk (see fig. 12.18). The adapted drain screen prevents the tub from draining and constitutes the lowest point in the bathtub. The tip of the pump's intake pipe is set at this low point to suction water from the tub.



Figure 12.17B. The vertical pipe conveys greywater siphoned from the bathtub (Note: For the siphon effect to work, the hand pump's corrugated outlet tubing must run through the wall then downward inside the exterior plastic pipe until it exits below the bottom elevation of the tub). The horizontal pipe rounding the corner of the house conveys gravity-fed greywater from the bathroom sink's three-way valve (see fig. 12.6), then the 1.5-inch (40-mm)-diameter ABS plastic pipe directs this greywater to mulched basins via a branched-drain system. While the system is under construction, the horizontal greywater pipe is supported by bricks in preparation for attaching the pipe to the wall with brackets. Basin edges will be stabilized with rock and the basins will be planted.

steel plate, which is available from metal shops), and are described in more detail below.

## Installation

Begin by setting the hand pump upright inside the tub or shower on the inside of an exterior wall. Lift the pump to an elevation where the bottom of the rigid plastic intake pipe can reach the bottom of the tub at the drain level. Cut the rigid plastic intake pipe at about the top edge of the bathtub. Next attach a section of braided vinyl tubing about 6 inches (15 cm) long to the two cut edges to create a flexible bend in the rigid intake pipe. This will allow you to place the pipe's inlet right at the tub's drain—the lowest point of the tub.

Acquire a rubber drain screen that has a depressed cup designed to catch hair but allow water to pass through. Adapt this drain screen for use as the intake point for the pump pipe by sealing the screen holes with white silicone caulk (fig. 12.18). Smear the caulking smooth and evenly with your finger on both

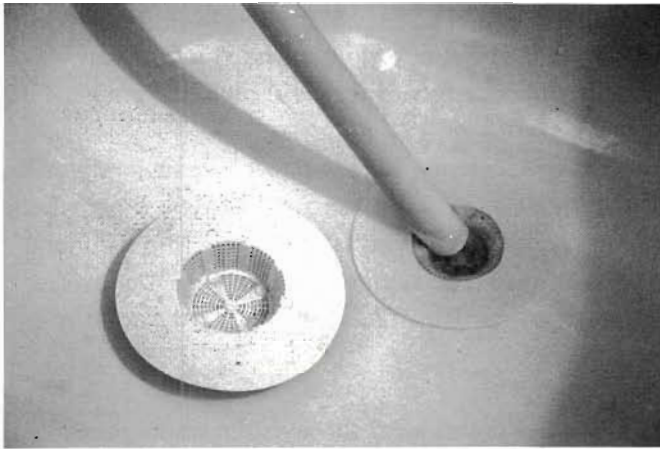

**Fig. 12.18.** An unadapted rubber drain screen (left) and an adapted rubber drain screen (right). The adapted rubber drain screen's holes have been sealed with white silicone caulk to capture the tub water. The pump's intake pipe is placed within the cup of the screen to siphon the maximum amount of collected water.

sides of the screen holes. Now when the adapted drain screen is placed on the bathtub drain it prevents the tub from draining and creates a small, low depression—the lowest point in the bathtub. The tip of the pump's intake pipe is set at this low point to suction the maximum amount of water from the tub. When you want to direct the tub water to the sewer or septic instead of the landscape, just lift the drain screen and let the water go down the drain.

Again, hold the hand pump up vertically at the desired height against the inside of the exterior wall. Mark a spot on the wall, at the elevation of the hand pump's outlet tubing, for the hole that will later be drilled through the wall. You will direct the hand pump's corrugated outlet tubing through this hole to discharge greywater to the outside. Drill the hole from the inside wall through the outside wall using a 1 3/8-inch (35 mm)-diameter ceramic hole saw. Insert a section of schedule-20 PVC pipe with an interior diameter of 1 3/16 inch (30 mm) into this hole to act as a protective sleeve for the pump's smaller-diameter corrugated outlet tubing. The length of the PVC sleeve should be just a tad longer than the length of the hole through the wall.

Now prepare to attach the siphon pump to the wall using two 3/8-inch (10-mm)-diameter galvanized steel eye-bolts. The rigid intake pipe of the hand

pump will be inserted through the eyes of the eye-bolts, so make sure the eye holes are large enough, at least 1-inch (25-mm) diameter to accommodate the intake pipe. The eye-bolts typically need to be at least 6 inches (152 mm) long, depending upon your wall's thickness, the width of the pump, and/or the thickness of the tub's edge, since you want the hand pump's intake pipe to drop inside the tub.

Hold the pump against the wall with its outlet tubing inserted through the sleeved hole in the exterior wall, and its intake pipe positioned correctly in the depression created by the retrofitted tub drain screen. Determine the correct locations for the two eye-bolts by first placing the highest eye-bolt just under the hand pump, so the hand pump base will rest upon the eye-bolt. The lower eye-bolt should be placed a few inches above the upper edge of the tub, maximizing the distance between the two eye-bolts through which the intake pipe is threaded. Use a torpedo level or carpenter's level to make sure the intake pipe is vertical, and mark the locations for the eye-bolt holes on the wall. You will need to drill the holes about one inch (25 mm) in diameter, through which you can insert toggle nuts screwed onto the threaded ends of the eye-bolts. But before I describe the toggle nuts further, I need to describe the steel plate.

The toggle-nut holes will be considerably larger in diameter than the eye-bolts, so you will need one non-rusting stainless-steel plate or plain steel plate (primed and painted to inhibit rust) to cover the two toggle-nut holes and the space in between. This also greatly strengthens the overall installation. Do not use 2-inch (50-mm)-diameter galvanized fender washers to cover the holes in the wall instead of a steel plate, because the eye-bolts would flex and move too much. The steel plate needs to be at least 2 inches (50 mm) wide with two 3/8-inch (10-mm) eye-bolt holes drilled where you need them. If you are using stainless steel, go to your local metal shop to have them cut and drill the plate to your measurements. You can do your own fabricating if using plain steel.

Once the steel plate is cut and has its eye-bolt holes drilled, attach it to the wall. Screw a hex nut, and then a lock washer, onto each eye-bolt. Then thread each eye-bolt through the steel plate. Next thread a toggle nut on the end of each eye-bolt. You

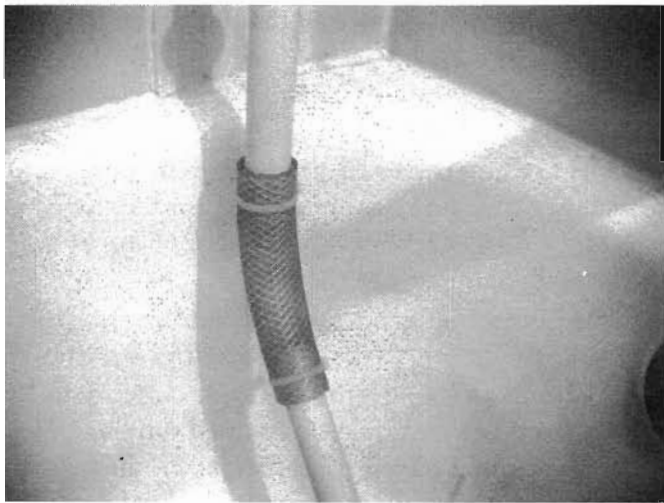

Fig. 12.19. Vinyl tubing zip-tied tight against the siphon pump's rigid intake pipe to prevent air leaks

are now ready to fold the toggles, and put them through the two holes in the wall. They will spring open once through the hole, so as you tighten the hex nuts on the tub-side of the wall and steel plate, you will compress everything into a tight, secure fit. The seam around the steel-plate and eye-bolt holes can be caulked to keep water out of the wall if needed. Mount the pump to the wall by threading the intake pipe through the eyebolts so the pump rests atop the uppermost eye-bolt in a vertical position on the wall.

Outside the wall, install 1.5-inch (40-mm) rigid ABS drainpipe to direct the siphoned water to mulched and vegetated basins. A branched-drain layout works well to spread the water out to a number of plantings. The pump's corrugated outlet tubing must run through the ABS drainpipe and extend to an elevation below where the intake begins inside the house or the siphon effect will not work. The ABS pipe protects the far less durable corrugated tubing from the elements and ensures greywater is directed where you want it without wind, people, or animals inadvertently redirecting the corrugated tubing.

## Troubleshooting

Sometimes the siphon effect can cease after you've got it going, requiring more hand pumping to get it going again. Should this happen, there are likely one or two causes and solutions:

1. There is an air leak where the vinyl tubing meets the rigid intake pipe, compounded by resistance from the cut edges of the rigid pipe.

Remedy: To lessen the resistance, file or sandpaper the inside ends of both sections of rigid pipe, where they join with the vinyl tubing, to a thin wall taper. To seal the air leak, zip tie the vinyl tubing over the rigid pipe (fig. 12.19). Caulking the seam may also help.

2. There is a vortex swirl through the water allowing air into the intake pipe.

Remedy: Cut an angle into the intake end of the pipe to get a flatter, closer interface with the drain screen. Then try different micro-adjustments of the intake pipe's placement within the drain screen as you siphon out the water. Keep the pipe where the vortex is less likely to occur.

## A MULTI-DRAIN SYSTEM FOR WASHING MACHINES

This is my favorite washing machine greywater system. It allows for easy and convenient control over where the greywater goes. Multiple drain pipes placed beside the washer direct greywater to a different mulched basin within the landscape (figs. 12.20A, B).

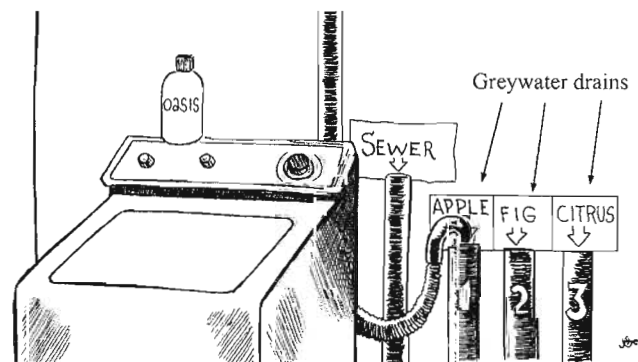

Fig. 12.20A. A multi-drain greywater system for washing machine located outside the home in a temperate non-freezing climate. Vent stack and P-traps are not necessary for outside greywater drains. Washer drain hose is moved to a different greywater drain pipe with each load of wash. Drains are marked with the names of trees they water. A well-marked sewer drain is available to shunt away non-greywater-compatible detergents or if landscape soil is already saturated.

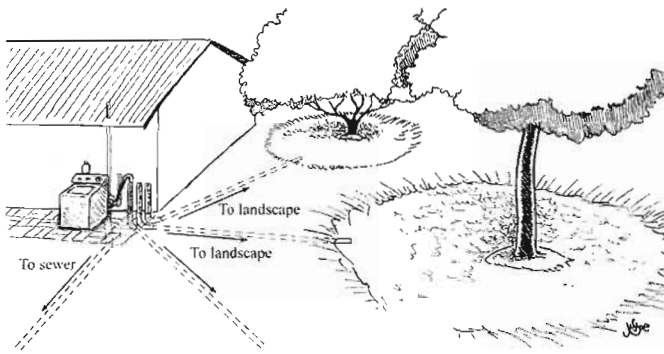

Fig. 12.20B. Expansion view of 12.20A. Multi-drain greywater system distributing greywater to mulched and vegetated basins.

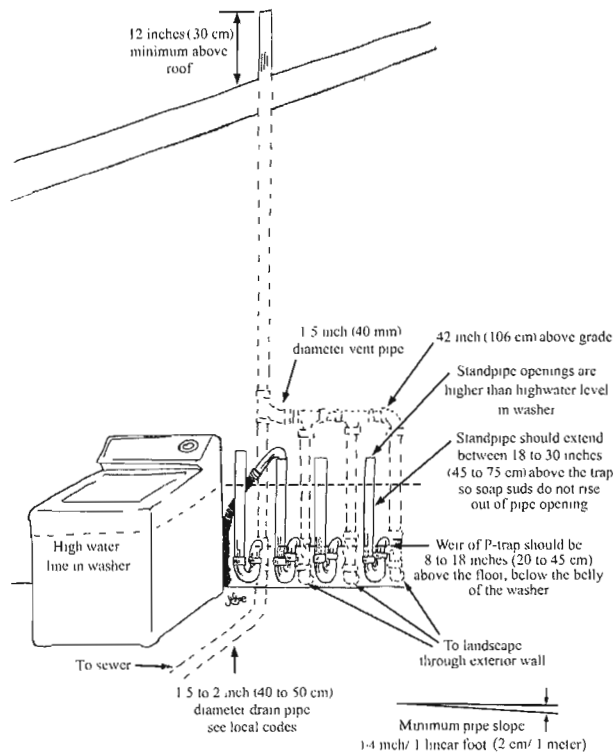

Fig. 12.21. A multi-drain greywater system for washer located inside the home. Vent stack and P-traps are necessary to keep vermin and potential odors out of building. Note 1: This is a conceptual drawing. Greywater drains should be installed closer together and closer to the washer for more convenient use. Note 2: Check with local authorities to see if a trap primer is required with this system. A trap primer occasionally injects a shot of water into seldom used P-traps to ensure there is always water in the trap—especially important for the drain to sewer. Or just cap sewer drain when not in use.

An additional pipe can direct greywater to the sewer or septic if bleach or non-greywater-compatible detergents are used in the wash. Mark the pipes to show their destination (fig. 12.20A). Permanent marker on strips of white electrical tape placed on the pipe makes great exterior-grade labels. *The washer drain hose can be moved to a different drainpipe with each load of wash depending upon where water is needed and what's going down the drain.*

This multi-drain system can easily be set up for existing homes by cutting holes in the wall to direct the greywater drains out to the landscape. If the washing machine greywater is inaccessible because the machine is in the core of a house with a concrete floor, consider moving the machine and its water and power hookups to a more accessible location. In new construction, design the installation of the multi-drain pipes into the laundry plumbing from the beginning. See the Real-Life Example section for more.

## KITCHEN RESOURCE DRAINS

For years my brother and I have been putting food waste, including grease, into a sink-side compost container (fig. 12.22), and safely and effectively recycling

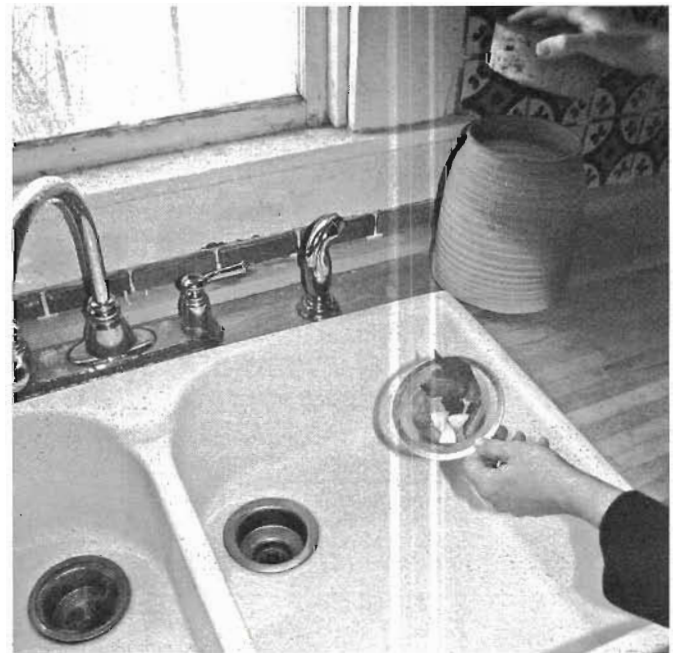

Fig. 12.22. Food caught in the wire screen of a kitchen sink is emptied into the compost bin or fed to chickens. Food waste becomes a resource and kitchen-sink greywater is much cleaner.

our kitchen-sink drainwater just using a branched-drain greywater system. It works well because we do not cook much meat, send grease down the drain, or use a sink garbage disposal.

Folks who want to maximize water conservation may be able to augment their greywater-harvesting system with kitchen-sink drainwater if they live in a location where regulations allow this. The Arizona Department of Environmental Quality's (ADEQ) definition of greywater does not include wastewater from a kitchen sink or dishwasher, so additional treatment of this wastewater is required. One allowed method of treatment in Arizona is the Kitchen Resource Drain (KRD), if certain criteria are met (fig. 12.23).

ADEQ has approved permits using the KRD for progressive new homes built with a composting toilet (a prerequisite for the KRD), and no sewer or conventional-septic-tank hookup. Both the KRD and a separate ADEQ-approved branched-drain greywater system for washers, showers, bathtubs, and non-kitchen sinks were used in these homes. This approach saved the owner-builders money, conserved water, and turned all wastewater and human waste into on-site resources.

## General components

The unique element of the KRD is the *interceptor*, which acts like a mini-septic tank that allows grease to float to the top, solids to sink to the bottom, and clearer water to flow out of the middle of the interceptor barrel. This water then flows to *subsurface leaching chambers* (also known as *outlet chambers*) that support vegetation in the landscape. The interceptor is hooked up to the kitchen-sink drainpipe just outside the house. Because of the interceptor, the KRD is *more* complex than other greywater systems and has *higher* maintenance requirements.

The interceptor can be constructed on site using either a 55-gallon (200-liter) plastic storage barrel (metal will rust) for single-bedroom residences, or a multiple-barrel system or larger manufactured grease trap for larger homes with greater water volumes. The interceptor is installed vertically with a removable lid and a capped inspection pipe so accumulated solids can be emptied periodically, as occurs with a standard septic tank.

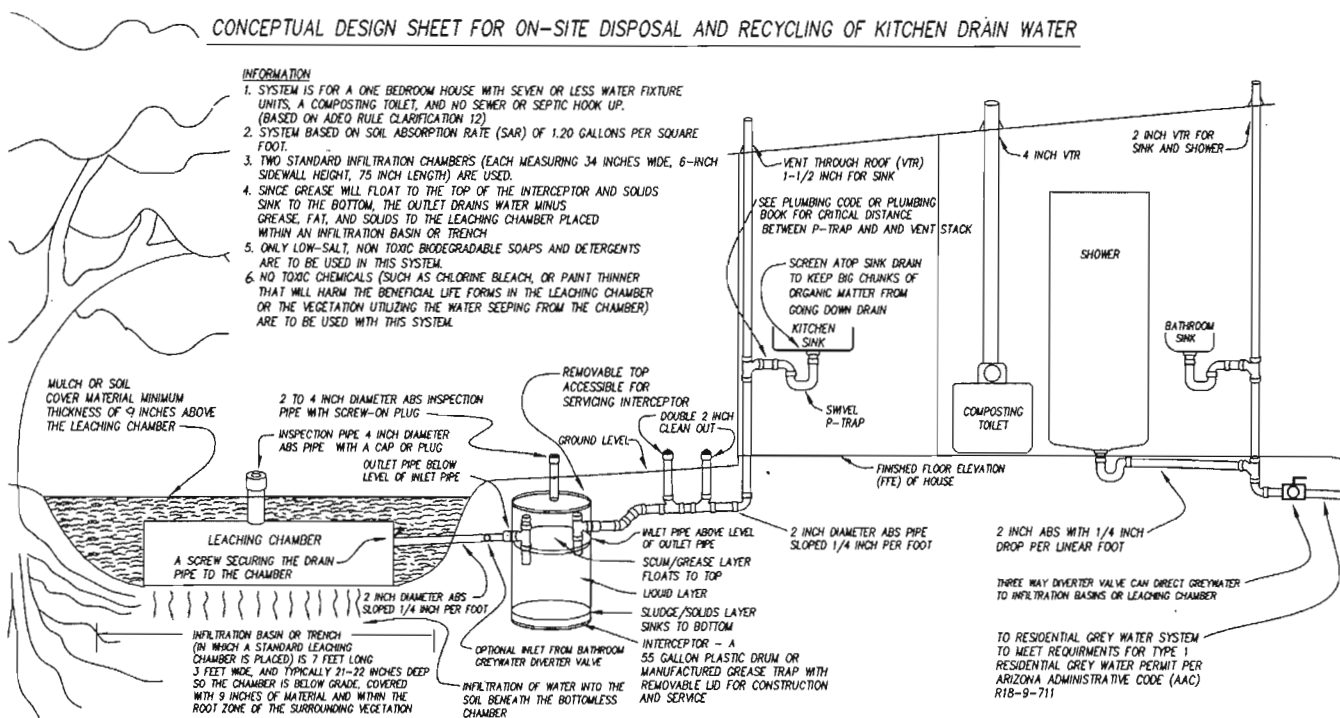

Fig. 12.23. Kitchen Resource Drain. Credit: Drawn by Bill Cunningham P.E., [www.southwest-solar.com](http://www.southwest-solar.com)



For more detailed sizing and implementation information on the KRD see appendix 5, and see the Real-Life Examples below.

## REAL-LIFE EXAMPLES

### AN OUTDOOR SHOWER PRODUCING FOOD, SHELTER, AND WILDLIFE HABITAT—TUCSON, ARIZONA

Our neighbor Kevin Moore wanted to bathe and water his backyard plants at the same time. Since plumbing in his old house was chaotic and hard to access, Kevin built a shower in his backyard. His outdoor shower consists of a basin-like concrete and stone platform surrounded by a screen of salvaged agave and sotol stalks. He constructed the platform about 12 inches (30 cm) above grade and installed three 1.5-inch (40-mm)-diameter drainpipes to gravity-feed greywater to three mulched and vegetated infiltration basins beside the shower. Each drain directs water to a different basin. Harvested greywater and localized rainwater runoff irrigate a multipurpose living screen made up of a citrus tree, pomegranate tree, artichokes,

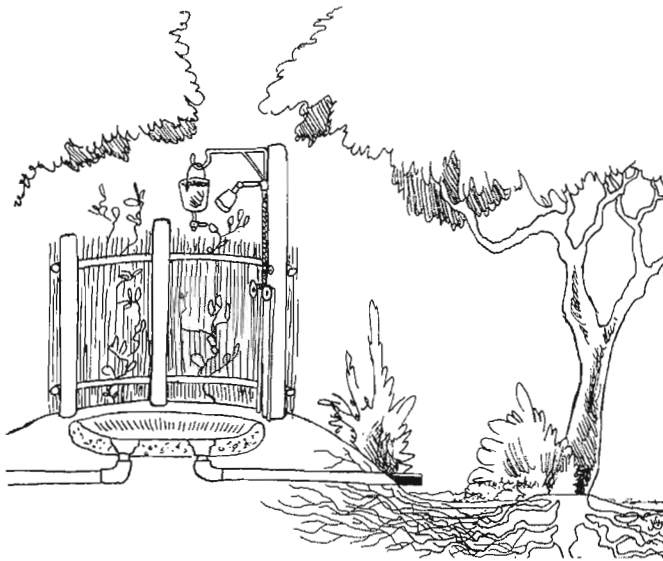

Fig. 12.24. Deluxe outdoor shower. A concrete platform bermed around the edge directs water to several drains, each directing greywater to different landscaped basins. A hook makes it possible to hang a shower bucket or bag containing cistern water. Pressurized municipal water—both hot and cold—is plumbed into the showerhead for comfortable multiseason outdoor bathing.

flowering vines, and native desert ironwood and velvet mesquite trees (fig. 12.24).

Kevin's greywater can be shared among the drains or he can focus all water to a single drain by temporarily plugging two of the drains using rubber drain covers or wet washcloths (fig. 12.25).

Plant growth is strong, birds love to hang out in the vegetation, and Kevin chows down on the produce. Visits from friends and family have even increased. They say hello, then slip into the emerging oasis for some feel-good outdoor bathing.

### COMPOSTING TOILETS AND GREYwater DISPERSAL VERSUS SEPTIC TANKS AND SEWERS—PIMA COUNTY, ARIZONA

Sustainable-home designers Barbara Rose and Dan Dorsey have designed and built fully permitted

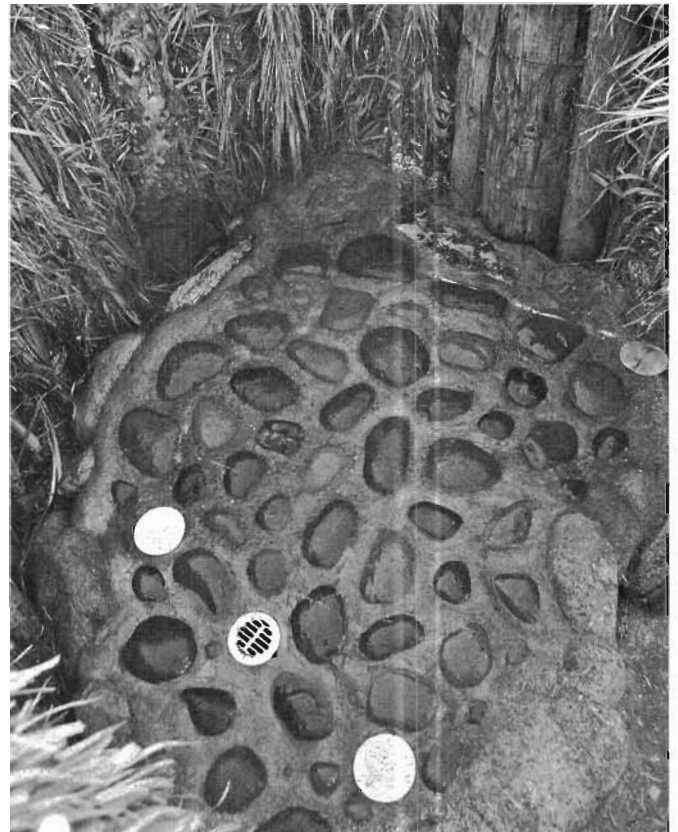

Fig. 12.25. Multi-drain system for an outdoor shower. Three drains at the bottom of an outdoor shower similar to Kevin's, each diverting greywater to different plantings in the landscape. Rubber drain covers can be selectively placed to direct greywater to selected drains.

rammed-earth and strawbale homes that are off the electric grid and free from conventional wastewater systems. In her beautiful rammed-earth home, Barbara is thrilled to be using a composting toilet that turns *humanure* into soil, ends the “need” to defecate into flush toilets filled with potable water, and avoids the cost and land disturbance of a conventional septic tank. All the greywater Barbara generates is recycled in the landscape in a manner consistent with Arizona Administrative Code (AAC) R18-9-711. According to the code, if residential discharge of wastewater is less than 400 gallons (1,512 liters) per day and meets the 13 requirements of the rule, a residence is automatically considered to have a general permit for reuse of greywater. The exception to the general permit is water from a kitchen sink, dishwasher, and toilet, which must be disposed of and permitted in a different way. Barbara has no dishwasher (see box 12.9) and her

kitchen-sink greywater is directed to the landscape via a Kitchen Resource Drain (KRD) (see the Variations section and appendix 5 for implementation information). The greywater from her bathroom sink and shower is distributed directly to the landscape via a branched-drain system (see fig. 12.26).

To obtain a permit for a Kitchen Resource Drain (KRD) and composting toilet in Pima County, Arizona, don't use the term “KRD.” Instead refer to the whole system as “an on-site wastewater treatment system with composting toilet, interceptor, leaching chamber(s), and greywater reuse”—terms staff members at the Department of Environmental Quality are more familiar with. Dan Dorsey recommends doing the following to obtain a permit (in addition to reading about KRDs in this chapter's Variations section).

Fill out and submit “R18-9-E303. 4.03 General Permit for Composting Toilet” to the Pima County



Fig. 12.26. Barbara Rose's garden watered with a KRD and harvested rainwater. Dancing Rocks Permaculture Community, Tucson, Arizona.

### Box 12.9. Automatic Dishwashers and the KRD

The drainwater from automatic dishwashers can be harvested within a kitchen resource drain (KRD), but dishwasher drainwater is often a poor greywater source. Art Ludwig reports in *The New Create an Oasis with Greywater* that it is high in salt and has a high pH due to conventional automatic dishwashing compounds. He also reports that alternative cleaners do not work well in dishwashers.<sup>19</sup> Instead wash your dishes by hand, harvest just the kitchen-sink drainwater, and forgo the cost of a dishwasher.

Department of Environmental Quality, and pay the fee of \$500. If the residence is within 400 feet of an existing sewer, apply for a waiver from hooking up to the sewer. Submit the specification sheet and owner's manual for the approved proprietary composting toilet, or approved compost toilet referenced design, along with the permit application. (Barbara installed the proprietary, or commercially manufactured, *Biolet XL* [see [www.biolet.com](http://www.biolet.com)] composting toilet. Dan used the proprietary *Envirolet® Basic Plus* [see [www.envirolet.com](http://www.envirolet.com)]. The retail prices of these toilets start at \$1,600 to \$2,000.)

When considering a composting toilet for your home, check out and use a variety of systems to see which might work for you, and whether you are truly willing to maintain it. Avoid smaller units whose capacity may be inadequate. If conditions allow, you might want to consider a well-designed homemade composting toilet—though you may not be able to get a permit for one in your area. See appendix 6 for composting-toilet resources. Questions about regulations for composting toilets should be directed to your state or county environmental quality or environmental health departments.

Dan offers the following 2007 cost comparison between greywater reuse systems and more conventional wastewater disposal options for a one bathroom, one bedroom home in Pima County, Arizona:

#### Method 1: Greywater reuse on-site

|   |                                    |
|---|------------------------------------|
| Composting toilet:  | \$2,000                            |
| Backhoe digging of site-suitability (percolation) test hole:                                  | \$350 to \$450                     |
| Site-suitability fee:   | \$250 to \$400                     |
| Permit review fees:   | \$500                              |
| On-site greywater-disposal system including a three-way diverter valve (not including labor): | \$400                              |
| On-site kitchen resource drain (KRD) (not including labor):                                   | \$400                              |
| <b>TOTAL COST:</b>  | <b>\$3,900 to \$4,150, or more</b> |

#### Method 2: Conventional septic system

|  |                                    |
|--|------------------------------------|
| Backhoe digging of site-suitability (percolation) test hole: | \$350 to \$450                     |
| Site-suitability fee:  | \$250 to \$400                     |
| Permit review fee:   | \$270                              |
| In-house drainpipe (not including labor):                    | \$300                              |
| Septic tank, leach field, and installation:                  | \$4,500 to \$6,500, or more        |
| <b>TOTAL COST:</b>   | <b>\$5,670 to \$7,920, or more</b> |

#### Method 3: Hookup to existing sewer abutting the property

|  |                                    |
|--|------------------------------------|
| Sewer Connection   |                                    |
| Permit fees:   | \$4,000 to \$5,000                 |
| Installation and connection of 4-inch sewer pipe to the municipal sewer line:                | \$2,000 or more                    |
| (price will be <i>much</i> higher if there is no existing sewer line abutting your property) |                                    |
| In-house drainpipe (not including labor):  | \$300                              |
| <b>TOTAL COST:</b>   | <b>\$6,300 to \$7,300, or more</b> |

*Costs in Pima County will vary with site location, local regulations, and material selection.*

## Box 12.10. The Influence of Time and Temperature on the Composting Process

There are a number of different types of composting toilets based on different means of composting. What is important is that the composting process is complete before using the toilet's composted materials. Thus, the Washington State Department of Health publication, *Water Conserving On-Site Wastewater Systems: Recommended Standards and Guidance*, states that four temperature ranges should be recognized when considering the composting process:

- Below 42°F (5.5°C) – little to no active microbial processing takes place. Within this temperature range, the system will serve only as a storage vessel for excrement, toilet paper, and additives.
- From 42°F (5.5°C) to 67°F (19.4°C) – psychrophilic microorganisms dominate (e.g., actinomycetes and fungi), which results in a moldering processing. Moldering toilets are designed to operate within this temperature range. Because the composting process is so much slower in this range, larger composter-vessel sizes may be needed to compensate for the slow volume reduction of the composting mass.
- From 68°F (20°C) to 112°F (44.4°C) – mesophilic bacteria dominate. This is the typical temperature range for most composting toilets.
- From 113°F (45°C) to 160°F (71.1°C) – thermophilic bacteria dominate (atypical of most compost systems unless assisted by an external heating system or well managed/turned/moistened by user).

Note: Joseph Jenkins has popularized a system based on aerobic, thermophilic composting in his book *The Humanure Handbook*, wherein he states, "Complete pathogen destruction [by composting] is guaranteed by arriving at a temperature of 62°C (143°F) for one hour, 50°C (122°F) for one day, 46°C (114.8°F) for one week, or 43°C (109.4°F) for one month."

For more information on composting toilets, see appendix 6.

## GREYWATER HARVESTING HELPS CREATE A FIRE-RESISTANT OASIS— CENTRAL ARIZONA

Brian Thacker of Arizona Renewable Resources was prowling Google Earth studying the satellite images of the catastrophic Rodeo-Chedeski fires of June 2002 when he came upon something amazing. There in the middle of a charred landscape of burned pine trees he saw two green areas surrounding two undamaged homes—thriving oases amidst devastation. He had to know why these homes were spared a fiery end, and called up the area fire marshal to investigate. He found the homeowners did two key things.

First, they used fire-defensive practices in their landscape. Within a 50- to 75-foot (15-to 22.5-m) radius around their homes they removed all ground-ladder fuels that could spread a low-burning fire into the canopy of trees and shrubs. They pruned tree branches up 4 feet (1.2 m) from the ground; cleared, chipped, and shredded dead limbs and brush; spread

the resultant mulch over the soil to retain soil moisture; removed conifers and shrubs right next to or against the house; and cleared pine needles from the roof and gutters.

Second, the homeowners directed their greywater into the surrounding landscape, particularly the oasis zone around their homes. This supplied the native vegetation with enough moisture to keep it from igniting so it acted like a fire break around the homes.<sup>20</sup> See appendix 6, chapter 2 section, for more information on designing for fire prevention.

## A BACKYARD GREYWATER SYSTEM THAT BECAME A FOOD-PRODUCING NEIGHBORHOOD LAUNDROMAT— TUCSON, ARIZONA

My brother and I have grown fruit with our dirty laundry for years, and now we grow fruit with our neighbors' dirty laundry too. A multi-drain system of

four greywater drainpipes placed beside our washing machine diverts greywater to four different fruit trees (fig. 12.20). Each time we wash a load of clothes we rotate the washing machine drain hose clockwise to the next drainpipe. This distributes greywater around the relatively flat yard and allows each area receiving greywater to drain after watering.

Each greywater drainpipe empties into a mulched basin via an outlet shield constructed of an upside down 5-gallon (20-liter) bucket (fig. 12.11). The shields have no bottoms and are placed on a couple of paving bricks to create a space between soil and the shield's underside to improve water drainage. Mulch, not soil, is backfilled around the shield's sides. Each shield is placed in a mulched infiltration basin in which we've planted a fruit tree. The tree is planted on a terrace or pedestal of soil within the basin to keep the root crown, or base of the tree, just above the mulch surface to reduce crown rot. The shield creates a large empty space that prevents mulch from stopping up the outlet, and deters tree roots from growing into the pipe. Greywater is released inside the shield and then quickly flows out into the surrounding basin beneath the mulch to rapidly infiltrate the basin's soil. In the dry season, greywater is the primary water source for these trees, with municipal water as a backup. In the rainy seasons, rainwater harvested from the house roof and surrounding landscape is the primary water source, leaching greywater-introduced salts out of the root zones of the trees.

Rodd and I didn't do enough laundry to keep our trees thriving in the dry months. Then it dawned on us that many neighbors washed their clothes in laundromats where greywater was sent wastefully down the sewer. Perfect!

We approached environmentally minded neighbors and proposed a deal. They could use our washing machine at the same price per load as the laundromat if they used detergents we approved (see box 12.4). They no longer had to leave the neighborhood to do their laundry and could harvest fruit from the trees irrigated with their "wastewater" (fig. 12.27)! And as a bonus our home and washing machine are solar powered, reducing the pollution-generating use of municipal electricity generated by burning coal. We committed to using the laundry proceeds to maintain the system, install an additional cistern to collect roof



Fig. 12.27. Rodd eating the white sapote fruit grown with harvested rainwater and greywater

runoff for washing and irrigation, and pay off the very water- and energy-efficient Staber washing machine we just purchased.

With three to seven households using our system, we have dramatically reduced supplemental irrigation with municipal water, neighbors learning about water conservation and water harvesting spread these techniques to others, and community ties are strengthened. It makes us feel great and keeps us motivated to do even more.

## POOLING AND CONSERVING RESOURCES TO BUILD COMMUNITY—TUCSON, ARIZONA

A common "wash and well" was created when 19 members of Sitting Tree, an urban community of apartment dwellers, pooled \$1,750. They installed a laundry shed, efficient horizontal-axis washing machine, outdoor shower, homemade solar water heater, Oasis 4-stage reverse-osmosis water filter (the "well"), clothes line, and compost bins. Garden plots, fruit trees and grape vines are now watered by greywater harvested from the outdoor shower, washer, and water filter. None of the community members could afford the system on their own but together it was easy. One system, rather than 19, serves them all. Households pay 50 cents for each load of wash and \$7 per month toward repayment of their self loan, paid off in five years. The "wash and well" has become a thriving gathering spot strengthening community ties through interaction, cooperation, conversation, jokes, and play. See figures 12.28A, B, and 12.29.



Fig. 12.28A. Wash and Well, front view. The batch-style solar water heater on compost bins heats water for the outdoor shower behind the vine-covered wall. The solar water heater atop the laundry shed roof is for the washing machine. An old refrigerator is used for the heater's insulated box. Its door can be closed to hold in more heat at night, and then opened again in the morning to let in the sun.



Fig. 12.28B. Wash and Well, back view. Tom is at the "well" filling his water jug from the faucet of the reverse-osmosis water filter, which is located behind the corrugated metal. Chet folds laundry dried by the solar clothes drier (clothesline) in the foreground. For color photo see inside back cover.

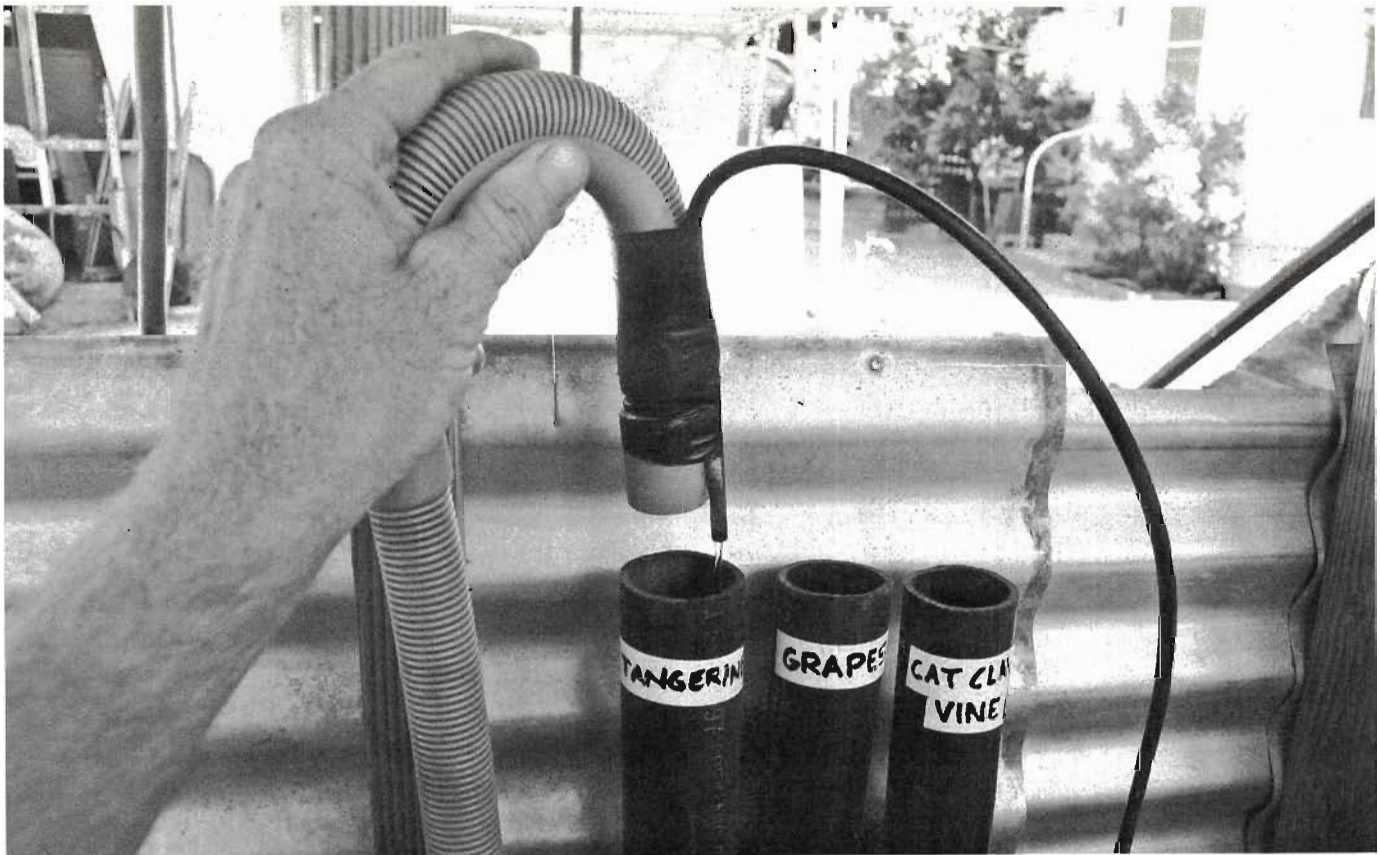

Fig. 12.29. Multi-drain greywater system for washer and water filter. The drain tube taped to the washing machine drain hose conveys backwash water from the reverse-osmosis filter. The joined hoses are moved to a different greywater inlet pipe with each load of wash.

# Epilogue

*Be the change you want to see in the world.*

—Gandhi

**W**e all live in watersheds within watersheds; we are all neighbors of neighbors. Whether we are conscious of it or not, we are part of interconnected ecological and human communities. We live both upstream and downstream of our neighbors; what we do affects them and what they do affects us. This book is an invitation to recognize and rejoice in these connections, and to act now to improve life for everyone by starting right where we are. Having read this book (and Volume 1), you have the tools to establish a relationship with your watershed and beneficially harvest water. Now *do* it!

Once you've begun to live within your sustainable water supply and enhanced your piece of the community watershed, CONGRATULATIONS! You have proactively become part of the solution rather than the problem. Use the water-harvesting principles and ethics. Continually look for ways to improve your system. By setting an example you are planting a seed of abundance—because living by example is the most powerful tool for inspiring change. The more you actively share your learning and passion, the quicker the bounty will spread.

This book contains many water-harvesting options and examples to motivate and inspire you. For more techniques and ideas, seek out water-harvesting information around the world—particularly in climates similar to your own. Check out water-harvesting workshops, demonstration sites, literature, the web,

videos, archaeological sites, and historical records. Learn more about your local ecosystem, climate, soils, history, and flora and fauna to work *with* the natural world. Build on successes and failures—yours and other's—to leap frog to more effective ways to harvest rain. Join with friends to critique, improve, and learn from each other's efforts. And most important, celebrate everyone's efforts.

Remember, water harvesting is always site specific, so success depends on your growing site-observation skills—before, during, and after implementing the range of water-harvesting techniques you select. Water harvesting is a dynamic process that enhances continually evolving *living* systems made up of billions of living organisms such as those within the soil, the vegetation, the wildlife, and the human community. As humans we can choose how we interact with the system. It's my hope—and the reason I wrote this book—that you will choose the path to sustainable abundance and you'll have fun shaking your rear end doing “a bun dance” along the way (fig. E.2).

## THE FUN AND EASY PATH TO ABUNDANCE

For me, finding and taking the path to abundance comes down to a few simple questions:

- What choice leads to more good for people and the earth?



Fig. E.1. The wasteful path to *scarcity*. The site rapidly dehydrates itself by erosively draining rainwater and runoff away to flood downslope areas and contaminate surface water with sediment. Greywater is lost to the sewer. Costly municipal or well water is pumped in to replace the free water that was drained away. Leaf drop/mulch is also drained away, further depleting fertility and water-holding capacity. This leads to a depletion of resources and feeling *scared in the city* due to the resulting *scarcity*.

- What choice makes things better both now and in the future?
- What choice gives back more than it takes from the living system?
- What choice leads to abundance for all?

The water-harvesting ethics (preface) and the concept of regenerative systems (chapter 1) can help answer these questions, but ultimately it's your powers of observation you should rely on. How might your proposed action lead to more good for people at home, in your community, and beyond, and for the earth? How might it make things worse? Choose your course of action accordingly. Positive actions will be followed by many positive outcomes, like dominoes falling in a line.

Max O. Lindegger, a planner of sustainable communities around the world, describes choosing a path to abundance through adopting holistic, integrated design. The aim of such design, "is to allow everything to work together harmoniously, and you know you are on the right track when you notice that your solution for one problem has accidentally solved several other problems. You decide to minimize the use of automobiles in order to conserve fossil fuels, for example, and you realize this will also reduce air pollution, encourage healthful exercise, reduce noise, conserve land by minimizing streets and parking, multiply opportunities for social contact, beautify the neighborhood and make it safe for children."<sup>1</sup> As you have seen from stories and examples throughout this book, integrated water harvesting yields the same positive stream of outcomes.





Fig. E.2. The stewardship path to *abundance*. This site passively hydrates itself by harvesting and infiltrating rainwater, runoff, and greywater on site, reducing downslope flooding and overall water consumption and contamination. The need to pump in water is greatly reduced or eliminated. Leaf drop/mulch is also harvested and cycled back into the soil and plants, further increasing fertility and water-holding capacity. This leads to an enhancement of resources and a *bun dance* of celebration due to the resulting *abundance*.

## A DROP IN THE BUCKET OF ABUNDANCE

Don't worry if your efforts seem small compared to the magnitude of regional, national, or global challenges. Many people stop themselves from moving forward by thinking their actions are just a drop in a bucket. But even one drop is great if it's a drop in the bucket of abundance. With enough drops we'll fill the bucket! A drop in the bucket is an issue only if it's a drop in the wrong bucket—the bucket of scarcity.

## START NOW

*"Gradualism is little more than escapism and do-nothingism, which ends up in stand-stillism."*

—Martin Luther King, Jr.

*We must achieve the character and acquire the skills to live much poorer than we do. We must waste less. We must do more for ourselves and each other. It is either that or continue merely to think and talk about changes that we are inviting catastrophe to make.*

—Wendell Berry, from the essay "Word and Flesh," *What Are People For?*

The best time to plant a tree was twenty years ago, or today. It's the same with water harvesting and the interconnected pursuits of passive solar design, harvesting or producing local foods, and reconnecting with your Place and your community. These activities enable us to learn from, and work with, natural systems—do them now. Begin with long and thoughtful observation and keep on observing long into the future. Learning begins the moment we actively engage with our surroundings. Walk your site; become

an observational sponge. What's naturally working? What's not? Why? How might you enhance what's working and change what's not working? Use the observation worksheets in appendix 5 of Volume 1 to record your thoughts. Go outside when it's raining—that's when you'll learn the most and have the most fun. When it's raining at my house I'm out in it, watchin', learnin', swingin' a shovel to redirect water flow, and lovin' it! If I'm at a friend's house when it rains I do the same thing, with my friend and me egging each other on.

Experiment and play with your observations. Don't let inexperience stop you from harvesting water. Get started. You will gain experience, make mistakes, and learn by fixing them. Always follow the eight water-harvesting principles and adhere to the three ethics. Using these will speed your learning process. Start at the top. Start small. Start! Your experience and learning will cross-pollinate to generate a whole new understanding of the system. Add critical thinking, and it becomes wonderfully delicious.

Is the east or west side of your home exposed to too much summer sun? Is there runoff you can use? If so, plant a tree within or beside a water-harvesting earthwork east or west of your home to shade out the sun. Then observe, and stay engaged. Does the tree suffer from too little water? How can you get more water to it? Is there room to expand the earthworks? Can you direct greywater to the earthwork? How can you reduce the tree's water needs? Mulch the earthwork? Swap it for a tree that uses less water? Is the tree in an ideal spot? If not, what would the ideal spot look like? Why? What other plants could benefit by being placed with the tree and earthwork? What other site-appropriate plants could produce more resources such as food? What potential production plants are missing or needed in your neighborhood? No sense in planting more pomegranates if your neighbor is overloaded with them. Plant something else, get to know your neighbor, and trade. Keep these questions and recommendations in mind when placing other earthworks and planting other trees and understory vegetation. It will be easier each time, since you'll draw on what you learned before.

## CHOOSING TO BE A HERO

*There is only one rule of good husbandry—leave the land far better than you found it.*

—George Henderson, *The Farming Ladder*

By choosing to take the path to sustainable abundance you are a true hero because you are actively, consciously working to make things better. Not just for you, but for the greater living system that we are all part of, now and in the future. That's what heroes do. Everyone harvesting water in this book is a hero and I want you to be one too. None of these heroes are unusual, they're just regular folks seeking a better way and doing it. This inspires me. So, I finish this book with four brief examples/stories from my region. Start now to create your water-harvesting story for your region.

## REAL-LIFE EXAMPLES

### DAN: TURNING A FLOODING BACKYARD INTO A NEIGHBORHOOD OASIS—TUCSON, ARIZONA

Dan Dorsey knows opportunity when he sees it, and he saw it when he noticed the home he wanted to buy was bare of vegetation and prone to flooding. Runoff from the back alley poured down the bare, compacted back yard into the home's back door and around a corner, cutting a gully that left part of the foundation jutting into mid-air. Soil and sediment carried by the last storm covered the street in front of the house. "Perfect," thought Dan. He pointed out his observation to the realtor, resulting in a substantial price reduction.

Dan bought his home and set to work creating a series of zig-zag boomerang and contour berms to spread runoff throughout the yard—starting at the top of the site watershed (the back yard and alley), and continuing to the bottom of the watershed (the front yard). Vegetation was planted within the earthworks, then mulch and compost were applied, producing a vast network of living sponges to soak up water, turning runoff into soak-in. To handle water in large rains,

he placed a diversion swale on the east side of his house to carry back yard overflow water around the side to water-harvesting earthworks in the front yard, keeping it from pooling against the house and eroding soil as it once had.

The floods from the alley are now the primary water source for Dan's thriving plants. Household greywater flows to water-harvesting earthworks, augmenting irrigation for fruit trees within the oasis zone. The once-sprawling compacted-earth parking area of the backyard is now a one-car/multi-bicycle carport; a thicket of native, shading vegetation full of song birds; tangerines aplenty; and a fertile kitchen garden. Dan happily shares this back yard bounty with neighbors, hosts workshops and gatherings at his site, has organized neighborhood tree plantings, and shows others how to use stormwater that would otherwise flood the street. It's got the community planting the rain and a whole lot more.

## PARASOL: COLLEGE STUDENTS, FACULTY, AND STAFF WORKING TOGETHER TO CREATE PUBLIC WATER-HARVESTING DEMONSTRATION SITES—UNIVERSITY OF ARIZONA, TUCSON, ARIZONA

Chet Phillips and Emilie Brill-Duisberg are founding members of a dynamic 50-student group named PARASOL that's changing their university and world for the better. PARASOL promotes and implements common-sense sustainable practices such as passive water-harvesting and solar-power installations, along with sister group ECLIPSE collaborating under the umbrella ECOalition at the University of Arizona campus. Members undertake hands-on projects, promote a sustainability curriculum, and work to see integrated sustainable strategies incorporated into campus renovation and building projects.

At the core of their efforts is a water-harvesting course that emphasizes action and example. The course was developed using grant funds obtained by course professor and PARASOL advisor, Dr. Jim Riley. In class, students assess campus areas prone to stormwater flooding, learn how rainwater harvesting can control flooding and conserve water, and examine

ways to reduce energy consumption using landscapes that passively heat and cool. Next they work with campus planners, facility managers, and grounds keepers to design and implement solutions.

In just two semesters, students, faculty, and staff have created two campus water-harvesting landscapes that stop flooding, stem erosion, dramatically reduce irrigation needs, and support cooling shade trees. Students worked with and learned from faculty, staff, and administration members who shared their passion for making a tangible difference in the built environment at the U of A: Dr. Jim Riley of Soil, Water, and Environmental Science; campus planner Grant McCormick; and facilities manager Mark Marikos provided expertise, advice, equipment, materials, approvals, and links to others to extend these strategies even more broadly.

What excites the students' allies? According to Emilie, "They've all been stewing on this for a long time, and now here are students dedicated and motivated enough to help them make it happen. And it *is* happening!" According to Chet, "As soon as we love anyone or anyplace, we have an obligation to work for that which creates hope. We love this place, we want to make a difference here, we want to ensure it survives, and we're acting on this. This excites others, and they too want to make a difference. As more people see what can be done, more cast their lots in with our efforts of hope."

The students' desire for positive solutions and use of a non-confrontational approach has earned the trust and support of those they work with. As Emilie says, "When you do something right, word gets out. People take notice and solicit your input." The water-harvesting course is now rooted in the curriculum. Students continue to coordinate with facilities management to convert consumptive landscapes into sustainable landscapes and to help design landscapes for new building projects. And PARASOL has received funding to conduct a campus-wide inventory of potential water-harvesting and solar-panel installation sites to help further the transformation to more rain- and solar power-based strategies on campus. Now that's revolutionizing the institution!

## ARIVACA: A COMMUNITY HELPING ITSELF ATTAIN WATER SUSTAINABILITY—SOUTHERN ARIZONA

Meg Keoppen was looking for ways to foster a cooperative, close-knit spirit in her rural community of Arivaca, Arizona, when she got the news that the Buenos Aires Wildlife Refuge and a local rancher had simultaneously applied for more water rights than the volume of water known to exist in the entire Arivaca watershed. Overnight the community was up in arms! What would happen to their water? Meg and fellow community member Francine Pierce quickly organized a community-wide discussion so everyone could speak on an equal basis about the health of their watershed and their water supply.

From that discussion, two groups—Earthworks, and AWET (the Arivaca Watershed Education Task Force)—were formed. Members included ranchers, organic farmers, local business people, civilians, progressives, and conservatives. AWET set out to collect data on the community's watershed and water supply and educate the community on their findings. Earthworks empowered the community to take immediate steps to improve the watershed by implementing water-harvesting and erosion-control strategies. A \$4,100 PRO-Neighborhoods grant paid teaching fees for skilled water-harvesting teachers who taught Earthworks' first hands-on workshops, offered free to community members. Construction of highly visible water-harvesting earthworks and cisterns throughout the community showed folks the potential of such work and got them working together to heal the watershed. In one workshop a group of 10 people built over 65 small- to medium-sized check dams in just three hours. These served to stabilize the landscape and provide moisture to adjacent vegetation.

Water-harvesting earthworks started appearing on private lands as folks implemented the techniques they had learned about from workshops and neighbors, or imitated techniques they had seen around town. To encourage more implementation, large piles of donated rocks were placed around town for people to make their own check dams. Though a few incorrectly placed and incorrectly built earthworks failed, the majority worked fine.

Actions funded by a \$13,000 grant from the U.S. Fish & Wildlife Services' Partners for Fish & Wildlife Program fanned community enthusiasm by supporting workshops and presentations to help participants design site-specific strategies for their sites. In addition, water-harvesting resources were purchased for the community library. And free resources were made available to Earthworks members—who earned their membership by helping others. This assistance included hands-on implementation of water-harvesting strategies, and organizing and preparing meals for community events and workshops. (Good food brings people together, energizes them, and gets them talking to one other.) Earthworks members could then request free volunteer labor, delivery of check-dam materials, and use of a backhoe and operator to create water-harvesting earthworks on their sites.

In only four years, more than 500 loose-rock check dams and gabions were built, many of them stabilizing road crossings at drainages that had washed out for years. A cumulative mile (1.6 km) of berm n' basins was constructed, numerous infiltration basins were created, and a half dozen cisterns were installed. These water-harvesting structures improve watershed conditions, provide on-the-ground examples, and inspire people to continue their efforts. Many new working relationships and friendships have been forged as a stronger community continues to cooperatively steward their common watershed.

## CARLOS OCHOA AND RICHARD MARTINEZ: WORKING TO BRING BACK THE RIVER OF THEIR CHILDHOOD—TUCSON, ARIZONA

At 49 years of age, Carlos Ochoa loves to tell stories of how as a kid, he and his kin swam, played in, and drank from the now dry Santa Cruz River in Tucson. And he loves to share stories and techniques about how he and his older friend, Richard Martinez, are working to bring the river back.

Their lives are rooted to the river and adjoining neighborhood where their families have continuously lived since the 1800s. And their memories are full of verdant landscapes. Large river-side trees shaded the soil so they could walk bare-foot all summer long.

### Box E.1. Important Tips for Those Doing Community Work

With so much exciting work to be done, there is a tendency to overextend ourselves. A word to the wise: If you take the path of community work and outreach, strive to avoid burnout. If possible, include financial compensation for a coordinator(s) in your grant application. Get co-coordinators to share the workload. Develop local talent as you train replacements and substitutes. Apply for funding only for what you want to do and what you can reasonably accomplish, and remember that a smaller project on the ground is better than any grand project just on paper. Organizations giving grants will typically help you with the application. It's not necessary to have prior grant-writing experience before applying for funding. With or without grant funding, you may ask for help from people in paid positions whose job responsibilities address the organizational or technical needs you have. Transportation departments can coordinate gabion work along roadways. Libraries and churches can organize public talks and workshops. Public building landscapes, school grounds, and community centers can become public demonstration sites. Rather than starting from scratch, observe and build on what already works, not just on the land, but in the community.

And remember to have fun and celebrate the good works!

Many trees held rope swings to launch kids into the water. Laughing, Carlos recounts how his uncle Henry Ochoa loved to jump into the water and surface open-mouthed to eat the watercress on the water's surface.

Today the river is dry. Old river-side trees have died, and the soil is too hot and exposed in summer to walk bare-foot. A narrow trail within a linear river park lines the now-sterile banks, which are channeled and stabilized with a cement-soil mix. Young trees and shrubs line the path, dependent on piped-in irrigation since most rainwater and runoff is directed away from vegetation to the dry riverbed 20 feet (15 m) below.

But one section of the river park is very different from the rest. This is where Carlos and Richard work to maintain the park for the county. I remember the

first time I saw it. I was riding my bike along the park lamenting how most of the landscape I had seen up to that point was designed to drain away water and consume resources—when I suddenly noticed boomerang berms on the downslope side of many plants. And mulch had been *spread out* under the trees instead of raked away. I was overjoyed and wondered who was doing it: Kids? The Parks Department? Guerrilla water-harvesters? Superheroes? No one was around, so I didn't find out.

I returned every few weeks to watch the progress. More berms were constructed, beautiful rockwork was added to stabilize berms and overflow spillways, and more mulch appeared. I noticed areas that had eroded in the past from unchecked runoff that were now repaired, and more earthworks were created upslope to harvest runoff. But I never saw anyone doing the work.

Months later, I met Carlos and Richard when they helped set up a Desert Harvesters mesquite-pod-milling event at a farmers' market along the river. Carlos and Richard are both jovial, passionate men who care deeply about their community, its lifeblood—water—and the now-dry river. When they realized I'd written a water-harvesting book their stories began to flow. They told me about the verdant past and their current efforts—taken on their own initiative—to transform their section of the park from a pumped-water-dependent landscape to a water-harvesting landscape. “We killed that river with our overpumping,” said Carlos. “We used too much water, and we keep increasing our use.” Then he shot out the questions, “Why don't people value water? Why do they waste so much? Why do they drain the rain away from their yards, and then give city drinking water to the plants? Why do we do that in our parks?” He didn't answer the questions or wait for me to respond, but said, “You need to come to my section of the river. I'm harvesting the rain so we can take the plants off drinking-water irrigation.” I told him I had seen his work, I thought it was wonderful, and I thanked him enthusiastically for doing it. He laughed and said, “Yeah, well, we gotta do it. We have to show people how to do it. We gotta get more of them doing it. We get enough of them doing it, and we'll bring that river back.”

These heroes epitomize my vision—people reengaging with their surroundings, their community, and the natural world to at least become better stewards and caretakers, or better yet, partners. These are people working *with* rather than against natural systems to improve the quality of life for all, while re-watering

their watersheds. We show each other the way—there is no one right way, there are many. The more people and ways of doing this there are, and the more interconnected things are, the better the outcome will be for all of us.

*Soul-ar powered watershed regeneration rests in the hands and hearts of each one of us:  
the power to restore ourselves by restoring our relations with our home basins.*

—Brock Dolman, wildlife biologist, watershed restoration consultant, ecological educator,  
“Restoring a Watershed State of Being:  
Basins of Relations”

# Appendix 1

## Patterns of Water Flow and Erosion with Their Potential Water-Harvesting Response

### PATTERNS OR TRACKS

The patterns or “tracks” left by the flow of water and sediment are excellent guides directing the selection and placement of water-harvesting efforts. Erosion is one such pattern. Erosion is a natural occurrence, which in healthy watersheds is naturally checked and slowed by vegetation and porous, living soils. In healthy watersheds erosion is slow and is a normal part of a dynamic equilibrium that moves sediments downstream. As organic matter and soil migrate downslope, they are replaced by on-site leaf drop from vegetation, soil migrating downwards from farther upslope, and digested plant material that “migrates uphill” and gets deposited in the form of animal droppings. All along the slope (except at the peak) the slow, downward migration of organic matter and soil is checked by its replacement.

In unhealthy watersheds, unchecked erosion can be like a deep cut in the human body, leading to a rapid loss of water and soil. It is a sign of depleting resources in an unstable landscape. Learning to recognize erosion patterns/tracks and their causes is an essential step in planning effective water-harvesting strategies that break the erosion triangle in figure A1.1.

SPEED, DISTANCE, and VOLUME refer to characteristics of water flowing on the land’s surface. Reduce any of the three and you begin to cut the erosion cycle. The more you break the cycle the more you reduce erosion. If you put in a water-harvesting strat-

egy such as a berm ’n basin, check dam, or infiltration basin in the path of water flowing over the land, you will reduce erosion by reducing the SPEED of water flow. You’ll be putting an earthen speed bump on the erosion highway.

If you place one or more of these strategies at the top of the watershed rather than at the bottom, you will be reducing erosion by reducing the DISTANCE the water travels before infiltrating into the soil. This is like placing the speed bump at the top of the driveway so the water doesn’t ever get a chance to destructively speed up.

If numerous strategies that hold and infiltrate runoff water into the soil are placed throughout a watershed—from tops of slopes to their bottom—erosion is reduced further by reducing the VOLUME of surface water flow. Surface water will not be able to accumulate into a destructive volume before being absorbed into the soil. Flowing overland in an erosive

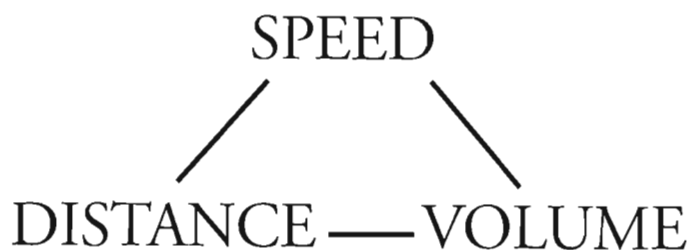

Fig. A1.1. Erosion triangle

manner will become so difficult for the water, it will choose to stay home in the soil or calmly walk through the landscape.

Below are a number of water and erosion flow patterns, and our potential response with water harvesting earthworks. The response techniques are covered in detail in this book.

## PATTERN AND RESPONSE

### SHEET FLOW

Sheet flow is the relatively even distribution of runoff water over the land surface, following the slope of the land downward but not focused into distinct channels. Sheet flow has most likely occurred after a large rainfall if you don't see distinct channels in an area of sloping bare dirt. If the water hasn't focused into a channel, it must be crossing the land as sheet flow. Other indicators are microdetritus berms and plant pedestals described below.

#### Microdetritus Berms

**PATTERN:** Microdetritus berms are small, curved lines of organic matter such as leaf duff that has been carried by sheet flow, and has then settled out perpendicular to the flow. The outer bow of the curve usually points in the downward direction of the slope. They are typically less than two inches high, and often don't last more than a few weeks after a rain. They're found only on gentle slopes in yards or in the broad landscape, not in drainages. (See fig. A1.2.)

**RESPONSE:** These tiny berms of organic matter are an indicator of calmer sheet flow, and therefore typically don't signal a pressing need for erosion control. They do, however, help confirm the direction of a gradual slope and water flow. This is useful when laying out contour berm 'n basins, boomerang berms, or planting on contour.

#### Pedestals

**PATTERN:** Pedestals are mounds of soil held in place by grasses, shrubs, and low trees (fig. A1.3A). The

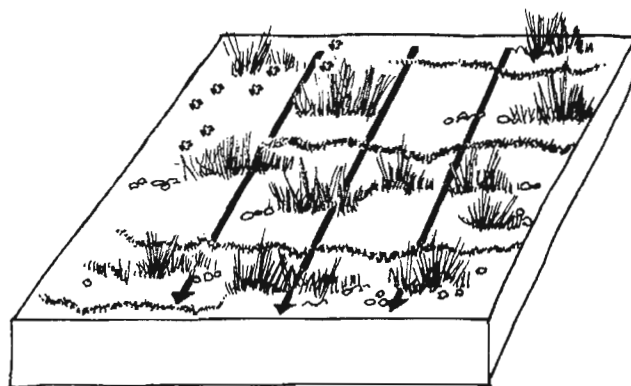

Fig. A1.2. Microdetritus berms and sheet flow

ground outside the perimeter of the pedestals is lower. A close look reveals that plant roots and protective canopies of leaves keep the pedestal from washing away. This same netlike canopy of leaves and branches also helps build the mounds by catching wind- and water-borne soil and organic matter, and by contributing leaf- and twig-drop to the soil below. The presence of pedestals usually indicates that more substantial sheet erosion is occurring within the broad landscape, though sometimes pedestals are observed in drainages where concentrated flow washes away sediments not held in place.

**RESPONSE:** Strategies that slow runoff and increase infiltration in the broad landscape, such as berm 'n basins, infiltration basins, imprinting, and increased vegetation, are usually appropriate to reduce substantial sheet erosion (fig. A1.3B).

### CHANNEL FLOW

Channel flow is the concentrated distribution of runoff within distinct channels or drainages. Look for nick points, rills, gullies, bank cutting, different sediment sizes, vegetation growing within channels, and exposed roots. These patterns are described below.

#### Nick Point or Headcut

**PATTERN:** A nick point or headcut is an erosion feature created when sheet flow has concentrated into channel flow by cutting a nick or gouge into



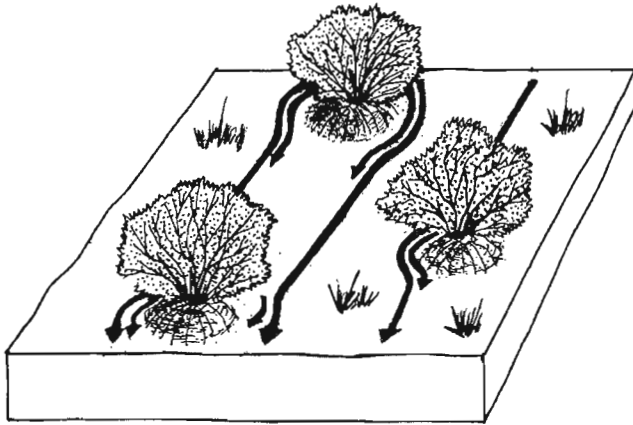

Fig. A1.3A. Pedestals and sheet flow

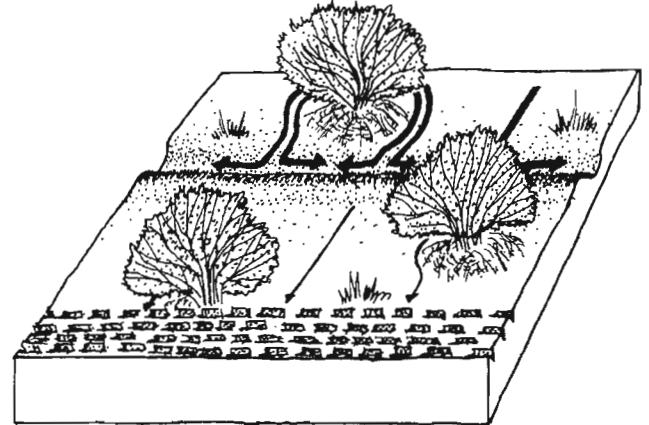

Fig. A1.3B. With added contour berm and imprints

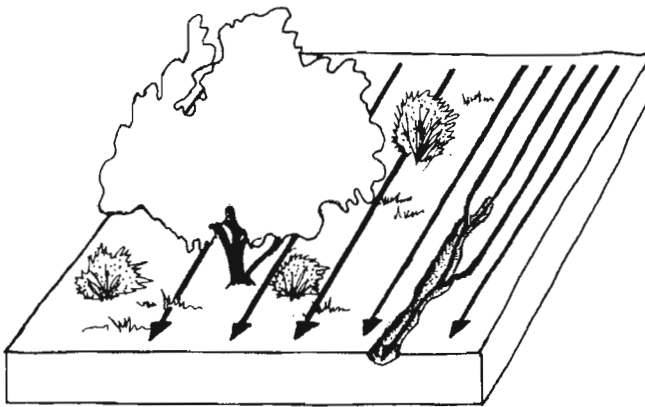

Fig. A1.4A. Nick point at head of rill

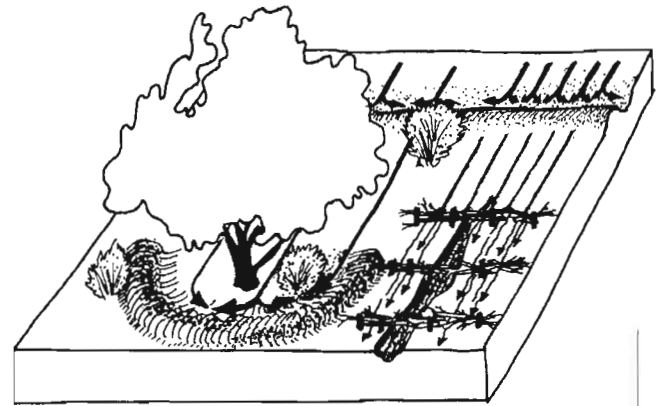

Fig. A1.4B. With added contour berm upslope, boomerang berm with tree, and brush weirs

the earth (fig. A1.4A). Nick points start small, but can grow to be quite severe. They are the growing edges of both rills and gullies, and will continue growing upstream as long as there is soil to cut, or until they are corrected and stabilized. Thus the erosion moves upstream as water moves downstream.

**RESPONSE:** Nick points need to be quickly addressed to check erosion. Overland sheet flow should be slowed, spread out, and infiltrated into the soil as much as possible before it reaches a nick point. Water-harvesting strategies such as berm 'n basins, imprinting, vegetation, mulch, and infiltration basins may all be useful upslope of a headcut. Within the eroding channel itself, spread and infiltrate the flow

with permeable barriers appropriate to the scale of the channel (see below: "Rill Erosion" and "Gullies" for examples). See figure A1.4B.

### Rill Erosion or Runnels

**PATTERN:** Rills or runnels are tiny erosive drainages in which loose soil has washed away. They are very common on eroding slopes where roadways have been cut into hillsides or on bare dirt driveways and roads that run downslope (fig. A1.5A). Rills are an early stage of the type of channel erosion that occurs downhill from nick points.

**RESPONSE:** Look first to spread and infiltrate sheet flow above the rill or runnel. Berm 'n basins,

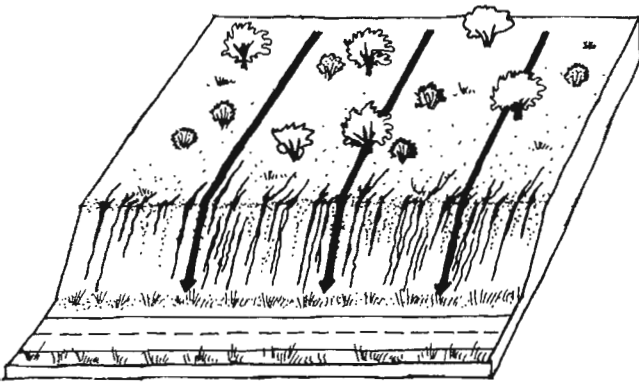

Fig. A1.5A. Rills on roadcut

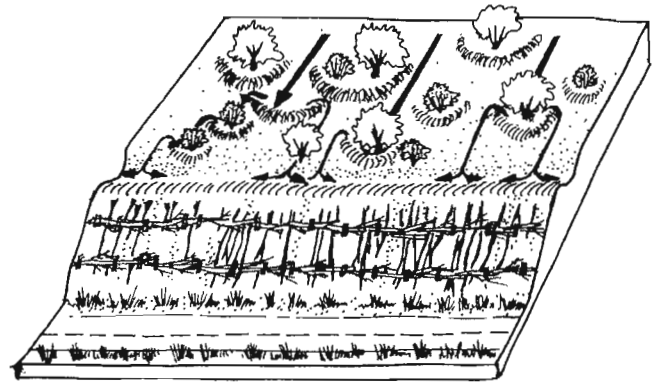

Fig. A1.5B. With added boomerang berms, contour berms, and brush weirs

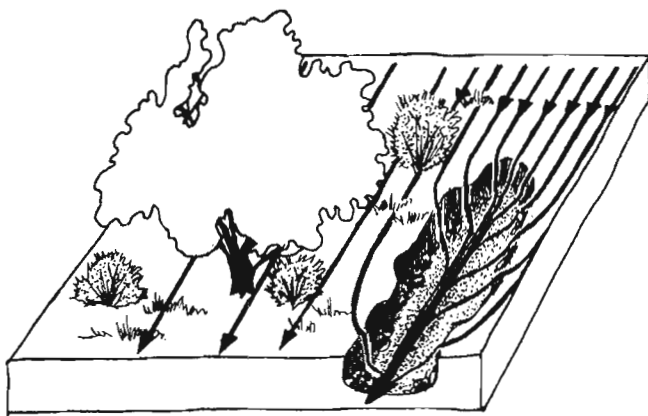

Fig. A1.6A. Gully

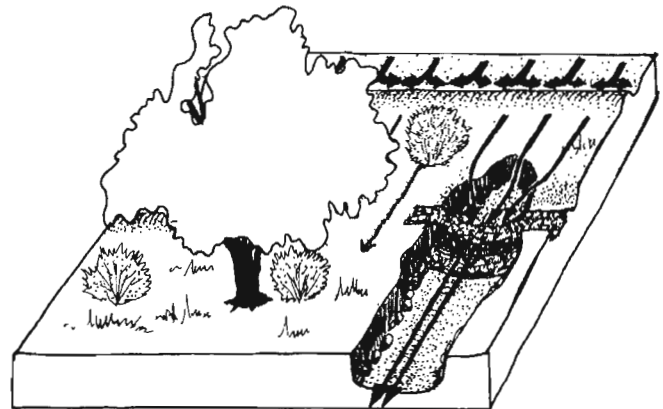

Fig. A1.6B. With added contour berm and gabion

vegetation, and mulch can all be effective. Then spread and infiltrate the flow within the rill itself, with a series of very small check dams constructed of branches and rock piles laid across the cut (fig. A1.5B).

## Gullies

**PATTERN:** Gullies are large erosive drainages or arroyos. Oftentimes they were runnels or rills that continued to erode, deepen, and grow. Gullies are a channel erosion feature (fig. A1.6A).

**RESPONSE:** The overland flow draining toward the channel should be slowed, spread, and infiltrated into the soil as much as possible before reaching the drainage. Berm 'n basins, imprinting, vegetation,

mulch, and infiltration basins may all be appropriate. Within the drainage itself a series of sturdy, well-placed check dams constructed perpendicular to the flow can help stabilize the drainage as the broader landscape is simultaneously repaired (fig. A1.6B).

## Bank Cutting at Curves

**PATTERN:** Bank cutting occurs where channelized water flows around a curve and the forward momentum of the water cuts the outside bank of the drainage. The slower-moving water on the inside of the curve often allows this cut sediment to deposit at the inside curve location. Notice the shape of the cutting side of the flow, usually a vertical cliff. Then

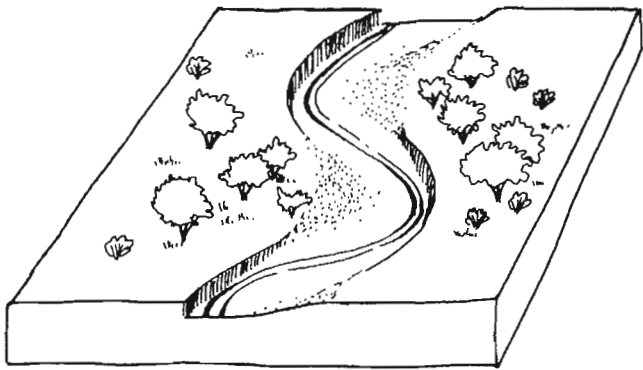

Fig. A1.7. Bank cutting at curves

notice the shape of the deposition side, usually a gently sloping bank. (See fig. A1.7.)

**RESPONSE:** Such bank cutting on a curve can help “spread and infiltrate” water by eventually widening and elongating the flow path via an ever more serpentine channel. This can reduce the gradient (slope) of a drainage and slow the water’s flow. Do not attempt to control this curving of a channel. Instead use your recognition of the curving to encourage induced meandering where appropriate, or to correctly place check dams if erosion control within the channel is necessary. Check dams are water-harvesting and erosion-control structures placed perpendicular to the channelized water flow in straight sections of channels upstream from curves. Proper construction and placement of these structures helps ensure that bank cutting does not occur around the edges of the check dams.

### Sediment Size within the Streambed

**PATTERN:** Different sizes of sediment are clues to past flows of water and sediment in a watercourse. The larger the sediment pieces, such as large rocks or boulders, the faster and stronger the past water flow was, and the potential flow could be. The presence of large rocks or boulders indicates fast-moving water, since these are the only objects heavy enough to settle out of fast-moving water. As the water slows, smaller and lighter sediment falls out. Stones are deposited first, then sand, and finally silts and clays when the water slows greatly. (See fig. A1.8.) A boulder-strewn



Fig. A1.8. Different sizes of sediment

drainage may be dry at the time of observation, but when it floods it will flood with force.

**RESPONSE:** Determining potential flow is key to selecting and placing appropriate water-harvesting and erosion-control structures. It is usually better to stay out of boulder-strewn drainages with potentially intense flows. Instead, focus water-harvesting and erosion-control efforts on the gentler flows of the broad landscape and on smaller drainages that feed the more intense flows.

### Vegetation in the Bottoms of Drainages

**PATTERN:** Vegetation (or the lack of it) growing in the bottom of an arroyo gives you an idea of past flows. Notice the amount of down-cutting, or erosive deepening, that has occurred in the drainage. Then try to determine the ages of the younger trees, perennial grasses, and other vegetation growing in the bed of the waterway.

**RESPONSE:** The size, density, and age of vegetation growing in a drainage bed and along its lower banks is a good indicator of flood frequency, as floods will usually scour out small vegetation. If you are trying to revegetate a drainage, the presence or lack of vegetation can “teach” you where it is acceptable to plant to reduce the risk of losing the new vegetation to flooding.

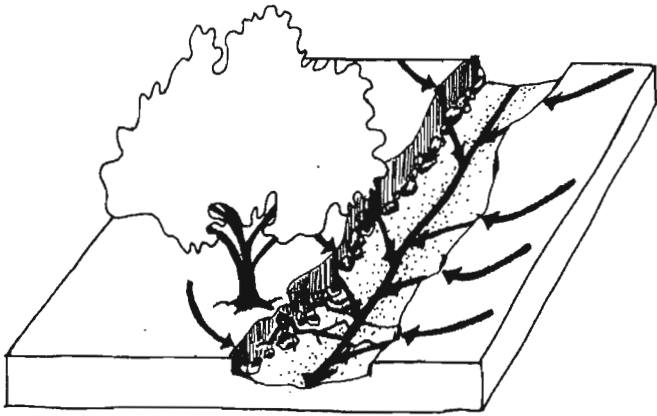

Fig. A1.9A. Exposed roots

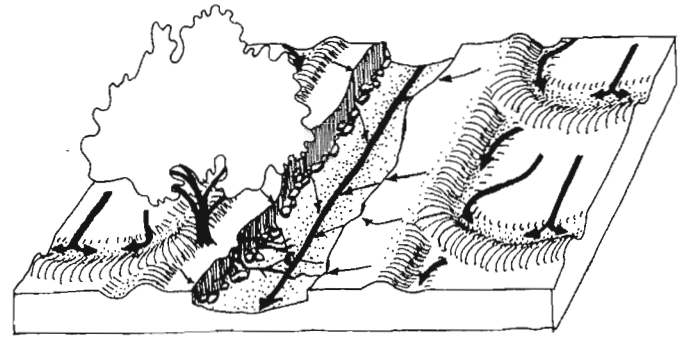

Fig. A1.9B. With added berm 'n basins

## Exposed Roots

**PATTERN:** Exposed roots of trees and shrubs may be evident along large and small eroding drainages (fig. A1.9A).

**RESPONSE:** A result of channel and bank erosion, exposed roots clue you in to the degree of erosion and potential water flow in a drainage. Generally, the more roots are exposed, the more intense the flow and the greater the depth and width of erosive cutting. Appropriate erosion-control strategies are generally the same as for gullies, though if the active bank-cutting is too severe, first concentrate on reducing the severity of the flow by harvesting water and reducing erosion higher in the watershed. (See fig. A1.9B.)

## GENERAL PATTERNS OF WATER, SLOPE, AND FLOW

The following patterns are not limited to sheet or channel flow alone. They are caused by various flows of water, the life forms it supports, and the slopes it helps shape. Look for sediment deposition, break lines and keylines, high-water marks, scour holes, vegetation, and animals. These patterns are described below.

### Sediment Deposition

**PATTERN:** Sediment deposition occurs where rocks, sand, soil, twigs, seeds, animal droppings, and other materials carried by runoff have dropped out of the

flow. Branches, stones, and patches of grass or shrubs occasionally capture these sediments. Look for these deposits on the broad landscape where sheet flow is present or in drainages, and speculate about their source.

**RESPONSE:** The presence of different types of sediments can give you a good idea of the size and extent of your watershed. If you're in a low desert valley and oak, walnut, or pine debris is present, your watershed probably extends into the higher elevations where that vegetation naturally occurs. If grass clippings and mulberry leaves appear in your yard, but you have neither a lawn nor a mulberry tree, search for their upslope source.

### Break Lines and Keylines

**PATTERN:** Break lines are places in the landscape where slopes change from gentle grades where sediments settle out of slow-moving runoff, to steep grades where sediments are picked up and carried away by faster-moving runoff. Keylines are where slopes change from steep grades where sediments are picked up and carried away by faster runoff, to more gentle grades where sediments settle out of slower moving runoff. On a microlevel, you may see a break line where a slope covered with leaves and silts changes to a steeper patch of naked sloping dirt. The keyline would be downhill where that naked slope changes to a more gradual slope where collected fines, silts, and

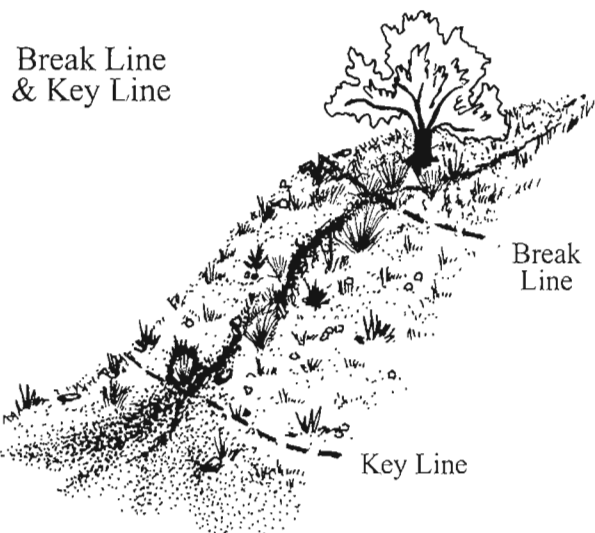

Fig. A1.10. Break line and keyline

organic matter accumulate. The land below that keyline could be a good location for planting, since it is not eroding but instead is receiving water and organic matter. On a macrolevel, a mountain or hilltop slopes down to a break line where it steepens and erosion increases, then comes the keyline where the slope lessens at the top of an alluvial fan composed of depositing sediments. (See figure A1.10.)

**RESPONSE:** Concentrate water-harvesting efforts where less effort is required—above break lines first, then below keylines second. Be wary of the slope between the break line and the keyline as it may be too steep or challenging to do more than plant vegetation on contour, or carefully lay out contour berms or terraces made of brush or single courses of rock. If you are building a small earthen dam or pond, make sure you will not back water up above a keyline. You need to keep the water level below the keyline, so you can direct your overflow across more gentle, easily managed slopes.

### High-Water Marks

**PATTERN:** High-water marks are the highest points in drainages or floodplains where you can see evidence of past high-water flow. Look for lines of discoloration on rocks and vegetation and deposits of branches,



Fig. A1.11. High-water-flow detritus on young cottonwood

twigs, grass, and other debris that indicate the high-water mark from flooding. Sometimes these deposits are surprisingly high on a fence or in the branches of a tree. Within your property or yard make sure no high-water marks appear above or near the level of your home's foundation. (See fig. A.11.)

**RESPONSE:** High-water marks tell you of potential high-water events in drainages and floodplains. No strategy is used to change this on the broad landscape; just don't build, or plant extensively, within the area of potential flooding. If you find evidence of water backing up onto a building's foundation, try to harvest

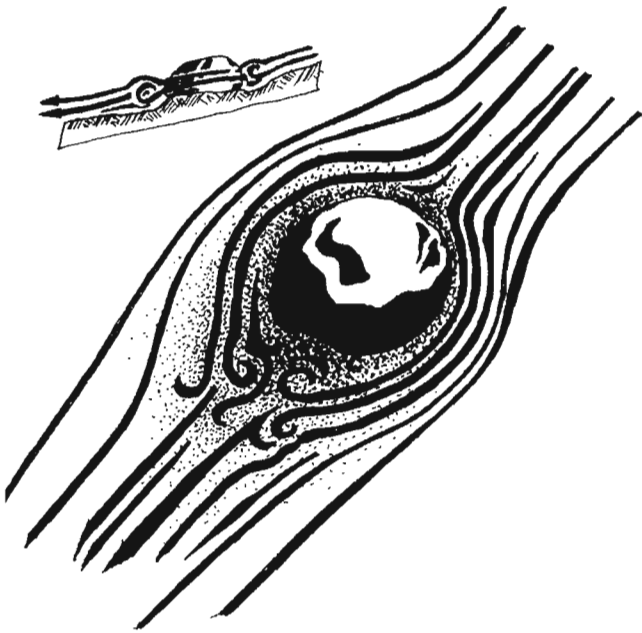

Fig. A1.12. Scour hole

that water with earthworks before it reaches the building, and make sure the grade around the building drains water to a point 10 feet (3 m) away from the building. Urban flood peaks can become more intense as more land in the watershed gets covered in roofs, streets, and parking lots. It is not wise to buy a home located on flood-prone land.

## Scour Holes

**PATTERN:** Scour holes form in locations where water is forced around an immovable object such as a boulder, often creating a whirlpool directly downstream of the obstruction. These whirlpools leave behind distinctive circular holes in the bottoms of arroyos, and on broad landscapes experiencing sheet flow (fig. A1.12).

**RESPONSE:** Scour holes do not necessarily indicate a need for erosion control, but can help confirm the direction and force of potential water flow even when no water is currently flowing.

## Vegetation

**PATTERN:** Vegetation is generally densest where water is present. Hydric vegetation—plants that tolerate some waterlogging—flag water at or close to the surface. In the Southwest, water-needy broad-leaved cottonwood (*Populus fremontii*) and sycamore trees (*Platanus wrightii*) typically indicate the presence of springs, perennial water flow, or shallow groundwater levels. Hardy triangle-leaf bursage shrubs (*Ambrosia deltoidea*) are found in arid, drained zones. Everything is relative; however, in extremely dry areas sometimes even bursage cannot grow in the arid drained zones of the broad landscape, and instead is found along drainages and other areas of greater water concentration. Short-term indicators of soil moisture include native annuals such as peppergrass (*Lepidium thurberi*) and abundant invasive annuals such as tumbleweed (*Salsola iberica*).

**RESPONSE:** Familiarize yourself with the water needs of local plants. They'll tell you how much water is in the soil and what types of vegetation with similar water needs the landscape can support.

## Animals

**PATTERN:** Animals, insects, and birds that need water can signify the proximity or dependability of a water source. Dragonflies are found near open bodies of water. A high number of toads probably means that a water source is ephemeral or too small to support predatory fish.

**RESPONSE:** Familiarize yourself with the water needs of local animals, insects, and birds. When assessing a site, use sightings or evidence of these life forms to clue you in to local water sources. In urban settings with fountains and pools, the presence of water-dependent creatures may not indicate the presence of natural water supplies.

# Appendix 2

## Bunyip Water Levels and A-Frame Levels

### SIMPLE TOOLS FOR MEASURING SLOPE AND DETERMINING THE PLACEMENT OF WATER-HARVESTING EARTHWORKS

Professionals typically use transits or surveyor's levels to measure slope and define how they want to shape the land. These tools work well, but they are expensive and require training to use. Here are two effective and inexpensive alternatives you can make—a “bunyip” water level and an *A-frame level*.

#### THE “BUNYIP” WATER LEVEL

The “bunyip” (fig. A2.1), as this water level is called in Australia, is a simple tool that enables you to find a land “contour” (a level line on the landscape), determine elevation differences between two points, and determine the slope of the land.

You can use this tool to mark the locations for contour berms, slopes of diversion swales, end points of boomerang berms, depths of basins, and appropriate locations for overflow routes.

A bunyip consists of a long clear vinyl tube, with each end attached to a tall stake that is marked in inches or centimeters. When the two stakes stand vertically, the tube becomes “U” shaped. Water is then carefully poured into the tube so no air bubbles are entrained in the water. The bunyip works on the principle that still, standing water is level across its entire surface, as you would find on a calm lake. A bunyip is basically a lake in a tube.

The tube is filled with enough water so the surface of the water reaches about halfway up each vertically

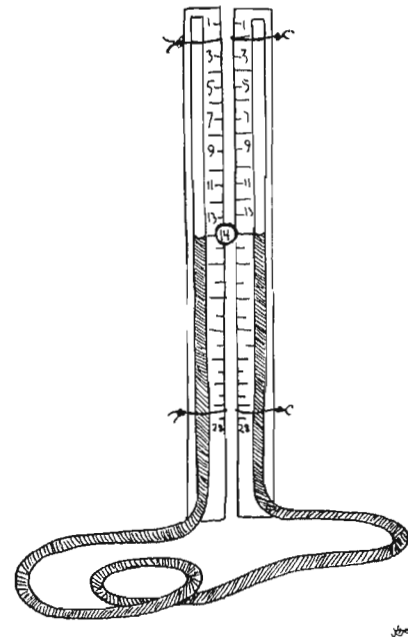

Fig. A2.1. Bunyip water level

held stake. If the stakes are standing right next to each other on level ground, the water level will be the same in both ends of the tube, and the measurement reading on each stake will be the same. If one stake is raised onto a small dirt mound while the other stays where it was, the water level will stay straight across, but the measurement readings on the stakes will be different, reflecting the elevation difference of the land

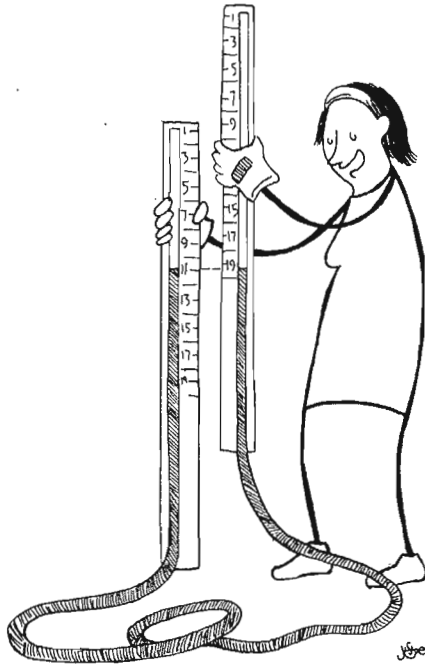

Fig. A2.2. Testing the bunyip level; the water is level.

the stakes are standing on. It takes two people to use a bunyip water level—one to hold each stake. Bunyips are easy to make using the materials and instructions below.

## WHAT YOU NEED TO MAKE A BUNYIP

- Two 5- to 6-foot (1.5- to 1.8-m)-tall, straight stakes
- 30 feet (9.1m) or more of 5/8-inch (16-mm)-diameter clear vinyl tubing, available in the plumbing section of most hardware stores
- 3 feet (90 cm) of wire or string to bind the tubing to the stakes
- Yard (meter) stick or tape measure
- Permanent ink marker
- 2 to 3 gallons (9 liters) of water
- Funnel to pour water into the tubing
  - Optional: 2 corks and 2 strings. Corks are used to plug the tube ends when moving the water level around, then removed during use. Wine bottle corks can be whittled down to fit the tubing. Tie one end of a string to the top of the bunyip stake and the other end to a cork so you don't lose the corks.

## HOW YOU MAKE A BUNYIP

Lay the stakes beside one another on the ground with the bottom ends even. Measure 5 feet (1.5 m) up from the bottom of each stake and mark this point. These marks should be level with one another since the bottom ends of the stakes are even. Starting from the upper mark of each stake, use the measuring tape or yard stick and permanent marker to mark each inch (or centimeter) going down for 30 inches (or 75 cm). Check the accuracy of the marks by standing the stakes next to each other on level ground to confirm they line up. Starting with zero at the top, number the marks from top to bottom on each stake so the numbers also correspond.

Bind the tubing near the top of each stake using wire or string. Lash it tight enough to hold the tubing in place, but not so tight that it significantly pinches the tubing. Pull the tubing straight down along the stake and lash it in the middle, then near the bottom of the stake.

Fill the tubes with water in one of two ways:

**Method 1: Pour the water in.** With both stakes in an upright position, carefully pour water into one end of the tube until water overflows the tube. Any air bubbles that become entrained in the tubing will prevent accurate water level measurements. Remove air bubbles from the tube (see box A2.1 for instructions), and add more water until the desired water level is attained.

**Method 2: Siphon the water in.** Lay one stake on the ground. Set the other stake upright against a table that has a bucket of water standing on it. Release the upper tubing from the upright stake and stick the end of the tubing in the bucket of water. Wash the end of the tubing of the stake laying on the ground, then suck on the end of the tubing to initiate water siphoning. Air bubbles typically do not get entrained in siphoned water running from the bucket into the tubing.

With the air bubbles removed, hold the stakes upright next to one another on level ground. Check that the level of water is about halfway up the stakes. Drain or add water as needed to get water to the right level. Water should move freely up and down in the



### Box A2.1. Getting Rid of Air Bubbles in Bunyip Tubing

To ensure accurate water level measurements, enlist a friend to help you remove air bubbles in tubing. First, pour water into bunyip tubing. Next have your friend stand on a spot several feet higher than surrounding land and hold the two bunyip stakes upright next to each other. Then stretch the intervening tubing out along the ground. Where the tubing "folds" back on itself (the bottom of the "U"), pick up both parts of the tubing 2 feet (0.75 m) from the bottom of the "U," using one hand. Make sure the tubing is not pinched anywhere. The bottom of the "U" will hang down forcing any air bubbles in that length of tubing to rise toward your raised hand. Now slowly slide your hand up the tubing, always keeping the bubble-free section of tubing lower than the tubing in your hand. Tap the tubing with your free hand to help free any bubbles sticking to the side. When your hand gets to the stakes, drop your hand slightly or lift the stakes slightly so the collected air bubbles can escape out the open ends of the tubing (fig. A2.3).

You may need to add more water in the tubing to fill the space the bubbles occupied. After you've put more water in, check for bubbles again.

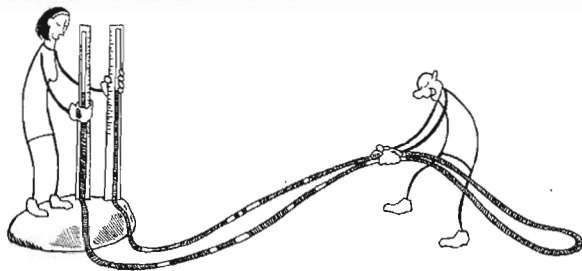

Fig. A2.3. Removing air bubbles from tubing

tubing when you move the stakes. If water does not move, check the tubing for kinks, remove the kinks, and verify that water moves correctly. Once the water becomes calm after moving the tubes, check that the water level lines up in both tubes, and that the measurement reading is the same on both stakes. If the water levels are not at the same height when the stakes are standing next to each other on level ground, check again for air bubbles or a kink in the tubing. If the measurement reading is not the same, check for mis-marked stakes.

Now your bunyip is ready to use. While carrying it around, use the corks or your thumbs to plug the tubing to keep water from sloshing too much in the tubing. Remove corks or thumbs when you are reading water level measurements. During a long project, it's a good idea to periodically set stakes on level ground next to each other to verify no new bubbles or kinks have formed.

## USING YOUR BUNYIP—TWO HYPOTHETICAL EXAMPLES

### Marking a level line for a contour berm

Al and Bonnie want to mark a level contour line on their land where they plan to dig a contour berm later that day. They get out their bunyip water level and Bonnie holds the two stakes upright as Al fills the tubing with water and gets rid of air bubbles. The water is about halfway up their stakes and is level, so they are ready to start.

To refamiliarize themselves with the water level, Bonnie holds one of the stakes a few inches higher than the other. When the water stops moving, the water in the higher stake reads "19" while the lower stake reads "11" (fig. A2.2), so they are reminded that the stake that reads the higher number is also higher in the landscape than the other stake.

As they walk to where they want to begin measuring the contour line, they each hold a stake with their thumb over the open end of the tube to keep water from spilling out. Bonnie sets the bottom end of her stake down where they want to begin the berm. Al walks 5 to 20 feet (1.5 m to 6 m) along what he thinks is the contour line (20 feet if the land is relatively flat, closer if the land is more undulating). Al puts his stake down in a spot he feels is on the same contour line as Bonnie's stake. Standing in these positions, they each gently tap the top of their end of the tube with their thumb to stop the water sloshing around within the tubing. When the water is still, and they've removed their thumbs from the end of the tubing, they tell each other what water level measurement they have. Bonnie reads 13 while Al reads 17.

"I have the higher number, so my stake is higher than yours," says Al. "So I'll move my stake downslope

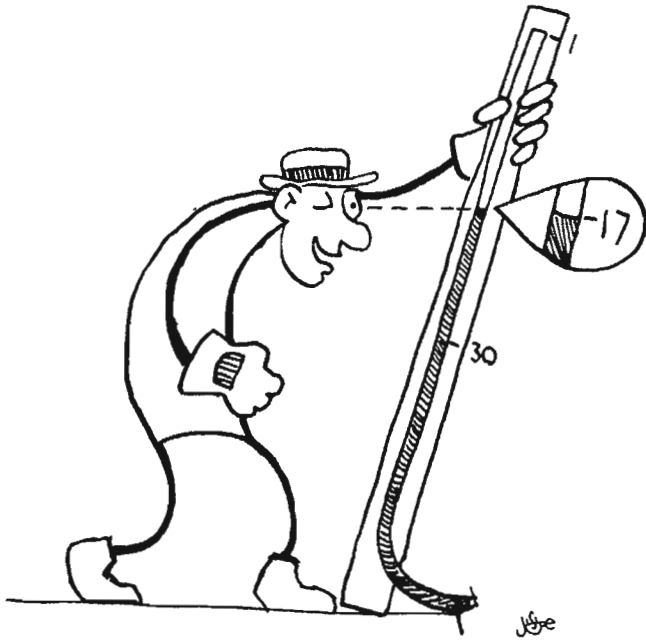

Fig. A2.4A. A non-vertical bunyip stake will give a lower, incorrect reading

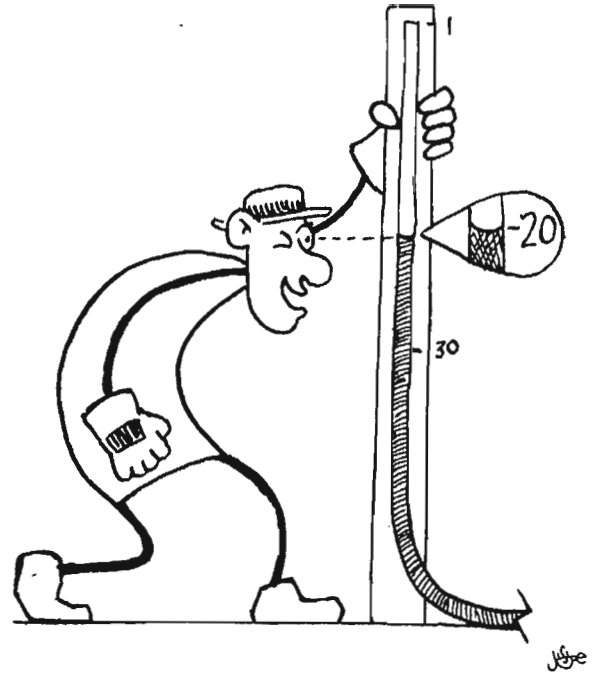

Fig. A2.4B. The bunyip stake must be vertical for a correct reading

a bit. You stay where you are since you're in the spot where we want to begin the berm." After moving his stake several times, Al and Bonnie each read 15 on their stakes, so they are now at the same elevation. They scuff a line in the dirt connecting Bonnie's point to Al's. With that done, Al keeps his stake in place and puts his thumb on the top of the tubing. Bonnie plugs her end of the tubing and walks her stake beyond Al ("leapfrogging him") to a point she thinks is level with his stake (fig. A2.5).

As Al and Bonnie find a series of points on the same land contour, they continue to connect the dots by scuffing the contour line into the dirt. They could have marked the contour line with wooden stakes or other markers, but since they planned to dig a berm 'n basin along the contour line right after lunch, scuffing is sufficient. They keep going until they reach the full length chosen for the contour berm. If they had encountered a landform that presented a natural barrier, they would have stopped there instead.

With the contour line marked, they prop the bunyip water level against a tree to keep water from running out of the tubing, call some friends, and dig a contour berm along the line they just marked

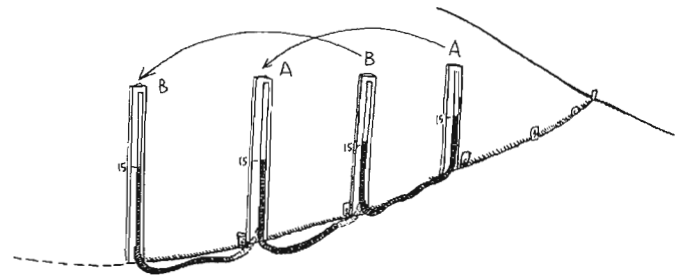

Fig. A2.5. Leapfrogging the bunyip to mark a level contour line on the land. Here the contour line is marked both by scuffing a line in the dirt and with stakes.

(see chapter 2 on Berm n' Basins for more information about construction). By four o'clock that afternoon, the contour berm is complete.

### Using a bunyip to determine a difference in elevation and measure slope

In the middle of a record-breaking drought, friends of Bonnie and Al decide to make use of the

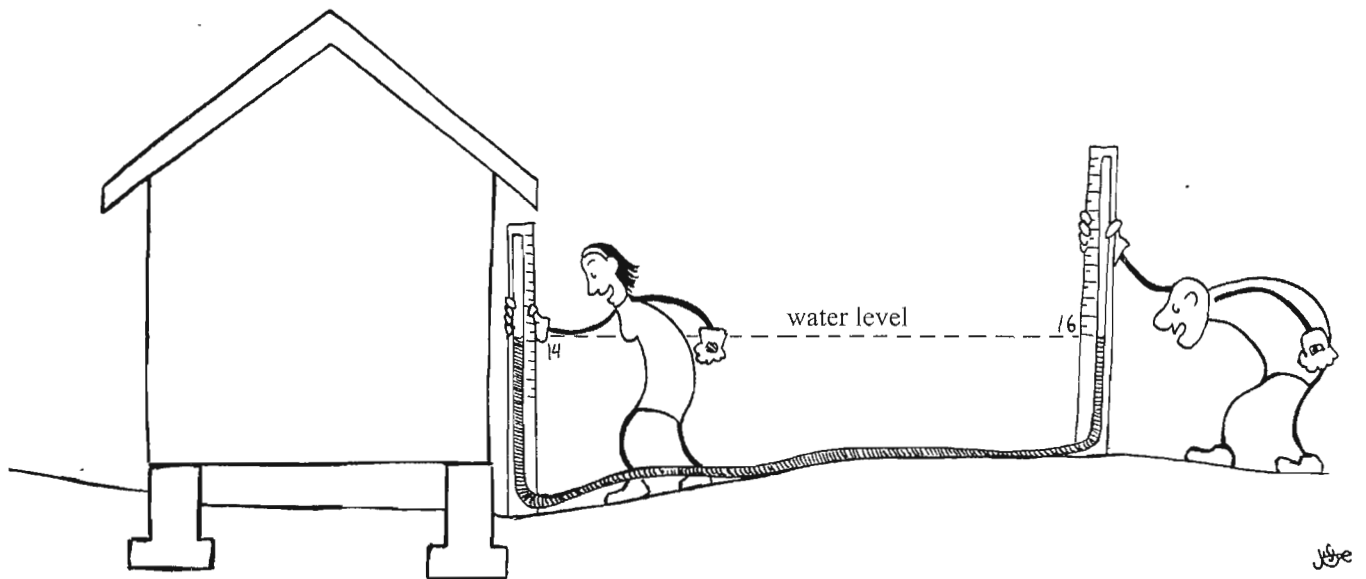

Fig. A2.6. Bunyip shows land slopes toward house.

rain that does eventually fall by putting in a water-harvesting basin in front of their house. To make sure they don't dig into and damage underground utility lines they call their free local utility-marking service (this is called Blue Stake where I live in Tucson) to have buried lines marked between the public right-of-way and the meters. Then they hire a private utility-marking service to continue marking buried lines from the utility meters to the house. Once all utility lines are marked, they ask Bonnie and Al to bring their bunyip over and help them figure out the direction water naturally drains around their new home.

Bonnie and Al look at the relatively flat lot and try to eyeball the way water would flow, then get out their bunyip water level to see if they are right. "OK," says Bonnie, "I'm putting my stake by the house." Al places his stake 10 feet (3 m) away from the house at a point he thinks is directly downhill from Bonnie. When the water stops moving within the tubing, Al and Bonnie tell each other the water level readings they have (fig. A2.6).

"I've got 14," says Bonnie. "My stake reads 16," says Al, "and with our bunyip that means you are a full two inches lower than me, so water will drain toward this house...which is bad news!"

Al, Bonnie, and their friends decide to dig a shallow basin about 15 feet (4.5 m) from the house to intercept rainwater, and to move the soil from the

basin to the house foundation to deflect rainwater away from the house. They dig out a level-bottomed basin 6 feet (1.8 m) wide and 8 feet (2.4 m) long, and put most of the fill dirt next to the house, making sure the dirt is at least 6 inches (15 cm) below the top of the foundation's stem wall (as recommended by local building codes to keep termites and/or soil moisture from entering the home). They rake the area between the newly dug basin and the house so the grade slopes away from the house and into the basin. Then they use the bunyip water level to check their work. Bonnie again stands by the house and Al places his stake about halfway between the house and the basin on the new slope they created.

"My stake reads 16," announces Bonnie.

"And I read 14, so we did reverse the slope and water will now drain away from the house," cheers Al. "Bonnie, stay up against the house while I move my stake to the bottom of the basin to see how much deeper it is than the soil by the house."

Al moves to the bottom of the basin and reads 6 on his stake (fig. A2.7).

"I've got 24" exclaims Bonnie. "Subtract your 6 from my 24 and that tells me you are 18 inches lower than me. We did a good bit of digging!"

"This basin will catch a lot of rainwater! Let's make sure when it fills up, any surplus water will overflow away from the house," says Al.

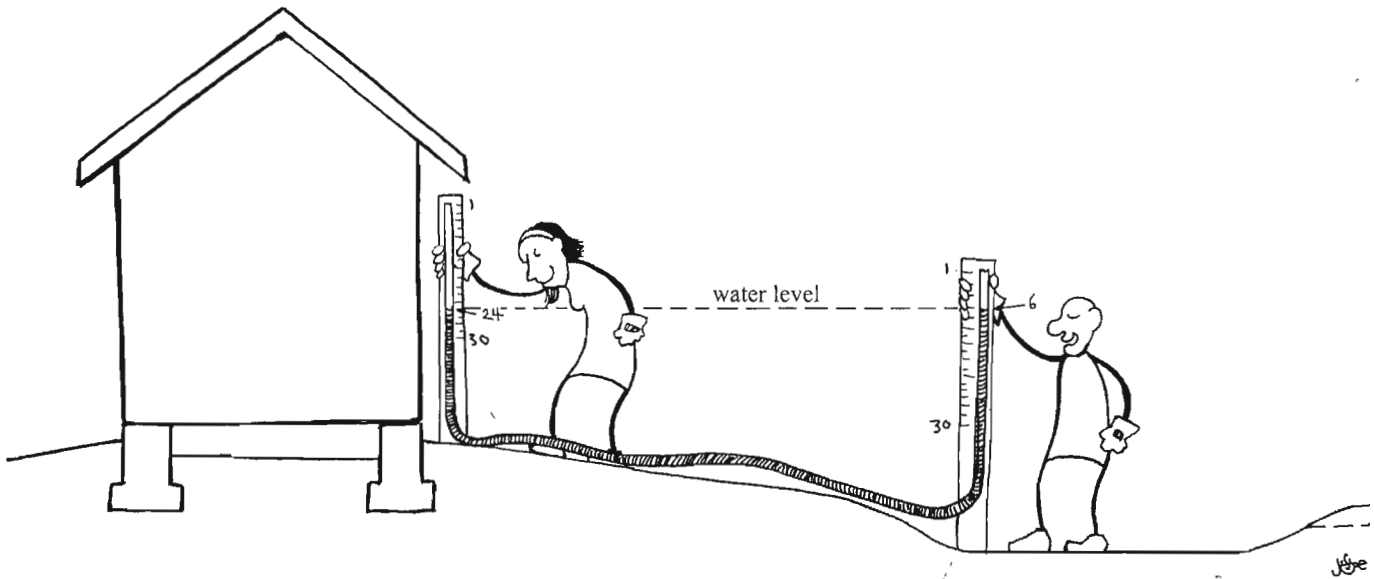

Fig. A2.7. Using a bunyip to measure how much lower the bottom of the basin is than the area near the house, confirming that the slope now drains away from the house

They take land-surface readings all around the edge of the basin using their bunyip water level. They learn from the readings that if water flows out the lowest point around the edge of the basin, it will drain water toward the neighbor's house. To change this, they pick up the shovels and alter the dirt level of the basin's rim slightly so the lowest point on the basin's edge will now direct overflow into another basin on site.

Checking their work with the bunyip as they go along, they dig several more basins, this time located in the public right-of-way (public land located between their property line and the street). These basins will harvest even more rainwater and will receive overflow from the basin they dug in front of the house. So this series of basins will direct overflow water all the way from the house to the street. The edges, bottoms, and general slope of the basins are checked using the bunyip one last time.

The basins were constructed so that while the overflow spillways that move water from one basin to the next are at the same elevation, that elevation is well below the soil level abutting the house. This way the house will stay high and dry. The elevations of the level bottoms of the basins varied, but were all lower than their respective overflow spillways, so some water will be retained in each basin. The depth between a

basin's overflow spillway and the bottom of the basin determines the storage capacity of the basin.

Bonnie and Al's friends are delighted with their new water-harvesting basins. After taking a break, they plant the basins. Hardy native trees go in along the street in the public right-of-way basins. The basin in front of the house is planted with a drylands-adapted peach tree to provide fruit for future pies. Along with it, they plant a wolfberry, a chuparosa, and native flowers that produce native foods and medicinals and attract hummingbirds. This basin will receive direct rainfall, harvested runoff, and greywater from the home.

Bonnie and Al's friends are so inspired, a week later they dig several more basins near their house. A vegetable garden goes into the basin south of the house where it will receive winter sunlight. A native mesquite tree is planted in a basin west of the house to fix nitrogen in the soil and screen the vegetable garden from harsh summer-afternoon sun. Once all the basins are dug, planted, and well-mulched, Bonnie and Al's friends dance together to entice the rain (fig. A2.8).

For more information see chapter 5 on infiltration basins, chapter 11 on vegetation, and chapter 4 in Volume 1 on integrated design.

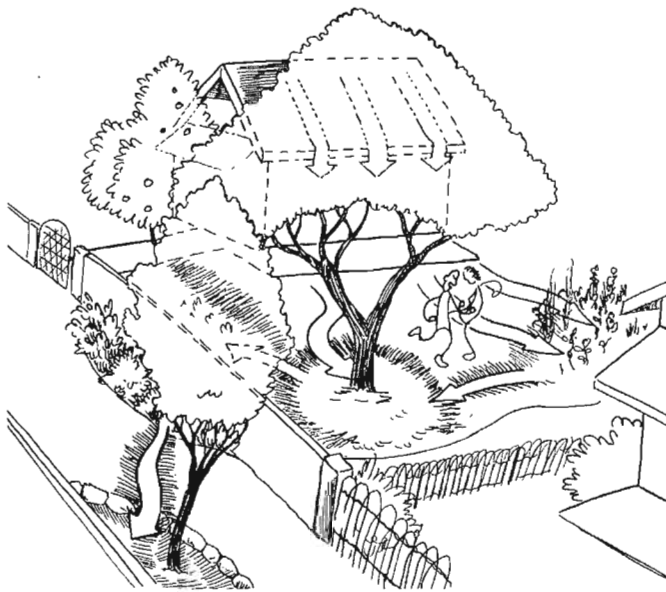

Fig. A2.8. Celebrating completion of a water harvesting landscape

## THE A-FRAME LEVEL

The A-frame level (fig. A2.9) is even simpler to construct than the bunyip water level. No tubing or water is needed, and you can use it all by yourself. An A-frame level can be used to find a contour line on the landscape, but unlike the bunyip, you cannot measure the elevation differences between two points at different levels, nor can you measure the slope of the land. It does come in very handy for marking the line on which to construct contour berms and for checking to see if the two ends of a boomerang berm are level.

The A-frame level is made of three poles or sticks tied or fastened together to form a capital “A” (thus the name). A weighted string is hung from the top of the “A” like a plumb bob. When both “feet” of the “A” are level with one another the weighted string will hang alongside a center line marked on the horizontal stick of the A-frame. If the two feet are not level with one another, the string will hang to one side or the other of the center mark, depending on which foot of the A-frame is lower.

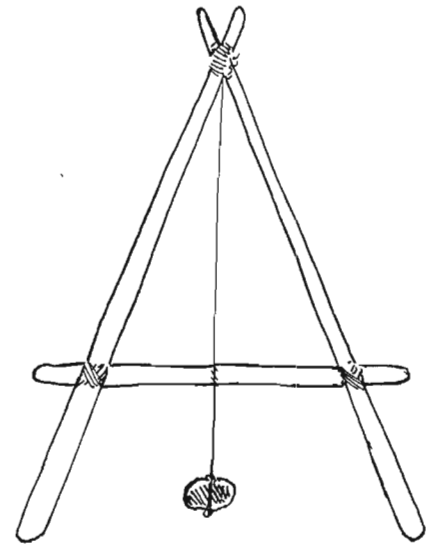

Fig. A2.9. A-frame level

## WHAT YOU NEED TO MAKE AN A-FRAME LEVEL

- 3 straight poles, pipes, sticks, or something similar. They must be long enough so that the top of the “A” is about as tall as you are and the feet of the “A” are at least 3 feet (0.9 m) apart. The feet can be closer together, but the narrower the “A” the longer it will take to mark a level contour line on a slope.
- Rope, cordage, nails, or screws to securely fasten the poles, pipes or sticks together at 3 points
- A piece of string about 4 feet (1.2 m) long and a weight of some sort (stone, horseshoe, etc.) to tie to one end of the string
- Marker, knife, or paint

## HOW YOU MAKE AN A-FRAME LEVEL

Lay your three stakes, poles, or sticks on the ground in the form of a capital “A.” Tie or screw the three stakes together in the three points where they touch. This is a great opportunity to live out your Boy Scout or Girl Scout knot-tying fantasies with clove hitches and lashing! Make sure all bindings are tight so

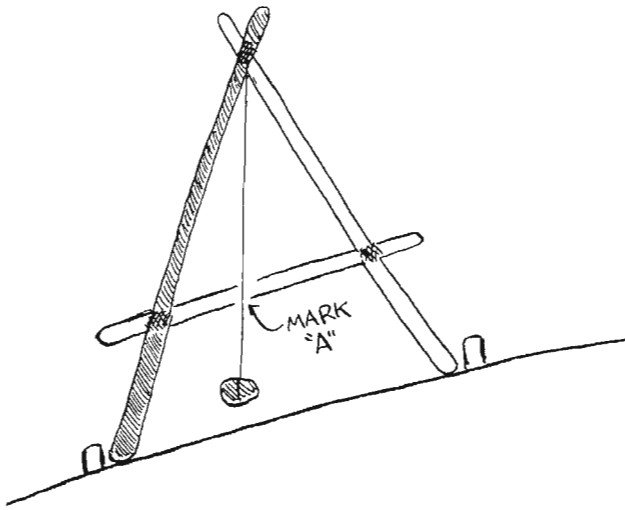

Fig. A2.10. Calibrating the A-frame, step one

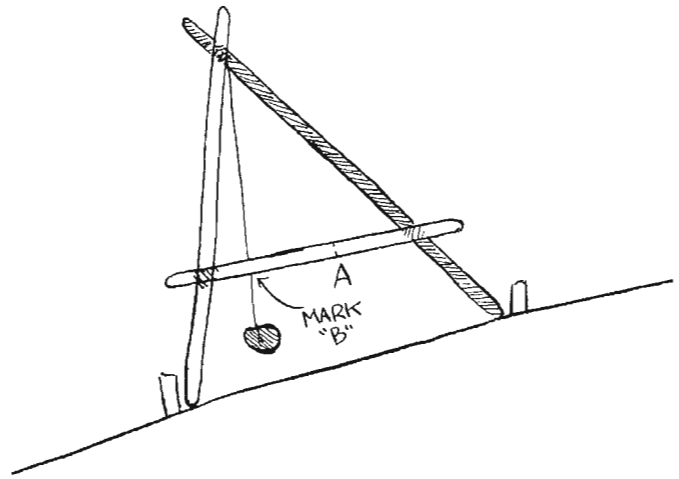

Fig. A2.11. Calibrating the A-frame, step two

that your A-frame level won't come apart and the joints don't loosen, as that would result in inaccurate readings.

Once bound, set the A-frame upright and tie one end of the string to the top of the "A." Tie the weight to the other end of the string. The heavier the weight, the less likely it will get blown around on a windy day. The weighted end of the string should hang below the cross stake (the stake parallel with the ground). To make the center mark on the cross stake, place the feet of the upright A-frame on a section of unlevel ground, so one foot of the A-frame is a little higher than the other. When the weighted string comes to rest in a spot alongside the cross stake of the A-frame, lightly mark that spot (fig. A2.10).

Now, mark the two points where the A-frame is standing on the ground. Lift the A-frame, rotate it, then set it back down with the "feet" switching places. When the weighted string again comes to rest alongside the cross stake, lightly mark that spot (fig. A2.11).

Now you have two marked spots on the cross stake. Permanently mark the midpoint between these two spots on the cross stake (fig A2.12).

From now on when the weighted string comes to rest alongside this permanent mark you will know the two feet of the A-frame are standing on two points level with one another.

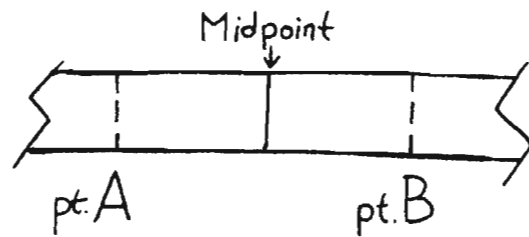

Fig. A2.12. Calibrating the A-frame, final step

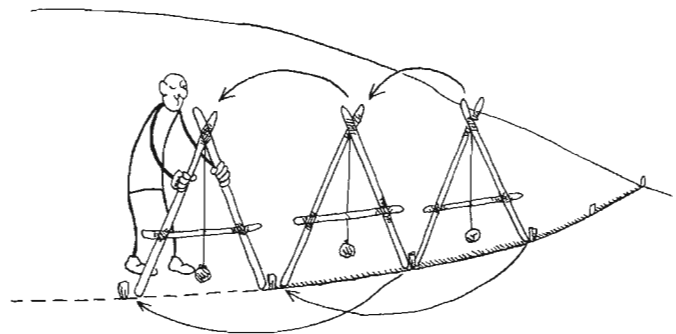

Fig. A2.13. Using an A-frame level, finding and marking a level contour line

Your A-frame will read accurately as long as it does not loosen up and change shape. You can quickly test it by going through the steps just described. If the heavy mark is still at the midpoint when you test it on level ground, then your A-frame will read correctly. If the mark is not at the midpoint, retighten the joints and make a new midpoint mark.

## HOW TO USE AN A-FRAME LEVEL

Go to a spot where you want to mark a level contour line across the landscape. Place the A-frame upright with its “feet” on what you think is level ground, and see where the weighted string comes to rest along the cross bar. If the string comes to rest alongside the permanent mark, the feet of the A-frame are on a level line. Now mark a straight line in the dirt from one foot of the A-frame to the other. Rotate the A-frame 180° with one foot left standing on the end of the line you just marked and the other foot moved to a new spot you think will be level with the first (fig. A2.13). If the weighted string comes to rest to either side of the

permanent mark, the A-frame is not on a level line. Move the newly placed foot slightly up or down the slope until it rests on a spot that is level with the other foot. Again, mark this straight line in the dirt. Continue finding and marking the level contour line by rotating and stepping the A-frame across the landscape. Repeat this process until you have marked the contour line length needed for your project.

## AN A-FRAME VARIATION FOR WINDY SITES

On very windy days the weighted string of the A-frame will blow around. A variation used by Chris Meuli on his windblown New Mexico land was built by lashing a line-level tool to the horizontal cross stake of the A-frame instead of using a weighted string. If you construct this type of A-frame, you’ll need a line level, a *straight* cross stake, and a level place to build the device. With both feet of the “A” on level ground, secure the cross brace so the line level’s bubble is right in the middle of the cross brace reading “level.”



Fig. A2.14. Chris Meuli's line-level A-frame. A bubble level tool is lashed to horizontal bar below Chris' toes. Chris bolts his A-frame together with wing nuts so he can disassemble and fold it up for easy storage. His A-frame is only as tall as his waist, which allows him to use the tool under the branches of trees.

# Appendix 3

## Water-Harvesting Earthworks Calculations

### List of Equations and Other Information

Box A3.1.  
Abbreviations, Conversions, and Constants for  
English and Metric Measurement Units

Equation 1.  
Catchment Area of Rectangular Surface

Equation 2.  
Catchment Area of Triangular Surface

Equation 3.  
Catchment Area of Circular Surface

Equation 4.  
Potential Volume of Runoff from a Roof or  
Other Impervious Catchment Area

Box A3.2.  
Estimating Maximum Rainfall Runoff Using  
Rules of Thumb

Box A3.3.  
Meteorological and Climate Resources

Equation 5.  
Estimated Net Runoff from a Catchment  
Surface Adjusted by its Runoff Coefficient

Equation 6.  
Berm 'n Basin Water-Holding Capacity

Equation 7.  
Berm 'n Basin Capacity per Unit of Length

Equation 8.  
Berm 'n Basin Spacing Distance

Equation 9.  
Terrace Capacity

Equation 10.  
Terrace Capacity per Unit of Length

Equation 11.  
Terrace Spacing

Equation 12.  
Optimum Terrace Width

Equation 13.  
Circular Infiltration-Basin Capacity

Equation 14.  
Rectangular Infiltration-Basin Capacity

Equation 15.  
Diversion-Swale Sizing



## Box A3.1. Abbreviations, Conversions, and Constants for English and Metric Measurement Units

Note: \* items are approximate

### ABBREVIATIONS FOR EQUATIONS

sqrt = square root, which is a function on most calculators

### ABBREVIATIONS FOR ENGLISH UNITS

inches = in

feet = ft

square feet = ft<sup>2</sup>

cubic feet = ft<sup>3</sup>

gallons = gal

acre = a

Fahrenheit = F

### CONVERSIONS FOR ENGLISH UNITS

To convert cubic feet to gallons, multiply cubic feet by 7.48 gal/ft<sup>3</sup> \*

To convert inches to feet, divide inches by 12 in/ft

1 acre = 43,560 square feet

1 square mile = 27,878,400 square feet

### CONSTANTS

Ratio between a circle's diameter and its circumference is expressed as  $\pi = 3.14$  \*

### ABBREVIATIONS FOR METRIC UNITS

millimeters = mm

centimeters = cm

meters = m

liters = l

hectare = ha

Celsius = C

### CONVERSIONS FOR METRIC UNITS

To convert cubic centimeters to liters, divide cubic centimeters by 1,000

### CONVERTING BETWEEN ENGLISH UNITS AND METRIC UNITS

To convert inches to millimeters, multiply inches by 25.4 mm/in

To convert inches to centimeters, multiply inches by 2.54 cm/in

To convert feet to meters, multiply feet by 0.30 m/ft \*

To convert square feet to square meters, multiply square feet by 0.092 m<sup>2</sup>/ft<sup>2</sup> \*

To convert cubic feet to cubic meters, multiply cubic feet by 0.028 m<sup>3</sup>/ft<sup>3</sup> \*

To convert gallons to liters, multiply gallons by 3.79 liter/gal \*

To convert acres to hectares, multiply acres by 0.404 a/ha \*

To convert miles to kilometers, multiply miles by 1.6 km/mi \*

To convert Fahrenheit (F) to Celsius (C) for actual indoor/outdoor temperature measure ("it's 70 degrees outside today"), subtract 32 from Fahrenheit temperature, multiply result by 5, then divide by 9.

To convert Fahrenheit (F) to Celsius (C) for temperature difference ("it's 20 degrees hotter today than yesterday"), multiply Fahrenheit by 5, then divide by 9.

### Equation 1A.

#### Catchment Area of Rectangular Surface (English units)

$$\text{length (ft)} \times \text{width (ft)} = \text{catchment area (ft}^2\text{)}$$

#### EXAMPLE:

A house measures 47 feet long by 27 feet wide at the drip line of the roof. Note that it does not matter whether the roof is flat or peaked: The roof dimensions at the drip line are the same. It is the “footprint” of the roof’s drip line that matters.

$$47 \text{ ft} \times 27 \text{ ft} = 1,269 \text{ ft}^2$$

$$1,269 \text{ ft}^2 = \text{catchment area}$$

If the roof consists of two or more rectangles, calculate the area for each rectangle and add together. Again, take the view of a falling raindrop, and look only at the “footprint” of the roof’s drip line. Roof pitch cannot be seen from above and does not matter. With conical, octagonal, or other non-standard roof shapes, again calculate the area based on the drip line.

### Equation 1B.

#### Catchment Area of Rectangular Surface (metric units)

$$\text{length (m)} \times \text{width (m)} = \text{catchment area (m}^2\text{)}$$

#### EXAMPLE:

$$15 \text{ m} \times 9 \text{ m} = 135 \text{ m}^2$$

$$135 \text{ m}^2 = \text{catchment area}$$

Again, all the considerations in Equation 1A will apply.

### Equation 2A.

#### Catchment Area of Triangular Surface (right triangle)

Multiply the lengths of the two shorter sides of the triangle then divide by 2 = catchment area

#### EXAMPLE:

A triangular section of roof measures 9 feet by 12 feet by 15 feet. This is a right triangle, with the 90-degree angle between the 9-foot and 12-foot sides. Taking the measurements of the two shorter sides:

$$(9 \text{ ft} \times 12 \text{ ft}) \div 2 = \text{catchment area (ft}^2\text{)}$$

$$108 \text{ ft}^2 \div 2 = 54 \text{ ft}^2$$

$$54 \text{ ft}^2 = \text{catchment area}$$

### Equation 2B.

#### Catchment Area of Triangular Surface (standard math formula)

Multiply the triangle's base times its height then divide by 2 = catchment area  
where the base can be any side, and the height is measured perpendicularly from the base to the opposite vertex.

#### EXAMPLE:

You want to know the area of a triangular section of patio. The length of the section in front of you is 20 feet (triangle base) and you measure 4 feet perpendicularly to the opposite vertex of the triangle.

$$(20 \text{ ft} \times 4 \text{ ft}) \div 2 = \text{catchment area (ft}^2\text{)}$$

$$80 \text{ ft}^2 \div 2 = 40 \text{ ft}^2$$

$$40 \text{ ft}^2 = \text{catchment area}$$

### Equation 2C.

#### Catchment Area of Triangular Surface (Heron's formula)

This formula, attributed to Heron of Alexandria (first century A.D.), involves no trigonometry. It needs only the square root (sqrt) function found on most electronic or computer calculators. It may be useful when dealing with non-right triangles where you can measure (or know) all sides of the triangle.

Step 1: Determine the lengths of the sides of the triangle. These are a, b, c.

Step 2: Calculate s.

$$(a + b + c) \div 2 = s$$

Step 3: Calculate S, using:

$$s \times (s - a) \times (s - b) \times (s - c) = S$$

Step 4: Calculate the catchment area, which is the square root of S.

$$\text{sqrt } S = \text{catchment area}$$

### Equation 3.

#### Catchment Area of Circular Surface

$$\pi \times r^2 = \text{catchment area}$$

Note: r = radius of the circle. A circle's radius is half its diameter.

#### EXAMPLE:

A circular roof has a 25 foot diameter. Divide the diameter by 2 to get the radius of 12.5 feet.

$$\pi \times (12.5 \text{ ft} \times 12.5 \text{ ft}) = \text{catchment area (ft}^2\text{)}$$

$$3.14 \times 156.25 \text{ ft}^2 = 490.6 \text{ ft}^2$$

$$490.6 \text{ ft}^2 = \text{catchment area}$$

### Box A3.2. Estimating Maximum Rainfall Runoff Using Rules of Thumb

#### ROUGH RULE OF THUMB FOR CALCULATING MAXIMUM RAINFALL RUNOFF VOLUME ON A CATCHMENT SURFACE (ENGLISH UNITS):

You can collect 600 gallons of water per inch of rain falling on 1,000 square feet of catchment surface.

#### ON THE REALLY BIG SCALE:

You can collect 27,000 gallons of water per inch of rain falling on 1 acre of catchment surface.

#### RULE OF THUMB FOR CALCULATING MAXIMUM RAINFALL VOLUME ON A CATCHMENT SURFACE (METRIC UNITS):

You can collect 1,000 liters of water per each 10 millimeters of rain falling on 100 square meters of catchment surface.

#### ON THE REALLY BIG SCALE:

You can collect 100,000 liters of water per 10 millimeters of rain falling on one hectare of catchment surface.

### Box A3.3. Meteorological and Climate Resources

#### ONLINE RESOURCES

[www.wrh.noaa.gov](http://www.wrh.noaa.gov). This is the United States National Weather Service's website. Locate the weather stations closest to your site and find out their elevations. Download data from those stations that are most like your site.

[ag.arizona.edu/azmet](http://ag.arizona.edu/azmet). Arizona Meteorological Network. Evaporation rates, prevailing winds, soil temperatures, and minimum/maximum temperatures are listed for various sites. For other states contact your local agricultural extension service for similar meteorological networks.

#### MISCELLANEOUS

The U.S. National Forest Service compiles data for remote weather stations, though the data is not as comprehensive or as standardized as the above two resources. However, for rural sites a Forest Service weather station may be closer to a given site than one monitored by other agencies.

Local airports, since they collect and record climatic data.

Rain gauge from a hardware or garden store with which to begin keeping precipitation records for your site.

## Equation 4A.

### Potential Volume of Runoff from a Roof or Other Impervious Catchment Area (English units)

$$\text{catchment area (ft}^2\text{)} \times \text{rainfall (ft)} \times 7.48 \text{ gal/ft}^3 = \text{maximum runoff (gal)}$$

Note: For a more realistic estimate, see Equation 5.

#### EXAMPLE CALCULATING ANNUAL RUNOFF:

Calculate the maximum volume of rain, in gallons, running off the roof in an average year from a home that measures 47 feet long and 27 feet wide at the drip line of the roof. (In the example below, the roof dimensions at the drip line are included in the calculation; the catchment area is the same whether the roof is flat or peaked.) Rainfall in this location averages 10.5 inches per year, so you will divide this by 12 inches of rainfall per foot to convert inches to feet for use in the equation. (Note: You can use the same equation to calculate the runoff from a single storm, by simply using the rainfall from that storm instead of annual average rainfall in the equation.) Since the roof is a rectangular area, use the following calculation for catchment area:

$$(\text{length (ft)} \times \text{width (ft)}) \times \text{rainfall (ft)} \times 7.48 \text{ gal/ft}^3 = \text{maximum runoff (gal)}$$

$$(47 \text{ ft} \times 27 \text{ ft}) \times (10.5 \text{ in} \div 12 \text{ in/ft}) \times 7.48 \text{ gal/ft}^3 = \text{maximum runoff (gal)}$$

$$1,269 \text{ ft}^2 \times 0.875 \text{ ft} \times 7.48 \text{ gal/ft}^3 = 8,306 \text{ gal}$$

$$8,306 \text{ gal} = \text{maximum runoff}$$

#### EXAMPLE CALCULATING RUNOFF FROM A SINGLE RAIN EVENT:

Calculate the maximum volume of rain, in gallons, running off the roof in a single rain event from a home that measures 47 feet long and 27 feet wide at the drip line of the roof. It is not unusual for heavy storms in the example area to drop 2 inches of rain. To determine the runoff from such a rain event you will divide the 2 inches of rainfall by 12 inches of rainfall per foot to convert inches to feet for use in the equation. Since the roof is a rectangular area, use the following calculation for catchment area:

$$\begin{aligned} &(\text{length (ft)} \times \text{width (ft)}) \times \text{rainfall (ft)} \times 7.48 \text{ gal/ft}^3 = \text{maximum runoff (gal)} \\ &(47 \text{ ft} \times 27 \text{ ft}) \times (2 \text{ in} \div 12 \text{ in/ft}) \times 7.48 \text{ gal/ft}^3 = \text{maximum runoff (gal)} \\ &1,269 \text{ ft}^2 \times 0.167 \text{ ft} \times 7.48 \text{ gal/ft}^3 = 1,585 \text{ gal} \end{aligned}$$

$$1,585 \text{ gal} = \text{maximum runoff}$$

#### Equation 4B.

##### Possible Volume of Runoff from a Roof or Other Impervious Catchment Area (metric units)

$$\text{catchment area (m}^2\text{)} \times \text{rainfall (mm)} = \text{maximum runoff (liters)}$$

Calculations for annual rainfall, a rainy season, or an event would be similar to those for English units.

#### Equation 5A.

##### Estimated Net Runoff from a Catchment Surface Minus Potential Water Loss (English units)

$$\text{catchment area (ft}^2\text{)} \times \text{rainfall (ft)} \times 7.48 \text{ gal/ft} \times \text{runoff coefficient} = \text{net runoff (gal)}$$

Impervious catchment surfaces such as roofs or non-porous pavement can lose 5% to 20% of the rain falling on them due to evaporation, wind, overflow of gutters, leaks in downspouts, and minor infiltration into the catchment surface itself. The more porous or rough your roof surface, the more likely it will retain or absorb rainwater. On average, pitched metal roofs lose 5% of rainfall, allowing 95% to flow to the cistern. Concrete or asphalt roofs retain around 10%, while built-up tar and gravel roofs can retain 15% to 20%. (However, the percent of retention is a function of the size and intensity of the rain event so more porous roof surfaces could absorb up to 100% of small, light rain events.) To account for potential loss, determine the runoff coefficient that is appropriate for your area and impervious catchment surface (0.80 to 0.95).

#### EXAMPLE CALCULATING NET ANNUAL RUNOFF FROM A ROOF:

Calculate the net volume of rain, in gallons, running off the roof in an average year from a home that measures 47 feet long and 27 feet wide at the drip line of the roof. Rainfall in this location averages 10.5 inches per year, so you will divide this by 12 inches of rainfall per foot to convert inches to feet for use in the equation. (Note: You can use the same equation to calculate the runoff from a single storm, by simply using the rainfall from that storm instead of annual average rainfall in the equation.) Assume that the loss of water that occurs on the catchment surface is at the high end of the range so you get a conservative estimate of net runoff. This means you select a runoff coefficient of 80%, or 0.80. You might want a conservative estimate if planning water needs for landscaping, but you might want an unmodified estimate if trying to size a cistern. Since the roof is a rectangular area, use the following calculation for catchment area, LENGTH  $\times$  WIDTH as in Equation 1A:

$$\begin{aligned} &(\text{length (ft)} \times \text{width (ft)}) \times \text{rainfall (ft)} \times 7.48 \text{ gal/ft}^3 \times 0.80 = \text{net runoff (gal)} \\ &(47 \text{ ft} \times 27 \text{ ft}) \times (10.5 \text{ in} \div 12 \text{ in/ft}) \times 7.48 \text{ gal/ft}^3 \times 0.80 = \text{net runoff (gal)} \\ &1,269 \text{ ft}^2 \times 0.875 \text{ ft} \times 7.48 \text{ gal/ft}^3 \times 0.80 = 6,644 \text{ gal} \end{aligned}$$

6,644 gal = net runoff

Based on this, a realistic estimate of the volume of water that could be collected off the 47 foot by 27 foot example roof in an average year is 6,644 gallons.

## RUNOFF COEFFICIENTS

The runoff coefficient is defined as a decimal fraction of water that runs off a surface onto which it falls. A runoff coefficient of 1.00 means that 100% of the water runs off the surface; a runoff coefficient of 0.00 means all rainwater will infiltrate into the soil (none runs off; this can happen with highly mulched and vegetated landscapes); 0.50 means that half the water falling on the surface will sink in, the other half running off.

The runoff coefficients on this page are rough estimates, for they are dependent on many factors, among them:

- Climate and season of the year (which will affect whether the ground is saturated or frozen, for instance; the type of precipitation, and the amount of vegetation that can be supported)
- Soil type (clayey soils allow less water to infiltrate and have higher runoff coefficients, while sandy porous soils will have low ones)
- Slope of the surface (runoff coefficient will be higher on a sloped surface versus a flat one)
- Vegetation: amount, type, and spacing (generally, more vegetation leads to more infiltration, and a lower runoff coefficient)
- Intensity of rainfall (a heavy or prolonged rain will produce greater runoff as the soil or its surface becomes saturated; a light rainfall may just cling to the soil surface or vegetation and evaporate)

The following runoff coefficients are for the southwestern U.S., though they give ballpark ranges for many situations:

- Impervious paving or a building's roof: range 0.85-0.95
- Healthy Sonoran Desert Uplands: range 0.20-0.70, average 0.30-0.50
- Bare earth: range 0.20-0.75, average 0.35-0.55
- Grass/lawn: range 0.05-0.35, average 0.10-0.25
- For gravel, use the coefficient of the surface below the gravel.

For additional runoff coefficients and information see the following urls:  
[www.emrl.byu.edu/gsda/data\\_tips/tip\\_soiltype\\_table.html](http://www.emrl.byu.edu/gsda/data_tips/tip_soiltype_table.html), and  
[water.me.vccs.edu/courses/CIV246/table2.htm](http://water.me.vccs.edu/courses/CIV246/table2.htm)

## EXAMPLE CALCULATING ANNUAL NET RUNOFF FROM A BARE SECTION OF YARD:

In an area receiving 18 inches of rain in an average year, you want to calculate the runoff from a 12 foot by 12 foot bare section of yard that drains to an adjoining infiltration basin. The soil is clayey and compacted, and you estimate its runoff coefficient to be 60% or 0.60.

catchment area (ft<sup>2</sup>) × rainfall (ft) × 7.48 (gal/ft<sup>3</sup>) × runoff coefficient = net runoff (gal)

$$12 \text{ ft} \times 12 \text{ ft} \times (18 \text{ in} \div 12 \text{ in/ft}) \times 7.48 \text{ gal/ft}^3 \times 0.60 = \text{net runoff gal}$$
$$144 \text{ ft}^2 \times 1.5 \text{ ft} \times 7.48 \text{ gal/ft}^3 \times 0.60 = 969 \text{ gal}$$

969 gal = net runoff

Based on this, a realistic estimate of the volume of runoff that could be collected off the 12 foot by 12 foot section of bare earth within the adjoining infiltration basin is 969 gallons in an average year.

#### EXAMPLE CALCULATING RUNOFF FROM A SINGLE STORM EVENT ON ESTABLISHED LAWN (GRASS):

The runoff coefficient for this established lawn is assumed to be 20% or 0.20, and the maximum storm event is 3 inches:

$$12 \text{ ft} \times 12 \text{ ft} \times (3 \text{ in} \div 12 \text{ in/ft}) \times 7.48 \text{ gal/ft}^3 \times 0.20 = \text{net runoff gal}$$
$$144 \text{ ft}^2 \times 0.25 \text{ ft} \times 7.48 \text{ gal/ft}^3 \times 0.20 = 54 \text{ gal}$$

54 gal = net runoff

#### Equation 5B.

#### Estimated Net Runoff from an Impervious Catchment Surface Minus Potential Water Loss (metric units)

catchment area (m<sup>2</sup>) × rainfall (mm) × runoff coefficient = net runoff (liters)

#### EXAMPLE:

In an area receiving 304 millimeters of rain a year, you have a rooftop catchment surface that is 15 meters long and 9 meters wide, and you want to know how much rainfall can realistically be collected off that roof in an average year. You want a conservative estimate of annual net runoff, so you use a runoff coefficient of 80% or 0.80. (Since the roof is a rectangular area, use the following calculation for catchment area as in Equation 1B—CATCHMENT AREA m<sup>2</sup> = LENGTH m × WIDTH m—which is figured into the equation below.) Note: An explicit conversion to liters is not necessary in this equation because there are 1,000 mm/m and 1,000 liters/m<sup>3</sup>.

$$(\text{length (m)} \times \text{width (m)}) \times \text{rainfall (mm)} \times 0.80 = \text{net runoff (liters)}$$
$$(15 \text{ m} \times 9 \text{ m}) \times 304 \text{ mm} \times 0.80 = \text{net runoff (liters)}$$
$$135 \text{ m}^2 \times 304 \text{ mm} \times 0.80 = 32,832 \text{ liters}$$

32,832 liters = net runoff

A realistic estimate of the volume of water that could be collected off this 15 meter by 9 meter roof in a year of average rainfall is 32,832 liters.

### Equation 6A.

#### Berm 'n Basin (b'nb): Approximate Maximum Water-Holding Capacity or Volume (English units)

$$1/2 \times \text{width (ft)} \times \text{depth (ft)} \times \text{length (ft)} = \text{volume (ft}^3\text{)}$$

- **Width** is the horizontal distance from the top of the lip of the berm's spillway to the point upslope where water will back up to.
- **Depth** is the vertical distance from the bottom of the basin to the top of the berm's spillway.
- **Length** is the distance that the b'nb runs along the land contour.

To calculate the maximum volume of water your berm 'n basins could hold at one time, you will need to know the depth, width, and length of your b'nb. Since the water will be held within a rounded triangular space rather than a rectangular space, you will use the equation for the area of a triangle, in this case:  $\text{AREA} = 1/2 \times \text{WIDTH} \times \text{Maximum DEPTH}$ , and therefore the  $\text{VOLUME OF WATER-HOLDING CAPACITY (ft}^3\text{)} = \text{AREA} \times \text{LENGTH}$ . Then multiply the gallons by 7.48 gallons per cubic foot. So:

$$0.5 \times \text{width (ft)} \times \text{depth (ft)} \times \text{length (ft)} \times 7.48 \text{ gal/ft}^3 = \text{b'nb capacity (gal)}$$

#### EXAMPLE BERM 'N BASIN:

You wish to capture runoff from a large sloping yard and are considering a b'nb. Calculate the approximate volume in gallons of a basin that's 10 feet wide, 2 feet maximum depth, and 40 feet long:

$$0.5 \times 10 \text{ ft} \times 2 \text{ ft} \times 40 \text{ ft} \times 7.48 \text{ gal/ft}^3 = \text{b'nb capacity (gal)}$$
$$400 \text{ ft}^3 \times 7.48 \text{ gal/ft}^3 = 2,992 \text{ gal}$$

Note that the calculations in equations 6A, 6B, 7A, and 7B do not take into account any water infiltrating into the soil, only water collected on the surface and runoff from upslope.

### Equation 6B.

#### Berm 'n Basin: Approximate Maximum Water-Holding Capacity or Volume (metric units)

$$1/2 \times \text{width (m)} \times \text{depth (m)} \times \text{length (m)} = \text{volume (m}^3\text{)}$$

Measure the width, depth, and length of the b'nb using the definitions provided in Equation 6B. Remember that every cubic meter contains 1,000 liters.

$$0.5 \times \text{width (m)} \times \text{depth (m)} \times \text{length (m)} \times 1,000 \text{ liters/m}^3 = \text{b'nb capacity (liters)}$$

#### EXAMPLE:

A b'nb is 6 meters wide, 0.5 meters deep, and 15 meters long.

$$0.5 \times 6 \text{ m} \times 0.5 \text{ m} \times 15 \text{ m} \times 1,000 \text{ liters/m}^3 = \text{b'nb capacity (liters)}$$
$$15 \text{ m}^3 \times 1,000 \text{ liters/m}^3 = 22,500 \text{ liters}$$



### Equation 7A.

#### Berm 'n Basin: Approximate Capacity in Cubic Feet per Foot of Length (English units)

$$0.5 \times \text{width (ft)} \times \text{depth (ft)} \times \text{length (1 ft)} = \text{b'nb capacity (ft}^3\text{/1 ft length of b'nb)}$$

To calculate the water-holding capacity for each 1-foot length of the b'nb instead of for a specific length, you need the capacity in cubic feet only, not gallons. You will need this information to calculate b'nb *spacing* distance (Equation 8A):

#### EXAMPLE:

For the b'nb that's 10 feet wide and 2 feet maximum depth:

$$0.5 \times 10 \text{ ft} \times 2 \text{ ft} \times 1 \text{ ft length} = 10 \text{ ft}^3\text{/1 ft length}$$

Note: To get gallons, multiply your cubic-foot result by 7.48 gal/ft<sup>3</sup>. In this case you get 74.8 gal/1 ft length of b'nb.

### Equation 7B.

#### Berm 'n Basin: Approximate Capacity in Liters per Meter of Length (metric units)

$$0.5 \times \text{width (m)} \times \text{depth (m)} \times \text{length (1 m)} \times 1,000 \text{ liters/m}^3 = \text{b'nb capacity (liters/1 m length of b'nb)}$$

This calculates the water-holding capacity for each 1 meter length of the b'nb instead of for a specific length.

#### EXAMPLE:

For the b'nb that is 6 meters wide and 0.5 meters maximum depth:

$$0.5 \times 6 \text{ m} \times 0.5 \text{ m} \times 1 \text{ m} \times 1,000 = 1,500 \text{ liters/1 m length}$$

You will need this information to calculate metric b'nb spacing distance (Equation 8B).

### Equation 8A.

#### Berm 'n Basin Spacing Distance (English units)

$$(\text{b'nb water holding capacity (ft}^3\text{/1 ft length)}) \div (\text{runoff coefficient} \times \text{rainfall from a large storm (ft)}) = \text{b'nb spacing distance (ft)}$$

To figure out the spacing distance between b'nbs, i.e., the distance between one berm and the next berm above it, you will first need to calculate the per-foot holding capacity of your b'nb. You will also need to know the approximate typical percentage of total rainwater that will run off a slope, known as the *runoff coefficient*; see the information and sample runoff coefficients in Equation 5. Finally you will want to know the rainfall from a large storm.

#### EXAMPLES:

Now, we'll figure out how far apart to put several b'nbs. The example site has bare earth with clayey soils, so we'll use the high end of the average runoff coefficient for bare earth, 0.55. We want to harvest most of the rainfall runoff from a large storm—in Tucson, Arizona, this is a 2-inch rainfall event. We want rainfall to be expressed in units of feet instead of inches, with 2 inches divided by 12 inches/foot = 0.17 feet of rainfall.

Then, we use the water-holding capacity of the b'nb calculated in Equation 7A, expressed in units of cubic feet of volume *per 1 linear foot* of berm 'n basin (the result in Equation 7A was 10 ft<sup>3</sup> per foot of length).

$$(10 \text{ ft}^3 / 1 \text{ ft length of b'nb}) \div (0.55 \times 0.17 \text{ ft}) = 107 \text{ ft spacing}$$

This means if you construct your b'nbs about 100 feet apart on the landscape, you will capture most of the rainfall runoff from a large storm in Tucson, Arizona, most of the time.

To capture all of the water from larger rainfalls in Tucson, we use the highest runoff coefficient for bare dirt, 0.75, and use a rainfall of 3 inches, or 0.25 feet (the chance of a 3-inch rain storm happening in any given year in Tucson is 1 in 100) and calculate spacing distance:

$$(10 \text{ ft}^3 / 1 \text{ ft length of b'nb}) \div (0.75 \times 0.25 \text{ ft}) = 53 \text{ ft spacing}$$

So b'nbs spaced about 50 feet apart in Tucson would catch every drop of runoff water in a rain event not exceeding 3 inches of precipitation. Remember b'nbs *collect silt and detritus over time*, plus they lose some volume when mulch is thick, so always err on the side of making b'nbs closer together and larger.

#### Equation 8B.

##### Berm 'n Basin Spacing Distance (metric units)

b'nb water-holding capacity (liters/1 m length)  $\div$  (runoff coefficient  $\times$  rainfall from a large storm (mm)) = b'nb spacing distance (m)

See Equation 8A for more information. Again you will use the runoff coefficients found in Equation 5 and the result from the b'nb capacity per meter length (Equation 7B). Note: An explicit conversion to liters is not necessary in this equation because there are 1,000 mm/m and 1,000 liters/m<sup>3</sup>.

#### EXAMPLE:

Using 1,500 liters per meter length (Equation 7B), and assuming a runoff coefficient of 0.30 from established grass growing in poor soil, you want to catch every drop from a maximum 50-mm storm:

$$(1,500 \text{ liters per 1 m length}) \div (0.30 \times 50 \text{ mm}) = 100 \text{ m}$$

So the b'nb spacing distance in this case is 100 meters or less.

#### Equation 9A.

##### Terraces: Approximate Water-Holding Capacity or Volume (English units)

width (ft)  $\times$  depth (ft)  $\times$  length (ft) = volume of water-holding capacity (ft<sup>3</sup>)

The calculation process for terraces is generally the same as that used for berm 'n basins. The one difference, because a terrace is flat, is that the terrace calculation is adjusted to reflect the more rectangular shape (in cross-section) of the terrace.

- **Width** is the distance from the inside of the outer berm of the terrace to the slope into which the terrace is cut and where water will back up to.
- **Depth** is the vertical distance from the bottom of the terrace's basin to the top of its overflow spillway.
- **Length** is the distance that the terrace runs along the land contour.

**EXAMPLE:**

You're planning to build a terrace that's 8 feet wide, 4 inches or 1/3 foot (0.33 feet) in depth below the spillway, and 24 feet long, and want to determine its capacity in square feet or gallons to know what vegetation it could support without supplemental watering.

$$8 \text{ ft} \times 1/3 \text{ ft} \times 24 \text{ ft} = 64 \text{ ft}^3$$

To get gallons, just multiply your cubic-feet result by 7.48 gal/ft<sup>3</sup>.

$$64 \text{ ft}^3 \times 7.48 \text{ gal/ft}^3 = 479 \text{ gallons}$$

So this terrace can hold about 480 gallons. Remember that this amount does not include water infiltrating into the soil, etc. See appendix 4 for calculating water needs of plants.

**Equation 9B.**

**Terraces: Approximate Water-Holding Capacity or Volume (metric units)**

$$\text{width (m)} \times \text{depth (m)} \times \text{length (m)} \times 1,000 \text{ (liters/m}^3\text{)} = \text{volume of water-holding capacity (liters)}$$

See Equation 9A for information on width, depth, and length measurements.

**Equation 10A.**

**Terrace Capacity per Foot of Length (English units)**

$$\text{width (ft)} \times \text{depth (ft)} \times \text{length (1 ft)} = \text{terrace capacity (ft}^3\text{/1 ft length of terrace)}$$

This calculates the per-unit volume of your terrace. In some cases, you may not need this calculation, as the constraints of a small back yard may determine the size of your terrace. However, in terracing a larger area with catchment area upslope, it will be useful for calculating spacing between terraces in Equation 11.

**EXAMPLE: ENGLISH UNITS**

To get cubic feet per 1 foot of terrace length, using the example of a terrace that's 24 foot wide and 4 inches or 1/3 foot deep:

$$24 \text{ ft} \times 1/3 \text{ ft} \times 1 \text{ ft} = 8 \text{ ft}^3 \text{ per 1 foot of terrace length}$$

## Equation 10B.

### Terrace Capacity per Meter of Length (metric units)

width (m)  $\times$  depth (m)  $\times$  length (1 m)  $\times$  1,000 liters/m<sup>3</sup> = terrace capacity (liters/1 m length of terrace)

#### EXAMPLE: METRIC UNITS

This terrace is 7 meters wide, and 10 centimeters (0.10 meters) deep. Note that you need to multiply by 1,000 liters/m<sup>3</sup> to get a result in liters.

$$7 \text{ m} \times 0.10 \text{ m} \times 1 \text{ m} \times 1,000 \text{ liters/m}^3 = 700 \text{ liters per 1 meter of terrace length}$$

## Equation 11A. Terrace Spacing Distance (English units)

Use the same equation as 8A, substituting “terrace” for b’nb

## Equation 11B. Terrace Spacing Distance (metric units)

Use the same equation as 8B, substituting “terrace” for b’nb

## Equation 12: Optimum Terrace Width

maximum depth of cut in the soil  $\div$  the degree of the slope = width of terrace

In dryland areas, you can calculate the optimum width of a terrace with this calculation from Herman J. Finkel’s *Semiarid Soil and Water Conservation*. Note that “maximum depth of cut” refers to the depth of soil, which can be shallow on steep slopes.

#### EXAMPLE: ENGLISH UNITS

On a 10% or 0.10 slope, if the maximum allowable cut is 1.5 feet, calculate as follows:

$$1.5 \text{ ft} \div 0.10 = 15 \text{ ft}$$

The width of the terrace would be 15 feet.

#### EXAMPLE: METRIC UNITS

For metric the calculation is similar.

$$0.5 \text{ m} \div 0.10 = 5 \text{ meters}$$

## Equation 13. Circular Infiltration-Basin Capacity or Volume

$\pi \times \text{depth} \times ((R_1 \times R_2) + R_1^2 + R_2^2) \div 3 = \text{basin capacity}$

The measurements taken as follows:

- **Depth** is the distance from the bottom of the basin to the top of its rim (or the lip of the spillway if you have one).
- **Diameters (circular basin)**. Because the edges of the basin are sloped, two different diameter measurements are used: one ( $D_1$ ) measured at the bottom of the basin, and the second ( $D_2$ ) measured at the top of the basin. Diameter is easier to measure than radius, but the radius of each circle is 1/2 its diameter: Hence  $R_1$  and  $R_2$  are each half of  $D_1$  and  $D_2$ , respectively.

Keep in mind that because it's so difficult to measure large basins accurately, all your calculations will in any case give approximate volumes. In the calculations below, all numbers, including  $\pi$ , have been rounded off to two decimal places, and the results have been rounded off to whole numbers. Note: the one-third factor (the number 3) in the equation is a geometric constant associated with conical volumes.

Use the same unit for all measurements, for instance, all English measurements should be in feet, all metric measurements in meters or in centimeters.

#### EXAMPLE (ENGLISH UNITS):

For a circular basin with a depth of 2 feet, bottom radius of 6.5 feet, and top radius of 12.5 feet, the calculation is as follows:

$$\begin{aligned}\pi \times 2 \text{ ft} \times ((6.5 \text{ ft} \times 12.5 \text{ ft}) + (6.5 \text{ ft})^2 + (12.5 \text{ ft})^2) \div 3 &= \text{Basin capacity (ft}^3\text{)} \\ \pi \times 2 \text{ ft} \times (81.25 \text{ ft}^2 + 42.25 \text{ ft}^2 + 156.25 \text{ ft}^2) \div 3 &= \text{Basin capacity (ft}^3\text{)} \\ 3.14 \times 2 \text{ ft} \times 279.75 \text{ ft}^2 \div 3 &= \text{Basin capacity (ft}^3\text{)} \\ \text{Basin capacity} &= 586 \text{ ft}^3\end{aligned}$$

Then, to convert cubic feet to gallons:

Multiply  $586 \text{ ft}^3$  by 7.48 gallons/ $\text{ft}^3$  to convert to 4,383 gallons of basin capacity.

If your basin calculation uses meters, multiply the result of cubic meters ( $\text{m}^3$ ) by 1,000 liters/ $\text{m}^3$  to convert to liters.

#### OTHER APPLICATIONS OF THESE INFILTRATION BASIN CALCULATIONS:

The circular and rectangular basin-volume calculations can also be used in reverse, i.e., for calculating the volume of soil removed from an excavation, or estimating the volume of soil needed to fill a planter, as below:

#### EXAMPLE:

You want to know the capacity or volume of a circular planter that measures 2 feet in diameter at its base, 3 feet at its top rim, and is 2 feet tall. The bottom and top radii ( $R$  = half the diameter  $D$ ) are 1 and 1.5 feet, respectively.

$$\begin{aligned}\pi \times \text{depth} \times ((R_1 \times R_2) + R_1^2 + R_2^2) \div 3 &= \text{capacity} \\ \pi \times 2 \text{ ft} \times ((1 \text{ ft} \times 1.5 \text{ ft}) + 1 \text{ ft}^2 + 2.25 \text{ ft}^2) \div 3 &= \text{capacity} \\ 3.14 \times 2 \text{ ft} \times 4.75 \text{ ft}^2 \div 3 &= \text{capacity}\end{aligned}$$

$$\text{Capacity} = 9.94 \text{ ft}^3$$

Just a bit over 1/3 cubic yard, or multiplying by 7.48 gals/ $\text{ft}^3$ , you get about 74 gallons.

## Equation 14. Square or Rectangular Basin-Capacity or Volume

$$(\text{depth} \times ((L_1 \times W_1) + (L_2 \times W_2) + (\text{sqrt}(L_1 \times W_1 \times L_2 \times W_2)))) \div 3 = \text{basin capacity}$$

with the sqrt being the square root, which is a function found on most calculators. Note: the one-third factor (the number 3) in the equation is a geometric constant associated with pyramid volumes.

The measurements for the rectangular basin calculation:

- **Depth** is the distance from the bottom of the basin to the top of its rim (or the lip of the spillway if you have one).
- **Widths (rectangular basin)**. Because the edges of the basin are sloped, two different width measurements are used: one measured at the bottom of the basin ( $W_1$ ), and the second measured at the top of the basin ( $W_2$ ).
- **Lengths (rectangular basin)**. Because the edges of the basin are sloped, two different length measurements are used: one measured at the bottom of the basin ( $L_1$ ), and the second measured at the top of the basin ( $L_2$ ).

Use the same unit for all measurement. For example, all English measurement should be in feet.

### EXAMPLE:

Using the example basin (with a depth of 1.5 feet, bottom length of 16.5 feet, bottom width of 14 feet, top length of 20 feet, and top width of 17 feet), the calculation is as follows:

$$\begin{aligned} & (1.5 \text{ ft} \times ((16.5 \text{ ft} \times 14 \text{ ft}) + (20 \text{ ft} \times 17 \text{ ft}) + (\text{sqrt}\{16.5 \text{ ft} \times 14 \text{ ft} \times 20 \text{ ft} \times 17 \text{ ft}\}))) \div 3 = \text{basin capacity (ft}^3) \\ & (1.5 \text{ ft} \times ((16.5 \text{ ft} \times 14 \text{ ft}) + (20 \text{ ft} \times 17 \text{ ft}) + (\text{sqrt}\{78,540 \text{ ft}^4\}))) \div 3 = \text{basin capacity (ft}^3) \\ & (1.5 \text{ ft} \times ((16.5 \text{ ft} \times 14 \text{ ft}) + (20 \text{ ft} \times 17 \text{ ft}) + (280.25 \text{ ft}^2))) \div 3 = \text{basin capacity (ft}^3) \\ & (1.5 \text{ ft} \times (231 \text{ ft}^2 + 340 \text{ ft}^2 + 280.25 \text{ ft}^2)) \div 3 = \text{basin capacity (ft}^3) \\ & (1.5 \text{ ft} \times 851.25 \text{ ft}^2) \div 3 = \text{basin capacity (ft}^3) \\ & 1,267.86 \text{ ft}^3 \div 3 = \text{basin capacity (ft}^3) \\ & \text{basin capacity} = 426 \text{ ft}^3 \end{aligned}$$

Then, to convert cubic feet to gallons:

Multiply 426 ft<sup>3</sup> by 7.48 gallons/cubic foot to convert to 3,186 gallons of basin capacity.

If you used meters and your result was in cubic meters, multiply by 1,000 liters/m<sup>3</sup> to convert to liters.

## Equation 15. Engineering Calculation for Diversion-Swale Sizing

There are two steps needed to calculate an adequate size for the diversion swale. The *first step* is to estimate the maximum water flow into the swale. The second step is to estimate what dimensions the swale will need to have to handle this inflow.

For the first step, we will use what engineers refer to as the Rational Method to estimate peak water flow. Note that the Rational Method is best used as a simple formula for small properties, and is not considered applicable for large catchments (i.e. over 300 acres or 121 ha). For large catchments the Soil Conservation Service “Curve Number” approach is recommended, for which references are widely available.

The basic formula of the Rational Method is:

$$Q = CiA$$

where Q = peak flow (cubic feet per second)  
C = runoff coefficient for the catchment  
i = rainfall intensity (inches per hour)  
A = catchment area (acres)

The runoff coefficient is dimensionless, theoretically varying between 0 and 1. The runoff coefficient is smaller for catchments that have high infiltration and higher for those with low infiltration. Typical runoff coefficients are: paved areas 0.9; residential lots 0.3-0.7 (dependent on amount of impervious area, type of soil and amount of vegetation); unmodified ground 0.2-0.6 (dependent on type of soil and amount of vegetation).

The rainfall intensity the swale is designed for can vary, but we suggest using a 100-year rainfall event recurrence interval. A 100-year rainfall event is defined as a rainfall of a given duration of time that can be expected to occur in the area once in a 100-year period. To estimate peak flow, rainfall duration should match the time of concentration for the catchment. The time of concentration for the catchment is defined as the length of time after rain begins that all portions of the catchment contribute to catchment outflow. The minimum time of concentration to use is 5 minutes, which would apply to most residential properties. Larger scale applications will have larger times of concentration, which can be either estimated with personal judgment, observed directly on site during a storm, or found using the formula below.

$$T_c = 0.0078 L^{0.77} S^{-0.385}$$

where  $T_c$  is time of concentration (minutes)  
L is length of channel through the catchment from boundary to outflow (feet)  
S is slope (ft/ft)

After the time of concentration is obtained, visit [dipper.nws.noaa.gov/hdsc/pfds/](http://dipper.nws.noaa.gov/hdsc/pfds/) to find rainfall depth. This government-data website allows you to focus on different regions of the U.S., and then pull up a table of rainfall depths for different rainfall durations (such as 5 minutes) and different recurrence intervals (such as 100 years). With the rainfall depth we can calculate rainfall intensity:

$$i \text{ (inches per hour)} = 60 \times \text{rainfall depth (inches)} \div T_c \text{ (minutes)}$$

Catchment area in acres should be straightforward to measure. To convert square feet to acres, divide by 43,560. Now we have all variables necessary to calculate peak flow.

Peak Flow Example Calculation:

Consider a typical Tucson, Arizona, property about 0.2 acres in size.

The runoff coefficient is estimated at 0.4.

We estimate the time of concentration to be 5 minutes.

For a weather site listed in Tucson, using the map found at [dipper.nws.noaa.gov/hdsc/pfds/](http://dipper.nws.noaa.gov/hdsc/pfds/), the rainfall depth associated with a 5-minute storm of 100-year recurrence is 0.77 inches. The rainfall intensity is 9.24 inches per hour.

The peak flow ( $q$ ) associated with design conditions is 0.75 (rounded up) cubic feet per second.

After estimating the peak flow, the *second step* is to size the diversion swale to handle the peak flow. For this we will use the Manning equation to estimate average velocity of flow in a given-dimensioned swale and see if this is adequate to pass the design flow. Through iteration, minimum dimensions of the swale can be estimated. The Manning equation is:

$$V = (1.49 R^{2/3} S^{1/2}) \div n$$

where  $V$  = velocity (feet per second)

$R$  = hydraulic radius (feet)

$S$  = slope (ft/ft), here slope is vertical fall divided by horizontal distance

$n$  = Manning's roughness factor

Hydraulic radius is the linear distance across the most limiting (smallest) swale cross-section, measured along the earth from the swale edge down to the bottom, across the swale floor, and up to the facing swale edge. A typical Manning's roughness factor for an earth swale is 0.05. A very clean swale might be as low as 0.03, and a very obstructed (i.e. with check dams) swale might carry a roughness as high as 0.1. After velocity has been estimated with the Manning equation, the volume capacity of the swale can be found by multiplying velocity by the most limiting cross-sectional area of the swale.

#### SWALE VOLUME-CAPACITY CALCULATION EXAMPLE:

Continuing the example of a typical Tucson property begun above, suppose we are planning to excavate a diversion swale with hydraulic radius of 2 feet, a slope of 1/100, and a cross-sectional area of 0.3 square feet. Let's use a typical Manning's roughness value of 0.05. Velocity and volume are then:

$$\begin{aligned} V &= 1.49 \times 2^{2/3} \times 0.01^{1/2} \div 0.05 \\ &= 4.73 \text{ feet per second} \end{aligned}$$

$$\begin{aligned} Q &= V \times A \\ &= 4.73 \times 0.3 \\ &= 1.41 \text{ cubic feet per second} \end{aligned}$$

The 1.41 surpasses the 0.75 result as found in step one using the Rational Method, so we're good to go. The designed swale would still have capacity beyond the 100-year rainfall event associated with the time of concentration for the catchment. While the swale could be sized smaller and still handle the 0.75 cubic feet per second design flow, the margin might come in handy as swales tend to fill in over time (reducing the cross-section) or as any vegetation in the swale matures (increasing the Manning's roughness factor).

#### REFERENCES:

David R. Maidment, ed., Handbook of Hydrology, McGraw-Hill Inc, 1992.  
[dipper.nws.noaa.gov/hdsc/pfds/](http://dipper.nws.noaa.gov/hdsc/pfds/) Accessed 6/7/0-



# Appendix 4

## Example Plant Lists and Water-Requirement Calculations for Tucson, Arizona

This appendix contains estimated water needs for vegetable gardens along with three multiuse perennial plant lists specific for Tucson, Arizona (water needs will fluctuate depending on planting density, soil type, placement, and exposure). There is a far more diverse array of suitable plants and cultivars available for this area than the lists suggest. These lists are meant simply as a partial introductory guide for Tucsonans, and as a template for people elsewhere to create plant lists specific to their location and climate.

Estimated annual or monthly water requirements can be easily calculated for plants by looking up their mature size, water needs (low, medium, high), and evergreen or deciduous nature on the plant lists, and then using the simple calculations that follow the lists. These estimates are very helpful in determining what plants, and how many, can be sustained within a Tucson, Arizona, site's rainwater budget (see chap-

ter 1) and potential supplementary water from household greywater (see boxes 12.5 through 12.7).

The vegetation section of this volume's resources appendix lists some of the books from which I compiled the information. Local gardening groups, herbalists, primitive-skills enthusiasts, native-plant societies, locally owned plant nurseries, and my own direct observations then fleshed out the lists, and can help you form your lists too. This book's chapter 11 on vegetation, and the planting section of the chapter on infiltration basins offer still more tips.

The first table in box A4.1 shows, for various sized vegetable gardens (square feet or square meters), approximate annual water needs. Note that these gardens are mulched and in sunken basins, in conformance with the principles and strategies of water harvesting.

**Box A4.1. Approximate Annual Water Requirements for Mulched Vegetable Gardens in Tucson, Arizona, Planted in Sunken Basins**

Based on "Economic Value of Home Gardens in an Urban Desert Environment" by David A. Cleveland, Thomas V. Orum, and Nancy Ferguson, *HortScience* 20(4):694-696.1985

|                                     |                                   |                                      |                                    |                                      |                                    |
|-------------------------------------|-----------------------------------|--------------------------------------|------------------------------------|--------------------------------------|------------------------------------|
| 50 ft <sup>2</sup><br>3,180 gallons | 100 ft <sup>2</sup><br>6,360 gal. | 150 ft <sup>2</sup><br>9,540 gal.    | 200 ft <sup>2</sup><br>12,720 gal. | 250 ft <sup>2</sup><br>15,900 gal.   | 300 ft <sup>2</sup><br>19,080 gal. |
| 4.5 m <sup>2</sup><br>12,080 liters | 9 m <sup>2</sup><br>24,160 liters | 13.5 m <sup>2</sup><br>36,250 liters | 18 m <sup>2</sup><br>48,080 liters | 22.5 m <sup>2</sup><br>60,420 liters | 27 m <sup>2</sup><br>72,500 liters |

In the plant list tables that follow (boxes A4.2–A4.4), APPROXIMATE WATER NEEDS are listed as:

LW = low water use of 10 to 20 inches of water per year

MW = medium water use of 20 to 35 inches of water per year

HW = high water use of 35 to 60 inches of water per year

The numbers 1, 2, 3, or 4 in parentheses signify the approximate irrigation needs of the plants once they become established (this often takes 2 to 3 years).

(1) = no supplemental irrigation

(2) = irrigation once a month in the growing season

(3) = irrigation twice a month in the growing season

(4) = irrigation once a week in the growing season

Ratings based on Arizona Department of Water Resources Low Water Use/Drought Tolerant Plant Lists and direct observation.

Abbreviations signify: D=deciduous, E=evergreen, EO=essential oil, EPS=earth plaster/pigment stabilizer, F=food, FB=firebreak species, FR=fragrant, FW=fiber/basketry/weaving material, G=glue, H=hardy, HC= hair conditioner, LF=living fence, M=medicinal, NF=nitrogen-fixing, P=pigment or dye, S=shelter/shade, SC=screen, SD=semi-deciduous, SH=semi-hardy, SP=soap, T=tanning hides, W=wood/timber, WB=windbreak.

“Pollinators” can include butterflies, native solitary bees, and beneficial predatory wasps.

Box A4.2. Native Multiuse Trees for the Tucson, Arizona Area

| Species  | Water    | Size           | Cold Tolerance | Elevation Range (ft.) | Growth Rate      | Type of Tree | Human Uses            | Wildlife   | Domestic Animals That Use Plant           |
|--|----------|----------------|----------------|-----------------------|------------------|--------------|-----------------------|--|---|
| Desert Ironwood ( <i>Olneya tesota</i> )                 | LW (1)   | 25 × 25'       | SH 15°F        | 2,500' and below      | Moderate         | E            | F, M, NF, S, T        | Birds, pollinators, large and small mammals                  | Chickens, goats                           |
| Velvet Mesquite ( <i>Prosopis velutina</i> )             | LW (1)   | 30 × 30'       | H 5°F          | 1,000–5,000'          | Fast             | SD           | F, FW, M, NF, P, S, W | Birds, pollinators, large and small mammals                  | Chickens, goats, cattle, honey bees, dogs |
| Screwbean Mesquite ( <i>Prosopis pubescens</i> )         | LW (2–3) | 20 × 20'       | H 0°F          | 4,000' and below      | Moderate         | D            | F, FW, M, S, W, WB    | Birds, pollinators, large and small mammals                  | Chickens, goats, cattle, honey bees, dogs |
| Cat claw Acacia ( <i>Acacia greggii</i> )                | LW (1)   | 20 × 20'       | H 0°F          | Below 5,000'          | Moderate to fast | D            | M, P, S, T, W         | Birds, pollinators, large and small mammals                  | Cattle, honey bees                        |
| Whitethorn Acacia ( <i>Acacia constricta</i> )           | LW (1)   | 10–15 × 10–15' | H 5°F          | 2,500–5,000'          | Moderate to fast | SD           | F, G, M, S            | Birds, pollinators, large and small mammals                  | Cattle                                    |
| Desert Willow ( <i>Chilopsis linearis</i> )              | LW (2–3) | 25 × 25'       | H -10°F        | 1,500–5,000'          | Fast             | D            | FR, FW, M, S, W, WB   | Birds and pollinators  | Cattle, honey bees                        |
| Canyon Hackberry ( <i>Celtis reticulata</i> )            | MW (2–3) | Up to 35 × 35' | H -20°F        | 1,500–6,000'          | Moderate         | D            | F, S, W, WB           | Birds, pollinators, large and small mammals                  | Chickens                                  |
| Foothills Palo Verde ( <i>Parkinsonia microphyllum</i> ) | LW (1)   | 25 × 25'       | H 15°F         | 500–4,000'            | Slow to moderate | D            | F, S, W               | Birds, pollinators, large and small mammals, desert tortoise | Cattle, honey bees                        |
| Blue Palo Verde ( <i>Parkinsonia floridum</i> )          | LW (2)   | 30 × 30'       | H 15°F         | 500–4,000'            | Fast             | D            | F, S, W               | Birds, pollinators, large and small mammals, desert tortoise | Sheep, honey bees                         |

### Box A4.3. Native Multiuse Shrubs, Cacti, and Groundcover for the Tucson, Arizona Area

| Species   | Water    | Size           | Cold Tolerance  | Elevation Range (ft.) | Growth Rate      | Type Of Plant       | Human Uses           | Wildlife                              | Domestic Animals That Use Plant        |
|---|----------|----------------|-----------------|-----------------------|------------------|---------------------|----------------------|---------------------------------------|--|
| Oreganillo<br>( <i>Aloysia Wrightii</i> )         | LW (2)   | 5x5'           | H 15°F          | 1,500–6,500'          | Moderate         | D shrub             | F, FR                | Pollinators                           | Honey bees, livestock                  |
| Quail-brush<br>( <i>Atriplex lentiformis</i> )    | LW (1)   | Up to 8x12'    | H 15°F          | Below 4,000'          | Fast             | E shrub             | F, FB, M, NF, SC, SP | Birds, large mammals                  | Honey bees, livestock                  |
| Chiltepine<br>( <i>Capsicum annum</i> )           | LW (2)   | Up to 3'       | Frost sensitive | Below 4,000'          | Slow to moderate | E shrub, D w/ frost | F, M                 | Birds                                 | Chickens                               |
| Desert hackberry<br>( <i>Celtis pallida</i> )     | LW (2)   | Up to 10'      | H 20°F          | 1,500–3,500'          | Slow to moderate | SD shrub            | F, M, SC, W          | Birds, pollinators, mammals           | Chickens, Honey bees, cattle           |
| Brittlebush<br>( <i>Encelia farinosa</i> )        | LW (1)   | 3'             | SH 28°F         | Below 3,000'          | Fast             | E shrub             | M, G                 | Pollinators, birds, large mammals     |  |
| Mormon Tea<br>( <i>Ephedra trifurca</i> )         | LW (2)   | 3–12'          | H               | Up to 4,500'          | Slow             | E shrub             | E, M, P, T           | Pollinators, birds, large mammals     | Honey bees                             |
| Ocotillo<br>( <i>Fouquieria splendens</i> )       | LW (1)   | Up to 15' tall | H 10°F          | Below 5,000'          | Slow             | D "shrub"           | E, M, LF             | Pollinators, birds                    |  |
| Chuparosa<br>( <i>Justicia californica</i> )      | LW (2–3) | 4'             | SH 28°F         | 1,000–2,500'          | Moderate to fast | D shrub             | F                    | Birds, pollinators                    |  |
| Creosote ( <i>Larrea tridentata</i> )             | LW (1)   | Up to 11'      | H 5°F           | Below 4,500'          | Slow to moderate | E shrub             | G, M, W              | Birds, pollinators, mammals           |  |
| Wolfberry<br>( <i>Lycium fremontii</i> )          | LW (1)   | 3–5'           | H               | 2,500' and below      | Moderate to fast | D shrub             | F, M, SC             | Birds, pollinators                    | Chickens, honey bees, livestock        |
| Penstemon<br>( <i>Penstemon parryi</i> )          | LW (1)   | Up to 3' tall  | H 15°F          | 1,500–4,500'          | Moderate         | E ground cover      | M                    | Birds, pollinators                    |  |
| Jobba<br>( <i>Simmondsia chinensis</i> )          | LW (1)   | Up to 7'       | H 20°F          | 1,000–5,000'          | Slow to moderate | E shrub             | FB, M, SC, SP, WB    | Large and small mammals               | Cattle                                 |
| Saguaro<br>( <i>Carnegiea gigantea</i> )          | LW (1)   | Up to 40' tall | SH 21°F         | 600–3,600'            | Slow             | E cactus            | F, G, M, W, T        | Birds, bats, pollinators              | Chickens                               |
| Barrel Cactus<br>( <i>Ferocactus wislizenii</i> ) | LW (1)   | 4–8' tall      | H 15°F          | 1,000–5,600'          | Slow             | E cactus            | F, HC, M, P          | Birds, pollinators, mammals           | Pigs                                   |
| Staghorn Cholla<br>( <i>Opuntia versicolor</i> )  | LW (1)   | 3–10' tall     | H               | 2,000–3,000'          | Moderate to fast | E cactus            | F, M, SC             | Birds, pollinators, mule deer         |  |
| Prickly Pear<br>( <i>Opuntia engelmannii</i> )    | LW (1)   | Up to 5' tall  | H 10°F          | 1,000–6,500'          | Moderate         | E cactus            | EPS, F, LF, M, P     | Birds, pollinators, mammals, tortoise | Sheep, cattle (when thorns burned off) |

### Box A4.4. Exotic Multiuse Fruit Trees, Vines, and Cacti for the Tucson, Arizona Area

| Species                                   | Cultivars  | Water    | Size            | Cold Tolerance or Needs              | Growth Rate      | Type of Plant    | Human Uses            | Wildlife                               | Domestic Animals That Use Plant              |
|---|--|----------|-----------------|--------------------------------------|------------------|------------------|-----------------------|--|--|
| Apple ( <i>Malus pumila</i> )             | Anna, Ein Shemer   | MW (3)   | 15-20' X 15-20' | 150-250 chill hours                  | Moderate         | D tree           | F, S                  | Birds, pollinators, deer               | Chickens                                     |
| Apricot ( <i>Prunus armeniaca</i> )       | Royal or Blenheim, Katy  | MW (2-3) | 25 X 25'        | 300-400 chill hours                  | Moderate         | D tree           | F, FB, S, WB          | Pollinators                            | Chickens                                     |
| Carob ( <i>Ceratonia siliqua</i> )        | Casuda, Santa Fe, Sfax   | MW (3)   | 25 X 25'        | SH 23°F                              | Moderate         | E tree           | F, FB, S, WB,         |  | Honey bees, sheep, goats, pigs, cows, horses |
| Chinese Jujube ( <i>Ziziphus jujuba</i> ) | Lang, Li   | LW (2)   | 20-30 X 10-20'  | H 0°F                                | Moderate         | D tree           | F, M                  |  | Chickens                                     |
| Citrus – grapefruit                       | Duncan, Ruby Red, Marsh  | HW (3)   | 14-20'          | SH 27°F                              | Moderate         | E tree           | EO, F, FB, M, S       | Pollinators                            | Honey bees                                   |
| Citrus – lemon                            | Improved Meyer, Lisbon   | HW (3)   | Up to 20 X 20'  | SH 31°F                              | Moderate         | E tree           | EO, F, FB, M, S       | Pollinators                            | Honey bees                                   |
| Citrus – Sweet orange                     | Valencia, Trovita, Marrs, Sanguinelli Blood                              | HW (3-4) | 12-20 X 12-20'  | SH 27°F                              | Moderate         | E tree           | EO, F, FB, FR, M, S   | Pollinators, hummingbirds              | Honey bees                                   |
| Date palm ( <i>Phoenix dactylifera</i> )  | Medjool, khadrawy, halawy, zahidi, maktoom<br>Only females produce fruit | MW (3-4) | Up to 40' tall  | SH 22°F                              | Moderate         | E tree           | F, FW, M, S, W, WB    | Birds                                  | Chickens, dogs, camels, horses               |
| Grape ( <i>Vitis spp.</i> )               | Flame, Ruby, Lomanto, Black Manukka, Thompson                            | MW (4)   | 5-90' long      | H 0-10°F                             | Moderate         | D vine           | F, FW, S (on trellis) | Birds, pollinators, small mammals      | Chickens, Honey bees                         |
| Fig ( <i>Ficus carica</i> )               | Black Mission, Conadria  | MW (3)   | 15-30 X 15-30'  | H 15°F >100 chill hours              | Fast             | D tree           | F, FB, M, S           | Birds, bats, pollinators               | Chickens                                     |
| Loquat ( <i>Eriobotrya japonica</i> )     | Big Jim, Tanaka, Champagne, Gold Nugget                                  | HW (4)   | 20 X 20'        | Tree H 10°F, fruit & flowers SH 28°F | Moderate         | E tree           | F, S, WB              |  | Chickens, honey bees                         |
| Nopal ( <i>Opuntia ficus-indica</i> )     | Burbank, Quillota, Papaya, Honey Dew, Florida White                      | LW (1-2) | Up to 10' tall  | H 20°F                               | Moderate-fast    | E cactus         | EPS, F, FB, LF, M, SC | Pollinators, desert tortoise, javalina | Chickens, pigs, sheep, cattle                |
| Olive ( <i>Olea europaea</i> ) *          | Ascolano, Barouni, Haas, Manzanillo, Mission                             | MW (2)   | Up to 30 X 30'  | Trees H 15°F, Green fruit SH 28°F    | Moderate         | E tree<br>F, FB, | M, S, W, WB           | Birds                                  | Chickens                                     |
| Peach ( <i>Prunus persica</i> )           | Desert Gold, Mid Pride, Rio Grande                                       | MW (3-4) | 15-25'          | 250-350 chill hours                  | Moderate to fast | D tree           | F, FB, M, S           | Birds, pollinators                     | Chickens, honey bees                         |
| Pomegranate ( <i>Punica granatum</i> )    | Wonderful, Fleshman, Papago, Sweet                                       | LW (2-3) | 12-15'          | H 15°F, 100-200 chill hours          | Moderate         | D shrub to tree  | F, FB, M, P, SC, T    | Birds                                  | Chickens, honey bees                         |

\* Order fruiting olives from Santa Cruz Olive Tree Nursery ([www.santacruzolive.com](http://www.santacruzolive.com)) or Peaceful Valley Farm Supply ([www.groworganic.com](http://www.groworganic.com)).

## How to Estimate the Water Requirements in a Given Month for a Listed Plant in Tucson, Arizona

Based on the “How To Develop A Drip Irrigation Schedule” handout from the LOW 4 Program of the Pima County Cooperative Extension/University of Arizona Water Resource Research Center, 350 N. Campbell Ave., Tucson, AZ 85719. Ph. 520-622-7701.

A similar “plant water-requirement estimator” can be created for other areas according to local evapotranspiration rates.

For an additional resource, see the Arizona Department of Water Resources for their Drought Tolerant/Low Water Use Plant Lists [www.water.az.gov/adwr/Content/Conservation/LowWaterPlantLists/default.htm](http://www.water.az.gov/adwr/Content/Conservation/LowWaterPlantLists/default.htm)

They have plant lists specific to Tucson, Phoenix, and the Pinal, Prescott, and Santa Cruz Active Management Areas (AMAs).

1. Identify the plant as evergreen or deciduous, and as having a high, medium, or low water requirement. *For example, a velvet mesquite is deciduous with a low water requirement.*

2. Determine the canopy diameter of the plant (the diameter of the leafy part of the plant). This can be the plant’s current canopy or its potential canopy at maturity. *Let’s say our example mesquite has a 20-foot canopy.*

3. Determine the plant’s water requirement in inches for a given month. See the tables in boxes A4.5A and A4.5B, which show how many INCHES of water the plant needs to receive beneath its canopy to maintain its health. *According to the table in box A4.5B, the June water requirement of our deciduous, low-water-requirement mesquite is 3 inches.*

4. Convert the plant’s water requirement from inches to gallons. Find the plant’s canopy diameter in Box A4.5C. Then find the corresponding number of gallons per inch of water beneath the canopy, and multiply it by the number of inches required in June to get the total GALLONS of water required in that month.

*For example, the number of gallons in an inch of water under a 20-foot diameter velvet mesquite is 196 gallons. The tree needs 3 inches of water in June, so multiplying  $196 \times 3 =$  a June water requirement of 588 gallons.*

**Box A4.5A. Monthly Water Requirement in Inches—Evergreen Plants**

| Water Requirement | J | F  | M  | A  | M  | J  | J  | A  | S  | O  | N  | D | Annual Total |
|-------------------|---|----|----|----|----|----|----|----|----|----|----|---|--------------|
| Low               | 0 | 0  | 2" | 2" | 3" | 3" | 3" | 2" | 2" | 2" | 1" | 0 | 20"          |
| Medium            | 0 | 0  | 3" | 4" | 5" | 5" | 5" | 4" | 4" | 3" | 2" | 0 | 35"          |
| High              | 0 | 3" | 5" | 6" | 8" | 9" | 7" | 6" | 6" | 5" | 3" | 0 | 58"          |

**Box A4.5B. Monthly Water Requirement in Inches—Deciduous Plants**

| Water Requirement | J | F | M | A  | M  | J  | J  | A  | S  | O  | N | D | Annual Total |
|-------------------|---|---|---|----|----|----|----|----|----|----|---|---|--------------|
| Low               | 0 | 0 | 0 | 2" | 3" | 3" | 3" | 2" | 2" | 0  | 0 | 0 | 15"          |
| Medium            | 0 | 0 | 0 | 4" | 5" | 5" | 5" | 4" | 4" | 0  | 0 | 0 | 27"          |
| High              | 0 | 0 | 0 | 6" | 8" | 9" | 7" | 6" | 6" | 5" | 0 | 0 | 47"          |

**Box A4.5C. Conversion Table: Canopy Diameter vs. Gallons/Inch under Canopy**

|   |   |   |    |    |    |    |    |     |     |     |     |     |
|---|---|---|----|----|----|----|----|-----|-----|-----|-----|-----|
| Canopy Diameter in Feet                       | 2 | 4 | 6  | 8  | 10 | 12 | 14 | 16  | 18  | 20  | 25  | 30  |
| # of Gallons per Inch of Water beneath Canopy | 2 | 8 | 18 | 31 | 49 | 71 | 96 | 125 | 159 | 196 | 306 | 441 |

### How to Estimate the Annual Water Requirements for a Listed Plant in Tucson, Arizona

Use the tables in box A4.5A or A4.5B to find the plant’s estimated ANNUAL water requirement in INCHES. Multiply that number by the number of gallons per inch of water beneath the canopy (table in box A4.5C), and the plant’s canopy diameter. *For example, the 20-foot diameter velvet mesquite needs 15 inches of water annually, and from Table A4.5C we see that there are 196 gallons per inch of water beneath a 20-foot canopy. So multiplying  $15 \times 196 =$  an annual water requirement of 2,940 gallons.*

Note 1: Annual water-requirement estimates are likely all you will need to consider when designing a landscape of local native plants based on natural wild plant densities and sizes. Such vegetation is naturally adapted to the local rainfall patterns and, once established, can survive the dry periods between rains.

Monthly water-requirement estimates are better suited for designing landscapes of exotics or native plants that are planted at a higher-than-normal density or are irrigated for larger-than-normal plant sizes. These estimates give you a better idea of what seasons or months require more water so that you can better

plan for needed water storage and the timing of supplemental irrigation with cistern water or greywater.

The water requirements for all plants will increase as they grow, since the amount of water they transpire through their leaves increases with the increase in cumulative leaf surface area. Therefore, it is important to plan for the water needs of your plants at their mature size. However, by minimizing the amount of water available to native plants you can reduce their mature size—reducing the need for more water. For example, a velvet mesquite receiving approximately 6,600 gallons of water per year can grow to be 30 feet tall and wide, but if only 2,940 gallons of water per year is available to the tree, it will likely not grow to be taller and wider than 20 feet.

Note 2: For another method of estimating landscape water needs and tables of information allowing you to do so for many locations in Arizona see the free publication, *Harvesting Rainwater for Landscape Use*, 2nd Edition by Patricia H. Waterfall and Christina Bickelmann, 2004. The document may be ordered from the Arizona Department of Water Resources, Tucson Active Management Area, 400 W. Congress, Suite 518, Tucson, AZ 85701, Phone 520-770-3800, Website [www.water.az.gov](http://www.water.az.gov).

# Appendix 5

## Sizing and Implementation of the Kitchen Resource Drain (KRD) in Arizona

This appendix builds on the information presented on the KRD in the Variations and Real-Life Examples sections of chapter 12. The reason this information is presented in this appendix, instead of in chapter 12, is because much of it is specific to the current Arizona Department of Environmental Quality regulations, which will likely change as the system is more widely used and tested. Those changes will be easier to make in the appendix of this book (and at [www.HarvestingRainwater.com](http://www.HarvestingRainwater.com)) than in the book's core.

### SIZING

This KRD-sizing discussion is based on requirements in Arizona, per Aquifer Protection Permit provisions R18-9-E303-F-1-i and R-18-9-E302-C-4-b. Check regulations in your area to determine whether KRDs can be used and what your local sizing requirements are.

The size of the KRD's interceptor is determined based on the potential volume of water going down the drain. In Arizona, the size of the interceptor is calculated based on the number of bedrooms and water fixture units in the home. The minimum interceptor capacity is 42 gallons (159 liters) for a one-bedroom house with seven or fewer fixture units. For each additional bedroom up to a total of three, you need an additional 42 gallons (159 liters) in interceptor capac-

ity. For each additional bedroom over three bedrooms you need an additional 25 gallons (95 liters) in interceptor capacity.

Water flows out of the interceptor drain into the soil via one or more bottomless quonset-hut-style *leaching chambers* (figs. 12.12A, B, C). Leaching chambers vary in size depending on the model and manufacturer.<sup>1</sup> Common dimensions for one standard-style chamber with a capacity of 78 gallons (295 liters) are 34 inches (85 cm) wide, 6 inches (15 cm) tall at its louvered sidewall, and 75 inches (187.5 cm) long. This chamber has an effective absorption area of 38 square feet (3.5 m<sup>2</sup>). Multiple chambers can be connected to one another to increase their overall capacity.

In Arizona, you determine the total required volume and/or length of KRD leaching chambers based on the design flow of water entering the system, and an on-site percolation test or soil evaluation (box A5.2). In Arizona, per ADEQ's Aquifer Protection Permit General Provision R18-9-A314, each kitchen sink (with or without a dishwasher) is counted as two fixture units so each kitchen sink will require a design flow of 50 gallons (189 liters).

However, if the home is built with no sewer or septic hookup because only composting toilets are used, and *all* greywater and KRD drainwater is sent to the landscape, the capacity of the leaching chambers must be designed to handle all the household greywater, at a design flow of 90 gallons (341 liters) per

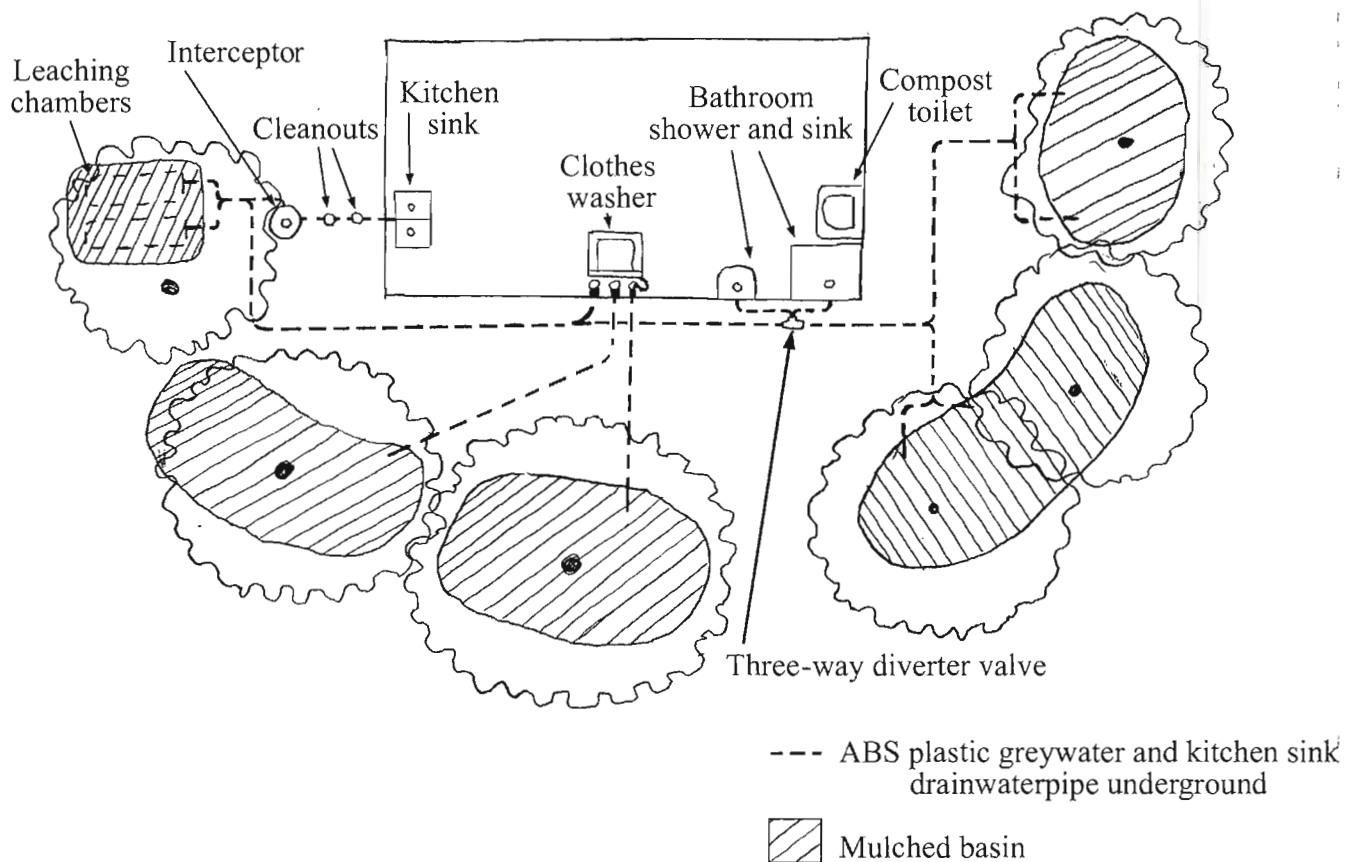

Fig. A5.1. Plan view of a Kitchen Resource Drain, composting toilet, and greywater system for a single-bedroom household, having no backup sewer or septic system. In such an instance, the State of Arizona requires all greywater lines (here the washing machine, bathroom sink, and shower) to be linked to either a multi-drain system or a three-way diverter valve that can direct the greywater to the KRD's subsurface chambers (after bypassing the interceptor) if the greywater basins become a nuisance.

In a more conventional household with a backup sewer or septic system, only the kitchen sink drainwater would be directed to the KRD chambers, while the diverter valve(s)/pipe(s) on the greywater lines would instead provide the option of sending the greywater either to the infiltration basins in the landscape or to the sewer or septic system.

The KRD's leaching chamber number/length was determined by design flow (box A5.3) and the site's soil percolation rate—in this case the most rapid rate of acceptable percolation (box A5.2).

Note 1: The greywater-harvesting basins are sized to also maximize the passive harvest of roof runoff.

Note 2: Try to minimize distance of pipe runs to ensure you can maintain a minimum 2% slope in all pipes, while still reaching the desired outlet points in the landscape or chambers.

bedroom per day. This is because the State of Arizona requires that you have a backup system, in the unlikely event that the greywater infiltration basins become a nuisance due to mismanagement that fails to meet the guidelines of R18-9-711. This backup system is accessed with a three-way diverter valve or multiple drainpipes. In a conventional home *with* sewer or septic hookup, the sewer or septic drains would be the

backup drains for the greywater system. In a progressive home *without* sewer or septic hookup, the State of Arizona wants you to use the leaching chambers (after bypassing the interceptor), of the KRD as your greywater system's backup drain field. See figure A5.1 for a plan view schematic, and see box A5.3 for the steps to determine the number of leaching chambers needed for a residence with composting toilet and no sewer or



## Box A5.1. A Potential Variance for the Chamber's Inspection Port

David Omick likes to use the KRD's leaching chamber inspection pipe as an auxiliary air vent. So instead of a cap atop the inspection pipe, he glues two 90° elbows together to form an upside down "U", then slides one end of the "U" over the inspection pipe(s) of the chamber(s) farthest from the interceptor. The other end of the "U" is covered with a piece of aluminum mosquito/window screen hose-clamped in place (to keep out vectors, such as insects). The two 90° elbows make it harder for woodpeckers to peck and damage the screen. Assuming that the plumbing system is properly vented through the roof and that the interceptor is properly plumbed for flow-through ventilation, the auxiliary air vent will permit a draft through the chambers and out the roof vent. This allows more air into the chamber to aid beneficial aerobic decomposition of organic matter and improve treatment levels. This should also reduce odors and direct them out the vent stack exiting above the home's roof, rather than emitting odors from the chamber's auxiliary air vent. Do not glue the 90° elbows of the vent in place, so they can be easily removed to inspect the interior of the chambers, and in case you experience odors emitting from the chamber vent. If there are odors, you can remove the elbows and replace them with a cap that will not allow air or odors to exit the inspection pipe.

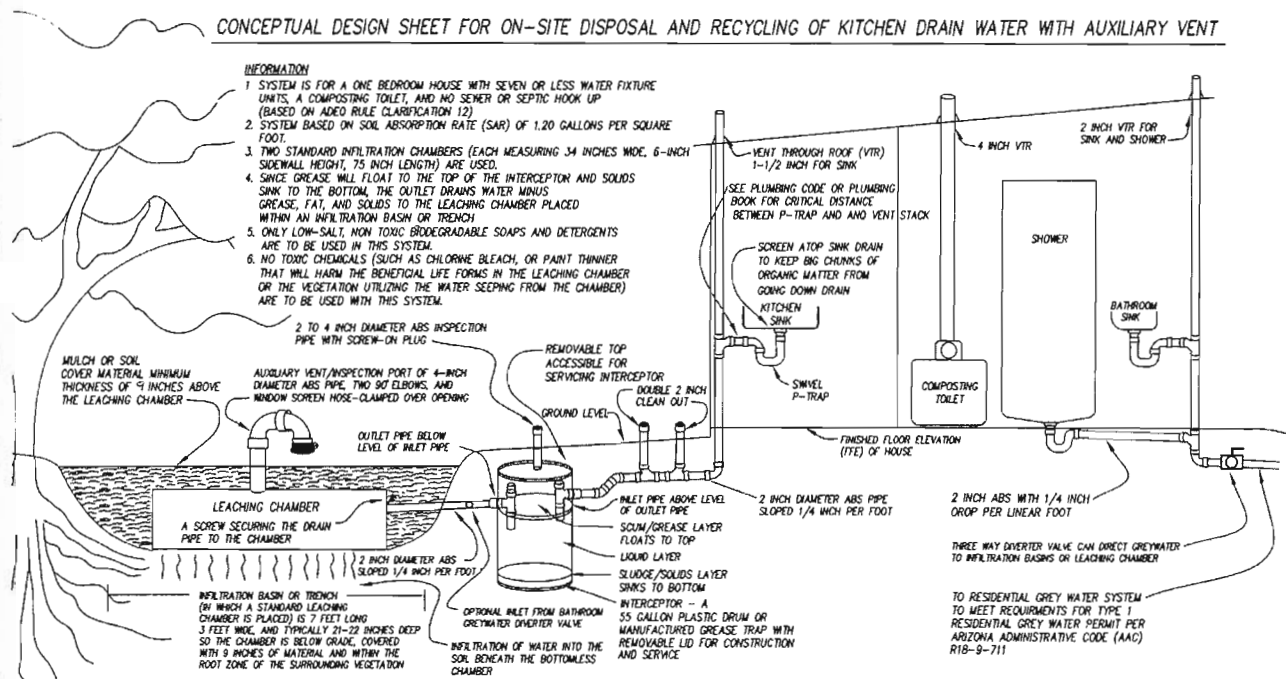

Fig. A5.2. Kitchen Resource Drain with inspection pipe doubling as an auxiliary vent. Compare this to an alternate installation in fig. 12.23. Credit: Drawn by Bill Cunningham P.E., [www.southwest-solar.com](http://www.southwest-solar.com)

septic hookup. Note that conventional homes hooked up only to the sewer or septic have no backup.

Locate KRD leaching chambers where their water output can be beneficially and conveniently reused in the landscape. The required setbacks for these systems are just one-fourth of the required setbacks for conventional septic leach field chambers (excluding setbacks from domestic wells which remain at 100 feet

[30 m]), so KRD chambers can be placed as close as 1.25 feet (0.37 m) to a property line, while septic leach field chambers must be at least 5 feet (1.5 m) from a property line.

Install the leaching chambers on the level bottom of an infiltration basin or trench that has been dug on contour, and is free of rocks and debris that could reduce infiltration rates of the drainwater. The basin

or trench must be deep enough so the top of the chamber can be fully covered with 9 inches (22 cm) of cover material. The basin or trench should not be deeper than necessary—it's important to keep the bottom of the chamber and infiltrating water well within the root zone of surrounding plants (the top 2 feet or 0.6 m of soil). Because of this, I do not use chambers taller than 13 inches (33 cm). The chambers come in a number of different sizes and heights, so be careful which you order. With the appropriate chamber in place, install end plates to keep it from filling with soil. A capped inspection pipe is installed through the top of the chamber extending above grade.

After the end plates and all plumbing are in place, fully cover the sides and top of chambers with at least 9 inches (22 cm) of an appropriate material. The cover material is not specified by code, and could be soil pumice, mulch, or finished compost. In dry climates, shape the surface of the cover material to be concave to harvest rainfall rather than convex, which would wastefully drain rainwater away.

I especially advocate using a cover material of finished compost. Compost is rich in beneficial microorganisms that will help filter drainwater and convert organic matter, soap scum, and grease into plant nutrients. Compost will also help prevent these substances from sealing the soil, and enhance percolation through the chamber's louvered sides in poorly draining clay soils. However, compost or any other organic cover material needs to be replaced annually because it naturally decomposes into porous, fertile soil.

Do not fill the chamber with compost, mulch, or any other materials. The chamber cavity is intentionally left void so roots cannot grow into it, and so there is plenty of room to handle water surges before the water infiltrates through the chamber into the compost and soil outside the chamber. Perennial vegetation is planted beside the chamber to utilize, and help filter, the water.

To further enhance the performance of the KRD, greywater expert David Omick makes the following recommendations:<sup>2</sup>

- Be careful about what you put down the drain. Avoid anything that is toxic such as paint thinner,

poisons, or bleach. Use appropriate soaps (see box 12.4) and keep grease output to a minimum.

- Place a wire screen within the drain of your kitchen sink to prevent big chunks of organic matter from going down your drain (fig. 12.22). Empty the screen into a compost bucket as needed. These screens are available at most hardware and grocery stores in the kitchenware section.
- Do not install or use a garbage disposal in conjunction with this system since this could overload it. It is much simpler and more efficient to compost and reuse this organic matter in your garden or landscape. See appendix 6, section xxii, for resources on composting.
- For lengths of KRD leaching chambers that are sized to handle kitchen sink drainwater and act as a backup disposal for all household greywater (for systems with no backup sewer or septic connection), place the bulk of your vegetation, or at least the more water-needy vegetation, nearer the inlet into the chambers. In such cases, the required length of chambers is increased to handle the rare diversion of all household greywater into the system. So typically, little greywater will make it to the far end of the chambers.

You may want to consider trying a controlled experiment of a KRD with and without interceptors to see if performance changes. Art Ludwig suggests that an interceptor would improve performance for households with lots of grease going down the drain, but would be a disadvantage for those with minimal grease. Simply adding more infiltration area, rather than an interceptor, might be a lower-maintenance alternative.<sup>3</sup>

See “Composting Toilets and Greywater Dispersal Versus Septic Tanks and Sewers” in the Real-Life Examples section of chapter 12 for more information, and the “Greywater Harvesting” page of my website, [www.HarvestingRainwater.com](http://www.HarvestingRainwater.com), for updates on KRD requirements and potential reference designs.

## Box A5.2. How To Do a Simple Percolation Test of Your Soil

To get an idea of the percolation rate of your soil, follow these steps, which are adapted by David Omick from Arizona Aquifer Protection Permit Rules, R18-9-A310-E. This information is useful if you are designing a greywater-harvesting system or planning to install a KRD.

- 1) At the site where you intend to locate the KRD leaching chambers or a mulched greywater-infiltration basin, dig a circular hole about 15 inches (38 cm) in diameter and about 12 inches (30 cm) deep. The sides of the hole should be vertical and the bottom level.
- 2) Slowly fill the hole with water.
- 3) As the water level in the hole drops, refill the hole with more water. Continue to do this periodically for several hours. This will saturate the soil around the hole to simulate a worst-case scenario of very rainy conditions.
- 4) Once the soil is fully saturated, fill the hole with about 6 inches (15 cm) of water and place a ruler vertically into the hole, securing it in place (fig. A5.3). This works best using a metal ruler, which won't float.
- 5) Note the number of minutes it takes for the water level to drop (percolate) 1 inch (1 cm). This is a first estimate of your soil's percolation (i.e. infiltration) rate in minutes per inch (or minutes per cm).
- 6) Repeat steps (4) and (5) the next morning after clay particles in the soil have had time to swell up. If there is a difference in the percolation time from the previous day, use the longer time as your soil's percolation rate.

See Art Ludwig's *The New Create An Oasis With Greywater* to size your greywater-harvesting basins based on that percolation rate.

- 7) To determine the number of leaching chambers you need for a KRD system, use your soil's percolation rate and follow the steps shown in box A5.3.

Note: As Art Ludwig says, "If water takes hours to drop an inch, if water infiltrates an inch in less than a minute, or if the hole fills with water by itself, you've got a problem!"<sup>4</sup> If any of these scenarios occur, find another location for leaching chambers or consider a different system (see appendix 6 as well as Art Ludwig's website, [www.oasisdesign.net](http://www.oasisdesign.net), for resources on other greywater systems).



Fig. A5.3. Percolation test measuring infiltration rate with watch and ruler

### Box A5.3. Steps for Determining the Number of Leaching Chambers Needed for a Residence with Composting Toilet, and No Sewer or Septic Hookup, Using ADEQ Regulations:

If prior to the permitting process you want to get an idea of how many leaching chambers your system would require in Arizona, David Omick describes how to do it:

- 1) Determine the following:
  - a) Number of bedrooms and fixture units in residence
  - b) Percolation test rate (in minutes per inch) of soil where leaching chambers will be placed. Note: ADEQ may require a consultant to do a soil analysis in addition to the percolation rate, depending on site characteristics.
  - c) Dimensions of infiltration chambers you plan to use, including exterior width of bottom of chamber, height of louvered sidewalls, and length of chamber (go to manufacturer's website to find these dimensions)

*Example:*

- a) 1 bedroom and 5 fixture units
- b) Percolation test rate — 2 minutes per inch
- c) Standard Infiltration Chamber (from Infiltrator Systems website)—34-inch width, 6-inch louvered sidewall height, 75-inch length

- 2) Go to: [www.azsos.gov/public\\_services/Title\\_18/18-09.htm](http://www.azsos.gov/public_services/Title_18/18-09.htm)

- 3) Scroll to R18-9-E303, then scroll to subsection F-1-i. In the first column of the table, choose the number of bedrooms and fixture units and note the corresponding design flow in gallons per day.

*Example:* 1 bedroom (and 7 fixtures or less, in this case 5 fixtures – 2 for the kitchen sink, 1 for the bathroom sink, and 1 for the washing machine), 90 gallons per day.

Note: "Design flow" refers to all wastewater from the residence (greywater plus blackwater). ADEQ requires leachfield area to be large enough to accommodate all on-site wastewater in case of greywater-system failure.

- 4) Scroll to R18-9-A312, then scroll to D, then scroll to 2. In the first column of the table, choose the percolation rate that corresponds to the results of your percolation test. In the second column, note the corresponding SAR (soil absorption rate) in gallons per day per square foot.

*Example:* percolation test result is 2 minutes. SAR = 1.20 gallons per day per square foot

- 5) Scroll to R-18-9-E302, then scroll to subsection C, then 4, then a. Using the formula given, determine the effective absorption area of each chamber:

$$A = (1.8 \times B \times L) + (2 \times V \times L)$$

- i. "A" is the effective absorption area of each chamber
- ii. "B" is the exterior width of the bottom of the chamber
- iii. "V" is the vertical height of the louvered sidewall of the chamber
- iv. "L" is the length of the chamber

*Example:* chamber 34 inches wide at base, 6 inches high at louvered sidewall, and 75 inches long

$$A = (1.8 \times B \times L) + (2 \times V \times L)$$

$$A = (1.8 \times 34 \times 75) + (2 \times 6 \times 75)$$

$$A = 4,590 + 900$$

$$A = 5,490 \text{ square inches}$$

Convert "A" to square feet by multiplying 5,490 by 0.0069444 = 38 square feet of effective absorption area per chamber

- 6) Scroll to R-18-9-E302, then scroll to subsection C, then 4, then b. It says—"Calculate the disposal works size and number of chambers from the effective absorption area of each chamber and the soil absorption rates specified in R18-9-A312(D).

To do this, first determine disposal works size (in square feet) by dividing design flow by SAR (soil absorption rate).

*Example:* Design flow of 90 gallons per day divided by SAR of 1.2 gallons per day per square foot = disposal works size of 75 square feet.

Then, **determine the number of chambers needed** by dividing disposal works size by effective absorption area per chamber.

*Example:* **Disposal works size of 75 square feet divided by effective absorption area per chamber of 38 square feet = 2 chambers.**

# Appendix 6

## Resources

This appendix provides a comprehensive list of helpful resources; it includes much more than just the texts cited in this volume. Section I begins with general rainwater-harvesting resources. Sections II through XXV follow the topical order in the preface, introduction, chapters, and epilogue. Sections XXVI through XXIX provide helpful funding, financial incentives, human-powered pumps, and water conservation resources.

In the interest of saving paper and other resources, as well as allowing for more up-to-date content and revisions, the Resources appendix now appears solely on the volume 2 page of [www.HarvestingRainwater.com](http://www.HarvestingRainwater.com).



Figure A6.1. Children playing on a PlayPumps merry-go-round provide the power to pump groundwater into the raised water tank for gravity-fed distribution. The advertisement signs around the tank help pay for the system. Courtesy of PlayPumps International. [www.playpumps.org](http://www.playpumps.org).

# References

## PREFACE

1. Mollison, Bill, *Introduction to Permaculture* (Talgum, Tasmania: Tagari Publications, 1988).
2. Ibid.
3. Ibid.
4. Ibid.
5. Ibid.
6. United Nations Environment Programme (UNEP), *World Atlas of Desertification*, 2nd ed. (London: Arnold; New York: John Wiley & Sons, 1997).
7. Ibid.
8. Pearce, Fred, *When the Rivers Run Dry: Water—The Defining Crisis of the Twenty-First Century* (Boston: Beacon Press, 2006).

## INTRODUCTION

1. Lancaster, Brad, *Rainwater Harvesting for Drylands and Beyond, Volume 1: Guiding Principles to Welcome Rain Into Your Life and Landscape* (Tucson: Rainsource Press, 2006).
2. Ibid.
3. Evenari, Michael, Leslie Shanan, and Naphtali Tadmor, *The Negev: The Challenge of the Desert* (Cambridge: Harvard University Press, 1971).
4. Agarwal, Anil, Sunita Narain, and Indira Khurana, *Making Water Everybody's Business – Practice and Policy of Water Harvesting* (New Delhi: Centre for Science and Environment, 2001).
5. Pearce, Fred, *When the Rivers Run Dry: Water—The Defining Crisis of the Twenty-First Century* (Boston: Beacon Press, 2006).
6. Agarwal, Narain, and Khurana, *Making Water Everybody's Business – Practice and Policy of Water Harvesting*.
7. Evenari, Shanan, and Tadmor, *The Negev: The Challenge of the Desert*.
8. Cleveland, David and Daniela Soleri, *Food From Dryland Gardens* (Tucson, AZ: Center of People, Food and Environment, 1991).
9. Pearce, *When the Rivers Run Dry*.
10. Personal communication with Frank Ramberg, Research Scientist, Department of Entomology, University of Arizona on 24 January 2005.
11. Mayer, Peter W., William B. DeOreo, Eva M. Opitz, Jack C. Keifer, William Y. Davis, Benedykt Dziegielewski, and John Olas Nelson, *Residential End Uses of Water* (American Water Works Research Foundation, 1999).
12. Vickers, Amy, *Handbook of Water Use and Conservation* (Amherst, MA: WaterPlow Press, 2001).
13. Ibid.
14. Ibid.
15. Ibid.
16. Phillips, Ann and James J. Riley, Charles P. Gerba, Richard Brittain, Martin R. Yoklic, Kendall Kroesen, Robert Seaman, Brad Lancaster, David Confer, and James Robinson, *Final Report: Demonstration of the Sustainability of Harvested Rainwater in Arid Lands to Meet Water Requirements and to Improve Quality of Runoff R9 # 03-478* (Tucson, AZ: Tucson Audubon Society, University of Arizona, October 2005).
17. Hemenway, Toby, *Gaiá's Garden: A Guide to Home-Scale Permaculture* (White River Junction, VT: Chelsea Green Publishing Company, 2001).
18. Ibid.
19. Ibid.
20. Ibid.
21. Cleveland and Soleri, *Food From Dryland Gardens*.
22. Pearce, *When the Rivers Run Dry*.
23. Evenari, Shanan, and Tadmor, *The Negev: The Challenge of the Desert*.

24. Flannery, Tim, *The Weather Makers – How Man Is Changing the Climate and What It Means for Life on Earth* (New York: Atlantic Monthly Press, 2005).
25. “Combining Storm and Rainwater Harvesting at Commercial Sites,” presentation by Bill Hoffman, City of Austin Water Conservation, at the First American Rainwater Harvesting Conference, August 21-23, 2003.
26. Flannery, *The Weather Makers*.

## CHAPTER 1

1. *2000 International Building Code, section 1803.3*, (International Code Council, 2000).

## CHAPTER 2

1. Mollison, Bill, *Introduction to Permaculture* (Tyalgum, Tasmania: Tagari Publications, 1988).
2. Personal communication with Ann Audrey, 28 May 2003.
3. Evenari, Michael, Leslie Shanan, and Naphtali Tadmor, *The Negev: The Challenge of the Desert* (Cambridge: Harvard University Press, 1971).
4. For more about the Lama Foundation fire and recovery from it, see Ben Haggard, “Reading the Mountain,” *Tricycle Magazine* (Summer 1997): 56-58.
5. Hemenway, Toby, *Gai’a’s Garden: A Guide to Home-Scale Permaculture* (White River Junction, VT: Chelsea Green Publishing, 2001).

## CHAPTER 3

1. Barrow, Christopher J., *Alternative Irrigation: The Promise of Runoff Agriculture* (London: Earthscan Publications, 1999).
2. Mollison, Bill, *Permaculture: A Designers’ Manual* (Tyalgum, Tasmania: Tagari Publications, 1988).
3. Barrow, *Alternative Irrigation*.
4. Finkel, H. J., *Semi-arid Soil and Water Conservation* (Boca Raton: CRC Press, 1986).
5. Reed, David, *The Art and Craft of Stonescaping: Setting and Stacking Stone* (Asheville: Lark Books, 2000).
6. Barrow, *Alternative Irrigation*.
7. Editors of Sunset Books, *Basic Masonry* (Menlo Park: Sunset Publishing, 1995).
8. Barrow, *Alternative Irrigation*.
9. Editors of Creative Homeowner, “Projects Online: Building a Dry-Stacked Stone Wall.” [www.creativehomeowner.com/index.php?pane=project&projectid=chwlk137](http://www.creativehomeowner.com/index.php?pane=project&projectid=chwlk137)
10. Reed, *Art and Craft of Stonescaping*.
11. Ibid.
12. Ibid.
13. Ibid.
14. Editors of Creative Homeowner, “Projects Online.”
15. Reed, *Art and Craft of Stonescaping*.

16. Barrow, *Alternative Irrigation*.

## CHAPTER 4

1. U.S. Environmental Protection Agency, “When are Storm Water Discharges Regulated as Class V Wells?” EPA-816-F-03-001 (Washington, DC: U.S. Environmental Protection Agency, June 2003). [www.epa.gov/npdes/pubs/sw\\_class\\_v\\_wells\\_fs.pdf](http://www.epa.gov/npdes/pubs/sw_class_v_wells_fs.pdf)
2. Hoffman, Bill, “Combining Storm and Rainwater Harvesting at Commercial Sites,” in *First American Rainwater Harvesting Conference, August 21-23, 2003 Proceedings* (San Antonio: American Rainwater Catchment Systems Association).
3. Ibid.

## CHAPTER 5

1. Tipton, Jimmy L., *Water Requirements of Landscape Trees: Final Report* (Phoenix: Arizona Department of Water Resources, 1997).
2. Ibid.
3. Ibid.
4. McPherson, E. Gregory, *Energy-Conserving Site Design* (Washington, DC: American Society of Landscape Architects, 1984).
5. Cleveland, David and Daniela Soleri, *Food from Dryland Gardens* (Tucson: Center for People, Food and Environment, 1991).
6. Bainbridge, David A., “Buried Clay Pot Irrigation.” [www.ecocomposite.org/restoration/claypot.htm](http://www.ecocomposite.org/restoration/claypot.htm). Or, for more information, do a web search under “clay pot irrigation.”
7. Mondal, R.C., “Farming with a Pitcher: A Technique of Water Conservation,” *World Crops* (March/April 1974): 94-97.
8. For more information see Brad Lancaster, “Casting Seed and Deepening Roots: Creating a Community Garden in Tucson,” *Permaculture Activist*, no. 42 (December 1999).
9. Rain Gardens of West Michigan website, [www.RainGardens.org](http://www.RainGardens.org).

## CHAPTER 6

1. Dixon, Robert M. and Ann B. Carr, “Land Imprinting for Restoring Vegetation in the Desert Southwest,” in *Proceedings of the 25th Annual Conference on Ecosystems Restoration and Creation held May 1998*, ed. P.J. Cannizzaro (Plant City, FL: Hillsborough Community College, 1999), 103-9.
2. Dixon, Robert M. and Ann B. Carr, “Land Imprinting Specifications for Ecological Restoration and Sustainable Agriculture,” in *Proceedings of Conference 31 of the International Erosion Control Association held February 21-25, 2000*.



3. Dixon, Robert M., "The Imprinting Revegetation System Versus The Pitting Revegetation System," (Tucson: Imprinting Foundation, 1998).
4. Dixon and Carr, "Land Imprinting for Restoring."

## CHAPTER 7

1. Cleveland, David and Daniela Soleri, *Food From Dryland Gardens* (Tucson: Center for People, Food and Environment, 1991).
2. Stout, Ruth, *Gardening Without Work* (Old Greenwich, CT: Devin-Adair, 1961).
3. Cleveland and Soleri, *Dryland Gardens*.
4. Campbell, Stu, *Let It Rot: The Gardener's Guide to Composting* (Pownal, VT: Storey Publishing, 1990).
5. Del Porto, David and Carol Steinfeld, *The Composting Toilet System Book: A Practical Guide to Choosing, Planning, and Maintaining Composting Toilet Systems, an Alternative to Sewer and Septic Systems* (Concord, MA: Center for Ecological Pollution Prevention, 1999).
6. Ibid.
7. Jenkins, Joseph, *The Humanure Handbook: Guide to Composting Human Manure*, 2nd ed. (Grove City, PA: Jenkins Publishing, 1999).
8. Cleveland and Soleri, *Dryland Gardens*.
9. Fish, Suzanne, Paul Fish, Charles Miksicek, and John Madsen, "Prehistoric Agave Cultivation in Southern Arizona," *Desert Plants*, vol. 7, no. 2 (1985).
8. Ludwig, Art, "What Does Driving Really Cost?" (Santa Barbara: Oasis Design, 11/5/2007). [www.oasisdesign.net/transport/cars/cost.htm](http://www.oasisdesign.net/transport/cars/cost.htm)
9. American Automobile Association, "Annual AAA Study Shows Driving Costs Average 52.2 Cents Per Mile." (American Automobile Association, 3/28/2006). [www.aaanewsroom.net/Main/Default.asp?CategoryID=4&ArticleID=437](http://www.aaanewsroom.net/Main/Default.asp?CategoryID=4&ArticleID=437)
10. Victoria Transport Policy Institute, "The Cost of Driving and the Savings from Reduced Vehicle Use," in *Online Transportation Demand Management Encyclopedia* (Victoria, BC: Victoria Transport Policy Institute). [www.vtppi.org/tdm/tdm82.htm](http://www.vtppi.org/tdm/tdm82.htm)
11. Cool Communities, "Urban Shade Trees" (Rome, Georgia: Cool Communities). [www.coolcommunities.org/urban\\_shade\\_trees.htm](http://www.coolcommunities.org/urban_shade_trees.htm)
12. *Urban Small Sites Best Management Practice Manual* (St. Paul: Metropolitan Council Environmental Services, 2001). [www.metrocouncil.org/environment/Watershed/bmp/manual.htm](http://www.metrocouncil.org/environment/Watershed/bmp/manual.htm)
13. Ibid.
14. Ibid.
15. Ibid.
16. Ibid.
17. Environment Canada, Freshwater website, "Quickfacts" webpage. [www.ec.gc.ca/water/en/e\\_quickfacts.htm](http://www.ec.gc.ca/water/en/e_quickfacts.htm)
18. Ibid.
19. U.S. Department of Energy, *Industrial Technologies Program, Energy, Environmental, and Economics (E3) Handbook, Appendix F* (Washington, DC: U.S. Department of Energy, 1997). [www.oit.doe.gov/e3handbook/appenf.shtml](http://www.oit.doe.gov/e3handbook/appenf.shtml)
20. Cool Communities, "Urban Shade Trees."
21. Hun-Dorris, "Advances in Porous Pavement."
22. Ferguson, Bruce K., *Porous Pavements* (Boca Raton, FL: CRC Press, 2005).
23. Ibid.
24. Ibid.
25. Low Impact Development Center, "General Permeable Paver Specifications." [www.lid-stormwater.net/permeable\\_pavers/perm\\_paver\\_specs.htm](http://www.lid-stormwater.net/permeable_pavers/perm_paver_specs.htm)
26. Personal communication with Eco-Stone representative about permeable pavers, 31 December 2003.
27. Ferguson, *Porous Pavements*.
28. Ibid.
29. Ibid.
30. Ibid.
31. Ibid.
32. Ibid.
33. Low Impact Development Center, "General Paver Specifications."
34. Ferguson, *Porous Pavements*.
35. Ibid.
36. Ibid.
37. Ibid.

## CHAPTER 8

1. Lehner, Peter H., George P. Aponte Clarke, Diane M. Cameron, and Andrew G. Frank, *Stormwater Strategies: Community Responses to Runoff Pollution* (New York: Natural Resources Defense Council, 1999).
2. Ibid.
3. *Paving Our Way to Water Shortages: How Sprawl Aggravates the Effects of Drought* (American Rivers, Natural Resources Defense Council, Smart Growth America, 2002). [www.smartgrowthamerica.org/Sprawl%20Report-FINAL.pdf](http://www.smartgrowthamerica.org/Sprawl%20Report-FINAL.pdf).
4. Lehner et al., *Stormwater Strategies*.
5. Hammond, Jonathan, Marshall Hunt, Richard Cramer, and Loren Neubauer, *A Strategy for Energy Conservation: Proposed Energy Conservation and Solar Utilization Ordinance for the City of Davis, California* (Davis, August 1974).
6. Hun-Dorris, Tara, "Advances in Porous Pavement," *Stormwater*, vol. 6, no.2 (March/April 2005).
7. Morgan, David and Sandy Trevathan, *Stormwater as a Resource: How to Harvest and Protect a Dryland Treasure* (City of Santa Fe, College of Santa Fe, and New Mexico Environment Department, 2002). [www.nmenv.state.nm.us/swqjb/Storm\\_Water\\_as\\_a\\_Resource.pdf](http://www.nmenv.state.nm.us/swqjb/Storm_Water_as_a_Resource.pdf)

38. Hun-Dorris, Tara, "Advances in Porous Pavement," *Stormwater*, vol. 6, no. 2 (March/April 2005), quoting Bruce K. Ferguson.
39. Ferguson, *Porous Pavements*.
40. Ibid.
41. Ibid.
42. Ibid.
43. Slivka, Judd, "It Stays Hotter Here," *The Arizona Republic*, 11 June 2002. [www.azcentral.com/weather/monsoon/0611heatisland.html](http://www.azcentral.com/weather/monsoon/0611heatisland.html)
44. Hammond et al., *Proposed Energy Conservation Ordinance*
45. Brown, G.Z. and Mark DeKay, *Sun, Wind and Light: Architectural Design Strategies* (New York: John Wiley & Sons, 2001).
46. Lehner et al., *Stormwater Strategies*.
47. U.S. Environmental Protection Agency, National Water Quality Inventory: 1996 Report to Congress, EPA841-R-97-008 (Washington, DC: U.S. Environmental Protection Agency, April 1998).
48. James, William, "Green Roads: Research into Permeable Pavers," *Stormwater*, vol. 3, no. 2 (March/April 2002).
49. Ferguson, *Porous Pavements*.
50. Hun-Dorris, "Advances in Porous Pavements."
51. Seattle Public Utilities, Street Edge Alternatives Project website, *SEA Street Virtual Tour* (Seattle: Seattle Public Utilities). [www2.cityofseattle.net/util/tours/seastreet/slide1.htm](http://www2.cityofseattle.net/util/tours/seastreet/slide1.htm)
52. Plant water use figures determined from calculations in "How to Develop a Drip Irrigation Schedule," a handout from Cooperative Extension, Water Resources Center, Low 4 Program, Pima County, Arizona.

## CHAPTER 9

1. Mollison, Bill, *Permaculture: A Designers' Manual* (Tyalgum, Tasmania: Tagari Publications, 1988).
2. Mollison, Bill and Reny Mia Slay, *Introduction to Permaculture* (Tyalgum, Tasmania: Tagari Publications, 1991).
3. Yeomans, Ken and P.A. Yeomans, *Water for Every Farm: Yeomans Keyline Plan* (Southport, Queensland: Keyline Designs, 1993).
4. Mollison, *Permaculture Manual*.
5. Yeomans and Yeomans, *Water for Every Farm*.
6. Mollison, *Permaculture Manual*.
7. Ibid.
8. Pinkham, Richard, *Daylighting: New Life for Buried Streams* (Snowmass, CO: Rocky Mountain Institute, 2000). [www.rmi.org/images/other/Water/W00-32\\_Daylighting.pdf](http://www.rmi.org/images/other/Water/W00-32_Daylighting.pdf)
9. Corbett, Michael and Judy Corbett, *Designing Sustainable Communities: Learning from Village Homes* (Washington, DC: Island Press, 2000).
10. Mollison, *Permaculture Manual*, 169-70.

## CHAPTER 10

1. Heede, Burchard H., "Gully Development and Control: The Status of Our Knowledge," *Research Paper RM-169: Rocky Mountain Forest and Range Experiment Station* (Fort Collins, CO: USDA Forest Service, 1976).
2. Riley, Ann, *Restoring Streams in Cities: A Guide for Planners, Policymakers, and Citizens* (Washington, DC: Island Press, 1998).
3. Heede, "Gully Development."
4. Zeedyk, Bill, *An Introduction to Induced Meandering: A Method for Restoring Stability to Incised Stream Channels* (Earth Works Institute and the New Mexico Environment Department, 2003). [www.earthworksinstitute.org/publications/publications.html](http://www.earthworksinstitute.org/publications/publications.html)
5. Zeedyk, Bill and Jan-Willem Jansens, *An Introduction to Erosion Control* (Earth Works Institute, Rio Puerco Management Committee, Quivira Coalition, May 2004).
6. Zeedyk, *Induced Meandering*.
7. Ibid.
8. Ayres, Quincy, "Recommendations for the Control and Reclamation of Gullies," *Bulletin 121: Iowa Engineering Experiment Station* (Ames, Iowa: Iowa State College, March 13, 1935).
9. Norton, J.B., F. Bowannic, P. Peynetsa, W. Quandelacy and S.F. Siebert, "Native American Methods for Conservation and Restoration of Semiarid Ephemeral Streams" *Journal of Soil and Water Conservation* 57.5, Sept-Oct 2002): p. 250
10. Norton, J.B. 2000. *Agroecology, Hydrology, and Conservation of Ephemeral Streams and Alluvial Fans, Zuni Pueblo, NM*. Ph.D. Dissertation. University of Montana, Missoula, MT Pub. No. AAT 9993970.
11. Norton et al., "Native American Methods."
12. Dougherty, John, "Dark Days on Black Mesa," *Phoenix New Times*, 24 April 1997. [www.phoenixnewtimes.com/issues/1997-04-24/feature2.html](http://www.phoenixnewtimes.com/issues/1997-04-24/feature2.html)
13. Sponholtz, Craig, *Agroecological Restoration in Southwestern Woodlands: A Comparative Analysis of Water Harvesting and Erosion Control Methods*, July 2005. Write Craig at 607 Salazar St., Santa Fe, NM 87505.

## CHAPTER 11

1. Heede, Richard and Staff of Rocky Mountain Institute, *HOMEmade Money*, Rocky Mountain Institute, 1995.
2. Walheim, Lance and Robert L. Stebbins, *Western Fruit Berries & Nuts: How to Select, Grow and Enjoy* (Tucson: HP Books, 1981).
3. Ibid.
4. Ibid.
5. Personal communication with Michael A. Crimmins, Ph.D., Assistant Professor/Climate Science Extension Specialist, Department of Soil, Water, and Environmental Science, University of Arizona on 7 February, 2007

6. Figures determined from calculations from Pima County, Arizona, Cooperative Extension, Water Resources Center, Low 4 Program. "How to Develop a Drip Irrigation Schedule" handout.
7. Phillips, Ann Audrey, James J. Riley, Charles P. Gerba, Richard Brittain, Martin R. Yoklic, Kendal Kroesen, Robert Seaman, Brad Lancaster, David Confer, and James Robinson, *Final Report: Demonstration of the Sustainability of Harvested Rainwater in Arid Lands to Meet Water Requirements and to Improve Quality of Runoff* R9# 03-478, October 2005.
8. Ludwig, Art, *Create an Oasis with Greywater: Choosing, Building, and Using Greywater Systems* (Santa Barbara: Oasis Design, 2006).
9. Hodgson, Wendy C., *Food Plants of the Sonoran Desert* (Tucson: University of Arizona Press, 2001).
10. Walheim, Lance, *Citrus: Complete Guide to Selecting & Growing More Than 100 Varieties For California, Arizona, Texas, The Gulf Coast, and Florida* (Tucson: Ironwood Press, 1996).
11. Bowers, Janice Emily, *Shrubs and Trees of the Southwest Deserts* (Tucson: Southwest Parks and Monuments Association, 1993).
12. Nabhan, Gary Paul, *Gathering the Desert* (Tucson: University of Arizona Press, 1985).
13. Stamets, Paul, *Mycelium Running: How Mushrooms Can Help Save the World* (Berkeley: Ten Speed Press, 2005).
14. Murphy, Tim, "Hackberry/Walnut Guilds," *Permaculture Activist*, Vol. V, No. 2, (May 1989).
15. Tipton, L. Jimmy, Elizabeth Davison, and Juan Barba, "Effect of Planting Practices on Tree Performance," *1997 Turfgrass Ornamentals Research Summary*, Series P-107, Cooperative Extension Station, University of Arizona, U.S. Department of Agriculture.
16. Personal communication with George Montgomery, Curator of Botany, Arizona-Sonora Desert Museum on May 28, 2003.
17. Tipton, Jimmy L., *Water Requirements of Landscape Trees: Final Report* (Phoenix: Arizona Department of Water Resources, 1997).
18. Cromell, Cathy, Jo Miller, and Lucy Bradley, *Earth-Friendly Desert Gardening* (Arizona Master Gardener Press in cooperation with The University of Arizona Maricopa County Cooperative Extension, 2003).
19. Pollan, Michael, *The Omnivore's Dilemma: A Natural History of Four Meals* (New York, Penguin Press, 2006).
20. Halweil, Brian, "Home Grown – The Case for Local Food in a Global Market," *Worldwatch Paper 163*, Worldwatch Institute 2002.
21. Corbett, Michael N., *A Better Place to Live: New Designs for Tomorrow's Communities* (Emmaus, Rodale Press, 1981).
22. Tree People with Andy and Katie Lipkis, *Citizen Forester's Guide: The Simple Act of Planting a Tree: Healing Your Neighborhood, Your City, and Your World* (Los Angeles, Jeremy P. Tarcher, Inc., 1990).
23. Cool Communities website, "Urban Shade Trees" [www.coolcommunities.org/urban\\_shade\\_trees.htm](http://www.coolcommunities.org/urban_shade_trees.htm)
24. Moll, Gary and Sara Ebenreck, *Shading Our Cities: A Resource Guide for Urban and Community Forests* (Washington, D.C., Island Press, 1989).
25. Keating, Janis. "Trees: The Oldest New Thing in Stormwater Treatment?," *Stormwater*, March 2002. [www.forester.net/sw0203trees.html](http://www.forester.net/sw0203trees.html)
26. Moll and Ebenreck, *Shading Our Cities*.
27. Ibid.
28. Ibid.
29. Cool Communities website, "Urban Shade Trees," [www.coolcommunities.org/urban\\_shade\\_trees.htm](http://www.coolcommunities.org/urban_shade_trees.htm)
30. Ibid.
31. Flannery, Tim, *The Weather Makers: How Man Is Changing the Climate and What It Means for Life on Earth* (New York: Atlantic Monthly Press, 2005).
32. Ibid.
33. Appenzeller, Tim, "The Case of the Missing Carbon," *National Geographic*, February 2004.

## CHAPTER 12

1. "Greywater Collection Plumbing and Stub-outs," [www.oasisdesign.net/greywater/stubout.htm](http://www.oasisdesign.net/greywater/stubout.htm).
2. Ludwig, Art, *The New Create An Oasis With Greywater: Choosing, Building, and Using Greywater Systems* (Santa Barbara: Oasis Design, 2006).
3. Ludwig, Art, *Builder's Greywater Guide: Installation of Greywater Systems in New Construction and Remodeling: A Supplement to the Book Create an Oasis with Greywater* (Santa Barbara: Oasis Design, 2006).
4. U.S. Environmental Protection Agency, "Cleaner Water Through Conservation," April 1995. [www.epa.gov/OW/you/chap3.html](http://www.epa.gov/OW/you/chap3.html).
5. Giffords, Gabrielle, and Val Little, "Tax Credits for Graywater Use Would Boost Conservation," *Arizona Water Resource*, Vol. 13, No. 3, November-December 2004, Water Resources Research Center, College of Agriculture and Life Sciences, University of Arizona.
6. Little, Val, *Graywater Guidelines* (Tucson: Water Conservation Alliance of Southern Arizona) [www.watercasa.org](http://www.watercasa.org).
7. "Using Gray Water in New Mexico's Residential Landscapes," brochure published by the New Mexico Office of the State Engineer, [www.ose.state.nm.us](http://www.ose.state.nm.us).
8. Ludwig, *Create an Oasis*.
9. Ibid.
10. Ibid.
11. Jenkins, Joseph, *The Humanure Handbook: A Guide to Composting Human Manure* (Grove City, Jenkins Publishing, 1999).
12. [www.greywater.com](http://www.greywater.com)
13. Ludwig, *Create an Oasis*.

14. Ibid.
15. Ibid.
16. Ludwig, *Builder's Greywater Guide*.
17. Ludwig, *Create an Oasis*.
18. *Water Conserving Onsite Wastewater Treatment Systems: Recommended Standards and Guidance for Performance, Application, Design, and Operation & Maintenance* (Washington State Department of Health, effective date May 15, 2000).  
[www.doh.wa.gov/ehp/ts/WW/pubs-ww-rsg.htm](http://www.doh.wa.gov/ehp/ts/WW/pubs-ww-rsg.htm)
19. Ludwig, *Create an Oasis*.
20. Personal communication with Brian Thacker on 8 March 2006.

## EPILOGUE

1. Personal communication with Max O. Lindegger, Planner, Crystal Waters Community, Queensland, Australia on 26 April 1996.

## APPENDIX 5

1. Infiltrator Systems ([www.infiltratorsystems.com](http://www.infiltratorsystems.com)) and Hancor ([www.hancor.com](http://www.hancor.com)).
2. Personal communication with David Omick on 27 February 2005.
3. Personal communication with Art Ludwig on 2 March 2007.
4. Ludwig, Art, *The New Create An Oasis With Greywater: Choosing, Building, and Using Greywater Systems* (Santa Barbara: Oasis Design, 2006).

# Glossary

- Aerobic.** A condition which supports organisms that thrive only in the presence of oxygen
- Air-conditioning condensate.** Atmospheric water that condenses on the cold coil of an air-conditioning unit
- Airshed.** The total area of the atmosphere that contributes air and the potential contaminants within it to a particular site
- Algae.** Microscopic plants which contain chlorophyll and live in water. Algae can impart tastes and odors to stored water.
- Alluvial fan.** A fan-shaped accumulation of sediment forming at the base of a rill, arroyo, ravine, or canyon onto a flatter plain
- Anaerobic.** A condition which supports organisms that thrive only in the absence of oxygen
- Angle of repose.** The maximum angle or steepness of slope at which a pile of unconsolidated material can remain stable
- Angular aggregate.** Aggregate whose particles are angular in shape so their flat faces interlock with each other to resist rotating and shifting. See also Open-graded aggregate.
- Annual.** Plant that takes one year or less to go through its entire life cycle: germination of the seed, vegetative growth, flowering, and seed production, after which it dies
- Apron.** A platform of rocks acting as a stabilizing check-dam spillway that absorbs and breaks up the erosive force of water spilling over the dam
- Aquifer.** Subterranean layers of sedimentary particles (sand, gravel, and rocks) laid down over geologic time, in which water fills the tiny spaces between the particles
- Arroyo.** A water-carved gully or channel in arid lands, usually somewhat small with steep banks, and dry most of the time due to infrequent rainfall and the shallowness of the cut which does not penetrate below the level of permanent ground water
- Auxin.** A natural plant hormone that regulates various functions of plant growth, including cell elongation
- Bankfull.** A flow of water through a watercourse that just fills the channel to the top of its banks and at a point where the water begins to overflow onto a floodplain
- Batter.** A deliberately constructed lean of a retaining wall back toward the slope to prevent shifting soil from eventually toppling the wall
- Berm 'n basin.** A water-harvesting earthwork laid perpendicular to land slope, consisting of an excavated basin and a raised berm located just downslope of the basin
- Biocompatible.** A material whose decomposition creates products that are beneficial for, or at least not harmful to, the environment in which it is deposited.
- Biofiltrate.** The science of filtering water-borne pollutants with plants and other living organisms
- Bioremediate.** The use of living organisms such as bacteria, fungi, and vegetation to clean up or remove other pollutants from soil, water, and wastewater
- Blackwater.** Wastewater from toilets (some regulators consider kitchen sink and dishwasher wastewater as blackwater too), that has higher levels of solids and coliform bacteria than greywater sources
- Bladed land/Blading.** Practice of scraping away topsoil and compacting remaining subsoil with large earth-moving machinery to create a building pad devoid of organic matter
- Bleed-off (cooler).** Water discharged from evaporative coolers to remove accumulating salts
- Boomerang berm.** Semicircular berm open to, and harvesting, incoming runoff from upslope
- Branched drain greywater system.** System of pipes, valves, or "double L" or "Y" fittings that "branch" or split

- a gravity-fed flow of greywater to as many as sixteen outlets within mulched basins distributed in a landscape
- Break line.** The dividing “line” in a landscape where a slope changes from a gentle grade where sediments settle out of slow-moving runoff, to steep grades where sediments are picked up and carried away by faster-moving runoff
- Brownfields.** Abandoned or underused industrial or commercial facilities where redevelopment is complicated by environmental contamination of soils and/or water
- Btu.** British Thermal Unit. A unit used to measure the energy required to raise the temperature of 1 pound of water by 1 degree Fahrenheit. One Btu equals 252 calories, 778 foot-pounds, or 0.293 watt hours.
- Canale.** Roof drain found on Santa Fe-style buildings with parapet walls
- Catchment surface.** Surface from which runoff is captured with earthworks or a cistern for beneficial on-site use
- Central Arizona Project (CAP).** A multibillion dollar canal project that diverts water from the Colorado River and pumps it 1,000 feet (300 meters) uphill and over 300 miles (482 km) through the desert to reach farms and the cities of Phoenix and Tucson, Arizona
- Channel flow.** The concentrated distribution of runoff within distinct channels or drainages. Look for nick points, rills, gullies, bank cutting, different sediment sizes, vegetation growing within channels, and exposed roots to assess the force of the flow and the health of the channel.
- Channelization.** Constricting and straightening water flow by sealing and smoothing the banks and sometimes the bed of a waterway, often with concrete. It can be compared to a shotgun barrel for water. Channelization increases the velocity of water flow through, and downstream of, the channelized area, reducing infiltration of water into the soil and sometimes deepening the channel.
- Check dam.** A low, leaky barrier placed perpendicular to the flow of water within a drainage to slow the water’s flow, infiltrate more water into the soil, and hold soil and organic matter higher in the watershed
- Chill hours.** The number of winter hours below 45° F needed for dormant deciduous trees grown in warm-winter climates to leaf out and flower in the spring. The number of winter hours above 60° F is subtracted from the number of hours below 45° F to figure the number of hours of chill received for a particular day.
- Cistern.** A tank used to store rainwater
- Coliform bacteria.** Common bacteria, found in soil and water, that grow in the intestines of warm-blooded animals. Generally they are not harmful, and testing water for total coliforms is not a suitable indicator of fecal contamination. Instead, test for *Escherichia coli* (*E. coli*) when measuring microbial quality of drinking water and the presence of fecal contamination.
- Combined sewer.** Sewer that contains sewage, household wastewater, and rain runoff from streets, yards, and driveways
- Commodify.** To turn a natural resource into a limited-access commodity to be bought, sold, and hoarded
- Commons.** A natural resource or ecosystem that provides the ecological basis of life and whose sustainability and equitable allocation depends on cooperation among its community members
- Communitify.** To work together to enhance a natural resource and the related community by managing the sustainable, fair use, and equal accessibility of the resource
- Community.** Represents all living and interacting organisms in an ecosystem, including people, other animals, plants, fungi, and bacteria
- Compost.** A soil amendment made from decomposed organic matter. The act of composting speeds up the decomposition of the organic matter, while retaining more nutrients by keeping the compost pile moist (in a pit, in the shade, covered in mulch), lightly aerated, and by balancing the amount of carbon material (dry woody material like straw or sawdust) to nitrogen-rich material (green plant material, fresh manure, urine), which also prevents odors.
- Composting toilet.** A waterless toilet in which dry carbon-rich material such as straw or sawdust is added to its aerobic composting chamber to help decompose (without objectionable odor) nitrogen-rich human feces and urine into high-grade fertilizer
- Contour berm.** A berm ’n basin constructed along a contour line
- Contour line.** A level line perpendicular to the slope of the land
- Coppice/coppicing.** A method of cutting/pruning trees and shrubs to obtain wood without killing the plant, while also encouraging new vigorous growth
- Crossover riffles.** Also called a “meander crossover,” this is a straight section of drainage where sediments naturally deposit in areas of slower-moving water.
- Culvert.** A drainage pipe made to transport water beneath a roadway. Metal culverts can be made into above-ground cisterns.
- Curb cut.** An opening in a street-side curb that allows street runoff to exit the road and enter and infiltrate well-mulched and vegetated street-side water harvesting earthworks
- Daylighting pipe.** Outletting a pipe into the open air
- Daylighting a waterway.** Uncovering and revegetating a previously piped or buried waterway to recreate a natural, living watercourse.
- Deciduous.** A characteristic of a plant to seasonally drop its leaves to better survive cold, heat, or drought
- Debris.** Large items that could clog a rainwater system, such as a downspout screen, irrigation emitter, or permeable

pavement. Debris may include leaves, branches, sediment, or trash.

**Degenerative.** A type of investment that starts to degrade or break down as soon as it is made, requires on-going investments of energy and outside inputs to keep it functional, *consumes* more resources than it produces, and typically serves only *one* function

**Detention/Retention basin.** A structure that decreases stormwater flow from a site by temporarily holding the runoff on site. This is not a water-harvesting structure unless the held water is beneficially utilized on site (irrigating vegetation for example).

**Ditch Witch.** Gas-powered ditch digger, for digging large ditches. See [www.ditchwitch.com](http://www.ditchwitch.com) for photos and dealers.

**Diversion swale.** A gently sloping drainageway that moves water slowly downslope across a landscape, while simultaneously allowing some of it to infiltrate into the soil

**Drip irrigation.** An irrigation strategy applying water via an emitter to the root zone of a plant at a rate slow enough (usually less than 3 gallons [about 11 liters] per hour) to allow the soil to absorb it without runoff

**Dry farm.** Farming without supplemental irrigation, and relying solely on rainfall for needed irrigation

**Dryland.** Area of the world where potential average yearly moisture loss (evapotranspiration) exceeds average yearly moisture gain (precipitation)

**Dry-stacked retaining wall.** A naturally porous wall of stone, brick, or salvaged concrete laid “dry” without mortar, and maintaining a batter or lean of 5° to 15° into the slope to help counter the weight of upslope earth

**Dumpster.** An exterior trash container from which opportunistic scavengers can salvage discarded resources

**Ephemeral water flow.** Water that flows only seasonally or during and just after storms

**Erosion.** Wearing away of soil and rock by gravity, wind, and water, intensified by human land-clearing practices

**Evaporation.** The change of water from a liquid to a gas

**Evapotranspiration.** The combined measurement of water loss to evaporation and transpiration through the pores of vegetation

**Evaporative cooler.** Also known as swamp coolers, these coolers wet porous pads of cardboard, wood shavings, or burlap through which air passes and is then cooled by the evaporating moisture. A fan blows the cooled air into a building or area needing to be cooled.

**Exotic vegetation.** Plants that were originally not native to an area. In drylands, such plants often have higher water requirements than low-water-use native or indigenous vegetation, and sometimes can become invasive, but are introduced for ornamentation, fast growth, food produc-

tion, or other characteristics. Examples of exotic vegetation in Tucson, Arizona, would be Chilean mesquite trees (invasive), buffle grass (extremely invasive), and citrus trees. See also Native vegetation.

**Ferrocement.** A method of building or a building material using cement, sand, and water to cover a reinforcing skeleton of metal wire or mesh material; often called thin shell

**First flush system.** A device or length of capped pipe that diverts the dirtiest or foulest first flush of water running off a catchment surface away from a cistern

**Flow splitter.** A “double L” or “Y” pipe fitting that splits or “branches” greywater flow in two for wider passive distribution within a landscape

**Foodshed.** The total food system (gardeners, farmers, bakers, butchers, transportation system, markets, restaurants, etc.) and the geographical area in which it resides or travels before it gets to a particular community or mouth

**French drain.** A trench or basin filled with porous materials such as gravel or mulch that have ample air spaces between them allowing water to infiltrate quickly into the drain and percolate into the root zone of the surrounding soil, while creating a stable walkable surface

**Gabion.** A check dam in which rocks are encased in a wrapping of wire fencing or a wire basket that holds everything together, sort of a rock burrito in a wire tortilla

**Gabion basket.** A rectangular wire basket made to contain many rocks, forming a check dam across a drainage

**Generative.** A type of investment that starts to degrade as soon as it is made, requires on-going investments of energy and outside inputs to keep it functional, *produces* more resources than it consumes, and typically serves *multiple* functions

**Geocell.** A matrix of open, plastic cells that can be filled with aggregate, soil, or turf to create a stabilized porous pavement

**Greywater.** Wastewater originating from a clothes washer, bathtub, shower, or sink that can be safely reused to irrigate a landscape

**Greywater harvesting.** The practice of safely directing the greywater generated at a site to the root zone of perennial plants in the yard where it can help grow beautiful and productive landscapes

**Greywater stub out.** A greywater plumbing connection installed during a building's construction or remodeling, allowing easy and inexpensive future access to the drainwater stream. To utilize the greywater, a simple greywater distribution system is set up within the landscape, then hooked up to the stub-out.

**Groundwater.** Water that has naturally infiltrated into and is stored within an underground aquifer

**Guild.** A harmonious assembly of living species such as plants, animals, and people and nonliving elements such as rocks or buildings that perform better through their cooperative interrelationships than they would as individuals

**Gully.** A large erosive drainage or arroyo

**Hard water.** A characteristic of water containing dissolved calcium and magnesium, which is responsible for most scale formation in water heaters and pipes

**Hardscape.** Hard paving material such as concrete sidewalks, asphalt streets, and brick patios

**Headcut.** The growing upstream edge of an erosive gully or rill

**Heat-island effect.** A rise in temperature caused by hardscape (concrete, asphalt, buildings) that is heated by the sun, stores the heat like a battery, and then releases the heat during the evening

**Heel-to-toe.** Stable placement of check dams where the toe of the level terrace of accumulating soil and sediment behind a downstream dam extends to the heel of the downstream-facing base of the next upstream dam

**Humanure.** Composted human feces and urine used as a high-quality fertilizer

**Hydrologic cycle.** The continual movement of water between the earth and the atmosphere through precipitation, infiltration into, and release from living systems, evaporation, evapotranspiration, and precipitation again

**Impervious.** A nonpermeable solid surface

**Imprinter roller.** An imprinting tool fabricated from a 10- to 20-foot (300–600 cm) long, 20- or 24-inch (50–60 cm)-diameter smooth roller with 10-inch (25-cm) lengths of 6 × 6-inch (15-cm) to 8 × 8-inch (20-cm) angle iron welded onto the roller in a pattern of staggered star rings. When rolled behind a tractor, each angle iron tooth will create a depressed microwatershed about 1 foot (30 cm) square, capable of holding 0.79 to 1.3 gallons (3 to 5 liters) of water per imprint on level ground. Imprinted soil will retain and encourage the infiltration of all the water from a 2- to 3.5-inch (50- to 88-mm) rainfall.

**Imprinting.** A water-harvesting technique used to accelerate the revegetation of disturbed or denuded land with annual precipitation from 3 to 14 inches (76 mm to 330 mm) by creating numerous small, well-formed depressions in the soil that collect seed, rainwater, sediment, and plant litter, and provide sheltered microclimates for germinating seed and establishing seedlings

**Infiltration.** The movement of water from the land's surface into the soil -

**Infiltration basin.** A landscaped, level-bottomed, relatively shallow depression dug into the earth that collects, infiltrates, and utilizes the rain that falls within it, the runoff draining into it from the surrounding area, and potentially household greywater too

**Infiltration chamber.** An empty, bottomless, subsurface plastic chamber into which greywater is released, reducing direct human or animal contact with the greywater, and reducing the risk of roots growing into the greywater pipe

**Integrated design.** A very efficient design methodology that provides on-site needs (e.g., water, shelter, food, aesthetics) with on-site elements (e.g., stormwater runoff, greywater, cooling shade, warming sun, vegetation) by assessing all on-site resources, and placing and designing all new elements so they build on these existing resources and help divert, deflect, or convert the site's challenges into still more resources. Integrated design saves resources (e.g., energy, water, money), while enhancing the function and sustainability of a site.

**Jandy valve.** My preferred, fully adjustable, three-way diversion valve for a household greywater distribution system

**Keyline.** A contour line surveyed to run through the keypoint of the first, uppermost, or primary valleys. The keypoint is the point where the slope of a valley floor suddenly increases in steepness as you walk up the watercourse. Thus, the steeper erosional slope is above the keyline and the more gradual depositional slope is below it. See also Break line.

**Keyline concept.** A concept developed by P.A. Yeomans that improves contour plowing through observing normal landform and topography. Successive natural contour lines vary from one another, rather than forming even parallel lines. Thus when plowing a number of furrows parallel to a contour line the plow furrows soon deviate from a true contour. Rainwater in these furrows will thus flow sideways along the falling "contour" line. This can often concentrate water in a way that exacerbates erosion instead of reducing it. Yeomans was the first to appreciate the significance of this phenomenon, and created keyline cultivation to utilize this "off contour" drift in cultivating furrows to control the movement of rainwater for the benefit of the land. The keyline contour must first be surveyed. Above the keyline, contour plowing must progress up the slope parallel with the keyline. Below the keyline, contour plowing must progress down the slope parallel with the keyline. The keyline furrows then direct water from wetter valleys to drier ridges to spread the water out rather than concentrating it, and to markedly increase the time of contact between rainwater and soil to increase infiltration and reduce erosion.

**Land subsidence.** The settling or sinking of land resulting from the compaction of the sedimentary layers of an aquifer. This occurs when groundwater is withdrawn from the pore spaces of these sedimentary layers faster than the water can be naturally replaced

**Landscape fabric.** Permeable fabric sometimes used under gravel paving to keep gravel from migrating into the subsoil, or around French drains with perforated pipes to slow root growth into the pipe. The fabric allows water to pass through but hinders the movement of solid material.



Landscape fabric is available from garden, landscape, and hardware suppliers.

**Lawn roller.** A cylinder that can be filled with water, then pulled with a handle and rolled over soil, gravel, or a lawn to compact and flatten the surface

**Living sponge.** A natural mix of fertile soil, soil organisms, organic surface mulch, and vegetation that quickly infiltrates water into the soil and pumps some of it back out through the vegetation to produce additional resources such as food, shelter, wildlife habitat, and beauty

**Low-water-use vegetation.** Vegetation that, once established, can subsist on natural rainfall alone

**Microcatchment.** A small, localized catchment surface, such as a roof, section of road or pathway, or earthen surface directing its runoff to an adjoining water-harvesting strategy in which plants are watered directly by the harvested runoff

**Microclimate.** A more temperate or extreme localized climate created by the shelter or exposure of adjacent landscape features or buildings

**Microorganisms.** Plants or animals of microscopic size

**Mulch.** A porous layer of organic matter or rock on the surface of the soil (not mixed into the soil) that increases the porosity and fertility of the underlying soil, while reducing soil moisture loss to evaporation

**Municipal water use.** Use of "city water" that you pay for, and which often is piped and pumped long distances. The source is typically surface water (such as from reservoirs or rivers) or groundwater pumped from aquifers.

**Native vegetation.** Vegetation indigenous to a 25-mile (40-km) radius of a site and found within 500 feet (150 m) of the site's elevation. Some sites may require defining native with a larger radius to bring in more plant diversity, but the smaller the radius the more likely that plants can thrive within the climatic constraints of the site.

**Natural recharge.** The rate at which water naturally fills or replenishes an aquifer

**Net-and pan system.** A modified series of boomerang berms connected directly to one another, concentrating harvested runoff at multiple points in the landscape. A completed system looks like a "net" of berms draped over a hillside with "pans" or basins inside each segment of the "net."

**Nitrogen-fixing.** The ability of a microorganism to "fix" or convert atmospheric nitrogen gas to a chemically combined form, ammonia, which is essential to plant growth. These microorganisms have a symbiotic relationship with certain plants, whereby they live in their root nodules and convert atmospheric nitrogen into a form usable for the plant. Bacteria of the genus *Rhizobium* inoculate plants in the families of Leguminosae and Ulmaceae, while an actinomyce of the genus *Frankia* inoculates plants in the

Betuleceae, Casuarinaceae, Coriariaceae, Elaeagnaceae, Myricaceae, Rhamnaceae, and Rosaceae families.

**Nonpoint-source pollution.** Pollutants from many diffuse sources. Nonpoint-source pollution is caused by storm-water or snowmelt moving over the ground. The runoff picks up and carries away natural and human-made pollutants, finally depositing them into lakes, rivers, wetlands, coastal waters, and even underground sources of drinking water.

**Nonpotable water.** Water that is not safe for human consumption without adequate filtration and/or treatment

**Oasis zone (drier).** An unpaved area naturally receiving more water than rainfall due to runoff from adjoining areas, but *not* receiving supplemental greywater. In the built environment the drier oasis zone is typically within 10 to 20 feet (3 to 6 m) of an impervious hardscaped area where the hardscape's runoff supports a greater density and/or diversity of vegetation.

**Oasis zone (wetter).** An unpaved area naturally receiving more water than rainfall due to runoff from adjoining areas *and* supplemental greywater. In the built environment the wetter oasis zone is typically around gathering spots of human caretakers like patios, front porches, and paths within 30 feet (9 m) of a home where water resources such as roof runoff and/or path and patio runoff and household greywater are readily available to support a greater density and/or diversity of vegetation.

**On-site water budget.** The total water "income" on a site is the rain falling on it, plus water gained by natural runoff, minus water lost to runoff. To achieve water sustainability at a site, the annual on-site water "withdrawal" or consumption (domestic/interior and landscape/exterior) must be less than this water income. Note that greywater generated and reused on site is sometimes also included in the site's water income, but unlike rainwater, this is not necessarily a sustainable water source if originally pumped or trucked in from off site before the water is used and becomes greywater.

**Open-graded aggregate.** Aggregate having a narrow range of particle sizes and open void spaces that improve porosity between the particles. See also Angular aggregate.

**Open-pollinated.** Nonhybrid plants produced by transferring pollen from two parents from the same variety, which in turn produce offspring just like the parent plants. Heirloom vegetables are open-pollinated varieties passed down from generation to generation.

**Organic.** Non-genetically modified life grown or raised without synthetic fertilizers, pesticides, or sewage sludge in such a way that the fertility of associated soil improves with time

**Organic groundcover.** Natural materials, such as dead plant material, manure, or compost, that break down and improve the soil

**Orientation.** How a building or plantings are oriented in relationship to the winter's noonday sun, and the angles of

- the rising and setting sun year round. Buildings with their longer wall and windows facing the winter noonday sun, and shorter walls and fewer windows facing the rising and setting sun, are much easier to passively heat and cool than buildings of the opposite orientation.
- Outlet chamber.** An empty, bottomless, louver-sided subsurface chamber into which greywater is released, reducing the potential that people or animals come into direct contact with the greywater, and reducing the risk of roots growing into the greywater pipe
- Overflow.** The planned and stabilized exit route for excess water from a water-harvesting earthwork or tank
- Overflow water.** Excess water exceeding the storage capacity of a water-harvesting earthwork or tank
- P-trap.** Drain pipe in the shape of the letter “P” used to prevent sewer gas from entering a building by keeping a water seal in the bend of the pipe
- Partnership.** A model of relating that emphasizes equality between all people and the natural environment and its life forms. Since the primary organizational concern is not ranking, relationships do not revolve around figuring out who is boss, who is in control, or who is the steward. Rather, the primary organizational principle is linking and understanding, bringing people and whole ecosystems together in mutually beneficial relationships, and figuring out how individual responsibilities and contributions blend with natural processes to produce extraordinary creative results benefiting the whole.
- Parts per million (ppm) and parts per billion (ppb).** Used to quantify amounts of pollutants in water, and other substances
- Pathogen.** An organism that may cause disease
- Peak surge.** The highest short-term volume of expected water flow
- Percolation.** The downward movement of water infiltrating the soil
- Perennial.** Plant that lives longer than two years
- Perennial water flow.** Water that continually flows year round, year after year
- Permaculture.** A methodology of integrated, sustainable design based on natural systems
- Permeable paving.** A broad term for water-harvesting techniques that use porous hardscape/paving materials that let water pass through the pavement and infiltrate into soil, passively irrigating adjoining plantings, dissipating the heat of the sun, reducing soil compaction, allowing tree roots beneath the paving to breathe, filtering pollutants, and decreasing the need for expensive drainage infrastructure
- pH.** The measure of acidity or alkalinity ranging from 1 to 14. Below 7 is increasingly acid, 7 is neutral, and above 7 is increasingly alkaline.
- Pond.** An open earthen holding area for water. Ponds can be appropriate in drylands if filled with runoff harvested on site to provide a backup water supply in the dry season, but are inappropriate if groundwater or off-site water is consumed or pumped into the pond to keep it full.
- Potable water.** Water that is safe for human consumption and can be used for the greatest variety of uses
- Rain sensor.** A water-saving device that monitors rainfall and is connected to an automatic irrigation timer in order to shut the timer and irrigation off during or immediately after rainfall
- Ramada.** An outdoor shade structure under which it is comfortable to gather
- Reclaimed water.** Greywater and blackwater drained offsite, treated offsite to meet nonpotable standards, and then pumped to selected destinations for reuse
- Regenerative.** A type of investment that starts to grow or improve once it is made, does not require on-going investments of energy and outside inputs to keep it functional, *produces* more resources than it consumes, typically serves *multiple* functions, and can *reproduce itself*
- Renewable.** A resource that can be replaced in a short period of time. Renewable does not necessarily mean sustainable. For instance, the transport of “renewable” Colorado River water pumped to Tucson and Phoenix, Arizona, consumes huge amounts of resources, while over-allocation of the river has so depleted its flow that vast tracts of the Colorado River delta and much of the culture of the indigenous people of the area have been destroyed.
- Reservoir.** A structure for storing water. It may be open or covered.
- Retaining wall.** A structure that holds back a slope, preventing erosion
- Reverse osmosis.** A process of forcing water through porous membranes to filter out such solids as microorganisms, and organic and inorganic chemicals, to produce very pure water
- Rill.** A tiny erosive drainage in which loose soil has washed away. It is very common on eroding slopes where roadways have been cut into hillsides or on bare dirt driveways and roads that run downslope.
- Riparian.** Relating to or living within or beside a perennial body or flow of water such as a lake, spring, creek, or river
- Runoff.** Water that flows off a surface when more rain falls than the surface can absorb
- Runoff coefficient.** A number between zero and one that indicates the average percentage of rainwater that runs off a type of surface. For example, a rooftop with a runoff coefficient of 0.95 indicates that 95% of the rain falling on that roof will run off.
- Runon.** Runoff water that runs onto a site

- Saturated soil.** Soil in which the pore space is completely filled with water
- Sediment.** Soil, sand, and minerals washed from land into water or lower reaches of land, usually after rain. Excessive sediment can destroy fish-hatching areas; clog animal habitats, French drains, and porous pavement; and obscure waters so that sunlight does not reach aquatic plants.
- Sewer.** A pipe used to transport sewage elsewhere
- Sheet flow.** The relatively even distribution of runoff water over the land surface, following the slope of the land downward but not focused into distinct channels. Sheet flow has most likely occurred after a large rainfall if you don't see distinct channels in an area of sloping bare dirt.
- Slope.** A measurable steepness indicating a change in elevation from one point to another. Slope can be measured in degrees from horizontal, percentages, and proportions. The greater the slope the greater the need for vegetation, and the more care needs to be taken in designing earthworks.
- Soakin.** Water that infiltrates the soil rather than being lost to runoff
- Soft water.** Water containing little or no dissolved calcium and magnesium
- Solar access.** Maintaining full winter-sun exposure to winter-sun-facing windows, solar water heaters, solar photovoltaic panels, solar ovens, and winter gardens
- Solar arc.** A number of shading elements such as trees, cisterns, trellises, covered porches, and overhangs laid out in the shape of an arc or semicircle, open to the winter sun and deflecting the rising and setting summer sun from any objects, such as a home or garden placed within the arc
- Spillway.** A planned and stabilized route for overflow water
- Sponge.** A material able to quickly absorb and hold water.  
See also Living sponge.
- Spreader drain.** A diversion swale variation, designed with the upper and middle portion of its basin sloping gradually, while the bottom length of the basin is constructed dead level on contour without a downslope berm, to create a very wide overflow spillway. Due to the very wide, level spillway the overflow water flows as a sheet flow.
- Stabilizing.** Methods used to reduce further erosion. Can include reduction of slopes, retaining walls, rock-clad spillways and aprons, and vegetation
- Stewardship.** The duties and obligations of a steward. The careful and responsible management of communities, natural resources, and ecosystems. The weak link of the stewardship model is that it can become a dominator, rather than a partnership model. In such a case, the steward may view him- or herself as being above or dominant of that which is being stewarded, rather than being just another integral part among the myriad others, that equally make up and are responsible for the health of the whole.
- Stormwater.** Rainwater once it has landed on a surface
- Stub outs (greywater).** Plumbing connections installed in new construction that allow easy future access to the drainwater stream to redirect greywater to the landscape.
- Subsoil.** The naturally compacted soil found beneath less compacted, more organic-matter-rich topsoil
- Subwatershed.** A smaller watershed within, and making up part of, a larger watershed
- Sun trap.** An area having a more comfortable and moderate microclimate due to the site's being open to the winter's rising and noonday sun, while shaded from the afternoon sun primarily in summer
- Supplemental water.** An auxiliary source of water meant to augment natural on-site rainfall resources
- Surface water.** Water that flows on the surface of the land, such as water flowing in creeks and rivers
- Surge basin.** A pond placed at the inlet point of a diversion swale to diffuse the kinetic force of the incoming water with the water standing in the pond. It is often 12 to 18 inches (30 to 45 cm) deep.
- Sustainable.** Describes a condition or practice in which biodiversity and renewability of ecosystems, cultures, and natural resource production and quality are maintained over time
- Tamping.** Compacting dirt or gravel by foot stomping or other means
- Terrace.** A relatively flat "shelf" of soil, sometimes called a bench, built parallel to the contour of a slope. The terrace reduces the steepness of a section of a slope, reducing runoff and erosion, while increasing infiltration. Terraces can be built with or without a retaining wall depending on the steepness of the slope.
- Thermophilic.** Characterized by having an inclination for high temperatures above 105° F (40.5° C), or for being able to generate high temperatures
- Three-way diverter valve.** A valve used to direct or divert water flow in one of two directions. Found at pool and spa supply stores, these valves can be incorporated into greywater plumbing to allow the user to send the greywater to the landscape or sewer as they please.
- Tinaja.** A desert water hole naturally carved into bedrock
- Topsoil.** The upper layer of soil containing most of the organic matter and fertility
- Total dissolved solids (TDS).** Indicates how many minerals and other solvents are contained in one gallon or liter of water. Technically, these are the dry residues that remain after the water has been heated to 180° C.
- Toxic.** Any substance able to cause injury to living organisms when eaten, absorbed through the skin, or inhaled into the lungs

**Transpiration.** The loss of moisture from plants to the air via the stomata within their leaves

**Vegetation.** Plants. However, in a water-harvesting context, vegetation is the life that emerges from a water-harvesting system, the living cistern that makes your system regenerative. Vegetation invites rainfall and runoff water into the soil; we can then use that water in the form of shade and passive cooling, shelter, fruit, vegetables, fiber, soil-builder, forage for livestock and wildlife, erosion control, building materials, herbal medicine, and beauty.

**Wastewater.** Water used by humans and considered a “waste” needing to be disposed of. Creating such a thing is the real waste.

**Water budget** (of a site). See On-site water budget.

**Water softener.** A device that replaces calcium and magnesium ions from hard water with sodium ions. Without the calcium and magnesium the water becomes “soft,” but the added sodium or salt is not good for plants or soil. Softened water is not good for use with greywater systems, and the softener backwash is even worse since it has an even higher salt content.

**Water table.** The upper limit of a body of groundwater

**Watercourse.** An ephemeral or perennial waterway, large or small. Sometimes referred to as a drainageway, arroyo, stream, or wadi

**Watershed.** The total area of a landscape draining or contributing water to a particular site or drainage

**Well.** A human-made hole in the earth from which groundwater is withdrawn

**Winter-sun side.** In the northern hemisphere, the south-facing side of buildings, walls, and trees; the north-facing side is the “winter-shade side.” This is because the winter sun stays in the southern sky all day. In the southern hemisphere the “winter-sun side” is the north-facing side.

# Index

## A

abundance, 9, 16, 323–25  
acacia, 265  
advantages, of rainwater harvesting, 10  
A-frame level, 37, 339, 345–47  
agave, 166, 167, 251  
aggregate, 110, 182–84, 186  
    See also gravel  
agriculture  
    and diversion swales, 205, 207  
    dry-farmed fields, 16  
air conditioners, 116, 290, 291, 294,  
    298, 301  
    trees as, 285  
Alaska, 186  
alluvial fans, 246  
altitude, temperature drop, 267  
American Disabilities Act (ADA), 182  
American Forestry Association, 284  
American Forests, 284  
American Rivers, 173  
American Water Works Foundation, 18  
Americorps, 252  
Andes, 89  
angle of repose (rocks), 235  
animals  
    fencing, 277–78  
    as water indicators, 338  
    See also wildlife  
Apache plume, 245, 248  
apples, 260  
apron (spillway), 98  
    check dams and gabions, 242–45,  
    248  
aquifers, 16  
arc of vegetation, 263

Arivaca Watershed Education Task  
    Force, 328  
Arizona, 24, 82, 147, 150, 166–67, 246,  
    252, 253, 271, 317, 274, 393  
    Arivaca, 328  
    buildings, residences, locations, 24,  
    38, 139, 150, 151, 154, 173, 175,  
    211, 246, 247, 251, 253, 254, 256,  
    293, 322  
    Cascabel, 252–3  
    greywater legality, 294, 295, 304  
    Kitchen Resource Drain, 303, 318,  
    371–77  
    Marana, 150–51  
    Oracle, 266  
    Phoenix, 18, 301, 311  
    Pima County, 38, 317, 319  
    See also Tucson  
Arizona Department of Environmental  
    Quality (ADEQ), 316, 318, 319,  
    371, 376  
Arizona Department of Water Resources,  
    252, 269–70, 369  
Arizona Meteorological Network, 352  
Arizona-Sonora Desert Museum, 211  
arroyos, 228  
    See gullies  
Ashworth, Suzanne, 267  
asphalt, 180, 191  
ATV trails, 186  
Aubrey Organics' shampoo, 298  
Audrey, Ann, 79  
Austin, Joe and Valer, 253–56  
Australia, xxiii  
automobiles, 173, 175, 179  
    alternatives, 178, 384  
    pollutant oil, 174, 180

## B

backyard  
    application, definition, 88  
    sprawl, 44  
    See also yard  
bacteria, 174  
    and greywater, 291, 294, 295  
Bainbridge, David, 115, 138  
banana check dam shape, 236  
banks, 335–36  
    for check dams, gabions, 234–35,  
    236  
bar ditch and diversion swale, 205, 221  
bark beetles, 169–70  
bark mulch, 157, 159, 182  
Barrow, Christopher, 98  
basins, 29, 50, 123, 127, 196, 215,  
    216, 275  
    for berm 'n basins, 68, 69, 74  
    depth, 127, 128, 339  
    and existing vegetation, 132  
    and greywater, 294–97, 302–306,  
    308, 314  
    sub-basins, 124  
    vegetation water needs, 129–31  
    See also berm 'n basins; infiltration  
    basins  
bathroom sinks, 289, 292, 293, 297,  
    298, 299, 300  
bathtub greywater, 293, 297, 298,  
    299, 300  
    accessing with siphon tube system,  
    303, 310, 311–14  
bats, 271  
Beckoning Cistern (Seattle), 103  
Bedrock Watershed, 253  
berm 'n basins (b'nbs), 41, 42, 65, 188,  
    267, 381 (see chapter 2)

calculations, 71, 72, 356–58  
 construction, 73–77  
 dimensions, 69, 73  
 and erosion control, 332, 333,  
 334, 336  
 and slope, 67  
 berms, 29, 50, 65, 74, 75, 80, 81  
 for berm 'n basin, sizing, 68, 69  
 of diversion swales, 214, 215,  
 216, 218  
 and infiltration basins, 123, 128  
 for terraces, 93, 96, 97, 109  
 See also berm 'n basins; contour  
 berms  
 Bermuda grass, 157, 164, 165, 283  
 bindweed, 157  
 Bioler toilet, 319  
 Bio-Pac products, 298  
 bioremediation, 174, 180  
 bioswale, 205  
 birds, 32, 266, 273, 286, 338  
 Black Mesa Permaculture Project, 252  
 blackwater, 291  
 bladed landscape, 153, 154  
 bleach, 298  
 Blue Stake, 44, 195, 198, 343  
 boomerang berms, 28, 66, 79, 132, 333,  
 334, 339  
 boron, 298  
 branched-drain greywater system, 302,  
 303–304  
 break lines, 79, 207, 208, 211,  
 336–37, 386  
 brick porous paving, 186  
 bridges, check dams as, 250  
 Brill-Duisberg, Emilie, 327  
 Brooks, Jim, 168  
 brownfields, 181  
 brush  
   berms, 81, 169  
   check dams, 230, 246–48, 387  
   rill-repair, 247  
   weirs, 333, 334  
 bucket drip irrigation, 280  
 bucket greywater outlet shield, 305, 321  
 Buenos Aires Wildlife Refuge, 328  
 buildings, 272  
   basements, 181  
   footprints, 179, 385  
   foundations, 44, 56, 107, 343  
   stem wall, 56, 128  
   and water-harvesting basins, 77, 121  
 bulldozers, and imprinting, 145, 146  
 bunyip water level, 41, 66, 89, 339–44  
   to determine contour, 67, 68, 91,  
   206, 208, 221  
 Burns, Barney, 102  
 Bwannie, F., 246  
 Byrd, Don, 169

**C**  
 cacti, 130, 258, 266, 270, 272,  
   and mulch, 162, 163  
   plant list, 367, 368  
   See also nopal; saguaro  
 calculations, 348–64  
   basin volume, 125–26, 360–62  
   berm 'n basin, 71, 72, 356–58  
   catchment areas, 59, 60, 350–51  
   diversion swale, 362–64  
   infiltration basins, 360–62  
   plant water requirements, 369–70  
   runoff and runoff, 60, 63, 352,  
   353–55  
   terrace, 90, 91, 358–60  
 caliche, 275  
 California, 210  
   Berkeley, 219  
   Davis, 179, 219–20  
   Occidental Arts and Ecology Center,  
   247, 267  
   San Diego, 18  
   Santa Monica, xxvi, 283  
   See also Los Angeles  
 California poppy, 251, 274  
 campsites, and mulch, 163–64  
 Canada: Ontario, 190  
 canales (from roofs), 106, 107, 110–11  
 Canary Islands, 219  
 canopy diameter, and water  
   requirements, 370  
 Cape Verde, 88  
 carbon dioxide, 25, 284, 285  
 carbon-nitrogen ratio and mulch, 154,  
   156, 159, 165, 168  
 cardboard, 110, 157, 164  
 carob tree, 130, 272  
 Carr, Ann, 144  
 cars. See automobiles  
 catchment calculations, 352–55  
 Catholic Church, 101  
 cattle, 229  
   and imprints, 146, 148  
   rotation, 252, 255  
 cautions, earthworks, 44  
   French drains, 106, 113  
   check dams, 233  
   terraces, 88  
   greywater, 295  
 channelization, channel flow, 332–36  
 check dams, 23, 27, 43, 101, 211, 228,  
   328, 387–88 (see chapter 10)  
   as erosion control, 334, 335  
   vs. gabions, 229  
   loose rock construction, 234–36  
   one-rock check dam, 77, 216, 217,  
   245–46, 387  
   siting, size, spacing, 230–34  
   See also gabions  
 chemicals and greywater, 296  
 chicane or pullout, 176, 177

chickens, 165, 283  
 chilling requirement, fruit trees, 261  
 chiltepine, 272, 273  
 Chiricahua Mountains, 253  
 chlorine, 298  
 cholla, 272  
 chouka system, 28–33  
 Christmas trees, southwestern, 288  
 chuparosa, 266, 270  
 Cienega Creek, 38  
 circular calculations  
   basin volume, 125, 360  
   catchment area, 351  
 cisterns, water tanks, xxiii, xxv, 137, 269  
   vs. earthworks, comparison, 11–12,  
   12, 200  
   Jaipur Fort, 213, 214  
   Seattle, 102–103  
   See also tanks  
 Citizen Forestry Movement, xxvii  
 citrus trees, 130, 260, 261, 269, 274  
   orange, 272, 283  
 Civano (Tucson), 175  
 Civilian Conservation Corps, 21  
 Clark, Barbara, 252  
 clay pot irrigation, 138, 383  
 clay soil, 88, 159  
 clearwater, 294  
 Cleveland, David, 163  
 climate, 260, 352  
   change, 25, 285  
   cold, 96, 135, 297  
   wet, 85, 119, 140, 297  
 clothing as mulch, 157  
 cohousing, 179  
   See also Milagro  
 cold air, and vegetation, 263  
 Colorado: Denver, 18  
 commons activism resources, 392  
 community, 392  
   forests, xxiv  
   garden, 138–40  
   and sheltered tree environment, 258,  
   259  
   water harvesting, 33, 100, 101,  
   252, 321  
   work, 329  
 compost, 296, 315, 374, 391  
   as mulch material, 156, 159  
   time, and temperature, 320  
 Composting Toilet System Book, The,  
   302  
 composting toilets, 303, 316, 317, 318,  
   319, 320, 371, 372, 374, 376, 392  
 concrete pavers, 186, 188  
 concrete slabs, salvaged, 94, 117,  
   186, 230,  
 Confer, David, 137  
 Connecticut, 171  
 conservation, 62, 379, 394

contour berms, 73, 78, 169, 170, 333, 334, 337, 341–42  
 contour, marking, 67, 68, 221, 222, 339, 345–47  
   and diversion swale, 205, 208, 209, 210  
 Cool Communities, 285  
 Corbett, Judy and Michael, 219  
 corn-bean-squash, 272  
 cost, earthworks vs. cisterns/tanks, 11, 42–43, 200, 201  
 cottonwood, 132, 211, 265, 338  
 crabgrass, 164  
 creosote bush, 288  
 crown rot, 270, 271  
 cul-de-sacs, 177  
 cultivars, 260  
 culverts, 205, 206, 208, 213, 219, 221–24, 228, 229, 250  
 curbs, 176, 177, 188, 189, 192  
   cutting, 192, 193, 194, 196, 198–203, 221, 224

## D

dam, 208, 337  
   See also check dams  
 Dancing Rocks Permaculture Community, 57, 81, 318  
 dark grey water, 294  
 daylighting streams, 219  
 deciduous trees, plants, 261, 265  
 deep pipe irrigation, 115, 131, 382  
 degenerative investment, 36  
 degraded lands and imprinting, 143–44  
 degrees, from horizontal, slope, 39  
 Del Porto, David, 302  
 Des Plaines River, 190  
 Desert Harvesters, 176, 287, 329  
 desert willow, 129  
 deserts, 162, 167  
   trees, 158  
   See also dryland; Negev; Sonoran; Thar  
 detention/retention basin, 44, 51, 135, 136, 137, 185  
 detergents, laundry, 296, 298  
 developers, and imprinting, 144  
 developments, clustered, 179  
 dishwashers, 298, 316, 319  
 Ditch Witch, 66, 106, 122, 404  
 diversion swales, 43, 55, 192, 205, 339, 386–87 (see chapter 9)  
   calculation, 362–64  
   connecting earthworks, 54, 98, 129, 205, 214  
   size, 213–14, 362–64  
   and slope, 210  
 Dixon, Bob, 144, 148  
 dormancy, native plants, 279  
 Dorsey, Dan, 317, 318, 326–27  
 downspouts, 53, 111, 112, 132, 133,

214  
 Dr. Bronner's liquid soap, 298  
 drainage(s), 35, 120, 121, 182, 192, 335  
   and check dams, 227, 228, 229, 230–32  
   ditch, 193, 212, 216, 250, 251  
   multiple flows, and check dams, 250  
   See also banks; culverts; stormwater  
 drip irrigation, 18, 138, 140, 168, 279, 280, 281, 302  
   vs. clay pots 138  
   emitters, moving, 281  
 driveways, 81, 212  
   and French drains, 105, 106, 116–17  
   and hardscape reduction 175, 191–92  
 drought, 8, 130, 173, 280  
   stress, 279, 283  
 drylands, 8, 9, 47, 119, 120, 143–44, 189  
   trees, pruning, 158, 281, 282  
   See also deserts  
 Dunbar/Spring Community Garden, 138–40  
 dust control, 143, 150

## E

Earthship Visitors Center, 297  
 earthworks, 8, 10, 13–14, 21, 23, 44–63  
   cautions, 44  
   comparison, 42–43  
   vs. water tanks, 11  
   See also various earthworks techniques  
 Earthworks discussion group, 328  
 earthworms, 20, 140, 155  
 ECLIPSE, 327  
 ECOalition, 327  
 economic value of vegetation, 284  
 ecosystems, disturbed, 47  
 El Coronado Ranch, 253  
 electricity, U.S. consumption, 25  
 elevations  
   differences, finding, 339, 342–44  
   earthworks, 50, 134  
 emergency vehicle/fire truck access, 177, 184, 186  
 engineers/experts, when needed, 44, 88, 92, 93  
 Envirolet toilet, 319  
 EPA. See U.S. Environmental Protection Agency  
 erosion, 37, 47, 143, 211, 212, 331  
   control, 81, 153  
   patterns and response, 331–38  
 ethics, water harvesting, 8, 44  
 Evenari, Michael, 21, 80  
 evaporation, and mulch, 153  
 evaporative coolers, 290, 298, 301  
 evergreen trees, 265  
 exotic (non-native) plants, 58, 266  
   invasive, 164, 271  
   and oasis zone, 57, 297

plant list, 368

## F

feedback-loop principle, 7, 28, 33  
 fence gabions, 249–50  
 fences, for animals, 277, 278  
   and perimeter plantings, 258  
   wire for gabions. See gabions;  
   wire fencing  
 Ferguson, Bruce K., 181, 188, 191  
 Finkel, Herman J., 91  
 fire, 82, 132, 160, 169, 268, 283  
   breaks, 82, 381  
   in natural ecosystems, 169  
   resistant vegetation, 82, 251, 320  
 Fish, Suzanne and Paul, 166  
 flat sites, 120, 130, 132  
 floods, 8, 173, 246, 337  
   and berm 'n basin overflow, 76, 77  
   control, xxiv, 135, 180, 190  
   See also stormwater  
 Food from Dryland Gardens, 135, 163  
 food, 271, 283  
   crops and greywater, 295  
   local, 284, 285–87  
   plants placement, 260  
   See also fruit trees; gardens;  
   vegetables  
 forest fire, 82  
   See also fire  
 forests. See trees  
 fossil fuel consumption choices, 26  
 Four Corners, 252  
 four-wing saltbush, 148, 274, 283, 290  
 French drains, 42, 105, 192, 382  
   (see chapter 3)  
   drain box, 110–11  
   without pipe, 106, 108, 109  
   with pipe, 106, 110–14, 116  
 frost, 263  
 fruit trees, 70, 130, 261, 270, 368  
   urinal, 165–66  
   See also citrus; trees  
 funding, 329, 393  
   See also grants

## G

gabions, 227, 228, 229, 234, 241, 252, 334, 387–88  
   aprons, 242–45, 249  
   baskets, 230, 237–40  
   construction, 236–40  
   fence, 249  
   mattress, 215, 243  
   See also check dams  
 Gaia's Garden, 19, 85, 192  
 gardens, 262, 365, 390  
   beds, sunken, 120, 134, 135, 139  
   community, 138–40  
   trinchera, 101  
   See also vegetables  
 gasoline and oil, 179

generative investment/landscape, 36  
 Geoblock geocells, 186  
 geocells, plastic, 184–86, 189  
 Georgia, 191  
   Atlanta, 173  
 geotextile, 183, 186  
   See also landscape fabric  
 global warming, xxiv, 25, 285  
 gophers, ground squirrels, 168, 214  
 government role, xxiv, 33  
 Gram Vikas Navyuak Mandal Laporiya  
 (GNVML), 27, 28, 31, 33  
 granite, decomposed, mulch, 158, 161  
 grants, 329, 393  
 grapes, 267  
 grass, 28, 30, 67, 98, 150, 164–65, 171,  
   189, 216, 245, 268, 389  
   clippings as mulch, 157  
   seeding, 77, 131, 147, 148, 274, 276  
   See also lawn  
 Grasspave<sup>2</sup>, 189  
 gravel (aggregate), 94, 106, 110,  
   182–84, 186  
   for French drains, 106, 109  
   mulch, 154, 156, 158–59, 161, 163  
 Gravelpave<sup>2</sup>, 184, 185, 186, 189  
 green burials, 390  
 Green Grid Project (Seattle), 191  
 green roofs, 41  
 Green Streets Project (Portland),  
   193–94, 385  
 greeninfrastructure, 288  
 greenhouse, and greywater, 297, 302,  
   308, 310  
 greythorn, 272, 273  
 greywater, 12, 121, 137, 268, 269, 281,  
   289, 294, 391 (see chapter 12)  
   basic cautions and solutions, 295–96  
   branched-drain greywater system,  
     302, 303–304  
   drain outlet, 305, 306  
   gravity feed, 294, 296, 304, 307  
   and Kitchen Resource Drain, 316,  
     317–19, 371, 372, 374  
   and mulched basins, 294–97,  
     302–306, 308, 314  
   multidrain greywater system, 290,  
     303, 314–15, 317, 322  
   quality comparison, 297–98  
   site considerations, 296–97  
   and soaps, detergents, 298  
   systems advantages, 304  
 groundwater, 121  
 Growing Vine Street (Seattle), 102–3  
 Guido Jr., Tomas E., 137  
 guilds, plants, 272, 273, 389  
 gullies, 228, 334  
   See also drainages  
 gutters, rain, 192, 219  
 Guzar, Chotu, 31

## H

h2ouse.org, 58  
 hackberry, 129, 165, 273, 283  
 Haggard, Ben, 116–17, 191  
 Hall, Rozella, xxv  
 hammerhead turnaround, 178  
 Hancor, 106, 113, 114, 307  
 hardpan, 275, 277  
 hardscape, impervious surfaces, 15,  
   173, 258  
   reduction, removal, 43, 174–180,  
     384  
 Hawkins, Debbie, 252  
 headcut erosion, 233, 332–33  
 heat-island effect, 174, 190, 258  
 heel to toe check dams, 233  
 Heisler, Gordon, 284  
 Hemenway, Toby, 19, 85, 192  
 herbs, 268  
 high water detritus in drainages, 232,  
   337  
 highway runoff and trees, 24, 174  
 hog ring pliers, 240  
 Hohokam rock mulching, 166–67  
 holes for planting, 274–75  
 home value and trees, 284  
 Hopi, 159  
 hose shower, 308, 310  
 Howard, Albert, 283  
 Howell, Dan and Karen, 73  
 humanure, 318, 320  
   See also composting toilets

## I

Illinois, 190  
 imperviousness. See hardscape  
 Imprinting Foundation, 147  
 imprinting, 42, 143, 332, 333, 334,  
   383 (see chapter 6)  
   roller, 145, 147, 149  
   steep slope, 145, 149  
 India, 16, 138, 163, 380–81  
   Jaipur Fort, 213, 214  
   Rajasthan, 21, 22, 25, 27–33  
   See also Laporiya  
 induced meandering, 231, 387  
 infiltration basins, 42, 46, 119, 188,  
   383 (see chapter 5)  
   calculations, 125–26, 360–62  
   and diversion swales, 129, 215  
   and greywater, 297 (see also mulched  
     basins and greywater)  
   and erosion control, 332, 333, 334  
   for harvesting street runoff, 195, 198,  
     200, 202  
   sizing, 123–26  
 infiltration chambers, 106, 113–14,  
   306, 307  
 Infiltrator Systems, 106, 113, 114,  
   306, 307  
 integrated design, 324

interceptor drain, 206  
 interceptor for KRD, 316  
 International Building Code 44,  
 Introduction to Erosion Control, 245  
 ironwood, desert, 132, 195, 272, 285,  
   286, 288  
 irrigation, 13, 18, 21, 131, 140,  
   274, 279  
   alternative, 98, 390  
   bucket, 280  
   clay pot, 138  
   drip, 18, 138, 140, 168, 279, 280,  
     281, 302  
   and spreader drain, 205, 216  
   timer, automatic, 18  
   vs. earthworks, 13  
   See also watering  
 Israel: Negev Desert, 16, 21, 65, 80, 246

## J

Jackson, Scott, 168  
 Jaipur Fort, 213, 214  
 Jandy-Valve, 293  
 Jansens, Jan-Willem, 245  
 Jenkins, Joseph, 320  
 Jennings, Richard, 110  
 Johnson, Jay, 311  
 jojoba, 251  
 jujube, 117, 272  
 junk mail mulch, 157, 159, 167–68

## K

Keoppen, Meg, 328  
 K'etami Wasar'a, 100, 101  
 keylines, 79, 207, 208, 211, 336–37,  
   386  
 Kidd, Jeremiah, 116  
 Kitchen Resource Drain (KRD), 303,  
   304, 315–18, 371–77  
 kitchen sink  
   garbage disposal, 296, 316, 374  
   greywater, 291, 298, 303, 304,  
     315–18, 371  
 Kumar, Yogesh, 27, 32

## L

Lama Foundation, 82  
 Lancaster, Brad, 21, 25, 27, 31, 100,  
   137, 194–97, 320–21, 323, 329  
 Lancaster, Brad and Rodd, residence,  
   2, 120, 194, 320–21  
 Lancaster, Chi, 286  
 Lancaster, Rodd, 194–97, 284, 320, 321  
 land disturbance, drylands, 120, 121,  
   144, 153, 154  
 landscape, draining vs. harvesting,  
   14–16  
 landscape fabric, 96, 116  
   and check dams, gabions, 237, 243  
   and French drain, 111, 113  
 Laporiya, India, 25, 27–33



laudromat, outdoor, 320–21  
   See also washing machines  
 lawn, xxv, 269  
 leaching chamber for KRD, 306, 307,  
   316, 371–74, 376–77  
 lead, uptake by plants, 166  
 leaf drop, 124, 132, 155, 156, 160  
 leaves as mulch, 157, 161, 168  
 legal issues  
   check dams, 233  
   curb cutting, 201  
   greywater, 294, 304, 391  
   See also permits  
 limberbush, 270  
 Lindegger, Max O., 324  
 line level to measure slope, 40  
   See A-frame level  
 Lipkis, Andy, xxiii–xxvii, 288  
 liquid soaps, 298  
 livestock pens and mulch, 165  
 living sponge, 6, 17, 20, 31  
   See also soil, vegetation  
 log erosion barriers, 82  
 loose rock check dams, 228, 229,  
   234–36, 242  
   See also check dams  
 Los Angeles, xxii, xxiv, xxv, xxvi, 173,  
   288  
 Los Angeles River, xxiv  
 Ludwig, Art, 291, 303, 307, 374, 375

**M**

Maccaferri gabions, 237  
 Mackzum, Garth, 287  
 Madsen, John, 166  
 maintenance  
   berm 'n basins, 77  
   check dams, 245  
   diversion swales, 216  
   French drains 115  
   greywater systems, 308  
   imprints, 149  
   infiltration basins, 132  
   mulch, 163  
   permeable paving, 190  
   plantings, 279  
   terraces, 99  
 manure, 31  
   as mulch, 157, 159  
 Marikos, Mark, 327  
 Martinez, Richard, 328  
 Maryland, 140  
 McCormick, Grant, 327  
 mesquite trees, 269, 273, 275  
   guild, 272, 273  
   pods, 273, 286, 287  
   screwbean, 290  
   velvet, 129, 181, 211, 286  
 Metropolitan Council Environmental  
   Science, 177  
 Meuli, Chris, 78, 83, 84, 85, 167–71,

221–225, 347  
 Mexico: Sierra Madre, 100–102  
 Michigan, 140  
 microclimates, 258, 261, 266, 270  
 microdetritus berms, 332  
 microorganisms and greywater, 295  
 Miksicek, Charles, 166  
 Milagro Cohousing (Tucson), 136–37,  
   185  
 Minnesota, 140  
 Mollison, Bill, 8, 219, 221  
 Montgomery, George, 279  
 Moore, Kevin, 317  
 Mormon tea, 283  
 mosquitoes, 17, 140, 211, 295  
 mounds vs. basins for planting, 15, 120,  
   121  
 mulch, 42, 153, 182, 276, 333, 334,  
   383 (see chapter 7)  
   common materials, 156–59  
   gravel and rock 154, 156, 158,  
   161, 163  
   infiltration basins, 131, 132, 202  
   layering, 159, 163  
   thickness, 161, 162  
   and vegetables, 162  
   vertical mulching, 154–5, 163,  
   167–69  
   weed control, 164–65  
 mulched basins and greywater, 294–97,  
   302–306, 308, 314  
 multidrain greywater system, 290, 303,  
   314–15, 317, 322  
 Murphy, Tim, 273  
 mycelium, 273

**N**

Nabhan, Gary P., 273  
 National Wildlife Federation, 175  
 Native/indigenous people, 16, 21,  
   159, 252  
   See also Hohokam; Hopi; Navajo;  
   Tarahumara; Tohono O'odham;  
   Zuni  
 Native Seeds/SEARCH, 101  
 native vegetation, 23, 57, 58, 208, 260,  
   265, 266, 271, 279, 297, 388, 389  
   seeds, 266, 268  
   lists for Tucson, 366, 367  
   See also plants; vegetation  
 natural fibers as mulch, 157  
 Natural Resources Conservation Service,  
   210, 234, 252  
 Natural Resources Defense Council, 173  
 Nature Conservancy, 252  
 Navajo, 159  
 Negev Desert, 16, 21, 65, 80, 246  
 neighborhood, 284, 285–87  
   See also community  
 net and pan system, 80

New Create an Oasis with  
   Greywater, The, 291, 296,  
   303–304, 307, 308, 375  
 New Mexico, 116  
   Albuquerque, 18, 167, 168, 169  
   buildings, residences, and locations,  
     87, 93, 169, 191–92, 212, 221,  
     223, 225, 237, 241, 297, 306  
   Edgewood, 168  
   greywater laws, 294, 304  
   Lama, 82  
   Los Alamos, 87, 191–92  
   Moriarty 83, 221–25  
   Santa Fe, 93, 96, 116–17, 212  
 newspaper as mulch, 157, 168  
 nick point, 332–33  
 nitrogen, 156, 165, 166  
   carbon-nitrogen ratio 154, 156, 159,  
   165, 168  
 nonpoint source pollution, 16  
 nopal cactus, 82, 130, 272  
 Northwest U.S., 140  
 Norton, Jay, 246  
 no-work gardening, 171  
 Nys, Christian, 311

**O**

oak, 253, 275, 285  
 Oasis brand detergent, 298  
 Oasis reverse osmosis water filter, 321  
 oasis zones, 45–47, 48, 49, 57, 283  
   drier, 47  
   and greywater, 297  
   and initial projects, 260  
   wetter, 46, 47, 266  
 OasisDesign.net, 291  
 observation, 4, 35, 58, 232, 260, 270,  
   308, 325–26  
 Occidental Arts and Ecology Center,  
   246, 267  
 Ochoa, Carlos, 328–29  
 Old Community food Bank, Tucson,  
   180  
 olive, 266  
 Omick, David, 373, 374, 375, 376  
 one-rock check dams, 77, 216, 217,  
   245–46, 387  
 orange tree, 272, 283  
   See also citrus  
 orchards, 267, 270  
   street tree, 285–87  
 oreganillo, 270  
 Oregon, 85, 191  
   Portland, 141, 193–94, 195,  
   196, 393  
 organic foods, 283  
 organic matter, 166  
   See also compost; mulch  
 outdoor shower, 303, 308, 310, 317  
 outlet chamber, greywater, 306–307  
 outlet shield, greywater, 305, 306

overflow, 6, 28, 137  
and mulch, 162  
from various earthworks, 50, 75–76,  
97, 109, 111, 122, 128–29, 188,  
205, 213  
See also spillways  
oxygen, and trees, 284

## P

palm tree, 129, 283  
palo verde, 272  
blue, 129, 195, 270, 271–72, 286  
foothills, 130, 195, 266, 271–72, 286  
paper as mulch, 157  
PARASOL, 327  
parking, parking lots, 178, 181, 183,  
184, 185, 186  
paths, 99, 117, 124, 163, 218  
raised, 70, 80, 123  
patterns, erosion, and water flow, 35,  
37–40, 331–38  
pavement, 173, 174, 175, 178  
See also chapter 8; driveways;  
hardscape; parking; permeable  
paving; streets  
paving blocks, open jointed, 186–88  
Pearce, Fred, 16  
pedestals (in basins for trees), 130, 270,  
276, 277  
pedestals (soil formation), 332, 333  
pedestrians, 198  
Pennsylvania, 181  
penstemon, 270  
percents, slopes, 40  
percolation test, 371, 375  
perennial plants, 58, 265, 266, 274  
permaculture, 8, 66, 223  
permeable paving, 173, 180–90, 386  
See also chapter 8  
permits, possibly needed, 113  
curb cut, 198, 200, 201  
permeable paving, 182  
retaining wall, 93  
Peru, 89, 100  
Peynetsa, P., 246  
Phillips, Chet, 253, 327  
Phiri, Maseko, Zephaniah, 1, 2, 121,  
260, 281, 379  
Pierce, Francine, 328  
Pierson Street Ecohood, 311  
pioneer species, 164  
pipe  
and greywater, 302, 303  
and French drain, 106, 110–14  
piped vs. overland flow, 53, 54, 55  
pistachios, 267  
plant guilds, 272, 273, 389–90  
planting  
earthworks, 76, 98, 114, 129, 148,  
189, 216, 245  
how to, 274–77

plants, 58, 189, 276, 283  
care while digging earthworks, 73,  
132  
density, native plant, and earthworks,  
24  
fencing, 277, 278  
lists for Tucson, 365–68, 389  
size and spacing, 123, 264, 272,  
274, 279  
water needs and tolerance, 131, 270,  
275  
See also gardens; native plants; roots;  
trees; vegetation; watering  
plastic “mulch” 155  
to destroy bark beetles 170  
PlayPumps, 394  
plumbing, 296. See also greywater  
chapter 12  
Poar, Ramkaran, 27, 33  
pole cuttings for check dams, 230  
pollution, 141, 173, 180, 190, 196  
pomegranate, 80, 165, 251, 266  
ponds, 205, 208, 210, 211, 263,  
337, 386  
poplar, 248  
potable water, 12, 18  
potassium, and greywater, 298, 299  
prickly pear, 287  
PRO Neighborhoods, 328  
proportion, measuring slope, 39  
pruning, 281–82  
desert dryland trees, 158, 281, 282  
prunings, as mulch, 158, 163, 282, 283  
P-trap, 291, 296, 308  
pullouts, 176, 177  
pumice, 106, 109  
wick, 116  
pump, 394  
hand, for accessing greywater, 310,  
311–14  
pungie posts, 247, 248  
purslane, 283

## Q

Quandelacy, W., 246

## R

Rabin, Anastasia, 23  
rain gardens, 119, 140–41, 193, 383  
rain sensor, 140  
rainwater, 10  
small rainfall events, 131  
volumes calculating, 59  
rainwater harvesting, xxiii  
principles, vi, 4–7, 25, 44  
ranches, 143, 144, 147, 253–57  
Real Life Examples, 9  
Arivaca community, 328  
Arizona, 82, 136, 138, 150, 166,  
194, 252, 253, 285, 317, 320, 321,  
326, 327, 328

California, 219, 288  
check dams building community 252  
check dams, El Coronado Ranch,  
253  
clay pot irrigation, 138  
community garden, 138  
composting toilets and greywater  
disposal, 317  
Connecticut, 171  
contour mulching thinned, dead  
trees, 169  
curb and gutter drainages, 192  
diversion swales and stormwater, 219  
driveway gardens, 191  
fire-resistant oasis, 320  
flood control, 136  
flooding backyard into oasis, 326  
French drain and driveway, 116  
gabions create spring, Black Mesa,  
252  
grandmother approach, 82  
green streets and parking lots, 193  
greywater neighborhood laundromat,  
320  
Hohokam rock mulching, 166  
India, 25, 138  
junk mail as vertical mulch, 167  
Mexico, 100  
mulching in wet lands, 171  
native living Christmas trees, 288  
New Mexico, 82, 83, 116, 167,  
169, 191, 221  
Oregon, 193  
outdoor shower, 317  
PARASOL, college students, 327  
planting an urban forest, 288  
pooling resources to build  
community, 321  
pumice wick, 116  
rain gardens, 140  
restoring bladed land, 150  
Santa Cruz River restoration, 328  
spreader drain, 221  
street trees, 194, 285  
terrace building, Tarahumara, 100  
terraced cistern steps, 102  
trees killed by fire, using, 82  
Washington, 102, 192  
water scarcity to water abundance, 25  
windswept snow, 83  
reclaimed water, 294  
rectangular calculation  
infiltration basin volume, 126, 362  
catchment area, 350  
recycling, water. See greywater  
Reed, David, 97, 186  
refrigerator unit bleedoff, 294  
regenerative systems, 36  
reservoirs, earthen tanks, 29, 31, 32  
See also ponds; tanks  
resources. See appendix 6: 378–94  
retaining walls, 87, 89, 98, 99, 100  
building, 93–97, 112, 117, 382

height, 91, 92, 93  
 and slope, 66, 67, 89  
 and terraces, 87, 88, 89, 91, 92,  
 93–97 (see also under terraces)

revegetation  
 of berm and basin after digging,  
 73–74  
 and imprinting, 144  
 See also planting; vegetation

reverse osmosis filters, 290, 294, 301,  
 321, 322

Reynolds, Michael, 302

right-of-ways, 128, 175, 194–97, 201

Riley, Jim, 327

rill erosion, 229, 246, 333–34

rip-rap for diversion swales, 215

rivers, xxiv, 3, 16, 150, 190, 328–29  
 See also Santa Cruz River

roads, 80, 81, 120, 121, 176, 177, 181,  
 191, 205, 216, 218, 229, 250, 251,  
 333, 381, 386  
 See also paths; streets

rock tube irrigation, 115, 116, 131

rocks (stones)  
 and check dams/gabions, 228, 229,  
 235, 238–40  
 mulch, 154, 158, 163, 166–67  
 stabilizing basins, 120, 127, 128, 129  
 stabilizing spillways, 75, 76, 98,  
 130, 133  
 See also under stone

rodents, and rock mulch, 167

Rodeo-Chedeki fires, 320

Roguerrachi (Mexico), 101

roofs, 41, 45  
 runoff, 12, 128 (see also canales;  
 downspouts)

roots, 107, 124, 167, 304, 305  
 exposed in drainages, 335–36  
 disturbing in earthworks, 132  
 encouraging growth, 280, 281  
 when planting nursery stock,  
 274–277  
 See also plants; trees; vegetation

Rose, Barbara, 317, 318

Rowntree, Rowan, 285

rules of thumb for runoff, 352

Running Rain Society, 73

runoff coefficients, 60, 72, 354

runoff, 38, 52, 58  
 and permeable paving 188, 189, 190  
 from pavement, roads, streets, 24, 46,  
 173, 174, 198–202  
 volumes calculations, 60, 63, 352–55  
 See also stormwater

runon, volumes calculating, 58, 60, 63

Russian thistle. See tumbleweed

## S

saguaro, 271, 272, 273, 285, 287, 288

salmon, xxvi, 191, 192, 193

salt cedar (tamarisk), 230, 267, 271

salt(s), 10  
 and evaporative cooler, 290, 298  
 and greywater, 296, 297, 298, 308  
 and soil, 21, 22, 137, 140, 206  
 tolerant plants, 21, 290, 298  
 in urine, 166  
 and water softener, 299

San Isidro Permaculture, 96, 116, 241  
 and Raincatcher, 93, 212

Santa Cruz River, 3, 150, 328–29

Santa Fe style homes, 106

Santa Monica mountains, 283

scarcity, 324

scour holes, 338

scouring, in drainages 230

sediment, 335, 336

seeds, 145, 389  
 grass, 77, 131, 389  
 for imprinting, 145, 147, 148–49  
 native wildflower, 21, 131, 276  
 vs. nursery stock, 277  
 saving, collecting from plants, 77,  
 266, 268

seep willow, 230, 245, 248

septic drain fields, 121

septic tanks, 181, 297, 303, 316,  
 317, 374

shade, from trees, 263, 265

shadow ratios, 263

sheet flow, 217, 332–33

shells, crushed, as mulch, 182

showers, 297, 298, 299, 300, 303  
 and greywater from, 297, 310,  
 311–14  
 outdoor outdoor shower, 303, 308,  
 310, 317  
 See also bathtubs

sidewalks, 175, 178, 190, 193, 201  
 and infiltration basins, 127, 134, 137

Siebert, S.F., 246

Simple Act of Planting a Tree, The,  
 xxvii, 284

Singh, Jagveer, 27, 33

Singh, Laxman, 27, 28, 29, 31, 33

siphon for greywater access, 303, 310,  
 311–14

site assessment, 35–40, 381  
 for earthworks strategies, 67, 89, 107,  
 122, 145, 160, 188, 207, 230,  
 260, 296

site plans, 51, 108, 136  
 branched drain greywater system,  
 302, 308, 309  
 runoff, runon, 61, 63  
 urban lot, 48, 49, 55

Sitting Tree, 321

slope, 35, 39–41  
 berm 'n basin, 66, 67  
 and bunyip, 339, 342–44  
 and diversion swale, 208, 213, 221  
 how to measure, describe, 39–41, 339

of infiltration basin berms, 127  
 and permeable paving, 181, 184, 186  
 terraces, 67, 87, 88, 89, 92, 93, 98

slow, spread, infiltrate principle, 5

small and simple principle 5, 45

snapdragon vine, 266

snow harvesting, 83, 84

snowbreaks, 382

soaps and detergents, 296, 298

sodium, and plants, 298, 299

soil, 144, 206, 378, 396  
 clay, 88, 159  
 disturbed and earthworks, 47  
 and greywater, 296  
 importing exporting, 55  
 percolation test, 371, 375  
 and permeable paving, 181–82  
 runoff coefficients, 60, 72, 354  
 and salts, 21, 22, 137, 140  
 and soil life, 19, 20, 155, 273  
 See also earthworks

solar arc, 45, 121, 122, 132, 262

solar orientation, 260–63, 265

solar water heater, 263, 321, 322

Soleri, Daniella, 163

Sonoran Desert, 148, 271, 285

Southeast Asia, 89

spacing  
 berm 'n basins, 70, 72  
 check dams, 233  
 terraces, 90, 91, 92

speed humps, 177, 211, 218

spillways, 50  
 berm 'n basins, 68, 75, 76, 79  
 check dams, 236, 242–45  
 and diversion swales 215, 216  
 infiltration basins, 120, 128–29,  
 130, 133  
 terraces, 91, 97, 98  
 zig-zagged, 97  
 See also overflow

sponge. See living sponge

sponge mulch, 168

spreader drain, 205, 206, 216, 217,  
 221–25

stacking functions principle, 7, 29, 31,  
 47, 62, 307

Steinfeld, Carol, 302

steps, check dam/gabion, 241, 250

stewardship, 16, 32, 325, 410, 411

stone  
 dry laid for retaining walls, 87, 88,  
 89, 93–97  
 pavers, 186  
 See also rocks

storage of rainwater. See cisterns; tanks

stormwater, storms, 12, 141, 219, 384  
 harvesting runoff, and Seattle, 102,  
 193

Stout, Ruth, 155, 161, 171

straw bale check dams, 230, 248–49

straw mulch, 157, 167, 168  
 Strawberry Creek Park (Berkeley), 219  
 Street Edge Alternatives/SEA (Seattle),  
 192–93  
 streets  
   medians, 175  
   runoff harvesting, 198–202  
   runoff, 192–94  
   runoff per mile or kilometer, 195  
   and trees, 175, 176, 194–97  
   See also roads  
 stub-out for greywater, 290, 291, 292  
 subwatersheds, 38  
   creating with earthworks, 51, 213  
 Sun Valley Watershed, xxvi  
 sunken garden beds, 120, 134, 135, 139  
 surface water rights, 201  
 surge basin, 224  
 sustainable landscapes, 17  
 swale, 66. See also berm 'n basin;  
   diversion swale  
 Sweden, 166  
 sycamore, 338

## T

tamarisk. See salt cedar  
 tamping, 74, 95  
 tanks, xxii, xxiv, xxv, 29, 31, 32, 214  
   compared to earthworks, 11–12  
   See also cisterns  
 Tarahumara Indians, 100–102  
 Teran Watershed, 252–53  
 termites, 44, 56, 128  
 terraces, 42, 87, 101, 337, 382  
   (see chapter 3)  
   calculations, 90, 91, 358–60  
   earthen, without retaining walls, 88,  
   92–93  
   with retaining walls, 88, 89, 93–97  
   and slope, 67, 87, 88, 89, 92, 93, 98  
 Texas, 393  
   Austin, 70, 116, 393  
   Garland, 284  
   Houston, xxvi  
 Thacker, Brian, 320  
 Thar desert, 27  
 thermal belts, 263  
 three-way valve, 290, 291, 292, 293,  
 294, 299, 307  
 tires  
   in retaining walls, 99  
   shredded, in check dams, 247  
 Tohono O'odham, 271  
 toilets, 18, 165, 291  
   composting, 303, 316, 317, 318,  
   319, 320, 371, 372, 374, 376, 392  
 top of the watershed principle, 4, 9, 38,  
 53, 67, 70, 91, 96, 229  
 traffic calming, 176–77, 194, 385  
 traffic circle, 176  
 Trawick, Paul, 100

Tree People, xxiv, xxvii, 288  
 trees, xxiv, 21, 25, 31, 73, 78, 121, 158,  
 175, 179, 202, 257, 263, 271, 274,  
 281, 284  
   canopy, 124, 132, 190  
   community forests, xxiv  
   initial irrigation benefit, 23, 196, 279  
   as living monuments, 285  
   mature size, 124, 132, 195, 263,  
   264, 275  
   and permeable paving, 181, 190  
   pruning, 158, 281, 282  
   root zone, 124, 190  
   and sponge mulch, 167–68  
   staking, 278  
   and street/road runoff, 24, 174, 175,  
   194, 195  
   thinning, 83, 170  
   Tucson, lists for, 366, 368  
   See also native plants; vegetation; and  
   under individual tree names

Trees for Tucson, 286  
 T.R.E.E.S. Project, xxv  
 triangle calculations, 350  
 trinchera system, 101, 102  
 Tucson, 2, 136, 137, 138, 166, 180,  
 187, 194, 275, 285, 317, 320, 321,  
 326, 327, 328  
   buildings, residences, locations, 2, 3,  
   21, 23, 24, 57, 81, 99, 120, 136,  
   137, 138, 174, 180, 183, 185, 187,  
   196, 197, 211, 246, 247, 256, 271,  
   286, 287, 318, 322  
   community garden, 138–40  
   irrigation demand, annual, 269  
   Pima Canyon, 23  
   plant lists and water requirements,  
   270, 365–70  
   rainfall, 19, 70  
   Santa Cruz River, 3, 328–29  
 Tucson Audubon Society, 79  
 Tucson Electric Power Company, 286  
 tumbleweed (Russian thistle), 143, 148,  
 149, 150, 338  
 Turkey Pen Watershed, 253, 254

## U

U.S., 18, 173, 284  
 U.S. Army Corps of Engineers, xxiv, 233  
 U.S. Department of Agriculture, 284  
 U.S. Environmental Protection Agency  
 (EPA), 113, 190  
 U.S. National Forest Service, 352, 284  
 U.S. National Weather Service, 352  
 University of Arizona, 183, 327  
 urban lots, 48. See also yards  
 urine and fruit tree urinal, 165–66  
 Utah: Salt Lake City, 285  
 utility lines, 44, 55, 195, 198, 203, 343

## V

vegetables, 162, 261

garden beds, 120, 134, 135, 139,  
 267, 365  
 See also gardens  
 vegetation, 6, 17, 43, 82, 120, 123, 124,  
 213, 214, 251, 257, 320  
   (see chapter 11)  
   erosion control strategy, 333, 334  
   in drainages, 335, 338  
   as “living mulch”, 158  
   native. See native plants  
   resources, 388–91  
   See also gardens; native vegetation;  
   planting; plants; trees  
 vertical mulching, 154–55, 163, 167–69  
 Village Homes (Davis, CA), 219, 220  
 Villalobos, Juan Daniel, 100, 101  
 Virginia, 140

## W

Wajurana (Mexico), 100, 101  
 Wash and Well, 321  
 washing machines, 297, 298, 299, 300,  
 314–15, 321, 322  
 Washington, 88, 99, 102, 103  
   Seattle, xxvi, 192–93  
   State Department of Health, 320  
 water, 6, 19  
   with earthworks, tips, 44–63  
   flow, 35, 37–40, 331–38  
   harvesting priorities in watershed, 53  
   hierarchy of use, 18, 268, 294  
   infiltration of water along diversion  
   swale, 50, 143, 216  
   needs, plants, 123, 129–131, 269,  
   270, 369–70  
   pollution. See pollution  
 water budget, 58  
 Water from the Sky, 302  
 water level. See bunyip water level.  
 water requirements, Tucson, 365–70  
 water softener, 299  
 watering, 279–81  
   with hose, 18  
   supplemental for young trees/  
   vegetation, 23, 77, 120, 196, 274,  
   279, 280  
   See also irrigation  
 waterlogging, 206  
   See also crown rot  
 watersheds, 38, 51, 53, 173  
   with check dams. See check dams  
 Weber, Matt, 2  
 weeds, 143, 148, 149, 150, 157,  
 164–65, 283  
 wells, water, 394  
   in Laporiya, 31, 33  
   monitoring water level, 58  
 wheelchair accessibility, 182  
 wild, natural areas, 58  
 wildflowers, 21, 23, 85, 131, 161,  
 268, 274

wildlife, 31, 32, 53, 57, 117, 158, 227,  
252, 253, 255, 266, 268, 273, 281,  
284, 317, 338  
willow, 248  
wind, 83, 261, 262  
    and A-frame level, 347  
    berms, 83, 84  
    breaks, 261, 262, 382  
    and seedlings, 135, 144  
winter, solstice shadow, 263, 265  
    sun exposure, 261, 284  
wire  
    -fence gabions, 249  
    fencing for gabions, 229, 236, 237,  
    238, 240, 242, 243, 244  
    Wisconsin, 140, 186  
wolfberry, 165, 270, 272, 273, 290

wood chip berms, 170, 171  
wood chip mulch, 157

## Y

Y or double L connector, 304, 310  
yard, 55, 63, 258  
    urban, small, 50, 105, 124, 129,  
    132, 134  
Yeomans, P.A. 207, 406  
yerba de venado, 270

## Z

Zeedyk, Bill, 245  
Zemach, Mary and Charles, residence,  
87, 191, 192  
Zimbabwe, 1, 121  
Zuni brush dams, 246–48

# The series ...

## Rainwater Harvesting for Drylands and Beyond, Volume 1

### Guiding Principles to Welcome Rain into Your Life and Landscape

Turn water scarcity into water abundance! Volume 1 is the core of the complete three-volume guide on how to conceptualize, design, and implement sustainable water-harvesting systems for your home, landscape, and community. This book enables you to access your on-site resources (rainwater, greywater, topsoil, sun, plants, and more), gives you a diverse array of strategies to maximize their potential, and empowers you with guiding principles to create an integrated, multifunctional, and water-sustainable water-harvesting landscape plan specific to your site and needs.

Clearly written with more than 40 photos and 115 illustrations, this volume helps bring your site to life, reduce your cost of living, endow yourself and your community with skills of self-reliance and cooperation, and create living air conditioners of vegetation growing beauty, food, and wildlife habitat. Stories of people who are successfully welcoming rain into their life and landscape will invite you to do the same!

Real life stories and examples permeate the book, including:

- How both a farmer in Zimbabwe's driest region and homeowners in downtown Tucson, Arizona, USA have turned wastelands into oases by planting the rain—and how you can do the same
- How suburban homeowners and rural homesteaders in the U.S. are providing 95 to 100% of their water needs with the rain
- How the orientation of your home and landscape to the sun can freely heat them in winter and cool them in summer, while dramatically reducing water and power needs
- Traditional Native American water-harvesting techniques
- Simple calculations and figures to determine your site's rainwater and greywater budgets and water needs.
- Simple tips, strategies, and patterns to move away from the wasteful path to scarcity and take the stewardship path to abundance

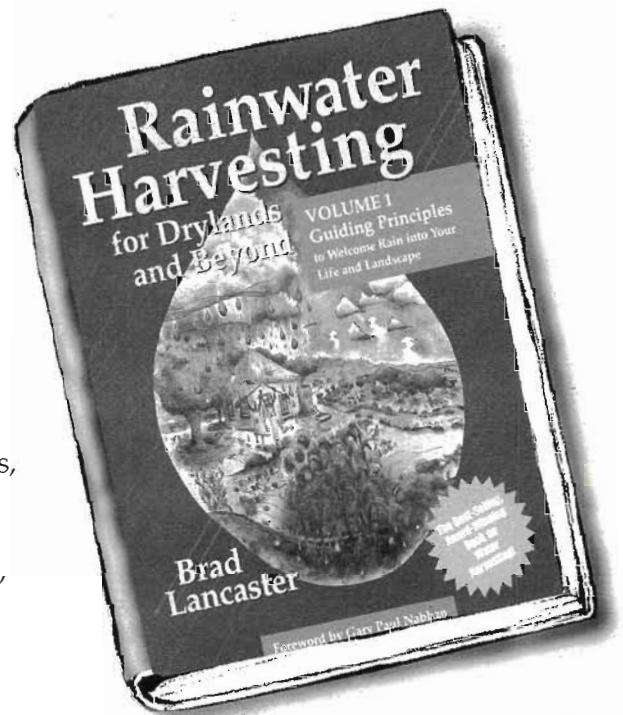

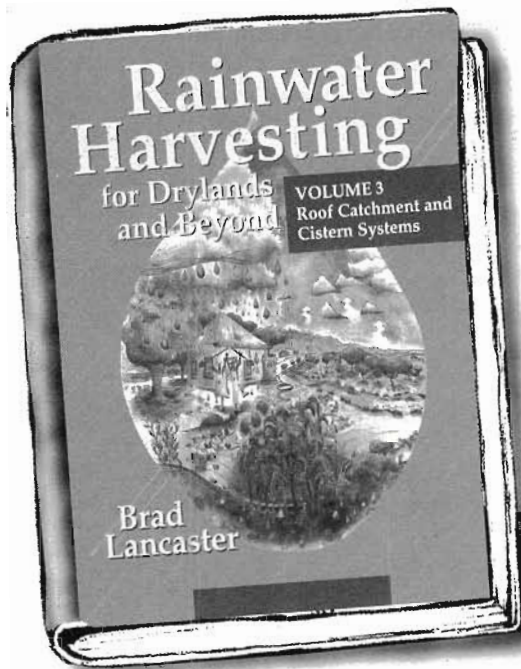

## Rainwater Harvesting for Drylands and Beyond, Volume 3

### Roof Catchment and Cistern Systems

Cisterns harvesting runoff from rooftop catchments have the potential to harvest the highest quality rainwater runoff on site, and allow for the greatest range of potential uses for that water. Water uses range from irrigation to fire protection, bathing, and washing, as well as potable water for drinking.

Building on the information presented in Volume 1, this book shows you how to select, size, design, build, or buy and install cistern systems harvesting roof runoff. Guiding principles unique to such systems are presented along with numerous tank options, and design strategies that will improve water quality, save you money, reduce maintenance, and expand the ways you can use your tanks and the water harvested within.

Additional information includes:

- How to size gutters and downspouts
- How to turn a drain pipe into a storage tank—how to build culvert cisterns
- How to retrofit ferrocement septic tanks for cistern use
- How to create a gravity-fed drip irrigation system for use with above-ground tanks
- How to create a pump-fed drip irrigation system for use with below-ground tanks
- System setup, maintenance tips, and water treatment options
- More than 60 illustrations and photographs

For more details, publication dates, and ordering info see [www.HarvestingRainwater.com](http://www.HarvestingRainwater.com).



## Inside front cover figure captions:

*All images below appear again in the book to illustrate case studies or concepts.*

*Figure numbers correspond to where in the book they can be found.*

I.11. A spring created by slowing, spreading, and sinking water flow. A check dam built long ago atop bare bedrock has accumulated a level terrace of soil and organic matter upslope of the dam in which vegetation now thrives. The harvested soil and organic matter acts as a sand tank that quickly infiltrates stormwater flow, then slowly releases it to the plants' roots, and as a seeping flow over the bedrock that continues to run for weeks after the last rain. Anastasia Rabin enjoys a drink of this tasty water. Pima Canyon, Tucson, Arizona

Fig. 10.39. Planting the rain. Turkey Pen watershed check dam. This is one of 20,000 loose rock check dams on El Coronado Ranch in southeastern Arizona. Before the construction of these check dams water only flowed in the creek part of the year. Now it flows all year round. Ground water levels have risen on the ranch and on downstream properties.

5.29. Celebrate the rain! Steelhead trout swim up a steel downspout directing roof runoff to a rain garden below. Portland, Oregon.

7.14. Contour berms of woodchips. Chris Meuli's land, Edgewood, New Mexico. Credit: Chris Meuli

7.15. Abundant growth of new grasses above and below woodchip berms. Living grass will take over acting like a living, comb-like berm as woodchip berms decompose. Chris Meuli's land, 2006, post rains. Credit: Chris Meuli

## Inside back cover figure captions:

5.14. Rain and greywater gardens/basins (right side of photo) in small Tucson, AZ yard. No potable water used to irrigate the landscape. Roof runoff is directed to the basins via a downspout (out of view) then a pipe beneath the path. Path is sloped to basin to direct its runoff to the raingarden. Greywater from a sink and washing machine is also directed to the basin as explained in chapter 12.

12.26. Rainwater-, greywater-, and kitchen sink drainwater-irrigated garden. No drinking water used for irrigation. Soils amended with on-site mulch and compost. Dancing Rocks Permaculture Community, Tucson, AZ.

12.28B. Community Wash and Well. 19 people share this washing machine and reverse-osmosis water filter. Tom is filling his water jug from the filter (behind corrugated metal). The filter backwash and washer greywater are both passively harvested and distributed into the landscape. Chet dried his clothes on the solar clothes drier (clothes line)

12.29. The multi-drain greywater harvesting system for the community washer and filter. The drain tube taped to the washing machine drain hose conveys backwash water from the reverse osmosis filter. The joined hoses are moved to a different greywater drain and plantings (marked on pipe) with each load of wash.

Fig. 7.16A. Before - *impervious* concrete *drainageway*. South of Architecture building, University of Arizona, Tucson, AZ.

Fig. 7.16B. After - *porous* cobble *infiltrationway* after the concrete was jackhammered and left in place. A few native boulders were interspersed amongst the cobble to naturalize the look. The infiltrating water passively irrigates the native vegetation growing through the cobble.