

Cornell Guide to Growing Fruit at Home

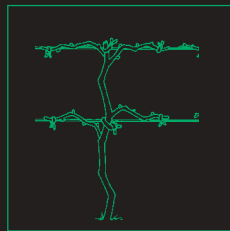

Cooperative Extension

Acknowledgments

The following specialists in the Department of Horticulture, Cornell University, contributed to the development of this publication: Marcia Eames-Sheavly, Marvin Pritts, Craig Cramer, Lori Bushway, Ian Merwin, and Richard Reisinger. Steven McKay, a commercial fruit specialist with Cornell Cooperative Extension in the Hudson Valley, also shared his expertise.

Recipe for training young trees (page 28) adapted from materials by Terence Robinson and Steve Hoying.

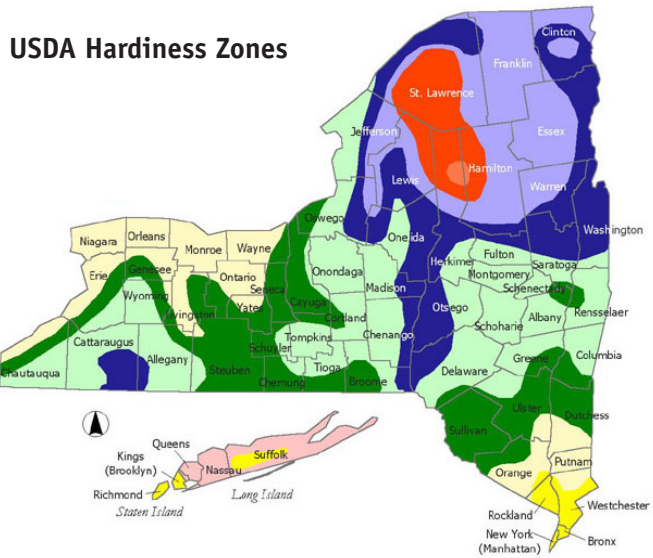





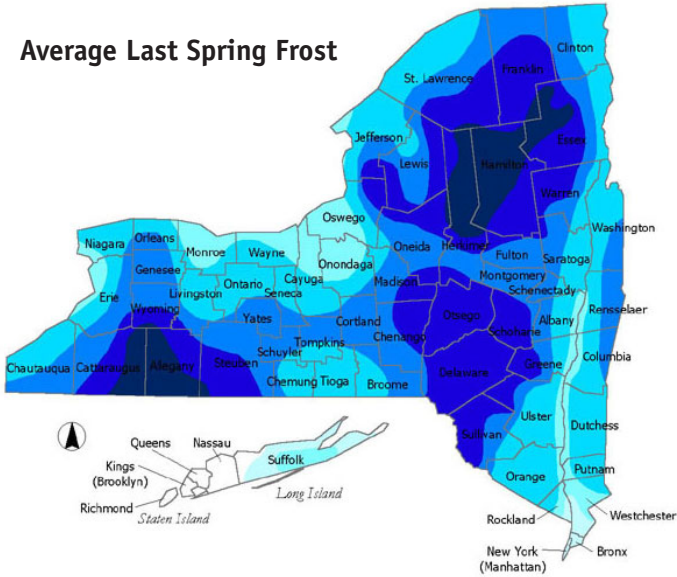

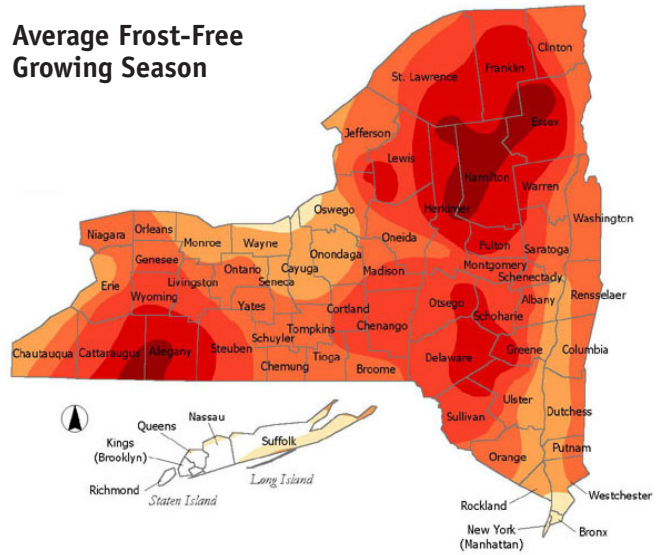

Zone	Average Minimum Temperature Range
3a	-40 to -35°F -37 to -40°C
3b	-35 to -30°F -34 to -37°C
4a	-30 to -25°F -32 to -34°C
4b	-25 to -20°F -29 to -32°C
5a	-20 to -15°F -26 to -29°C
5b	-15 to -10°F -23 to -26°C
6a	-10 to -5°F -21 to -23°C
6b	-5 to 0°F -18 to -21°C
7a	0 to 5°F -15 to -18°C







Average Last Spring Frost



Average Frost-Free Growing Season



	Before April 10
	April 10–20
	April 20–30
	April 30–May 10
	May 10–May 20
	May 20–May 30
	After May 30

	Fewer than 103 days
	103–123 days
	123–143 days
	143–163 days
	163–183 days
	183–203 days
	More than 203 days

Before You Begin

Growing fruit at home can be fun and provide your family with fresh, flavorful, and nutritious food. The benefits are many:

- You can grow large amounts of fruit in a relatively small area.
- Fruits are a good source of vitamins, minerals, carbohydrates, and fiber (see Table 1).
- If you carefully choose the kinds and cultivars (varieties) of a fruit before you plant, you can harvest dessert-quality fruit from early summer through the fall.
- As an added bonus, the fruits you grow will taste much better than the fruits you find in the grocery store.

Before you begin, you need to invest considerable effort into site selection, soil preparation, and planting plans. Before you order plants, you also need to learn about their pollination needs, their winter hardiness, and how susceptible they are to pests.

Some fruits are easier to grow than others. Strawberries aren't much harder to grow than most annual garden crops and bear fruit quickly. Most tree fruits, on the other hand, require a large commitment to pruning, pest management, and care, and they won't bear fruit right away. Make sure you are ready to devote the time to your planting before you start.

Keys for Success

Plan ahead. Study this publication, nursery catalogs, and other sources of information and develop a thoughtful plan before you prepare soil or order plants.

Match plants to your site. Most fruit plants need full sun, well-drained soil, and good air circulation. Some have more specific needs. To prevent problems, make sure your plants and your site are a good match before you start soil preparation.

Table 1: Approximate nutrient composition (per 100 g) of various fruits

<i>Fruit</i>	<i>Calories (kcal)</i>	<i>Vitamin C (mg)</i>	<i>Sodium (mg)</i>	<i>Calcium (mg)</i>	<i>Phosphorus (mg)</i>	<i>Potassium (mg)</i>	<i>Iron (mg)</i>	<i>Magnesium (mg)</i>	<i>Zinc (mg)</i>
Apple	55.4	12.0	3.0	7.1	12.0	144	0.48	6.4	0.12
Banana	49.4	12.0	1.0	8.7	28.0	393	0.55	36.0	0.22
Blueberry	62.4	22.0	1.0	10.0	9.1	65	0.74	2.4	0.10
Cherry	60.2	12.0	2.0	8.0	7.0	114	—	8.0	—
Currant	45.0	36.0	1.4	29.0	27.0	238	0.91	13.0	0.20
Elderberry	46.4	18.0	0.5	35.0	57.0	305	—	—	—
Orange	53.8	50.0	1.4	42.0	23.0	177	0.40	14.0	0.10
Peach	46.0	9.5	1.3	7.8	23.0	205	0.48	9.2	0.02
Pear	55.7	4.6	2.1	10.0	15.0	126	0.26	7.8	0.23
Raspberry	40.2	25.5	1.3	40.0	44.0	170	1.00	30.0	—
Strawberry	36.9	64.0	2.5	26.0	29.0	147	0.96	15.0	0.12

The success of your home fruit planting will be determined largely by

- how susceptible your site is to frost.
- whether your site receives adequate sun.
- whether your site has well-drained soil at least 8 inches deep.
- whether you choose plants that are adapted to your site and are winter hardy.
- your ability to prevent damage from diseases, insects, weeds, and wildlife.
- your ability to use good cultural practices, including providing adequate water.
- your ability to do what is required in a timely manner.

Site Selection and Soil Preparation

Fruit plants are most productive if you carefully match them with the proper planting site. Very few sites are naturally ideal. To succeed, you may have to overcome some combination of weeds, diseases, pests, poor drainage, low soil organic matter, and poor soil fertility.

Each of these can severely reduce the size of your harvest and the health of your plants. So it's best to take care of them before planting. Once plants are in the ground, it is very difficult to reduce soil pest populations or correct nutrient deficiencies. The most important year for production is the one before planting when you modify the site to take care of these problems. This is very important, especially if you want to use a low-spray/no-spray approach to pest control.

A previously cultivated site is often preferable to a new site because you usually do not have to work the soil and perennial weeds are often already under control. But you should not plant strawberries or raspberries where crops that are susceptible to verticillium wilt have been grown (these include potatoes, tomatoes, eggplants, and peppers). If you must plant strawberries or raspberries following these crops (or following strawberries or raspberries), choose cultivars resistant to verticillium wilt.

While gooseberries and currants perform adequately in partial shade, other fruits require direct sun for at least six hours a day, preferably more. All fruits require well-drained soil with good water-holding capacity. Although a commercial fruit grower may use tiling or grading and leveling to improve drainage, these methods are not usually affordable for home gardeners. For best results, simply choose a well-drained site or plant on raised beds.

To reduce weed pressure, to increase soil organic matter, and to improve soil structure and drainage, grow a cover crop before planting fruit. Plant rye or wheat in late summer or early fall as an overwintering cover crop

Solve site-related problems the year before planting.

before a spring fruit planting. Oats planted at the same time will grow in the fall and then die over the winter, leaving a dead mulch on top of the soil. For additional soil improvement, plant buckwheat as a summer cover crop before establishing the winter cover crop. Growing marigolds, Sudangrass, or certain mustards (oilseed rape) for a year or two before planting fruit can help control certain parasitic nematodes, which are occasionally a problem in certain soils.

Weeds are extremely difficult to control once a planting is established, so eliminating most weeds before you plant is an important first step. Before planting cover crops, kill existing vegetation and eliminate perennial weeds such as dandelions and quackgrass. You can do this by applying a postemergent broad-spectrum herbicide that leaves no residue in the soil, by covering the area with black plastic for a year before planting, or by cultivating the site regularly throughout the year before planting.

Because it's difficult to correct nutrient deficiencies and adjust soil pH after you've planted, it is critical to test your soil before planting to see if you need to add lime and nutrients. Collect subsamples from several locations to provide a representative sample of the site. (Contact your county Cornell Cooperative Extension office for more information, or see www.cce.cornell.edu/local_offices.cfm.) The soil test will report the pH (relative acidity or alkalinity of the soil), the cation exchange capacity (a measure of the resistance of the soil to changes in pH), and the amounts of various nutrients present.

Fruit trees, grapes, strawberries, brambles (blackberries and raspberries), currants, and gooseberries grow best when the soil pH is between 6.0 and 6.5. If your soil tests below this range, add lime to raise the pH as recommended on your soil test report.

Blueberries require acid soil with a pH of about 4.5. You can apply sulfur to lower the pH before planting. On some soils it may be too difficult to lower the pH enough to grow blueberries, especially soils with a natural pH of 7.0 or higher.

Because it takes about a year for sulfur or lime to affect soil pH, you need to apply them the year before planting. Acidifying the soil with aluminum sulfate is not recommended because it requires six times more chemical than acidification with sulfur does. In addition, aluminum sulfate applications are expensive and can contaminate the soil with excess aluminum.

Phosphorus is important for root growth and flower bud formation, but it does not move easily through the soil. For this reason, incorporate fertilizer based on your soil test recommendations into the top 8 inches of soil before planting.

Plants need potassium to activate enzymes, move sugars into the fruit, open stomates, and assist in nitrogen uptake. The amount of potassium required by fruit plants depends on the soil type. It is important to incorporate phos-

Keys for Success

Prepare the soil. The most important year in the life of your fruit plants is the year before you plant them. Test the soil and begin preparing it by adding organic matter and planting cover crops about a year before you plan to establish your planting. This is particularly important if you need to adjust soil pH.

Start small. Consider how much time you have to care for your planting. You will probably get more fruit—and satisfaction—from a small, well-tended planting than you will from a large, neglected one.

What's available locally? If you already have a good local source of a particular fruit, do you really want to grow more? You might want to focus your planting on hard-to-get species or varieties with special traits (such as good flavor, early harvest, disease resistance) that you can't find locally.

phorus and potassium before planting because severe deficiencies cannot be corrected later.

A soil test also will include results for magnesium, which is necessary for chlorophyll formation, and calcium, which is essential for fruit development, pollen germination, and membrane integrity. Because lime contains varying amounts of magnesium and calcium, choose a type of lime that will adjust calcium or magnesium levels as well as raise pH. If calcium is low, use calcitic lime. If magnesium is low, use dolomitic lime.

Levels of other nutrients needed by fruit crops are best indicated by a leaf analysis during the first growing season. (For more information about leaf analysis testing, contact the Cornell Nutrient and Elemental Analysis Laboratory, telephone: (607) 255-1785, web site: www.hort.cornell.edu/departments/facilities/icp.)

A good strategy is to test the soil and carefully prepare and fertilize the soil at least a year before establishment. Then retest the soil to make sure that soil nutrient levels are adequate before planting. Once you've established the planting, have the soil tested every three or four years. If you see signs of nutrient deficiency that are not showing up in your soil test, have a leaf tissue analysis done.

Climate Concerns

Minimum winter temperatures at your site largely determine which fruit cultivars you can grow successfully. In addition to the genetics of the cultivar (including both the tree and the rootstock in the case of fruit trees), many other factors affect whether or not your trees or small fruits will survive over the winter. If your soil is poorly drained, your plants are less likely to make it to the spring. Likewise, other stresses will reduce the plants' hardiness, including a heavy crop the previous season, too much or too little nitrogen or other nutritional problems, and defoliation or other pest damage.

Predicting winter hardiness is an inexact science, but a good place to start is by determining which USDA Hardiness Zone you live in (see Hardiness Zones map on the inside cover). The USDA Hardiness Zones are determined by the average low temperature in winter. Keep in mind that these are averages, and in extreme years the temperatures may get even colder. Compare your expected low temperatures with the information below.

Most cultivars of apple and pear trees can withstand winter lows of -25 degrees F (USDA Hardiness Zone 4b).

Sour cherries, plums, and blueberries suffer winter injury when the minimum temperature is lower than -20 degrees F, so they are not reliably hardy beyond Zone 5a. Brambles will survive these temperatures but may not bear fruit the following season.

Poorly drained soil reduces winter survival.

The wood of sweet cherries and peaches can sustain damage when temperatures approach -20 degrees F, and the flower buds of peach trees are usually killed when temperatures reach -15 degrees F. Sweet cherries are usually successful only in Zones 5 and warmer, and peaches in Zones 6 and warmer.

During cold winters with little snow cover, unmulched strawberry plants often sustain winter injury. Although some grape cultivars such as Concord can withstand temperatures around -20 degrees F, vinifera-type grapevines survive weather this cold only if they are buried for the winter.

Keep in mind that winter hardiness is just one factor in determining whether a particular fruit cultivar will perform well on your site. Your location may not have extremely low winter temperatures, but if it's prone to late spring frosts, freezing temperatures may kill blossoms on early-flowering cultivars (see the Average Last Spring Frost map on the inside front cover). Expect losses due to flower damage on many types of fruit where frost occurs frequently after May 10.

Temperatures in a given region can vary greatly depending on elevation, exposure, and proximity to large bodies of water. Cold air settles into low areas, and even during periods of a hard freeze, temperatures at the middle or top of a slope can be several degrees warmer than at the bottom. If at all possible, avoid planting fruit in these low-lying frost pockets.

The length of your growing season is also important, as some cultivars require a long frost-free period to ripen fruit (see Average Frost-Free Growing Season map on the inside front cover). Some also require a minimum number of "growing degree days" (GDDs), essentially a measure of how much warm weather you have at your site.

Carefully check hardiness information in nursery catalogs before ordering plants to make sure that they are winter hardy in your area and are well matched to the length of your growing season. If your location is prone to late spring frosts, look for late-flowering varieties. The fruits of fall-bearing raspberries and early-blooming grapes are more likely to ripen in areas that have early fall frosts.

Winter Protection

While it's important to select cultivars that are hardy for your area, other stresses, such as insect and disease damage, can weaken plants and make them more susceptible to winter injury.

Taking care of your trees throughout the year can minimize stress and improve their chances of surviving over the winter. One of the most important factors influencing cold hardiness is the nutrient status of your plants. If plants are deficient in one or more nutrients, winter injury is likely to occur.

Keys for Success

Are you ready for commitment?

Tree fruits, in particular, require a lot of care and don't come into full production for several years. Strawberries, on the other hand, aren't much more difficult to grow than most garden crops. Most of the other small fruits fall somewhere in between but still require regular pruning and care and, in some cases, trellising. If deer or other wildlife are abundant, plantings may require fencing or other protection. Make sure you are ready for the commitment before you jump in.

Yet if plants have too much nitrogen in their tissues, they do not “harden” properly. Hardening is a physiological process that cold-climate plants go through, which includes storing carbohydrates and proteins in ways that allow them to survive cold weather.

For most fruit plantings, nitrogen should be applied only in the spring (strawberries are an exception). Late applications of nitrogen fertilizer can cause a late-season flush of growth and delay hardening, increasing the risk of winter injury.

To help plants harden off, do not water them after mid-September unless there is a severe drought. Many growers allow weeds to grow late in the season to help remove water and excess nitrogen from the soil and thereby help plants harden properly. Others plant a cover crop. Mulch applications help prevent soil heaving in new plantings.

Plants store energy collected from the sun through photosynthesis as carbohydrates. Those entering winter with few carbohydrates stored in their roots and buds are likely to grow poorly in the spring or be injured by cold temperatures. Proper pruning at the right time allows plants to maximize sun exposure and improve carbohydrate storage. Pruning too late in the season may cause a flush of growth and reduce a plant’s hardiness.

Mulching strawberries helps prevent significant winter injury, but mulching too early can be as detrimental as not mulching at all. Early mulching shades the leaves from sunlight and prevents the plant from accumulating sufficient carbohydrates. Strawberry plants should not be mulched until the temperature falls below 20 degrees F for three nights in any one week, usually near Thanksgiving in much of New York State. It is best to mulch immediately before the first heavy snow and remove straw mulch before the end of March.

Designing a Planting

While growing fruit at home can be rewarding, it will cost time and money. To reduce these costs, carefully consider the design of your planting, including arrangement, spacing, cultivar selection, number of plants, and aesthetics.

One common mistake is to put the plants too close together. Allow ample room for growth so you can prune and perform other tasks.

Another common error is to put in more plants than you need. A small planting that receives proper care will yield more good-quality fruit than a larger planting that is neglected. Use Table 2 to help draw up a planting design that will meet family and space requirements.

Many fruit plants are aesthetically pleasing and are good for “edible landscaping.” But if production and ease of management are your primary goals, maintaining a home fruit planting will be easiest if you devote separate

A small, well-tended planting will yield more high-quality fruit than a larger, neglected one.

Table 2: Planting and harvesting guidelines for various fruit crops

<i>Fruit and Rootstock</i>	<i>Spacing (ft.)</i>		<i>Bearing Age (years)</i>	<i>Potential Yield at Maturity (lb./plant)</i>	<i>Harvest Period</i>	<i>Cultural Demands</i>
	<i>Between Plants</i>	<i>Between Rows</i>				
Tree fruits						
Apple, M.9	7	13	3-5	60	late July through Oct.	High
Apple, M.26	10	15	3-5	100	late July through Oct.	High
Apple, M.7, M.9/MM.106	12	18	4-5	250	late July through Oct.	High
Apple, MM.106, MM.111	18	24	5	300	late July through Oct.	High
Apricot	15	20	4	100	mid-July to early Aug.	High
Cherry, sweet	24	30	7	300	early to mid-July	High
Cherry, tart	18	24	4	100	mid- to late July	Low
Nectarine	15	20	5	100	early Aug. to early Sept.	High
Peach	15	20	4	100	late July to mid-Sept.	High
Pear, Old Home/quince	15	15	4	100	mid-Aug. to Oct.	Moderate
Pear, standard	20	20	5	100	mid-Aug. to Oct.	Moderate
Plum	10	15	5	75	late July to mid-Sept.	Moderate
Grapes						
American type	8	9	3	20	early Sept. to Oct.	Moderate
Vinifera type	8	9	3	10	early Sept. to Oct.	High
Small fruits						
Blackberry	2	10	2	2-3	late July to Aug.	Moderate
Blueberry	4-5	10	3-6	3-10	late July to Sept.	Low
Currant	4	8	2-4	6-8	July	Low
Elderberry	6	10	2-4	4-8	Aug. to Sept.	Low
Gooseberry	4	10	2-4	2-4	July to Aug.	Moderate
Raspberry	2	8	2	1-2	July or Sept.	Moderate
Strawberry (June-bearing)	2	4	2	1-3	June to early July	Moderate
Strawberry (Day-neutral)	0-5	3-5	1	1	June through Oct.	High

areas to fruit trees, small fruits, and vegetables. Some people find a natural setting with plants placed throughout the landscape most aesthetically pleasing. But this makes maintenance more challenging.

Pollination and Fruit Set

One of the most common questions home fruit growers ask is, “Why won’t my plants set fruit?” There are many possible reasons for poor fruit set, including

- a late spring frost.
- cold or rainy weather during bloom.
- disease.
- poor plant nutrition.
- inadequate pollination.
- lack of a compatible cultivar for cross-pollination in species that are not “self-fruitful.”

Pollination and subsequent seed development are prerequisites for fruit set. With most fruits, flowers that appear in early spring begin as buds that form in the axils of the leaves during the previous year. Flowers of many fruits bloom during early spring and can be damaged by frost. If temperatures fall below 30 degrees F when the flowers are vulnerable, some or all may be killed, reducing or eliminating fruit set.

Pollination occurs after the flowers have opened. Some fruits, such as grapes and peaches, shed pollen from their anthers (the male part of the flower), which falls by gravity or is carried by wind currents to the pistil (female part of the flower).

With strawberries, blueberries, apples, plums, and sweet cherries, insects carry the pollen from flower to flower. Heavy rains during bloom can interfere with pollen distribution or insect activity. Seed formation will be poor if pollination is inadequate, and seed formation is essential for the growth and development of most fruits. For example, apples with only a few seeds will fall off the tree in June or remain small and misshapen.

Some fruits, such as strawberries, raspberries, peaches, tart cherries, and grapes, are self-fruitful. Each plant can set fruit with just its own pollen.

Other fruits, such as apples, sweet cherries, pears, plums, apricots, and elderberries, are not self-fruitful. They require cross-pollination from another cultivar for fruit to set. Blueberry plants are self-fruitful, but berry size is larger with cross-pollination from another cultivar. Most nursery catalogs provide information about which cultivars are good for pollinating each other—for blueberries and other fruit crops as well.

Some fruits require cross-pollination from another cultivar.

Certain apple cultivars, such as Jonagold and Rhode Island Greening, produce pollen that is ineffective in setting fruit on other cultivars. To be sure of adequate cross-pollination, plant at least three different apple cultivars.

With groups of sweet cherry cultivars, the pollen of some cultivars is not compatible with others within the group. Yet the cultivar Stella is cross-compatible with most sweet cherry cultivars and provides a good source of pollen for other cultivars. Stella is also self-fruitful.

Many European plums (often called prune plums because of their high sugar content) are partially self-fruitful. But you can improve their fruit set by planting two or more cultivars. You will need to plant two or more cultivars of Asian plums because most are not self-fruitful.

Plant all fruit trees used as “pollenizers” within 100 feet of the cultivar to be pollinated. You may need fewer plants if you rely on neighbors’ trees as pollenizers, but you could have a major problem if those trees are destroyed.

Vertebrate Pest Control

Voles, deer, and birds are the three major vertebrate pests of fruit plantings. Voles are mouse-like mammals that eat the bark and roots of young fruit trees and thornless blackberries in winter and are frequently a serious problem. Deer consume the new shoots of fruit trees. Birds damage the fruits of blueberry, cherry, gooseberry, and grape plantings.

Two different vole species cause problems: the meadow vole (which lives aboveground) and the pine vole (which lives belowground). During the spring, summer, and fall, voles eat vegetable matter and seeds. But in the winter they feed on the bark and roots of young trees, often girdling and killing them.

To assess whether or not you might have vole problems before they do damage, place half an apple under a shingle or a 1-foot-square piece of plywood in a grassy area near your trees. Check it the next day. If the apple is completely gone, you’ve got problems that need treating. If there are only a few nibbles, voles are probably present, so you should keep monitoring and consider control measures.

A good way to prevent meadow vole damage is to manage their aboveground habitat. Keep grass cut short so they have no place to hide. Keep weeds and grass cleared out around trees (about 40 percent ground coverage is OK). Don’t use straw or fabric mulches, which provide the voles with shelter. But woodchips are OK.

To protect young trees from injury, enclose the base of each trunk with a cylinder of quarter-inch hardware cloth. The cylinder should be about 8 inches in diameter. Bury the bottom shallowly in the soil, being careful not to disturb the roots. The top should be about 18 inches tall and not interfere with

Voles feed on bark and roots of young trees in winter.

the lowest scaffold branch. Mound up pea gravel or mulch a few inches around the cylinder to hold it in place.

Hardware cloth cylinders are less effective with pine voles because you can't install them deep enough to keep out these underground dwellers without damaging tree roots. Because they come aboveground to feed, keeping grass mowed and clear areas around trees helps. But other control measures may be called for.

Using poison baits in orchards can pose risks to pets and other wildlife. Box traps, "mouse hotels," and similar control measures are surprisingly effective with voles. Try using apples for bait. Encouraging natural predators such as hawks and owls can also help keep rodent populations under control.

Deer will eat just about anything if they are hungry enough. In areas with heavy deer pressure, the most reliable method to keep them from destroying fruit plantings is to construct an 8-foot-tall fence. Several repellents also can be effective in small home plantings if they are applied and reapplied properly. Hanging a single unwrapped bar of fragrant soap from each tree or bush may discourage feeding if deer pressure is low.

Ripening fruits (especially cherries and berry crops) are frequently damaged by birds. Whether the birds are flocking or nonflocking, migratory or resident, the resulting fruit injury can cause significant losses. The extent of damage varies from year to year and depends on factors such as weather conditions and food supplies.

Which bird species you can expect to damage fruit crops depends on the surrounding environment. Plantings that border forests or brush, for example, attract different bird species than plantings surrounded by open fields or croplands. Plantings located near wooded areas, where birds find shelter and nesting sites, are particularly susceptible to damage. Fruits planted in an isolated area also are vulnerable because the fruit may be the main food source for birds. Some bird species are attracted to plantings near trees or power lines. Planting grass alleyways and controlling weeds within and adjacent to the planting reduces problems with birds. Certain weed species supply food and cover to birds and attract them into the area.

In general, birds feed most heavily early in the morning and again in late afternoon (starlings, which feed throughout the day, are an exception). Adjust your control schedule to coincide with the feeding schedules of the birds.

Several nonlethal methods of bird control are available to home fruit growers. Netting is a traditional and widely used strategy that physically prevents birds from reaching fruit. It is both quiet and effective, but you must apply the netting before the birds discover the ripening fruit (the changes in color as fruit ripens signal the birds to start feeding).

Repellents or fencing can keep deer at bay, depending on how hungry deer are.

Roll the netting out over the tops of plants and secure it to a support system such as a trellis. The major disadvantages of netting are the high initial cost and the labor involved. Setting up and removing netting on a large scale can be difficult and may require specialized equipment.

Electronically recorded, species-specific distress calls are fairly expensive but effective against certain bird species. The downside is that neighbors may find them as distressing as the birds do. Before purchasing the distress calls, know which species are eating your fruits. Distress calls are most effective when supplemented with some type of visual scare device, such as one of the kite or balloon products bearing the silhouette of a hawk or owl.

Such visual scare devices don't work with all species, however. The hawk kite, for example, scares away starlings, robins, and northern orioles but is not effective with mockingbirds or brown thrashers. Another limitation is local weather. Kites function best in breezy but not windy weather. Furthermore, birds get used to them very quickly and they lose their effectiveness unless supplemented with a noise device.

There are no magic solutions to controlling bird damage. Assess the extent of damage and then determine what species of bird is doing the damage. Netting is probably the most effective but most expensive physical method. Scare devices should be used early to prevent birds from establishing a feeding pattern. A combination of techniques is usually most effective.

For more information, see these Cornell Cooperative Extension publications:

- *Wildlife Damage Management in Fruit Orchards* (1994)
- *Managing White-Tailed Deer in Suburban Environments: A Technical Guide* (2000)

For ordering information, see: "Related Cornell Cooperative Extension Publications," page 103.

Low-Spray/No-Spray Pest Management

Because of the cost of spray materials, the lack of equipment, or a concern for their health and the environment, many home gardeners want to grow fruit using little or no pesticide. But many gardeners become frustrated when pests ruin a crop or render fruit inedible. The following suggestions can help you manage your fruit planting with fewer pesticides.

Closely monitor pest populations. This means checking plants every day or so. Too often, gardeners allow diseases and insects to build up to unacceptable levels before taking steps to control them. By looking for pests every day, you will develop a sharper eye for potential problems and can readily treat or remove localized infestations. Commercially available sticky traps or pheromone traps are helpful in monitoring levels of certain insect populations.

Check plants every day or so to nip pest problems in the bud.

Plants that are healthy from the start are less likely to be attacked by pests. Do a good job of selecting a site and preparing the soil. Plant only top-quality stock, and discard moldy planting stock. Avoid disease and winter injury by planting disease-resistant, cold-hardy cultivars. For example, select only strawberry cultivars that are resistant to red stele and verticillium wilt. Many cane diseases attack bramble or blueberry plants that have been weakened by winter damage.

Avoid planting fruits that require pesticides. In this regard, the apple cultivars Freedom and Liberty are superior to McIntosh, and blueberries are preferable to day-neutral strawberries.

Closely follow the cultural practices recommended in the “Diseases and Insects” section for each fruit in this bulletin. Clean up dropped fruit (and if possible, leaves) and compost them, preferably in a hot compost pile, or at least bury them deeply in a cold compost pile. Remove and burn any branches infected with fire blight. Keep grass and debris away from the trunks and the bases of plants. Many insects overwinter in or under surface debris such as old boards, fallen leaves, brush, and other vegetation. Maintain a clean home fruit planting to reduce insect populations in successive years.

Destroy pest insect egg masses whenever possible. Plant cover crops such as marigolds to deter nematodes, and use mulch to control weeds. Cover strawberry plants with fabric row covers to prevent damage by tarnished plant bugs and other pests.

Trellis brambles and prune blueberries, brambles, currants, gooseberries, elderberries, and fruit trees annually to increase light penetration and air circulation. This can help reduce disease problems. Trellising also keeps fruit off the ground, reducing the likelihood of a dirty harvest. Harvest fruit as soon as it is ripe. Overripe fruit spoils, rots, and attracts insects.

Biological control measures involve encouraging the natural enemies of insect pests. Many of the insect and mite pests that attack fruits have natural enemies that help keep them in check or under control. In particular, lady beetles, parasitic wasps, aphid lions, ground beetles, and praying mantises are effective against scales, aphids, and mites. Flowering ground covers in the vicinity (not under fruit trees) can provide habitat and pollen and nectar for these beneficial insects. Plants in the aster family are particularly good. (For more information, see “Biological Control: A Guide to Natural Enemies in North America” at [www.nysaes.cornell.edu/ent/biocontrol/.](http://www.nysaes.cornell.edu/ent/biocontrol/))

In general, maintaining a complex habitat surrounding your planting can be helpful. Hedgerows can make it easier for foxes to hunt rodents. Perches and nesting areas for raptors and owls can encourage them to stay and hunt. Providing roosting boxes for bats can encourage them to hunt insects at dusk.

Trellising berry plants increases air circulation and decreases disease.

Money and Time Demands

Home fruit growers may find it more difficult and expensive to grow high-quality tree fruit than small-fruit plants, such as strawberries, grapes, blueberries, and brambles. One reason for this is that many different pests and diseases plague tree fruits. Summer rainfall and high relative humidity favor the growth and spread of disease-causing organisms. Insects also are a challenge. Power-driven spray equipment is not practical for a small home planting, so getting spray into the canopy of a large fruit tree is difficult. Dwarf fruit trees are one solution because pesticides can be applied with hand-operated equipment.

Berries and grapes have definite advantages for home gardening. They require a minimum of space for the amount of fruit produced, and they bear at an early age. Their small stature makes disease and insect control easier and less expensive than with most tree fruits. But do not assume that diseases and insects cause less damage to small-fruit plants than to fruit trees.

Before undertaking an extensive home fruit planting, carefully consider the amount of time required. Discuss this commitment with other family members. If this is your first attempt at growing fruit, consider planting on a small scale to get a realistic idea of the demands.

Consider how much time you can devote before planting.

Tree Fruits

Keys for Success

Choose cultivars that are hardy in your area. Dwarf cultivars bear fruit earlier than standard trees and are easier to manage in home plantings.

Except for peaches (which are self-fruitful), plant at least two different cultivars for good pollination.

Start with nursery-grown one- or two-year-old bare-root plants. Older plants are more difficult to train.

Choose a site with good air drainage that is not vulnerable to late spring frosts.

Plant trees in early spring as soon as the soil has warmed and drained. Begin preparing soil (adjust pH and add organic matter) and controlling weeds a year before planting.

Mulch with bark or wood chips to provide a grass-free zone within 2 feet of each tree.

Stake dwarf and semi-dwarf trees, and commit to timely pruning and fruit thinning.

Protect trees from deer, rodents, and other pests and diseases.

Tree fruits became popular in America in the early 19th century, thanks, in part, to the efforts of John Chapman, also known as Johnny Appleseed.

Today, New York is the nation's second-leading apple producer. The Northeast also produces significant quantities of sweet and tart cherries, peaches, pears, plums, nectarines, and apricots. The New York State Agricultural Experiment Station at Geneva, New York, maintains one of the world's foremost tree fruit breeding programs and a collection of apple germplasm from around the world.

Tree fruits are classified according to the type of fruit they produce. Apples and pears are pome fruits. They are fleshy with several seed chambers. Stone fruits have a hard pit in their center and include cherries, peaches, plums, nectarines, and apricots.

Choosing Cultivars

There are so many cultivars (short for cultivated varieties) to choose from! Deciding what to plant is one of the most enjoyable tasks of growing fruit trees. But it also can be frustrating for those who are new to growing fruit.

Fortunately, there are many tried-and-true cultivars to consider (see Table 3 and “Sure-Fire Winners,” pages 16 and 15, respectively). Lengthy test periods have proven the value of many newer fruit tree cultivars that offer home fruit growers the widest choice ever of high-quality fruit with other desirable characteristics, such as disease resistance.

Many older cultivars are still available, but they are planted infrequently because either the trees are too challenging to grow or the fruit they produce is often of poor quality.

When choosing cultivars, look for those with outstanding hardiness, disease resistance, and fruit quality. Many of the newer cultivars provide top-quality fruits not often available in local markets. For example, try growing the disease-resistant apple cultivar Liberty rather than the popular but apple scab-susceptible McIntosh. Home fruit growers whose livelihoods do not depend on their garden harvest may find a lower-yielding yet higher-quality cultivar the best choice.

Keep in mind that peaches and sour cherries are the only tree fruits grown in New York that are self-fruitful. When growing other tree fruits discussed in this publication, you need to plant at least two different cultivars to get good pollination and fruit set (see “Pollination and Fruit Set,” page 8). Look in nursery catalogs for information about which cultivars make good “pollenizers.”

Cultivars also need to be winter hardy in your area. For more information, see “Climate Concerns,” page 4.

The cultivars listed in Table 3 are adapted to a wide range of conditions and yield fruit for eating fresh as well as for storing or preserving. By choosing early-, mid-, and late-ripening cultivars from this list, you can stretch your tree fruit harvest season.

Rootstocks

Most home gardeners prefer small, size-controlled fruit trees grown on “dwarfing” rootstocks. Smaller trees make picking, pruning, and pest control easier, and they set fruit at a younger age than full-sized trees.

Rootstocks for apple trees are special apple varieties that control the height of the tree and give it other special characteristics, such as resistance to insects or diseases, solid anchorage in the ground, and early fruit production. A cultivar is grafted onto this special rootstock, so you are essentially buying two plants—the rootstock that anchors the tree and the cultivar that produces the fruit.

In this publication and elsewhere, you may read references to “dwarf apple cultivars.” This is usually shorthand for “apple cultivars grown on dwarfing rootstock.” For example, the cultivar Yellow Delicious can be grown on a dwarfing rootstock or on a rootstock that allows it to grow into a full-sized tree. This is different from most landscape trees, where dwarf cultivars are distinctly different genetically from their full-sized relatives.

Mature tree size depends on the vigor of the rootstock, the scion cultivar (the cultivar grafted onto the rootstock), the depth and physical characteristics of the soil, and cultural practices. Fully dwarf apple trees grow just 8 feet tall when fully mature at 15 to 20 years of age. The fruit of a small tree is as good in flavor as, or better than, the fruit of the same cultivar grown on intermediate- or full-sized trees.

Common apple rootstocks include:

M.9—A strongly dwarfing rootstock that produces a very short, 8- to 10-foot-tall tree (see Figure 1). It needs a soil with high water-holding capacity and good drainage. Plants should be staked or trellised, and they are very susceptible to the disease fire blight. Trees grown on M.9 rootstock can bear fruit the second or third year after planting and reach full production in six years.

M.26—Produces slightly larger, 11- to 14-foot-tall trees that tend to be poorly anchored in the ground. Trees must be planted in well-drained soil but cannot tolerate very dry conditions. Trees grown on M.26 rootstock can bear fruit the second or third year after planting and reach full production in six years.

Sure-Fire Winners

These apple cultivars are easy to prune and set fruit most every year. (You'll still need to tend to pest management.)

- Jonamac
- Sansa
- Liberty
- Empire
- Golden Delicious
- GoldRush

Fruit trees grown on dwarfing rootstock bear fruit sooner and are easier to manage.

Table 3: Recommended tree fruit cultivars (listed in order of ripening for each fruit type)

<i>Fruit</i>	<i>Cultivar</i>	<i>Fruit</i>	<i>Cultivar</i>
Apple	Williams Pride*	Nectarine, white flesh	Morton
	Sansa*		Nectacrest
	Gala	Peach, yellow flesh	Harrow Diamond
	Jonamac		Brighton
	Freedom*		Redhaven
	Priscilla*		Madison
	Liberty*		Canadian Harmony
	Empire		Cresthaven
	Golden Delicious		
	Keepsake		
GoldRush*			
Apricot	Harcot	Peach, white flesh	Surecrop
	Harogem		Raritan Rose
	Harlayne		Eden
	Goldcot		
Cherry, sweet	Stella	Pear	Bartlett
	Emperor Francis		Gorham
	Royalton		Bosc
	Hartland	Plum, European (prune)	Green Gage
	Hedelfingen		Richards Early Italian
Cherry, tart	Montmorency		Stanley
	Balaton		French Damson
Nectarine, yellow flesh		Plum, Asian	Early Golden
	Pocohontas		Shiro
	Mericrest		Seneca
	Nectared 4		
	Nectared 6		

* Scab-resistant apples

M.7—Produces 15- to 18-foot-tall trees with deep roots. But if for any reason the soil has a restrictive layer, trees will be poorly anchored. Roots also are susceptible to root rot and crown gall diseases. Trees will take at least one year longer to fruit than those grown on M.9 or M.26 rootstocks, usually bearing in their third or fourth year after planting and reaching full production in 8 to 10 years. These trees are a good size for planting in areas with heavy deer pressure if you can protect them from browsing deer when they are small.

MM.106—Produces large, 18- to 20-foot tall trees, nearly standard size. Trees often grow late into the fall, making them more susceptible to winter injury. They will not tolerate poorly drained soils, and collar rot

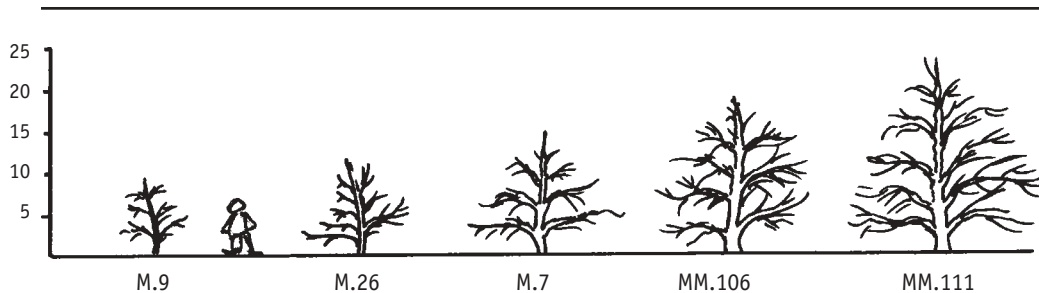

Figure 1. The type of rootstock that apple varieties are grafted onto determines the mature height of the tree. For example, M.9 rootstock produces an 8- to 10-foot-tall dwarf tree that can be pruned and harvested from the ground. Varieties grown on M.111 rootstock grow to be 19 to 24 feet tall.

is a common problem. Trees grown on MM.106 rootstock can bear fruit their third or fourth year after planting and reach full production in 8 to 10 years. These trees are a good size for planting in areas with heavy deer pressure if you can protect them from browsing deer when they are small.

MM.III—Produces large, standard-sized, 19- to 24-foot-tall trees. Roots tolerate a wide range of soil conditions, including dry soil, and plants are less subject to collar rot than are those grown on MM.106. Trees grown on MM.III rootstock can bear fruit their third or fourth year after planting and reach full production in 8 to 10 years. These trees are a good size for planting in areas with heavy deer pressure if you can protect them from browsing deer when they are small.

The recently developed Cornell Geneva rootstock series has two rootstocks that are highly resistant to fire blight:

CG.16—Produces dwarf trees similar in size to M.9. The trees are very productive at an early age, fruiting during the second or third year and reaching full production in six years.

CG.30—Produces mid-sized trees similar in size to M.7, but it sets fruit a year or two earlier and produces fewer root suckers.

Bud.9 is a fully dwarfing rootstock similar to M.9 but more cold hardy and fire blight resistant.

Size-controlling rootstocks are also available for other tree fruits. For pears, Old Home x Farmingdale rootstock offers good fire blight resistance. OHxF 333 performs well in New York and produces trees that are about 10 to 12 feet tall. Pear trees grown on OHxF 97 rootstock are nearly as tall as standard trees but produce fruit much sooner.

For peaches, Lovell and Bailey are acceptable rootstocks wherever peaches can be grown in New York and produce 12- to 15-foot-tall trees.

Plum and prune cultivars grafted on sand cherry or Nanking cherry rootstocks grow just 15 feet tall. Plum trees are commonly propagated on *Prunus* St.

Apple trees can grow from 8 to 24 feet tall depending on the rootstock you choose.

Julian A and myrobalan (*Prunus cerasifera*) rootstocks. Myrobalan grows in a wide range of soils, including poorly drained sites.

Cherry trees were traditionally propagated mostly on Mahaleb and Mazzard rootstocks, which usually don't produce fruit until about their seventh year. Mahaleb is the more winter hardy of the two and produces a smaller, 15- to 18-foot-tall tree. However, it is damaged by collar rot in poorly drained soils. Mazzard rootstock generally produces larger, 24- to 28-foot-tall trees and is preferred for sites with questionable drainage. Giessen rootstock, developed in Germany, produces smaller trees and begins fruiting as early as the third year.

Nursery Stock

To get off to a good start, buy high-quality plants from a reliable nursery. The most commonly sold stock are half-inch-diameter, bare-root, one-year-old "whips," usually just a single stem. Nurseries sometimes sell two-year-old trees that may have several branches (sometimes called "feathers"). These two types of stock usually perform better than larger and older trees because small trees are easier to transplant and train to a desired shape. When ordering, request that plants arrive before growth has started, to prevent damage from shipping.

Improper care after plants arrive from the nursery can cause serious injury. The ground should be prepared and ready to plant before plants arrive. If the ground hasn't yet been prepared, unpack the plants immediately and "heel in" the trees in a well-drained, shady, cool location. Dig a temporary trench about 1 foot deep, and set the trees close together in the trench. Pack soil firmly over all the roots, mounding it so excess water will drain away. Make every effort to set the plants in their permanent location before growth starts, and never let the roots dry out or expose them to prolonged direct sunlight.

You also can store plants in a walk-in cooler for a short time before planting or heeling-in. But do not store them in coolers with ripening fruits, which give off ethylene gas that can damage the nursery stock.

Planting

Early spring is the best time to plant fruit trees. Plant as soon as you can after the soil has thawed and drained enough to work without destroying its structure and before your nursery stock starts to break bud and leaf out. It is best to prepare the soil the year before planting. See the section "Before You Begin" (page 1) for detailed instructions.

Before you plant trees, trim off broken or injured roots. Do not let the roots dry out. Plants can die if roots are exposed to sun and wind. You may want to soak the roots in a pail of clean, cool water for 6 to 12 hours before planting.

"Heel in" young trees if you can't plant them immediately.

Dig planting holes large enough to accommodate the tree roots in their natural position. Put aside the topsoil so you can replace it after planting. Don't skimp on the digging and preparation of the planting hole. Your tree has a much better chance of surviving and thriving if you do a good job.

Plant rootstocks with the graft union about 2 inches above ground level. If the graft union is below the soil line, roots may develop on the base of the scion cultivar (upper portion of the graft), which results in the loss of the effect of the rootstock.

Carefully spread the roots out over loose soil in the bottom of the hole. Move the tree up and down slightly as you spread the first few shovels of topsoil back on top of the roots. This helps to settle the soil under and around the roots and gets rid of air spaces. Tamp the soil firmly while filling the hole.

Water trees immediately after planting and water at weekly intervals for four to five weeks unless rainfall is adequate. Do not mix dry fertilizer with the soil used to fill the hole. It can damage the tender new roots. Add 1 tablespoonful of starter solution (high-analysis, water-soluble fertilizer similar to 20-20-20) to 1 gallon of water and apply this solution to the soil around each tree immediately after planting.

The root system of M.9 rootstock is brittle, and trees on this stock may tip over when the tops become large enough to catch a strong wind. These trees need the support of a stake, post, trellis, or fence. (You may want to stake other trees as well, especially on exposed sites.) A 1-inch-diameter metal electrical conduit pipe makes an ideal support. These are 10 feet long and are easy to pound into the ground. Place the post about 4 inches from the trunk and about 2 feet into the soil. Secure the tree to the post with several strong, durable ties. Specially made tree ties or a heavy wire covered by a section of garden hose work well. Always be certain when tying trees or branches to posts or other supports that the tie is loose enough to prevent binding or girdling as the trunk grows.

Managing Grass and Weeds

You need to minimize competition for water and nutrients from weeds and grass growing adjacent to your trees. Two approaches commonly used in home fruit plantings are mulches and permanent sod.

When planting trees into a lawn, follow the planting steps described previously. In addition, remove the sod within 2 feet of the tree to prevent competition between the tree and grass. If you don't water your trees or if they otherwise fail to thrive, you may want to expand this cleared area as the tree grows. Keep grass mowed short near the trees.

Mulches have several advantages. In addition to suppressing weed growth, they can reduce moisture loss, helping to keep the soil evenly moist. As they

Don't plant a 10-dollar tree in a 10-cent hole.

When planting into lawn, remove sod from within 2 feet of the tree.

decompose, they improve soil structure and release nutrients that the trees can take up and use. Mulches also cushion fruits that drop from the trees and reduce soil erosion.

Using mulches also has disadvantages, but if you recognize the drawbacks and deal with them, mulching is an excellent cultural practice. Mulches can carry in noxious weed seeds, be a fire hazard, and attract rodents. They may be expensive or difficult to obtain, and some people consider them unsightly.

In wet years or on poorly drained soils, mulches can hold excessive moisture, forcing growth that fails to harden off in the fall and resulting in winter injury or collar rot. When using mulch, it is difficult to judge how much nitrogen fertilizer to apply. If you use high-carbon materials, more fertilizer may be needed for the first few years. But as the mulch decays, less is required.

Although there are many different types of mulches, wood chips or bark mulch work best, in part because they are less attractive to voles, which can damage trees over the winter. Apply these mulches 4 inches deep, and they will settle into a mat less than half this thickness. For good weed control, add more mulch as it decomposes to maintain a 2- to 4-inch layer. The mulched area should extend from near the tree trunk to a point just beyond the spread of branches. To prevent tree injury by voles and other rodents, do not place mulches against the trunk of the tree, and place a hardware cloth ring around the trunk base. (See “Vertebrate Pest Control,” page 9.)

A thick layer of mulch slows soil warming in the spring. This can delay flowering, which can be an advantage if your site is prone to late spring frosts.

Fertilizing

Fruit trees require little if any fertilizer the year they are planted, particularly if you did a good job preparing the soil—adjusting pH and adding organic matter—the previous year. A starter solution applied at planting usually supplies enough nutrients for the first season’s growth. In subsequent years, some fertilizer may be needed for good annual growth.

Most soils contain many of the elements essential for plant growth. Fruit trees have large root systems. Under favorable conditions, the roots tap a large volume of soil, foraging for nutrients. Fertilizer is needed only when plants are unable to get sufficient quantities of these elements from the soil. When trees can’t get enough nutrients from the soil, the result can be decreased vegetative growth, light fruit set, and small fruit.

Whatever you do, don’t overdo the application of fertilizers! Too much fertilizer can be as detrimental as too little, particularly when it comes to nitrogen. Nitrogen fertilizers, represented by the first number on the fertilizer

Wood chip or bark mulch is least attractive to voles.

bag, fuel the annual extension growth in the trees (see Figure 12, page 31). Annual extension growth is the amount that a branch grows each year.

To gauge annual extension growth, measure the distance from the tip of the branch back to the “ring” formed by the scars from the previous year’s buds that encircle the branch, marking the end of the previous season’s growth. You generally should get about 18 to 24 inches of annual extension growth during the first several years. Thereafter, 10 to 12 inches is sufficient for mature trees.

As a general rule, determine how much fertilizer to apply based on the guidelines in the chart below. These are the rates that you should apply if your trees are **not** producing enough annual extension growth as described above.

Note that the amounts are small, but don’t be tempted to overapply! Overfertilization with nitrogen, phosphorus, and potassium can cause deficiencies in other nutrients. If your young trees are growing as described above, then apply no fertilizer and reevaluate your need next year.

Too much fertilizer is as bad as too little.

	Nitrogen rate	Ammonium nitrate		
		(33% N)	10-10-10 (10% N)	20-20-20 (20% N)
Young trees	0.04 lb./tree	2 oz./tree	6 oz./tree	3 oz./tree
Mature trees	0.08 lb./tree	4 oz./tree	12 oz./tree	6 oz./tree

If your trees flower every year but don’t produce fruit, a micronutrient deficiency might be the cause. After eliminating other possibilities, such as late frosts, have a leaf tissue analysis done. (For more information about leaf analysis testing, contact the Cornell Nutrient and Elemental Analysis Laboratory, telephone: 607-255-1785, or via the web at www.hort.cornell.edu/departments/facilities/icp)

Pruning and Training Basics

Apples, pears, cherries, and plums produce their best fruit on two- to three-year-old wood. Peaches bear their fruit on the last year’s vegetative growth. One of the prime reasons for annual pruning is to encourage lots of productive fruiting wood—one-year-old wood on peaches and two- to three-year-old wood on the others. Unpruned trees can quickly become unproductive, while 70-year-old fruit trees can still bear lots of fruit because annual pruning promotes the right amounts and kinds of growth.

How you prune your trees affects how they grow as well as how much they fruit (see Figures 3 and 4). The buds at the tip of each branch produce plant hormones that suppress the growth of buds below the tip. You can manipulate the effects of these hormones by pruning and bending branches. For

Annual pruning keeps trees productive.

example, when you cut off buds while pruning the tip of a branch, you release dormant buds farther back on the branch, which grow and produce new branches.

The effects of plant hormones are greatest on vertical shoots and least on horizontal limbs. Spreading branches from vertical positions so that they are nearly horizontal has an effect similar to that of pruning off the buds at the tip of the branch. This spreading promotes new shoot development, initiates fruit buds, and slows the extension growth at the branch tip. That is why most fruit trees are pruned and trained to produce horizontal branches that yield more fruit, while much of the vertical growth is pruned out of the tree (see Figures 3 and 4).

Figure 2. Pruning terminology

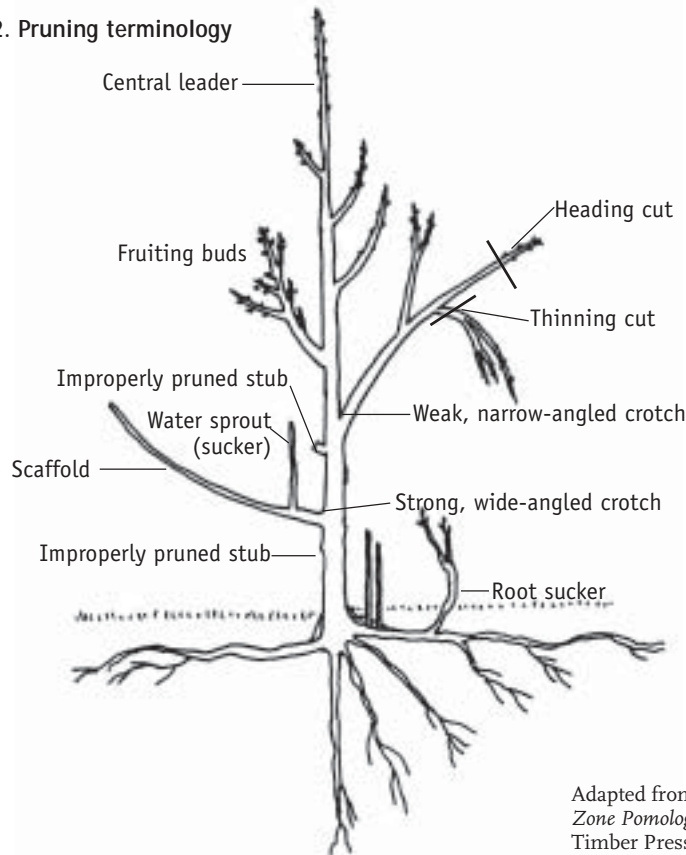

Adapted from Figure 6-25, *Temperate Zone Pomology* by Melvin N. Westwood. Timber Press, Oregon. 1988

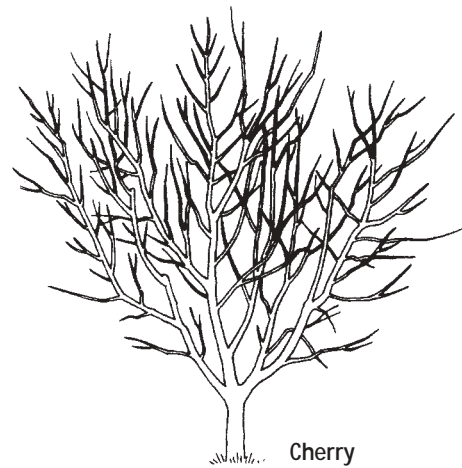
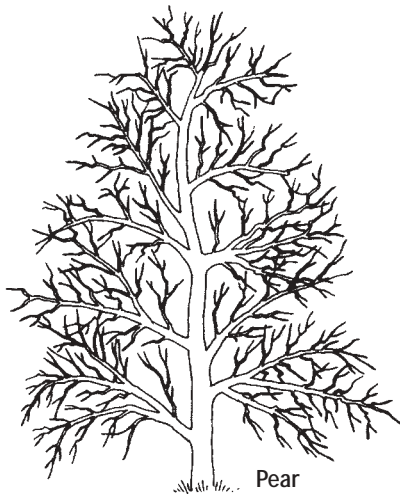
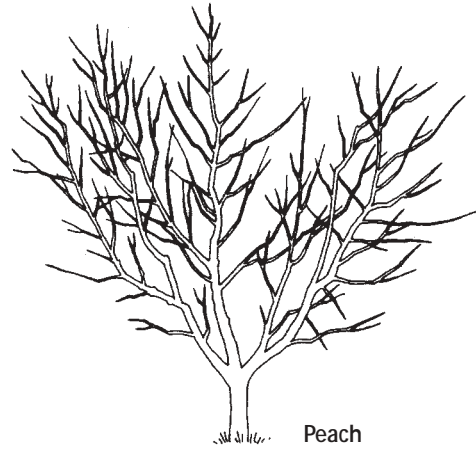
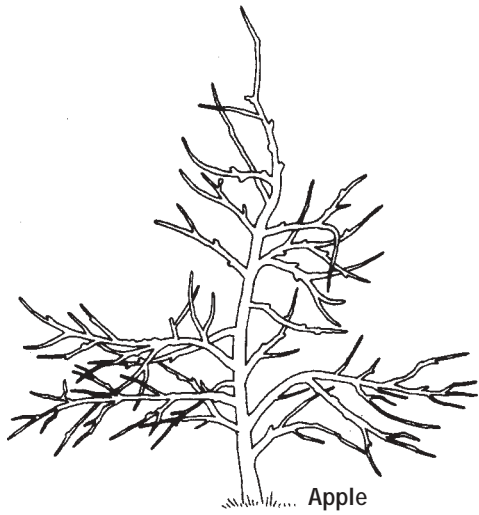
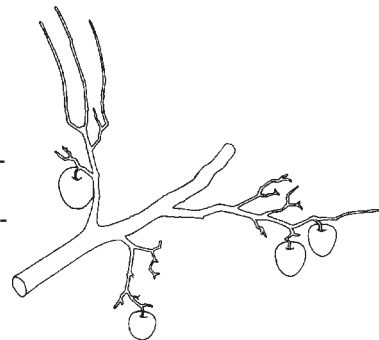

Figure 3. When pruning and training a young tree, it's important to keep in mind the form of the mature tree. Note the central leader and conical shape of the apple and pear trees and the more vase-like shape of the peach and cherry trees.

Figure 4. Horizontal branches produce more fruit. The upright branch produces lots of vegetative growth but little fruit. What fruit it does produce is often soft and poorly colored. The branch growing from the underside of a larger branch is heavily shaded. As a result, it produces little vegetative growth and small fruits of poor color. Therefore, prune to encourage horizontal branches. They produce moderate vegetative growth and are very fruitful. Because of good light exposure fruits have better color.



The other reason for encouraging horizontal growth is that branches with narrow crotch angles—where the angle formed between a branch and a vertical leader is less than about 60 degrees—are weak and break more easily under the weight of fruit. Narrow crotches also can serve as an entry point for organisms that cause disease and decay.

Each growing season, the diameter of each branch enlarges a bit, and each branch grows longer. You can follow the sets of “rings” on a branch to see how much annual extension there has been in preceding years and study the effects from past pruning, rainfall, and fertilization. Ten to 12 inches of annual extension growth is about right for mature fruit trees.

**February to April
is the best time
to prune apple
and pear trees.**

You should do most of your pruning during the dormant season—after the leaves have fallen from the trees but before new growth starts in the spring. The ideal pruning time is usually from February to April. (Pruning in early winter can sometimes cause injury.) Other training tasks are carried out in the spring and summer. Older trees sometimes need additional pruning in the summer, but pruning too late in the season can encourage growth that won’t harden off by winter and can weaken the tree.

Many people tend to prune too much. Prune what needs pruning, but don’t overprune, either (Figure 5). Too much pruning can cause excessive vegetative growth at the expense of fruiting.

To get started, you need to know three basic types of pruning cuts:

- Pinching—removing growth near the apical meristem (the growing tip of a shoot) while it is still young and succulent.
- Heading—removing some, but not all, of a branch or shoot (called a shortening cut on older wood).
- Thinning—removing an entire shoot at its point of origin (called a renewal cut on older wood).

Normally, when pruning trees of all kinds, you make your cut flush with the branch collar that forms where the shoot meets the branch or trunk. Where larger branches meet the main trunk, it's important to undercut the branch a few inches away from the trunk, then finish the cut from above. Remove the stub by cutting close to the branch collar. This helps prevent damaging the bark on the trunk.

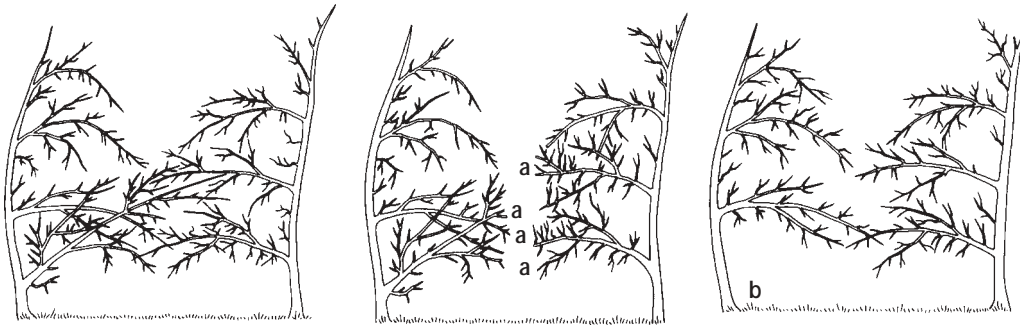

Figure 5. Thinning cuts (removing branches at their base) are usually better than heading cuts (removing the ends of branches). Here, branches from two adjacent trees are crowding each other.

Incorrect pruning: Numerous heading-back cuts (a) stimulate undesirable vegetative growth in the vicinity of the cuts and result in loss of fruitfulness farther back on the branches.

Correct pruning: Removing the large branch (b), eliminates crowding without stimulating undesirable vegetative growth.

Training and Pruning Young Apple and Pear Trees

Pruning is especially critical just after planting and during the first few years of growth to make sure that the overall structure of the fruit tree is correct and to encourage early fruiting. Pruning cuts on young trees stimulate vegetative growth below the cuts and delay fruit bearing. So keep the number of cuts made on a young tree to a minimum, making only cuts that are necessary for proper structural development. If you do a good job of pruning and develop a structurally strong tree with limbs that are well exposed to full sunlight, you'll greatly reduce the amount of corrective pruning needed during the production years.

The pruning guide "Recipe for Training Young Trees to a Central Leader" (starting on page 28) is for semidwarf apples and pears, but it also can be used for cherries and plums. Your goal with this type of pruning is to develop a single central trunk with "scaffold" limbs spaced evenly around the trunk

Proper pruning is especially critical in the first few years after planting.



Figure 6. It's important to prune young apple trees to maintain the dominance of a single central leader. After heading back at planting (a), several leaders will compete for dominance (b). Remove all but the strongest while they are still succulent (c).

different levels, allowing for optimal exposure of the leaves to sunlight (see Figure 10). The tree will eventually assume a nearly conical shape, with longer scaffolds at the bottom of the tree and shorter ones near the top (see the apple and pear trees in Figure 3). In addition, you will need to spread or train the scaffold limbs so that they are nearly horizontal with the ground and their crotch angles (the angle formed where the limbs meet the central leader) are at least 60 to 70 degrees (Figure 7).

Keep in mind that the “central leader” method is just one way of pruning trees. There are many other methods—especially for high-density plantings of dwarf apple trees—that are variations of this method and designed to produce earlier harvests and high yields. (The general principles of central leader training can be used on dwarf trees as well.) As long as you keep in mind the effects that the different pruning cuts will have on your tree, you

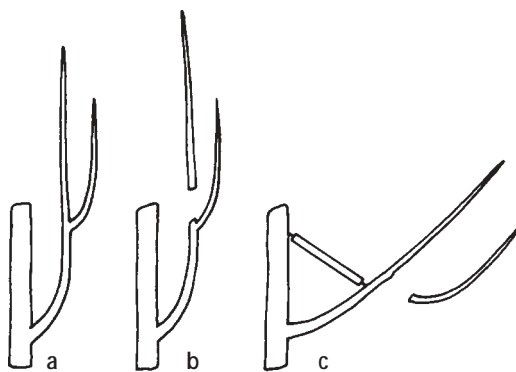

Figure 7. Use spreaders to train scaffold limbs to wide angles. The narrow crotch angle and small, upright lateral branch make this a poor scaffold without pruning and spreading. Incorrect pruning (b) does not improve the crotch angle or limb position, and because the limb is near vertical, the cut will stimulate vigorous vegetative growth. The correct procedure (c) spreads the limb to improve the crotch angle and properly positions the scaffold. Remove the lateral because it will be shaded by growth from the main scaffold limb.

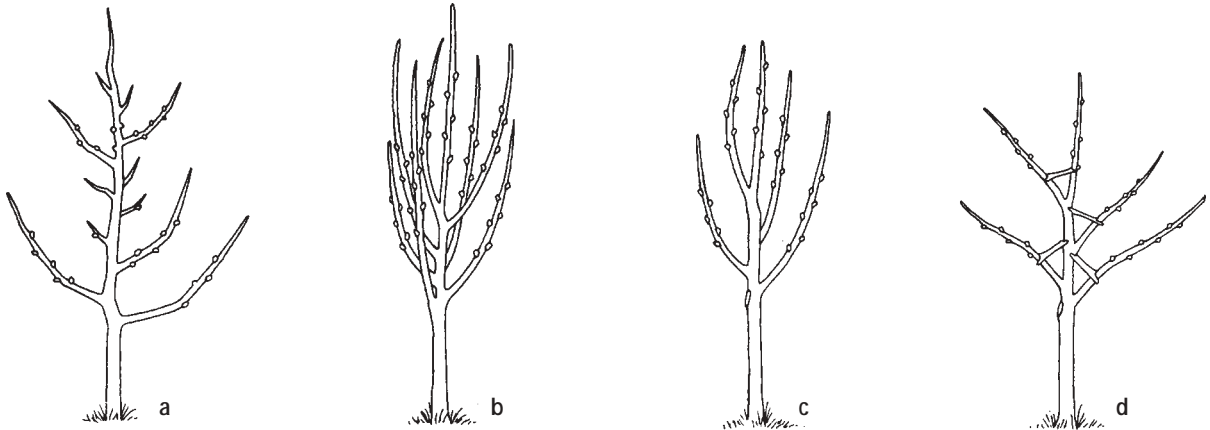

Figure 8. The cultivar Golden Delicious (a) is great for home gardens because its natural growth habit features a well-defined central leader, wide-angled crotches, and moderate extension growth, making it easy to prune.

At the other end of the spectrum, young Red Delicious trees (b) are more difficult to prune because their vigorous, upright growth competes with the central leader and they have an excessive number of scaffold limbs and narrow crotch angles. Red Delicious and cultivars with difficult growth habits can still be trained to grow into structurally sound trees.

Note the improved form of the Red Delicious tree (c) after scaffold selection and heading back the central-leader shoot.

The insertion of limb spreaders (d) improves the crotch angle, reduces scaffold vigor, favors flower bud formation, reduces competition with the leader, and eliminates interference of lower scaffolds with the growth of scaffolds originating higher on the trunk.

can modify this pruning method to meet your needs. For example, if deer pressure in your area is heavy, you may want to limit heading cuts on the leader or start your scaffold branches higher so that the trees more quickly outgrow their reach. Also keep in mind that different cultivars and different rootstocks may require or respond differently to various pruning strategies (see Figure 8).

For additional information on pruning and training, refer to the Cornell Cooperative Extension publications *Training and Pruning Apple Trees* and *Cultural Practices for Commercial Vineyards*. For ordering information, see “Related Cornell Cooperative Extension Publications,” page 103.

As your trees develop, continue with dormant-season pruning, fruit thinning, branch spreading, and scaffold supporting as needed, similar to the fourth-year recommendations given in the following pruning guide. By the sixth or seventh year, you may need to remove the least desirable scaffold in the bottom tier so that no more than four remain in that tier. Remove larger limbs in the top of the tree if their diameter is more than half the diameter of the leader where they join or they cast too much shade on the scaffolds below. Continue pruning to maintain the pyramidal shape of the trees.

Recipe for Training Young Trees to a Central Leader: First Year

<i>When:</i>	<i>What to do:</i>
At planting	Plant so that the graft union is 2 inches above the soil level. (Tamp soil firmly.) Remove any shoots below about 18 inches. “Head” (cut off) the leader at about 32 to 36 inches (26 inches for pear trees) to stimulate branch development (see Figure 9). If the tree is well-feathered (has lots of side branches), head the leader about 12 inches above the top branch.
Soon after planting	Stake trees, especially those on M.9 rootstock (see “Planting,” page 18).
1/4 to 1 inch of new growth.	Choose a strong bud (usually the one just below your heading cut) to be the central leader, and pinch off the two or three competing buds below it. Remove any flowers that appear on the trees.
2 to 4 inches of new growth	<p>Choose several sideshoots to become scaffolds. They should be spaced about 3 to 4 inches apart on dwarf varieties and up to 8 to 12 inches apart on larger varieties. Make sure they are well distributed around—as well as along—the central leader (see Figure 10). Especially make sure that no two branches arise from the trunk at the same height.</p> <p>Attach clothespins to the main trunk so that their opposite ends gently spread the scaffolds to near-horizontal positions (see Figure 11).</p>
Mid-July	<p>Remove any vigorous sideshoots that compete with the central leader (see Figure 6). Tie the developing leader to the stake.</p> <p>Remove clothespins. If any scaffolds are turning up at the end and trying to grow vertically, hang one or more clothespins from near the end of the scaffold (attach extra weight to the clothespins if necessary) to bring them back closer to a horizontal position.</p>
Fall	Install a permanent plastic tree tie above the first tier of scaffolds, leaving a 2-inch diameter loop to allow for trunk growth.

Recipe for Training Young Trees to a Central Leader, Second Year

<i>When:</i>	<i>What to do:</i>
	Remove any vigorous sideshoots that are competing with the central leader. The leader should have grown at least 18 inches the previous season (see Figure 12).

Figure 9. To train semidwarf apple trees to a central leader, it's important to start pruning right after planting. Remove any shoots below about 18 inches, and "head" (cut off) the leader about 32 to 36 inches from the ground to stimulate branch development (a). After heading, several side branches will grow just below the cut. While they are still small, choose a strong one to become the new central leader and remove the two or three competing buds just below it (b).

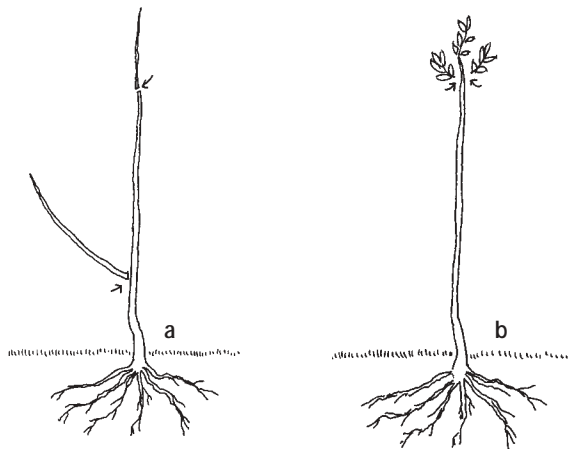

Figure 10. When training a young tree, choose scaffold branches that form wide angles with the central leader and are spread out along the trunk (a). From above (b), the scaffolds also should be evenly spaced around the trunk. Keep upper scaffolds pruned shorter so that they don't shade the lower scaffolds.

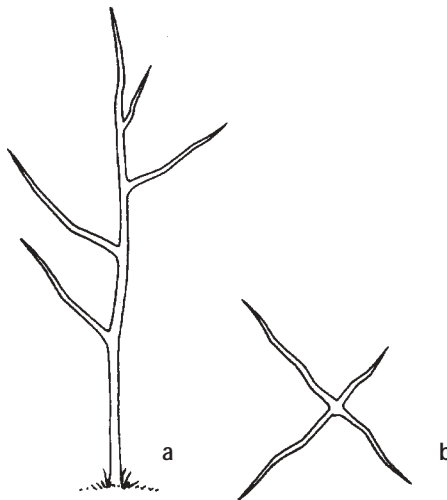
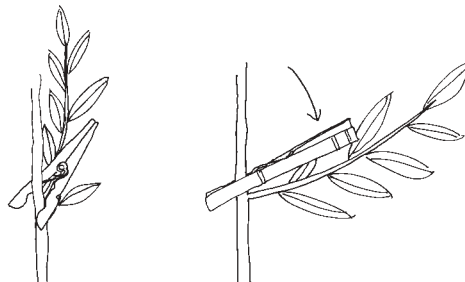

Figure 11. Use clothespins to gently spread the scaffolds to near-horizontal positions.



Late winter	<p>If the leader grew more than 18 inches, head it back by about one-fourth to encourage the formation of sideshoots for scaffold selection. If growth was less than 18 inches, head the leader and scaffolds, removing about one-third of last year's growth.</p> <p>If the tree has less than three acceptable scaffold limbs, remove all scaffolds, rehead the leader at about 36 inches, and repeat the first-year training procedure.</p> <p>If you are trying to encourage quick vertical growth or are growing dwarf trees that you want to encourage to fruit early, skip heading the central leader.</p> <p>As a rule of thumb, remove sideshoots that are more than one-half to two-thirds of the diameter of the trunk where they meet.</p>
2 to 4 inches of new growth	<p>Choose and clothespin the second tier of scaffolds growing from one-year-old wood on last year's leader, similar to your scaffold selection the previous year. Again, make sure they are well spaced along the central leader and well distributed around the trunk.</p> <p>Choose a new central leader (if you headed off the old one), and remove any vigorous sideshoots that compete with it.</p>
Mid-July	<p>Tie the developing leader to the stake and remove the clothespins. Remove any vigorous sideshoots that compete with the central leader.</p> <p>Use "spreaders" of various lengths to spread vigorous scaffold limbs selected the previous year that have crotch angles less than 45 degrees, bringing them down to nearly horizontal (see Figure 8d). You can make your own spreaders by cutting notches into the ends of a wood lathe or driving finishing nails into the ends of one-by-twos and sharpening the protruding head. (The sharp ends hold fast in the branches without doing permanent damage.) Alternatives to spreaders include hanging weights from the limbs or tying them down to the base of the tree.</p>

Recipe for Training Young Trees to a Central Leader: **Third Year**

<i>When:</i>	<i>What to do:</i>
Late winter	<p>Make sure the tree is tied securely to the stake.</p> <p>Remove any vigorous sideshoots that compete with the central leader. Head the leader if needed, following the directions given for late winter of the second year.</p>
2 to 4 inches of new growth	<p>Choose and clothespin more scaffolds growing from the one-year-old wood on last year's leader, similar to the scaffold selection of the previous year. Again, make sure they are well spaced along the central leader and well distributed around the trunk.</p>

Figure 12. In late winter following planting, remove sideshoots competing with the leader. The leader should have grown at least 18 inches (extension growth) the previous season.

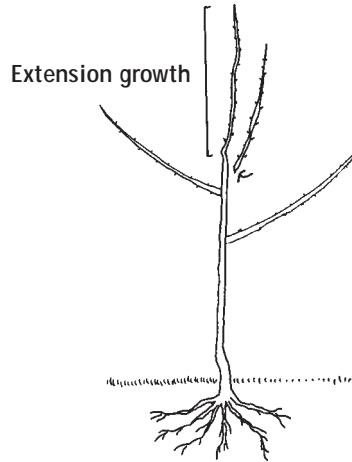

Figure 13. As the tree matures, remove vigorous sideshoots that compete with the central leader (a), scaffolds that threaten to overtake and shade lower ones (b), and suckers (c).

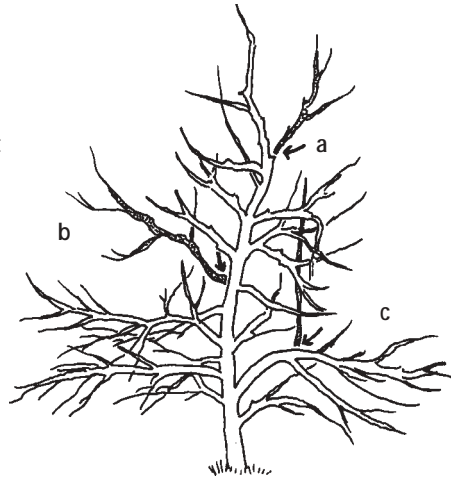
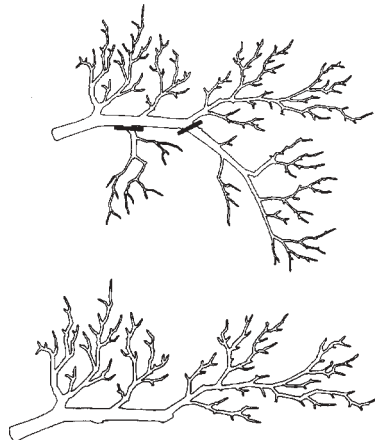

Figure 14. Remove drooping branches because they produce less fruit, are not well exposed to light, and usually shade other branches. Remove the ends of such branches back to a lateral in a near-horizontal position, and remove all branches growing downward from the bottom of larger branches.



2 to 4 inches of new growth	Choose a new central leader (if you headed off the old one), and remove any vigorous sideshoots that compete with it.
June	Hand-thin the fruit to singles spaced 6 inches apart (see “Thinning Fruit,” page 36).
Mid-July	<p>Tie the developing leader to the stake and remove the clothespins. Remove any vigorous sideshoots that compete with the central leader.</p> <p>Use spreaders or alternatives to spread scaffolds with narrow crotch angles.</p> <p>Use twine, heavy string, or wooden props to tie up permanent scaffolds if it appears they will not support the fruit load.</p>

Recipe for Training Young Trees to a Central Leader: **Fourth Year**

<i>When:</i>	<i>What to do:</i>
Late winter	<p>Remove any vigorous sideshoots that compete with the central leader (see Figure 13). Head the leader if needed.</p> <p>Thin out overcrowded areas. Remove branches whose tips hang below horizontal, or prune them back to a new shoot that is pointing up slightly (see Figure 14). Reposition the spreaders if necessary.</p> <p>Remove any vigorous upper scaffolds so that they do not overtake and shade the lower ones (see Figure 13). If the diameter of any of those branches is greater than half the diameter of the central leader where they meet, remove them completely with a thinning cut.</p>
Budbreak to Mid-July	Spread the scaffolds where necessary.
June	Hand-thin the fruit to singles spaced 6 inches apart (see “Thinning Fruit,” page 36).
July	Use twine, heavy string, or wooden props to tie up the permanent scaffolds if it appears they will not support the fruit load.

Pruning Bearing Apple and Pear Trees

For apples and pears, a cone-shaped tree—with longer scaffold branches at the bottom of the tree and shorter ones at the top—intercepts light most efficiently. While this shape is easy to maintain in a young tree, it is difficult to preserve as the tree ages. The top of the tree, which has the most vigorous growth, tends to spread and shade the lower limbs.

When pruning mature trees, avoid small cuts, which can encourage too much vigorous vegetative growth. Making one or two large cuts, either removing an entire branch or cutting a major portion back to a vigorous fruitful lateral, is more effective. For fruit-bearing central leader trees, follow these guidelines:

- First, remove diseased, broken, or dead branches completely.
- Make big strategic cuts first, especially high in the trees. Thinning cuts (removing entire branches at their bases) are almost always preferable to heading cuts, which can encourage unwanted vegetative growth just below them.
- If two limbs overshadow, cross, entangle, or otherwise compete with each other for the same space, don't head both of them. Instead, remove one of them completely with a thinning cut at its base.
- To reduce overall tree height, cut off the top just above a weaker side limb or sucker. Often, the top of the tree will take care of itself, with upright suckers bending into more horizontal positions under the weight of fruit or even breaking off, limiting the height of the tree.
- Remove any limb above the bottom tier of scaffolds that is more than half the diameter of the branch that it originates from.
- Remove suckers or water sprouts (vigorous vertical limbs growing straight up from nearly horizontal branches) that are larger than 1/4 inch in diameter.
- Use a pruning saw or bypass blade (not anvil-type) pruning shears. Make cuts close to the branch collar at the base of the limb. Under cut large limbs first to avoid tearing the bark, which can damage the tree.
- Stand back from the tree frequently and check your work. Try to develop a clear mental image of what you want the tree to look like.

While the central leader system works with pears as well as apples, pears have some differences. They tend to grow more vertically, but branches with narrow crotch angles are less likely to split. Branches that spread more than 45 degrees tend to produce water sprouts from their bases. Because of the risk that fire blight may girdle the leader, pear trees are sometimes pruned to multiple leaders; if one dies it won't take the whole tree.

Step back and picture what you want the tree to look like.

Rejuvenating Old Apple and Pear Trees

Many old, neglected apple trees can be rejuvenated by proper pruning during the dormant season. Many will have grown too tall to manage and harvest conveniently. Most will have too much old wood and not enough young, productive fruiting wood. Here are some suggestions for bringing them back into production, but keep in mind that it usually takes several years of corrective pruning. Don't try to make up for years of neglect in a single season.

- Remove dead branches, rotten and diseased wood, and water sprouts (suckers).
- Next, make big thinning cuts to the top and middle of the tree, removing whole limbs from their point of origin. Reduce the height of the tree by as much as a third, cutting just above a large side branch. Remove water sprouts that grow just below those cuts in July and August to keep them from shading the center of the tree.
- Remove shoots that are growing toward the ground.
- Make thinning cuts to remove limbs that cross or compete with each other.
- Leave some well-positioned vigorous shoots, which will eventually replace older limbs and laterals.

Pruning and Training Cherry and Plum Trees

Unlike apple and pear trees, the best time to prune cherry and plum trees is late spring, after the trees have flowered. At this point, you can see how pruning will affect your crop.

You can train young cherry and plum trees as central leader trees, as described for apples and pears (see the steps beginning on page 28). Or you can train them as open-center (vase-shaped) trees (see "Pruning and Training Peaches," next page). Perhaps the best way is somewhere in between, as a modified central leader tree.

Weak unions between the rootstock and the scion cultivar are common with most cultivars of sweet cherry. To prevent damage, stake young trees using an elastic tie to prevent canker formation where the tie contacts the tree.

Training a tree as a modified central leader is similar to training a central leader tree, except that after you've selected four or five good scaffold limbs with wide crotch angles where they meet the leader, you top the central leader.

After this initial training, cherry and plum trees need few corrective cuts during the next five or six years or until the trees begin bearing. During this time, limit pruning to removing water sprouts and limbs that cross and rub

After initial training, cherry and plum trees require less pruning than other fruit trees.

against a permanent branch. Also, prune to prevent the development of narrow crotches that could split and ruin the shape of the tree when it bears a crop. A narrow crotch is a fork where two branches of equal length and diameter arise at a common point. Generally, you can simply remove one of the branches of a narrow crotch.

Cherry and plum trees that have had proper corrective pruning from the beginning need little if any pruning during their early bearing years. But overpruning during the formative years delays bearing.

Once mature, cherry and plum trees require the least pruning of all fruit trees. They bear fruit on spurs in two- to six-year-old wood, so prune to maintain bearing wood in these age classes. When pruning, also observe the following:

- Remove dead, broken, or diseased branches.
- To keep the tree from growing too tall, head back leaders to a strong lateral branch.
- Thin out branches to provide good light exposure to remaining limbs.

Pruning and Training Peaches

Like cherry and plum trees, peach trees are best pruned in the late spring. They are unique among major tree fruits in that they bear most of their fruit on lateral buds in the lower half of vigorous one-year-old shoots. To maintain a constant flush of this growth for the next crop, prune peaches hard every year.

Peach and nectarine trees are very susceptible to perennial canker, which is caused by a fungus that infects open wounds when temperatures are cool. Don't prune them unless the weather is expected to be dry with temperatures over 60 degrees F for two to three days after pruning. Delaying pruning until flowering helps reduce the spread of this organism, and you can see how your pruning will reduce the crop.

Because of the way they grow, you should not train peaches as central leader or modified central leader trees. They are best trained as open-center trees, selecting three to five scaffold limbs that give the tree a vase-like shape.

One-year-old nursery peach trees are usually 3 to 6 feet tall with some lateral branching. At planting

- head the leader back to about 8 inches above the first side shoot.
- prune off any side shoots below 18 inches from the ground.
- prune off all side shoots that have crotch angles of less than 45 degrees.

Unlike most other tree fruits, peaches bear on one-year-old wood.

- head back all remaining shoots so that each has just two buds remaining.

If you don't have at least three to five branches with wide crotch angles, leave some narrow ones and spread them using clothespins, as described for apple trees. If you have more than five with wide angles, wait until early June, after they've grown a few inches, and select three to five of the strongest. They should be spaced evenly around the trunk with about 4 to 6 inches between them.

Later that summer, around late July, remove any additional shoots that started growing closer than 18 inches from the ground or that have narrow crotch angles (less than 45 degrees).

In late spring of the second year, remove the central leader just above the first wide-angled side limb to create an open-centered tree. Keep only four to six wide-angled scaffold limbs on the main trunk, and remove other limbs. Lightly head back the scaffolds to outward-growing laterals, and thin out shoots growing from the scaffolds that are less than pencil-sized.

The purpose of heading back scaffolds is to continue the development of an open-center tree that will be low, strong, and spreading for convenient thinning, pest control, and harvesting. Leave some small shoots that cross in the center because they will bear the first fruits.

Pruning during the third and fourth years should be limited to removing decidedly crowded limbs or low-hanging, shaded branches in the center of the tree. Also, head back main scaffold limbs to laterals if they are too high or out of balance with the others. Fruit will be produced on one-year-old branches, which should be spread evenly throughout the tree.

As trees reach full size, severe pruning maintains and renews vigorous fruiting wood throughout the tree. Terminal shoot growth of 12 to 18 inches is desirable. If the shoot growth is weak or the lower limbs become too long, cut the branches back into two- or three-year-old wood. Make the cuts to an outward-growing side branch.

After heading back all of the main branches, thin and space the fruiting shoots so they are about 6 to 8 inches apart. This spacing provides good light exposure to the fruiting shoot and allows development of new shoots for next year's crop. The fruiting shoots should not be headed back, but the fruits should be thinned because fruit set generally is excessive.

Thinning Fruit

Young trees seldom set so much fruit that they need to be thinned. But once apple, pear, peach, and plum trees start bearing well, thinning produces larger, better-colored, and higher-quality fruit. If you don't thin fruit, trees

Train peaches to vase-shaped trees.

may expend so much energy ripening the crop that they will not rebloom the following year.

The proper time to thin fruit is about two to three weeks after bloom, after early fruit drop when fruits are about the size of a quarter. The first step is to remove small and insect- or disease-injured fruit. Then remove all but one fruit where there are several in a single cluster, leaving the largest of the fruit.

Then with peaches remove additional fruit so that the remaining ones are spaced 4 to 8 inches apart (early cultivars require wider spacing). Thin plums so the fruits are 4 inches apart (cherries do not require thinning).

Fruit thinning is especially important with apples. Excessive fruit set reduces flower bud formation for the next season and results in alternate bearing—a heavy crop of small-sized fruit one year and little or no crop the next. Thinning within the month after bloom helps prevent alternate bearing. Space apples 4 to 6 inches apart so that one apple occupies every second or third spur. Thinning actually requires very little time, and the improvement in size, quality, and repeat bloom is worth the effort.

Be cautious about postbloom use of the insecticide carbaryl (Sevin), which also acts as a fruit thinner.

Diseases and Insects

Your ability to grow terrific tree fruits depends in large part on your ability to control pests and diseases. You will face many of the same challenges as commercial growers, but it's unlikely that you will have the same powerful pest control tools that they have. For example, home fruit growers typically use hand-operated sprayers or those run by small electric or gasoline motors. Compared with commercial-sized sprayers, these machines have a smaller capacity and lower pressure and require more energy to do an effective spraying job.

This makes it especially important for you to follow cultural practices that keep trees healthy and minimize disease and pest buildup. If you plan to spray your trees, it's easier to get good coverage with home-scale equipment if you plant dwarf or semidwarf cultivars.

In addition to doing a good job of site preparation, choosing a location with good air drainage, and planting disease-resistant cultivars, there are several easy steps you can take to help prevent pest and disease problems:

- Maintain a complex ecosystem around your plantings that provides habitat for beneficial insects.
- Prune out dead twigs and branches during the dormant season.

Without the pest control tools of commercial growers, you need to follow best cultural practices to keep trees healthy.

Dormant oil sprays can control mites, scabs, and pear psylla.

- Rake up and destroy leaves and diseased fruit in the fall, after harvest.
- Familiarize yourself with disease and insect life cycles so that you can correctly time control measures.
- If sprays are necessary, always use pesticides according to the label.

One particularly effective treatment that home fruit growers should consider is the use of dormant oil spray. If applied when up to 1/2 inch of green is showing on the buds, it can effectively control mites, scales, and pear psylla.

Home gardeners should be aware of the following major diseases and insects of tree fruits. For a more complete description of pests and control methods, see the Cornell Cooperative Extension publication *Pest Management around the Home: Part I, Cultural Methods*. For ordering information, see: “Related Cornell Cooperative Extension Publications,” page 103.

Apple scab. This fungal disease is easily recognized by the olive-green to black spots it causes on fruit and foliage. Severely infected leaves are dwarfed, cupped, or curled and drop prematurely. Fruits infected during the early season may be severely deformed or may drop by early June. The scab organism survives the winter in dead apple leaves on the ground. Primary infections occur during rainy periods from the time green tissue appears in the spring until the end of June. Many secondary spores are produced within the primary lesions. These are washed from the lesions by rain and are spread to other susceptible tissues, where, under appropriate environmental conditions, they cause secondary infections.

Choose scab-resistant apple cultivars.

Good scab control early in the season makes control in late summer easier. Home gardeners should seriously consider selecting cultivars that are resistant to scab. McIntosh and Cortland are likely to become infected with apple scab in home orchards. Freedom, Liberty, Prima, Jonafree, GoldRush, and MacFree are very resistant.

Powdery mildew. This fungal disease overwinters in dormant buds. Leaves that emerge from infected buds are covered by a white, powdery fungal growth. Secondary spread of the disease to other plant tissues occurs from the time the buds open until the terminal buds form in late June. If powdery mildew is a serious disease in your area every year, do not plant the susceptible cultivars Idared, Monroe, Rome Beauty, Jonathan, Paulared, Gingergold, or Cortland.

Fire blight. This bacterial disease causes severe damage to pear and apple trees during warm, rainy spring weather. Branches blacken and droop rapidly as if scorched by fire. Fire blight bacteria overwinter between live bark tissue and the tissue killed the previous season. In the spring, the bacteria

are spread by windblown rain, insects, or pruning tools. The disease usually affects blossoms but also can directly infect succulent shoots during late spring and summer.

To avoid fire blight, do not grow trees on poorly drained, highly acidic, or overfertilized soils. Cut off infected twigs and branches in late winter, making the cuts at least 6 inches below the dead area. If you are pruning during the summer, disinfect pruning tools with denatured alcohol or a 10 percent bleach solution between each cut. Be sure to clean and oil pruning tools after use. All pear cultivars except Seckel are very susceptible to fire blight. Susceptible apple cultivars are Idared, Jonagold, Jonathan, Lodi, Crispin (Mutsu), Greening, Paulared, Rome, Sir Prize, Spigold, Twenty Ounce, York, and Gala.

Brown rot. This fungus attacks peaches, plums, cherries, and nectarines. This disease is easy to diagnose by the unsightly brown rot that forms on the fruit, rendering it inedible. Spores are released during rainy periods in the spring and summer, infecting the blossoms and fruit. The fungus overwinters in infected twigs or fruits that remain on the tree or nearby on the ground. Remove and destroy diseased fruits to help reduce infection.

Remove and destroy diseased fruit to reduce brown rot.

Black knot. This fungus infects plum and cherry trees, causing rough, black enlargements on the twigs. The knots are often two to four times the diameter of the twigs and up to 8 inches long. Prune black knot–infected twigs at least 8 inches below the knot in winter or early spring and destroy them. Do not allow this disease to build up, or severe pruning will be necessary.

Cytospora canker. This fungal disease is very devastating to peach trees and also infects apricot, plum, nectarine, and cherry trees. Cytospora canker can girdle scaffold branches, reducing yields or even killing trees. The disease first appears in April or early May as an oozing, light amber to dark brown gum near the point of infection. Beneath the gum, the inner bark begins to collapse, leaving a depressed area on the surface. By the second year, this area develops into an elongated or elliptically shaped canker. Although the bark dries out, it usually remains intact during the first year. In later years, the bark becomes broken, malformed, and covered with a black fungal overgrowth.

To avoid cytospora canker, plant cold-hardy cultivars, fertilize only in the early spring, and follow proper pruning procedures. Do not apply excessive nitrogen, and do a good job of controlling other stressors, especially brown rot and insects such as the peach tree borer and the lesser peach tree borer. Trees already stressed are most likely to suffer from cytospora infection.

Cedar-apple rust. This fungus can defoliate apple trees and blemish fruit. It requires two hosts to complete its life cycle—an apple tree and an eastern red cedar tree (*Juniperus virginiana*). It survives the winter in spherical galls

on cedar trees. Spring rains promote the growth of hornlike structures that extrude from the galls. These structures release spores that travel by wind to apple trees and cause orange pustules on the upper surfaces of the leaves. One to two months after the appearance of these pustules, the fungal rust produces other structures on the undersides of the leaves or on the fruit. Fruit becomes infected during moist conditions when the temperature ranges between 46 degrees F and 75 degrees F. Spores produced on the leaves and fruit are released into the air during the dry conditions of summer and infect the leaves of cedar trees, completing the cycle.

Control strategies include applying fungicides, removing nearby red cedars, and using resistant cultivars. Very resistant apple cultivars include Delicious, Liberty, Nova Easygro, Novamac, and Tydeman. Susceptible cultivars are Golden Delicious, Jonathan, Lodi, Prima, Rome, Twenty Ounce, and York.

Apple maggot. This is the most destructive of all the insects that attack apples. The adult flies are slightly smaller than houseflies. They emerge from the soil between mid-June and mid-August and feed for about a week. Then the females lay eggs under the skins of apples. After hatching, the maggots bore through the fruit. In heavy infestations, many larvae can be found in a single fruit. Picking up and destroying fallen fruit once a week from early August through harvest reduces the potential for maggot infestations the following year. Apple maggot emergence and activity can be monitored by hanging red ball sticky traps.

Cherry fruit fly. This pest is closely related to the apple maggot and has a similar life cycle, but it attacks only sweet and tart cherries. Adults emerge for about a month beginning in early June. Use red ball sticky traps to monitor adult activity.

Plum curculio. This small, 1/4-inch-long weevil attacks all tree fruits. Adults overwinter in hedgerows or other sheltered areas and emerge in the spring when newly formed fruit is exposed—around petal fall in apples and shuck split in stone fruits. The most serious damage occurs when females deposit eggs in the fruit, causing small crescent-shaped scars. The larvae bore to the center of the fruit to feed. Infested fruits often drop to the ground in June. Picking up and destroying all drops in early June helps reduce developing larvae. If your planting is near woodland or other areas that provide good shelter for overwintering adults, infestations can destroy the entire crop. Chemical control measures are usually directed at the adults during the three weeks after bloom.

Apple tree borers. These pests are often found in home fruit plantings, especially in the trunks of young, unsprayed trees. Roundheaded apple tree borers are a particular problem. Adults feed on the fruit, bark, and foliage, but larvae cause the most significant damage. Females make a longitudinal slit in the bark of trunks and insert an egg. When the egg hatches, the larva bores into the sapwood and moves along the trunk, developing and enlarg-

ing tunnels. These tunnels weaken the tree structurally, cut off the flow of sap, and create a wound site that predisposes the tree to diseases and other insects. The downy woodpecker is the only known natural enemy of the roundheaded apple tree borer.

Pear psylla. This is the most common insect pest of pear trees. Adults resemble tiny cicadas. The nymphs secrete a sticky exudate called honeydew, which supports the growth of an unsightly black, sooty mold that soils leaves and fruit. If not controlled, psylla can cause early defoliation and crop loss.

Peach tree borers. These pests feed on the inner bark of peach trees and other stone fruits, girdling the conductive tissue. The two species, the peach tree borer and the lesser peach tree borer, are both clear-winged moths that lay eggs on the bark of the trees. The peach tree borer deposits its eggs at the base of the trunk and can kill the entire tree. The lesser peach tree borer attacks individual branches. Look for a gummy exudate mixed with a sawdust-like material excreted from small holes in the trunk. Gum secretions also can be caused by other injuries to the tree. To ensure positive identification of borers, cut away the bark and look for the larvae in their burrows. Avoid borers by painting tree trunks with a mixture of one part white latex paint and one part water.

San Jose scale. This insect pest infests apple, pear, plum, sweet cherry, apricot, peach, and nectarine trees. It sucks sap from all parts of the tree, including the fruit, causing the tree to decline in vigor. Badly infested areas on the bark appear ashy gray with encrusted scales. Fruit spotting can occur, particularly on apples. Females are about the size and shape of a pinhead and do not look like insects. To control scale insects, prune infested branches and suckers.

Codling moth. The larva of this moth is a worm found commonly in home-grown apples. As an adult, this iridescent gray moth deposits eggs on leaves and fruit. The eggs hatch about 6 to 20 days later, usually after the petals have fallen. Although other generations may occur during the season, it is most important to control this first generation, especially the adults before they lay eggs and the larvae that hatch from eggs deposited on fruit and foliage. If you spray trees for plum curculio and apple maggot, codling moths probably won't be a problem.

Aphids. These tiny insects—often called plant lice because of their small size and large populations—cause apple leaves to twist and roll. Two species are destructive—the rosy apple aphid and the green apple aphid. The rosy apple aphid damages fruit early and causes the fruit of certain apple cultivars to become dwarfed and deformed. Both aphids secrete honeydew, and sooty spots may develop on fruit and foliage. Green apple aphids should not require chemical control in home orchards.

Mites. While technically not insects, these tiny pests can bronze or discolor the leaves of many fruit trees. The European red mite and the two-spotted

mite are common in the Northeast and thrive in hot, dry weather. Both reside on the undersides of leaves and cause damage by sucking plant juices. Natural enemies usually keep populations low.

Harvest

For best quality and flavor, allow fruit to ripen on the tree. The best way to tell when they are ripe is to taste them. When they are sweet and full-flavored, they are ready to pick.

If you plan to store apples or pears, however, you should harvest them before they are fully ripe. In general, early-ripening apple and pear cultivars do not keep well. Their fruit should be eaten or preserved as soon as possible.

Always harvest with care. Handle fruit gently to avoid bruising it. For long-term storage, keep fruit in a refrigerated area or cold cellar. Store only fruit that is in excellent condition and of the highest quality. Do not store diseased or damaged fruit.

Grapes

Grapes have the longest history of all the cultivated fruits and are among the most widely grown. The fruits are used to make juice, jellies, wine, and pies, and the leaves can be used in cooking. Grapes also are delicious eaten fresh, and their popularity has increased since the development of new seedless table grape cultivars for the Northeast and the Southeast.

Choosing Cultivars

Home gardeners can choose from a wide variety of grape cultivars, each differing in time of ripening, productivity, vigor, hardiness, fruit size, color, and flavor. The grapes most widely cultivated in the Northeast are derived primarily from *Vitis labrusca* and are referred to as American bunch grapes. The following cultivars of this species produce well in much of New York State:

- **Concord**—the primary cultivar grown in the Northeast and the standard for hardiness.
- **Niagara**—the leading white grape cultivar, though it is not as hardy as Concord and is moderately susceptible to several grape diseases.
- **Catawba**—a late-ripening red cultivar that requires a favorable site and a long growing season to reach full maturity.
- **Delaware**—one of the highest-quality American bunch grapes, both for eating fresh and for making white wine. It ripens two weeks before Concord. The tender skin of the red berries, however, is subject to cracking, and the leaves are susceptible to fungal diseases. It requires a deep, fertile, well-drained soil for satisfactory vine growth.
- **Ontario**—the best of the early-ripening American cultivars. It produces white fruit. Vines are vigorous but not as hardy as those of Concord.

Another grape species, *Vitis vinifera*, is native to southern Europe and recognized throughout the world for its wine quality. Chardonnay, Riesling, Cabernet Sauvignon, and Gewurztraminer are cultivars derived from *V. vinifera*. Unfortunately, these cultivars are extremely sensitive to cold temperatures. Some are grown successfully in the Northeast by taking special precautions, such as burying the canes each fall and tying them back up to a trellis in the spring.

Keys for Success

Choose disease-resistant cultivars that are hardy for your site.

Make sure your site gets full sun and has good air drainage.

Prune vines annually during the dormant season, removing up to 90 percent of new growth.

Vinifera grapes are too sensitive to cold to be grown in the coldest areas of the Northeast.

Several cultivars have been derived from crosses between species. The most important group is from crosses between *V. vinifera* and *V. labrusca*. These French-American hybrids produce good wines yet are much hardier than the *V. vinifera* parent.

Baco Noir and De Chaunac are very vigorous red wine grape hybrids, but they require cluster thinning to keep plants from producing too much fruit and weakening the vines. Aurore is one of the best white-wine grape hybrids for consistency of production, but the berries tend to split. Seyval, Vidal, and Cayuga (white), Marechal Foch (black), Cascade (blue), and Chancellor (red) are all excellent wine grape hybrids. Horizon is a high-yielding cultivar that produces neutral white blending wine grapes, and it is relatively free of defects that affect its culture or use for wine.

Seedless grapes for fresh consumption can be grown throughout the country, but the cultural practices used to grow them are different from those for the other three groups. See “Seedless Table Grapes,” page 52.

For more information on cultivar selection, see “Wine and Juice Grape Varieties for Cool Climates” at www.nysaes.cornell.edu/hort/faculty/reisch/bulletin/wine/index.html.

Purchasing or Propagating Vines

Purchase grapevines from a reputable nursery. Place orders early to ensure that the desired cultivars will be available. Request that the grapevines arrive in early spring, and plant as soon as possible after they arrive.

An alternative to purchasing vines is to propagate vines from cuttings of a known variety. (It is illegal to propagate vines that are patented.) Making your own cuttings is inexpensive, requires no special equipment, and is usually successful. Most grape cultivars root readily from dormant hardwood cuttings.

First, choose healthy plants of moderate vigor growing in sunny areas to supply cutting stock. Take cuttings (no more than one or two per plant) anytime from late fall after the leaves have dropped to early spring before

Figure 15. You can propagate your own grape vines by making cuttings from dormant one-year-old canes.

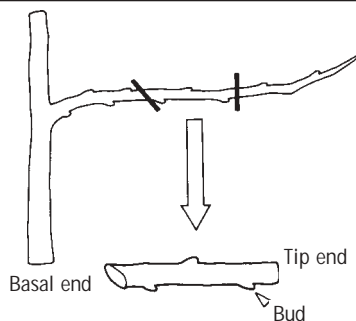

buds swell. Select one-year-old canes that are 1/4 to 1/3 inch in diameter (see Figure 15).

Cut the bottom of the cane at a 45 degree angle just below a bud or node, and make an upper cut 1 inch above a bud. Each cutting should have about three buds. Place cuttings in damp peat moss, seal in a plastic bag, and store at 30 to 40 degrees F in a root cellar, refrigerator, or hole in the ground until the spring. If stored in the ground, place mulch over the top to maintain uniformly cold temperatures.

When planting in the spring, be sure to position the end of the cutting that was closest to the trunk in the ground and the end of the cutting that was nearest the tip above ground. If planted in well-prepared soil, roots will form from the bottom of the cutting.

Site Selection

A favorable site and climate is essential for successful grape growing. Specific requirements include

- full sun.
- good air drainage.
- a 150-day frost-free growing season.
- minimum winter temperatures above -25 degrees F (USDA Hardiness Zone 4b or warmer).
- 2,000 growing degree days above 50 degrees F (see www.hort.cornell.edu/gardening/weather/ for more information on growing degree days).
- soil that is neither excessively wet nor droughty.

Southern slopes or exposures protected by buildings or windbreaks are preferable to northern slopes and low ground, which tend to be cooler throughout the growing season and delay fruit ripening. Grapes tolerate a wide range of soil types and are not as sensitive to extremes in drainage as other fruit crops. Still, they are most successfully grown on deep, well-drained sandy loams.

It's important to choose cultivars that are well-matched to your site. You can grow grapes just about anywhere in New York, but not all varieties will survive (much less thrive) in every location. If you are in Zone 4 or Zone 5, be sure to carefully check nursery catalog information about hardiness. Cultivars vary in their susceptibility to winter injury. Temperatures below -15 degrees F can cause winter injury to all but the hardiest cultivars (see Table 4).

Grapes tolerate a wider variety of soils than most other fruits.

Table 4. Choose grape varieties that won't suffer winter injury in your area.

<i>Low Winter Temperature (USDA Hardiness Zone)</i>	<i>Suitable Varieties</i>
0°F (Zone 7a)	Almost any
-5°F (Zone 6b)	Most northern vinifera
-10°F (Zone 6a)	Hardy vinifera and moderately hardy hybrids
-15°F (Zone 5b)	Hardy hybrids and most American varieties
<-15°F (Zone 5a and colder)	Hardy American varieties

Planting and Early Care

Prepare the soil and adjust pH and nutrient levels as indicated by a soil test the season before planting (see “Before You Begin,” page 1). Plant purchased vines in spring as soon as the soil can be worked. Space vines a minimum of 8 feet apart both within and between rows, digging a hole large enough to spread out roots sufficiently.

After trimming away broken or excessively long roots, lay out the root system in the hole and cover completely with soil. Planting depth should be the same as in the nursery, usually about 2 to 3 inches above the root level. Remove all but the best single cane and tie it to a stake or the bottom wire of a trellis to hold it erect. This cane will become the trunk. It won't grow straight without support.

After several weeks, buds should begin to grow. When the new shoots are about 10 inches long, remove all but the strongest as well as any other shoots that arise from the trunk. Also remove any flower clusters or side shoots as the single cane grows.

Fertilizing

Use no fertilizer the first year. In following years, apply 10-10-10 around the vines in early spring before growth begins:

Year 2: 2 ounces per vine

Year 3: 4 ounces per vine

Year 4: 8 ounces per vine

Year 5 and after: 16 ounces per vine

Commercial grape growers usually test the soil and conduct leaf analyses at least every three years to detect nutrient deficiencies or imbalances.

Stake canes at planting. They won't grow straight without support.

Pruning and Training Young Vines

Grapes will grow on just about anything. In the wild, they climb large trees to get their leaves into the sun. But in home plantings, you need to rein in that vigor by pruning and training the plants to keep them manageable and productive.

You can train grapes to grow on an existing arbor, fence, or other structure. If you are starting from scratch, a good trellising method is the four-arm Kniffen system (see Figures 16 and 17). No matter what system you use to support your vines, the principles are the same. There are several things to keep in mind:

- You don't want the vines to become overgrown. You should have only one or two layers of leaves during the growing season.
- Typically, you should remove 90 percent of the new growth during dormant-season pruning.
- Grapes bear fruit from buds on one-year-old wood that elongate into new shoots.

Figure 16.
Stages of
training a vine
to the four-arm
Kniffen system
on a two-wire
trellis

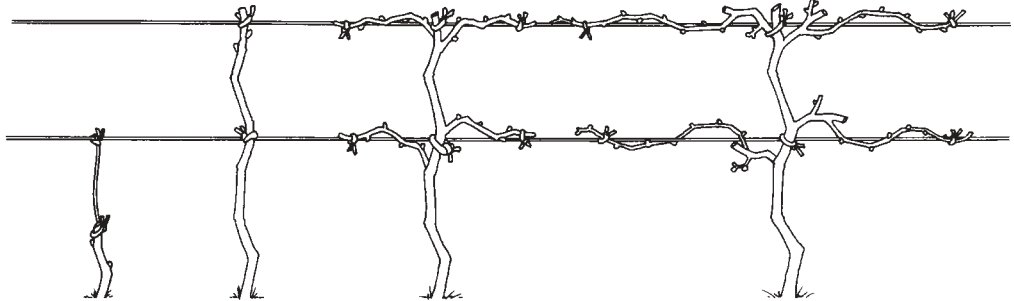

The four-arm Kniffen system uses a trellis made by stringing two lines of galvanized wire (size 9, 10, or 11) or monofilament between durable wooden trellis posts set about 24 feet apart. The top wire of the trellis should be about 6 feet high and the lower wire about 3 feet high.

During the first year, follow the recommendations for planting and fertilization given previously. If the cane does not reach the top trellis wire in the first year, train it to grow as a single cane the following year until it reaches the top wire.

In early spring of the second year, tie the cane to the top trellis wire and cut it off just above the wire. Leave four to six buds in the vicinity of each wire and remove the rest. As new shoots begin to grow from the remaining buds, remove any flower clusters that form.

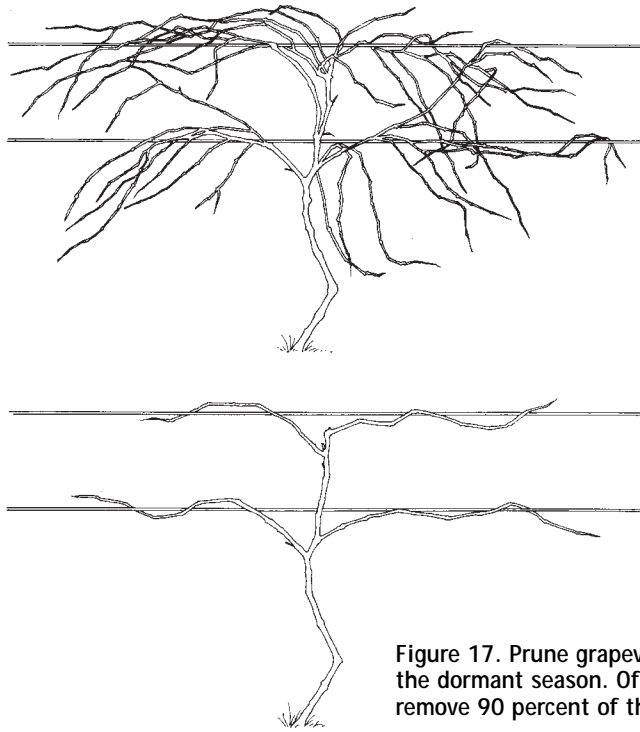

Figure 17. Prune grapevines hard during the dormant season. Often, you need to remove 90 percent of the new growth.

In early spring of the third year before growth starts, select four canes near the top wire and four canes near the bottom wire. Remove the rest. Tie one cane going in each direction on both wires. Allow these four arms to fruit up to the sixth bud along the arm. Cut the other four canes back to a stub containing two buds. These stubs are the “renewal spurs,” which will produce fruiting canes next season.

Pruning Mature Vines

In early spring, remove the fruiting canes from the previous year. Tie one of the two canes from the renewal spur to the trellis wire and cut after the 10th bud. Cut the remaining cane to two buds for next year’s renewal spur.

Continue this pattern of choosing fruiting canes and renewal spurs each season, adjusting the number of buds on each fruiting arm. Too many buds results in poor fruit quality and vegetative growth. A shortage of buds reduces the crop.

Grape buds vary greatly in fruitfulness. The most productive buds form at the top of the trellis where the shoots of the previous season were exposed to the most light. The distance between leaves should be about 6 inches, and the diameter of the cane between the leaves should be 1/4 inch or more.

Pruning Neglected Vines

Renew old neglected vines in stages. In the first year, limit the vine to a few new canes originating as close to the trunk as possible, and remove all fruit clusters from the new canes. Do not remove the old canes at this time.

Select one vigorous cane originating from the root or low on the trunk and tie it to the wires of the trellis to form a new trunk. Treat this sprout as a young vine, training it to the four-arm Kniffin system. Remove the old trunk after one year.

Training Vines to an Arbor

You can grow grapevines on arbors to furnish shade as well as fruit. Follow the same principles for pruning, modified to match your vines to the size of the arbor.

The primary differences between trellis training and training vines to an arbor are in the amount of old wood left, the number of buds retained, and the distribution of the fruiting canes. Keep more fruiting canes and spurs, and consequently more buds, than you would on a vine confined to less space.

Allow the trunk to grow longer on taller arbors. Train short permanent arms originating from the trunk so the foliage will cover the arbor to the best advantage. For best results, prune arbor vines annually.

Diseases and Insects

Insect and disease problems can be reduced by planting vines in a sunny location with good air drainage. Troubles can still occur even when following proper growing practices in an ideal location. Weather conditions, winter hardiness of the cultivar, infection from the previous year, history of pesticide use, surrounding vegetation, and insect life cycles all influence a cultivar's susceptibility to insects and diseases for a particular year.

Below are the insects and diseases that you are most likely to encounter:

Powdery mildew. This fungus can infect all green tissues of the grapevine. It appears as a white or grayish white powdery covering on the upper and lower surfaces of the leaves and fruit. Leaves infected while they expand become distorted and stunted. When green shoots are infected, the fungus appears dark brown to black and remains as brown patches on the surface of dormant canes. Cluster infection before or shortly after bloom can result in poor fruit set and considerable crop loss.

Fruits are susceptible to powdery mildew as well. If grapes are infected when they are pea size or larger, their skin stops growing but the pulp continues to expand and the berry splits. When attacked as they begin to ripen, purple

Trained to an arbor, grapes provide shade as well as fruit.

or red cultivars fail to color properly and look blotchy at harvest. High relative humidity promotes infection. Infected shoots should be pruned and destroyed. Good winter pruning increases air circulation and reduces the chances of heavy infection.

Susceptible cultivars include Aurore, Chancellor, Chardonnay, Delaware, Einset, Niagara, Riesling, and Cabernet Sauvignon. Less susceptible cultivars include Canadice, Cayuga, Ives, and Steuben.

Black rot. This fungal disease can cause complete crop loss in warm, humid climates. All green tissues can be infected. Leaves are susceptible for about one week after they unfold. When infected, they develop brown circular lesions, and within a few days black spherical spore-producing bodies form within the lesions. Leaf stem infection causes the leaves to wilt. Shoots display large, black elliptical lesions, weakening them and making them easily broken by wind. Berries are susceptible from bloom until they begin to ripen, and fruit infection can result in substantial loss. An infected berry first appears light brown, and then black spore-producing bodies develop on its surface. Later, the berries shrivel and turn hard and black to become so-called mummies.

Warm, humid, or wet weather encourages the spread of black rot. Preventive measures include proper site selection and row orientation to maximize good air drainage. Proper pruning, to open up the canopy to improve air circulation and spray coverage, and spring cultivation of mummies are also beneficial. American cultivars and their hybrids vary widely in their susceptibility to disease. Susceptible cultivars include Concord, Dutchess, Niagara, Riesling, Seyval, Aurore, Catawba, Canadice, and Cabernet Sauvignon. Less susceptible cultivars include Cayuga, Chancellor, Elvira, Foch, Fredonia, Ives, and Remaily.

Downy mildew. This fungus can infect all green, actively growing parts of the vine. Leaves develop yellowish green lesions on their upper surfaces 7 to 12 days after infection. As lesions expand, the affected areas become brown, withered, or mottled. A white “downy” fungus grows on the lower leaf surface within the borders of the lesion. Severely infected leaves curl and drop from the vine. The disease attacks older leaves in late summer and autumn, producing a mosaic of small, angular yellow to red-brown spots on the upper leaf surface. When young shoots, leaf stems, tendrils, or cluster stems are infected, they frequently become distorted, thickened, or curled with a white downy appearance. Eventually, severely infected portions wither, turn brown, and die. Infected green grapes turn light brown to purple, shrivel, and detach easily. White cottony spores are abundant on these berries during humid weather.

In general, Catawba, Chancellor, Chardonnay, Delaware, Fredonia, Ives, Niagara, White Riesling, and Rougeon are susceptible to downy mildew. Canadice, Cascade, Concord, Himrod, Remaily, and Steuben are less sus-

ceptible. Watch for this disease in warm, humid weather, and follow the cultural practices recommended for controlling black rot.

Botrytis. This fungus causes blight infection and bunch rot of grapes. Blight infection begins on the leaves as a dull green spot (commonly surrounding a vein) that rapidly becomes a brown, withered lesion. The fungus also causes blossom blight or shoot blight, resulting in significant crop losses if not controlled. It can grow on dead blossom parts in the cluster and then, before grapes begin to ripen, move from berry to berry within the bunch, initiating the early development of sour rot. Botrytis occurs most commonly on ripening berries, where infection and rot spread rapidly throughout the clusters. The berries of white cultivars become brown and shriveled, and those of purple cultivars develop a reddish color. Under proper weather conditions, the fungus produces a fluffy, grayish brown growth.

The fungus readily colonizes tissue injured by hail, wind, birds, or insects. Fog or dew and temperatures of about 60 to 80 degrees F are ideal for spore production. Rainfall is not required for disease development. Again, good cultural practices assist in controlling this disease. Aurore, Chardonnay, Elvira, and Riesling are susceptible cultivars.

Japanese beetles. Most gardeners will experience Japanese beetle damage on grapevines nearly every year. Fortunately, vines can tolerate a large amount of feeding before fruit quality or yields are reduced. But if populations are high enough, beetles can defoliate a grapevine in just a few days. Check vines daily once beetles appear. Most gardeners either pick the beetles off the vines and kill them or treat the vines with an insecticide.

Grape berry moth. Not frequently a problem, these small, inconspicuous brown moths lay eggs singly on buds, stems, or newly formed berries in early spring. Later, the moth usually deposits eggs directly on the grapes. The newly hatched larvae feed on tender stems, blossom buds, and berries, often inside protective silk webbings that can surround the entire cluster. When grapes are about 1/8 inch in diameter, the larvae burrow into them, creating sites for infection by fungi and attack by fruit flies. Infestations vary greatly from year to year and even within a vineyard.

With light infestations, remove injured berries by hand and destroy them (do not discard them on the ground because insects may continue to develop). You can control the moths somewhat by gathering the infected leaves in the fall and destroying them.

Grape cane girdler. Adults are small, shiny black weevils. In May the female hollows out a small cavity in a shoot and deposits a single egg into it. She then girdles the cane just below and several inches above the egg cavity. The shoot either breaks off at the girdled point or dies back to the first node below the egg cavity and drops to the ground. The girdling by the female causes the terminal growth of new shoots to bend over above the upper

girdle and blacken, shrivel, and drop to the ground. Later the whole infested shoot dies back to the lower girdle and falls from the vine. Vines “pruned” by the grape cane girdler have a ragged appearance, suggesting serious injury to the plant. But the actual damage is usually minor. Girdling of the terminal growth has little or no effect on the crop unless fruit-producing nodes are close to the attacked shoot tips

Grape leafhoppers. Populations of these insects fluctuate widely from place to place and year to year. Adults begin feeding in May on grapes and other plants such as strawberries, raspberries, and several woody plants. In June, they lay eggs singly, just beneath the underside of the leaf, producing a slight blister. Nymphs appear in late June and reach the adult stage by late July. Adults and immature leafhoppers feed on the undersides of leaves, sucking out the leaves’ juices. Feeding is limited initially to the lower leaves. The tissue surrounding the feeding puncture turns pale white and eventually dies. Plant injury shows up first along the veins, but later the whole leaf is affected. Heavy feeding by leafhoppers causes premature leaf drop and lowered sugar content, increased acidity, and poor fruit color. Ripening fruit is often smutted or stained by the sticky excrement of the leafhoppers.

Cold, wet weather in the spring and fall decreases leafhopper populations, as do wet winters. Fall cultivation and cleaning up adjacent weedy land eliminate favorable overwintering sites in and near a vineyard.

Harvest

Harvest grapes only after they are fully ripe. The sugar content of grapes does not increase after they are picked. Often grapes have good size and color one week before the sugar content is sufficiently high. After the sugar content has peaked, quality deteriorates rapidly.

Yields depend on the cultivar, the weather, the vigor of the vine, and your management. By the third year, you can expect each vine to produce 5 to 10 pounds of fruit.

Grapes harvested in the best condition will store longest. Handle clusters with care and remove any discolored, injured, or undesirable berries. Cool them as soon as they are picked. Storing them in a refrigerator with the temperature set around 35 degrees F is preferable to a cellar or other cool place where temperatures fluctuate. Wrap grapes loosely in plastic material to prevent excessive moisture loss.

Seedless Table Grapes

Seedless grape cultivars suitable for the Northeast are a relatively recent development. They are more challenging to grow in home plantings than other cultivars and require different practices. While moderately hardy, they may

Pick grapes only after they are fully ripe, about a week after they reach full size and color.

not perform well in colder sites. Even though they are less than perfect, their flavor far exceeds that of Thompson or Flame seedless grapes from the West Coast.

Seedless cultivars suitable for the Northeast include:

- **Canadice**—a hardy, productive, and popular vine, but berry size is small and bunch rot is often a problem.
- **Himrod**—a vigorous vine that has moderate resistance to disease, responds well to cultural practices, and produces a good white grape.
- **Einset**—a grape with excellent storage qualities, productivity, flavor, and hardiness, although some people do not like its thicker skin.
- **Vanessa and Reliance**—high-quality grapes, but with thin skins that are susceptible to cracking and diseases.

Growing top-quality seedless grapes involves many time-consuming steps. Commercial growers spray gibberellic acid and use special tools to girdle trunks or individual fruiting canes to improve berry set and increase berry size. They also increase berry size by thinning individual berries from each cluster and thinning clusters before and after bloom.

Home gardeners can grow seedless grapes without using all these commercial practices. The grapes will be just as flavorful but smaller than those found in the supermarket.

A common system for training seedless grapes uses cross-arms on trellis posts up to 42 inches wide. Wires in the middle of the cross-arms support fruit canes. Catch wires at the ends of the cross-arms support the shoots. The wires position the fruit for easy harvest.

Because seedless grapes tend to be large, they attract birds as well as raccoons. Diseases and insects also can cause more problems than with other varieties.

Homegrown seedless grapes are smaller but usually are more flavorful than store-bought grapes.

Strawberries

Keys for Success

Choose a site with full sun, good drainage, and a pH between 5.5 and 7.0. Begin improving the soil the year before planting, especially if the pH needs adjusting.

Plant in early spring in soil where no strawberries, brambles, or crops in the tomato family (including potatoes, peppers, and eggplants) have been grown for several years.

Strawberries are shallow rooted. Keep plants well watered, especially just after planting.

Do a good job of early weed control during the establishment year to prevent problems later.

If using the matted-row system, pluck flowers the first year to encourage runners to fill out a 12- to 15-inch-wide strip, but don't let plants get too crowded.

Because they bear early and are relatively easy to grow, strawberries are a great crop for you to start with in your home fruit planting. Strawberries are the most widely grown fruit crop in the world. They can flourish from tropical highlands to subarctic regions. The plants are hardy throughout New York State (if managed and mulched correctly) and can tolerate a wide range of soil types. Strawberries provide more vitamin C than oranges and have fewer calories than most other fruits (see Table 1, page 1).

Day-neutral cultivars, which bear fruit from June through October in the Northeast, are now available (see the section “Day-Neutral Strawberries” starting on page 62). The section below discusses traditional “June-bearing” cultivars that fruit in June and July.

Choosing Cultivars

You can find June-bearing cultivars adapted to northern climates in many nursery catalogs. Some cultivars perform better than others, but it is difficult to predict which will grow best in a particular garden.

Cultivars differ in flavor, disease resistance, cold tolerance, when they ripen, and suitability for frozen storage. Perhaps the best way to decide which cultivars to grow is to find out what works well for your neighbors or local commercial growers. Then try several promising cultivars before planting a large area.

June-bearing strawberry cultivars are reliably winter hardy throughout New York (as cold as USDA Hardiness Zone 3), provided they are properly managed and mulched. Some cultivars that perform well include:

- **Earliglow**—perhaps the best-flavored cultivar, it is among the earliest to ripen.
- **Northeast**—ripens about the same time as Earliglow. It is resistant to red stele and does well on heavier clay soils. The berries are large and have a hint of grape flavor, which some people love and others dislike.
- **Sable**—has excellent flavor and also ripens early.
- **Allstar**—a reliable producer with large light red to orange, sweet-flavored berries.
- **Honeoye, Cavendish, Kent, Raritan, Redchief, and Scott**—good midseason strawberries.

- **Jewel**—the most widely grown variety in the Northeast, it has excellent flavor. It is productive and maintains a large fruit size throughout the season.
- **Lateglow**—a reliable late-season cultivar.

All these cultivars are cold hardy, yield well, and produce firm fruit with good freezing quality. Allstar, Cavendish, and Jewel produce exceptionally large fruits.

Buying Plants

Purchase dormant, virus-indexed plants from a reliable nursery. (For an updated list of nurseries, see www.hort.cornell.edu/nursery.) Nurseries usually sell plants in bundles of 25. Ask that they be shipped in late April or early May.

When plants arrive, check them for signs of winter injury, mold, and root rot. Plants showing signs of winter injury—a brown- or orange-colored internal crown—are likely to die if the weather quickly turns hot and dry after planting. A heavy mold on roots and crowns indicates that they weren't stored properly. If plants are moldy, discard them. Store healthy plants in a refrigerator until you are ready to plant.

Site Selection

Strawberries grow best in a sunny location with deep, well-drained sandy loam soil with a pH of approximately 6.2. The plants do not tolerate extremes in pH, either below 5.5 or above 7.0. Determine pH by testing the soil, and follow recommendations to adjust the pH accordingly a year before planting. (Contact your county's Cornell Cooperative Extension office for more soil test information. See www.cce.cornell.edu/local_offices.cfm.) Lime and other soil amendments that are used to adjust pH require at least two months of warm weather to work, so don't wait until the fall before planting to apply them.

Plants can be productive over a broad range of soil types, but avoid extremes. Heavy clay soils retain moisture but are often poorly drained, while sandy soils drain well but require irrigation. Add organic matter to sandy or clay soils to reduce those shortcomings.

Adequate drainage is essential for healthy strawberries. If your site is poorly drained, plant on ridges or in raised beds. Strawberry plants are shallow rooted and benefit from irrigation. Consider using irrigation to prevent yield reductions caused by drought, particularly on raised beds, which can dry out quickly. Drip irrigation works well for home gardens.

Keys for Success

Cover plants with mulch when nighttime temperatures approach 20 degrees F. In early spring, rake mulch off the plants into the space between the rows.

To get good production and a long-lived planting, renovate the planting by mowing it after harvest.

When the planting starts to decline, generally after about the third year of fruiting, start a new planting with virus-indexed plants purchased from a reliable nursery.

Do not plant strawberries in an area where they were recently grown. Also avoid planting them where crops in the tomato family (Solanaceae, including eggplants, potatoes, and peppers) have been grown.

Before planting, find out about the soil and its history. It may harbor troublesome pests, particularly perennial weeds or weed seeds, insects, soilborne diseases, or nematodes. Control insects that reduce strawberry yields, such as white grubs, strawberry root weevils, and European chafers, by growing a crop other than strawberries for a year before planting.

In soils where the fungi causing red stele and verticillium wilt are known to be present, plant only resistant cultivars. Northeaster, Allstar, Cavendish, Redchief, Scott, and Lateglow are resistant to both red stele and verticillium wilt. Honeoye, Kent, Raritan, and Jewel are susceptible to these two diseases.

Growing Methods

Keep topsoil covered with plants, but avoid overcrowding.

There are several different systems that you can use to grow strawberries. You should decide which is best for you before ordering plants.

The **matted-row system** is the easiest to maintain. Set plants 12 to 24 inches apart in rows that are 48 inches apart. Pluck off the flowers the first season to encourage vegetative growth. The plants will produce side stems with daughter plants called runners. Ideally, you want about six to eight runners per plant. Your goal is for the runners to fill out a strip about 12 to 15 inches wide (18 inches at the most). If you set the plants closer than 12 inches at planting, you'll have too many runners and the planting will be too crowded. You'll have to either spend more time thinning the plants or settle for lower yields from the overcrowded plants and possibly more risk of disease.

Harvest fruit from these 12- to 15-inch-wide rows in subsequent years. The planting will be most productive on the edges. Rows any wider are harder to weed and harvest, and the plants are at greater risk of disease.

Use a rototiller or hoe to remove plants that stray into the area between the rows. Within the rows, you want to keep the soil covered with plants, but you don't want them to be too crowded—no less than about 6 inches apart. Clip off runners to keep the plants from getting too crowded. Clipping runners is hard work, but it increases fruit size, decreases rotting, and makes harvest easier.

With most plantings, you can expect about three years of harvests before the stand declines seriously. As the planting ages, weeds will become more difficult to control, and diseases often become more of a problem. At some point, you'll want to start over at a new location. You may be tempted to use runners from your existing planting. But it's usually best to purchase new, disease-free planting stock. Otherwise, you will just move any disease problems right into your new planting.

The **ribbon-row system** is more labor intensive and requires purchasing more plants, but it produces fruit the first year. Space the plants just 4 inches apart in rows 36 inches apart. Do not remove flowers, and clip all runners. Plants managed this way are very productive and produce large berries. Continue harvesting berries for about three years or until productivity declines.

Planting and Early Care

No matter which planting system you use, plant strawberries as soon as possible in the spring (fall planting is not recommended in the Northeast). Prepare soil the season before planting to speed soil warming and minimize the need to work the ground before planting. If the soil is still frozen when your plants arrive, refrigerate them until the ground has thawed.

Avoid exposing the plants to sun and wind. Cool, cloudy weather is ideal for planting. Dig a hole large enough so that the roots can extend vertically, then cover the plants with soil to just below the crown (see Figure 18). Do not bury the crowns. You may need to cut the roots back to 4 inches before planting to avoid J-shaped root systems. During the first few weeks after planting, make sure the plants have adequate water.

Plant strawberries in early spring.

Figure 18. When setting out strawberry plants, do not bury the crown (a) or leave roots exposed (c). The correct planting depth is indicated (b). You may need to trim roots back to about 4 inches (d).

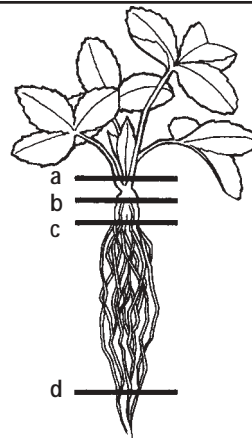

Several weeks after planting, the plants will begin to flower from buds formed within the crown the preceding fall. If you are using the matted-row system, remove these flowers to prevent fruiting and encourage runners. Berries on first-year plants rob the plants of energy necessary for growth, runner production, and winter survival. Although some strawberry cultivars produce only one flower cluster per plant, others produce several sets, so you may need to check the planting and remove flowers several times.

About six weeks after planting, apply 2 pounds of 10-10-10 fertilizer per 100 linear feet of row. Apply another 2 pounds in early September before flower

buds form. Sprinkle the fertilizer evenly over the row area, and try to avoid contact with the foliage. Don't work the fertilizer into the soil, or you may damage the shallow roots.

Managing Your Planting

Watering. Because of their shallow root systems, keeping strawberries well watered is extremely important. There is a tendency to overfertilize strawberries when actually a lack of water is holding back yields.

**Don't
overfertilize or
underwater your
strawberries.**

Strawberry plants need about 1 inch of water each week, either by rainfall or irrigation. Avoid watering in the very early morning or late evening so the plants are not wet for long periods.

When overnight frost threatens blooming plants, cover them with row covers or use sprinklers to deliver a fine mist over the planting. Ice that forms on the plants actually prevents the flowers from freezing. Apply the mist continually from the time the temperature falls below 34 degrees F until the ice melts in the morning.

Weed control. Remove weeds by cultivation, hand hoeing, or pulling. The most important time to keep the strawberry planting weed-free is the first few months after planting while the plants are sending out runners and new plants are getting established. Do a good job of soil preparation and weeding early and you will have fewer weed problems later. Few herbicide options are available to home gardeners. Consult your local Cornell Cooperative Extension office for specific recommendations.

Mulching. In the fall cover your strawberry plants with mulch to prevent injury from low temperatures. Mulching is particularly important on clay soils or those that remain wet for much of the year. Clean straw is traditionally the mulch of choice (avoid mulches that might contain weed seeds, such as hay). Apply mulch when nighttime temperatures approach 20 degrees F, covering the plants 2 inches deep.

Remove the mulch in early spring—around the end of March to mid-April, after the threat of severely cold weather has passed. Strawberries are evergreen. The plants that have overwintered will have green leaves, and they will begin photosynthesizing when you remove the mulch and expose them to the sun. Place the mulch between the rows to help smother weeds and to keep mud from splashing onto the fruit.

If you remove mulch early, you can cover plants with a floating row cover to provide additional protection and encourage early growth. Plants will flower and set fruit earlier. But use caution in areas prone to late spring frosts that could kill the flower buds. (If you lose the first flowers to frost, fruits from later flowers usually compensate.) Remove row covers before flowers appear so that insects can pollinate them. This also reduces the chance of *Botrytis* fungus causing fruit rot.

In the Northeast strawberries typically flower in May and produce fruit in early June through early July (depending on the cultivar and weather). Watch the flowers for signs of insect damage, particularly by tarnished plant bugs. Fruits ripen about 30 days after the flowers open.

Renovation and fertilization. Renovate your strawberries immediately after harvesting to help reduce disease, stimulate vigorous new growth, and prolong the life of your planting. Mow or clip the plants to a height of 3 inches. If you can, collect your clippings in the mower bag or rake them off and remove them to the compost pile to help reduce disease.

After harvest, mow or clip plants to 3 inches tall.

Rototill the area between the rows to incorporate the mulch. While you are tilling, reduce the width of matted rows to about 12 inches. Rake or hoe soil from the alleyways to cover the plants left in the row to about 1 inch deep.

While renovating, fertilize at a rate of 5 pounds of 10-10-10 fertilizer per 100 feet of row. Never fertilize with nitrogen before harvest because this increases fruit mold. (The one exception is fertilizing at planting, but you remove flowers during the planting season when you use the matted-row system so there is no harvest that year.) For more efficient fertilizer use, apply about two-thirds of that rate at renovation and one-third in September.

Diseases and Pests

Many insects feed on unripened fruit and young vegetative growth, and several diseases render the berries inedible or attack the roots. Whenever possible, select disease-resistant cultivars and virus-free plants. For assistance in diagnosing problems with strawberries and other berry crops, see www.hort.cornell.edu/diagnostic.

Botrytis fruit rot (gray mold). This disease is the most common and serious fungal disease of strawberry plants. It affects the flower petals, flower stalks, fruit caps, and fruit, and it is most prevalent during prolonged rainy and cloudy periods just before or during harvest. Blossoms are very susceptible and often turn brown and dry into their stems. Blossom infection leads to fruit infection, which begins as soft, light-brown areas that enlarge rapidly. In later stages, a gray dust of spores covers the fruit as it shrivels and mummifies. Handling diseased fruit while picking spreads the fungus to healthy berries. Under conditions favorable for disease development, healthy-looking fruit can rot within two days of picking.

To prevent botrytis fruit rot, practice good weed control and provide adequate nutrition. In particular, be sure that calcium and potassium are sufficient, and do not overfertilize with nitrogen. Fungicides are most effective when used during bloom.

Verticillium wilt. This fungal disease infects about 300 different host plants, including fruits, vegetables, woody ornamentals, flowers, and weeds. Once

established in the soil, it infects plantings for many years. In new strawberry plantings, the first symptoms often appear about the time runners form. With older plants, symptoms appear just before the berries ripen. Symptoms differ with cultivar susceptibility. Generally, the outer older leaves turn reddish or dark brown at the margins and between the veins. Then they wilt and drop. Few new leaves develop, and those that do emerge are stunted, wilted, and curled up along the midvein. Severe infections produce stunted and flattened plants with small yellowish leaves. Many plants wilt and die rapidly. With less severe cases, occasional or scattered plants wilt and die.

To minimize verticillium wilt, always start with healthy plants, and do not plant them in low-lying wet areas. Always clean garden tools before use, particularly if they are borrowed, to prevent the spread of infection. Avoid planting susceptible cultivars where other plants commonly infected by verticillium wilt (tomatoes, potatoes, eggplants, peppers, brambles, or other strawberries) have been grown in the past several years.

Red stele. This fungal disease is commonly found in low-lying, poorly drained areas of a strawberry planting. It can spread and become well distributed over an entire patch, especially during cool, wet springs. Infected plants are stunted, lose their shiny luster, and fail to send out runners. With the first hot, dry weather of the season, diseased plants quickly wilt and die. To identify the disease, dig up the plants and look at their roots. Infected plants show few new roots compared with healthy plants, whose roots are thick and bushy. Peel away the outer portion of the white roots and the central part (stele) appears pink to red or brownish red. Normally, the stele is yellowish white.

The best way to control red stele is to plant only resistant cultivars. Whenever possible, choose a well-drained site that has no history of red stele, and avoid planting in low-lying areas.

Leather rot. This disease infects primarily fruit at any stage of development, but it also can infect blossoms. It is common in poorly drained areas or where berries are in direct contact with the soil. Leather rot first appears as a darkened spot on the berry, but as the infection spreads, the entire berry becomes brown, leathery, and rough. Infected berries have a distinctively unpleasant smell and taste. To confirm the presence of leather rot, cut through several berries and look for a marked darkening. Unfortunately, mild infections that go unnoticed can ruin a batch of jam or jelly. To help prevent leather rot, mulch early in the season to prevent the fruit from contacting the soil and avoid planting in wet sites.

Leaf diseases. Leaf spot and leaf scorch generally appear in early to mid-spring. Severe infections cause premature death of the leaves and reduce fruit quality. The most obvious symptoms of leaf spot are small round purple

spots on the upper surface of the leaf. Leaf scorch is characterized by round to angular dark purple spots that enlarge to resemble small drops of tar. Strawberry leaf diseases are most prevalent on old weak plants. To minimize their occurrence, remove old and infected leaves from runner plants. Choose a site with full sun, well-drained soil, and good air circulation. Control weeds and fertilize to keep the plants in good condition.

Tarnished plant bugs. The brownish adults are about 1/4 inch long and marked with yellowish and black spots. The nymphs suck plant juices and inject toxic substances that kill the surrounding tissues in the bud. Injured berries remain small, have a woody texture, and fail to mature. “Button berry,” or seediness around the tip of the fruit, is a serious problem that occurs when the bug punctures young fruits before they fully develop. Tarnished plant bugs are more troublesome in fields bordered by woods and fencerows, where weeds are plentiful. They appear in the strawberry patch when plants start to bloom. To confirm their presence, hold a shallow white dish under the leaves and blossoms of a strawberry plant and tap the flower clusters over the dish. If several small green nymphs fall into the dish, consider using an insecticide to prevent the formation of nubby, inedible berries.

Strawberry bud weevil. This insect typically cuts buds and partially severs stems, resulting in the loss of blossoms. Injury is most likely to occur in strawberry patches near woodlots or other protected sites where the weevils overwinter. The dark reddish brown weevils leave these hiding places in the spring when temperatures approach 60 degrees F and infest plants having early fruit buds. Injury is often noticed before bloom and during blossoming. Late cultivars usually suffer the most damage.

Spittlebugs. Named for the mass of frothy material that covers their bodies, nymphs of this insect appear in April or May and complete development in five to eight weeks. The adults have sharp beaks that they use to pierce the stems of plants and suck their juices. Spittlebugs also attack flower bud clusters, leaf stems, and new crown growth. Although heavy feeding by spittlebugs can stunt berry and plant growth, the problems are generally cosmetic. Infestations are usually not severe enough to warrant the use of an insecticide.

Spider mites. These pests often go unnoticed because of their small size, but their damage is easy to see. As spider mites feed and deposit eggs on the undersides of leaves, plants lose their healthy green luster and become a coppery bronze color. Severe infestations weaken strawberry plants and interfere with sugar production and other normal processes. Mite life cycles vary with the season and weather. They can reproduce continuously from early spring until late fall. In general, hot, dry weather (particularly in July and August) and high nitrogen fertilizer rates favor rapid population increases. Insecticides are not effective because technically the mite is not an insect. Avoid overfertilization and keep the plants watered. Natural enemies often keep mites in check.

Instead of producing a bumper crop in June, day-neutral strawberries can be harvested through fall.

Slugs. Few creatures evoke as much frustration for gardeners as the common slug. These mollusks (related to snails and shellfish) come in all sizes and leave slimy trails. As they feed at night or on dark, overcast days, they make small, moderately deep holes in ripening berries. Slugs overwinter in protected places beneath mulch. Various homemade traps, such as shallow pans of beer placed at ground level, and handpicking can reduce populations. Several control products and baits are available.

Day-Neutral Strawberries

Unlike the common June-bearing strawberries discussed above, day-neutral strawberries flower and produce fruit anytime temperatures are between 35 and 85 degrees F. Instead of a bumper crop in June and July, harvest is spread out through the summer to as late as October, and plants yield well during the planting year. Because they do not send out runners as profusely as June bearers, you need to manage them differently.

Cultivar selection. The most successful day-neutral cultivars for the Northeast are Tribute, Tristar, and Seascape. All three are far more productive than older “everbearing” types such as Ozark Beauty. They produce small-to medium-sized fruit, topping out at about 1 inch in diameter. But their flavor is excellent, particularly Tristar.

Tristar produces a large amount of fruit early in the planting year, but the larger-fruited Tribute surpasses its production by the middle of September. Seascape, from California, has the largest fruit—nearly as big as June-bearing cultivars—and is the most productive of the three.

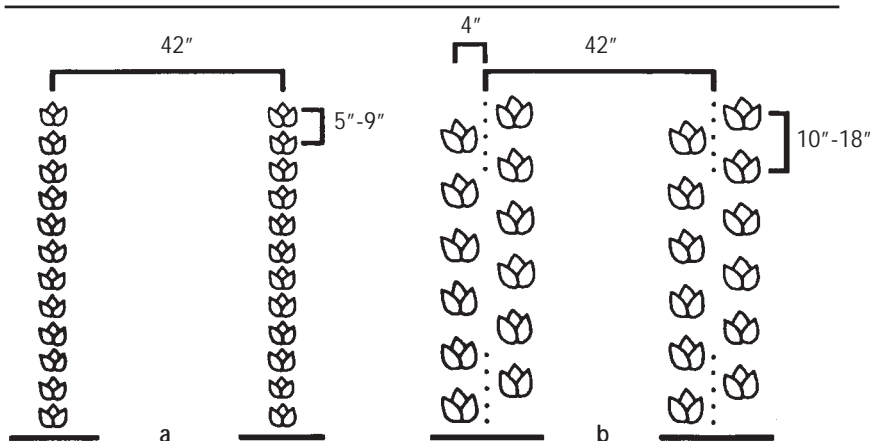

Figure 19. You can plant day-neutral strawberries in single rows (a), but staggered double rows (b) are more productive.

Early care. Day-neutral strawberries prefer the same soil and sites as their June-bearing cousins. Plant them in the early spring, at the same time as June-bearing strawberries. They also are ideal for growing as annuals in containers. Day-neutral cultivars do not produce runners profusely, so matted-row management is not practical. Instead, plant them closer together—about 5 to 9 inches apart—in rows about 42 inches apart. Remove runners for the entire first season. This will increase yield significantly without excessive plant costs.

Planting day-neutral strawberries in a staggered double row reduces competition between plants and increases yields (see Figure 19). Space plants 10 to 18 inches apart, alternating them in two narrow rows just 8 inches apart. Space these staggered double rows 42 inches apart on center.

Day-neutral strawberries perform best when mulched with straw immediately after planting. Mulch reduces drought stress and keeps fruit clean. Remove flowers for several weeks after planting so plants can become established without premature fruiting.

If the summer is hot and dry, little fruit will be produced in the fall because day-neutral strawberries are sensitive to extreme heat and have very shallow root systems.

Watering. Because of these shallow root systems, keeping day-neutral strawberries well-watered is even more important than it is with June-bearers. Make sure they get at least an inch of water per week from rain and/or irrigation.

Fertilizing. During their first year, apply 1 to 2 pounds of ammonium nitrate or 3 to 6 pounds of 10-10-10 per 100 feet of row at the beginning of each month from June through September. Thereafter, apply the same amount at the beginning of each month from May through September. Be very careful to sidedress the fertilizer and avoid contact with the leaves, especially when they are damp and the weather is hot. Instead of monthly applications, you can use annual applications of slow-release fertilizer that deliver the same amount of nitrogen.

Flowering and fruiting. Day-neutral plants produce flowers from the time of planting through frost in autumn. Fruits form from open flowers in about 30 days. Because the flowering season is so long, flowers are more susceptible to insect attack than those of June-bearing strawberries.

Many growers till under their day-neutral strawberries at the end of the first year and start over with a new batch of plants the following spring. If you decide to hold your plants over for another year, cover them with mulch, as you would June-bearing strawberries. The following spring, they will produce a crop in June, then another crop in August. They will not fruit as long into the fall as the first-year planting.

Because of their shallow root systems, day-neutral strawberries need more attention to watering than June-bearers.

Control weeds with frequent hand weeding, light cultivation, and mulch.

Weed control. Because they are always fruiting and there is no good time for renovation, controlling weeds can be a challenge with day-neutral strawberries. These cultivars are also more sensitive to herbicides than June-bearing plants. Planting through black plastic mulch aids in weed control and warms the soil early. But this can hurt Tristar and Tribute cultivars in the summer because they are sensitive to heat. The best approach for home gardeners is to stay ahead of the weed problem. This can be done with light, frequent hand pulling, with light cultivation that avoids damaging shallow roots, and by mulching with straw.

Diseases and insects. Tarnished plant bugs are a major insect pest of day-neutral strawberries. They can be an even greater problem than they are on June-bearing plants because their populations can soar during the summer months when day-neutral cultivars are struggling to cope with the heat. Gray mold also can be a severe problem with day-neutral cultivars, because the fungus accumulates during the growing season, especially if you do not harvest berries regularly. (For more information, see the section “Diseases and Pests” for June-bearing strawberries, page 59.)

Harvest

For maximum sweetness and flavor, pick June-bearing and day-neutral berries a day or two after they are fully red. Berries picked before they are completely red will eventually turn red, but they will not sweeten. Slightly unripe fruit can be used for making jam. Under favorable conditions, expect a total yield of about 1 quart of fruit per foot of matted row. Immediately remove berries that do not ripen because they harbor diseases and attract insects.

For long-term storage of fresh berries, select firm berries that are not yet fully ripe and cool them immediately after harvest. Store as close to 33 degrees F as possible, but be sure the berries do not freeze. Their quality should remain acceptable for several days. Freezing sliced strawberries with sugar and then eating them months later is a great way to recall spring during the cold winter.

Brambles

Brambles—raspberries and blackberries—are perhaps the most diverse group of cultivated fruits in the world. Hundreds of species grow throughout northern temperate regions. Because brambles grew wild and abundantly across North America, they have been cultivated only relatively recently.

The demand for processed raspberries increased in the early 1900s. In response, New York growers planted more than 10,000 acres. But a viral disease decimated the industry. The development of methods to control this disease has fueled a resurgence in raspberry cultivation in the Northeast.

Choosing Cultivars

You can tell the difference between raspberries and blackberries when you pick the fruit. When you pick a blackberry, the white core (receptacle) comes off with the fruit. When you pick a raspberry, the core remains attached to the plant, leaving a hollow center in the fruit.

Blackberries can be either thorny or thornless. Raspberries can be red, black, purple, or yellow. Some red and yellow raspberries are called fall-bearing (or sometimes everbearing). They produce fruit in the fall on primocanes (first-year canes) and in the summer on floricanes (second-year canes).

Blackberries and red raspberries produce many suckers and spread laterally. Black raspberries and purple raspberries generally stay confined to the area of the original planting hole.

There are many bramble cultivars for home gardening (see Table 4). For an updated list of nurseries, see www.hort.cornell.edu/nursery. Choose cultivars that can withstand the winter temperatures in your area. Also consider productivity, use, season of ripening, and fruit quality when making your selections. If your location is prone to early fall frosts, fall-bearing cultivars may not be a good choice.

In general, raspberries produce crops reliably only in USDA Hardiness Zone 5 and warmer regions up to Zone 7. The plants will survive in colder regions. But in most winters the aboveground canes (which produce the flowers and fruit) will be damaged, reducing that year's crop sometimes to zero.

The intimidating thorns on blackberries discourage most people from growing them. Thornless blackberry cultivars may seem like a good alternative, but they have limitations as well. They are susceptible to rodent damage, are only marginally hardy in most of the Northeast, and need to be planted in protected areas.

Keys for Success

Choose a sunny site with well-drained soil. Brambles need lots of moisture, but they will not tolerate soggy soil.

Do not plant brambles in a site where strawberries or plants in the tomato family (including potatoes, peppers, and eggplants) have been grown.

Prepare the soil at least a year before planting, particularly if pH and nutrient levels need to be adjusted. Get weeds under control before planting.

Trellis the plants for easier management and harvesting and to keep the fruit from coming in contact with the ground and rotting.

Be prepared for annual or even twice-a-year pruning. With most types of brambles, you'll need to thin the plants to get a good harvest of high-quality fruit.

Table 4. Bramble cultivars that consistently perform well in the Northeast

<i>Cultivar</i>	<i>Season</i>	<i>Attributes</i>				<i>Quality</i>
		<i>Hardiness</i>	<i>Fruit Productivity</i>	<i>Fruit Size</i>	<i>Fruit Firmness</i>	
Summer-bearing reds						
Prelude	1	3	1	1	2	2
Reveille	1	3	3	1	1	3
Killarney	1	3	2	2	2	2
Canby*	2	2	3	3	3	3
Festival*	2	3	3	2	2	1
Titan	4	2	3	3	2	1
Encore	5	3	2	3	3	2
Summer-bearing yellow						
Amber	4	1	1	2	1	3
Summer-bearing blacks						
Allen	2	2	3	3	3	2
Bristol	2	1	2	2	3	3
Alleghany	2	2	1	2	3	1
Jewel	2	2	2	2	3	2
Huron	3	2	1	2	3	1
Summer-bearing purples						
Brandywine	4	3	2	2	2	1
Royalty	4	2	3	3	2	3
Fall-bearing reds						
Heritage	7	3	3	2	3	3
Autumn Bliss ⁶	3	2	2	2	2	
Fall-bearing yellows						
Kiwigold	7	3	2	2	1	3
Fallgold	7	3	1	2	2	3
Goldie	7	3	2	2	1	3

* Nearly thornless

Note: Season: 1 (early) to 7 (late fall), Attributes: 1 (poor) to 3 (good)

The thornless cultivars Black Satin and Thornfree are damaged around -5 to -10 degrees F (meaning they may sustain damage in the colder areas of USDA Hardiness Zone 6 and colder). Triple Crown, Chester, and Hull suffer cold injury at temperatures of -10 to -15 degrees F (meaning they may sustain damage in Zone 5 and colder). But because they are high yielding, you still can expect a blackberry crop even if they sustain some winter damage. In many cases, fluctuating spring temperatures cause more damage than midwinter low temperatures.

Propagation

It is against the law to propagate patented bramble varieties. It also is not wise to propagate brambles from older plantings because they are likely to be infected with viral diseases.

Nurseries traditionally propagate red and yellow raspberries by removing suckers from the underground stems of virus-free plants. The suckers are harvested during the dormant season and referred to as one-year-old plants in nursery catalogs. Often the suckers are transplanted in the nursery and grown for an additional year. Then they are sold the following year and referred to as transplants. Despite the extra year in the nursery, there is no real difference in performance between one- and two-year-old plants when establishing a planting.

Black raspberries and blackberries are propagated in late August by tip layering. Tips of the current season's canes are buried 2 to 4 inches deep in the soil. The tips develop roots and form new plants before dormancy the same year. They are cut from the original plant before digging with about 6 inches of the old cane left attached to the rooted tip.

Tissue culture is rapidly becoming the preferred technique for raspberry propagation. Plants are cloned from tissues of virus-free stock in sterile surroundings. They are uniform and vigorous when planted in the field. The main drawback of tissue-cultured plants is their initial sensitivity to herbicides and frost. You must take care not to plant them before the last frost in the spring, and you should delay herbicide applications until plantings are well established.

Site and Soil Preparation

Brambles grow best on a sunny site in sandy loam soil with a pH between 5.5 and 6.5. While they tolerate a broad range of soil types, the soil must be well drained. Phytophthora root rot is a common cause of death in sites where there is excessive water, either on the soil surface or below. Excessive water also can be troublesome during the winter when alternate freezing and thawing can heave plants from the soil.

For these reasons, do not plant brambles on sites where water accumulates after rainfall. If this is not possible, plant them on raised beds at least 10 inches tall. Select a site somewhat higher than nearby land. This improves drainage and reduces the danger of cold injury and late spring frosts.

Adequate moisture during the growing season is essential for good cane growth and fruit production, particularly during drought, so be sure to locate plantings near a water source for irrigation.

Begin soil preparation at least a year before planting, especially if the pH needs to be adjusted.

Wild brambles are the principal source of diseases, so choose a site as far as possible from woodlots and old fields where wild brambles grow. If possible, destroy any brambles growing nearby. A previously cultivated site is best, but only if crops susceptible to verticillium wilt have not been grown

Brambles tolerate a wide range of soils but not poor drainage.

there before. These include brambles, strawberries, tomatoes, potatoes, peppers, and eggplants. If you choose a new site, till the sod under and plant a cover crop one year before planting.

Planting

Set plants 1 inch deeper than they were grown in the nursery and at least 30 inches apart in rows 9 to 10 feet apart. Plant rooted canes in early spring and tissue culture plantlets after the danger of frost has passed.

Remove any old dead canes that are attached to the new living plant because they can be a source of disease. Do not fertilize at planting or for several weeks after planting. Water liberally because brambles have shallow root systems.

Care

Brambles are easily injured by too much fertilizer. Apply no more than 5 pounds of 10-10-10 per 100 linear feet of row the first year and no more than 10 pounds per 100 feet in subsequent years. Apply fertilizer only in the early spring before flowering. Sprinkle it evenly in about a 3-foot-wide band over the row. Leave fertilizer on the soil surface because working it in could damage the plants' shallow root systems. Avoid using fertilizers that contain chlorides. For best results, test the soil every two to three years and follow recommendations based on the soil test.

Plants will likely need irrigation between bloom and harvest. Water them early in the day, after they have dried from the morning dew. Plants that remain wet during warm nights are more susceptible to disease.

Better yet, install a drip or trickle irrigation system to avoid wetting foliage. Drip tubes, tricklers, or emitters drip water continuously or intermittently into the root zone around the plant so that the plant receives as much water as it can use but no more. With this system, spaces between the rows remain firm and dry, and the root zone remains moist at all times; very little water is lost from evaporation or wind drift. But you must monitor your system carefully to make sure that the soil stays evenly moist and is not saturated.

Commercial growers usually cultivate the area between rows from early spring to mid-July to control weeds and eliminate suckers. For home plantings, keep about a 3-foot-wide strip cultivated around the plants, and mow the alleyways between the strips. To avoid injuring roots, cultivate no deeper than 2 inches near the plants. Unlike some other fruit crops, with brambles it is not a good idea to mulch the row area. Mulch can retain too much moisture and cause root disease problems.

Brambles are shallow rooted and will probably need watering between bloom and harvest.

Cane Management

To get good-quality fruit, you need to prune plantings annually. Some types of brambles require thinning to keep the plants from getting too crowded and producing poor-quality fruit. With others, you can mow off the canes annually to keep them under control. Proper pruning and cane management can reduce the incidence of disease and improve growth, yield, and fruit size, quality, and sweetness.

Different types of brambles require different kinds of management:

Primocane-fruiting raspberries (fall-bearing raspberries) produce fruit at the top of first-year canes (primocanes) in late summer or early fall and on the lower portion of those same canes in early summer of the second year. If the growing season cooperates, you can expect fruit from primocane raspberries in the fall of the year of planting.

Most growers sacrifice the early-summer crop by pruning or mowing down canes between fall harvest and bud break in early spring. Cut the primocanes as close to the ground as possible to force new buds to break below the soil surface. New primocanes from these buds will grow and fruit in late summer or early fall. This produces a smaller but higher-quality late summer crop.

If you plan to harvest your raspberries only in the fall, you want to maximize the number of canes, so thinning isn't needed. To harvest an early summer crop as well, manage the canes like floricane-fruiting brambles (see below), and remove the portion of the cane that's fruited after harvest in the fall.

Floricane-fruiting raspberries and blackberries produce fruit from buds on second-year canes (floricanes). Unlike primocane types, the canes must remain intact throughout the winter and until after harvest during the second year. After they bear fruit, the floricanes die. You can expect your first crop the year after planting and full production in the summer of the third year.

While the floricanes are flowering and fruiting during their second year, new primocanes also are growing. Some of these will replace the floricanes next season. But these new primocanes compete with the floricanes for sun and water, and they can interfere with spraying and harvesting. Proper pruning and trellising reduces this competition.

The traditional way to manage floricane-fruiting plants is to permit primocanes to grow through their first season and fruit the following year and then cut them off at ground level after harvest when they are dead. The key is to prune and thin the canes in early spring of their second season. In general, you remove any spent floricanes left from the previous season as well as any diseased or winter-damaged wood. Then thin out the canes to about three or four per foot. Finally, head back the remaining canes to a convenient height for picking—about 4 to 5 feet—but by no more than

Good-quality fruit requires annual pruning.

25 percent. (See “Pruning”, page 72, for more details about pruning different types of brambles.)

Another way to reduce plant interference and competition is to mow half of the planting alternately each year during the dormant season. During the spring after mowing, primocanes emerge and grow without interference from fruiting canes. The following year, the floricanes flower and fruit, and then you mow them to the ground once again. This system requires less labor because thinning and pruning are not necessary. It also reduces spray material costs. But because of the high cane density, you can expect poorer quality fruit, smaller berries, and lower yields.

A third alternative is to select four or five primocanes per linear foot of row in June that you will carry through to fruiting the following year and remove the rest. Cut the primocanes that you don’t want when they are about 8 inches tall. They are much easier to prune out while they are still small and succulent instead of large and thorny. This method also increases the fruit size and yield of the current season’s crop. The disadvantage is that if any of these canes become diseased or damaged, you don’t have others to choose from to replace them.

Trellising

It’s a good idea to trellis plants to keep them from drooping over to the ground when they are heavy with fruit. Trellising makes harvesting fruit easier and keeps berries from rotting when they come in contact with the ground.

With primocane-fruiting raspberries, some growers use a temporary trellis during the fall harvest season. One system that works well consists of T-shaped wooden or metal posts approximately 7 feet tall with 3-foot-long cross-arms (see Figure 20).

Figure 20. Temporary trellises for primocane-fruiting raspberries make it easy to mow canes during the dormant season.

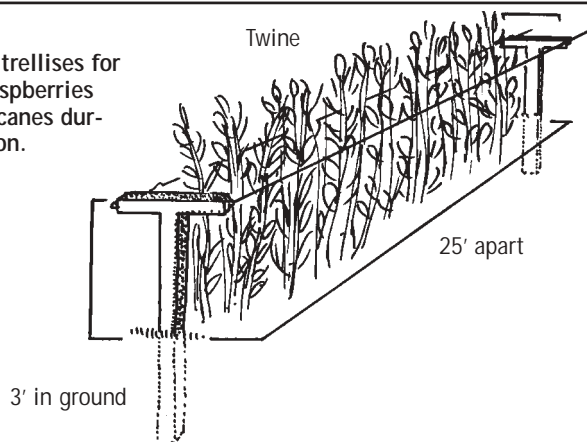

Prune primocanes while they are small and succulent, not big and thorny.

Dig post holes no more than about 25 to 30 feet apart in the center of each row. Make the holes slightly wider than the base of the post and 3 feet deep so that the trellis is about 4 feet tall when assembled. Line the holes with a 3-foot section of plastic pipe.

As harvest approaches, insert the posts into the holes. Run baling twine (tied to screw eyes in the ends of the cross-arms) along either side of the row. Twine is cheap and biodegradable yet strong enough to support the canes. After harvest, cut the twine and remove and store the posts for next season. Because the plastic pipes are buried, they do not interfere with cane-cutting operations.

Trellising floricanefruiting raspberry and blackberry plants helps reduce interference from primocanes and improves production. Without trellising, fruiting canes must be cut short in the dormant season to prevent the canes from breaking or tipping over. Because most of the fruit buds are on the top half of the cane, pruning low can significantly reduce yields.

Use a V-shaped trellis to reduce primocane interference and increase yields by separating the fruiting floricanes from the vegetative primocanes (see Figure 21). Set pairs of opposing posts about 1 1/2 feet apart every 30 feet. Angle the posts away from each other so they are about 20 to 30 degrees from perpendicular to form the V. The posts should stand about 6 feet tall. Run two wires (twine works well for short runs) between the posts and secure them to the anchor posts at the ends of the rows. The top wire should be about 4 feet from the ground, and the second wire—about 2 feet high—provides additional support. These can be adjusted depending on the size and vigor of the plants or how much winter damage they suffer.

Trellising reduces competition and increases yield and quality.

Figure 21. A V-trellis system for floricanefruiting raspberries reduces competition between primocanes and floricanes.

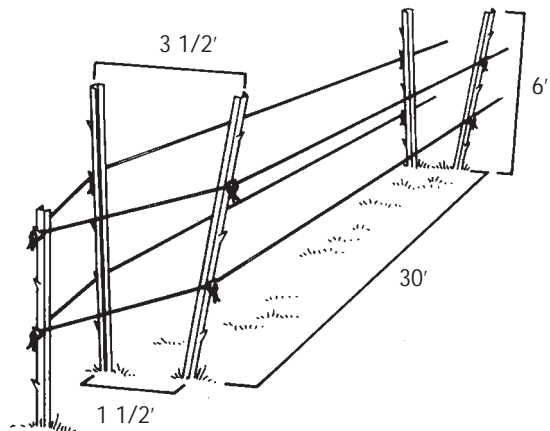

After thinning in early spring, tie the floricanes to the top wires. Allow the primocanes to grow in the middle of the V where they won't interfere or compete with the floricanes for light. Spraying, harvesting, and pruning are easier because trellising pulls the floricanes to the outside where they are accessible. The presence of primocanes in the middle forces lateral growth by the floricanes outward. Studies of several raspberry cultivars showed higher yields using V-trellises, primarily because the practice increases the amount of light reaching the canopy (see Figure 22).

Figure 22. With a V-trellis, primocanes grow in the center of the V the first year (left). During their second season (when they become fruit-bearing floricanes), tie them to the trellis to keep them from shading the new primocanes (right). This system also makes the berries easier to harvest.

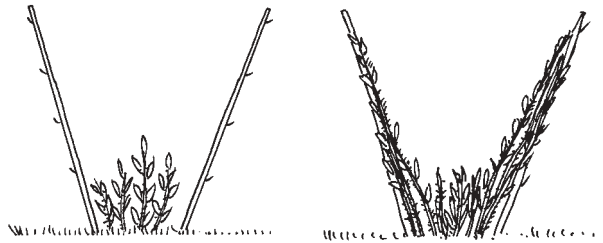

You can build a similar system using T-shaped posts by adding a second cross arm to support the lower wire. The disadvantage of the T-posts is that they aren't as flexible when it comes to adjusting the height of the wires to accommodate annual variation in cane height.

Select trellis posts and anchors from readily available materials. You can make them from wood, steel fence posts, rebar, or similar materials. Monofilament plastic wire, now the material of choice for trellis systems, is as strong as wire but much lighter and easier to handle. Inexpensive devices are available to hold the monofilament taut at the anchoring post and to rejoin lines that have accidentally been cut. Consult nursery and commercial grower catalogs for more information on trellising materials. When designing a trellis and choosing materials, keep in mind the potential 15-year life of the planting. Strong anchor posts are essential for a good trellis.

Pruning

Different types of brambles require specific pruning methods.

Red raspberries. Around mid-March, thin canes leaving three or four per linear foot of row (see Figure 23). Prune off winter-damaged tips. Cut top canes no more than 1 foot beyond the top wire of the trellis but below the point of any winter injury. (Lower the trellis wire if damaged canes require hard pruning.) Tie canes loosely to the trellis wire to prevent wind damage.

Black raspberries. In the summer when the primocanes reach about 2 feet tall, cut back their tips at least 4 inches to encourage lateral growth. By the end of the season, primocanes will be branched with long laterals. These

Figure 23. Red raspberries require thinning to three or four canes per foot for high-quality fruit.

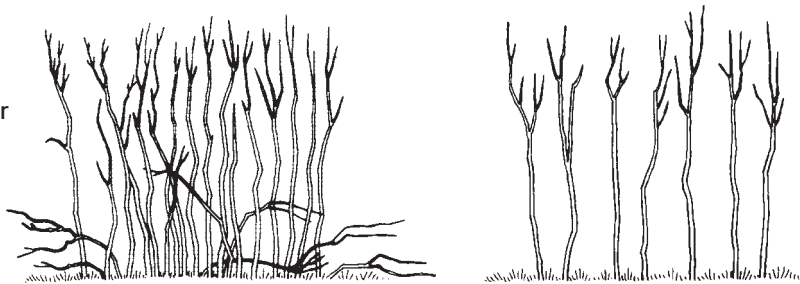

should be supported by trellis wires in the winter to prevent breakage from snow. In early spring, remove any winter-damaged wood and shorten the laterals to about 1 foot long to increase berry size. Thin canes to about two or three per linear foot of row.

Purple raspberries. Purple raspberries are hybrids of red and black raspberries and can be managed like either. However, when managed like red raspberries, they grow very tall and don't yield as well. A better alternative might be to pinch primocanes when they are about 3 to 4 feet tall in June. This produces a stockier plant, more laterals, and better yields, but there is some increased risk of disease, especially if weather is hot and wet following pinching. In early spring, remove any winter-damaged wood and shorten the laterals to about 1 foot long to increase berry size. Thin canes to about two or three per linear foot of row.

Thorny blackberries. Prune twice, similar to pruning black raspberries. Tip primocanes when they are about 3 to 4 feet tall in the summer to stiffen the canes and encourage lateral branching. In early spring, shorten the lateral branches to between 12 and 16 inches, and thin canes to two per linear foot of row. Alternate-year mowing helps avoid the difficult task of pruning (see "Cane Management," page 69).

Thornless blackberries. In early spring, shorten fruiting canes to the top trellis wire, or weave them around the wire. Shorten laterals to about 18 inches. Low-growing laterals are less likely to suffer winter injury. For good production, maintain six to eight canes per clump.

Diseases and Pests

Your best first line of defense against diseases and pests is to choose disease-resistant cultivars and to keep your plants healthy. Choose your site and prepare the soil carefully, paying special attention to good drainage. Make sure plants get adequate water, but avoid saturating the soil. Remove wild brambles, which can harbor diseases that can spread to your planting.

For more help identifying disease, pest, and other problems with raspberries, see www.hort.cornell.edu/diagnostic.

Choose disease-resistant cultivars and plant them in a well-drained site.

Mosaic virus. Aphids and leafhoppers infect and spread this disease through bramble plantings. Leaves become mottled with yellowish or light green blotches on a dark background. They also are smaller than normal and frequently deformed or cupped. The virus stunts infected plants, which produce dry fruit of poor quality.

Royalty, a purple raspberry cultivar, is immune to the aphid that transmits this virus. Black raspberries are very susceptible. Red raspberries can carry the virus without showing any symptoms, so do not plant black raspberries near red raspberries unless you are certain the red raspberries are virus-free.

To reduce the incidence of mosaic virus, plant only virus-indexed stock. Plantings located far away from wild brambles are less likely to become infected. Remove infected plants, because once infected, they cannot be cured.

Ringspot virus. This virus is transmitted by nematodes (tiny soil-dwelling, wormlike creatures) and causes berries to crumble when picked. Plants cannot be cured once they are infected. Plant only virus-indexed stock, and do not replant into a site where crumbly berry plants have been recently removed.

Phytophthora root rot. This disease causes plants to wilt or collapse during the heat of summer. It stunts leaves, which show poor color before wilting. Digging up plants will reveal that many of the roots are dead or chocolate-brown in color. This root-rotting disease is associated with wet sites. To avoid it, plant only in well-drained soils or on ridges or raised beds. Black raspberries are generally the least susceptible. Red raspberries vary in their susceptibility.

Verticillium wilt. This disease can be found in soil where strawberries or tomatoes, potatoes, peppers, eggplants, or other crops in the tomato family have been grown. It causes leaf wilting and yellowing from the bottom up and may appear on only a few canes of each plant. Verticillium wilt is most severe on black raspberries. Grow a cover crop of a grass species for a couple of years before planting raspberries if the site was once used to grow any of the susceptible crops listed above.

Spur blight, cane blight, and anthracnose. These diseases infect canes and weaken plants. Spur blight is identified by chocolate-brown or purple cankers around individual buds. Buds within the discolored areas fail to grow, or laterals from those buds collapse before fruiting. Cane blight cankers grow around the entire cane below wilting branches. Symptoms of anthracnose include small purple spots on young canes in the spring. The spots become sunken and turn gray with a purple border. This disease is most severe on black and purple raspberries.

To control these cane diseases, prune out and burn diseased canes before new canes emerge in the spring. Also, remove the fruiting canes after they have fruited, usually sometime in August. Fall-bearing raspberries that are mowed annually are not infected by these diseases.

Botrytis fruit rot. This fungus develops during cool rainy weather as a gray mold over the fruit. Practices that improve air circulation reduce its incidence. Fungicides are most effective when applied during bloom.

Orange rust. This disease affects black raspberries and blackberries, turning the undersides of new leaves orange in the spring. Plants produce new canes that are weak, spindly, and thornless. The disease is systemic in the plants, returning every year.

Raspberry cane borers. Adults of this insect pest appear in June. The first symptoms are wilting tips on new canes and laterals. Closer examination reveals two rows of punctures 1/2 inch apart encircling or girdling the stem. These marks are made by the female borer before she deposits her eggs between them. Larvae hatch from the eggs and burrow toward the base of the cane. They spend their second year in the roots and crown.

To avoid this insect, do not plant near wild brambles. When infestations occur, cut off the wilted tips below the girdle and crush the old stubs of canes in early spring.

Raspberry fruitworms. Early cultivars of red raspberries are most likely to be attacked by this pest. Larvae are usually first noticed at picking either inside the berry or on the receptacle. Infected fruit is usually unfit for consumption. The adults can severely injure leaves by eating holes in them.

Spider mites. These tiny pests are most prevalent during hot, dry weather. They are found on the undersides of leaves, preferring older, less succulent ones. Injury appears as bronzing on the leaf surface. Excessive fertilization can lead to high mite levels.

Blackberry leafminers. These insects feed on foliage, weakening the plant and causing poorly developed fruits. Larvae hatch from eggs laid in the leaf tissue and excavate large blotched “mines” between the leaf surfaces. Two generations occur each year—the first in late May and the second in late August.

Raspberry sawflies. Look for these small pale green larvae feeding first on the outer edges or undersides of the leaves and then chewing holes in the leaves. In heavy infestations, all leaf surfaces except the vein are destroyed.

Japanese beetles. These familiar insects chew leaves randomly in midseason. They prefer particular cultivars. Plantings near grub-infested turf are particularly susceptible.

Harvest

Raspberries do not keep well on the plant and must be harvested every two or three days. Expect a small crop the first year after planting. Fall-bearing raspberries may produce a small crop in the fall of the planting year. Production usually peaks about the third year after planting and slowly declines after that. Many growers replant after about 10 years.

Bramble berries are very fragile. The reason they are usually sold in shallow, half-pint containers is that in deeper containers the weight of the berries on the top crushes the berries on the bottom. The rule of thumb is never to pile bramble berries more than four high. Unless you are planning to make jam or jelly from your crop, do not harvest berries into containers more than 1 or 2 inches deep.

To store raspberries for later use, proper postharvest care is critical. Select only berries in good condition and immediately cool them as close as possible to 33 degrees F without freezing.

Blueberries

Blueberries, and their cousin the cranberry, are the only commercially produced fruit crops that are native to North America. Wild blueberries grow in all regions of the country except in the High Plains and the desert Southwest.

In the early 1900s, Elizabeth White of New Jersey and Fred Coville of the U.S. Department of Agriculture cooperated to develop the first hybrid blueberries. Many of their cultivars are still grown commercially today.

Blueberries often are incorrectly called huckleberries. Huckleberries belong to the genus *Gaylussacia*. Unlike blueberries, they have 10 comparatively large seeds in each berry, which crunch between your teeth when you eat them. Blueberries belong to the genus *Vaccinium*, and the 20 or more small seeds in each berry are not noticeable when eaten.

The wild lowbush blueberry, *Vaccinium angustifolium*, is a hardy shrub that usually grows no more than 15 inches tall. Many species of wild blueberry grow naturally throughout the United States. The cultivated blueberry industry is founded on cultivars developed by extensive breeding and selection from the northern highbush blueberry, *Vaccinium corymbosum*, and several related species.

Choosing Cultivars

Selecting appropriate cultivars for home plantings is not a simple matter. In the coldest areas of New York State, gardeners are limited to only the hardiest cultivars, such as Northblue, Northcountry, and Northland, which will survive winters in most areas of USDA Hardiness Zone 3. Patriot, Bluecrop, Jersey, and Blueray will overwinter in most areas of Zone 4. Gardeners in warmer areas can choose from these and less hardy cultivars, such as Herbert, Darrow, Spartan, and Bluejay.

Cultivars differ in the size, color, and flavor of their berries and when they ripen. Cultivars are self-fertile, but planting at least two different cultivars improves pollination and increases berry size. The following cultivars are listed by harvest period, from early- to late-ripening blueberries. (For an updated list of nurseries selling blueberry plants, see www.hort.cornell.edu/nursery.)

- **Earliblue**—hardy in Zones 5 to 7. Berries are large with light blue skin and have a soft flesh and mild flavor. The fruit does not shatter (drop easily) from the bush, and it is resistant to cracking. Plants are vigorous, productive, upright, and well shaped.

Keys for Success

Your soil **must** be acidic, with a pH of less than 5.0. Test the soil and start reducing its pH at least a year before planting. If the pH is more than 7.0, it may be too difficult to reduce pH. Consider growing something else instead.

Choose a sunny site and avoid frost pockets. Plants require at least a 140-day frost-free growing season.

Blueberry plants prefer a moist but well-drained soil but will tolerate a wide range of soils (as long as the pH is less than 5.0). Plants are sensitive to moisture stress, especially the first few years after transplanting.

Test your soil before you even think about which cultivar to grow. Its pH must be less than 5.0.

- **Duke**—hardy in Zones 5 to 7. This productive newer variety from New Jersey has large fruit with good flavor.
- **Blueray**—hardy in Zones 4b to 7. Berries ripen in early midseason and are crack resistant and very large with medium–light blue skin, firm flesh, and a strong flavor and aroma. The plants are upright, spreading, and consistently productive. It overproduces (produces too much fruit, weakening the plant) unless carefully pruned.
- **Patriot**—hardy in Zones 4 to 7. It is partially resistant to phytophthora root rot and has excellent-tasting fruit. The plants are vigorous, productive, open, upright, and smaller than other cultivars.
- **Berkeley**—hardy in Zones 4 to 8. Berries are very large and light blue and have a mild flavor and firm flesh. Berries ripen in midseason, store well, resist cracking, and do not shatter from the bush. The plants are vigorous, open, spreading, and easy to grow.
- **Bluecrop**—hardy in Zones 4b to 7. Berries are medium large and have a light blue skin, an excellent flavor, and firm flesh. Berries shatter somewhat from the bush, but they resist cracking. The plants are vigorous, consistently productive, spreading, and drought tolerant. This is the most popular variety in the world.
- **Herbert**—hardy in Zones 5 to 7. Berries ripen in late midseason, are very large and medium blue, and have tender flesh and a very good flavor. They resist cracking and do not shatter from the bush. The plants are consistently productive, vigorous, open, and spreading.
- **Darrow**—hardy in Zones 5 to 7. Another variety with exceptional flavor for the home gardener.
- **Jersey**—hardy in Zones 4 to 8. Berries are medium sized with medium-blue skin and firm flesh. They keep well, resist cracking, and have a good flavor. The plants are vigorous, productive, erect, and easy to prune.
- **Coville**—hardy in Zones 5 to 8. Berries are large and aromatic with medium-blue skin and a tart flavor. They do not shatter from the bush. The plants are productive and late ripening with vigorous, open, and spreading growth that is easily pruned.
- **Lateblue**—hardy in Zones 5 to 7. Berries are late ripening, firm, light blue, and highly flavored. The plants are productive and vigorous with erect growth. They ripen in a relatively short time, about seven days after Coville.
- **Elliot**—hardy in Zones 4 to 7. These productive plants bear berries that are firm, light blue, and medium sized with a good, mild flavor. They ripen very late in the season, around Labor Day.

Site Selection and Soil Preparation

For best results, blueberries need a frost-free growing season of at least 140 days. Cultivars differ greatly in their susceptibility to winter injury. The condition of the wood also determines whether cold temperatures will injure the plants. Very vigorous plants that continue to grow late in the season are injured more easily than plants growing normally.

Even when low winter temperatures kill the tops of the plants, the crown and roots are often protected by snow cover. The plants usually recover and put out new shoots that frequently bear fruit the following year. Where deep snows prevail, much of the bush is protected from extreme low temperatures, but heavy snows can break canes.

An early fall frost sometimes kills back late-growing shoots from the tip, but in most cases this injury can be pruned away. A late spring frost, however, can injure partly opened flowers, causing a partial to total crop loss on some early-flowering cultivars. Avoid these early cultivars if your site is prone to late spring frosts.

Blueberries grow best on a sunny site in sandy peat soil, but they also do well in heavy soils if they are well-drained, aerated, and high in organic matter and receive adequate moisture.

The most important requirement for growing blueberries is acidic soil. Few soils are naturally suitable for blueberry cultivation because the pH is above 5. If the pH of your soil is greater than 5 but less than 7, you can increase the acidity with applications of sulfur or acid peat.

Soil acidity increases very slowly after applying sulfur, so it is important to test the soil and adjust the acidity and nutrient levels as needed the season before planting. Because it will take at least two months of warm weather for the sulfur to lower the pH, don't wait until the fall before a spring planting to apply it. Also, incorporate organic matter such as compost or peat, particularly if the soil is very light and sandy. It is impractical to reduce the pH of alkaline soils (those with a pH greater than 7) low enough to grow blueberries.

Planting

Blueberries are difficult to propagate, and survival of rooted cuttings is poor. Purchase two- or three-year-old plants from a reliable nursery. Avoid one-year-old cuttings because they have a high mortality rate.

Planted properly, bare-root plants perform as well as container-grown plants and usually cost less to ship. If container-grown plants are pot-bound, prune the roots before planting.

Keys for Success

To control weeds early in the season, cultivate around the plants no more than 2 inches deep. After harvest, apply mulch to control weeds and conserve soil moisture.

Prune first-year growth so that just the two strongest canes remain. Keep one or two canes from each year until they are eight years old. Remove nine-year-old canes in early spring.

Harvest early or protect the fruit from birds.

As soon as possible after the plants arrive in early spring, plant them in soil that you prepared the previous season. Soak the roots in water for several hours before planting. Space the plants a minimum of 4 feet within rows and 10 feet between rows. Set plants 1 inch deeper than they were grown in the nursery, and prune them to half their original size. This will remove most of the flower buds, balancing the top growth with the still-small root system.

Remove any flowers that appear the first year to divert energy and nutrients to the vegetative growth. Keep plants well watered because blueberry plants are extremely sensitive to dry conditions, particularly during the first two years after transplanting.

Fertilization

Do not use fertilizer the year you set out the plants because the roots are easily damaged at this time. When plants flower during the spring of the second year after transplanting, apply 4 ounces of ammonium sulfate or 2 ounces of urea to each plant. Sprinkle the fertilizer in a ring around the bush, but don't work it into the soil because it might damage the shallow roots. Never fertilize after flowering as it may make the plants more prone to winter injury.

Increase the amount of ammonium sulfate you apply to each plant by 1 ounce each year (1/2 ounce for urea) until the sixth year. After that time, use 8 ounces of ammonium sulphate (4 ounces of urea) per application. Fertilizers containing chlorides or nitrates are not recommended because they can harm blueberry roots.

Sometimes plants need supplemental fertilization with magnesium sulfate and a balanced fertilizer. To find out, you can test the soil. (Contact your county's Cornell Cooperative Extension office for soil testing information; see www.cce.cornell.edu/local_offices.cfm.) For a more precise assessment, you have a leaf analysis done (cost: about \$30; for more information, contact the Cornell Nutrient and Elemental Analysis Laboratory; phone 607-255-1785, on the web at www.hort.cornell.edu/departments/facilities/icp).

Cultivation and Mulching

To avoid root damage, avoid cultivating within 2 feet of the plant, and never cultivate more than 2 inches deep. Cultivation after July increases susceptibility to winter injury.

To conserve moisture and control weeds, apply mulch in mid to late summer. Sawdust, wood chips, or chopped cornstalks make excellent mulch. Plant grass or another groundcover between rows.

Never cultivate blueberries more than 2 inches deep. Apply mulch to control weeds and conserve moisture.

Pruning

Proper pruning practices contribute significantly to consistent production, high yields, and good fruit quality and help ensure a long life for your planting.

The best time to prune is in the early spring when you can assess and remove winter injury. If you prune in the fall, wait until after the leaves fall off. Simply topping the canes to stimulate lateral growth is generally not recommended. To prune properly, it helps to understand more about how blueberries grow and produce fruit.

The largest blueberry canes do not produce the most fruit. Rather, canes that are $\frac{1}{2}$ to 1 inch in diameter at their bases are the most productive. In fact, canes greater than 1 inch in diameter allocate increasing amounts of energy to the leaves at the expense of the fruit. Removing these old large canes makes the bush behave like an efficient young plant, even though the underground portion is quite old (see Figure 24).

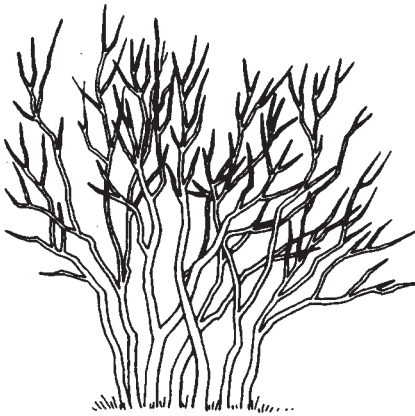

Figure 24. Unpruned blueberry bushes (left) become unproductive when older canes dominate. Properly pruned bushes each have about 12 to 16 canes, with one or two that are from one to eight years old.

The ideal blueberry plant should have at most 16 canes. The oldest one or two should be eight years old, and then there should be one or two left from each of the previous years. You can accomplish this by allowing only the two strongest new canes to grow each year from the time the bushes are planted until they are eight years old. By that time, the oldest two canes should be about 1 inch in diameter.

Early in the ninth year, prune out the two largest canes and all but the two largest one-year-old canes. If repeated annually, this practice minimizes uneven growth and production. The oldest canes are continually replaced with the same number of new canes, and the bushes remain the same size.

If you are pruning old neglected bushes, you can remove up to 20 percent of the basal area (the total diameter of all the main stems) of a bush without

adversely affecting the current year's yield. Although pruning this hard will reduce the number of berries, the increase in fruit size compensates for the reduced number.

Flowering and Fruiting

Blueberries will produce a small crop the third year after planting and will reach full production in about eight years if you follow the recommended pruning strategy. Most cultivars flower in May and the fruit ripens in July, August, or even as late as September, depending on the cultivar.

Blueberries can self-pollinate, but planting two different cultivars increases pollination, berry size, and total harvest. If you only pick two cultivars, don't make one of them a very early variety and one a very late variety. If you do, their bloom times may not overlap. A midseason variety such as Bluecrop is likely to overlap with the flowering of most any other variety.

Diseases and Pests

Fortunately for home gardeners, blueberries have fewer pest problems than other fruits. There are, however, some diseases and insects to watch for, which are described below. For more help identifying these and other problems with blueberries, see www.hort.cornell.edu/diagnostic.

Fusicoccum canker. Jersey, Earliblue, and Bluecrop are all very susceptible to this disease, which appears as small reddish spots on the canes, frequently at a leaf scar near the ground. As the canker enlarges, a bull's eye pattern develops. Plant parts above the canker suddenly wilt and die during warm dry weather, calling attention to the disease. Prune diseased canes as they appear. Fusicoccum canker is relatively uncommon except in colder regions. If this disease is a problem in your area, plant the resistant cultivar Rancocas. Coville, Berkeley, Blueray, Burlington, and Rubel are moderately susceptible.

Phomopsis canker. This disease causes new shoots to wilt and die back from the tips toward the crown. The pith and wood of infected mature canes become discolored, and the canes suddenly wilt and collapse in the summer. If single canes suddenly die while the rest of the plant remains healthy, suspect phomopsis canker. Usually, infected plants were previously injured or already in a weakened condition. Good preventive measures include maintaining your plants in a vigorous condition and taking all possible precautions to minimize winter injury and early frost damage. To reduce the spread of phomopsis canker, prune and burn diseased twigs and canes as they appear.

Mummyberry. This fungal disease causes young shoots and leaves to wilt, turn brown, and die. Infection is similar in appearance to frost damage. The tissue at the base of flower clusters appears water soaked or brown. As harvest approaches, berries that develop from infected blossoms become tan or cream-colored, shrivel into hard mummies, and shatter easily from the

Planting two different cultivars increases berry size and yield.

bushes. To limit the spread of the fungal spores, rake all old berries into the ground before budbreak in spring, or cover the planting with 2 inches of sawdust mulch. In most years, mummyberry is not common in the Northeast. Resistant varieties include Burlington, Collins, Jersey, Darrow, Rubel, Bluetta, and Dixi. Earliblue and Blueray are most susceptible.

Blueberry maggot. While this is potentially a very destructive pest, it has not been a serious problem in the Northeast except in some areas of New Jersey. Small white maggots attack the berries, one per fruit, and usually cause them to drop, decreasing the yield. When infested berries remain on the plant, the crop is unacceptable for consumption.

Stem galls. These oblong swellings develop on the tips of canes anytime during the season. The best control is to prune and destroy the galls before their insect inhabitants emerge as adults.

Harvest

If left on the bush after ripening, blueberries do not spoil for at least one week. Their flavor and sweetness continue to increase. Unfortunately, this makes the berries very attractive to birds. (See suggestions for bird damage control in the section “Before You Begin,” page 1.)

For the home gardener, covering plants with bird netting is a practical, though labor-intensive, option. Another option is to pick the berries while they are still slightly tart to avoid extensive losses to birds. Keeping the fruit at a cool temperature after picking maximizes storage life.

Currants and Gooseberries

Keys for Success

Check with your local Cornell Cooperative Extension office to be sure that it is legal to grow *Ribes* species in your area.

Unlike most other fruits, currants and gooseberries grow well in partial shade. They prefer cool, moist locations on a north slope or the northern side of a building, for example.

Choose a site with good air circulation to avoid powdery mildew, a disease that commonly plagues *Ribes*.

Currants and gooseberries prefer rich soil with a high water-holding capacity. To prepare your site, incorporate organic matter well ahead of planting, particularly if you have light, sandy soil.

Ribes are heavy nitrogen feeders. Mulches high in nitrogen, such as grass clippings, are ideal. If you use high-carbon mulches, such as straw, you may need to apply extra nitrogen fertilizer.

Prune annually to remove four-year-old canes. Mature plants should have about eight bearing canes.

Currants and gooseberries (*Ribes* species) are hardy and easy to grow. Their sweet-tart fruits make excellent jams, pies, and jellies, and they are popular ornamental plants. Although many people today are unfamiliar with these fruits, New Yorkers grew 2,700 acres of them in the 1920s.

Choosing Cultivars

The *Ribes* are a very diverse species with hundreds of varieties that differ in plant size and form and fruit flavor, shape, texture, color, and hairiness. While most are hardy in Zone 3 or Zone 4, a few are hardy in Zone 2. Several types of interest to home gardeners include:

Red currants (*Ribes rubrum*, *R. sativum*, and *R. petraeum*). Fruits range in color from dark red to pink, yellow, white, and beige, and they continue to sweeten on the bush even after they appear to be in full color. Many people consider Rovada to be the best red currant cultivar. Plants are dependable, vigorous, late ripening, and very productive, bearing long-stemmed clusters of large red berries that are easy to pick.

White currants. A type of red currant, white currant cultivars are sold less frequently by nurseries. Blanka is most commonly available. The berries are large and mild in flavor with a pale yellow color. Most people prefer White Imperial or Primus if they are available.

Black currants (*Ribes nigrum*). Black currants are currently illegal to grow in New York, but it may soon be legal to grow cultivars that are immune to white pine blister rust (see “Legalities of Growing,” page 85).

Gooseberries. There are two types of gooseberry plants—American (*Ribes hirtellum*) and European (*Ribes uva-crispa*). Cultivars of the American type are smaller but more resistant to powdery mildew. They tend to be healthier and more productive. American cultivars include:

- **Poorman**—one of the largest of the American cultivars. Productive and vigorous, with medium-sized but high-quality fruit, it is a good cultivar for the home garden.
- **Oregon Champion**—medium to large yellow-green berries; excellent for processing.
- **Hinnonmaki Red** and **Hinnonmaki Yellow**—medium-sized red and green fruit, respectively.

- **Captivator**—a cross of American and European cultivars, it has red teardrop-shaped fruit, is nearly thornless, and is resistant to powdery mildew.
- **Pixwell**—easy to propagate, commonly sold, and very productive, but its fruit quality is poor and it is hardy only to Zone 5.

The fruits of the European cultivars are larger and better flavored. They include:

- **Invicta**—considered by some to be the best gooseberry available in North America, it is resistant to powdery mildew but susceptible to leaf spot and has very large fruit with a bland flavor.
- **Leveller** and **Careless**—the standards for British fruit production; yellow and green fruit, respectively.
- **Early Sulfur**—yellow, hairy fruit with good flavor but susceptible to powdery mildew.
- **Catherina**—large green fruit.
- **Achilles**—large red fruit.

Gooseberries are easily propagated through tip layering or stool bedding (mound layering). Sources of gooseberry and currant plants can be found at www.hort.cornell.edu/nursery.

Legalities of Growing

In the early 1900s the federal and state governments outlawed the growing of currants and gooseberries to prevent the spread of white pine blister rust (*Cronartium ribicola*). This fungal disease attacks both *Ribes* and white pines, which must live in close proximity for the blister rust fungus to complete its life cycle. Black currants (*Ribes nigrum*) and white pines (*Pinus strobus*) are extremely susceptible, and red currants and gooseberries exhibit varying degrees of susceptibility.

Although the federal ban was rescinded in 1966, some northern states, including New York, still prohibit the planting or cultivation of black currants. Some black currant types, such as the cultivars Consort, Crusader, and Titania, are hybrids that are resistant to the blister rust fungus. They can be planted in areas where other currants and gooseberries are permitted. Some towns and counties, however, restrict the planting of any *Ribes* species, so it is best to check with your local Cornell Cooperative Extension office to determine the legality of growing currants and gooseberries in your particular location.

Check with your local Cooperative Extension office to make sure it is legal to grow *Ribes* species.

Site Selection and Soil Preparation

Unlike most other fruit crops, currants and gooseberries tolerate partial shade and prefer a cool, moist growing area. Northern slopes with protection from direct sun are ideal. Planting along the side of a building or shady arbor is suitable as well. Avoid sites with poor air circulation, which increases the incidence of powdery mildew. Sloping ground alleviates this condition.

Also avoid light-textured, sandy soils. Rich, well-drained soils that have a high moisture-holding capacity are best. Incorporate organic matter (compost, peat, or manure) to improve the soil, particularly if it is somewhat sandy. The ideal soil pH is about 6.5.

Planting

Purchase strong, well-rooted plants from a reliable nursery, selecting either one- or two-year-old vigorous stock. Because currants and gooseberries begin growth very early in the spring, you should plant them in the early fall or very early in the spring, before the plants begin to grow.

Before planting, remove damaged roots and head back the tops to 6 to 10 inches. Do not allow the root systems to dry out. Set plants as soon as possible in properly prepared soil, slightly deeper than they grew in the nursery. Firm the soil around the roots.

Space plants according to the vigor of the cultivar, keeping in mind that plants are more vigorous on very fertile soil. As a general rule, plants should be spaced 3 to 5 feet apart in the row, with 8 to 10 feet between rows.

Fertilizing

Currant and gooseberry plants are heavy feeders. To give the plants a healthy start, work manure into the soil before planting. Annual topdressings of composted manure are beneficial as well. If plants are not vigorous, lightly broadcast about 1/4 to 1/2 pound of 10-10-10 fertilizer per plant. Avoid fertilizers containing muriate of potash (potassium chloride).

Mulching

Mulch keeps the soil cool in the summer, retains moisture, and controls weeds. Spread 2 to 3 inches of mulch around plants and replenish it yearly. Suitable mulches include straw, lawn rakings, composted manure, compost, wood chips, or similar materials. Grass clippings make excellent mulch. If you use fresh straw or sawdust, you may need to apply nitrogen fertilizer because these high-carbon mulches tie up nitrogen while they decompose.

***Ribes* tolerate partial shade and prefer cool, moist conditions.**

Figure 25. Trellising gooseberries increases air circulation (decreasing disease problems), makes fruit easier to harvest, and allows you to grow more plants in less space.

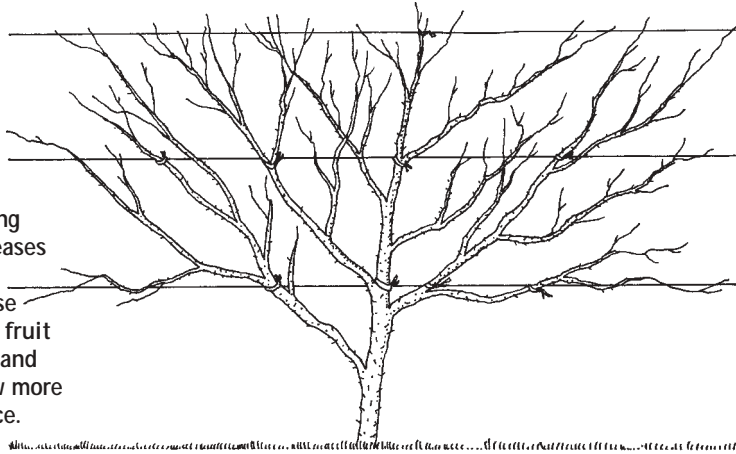

Pruning

Prune currants and gooseberries when the plants are dormant in late winter or early spring. Remove any branches that lie along the ground as well as branches that are diseased or broken.

Ribes species produce fruit at the base of one-year-old wood. Fruiting is strongest on spurs of two- and three-year-old wood. After the first year of growth, remove all but six to eight of the most vigorous shoots. At the end of the second growing season, leave the four or five best one-year-old shoots and up to three or four two-year-old canes. At the end of the third year, prune so that approximately three or four canes of each age class remain.

By the fourth year, the oldest set of canes should be removed and the new canes allowed to grow. This system of renewal ensures that the plants remain productive because young canes always replace those that are removed. A strong, healthy, mature plant should have about eight bearing canes, with younger canes eventually replacing the oldest.

Diseases and Pests

Visit www.hort.cornell.edu/diagnostic for assistance in diagnosing problems with currants and gooseberries. Currant aphids, leaf spot, and powdery mildew are the most common problems that plague currant and gooseberry plantings. All disfigure or damage the leaves and can cause defoliation.

Currant aphids. These tiny, soft-bodied insects feed under young leaves toward the shoot tips, causing affected leaves to curl downward, blister, and become reddish. In severe cases, the leaves become excessively distorted and fall off, and the fruit does not ripen properly. Insecticidal soap and certain horticultural oils (check labels) can help control aphids.

Powdery mildew. This fungal disease is a problem particularly on European gooseberries. In early summer a whitish, powdery growth appears on the

Prune to maintain about eight bearing canes.

surface of leaves, shoots, and branch tips. If left unchecked, the fungus can progress to the berries themselves. Later in the summer, the growth may turn from white to brown. Warm, humid conditions and poor air circulation favor powdery mildew. Prune and dispose of infected branch and shoot tips in early spring. Some home gardeners are experimenting with trellising gooseberries because it makes disease management and harvesting easier (see Figure 25). Certain horticultural oils (check labels) applied at the first sign of powdery mildew can prevent its spread.

Anthracnose and leaf spot. Both these diseases can become serious problems, especially in wet, humid years. Symptoms range from brown spots and yellowing on leaves, young shoots, and stems to early defoliation. Destroy affected leaves, and apply mulch after leaf drop.

San Jose scale. These insects occasionally infest currant and gooseberry plants. They feed by sucking valuable plant juices, and in severe cases they affect the fruit as well. Scale insects are easily seen on the dormant wood. Prune out and destroy infested canes before new growth begins in the spring. Certain horticultural oils (check labels) can help reduce infestations.

Currant borers. These moth larvae burrow in the pith of currant and gooseberry canes. Infested canes do not die in the fall, but they put out sickly growth in the spring. The adult, a clear-winged moth, appears in June and lays eggs in leaf axils. To prevent the next generation of moths from emerging, remove and destroy infested canes before June 1. Proper pruning to remove old canes is the best control.

Currant stem girdler. This immature sawfly eats around, or girdles, the tips of new shoots, which eventually die and fall off. Cut off affected tips in May or June about 3 to 4 inches below the girdle, or if left until later in the season, about 8 inches below the girdle.

Imported currantworm and other sawflies. As soon as leaves expand in the spring, adults deposit eggs on the undersides of leaves along the major veins. A week to 10 days later, tiny larvae emerge and begin eating holes in the leaves. If numerous, they can strip a bush of its foliage in a few days. Remove leaves harboring eggs by hand.

Gooseberry fruitworm. This greenish caterpillar feeds in the fruit, causing it to color prematurely and fall off. The adult moth lays eggs on the fruit, and the larvae enter the developing berries and feed on the pulp, moving from one fruit to another. Several berries may be tied together by a silken webbing. Handpick infested berries before larvae move to adjacent ones.

Harvest

Remove any flowers so that the plants don't develop fruit during their first season of growth. Expect a light crop the second year and a full crop by the third. Currants and gooseberries ripen over a two-week period in June. Berries do not drop immediately upon ripening, so they usually can be harvested in one or two pickings. Currants can be picked in clusters, and gooseberries are picked as individual fruits. Expect mature plants to yield about 90 to 150 pounds per 100 feet of row.

Wait for the fruit to turn color before picking. Gooseberries come off easily when they are ripe. Determining the right time to pick currants requires some trial and error.

Elderberries

Keys for Success

Avoid disturbing the shallow root system.

Prune to remove canes more than four years old.

Plants tolerate a wide range of soils and are relatively pest free.

Elderberries are popular for their unusual taste in pies, jellies, and jams. They are occasionally used in making wine. The plants are very hardy (usually in areas no colder than Zone 4 but some kinds in Zone 3), and because they flower in late June, the crop is seldom damaged by a late spring frost. They are attractive and easy to grow and are great in landscape plantings. Elderberries contain more phosphorus and potassium than any other temperate fruit crop. The fruits also are rich in vitamin C.

Choosing Cultivars

Elderberries belong to the genus *Sambucus*. Individual flowers are small and white and appear in large compound clusters. They are nearly self-unfruitful, so plant two different cultivars within 60 feet of each other to provide adequate cross-pollination.

Adams No. 1 and Adams No. 2 are two old cultivars introduced by the New York State Agricultural Experiment Station in 1926. They are strong, vigorous, productive, and hardy in areas up to Zone 4, and they bear large fruit clusters. They also ripen late, with fruit maturing in early September. Other cultivars with large clusters and berries include York, Johns, Kent, Nova, and Scotia. York is somewhat more productive than the Adams series, and the berries tend to be larger.

Planting

Elderberries grow best in moist, fertile, well-drained soil with a pH between 5.5 and 6.5. But they will tolerate a wide range of soil texture, fertility, and acidity. It's a myth that they prefer swampy areas. In fact, they do not tolerate poor drainage.

Plant elderberries in the spring as soon as possible after they arrive from the nursery to prevent plants from drying out. Space plants 6 to 10 feet apart. Elderberries are shallow rooted, so keep them well watered during the first season.

Plants are easy to propagate from hardwood cuttings taken when plants are dormant.

Fertilizing

Elderberries respond well to fertilization. In addition to incorporating manure or compost before planting, apply additional fertilizer annually in early

spring. Apply 1/8 pound of ammonium nitrate (or 1/2 pound of 10-10-10) for each year of the plant's age, up to 1 pound per plant (or up to 4 pounds 10-10-10).

Weed Control

The most difficult problem you will face when growing elderberries is weed control. Because they have shallow roots, do not cultivate deeper than 2 inches. After the first year, it is best to avoid disturbing the soil at all because the slightest injury can damage the fibrous root system or kill one of the new upright shoots. To control weeds without disturbing the elderberry roots, use a combination of pulling weeds by hand—especially while they are still small—and mowing and mulching. Once you develop a thick hedgerow of plants, elderberries can suppress weeds quite well.

Avoid disturbing the soil, because the shallow root system is easily damaged.

Pruning

Elderberries send up many new canes each year. The canes usually reach full height in one season and develop lateral branches in the second. Flowers and fruit develop on the tips of the current season's growth—often on the new canes but especially on laterals.

Second-year elderberry canes with good lateral development are the most fruitful. In the third or fourth year, older wood tends to lose vigor and become weak. In late winter to early spring while the plants are dormant, remove all dead, broken, or weak canes plus all canes more than three years old. Leave an equal number of one-, two-, and three-year-old canes.

Diseases and Insects

Elderberry plants are generally free of pests, which makes them great for landscape plantings. Powdery mildew is a problem in some years, especially when it affects the fruit. Cane borers occasionally cause damage but are usually not present in large numbers. Pruning out infested canes is the best remedy for home gardeners.

Harvest

Harvest elderberries in late August through early September, depending on the cultivar. When ripe, the entire fruit cluster should be removed and the berries stripped from the cluster for use. Uncooked berries have a dark purple juice and are astringent and inedible. Use the fruit as soon as possible or keep it at a cool temperature for later use. It is difficult to transport elderberries because the fruits fall off the cluster during transit.

Hardy Kiwifruit

Keys for Success

Be sure to choose cultivars of *Actinidia arguta*, the hardy kiwifruit—not *A. chinensis*, which will not survive New York winters.

Purchase at least one male plant for every nine female plants to ensure pollination and fruit set.

Avoid planting in frost pockets. Sites with northern exposure are good because they delay early growth in the spring, which can be damaged by late frosts.

Construct a trellis system or otherwise support the vines.

Prune plants at least two or three times during the growing season and once during the winter.

While their tastes are similar, hardy kiwifruits are different from the kiwifruits you find in the produce aisle at the supermarket. The hardy kiwifruit (*Actinidia arguta*) is native to northeastern Asia, while its commercially available cousin (*A. chinensis*) is native to southern China. In the eastern United States, the commercial kiwifruit grows only as far north as Maryland and then only in protected spots.

Hardy kiwifruit plants tolerate temperatures as low as -25 degrees F or so, but they are sensitive to late spring frosts. The fruits, which are about the size of a large grape, are not covered with fuzz, have small seeds, and can be eaten out of hand without peeling. They have an excellent flavor, can be dried or made into wine, and are higher in vitamin C than most citrus fruits. Some people find they have a strong laxative effect.

Choosing Cultivars

The hardy kiwifruit plant is a strong-growing perennial vine with small leaves and bright red stems. It can grow to 40 feet in length. If not pruned and trained, the vines will grow up trees and over fences.

Most plants are dioecious—they bear either male or female flowers but not both. For this reason, you need to plant both a male and a female plant if you want to harvest fruit. Some nurseries sell hermaphroditic plants, which bear flowers of both sexes, but their performance has been poor.

In early summer, the vines bear small white flowers with chocolate-colored centers on the previous season's spur growth. They have a fragrance similar to that of lily-of-the-valley and are pollinated by wind or insects. Greenish yellow fruits develop in the summer and into the fall and ripen very late in the season. Plants usually fruit by their fourth year and bear full crops after the eighth year. Once established, plants can live for 50 or more years.

Several cultivars are available through various nurseries. Improved selections that perform well in New York include Ananasnaja, Geneva, Meader, MSU, and the 74 series.

Propagation

Kiwifruit can be propagated from cuttings or seeds. Take hardwood cuttings anytime after the plant has received 500 hours of chilling, or make softwood cuttings in July. Kiwifruits also can be propagated by layering.

To grow plants from seed, remove the seeds from a mature fruit and let them dry for two days. Refrigerate them in moist perlite at 40 degrees F for

four months. Then plant the seeds no deeper than 1/8 inch in a sterile potting mix and cover the container to keep the humidity high. The soil should be moist but not wet. As soon as the plants germinate, uncover the container. After the seedlings are up, put a thin layer of clean sand on top of the medium. When plants have four true leaves, transplant them to individual pots. At this time, use a low rate of liquid fertilizer. Transplant the seedlings to the site where they will grow when they are several inches tall.

Site Selection and Soil Preparation

Kiwifruit can be grown in any garden soil provided the pH is between 5.5 and 7.0. The plants thrive in moist soils but do not tolerate poorly drained soils. They benefit from the incorporation of organic matter before planting.

While most cultivars are hardy in areas up to Zone 4, they require about a 150-day frost-free season. Vines perform best in full sun, but on such sites they tend to break dormancy too early in the spring, when late frosts can damage new growth. Planting them with a northern exposure delays early growth and minimizes this risk. Early fall frosts also can cause damage, so avoid planting in frost pockets. Plants usually regrow if damaged by a spring frost, but this will delay fruit development. The succulent growth is also susceptible to wind damage and hot, dry conditions. Protected moderate microclimates are best, as kiwifruit also do not like sudden changes in temperatures.

Planting

Plant kiwifruit 10 feet apart in mid-May, or after the danger of frost is past. Plant one male for every nine females. Plants require frequent watering from the time they are transplanted.

It is important to select one or two new canes and train them to grow vertically. Do not allow them to twist around the support pole or wire.

Trellising

Kiwifruit require a trellis or other support structure. Set trellis posts 10 feet apart. Trellis wire should have 300 pounds of tension. Kiwifruit trellises are usually in the shape of a T, with the cross-arm about 7 feet off the ground and about seven wires across the 5-foot-long cross-arm. Train the main cane up the pole to the height of the cross-arm, then train arms along the center wire. Laterals grow from these arms and can be tied to the outside wires. (Fastening them will help keep them from breaking off, especially on windy sites.) The fruit hang down through the trellis wires, where they are easy to harvest.

Kiwifruit do best in protected locations.

Pruning and Mulching

Pruning is necessary during both the dormant season and the growing season. Two or three times during the summer, cut nonflowering laterals back to the outside wire on the trellis. Trim flowering shoots back to four to six leaves beyond the last flower.

In the dormant season, remove canes that fruited during the previous season as well as dead, diseased, or tangled canes. Keep the best one-year-old lateral canes that haven't fruited, spaced about a foot apart along the arms. Trim them back to about eight buds.

Plants benefit from a thick layer of organic mulch, which helps control weeds, adds organic matter to the soil, and aids in moisture retention. Keep the trunks of young vines from cracking in cold temperatures by wrapping them with cloth or painting them with white latex paint.

Fertilization

Do not fertilize kiwifruit the year of planting. In early spring of the second year, sprinkle 2 ounces of 10-10-10 around each plant. Increase this amount by 2 ounces each year until the plants are receiving 8 ounces, then do not exceed this amount.

Harvest

Kiwifruit will not reach maturity and flower until about their fifth year. The fruit matures in October, which is after the date of the first frost in many northern regions. For this reason it is difficult to harvest vine-ripened fruit. Fruits will ripen in the refrigerator, but their storage life is much shorter than that of commercially available kiwifruit. Flavor is better, however, in the fuzzless hardy kiwifruit.

For more information, see Oregon State University's web site on kiwifruit production at <http://berrygrape.orst.edu/fruitgrowing/berrycrops/kiwifruit.htm>.

More Minor Fruits

You likely won't find the fruits discussed next in the grocery store. That's because, for one reason or another, they aren't suited to commercial production and marketing. About the only way you'll enjoy their unique flavors is to grow them yourself. As a bonus, many of these trees and bushes make fine landscape plants.

Persimmons

Diospyros virginiana

This attractive tree can grow up to 30 feet tall. Persimmons are more common in the South but are hardy in Zones 4 to 9. They require full sun and well-drained soil for optimum growth.

Persimmon trees have a pendulous branching habit and a narrow, somewhat rounded shape. The leaves are shiny and dark green and the flowers are greenish yellow. Most trees are either male or female, so plant several trees to ensure pollination.

Persimmon fruits range from 3/4 to 2 inches in diameter. They are pale yellow to deep orange with reddish cheeks. Unripe, the fruits are extremely astringent. When fully ripe, they are soft, nearly free of astringency, and have a mild flavor.

The fruits also are highly ornamental and remain on the tree for a long time after the leaves fall. Frost is not necessary to ripen the fruit and will ruin immature fruit. In colder regions, the season is not long enough to ripen many of the late cultivars, so choose only early-ripening ones.

Persimmon trees have a bark with an interesting texture and attractive fall foliage, making them a good accent plant in landscaping. They're also well suited to espalier training.

Growing Persimmons

In addition to full sun and well-drained soil, persimmons require a soil that has adequate fertility, but it need not be extremely rich. Some gardeners have found that excessive nitrogen can cause fruit drop. Trees are drought resistant but benefit from deep watering during extremely dry weather.

Begin training trees early to four to five main stems to produce an attractive structure. They should require little maintenance beyond that, and plants typically are not very prone to pests and diseases.

American types are hardier and better adapted to cold climates than Asian types. But they still benefit from planting in somewhat protected locations and perform best in milder parts of New York State. Cultivars include:

- **Garretson**—a superior cultivar for northern areas. Blooms are heavy and the fruit ripens in early October. The fruit, about 1 1/2 inches in diameter, is light orange with a reddish blush and it has tender skin and soft flesh.
- **John Rick**—produces larger, more attractive fruit than Garretson.
- **Early Golden**—not as productive as some of the other cultivars, but fruit is of good quality.
- **Hicks and Juhl**—perform well but are not as good as Garretson.

See also California Rare Fruit Growers at www.crfg.org/pubs/ff/persimmon.html

Pawpaws

Asimina triloba

Pawpaws are small deciduous trees that are hardy in Zones 5 to 8 and usually grow 15 to 20 feet tall (up to 40 feet under ideal conditions). They are attractive, with large showy leaves and a pyramidal shape. Sometimes suckers form, creating a pawpaw thicket. Like persimmon trees, they are more commonly grown in the South.

Pawpaw flowers are maroon and inconspicuous, about 1 1/2 inches across, and appear in late May before the leaves expand. Depending on pollination, trees bear clusters of one to six fruits. The fruits are usually 4 to 6 inches long with thin green skin and whitish flesh.

Two unrelated pawpaws are required for successful pollination. Hand pollination can increase fruiting because bees show little interest in the flowers. Flies can pollinate pawpaw flowers, so some growers hang pieces of rotting meat from the plants to attract them.

When ripe, the fruits turn yellowish black, resembling overripe bananas in looks and texture and somewhat in flavor. The flesh is rich and sweet with a custard consistency, has a very distinctive flavor, and has many dark brown seeds about the size of lima beans. The fruits ripen from mid-September until frost. They are very perishable and too fragile for commercial handling. While usually eaten fresh, some gardeners dry or freeze them.

Growing Pawpaws

Pawpaws prefer full sun and fertile, moist but well-drained soil. They are difficult to transplant and should be moved to their final location while still small. Keep them weed-free, especially as they are getting established. They

are not as cold hardy or drought tolerant as persimmons. Water plants deeply during dry periods.

Insect pests and diseases are seldom a problem. The principal maintenance concern is removing suckers. If you want a single-stemmed plant, remove all the suckers as they appear. If you prefer a hedge or screen of pawpaw plants, allow them to grow. Suckering diminishes as the tree ages.

Some cultivars for New York home gardens include Davis, Sunflower, Taylor, and Taytwo. Seedlings are interesting to grow because of the variable fruit size and quality. Fruit from seedlings may fail to ripen before frost. You can harvest fruit before frost and allow it to ripen indoors. Select only dark-fleshed cultivars because white-fleshed fruit may be bitter.

See also:

California Rare Fruit Growers at www.crfg.org/pubs/ff/pawpaw.html

Kentucky State University Pawpaw Planting Guide at www.pawpaw.kysu.edu/pawpaw/ppg.html

Mulberries

Morus spp.

Mulberry trees are as ornamental as they are fruitful. The mulberry was once considered the “king of the tree crops.” But its weedy invasiveness and soft fruit caused it to fall out of favor.

Mulberry flowers are small and inconspicuous. The fruits are numerous and resemble slender blackberries. They do not ripen all at once, but when they are ready they drop from the tree. They can be gathered by covering the ground with a sheet or canvas and shaking the tree. The fruits are used for jelly, wine, and desserts. The fruits also attract birds in large numbers and can be messy, making the tree unsuitable for public spaces. Plant mulberries to draw birds away from the fruit crops.

Growing Mulberries

Mulberries are generally hardy in Zones 4 or 5 to 8. They perform best in full sun and good soils—but will tolerate part shade—and do surprisingly well on a wide range of adverse soil conditions, including thin, gravelly soil; rocky slopes; dry, wet, or alkaline soils; and other difficult areas. This makes them well adapted for erosion control. They are easy to transplant and salt tolerant and produce fruit reliably in frost pockets and exposed areas.

Three species are commonly grown in the Northeast:

Black mulberries (*M. nigra*) produce the most flavorful fruit but are only adapted to the mildest parts of New York State (Zone 6 and warmer). They are native to western Asia.

Plant mulberries to draw birds away from other fruit crops.

Red mulberries (*M. rubra*) are hardier than black mulberries and may grow to become very large trees. These North American natives prefer deep, rich soils and are usually found on bottom lands and along streams. Young trees are not as hardy as older ones. Superior red mulberry selections include Hicks Everbearing, Johnson, Stubbs, Townsend, Illinois Everbearing, and Travis.

White mulberries (*M. alba*) are the most widely grown in New York State. Many cultivars have been selected for their foliage for silkworms (this species was originally imported from China to feed silkworms); several also have excellent fruit. New American is considered the best, but Trowbridge, Thorburn, and Victoria are very good. There is little cultivar development today. Seedlings are very variable in performance.

See also California Rare Fruit Growers at www.crfg.org/pubs/ff/mulberry.html

Juneberries

Amelanchier spp.

More than 25 species of Juneberries—also known as shadbush, Alleghany serviceberry, sugar pear, and Saskatoon—are native to North America. The fruit is technically a pome (like an apple), not a berry. These small trees grow up to 25 feet tall and are very attractive, with plentiful white flowers that bloom in late April to early May, usually showing before the fine-textured leaves fully develop. Juneberries have attractive gray bark, an upright branching habit that becomes horizontal with age, and showy red fall foliage. Use a dark background to emphasize these fine landscaping qualities.

The fruits are 1/4 to 3/8 inch in diameter and fleshy red, turning purplish blue to black. They are juicy with a mild flavor, ripening in late June. Birds are fond of Juneberries. Native Americans and early settlers gathered them and dried them for winter use. Juneberries are commonly used in pies and preserves, and lemon enhances their flavor.

Growing Juneberries

Most Juneberries are hardy in Zones 3 to 9 (some are hardy in Zone 2) and grow well throughout most of New York State. They prefer full sun and acidic, moist, well-drained soil, but they will tolerate shade and a wide range of soil types. Red spider mites are an occasional pest problem on dry sites, and Juneberries are susceptible to common apple pests.

Naturalistic sites are ideal for Juneberries. They are difficult to train to a single stem. You can remove suckers to train to a single-stemmed small tree or leave them for a multistemmed shrubby effect. Otherwise, they require little or no pruning.

Shannon and Indian are very productive cultivars with large fruit. Smoky and Pembina have the best flavor. Success and Dwarf Mountain are common older cultivars.

Highbush Cranberries

Viburnum trilobum, *Viburnum opulus* var. *americana*

Highbush cranberries (also known as American cranberry bush) are in the same family as elderberries. The size and color of the fruit are the only characteristics this species has in common with commercial cranberries.

Bushes grow to 15 feet tall and become rather formal and rounded in shape. They make a great hedge or privacy screen. The flowers are very small and white and are borne in large terminal cymes that are 3 to 4 inches across, similar to other ornamental viburnums. The fruits are 3/8 inch in diameter, showy red, and very persistent, remaining on the bushes well after frost and brightening the winter landscape. Harvest the fruits in late summer or fall to avoid astringency. Freezing and thawing softens the fruits, which are seldom eaten by birds. Use the fruits in jelly, preserves, or sauces.

Growing Highbush Cranberries

Highbush cranberries are very winter hardy and grow well in Zones 2 to 7. They are easy to transplant, grow in both sun and partial shade, and perform well on a wide range of soils. They tend to decline if subjected to too much moisture stress.

Bushes require pruning only when they become overgrown. Make thinning cuts to remove larger, older stems at the base, and remove broken branches. Pests are usually not a problem. However, the bushes are among the viburnum species that are most susceptible to the viburnum leaf beetle, which has recently spread across most of New York State.

Most highbush cranberries are sold simply as the species, but some cultivars are available. Wentworth, Andrews, and Hahs were selected for their high-quality fruit.

Viburnum opulus, the European cranberry bush, is similar in appearance but has astringent fruits with large seeds and high acidity and is plagued by aphids. If you intend to eat the fruit, make sure that you only grow the American species.

Cornelian Cherries

Cornus mas

Cornelian cherry is the only species of dogwood that produces edible fruit. It is a small, upright to spreading, 15- to 20-foot-tall tree that bears small yellow flowers very early—in late winter or early spring, before leaves develop. Flower buds are conspicuous and attractive in the winter, and the bark is flaky, exfoliating, and gray brown to brown. Foliage turns purplish red in the fall.

The fruits, about the size and shape of a medium-sized olive, ripen to a dark reddish maroon in late summer. They are delightful in jellies, tarts, and

sweetmeats and also are used to flavor sherbets and distilled spirits. Fruits contain twice the vitamin C by weight as oranges.

Growing Cornelian Cherries

Cornelian cherries are hardy in Zones 5 to 8. They grow in full sun and partial shade and prefer fertile, well-drained soils but tolerate a wide range of soil types. They are easy to transplant when young but take a while to get established. Cornelian cherries tend to be multistemmed with branches to the ground, but they can be pruned and trained into single-stemmed trees. This tree is one of the few small landscape trees with edible fruit that you can plant in shady areas under large trees. Plants are usually pest-free.

Cultivars include Aureo-elegantissima, which has creamy-white variegated leaves; Flava, which has yellow fruits that are larger and sweeter than the other species; and Golden Glory, which has upright branching and bears large, abundant flowers and large red fruit.

Beach Plums

Prunus maritima

Beach plums are stone fruits, related to other plums, cherries, and peaches. They are native shrubs common to coastal sand dunes from Maryland to southern Maine. Plants grow 4 to 10 feet tall and produce a profusion of white or pink flowers in mid-May, later than most other stone fruits.

The 1/2- to 1-inch diameter fruits ripen in late summer and are generally reddish to deep purple with a waxy bloom. They are quite acid with a crisp, tart, juicy flesh and a cherry-like pit and can be substituted for cherries or plums in recipes. Mostly wild-gathered fruits are used to make jams and jellies, which are often sold in resort areas along the coast.

Plants are often quite thorny and can be used as a low-growing hedge. Seaside plantings become gnarled and picturesque with age. The foliage is attractive, and the bark is dark and shiny.

Growing Beach Plums

Grow beach plums as you would other stone fruit. While found almost exclusively on sandy soils in the wild, beach plums will tolerate heavier soils if they have good drainage. They require full sun and are hardy in Zones 3 to 7. Beach plums are popular for erosion control and seaside plantings because they tolerate sandy soil and salt spray. Tent caterpillars and brown rot are occasionally troublesome, and birds especially enjoy these fruits.

Cultivars are not easy to come by. Autum has a spreading, low-growing habit and produces a large annual crop with good-size, high-quality fruit. Stearns is a good ornamental with fruit that processes well. Northneck and Squibnocket are recommended as ornamentals and soil binders.

Cornell researchers are working with growers to revitalize the once-vibrant beach plum industry. For more information, see www.beachplum.cornell.edu.

Other lesser-known *Prunus* species include:

Western sand cherries (*Prunus besseyi*)—small, spreading shrubs that grow up to 4 feet tall and are hardy in Zones 3 to 6. This cultivar bears 1/2-inch white flowers in late April or early May that ripen into 3/4-inch purple-black fruits in late summer. The fruit is astringent but sweet and used in jellies or jams and in combination with apples in pies. Plants are native to the Great Plains and very tolerant of dry, sandy soils.

Nanking cherries (*Prunus tomentosa*)—an attractive, dense shrub from China that grows 6 to 10 feet tall and spreads to 15 feet. Also known as Manchu cherry, this species bears fragrant white flowers very early in the spring, which ripen into bright red fruit about half the size of a sour cherry. The fruits are covered with inconspicuous hairs and are juicy and slightly acid. Plants are very winter hardy and grow in Zones 2 to 7.

Buffaloberries

Shepherdia argentea

Also known as the silver buffaloberry, this thorny shrub or 6- to 10-foot-tall tree has an overall silvery or whitened appearance. The leaves are narrow and silvery white on both sides, and the flowers are very small and yellow and are borne on small branches. The scarlet to yellow fruits are borne in small clusters and vary in size from that of a currant to a small gooseberry. They ripen in July and may remain on the bushes until frost or later. Its silvery appearance and attractive fruit make this plant a pleasing ornamental.

Early settlers served the berries as a sauce with buffalo meat. They can be dried and stored or used in jellies, sauces, and preserves. Their agreeable flavor lends well to out-of-hand eating, but harvest is difficult due to the 1- to 2-inch thorns. Like legumes, these plants fix nitrogen from the atmosphere.

Growing Buffaloberries

Plant buffaloberries in sites with full sun but cool northern exposures to delay flowering and avoid damage to flower buds by late spring frosts. Otherwise, the plant is very hardy, growing in Zones 3 to 7. While buffaloberries prefer moist, well-drained soil, they tolerate poor dry soils and a high pH quite well. Plants are slow growing.

To ensure successful pollination, plant both male and female plants. Male flowers are sessile (stalkless) and clustered at the nodes. Female flowers are smaller and more slender with stalked buds arranged in less compact clusters.

Birds enjoy buffaloberries. If any fruit remains after frost and bird feeding, they can be gathered anytime during the winter.

A related species, the russet buffaloberry (*Shepherdia canadensis*) is thornless but has bitter, sour berries.

Quinces

Cydonia oblonga

Quinces are small, irregularly shaped trees that grow to about 15 feet tall. They often are used as rootstock for dwarf pears. The trees bear white or pink showy flowers at the ends of leafy shoots in the spring. The flowers are susceptible to winter injury at temperatures below about -15 degrees F, but trees are hardy in Zones 5 to 9. As they mature, the trees take on an unusual gnarled form.

The foliage is deep green with a fine soft fuzz underneath and turns yellow in the fall. The fruits are very fragrant and are commonly used to make jelly. Harvest them when they are golden yellow. Quince is a good source of pectin.

Don't confuse these quinces with several other quince-like species grown for ornamental purposes. There are many varieties of Japanese quince (*Chaenomeles japonica*) and common flowering quince (*C. speciosa*, *C. lagenaria*)—attractive shrubs bearing showy pink, red, or orange flowers in early spring but most producing fruits that are hard and nearly inedible. These fruits do, however, have a high pectin content and are occasionally mixed with other fruits in jellies and preserves.

Growing Quinces

Quinces prefer a fertile site in full sun. They are slightly more tolerant of wet soils and drought than apples and will fruit more reliably on moist but well-drained soil. Cross-pollination is needed for good fruiting. Plant quinces in a protected area because they respond poorly to rapid changes in temperature and exposure.

Although quinces were once grown extensively in New York, pest problems limit their use today. Flower bud injury, fire blight, borers, codling moth, curculio, scale, and tent caterpillars all can cause problems. To avoid fire blight, do not use excessive nitrogen and keep pruning to a minimum. Thin out suckers in winter or early spring. Although quinces are attractive and have interesting fruit, an aggressive maintenance program may be needed if you use these plants extensively in your landscape.

The cultivars Angers, Orange, Pineapple, Champion, and Smyrna are generally available.

For More Information

Web Sites

Cornell Gardening Resources

www.gardening.cornell.edu

Cornell Fruit Resources

www.fruit.cornell.edu

New York State Agricultural Experiment Station

www.nysaes.cornell.edu

USDA Plant Genetics Resource Unit, Geneva, N.Y.

www.ars-grin.gov/gen

Related Cornell Cooperative Extension Publications

For descriptions and ordering information visit:

www.cce.cornell.edu/publications/catalog.html

Or write:

Media and Technology Services Resource Center

Cornell University

7 Cornell Business and Technology Park

Ithaca, NY 14850

Telephone: 607-255-2080

Fax: 607-255-9946

E-mail: resctr@cornell.edu

The Appealing Apple

Biology and Management of Apple Arthropods

Bramble Production Guide

Conservation Practices for Vineyards

Cultural Practices for Commercial Vineyards

Day-Neutral Strawberry Production Guide

Economics of Apple Orchard Planting Systems

Fire Blight—Its Nature, Prevention, and Control

Garden Strawberry

Highbush Blueberry Production Guide

Integrated Weed and Soil Management in Fruit Plantings

Managing White-Tailed Deer in Suburban Environments
Orchard Nutrition Management
Pest Management around the Home: Part I, Cultural Methods
Pest Management around the Home: Part 2, Pesticides
Pollination and Fruit Set of Fruit Crops
Pruning Grapes
Simplified Insect Management Program: A Guide for Apple Sampling
Procedures in New York
Strawberries (Integrated Pest Management in)
Strawberry IPM Scouting Procedures: A Guide to Sampling for Common
Pests
Table Grape Varieties for Cool Climates
Training and Pruning Apple Trees
Wildlife Damage Management in Fruit Orchards
Wine and Juice Grape Varieties for Cool Climates



CORNELL Cooperative Extension

This publication is issued to further Cooperative Extension work mandated by acts of Congress of May 8 and June 30, 1914. It was produced with the cooperation of the U.S. Department of Agriculture; Cornell Cooperative Extension; and College of Agriculture and Life Sciences, College of Human Ecology, and College of Veterinary Medicine at Cornell University. Cornell Cooperative Extension provides equal program and employment opportunities. Helene Dillard, Director.

Alternative formats of this publication are available on request to persons with disabilities who cannot use the printed format. For information call or write the Office of the Director, Cornell Cooperative Extension, 365 Roberts Hall, Ithaca, NY 14853 (607-255-2237).

This information is presented with the understanding that no product discrimination is intended and no endorsement of any product mentioned, or criticism of unnamed products, is implied.

Produced by Media and Technology Services, Cornell University
Printed on recycled paper
© 2003 Cornell University



Home-grown fruit. Nothing tastes better or is more satisfying to cultivate.

In simple language and informative graphics, the *Cornell Guide to Growing Fruit at Home* tells you how to grow and harvest the freshest, highest-quality fruit right in your own backyard, including

- choosing the best varieties.
- site selection.
- soil preparation.
- planting.
- pruning and training.
- pest and disease management.

From easy-to-grow berries that you can plant and harvest this season to more challenging grapes and fruit trees that can provide a lifetime of crops, it's all here. There's even a section on little-known fruits that make handsome landscape plants as well as provide tasty harvests.

In just a few short years, you can turn your yard into an edible landscape. Here's how...

Additional copies of this publication can be purchased from

Cornell University, Media and Technology Services Resource Center
7 Cornell Business and Technology Park
Ithaca, NY 14850

Phone: 607-255-2080. Fax: 607-255-9946. E-mail: resctr@cornell.edu

A free catalog of Cornell Cooperative Extension publications and audiovisuals is available from the same address, or from any Cornell Cooperative Extension office. The catalog also can be accessed at the following web site:
www.cce.cornell.edu/publications/catalog.html