

AT MICROFICHE
REFERENCE
LIBRARY

A project of Volunteers in Asia

LeJay Manual

Published by:

Le Jay Manufacturing Co., Inc.
Belle Plaine, MN 56011

Paper copies are \$ 3.50.

Available from:

Le Jay Manufacturing Co., Inc.
Belle Plaine, MN 56011

Reproduction of this microfiche document in any form is subject to the same restrictions as those of the original document.

Le Jay **MANUAL**

5th Revised Edition

LEJAY MFG. CO., Inc.
Belle Plaine, Minnesota 56011

Copyright 1945
U.S., GREAT BRITAIN AND CANADA
All Rights Reserved

Plan I

PLANS FOR 110 VOLT A. C. LIGHT PLANT

made from Ford Model 'T' Generator

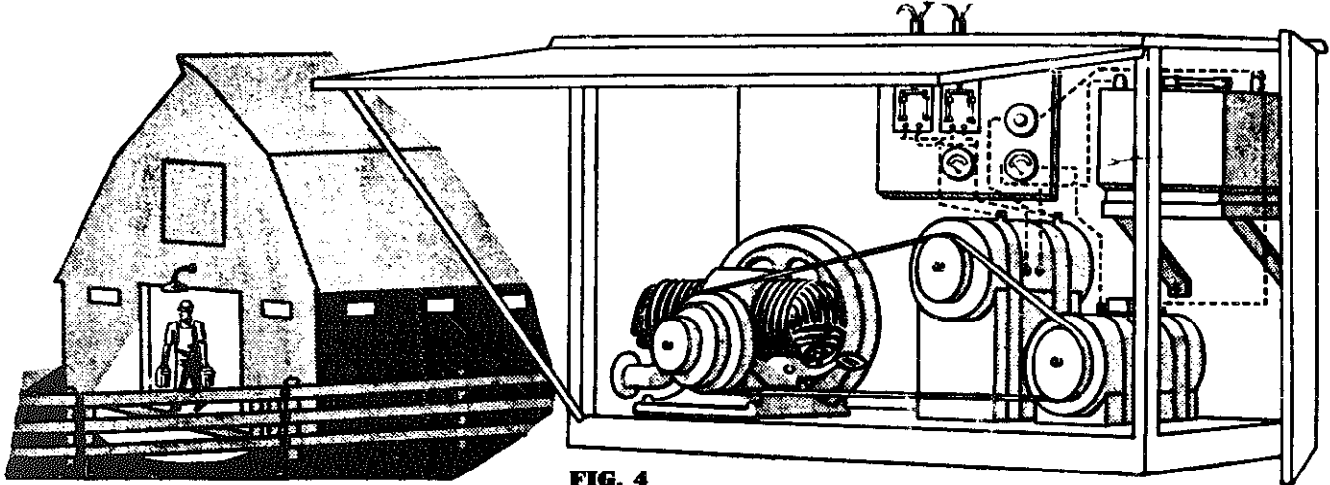

FIG. 4

By following these step by step plans carefully and correctly you will be able to build a complete 110 volt A. C. plant that will supply power for your farm. Just the plant for operating your 110 volt A. C. radio and about 4 or 5 of the 25 watt bulbs all at the same time. Without radio turned on this plant will light 5 or 6 of the 25 watt bulbs, or the equivalent. Just so the entire load does not exceed 150-200 watts or thereabouts.

A 25 watt bulb will give from 3 to 5 times more light than the kerosene lantern; this you see is enough light for about all kinds of work. A 25 watt bulb is also bright enough to read or write by if used in a reading lamp or desk lamp, however, if used in a ceiling fixture we suggest that a 40 watt be used.

Other 110 volt A. C. apparatus may be used on this plant if it does not consume more than 150 watts. If the entire load is more than 150 watts the A. C. generator will probably get hot and if left on too long is liable to burn out. If you use a 110 volt A. C. meter across the line at all times it will be easy to tell if the generator is overloaded as the voltage will drop.

Frequency of this plant is not a matter of importance as it is high enough for all practical use, develops 60 cycle at 1800 r.p.m. If your radio is made for 25, 50 or 60 cycles it will work on this plant—most radios are designed for 60 cycles.

Motors of $\frac{1}{4}$ h.p. or less will work providing they are of the brush type. Larger than $\frac{1}{4}$ will not work as they take more watts power than the plant will deliver.

DIRECTIONS

First secure an old model "T" Ford generator that has good field coils (field coils are the stationary coils), a good commutator and good bearings. It is not necessary to get a new generator for this change. Remove the gear and take generator apart. By using a screwdriver carefully you can pry the wires out of commutator risers (be sure not to use too much force which will harm the commutator), (J) Fig. 2, then push out all the wedges that are now holding windings in place, (D) Fig. 1. After wedges are pushed out remove all wire and clean slots thoroughly. Next take a piece of No. 14 or No. 16 copper wire and wrap it around the commutator risers, (C) Fig. 1 and (I) Fig. 2, then solder each segment of commutator to this wire; in other words, fasten all segments of the commutator together so commutator will function as collector ring. A large soldering iron will be needed for this operation in order to sweat the solder to the heavy copper segments. You may use a blow torch if one is handy; it would perhaps be a little faster. If you have access to a lathe, then a better way of doing this operation will be to cut a groove around and into the risers and place the copper wire into the groove, then solder.

Remove both fiber end laminations and replace with new laminations. To put commutator end lamination on, cut through one side, and spread cut portion to slide over shaft. Both laminations are held in place by means of rubber binder or string, which can be run through slots. Wrap insulation tape around both ends of shaft to protect new windings from touching shaft.

Next take insulation material .007 thickness and cut into pieces $2\frac{1}{4}$ by $1\frac{1}{4}$ inches. 21 pieces are needed. Put one piece in each slot. This size paper will extend a little above the slots which will later be folded over to protect tops of windings.

Now hold armature in your hand with commutator end away from you. By using a piece of white chalk or bright crayon, number each slot. It makes no difference which slot you start with just so your numbers are in rotation from 1 to 21. Picture in your mind the armature as a flat surface instead of round like Fig. 2 with slot number 1 at left end.

You will now need about 1 pound of No. 25 heavy Formvar magnet wire. Wrap several turns around the armature shaft on gear end or end next to you; this will later be soldered to shaft. (A) Fig. 1. Start winding in slots numbers 3 and 4 as shown in Fig. 2 by placing in 80 turns. Be sure to pack the wires in tightly and carefully using a blunt wooden stick—use this packing stick about every 10 or 15 turns in order that all turns will fit in properly.

From slot 4 move to slots 2 and 5 and continue by winding 80 turns in these slots—pack every 10 or 15 turns as you did before. From slot 5 continue to slots 1 and 6 and wind in only 40 turns. After these 3 coils are completed you will have finished 1 pole.

There are 4 poles to the armature so you will have to repeat this same operation 3 more times. Continue next by running wire from slot 6 to slots 9 and 5 and wind in 80 turns—be sure to pack in windings—from slot 8 move to 10 and 7 and place in 80 turns. From 7 to 11 and 6, here place in only 40 turns. From 6 move to 13 and 14 and wind in 80 turns, then to 12 and 15 and wind in 80 turns, then to 11 and 16 where you put in only 40 turns. From slot 16 move to 19 and 15 and put in 80 turns, then to 20 and 17 and put in 80 turns and finally to 21 and 16 where you put in 40 turns, then finish by bringing wire out slot 21—allow about 6 inches and cut off. This gives you one continuous winding on armature.

If you will notice slots 1 and 21 have only 40 turns each so fill in remaining space with wooden wedges.

Trim off insulation paper flush with laminations and fold down into slots, then force a wooden wedge into each slot as (D) Fig. 1. These wedges hold windings in place.

If you desire to test the winding for ground use an old radio head phone and dry cell. Connect one wire from phone to armature shaft, connect other phone wire to one side of battery and other side of battery to winding. If you hear a click when contact is made then your winding is grounded, if you do not hear a click then winding is O. K. If grounded then start unwinding until ground is located, insulate, then rewind. Now connect end wire from slot 21 to commutator riser and solder. (B) Fig. 1 and (H) Fig. 3. Solder the starting end of winding to shaft at point close to windings, (A) Fig. 1 and (G) Fig. 2, and be careful not to damage windings with soldering iron.

The armature is now ready for varnishing.

Use a non-conductor varnish and soak the armature well. You might set the armature into pan and pour the varnish over armature and keep doing this by using the varnish over and over until all windings are well soaked.

Field coils are next. Disconnect the two field coil leads and bring out of generator frame as shown by (K) Fig. 3. Keep coil to coil connections as they are. Remove from the generator the grounded and movable brushes (it is not necessary to take out the brush holders) which leaves only one brush, (M) Fig. 3, this remaining brush is ungrounded. A wire (P) should be connected from this brush to the terminal post (N) Fig. 3. After this work is properly done install the armature and put generator together, then you will have a complete 110 volt A. C. generator.

Leads (K) Fig. 3 are connected to regular 6 volt generator which is turned at same time the A. C. generator is turned. This 6 volt generator functions as an exciter for the A. C. generator, however, to keep A. C. voltage more constant it would be better to connect leads (K) to a 6 volt storage battery then connect the 6 volt generator direct to the battery. It makes no difference which lead from A. C. generator goes to positive terminal on battery, but be sure to connect the lead from 6 volt generator cutout to positive terminal on battery. The 110 volt machine will draw about 5 amperes so you should adjust the 6 volt generator to charge about 5 amperes. This plant will function without the battery but as stated before the battery will help keep voltage steady.

To get 110 volts A. C. connect leads to generator post (N) Fig. 3 and to generator frame (O) Fig. 3. The generator cutout is not used. Wire from (O) should also be run to ground which may be made by running a long rod into ground at least 6 to 10 feet.

Run this A. C. generator at about 1,800 r.p.m. 6 volt machine can be run slower. Speed is governed by pulley sizes.

To make the entire system more flexible we have made a special rheostat to be used in field circuit of A. C. generator as shown in Fig. 5. By adjusting this rheostat you will be able to change the A. C. voltage to correspond with load you are using. For instance, 2 or 3 lights would take less power than 5 or 6 lights, so you can set the rheostat back to accommodate this and always have 110 volts, without rheostat the voltage will vary slightly.

The A. C. machine can be turned in either direction, however, the 6 volt generator should be turned in counter clockwise direction as you face the commutator. A $\frac{1}{4}$ h.p. engine will be large enough but better results will be obtained if you use a $\frac{3}{4}$ or 1 h.p.

Some builders will prefer a voltmeter hooked across the line at all times so they can tell exactly what the voltage is. Hook same from (N) to (O) Fig. 3. An inexpensive A. C. voltmeter with range from 0 to 150 is O.K. (Like meter No. 348P in catalog.)

This generator can be made to deliver up to 175 watts for a fairly long period by changing field connections as follows: Disconnect (4) and (5) Fig. 3, then connect (4) to (8) and (5) to (1). Field coils are now in series parallel and will draw about twice the current from battery. This means the charging rate of 6 volt generator will have to be advanced to about 8

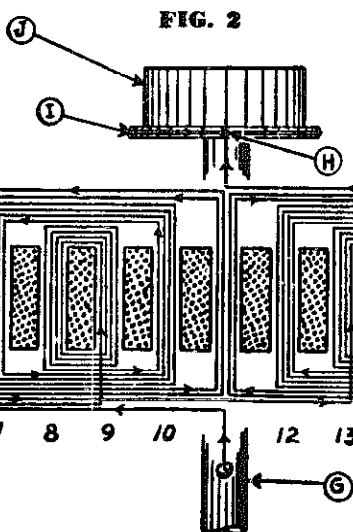

plant is turned on the battery will again be charged up. You see the plant has many valuable advantages and the overall cost is very low.

A suggested layout for you to follow in setting up your plant is shown by insert in Fig. 4.

A suggested schematic hookup is shown by Fig. 5.

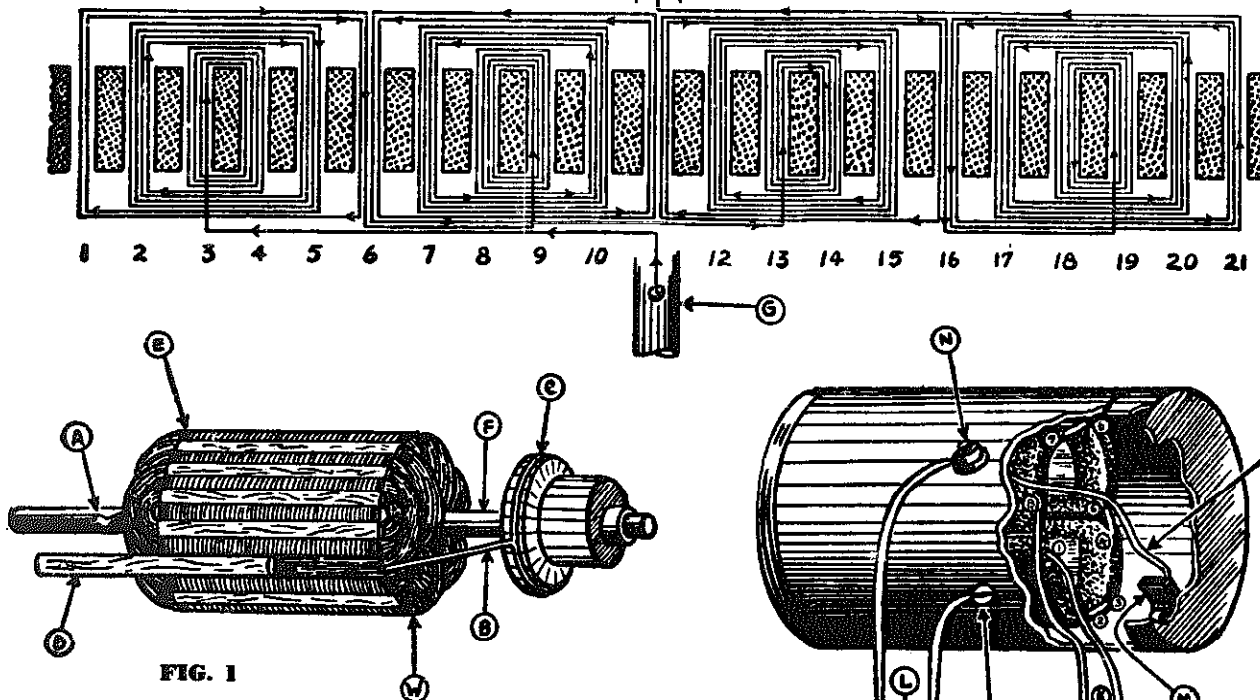

FIG. 1

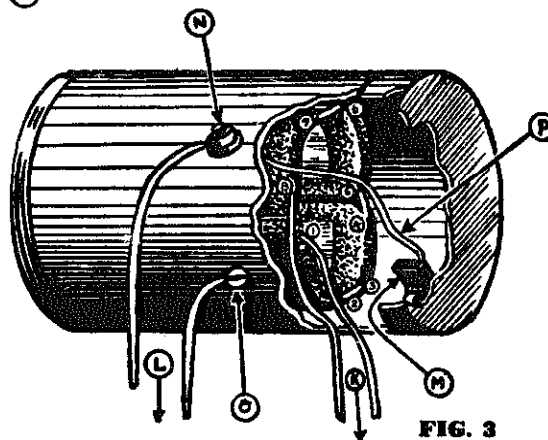
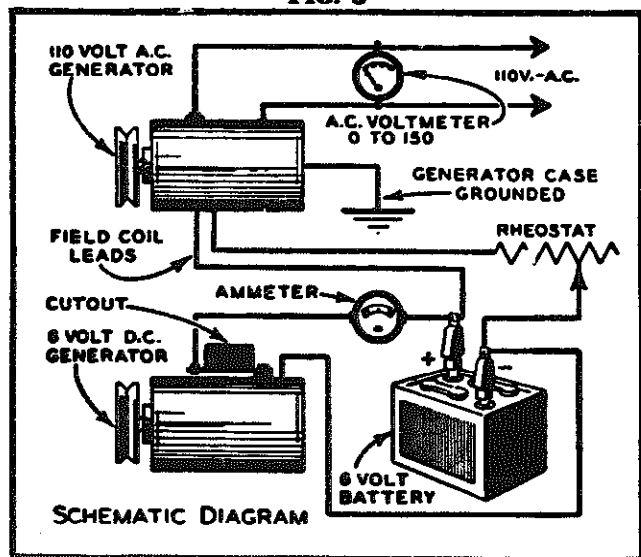

FIG. 3

or 9 amperes. In view of increased A. C. output it will be necessary to drill about three more $\frac{3}{16}$ " holes in drive end-bell for ventilation. Even 200 watts can be had for short periods without danger of burning out. Another way to increase A. C. output is to excite the generator with 12 volts instead of 6 volts, field coils are left in series for 12 volt excitation.

FIG. 5



SCHEMATIC DIAGRAM

If you own a 6 volt radio set then this plant will come in handy for charging the battery. Just advance the charging rate of 6 volt generator and hook on radio battery and it will be charged in one or two nights run at no cost to you. You can charge more than one battery at one time if you wish. They should be hooked in parallel. Parallel means that positive terminal is hooked to positive and the negative terminals are hooked together, then connected to generator. You may also have 6 volt lights where you want them by connecting to the plant battery. These lights can be turned on at any time whether the plant is running or not, then when the

Listed below are supplies for making the above change. These supplies are offered at low prices and fully guaranteed.

ARTICLE

Kit No. 101—A complete kit for rewinding your own Ford model "T" generator which consists of the following parts:

- 1 pound No. 25 heavy Formvar magnet wire.
- 1 can air drying varnish.
- 21 wooden armature slot wedges.
- 21 insulation papers for slots .007 thickness.
- 2 fibre end laminations.
- 2 pieces scotch electrical tape. Use of same previously described.
- 1 commutator brush.

Complete above kit—we pay postage.....(See catalog for price.)

7G19—Model "T" Vee type pulley, postpaid.....(See cat. for price.)

W2—Voltage control rheostat (double duty)—postpaid.....(See catalog for price.)

550—Factory rewound Ford Model "T" A. C. generator, 110 volt, 150 watts (enough power to light 5 or 6 of the 25 watt bulbs or 4 bulbs and radio)—shipping weight, 16 lbs. F.O.B.....(See catalog for price.)

348P—0 to 150 scale A. C. voltmeter (110 volts), panel mounting—we pay postage.....(See catalog for price.)

97—Exchange price on rewound and reconditioned Model "T" armature for 110 volts A. C.....(See catalog for price.)

310—Complete plant consisting of the following items:
 1 No. 348P voltmeter.
 1 No. 550 generator (110 volt A. C.).
 1 No. W2 voltage control rheostat.
 Complete plant, ship. wt. 18 lbs.....(See catalog for price.)
 You save over \$1.00 when you order all 3 items at one time.

Plan 2

200 WATT A. C. GENERATOR FOR AUTOMOBILE

made from Ford Model 'A' Powerhouse

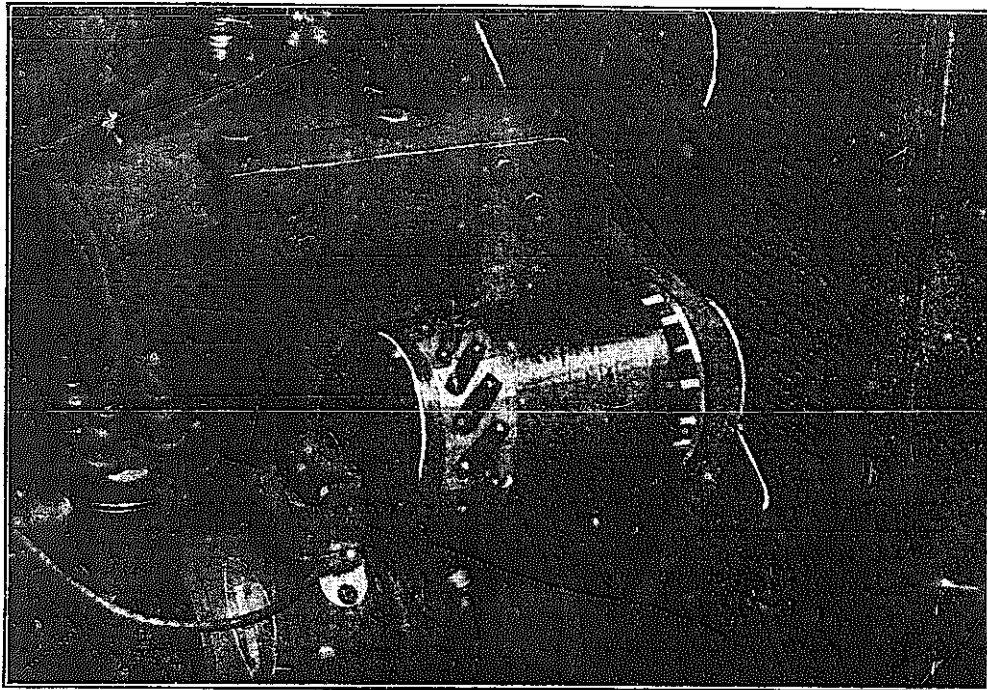

In changing the Powerhouse to 110 volts suitable for mounting on car engine to be run by the fan belt, follow the diagram below when winding the armature use No. 24 heavy Formvar wire. Study Plan No. 1 for other information. Remove all brushes except ungrounded main brush which is used like (M) Fig. 3, Plan 1. Field coils are to be connected in series parallel. First connect any 3 adjacent coils in series, next connect remaining 3 coils in series then connect both groups in parallel. When connecting wires (K) (Fig. 3, Plan 1) of Powerhouse run one wire to battery side of cut-out and other wire to frame of car generator. Wires (L) (Fig. 3, Plan 1) deliver 110 volts A. C.

Use regular angle iron for car mounting (see above picture).

We recommend a 2 1/4" or 3" pulley so generator will turn fast enough when motor idles. Speeds over 300 r.p.m. will operate lights and radio O. K. Delivers 60 cycles at 1200 r.p.m.

Kit No. 402—A complete kit for rewinding Ford Powerhouse for fan belt operation; consists of the following items:

- 1 pound No. 24 heavy Formvar magnet wire.
- 1 can impregnating varnish (air drying).
- 20 wooden armature slot wedges.
- 20 insulation papers .007 thickness.
- 2 fiber end laminations.
- 1 commutator brush.

Complete above kit, postage paid. (See catalog for price.)

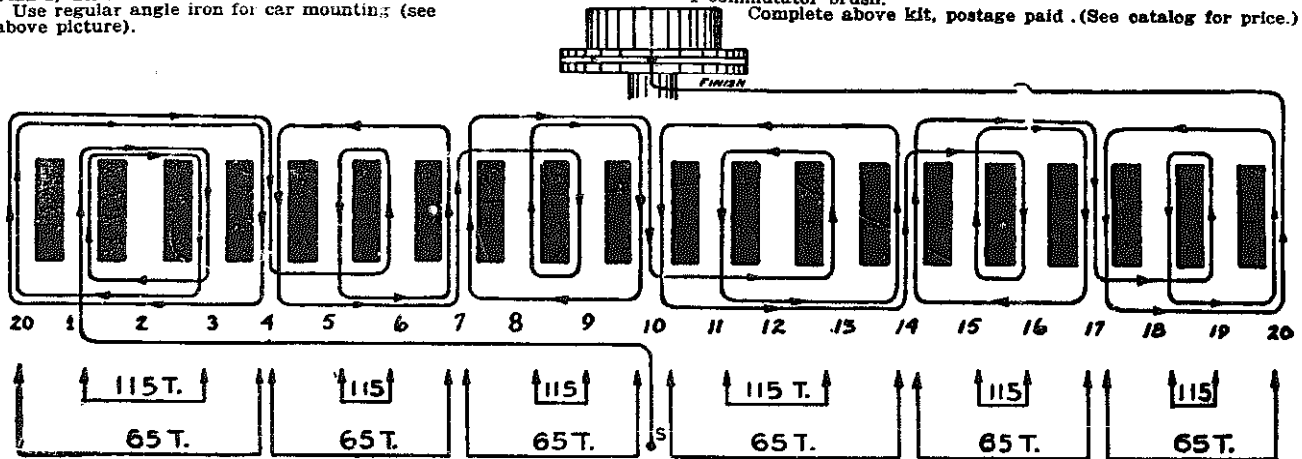

Plan 3

A 6 VOLT SLOW SPEED GENERATOR

made from Ford Model 'A' Powerhouse

By following this step by step plan carefully and correctly you will be able to build in a few hours time, a slow speed 6 volt generator that will start to generate at about 375 r.p.m. and will deliver up to 12 amperes. Especially designed for direct drive propeller.

First secure an old model "A" Ford generator of the powerhouse type that has good field coils (field coils are the stationary coils), good commutator and good bearings. It is not necessary to get a new generator for this change. Next remove the pulley and take generator apart. By using a screwdriver carefully you can pry the wires out of the commutator risers (be sure not to use too much force which will harm the commutator), then push out all old wedges that are holding old windings in place. Remove old wire and clean slots thoroughly.

Next take insulation material .007 thickness and cut into pieces about 1 1/4 by 1 1/4 inches. 20 pieces are needed. Put one piece in each slot. This size paper will extend a little above the slots which will later be folded over when wedges are put in to protect the new windings.

Now hold the armature in your hand with commutator next to you; draw an imaginary line along the left edge of any one slot and parallel with that slot and through to the commutator bars such as shown in diagram by line "A." The bar which "A" strikes will be center of coil one or starting coil. Start with this bar and count to the left 7 bars, the 7th bar will now be called bar 1 and the bar which line "A" strikes will be bar 7 as shown. Continue on to the right, giving each bar a number—40 bars in all.

Use number 19 heavy Formvar wire, and as there will be two coils in each winding we will refer to them as wire No. 1 and wire No. 2. Fasten wire No. 1 to bar 1 and wire No. 2 to bar 2, then run both wires together through slot 1 and back through slot 4—return to slot 1 again and wind in 12 turns, then from slot 4 extend wire No. 1 to reach bar 14 and wire No. 2 to bar 15 as shown by heavy lines in diagram, but do not fasten to commutator. Fold the ends back as they will be soldered to commutator after all windings are complete.

Next fasten wire No. 1 to bar 3 and wire No. 2 to bar 4; run both wires together through slot 2 and back through slot 5 as shown. Here wind in 12 turns also then from slot 5 extend wire No. 1 to reach bar 16 and wire No. 2 to bar 17. Again fold ends back. Continue on in like manner until all 20 double coils are wound, 12 turns to each coil.

When winding coil four you will note that when you pass through slot 4 it will already have windings of coil one in it. Therefore, it will be necessary to pack the windings down with a blunt wedge-shaped stick so that you can get all turns into slot. After this coil is wound cut insulation paper off flush with top of core, fold insulation paper over wire and insert wooden wedge. Keep on inserting these wedges as fast as coils become completed. Next wrap the moon shaped paper over leads already connected to commutator—then fold ends of each coil over this paper and fasten to proper commutator bars. Solder all wires to commutator (a large soldering iron will be needed for this operation in order to sweat the solder to commutator bars).

Next test each coil for grounds and shorts—use a non-conductor varnish and soak armature well and allow to dry—put on two or three coats in like manner, allowing each coat to dry thoroughly. Generator is now ready to assemble.

Now test your generator. Field coil connections to remain as they are, in series. If the maximum output is below the rated maximum, with the control brush fully advanced, it will be necessary to make a further change on the generator. To make this change it will be necessary to shift the entire brush rigging. First, connect the grounded brush to the frame of the generator with a piece of flexible wire. Then remove the screws that hold the brush rigging to the shell. With the generator running at a good speed, shift the entire brush rigging to the position at which maximum results are obtained. Mark the position of the brush rigging spider arms on the generator and drill and tap new screw holes into the shell at this position. Assemble the generator with the brush rigging in its new position. Lubricate as you do your car generator. A well made propeller six feet long will turn this changed generator as fast as necessary in the average wind to charge well.

The maximum output of this generator can be controlled by shifting the control brush. When the brush is shifted to limit the output at a lower value, the cut in speed will increase slightly.

Listed below are supplies for making the above change. These supplies are offered at low prices. All supplies fully guaranteed.

- | | |
|--------------------|--|
| Part Number | Article |
| 103— | Complete kit for rewinding your own Ford "A" powerhouse generator to 6 volts slow speed. |
| 1 1/2 | pounds No. 19 heavy Formvar (2 wires). |
| 1 | can impregnating varnish (air drying). |
| 20 | wooden slot wedges. |
| 20 | insulation papers .007 thickness. |
| 2 | fiber end laminations. |
| 1 | end insulation paper. |
| | Complete set new brushes (advise if your generator takes 3 or 5 brushes when ordering this kit). |

Above kit complete, postpaid.....(See catalog price)
104—Same as 103 kit, less brushes.....(See catalog price)

3E—FOR SLOWER CUT-IN SPEED

6 Volt Slow Speed Generator

To rewind the Ford "A" powerhouse generator so it will start to generate about 290-325 r.p.m., wind the armature with 13 turns of 20 H. Formvar. Coil span and commutator connections remain the same. Add letter "A" to either of above kits and the kit will come with No. 20 wire in place of No. 19 wire, 12 amperes maximum.

3C—TOWER AND TURNTABLE ASSEMBLY

This plant has been designed for the model "T" generator because it makes the best slow speed generator, being of the four-pole type, and because this model generator is plentiful. One can be procured in any locality with little trouble and small cost.

The entire plant assembly is made of metal, is of simple construction, and can be built with tools used in the ordinary farm workshop.

(A)—14" length of 1 1/2" (inside measurement) iron pipe to which the four tower legs are bolted. Build tower according to dimensions on Fig. 1. (B)—15" length of 1 1/2" (outside measurement) iron pipe which slips 8" down into pipe (A) inside of which it rotates. Plates (F) and (G) are 4" lengths of 2" by 1/2" strap iron which support vane arms on pipe (B). The holes in (F) and (G) through which pipe (B) passes should fit the pipe so snugly that the plates have to be driven onto the pipe. In fastening the vane arms to (F) and (G) use flat head bolts and countersink them. Build vane support, as illustrated of 3/4" angle iron. Side of upper vane arm (S) extended, bolts to pipe (B) as shown. (H) and (H2) of 2" strap iron, support generator and assembly on pipe (B). The holes in the ends of (H) through which pipe (B) passes should be just large enough so that (H) can swing freely on (B) with no side play. (E)—A piece of 3/4" strap iron which is bent up at (X) Fig. 4, to catch on upper vane arm (S), and stop the generator assembly at the proper point when it swings into operating position. (I)—1/2" copper twist cable fastens to the outer end of (E), passes over pulleys and down through pipes (B) and (A). Equip with small swivel below bottom of pipe (A). (D)—3/4" strap iron brace on generator

support as shown. Use flat head bolts and countersink them. (C)—7-1/2" piece of 3/4" angle iron bent at a point 2" from one end, bolts to generator support holding (D) in place as shown. Use flat head bolts and countersink. (M)—20" screen-door spring fastened to vane arm (S) and end of arm (C) pulls generator assembly into operating position when cable (L) is released. A new 20" spring stretched to 22" and then fastened to arm (S) will hold assembly in operating position at safe wind velocities, but will allow assembly to swing back automatically to idle position (Fig. 4-A) when forced back by wind too fast for safe operation. (J)—Collector ring, 1" length of 1 1/4" brass pipe. Collector ring slips over pipe (A) with three to five turns of .007 armature paper wrapped around pipe for insulation, so that (J) fits snug. Keep (J) 1/4" below top of pipe (A). (P)—Rubber covered stranded wire, size No. 6 or No. 8. End of wire (P) to be flattened and soldered to inside of collector ring as shown. Other end of wire (P) leads to the positive side of the battery. (See wiring diagram and instructions.) (K)—1" by 6 1/2" strip of 1/8" spring brass mounted on hardwood block which is bolted to under side of generator support (H), (Figs. 3 and 5). Bend (K) so it presses hard on collector ring for contact. (O)—Same as (P). One end soldered to strip (K), and other end connects to positive post on generator. (N)—Vane of 26 gauge galvanized iron. Strengthen vane with a 10" piece of 3/4" by 1/2" strap iron as shown. (Q)—Propeller. A 6 foot propeller is to be used with this plant.

NOTE: If collector ring is not desired No. 10 fine stranded insulated wire, run from generator down through pipes (B) and (A) and to the battery, will resist for a long time the twisting action caused by the rotation of the plant in the wind. This method has been tested and proven over a two-year period during which time it was not found necessary to change the wire.

The wiring diagram shows a wire from the positive (+) post of the generator to the ammeter. This is the wire (P) on the plans, leading from the collector ring. It is to be connected to one side of the ammeter. A wire from the other side of the ammeter connects to "G" (generator terminal) on the cutout. The wire from "B" on the cutout leads to the positive side (+) of the battery.

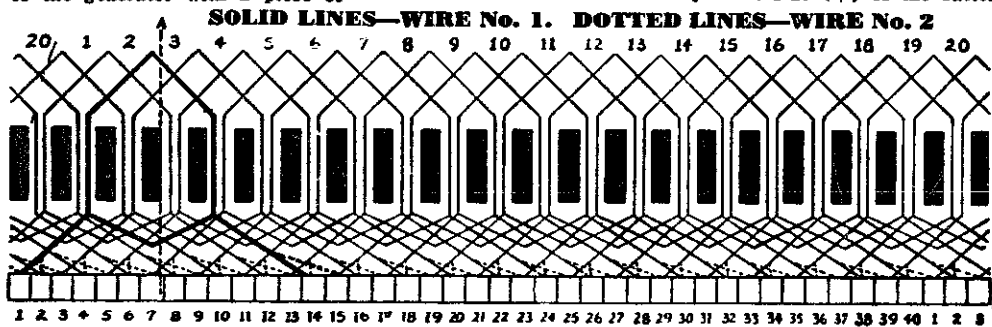

Since the generator is grounded to the frame of the plant, the frame carries the negative (-) charge, and it is only necessary to connect to the plant frame instead of running a wire all the way to the frame of the generator. Now, connect a wire from the tower to the negative (-) post on the battery, and also connect this lead to the frame of cutout as indicated by "F" in the wiring diagram.

- | | |
|----|---|
| J— | Machined Brass collector ring complete with insulation material.....(See catalog for price) |
| K— | Spring brass collector ring wiper.....(See catalog for price) |
| M— | Coil spring for governing tension.....(See catalog for price) |
| L— | 1/4" copper twist pullout cable, 8 ft. for.....(See catalog for price) |
| 1" | Pulley, 2 for.....(See catalog for price) |
- Add 4c to each above item for postage.

3D—6 FOOT PROPELLER

For making a 6-foot propeller for the 6-volt standard generators: Shorten each 7" length to 6"—shorten the 3" length to 2 1/4"—then shorten the 4" length to 3 1/4". Use regular 3/4" stock 4 1/2" wide. Finished tip to be 2 1/4" wide. Next change figure 1 1/2" to 1 1/4"; change 1 1/4" to 1 1/8"; 1 1/8" to 1 1/16"; then change 1 1/16" to 1/16"; 1 1/16" to 1/32"; 1 1/32" to 1/64" and 1/64" to 1/128". The remaining figures, which give the pitch, remain the same.

3E—7 FOOT PROPELLER

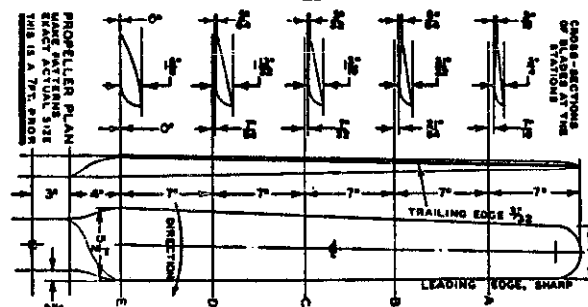

3F—8 FOOT PROPELLER

For making an 8-foot propeller refer to plan and lengthen each 7" section to 8", also lengthen the 3" section to 4". All other dimensions remain the same. The 7 and 8-foot propellers are for Dodge or other 600 to 800-watt generators.

3G—10 FOOT PROPELLER

For making a 10-foot propeller, refer to plan and lengthen each 7" section to 10", also lengthen the 3" section to 5", and the 4" section to 5". All other dimensions remain the same. This 10-foot propeller is for wind plants using a reduction drive.

3C—PLANS FOR COMPLETE WIND DIRECT DRIVEN PLANT ASSEMBLY. ALL METAL CONSTRUCTION

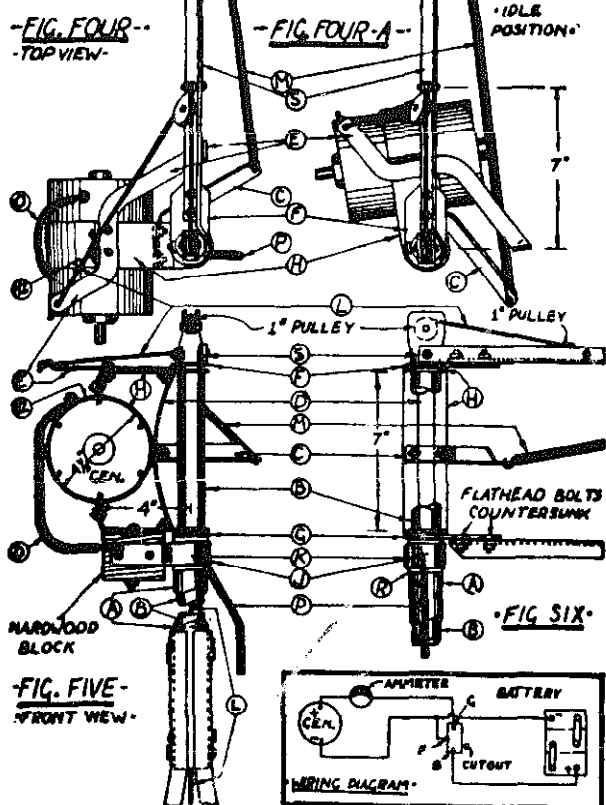
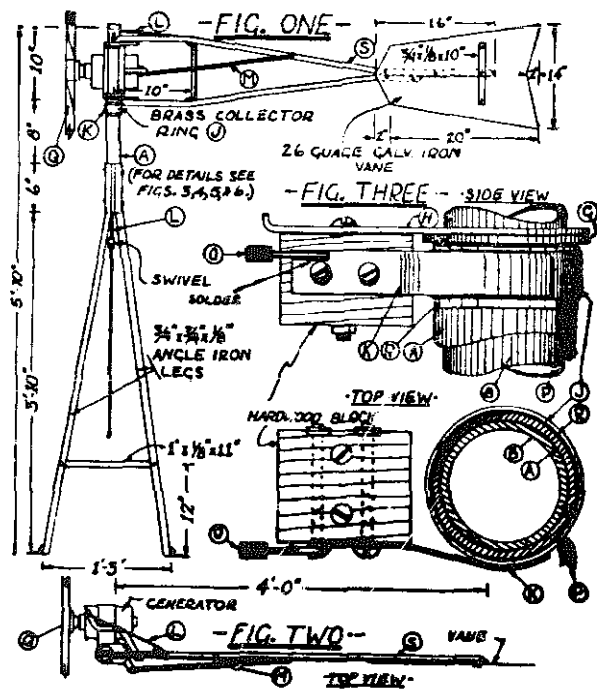

Plan 4

6 VOLT and 12 VOLT SLOW SPEED GENERATOR from Dodge 'G' or 'GA' Northeast Generator also from other Generators

4A—A 12 VOLT SLOW SPEED GENERATOR

This 12-volt slow speed generator is rewound from the Dodge "G" or "GA" 12-volt generator for wind propeller direct drive and has a cut in speed about 250 r.p.m. Delivers up to 35 amperes and will charge as many as four 12-volt batteries. Maximum output at 600 r.p.m.

Study Plan No. 5 to simplify procedure. When winding armature use No. 16 H. Formvar magnet wire and wind in 13 turns per coil. The commutator connections and coil span to remain the same. Use No. 18 P. E. magnet wire and wind four new field coils, winding 350 turns per coil. Assemble generator; hook fields in series and connect as shown in Fig. 2. Turn clockwise direction.

Kit No. 152X

Complete kit for rewinding Dodge 12-volt generator to 12 volts slow speed includes the following list of parts:

- 5 pounds No. 16 heavy Formvar magnet wire.
- 7 1/4 pounds No. 18 p.e. wire for fields.
- 1 large can impregnating varnish (air drying).
- 25 wooden armature slot wedges.
- 25 insulation papers .007 thickness.
- 2 pieces tape for insulating shaft.
- 1 roll cotton tape for field coil leads.
- Cotton sieving for field coils.
- Set of 2 special commutator brushes.

Complete kit, shp. wt. 16 lbs. F.O.B. (See catalog for price)

4B—A 6 VOLT SLOW SPEED GENERATOR

This 6-volt slow speed generator is rewound from the Dodge 12-volt generator for wind propeller direct drive with cut in speed about 250 r.p.m. Delivers up to 35 amperes and will charge as many as six 6-volt batteries. Maximum output at 600 r.p.m.

Study Plan No. 5 and above 12-volt change to simplify procedure. Wind armature with 6 turns No. 16 heavy Formvar magnet wire (two wires in hand) that is two wires to each winding. Solder the two starts and the two finishes as though they were one wire. Two wires are used instead of one heavy wire for purpose of making the work easier and yet carry the desired current. Coil span and commutator connections remain the same.

Make new field coils by winding 400 turns No. 18 plain enamel magnet wire. Connect fields in parallel; varnish, test and assemble. Turn in clockwise direction. Connect brushes as shown in Fig. 2.

Kit No. 151

Complete kit for rewinding Dodge 12-volt generator to 6 volts slow speed including the following list of parts:

- 5 pounds No. 16 heavy Formvar magnet wire.
- 8 1/4 pounds No. 18 p.e. wire for fields.
- 1 large can impregnating varnish (air drying).
- 25 wooden armature slot wedges.
- 25 insulation papers .007 thickness.
- 2 pieces tape for insulating shaft.

- 1 roll cotton tape for field coil leads.
 - Cotton sieving for field coils.
 - Set of 2 special commutator brushes.
- Complete kit, shipping weight 16 lbs. F.O.B. (See catalog for price)

4C—FOR SLOWER CUT-IN SPEED (6 Volts)

To rewind the Dodge 12-volt to 6 volts so it will start to generate about 175 r.p.m., wind the armature with 9 turns No. 14 heavy Formvar. Coil span and commutator connections remain the same. Wind fields with 400 turns No. 18 plain enamel. Order this kit by number 151A and kit will come with No. 14 and No. 18 wire. Only one wire in hand, when winding armature. Hook fields in parallel. This generator will deliver 35 amperes at 600 r.p.m.

4D—OTHER GENERATORS

6-VOLT SLOW SPEED GENERATOR from other standard 4-volt auto generators for wind propeller direct drive with cut in speed between 350 and 475 r.p.m. Delivers up to 15 amperes depending upon the generator used.

First remove armature and measure wire size, also count number of turns per coil and make note of commutator connections and coil span. As most auto armatures are originally wound with No. 16 wire and assuming that your armature is of 16 wire the proper size to rewind with will then be 19 heavy Formvar as 3 sizes smaller is usually used for slow speed.

Clean all slots thoroughly and insert insulation papers of proper size in each slot—this paper to be .007 thickness. Before you start winding it is necessary to figure out how many turns is to be made in each coil. As armatures vary in total slot number and slot sizes it is hard to give a definite figure that can be applied to all armatures, yet it is very simple to determine if you follow these easy instructions. Cut several pieces of No. 19 (or the wire you are going to rewind with) about 1/4" longer than slot length. Use one slot and start laying the cut wires into this slot, counting each one and packing them in often so no space will be wasted. After the one slot is full and wedge is inserted, remove wedge and take out wires, recount so you will have a double check. Supposing you placed 36 wires in this slot—and as there will be two coils in each slot you will then wind each coil with 18 turns, making a total of 36 wires in each slot. Commutator connections and coil span the same as original winding.

Some armatures have twice as many commutator bars as slots, therefore it will be necessary to wind with two wires in hand which would mean each slot will have 4 coils instead of 2. In this case the proper number of turns per coil will be 9 turns, two wires in hand or a total of 36 wires in each slot.

Field coils to remain the same, however, the cut-in speed can usually be lowered some if you make new coils using wire 2 sizes larger and same number of turns as original coil. Brush connection to remain the same.

Plan 5

A 32 VOLT SLOW SPEED WIND LIGHT PLANT GENERATOR

made from Dodge 'G' or 'GA' Generator

5A-25 BAR COMMUTATOR TYPE

This changed generator has a cut in speed of 350 r.p.m. and will generate a maximum of 14 amperes.

A good Dodge 12-volt generator, Model G or GA, with good brush rigging, commutator, shaft and core, is required.

First tear down generator, removing old field coils and armature wire. Clean thoroughly with gasoline and allow to dry.

Insert new armature insulation paper in each slot. The edges of the paper will stick up above the slot and should be folded over when coils are finished and before wedge is inserted—this protects the windings.

Run an imaginary line parallel to the shaft through one bar and slot as is indicated by line running through center of slot 4 and bar 7 of Fig. 1. Number all bars and slots to right, as indicated.

Use No. 17 H. Formvar wire. Fasten the wire to bar 1. This connection is just temporary as it will be soldered later, so the wire can be held in place by means of a rubber band wrapped around the commutator, or it can be driven into the riser in the bar by means of a hammer and small blunt chisel or screwdriver point. Now run the wire through slot 1 and back through slot 7, through slot 1 again and back through 7, winding in a total of 20 turns. On the last turn run wire to bar 13 and cut it off. Fold this tail end out of slot 7 temporarily. Now start with bar 2, wind through slot two, back through slot eight, again winding in 20 turns and leading tail end of coil to bar 14, cut off and fold back. Continue on in like manner until all 25 coils have been wound. When winding the 7th and following coils you will be winding in slots which already have wire in them. It may be necessary to press this wire down to make room for all the turns. This can be done by pressing with a wedge-shaped wood or fiber slab. After each slot which contains parts of two coils is filled, the tail end wire which was lifted out should be placed back, the paper folded down and the wooden slot wedge inserted. Continue on until all 25 slots are filled and closed.

Now lay a moon-shaped paper over the ends of the coils on the commutator end, and lay the tail end wires down, connecting them to their proper bars. Wrap a few turns of string around these wires close to the bars to hold the wire in place and to prevent solder from dropping behind the bars. Now solder the wires to the bars, using a heavy soldering iron to properly sweat the solder to the heavy risers. Test the armature for grounds and shorts, saturate with insulating varnish, and allow to dry.

Wind four new field coils, using No. 18 p.e. magnet wire, and winding 450 turns per coil. The first and third coils will be wound in one direction and the second and fourth are to be wound in the opposite direction. It will be necessary to wind these on a form. After the coils have been removed from the form, wrap with cotton tape, shape, saturate with insulating varnish and allow to dry. (Be sure to shape coils before varnishing.) The coils may be shaped by installing them into the shell before varnishing, then remove and varnish. Assemble finished coils in shell, connect in series and test for polarity. Assemble the generator, using only the two main brushes, one of which should be grounded. Connect generator positive terminal and one field lead to the ungrounded brush. Connect the other field lead to ground or to ungrounded side of fuse and ground the other end of the fuse (if a fuse is desired in the circuit). These connections are shown in Fig. 2. (Fuse used is regular auto type, 4 amperes. Purpose of fuse is to keep generator from burning out when not connected to battery.) If the generator rotates in counter-clockwise direction when operated as a motor, simply reverse field lead connections.

Should the generator show excessive arcing at the brushes and show a tendency to charge only at low rates, this can be readily overcome.

On the "GA" generator simply remove the four screws which hold the brush end bell to the shell. Then shift the end bell to the position

at which best results are obtained with the generator revolving at about 750 r.p.m. Drill new holes in the end bell to take the screws in the new position. If the generator is a Model "G" it will be impossible to overcome this except by installing an adjustable brush rigging of another type, such as the rigging removed from a Ford Model "T" starter.

Kit No. 5012C—Dodge to 32 Volts—Slow Speed

Complete kit for rewinding your own Dodge 12-volt generator into a 32-volt slow speed generator:

- 5 pounds No. 17 heavy Formvar magnet wire.
- 9½ pounds No. 18 plain enamel wire.
- 1 can impregnating (air drying) varnish.
- 25 wooden wedges for slots.
- 25 insulation papers for slots.
- 2 slow speed commutator brushes.
- 1 roll tape for field coils.
- 2 pieces tape for insulating shaft.
- Cotton sleeving for field coils.
- One 4-ampere field fuse.

Above kit complete, f.o.b. (See catalog for price)

5B—SLOWER CUT-IN SPEED—49 BAR COM. TYPE

32-volt, 49-bar generator from Dodge "G" or "GA" having a cut-in speed of 250 r.p.m. and a maximum output of 15 amperes. It is not necessary to use a 49-bar commutator on any of the Dodge 6 or 12-volt slow speed changes.

Remove old 25 bar commutator by means of a press, and install new commutator so that mica will line up directly with center line of slot as shown by arrow in slot 7, Fig. 3.

Insert armature paper as described in Plan 5A in each slot. Assign number 7 to the slot used for aligning commutator to the core. Number all the slots from 1 to 25 as shown in Fig. 3.

Because there are two wires in each coil, we will designate them as wires A and B. For ease in winding it is well to have these wires on separate spools, fasten wire "A" to bar 1 and wire "B" to bar 2. This connection will be but temporary until they are soldered, so they can be held in place by means of a rubber band passed around the commutator, or they can be wedged into the riser slots of the bars by means of a small blunt chisel or screwdriver. Now take both wires in hand and run through slot 1 and back through slot 7, through slot 1 again, winding in 14 double turns of No. 18 heavy Formvar wire. On the last turn run both wires so that wire "A" will reach bar 25 and wire "B" will reach bar 26. Cut the wires off, leaving them about 2 inches longer than is necessary. Mark wire "A" to identify it, making a kink in the wire. Now lift these tail end wires out of slot 7 and fold back.

Next fasten wire "A" to bar 3 and wire "B" to bar 4; run them through slot 2, and then back through slot 8, again winding in 14 double turns. On the last turn bring tail end wires to bars 27 and 28, and again cut them off. Continue on in like manner until 24 double coils have been wound. On the 25th coil only one live wire will be used, the starting end of it being connected to bar 49 and the finishing end to bar 24. The other wire will also be wound in, but will be used only to fill the slot and to balance the armature, but both ends of the second wire will be clipped off near the armature core as they will not be fastened to bars. This is shown in coil 25 at the extreme left end of the connection diagram Fig. 3.

Wind four new field coils, using No. 18 p.e. magnet wire and wind 450 turns per coil. Wind coils 1 and 3 in one direction and coils 2 and 4 in opposite direction, then connect coils in series. If you insert a 4 ampere fuse in field circuit the generator will not burn out if battery becomes disconnected while charging.

Kit No. 5012B—Dodge to 32 Volts—Extra Slow Speed

Same as kit 5012C except it includes 5 lbs. 18 heavy Formvar, 9½ lbs. No. 18 1/2, and 49 bar commutator. (See catalog for price.)

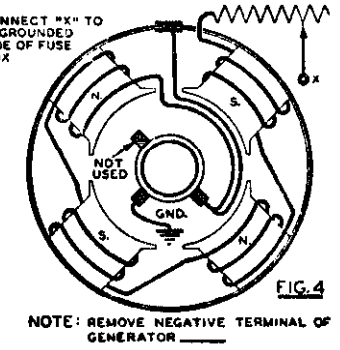
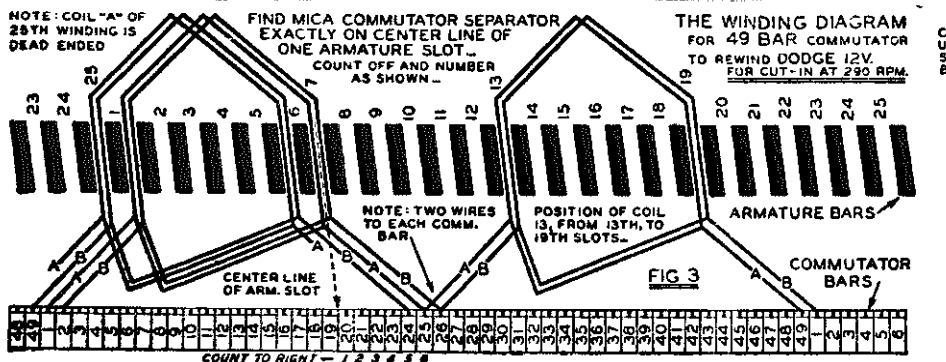
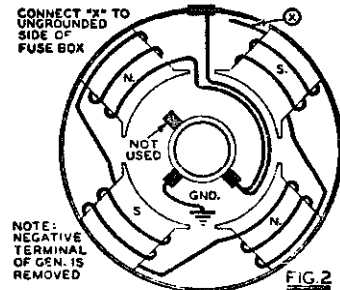
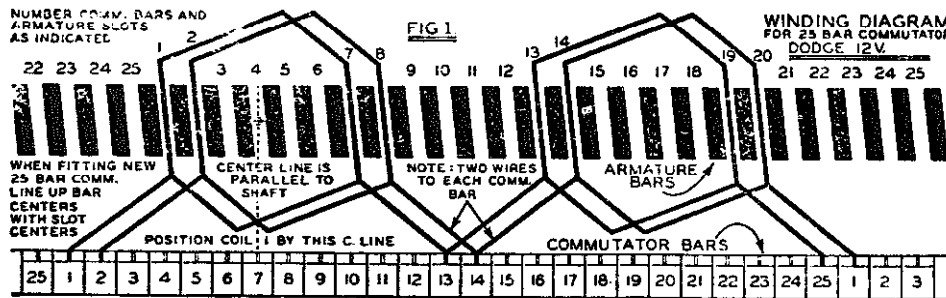

Plan 6

One 32 V. Motor, One 110 V. Motor, One 32 V. Generator and One 110 V. Generator from Dodge Generator

6A—32 VOLT CONSTANT SPEED GENERATOR

This 32-volt constant generator rewound from the Dodge 12-volt generator is for engine drive, or for wind plant with a reduction drive of 4 to 1 ratio. Delivers about 20 amperes at 1100 r.p.m. Cut-in speed approximately 750 r.p.m.

Study Plans Nos. 4 and 5 to simplify procedure. Wind four new field coils, winding 450 turns No. 18 P.E. wrapped with 3/4" cotton tape. Connect field coils in series. Armature to be wound with 6 turns No. 15 heavy Formvar wire (2 wires in hand). Armature requires a 49-bar commutator. Clockwise rotation.

Kit No. 160

Complete kit for rewinding your own Dodge 12-volt generator into a 32-volt 1100 r.p.m. generator.
5 pounds No. 15 heavy Formvar wire.
9 1/2 pounds 18 plain enamel wire.

- 1 can impregnating (air drying) varnish.
- 25 wooden wedges for slots.
- 25 insulation papers for slots.
- 2 commutator brushes.
- 1 roll 3/4" tape for field coils.
- 2 pieces tape for insulating shaft.
- Cotton sleeving for field coils.
- One field fuse, 4 ampere.
- 1 special 49 bar commutator.

Above kit complete, F.O.B. (See catalog for price)

6B—32 VOLT D.C. MOTOR

This 32-volt D. C. motor is made from the Dodge 12-volt generator. This motor develops 1/2 H.P. at 1800 r.p.m. and is shunt connected, constant speed.

Study Plans 4 and 5 to simplify procedure. Wind 4 new field coils, winding 500 turns No. 21 plain enamel wire, wrapped with 3/4" cotton tape. In this motor there is no change to be made in the armature. Only two main brushes are used—control brush not used. It is well to have the armature and brush holders tested for grounds and shorts.

Connect field coils in series then connect to brushes as shown in Fig. 2, Plan 5. If you want to vary the speed then connect as in Fig. 4, Plan 5 and use a No. W15 rheostat (15 ohm, 25-watt). (See catalog for price.)

Kit No. 162A

Complete kit for rewinding your own Dodge 12-volt generator into a 32-volt 1/2 H.P. motor. Rheostat speed control not included with this kit but sold separately.

- 7 pounds No. 21 plain enamel wire.
- 1 can impregnating (air drying) varnish.
- 1 roll 3/4" tape for field coils.
- Cotton sleeving for field coils.

Above kit complete, F.O.B. (See catalog for price)

6C—110 VOLT D.C. GENERATOR

This 110-volt D. C. generator is made from the Dodge 12-volt generator. Follow 32-volt constant speed generator change except wind armature with 12 double turns (two wires in hand). No. 18 H. Formvar and field with 1350 turns No. 25 P.E. Connect field coils in series and hook up as shown in diagram 2. Clockwise rotation.

Requires 49 bar commutator. Generator is for engine drive, or for wind plant with reduction drive of 2 1/2 to 1 ratio. Delivers about 750 watts at 1200 r.p.m.

Kit No. 161

Complete kit for rewinding your own Dodge 12-volt generator into 110-volt 1200 r.p.m. generator.

- 4 1/2 pounds 18 heavy Formvar wire (2 wires in hand).
- 5 1/2 pounds 25 plain enamel wire.
- 1 can impregnating varnish (air drying).
- 25 wooden wedges for slots.
- 25 insulation papers for slots.
- 2 commutator brushes.
- 1 roll 3/4" tape for field coils.
- 2 pieces tape for insulating shaft.
- Cotton sleeving for field coils.
- 1 special 49 bar commutator.

Above kit complete, F.O.B. (See catalog for price)

6D—110 VOLT D.C. MOTOR

This 110-volt D. C. motor is made from the Dodge 12-volt generator. This motor develops 1/2 H.P. at 1800 r.p.m. and is shunt connected, constant speed.

Study Plans 4 and 5 to simplify procedure. Wind 4 new field coils, winding 1350 turns No. 26 P.E., wrapped with 3/4" tape. Connect field coils in series then connect to brushes as shown in Fig. 2, Plan 5. Rewind armature with 10 double turns 17 heavy Formvar (two wires in hand). Requires special 49 bar commutator.

Kit No. 163

Complete kit for rewinding your own Dodge 12-volt generator into a 110-volt D. C. 1/2 H.P. motor.

- 5 pounds 17 heavy Formvar wire (2 wires in hand).
- 5 pounds 26 plain enamel wire.
- 1 can impregnating (air drying) varnish.
- 25 wooden wedges for slots.
- 25 insulation papers for slots.
- 2 commutator brushes.
- 1 roll 3/4" tape for field coils.
- 2 pieces tape for insulating shaft.
- Cotton sleeving for field coils.
- 1 special 49 bar commutator.

Above kit complete, F.O.B. (See catalog for price)

Plan 7

This Plan Tells How To Make a Grinder, Series Motor, Constant Speed Motor, A Universal A.C. or D.C. Motor and a Soldering Iron.

7A—32 VOLT GRINDER OR BUFFER

This 32-volt bench grinder or buffer is made from an old Ford Model "T" generator or other 6-volt standard auto generators without rewinding the field and using original armature.

First make sure that all field coils are connected in series as shown in Figure No. 1, thus coils C, D, E and F are all connected in one continuous circuit. The start of coil C is fastened to ungrounded stationary brush Y while the end of coil F goes to one side of the 32-volt line. Brush X which is other stationary brush is grounded in the generator you are using. Movable brush Z or 3rd brush is not used in this hookup. Other side of 32-volt line is connected to generator frame. a—generator, b—generator hold down strap, c—wood screws, d—wooden base shaped to fit generator, e—buffer or emery wheel, f—lock nut to hold buffer or emery on generator shaft. Not made for production work.

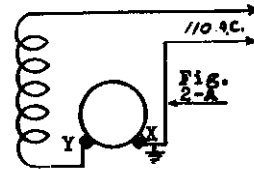
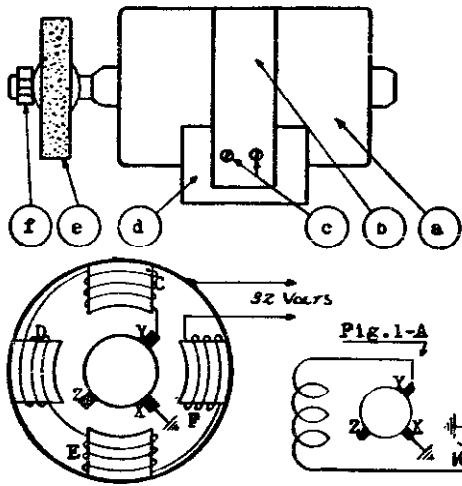

Do not run this motor over 5 minutes or so unless it is well ventilated. To ventilate drill 1/2 inch holes through each end plate at points in midsection of field coils. 4 holes in each end. Fasten a small home-made fan on generator shaft between the pulley and generator. Not made for production work.

7B—HIGH SPEED 110 VOLT A.C. SERIES MOTOR

This high speed 110-volt motor is made from an old standard 6-volt generator without rewinding the field and using original armature.

First make sure that all field coils are connected in series as shown in the Figures 2 and 2-A, thus coils C, D, E and F are all connected in one continuous circuit. The start of coil C is connected to stationary and ungrounded brush Y while the end of coil F goes to one side of a 50-ohm 3-ampere variable resistor M which is used as a speed control. Brush Z is not used in this hookup while brush X or other stationary brush is connected to the generator frame. One side of the 110-volt line is connected to the generator frame and the other side of the 110-volt line is connected to the control M.

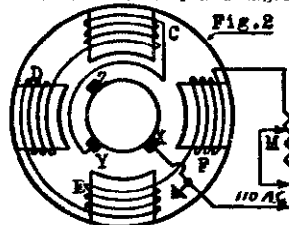

7E—SOLDERING IRON

Here is a soldering iron that will work on 6, 12 or 32-volt storage batteries and easily made from scrap parts.

First remove the center carbon from a flashlight cell leaving the metal cap in place. File the carbon end to a point and solder an insulated wire on cap. Mount carbon in small iron pipe about 10 inches long and run wire through handle end of pipe. Handle made of wood. Connect wire to battery and connect other side of battery to work. Clean spot to be soldered, apply flux and bring carbon point in contact with work, draw back a little and apply solder as soon as arc has heated the work. Repeat until work is completed.

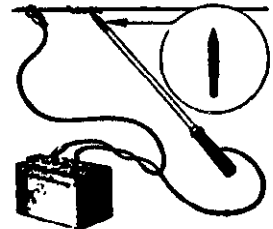

7C—CONSTANT SPEED MOTOR

This constant speed 110-volt A. C. motor is made from an old standard 5-volt auto generator.

Uses original field coils and original armature.

This change is described in Fig. 3 and 3-A. All brushes are hooked together and entire brush rigging is to be movable. The generator frame is not grounded to line.

Coils C, D, E and F are hooked in series as above two generator changes. Brushes are connected to end of coil F and to one side of line while start of coil C is connected to other side of the line.

Operate for a short period only as it will get too warm. Not made for production work.

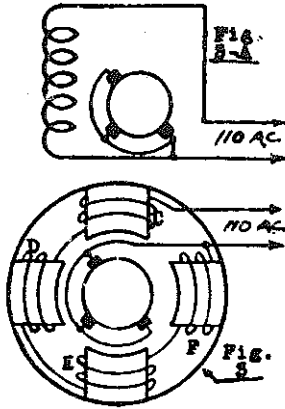

7D—A UNIVERSAL A. C. OR D. C. 32 VOLT MOTOR

Here is a universal A. C. or D. C. 32-volt motor that can be made from an old 6-volt standard auto generator without rewinding the field coils and using the original armature.

First connect the field coils as shown in Figures 4 and 4-A, thus coil C connected with coil D and the two coils E and F connected together. The start of coil C is connected to stationary ungrounded brush X while end of coil D goes to one side of the 32-volt line. The start of coil F is connected to stationary and ungrounded brush Y while end of coil E goes to other side of the 32-volt line. Movable or 3rd brush Z is not used. Entire brush rigging should be movable for this change while Y and Z to be opposite each other. Generator frame is not connected to either side of the line.

This change makes a very high speed motor and will also work on 110 volts A. C. for a short time without getting too warm. Will also work on 110 D. C. Not made for production work.

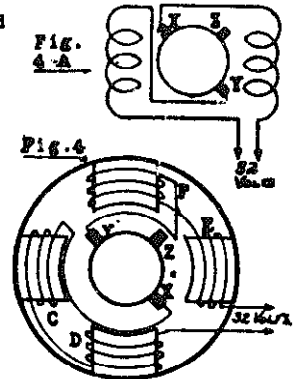

Plan 8

A 75 to 110 Ampere Arc Welder Made From Dodge 'G' or 'GA' Generator. Also Dual Welders.

An arc welder made from the Dodge "G" or "GA" 12-volt generator which produces 40 volts and up to 110 amperes, and two welders in parallel produce up to 200 amperes for short periods.

First remove armature from generator and remove all the field coils. To take out these coils you will need a heavy punch and hammer for loosening the eight screws that hold pole pieces to generator frame. Discard these coils. The original armature is used without rewinding. Be sure it tests O. K.

Build a winding spool to the dimensions given (Fig. 5). To be certain of accuracy, clamp the spool ends together while drilling. Mark corresponding corners of the spool ends with black paint, and assemble the spool. Polish all roughness from four 1/2"x2" nails, and insert them in their proper holes after dipping them in paraffin. The nails should fit snugly in place.

On this form wind four new field coils, each having two separate

windings. The light winding, which is wound first, consists of 250 turns of No. 30 P.E. magnet wire. After you have wound on 350 turns, then without removing coil from winding form, a piece of armature paper is then placed around the coil so as to separate this winding from winding next to be put on. Now use No. 8 DCC magnet wire and wind on 10 turns, in same direction as No. 20 is wound (layer wound, 5 turns to layer), have all leads start and finish at same end of coil. The 350 turns of No. 20 will weigh approximately 1 1/4 pounds. The 10 turns of No. 8 will weigh approximately 1/4 pound. Tie the coil with strings through the saw cuts (Fig. 5).

Remove coil from winding form then use 1/4" or 1" cotton tape for wrapping. Soak well in a good insulating varnish and allow to dry. The coils can be shaped when drawing them into place in the generator frame.

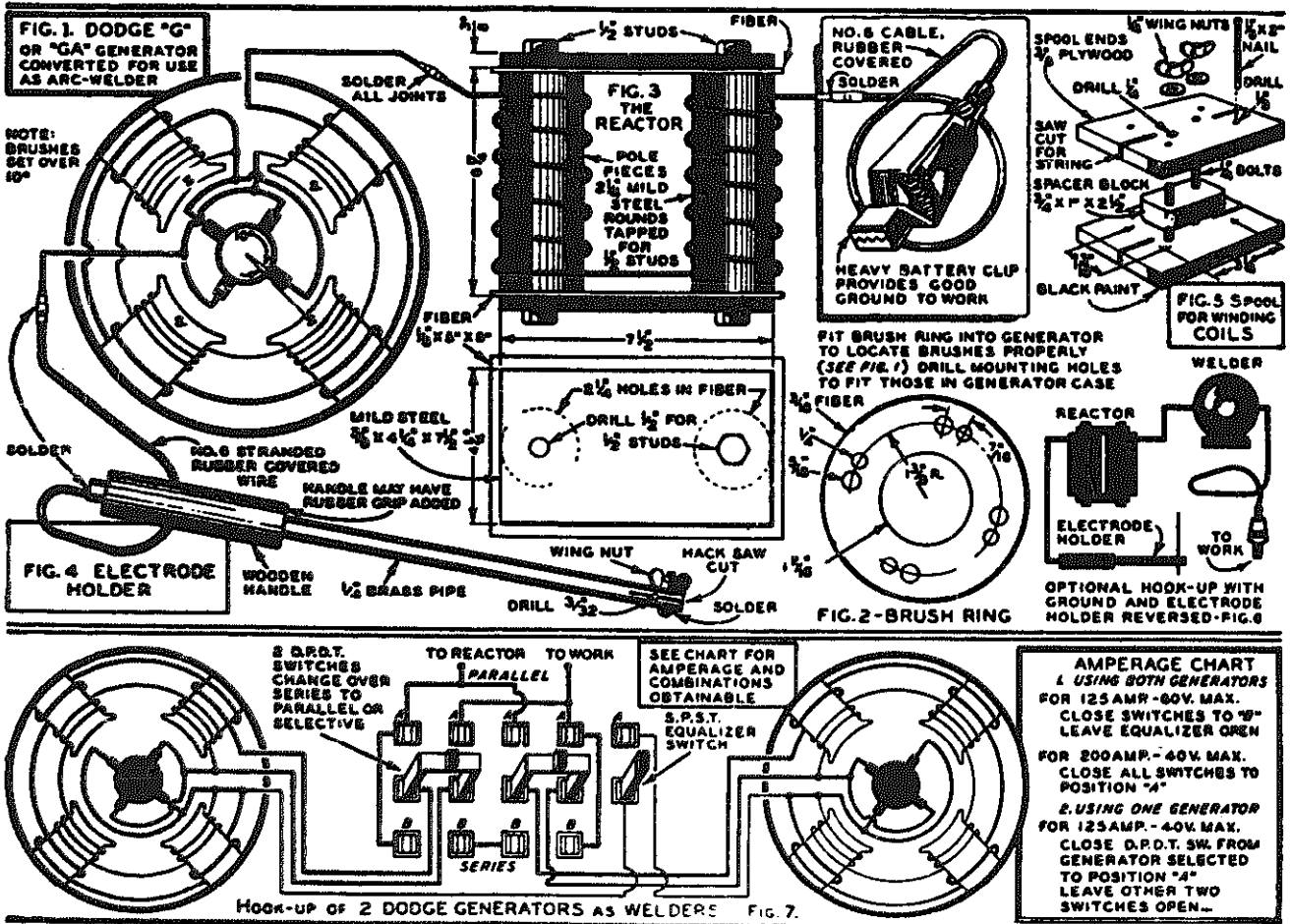

Two of the above field coils are wound in one direction and two are wound in opposite direction so when inserted in frame the two like coils will be opposite each other, making both of these coils of same polarity—the other two wound in opposite direction will be of opposite polarity. See Fig. 1—both opposite poles are alike. Connect small wire coils in series and connect one lead to each pair of brushes. Connect large wire coils in series with only one lead connected to one pair of brushes. The other end will be connected directly to reactor. See Fig. 1. Use No. 6 stranded, heavy rubber covered cable for the terminal leads. Solder all connections. If generator rotates in wrong direction, then reverse brush connections.

This welder requires a changed brush rigging consisting of four Dodge brushes spaced equally on a $\frac{1}{4}$ " fiber ring (Fig. 2). Locate brushes 10 degrees ahead of the pole centers in the direction of rotation, and connect opposite brushes together (Fig. 1). All connections in the welder are No. 8 wire or its equivalent.

To increase the efficiency of the welder, provide four ventilating holes in each end of the case. These holes are $\frac{3}{4}$ " and are drilled exactly between the pole pieces, and should be $\frac{1}{4}$ " in from the edge of the frame. Remove brush band to allow air circulation.

A reactor is necessary with this welder. There are two types of reactors in common use: (1) solid core type, and (2) the laminated core type. The laminated core type is a little more efficient, however, the solid core reactor is much simpler to build, and the difference in performance is so small that it is not worth the extra effort required to construct the laminated core type. A solid core reactor is explained in Fig. 3. On each pole piece wind one layer of No. 6 DCC magnet wire, over a double layer of .010 armature paper, allowing the same number of turns for each leg. Each layer approximates 1 $\frac{1}{2}$ pounds of wire (total for both poles is about 3 $\frac{1}{4}$ pounds). Wind turns close together. The flat pieces which hold the reactor legs together are mild steel flats, and are bolted to form a metal to metal contact with the legs. The fiber strips near the flats are for the purpose of insulating the ends of the coils, and have $\frac{1}{4}$ " holes cut into them to enable them to fit around the legs. Connect as shown in Fig. 3. Some operators recommend the hookup shown in Fig. 6. In this hookup the ground and electrode connections are the reverse of those shown in the large diagram. A simple holder can be made from a $\frac{3}{4}$ " brass pipe as shown in Fig. 4 which will hold a $\frac{1}{4}$ " or $\frac{1}{2}$ " welding stock.

This reactor can be used with other welding generators producing up to 200 amperes.

This machine is easily capable of welding materials up to $\frac{1}{4}$ " thick. Heavier materials can be welded if more time is taken and weld gradually built up. When two machines are used much heavier work can be done.

A control may be inserted in series with the shunt field (shunt field is the light winding, 350 turns No. 28) and can be inserted by disconnecting the field lead that connects to same two brushes that electrode holder connects to. (See Fig. 1.) Here connect one side of rheostat to field lead and other side of rheostat to brushes. No. 18 or 20 rubber covered stranded wire is recommended for connecting rheostat and rheostat can be mounted up to 2 or 3 feet from welder if necessary. (Rheostat No. WW15 is recommended, see catalog for price).

Caution: Never turn this rheostat to full "OFF" position. This control varies the arc-striking voltage and is beneficial when welding light materials.

Use No. 6 stranded rubber covered cable from welder to electrode holder, from welder to reactor and from reactor to work. The reason No. 6 is recommended is to prevent any possible losses. When using two welders then use No. 4 wire from the switches to reactor and to work, also from reactor to work. When using two welders it is best to use two belts and they can be "V" type.

Instructions for connecting voltmeter and ammeter in welding circuit: The ammeter is to be connected in series with the lead from welder to reactor—that is, connect output of welder to one side of ammeter and other side of ammeter to input of reactor. All the current then passes through the ammeter. If reading is reverse on ammeter, just interchange ammeter connections. The voltmeter is to be connected across the output of welder by connecting one side of voltmeter to lead that goes from welder to reactor and other side of voltmeter to lead that goes from welder to electrode holder. No current is allowed to pass through the voltmeter as it measures the voltage across the welder output only. If reading is reverse on voltmeter just interchange the voltmeter connections. If dual welders are used, the ammeter is then connected in series with lead that goes from "A" side of switches (see Fig. 7) to reactor. Voltmeter is connected from lead that goes to reactor and to lead that goes to work on "A" side of switches. Ammeter No. 5LA is recommended for single welder and No. 50LA for dual welders. Voltmeter No. 5LV recommended for either single or dual welders. (See catalog for description of meters and prices.) It is sometimes advisable to build a metal shield around both meters to protect them from the magnetic field set up by reactor. This magnetic field may produce false readings unless meters are shielded. A light sheet iron container is all that is necessary—if meters are mounted several feet from reactor the shield may not be necessary.

Welder to be driven by a $\frac{3}{4}$ H. P. electric motor or 6 H. P. gasoline at 1800 to 2200 R.P.M. Dual welders require 7 H. P. electric or 12 H. P. gasoline. Clockwise rotation looking at welder from shaft end.

Following is list of supplies for making this change and offered at low prices. All supplies fully guaranteed.

| Part No. | Article |
|----------|--|
| 8206 | Complete kit for rewinding your own Dodge generator, for arc welder. |
| | 3 pounds No. 6 DCC magnet wire. |
| | 4 $\frac{1}{2}$ pounds No. 20 P.E. magnet wire. |
| | 1 roll $\frac{3}{4}$ " cotton tape. |
| | 1 $\frac{1}{4}$ " fiber for brush rigging, cut to fit. |
| | 1 large can impregnating varnish. |
| | Insulation paper for use in field coils. |
| | 12 feet No. 6 lead wire, rubber covered. |
| | Complete kit, F.O.B. Mpls. (See catalog for price) |
| 8235 | Complete kit for winding your own reactor. |
| | 2 pieces $\frac{1}{4}$ "x5"x8" fiber. |
| | 2 pieces .010 armature paper, 6"x17" for legs. |
| | 3 $\frac{1}{4}$ pounds No. 6 DCC magnet wire. |
| | 12 feet No. 6 lead wire, rubber covered. |
| | 1 large battery clip. |
| | Complete kit, ship. wt. 12 lbs. (See catalog for price) |
| 824 | Steel for reactor, cut and machined to size, drilled and tapped. |
| | Shp. wt. 21 lbs. F.O.B. Mpls. (See catalog for price) |

Plan 9

PENDULUM TYPE FENCE CONTROLLER

Made From Ford 'T' Coil

An electric fence charger operating on a six-volt battery and capable of charging 2 or 3 miles of fence, however, if you do a perfect job of insulation over entire circuit, especially noting that posts are as far apart as possible, then the unit will handle at least 4 to 6 miles of fencing. Reason for this is very simple—the control puts a high voltage low current shock into the fence, and because it is of high voltage its tendency for leakage is very great and a certain amount of loss will incur at every post or point of insulation regardless of type of insulator. (Therefore, as above mentioned, be sure to have as few posts per mile as possible.) You can readily understand why good insulation is of vital importance and why we recommend the use of porcelain insulators.

The fencing of livestock is no doubt the most important application of the charged single wire yet there is no limit to the number of uses. For instance, with aid of a real low fence, rats and mice can absolutely be kept out of corn cribs, granaries, etc. By placing a single wire on a board, then embedding the board flush into the ground (wire about 2" above board and suspended with porcelain insulator), then encircle hen house or entire chicken fences, you absolutely keep out skunks, weasels, rats and all other thieving animals. Once they get shocked they stay away. Easily keep dogs away from shrubs, cats away from fish ponds, rabbits out of gardens, coyotes out of grazing grounds, and other unwelcome intruders from places they are not wanted.

The fence does not need to be in one continuous length. It may have many branches and loops as are needed just so they are all connected; also the wire does not need to return to fence controller. (In other words there is just one wire leading from controller to fence wire and fence wire may end any place on farm.) The barbed wire is recommended for livestock while just bare wire may be used for small animals. The controller keeps working whether an animal touches the wire or not.

Once animals become acquainted with electric fence the unit may be turned off for days at a time without any trouble.

DIRECTIONS

First obtain a Model "T" Ford spark coil (1) in good condition (see Fig. 1). Remove the coil points (2) and (3) and cut off the point adjustment screw close to the nut (4). Remove the little rivet (5) in the coil point (2). Now, carefully bend the point support (2) into the shape indicated in Fig. 2. This bending must be done slowly, and a little at a time, to avoid breaking. The end of the point support (2), may be cut off to a convenient length. Drill a hole in the point support (2) and tap it to receive the bolt (6),

which is a 6-32, 8-32 or 10-32 bolt, on the end of which a lock nut and small rubber knob "A" are fitted. The tension spring (7) is the one which was used on the adjusting screw cut from the coil (1) at (4). The small knob "A" may be found on an old "B" battery, or perhaps, on the terminal post of an old radio.

From 30 gauge spring brass, or spring copper cut the two pendulum blades according to the dimensions given (see Fig. 2). Solder a $\frac{3}{8}$ " carriage nut to the top end of blade (8). Solder large end of blade (9) to the coil point (3) allowing the solder to grip for a distance of only $\frac{1}{8}$ ". Now clamp the two blades (8) and (9) together in the position shown, and solder them as indicated (see Fig. 2), again allowing the solder to grip for only $\frac{1}{8}$ ". Now replace the rebuilt coil point assembly as in Fig. 1.

To the coil points (10), (11) and (12) connector clips can be soldered or if you do not have clips just solder on wires without clips. All wiring must be heavy rubber covered to avoid any possibility of a high tension short circuit. Regular battery clips are used on the battery wires.

The wiring diagram (see Fig. 3) shows a wire from coil terminal (10) to the battery. In this wire, an "OFF" and "ON" switch may be inserted at (13) but is not necessary. From coil terminal (11) a wire is run directly to the fence. From coil terminal (12) run one wire to the other side of the battery, and one wire to a good ground connection. This ground connection is made by soldering the wire to a six-foot length of galvanized iron pipe, or other suitable rod driven into the earth. Moist ground near this pipe occasionally during dry weather which will help to make shock more effective.

Fig. 4 shows the method of making the connection to the fence wire. The fence wire is mounted on porcelain knobs (16). All splices in the fence must be thoroughly cleaned and made real tight.

To form a gate in the electric fence, which may be opened or closed without danger of a shock while the control is operating, form a loop in the main wire into which a connecting hook may be fitted. A piece of inner tube is taped around the gate wire to form an insulating handle (15).

A protecting case for the completed fence control is shown in Fig. 5. The four sides and the bottom of the case may be of light metal. The top is of light wood or other non-conductor. Holes are cut in the top and end of the box to allow the pendulum and adjustment knob to protrude. When leading the wires through the metal case, the insulation on the wires must be increased to the thickness of a lead pencil by wrapping tape around them for about 1" on each side of the metal.

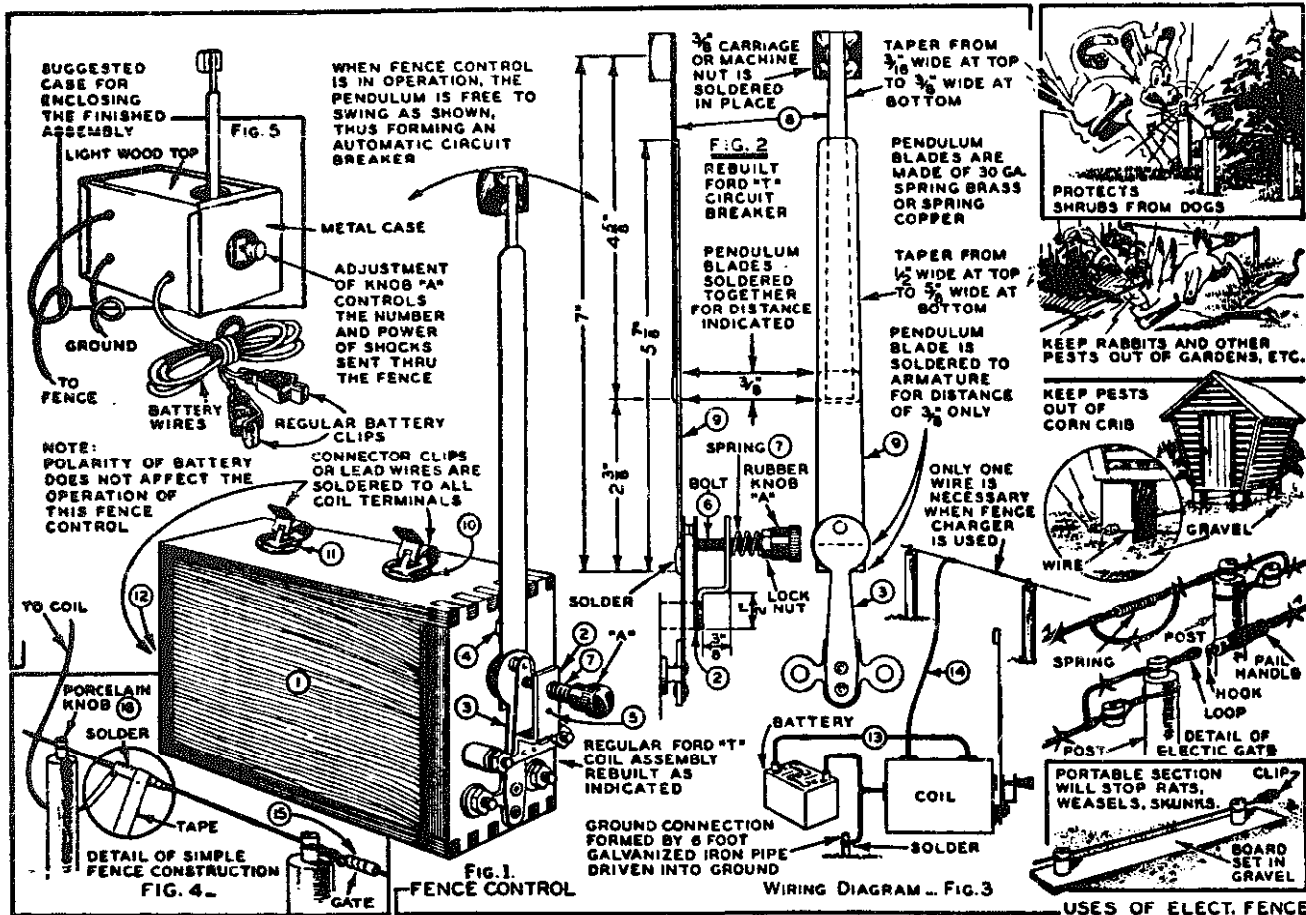

To operate the control, close the switch (13) (see Fig. 3) and adjust the knob "A" until the pendulum will swing at the proper speed. It will be necessary to give the pendulum a start with the fingers until the proper adjustment is found. Thereafter it will usually start by itself. It may be necessary to touch up points occasionally with regular point file to insure best results.

A Portable Neon Fence Tester (No. 63) may be connected at any point in the wire leading from terminal (11) to the fence (see Fig. 3), this lamp will glow at each charge sent into the fence and its purpose is to determine whether or not the control is working.

This control will also operate on 4 volts but will produce a weaker shock than if used on a 6-volt storage battery. (A storage battery is recommended instead of a hot spot.) For 32-volt operation connect to any 6 volts of the 32-volt battery, and the same thing applies to a 110-volt battery.

PORCELAIN INSULATORS

No. 95—Porcelain Fence Insulator with leather, less nails.

Shipping weight 2 ounces. F.O.B. Minneapolis.

Carton of 100. Ship. wt. 19 lbs. F.O.B. Minneapolis.

(See catalog for price)

(See catalog for price)

CORNER INSULATORS

High quality porcelain insulators for use at corners, gates or end of fence.

No. 94—End Insulator. Ship. wt. 2 1/4 oz. F.O.B. Minneapolis.

Carton of 25. Ship. wt. 4 lbs. F.O.B. Minneapolis.

(See catalog for price)

(See catalog for price)

NEON TESTER

No. 63—Portable Neon Fence Tester for testing fence.

(See catalog for price)

Plan 10

Plans for Building a Complete Wind Light Plant Including Tower, Propeller and Generator Charger

10A—6 VOLT SLOW SPEED GENERATOR

By following this step by step plan carefully and correctly you will be able to build in a few hours time, a slow speed 6-volt generator that will start to generate at about 375 r.p.m. and deliver up to 12 amperes. Especially designed for wind propeller direct drive.

DIRECTIONS

First secure an old model "T" Ford generator that has good field coils (field coils are the stationary coils), good commutator and good bearings. It is not necessary to get a new generator for this change. Remove the gear and take generator apart. By using a screwdriver carefully you can pry the wires out of the commutator fliers (be sure not to use too much force which will harm the commutator), then push out all old wedges that are holding old windings in place. Remove wire and clean slots thoroughly.

Next take insulation material .087 thickness and cut into pieces 2 1/4 x 1 1/4 inches. 21 pieces in all. Put one piece in each slot. This size paper will extend a little above the slots which will later be folded over when wedges are put in to protect the new windings.

Now hold the armature in your hand with the commutator next to you and number each commutator bar with white chalk. 21 bars in all. Use No. 19 heavy Formvar magnet wire.

Connect wire to bar 1. This connection is just temporary as it will be soldered later, so the wire can be held in place by means of a rubber band wrapped around the commutator, or it can be driven into the pier of the bar by means of a hammer and small blunt chisel or screwdriver point. Now run wire out through slot

3 and back through slot 8—return to slot 3 again, and place in a total of 17 turns. On the last turn, run wire to bar 11 as shown in diagram. Cut this wire off and fold tail end out of slot 8 temporarily.

Now start with bar 2, go out through slot 4 and back through slot 9, again winding in 17 turns. Lead wire to bar 12 and cut off, again folding tail wire end out of slot. Continue on in like manner until all 21 coils have been wound. When winding the 6th and following coils you will be winding into slots which already have wire in them. It may be necessary to press this wire down to make room for all the turns. This can be done by pressing with a wedge shaped wood or fiber slab. After each slot which contains parts of two coils is filled, the tail end wire which was lifted out will be placed back, the paper folded down and the wooden slot wedge inserted. Continue on until all 21 slots are filled and closed.

Now lay a moon shaped paper over the ends of the coils on the commutator end, and lay the tail end wires down, connecting them to their proper bars. Wrap a few turns of string around these wires close to the bars to hold the wire in place and to prevent solder from dropping behind the bars. Now solder the wires to the bars, using a heavy soldering iron to properly sweat the solder to the heavy risers. Test the armature for grounds and shorts, saturate with insulating varnish and allow to dry.

Assemble the generator and note the space between the armature and field pole pieces. The cut in speed can be lowered still more by decreasing the width of this space. This can be done by cutting shims from a baking powder or tobacco can, just the size of the

base of the pole piece, piercing a hole through the center of the shim to accommodate the pole bolt. Place one of these shims under each pole piece and the air gap will be less. It is important that the pole be drawn up tight and that the bearings are in best of condition. If the poles are not up tight or if the bearings are loose, then the armature may rub one or more of the poles which will immediately cause excessive heat and as a result a burned out generator. The shims can also be used for lowering the cut in speed when using the DeLuxe field coils. These shims must be made of iron. Fiber, paper or brass shims will not work. Set of 4 Special LeJay Shims may be purchased direct from us.

Should the generator show excessive arcing at the brushes or show a tendency to charge only at low rates, advance the control brush to fullest extent. Then, with generator rotating at about 750-1000 r.p.m., adjust entire brush rigging to point at which best results are obtained. The maximum output can be governed by means of the control brush, but if this is necessary, the cut in speed will be raised somewhat.

A well made propeller 6 feet long will turn this changed generator as fast as necessary in the average wind to charge well. Lubricate as your car generator.

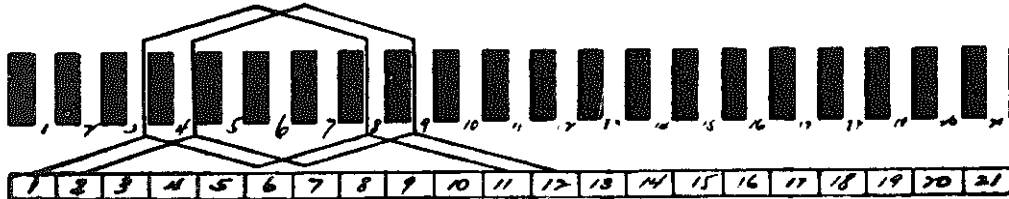

Listed below are supplies for making the above change. These supplies are offered at the following low prices and guaranteed.

- | Part Number | Article |
|-------------|--|
| 105 | Complete kit for rewinding your own Ford "T" generator to 6 volts slow speed for direct drive propeller. |
| | 1 1/4 pounds No. 19 heavy Formvar magnet wire. |
| | 1 complete set new brushes. |
| | 2 fibre end laminations. |
| | Scotch tape to hold laminations. |
| | 1 can special air drying varnish. |
| | 21 wooden slot wedges. |
| | 21 insulation papers. |
| | 1 end insulation paper. |

Above kit complete, postage paid.....(See catalog for price)
105—105 kit as above, less brushes.....(See catalog for price)

106—SLOWER CUT-IN SPEED, 10 AMP. OUTPUT

To rewind the Ford "T" generator so it will start to generate about 325 r.p.m., wind armature with 20 turns No. 20 heavy Formvar wire. Coil span and commutator connections to remain the same. Add letter "A" to either of above kit numbers and that kit will come with No. 20 heavy Formvar magnet wire in place of No. 19 heavy Formvar magnet wire.

100—EXTRA SLOW CUT-IN SPEED, 15 Amp. Output

To rewind the Ford "T" generator so it will start to generate about 230 r.p.m., wind the armature with 17 turns 19 heavy Formvar; coil span and commutator connections remain the same. Wind new field coils winding 125 turns No. 18 P. E. wire per coil. The first and third coils will be wound in one direction and the second and fourth are to be wound in the opposite direction. It will be necessary to wind these on a form. After the coils have been removed from the form, wrap with cotton tape, shape, saturate with insulating varnish and allow to dry. (Be sure to shape coils before varnishing.) The coils may be shaped by installing them into the shell before varnishing, then remove and varnish. Assemble finished coils in shell, connect in series and test for polarity. Assemble the generator as it was before, with brushes in their proper position. It might be well to mark the position of the brush rigging before removing it if this is found necessary.

Connect generator terminal to main insulated brush. Connect one field lead to control brush and other field lead to main grounded brush. Run generator for a moment as a motor. If it rotates in clockwise direction, leave connections as they are. If it rotates in counter-clockwise direction, simply reverse field lead connections.

- Kit No. 107—Super DeLuxe "T" to 6 Volts Slow Speed.
Includes Kit No. 105 plus the following field coil materials:
2 pounds 18 plain enamel magnet wire.
1 roll cotton tape.
Cotton sleeving for field coil leads.
A larger can of varnish than included in 105.
4 pole piece shims.

Above kit complete. Ship. wt. 4 lbs. F.O.B. (See catalog for price.)

108—EXTRA SLOW CUT-IN WITH 10 Amp. Output

For 275 r.p.m. cut in speed, wind armature with 20 turns No. 20 heavy Formvar and fields with 125 turns No. 18 plain enamel, connect in series.

- Kit No. 107A.
Includes Kit No. 105A plus the following field coil materials:
2 pounds 18 plain enamel magnet wire.
1 roll cotton tape.
Cotton sleeving for field coil leads.
A larger can of varnish than included in 105A.
4 pole piece shims.

Above kit complete. Ship. wt. 4 1/2 lbs. F.O.B. (Same price as kit No. 107).

109—6 FOOT PROPELLER

For making a 6 foot propeller for the 6-volt standard generators: Shorten each 2" length to 6"—shorten the 3" length to 2 1/2"—then shorten the 4" length to 3 1/2". Use regular 3/4" stock 4 1/2" wide. Finished tip to be 2 1/2" wide. Next change figure 1/2" to 3/8"; change 1 1/2" to 1 1/4"; 2 1/2" to 2 1/8"; 3 1/2" to 3 1/4"; then change 1 1/4" to 3/4"; 1 1/2" to 1 1/8"; 1 3/4" to 1 1/4"; 2 1/4" to 2 1/8"; and 3 1/4" to 3 1/8". The remaining figures which give the pitch, remain the same.

10F—7 FOOT PROPELLER

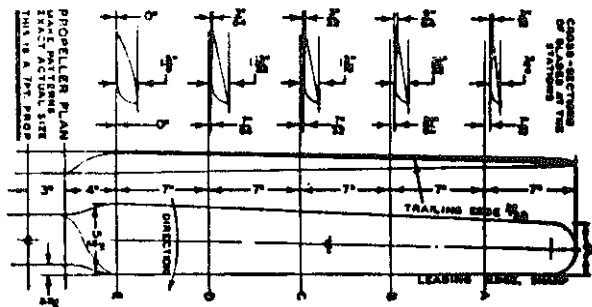

10G—8 FOOT PROPELLER

For making an 8-foot propeller refer to plan and lengthen each 7" section to 8", also lengthen the 3" section to 4". All other dimensions remain the same. The 7 and 8-foot propellers are for Dodge or other 600 to 800 watt generators.

10H—10 FOOT PROPELLER

For making a 10-foot propeller, refer to plan and lengthen each 7" section to 10", also lengthen the 3" section to 5" and the 4" section to 5". All other dimensions remain the same. This 10-foot propeller is for wind plants using a reduction drive.

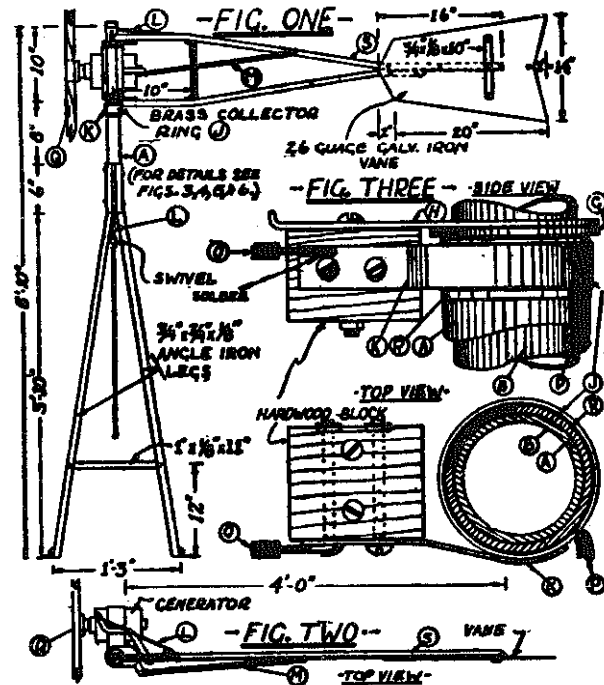

10J—TOWER AND HEAD ASSEMBLY

This plant has been designed for the model "T" generator because it makes the best slow speed generator, being of the four pole type, and because this model generator is usually available.

The entire plant assembly is made of metal, is of simple construction, and can be built with tools used in the ordinary farm workshop.

(A)—14" length of 1 1/2" (inside measurement) iron pipe to which the four tower legs are bolted. Build tower according to dimensions on Fig. 1. (B)—13" length of 1 1/2" (outside measurement) iron pipe which slips 8" down into pipe (A) inside of which it rotates. Plates (F) and (G) are 4" lengths of 2" by 1/2" strap iron which support vane arms on pipe (B). The holes in (F) and (G) through which pipe (B) passes should fit the pipe so snugly that the plates have to be driven onto the pipe. 1" fastening the vane arms to (F) and (G) use flat head bolts and countersink them. Build vane support, as illustrated of 3/4" angle iron. Side of upper vane arm (S) extended, bolts to pipe (B) as shown, to hold (B) rigid and keep pulley in line. Slot sides of pipe (B) at top and shape to house a 1" pulley with no side play. (H) and (H2) of 2" strap iron, support generator and assembly on pipe (B). The holes in the ends of (H) through which pipe (B) passes should be just large enough so that (H) can swing freely on (B) with no side play. (E)—A piece of 3/4" strap iron which is bent up at (X) Fig. 4, to catch on upper vane arm (S), and stop the generator assembly at the proper point when it swings into operating position. (L)—3/8" copper twist cable fastens to the outer end of (E), passes over pulleys and down through pipes (B)

and (A). Equip with small swivel below bottom of pipe (A). (D) $\frac{3}{4}$ " strap brace on generator support as shown. Use flat head bolts and countersink them. (C) $7\frac{1}{2}$ " piece of $\frac{3}{4}$ " angle iron bent at a point 2" from one end, bolts to generator support holding (D) in place as shown. Use flat head bolts and countersink. (M) 20 " screen-door spring fastened to vane arm (S) and end of arm (C) pulls generator assembly into operating position when cable (L) is released. A new 20 " spring stretched to 22" and then fastened to arm (S) will hold assembly in operating position at safe wind velocities, but will allow assembly to swing back automatically to idle position (Fig. 4-A) when forced back by wind too fast for safe operation. (J) Collector ring, 1" length of $1\frac{1}{4}$ " brass pipe. Collector ring slips over pipe (A) with three to five turns of #07 armature paper wrapped around pipe for insulation, so that (J) fits snug. Keep (J) $\frac{1}{4}$ " below top of pipe (A). (P) Rubber covered stranded wire, size No. 6 or No. 8. End of wire (P) to be flattened and soldered to inside of collector ring as shown. Other end of wire (P) leads to the positive side of the battery. (See wiring diagram and instructions.) (K) $1\frac{1}{2}$ " by $6\frac{1}{2}$ " strip of $\frac{1}{8}$ " spring brass mounted on hardwood block which is bolted to under side of generator support (H). (Figs. 3 and 5.) Bend (K) so it presses hard on collector ring for contact. (O) Same as (P). One end soldered to strip (K), and other end connects to positive post on generator. (N) Vane of 28 gauge galvanized iron. Strengthen vane with a 10 " piece of $\frac{3}{4}$ " by $\frac{1}{2}$ " strap iron as shown. (Q) Propeller. A 6 foot propeller is to be used with this plant.

NOTE: If collector ring is not desired, No. 10 fine stranded insulated wire, run from generator down through pipes (B) and (A) and to the battery, will resist for a long time the twisting action caused by the rotation of the plant in the wind. This method has been tested and proven over a two-year period, during which time it was not found necessary to change the wire.

The wiring diagram shows a wire from the positive (+) post of the generator to the ammeter. This is the wire (P) on the plans, leading from the collector ring. It is to be connected to one side of the ammeter. A wire from the other side of the ammeter connects to "G" (generator terminal) on the cutout. The wire from "B" on the cutout leads to the positive side (+) of the battery. Since the generator is grounded to the frame of the plant, the frame carries the negative (-) charge, and it is only necessary to connect to the plant frame instead of running a wire all the way to the frame of the generator. Now, connect a wire from the tower to the negative (-) post on the battery, and also connect this lead to the frame of cutout as indicated by "F" in the wiring diagram.

- J—Machined Brass collector ring complete with insulation material.....(See catalog for price)
- K—Spring brass collector ring wiper.....(See catalog for price)
- M—Coil spring for governing tension.....(See catalog for price)
- L— $\frac{1}{2}$ " copper twist pullout cable, 8 ft. for.....(See catalog for price)
- 1"—Pulley, 2 for.....(See catalog for price)

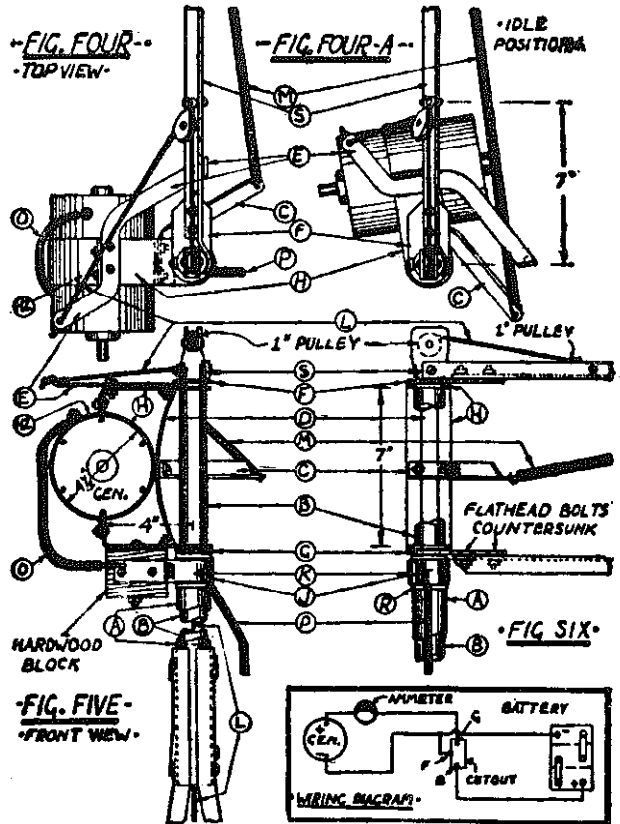

Plan II

A 110 VOLT A. C. LIGHT PLANT GENERATOR

made from Dodge 'G' or 'GA' Generator

This 110 volt A. C. 750 watt light plant generator is made from Dodge "G" or "GA" generator. Produces current to light 27 of the 25 watt bulbs and an electric radio or about 30 bulbs without radio.

sert wedges. Use just one brush and place this in any ungrounded holder. Connect this brush to terminal post on generator. Wind 4 new field coils with 300 turns of No. 17 P.E. per coil. Tape and varnish, then connect in series.

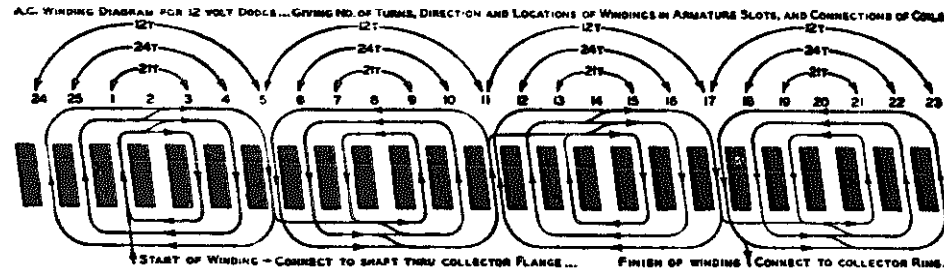

For excitation connect field leads to standard 6 volt generator, and turn this 6 volt generator at same time you turn A. C. Generator. For battery excitation the field leads should be connected in series parallel (two sets of two coils). See diagram in plan 28C General Information if you do not understand how to make series parallel connections.

See catalog part No. 051 for armature exchange and No. 9A for field coils, also if you wish to use a rheostat as shown in diagram refer to No. W1-1 ohm.

First take generator apart removing old field coils and armature wire. Insulate each armature slot. Hold armature in left hand with commutator away from you. Use No. 15 heavy Formvar magnet wire. Allow about 10 inches excess and wrap this excess around armature shaft. Then start winding in slot No. 1 toward commutator, then over to slot 3 and back through slot 3; here place in 21 turns. From slot 3 move to slot 25 and continue by winding through slot 25 toward commutator and back through slot 4. In these two slots wind in 24 turns. From slot 4 move to slots 24 and 5, here wind in 12 turns. This completes one pole. Remember that entire winding on this armature is one continuous winding—you move from pole to pole as shown in diagram.

This completes the armature winding. Solder the start of armature winding to armature shaft at a point close to windings but be careful not to burn windings with soldering iron. See A in Figure 1. Next wrap a piece of heavy copper wire around commutator on the risers like C, Figure 1. This connects all bars together and converts commutator into collector ring. Next allow slack and connect finish of armature winding to commutator risers as shown by B, Figure 1. Test for grounds and shorts. Fold insulation papers down and in-

Figure One

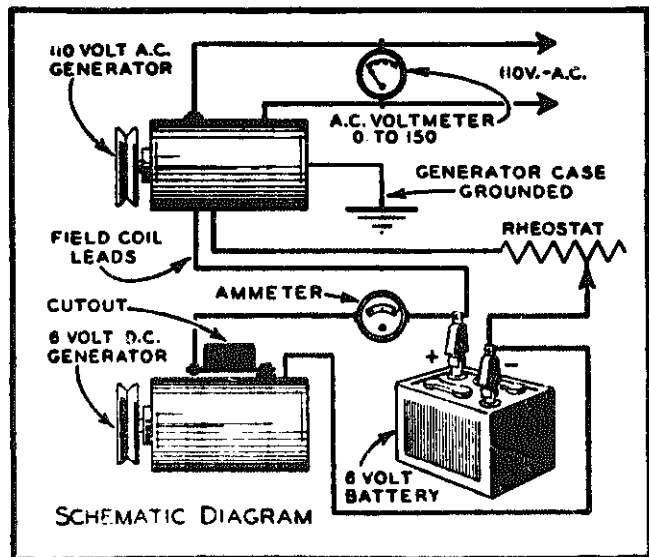
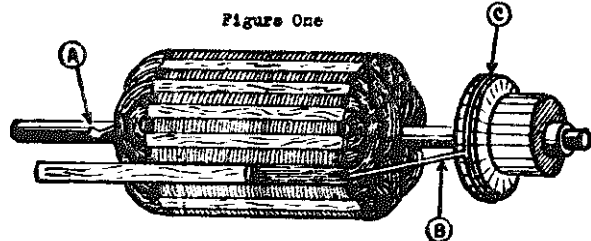

For 110 volt output, connect to generator frame and terminal post. The A. C. generator can be turned in either direction. 60 cycles is obtained at 1800 r.p.m.

153A—Complete kit for rewinding Dodge 12 volt generator to 110 volt A.C. constant speed including the following list of parts:
2½ pounds of 35 heavy Formvar magnet wire,
7½ pounds of No. 17 plain enamel magnet wire,
1 roll ¼" cotton tape.

- 25 wooden slot wedges.
- 25 insulation papers for slots.
- 1 can special air drying varnish.
- 1 commutator brush.

Above kit complete, F.O.B. (See catalog for price).

NOTE: After winding field coils for Dodge generator be sure to shape the coil to fit before varnishing.

Plan 12

A "B" Eliminator For Your Battery Operated Radio

"B" eliminator for your battery radio. Makes your radio All Electric and operates entirely from a 6 volt battery. No. B or C batteries needed.

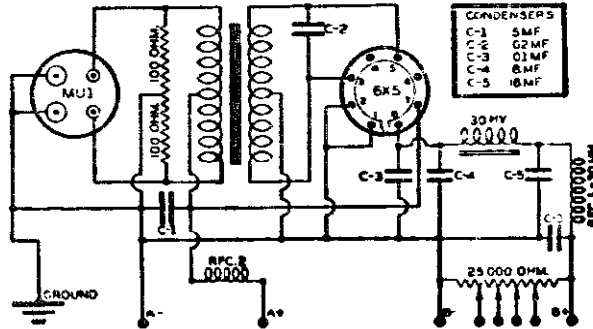

First secure the following list of parts: Line cord, line switch for off and on, one-punched and drilled chassis base, one-6 volt power transformer, one-8-16 m.f.d. electrolytic filter condenser, one-30 ohm filter choke, one-8 prong tube socket, one-4 prong vibrator socket, one-.5 m.f.d. 200 volt bypass condenser, two-.01 m.f.d. 600 volt bypass condenser, one-.02 m.f.d. 2,000 volt buffer condenser, one-30 ohm RF choke RFC1, one-fuse holder, one-6 lug terminal strip, one-Electrad 25,000 ohm adjustable voltage divider, two-100 ohm resistors ½ watt, one-Mallory MUI vibrator and one-Raytheon 6X5 tube. Some radio hook-up wire, solder, miscellaneous bolts and nuts, etc., will also be needed.

RFC2 consists of 40 turns of No. 16 enameled wire, coil wound to ¼" in diameter.

Inasmuch as this eliminator has not been designed for your particular radio, it may hum a little; in such case try additional bypassing by connecting an additional 8 m.f.d. 300 volt condenser in parallel with C4 or C5, or both.

CAUTION: As far as operation of eliminator is concerned, polarity of battery makes no difference but be sure to connect the grounded side of eliminator to terminal post on battery that formerly was connected to negative "B".

Plan 13

An Automobile Generator Booster Control

A generator booster control for your automobile generator when operating the car radio, hot water heater, etc. Boosts the charging rate for these extra loads without third brush adjustment. Also cuts down generator for daytime driving if battery is fully charged.

INSTALLATION: On the average automobile generators the field coils are hooked in series with one side grounded to generator frame and the other side going to regulating brush as shown in diagram. Disconnect the lead that goes to generator frame and to this lead connect one lead of the LeJay Control or any other suitable control. Punch a hole through generator brush cover and run lead to control through this hole. Mount control on instrument panel or other suitable place, then return other side of control to generator frame to a point on generator frame that is most convenient. A simple and efficient way of assembling would be to use stranded rubber covered wire encased in a copper shield. The isolated wire going from control to field lead while the shielding itself is connected to generator frame and other side of control. This hook-up applies to all generators regardless of number brushes used or their positions.

Move adjustable brush to a point of highest charging rate, then

adjust output of generator with the LeJay Control. A 2 ohm, 25 watt variable rheostat is suited for this control.

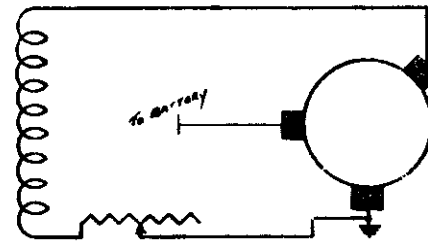

No. SW3L—The LeJay Control including 5 feet copper shielded wire, mounting nuts and knobs. (See catalog for price)

Plan 14

A 6 Volt Slow Speed Generator from Stand. 14 Slot 28 Bar Generator

Changing the Chevrolet, Ford A. Pontiac, Plymouth and all other 14 slot 28 bar Autolite or Delco-Remy generators into 6 volt, slow speed for direct drive; will start to generate about 420 r.p.m. and deliver up to 16 amperes.

DIRECTIONS

Remove old windings from armature and clean slots thoroughly. Cut insulation papers 2x3½ inches. 14 pieces in all. Put one piece in each slot.

Now hold armature in your hand with commutator next to you; number each bar and each slot with white chalk. Slot 1 will be directly above bar 1 as shown in diagram on other side.

Use No. 20 heavy Formvar wire and as there will be two wires in each winding we will call them wire No. 1 and wire No. 2 for identification. Connect wire 1 to bar 5 and wire 2 to bar 6. These connections to be made temporary as they will be soldered later—wire can be held in place by means of a rubber band wrapped around the commutator or can be driven into the risers by means of a hammer and small blunt chisel or screwdriver. Now run both wires through slot 1 and back through slot 7, return to slot 1 again and wind in a total of 12 turns. On the last turn, run wire 1 to bar 6 and wire 2 to bar 7 as shown in diagram. Cut wires off but be sure to bend a kink in wire 2 to identify it, then fold ends out of slot 7 temporarily.

Now start second coil by connecting wire 1 to bar 7 and wire 2 to bar 8. Run them together through slot 2 and back through slot 8, again placing in 12 double turns, then extend to bars 8 and 9 and cut off, making a kink in wire 2 for identification as before. Also fold ends out of slot 8 as you did when finishing previous coil. Continue on in like manner until you have wound all 14 double coils. When winding the 7th and following coils, you will be winding into slots which already have wire in them. It may be necessary to press this wire down to make room for all the turns. This can be done by pressing with a wedged shaped wood or fibre slab. After each slot which contains parts of two coils is filled, the tail end wires which were left folded back out of slots will now be placed back, paper folded down and the wooden slot wedges inserted. Continue on until all 14 slots are filled and closed.

Next place a moon shaped paper over the ends of the coils on the commutator end of the armature, then lay the tail end wires down into their proper commutator bars. Wrap a few turns of string around these wires close to the bars for purpose of holding the wires in place and to prevent solder from dropping behind the bars. Solder wires to bars using a heavy soldering iron to properly sweat the solder to heavy copper risers.

Test the armature for grounds and shorts, saturate with good non-conducting insulating varnish and allow to dry. No changes are necessary in the field coils.

Should the generator show excessive arcing at the brushes or show a tendency to charge only at low rates, advance the control brush to fullest extent. Then remove the through bolts which hold the generator together, also the pin which holds the end bell in place, and shift the entire end bell to the position at which best results are obtained—this to be done while generator is turning at a speed from 750 to 1000 r.p.m. New holes will then have to be drilled to take the through bolts and end bell pin. The maximum output can then be controlled by means of the control brush, but if this method is used the cut in speed will be raised somewhat.

A well made propeller 6 feet long will run this changed generator as fast as necessary in the average wind to charge well. Lubricate as you do your car generator.

Listed below are supplies for making the above change. These materials are offered at the following low prices. All supplies are fully guaranteed.

- | | |
|-------------|---|
| Part Number | Article |
| 204— | Complete kit for rewinding the Chevrolet and other 28 bar, 14 slot generators as above described. |
| | 1½ pounds No. 20 heavy Formvar wire (two wires). |
| | 1 can air drying varnish. |
| | 14 wooden slot wedges. |
| | 14 insulation papers. |
| | 2 fiber end laminations. |
| | Scotch tape for laminations. |
| | 3 new commutator brushes. |
| | 1 end insulation paper. |
| 205— | Above 204 kit, less brushes. (See catalog for price). |
| | Complete above kit postpaid. (See catalog for price). |

Plan 15

A 32 Volt Constant Speed Generator made from Ford 'T' Generator

Changing the Ford Model "T" generator into a 32 volt Constant Speed generator that will deliver 5 amperes at 1250 r.p.m.

DIRECTIONS

First secure an old model "T" Ford generator that has good field coils (field coils are the stationary coils), good commutator and good bearings. It is not necessary to get a new generator for this change. Remove the gear and take generator apart. By using a screwdriver carefully you can pry the wires out of the commutator risers (be sure not to use too much force which will harm the commutator), then push out all old wedges that are holding old windings in place. Remove wire and clean slots thoroughly.

Next take insulation material .007 thickness and cut into pieces $2\frac{1}{2} \times 1\frac{1}{2}$ inches, 21 pieces in all. Put one piece in each slot. This size paper will extend a little above the slots which will later be folded over when wedges are put in to protect the new windings.

Now hold the armature in your hand with the commutator next to you and number each commutator bar with white chalk, 21 bars in all. Use No. 22 heavy Formvar magnet wire.

Connect wire to bar 1. This connection is just temporary as it will be soldered later, so the wire can be held in place by means of a rubber band wrapped around the commutator, or it can be driven into the riser of the bar by means of a hammer and small blunt chisel or screwdriver point. Now run wire out through slot 3 and back through slot 8—return to slot 3 again, and place in a total of 35 turns. On the last turn, run wire to bar 11 as shown in diagram. Cut this wire off and fold tail end out of slot 8 temporarily.

Now start with bar 2, go out through slot 4 and back through slot 9, again winding in 35 turns. Lead wire to bar 12 and cut off, again folding tail wire end out of slot. Continue on in like manner until all 21 coils have been wound. When winding the 6th and following coils you will be winding into slots which already have wire in them. It may be necessary to press this wire down to make room for all the turns. This can be done by pressing with a wedge shaped wood or fiber slab. After each slot which contains parts of two coils is filled, the tail end wire which was lifted out will be placed back, the paper folded down and the wooden slot wedge inserted. Continue on until all 21 slots are filled and closed.

Now lay a moon shaped paper over the ends of the coils on the commutator end, and lay the tail end wires down, connecting them

to their proper bars. Wrap a few turns of string around these wires close to the bars to hold the wire in place and to prevent solder from dropping behind the bars. Now solder the wires to the bars, using a heavy soldering iron to properly sweat the solder to the heavy risers. Test the armature for grounds and shorts, saturate with insulating varnish and allow to dry. Make four new field coils, winding each with 300 turns No. 23 p.e. Connect in series.

Listed below are supplies for making this 32 volt change. These materials are offered at the following low prices and are fully guaranteed.

| Part Number | Article |
|-------------|--|
| 32A | Complete kit for rewinding your own Ford "T" generator to 32 volts Constant Speed. |
| | 1 1/2 pound No. 22 heavy Formvar magnet wire. |
| | 1 1/2 pounds No. 23 P.E. magnet wire. |
| | 1 roll cotton tape for field coils. |
| | 1 complete set new brushes. |
| | 2 fiber end laminations. |
| | Scotch tape to hold end laminations. |
| | 1 can special air drying varnish. |
| | 21 wooden slot wedges. |
| | 21 insulation papers .007 thickness. |
| | 1 end insulation paper. |
| | Above kit complete; weight 4 1/2 lbs. (See catalog for price). |
| 32X | Kit 32A as above, less brushes. (See catalog for price.) |

FOR SLOWER CUT-IN SPEED

Wind new field coils winding 600 turns No. 25 P. E. wire per coil. The first and third coils will be wound in one direction and the second and fourth are to be wound in the opposite direction. It will be necessary to wind these on a form. After the coils have been removed from the form, wrap with cotton tape, shape, saturate with insulating varnish and allow to dry. (Be sure to shape coils before varnishing.) The coils may be shaped by installing them into the shell before varnishing, then remove and varnish. Assemble finished coils in shell, connect in series and test for polarity. Assemble the generator as it was before, with brushes in their proper position. It might be well to mark the position of the brush rigging before removing it if this is found necessary.

Connect generator terminal to main insulated brush. Connect one field lead to control brush and other field lead to main grounded brush. Run generator for a moment as a motor, if it rotates in clockwise direction, leave connections as they are. If it rotates in counterclockwise direction, simply reverse field lead connections. Lubricate as your car generator.

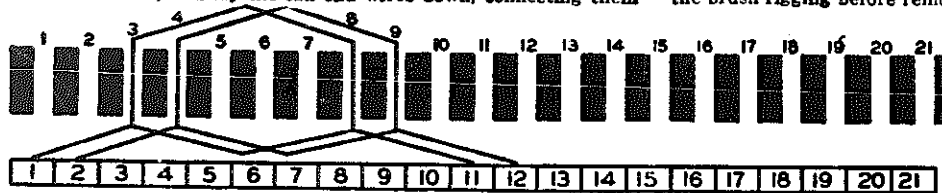

Plan 16

A 2 Volt Slow Speed Generator from Stand. 14 Slot 28 Bar Generator

Changing the Chevrolet, Ford "A", Pontiac, Plymouth and all other 14 slot, 28 bar Autolite or Deico-Remy generators into 2 volt slow speed for wind propeller direct drive; starts to generate about 350 r.p.m.

DIRECTIONS

It will be necessary to follow plan 14 to make this change, and plan 14 may be followed in detail except that the armature will be wound with 10 double turns of No. 19 heavy Formvar magnet wire per coil. No changes are to be made in the fields.

The following are supplies for making this 2 volt change, and these materials are offered at low prices. All supplies are fully guaranteed.

| Part Number | Article |
|-------------|---|
| 22 | Complete kit for rewinding the Chevrolet and other 14 slot, 28 bar generators into 2 volts slow speed as above described. |
| | 1 1/2 pounds No. 19 heavy Formvar magnet wire. |
| | 1 can special air drying varnish. |
| | 14 wooden slot wedges. |
| | 14 insulation papers .007 thickness. |
| | 2 fiber end laminations. |
| | Scotch tape for end laminations. |
| | 3 new commutator brushes. |
| | 1 end insulation paper. |
| | Complete above kit, postage paid.....\$2.25 |
| 22X | Kit 22 as above, less brushes, postpaid..... 2.10 |

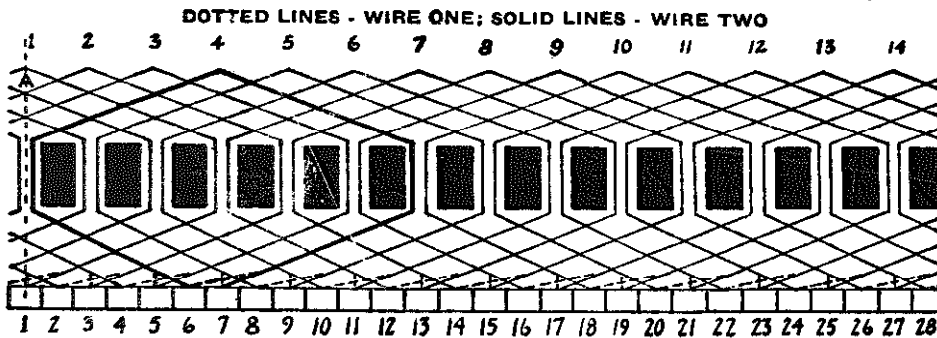

Plan 17

How To Convert A 6 Volt Cut-Out for 2 Volt Operation

Directions for making a 2 volt cutout from the standard 6 volt auto cutout: First test cutout and make sure that it works satisfactorily on 6 volts, then remove cover and by using a soldering iron you will be able to remove the heavy winding. Remove this winding with care as it has to be replaced later into same position as before removed.

After the heavy winding is removed you will find a layer of insulation paper which is wrapped over the first winding or potential coil. This potential coil is now wound for 6 volts and it is this coil

that has to be changed so cutout will close at 2 volts. Remove all the wire from this winding, then measure the entire length. Note that 2 volts is just 1/3 of 6 volts, it will be necessary to cut this wire into 3 equal lengths—make a 3 strand cable of these 3 pieces by soldering the ends together at the start. Rewind this cable onto core and finally join the 3 outer ends by soldering, then be sure to connect as before. After this 3 wire cable is replaced, insulate same as it was before, then replace the heavy winding and the cutout will work on 2 volts in place of 6 volts. This cutout is designed for those who wish to charge their 2 volt radio battery.

Plan 18

Directions For Repairing Your Own Batteries

Pour out old acid. Be careful not to spill on clothing or wood. If any is spilled, its action can be neutralized by covering with baking soda.

(a) Next bore a slight depression on center of spot where strap is connected to each terminal, using a $\frac{1}{8}$ " drill. Pry off straps with screw driver. If strap refuses to loosen, bore a bit deeper. It should not be necessary to bore any deeper than thickness of strap.

(b) Next fill battery with hot water and allow to stand until sealing compound is loosened. Pull out the elements, using two pairs of pliers. If the elements refuse to pull out, dump water and fill again with hot water. It will also help to pour hot water over cover and prying out the compound with a narrow screw driver. After elements are removed scrape off remaining sealing compound from box and cover, putting this in an old coffee pot with the spout narrowed for easy pouring. Clean out sediment.

(c) Now remove the nuts from around the posts and take covers off the elements. Remove separators and positive and negative plates will come apart in groups very readily. Examine plates and remove all loose filler. Remove all used-up plates. Wash off separators, examine for breakage and place in container filled with water to keep moist; if allowed to dry they may crack.

(d) Next cut slots in connecting strap to take the lugs off the new plates. Place unit in burning rack (see sketch). Now place new plate with lug in slot provided for it. Burn in with burning torch or small welding outfit. It would be well to practice this on ruined plates first.

(e) Next assemble with ridged or corrugated side of separator facing positive (brown) plate. Care must be taken so the posts are placed proper distance apart, otherwise it will be difficult to put the cover back on. Place flat board on each side of unit and squeeze in vice. You are now ready to assemble the units in the case. Note carefully to which post the brown or positive plates are fastened.

(f) Next put groups into boxes, placing the first group in the first box with the positive post to the right. Place the other unit with positive post to right. Put on gaskets, covers and nuts. Lay the straps over their respective posts and burn in. If you are using groups of mixed new and old plates, fill battery with iron free water and charge until terminals show from 2 to $2\frac{1}{4}$ volts. Dump out the water.

(g) Mix your new electrolyte to 1.280 specific gravity (hydrometer reading) being careful to pour acid into the water. If water is poured into the acid it will cause excessive heat and break the container in which the solution is being mixed. The mixture may also boil over, causing a loss of valuable acid.

(h) See that box covers are thoroughly dry and pour molten sealing compound around covers. If covers are not dry the compound will not stick to them. Pour in new electrolyte. Let stand for 3 or 4 hours and then charge at 5 amps. until terminal voltage is 2.5 volts per cell or until battery bubbles freely. Your battery is now ready for service.

(i) For lead burning a handy auxiliary tool is an iron or steel rod about 6 inches long, pointed and then flattened at the tip. This

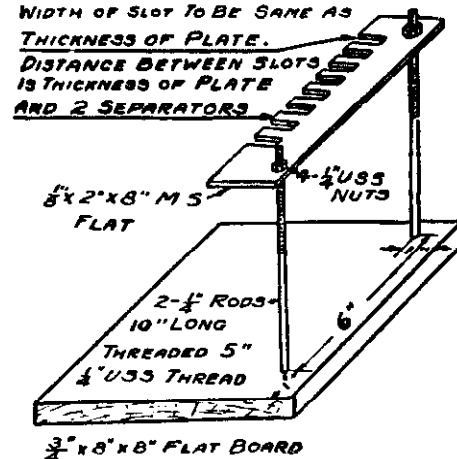

may be used when lead is at melting point to stir in order to prevent oxidation of lead and insure a more perfect bond.

(j) For ease in handling the additional lead which may have to be used at the joints, melt up all the old scrap lead you have and pour it into moulds, forming the lead into strips about $\frac{1}{4}$ inch wide and about $\frac{3}{8}$ inch thick and as long as is handy. These strips may also be fastened to plate lugs if it should be necessary to increase their lengths. These moulds may be made of clay which afterwards have been allowed to dry. Another type may be made by laying the two pieces of steel on another flat piece of steel, laying the two pieces the desired distance apart and plugging the ends.

(k) Useful hints and things to remember: Always keep your work clean. You are working with acids and foreign substance in a battery cell will cause ruinous chemical reaction. Always use water that is free of iron. Use sulphuric acid of 1.835 S. G. This may be furnished by us or by any drug store. Never pour the water over the acid in mixing the electrolyte. Pour the acid into the water.

(l) In rebuilding farm light batteries, a rubber band cut from an automobile tube may be used for binding the plates together when the old method of binding as used in some batteries has decayed. A permanent burning rack may be built by following the sketch.

Plan 19

A Water Wheel Made From Old Automobile Wheel

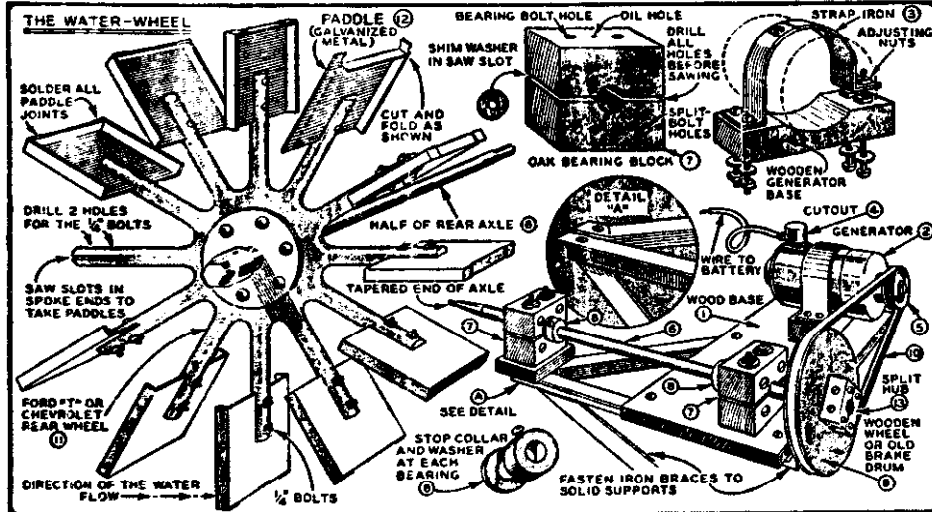

Building a Water Wheel suitable for running auto generators for light plant use. Generator can be either rewound for slow speed such as wind generators or left in original condition—depending upon flow of stream and equipment available.

Since water weighs 62½ pounds per cubic foot and a horsepower equals 33,000 foot pounds, then to figure the horsepower in your stream follow this rule. First figure out the number of cubic feet of water that flows per minute, then multiply this figure by 62½. Now multiply the product by the distance drop in feet and then divide your answer by 33,000 and you will get the exact horsepower rating of your stream.

DIRECTIONS

Take a flat 1" board (No. 1), 12x18, braced across bottom. On this board mount auto generator (No. 2) by means of hold-down strap (No. 3), a metal strap $1\frac{1}{2}$ " wide, secured to board by machine bolts through holes in strap and board. The generator is to be equipped with a cutout (No. 4) and belt pulley, "V" type (No. 5). Mount a Ford or Chevrolet rear axle shaft (No. 6) with hub and wheel but no rim (No. 11) to the board by means of wooden block

bearings (No. 7), the end motion of the shaft being taken up by stop collars (No. 8) drilled and tapped for $\frac{1}{4}$ " set screw. Drill all holes in the top half of bearing. The bearing blocks to be made of hardwood. On end of shaft opposite from hub, press on wooden or metallic wheel (No. 9) of a diameter from 3 to 4 times that of the generator pulley. A Vee belt (No. 10) will stay on this pulley, which may also be a brake drum mounted on a split hub (No. 13), with appropriate bolts for tightening hub to shaft.

The water wheel (No. 11) is built up by removing the rim from the wheel and sawing a slot down to desired depth crosswise of the wheel. To this is mounted the paddles (No. 12) as shown, by means of two machine screws, the paddle being made of fairly heavy sheet metal with one side of two corners cut, the edges turned up on the dotted line and the corners soldered.

The size of the paddles being determined by the size of the flume or stream. For an over-shoot wheel the paddles will be reversed. Where the water power is derived from water under pressure and flowing through a pipe, a nozzle may be fitted to the pipe and cups substituted for the paddles on the wheel.

Plan 20

An Electric Outboard Motor from Old Ford 'T' Generator

Easily done in a few hours time. Runs from 8 to 12 hours on standard 6 volt storage battery. Low cost, light weight, silent and variable speed.

First secure a model "T" Ford generator. If the bearings, brush holder, brushes, commutator or other parts are badly worn they may be replaced by purchasing from us—see catalog for parts list. Remove gear and take generator apart. By using a screw driver carefully pry wires out of commutator risers (be sure not to harm commutator), then push out old wedges holding old winds in place. Remove wire and clean slots thoroughly.

Next take insulation material .007 thickness and cut into pieces $2\frac{1}{2} \times 1\frac{1}{2}$ inches 21 pieces in all. Put one piece in each slot. This size paper will extend a little above the slots which will later be folded over when wedges are put in to protect the new windings.

Now hold the armature in your hand with the commutator next to you and number each commutator bar with white chalk. 21 bars in all. Use No. 16 heavy Formvar wire (two strands of wire in hand when winding), solder ends of both wires to bar 1 (a large soldering iron will be necessary for this operation in order to sweat the solder to the heavy copper segments), then run both wires through slot 3 and back through slot 8—return to slot 3 again and place in 4 turns, then from slot 8 solder both wires to bar 11 as shown in diagram. You now have completed one coil.

Next solder both wires to bar 2 and run through slot 4 and back through slot 9 as shown. Here wind in 4 turns also then from slot 9, solder both wires to bar 12 as shown in diagram below. Continue on in like manner until all 21 coils are in place. 4 turns of two wires to each coil.

Fold insulation paper down in slots over wire and insert wooden wedges. Next test each coil for grounds and shorts. Use a non-conductor varnish and soak armature well and allow to dry—repeat two or three times, allowing to dry each time.

Next remove all 4 field coils. Use No. 18 P. E. wire, two strands in hand and wind 4 field coils to same size and shape as coils just removed. Wind these coils carefully, winding 57 turns per coil. Tape, shape, then varnish. Connect all field coils in parallel, see Fig. 2. "Schematic Connection Diagram." The two main brushes are only brushes used, thus eliminating control brush. Connect one field lead to generator terminal and other field lead to main ungrounded brush. Other main brush is already grounded. Be sure to use best brushes obtainable. Connect 6 volts to generator frame and generator terminal. Polarity has no effect. If motor runs in wrong direction then reverse the two field leads. Lubricate as you do your car generator.

Listed below are supplies for making this change which are offered at following low prices. All supplies fully guaranteed.

Part Number Article
 0-1618—Complete kit for rewinding your own Ford "T" generator to a 5 volt outboard motor.
 1 1/2 lbs. No. 16 heavy Formvar magnet wire.
 2 lbs. No. 18 P. E. magnet wire.

- 1 roll cotton tape.
- 2 copper carbon brushes.
- 2 fibre end laminations.
- Scotch tape to hold laminations.
- 1 can special air drying varnish.
- 21 wooden slot wedges.
- 21 insulation papers .007 thickness.
- Above kit complete, shipping weight 5 lbs., F.O.B. (See catalog for price.)

0-1620—Set of two copper carbon outboard motor brushes postpaid.....(See catalog for price).

FACTORY WOUND ARMATURE AND FIELD COILS

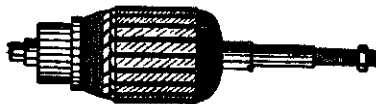

Assemble your own motor without doing the rewinding work. Use a factory rewound armature and LeJay factory made field coils. Will work in any "T" generator.



0-18—Set of 4 special LeJay field coils for 5 volt outboard motor. Ship. wt. 3 1/4 lbs. F.O.B.....(See catalog for price).

0-16—Ford "T" factory rewound and reconditioned armature for 5 volt outboard motor. Shipping weight 6 lbs. F.O.B. Minneapolis; exchange price.....(See catalog for price).

FACTORY BUILT MOTOR FOR OUTBOARD

5 volt motor for outboard built from "T" generator including rewound and reconditioned armature, new brushes, new field coils grease sealed bearings, etc. Especially designed for outboard motor use.

0-48—Shipping weight, 17 lbs. F.O.B. (See catalog for price.)

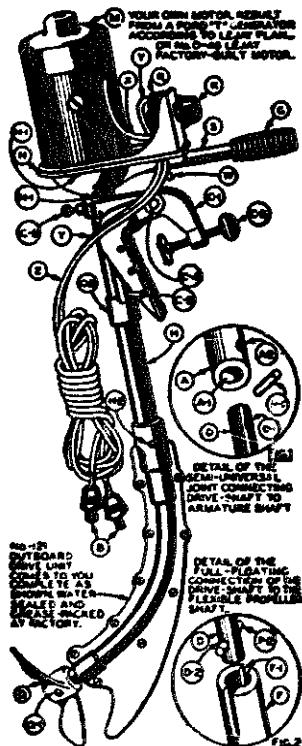
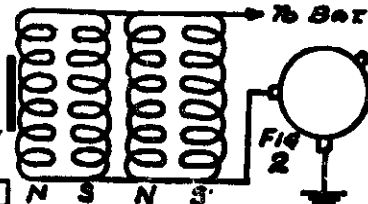
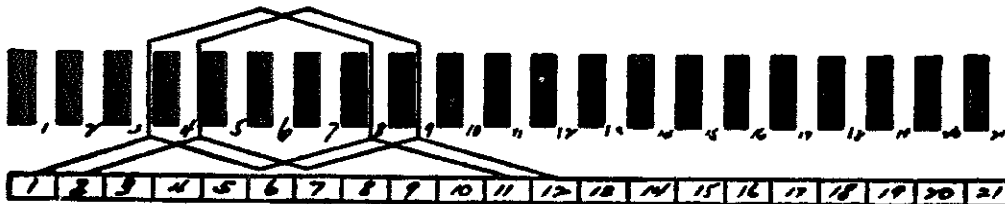

ELECTRIC OUTBOARD IN KIT FORM

The information above shows in detail how to rewind a "T" generator into a motor suitable for this kit. After completing the motor it will be necessary to drill a 1/8" hole A1 Fig. 1 into end of armature shaft A to a depth of 1/2". The 1/4" drive shaft D Fig. 1 will then fit into hole A1 loosely and held in place by pin P1 or rivet which is inserted through armature gear pin hole A2 and shaft hole D1 thus making a perfect semi-universal coupling. Fig. 2 shows how lower end of drive shaft fits into upper coupling of flexible shaft assembly No. 121.

PRICE LIST

- B—Battery clips. Included with Y and Z.
- C1—Main clamp casting. Ship. wt. 5 oz. F.O.B.\$1.88
- C2—Tube clamp casting. Ship. wt. 5 oz. F.O.B. 1.70
- C3—Clamp screw assembly. Postpaid..... .49
- C4—A"x2 1/4" bolt and nut. Postpaid..... .15
- C5—1/4"x2 1/4" rod bent 90° from end at right angles with hole and cotter pin in other end. Postpaid15
- C6—1/4"x1 1/2" thumb screw..... .12
- D—Drive shaft 13"x3/4". Pin hole D1 drilled with 1/8" drill 1/2" from end. Pin hole D2 drilled with 1/8" drill 1/2" from end so pin P2, which is 1/8" rod 1/2" long, will fit snug. Rod complete. Postpaid..... .73
- G—Rubber grip. Postpaid..... .24
- H—Housing 1" O. D. 1/4" wall X 13 1/4". Ship. wt. 1 pound F.O.B..... .66
- H1 and H2—Nickel plated oval head brass 10/32 screws X 1/2". Postpaid..... .29
- K—Rheostat knob. Included with R.
- M—5-Volt Factory built motor. Same as 0-48 in catalog. Ship. wt. 17 lbs., F.O.B.....(See catalog for price)

- N—Casting machined to take housing H, motor M, rheostat R, and steering handle S. Ship. wt. 2 lbs., F.O.B..... 1.68
- N1—Oval head brass nickel plated 10/32 X 1" screws for holding motor M to casting N. Postpaid29
- P1—Soft iron rivet 1/4"x1/4". Postpaid..... .06
- P2—Pin 1/4"x1/4". Postpaid..... .06
- Q—Special cast propeller. Ship. wt. 1 lb. F.O.B. 4.70
- Q1—Oval head brass nickel plated 10/32 propeller bolt and nut. Postpaid..... .06
- R—Rheostat complete with knob..... (See catalog for price)
- S—Steering handle 5/8" piece of 1/2" O.D. tubing with a 1/4" hole drilled 1 1/2" from the end to take holding bolt and wing nut W.18
- W—1/2" wing nut and bolt. Included with S.
- X—One 5-foot length of No. 8 stranded rubber covered flexible wire connecting to either battery post and direct to motor terminal. Includes battery clip B..... .48 (Make this ground connection under bolt head W.)
- Z—One 5-foot length of No. 8 stranded rubber covered flexible wire connecting to other battery post then to other terminal on rheostat. Includes battery clip B..... .48
- No. 121—Complete flexible shaft drive assembly sealed and greased at factory. Flexible shaft housed in special casting. Does not include propeller Q or bolt Q1. Comes all assembled and includes the two holding bolts H2. Ready to fit into housing H. Is not sold in parts..... 14.78

Plan 21

A Gas Engine or Motor Driven Generator with Drawings In Detail

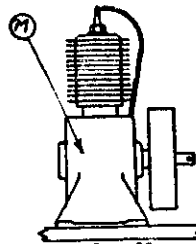
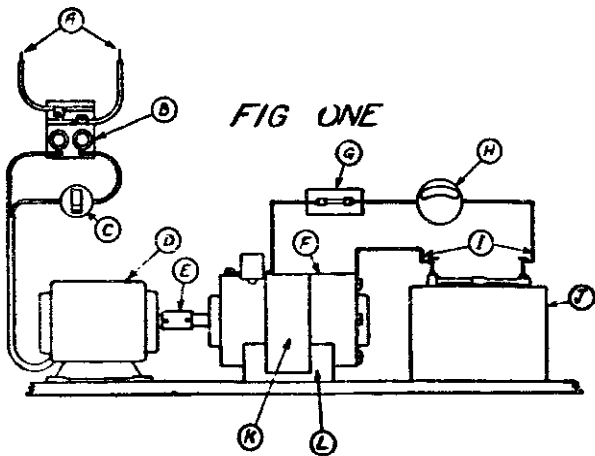

Directions for Fig. 1

- A—Connect to electric line wires.
- B—Line fuses.
- C—Line switch.
- D— $\frac{1}{4}$ H.P. driving motor with counter clockwise rotation; or, if the motor has a shaft on each end, then be sure to use the end that rotates counter clockwise.

E—Common garden hose from 2 to 4 inches in length. Drill $\frac{1}{4}$ " holes through the shaft at a point $\frac{1}{4}$ " from shaft ends. Now make corresponding holes in rubber hose and mount with stove bolts through holes as shown in diagram, after both shafts are in alignment. F—6 volt automobile generator with cut-out. G—20 ampere automobile fuse. H—Automobile dashboard type ammeter. I—Connecting wires from generator to storage battery. Wire coming from the cut-out is to be run to one side of the fuse mounting; from opposite side of fuse mounting run wire to one terminal in back of ammeter; from other ammeter terminal fasten a piece of wire which has a shingle-nail soldered to under part of head—said nail to be slightly driven into one terminal of the battery. Make up a similar connection of nail and wire and connect from other battery post to a bolt on generator frame. Now the generator polarity must be determined (from local garage man) and the battery connected accordingly. When in operation, if the ammeter reads discharge, simply reverse the two wires on back of ammeter. All connecting wires should be no smaller than No. 14 and of rubber covered insulation. J—6 volt storage battery. K—Metal hold down band over generator. L—Generator mounting block. M—Gas engine which can be used in place of motor and should be coupled in same manner. Generator can also be run with belts and pulleys if necessary.

Plan 22

An Armature Growler for Testing Auto or Slow Speed Armatures

First secure the shell and fields of a Ford "T" generator and make sure that at least two of the field coils are in good shape. Mount the generator shell into a vise and cut the shell into two parts with two field poles in each half. A hack saw may be used for cutting.

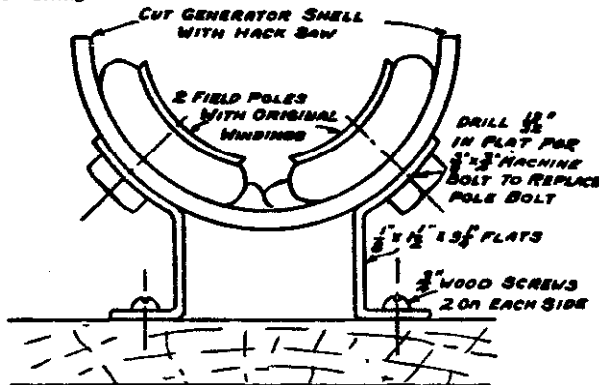

Make two legs for the growler, using two pieces of $\frac{1}{4}$ " x $1\frac{1}{2}$ " x 3" long pieces of flat steel. Bend as shown in sketch and drill one hole to take pole bolt, drill two smaller holes in feet to take wood screws. Remove the two pole bolts and bolt on these legs, using $\frac{1}{4}$ " x $\frac{1}{4}$ " machine bolts. A hammer and punch may be necessary to loosen

the original pole bolts. If you are using the field coils which are already there, do not disturb the connection. If you are forced to substitute other field coils to replace those that are damaged, be sure that they are of opposite polarity. Connect the leads as shown with the auto starter switch in series with one lead. A door bell button may be substituted for the starter switch.

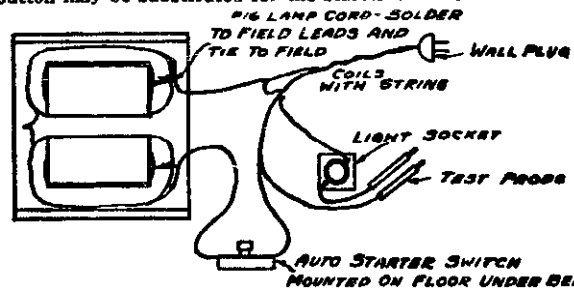

The test lamp need not be connected to the growler leads, but this may be necessary where only one wall receptacle is available. The test probe are made of two pieces of No. 6 or No. 8 wire soldered to the ends of the leads, and insulated to about one inch from the ends by means of fibre or rubber tubing, or wrapping with friction tape.

This growler is to be used on AC only and for best results use common reflector heater element (200 watt to 250 watt) in series with growler input. If used continually this growler will get hot. Not made for production work.

Plan 23

Two 32 Volt Series Motors Made from Dodge 'G' or 'GA' Generator

23A—32 VOLT SERIES MOTOR

This motor will turn up to 2700 R.P.M., the speed depending on the load, with 10 amps. starting load and 4 amps. running load, at no power load. If higher loads are put on the motor, the amperage will increase up to a maximum of 22 amperes, which is the stalling point of the motor.

To make this change, only the shunt windings of the generator fields are used, no change being made on the armature or brushes, other than removing the control brush and grounding one of the other two brushes. Field coils to remain in series connected.

Now connect one field to positive terminal on battery. Connect other field lead to ungrounded brush, then connect other battery terminal (negative) to generator frame. To reverse direction of the motor, simply reverse the field connections.

23B—32 VOLT HIGH SPEED SERIES MOTOR

This motor requires no new installation of parts or wire. The armature, brush holders and shunt fields (small wire) in the fields are to be tested for grounds and shorts. The series fields (heavy winding) are to be disconnected and allowed to remain on the field poles only for a filter.

Remove the control brush which will not be used. Connect the first and second field coils in series and also the 3rd and 4th. This gives you two groups of two fields in series. Connect the two groups of fields in parallel, and connect in series with the armature. See Fig. 3. There is to be no change made in the armature.

This motor takes 8 amperes at no load and reaches a speed of 4200 H.P.M. It is capable of $\frac{1}{2}$ H.P. at about 1800 R.P.M.

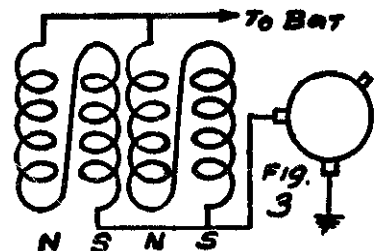

Plan 24

A 32 Volt Heavy Duty Motor made from Dodge G or GA Generator

This motor is capable of high speeds, and because of the large winding in the fields is also capable of handling a heavy load for an indefinite period. Develops $\frac{1}{4}$ H.P. at 1750 R.P.M. Motor especially designed for cream separator or any other machine requiring a great amount of starting torque.

In this motor there is no change made on the armature, and only the two main brushes are used. It is well to have the armature and brush holders tested for grounds and shorts.

Remove original field coils from the generator. Wind 4 new field coils using about $1\frac{1}{2}$ pounds of wire for each coil. Use number 13 P.E. wire and with two wires in hand, wind only 48 turns per coil.

Kit No. 162—Dodge to 32 Volt Series Motor.

Complete kit for rewinding your own Dodge 12 Volt generator into a 32 volt series motor $\frac{1}{2}$ H.P.

$6\frac{1}{2}$ pounds 13 P.E. wire (2 wires in hand).

1 can impregnating (air drying) varnish.

1 roll $\frac{3}{4}$ " cotton tape for field coils.

Cotton sieving for field coils.

Above kit complete, F.O.B. (See catalog for price)

Install the new fields in the motor and connect them in series, with the field connected in series with the armature. See Fig. 4.

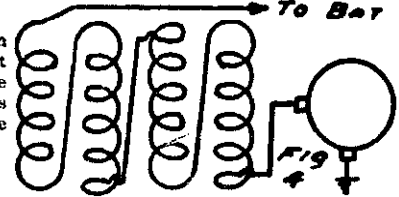

Plan 25

A Bench or Breast Drill for 6, 12 or 32 Volts made from 'T' Generator

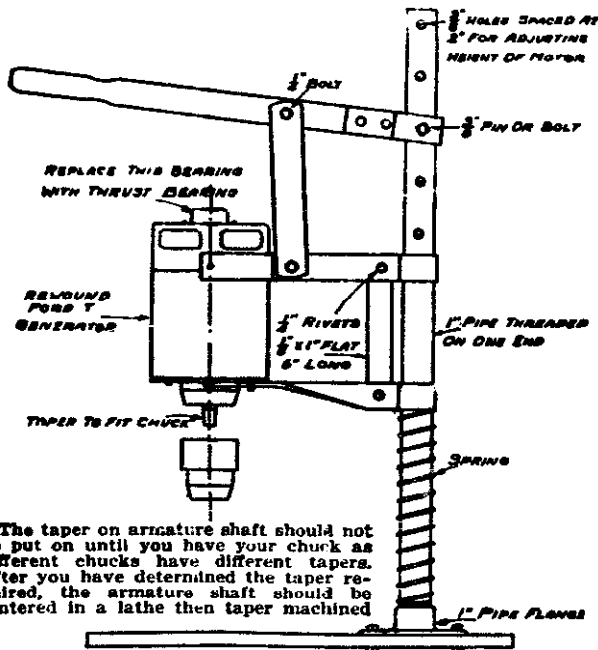

The taper on armature shaft should not be put on until you have your chuck as different chucks have different tapers. After you have determined the taper required, the armature shaft should be centered in a lathe then taper machined

to fit chuck. If you want to use chuck No. 360 listed in catalog then weld a $1\frac{1}{2}$ " length of stock to end of armature shaft. With a lathe turn the shaft to $\frac{1}{2}$ " diameter for a distance of 2" from end then with a $\frac{1}{8}$ " die (24 threads to inch) thread the shaft for a distance of $1\frac{1}{4}$ " from end. This is same chuck used on our factory made drills.

FINISH THESE EDGES AFTER ASSEMBLY TO MOTOR

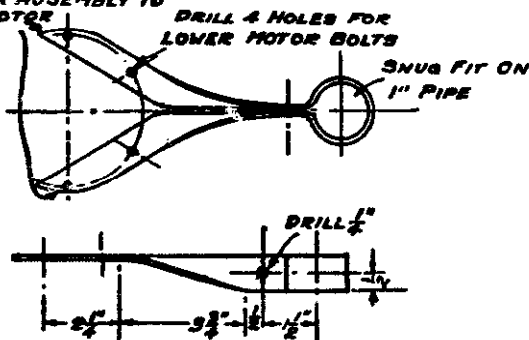

DETAIL OF LOWER BRACE - $\frac{1}{2}$ X 1" - 24" LONG

When the motor is used in either the breast drill or bench drill, it is obvious that the top bearing is to take a considerable thrust. Therefore, we recommend that this bearing should be replaced with a new combination end thrust bearing which can be purchased from us and is No. L.J.Y. (See catalog for price.)

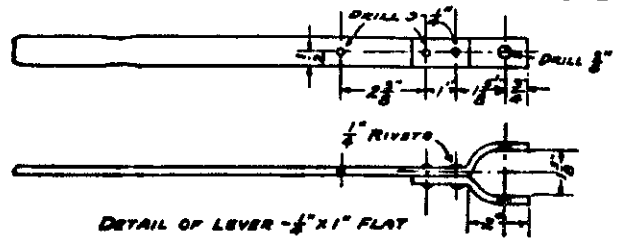

DETAIL OF LEVER - $\frac{1}{2}$ " X 1" FLAT

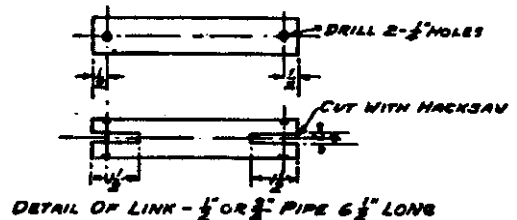

DETAIL OF LINK - $\frac{1}{2}$ " OR $\frac{3}{4}$ " PIPE $6\frac{1}{2}$ " LONG

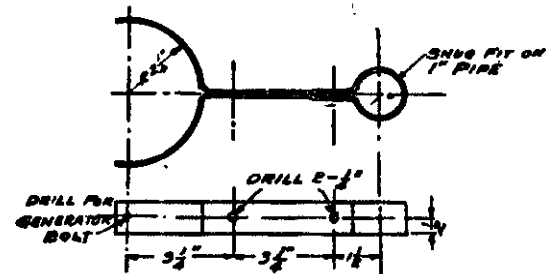

DETAIL OF TOP BRACE - $\frac{1}{2}$ " X 1" FLAT - 24" LONG

Replace This Bearing With Thrust Bearing

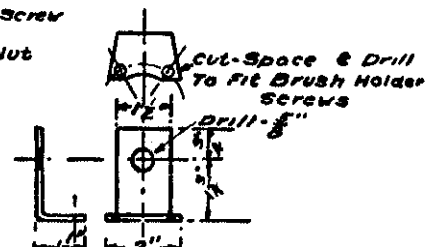
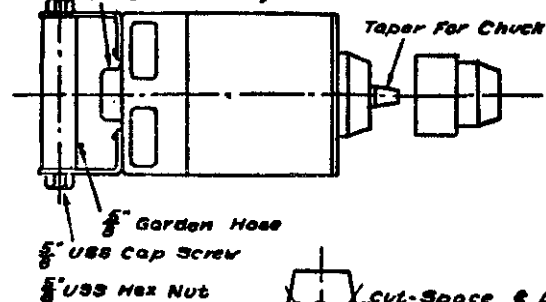

Detail of Handle Brace - 2 Req'd

Plan 26

A 6 Volt Motor for Drill Press, Washing Machines, Etc. made from Model 'T' Generator

First secure an old model "T" Ford generator that has good commutator, good bearings, and a good brush holder. It is not necessary to get a new generator for this change. Remove the gear and take generator apart. By using a screwdriver carefully you can pry the wires out of the commutator risers (be sure not to use too much force which will harm the commutator), then push out all old wedges that are holding old windings in place. Remove wire and clean slots.

Next take insulation material .007 thickness and cut into pieces 2 1/4 x 1 1/4 inches. 21 pieces in all. Put one piece in each slot. This size paper will extend a little above the slots which will later be folded over when wedges are put in to protect the new windings.

Now hold the armature in your hand with the commutator next to you and number each commutator bar with white chalk. 21 bars in all. Use No. 15 heavy Formvar wire (two strands of wire in hand when winding), solder ends of both wires to bar 1 (a large soldering iron will be necessary for this operation in order to sweat the solder to the heavy copper segments), then run both wires through slot 3 and back through slot 8—return to slot 3 again and place in 3 turns, then from slot 8 solder both wires to bar 11 as shown in diagram. You now have completed one coil.

Next solder both wires to bar 2 and run through slot 4 and back through slot 9 as shown. Here wind in 3 turns also then from slot 9, solder both wires to bar 12 as shown in diagram below. Continue on in like manner until all 21 coils are in place. 3 turns of two wires to each coil.

Fold insulation paper down in slots over wire and insert wooden wedges. Next test each coil for grounds and shorts. Use a non-conductor varnish and soak armature well and allow to dry—repeat two or three times, allowing to dry each time.

Next remove all 4 field coils. Use No. 18 P.E. wire, two strands in hand and wind 4 field coils to same size and shape as coils just removed. Wind these coils carefully, winding 57 turns per coil. Tape shape, then varnish. Connect all field coils in parallel, see Fig. 2 and "Schematic Connection Diagram." The two main brushes are only brushes used, thus eliminating control brush. Connect one field lead to generator terminal and other field lead to main ungrounded brush. Other main brush is already grounded. Be sure to use best brushes obtainable. Connect 6 volts to generator frame and generator terminal. Polarity has no effect. If motor runs in wrong direction, reverse the field leads. Lubricate as you do car generator.

Listed below are supplies for making this change.

- | Kit No. | Article |
|---------|--|
| 164 | Complete kit for rewinding your own Ford "T" generator to 6 volt motor suitable for bench drill, washing machine, etc. |
| | 1 1/2 lbs. No. 15 heavy Formvar magnet wire. |
| | 2 lbs. No. 18 P.E. magnet wire. |
| | 1 roll cotton tape. |
| | 2 copper carbon brushes. |
| | 2 fibre end laminations. |
| | Scotch tape to hold laminations. |
| | 1 can special air drying varnish. |
| | 21 wooden slot wedges. |
| | 21 insulation papers .007 thickness. |
| | Above kit complete, shipping weight 5 lbs. |
| | F.O.B. (See catalog for price) |
| 1620 | Set of two copper carbon motor brushes, postpaid.....\$0.00 |

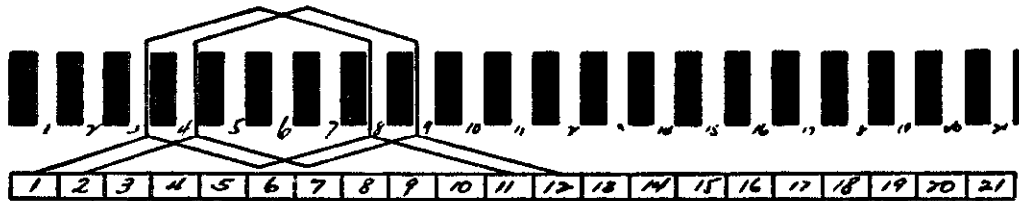
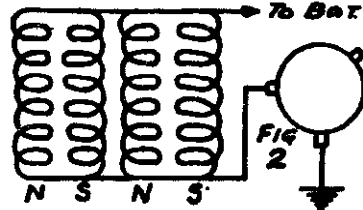

Plan 27

One 12 Volt Motor and One 32 Volt Motor made from Model 'T' Generator

27A—12 VOLT MOTOR FOR DRILL PRESS, WASHING MACHINES, ETC.

Wind armature with 3 turns of 15 H. Formvar with two wires in hand. See diagram in Plan 26. Use original field coils. Field connections changed so only 2 brushes are used—connect one field lead to grounded main brush then other field lead connected to ungrounded main brush. Control brush not used. Also connect ungrounded main brush to terminal post.

Kit No. 165A—"T" to 12 Volt 1/5 H.P. Motor. Includes armature kit complete for making a 12 volt 1/5 H.P. motor like our Model No. 732. Develops 1/5 H.P. at 1800 R.P.M.

- 1 1/2 pounds No. 15 heavy Formvar wire.
- 2 commutator brushes.
- 2 fibre end laminations.
- Scotch tape to hold laminations.
- 1 can impregnating (air drying) varnish.
- 21 wooden wedges for slots.
- 21 insulation papers for slots.
- 1 end insulation paper.

Above kit complete, postpaid..... (See catalog for price)
No. 021—Factory rewound "T" armature for 12 volt motor. (See catalog for price.)

27B—32 VOLT MOTOR FOR DRILL PRESS, WASHING MACHINES, ETC.

Study above 6 volt change to simplify procedure. Wind four new

field coils, winding 400 turns No. 23 plain enamel wire.

There is no change made on armature. Connect the four new coils in series and connect to armature like a shunt motor as shown in Fig. 5.

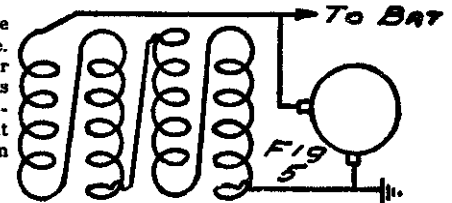

Kit No. 166—"T" to 32 Volt 1/4 H.P. Motor. Armature does not need to be rewound when using this kit. Kit includes field coil materials only. This motor is like our Mod-4 No. 732. Develops 1/4 H.P. at 1800 R.P.M.

- 2 pounds No. 23 plain enamel wire.
- 1 roll cotton tape for field coils.
- 1 can impregnating (air drying) varnish.
- Cotton sieving for field coils.

Above kit complete, F.O.B. (See catalog for price)
Coils 5P used with original armature make a 32 volt motor like our 732. (See catalog.)

Plan 28

Two 6 Volt Generators from the Dodge, Also General Information

25A—6 VOLT SLOW SPEED GENERATOR

This rebuilt generator has a cut-in speed of 350-450 R.P.M. and delivers a maximum output of 35-40 amperes. Original armature and rewound field coils.

Secure a Dodge "G" or "GA" generator with good armature and brushes. Have the armature tested on a growler if possible to make sure that it is in good shape, as the armature in this generator will be used without rewinding.

Next remove the old field coils. A hammer and punch will have to be used to loosen the pole bolts. Clean generator thoroughly with gasoline and allow to dry.

Make new field coils, using 400 turns of No. 18 wire. Wind so that the 1st and 3rd field coils are wound in one direction and the 2nd and 4th coils are wound in the other direction. Wrap with cotton tape, dip in air drying varnish and allow to dry. Install these coils into the shell, drawing the pole bolts as tight as possible, using the hammer and punch to tighten. The coils will shape when drawn tight with pole shoe. Connect the fields in parallel by connecting the starting ends of each coil to one field lead and the finishing ends of each coil to the other field lead. Test for field polarity by connecting a 6 volt battery across the field coils, with armature still removed from the generator. With the battery connected to the fields, pass a pocket compass inside the shell and near each field pole in turn. As the needle passes each pole, the needle will change ends, the north end of the needle pointing to one pole, the south end to the next one, and so on. If any two adjacent poles show the same polarity, one of them should be changed to opposite polarity by reversing the connections of that coil.

Connect one end of the field coils to grounded main brush, then connect other end of field coils to ungrounded main brush. Also connect ungrounded main brush to positive terminal of generator, frame of generator will serve as negative terminal. Control brush and holder may be removed as they are not used.

Assemble the generator and run for a moment as a motor. If it rotates in the direction desired, leave generator as it is. If it rotates in the opposite direction, the direction of rotation can be changed by either reversing the field lead connections or by shifting the end bell ¼ turn in either direction.

A new set of factory made field coils can be purchased directly from us. Refer to Dodge Slow Speed Field Coils, part number 5A in our catalog.

Kit No. 151B—Dodge to 6 Volt—S. S.

Armature does not need to be rewound when using this kit. Kit includes field coil materials only. Cut-in speed 350-450 R.P.M. with maximum output 35 amperes. Use original armature.

8¼ pounds 18 plain enamel wire.
1 can impregnating (air drying) varnish.
1 roll ¼" tape for field coils.
Cotton sleeving for field coils.

Above kit complete, F.O.B. (See catalog for price)

25B—6 VOLT HIGH SPEED GENERATOR

Like our model No. 2116. No. rewinding of field coils or armature.

This plan uses the original Dodge shunt fields only. It is not necessary to remove the series field winding (heavy wire winding) as it can remain as a space filler. Cut all connections to these series coils and leave unconnected. The shunt fields (small wire winding) are already connected in series. Study 28A and connect field coils the same, also connect as a generator the same as 28A.

28C—GENERAL INFORMATION TESTING FIELD COILS

To test the field coils for grounds or shorts, first make sure that there is no contact between any of the wires and the brushes or the frame of the generator. Then connect two wires to a battery or other source of power with a light bulb of proper voltage in series with one wire. Connect one of the wires to one end of the field coils, and touch the other wire to the other end of the field circuit. The light should go on to indicate that there is a continuous circuit through the fields. Now touch the other wire to the frame of the generator. The light should not light. If it lights, it indicates a short circuit between the fields and the frame. To locate this short, it will be necessary to remove one field pole and move the coil so it does not touch the shell. Try the light again, and if it still lights, remove another field. Continue in this manner until you have found the short. Insulate this spot, and replace each coil, making the light test between every installation to be sure that no other shorts exist. This same method can be made in testing the brushes for shorted brush holders, also to find out if the terminal post is properly insulated.

The next test is for field polarity. To do this, first secure a small pocket compass. Join field leads to the battery so that you will have a current passing through all the field coils. With this current on, pass the pocket compass near each pole in turn. The first and third poles in a 4 pole machine should attract one end of the needle and the second and fourth poles in a 4 pole machine should attract the other end. In a 2 pole machine each pole should attract opposite ends of the needle, and in a 6 pole machine, every other pole should attract the one end of the needle. If any one or more pole fails to attract the proper end of the needle, discon-

nect that pole, and reverse the wires of that pole only, with respect to connection with other poles.

TESTING ARMATURES

An armature test is more difficult unless there is A.C. power available. In this case, all that is necessary is to make a growler like in plan 22 which operates on A.C. To use the growler, place the armature into the growler, turn the switch, and with the machine making a growling noise, pass a hack saw blade over the top side of the armature. If the blade is strongly attracted by the armature, the armature is shortened, and the only positive cure for it is to rewind the entire job. If the blade is not attracted to the armature, the armature is free of grounds and shorts. Continue this procedure until all sides of the armature have been tested. Sometimes a short or ground results from a piece of metal between the commutator bars or extending from the bars to the shaft or commutator core. These shorts can be cleared by scrapping them out with a hack saw blade, the teeth of which have been ground on sides to remove the "set" of the saw.

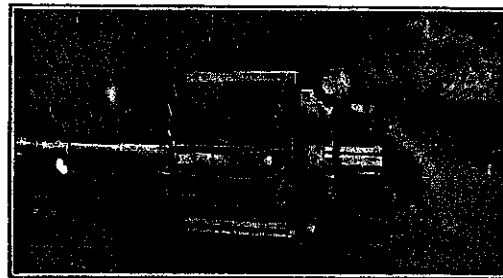

Figure 1

Where a growler is not available then satisfactory tests can be made as follows: Have the tail end wire of each coil disconnected from its bar. Then test for grounds by connecting one side of your test lamp (as described in first paragraph) to the shaft of the armature. Touch the other lead to each of the bars in turn. Since the tail wires are not connected to any of the bars, there can be no circuit from bar to bar, and the light will then indicate a circuit between the coil and the armature core. Wherever this appears the coils will have to be rewound. Now connect one lead to the tail end wire of any coil. Touch the other lead to each of the bars in turn. The lamp will light only when the lead is touching the bar which is fastened to the starting end of the coil. If the lamp lights at any other time it indicates a short circuit between two coils and this short will have to be found by unwinding the armature until it has been located. It should then be reinsulated and rewound.

Now replace the light with an ammeter, and carefully measure the current which passes through each armature coil. It is generally safe to assume that the lowest reading coil or coils are all right. If any coil shows a higher reading it indicates that that coil has an internal short or is shy some turns.

WINDING ARMATURE

When winding an armature, the job can be simplified by mounting the armature into a rack such as shown in Fig. 4. A rack of this nature can be easily constructed of wood by having the upright pieces mounted on a solid base and using wood screws or nails to form the points which fit into the center holes in the ends of an armature shaft.

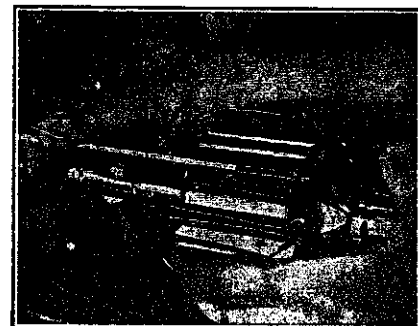

Figure 2

The first step after the armature has been stripped is to test each bar to see that there is no short between it and the bar on either side of it or to the shaft. This can be done by means of the lamp test as described above. If any shorts or grounds appear they will have to be cleared by means of scraping away any foreign substances from between the bars and the shaft. If this cannot be done, it will be necessary to replace the commutator. Next, insulate that portion of shaft between the core and the commutator by means of adhesive tape or gummed paper as shown in Figure 1. This figure also shows the end laminations and armature insulation paper in place. Figure 2 shows an advanced stage in winding, with several coils wound, also showing some of the slots closed by means of the wooden wedges. Figure 3 shows the slots all closed. Note carefully how the tail end wire of each coil is folded back to

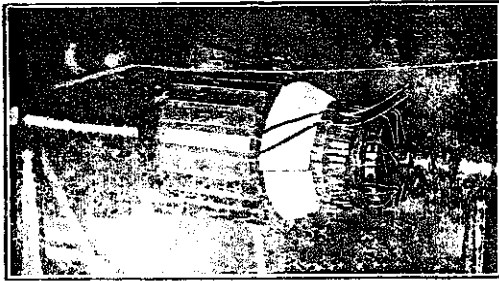

Figure 3

allow the moon-shaped insulation paper to be placed over the coils on the commutator end. Notice also how the starting wires are held to the commutator by means of the rubber bands, and how the tail end wire of each coil is brought down on top of the moon-shaped paper and joined to its proper bar.

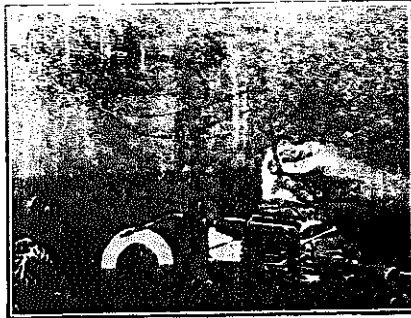

Figure 4

Where it is necessary to wind with two wires in each coil, such as is done on the Dodge 19 bar job and all Delco-Remy generators, Fig. 4 shows this work simplified by means of using two spools to take the wire from. This can also be done by having two wires wound on one spool but care must be used to see that each wire is followed through carefully as the wires should not be mixed; see instruction sheet of the armature to be wound.

These wires can be of the same colors, the wire which comes from one or the other spool can be marked whenever it is cut, by means of leaving one wire longer than the other or by placing a kink in the end of either wire.

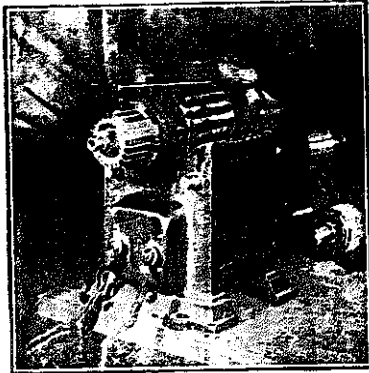

Figure 5

Figure 5 shows a test being made on a growler, this test having been described above.

CONNECTING FIELD COILS

The method of winding field coils is described in the plans where such changes are necessary. The connections between coils are different in some changes, and various connections are as follows:

Series connections (finishing end of first coil being connected to starting end of second coil, etc.).

Series parallel connection (the two coils connected in series with

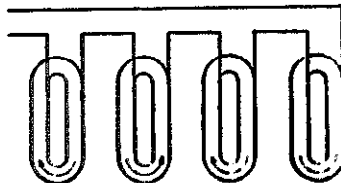

SERIES

starting wire of starting coil of each group joined to one field lead and finishing ends of last coil in each group being connected to other lead).

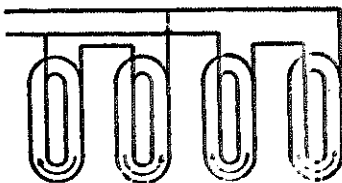

SERIES PARALLEL

Parallel connection (starting ends of each coil are joined to one field lead and finishing ends of each coil joined to other lead). Where the machine has more than 4 poles, the same methods may be used throughout.

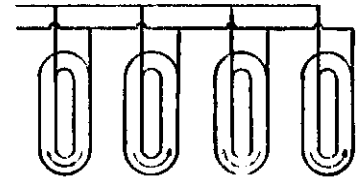

PARALLEL

FORMING FIELD COILS

It is necessary to wind field coils over a form to simplify the work. A form may easily be made by using a piece of wood the thickness of the coil just removed from the generator but $\frac{1}{4}$ " longer and wider than the small portion of the pole shoe. If the block tapers to one side somewhat it will be easier to remove the finished winding from it. To this block are fastened two slabs of wood or metal, giving the form the general appearance of a spool. It is well to make saw cuts in both sides of the spool to hold the string which is first placed across the spool on each side and is afterwards tied to hold the windings in place until they can be secured by the tape covering. The general appearance of the spool or form is as shown here.

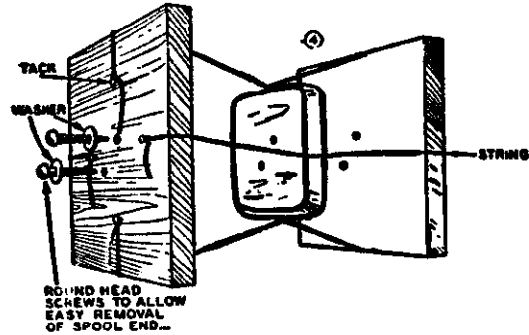

COIL WINDING FORM

The sides of the spool are held on by means of screws which are to be removed after the strings have been tied around the sides of the coil. It is then a simple matter to remove the coil from the wooden core.

MOTORIZING

We mention motorizing several times in the plans. By this is meant that a generator will run as a motor when connected directly to a battery. All generators will run as a motor but at a much slower speed, the direction of rotation being always in the direction in which the generator is to be driven to charge.

When new field coils have been installed into a generator or motor, they should always be tested for polarity. This can be done as follows: Remove the armature but have the fields in position. Now connect the fields to a battery to allow a current to flow through the fields. Now pass a pocket compass near each of the fields in turn. In a two-pole motor or generator, one of the fields will attract one end of the compass needle and the other pole will attract the other end of the needle. Where the machine has 4 poles, the first and third poles should attract one end of the needle and the second and fourth poles should attract the other end of the needle. If any of the poles attract the wrong end of the needle, simply reverse the connections of that coil. Where new fields are being installed in a machine like our arc welder, the heavy coils and light windings should be tested separately. The above test is used, and both the heavy and light windings of each pole should attract the same end of the compass needle. Reversing the connections of the pole attracting the wrong end of the needle will always reverse the polarity of that coil. The generator is to be then assembled and run as a motor. If it is ever found necessary to reverse the direction of rotation of the armature, all that is necessary is to reverse the field lead connections.

ARCING AT BRUSHES

Should the generator show excessive arcing at the brushes and show a tendency to charge only at low rates, this can be readily overcome: On the Dodge "GA" generator simply remove the four screws which hold the brush endbell to the shell. Shift the endbell to a position at which best results are obtained while the generator is revolving at a charging rate. Drill new holes in the endbell to take the screws in this new position. If the generator is a Dodge model "G" it will be impossible to overcome the arcing except by installing an adjustable brush rigging of another type, such as the rigging removed from a Ford model "T" starter.

LOWER CUT-IN SPEED

In some generators the cut-in speed can be lowered somewhat by reducing the air space which is between the field shoes and the armature. This is especially true of the Ford "T" generator. This space can be reduced by placing thin shims cut from a baking powder can to same size as the base of field pole shoe then inserted between the pole shoe and the generator shell. These shims must be of material containing iron or steel as shims of brass, copper or paper are useless. Place shim under each pole.

CONNECTING BATTERIES

Each cell of a lead plate battery has a potential of 2 volts. In an ordinary 6 volt auto battery three of these cells are connected in series. To make a 12 volt battery out of two 6 volt batteries they are to be connected in series as shown on next page.

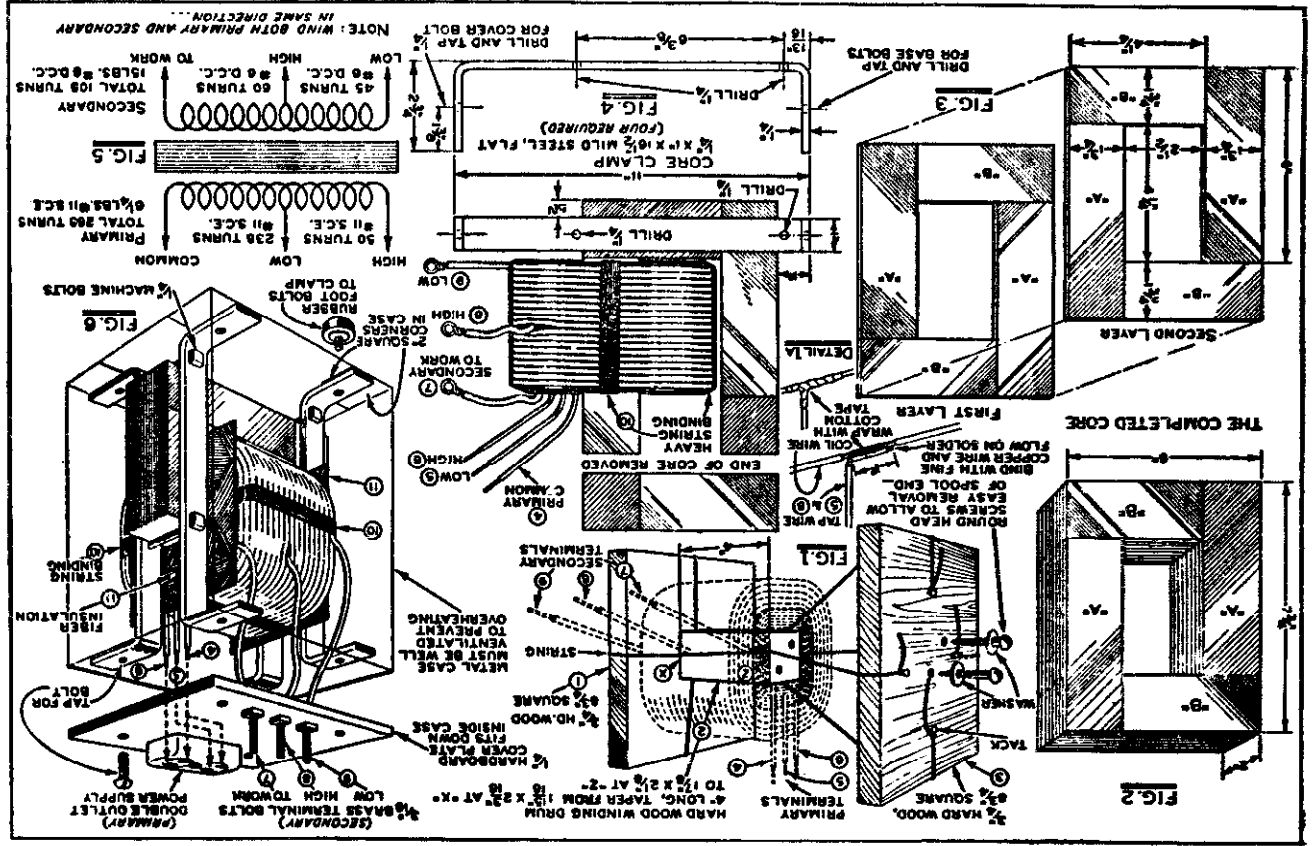

The accompanying diagrams and the following instructions explain clearly the construction of a heavy duty arc welder with an input of from 1 1/2 to 3 K.W., and an output of from 35 to 110 amperes. It will work on any 110V. A.C. line, through 30 ampere fuses. See note for 220V. construction.

The building of this welder is not difficult. It consists of four important parts: (1) the coil; (2) the core; (3) the terminal panel; and (4) the transformer case.

The coil consists of a primary winding of 238 turns tapped at the 238th turn, and a secondary of 105 turns tapped at the 105th turn. Prepare a winding spool of hard wood, to the dimensions given in Fig. 1. Fasten the spool end (1) to the large end (X) of the spool drum (2) with flat head wood screws, and fasten spool ends (3) and (4) to the terminal panel.

The building of this welder is not difficult. It consists of four important parts: (1) the coil; (2) the core; (3) the terminal panel; and (4) the transformer case.

Plan 29 A 110V. or 220V. A.C. Portable Transformer Arc Welder

Note that batteries are connected negative to positive. When it is desired to use 6 volt batteries on a 33 volt plant, 5 batteries can be connected in series as above, giving you 30 volts, which will work on a 33 volt plant. When 5 or 3 of these are used, and you desire to time from a 6 volt plant, they should be connected in parallel.

Note that in this case the negative posts are all joined to the negative wire and the positive posts to the positive wire. When batteries are joined like this it is best that all batteries have about the same charge in them before joining them, as the stronger batteries will discharge slightly and build up the weaker ones, until all have the same charge.

As follows: Connect the generator terminal to the generator side of the circuit. Connect the battery terminal to the generator side of the circuit. Generally the terminal to the left, as the ammeter is seen from the rear, connect the other side of the ammeter to the positive post of the battery. The proper sides of the circuit are always indicated by the words "GEN." or "BATT." on the connecting straps. Connect the negative battery post direct to the frame of the generator.

When connecting the battery to the generator, the procedure is as follows: Connect the generator terminal to the generator side of the circuit. Connect the battery terminal to the generator side of the circuit. Generally the terminal to the left, as the ammeter is seen from the rear, connect the other side of the ammeter to the positive post of the battery. The proper sides of the circuit are always indicated by the words "GEN." or "BATT." on the connecting straps. Connect the negative battery post direct to the frame of the generator.

There are two important things to remember when operating a third plant or any other generator. Never allow the generator to run with the battery disconnected. Never allow the generator to charge more than its maximum rated charge, even for a short time. Either of these cases will result in a burned out generator. Make sure that your generator bearings are in good condition, as loose bearings will allow the armature to rub on the poles, causing excessive heat which will also result in a burned out generator.

To see that your ammeter is connected correctly, close the circuit or short circuit it by touching a piece of wire to both connections of it at the same time. The generator will now run as a motor and the ammeter will show discharge if the wind is not turning the generator over. If the ammeter shows charge when this is done, simply reverse the ammeter connection. There are times when the cut-out refuses to close when the plant is first put into operation. This is because the cut-out is improperly polarized. To correct this, simply close or short circuit the cut-out as described above, and the trouble will be corrected.

There are two important things to remember when operating a third plant or any other generator. Never allow the generator to run with the battery disconnected. Never allow the generator to charge more than its maximum rated charge, even for a short time. Either of these cases will result in a burned out generator. Make sure that your generator bearings are in good condition, as loose bearings will allow the armature to rub on the poles, causing excessive heat which will also result in a burned out generator.

SCHEMATIC DIAGRAM

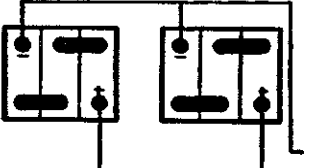
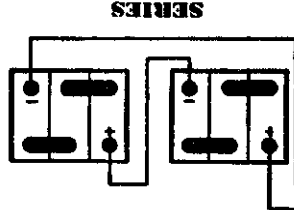
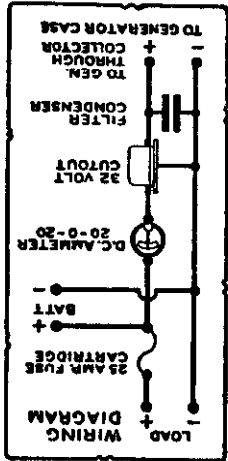

The generator or to any piece of metal having direct contact with the frame of the generator, the frame of the cut-out must be connected directly to the negative wire of your circuit. A connection scheme appears below:

Detail 1A in the diagram illustrates the correct method of attaching the tap wire to the main winding wire. Now continue winding until 50 additional turns have been completed, making a total of 288 complete turns, and allow a 12" lead (6) for the high output connection of the primary. Fasten this lead firmly in place with a piece of cotton tape where it leaves the coil, and cover the completed primary winding with a layer of .010 armature paper, bound in place with thread.

The secondary winding of No. 6 D.C.C. magnet wire may now be wound directly over this paper layer. Both primary and secondary windings are in the same direction.

Allowing a 12" lead (7) at the beginning, carefully wind on one layer. Note the exact number of turns, and wrap a layer of the .010 armature paper over it. Continue winding in this manner, placing a layer of paper over each layer of wire, until 60 complete turns have been wound on. At this point splice a 12" piece of No. 6 D.C.C. wire to provide the high output lead (8) of the secondary. (See Detail 1A.) Allow this lead to project directly through the remaining layers of the coil. Wind on exactly 45 more turns, remembering the paper between layers, and the secondary will now contain 105 complete turns. Allow a 12" lead (9) as the low output connection of the secondary, and fasten it in place where it leaves the coil with a piece of cotton tape. Tie each of the four stout strings tightly over the completed winding, remove the spool end held by the round head screws, and very carefully slip the whole coil off the wooden drum. Use every caution in slipping the coil from the drum, as it will be impossible to mount it on the iron core if it should "spill," or lose its shape by spreading. Now bind the coil tightly with a dozen turns of the stout string on each of the four sides (10). Soak the coil in the insulating non-conducting varnish until it is thoroughly saturated, that is, until no bubbles continue to rise, then hang it to dry.

Build up the iron core as in Fig. 2. Requires 17 to 18 lbs. of 26 ga. silicon steel. All core dimensions are given in Fig. 2 and Fig. 3. In Fig. 3, "First Layer," and "Second Layer," explain the method of arranging the alternate layers. Stagger all joints as shown in these diagrams, and be sure to fit all joints accurately. Tight joints in the core iron will prevent power loss and overheating. Use sufficient metal in the core to give a stack $1\frac{1}{2}$ " thick when compressed. A total of 93 pieces to each of the four sections.

Form the four core clamps according to Fig. 4. Carefully clamp one end of the core, drawing the $\frac{1}{4}$ " bolts up snugly enough to hold the core while the clamps are put on the other end. Now tighten both clamps, and wrap one layer of armature paper on the core leg that is to hold the coil. Over the paper, wrap one layer of "Empire Cloth" or varnished cloth, starting at the bottom, and spiraling toward the top. Allow it to overlap a little less than half its width. A little of the insulating varnish applied to the under side of the cloth as it is wound will hold it. Trim away the surplus cloth and allow the varnish to dry. In the centers of two 5" squares of $\frac{1}{4}$ " fiber (11, Fig. 6), cut openings one and thirteen-sixteenths by two and one-sixteenth inches. Take off the top core clamp and carefully remove the end section of the core as shown in Fig. 4. Slip one of the fiber squares over the cloth covered core leg, slide

the coil into place over the cloth, drop the second square of fiber into position, and replace the end section of core. Clamp the core as tightly as possible, after making sure all core joints are perfect.

Lay out and drill the terminal panel made from $\frac{1}{4}$ " tempered pressed wood obtained from lumber yard. Form loops in the ends of the secondary leads by wrapping them around the brass bolts forming the secondary terminals. Run solder over these loops, Fig. 4. Cut the brass buss bar in the double outlet, removing enough of it so that no short will be possible between the high and low primary leads, which are connected to the two resulting terminals as shown in Fig. 6. The primary common lead (4) is connected to the brass buss as is, thereby making contact with both outlets, Fig. 6. Connect the secondary leads to their proper terminals, Fig. 6, and label them. Bolt the panel in place on the core clamps.

Build a metal case to fit the finished transformer. The design is unimportant, but plenty of ventilation is essential. The side panels of a Model "T" Ford hood might be used, as the louvers would provide adequate circulation of air. The case is held in place by the same bolts that fasten the rubber feet to the bottoms of the core clamps.

The working leads for this transformer welder are of flexible rubber-covered No. 6 cable. Connect one of the cables permanently to terminal (7), Fig. 6. Provide a heavy clamp at the other end to connect to the work. The second cable is of course fastened to the electrode holder, and has a clamp at its opposite end to enable it to be connected to either terminal (8) or (9) for high or low output. To vary the input, the power supply is easily changed at the double socket.

This welder will handle the heavy welds if the weld is built up from the bottom. Will handle $\frac{1}{8}$ ", $\frac{3}{16}$ " and $\frac{1}{4}$ " rods. $\frac{1}{4}$ " rods can be used for short interval work. The addition of handles to the sides of the case make it an easily portable unit.

Kit No. 12

Includes transformer materials only.

6 $\frac{1}{2}$ lbs. No. 11 S.C.E. magnet wire.

15 $\frac{1}{2}$ lbs. No. 6 D.C.C. magnet wire.

2 pieces fiber 5"x5"x $\frac{1}{4}$ ".

1 roll cotton tape.

Sufficient armature paper .010 for insulation over core and

between layers.

1 piece varnish cloth .010.

1 large can impregnating varnish (air drying).

A total of 372 pieces, 26 ga. silicon steel cut to size.

Complete kit. Ship. wt. 46 lbs. F.O.B. (See catalog for price)

NOTE.—For 220V. construction wind the primary with 576 turns

No. 14 S.C.E. Tap at 476 turns. (6 $\frac{1}{2}$ lbs. 14 S.C.E. required.)

WELDING CABLE

A tough rubber jacketed cable for lasting service, suitable for

above welder. Connecting welder to work and electrode holder.

No. 6 Gauge—Ship. wt. 1 $\frac{1}{2}$ lbs. per 10 ft. F.O.B. Minneapolis.

Per foot..... (See catalog for price)

Plan 30

A 110 Volt Spot Welder—1 Kw. Input Normal Draw 10 to 11 Amps.

This outfit will weld a $\frac{1}{8}$ " maximum thickness of material. The welder will operate satisfactorily through 15 amp. fuses, with a normal draw of from 10 to 11 amps. It is designed for 110 volts, 60 cycles, but can be used without any change on 110 volts at 50 cycles.

The core, Fig. 1, compresses to a thickness of 2 $\frac{1}{2}$ " and is built up to the specifications in Fig. 2.

Note carefully that layers are laid so that all joints are staggered and overlap. Be sure to fit all joints tightly as loose joints will impair the efficiency of the machine, causing core losses and overheating.

The coil is wound on a spool (Detail 3C). Lay 24" pieces of strong string along the four sides of the spool drum, and over them a double layer of armature paper (.010) is bound in place with thread. (Fasten the ends of the string out of the way by means of small tacks on the outsides of the spool ends.) Over this paper, wind the primary (Fig. 4 and Fig. 3 key), tapping the winding at various number of turns as indicated. All terminal leads (1), (2), (3), (4) and (5) are of No. 8 wire. They are all 12" long and are labeled. Taps are bound to the main wire with fine copper wire, the joints soldered and taped. Fasten lead (5) with tape and wrap the primary with two layers of armature paper and one layer of varnish cloth .007 thickness, bound with thread.

Detail 3B shows the first steps in building the secondary winding. Tape a little of the ribbon at a time as the secondary is wound over the primary. When the secondary is entirely in place, tie up the strings, to hold the coil in shape temporarily, and remove it from the spool. Bind the coil with friction tape and saturate thoroughly with insulating varnish, and hang it to dry.

Fasten core clamps to one side of core. Make sure the bolts are drawn up evenly and are tight. Then remove the laminations from one side of the core to make it possible to insert the coil on the center leg of the core. Replace the laminations into the exact position in which they were, making sure all joints are tight. Clamp up other side of core.

Fig. 3 shows the completed transformer. Detail 3A shows the construction of the core clamps and the terminal panel ($\frac{1}{4}$ " or $\frac{1}{8}$ " tempered pressed wood, obtained at lumber yard) which mounts to clamp (6). Mount the clamps and panel.

Turn the copper electrodes (Fig. 5).

Build up the machine as in Fig. 6. Fit the transformer mount holes to the $\frac{1}{4}$ " studs in the transformer clamps. Detail 6B explains a secondary connector having the same cross-section as the winding itself, yet is of a shape easier to handle. Three 7-8" rib-

bons are soldered to each of the ribbons in the secondary winding. By forming them as shown, they are brought to the outside of the coil and may be readily handled to meet the copper bars carrying the current to the electrodes. The method of connecting the connectors to the bars as shown at (8), Fig. 6. Of the utmost importance to the successful operation of this welder is the quality of the contact between the electrodes and the copper bars. Be sure that the bars and the electrode bases are bright and then clamp the holding nuts as tight as possible without stripping.

The tape bindings on the secondary connectors may be shellacked. Now the primary terminal leads may be soldered to their properly numbered contacts on the panel. No. 2 on the panel gives the secondary its low output, and Nos. 3, 4 and 5 will increase the output to maximum.

Details 6A and 6D are important as they are figured to give the exact leverage to bring the electrodes together in the proper manner. Pay particular attention to these dimensions.

To connect this welder to your source of supply, have a snap switch in the primary, in such a position as to be readily accessible to the operator. Connect the primary to the power supply. When being used, the stock being welded is placed between the electrodes and the pressure applied. The switch is then closed long enough to complete the weld (from one to three seconds, depending on material thickness) and is then opened before the pressure is removed. If the pressure is removed while the switch is still on, there will be a considerable arc from the electrode to the work, which may result in a burned job.

Kit No. 10.

Includes transformer and copper materials only. We do not stock the other materials required.

27 lbs. No. 8 D.C.C. magnet wire.

25 lbs. No. 20 ga. 2 $\frac{1}{2}$ "x72" (72 feet) copper.

3 lbs. 20 ga. $\frac{5}{16}$ " copper for connectors.

$\frac{1}{4}$ lb. bare copper wire for joints.

1 copper bar $\frac{1}{2}$ "x1"x17 $\frac{1}{2}$ " (upper).

1 copper bar $\frac{1}{2}$ "x1"x12 $\frac{1}{2}$ " (lower).

1 copper bar $\frac{1}{2}$ "x1"x5 $\frac{1}{4}$ " for splice.

2 copper electrodes machined to fit.

Sufficient cotton tape for binding secondary.

Armature paper .010 thickness.

Varnish cloth .007 thickness.

1 large can impregnating varnish (air drying).

50 lbs. 26 ga. silicon steel cut to size.

Complete Kit. Ship. wt. 140 lbs. F.O.B. (See catalog for price)

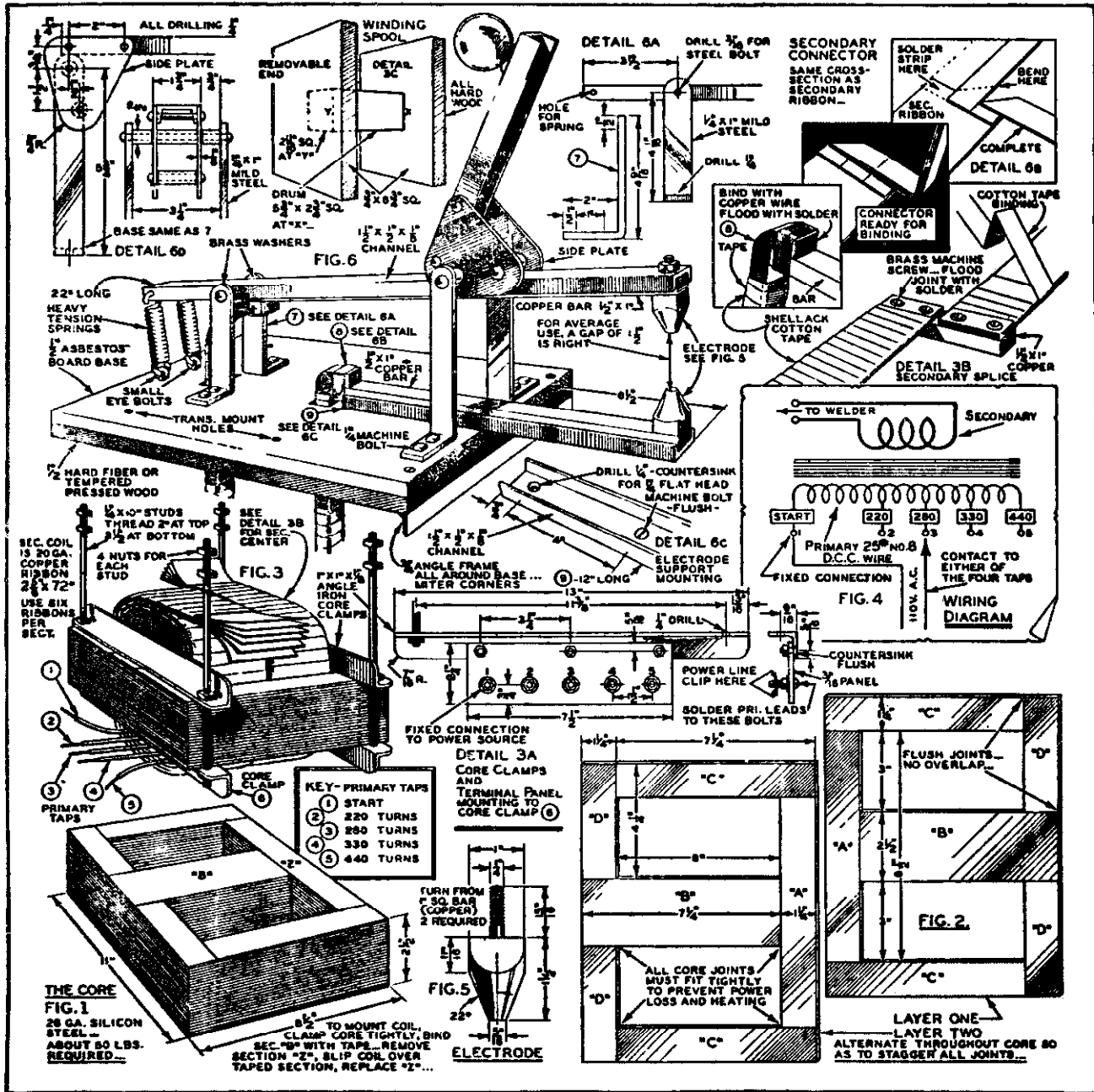

Plan 31

A Direct Drive 32 Volt Wind Plant—All Metal Construction

This plant has been designed for the Dodge "G" or "GA" generators because, being of the four pole type, these generators are readily adaptable to slow speeds.

The propeller plan gives the full dimensions for laying out actual size patterns and templates for a 7'-0" propeller which is the size recommended for this plant. Note that the leading edges of the two blades are parallel $5\frac{1}{2}$ " apart, and the propeller carries a width of $5\frac{1}{2}$ " for a distance of 7" on each side of the center. From this point the blade tapers to a tip width of 4" measured from the leading edge. Carefully maintain the $\frac{1}{8}$ " trailing edge for the whole length of the blade. Note the riser dimensions for positioning the cross-section heights and widths at the section lines "A", "B", "C", "D", and "E". All tapers from "E" to the tip are straight lines and should be laid out with a straight-edge. The best results may be had with redwood or straight grained fir.

The propeller hub is a washer of 4" diameter welded to the helical gear of the generator, or a cast iron hub selected from the LeJay catalog.

The collector assembly "E" and the generator bracket "A" which includes the clamp "B," may be purchased direct from LeJay

factory, but may be home-made as illustrated in Figs. 1, 2, 3, 4 and 5.

The tower is four sided. The corner pieces are 60" long. The pipe "Y" is 32 $\frac{1}{2}$ " long if used with the factory head assembly, but only 24" long if the head is to be home-made. The length of this pipe is the only necessary change in the tower construction to adapt it to either the factory head or the home-made head.

The pipe support collars "K" are of cold rolled steel, 2 $\frac{3}{4}$ " in diameter by 1 $\frac{1}{2}$ ". A hole is bored in the center of each collar to provide a tight fit on pipe "Y," which is a piece of 1 $\frac{1}{2}$ " standard pipe. Drill $\frac{3}{8}$ " holes through tower legs and collars to pass the $\frac{1}{2}$ " x $1\frac{1}{2}$ " square head machine bolts "L," which are threaded into the pipe "Y." The bolt holes are $\frac{3}{4}$ " down from the tops of the tower legs, then the lower bolt holes are 8" below center of top holes.

The brass collector ring "O" is a tight fit to the pipe. Saw a slit in the ring, and by spreading the slit the ring is slipped over the several layers of varnished cloth and the bit of electricians' tape which lies under the slit. Insert the end of the weather-proof wire in this slit and flow solder over the joint. Clamp the ring while soldering to make it fit tightly. File the soldered joint smooth.

Plan 32

A Battery Spot Welder

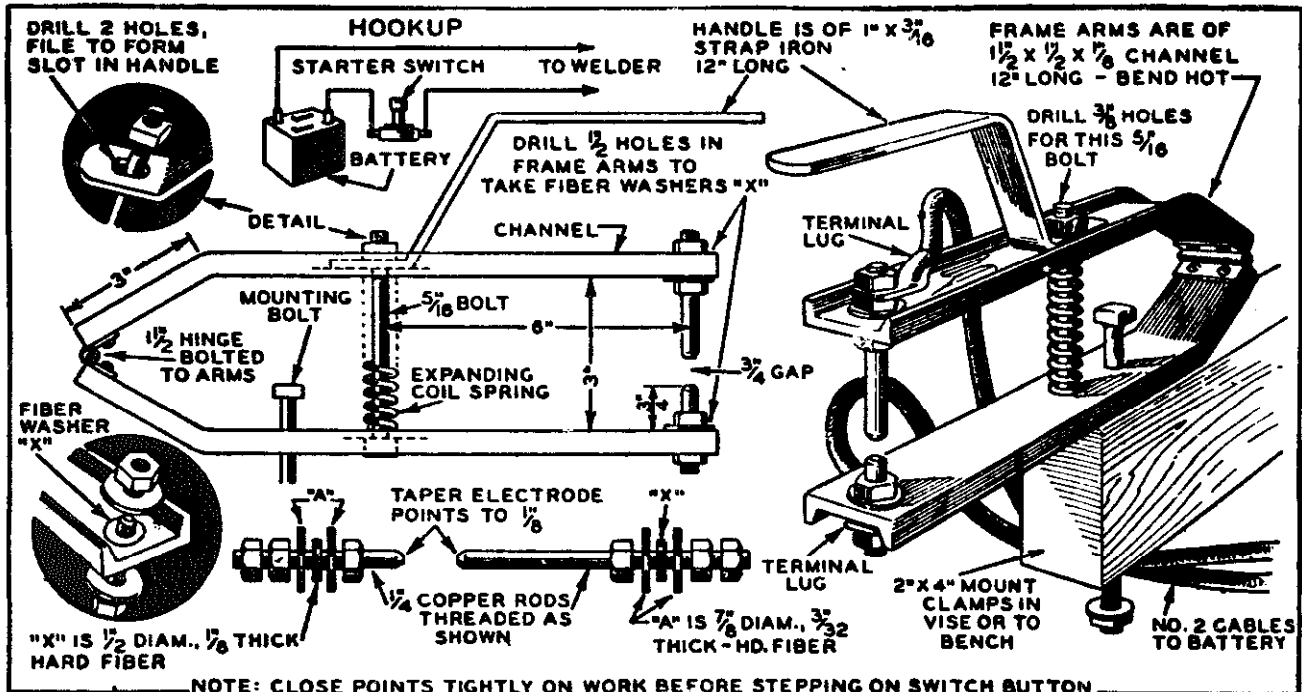

The accompanying diagrams and following instructions explain clearly the construction of a spot welder designed to work off any ordinary 6 volt storage battery and spot weld two pieces iron 22 gauge or lighter. Under proper conditions much heavier materials can be welded. Very thin materials may better be welded on 2 or 4 volts; more than 6 volts not recommended.

First secure two pieces of channel iron 1 1/2" x 1 1/2" x 1/8" each 12" long and bend 3" from one end as shown. On the bent ends small holes are to be drilled so hinge 1 1/2" long can be fastened. This hinge permits welder to actuate freely.

Next drill 1/2" holes in other end of channel to accommodate the electrodes. In drilling the 1/2" holes, be sure their centers are at least 1/4" from end. Three fiber washers are then made for each electrode and installed according to diagrams so each electrode is insulated from channel iron.

Handle is made from piece of 1" x 3/16" iron 12" long and bent so it will not touch upper electrode when welder is in operation. Slot the hole in handle as described in detail at upper left by drilling two holes, then file—this will allow handle to give proper leverage on upper channel without binding on the 3/8" holding bolt.

Any coil spring that can nicely fit over the 5/16" holding bolt and hold the two channel arms apart, so electrodes do not touch, can be used.

Be sure the cable connecting electrodes and battery are of No. 2 cable or heavier. Lighter wire will not work as anything lighter cannot carry the desired current. For best operation use an auto starter switch in one cable, then connect to battery as "hookup" in drawing indicates.

When being used, the stock to be welded is placed between the electrodes then pressure applied. The foot switch is then closed long enough to complete the weld, taking from 1/4 second to 1 or 2 seconds, depending on thickness of materials. Switch must be turned off before pressure is released—if pressure is released while the switch is still on, there will be a considerable arc from the electrode to the work, which may result in a burned job.

This welder draws a large amount of current at each operation but because the length of contact is so short a good full charged battery will make a large number of welds before battery needs to be recharged.

Plan 33

(See Directions Plan 41)

Armature Diagrams for Autolite, Bosch-Autolite and Bosch Generators

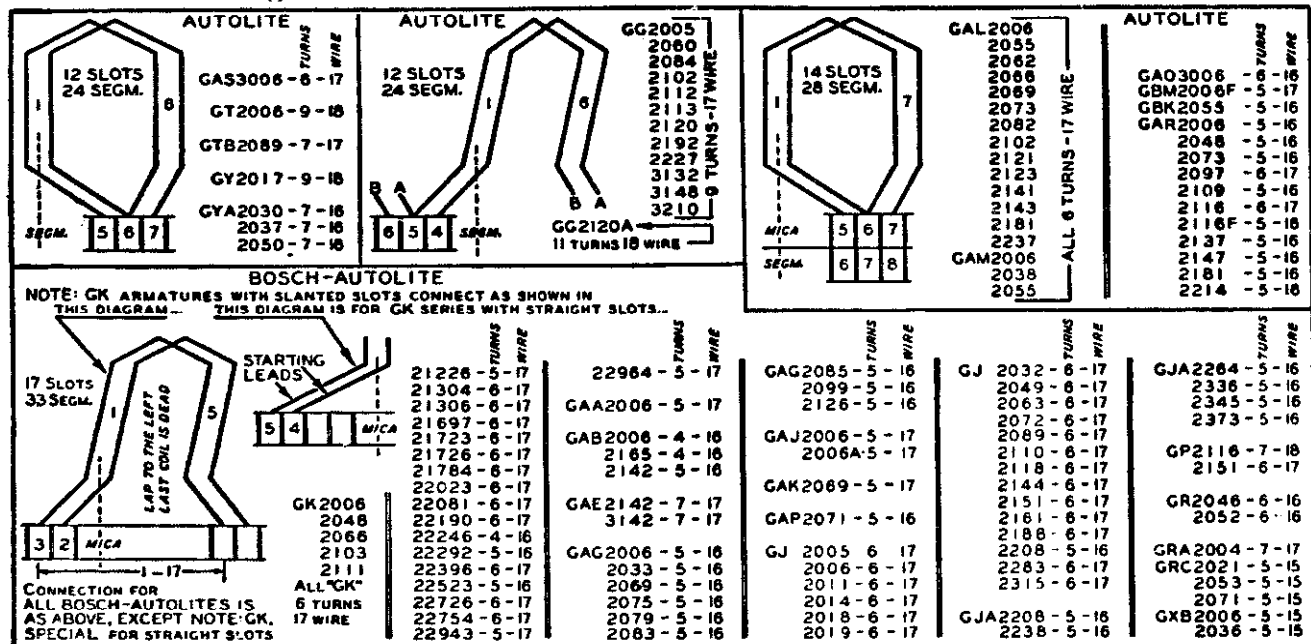

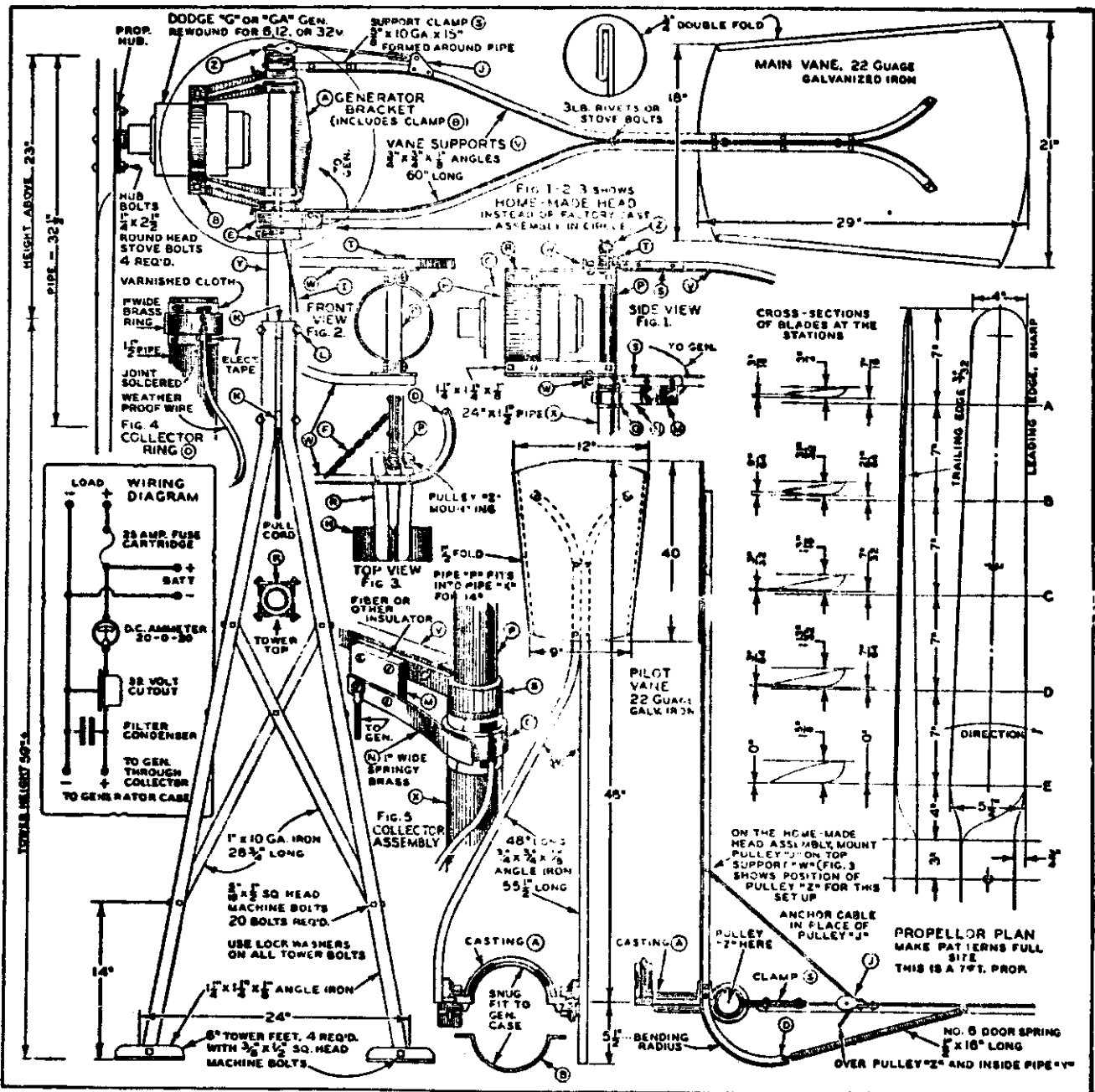

The lower half of assembly "E" is held in place by a 3/8"x1" square head machine bolt which is screwed into pipe "Y."

From 10 ga. band steel 3" wide, form the clamps "H," Figs. 1, 2 and 3. The angle irons "R" are 10" long, and have a slight bend, Fig. 3. Pipe "P" is threaded at the top, as is pipe "Y" to take a lock nut cut from a standard coupling. This nut holds the head in place.

The main vane has its lower support bolted to the top or brush half of the "E" assembly in the factory job. The top support is hung from the clamp "S." The main vane of the home-built plant has both supports hung from "S" clamps, Fig. 1. The "S" clamps are fitted to the pipe on which they are used.

The pilot vanes on both plants are identical.

The pull cord on the factory job is anchored to the top pilot vane support, passes through the pulley "J" on the top main vane support, through the pulley "W" mounted on the "S" clamp of the top support of the main vane (by means of a small bracket), and then is drawn down inside pipe "Y."

The pull cord on the home-built plant is anchored to the main vane top support, passes through pulley "J" which is mounted on the top pilot vane support, through pulley "W" which is mounted directly on the top generator rest "R" and then down through pipe "Y."

On the factory casting of the head assembly stops are provided at the open and closed positions of the vanes. The home-built head uses a small chain "F," Fig. 3, to hold the vanes in the open position. A tension spring connected at point "D" on the top pilot vane support "W" holds the vanes at right angles when the pull cord is released. The cord is of 3/8" light stranded flexible cable.

The wiring diagram is clear, and needs no explanation. Much of the success of the plant depends, however, on the brush assembly described in Fig. 5. Adjust the wiper arm "N" to give a good strong contact through the ring at any position and provide a strong flexible cable for the connection to the generator from the fastening bolt in the insulator block. This circuit is the positive shown in the diagram. The negative travels through the generator case to the tower and may be taken off tower at any handy point.

If you desire to run this plant with a governing propeller there will be no need of a pilot vane. Cut off upper pilot vane support "W" at a point 1" beyond where pullout cable fastens to support. This portion of upper support "W" will be used as arm for pulling plant in or out of wind. There will be no lower support "W."

PARTS

- No. A—Cast iron generator bracket with clamp. Factory machined\$4.95
- No. E—Cast iron collector ring assembly. Includes a special machined brass wiper brush which is held firmly by means of tension spring, and insulated with fiber tube. This brush makes constant contact onto a machined brass ring which is pressed onto insulated lower casting. Wires are soldered to wiper and ring so quick connection to battery and generator can be made. Complete assembly, weather-proofed\$9.50
- No. C—Brass collector ring to fit 1 1/2" pipe—insulation material included\$0.25
- No. N—Spring brass wiper complete with bakelite M; drilled and (See catalog for price.)
- No. 2M—Coil spring for governing tension.\$0.15
- No. 2L—3/8" copper twist pullout cable, 10 feet for.\$3

Plan 34

Armature Diagrams for Delco, Delco-Remy and Remy Generators (See Directions Plan 41)

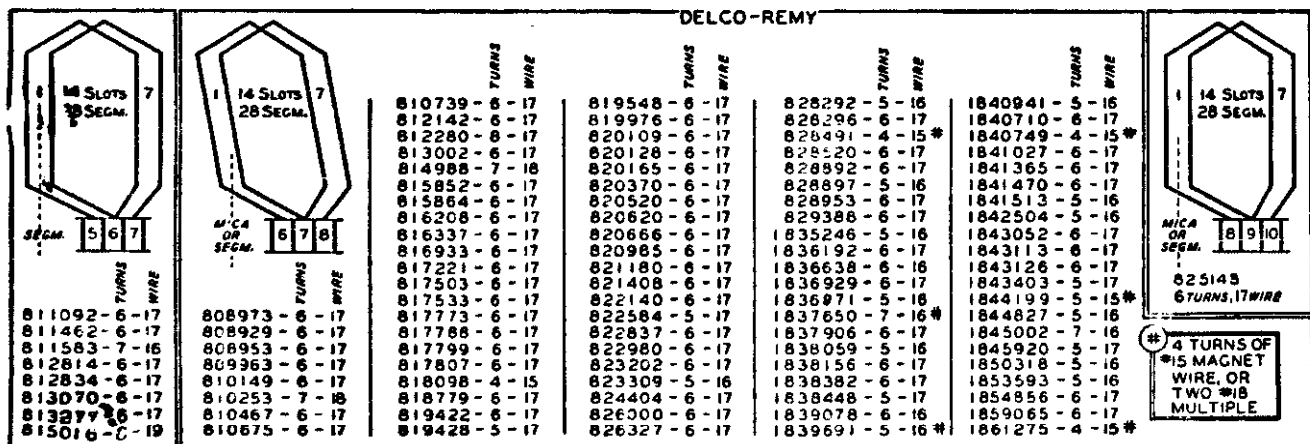
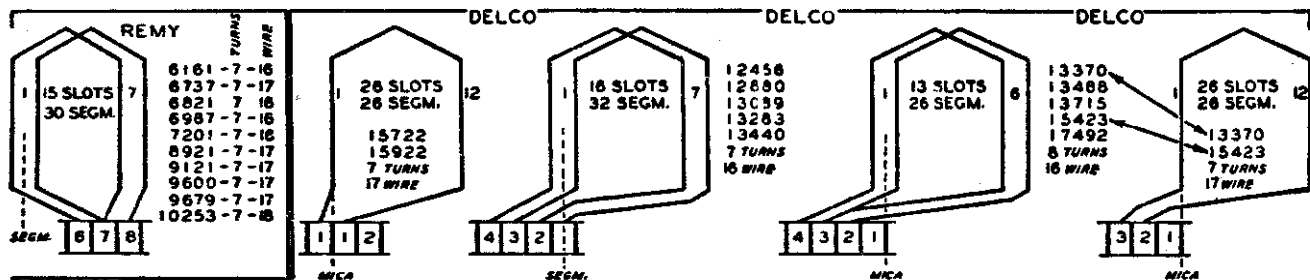
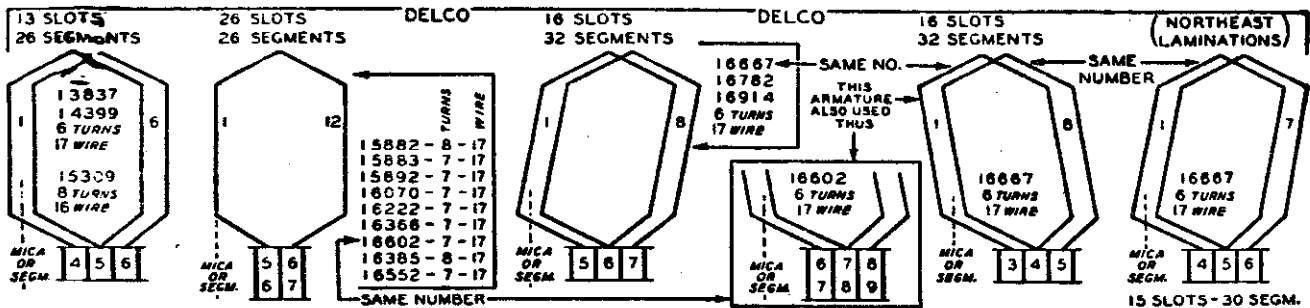
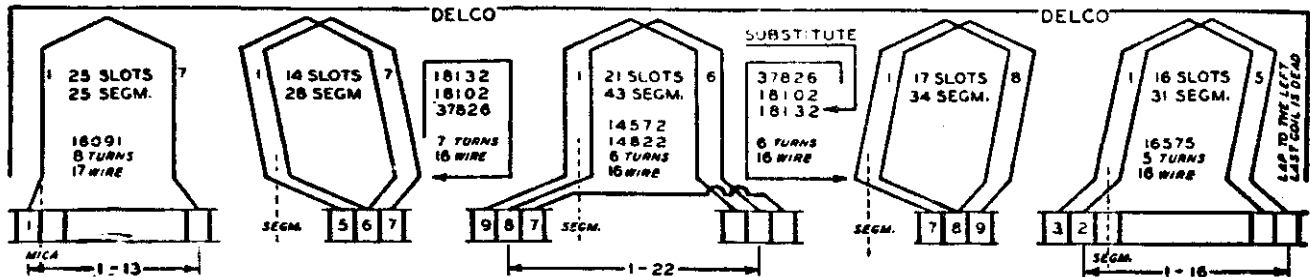
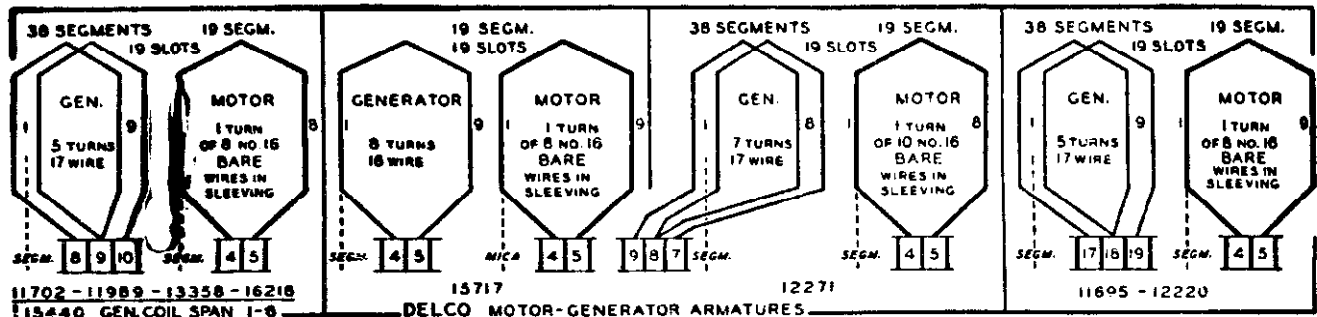

Plan 35

Armature Diagrams For Ford A, B and V8 Generators. (See Directions Plan 41)

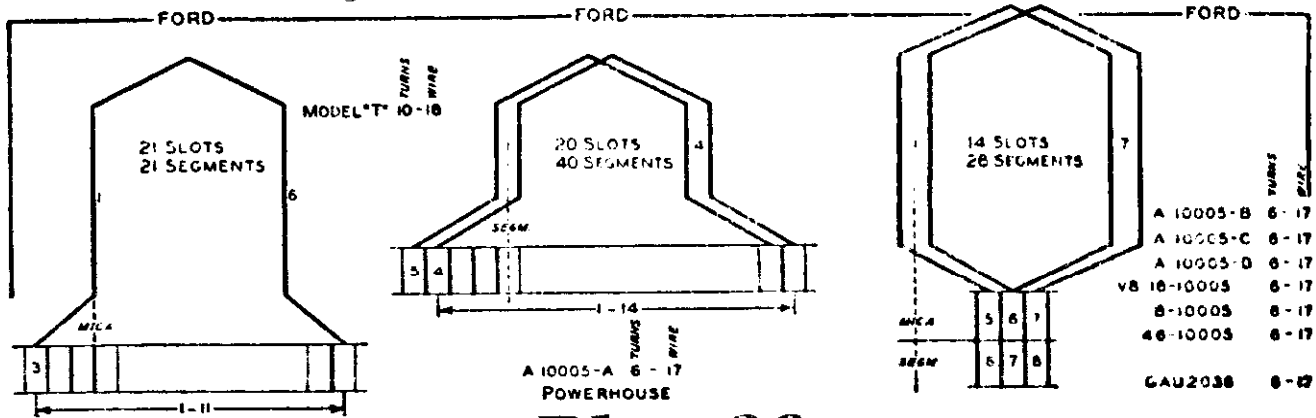

Plan 36

Armature Diagrams For Northeast Generators. (See Directions Plan 41)

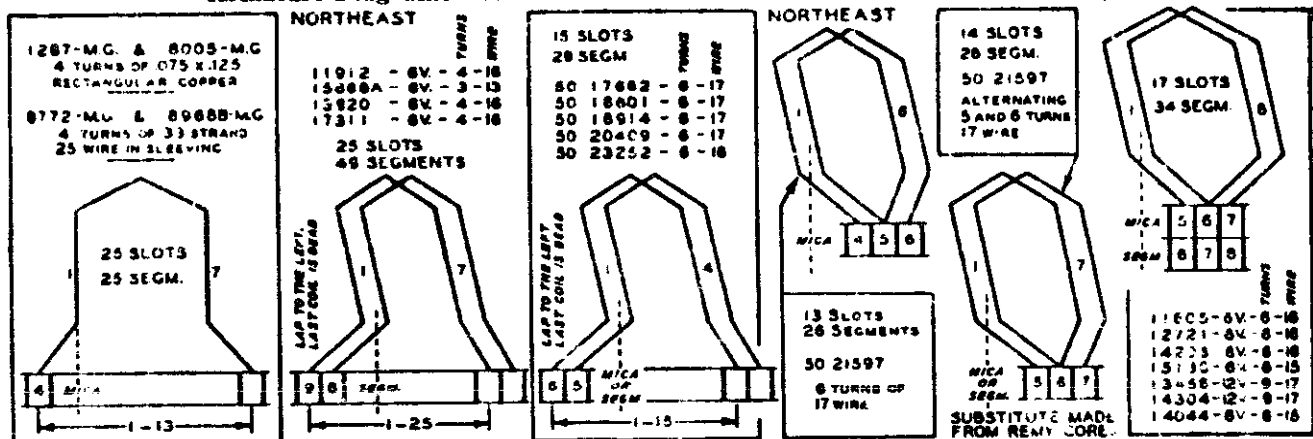

Plans 37 and 38

Armature Diagrams For Atwater-Kent and Dyneto Generators. (See Directions Plan 41)

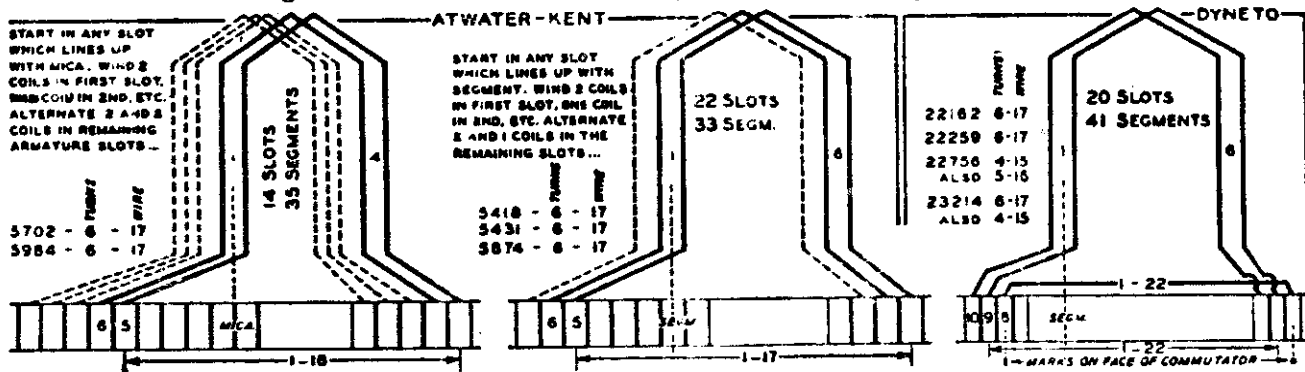

Plan 39

Armature Diagrams For Leece-Neville Generators. (See Directions Plan 41)

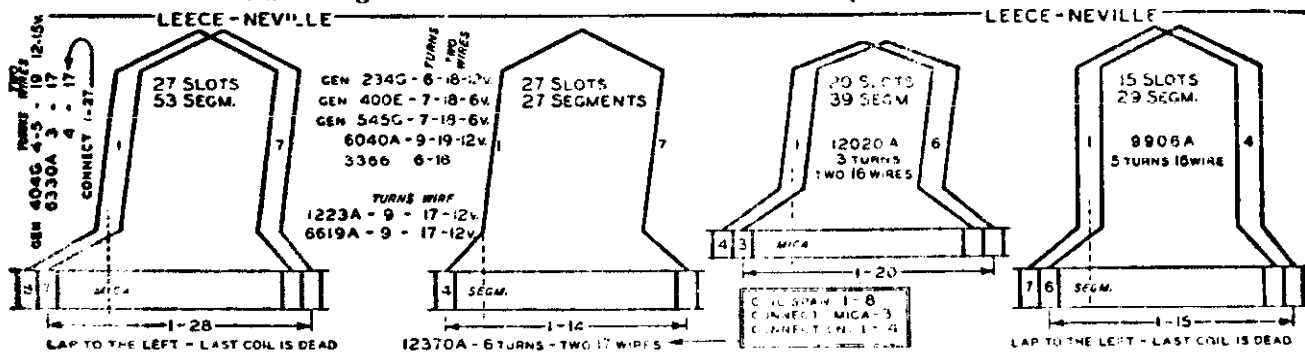

Plan 40

Armature Diagrams For Wagner Generators

(See Directions Plan 41)

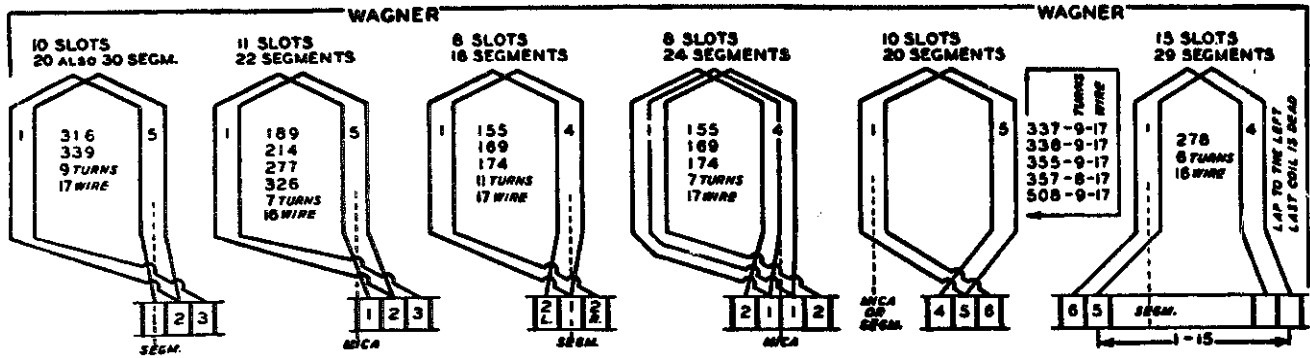

Plan 41

Armature Diagrams For Westinghouse Generators

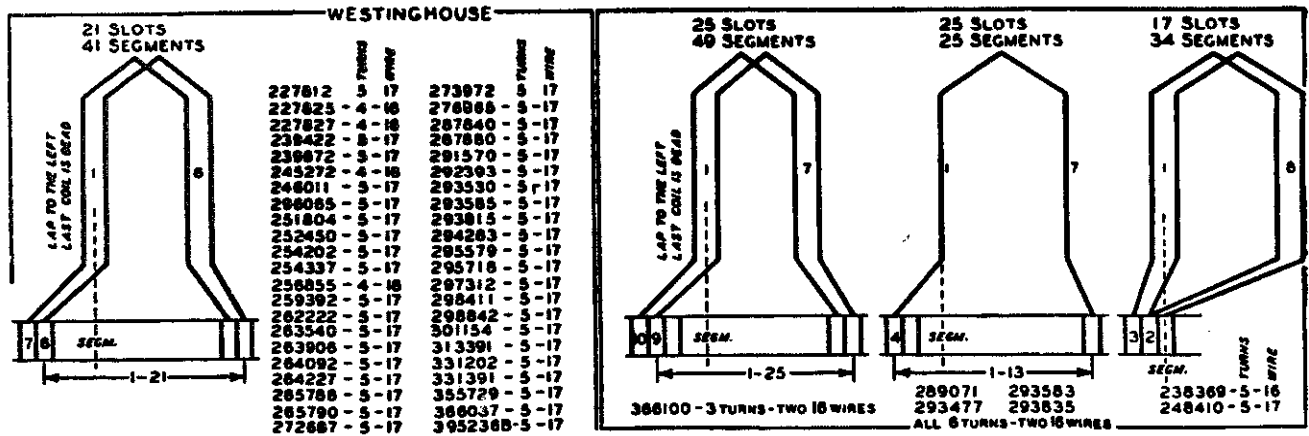

DIRECTIONS

The accompanying winding diagrams are given with the connections, number of turns and wire sizes as used in standard high speed generators for automobile use, constant speed generators or reduction drive wind generators. The principal secret of converting one of these generators into slow speed windcharger use is to rewind the armature with more turns of wire (using the same commutator connections and coil span as the original winding). Owing to the large number of generators involved we are attempting to condense this explanation into a general plan which will cover the most complicated features of all types per attached cuts. We wish to call your attention to the fact that some of these generators are covered in detail with respect to converting them into windcharger machines in previous plans which may be purchased singly or in the manual.

First find the drawing that applies to your particular generator. In most cases there are several groups-of-numbers listed with each drawing. These numbers represent the variety of armatures used in that particular generator. After each armature number, the size wire and number of turns of original windings is also listed. For instance one model generator can have as many as a dozen different armatures, therefore, be sure to check your armature number so you can determine the correct size wire to use for rewinding.

Now remove all the old wire with care, so as not to harm the commutator bars. Take particular notice how the old wire was removed as the new wire will be installed identically for high speed work, or identically except for number of turns and size of wire for windcharger or other slow speed work. Clean the stripped armature thoroughly. A dirty armature can cause no end of trouble through grounds and shorts.

Select your wire size. For automotive and other high speed work use the wire sizes as recommended in the drawing. For windcharger work we have found the following wire sizes to give best results for lowest cut-in speeds with highest safe maximum output—where the drawing calls for No. 15 or No. 16 wire use No. 19 wire; where the drawing calls for No. 17 or No. 18 wire, use No. 20 wire. Heavy Formvar magnet wire is recommended instead of a.c.e. as more turns can be installed in each slot.

First remove armature and measure wire size, also count number of turns per coil and make note of commutator connections and coil span. As most auto armatures are originally wound with No. 16 a.c.e. and assuming that your armature is of 16 s.c.e. the proper size to rewind with will then be No. 19 heavy Formvar, as 5 sizes smaller is usually used for slow speed.

Clean all slots thoroughly and insert insulation papers of proper size in each slot—this paper to be .507 thickness. Before you start winding it is necessary to figure out how many turns is to be made in each coil. As armatures vary in total slot numbers and slot sizes it is hard to give a definite figure that can be applied to all

armatures, yet it is very simple to determine if you follow these easy instructions. Cut several pieces of 19 wire (or the wire you are going to rewind with) about 1/4" longer than slot length. Use one slot and start laying the cut wires into this slot, counting each one and packing them in often so no space will be wasted. After the one slot is full and wedge is inserted, remove wedge and take out wires, recount so you will have a double check. Supposing you placed 36 wires in this slot—and as there will be two coils in each slot you will then wind each coil with 18 turns, making a total of 36 wires in each slot. Commutator connections and coil span the same as originally wound.

Some armatures have twice as many commutator bars as slots, therefore it will be necessary to wind with two wires in hand which would mean each slot will have 4 coils instead of 2. In this case the proper number of turns per coil will be 9 turns, two wires in hand or a total of 36 wires in each slot. Remember that the low cut-in speed depends entirely on the number of turns in the armature and not by the size of wire used. Therefore, the more turns in the armature, the lower the cut-in speed is going to be. The dotted line in each drawing indicates whether the starting slot, or slot No. 1 lines up with a commutator segment or with the mica between any two segments. The numbers appearing under the commutator bars such as (1-11 in Ford, 31 slot, 31 segment, Plan No. 35) means that the end bar for coil one is the 11th bar to the right of the starting bar.

In winding any armature the job is simplified by fastening the wire or wires of the coil to the commutator bar or bars, then winding in the proper number of turns, then bringing the wire or wires to the finishing bar of the coil. These end wires are then cut off and folded back until following coils have been wound, in identically the same fashion. After the last coils have been wound, lay a moon-shaped paper over the starts which have been fastened to commutator, then bring the folded wires back through the slots, on top of wires already there and on top of moon-shaped paper, then fasten to proper bars. When 2 wires are wound through each coil we recommend the use of wires of two colors since it is necessary that the two wires are fastened to the proper bars. For example we will take the first drawing in Plan 33. In this armature we wind with 3 wires in hand, a white wire joined to bar 5 and a red wire joined to bar 6. These two wires are then taken as if they were one single wire and wound with proper number of turns through slots 1 and 6 after which the white wire is to be fastened to bar 6 and the red wire to bar 7. The same scheme is used throughout.

When you come to a case such as the Bosch Autolite armature in Plan 53, you will find the notation "Lap to the left—Last coil is dead." This means that coils should all be laid to the left. An examination of this armature reveals that there is one less bar than twice the number of slots which is common in two-in-hand wound armatures. Therefore, when the last coil is to be wound, there will

be bent one bar while there are two wires. In this case, the red wire may be eliminated from this last coil if so desired, though it is advisable to use it as a filler to aid in balancing the armature. Thus the white wire will be fastened to starting and ending bars of that coil while the red wire is clipped off close to the slot at each end of the coil. When an armature is wound, it should have two wires fastened to each bar and wires of at least two coils lying in each slot.

After the armature is finished it is well to wind string around the wires just back of the commutator bars as on the original winding. Then saturate with varnish, allow to dry and test.

A new commutation point may have to be found on slow speed generators, which can be readily accomplished by fully advancing the control brush, then shifting all brushes as a unit (the entire end bell) to a point where best results are obtained. The method of fastening the end bell of the generator, will best be determined by the mechanical construction of the generator. In most cases by drilling new holes for the bolts which hold the end bell to the generator. No changes need be made in the field coils or brush connections.

Owing to the large number of generators involved it is impossible to give minute details for tests and instructions to cover each case separately, but by reading over carefully Plan 3 of the manual for armatures wound one wire in hand, and Plans 5 and 15 for armatures wound with two wires in hand, no difficulties should be encountered.

The following Kits are made up so you can rewind any automobile armature for slow speed windcharger or for automobile use. There is considerable difference between the size wire used for slow speed windcharger use and that for automobile use—there is also a difference in number of turns, so be sure to state whether you wish to rewind your armature for regular automobile use or for slow speed windcharger use. On all armatures other than the "T" be sure to copy and send with your order, THE NUMBER WHICH APPEARS ON THE ARMATURE LAMINATIONS. It is also necessary to state number of armature slots and number of commutator bars. Make and year of car the generator was taken from, is also helpful to us when filling your order.

You pay postage on following kits.

Kit No. 170—To rewind "T" armature for automobile use. Includes all armature materials, less brushes.

Ship. wt. 3 lbs. (See catalog for price)
For "T" slow speed windcharger kit see No. 105.

Kit No. 171—To rewind Autolite, Bosch, also Bosch-Autolite armatures for automobile use. Includes all materials, less brushes. Ship. wt. 2½ lbs. (See catalog for price)

Kit No. 1818—For slow speed windcharger use (not including the 14 slot 28 bar). Ship. wt. 2½ lbs. (See catalog for price.) For the 14-28 slow speed kit see No. 204.

Kit No. 172—To rewind Delco also Delco-Remy armatures for automobile use. Includes all armature materials, less brushes. Ship. wt. 2½ lbs. (See catalog for price)

Kit No. 1828—For slow speed windcharger use (not including the 14 slot 28 bar). Ship. wt. 2½ lbs. (See catalog for price.) For the 14-28 slow speed kit see No. 204.

Kit No. 173—To rewind Ford "A," "B" and "V-8" armatures for automobile use. Includes all armature materials, less brushes. Ship. wt. 2½ lbs. (See catalog for price)

For slow speed windcharger kit see No. 204.
Kit No. 174—To rewind Ford Powerhouse armature for automobile use. Includes all armature materials, less brushes. Ship. wt. 2 lbs. (See catalog for price)

For slow speed windcharger kit see No. 103.
Kit No. 175—To rewind Northeast armature for automobile use. Includes all armature materials, less brushes. Ship. wt. 2½ lbs. (See catalog for price)

Kit No. 1858—For slow speed windcharger use. Ship. wt. 2½ lbs. (See catalog for price)

Kit No. 176—To rewind Westinghouse armature for automobile use. Includes all armature materials, less brushes. Ship. wt. 2½ lbs. (See catalog for price)

Kit No. 1848—For slow speed use. Ship. wt. 2½ lbs. (See catalog for price.)

Kit No. 177—To rewind Wagner armature for automobile use. Includes all materials, less brushes. Ship. wt. 2½ lbs. (See catalog for price.)

Kit No. 1878—For slow speed use. Ship. wt. 2½ lbs. (See catalog for price.)

Plan 42

Plans For Installing Lights On Your Tractor

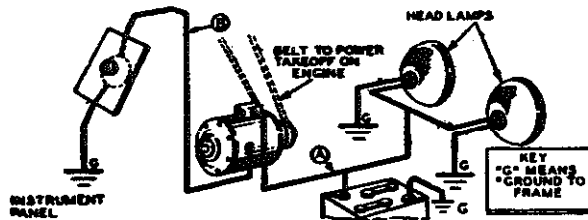

First secure an old auto generator, any make will do, but be sure it is in operating condition. Next determine how the generator is to be driven—either by fan belt or power take-off. If your tractor uses a "V" type fan belt, then perhaps you can secure a longer belt so that after generator is lined up, the longer belt will also operate generator. Some builders will want to put a small pulley on power take-off—this pulley can be either "V" type or flat. If you use a flat pulley, the "V" pulley on generator will keep belt in line.

Next mount the generator and connect according to diagram. Be sure the generator operates from 1200 to 2400 r.p.m. or faster for best results.

Wire "A" connects to battery side of generator cutout and goes directly to battery positive post, also to one side of each head lamp. Other side of battery is grounded to tractor frame, also other side of each lamp is connected to tractor frame.

Next take generator apart and locate the field lead wire that connects the field coils to ground (generator frame). Remove this field coil lead and connect to it a No. 12 flexible rubber covered wire long enough to reach to instrument panel, which is mounted close to

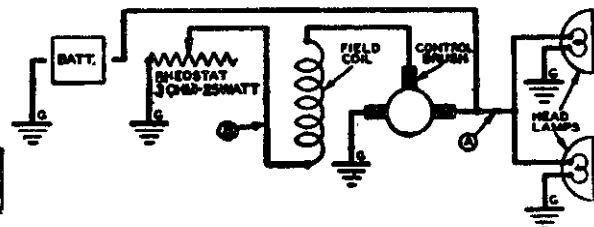

driver's seat. This wire can be brought out of generator by drilling or slotting small hole in cover band—this wire is "B" in diagram. Connect wire "B" to one side of a 3 ohm 25 watt rheostat with other side of rheostat connected to tractor frame. You now will have a 3 ohm variable rheostat in series with the field circuit which will give you a direct control of generator output.

Reason for control is so you can adjust charging rate of generator to any desired amount, depending on condition of battery—if battery is fully charged the generator can be turned off entirely, however, if battery is nearly full, you may wish to reduce the rate to only 2 or 3 amperes. If you have other batteries that need to be charged occasionally then this idea of generator on your tractor will prove to be very practical and profitable.

No. W3 Rheostat is recommended. (See catalog for price.)

No. 57X—Instrument panel with 3 ohm 25 watt rheostat, 10 feet of No. 12 flexible rubber covered wire—ready to mount on your tractor. Shipping weight 1½ pounds. (See catalog for price.)

No. 57W—Same instrument panel as 57X except panel includes a 20-0-20 ammeter. (See catalog for price.)

Plan 43

Two Types 110 Volt, A. C. Insect Exterminators

Either of the two types of exterminators described in the following plans will work satisfactorily on standard house wiring of 110 Volt, 60 Cycle, A. C. Their use will add to the comfort of screen porches, and they will quickly rid a house or building of the bugs and insects which invariably find their ways through the finest protections.

DIRECTIONS

The grid cage top (1), and the grid ring (2), are of ¼" shellacked plywood, or ¼" fiber, and are 6" in diameter. The grid ring (2) is 1" wide. Drill a ¼" hole (3) in the center of the top (1). Cut a 4" hole in the grid ring (2), so the hand can easily pass through to install light bulb. The four grid posts (4), are of ¼" bakelite, ¼" wide, and 6" or 8" long, or something equally as strong. To hold the 22 Ga. bare copper grid wires "A", and "B", cut grooves ¼" apart in the outside edge of each grid post, beginning ¼" from one end, and continuing to a point ¼" from the other end. Notch the posts (4) into the cage top (1), and the grid ring (2). Assemble the cage. If made of wood be sure to glue old joints.

The socket shell (5) is taken from a standard base socket. The socket shell (6) is taken from a "miniature" base socket. Washers (7), and (8), are of fiber. The brass screws (9), and (10), are 6/32

size, and just long enough to pass through the necessary parts and finish flush after the nuts (11), and (12) are in place. (13) is a brass washer. The ¼" hole (14), is 2" from hole (3); the ½" hole (15) is ¼" from hole (14), on a line with hole (3). Loop the end of a piece of No. 14 wire to fit under the head of bolt (10), and bend it to pass through hole (15).

The plug (17) is made of an old fuse plug, or an ordinary screw-in type plug, with the inside parts removed. Drill a ¼" hole (18) through the center of the plug, and cut the notch (19) in the rim. Solder a 14" piece of No. 14 wire to the side of shell (5). Drill a ½" hole (21) to allow the wire (20) to pass through when the shell (5) is centered over the hole (3).

When the plug is dry in all the cage joints, the assembly can begin. Fit washer (8) into shell (5). Pass wire (16) through side opening in shell (5), and pass bolt (10) through the loop in wire (16), through hole in washer (8), which prevents bolt from touching shell (5). Pass wire (20) through hole (21), pass wire (16) through hole (15), pass bolt (10) through hole (3). Slip the plug (17) over bolt (10) so that wire (20) fits into the notch (19), then tighten nut (12) into place. File the bolt flush with surface of nut, and hold permanently with a drop of solder. Solder the wire (16) to the ferrule on plug (17) after cutting off any extra length which might prevent the plug from being screwed firmly into a light socket.

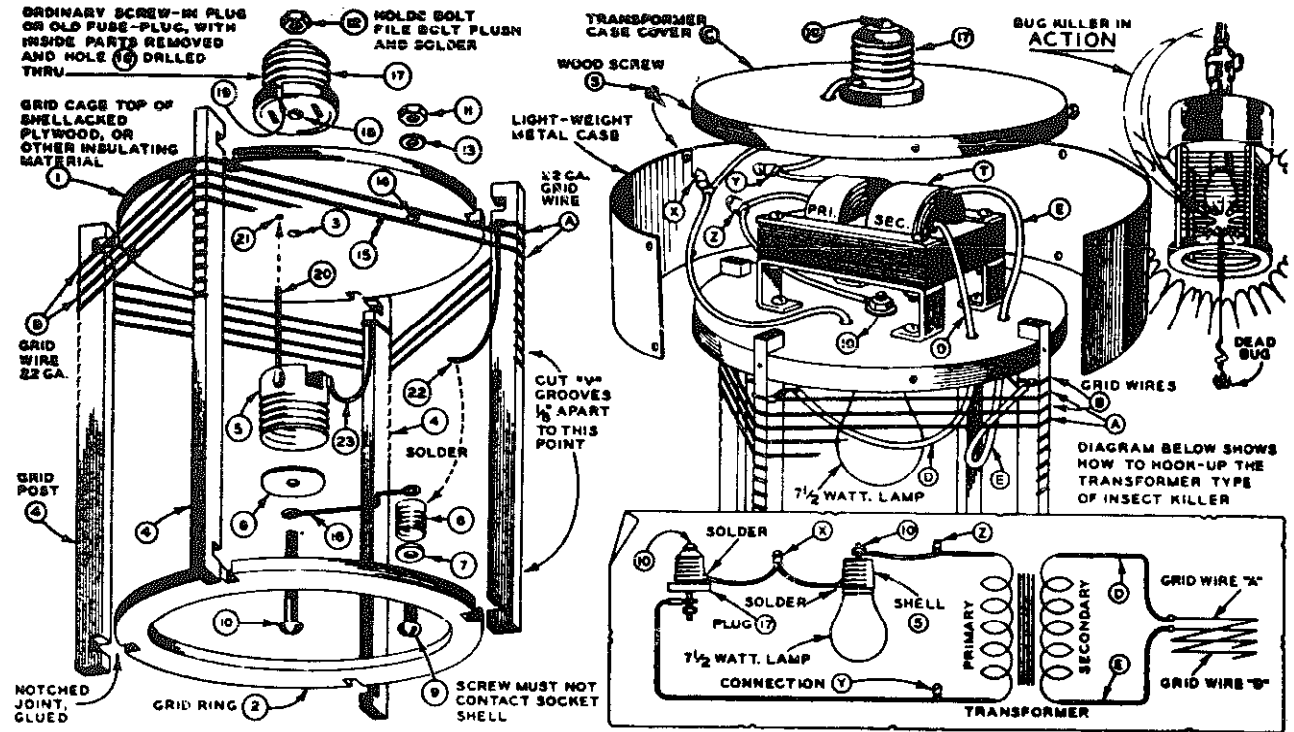

Pass bolt (9) through washer (7), through hole in bottom of shell (6), and through hole (14). Slip washer (13) over bolt (9), loop the end of wire (10) around the bolt and tighten nut (11) into place. Hold permanently with solder.

The grid consists of the two parallel wires "A", and "B", wound side by side the length of the grid posts. Begin the windings by a connection (22) from wire "A" to the socket shell (6). A similar connection (23) is run from the wire "B" to socket shell (5). Fasten the lower ends of the wires by binding them around the posts on which they finish. Put a drop of solder on the bind. The grid wires must not touch each other at any point.

To operate electrocutor, screw into a light socket, insert a standard base 25 watt lamp in the socket (5), and a 110 V. 7 1/2 watt miniature base lamp in socket (7). Turn on the current. Any small insect attracted by the light will be electrocuted upon coming in contact with the wire grid. If the small bulb glows, there is a short somewhere in the grid. This type of electrocutor is of the simplest operation. The small bulb allows a limited amount of current to pass into the grid wires, and this controlled current electrocutes the insect as it comes in contact with the wires, forming a short circuit of its body.

TRANSFORMER TYPE

The transformer type of electrocutor, while a bit more expensive, is no more difficult to construct, and has the power to electrocute all size bugs and insects although they may make just an instant contact with the grid wires.

The grid cage top, the grid ring, and the grid posts are exactly the same as those in the lamp type. In addition, the transformer case

cover is cut of the same material, 6" in diameter. (C). A special transformer (T), is fastened to the Grid cage top (1). A socket shell, fiber washer, and bolt similar to items (5), (8), and (10) are mounted underneath the cage top. A plug (17), is mounted on the case cover, and a flexible wire connection (X), is run between the two shells as in the diagram below. The center bolt (10) of the top plug is connected to one side of the transformer, and the center bolt of the shell (5) below the cage top is connected to the other primary lead. These are connections (X), and (Y), in the diagram. Connect one side of the transformer secondary to wire (A), and the other side of the secondary to wire (B) of the grid winding. These are connections (D), and (E), in the diagram. Cut a strip of light metal to form a case between the grid top and the case cover. Fasten it in place with small wood screws (3). This strip is wide enough to allow 1" clearance between the transformer and the case cover. Insert a 7 1/2 watt lamp in the socket (5), and screw the killer into a light socket, as shown in the small drawing at the right. Turn on the juice, and the killer is at work. The lamp will glow, though not at full brilliance. This lamp controls the amount of power admitted to the transformer primary. The transformer then raises the voltage to a high tension which is discharged through the grid wires. Any bug or insect coming into contact with grid wires for a split second will be destroyed.

The secondary of this transformer is wound with approximately 15,000 turns No. 40 P.E. wire making it impractical for a home workshop job—therefore we suggest you purchase this item from us. We do not have for sale any other parts for exterminators. No. T—Special Transformer for this plan. Ship. wt. 4 lbs. F.O.B. (See catalog for price.)

Plan 44

An Electric Scooter Using a 6 or 12 Volt Battery For Power

RUNS 50 TO 75 MILES ON SINGLE BATTERY CHARGE

The LeJay Electric Scooter is one that knows no equal in performance, long life and low operating cost. Because you can charge on a 6 or 12 volt battery at home, it is as convenient as 5c and because the LeJay scooter runs 50 to 75 miles on one charge, it is the most economical possible the extreme low operating cost. Operates on either 6 or 12 volts. To start it you merely turn the knob control and you have a smooth running silent motor. No cranking, chugging, bucking, coughing or vibration with a LeJay Electric Scooter. Assemble it yourself and save.



DIRECTIONS

First secure a model "T" Ford generator. If the bearings, brush holder, brushes, commutator or other parts are badly worn they may be replaced by purchasing from us—see catalog for parts list. Remove gear and take generator apart. By using a screw driver carefully pry wires out of commutator risers (be sure not to harm commutator), then push out old wedges holding old windings in place. Remove wire and clean slots thoroughly.

The armature shaft has to be extended to 3 3/4" measuring from outside edge of 203 bearing, instead of 4 1/2" which is original measurement. The extended shaft may either be welded or machined and pressed on, then turn to 1/2" in diameter for a distance of 2 1/4" from end. Thread with 1/2" die 24 threads per inch. The rubber drive roller will fit this extended shaft perfectly.

Next take insulation material .007 thickness and cut into pieces 2 1/2 x 1 3/4 inches, 21 pieces in all. Put one piece in each slot. This size paper will extend a little above the slots which will later be folded over when wedges are put in to protect the new windings.

Now hold the armature in your hand with the commutator next to you and number each commutator bar with white chalk. 21 bars in all. Use 16 H. Formvar magnet wire (two strands of wire in hand when winding), solder ends of both wires to bar 1 (a large soldering iron will be necessary for this operation in order to sweat the solder to the heavy copper segments), then run both wires through slot 3 and back through slot 8—return to slot 3 again and place in 4 turns, then from slot 8 solder both wires to bar 11 as shown in diagram. You now have completed one coil.

Next solder both wires to bar 2 and run through slot 4 and back through slot 9 as shown. Here wind in 4 turns also then from slot 9, solder both wires to bar 12 as shown in diagram below. Continue on in like manner until all 21 coils are in place. 4 turns of two wires to each coil.

Fold insulation paper down in slots over wire and insert wooden wedges. Next test each coil for grounds and shorts. Use a non-conductor varnish and soak armature well and allow to dry—repeat two or three times, allowing to dry each time.

Next remove all 4 field coils. Use No. 18 P. E. wire, two strands in hand and wind 4 field coils to same size and shape as coils just removed. Wind these coils carefully, winding 57 turns per coil. Tape, shape, then varnish. Connect all field coils in parallel, see Fig. 2. "Schematic Connection Diagram." The two main brushes are only brushes used, thus eliminating control brush. Connect one field lead to generator terminal and other field lead to main ungrounded brush. Other main brush is already grounded. Be sure to use best brushes obtainable. Connect 6 or 12 volts to generator frame and generator terminal. Polarity has no effect. If motor runs in wrong direction then reverse the two field leads. Lubricate as you do your car generator.

Listed below are supplies for making this change which are offered at following low prices. All supplies fully guaranteed.

- Part Number Article**
 0-1818—Complete kit for rewinding your own Ford "T" generator to a scooter motor.
 1 1/4 lbs. No. 16 heavy Formvar magnet wire.
 2 lbs. No. 18 P. E. magnet wire.
 1 roll cotton tape.
 2 copper carbon brushes.
 2 fibre end laminations.
 Scotch tape to hold laminations.
 1 can special air drying varnish.
 21 wooden slot wedges.
 21 insulation papers .007 thickness.
 Above kit complete, shipping weight 5 lbs., F.O.B. (See catalog for price).

FACTORY MADE ARMATURES and FIELD COILS

This armature has an extended shaft and threaded so the friction drive rubber roller may easily be installed. Armature comes completely rewound, varnished baked and ready to install in your "T" frame and to be used in conjunction with LeJay factory made field coils.



No. ER18—Ford "T" factory rewound and reconditioned armature with extended shaft, threaded and lock nut included for use in Scooter Motor. Ship. wt. 7 lbs. F.O.B. (See catalog for price.)
 LeJay factory made field coils when used with above armature make a Scooter Motor like our Model No. ER48. Use these coils and above armature in your own "T" frame and save the difference.

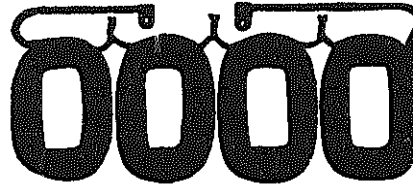

Field coils are connected in parallel when you receive them so all that is necessary for you to do is connect your motor as shown in figure 2 "Schematic circuit diagram."

No. ER18—Set of 4 special LeJay field coils for LeJay Scooter Motor. Ship. wt. 3 1/2 lbs. F.O.B. (See catalog for price.)

0-1820—Set of two copper carbon scooter motor brushes, postpaid. (See catalog for price)

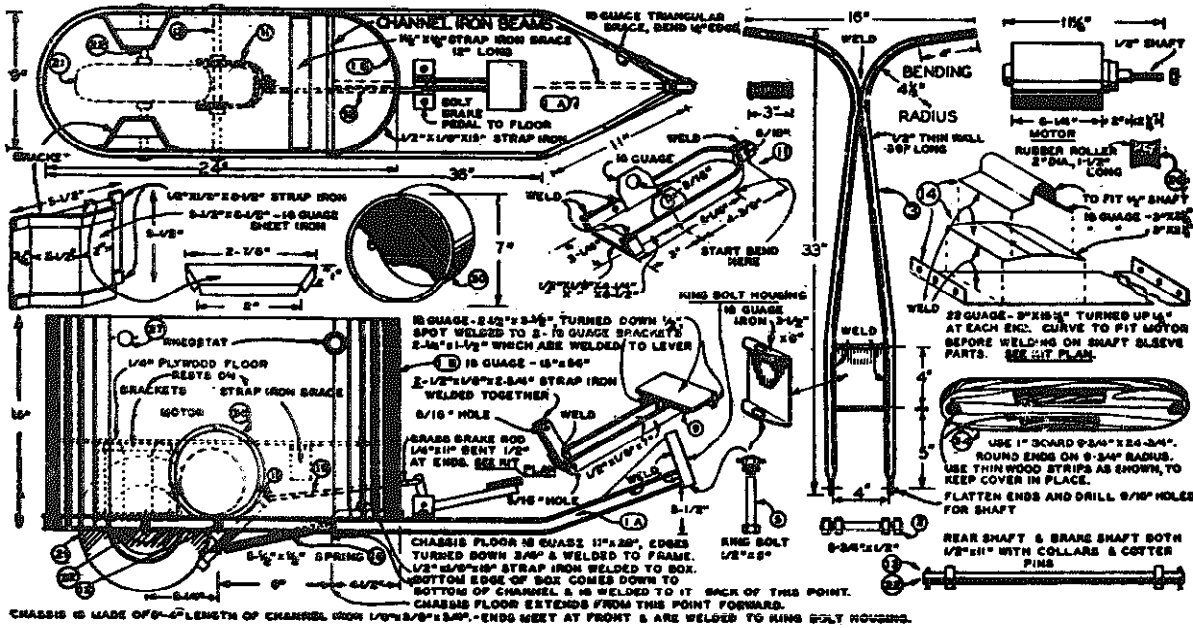

The accompanying diagrams and instructions explain clearly how to construct and assemble the LeJay Electric Scooter. There are two large drawings to consult, showing all details for making each piece and for assembling, which should eliminate all questions.

12 volts produces approximately twice the power and speed as 6 volts. The LeJay Scooter will carry a 175 pound person up to 15 miles per hour on 12 volts.

FACTORY BUILT MOTOR FOR SCOOTER

LeJay Scooter Motor built from "T" generator including rewound and reconditioned armature with long threaded shaft and nut, new brushes, new field coils, grease sealed bearings, etc. Especially designed for Scooter. Does not include rubber roller drive. Operates on either 6 or 12 volts.

No. ER48—Motor as above described. Ship. wt. 18 lbs. F.O.B. (See catalog for price.)

No. RX speed control rheostat and switch 10 oz. (See catalog for price.)



Before beginning the actual assembly, lay all of the parts out on the floor and study the plan until you are familiar with the proper numbering of each part as well as its purpose and operation.

The front wheel (1), rides on the axle (2), between the legs of the steering fork (3). Adjust the tension on the bearing by means of the two inside nuts and lock securely with the outside nuts in the same manner as you would adjust the front wheel of a bicycle. The Wheel must turn freely but must not wobble.

Now slip the fork over the king-bolt housing (4), and run the king-bolt (5), up through the housing and fork bracket. Place the lock-washer (6), on the king-bolt and screw the nut (7), down tightly. Lock the nut in place with the cotter-key (8).

Fasten the brake-pedal (9) in position on the floor with the bolts (10).

The brake-carrier (11), and the brake-shoes (12), are already assembled on the brake-shaft (13), and are held firmly in place by two collars.

If you have built your own motor according to the plan, clamp it loosely in the cradle with the three bolts, and mount the roller (26), on the shaft with the washers and nut provided. The roller must be held very tightly to prevent slipping.

Slide the motor assembly onto the brake-shaft (13), and fit the shaft into the holes (15) in the frame. Lock the shaft in place with cotter-keys.

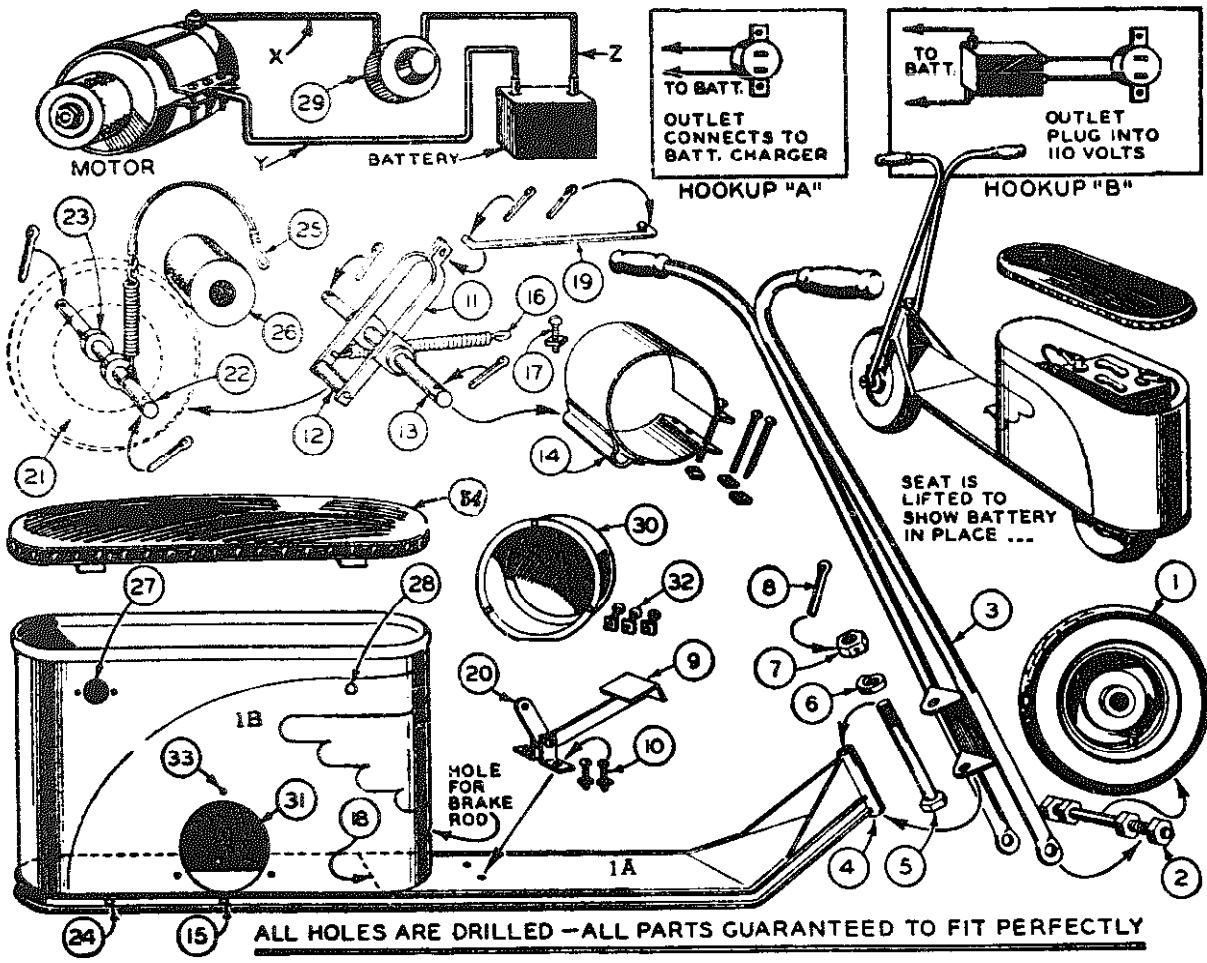

Mount the rear wheel (21), on the shaft (22), with one lock-collar on each side to hold the wheel in place. Slide the spring (25), onto the shaft and place the axle in the holes (24), in the frame. Place cotter-keys in the holes in the shaft, and center the wheel. Tighten the set-screws in the collars (23).

Slide the motor in its cradle to center the rubber roller on the tire of the wheel, and tighten the bolts in the cradle. Loop the spring (25), over the top of the motor and hook it on one of the clamp bolts (18). This spring causes the roller to bear on the tire with sufficient pressure to drive the Rocket.

Fit the brake-rod (19), into the hole (20), in the brake-pedal, run it through the hole in the front of the seat-box and through the hole in the brake-carrier (11). Fasten the spring (16), to the frame cross-member at (18), by means of the bolt (17). Place cotter-keys in the holes in the brake-rod.

Mount the rheostat (29), in the hole (28), and the outlet plug in the hole (27). The end of motor extends through hole (31) which is covered and protected by cover (30) and fastened with bolts (32) into holes (33). Follow the diagram for connections. Run a wire

(x) from the motor terminal to the rheostat. Run a wire (Y), from the NEGATIVE side of the battery to the motor case. (This wire may be clamped under one of the motor cradle bolts.) Run a wire (Z), from the rheostat to the Positive side of the battery. Battery clips are provided for the battery connections.

The outlet plug provides a convenient connection for recharging the battery without its removal. If you wish to set up your charger at home, connect it as shown in "HOOKUP A." Mark the positive side of the plug to avoid mistakes in charging.

If you desire to be able to recharge the battery anywhere without the necessity of returning home, connect the outlet plug as shown in "HOOKUP B," to a charger of the dry type, mounted inside the seat-box. Carry a length of extension cord in the seat-box for plugging into 110 volts wherever necessary and you may extend your cruising radius indefinitely.

Now, place one or two six-volt, or one twelve-volt battery in the seat-box, clamp them down firmly, and as soon as the battery clips are fastened and the seat cover is in place, your LeJay Electric Rocket is ready for the road.

Plan 45

An Electric "Go-Bike" Using a 6 or 12 Volt Battery For Power

RUNS 50 to 75 Miles on Single Battery Charge—

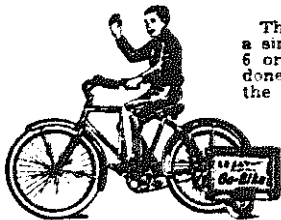

DIRECTIONS

First secure a model "T" Ford generator. If the bearings, brush holder, brushes, commutator or other parts are badly worn they may be replaced by purchasing from us—see catalog for parts list. Remove gear and take generator apart. By using a screw driver carefully pry wires out of commutator risers (be sure not to harm

commutator), then push out old wedges holding old windings in place. Remove wire and clean slots thoroughly.

The armature shaft has to be extended to $3\frac{1}{4}$ " measuring from outside edge of 203 bearing, instead of $\frac{11}{16}$ " which is original measurement. The extended shaft may either be welded or machined and pressed on, then turned to $\frac{1}{4}$ " in diameter for a distance of $3\frac{1}{4}$ " from end. Thread with $\frac{1}{8}$ " die 24 threads per inch. The rubber drive roller will fit this extended shaft perfectly.

Next take insulation material .007 thickness and cut into pieces $2\frac{1}{2} \times 1\frac{1}{4}$ inches. 21 pieces in all. Put one piece in each slot. This size paper will extend a little above the slots which will later be folded over when wedges are put in to protect the new windings.

Now hold the armature in your hand with the commutator next to you and number each commutator bar with white chalk. 21 bars in all. Use 16 H. Formvar magnet wire (two strands of wire in hand when winding), solder ends of both wires to bar 1 (a large soldering iron will be necessary for this operation in order to sweat the solder to the heavy copper segments), then run both wires through slot 3 and back through slot 8—return to slot 3 again and place in 4 turns, then ~~return~~ slot 8 solder both wires to bar 11 as shown in diagram. ~~Two~~ you have completed one coil.

Next solder both wires to bar 2 and run through slot 4 and back through slot 9 as shown. Here wind in 4 turns also then from slot 9, solder both wires to bar 12 as shown in diagram below. Continue on in like manner until all 21 coils are in place. 4 turns of two wires to each coil.

Fold insulation paper down in slots over wire and insert wooden wedges. Next test each coil for grounds and shorts. Use a non-conductor varnish and soak armature well and allow to dry—repeat two or three times, allowing to dry each time.

Next remove all 4 field coils. Use No. 18 P. E. Wire, two strands in hand and wind 4 field coils to same size and shape as coils just removed. Wind these coils carefully, winding 57 turns per coil. Tape, shape, then varnish. Connect all field coils in parallel, see Fig. 2. "Schematic Connection Diagram." The two main brushes are only brushes used, thus eliminating control brush. Connect one field lead to generator terminal and other field lead to main ungrounded brush. Other main brush is already grounded. Be sure to use best brushes obtainable. Connect 6 volts to generator frame and generator terminal. Polarity has no effect. If motor runs in wrong direction then reverse the two field leads. Lubricate as you do your car generator.

Listed below are supplies for making this change which are offered at following low prices. All supplies fully guaranteed.

- | Part Number | Article |
|-------------|---|
| 0-1618 | Complete kit for rewinding your own Ford "T" generator to a Go-Bike motor. |
| | 1 1/4 lbs. No. 16 heavy Formvar magnet wire. |
| | 2 lbs. No. 18 P. E. magnet wire. |
| | 1 roll cotton tape. |
| | 2 copper carbon brushes. |
| | 2 fibre end laminations. |
| | Scotch tape to hold laminations. |
| | 1 can special air drying varnish. |
| | 21 wooden slot wedges. |
| | 21 insulation papers .007 thickness. |
| | Above kit complete, shipping weight 5 lbs., F.O.B. (See catalog for price.) |

FACTORY MADE ARMATURES and FIELD COILS

This armature has an extended shaft and threaded so the friction drive rubber roller may easily be installed. Armature comes completely rewound, varnished, baked and ready to install in your "T" frame and to be used in conjunction with LeJay factory made field coils.

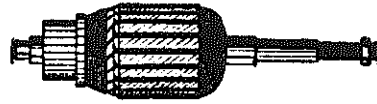

In all cases your armature must be sent in when exchange is desired as we do not make outright sales.

No. ER16—Ford "T" factory rewound and reconditioned armature with extended shaft, threaded and lock nut included for use in GO-BIKE Motor. Ship. wt. 7 lbs. F.O.B. (See catalog for price.)

LeJay factory made field coils when used with the above armature make a GO-BIKE Motor like our model No. GB48. Use these coils and above armature in your own "T" frame and save the difference.



Field coils are connected in parallel when you receive them so all that is necessary for you to do is connect your motor as shown in figure 2 "Schematic circuit diagram."

No. ER18—Set of 4 special LeJay field coils for LeJay GO-BIKE motor. Ship. wt. 3 1/4 lbs. F.O.B. (See catalog for price.)

0-1620—Set of two copper carbon GO-BIKE motor brushes, post-paid. (See catalog for price.)

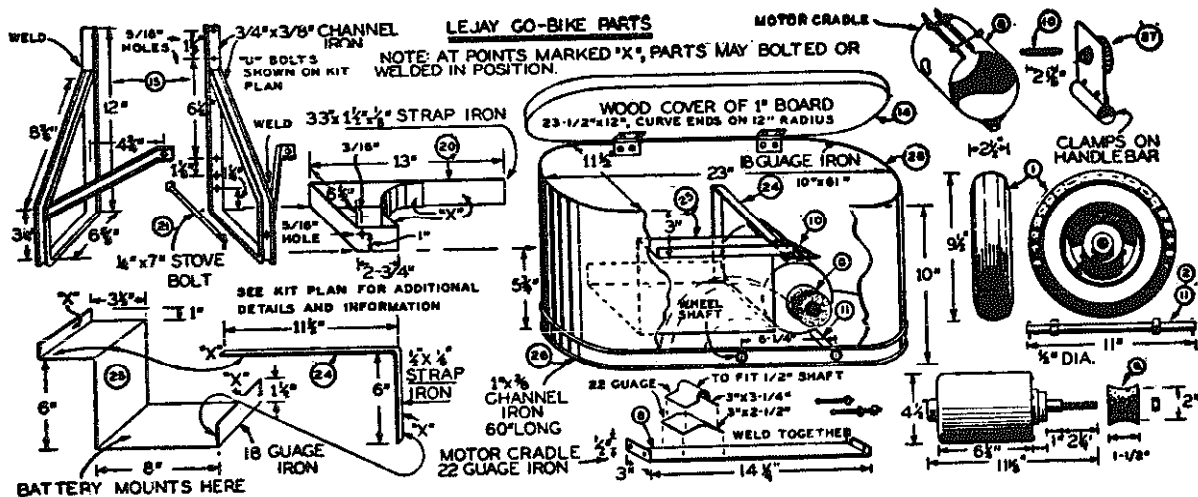
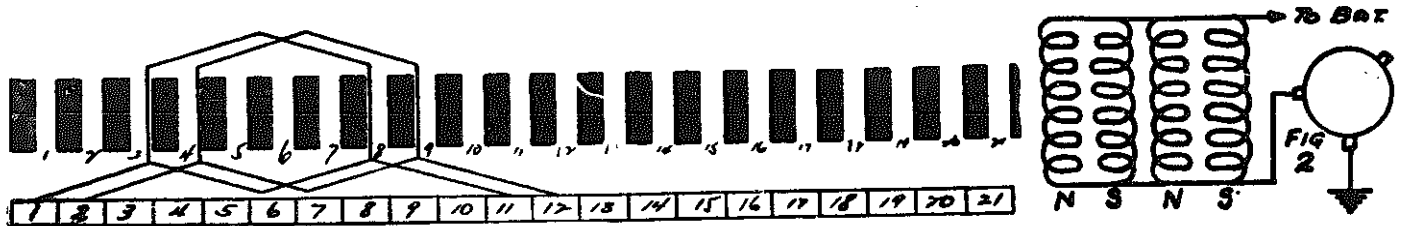

The accompanying diagrams and instructions explain clearly how to construct and assemble the LeJay Electric Go-Bike. There are two large drawings to consult, showing all details for making each piece and for assembling, which should eliminate all questions. 12 volts produces approximately twice the power and speed as 6 volts. The LeJay Go-Bike will push a bicycle with a 175 pound man up to 10 miles per hour on 12 volts.

FACTORY BUILT MOTOR FOR GO-BIKE

LeJay GO-BIKE Motor built from "T" generator including rewound and reconditioned armature with 1/2" threaded shaft and

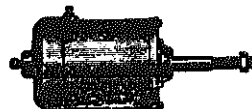

No. RX—Speed control rheostat and switch, 10 oz. (See catalog for price.)

nut, new brushes, new field coils, grease sealed bearings, etc. Especially designed for GO-BIKE. Does not include rubber roller. Operates on either 6 or 12 volts.

No. GB48—Motor as above described. Ship. wt. 18 lbs. F.O.B. (See catalog for price.)

Plan 46

A Carbon Electrode Holder for Soldering, Brazing and Light Welding Direct From Six-volt Storage Batteries.

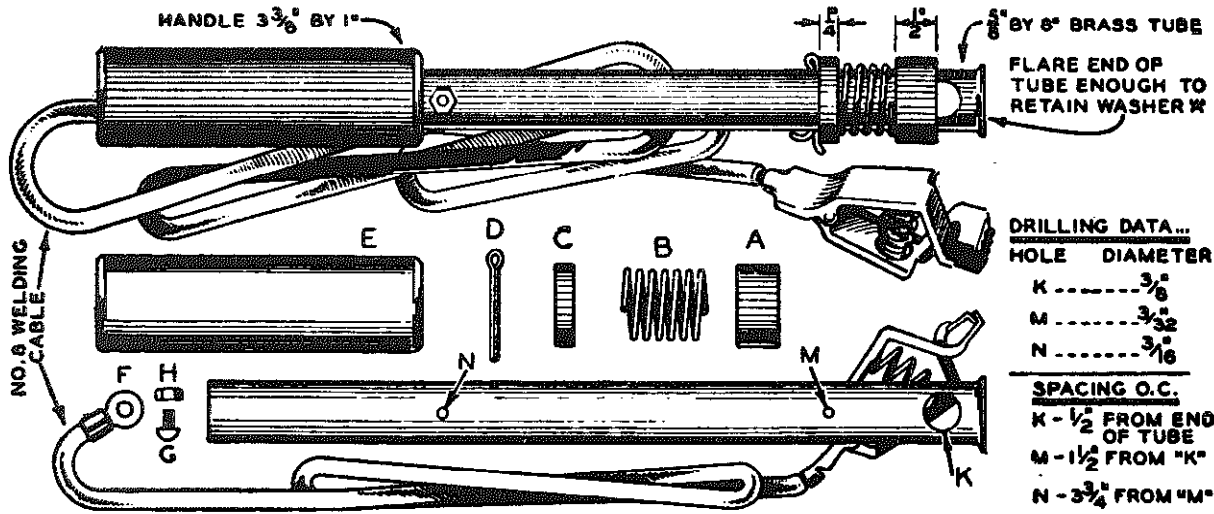

DRILLING DATA...

| LETTER | HOLE DIAMETER |
|--------|---------------|
| K | 3/8" |
| M | 3/32" |
| N | 3/16" |

SPACING O.C.

| | |
|---|-----------------------|
| K | 1/2" FROM END OF TUBE |
| M | 1 1/2" FROM "K" |
| N | 3 3/4" FROM "M" |

In and about the shop of average size, a situation will arise from time to time, wherein the shopman finds himself in need of a bit of soldering, brazing, or welding at a point where ordinary commercial methods are neither available nor practical. He may find no power source at hand, or the necessary equipment may be too expensive. In such a case, the small portable type of welder illustrated and described in this plan will be found worth many times its cost.

For convenience, the power source most portable, and most usually available, is the storage battery. Converting its power into the heat necessary for the work desired, requires a carbon contact. Therefore, the construction of a carbon electrode holder of a size and capacity suited to handle the maximum output of the battery is all that is necessary to put into the hands of the workman the ability to handle emergency jobs that otherwise might cause no end of annoyance in the loss of time and expense.

DIRECTIONS

Cut the washers (A), and (C), from ordinary pipe having 1/4" walls and an inside diameter of sufficient dimension to slip easily over the 3/8" tube. The end of this 8" brass tube is flared to prevent the washers from slipping off. This is done by tapping with a small ball peen hammer, or by means of a large lathe center or punch. Not much of a flare is required. The spring (B) fits loosely on the brass tube, but will not slip over the washers. It is about 1 1/4" long when expanded, and should be fairly stiff. 15 or 16 gauge spring steel wire is about right. The 3/4" hole (K), which accommodates the carbon electrode, is centered 1/2" from the end of the tube. This hole is drilled thru both walls of the tube. Hole (M), is centered 1 1/2" from the center of (K), and is drilled 3/32" to take the 1" cotter key (D), which holds washer (C) in place. This hole is also drilled thru both walls of the tube. Hole (N) is centered 3 3/4" from the center of (M), and is drilled 3/16" to take the connector bolt (G). This hole is drilled thru only one wall of the tube.

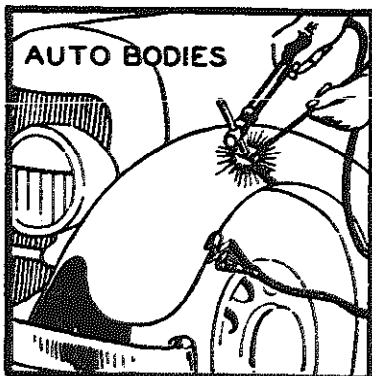

the free end of the cable, and solder.

A ground cable is necessary with which to connect the positive side of the battery to the work. This ground cable consists of a six-foot length of No. 8 welding cable with a heavy battery clip soldered to each end.

Now, slip the two washers and the spring onto the tube and set the cotter key in place. Slip the handle onto the tube to the position indicated in the drawing. This handle may be of wood, bicycle grip or a 3" to 4" piece of regular garden hose.

Place the bolt (G) in the lug (F), and solder it in place. Insert the cable in the tube until the bolt can be fed thru the hole (N), where it can be tightened securely by means of the nut (H). Flow solder over this nut and bolt. Fasten a heavy battery clip to

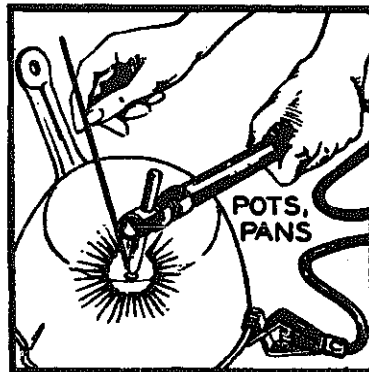

You may take your own carbon tips by shaving old dry cell carbons down to the proper size, but better results will be had by the use of the commercial tips manufactured especially for this purpose.

The hookup diagrams explain clearly the method of connecting the welder for work. For soldering, brazing, and very light welds, one six-volt storage battery will serve nicely; but for heavier work, two six-volt batteries in parallel with a driven generator and cutout

will help materially. Remember that this tool is for all around soldering, medium brazing, and very light emergency welding. Therefore, it should never be expected to compete with the transformer or heavy generator type of commercial welder. However, for light gauge metals, and for welds requiring currents of comparatively short durations, this midget welder will prove its great value in a short time.

For light body and fender work, or minor engine repairs, the car's own battery may be used. Simply clip the main cable directly to the terminal of the starting motor. No ground cable is needed, as the frame of the car will form its own return.

Preheating with a blow-torch will be found of material assistance in the successful forming of joints heavier than ordinary.

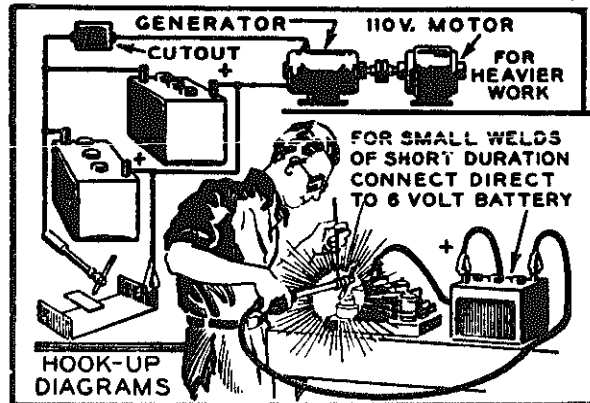

The cutout must be mounted onto generator; or, be sure that cutout frame is connected to generator frame otherwise cutout will not function properly. Batteries to be connected in parallel (positive to positive and negative to negative).

Parts for making this welder are not sold separately but a complete kit of parts (you assemble it) may be purchased from us at a very surprisingly small amount. (See catalog). Also listed in the catalog are goggles for use with this welder, small brazing and welding rods also other welding supplies at low prices.

Kit Plan

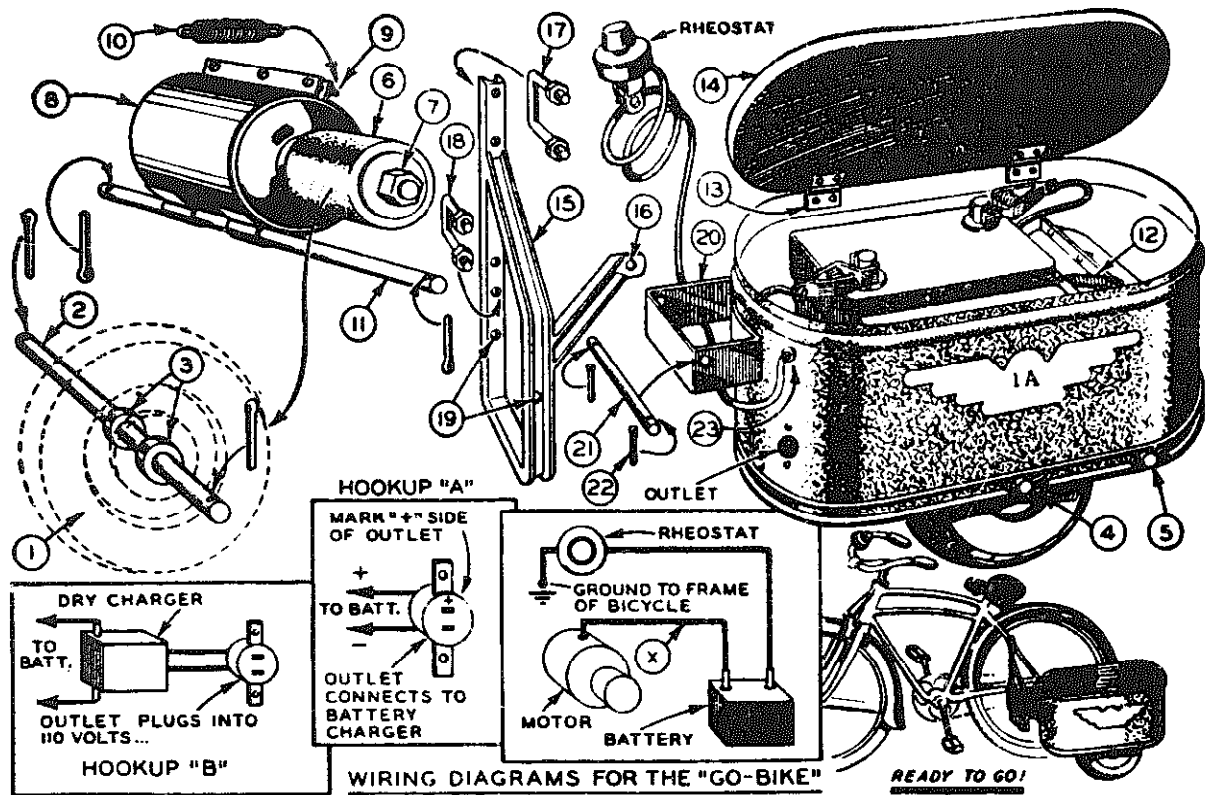

WIRING DIAGRAMS FOR THE "GO-BIKE"

READY TO GO!

Before beginning the actual assembly, lay all of the parts out on the floor and study the plan until you are familiar with the proper numbering of each part as well as its purpose and operation.

The drive wheel (1) rides free on the axle (2), and is held in position by the two collars (3). Place the wheel in position, run the axle through the holes (4), in the main frame, allowing the collars (3) to remain loose until the cotter-keys (5) are in place. Now center the wheel on the shaft and tighten the set-screws in the two collars. The wheel must turn freely, but it should not wobble nor rub against the sides of the wheel well.

If you have built your own motor according to a LeJay Plan, fasten the roller in place on the shaft between the washers provided, and tighten the nut (7) securely. Slip the motor into the cradle and clamp it loosely by means of the bolts (9).

Fit the rod (11) into the holes (5) in the main frame, bringing the motor assembly into approximately the proper position.

Adjust the motor back and forth in its cradle to center the roller (6) exactly on the tire of the drive wheel, and tighten the cradle bolts (9). The spring (10) is slipped over one of the bolts (9) and hooked into the hole in the cross member as shown at (12). This spring provides sufficient tension between the roller (6) and the tire of the drive wheel to propel the GO-BIKE.

Two hinges (18) are provided, complete with nuts and bolts, to fasten the cover (16) in place over the motor housing.

To mount the bike bracket on your bicycle, remove the nut from the rear axle (on the left side), fit the hole (16) in the brace over the axle stub and replace the nut. Fasten the upright leg of the bracket to the bicycle frame members by means of the two "U" bolts shown at (17) and (18). Adjust the bracket to a vertical position and tighten all of these bolts.

Fit the holes (19) in the bracket over the holes in the hanger bracket (20), and slip the hanger pin (21) into place. Lock it in position with the cotter-keys (22).

A wire (x) runs from the terminal on motor to either one of battery posts. One end of control cable is connected to the other battery post then brought out through the hole (23) which has a rubber bushing. Connect other end of this cable to un-grounded terminal of rheostat. Because other terminal of rheostat is already grounded there will be no other connections necessary.

The plug marked (outlet) may be connected as in hook-up "A" to allow quick connection to a home charger. If you desire to be able to recharge the battery anywhere without the necessity of returning home, connect the outlet plug as shown in "HOOKUP B" to a charger of the dry type, mounted inside the battery box. The battery may now be recharged by simply plugging into 110 volts A.C. wherever available. An unlimited cruising radius is yours with the GO-BIKE when it is equipped with the self-charger.

Now place a 6 or 12 volt battery in the carrier box and clamp down firmly, then as soon as the battery clips are connected your LeJay GO-BIKE is ready for use.

Plan 47

Ball Type Fence Controller Made from Ford T Coil

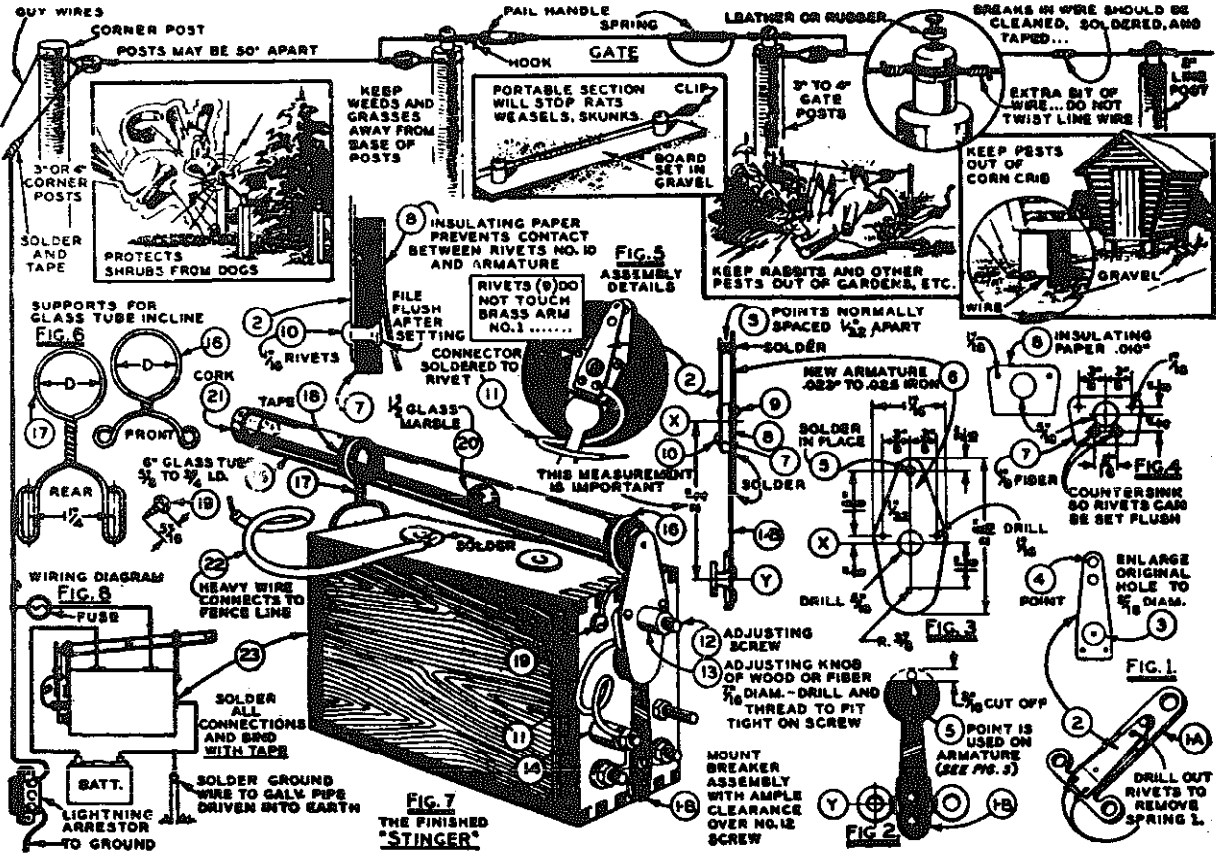

Everyone has a Ford "T" Coil or can easily get one from his neighbor or used auto parts yard. This is one reason the "T" is used for this plan. Another reason is that it has mounting posts on end of coil which make it easy for holding various fittings.

Operating on a six volt battery, the Fence Control built from a Ford "T" Coil is capable of charging from 5 to 8 miles of fence. If special attention is given to proper insulation of the entire circuit, and to spacing the posts as far apart as possible, 10 to 12 miles of fence can be electrified successfully. The reason for this added coverage is simple.

The Fence Control delivers a shock of low current at a very high voltage. Because of this high voltage, there is a marked tendency toward leakage at every point of support regardless of the type of insulation used. Therefore, use only first quality porcelain insulators and allow only as many posts to the mile as are necessary to support the wire without undue sag. The superior performance of this installation will more than compensate for the slight additional effort and expense involved.

The control of livestock is without doubt the most important application of the charged fence, yet the number of ways in which it may be used to advantage is limitless. For instance, by encircling the foundations of buildings with but a single wire supported only by porcelain knobs, a barrier is formed only one inch from the surface of the wall. This will prevent rats, mice, ground squirrels and similar pests from crawling into the protected building. In the case of corn-cribs, granaries, and other buildings sometimes built upon piers, the charged wire is led from pier to pier at a height of 5' above the ground, and around each pier on the porcelain insulators. The wire 5' above the ground will keep rabbits, skunks, woodchucks and the like from under the structure, and the wires around the piers will keep out the rats, mice, weasels, squirrels, etc. Gravel should be spread on the ground directly under the wire to hold down weeds and grass which would short-circuit the charged wire upon contact.

Trees, shrubs, flowers and gardens will be free from damage by dogs, rabbits, skunks, woodchucks and the larger squirrels if a wire surrounds the area supported by porcelain insulators on stakes of the proper heights.

By applying the various methods outlined above to chicken houses and yards, danger to the fowls from weasels, mink, rats, mice,

skunks, foxes, and stray cats can be eliminated. For the protection of temporary or movable structures such as brooder houses and range shelters, the most convenient installation is in the form of portable sections capable of being set up in a few minutes time to enclose areas of almost any size or shape; these sections consist of lengths of bare wire mounted on flat boards by means of porcelain insulators, one at each end. A clip of one kind or another fastened to one end of the wire makes the connecting easy.

Where numbers of widely separated buildings must be effectively fenced, it would not be amiss to suggest the building of an individual control for each structure. This would eliminate the need of long lines of connecting fence which would be of no value whatever.

An electric fence does not have to be one continuous length of wire. It may contain as many branches as are necessary to your needs; and no return wire is required, as the control itself is grounded and any animal touching the charged wire forms the return through the ground. There is but one wire from the control to the fence line, and the fence line may end anywhere on the farm. Barbed wire is recommended for livestock, while ordinary bare wire is suitable for small animals. The controller works steadily whether or not an animal is touching it.

Once the animals become acquainted with an electric fence, they will stay clear of it and it may be turned off for days at a time.

Protection against lightning damage is an important part of the installation of any electrified fence. A lightning arrester to by-pass the lightning surges to the ground, and a small fuse between the fence line and the charger are all that is needed for ample protection. Ordinary radio lightning arresters cannot be used. The high voltage of the fence current will ground itself across the small gap provided in these instruments, therefore, an arrester made especially for fence use must be purchased. A 7 1/2 watt lamp may be used instead of the fuse.

It is a good idea to disconnect the control from the fence line entirely during a severe electrical storm.

There will be less danger to the cattle from lightning where electrified fences are used, because they are soon trained to keep a respectable distance away from the wire, in fact, away from all wires.

DIRECTIONS

Obtain a Model "T" Ford spark coil in good condition, and remove the coil points, (1A), and (1B). Drill through the three rivets on (1A), remove the point spring, (2), and enlarge the hole, (3), to a diameter of $\frac{1}{8}$ " as seen in Fig. 1. The contact point (4), remains as is.

From the top of the vibrator point (1B), cut a $\frac{1}{8}$ " section containing the contact point (5), as in Fig. 2. Now, following the dimensions in Fig. 3, prepare the armature (6), and solder the contact point (5) accurately in position. This position may be checked by placing point spring (2) on the armature, with the hole (3) centered over the $\frac{1}{8}$ " hole in the armature. The two contact points must align perfectly. Fig. 4 gives the dimensions of a spacer block (7) of $\frac{1}{8}$ " fiber. This block may be of bakelite, hard rubber or pressed wood, and fits exactly the contour of armature (6). Note that of the four $\frac{1}{8}$ " holes, two are countersunk. The reason for this will be explained later. When using block (7) as a pattern, cut a rivet flap (8) from .010 insulating paper. Note that there are but three, instead of five holes in this flap.

Guided by the assembly details in Fig. 5, solder the armature (6) to the vibrator spring (1B), fixing the center (X) of the $\frac{1}{8}$ " hole in the armature exactly $2\frac{1}{4}$ " from (Y), the center of the mounting holes in (1B). Now, pass the $\frac{1}{8}$ " rivets (19) through the point spring (2), and through the spacer block (7), setting them down into the countersunk portion of the holes. Place the rivet flap (8) to cover the rivets (10) which have been filed flush with the surface of block (7), and rivet through the spacer block (7), the flap (8), and the armature (6). Rivets (9) must not touch the spring (2), and the rivet flap (8), prevents the rivets (10) from coming in contact with the armature. Be sure that the two points are perfectly lined up with each other, and the $\frac{1}{8}$ " holes are even.

Solder a 3" or 4" length of flexible insulated wire to one of the No. (10) rivets for connecting, and mount the unit on the coil as in Fig. 7. Be sure of clearance of the adjusting screw (12) as it passes through the $\frac{1}{8}$ " hole in the armature. Connect the pig-tail (11) to the stud (14).

Now, having obtained a glass tube of the dimensions shown in Fig. 7, form front and rear supports of wire as shown in Fig. 6. The inside diameter (D), of the supporting rings is governed by the outside measurement of the glass tube, with a slight allowance made for the tapes (18), which may be friction or paper or anything to give a cushioned non-skid grip. Locate the tube supports on the glass, and fasten the front support (16) in a position which will allow the marble (20) to strike the exact center of the breaker points as it rolls down the incline.

The rear tube support (17) is located on the back of the coil box so that in its lowest position the glass tube is not more than 3 to 5 degrees from horizontal. The support mounting screws (19) are shown to be $\frac{1}{8}$ " long, to prevent them from puncturing the coil inside the box. A washer may be necessary on these screws, in which case the screws may be $\frac{1}{8}$ " longer. Drop the marble (20) into the tube and close the end of the tube with a cork (21) or rubber stopper.

The wire (22) which carries the high voltage to the fence line, is a heavy stranded conductor, rubber covered, and is soldered to its proper terminal on the coil box. Solder the battery leads to their terminals on the coil, and provide a ground lead from the end terminal (23).

Connect the finished unit to the battery by means of small battery clips and tilt the unit back and forth to start the marble rolling.

NOTE: IF NO ACTION IS APPARENT IMMEDIATELY, SHIFT THE PIGTAIL (11) FROM THE STUD (14) TO THE CORRESPONDING STUD ON THE OTHER SIDE OF THE COIL.

To adjust the action of the spark, tilting the glass tube more or less will vary the interval between shocks, and adjustment of the knob (13) increases or decreases the power of each shock.

Of course the battery will last a longer time when the fence is delivering as few shocks per minute as are absolutely necessary. After the cattle have become trained to electrified fencing, this economy is not at all risky, as the effectiveness of the fence is not changed.

A portable Neon Fence Tester, such as described in the LeJay catalog, can be used for testing the controller at any point along its entire length. If a dead portion of fence line is found after other parts of the line have been found to be O. K. the trouble is probably in the fence line itself. Look for a broken insulator or grounded wire, and check the connections at joints in the wire.

This control will also operate on 4 volts but will produce a weaker shock than if used on a 6 volt storage battery. (A storage battery is recommended instead of a hot shot.) For 32 volt operation connect to any 6 volts of the 32 volt battery, and the same thing applies to a 110 volt battery.

Kit No. B—Complete kit for building your own fence control using a Ford "T" coil and including the following items:
1 special constructed glass tube with ball.
1 special made point assembly.
1 tube cradle—rear tube support.
1 front tube support rack.
Double conductor battery lead wire.
Single conductor hook-up wire.
Complete directions and guarantee.
Complete kit, well packed and postpaid. (See catalog for price.)

PORCELAIN INSULATORS

No. 95—Porcelain Fence Insulator with leather, less nails. Shipping weight 3 ounces. F.O.B. Minneapolis. (See catalog for price.)
Carton of 100. Ship. wt. 19 lbs. F.O.B. Minneapolis. (See catalog for price.)

CORNER INSULATORS

High quality porcelain insulators for use at corners, gates or end of fence.
No. 94—End Insulator, Ship. wt. $2\frac{1}{4}$ oz. F.O.B. Minneapolis. (See catalog for price.)
Carton of 25. Ship. wt. 4 lbs. F.O.B. Minneapolis. (See catalog for price.)

NEON TESTER

No. 83—Portable Neon Fence Tester for testing fence. (See catalog for price.)

Plan 48

110 Volt A. C. 500 Watt Self Excited Generator from Dodge Model 'G' or 'GA' Generator

THIS GENERATOR IS LIKE OUR MODEL NO. 155

Completely dismantle your Dodge 12 volt generator, removing all windings so that the whole machine may have a thorough cleaning before beginning the rewinding operations. Armature windings are easily removed from their slots if they are cut through with a hack saw just behind the commutator. Be careful not to damage the commutator. Slot the commutator risers with a hack saw to take No. 19 wire. Check it for short circuits and grounds. If any appear, they will usually be cleared by scraping any foreign substances from between the commutator bars, and from between the commutator and the shaft. If the fault cannot be corrected, the commutator must be replaced.

Insulate the armature shaft between the laminations and the commutator, by a binding of insulating paper, gummed paper, or adhesive tape. Number the commutator bars 1 to 25. A line through the center of bar 7, parallel with the shaft, will locate slot No. 4 of the armature. Determine slots 1 and 7 from this point. Insulate each slot with .007 insulation paper.

Strip $\frac{1}{4}$ " of the start end of No. 19 heavy Formvar magnet wire. Wind 3 turns through slot 1 and back through slot 7. Allow a finish lead of sufficient length to reach the outer edge of the commutator coming straight out of the slot. Back this last $\frac{1}{2}$ turn out of slot 7 and point it toward the back of the armature.

Start another coil from bar 2, and wind 3 turns in slots 2 and 8. Lift the last turn out of slot 8, point it toward the back and cut off equal to the other lead. Work to the right all around the armature. Now, 3 turn coils have been wound in all core slots, and the starting

wires are in place in the commutator. Now begin to replace the finish leads in their proper core slots, and lead the wires to their proper commutator bars. Use a test lamp for accuracy. The coil leads connect to bars 1 and 13, 2 and 14, 3 and 15, etc. There are now two wires in each commutator bar—press down firmly then solder. Be careful so as not to short circuit the commutator bars with solder. Tamp the coils down in the core slots with a piece of $\frac{1}{8}$ " fiber or piece of wood. Bind the finish leads down with cord, and clip any projecting bits of wire from the commutator risers. This completes the D.C. winding used for excitation.

Cut 25 pieces of .007 insulating paper just wide enough to cover the D.C. winding and place into the core slots. These papers insulate the D.C. windings from the A.C. windings.

Study the accompanying diagram for A.C. winding. In this diagram the commutator end of the armature is away from you. The winding starts from the end of core next to you. Now number the slots as shown and start the first coil in slot 1 and back through slot 3 using No. 16 heavy, Formvar magnet wire. Note the direction of the winding; also note that slot 2 is empty. Wind in 21 turns, then without a break in the wire, move into slots 25 and 4. Wind on 24 turns, and move into slots 24 and 5. Wind on 12 turns. Lead the wire over to slots 9 and 7, noting the change in direction of winding, and wind on 21 turns. Move into slots 6 and 10, and wind on 24 turns. Move into slots 5 and 11, for 12 turns. Continue winding according to the diagram until the A.C. winding is complete. The starting lead of the A.C. winding connects to the shaft through the flange of the collector ring assembly. The finish lead connects

Plan 49

110 Volt A. C. 60 Cycle 1/2 H. P. Synchronous Motor from Dodge Model 'G' or 'GA' Generator

This is a very serviceable 110 A.C. motor which is built from the Dodge frame and including a "Squirrel Cage," which is shown in Fig. 1. The purpose of this "Squirrel Cage" is to smooth out the somewhat uneven operation, or vibration, ("Hunting Action"), usually observed in this type of motor. This "Hunting Action" is caused by the attempts of the armature to locate its true position in the changing field. By eliminating this "Hunting" as far as possible, the life of the motor will be lengthened, and its power increased.

While the squirrel cage cannot be assembled in the frame until the field coils are in place, preparation for its installation is the first thing that must be done. Fig. 2 shows the location of the cage, and explains the reason for the groups of holes which must be drilled through the pole shoes. This drilling must be carefully done, and haste or lack of proper preparation for the job will surely be found costly before the job is finished. The easiest way to accomplish these drillings is to bolt the pole shoes firmly in place in the generator shell, then place the entire unit on the drill table, and clamp it solidly in position. Drill slowly, to allow the drill point to keep accurately in line. Too much pressure will tend to make the drill "walk," as it passes through one lamination into another. Center the middle hole, and group the other four holes as close as possible to it, leaving about 1/8" of metal between the holes, and locating all holes about 1/4" back from the pole face. These holes are drilled 1/4", which will take a No. 6 round copper wire, from which all the lateral bars of the squirrel cage are made. For No. 6 wire use regular No. 6 D.C.C. and remove the cotton covering. The cage rings can be formed of square copper bar, as shown in Fig. 1, or they can be of the same No. 6 wire as the bars. All joints in the squirrel cage must be firmly soldered. When this soldering is done, place a bit of fiber over the field coils to prevent damage to them by the heat of the iron, and use only a non-corrosive fluid.

Now that the construction of the squirrel cage has been so thoroughly explained, and we know that it cannot be installed in the generator, or motor frame until all of the field coils are in place,

cage is compact enough to allow the two end balls to fit snugly in place. Some of the projections on the inside surfaces of the end balls may have to be filed or ground down a little, but only to allow them to be drawn tightly into place. If the squirrel cage touches them, no harm is done as the cage is already in direct contact with the frame.

Now for the rewinding of the armature. After a thorough cleaning, insulate the slots with .006 armature paper, and lay on the D.C. winding as shown in Fig. 4. This is a "wave type" winding. Each coil consists of 6 turns of heavy Formvar wire, and each coil follows a similar course to that of coil No. 1, which is wound in through slot 1 and back through slot 7. The winding is begun by driving the cleaned end of the wire into the riser slot of a commutator bar. This bar is bar No. 1. Count to the right on the bars to locate bar No. 7. A line drawn from this bar parallel to the shaft, and through one of the core slots, locates slot No. 4, which is the center of coil No. 1, and from which all of the slot numbers are determined. Wind 6 turns in slots 1 and 7, and bring the finish lead out to bar riser No. 13. Remember that all wires leading to the commutator bars must all be formed as close as possible to the shaft of the armature. Note that there are two connections to each commutator bar when the winding is completed. Now solder the leads to the risers, being careful to avoid short circuits between bars. Clean up the commutator, clipping excess wires from the risers, and bind the lead wires down tightly with cord or tape. Now tap the finished windings down snugly in the slots, and place a layer of insulating paper over them in preparation for the winding of the A.C. section of the armature.

The A.C. distributed winding is wound in next and with only a slender piece of .007 insulation paper between it and winding just completed. The Start and Finish leads of this winding protrude from the end of the armature core opposite the commutator as shown in Fig. 5. Start the winding in slot No. 1, lap 5 slots, and return through slot 7. Wind on 12 turns, using No. 16 heavy Formvar wire, and then pass the wire into slots 2 and 8, here wind

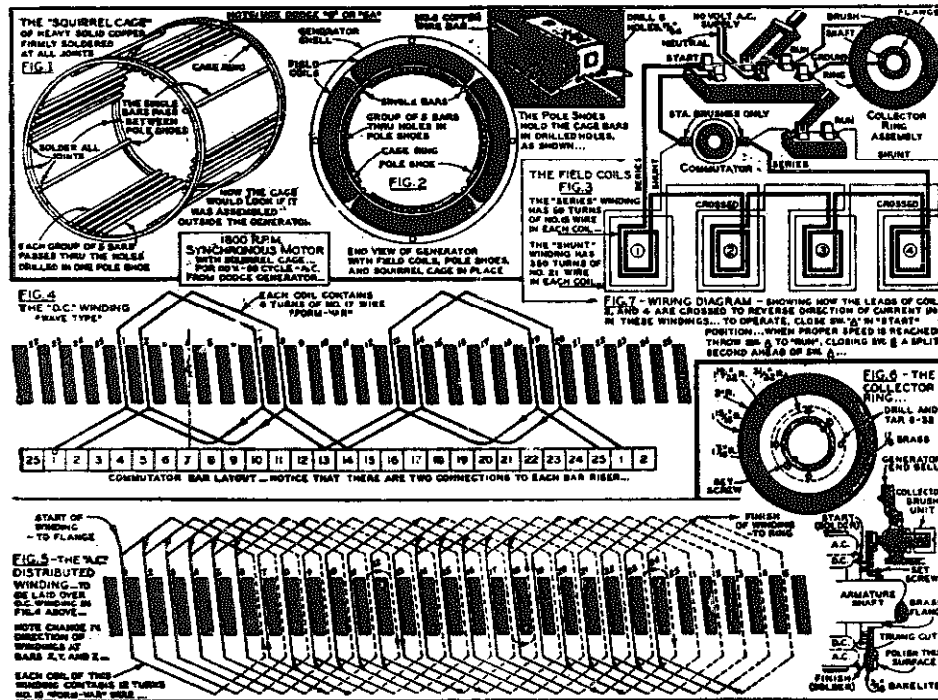

let's turn our attention to the winding of the field coils. Build a winding form of the same dimensions as the pole pieces, and on this form wind the four coils according to the directions given in Fig. 3. The "Series" or heavy winding is put on first, and consists of 50 turns of No. 15 heavy Formvar wire. Wrap a layer of insulating paper over this winding and proceed with the "Shunt" winding, which has 350 turns of No. 21 heavy Formvar wire, wound in the same direction as the series coil. Wind four of these coils, all in the same directions, but cross the leads of two of them, as shown in Fig. 3, to reverse the flow of current in alternate coils. Tape all four coils with 1" cotton tape overlapped 1/2", and dip them in insulating varnish. Be sure to mark the coils with crossed leads, and mark the tops of all coils so that no mistakes will be made in connecting them together. Hook them up as indicated in Fig. 3, and mount them on their poles in the motor case. Shape them carefully, especially at each end, to allow room for the two cage rings, and then you may finish assembling the squirrel cage. Be sure that the

on 12 turns, and pass the wire into slots 3 and 9. Continue on in this manner until six coils are completed, then reverse the direction of the winding by bringing the wire around the top end of bar "X" and into slots 13 and 8. Wind on 12 turns and move into slots 9 and 14. Continue on until the coil in slots 12 and 18 is completed, then reverse the direction again by bringing the wire around the bottom end of bar "Y," and into slots 19 and 13. Finish the winding, noting a third change of direction around the top end of bar "Z," and bring the finish lead out at the top of slot 24. Fold the insulating paper over the windings after tamping them down, and slide wedges into place. The whole armature may now be varnished using either air drying or baking varnish—if baking varnish be sure to bake at not over 250 degrees.

The collector ring assembly is explained in Fig. 6. After the brass flange is turned to fit the armature shaft, bore the center of the bakelite disc to fit on the flange, and take a truing cut off the side of the disc toward the flange. Drill the necessary bolt holes in the

to the collector ring itself, through one of the bolts holding it to the bakelite disc (see diagram).

The construction of the collector ring assembly is quite simple, and can be easily understood from the diagram. The flange is first bored out to snug fit (not too tight) onto the armature shaft, then, the shoulder is turned in a lathe against which the bakelite disc is to be bolted. Drill and thread holes in the flange to take the disc bolts, and the set screws to the shaft. Bore out the center of the bakelite

Only two of the three brushes are used in this conversion. Connect one field lead to one main brush, and the other to the other main brush. The regulator brush is to be removed and the generator is ready for the test. Start the generator, and check the A.C. terminals by means of a test lamp (110 volt), if the bulb refuses to light reverse the leads on the D.C. brushes.

Properly operating, this generator produces 500 watts, 110 volts at 60 cycles, when turning at a speed of 1800 r.p.m.

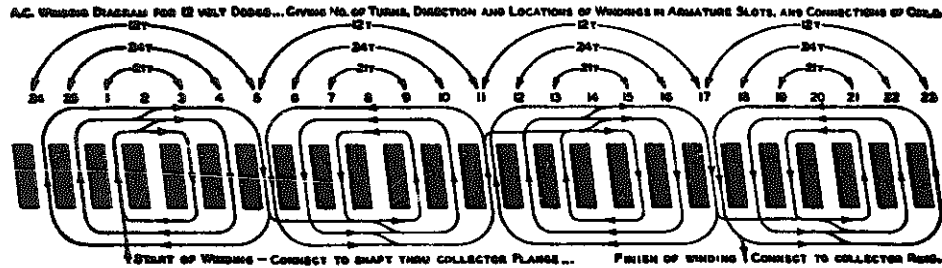

disc, drill the bolt holes and mount it to the flange. Take a trueing cut in the bakelite to receive the collector ring, and drill and counterbore the ring bolt holes. Face the ring on one side, drill and thread holes for the ring bolts, and mount the ring on the bakelite disc. Take a finish cut on the ring, facing the bolt ends off smoothly.

Locate and drill the hole in the end bell to take the collector brush bushing. Examine the inside and outside surfaces of the end bell and the logical position of this brush will be easily determined. Be sure that the insulating washers and bushings are properly in place to avoid the possibility of shorting at this point.

The special field coils for this generator consist of 350 turns each of No. 18 P.E. magnet wire. They can be wound most easily on a wooden form shaped to the dimensions of the pole pieces. Now tape the coils securely with cotton tape overlapping about 1/4 width of tape. The coils are made to conform to the curve of the generator case by tightening the pole pieces down with the coils in place. Connect the field coils in series parallel. Remove from case then dip in air drying varnish and allow to dry or in baking varnish and bake 2 hours at 250 degrees Fahrenheit. Dip armature in air drying varnish and allow to dry or in baking varnish and bake 2 hours. This baking may be done in an ordinary oven at a temperature of about 250 degrees.

After the armature is dry it is placed in a lathe, and the commutator trued up.

- Kit No. 154A—Complete kit for rewinding Dodge generator into a 110 volt A.C. 500 watt self-excited generator.
- 3/4 lbs. No. 19 heavy Formvar magnet wire.
 - 2 1/2 lbs. No. 16 heavy Formvar magnet wire.
 - 7 lbs. No. 18 plain enamel magnet wire.
 - 1 roll cotton tape.
 - 25 slot wedges.
 - 25 slot insulation papers.
 - 25 insulation papers for insulating D.C. from A.C. winding.
 - 1 can air drying varnish.
 - 2 commutator brushes.
 - 2 bronze rings (A and B) for collector ring.
 - 1 fiber piece for collector ring.
 - 1 collector brush assembly complete. No. 48B
- Complete kit. (See catalog for price.)

Kit No. 154D—Same as 154A but includes factory made collector ring No. 48C instead of the two bronze rings and fibre ring. (See catalog for price.)

No. 48C—Collector ring completely assembled and ready to place onto your armature. (See catalog for price.)

No. 48B—Brush holder assembly with brush. To be used in conjunction with collector ring No. 48C. (See catalog for price.)

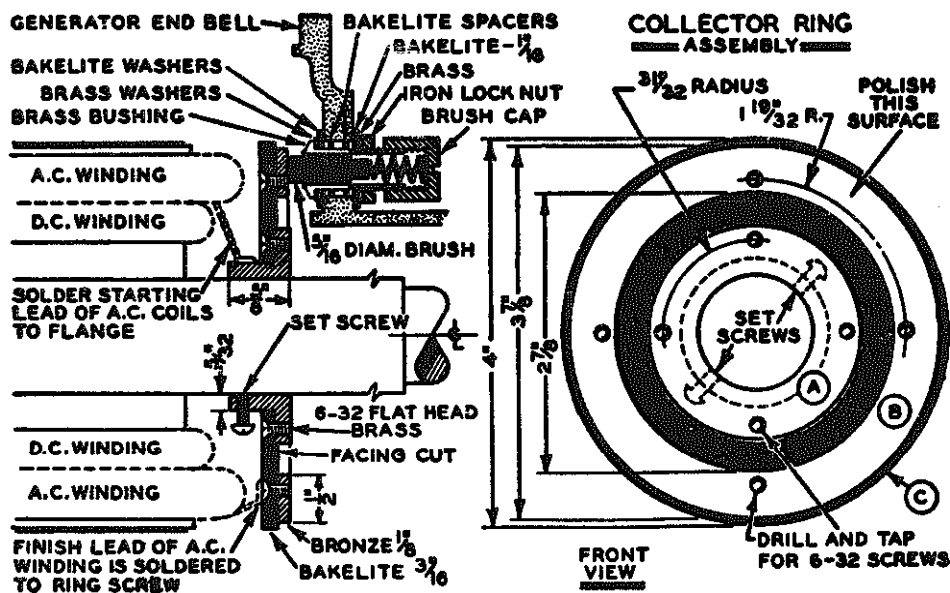

disc, drill and tap the set screw holes in the flange, and mount the disc on the flange. Drill and tap the bolt holes in the brass collector ring, and mount it on the bakelite disc. Take a finishing cut off the face of the ring, and polish it for the carbon brush. The collector brush and its holder is a standard assembly. Push the collector ring onto the armature shaft, solder the starting lead from the A.C. winding to the flange, and the finish lead to one of the ring bolts. Now set the whole collector unit permanently in place as close as possible to the winding. Check the location to see that no part of it will rub on the end bell when it is put in place.

The only change in the brush rigging is the removal of the regulating or movable brush. Only the two stationary brushes are to be used.

Make all the connections of the completed motor as shown in Fig. 7, using a D.P.D.T. switch (A), to control the A.C. input, and a S.P.S.T. switch (B), to place the shunt winding of the armature in the circuit. Note that in the "RUN" position of the switch "A," the neutral wire from the A.C. supply is led through one blade of the switch and through a wire marked "GROUND," to the shaft of the armature. The wire marked "Ground" need only be connected to the frame of the motor.

In operation, allow the motor to attain its full speed before making the change over to the run position, as it will not pick up speed after the change is made, but will tend to stop if it is turning over too slowly. If the r.p.m. is more than 1800 at the time of the change over, the motor will drop back to 1800 r.p.m. and hold that speed.

Approximately 25 volts D.C. may be obtained from the two commutator brushes while the motor is operating in the "RUN" position. A D.P.S.T. switch must be connected across the two brushes to provide a definite disconnection at any other time. This D.C. may be used to charge batteries or light lamps of the proper voltage. About 250 watts of power is available at this point.

A certain amount of adjusting and experimentation will probably be found necessary to achieve the best results from this motor.

Run it as a series motor to check the direction of rotation. This direction may be changed by transposing the series field leads at switch "A," and at the commutator brush. Check the D.C. winding by running with switch "A" open, and a battery connected across the "Start" terminals of this switch.

When you have this motor working properly, the accuracy of its speed, and its great versatility will be found a fine reward for the painstaking care and effort you have spent in its construction.

Kit No. 155A—Complete kit for rewinding Dodge generator into a 110 volt A.C. synchronous motor developing $\frac{1}{2}$ h. p.

- 1 lb. No. 18 heavy Formvar magnet wire.
- $2\frac{1}{2}$ lbs. No. 16 heavy Formvar magnet wire.
- 5 lbs. No. 21 plain enamel magnet wire.
- $2\frac{1}{4}$ lbs. No. 15 heavy Formvar magnet wire.
- $1\frac{1}{2}$ lbs. No. 6 D.C.C. magnet wire.
- 1 roll cotton tape.
- 25 slot wedges.
- 25 slot insulation papers.
- 25 insulation papers for insulating D.C. from A.C. windings.
- 1 can air drying varnish.
- 2 commutator brushes.
- 2 bronze collector rings, A and B.
- 1 fibre piece for collector ring.
- 1 collector brush assembly, complete—No. 48B.
- 1 single pole single throw switch.
- 1 double pole double throw switch.

Complete kit. (See Catalog for price.)

Kit No. 155B—Same as kit 155A but includes factory made collector ring No. 48C instead of the two bronze rings and fibre ring. (See Catalog for price.)

No. 48C—Collector ring completely assembled and ready to place onto your armature. (See Catalog for price.)

No. 48B—Brush holder assembly with brush. To be used in conjunction with collector ring No. 48C. (See Catalog for price.)

Plan 50

An A. C. Welding Transformer Using Dodge Generator Coils

PRODUCES 35-55 AMPERES. 3 TO 48 VOLTS.
NO REWINDING NECESSARY.

(See Notice at end of this plan if you wish to build this welder at very little cost.)

By properly connecting a combination of 8 coils taken from two Dodge NORTH-EAST "G" or "Ga" Generators and mounting them on a core built to the specifications given in the accompanying detailed drawing, you may build yourself an AC Arc Welder to operate on either 110 or 220 volts, 60 cycles.

This welder is adaptable to almost any type of work, and will solder, braze, weld, or cut. Very satisfactory results will be obtained on any job excepting extremely heavy work. For short interval work, $\frac{1}{8}$ " flux-coated rods can be handled, but for continuous duty, $\frac{1}{4}$ " or $\frac{3}{8}$ " rods should be used. This welder can't be beat for economical operation, and as no special winding is needed, its construction is quite simple. The small size makes it readily portable.

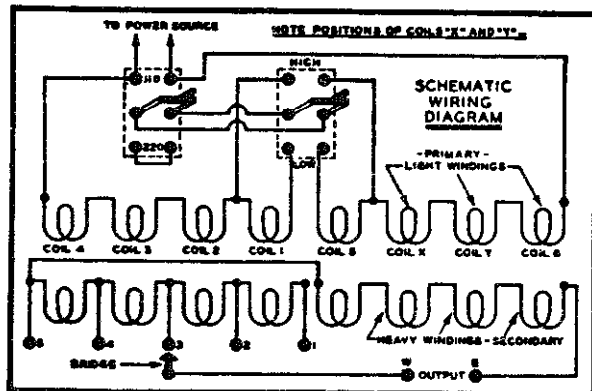

Having obtained the two necessary Dodge generators, dismantle them, taking care to not damage the coils. Cut the coils apart, leaving approximately the same length leads on each coil. Should the insulation become damaged, bind the break with cotton tape and soak it thoroughly with varnish. Study the "SCHEMATIC WIRING DIAGRAM," to understand thoroughly the exact circuit which must be provided in the hook-up of the completed welder.

Note that all similar coils are connected in series. Also note that the coils are numbered 1, 2, 3, 4, 5, X, Y, and 6. Number your coils accordingly. By examining Figure 3 in the plan, you will see that coils 1, 2, 3 and 4 have both start and finish leads of the heavy winding coming out on the same side of the coil. Note also that coils 5, X, Y, and 6 have the start and finish leads of their heavy windings coming out on opposite sides of the coils. These heavy windings will form the Secondary of the completed transformer when they have been connected according to the plan.

Then you will see that while all of the numbered coils have the leads from their light windings coming out on the same end of the coils, coils X and Y have their light leads at opposite ends of the coils. This difference is shown in Figure 5. To facilitate connection,

coils X and Y are placed on the core leg between coils 5 and 6. The light windings of all 8 coils are connected in series in two groups to form the Primary of the completed transformer.

Note: In some "G" and "Ga" generators the light windings of all 8 coils will be alike which means you will not have 2 coils like X and Y. If this be your case then connect the light windings of all 8 coils in series, just like coils 1, 2, 3 and 4 are connected.

Now let's get to the actual construction of the welder. First we must prepare the core. Figure 1 in the Plan gives all the needed information. It will be possible to cut all of the pieces by hand if they are not otherwise available, but it will be found more satisfactory and certainly more convenient to purchase them already cut to measure. Prepare two sets of core clamps 1" angle iron like those shown in Figure 1. Stack the core as shown in Figure 1 and clamp one end of it tightly by means of one set of clamps. Completely remove the core section shown partly removed, and it will be easy to slip the coils into place over the legs of the core. Be sure to place them on the core in the proper position as shown in Figure 2, that is, with the curves of the coils pointing UP on one leg of the core and DOWN on the other. Re-check the coil positions to be sure that they are properly placed, then fit the loose leg of the core back into position (one piece of steel at a time) and clamp it tightly with the other clamp.

Now build the control panel illustrated in Figure 2. Its size is not important as long as it will accommodate the instruments conveniently. The controls consist of two double pole double throw (DPDT) switches, two heavy bolts to be used as welding terminals, and a bridge arrangement whereby any one of five heats may be chosen at will to suit the work being done. Notice especially the construction of the bridge piece. Slots are cut in each end of this bridge from the edge to the drilled hole in such a way that tightening the wing-nuts will tend to force the bridge more firmly into contact with its bolts. The bridged connector bolts and the switch points are all $\frac{1}{2}$ " brass. The panel itself may be built of any insulating material, but tempered pressedwood is recommended because of its toughness and economy.

We can now start connecting the coils on the transformer. Begin with coils 1, 2, 3 and 4. Connect the heavy windings together as shown in Figure 3, and provide taps at each connection to be led to the bridge switch points, 1, 2, 3, 4, and 5. These taps are of No. 6 flexible cable and are attached to the splice between each coil as shown in Figure 4. Now from coil 4, the bar connector is run to the heavy winding of coil number 5, as shown in Figure 3. This bar connector may also be made of a piece of No. 6 cable if more convenient. The heavy windings of coils 5 and X are connected by means of No. 6 cable. Similar connections must be made between coils X and Y, and Y and 6. From the finish of the heavy windings of coil 6, a piece of No. 6 cable is brought to terminal E on the panel. Another piece of No. 6 cable is run from the bridge pivot bolt to terminal W. This completes the entire Secondary hook-up.

If your generator has only one coil like X and Y instead of two coils, then connect the one like X and rest in series. Solder all splices after binding them with wire, then wrap them with cotton tape and shellac thoroughly.

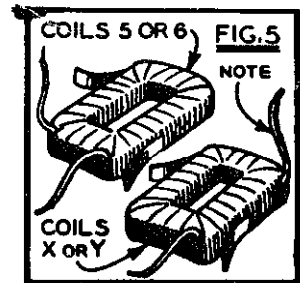

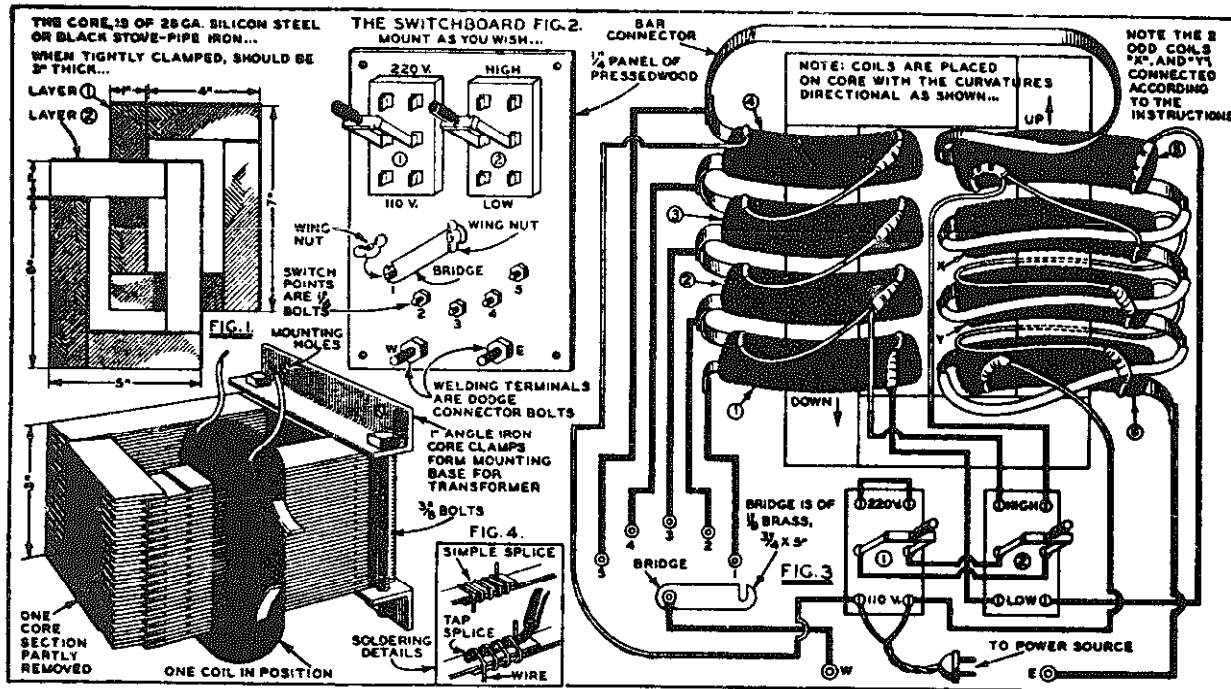

Next is the Primary hook-up. A flexible cord with a plug (to connect to the power source), is brought out from the two lower terminals of Switch 1. From the lower right terminal of Switch 1, run a No. 10 flexible wire to the light winding of coil 6. Connect coils 6, Y, X and 5 as shown with No. 10 cable. At the joint connection between coils X and 5, bring out a tap lead to connect to the upper right terminal of Switch 2. The remaining lead from coil 5 is connected to the lower right terminal of Switch 2. The lower left terminal of Switch 2 is then connected to the light winding of coil 1. Connect the light winding of coils 1, 2, 3 and 4 as shown. Bring a tap lead from the joint connection between coils 1 and 2 to the upper left terminal of Switch 2. Connect the finish lead of coil 4 to the lower left terminal of Switch 1. The two upper terminals of Switch 1 have a jumper connected across them. Now connect the right center terminal of Switch 1 to the left center terminal of Switch 2. Then connect the two outside center terminals of the two switches. All of these connections in the Primary circuit are of number 10 flexible wire. All connections in the Primary circuit must be soldered, taped, and soaked with shellac.

Label the Switch Positions on the control panel as shown in Figure 2. Also, number the Switch Points. The Welding Terminals must have some sort of indication to be sure that terminal E is at all times connected to the electrode holder, and that terminal W will always be connected directly to the work.

This welder can be plugged into either 110 or 220 volts.

To operate the control panel when connected to 110 volts, Switch 1 should be at the 110 V. position. However, if Switch 1 is swung to the 220 V. position when using 110 volts, it will cut the output approximately in half, which is sometimes desirable for brazing or soldering. The High-Low Switch is used to give half-step advances between the switch points, thereby providing 10 different heats on either 110 or 220 volts plus the possible half-heat outputs obtainable on 110 volts with Switch 1 in the 220 volt position.

CAUTION:

Never use 220 volts on this transformer unless Switch 1 is in the 220 V. position, otherwise a serious burnout will result. If fuses are used in input we recommend 35 amp. size.

Kit No. 50Y—A complete kit for building your own transformer arc welder. Ready to assemble, plug into line and operate. Includes following materials:

- 8 coils taken from 2 Dodge generators (inspected and tested).
- Cord for plugging into line including plug, 7 feet long.
- Wire for connecting up primary.
- Wire for connecting up secondary.
- 2 Welding cables, 7 feet long each.
- 4 angle iron clamps including 4 bolts and nuts.
- 16 pounds 26 gauge silicon steel cut to size, varnish coated.
- A total of 644 pieces.
- Complete above kit. (See Catalog for price.)

Kit No. 50W—Complete kit of materials needed to make this welder exclusive of the Dodge field coils, also does not include Control panel 50Z but includes all materials for you to assemble your own panel.

- 2 double pole double throw switches.
- Material for assembling amperage switch.
- Wire for connecting primary.
- Wire for connecting secondary.
- Cord for plugging into light socket, including plug. (7 feet long.)
- 4 angle iron clamps including 4 bolts and nuts.
- 16 pounds 26 gauge varnish coated silicon steel cut to size.
- A total of 644 pieces.
- Complete above kit. (See Catalog for price.)

No. 50Z—A special designed control panel with new type factory made selector switch for adjustment of various heats—also includes 2 double pole double throw switches and terminal bolts with wing nuts for connecting welding leads. (See Catalog for price.)

No. D34—Dodge field coils per set of 4 (tested and inspected). (See Catalog for price.)

NOTICE

Trade your generators in toward above kit. If you already have two Dodge "G" or "GA" generators then you can build this welder with very little expense. After you remove both sets of field coils from these two generators you can send all remaining parts of both generators to us and we will allow you a credit of \$4.00 which can be applied toward the purchase of Kit 50W.

WIND PLANT INFORMATION

Wind power can be harnessed to generate electricity for lights, radio, and power.

The amount of power possible in your locality depends on the average yearly wind velocity.

Wind velocities vary in different sections of the country. Average velocities for your location may be obtained from your State Weather Bureau.

Wind velocities are given daily by the Weather Bureau. WIND POWER IS FREE.

The equipment for converting the Wind into usable electricity is your only cost.

Be certain that the plant you choose has a power output large enough to keep your batteries fully charged at all times. To determine the size of plant you need, get the average wind velocity for your location from your Weather Bureau. Then find a plant with a power rating sufficient to show a surplus of output over your needs within the time limit of the proven wind velocity shown by the observations of the Bureau.

Propellers used on wind plants are of the power type. Propellers for direct drive are High Speed.

The speed of the propeller changes with the pitch of the blade. The pitch of the propeller is the angle of the blade away from a position flat against the wind.

Proper propeller design increases the r.p.m. speed of the propeller to 3 or 4 times that of the wind velocity.

Propellers are liable to be damaged if allowed to run in rain, sleet, snow or sand storms. Therefore, all wind plants should be provided with a positive shut-off.

Centrifugal force increases with the speed in r. p. m. Gyroscopic action increases with the speed in r.p.m. In high winds, these actions may cause the propeller to fly apart, or cause the plant to run out of control, ruining the generator. Therefore, all wind plants should be provided with an efficient automatic governor.

Generators geared or belted to the propeller require 25% more power to operate.

Direct drive propellers in combination with specially wound slow-speed generators eliminate gears and belts. Therefore, power losses through friction is reduced to a minimum.

Wind velocity is more constant at higher altitudes.

Wind electric plants operate more efficiently at constant speeds. Therefore, wind plants should be mounted as high off the ground as is reasonably possible; at least high enough to clear all surrounding wind obstacles for a distance of at least 150 feet.

An electric lamp connected directly to a wind plant will burn out as the speed of the generator increases.

The amperage of the current generated by the wind plant increases with the speed of the generator, but the voltage remains constant. Therefore, the current generated by a wind plant must be run into a storage battery or batteries.

Lamps can be used direct from the plant if all lamps are turned on to the full capacity of the generator. They will, however, grow dim during lulls in the wind, and brighten with the increase in output due to a rise in the wind.

Voltage drop is loss of pressure due to resistance of the circuit or load.

Line loss is current that is used up in forcing the power through the connecting wires.

Conductivity . . . The ability to conduct electrical current.

Conductor . . . Any substance or material which will carry electricity.

Connector . . . A device for joining conductors together.

Consumed . . . Used up—Not possible of recovery.

Core . . . The air or metallic center around which a coil is wound.

Counter-Clockwise . . . Opposite to the direction of rotation of the hands of a clock—To the left.

Corrosion . . . A destructive deterioration caused by the action of chemicals or weather conditions.

Cross Arm . . . The cross member on a pole supporting electrical wiring.

Cross-Section . . . Cut-away view to show some otherwise hidden part or point of interest.

Current . . . The flow of electricity, measured in watts.

Cutout . . . An automatic device which disconnects a generator from its load when the output voltage becomes lower than is required.

. . . Used to prevent a flow-back of current from a battery.

Cycle . . . One complete alternation . . . (from neutral to positive, to neutral, to negative to neutral) . . . or (from zero to high, to zero to low, to zero).

Damp-Proof . . . Non-absorbent insulation.

D.C. . . . Direct current.

Dielectric . . . Insulator . . . Insulation value.

Double Throw Switch . . . D.T.S. A switch having a common connector capable of contacting either of two terminals at will.

Drop . . . The loss in pressure of an electric current caused by resistance or load.

Dutchman . . . A metal filler used to complete a desired path for E.M.F.

Dynamo . . . A machine for converting mechanical energy into electrical power.

Eddy Currents . . . Contrary magnetic currents in iron.

Efficiency . . . Work accomplished in comparison with the expended energy.

E.M.F. . . . Electro motive force.

Energy . . . Power efficiently and forcibly exerted . . . Capacity for work.

Exciter . . . D.C. generator or battery supplying the field current to another generator.

Fiber . . . An insulation paper or board produced by tremendous pressure.

Field . . . The space in which lines of force are active.

Filter . . . Device to eliminate electrical lines or machinery noises.

Fish Paper . . . Thin fiber paper.

Flash-over . . . The arc resulting from the opening of a switch or the breaking of a circuit.

Flexible Coupling . . . A non-rigid connector for the transmission of power from one shaft to another not in absolutely true alignment.

Flux . . . Magnetic lines of force . . . A soldering or welding compound.

Force . . . Any cause resulting in the motion of, or changing the direction of the motion of matter.

Frequency . . . The rapidity of the changes in direction of an alternating current . . . Recorded in "Cycles per second."

Friction . . . Resistance to the motion of a part of a machine, caused by contact with the surface upon which it moves . . . Loss of power, or energy expended, in overcoming this resistance.

Fuse . . . A protective device for electrical circuits . . . A wire designed to open a circuit by melting at the passage of a current of greater amperage than its rated capacity.

Gauge . . . The diameter of a wire.

Generator . . . A machine for converting mechanical energy into electrical power.

Growler . . . A transformer with only a primary coil, used for testing electrical windings, the winding being tested acting as a secondary.

Ground . . . The part of a circuit making a contact with the earth. Part of a winding or circuit contacting the metal it is wound on or enclosed by.

Hard Drawn . . . Wire as it comes from the drawing machines . . . Unannealed.

Hardened . . . Wire tempered after manufacture.

Helix . . . Helical . . . Spiral wound, similar to a spring.

Horse-Power . . . The unit of power sufficient to raise 33,000 pounds a distance of one foot in one minute . . . Electrical energy used or expended at the rate of 746 watts per hour.

Hunt . . . When the rotor of an electrical machine is incorrectly centered in its bearings, and it moves back and forth in an attempt to locate its magnetic center, it is said to "HUNT."

Hydro-Electric . . . The use of water-power as the driving force to operate a generator of electricity.

Hysteresis . . . The loss or wasting of electrical energy through iron core loss . . . (see "Eddy Currents").

Induction . . . The transference of an electrical force by magnetism.

Insulate . . . To separate two electrical conductors by a dielectric, or non-conductor.

Insulator . . . Any substance which prevents the flow of an electrical current.

Kilo . . . 1,000.

Kilovolt . . . 1,000 volts.

Kilowatt . . . 1,000 watts.

Knife Switch . . . An electrical switch having one or more blades operating like a jack-knife.

K.V.A. . . . One ampere at 1,000 volts, A.C.

Lag . . . When the amperage rise is slower than the voltage rise in an A.C. cycle, it is said to lag.

Lamination . . . A single one of the many thin sheets of metal used to build up the core rotor, or frame of an electrical machine.

Lap Wound . . . The armature of a D.C. generator is said to be "Lap Wound" when the start and finish of its coils are connected to adjacent bars of the commutator.

Lateral . . . The distance it is possible for an armature to travel back and forth between its bearings.

Lay . . . The length of one entire twist in multiple wires or cables . . . (One complete twist per inch is called a "lay of one inch").

Lead . . . Connector wire . . . Also, when the amperage rises faster than the voltage in an A.C. cycle, it is said to "lead."

Leakage . . . The loss of electricity or magnetism through an undesirable cause.

Line . . . An outdoor circuit . . . The pair of wires carrying the applied power to a circuit or machine.

DEFINITIONS

A.C. . . . Alternating current.

Accelerate . . . To increase speed.

Accessories . . . Extra or additional parts or pieces of equipment to improve an appliance or machine, or widen its range of usefulness.

Adapter . . . A device or fitting allowing attachments or applications other than those for which the original unit was intended.

Air Gap . . . The air space between two elements. In a generator, the clearance between the pole pieces and the armature core.

Alloy . . . A combination of metals to provide desirable characteristics of each.

Alternate . . . To perform by turns, a repeated changeover from one unit to another.

Alternating Current . . . A current whose polarity reverses itself continually.

Alternator . . . An electric generator which produces A.C.

Ammeter . . . An instrument for measuring current flow in amperes.

Ampere . . . The unit of measure of the flow or strength of an electrical current.

Ampere Turns . . . The number of amperes in a current, multiplied by the number of turns in a coil through which the current flows.

Arc . . . An electrical current flowing through or across the space between two conductors.

Armature . . . A part of an electrical machine in which an electric current is built up to cause or provide power or motion; or which in itself by reason of applied power, produces an electro magnetic force opposed to a constant field of force to manufacture usable current.

Arrestor . . . A device to protect electrical circuits or instruments from damage by lightning or heavy induced currents.

Band . . . A series of turns of wire or twine bound around an armature or rotor to hold the wiring in position.

Bar Segments . . . The segmented or separate parts of a commutator which carry the current from brush to winding.

Battery . . . A group of electric cells connected together.

Blinding Post . . . The terminal of an electric machine or piece of apparatus to which a connecting wire may be easily attached.

Braided Cable . . . A cable or conductor composed of many individual wires braided or interlaced instead of being twisted.

Breaker Circuit . . . A protective circuit employing an automatic circuit breaker adjustable to a desired amperage, to open the circuit in case of a dangerous overload.

Brush . . . A carbon or other highly conductive part of an electrical apparatus, which carries current to or from a moving element by a wiping contact on a commutator or collector ring.

Bus Bar . . . A large rectangular bar of copper for transmitting heavy currents.

BX . . . Flexible metal-armored conduit.

Calibrate . . . To determine a scale or measurement whereby the action of an instrument may be known by an accepted standard.

Carrying Capacity . . . The maximum current strength which may be safely transmitted by a conductor.

Cartridge Fuse . . . An enclosed fuse of cylindrical form with metal contacts on each end.

Cell . . . One unit of a battery containing both positive and negative poles.

Choke Coil . . . A coil of wire inserted in a circuit to reduce or retard the flow of current.

Circuit . . . A path of conductors provided for the distribution of electricity.

Clockwise . . . The direction of rotation of the hands of a clock . . . To the right.

Cord . . . Length of insulated conductor for connecting a piece of electrical apparatus.

Core Wire . . . Soft iron wire incapable of retaining an induced momentary magnetism.

Closed Circuit . . . A circuit providing a complete path for a current from beginning to end.

Coil . . . A turn or number of turns of wire.

Collector Ring . . . A conductive ring for transmitting a current from a brush to the winding of a moving element, or to a portion of a circuit which is not stationary.

Commutator . . . A segmented collector ring carrying current from brushes to numerous coils or circuits in a moving element.

Compound . . . When field coils of a D. C. motor or generator have two sets of windings—the smaller windings shunted across the line and the armature, and the larger windings in series with the line or load—the machine is said to be COMPOUND WOUND.

