

AT MICROFICHE REFERENCE LIBRARY

A project of Volunteers in Asia

The Production of School Science Equipment

by Keith Warren and Norman Lowe

Published by:

Commonwealth Secretariat

Available from:

out of print

Reproduced by permission.

Reproduction of this microfiche document in any form is subject to the same restrictions as those of the original document.

The production of school science equipment

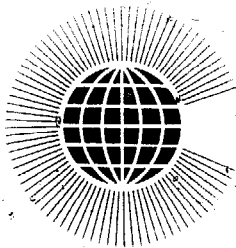
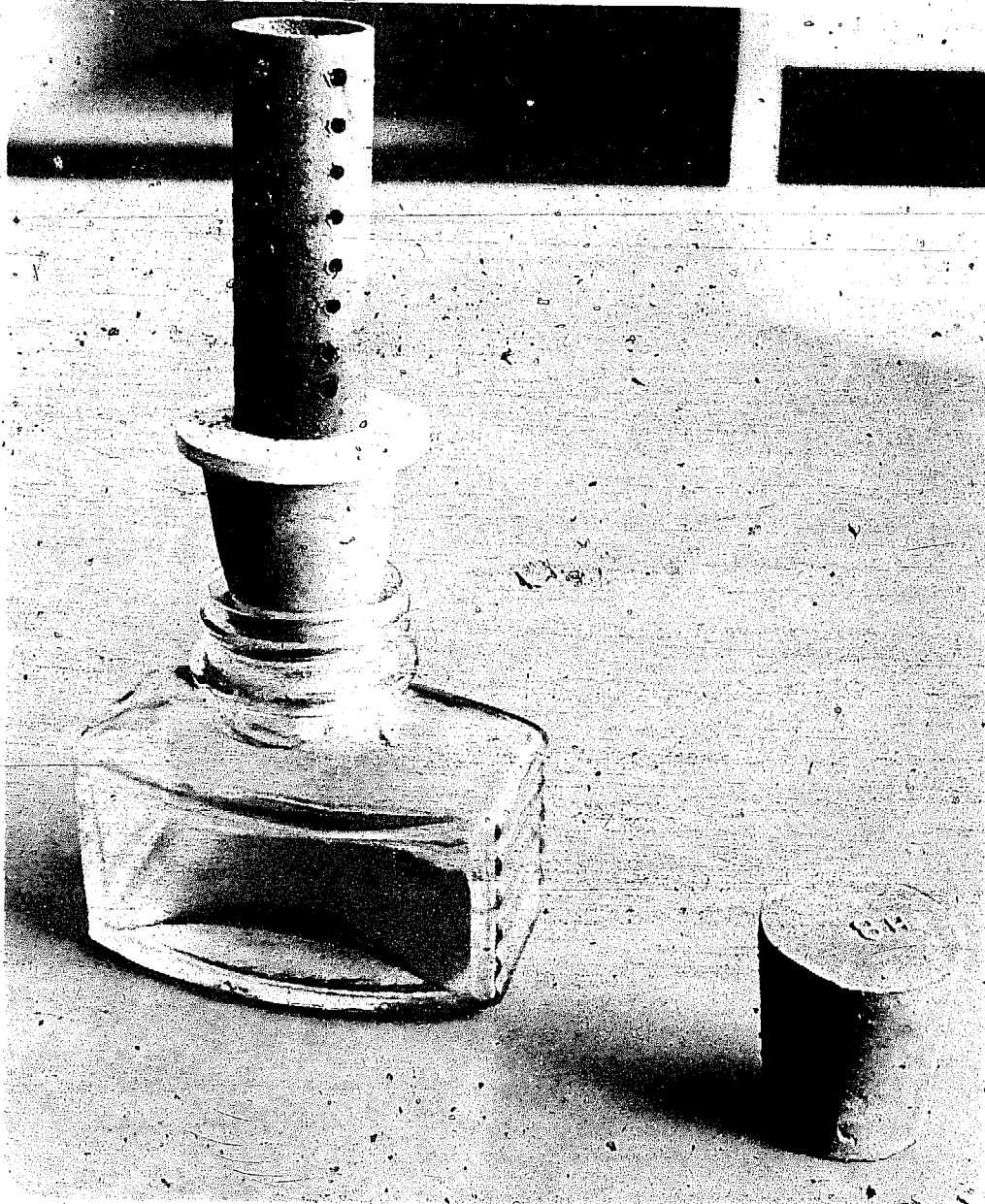

Commonwealth Secretariat

COVER PICTURE.

An inexpensive spirit burner
made out of an old ink bottle.

THE PRODUCTION OF SCHOOL SCIENCE EQUIPMENT

a review of developments

Keith Warren
and
Norman K. Lowe

Commonwealth Secretariat

COMMONWEALTH SECRETARIAT

Marlborough House Pall Mall London SW1Y 5HX

First published 1975

Copyright © Commonwealth Secretariat 1975

ISBN 0 85092 100 7

Governments of developing Commonwealth countries wishing to reproduce the material in this book in whole or in part in any language should inform the Commonwealth Secretariat which may be able to offer them some assistance in doing so.

Copies may also be purchased from the Publications Section of the Commonwealth Secretariat

Published and Printed by the Commonwealth Secretariat

Contents

	Page
INTENTION	(i)
SECTION 1: Food for Thought	1
SECTION 2: Current Developments	17
Africa	17
Botswana, Lesotho, and Swaziland; Kenya; Nigeria	
Asia	19
Regional Centre, Penang; Burma; India; Indonesia; Khmer; Korea; Laos; Malaysia; Nepal; Pakistan; Papua New Guinea; Philippines; Singapore; Sri Lanka; Thailand; Vietnam	
Latin America	31
Brazil; Costa Rica	
Other Countries	32
Israel; Turkey	
SECTION 3: Sources of Reference	34
SECTION 4: Photographs	48

Intention

In this book we have tried to provide a review of the kinds of science teaching equipment that are likely to be of interest to organizations and school systems that are planning to make, or to select, apparatus for situations in which items from the main science equipment supply houses are unsuitable or unobtainable.

It is a great waste if people with similar problems and with usable solutions do not communicate with one another. The needs of the many schools struggling to teach science with inadequate apparatus are enormous - not only in the volume of the items required but also in the suitability of design. A sharing of ideas and a knowledge of how others are coping with similar problems can bring about considerable economies of time, effort and money.

Throughout the world there are some fifty to a hundred organizations working on the design of elementary science education apparatus for primary and lower secondary schooling. Some are fully commercial producers, others are state enterprises; some are curriculum centres, others are teachers' colleges. The intention of this book is to help spread some of their ideas for consideration by other organizations which may be able to use them to assist in the solution of some of their own problems. It is not, of course, an exhaustive collection; there are undoubtedly other projects and ideas that are not mentioned here. Good ideas often come from unexpected sources - for example from toy manufacturers, hippy communes or hardware stores. In fact, the field of ideas is so wide that this review provides little more than a taste of what is going on, together with some photographs, comments, and an indication of some sources of further information.

In order to provide continuing assistance to developing countries, the Commonwealth Secretariat will be very pleased to receive further details and up-to-date information about low cost, locally produced school science equipment and the organizations producing it.

Keith Warren

Norman K. Lowe

May 1975

Note: Anyone wishing to purchase any of the books listed in this publication is advised to order them direct from the publisher only if they cannot be obtained by a bookseller.

Section 1 Food for Thought

CONFERENCES ON THE PRODUCTION OF LOCAL APPARATUS

There have been several conferences on the production of teaching equipment - sometimes specifically on science but sometimes more general - and the subject is frequently discussed at other conferences. As can be seen from the reports, there is a great similarity about most of them. The impression one gets is that they are often seen by the organizers as lecture presentations by foreign specialists who indicate that they have identified the local problems and know how to implement the solutions. While this is valuable on technical matters of a certain sort, surely the job of a foreign specialist is to act more in a consultant capacity - that is, to lead his 'clients' to identify and to define the problems for themselves. In the case of providing science teaching apparatus for schools, the problems are not as obvious or as easy to solve as they have generally seemed to be - as the many failures witness.

Similarly, the resolutions passed by many conferences have a naive air. There are rarely any operational proposals - no timings, allocations, responsibilities, flows; nor is there any attempt at scheduling. Though the lecturers may have referred to 'objectives' in educational discussions during the conference, the final resolutions reveal that they know little of the way a system of objectives is written for the scheduling of activities in real life. They have borrowed a jargon but not understood it. Perhaps if a businessman from the locality were to be present at all conferences on the production of teaching equipment, a more practical result would be achieved.

It may be useful here to list some of the conferences, seminars, workshops and courses which have taken place and which were directly or indirectly concerned with the design and production of school science apparatus.

At RECSAM, Penang, there was 'Production of Low-cost Teaching Materials for Primary Level Science and Mathematics' in October 1973. This was jointly sponsored by the South-East Asian Ministers of Education Organization (SEAMEO) and the German Foundation for International Development (DSE).

There was a Regional Conference on 'Problems of the Promotion and Production of Teaching Materials in South-East Asia', also sponsored by SEAMEO and DSE, in October 1972 in Singapore. This was organized by the SEAMEO Regional Centre for Educational Innovation and Technology (INNOTECH).

Food for thought

Aspects of apparatus needs are covered in the book 'Science Education in Africa' (1), which is a report of the sixth Levershulme Inter-University Conference in Africa held at the University of Malawi in March 1968. There is a section on 'Science Teaching Equipment, Materials and Facilities' in 'Planning for Integrated Science Education in Africa' (2), which is the report of a Workshop for Science Education Programme Planners in English-speaking African countries held at Ibadan, Nigeria in September 1971. There was a Regional Seminar on School Science Equipment in New Delhi in December 1972. The final report is published by UNESCO Regional Office for Education in Asia, Bangkok, 1973.

There was a course at RECSAM in June 1973 on 'The Development of Primary Science Apparatus'. It was the second of its kind and it aimed at training some key educators in the theory and practice of apparatus production in their countries and at developing some prototypes. There is a report (August 1973) and a description of the prototypes, with photographs, in a 50-page booklet ('Collection of Assignments by Participants of RME-1 (1973) Course'). It would serve as a model for similar courses which other production units might like to consider.

- (1) Science Education in Africa (Gilbert and Lovegrove) published by Heinemann Educational Books Limited, 48 Charles Street, London W1X 8AH, England.
- (2) Planning for Integrated Science in Africa published by UNESCO, 7 place de Fontenoy, 75700 Paris, France.

EUROPEAN PRODUCTION FOR SCHOOLS IN AFRICA, ASIA AND LATIN AMERICA

A number of European firms are aiming at markets for school science apparatus in Africa, Latin America and Asia. Most, of course, hope to sell their home style of product but a few are attempting to design realistically for the situation, seeing their long-term advantage in doing so. Their very reasonable hope is that if they come to know the real needs of the market by struggling with it at first-hand during the development stages of such educational schemes as are now beginning to get under way, and if the market gets to know them in these early stages, they will be of greater commercial advantage and value to their customers than they will if they come in later.

It is a high-risk venture. International agencies with an interest in the presence of satisfactory equipment in new curricula could very helpfully collect and make available publicly a great deal of information and advice which could assist such firms. There are, of course, difficulties in this but probably they could be overcome.

Cornelsen, Velhagen and Klasing of Berlin have produced a number of kits of considerable interest to primary schools wanting a collection of items dealing with a single subject such as Weather or Heat. Photograph 1 shows one of the more complicated kits - a class kit for eighteen pairs of children. Educationists in New Delhi and teachers in Calcutta who were shown the CVK kits made certain criticisms: that they were bulkily packed; that though they

incorporated some good points (like the mounting of thermometers for pupils in a particularly neat way in a metal angle) they were in some respects flimsy; that a kit needs an accompanying text in the appropriate language; and that the price was totally out of reach of most schools in a developing country.

The German Foundation for International Development (DSB) arranged a conference (Calcutta, September 1973) at which teachers, educationists, apparatus designers, and so on, from all over India, had a look at science and mathematics teaching kits produced in Germany. The intention was to see whether the kits themselves, or modifications or ideas from them, were useful in the Indian classroom. The conference members actually used the kits with school pupils from a local bustee (slum) in the mornings over two weeks, sitting on the floor, each with some half dozen children. The resulting reports, though not edited and published, are detailed and valuable. This real attempt at testing European materials in Asian classrooms had several aims: - to educate local teachers and designers as to what materials exist; to demonstrate to distant manufacturers how their products fit into the Indian context; and to indicate to the international organization whether they are on the track of a process to help Asian children, local production and European manufacturers. The impression at the conference was that this is an enormously valuable process which many international agencies should copy. What made this particular one successful was an informality which allowed truth to come out, properly-based analyses to be made (still unpublished possibly because of the informality) and the fact that people were actually influenced, not merely informed. The kits have since been sent around India as an exhibition.

During discussions about kits in New Delhi and Calcutta, one point arose that is of importance to designers of apparatus - the idea of kits rather than individual items was warmly welcomed. Indeed at Delhi UNICEF was urged to put its supplies into kits. A pre-selected collection is usually gratefully seized on by those who otherwise would have to make their own selection. Most people at the New Delhi conference averred that some dreadfully poor selections and omissions were commonly perpetrated by administrators or by sincere but inexperienced or rushed officials. There was a strong feeling in favour of kits because of this great risk; the possibility that a ready-made kit might contain an inappropriate selection seemed to be less feared. Of course, in practice it is unlikely that anyone would consider attempting a totally international kit for a wide range of levels. Nevertheless, large manufacturers do need to bear in mind that a grade 8 level kit for a Bengal village is unlikely to be appropriate for, say, the same grade in a Mexican city school. How it would need to differ is a matter for research in the locality.

That some kind of warning is necessary, however, is evident from the proposal of a European firm to market, in countries poor in school apparatus, a large, expensive universal science teaching kit - photographs 2 and 3. Though handsome and excellently designed for Europe, several factors put it right out of consideration: for instance, the irreplaceability of its multi-use parts; the need for access to some repair skill and facilities; the fact that it does not fit a local syllabus and needs local-language software and an optimistically well trained-teacher; and its general air of sophistication. The international organizations can already blushing tell us of the many European science kits standing unused on shelves in Nepal, Indonesia, Jamaica....

Food for thought

A further advantage of a kit is that it can have a box which serves as the store-cupboard for the items in the classroom. Most classrooms, certainly in primary schools, have no storage space at all. The NCERT kit has a metal case which can lock with a padlock - photographs 6 and 7. When making new designs, production units will need to bear in mind this lack of storage space or their apparatus will not last a year. (Though what they can do to cater for those schools in Vietnam without roof or walls, or those in Malaysia which are occasionally entirely submerged by water, is not so easy to decide.)

APPARATUS FOR THE FEW OR THE MANY

If ninety-nine per cent of the school population are not going to be academic scientists, it might be expected that only one per cent of the apparatus manufactured for school science (in a country where manufacture must not be wasted because of its difficulty) would be of the conventional standard type. Surprisingly the opposite is usually found to be more nearly the case. Consequently the majority of the children are starved of relevant practical scientific experience. This grossly undemocratic practice comes about for three reasons: a policy of elitism (usually not expressed); a tradition from the days when science teaching was given only in superior secondary schools (or, in the case of a country newly undertaking science teaching, by accepting advice from people in whom that tradition was ingrained); or a belief that low level science needs no apparatus.

This review does not contain much primary school science apparatus made outside Europe and the USA because there is good justification for supposing that in the early primary school very little manufactured apparatus (apart from scissors, containers, string, rulers, and a balance) is needed. It is actually better for the pupils to make simple things with their own hands. Such a policy remains a good one for the later primary and early secondary school, but in a much smaller part. Children cannot make flash lamp bulbs, or reasonably good weighing devices, or the 'clip together' blocks they need for number theory. Ten stones or a handful of maize seeds are just not suitable.

BAD DESIGN FOR THE SITUATION

If there were a record of attempts to get suitable science teaching apparatus used in schools, it would show a great proportion of failure and waste of money. Only too often dusty piles of unused apparatus at the backs of cupboards, bills at the headquarters of an international organization, perhaps a bland report or two written near the end of a project - and untaught children - make up the only sad record.

Yet most science teaching equipment has been excellently made. It is strong; its joints work freely; everything fits together properly; it does not leak; it is well finished. In proper hands it can demonstrate exactly what it has been made to demonstrate. Usually it is wellnigh perfect except in one very important respect - it is not usable in the situation into which it has been put. It lies totally ineffective on a shelf. Nobody checked whether the teachers could and would use it, and it was found too late that they could not or would not. It is irresponsible on the part of the designer to blame the

teachers for this. The designer of a dam must first study the site on which the dam is to be built. Should the dam fail, the designer cannot escape responsibility by asserting that the design was good but the earth on which it was built was not suitable. It is in this sense that the failure of a science apparatus project can be attributed to poor design. The reasons are usually clear and discoverable.

Much of the apparatus in this review is excellent in many ways, though it may not be well-designed in its most important aspect - its real suitability for the teacher, the children and the classroom situation in which it is to be used (see photographs 4 and 5). The primary job of the apparatus designer is therefore to watch the operation of some examples of his proposed apparatus in a genuinely average class, undisturbed by his presence. To find a person with the necessary empathy and ability for this task is not easy, but the ability to do such research is essential. The natural choice, particularly for a primary school, is probably a woman. She must also have good mechanical design ability or work with someone who has.

These paragraphs are intended as a warning against an easy misuse of this review.

CONVENTIONAL VERSUS NEW DESIGNS

Some apparatus makers see their job as reproducing conventional American or European items; for example, the commercial manufacturers in Ambala, India. They are supplying the needs of schools which work from essentially pre-1960 texts.

In the 1960s however, school texts and apparatus began to change rapidly in countries with sophisticated school science systems. The change came first in secondary then in primary schools. At the same time countries without much tradition for teaching science with apparatus were changing to new curricula. Sometimes these demanded new styles of apparatus. For instance, UNESCO helped initiate curricula in Africa which needed the English 'Nuffield' equipment. The Nuffield system needed complete class sets of items, but countries found they could not afford the apparatus, particularly if it was to be purchased with foreign currency. They therefore considered local construction of one sort or another - such as teachers' do-it-yourself construction, science centered prototype making, and teachers' college small-scale production units. (Full-scale local manufacture has been talked of in several conferences but rarely undertaken.) In most cases the aim seems to have been to copy existing items. The result has been massive wooden ticker-tape timers and bamboo test-tube racks - simple copies in local material of new-style and old-style items - in batches of 100 or less. That teachers in general have little time or ability to construct these things has been a major problem.

The Science Education programme for Africa has had a different method for primary school teaching. It uses common objects such as grass, bamboo, automobile tyres, and cooking pots which the children manipulate for themselves and do their own construction as part of the lessons (see photographs 16, 17, 18). This method needs its own special texts. Other projects, for example FUNBEC in Brazil, have created entirely newly-designed apparatus and their own system. They manufacture (and seem to be commercially

Food for thought

successful with) some fifty pocket-sized packs of very simple experimental kits with small accompanying books and a larger text (see photograph 58).

Most school systems in the world work with conventional apparatus and do not envisage much change within the next ten years. Their need, presumably, is for such equipment. Most of those secondary schools that teach science with apparatus in Britain, Thailand and Colombia, for example, use types of equipment hardly different from that used in a German secondary school in 1900. By far the largest proportion of the science apparatus manufactured in the USA, India, or in the newly-started production unit in Burma, is of the ordinary, standard, old-fashioned kind. In great part, this is quite natural. Standard academic physics is the same the world over and, if this is to be taught in the secondary schools, the same apparatus will be suitable, more or less, even if it is a bit pedestrian to the eyes of a technologically highly-developed country. Computers, quick-fit apparatus and photographic microscopy are not inherently superior for teaching: the academic stream of the secondary school in a less technically advanced country is as well provided for with slide rules, test tubes and magnifiers.

DESIGNING VERSUS COPYING

There is ample evidence that many so-called designers are merely copyists who have opened another manufacturer's catalogue and made what they saw there. This can be futile. Many educational analysts believe that though the introduction of a piece of machinery or a new technique into an educational system may seem straightforward, it can have deep social, religious and political effects (through an inevitable process of contingent texts, training and other influences). Thus the British have introduced intellectual elitism with their school apparatus into some countries, and the Americans have introduced a questioning of parental and religious authority as a concomitant of their approach to science.

In most countries mechanics are social engineers, whether they know it or not. They should therefore beware of copying Japanese, European or Brazilian items without due thought. When any of the items in this review are being considered this warning should be borne in mind. They are presented here not for copying, but as an encouragement to designers to be inventive and to make their own modifications to meet the needs of the teachers and children with whom they are specially concerned.

CURRICULUM/APPARATUS LIAISON

Collaboration between curriculum designers and apparatus designers should be very close. A sequence of experiments which an apparatus designer may have discovered to be possible, given the manufacturing capabilities which he knows of, might well be a useful suggestion to incorporate in the curriculum. On the other hand, an activity which an apparatus designer knows cannot be instrumented in the given situation will have to be modified if the curriculum designer wants it to be done practically. There are numerous similar situations where collaboration is necessary. A much larger general question which has to be settled between the two designers is which experiments are for demonstration by the teacher and which are to be done by the pupils.

Most of the apparatus in this review would not fit most textbooks: one or the other would need to be modified, for the text and its pictures must be compatible with the apparatus. Cases have been known of apparatus being manufactured without the makers knowing what text or curriculum it was to be used with. Frequently, too, textbooks are written without the required apparatus being available. Poor planning of this kind is particularly apparent in countries where there is no wide and varied supply of apparatus and texts. And the children suffer.

THE NEED FOR SYSTEMATIC OVERALL PLANNING

Rather distant from the task of this booklet, seen as a review of apparatus, are two important aspects of apparatus production: organization, and financing.

Many production units are conceived without a clear policy, particularly if they are set up by an international bilateral organization. The danger is that a project proposal is made out in rather general terms and is funded without an analysis of the 'market' being undertaken. The market is the school system whose needs (by reference to curriculum and ministry policy) are presumably fairly easily assessable. No estimation of production flow, costing, permitted amortization of capital, and so on, is undertaken. It is unclear what the long-term operational problems are, who the imported machinery belongs to, and who is responsible for servicing. No analysis is undertaken of the whole system into which the production unit fits. Items for production are selected ad hoc, and often the organizations concerned do not know whether they are making prototypes, pilot batches or are mass producing. Consequently things are likely to go wrong, and when they do it is difficult to see what the error was and how to avoid it next time. There may even be no contingency plans to meet the present difficulty. The international organization may be hoping that the unit will eventually become self-supporting, while local government - perhaps by failing to provide counterpart staff to take over from foreign experts - may not be contributing to this aim. The ministry may, by mere lack of understanding, permit the unit to be elitist in its production (in the sense described earlier) in opposition to the government's educational policy. As a result of this lack of systematic planning, enterprises may founder altogether.

As far as the workers and advisers are concerned, the reasons are understandable and forgivable. It is less easy to forgive the higher echelons. Planning is their reason for existence.

A further moral for the use of this booklet is obvious. The ideas to be found here are often in the nature of single bright ideas. They are useless unless they enter as part of a system.

PROFIT-MAKING AND NON PROFIT-MAKING PRODUCTION UNITS

Some economists divide all human enterprises into a mere two categories: those which make profits and those which educate. It is necessary for any organization which wishes to get science equipment used in schools to decide in which category its intentions lie.

Food for thought

If a producing factory is set up in a country which permits private enterprise, and if that factory makes a real profit for the owners, there is a strong likelihood that it will continue to exist and to supply science apparatus. The managers are likely to respond to market demands quite sensitively since their income depends on it. If, however, the factory is an educational enterprise making a financial loss, its continued existence depends on an external budget. In this case its educational effectiveness depends on planning according to external criteria, such as researched needs of the classroom. The educational effectiveness can be zero as easily as can financial profit. The physical existence of a unit in these circumstances is assured as far into the future as the certainty of a budget. If the unit is small and the funds are directly from ministry of education sources, the certainty may be one year or less. This is particularly likely when the unit is isolated from some kind of mother-body, but if it is within, say, a teachers' college, it is likely to have a much longer lasting budget.

If the funds are from some other agency, the intention will usually be to get the unit going and then for the government to take it over (assuming it is a non-profit making unit). This has happened in Burma. Alternatively the unit may be set up to demonstrate possibilities, processes, costing, and so on, to local (small-scale) industry. The intention to make it really profitable is rare; though this is intended for the unit in Sri Lanka and it has actually occurred with FUNBEC in Brazil.

INTEGRATION OF THE UNIT INTO THE COUNTRY'S SYSTEM

The risk, of course, with any size of production unit is that it may absorb funds over a long period while having only a small or insignificant effect on actual classroom practice. It may have excellent ideas and produce some useful items but unless it is well-designed as part of the system into which it must fit - that is, into the educational set-up of the ministry, the social reality of the classroom, the commercial environment, and so on - its effect will almost certainly be merely local.

Any relatively modest enterprise intended to help to get apparatus into schools would therefore be well advised to avoid any risk of isolation from the system. Quite apart from what this means in terms of planning, it probably means that the effort should go into an existing institution, such as a teachers' college or a science or curriculum centre. There is also a good chance that this will decrease certain overhead and capital costs. Space and skill will be at premium but almost certainly there will be the access to valuable informal knowledge and existing channels through which to feed out information and apparatus. Isolation and fragmentation are likely to be ineffective.

SUITING THE APPARATUS TO THE CHILDREN

There are other considerations besides those of management, organization and item design. A major one is curriculum, and as the apparatus designers and curriculum designers are both parts of the design system, they should work closely together. In doing so they should be aware of the profound effect their work will have on the whole society. There is a big move, particularly among the younger engineers of Britain and the USA, towards social

responsibility for the use and potential of the equipment they make. In an equipment production unit in a poor country there should be (and increasingly these days, there is) someone who understands the arguments presented in such publications as: 'Pedagogy of the Oppressed' by Paulo Freire (1); 'One Hundred Countries, Two Billion People' by Robert McNamara (2); 'The Wretched of the Earth' by Franz Fanon (3); 'Education in Rural Areas' (4); Charles Silberman's 'Crisis in the Classroom' (5); 'Modernizing Peasant Societies' by Guy Hunter (6); 'The Age of Discontinuity' by Peter F. Drucker (7); and the monthly 'New Internationalist' (8).

A review of much relevant literature up to 1969 is 'Preparation of the Child for Modernization' (9), a very helpful working paper constituting a report on a study by the UN Research Institute for Social Development. It gives brief comments on original papers (which it lists) concerning developing countries, children's problems, abilities, experiences, intellectual development, traditions, and so on, under various headings. All are of great interest to a school science apparatus designer, being such matters as: childhood experiences in technological and non-technological environments; living and learning; conditions of children; skills and intellectual requirements of modern technological activity; the use of tools by children in what it calls 'traditional' environments; two-dimensional representations of reality; absence of technical words in a traditional environment; scientific thinking and development; transfer of traditional physical capacities to modern tasks; formal and informal training of the pre-school child; the penalization of children's questions by parents; the use of toys and games and household objects for play, and so on. Much of the bibliography is on Africa. The review points out how little is really known and how little research has been done. More may be available now that a number of child development institutes have been established, such as the one initiated by UNESCO beside Prasarnmitr College in Bangkok.

An unusual and valuable book which demonstrates how clever children are if they are allowed to solve problems in their own way, particularly when adults sympathetically attempt to understand the elements of what the child - lacking appropriate terminology and wide experience - is trying to say, is: 'Children Solve Problems' (10).

- (1) Pedagogy of the Oppressed (Freire)
published by Sheed and Ward Limited, 33 Maiden Lane,
London W.C.2., England.
- (2) One Hundred Countries, Two Billion People. Dimensions
of Development (McNamara)
published by Praeger Publications, 111 Fourth Avenue,
New York, N.Y. 10003, USA.
- (3) The Wretched of the Earth (Fanon)
published by Penguin Books, Harmondsworth, Middlesex,
England.
- (4) Education in Rural Areas: Report of the Commonwealth
Conference on Education, Ghana 1970
published by the Commonwealth Secretariat, Marlborough
House, Pall Mall, London SW1Y 5HX, England.

Food for thought

- (5) Crisis in the Classroom (Silberman)
published by Random House, 201 E. 50th Street, New York,
N.Y. 10022, USA.
- (6) Modernizing Peasant Societies: Comparative Study in
Asia and Africa
published for the Institute of Race Relations by Oxford
University Press, Ely House, 37 Dover Street, London
W1X 4AH, England.
- (7) The Age of Discontinuity (Drucker)
published by Heinemann Educational Books Limited,
48 Charles Street, London W1X 8AH, England.
- (8) New Internationalist (monthly)
published by Research Publications Services Limited,
Victoria Hall, Greenwich, London SE10 0RF, England.
- (9) Preparation of the Child for Modernization (Mandl)
published by UNRISD, UN Palais des Nations, Geneva,
Switzerland.
- (10) Children Solve Problems (de Bono)
published by Penguin Education, Harmondsworth,
Middlesex, England.

THE USE OF TOYS AND DOMESTIC OBJECTS

Something which teachers have always done to some extent is to use common objects and toys to illustrate scientific principles. Several apparatus projects throughout the world have used this principle too. It is possible to avoid special manufacture if there is an object already available within the country which can illustrate a concept, or replace a chemistry beaker, and so on. Indeed, it may be an educational advantage to use an object which the children recognize rather than a foreign-looking object remote from their experience. Cheap plastic roller skates may replace a special dynamics trolley; a local flute may serve as a source of sound much better than a tuning fork; even a mouse-trap may serve to teach several ideas about mechanics. Of course, these will need testing by children and by teachers as well as from the economic point of view.

For teaching a whole range of projectile mechanics, a toy in England called a 'flickball' - which flings a pierced ball off a stick - is remarkably versatile. Many electrical items are obtainable, as wholes or as parts, from quite small hardware stores, radio shops or garages. Examples are torch bulbs, rectifiers, and power supplies bought as battery charges. Bicycles are a prolific source of material for experiment. (Photographs 8 - 12 illustrate some of the things mentioned so far.) Objects of use in teaching may not only be found but modified, or assembled from parts, or wholly constructed. These processes may be undertaken by pupils or teachers, local craftsmen or a central manufacturing concern. The practical limits are set by local conditions.

Toys which exist in many cultures may be more suitable pedagogically, culturally and mechanically for helping children to understand science than specifically manufactured educational apparatus. For example, the Indian

NCERT primary science kit contains a large plastic wind direction indicator. This is expensive to make, occupies a lot of space in the small cabinet, points upwind which confuses the children, and, to make things even more difficult, has a base to stand on a table instead of a hand-grip to suggest its being held high outside. In fact it is unnecessary to have a specially constructed wind vane in India since children there commonly fly flags, pennants and kites, all of which indicate wind direction. Moreover, before launching a kite the young boy usually throws up some dust to see which way it drifts. From this he gets not only an indication of the wind direction but an estimation of wind speed as well.

Thus it will be wise for apparatus production units to investigate local toys and games so as to avoid unnecessary manufacture.

GAMES AS TEACHING APPARATUS

The difference between games and toys is that games are competitive and operate with symbols while toys represent real things for individual play. Although a number of games are claimed by their makers to be educational, few of them really teach much of significance. However, there are some good ones, and production units might like to consider them. Invicta Plastics (1) make several which teach elements of logic and mathematics. One which develops children's sense of strategy and gives much enjoyment is called 'Master Mind'. This is a simply manufactured device (pegs and peg board) and a model of what can be done. Of course, such games should not be copied too closely; all countries have their own idiom in games and this should be incorporated in the design of educational games if they are to work effectively (see photograph 15).

Nowadays, management training in industry makes use of games to simulate real situations. There is no reason why this should not be done in schools, though there is always a risk that it will make a subject theoretical instead of practical. It is of obvious use in non-formal education to teach about social matters and it is also applicable to subjects such as health, family planning, agriculture and similar topics which involve both science and social matters. A very interesting project which approaches this area is the 'Ecuador non-formal education project', being aided by the Centre of International Education, Massachusetts (2). Photographs 13 and 14 show a game-board and some cards from a Monopoly-like game from the project. The games are not manufactured but are made by those who want to use them; they are made to simulate the local situation about which participants want to learn.

(1) Invicta Plastics, Oadby, Leicester, England.

(2) Centre of International Education (School of Education),
University of Massachusetts, Amherst, Massachusetts 01002,
USA.

DESIGNING FOR THE TEACHERS' ABILITIES - TEACHERS' GUIDES

To help the teacher and the children to use apparatus, a guide of some sort is necessary. Most textbooks assume that the teacher can assemble and use

Food for thought

equipment, although in fact most teachers cannot. Teachers' courses may endeavour to provide the necessary training but it is as hard for the average teacher to learn to handle science teaching apparatus satisfactorily as it is for the average person to learn to play the piano. If the apparatus designer discovers - and it is an important part of his job to research this aspect - that not more than half the teaching population will be able to use his proposed new apparatus in the next ten years, he must realistically plan for that fact.

Probably no one knows how much or how well a teacher will use a guide book. Common sense suggests that a small book is more likely to be read than a big one and that pictures are better than words. In many countries photographs are much more understandable than diagrams. Some examples of guide pages have been included to show some of the 'software' that apparatus makers put out with certain kits. It is certainly more the task of the apparatus designer than the textbook writer to describe the practical use of his apparatus. Often it is quite small matters which puzzle a teacher who is unpractised at handling physical apparatus and, naturally, any unusual aspects of design need explaining fully.

TAKING ACCOUNT OF AVAILABLE MATERIALS AND OF PREJUDICES

This review attempts to search out new ideas in methods of production. An important one to consider is the use of readily available materials for production wherever possible. For instance, the use of common mild steel stock sizes, half-inch iron piping, and so on, instead of special materials, will bring great advantages to the producer who must otherwise import stock or use skilled operators on expensive milling machines. Though this kind of designing is now common in industry, it is unfortunately less widespread among science teaching apparatus production units. Allied to it is the art of not over-specifying (for instance, on accuracy or surface finish).

A disadvantage of modifying an engineering specification to suit available machinery and skills is that it does tend to give the manufactured item an unusual, simple or even crude appearance. Though this may make an item less acceptable in the eyes of a country's educational officials and secondary school teachers, it rarely influences primary teachers and never affects their pupils. However, if prejudice exists it must be discovered and taken into account in designing the system.

KITS AND STORAGE BOXES

Much locally-produced apparatus is conceived as a kit to suit a curriculum. It is a ready-made collection for presentation to a teacher and often fits in with a text. Sometimes it is a collection of items for a particular teaching topic of very limited extent - such as a clip-together style of microscope or electric motor, or a little set of chemicals and test tubes together with a booklet for discovering pollution in streams. It may even comprise a whole set of items for several years' experiments or a complete primary science course (for teacher demonstration) in one box. Since teachers' storage problems need to be thought of, ideas for solutions are worth noting. There are not many solutions in this review.

SAFETY

Production units and others concerned with putting into schools apparatus with which teachers and children could have accidents, might consider their responsibility for providing suitable advice on accident prevention. Useful booklets are 'Safeguards in the School Laboratory' (1), and 'Safety in Science Laboratories' (2).

- (1) Safeguards in the School Laboratory published for the Association for Science Education by John Murray Limited, 50 Albemarle Street, London W1X 4BD, England.
- (2) Safety in Science Laboratories - DES Safety Series No. 2 published by H.M.S.O., Head Office, Atlantic House, Holborn Viaduct, London E.C.1., England.

WORKSHOP STAFF SELECTION

Selecting the right workers for the various jobs in a workshop is very important, and production units may find some of the publications of the International Labour Office of help to them in undertaking the task (1). A review of available tests (which might suggest some equivalent home-made versions to the selection staff at production units) is 'Personnel Selection and Training' by R. Goldstein of the ILO (2).

The trained science laboratory technician is invaluable in the school equipment production and development unit. The appropriate course of study for science laboratory technicians is the City and Guilds of London Institute Course 735 Parts 1, 2 and 3. Advice on the availability and training of such personnel can be obtained from the Institute of Science Technology (3).

- (1) ILO Publications, Sales Service, 1211 Geneva 22, Switzerland.
- (2) Personnel Selection and Training (Goldstein) a mimeographed book produced for the Jamaica National Industrial Vocational Training Programme (Kingston 1973), available through the Ministry of Labour and Employment, 112 East Street, Kingston, Jamaica, West Indies.
- (3) Institute of Science Technology, 345 Grays Inn Road, London WC1X 8PX, England.

LOCAL REPAIR

Apparatus should obviously be designed in such a way that it can be kept in working order. For primary schools which are mainly located in country areas and shanty towns and which lack funds for apparatus and skill in repair any possible breakage needs to be replaceable or repairable locally. There is plenty of glib reference to local repair but little realization of what is implied - such as a hammer and wire job by an itinerant tinker (see photograph, 5). It is the designer's job to discover the realities here as well as in

Food for thought

the classroom.

INFORMATION NEEDED BY COMMERCIAL FIRMS

The initiative towards producing sets of items, or indeed individual items, to fit curriculum developments need not come only from government ministries or educational agencies. In many countries it will seem appropriate for production to be undertaken by private enterprise. Even if they are not themselves the originators, it seems essential that (where the form of government permits) commercial firms should eventually undertake production and marketing. If a product is viable, they will undertake it and thereby provide an assurance that production is likely to continue. For this reason potential manufacturing firms should have early access to as complete a range of information as they need for their planning - from clear help with teachers' apparatus guide publication to firm offtake numbers for items over the next few years. This is especially necessary with kits - and it is largely with kits, in one form or another, that most production units will be concerned.

This is an area in which the international organizations could and should help. To what extent, at present, do production units who are contracting for production with other firms, let those firms know what is to happen in the future, or try to draw them into the marketing procedures in any way? If this is not done, an international organization that conceives and nourishes a new enterprise will find itself holding a baby that should long ago have grown up.

UNWISE RETICENCE OF AID RECIPIENTS

External aid, through bilateral or multi-lateral arrangements, is, of course, often given to production units: for example, UN aid to Sri Lanka and Nigeria; German aid to RECSAM; Japanese aid to South Vietnam. Naturally the organizations receiving this aid are grateful. At times, perhaps, their gratitude disinclines them to make useful criticisms lest they be misconstrued. This may be compounded by a somewhat insensitive donating agency which, without having really taken the trouble to understand the real needs of the situation, assumes that what it gives is certain to be useful. It may accept unsuitable advice; it may tie its funds to purchases from the donor country; or it may for other reasons provide unsuitable items, production machines or other facilities. The outcome may be worse than a waste of effort: there is a real likelihood that the effect will be negative, concreting the enterprise into the wrong path.

To avoid this it may be necessary for the donating agency to use people of exceptional sensibility to research the local situation; it will certainly be essential carefully and sympathetically to encourage local educators, administrators and others to reveal their needs, hopes and doubts. In any situation this is not an easy thing to do. In much of Asia for instance, people's natural courtesy, reticence towards foreign experts, and gratitude for foreign interest and funds, can lead to the setting up of poorly-based projects. I have heard a senior UNESCO expert say in a large conference that UNESCO has too often found that its pilot projects have ended in failure because of lack of maturity in the necessary supportive services of

the country involved. It is clear that this is an indication of badly-designed projects, yet the same kind of mistakes are still being made. Aid recipients can help by striving to eliminate unwise reticence so that aid from donating agencies is never wasted but channelled into well-designed and fruitful schemes.

A SUCCESSION OF ADVISERS

A problem allied to that of bad advice is too much varying advice coming from a succession of visiting or short-term advisers, resulting in the lack of a single coherent policy. It is not at all unusual for this year's adviser to denigrate the work of last year's adviser, set it aside, and start almost anew. The unfortunate ministry or other authority concerned can recognize the evil of this in general terms but can hardly see what to do about it since the man is paid by the agency funding the project. It looks ungrateful to criticize him for many reasons, not least because the agency has approved him - even though it failed to vet his intentions and ascertain whether they were concordant with previous policy. A further difficulty is that the ministry usually cannot be sure which adviser's policy is the right one - or it would not have needed an adviser in the first place. A study of some projects which have failed for these reasons, and of others which have been successful in spite of them, would be valuable. Such a critical analysis could help subsequent designs.

A very small project, which is reported as successful, is a CEDO (now British Council) laboratory/workshop at Prasarnmitr, the principal teacher training college in Thailand. This gives teachers-in-training experience in the use and construction of science teaching apparatus and originates some new designs. A senior adviser went out to look at the needs, and advised funding after a country-wide inspection of schools and colleges. A second adviser did a feasibility study showing specifically how the project would fit the system and how the system would integrate it and run it as the aid phased out. A third adviser, who was sympathetic with the intentions of the feasibility study, then ran the project for two years. The courses - now part of the college's system - are being run by local staff; the new apparatus and the tools are in full use; there is a store of apparatus made by successive courses; and the course is now also established at the sister college of Bangsaan, 45 miles away, and is likely to spread further. This small success story is worth critical analysis as suggested in the foregoing paragraph. There is a report - full of insights - in the now defunct British Council publication 'Educational Development International' for January, 1974.

PROPOSAL FOR AN INFORMATION AND PLANNING SERVICE

A potentially valuable service, which could be offered by an organization wishing to help a school system to initiate or improve its production of apparatus for schools, would be the provision of a wide range of information, with ideas for designers and administrators on how to make the most successful use of it. This might be run at two linked levels: one concentrating on the design of apparatus, the other on the design of systems. The information could be presented, perhaps in an existing journal, in the form of reports, critical analyses and sources. It would be accompanied by courses in the

Food for thought

theory and practice of all that pertains to design at these two levels. The scope might thus extend from bright ideas about teaching chemistry with plastic bags to how to amortize capital; from large-scale production of toys in Turkey to a one-man production unit in Colombia. There is a great deal of information available on such matters and equally evident need for its propagation. No less is there a need for its analysis, followed by some practical use of the results; potential apparatus producers and users could be helped to benefit their own societies by searching out some of the reasons behind the various successes and failures.

Section 2 Current Developments

Africa

AFRICAN STATES

The Science Education Project in Africa (SEPA) which began life as the African Primary Science Project (APSP) uses common materials from home and surroundings with which to teach. There are some thirty teachers' guides with titles like 'Chicks in the Classroom', 'Common Substances Around the Home' and 'Playground Equipment'. This latter is a delightful example of the use of cheap equipment on a large scale. Bamboo, rope, car tyres and other objects, are used to construct towers, slides, swings, roundabouts, large balances and a giant shadow calendar. As the book says: 'Without too much trouble and very little expense, teachers can make playground equipment which will fascinate and excite their pupils... they will be experiencing with their whole bodies some of the important laws of science'. See photographs 16, 17, and 18.

These materials were developed in the USAID programme by a large number of people in the countries of Ghana, Kenya, Nigeria, Sierra Leone, Tanzania and Uganda, with assistance from the Education Development Centre, Massachusetts (1).

- (1) Science Education Project in Africa (SEPA) details of available materials from the Education Development Centre, Newton, Massachusetts, USA.

BOTSWANA, LESOTHO AND SWAZILAND

These three countries are concerned in the experimental teaching of a New Junior Certificate Integrated Science Scheme which has considerably involved in-service teacher training. The Francistown Teachers' Training College, Botswana, is an example of an approach to teacher training whereby the teachers actually construct apparatus themselves. (There is a similar approach in the Nigerian situation.) Most of the developments are

Current developments

based on the University of Botswana, Lesotho and Swaziland, but as yet no concentrated effort in apparatus production exists.

KENYA

The Production Unit of the Kenya Science Teachers' College has designed, and is currently producing, some equipment. This is how it describes itself:

'The unit is a non-profit making body run by the Production Board of KSTC. The workshops are equipped with the most modern metal and wood working machinery. It is capable of producing almost any teaching aid required by Kenyan Schools.

'One of the main projects of the unit is to produce scientific equipment to relieve one of the many problems facing Kenyan schools. A physics kit has been developed and is produced. In the near future chemistry and biology kits will be developed. The annual turnout is expected to be about 1,000 kits. This capacity can be increased if the demand grows.

'Learning by doing is the motto of the scientists today and the kit gives just that possibility without high costs.

'The kit also gives an excellent opportunity for the students to train their manipulative skills. Until recently very few students in the country really got an experimental background in science subjects. The kit gives the teacher the opportunity of teaching science experimentally. By spending just a small amount of money the student will be able to perform most of the basic experiments in physics.

'The kit, although small, can be used as a demonstration kit as well. A manual is supplied with the kit to guarantee a good layout of the experiments.'

There is a pupil's text accompanying this equipment, some of which can be seen in the Curriculum Information Service (Education Information and Research Department) of the British Council, 10 Spring Gardens, London S.W.1.

NIGERIA

Considerable activity in curriculum development is going on in Nigeria, and alongside it is equipment development and improvement.

In 1970, the Federal Ministry of Education with the assistance of UNESCO established a Science Equipment Centre in Lagos. The function of the Centre was to provide facilities and expertise for the design and production of prototypes of school science equipment; the repair and maintenance of existing school science equipment; in-service training courses for primary and secondary school teachers and training courses for laboratory personnel;

and an advisory service in science teaching equipment. The aim was for the Centre to provide a service throughout the Federation, which consists of 12 educationally-autonomous States. To achieve this aim, a network of centres was planned which would be linked by Mobile Repair Units.

Components of the in-service training courses include woodwork, metalwork and glasswork, and participants construct apparatus themselves. It is not intended that teachers should be bulk producers of apparatus, but the activity is designed to boost the practical expertise of the teacher so that he may become more confident in his ability to experiment and more innovative in his science teaching.

Apparatus so far constructed by the Centre has been based on designs from the 'Guidebook to Constructing Inexpensive Science Teaching Equipment', Volumes 1, 2 and 3 (1) - see photograph 41. In addition, apparatus has been constructed for the Nigerian Secondary Science Project pilot schools, and also for the Primary Science Project based in Ahmadu Bello University, Zaria. The Centre workshops have been able to cater for 50-100 pieces of a particular item at one time and development of the workshops currently being undertaken should increase this capacity. The financing of the Centre is by the Federal Ministry of Education with UNDP/UNESCO assistance until 1976.

- (1) Guidebook to Constructing Inexpensive Science Teaching Equipment
published by the Science Teaching Centre, University of Maryland, College Park, Maryland 20742, USA.

Asia

REGIONAL CENTRE - RECSAM, PENANG

RECSAM is the Regional Centre for Education in Science and Mathematics, in Penang, Malaysia. It is part of the South East Asian Ministries of Education Organization (SEAMEO). It serves Thailand, Malaysia, Philippines, Indonesia, Singapore, Laos, Khmer and South Vietnam. It runs conferences and three-month courses for teachers, introducing them to science and mathematics teaching methods. It receives multi-lateral and bilateral assistance; for example, the German Foundation for International Development (DSE) is probably about to equip a prototype development workshop there, and the British Council has funded some lecturers. Mr Khoo Tiang Lim, the science training officer, has originated a lot of the interesting science apparatus prototypes which are on display, and there is a wide-ranging stock of examples of science and mathematics apparatus from many modern projects. There is a proposal to set up the prototype workshop (with DSE funds) quite soon to design equipment for the SEAMEO countries which, it is hoped, will thus be helped and encouraged by this regional effort to set up their own national centres, or to improve them where they already exist.

Current developments

As in most such centres, the work is seen as involving engineering and educational effort, but without systematic analysis of either the varied classroom situations into which the apparatus must fit or of the administrative and commercial networks upon which its effective use will depend. This important aspect of the design of apparatus production is often neglected. RECSAM, however, does at times hold high-level conferences for administrators and involves administrators in its courses. The extent to which institutes of education in the universities of the region concern themselves with such analysis is uncertain, but no contribution from them seems to have reached any of the conferences on apparatus production.

Clearly there are specific and local examples of such planning with some Ministries of Education and with various projects (such as those of the UN organizations) which have undertaken educational development work involving school apparatus. It would be valuable to collect information on some of these initiatives, with a view to analysing it and making it available to the planners of production units. The Regional Centre for Educational Innovation and Technology (INNOTECH) is, in fact, already undertaking aspects of this at quite a high level in a long-term project. It holds courses for key educators. However, its work seems never to be referred to in the ground planning of actual apparatus production - plans which are rapidly becoming concrete in the region.

PRODUCTION CENTRES IN SOUTH EAST ASIA

THE UNIT IN BURMA

The following account, taken from a UN Newsheet, will help to set the Indian NCERT production unit (see pages 22 - 23) in context and provide an indication of the history and the hopes that people in the region have with regard to such enterprises. It consists of an interview with Soren Hakansson of UNESCO, Bangkok, the originator of and adviser to many of the apparatus production schemes in the region.

'This production unit is one of several in Asia which owe their existence to the example of a small industry set up in 1964 at the Rangoon Arts and Science University to make science equipment for education. All Asian nations have expressed a commitment to mass education and many have made remarkable progress towards achieving it. This commitment, coupled with the wish that the pupils should experiment for themselves in their science learning, has brought home to them the need for vast quantities of science teaching equipment. Production in Rangoon began in 1965 and has risen to the point where by 1972 about 200,000 Kyat-worth of such equipment per year was being turned over to the Director of Education. To have imported this would have cost the equivalent of about 460,000 Kyat. A very important point, of course, in all this is the saving of local currency, which in this case is a saving of nearly 100,000 US dollars. (One dollar is worth about 4.8 Kyat at the official exchange rate.) By 1972 the Rangoon workshop had 52 full-time technicians plus up to 100 temporary workers during summer vacations - physics and chemistry students from the University who volunteer their services for no pay. The items currently being produced cover nearly all those needed for high school physics and chemistry: balance, glassware, galvanometers, magnets,

prisms, calorimeters, tuning forks, lenses, hydrometers, etc.

'This project is mentioned in some detail here both because it was the first of its kind in the region and because its success and the consequent spread of the idea is a pointer to the future. It has been given help by the UN through the provision of UNESCO experts in equipment production and building planning and by the contribution of some 290,000 US dollars-worth of assistance by UNICEF. Under the Colombo Plan, Australia has contributed some 40,000 US dollars-worth of machinery and supplies.

'From its Burmese place of origin the idea of local manufacturing of science teaching equipment has spread outward to other countries of the region. Experts from UNESCO and other international organizations, much impressed during visits to the country, have carried the message. The idea has been repeatedly promoted at the regional science-teaching and school science equipment seminars, which UNESCO sponsors.

'The success of the project has overcome some of the doubts of surrounding countries as to whether they could find the trained personnel, the machinery and the facilities. The doubt, of course, remains as to whether such an enterprise could be instituted and continue as an ordinary commercial, self-financing (if not profit-making) enterprise. This seems very unlikely over an initial period of ten years. The financial input to the Rangoon workshop has been of the order of half-a-million US dollars while the apparatus produced has been of value about one quarter of a million US dollars. The funding agencies would have been able to provide twice as much equipment to the schools over this period if they had merely imported the items. This, of course, is invalid as adverse criticism on several counts.

'It is a primary task of international agencies to help countries to help themselves even though long periods elapse before countries can support the work themselves. It would, of course, seem natural that the shorter this period is the better, provided that the burden that the country thereby imposes on itself is acceptable. Further, aid of the type considered here is fully intended as a free initial provision, not part of a profit and loss transaction. Of great importance too is the model it provides for subsequent developments in other areas - and in this the Burmese project has been particularly fertile.

'Today one form or another of a school science equipment facility exists or is about to be established in Bangladesh, India, Indonesia, the Republic of Korea, Nepal, Pakistan, the Philippines, and Sri Lanka. In some, the Burmese pattern prevails, with the manufacturing of the school science equipment done at the facility itself. In other countries, with an established tradition of small-scale manufacturing - for example Bangladesh, India and Pakistan - the facility merely does the design work, producing pilot models suited to the needs of both student and serial production, with actual production being carried out by private industry.

Current developments

'In Burma, the Science Workshop Superintendent U Chit Kiang says: "We expect to see annual production volume, as well as the number of employees, multiply by 4 or 5 times over the next four years. Right now we're producing science kits for high schools. But we intend soon to produce science kits for use in primary and middle schools. We're already testing the pilot kits."

'The ultimate aim is to manufacture all the science teaching equipment needed at primary level (for use by teachers) as well as all that required at middle and high school levels. The anticipated expansion includes broadened production facilities. To their present machinery for metal-working and glass-working the Workshop directorate expects to add machinery for plastics working - injection moulding, blow moulding and vacuum forming.

'Dr Maung Maung Kha, Rector of the Rangoon Arts and Science University says, : "The advantages of setting up our own plant for producing school science equipment go beyond just a saving of foreign exchange. We have provided new jobs. We now have trained technicians, we have acquired technical know-how. Moreover, the school science kits we produce are better suited to the needs of our own science courses, that we have ourselves developed, than foreign-produced kits."

'The chemistry kit built at the Workshop, which was designed by a professor at the Rangoon Arts and Science University, demonstrates the point. A semi-micro kit, it not only consumes one-tenth the quantity of chemicals required by normal-scale lab kits, but makes ingenious use of discarded materials - empty penicillin bottles, for example, serve perfectly as semi-micro reagent bottles.

'The Burmese project has also introduced another change into the region. Many of the countries of Asia have had no small precision industry at all. They do not have the technicians such industry needs. Good craftsmen they have, men who can turn out one beautifully-made item of a kind; but precision technicians, who can turn out 500 units exactly the same, exactly meeting blueprint specifications, and completely interchangeable - these have not been available.'

Soren Hakansson, the UNESCO consultant principally associated with the workshop in Rangoon said recently: 'I look ahead ten or twenty years. I see the Asian science teaching equipment industry largely taking care of the needs of the countries here; but I see more. Because a large part of the total cost of school science equipment is skilled labour, and labour is much cheaper here than it is in the developed countries, it is quite possible that in the future Asia will become an exporter of school science equipment to the West. Instead of just saving foreign exchange the industry will be earning it.'

INDIA.

The National Council for Educational Research and Training (NCERT), New Delhi, India, is undertaking a very large scheme of curriculum reform, textbook production and apparatus manufacture.

Some of the apparatus has been designed by UNESCO experts. It takes the form of kits for primary and secondary level. The primary science kit is for an integrated study, though most of the materials are for physics. The secondary kits are at a series of levels in physics, mathematics, chemistry and biology. The NCERT workshops produced the early prototypes and Soren Hakansson of UNESCO drew the blueprints. UNICEF is supporting early stages of the production of primary kits, some 20,000 of which have been produced by local industry. (This is, of course, only a small proportion of the need: there are 500,000 primary schools in India.) In fact, it is rare for UNICEF to purchase locally - usually it is cheaper to purchase in Europe to an easily checked good quality. In this case, they must feel that, provided the schools use the apparatus effectively, the project will prove worthwhile. At present, UNICEF is responsible for seeking out manufacturers of the items, quality controlling them and getting them assembled into the kits. Photographs 19-25 show examples from the primary science kit, mostly prototypes. The quality is now higher though quality control is still a serious problem.

CEDO (now British Council) did a feasibility study in 1970/71 for UNICEF and reassured them about the project into which they are putting some millions of dollars for at least the pilot phase. The CEDO recommendations included the following points:

The NCERT should not be left high and dry for funds with a partially complete project - there is a moral obligation upon the Indian Government and UNICEF to help see it through.

The planned staffing and physical facilities of key institutions should be strictly enforced before apparatus is supplied.

The supply of modern syllabuses and instructional materials in training colleges is an urgent necessity.

The kits must go to all colleges which train elementary and middle school teachers.

The project must be widely and realistically spread within the States of India in a properly phased manner and the release of kits and materials must be dependent on the maintenance of a good standard of training.

Teacher re-training courses should be six weeks or at the worst, four. It is no use aiming to train only one teacher per school.

The project should be tried in careful steps for three years before general implementation is considered.

The States should be responsible for their own curriculum and should be prepared to vary the written materials as they translate them.

There must be a proper repair service for the school kits.

Supervisors have a very important role in getting the materials used.

The ministry must have an officer concerned exclusively with the project.

There should be improved communications between States, between the Ministry and States, and between NCERT and UNICEF and the States.

Current developments

The NCERT has itself written a great deal about all aspects of this project, from simple explanatory books to detailed reports. There are, of course, school texts, apparatus lists, teacher's guides, many of these in several versions and various State languages. Although it does not concern this present review booklet, the NCERT is working in all the school subjects and similar materials for these subjects are being created.

Some States in India have their own science development projects with apparatus and written materials. That of Bombay is perhaps the most developed of these.

COMMERCIAL INDIAN MANUFACTURE

A certain amount of school science apparatus is made commercially in India. There are small industries for this in Bombay; there is the Dynam Company in Bangalore, and over one hundred factories (some very small) in Ambala, between Delhi and Chardigarh. Some of these are highly-sophisticated, producing, for example, some good microscope series. Ambala produces much industrial scientific equipment. It has a consortium or chamber of manufacturers and a government standards certification establishment. The school science apparatus produced is the standard, sturdy, old-fashioned stuff.

These Indian commercial manufacturers might possibly benefit greatly from some good advice on how to suit their production to the new educational needs of their country, the region, and the rest of the world. They have adequate potential, the needs exist, and the government could encourage export in material ways - such as tax rebates on materials purchased abroad and subsequently exported as manufactured goods. In many cases the government will provide loans to industry. A parallel could be drawn here with Pakistan, which manufactures and exports to Europe surgical operating equipment to a high standard. The factory at Sialkot was, apparently, set up with German assistance, and the equipment bought by UNICEF. UNICEF and other international agencies would consider the purchase of science teaching apparatus from India if they could be assured of a commercially satisfactory supply. Naturally there are many economic factors, such as currency availability, to be considered in such export hopes. As yet, Indian production is still in a seller's market within the country and is hardly export-conscious.

Information on Indian manufacture exists in various trade directories produced in the country. Organizations such as the National Small Industries Corporation can provide surveys of potential manufacturers, production capacity, quality standards, prices inspection and distribution. Many countries have similar potential for obtaining such necessary information. India has some 30,000 large industries and 9.8 million smaller ones, excluding those concerned principally with agriculture, so the need for making explanatory surveys before embarking on a commercial or quasi-commercial venture is obvious. In most countries it is equally wise if not so obvious.

INDONESIA

Indonesia has some 14 million primary school pupils. The schools rarely have more than a blackboard, some chalk and a few textbooks. The teachers, if they do any science at all, teach it by rote, knowing little of the subject or of the new approaches to teaching. There is almost no science apparatus in the schools. There are other formidable problems. Indonesia's population of some 116 million is spread over three thousand islands, and probably some 30 million children have never attended school.

Now that events connected with the rise in oil prices have made Indonesia richer, it proposes to spend some millions of US dollars on school science equipment. This is already going ahead at the secondary level although there are at present few schools and teachers satisfactorily prepared for using the equipment. The teacher problem is much worse in the primary schools. Over the years Indonesia has received quite a lot of apparatus from international aid schemes, though educationists there have reported that much of it is unused by teachers because they lack the necessary preparation to handle sophisticated equipment. This sort of waste has been perpetrated in many countries and will occur again unless designers look realistically at the whole system of countries into which apparatus is to be introduced.

The curriculum in science is aligned with environmental needs between grades 4 and 6 (72 per cent of the working population are in agriculture), but the teaching has been very rigid. New curricula in mathematics and science are now in existence and about 60 million textbooks have been published to date, with aid from UNICEF and the Canadian government.

Some prototypes of apparatus and kits are designed at the Science Teaching Centre in Bandung. There is one small manufacturer of school apparatus in Indonesia and some expensive foreign apparatus is available.

KHMER

In the Khmer Republic, the Division of Pedagogic Services attempts the supply of apparatus on a small scale. Some courses in simple apparatus construction are available for teachers. There are no teachers' centres but UNICEF has equipped workshops with hand tools and they make some use of these. With the intention of making some apparatus locally, they have imported some prototypes (from Western catalogues). There have been meetings concerned with modifying and simplifying these prototypes but no one there is expert in the matter.

Khmer has sent a lot of trainees to RECSAM over the years. Some prototypes, based on RECSAM and UNESCO designs, have been designed by the Primary Inspectorate for schools in Phnom Penh. These prototypes are to be tried out in selected classes and, if they are satisfactory, pupils' books and teachers' guides will be prepared to guide their use.

Photograph 26 shows examples of papier mache bas-relief models and lino-cut printing blocks made in Khmer. This is about the limit of what is made at present. Priority of interest is in the use of local material, and

Current developments

during 1973 some thirty teachers had a six-month training course in its construction. The thirteen small workshops, set up originally by UNICEF for developing skills of primary school children, are currently being used to produce teaching items. The raw material used is what the children can bring in, plus that bought with what funds the Educational Development Committee can provide. The hope is that eventually all the primary schools of Phnom Penh can be supplied. In-service training of district supervisors and principals will be organized in order to pass on the new ideas. Then the principals will train their staff. This training concentration on key personnel is insisted upon. (See also the section on Vietnam.)

In the long term, Khmer realizes something much bigger is needed. There are some general plans, and some help from RECSAM and INNOTECH and other international and regional agencies is hoped for in developing them. There is a strong realization that their educational system is irrelevant to the needs of the country and that training methods are outmoded. Any improvements have happened only in Phnom Penh but they feel that improvement in rural schools is becoming a priority. The war has, of course, prevented this.

KOREA

There is a small amount of science teaching apparatus manufactured in the Republic of Korea by commercial firms. In addition, the Kyongpook Student Science Centre, Taegu, and Hoesung Teaching Materials Warehouse, Kangwon-do, produce small quantities. Some small-scale industry which once produced science teaching apparatus has now turned over to other products - but the capability to produce it must still exist. There is commercial production of scientific equipment - such as ovens, thermometers, balances - not specifically intended for schools but usable by them.

Mr Hakansson, who prepared a report on design and production of school science equipment in Korea (UNESCO-Regional Office for Education in Asia, Bangkok, August 1972), states that although there was a fair amount of apparatus in schools and colleges, much of it was traditional and not designed for the present curriculum and student use. The equipment in most of the colleges was supplied through UNICEF assistance.

There is a proposal to set up a School Science Equipment Centre to design for mass production, and this may well by now have made some progress. Details of this proposal are fully set out in Mr Hakansson's report.

LAOS

Laos trains its teachers, to some extent, to make science apparatus with local materials, and an in-service training course on this, run by Dr Ponniah of RECSAM, took place in July 1973. The Laotian schools have few materials - particularly at primary level - and, of course, the country is terribly war-racked. Most innovation is introduced through inspectorial visits to schools. The inspectors demand much initiative from the teachers, particularly in such matters as using local material, and assert that teachers can and will make things for themselves.

The Directorate of Materials and Educational Productions produces some very simple materials. The Ministry of Education has created the National Pedagogic Centre, within which the Department of Pedagogic Materials will produce materials for primary schools throughout the country.

They express the need for some short-term consultants in the development of science teaching material. They also wish to duplicate in large quantities some suitable materials developed by RECSAM. Thus here, as in most countries of the area, there is a need for help to set up a national science/mathematics workshop and get advisers to train counterparts. As with many other countries in a like situation in the area, their need would attract funds if an adviser would help them prepare and submit a project proposal.

MALAYSIA

Malaysia already manufactures more than half its secondary school needs for science teaching apparatus. It has recently instituted new curricula at this level. The Curriculum Development Centre in Kuala Lumpur is re-designing equipment for the teaching of integrated science in the classroom (as opposed to apparatus which needs to be used in laboratory rooms). Presumably it is hoped this will then be produced by local manufacturers, since there will be a large market.

Primary curricula remain as they were. Apparatus is being developed at the Centre to suit these curricula - apparatus prototypes for local component manufacture. These components will be assembled in schools.

A few items in course of development at the Curriculum Centre are shown in photograph 27. The full work on apparatus development will begin in 1975 when a permanent building is put up. This will:

- Develop prototype equipment of physics, chemistry, biology and social science, for pre-school, primary and lower secondary level, for pupil use and teacher demonstration.

- Investigate the use of local materials.

- Give technical know-how to local manufacturers (in die and mould-making, for instance) and educational/curriculum advice.

- Lend its machine facilities to other Ministry of Education departments - ETV, for example.

- Effect quality control on manufacturers, vet samples and advise on the suitability of tenders.

- On rare occasions, actually manufacture.

- Exhibit.

Malaysia does not expect its teachers to improvise the necessary apparatus for teaching; there are too many difficulties. In any case, school science equipment manufacture is now a fast-developing local industry. Plenty of commercial production facilities exist, much of it in small workshop/cottage industry form, given to a single type of product - such as

Current developments

thermo-plastic articles. These are often in the nature of family affairs, often with rather crude machinery and ill-paid workers, but well-suited to science apparatus manufacture. There is also a rapidly-expanding sophisticated industry: this can be seen in the industrial estate beside Penang airport.

Malaysia would provide a very informative case-study for anyone wanting to examine how school science apparatus production is being successfully pursued. The Ministry of Education is obviously both keen and effective in getting the process going. RECSAM has provided advice and training, and the materials are available in the country. CEDO (British Council) has provided consultants for the new curricula and textbooks.

NEPAL

A Science Equipment Centre has been established in Kathmandu. It was initially set up as a distribution centre for imported school science equipment. Plans are now in hand for the Centre to be used to develop and produce equipment locally, alongside the development of curricula being carried out by the Curriculum Development Centre.

PAKISTAN

There has been for some time an Educational Equipment Centre in Lahore. This Centre has been attempting to construct apparatus suitable to local needs: generally such items have been copies of traditional apparatus. Plans exist to improve the facilities and activities of this Centre.

PAPUA NEW GUINEA

An example of an 'integrated science' primary school course which uses a mixture of standard and local resource material is the Papua New Guinea Primary Science project (1). It is an easy one for other projects to study because its 200 or so work-cards - produced in three handbooks for teachers - each carry a photograph of the materials being used. An example is shown in photograph 30.

UNICEF originally supplied the standard apparatus, consisting of sixteen types of item for the pupils to use and about two dozen types of item with which the teacher can demonstrate. The Education Department supplied some sixteen types of common or domestic item, available locally. Each kit caters for forty pupils and is housed in a lockable cabinet with pull-out trays. In addition, children collect and bring in materials from home and their surroundings. Thus there are similarities with the African Primary Science Programme but the PNG project has a more defined set of experiments and uses some school science apparatus of a standard type.

- (1) Papua New Guinea Primary Science
published by the Jacaranda Press, Elizabeth Street,
Brisbane, Australia.

THE PHILIPPINES

The Philippines school system is very active in curriculum development. In addition to the work of the Department of Education and Culture, the University of the Philippines, through its Science Education Centre, has produced curriculum guides, teachers' guides and pupils' texts, some still in a pilot stage and some in commercial publication.

There are private and public schools. Despite efforts by the Department and foreign and UN agencies, the problem of supplying science materials to the 38,000 primary and intermediate schools is almost insurmountable. Standard items of equipment are available locally (imported) at very high prices which means that only the richer schools can acquire them. Most other apparatus is of a home-made sort purchased out of petty cash or the teacher's own pocket. There are courses on the use of inexpensive apparatus or kits provided by international agencies. Teachers organize workshop courses based on the construction of UNESCO Source Book items. Some private technical schools make a small amount of apparatus but this cannot be widely spread and is little known about. One or two equipment firms have opened up in the last few years and some importers have begun manufacture to new curriculum specifications but the output is small at present.

UNESCO has done a study of science equipment in Philippine schools with a view to getting a pilot production unit in operation. Essentially, this unit would make prototypes and pursue their manufacture far enough to demonstrate to local industry the viability, costing, and technical processes involved; and, hopefully, convince local industry to undertake manufacture.

The UNESCO report itself is 'UNESCO-UNDP Feasibility Study on the Production of School Science Equipment in the Philippines' by Crunden, Hakansson and Crellin. (Manila, July 1972. Published, internal document, at Bangkok by UNESCO. BK/72/D291-200.) This very thorough study brings out many of the problems and possibilities faced by a school science apparatus production unit.

SINGAPORE

Singapore schools are relatively rich and there are few major problems in getting apparatus into the schools. The curricula are changing, however, so new apparatus has to be obtained. At present apparatus is bought locally from firms which either manufacture or import the items. Quasi-governmental industrial agencies have helped in the design and production of science apparatus for sale to schools.

SRI LANKA

Sri Lanka has a production unit at Pattalagedera, Veyangoda, set up and equipped with help from UNESCO and UNICEF. Unlike most production units, there is a proposal to mass-produce there. (Most other units are prototype makers; or they make small batches; or they set out to demonstrate possibilities and costings to encourage local industry to undertake

Current developments

production.) To this end, it is getting mass-production machines such as turret lathes, a foundry, and a glass-blowing unit. Mr Hakansson visited the unit in early 1974; there is a report (internal document with restricted circulation, UNESCO, Bangkok 1974, BKS/74/D/219-25). CEDO (now British Council) was earlier involved in this unit and has documentation on various aspects.

THAILAND

In Thailand, elementary schools desperately lack teachers capable of teaching any science. There is a general teacher shortage and many teachers have to do a second job in the evening to earn a living wage. Text-books are, on the whole, unsatisfactory; some are very poor. Most elementary schools in Thailand are totally devoid of any sort of teaching material for science, or indeed other subjects.

A number of Elementary Science Supervisors have prepared some teachers' manuals, supplementary books, experiment books, and lists of apparatus, to help develop science education. Some of the supervisors have been to RECSAM for courses over the last three years, and since their return have been writing work-sheets in conjunction with a Ford Foundation research project. One supervisor has designed a sample science kit - photograph 29 - with the hope of getting it replicated and distributed to elementary schools. However, its cost is around 65 US dollars, and it therefore reflects rather badly on the realism of this and other supervisors' projects.

The Department of General Education run short courses for supervisors on modernizing elementary education which include apparatus use and improvization. UNICEF has started planning an elementary science centre in Phayathai School, Bangkok (a library, laboratory and workshop) to be equipped with apparatus, audio-visual aids and workshop tools.

In a very well-endowed programme for the improvement of secondary science teaching, the Institute for the Promotion of Teaching Science and Technology (a Thai government and UNDP project) in Bangkok designs and makes prototype and small-scale production runs of apparatus for its newly-designed curricula. Examples are shown in photographs 28 and 31. It expects to work on primary level equipment later. It has a fine display of this equipment - for mathematics, chemistry, physics and biology - in its huge new building behind the UNESCO office. The British Council Curriculum Information Service (Education Information and Research Department, 10 Spring Gardens, London S.W.1.) has a few of the materials and also some of the books of specifications and photographs of the IPTST apparatus.

Prior to the full IPTST programme, Keith Warren and Lars Rudstrom (UNESCO) designed some apparatus at Bangkok, largely for the training of technicians (see photograph 32). One of those technicians remains with the IPTST; the other two, attracted by wealthier employment, have left. This is a frequent problem: nationals in many countries may be paid only at national civil service rates if in a government project. The result is that once they are trained they realize they have a high market value and leave for industry.

The UNESCO Pilot Project for Chemistry Teaching in Asia 1964-1970, took place in Bangkok. It was a high-level chemistry project using high-level techniques and was mostly in English. A bland evaluation was prepared in January 1972 by UNESCO, Paris (SC/WS/505). In contrast, the IPTST has looked for locally-available chemicals and materials and has to some extent, aligned its syllabus on these.

VIETNAM

The Republic of Vietnam has no spare space in its classrooms so there is little chance of science materials being used for years to come - at primary level, at least. Teachers use some flash-cards and wall-charts, locally produced by silk-screen printing, but with sixty or seventy pupils per class - and sometimes three such classes in one room - there is no other possibility in the public schools. Private schools have around 100 pupils per class.

In a recent conference, the Vietnamese delegate officially reported his country's difficulties in terms such as 'How can we get an overhead projector easily?' 'How can we buy a video recorder without tax?' Meanwhile, the morning's newspaper (which the conference delegates had just read) carried pathetic pictures of children taking home-made desks along to sit on the beach near Quang Tri. Formal reports at international conferences often do not show the truth, and this in no way helps donors to hit the right level of international aid. The USAID programme has supplied Vietnam with one hundred movie projectors; the Overseas Technical Agency of Japan has given projectors and video-tape recorders to set up an audio-visual centre. Yet, in most Vietnamese schools there is no electricity; only a few of the largest schools have a laboratory; and there are no repair facilities except in the central workshop in Saigon (Ho Chi Minh City).

There are divisional, provincial and regional centres through which apparatus innovation could be introduced - at present these are largely supervisory. In a conference in Penang in 1973, an officer remarked that in ex-French colonies no teacher would dare to introduce new ideas that were not first suggested by the inspectorate. This is therefore an organizational matter. Its positive side was also asserted; if an inspector passes on some new ideas and says that he will later check and see whether they have been implemented, they will be taken up. The officer asserted that RECSAM should 'go and thump the table and get this done'.

Latin America

BRAZIL

The UNESCO Pilot Project on the Teaching of Physics operated in Sao Paulo, Brazil from 1963-1964 at the Instituto Brasileiro de Educacao, Ciencia e Cultura (IBECC). It was conceived as being for the whole of Latin

Current developments

America (as was the Chemistry Project in Bangkok for Asia, and the Biology Project for Africa).

The project limited itself to the topic of Light. The team was made up of three UNESCO experts, three consultants, and twenty-six teachers from universities and pedagogical institutes in eight Latin American countries. They developed, and physically made, 200 lots of eight kits. One of these is shown diagrammatically in photograph 33. These experimental kits were accompanied by 50 hours of student instruction in mimeographed programmed-learning texts in Spanish and Portuguese. The team also produced twelve short silent (single-concept) 8mm. films, and prepared a 30 minute sound film and eight television programmes. This tour de force took only one year.

The materials are still available (commercially, it is thought) and are probably now at least partly translated into English. Further details can be had from Dr Nahum Joel (who was assistant director of the project), UNESCO, Paris. The project is also described in a UNESCO booklet (reference SC/WS/160).

The FUNBEC kits, which have already been mentioned on pages 5 - 6 and which will be mentioned again on pages 43 and 44, are also of importance in Brazilian and Latin American context.

COSTA RICA

Apparatus for local construction has been designed in Costa Rica by the Programa Conjunto Gobierno-UNESCO-UNICEF, under the Ministry of Public Education, San Jose. Detailed drawings have been produced and some prototypes made, using wood, tinsplate and metal strip. A few of these items are shown in photograph 36. Blueprints are shown in photographs 34 and 35. It was hoped that local workshops would be able to undertake the production but there was some doubt about the commercial viability of the enterprise, but this information is only up to 1972. At that stage, they were considering using instead the low-cost Japanese mini-science plastic kits.

Other Countries

ISRAEL

The Curriculum Centre of the Ministry of Education and Culture in Jerusalem, Israel, has created a non-vocational curriculum for a modern approach to agriculture and rural science. They have produced apparatus kits, books, work-sheets, blueprints for 'land laboratories' and so on. There is a general description of the project in a Ministry publication in English: 'Let's Grow Plants' (Ministry of Education and Culture, Jerusalem, 1971).

In Israel, a commercial firm, Or and Kol (1), produces science teaching apparatus of a simple, modern kind - some of which may be to Soren Hakansson's designs. It is mainly applicable to secondary level and most of it is for physics. Some samples are shown in photographs 37 and 38. The firm, which is half government owned, planned the apparatus partly under the sponsorship of UNESCO. The simplicity of form (and presumably the consequent relatively lower cost) of many of the items is a pleasing contrast with much of the commercial apparatus available elsewhere.

- (1) Or and Kol, Israeli Corporation for Educational Materials Limited, 40 Eben Gvirel Street, Tel-Aviv, Israel.

TURKEY

The Ministry of Technical Education established, some eighteen years ago, a Trade School to construct apparatus and equipment for the school system. This 'Trade School' employs some 1,400 people, and produces approximately 80% of the country's educational equipment needs.

Approximately five years ago an Audio-Visual Aids Unit was separately established to meet the educational requirements in this field.

Section 3 Sources of Reference

DESIGNS, DRAWINGS AND SPECIFICATIONS OF APPARATUS

A source for specifications, descriptions, suggestions and names of English manufacturers of primary level mathematics apparatus is 'Mathematics Apparatus for Primary Schools' (1). This also gives guidance on the use of the items. A similar source for primary science is 'Science for Primary Schools Part 4 - Materials and Equipment' (2). Guidance on this material is given in Part 1 in the same series and sources of 'software' are listed in Parts 2 and 3.

For designs of modern apparatus for teaching secondary level science, a good source is 'Nuffield Secondary Science - Apparatus Guide' (3). This contains 120 pages of very clear line drawings in accurate plan or isometric projection showing important dimensions, with descriptive notes beside each of them. Another section of the book gives guidance on where it all fits into the Nuffield Secondary Science curriculum with further notes on design, quantities needed, etc. A typical drawing is shown as photograph 39.

Some texts are good sources of designs. One with a lot of new ideas is 'Physics is Fun' by J. Jardine (4). Another, with peg-board mounting apparatus is 'Introductory Physical Science: Laboratory Equipment and Apparatus' (5).

Blueprints and dimensional engineering drawings have already been mentioned as produced by several production units. The largest series of these (outside the presumably unavailable designs of US, European and Japanese firms) is that of the NCERT, India. They have produced five large folders of 'Specifications and Manufacturing Drawings': Primary Science, Chemistry for middle stage, Biology for middle stage, and two Physics kits. (There may now be more.) An example is shown as photograph 25.

- (1) Mathematics Apparatus for Primary Schools (Howson) published for CEDO (now British Council) by Heinemann Educational Books Limited, 48 Charles Street, London W1X 8AH, England.
- (2) Science for Primary Schools Part 4 - Materials and Equipment published for the Association for Science Education by John Murray, 50 Albemarle Street, London W1X 4BD, England.

- (3) Nuffield Secondary Science - Apparatus Guide
published by Longman Group Limited, Burnt Mill, Harlow,
Essex, England.
- (4) Physics is Fun series by J. Jardine
published by Heinemann Educational Books Limited,
48 Charles Street, London W1X 8AH, England.
- (5) Introductory Physical Science: Laboratory Equipment and
Apparatus
published by Prentice Hall Incorporated, Englewood Cliffs,
New Jersey 07632, USA.

APPARATUS ASSESSMENT AND CRITIQUE

An important source of critiques of schools science apparatus along with much associated information of a helpful and practical kind is in the monthly bulletins of the Scottish School Science Equipment Research Centre (1). These have been produced since 1966 and the back copies constitute a mine of information.

- (1) School Science-Equipment Centre, 103 Broughton Street,
Edinburgh EH1 3RZ, Scotland.

POTENTIALLY USEFUL BOOKS

Conferences, other than some of those arranged by INNOTECH, rarely look at the needs and problems of educational aid production as a system or part of a system - at least not in an analytical and realistic way. There are, however, books which do this, and although some of them are oblique to the purpose of this review, they throw light on pertinent but neglected aspects of the design and provision of school teaching aids.

The principles of designing any kind of equipment for satisfactory use by human beings are covered in 'Ergonomics' by K. F. H. Murrell (1). Although this is nominally about man in his working environment, much of it can be transferred with a little imagination to children working with apparatus at school. This study not only concerns itself with a worker handling a piece of equipment but with the design of working environments to encourage motivation, good working attitudes, and so on. It is enlightening because it reveals that many problems in school parallel those in industry. Though many of the problems have been solved or partially solved in industry little thought seems to have been given to applying these analyses and techniques to schools, whose problems grow daily.

An introductory book about which much of the foregoing also applies is 'Organization Theory' edited by D. S. Pugh (2). Again, although concerned with industrial organization, its approach suggests powerful techniques for helping children to work in school. It covers many basic considerations that apply to designing an organization for introducing teaching apparatus into schools. It is sad that errors long ago recognized and corrected in industrial management organization, and recounted as history in this book, are still current in the administration of many of the projects described in this review.

Sources of reference

Very relevant and specific to such problems is 'The Emerging Dimensions of Indian Management' (3) by Professor A. N. Agarwala of the University of Allahabad, especially the chapter 'The Management of Small Businesses in India'. One paragraph in particular makes a point which production units with foreign advisers should consider seriously: as many small Indian businesses are badly managed, is it not part of the duty of production unit designers, who in some way or another make use of such local businesses, to help to educate them effectively in the techniques of good management? If a school equipment production unit, aided by foreign funds and having valuable expertise, merely makes use of cottage industries and the like for its main purpose (however valuable) but fails to aid their management (which it often could do relatively easily) it lays itself open to the same charge. Moreover, this is truly short-sighted, for its main purpose will not be served if the small industries on which the continuance of the project will depend, remain inefficient or go out of business. The disappearance rate in India is high but the principle applies to all countries. Professor Agarwala says:

'It is, therefore, important to determine the specific methods in which the management of small and tiny business units of various categories can be improved, and to make constructive endeavours to get these methods inserted into their working practices. India has not had time or resources to do much in this direction. It has nevertheless made, and is making, some efforts, though they are frankly of a casual or coincidental nature. Even in the case of small-scale industries, which are the proud and much-courted queens of this kingdom, such consideration as is given to management aspects is often a by-product of the thought devoted to administrative, technological or some other type of problems. Questions like the following have to be directly faced and answered: How can a small-scale industrial entrepreneur manage his enterprise better? How can the village artisan or urban handicrafts-man manage his cottage unit more satisfactorily? How can a small money-lender or road-transportation operator manage his affairs more efficiently? In all such cases, the immediate criterion of efficiency will have to be the profit made from the business pursuit. Answers to such questions can only be given after careful case studies, empirical surveys, a priori deductions, discriminatory consultancy projects, and trans-disciplinary researches, in which respect foreign experiences and research techniques should be most useful.'

Thus a school science apparatus production unit is, or should be, more deeply concerned in the wider educational processes of the country than it may, at first sight, realize.

- (1) Ergonomics: Man in his Working Environment (Murrell) published by Chapman and Hall Limited, 11 New Fetter Lane, London.EC4P 4EE, England.
- (2) Organization Theory (editor Pugh) published by Penguin Books Limited, Harmondsworth, Middlesex, England.
- (3) The Emerging Dimensions of Indian Management published by Asia Publishing House, 447 Strand, London WC2R 0QU, England.

REFERENCE BOOKS ON THE USE OF SIMPLE APPARATUS

There are many books which describe the use of common objects for teaching science. The classic is the original UNESCO 'Source Book for Science Teaching' (1). (The new version uses less common material and is at a rather higher level of sophistication. See photograph 40.) Such books usually include a lot of apparatus for teachers to construct for themselves. From such sources, production units can get innumerable ideas. The best such construction book series is the 'Guidebook to Constructing Inexpensive Science Teaching Equipment' (2), with separate volumes for chemistry, physics and biology. Photograph 41 shows a page from this. UNICEF's apparatus catalogue (Guide List EVE Science Revision (3)) includes a resource materials kit (photograph 42) to help teachers do such construction.

Other similar books are: 'Making Elementary Science Apparatus' (4); 'Experiments with Heat' (5) and others in the mimeographed series by the Don Bosco technical school in the Philippines; a series of leaflets from the Dryad Press on techniques such as 'Making Papier Mache' (6); the cyclostyled 'Elementary Economic Experiments in Physics' (7), which contains dimensioned line drawings for secondary level modern science apparatus; books from the 'Science 5/13' project in England, such as 'Working with Wood' (8); the Nuffield Junior Science Book on 'Apparatus' (9); the 'Elementary Science Study Series' (10), shown in photographs 44 and 47; books from the project on Elementary School Mathematics and Science of the University of Illinois, such as 'A Conglomeration of Gadgets and Gizmos' (11).

Some other useful sources are: 'The Book of Experiments' (12) by Leonard de Vries and 'After-dinner Science' (13) by K. M. Swezey - these both use domestic items for science demonstration; the 'Junior Science Source Book' (14); the publications of Project Technology, which describe constructions and children's investigations of them, mainly at secondary level, such as 'School Technology Volume 1' (15). Both the old 'Demonstration Experiments in Physics', which may be difficult to obtain, and its huge recent two volume replacement 'Teaching Science with Everyday Things' (16) by Schmidt and Rockcastle, are valuable.

Some textbooks and teachers' guide books for older or new science courses are full of ideas for apparatus. In biology: 'Simple Experiments in Biology' (17) by C. Bibby; in chemistry: 'Gas Syringe Experiments' (18) by M. Rogers; and in integrated science: 'Teaching Science to the Ordinary Pupil' (19) by Laybourn and Bailey. The new English and US curriculum books in science also have useful ideas on new apparatus.

More unusual sources for designers looking for simple ideas, particularly those appropriate to situations needing low-level technology, are the hippie manuals for communes and the books which have grown from the simplified-life movement: 'The Foxfire Book' (20); 'The Last Complete Whole Earth Catalogue' (21); the 'Survival Scrapbook' (22) volumes on Tools and Energy - volume 3, 'Access to Tools', is particularly good for a design workshop. There are many books of similar intent; a good collection may be seen in the library of the Intermediate Technology Development Group, 9 King Street, London W.C.2., whose own books and pamphlets are likely to be valuable both for ideas for items and for their background philosophy of design.

Sources of reference

Books for home experiments by children sometimes provide model approaches which would be of interest to production unit designers and curriculum writers. Sometimes they also contain ideas for making or improving simple apparatus. The recently published 'Technicians Manuals' associated with the Schools Council Integrated Science Project 'Patterns' (23) scheme, provide a guide for the laboratory technician on what apparatus is required and what can be made. A very useful small book on apparatus storage in schools is 'Storage of Apparatus' by O. M. Stepan (24).

- (1) Source Book for Science Teaching
published by UNESCO, 7 place de Fontenoy, 75700 Paris,
France.
- (2) Guidebook to Constructing Inexpensive Science Teaching
Equipment
prepared by the Science Teaching Centre, University of
Maryland, College Park, Maryland 20742, USA.
- (3) EVE Science Revision
published by UNICEF, 866 United Nations Plaza, New York,
N.Y. 10017, USA.
- (4) Making Elementary Science Apparatus (Bowker and Hunt)
published by Thomas Nelson and Sons Limited, 36 Park Street,
London W1Y 4DE, England.
- (5) Experiments with Heat
series prepared and mimeographed by the Don Bosco Technical
School, Philippines.
- (6) Making Papier-Mâché
series published by the Dryad Press Limited, Northgates,
Leicester, England.
- (7) Elementary Economic Experiments in Physics (Melton)
available from the British Council, E.P.D., 10 Spring Gardens,
London SW1A 2BN, England.
- (8) Working with Wood
published by Macdonald Educational Limited, St Giles House,
49-50 Poland Street, London W1A 2LG, England.
- (9) Nuffield Junior Science - Apparatus
published by Wm. Collins Limited, 144 Cathedral Street,
Glasgow G4 0NB, Scotland.
- (10) Elementary Science Study Series
published by McGraw Hill, 1221 Avenue of the Americas,
New York, N.Y. 10036, USA.
- (11) Project on Elementary School Mathematics and Science
available from Booker T. Washington School, 606 East Grove
Street, Champaign, Illinois 61820, USA.
- (12) The Book of Experiments (de Vries)
published by John Murray Limited, 50 Albemarle Street,
London W1X 4BD, England.
- (13) After-dinner Science (Swezey)
published by Kaye and Ward Limited, 21 New Street,
London EC2M 4NT, England.

- (14) Junior Science Source Book (Wastnedge)
published by Wm. Collins Limited, 144 Cathedral Street,
Glasgow G4 0NB, Scotland.
- (15) School Technology Volume 1
published by English Universities Press Limited, St Paul's
House, Warwick Lane, London EC4P 4AH, England.
- (16) Demonstration Experiments in Physics (Sutton) and
Teaching Science with Everyday Things (Schmidt and
Rockcastle)
published by McGraw Hill, 1221 Avenue of the Americas,
New York, N.Y. 10036, USA.
- (17) Simple Experiments in Biology (Bibby) and
- (18) Gas Syringe Experiments (Rogers, Martin)
both published by Heinemann Educational Books Limited,
48 Charles Street, London W1X 8AH, England.
- (19) Teaching Science to the Ordinary Pupil (Laybourn and Bailey)
published by the University of London Press Limited, St Paul's
House, Warwick Lane, London EC4P 4AH, England.
- (20) The Foxfire Book
published by Doubleday and Company Incorporated, Garden
City, New York 11530, USA.
- (21) The Last Complete Whole Earth Catalogue
published by Penguin Books Limited, Harmondsworth,
Middlesex, England.
- (22) Survival Scrapbook (Szczelkun)
published by the Unicorn Bookshop, Brighton, Sussex,
England.
- (23) Patterns Technicians' Manuals
published by the Longman Group, Burnt Mill, Harlow,
Essex, England.
- (24) Storage of Apparatus (Stepan)
published by the Association for Science Education, College
Lane, Hatfield, Hertfordshire, England.

WIDE-RANGE REFERENCE BOOKS

There are, of course, many written sources of information about apparatus production. A world-wide listing of almost everything that is going on is: 'Report of the Clearing-house on Science and Mathematics Curricular Developments' (free to interested institutions from the Science Teaching Centre, University of Maryland, College Park, Maryland 20742, USA). This centre in Maryland contains most of the materials and many examples of apparatus from the projects listed. There is a great deal of information in the Briefing Room, Division of Pre-University Science and Technology Education, UNESCO, Paris and in the libraries of UNESCO major field offices. The British Council has a display area at its Curriculum Information Service (Education, Information and Research Department, 10 Spring Gardens, London S.W.1.) where a wide range of apparatus and materials from projects all over the world can be seen. It has, for example, many of

Sources of reference

the NCERT Indian kits; The British Council's 'Science Education Newsletter' (free to overseas institutions from local British Council offices) lists and describes world-wide educational projects, including apparatus production information.

An excellent critical review and appraisal of the provision of teaching equipment to schools is 'Problems of the Promotion and Production of Teaching Materials in Developing countries' edited by Edda Eisenlohr et al, and published by the German Foundation for International Development (DSE., 53 Bonn, Simrockstrasse, West Germany). It is the report of an international conference in Berlin in October 1971. There is a brief but good analysis of production problems facing apparatus makers and book publishers, and a perceptive outline plan for the production of teaching materials by Mats G. Hultin of the World Bank (IBRD). The report covers a wide range of world projects.

REFERENCE PEOPLE

There are a number of more or less single-person initiatives in apparatus design all over the world. These range from individual teachers working in their own school whose productions are not seen by a wider public unless perhaps in the pages of a local teachers' journal, to people who have published their designs in a book. The journals of the Association for Science Education (1) in the UK, and the publications of the National Science Teachers Association (2) of the USA are sources of the first type. An example of the second type is R. F. Simpson's 'Simple Physics Apparatus' (3) which shows a wide range of science teaching items made up from common hardware store goods, such as pencils, magnifying glasses, electric iron elements and bottles. The items - some of which are shown in photograph 48 - make up a kit which can be packed in a small case. A similar example which uses simpler apparatus for an elementary level is Bowker and Hunt's 'Making Elementary Science Apparatus' (4).

In a small scheme supported by the British Council and the Ministry of Overseas Development, R. M. Garratt in Colombia was (in 1972) developing materials and apparatus for schools of Latin American type. Its aims were to use local resources to create adaptable materials which could be gradually built up in range as the needs became better understood. There are 'modules' of apparatus and appropriate work-sheets.

Other people who are creators, or repositories of information, in respect of apparatus ideas exist all over the world. Just a few are: Mrs Dora Whittaker (108 Parkside, Wollaton, Nottingham, England), chairman of the Schools Council committee on mathematics, who has until recently run a mathematics centre in Nottingham and is in touch with a wide range of sources for mathematics teaching apparatus. She herself is a creator, and a good source for US mathematics projects, with which she often works. Dr Ken Magnus (Chemistry Department, University of the West Indies, Kingston 7, Jamaica) is a source for Caribbean project information. Mr Brian Steven of City College, Leeds, England, is an inventor of apparatus from domestic materials. Many people in the Nuffield Science Teaching Project (Chelsea College of Science and Technology, Bridges Place, London S.W.6.) know about new apparatus for British schemes. Mr Norman Lowe, (97 Constance Road, Whitton, Twickenham, Middlesex, TW2 7HX, England) is a source of

for information on African science schemes. The Division of Pre-University Science and Technology Education, UNESCO, Paris, is another source of information, with two individuals in particular being Dr Nahum Joel and Mrs S. Haggis. Keith Warren (The Grange, Ripley, Derby, DE5 3FT, England) has undertaken several studies of apparatus use and production, from reviews and critiques to design studies and inventions for village school science (unpublished). The best source for practical experience and design of production units is Mr Soren Hakansson (sometime Asia Regional UNESCO Adviser on School Science Equipment, and now at UNESCO headquarters in Paris).

- (1) Association for Science Education, College Lane, Hatfield, Hertfordshire, England.
- (2) National Science Teachers Association, 1201 16 Street, N.W., Washington, D.C., 20036, USA.
- (3) Simple Physics Apparatus (Simpson) published by the Hong Kong University Book Store, Hong Kong.
- (4) Making Elementary Science Apparatus (Bowker and Hunt) published by Thomas Nelson Limited, 36 Park Street, London W1Y 4DE, England.

TOYS AS TEACHING APPARATUS

For young children, especially pre-school, play apparatus may be desirable for helping them to understand aspects of science through body movement and through acting-out their 'experiments'. A collection of such play apparatus and materials is in UNICEF's Guide List 'Pandora' (1) which gives guidance on the choice and use of such material and its place in the child's development. There are lists and guide lines applicable to children in four age ranges: under 1 year, 1 to 3 years, 3 to 6 years and 6 to 9 years old. Local resource material is stocked by UNICEF for supply to group programmes.

Production units wishing to know what materials are used in pre-school and early primary school education in European countries and the USA can consult catalogues of supply houses or of shops which deal in these. A two-page list of basic items (such as paper, paint, scissors, paste) which may be used for early mathematics experience is available from Childsplay, 112 Footing High Street, London S.W.17., England.

- (1) Pandora Guide List published by UNICEF, 866 United Nations Plaza, New York, N.Y. 10017, USA.

KITS OF PLASTIC COMPONENTS

Kits come in many forms. They can be many-item collections - like the complete primary science kit of the NCERT - for teacher demonstrations. The CVK kit is for class use and is for a limited subject. Other types of collection, but still referred to as 'kits' are more limited: they may be, for instance, parts of a single device which is to be assembled; or a collection

Sources of reference

of simple things for use by an individual child; or even a set of blocks for pre-school or primary school experience.

The sets of 'new maths' equipment for primary level are fairly simple to manufacture, because they are plain designs. They can be conceived in plastic, as can many of the components of science kits. Once machines are obtained, the facility with which many items may be made rapidly by plastic injection or vacuum-forming techniques should almost make their use obligatory in teaching apparatus production units. However, making moulds and dies is skilled work, and technicians need proper training; only a skilled machinist could make the brass and steel injection dies for the plastic nuts and bolts kit shown in photograph 46. A high degree of skill is also needed to achieve the necessary accuracy to make the Centicubes in photograph 45 clip together properly - a skill probably beyond the range of most production units outside Europe, Japan and the USA.

It is quite possible that European firms would be willing to give advice, training or other aid. A helpful and informative source of advice on such matters is the Educational Division of Invicta Plastics (Oadby, Leicester, England). This firm, the largest of its type in Europe, markets in all continents and has a philosophy concerning local production, apparatus input from foreign sources, and aspects of bilateral aid, which makes it important for any production unit proposing to use plastics to get in touch with them.

Mr Hakansson, who has helped production units in South-East Asia to get plastics production of science teaching apparatus started, has written 'Use of Plastics and Other Techniques for Production of Low-cost Science and Mathematics Equipment for Schools'. This was a document at the RECSAM workshop of October 3 - 12, 1973, reference: SEAMEO/DSE/PLCTM/7.

KITS OF SCIENCE APPARATUS

Macalaster Scientific Company, (Route 111 and Everett Turnpike, Nashua, New Hampshire, USA) have produced kits of physics items for student assembly. The materials are unpainted and unfinished where 'finish' is unimportant; for example, the bases of items are often raw chipboard. Nuts and bolts, and so on, are supplied in envelopes and there are assembly plans. There may have been some consumer-reaction against their somewhat crude appearance, but the items generally worked well and covered some very sophisticated physics. Many of the items were designed for the PSSC course of the USA. They are worth study as a possible model for a production unit which can make and pack the items but has to leave their assembly, with its intricate processes, to teachers or even to pupils.

Some Japanese firms make small kits of parts for assembly into physics apparatus - such as electric motors and bells, balances and pumps. There are similar kits of lenses, rulers, screens, for a range of experiments on the topic of Light, and other experimental assemblies. These kits were easily available in England and the US until a short while ago, but seem to have disappeared from toy shops. (UNICEF headquarters in New York know the Japanese manufacturer). They are well worth study and possibly some kind of imitation. Some are shown, with instruction sheets, in photographs

49 - 55. Much of the material is injection-moulded plastic or stamped tin-plate. They are flimsy and look like toys, but they are astonishingly well-dimensioned for exact fit and were astonishingly cheap. Despite the recent rises in plastic prices, plastic construction is still an attractive consideration for production units, since the quantity of plastic involved is very small (for example the weight of all the plastic parts of the pump shown in photograph 54 is less than 50 grammes) - though it would be much cheaper to buy than to produce them.

Kits of this sort are often not created to serve a particular curriculum. Probably kits can be designed which will be pleasurable as a kind of informative toy, game or hobby, and also serve a teaching purpose in schools. A production unit making small kits might consider this dual role for their product. As well as increasing the education of middle-class children by providing a kind of homework which can be presented as a gift, it can also be a way of widening the market and perhaps subsidizing other aspects of the unit's production.

The importance of having adequate guidance (for teacher or pupils) in the form of 'software' accompanying science apparatus was urged at a RECSAM conference in October 1973. It was pointed out that it is much easier to provide software for kits than for individual items because the writers know the total set of materials with which the teacher will be working. Booklets accompanying kits are also usually fairly small, and this is in itself attractive to teachers who often feel daunted by a bulky book. UNICEF's EVE catalogue (see photograph 43), for example, presents many problems to teachers selecting apparatus for themselves. It is arranged in alphabetical order in English. (In French and in Spanish the order remains the same, which makes the list un-alphabetical.) In any case, an alphabetical arrangement makes selection of items for a particular science topic rather difficult, despite the guidance and notes provided for the items. UNICEF is publishing a teacher's guide 'Using Science Apparatus', which attempts to meet this difficulty by describing a typical use of each of the EVE items, collected under topics - but this makes a very large book.

Software should be in the appropriate local language. In the case of a single large book, translation becomes a long-term job. If, however, it can be produced in sections, these can be written, translated, published and printed in stages, allowing gradual correction and improvement as faults of style and presentation become apparent. This is important because any production unit or curriculum project has to feel its way, and a facility for the incorporation of improvements must be included. Any large, 'one shot' approach militates against this possibility.

As a model for software, the FUNBEC booklets are very good, and the sheets accompanying the other kits reviewed here are useful. The NCERT software (of which there are several versions and types) is more an example of the single-book type, since the kits are large and extensive. One reason for this - which will be of interest to other production units - is that distribution in India is a major problem, so kits produced in a timed series would present additional difficulties.

The American 'Elementary Science Study' series consists of a wide range of pupils' kits, teachers' kits, pupils' books, teachers' guides, work-sheets, problem cards, and film loops, for elementary school use. There are about

Sources of reference

60 main unit titles, such as: Bones, Gases and Airs, Growing Seeds, Whistles and Strings, Clay Boats, Match and Measure, Primary Balancing, and Pond Wafer. A unit is designed to be used for an average of six weeks. Some examples of these kits in use are shown in photographs 44 and 47. The principle might well be imitated by production units.

There are several somewhat similar mini-science kits around the world. In England the Precision Jigs Company Limited, (79 Caterham Avenue, Ilford, Essex) make nine types of kit for electricity experiments (with instructional leaflets). They use simple materials and are easily built up and used by English 12-year-olds. Photographs 56 and 57 show examples. Also in England, the Advisory Centre for Education (ACE) of 32 Trumpington Street, Cambridge, produces kits and packs called 'Things of Science'. Some are as simple as an instruction sheet for a game, with a little pack of nuts or seeds for play (photograph 15). Others may be as complex as a 20-piece geological collection with plastic magnifier and some equipment for testing samples, or a 'research pack' for investigating the pollution of streams (photographs 59 and 60). All of them contain interesting instructional material well-designed for children.

One of the most extensive range of kits is that produced in Brazil, (in Portuguese) designed by FUNBEC (Fundacao Brasileira para o Desenvolvimento do Ensino de Ciencias, Caixa Postal 2921, San Paulo, Brazil) and marketed by Abril S.A. Cultural e Industrial (Caixa Postal 2372, Sao Paulo). There are fifty kits, each in a pocket-sized box containing apparatus, usually fairly simple but often capable of being used in quite an advanced way (photograph 58). Each kit is associated with the work of a scientist, for example 'Newton and the Laws of Movement', 'Benjamin Franklin and Static Electricity', 'W. H. Carothers and Nylon'. Each has a booklet of some 20 pages containing constructional information and questions. There are plenty of photographs, small but clear, and several diagrams. There are three volumes of text, provided separately. Not only each kit with its text, but the whole system, evidences a creative imagination allied to careful design. It is all interesting and lively, and deserves widespread popularity.

KITS FOR TECHNICAL STUDIES

Kits of apparatus for secondary level technical studies are produced by Griffin and George Limited, in England. In the form in which this firm markets them they are extensive, and therefore costly relative to the budget of schools in poor countries. However, the concept and the specific ideas are well worth study by any production unit concerned with designing apparatus, and possibly kits, for a country which wants some of its school leavers to have had some practical technological experience. There are kits on Homecraft, Detergents, Human Mechanics, Dyeing, Cosmetics, and similar topics useful to home-makers; and there are science kits such as those on Microscopy, Crystals and Colour in Nature.

Production units supplying not only the conventional type of academic school but also those with technical biases, or even vocational schools, will also find the Griffin technical studies kits very valuable as exemplars in various ways. Some of these are: Adhesives Kit, Metallurgy Kit, Plastics Casting Kit, Paper Kit, Fibres Kit, Glassmaking Kit, Photographic Kit, Flow Kit, Surfaces Kit, Corrosion Kit and Computer Games.

- (1) Griffin and George Limited, Ealing Road, Alperton, Wembley, Middlesex, England.

MINI-SCIENCE AND OVERHEAD PROJECTORS

There are not many schools in the world with overhead projectors - at least not at primary and lower secondary level. However, production units might find much of interest (because the techniques are suggestive for different applications) in the 'Tested Overhead Projection Series' of small-scale chemistry experiments for overhead projection, using small quantities of chemicals and reagents in small square-section transparent tubes. There is a kit and a guide full of diagrams and experiments. The address is TOPS, Hubert N. Alyea, 337 Harrison Street, Princeton 08540, Massachusetts, USA.

UNICEF SCHOOL SCIENCE SUPPLIES

The United Nations Children's Fund (UNICEF) stocks and supplies a wide range of materials within the fields of education, agriculture, health and child care. The items are available to UN agencies. They are catalogued in some seventeen lists, including vocational training materials and tools, audio-visual equipment, school subject items, and agricultural implements.

A revision of the science teaching sections of one of the Guide Lists (EVE Science Revision: OSU-6000) has been undertaken in conjunction with UNESCO. This provides a wide range of apparatus consisting of:

- (1) Primary Science and Mathematics (93 items)
- (2) Tools for the Primary Science Workshop (15 items)
- (3) Secondary Science: Biology, Chemistry and Physics (327 items)
- (4) Tools for the Secondary Science Workshop (32 items)
- (5) Chemicals and Reagents for Secondary Science (160 items)
- (6) Curriculum Development Equipment for Teacher Training Institutions: Biology, Chemistry and Physics (76 items)

The items are listed as fairly detailed specifications, generally in a form suitable for commercial tendering purposes. Thus they form a good reference list of basic standard items and chemicals, with detailed notes on many aspects of their selection for schools.

A supplement ('Illustrations of Science Teaching Apparatus and Equipment', available from UNICEF as OSU-6000 Supplement 1) provides line diagrams of all items except tools. Examples from the EVE catalogue are shown in photographs 42 and 43.

The items have been carefully selected to cover most science teaching requirements except those that are highly sophisticated and very expensive. Items shown by previous experience to be too breakable in transit have also been omitted.

The main lists: (a) show suggested quantities per school stream at the various levels; (b) indicate an 'economy' selection of the most essential items; (c) show which laboratory (biology, etc.) each item is needed for;

Sources of reference

(d) indicate by notes beside entries ancillary apparatus which will be needed, what the item is for and similar helpful information; and (e) give the UNICEF price.

Introductory pages provide guidance to field officers on estimating requirements, new attitudes in science teaching, the use of local resource materials and tools, curricular developments, and so on.

UNICEF's practice of buying for the Copenhagen Warehouse (UNIPAC) in large quantities from actual manufacturers is reflected in appreciably lower prices for a given quality than those of commercial apparatus supply houses. Other advantages are the UNESCO surveillance of the items, single-source supply of wide range, easy control of delivery dates, ready access to spares and replacements, and suitability of the items to the situation in developing countries.

A Teacher's Guide to the EVE items, 'Using Science Apparatus' is being published by UNICEF, covering use of the items, maintenance, repair and the supplementing of them from local resources.

UNICEF SUPPORT FOR WRITING AND PUBLICATION OF BOOKS

Requests may be made for the support of local schemes to write or to translate textbooks, and to publish, print, and obtain supplies of paper in connection with such schemes.

USEFUL ADDRESSES

United Nations Children's Fund (UNICEF)
United Nations Plaza, New York, N.Y. 10017, USA.

Regional Centre for Education in Science and Mathematics (RECSAM)
c/o Malayan Teachers' College, Penang, Malaysia. - (established under the South-East Asian Ministers of Education Organization).

Regional Centre for Educational Innovation and Technology (INNOTECH)
P. O. Box 3049, Saigon, Republic of Vietnam. - (established under the South-East Asian Ministers of Education Organization).

Science Education Programme of Africa (SEPA)
c/o P. O. Box M-188, Accra, Ghana.

National Council for Educational Research and Training (NCERT)
Sri Aurobindo Marg, New Delhi-16, India.

Institute for the Promotion of Teaching of Science and Technology (IPTST)
c/o Physics Building, Chulalongkorn University, Bangkok, Thailand.

German Foundation for International Development (DSE)
53, Bonn, Simrockstrassel, West Germany.

UNESCO, 7 place de Fontenoy, 75700 Paris, France.

UNESCO Regional Offices

UNESCO Regional Office for Education in Latin America and the Caribbean, P. O. Box 3187, Santiago, Chile.

UNESCO Regional Office for Education in Asia, P. O. Box 1425, Bangkok 11, Thailand.

UNESCO Regional Office for Education in Africa, B.P. 3311, Dakar, Senegal.

UNESCO Regional Office for Education in the Arab States, B.P. 5244, Beirut, Lebanon.

UNESCO Regional Office for Science and Technology in Africa, P. O. Box 30592, Nairobi, Kenya.

UNESCO Regional Office for Science and Technology in Latin America, 1320 Bulevar Artigas, P. O. Box 859, Montevideo, Uruguay.

UNESCO Regional Office for Science and Technology in the Arab States, 8 Sh. El Salamlik, Gardent City, Cairo, Arab Republic of Egypt.

UNESCO Regional Office for Science and Technology in South and Central Asia, UNESCO House, 40B Lodhi Estate, New Delhi 3, India.

UNESCO Regional Office for Science and Technology in South-East Asia, U.N. Building, 2nd Floor, Jalan Thamrin 14, 273/JKT Tromolpos, Jakarta, Indonesia.

The British Council, 10 Spring Gardens, London, SW1A 2BN. (Addresses of Overseas offices can be obtained from the British Council's Information Department at 10 Spring Gardens.)

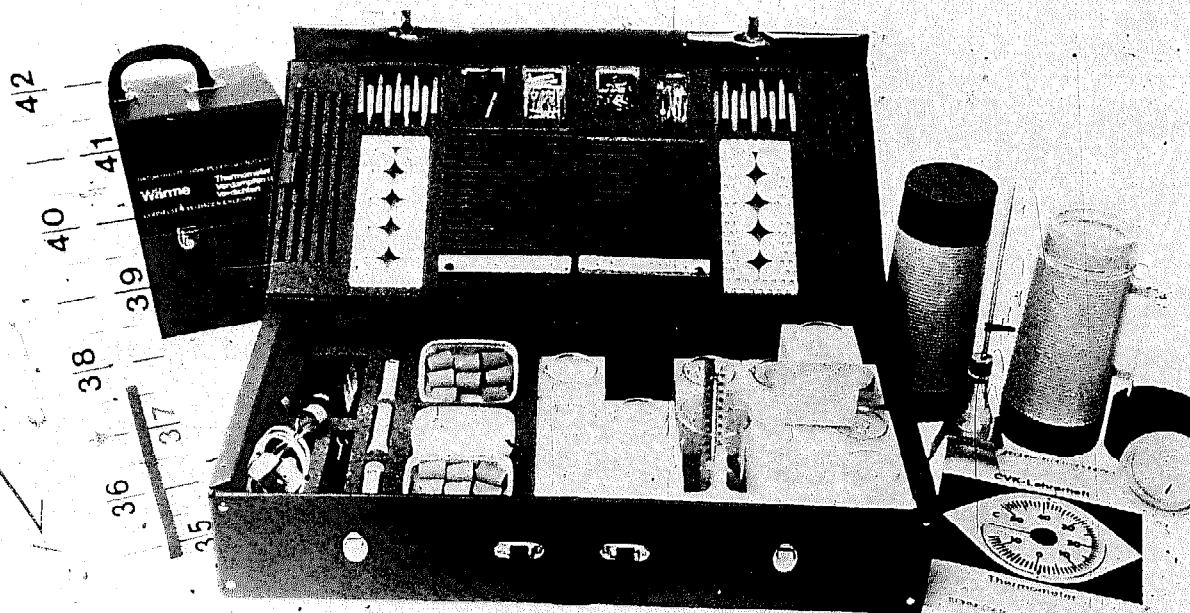

1

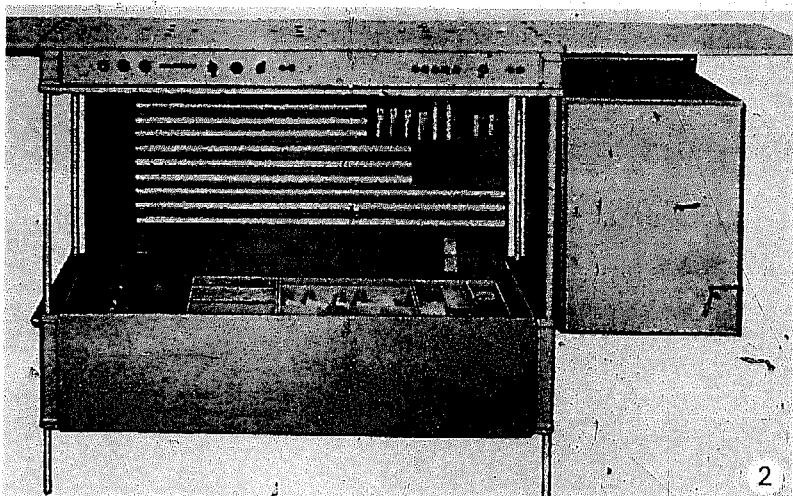

2

1 Primary school kit produced by Cornelsen, Velhagen and Klasing of Berlin

2 & 3 A 'universal' science teaching kit, made in Europe

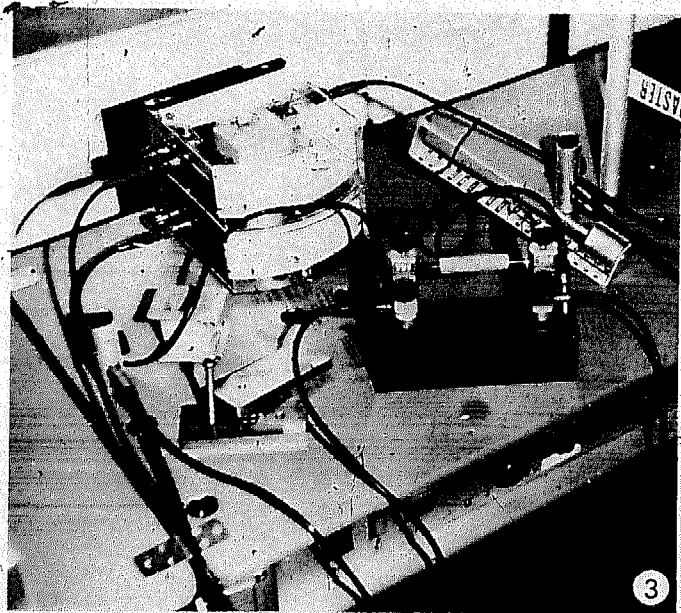

3



4

4. A Bengal village school—typical of situation in which many children in the world are taught, and into which teaching apparatus must fit

5. An itinerant tinker's tools—an example of local repair facilities in a Bengal village

6 & 7. A kit can be in a box which serves as a storecupboard for the items in the classroom

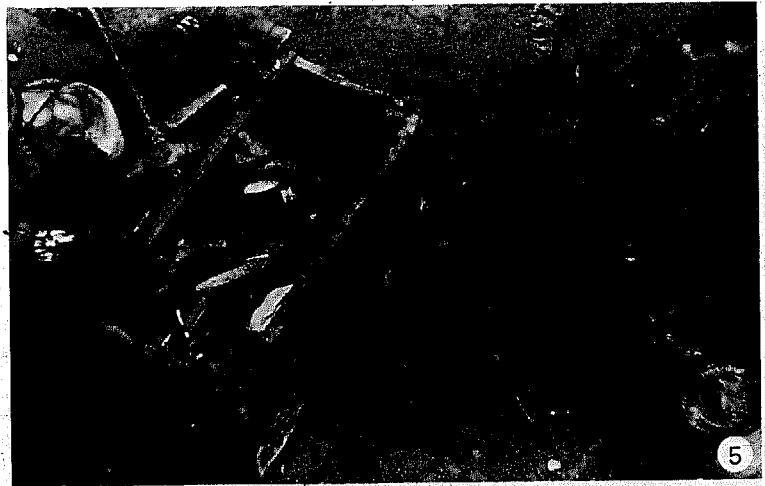

5

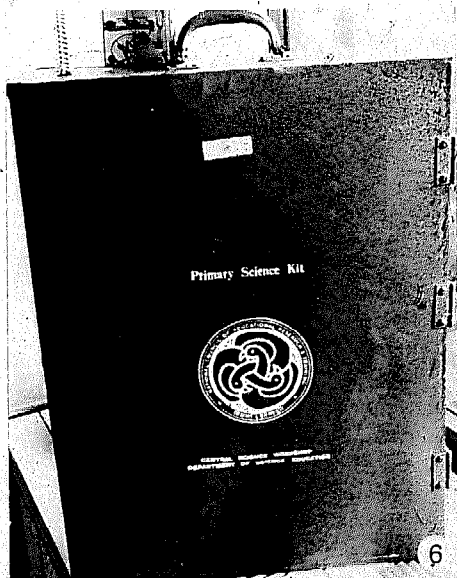

6

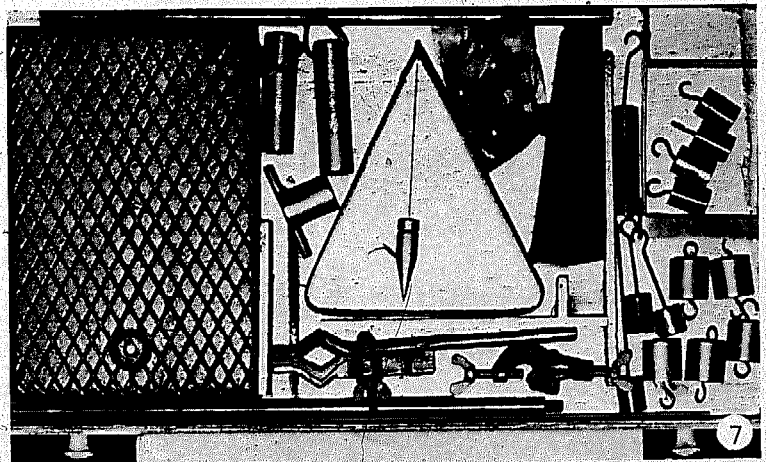

7

8 Bicycle wheels can be used to teach mathematics

9 A Burmese flute—a local source of sound to replace a tuning fork

10 A plastic roller skate can, for some purposes, replace a dynamics trolley

11 'Flikball'—a toy which can be used to teach

12 Simple objects such as a mousetrap may be used to teach

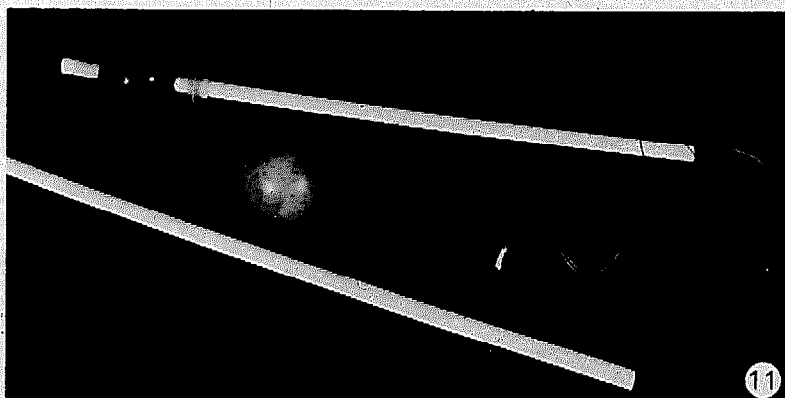
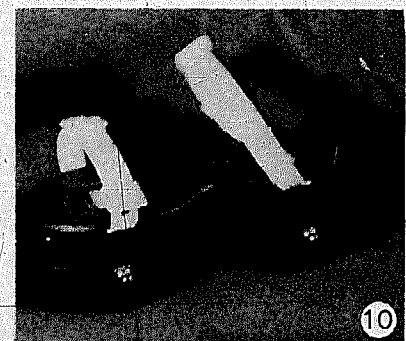
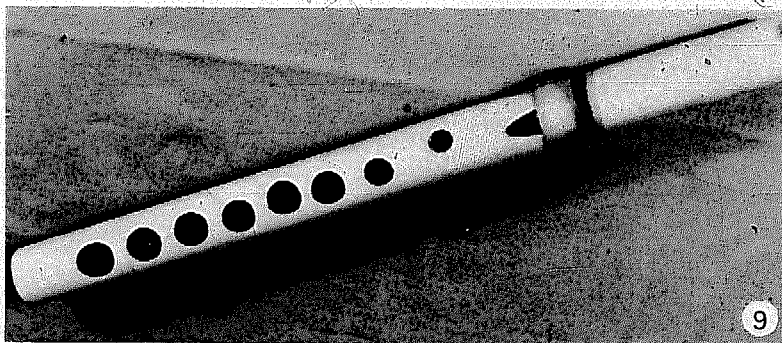
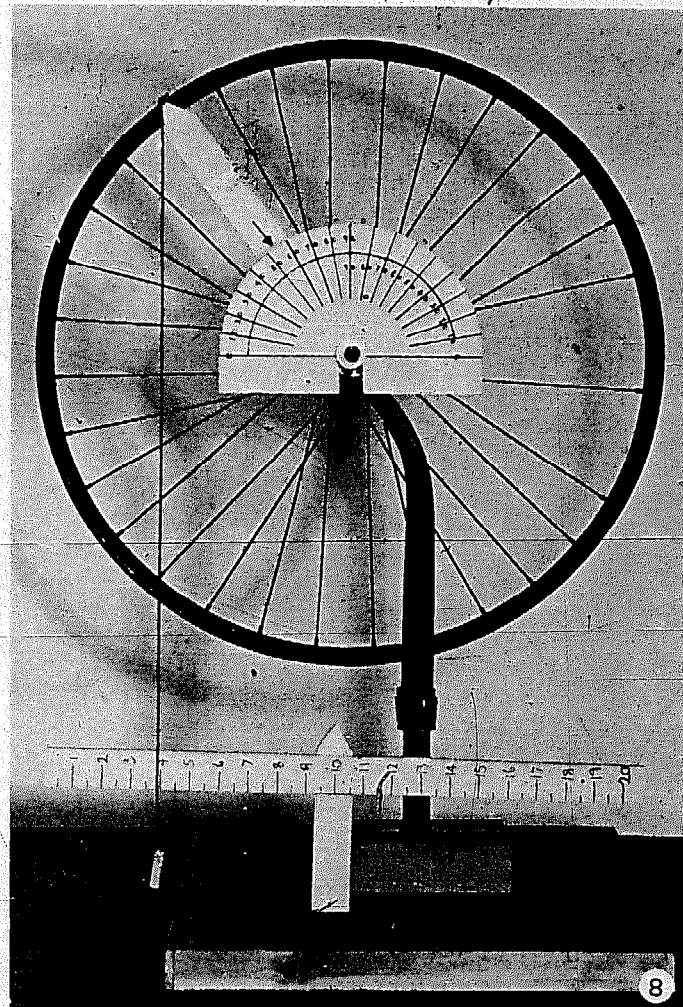

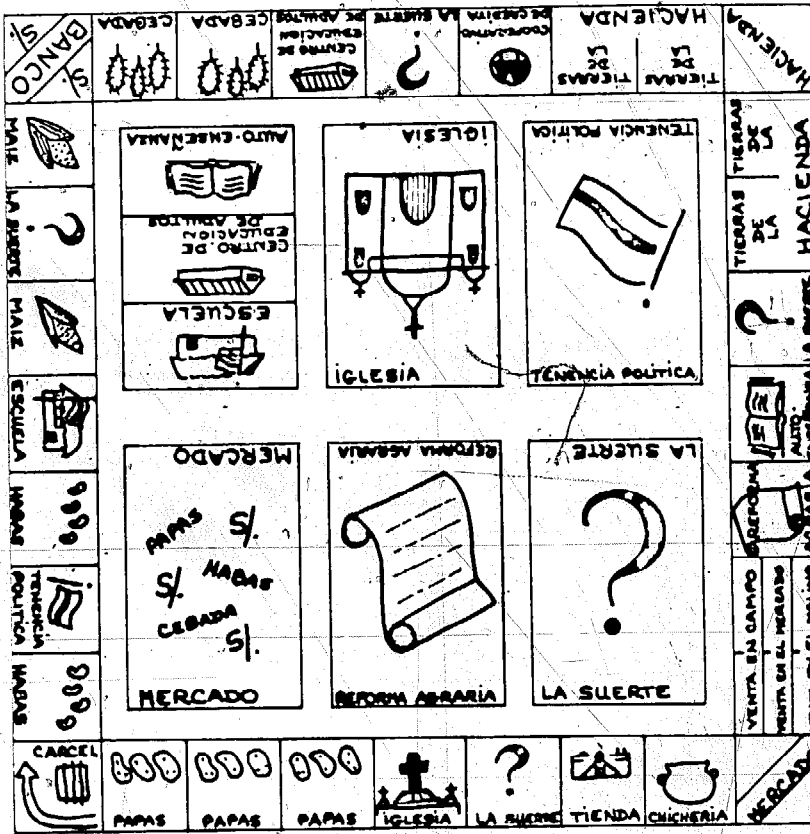

MARKET
 Security of goods in the market place.
 COLLECT HIGHEST PRICE.

?
 You just had a new baby. Pay medical expenses.
 100 SOCCES

ADULT EDUCATION
 After having studied cooperativism you may join the coop and take out loans to meet your needs.

COOPERATIVE SECURITY
 Composites with four of these cards are entitled to take over 1/4 of the Hacienda's poorest land.

SELF-EDUCATION
 For having studied a pamphlet on fertilizer you learn of its benefits. Receive 500 SOCCES in credit to fertilize your land.

CHURCH
 You have been selected to give a high Mass with flowers for the community.
 PAY: 500 SOCCES

HACIENDA

13

14

13 & 14 Gameboard and sample cards from 'Hacienda', a teaching game simulating the economic and social realities of the Ecuadorian sierra

15 The Advisory Centre for Education makes use of games based on 'Ludo' and others well-known to English children

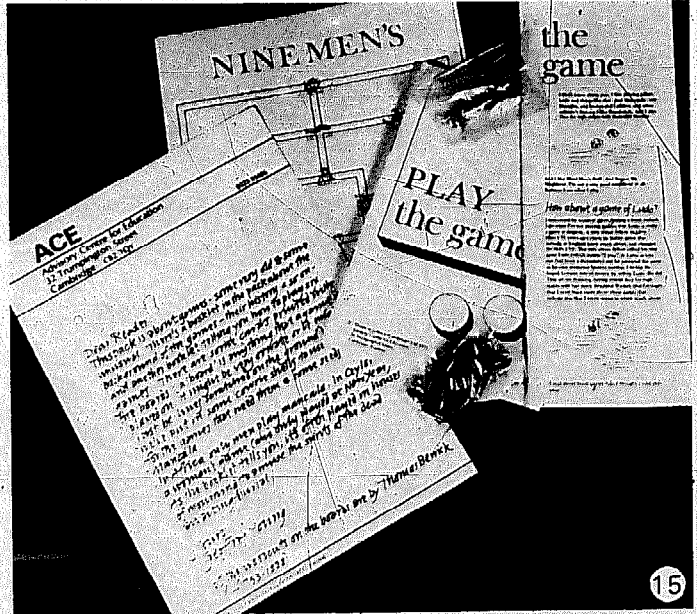

15

Science Education Project in Africa

16 Bamboo and rope make an exciting tower

17 Seeing the world from a moving system

18 Sample page from the Teachers' Guide

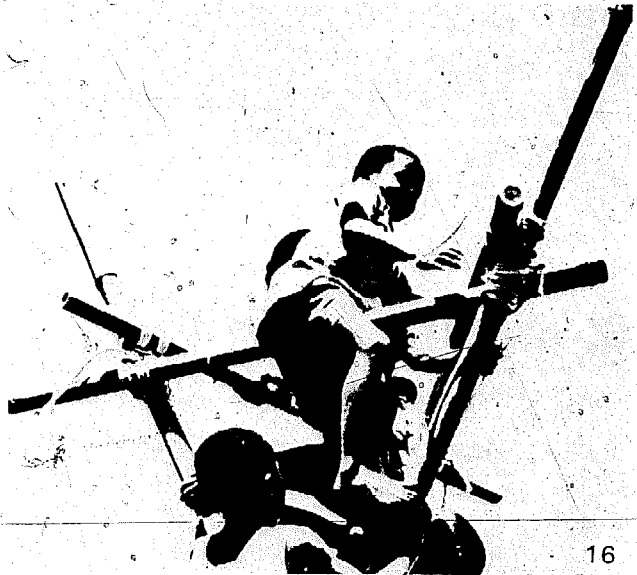

16

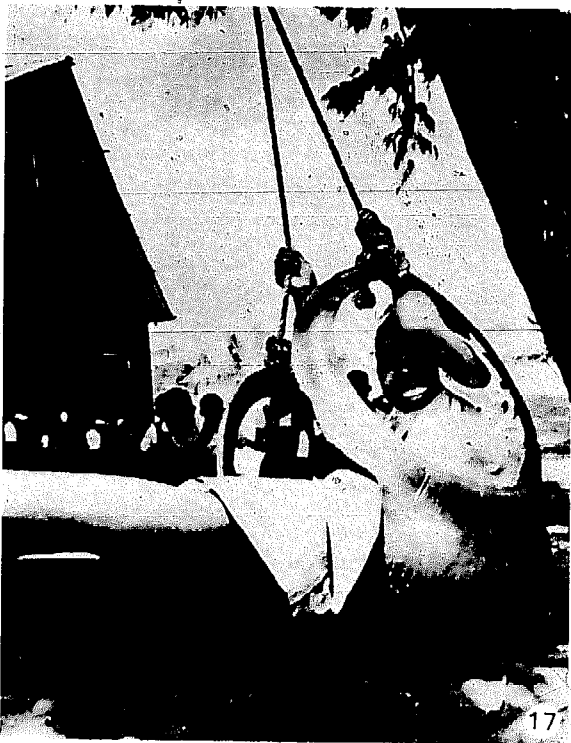

17

Or they put several tins in one spot.

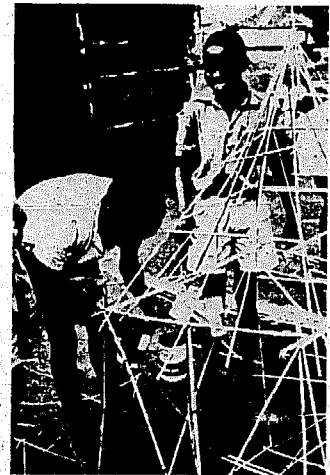

As your pupils place the tins of sand at different parts of their houses, they may not pay much attention to what is happening. Each time they put a tin on one of the grasses, the grass will bend in a certain way. To prevent it from breaking, children usually add many more pieces of grass. Encourage them to be more methodical. For instance, sometimes when pupils hang a tin on their house, it bends in certain places, slants in one direction, or even tips the whole house over. In the following illustration, consider the solid lines only.

Weight is placed here

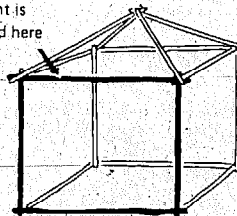

Weight added, house slants

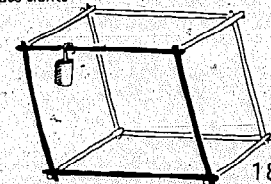

18

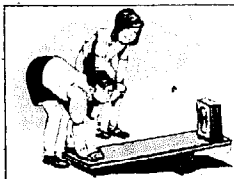
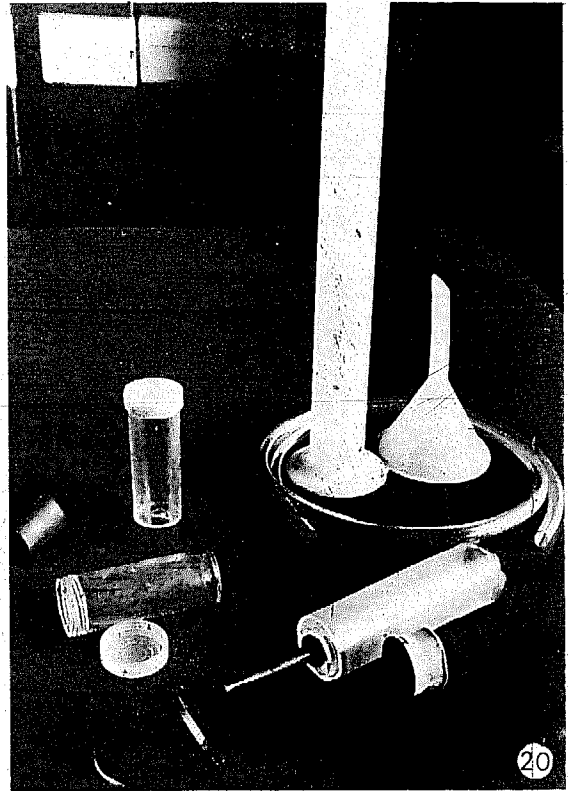
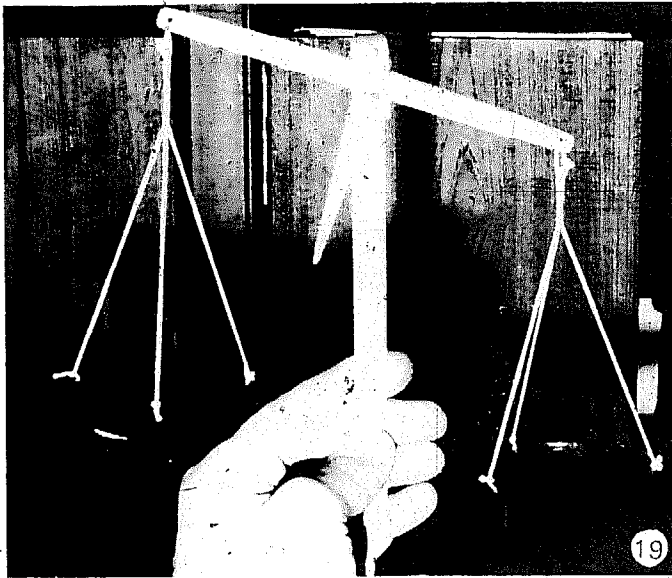

Let us find out

Take a brick. Lift it up in your hand. You will find that it is quite heavy. Now take a short plank. Place it over another brick as shown. Put the first brick on one end of the plank as shown. Now press down the free end of the plank. Is it hard to lift the brick or is it easy?

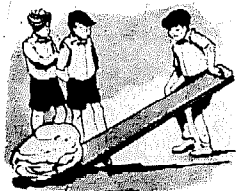

The see-saw on which you may have played, is a lever. Sometimes you may have been able to lift a boy or a girl much heavier than yourself on the see-saw.

How did you do this?

Let us find out

Go out to the field. Select a large rock which you cannot easily lift. Take a long plank and push one end towards the rock. Place another small stone below the plank as shown. Now press down at the free end of the plank. Can you move the rock easily?



With this lever you were able to apply on the rock a large force which could move it. You could not do this with bare hands. The lever did not do any work itself. It only helped you to do the work more easily.

The pan-balance is another example of a lever. It is used for weighing many things, such as corn, pulses, rice and wheat.



How do you buy kerosene and milk? Do you buy it by weight? Can you buy a kilo of kerosene? No, kerosene is sold by volume.

What is volume?

Let us find out

Take an empty kerosene bottle. Fill it with water to the top. How much water have you in the bottle? How can you find out?

NCERT, India.

19 & 20 Items from the primary science kit

21 A page of pupil's text

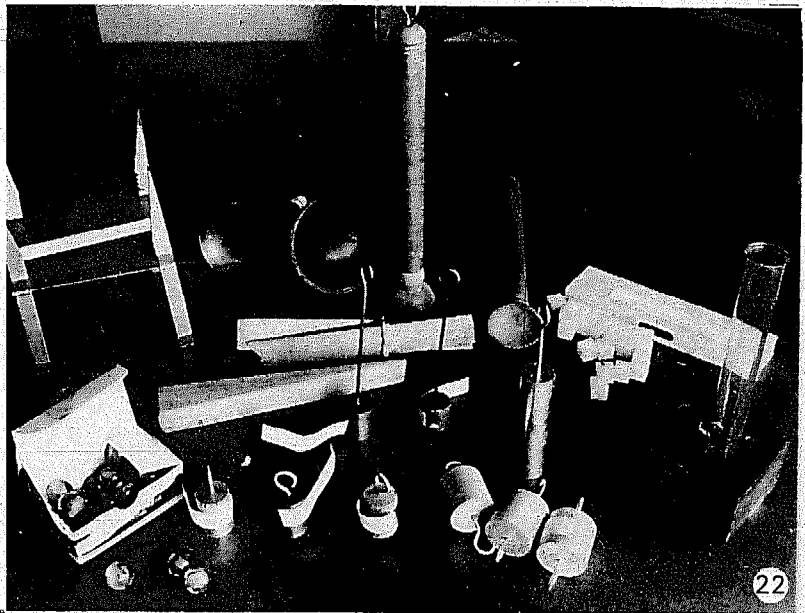

22

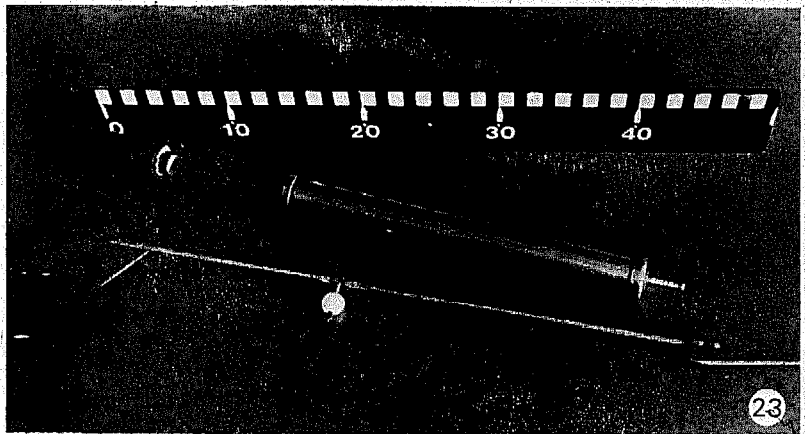

23

NCERT, India

22, 23 & 24 Items from the primary science kit

25 Dimensional drawing for the kit

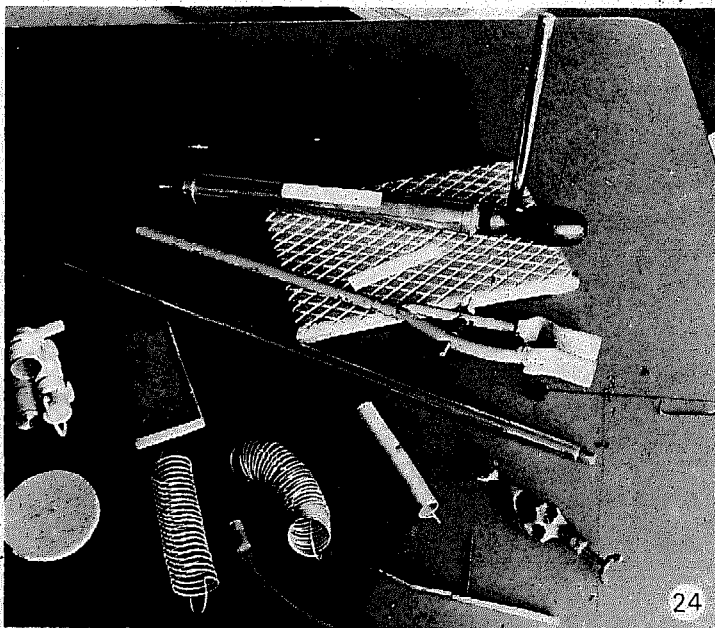

24

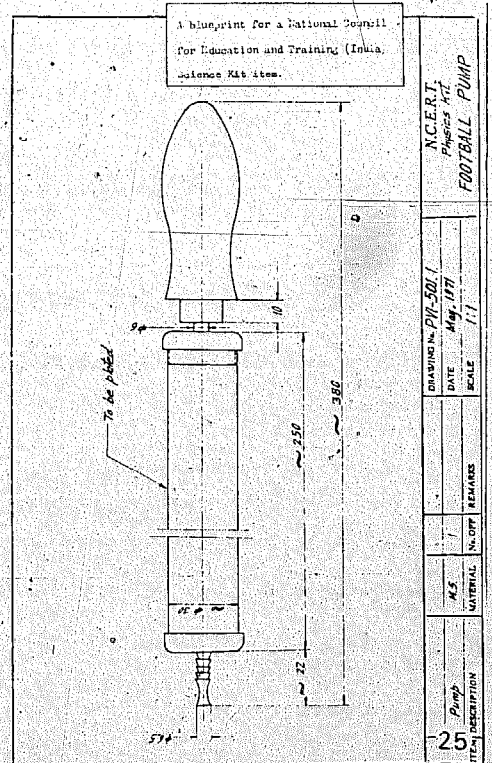

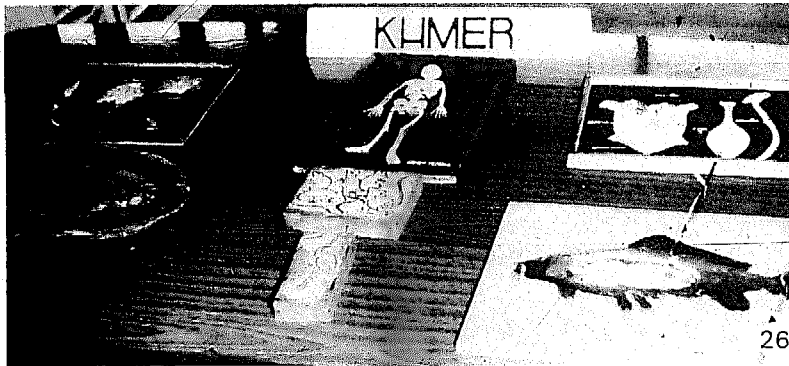

26 Some papier-mâché models and lino-cut blocks from Khmer



27 Examples of science teaching apparatus from Malaysia

28 Some secondary apparatus, IPTST Programme, Bangkok

29 Elementary science kit designed for Thailand

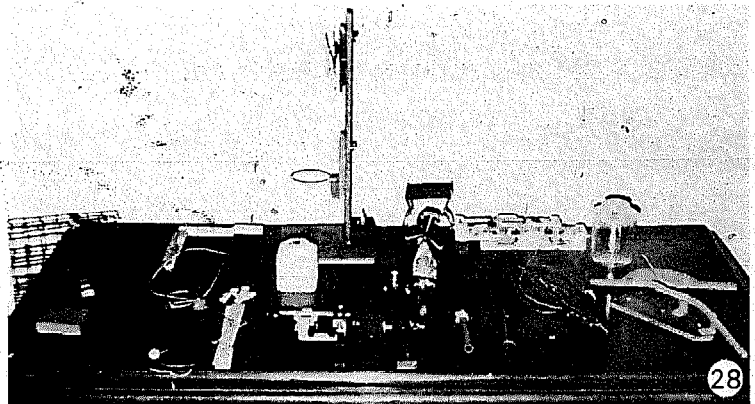



FORCES

PHASE IIIA
NO. 19

ORGANIZATION

LET'S FIND OUT HOW TO USE A PULLEY

Groups

You will need:

- 1 ball of string.
- 10 *small* cartons, chalk boxes or plastic bags of sand (loads).
- 10 pulleys.



Do this:

1. Group leaders collect 3 metres (10ft) of string and bag or carton of sand.
2. Tell the children to tie the load to the string and pull the load to a new position on their desks.
3. Give the children this problem. "See if you can find a way to move the load away from you by pulling the string". (This can be done if a pencil is held by another child at one end of the desk and the string passed around the pencil.)
4. Ask successful groups to show how they managed.
5. Give out a pulley to each group. Tell the children to use the pulley instead of the pencil and try again.
6. See if the children can suggest a way of lifting the load above their heads using the string and pulley.
7. Tie the pulleys to a beam across the classroom, and tell the children to pull up their loads using these.
8. Tell the children to make a record of what they have done in their note books. A drawing will be sufficient.

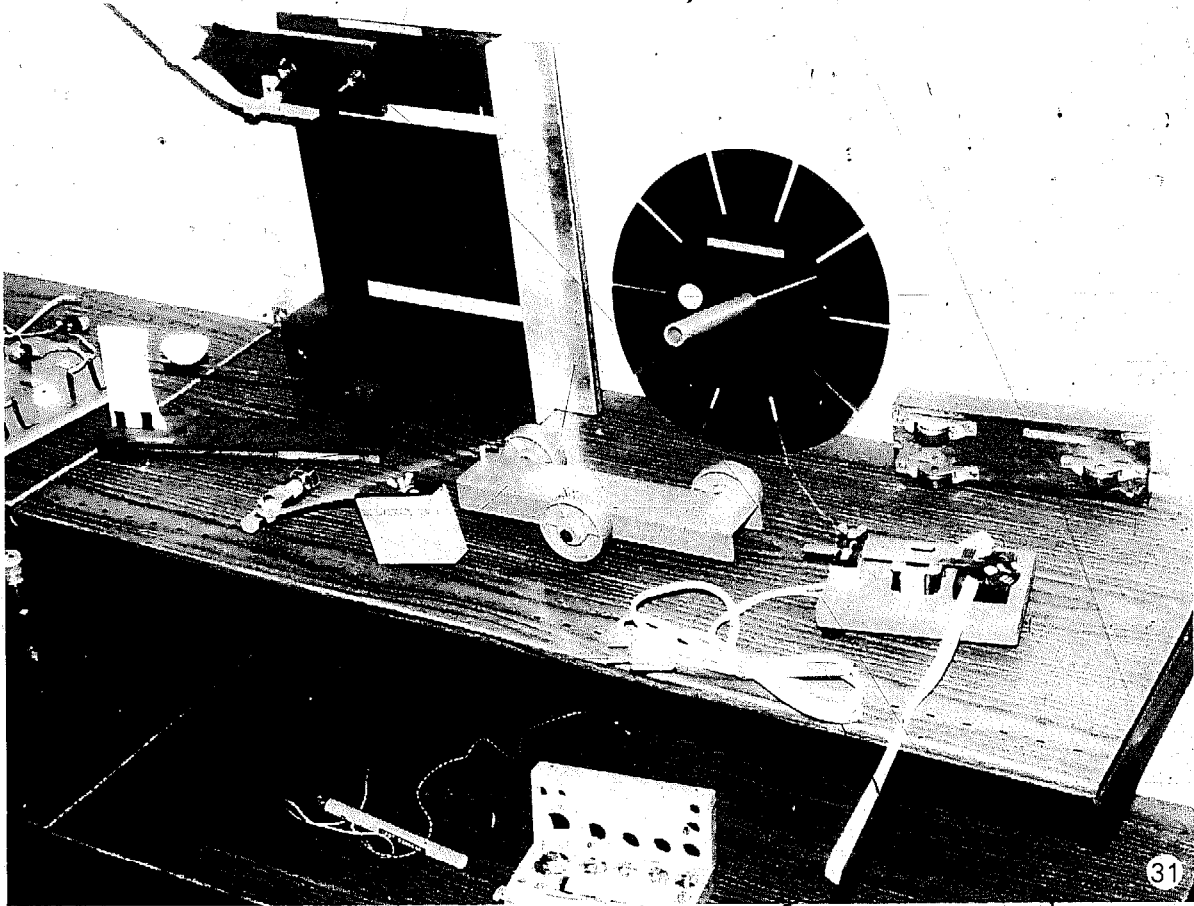

31 Some secondary apparatus,
IPTST programme, Bangkok

32 Equipment largely for the train-
ing of technicians. Bangkok – prior
to IPTST

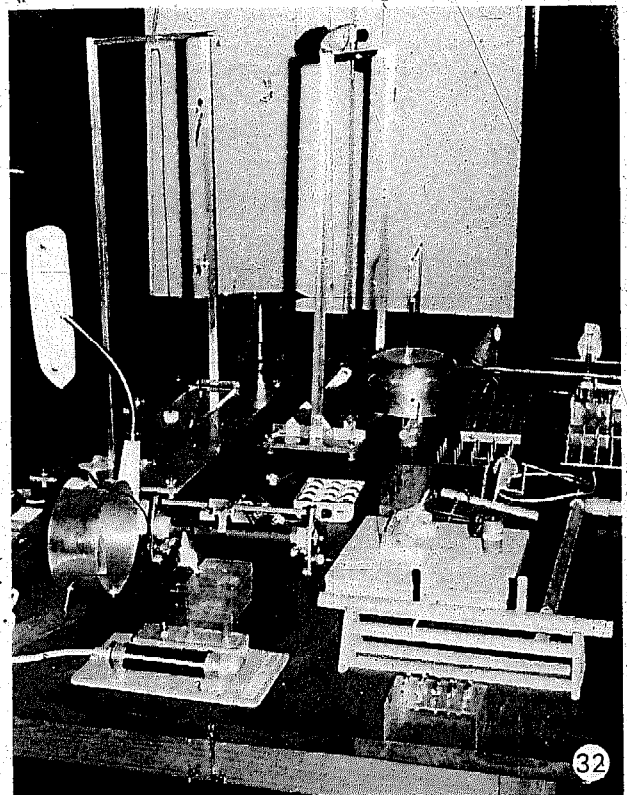

FOTOMETRIA

Nº	MATERIALES	Cont.
1	PROYECTOR DE ALUMINIO	1
2	LAMINA CON ORIFICIOS	1
3	LAMPARA 60W	1
4	BASE PORTALAMPARAS	1
5	BLOQUES DE PARAFINA	2
6	HOJA DE ALUMINIO	1
7	CAJA DE CARTON	1
8	TUBO DE CARTON	1
9	LAMPARA DE FILAMENTO RECTO	1
10	PORTALAMPARAS MADERA	1
11	REGLA	1
12	REGILLA DE 50cm	1
13	REGILLA DE 50 cm	1
14	ENCHUFE TRES VÍAS	1
15	CARTULINA NEGRA	1
16	PAPEL MILIMETRADO	3
17	DIPOSITIVAS	2
18	ALFILERES	5
19	HOJA DE AFEITAR	1
20	ROLLO DE CINTA NEGRA	1

33

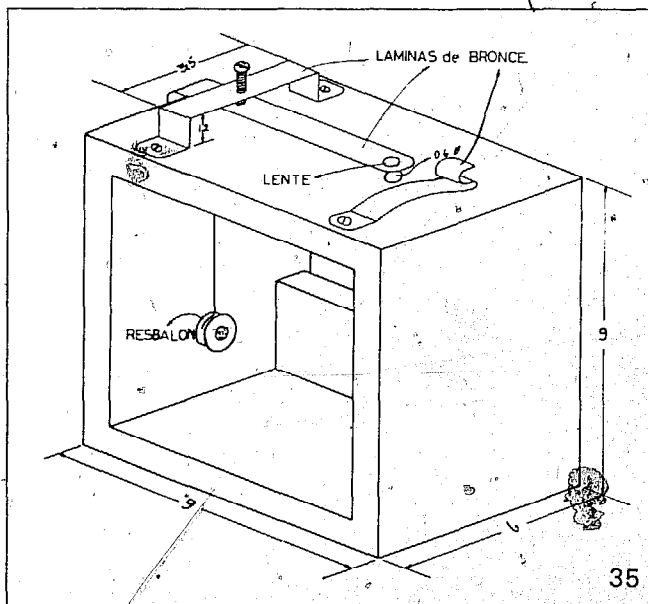
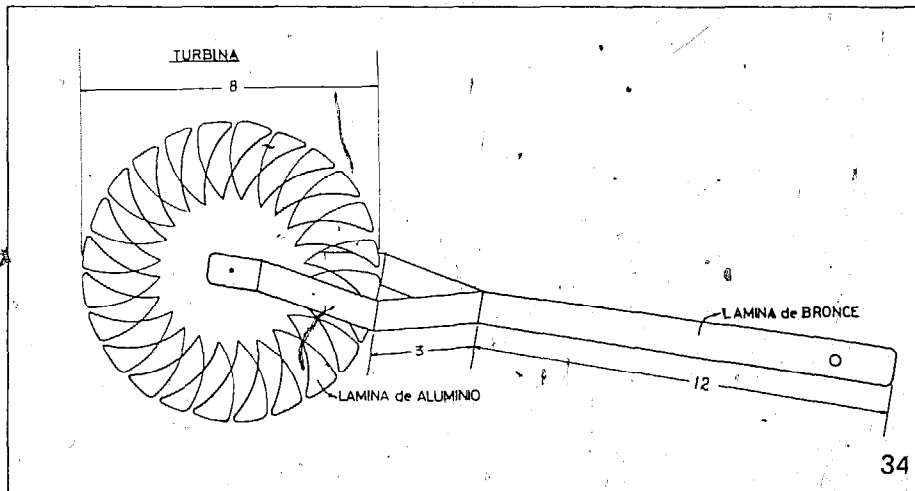

33 A Sao Paulo project kit

34 & 35 Dimensional drawings from Costa Rica

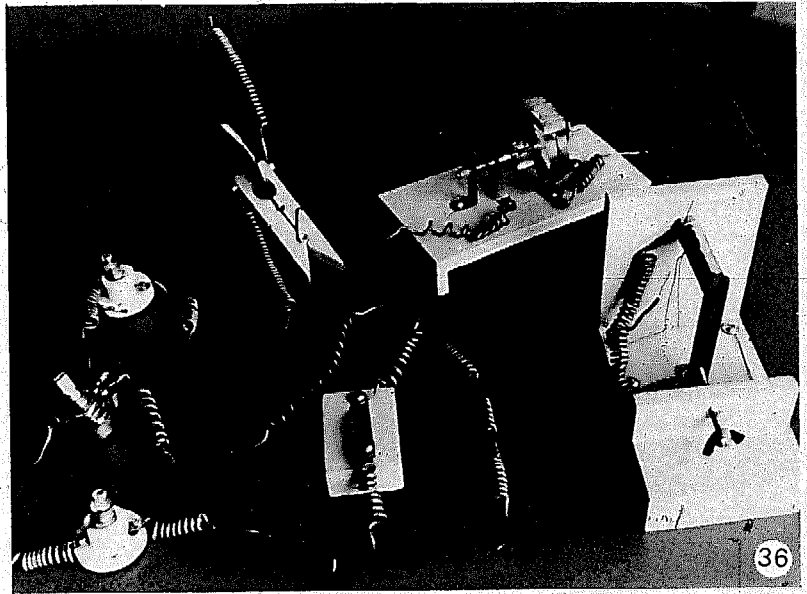

36 Some prototypes of science teaching equipment from Costa Rica

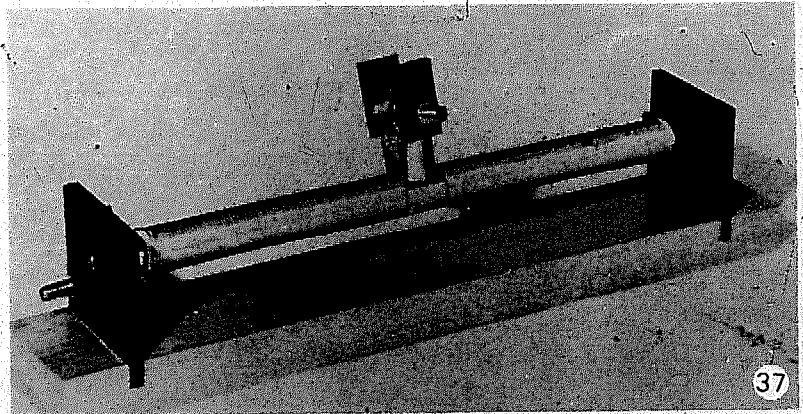

37 & 38 Items manufactured by Or & Kol, Israel

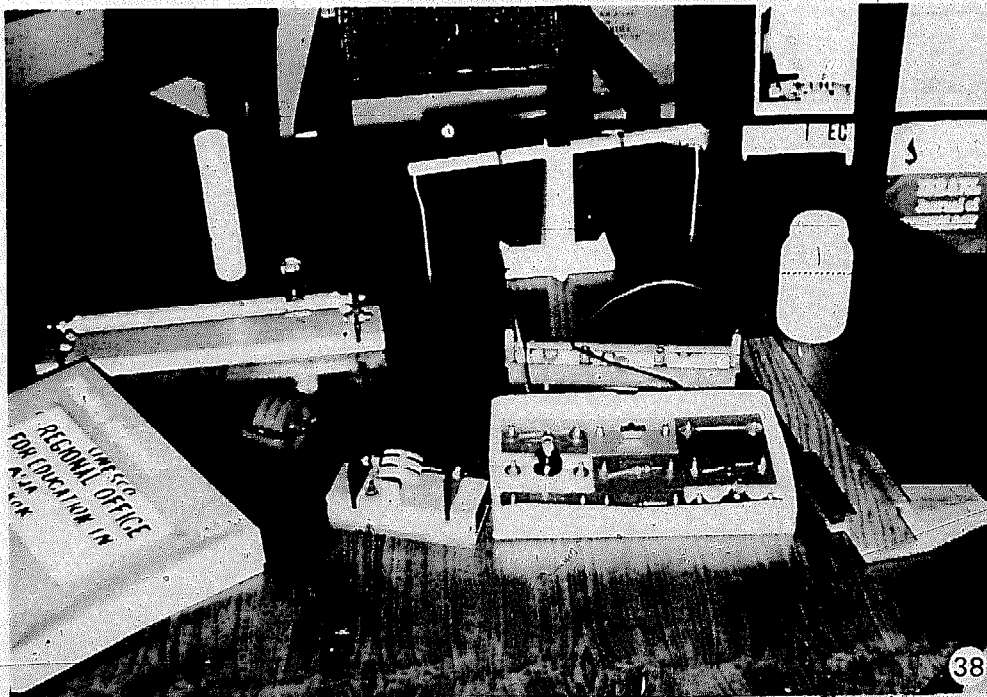

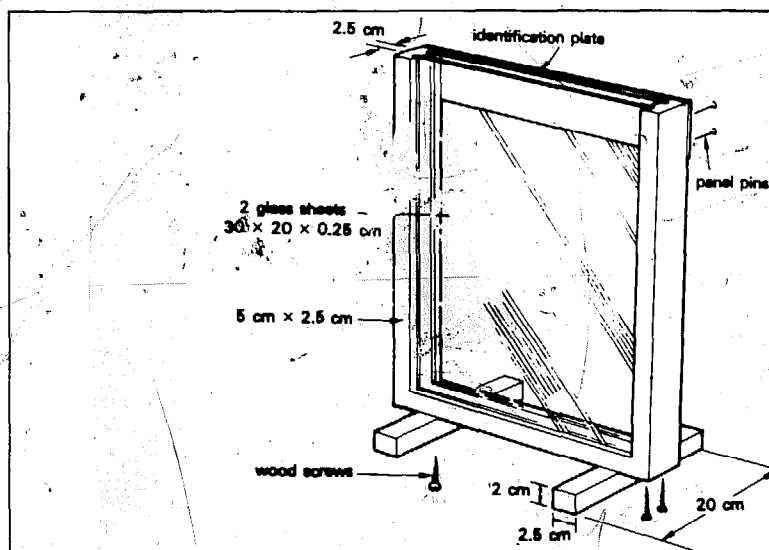

Diagram #1
Wormery (Rothemann pattern)
Final of study 6.2

The frame is made of ready grooved wood and is cut to fit around the glass. The frame should be glued and screwed together, ensuring that the glass can still be removed. If the feet are attached by one screw only, they can be turned to lie in line with the base for easier storage. In use the glass sheets are covered with a sheet of cardboard to exclude the light and the seal is covered with a strip of polythene.

39

39 Dimensional drawing from 'Nuffield Apparatus Guide'

40 Example from the UNESCO 'Source Book'

41 Example from 'Guidebook to constructing inexpensive science teaching equipment'

2.30 Chemistry 50

2.30 Potassium permanganate gives off a gas

blue copper sulphate crystals + heat = white (anhydrous) copper sulphate + water

This is a reversible change. Pupils might discuss whether the previous experiments on heating substances were reversible changes.

2.31 Some substances neither gain nor lose mass when heated. Heat dry zinc oxide in a test-tube in the same way as in the last experiment. Is something lost or something gained?

2.32 Observing the effect of heat on copper sulphate crystals. Crush some blue copper sulphate crystals and put them into a dry test-tube to a depth of 4 cm. Arrange as shown in the diagram. Heat the tube gently. What can pupils observe? Vapour collecting on the cooler parts? Change of colour from blue to white? Liquid collecting in the receiving

2.32 Collecting the product of heating copper sulphate crystals. A cold water in a beaker

2.33 Collecting hydrogen gas

40

Insert each short-piece of glass tubing (F) into a short piece of rubber tubing (E). Insert each rubber tube into one of the two small holes in the can. If the rubber tubes do not fit snugly by themselves, make a watertight seal with candle wax or epoxy resin.

Set the can in place in the frame support. To secure it in position, nail two pieces of strapping (C) to the frame support, one on each side of the can.

Choose a one-hole rubber stopper (H) that tightly seals the hole in the bottom of the water-jacket can. Insert a short piece of glass tubing (I) part way through the stopper, from the large end. Insert the copper pipe (G) into the stopper from the other end.

(3) Condensing Pipe

41

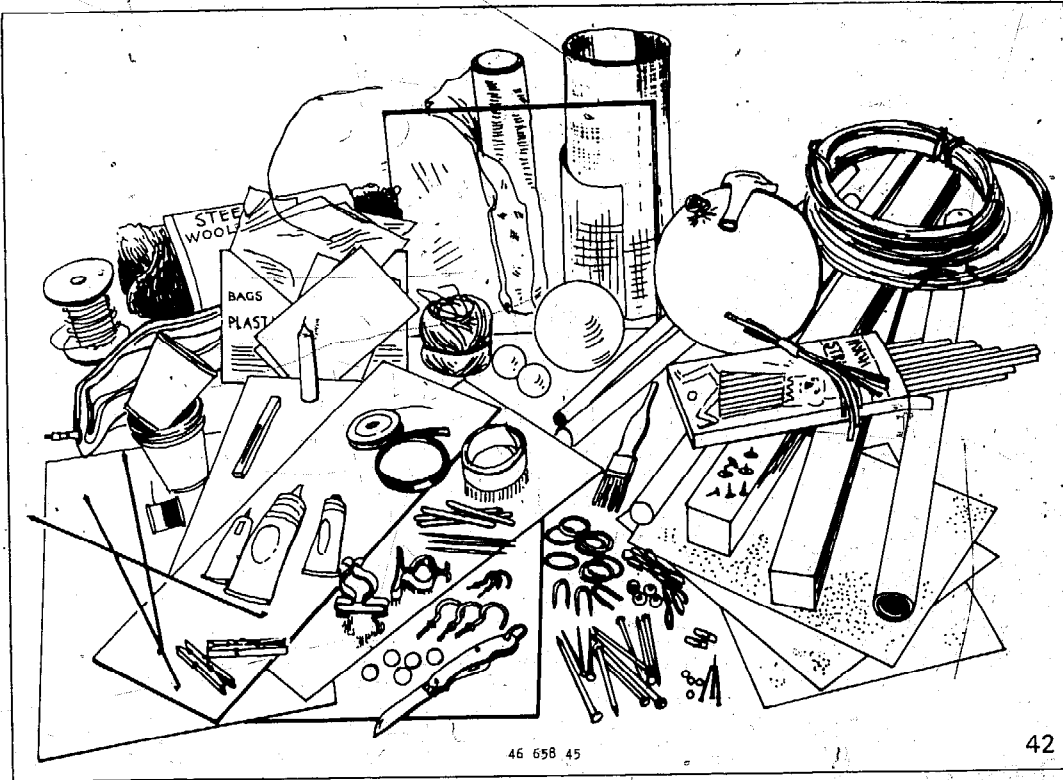

46 658 45

42

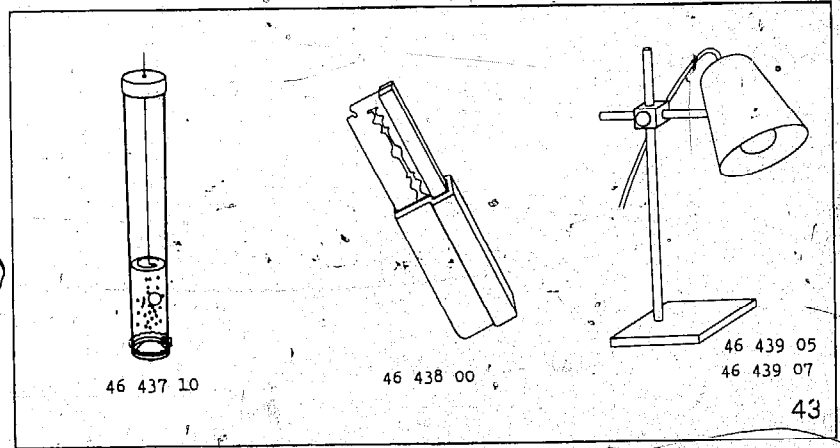

46 437 10

46 438 00

46 439 05
46 439 07

43

42 Resource materials kit, 'EVE' catalogue

43 Other items in 'EVE' catalogue are shown and listed separately



44

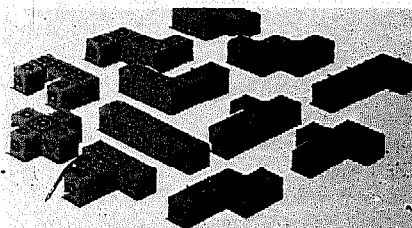

Polyminos. The 12 pentminos

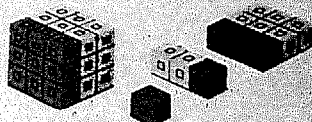

Multi-base. Base 3. Any Base can be made with Centicubes

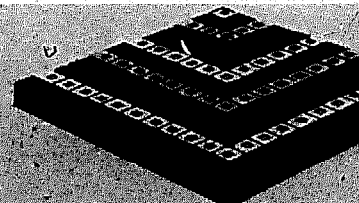
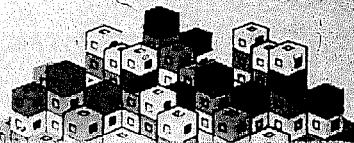

Erastosthenes' Sieve. The odd numbers arranged in a column will provide the next square number when all square numbers. The series is 1, 3, 5, 7, 9, 11, etc.

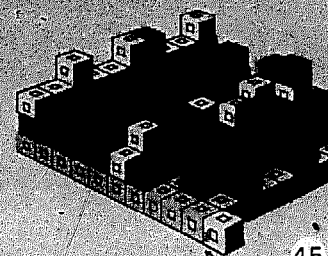

Erastosthenes' Sieve. Build a base of 100 cubes. In column add cubes for each multiple of 2, 3, 4, 5, 6, 7, 8, 9, 10, 11, 12, 13, 14, 15, 16, 17, 18, 19, 20, 21, 22, 23, 24, 25, 26, 27, 28, 29, 30, 31, 32, 33, 34, 35, 36, 37, 38, 39, 40, 41, 42, 43, 44, 45, 46, 47, 48, 49, 50, 51, 52, 53, 54, 55, 56, 57, 58, 59, 60, 61, 62, 63, 64, 65, 66, 67, 68, 69, 70, 71, 72, 73, 74, 75, 76, 77, 78, 79, 80, 81, 82, 83, 84, 85, 86, 87, 88, 89, 90, 91, 92, 93, 94, 95, 96, 97, 98, 99, 100.

45

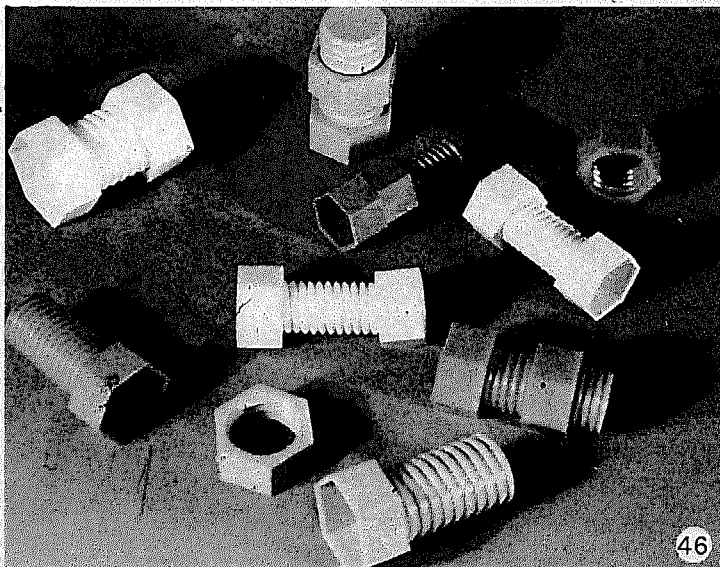

46

44 / Practical work from 'Elementary Science Study' series

45 Centicubes

46 Plastic nuts and bolts kit

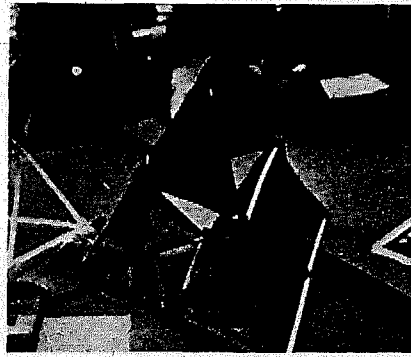

This is a model of Bell's structure which was presented to the students as their single source of information. With no assistance, each student was to reconstruct the model using 8-inch straws, pins, and paper.

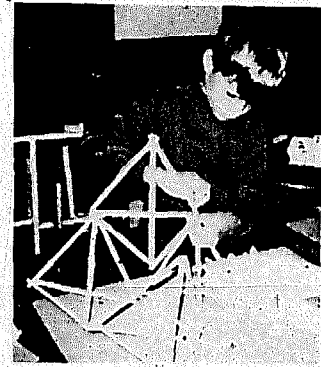
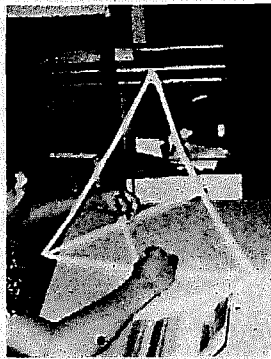

47 An example from 'Elementary Science Study' series

48 Some items from the kit compiled by Dr Simpson of Hong Kong

And so they did.

47



48

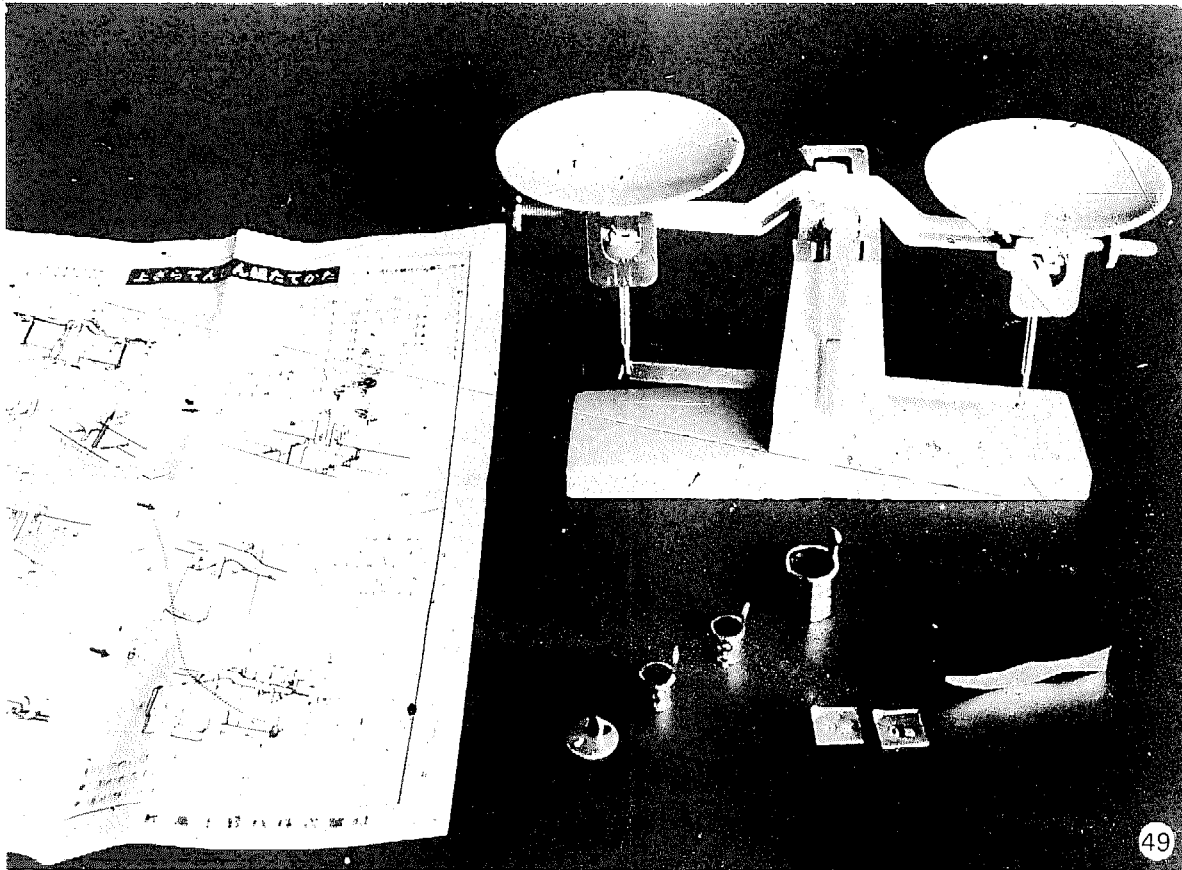

49

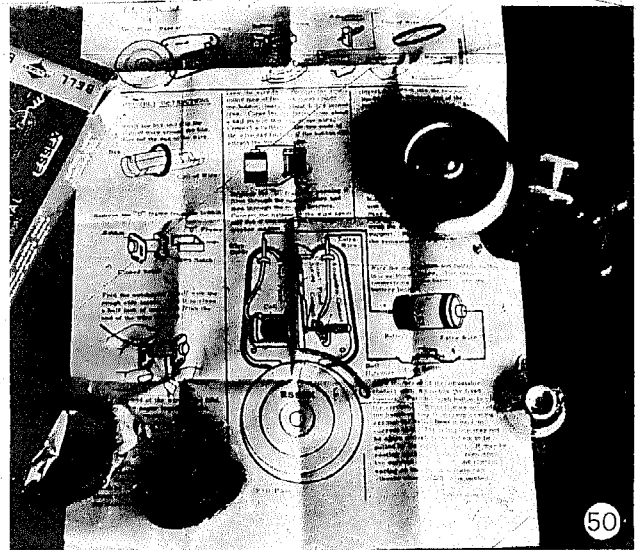

50

THE ELECTRIC BELL KIT **PARTS LIST**

Assembly of Telegraph Key

1. Remove the base of the magnet and the bell from the kit and set them in a clean place to be used later.
2. Take the tub, bobbin, and remove the metal "U" bracket.
3. In the magnet kit, insert the bobbin on one end, and wrap it tightly and evenly around the bobbin in 10 layers. Use 20 layers of wire 22 or 24 gauge. The magnet should be 1/2 inch in diameter. The wire should be wrapped in a spiral pattern, and the ends of the wire should be left long enough to be used for connecting the magnet to the battery.
4. Strip the wire of its insulation for 1/2 inch at each end.
5. Replace metal "U" bracket on to the plastic holder.
6. Insert the bobbin into the magnet holder as in Figure 4.
7. See Figure 4. Place the bell at the end of the metal spring into the hole, and push it into the magnet holder. The bell should be pushed over the metal spring to add its contact.
8. Mount magnet holder assembly on the main base as in Fig. 5.

51

Japanese plastic mini science kits

49 Scales

50 Electric bell kit

51 Parts lists for electric bell kit

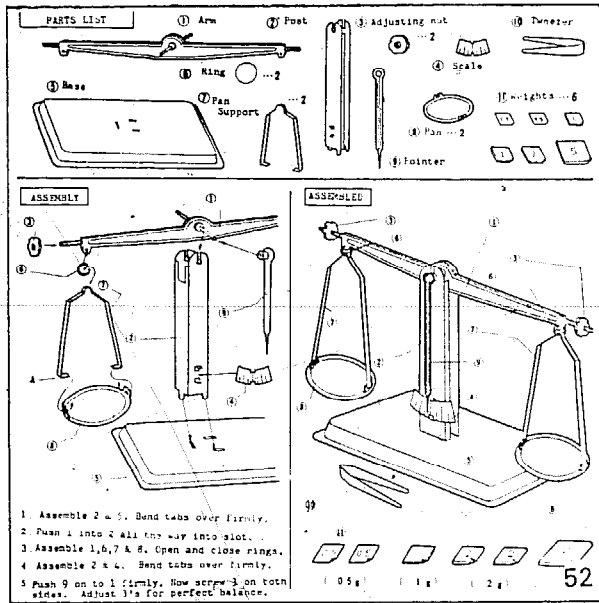

Japanese plastic mini science kits

52 Parts list for balance

53 Kits for pump, balance and electro-magnet

54 Parts list for hydraulic pump

55 Parts list for electro-magnet

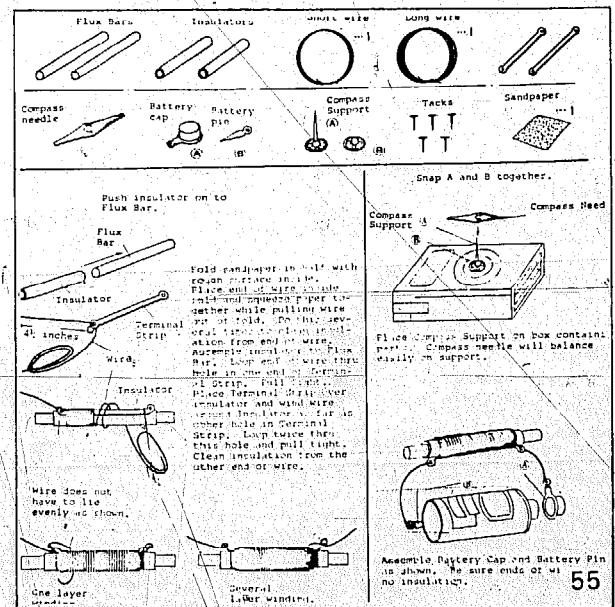
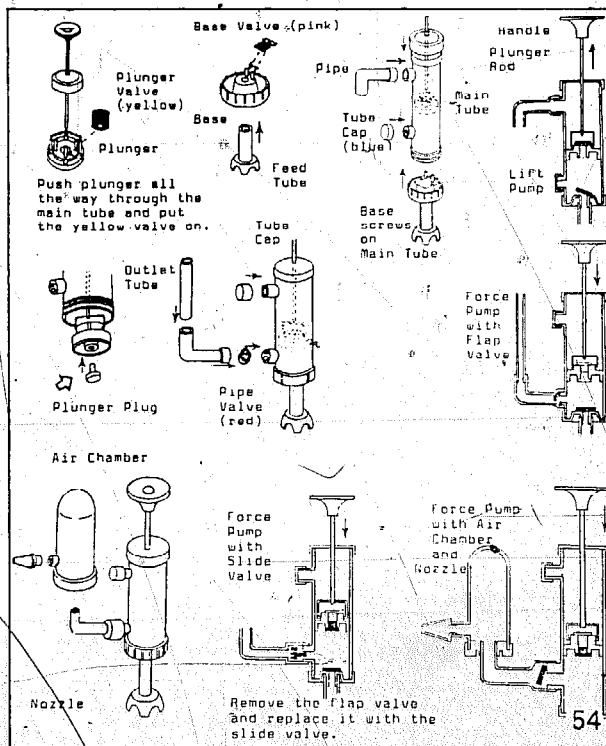

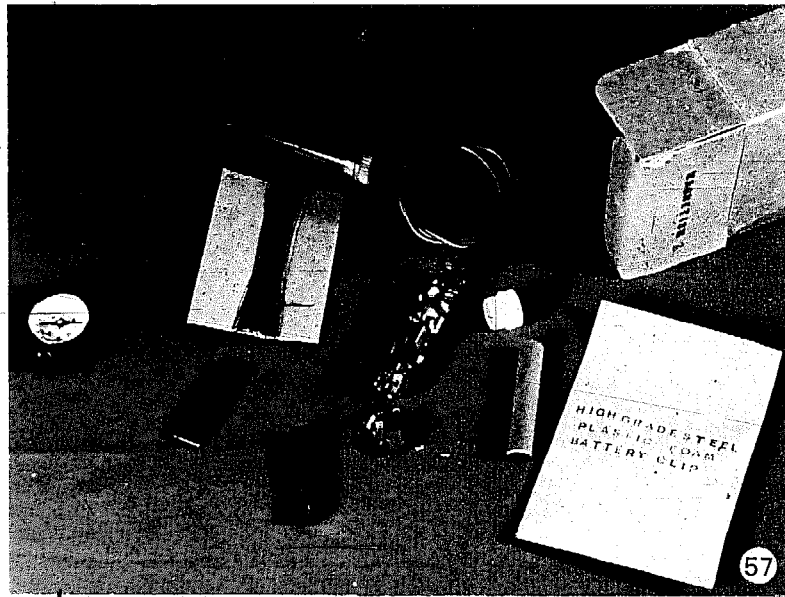
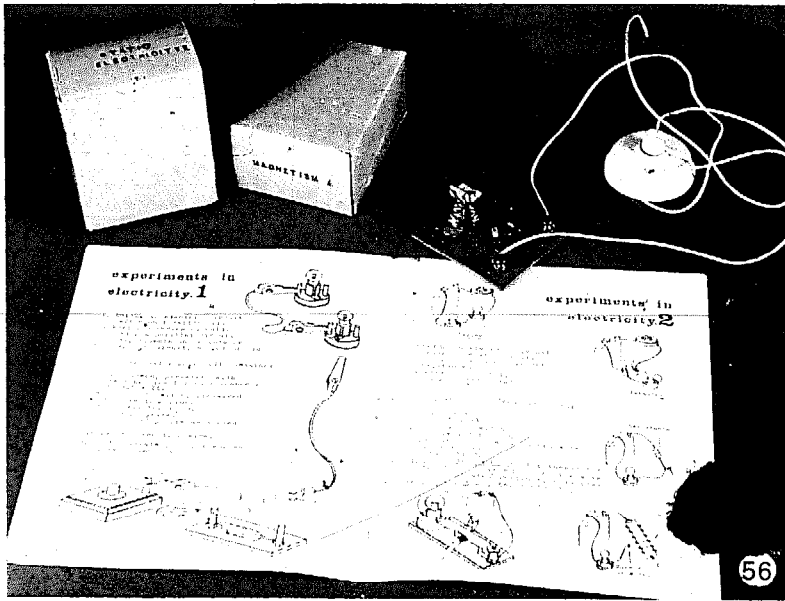

56 & 57 Kits from Precision Jigs Co. Ltd.

58 A sample kit from FUNBEC

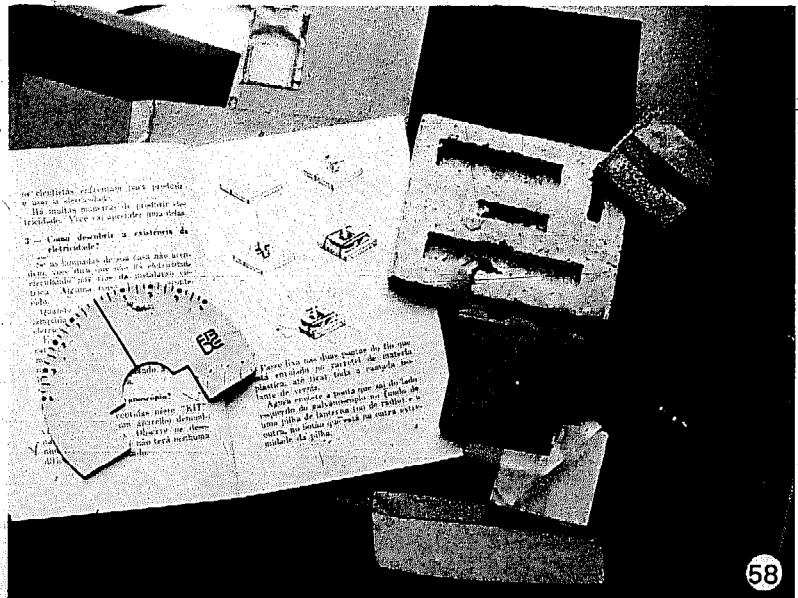

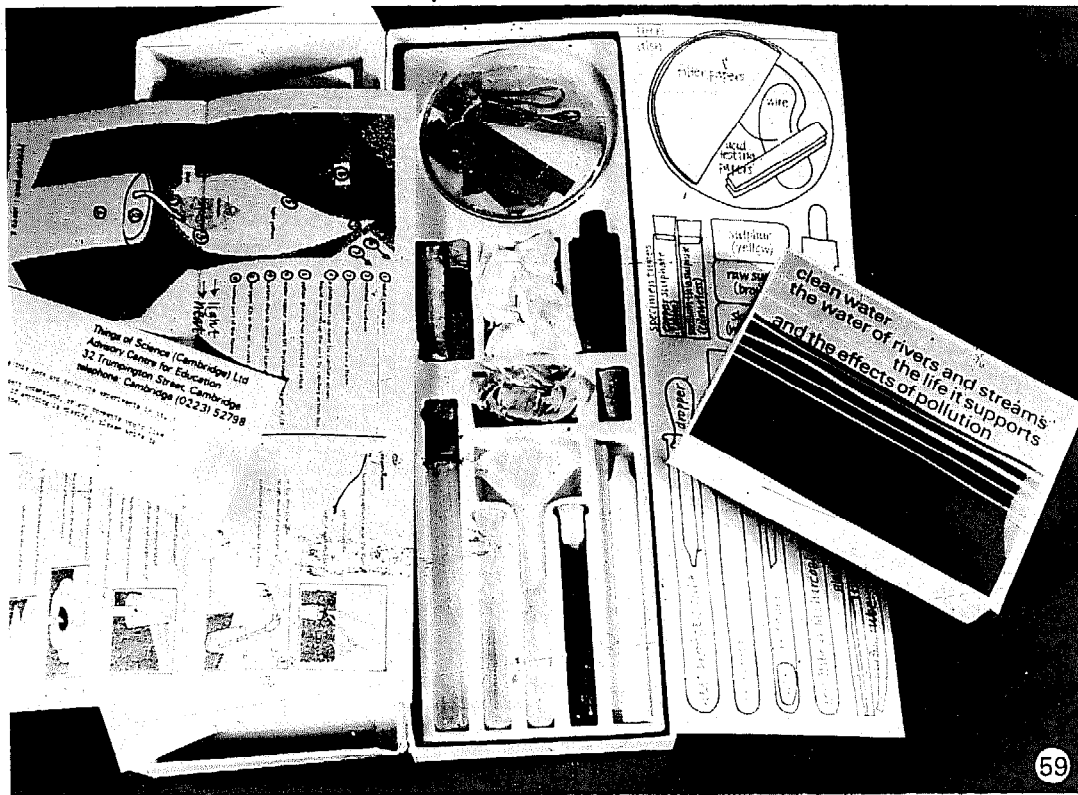

59

59 & 60 Kits from the Advisory Centre for Education (ACE)

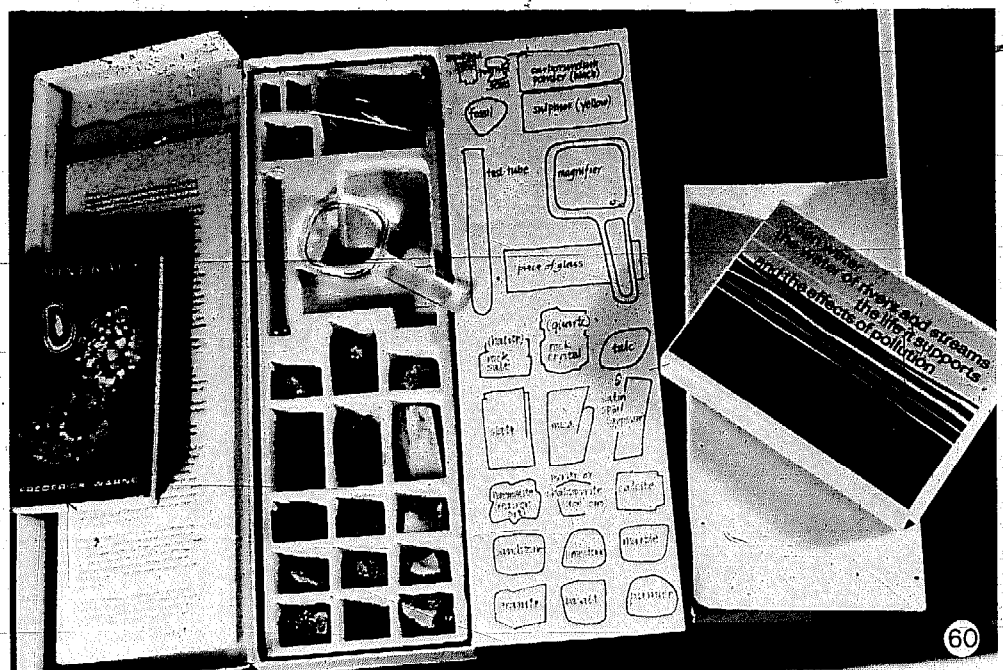

60

Published by the
COMMONWEALTH SECRETARIAT

May be purchased from the

Commonwealth Secretariat
Publications Section,
Marlborough House
Pall Mall
London SW1Y 5HX

Price £1.25