

**AT** MICROFICHE  
REFERENCE  
LIBRARY

A project of Volunteers in Asia

Wood Harvesting with Hand Tools: An illustrated Training  
Manual

By: International Labour Office

Published by: International Labour Office  
Publications Branch  
CH-1211 Geneva 22  
SWITZERLAND

Available from: ILO Publications  
International Labour Office  
CH-1211 Geneva 22  
SWITZERLAND

Reproduced with permission.

Reproduction of this microfiche document in any form is subject to the same restrictions as those of the original document.

# Wood harvesting with hand tools

An illustrated training manual

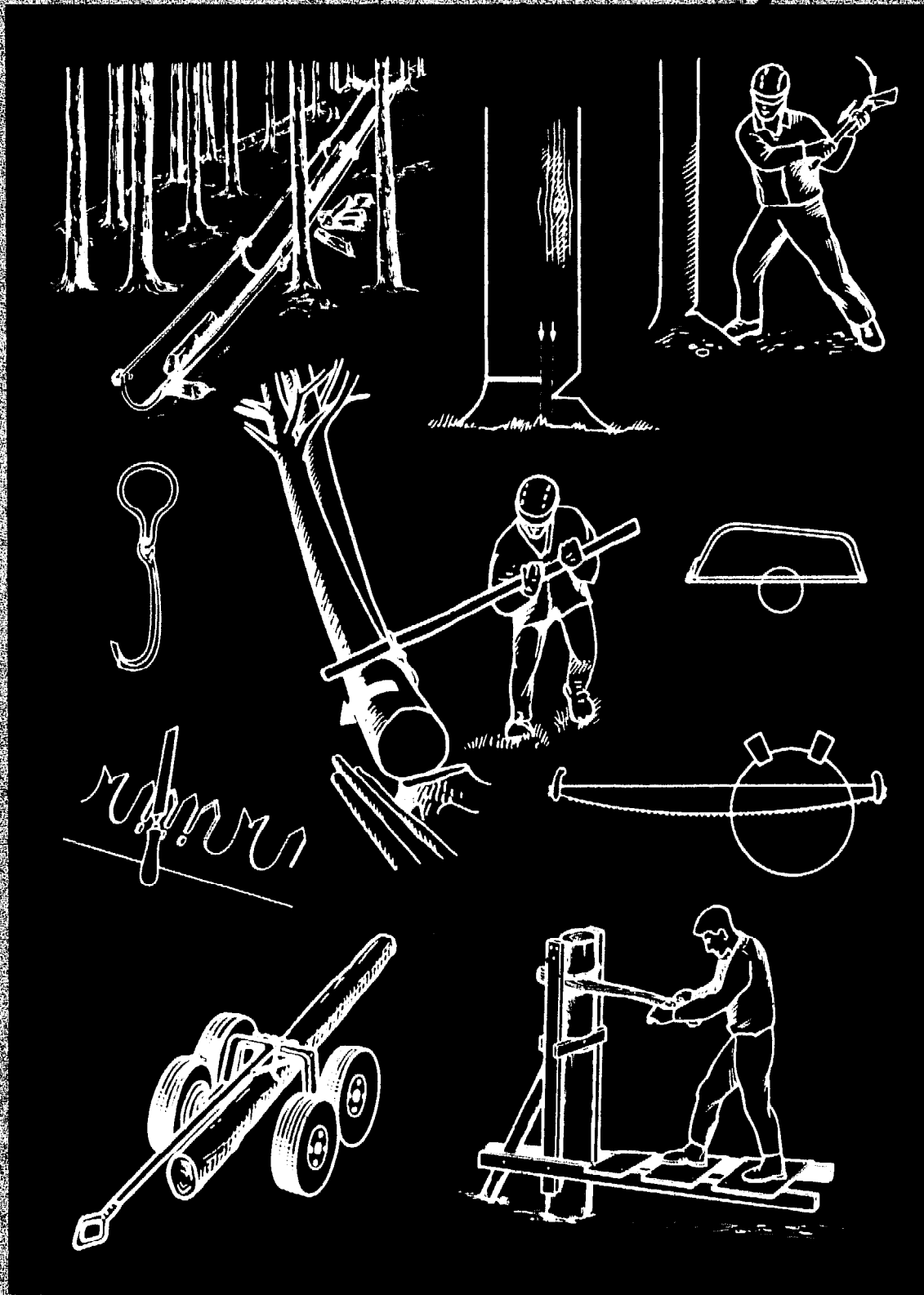

International  
Labour  
Office  
Geneva

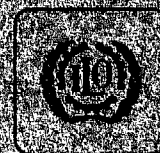

# **Wood harvesting with hand tools**

**An illustrated training manual**

**Copyright © International Labour Organisation 1987**

Publications of the International Labour Office enjoy copyright under Protocol 2 of the Universal Copyright Convention. Nevertheless, short excerpts from them may be reproduced without authorisation, on condition that the source is indicated. For rights of reproduction or translation, application should be made to the Publications Branch (Rights and Permissions), International Labour Office, CH-1211 Geneva 22, Switzerland. The International Labour Office welcomes such applications.

---

**ISBN 92-2-106217-1**

*First published 1987*

---

The designations employed in ILO publications, which are in conformity with United Nations practice, and the presentation of material therein do not imply the expression of any opinion whatsoever on the part of the International Labour Office concerning the legal status of any country, area or territory or of its authorities, or concerning the delimitation of its frontiers.

The responsibility for opinions expressed in signed articles, studies and other contributions rests solely with their authors, and publication does not constitute an endorsement by the International Labour Office of the opinions expressed in them.

Reference to names of firms and commercial products and processes does not imply their endorsement by the International Labour Office, and any failure to mention a particular firm, commercial product or process is not a sign of disapproval.

ILO publications can be obtained through major booksellers or ILO local offices in many countries, or direct from ILO Publications, International Labour Office, CH-1211 Geneva 22, Switzerland. A catalogue or list of new publications will be sent free of charge from the above address.

---

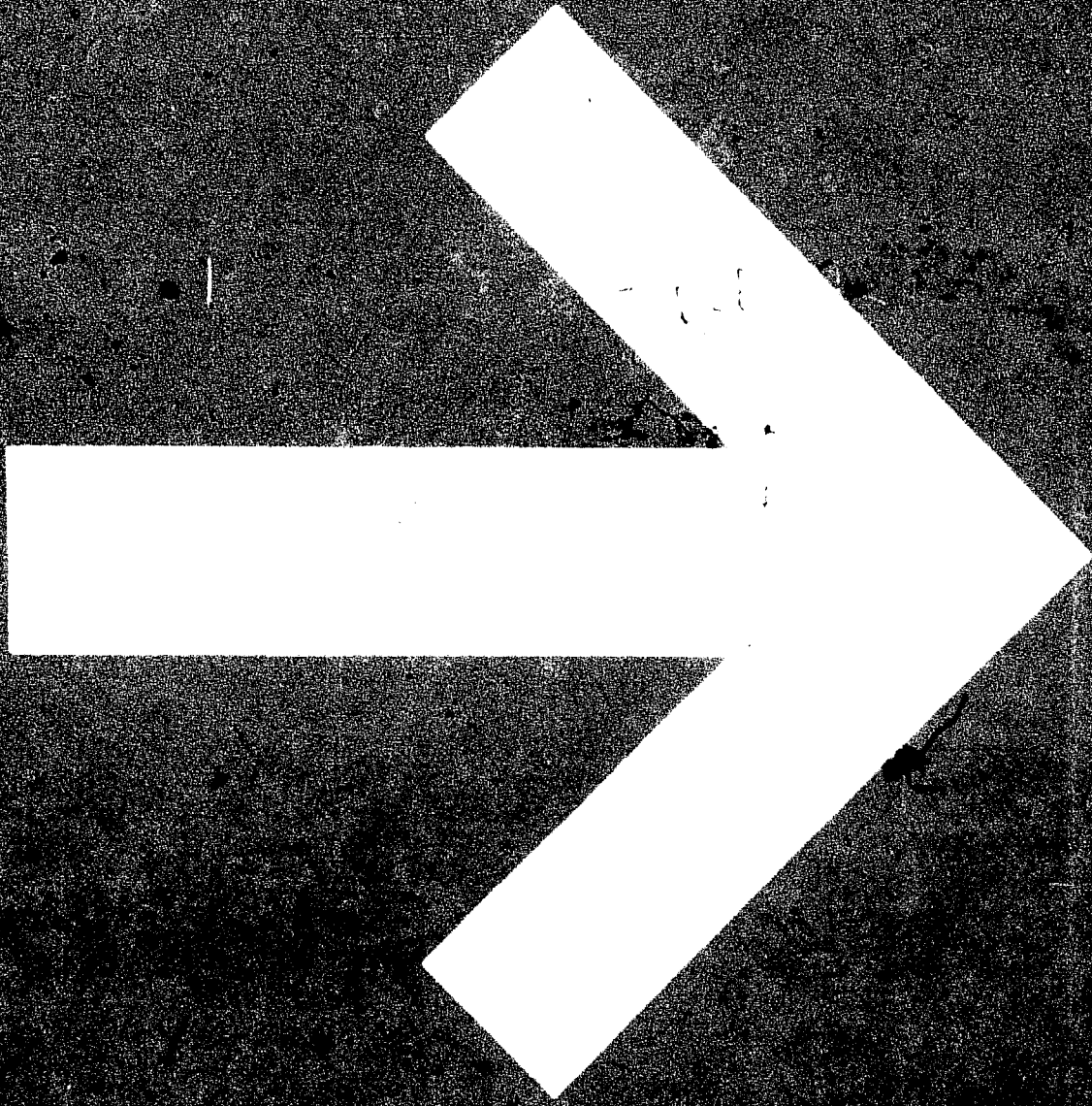

## CONTENTS

	<u>Page</u>
<b>INTRODUCTION</b> .....	1
<b>BASIC WORK AND MAINTENANCE TOOLS</b>	
HAND TOOLS FOR WOOD HARVESTING .....	4
FILES .....	6
GRINDSTONES AND WHETSTONES .....	8
SPLITTING HAMMER AND WEDGES .....	10
MAKING TOOL HANDLES .....	12
<b>AXES</b>	
USE AND TYPES OF AXES .....	14
MAINTAINING AN AXE .....	16
MAKING AN AXE HANDLE .....	20
SHAFTING AN AXE .....	22
<b>BOW SAWS</b>	
USE AND TYPES OF BOW SAWS .....	24
<b>CROSS-CUT SAWS</b>	
TYPES OF CROSS-CUT SAWS .....	26
MAINTENANCE TOOLS FOR CROSS-CUT SAWS .....	28
FILING VICES, SELF-MADE .....	30
FILING VICES, COMMERCIALY-MADE .....	32
MAINTAINING A PEG-TOOTH CROSS-CUT SAW .....	34
TYPES OF RAKER-TOOTH CROSS-CUT SAWS .....	36
MAINTAINING A RAKER-TOOTH CROSS-CUT SAW .....	38
MAJOR OVERHAUL OF CROSS-CUT SAWS .....	42
<b>THE WORKER</b>	
CLOTHING, PERSONAL PROTECTIVE EQUIPMENT, FIRST-AID EQUIPMENT .....	44
FOOD, NUTRITION AND REST .....	46
WORKING POSTURES AND MOVEMENTS .....	48

	<u>Page</u>
<b>THE WORKER (continued)</b>	
WORK PLANNING AND ORGANISATION .....	52
ACCIDENT PREVENTION .....	54
<b>TREE FELLING</b>	
PREPARATION FOR TREE FELLING .....	58
TREE FELLING WITH AXE AND BOW SAW .....	60
TREE FELLING WITH AXE AND CROSS-CUT SAW .....	62
PRECAUTIONS WHEN MAKING THE UNDERCUT AND THE BACK CUT .....	64
FELLING TREES LEANING INTO THE PLANNED FELLING DIRECTION .....	66
FELLING TREES LEANING TO THE SIDE .....	68
FELLING TREES IN DENSE TROPICAL FORESTS .....	70
FELLING OF TREES WITH PLANK BUTTRESSES .....	72
WOOD WASTAGE DUE TO POOR WORKING TECHNIQUES IN FELLING .....	76
<b>RELEASING LODGED TREES</b>	
RELEASING LODGED TREES WITH SIMPLE TOOLS .....	80
RELEASING LODGED TREES WITH SPECIAL EQUIPMENT AND MACHINES .....	82
<b>DEBRANCHING AND DEBARKING</b>	
DEBRANCHING .....	84
DEBARKING .....	86
<b>CROSS-CUTTING</b>	
GENERAL RULES FOR CROSS-CUTTING .....	88
TOOLS FOR CROSS-CUTTING .....	90
SUPPORTS AND TRESTLES .....	92
CROSS-CUTTING OF TREES UNDER TENSION .....	94
WOOD WASTAGE IN CROSS-CUTTING .....	96
<b>CUTTING WINDFALLS .....</b>	<b>98</b>
<b>WOOD SPLITTING .....</b>	<b>100</b>

	<u>Page</u>
<b>WOOD HANDLING AND TRANSPORT</b>	
HANDLING BILLETS AND LOGS .....	102
MANUAL TRANSPORT OF SMALLER-SIZED WOOD .....	104
USE OF SKIDDING SULKIES .....	106
SLIDING WOOD DOWNHILL .....	108
<b>STACKING AND STORING OF WOOD .....</b>	<b>110</b>
<b>PIT-SAWING .....</b>	<b>112</b>
<b>TRAINING IN WOOD HARVESTING .....</b>	<b>114</b>



## INTRODUCTION

This training manual updates and amalgamates the following previous ILO publications:

- Felling and cross-cutting of tropical trees in natural forests (1969); and
- Selection and maintenance of logging hand tools (1970).

These publications were prepared by B. Strehlke, on the basis of substantial inputs from H. Gläser and R. Wettstein and with illustrations by B. Schmidle. The first of these two publications dealt with axes, hand saws and chain saws. Its English version has been out of print for several years. In 1980, in collaboration with the FAO, the section dealing with chain saws was expanded to include work in man-made forests and chain-saw maintenance and this was published separately under the title:

- Chainsaws in tropical forests (Rome, FAO/ILO, 1980).

During the last decade, the use of chain saws has spread increasingly to the developing countries where they are found in commercial logging operations, especially in countries with higher wage levels. However, wood harvesting with manual tools continues on a large scale and, with the shift of emphasis to trees grown by rural people, it will gain more importance in the years to come.

It is for this reason that a need was felt to compile information on basic wood harvesting, excluding machines and techniques which in many developing countries are out of reach of the rural population. This view was fully supported by the participants in an FAO/ECE/ILO Workshop on the Transfer of Basic Technology, held in 1986.

For several years it looked as if experience in efficient basic logging and supplies of hand tools of adequate quality would become less and less available. This trend has changed thanks to the manufacture of improved forestry tools in several developing countries and the reappearance of logging hand tools in the catalogues of some of the major dealers in forestry tools and equipment.

Attempts have also been made in Central Europe and Scandinavia to keep alive experience in manual logging accumulated in previous periods and to encourage further improvement of manual tools and techniques. An example of this is the logging sulky of which a bogie type has been developed only recently.

This manual is addressed primarily to trainers, extension workers, work supervisors and foremen.

As in the three publications mentioned above, an attempt has been made to use simple terms and to describe as much as possible by means of drawings. Users are encouraged to translate the text into other languages and to copy illustrations in any way they might find useful for training purposes.

The reader interested in supplementary information is referred to the following publications:

- Equipment planning guides for vocational and technical training and education programmes: No. 17 - Forestry (Geneva, ILO, 1981);
- Basic technology in forest operations (Rome, FAO, 1982);
- Swedish forestry techniques with possible applications in the Third World (Spånga, SIDA, 1983);
- Handbook on appropriate technology for forestry operations in developing countries (Helsinki, FINNIDA, 1986).







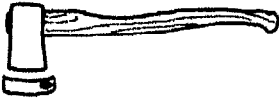
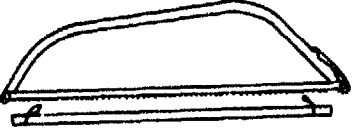
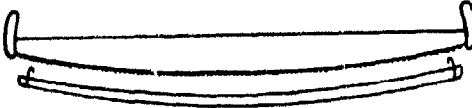

The present publication was compiled by B. Strehlke in collaboration with E. Fosser. Hazel Cecconi edited and typed the text and Michel Bagès amended and supplemented the drawings. DANIDA provided the finance.

**HAND TOOLS FOR WOOD HARVESTING**

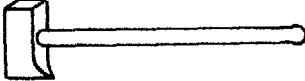
The following tools are needed for efficient manual wood harvesting:

- (1) Axe (weight between 0.8 and 1.5 kg)
- (2) One-man bow saw (length approx. 1 m)
- (3) Cross-cut saw (length usually 1.20-1.60 m)
- (4) Machete
- (5) Splitting hammer (weight about 2.5 kg)
- (6) Wedges (for felling, cross-cutting and splitting)
- (7) Turning hook
- (8) Timber tong and timber pick
- (9) Measuring stick or tape measure
- (10) Caliper (to measure diameter)
- (11) Debarking spade

More detailed information is given in: Equipment planning guide for vocational and technical training and education programmes: No. 17 - Forestry (Geneva, ILO, 1981).

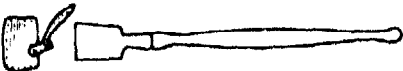
- ① 
- ② 
- ③ 
- ④ 
- ⑤ 
- ⑥ 
- ⑦ 
- ⑧ 
- ⑨ 
- ⑩ 
- ⑪ 

## FILES

The following types of file will commonly be used for maintaining forest tools. An effort has been made to keep these to the minimum to simplify stocking and distribution.

### For cross-cut saws

Millsaw file, 20 cm, single cut, smooth (22.4 cuts per cm), flat with two round edges for sharpening cutter and raker teeth and for deepening small gullets (1).

A worn file of this sort can be used for jointing the saw and for lowering the raker.

Round file, 25 cm, constant diameter of 12.5 mm for deepening the big gullets between rakers (2).

### For axes and other edged tools

Millsaw file, 25 cm, single cut, tapered or blunt for reshaping (3).

### For tool handles

Wood rasps are used for shaping wooden handles (4). They must never be used on metal.

### File handles

A file or rasp must never be used without a handle (5). The handle should have a length of 12 cm.

### Care of files

When file or rasp teeth become clogged, they must be cleaned with a wire brush (file card) which must be kept clean and dry (6).

Files must never be allowed to become rusty, knocked or dropped and are best kept in a canvas holder when not in use.

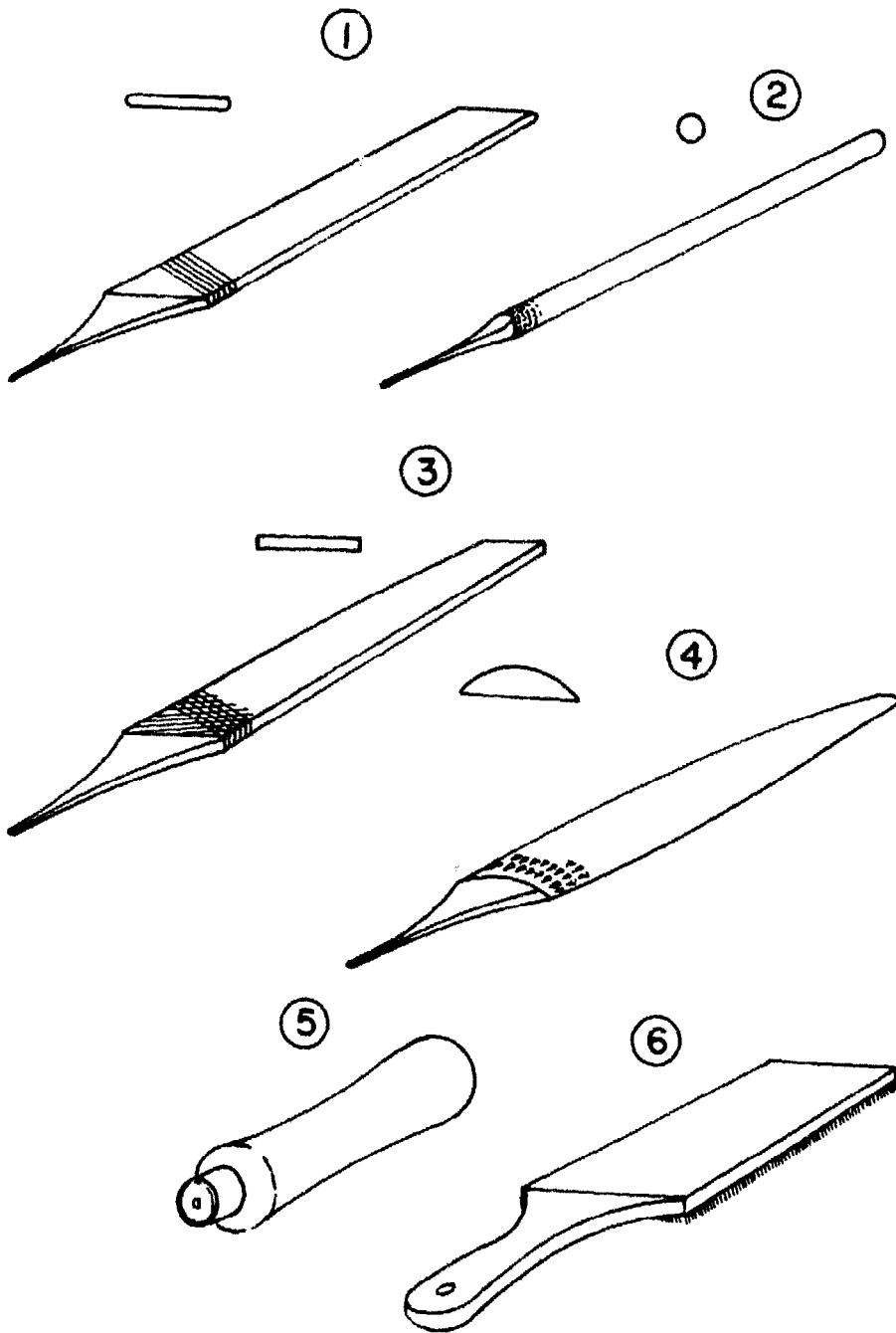

### GRINDSTONES AND WHETSTONES

For sharpening axes, debarking spades and other cutting tools, revolving grindstones operated by hand or foot are used for regular overhauls (1). They should have a minimum diameter of 50 cm and a minimum width of 10 cm, be made of sandstone or appropriate artificial material and be used with water. When not in use, the stone must be kept dry to prevent moisture softening the part of the stone under water. From time to time, the stone must be "dressed", that is, restored to its original circular shape.

Grindstones can easily be made locally from 20 litres of good quality cement and 50 litres of quartzitic sand with 1 mm or smaller particle size. The sand must be sieved (e.g. with mosquito netting), be washed and clean from clay or salt. In addition, an iron tube or rod is needed, about 60 cm length and 2 cm diameter with a nail welded to its middle.

The grindstone is made in a wooden mould (2) which is set up in a shady place. The mould is approximately 50 by 50 cm in size and 15 cm high. It consists of two parts (2a) which are placed on a board (2b) resting on two supports (2c).

Exactly in the centre of the mould the iron rod is placed, forming a perfect right angle with the mould and securely held in position by small boards nailed on the mould (3a).

After filling the mould with mortar and compacting it carefully, the grindstone is left to dry for about three days. Some sprinkling with water may be required to avoid too rapid drying.

After removing the grindstone from the mould, the stone is placed in a trestle with a piece of an old tyre fitted underneath as a water container (4a).

This type of grindstone is also handy for sharpening agricultural tools such as hoes and spades and should be available in any village.

In addition to grindstones, whetstones are necessary where edged tools are in use for frequently touching them up during the day. They are also used for finishing axes after grindstone work and saws and axes after filing. Whetstones with a coarse and a fine side, of pocket size (5 by 10 cm), are required (5).



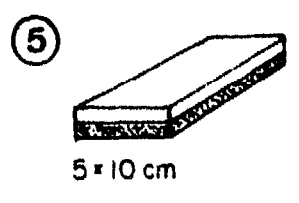
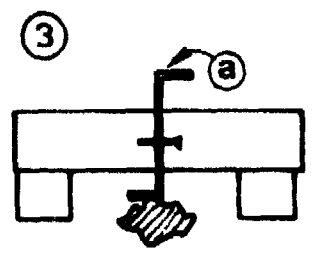
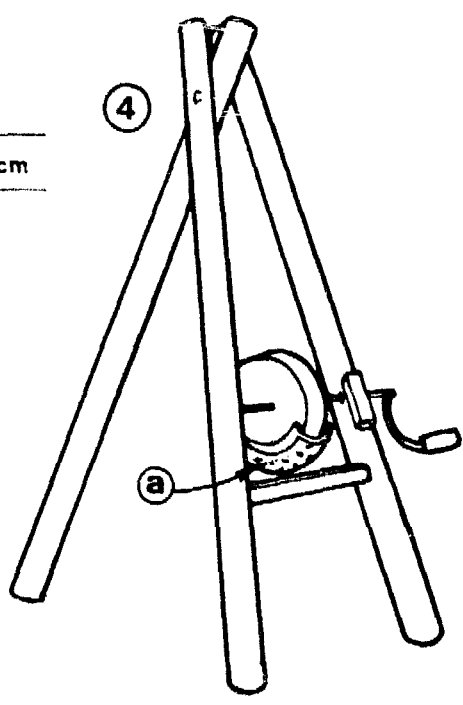
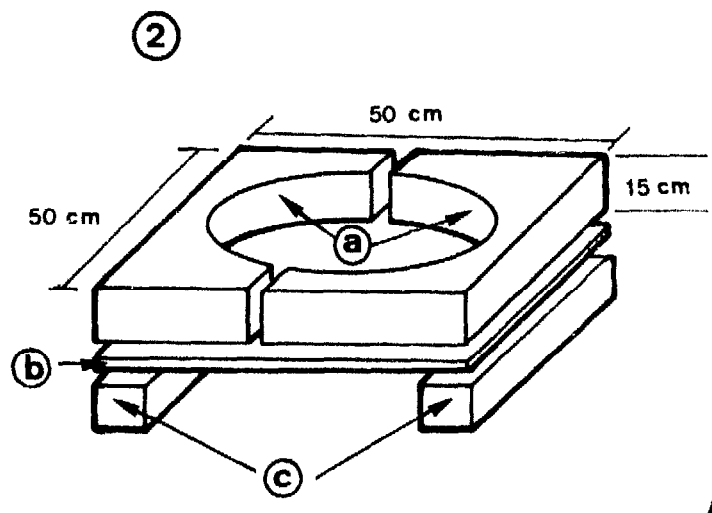
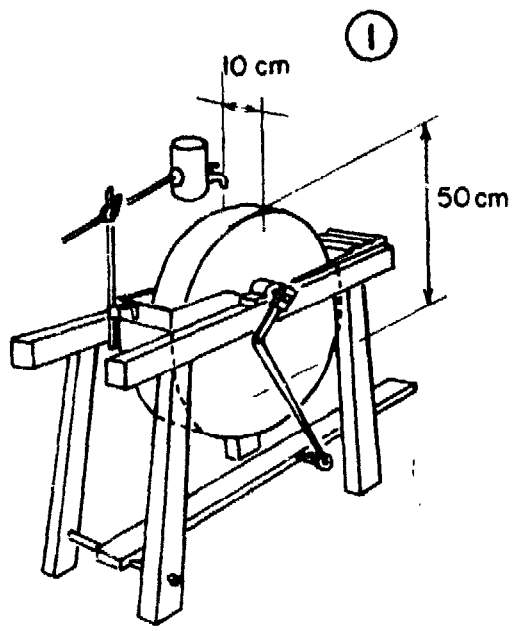

### SPLITTING HAMMER AND WEDGES

To avoid the saw blade getting caught in the saw cut (pinching), and to lift the tree into the intended direction of fall and for splitting wood, a splitting hammer (1) and wedges (2) are needed.

The splitting hammer should have a weight of about 2.5 kg and a straight handle about 90 cm long. For splitting, the edge should be kept sharp.

Wedges should preferably be made from aluminium alloys. They can also be made from hard wood. Steel wedges have the disadvantage of being very heavy and dangerous if splinters break off.

Three types of wedges are suggested for use:

Type 2a is a wedge commonly used for tree felling with a rather large surface and a narrow angle, opening up closed saw cuts even under very high pressure.

Type 2b consists of a metal shoe and a wooden head which can be replaced after wear. Additionally, the wooden head is secured with a metal ring. This type of wedge has a wider angle and therefore opens the saw cut farther up than type 2a. In the absence of a metal shoe, the head of a wooden wedge may be fitted with an iron ring to reduce wear.

Type 2c, made from metal, is very convenient for cross-cutting and felling. It can be carried in the pocket and should be inserted in the saw cut as a measure of precaution before the saw cut closes.

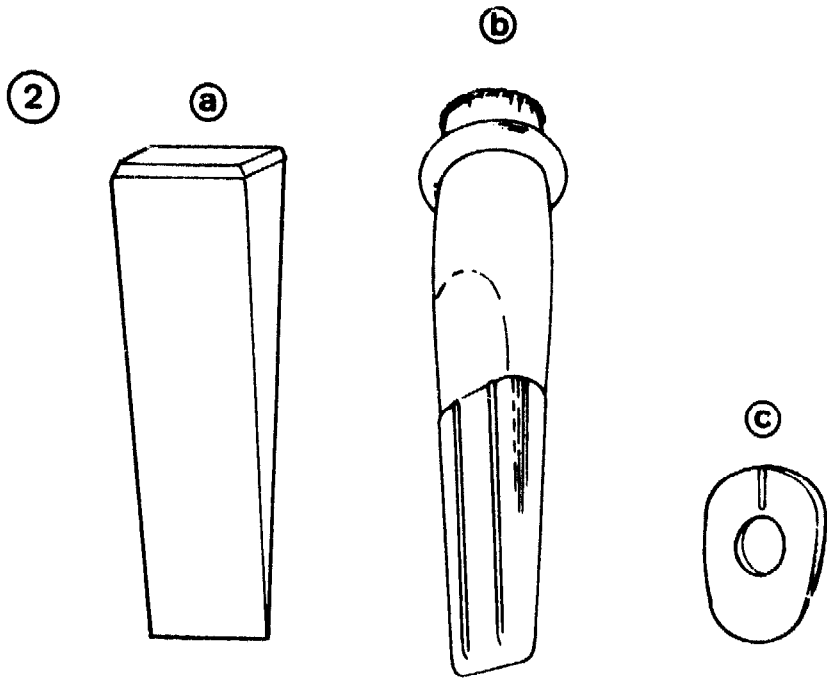
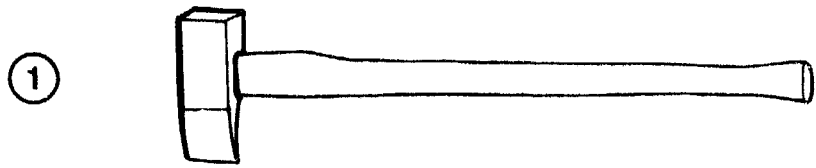

### MAKING TOOL HANDLES

This simple construction made from wood and two pieces of an old tyre (1a) is very practical for holding a piece of wood when making a handle.

The vice is closed when the platform is down (1b). It opens when the platform is lifted (2a). The tool is firmly held between the two rubber pieces when the worker is standing on the platform. His elbow height should then correspond to the height of the opening of the vice.

Good tool handles, for instance of axes, hooks and hoes, are extremely important to ensure that work can be done conveniently and efficiently. The handle should fit the worker (size of hand, length of arm, height) and the size and weight of the tool. It should be made from suitable wood in order to last for a long time.

The vice can be used for other purposes as well, such as holding an axe during sharpening.

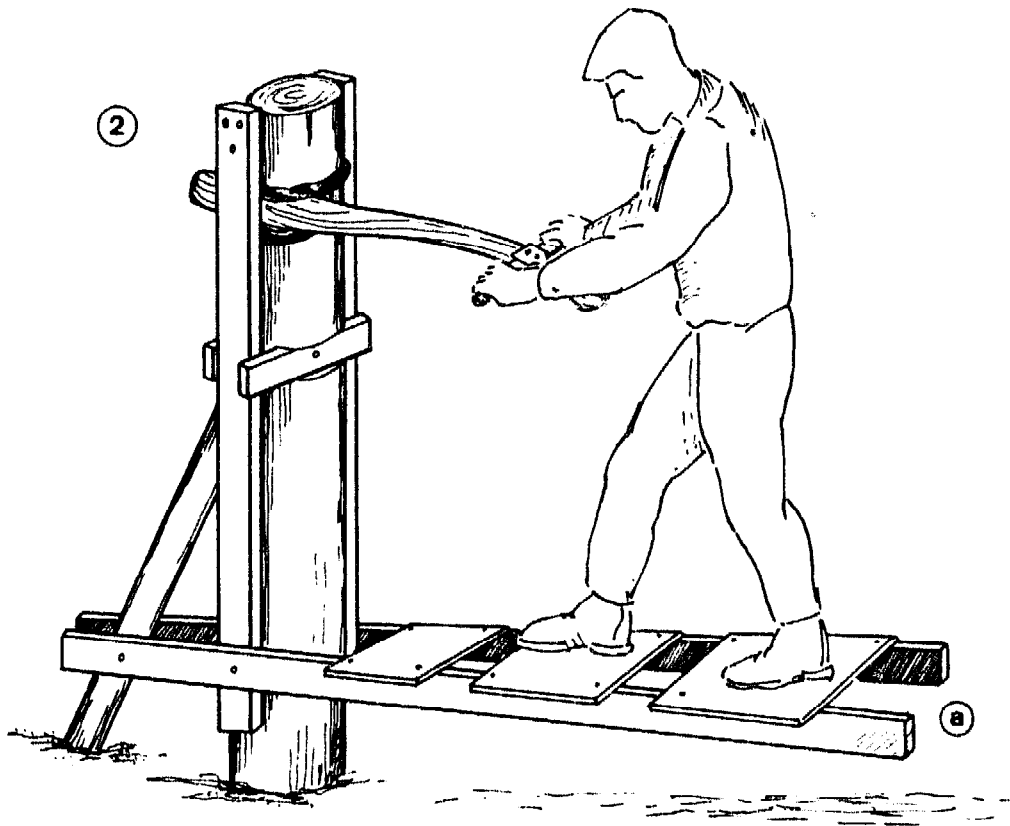
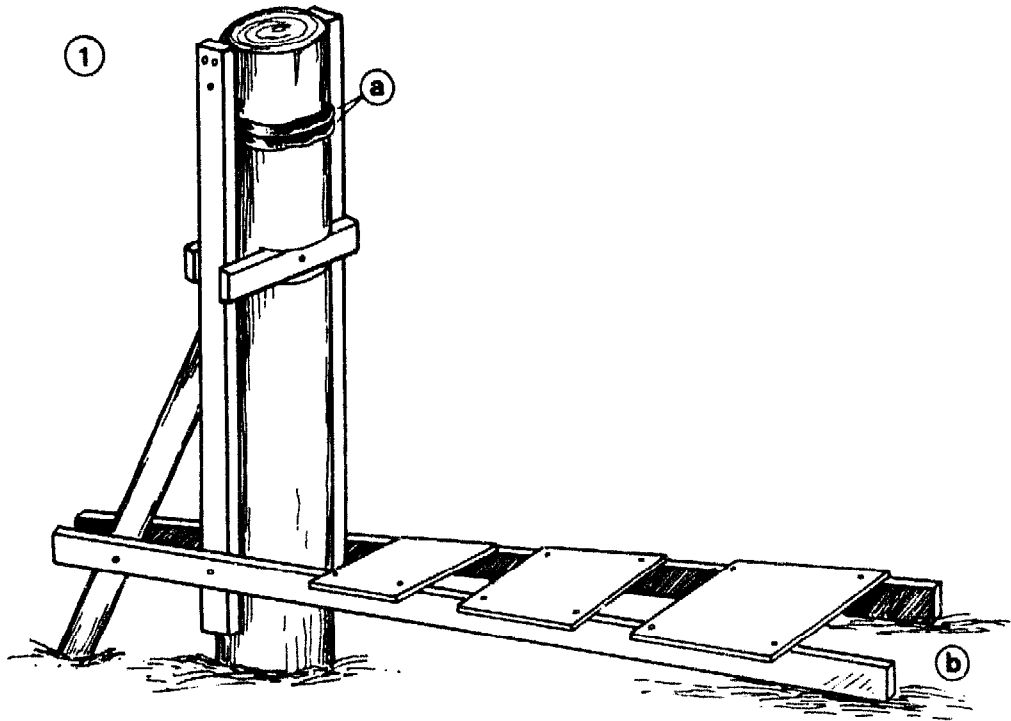

## USE AND TYPES OF AXES

In traditional wood harvesting, the axe is used as a universal tool for felling, debranching, cross-cutting, splitting and debarking.

The main advantages of axe work are the simple tool outfit and easy maintenance.

However, it is heavy work and may waste a lot of wood and cause many accidents, including very serious ones.

Axe work should be restricted to the felling of very small trees, to preparation for the felling of larger ones and to debranching.

Axes made by local blacksmiths may be quite good for traditional use if they are properly hardened and well shafted.

The axe consists of a steel head fitted to a wooden handle. The most important part of the head (1) is the blade (1a), ending in the edge (1b). The wooden handle is fitted into the eye (1c). Modern axes are shaped like a wedge and have an oval eye which prevents the handle from turning in the eye.

Special types of axes can be used for felling and debranching. However, in most cases a universal axe is used for both jobs.

For professional work, the type of axe shown in the picture is recommended (2). The weight should be from 0.8 to 1.5 kg, the length of the handle from 60-80 cm, depending on the length of the worker's arms (3). The handle should have fawnfoot shape (2) and be made of strong wood. Workers should be able to make handles and to replace broken handles themselves. During transport, the axe blade should be secured with a protective cover which can be made easily, e.g. from a worn bicycle tyre (2a).

To keep the axe sharp, repeated maintenance is needed during the course of the day using a whetstone (see page 8).

①

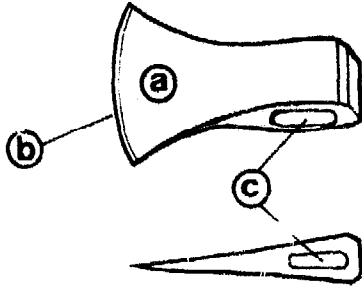

②

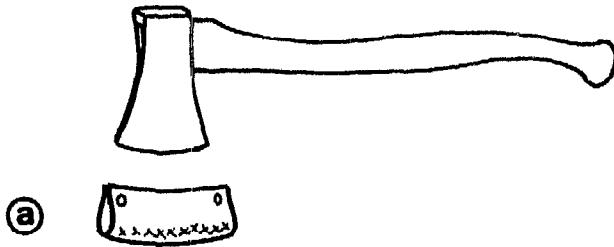

③

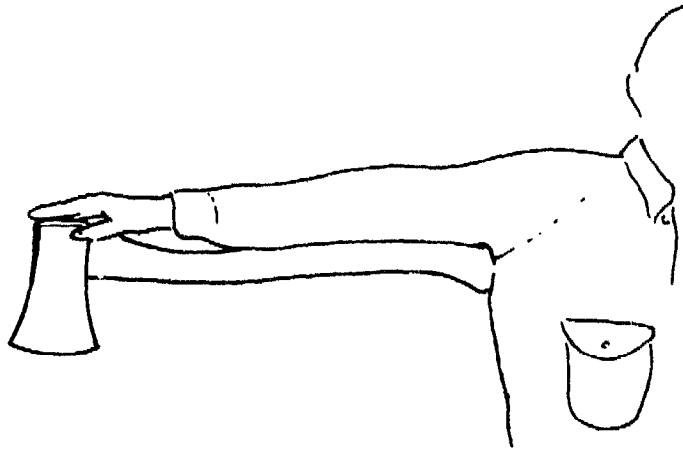

## MAINTAINING AN AXE

### Taper

The axe blade has a curved taper towards the edge. During sharpening it is important that the correct taper is maintained.

Heavy axes and axes used to cut hard wood and frozen wood require a stronger blade close to the cutting edge (1a).

Lighter axes and axes used for soft wood should be thinner close to the cutting edge (1b).

Although wood of coniferous trees is usually soft, branches may be very hard and axes may require the same taper as for hard wood.

### Taper gauge

The taper of new axes is usually suitable for average conditions. A gauge can be made from a piece of metal sheet corresponding to the taper of the new axe (2a). This gauge can be used during maintenance. If the axe "bites", the taper is too small and if the axe does not penetrate enough into the wood, the taper is too big. Adjustments are made during maintenance and when the taper corresponds to the requirements, the taper gauge can be adjusted accordingly.

### Daily maintenance

Hone the axe several times daily with a whetstone (3). Use water or spit on the whetstone to keep it moist. Honing is done downwards on one side with the handle down (3a) and on the other side with the handle up (3b).



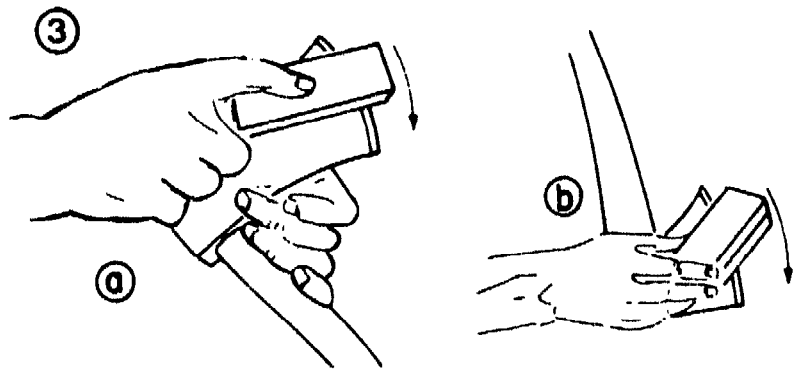
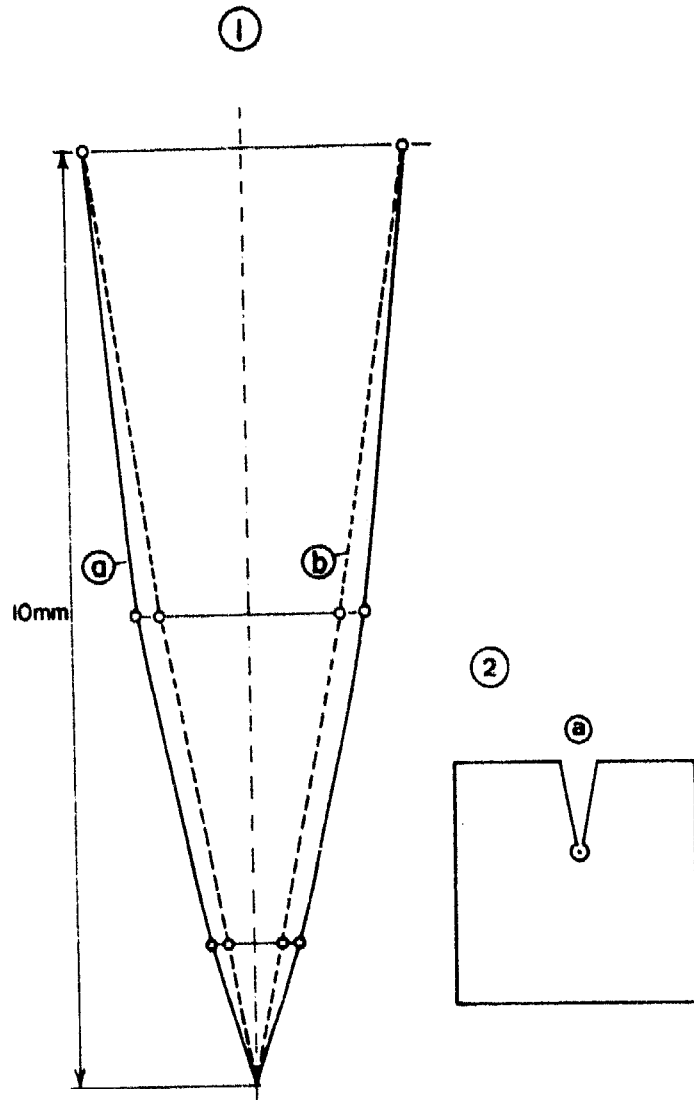

**MAINTAINING AN AXE** (continued)**Major overhaul**

This is done at intervals of about a week or longer depending on the use of the axe. Major overhaul is done by the following steps:

- Check curve of edge with a new axe or a curve gauge (1). A curve gauge can be made locally from a metal sheet (1a), using a new axe to copy the correct curve.
- If necessary, correct curve with millsaw file (page 6), holding the axe in a vice (2).
- Grind axe blade on grindstone in zone 3a, by moving the axe from right to left (4) and at the same time up and down (5). Grind zone 3b only at longer intervals, if necessary, by moving the axe from left to right (4).
- Final honing is done as for daily maintenance with a whetstone to remove burrs and to polish the surface of the axe (see 3, previous page).

If a grindstone is not available, a millsaw file can be used for sharpening. Care must be taken to file a correct taper. Always move file away from the cutting edge.

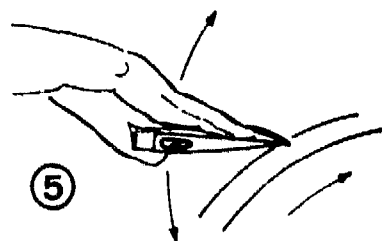
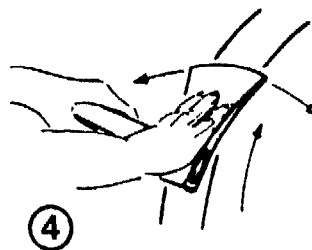
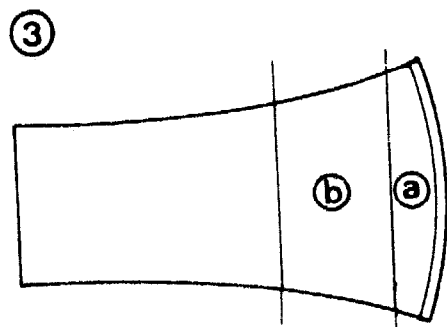
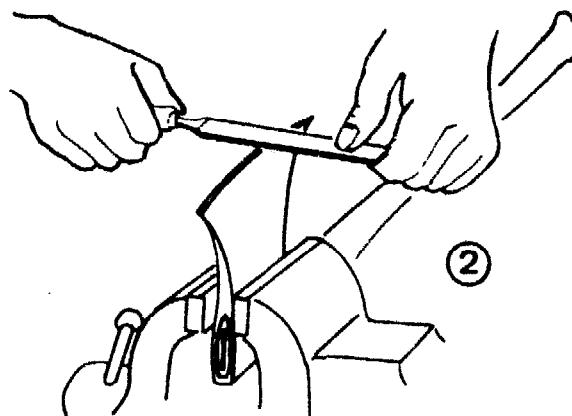
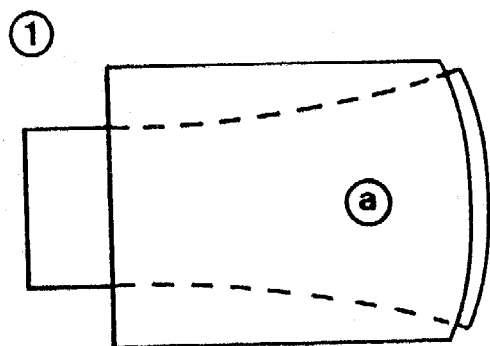

### MAKING AN AXE HANDLE

To make an axe handle, hardwood of high elasticity and strength is taken from the butt end of a young tree or from the outer zones of an old one. The wood must be well seasoned. It should have straight fibres and be free of knots and bends.

A scantling is sawn or squared with an axe out of a suitable piece of wood (1). Annual rings should run through the scantling as indicated in the drawing (2a). The scantling must be well seasoned before the handle is made.

A model of a fawnfoot handle is used for drawing the outline of the handle on the scantling (2b). The model can be copied from a new handle on a piece of cardboard.

A bow saw is used for making cuts into the wood to be taken off from the scantling (2c).

An axe can be used for shaping the outline of the handle.

Final shaping is done with a spokeshave (3), if available, and a wood rasp (see page 6).

The handle is finished by polishing with sandpaper (4), a piece of glass (for instance, window glass), or a knife.

Making an axe handle is easier if a vice can be used (see page 12).

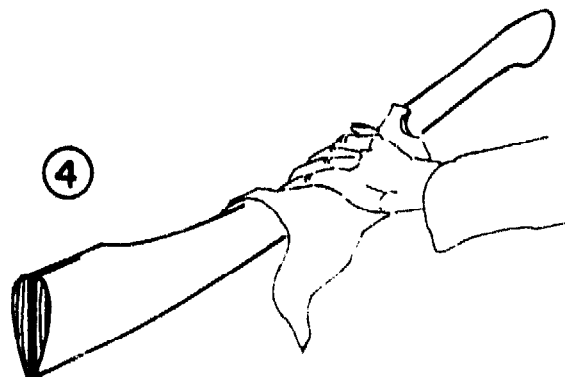
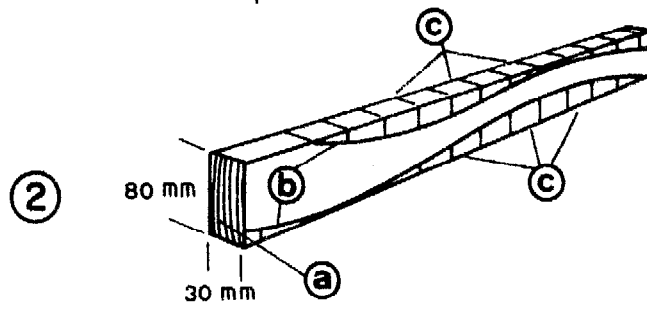
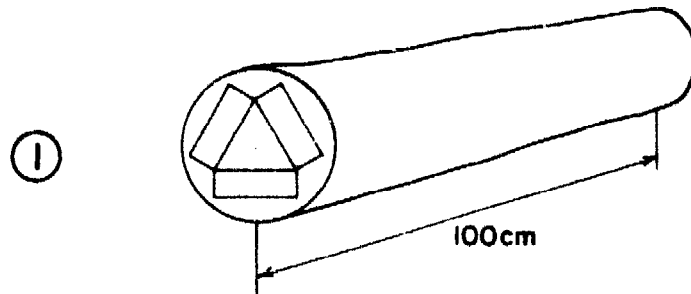

### SHAFTING AN AXE

When shafting an axe, care must be taken to ensure:

- that the blade and the handle are in exactly the same plane (1);
- that the centre of the blade touches the surface if the axe is placed with the blade and the end of the handle on a level surface (2).

Shafting is done by the following steps:

- Fit the handle exactly to the eye of the axe, preferably with a wood rasp (3).
- Put handle into the eye (4) and test for correct alignment (1, 2).
- Take the handle out and cut with a knife or axe to the depth of the eye (5).
- Put the handle into the eye again and drive a small hardwood wedge into the saw cut (6).
- Test for correct alignment (1, 2). If necessary, adjust alignment with the wood rasp after having taken off the head of the axe once more.
- If the alignment is correct, put 2 small nails across the handle, and wedge it above the head of the axe (6a), saw off the protruding part of the handle and wedge about 1 cm above nails.

Note: If an axe is reshafted, drive the remaining wood out of the eye either from the unwedged side or from the wedged side once nails and wedge have been removed. Never burn wood still remaining in the eye: by doing this, the axe's temper would be lost and it would become useless.

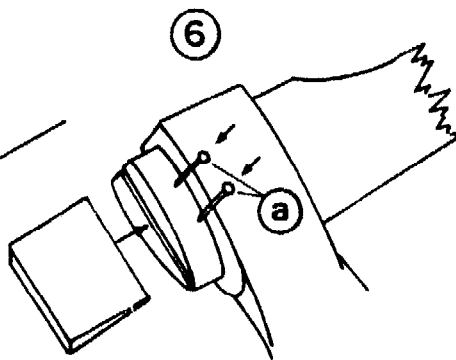
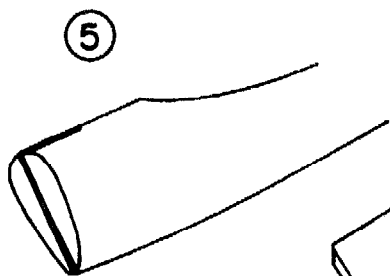
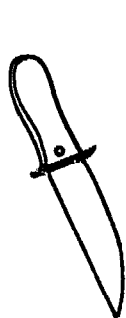
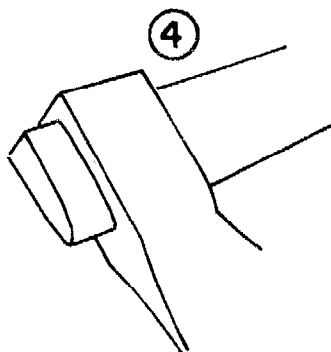
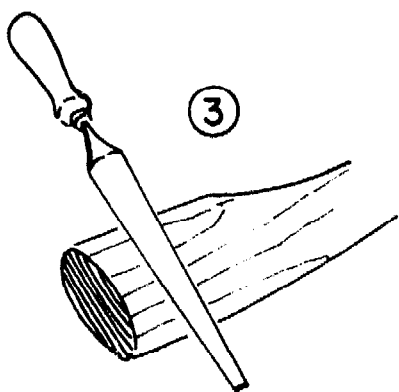
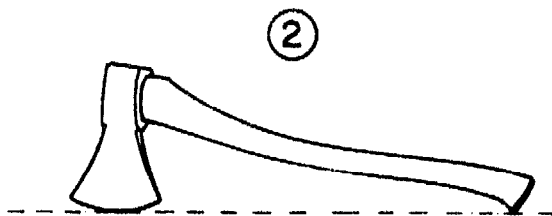

### USE AND TYPES OF BOW SAWS

Bow saws are handy for felling and cross-cutting small trees provided the wood is not too hard.

For professional use, the bow saw should consist of a high-quality oval steel frame holding a thin blade under high tension (1). A protective cover is needed to guard the blade during transport (1a).

A one-man bow saw with an asymmetric frame of approx. 100 cm length is recommended (1). There are also models with a symmetric frame and one side of the bow extended into a handle which allows more force in cutting but restricts movement if space is narrow (1b).

For a frame of 100 cm length, the corresponding saw blades (2) are 91.5 cm long and usually have hard-pointed peg teeth (2a) or raker teeth (2b).

When a hard-pointed blade loses its set and starts pinching, it should be re-set with setting pliers (3).

When the blade becomes dull, it can be re-sharpened with a whetstone (4). If the saw runs to one side, the whetstone should be used on the side to which it is running (5).

Hard-pointed blades wear out after some time and must then be discarded. Great care must be taken during cutting to avoid contact with soil, sand and stones.



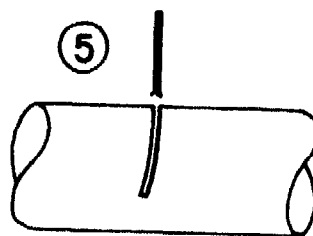
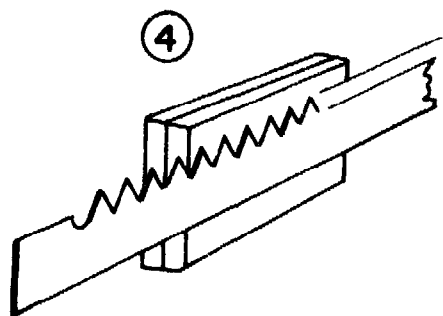
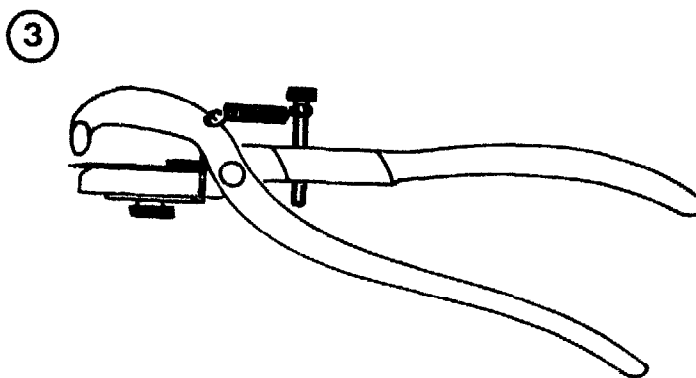
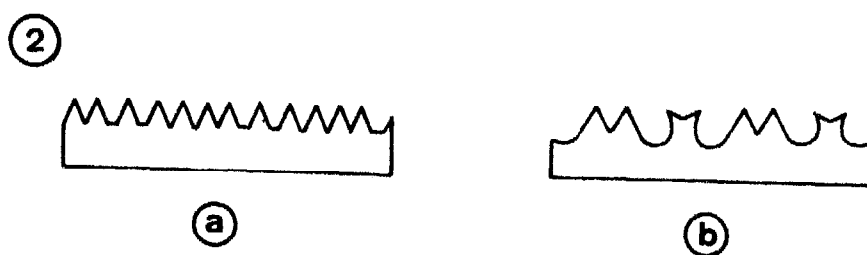
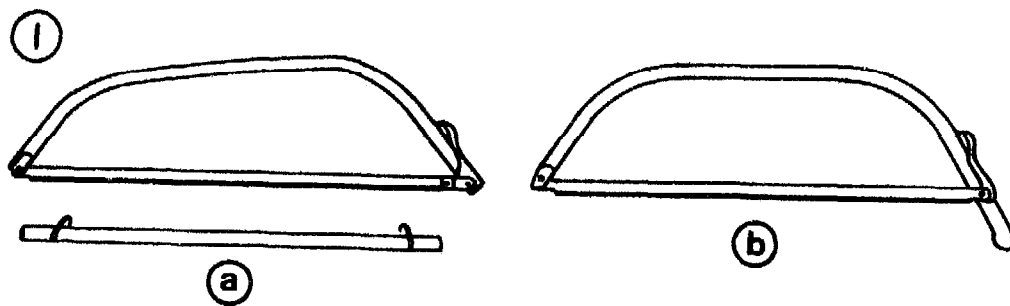

### TYPES OF CROSS-CUT SAWS

If cross-cut saws are used, a comprehensive tool outfit is required. The saw must be well maintained in order to make the job easy and efficient. Properly maintained saws require less energy in use and increase production.

The saw should be made of high-quality steel. For large trees, a straight-back type of saw is preferable (1a) and for small to medium trees a hollow-back type. The cutting edge should be thicker than the back in order to reduce friction and the risk of "binding". The length of the saw should be 100 cm plus the diameter of the tree. The saw should be fitted with detachable handles (1b) which can easily be screwed on and off. A protective cover (1c) is needed to guard the cutting edge during transport.

Peg-tooth type saws are common because they are easy to maintain (2a).

Raker-tooth type saws are preferred by professional workers. They cut faster but require more skill in maintenance (2b).

Saw teeth must do three things:

- cut through the fibres;
- break loose the cut fibres;
- remove the loose fibres (sawdust) from the kerf.

In peg-tooth saws, these three things are done by one tooth. In raker-tooth saws the first of the three actions is done by a group of cutters cutting on alternate sides of the kerf. The second and third actions are done by the raker following the group of cutters.

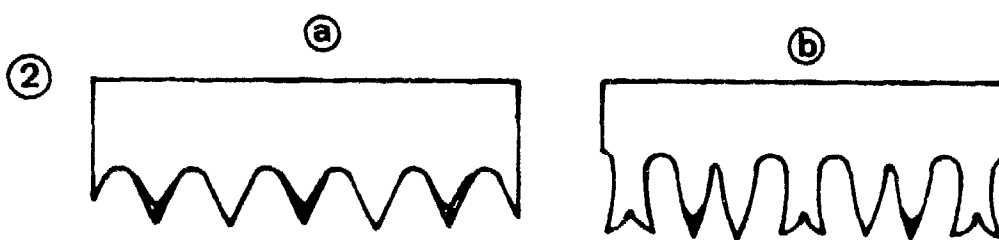
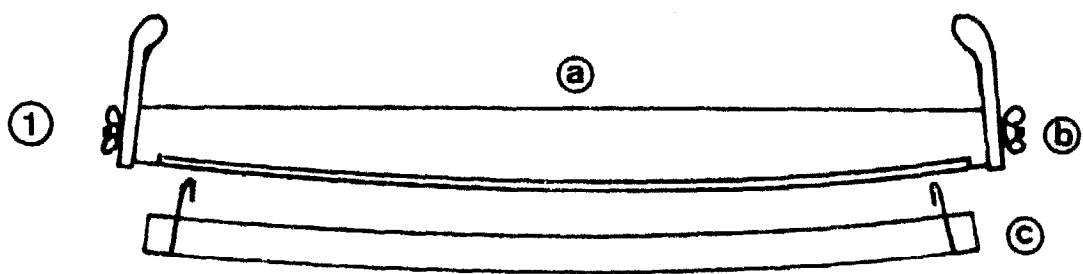

**MAINTENANCE TOOLS FOR CROSS-CUT SAWS**

The following maintenance tools are necessary for peg-tooth type saws:

- |   |   |
|---|---|
| (1a) Millsaw file (single cut)                          | (1e) Setting iron                               |
| (1b) Jointer, commercial or self-made using a worn file | (1f) Setting indicator, commercial or self-made |
| (1c) Angle gauge  | (1g) Whetstone                                  |
| (1d) Filing grid  | (1h) Filing vice                                |

(The self-made setting indicator consists of a piece of wood with three metal pins of the same length in a fixed position and an adjustable screw-type pin.)

For raker-tooth type saws, the same maintenance tools are needed, except for the following differences:

- a raker adjuster (or a combined raker adjuster and shaper) (2a) is necessary; and
- a setting hammer (2b) and a setting anvil (2c) replace the setting iron.

①



e



b

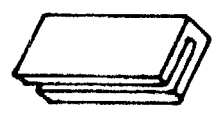

f

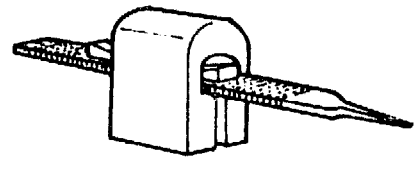

g



c



d

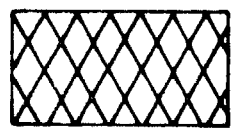

h

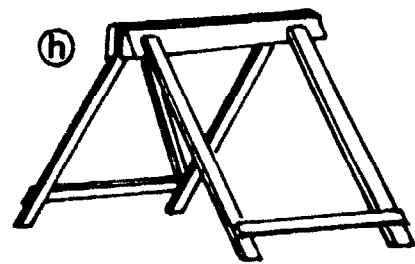

②

a

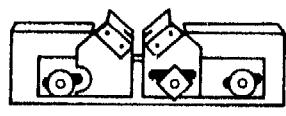
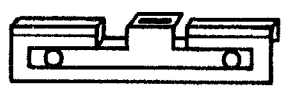

b

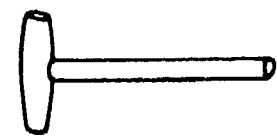

c

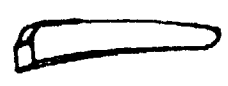

### FILING VICES, SELF-MADE

A filing vice holds the saw firmly in position during maintenance. Peg-tooth saws are held vertically. Filing vices for raker-tooth saws must hold the saw-blade firmly in vertical and oblique positions that can be easily changed. Opening and closing should be easy. Saw vices must have a length of at least 50 cm, preferably more. They must be steady. The saw should be held at the height of the worker's elbow allowing a comfortable working position whether he is standing or sitting.

A filing vice can easily be made from a standing tree of no or little commercial value sawn off at elbow height. As required, vertical and oblique cuts are made into the stump. The saw can be firmly held in these cuts by using small wooden wedges (1).

The Swedish saw vice (2) is built of two boards (2a) enclosing a wedge-shaped centre piece (2b) and connected by three leather straps (2c). Four wooden legs (2d) are screwed on to these boards. When the vice is erected, the saw is held between one of the two boards and the centre piece in a vertical or oblique position.

The Swedish saw vice can be made easily from locally-available materials and is easily transportable.

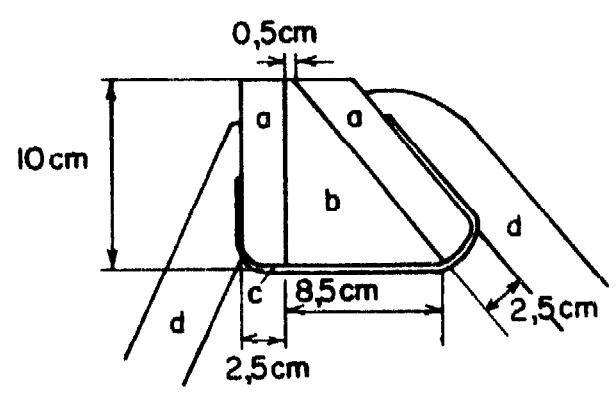
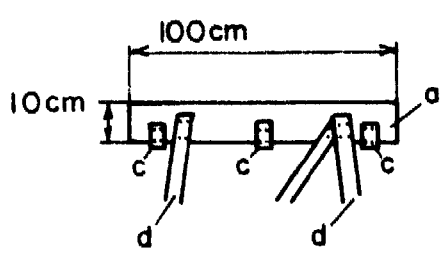
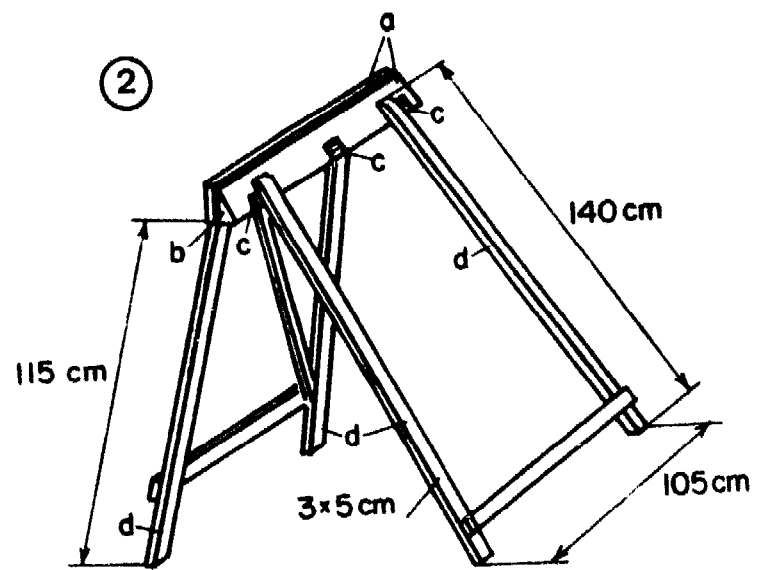
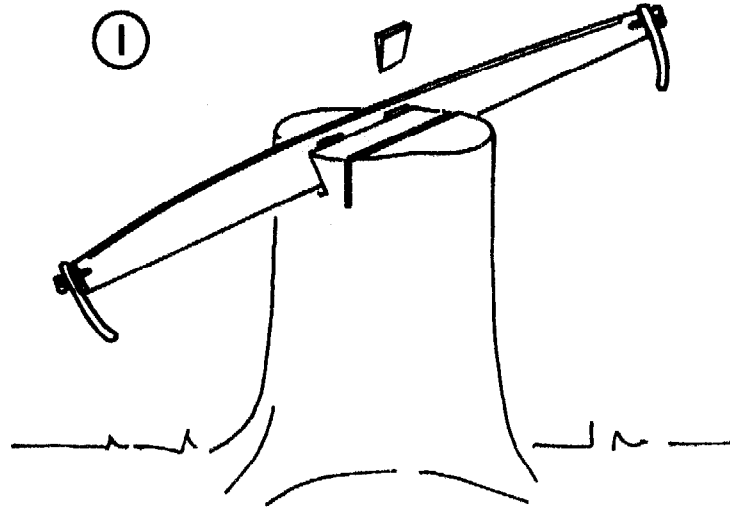

**FILING VICES, COMMERCIALY-MADE**

Commercially-made filing vices are available in various types. Two handy examples are given:

The Swiss filing bench has the advantage of enabling the worker to sit during filing (1).

An engineer's vice can be used as a filing vice by inserting two pieces of wood in a vertical position connected with flap hinges between the vice jaws. An oblique position of the saw can be arranged using two wedges (2).



①

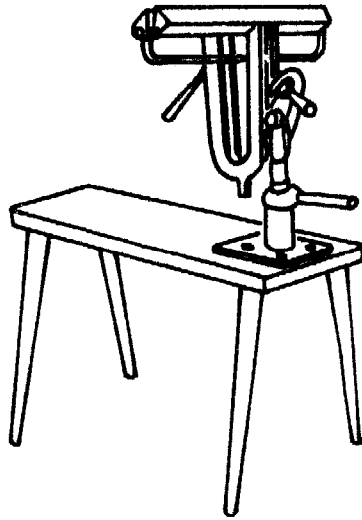

②

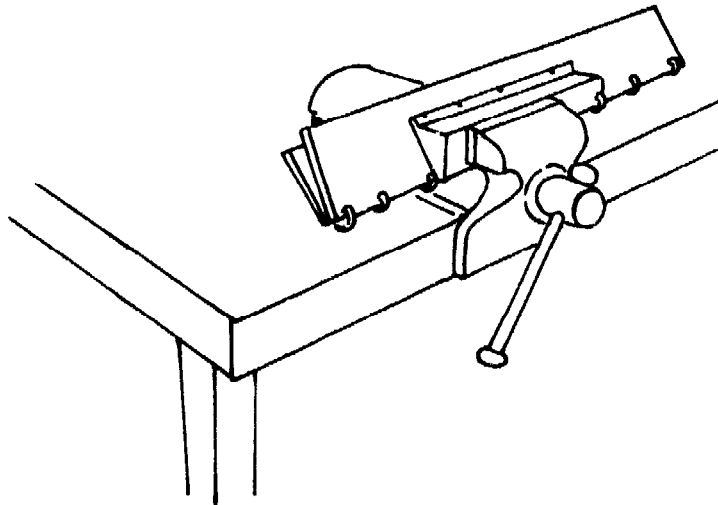

### MAINTAINING A PEG-TOOTH CROSS-CUT SAW

The following measures are recommended for triangular teeth:

<u>Hardness of wood</u>	<u>Distance between points of two teeth</u>	<u>Height of tooth</u>	<u>Width of gullet between two teeth</u>
Hard	17 mm	16 mm	6.0 mm
Soft	9 mm	12 mm	0.5 mm
Mixed hard and soft	14 mm	15 mm	3.7 mm

Maintenance starts with jointing while the saw is firmly held in a vertical position by the filing vice. The jointer is run along the saw teeth using very little pressure (1). In normal use, the teeth in the middle of the saw will wear more quickly than those at the end. This is adjusted by increased pressure at the beginning and the end of the jointing stroke.

The jointing is continued until all cutter teeth show a small "flat" and jointing should stop when this happens. One or a few (if evenly distributed) badly worn or broken teeth are not considered. Further jointings will bring them back into the tooth line.

Cutter teeth filing is done with a 20 cm millsaw file using horizontal strokes parallel to the lines of a grid attached to the vice (2). The sharpening angle marked on the grid (2a) is  $70^\circ$  for hard wood and  $60^\circ$  for soft wood. These angles may be copied from figure 3. The top angle (2b) is  $38^\circ$  for hard and soft wood. A gauge is needed to check the sharpening angle and the top angle (4). During filing, the gullet should be lowered at the same time (5). First file one side of the saw, tooth by tooth, and then turn the saw and file the other side. Care must be taken to stop filing when the flat is about to disappear.

Deburring is done with the whetstone, the fine side of which is run lightly along both sides (as for raker-tooth saws, see page 38).

Setting is carried out with a setting indicator (6a) and a special saw set (6b). The correct set is 0.3-0.4 mm for hard wood and 0.5-0.6 mm for soft wood.

Note: Badly worn saws may need gulleting before sharpening begins. This is best done after having marked the gullet depth and position (7a). The round edge of the millsaw file is used for gulleting (7b).

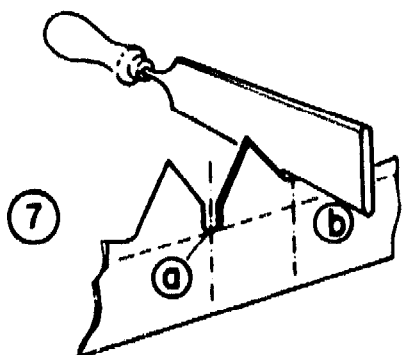
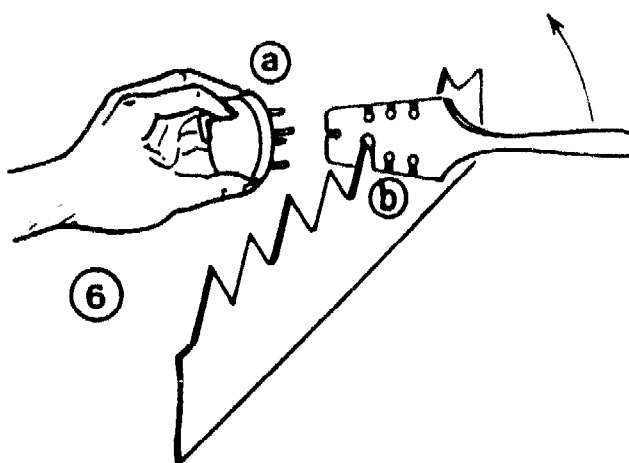
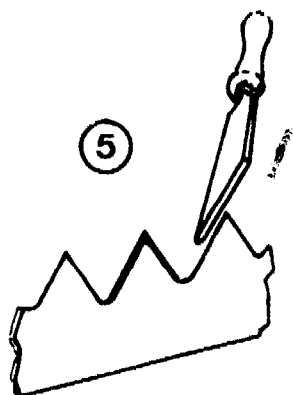
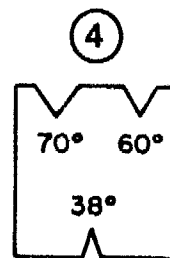
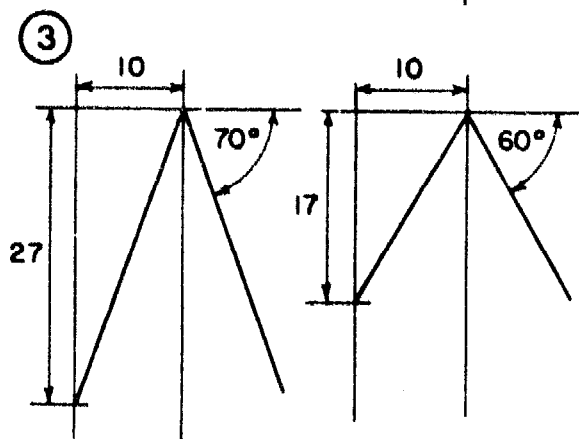
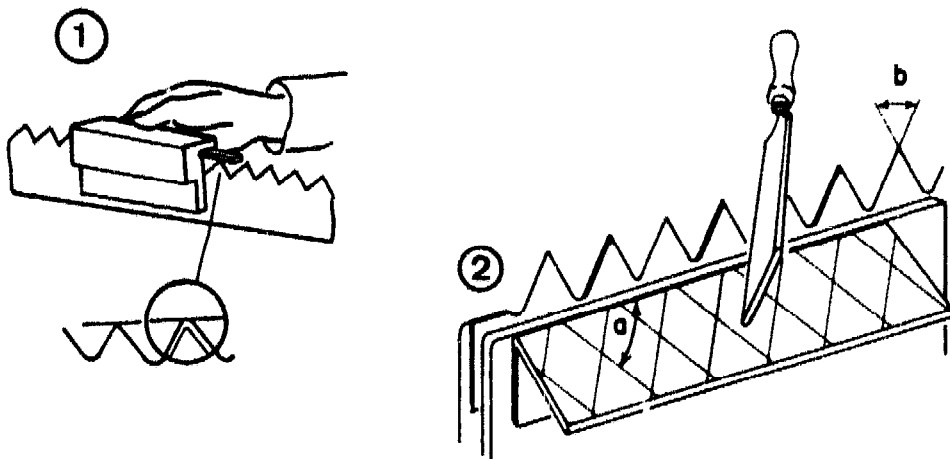

### TYPES OF RAKER-TOOTH CROSS-CUT SAWS

The raker-tooth cross-cut saw is the most efficient type of saw for felling and cross-cutting. This type of saw is recommended for professional use.

There are two types: one raker followed by two cutters (Champion teeth BM<sup>1</sup>) for harder wood (1) and one raker followed by four cutters (Lance teeth, 4 YM<sup>1</sup>) for softer wood (2).

The raker's work can be compared with that of a plane. It removes the fibres (3b) which are cut on both sides of the kerf by the cutters (3a). The raker must be slightly shorter than the cutters so that it will not break off uncut fibres. However, if too short, it will not sufficiently break loose the cut fibres and the cutters will jam in the kerf. A gullet of sufficient depth is needed to hold and transport the sawdust (3c).

Correct raker depth produces long chips with clean edges (4); if the raker depth is too long, chips tend to have whiskers (5); if too short, fine sawdust is produced.

---

<sup>1</sup> According to International Organisation for Standardisation.

①

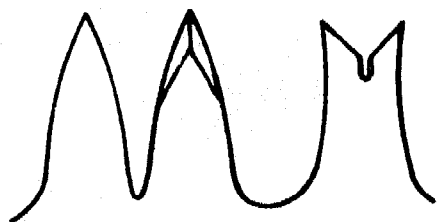

②

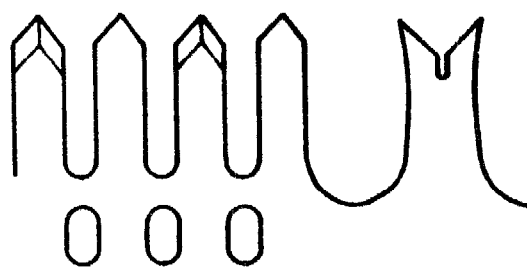

③

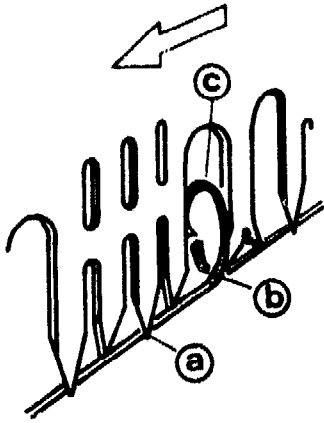

④

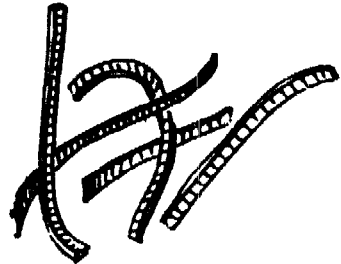

⑤

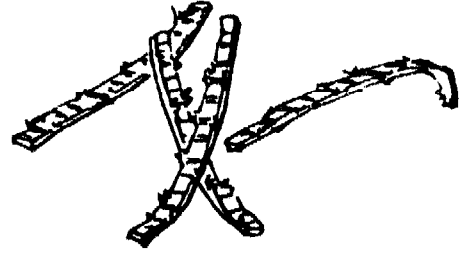

### MAINTAINING A RAKER-TOOTH CROSS-CUT SAW

Maintenance work follows the same pattern as for peg-tooth saws except that, additionally, raker adjustment is needed. The saw is held at all times in a vertical position during maintenance work.

Jointing is done in exactly the same way as for peg-tooth saws (1).

Raker adjustment. The raker adjuster, correctly set, is placed over a raker (2). Holding the tool firmly against the saw, the raker is filed flush with the tool guide plate (2a). The raker depth should be 0.2-0.5 mm for hard wood and 0.6-1.0 mm for soft wood (2b). The correct depth must be found under working conditions and will be indicated by properly-shaped saw chips.

Raker filing is done after adjusting the raker height (3). It is continued until the flat is as small as possible. Horizontal file strokes are used (3a). The raker angle should be  $90^{\circ}$ . It can be checked easily during filing with the top end of the mill-saw file (3b).

Cutter teeth filing is done with the saw in the oblique position (4). A top angle of  $70^{\circ}$  and a side angle of  $35^{\circ}$  must be produced. Filing strokes should not exceed 60 per minute. The full length of the file is used and an even pressure put on the file. Check the angles with the gauge frequently and when the flat almost disappears, tap the top of the tooth with the file handle or small piece of wood. This gives a true picture of how much flat is left. The last strokes with the file must be very gentle. Sharpening is finished when the flat is just about to disappear.

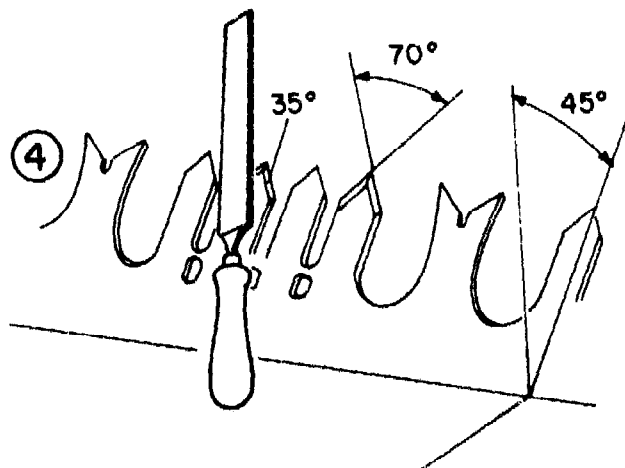
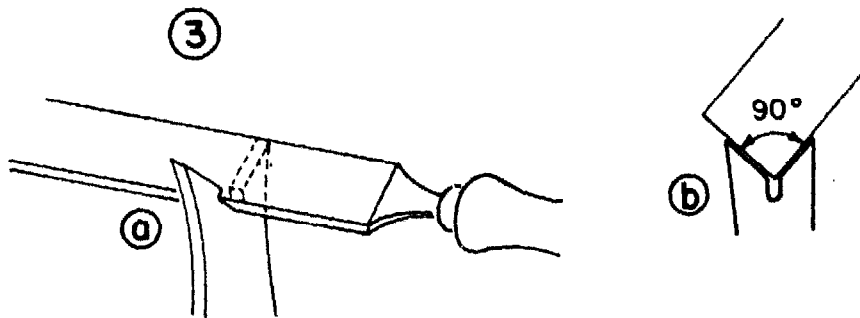
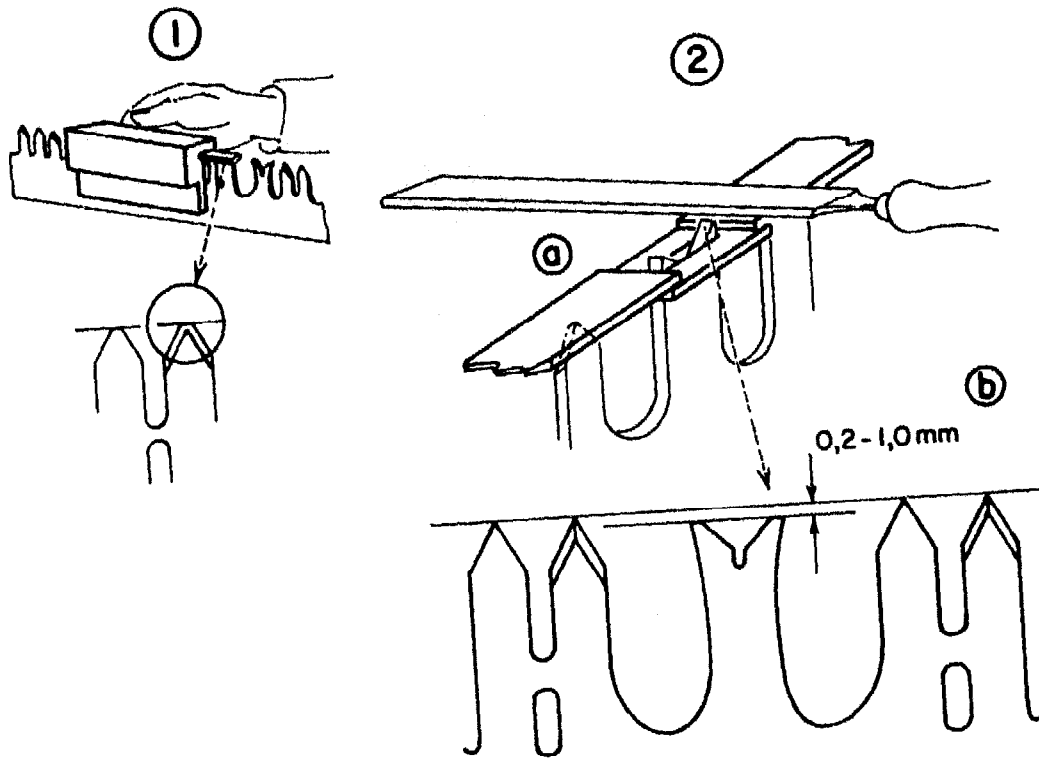

**MAINTAINING A RAKER-TOOTH CROSS-CUT SAW** (continued)

Deburring. Put the saw in a vertical position. The fine side of the whetstone is run along both sides of the saw to remove burrs (1). Be careful not to touch the sharp teeth with the fingers.

Setting (2). Check that the saw is held very firmly in the vice. For a right-handed man, the left arm is put over the saw, taking care not to catch the saw with the arm or body, and the anvil held in the left hand. Those teeth with the bevels towards the body are set first. The anvil is placed against the back of the cutter. The cutter is set with short and firm strokes of the setting hammer held in the right hand (2a, 2b).

The setting indicator is used to check the set of each tooth (3). The correct saw set for hard wood is 0.1-0.2 mm, for soft wood 0.2-0.4 mm (4). Insufficient set is corrected at once by further hammer strokes. If the set is too great it is removed with the setting hammer after the position of the anvil has been changed (5). After setting one side, the saw is turned round and the other side is set.

Note: The first six teeth on either end of the saw need no setting.

Setting normally follows cutter teeth filing but the order can also be reversed.

Deepening of gullets. At intervals of about four weeks, it is necessary to deepen the gullets on the cutters (6a) and the gullets between the rakers (6b) with the millsaw file and the big gullets between the rakers and the cutters (6c) with the round file.



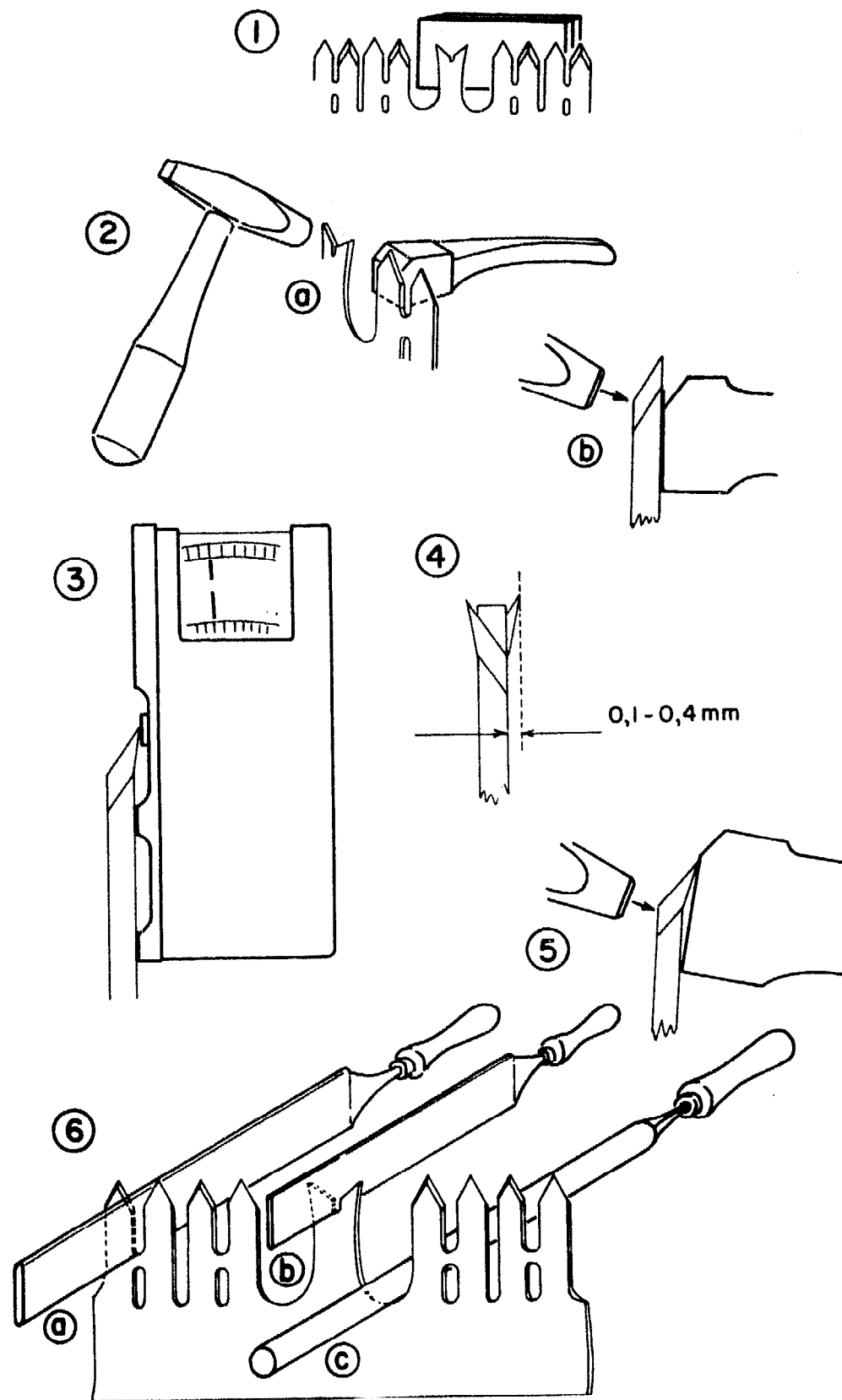

### MAJOR OVERHAUL OF CROSS-CUT SAWS

If saws become badly out of tooth line, it is necessary to adjust the tooth line. This can best be done by using a new saw which is properly shaped as a model. Its tooth line is marked with a scribe on the old saw (1). A second line is drawn underneath at the correct gullet depth. This can also be done after jointing with a scribe attached to the jointer (2). The position of tooth points is also marked on the old saw to avoid incorrect spacing.

If a new saw is not available, a thin flexible board (or a straight-back saw) can be used to draw the desired curve (3). It is fixed on both ends and bent in the middle to the correct tooth line shape. If a straight line (3) is drawn between the two ends of the board, the correct curve is obtained if the middle of the board is bent outward (3b) by 7 cm for 1.5 m saw length, by 8 cm for 2.0 m saw length and 9 cm for 2.5 m saw length.

Reshaping the curve according to the new tooth line marked on the saw is facilitated if shears can be used instead of files. Shears may be found in central workshops.

#### Use of a press

In central workshops, it may also be useful to provide a press for deepening gullets and reshaping worn saws (4). This saves files and time.

①



②

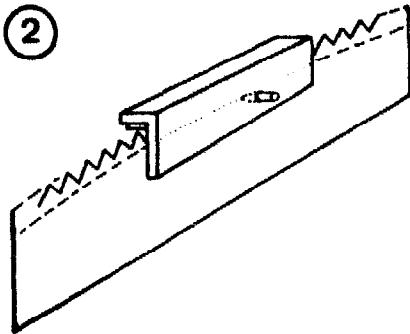

③

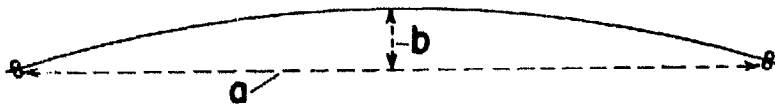

④

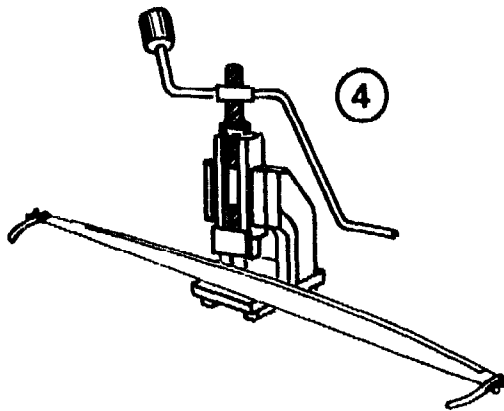

**CLOTHING, PERSONAL PROTECTIVE EQUIPMENT, FIRST-AID EQUIPMENT**

Workers should wear:

- (1) Long-sleeved shirt or jacket, preferably in a warning colour, fitting neither too loosely nor too tightly.
- (2) Long trousers.
- (3) Boots with non-slip soles.

In felling operations, the worker must wear:

- (4) Safety helmet with ventilation holes.

During the felling of large-sized trees, it may be advisable to use:

- (5) Knee protectors.

The following first-aid equipment must be available:

- (6) A pocket first-aid kit containing roller bandages and standard dressing for open wounds, carried by the worker.
- (7) A full first-aid kit for treating serious accidents, to be kept at the work site for a group of workers.

During rainy periods, workers should have:

- (8) Rubber boots.
- (9) Raincoats.

Simple shelters should be available for use during breaks as a protection against rain or sun (10).

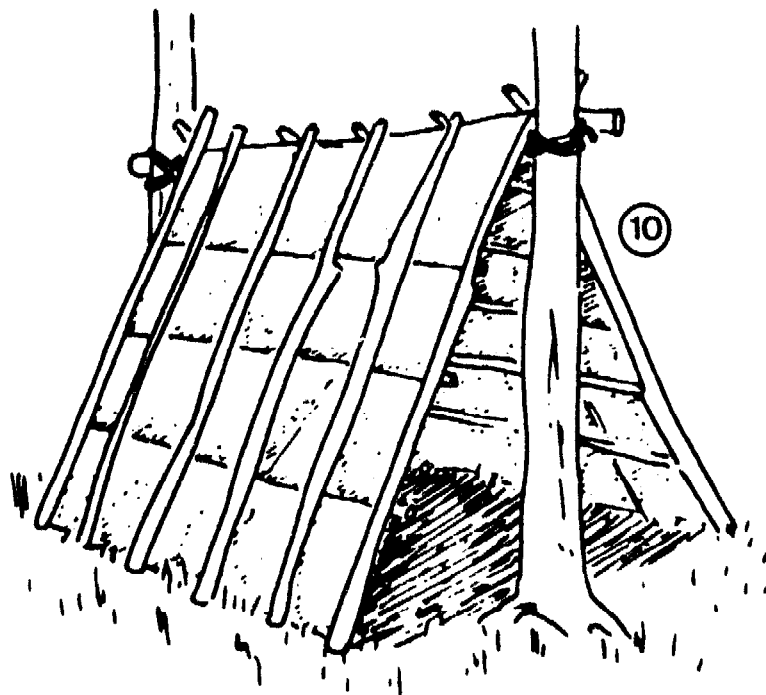
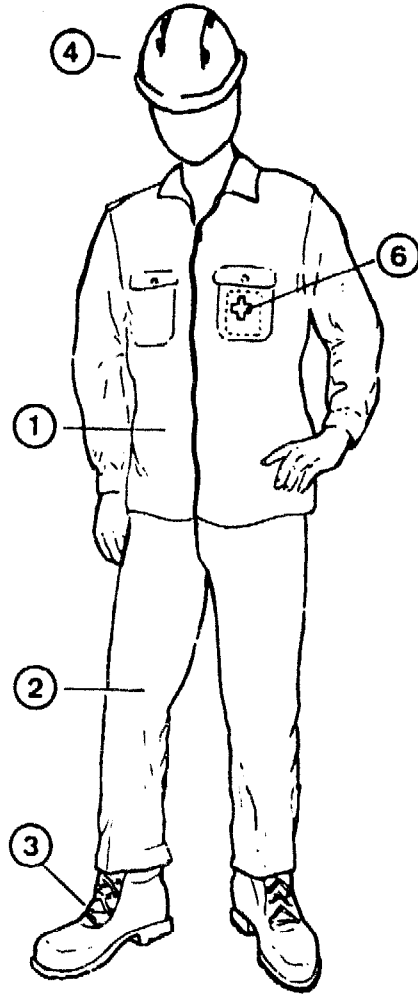
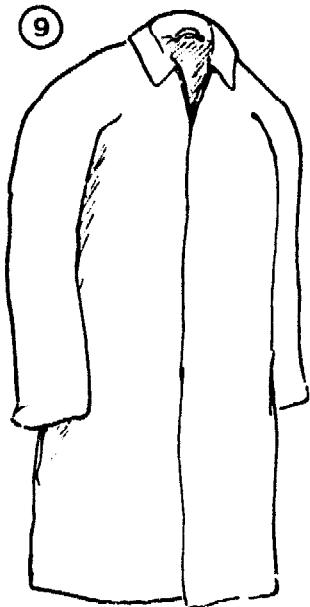
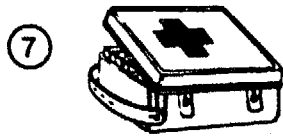

**FOOD, NUTRITION AND REST**

Wood harvesting is heavy work and over a period of time is tiring. The worker must therefore be in a good state of health and be well fed.

He should have a meal before starting work and eat during breaks.

Under severe climatic conditions (very hot weather or humid, tropical climate), not more than six hours of productive work can be expected. During a six-hour working day, two meal breaks of at least 30 minutes each should be taken (after the first two hours of work and again two hours later).

Food should be sufficiently rich in starches (rice, maize, wheat, millet, bananas, cassava); in proteins (beans, eggs, meat, fish); in fats (olive oil, coconut oil, cheese, butter); and in vitamins (fruit, vegetables).

During hard work and in hot weather, the body can lose 3 to 6 litres of liquid per day. This must be replaced. Workers should carry a container with boiled water, tea or other beverages and drink not only when thirsty but also at regular intervals during the day. Care must be taken to replace the salt lost through sweating.

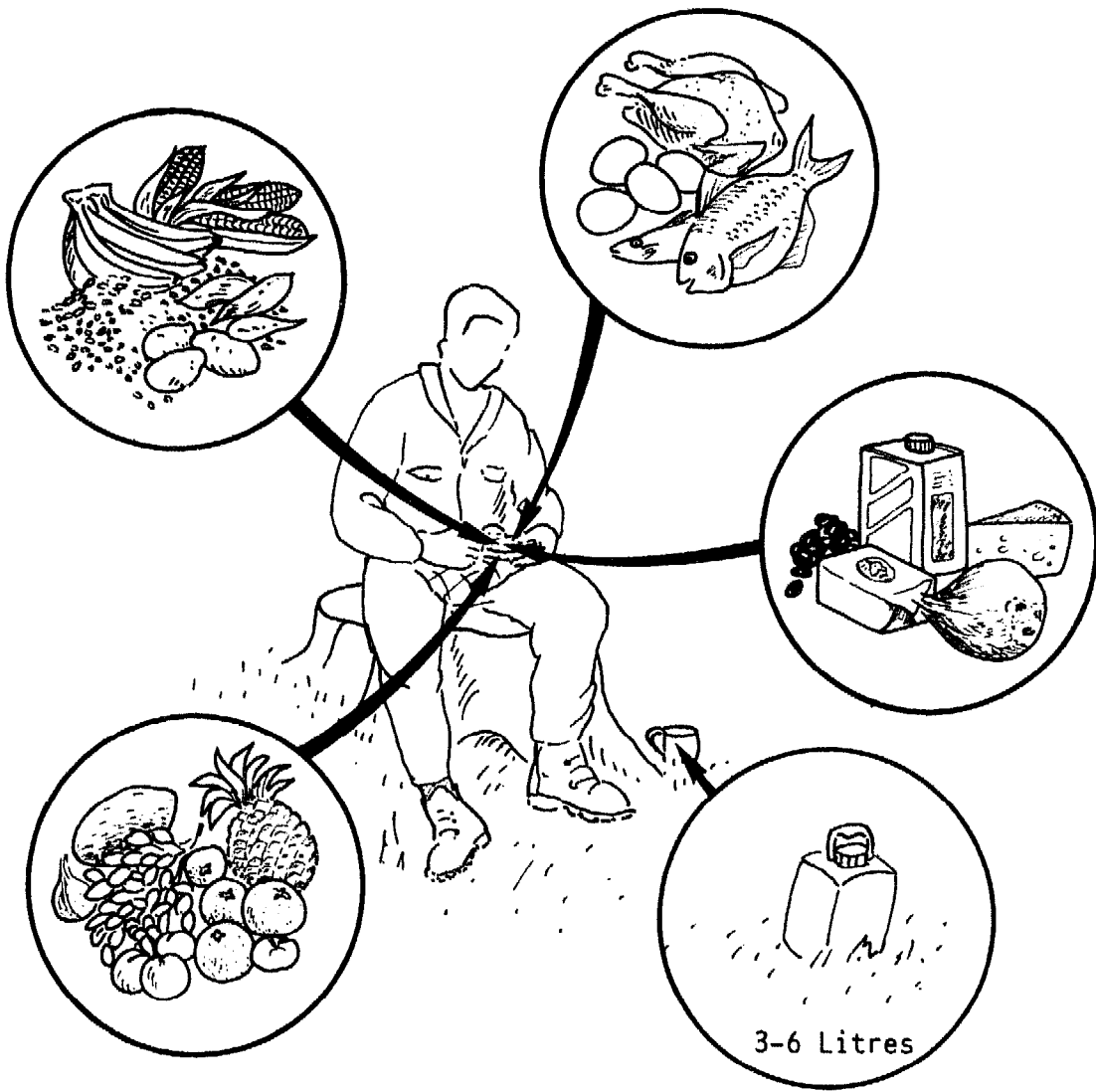

### WORKING POSTURES AND MOVEMENTS

Heavy physical work can be made easier by proper working postures and working movements.

Sawing can become very tiring and quite inefficient if the saw is pulled by the arms towards the body, if the body remains stiff and upright and consequently only short strokes can be made.

To make the job less tiring and more efficient, the saw should work along its full length and the load should be carried not only by the arm muscles but by the whole body swinging backwards and forwards and supporting the movement of the saw.

Efficient working techniques in the use of bow saws (1) and cross-cut saws (2) are indicated in the illustration, showing the change in working position. The same principles apply to other jobs, such as debarking (3).

Manual wood harvesting often involves heavy lifting and carrying of loads. In such work, the back should be kept straight to avoid excessive strain and the strong muscles of the legs should be used for lifting (4).



①

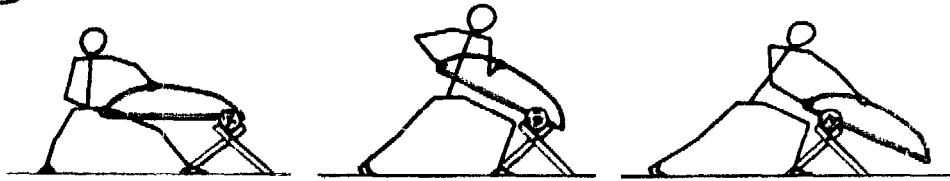

②

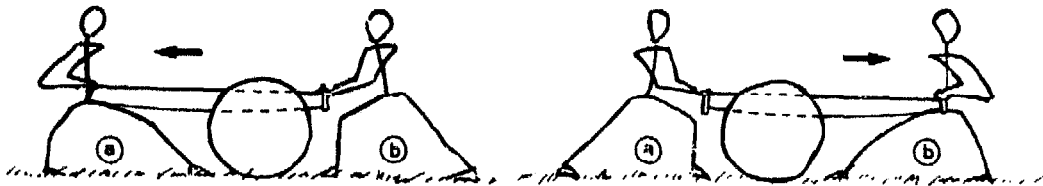

③



④



**WORKING POSTURES AND MOVEMENTS** (continued)

In axe work, the whole body moves and supports the stroke by changing the weight from the leg away from the cut to the leg near the cut while the upper hand slides down the handle. If the worker masters the left-hand grip (1), (2) and the right-hand grip (3), work is safer and less strenuous.

1

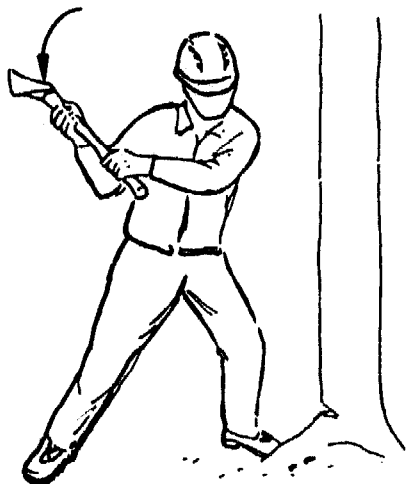

2



3

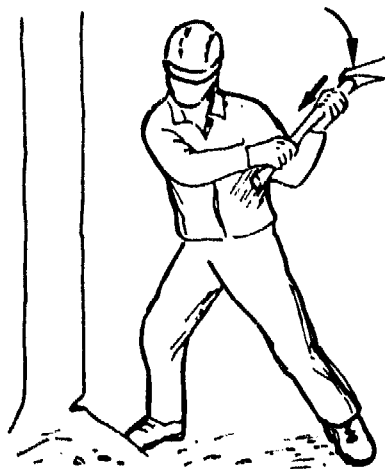

### WORK PLANNING AND ORGANISATION

Wood harvesting must be well planned and organised in order to make the best use of the raw material while keeping labour input and production cost low and minimising damage to the environment.

A variety of different harvesting systems can be applied depending on the wood species, size and assortment (fuelwood, poles or logs), type of forest (man-made or natural), type of cut (thinning or clear cut), kind of regeneration (artificial, coppice, natural), terrain (flat, steep, swampy), accessibility (roads, waterways) and means of transport (manual, animal, motorised).

In all these cases, good planning and organisation of work depends on:

- the assessment of the volume to be harvested;
- the determination of the assortments to be produced;
- the determination of wood storing places, skidding lines and felling direction;
- clearly-instructed and skilled supervisors and workers;
- availability of the necessary hand tools and maintenance and other equipment;
- clear separation of working areas for individual work teams and different operations (felling and transport).

The illustration shows an example of a harvesting map indicating the forest road network (1), the transport direction (2), the skidding lines (3), the felling direction (4) and the storage places for logs (5) and short wood (6).

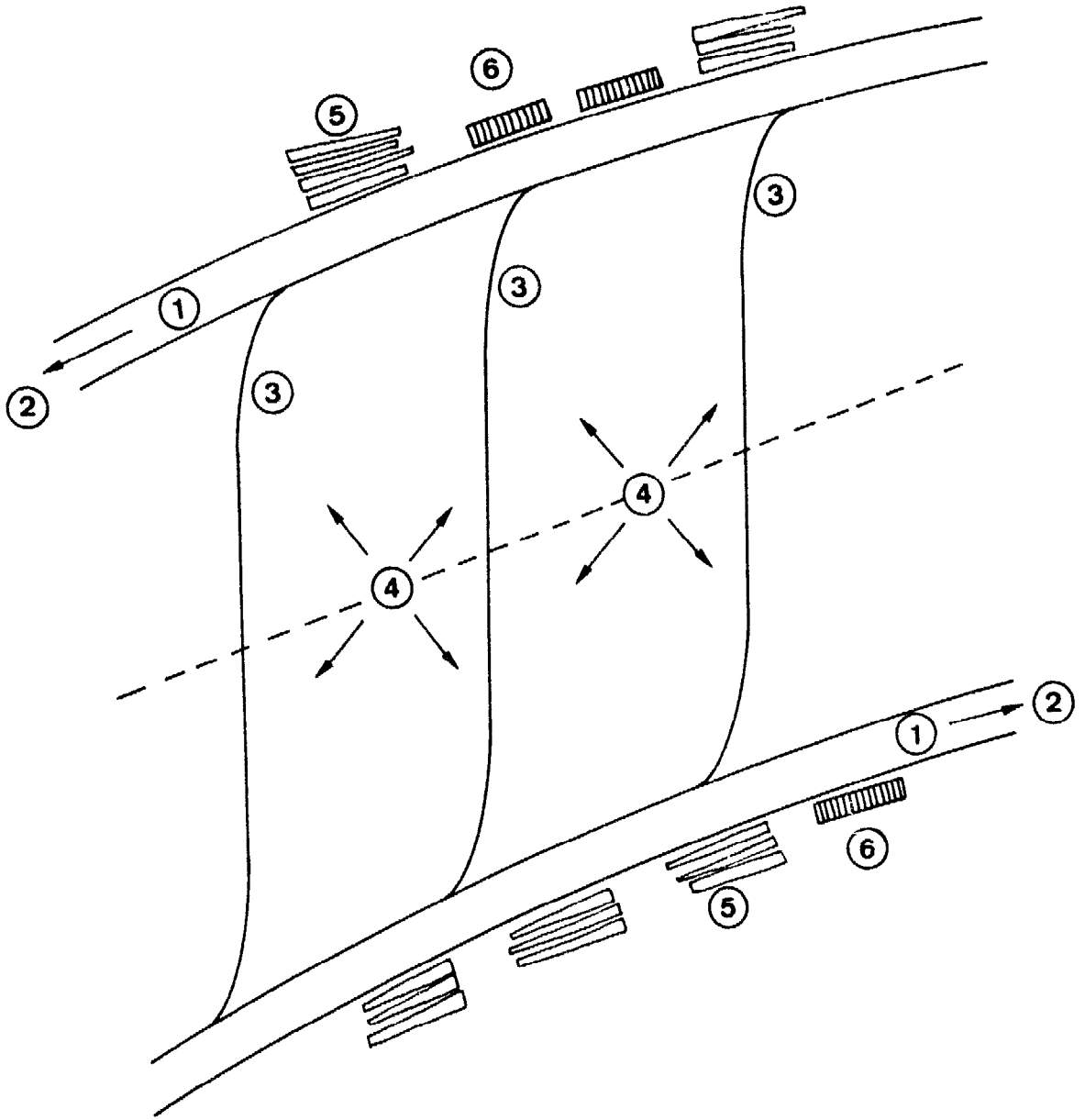

### ACCIDENT PREVENTION

Wood harvesting is extremely dangerous. Many workers are killed or severely injured in tree felling and transport. Cutting tools may lead to serious open wounds. Many accidents occur when workers slip, stumble and fall in difficult terrain or on slippery surfaces.

Adequate accident prevention is therefore a basic requirement of any type of wood harvesting.

Workers need to be healthy and in good physical condition. They must be well trained for their jobs. They must strictly observe a definite set of safety rules.

The most important safety rules are the following:

- In tree felling, workers must use safety helmets, wear good shoes with non-slip soles and carry first aid equipment.
- Axes, saws and helping tools should be available in sufficient number and be adequate as regards type and maintenance.
- The felling team must keep a minimum distance of two tree lengths from other workers (1). This distance may be increased to four tree lengths when visibility in the forest is poor. A warning should be given before a tree is about to fall.
- Greatest care is required in controlling trees during felling by an adequate undercut and back cut, leaving a sufficiently strong hinge.
- When the tree falls, the worker must retreat to a safe position and watch out for falling branches (2).

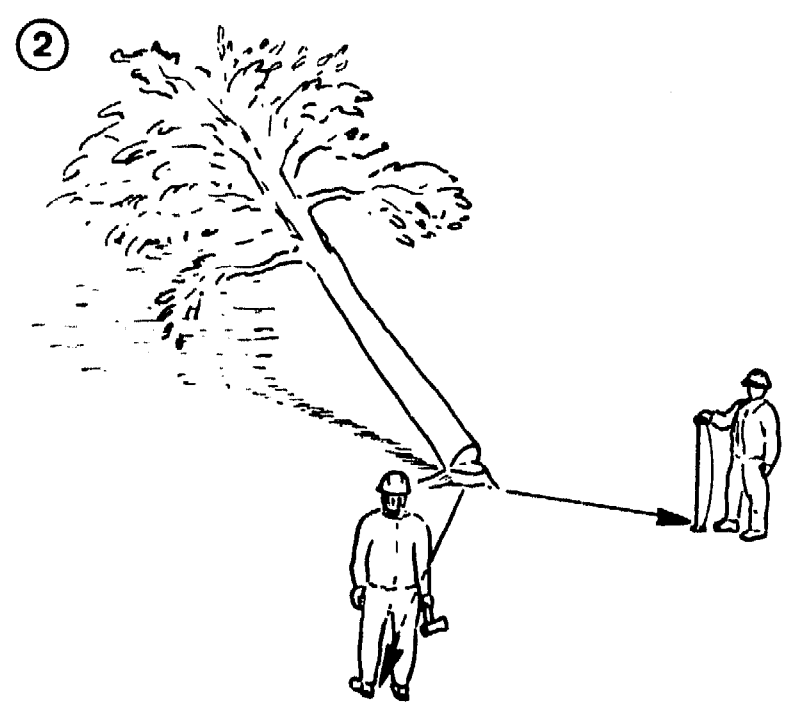
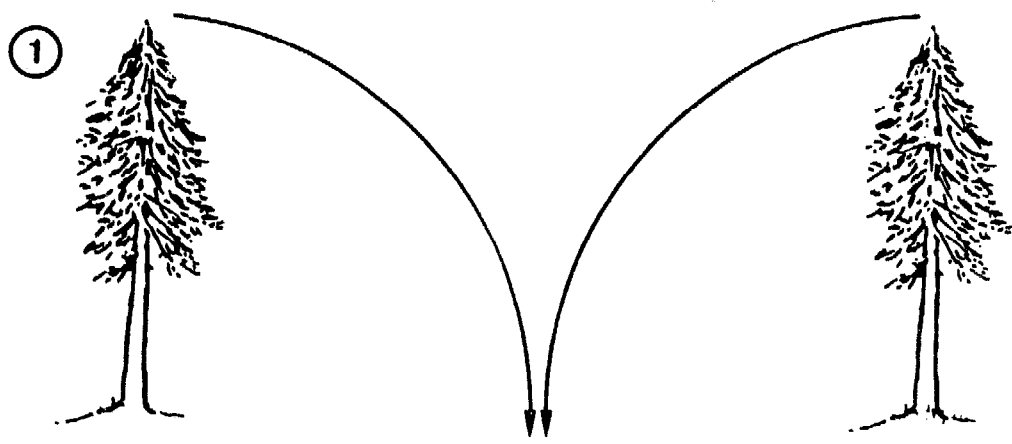

**ACCIDENT PREVENTION** (continued)

- Particular care is needed to bring lodged trees down safely (1).
- No tree felling should be done in stormy weather.
- During debranching, debarking and cross-cutting, workers must watch out that they are not caught by falling, sliding or turning trees or parts of trees, especially on slopes.
- When axes, debarking spades or splitting hammers are being used, other people must keep clear of the working range.
- Accidents are more frequent towards the end of the day when workers are tired. During this period, harvesting should preferably concentrate on the less dangerous jobs.

The working techniques described in this manual are specifically designed with a view to reducing hazards.



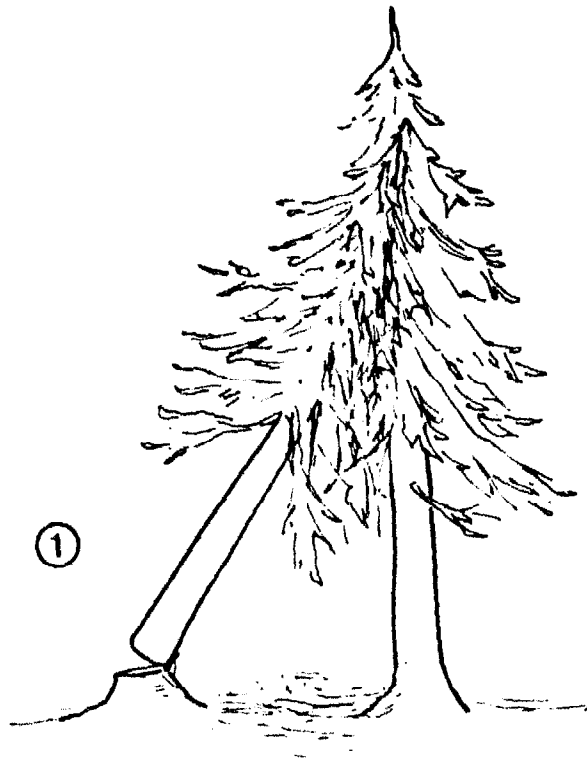

**PREPARATION FOR TREE FELLING**

The felling direction must be carefully determined (1). This will depend on the skidding direction, the lean of the tree, the shape of the crown, the wind, and on obstacles in the way of the tree's fall, obstacles on the ground and also on the possibility of retreating safely.

When the felling direction (1a) is determined, the tools are placed opposite to the felling direction, behind the tree (1b). The working area around the tree is cleared (1c). Two escape routes are cleared, as far as is necessary to allow easy retreat, placed sideways at about 45° angles to the rear (1d).

The base of the tree must be well cleared, using the axe or a machet in order to prevent the saw from blunting too quickly (2).

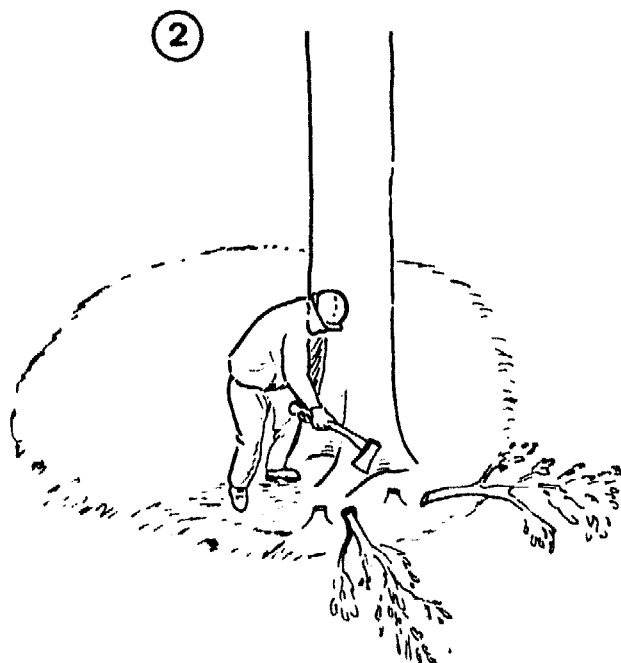
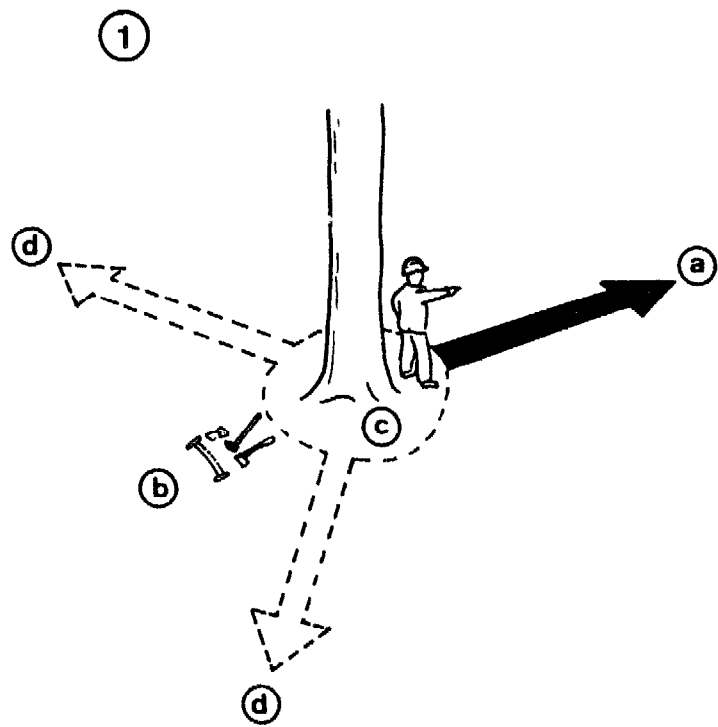

**TREE FELLING WITH AXE AND BOW SAW**

Small trees are felled with an axe, cutting from both sides (1).

For slightly larger trees, axes are used for making the undercut. In this case, the horizontal cut can be done with the bow saw (2). The back cut should not be made with the axe because too much wood is wasted and it is more difficult to maintain the desired direction of fall (3).

Axe felling of larger trees is allowed only in exceptional cases.

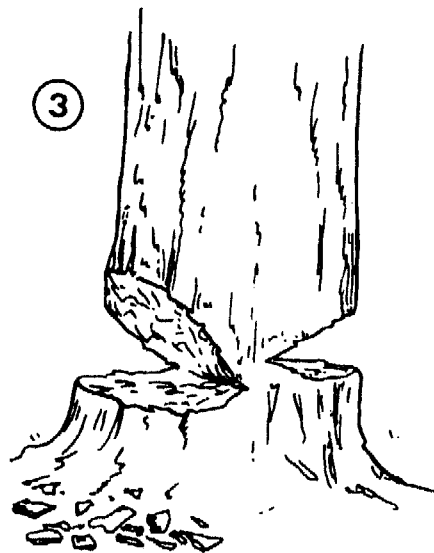
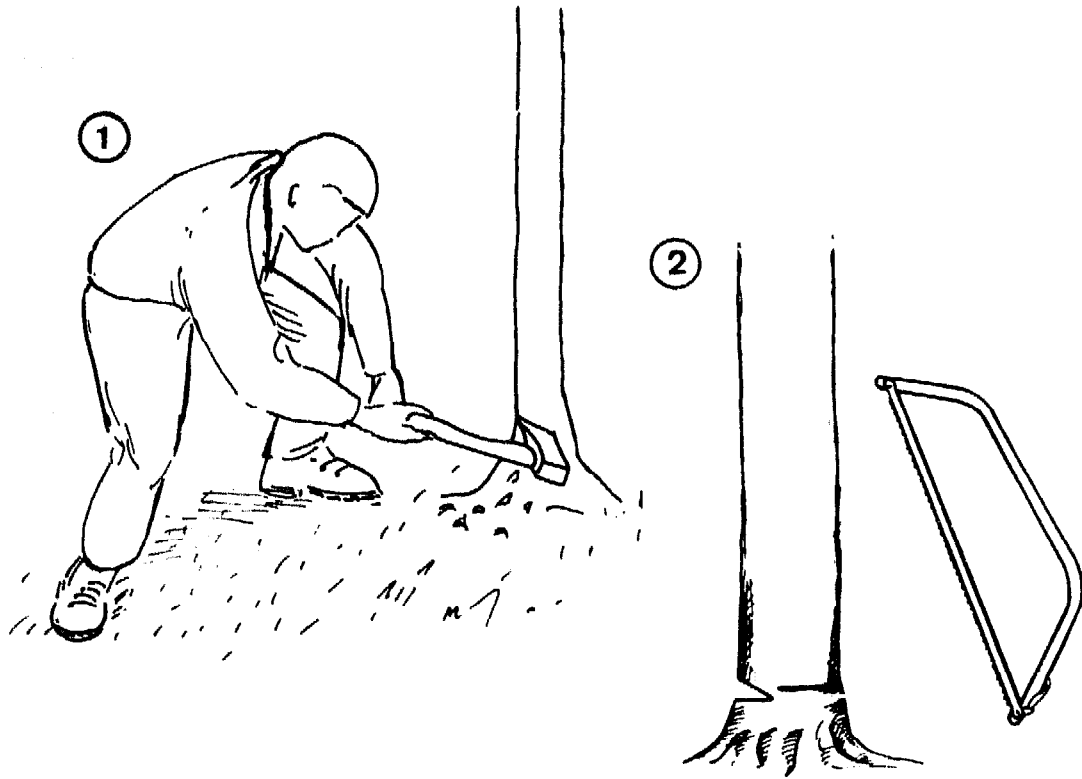

**TREE FELLING WITH AXE AND CROSS-CUT SAW**

Felling of medium- and large-sized trees is done with the axe and the cross-cut saw. This process requires special skills and experience.

A proper undercut (1a) and back cut (1b) are necessary, leaving a hinge (2a) to guide the tree into the desired direction of fall. Small lateral cuts (1c) and (2b) avoid tearing of fibres from the tree during felling. The depth of the undercut should be about 1/5 to 1/4 of the diameter; it should open at an angle of about 60°. The back cut should be about 2-5 cm higher than the undercut. In very large trees, the undercut may penetrate up to 1/3 of the diameter, depending on shape, and the back cut may be 10-20 cm higher.

Wedging will be necessary to avoid pinching of the saw (3). If necessary, wedging will also force the tree to fall.

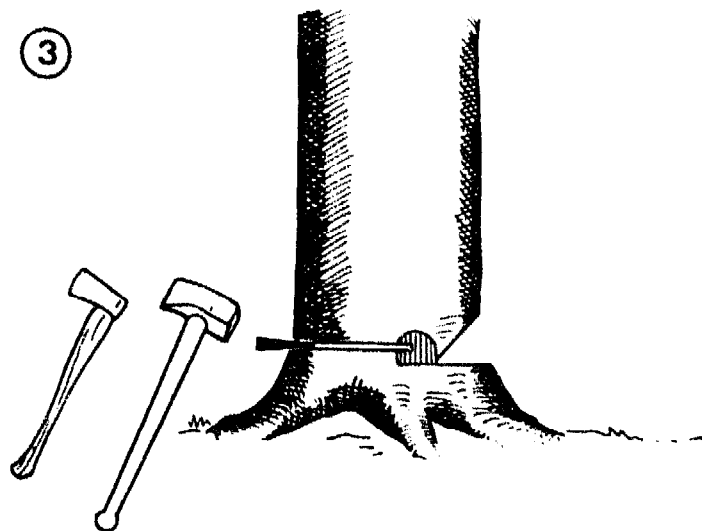
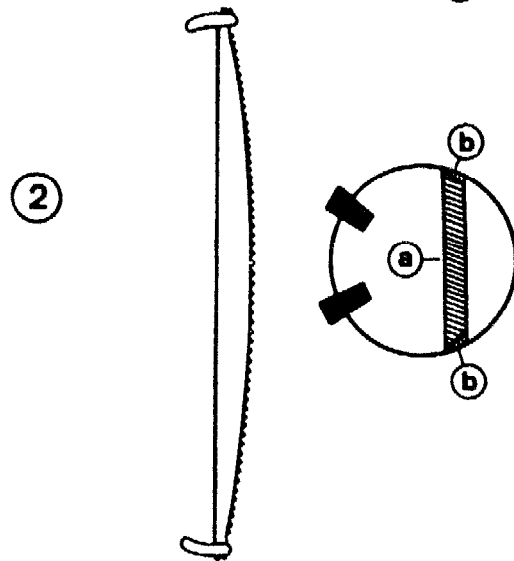
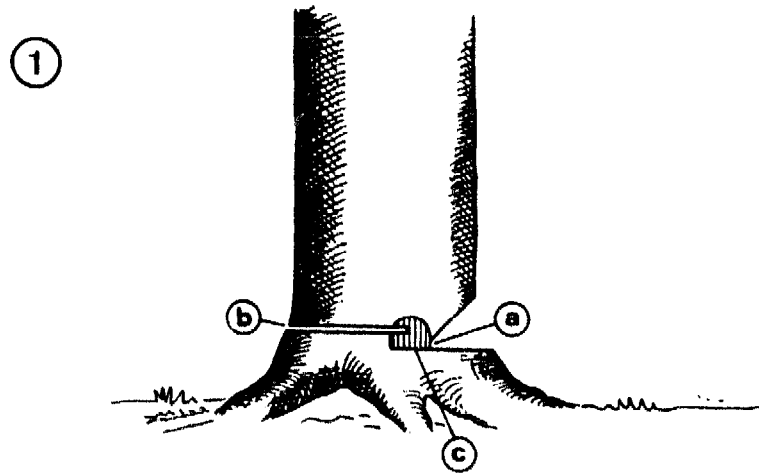

---

### PRECAUTIONS WHEN MAKING THE UNDERCUT AND THE BACK CUT

Accurate felling makes the job safer, facilitates subsequent operations and reduces timber wastage. Felling should therefore be done with the greatest care and precision. By looking at the stump, it can easily be seen whether a poor or a good felling job has been done.

When making the undercut, care must be taken that it points precisely into the felling direction. This can be checked by standing in front of the undercut (1). If necessary, the undercut should be corrected.

Sufficient holding wood which acts as a hinge must always remain in order to maintain control of the tree so that it does not fall in any direction other than that intended (2). 2a shows the correct depth of the back cut. If the cut penetrates as deeply as indicated by 2b in the picture, the tree is practically loose and a gust of wind may push it anywhere.

If trees have buttresses, it is necessary to remove them before making the undercut and back cut, which can then be made with more precision and ease (3). The buttresses should also be removed to facilitate transport and handling of the log. To make sure that the cuts are placed in the right position, it helps if they are marked with an axe.



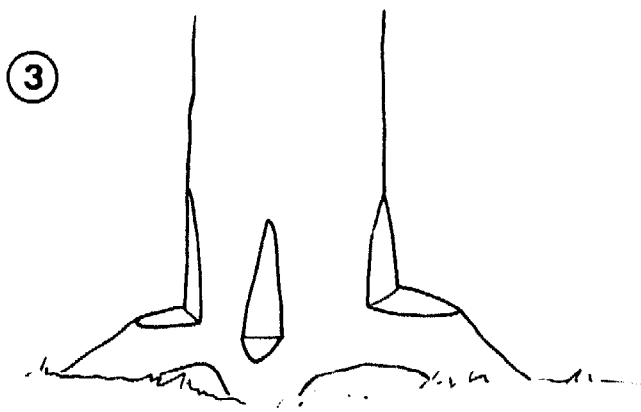
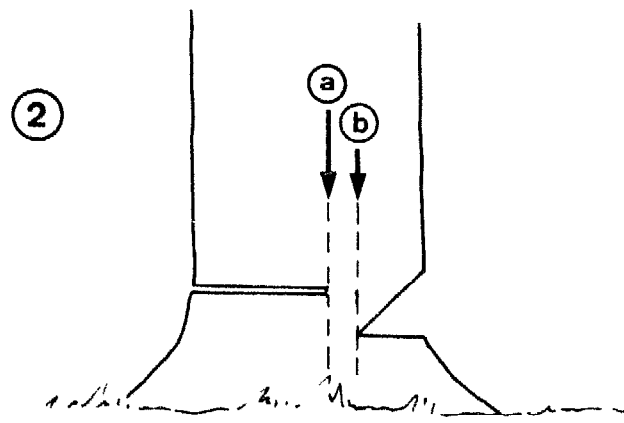
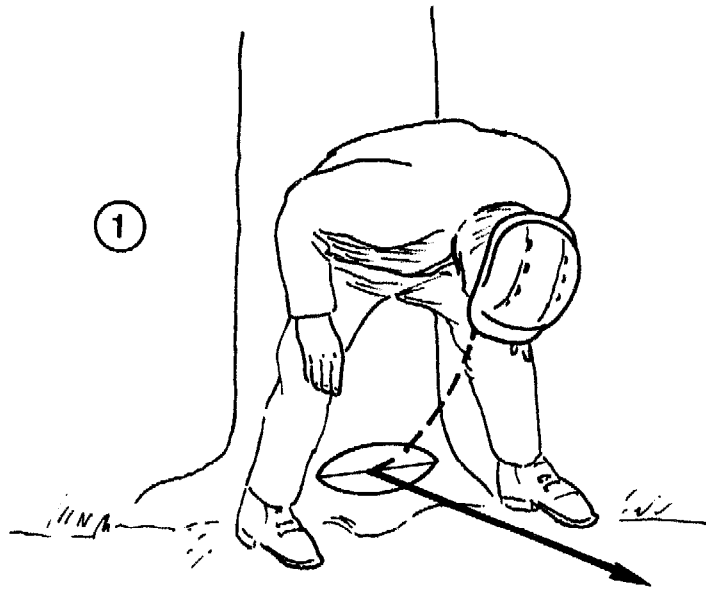

**FELLING TREES LEANING INTO THE PLANNED FELLING DIRECTION**

Trees leaning into the planned felling direction (1) have to be felled particularly carefully in order to avoid danger to the workers, damage to the saw and wastage of timber.

In such a case, the undercut (2) must penetrate more deeply into the tree. This may entail preparing the undercut in two steps (3) and (4). When the saw starts pinching, work should continue with the axe.

The back cut (5) must be done from both sides and only the remaining wood (6) be sawn parallel with the hinge.

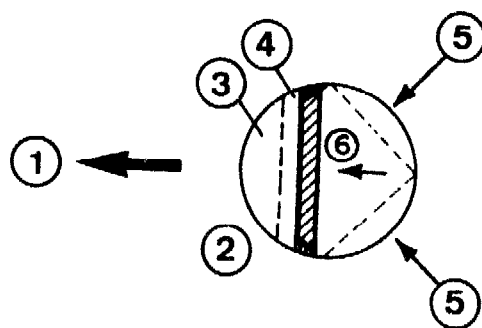
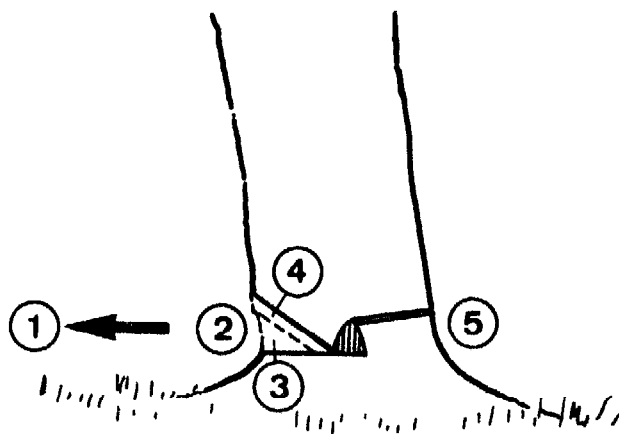

**FELLING TREES LEANING TO THE SIDE**

A tree can also be felled at an angle of about  $30^{\circ}$  from the lean. In this case, the undercut (a) should face the intended felling direction (b). The hinge (c) should be kept smaller on the side of the lean (d) and larger on the side to which the tree is to be felled. In addition, a wedge (e) placed on the side of the lean will help to direct the fall of the tree.

Felling larger trees against the lean is only justified in exceptional cases (e.g. to save young tree growth or near buildings) and requires special skills, techniques and equipment (e.g. winches).

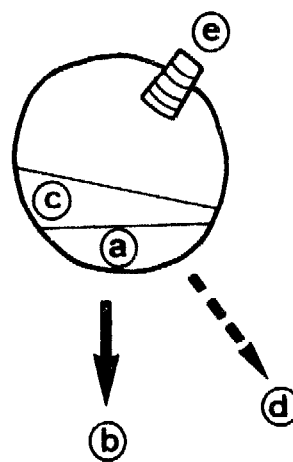
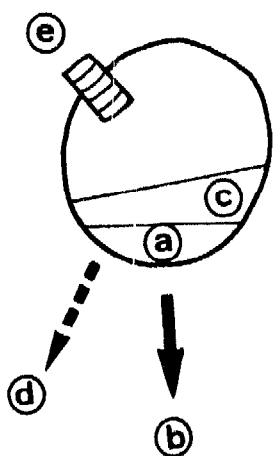
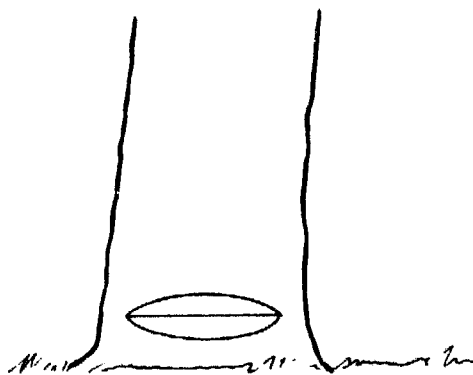
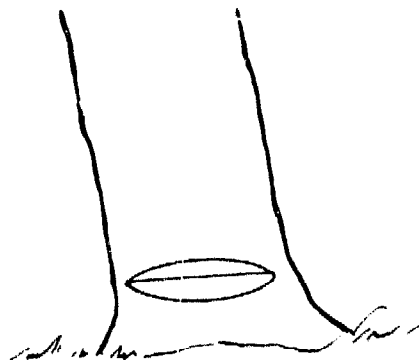

### TREE FELLING IN DENSE TROPICAL FORESTS

Felling in dense tropical forests can be particularly dangerous. Dense undergrowth makes it difficult to retreat from the tree during its fall. Dead branches may be hidden in the crown, which is often not visible. For the same reason, it may be difficult to assess the lean of the tree.

Trees may be over-mature and may therefore have hollow or rotten centres.

Trees are often connected to each other with climbers. When the trees fall, they frequently pull down other trees (1). Branches from the falling tree or from neighbouring trees (2, 3) are broken off and may swing backwards (4). Climbers are torn off or may break and snap back (5).

The accident risk when felling trees in dense tropical forests is considerably reduced if the area around the base of the tree and the escape routes are well cleared.

Two paths are cleared to a length of 20-30 m beyond the reach of the crown opposite the felling direction. The angle between them should be about 45°.

Climbers attached to the tree must also be cut before sawing begins.

It will often be necessary to clean the base of the tree to remove bark and dirt deposited by termites.

Tree harvesting in natural tropical forests still continues to some extent with hand saws although in the large commercial operations chain saws have taken over.



**FELLING OF TREES WITH PLANK BUTTRESSES**

Plank buttresses are common in tropical trees. They occur in many tree species once they have grown large.

Large trees with plank buttresses often attain a cylindrical shape only at a height of 3-5 m above ground level (1). At ground level the cross-section becomes larger and more irregular (2), (3).

Trees with large plank buttresses may be felled at a convenient working height while the workers are standing at ground level.

If felling from the ground is not possible, it may be necessary to build a platform (4), especially in steep terrain. Experienced workers will be able to do this quite quickly with material available locally. The platform should permit a sufficiently comfortable and safe working position.



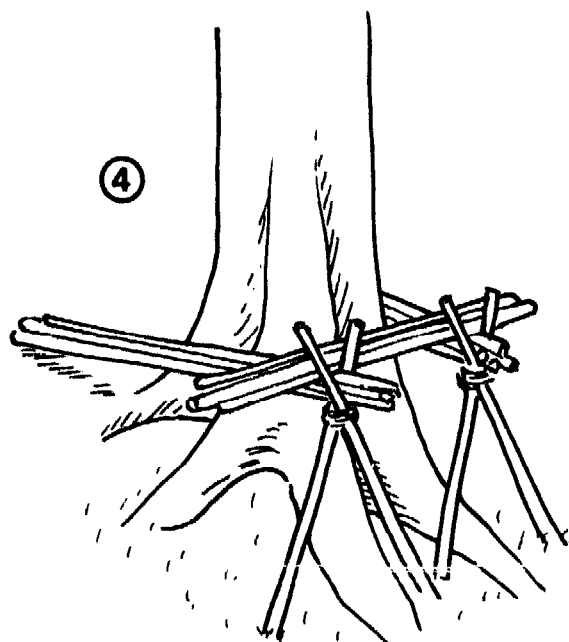
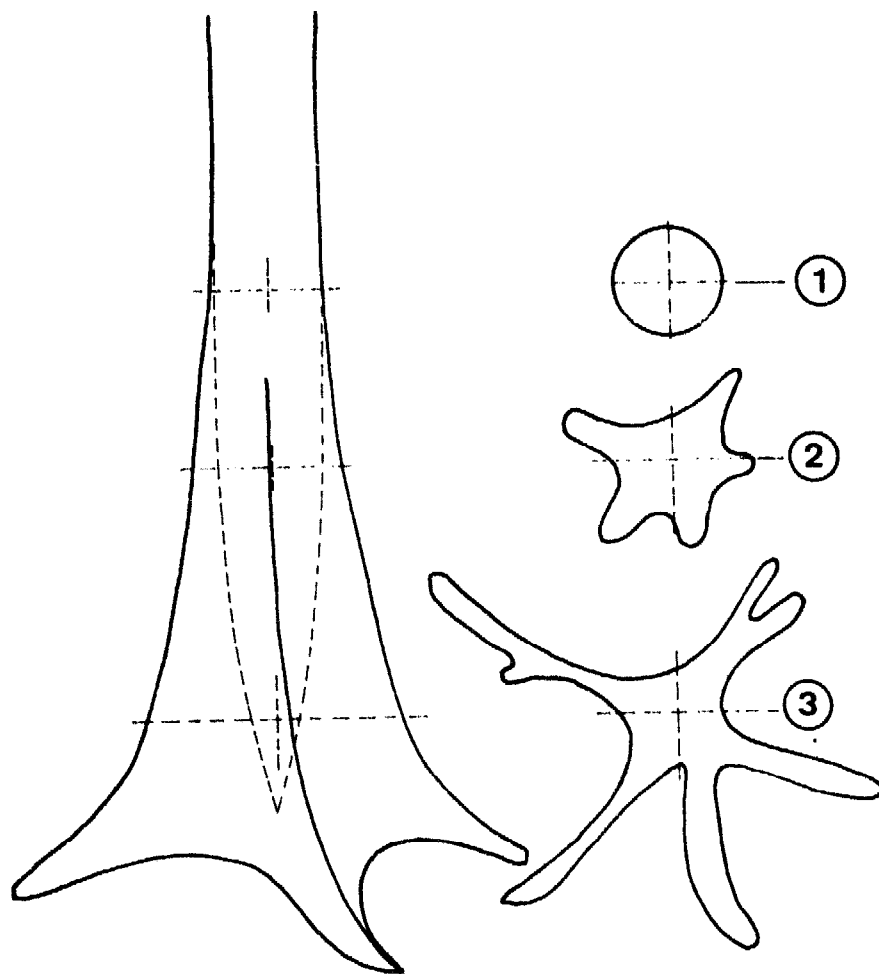

---

**FELLING OF TREES WITH PLANK BUTTRESSES** (continued)

If felling is done through the buttresses, the tree is usually felled into the direction of lean.

The undercut is made to a depth of about one-third of the diameter (1a). First the horizontal cut is made and then the oblique cut. The back cut is made about 20 cm higher (or more) than the horizontal cut of the undercut. The cut begins on the side buttresses (1b) and is finished on the rear buttress (1c). Wedging may be necessary on the lateral buttress in order to stabilise the tree and on the rear buttress to push the tree into the direction of fall (1d).

This technique must be adapted to the particular shape of the tree. The undercut may, for instance, have to be made in two buttresses (2a). If there are also two buttresses opposite the felling direction which have to cut one after the other, the smaller one should be cut first (2b) and then the larger one (2c). To assist felling, it is again advisable to insert wedges (2d).

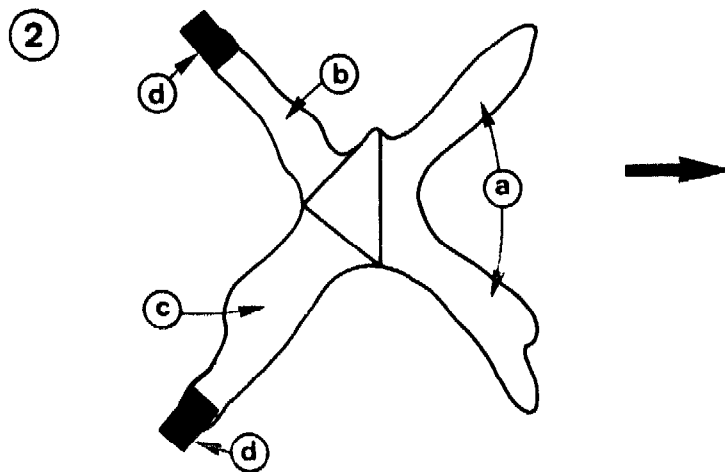
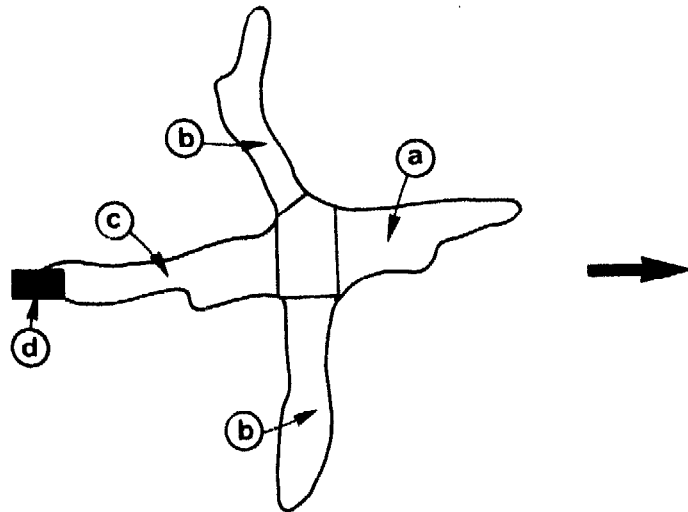
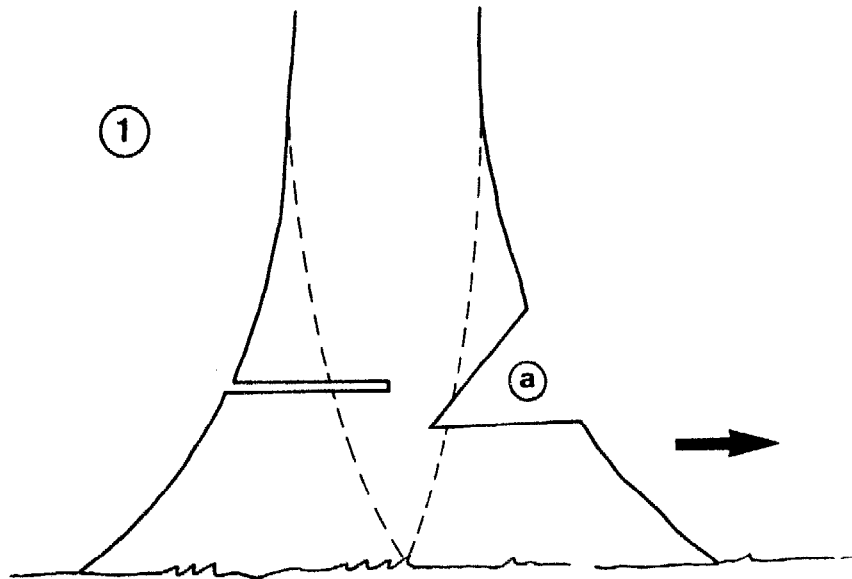

### WOOD WASTAGE DUE TO POOR WORKING TECHNIQUES IN FELLING

High stumps are an indication of poor workmanship and insufficient supervision. Often they are the result of putting felling marks, which are to be left on the stump for control purposes, too high. Sometimes workers find it more comfortable to cut about 1 m above ground level (1a). Except in special cases (e.g. hollow or heavily buttressed trees), the stump should be as low as possible (1b). This helps to avoid wastage of wood and because lower stumps make skidding easier.

Where the wage level is low and the timber price high, the value of wood left in one stump (1c) may correspond to a week's wages or more of the operator.

The following table gives information on volume loss:

<u>Stump recover- able height</u>	<u>Diameter cm</u>		
	40	60	80
20	0.025	0.057	0.100
40	0.050	0.113	0.200
60	0.075	0.171	0.300

Considerable wood losses in felling can also occur if the tree is felled without an undercut or with an insufficient undercut (2). If the undercut is at the same level as, or higher than, the back cut, there is a risk that wood fibre will be pulled out of the butt end, reducing the value of the log.

If the undercut is too small (3a), this can be most dangerous because the tree's fall is no longer properly guided. The tree may split and this results in considerable wastage on the valuable butt end.

---

**WOOD WASTAGE DUE TO POOR WORKING TECHNIQUES IN FELLING** (continued)

A considerable amount of valuable wood is lost when large trees are felled across obstacles on the ground such as hollows (1), ridges (2), logs or rocks (3). Most species break if they hit such obstacles. Although the broken part may be small, the loss caused by cutting out the break can be considerable.

The experienced worker will look carefully for obstacles and, when determining the felling direction, he will try to avoid them. This will be possible in many cases. Remember that even heavily leaning trees can be felled to a point about  $30^{\circ}$  on either side of the lean.

Efforts to avoid obstructions not only reduce waste but also facilitate work because unnecessary cross-cutting is avoided.

The breaking of a tree can cause serious losses, especially for valuable hardwood species.

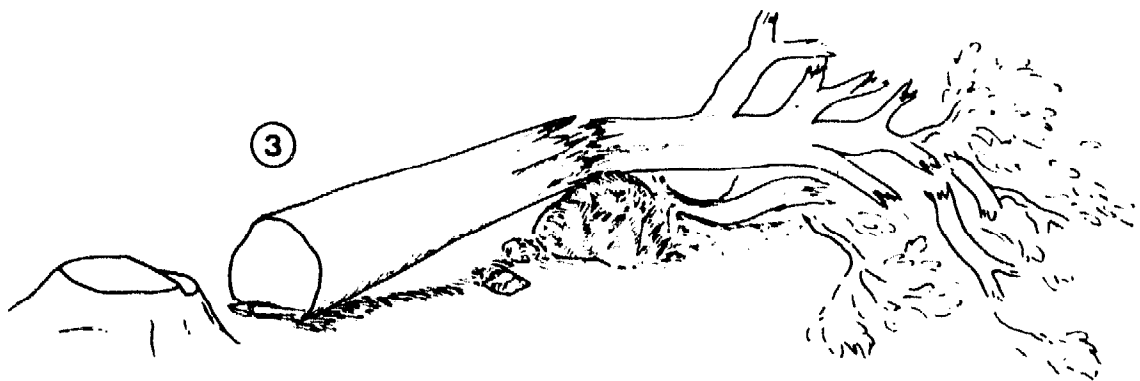
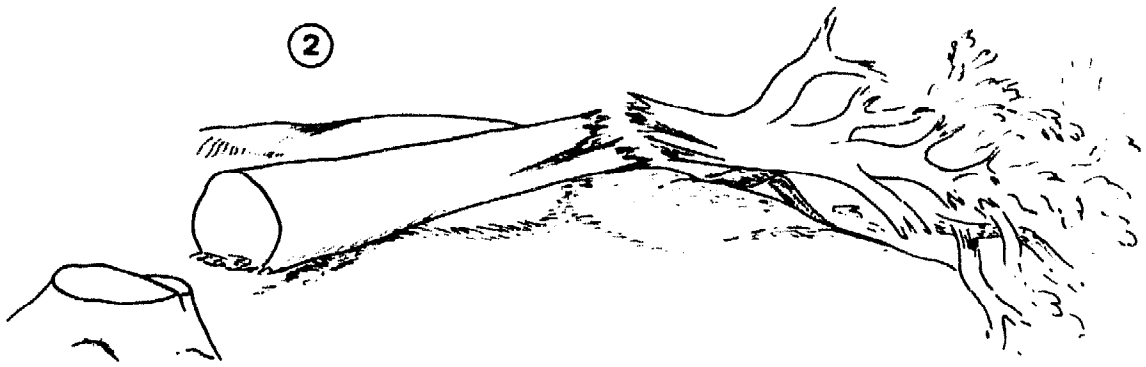

### RELEASING LODGED TREES WITH SIMPLE TOOLS

When thinning man-made forests, falling trees are frequently stopped by other trees. The tree is then said to be lodged and this is called a hang-up.

Skilled operators will try to avoid this by felling the tree into open spaces. A proper undercut, an adequate hinge and wedging will help to reduce lodging, but this cannot always be avoided.

**BEWARE** - dislodging hung-up trees is very dangerous. Think first before deciding how to take the tree down.

**Do not** walk or work below a hang-up.

**Do not** try to fell the tree which is holding the lodged tree.

**Do not** fell another tree on to the hang-up.

**Do not** climb the lodged tree to loosen its crown.

#### Recommended techniques for small trees

- Place suitable material (e.g. poles, split wood) on the ground on to which the tree might slide backwards (1a), (2a), (3a).
- Cut the remaining wood which may still connect the tree with the stump, preferably with an axe (1). If a saw is used, it might easily get pinched.
- Use the turning hook to roll the tree to one side (2).
- Use a pole to push the butt end backwards (3).
- Use a manual winch to pull the tree backwards (4). A pulley may help to increase the pull or to place the winch in a safe position, if necessary.

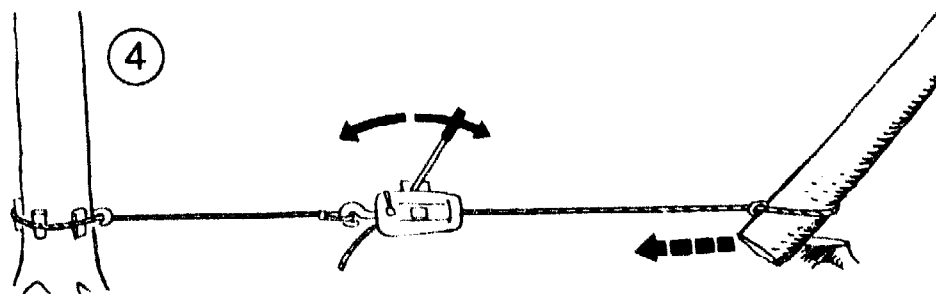
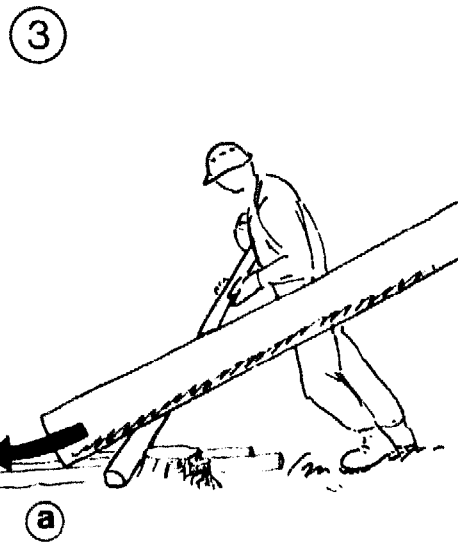
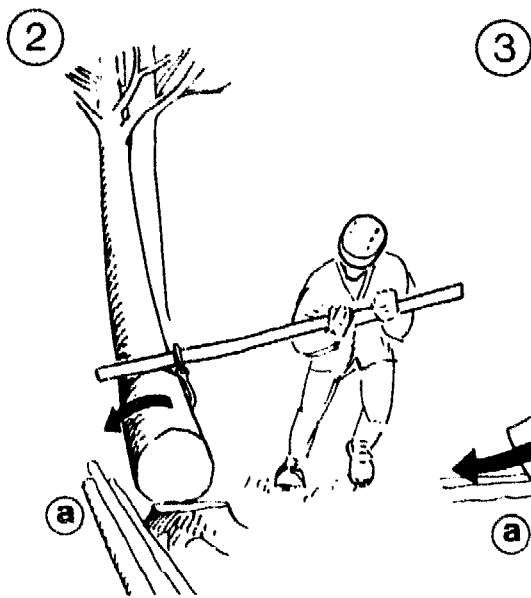
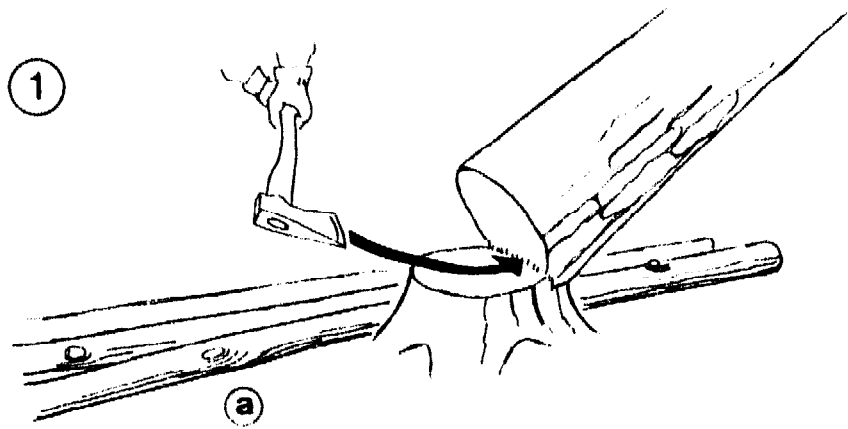



---

**RELEASING LODGED TREES WITH SPECIAL EQUIPMENT AND MACHINES**

If lodging occurs frequently, a sulky may be a convenient aid for lifting the tree up from the stump and to pull it down (1). The sulky may also be used to skid it to the skidding line. Sulkies are an excellent means of facilitating this heavy and dangerous job. Their use is restricted to trees up to a volume of about 0.5 cubic metres. Sulkies can be made in local workshops.

**BEWARE** - if the terrain slopes, the tree may push the sulky suddenly forward when it is lifted from the stump. In such cases, it is advisable to move the butt end to the ground before attaching the sulky. For braking, the handle of the sulky is lifted up.

Heavy trees which cannot be dislodged by manual work should be pulled down with draught animals or a skidding tractor (2). The tractor or animals must be placed at a safe distance from the lodged tree and the cable winch used.

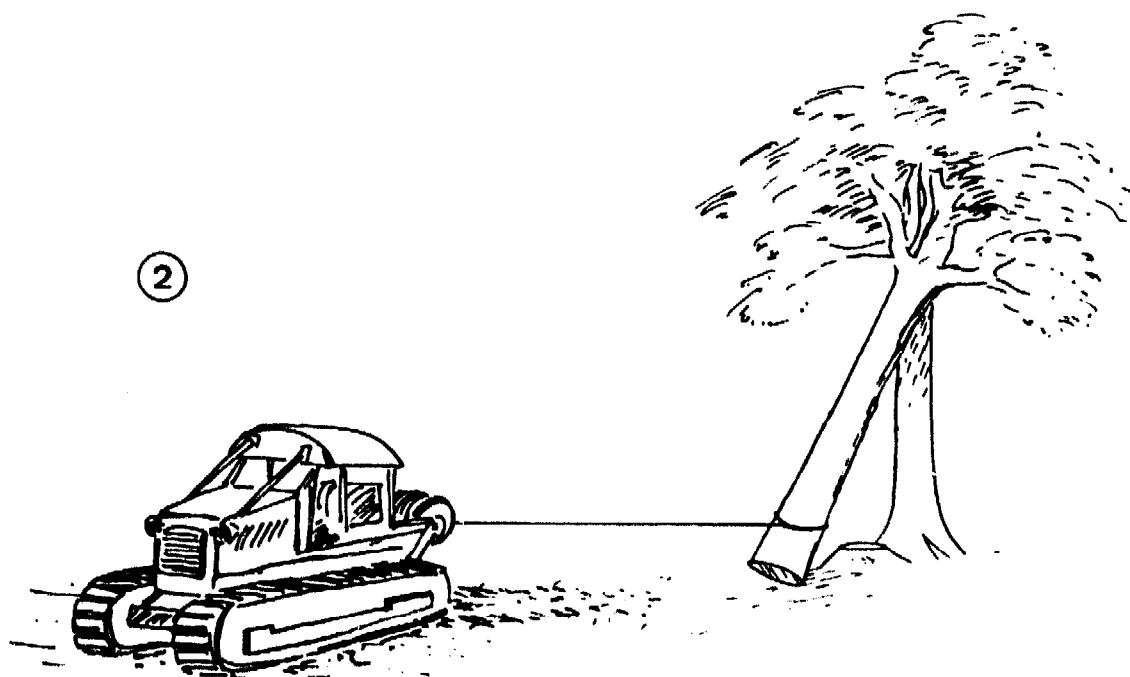
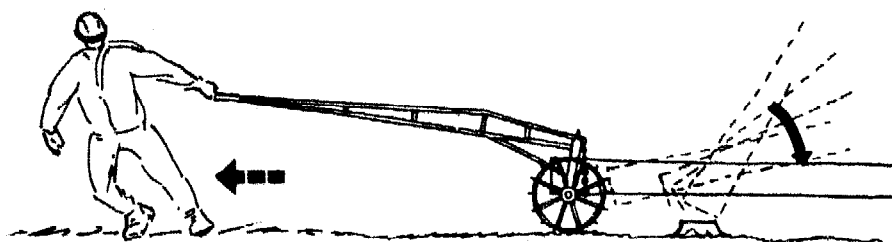
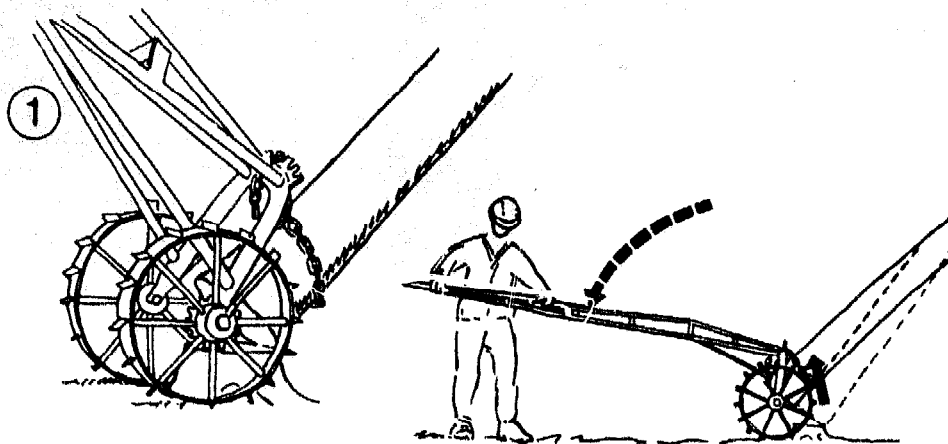

### DEBRANCHING

Debranching may be a rather time-consuming job, especially in coniferous trees. It is done with an axe. For small poles with thin branches, a machet can also be used.

Debranching is a dangerous job and easily causes accidents which may be quite severe, especially if a powerful stroke misses the branch and hits the leg. This may happen especially to young, inexperienced workers.

It is therefore essential never to cut towards the legs, to stand as far as possible on the side of the tree opposite the branch that is cut (1) and always to direct the stroke away from the body.

Debranching usually proceeds towards the top of the tree. If branches are thick and under tension, it may be preferable first to cut them off some distance from their base and subsequently cut the remaining part flush with the stem.

If trees are heavily branched, care must be taken to remove cut branches from the tree and to keep the working space clear.

After debranching the upper side, a turning hook (2) is needed to turn trees or logs (2a).



2

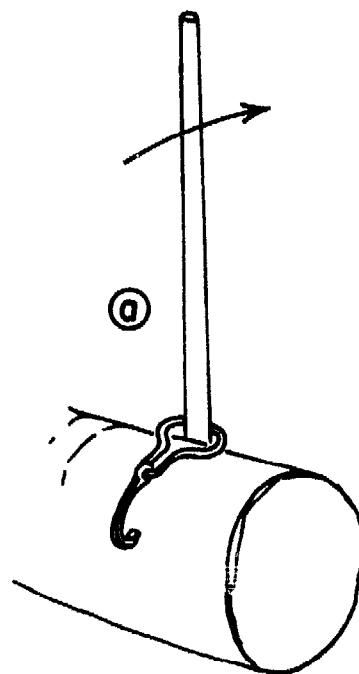
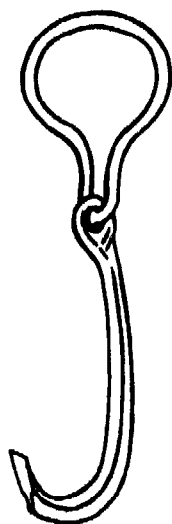

## DEBARKING

Debarking of wood may be required for a variety of reasons such as control of insects, acceleration of wood seasoning, reduction of weight in transport or simply the demand for wood without bark, for instance pulp wood, or the demand for the bark itself if it is used for tanning.

Large industries requiring debarked wood are usually equipped with debarking machines installed in the plant.

If manual debarking is required, a variety of different tools can be used. As debarking demands much time and effort, the tools should be suitable for the job and be handled efficiently.

Debarking of small- to medium-sized logs is usually done with debarking spades, of which different models exist. A short-handled debarking spade is used for harder bark (1a), a long-handled one for softer bark, to permit working in longer strokes (1b).

Axes may be used to debark trees or their butt ends if the bark is too thick and tough for the debarking spade.

It may be necessary to debark large logs of broad-leaved tropical trees which have very thick and strong bark. In such cases, an iron spoon should be used which permits, if necessary, beating the bark loose and peeling it off with the spoon (2).

Machetes are sometimes used for peeling off the thin bark of smaller trees, such as eucalyptus. They are less efficient and less convenient than debarking spades and should therefore be restricted to occasional work on a small scale.

As in debranching, a turning hook may be needed to turn logs during debarking.

1

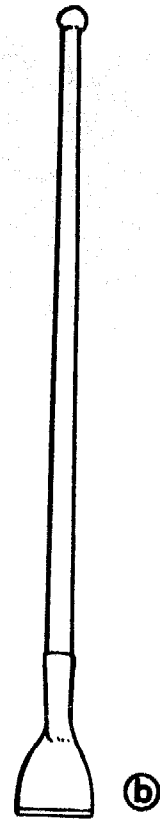
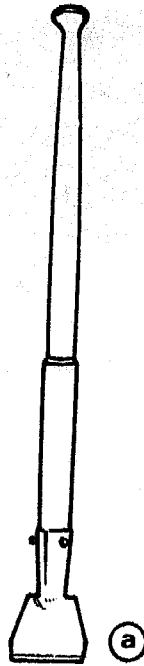

2

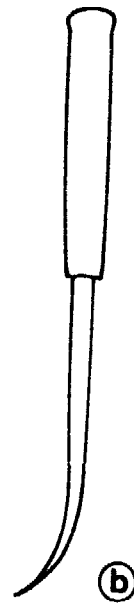
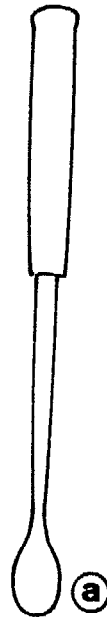
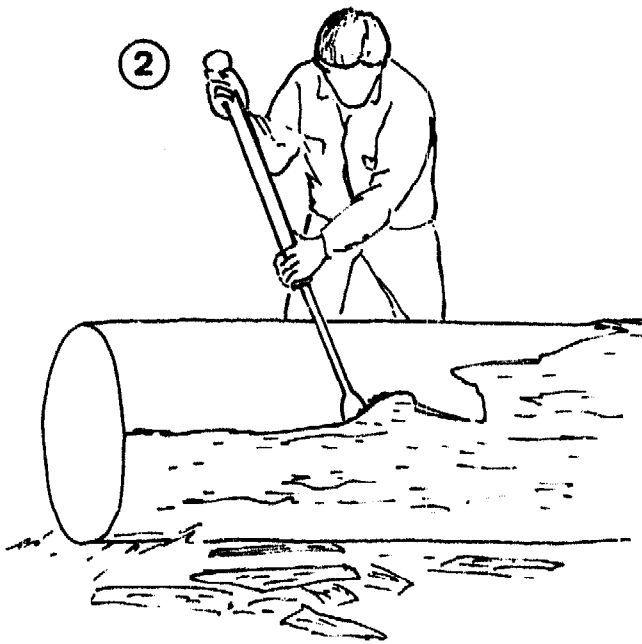

---

**GENERAL RULES FOR CROSS-CUTTING**

If the tree is not skidded to a landing for cross-cutting, this operation should be done in the forest by the same team which does the felling and debranching to avoid delays and additional time spent on getting to the tree. However, this process requires the presence of qualified supervisors or availability of workers having basic knowledge in timber grading unless only fuelwood is to be produced.

The greatest care is required to avoid losses in cross-cutting valuable trees. They should be thoroughly inspected for proper grading before cross-cutting begins. Clear instructions should be given for the grading of different logs. Simply cutting trees from the bottom into uniform log lengths may result in much wastage during utilisation.

A single tree may be cut into different assortments: for instance, higher-quality logs for the sawmill (1a), lower-quality logs for a chipboard plant (1b), and fuelwood (1c). Skilled grading can considerably increase the economic returns of the operation.

In many sawmills, it is common for saw logs to go straight from the forest without further cross-cutting into conversion. In such cases, tree shape and quality must be carefully assessed to allow a reasonable degree of recovery in the mill. Heavily tapering trees should therefore be cut into shorter lengths than straight trees with little taper (2). Minimum and maximum log length and size, however, will depend on transport facilities.

Crooked logs should normally be cross-cut in the bend and not between the bends (3).

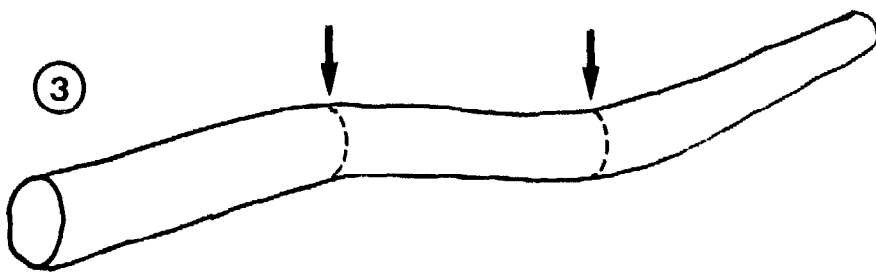
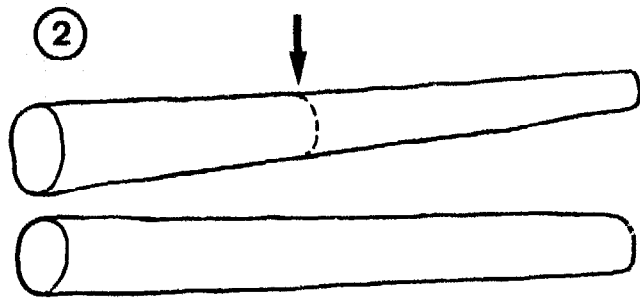
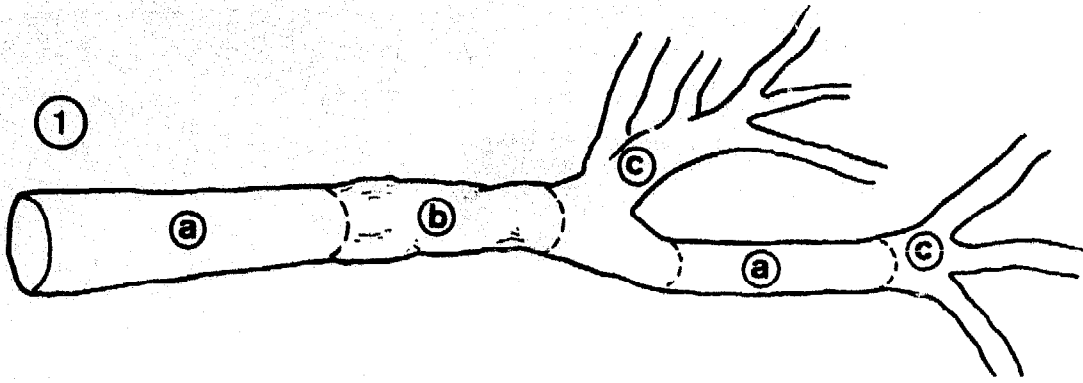



**TOOLS FOR CROSS-CUTTING**

For cross-cutting small-sized trees, e.g. for fuelwood, a portable support should be used (1). This facilitates the job and avoids contact of the sharp cutting tool with the ground. This type of support can easily be made on the spot and transported within the forest (see page 92).

Bow saws are handy for cross-cutting up to a diameter of 20 cm (2).

Above diameters of 20 cm, the bow saw should be replaced by the cross-cut saw (3).

To avoid pinching of the saw, wedging is required (4).

Furthermore, tools for correct measuring are needed, such as measuring sticks, tapes or calipers.

1

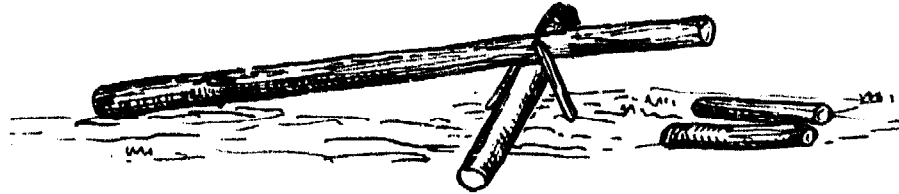

2

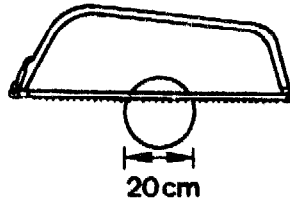

3

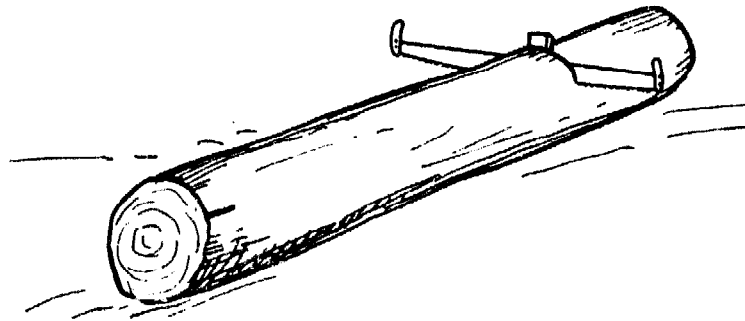

4

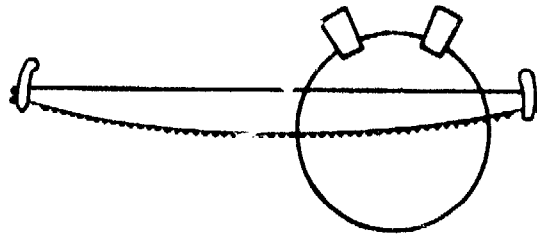

### SUPPORTS AND TRESTLES

These are made locally and used as an aid for work such as debarking and cross-cutting in the stand, at the roadside, landing or timber yard. In many cases, work is done more easily and quickly when using supports and trestles. Moreover, tool edges remain sharp for a longer time if work is not done close to the ground.

A forked branch is the easiest means of supporting a pole if rested against a standing tree in the forest (1).

Dovetail trestles consist of a wooden post and two legs. They can easily be made in the forest with no other tools than an axe and a bow saw. Dry and light wood is used. Two dovetail cuts are made on one end of the post (2). The top ends of the legs are square on three sides (3) and fitted into the dovetail cuts.

The low dovetail trestle (4) consists of a post 200 cm long and 12 cm thick (4a). The dovetail cuts 25 mm deep are made about 20 cm and 40 cm from the end. The legs are 70 cm and 80 cm long and about 7.5 cm thick. They are inserted into the dovetail cuts from below. Their feet should be about 65 cm apart. The top of the longer leg must be so fitted into the dovetail that it is 10 cm higher than the post. This extended leg and two notches made in the lower end of the post provide three resting positions for poles which can be put on to the trestle by tools such as a log turner or a sappie.

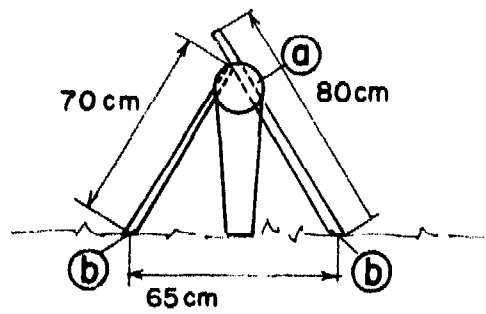
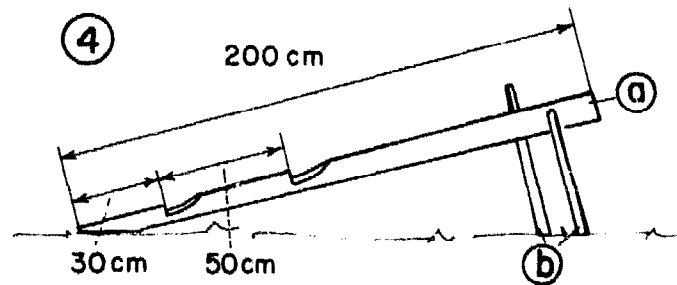
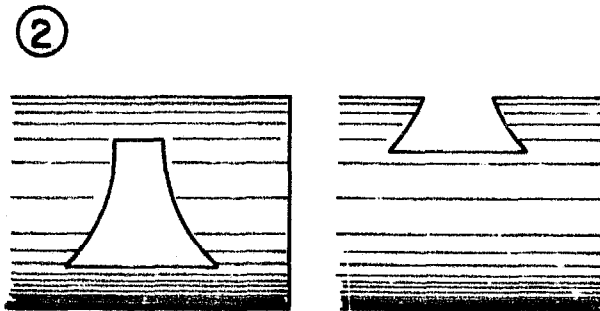
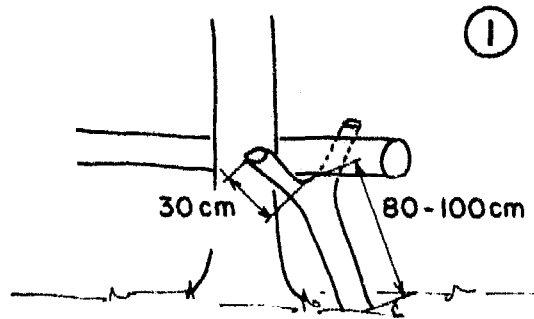

---

**CROSS-CUTTING OF TREES UNDER TENSION**

Cross-cutting of trees under tension may cause loss of wood and may also pinch the saw. This should be avoided as much as possible through special techniques.

Tension can often be reduced by putting supports under the tree (1a). If this is not possible, e.g. in a tree where the upper side is under tension and the lower side is accessible, then cross-cutting should be done from below (1b) until the saw starts jamming and then continued from above (1c).

If the lower side of the tree is under tension, an effort should be made to place a support under the tree (2a). In this case, sawing should start from above until the saw starts jamming (2b) and be continued from below (2c) unless wedging is feasible and sufficient.

In windfalls, cross-cutting under tension is very common. As shown on pages 98 and 99, a pressure rope or cable can be used in such cases to avoid cracking. Such equipment may in special cases also be useful in other harvesting operations.

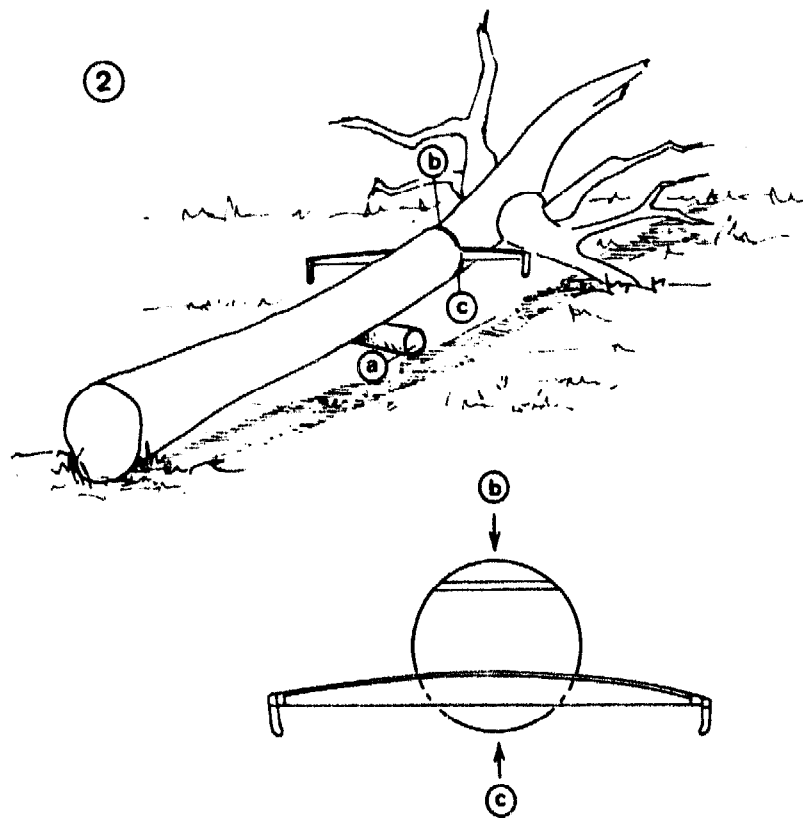
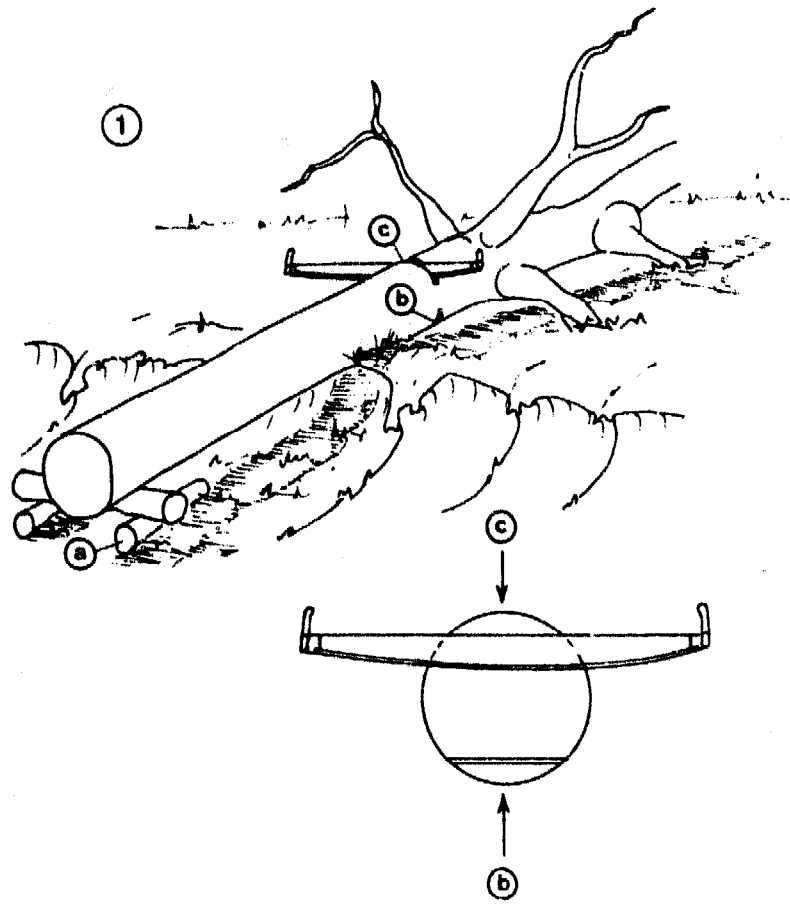

**WOOD WASTAGE IN CROSS-CUTTING**

Cross-cutting with axes should be avoided (1a). In large-sized wood, losses of 30 per cent of the total volume may occur if wood is cut into lengths of 1 m or less. The saw cut wastes only a minimal amount of wood and requires less effort than axe work (1b). Furthermore, a clean saw cut allows more precise measurement and stacking as well as denser loading in transport.

If cross-cuts on logs are not made at an angle of  $90^{\circ}$  (2a), wood is usually lost during utilisation since logs may require corrective cross-cutting.

Cutting from the side which is under tension causes the log to crack. This may be an advantage in special circumstances when the log would have to be split anyway into fuelwood or pulpwood. However, valuable logs should never be reduced by careless cutting to fuelwood quality (3a, 3b).

①

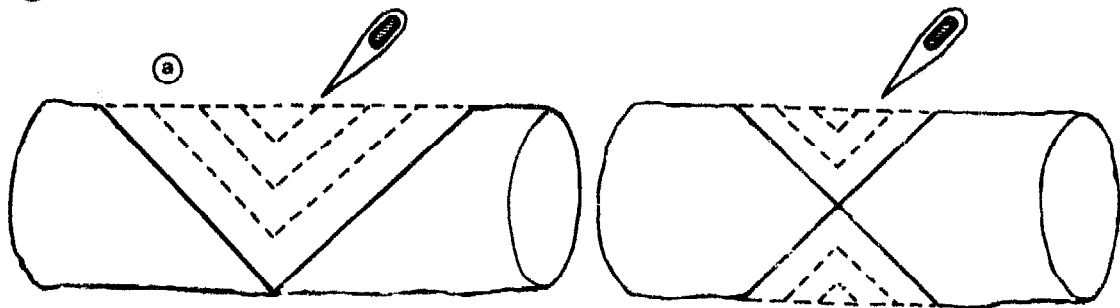

(b)

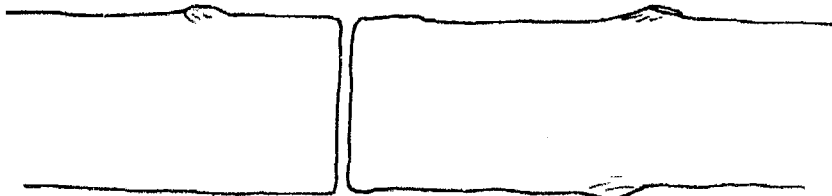

②

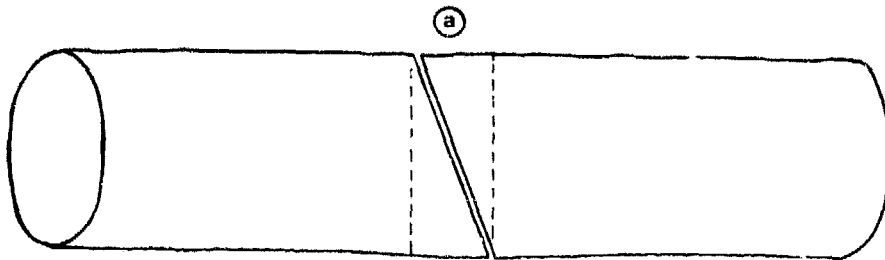

③

(a)

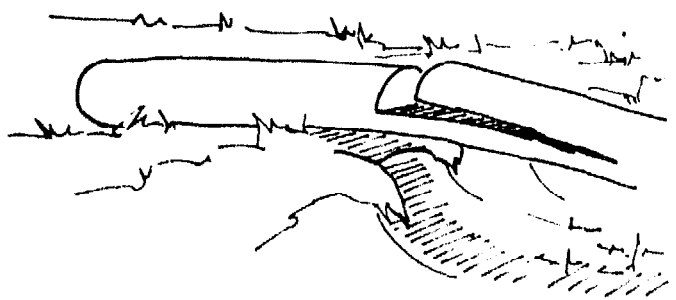

(b)

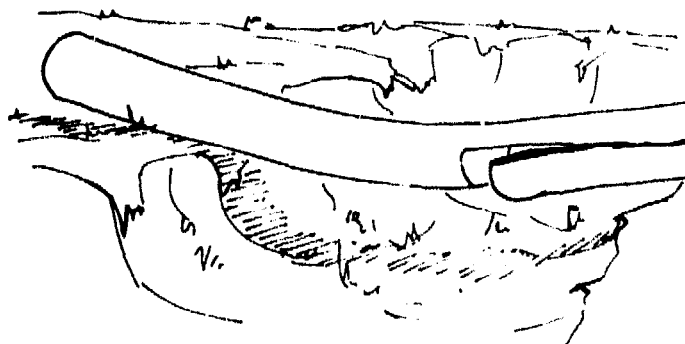



Windfalls are dangerous to cut: the wood is often under high tension; the working place is sometimes restricted and the tree difficult to get at. Stumps may tip forward or backward when cut loose from the trunk. Therefore, the worker must be well trained and experienced in order to avoid accidents and to reduce the loss of wood.

Chain saws have a definite advantage over hand saws in clearing windfalls as they can be more easily handled in restricted space and, compared to a cross-cut saw, only one man is exposed to danger. They permit special techniques for cutting wood under tension without cracking. Furthermore, in extensive windfalls where there is a danger of wood deterioration through insects and fungi, chain saws help to speed up the operation.

Wind-fallen areas are attacked from the side where the wind has entered. When working with hand tools, trees are worked up from the top end by debranching and cross-cutting to release tension.

When cutting the tree from the stump, special care must be taken if there is a danger of the stump turning over. To avoid the stump moving towards the sawyers, different means of support can be used, e.g. a piece of wood or a stone (1a), a pole (1b), or a cable (1c).

After cutting off the tree, stumps may fall back. The sawyers must therefore make sure that nobody is standing behind the stump whilst they are sawing.

In loose soil, the base of the tree may be pressed on the ground. In this case, it is necessary to dig a trench to allow salvage of the valuable butt end (2a).

Cutting of tensioned trees in windfalls may easily result in wood losses through cracking (2b). This risk can be reduced through pressure ropes or chains (3).

Work in windfalls is greatly facilitated if the wood is skidded after cross-cutting to storage places which are easy of access.

①

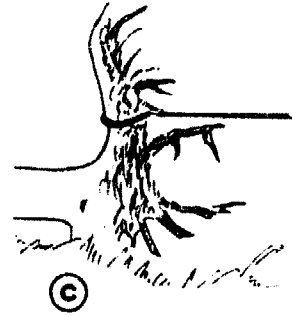
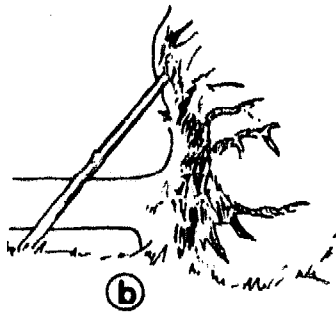
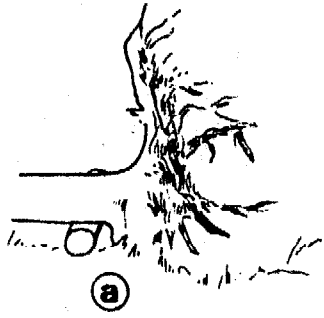

②

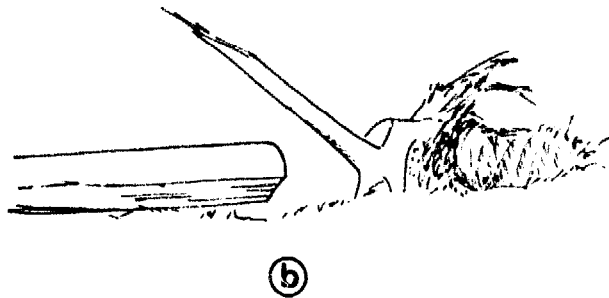
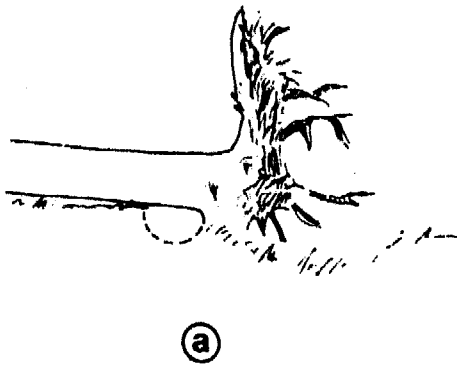

③

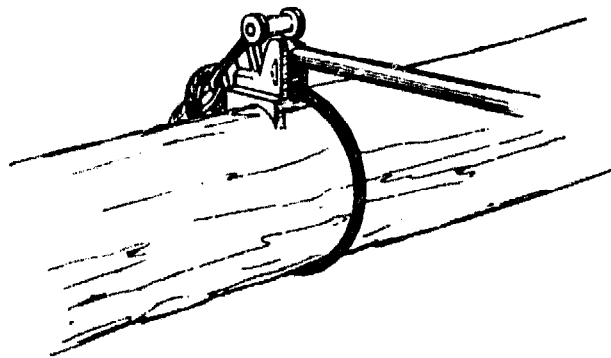

To make handling and transport of short pieces of wood easier and to reduce the time required for seasoning, wood of a diameter exceeding 20 cm is often split after cross-cutting. In the absence of splitting tools, bigger wood pieces of fuelwood quality often remain unutilised.

It may also be necessary to split wood to be used as fence posts.

Splitting requires good quality splitting hammers and wedges. The hammer should weigh about 2.5 kg and have a straight handle, about 90 cm long, with a knob (1). Steel wedges with a mushroom head should not be used (2). The safest wedge is a steel socket wedge with a wooden head and a steel ring (3).

Since the way wood splits differs a lot depending on the tree species, splitting techniques must be modified accordingly. For wood which splits easily, a few blows with the cutting side of the splitting hammer on the end of the billet will suffice. For wood which is more difficult to split, a wedge is inserted near the end of the billet and further wedges may be needed as the crack opens (3).

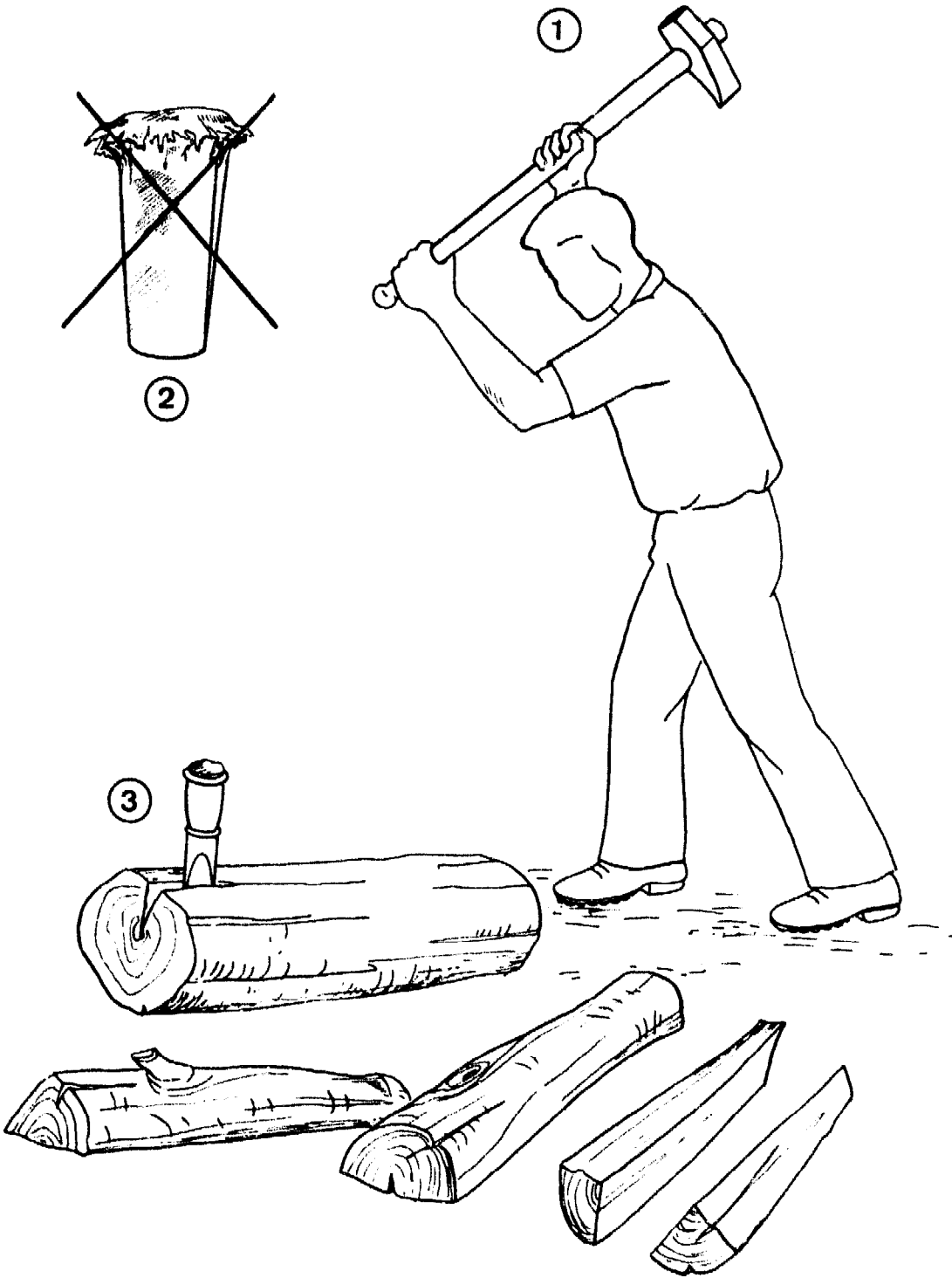

### HANDLING BILLETS AND LOGS

Loading and stacking of billets and moving of logs is easier if simple helping tools are used.

In the absence of such helping tools, the worker has to bend down and pick up the wood from the ground, which may be muddy (1a).

A timber pick makes it much easier to pick up and handle small pieces of wood (1b).

Different types of handling tools are available, such as metal hooks (2), timber picks with a short wooden handle, fitting the hand of the worker (3) and small timber tongs (4). The latter tool is particularly handy but the former ones can be locally made more easily.

The sappie is used for lifting or for short-distance skidding of logs (5). A model for heavier logs has a handle 190 cm long and a hook 42 cm long. A lighter model has a handle 110 cm long and a hook 28 cm long.

Sappies are typically used for pulling logs (6) and for turning them (7). In the Alpine countries they were widely used for gravity skidding of logs and continue to be indispensable in handling logs during tree felling and transport.

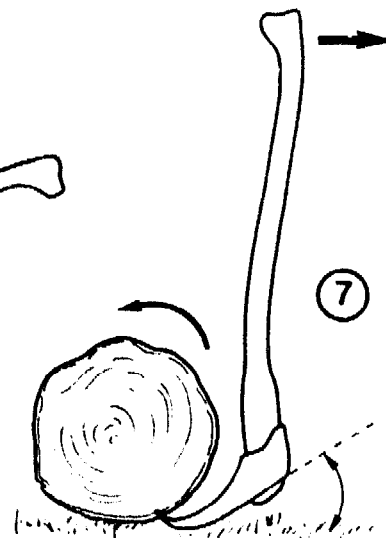
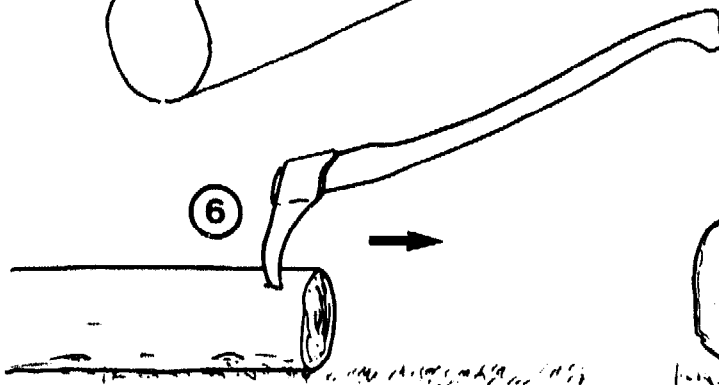
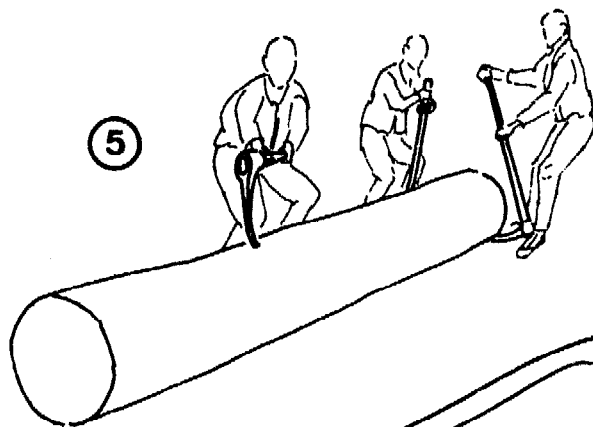
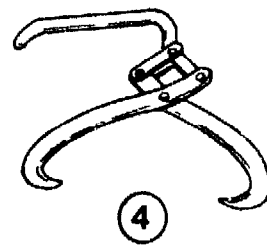
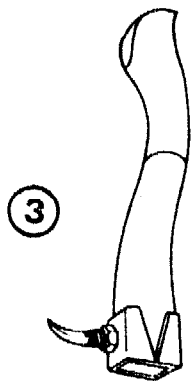
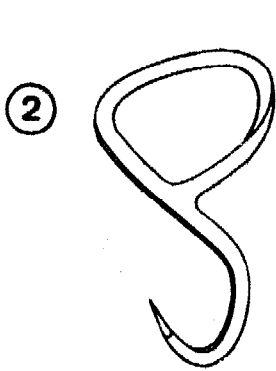
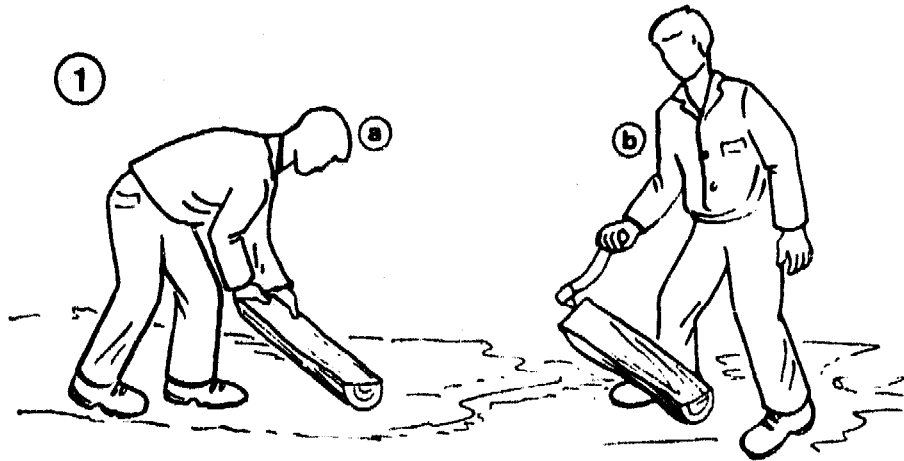

**MANUAL TRANSPORT OF SMALLER-SIZED WOOD**

Carrying wood manually should be avoided as much as possible. It is a heavy and inefficient job which is only permissible over short distances of just a few metres (1).

Small logs can be pulled more easily to the stacking or loading place using skidding tongs (2). The tong should be attached close to the end of the log to achieve a lifting effect and thus facilitate pulling.

If the terrain and ground cover permit, the wheelbarrow is an excellent means of assembling loads of short pieces of wood for transport over short distances, e.g. for taking wood to a site for a charcoal kiln (3).

①

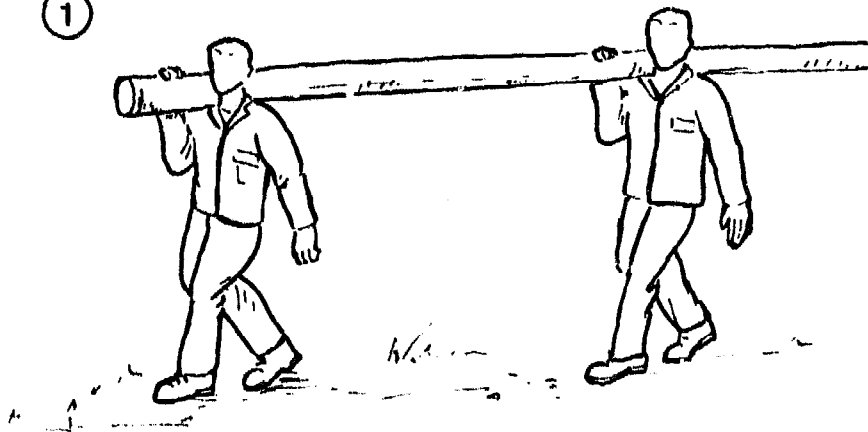

②

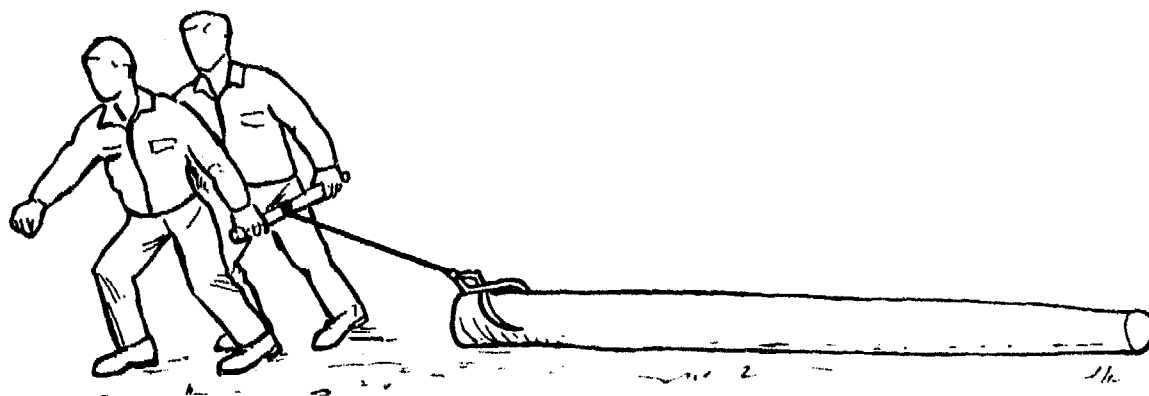

③

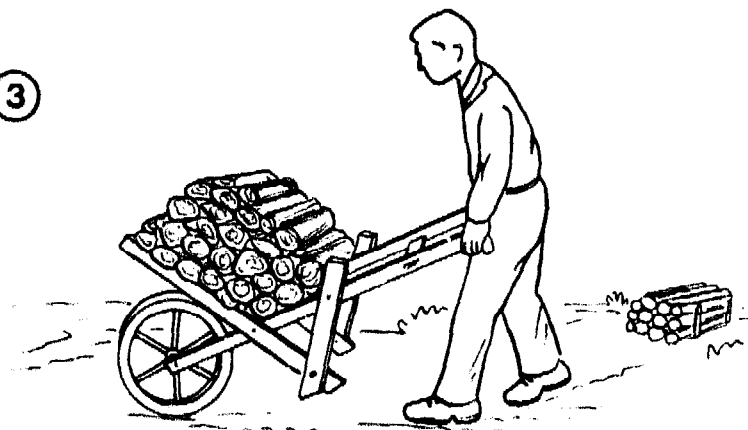



### USE OF SKIDDING SULKIES

The skidding sulky (1) is used for short-distance transport of small-sized logs, especially downhill on moderate slopes. Loads can consist of single logs or bundles and may have a weight of up to 200 kg. On flat terrain, loads are attached at the centre of gravity. On increasing slopes, the load is shifted more towards the back to serve as a brake. Skidding sulkies can be built with 2 wheels (1a) or with 4 wheels fixed to bogie axles (1b). The latter type is more sophisticated but permits the handling of larger loads and negotiating rougher surface conditions.

Two sulkies can also be connected to skid bigger logs (2). In this case, the load is guided by one handle in the front and one in the rear. On slopes, the rear part of the log should hang close to the ground to facilitate rapid braking when required.

On steep terrain, two sulkies may be operated together (3). They can be connected by a cable which is guided by two pulleys attached to trees (3a). The loaded sulky (3b) can thus be used to pull up the empty one (3c), together with the worker, who guides it by the handle.

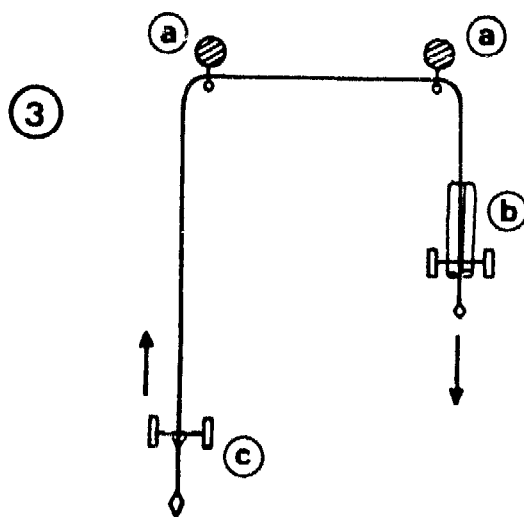
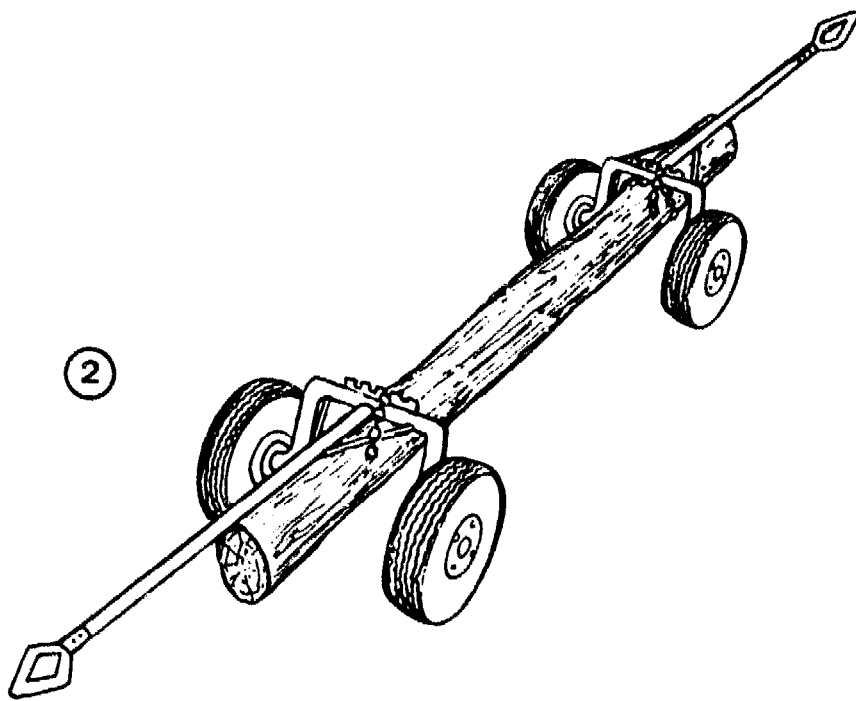
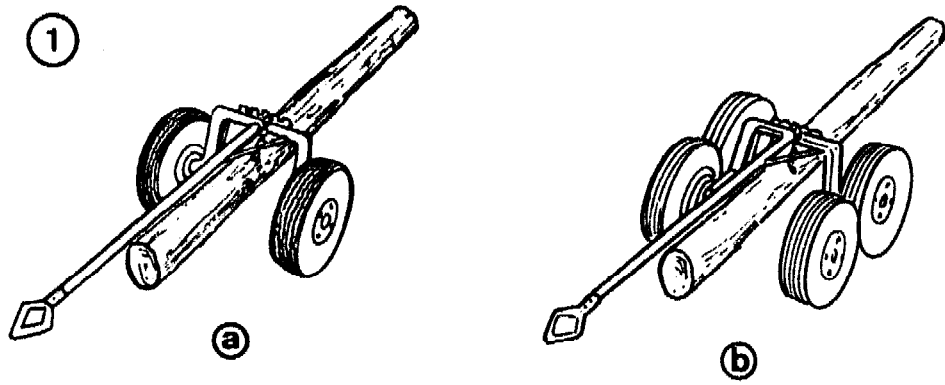

### SLIDING WOOD DOWNHILL

Timber chutes are used for sliding small logs or short pieces of wood downhill on slopes with a gradient of 25% or more (1).

Plastic chutes are commercially available in sections of 5 m and with a diameter of 35-50 cm. At a diameter of 40 cm, the chutes can take logs up to a length of 5 m and short pieces to a diameter of 30 cm.

Chutes may be used over distances of up to 150 m. Under favourable conditions, 2 m<sup>3</sup> stacked may be transported per hour over that distance.

Commercially-available chutes are easily assembled thanks to different connecting systems. Chutes may be made locally from plastic tubes cut lengthwise or from other materials, e.g. wooden boards, although these are heavier and more difficult to handle.

In clearfelling areas on moderate slopes, logs may be rolled down to the roadside across trees which have been felled up the slope (2). They can subsequently be cut into shorter assortments, if necessary, at the foot of the slope. This technique, if applied properly, can save considerable expense in skidding.

①

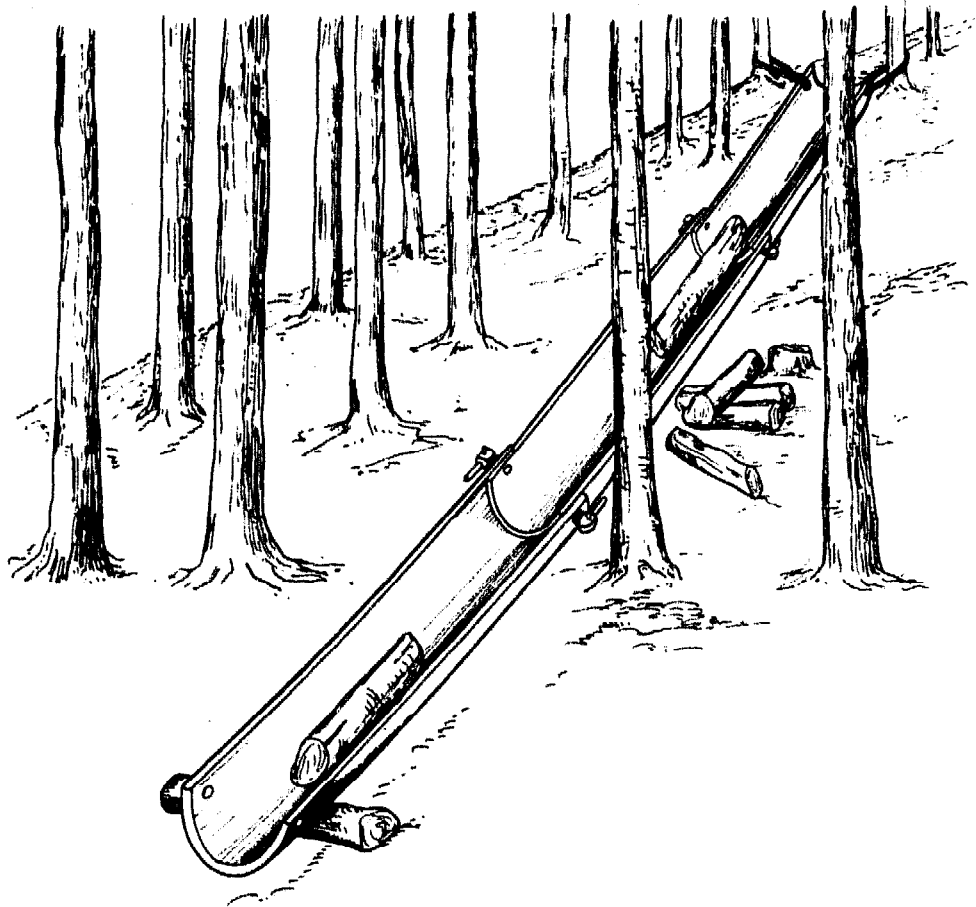

②

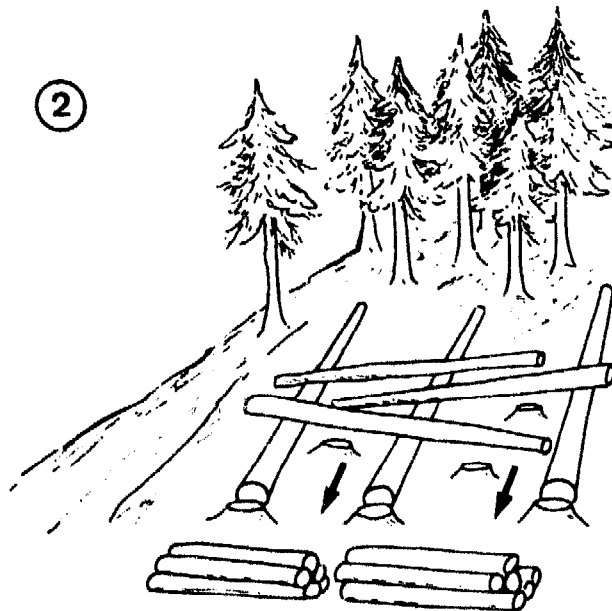

Proper stacking of wood at the roadside prior to transport aids seasoning, reduces weight and provides protection against deterioration. Stacking should if possible be done on the higher side of the road embankment if this facilitates loading (1).

Logs and poles should be placed on supports (1a) and be easily accessible for loading.

Short wood is usually piled in stacks which also require supports (2a). The stacks should be firmly secured by one or more stakes (2b).

Small-sized material used for fuel can be bundled prior to stacking and is thus more easily handled and marketed (3).

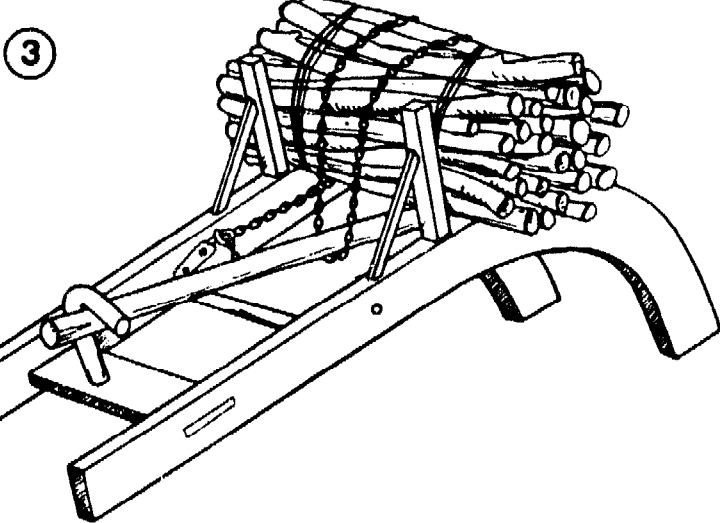
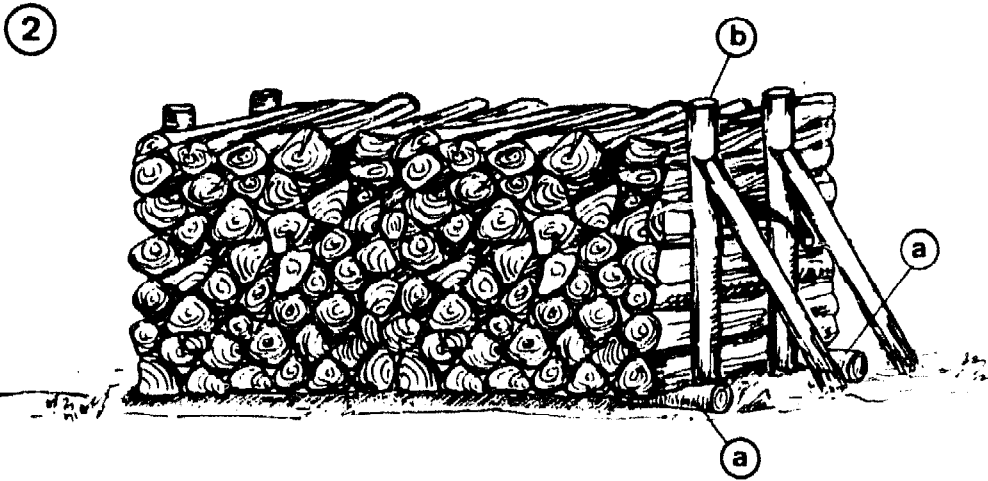
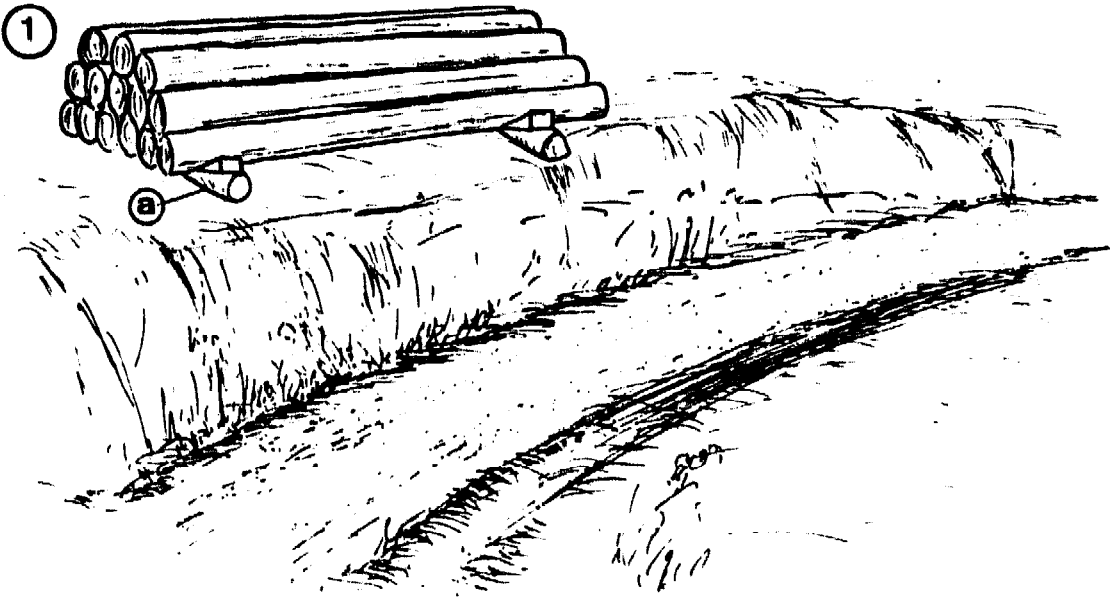

Pit-sawing continues to be widespread in rural areas of developing countries. It is used for cutting boards and planks at the felling site without transporting the logs. The sawnwood is mainly used locally as building material but sometimes it reaches distant markets. Pit-sawing provides jobs for many thousands of workers.

Pits are dug and large logs are easily rolled across for sawing. However, it is more convenient to set up a stand on which the log is placed (1). The saw cut is marked with a string soaked in moist charcoal dust (fines). A plumb line is fixed to the end of the cut to guide the worker standing on the ground. This worker should wear a wide-brimmed hat as a protection against sawdust. The saw cuts only on the way down but the worker standing on the log has the heavier job because he has to lift the saw up to shoulder height. Therefore, both workers should change places regularly.

The pit saw is tapering in shape (2). Depending on log size, pit saws may vary in length from 150 to 300 cm. Different types of handles are used. An example is given of a lower handle (3a) and an upper handle (3b), both of which must be easily removable.

The shape and size of the teeth is indicated in illustration 4. The height of teeth is from 15 to 20 mm, the distance from tooth to tooth from 20 to 25 mm, the front edge angle varies from 100 to 105° and the near edge angle from 20 to 25 mm.

Maintenance includes the following operations:

- jointing (as for cross-cut saws);
- gulleting (with round-edge millsaw file);
- sharpening of teeth (with millsaw at an angle of 90° with the saw);
- setting of saw (as for triangular cross-cut saws, saw set 0.8 mm);
- bevelling (teeth pointing away are given a slight bevel of about 5°).

The measures given must be adapted to size of log and hardness of wood.

②

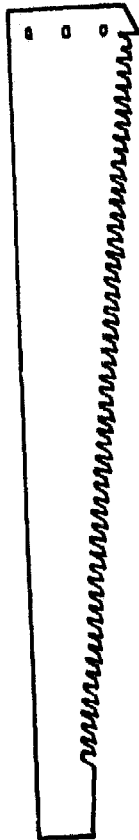

①

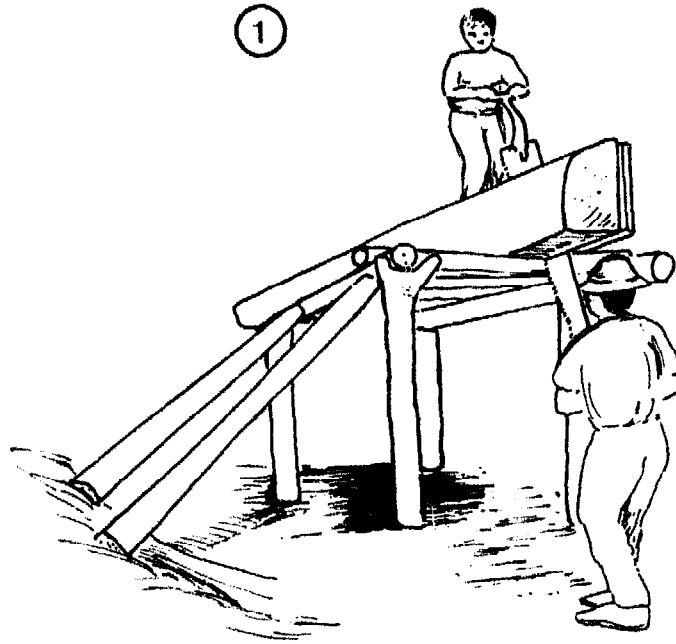

③

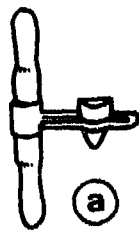

a

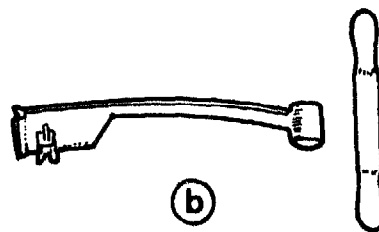

b

④

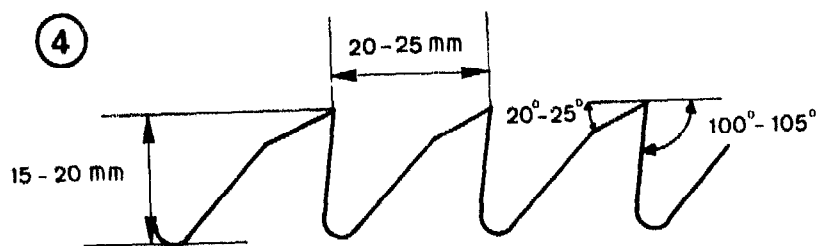



Wood harvesting, whether done with hand tools or with machines, can be a heavy and dangerous job. If it is done by unskilled persons with poor tools and inadequate working techniques, it generally results in excessive effort, numerous accidents, low productivity and also in wood waste. For this reason, training is indispensable not only for professional forest workers but also for occasional wood cutters such as rural people harvesting fuelwood or construction poles.

Obviously, such training must be adapted to the special conditions of wood harvesting. It must be done on the job, as much as possible in a practical way and on a short-term basis with follow-up visits. It should always be based on locally-available tools and equipment. The benefits of training may be lost if tools are brought just for the sake of training which cannot be bought locally or which are too expensive for village people. Under such conditions, it is important for the trainer to ensure that tools and tool handles made by rural artisans or sold by local hardware shops meet the requirements as much as possible.

Traditionally, skills are passed on from one generation to the next. Where the axe is the only wood harvesting tool, this transfer of skills normally produces quite experienced axe workers. However, the use of saws, saw maintenance tools and helping tools requires additional knowledge and skill for which training is needed.

Training of professional forest workers may last several weeks in order to reach acceptable levels of productivity with new tools and working methods. For the occasional wood cutter, the minimum would be a one-to-two day demonstration, but a one-week period including demonstrations and on-the-job practice would be preferable. This type of training should concentrate on safe working habits, reduction of physical effort and optimal wood utilisation more than on high productivity.

The trainee is provided with information, demonstrations and practice regarding tools and tool maintenance, safety rules, directional tree felling, debranching, cross-cutting, splitting, stacking and transport as required for his job. For the maintenance of tools, especially saws and wooden handles, it may be necessary to train specially selected persons who take care of this aspect for a group of workers.

Training will be readily accepted if it brings obvious benefits to the trainee. Follow-up visits are needed to further improve and correct the work.

---

The instructor plays a crucial role in training. He will only be accepted if he is perfectly skilled himself and if he is able to communicate in the language spoken locally. Ideally, instructors should themselves have extensive experience in wood harvesting and should undergo special training as instructors for several months.

Training of instructors for wood harvesting is included in ILO technical co-operation activities. Further information on this subject may be requested from:

Forestry and Wood Industries Specialist,  
International Labour Office,  
CH-1211 GENEVA 22,  
Switzerland.

Please send any comments which you might wish to make on the contents of this training manual and suggestions for its improvement to the same address.