

**AT** MICROFICHE  
REFERENCE  
LIBRARY

A project of Volunteers in Asia

The Gaudgaon Village Sailwing Windmill

by: William W. Smith III

Published by:

Volunteers in Technical Assistance  
1815 North Lynn Street Suite 200  
P.O. Box 12438  
Arlington, VA 22209 USA

Paper copies are \$ 5.95.

Available from:

Volunteers in Technical Assistance  
1815 North Lynn Street Suite 200  
P.O. Box 12438  
Arlington, VA 22209 USA

Reproduced by permission of Volunteers in  
Technical Assistance.

Reproduction of this microfiche document in any  
form is subject to the same restrictions as those  
of the original document.

Renewable Energy Series

# THE GAUDGAON VILLAGE SAILWING WINDMILL

By William W. Smith III

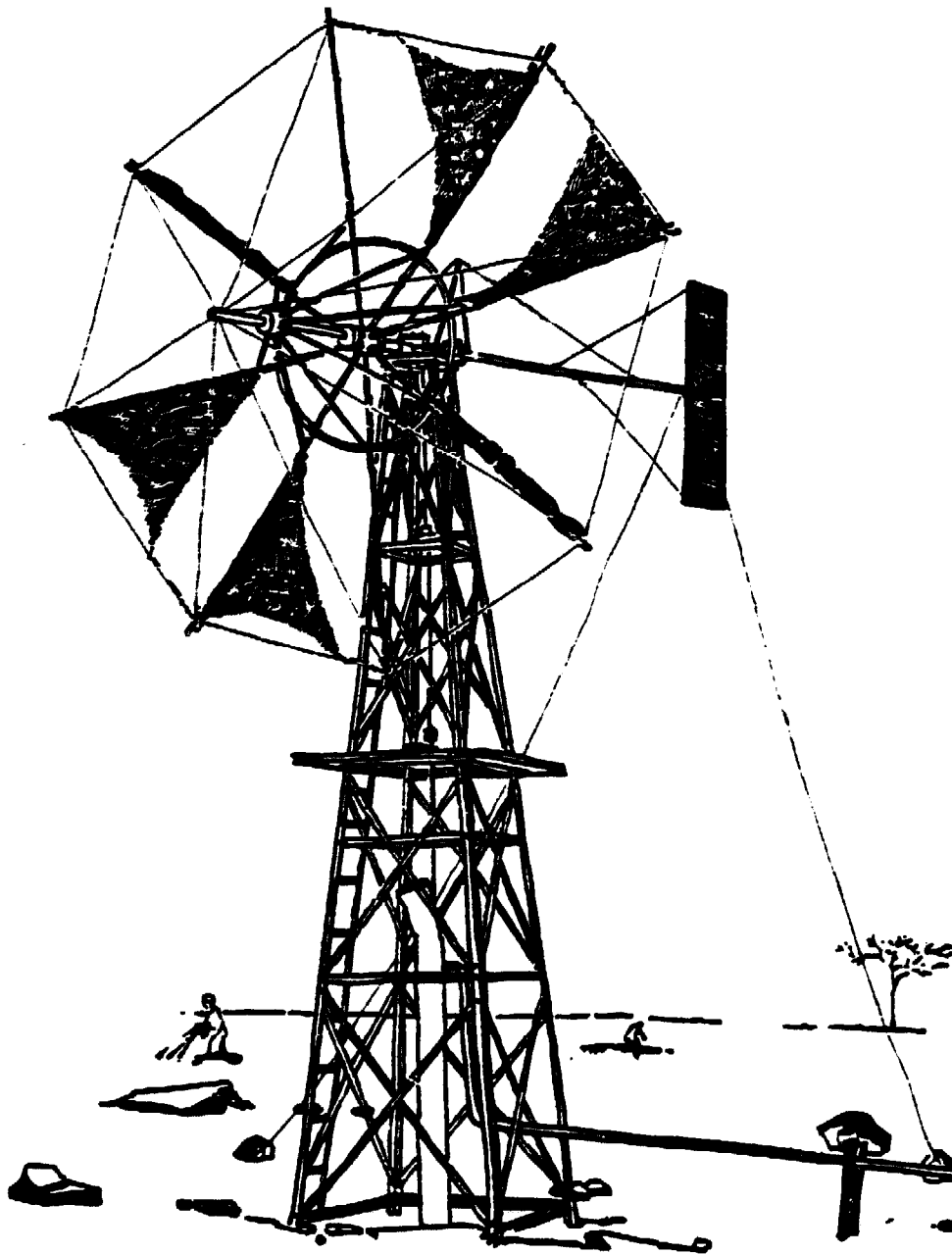

a **VITA** publication

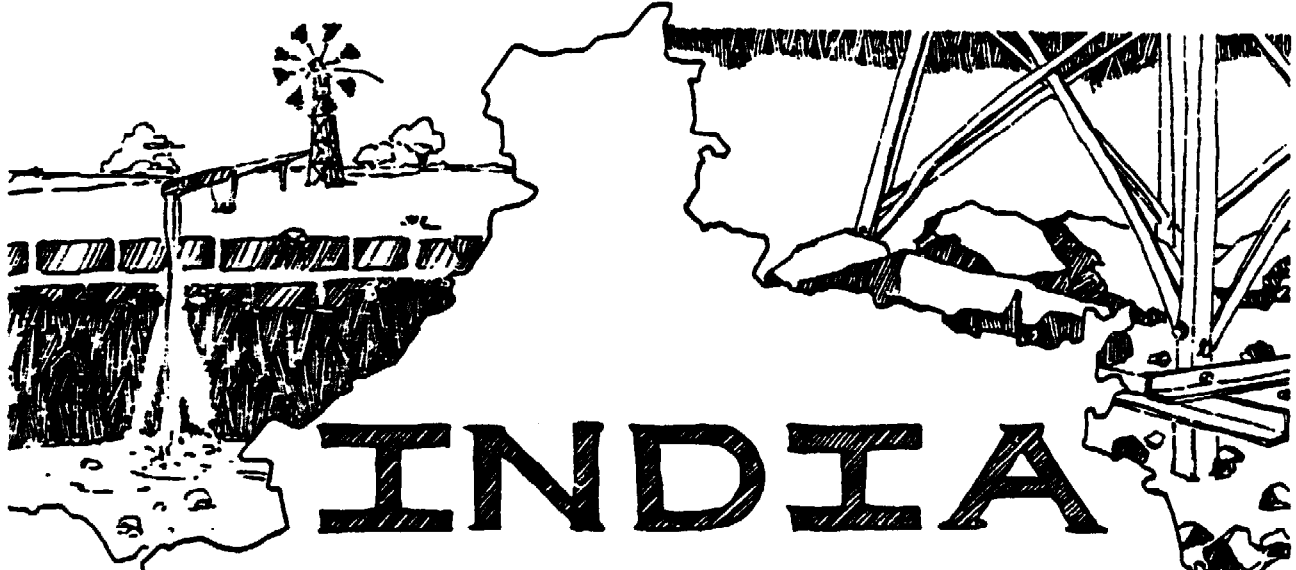

# INDIA

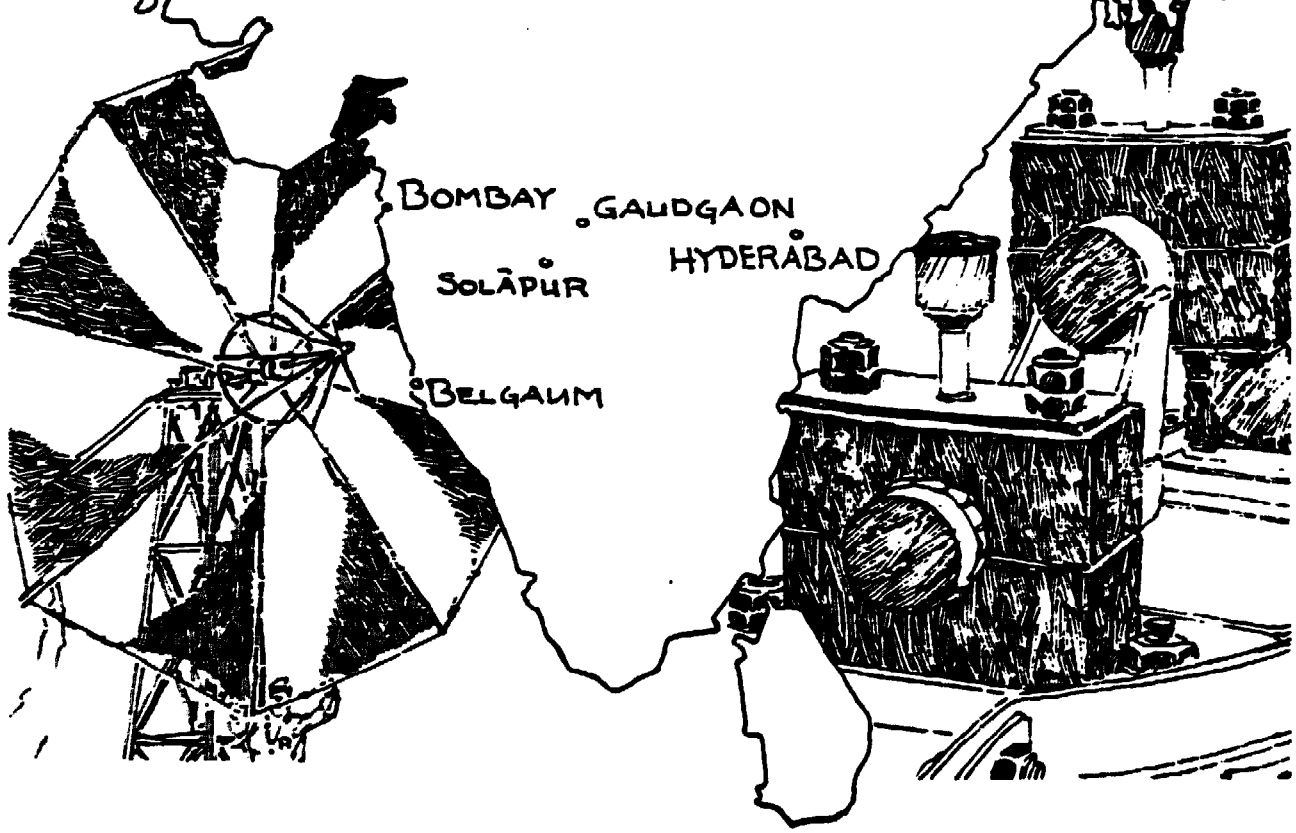

BOMBAY GAUDGAON  
SOLAPUR HYDERABAD  
BELGAUM

# **The Gaudgaon Village Sailwing Windmill**

by

**William W. Smith III**

**Illustrated by Bruce Towl**

**Blueprints by William Gensel**

published by

**VOLUNTEERS IN TECHNICAL ASSISTANCE, INC.  
1815 North Lynn Street, Suite 200  
Arlington, Virginia 22209-2079 USA**

This publication is one of a series  
issued by VITA to document the activities  
of its worldwide Renewable Energy Program.

ISBN 0-86619-165-8

© Volunteers in Technical Assistance, Inc. 1982

# TABLE OF CONTENTS

I. ABOUT THIS HANDBOOK.....	1
II. INTRODUCTION.....	3
The Gaudgaon project.....	3
Reasons for the designs.....	5
Three different designs.....	6
III. GENERAL WIND ENERGY PRINCIPLES.....	11
Wind resources.....	11
Windmill design.....	17
Windmill economics.....	21
IV. DETAILED DESCRIPTION OF THE 24-FT DIAMETER IRRIGATION WINDMILL.....	25
Materials.....	25
Tower.....	25
Windmill chassis and main shaft.....	27
Windmill rotor.....	29
Pump, levers, and pump rods.....	31
V. VILLAGE FABRICATION TECHNIQUES.....	35
Safety.....	35
Cold forging.....	35
Hot forging.....	38
Carpentry.....	40
Sewing.....	40
Masonry.....	40
Welding.....	40
Drilling.....	42
Threading.....	42
VI. CHECKLIST FOR CONSTRUCTION OF A 24-FT DIAMETER VILLAGE-BUILT WINDMILL.....	43
Tools.....	43
Check the windmill design.....	43
Purchase materials.....	44
Construction steps.....	44
VII. INSTALLING THE WINDMILL.....	51
Transporting the windmill.....	51
Erecting the windmill tower.....	52
Placing the tower foundations.....	53
Installing the windmill chassis, main shaft, and tail arm.....	53
Installing the windmill rotor.....	56
Installing the connecting rods and pump rod.....	58

Installing the pump.....	60
Checking the windmill machinery.....	60
Installing the counterweight.....	61
VIII. OPERATING AND MAINTAINING THE WINDMILL.....	63
Safety in operation of the windmill.....	63
Starting the windmill.....	63
Stopping the windmill in a normal wind.....	65
Stopping the windmill in a strong wind.....	65
Windmill maintenance.....	66
Pump maintenance.....	66
IX. USING THE WINDMILL FOR IRRIGATION.....	67
Storage tank.....	67
Pipeline.....	68
Auxiliary power sources.....	68
Intermittent irrigation.....	68
Borewell irrigation.....	68
APPENDIX I.....	71
Different types of windmills.....	71
APPENDIX II.....	73
Books and magazines about wind power.....	73
APPENDIX III.....	77
Materials list--24-foot windmill.....	77
APPENDIX IV.....	79
Construction drawings--24-foot windmill.....	79

# I. ABOUT THIS HANDBOOK

The windmill fabrication techniques described in this handbook are the result of my stays in Gaudgaon Village, Solapur, Maharashtra, India, in 1976-77 and 1980-81. The handbook is meant to be a practical guide for people in parts of India or other windy, arid areas who may wish to build windmills of the type now being demonstrated at Gaudgaon. Although it gives many details, this Handbook cannot describe everything that has been done at Gaudgaon. In particular, anyone wishing to build a windmill of this type should purchase the blueprint drawings of the machinery, or, even better, attend the three month windmill fabrication training course offered by the Shri Shivaji Shikshan Prasarak Mandal, Gaudgaon Taluka Barsi, District Solapur, Maharashtra, 413 406 India.

Many, many people and organizations have helped with this work, and I wish to thank particularly the Godbole family, who took care of me while I was in Solapur; Mr. J. G. Lohokare of Gaudgaon, whose determined support of the project helped us through many discouraging days; Nana and Prabakhar Gavali of Subashchandra Mechanical Works in Solapur, who donated use of their facilities; Oxfam-Nagpur, under whose grants a major portion of the work was undertaken; VITA's Renewable Energy Program, which supported both my work in India and publication of this handbook; Marcus Sherman, VITA's field representative in Asia, and the VITA staff in the United States, who provided important support; Bread for the World in Stuttgart, West Germany, who also supported part of the work; VITA Volunteer artists William Gensel and Bruce Towl, for the excellent drawings and blueprints; Chhagan Sutar, Nishicant Sutar, Naga Lohar, and Oudow Kazale, who taught me village fabrication methods; and my father, who taught me to work with my hands. Any mistakes or omissions in this handbook are my responsibility, and I will be grateful to receive suggestions for revisions. For those who work and think with metric measurements, my apologies.

Several things cannot be overemphasized. First, the windmills described here are undergoing testing and many of their features are not yet proven over time. It is almost certain that their designs will be changed in coming years. In fact, as long as people build windmills with their own hands for their own use, windmill design will continue to evolve.

Second, there can be no substitute for careful planning and attention to detail when building these windmills. Careful village craftsmanship can produce a windmill that is strong and that runs well. Sloppy work and careless planning generally



will create a machine that breaks down quickly and wastes a farmer's money.

Third and most important, these windmills can be dangerous at many times during their fabrication and operation. The chief dangers come from the power of the swung sledgehammer, the height of the tower above a well, and the power of the wind during a strong storm. A windmill fabrication crew that works together carefully and with comradeship will keep accidents to a minimum. Windmill builders and operators must always remember that their safety lies in their own hands as they work.

Many people have asked me why I have chosen to spend several years of my life working on this project as a volunteer in a land far from my home. To answer this question briefly, I am frightened to live in a world where nuclear power plants have spread to many countries, bringing with them the ability to manufacture atomic bombs. The possibility of atomic war now threatens the lives of all humans. It is my personal belief that we will never have world peace until we shun atomic technology in all of its forms, and take apart all the thousands of atomic warheads that have mistakenly been built. The vast sums of money spent on military preparations, particularly by the superpowers, must be used instead to provide food, water, and other basic human needs. As a recent United Nations report concluded, "the world can either continue to pursue the arms race --or move consciously and with deliberate speed toward a more sustainable international economic and political order. It cannot do both." People around the world must be aware of and vocal about these issues.

However, I also believe that we must not wait for our governments to change their policies. If we can build a windmill with our own hands, displacing a small amount of nuclear-generated electricity, then it is worth doing. In the process, we may find that we gain some independence and control over our own lives.

In peace,

William W. Smith, III  
P. O. Box 281, Jamestown, Rhode Island 02835 USA  
August 1982

## II. INTRODUCTION

Many small farmers in rural India and other developing countries around the world face a dilemma today. They must have irrigation water to get better crops. But the rapidly rising cost and frequent supply shortages of diesel fuel make it hard for them to get enough fuel to run their pumpsets. Electricity also is in scarce supply. In some areas, the electric lines have not arrived--and may never arrive. In other areas, where an electric line exists, supply is intermittent. Many farmers therefore are now avoiding diesel or electricity for pumping water, and are returning to the slow, costly, but reliable traditional methods of animal-powered irrigation pumping.

In areas where the wind is strong, however, farmers may be able to use windmills during some seasons of the year to pump water for drinking and irrigation.

There are many types of windmills. Some windmills are as small as the pinwheel that a young student makes from a matchbox and pin. Others are 100 meters in diameter and can produce 3 million watts of electric power. Every windmill design is different. The windmills described in this handbook are specifically designed for village fabrication with manual labor. They also require manual control when they are in operation. A village-built windmill may break down more often than a company-manufactured windmill, but it also may be much less expensive to buy or build. Also, the village-built windmill can be repaired and put back into operation easily by village laborers, without costly and time-consuming travel to a machine shop in a city.

### ***The Gaudgaon Project***

This handbook describes the methods for building one type of windmill, as used in a windmill demonstration project at Gaudgaon, Taluka Barsi, Solapur District, Maharashtra, India. This area of India is heavily populated and almost completely denuded of trees. Villages of 1,000 or more people are located every three to five miles in all directions. Almost every square foot of fertile land, and much of the marginal land, is tilled. Most land holdings are small--less than three acres. Almost all of the untilled land is heavily overgrazed by herds of cattle, sheep, goats, and water buffalo.

The monsoon (rainy) season usually begins in late June, but is often intermittent or even non-existent. Nevertheless, the majority of farmers use this scanty rainfall to grow food on which they and their families will subsist for the following year. They grow the rabi, or staple grain, crop from September-January, after the monsoon has finished. The rabi usually is a dry-farmed crop that may be grown on marginal farms with no irrigation at all. Farm labor is extremely plentiful and cheap, with many men and women working long hard hours in the sun for the minimum wage of Rs.6 (US\$ 0.85) per day or less.

During the dry season, from March through June, when no farming can take place, many farmers undertake improvements, such as land leveling, drainage, and well construction. Over the centuries, many wells have been dug to tap the water table for irrigation. These open wells are generally 30-50 feet in diameter, and 50 or more feet deep. The traditional method of lifting irrigation water is with a bullock-drawn "moat" (large leather bucket), which is lifted by a rope and pulley. More recently, diesel and electric pumpsets have come into use.

Due to the fertile soil and ample sunlight, irrigated plots are much more productive. Vegetables, fruits, high-yield grains,



Figure 1. Carrying water

and cash crops such as grapes, papaya, or sugar cane can be grown once water is available. By bettering the local diet, providing much-needed employment, and bringing cash into the local economy, the benefits of irrigated farming can extend beyond the farm owner to many people in the local village.

The Gaudgaon Windmill Demonstration Project was started in 1977 by the Shri Shivaji Shikshan Prasarak Mandal, a village-level nonprofit institution. By mid-1981, the project had five sailing water-pumping windmills in operation. These windmills are of different sizes, but their designs are similar. The most successful windmill, in operation since June 1978, pumps water from a bore well at the Ropa Devi dairy farm near Gaudgaon. It has proven its economic worth, as well as the feasibility of using windpower to pump water in the Solapur area climate (see Table 6, p. 22).

Other larger windmills to pump water for irrigation and to turn a chaff-cutter or flourmill are now undergoing testing at Gaudgaon Village. Within several years, these larger windmills may also prove economically useful to small farmers.

The basic design of the windmills in use at Gaudgaon is copied from the windmills on the island of Crete, in Greece. Cretan-type windmills have been used for hundreds, even thousands, of years. They are an ancient, proven design.

The purpose of the Gaudgaon windmill demonstration project is to see whether windmills of this type can be used for irrigation-pumping in the climate of central India. In adapting the windmills for use in India, some changes have been made from the Cretan windmill design. Many more changes in the design may be required before the most successful windmill is found. This handbook describes the cheapest, strongest, easiest, and safest methods of village-built windmill fabrication that we have yet found. In the future, even better ways to design and build irrigation windmills may be developed so that windmills become even more useful to rural farmers.

During 1981-82, with funding from Oxfam, a windmill fabrication training course was run at Gaudgaon to teach rural people the skills needed to build this type of windmill. The course was administered by the Shri Shivaji Shikshan Prasarak Mandal in Gaudgaon. Blueprint drawings of the 24-foot diameter windmill may also be purchased from this institution or from VITA.

### ***Reasons for the designs***

The windmill designs used at the Gaudgaon demonstration project are specifically meant for labor-intensive construction and

operation. They are somewhat cheaper and simpler than the automatic type of windmill manufactured commercially, but are based on the time-proven Cretan mill.

One unique feature of the Gaudgaon windmill is that it has a variable stroke lever that enables the operator to make the most of available winds. This compares favorably with most traditional windmills, which have a fixed pump stroke. Such windmills only work efficiently within a narrow range of wind speeds, and thus can neither start turning in light winds nor take full advantage from high winds. By comparison, the operator of the Gaudgaon windmill can adjust the stroke for different wind speeds. This greatly increases output. In fact, one operator in Gaudgaon paid a local person to tend his windmill and adjust the stroke frequently to get the most water possible.

Assembly of the windmill tower and chassis with nuts and bolts assures that any broken or bent parts can be removed easily for repairs. The simplicity of the windmill design, which utilizes fabrication skills that are available in the smallest villages, means that the machines can be repaired by village workers whenever they break. The hardwood bearings are cheap, strong, and easily replaced; they will last for several years if greased regularly. Ball bearings are not required because of the slow speed of rotation of the windmills. The open crankshafts are easy to fabricate and install. Finally, the piston pumps for the irrigation windmills are designed so that they may be fabricated in the village by a skilled carpenter. Some parts of the irrigation windmills do require welding, drilling, and threading. But these are small parts that can be transported by cart, bus, or bicycle to and from a nearby town where a workshop is available.

The Gaudgaon windmills are designed so that if a small farmer wished to build one, he or she could drive a bullock cart to town, purchase all the materials, load them into the cart, drive back to the village or farm, and build the windmill in a month's time with the help of three friends and the village blacksmith and carpenter.

### ***Three different designs***

Three different windmill designs are being tested at the Gaudgaon windmill demonstration project.

The smallest windmill is 16 feet (5 meters) in diameter, and is usually fitted above a borewell to operate an existing handpump. It has a crankshaft that is forged or welded from a solid steel bar, and is fitted with a variable stroke lever that can change the handpump stroke from 0-10 inches. The 16-ft diameter

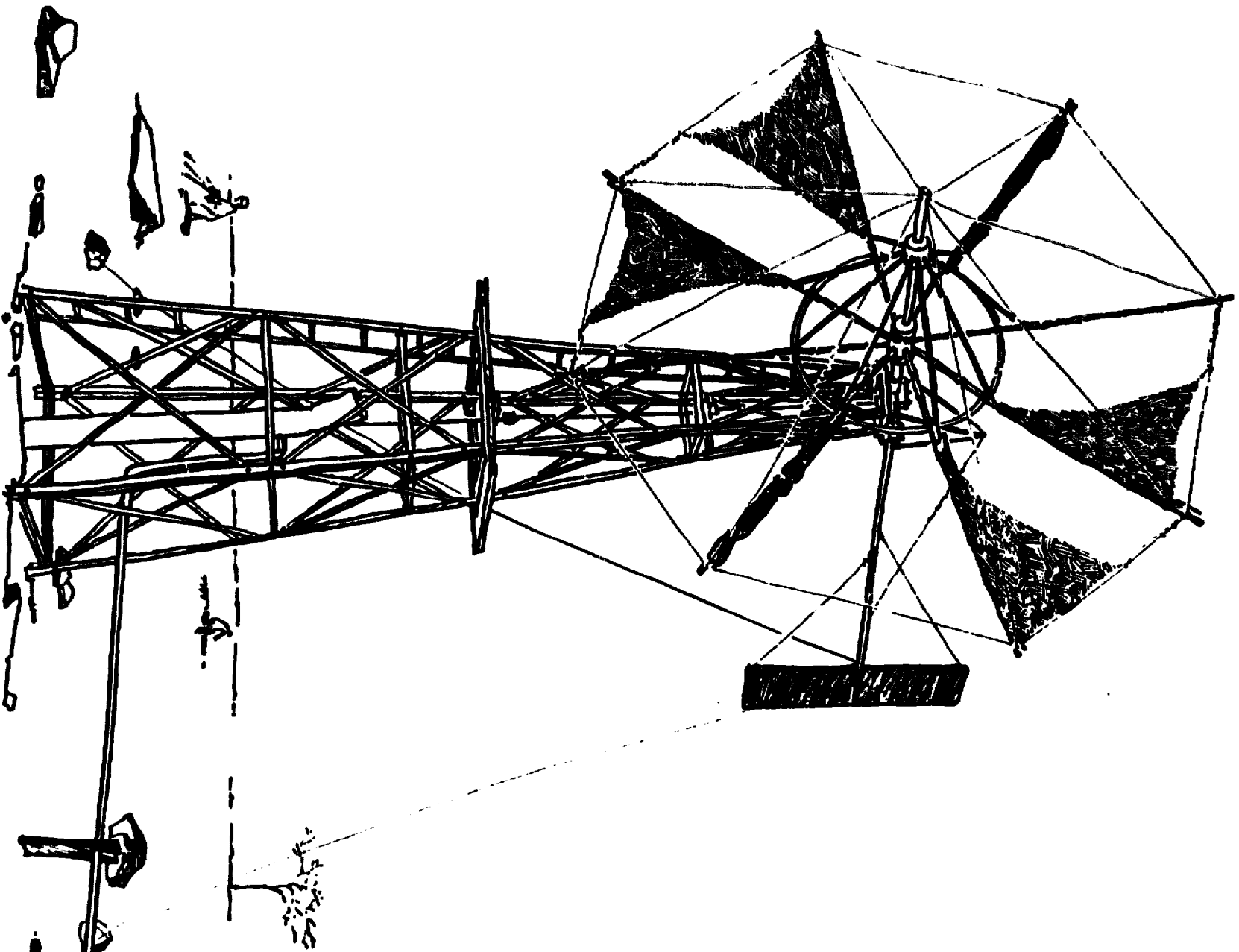

Figure 2. 16-ft diameter sailing windmill fitted on borewell with handpump

windmill is useful for pumping drinking water for a village or an institution, or for irrigating about one acre of land.

The second kind of windmill design being tested at Gaudgaon is the farmers' irrigation windmill. These windmills are 24 feet (7.5 m) in diameter, and are designed for installation beside an open well. A cantilevered arm on each windmill supports the delivery pipe and pump vertically inside the well. The pump is entirely supported on the delivery pipe so that it may be removed for maintenance even if the well is full of water. The pump rod runs inside the delivery pipe. The modified Cretan-type rotor turns with wind that comes from either the front or the back. A manually-controlled variable stroke lever varies the pump stroke from 0-22 inches. The windmill may be installed on rock or soil with the nearest tower legs about 2.5 feet from the side of the well. Large stones are placed on the bottom tower brace and are covered with four feet of stones and soil to prevent the tower from tipping over in storms. A stone and mortar wall is required in front of the windmill to prevent the footings from falling into the well. The rest of the well may be unbound. This kind of windmill may be useful for irrigating about three acres of land, depending on the wind and the type of crops. Section 4, which begins on page 25, describes these windmills in detail.

The third and largest kind of windmill now being tested at Gaudgaon is 32 feet (10 m) in diameter. Two of these windmills have been built, one for irrigation and one for rotary power. They use 6-inch pipe for the main shafts. Galvanized pipe has been used instead of bamboo for the rotor arms, although bamboo may be superior to galvanized pipe for the rotor. The rotary power windmill, which drives a 5-hp chaff-cutter or flour mill, uses a chain drive on V-grooved pulleys to transfer power to an adjustable ground-level jackshaft. A 7.5-ft-diameter pulley on the jackshaft drives a belt to the chaff-cutter or mill. A system of winches and ropes allows the operator to stop these large windmills from ground level in a storm.

In addition, one irrigation windmill built at Gaudgaon in 1977 uses a chain pump instead of a piston pump. The chain pump uses an endless loop of steel chain that is fitted every 10 inches with a cast iron washer. The washers are machined spherically on their outside diameters to a 1mm fit inside the 3-inch galvanized steel delivery pipe. A wood and steel sprocket wheel mounted on the ground level jackshaft drives the chain pump. The bottom end of the pipe is enlarged to the shape of a trumpet bell to allow the chain pump plugs to enter without jamming. Water exits at the top of the pump through a drum of larger diameter. Since the chain and washers are heavier than water, they sink by themselves; no idler wheel is required at the bottom of the pipe.

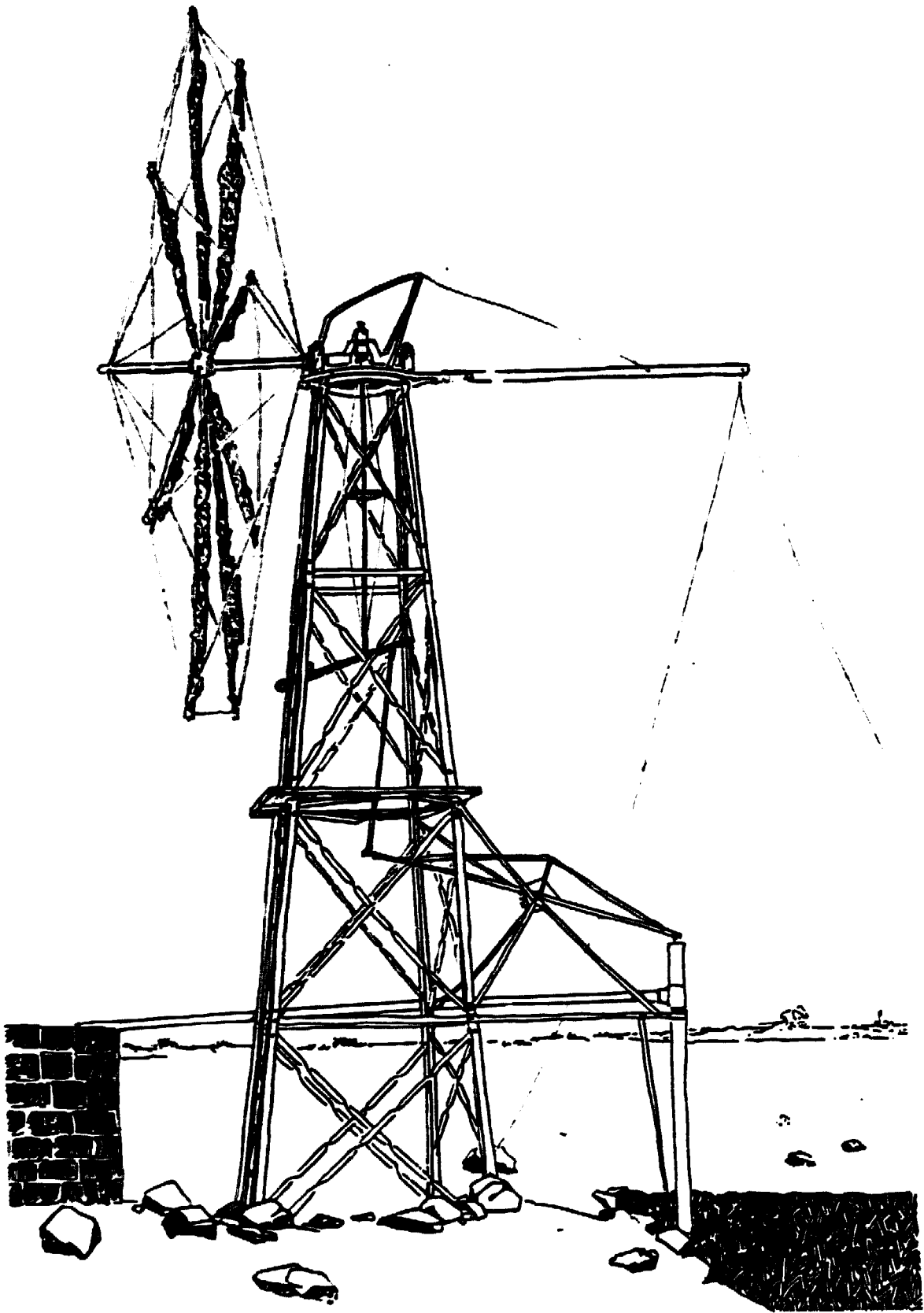
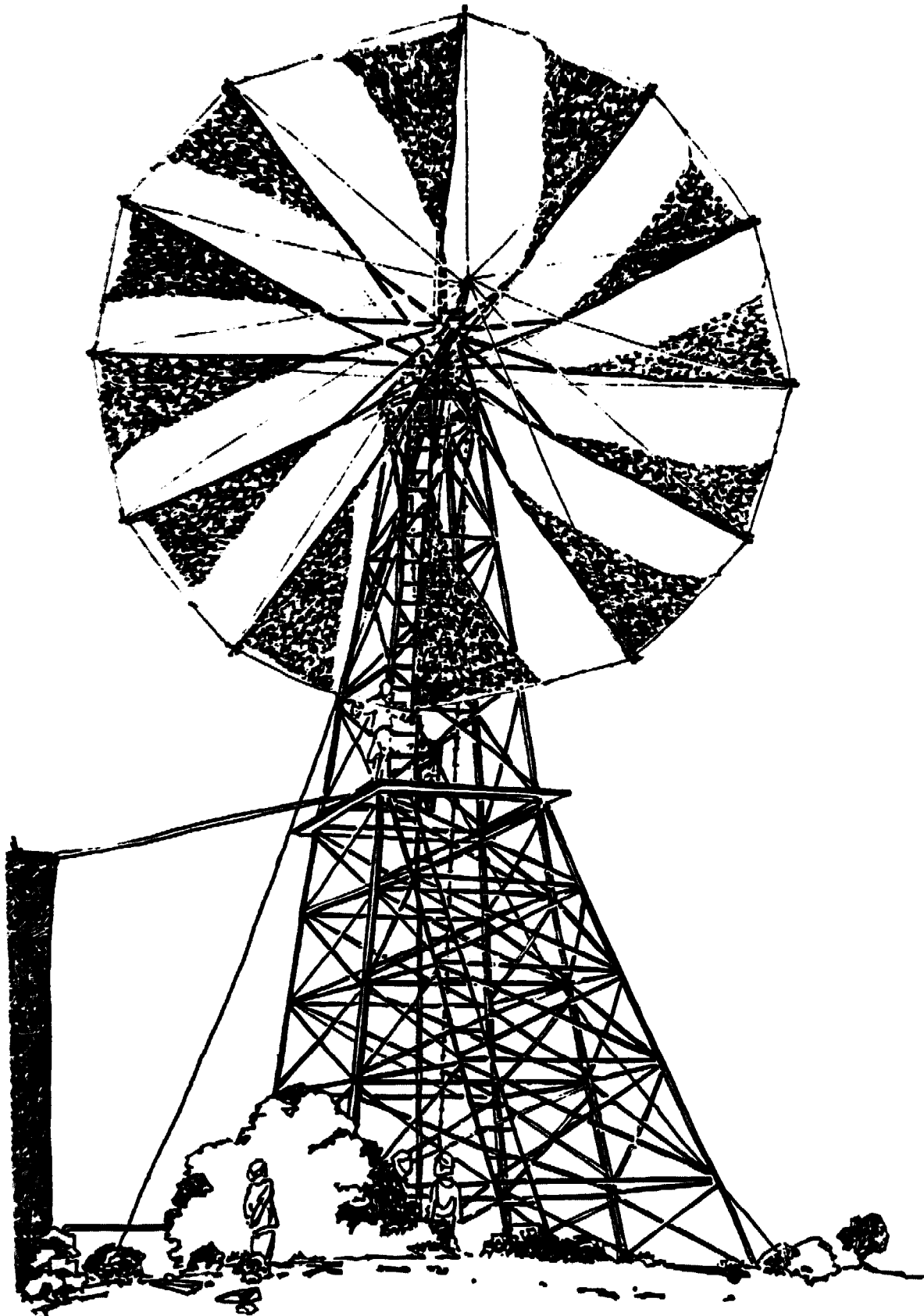

Figure 3. 24-ft sailing windmill showing rotor, levers, and storage tank





**Figure 4. 32-ft sailing windmill fitted with chainpump and elevated storage tank**

# III. GENERAL WIND ENERGY PRINCIPLES

## *Wind resources*

Wind can be a powerful energy source, distributed without cost to many different places. It is a renewable resource: wind is not depleted like coal or diesel fuel even if people use it day after day, year after year. It also is a vast resource that is important for irrigation in many windy regions. However, the use of windpower can be complicated by changes in wind direction, and by seasonal, hourly, and instantaneous changes in wind velocity.

### Measuring the Speed of the Wind

Wind speed can be measured with an anemometer. There are several types of anemometer designs. The most common is a "wind-run anemometer" with three rotating cups. It can be timed with a stopwatch to determine the average windspeed during an interval of time. If a wind-run anemometer is read every day, and the readings recorded, the data can be compiled after a year and compared to long-term data available from a weather observatory. This gives an estimate of the average yearly windspeed at a site.

Another simple anemometer can be made from a pingpong ball and a student's protractor (see Scientific American article listed in Appendix II). Electronic anemometers also are available, but they are costly. A simple method of estimating the speed of the wind, an abbreviated version of the Beaufort Scale, is given in Table 1.

### Changes in Wind Direction

Even winds that seem to blow most steadily really are changing their direction constantly. The Gaudgaon-type windmills must be faced into the wind manually. This can sometimes mean a lot of work for the windmill operator.

However, the most common daily winds usually blow from one average direction for many hours at a time. As they blow, small variations of only about 15 degrees will not seriously affect the power output of the windmill. So, once the windmill operator has found the proper direction, the windmill can be left in one position even while the wind direction varies slightly back and forth.

Winds that have frequent, wide direction changes, such as 90 degree changes every five minutes, usually do not contain very much power. It often is not worthwhile to run the windmill in such winds.

**Table 1. Windspeed Equivalents and Observable Effects**

Observable Effects	Windspeed in mi/hr	Windspeed in ft/sec	Windspeed in km/hr
Wind felt on face; tree leaves rustle	5.0	7.35	8.1
Leaves and small twigs in constant motion; wind extends a light cloth flag	10.0	14.7	16.2
Wind raises dust and loose paper; small tree branches move	15.0	22.0	24.2
Large tree branches in motion; whistling heard in wires; umbrellas hard to use	30.0	44.1	48.5

**Changes in Wind Speed**

Changes in windspeed can have a large effect on windmill power output. A wind that appears to be blowing steadily may in fact be near calm one moment and then gust up to twice the average windspeed the next moment. One short gust of higher windspeed may contain more power than several minutes of lighter wind, as can be seen from Table 2. Also, many types of water-pumping windmills will stop rotating in light wind, and will not start turning again until a strong gust of wind comes along.

For these reasons, the Gaudgaon piston-pump windmills are fitted with a manually controlled variable stroke lever. An attentive windmill operator can use this lever to reduce the load on the windmill in light winds and increase the load in stronger winds, ensuring that the maximum amount of water is pumped. In many wind conditions, twice the amount of water can be pumped by continuously adjusting the variable stroke lever.

**Seasonal Windspeed Changes**

In Gaudgaon and most other areas, some seasons of the year are windier than others. This may have some effect on the use of

windmills for irrigation pumping, and on the crops that can be grown with wind-powered irrigation.

In Solapur, the months of strongest winds are June-August, and of lightest winds, December-February. The times of highest water table are June-September. During these months, windmills can pump water to supplement the sometimes irregular rainfall to ensure a vegetable, legume, or cash crop that requires substantial irrigation.

The rabi, or staple grain crop, is traditionally grown during September-January. This is usually a dry-farmed crop, and is grown on many marginal farms without any irrigation at all. During these months, the water table may fall and wind speeds taper off. However, even in the calmest months of the year, there may be a few days with a strong, steady wind. Windmills therefore may be used to irrigate the rabi crop several times, increasing the chances of a bumper crop even if the required rains do not fall.

In Solapur, February-June is the hot season. There is no rain, and the water table may fall until the wells are dry. No farming can take place. Although the average wind speed may increase during this period, the winds are frequently changeable and stormy. People therefore do not use the windmills.

### Gaudgaon Wind Data

While there are some wind data available for Gaudgaon, information from other nearby locations helps give an indication of trends in the region. Monthly average wind speeds for the towns of Belgaum, Hyderabad, Solapur, and Gaudgaon are plotted in Graph 1. The locations of the towns are indicated on the map at the front of this manual. All data are based on long-term records of more than 25 years. The Solapur data are from an anemometer that is 10 feet (3 m) off the ground; there also are some trees near the instrument. The actual data from this anemometer have been scaled up to estimate winds at 33 feet (10m). This was done according to the formula:

$$V_1/V_2 = (h_1/h_2)^b, \text{ where}$$

$V_1$  = mean wind speed at 10 m  
 $h_1$  = 10 m  
 $V_2$  = mean wind speed at 3 m  
 $h_2$  = 3 m  
 $b$  = 0.24 (based on the terrain and wind speeds in the area)

The Gaudgaon data are from an anemometer on a windmill that is 45 feet above the ground. These data were scaled down with the above formula. The data from Hyderabad, Belgaum, and Solapur

are based on records of more than 25 years, while the data from Gaudgaon are based just on three years. Also, the heights and exposure of the anemometers in Belgaum and Hyderabad are not known. Since they are operated by the Indian national meteorological services, they most likely are 10 m, the world meteorological standard. In any case, the graph in Graph 1 shows clearly that wind patterns in all three locations are very similar, as they probably are through most of this part of India. Winds increase sharply during the monsoon season, from June through September. They are lower during other times of the year, including during the post-monsoon season when the rabi crop is grown. However, even during these periods of lower winds, there are days when the wind becomes stronger. This makes irrigation possible during these periods.

The Gaudgaon site data do not show such a strong rise in wind speed during the monsoon season. A variety of factors may account for this. First, the Gaudgaon data are based on readings only over three years, while the data for the other sites cover 25 years. Winds may have been low during these three years. Hills or other topographic obstructions also may have affected the values. In addition, placing an anemometer on a windmill affects its readings because of the nearby rotor movement.

The exact value of the wind at any particular spot depends in large part on the height and exposure of the site. Graph 2 shows estimated winds at 8, 10, 12, 14, and 16 meters, based on the Solapur data. The Solapur data were scaled up using the formula on p. 13. This gives an indication of the stronger winds at greater heights.

### **Windmill Sites**

A windmill can be located almost anyplace. However, it must be higher than nearby trees, buildings, or other large obstructions. A rule-of-thumb is:

A windmill should be located at least 20 ft above any fixed obstructions within 300 yards; and at least 30 ft above any trees within 300 yards. Trees may grow during the lifetime of the windmill.

A windmill generally will catch a stronger wind the higher it is placed. It often is economical to pay more for a taller windmill tower so that the windmill can produce more power. Of course, every site is different. Nevertheless, a windmill sited in a broad valley or between hills generally should be sited according to the above rule-of-thumb.

The only way to be sure of a windmill's power output in advance is to measure the windspeed on a tower at the site for at least

WIND SPEED (mph)

GRAPH 1

LONG-TERM MONTHLY  
MEAN WIND SPEEDS

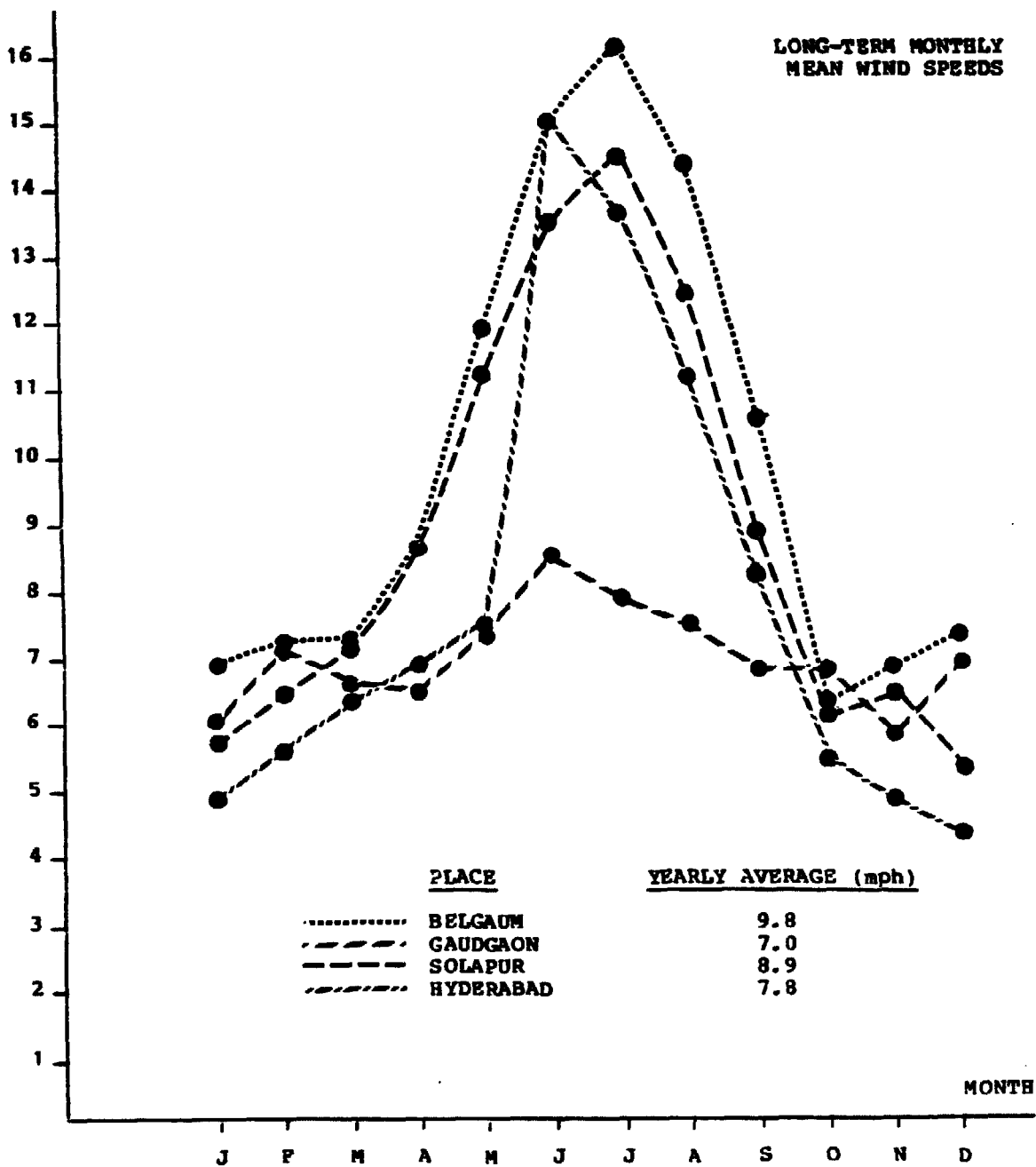

GRAPH 2

PROJECTED WINDS AT SEVERAL HEIGHTS

SOLAPUR  
(25 YEARS)

WIND SPEED (mph)

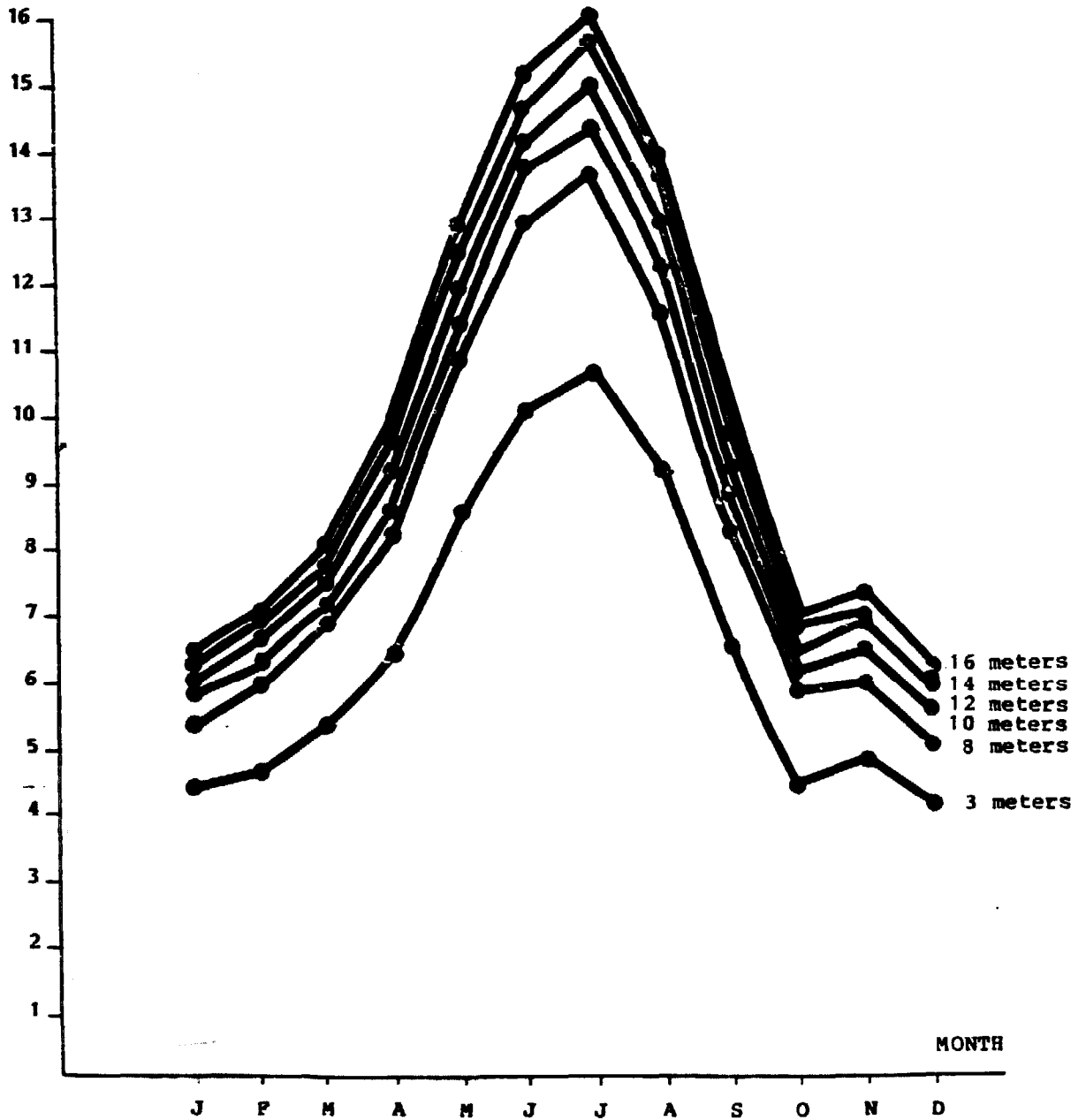

one year, as mentioned above. More information about choosing a windmill site is given in the references in Appendix II.

## **Windmill design**

### **Power in the Wind**

The power that a given-sized windmill can harness in a given windspeed is calculated according to the formula:

$$P = 1/2 \pi R^2 \rho V^3 C_p$$

where  $\pi = 3.14$

$R$  = radius of the windmill rotor

$\rho$  = density of air = .075 lb/ft<sup>3</sup>

$V$  = velocity of the wind

$C_p$  = coefficient of performance of the windmill

Thus, power increases as the cube of the windspeed. However, the windmill requires a certain minimum speed to begin operating. The Gaudgaon windmill typically will not begin turning at wind speeds below 5 mph.

For the village-built, Cretan-type sailing windmills with reciprocating pumps, the rotor efficiency is about 20% and the pump efficiency about 50%. This gives an overall coefficient of performance of  $C_p = .10$ . The power output of differently sized windmills in different windspeeds can be calculated as in Table 2 on page 18.

The volume of water pumped can be figured from this table by noting that 1hp gives the ability to pump 1,050 ft<sup>3</sup> per hour (or 7,920 gals per hour) from a 30-ft head.

Table 2 shows that a windmill does not have very much power in light windspeeds, no matter how big it is. Windmills work best at windspeeds of 10-20 mph. Table 2 also shows that in a very strong wind, a windmill becomes very powerful. In fact, a windmill can be dangerous if extreme care is not taken by the operator while stopping the windmill. For instance, Table 3 shows that a 16-ft diameter windmill in a 30-mph wind is as powerful as a Bullet motorcycle, and a 32-ft diameter windmill is as powerful as a state transport bus!



**Table 2. Power Output (in HP) of Waterpumping Windmills of Different Sizes in Different Windspeeds,  $C_p = 0.10$**

Windmill Diameter	Windspeed		
	10 mph	15 mph	30 mph
16 ft	.14 hp	.44 hp	3.7 hp
24 ft	.31 hp	1.0 hp	8.3 hp
32 ft	.55 hp	1.8 hp	14.8 hp
Calculations based on air density at sea level At 2,000 ft above sea level, multiply by .928 At 4,000 ft above sea level, multiply by .861			

### Choosing the Size of the Pump

The power required to move the piston pump depends on the windspeed, the size of the windmill rotor, and the total head of water to be pumped. The Gaudgaon windmill design uses a variable stroke lever, so that the output of the pump may be manually changed from zero to maximum.

However, since the pump will work very inefficiently when its stroke is near zero, it is best to follow the pump sizes listed in Table 3 when deciding what size pump to fit on a 24-ft diameter, village-built irrigation windmill. Table 3 has been calculated on the basis that the pump will deliver 1 hp output when the stroke is 22 inches and the windmill is rotating at 40 rpm in a strong wind of more than 15 mph. For use with a smaller rotor, or in lighter winds, the pump size can be made smaller than shown in Table 3. Total head equals suction height plus delivery height plus friction loss in pipes.

**Table 3. Pump Sizes for 24-Ft Diameter Irrigation Windmill for Different Total Heads**

Total Head in Feet	Pump Size in Inches	
	Side of Square Cylinder	Diameter of Round Cylinder
100 ft	3-1/4 in	3-5/8 in
80 ft	3-5/8 in	4 in
60 ft	4-1/8 in	4-5/8 in
40 ft	5-1/8 in	5-3/4 in
30 ft	5-7/8 in	6-5/8 in
20 ft	7-1/4 in	8-1/8 in
15 ft	8-3/8 in	9-3/8 in
10 ft	10-1/4 in	11-1/2 in
5 ft	14-3/8 in	16-1/4 in

### Delivery Pipe

It is always best to fit a long delivery pipe so that the pump is placed as deeply as possible in the well. It is much better if the pump is fitted below the level of the water. This is because there may be some leaks, even very small leaks, in the suction pipe below the pump or in the pump cylinder. If these leaks are immersed under water, they will not be noticed. But if the leaks are exposed to air, the suction capacity of the pump will be lowered and the water output less.

Also, it is best to fit as large a diameter delivery pipe as possible. A large delivery pipe allows the water to move slowly. The water column in the pipe must start and stop with every stroke of the pump. If the water moves fast in a small diameter delivery pipe, the losses will be greater. The windmills at Gaudgaon are now using 3-inch delivery pipes for pumping at a 30-ft head.

The following estimates for water output in gallons per hour can be made from the horsepower values listed in Table 2:

**Table 4. Output estimates in U.S. gallons per hour**

Windmill Diameter	15 ft head	
	10 mph	15 mph
16 ft	2,200	7,000
24 ft	4,900	16,000
32 ft	8,700	28,000

Windmill Diameter	30 ft head	
	10 mph	15 mph
16 ft	1,100	3,500
24 ft	2,500	8,000
32 ft	4,400	14,000

Windmill Diameter	60 ft head	
	10 mph	15 mph
16 ft	550	1,700
24 ft	1,200	4,000
32 ft	2,200	7,100

The tables are based on sea level air density and a windmill efficiency of 10 percent. They are meant to show the approximate output in the best of conditions, assuming that the operator has set the stroke at the optimum value for the existing winds, pumping head, and type of pump. The actual output will be less if the windmill is not on full stroke, or if some or all of the sails are furled.

Actual output measurements have not yet been carried out extensively. One test series on a 24-ft windmill at Ropa Devi, pumping at a 40-ft head, showed an average value of 1,900 gallons per hour in winds of 10 miles per hour. When adjusted for a 30-ft head, this indicates an output of 2,500 gallons per hour, which matches the value in the table. More tests are being carried out.

## An Example of a Windmill Daily Output Estimate

The preceding tables and graphs give average monthly and yearly wind speeds, windmill horsepower at different wind speeds, and windmill water output in different wind speeds. However, the wind varies every minute of every day. Another calculation must be made to estimate the daily windmill output.

For example, consider a sample September day, the time of year when the windmill might be most needed to irrigate the rabi crop. Wind might blow for 7 hours at 5 mph in the morning; then for 3 hours at 10 mph; 2 hours at 15 mph; 3 more hours at 10 mph; and then again for 8 more hours at 5 mph in the evening before becoming calm for 1 hour during the night. The windmill output for such a wind pattern could be calculated as follows:

Table 5. Windmill Output On a Sample September Day

24 ft diameter windmill pumping from 30 ft head Average windspeed = 6.9 mph			
WIND	HOURS	GALLONS/HR	TOTAL GALLONS
0	1	0	0
5	15	0	0
10	6	2,500	15,000
15	2	8,000	16,000
		TOTAL OUTPUT	31,000 gallons/day

This total would be enough water to irrigate 1/4 acre with 4.5 inches of water, minus losses through the water distribution system (see Section XI). If every day were as windy as this sample day, the windmill could irrigate 2 acres on an 8-day rotation. It is interesting to note that the two hours of strong wind provide more than half of the daily volume of water. Of course, this assumes that the operator sets the stroke properly.

### *Windmill economics*

Since the Gaudgaon village windmills have been in use for only a few years, their long-term economic value is not yet known. However, preliminary results are promising. Table 6 compares

the economic value of the 16-ft diameter Ropa Devi windmill, in daily operation near Gaudgaon since June 1978, with other methods of pumping water. The notes give the basis for the table, which is tailored to conditions in the Solapur area. To get yearly operation or maintenance costs, multiply the given daily costs by 360. (One U.S. dollar approximately equals Rs.7.50.)

**Table 6. Economics of the 16-ft diameter Ropa Devi windmill/handpump, compared with other pumping methods**

Type of Machinery	Capital Cost (Rs.)	Expected Lifetime (years)	Volume Pumped Per 8-hr day (m <sup>3</sup> )	Maintenance and Operation Costs per 8-hr day (Rs.)	Cost of Water Pumped (Rs./m <sup>3</sup> ) <sup>1</sup>
Bullock cart w/2 bulls & 1.5 workers <sup>2</sup>	4500	6	1.9	22	12.7
Borewell with handpump and 3 workers <sup>3</sup>	5500	25	9.26	18.5	2.06
Borewell with diesel engine and jetpump <sup>4</sup>	14000	15	11.5	25.5	2.44
Borewell with 1hp motor and jetpump <sup>5</sup>	15500	15	11.5	5.2	.70
Borewell with windmill and handpump <sup>6</sup>	10500	25	6.7	3.0	.62

1] The cost of water is computed by adding the daily capital cost and the daily operating cost, and dividing by the volume pumped. This ignores the rate of interest on borrowed capital. If borrowed capital is to be used, different calculations must be made.

2] Bullock cart brings water from a well 1 mile away. Cart makes five trips per day carrying two drums and requiring one driver and two workers one-quarter time for filling and emptying. Bulls cost Rs.1,500 each; cart costs Rs.1,500; total

salaries cost Rs.9; fodder costs Rs.12; cart maintenance costs Rs.360 per year, or Rs.1 per day.

3] Three workers operate the handpump continuously at 40 strokes/minute for 8 hours per day. Handpump has 6-inch stroke X 2.5-inch bore. Workers receive Rs.6 each per day. Cost of borewell is Rs.25/ft for 100 ft; handpump and piping cost Rs.3,000; handpump must be opened once per year at cost of Rs.180 per year, or Rs.0.50 per day.

4] Engine drives jet pump 8 hours/day. Engine costs Rs.5,000; jet pump costs Rs.3,500; pipes and fittings cost Rs.3,000; fuel cost is Rs.20/day; engine maintenance is Rs.3.5/day; jet pump maintenance is Rs.0.50/day; one-quarter person is required at Rs.1.5/day. (Diesel fuel is subject to rationing.)

5] Electric motor drives same jet pump as above. Motor and pump cost Rs.5,000; pipe and fittings cost Rs.3,000; line connection costs Rs.5,000. Motor draws 8kWh per 8 hour day, costing Rs.0.30/kWh; motor maintenance costs Rs.0.80/day; jet pump maintenance costs Rs.0.50/day; one-quarter person is required at Rs.1.5/day. (Electricity now is not available at Ropa Devi.)

6] Windmill runs intermittently at different speeds. For purposes of comparison, 260 days/year at moderate output (40rpm for 8 hours/day) is assumed. Windmill costs Rs.5,000. Windmill maintenance costs Rs.1/day, including replacement of cloth and bamboo. Handpump maintenance costs Rs.0.50/day; one-quarter person is required at Rs.1.5/day. (Handpump can be used to draw water when wind is calm.)

### **Review of Windmill Choices**

A farmer who is considering the installation of a windmill should follow these steps before beginning the construction steps outlined in the following chapter:

1. Measure or estimate the wind resources at the site, especially for the season when the pumping is to be done. The graphs in Figures 1 and 3 can serve as a guideline.
2. Estimate the depth of the water source, and the amounts of water that could be pumped by windmills of different heights and diameters, based on the data in Tables 4 and 5.
3. Assess the costs of windmill installation, and of diesel-, electric-, or traditional bullock-powered irrigation, using the methods outlined in Table 6.
4. Decide whether to install a windmill, and if so, what size tower, rotor, and pump.

## IV. DETAILED DESCRIPTION OF THE 24-FT DIAMETER IRRIGATION WINDMILL

The following description is meant to supplement the blueprint drawings for those people who may be interested in constructing one of these windmills. The 16-ft and 32-ft diameter windmills are not described in detail in this Handbook. However, many of their features are similar to the 24-ft diameter windmills.

### *Materials*

The detailed list of materials is contained in Appendix III. The approximate amounts of materials and 1981 cost in Indian rupees for the 24-ft irrigation windmill on a 32-ft tower, pumping from an open well at 30 ft total head, are:

. Mild steel, 650 kg @ Rs.5/kg	Rs.3,250
. Galvanized wire, 15 kg @ Rs.12	180
. Bolts and fittings, 20 kg @ Rs. 18	360
. Pipe and fittings	1,500
. Bamboos, 60 kg	96
. Cloth, 20m <sup>2</sup> @ Rs.8	160
. Leather, 1 kg @ Rs.20	20
. Tar, 4 kg @ Rs.5	20
. Hardwood, 3 ft <sup>2</sup> @ Rs.40	120
. Teakwood, 1.25 ft <sup>2</sup> @ Rs.120/ft <sup>2</sup>	150
. Stone and sand, 500 ft <sup>2</sup>	200
. Cement, 2 bags @ Rs.40	80
Approximate total of materials	Rs.6,136
	(equals US\$817)

When figuring the cost of a windmill installation, a farmer must also include:

. Transport	200
. Welding and machine shop	400
. Skilled labor	220
. Unskilled labor (120 person-days @ Rs. 6)	720
. Contingencies (10% of all above)	768
Total approximate cost of 24 ft windmill	Rs.8,444
	(equals US\$1,126)

### *Tower*

These windmills have towers made of mild steel angle iron, fastened with 1/2-inch bolts. The tower legs are of 2-inch X

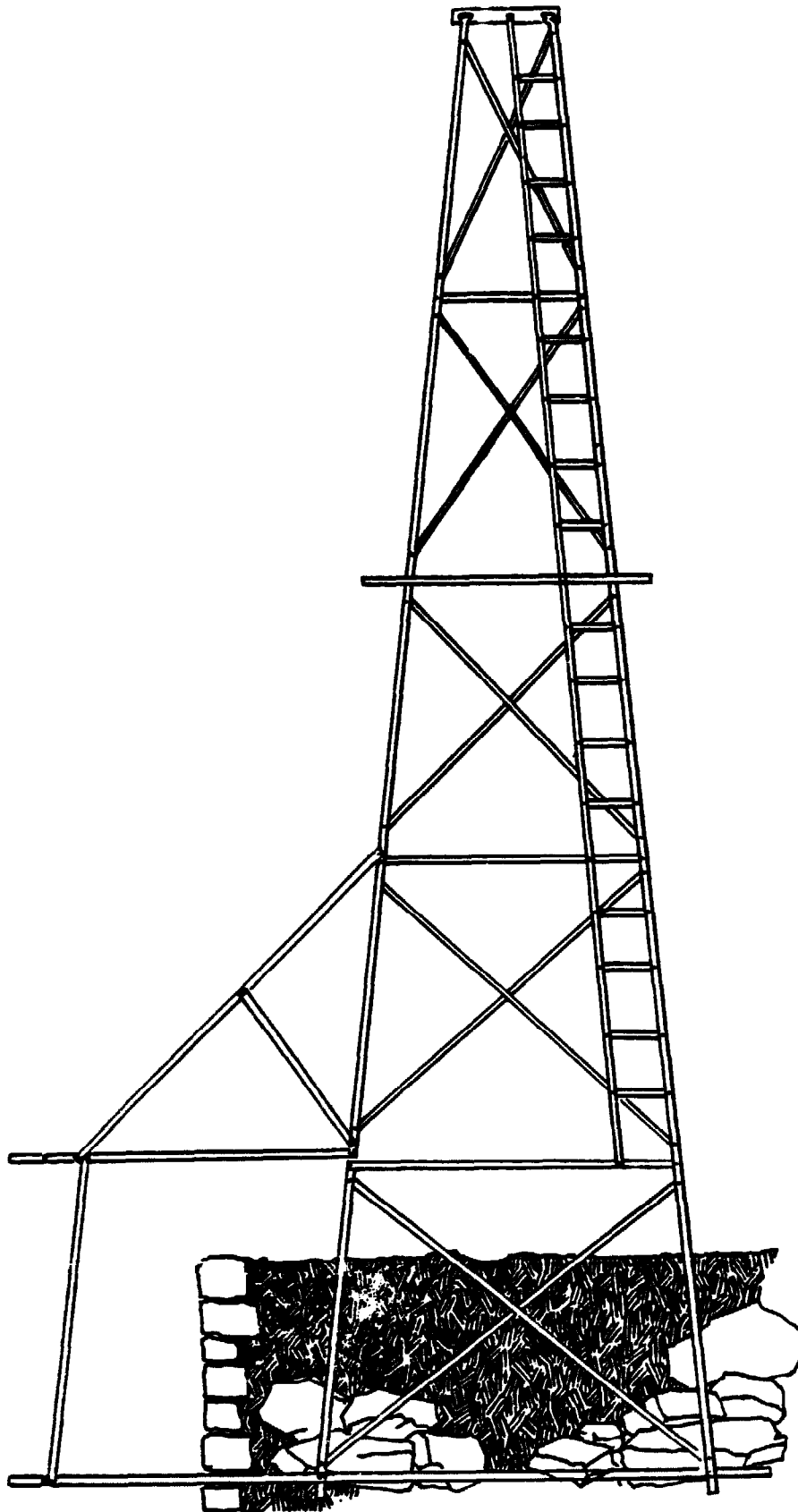

**Figure 5. Side view of windmill tower showing upper and lower pipe supports, masonry wall, and stone tower footings**



1/4-inch angle; the horizontal bracing is 1-1/2-inch X 1/8-inch angle on 6-ft 4-1/2-inch centers; and the "X" bracing is of 1-inch X 1/8-inch flat with 3/8-inch bolts, except for the eight bottom "X" braces, which are of 1-1/4-inch X 1/4-inch flat with 1/2-inch bolts. The standard towers, shown on the blueprint drawings, are 32 ft 3 inches tall and 7 ft 7 inches square at the base. The towers may be made as tall as 80 ft using this type of construction. The bottom horizontal braces extend 12 inches beyond the tower legs, catching securely underneath the foundation stones.

The bottom foundation stones are each a minimum of 3 ft long; there are two per corner. Above these stones, large and small fieldstones and soil or gravel are backfilled to a level 4 ft above the bottom horizontal braces. An area at least 14 ft X 14 ft must be backfilled to this level to provide enough weight to hold the windmill tower steady during storms. All steel parts buried in the foundation must be coated with tar to reduce rusting. The tower also may be painted or tarred to prevent rusting, if desired. In a dry climate such as Solapur, however, rusting may not be a major problem.

The towers have interior bracing at the level of the first and third horizontal braces above the bottom. At the level of the first horizontal braces, the cantilevered pump support arms are attached. The pivot point for the pump lever is also built into the cantilevered supports. The full weight of the pump and delivery pipe is carried on the cantilevered support arms. However, another pipe support may be fitted at the level of the tower footings, or lower in the well, if required to keep the pump and discharge pipe from swaying.

At the level of the third horizontal braces, approximately 13 ft below the windmill main shaft, the tower is fitted with a sail access platform. The platform extends around all four sides of the tower, and is made of 9-inch wide wooden planks supported on angle irons. This platform allows the windmill operator to stand or sit comfortably while working on the windmill rotor. At the top of the tower, the four legs are held together by a ring of 2 inch X 1/4 inch angle iron. The upper side of this ring also serves as the bearing surface for the windmill turntable. A ladder is built into one side of the tower.

### ***Windmill chassis and main shaft***

The chassis of the 24-ft diameter irrigation windmill is made of 2 inch X 1/4 inch angle iron. The two chassis side members are bent to the same shape as the tower head ring. Cross members hold the side members together and provide mounting places for the main bearings and lift arresters. The rear ends

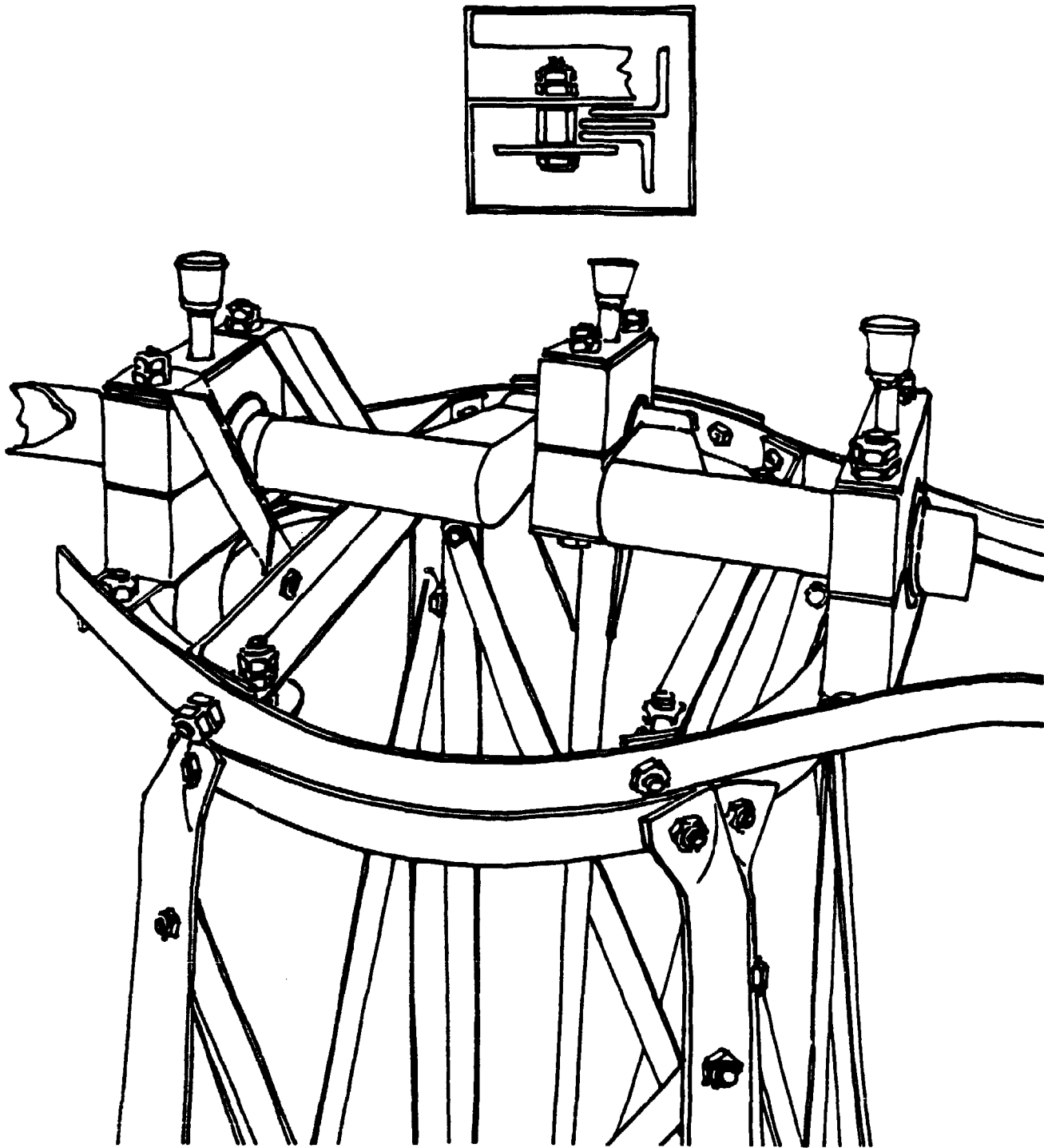

**Figure 6. Overall view of 24-ft windmill tower head, chassis, and main shaft, with detail of lift arrester**

of the chassis side members are bent and twisted so that they support the tail arm of 3-inch pipe. Two 3/16-inch-diameter steel wires lead from the tail arm to the ground to allow the windmill chassis to be turned to face the wind. A truss prevents the tail arm from bending towards the ground when the wires are pulled.

The windmill chassis is prevented from sliding off the tower head ring, or from lifting upwards, by the four lift arresters. These are simply heavy washers fastened to the chassis cross members so they fit below and inside the tower head ring. The lift arresters are tightened and locked with double nuts upon assembly. All friction at the turntable thus comes between the tower head ring and the chafing plates of forged truck spring, which are fitted below the chassis side members. The lift arrester spacers are made of gudgeon (piston) pins to resist wear. The tower head ring must be greased by the windmill operator for easy operation of the turntable.

The windmill main shaft of 3-inch B-class (0.216-inch wall thickness, or Schedule 40) pipe runs in hardwood bearings. The bearings are split for easy removal, and are capped with steel flats. The bearing bolts, and all of the bolts on the windmill chassis, have double nuts to prevent loosening. Wind thrust from both directions is taken at the forward main bearing by two thrust collars that are welded to the main shaft. Two thrust braces give the forward main bearing additional support. The main shaft is also reinforced at all three bearing journals with 1/8-inch-thick steel bushings to take any wear from the bearings. The bearings are fitted with grease cups for daily lubrication.

The crank pin of 3-inch B-class pipe is welded to the main shaft with ten fillet pieces of steel plate. The whole weld area is then heated red hot and allowed to cool slowly to relieve stress. Then the main shaft is cut away at the crank and the final two fillets welded into place. If galvanized pipe is used, care must be taken to remove the galvanizing from the pipes before welding. Otherwise, the zinc will enter the welds and make them weak.

The main shaft extends forward 6 ft 2 inches beyond the forward main bearing. Four pieces of 1-1/2-inch X 1/8-inch angle iron, 8 inches long, are welded to the main shaft to form a box section where the rotor hub is located, 3 ft forward of the bearing. The main shaft is also fitted with eight tabs near the forward main bearing, and is drilled at the forward end to take the 16 rotor side support wires. The main shaft, crank pin, and tail arm (which also serves as the gin pole) may be cut from one length of pipe that is approximately 20 ft.

### ***Windmill rotor***

The rotor hub is made of hardwood, 10-inch diameter by 5-inch wide, with two clamps of 1-1/4-inch X 1/4-inch steel flat around its circumference. The hub has a 3-1/2-inch square hole to fit the main shaft, and eight slightly tapered square holes to take the bamboo rotor arms. The hub is soaked in creosote or crankcase oil after fabrication to prevent rotting.

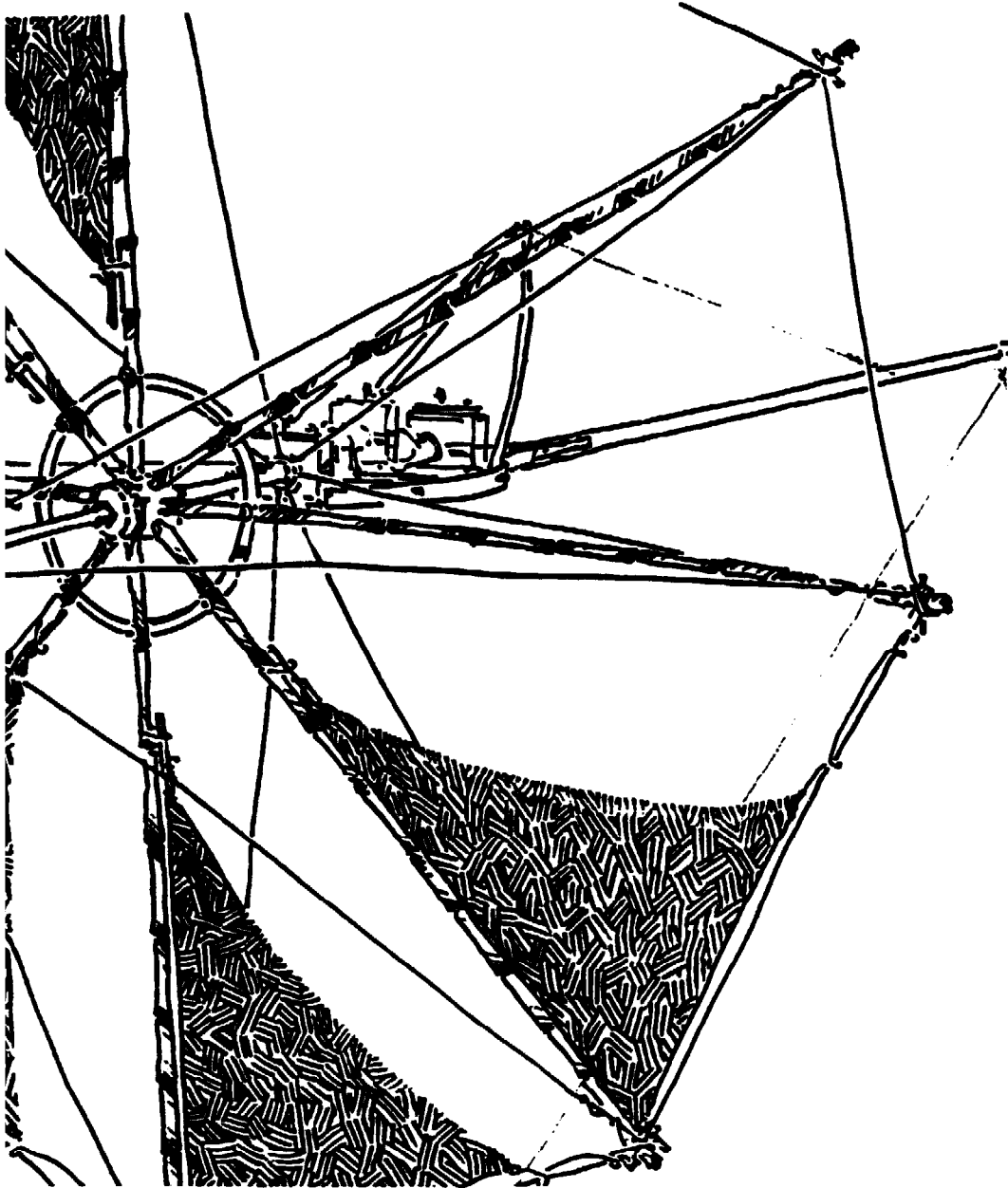

**Windmill rotor and chassis, with tower top omitted**

rotor arms are squared at the butt ends to fit in slots which are drilled in the bamboo to fasten the rotor arms to the bamboo, and the pin at the tip of the bamboo. The slots must be drilled carefully, or the bamboo may split. If the bamboo does split, it may be reinforced with a lashing of steel wire.

A 1-inch diameter rotor ring of 1-1/4-inch X 1/4-inch bamboo is fastened to the eight pieces of bamboo. The ring has a joint to assist assembly. It serves to hold the blades in place, and makes initial assembly of the rotor easy. The rotor is held to the chassis by a wire of 3/16-inch diameter galvanized steel

wire goes from tip to tip of all the bamboos, attaching around the 3/8 inch diameter steel pin through the end of each bamboo. Each bamboo is also braced with two other 3/16 inch wires. One wire attaches to the front of the main shaft, and one attaches to the welded tabs near the forward main bearing. Thus, the rotor arms are braced to take wind from either the front or the rear.

The eight triangular sails can be made of thick canvas, which may last as long as two years, or of thin cloth, which may last six months to a year. Although the thin sails wear out sooner, they are much cheaper to replace. In either case, the sails must be dried carefully after every rainstorm. They will mildew and rot within several days if they are left furled when wet.

Note: when laying out the pattern for the sails, it is important to make the trailing edge of the sail parallel to the weave of the cloth. This allows the sail to stretch near the leading edge while it remains taut at the trailing edge.

A sleeve is sewn into the leading edge of the sail to accept the sail bamboo. The sails may be fitted on the punka bamboo if desired. But if eight separate sail bamboos are used, the sails can be easily removed when necessary for repairs or for drying. Large buttonholes are used to attach the lashings on the leading edge of the sail. At the trailing corner, a loop of cord is sewn to the sail to accept the sheet rope. If the sails are made and assembled correctly, they should not flutter or flap at all when the windmill is running in a moderate wind.

### ***Pump, levers, and pump rods***

The piston pump design for village fabrication uses a square pump cylinder made from four teakwood planks that are clamped together. (The pump cylinder may also be made of brass or PVC plastic pipe, if available in the required size.) The planks must be carefully planed smooth and fitted together before assembly. The maximum pump stroke is 22 inches. The pump cylinder is 32 inches long, to allow 4 inches for the piston plus 3 inches clearance at each end. Wooden end plates are held against the top and bottom of the cylinder by four tie-bolts. Commercial cast iron pipe flanges bolt to the end plates for attaching the suction and discharge pipes. A flexible suction pipe may be used below the pump, with a commercial leather flap-type foot valve fitted at the bottom of the suction pipe.

The pump piston is fabricated from wood and metal, with a leather washer and either a leather flap valve or a ball valve. The piston is mounted on a cutaway 3/4-inch pipe flange for attaching to the pump rod. A pump rod guide plate is fitted between the upper end plate and flange to prevent the piston

from running off-center and scoring the side of the pump cylinder.

The pump rod is made of 3/4-inch galvanized pipe. It runs inside the 3-inch galvanized delivery pipe. Ten feet above the pump, a welded ring coupling is used in the pump rod to prevent the piston from scoring the cylinder walls. When assembled, the cylinder, upper end plate, upper flange, and delivery pipe must be lined up, so that the pump rod and piston will move properly.

The pump rod couplings must be of steel, not cast iron. The positions of the pump rod couplings and the delivery pipe couplings must be staggered so that extra friction is not caused by a pump rod coupling rubbing against the inside of a delivery pipe coupling. The top of the pump rod is flattened and drilled or punched for a 5/8-inch diameter bolt, which connects it to the pump lever.

The pump lever is 10 ft 6 inches long overall, and is made of two angles that are welded together to form a box section. It is reinforced with a truss of 1-1/4-inch steel flat to prevent it from bending under load. The two ends of the pump lever are forged parallel and drilled to accept the pump rod and lower connecting rod. The lever is slightly longer on one end than the other. The pump rod end of the lever is drilled only after it has been assembled and marked correctly. The lever pivots on a 5/8-inch bolt held rigidly in place by the support brackets. A wooden bearing is fitted at the pump lever support point.

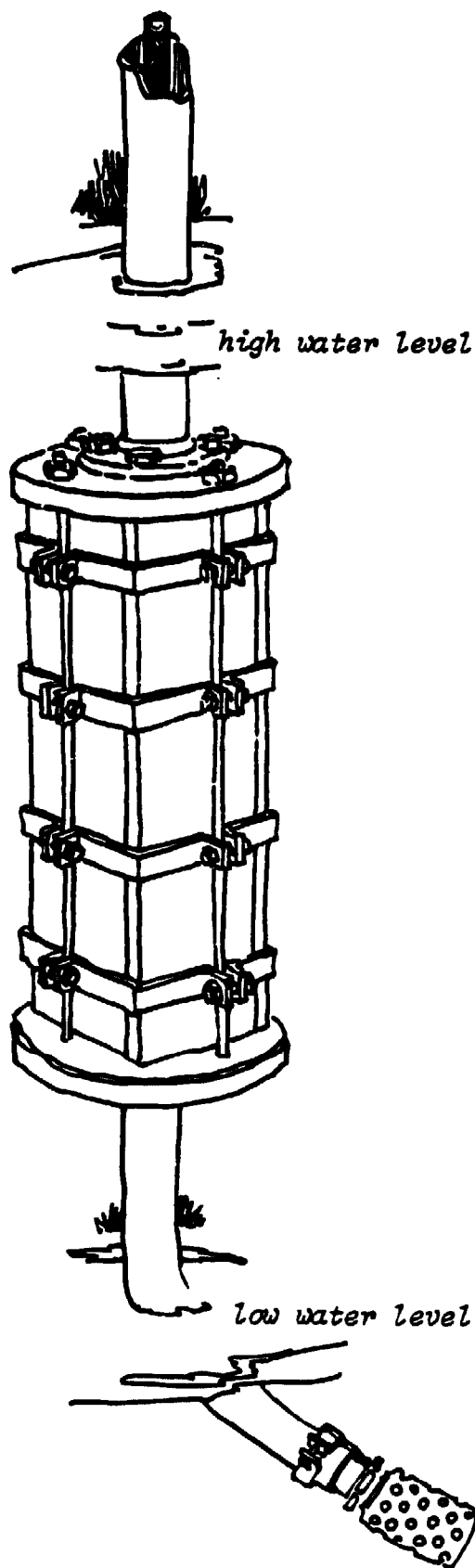

Figure 8. Village-built square piston-pump

The end of the lever opposite the pump rod is fitted with a counterweight. The size of the counterweight must be changed in different seasons as the height of the water in the well changes, so that the counterweight is equal to the pump rod plus half of the weight of the water on the piston. The easiest way to tell whether the counterweight is correct is to turn the windmill rotor by hand. The delivery pipe must be full of water. If the rotor is equally hard to turn when the connecting rods are moving up and when they are moving down, the weight is correct. The purpose of this counterweight is to make the load on the windmill rotor double-acting. That is, the rotor must do work during both halves of each revolution. Therefore, even though the pump is single-acting and the pump rod works under tension only, the connecting rods inside the tower are double-acting and must work under both tension and compression.

The lower connecting rod is made of a single piece of 1-1/2-inch galvanized pipe. It has flattened ends to allow connection to the pump lever on the bottom and the traveler of the variable stroke lever at the top.

The variable stroke lever is fitted inside the tower just above the sail access platform. A chain linkage with a pulley at

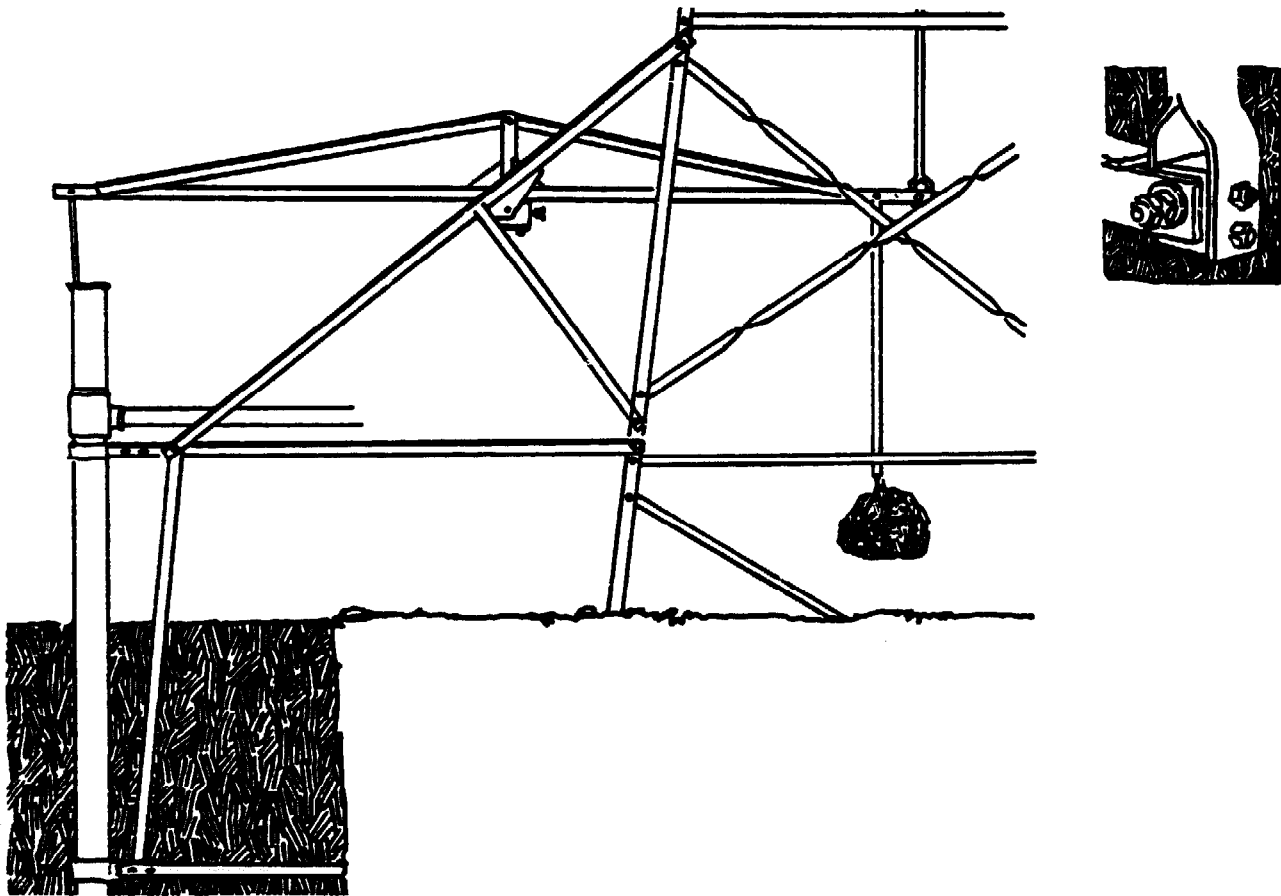
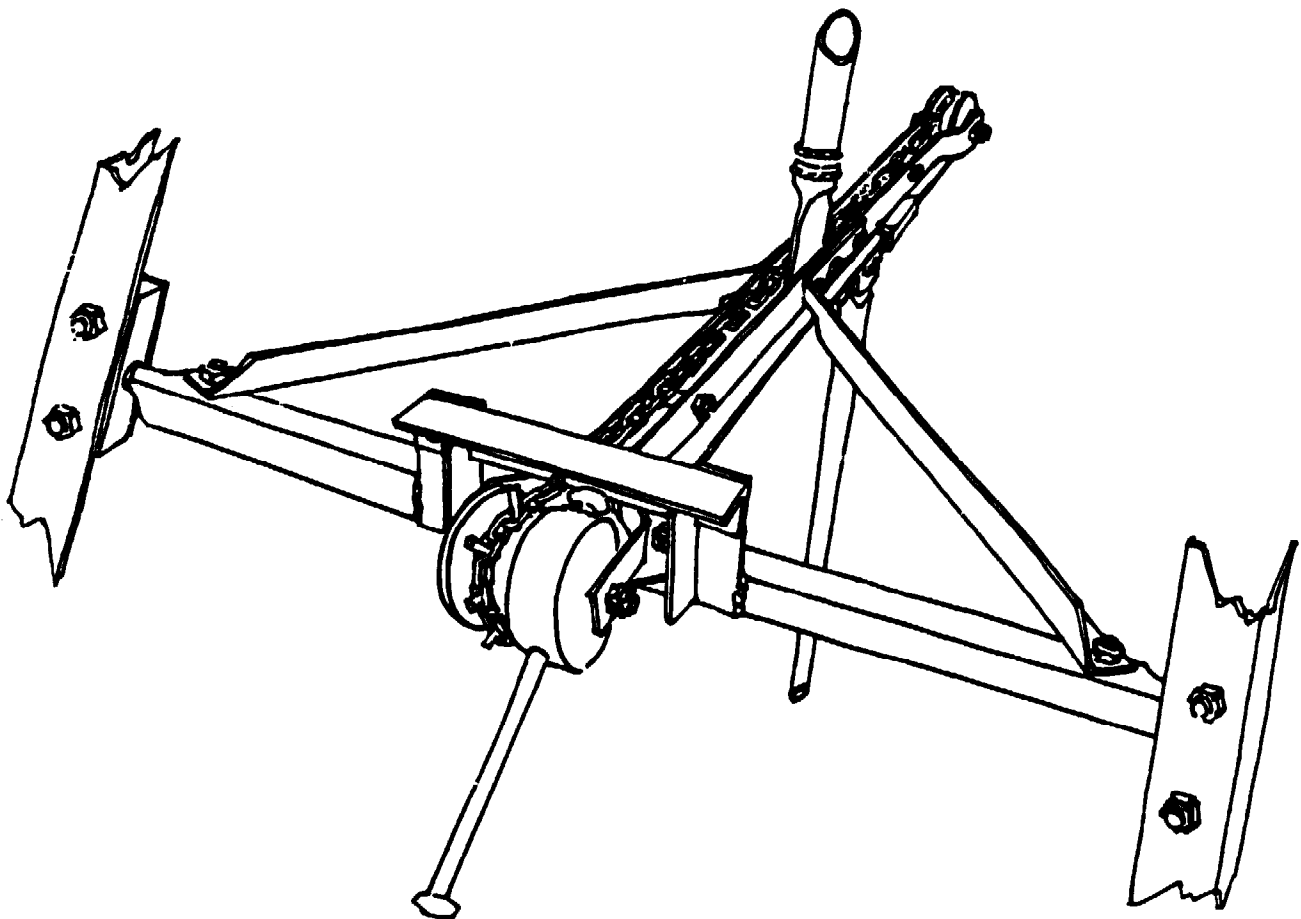

Figure 9. Pump lever showing delivery and discharge pipes, counterweight, and detail of wooden bearing at end of lever



**Figure 10. Variable stroke lever**

either end of the lever allows the traveler to be moved back and forth along the lever. Thus, the pump stroke can be varied from 0-22 inches. The traveler may be locked in position by a hinged latch that fits between the chain links.

The upper connecting rod of 1-1/2-inch galvanized pipe connects near the center of the variable stroke lever with a loosely-fitted 5/8-inch bolt. This allows the upper connecting rod to move from side-to-side when the windmill is running in different positions. The upper connecting rod is also fitted with a swivel so that the windmill can turn without the rod being twisted. The top of the upper connecting rod has a welded "T" fitting to accept the wooden connecting rod bearing that fits on the crankshaft. To reduce wear at all of the connecting rod 5/8-inch bolts, wooden bearings may be fitted, if desired.



## V. VILLAGE FABRICATION TECHNIQUES

The Gaudgaon sailing windmills were designed to use labor-intensive fabrication techniques that are widely available in rural areas. Workers can easily learn the necessary skills if they do not already have them, and the tools they need are very cheap.

### **Safety**

Every person on a windmill fabrication work crew must be aware of safety at all times. Work should be stopped immediately if anything appears unsafe. The leader of the work crew should constantly observe the work area for dangerous situations. Any small cuts must be disinfected and bandaged immediately. People who receive more severe injuries must be taken immediately to a doctor or a hospital. Specific precautions that should be taken include:

- . A sledgehammer must be swung only when the crew is prepared and the work leader says "ready" for each blow. Work pieces and punches must be properly positioned on the anvil and held securely by tongs. People holding larger work pieces must grasp the stock firmly, out of the way of the sledgehammer.
- . Small pieces of metal must be bent over and removed with a hammer, not sent flying with a sledgehammer blow. The work area must be kept clear of sharp chips that might cut someone's foot. All workers near the sledgehammer work area must wear safety glasses to protect their eyes from flying pieces of steel or dirt.
- . After hot forging, pieces must be allowed to cool completely. Any small hot pieces should be put on the ash pile to cool.
- . All sharp corners and edges of steel parts must be smoothed with a file or hammer immediately after fabrication, so that workers' hands are not cut.

### **Cold forging**

The sledgehammer is the basic tool with which the Gaudgaon windmills are built. An 8- or 10-pound sledgehammer with a 24- to 30-inch handle is usually used. A heavy anvil of steel or

cast iron is also required. However, if an anvil is not available, a large, hard stone may be used. The best anvil is a steel ring with an inner hole approximately 6-8 inches in diameter. If the anvil does not have a hole, it must at least have a step or depression, so that parts may be straightened and bent on it. The anvil should weigh at least 200 pounds for best working conditions. Other tools include a cold chisel, punch and die, 16-inch long tongs, and small hammer.

Angle irons, flats, bars, or small diameter pipes may be straightened with the sledge and anvil. The work leader holds the stock up to eye level and sights along it, seeing where the stock is bent. The piece is then placed on the anvil, with the bent side up and centered over the hole in the anvil. The sledge is always struck over the center of the anvil hole, as the work leader moves the stock back and forth until it is straight.

Angle iron or steel flats may be cut with the sledge and cold chisel. The helper holds the stock with the cutting mark resting directly against a solid place on the anvil. The work leader holds the chisel with the tongs and signals for the sledge blow. After the stock is cut about halfway through, it can be broken by bending.

Holes can be punched with the sledgehammer, punch, and die. The helper holds the stock with the mark over a solid place on the



Figure 11. Using a sledgehammer, punch, and die to make a hole

anvil. The work leader raises the stock and places the die directly under the hole mark, then holds the punch with the tongs directly over the mark, and signals for the sledge blow (see Figure 11). The die is a circular ring of steel, preferably tool steel, but a nut (from the next largest bolt size) can be used.

The die and punch must be placed correctly before each blow of the sledgehammer. When the punch goes through the stock, it may jam in place. It can be removed with a few blows of a small hammer against the stock. The stock is then turned upside down. The hole may be ragged and the stock bent. A few blows of the sledgehammer flatten the stock. The punch and die are then used again to open the hole from the bottom side, if required. If a hole is to be made near the end of a piece of stock, it is always better to punch the hole before cutting the stock; otherwise the stock may split under the impact of the punch.

Rings may be bent out of steel stock with the sledgehammer and anvil. The larger the diameter of a ring, the easier it is to make. When making a ring, the first step is to draw a pattern with a wire and two nails on a flat stone floor, or a sheet of metal, wood, or paper. The pattern may show the inside or outside of the finished ring, or both. The length of stock to be cut can then be estimated by multiplying the outside diameter of the pattern by  $3\frac{1}{8}$ . This will give a longer piece of stock than required; the extra amount can be cut off when the ring is complete.

When bending a ring, always start at the ends of the stock. Only when the ends are complete should you move on to the middle of the piece of stock. To bend the steel, the work leader should hold the stock directly across the hole in the anvil. The sledge is always struck directly at the center of the hole. After every few blows, the piece of stock may be compared to the ring pattern to see how the bend is progressing. If the stock has been bent too much, it may be straightened by holding it upside down against the anvil (or horizontally against the side of the anvil). The ring must also be kept straight as the bend is made. This will require laying the ring flat against the anvil and straightening it whenever it becomes crooked. Any nicks or dents made by the sledge or anvil should also be removed as the work progresses.

In this way, rings of flat stock may be made easily. Rings and bends in angle iron, such as the tower head ring and the chassis side members, are harder to fabricate. This is because the angle iron always bends sideways whenever it is bent. So, for every ten strong sledgehammer blows to bend the ring of angle iron, approximately four strong blows must be given on the side of the angle iron to keep the stock straight. Once this method is mastered, the tower head ring may be fabricated easily and

exactly (see Figure 12). Once the ring has been made exactly round, it must also be checked for flatness of its upper surface, and hammered flat if crooked.

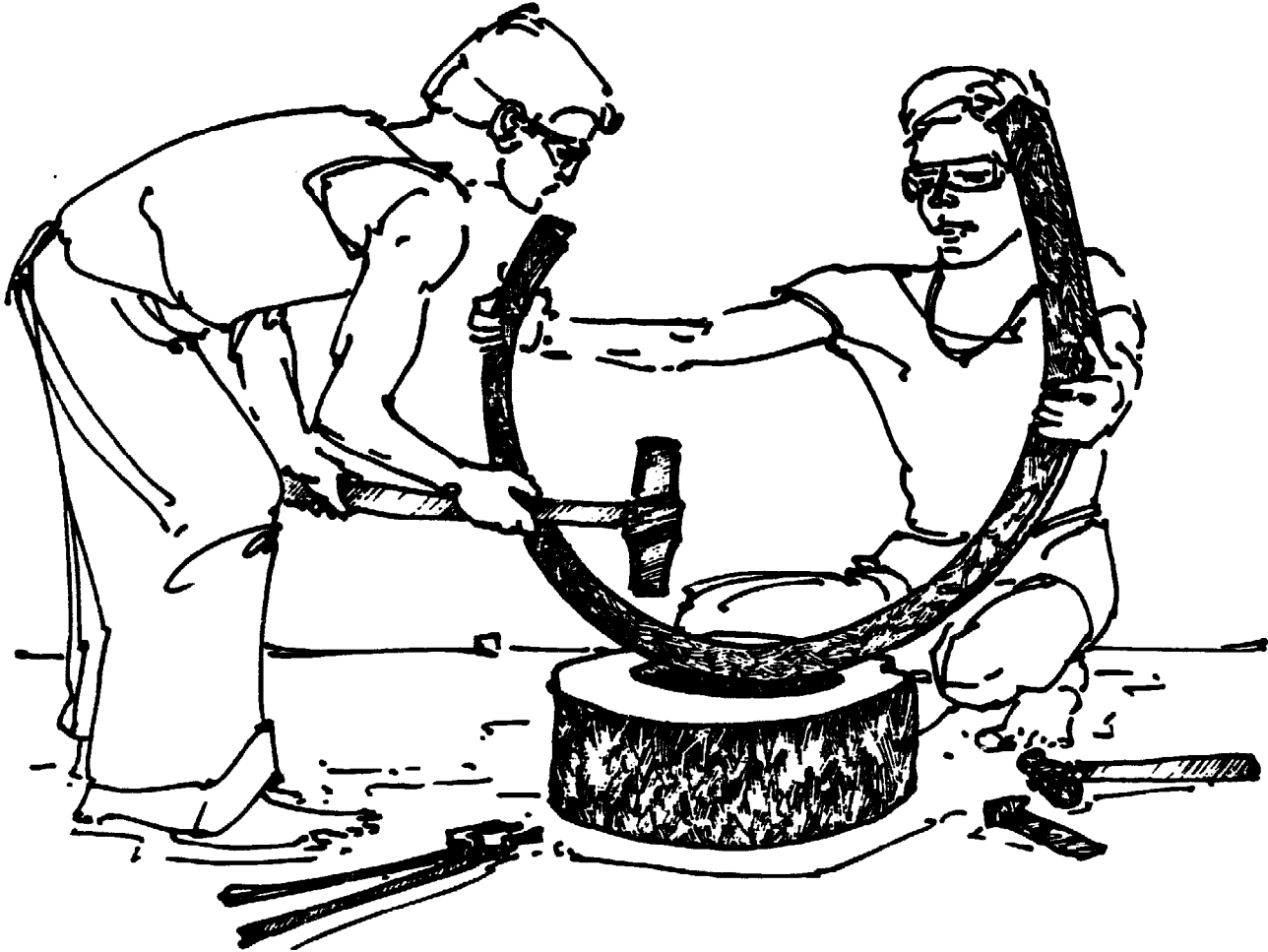

Figure 12. Bending the tower head ring

### **Hot forging**

Toolmaking and blacksmith work require skill, and can be dangerous, but can be learned by an intelligent and careful worker within about a month. A supply of coke or coal and a bellows or blower are required. A bar of tool steel stock is required to make cold chisels or punches.

A cold chisel or punch may be made by first heating a piece of tool steel stock red hot and hammering it to the desired shape. If desired, the chisel may be cooled and the point sharpened on a stone, such as a broken piece of flour mill stone. The tip of the tool is then reheated red hot for hardening and tempering. The red hot tip of the tool is held in a pan of water for several seconds until it is cold. This hardens the tool. The tool is then pulled out of the water and quickly scraped or filed so that the bright color of the steel can be seen. The

color of the steel will change as the heat travels from the body of the tool down towards the tip. When the tip of the tool is nearly yellow or straw-colored, the tip is tempered (toughened). The tool is placed upright immediately with only its tip resting in a shallow pan of water. The rest of the tool is allowed to cool slowly. This allows the tip of the tool to remain hard and tough, while the body of the chisel or punch becomes soft so that it will not shatter when struck by the sledgehammer (see Figure 13).

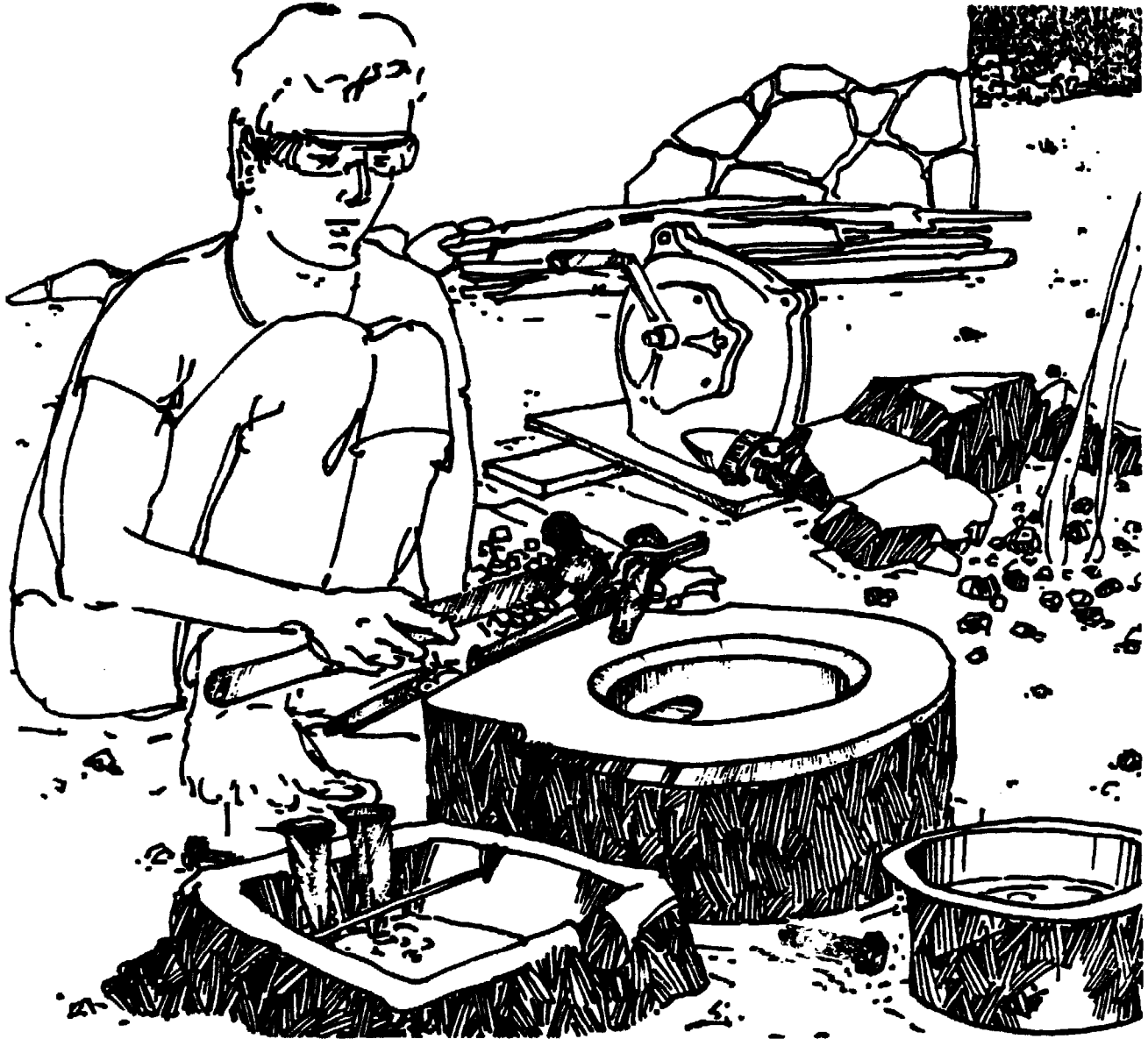

Figure 13. Shaping and tempering punches

Holes in thick pieces of steel (like the lift arrester washers) or in hard pieces of steel (like the truck spring chafing plates on the windmill chassis) may be hot punched with the sledge, punch, and die after heating the stock red hot.

## **Carpentry**

The windmill bearings, hub, bamboo, and sail access platform are made of wood, and require manual carpentry skills (see Figure 14). The village-built irrigation pump is also made of wood, and requires careful fabrication by a skilled carpenter.

The windmill hub is similar to the hub of a bullock cart wheel. It can be made on a lathe, if available. It also can be made by hand with a saw, square, plane, compass, and wood chisels. The main bearings can be made by hand using a saw, plane, compass, and wood chisels. Since all of the windmill's wooden parts are exposed to rain and weather, it is best to soak them in creosote or used crankcase oil after fabrication. Carpentry training for this level of work requires about three months.

## **Sewing**

The windmill sails require simple tailoring skills. The sails must be cut carefully on the pattern. The hems of the sails should be pinned carefully to the correct shape, and the curves checked for smoothness before sewing.

The sails can be sewn by hand, but the sewing is easier if a sewing machine is available. Heavy thread and a thick needle must be used so that the hems of the sails cannot be torn apart by hand when the sail is finished.

## **Masonry**

The irrigation windmill installation may require a stone or brick wall beside the well. This wall must be built strongly of large, flat stones or hard bricks, so that the windmill foundations will not collapse and fall into the well. The sand for the cement mortar must be screened and washed before use. A worker can learn this work within a month of training.

## **Welding**

Some of the 24-ft diameter irrigation windmill parts, such as the crankshaft, upper connecting rod, and pump lever, require welded fabrication. Training in the use of a welding machine should take no more than a month. If a welding machine is not available, the parts to be welded can be prepared in the village by manual work, and then transported to a workshop for welding.

Preparation of the parts for welding is very important. All galvanizing must be cleaned off the parts within 1/2 inch of

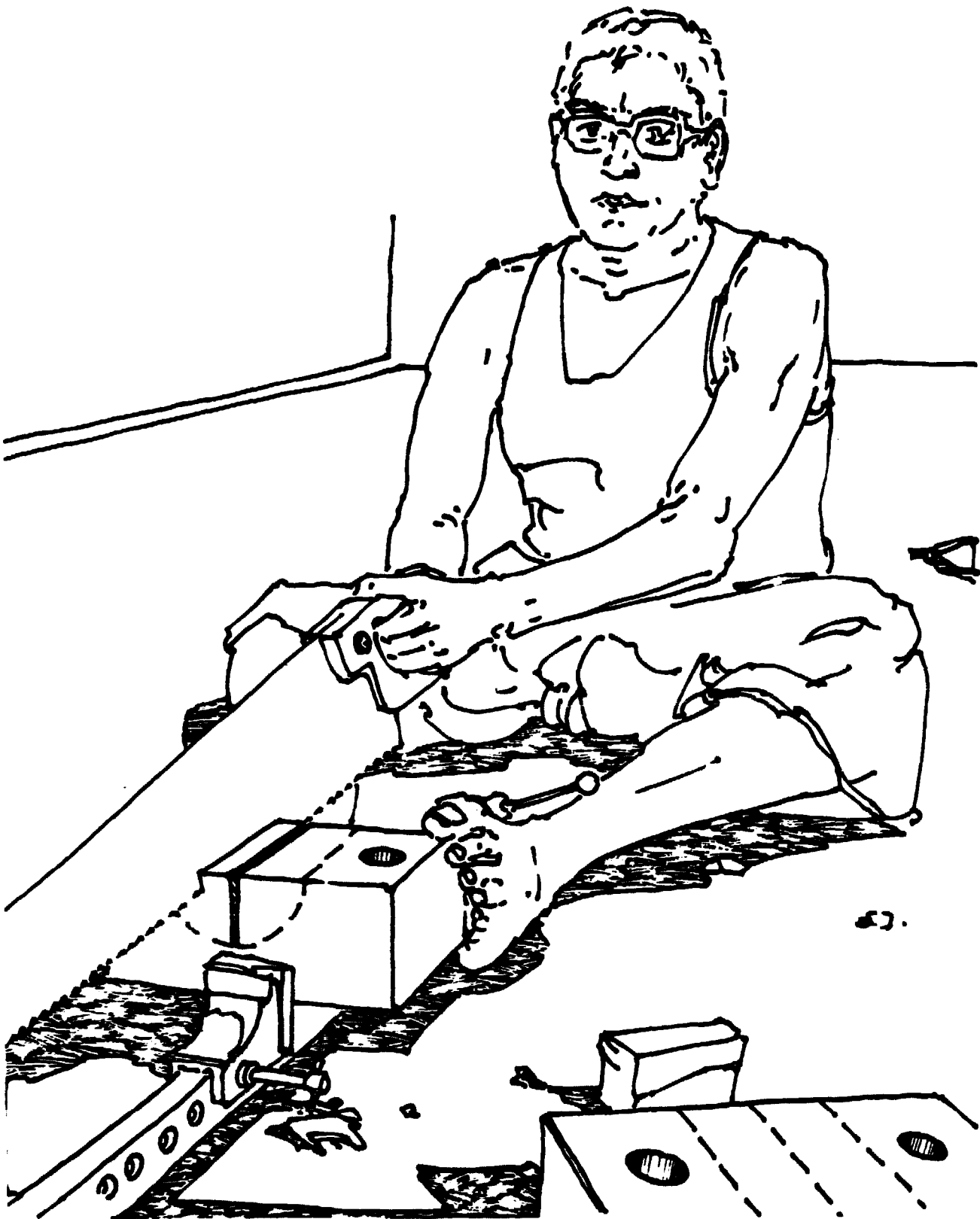

Figure 14. Fabricating the hardwood bearings

the point to be welded. The parts must be shaped so that they fit together closely. No crack to be welded should be wider than 1/8 inch. For strongest welding, the crack should be V-shaped, so that the weld will penetrate deeply. If possible, the parts should be held together tightly by clamps or bolts so that their positions cannot shift as the welding is started.

If the parts to be welded are carefully prepared beforehand, the actual welding is done easily and the cost of work done in the welding shop is reduced. After welding, the slag on each weld must be chipped and the weld inspected.

### ***Drilling***

Some of the windmill parts, such as the crankshaft of the 16-ft diameter windmill and any cast iron parts in the irrigation pump, may require drilling. This can be done in the village if electricity and a drill machine are available. Otherwise, the parts can be taken to a workshop. The parts must be marked and center punched where the hole is required. When drilling holes, the parts must be held securely. Small parts must be clamped in place. The drill must be sharp. All workers near the drill machine should wear safety glasses.

### ***Threading***

The four tie-rods for the irrigation windmill pump cylinder must be threaded. This can be done by hand if a threading die is available. Otherwise, they can be threaded in a workshop with a threading die or on a lathe. Or, the four rods can be fabricated by welding shorter bolts to a piece of 1/2-inch steel bar. To prepare the rods for threading, they should be tapered slightly at the end so that the threading die will start easily.



## VI. CHECKLIST FOR CONSTRUCTION OF A 24-FT DIAMETER VILLAGE-BUILT WINDMILL

This list gives the windmill fabrication steps in abbreviated form. If enough workers are available, several steps may be done at the same time. However, some parts must be fabricated and assembled before other parts, so that the lengths may be marked correctly.

If the welding is to be done at a workshop away from the site where the windmill is being made, all of the parts to be welded may be prepared and taken to the workshop at one time.

### **Tools**

The following tools are needed to fabricate the windmill:

- . sledgehammer
- . anvil
- . small hammers
- . cold chisels
- . punches and dies for 3/8, 1/2 and 5/8 inch holes
- . tongs, 16-inch (2)
- . pliers
- . half-round bastard file (teeth somewhat coarser than smooth file)
- . 3/8-inch round file
- . wrenches for 3/8, 1/2, and 5/8-inch bolts
- . hacksaw with extra blades
- . center punch
- . pipe wrench for 3/4-inch pipe (2)
- . pipe wrench for 3-inch pipe (1)
- . saw
- . plane
- . wood chisels
- . wood drill bits (girmits): 3/8, 1/2, 5/8, 3/4, and 1-inch square
- . compass
- . flexible tape measure
- . hand twist drill with 3/8-inch bits (high speed bit for steel and 3-pointed bit for bamboo)
- . angle iron wrench, 30 inches long (2) (may be fabricated from excess windmill stock)
- . access to welding, drilling, and pipe threading machines
- . access to blacksmith forge
- . access to sewing machine

## **Check the windmill design**

Answer these questions before building:

Will the tower be tall enough? (See rule of thumb on page 14.) Will the windmill tower foundations fit beside the well? Will the cantilevered pump support arms be long enough to allow the pump to hang vertically into the water in the well? How deep is the water level in the well? How long must the delivery and discharge pipes be? How large must the pump cylinder be? Is a flexible suction pipe required? Are all the necessary materials available?

### **Purchase materials**

The following materials must be purchased:

Steel angles, flats, pipes, bolts, wire. Wood, bamboo, cloth, stone, tar, and other items. Transport materials to the place where the windmill will be built.

### **Construction steps**

Here is a rough outline of how to build the windmill:

#### **Tower Head Ring**

Make ring pattern. Mark and cut stock for tower head ring. Bend ring. Make joint in ring by welding or bolting. Mark and punch holes in ring. Finish making ring round and flat.

#### **Tower Legs**

Lay out tower leg stock. Make joints in stock if required. Mark holes in tower legs. Punch holes. Straighten legs. Flatten upper ends of legs. Mark and punch holes for tower head ring.

#### **Horizontal Bracing**

Mark holes and cuts for tower horizontal bracing and sail access platform. Punch holes. Make cuts. Straighten pieces.

#### **Assemble Tower**

Assemble the tower horizontally on the ground. Leave bolts fastened loosely. Check the tower for squareness in all three

dimensions. Check tower legs for straightness. Block up and brace tower as required to keep it in the correct shape. Tighten bolts. Mark, punch, cut, and install "X" bracing. If the tower is to be transported without being disassembled, the "X" bracing may be twisted taut with the two angle-iron wrenches.

### **Pump Support Arms**

Mark, cut, bend, and punch pieces for the cantilevered pump support arms. There are six pieces including the arms and braces. Make the two reinforcing plates for the pump lever pivot bolt. Make the delivery pipe support clamp, ensuring that it fits easily between the ends of the pipe support arms. Assemble the arms and braces on the tower and check that all parts fit correctly. Mark, cut, and fabricate the lower pipe support arms, if required.

### **Interior Bracing**

Mark, punch, cut, bend, and install the tower interior bracing.

### **Variable Stroke Lever**

Mark and cut pieces for the variable stroke lever. Mark and punch holes. Make cutouts on ends of pivot piece. Forge ends of pivot piece round. Make lengthwise cuts on the two lever angles. Straighten and file them smooth. Make bends at the ends to take the two lever linkage pulleys. Assemble the lever. Mark, punch, bend, cut, and assemble the two braces. Make the two linkage pulleys of hardwood and the two wooden bearings, with steel caps. Mark, cut, and forge the traveler. Mark, cut, and punch the traveler clevis pieces, and prepare them for welding. Make the linkage latch parts and prepare them for welding to the lever angles. Make the welds on the traveler and latch. Assemble the variable stroke lever with the traveler, pulleys, latch, and linkage chain in place, and check for proper operation.

### **Pump Lever**

Mark and cut pieces for the pump lever, including the truss strut and fillets. Mark and punch the holes for the pivot bearing and end connections. (If drilling is available, these holes may be drilled after the lever welds are made.) Straighten the angles and prepare them for welding. Make the welds. Install the truss. Make the pivot bearing. Install the pump lever in the windmill tower and check for proper movement. Make and install the wooden lever end bearings.

## **Ladder**

Mark, punch, and cut the pieces for the ladder. Assemble the ladder on the tower.

## **Platform**

Mark and cut the wooden planks for the sail access platform. Drill the planks. Paint them with oil. Install the planks.

## **Windmill Chassis**

Draw a full-size pattern for the windmill chassis. Remember that changes must be made if the tower head ring is built larger or smaller than it is in the blueprint drawing. Mark and cut the chassis side members. Bend them to the correct shape. Forge the twists in their ends. Mark and punch the holes in the chassis side members. Mark, forge, and punch the truck spring chafing pieces to fit the chassis side members. Remove the tower head ring from the tower, and install it below the windmill chassis. Mark, cut, punch, and bend the four chassis cross members. Install them between the chassis side members. Fabricate and install the four lift arrester washers and spacers. Check the ring and chassis for proper fit and easy rotation. Reinstall the tower head ring on the tower.

## **Tail Arm**

Mark and cut the 3-inch B-class pipe into three pieces, for the tail arm, crank shaft, and crank pin. Punch or drill the tail arm pipe to fit between the chassis side members where they come together. Drill the tail arm for its support wire and the wires that lead to the ground. Cut the notch in the tail arm so that it can be used as a gin pole. Check that the tail arm fits properly on the tower in the gin pole position. Mark, punch, bend, and twist the two tail support truss angles, and install them on the chassis.

## **Crank Shaft**

Mark the main shaft for the positions of the crank pin weld, the bearing bushings, the hub square, and the holes at the forward end. Drill the shaft at the forward end. Mark, cut, and bend the bearing bushings. Make a clamp for the bearing bushings. Mark, cut, and bend the two thrust collars and eight rotor support wire tabs, and prepare them for welding. Mark and cut the crank shaft weld fillets and prepare them for welding.

Make two oblong clamps to hold the crank pin in place while it is being welded. Clamp the crank pin in position, using two

2-inch X 1/2-inch bolts with nuts as spacers between the crank pin and crank shaft. Check that the crank pin is held securely and is correctly lined up parallel to the crank shaft. Make the welds on the first ten crank fillets.

After the first welding, the crank shaft must be stress-relieved. Heat the crank weld area red hot in a slow, even fire and allow it to cool slowly. Then mark and cut the notch out of the crank shaft. Weld in the last two crank fillets. Weld the three bearing bushings, two thrust collars, eight rotor support wire tabs, and four hub square pieces in place. File the bushings round and smooth, if required.

### **Main Bearings**

Plane, mark, and cut the wood for the main bearings and connecting rod bearing. Mark for the bolt holes. Drill the holes. Mark the crank shaft holes to fit the bushings on the crank shaft, and cut out these holes. Make the bearing caps of steel flat, and install the grease cups. Install the bearings, grease cups, and bearing caps on the windmill chassis, with the crank shaft in place. Check for easy rotation. Prepare the connecting rod upper end for welding, with two fillets and one flat. Weld. Install the connecting rod bearing on the crank pin and check for easy rotation. Make and install the two bearing thrust braces. Make and install the tail truss forward support, and bend it as required to clear the connecting rod grease cup as the crank shaft rotates. Mark all the bearing pieces with numbers so that they can be installed easily. Soak the bearings in oil.

### **Connecting Rod Swivel**

Select a steel coupling that fits the 1-1/2-inch pipe threads of the upper connecting rod. Cut it in half, and bevel the cut edge to prepare for welding. File off any galvanizing. Mark, punch, and cut out the two swivel plates. Weld the plates to the coupling halves. Mark and cut the swivel spacers (or, have them made in a workshop with a metal lathe). Assemble the swivel, with a lock nut on the swivel bolt so that the swivel turns freely, but has almost no up-and-down play. Cut the swivel nipple and lower connecting rod of 1-1/2-inch pipe, leaving them both several inches long, until they can be marked and punched later.

### **Rotor Hub**

Mark and cut the piece of wood for the rotor hub. For manual fabrication, first saw the two ends parallel. Then choose a

center point on each end and mark the circumference. Smooth the outside of the hub until it is round. Mark the hub for the clamp recesses, and cut them out. Mark the hub for the eight bamboo holes, and cut them out. Mark the hub for the square hole to fit the main shaft, and cut it out. Make the four wedges that will be jammed inside the hub to expand the crank shaft square. Make the two steel clamps for the hub, and punch holes for retaining nails. Paint the hub with oil.

### **Rotor**

Cut the eight rotor bamboo pieces to length. Mark and cut the squares on the butts of the bamboo to fit the hub holes. Make the eight 3/8-inch steel pins for the bamboo tips. Draw a pattern for the rotor ring. Mark, cut, and bend the rotor ring. Mark and punch the holes in the rotor ring. Set the hub sideways on the ground. Install the eight bamboo pieces into the hub, and lay the rotor ring on them in the correct position. Mark the bamboo pieces for the rotor ring holes, pin holes, and the sail attaching holes. Before disassembling the bamboo pieces from the hub, mark them and the hub and rotor ring with numbers so that reassembly will be easy. Drill the bamboo with a sharp 3-pointed wood bit. Mark, cut, and drill the eight sail bamboo pieces.

### **Sails**

Make a full-size drawing of the windmill sails on a flat floor. First, draw the triangle with straight sides (8 ft 3 inches X 7 ft 6 inches X 4 ft 4 inches). Then add the curves to the leading and outside edges. Then add the width of the hems (6 inches on the leading edge, 3 inches on the trailing and outside edges). Lay the sailcloth over the pattern, with the weave of the cloth parallel to the trailing edge of the sail. Mark and cut the sail piece. Check to make sure the sail has been cut out right. Then, cut out seven more pieces the same shape. After cutting, lay the pieces of cloth on the pattern again, and fold their hems to the correct size. Pin the hems in place for sewing. Sew the sails with heavy thread, four lines of sewing per hem. Make sure to leave the open sleeve at the leading edge of the sail. Mark, cut, and hand stitch the four buttonholes on the leading edge of the sail. Hand stitch the rope loop at the trailing corner of the sail.

### **Pump Pipes**

Mark and cut the 3-inch delivery (vertical) and discharge (horizontal) pipes to the correct lengths. Have them threaded at a workshop if required. Check to make sure the threads on

the pipes, flanges, suction pipe nipples, and foot valve fit correctly.

### **Village-Built Piston Pump**

Mark, cut, and plane planks of teakwood for the pump cylinder. Cut the notches in the sides of the planks so they fit together tightly. Mark, cut, punch, and bend the sixteen steel clamps for the pump cylinder. Assemble the pump cylinder. Mark, cut, plane, and drill the two pump end plates. Mark and cut out the steel pump rod guide plate. Mark and cut the four pump tie rods. Have the rods threaded at a workshop (or, fabricate the tie rods by welding). Assemble the pump cylinder, end plates, guide plate, upper flange, and a section of delivery pipe. Check that the delivery pipe and pump cylinder are in a straight line.

Measure the inside of the pump cylinder. Using this measurement, mark and cut out the wooden and steel pieces of the piston. File them smooth. Punch and drill them as required. Mark and cut out the leather piston washer with flap valve. Make the flap valve weights. Assemble the piston and check for proper fit of the pump rod, piston bolts, and flap valve. Mark, cut, and bend the ring for the ring coupling in the pump rod. Cut the three fillets and prepare for the weld. Make the ring coupling weld. Soak the piston leather in water and assemble the piston inside the pump cylinder, with the pump rod installed through the guide plate, and the ring coupling in place. Check for proper movement of the piston.

## VII. INSTALLING THE WINDMILL

### *Transporting the windmill*

Once the windmill parts have all been made and the tower assembled, the windmill may have to be transported several miles to the site where it will be installed. If the site is within about ten miles, the windmill can be transported on two bullock carts. One cart is placed under each end of the tower. The cart at the back of the tower is tied securely in place. The cart at the front of the tower is tied loosely so that it can turn to allow the caravan to be steered. Two or four bullocks are harnessed to the first cart, and the windmill chassis and pipes are loaded into the carts. In this way, the windmill tower can be transported to its site without disassembly. (Note cantilevered pump support attached to tower in Figure 15.)

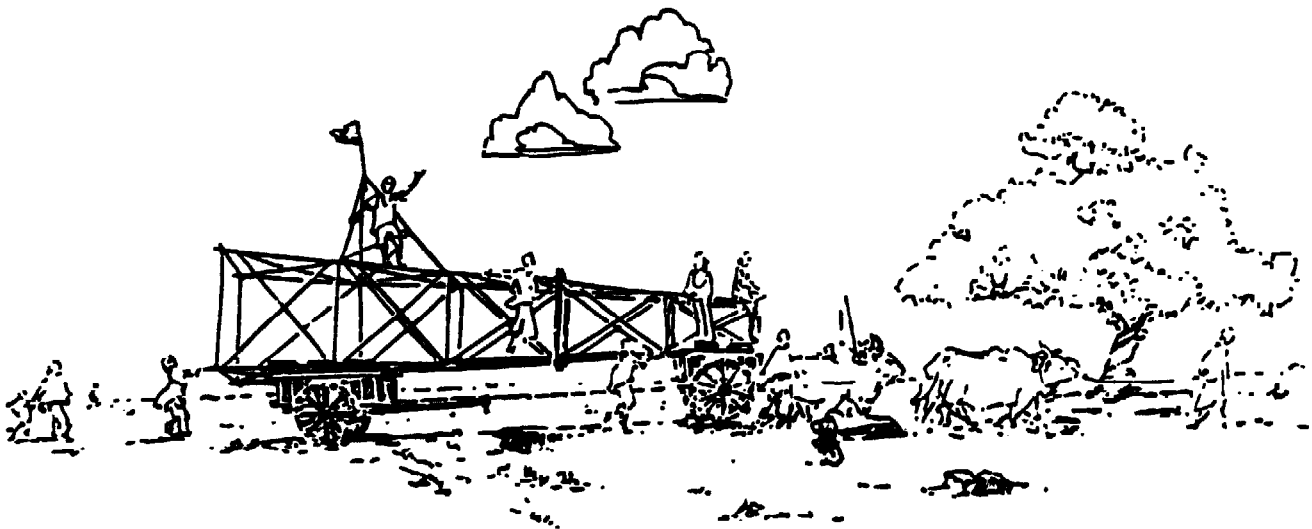

Figure 15. Transporting a tower on two bullock carts

If only one cart is available, or if the road is too long or too heavily traveled by buses to allow the tower to be moved as above, then the windmill tower must be disassembled for transport. If this is done, all the windmill parts must be marked carefully before taking the windmill apart so it can be reassembled more easily in the same order. This can be done by painting each of the four tower leg joints with a different color of paint, one color for each leg. Or, the joints can all be marked with numbers. When the tower is disassembled, it can be loaded into a bullock cart or tractor and moved to the installation site.



## **Erecting the windmill tower**

The towers for the Gaudgaon windmills are designed to be assembled horizontally on the ground and then raised into position as a single piece. Before raising the tower, all of the bolts should be checked for tightness and the "X" bracing should be twisted taut with the angle iron wrenches.

The tower must be placed with its top pointing away from the well and its two lower feet near their foundation position. If the ground has been excavated to allow the tower foundations to be below ground level, the side of the excavation away from the well must slope so that the tower feet will touch the ground once the tower has been raised to about 20 degrees.

With about 18 strong people, the tower is raised by hand until it is at an angle of 20 degrees or more. It can be temporarily propped in that position by two strong Y-shaped tree branches about 8 ft long. Four ropes are attached to the top of the tower. Two of these ropes are led to the sides of the tower, where two persons hold each rope about 100 ft away from the tower foundations to prevent the tower from falling to either side as it is raised. The third rope is carefully measured and tied to a large stone or tree so that the tower cannot fall completely over into the well once it has been raised. The fourth rope is led over the pump cantilever support to the opposite side of the well by the remaining 14 people. When all is ready, the 14 people pull on the rope and the tower is raised (see Figure 16). A pair of bullocks also can be used to help the people raise the tower.

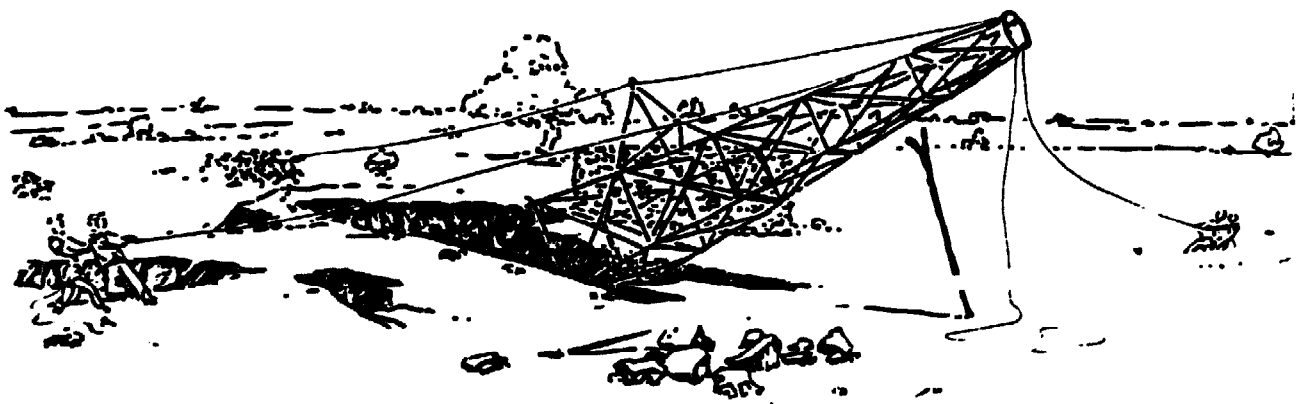

**Figure 16. Raising a tower**

## ***Placing the tower foundations***

Once the tower is raised, it is moved to its exact location by prying with a bar. A flat, hard stone about a foot square must be placed under each tower leg to prevent the tower from settling. These stones are especially important if the tower is erected on soft soil, or in a swampy location.

The tower must be checked to make sure it is vertical. This can be done with a plumb bob if there is no wind. If it is windy, a string can be tied tautly between the center of the tower head ring and the center of the tower at ground level. This string can then be checked with a square and bubble level to be sure it is vertical.

Once the tower is in its exact location and vertical, the foundation stones can be placed on the tower bottom braces. The stones must be placed so that all of their weight bears on the tower braces. For the 24-ft diameter windmill on a 32-ft tower, there must be two stones at least 3 feet long at each corner of the tower foundations (see Figure 17). Above these long stones, other stones and soil or gravel are backfilled until the level of the backfill is 4 ft above the tower bottom. If the tower is erected on flat ground without an excavation, a retaining wall must be built to keep the backfill in place. The area inside the retaining wall must be a minimum of 13 ft X 14 ft. If the lower pipe support arms are to be fitted, they must be installed before the foundation stones are backfilled, and before the masonry wall beside the well is built. The masonry wall must be built strongly so that the tower foundations cannot fall into the well.

## ***Installing the windmill chassis, main shaft, and tail arm***

Since these parts are heavy and awkward to lift and install at the top of the tower, a rope and pulley must be used to lift them. First, the tail arm is installed as a gin pole, which is a long pole or pipe that is used to gain leverage to lift the rotor onto the tower. A notch in the end of the tail arm allows it to fit on the top tower horizontal brace in a vertical position, and project at least 5 feet above the tower head ring. The middle of the gin pole is securely lashed to a tower leg just below the ring (see Figure 18). Then, the hook of a pulley can be set in the top of the gin pole pipe, and a rope passed through the pulley. In this manner, two or three people can raise the heavy windmill parts from ground level, while one person fits them into place at the top of the tower.

The windmill chassis is raised, fitted into place, and the four lift arrester bolts and washers installed. Then the main shaft is fitted with the rotor hub and the eight rotor support wires

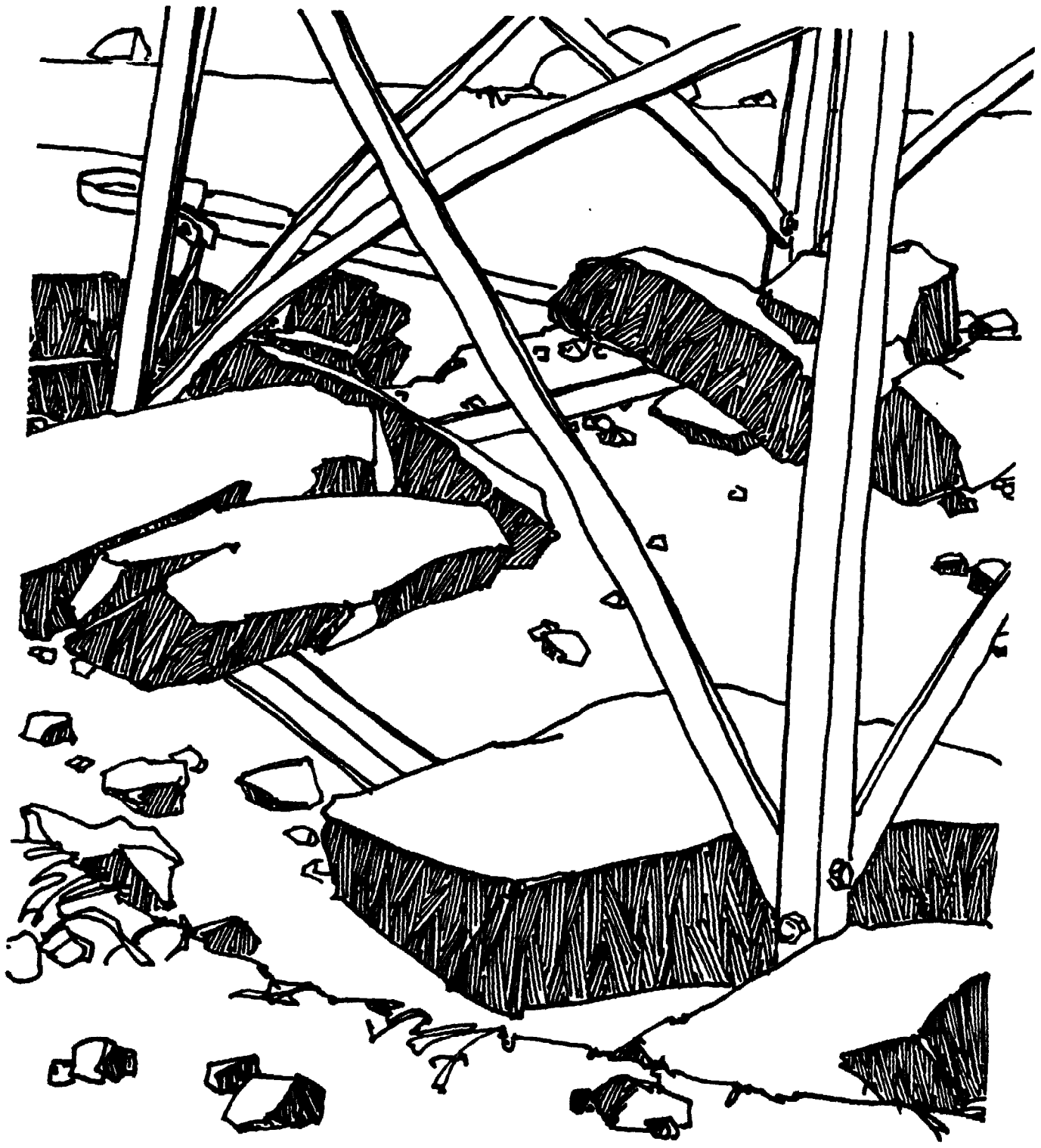
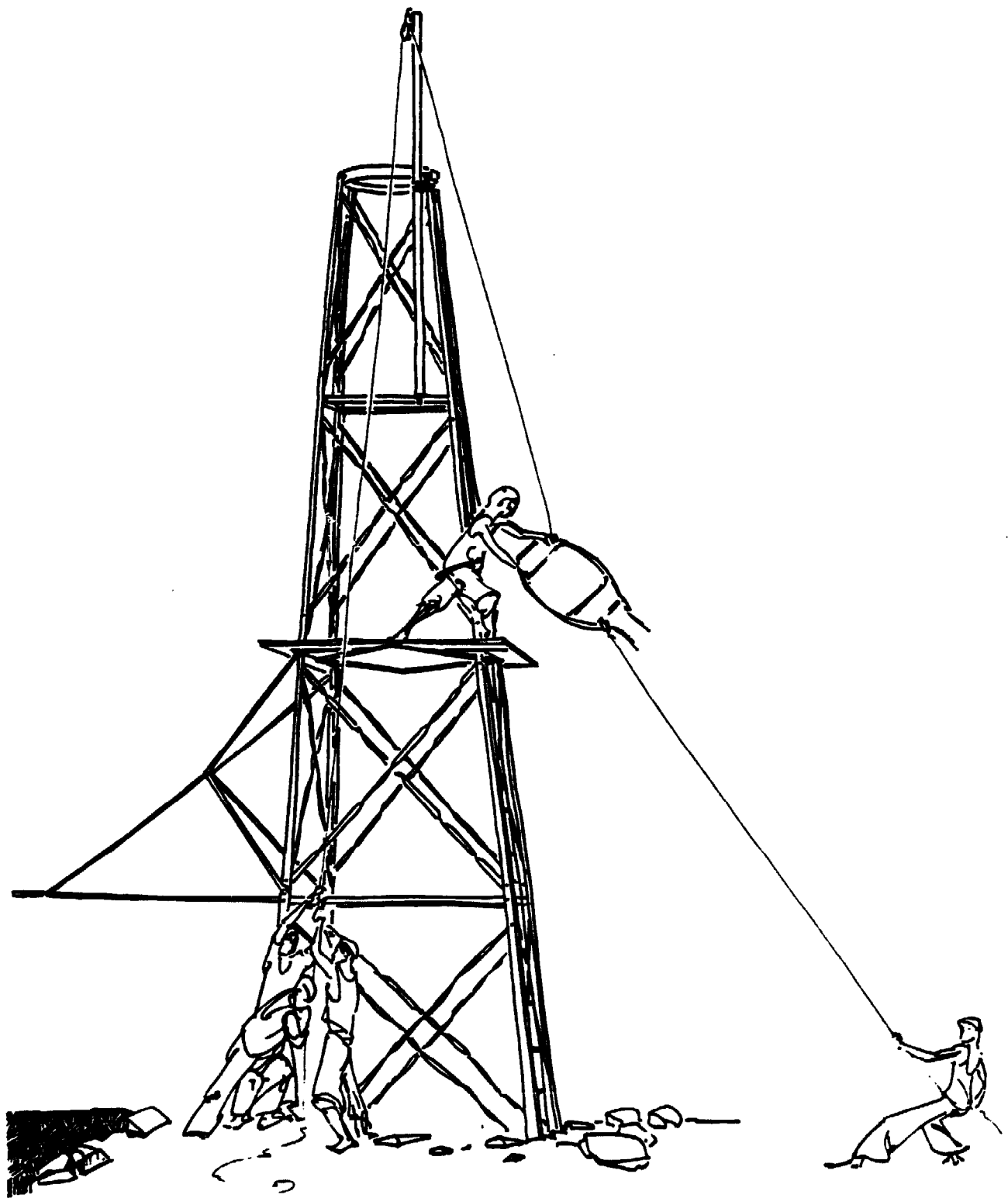

Figure 17. Windmill tower footings before backfilling



**Figure 18. Raising the windmill chassis with a gin pole, pulley, and rope**

at the forward end. The main shaft is raised and fitted into the bearings. The bearing tops are installed. Once the chassis and main shaft are installed, the tail arm may be removed from service as a gin pole and installed in its proper location, attached to the rear of the windmill chassis.

The wires must be attached to the tail arm before it is installed. Three people are needed to install the tail arm. First, two stand on the sail access platform and hold the pipe vertically so that one of its holes lines up with the holes in the chassis side members. The third person installs one of the two bolts, loosely. Then, using a pair of bamboos lashed together near their ends, the two people on the platform raise the tail arm so that the second bolt can be installed. The bolts can then be tightened and the tail arm truss wires installed and twisted taut. The windmill chassis can then be rotated 360 degrees to check for easy movement.

### ***Installing the windmill rotor***

If the rotor has been assembled on the ground first, and all the parts marked with numbers, then final assembly in the air will be much easier. The rotor is assembled by three people. One person stands on the top tower horizontal brace, and two stand on the sail platform.

First, the rotor ring is slipped over the main shaft and its bolt is tightened. Then the rotor bamboos are fitted one after the other into the rotor hub, and bolted to the rotor ring. When the third, fourth, and fifth bamboos are being fitted, the rotor will be very unbalanced, and one person will need to hold it in position from the platform, using a short Y-shaped stick. The second person fits the new bamboo into place, and taps it into position in the hub with a hammer from below. The third person fits the bolt in the rotor ring (see Figure 19).

Once all the bamboos are in place, the circumferential guy wire is installed. This wire can have the loops already bent. For the 24-ft diameter windmill, these loops are 9 ft 2 inches apart. The loops can be made by pounding two bars into the ground exactly 9 ft 2 inches apart, and bending the wire around them. When the circumferential guy wire (or "chiclos" wire) is fitted on the rotor, it must be pulled taut before it is joined together.

Next the bamboo support wires are installed, two wires for each bamboo. These support wires must be fitted carefully, so that the bamboo is held in position firmly. Also, the bamboos must all be exactly the same distance from the tower, so that they all run in the same plane when the windmill rotates. If the bamboos are not all the same distance from the tower, then some

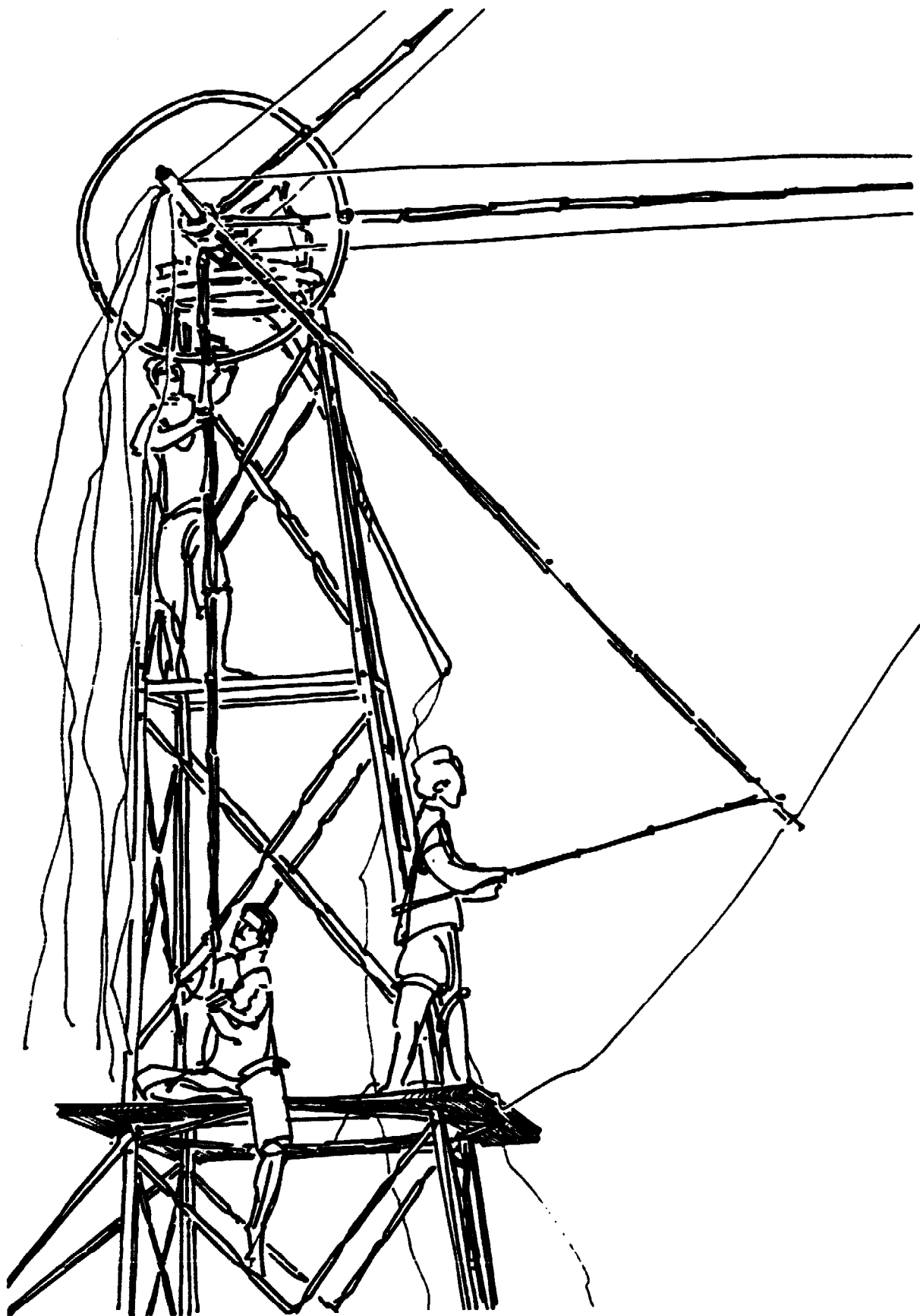

**Figure 19. Assembling the rotor with three persons**

of the windmill sails will catch more wind than others, causing them to flap and become torn sooner than others.

Next, the windmill sails are fitted on the sail bamboo with tight lashings at the top, middle, and bottom of the sail so that they cannot come loose as the windmill rotates. The sails are furled around both bamboos and left tightly lashed until the windmill is ready to operate. (Or, the sails can be kept indoors out of danger of rain until the windmill is ready for operation.)

### ***Installing the connecting rods and pump rod***

When the crankshaft, variable stroke lever, and pump lever have all been installed, the connecting rods may be measured, punched, and installed.

The crankshaft, variable stroke lever, and pump lever all are put in the horizontal (midstroke) position. The traveler of the variable stroke lever is put in the maximum stroke position. The connecting rod bearing, upper connecting rod, swivel, and swivel nipple are installed. The swivel nipple is flattened and fitted through the center of the variable stroke lever so that it can be marked for the hole. The nipple is removed, its hole punched, and installed.

With the levers still in the horizontal position, the lower connecting rod may be measured. One end is flattened and punched. The lower connecting rod is installed and marked for the other hole. It is removed and the hole is punched. The lower connecting rod is installed.

To measure the pump rod, the piston, pump rod, pump cylinder, delivery pipe, discharge pipe "T," and delivery pipe upper nipple first must be assembled horizontally on the ground. Then, the pump rod and piston are moved from their top position to the bottom. The length of the movement should be about 28 inches. Permanent marks are made on the pump rod with a cold chisel or hacksaw where the rod exits from the top of the delivery pipe upper nipple at the top and bottom positions. Then the pump rod and piston are put exactly in the middle between the two marks.

Next, a person must climb onto the tower and go out to the end of the cantilevered pump support. With the pump lever in the horizontal position, this person measures the distance between the hole in the end of the pump lever and the top of the discharge pipe support clamp. Then, the same distance may be measured up from the bottom of the discharge pipe "T" on the delivery pipe, and a mark made on the pump rod. The pump rod may then be flattened, punched, and cut.

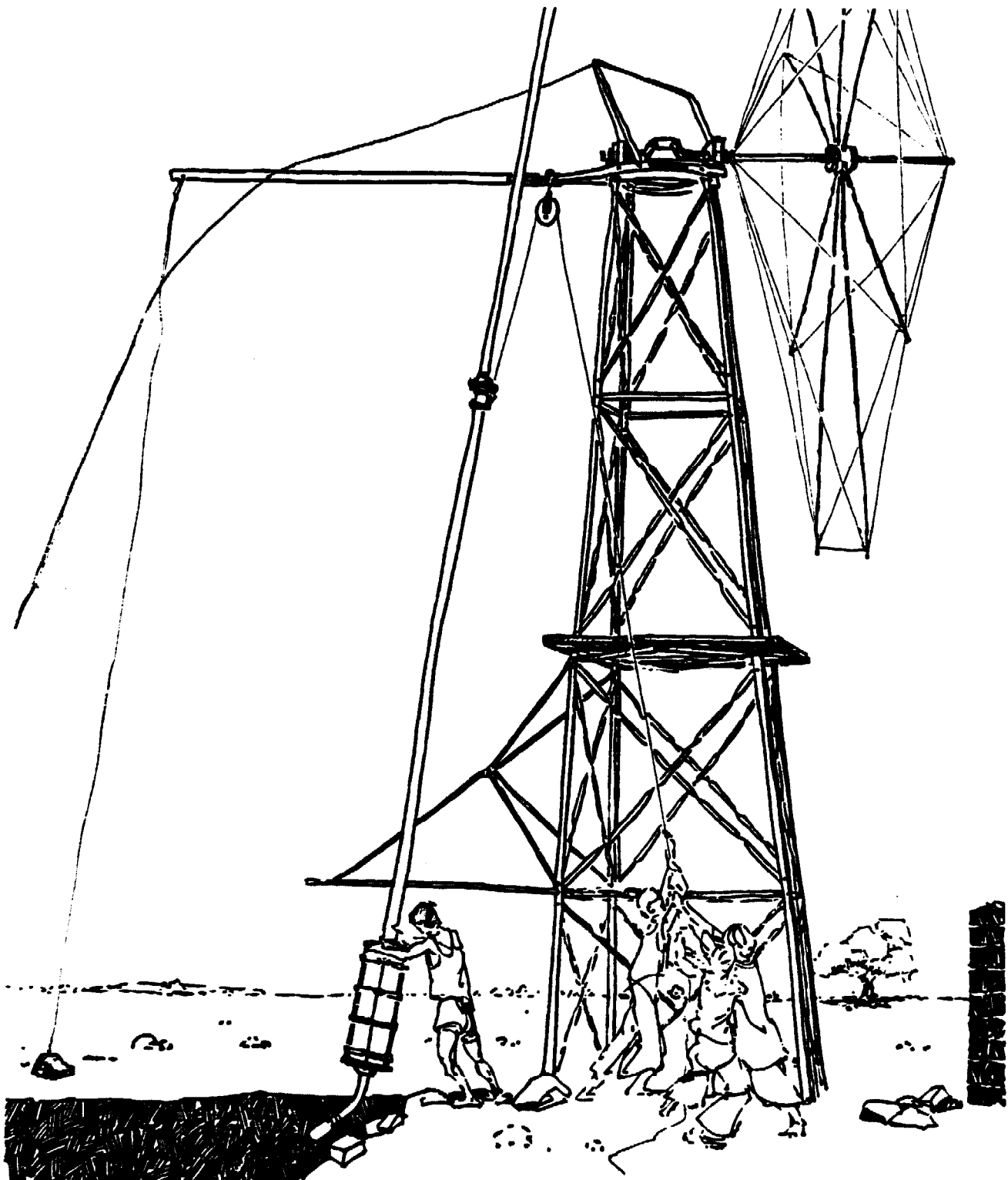

**Figure 20. Lowering the pump and delivery pipe into the well with a pulley and rope**

(Or, instead of this complicated measuring, the pump and delivery pipe may be installed in position and the pump rod measured directly against the pump lever to determine the



correct position of the hole in the pump rod. However, this method requires removal of the pump rod to punch the hole.)

### ***Installing the pump***

To install the delivery pipe with the pump and pump rod attached, the windmill chassis first must be turned so that the tail arm is over the pump support arms. A pulley then is attached to the tail arm support angles. A rope is tied securely near the middle of the delivery pipe. The rope then is led through the pulley and back to ground level.

Four people can lift the pipe and lower it into the well while another person shifts it into position. Once the clamp has been bolted into place, the pump can be lowered so that its weight rests on the cantilevered support. Then the pump rod can be attached to the pump lever. The suction pipe and foot valve can be fitted to the lower end of the pump and the discharge pipe fitted. The lower pipe support is fitted to prevent the delivery pipe from swaying.

### ***Checking the windmill machinery***

First, the windmill rotor is turned by hand with the lower connecting rod disconnected from the variable stroke lever. If the bearings are well greased, the windmill rotor should turn easily. When given a hard shove, the windmill rotor should turn at least 1/4-1/2 revolution by itself.

If the windmill rotor is hard to turn in all positions, the main bearings probably are jamming and must be made looser. If the windmill rotor is much harder to turn on one side than on the other, it may be out of balance. The balance of the rotor may also be checked by stopping the rotor consecutively in each of its eight positions, and observing in which direction it starts to turn at each position. If the windmill remains still at each position and its bearings are loose enough to allow it to turn freely, then the windmill is well balanced.

If the windmill is out of balance, it must be fixed by attaching weights to the light side of the rotor until the rotor turns equally easily at all positions. The balancing weights can be made of steel or cast iron, with two holes per weight for lashing to the rotor chiclos guy wire with wire lashings. Weights also can be made of stones that have grooves around the middle and are lashed to the chiclos guy with wire lashings. The weights must have no sharp corners or edges that might cut the windmill operator's hand. They must be lashed securely to the chiclos guy wire so that they do not move as the windmill rotates.

## ***Installing the counterweight***

The lower connecting rod must be attached to the variable stroke lever. The pump is primed by pouring water into the top of the delivery pipe, if required. The windmill rotor is rotated by hand until water is pumped. The counterweight is attached to the tower end of the pump lever. With the counterweight attached, the windmill rotor should be equally hard to turn on both sides. If the windmill rotor is harder to turn when the pump rod is moving up, then the counterweight must be made heavier. If the windmill rotor is harder to turn when the pump rod is moving down, then the counterweight is too heavy. The size of the counterweight should be changed whenever the level of the water in the well changes more than 5 ft up or down. The counterweight can be made of several stones lashed with wire. To change the size of the counterweight, stones can be added or removed (see Figure 9, page 33).

## VIII. OPERATING AND MAINTAINING THE WINDMILL

### *Safety in operation of the windmill*

Whether the wind is stormy or calm, it can be dangerous to work on the windmill. The operator must always be alert and careful to avoid falls from the tower. The operator must never climb to the top of the tower while the windmill is running. The operator must never try to stop the windmill rotor by hand when it is moving fast, because of the risk of being pulled off the platform. The operator must also be careful to keep hands and feet away from places where they might be crushed by the machinery. When the operator is using the variable stroke lever, the windmill rotor must always be running on the opposite side of the tower. The orientation of the windmill must never be changed when the operator is on the platform. No one must climb the windmill tower during very heavy windstorms or lightning storms.

### *Starting the windmill*

First the tail arm is pulled so that the windmill faces into the wind. On the 24-ft diameter irrigation windmill, the rotor may point upwind or downwind. The two tail arm wires are tied to large stones so that the windmill cannot change its position.

Next, the operator may go aloft and open the sails (see Fig. 21). Eight sails are required in light winds; six, four, or even two sails can be used in stronger winds. (Or, the sails can be opened only partially if the wind is very strong.) The sheet rope from the trailing corner of each sail should be given one turn around the chiclos (circumferential) guy wire, and then looped around the end of the next rotor bamboo. If an adjustable slip-knot is tied in the loop of the sheet rope, then the sail may be easily fitted to the correct tension (see Fig. 22).

Some experience will show that very taut sails prevent the windmill from starting easily, although it will run faster once it has started. Loose sails make the windmill start easily, but they will flap badly once the windmill begins to run. Medium tautness therefore is best for the sails.

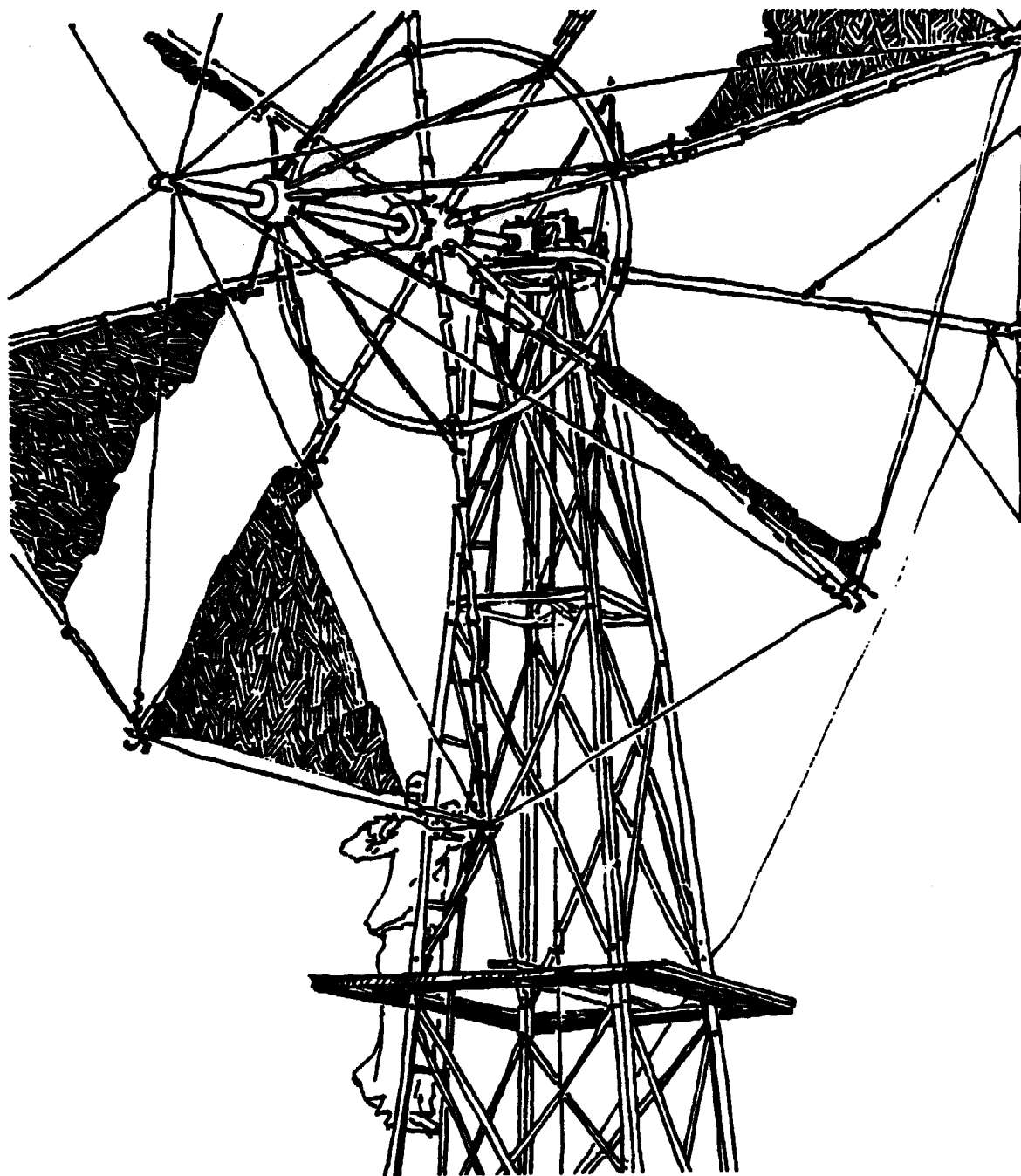

**Figure 21. Opening the windmill sails**

When the sails are set and the windmill is running, variable stroke lever can be adjusted as desired, and windmill left to run while the operator does other work n in the field. For maximum water output, however, the ope should stay on the windmill platform and continuously a the lever back and forth as the wind gusts and lulls.

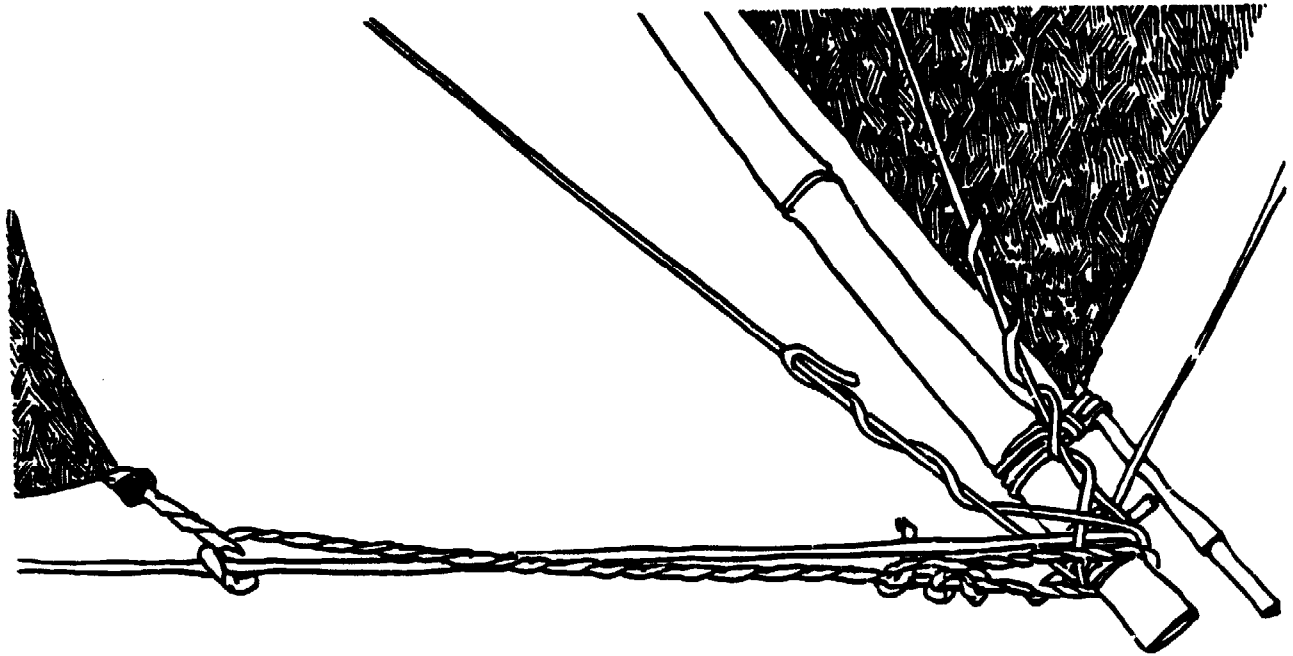

Figure 22. Detail of wires and rope attached to rotor bamboo

### ***Stopping the windmill in a normal wind***

At the end of the day's pumping period, the windmill operator may move the lever to maximum stroke position and wait for a lull in the wind. When the windmill rotor slows or stops, the operator grabs it by hand. First, all of the sails are let loose. Then, the sails are furled by wrapping them tightly around the rotor bamboo and lashing them securely in place. The windmill sails also may be removed whenever the windmill is stopped, if desired.

### ***Stopping the windmill in a strong wind***

If the wind is too strong to allow the windmill to be stopped by hand, two or three people may be needed to stop the machine. First, the tail arm is pulled so that the windmill rotor faces sideways into the wind. Then, two people hold the tail arm wire, or lash it to a large stone. The operator climbs to the windmill platform and stops the rotor as it turns slowly, untying and furling the sails.

If the wind is so strong that it is difficult for a person to stand upright on the ground, it will be too dangerous for the operator to go aloft on the windmill tower. In such a very strong storm, the windmill should be left to run and the rotor to collapse, if it so happens, rather than risk injury to the windmill operator. Thus, it is important for the windmill

operator to be alert at all times, and to try to foresee when heavy windstorms are about to arrive so that the windmill may be stopped before a heavy storm comes.

### ***Windmill maintenance***

The windmill operator must do all the windmill maintenance on a regular basis, with help from a carpenter, blacksmith, and tailor when required.

The bearings, connecting rod bolts, lever pivot bolts, and tower head ring must be kept greased. The sails must be securely furled, or removed from the rotor, whenever the windmill is stopped. The sails must be dried whenever they become wet, or else they will mildew and rot. The sails must be repaired or replaced whenever they are torn. Any loose or broken wires on the rotor must be repaired, and the bamboos must be replaced when they become rotten or split.

All of the nuts and bolts in the windmill chassis and tower must be checked for tightness once a month. Any broken bolts must be replaced immediately. Once every year, the main bearings need to be planed down so that they fit tight on the main shaft. The holes in the ends of the connecting and pump rods need to be repaired if they become oblong. Any other faults in the windmill must be fixed.

### ***Pump maintenance***

Every six to twelve months, the pump piston and valves will need new leather elements. If the well is nearly dry, this maintenance can be performed without removing the delivery pipe. If the well is full of water, the pump must be removed to replace the leathers. While the pump is open, the cylinder should be examined. If the inside of the cylinder walls are not smooth, they must be replaced. If the piston leather wears too quickly, the piston may be modified so that two or three leather washers are fitted.

## IX. USING THE WINDMILL FOR IRRIGATION

Farmers must use different methods with wind-powered irrigation systems than they do with those powered by diesel engines. The flow of water with a diesel or electric pumpset is large and constant. However, the flow with a windmill is erratic, since the wind blows more strongly on some days than others. A related problem is that even though a lot of water may be pumped during a given period, much of it may soak into the earthen distribution channels before it actually reaches the crops to be irrigated. These problems can be overcome in several ways.

### *Storage tank*

A storage tank can hold water pumped by a windmill until it is needed. It should hold as much water as the windmill can pump during several hours of heavy wind, or during several days of light wind. Once the tank is full, the water can be released to

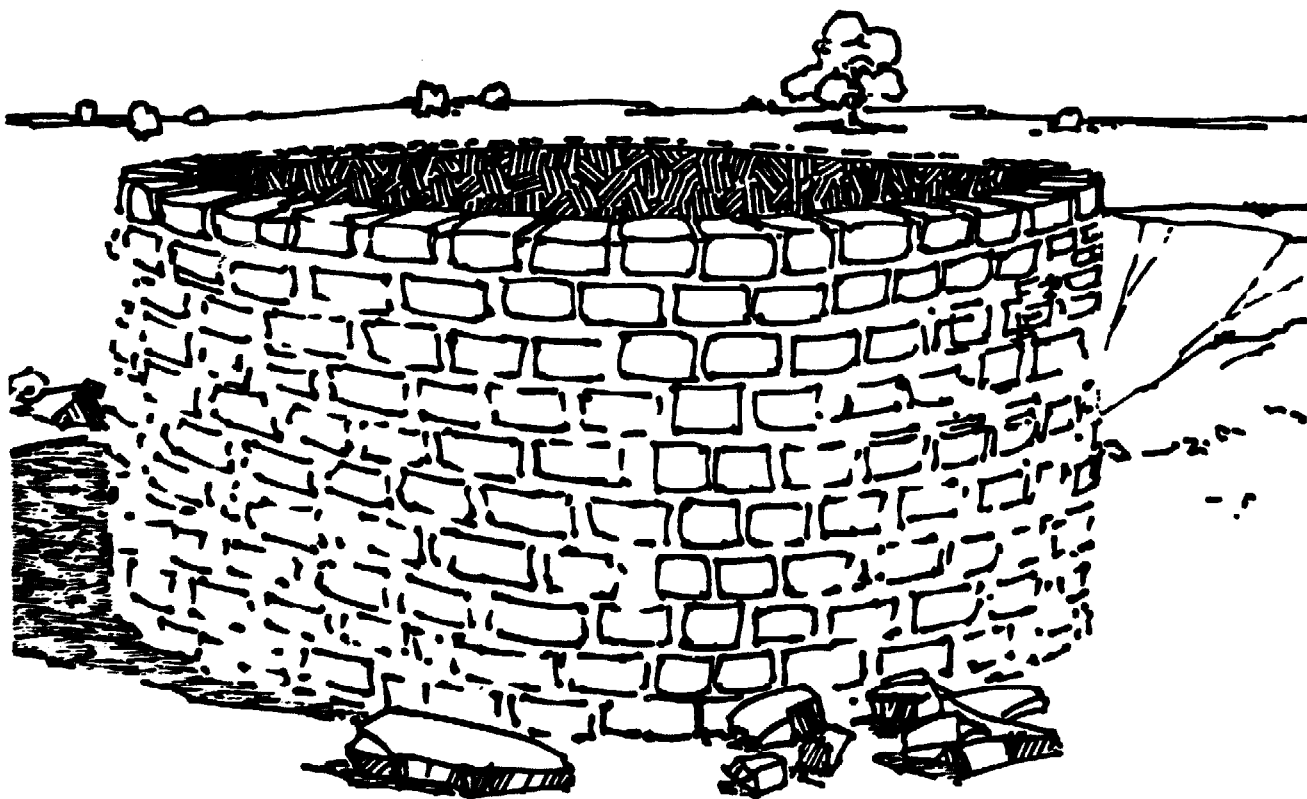

Figure 23. Storage tank

this period, but it does blow strongly on some days, ensuring that the crop can be irrigated several times.

### ***Borewell Irrigation***

A borewell drilled by machine may be used with a windmill to pump water for irrigation if its output is sufficient. This avoids the expense and labor of digging a large open well. A storage tank is needed with such a system.



# APPENDIX I

## *Different types of windmills*

There are so many different types of windmills that it would be impossible to cite them all. The following list includes some water-pumping windmills besides the Gaudgaon windmills that are under development in India, or available outside India.

1. Allahabad Windmills. An all-metal windmill of welded construction and with a piston pump has been developed at the Allahabad Polytechnic, Allahabad, India. Contact: Mr. R.N. Kapoor, Principal.
2. Thailand-type Windmills. A sailing windmill using wooden construction and a chain pump, patterned after the Thailand windmills, has been adapted for low-head saltwater pumping by the Bhagavatula Charitable Trust, Yellamanchilli, District Visakhapatnam, A. P. 531 055 India. Contact: Mr. Vijay Kumar Jerold, Windmill Program. The BCT is also testing several of the Allahabad-type windmills for saltwater pumping.
3. Toujours Mieux Workshop, Auroville. A number of different windmills have been built at this workshop in Auroville, near Pondicherry, T. N., India. Perhaps the most innovative and promising is a hydraulic windmill mechanism that automatically varies the power output of the windmill to match the power in the wind, thus relieving the windmill operator of the task of continuously varying the stroke, as the Gaudgaon windmills presently require. Contact: Pierre LeGrand or Jean Pougault, Djaima, Aspiration, Kottakuppam, T. N. 605 104 India.
4. Indian Institute of Science. Professor S. P. Govindaraju of the Department of Aeronautical Engineering, Indian Institute of Science, Bangalore 560 012 India, has developed a low-cost Savonius rotor for water pumping, and is also working on the development of a hydraulically operated windmill load-matching device.
5. Wind Energy Group. National Aeronautical Laboratory. Dr. S. K. Tewari and Mr. A. R. Venkatanarayana, Scientists, of the Wind Energy Group, NAL, Post Bag No. 1779, Bangalore 560 017 India, are developing a sailing windmill with a gear box and rotary pump. Their earlier work included development of the rugged, all-metal WP-2 windmill. They have written several important publications on wind power.

6. Low-Cost, Wooden Sailing Windmills. Shri A. M. M. Muragappa Chettier Research Centre, TIAM House, 28 North Beach Road, Madras 755 552 Ledia, has developed two low-cost windmills. The Anila Windmill is constructed of palm logs and cloth for coastal regions where the wind direction does not change. The Pogul Windmill has a wooden tower and can face different wind directions. Contact: Dr. Geethaguru.
7. ITDG Windmill. The Intermediate Technology Development Group, 9 King Street, London WC2E 8HN Great Britain, is developing a windmill that will be suitable for manufacture by small factories. Some Indian companies may be producing this windmill soon. This is an all-metal windmill driving a double-acting piston pump. Contact: Max Ewens, Peter Fraenkel. Also, ask for the ITDG Publications List.
8. American Farm-Type Windmills. These windmills are all metal, with galvanized parts and a machined crankcase. Three American manufacturers are: Aeromotor, P. O. Box 1364, Conway, Arkansas 72032 USA; Dempster Industries, Inc., P. O. Box 848, Beatrice, Nebraska 68310 USA; Heller-Aller Company, Perry & Oakwood Streets, Napoleon, Ohio 43545 USA. Similar windmills are manufactured in Great Britain ("Comet" windmills) and in Australia ("Southern Cross" windmills). Generally, the cost of importing one of these all-metal, farm-type windmills for use in rural India is very high.

## APPENDIX II

### **Books and magazines about wind power**

This is a very small selection from a large body of literature. These references cover both water-pumping and electricity-generating windmills.

#### **BOOKS**

Chakroff, Marilyn, and Chakroff, R. Paul, Environmentally Sound Small Scale Agricultural Projects: Guidelines for Planning. Arlington, Virginia: VITA/CODEL, 1979.

Valuable teaching aid presents environmental concepts as tools for planning agricultural projects.

Economic and Social Commission for Asia and the Pacific (ESCAP), Renewable Sources of Energy, Vol. 3: Wind Energy. Bangkok, Thailand: ESCAP Secretariat (UN), 1981.

A detailed assessment of wind energy potential and activities in Asia.

Fraenkel, Peter, Food From Windmills. London: I.T. Publications, 1975.

An excellent reference on adapting and using sailing windmills for irrigation in Ethiopia.

Hirshberg, Gary, The New Alchemy Water Pumping Windmill Book. Andover, Massachusetts: Brick House Publishing Co., 1982.

A detailed book on the use of multiblade and sailing windmills.

Mann, R. D., How to Build a 'Cretan Sail' Windpump. London: I. T. Publications, 1979.

Plans and description for building a steel sailing windpump, based on tools and skills found on workshops in developing countries. Also available from VITA.

Park, Jack, The Wind Power Book. Palo Alto, California: Cheshire Books, 1981.

A basic yet comprehensive book on all aspects of wind power use.

Sherman, Marcus M., "The Design and Construction of Low Cost Wind Powered Water Pumping Systems." In Proceeding of the Meeting of the Expert Working Group on the Use of Solar and Wind Energy. Bangkok: ESCAP, 1976.

Spangler, C.D., Handpumps for Village Wells. Arlington, Virginia: VITA, 1975.

How-to guidelines on building three inexpensive hand pumps.

Stern, Peter, Small Scale Irrigation. London: I.T. Publications, 1979.

Basic information on different irrigation techniques and water requirements.

Tillman, Gus, Environmentally Sound Small Scale Water Projects: Guidelines for Planning. Arlington, Virginia: VITA/CODEL, 1981.

Useful primer on small-scale water projects, designed for readers with limited experience.

van de Ven, N., Construction Manual for a Cretan Windmill. Amersfoort, The Netherlands: Steering Committee for Wind Energy in Developing Countries, 1977.

Detailed plans for a sailing windmill made from wood. Also available from VITA.

Vilsteren, A. V., Aspects of Irrigation With Windmills. Amersfoort, The Netherlands: TOOL and SWD, 1981.

Highly useful review of the different aspects of using windmills to irrigate relatively small land holdings.

Watt, S. B., and Wood, W. E., Hand Dug Wells and Their Construction. London: I. T. Publications, 1977.

A step-by-step guide to hand dug well construction.

Wegley, H. L., Orgill, M. M., and Drake, R. L., A Siting Handbook for Small Wind Energy Conversion Systems. Richland, Washington: Battelle Pacific Northwest Labs, 1978.

A review of the science and art of siting wind machines.

"Wind Power Introductory Packet," from Volunteers in Technical Assistance (VITA), 1815 N. Lynn St., Suite 200, Arlington, Virginia 22209-2079 USA.

Packet contains several articles on wind power theory, generating electricity, and pumping water.

## MAGAZINES

Alternative Sources of Energy magazine, from 107 S. Central Avenue, Milaca, Minnesota 56353 USA. Subscriptions \$62 per year, airmail overseas.

A practical bimonthly magazine on all renewable sources of energy.

"The Amateur Scientist Experiments with Wind: A Pendulum Anemometer," Scientific American, October 1971, pp. 108-110. Tells how to construct and use a simple, accurate hand-held anemometer made from a ping-pong ball and student's protractor.

VITA News magazine, published four times per year by Volunteers in Technical Assistance (VITA), 1815 N. Lynn St., Suite 200, Arlington, Virginia 22209-2079 USA. Donation to VITA of \$15 per year.

Includes articles on wind energy and many other village-level technologies for developing countries.

Wind Power Digest magazine, published four times per year from 398 E. Tiffin St., Bascom, Ohio 44809 USA. Subscriptions \$16 outside USA.

Useful magazine includes articles on all aspects of wind power, including a yearly "Wind Access Catalog" listing windmill manufacturers.

# APPENDIX III

## Materials list

### 24-FOOT WINDMILL WITH 28-FOOT TALL TOWER, 40-FOOT HEAD AND 6-SQ. IN. PUMP

Angle iron	
2" x 1/4"	282'
1-1/2" x 1/4"	19'
1-1/2" x 1/8"	200'
Flat iron	
1-1/4" x 1/8"	260'
1-1/4" x 1/4"	146'
1-1/2" x 1/4"	4-1/2'
2" x 1/4"	4-1/2'
Truck spring, 1/4" x 2" x 32"	2
Plate steel or iron	
1/8"	3 sq. ft.
1/4"	2 sq. ft.
3/8"	1 sq. ft.
Iron or steel bar	
1/4" diam.	3'
3/8" diam.	3'
1/2" diam. x 37", threaded	4
5/8" diam.	18"
Galvanized wire	
1/8"	16"
3/16"	430'
Grease cups with 1/4" pipe nipples	4
Bolts with nuts:	
5/8" x 1-1/2"	24
5/8" x 2"	9
5/8" x 3"	12
5/8" x 4"	4
5/8" x 5"	4
5/8" x 10"	4
extra 5/8" nuts	18
5/8" id spacers:	
2-1/4" long	2
7/8" long	4
1/2" x 1"	80
1/2" x 1-1/2"	20
1/2" x 2"	26
1/2" x 3"	12
1/2" x 4"	4
1/2" x 5"	2
1/2" x 5-1/2"	2
1/2" x 8"	2
1/2" extra nuts	16
1/2" x 5-1/2"	2

**MATERIALS LIST (Cont.)**

1/2" x 8"	2
1/2" extra nuts	16
3/8" x 1"	140
3/8" x 2"	20
3/8" x 3"	8
Washers, 3/8"	2 kg.
Nails, 1"	10
Welded chain, 1/4"	1 of 7' 6"
Black pipe, 3" B-Class (Sch.40, or 0.216 wall thickness)	20'
Galvanized pipe, 3" A-Class (0.160 wall thickness)	40' (or as required)
Flanges with rubber packings, 3"	6
Pipe (material as available)	
1-1/2"	23'
3/4"	32' (or as required)
Steel flange, 3/4"	1 piece
Commercial footvalve, 3"	1 piece
Flexible pipe with nipples & clamps	10' (or as required)
Bamboos	8 of 12'
	8 of 9' 6"
Cloth	20 sq. meters
String or twine, 1/4"	100'
Leather	1 of 7-1/4" x 7-1/4"
Tar	2 kg
Stone	8 stones 3' long
	240 cubic ft. fieldstone and cut stones for well wall
Wood:	
Hardwood (babul)	1 of 6" x 10" diam.   1
	1 of 1-1/2" x 3" diam.   sq.
	1 of 2-1/2" x 4" diam.   ft.
	2" x 2" x 2-1/2 ft.
	2-1/2" x 3-3/8" x 6'
Plank wood (limb)	2 of 1" x 9" x 5' 6"
	2 of 1" x 9" x 4'
Teakwood or similar wood	4 of 1" x 7-1/4" x 32"
	2 of 1-1/2" x 1"
	1 of 1-1/2" x 5-3/4" x 5-3/4"
	2 of 3/4" x 2" x 4-3/4"
Sand	as needed for mortar
Cement	2 bags

**LIST OF PARTS REQUIRING WELDING**

Main shaft with hub square, bushings, and crank  
 Upper connecting rod tee & swivel  
 Variable stroke lever traveller and latch  
 Pump lever with strut

NOTE: Materials list does not include stock lost in cutting and overlapping joints.

# **APPENDIX IV**

## ***Construction drawings***

### **24-FOOT WINDMILL**

Note: These drawings are greatly reduced from the original blueprints. Scale designations have therefore been omitted to avoid confusion. Full size blueprints are available by writing to VITA.





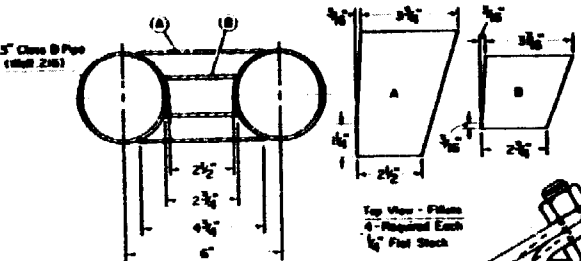

**Section View A-A and Fillets**  
Scale: Half Size

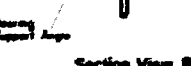
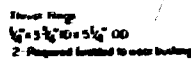
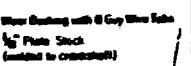
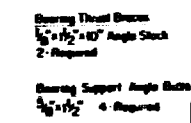

**Section View B-B**

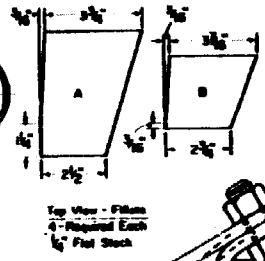

**Top View - Fillets**  
4 - Required Each  
1/2\"/>

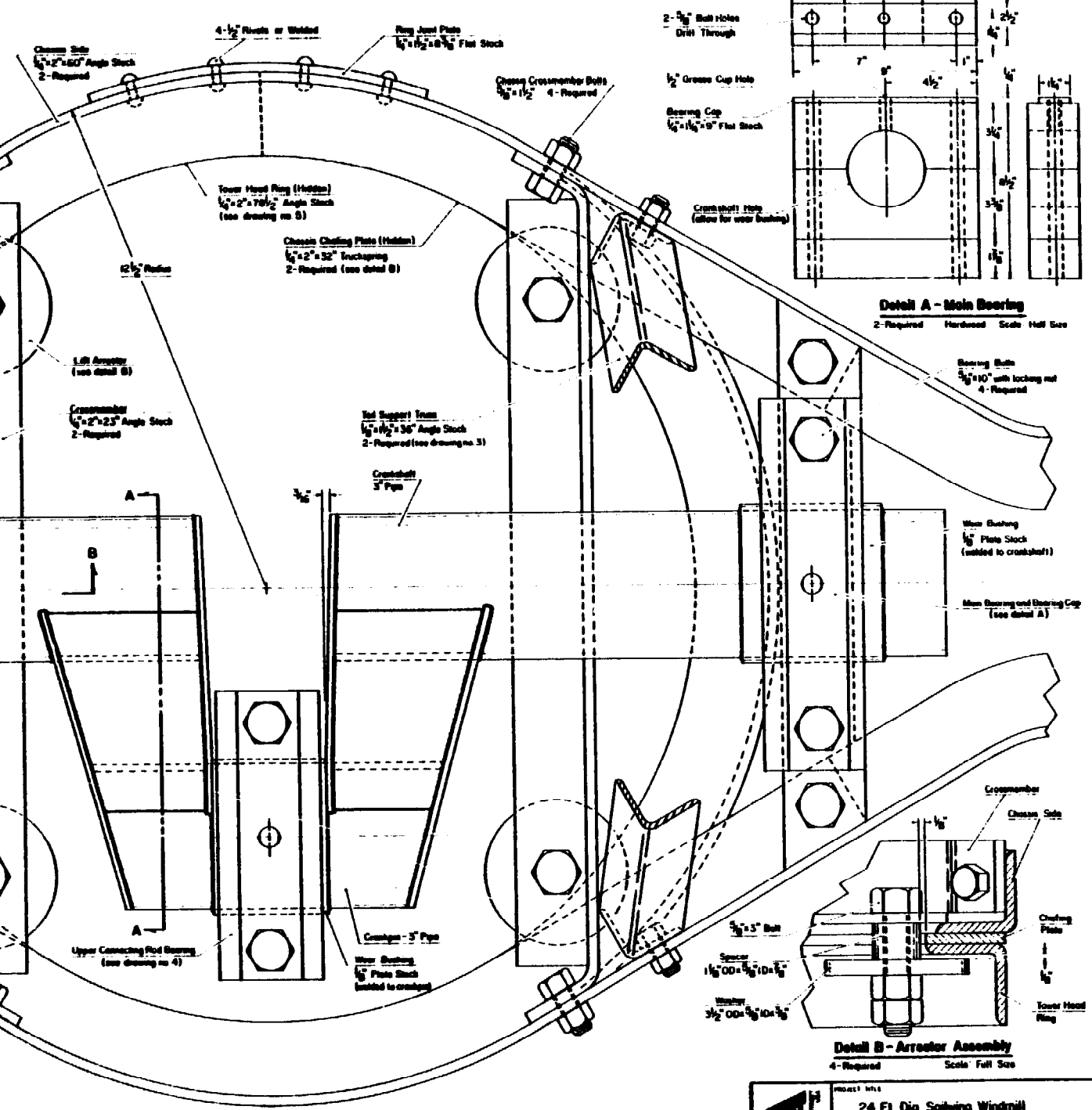

**Top View - Reciprocating Chassis Assembly**

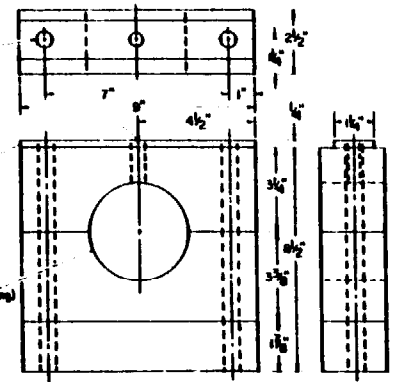

**Detail A - Main Bearing**  
2 - Required Hardwood Scale: Half Size

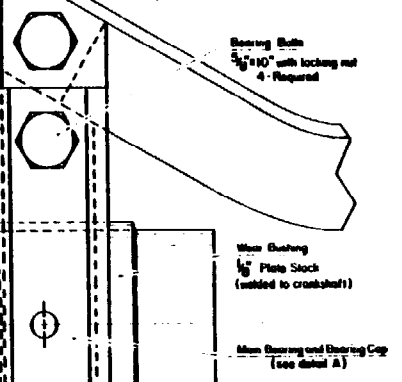

**Detail B - Arrestor Assembly**  
4 - Required Scale: Full Size

	PROJECT TITLE		
	24 Ft. Dia. Sailing Windmill		
	DRAWING TITLE		
Reciprocating Chassis Assembly With Crank, Lift Arrestor & Main Bearing			
DESIGNED BY	DRAWN BY	CHECKED BY	SCALE
W. Smith	W. Glass		2

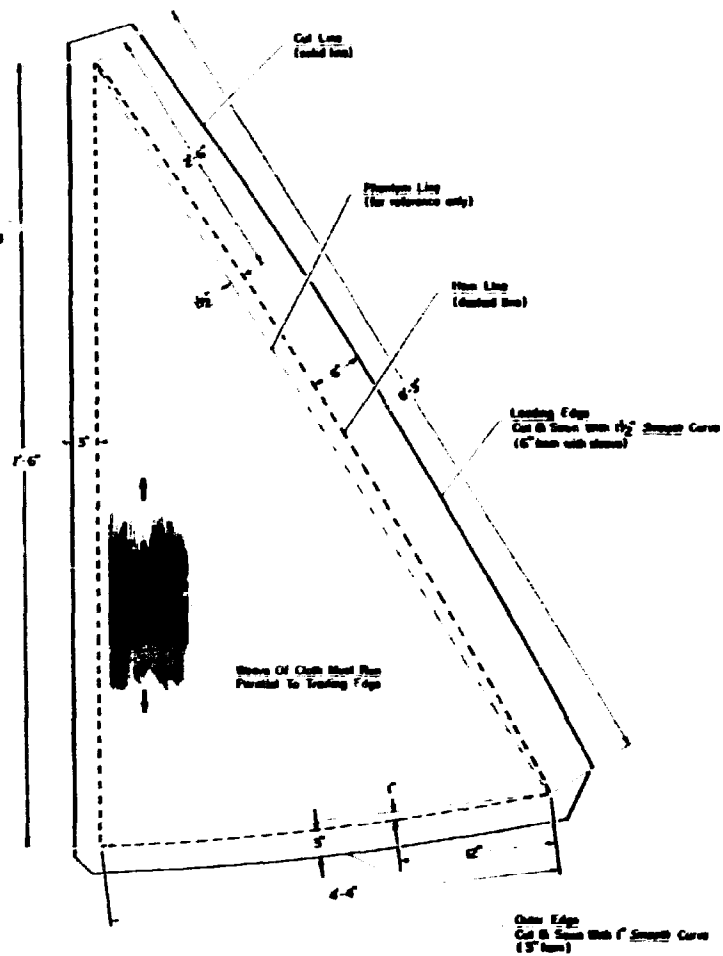

**Soil Cutting Pattern**  
 8 Required Scale Inches = 1 foot

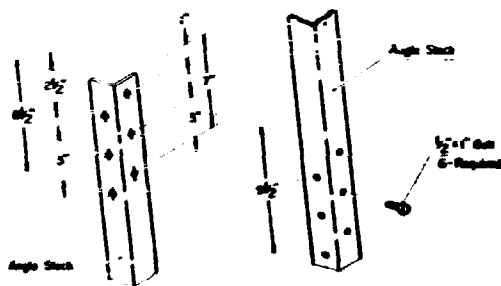

**Detail A - Tower Leg Joint**  
 As Required

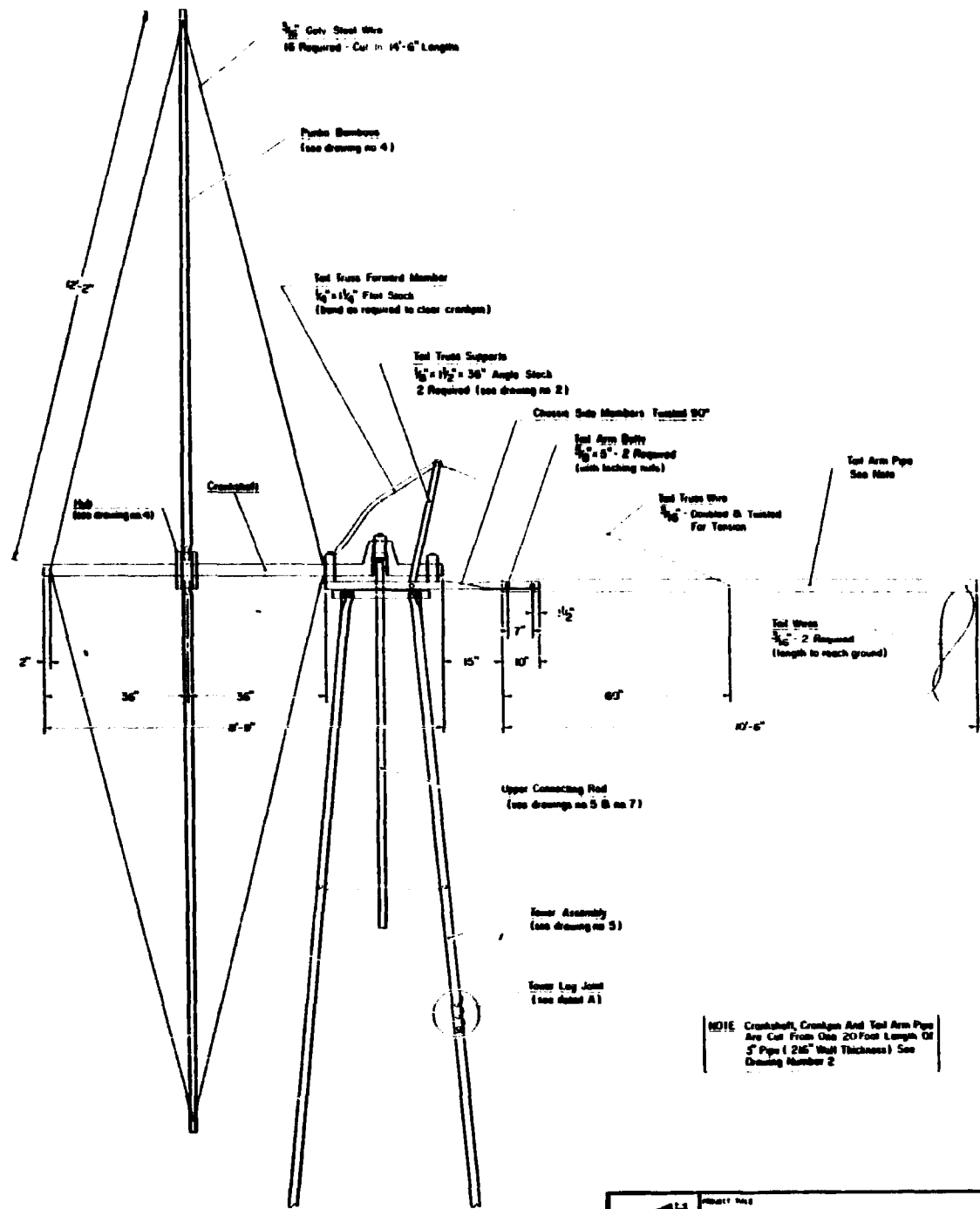

**Side View - Pusher and Tail Arm Assembly**

NOTE Crankshaft, Crankpin and Tail Arm Pipe are Cut From One 20 Foot Length of 3" Pipe (2 1/2" Wall Thickness) See Drawing Number 2

	Model No. 1 <b>24 Ft. Dia. Soiling Windmill</b>
	Drawing No. 4 <b>Pusher and Tail Arm Assembly &amp; Soil Cutting Pattern</b>
	Drawn by: W Smith Made by: W Gomez Checked by: W L L Project Number: 3

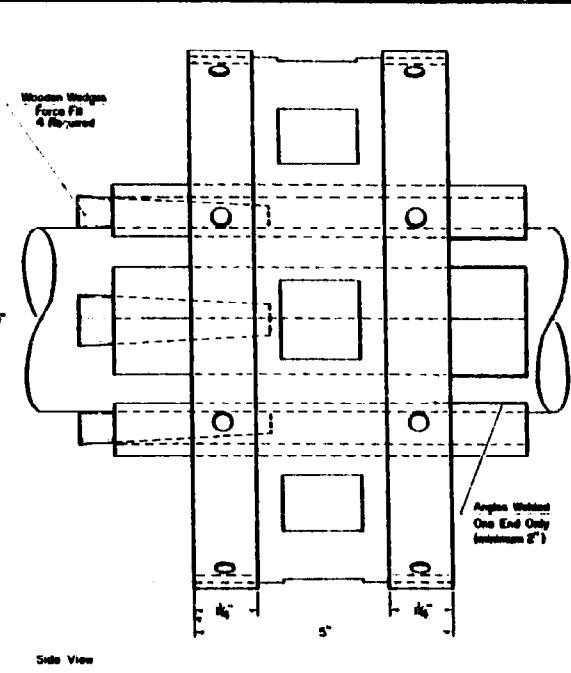
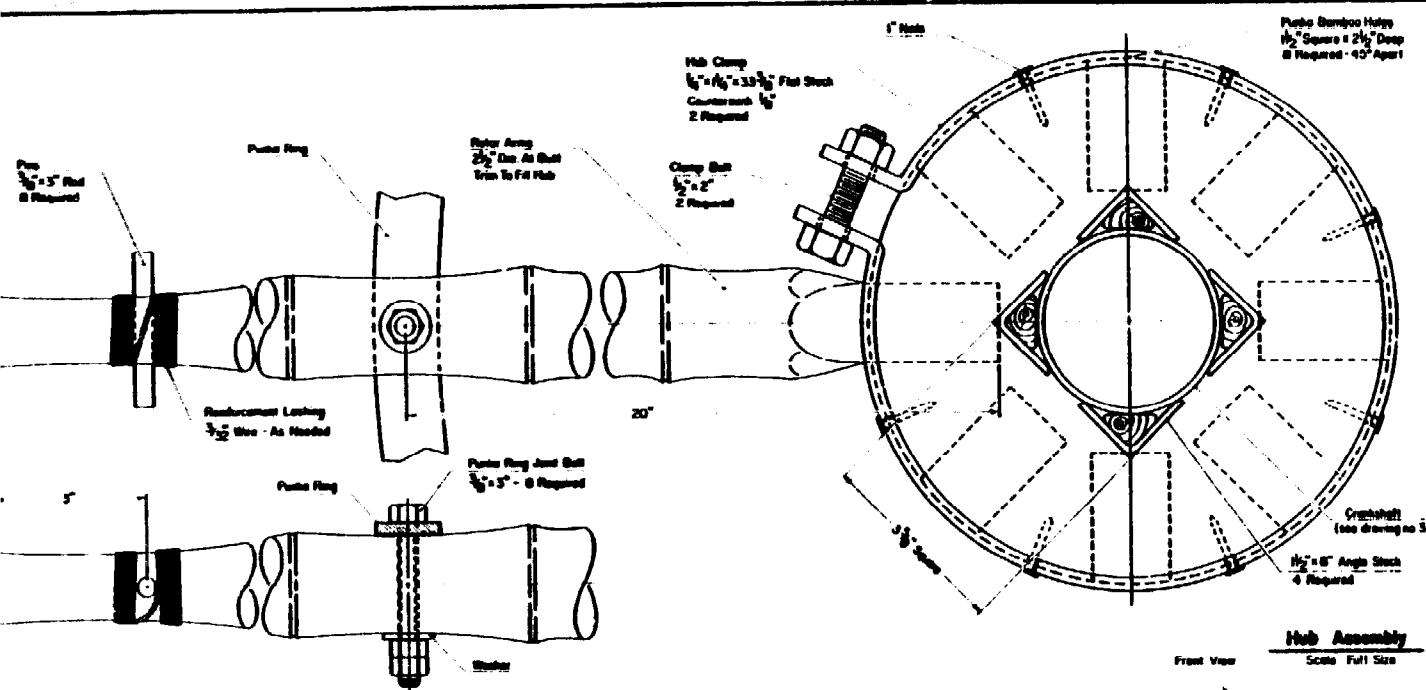

**Hub Assembly**  
Scale Full Size

**Top View - Bamboo Tip And Puntia Ring Joint**  
Scale Full Size

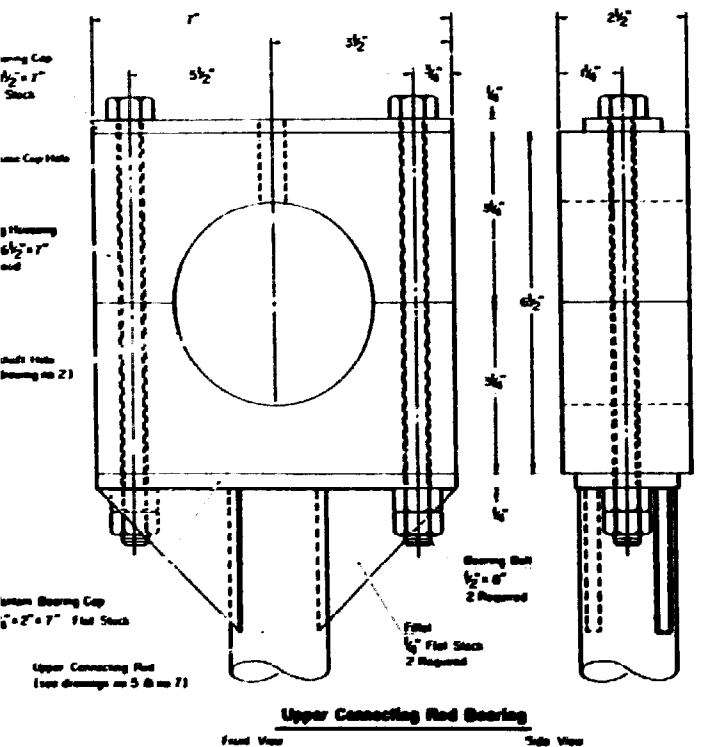

**Upper Connecting Rod Bearing**

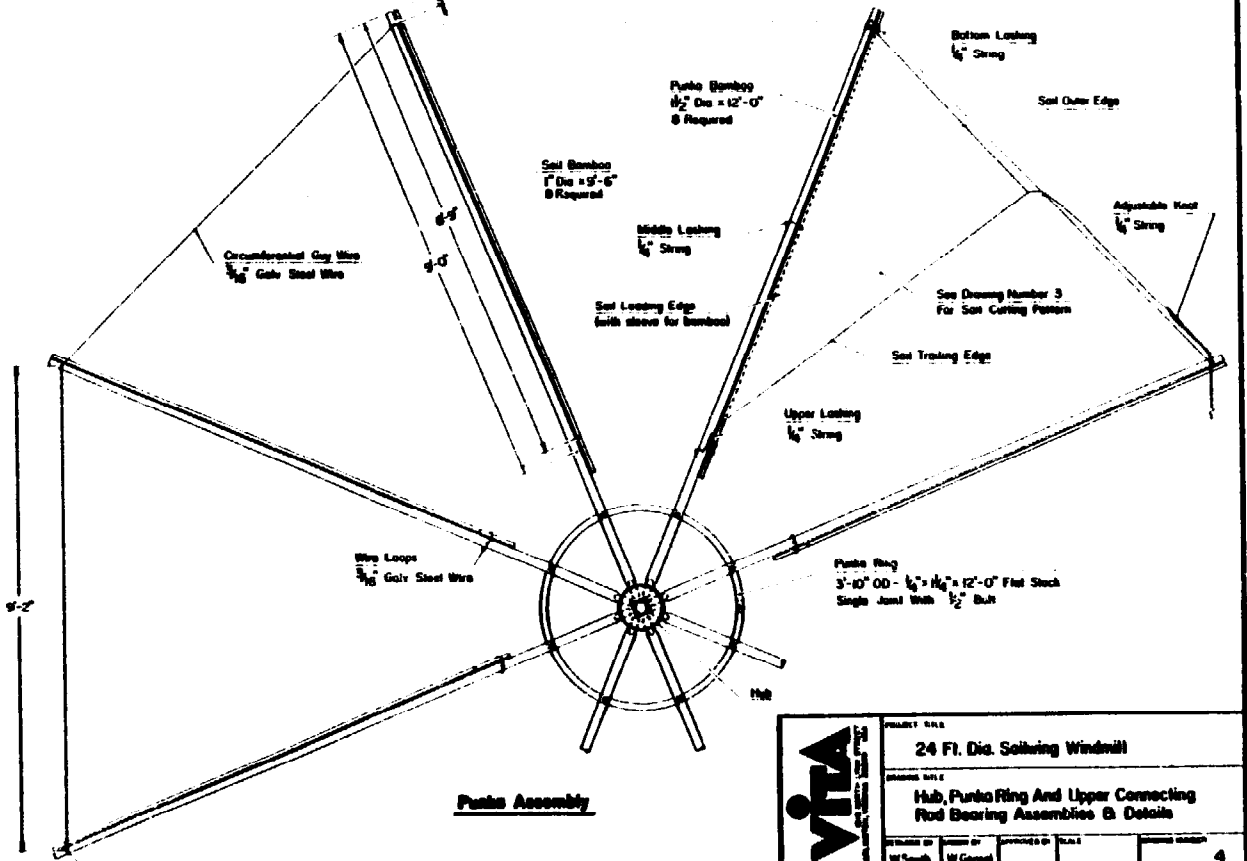

**Puntia Assembly**

	PROJECT TITLE	24 Ft. Dia. Soiling Windmill		
	DRAWING TITLE	Hub, Puntia Ring And Upper Connecting Rod Bearing Assemblies & Details		
	DESIGNED BY	DRAWN BY	APPROVED BY	SCALE
	W. Smith	M. Conrad		4

Upper Connecting Rod Bracing  
(See drawing no. 6.)

Reinforcing Chassis  
(See drawing no. 2.)

Tower Head Ring  
(See drawing no. 1.)

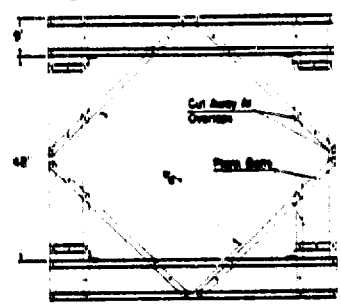

**Section View A-A Platform**  
Constructed Of  $1\frac{1}{2}$ " x  $1\frac{1}{2}$ " Angle Steel And  $\frac{1}{2}$ "  
Bars With 2-66" & 2-48" Wood Planks

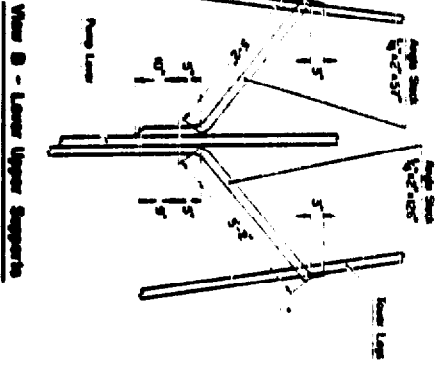
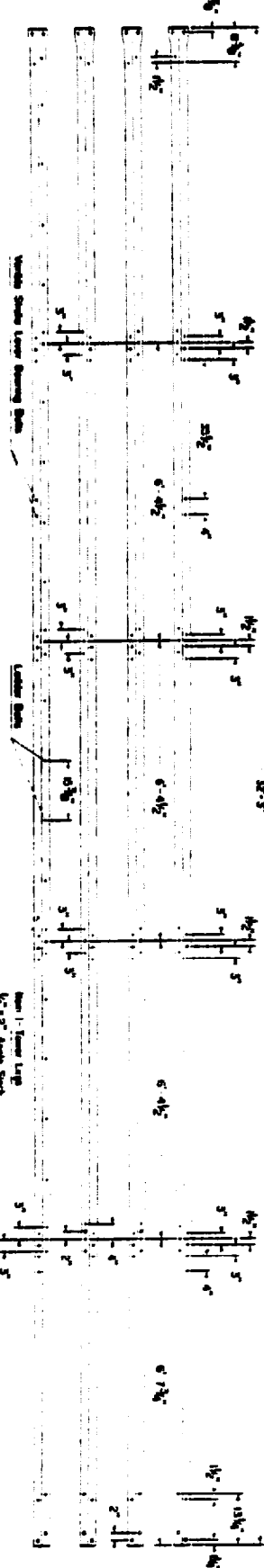

Upper Connecting Rod  
 $1\frac{1}{2}$ " x  $10$ "- $0$ " Pipe  
Including Barrel Coupling  
(12" Stress)

Barrel Coupling  
(See drawing no. 7.)

Variable Struts Layer  
(See drawing no. 7.)

Trussing  
2-6" Minimum Truss

Bar Access Platform

Legging  
 $1\frac{1}{2}$ " x  $1\frac{1}{2}$ " Angle Steel

Lower Connecting Rod  
 $1\frac{1}{2}$ " x  $11$ "- $6$ " Pipe  
(Min.  $0$ "-Min.  $10\frac{1}{2}$ " Stress)

Tower 'X' Bracing  
 $1\frac{1}{2}$ " x  $1\frac{1}{2}$ " Flat Steel  
(Tensile for tension)

**NOTE 1** All Buried Steel To Be Corrosion  
With Finish At The Time Of Assembly  
**NOTE 2** Weight (Wt.) Weight Of Pump Rod Plus  
One Half Of The Water Column Weight

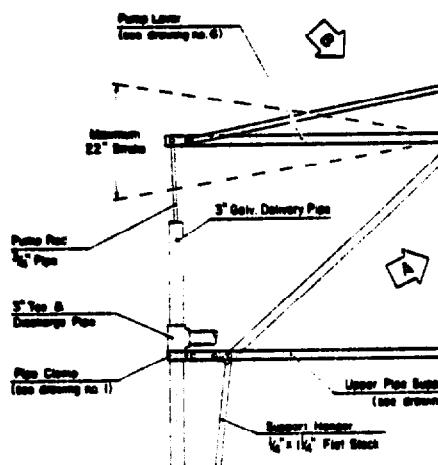

(See Note 2)

Grill  
(ground level)  
See Note 7

Tower 'X' Bracing  
 $1\frac{1}{2}$ " x  $1\frac{1}{2}$ " Flat Steel

Fasteners Fasteners  
Bottom Struts 3 Long  
(without corners)

**Tower And Pump Lever Assembly**

See Note Previous Page

Symbol	Notes
(Symbol)	Notes
(Symbol)	Notes
(Symbol)	Notes

**VITA**  
24 Ft. Dia. Scaffolding Windmill  
Tower And Pump Lever Assembly  
With Bolt Hole Patterns

5

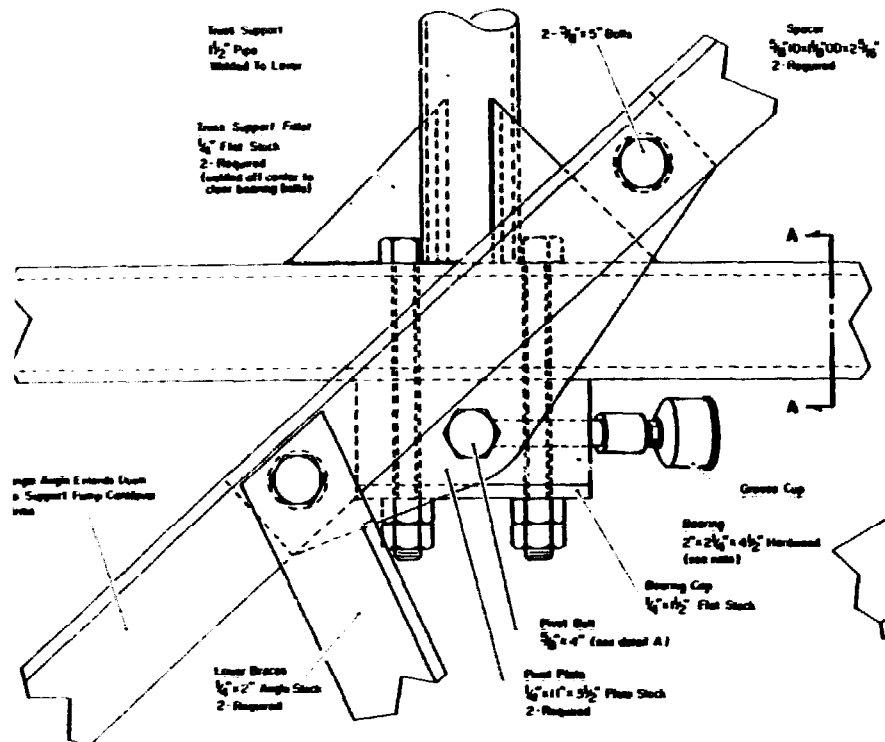

**Side View - Lever Pivot Point**

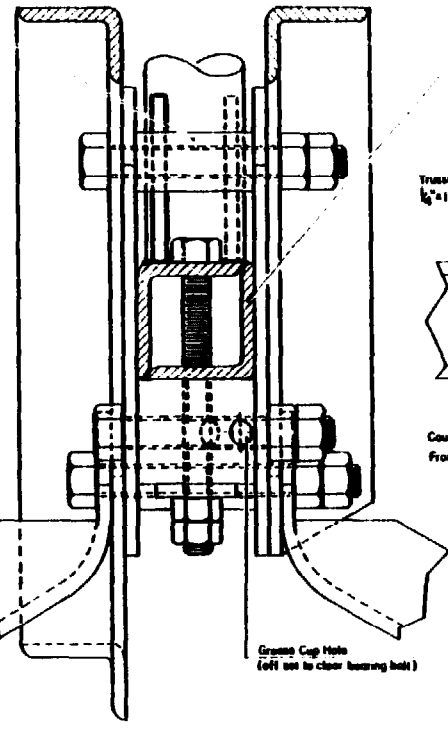

**Section View A-A**

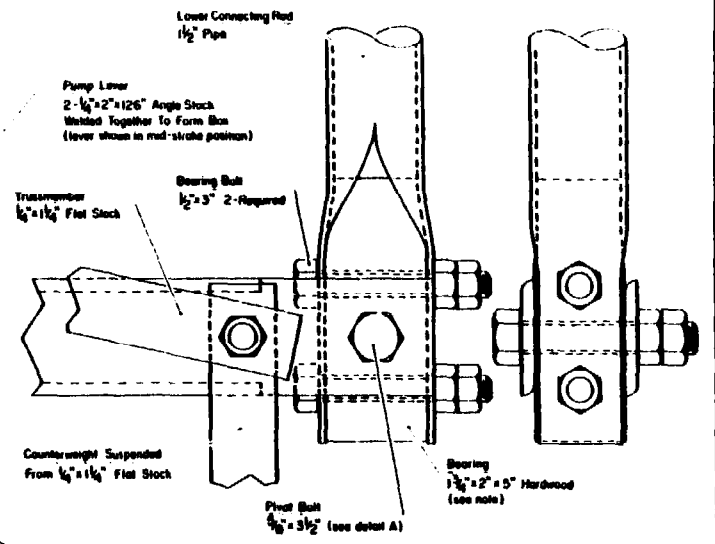

**Lever End Pivot**

Side View      End View

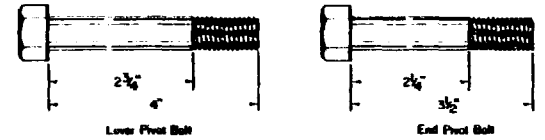

**Detail A - Pivot Bolts**

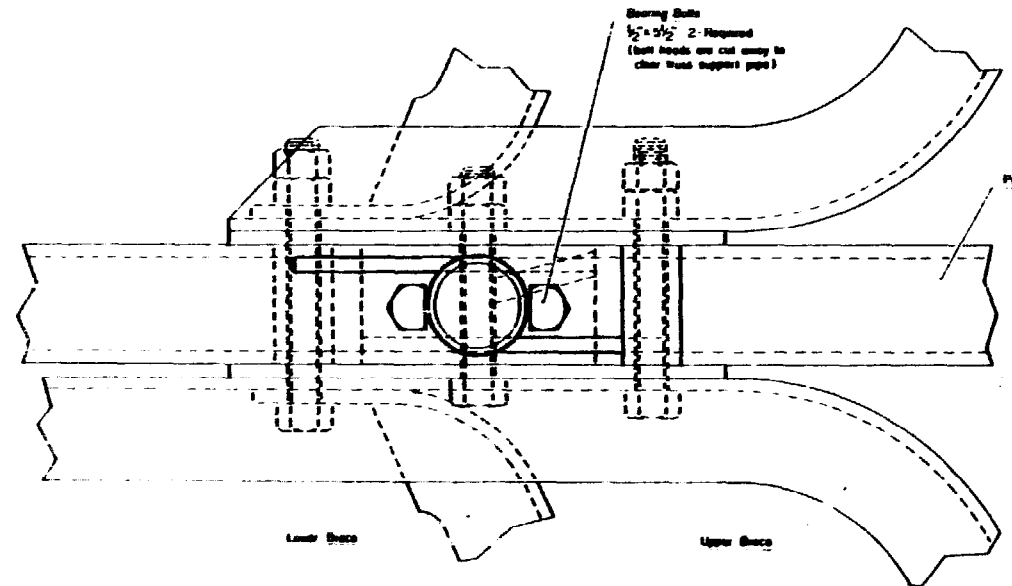

**Top View - Lever Pivot Point**

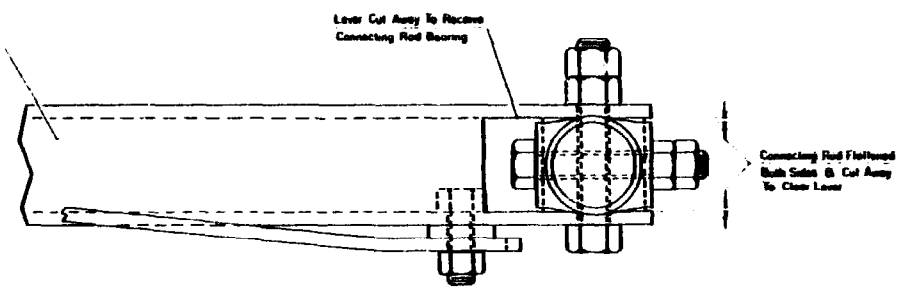

**Top View - Lever End Pivot**

Optional Grease Cap Omitted

NOTE: Replace Bearings Whenever Play Exceeds  $\frac{1}{32}$ "

	<b>24 Ft. Dia. Sailing Windmill</b>
	<b>Pump Lever Pivot Point Assembly With Lower Connecting Rod Pivot Point Assembly</b>
	<small>DESIGNED BY</small> W. Smith <small>ENGINEERED BY</small> W. Conrad <small>PREPARED BY</small> W. A. S. <small>PROJECT NUMBER</small>
	<b>6</b>

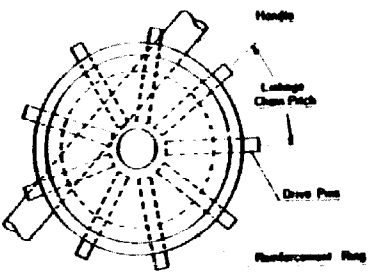

**Detail A - Linkage Drive Pulley**  
Side View Scale: Full Size

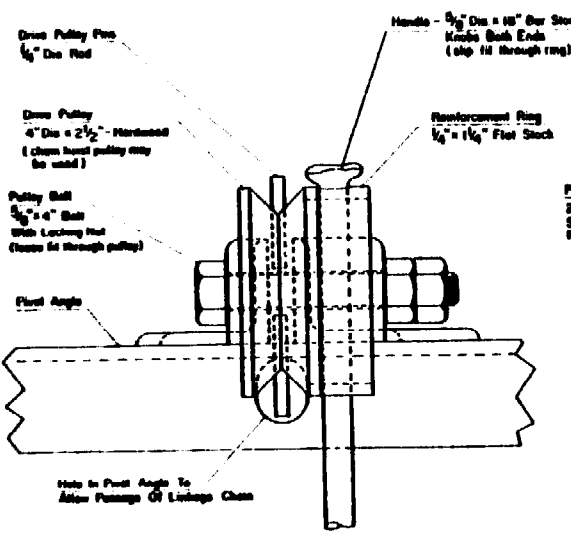

**Detail B - From View 'A' - Drive Pulley**  
Linkage Chain & Chain Latch Omitted Scale: Full Size

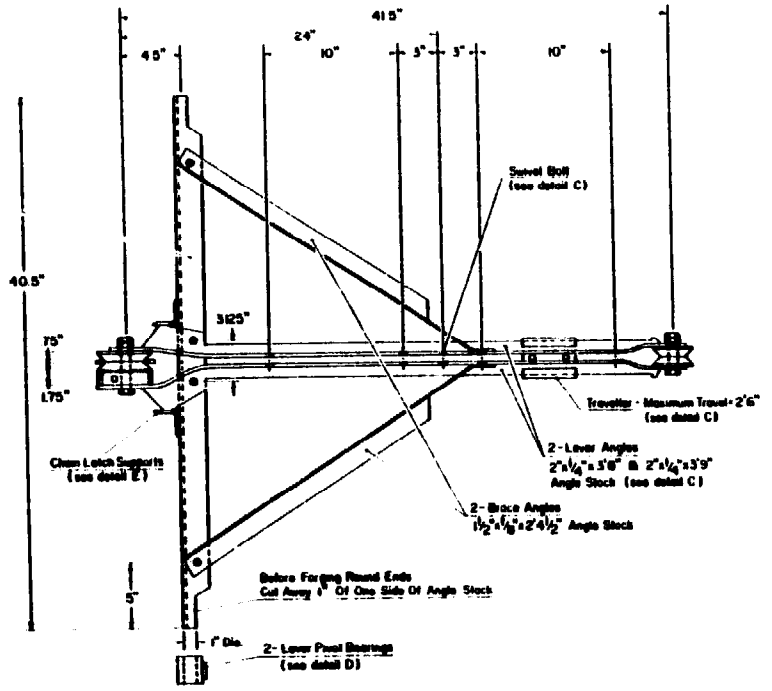

**Top View - Assembly**  
Linkage Chain & Chain Latch Omitted Scale: 3/8" = 1 foot

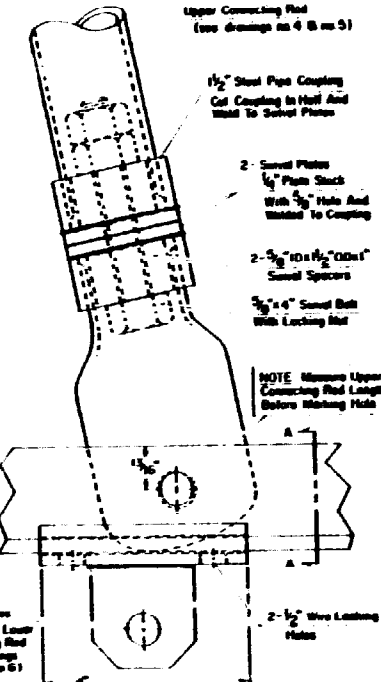

**Detail C - Traveler and Swivel**  
Side View Scale: Full Size

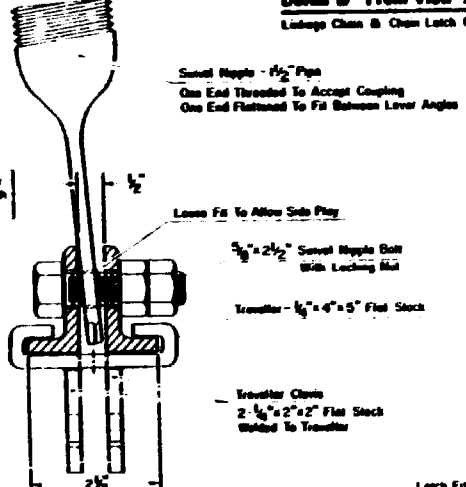

**Detail E - From View 'A' - Linkage Chain Latch**  
Drive Pulley Omitted

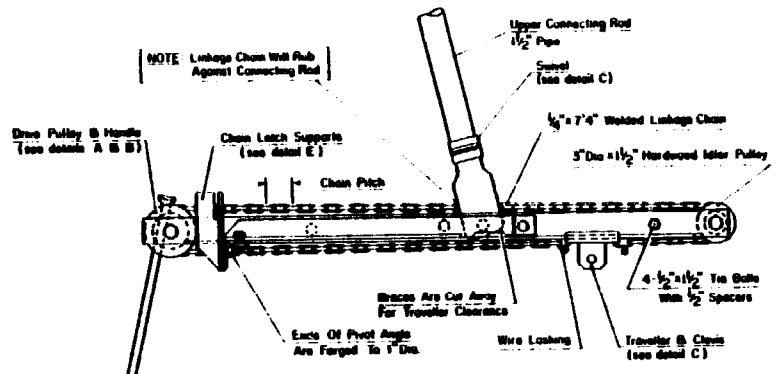

**Side View - Assembly**  
Chain Latch Omitted Scale: 3/8" = 1 foot

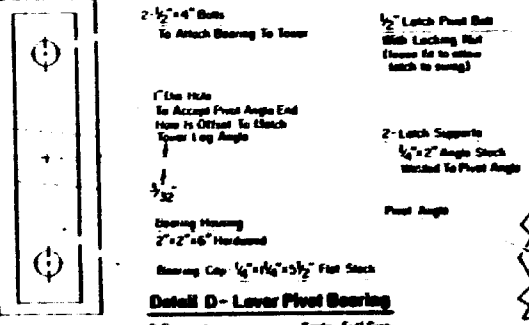

**Detail D - Lever Pivot Bearing**  
2 Required Scale: Full Size

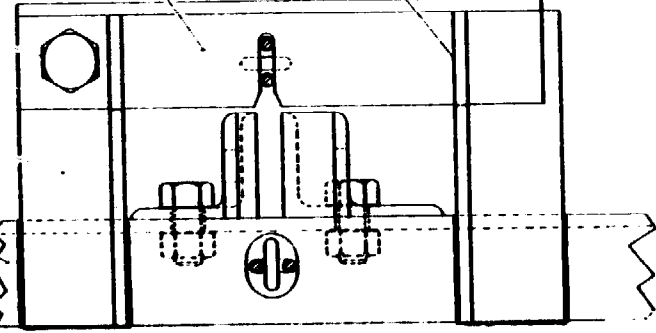

**Detail E - From View 'A' - Linkage Chain Latch**  
Drive Pulley Omitted

	PROJECT TITLE	24 Ft. Dia. Sailing Windmill	
	TITLE	Variable Stroke Lever Assemblies & Details	
	DESIGNED BY	W. Smith	
DRAWN BY	M. Gensel	CHECKED BY	
DATE		SCALE	7

## ABOUT VITA

Volunteers in Technical Assistance (VITA) is a private, non-profit, international development organization. It makes available to individuals and groups in developing countries a variety of information and technical resources aimed at fostering self-sufficiency--needs assessment and program development support; by-mail and on-site consulting services; information systems training.

VITA promotes the use of appropriate small-scale technologies, especially in the area of renewable energy. VITA's extensive documentation center and worldwide roster of volunteer technical experts enable it to respond to thousands of technical inquiries each year. It also publishes a quarterly newsletter and a variety of technical manuals and bulletins.

VITA's documentation center is the storehouse for over 40,000 documents related almost exclusively to small- and medium-scale technologies in subjects from agriculture to wind power. This wealth of information has been gathered for almost 25 years as VITA has worked to answer inquiries for technical information from people in the developing world. Many of the documents contained in the Center were developed by VITA's network of technical experts in response to specific inquiries; much of the information is not available elsewhere. For this reason, VITA wishes to make this information available to the public.

For more information, contact VITA, P.O. Box 12438, Arlington, Virginia 22209, USA.



**VITA**  
**VOLUNTEERS**  
**IN TECHNICAL**  
**ASSISTANCE**

P.O. Box 12438  
Arlington, Virginia 22209 USA

**ISBN 0-86619-165-8**