

**AT** MICROFICHE  
REFERENCE  
LIBRARY

A project of Volunteers in Asia

Helping People in Poor Countries Develop  
Fuel-Saving Cookstoves

by: Aprovecho Institute

Published by:

German Appropriate Technology Exchange  
P.O. Box 5180  
D-6236 Eschborn 1  
Federal Republic of Germany

And by:

Aprovecho Institute  
442 Monroe  
Eugene, OR 97402 USA

Free to serious groups.

Available from:

German Appropriate Technology Exchange  
P.O. Box 5180  
D-6236 Eschborn 1  
Federal Republic of Germany

And from:

Aprovecho Institute  
442 Monroe  
Eugene, OR 97402 USA

Reproduced by permission of the Aprovecho  
Institute.

Reproduction of this microfiche document in any  
form is subject to the same restrictions as those  
of the original document.

HELPING PEOPLE IN POOR  
COUNTRIES DEVELOP  
FUEL-SAVING  
COOKSTOVES

S 1/7

10/80

## QUESTION - AND - ANSWER - SERVICE

for "appropriate technologies"

---

The question- and-answer-service - a major service provided by GATE - supplies information, free of charge, on appropriate technologies. In performing this function, GATE is part of an international information and documentation system called SATIS (Socially Appropriate Technology Information System), in which ITDG (Great Britain), TOOL (Netherlands), ATOL (Belgium), VITA (USA), GRET (France) and SKAT (Switzerland) also participate.

The question-and-answer-service is made available to public and private institutions and selected persons in developing countries who are concerned with the development, adaptation, introduction and application of appropriate technologies. With this service GATE is aiming to supplement commercial private-enterprise activities by making a contribution to non-commercial technology transfer, particularly in the field of traditional, intermediate and alternative technologies. In addition to technology transfer from industrialized nations to developing nations, particular attention is given to cooperation between the developing nations themselves.

The activities of the question-and-answer-service are geared to the actual technological requirements indicated by the enquiries received from developing countries. At the same time, the demand for particular solutions is determined with the aid of a questionnaire distributed to institutions in developing countries dealing with situation-related solutions. Parallel to this, the questionnaire also makes it possible to ascertain solutions already available within these institutions. The question-and-answer-service relies not least on the documentation on newly-developed or traditional technologies supplied to it by such possessors of know-how.

When answering enquiries the question-and-answer-service uses documentation resources built up in this way. The information accumulated there on particular technological problem areas is - if frequently requested - combined to form "modules".

These answer packages, intended for dispatch, contain, where possible, technical descriptions and design drawings and are thus directly application-related, i.e. they provide an outline of technologies suitable for self-construction. The know-how of national research institutions and universities, with whom GATE works in close cooperation, is drawn upon to help answer specific enquiries, which can often be expected as feedback from the communication started with "modules".

In the event of enquiries dealing with typical problems encountered by a number of developing nations, but for which no suitable solution is available or can be obtained, GATE has the opportunity to suggest appropriate R & D measures to various sources of finance.

## AN IMPORTANT NOTE TO THE READER OF OUR INFORMATION MODULES

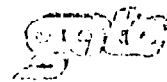

WITH THE MODULES EDITED WITHIN THE QUESTION-AND-ANSWER-SERVICE WE AIM TO GIVE AND COMPILE INFORMATION ON VILLAGE-LEVEL-TECHNOLOGY. WE TRY TO STIMULATE THE DEVELOPMENT OF MAINLY RURAL AREAS WITH A STRONG EMPHASIS ON THE SELF-HELP CONCEPT.

BY NO MEANS DO WE INTEND TO PRESENT A SORT OF RECIPE FOR AN APPROPRIATE WAY OF DEVELOPMENT OR FINAL TECHNICAL SOLUTIONS WHICH WE CONSIDER TO BE THE ANSWER TO THE PROBLEMS CONCERNING THE QUESTION OF DEVELOPMENT IN RURAL OR SUBURBAN AREAS.

KNOWING WELL THAT INFORMATION IS THE FIRST STEP WHEN CHOOSING ACTIVITIES AND THAT - ESPECIALLY IN THE FIELD OF TECHNOLOGY - THERE IS A GREAT AMOUNT OF INFORMATION AVAILABLE, WE TRIED TO SELECT SOME OF THE SPECIFIC TECHNOLOGY NEEDS OF THE MAJORITY OF PEOPLE IN DEVELOPING COUNTRIES. THESE PEOPLE LIVE IN AREAS WITH A LACK OF WATER SUPPLY, SANITATION FACILITIES, APPROPRIATE HOUSING POSSIBILITIES, WHERE GENERALLY THE FOOD PRODUCTION IS LOW AND INEFFICIENT, THE ENERGY DEMAND IS NOT AT ALL MET AND THE MAJORITY OF PEOPLE IS ONLY PARTLY OR NOT AT ALL EMPLOYED.

THE SELECTION OF TOPICS WITHIN OUR INFORMATION SERVICE NORMALLY IS THE RESULT OF AN EVALUATION OF INQUIRY-STATISTICS, I.E. AFTER HAVING RECEIVED SEVERAL QUESTIONS IN THE FIELD OF SOLAR COOKER, FOR INSTANCE, WE DECIDED TO COMPILE THE INFORMATION CONCERNING THIS TOPIC AND EDITED THE "SURVEY OF SOLAR COOKERS".

THUS, THE FEEDBACK WE GET FROM INSTITUTIONS AND INDIVIDUALS IN THE THIRD WORLD PLAYS AN IMPORTANT RÔLE FOR THE QUALITY OF OUR MODULES AND THEIR ORIENTATION TO PRACTICAL WORK. THEREFORE WE ASK YOU NOT JUST TO READ OUR INFORMATION BUT TO WRITE BACK TO US AND TELL US YOUR OPINION AND CRITICISM.

THIS IS THE BEST WAY FOR US TO CHECK THE QUALITY AND EFFICIENCY OF OUR QUESTION-AND-ANSWER-SERVICE. AND FOR YOU IT COULD BE OF HELP, TOO, BECAUSE WE MIGHT SUPPLY YOU WITH MORE DETAILED INFORMATION WHEN WE KNOW MORE ABOUT THE SITUATION YOU ARE IN AND TAKE INTO CONSIDERATION YOUR SPECIFIC PROBLEMS.

IN ADDITION, THE EXPERIENCE YOU HAVE GAINED AND INFORMED US ABOUT, MIGHT BE USEFUL FOR OTHERS. HAVING CONTACTS WITH MANY ORGANISATIONS IN DIFFERENT PARTS OF THE WORLD WE ARE IN A POSITION TO FORWARD YOUR IDEAS AND PROPOSALS IN THE FIELD OF TECHNOLOGY TRANSFER AND APPROPRIATE TECHNOLOGY.

PLEASE FILL IN THE QUESTIONNAIRE (NEXT PAGE) TO ENCOURAGE OUR EXCHANGE ACTIVITIES FOR OUR MUTUAL BENEFIT.

GATE  
C/O DEUTSCHE GESELLSCHAFT FÜR  
TECHNISCHE ZUSAMMENARBEIT  
(GTZ), GMBH  
POSTFACH 5180

D-6236 ESCHBORN 1

FEDERAL REPUBLIC OF GERMANY

241/BJ 10/79



Please fill in this questionnaire  
and send it to

Your name and address:

GATE c/o  
Deutsche Gesellschaft für  
Technische Zusammenarbeit, GmbH  
P.O. Box 51 80  
D-6236 E s c h b o r n . 1

QUESTIONNAIRE

MODULE No.

DATE

1. How did you get this information?

- I requested it from GATE
- Someone else gave it to me (Who was it? \_\_\_\_\_)
- or:

2. Did you read the complete module?

- yes, from the beginning to the end
- only in parts
- only the parts I was specially interested in
- or:

3. What is your opinion of it?

- a) general understandig
  - difficult
  - just right
  - easy
- b) theory and basic knowledge
  - too much
  - just right
  - to little
- c) orientation to practical work
  - lacking
  - limited
  - just right
- d) language, over-all presentation
  - appropriate for your needs
  - too complicated
- d) what else do you think is worth mentioning?

(Please use the back of this page for additional remarks and suggestions!)

4. Do you see any practical application for the received information?

# HELPING PEOPLE IN POOR COUNTRIES DEVELOP FUEL-SAVING COOKSTOVES

Published by

German Appropriate Technology Exchange (GATE)  
in:Deutsche Gesellschaft für Technische  
Zusammenarbeit (GTZ) GmbH  
Postfach 5180, D-6236 Eschborn 1,  
Federal Republic of Germany

Produced by

Aprovecho  
359 Polk Street  
Eugene, Oregon 97402  
U.S.A.

## Production Team

Tim Acott  
Gina Amalfitano  
Guy Ballard  
Susan Binder  
Michael Boutette  
David Cappaert  
Ianto Evans  
Elisabeth Gern

Elaine Hogg  
Laurence Jacobs  
Karen Kennedy  
Robert Larson  
Patrick Sitton  
Linda Smiley  
Margaret Thomas  
Uvé Wheeler

GATE stands for German Appropriate Technology Exchange and is part of the Deutsche Gesellschaft für Technische Zusammenarbeit (GTZ) GmbH. GATE promotes and propagates appropriate technologies in developing countries.

By appropriate technology GATE understands those technological solutions which are geared to the given social and cultural criteria and also particularly suitable from the economic viewpoint.

Traditional, intermediate or highly sophisticated technologies may be required, depending on the problem to be solved.

Essentially GATE offers a free information service on appropriate technologies to all public and private development institutions, especially for those institutions in developing countries, which are engaged in the development, adaptation and introduction of technologies.

APROVECHO is a small non-profit association of people from several countries, based in Oregon, USA. We offer ordinary people help in handling the inevitable changes that come with dwindling resources.

Locally, we teach and practice simple techniques for daily living: housing, cooking, heating and small scale food production.

Our work in poorer countries offers realistic alternatives to the current U.S. stereotype, often an inappropriate model for development, by assistance with technologies more relevant to their specific needs, skills and resources. We document native ingenuity, and by research and experiment adapt it to local conditions in the U.S. and other countries.

## What this book is about

Our purpose in this manual is to emphasize not so much construction methods for specific stove models, but the whole complex question of how we can help poor people develop solutions to their problems, focussing on cookstoves. This requires an understanding of deforestation, declining crop yields, migration to the cities, and the daily struggle to find fuel, seen from the viewpoint of the peasant, the villager and the urban poor.

Part one explains ways of working with villagers to design stoves; we look at systems for spreading information and for training builders; and we point out some of the worst mistakes you could make in this very delicate process.

The technical information in part two gives pointers for selecting, designing and testing stove systems, but it should be seen as a tool for accomplishing an integrated program which includes conserving fuel and land, employing local people, encouraging villagers' self-reliance and reducing dependence on imports.

The manual is especially directed to

1. Field workers: volunteers, extension agents and relief workers, in both rural and urban situations.
2. Administrators and policy planners: people involved in forestry and erosion control programs, renewable energy specialists.
3. Researchers in stove technology: workers at appropriate technology centers and rural development agencies.

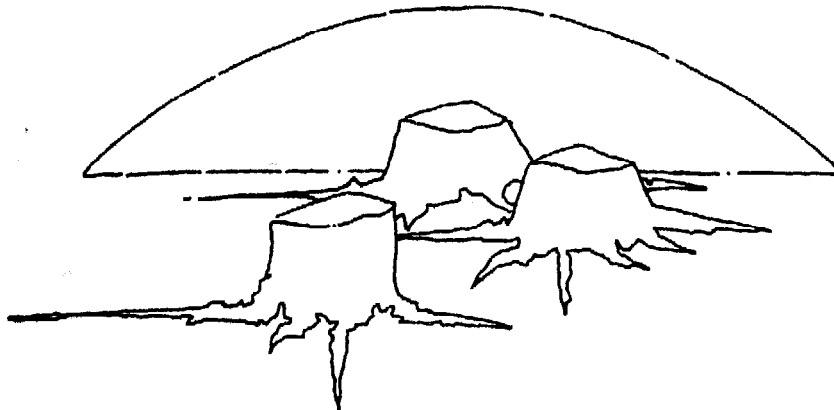

# Contents

STOVES AND THE GLOBAL FIREWOOD CRISIS	1
PART ONE	
Chapter I	HOW NOT TO DEVELOP A STOVE 15
Chapter II	FINDING INFORMATION 20
Chapter III	DEVELOPING STOVES WITH LOCAL PEOPLE: the role of the development worker 35
Chapter IV	PROMOTION AND DISSEMINATION 55
PART TWO	
Chapter V	HEAT, FIRE AND STOVES 77
Chapter VI	MEASURING STOVE PERFORMANCE 86
Chapter VII	BUILDING INSTRUCTIONS 97
	Cooking with Retained Heat 98
	The Lorena System 101
	Concrete Stoves 119
	A Clay Brick Stove: The Singer 127
	Charcoal Stoves 132
	Rice Hull Stoves 138
REFERENCES	145

# STOVES and the GLOBAL FIREWOOD CRISIS

**D**windling reserves of petroleum and artful tampering with its distribution are the stuff of which headlines are made. Yet for more than a third of the world's people, the real energy crisis is a daily scramble to find the wood they need to cook dinner. Their search for wood, once a simple chore and now, as forests recede, a day's labor in some places, has been strangely neglected by diplomats, economists, and the media. But the firewood crisis will be making news—one way or another—for the rest of the century.

- Erik Eckholm, The Other Energy Crisis: Firewood, p. 5

## The global firewood crisis

This introduction has a twofold purpose:

1. To provide information on the global firewood crisis and underline the need for action,
2. To explain why fuel-conserving cookstoves are a part of the solution to this crisis.

Let's begin by looking at the scale of the problem:

\* In 1974, the world use of wood was as follows:<sup>1</sup>

Developed world: 155 million cubic meters of wood used

Firewood = 0.4% of all energy used

Firewood = 10% of total wood used

Developing world: 1200 million cubic meters of wood used

Firewood = 25% of all energy used

Firewood = 90% of total wood used

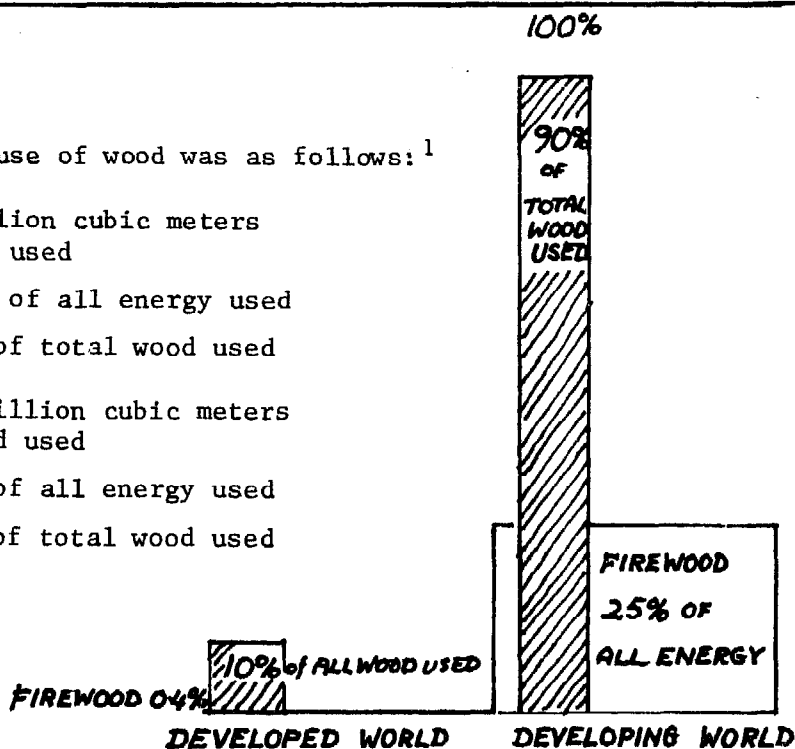
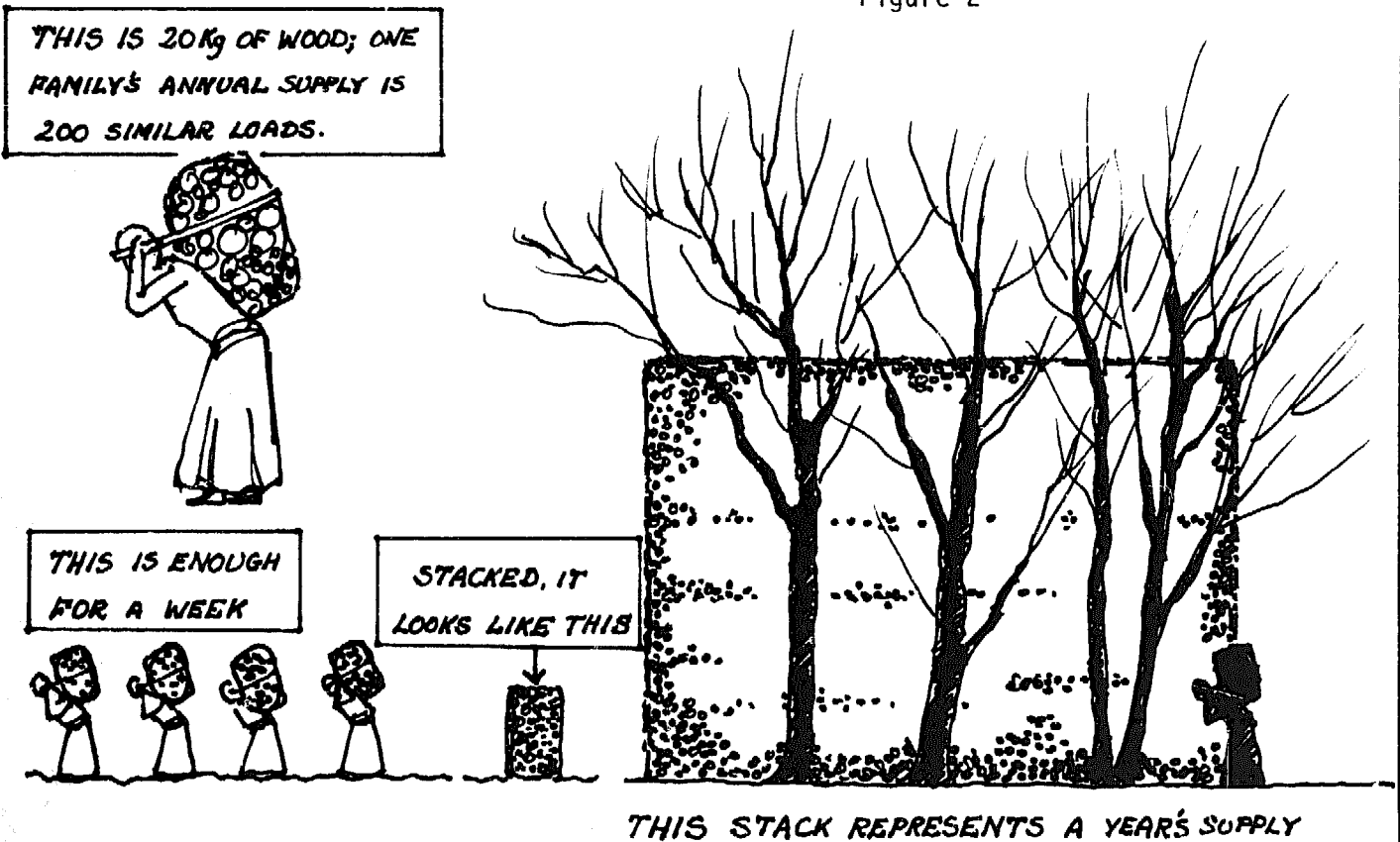

Figure 1

- \* The poorest countries rely heavily on wood as a primary energy source. For instance, Nepal derives 87% of all its energy from wood<sup>2</sup>; in Upper Volta, 94% of all energy is from wood<sup>3</sup>, most of it burned in domestic cooking fires.
- \* Nine out of ten people in the poorer countries of the world depend on firewood for their chief source of fuel. World wide, 1,500,000,000 people cook and heat with wood, the average family burning about 4 tons of wood a year (fig. 1). This is about twice as much wood as each family in the richer countries uses all together for construction, paper, furniture and firewood.
- \* 50 to 70% of all wood used on earth ends up under someone's cooking pot.

Figure 2



Forests influence the wind, temperature, humidity, soil, and water in ways often discovered only after the trees are cut, and these functions—usually beneficial to people—are sabotaged. Forests assist in the essential global recycling of water, oxygen, carbon, and nitrogen—and without any expenditure of irreplaceable fossil fuels. Rainwater falling on tree-covered land tends to soak into the ground rather than to rush off; erosion and flooding are thus reduced, and more water is likely to seep into underground pools and springs.

- Erik Eckholm, Losing Ground, p. 26

The world's forests are rapidly disappearing. As firewood prices climb, more people are forced to use petroleum-based products for fuel. At the same time, soaring oil prices make the shift to petroleum less possible. This in turn leads to increased pressure on the forests to supply more firewood. With both firewood and petroleum-based products too expensive for the poor, they switch to dung, the main fertilizer. The burning of dung depletes soil fertility, lowers crop yields, and contributes to widespread hunger and the migration of people and herds to more habitable land (already scarce) or to already overcrowded cities. In greatly simplified form the situation looks like this:

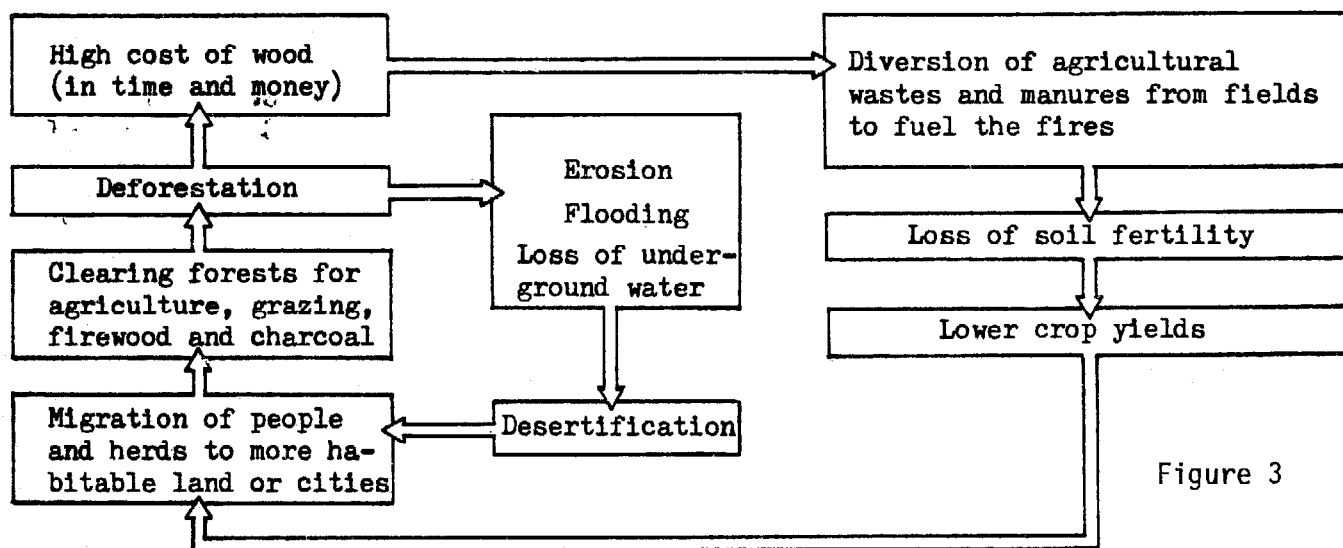
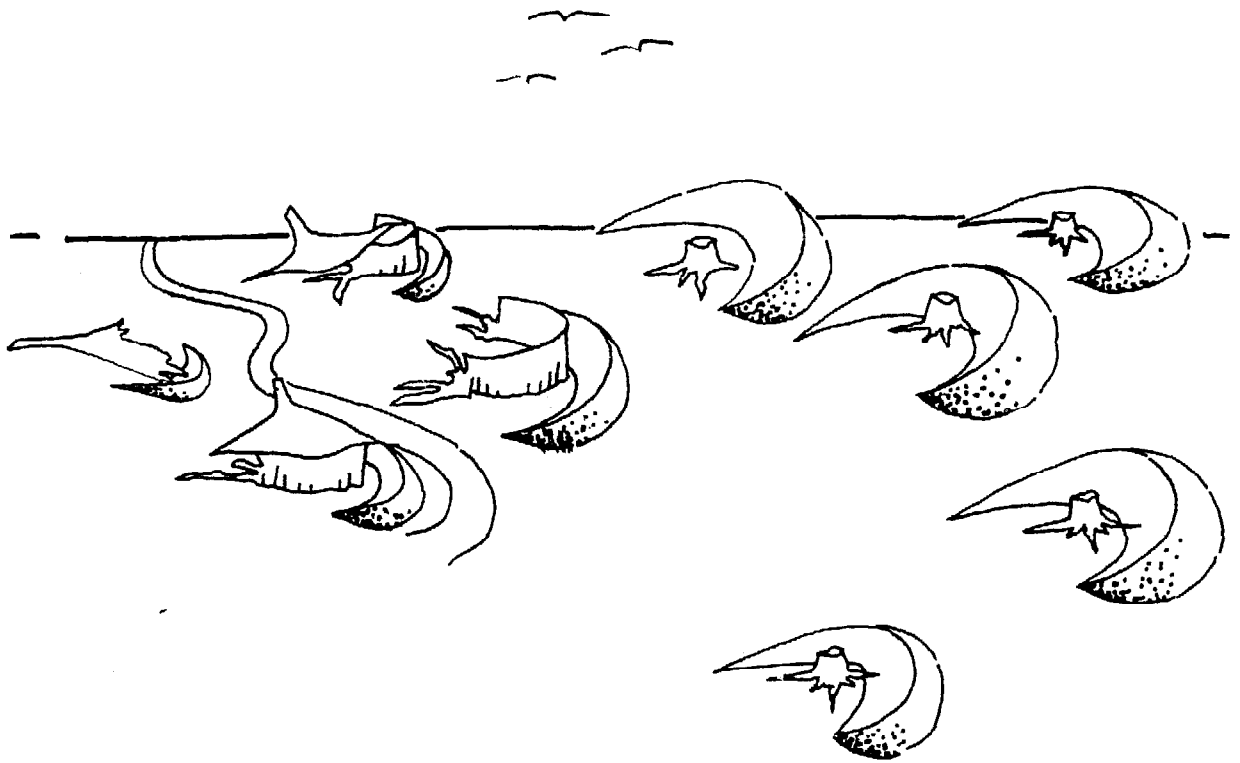

Figure 3

This cycle results in rapid desertification in many parts of the world, with both cropland and range land succumbing rapidly:

Similar pressures of overgrazing and deforestation in North Africa are having the same consequences. H.N. Le Houerou of the United Nations Food and Agriculture Organization figures that 100,000 hectares of land are lost to the desert each year due to human activities in Algeria, Morocco, Libya and Tunisia...India, too, is forfeiting farmlands and rangelands to desert sands, while vast dry regions, which stretch eastward from the Rajasthan Desert and constitute perhaps a fifth of the country, now present a nearly treeless landscape.<sup>4</sup>



One third of the land surface of the earth is already desert. The 1977 UN Conference on Desertification reports that the Sahara Desert claims 250,000 acres of once-productive land every year. In the regions of the world now turning into desert wasteland, the lives and livelihoods of some 630 million people are threatened.

Just as the Dust Bowl conditions in the 1930's forced many North American farmers to migrate westward and into large cities, the deteriorating productivity of the land and the encroaching desert now force the people who live in increasingly barren lands to move on. They move to places where they have relatives to help support them, or to areas with less exploited resources, only to repeat the cycle. Whole villages of people in the Sahel are slowly moving southward to escape the desert. Nepalese migrate to the Gangetic lowlands, Peruvians to the eastern slopes of the Andes.

These displaced people migrate to the cities in great numbers. And though the damage done to forests by rural people is more obvious, the increasing urban populations tax the forests even more.

When fuelwood from nearby sources is exhausted, urban people switch from using firewood to charcoal, which has about 45% more potential energy per unit weight than wood and is therefore cheaper to transport long distances. With gasoline and diesel prices rising this trend is likely to continue. However, even with improved processes of making charcoal from wood, at least 60% of the wood's calorific value is lost; 80% is more typical. Cooking with charcoal uses up 1 1/4 to 3 times as much wood as cooking with firewood.



The number of humans reached one billion about 1830, two or three million years after our emergence as a distinct species. The second billion was added in one hundred years, and the third billion in thirty years. One day in late 1975, just fifteen years later, world population reached four billion. At the present rate of growth, the fifth billion will come in thirteen years and the sixth in ten years after that

- Erik Eckholm, Losing Ground, pp. 18-19

Figure 4 shows how an increasing population can have disastrous effects on nearby forests within a relatively short time span:

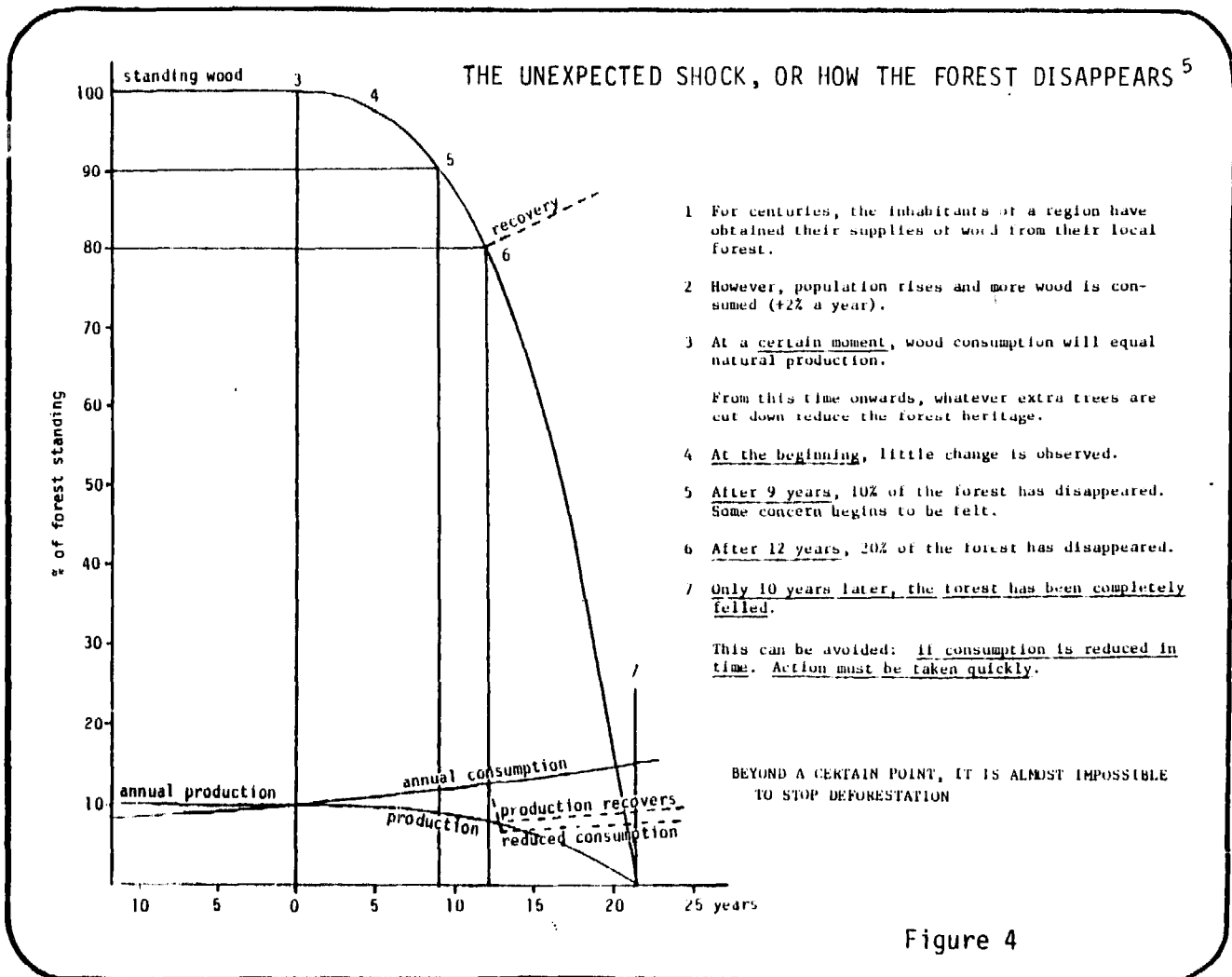

Figure 4

It must however be understood that population growth alone has not brought about the destruction of the world's forest. Inefficient use of the forest resources and outright waste also contribute. Poor planning and the lack of intensive long term reforestation further compound the problem, and above all, the unnecessary quantities of wood cut to feed wasteful cooking fires contribute more to the problem than any other factor.

## Possible solutions to the global firewood crisis

Reforestation, use of alternative fuels and fuel conservation through improved stoves are the three methods which offer possible solutions to the firewood crisis, though in the long term, only a reduction in the rate of population growth can solidify any gains made.

### Reforestation

The magnitude of reforestation needed is enormous. Two examples:

...to supply 30 million Sahelians in the year 2000  
...3 to 6 million hectares will have to be planted,  
which involves planting an average 150,000 to 300,000  
hectares of forest annually up to the end of the cen-  
tury.<sup>6</sup>

In order to meet demands for fuelwood..., Nepal will require about 1.3 million hectares of plantations by the end of the century. To provide this, a national reforestation program has been recommended under which 32,000 hectares of village woodlot would be planted annually in the Hills and 20,000 hectares in the Terai over the next twenty years.<sup>7</sup>

Reforestation programs have been started in many countries, but the high rate of growth in demand means that forests are being cut much faster than they are being replanted. Those countries in direst need have the least capital to invest in sustained yield forestry. Even where substantial reforestation is being done, new plantings have no hope of catching up with clearance. In the Sahel, for instance, plantings now make up for only 2% of the loss annually.

Firewood cannot be gathered for at least 7 to 10 years following the start of most reforestation projects, and the plantations must be protected during that time to avoid their destruction by people and animals whose need for fuel and fodder is immediate. Too often, reforestation is seen by local people as 'government plantings'. They have no feeling of ownership of the new plantations, and have no guarantee of benefits to themselves. The result is surreptitious cutting, grazing of animals and sometimes even deliberate burning to produce pasture.

Fortunately trees, unlike oil, are a renewable resource when properly managed. The logical immediate response to the firewood shortage, one that will have many incidental ecological benefits, is to plant more trees in plantations, on farms, along roads, in shelter belts, and on unused land throughout the rural areas of the poor countries. For many regions, fast-growing tree varieties are available that can be culled for firewood inside of a decade

- Erik Eckholm, The Other Energy Crisis: Firewood, p. 14

## Alternative sources of cooking fuel

As the cutting of wood for cooking fuel contributes so heavily to worldwide deforestation, the solution to the problem would seem at first glance to be easy: substitute other cooking fuels for wood. To do so, at present, is beyond the means of most poor people who cannot afford these fuels, even if available. At least in rural areas, firewood can usually be gathered free of cost, though the time needed to gather it takes longer and longer.

To supply enough petroleum or coal to provide for people's cooking needs is beyond the means of poor countries which would have to import them. The price of oil and coal continues to rise, mainly due to the high demand placed on them by the 'overdeveloped' world. Poor countries, with limited foreign exchange, cannot afford these fuels in quantity. For example:

### WOOD - AN IRREPLACABLE FUEL<sup>8</sup>

- It is estimated that total firewood consumption in the Sahel is at least 16 million m<sup>3</sup>/year (or 12 million tons), corresponding to 0.6 m<sup>3</sup>/per person per year.
- If wood were to be replaced by oil products, more than 2.5 million tons of oil would have to be imported every year (on the assumption that oil is used twice as efficiently as wood), i.e. almost three times the Sahel's current consumption of oil. In present circumstances, these imports would cost more than 60 billion CFA francs/year in foreign currency.
- Towards the end of the century, with a population of 50 million, and with world oil prices twice their present level, almost 240 billion CFA francs in foreign currency would be spent annually on these imports. This is out of the question.
- One may also think in terms of the cost "per inhabitant": the import cost of the substitute fuel would be:
  - 2 000 CFA francs per person per year or \$9 in 1978, i.e. 7.5% of the current level of GNP per capita (\$120).
  - 4 000 CFA francs per person per year, i.e. \$18 towards the year 2000.

This unit cost is utterly unbearable, the more so as refining, transport, storage and distribution costs and outlays by households for gas cooking stoves, bottles, etc., should be added in. These extra costs could more than double the import price of unrefined oil.

In other words, oil products cannot in practice replace wood on a large scale, as the substitution could not be borne by the economies of the Sahel countries.

Figure 5

These fuels should be considered as alternatives for instance in such countries as India, which has coal reserves, and Mexico, which produces its own petrochemicals. Costs to the householder must be kept below the world market price however, to make them affordable to the poor. Temporary subsidies for petroleum products or coal as cooking fuels should be considered where pressure on the forests is acute.

Biogas and solar energy have been promoted as other alternative means of providing heat for cooking. China, for instance, has installed several million biogas plants. Biogas is appealing because it uses manures and other organic waste to generate the gas while leaving a useable compost for fertilizer. However, biogas is not suited to small scale production and installation costs are often high.

Solar cookers are already available, but their high initial cost makes them unaffordable by the poor. They are unacceptable in areas with long cloudy periods or where the main meal is early or late in the day. They need further development to make them better suited to more people's needs, for example by including heat storage for times when the sun isn't shining.

Another problem with both solar cookers and biogas systems is that they are often seen as being too different from current cooking systems to be culturally acceptable. Solar ovens, though limited to baking and slow cooking, are relatively inexpensive and may therefore gain more widespread acceptance.

Solar energy is well suited to some uses such as water heating and space heating that might otherwise require firewood. The introduction of solar water heaters and modifications for solar heating of buildings should be investigated, as they would free up more firewood to be used for cooking.



In many countries the use of charcoal is increasing. Charcoal production, however, uses 1 1/4 to 3 times as much wood to deliver the same amount of energy for cooking, thus exacerbating rather than alleviating the demand for wood (fig. 6).

Figure 6

Comparison of the quantity of wood required for the same amount of useful heat (to boil 1,000 litres of water), using wood or charcoal in current models of cooking stoves.<sup>9</sup>

		Present situation	
		Wood	Charcoal
Heat to transmit to water	GJ	0.3	0.3
Combustion yield	%	5	10
Required primary heat	GJ	6	3
Weight of fuel	kg	330	100
Fuel density	kg/m <sup>3</sup>	600	250
Volume of fuel	m <sup>3</sup>	0.56	0.40
Transport load factor	%	40	75
Required volume for transport	m <sup>3</sup>	1.40	0.53
Wood to charcoal conversion rate	%	100	12
Weight of forest wood to be cut	kg	330	830

Charcoal should therefore not be considered an alternative cooking fuel. Where charcoal is currently being used it would be wise to provide assistance in improving the efficiency of both charcoal burning stoves and charcoal production processes. It might, however, be preferable to introduce more efficient wood-burning cookstoves. Far greater overall savings of wood would result. (See Chapter VII for a discussion of improved charcoal stoves.)

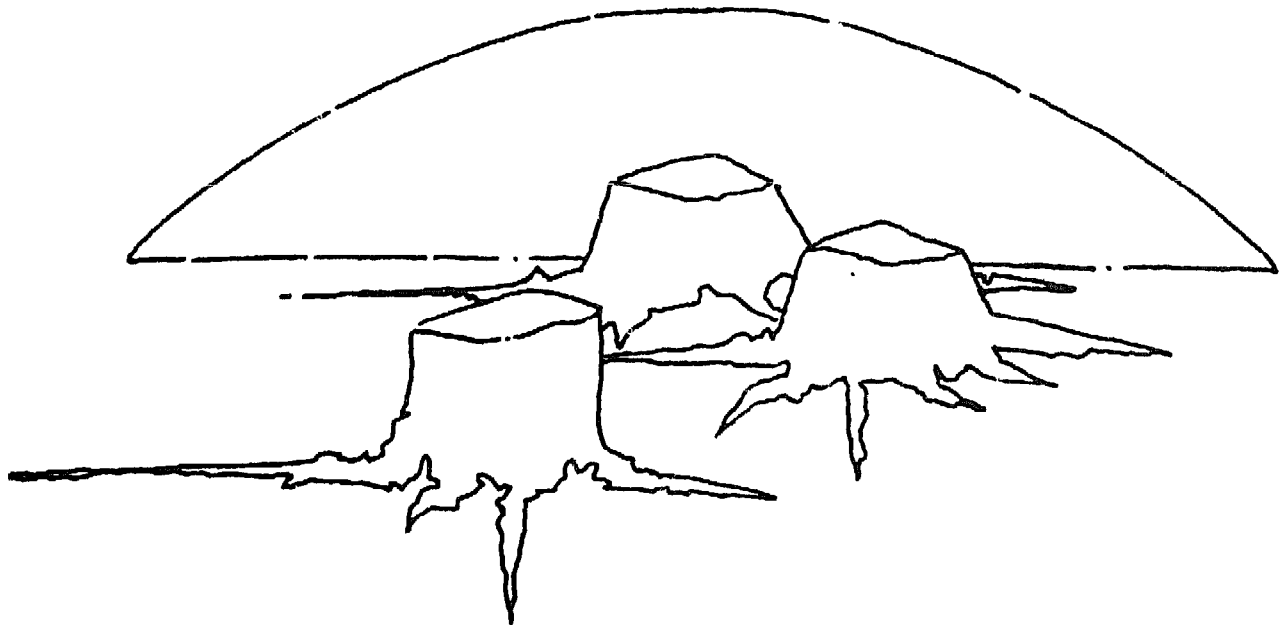

## Fuel conservation and improved cookstoves

WOOD IS AN IRREPLACEABLE FUEL in many countries today and will continue to be irreplaceable for a long time to come. The most immediate way to decrease its use as cooking fuel is to introduce improved wood- and charcoal-burning cookstoves. Simple stove models already in use can halve the use of firewood. A concerted effort to develop more efficient models might reduce this figure to 1/3 or 1/4, saving more forests than all of the replanting efforts planned for the rest of the century.

Yet, using simple hearths such as those used in India, Indonesia, Guatemala and elsewhere, one-third as much wood would provide the same service.

These clay "cookers" are usually built on the spot with a closed hearth, holes in which to place the vessels to be heated, and a short chimney for the draught. Their energy yield varies, depending on the model, between approximately 15 and 25%.

If these "cookers" were used throughout the Sahel, firewood consumption would be reduced by two-thirds: 0.2 m<sup>3</sup> instead of 0.6 m<sup>3</sup> per person per year...

Use of these improved cooking stoves has an immediate and lasting effect on wood consumption.<sup>10</sup>

In terms of cost, the introduction of fuel saving cookstoves compares very favorably with other programs. For example in Uttar Pradesh one reforestation project

contemplates spending \$46 million to provide the fuel required by 90,000 households and other benefits. If \$23 million of the costs are allocated to fuelwood the investment in fuel supply is \$256 per household. Improved stoves, on the other hand, are expected to cost \$5 and save half the fuel used by a household. Building 180,000 stoves would be equivalent to providing fuel for 90,000 households and cost only \$0.9 million, or \$10 per household. Thus, stoves have a 25:1 estimated cost advantage over tree planting as well as having the advantages of providing benefits without a long waiting period and directly to the households which participate.<sup>11</sup>

There are clear benefits of improved cookstoves to the individual family, the local community, the nation and the global community. In brief, they include:

## A. Potential benefits to the family:

- \* less time spent gathering wood or less money spent on fuel,
- \* less smoke in the kitchen; lessening of respiratory problems associated with smoke inhalation,
- \* less manure used as fuel, releasing more fertilizer for agriculture,
- \* little initial cost compared to most other kinds of cookers,
- \* improved hygiene with models that raise cooking off the floor,
- \* safety: fewer burns from open flames; less chance of children falling into the fire or boiling pots; if pots are securely set into the stove, less chance of children pulling them down on themselves,
- \* cooking convenience: stoves can be made to any height and can have work space on the surface,
- \* the fire requires less attention, as stoves with damper control can be easier to tend.

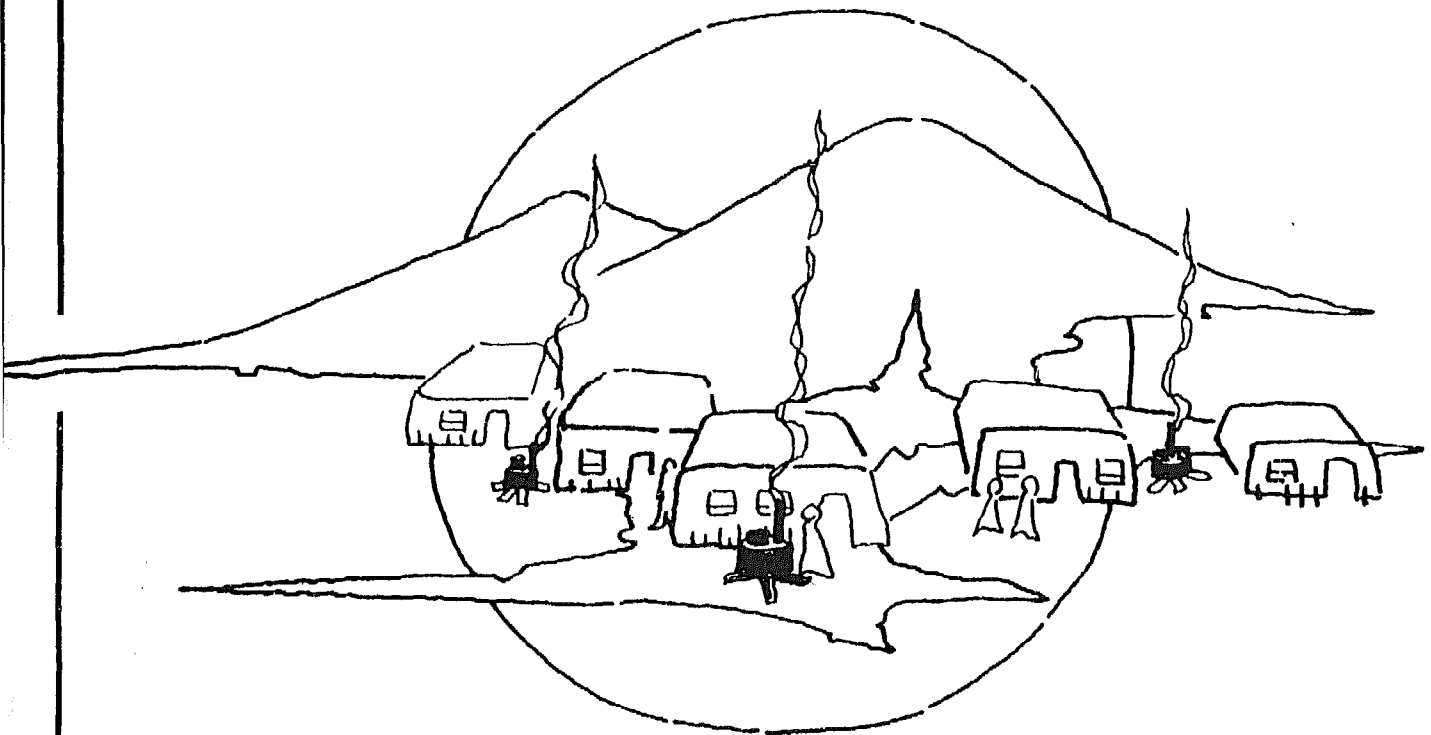

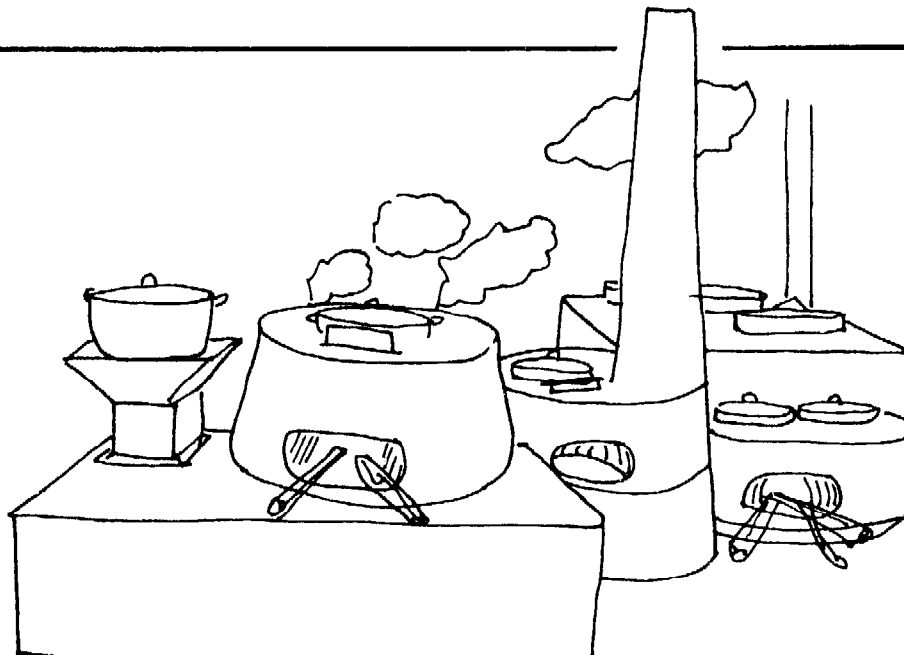

## **B. Potential benefits to the local community:**

- \* stove building may create new jobs,
- \* potential for using local materials and skills,
- \* potential for local innovations,
- \* money and time saved can be invested elsewhere in the community.

## **C. Potential benefits to the nation**

- \* lowered rate of deforestation improves climate, wood supply and hydrology; decreases soil erosion,
- \* potential for reducing dependence on imported fuel,
- \* potential for short-range solution to deforestation while long-range reforestation programs get underway,
- \* cost of providing improved cookstoves is low compared with other means of fighting deforestation.

## **D. Potential benefits to the global community**

- \* stoves can slow down the rate of deforestation and desertification,
- \* they allow time for reforestation projects to gain a foothold and help to change the balance toward extending forested areas once again.



Engineers build one dam after another, paying only modest heed to the farming practices and deforestation upstream that will, by influencing river silt loads, determine the dams' lifespan. Agricultural economists project regional food production far into the future using elaborate, computerized models, but without taking into account the deteriorating soil quality or the mounting frequency of floods that will undercut it. Water resource specialists sink wells on the desert fringes with no arrangement to control nearby herd sizes, thus ensuring overgrazing and the creation of new tracts of desert. Foresters who must plant and protect trees among the livestock and firewood gatherers of the rural peasantry receive excellent training in botany and silviculture, but none in rural sociology; their saplings are destroyed by cattle, goats, and firewood seekers within weeks after planting.

- Erik Eckholm, Losing Ground, pp. 21-22

## **A note to policymakers and politicians**

IMPROVED STOVE TECHNOLOGY IS AN ELEMENT OF COMPREHENSIVE PLANNING. Because of the magnitude of deforestation and desertification and the consequences which follow them, there is a grave urgency for action. Programs should be comprehensive integrated actions, aimed at both short and long-term solutions. Large scale reforestation programs and the better management of existing forests should be dovetailed into developing alternative energy sources for cooking, and into the introduction of fuel-efficient cookstoves. Comprehensive planning must also include such interrelated areas as literacy and education, health, birth control, nutrition, watershed planning, upgrading agriculture, urban sanitation and support for small businesses contributing to energy efficiency.

At the national level there is a need for broadest thinking. In many countries the whole energy budget leans heavily on firewood production. How that resource is used will largely determine the future of the country. National economic planning should now include stoves; their widespread use could affect national fiscal and demographic planning. Fuel conserving cookstoves are not simply a matter of domestic convenience for poor people; the economic autonomy of many poorer nations partially depends on them.

Where should a poor country invest? Where can foreign aid be best spent? As the fast growing populations of urban poor switch from using wood to charcoal, their demand on firewood resources will explode. Already in many countries the urban minority uses more wood than the rural majority because of inefficiencies in the production of charcoal. Future efforts must be directed at simple, fuel-saving cooking devices for city people.

For countries where the fuel scarcity is acute, an emergency program of subsidized kerosene or coal should be considered (Senegal, by comparison, subsidizes charcoal, which accelerates the problem of deforestation). Large initial subsidies could be gradually withdrawn over, for instance, ten years. This would encourage people to use fossil fuels which are at present too expensive for them, giving time to implement a massive firewood plantation scheme, to introduce pressure cookers, heat retaining cookers and other fuel-conserving tools and to enlist public support for treating the fuel shortage as a major emergency.

GOOD LUCK!

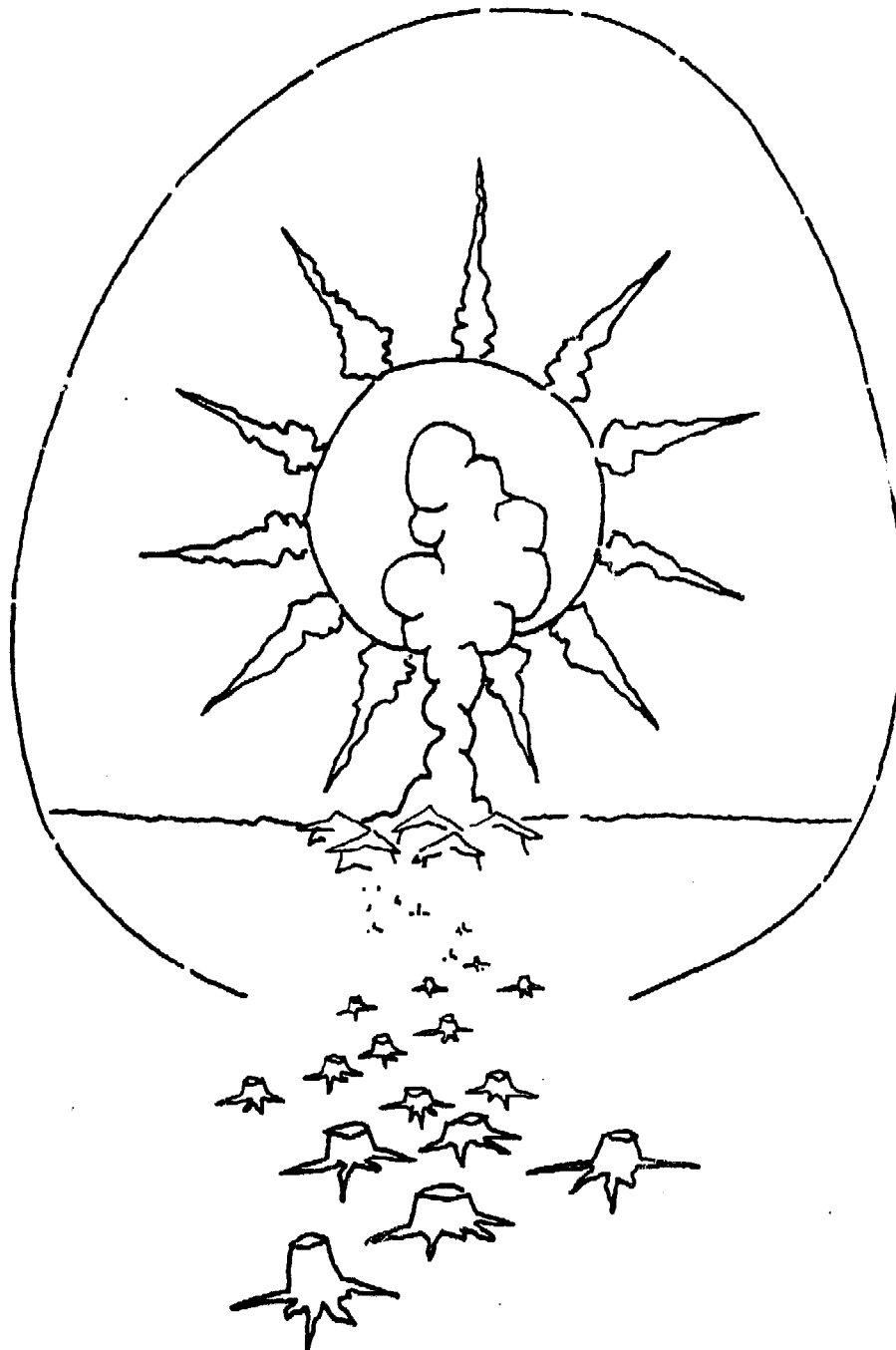

# Chapter I

## HOW NOT TO DEVELOP A STOVE

During the whole course of human evolution, cooking has been over open fires. Cookstoves were not invented until our great-grand parents' time and are still unknown to most of the world's people. Cooking follows ancient traditions; the three-rock fire is still used all over the world.

To most of us, fire is magical, it has a life of its own. Using fire is a link with our earliest days of being human; the hearth is the center of home and family. The introduction of any kind of stove, however simple, is a giant step, both technical and social. It changes far more than just cooking habits; the basic relationship between Man and one of the Four Elements has been altered.

The hearth, the place where cooking is done, is a place of great ritual significance, surrounded by taboos and customs which have accumulated over the millennia.

The cooking place is often the hub of the household, the kitchen is the room where most time is spent. This is equally true of modern European apartments, American dream homes and African grass huts.

Fires and hearths have a profound social importance; to many people their use is little short of sacred. Stove developers must understand and respect this and proceed with caution in changing so fundamental a part of the way of life.



## **Beware of the quick solution.**

Basic social research is essential to generating new technologies. Unfortunately, sociological studies, even when available, are often looking for something different from what you want. Even if studies have been made of the factors you need to know about, field correlations will probably reveal a very different situation when you apply them to what you are doing. There is no substitute for your own experience. It is dangerous and arrogant to suppose you can quickly assess the social information that will enable you to design perfect stoves in an unfamiliar area. The complex and subtle needs of a culture will only be revealed by living in it. It is possible that the people have no need for stoves, or that there are reasons they will never want them. Other problems may have priority.

Most good tools have evolved over centuries, their design shifting gradually to the near perfection of a good hammer or spade. No single person designed them overnight. The users tried them, adapted them, adjusted, made corrections. A stove should be a good tool so it needs this kind of refinement. If centuries are not available, then the background social and cultural research needs to be comprehensive; not statistically, but as an understanding of the people and how they live.

Read Chapters II and III before making any social assumptions.

## **Don't start with the idea that "stoves would be good for them".**

It may seem obvious to an outsider that stoves would be desirable. Unless this is equally clear to local people, attempts to introduce stoves could be seen as ways of undermining deep cultural traditions, and resented.

The idea of fuel-conserving stoves may come from outside, but local people know they will be there long after outsiders have gone away, so the desire to use stoves must be their own. In some places the need will be known: the people may hate smoke in their kitchens or be alarmed at the price of fuel. In these places, once it is known that solutions are available, adoption of stoves is likely to be fast and enthusiastic.

Any new technology, if it is to respond well to the real needs of people, must be an answer to a problem they themselves identify. When bathtubs were supplied in Scottish government-built housing, some tenants kept coal in them, outraging the middle class planners and architects whose concepts of cleanliness revolved around bathtubs. The tenants, who had come from slums without tubs, saw no need for bathtubs and had developed other techniques for keeping clean, but they had no place to keep their coal.

The first part of any stove introduction program must involve local people. Learning what they need will help you decide together whether there is indeed need for a stove, or rather for better information on the effects of smoke in kitchens, or the rural deforestation problem. If deforestation is not seen as a problem, if there is a good supply of wood, and if smoke doesn't bother them, they probably don't need a stove. If this is so, turn your attention to something else.

Read Chapter II, Finding Information, before assuming that stoves would be good for people.

## **Don't assume that a stove from another area will be suitable.**

Your own cultural prejudices will bias you towards selecting a stove that seems most suitable for the people on the basis of what you know. This is dangerous. The people will know what they like far better than you ever can. Don't assume that because you have a college degree or can read or have travelled a lot, that you are any smarter than they are.

The science of improved stoves is in its infancy. Not one of the stoves in this manual is perfect, even for the situation it was designed for, and each is probably quite unsuited to other conditions. If it is randomly taken into another culture, it is highly unlikely that foods, pots, fuel and attitudes toward fire will be similar; it won't fit.

Once people are involved in trying to solve their own problems your job may become simply that of an interpreter of information to which they have no other access, such as ways of building stoves in other countries. You can help them select techniques which will best suit their own conditions, by showing them testing methods, and encouraging experimentation.

Every year, our understanding of how to design really good stoves improves substantially; this is a fast-changing technology which is still open to quite original ideas from total amateurs. Of necessity, the materials and tools are simple, and the techniques are fast and easy. Here is an opportunity to evolve a design system for your own region which will truly respond to the needs felt by local people.

Read Chapters II and III before trying to design a stove for your area.

## How not to be a stove salesman.

It is unlikely you will be marketing a product. Unfortunately the models we have for spreading new ideas come chiefly from the marketing industry. Our concepts tend to revolve around the notion of salesmanship, that is, pressing a "product" which has been manufactured elsewhere, onto a "market" that may be resistant to it. If the product is toothpaste or aspirin or tractors it is fairly easy to demonstrate a need for it by advertising it persuasively until people are convinced they actually do need it. Pressure comes from the top. The need to produce comes from the industry itself.

This type of system works badly for rural people in poor countries. Because the product is manufactured elsewhere, it sucks scarce capital out of rural areas, making the people increasingly dependent on cities and other richer countries.

Stoves, because they are technically simple and often use local materials, belong to another system. This means that the people themselves can exert pressure for technical help, adding their ideas to those of outsiders to produce not a product but a technique. Through refinement by the people instead of for them, the technique spreads and adjusts to all of the local variations in cooking habits, fuels, climate and family structure. This allows people to be part of developing their own technologies, and ensures that technical solutions respond to their needs.

Read Chapter III on Developing Stoves with Local People before trying to persuade anyone they need stoves.

## Why not to build an untested model in a public place.

An item as important as a new way of cooking attracts a lot of attention. In most places that you build a new stove it will be under immediate scrutiny for any faults that people can find. They may however be impressed enough to copy it or order one for themselves, starting a chain of poorly adapted copies which is hard to break.

Conditions vary from place to place. A stove which has performed well in one country may be totally inappropriate in another. The heavier pots may break it, slightly different materials may wear badly, it may deteriorate quickly under the local climate. Above all, your construction methods may well be clumsy at first and you may immediately see improvements that can be made in construction and design.

You are advised to build an experimental prototype first, in privacy and in collaboration with a knowledgeable local artisan or cook who can contribute ideas which hadn't occurred to you.

Read Chapter IV, Promotion and Dissemination, before building a prototype.

## Don't get angry when people don't immediately adopt your stove.

Introducing anything new can take a long time. Often, early attempts will be failures because they are isolated experiments where the user is without support of other people trying the same innovation. The user sometimes doesn't want to stand out, and may lack inventive help in making adjustments to the new conditions.

Stoves may be abandoned because of minor difficulties the cook can't easily resolve - a pot that won't fit, a burnt dish before she learns how to control the fire, fuel not fitting in the firebox. These are difficulties an observant helper can notice before they cause too much trouble, so frequent visits to users' homes are advisable at first.

Then there are the people who find they like something about open fires after all, the extra heat on cold mornings, subtle ways they have grown accustomed to for adjusting the heat. Sometimes older people are more rigid and go back to open fires, where young folks might be more open to new ideas.

Failures are more revealing than successes in telling you what changes might be needed for a widespread program so it is important to monitor early introductions carefully.

Read Chapters III and IV before trying to interpret what's going wrong.



# Chapter II

---

## FINDING INFORMATION

Would a stove satisfy a need in your region? If so what kind of a stove? To help answer these questions, you must have a good grasp of two quite different kinds of information.

Social and cultural information will help ensure that a stove design responds to local needs. Particularly if your interest in stoves is largely technical, you will need to familiarize yourself with the culture they will serve. Every technical design decision has socio-cultural ramifications. Not only should you know how many people commonly cook and eat together, but you need to develop a feeling for the way a society operates. How do people inter-relate? What is correct behavior, what is outrageous? What do people find beautiful and pleasurable? If you are an outsider, this sort of background will also help you move more comfortably in the culture with which you are working.

You will also need technical information, both a body of theoretical knowledge (Chapter VI) and a wealth of data on local fuels, materials, resources. If you are already familiar with much of the local culture, but don't have a technical background, it is important that you gather quantitative information. Carry a measuring tape. Weigh bundles of wood. Make dimensioned drawings of cooking arrangements. Measure cooking time. This is particularly important if you must later work at a distance from the potential stove users.

Technical and social information are equally important in making sound design choices. This section is intended to give you an idea of where to start: what kind of information to get and where to find it, what skills to acquire and what pitfalls to avoid. It includes two checklists which can be adapted to your own investigation.

### **A word of caution**

As you go about your investigations, beware of the generalizations you make. What you see is not necessarily the norm. For example it is tempting to assume that people in northern Senegal eat mainly chicken because so often when an outsider visits a home, a chicken will be killed for the guest. This is a misleading conclusion. Meat is only used occasionally, generally to flavor sauces.

Cultural patterns vary between geographic regions, climatic zones, from one season to another and over time. Customs may differ among social classes, tribal and religious groups, from village to village and from household to household. Take care not to generalize from one or two observations; try to assess the range of variation.



The same caution applies to written sources. Statements such as "in Tanzania...", "in East Africa...", or even "in Africa..." are often erroneous generalizations. A case in point: One report states that in Upper Volta, millet stalks are used for cooking up to six months of the year because they are more readily available than firewood.<sup>1</sup> This study is based on observations made in the North Central part of the country. An investigation in other regions of Upper Volta, however, found no evidence that millet stalks are used as a primary fuel.<sup>2</sup> The discrepancy between the two reports may be due to geographical variation, or fuel use may have changed quite suddenly. In any case, it would be dangerous to use either study as a base for long-term fuel predictions in Upper Volta or West Africa.

## **Fires, fuels and fireplaces**

Ask someone to teach you how to build and maintain a fire. Tiny sticks require a different technique than firewood that is arm-thick and over a meter long. When should the fire be small and efficient, just hot enough to keep a covered pot simmering, and when should it be a quick, hot blaze? Learn what to use for kindling and how to assure good combustion. It may be possible to develop a stove that requires no change in fire building technique.

Many cooks routinely practice fuel conserving measures. They may withdraw embers to reduce the intensity of the fire, and when cooking is over, they may extinguish the fire with water or sand. Charcoal obtained in this way can be re-used later, e.g. for ironing.

Wood is not the only fuel commonly used. Charcoal, agricultural wastes, dung, peat and coal may be used along with wood or as alternatives to it. Are "modern" fuels popular, such as petrol, gas or electricity? Find out why a certain fuel is popular - maybe people have always used it, maybe it has special burning characteristics, or a pleasant smell. What you see people using is not always the fuel they prefer. When not enough of their favorite fuel is available, they may have to choose a less desirable alternative. People may be using dried dung even though they are quite aware that dung would be better left on the fields as fertilizer.

Think about substances that are available, but not currently used as fuel. They might become useful in an appropriate stove. Examples: corncobs, ricehulls, sawdust.

Find out what people like about their open fires. They fill many needs: they cook, provide warmth, dry out damp clothes, they are also a source of light and provide a social or ceremonial focus. They are moveable and easy to maintain. Their smoke may keep insects and rodents under control. A stove could incorporate some of these features. It could be built to heat the house in cold areas; it could be transportable if the cooking place is frequently shifted. Where insect control is important, the pots could periodically be removed to allow the smoke to fill the room. A stove will not provide light and may not be adequate for ceremonial needs. Where people must light an open fire to meet the needs a stove cannot fulfill, they may be better off without a stove. Take this option very seriously; especially where the open fire's drawbacks are seen as minor inconveniences.

An open fire can have considerable disadvantages. Constant exposure to smoke causes health problems similar to those caused by the use of tobacco: chronic bronchitis, emphysema and lung cancer. It also leads to eye diseases such as conjunctivitis. Cooking over an open hearth can be uncomfortably hot, and there is danger to small children who may fall in the fire or tip over a pot of scalding liquid. A stove can solve these problems, as well as reduce the amount of fuel needed for cooking.

A good stove should fill as many of the open fire's functions and have as few of its drawbacks as possible. It should make the fire more useful and versatile, not less so. Nevertheless, there are compromises that will have to be made if people decide to replace cooking fires with stoves. A stove may indeed use only half the amount of wood an open fire would use, but it may require that this wood be chopped into much smaller pieces to fit in the fire-box. People may feel that the wood savings do not offset the discomfort of cutting wood with crude tools in the tropical heat.

Cooking may be done on two or even three fires which are lit as needed, as is common in parts of West Africa. In Guatemala, the cook is constantly rearranging the pots around a single fire to take advantage of the hot flames as well as the cooler areas at the fire's edge.



Fires may be inside a kitchen hut, under an overhanging roof, in a shelter or in the open courtyard. There is usually a reason behind the choice of cooking location. Out of doors, smoke presents less of a problem. A hut provides protection from wind and rain. Would the choice of kitchen location change if there were less smoke or no problem with wind? Would it make sense to establish both an indoor and an outdoor kitchen, or should you consider a moveable stove?

Investigate any indigenous stoves already in use; they may be practical, efficient cookers. Simple means of enclosing or partially enclosing the fire may already save wood, or may have potential for development. What do food vendors cook their wares on? Stoves for special uses, ovens and kilns may be adaptable for other cooking purposes.

In parts of West Africa the shea nut is dried in a mud structure with a stick grid and a basal fire entrance.

Could this "oven" be used for an outdoor cooking stove, if it were built smaller?

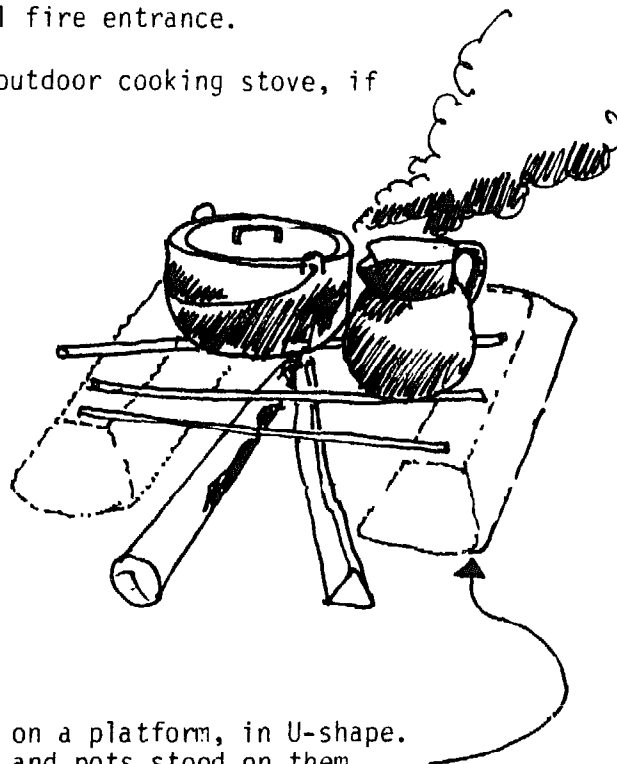
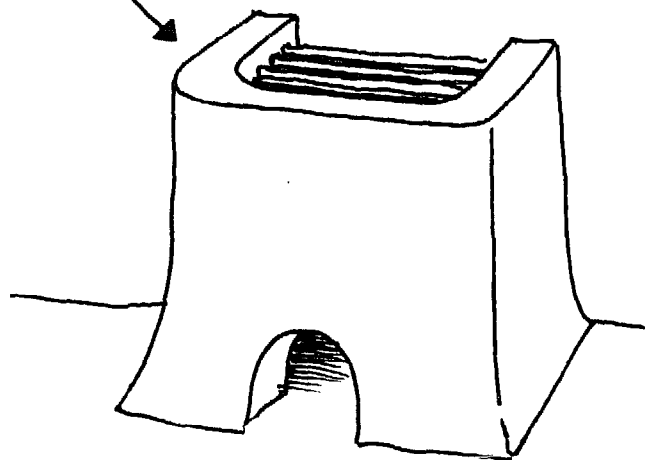

In Mexico a low mud wall is built on a platform, in U-shape. Iron bars are laid across the top and pots stood on them.

Find out who has the skills to build such indigenous structures. Work with these people. Build on existing practices wherever you can.

## Food and cooking practices

Explore the range of foods, and when they are prepared. When is breakfast cooked? When is it eaten? What is eaten for lunch, dinner, snacks, special occasions? What is never eaten? Note staple foods as well as specialty items, baby foods and medicines. Treats and foods sold on the street are worthy of special attention; a stove that can prepare these favorites is likely to become popular.

It is also important to find out what will ruin a meal and design stoves accordingly. It may be unthinkable to serve a mushy grain or tepid food. A Guatemalan sand/clay stove became thoroughly unpopular in one area because it had a habit of producing sandy tortillas - the local materials had not been properly analyzed to see if they were suitable (see *The Stove that Broke a Tooth*, Chapter III).

You should become thoroughly familiar with the preparation of common foods. Remember that these are not necessarily the foods you are being served; it is the custom in many cultures to prepare a special dish for a guest. If you were invited to an American home you might well get the impression that all Americans eat barbecued steak and that cooking is done on a charcoal grill by the men! Where local etiquette permits it, learn how to prepare the

staples in the traditional manner. This will teach you the important order of cooking steps, how much heat or stirring is needed to cook without burning, and any special tricks to ensure that the dish will be just right. A stove design must fit these local cooking needs very closely.

Measure how long each dish takes to cook, and note what heat intensity it requires.

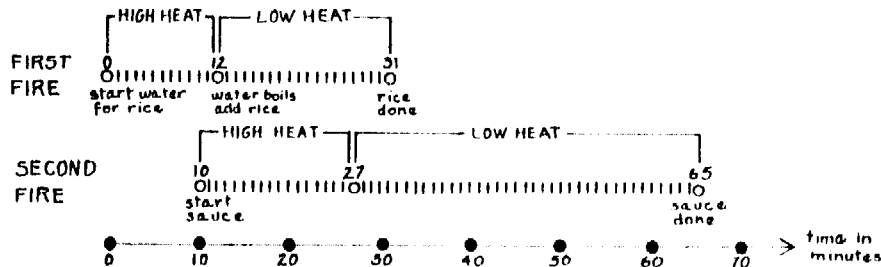

This is an example of a timeline you might observe somewhere in West Africa. Note that the rice requires a much shorter cooking time than the sauce. Would the cook like rice and sauce to finish at the same time, while using only one fire? If so, a two-pot stove could be developed that places the sauce pot over the fire box, and the rice pot next in line. In this way, the rice water heats up slowly while the sauce begins cooking, and both will be done at about the same time.

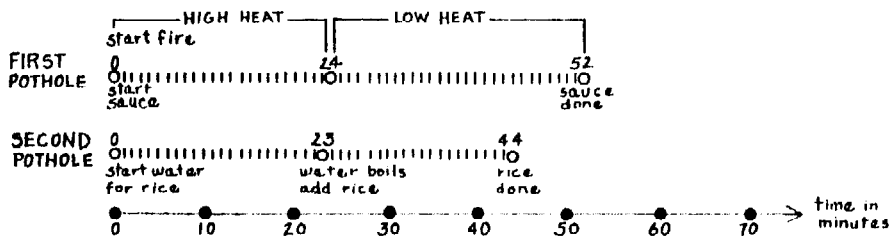

What is warm water used for in the area? How much of it is needed daily, and at what times of the day? Are there seasonal variations? Even in the tropics, large quantities of hot water are sometimes used for bathing, consuming huge amounts of wood. A multi-pot stove, for example, might be designed to include a permanent hot water vessel to ensure a ready supply of hot water, heated without having to light a separate fire.

If cooking is done on an open fire, the cook will most likely squat, stoop or sit on a low stool. Find out if this is the preferred cooking position, or would standing make the task more comfortable? A stove does not have to be at ground level; it can accommodate individual or cultural preferences.

How large and heavy are the pots? In West Africa, where families are large, the biggest pots are 60 cm in diameter. Care should be taken in determining the best height for a stove that is to accommodate very big pots. If the stove is too high, it may be difficult to lift a pot full of food. The stove could also have additional surface area so food could be served without having to set the pot on the floor.

## Household interactions

Work and responsibilities are usually divided quite clearly between men and women in a family. In many parts of the world, men contribute money or agricultural products to the household, and sometimes buy fuel; women frequently cook, carry water and collect fuel. There may be more than one woman in the household. Find out what their relationship is: mistress/servant, younger relative/grandmother, co-wife) How is work distributed between them? Who cooks? Here is an example of a household you might find in the Sahel:

A man has two wives, each living with her children in separate parts of a compound. They have agreed to split cooking chores; each wife cooks for five days for the entire household. There is one kitchen hut which each woman uses when it is her turn to cook. Each buys her own wood stack to provide fuel for cooking meals and to prepare specialty items on market days for extra income. The daughters help their mothers with cooking chores; they pound the grain and chop the vegetables. There is also the husband's mother; she is largely free of domestic duties.

From this you might conclude that in this family, both wives must be involved in the development process. Would they like a stove? Is one stove enough, or would they prefer some other arrangement? Can the market day specialities be prepared on the same stove, or is a specialized stove needed?

Because of the extensive segregation between men and women in some societies, it may be difficult for a female field worker to be accepted in the circle of men. It is often even more difficult for a man to have access to the women's domain. In parts of the Middle East, women's domestic activities in general, and cooking in particular, take place in a quite separate part of the house, compound or tent, screened off by a high wall. When the meal is ready, it is carried out to the men by a woman. Women and children eat what the men leave, in their own part of the home. Except for a husband, a brother or a son, no man may enter this area.

Working in male/female teams can enable you to obtain information available to only one sex. But the fact remains that women are almost always harder to reach. They are often illiterate. They may speak a local or tribal tongue rather than the lingua franca. There are fewer channels of communication open to them. Be sure to use a female interpreter if you do not speak the women's language, particularly if you are dealing with a culture where men tend to speak for women. You may get two entirely different stories from a man and his wife.

The importance of dealing with women at every stage of your investigation cannot be overstressed. They are usually the cooks;

they will judge if a stove does or does not meet their needs. You need their active support and good will. Enlist their help in learning about their culture. By asking them for assistance and by being quite open about the purpose of your investigation, you are beginning to involve them in the design process.

## Local customs and esthetics

As a stranger, you must be aware that the household fire is often very central to family life. In the Sahel, the fireplace symbolizes a family's well-being. Should a husband displace the three rocks which surround the fire, this amounts to rejecting his wife.<sup>3</sup> There are many rituals and taboos which are not easily shared with outsiders. Don't assume they do not exist because you have not heard of any. Tread lightly.

Where there is special significance attached to the three fire pit rocks, they might be incorporated into a stove design, or they could exist side by side with a stove. If it is customary to bless a new fire place, the same honor may be extended to a stove. One could modify or even invent a ritual. After all, new roofs, new cars and even transistor radios receive the priest's blessing in some parts of South America.

Every culture has a great number of food taboos and eating rules. This is what "table manners" really are. If you are unfamiliar with the culture, it is important to be especially conscious of serious breaches of local etiquette. For example, there are many areas throughout Africa and the Middle East where people eat out of a common bowl. In such areas, there is often a strict taboo against the use of the left hand for eating. Should someone accidentally use it, no one will touch the contaminated dish. By extension, it is with the right hand that money is exchanged, presents are given and received, or passing friends are greeted.

Develop a feeling for prevalent styles and tastes: favorite colors, textures, designs, shapes, number combinations. What do people decorate? Do they lavish special attention on any buildings or furniture? The local sense of beauty should be incorporated in a stove. Outside shape, color and ornaments may not be essential to its function, but they may make it pleasing and desirable to the owner. In northern India and Nepal, the cook wipes a red clay coating over the whole hearth area every day, keeping it clean and giving it a distinctive red-brown color. In Guatemala, people often whitewash their Lorena stoves regularly. It might be possible to mold relief patterns into a mortar finish - in Senegal, concrete blocks are often made in patterned molds.

There may also be taboos and prejudices in the sphere of esthetics. A European would probably not choose a swastika for a graphic motif, but in India or among the Hopi of the south-western USA it has connotations of the life-giving energy of the sun and might well be an appropriate decoration.

## The rich and the poor

It is worth noting how the very rich and the very poor live. How do their lifestyles differ? Are they both the product of the same culture, or have the rich adopted completely different, often western, habits? What items carry prestige and are therefore sought after?

Wealth influences cooking patterns. It affects the variety and kinds of food eaten. It may affect the choice of fuel and how it is used. In a wealthy household less attention may be paid to fuel conserving methods than in a poor family where fuel costs amount to a quarter of the family budget or all firewood has to be collected. For richer people the fact that a stove is beautiful, or is made out of a "modern" material like concrete, may be more appealing than the fact that it saves fuel. Rich and influential people are often emulated; you may want to convince them to use a stove. Furthermore, if they are currently cooking with wood or charcoal, they are depleting the local firewood supply as much or more than are poor people.

## Urban areas

City life presents special opportunities and constraints. Its investigation takes on increasing importance as urban areas increase two or three times as fast as rural ones. Look closely at life in the slums or squatter settlements: here, problems are likely to be most apparent and the need greatest.



In cities, people are tied into a money economy. They cannot grow their own food or gather their own fuel; their access to raw materials is limited. They rely on a source of cash income supplemented with barter, charity, or the help of relatives or friends. Under these conditions, it might be a good idea to develop cheap stoves that could be bought and sold through existing market places. Could transportable stoves be built? Or stoves that can be sold in components? Also think about stoves that can be made of the scrap materials frequently available in the poorest areas of big cities.

It may be possible to develop stoves specially suited to public cooking situations. Each town has restaurants, coffee or tea houses

and street vendors. They serve, among others, the large group of seasonal workers urban areas tend to attract. Not all cooking takes place in the home.

If you are unfamiliar with the culture, be careful not to use public eating places to make inferences about everyday home cooking. They are often not comparable. Literature on the fuel problem in Nepal, for instance, talks about "improving native stoves". From reading, one gets the impression that every household has a home-built cookstove. Stoves in fact exist, yet whole regions of the country are without domestic cook-stoves. Foreign observers are seeing the stoves in teahouses and are extrapolating that they must also be present in homes.<sup>4</sup>

## Community resources

Within a village, a town or a big city neighborhood you will find many resources that may be useful to you. Keep your eyes open for indigenous inventions you may never have thought of. Do people have a method of waterproofing roofs and walls that can be applied to an outdoor stove? Have they developed systems to keep their homes warm? (You might learn about local insulation materials.) Do they store food in ingenious ways?

Make a list of locally available materials and tools you may be able to adapt for stove building. Local crafts people are your best source of information. Potters and brickmakers know where to get the best clay, builders can tell you what mix makes the strongest adobe, blacksmiths have access to recycled metals and are resourceful at fashioning tools.

There is usually a source of cement and other imported materials. Keep in mind that a heavy reliance on imports may make a stove program susceptible to the fluctuations of international foreign markets, and may negatively influence the country's balance of trade. More significantly, the use of imports may raise the price of a stove above the means of a large part of the population.

## Printed resources

For background information about the country's geographical, economic, political and social make-up, a good recent atlas will give you a number of useful clues. For example: information on the lay-out of the transportation network can tell you to what degree the country is centered upon a primary city. From the road and rail map you can also speculate how well information is likely to travel between outlying areas; are there direct lines of communication or does all information have to travel through the capital?

There exists an excellent atlas for all African countries published by the news magazine Jeune Afrique. Excerpts containing information on some of the countries are available in booklet form. For Latin America, "The South American Handbook" is a comprehensive sourcebook on every country (including Central America and the Caribbean), though information is sometimes out of date.



Libraries (often attached to universities) and bookstores can be another good source, especially for general information and historical data. The more you can learn about the country's recent history, the better. Does it have a colonial past? Has it had a recent revolution? With this kind of knowledge it may be much easier to understand the country's administrative structure, or with which nations it has friendly or hostile relations. Valuable information can also be found in locally available newspapers and magazines. Keep interesting articles for later reference.

Government agencies may have useful printed material. Check with the ministries for rural development, health, women's affairs, forestry, environmental concerns, and with the national cartographic service. The government printing office may have interesting population and economic statistics.

But remember: one can document almost anything with statistics. Don't take them at face value. Were they compiled to validate someone's argument? Furthermore, they are not necessarily accurate. The difficulties of gathering statistical information in a country with poor transportation and communication can lead to quite distorted statistical results. In a country where a tax is levied on every rural inhabitant, you might expect the rural areas to be under-represented in the population statistics.

A further warning: beware of mistakes and inaccuracies that creep in when your information material is translated from another language. Even widely used terms can connote a range of concepts. Take the word "chula" used in India and Nepal. It can mean hearth, fireplace, stove or a specific improved stove.

Remember: there are many aspects of life you cannot pick up secondhand from statistics or from other people. Any information you are presented with, to be useful to you, must be processed in the light of your own experience. A couple of weeks spent in the right places may be more valuable than months studying the situation in an academic way.

## **Working with people**

If you are an outsider, you may need some coaching in the local way of doing business. Take the language seriously and learn it: this is one way of showing respect for local people. Find someone who knows the culture you come from, but who has lived in the country long enough to be familiar with local ways of doing things, and with what might be expected of you. A European or American may want to find a student who studied abroad, or a volunteer from a foreign group who has worked in the country for some time. Other contacts include missionaries, field researchers (anthropologists, sociologists, etc.) university professors, extension workers and health workers. But be wary of the viewpoints expressed by the elite - in many third world countries even social scientists learn disdain for poor people at a very early age. Further, the urban elite don't often visit the rural areas or poor parts of the city, and probably don't have firsthand knowledge of them.

If you walk into a government office or a village and start abruptly firing questions, you will probably not get very far. It is important to go through the proper channels, taking as much time as is necessary. To contact influential people in or out of the government you will need introductions. A phone call from a professor might arrange an interview with the minister of forestry. Find out who the right person is to contact. In Guatemala, for instance, you will not get any information if you do not talk to the highest official in the department first - he may be so angry at being slighted that he will block your inquiries indefinitely.

Most important of all, you need to start out well with the people you will be working with. If you are introduced by a trusted extension worker or volunteer your task will be much easier. Take your time. In many places it is polite to greet the village chief first. Stay and drink tea with him if he wishes it. Don't become impatient: the time "wasted" is establishing you as a polite and considerate person. Eventually, explain why you have come and who you would like to talk to. Be open about what you are doing. Involve everyone in your information gathering, from the village chief to the children who follow you around.

In some places, it may be easier to use a questionnaire, in others, informal talks make people more comfortable. Ask if it is permissible to take notes as you talk; do not use tape recorders and cameras without explicit permission. Cameras scare people in many cultures; you do not need to use them. Make drawings instead. People will be intrigued.

Be careful of the way you ask your questions. Most people like to help; rather than not give you an answer because they don't know, they may tell you what they think you would like to hear. Questions which require only a "yes" or "no" as an answer are especially dangerous in this respect. Check with several people to see if you get consistent answers. Typically, men give different answers to women than they would to other men, and vice versa.

Be patient. Don't start out with the most difficult and sensitive questions. As people trust you more, you will learn more about their lives, but accept that there will always be some things they will not tell you about.

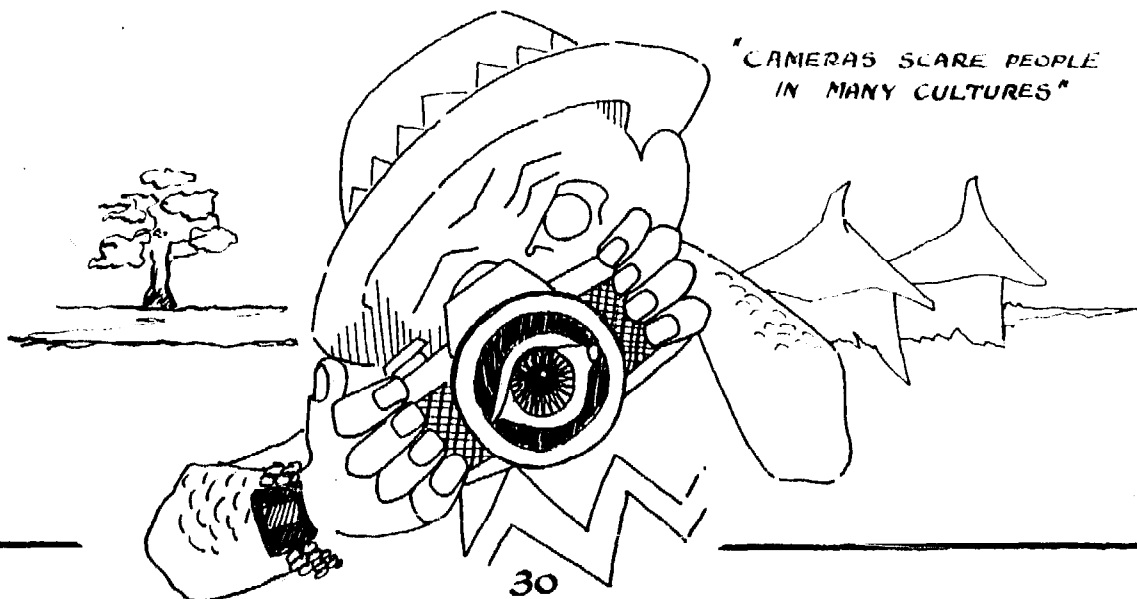

# SOCIO-CULTURAL CHECKLIST

- Fire:** What functions does the fire have? (e.g. cooking, warmth, light, social focus)
- Is smoke a problem?
- Have there been incidences of burns or scalding accidents?
- Is the cook exposed to too much heat?
- Likes and dislikes about open fire cooking.
- Fireplace:** Where is the fireplace located? (indoors, outdoors, under shelter) Why? (e.g. protection from wind)
- Are there seasonal variations in cooking location?
- Does a different fireplace exist for special occasions or special uses?
- Fuels:** How is fuel acquired? (e.g. bought, traded for, collected)
- Who supplies the household with fuel?
- Where does fuel come from? Is it easily available?
- What are fuel costs in time or money? Has this changed recently? At what rate are fuel prices, or the amount of time needed to collect fuel, increasing?
- Seasonal variation in fuel supply?
- Is fuel stored? How?
- What fuels do urban populations use? the rich? the poor?
- Likes and dislikes about available fuels.
- Pots:** Are pots well adapted to local cooking needs?
- What are the other cooking utensils? (coffee can, wok)
- Are cooking utensils locally made? centrally manufactured? imported?
- What kinds of pots does the cook prefer?
- Foods:** What do people cook and eat?
- What are staples? specialty items?
- Seasonal variations in foods eaten?
- What is considered especially delicious?
- What will ruin a meal?
- How does the urban menu differ from the rural? rich from poor?
- Cooking Practices:** Describe the order of cooking steps.
- Is there a need for hot water? How much? At what time?

- In what position do people cook? Is this their preferred cooking posture?
- Are there cooking rituals?
- Family:** How many people live in this family? (Men? women? old people? children?)
- Are there frequent visitors?
- How many people regularly eat together?
- How large is the average family?
- How is work divided in the household between the family members?
- Who cooks? who gets fuel? be specific. (e.g. two wives cook simultaneously in two kitchens)
- Sex Roles:** What is considered men's work or women's work around the house?
- How do men and women interact? men and men? women and women?
- Who works together?
- Who builds houses? granaries? furnishings? fireplaces?
- Are artisan skills limited to one sex? (e.g. pottery)
- Are there exceptions to the rules?
- Taboos and Rituals:** What sex role taboos are there in regard to working together, cooking and eating practices?
- What cooking and eating rituals are there? what food taboos?
- Are there fuel taboos? material taboos? shape taboos? number taboos? (e.g. number 13)
- Esthetics and Fun:** What colors do people like? what shapes? what adornments do they use?
- What colors, shapes or symbols do they dislike?
- To what do they give special care and attention? (e.g. living room, place of worship)
- What are important feasts? (e.g. baptisms, fairs)
- Public Eating Places:** What percentage of cooked food is prepared and eaten in public eating places?
- Statistical Information:** What proportion of the population lives in the cities? in rural areas?
- At what rate are these populations increasing or decreasing?
- Economic structure: where is a cash economy used? where a barter system? where and to what extent a mixture?
- What is the distribution of wealth?
- What is the rate of deforestation? reforestation?

# TECHNICAL CHECKLIST

- Fire:** How do people build fires? why? relate this to cooking practices. (e.g. small fire for simmering)
- How many fires are used simultaneously?
- What kind of fuel conserving practices are used? (e.g. windshields, cooking with retained heat.)
- What happens to the fire and fuel after cooking?
- Fireplaces:** Make dimensioned drawings of the local kinds of fireplaces.
- Are there indigenous stoves? ovens? kilns?
- Fuels:** What is used for kindling?
- What is used for fuel? Seasonal variation?
- Combustion characteristics of each fuel used. (e.g. straw burns fast and hot)
- Measure fuel size, length, diameter. How much variation is there?
- If the fuel is wood: what kind of wood? is it used wet or dry?
- Are there wood cutting tools?
- What are the local ways of measuring fuel? what are the units? is fuel measured by volume? by price?
- How much does a local unit (e.g. "a bundle") weigh? Establish the average for each area you work in.
- List possible alternative fuels. (e.g. agricultural wastes)
- Pots:** Make dimensioned drawings of the pots and cooking utensils.
- How much variation is there in pot sizes? Do pots come in standard sizes? how exact are these sizes?
- What materials are used for cooking utensils? List their properties. (e.g. clay pots: fragile, heat slowly)
- Are lids used? if not, why not? what could be used as lids?
- Are lids insulated? what could be used for insulation?
- Cooking Practices:** How long do commonly eaten foods take to cook? Measure, and draw up timelines (see Chapter II).
- Parameters: what foods require the shortest and longest cooking times? How long?
- Note fire and heat requirements to cook different commonly eaten foods.
- Measure the distance between the ground and the bottom of the cook pot.

Available Materials: Local material (e.g. sand, gravel, clay, straw, dung)

Recycled materials (e.g. old oil cans for sheet metal)

Imported materials (e.g. cement, steel)

Where are these materials available?

Are there preferred materials? why? (e.g. people like cement because it is strong, and because it is modern)

What other materials could be adapted to stove construction?

Skills: Are there adobe and/or mud construction skills? Describe.

Are there potters? Describe their materials and technique. (e.g. how do they fire their pots? do they use glaze? etc.)

Are there blacksmiths? Describe their technique. (e.g. is their furnace hot enough to permit welding?)

What other skills might be useful in stove construction? (e.g. are there local ways of waterproofing houses?)

Tools: What are a local mason's tools?

An adobe maker's?

A potter's?

A blacksmith's?

What tools and utensils could be adapted to stove construction? (e.g. machete can be used as metal cutter)



# Chapter III

## DEVELOPING STOVES

### with LOCAL PEOPLE:

#### the role of the development worker

### How to approach the problem

An understanding of the broader issues of technology transfer can help clarify the role of the development worker in introducing and promoting cookstoves. Without this understanding, a program can fail or have a lasting bad effect on the culture. Stoves can be totally rejected, along with any other innovation that comes from outside. Introduced technologies can lead to increased dependence on cities and imported goods, with a potential susceptibility to "technical fix" solutions that come with these dependencies. The example of solar cookers is a case in point.

Example: Mass produced aluminum parabolic collectors were introduced as cookers in India in the 1950's<sup>1</sup>. Technically they operate well. They are durable and cheap. Early demonstrations showed that they would boil water or fry a hamburger. Much of the development was done in the USA, where aluminum is cheap and hamburgers are plentiful. It was assumed that they would solve firewood problems over great areas of the tropics, especially deforested regions where sunlight is abundant. These are the very areas most needing alternative cooking systems. Almost everywhere they were introduced, solar cookers have been a crashing failure. Reasons given are ingenious and credible: that the cook must stand in the hot sun to operate them; that they work best at midday, yet many tropical people eat in the morning and evening; that gazing into the mirror can make you blind; that through neglect the aluminum surface dulls. The fact remains that for some reason people generally didn't like them, or they would be used more widely. Worse, in parts of West Africa, for instance, there is a general mistrust of new technology, because of the failure of solar cookers<sup>2</sup>.

It is significant that solar cookers were developed in isolation from their potential users. The cooks were presented with a ready-made product

in which they felt no involvement. Had local people been involved from the beginning in the development process, it might have been more successful for these reasons:

(a) People feel a pride of accomplishment in solving their own problems. The process of working out their own answers is part of the self-education that empowers people to deal responsibly with their own needs. If outsiders rob them of self-determination in techniques, unhealthy dependencies are created.

Where materials and energy are scarce, people are inventive. They have to be. No running down to the corner hardware store for every little gadget; you have to invent it. Technical design in poor countries can foster native ingenuity by crediting the people with intelligence and creativity, which isn't usually done.

(b) Local inventions work somewhat within the constraints of what can be locally manufactured. Local artisans and manufacturers will support only development of devices from which they themselves can profit. With local backing, cooker designs might have emerged to suit local production methods.

(c) The subtler needs of the people would have been incorporated, with all of the local variation that makes an artifact part of a culture - local symbolism and decoration and adaptations to local cooking.

(d) Maintenance is easier when only local materials are involved. The people have a familiarity with them; they know their materials' limitations and how to patch them up. For example, the polished aluminum of solar cookers loses efficiency as it gathers dust and grease, yet users may not understand the need to keep them clean.

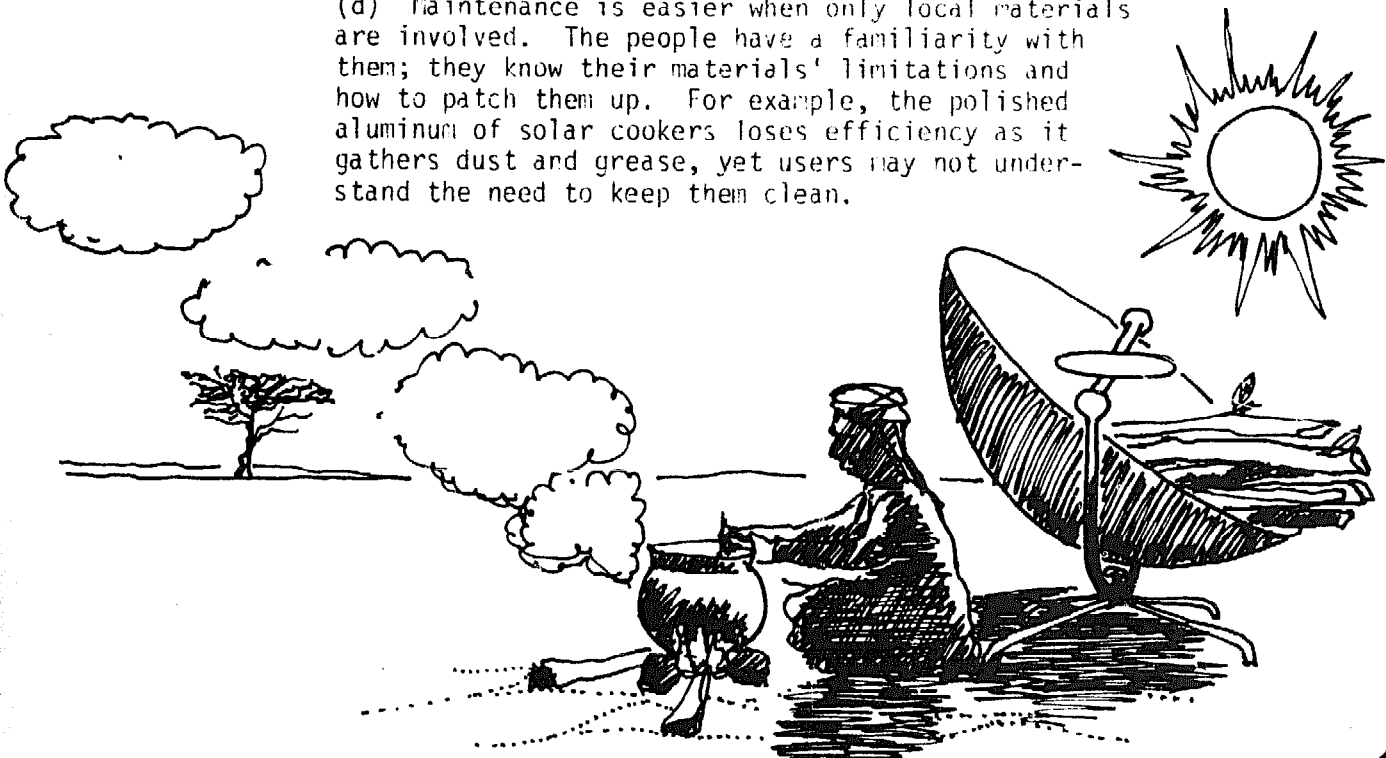



Our primary purpose in introducing improved cookstoves is to conserve fuel. But since the stove is so central to a family, its introduction can be an opportunity to help people take better charge of their own lives. This is especially important in countries that have suffered colonial rule (where decision making was often taken out of the hands of the local people), and in countries where a bureaucratic elite develops, following industrialized, consumer oriented patterns.

Here is an unusual opportunity for outsiders to help develop locally-responsive designs. In many poor countries the gradual introduction of mass produced goods depresses the economy of rural areas, creates an expectation of having to buy commodities rather than make them, and erodes traditional skills, making the village people increasingly dependent on cities for their livelihoods. In addition to saving fuel, simple cookstoves have the potential to reverse this trend, being especially suitable for local production using local materials.

- Often though, village people feel that the technology belongs to someone else, that it is being forced onto them from outside. Efforts should be focused on encouraging participation by villagers in any ways which may help promote local inventiveness. This will result in better stoves.

Especially in village cultures, people display ingenuity in solving their own problems. This has evolved as part of their way of life and should be fostered, watched for, listened to carefully and incorporated into the stoves' development whenever possible.

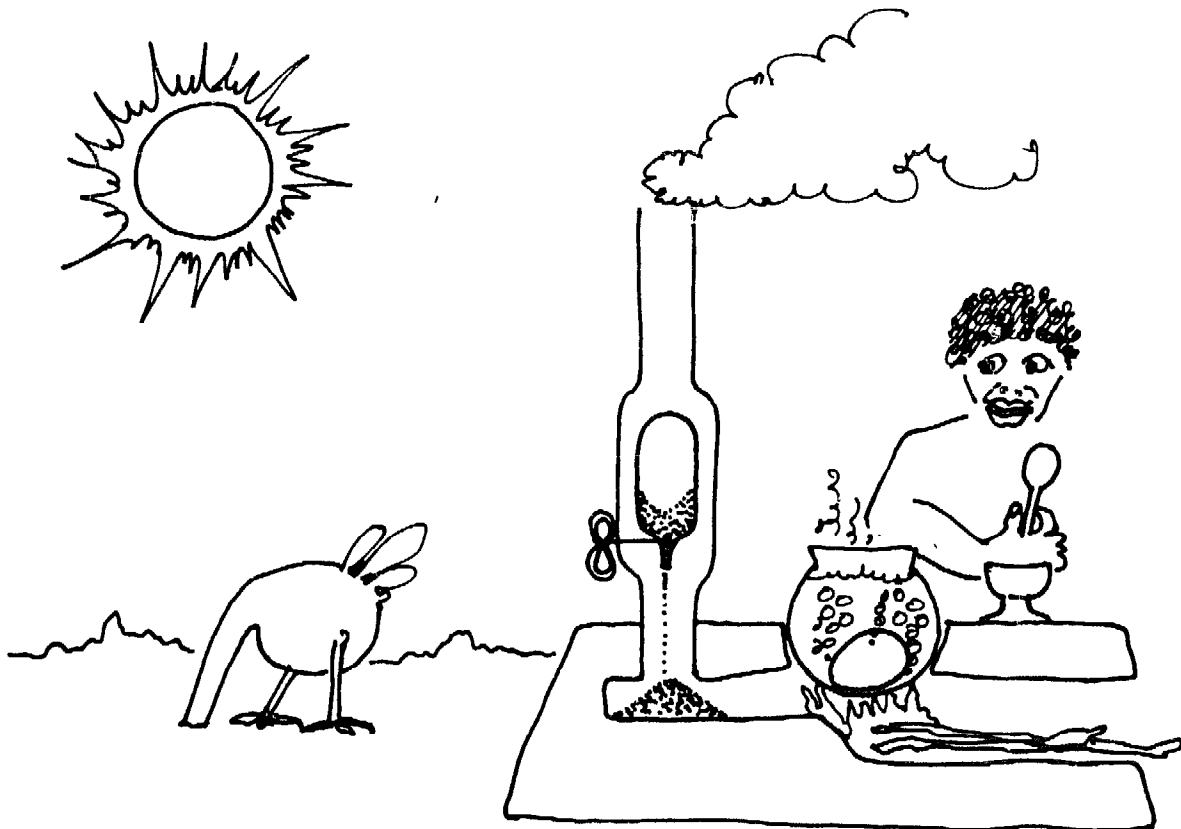

**THE BUSHMAN 9-MINUTE EGG-TIMER STOVE**

# Fostering native ingenuity

One needs to develop ways to encourage local inventiveness, and learn how to solicit input from local individuals. Unfortunately, there are few examples of how to develop new techniques with local people. The Consumerist model of development, prevalent in rich and industrialized countries, is often employed by development workers, for want of a better alternative. The consumerist approach used by the marketing industry first generates a mass-produced product, then persuades the public that they really want to buy it, often against their own good sense.

## CONSUMERIST MODEL

Figure III-1

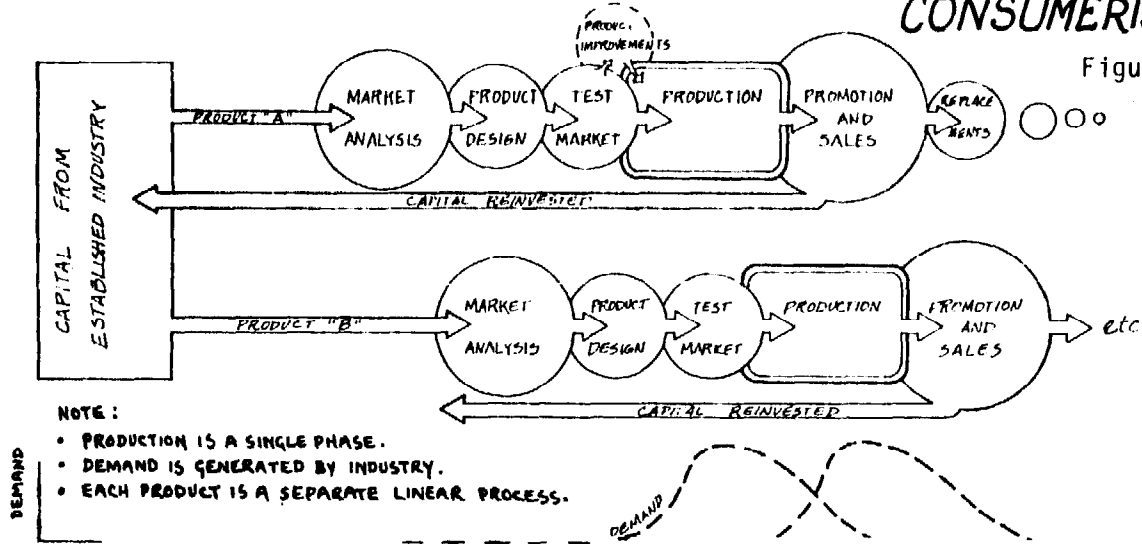

In many ways the consumerist model is inappropriate; more sensitive ways can be used which allow designs to evolve in response to the needs of individuals and cultures. This demands a totally different system, beginning not with the needs of industry but of the populace; ending with not a single product but a multiplicity of variable designs which continue to evolve, being constantly modified to meet the conditions which they must serve.

## DESIGN BY EVOLUTION MODEL

Figure III-2

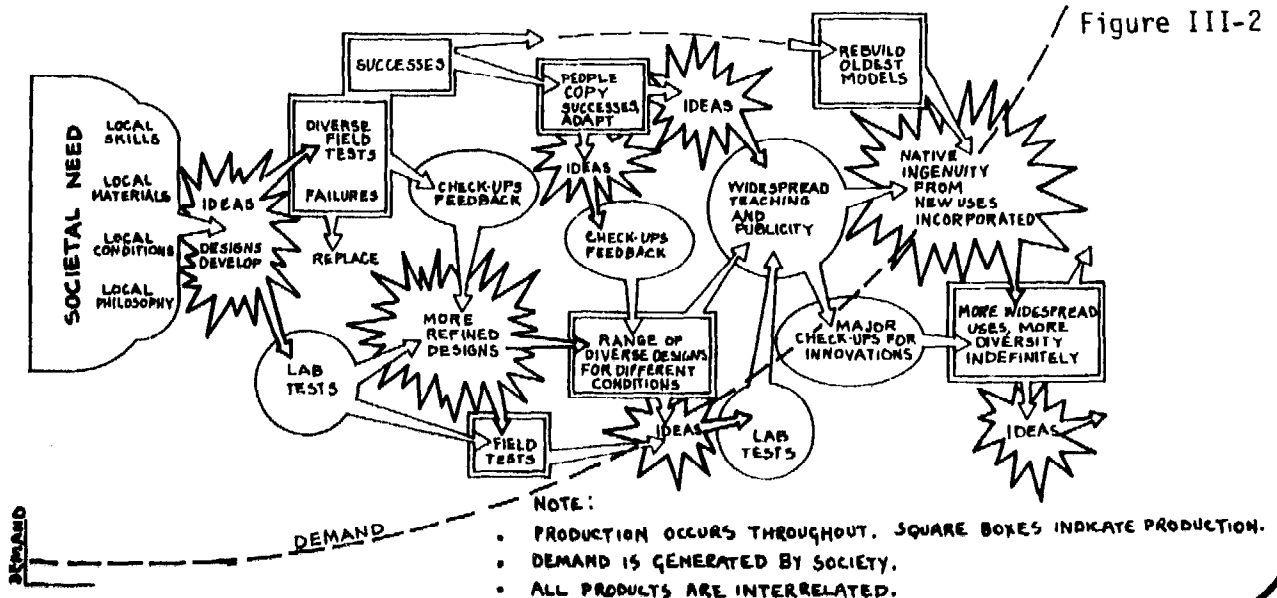

Throughout history, societies have slowly fashioned tools in response to gradual environmental and societal changes. We have developed a capacity to inventively solve our problems at a rate limited mainly by communications and the ways in which knowledge is dispersed.

Native ingenuity is present in every culture. Given normal rates of change we would expect cooking technology to develop in step with slowly decreasing fuel supplies.

In fact this has happened in many places. Almost everywhere, people cook using some kind of simple device to support the pot and contain the fire. Open fires using three rocks have developed into simple stoves, chiefly in two directions: toward the enclosed chimneyless rock and mud stoves of the tropics, and to the open hearth with chimney of medieval Europe.

Given unlimited time in which to adapt, and without the confusion of outside dependencies, it is likely that people anywhere with fuel shortages would evolve "stoves" along these lines. But the firewood crisis has come so suddenly upon most people that designs have not had time to evolve and spread throughout the areas affected. The job of the stove development worker is to accelerate the natural rate of native ingenuity. It is to help people design what in the course of time they might have invented anyhow.

In any one region it is likely that a variety of totally distinct stoves may be needed, to accommodate a wide range of cooking needs. By analogy, in transportation it is likely that in even a small area of a poor country several types of vehicles will be needed: heavy trucks, passenger cars, bicycles and buses all perform different functions. Similarly, the cooking needs of a street vendor, a housewife and a commercial baker suggest completely different stoves.

Figure III-2 hints at a possibility of infinite numbers of designs, each one responding perfectly to the needs of one small area, perhaps a single village. Under this system, the people would feel involved, would recognize the worth of the product and could have the satisfaction of solving their own problems. However, this might take a long time. At current rate of deforestation, the fuel could disappear entirely in many countries before a solution emerges.

Two opposite approaches have arisen in the development and supply of new technologies. For convenience let them be called the Grass Roots and Centralized approaches. The Centralized approach generally supports the Consumerist model; the Grass Roots approach is a product of Design by Evolution. A centralized system is not normally suitable for stove development; in fact stoves seem to be a product unusually well suited to decentralized development systems. (Paradoxically, dissemination may be most effective if it includes a centralized approach at national or regional levels.) The peculiar nature of the deforestation crisis indicates that some sort of combination approach will work out best.

Without advocating the wholesale adoption of either, here are the two systems laid out for comparison. Every circumstance will demand a different combination of the two approaches.

### **Grass roots development**

**ASSUMES:** that local people recognize their own needs and are capable of and interested in solving their problems, perhaps with a little technical help. (In places where strong dependency relationships are already developed, a grass roots approach assumes that peoples' interest in self-reliance can be revived.)

**ADVANTAGES:** People are involved in generating their own solutions, feel ownership of the idea, understand its relevance to their lives and are likely to support it. A wider range of more suitable designs will result.

**DISADVANTAGES:** Can be slow - needing patience, a well-organized extension system and personnel with sensitivity to cultural issues.

**MOST SUITED TO:** Rural poor in areas with traditional communication systems intact or good extension agencies. In cities: neighborhoods with close family or social organization. Suited to home production, small artisan workshops or custom on-site building.

### **Centralized development**

**ASSUMES:** that outsiders know better than locals, that people should be forced into a new technology for their own good. Implies an already designed product, usually to be sold aggressively.

**ADVANTAGES:** Sometimes fast. Able to reach many families quickly if they can afford it. People need no pre-education on the issues.

**DISADVANTAGES:** Alienation from decision making sometimes means rejection of the product. Discriminates against the very poor. Perpetuates people's inability to inventively supply their own tools. Accelerates the capital drain from country to city and to industrialized foreign countries.

**MOST SUITED TO:** Urban conditions in industrialized countries, richer people, sophisticated marketing systems; dense homogeneous populations; highly centralized social systems; mass production.

**NOTE** that neither system implies a political system. Nor are they exclusive of centralized policy planning, within which a Grass Roots approach can work, as in China.

## What is the role of the development worker?

If people are capable of developing their own stoves, then what is the job of the outside development worker? Apart from accelerating native ingenuity, his/her role should be that of a newscarrrier... "I saw this working in another country, perhaps you could adapt it to here..." who brings in new thoughts and experience. It is never to force people to accept new ideas, no matter how important they seem to be, but to expose them to a range of new alternatives. The worker should strive to become unnecessary, to not be missed when she/he leaves, because the locals will be taking full responsibility.

Assume you have chosen to work at a local level. An order of approach could be:

- 1) I'm here; I can do these sorts of things; if you have any problems maybe I can help.
- 2) I'm here. Do you have problems I can help with?
- 3) I see you have a problem. Can I help?
- 4) You clearly have a problem. Here are some solutions.
- 5) You definitely have problems. This is how you should solve them.
- 6) Solve your problem this way or action will be taken against you.
- 7) Your problem will be solved like this, however much you protest.

Usually it will be best to start with 1). If that fails, try 2) and so on. 6) and 7) should never be used; there are always alternatives. Here are three case studies to illustrate various levels of approach.



Lorena stoves were developed in highland Guatemala in 1976-7, initiated by a request from a peasant who was suffering from excess smoke in her kitchen. The primary development took place at Estacion Choqui in six months on a total budget of under \$1000 for salaries, tools and materials. At the end of that time the stoves were working well enough that broadscale promotion could be started. Although they were mainly developed by foreign technicians, if there had not been critical input from locals (who usually get no credit for their effort) the program would almost certainly never have got off the ground.

The project was initiated by a peasant woman who had real problems and knew what they were. When she saw a drawing of a stove in a visitor's notebook, she immediately recognized it as having value to her personally; "Is that a stove? Would it take smoke out of my kitchen? Can you build me one?"

The prototype never worked. It had been copied from stoves in India and the instructions were to build it of pure clay. Clay stoves crack badly unless they are really thin, so sand was added to the mix, first 30%, then 50%, finally in some cases up to 80%.

Once a non-cracking mix was established, the stoves needed refinement to suit local needs. The changes were of two separate types, physical and social. The physical changes were in general well thought out by the foreign developers. There were some exceptions when changes were made without taking the culture into account. The social changes on the other hand were dealt with badly until locals were involved.

First, some examples of physical developments:

In the Guatemalan highlands most of the population lives at 1500 to 3000 meters. Wood is scarce, so the poorest people supplement it with wastes such as bark, straw and corncobs, all of which burn really badly in open fires at high altitudes, due to lack of oxygen. The stoves, by enclosing the fire and directing the draft, make it possible to utilize these wastes.

Most families use several pots, cooking corn, beans, sauces and coffee for the same meal. They use several pots simultaneously, together with a wide earthenware hotplate for cooking tortillas, the mainstay of the diet. Any stove capable of utilizing waste heat from the first pot to cook or warm additional food will save fuel. Thus, Lorena stoves grew larger to accommodate the several pots used together.

Even with the physical problems partly solved, the stove needed adaptation to suit the local culture. Here is an example:

As cooking is usually done at ground level, several sociologists and knowledgeable friends suggested that we take care to conform with local custom and build stoves low to the ground.

"Demonstrations of these stoves were met with polite attention but without enthusiasm. Finally one woman scolded us: 'What kind of fools do you take us for? We know perfectly well how high a real cookstove is. Why are you building these insulting, floor-level, undignified cookstoves?' Feeling rather foolish, we immediately began building stoves 75-90 cms (30-36 inches) high. They were instantly recognized by the women to be stoves worthy of the name and attracted great interest."<sup>3</sup>

As Lorenas became more commonly used in the community, many adaptations were worked out by both the users and promoters, including for instance changing the metal can water heater for a ceramic jar because the metal rusts out over time. A list of these changes appears on page 109.

Early work on Lorenas started at about level 4 (You clearly have a problem. Here are some solutions.), see chart, page 41 then progressed to level 2 when it became clear that the people would not accept it at level 4. Had local people been closely involved from the beginning, instead of consulting only foreign "experts", stoves

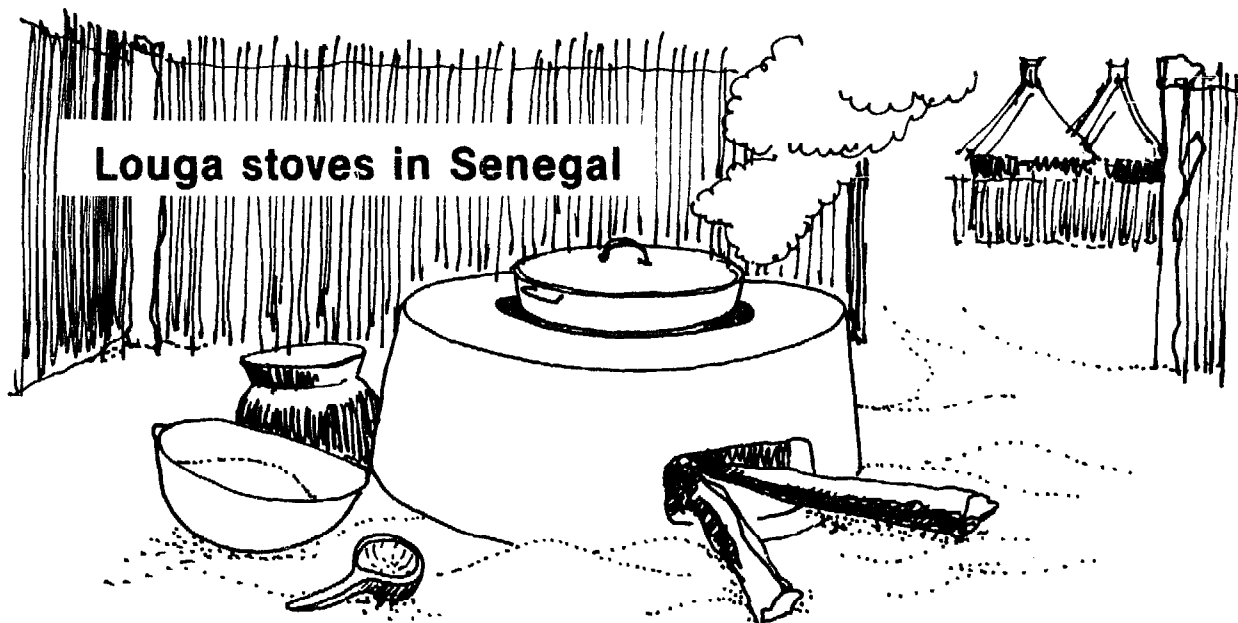

In north and central Senegal many families normally cook outdoors on a single fire supporting only one pot. The commonest food is a boiled grain with sauce, both of which are cooked consecutively in the single pot. Fuel is mainly firewood, 1 to 1 1/2 meters long, with dung and some millet stalks used seasonally.

First attempts at a stove for rural Senegal copied Guatemalan Lorena types, but it was clear to the developers that these were merely variations of a stove developed for another culture far away. The Louga stove by contrast, was developed in a unique way, with villagers in response to their own problems:

"They were already keenly aware of the amounts of wood they were using because of the energy survey being done in the village by the Peace Corps.

"During an informal evening's discussion we brought up the increasing wood scarcity. We all talked about that and women mentioned ways they used to reduce wood consumption: lids, windbreaks, putting embers out with sand. We talked about how fire heats a pot, where that heat goes, how it is lost around the sides of a fire, while making an analogy with the small lantern that was lighting the tiny hut where the fifteen of us were gathered.

"The men and women said 'Yes, we lose a lot of heat around the sides of the fire.' Again they chatted about windbreaks, their problems.

"At this point we passed around fired balls of lorena... 'Where did you get this?'... 'Where did it come from?'... 'Maybe we can make something with this.'

"From there, they came up with the modified windbreak based on the ideas that:

- 1) Heat radiates in all directions from an open fire like light from a lantern.
- 2) Wind blows heat away.
- 3) A pot loses heat around its sides and top.

"Basically what they came up with was a pot surrounded by lorena walls, a crude M3\*.... from their idea we suggested an entrance for wood and some technical points like spacing around the pot, thickness of walls. But it's their stove now."<sup>4</sup>

In some ways, development approached the ideal, levels 2) and 1) (chart, page 41), where local people were involved from the very beginning. However, dissemination of the Louga stove is now being set up at a national level. It is unfortunately still too soon to evaluate how well Louga-type stoves will spread, but initial acceptance has been enthusiastic.

This case should be compared with case studies of the Lorena and Nouna stoves, which both started with less local input.

\* This became the Louga stove.



## Nouna stoves in Upper Volta

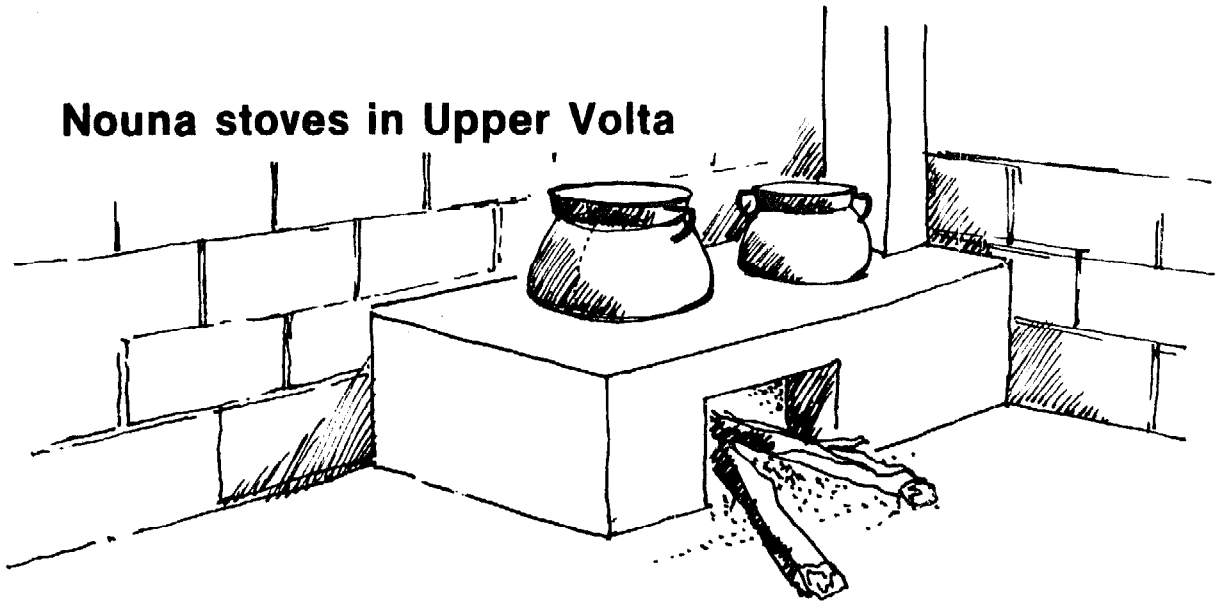

The Nouna stove was developed in Chad by a German volunteer who became aware that many women suffer from the smoke in their kitchens. As a model she used a stove she had seen in Europe as a child. She began working with a local mason to create a 2-hole stove with a long fire chamber and a chimney to allow the smoke to escape.

While the shape closely resembled the stoves of her childhood, she adapted the height to local cooking preferences and used adobe blocks and mud mortar, the most commonly available building materials.

When the volunteer was transferred to Nouna, Upper Volta, to work as a nurse, she continued her stove experiments on the side. She hired a local mason and taught him how to build the stove. A few women friends agreed to try it in their homes and found it to work well for local cooking needs. The word spread rapidly in the town, and she began to charge a fee for materials and construction. This became especially important after she and the mason decided to substitute fired bricks, mortar and concrete for the adobe, to make a stronger and more durable stove.

So far the approach had been at level 4 (chart, page 41). She was promoting the stoves, using friends and acquaintances as avenues of publicity. Her success in the town is not only due to the fact that the stoves were seen as an improvement on traditional cooking methods, but also that she had become respected and well known for the work she had been doing as a nurse.

By 1978 a German development agency began funding the project. A demonstration center has been built in the capital, and publicity campaigns have been started in the media.

Three or four different models, differently priced, were available by Spring 1980. Customers chose stoves at the demonstration center and had them built in their homes by a team of masons. Relations with the national government and international aid organizations were good; in fact many of the customers were government employees and their wives. Over 1000 stoves had been constructed in Upper Volta by mid 1980. The project had established itself at level 5.

- \* There is little flexibility to accommodate individual needs. Stove masons have become "experts" who sometimes assume they know better than the cook what she really needs.
- \* Most local people are not building their own stoves because construction relies on imported or scarce materials such as brick or cement. This periodically raises the price of stoves and draws capital out of the area.
- \* The cheaper original adobe models are not currently being built, which discriminates against poor people.
- \* There is limited opportunity for feedback from users, and no provisions for including such information in future stove designs.

Unless parallel models and new ways of development and dissemination are instituted, the limited market for Nouna stoves will have been saturated long before a significant reduction in wood consumption is achieved.

## **Stove development: Where and when to start**

There is always a temptation to try to solve problems from a comfortable vantage point for thinking out answers: your desk, the air-conditioned office, your home. All of these will be distant from the problem. The capital city is usually not representative of the country in general. However tempting it might be to work in comfort, try to go where the problems are immediate, in villages and the big urban squatter settlements, and live with the people you are working with.

Wherever you are working, first assess what you do best that will be helpful there; it may have nothing to do with stoves, but it will help you to gain trust and respect, and to establish yourself as a person with something to offer. Only when you have the respect of the community can you expect them to take your ideas seriously.

Where? Any stove development program should begin not only where the need is greatest, but where it stands the highest possible chance of success. Any of these factors will help - start where:

- \* fuel supplies are rapidly and dramatically diminishing,
- \* people are open to new ideas,
- \* there have been successful introductions of other simple technologies, and few failures,

- \* the people have enthusiasm and enough time to make, or enough money to buy their own stoves; if people are without hope the scheme may fail,
- \* rapport is good between the community and a well-respected woman extension worker,
- \* men and women are used to working together; in most places men are the builders and women the cooks, so cooperative efforts will be needed.

**When?** The dry season is the best time to start, especially immediately following the harvest, when people have plenty of free time. Roads are in good condition and travel is easier. For mud or sand/clay stoves, drying would be fastest in the dry season.

## **Developing prototypes with local people**

In order to develop a prototype model, ideally you would first build on knowledge and skills people already have. Your second move is to sit down with the cooks and solicit their ideas. Third, you may want to build a locally-responsive stove in a less visible place until you have a model you can comfortably put on public display.

1) Wherever possible, build on techniques people already have. Search out local stoves and other tricks for conserving fuel. These could include wind-shields, devices for stabilizing pots such as metal tripods, and terra cotta fire containers. In the Sahel, women douse the embers with sand, using the charcoal created to cook later meals; in Northern India, small children are delegated the tedious task of continuously feeding the fire with tiny twigs; Guatemalans build racks over the stove for drying firewood. In certain areas, stoves in some form may already exist.

By emphasizing the gains already made, you can focus on the fuel question, give credit for local inventiveness and prepare people to take the next step. If there are local stoves of any kind, they are probably well adapted to local conditions, though it may be easy to make simple improvements. Explain your logic carefully so that people understand the reasons for the changes. Often this will spark ideas from the people themselves, which may emerge as cautious suggestions, or more likely in modifications of stoves they build. Poor people in developing countries are accustomed to having their ideas devalued by outsiders, so be sensitive to innuendos and subtle hints which they may express without force or conviction. Development workers and technical specialists, however good their intentions, often fail by not knowing how to listen to the ideas of humble folks. The peasant may feel overawed by strangers, be uncomfortable with an unfamiliar language, or be conditioned to believe that as a person without formal schooling he or she has no worthwhile contribution to make.

Although in your own experience they may seem irrelevant, be especially careful to consider seriously even the most unlikely suggestions. The life experience of folks from totally different backgrounds enables them to notice things you will certainly miss. In this way, between you, new ways of solving problems will emerge which would be unattainable to either of you in isolation.

2) If there are no native stoves on which to improve, sit down informally and spend time discussing the fuel situation with cooks or whoever has to provide the fuel. Encourage solutions which people may already have thought out, things they have seen in other places... "Once when I went to Oaxaca to the market there was a woman cooking tortillas on a little metal box..." You could encourage them to try out their own ideas: "Why don't you build one? We could use it for the big fiesta on Sunday, but it might work better at this altitude if you build the place for the fire a bit bigger..." Alternatively you can offer your own experience, telling stories from other places; travellers tales are usually popular... "I saw people in China with a stove built of earth that worked really well..." Or, "A teacher in my own country told me that you use much less wood if you keep the lid on the pot". The Louga stove was developed in a Senegalese village in this way.

The conversation may open up ideas of other ways to solve the problem, changing your own fixed notion of a stove that would improve things. Villagers may see solutions in terms of planting more firewood species, stopping forest fires, switching to more uncooked foods, cooperative cooking or insulation of pan lids. Be open to their ideas, they may be right. In Nepal for instance, the terrible erosion caused by firewood collection is now so bad that a good case can be made for subsidizing cheap efficient kerosene stoves and using foreign aid to temporarily cut the price of kerosene. The price of kerosene could then be allowed to gradually rise, as firewood plantations began producing. This was suggested by a Nepalese peasant as a stopgap measure to allow the new firewood plantations to take hold. Although on first sight this is a questionable suggestion, seen from his viewpoint it makes a lot of sense.

As ideas start to solidify, try making small models of the kinds of stoves you are discussing, out of clay, paper or thin metal. Limit your suggestions - remember that each idea that comes from the people themselves is probably worth several of yours.

Finally, if there are already specimen stoves in your area, go with people to see them. Most people love an outing; they will then be able to discuss something tangible.

When ideas seem concrete enough, offer help in building a prototype. Try to involve as many people's ideas as possible when you work with them on developing their prototype stove. (Be careful, your assistance will be better respected if you already have experience. Spend a few days working alone with the materials to gain some insight.)

Do some simple fuel conservation tests with people to make sure it really does save wood; use your experience to suggest whether there might be more economical ways of using it. (See Chapter VI.)

3) If working directly with local people is impossible, a third and less desirable tactic is to develop a locally-responsive stove away from public view, with help from selected locals. This could be in the backyard of your house, in a school or experimental facility. The Lorena stove was developed very much this way. One advantage of this method is that you can make mistakes on prototypes without becoming a laughing stock and losing credibility for the whole project.

You could try either to evolve a design yourself from your understanding of the problem, or to take a recipe-book approach, modifying a design already proven elsewhere. If you build from a set of instructions, follow them closely the first time to become accustomed to the technique, then try modifications to suit local conditions.

Beware of using unmodified designs from other places. They may be effective within a single culture, for instance within a group of villages in the same region, or in several large cities which have close similarities. Yet it is highly unlikely, for instance, that an unmodified design from rural Guatemala would be appropriate in an Asian city.

Here are some criteria for design. You will certainly want to add your own; use them as a basic list.

- \* Design only things which can be locally produced either by householders or by artisans, using existing local skills.
- \* They should be built chiefly of local materials to prevent capital flowing out of the immediate community, and to cut down on transport difficulties.
- \* Materials should cost as little as possible.
- \* Construction should require no special tools or difficult techniques (though local people may have a wide range of unexpected skills; look around).
- \* Stoves should be designed so that it is impossible to use them in a way that consumes more fuel than an open fire.
- \* Rather than a single fixed design, there should be a set of principles which householders can use to choose a stove that suits their specific needs.

Beware of your own preconceptions of what a stove should look like. You are designing a method for using less fuel.

It is essential to involve local expertise; ask a nearby friend/cook to work with you and criticize. Encourage selected people to visit, particularly masons and metalworkers, to see whether they anticipate construction problems. If local artisans in related fields are available, ask them to work with you. You may have to pay them, or they may be enthused enough about the stove to volunteer. Try to have it working when visitors come; encourage people to cook on it - a cold stove is difficult for anyone to assess. Later, when you are satisfied with it, ask whoever cooks for you to spend a week using it or hire local women to cook on it. During early work on Lorena stoves local women were paid to spend several days cooking all of their family's meals on a whole range of different models. They were observed and asked to be openly critical of performance.

## Refinements through checkups

Conventional marketing theory suggests that consumers are on their own once the product is paid for. Unless replacements can be made of either the whole product or defective parts, there is no profit seen in following the product into the user's home. In contrast, the Design by Evolution model (Fig. III-2) demands that a close relationship develop between "designer" and "user", to the point where it is not always possible to decide which is which. Further refinements of the design will come chiefly from users, if only because there are so many more of them than there are designers. The designer becomes much more a coordinator, collecting innovations and refinements and redistributing the ideas to whoever can make use of them.

In Guatemala, the Lorena stove in the first two years of promotion spawned a great number of adaptations. Here are a few which have gained widespread acceptance:

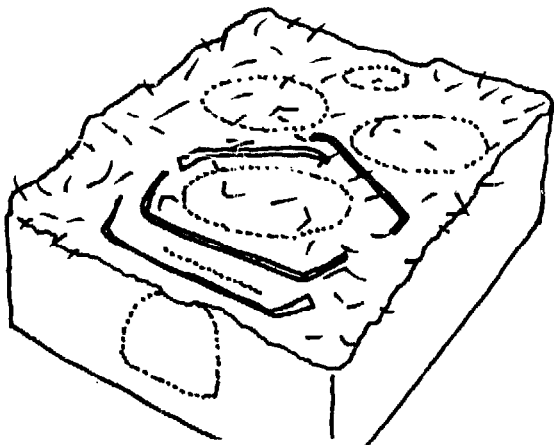

reinforcement using straw,  
pine needles, steel bars

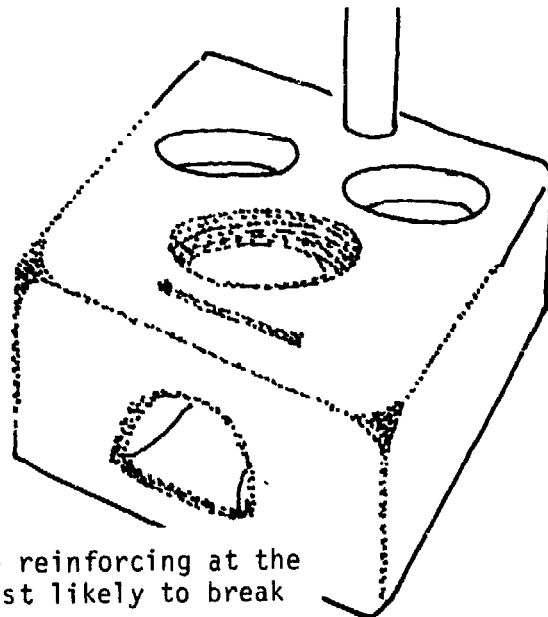

concrete reinforcing at the  
edges most likely to break

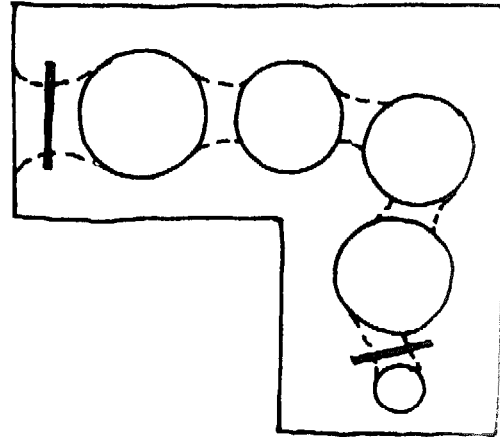
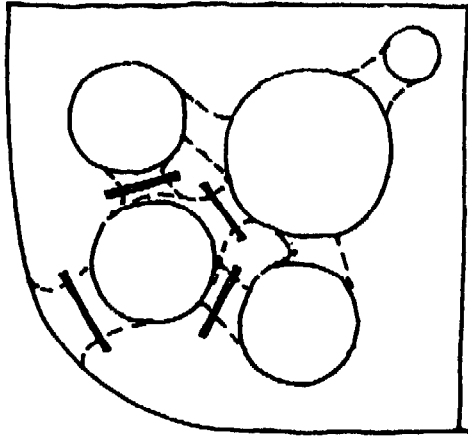

various unlikely shapes, including the Joyabaj 3-tunnel and L-shape

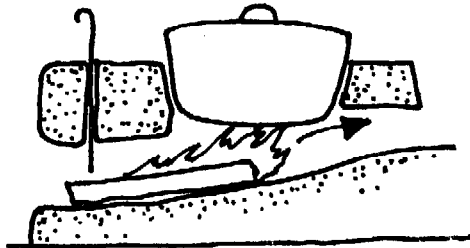

firebox rises to force flames across the pot bottom

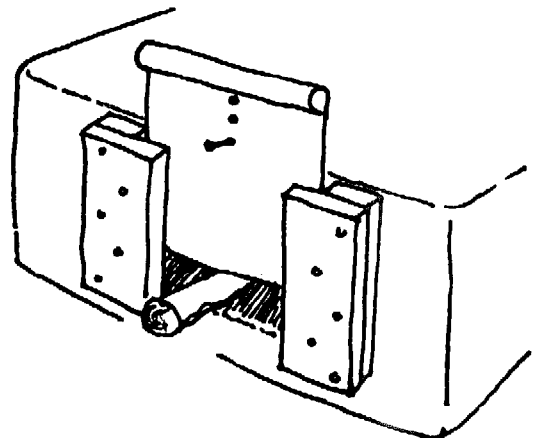

external damper door, wooden runners nailed on

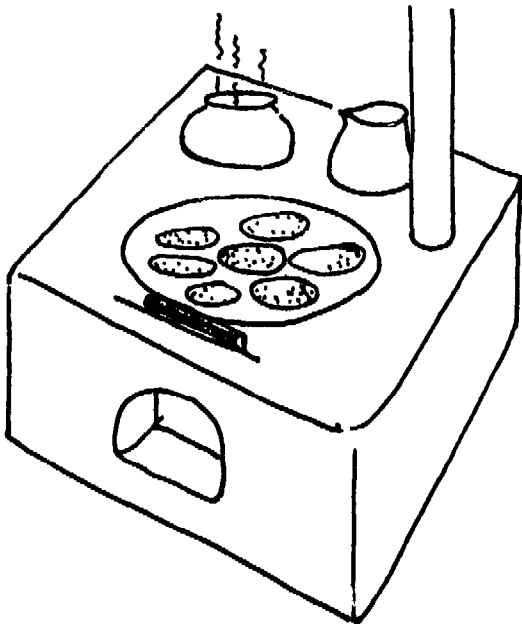

adaptations for 60 cm diameter hotplates

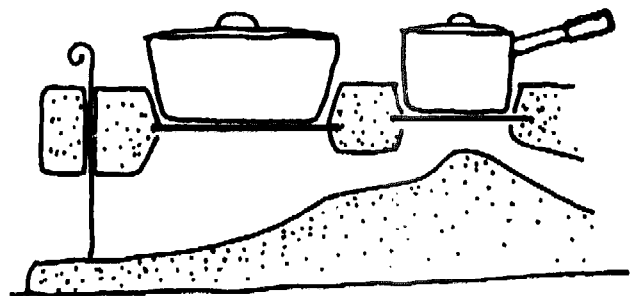

fixed metal hotplates



paint can hat on chimney

drying rack over the stove

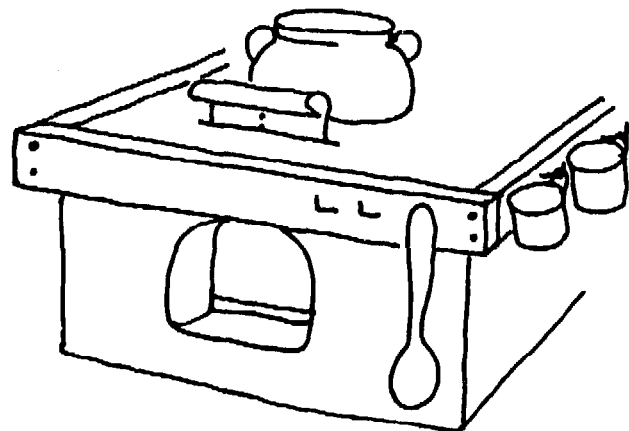

nailed-on wooden reinforcing with utensil hooks in it

Observations of stove use by follow-up teams also revealed defects which owners had found ways of circumventing; for instance, they found that on cold nights users would remove the front damper door to warm themselves: "...removing the firebox door in order to feel the warmth of the fire may detract from fuel savings, yet it may be just this adaptation which preserves the cooking place as the central gathering place in the Indian household."<sup>5</sup>

Checkups on stoves in use are as important in urban as in rural conditions though sometimes more difficult, particularly in the case of manufactured units sold through markets. In both country and city, investigators should look for:

- \* modifications and adaptations of the physical form of the stove which could be fed back to manufacturers,
- \* unanticipated uses which could be pointed out to other users,
- \* defects needing to be redesigned,
- \* fuel saving tricks to be circulated among other users,
- \* verification that each stove does in fact save fuel; users can be taught simple ways to check on fuel consumption (see Chapter VI).

Two phases of follow-up will do different things (see also Evaluation and Follow-up, Chapter IV).



1 month checkup: chiefly to assist the cook with any difficulties, but also to spot design faults.

6 month checkup: will be more useful to design modifications. The monitor can carry news of new ideas (a special cake recipe is always popular) and fuel-saving ideas. At this time look for second generation stoves, i.e., copies of the original made by neighbors, and assess what changes have been made. Are the changes beneficial or do they defeat the purpose of the whole thing?

In addition to field visits, there should be an accessible center or person who can be consulted by stove users and to whom they can make comments, complaints and suggestions for improvements in product and teaching (see Setting Up Stove Centers, Chapter IV).



## THE STOVE THAT BROKE A TOOTH

The importance of follow-up work and involving native people is exemplified by our first documented failure!

It occurred in Guatemala when we gave the first Lorena stove course away from the experimental station (Estacion Experimental Choqui, now called ICADA). The village of Patzicia had been destroyed by the 1976 earthquake. Two of us went there and we were received with enthusiasm and respect. Though the course had only twelve official participants, more than 200 people watched. The course ran extremely well. Two stoves were completed, both meticulously finished, giving them a polished marble-like appearance. Ceremoniously we lit small fires in each stove to demonstrate how they worked. The crowd was astonished to see smoke coming out the chimney. The townspeople seemed enthusiastic.

Six months later I returned to the village as planned. The family in whose home I had stayed during the stove course invited me to lunch. While waiting I browsed through the village. To my dismay I discovered that the two stoves built six months earlier had been destroyed, and not a single new stove had been built.

During lunch not a word was mentioned about stoves. I suspected the topic was being avoided out of respect for me as a visitor and a foreigner. As I prepared to leave I casually asked, "What happened to the stoves?" Their response was evasive - they had destroyed the stoves to make room for a new kitchen in which to build a new stove. That did not sound true. Something had happened to cause them to reject the stoves. What?

I was sensitive to their politeness. (Part of the culture is unwillingness to disappoint or insult a guest.) But I could not leave without some answers.

Instead of catching the first bus home I walked through the village out into the countryside. There I met a middle-aged man returning from the fields. As we talked the subject turned to cooking. He had heard about the stoves. "They are no good," he said. "They make tortillas with pebbles in them. Don Panteleon broke his tooth eating a tortilla made on the stove. It breaks teeth."

Now I knew why the stoves were rejected. But what had gone wrong?

The stoves require soil which contains a clay that fires. The soil around the village was a rich loam - high in silt with very little clay. Had we involved villagers in the project, we would have first talked with the local people about the quality of the area's soil. The village people knew their soil was not good for making clay bricks, that it would not fire. In the cooking process, pieces of the stove around the pot had crumbled into the food. These were the troublesome stones.

The experience with the stove that broke a tooth taught us two valuable lessons. The first was to involve local people in choosing materials and developing the stove for their village. The second was the importance of follow-up. Had I not returned, we might have continued the same error in other communities.

From a story by Laurence Jacobs

# Chapter IV

## PROMOTION and DISSEMINATION

Development and dissemination are not sequential but overlap; information on the benefits of improved cookstoves can be distributed well in advance of having perfect models for display. As soon as effective designs start to appear, dispersal systems can be started. This is how promotion, dissemination and design/development might dovetail together:

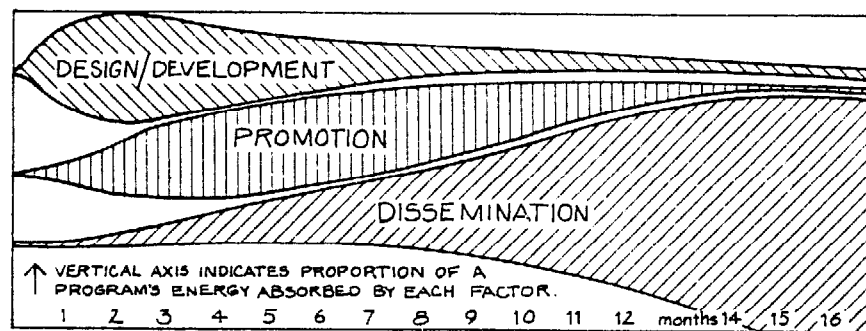

If improved stoves are to make a major impact on fuel demand, work will need to be immediate and broadscale. At current deforestation rates, it may be too late to merely seed a good idea, then go away, leaving it to grow naturally in its own time. Stove projects must be extensive, well-organized and adequately funded. Yet if heavy-handed methods are used for distributing or developing this technology, it may never be accepted. Involvement of the people is essential to effective dissemination.

There are as many ways of going about dissemination as there are cultures, but here are the points covered in this chapter:

- A. RAISING PUBLIC AWARENESS
- B. SETTING UP AN APPROACH FOR DISSEMINATION
- C. WHERE TO GO FOR HELP IN DISTRIBUTING INFORMATION
- D. PROMOTION: IDEAS TO TRY
- E. WHERE AND HOW TO START DISSEMINATION
- F. SETTING UP STOVE CENTERS
- G. TRAINING
- H. INVOLVING WOMEN
- J. EVALUATION AND FOLLOW-UP
- K. USE TRAINING
- L. SPONSORING AND ADVISING SMALL BUSINESSES

## A. Raising public awareness

Before starting stove promotion, there are two types of publicity that can be undertaken:

- 1) Alerting the general public to the fuel shortage and its effects on the ecology and economy of the region. This information should be based on local conditions, not borrowed from another country.
- 2) People should know that solutions are possible, not only at some vague bureaucratic level, but for individuals personally; furthermore, that they can effect these solutions themselves by practicing deliberate fuel economy and by providing themselves with stoves. They need to know that stoves exist which will substantially decrease their fuel consumption, are convenient to use and are easily built or cheaply bought.

Publicity on both points can be made simultaneously, using the full power of whatever communication systems are popular and widespread in the region, including both native news carriers and modern mass media. Native communication systems are often effective at reaching into every corner of society. T.V. and newspapers sometimes reach only an educated elite.

Stoves could be set up in conspicuous and prestigious locations such as the homes of top government officials. In at least one African nation there are plans for a demonstration stove and photo display in the lobby of the National Assembly. More down-to-earth communications include posters, radio, comic books, and public demonstrations at clinics, fairs, market places and mass gatherings, where stoves can be demonstrated in use, cooking food or heating water.



STOVES CAN ATTRACT GREAT ATTENTION AT LOCAL FAIRS

## B. Setting up an approach for dissemination

Supply and demand theory might suggest that if the need is great enough, carefully placed stoves in a few key locations would ensure rapid spread of the news through relatives and friends. It would then be necessary only to develop a good model for owner-builders, introduce the concept at a few influential places and teach some people how to build them; then go away and leave dissemination to pursue a natural course.

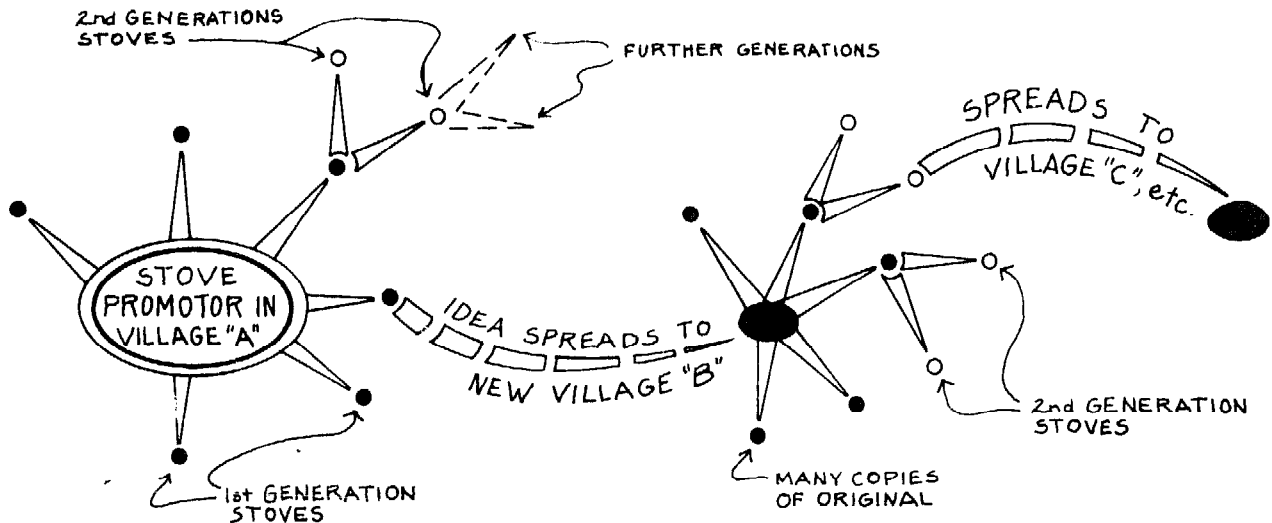

However, rural regions may in some cases be so dependent on Big City-village communication paths (rather than inter-village) that natural spread of ideas is now really slow. It is possible, too, that peoples' experience and common sense have become so dislodged by commercialism that only centralized promotion of a more spectacular kind will impress them. People may look down on something developed in another village, preferring instead shiny commercial products. A lack of pride in rural enterprise in general exists in some developing countries.

The stimuli that affect acceptance of technical innovations are very poorly understood. This is true even at the level of the consumer marketing industry (e.g., the failure of the Ford Edsel, despite millions of dollars spent on consumer research), and much more so when no economic gain is involved. Singer's stove failed to become widespread in Indonesia though it seems to have been a sound design. The Hyderabad Chula, introduced 25 years ago in a country of acute firewood shortages, has never gained widespread acceptance.

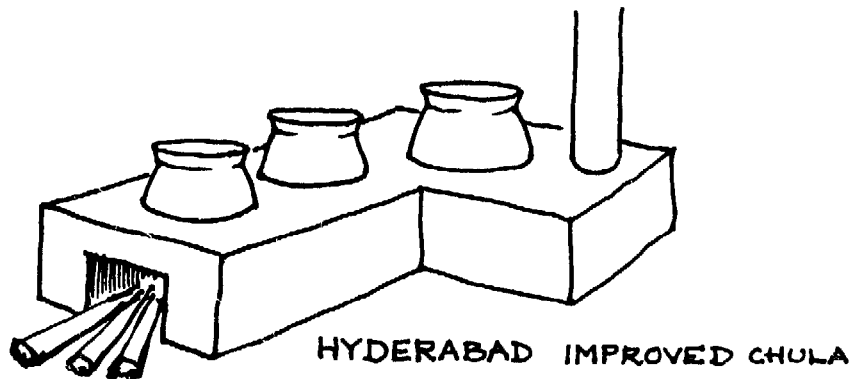

General principles of technology transfer and sensitivity to cultural values are still poorly understood. The success of any one introduction method or any particular design can hardly be predicted. No two informants agree with each other. Some advise working through religious leaders. In Senegal, which is 80% Moslem, they said, "If you convince the marabouts, they only have to order it, and in a few weeks everyone in the country will be building a stove." Others suggest working through rural health clinics, using radio propaganda, or building demonstration models in the foyers of the main government buildings. Hence, it makes sense to try as many approaches as possible, simultaneously.

We are, it seems, in the position of a gardener who wishes to grow flowers all over a big piece of poor land. He knows that watering will be irregular and that conditions differ all over his plot: soils change, the trees throw shadows in places, there are places flooded, parts very steep. He knows his personal energies are limited and that the soil is poor. Any single species might be lost completely.

So he takes packets of all the most promising seeds and broadcasts them randomly all over. He waters where he can, weeds whenever there is time and throws a little compost here and there.

Some flowers come up in the sunshine, others in the shade, some eventually die from drought before flowering. He stands to lose order, control and any assurance of particular combinations. What he gains is a better chance of some sort of flowers, scattered irregularly but covering most conditions. Further, it is likely that the successful survivors will hybridize, throwing up a second generation containing undreamed of varieties suited uniquely to the particular conditions that prevail.

Our knowledge of conditions in most poor countries is similar to the gardener's. We know that there is great diversity, and understand some of its limits. Dissemination should be tackled initially in as many differing ways as possible, aiming always at village-level word-of-mouth distribution as the desired end result, but encouraging both owner-builders and the emergence of a new class of professional stove builders to achieve this goal.

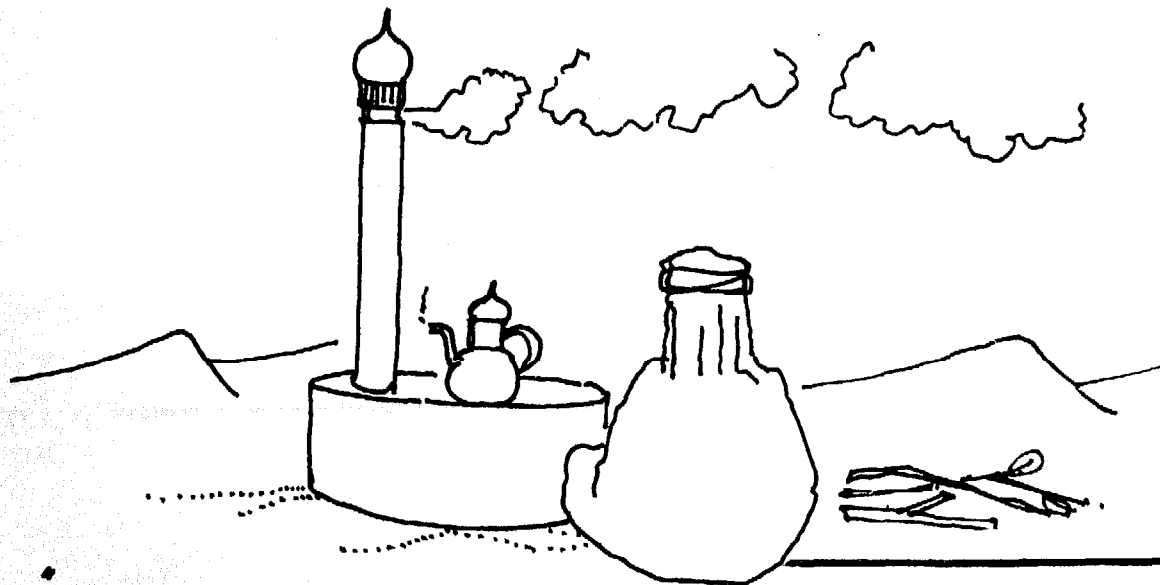

...IF YOU CONVINCED THE MARABOUTS".....

## C. Where to go for help in distributing information

It is often helpful to collaborate with other institutions in spreading information. First investigate which groups might stand to benefit from the introduction of stoves and in whose programs they would fit best. For example: an interesting experiment is ongoing in the Guatemalan highlands using Paolo Freire's principles to teach literacy, mathematics, nutrition, measurement, etc. all through the medium of improved stoves. Educacion Extraescolar, a branch of the Guatemalan government, is supervising the project.

Established groups may have experienced field workers who will be invaluable to you. These groups may also provide a structure to begin with. They may have experience with stove programs in other countries or may already be planning to promote stoves in your region. Here is a list of organizations you might contact:

- \* Health clinics - they may have particular interest in keeping smoke out of kitchens,
- \* Women's organizations (mothers' clubs, women's cooperatives, etc.),
- \* Indigenous religious institutions,
- \* Foreign religious groups such as agricultural missionaries,
- \* Literacy campaigns,
- \* International relief organizations - there are dozens, but CARE, SCF, Oxfam and World Neighbors have all contributed to stove programs,
- \* The prevailing political party - in communist countries the Communist Party may well help, and in countries like Mexico, with a single political party, the network already established may be useful,
- \* Foreign volunteer organizations: Peace Corps, VSO, IVS, SATA, CUSO, and dozens more,
- \* Other organizations such as civic groups, agricultural cooperatives, school lunch programs, etc.

## D. Promotion: Ideas to try

Investigations could be made of the motives that prompt people to install stoves or inhibit their doing so. To some degree social status is involved, "being first on your block;" "keeping up with the Jones's;" this should be studied further.

### Trickle down effect

Standard marketing theory suggests that innovations normally spread through society by the poor emulating those who are slightly richer. The marketing industry in poor countries capitalizes on this trend to sell consumer goods - transistor radios, bicycles and fashion goods are all examples. Poor people, by copying the visible ways of the rich, somehow hope to absorb some of the qualities of affluence.

If this is an accurate model, the most potent proof to poor people of the value of stoves would be to see rich, successful and respected people using them. (Conversely, the rich usually reject anything that might identify them as having peasant origins. There is far less possibility of fuel conserving stoves spreading from poor to rich than vice-versa.)

Attention should be directed to introduction of stoves into the homes of the urban middle class, village chiefs and religious and political leaders. It could be made known, with attendant pomp and ceremony, press conferences and radio coverage, that the president himself has adopted a fuel-conserving stove. Middle class stoves could be tile surfaced or painted bright colors (Lorena stoves in the USA and Guatemala have decorative paint work or tiled surfaces), and could include permanent hot water reservoirs (this has been very popular in Guatemala). The middle class models can be skillfully crafted, and perhaps be more expensive, but should incorporate fuel saving principles that are difficult to lose when people make copies, even from memory. The principles of why they save fuel should be reiterated in every explanation given.

### Fun

One aspect of introducing technology is often overlooked; that people need "fun" in their lives. In general, people enjoy color, music, ceremonies, parties and rituals. Perhaps it is more important to the cook that the stove is enjoyable to use than that it saves wood. Maybe introductions into new areas should be made with great unveiling ceremonies, celebrations and parties. It is possible that artifacts introduced in an atmosphere of music and happiness (Coca Cola for example) are accepted better than strictly utilitarian objects, however functional they may be.



## News media, traditional and modern

Take advantage of the news media, both traditional and modern. In every traditional culture there exist means of conveying important information. In Africa it is drum language; beacons systems and smoke signals have been used for thousands of years. Village meetings, the village well or clothes washing place, traders and markets are still used widely to spread news. Use could be made of these systems to disseminate stove information.

Transistor radios are popular throughout many poor countries; broadcasts reach a broad population and are often transmitted in local dialects. People tend to tune out advertisements and tune into news programs. Stoves make good news stories; e.g., interviews might be arranged with cooks from important families who have a stove, telling how well it works, that it makes delicious sauces, that it is more comfortable to cook on than an open fire, and that it has greatly reduced their firewood expenses (or time gathering wood).

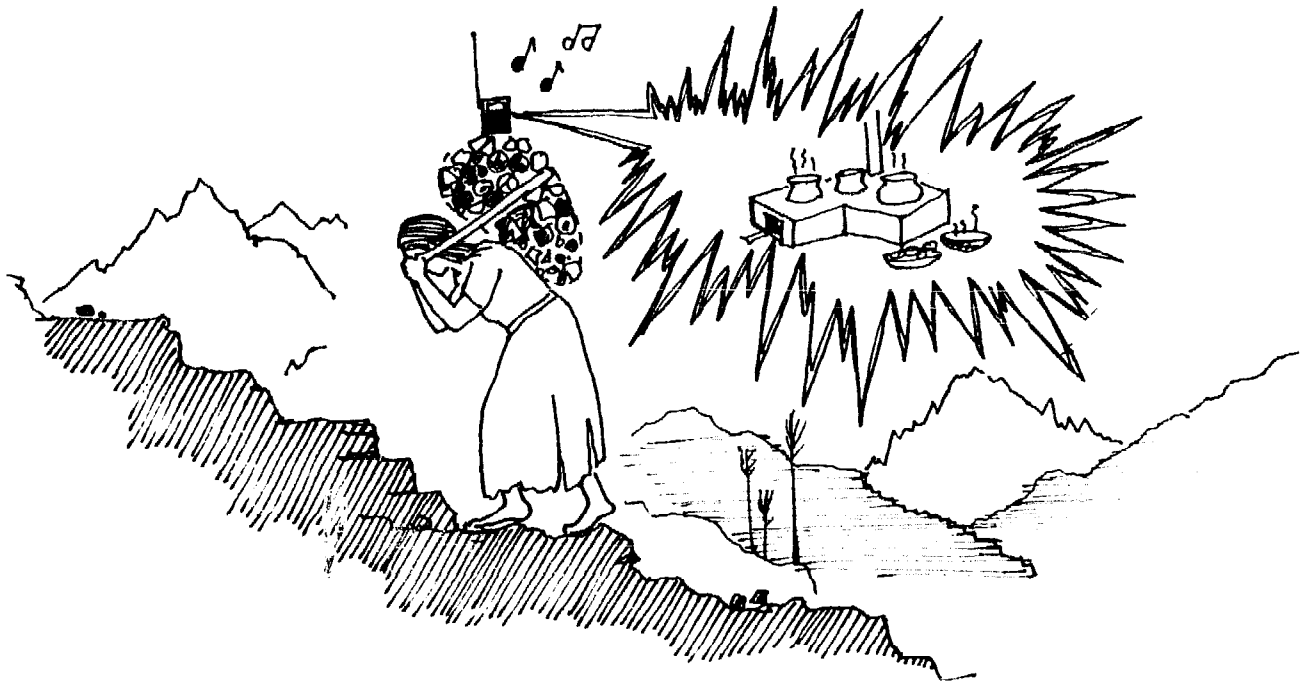

Television and newspapers usually reach only the better educated and relatively wealthy people. This is a limited but influential group, consisting of government officials, village leaders, business men, students, and development workers from different international, religious or other agencies. Their example is likely to be followed by poorer people, and their support and understanding is essential.

In some countries, good use could be made of educational T.V. Perhaps a weekly program on the fuel crisis could be produced, along with step-by-step instructions on how to build, maintain and cook on your own stove. Programs could be aimed at stove promoters and interested householders, using local people to describe the process, or perhaps showing animated cartoons. Involve local people, especially women, in designing these educational programs.

Take care not to let the media make exaggerated claims for stoves. Be cautious in your claims. If you suspect that a particular model will need to be rebuilt every two or three years, promote it as a stove "that will last a whole year without rebuilding". Set the expectation that it will at least need thorough inspection each year, and maybe some repair work.

In Mexico, poster campaigns are used to publicize information on agriculture, health, family planning and other public issues. Pictorial posters reach everybody, rich and poor, urban and rural, literate and illiterate. A well designed poster will attract attention, deliver a message and sell an idea. At a small capital outlay, hundreds of thousands of colorful posters could be printed for distribution to village leaders, cooperatives, stores, clinics, etc. all over the country.

The design of such posters needs to be carefully adjusted to local norms of decency and interest, and should be understandable by illiterate people. Recent research on posters for illiterates indicates that cut-out photographic images are recognized more easily than most drawings. The more abstract imagery that many graphic designers favor is especially hard to understand.

In countries where comic books are read, a skillfully written story about the advantages of stoves might be a rapid way to spread the general idea of stoves. Again in Mexico, the "fotonovela" format (cheap comic book with photographs in place of drawings) has been used to carry social messages about the importance of birth control, not using drugs, etc. More specific instructions on how to construct stoves could maybe use this type of format. Often, the distribution and preparation of such booklets is already well organized; a stove program could plug into the existing system.

Health clinics are a good way to reach women. Sometimes there are classes in nutrition and cooking, kitchen hygiene, etc.; demonstration stoves could easily be used for these classes. Trained health workers will see the advantages of stoves and be keen to promote them; many of them know the local culture and people well and sometimes speak local languages.

In China, drama has been extensively used to carry social messages. If drama, dance, or song is an important part of the local culture, it may be suitable for carrying really graphic messages about the fuel crisis and stoves.

## **Stove-building contests**

National, regional or local cookstove competitions would generate ideas, encourage local inventiveness, stimulate awareness of the fuel problem, and popularize the concept of fuel conserving cookstoves. Stoves could be judged on:

- \* firewood savings,
- \* low cost,
- \* suitability to the cook's needs,
- \* ease of use,

- \* chimney design,
- \* aesthetics,
- \* types of materials used (availability, cost, innovativeness).

Competitions could be organized by a National Stove Committee, making use of local skills, right down to village level, to set up and adjudicate them. This would draw a wide sector of the population and involve ordinary people, educating them to the problems and potentials. Pots, pans, pressure cookers, utensils, tools or cash could be given as prizes. In some places civic awards, medals, honors or titles might be more appropriate.

### **Using status locations for early models**

A possible approach would be to build the first stoves in an area in places where their very position confers respectability and acceptance. In villages the house of the chief or a respected family, in cities the homes of high-ranking officials are good places to start. In one African country the President himself is intending to adopt improved cookstoves in his kitchen as an example.

In cultures where religion plays an important role, ask the local religious leader if he or she would like the first model in the area. Schoolhouses, local clinics, community meeting halls are all used and visited by large numbers of people, though in some cultures it will be hard to contact women this way. In Catholic countries the Parish House often has need for cooking facilities; stoves could be both demonstrated and sometimes monitored there. Nepal's improved stove program will build some of the first demonstrations in the homes of teachers, village notables and religious leaders, and in local schools.

### **Fairs and festivals**

In many traditional cultures, there are long-established seasonal fairs. These are times when people gather to trade goods and news, meet friends, eat, drink, dance and have fun. People look forward to them from year to year and talk about them for months afterwards. Fairs and large gatherings are good places to demonstrate stoves as the stove will then become associated in people's minds with the festivity and gaiety of the fair. There should always be something simple, tasty, and sweet cooking on the stove, preferably a delicacy that people can not at present prepare but that would be easy with a stove. It should be given away or sold at a low price. When pancakes were made at fairs in Guatemala, the pancakes became almost as big an attraction as the stove.

Stove exhibitions in Guatemala at local fairs attract thousands of people because:

- \* many people see the stove working,
- \* the stove is seen repeatedly at nearby fairs, and the following year when the fair returns to the same town,

- \* people who want stoves can sign up right there to have one built or to take a construction course,
- \* people become interested and enthusiastic upon seeing the enthusiasm of others, which attracts more people,
- \* skilled extension agents are present to answer questions and give demonstrations.

## Public cooking places

In most poor countries, it is common for food to be cooked at stalls in markets and on the street in full view of the public. Cooking is often done on inefficient and bothersome contraptions which are hot and smoky and irritating to eyes and lungs. If stallholders were supplied with well tested trial models, the new cook-stoves would likely be well-discussed and proudly displayed, especially to influential customers.

In Nepal, where 15,000 demonstration stoves are projected in the early '80's, many prototypes will be used in the tea houses which are found along every road and walking path. This way travellers who stop for tea will have the opportunity to closely examine a stove which will always be in use.

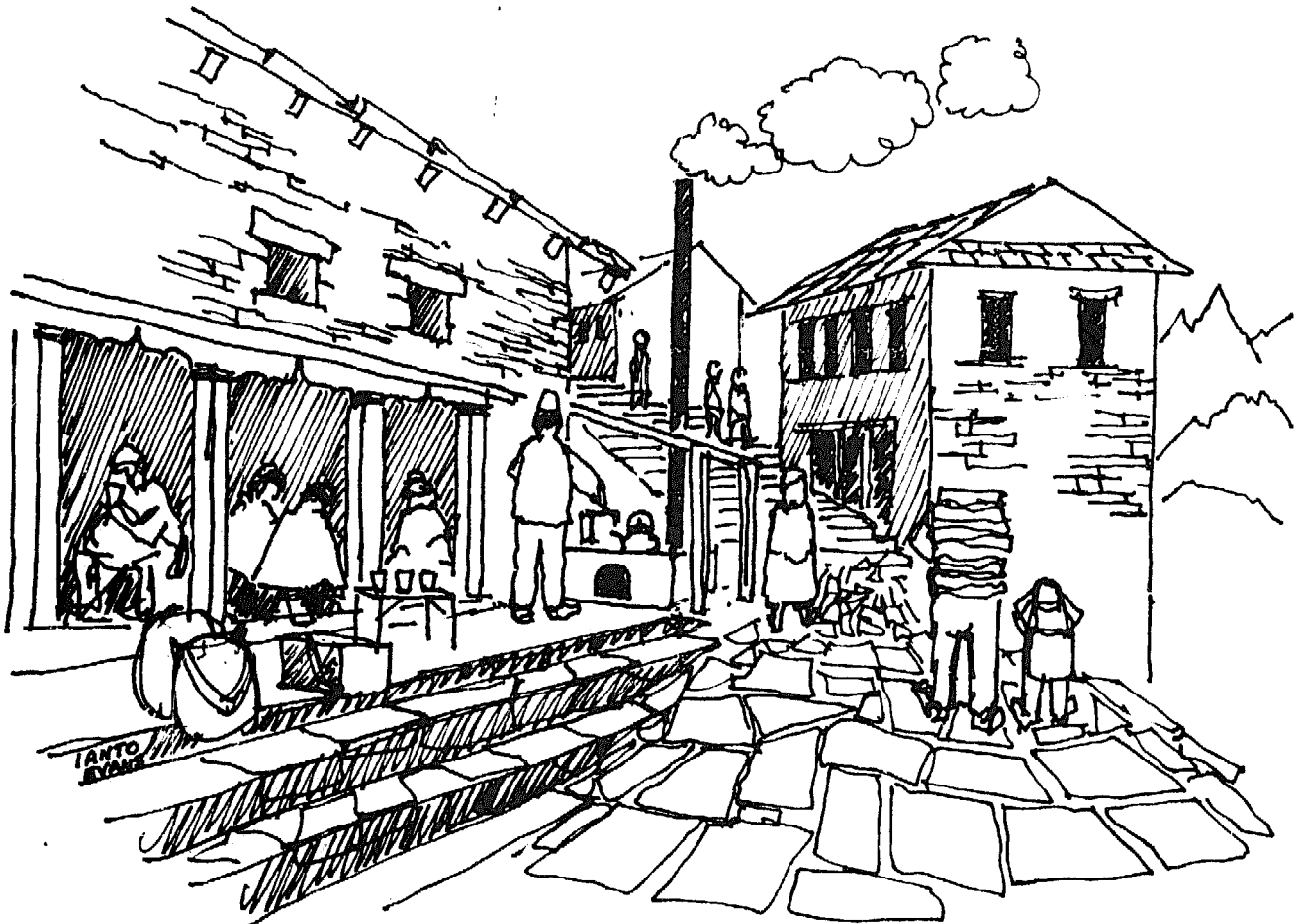

"IN NEPAL, PROTOTYPES WILL BE USED IN THE TEAHOUSES FOUND ALONG EVERY ROAD AND WALKING PATH"

## E. Where and how to start dissemination

When a general public interest in stoves has been established, further steps might follow this sequence:

Build demonstration models in key locations

in public places  
in homes of influential families

Training in construction

for householders and cooks  
for official stove promoters  
for professional stove builders

Use and maintenance training

follow-up courses  
1-month home checkup

Seek out new ideas

1-month home checkup  
6-month home checkup

Note that the follow-up sector occupies half the chart. Checkups are of major importance in dissemination (see page 74).

To raise the chances of success the first stove introductions in each region should be in carefully chosen places where, to use marketing jargon, "the market is softest," i.e., where conditions make it easiest (see Where and When to Start, Chapter III). Having achieved success in one place, it is then possible, in further introductions, to use that area as a demonstration of what may be done.

Try totally different approaches at first. In the earliest attempts at dissemination, a carefully controlled experiment might be generated, where two separate approaches can be studied simultaneously. For instance:

Approach 1: Slow, careful introduction of a few stoves by an extension worker in one village. No financial help, no outside specialists, no publicity, careful monitoring of:

- \* quality of fuel used,
- \* quantity of fuel used, before and after stoves,
- \* spread of stoves within the village, who built them and when,
- \* spread to other villages,

- \* how the stoves are used,
- \* any innovations or changes that develop with second generation and subsequent models,
- \* expressed shortcomings; ideas that villagers have to remedy them,
- \* sociocultural factors which inhibit or stimulate dissemination, acceptance and use.

Approach 2: In an area not in communication with the area used for Approach 1, but close enough to have good ethnic and cultural parallels (about 50 kms might be suitable, depending on geography and population spread), a government agency could recruit, train, and pay a 3-person mason team working within an easy day's travelling distance of their home base. In one village they might build stoves without charge for anyone who asks for one; in another, teach anyone who wants to learn how to build and maintain them; in a third, build stoves for a small fee. Monitoring should be standardized with Approach 1.

Several parallel trials of this kind, perhaps with minor variations, should be run as early as possible. Variants could be tried on systems of payment, one team earning a flat salary, another being paid a bonus on each stove in regular use in their territory after three months. A third could be paid salary for three months as a starter, after which they would earn only bonus. Results from these experiments would form the basis for any wider extension project.

A third system: Here is another system, perhaps more suited to areas where there are strong formal women's associations.

If this is to be a widespread introduction effort, there should be a regional program manager with experience in technical extension work. The manager could be male or female and would preferably be a national, though a foreign person with extensive experience of the region could be hired.

An extension team is formed. Suitable members could be the project manager, a technician in charge of training or testing, a female extension worker and a representative of the local women's group. The importance of women in the whole scope of extension work cannot be overemphasized.

Meetings to introduce the concept should be set up between the team and women, at a time when they have plenty of free time (the time after harvest for instance). The women should be consulted on whether local chiefs, civic dignitaries or husbands should be part of meetings or consulted at different stages. The local women's ideas and reactions should be recorded and discussed by the team after each meeting.

Women volunteers are selected to be official experimenters. They will be the first to receive stoves and will participate in evaluations as long as they have stoves. They may be paid in cash or in kind, or the cost of their stove may be reduced. Other incentive systems may work locally - titles, medals, trophies, photos in newspapers are all commonly used. Find out how society honors its important volunteers with rewards other than money.

Sometimes the women participants are involved in building their own stoves; more often the stoves are supplied. Before the stove is installed each woman is helped to learn methods of measuring wood consumption, usually by the simplest method - woodstack measurement.

Work with existing agencies: Government agencies, international organizations and local groups such as agricultural cooperatives should be encouraged to initiate their own stove dissemination programs and stove centers. Technical expertise should be made available to these different government and development agencies. They represent an important resource for dissemination; they have established extension services; their promoters are familiar with local problems and are known by the community.

Regular meetings of people from each agency should be held to exchange information and adaptations being used.

In both Guatemala and Honduras it was these organizations who were responsible for diffusing Lorena stoves into the communities. By mid 1979, two years after the beginning of the program, at least 11 separate agencies were involved in this work in Guatemala alone. They concentrated their efforts in areas where they were established, by including their stove programs in existing activities such as health extension and reforestation.

Diversity of methods should be stimulated with each agency's center developing its own system of training and dissemination.

## **F. Setting up stove centers**

In setting up regional and national stove programs it will be invaluable to have stable centers whose job is to deal chiefly with stoves. A national center could act as a liaison with other organizations, both domestic and foreign, collecting experience and collaborating with stove development organizations in other countries. The function of each regional center might be:

- \* demonstrations of working models,
- \* experimentation and testing,
- \* stimulating public awareness,

- \* coordinating training programs in design, construction, testing, repair and use,
- \* followup studies and processing ideas from villages (see next section).

Regional centers are designed to make the local people feel comfortable. They should be as humble as possible; e.g., imposing architecture will not be inviting to native women as it may feel awesome to them. By including local stove developers and builders on the board of directors, their concerns will be better represented and the center may have closer ties with the general public.



HUMBLE SURROUNDINGS

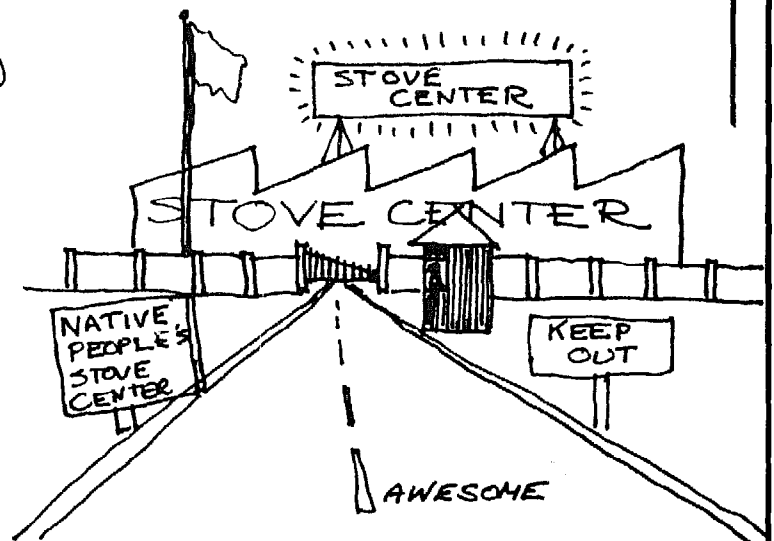

AWESOME

Location is important; close to public transport and not too remote from towns, so that ordinary people can come for advice. If centers are accessible to stove promoters and others involved day to day in stove work, there is a chance that such people will visit casually to share experiences. Estacion Choqui, for instance, is eight kms outside of a regional capital, on a public bus route and main highway. In Senegal, IPM is 1/2 km from a city bus stop on the outskirts of Dakar.

These will be demonstration centers, having on display a range of stove models made of different materials, and for different purposes. This is not a museum - experimental models should be an active part of a center. As long as successful models are on display, there is no reason to hide test and experimental stoves, even complete failures - they are sometimes useful in explaining what not to do.

People who work at a stove center can be encouraged to use the stoves for making hot drinks, heating their lunches, etc., keeping the stoves constantly in use. A stove with something cooking on it, even if it is only water, is much more convincing than a cold stove.



Local women can be invited to cook trial meals for their families on the center's demonstration models. This helps to get direct feedback to technical researchers, adds to the realism of demonstrations and helps encourage cooks to try installing their own stoves.



Stove centers can be places to experiment with and test different models, with free access to the general public, creating an air of activity.

Testing might include: efficiency tests for all stove models being used and promoted in the region; materials tests such as durability of concrete or clay/sand mixes; firing capabilities of local clays; tests for adaptability of native cooking techniques, local stoves, etc. Equipment need not be complex or expensive. A range of inexpensive thermometers and a simple pyrometer, measuring and weighing equipment, a covered space big enough to continue work during the wet season, and lockable buildings for records would be enough to start with. (See Chapter VI, for further details.)

Other functions of the centers would be stimulating public awareness and arranging dissemination programs. These would include demonstrations at local fairs, press and radio coverage of the fuel situation, and contacting local officials who could be influential in promoting stoves.

## G. Training

Stove centers should also be training centers for groups of promoters, development workers and the general public. Training programs are part of the dissemination process, and because of their importance merit special discussion.

One training scheme that has worked is to hold two or three-day construction courses that train a broad range of people to design and build an inexpensive efficient stove.

In Guatemala, the range of trainees has included:

- \* workers from other organizations,
- \* groups from peasant cooperatives,
- \* members of women's groups,
- \* foreign volunteers from Peace Corps, CUSO, SATA, VSO, etc.,
- \* interested individuals without agency affiliation,
- \* masons intending to diversify their businesses,
- \* journalists writing about or filming the work,
- \* sociologists and anthropologists studying the dissemination of stoves,
- \* inventor/developers from other research organizations,
- \* technicians from other Central American countries intending to establish programs in their own countries,
- \* government extension workers in community forestry, rural education, health, agriculture, and social service,
- \* university students who see the training as a way they can help their compatriots,
- \* persons intending to become stove promoters/trainers,
- \* teachers of technical subjects in high schools,
- \* mayors and other community leaders,
- \* restaurant owners and people with small businesses preparing specialty foods.

Each training session should include a wide range of participants, if possible, representing most of the above groups, to encourage sharing different ideas and experiences.

From Guatemalan experience, although people can and do build their own Lorena stoves, a professional builder is able to create a better stove. The professional develops an adroitness of finish and a grasp of principles that is possible only with practice, often supplying a more durable, economical product.

Estacion Choqui at first taught mainly at the Experimental Center. Promoters, professionals, etc. were trained at the center, where they could be exposed to a range of stoves from which they could select the ones most appropriate to their situation. Gradually, as contacts were made in outlying villages, the emphasis shifted to training peasant groups in their own villages.

Conducting workshops in the villages has advantages: it means the transport and housing of only one promoter in place of 10 or 20 trainees. Also some peasants are reluctant to leave the village overnight, for all sorts of reasons. The disadvantages include not exposing villagers to a range of stoves - and potentially other simple technologies - and difficulties the promoter may find in a strange village, where materials may not be assembled ready for use.

Development of teaching aids will improve the quality of these courses. Slide shows, models showing cross-sections of the insides of closed stoves, and small leaflets designed for illiterate people will all be helpful.

At Choqui, each 2-day course begins with a narrated slide show in the language(s) most appropriate to the trainees. Many Guatemalan peasants have never seen color slides so they are attentive and alert to new ideas. Many questions are asked and discussed. Then they begin construction. (It may be best to ask people to bring their own tools; this will force the trainer to adapt methods to those tools.) Lunches are cooked on existing stoves from previous courses throughout the workshop; a range of models is kept for comparison and criticism.

Promoters from CEMAT, another Guatemalan organization, carry with them to the villages scale models of the stoves they will build in training courses.

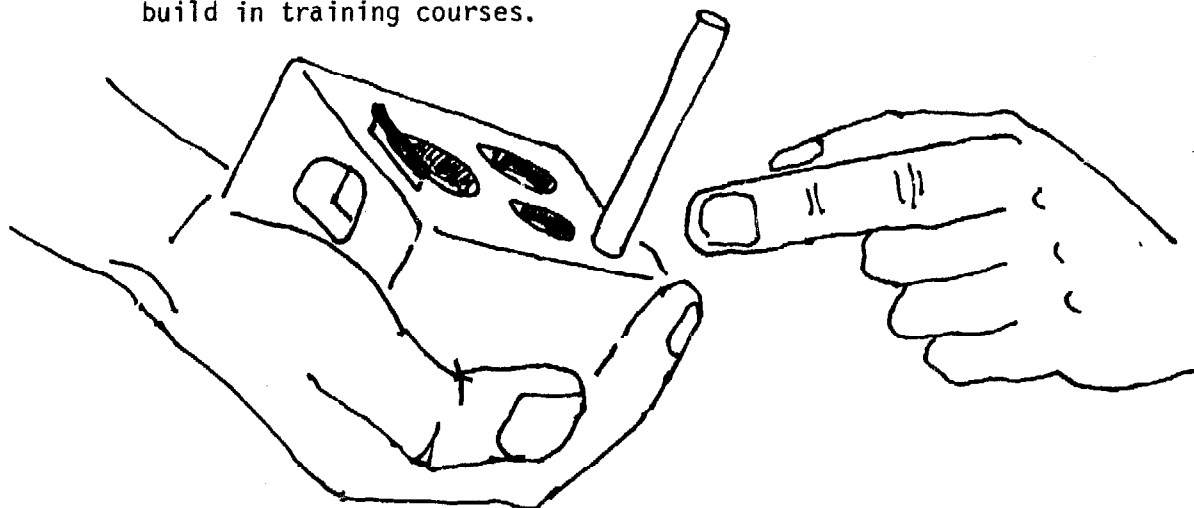

This system of workshops has several strong points:

- \* Rapid spread of information - promoters from other organizations who learn stove building techniques will take their newly acquired skills back to their region where they can teach others, who in turn teach others.
- \* The faster stoves spread in a community, the greater the chance of local improvements and adaptations that can be incorporated into the training courses.
- \* The greater the number of stove builders, the greater will be the capacity of the program to reach out into the community to more families. Training programs provide poor people with an alternative to hiring a mason, giving them the skills to build stoves for members of the family. Many village people are expert in the use of local materials, and can use this experience in stove building.
- \* People are given the opportunity to start their own business building stoves; this has happened in Guatemala.
- \* Every trainee becomes a stove promoter, tester and innovator.

## What should training comprise?

All trainees: an explanation of how heat works, how fire burns, the flow of hot gases through the stove, and the function of chimneys. Teaching methods will need to be very practical for most trainees, and carefully pitched to their understanding of the work. Most ordinary people have no sense of physics as it is taught in high schools. You will have to design special training tricks appropriate to your trainees. Find out what makes them laugh. In Central America for instance puns are remembered and are used in teaching. An example is telling the trainees that they should make tunnels in Lorena stoves "big enough to take two eggs in your hand and pass them through the tunnel". The Spanish word for eggs, huevos, also is local slang for testicles. -- "Then if you break your eggs it will be disastrous..." This one is less suitable for mixed groups of trainees. Find out what subjects are taboo or unmentionable and avoid them.

Illiterate people sometimes have trouble working in figures; use body measurements or local units of measurement with which they are familiar. The handspan, stride, fingerwidth, boiling, are units anyone can understand.

Promoters: can be taught flexibility in approach, which is sometimes difficult for people whose formal education has been by rote. They somehow should find a balance between promoting a single well-trying model, which is how most Guatemalan trainers work, and offering a way of using the principles of the material to give people a range of stoves from which to choose.

Playacting is usually well-understood. One possible scenario has two trainers dress up as a stove promoter and a housewife; they act out the scene of promoter coming to the house and persuading the cook that she could use less firewood with a stove. She protests in every way possible but the promoter's arguments finally convince her. This will give potential promoters a chance to preview the attitudes that cooks may have; they can evaluate the cook's reluctance or enthusiasms, and discuss them in the class.

Training monitors: (these will always be local people, usually women with some formal education, who are respected). Teach them a thorough understanding of the function of the stove, how it would be operated for best efficiency. Their job could include looking out for initiative from the cook in inventing new ways of using the stove, and encouraging people to try new ideas.

## H. Involving women

As cooking is so often a woman's job, and construction often a man's, deliberate efforts should be made to involve women in the introduction of stoves, as promoters, teachers and extension workers.

Most importantly, the women who are to cook on the stoves need to be introduced to building them, caring for them, and using them really efficiently. As this is a new craft, no precedent exists for who should build them; here is an opportunity to involve women artisans from the outset.

In Guatemala, Estacion Choqui has developed some interesting methods for involving women, who are sometimes difficult to reach. A few weeks after teaching a workshop on building Lorena stoves (to groups containing mostly men), Choqui offers a followup course for women to learn specialty cooking. This is taught by local women in the local language. As it is the ambition of every Guatemalan cook to make cakes and fancy baked goods, the courses are well attended. Then, in addition to teaching baking, they are able to talk about how to feed the stove, maintain it and use little tricks for fuel economy. This is a good time to demonstrate some principles of stoves which may be hard to grasp at first; for instance the concept that on multiburner tunnel-type stoves the second pot cooks on hot air alone, you don't have to get a flame under it.

## J. Evaluation and follow-up

Centers provide essential evaluation and followup, to help assess the progress of stove dissemination. This involves:

- \* maintaining contact with stove users to help them with difficulties,
- \* evaluating acceptance, finding weak points in the program, and learning what needs more emphasis,
- \* testing innovations for inclusion in other designs,
- \* watching for poor stove models so they are not copied,
- \* maintaining quality in craftsmanship and teaching methods.

Experience in Guatemala and Senegal shows that villagers themselves usually initiate the most appropriate adaptations - after all, they know their own needs better than anyone else. Ways should be developed to catalogue and test these innovations in the regional centers and make them widely available.

Keep records of all known stoves; in the early days of a program, check up on every one built, especially the first few in each location, after about a month of use. This is the best time to catch any problems before they become serious issues. (See "The Stove that Broke a Tooth", Chapter III).

A local person trained as a monitor checks up on all stoves about a month after they are first in use. These visits will be chiefly to help with maintenance, to teach new cooking techniques and show how to derive the most benefit from the stove. For many people, switching from open fire to the stove is the biggest technical change of their lives; it will take time and assistance for them to make the adjustment. Visiting users' homes is not merely for observation; you should involve the cook in the whole investigation, make her feel she is an important part of an effort that may improve the quality of her life. The monitor should be prepared to answer questions as well as ask them. Here is a checklist of the kinds of things to look out for:

### **Problems:**

- \* mechanical failures and construction faults,
- \* chimney failures - not taking smoke away,
- \* wet fuel,
- \* overfeeding the fire,
- \* not keeping pot lids on

- \* inefficient use of stove, for instance not using dampers,
- \* stove not satisfying basic needs - warmth, light...,
- \* not satisfying cooking needs - pots too big, fire too cool, too far from pots, special foods not accommodated.

### **Bonuses:**

- \* adaptations of the basic design,
- \* innovative uses,
- \* fuel saving tricks.

## **K. Stove use training**

Use training is really important; without it even the best designed stoves can be misused so as to consume more fuel than open fires.

Research (Aprovecho, 1980) is showing that careful attention to how fires are built and how stoves are used may have more impact on fuel use than what kind of stove is utilized. A well-built fire can save more wood than a badly-used stove. Promoters, artisan-builders and users should all be given clear demonstrations of how much difference this can make.

Simple lists of do's and don'ts are easily remembered; one good one is the Ten Laws of Conserving Firewood. These are guidelines; you might want to substitute some which are more relevant to local conditions.

1. Use only wood that is dry enough.
2. Split your wood really thin.
3. Simmering cooks food almost as fast as a fast boil.
4. Keep lids on the pots.
5. Cook out of the wind.
6. Use pressure cookers or metal pots whenever you can.
7. Make your fire as small as you can.
8. Use residual heat to slowcook, and to pre-cook the next meal.

9. Cook all your dishes for one meal at the same time.
10. Attend the fire regularly to make sure it is doing what you want and is not wasting fuel.

Use training teaches several things including how to maintain and repair stoves and how to cook on them efficiently. The benefits can be demonstrated to the users, directly. For many cooks this will be the first time in their lives they have cooked on anything other than an open fire. They will be less discouraged by problems which may arise if they learn to cope with them in advance. Their enthusiasm and expertise may then spread within their communities.

## **L. Sponsoring and advising small businesses**

As an outsider, the development worker or official is in a good position to help set up small stove builders in business: by technical assistance such as design suggestions, by making sure the builder is responding to what is really needed, by being a go-between who can arrange loans or grants, by ensuring the product is economical in fuel consumption.

Stove popularization programs can take advantage of local street markets which sell local metal and terra cotta products. In most parts of the world an extensive street marketing system has existed for hundreds of years. Today, merchants in these markets sell metal cooking stands and rings. A lightweight fuel conserving stove could be sold by the same merchants. Merchants who sell ceramic cook pots could sell terra cotta stoves.

Potters, metal workers and concrete/adobe workers should be helped to establish small stove businesses. Local artisans are a part of the market system and could make a profit building stoves, either custom-built to order or for sale in the markets. Artisans building stoves professionally would be pressured by competition to constantly improve their quality or drop their price, helping to ensure good quality and keep the product affordable.

On a bigger scale, brickworks and large manufacturers of concrete components may be suitable for production of ready-made stoves, either complete or in kits. They might, for instance, sell just the top plates for stoves that are built up of adobe by the owner, or kits for insulating pot lids with fireproof covers.

Industrial production of ready made stoves will certainly be appropriate under some conditions. However, the workings of industrial-commercial marketing systems are so well known that it seems unnecessary to deal with them at any length in this manual.



# Chapter V

## HEAT, FIRE and STOVES

Cooking requires the transformation of the potential energy in fuel into heat energy. To improve the efficiency of cooking, we need to understand how heat is transmitted, how it is released in combustion and how heat loss can be minimized. Finally, we need to know how heat is made useful in a stove.

### How heat generated in a fire is transmitted.

#### Radiation

Radiant energy is emitted from hot objects and does not become perceptible heat until absorbed on the surface of another object. It is a form of electromagnetic energy, as is light.

- \* Radiation is emitted equally in all directions. An object moved twice as close to a radiant heat source (e.g. a fire) receives four times as much radiation. (The intensity of radiant heat is inversely proportional to the square of the distance.)
- \* Emission of radiant energy increases dramatically with temperature difference. If the difference in absolute temperature between an object and its environment is doubled, radiant heat transfer will be increased by sixteen times. (Radiant heat transfer increases as the fourth power of the temperature difference.)

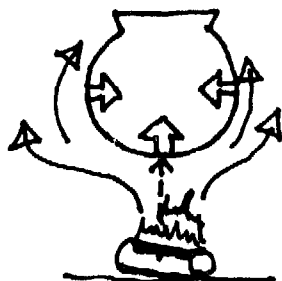
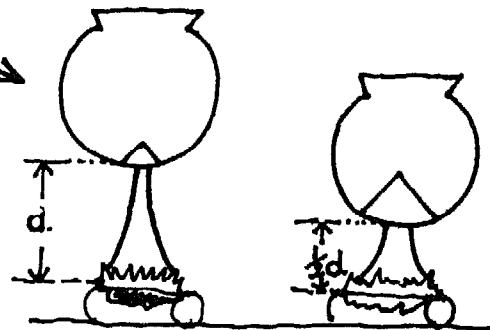
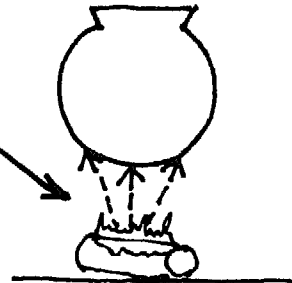

#### Conduction

Conduction is the movement of heat through solid materials. Heat flows rapidly through good conductors like steel or aluminum. Materials which conduct heat slowly, like wood or cement, are called insulators. Substances with many tiny trapped air spaces are really good insulators (charcoal, sawdust, straw).

- CHARCOAL .09
- ASH .12
- CORK .13
- SAWDUST .14
- WOOD .18- .42
- BRICK 1.5

## THERMAL CONDUCTIVITY

IN

CAL SEC CM<sup>2</sup> (°C/CM) × 10<sup>3</sup>



## Convection

Convection involves the transfer of heat by the movement of a gas or liquid. As air is heated, it tends to rise and is replaced at the heat source by cooler air, which is heated and then rises, and so on. This type of heat transfer, which occurs because of the buoyancy of the heated air, is called natural convection. When heat is carried away from hot objects by air currents, this involves forced convection, or advection.

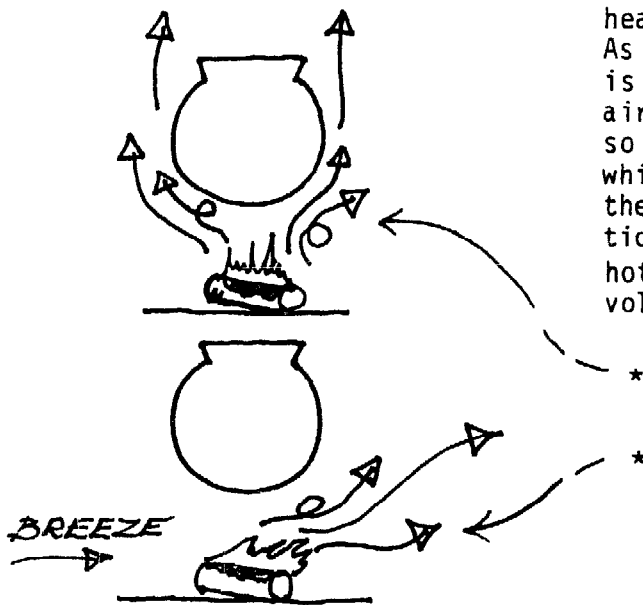

- \* Air heated by the flames of a fire will rise in still air.
- \* In a breeze, the hot air will move with the prevailing current.

## How heat is released in combustion.

Fuel, oxygen and high temperatures are required for combustion to take place. For a chemically simple fuel such as natural gas, or methane, combustion involves a relatively straightforward conversion of chemical energy into heat. The carbon and hydrogen in methane combine with oxygen from the air to produce carbon dioxide, water, and heat:

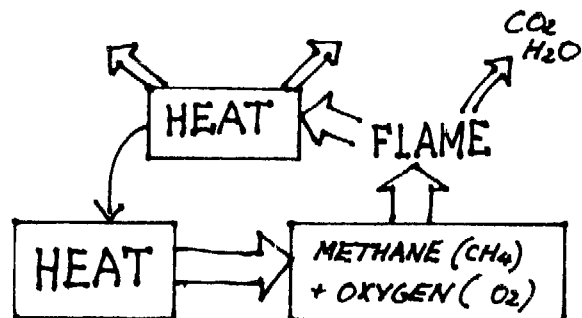

Once ignited by heat from another source (such as a match), the heat from the burning fuel is adequate to sustain combustion. When pre-mixed with air, as in gas stoves and furnaces, natural gas will burn completely.

The combustion of wood also involves the combination of carbon and hydrogen with oxygen to produce heat. However, wood is a much more chemically complex substance than methane. It is composed primarily of carbon, hydrogen, and also oxygen occurring together in the form of cellulose, lignin, gums and resins.

The combustion of wood has these characteristics:

1. Wood burns in two stages. First, volatile gases are produced and burn, leaving solid charcoal, which then burns.
2. Oxygen must come from the air surrounding the zone of combustion.
3. The size, shape, and arrangement of fuel pieces affects the rate and completeness of combustion.

### 1. Wood burns in two stages.

When a piece of wood is added to a fire, chemical changes occur in the presence of heat. At first, non-flammable carbon dioxide and water are given off. As the temperature increases, combustible gases and tars are also evolved. This process of chemical degradation in wood is called pyrolysis. When the temperature exceeds about 280°C, the proportion of flammable gases emitted is high enough to burn. Combustion will then occur only in the presence of oxygen, and at temperatures exceeding the ignition temperature of the fuel. (The average ignition temperature for the evolved gases in a wood fire is about 600°C.) The gas is ignited by radiant heat from the already burning pieces of wood.

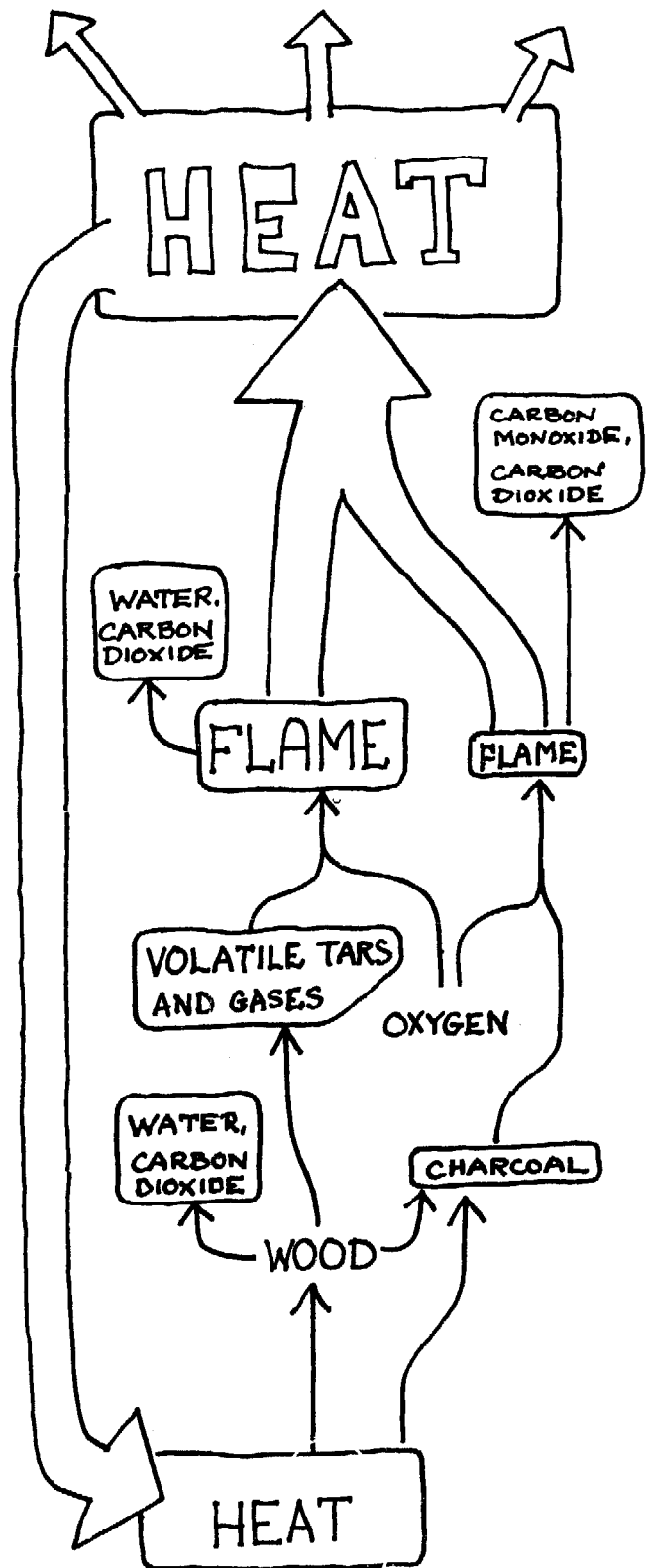

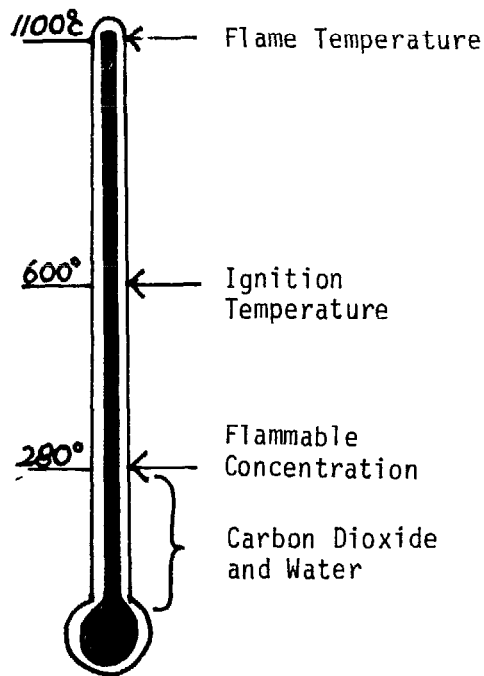

Once ignited, the pyrolyzed gases will burn at a temperature of 1100°C; the flames then provide radiant heat which maintains and accelerates pyrolysis. The flames of a wood fire are these burning gases.

The flames probably do not even touch the surface of the wood. The flow of gases, which greatly increases with the heat of the flames, prevents oxygen from reaching the surface of the wood. It is only after this flow of gases subsides that the charcoal starts to burn. It burns with only a faint blue flame, and the by-products of combustion are mostly carbon dioxide and carbon.

All of these processes are normally occurring simultaneously in a wood fire; charcoal may be burning on the surface of a small piece of wood within a minute after it is added to the fire, while the center of a much larger piece may not even become warm for an hour or more.

## 2. Oxygen must come from the air surrounding the zone of combustion.

For optimum combustion, the supply of air to the fire is critical.

- \* Insufficient oxygen, due to restricted air flow or poor air distribution, may allow some combustible gases to escape without burning. A fire which produces a lot of smoke usually indicates a problem of this sort.
- \* Up to a certain point, increased air flow increases both the rate and efficiency of combustion.
- \* Air flow that greatly exceeds that required for combustion may carry off enough heat to lower the temperature of the fuel below its ignition temperature.

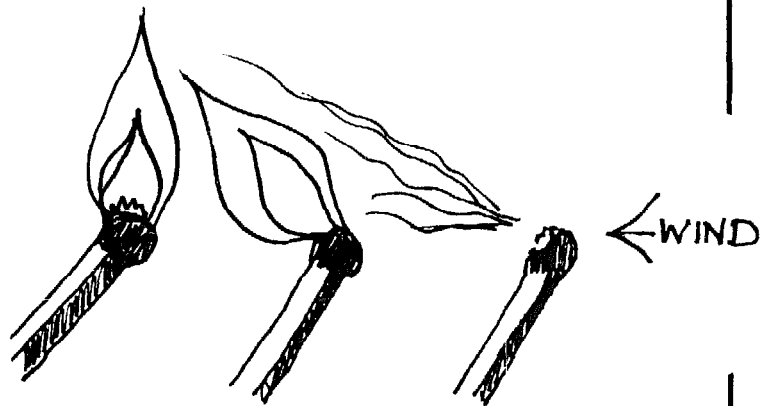

- \* Excess air may also lower the concentration of flammable gases so that not enough chemical reactions occur to maintain the high temperatures necessary to sustain combustion.

## Size, shape and arrangement of fuel pieces.

\* The rate of combustion depends in part on the size of wood pieces. A larger piece of firewood has a greater volume in proportion to its surface area than does a smaller piece. Smaller pieces therefore have proportionately greater exposure to air flow and will burn faster. Small wood pieces heat quickly and will produce vigorous flames and little charcoal. This is because rapid pyrolysis of wood gives a high yield of flammable gases in proportion to remaining charcoal.

\* The large surge of volatile gases from small wood pieces may not burn completely if the supply of oxygen is limited, such as in an enclosed stove.

\* Large pieces of wood burn slowly and steadily.

\* Large pieces of wood may not burn at all, however, if there is not an external source of heat (such as other burning wood). This is because too much heat is conducted into the interior of the piece for the ignition temperature to be sustained on the surface.

\* Straight pieces of wood arranged in a parallel fashion lie tightly together and impede air flow. As a result, gases will move away from areas of sufficiently high temperature before mixing with enough air to burn.

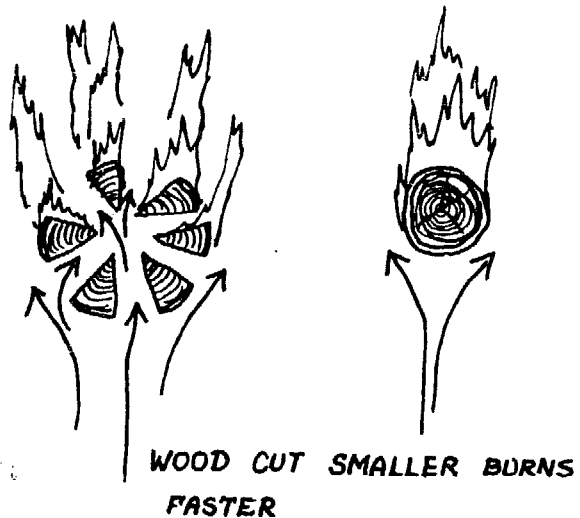

## Moisture in the wood

\* Wet wood puts out less heat because a large fraction of the heat generated goes into evaporating water. Up to 12% of the heat energy in green wood may be consumed in this way.

\* The evaporation of water from wood will dilute the flammable gases, which slows the combustion rate and decreases combustion efficiency. This results in a smokier fire and increases the condensation of tars in the stove and chimney.

## Combustion of other fuels

### Charcoal

As charcoal is formed in a wood fire, it combines with oxygen and burns. It is made commercially by slowly heating wood in the absence of air, and the flammable tars and gases produced escape unburned.

\* Charcoal is composed mainly of carbon, with some hydrogen.

\* It has about 45% energy per unit weight than wood.

\* Because charcoal has few remaining volatile components, there are no appreciable flames. Heat is generated on the burning surface.

\* Charcoal pieces fit tightly together. For efficient combustion in charcoal stoves, air is usually provided over a large surface area through a grate from underneath.

\* The interior walls will absorb the radiant heat and will then re-radiate some of this heat to the cookpot.

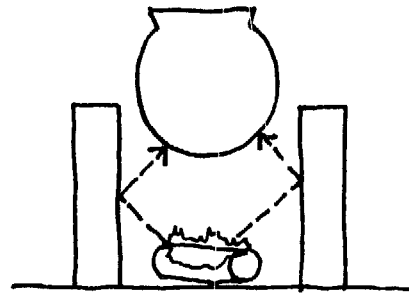

### Agricultural wastes

These are similar in chemical composition to wood. The usual problem with burning rice hulls or sawdust is that air flow through the fuel is very restricted. To provide sufficient air for combustion, either the air velocity across the surface of the fuel bed must be increased, or air must be supplied through a grate from below (see Rice Hull Stoves, Chapter VII). On the other hand, if fuels such as straw, corn husks, etc. are stacked loosely, the fuel density is too low to provide a useful amount of heat in a stove.

Some heat will still be escaping. Heat conducted through the stove walls is lost by radiation, and by convection to the outside air. Metal stoves are very hot to the touch because of this conducted heat loss. Conductive loss may be reduced by insulating the stove walls so that heat is retained. The Thai Buc-Bucket is a metal and terra cotta charcoal stove that uses a layer of ash for insulation. The insulating properties of sand/clay or adobe stoves could be improved upon if finely chopped organic matter, such as rice hulls or sawdust, were added to the mix. These materials form small cavities, in which trapped air functions as an excellent insulator.

### How heat loss can be minimized.

Heat loss to the surrounding area is minimized by enclosing the fire. Two things are accomplished by this:

\* The enclosing walls block the wind so that convective heat is retained.

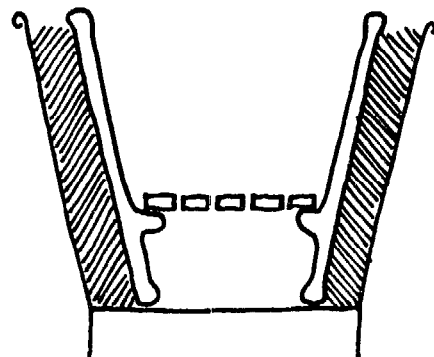
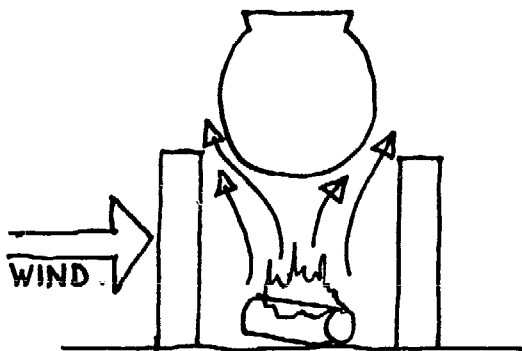

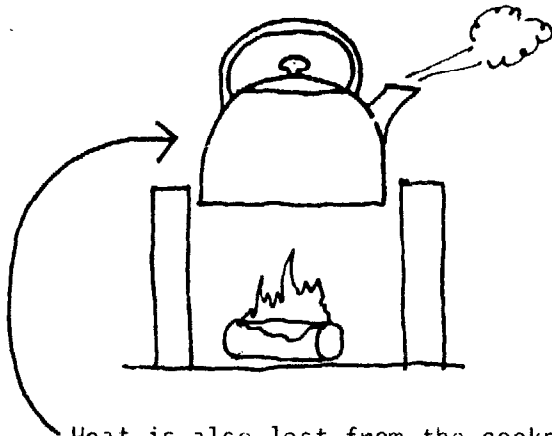

Heat is also lost from the cookpot. For heating efficiency, the best cookpot would have a large surface area exposed to the fire, and a small area exposed to the air. Both convective and radiant heat loss from the exposed surface of the pot can be lessened by sinking the pot into the stove. The pot will also gain conducted heat from the hot stove walls. Covering the cookpot prevents convective and evaporative heat losses from the contents inside. This may reduce total heat loss by up to one half.

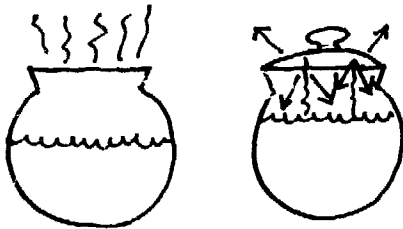

The heat lost in the exhaust gases from the fire can be utilized by:

- \* Directing the rising smoke around the sides of a single cookpot.

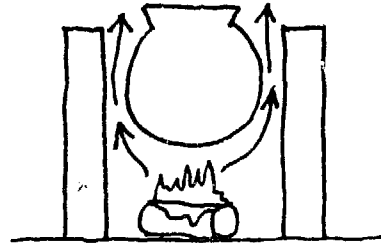

- \* Using the exhaust gases from the fire under the first pot in a multi-pot stove to heat subsequent pots. Hot gases can be directed to the additional pots by a flue, or internal passageway. Hot, light gases rising in the chimney draw hot air through the stove.

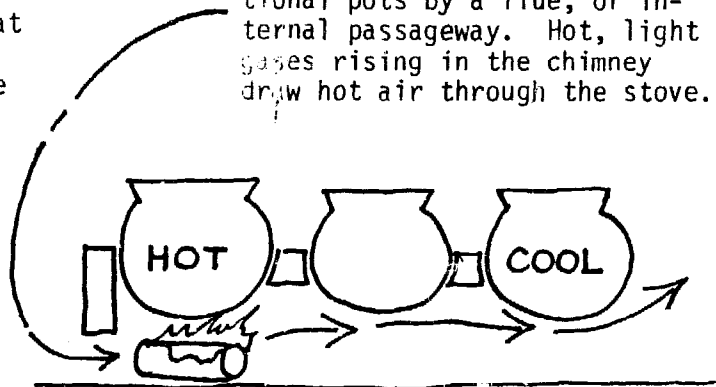

## How heat is made useful in a stove.

The preceding discussion outlined the theoretical principles operative in any cookstove. In this section, the structural design principles of a generalized stove are explained.

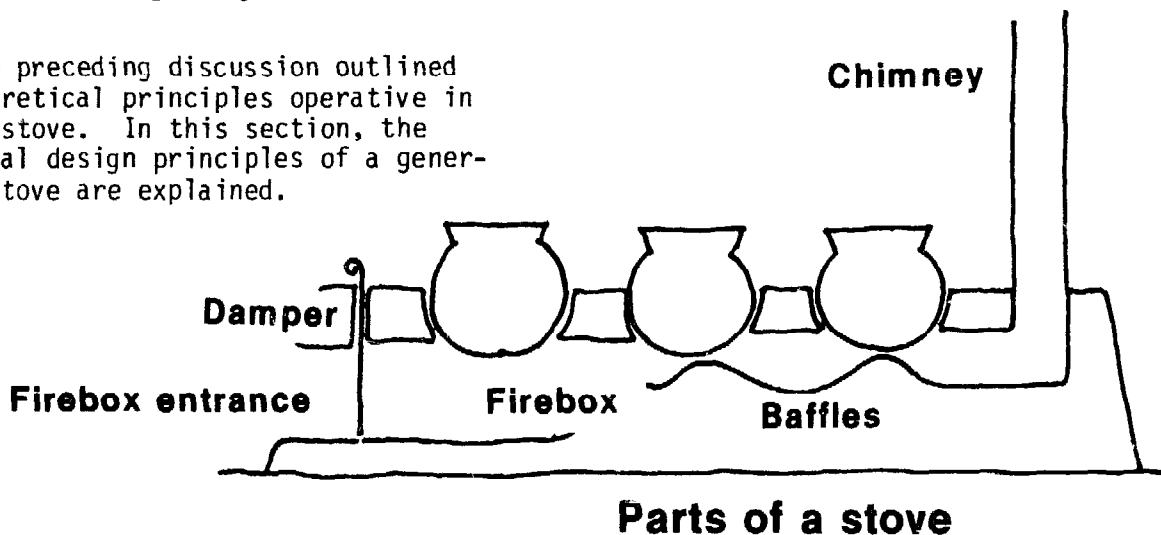

## Firebox

The firebox is where the fire is contained, and combustion occurs.

- \* It must be large enough to accommodate the size and type of fuel used, but narrow enough to confine the fire beneath the pot.

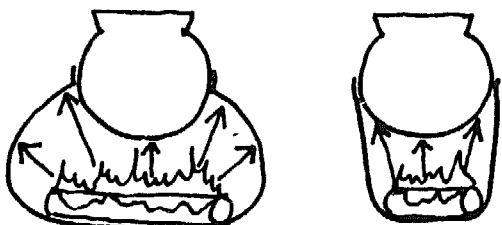

- \* The cookpot should be as close to the heat source as possible, to take full advantage of radiant heat, yet not so close that it smothers the fire.

## Firebox entrance

The firebox entrance is where fuel is fed into the stove, and where air enters. The size and placement of the entrance will affect the structural arrangement of the fire.

- \* The firebox entrance should be wide enough to permit easy access to the fire, and allow a criss-cross placement of fuel pieces. With some designs, two or three smaller entrances might work well (e.g. the Louga Stove; see Chapter VII).

**Dampers** are doors which control the flow of air.

A front damper, placed before the fire, reduces airflow into the firebox. A back damper, placed in the flue downstream from all the pot holes or in the chimney, controls draft through the stove. Dampers can be made of sheet metal, clay blocks, or concrete blocks.

- \* They should close as tightly as possible.

- \* The front damper should be designed to focus air on the base of the fire. This improves overall combustion.

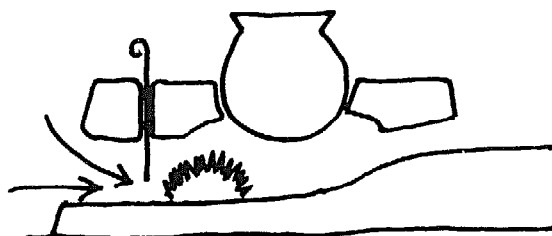

- \* Back damper doors further control air flow by reducing draft from the chimney.
- \* After the fire dies both dampers can be closed to conserve heat.

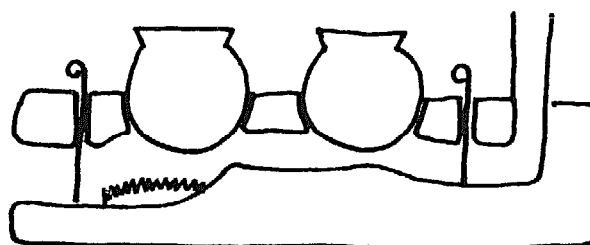

- \* Dampers are important. They should be permanently secured to the stove so they cannot be lost.

## Baffles

Baffles are obstructions to the flow of hot air and gases. They increase turbulence and direct airflow around the bottoms of the pots.

- \* There should be baffles under all pots not over the firebox.
- \* The space between the bottom of the cookpot and the baffle should be the minimum required to maintain adequate draft.



## Chimney

The chimney carries smoke out of the kitchen. The force that pulls smoke through the chimney is called draft; it occurs because the hot gases from the fire are lighter than the surrounding air, and therefore rise, drawing hot air through the stove. The pull of the chimney also draws cold air through the fire-box entrance, and any open spaces or cracks in the stove.

- \* The draft should be strong enough to aid combustion and draw the smoke up the chimney.
- \* Too strong of a draft may draw in excess air which dilutes the heat of exhaust gases.
- \* Draft increases with the height and diameter of the chimney.
- \* The chimney should extend 75 cm above the highest point of the roof, for safety and to prevent downdrafts. (Downdrafts may occur with the air turbulence that results when wind flows over a house.)
- \* The chimney should have a cap to keep rainwater out.

- \* If the chimney is near any flammable material (e.g. a thatched roof) it should have a screen covering to prevent sparks from flying out.
- \* Both rain cap and spark screen should be removable to permit regular cleaning of the chimney.
- \* Where the chimney penetrates a combustible roof or wall, the chimney should have a nonflammable spacer around it. If the chimney becomes very hot (as in a flue fire) heat conducted through a metal spacer might cause a fire. It may be wise to avoid metal and use a less conductive chimney material such as clay pipe, or to leave an air space around the chimney where it penetrates the roof.
- \* The chimney must be cleaned regularly because a black, sticky substance called creosote condenses inside the chimney. Creosote is flammable and can catch fire from a spark. In addition to being a fire hazard, it can clog up the chimney. The chimney should be cleaned at least every six months.

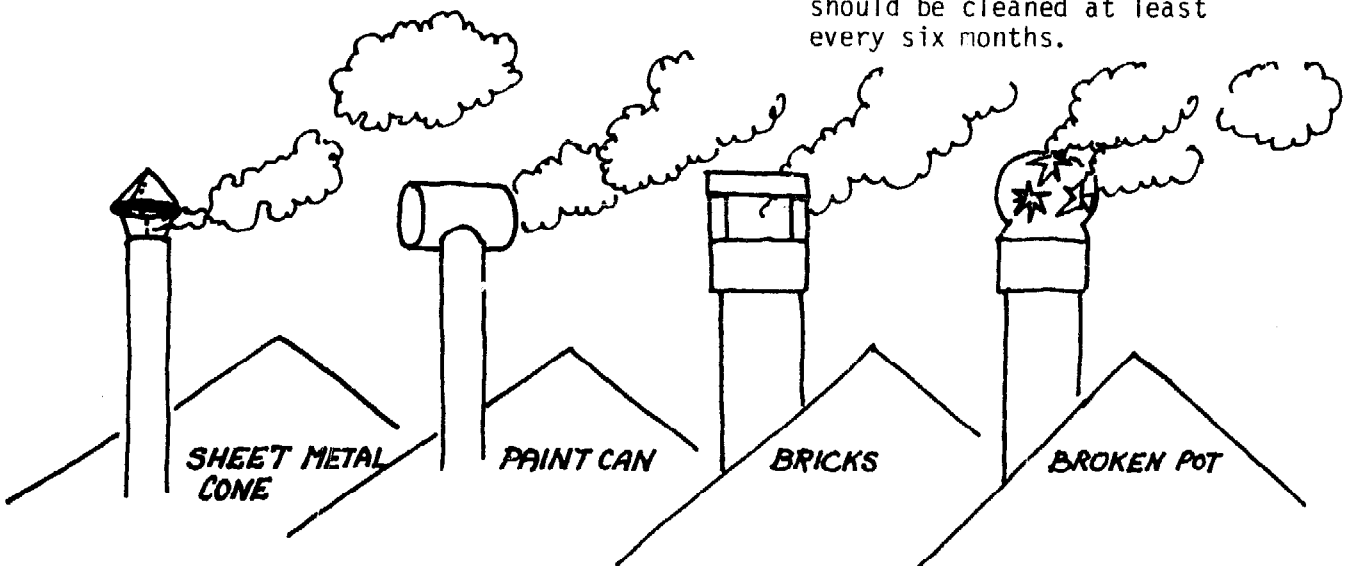

# Chapter VI

## MEASURING STOVE PERFORMANCE

It is the intent of this section to suggest how the field worker can integrate testing with the design process. Testing is important because it permits comparison of the effects of various design features on technical objectives such as reduced fuel consumption or shortened cooking time. The results of testing indicate to what extent design modifications improve (or fail to improve), stove performance.

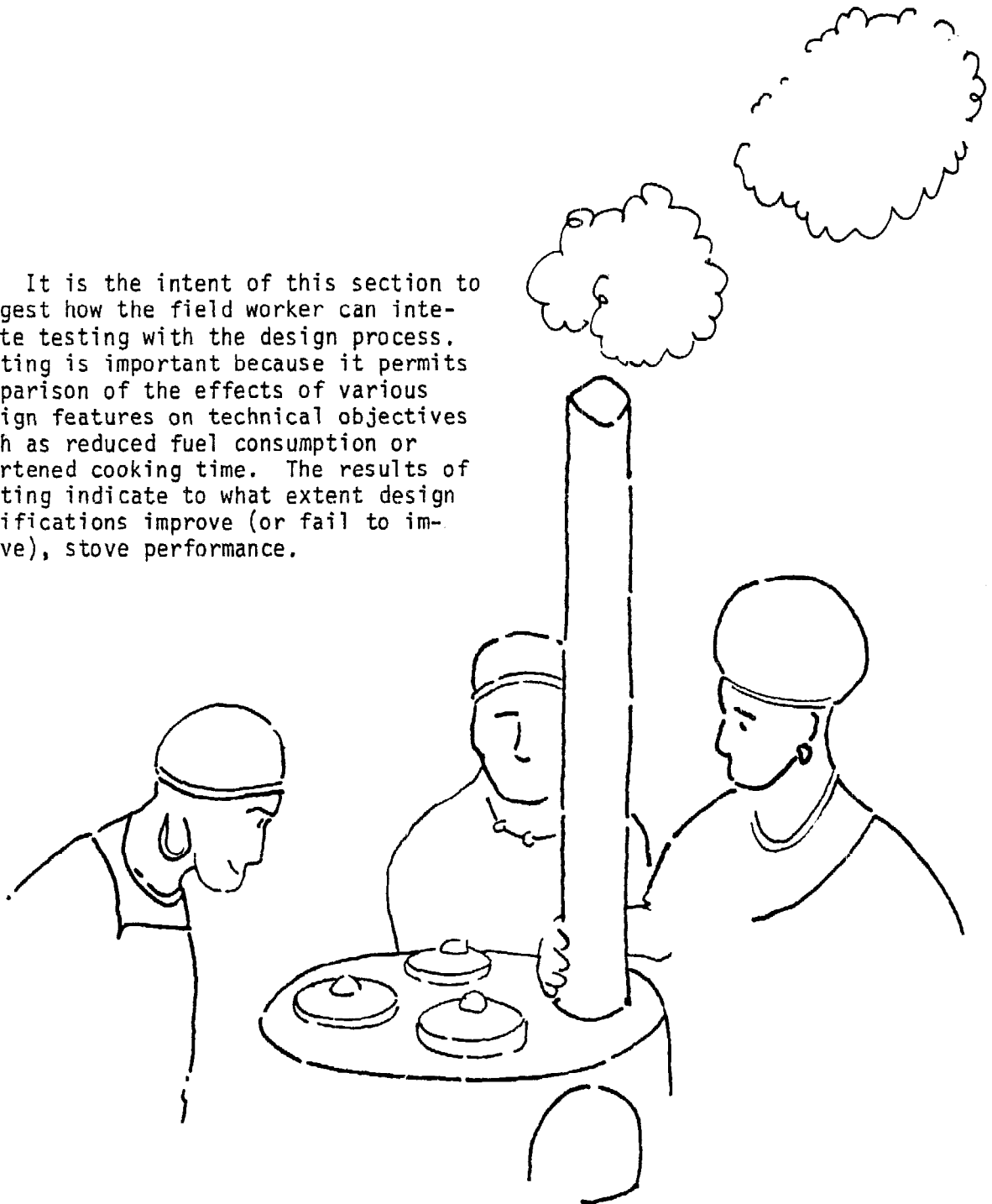

While providing quantitative data, testing also helps to:

- \* Develop an understanding of how stoves and fires work. This is especially important to people for whom cooking with fire is not a lifelong experience.
- \* Stimulate design ideas. Observations of the characteristics of air flow, heat loss, etc. in testing may suggest improvements in design.

Testing methods must take into account three factors that affect cook-stove performance:

1. Behavior of the cook: The way the cooking fire is built and tended strongly influences stove performance.
2. The variety of cooking tasks: Frying, boiling, and roasting involve different heat requirements. Meals may be cooked either simultaneously or in sequence.
3. Variations in fuel: Fuelwood may be of various species and moisture contents, shapes and sizes. Alternative fuels such as dung and agricultural wastes are sometimes used seasonally, with fluctuating availability.

Testing should represent local conditions. The simultaneous influence of these three variables can be studied in trials with users. These consist of cooking observations, to determine how people use stoves (remember that people don't actually "use stoves", they cook), and fuel use measurements, to compare fuel consumption of traditional cooking arrangements with that of improved stoves.

For specific technical analysis of stove performance tests of isolated variables are more easily controlled as they are conducted independently of the users. They are of two kinds: in standard meal tests, measured amounts of food are cooked while fuel consumption is measured; cooking simulation tests use simulated cooking conditions to study more precisely the effects that stove design and operation have on performance. Both of these tests are used in the development process to answer technical questions.

So, appropriate testing starts with cooking observations as a basis for design and to establish performance standards for isolated variable tests. Isolated variable tests are then used for feedback on design performance. When improved stoves are sufficiently developed for trial introduction, performance of stoves in normal use is monitored to further refine designs, and so on, as illustrated in Figure VI-1.

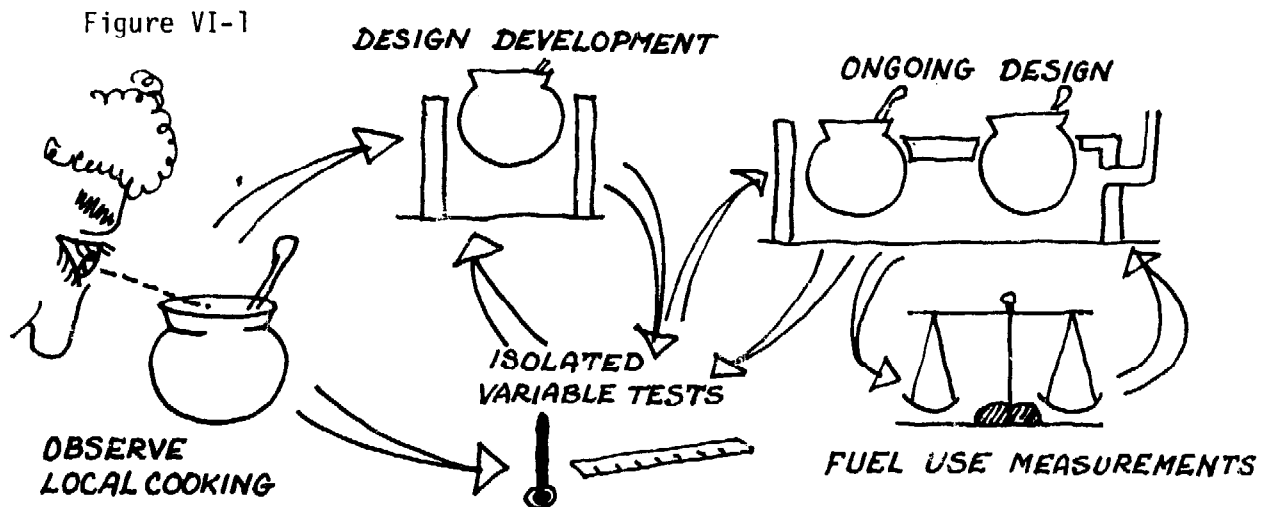

## Trials in users' kitchens.

### Cooking observations

Consider how difficult you yourself might find it to precisely describe something as routine (but complicated) as daily cooking habits. You can talk to people, and ask a lot of questions, but it would be best to obtain this information by actually watching people cook at home. Try to do this in as many situations as possible, so as to fairly represent the local range of variation in family size, economic status, etc.

You will need to find the answers to such questions as:

- \* What are typical meals? -type of food and quantity.
- \* How does the cook control the fire? -techniques of heat regulation, cooking sequence.
- \* How long do various cooking processes take?
- \* How often is the stove used in a day? -Does this change seasonally?
- \* How much fuel is consumed during each stove use?
- \* What other uses do fires have? -special foods, social uses, heating.
- \* What kinds of pots are used? -size, shape, material.
- \* What kind of fuel is used? -size, shape, species of wood -green or dry wood?

Get specific information, useful for comparison with improved stoves. Measure pot sizes, weigh fuel, and record the time involved in various cooking processes.

These variables of operation affect not only how well a stove performs, but also how different stoves or traditional cooking fires compare in performance when used under differing cooking conditions.

For example:

The amount of fuel an enclosed stove saves over an open fire depends on the size of fire that is customarily built. A large open fire under a single pot loses large amounts of heat by radiation and convection, particularly in windy conditions. A lesser proportion of heat is lost from a smaller fire carefully maintained under the cookpot; a smaller open fire is more efficient (fig. VI-2).

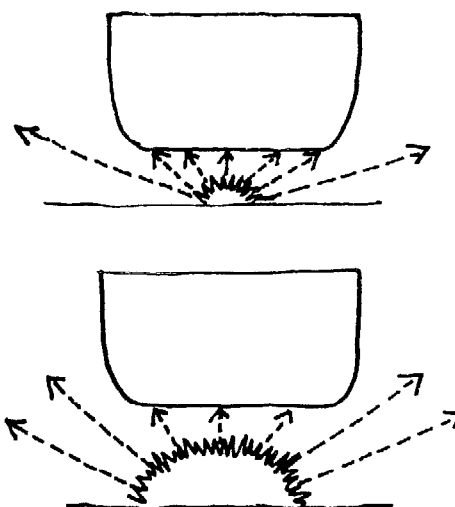

Figure VI-2

On the other hand, in an enclosed stove, much of the heat that would be lost from a large open fire is retained; efficiency is greater with a large fire (fig. VI-3).

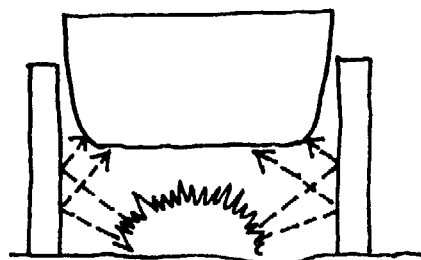

Figure VI-3

In an actual test comparing an open fire and a simple enclosed stove (the Louga stove), the proportion of heat transferred to the cookpot (efficiency) was measured for different fire sizes. As can be seen in the graph in Figure VI-4, the Louga stove would be only a small improvement over an open fire where traditional cookfires are built conservatively, but a great improvement where fires are large. This test indicates that varying factors such as the customary fire size affect the relative advantage of a given stove. Thus, observations of cooking behavior are necessary to later design representative tests.

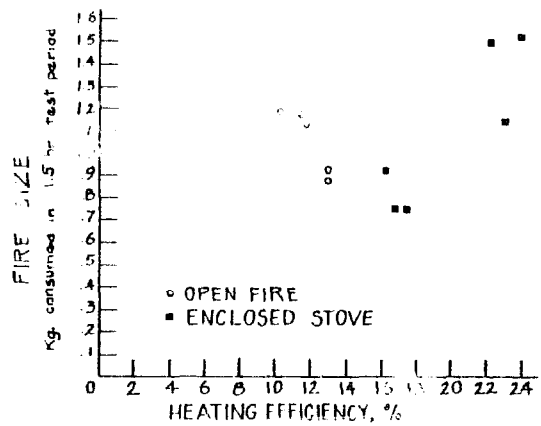

Figure VI-4

Watching people may provide insights to how a stove might affect traditional cooking techniques. For example:

New stoves may radically change the customary methods of building fires. A "three rock" open fire is easily controlled by adding or removing firewood from three directions, and the progress of the fire is visible to the cook (fig. VI-5). The techniques for control of a fire in an enclosed stove are quite different. The fire is controlled through the use of dampers, and the fire can be seen and tended only through the entrance door (fig. VI-6).



Figure VI-5

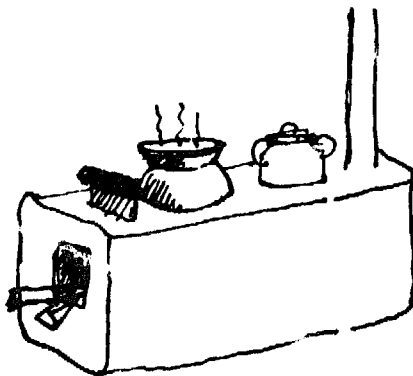

Figure VI-6

By observing these differences from the cook's point of view, design can be modified to incorporate some of the advantages of the open fire, for instance, by adding a second firebox door to the enclosed stove, or making the fire visible by raising the stove.

An understanding of cooking behavior may also suggest how design might be modified to deliberately change traditional practices. For example, even if people traditionally build larger fires than seem necessary (perhaps simply for convenience), they may accept an introduced stove with a small firebox to limit the size of the fire.

## Fuel use measurements

Fuel use measurements made on stoves in use by local people are an integral part of follow-up work; they are the real measure of success for improved stove designs.

Tests should be administered by workers who have a good rapport with the families chosen for the tests, and fluency in the local language. They should also understand the local culture -how people measure time, the size of standard wood measurements, times of year when other fuels are used, etc. Equivalent tests should be made both before and after the introduction of an improved stove, over a period of several weeks of normal use. Compare changes in fuel consumption for the same family, using the same kind of firewood.

Concurrently with fuel use measurements, observations of stoves in use might be made, to assess what changes may have occurred in daily cooking routines, and how on-going design might be made more responsive to local conditions.

Simple test should be designed for users to monitor their own fuel savings. These might be based on how long it takes to use a given quantity of fuel, or how much fuel is consumed in a given time. These tests could then be facilitated by a local representative, so that users could trade experience in a formal way.

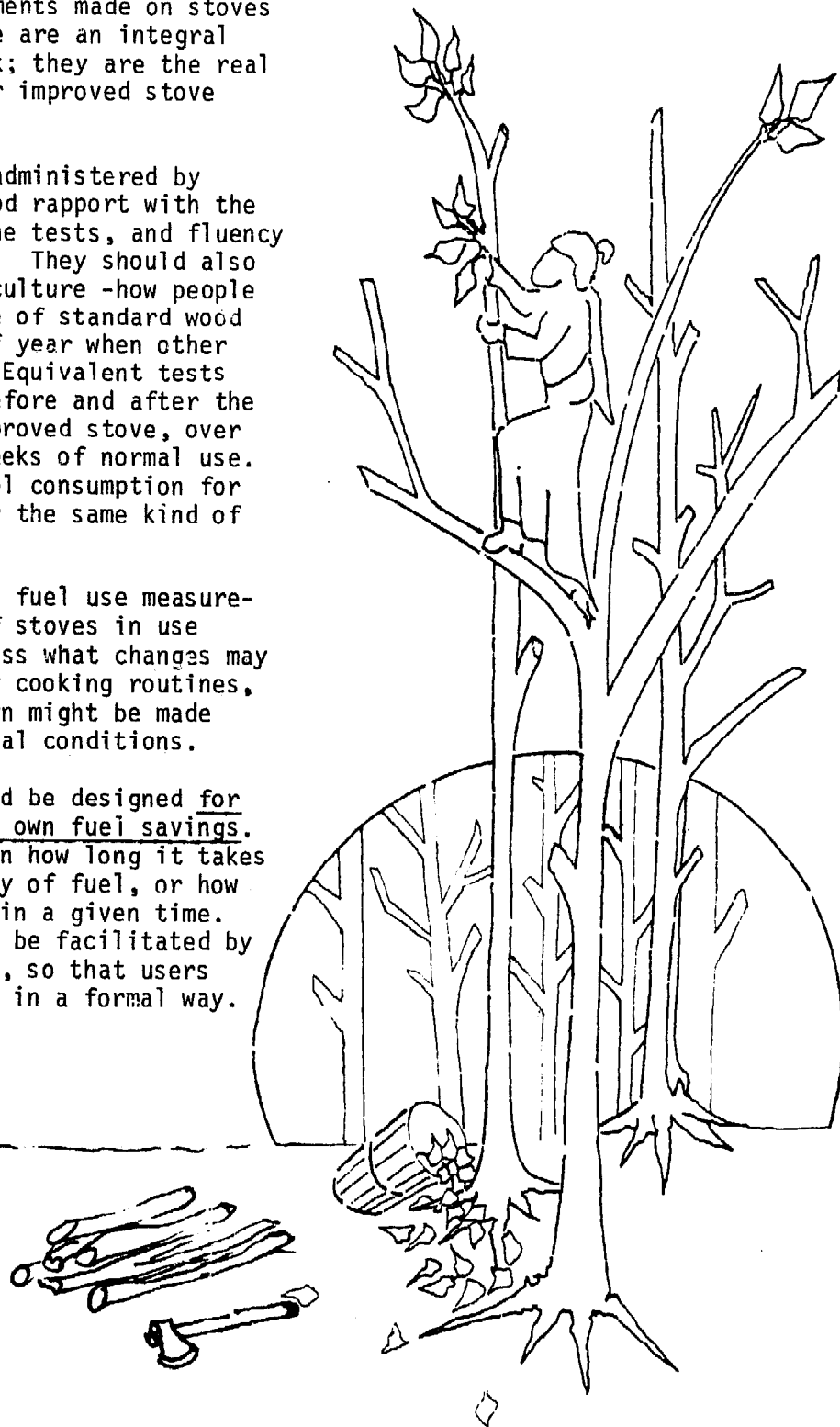

# Tests of isolated variables

## Cooking efficiency: Analyzing variables

Tests of isolated variables measure the specific effects on stove performance of any one variable of stove design or operating conditions. Because they eliminate the varying circumstances of weather, cooking habits, etc., isolated variable tests yield more precise quantitative information than field trials.

Efficiency is a term used to express the proportion of the heat potentially available in cooking fuel that is actually captured by the contents of a cooking vessel. Efficiency decreases with heat losses due to incomplete combustion, incomplete heat transfer to the pot, and heat losses from the cooking pots (see Chapter V).

Isolated variable tests can be used to assess where heat loss can be minimized by watching the effect on efficiency when one variable at a time is changed.

A simple example: heat loss was measured for a cast iron pot containing 1 liter of water at 100°C, both with and without a lid. The graph in Figure VI-7 illustrates quantitatively the extent of heat loss from the uncovered pot. Clearly, the use of a lid greatly improves efficiency. Further tests might look at pot design as a variable.

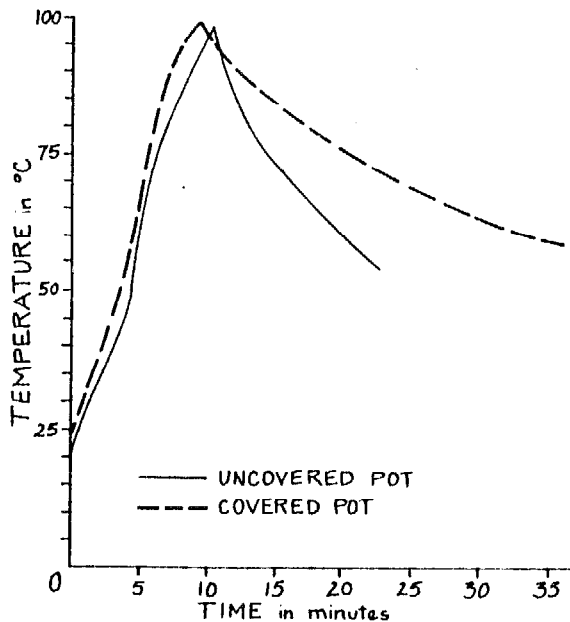

Figure VI-7

In a second experiment, a smaller covered pot (having less exposed surface area), also containing 1 liter of water at 100°C, lost heat much more slowly than the pot in the first experiment, as seen in Figure VI-8.

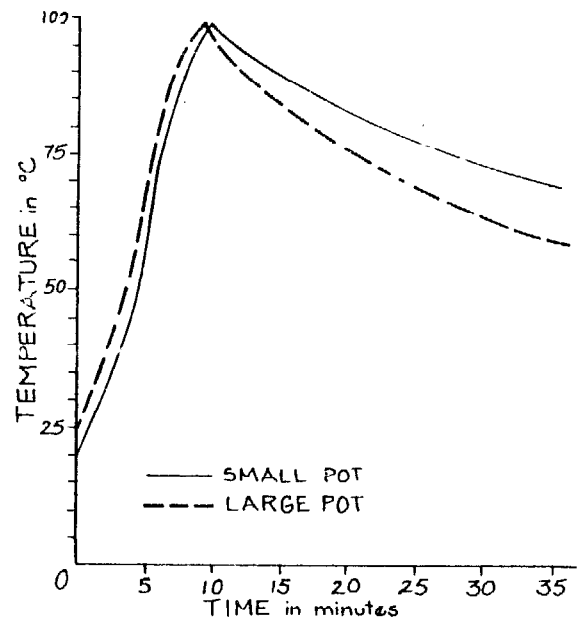

Figure VI-8

These tests could be used in demonstrations with local people to show the influence of pot design on efficiency and the importance of covering the cookpot.

To assure that differences in stove performance are a function of only the one variable in question, other variables should be standardized within each test. The following is a list of some variables that have major effects on stove performance. Also listed are some variations that might be studied in subsequent tests:

Cookpot -start with typical local pots.

- \* different types locally used
- \* metal vs. terra cotta
- \* improved types
- \* lids vs. no lids

Fuel type -wood used in comparative tests should be of consistent species, size, and moisture content.

- \* green vs. seasoned wood
- \* various sizes
- \* other fuels used seasonally

Ambient conditions -constant air temperature and windless environment

- \* inside vs. outside
- \* simulated wind from an electric fan

Combustion air control -use the same chimney, same damper positions

- \* experiment with air flow pattern, (e.g. secondary air inlet)
- \* dampers vs. no dampers
- \* change draft by using damper control or varying chimney size

Fuel feed rate -should represent typical pattern

- \* examine how changes in fuel feed rate affect heat transfer; how they affect heat distribution on multi-pot stoves

Cooking time -should represent typical pattern

- \* study fuel feed rate vs. cooking time vs. fuel consumption
- \* vary the relative positions of pots on multi-pot stoves to find the best use of heat

Cooking sequence -start with local pattern

- \* different designs
- \* compare to traditional cooking arrangements
- \* modify baffles
- \* vary internal geometry, e.g. firebox depth and shape

Stove -use one stove design in study of non-design variables

- \* test different typical foods
- \* could use heat input to water to simulate cooking

Food -different foods have different heat and time requirements; be consistent

- \* on multi-pot stoves, study the effect on performance of uncovered pot holes

Test operator -comparative tests should be conducted by the same person

- \* observe how other people control tests and influence stove performance



# Measuring performance

## Standard meal tests

Standard meal tests determine how well stoves operate under standardized local conditions; whether they actually save fuel when cooking, and if they are well adapted to local foods.

In a comparative test, if identical foods are cooked in the same way, performance can be assessed simply by measuring differences in fuel consumption.

Use what you know about local cooking practices to determine stove performance objectives. You might start with a cooking timeline.

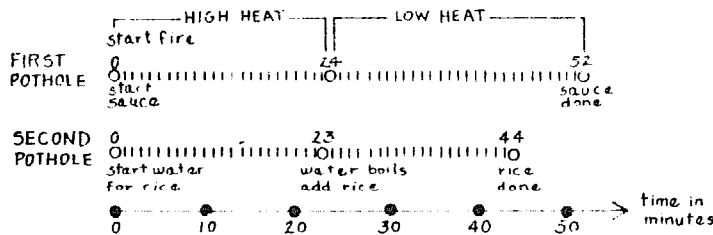

Figure VI-9

Using this, cook a few meals in traditional fashion, assuming the perspective of a local cook. When you have been 'trained' in local cooking techniques, measure the fuel used in preparing a typical regional meal. In comparison of improved designs, you need only prepare the same meal and measure fuel consumption.

If water is substituted for food in the cookpots, heat input to the water can be used as a measure of stove performance. The primary advantage of these "boiling water" tests lies in the uniform thermal properties of water.

The transfer of heat energy to water is easily quantified by measuring both its rise in temperature, and heat loss by evaporation:

$$\begin{aligned} & \text{Temperature increase ( } ^\circ\text{C) } \times \text{ weight of} \\ & \text{water (kg) } + \text{ weight of water evaporated} \\ & \text{(kg) } \times \text{ latent heat constant}^* \text{ (540 Kcal/kg)} \\ & = \text{Heat input (Kcal)} \end{aligned}$$

A figure for theoretical efficiency could then be calculated if the heat input to the water is divided by the chemical energy content of the fuel:

$$\frac{\text{heat input (Kcal)}}{\text{weight of fuel (kg) } \times \text{ energy content (Kcal/kg)}} \times 100 = \text{efficiency (\%)}$$

However, the efficiency of a stove in heating and evaporating water may be unrelated to cooking efficiency for several important reasons:

1. Consider the relationship between heating rate and useful heat when, for instance, cooking a grain in boiling water. As heat is put into the bottom of the pot, it is simultaneously lost from the top and sides. Ideally, the pot would be heated to the boiling point instantaneously, to minimize this loss. This would require a high power input for a short time. Then, the power input would be lowered to equal the heat loss, and the pot would simmer at 100°C. If the heating rate exceeded the loss from the pot, the water would not increase in temperature, but would merely boil faster, increasing the rate of evaporation. In the case of constant high heat input, the efficiency calculated from a cooking simulation test would not represent actual cooking efficiency because the high heat input rate does not cook the food any faster, but consumes more fuel.

2. If a pot has a lid, some of the water evaporating from it will be recovered as it condenses on the inside of the lid, and thus evaporative loss is not measurable. Therefore in a boiling water test conducted with lids on the pots, efficiency would appear artificially low.

- \* This constant represents the amount of energy consumed in converting liquid water to vapor.
- + The energy content of dry firewood is about 4800 Kcal/kg.

3. The thermal properties of water and many foods are different. Some of the heat utilized in cooking food is consumed in chemical changes and is thus not easily accounted for in a simulation test using boiling water.

For these reasons, boiling water tests do not directly measure cooking efficiency; they should not be used to project fuel savings that will occur under normal use conditions.

Nevertheless, boiling water tests have certain specific uses. Because heat input to water is precisely quantified, simulation tests may be more easily replicated than standard meal tests; the effects of some variables on stove performance might be easier to compare.

For example, heat distribution was studied in the following test. Comparing two multi-pot stoves, the relative amount of heat available to the first cookpot was measured. Using two kilograms of firewood, the fire was regulated so as to heat one liter of water in the first pot quickly to a boil, and then maintain a simmer for as long as possible. One liter of water was also placed in each subsequent pot to absorb the potentially useful heat available downstream from the first pot. The temperature profiles of the first pot, and of subsequent pots, for both stoves are graphed in Figures VI-10a and VI-10b. From this it appears

that the #1 stove (the Singer, see Chapter VII) might be better suited to efficient cooking where only one dish is to be prepared. The #2 stove (the Lorena, see Chapter VII) appears to distribute the heat of the fire more uniformly to all pots.

Evaporative loss of water was measured in this test only as a means of determining that the heat delivery rate to the first pot was approximately the same in each test.

The relative performance of these stoves might be quite different under normal cooking conditions, e.g. if the thermal mass of the pot contents were different, if lids were on the pots, etc. Thus the results of this kind of test indicate the relative performance under conditions that were simplified for expediency. The conclusions should be regarded as tentative.

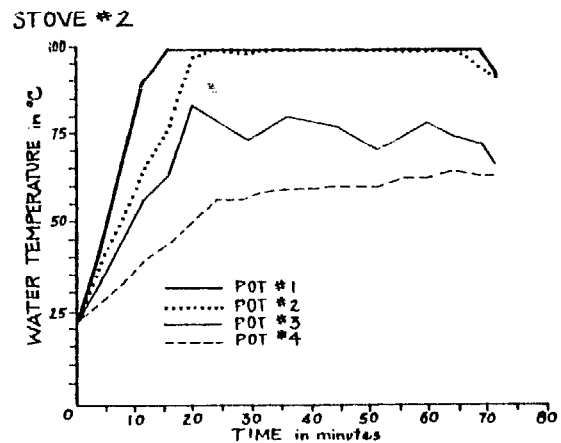

Figure VI-10b

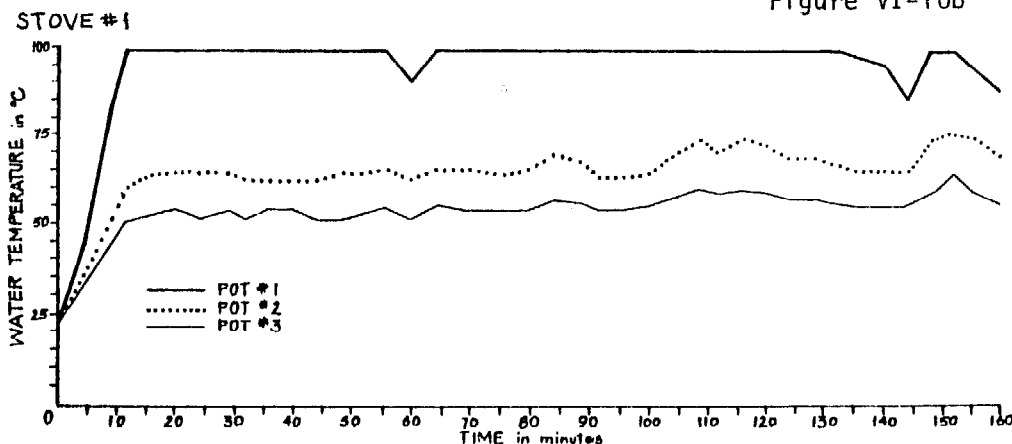
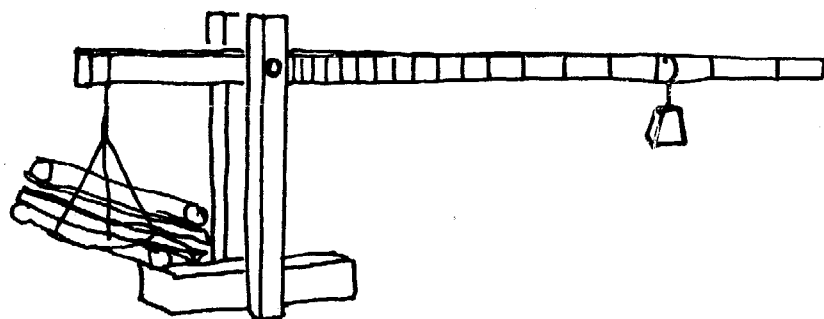

Figure VI-10a

## Hints on testing

During each test note anything that might influence stove performance, as it is hard to know what might be significant later.

You don't need expensive equipment to conduct these tests. Fuel can be weighed on a produce scale or an improvised balance could be built from a wooden rod and paint cans (see fig. VI-11). A milk bottle, or any container calibrated against a known standard (such as a canning jar) could be used to measure water and food volumes.\*



*MOVEABLE WEIGHT ON  
CALIBRATED BAR*

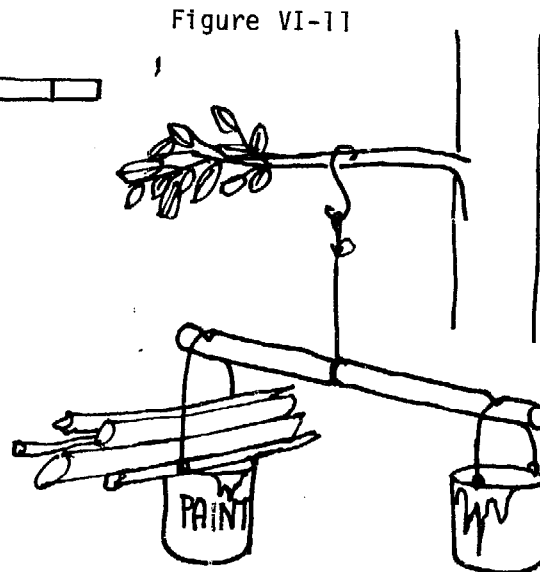

*LEFT-HAND CAN HAS LONGER  
HANDLE TO FIT FIREWOOD*

It might be useful to devise your own system of measurement, for some important variables. For example, you could describe a pot of water as boiling at a "light", "medium", or "furious" rate; or as a means of judging combustion efficiency, the opacity of smoke from the chimney of a stove could be rated as a percentage, no smoke at all being 0%, totally opaque smoke, 100%.

\* Volumes of H<sub>2</sub>O might also be used as a counter-weight for a balance. In the metric system, 1 liter of water = 1 kg; in the English system, 1 gal of water = 8.345 lbs.

# Chapter VII

## BUILDING INSTRUCTIONS

This section is not an exhaustive list of fuel-conserving cookstoves; nor does it contain the solutions to all technical problems that will arise in the field. It would be a mistake to apply any single design from the section without first considering its appropriateness carefully. We ask, rather, that people using this book look at each stove as an example of the design process.

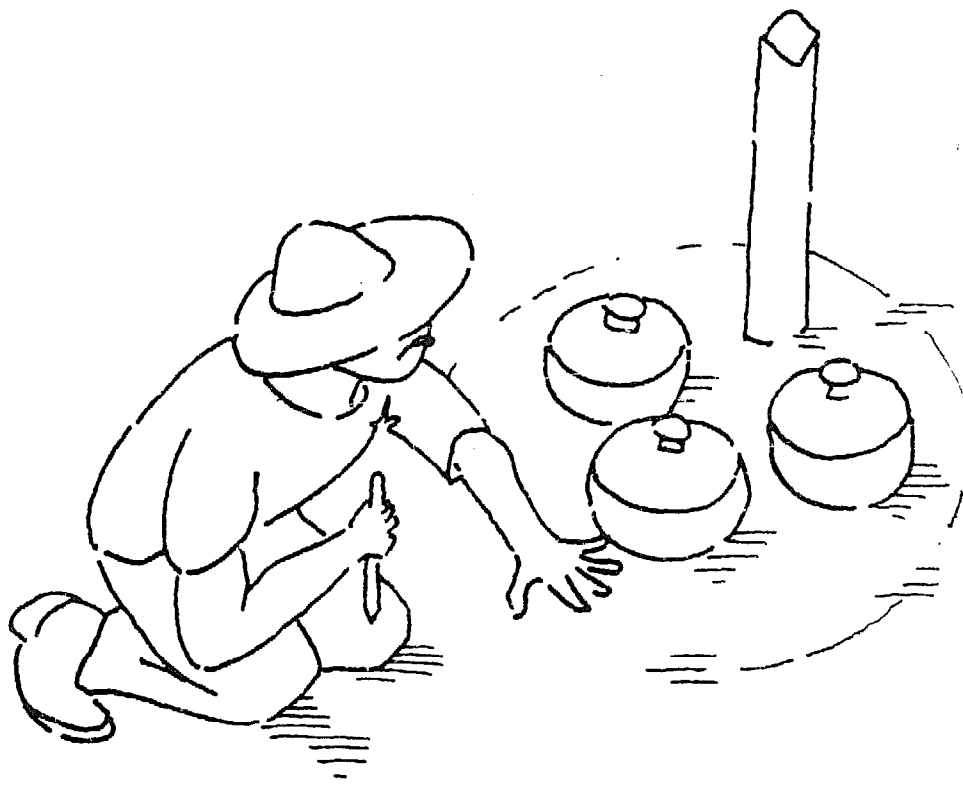

### A note on measurement (rules of thumb, hand and arm)

The dimensions of the stoves in this section are given as metric measurements. When teaching stove building in another culture (particularly to illiterate people), convert these to the local units of measure. You could use the thickness of a finger, the breadth of a hand or the length of a forearm as a basis for measurement.

## COOKING WITH RETAINED HEAT

In regions where much of the daily cooking involves a long simmering period (required for many beans, grains, stews and soups) the amount of fuel needed to complete the cooking process can be greatly reduced by cooking with retained heat. This is a practice of ancient origin which is still used in some parts of the world today.

In some areas a pit is dug and lined with rocks previously heated in a fire. The food to be cooked is placed in the lined pit, often covered with leaves, and the whole is covered by a mound of earth. The heat from the rocks is retained by the earth insulation, and the food cooks slowly over time.

Another version of this method consists of digging a pit and lining it with hay or another good insulating material. A pot of food which has previously been heated up to a boil is placed in the pit, covered with more hay and then earth, and allowed to cook slowly with the retained heat.

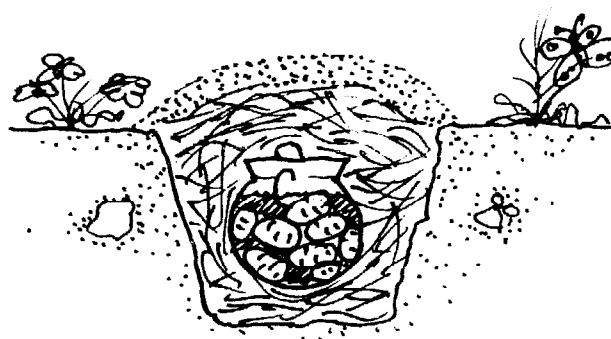
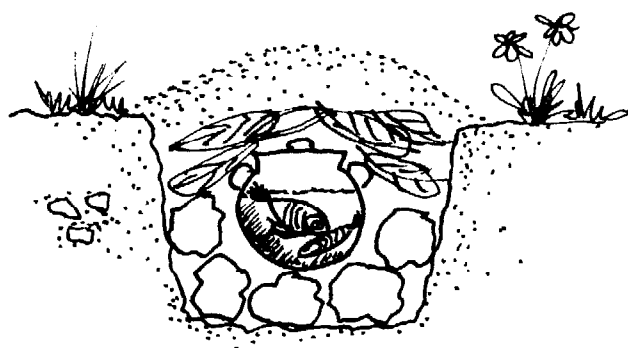

## THE HAYBOX COOKER

This latter method is the direct ancestor of the Haybox Cooker, which is simply a well insulated box lined with a reflective material into which a pot of food previously brought to a boil is placed. The food is cooked in 3 to 6 hours by the heat retained in the insulated box. The insulation greatly slows the loss of conductive heat, convective heat in the surrounding air is trapped inside the box, and the shiny lining reflects the radiant heat back into the pot.

Simple Haybox style cookers could be introduced along with fuel-saving cookstoves in areas where slow cooking is practiced. How these boxes should be made, and from what materials, is perhaps best left to people working in each region. Ideally, of course, they should be made of inexpensive, locally available materials and should fit standard pot sizes used in the area.

## Building instructions

There are several principles which should be kept in mind in regard to the construction of a Haybox cooker:

1. Insulation should cover all six sides of the box (especially the bottom and lid). If one or more sides are not insulated, heat will be lost by conduction through the uninsulated sides and much efficiency will be lost.
2. The box should be airtight. If it is not airtight, heat will be lost through warm air escaping by convection out of the box.
3. The inner surfaces of the box should be of a heat reflective material (such as aluminum foil) to reflect radiant heat from the pot back to it.

A simple, lightweight Haybox can be made from a 60 by 120 cm sheet of rigid foil-faced insulation and aluminum tape. The insulation can be cut with a hand saw or knife according to the following pattern:

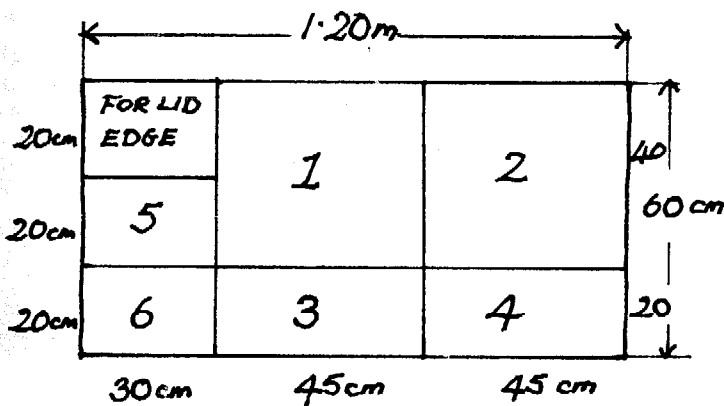

The pieces are taped together with 5 cm wide aluminum tape (aluminum-faced tape sticks better and reflects more heat than duct tape) in the manner shown below to produce a box with an internal volume of 35 x 30 x 20 cm.

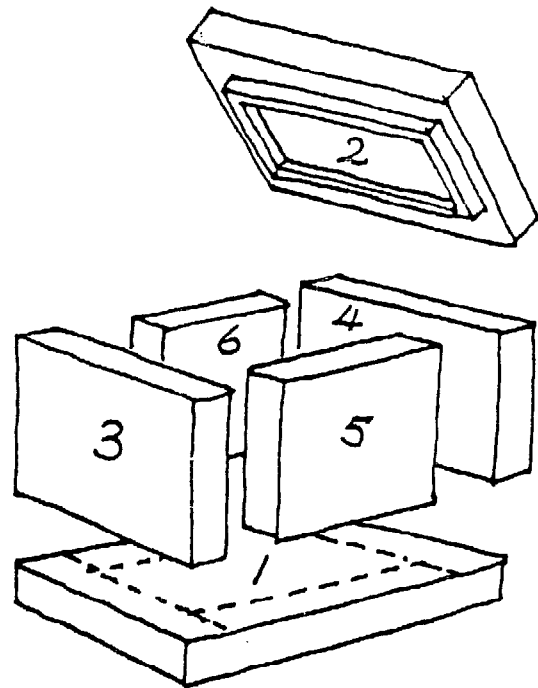

Other layouts can be used for pots of different sizes.

Use waste for edging the lid for a tight fit. Make sure no holes are left for the air to escape through. You will need 20 meters of tape to make the box.

A really simple Haybox cooker can be made from a cheap styrofoam cooler with aluminum foil taped to the inside walls. It works fine.

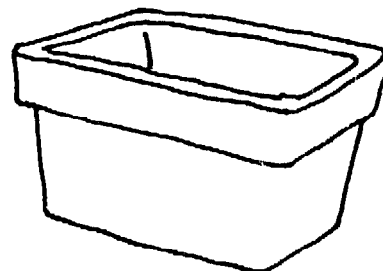

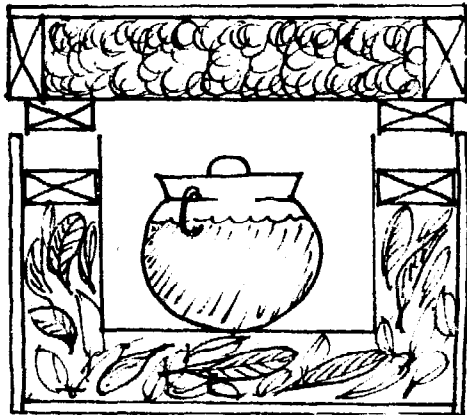

Haybox cookers can also be constructed as a box-in-a-box with the intervening space filled with any good insulating material. The required thickness of the insulation will vary with how efficient it is (see below):

Good Insulating Materials	Suggested Wall Thickness
Cork	5 cm
Polystyrene sheets/pellets/drinking cups	5 cm
Other foam insulation	5 cm
Hay/straw/rushes	10 cm
Down/feathers	10 cm
Sawdust/wood shavings	10 cm
Rags/old woolen clothes/old sleeping bags	10 cm
Wool/fur	10 cm
Raw cotton	10 cm
Fiberglass/glass wool	10 cm
Shredded newspaper/coalboard	10 cm
Ash/pumice	15 cm
Chaff/rice hulls/nut shells	15 cm

The inner box should have a reflective interior: aluminum foil, shiny aluminum sheeting, old printing plates, other polished sheet metal, or silver paint will all work.

The box can be wooden, or a can-in-a-can, or cardboard, or any combination; a pair of cloth bags might also work. Be inventive. Always be sure the lid is air tight.

## Instructions for use

There are some adjustments involved in cooking with Haybox cookers:

1. Less water should be used since it is not boiled away.
2. Less spicing is needed since the aroma is not boiled away.
3. Cooking must be started earlier to give the food enough time to cook at a lower temperature than over a stove.
4. Haybox cookers work best for large quantities (over 4 liters) as small amounts of food have less thermal mass and cool faster than a larger quantity. Two or more smaller amounts of food may be placed in the box to cook simultaneously.

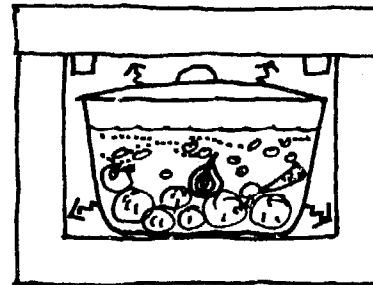

5. The food should boil for several minutes before being placed in the box. This ensures that all the food is at boiling temperature, not just the water.
6. The boxes perform best at low altitudes where boiling temperature is highest. They should not be expected to perform as well at high altitudes.

One great advantage of Haybox cookers is that the cook no longer has to keep up a fire or watch or stir the pot once it's in the box. In fact, the box should not be opened during cooking as valuable heat is lost. And finally, food will never burn in a Haybox.

# SAND/CLAY STOVES: THE LORENA SYSTEM

The Lorena system involves building a solid sand/clay block, then carving out a firebox and flue tunnels. The block is an integral sand/clay mixture which, upon drying, has the strength of a weak concrete (without the cost). The mixture contains 2 to 5 parts of sand to 1 part of clay, though the proportions can differ widely.

Pure clay stoves crack badly because the clay shrinks as it dries and expands when it is heated. Sand/clay stoves are predominantly sand, with merely enough clay to glue the sand together. The mix should contain enough clay to bind the sand grains tightly together, but enough sand to prevent the clay from shrinking as a mass.

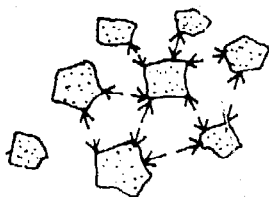

**SAND GRAINS APART  
LEAVE ROOM FOR CLAY  
TO SHRINK ALONG ARROWS**

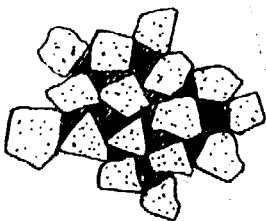

**SAND GRAINS BIND  
TOGETHER. SHRINKING  
CLAY CAN'T SHRINK  
THE WHOLE MASS**

## General characteristics of sand/clay stoves

The sand/clay mixture is strong in compression, but resists impact poorly. It is adequately strong in tension if thin walls are avoided. Unlike concrete, which works well as a thin shell, the sand/clay mixture relies upon mass for tensile strength.

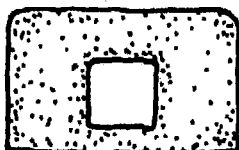

**THIS**

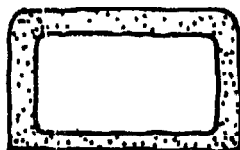

**NOT THIS**

### Advantages:

- \* Sand and clay are available in most places, and cheap.
- \* The material is versatile; it can be used to build almost any size or shape of stove.
- \* The tools required are simple.
- \* Construction of the stoves requires simple skills.
- \* Stoves are easy to repair or replace.

### Disadvantages:

- \* Construction relies on heavy materials that are not always available at the building site and are difficult to transport.
- \* The stoves are not transportable.
- \* Sand/clay stoves are not waterproof.
- \* Stove construction can require several days of hard work.
- \* Efficiency of the stoves relies on the quality of the workmanship in their construction.

It is unknown how long sand/clay stoves will last, the oldest Guatemalan Lorena being only three years old at the time of this writing (September 1980). Normally, they can be expected to work well for at least a year, after which they may need to be repaired.



## General construction principles

1. Choose the clay. Pure clay is not necessary; any clay soil will work if it contains little silt and if it fires well. Dig down; purer clay tends to lie below 30 cm. Look at excavation sites (road cuts, wells).

Clays containing sand, even in quite high proportions, may be excellent; too much silt, on the other hand, may cause real problems. Silt particles (smaller than sand but larger than clay) are not large enough to be bound by the clay. Avoid soils that contain a high proportion of silt. The best clays are those used for making bricks, tiles or adobes; ask local potters or brickmakers where they might be obtained.

To test for clay content: wet the sample until it is a stiff mud. Roll a small amount into a worm the thickness of a pencil, 5-10 cm long. Carefully pick up the worm at one end, using three fingers; hold it parallel to the ground. If it bends or sags but doesn't break, it contains a lot of clay.

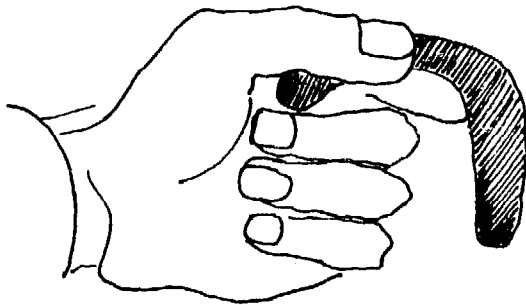

To test for firing qualities: dampen a handful of clay soil and form a ball. When thoroughly dry, put the ball in a fire for 1/2 hour. If the surface doesn't crumble or flake away when scratched with a fingernail, the clay should be suitable.

2. Choose the sand. Almost any sand will work well, though sand with particle sizes between 0.5 and 4 mm will work best. Silty sand can cause problems. If necessary, pass the sand through a 4 mm screen to remove the larger stones and over a 1 mm screen to remove silt.

When you have selected your materials make a small trial mix for building test blocks (see point 5).

3. Mixing. Your objective is to distribute the clay evenly through the sand. The dry clay should be pulverized, the lumps removed by passing it through a 4 mm or smaller screen. As if you were mixing concrete or mortar, mix the dry ingredients well before adding water.

If the only available clay is damp, soak it in water for several days, until there are no lumps and the clay will squeeze easily through your fingers. Then mix it with the driest sand you can find.

4. Add water. If your mix is still dry, mix in water, a little at a time, until the whole mix is moist. Mix it really thoroughly, making sure there are no little lumps of clay left. Mixing may take a long time. The better you have mixed clay and sand before adding water, the quicker the work will be. Methods for mixing include:

- a) stamping and grinding with bare feet, turning the mix occasionally with a large hoe or shovel,
- b) using a concrete mixer, if available, containing a few head-sized boulders to smash up clay lumps.

To test whether it is mixed, slide the back of a wet shovel across the surface of the pile. Clay lumps will show up as slightly shinier patches on the flat shiny surface you have just created.

- a) If you are using the Dry Method (see point 7): To test for water content, take a handful of mix and form a hard pressed ball 5-7 cm in diameter. Throw it about a meter into the air and catch it, letting it fall hard into your hand - don't cushion it. If it cracks, the mix is too dry. If it deforms, the mix is too wet. If it holds its shape, you are using the right amount of water.

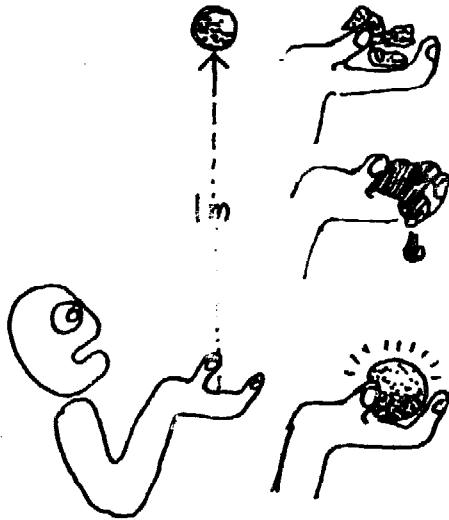

Try several sand/clay mixtures, for instance 2 to 1, 3 to 1, 4 to 1, etc. Make duplicate or triplicate blocks for each mixture. Let them dry thoroughly, turning them carefully so the sun can dry both sides. Choose the block that cracks least and whose surface doesn't crumble when you scratch it with something sharp; this is the best mixture.

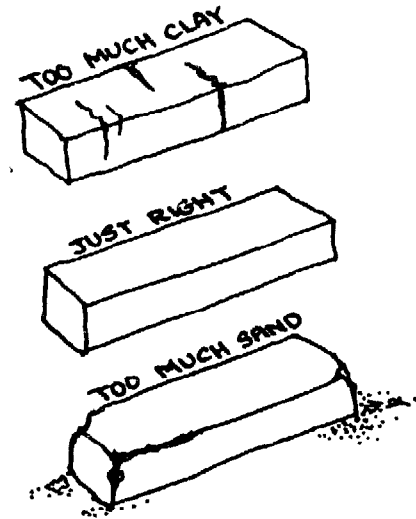

- b) If you are using the Wet Method (see point 7): Prepare a stiff paste or mortar, soft enough to spread with a shovel or trowel, hard enough to stand up and not slump.

5. Make test blocks. Before building a full-sized stove, make test blocks large enough to simulate cracking conditions for your stove. These are large bricks, at least 60 cm long, about 20 cm wide and 10 cm deep. Tamp the mixture (made by the wet method) into a wet wooden mold. Be careful to avoid cracking the block when removing the mold.

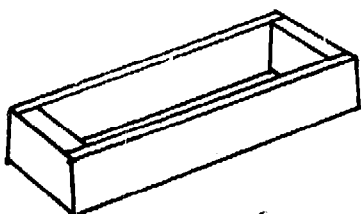

**TEST BLOCK MOLD.**

**NOTE SLIGHTLY SLOPED SIDES**

6. Layout. Before stove construction begins, the overall dimensions, pot hole sizes, pot sequence and other design features must be laid out. A stove plan can be drawn out on the floor where construction will take place or a scale drawing can be done on paper.

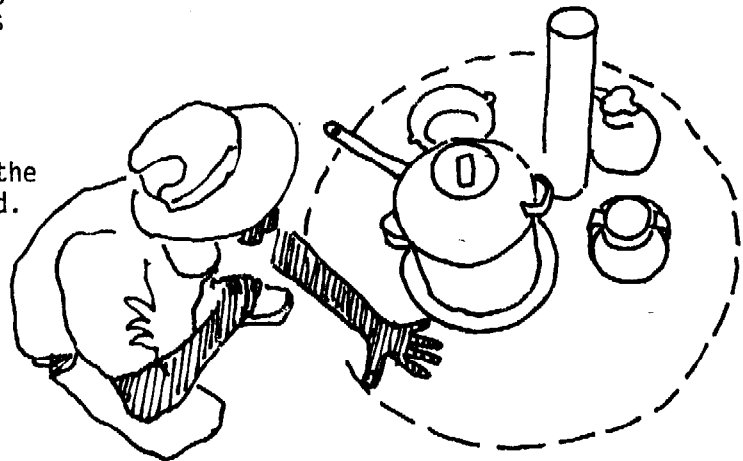

The schematic drawing under Point 9 illustrates those stove dimensions which must remain fixed (such as distance of firebox from edge of stove). Some basic design principles for the Lorena system are covered at the end of this section. Refer to the Guatemalan Lorena and the Louga stove sections for more design considerations and ideas.

7. Prepare the base. Build a solid base for the stove, either at ground level or raised. Sand/clay stoves are very heavy, so the base must be stable so it doesn't shift later, cracking the stove. Use concrete blocks, earth bricks, fired bricks, rocks, or whatever is locally available to build the base.

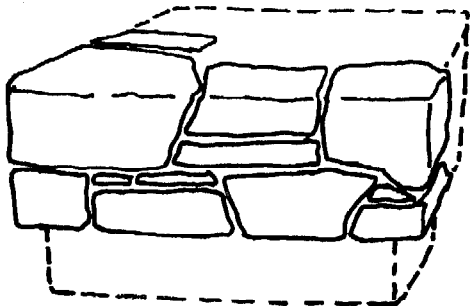

8. Build up the block.

- a) Dry Method. This technique is faster and uses less water; it should be used whenever possible. If many identical sized stoves are to be built, it may be worthwhile to make a wooden or metal form or mold which can be used for every stove. For single stoves, use a simple hand form, made out of two pieces of smooth plank for stoves with straight sides, or of a piece of sheet metal for curved ones.

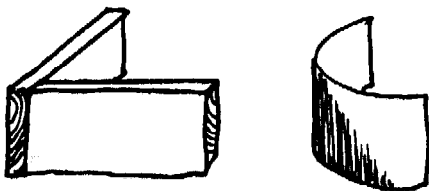

The form is used as shown.

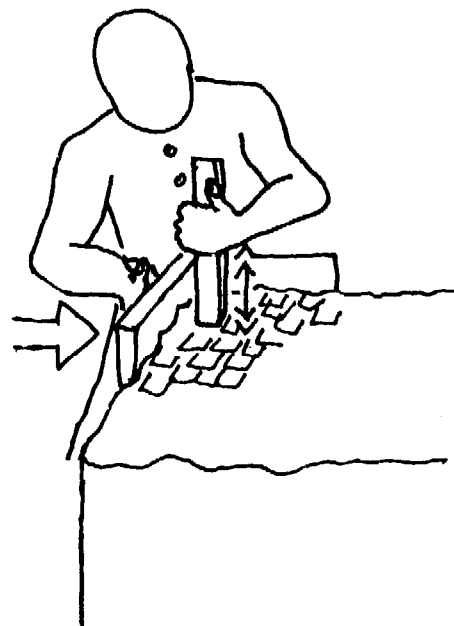

Shovel the ready made mixture onto the stove base, pounding it into place with a small piece of wood about the size of a hammer handle. Build up the sides and then fill in the center. Be sure to tamp each shovelful down before adding another. Press your mold against the side when you are building up the edge; make sure the edges hold firm. If you stop work, cover the block. If it dries out, moisten it. Don't build on a dry surface, or bonding will be poor and lines of weakness will appear at those levels.

- b) Wet Method. In some conditions, for instance if dry materials are unavailable, you may want to use the Wet Method. Prepare the mixture as a stiff paste or mortar, soft enough to spread, but dry enough not to slump when piled up 10 cm. Lay the mixture down with a shovel, trowel or piece of board, in layers 3-8 cm thick. At this stage, don't bother to make the surface smooth and regular; rough layers bind

better. Additionally, overworking the mix can weaken it. When each layer is just dry enough so you can't easily insert your fingertip, add another layer.

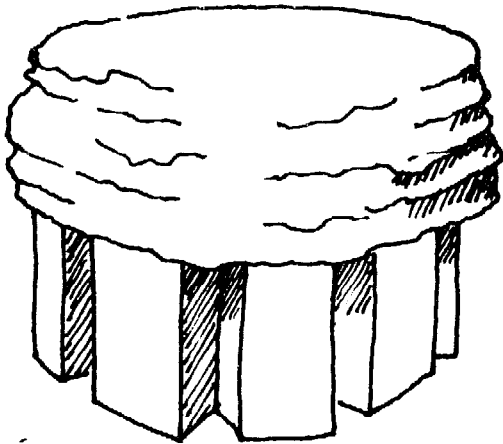

The sides of the stove must remain fairly straight as you build up the block. Carving must wait until the whole block hardens to the point where it is impossible to insert a fingertip more than 5 mm.

9. Damper slots. The Lorena system usually has one damper on chimneyless stoves, two on chimney types, one front and one back. They can be cut out of sheet metal, sliding up and down in runners attached to the front

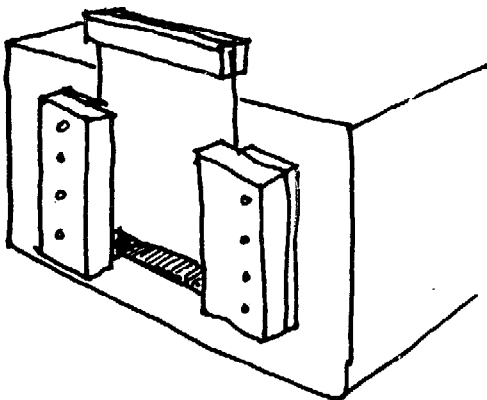

of the stove or in a permanent groove cut into the body of the stove. Cut a V-shaped notch the length of the damper slot into the surface of the stove. Then cut the damper slot very carefully, sawing up and down with a big knife or machete. Keep the knife wet at all times to prevent the block from cracking. The slot should be slightly wider than the tunnel which

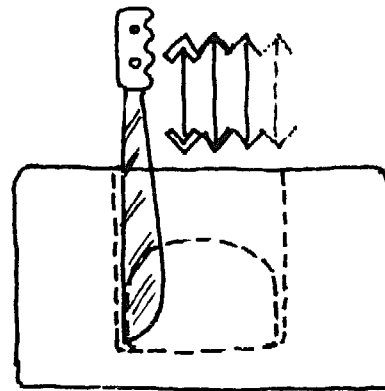

the damper will close, and as deep as the floor of the tunnel. Sliding front dampers work well as they channel air directly to the base of the fire. Alternatively, a solid plug of brick, concrete or adobe set into the mouth of the firebox might be used as a damper, or a brick or piece of pottery can be leaned against the stove to cover the fire box entrance.

10. Rough excavation. Excavate using a big metal spoon, a machete or a big knife, and your hands. Keep all your tools wet when in use to minimize friction and crumbling of the block. Use a scooping action, carefully carving away the space for the firebox and potholes and the tunnels

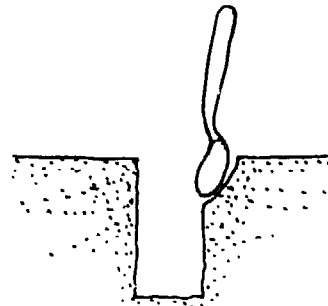

which connect them. The wet stove cannot withstand much stress. Don't lean on it while excavating. Remember that the material is easier to remove than to replace, so be cautious, carving away only a little at a time. Structural limits as shown in the following diagram must be observed in the excavation.

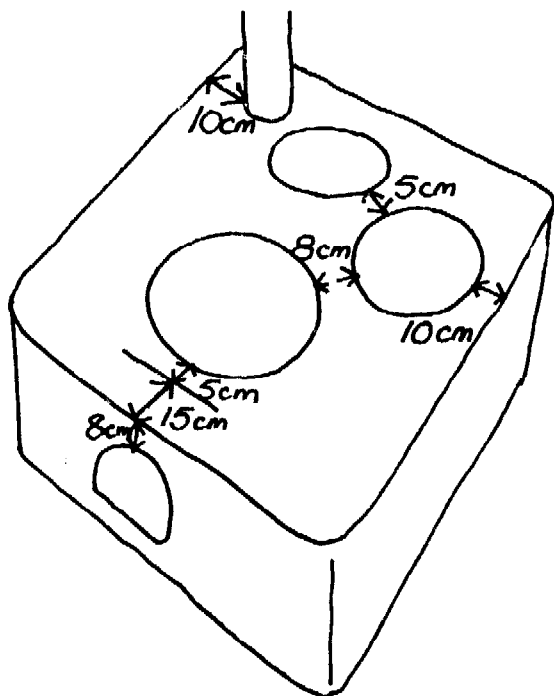

11. Fitting the pots. Unless space is deliberately left around the sides of the pot (see building instructions for the Louga stove), pots should fit snugly and the pot seats should be hard and smooth. Use the pots themselves to achieve this tight fit, wetting the pot and revolving it carefully in the hole, using it to smooth the seat. Set the pots deeply into the stove.

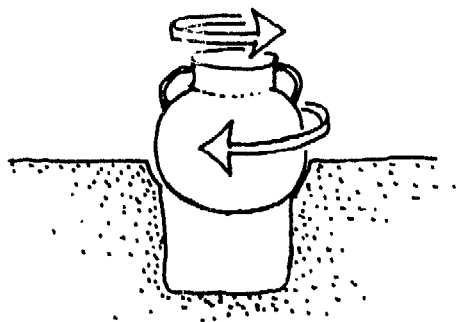

12. Baffles. Baffles are built up beneath each pothole to direct exhaust gases to the pot bottom. Add a small amount of lorena mix to the flue tunnel beneath the pot so that the tunnel rises to within 5 cm of the pot bottom.

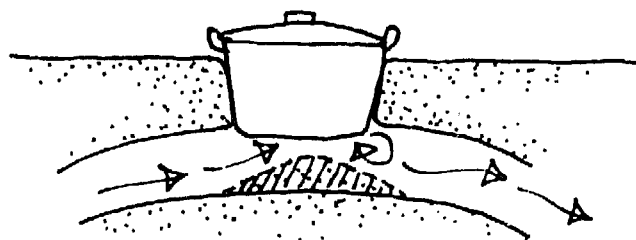

13. Repairing the stove. Structural cracking can occur during construction and excavation. Inspect the stove block while under construction for cracks so that they can be caught early. Cracks, holes and even seemingly destroyed sections of a sand/clay stove can be repaired.

When repairing a large structural crack or crumbled section, cut away enough material to leave a clean, solid shelf on which to rebuild. Dampen and score the surface of the surrounding material. Rebuild the section in layers, making sure that each layer is solid enough to accept more material. If a cave-in has occurred where a flue tunnel is being excavated, the tunnel may have to be partially filled to do the repair work and then re-excavated.

Surface cracks are not serious, they are only esthetic problems. They can easily be repaired by wetting the crack and cutting a V-shaped notch with a knife or machete. It is then filled with wet sand/clay mixture, and smoothed.

14. Finishing the stove. Burnish the inside of the firebox and tunnels with the back of a spoon or other rounded object. Smooth pebbles also work well. The material will be more durable if it is smoothed in this way. Even out the exterior of the stove by cutting off any lumps with a wet machete or trowel and filling in holes on the sides. Level the top with a machete or a smooth, wet board. Round off sharp corners or edges; this reduces the likelihood that they will be chipped off. The stove can be burnished with a trowel or spoon, or rubbed with a damp cloth.

15. Surface coatings. For protection against rain and spilled liquids, various coatings can be used. Try paint, whitewash, old motor oil, varnish, starch or a thin cement/sand plaster.

16. Chimney. Where earthquakes are no problem, the chimney can be built of sand/clay blocks cast in a small mold and thoroughly dried, using a mixture with slightly more clay for mortar. In earthquake-prone areas, chimneys should be constructed from materials that will not shatter, such as sheet metal.

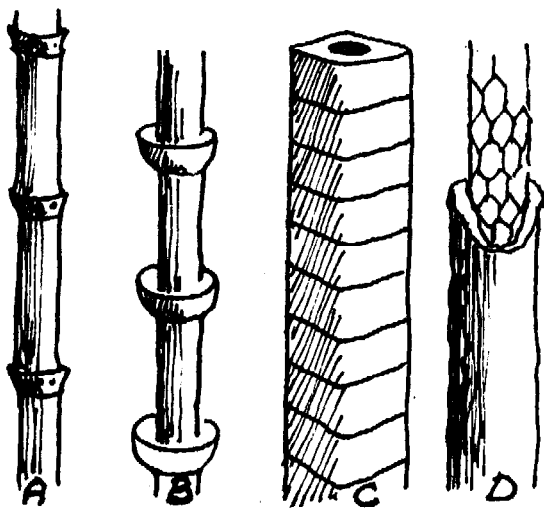

**A BAMBOO CHIMNEY**  
**B TERRA COTTA DRAINAGE PIPES**  
**C SAND/CLAY BLOCKS**  
**D FERRO-MUD (WIRE NETTING AND MUD)**

17. Recycling the stove. If after long use the bridge over the firebox entrance wears out, or if you would like a new stove for some other reason, break the block apart, crush the pieces, add some water and begin anew. Except for the material around the firebox and flue tunnels the sand/clay mixture can be used over and over.

## Designing with the Lorena system

The Lorena system, although it was developed in Guatemala, has been adapted to conditions elsewhere. Building instructions are given for stoves from Guatemala, Nepal and Senegal. You may be able to modify one of the examples given to suit local conditions by using the principles to generate your own design.

### Principles:

- \* Keep the firebox as small as is practical.
- \* Keep a high proportion of solid to void in the stove.
- \* Use dampers to control air supply.
- \* Sink pots as low as possible into the block. This will expose a large surface area of all pots to the hot gases.
- \* With multi-pot stoves, put the pot needing the highest temperature or longest cooking time directly over the fire. Pots needing less heat are placed close together along the tunnel. They extract heat from hot gases passing to the chimney.
- \* Baffles or bends in the tunnel under a pot will create turbulence in the airflow; this will transfer more heat to the pots.
- \* You can utilize the last remnant of waste heat to heat water before the warm gases escape up the chimney.

## THE GUATEMALAN LORENA STOVE

This was the first stove developed under the Lorena sand/clay system.

It was developed at Estacion Experimental ICADA-Choqui in highland Guatemala, where cooking is traditionally done over an open fire. The stove was specifically designed for the following conditions:

- \* Fuel is scarce.
- \* Wood is the primary fuel; other organic wastes are available, but burn poorly in open fires at high altitudes.
- \* Cooking is done indoors; smoke from open fires is a health problem.
- \* The staple food, tortillas, is cooked over a hot fire on a hot plate, which is usually 25-40 cm in diameter.
- \* Other foods require slow heat for a long time; several dishes are prepared for each meal, 2-3 times a day.
- \* The pots commonly used vary widely in size and shape.
- \* There is a great need for hot water for bathing.

The result was a stove responding to many of the above needs:

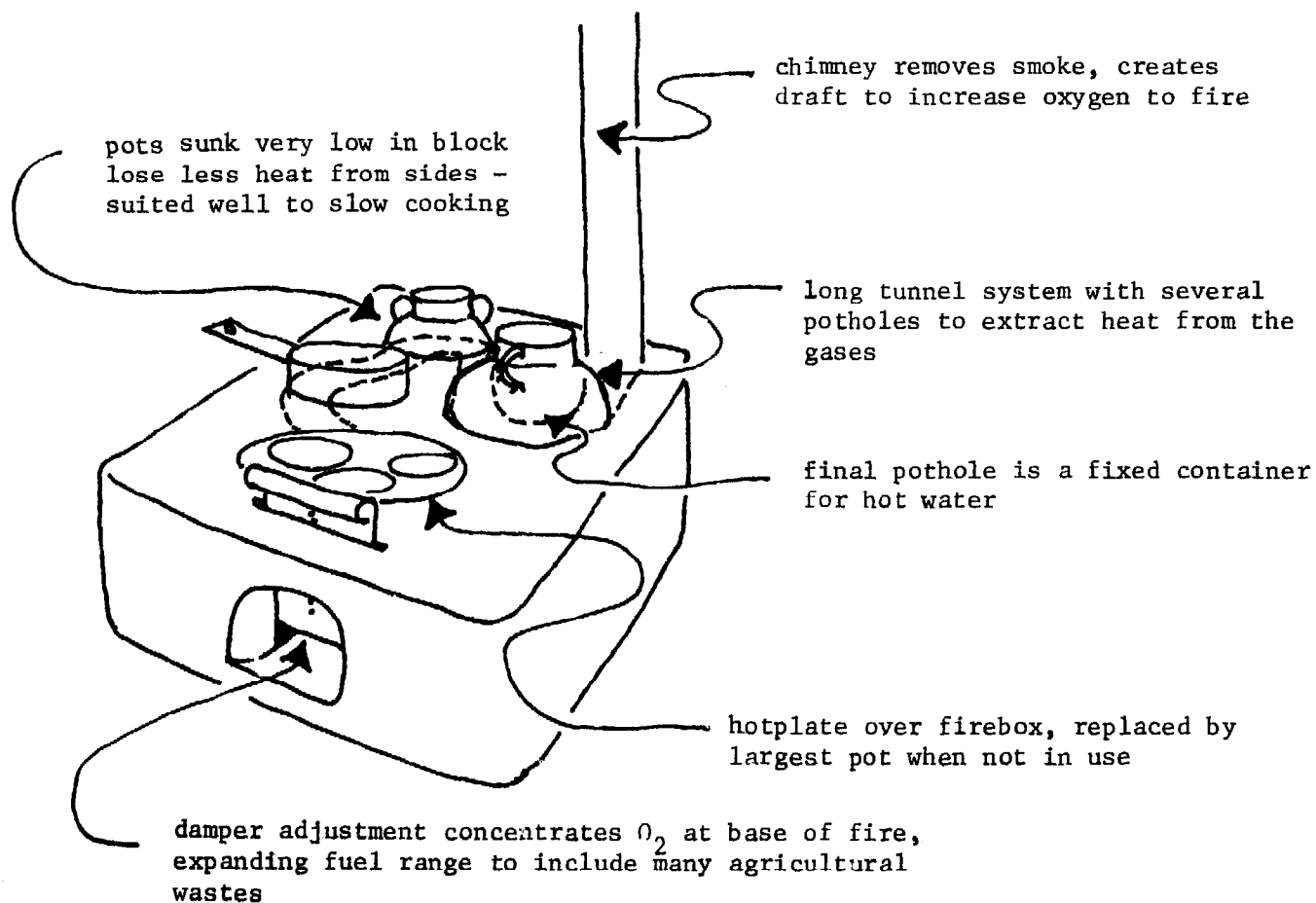

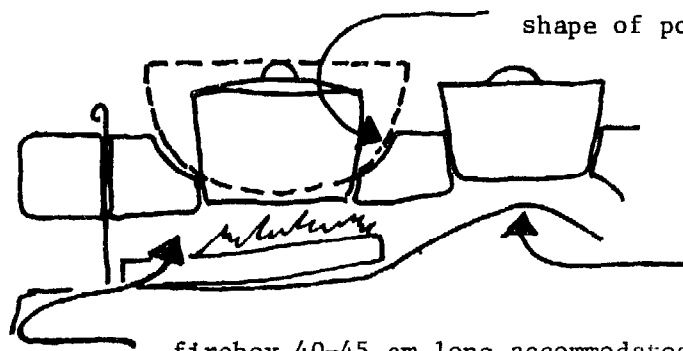

shape of pot seats can be made to take two different size pots

raised baffle/dam under each pot directs heat to pot bottom

firebox 40-45 cm long accommodates local cut firewood with damper closed

## Building instructions

Basic building instructions for the Guatemalan Lorena are outlined in the Lorena System's General Construction Principles.

## Technical assessment

The great advantage of the Lorena stove is its design flexibility. Each stove can be easily adapted to suit a wide range of individual needs. This is because of the plasticity of the material; sculptural excavation techniques permit the carving of diverse forms. Fluid interior shapes and custom-fit pot seats make the best use of heat in the stove.

### Other advantages:

- \* The high thermal mass of the material (a Lorena may weigh 500 kg) retains heat for a long time; this stored heat permits long slow cooking with minimal fuel.
- \* Stored heat can also be used for baking; the fire is removed from the stove, and food is cooked in the firebox.
- \* The damper system allows fine control of combustion rate.
- \* The stove can be owner-built with simple skills and tools.

### Disadvantages:

- \* Learning building skills may require several days' training. To build stoves well takes practice.
- \* The stove may be inefficient for cooking with only 1 or 2 pots.
- \* The stove doesn't keep people warm unless specially modified to do so.

## Ideas for variations

Since it was introduced in Guatemala in 1976, the basic Lorena design has been adapted to many diverse situations. Some of the adaptations developed in Guatemala are described in Chapter III. They include concrete reinforcing, nailed-on exterior dampers, nailed-on wooden rails with hooks for kitchen utensils, a 60 cm hot plate, and many different interior and exterior shapes.

For further information on Lorena stoves, see:

Lorena Owner-Built Stoves, by Ianto Evans, available from

Appropriate Technology Project  
Volunteers in Asia  
P.O. Box 4543  
Stanford, CA 94305  
U.S.A.

or write to

Estacion Experimental ICADA-Choqui  
Apartado 159  
Quezaltenango  
Guatemala  
C.A.



## Lorena stove variations

### United States

In the northwestern United States, the Lorena has been modified for home heating. The long flue tunnel through the Lorena allows much of the heat of the fire to be absorbed in the body of the stove; this heat is eventually released into the room. However, the high thermal mass of the material transfers this heat very slowly; the outside surface of the stove never gets very hot, but stays warm for a long time. Thus the Lorena provides constant heat even from an intermittent fire, as opposed to traditional metal heating stoves, which provide intense radiant heat only while the fire burns. The stove has been modified to increase its radiant heat emission, while retaining heat storage, by incorporating metal panels into the side of the firebox and flue tunnels:

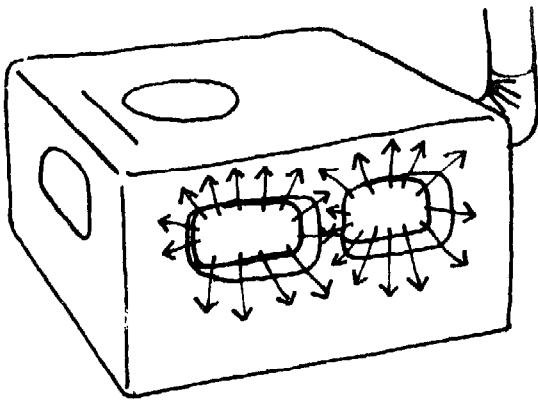

This stove tended to crack badly due to the expansion with heat of the plate steel panels:

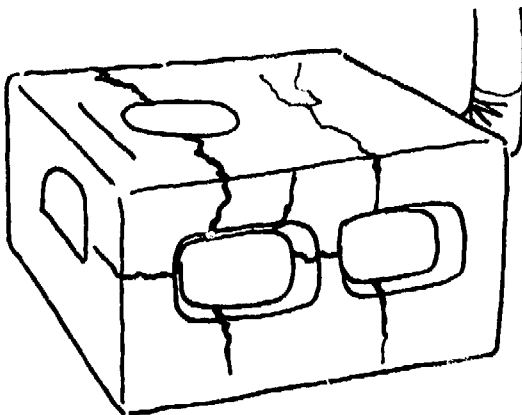

Another design used a buried metal pipe to circulate cool room air through the interior of the stove:

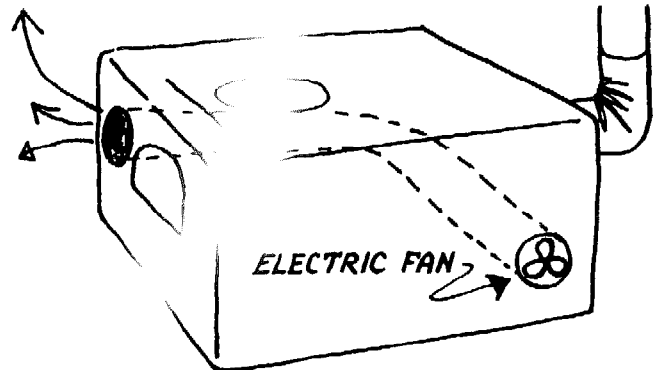

A simpler adaptation uses an inverted metal can over the first pot hole:

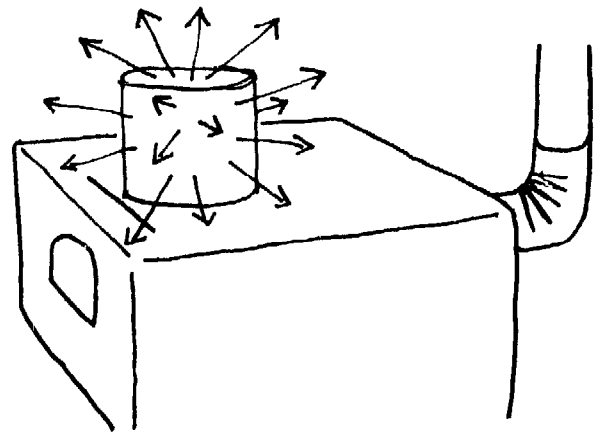

Another application of the heat storage capacity of the Lorena is for contact heating:

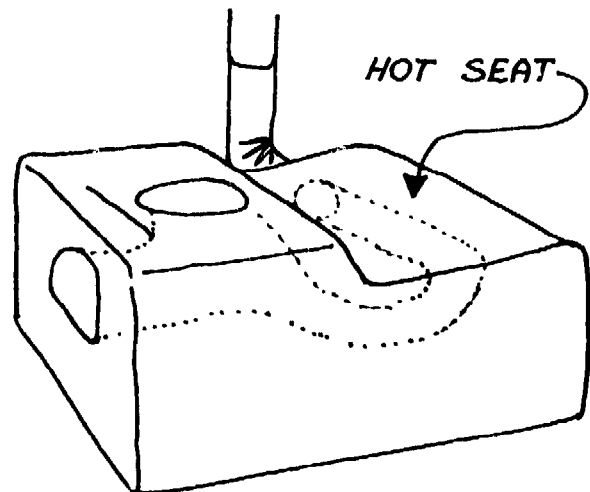

## Nepal

The New Nepali Chulo was developed at the Research Center for Applied Science and Technology, Tribhuvan University, Kathmandu. The Nepali stove combines features of the improved chulas of India with the Lorena building technique. The stove is built of the sand/

clay mixture and has the same basic interior design as the Lorena stove. However, it is much smaller and lower, as the wood used by the Nepalese is of small size and Nepali cooks prefer to squat. It also features a grate to improve combustion efficiency.

### HYDERABAD CHULA

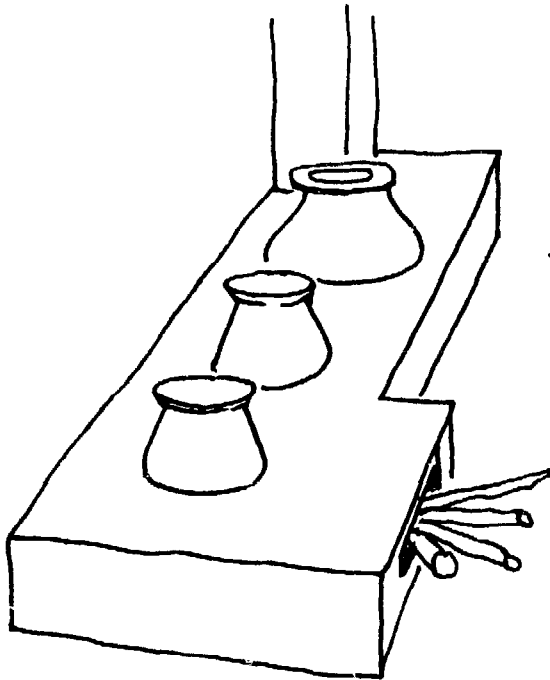

#### Advantages:

- \* small size; low to the ground
- \* simple design; easy to build

### GUATEMALAN LORENA

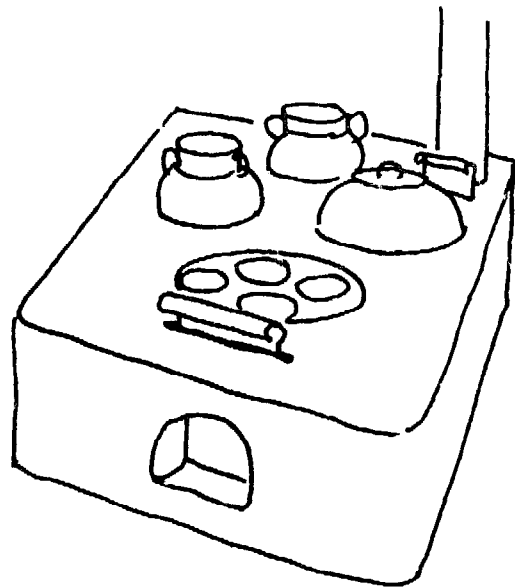

#### Advantages:

- \* fuel efficient
- \* damper system for air control
- \* carved flue tunnels with baffles
- \* stronger construction than Chula

# THE NEW NEPALI CHULO

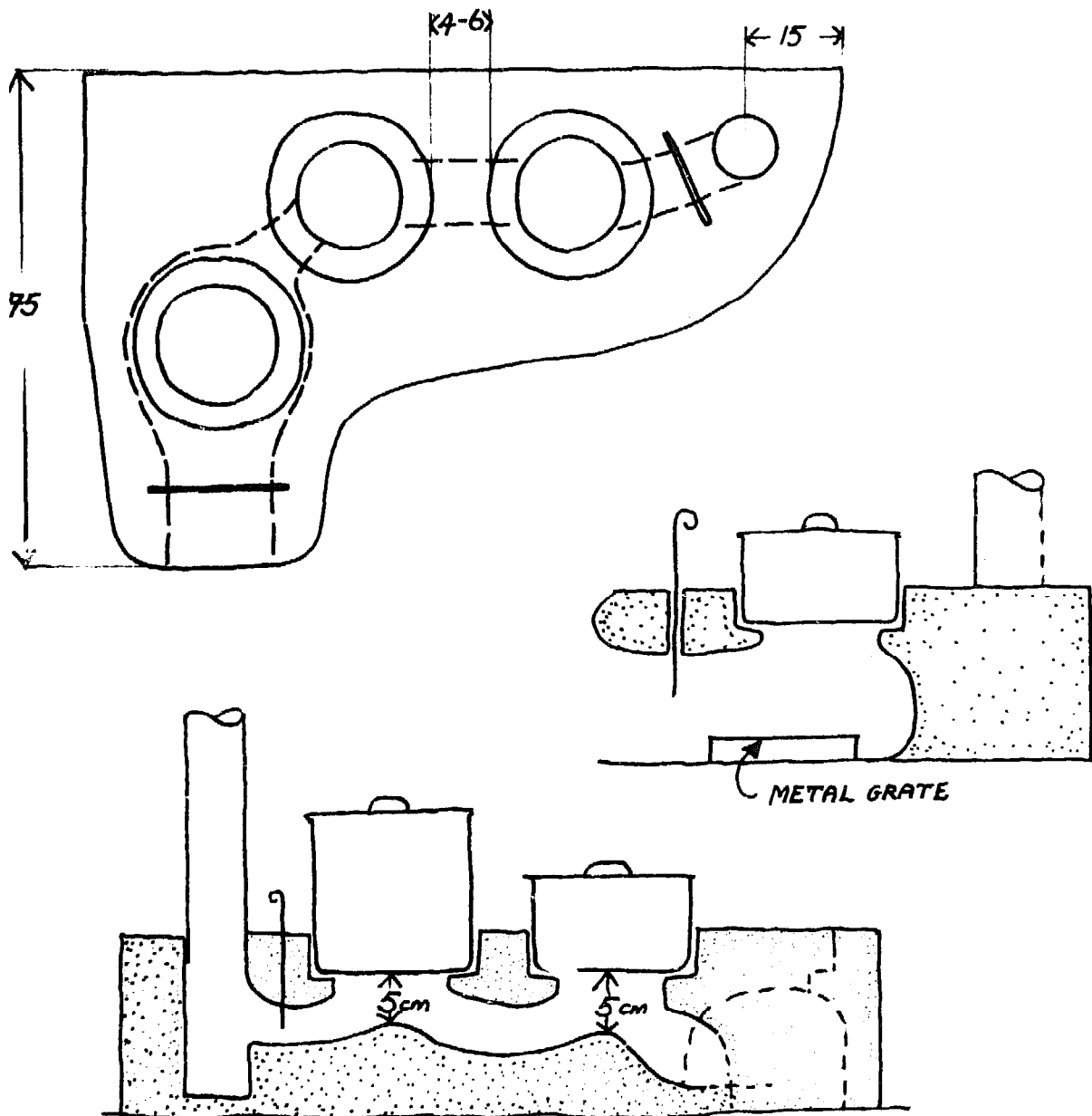

## Advantages of the New Nepali Chulo:

- \* fuel-efficient design, including dampers and baffles
- \* pots are sunk in low to reduce heat loss
- \* chulo is low to the ground to suit cooking customs
- \* strong and durable
- \* keeps the kitchen smoke free

## Upper Volta

In Upper Volta, yet another modification was tried at the Stove Demonstration Center of the German Forestry Mission in Ouagadougou. It combines the simple shape and block walls of a stove currently being introduced in Mali, and the structural strength and fuel-effi-

cient design of a Lorena stove. To build it, a frame of mud blocks is filled in with sand/clay mix, then a tunnel system is carved out, baffles are built and dampers cut (see General Construction Principles in the Lorena System for building instructions).

### MALIAN MUD STOVE

MUD SURFACE MOLDED AROUND POTS, REINFORCED WITH METAL

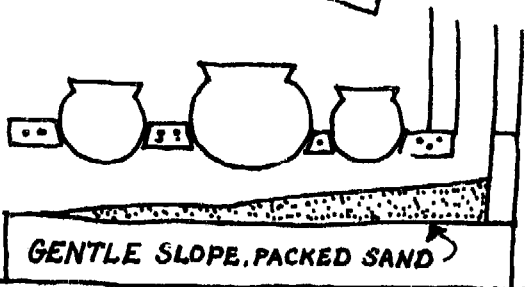
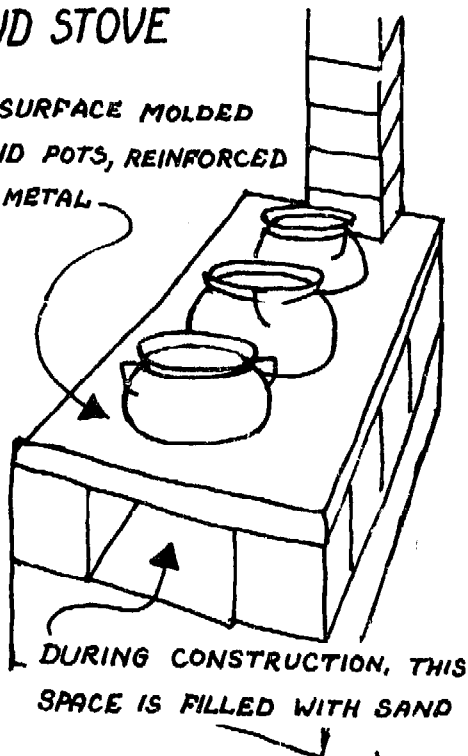

#### Advantages:

- \* simple to build
- \* quick construction

#### Disadvantage:

- \* top surface tends to deteriorate

### GUATEMALAN LORENA

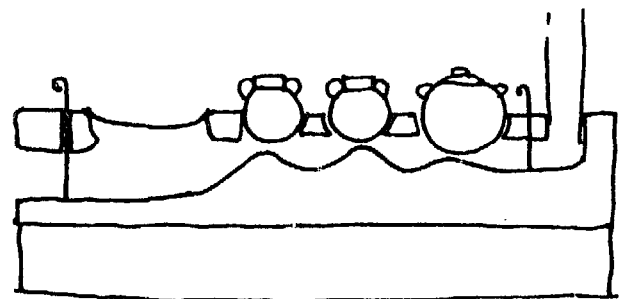
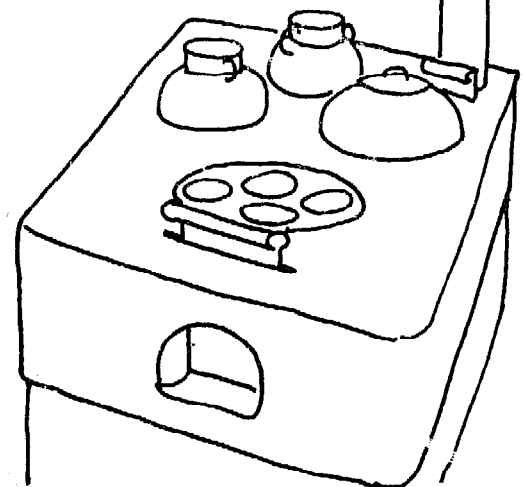

#### Advantages:

- \* baffles to improve heat transfer
- \* fuel-efficient
- \* damper system for air control
- \* durable

# THE VOLTENA STOVE

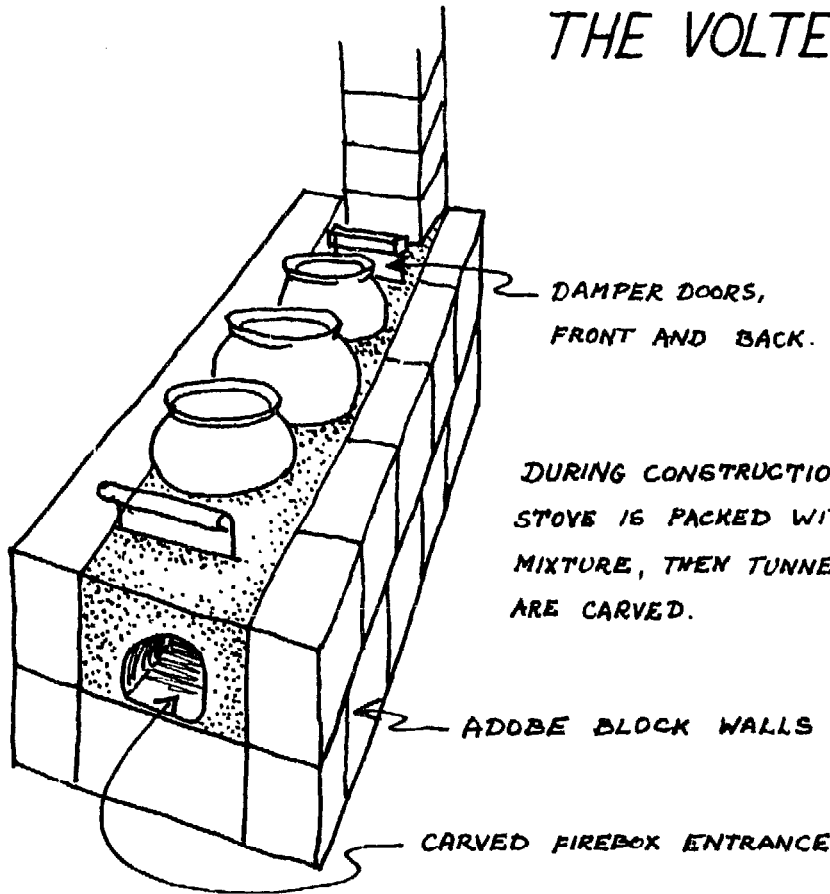

DURING CONSTRUCTION, INTERIOR OF STOVE IS PACKED WITH SAND/CLAY MIXTURE, THEN TUNNEL AND POTHOLES ARE CARVED.

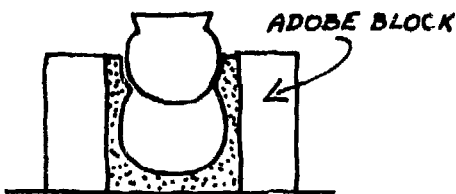

CROSS-SECTION,  
FIREBOX

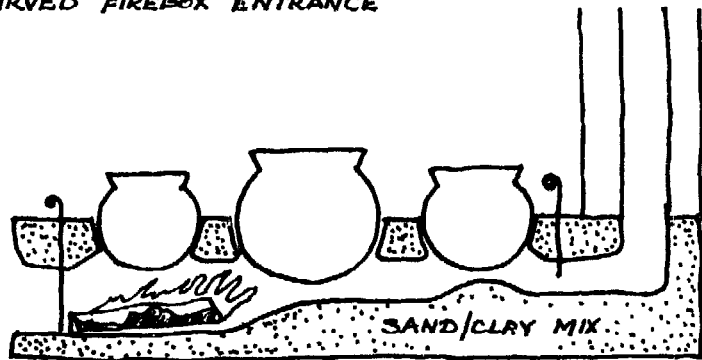

SECTION ALONG TUNNEL

The Voltena stove combines the advantages of both parent stoves:

- \* It is strong and durable.
- \* It includes dampers and baffles as fuel-saving devices.
- \* It takes less material to construct than a Guatemalan Lorena.
- \* It takes less time to construct than a Guatemalan Lorena.

## THE LOUGA STOVE

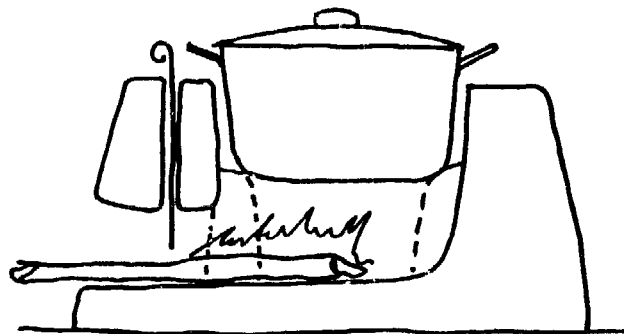
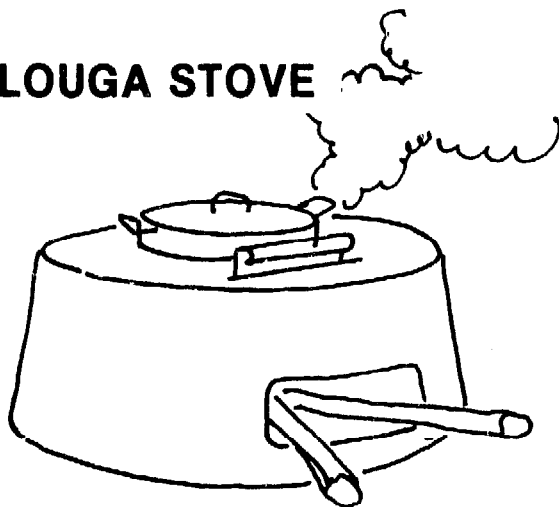

The Louga stove was designed in northern Senegal where people cook outdoors with only one pot. It differs substantially from the Guatemalan Lorena and the new Nepali chulo in that it is a one burner stove with no chimney; it has, instead of a chimney, a space all around the pot where the smoke escapes. Since the pot is set in deeply, hot gases heat the sides of the pot as they leave the stove. The pot is supported by three pillars set into the base of the firebox. They steady the pot at the ideal height for building a fire underneath. Stove walls are built fairly thick, thicker at the base for strength.

A Louga stove has at least one firebox entrance (sometimes two or three), large enough to allow pieces of firewood to cross under the pot. It may include a damper door at each firebox entrance; these improve the stove's performance.

The chimneyless Louga stove was designed to be used outdoors. It should therefore have a waterproof coating to protect it from the rain, or be built under an overhang or have a roof constructed over it. Louga stoves can be built at ground level or on a base, according to cultural or individual preferences.

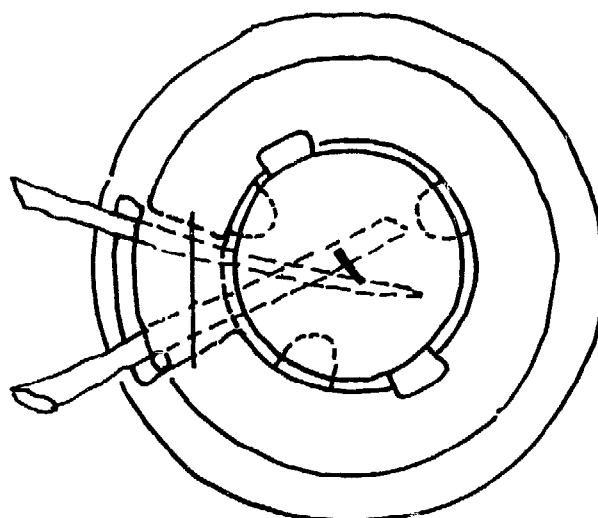

## Background

The Louga stove derives its name from the region of northern Senegal where it was developed by villagers in the spring of 1980 (see case study in Chapter III). In this area, meals, typically a grain steamed over a sauce, are cooked in a single pot.

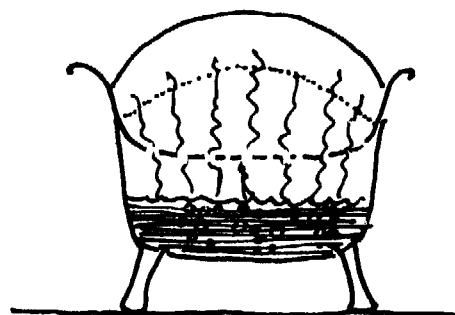

This cooking method uses a minimum of fuel in an area which is desperately short of firewood. The Louga stove works well, burning wood, grainstalks and dung. In field trials, it has saved over half of the fuel compared with an open fire. Its use is spreading very rapidly at the time of this writing (September 1980).

To determine the correct height for the stove walls, allow 5 cm beneath the fire, plus 10-15 cm for the fire, plus  $\frac{2}{3}$  the height of the pot.

Using the Dry Method, build up the block of the stove. Use the pot itself as a form around which to mold the sides, gradually raising the pot as you build up the sides.

## Building instructions

Follow the general instructions for sand/clay stoves. Here are specific instructions for the Louga:

1. Establish which pot the stove will be used for.
2. Level the space where the stove will be built. Make sure the ground is solid; tamp it hard if necessary.
3. If you need one, build a solid base,  $2\frac{1}{2}$  times the width of the pot, using bricks, adobe or rock. Fill in the spaces with soil, sand or debris, and pack it down hard.



4. The block of the stove should be at least twice the width of the pot.

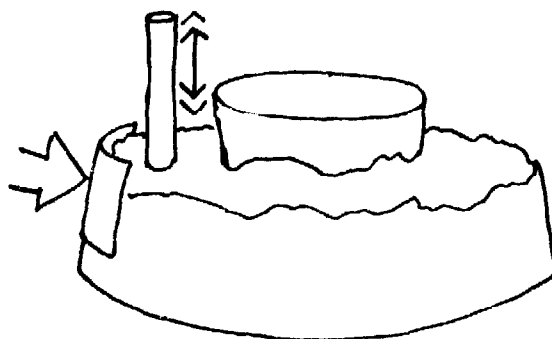
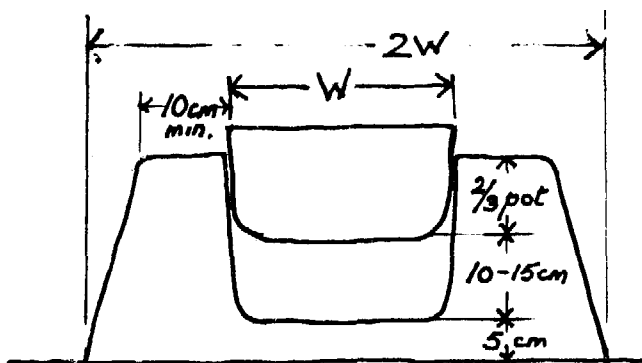

The sides can be tapered inward as long as they are not less than 10 cm thick at the top.

5. If you decide to use sheetmetal sliding dampers, cut a damper slot for every firebox entrance with a wet machete or long knife. Cut the slot slightly larger than the firebox entrance will be, using the method described in the Lorena System instructions.

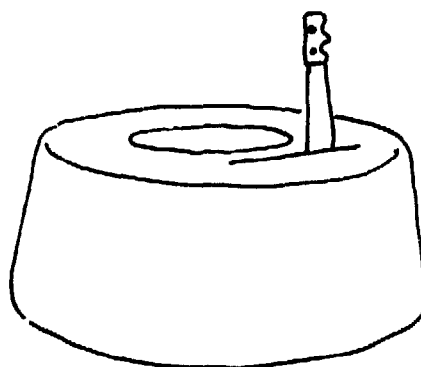

Other damper systems may be used, e.g. a brick or a specially shaped plug can be inserted into the firebox entrance, or runners for an exterior sliding damper can be nailed on once the stove is dry.

- Before the stove dries, carve out the pothole slightly wider than the pot, using a wet spoon. There should be one or two fingers' width of space between the pot and the stove wall. Leave a 5 cm layer of mixture at the bottom of the firebox, between the fire and the base.

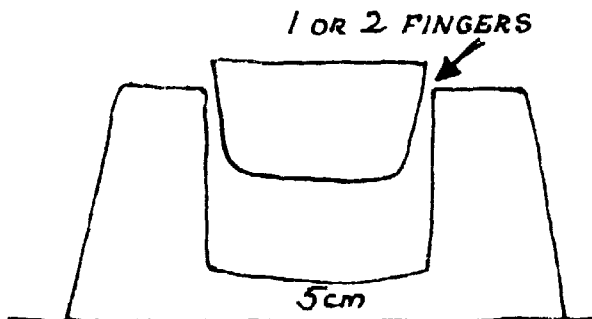

- With the wet spoon, carve out the firebox entrance. If only one entrance is made, it should be wide enough to allow sticks to cross inside the stove. If two or three entrances are carved, each one can be much smaller. The bridge above the firebox entrance should be at least 15 cm high.

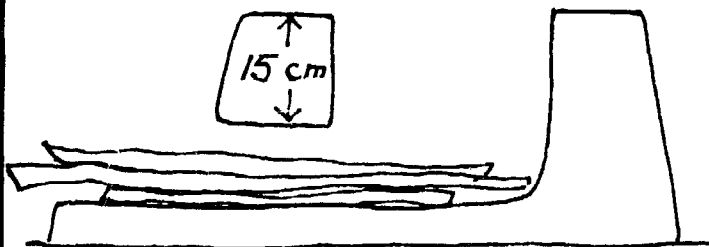

If the fuel to be used is long, build a slab in front of the firebox entrance.

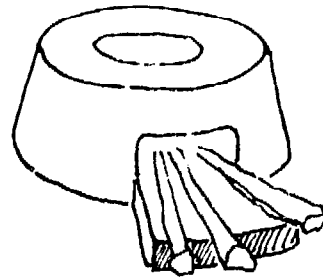

- Build three pot supports, 10-15 cm high (the height of the firebox), into the firebox walls. The supports can be rocks imbedded in the stove walls, or can be molded from the sand/clay mix with rocks set into the top surfaces for durability. The pot, when it rests on the supports, should extend about 5 cm higher than the stove surface; if the pot is lower, there tends to be a problem with smoke flavoring the food.

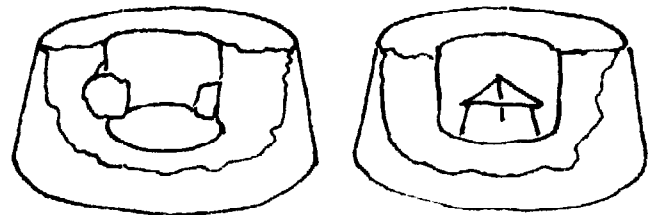

Alternatively, a three legged metal stand can be placed in the firebox to hold the pot.

- Smooth the interior and the exterior of the stove with the back of a spoon to harden it.

Make dampers to fit the damper slots.

Cover finished stove with a weather-proof coating if it will be exposed to rain. A protective coating used in West Africa is made from an oily substance (e.g. old motor oil) mixed with clay and water, and smeared on in a thin coat.



## Technical assessment

### Advantages:

- \* Burns less fuel than an open fire.
  - \* Well adapted to outdoor cooking -wind protection.
  - \* Protects the cook from radiant heat.
  - \* Cheap -costs little or nothing for materials.
  - \* A multi-entrance stove requires no change in traditional fire building techniques and is therefore easy to use.
- \* An insulant cover dropped over the pot and the top of the stove could make use of retained heat for slow cooking long after the fire is dead.

### Disadvantages:

- \* Smoky -must be used outdoors.
- \* Not transportable.
- \* One stove cannot accommodate a wide range of pot sizes.
- \* Can cook only a single pot at a time.

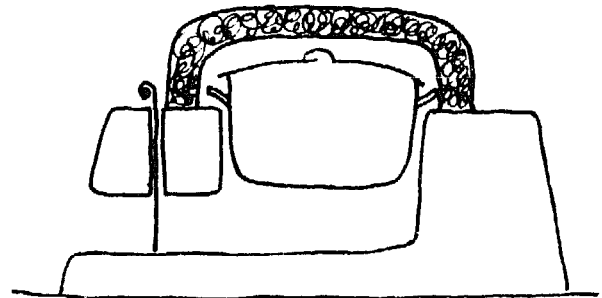

For further information on the Louga stove, see

## Ideas for variations

- \* Multi-pot designs could be tried.
- \* Louga stoves could be built as special occasion stoves for the very large pots that do not fit on an improved stove regularly used in a household.

Improved Cookstoves in Rural Senegal, report by Ianto Evans, Elisabeth Gern, and Laurence Jacobs, available from:

Volunteers in Technical Assistance  
(VITA)  
3706 Rhode Island Ave.  
Mt. Ranier, MD 20822

or write to:

Programme Ban ak Suuf  
C.E.R.E.R.  
B.P. 476  
Dakar  
Senegal

## CONCRETE STOVES

Concrete is a mixture of cement, sand, gravel and water. The strength of concrete depends on the quality and proportions of the materials, the way it is mixed and handled, and the way it is cured.

Cement is a finely pulverized mixture of lime, silica, and aluminum and iron compounds. When cement is mixed with water, a paste is formed which first sets (or stiffens) and then hardens into a solid mass. Setting and hardening involve hydration (curing), a chemical reaction between cement and water.

The sand used should contain particles varying in size up to 6 mm. The fine particles help fill the spaces between larger particles, so that the finished concrete is non-porous and strong. Fine particles are also necessary to provide good workability and a smooth finish. Too many fine particles increase the proportion of cement needed, and so increase the cost.

Gravel is between 6 mm and 30 mm in size. Gravel is used to economize on cement.

Concrete can be cast to form a single unit. This is the way the Kaya stove is constructed. In a Nouna stove, concrete is used as a binder for inexpensive bricks. Here are the characteristics of concrete as a stove building material:

### Advantages:

- \* Concrete is very strong. It is, however, questionable whether the strength of concrete is really needed to build a solid stove.
- \* Concrete is weatherproof.
- \* Concrete can be worked to a smooth finish, or coated with a cement slurry. This may improve a stove's esthetic appeal and facilitate kitchen hygiene.

- \* In some areas or social strata, concrete is considered a "modern" material. This may enhance a stove's popularity.
- \* A concrete stove of sufficient strength can be built light enough to transport it by truck or handcart: this permits central manufacture.
- \* Concrete is suitable for mass production. Identical forms can be cast rapidly, assembly-line style.

### Disadvantages:

- \* Cement, concrete and reinforcing steel are expensive. Because they are such heavy materials, transportation costs add substantially to the end price. This discriminates especially against hard to reach rural areas.
- \* Cement is often imported. Its price and its supply may therefore be subject to the fluctuations of international markets. It must be paid for in precious foreign exchange; this creates a drain on the country's resources.
- \* To produce strong concrete, builders must have a knowledge of proper mixing and curing. Since construction requires mason's skills, concrete stoves are less suited to be owner built.
- \* Concrete stoves are difficult to repair. It may be necessary to completely rebuild a broken stove.
- \* Concrete cannot be recycled.
- \* Properly curing concrete takes several days. If proper attention is not given, an inferior product will result.

Durability: It is not clear how well concrete holds up under long-term heat stress. Expansion cracks are common in both the Nouna and the Kaya stoves. Further work is needed to find a concrete mixture suitable to temperature extremes in a stove.

## Working with concrete

A concrete of suitable strength may be composed of cement, sand and gravel in a ratio of 1:3:4.

1. Mix the dry ingredients thoroughly on a board or concrete surface.
2. Add the minimum amount of water necessary to make a workable mixture. Excess water decreases the strength of concrete.
3. Wet the surface to which the concrete will be bonded. This prevents too much water being extracted from the concrete, hampering the curing process.
4. As it is laid, compact the concrete into place.
5. Concrete does not dry, it cures. Its strength derives from the crystalline structure established during hydration. The curing process requires moisture. If the concrete dries too fast, it may be weak and tend to powder or crack. To ensure proper curing, cover the finished concrete with gunny sacks or a sheet of plastic to slow down the evaporation process. Keep the concrete moist for a minimum of three days, and up to a week.

## THE NOUNA STOVE

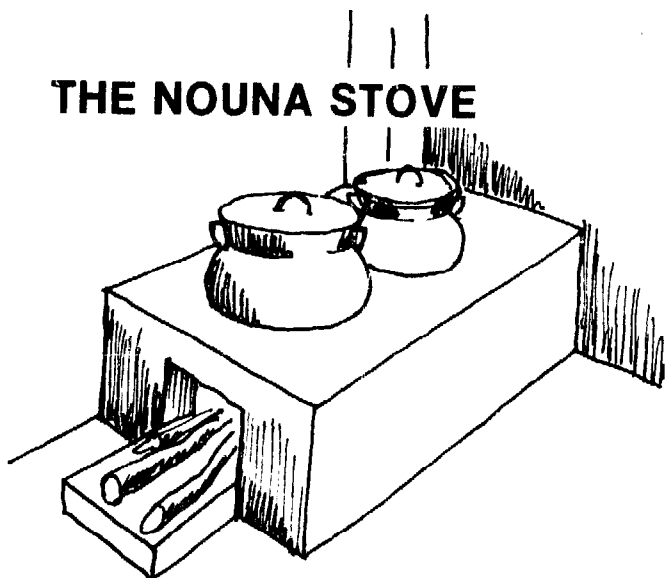

The Nouna stove is built chiefly from fired bricks, using cement mortar as a binder. A reinforced concrete surface layer is added for strength. Currently, Nouna stoves are built in the user's home, usually by specially trained stove masons. Curing is the responsibility of the owner.

Nouna stoves began as simple mud-brick boxes to enclose the fire (see case history, Chapter III). They have evolved into several designs that are well adapted to cooking customs in Upper Volta, keep kitchens smoke-free and save fuel.

## Background

Nouna stoves were developed by Rosemarie Kempers, a German volunteer, first in Chad, then in Nouna in the northwest of Upper Volta. They are designed to suit cooking conditions in Upper Volta, where:

- \* wood is the main fuel, but it is getting increasingly scarce and expensive,
- \* smoke is a problem wherever cooking is done indoors,
- \* the basic meal is a grain (millet paste or rice) and a sauce, although two sauces are not uncommon,
- \* millet paste must be stirred vigorously; the pot must therefore be held firmly,
- \* the cook sits on a low stool while preparing millet paste,
- \* hot water is needed for bathing, especially early in the morning.

In response to these needs, the Nouna stove features deep-set pots, is 30-40 cm high, has a chimney, saves wood and can keep water warm overnight with the heat retained in the mass of the stove.

## Building instructions

1. Wet down the ground and lay a slab of mortar (1 part cement:6 parts sand) the size of the stove.

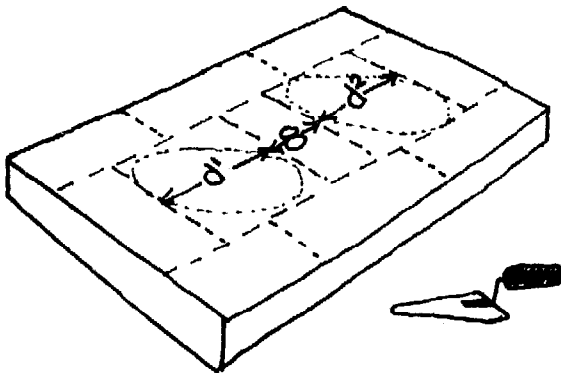

The stove's width should be the diameter of the largest pot plus two brick widths.

2. Soak the bricks well, then set them to form the walls and mortar them together. Where the chimney will be, the bricks are cut to provide a smoke exit. A space is left open for the firebox entrance, not more than 20 cm wide.

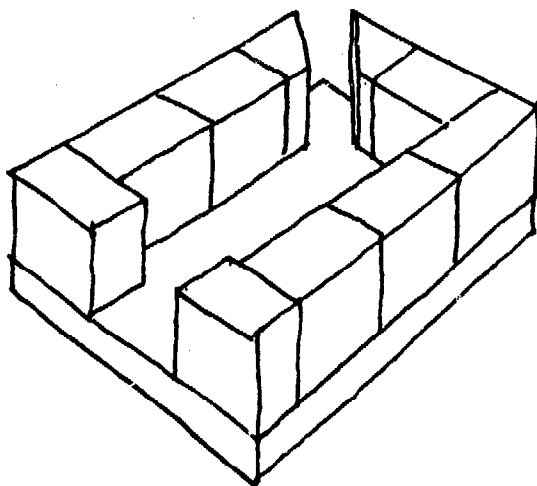

3. Mortar is laid on top of the wall bricks. The pots are wedged in place between the walls with thinner fired bricks, so no more than a third will be above the stove surface.

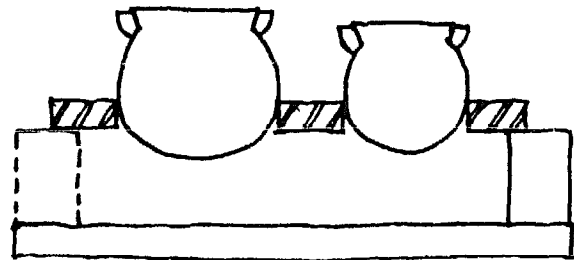

LONG SECTION

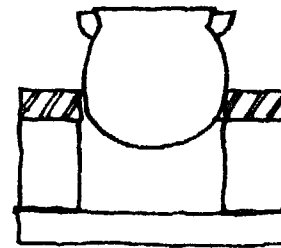

CROSS SECTION

Fired bricks should cover as much of the stove surface as possible.

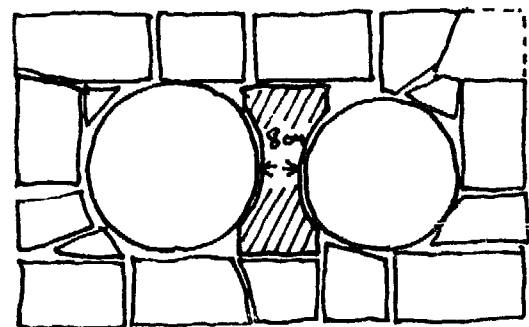

The brick between the pots should be trimmed to a width of 8 cm. Make sure all bricks are well soaked before using them.

4. A 3 cm layer of concrete is applied over the fired bricks. Set in a loop of reinforcing metal, then build up the concrete to a layer of 5 cm.

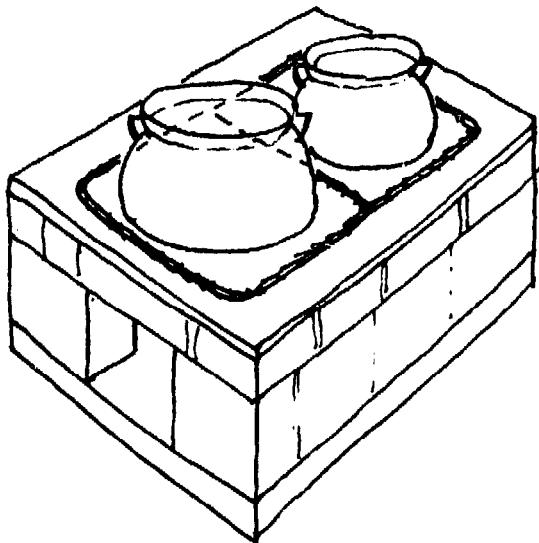

5. The chimney is built of fired brick and mortar, or of specially molded chimney bricks (see Kaya stove). The chimney should penetrate the roof and be covered (see Chimneys, Chapter V).

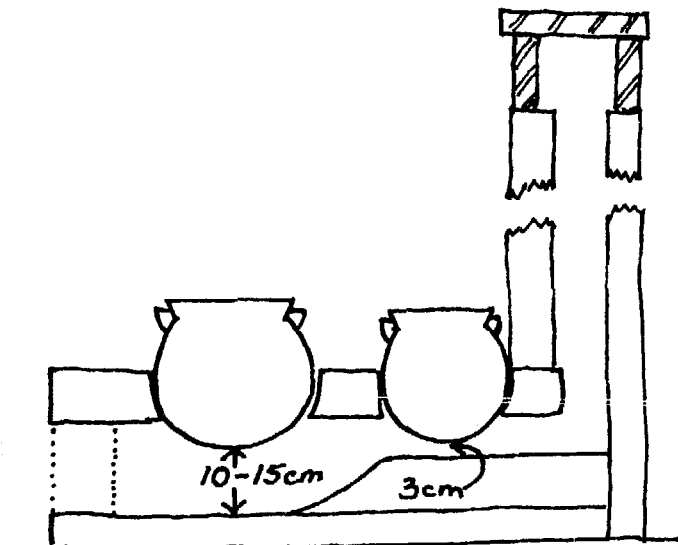

6. The floor of the stove is raised so there is a 10-15 cm space for the fire under the first pot and 3 cm under the second pot. This forces the hot gases to pass directly under the second pot.

7. The interior and the exterior are smoothed with a trowel, and a thin coat of mortar is applied to the outside. If long firewood is to be used, a slab is added to support the pieces that stick out of the firebox.

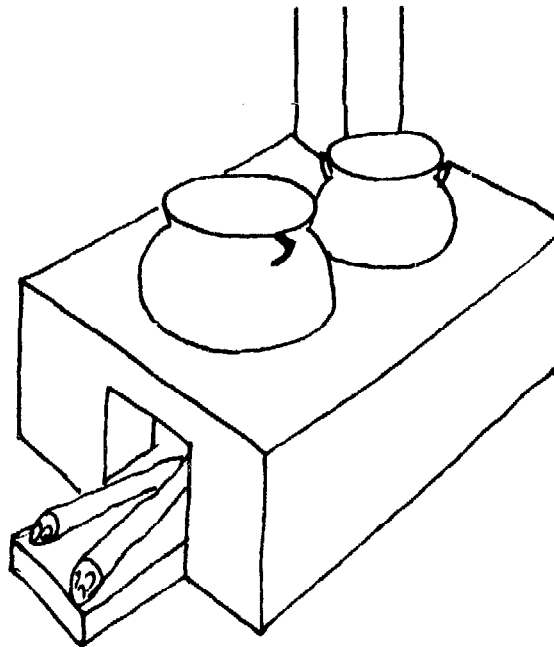

8. The stove is kept moist for seven days to cure.

## Technical assessment

### Advantages:

- \* Nouna stoves use less fuel than an open fire.
- \* They hold pots steady for cooking that requires vigorous stirring.
- \* They free kitchens from smoke.
- \* They can be custom built to fit individual needs.
- \* They can be partially rebuilt, should the area around the firebox deteriorate with prolonged use.

Disadvantages:

- \* Nouna stoves are expensive: in spring of 1980, they cost between \$15 and \$25 in Upper Volta.
- \* They tend to crack over the firebox entrance if fired up before they have cured.
- \* They are not transportable.
- \* The stoves use concrete inefficiently; i.e. they do not take advantage of its structural strength, but use it as binder or filler.

- \* A damper system could improve the stove's performance significantly. A simple front damper could be made by mortaring runners on either side of the firebox entrance and inserting a sliding damper.

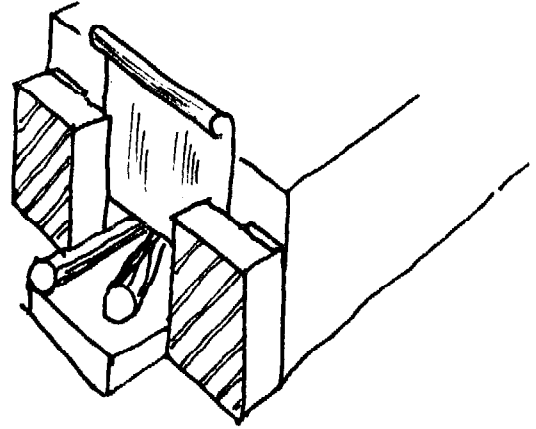

**Ideas for improvement**

- \* A special seat could be made over the firebox to set in a large water pot, or an additional pot hole could be used for a permanent hot water reservoir.

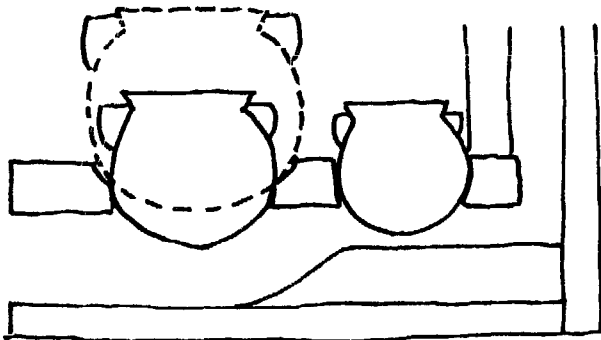

A back damper could be inserted sideways through a slot left between two of the rear bricks.

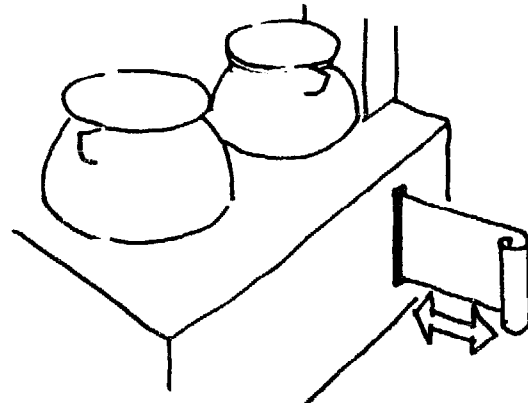

- \* Where more than two dishes are cooked simultaneously, a multi-pot stove could be built, possibly with two pot holes the same size so pots can be switched.

For further information on the Nouna stove, write to:

Improved Stove Project  
German Forestry Mission  
B.P. 13  
Ouagadougou  
Upper Volta

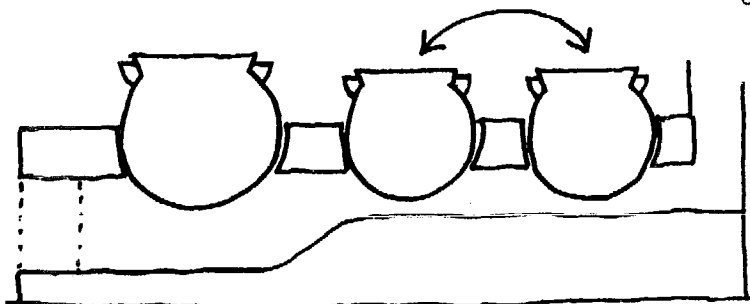

## THE KAYA STOVE

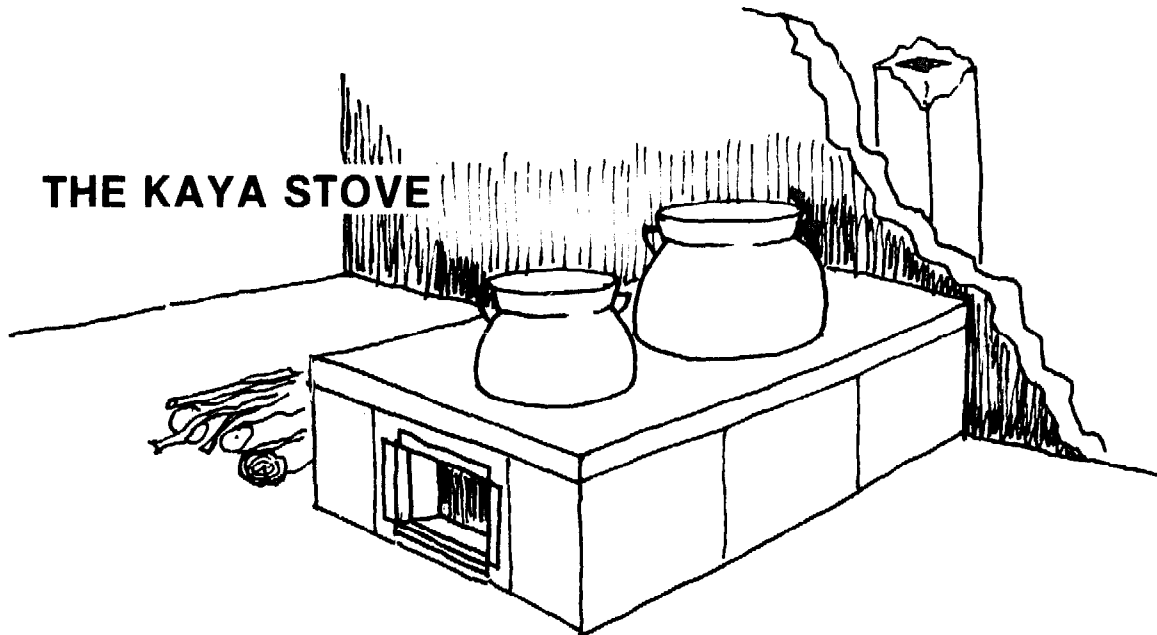

The Kaya stove is a semi-transportable concrete stove with a cast top-plate. It is designed to be prefabricated in a central location where it can be properly cured, and later installed in the user's home. Central manufacture allows a quality control not possible when stoves are custom-built and curing is left to the owner.

Stoves have two holes to accommodate two pots cooking simultaneously, and a chimney to draw smoke out of the kitchen. A feature worth noting is the very small firebox door which prevents the cook from building too big a fire, and which limits air intake. By means of this small firebox entrance and of a relatively short chimney, draft is regulated without the use of dampers.

### Background

The Kaya stove was developed in 1979/80 by Jonathan Hooper, a Peace Corps forestry volunteer based in the town of Kaya in north-central Upper Volta. His concern was not only to design a stove appropriate to cooking conditions in Upper Volta (see Nouna stove) which saved significant amounts of firewood, but to develop a method of production suitable for small local stove-building businesses. He began operating out of a central workshop, which allowed him to make use of the

advantages of mass production. Special tools simplify the production process and speed it up. These tools include:

- \* specially cut sheetmetal templates in the shape of the fire chamber to align the base bricks and to serve as a foundation on which to cast the top plate,
  - \* concrete molds the size of different pots, used to cast the pot-holes in the top-plate,
- 
- \* a special mold to form chimney bricks,

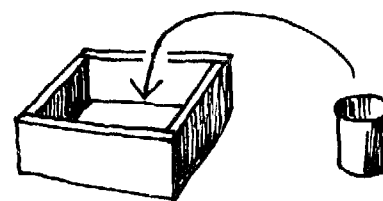

- \* a metal bending stand to shape the reinforcing iron.

With these specialized tools, stoves can be rapidly manufactured by workers skilled in basic masonry.

## Building instructions

1. Concrete blocks are set up around a metal template. The template is propped up with sand or wooden blocks so it is level with the blocks.

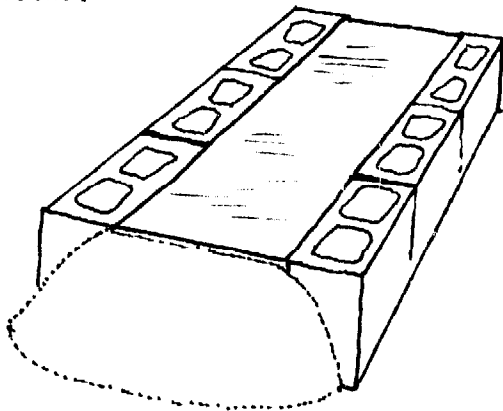

2. The concrete blocks are filled half-way with sand, and the sand wet thoroughly.

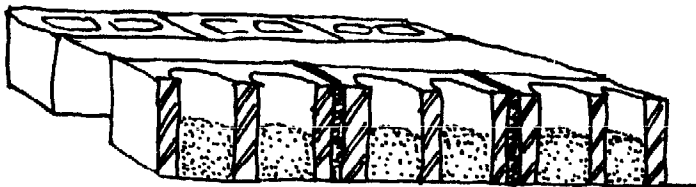

3. Concrete pot molds of the desired size are set on the template.

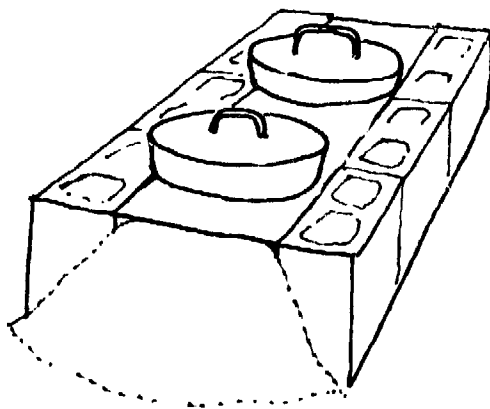

4. Concrete is applied in and over the bricks and around the pot molds to a thickness of 2-3 cm.

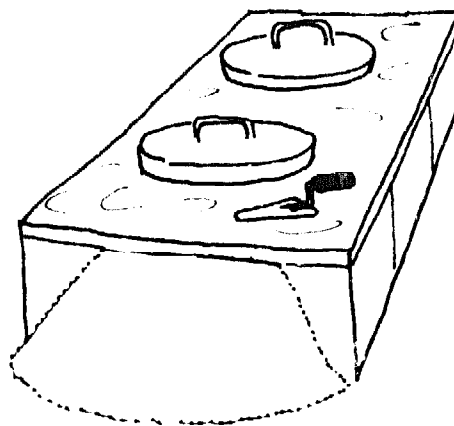

5. A reinforcing steel loop with two cross pieces, tied with wire, is formed and set in.

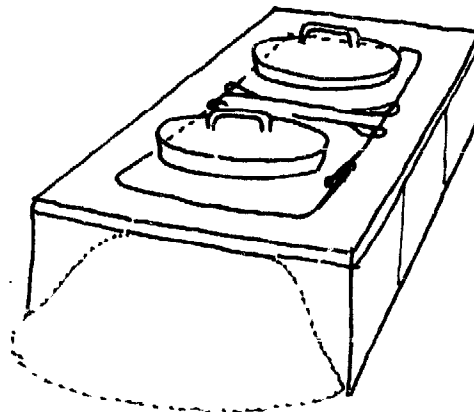

6. The concrete layer is built up over the reinforcing rod, to a total thickness of 5 cm. The surface is then smoothed, making sure the concrete around the pot molds is well worked.

7. After 2 hours, the pot molds are removed. After 24 hours, the metal template is pulled out. A pre-fabricated door frame (consisting of a metal angle-iron frame set into concrete) is then mortared into place.

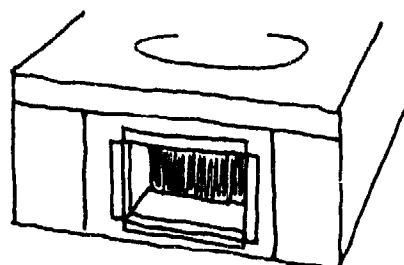



8. The finished stove is kept moist for five days. It is then installed, against a wall, in the user's home. Chimney blocks are stacked to form an exterior chimney. A specially molded block allows the smoke to pass from the stove through the wall into the chimney.

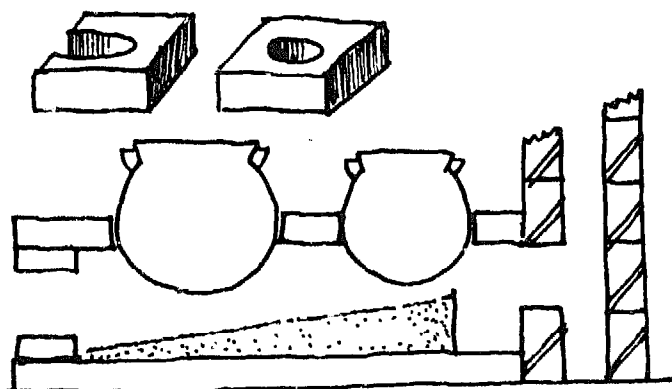

9. The floor of the stove is made of packed sand. It rises gently towards the back of the stove, ending in a baffle of scrap metal.

## Technical assessment

### Advantages:

- \* The Kaya stove uses less fuel than an open fire.
- \* It holds the pots steady, permitting vigorous stirring.
- \* It eliminates smoke from the kitchen.
- \* The Kaya stove is simple, suited for small business production. It requires relatively little labor.
- \* The prefabricated stove can be transported by trailer to the user's home.
- \* As with any mass stove, the Kaya stove's retained heat can be used long after the fire is dead.

### Disadvantages:

- \* The Kaya stove is expensive: in 1980, it cost about \$15 in Upper Volta.
- \* A mason's skills are necessary for construction.
- \* A Kaya stove cannot be partially repaired. Once the top-plate deteriorates, the whole stove has to be replaced.

## Ideas for improvements

- \* A damper system might further improve fuel efficiency.
- \* A baffle directly under the second pot would increase the amount of heat transferred to that pot.
- \* Multi-pot models could be tried.

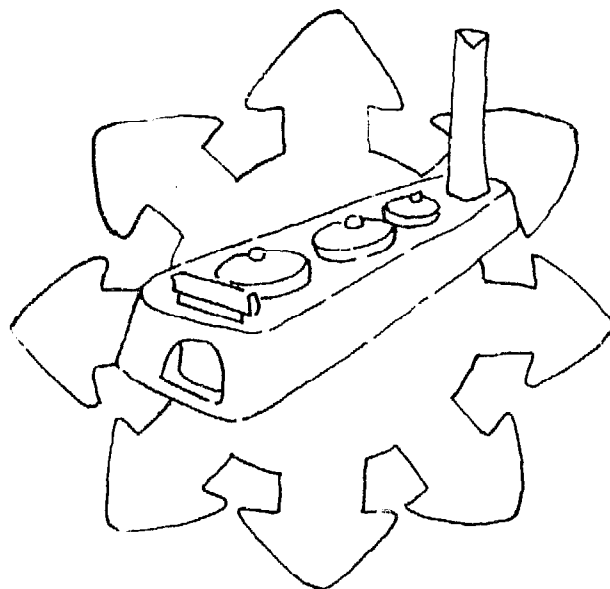

# A CLAY BRICK STOVE: THE SINGER

This stove is built of sun-dried or fired clay bricks. Fired bricks are more durable and may be easier to work with; however, a stove of sun-dried bricks may last for years, is less expensive, and can be built anywhere there is suitable clay and sand.

A stove of brick construction has these advantages:

- \* It is well adapted to small business enterprise, using the widely available skills of brick makers and masons.
- \* Manufactured bricks are available in most places. Sun-dried bricks can be produced with only clay, sand and short boards for forms.
- \* Clay bricks shrink as individual units; large cracks through the stove are unlikely.
- \* A good clay mix is nearly as strong as concrete.
- \* Surface plates custom made to fit pots can be replaced to fit new pots.
- \* With pre-fabricated bricks, construction requires little time.

## Disadvantages:

- \* Brick stoves are not suited to centralized production and distribution.
- \* The stoves are not portable.
- \* Well built stoves may require a mason's skills and tools.

## Making clay bricks

Making suitable clay bricks will involve some experimentation and considerable time; if locally made bricks are already available, use them. You will, however, need to use the clay brick material to form the surface burner plates and firebox door for the stove. Pure kaolinitic (well weathered) clays when used alone make suitable bricks. However, other more easily available clays often require additives to reduce shrinkage and cracking.

Sand is used to reduce shrinkage. The clay in a clay/sand brick shrinks only in the interstitial spaces; sand particles that touch each other prevent overall shrinkage of the entire brick.

Chopped straw, rice hulls, or other fibrous organic matter added to the mix have two effects: they add structural reinforcement, and, by providing channels for moisture flow, facilitate uniform drying, thus reducing cracks.

*SHRINKAGE  
IN CLAY BRICK*

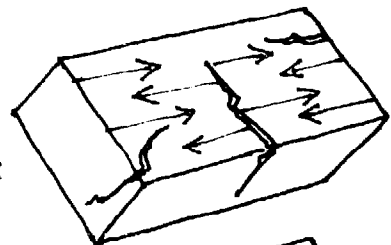

*CHOPPED STRAW  
SPREADS CONTRACTION*

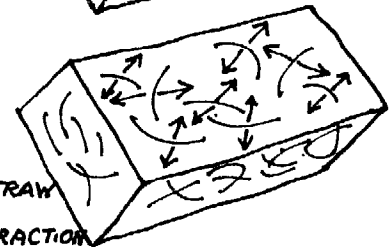

Some combination of clay, sand, and organic material will probably make a strong brick. You might try proportions, by volume, of 3 clay:6 sand: 2 chopped straw; 3:3:1; etc. Experiment with different mixtures. 100-300 bricks may be used in building a stove, so 20 trial bricks of different mixtures would be a good investment. Test trial bricks for relative strength and firing characteristics.

Some other additives:

- \* Cement in the mix might be necessary if sufficient clay is not available. (Try 1 part cement: 20 parts sandy soil.)
- \* Ashes sometimes improve the mix by emulsifying the clay.

#### Mixing:

With dry clay:

1. Pulverize and sift the clay through a 4 mm screen.
2. Mix the other dry ingredients in thoroughly.
3. Add just enough water to make a mix that is pliable enough to work easily, but firm enough to hold its shape.

If clay is wet:

1. Break the clay into pieces, and soak it thoroughly. When the clay has dissolved, the mix should be not quite liquid.
2. Mix the clay with the other ingredients, and add more water if necessary.

Mixing can be done with the hands, or more quickly with the feet.

## Background

The singer stove was developed by H. Singer for use in Indonesia. In a 1961 FAO report to the government of Indonesia Singer outlined the problems associated with deforestation there.

The report went on to describe the traditional open-hearthed Indonesian stoves. In tests conducted by Singer, the indigenous stoves were found to be very wasteful of fuel. By his measure, only 6-7% of the fire's heat was transferred to the cooking pots.

Finally, Singer designed and built a prototype fuel-saving cookstove. His improvements on the traditional stoves included:

- \* An enclosed hearth and limited air intake,
- \* A flue for flames and smoke,
- \* A chimney to provide draft.

Singer's cooking simulation indicated over 20% efficiency for the new design.

See, for further information:

Improvement in Fuelwood Cooking Stoves and Economy in Fuelwood Consumption, Report to the Government of Indonesia by H. Singer, FAO Report No. 1315, 1961, available from

Food and Agriculture Organization  
(FAO)  
Rome, Italy

## Building instructions

### Molds

Three molds will be needed:

1. Surface plates: using straight, smooth boards, construct a mold to form the plates for the cooking surface. Suggested dimensions for a finished plate are 5.5 cm thick, 27 cm wide, and 34 cm long. This will be adequate to support a pot up to 20 cm in diameter. The pots intended for use with the stove can be used as interior molds to form the cooking holes.

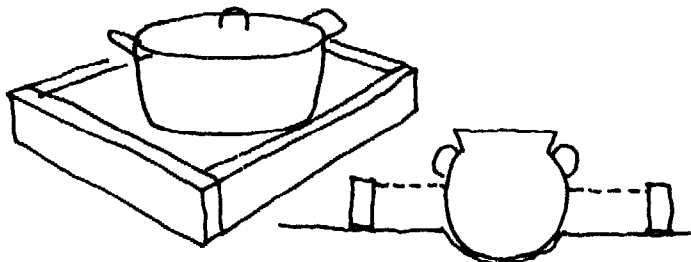

**POTS MAY BE SUNK THROUGH THE PLATE BY DIGGING THEM INTO THE GROUND BEFORE CASTING**

Place the mold on a flat surface with the pot in the center. Sprinkle the inside of the mold with ash to prevent sticking (a sheet metal lining also works well). Fill the mold with the clay mixture, tamp it down firmly, and level the surface. Remove the mold carefully; if the consistency of the mix is right, the plate should slump only slightly. Cast a plate for each pot to be used and let them sun dry for several days.

2. Bricks are formed the same way as surface plates. A suggested size for the brick mold is 5 cm thick, 10.5 cm wide, and 22.5 cm long. However, many of the bricks will need to be cut to accommodate the internal dimensions of the stove. If more than one stove is to be built, it may be simpler to make brick molds of several sizes. Approximately 100 bricks will be needed to build the 3-pot stove illustrated.
3. The firebox door mold should be 14 cm high, 16 cm long, and 5 cm thick. Along one 16 cm edge, place a 4 cm by 6 cm interior mold to form an opening for the damper.

A handle and a damper are fitted to the firebox door while the clay is still damp.

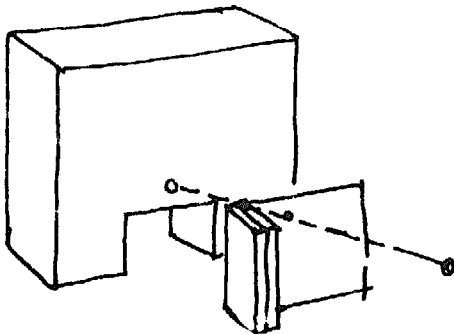

To make the damper, cut a piece of sheet metal into a rectangle approximately 8 cm by 10 cm. Bend the metal as shown to form a hand grip. The damper will get hot; nail thin wooden strips on either side of the 2 cm fold to protect the fingers. With a large nail, punch a hole in the damper near the top edge. Push the nail through the damper, then press it into the damp clay so that the damper completely covers the opening. The damper should pivot on the nail, yet fit snugly against the block.

For the handle, cut two holes half way through the block. These holes should be made to fit the handle. The handle can be a smooth forked stick, or a metal rod bent to shape.

For a permanent handle, make two bolt holes all the way through the clay block. When the clay has dried hard, attach a wooden handle with bolts.

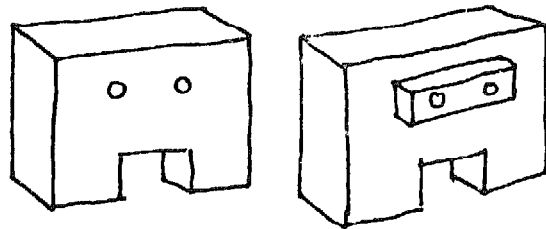

## Construction

The schematic illustrations of the Singer stove indicate very precise measurements; it may be difficult to exactly reproduce the design shown. You may also need to deliberately alter this design to better suit local requirements. However, it is important to retain the essential design features discussed under Technical Assessment.

Mark on the ground the outline of the base of the stove. Lay the bricks one layer at a time, overlapping joints whenever possible. The same clay mixture used for making the bricks may be used as mortar.

The bricks will need to be cut or shaped while forming the interior of the stove. Sun-dried bricks can be wetted and shaped; fired bricks can be split fairly precisely with a chisel or mason's hammer.

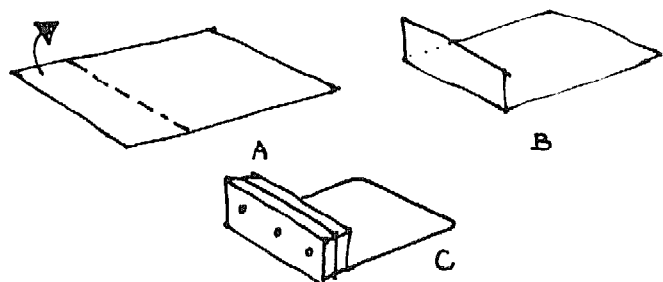

OVERALL VIEW

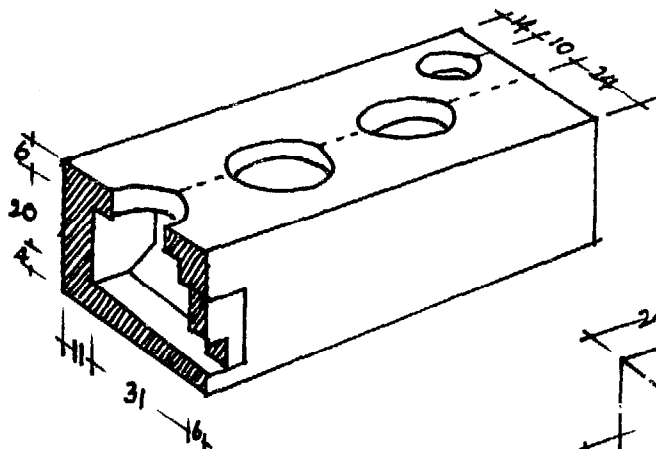
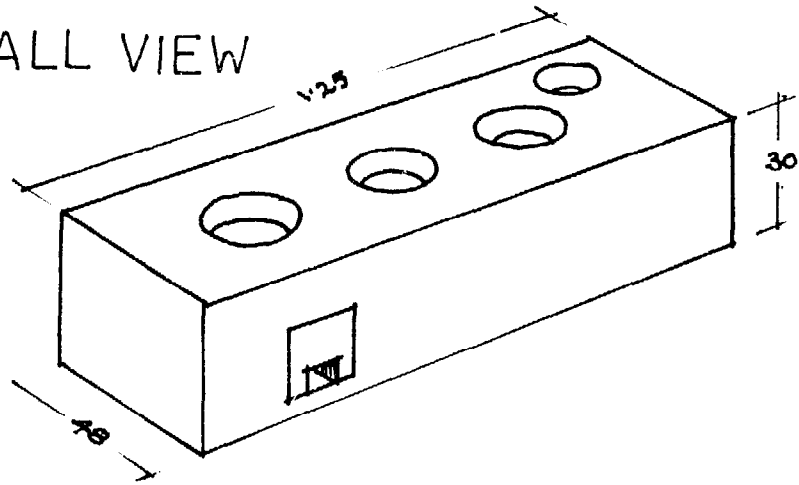

CROSS SECTION THROUGH FIREBOX

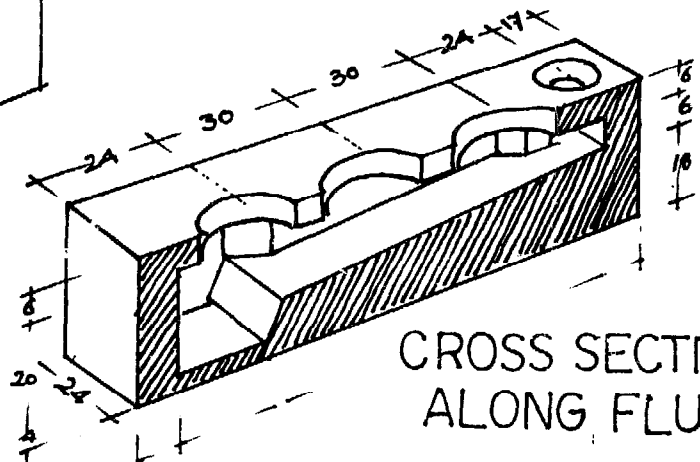

CROSS SECTION ALONG FLUE

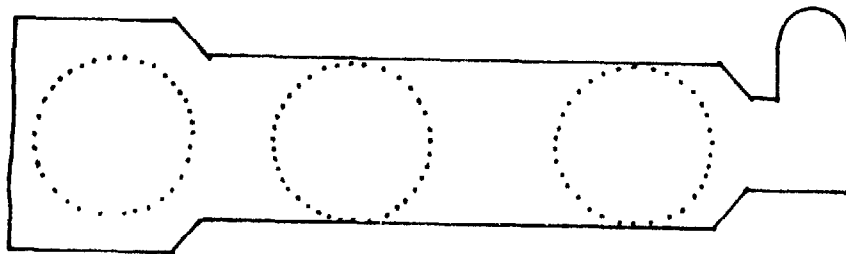

PLAN OF TUNNEL SYSTEM

Mortar the surface plates into place just as you would another layer of bricks. The cooking holes should be sanded or cut so as to allow each pot to extend 3 cm into the flue below.

The chimney could be made of metal, clay tile, masonry, or brick. It could be fitted to a surface plate in the same way as the pots, or built into the back of the stove.

## Technical assessment

The Singer stove was carefully designed for fuel efficiency.

- \* The relatively small interior size of the firebox contains the fire directly beneath the first pot. The first pot is also well exposed to the flames because of the high exit from the firebox. For these reasons, the Singer stove probably uses considerably less firewood than other multi-pot stoves, especially when cooking with only one pot.
- \* The wide, shallow flue is also a good design feature. A maximum amount of heat is extracted from hot flue gases as they squeeze past each pot.
- \* The strength of the molded surface plates allows close spacing of the pots along the flue; relatively little of the interior surfaces of the stove is heated at the expense of the cookpots.

The main difficulty with the Singer probably lies in building technique. Neatly reproducing the design is tricky if you're not a trained mason. Other limitations of the Singer stove are.

- \* The small firebox will not hold firewood pieces longer than 25 cm.
- \* Lumber for brickmaking forms may be unavailable in some places.

- \* The first pot receives most of the useful heat from the fire. It might be hard to provide enough heat to downstream pots without burning the contents of the first pot.
- \* The stove is heavy and cannot be moved, and must therefore be built in place.
- \* Making the bricks involves a lot of hard work.

## Possible modifications

- \* Rather than using modular block construction, the stove could be molded directly of clay. A single piece molded clay stove could be built faster. Alternatively, the Singer design could be constructed of sand/clay (see The Lorena System).
- \* Sheet metal could be used to provide additional support for the surface plates, if needed. Metal reinforcement is used in building the Hyderabad Chulo, a similar Indian stove.
- \* Fired clay or metal rings that would accommodate smaller pots to the cooking holes would be a good accessory.
- \* A large proportion of finely chopped organic matter could be incorporated into the bricks to produce insulating air spaces. An insulated stove would retain more heat in the firebox, losing less to the body of the stove.
- \* A sliding metal damper door, such as described for the Lorena stove might be best for long firewood pieces, which could then protrude from the front of the stove.

## CHARCOAL STOVES

In areas where charcoal is the predominant fuel, simple stoves have evolved to take advantage of its special burning characteristics. They are usually one pot cookers and usually include a grate on which the charcoal is placed, an opening for air intake below the grate, and supports for the pot. A good charcoal stove places the pot as close to the burning embers as possible without actually touching them. In this way maximum advantage can be taken of the fire's radiative heat. Since burning charcoal emits no smoke and little hot gases, most heat is transferred by radiation and conduction.

Charcoal tends to pack tightly. To supply the fire with adequate oxygen for combustion, air intake is best assured from below through a grate.

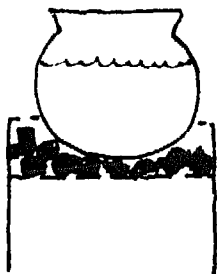
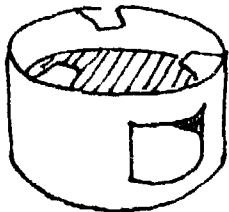

## METAL STOVES

Advantages of the material:

- \* Metal is durable, impact resistant and weather proof.
- \* Sheet metal is relatively light and therefore lends itself to portable stoves.
- \* Local craftspeople in poor countries are likely to be skilled in metal work; it would be easy for them to manufacture stoves.
- \* Metal objects are commonly traded in the market places; metal stoves could be bought and sold through the same channels.
- \* Scrap metal (e.g. old oil cans, scrap corrugated steel, aluminum cans) provides a cheap source of material if available.

Disadvantages of the material:

- \* Metal is an excellent conductor; therefore heat is lost rapidly through all sides of a metal stove. Cooking on a metal stove may be uncomfortably hot for the cook.
- \* Where metal has to be imported, metal stoves may be expensive.
- \* In some areas, the technology for manufacture may be unavailable.

## Feu Malgache

The feu malgache or malagasy stove is widely used wherever charcoal is burned in West Africa. These stoves are either welded or riveted out of steel sheet or recycled metal. They are sold in various sizes to accommodate teapots as well as family size kettles.

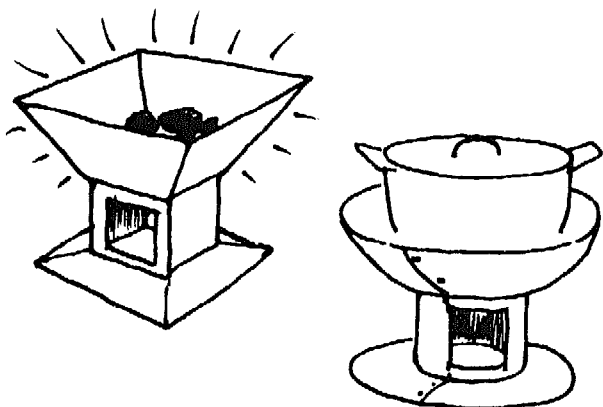

### Advantages:

- \* These stoves are within the means of most poor people.
- \* They provide some wind shelter for the fire.
- \* The slanted firebox walls automatically move charcoal onto the grate: "automatic" stoking.
- \* The square stoves especially are strong and durable.

### Disadvantages:

- \* There are no pot supports.
- \* The square stove does not correspond to a pot's round shape: the heat of some of the burning coals is wasted.
- \* The round stove is difficult to manufacture out of heavy steel sheet: because they are thinner, round stoves tend to be less durable.

- \* The small bases make the stoves unstable and therefore dangerous. For this reason they are badly suited for foods that require vigorous stirring.

## Ideas for improvement

The stove could be partially buried to reduce heat loss; this would also make it more stable.

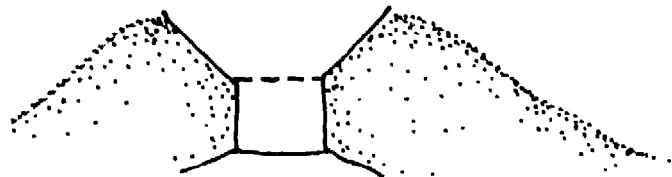

The metal walls could be lined with clay to reduce heat loss. Materials such as charcoal bits or organic matter could be added to the clay to further increase its insulating properties.

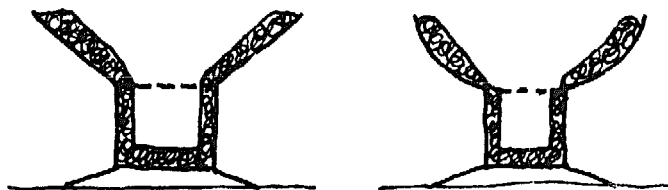

Wind shields could reduce heat loss from the pot's sides.

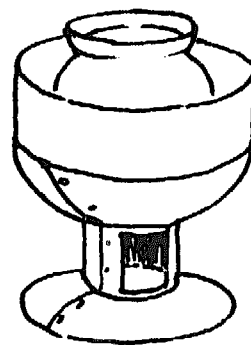



## East African Metal Stove

This stove is the East African counterpart of the feu malgache. It is common in urban areas, where charcoal is the predominant fuel. It differs from the feu malgache in that it has straight firebox sides and uses three iron rods to support the pot. The air inlet has a damper door to regulate the airflow for combustion.

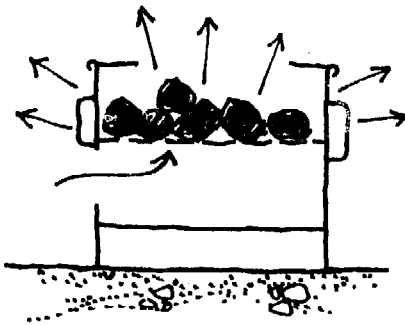

## Ideas for improvement

Work on improving the East African metal stove has been done by Keith Openshaw and his collaborators in Tanzania. They found that by lining the inside of the firebox and the ash chamber with a 3 cm clay layer and increasing the air space in the grate to 25%, charcoal consumption could be reduced.

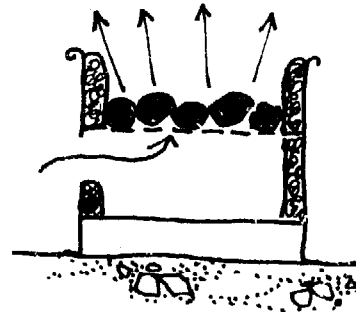

### Advantages:

- \* The stoves are within the means of most people.
- \* They provide some wind shelter.
- \* They feature a damper door to control air flow. If well used, a damper door can save fuel, and regulate heat intensity.

### Disadvantages:

- \* Construction requires at least some imported iron (rods for the pot supports) which may make the stove relatively expensive.
- \* It is necessary to rearrange and stoke the charcoal occasionally to keep it burning.

The Tanzanian team recommends modifying the East African stoves only as an interim measure. To get substantially better performance, a stove of the Thai bucket type should be used (see Thai Bucket, this Chapter).

For further information see:

A Comparison of Metal and Clay Charcoal Cooking Stoves, a paper by Keith Openshaw; available from

Division of Forestry  
Faculty of Agriculture, Forestry  
and Veterinary Science  
University of Dar es Salaam  
Box 643  
MOROGORO  
Tanzania

## Central American Metal Stove

Charcoal stoves exist in Central America. They differ from African charcoal stoves in that they have a shallow firebox and a large grid to support the pots. This allows more than one pot to cook at the same time.

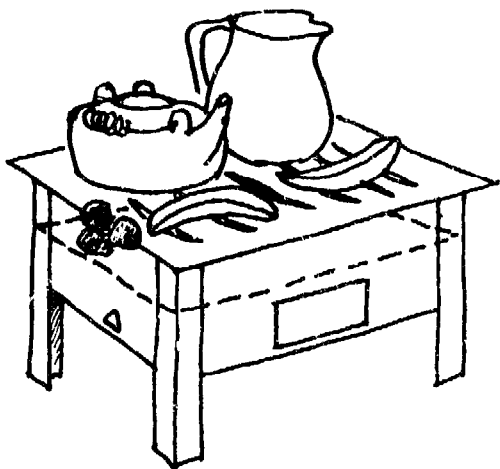

### Advantages:

- \* They are within the means of most people.
- \* They provide wind protection for the fire.
- \* More than one pot can be heated at the same time on these stoves.

### Disadvantages:

- \* Because the shape of the firebox does not correspond to the shape of the pots, some of the charcoal burns uselessly. Much heat is lost around the pots.
- \* The cook is not protected from the heat.

## TERRA COTTA STOVES

### Advantages of the material:

- \* Good clay is available in many places, usually free.
- \* Clay can be molded to almost any shape.
- \* Simple firing techniques can turn clay into terra cotta.
- \* Terra cotta is more durable than unfired clay.
- \* Terra cotta is weather proof.
- \* Terra cotta is a much better insulant than metal, so less heat is lost from a terra cotta stove.
- \* There are local channels for trading terra cotta goods.
- \* Terra cotta is fire resistant and relatively light; it is therefore a suitable material for transportable stoves.

### Disadvantages of the material:

- \* Terra cotta stoves are heavier than metal stoves.
- \* Terra cotta is less durable than metal: terra cotta stoves will not last as long.

### Ideas for improvement:

Including organic matter (fibers, charcoal) with the clay makes terra cotta a better insulant.

## Indonesian Terra Cotta Charcoal Stove

In southeast Asia, terra cotta charcoal stoves are more common than sheet metal stoves. They are made by local craftspeople and traded in local marketplaces.

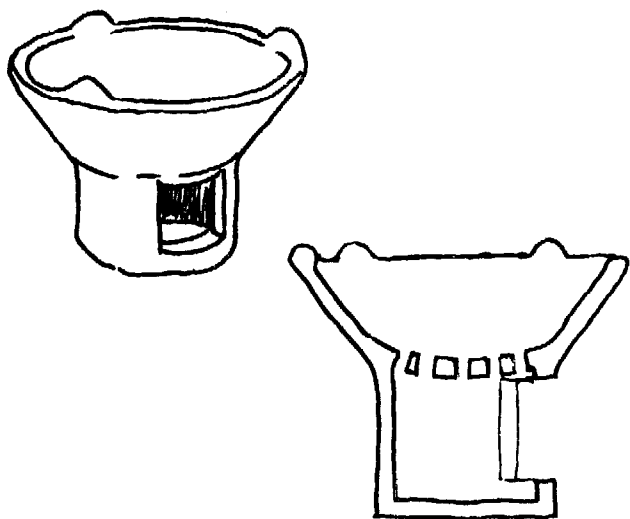

### Advantages:

- \* These stoves save considerably more fuel than metal stoves.
- \* They can be made by local craftspeople, using cheap, local materials.
- \* They are affordable, usually cheaper than metal stoves.
- \* They provide some wind shelter.
- \* Fuel slides into the center due to the slanted firebox walls. This acts as an "automatic" stoking device.

### Disadvantages:

- \* The stoves are fragile; their walls are very thin.

## Ideas for improvement

The Ceramics Institute of Bandung, Indonesia, has experimented with ways to improve on the Indonesian terra cotta charcoal stove. These changes were made:

- \* The walls were built thicker.
- \* The grate was made out of refractory (high heat resistant) clay rather than terra cotta.
- \* A small iron damper was added to regulate air intake.

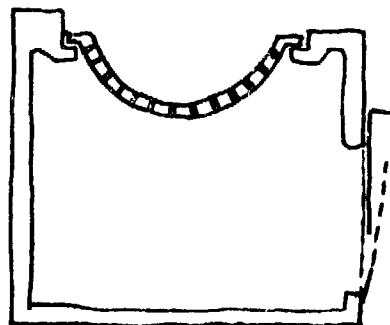
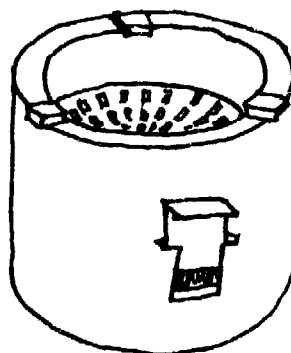

For further information see:

Improvement of Fuelwood Cooking Stoves and Economy in Fuelwood Consumption, Report to the Government of Indonesia by H. Singer, FAO Report No. 1315, 1961, available from

Food and Agriculture Organization  
(FAO)  
Rome, Italy

## THE THAI BUCKET

Thai buckets consist of a terra cotta stove set into a metal shell (often a bucket). The space between stove and shell is packed with ash, sealed in with a little cement. This stove combines the durability of a metal stove with the insulating qualities of terra cotta, further enhanced by the ash layer. A metal damper door may be added for draft regulation.

The terra cotta part of the Thai bucket is also sold without its metal casing as a cheaper version of the stove.

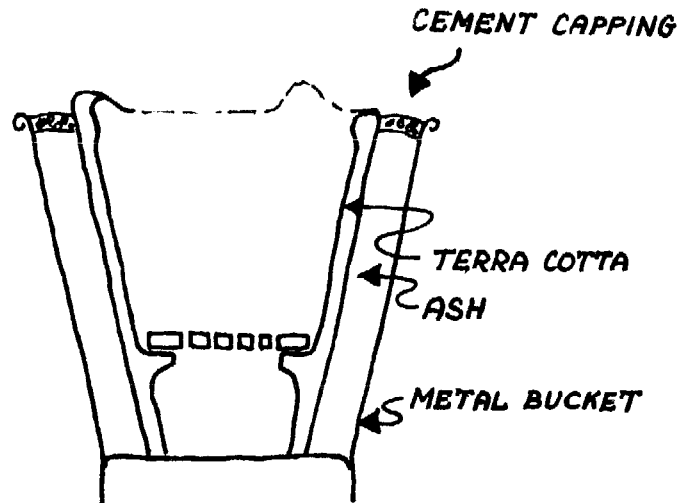

### Advantages:

- \* A Thai bucket uses less fuel than either a metal stove or a terra cotta stove. Heat loss is minimal. Although it is only suited for a narrow range of pots, it is very efficient because the fuel is used with very little waste.
- \* They are compact, transportable stoves.
- \* They are less fragile than terra cotta stoves.
- \* They are made largely from local or recycled materials: clay and ash are commonly available, and the metal used is generally recycled.
- \* The stoves are produced by local artisans and sold in local markets.
- \* They provide some wind shelter.
- \* The slanted walls assure that charcoal is continually fed into the fire.

### Disadvantages:

- \* The Thai bucket is heavier than either a metal or a terra cotta stove.
- \* It is more expensive than either.
- \* More skill is needed to make the stove.
- \* Metal and cement may have to be imported.

## Ideas for variations

Any two containers could be insulated with a layer of ash, or other insulating materials. This would be an easy way to improve metal stoves.

For further information see:

A Comparison of Metal and Clay Charcoal Cooking Stoves, a paper by Keith Openshaw; available from

Division of Forestry  
Faculty of Agriculture, Forestry  
and Veterinary Science  
University of Dar es Salaam  
Box 643  
MOROGORO  
Tanzania

# RICE HULL STOVES

## Characteristics of the fuel:

Rice hulls are a difficult fuel to burn; if piled in a heap and lit, they will smolder but not burn. However, if enough oxygen can be provided, they will ignite. Two solutions to this problem have been developed in Indonesia: Packed Stoves and Natural Draft Stoves.

## PACKED STOVES

### Background

Packed Stoves are hollow containers, usually built of brick and mud, or fired clay. There is a door at the base and a pothole, slightly smaller than the cookpot to be used, at the top.

A common type of Packed Stove for use in households and small restaurants in Bali is made of brick, holds about 1½ kg of rice hulls and burns for about 6 hours on one filling of fuel. In central Java, similar stoves are used when boiling coconut sap to make sugar.

There is a wide range of stoves that burn packed rice hulls. Probably the simplest is a fired clay bucket, a type that has been used in the city of Jogjakarta and the areas of Indonesia surrounding it for at least 30 years. It holds, when packed, about ½ kg of rice hulls and burns about 2 hours. Multiple pot Packed Stoves are usually several separate stoves combined into a unit. Villages in Bali reportedly prepare food for festivals on larger versions of the household and restaurant stove described above. These hold between 1 and 2 gunny sacks of rice hulls (10 to 25 kg) and burn continuously for 4 to 7 days; they are disassembled after the festivals.

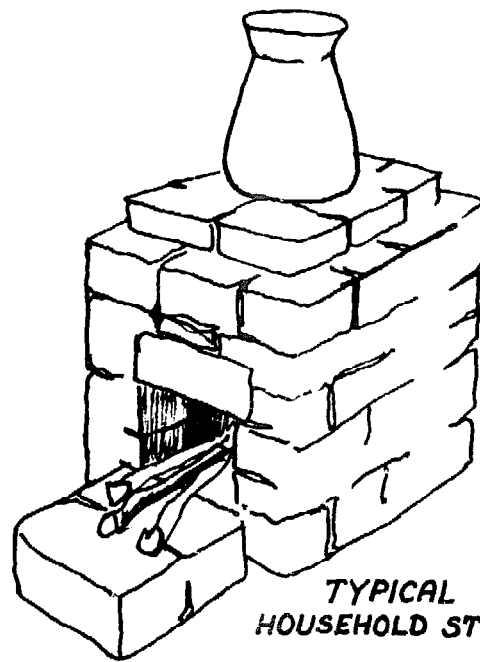

TYPICAL  
HOUSEHOLD STOVE

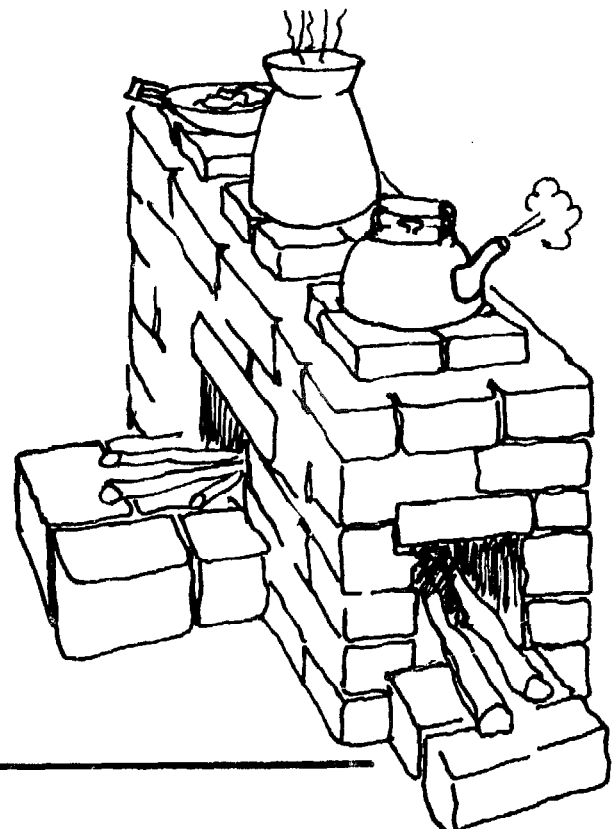
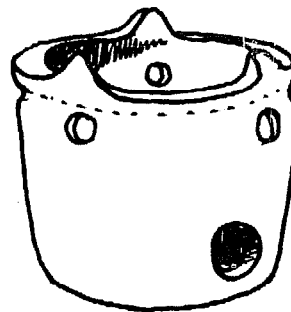

Packing the stoves as shown makes a flue up the center which provides the necessary flow of oxygen for combustion.

The stoves are lit by shoving 2 or 3 burning sticks in through the door at the base. As long as the burning sticks are inside, the stove burns with a vigorous, smoky flame; if the sticks are removed, the flame goes out and the rice hulls smolder until they are completely consumed. A Packed Stove burning rice hulls will use about 20% of the wood used by an open fire. Small sticks and twigs are good enough for this purpose.

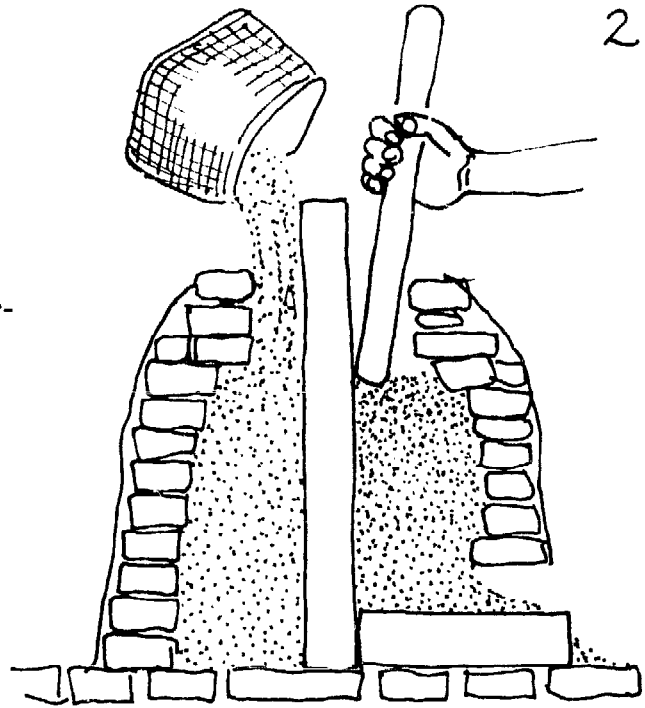

2.

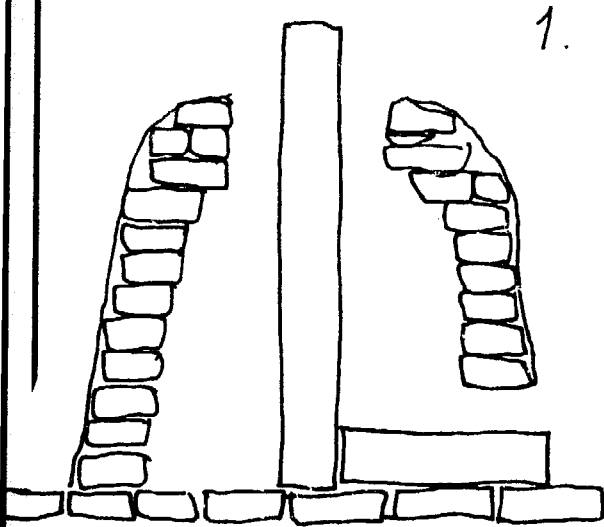

1.

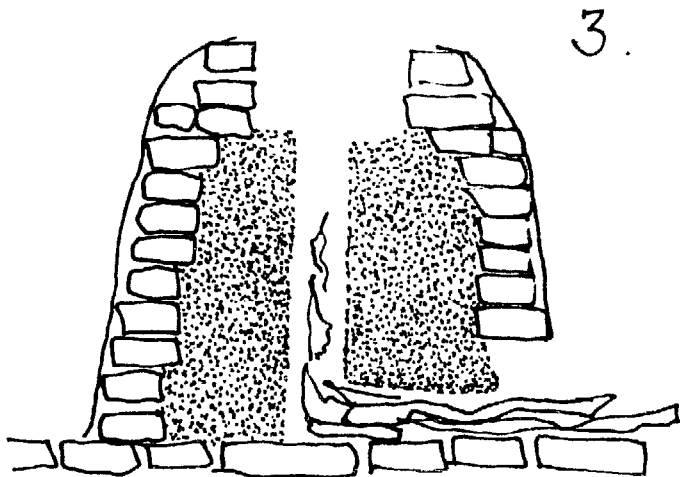

3.

## Construction

Construction is simple and involves, at most, basic masonry work. It should be possible to make Packed Stoves out of fired bricks, unfired bricks, fired clay, sand/clay mixture, concrete, or any other material capable of withstanding heat and the slight amount of pressure exerted on the walls by the packing. Cans, oil drums, and other already existing containers can be used for Packed Stoves.

## Technical assessment

### Advantages:

- \* Packed Stoves can be made very quickly and inexpensively.
- \* A wide variety of containers is suitable, without major alteration, for use as Packed Stoves.
- \* Construction, if necessary, is extremely simple. A mason or other craftsman will probably not be necessary. Packed Stoves are suitable for owner-building.
- \* Rice hulls are cheap; they may be available without cost in some areas.
- \* Small Packed Stoves (e.g. terra cotta bucket) are easily portable.
- \* Small Packed Stoves are suited to mass production and distribution.
- \* A Packed Stove can, if rice hulls are temporarily unavailable, burn wood by itself.
- \* Rice hulls surrounding the fire insulate it and retain heat.
- \* Rice hulls pack best if they are of a powdery consistency. Old mills, previously used in Indonesia and other parts of Asia, ground the hulls off rice into suitably fine fragments. Unfortunately, modern milling equipment passes rice between rubber rollers and cracks the hulls off as large half shells. These large pieces do not pack well in stoves and the mass of packed hulls collapses into the bottom of the stove before burning completely. Because of this, it is necessary to add equal amounts of expensive rice polishings to the rice hulls in order to make them pack well. This adds to the cost, but the resulting fuel mixture is still much cheaper than wood.

### Disadvantages:

- \* Packed rice hulls, once lit, cannot be extinguished, but continue to smolder until consumed.
- \* Packed Stoves smoke a great deal.
- \* Removing the ashes and repacking the stove can be very messy.

## Ideas for variations

- \* Other agricultural wastes and low-grade fuels may be burnable in Packed Stoves. Sawdust, wood shavings, straw, and chaff are all possibilities. Try mixtures of fuels.
- \* It may be possible to find inexpensive binders for fuels that do not pack well. This would eliminate the need in some areas to use rice polishings as a binder. On the other hand, it might be better not to pack such fuels, but to consider using, instead, a Natural Draft Stove similar to those described later in this section.
- \* Dampers would improve control of the fire.

- \* It should be possible to easily fit a chimney to Packed Stoves. It would be permanently attached, as shown, above the packed fuel and below the pot. A chimney would improve the draft and also diminish the smoke problem common with these stoves.

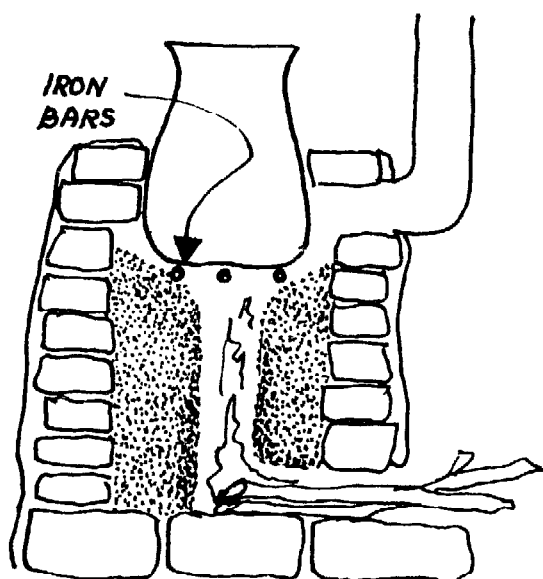

- \* The ideas incorporated in the Louga Stove should be very useful in Packed Rice Hull Stoves. Try sinking the pot into the surface of the stove to improve heat transfer, gain wind shelter, and make better use of residual heat. The Louga Stove, itself, might be directly adaptable to burning rice hulls if packed as shown.

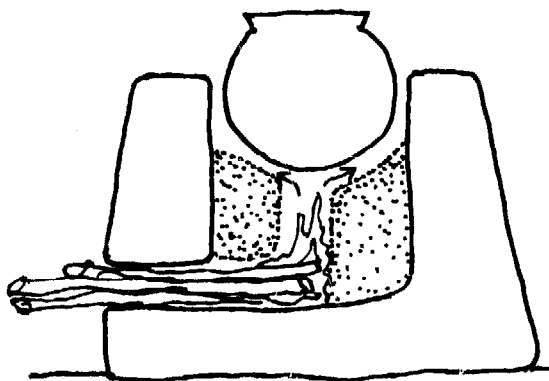

## NATURAL DRAFT STOVES

### Background

Smoke and hot gases rising through a flue create a strong suction that draws air through a slanted grate located at the front of this type of stove. Rice hulls burned in this fashion burn rapidly with a clean, hot flame producing almost no smoke.

Natural Draft Stoves in Indonesia are generally large and used for commercial processes that require long, vigorous boiling. They incorporate a hopper that feeds a steady supply of rice hulls to the grate. The pots are usually fixed and sealed in place; pots that are removable must be carefully resealed with a mixture of mud and rice hull ash, or the draft will be spoiled and the stove will not operate. The grates are usually flat iron bars set in as steps, though one stove seen used a slanted sheet of perforated iron for a grate that seems to work well. They are commonly made of fired bricks, cement mortar and plaster.

Natural Draft Stoves have been in use in some parts of Java for more than 20 years and are a well developed technology. It is generally accepted there that the following design criteria are important:

- \* The wider the grate, the hotter the fire.
- \* The grate should be steeper than  $45^{\circ}$ .
- \* The taller the flue, the stronger the draw, meaning a longer flame, more heat, and greater fuel consumption.
- \* On stoves employing more than one cookpot, the floor should slant slightly upwards towards the stack end.



"Tahu" (soy curd) stove of a type commonly used in Jogjakarta and Central and East Java. This stove is used to boil between 800 and 1400 liters of soy milk daily, in 150 liter batches. This consumes about 10 gunny sacks (125 kg) of rice hulls. During cooking, the hulls in the hopper are stirred and pushed down onto the grate about every 10 minutes. The 4 meter stack produces a strong draft, resulting in a powerful, yellow flame. The stove has been in use for 15 years and the only maintenance has been to replace the iron grate after 3 to 5 years of constant use.

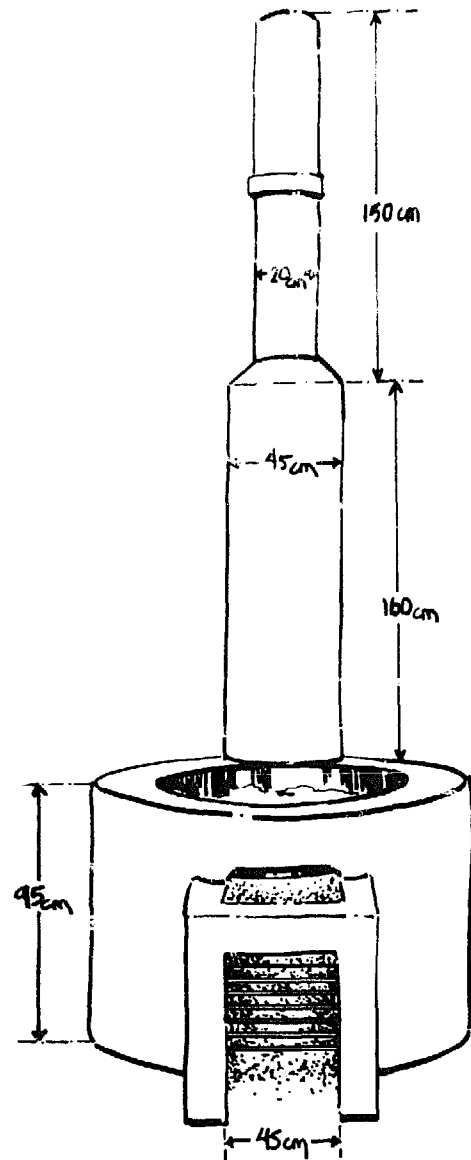
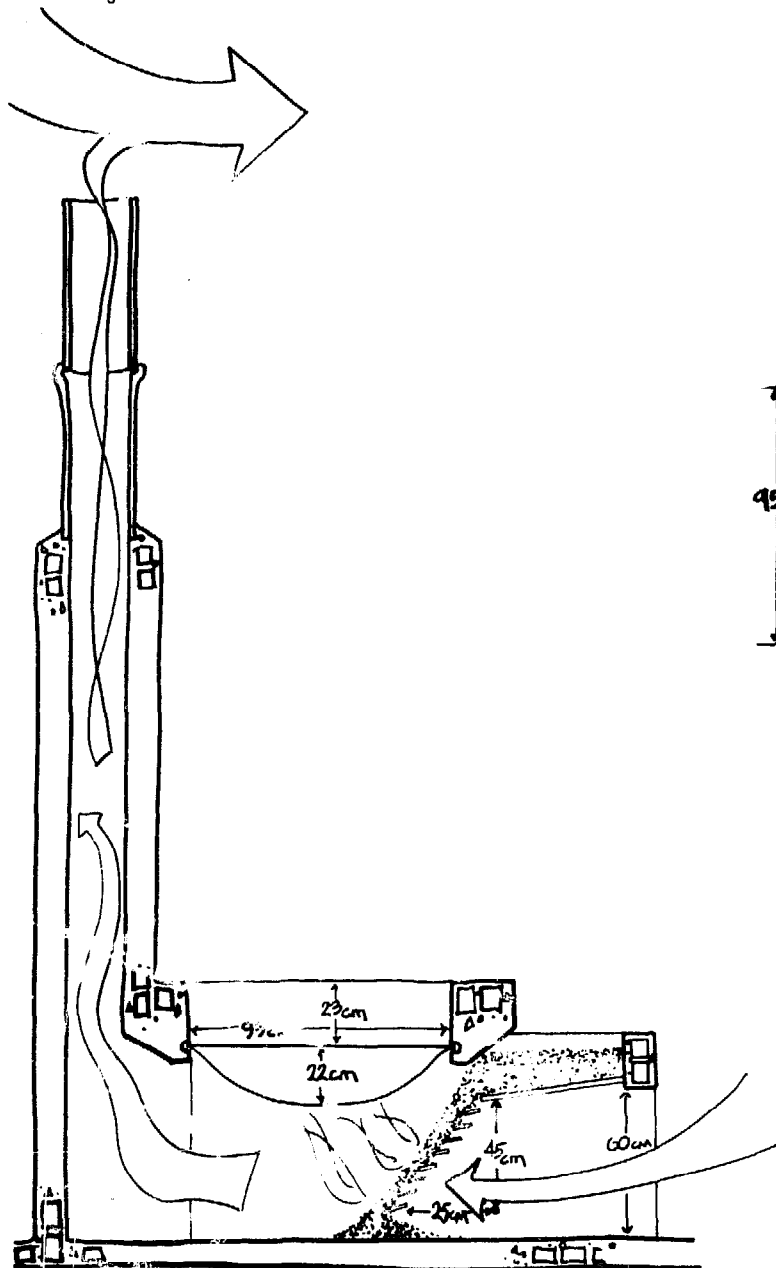

"Gula Jawa" (coconut sugar) stove used in Blitar, East Java. This stove boils about 50 liters of coconut sap down to 7 kg of sugar cake daily. This requires 4 hours cooking time and uses half a gunny sack of rice hulls (6 kg). The process of boiling the sap makes full use of the range of temperature in the three pots; all three pots boil, and, as the sap is reduced in volume, it is transferred to the slower boiling pots. Clay mortar is used in this stove rather than cement. This stove was inexpensive, costing only Rp. 3500 (about U.S. \$8).

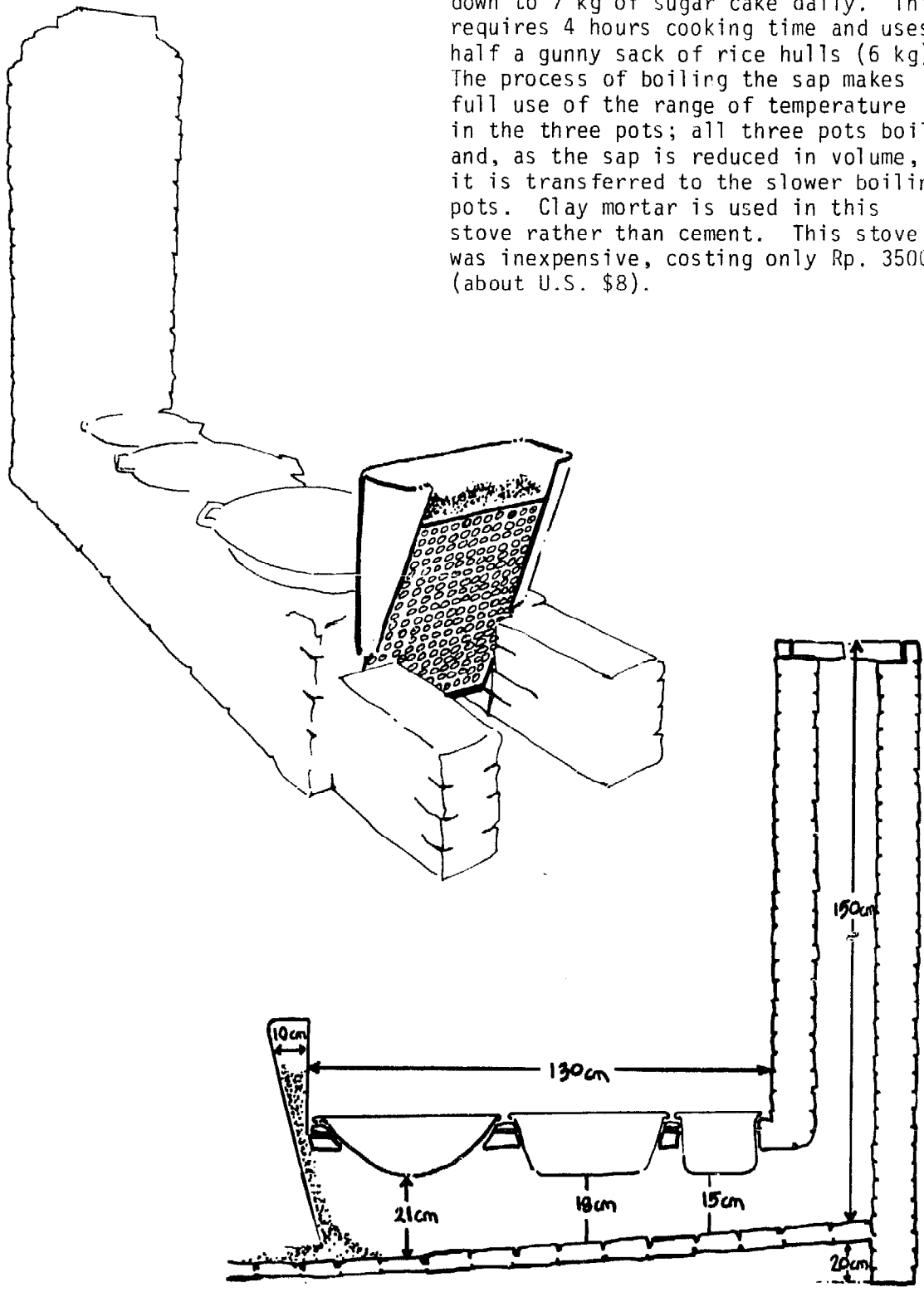

"Ipa" stove. A 3 pot Natural Draft Stove called the Ipa stove is being disseminated throughout the Philippines. It is constructed from adobe blocks, except for the top, which is cement.

## Technical assessment

### Advantages:

- \* Natural draft stoves make efficient use of a low-grade fuel that is difficult to burn, but very cheap and readily available in the region where they are employed.
- \* They are capable of producing a great deal of heat for extended periods.
- \* Natural Draft Stoves are well-suited to burning the hulls left by modern rice milling machines. They do this better than do the Packed Stoves.
- \* They can be built from inexpensive materials. Although most of the stoves are built from fired bricks, both unfired bricks and sand/clay mixture should be suitable materials.

### Disadvantages:

- \* Natural Draft Stoves usually require a mason for their construction.
- \* Natural Draft Stoves are relatively complex stoves and take a long time to construct.
- \* Of the two types of Rice Hull Stoves Natural Draft Stoves are by far the more expensive.
- \* Natural Draft Stoves require the use of metal for the grates. This can, in some places, be expensive.

## Ideas for variations

- \* Dampers to adjust the burning rate would probably make Stepped Grate Stoves more versatile and efficient.
- \* Centralized manufacture and distribution of any components requiring critical accuracy in manufacture would expedite dissemination.
- \* Cost of Natural Draft Stoves would be reduced and construction simplified if, in their construction, sand/clay mixture or unfired bricks were substituted for fired bricks. Use of sand/clay mixture, however, would make measuring and layout crucial; use of standard-sized bricks is one way to assure dimensional accuracy in construction.
- \* Natural Draft Stoves are probably capable of burning such other fuels as chaff, sawdust, and wood shavings. Consider them for use with fuels to which it is difficult to supply oxygen.
- \* Tunnel design principles from Lorena-type stoves are, to some extent, applicable to these stoves. Baffles under the pots to direct the hot gases against the pots are a good thing to consider. A winding flue with potholes situated at the turns is also possible. One might easily end up with a stove looking like a Guatemalan Lorena or Nepali Chulo, but with a stepped grate built into the firebox.

For more information about Rice Hull Stoves see Technologies for the Utilization of Rice Hulls as a Fuel in Java and Bali, report from a survey conducted by the Development Technology Center of the Institute of Technology, Bandung, for the ASEAN Food-handling Subcommittee. The drawings were originally by Craig Thorburn. This report is available from

Volunteers in Asia,  
Box 4543  
Stanford, CA 94305  
U.S.A.

## References

### STOVES AND THE GLOBAL FIREWOOD CRISIS

1. Arnold, J.E.M. and Jongma, Jules. "Fuel Wood and Charcoal in Developing Countries." Proceedings of the Eighth World Forestry Congress. Jakarta, Indonesia, 1978. (FAO, Rome, Italy).
2. Evans, Ianto. "The Non-Existent Nepali Chulo." Unpublished paper, 1979, p. 2.
3. Club du Sahel, CILSS. Energy in the Development of the Sahel: Situation - Perspectives - Recommendations. Paris, France: Club du Sahel, October, 1978, p. 37.
4. Eckholm, Erik P. "The Other Energy Crisis: Firewood." Worldwatch Paper 1. Washington, D.C.: The Worldwatch Institute, September, 1975, p. 9.
5. Club du Sahel. op. cit., p. 45.
6. Ibid., p. 57.
7. Evans, Ianto. op. cit., p. 5.
8. Club du Sahel. op. cit., p. 40.
9. Ibid., p. 56.
10. Ibid., pp. 49-51.
11. Hughart, D. Memorandum to R. Moreno, about Uttar Pradesh Social Forestry Project, India. March 1, 1979.

### CHAPTER II

1. Ernst, Elizabeth. "Fuel Consumption Among Rural Families in Upper Volta, West Africa." Proceedings of the Eighth World Forestry Congress. Jakarta, Indonesia, 1978. (FAO, Rome, Italy).
2. Gern, Elisabeth; Jacobs, Laurence; and Evans, Ianto. Improved Cookstoves in Upper Volta. Report to the German Agency for Technical Cooperation, GTZ, Eschborn, West Germany, June, 1980.
3. Ki Zerbo, Jacqueline and de Lepeleire, Guido. L'Amelioration des Foyers pour l'Utilisation Domestique du Bois de Feu: Ses Possibilities et son Impact au Sahel. Report to CILSS and Club du Sahel, Paris, France, May, 1979.
4. Evans, Ianto. "The Non-Existent Nepali Chulo." Unpublished paper, 1979, p. 5.

### CHAPTER III

1. Daniels, Farrington. Direct Use of the Sun's Energy. New York: Ballantine Books, 1975.
2. Evans, Ianto and Gern, Elisabeth. Personal notes taken while working in Senegal and Upper Volta, West Africa, 1980.
3. Evans, Ianto. Lorena Owner-Built Stoves. Stanford, California: Appropriate Technology Project, Volunteers in Asia, 1979.
4. Jacobs, Laurence. Personal communication, 1979.
5. Shaller, Dale V. "A Sociocultural Assessment of the Lorena Stove and its Diffusion in Highland Guatemala." Postscript in Lorena Owner-Built Stoves, 1979.

### Chapter VII

References contained within the chapter.

SOURCE MATERIAL FOR INFORMATION IN THIS BOOK

- CEMAT. Project of Diffusion and Construction of Stoves Made of Sand and Mud in the Rural Area of Guatemala. Guatemala City, Guatemala: CEMAT, January, 1978.
- Club du Sahel, CILSS. Energy in the Development Strategy of the Sahel: Situation - Perspectives - Recommendations. Paris, France: Club du Sahel, October, 1978.
- Dutt, Gautam S. Reducing Cooking Energy Use in Rural India. Report for Center of Environmental Studies, Princeton University, Princeton, N.J., U.S.A., November, 1978.
- Dutt, Gautam S. "Efficient Wood Burning Cooking Stove Literature." Princeton, N.J., U.S.A.: Center for Environmental Studies, November, 1978. (Draft).
- Earl, D.E. Forest Energy and Economic Development. London, Great Britain: Oxford University Press, 1975.
- Eckholm, Erik P. Losing Ground. New York, U.S.A.: W.W. Norton Company, Inc., 1976. Excellent resource on deforestation and related environmental problems.
- Eckholm, Erik P. "The Other Energy Crisis: Firewood." Worldwatch Paper 1. Washington, D.C., U.S.A.: Worldwatch Institute, September, 1975.
- Evans, Ianto; Gern, Elisabeth; and Jacobs, Laurence. Improved Cookstoves for Rural Senegal. Report to VITA, Mt. Ranier, MD, U.S.A.; April, 1980.
- Evans, Ianto. Lorena Owner-Built Stoves. Stanford, California, U.S.A.: Appropriate Technology Project, Volunteers in Asia, 1979.
- French, David. Firewood in Africa. Discussion Paper for the Africa Bureau Firewood Workshop, USAID Africa Bureau, Washington, D.C., U.S.A., June, 1980.
- Geller, Howard S. Rural Indian Cookstoves: Fuel Efficiency and Energy Loss. Paper for Center for the Application of Science and Technology to Rural Areas, Indian Institute of Science, Bangalore, India, July, 1980. (Draft).
- Hoskins, Marilyn W. Community Participation in African Fuelwood Production, Transformation and Utilization. Discussion Paper prepared for Workshop on Fuelwood and Other Renewable Fuels in Africa, Paris, November, 1979. (Draft). (USAID Overseas Development Council, Washington, D.C., U.S.A.).
- Hoskins, Marilyn W. Women in Forestry for Local Community Development: A Programming Guide. Paper for AID Office of Women in Development, Washington, D.C., U.S.A., September, 1979.
- Ki Zerbo, Jacqueline and de Lepeleire, Guido. L'Amelioration des Foyers pour l'Utilisation Domestique du Bois de Feu: Ses Possibilites et son Impact au Sahel. Report to CILSS and Club du Sahel, Paris, France, May 1979.

- Shaller, Dale V. "A Sociocultural Assessment of the Lorena Stove and its Diffusion in Highland Guatemala." Postscript in Lorena Owner-Built Stoves by Ianto Evans. Stanford, California, U.S.A.: Volunteers in Asia, 1979.
- Shelton, Jay and Shapiro, Andrew. The Woodburner's Encyclopedia. Waitsfield, Vermont, U.S.A.: Vermont Crossroads Press, 1976.
- United Nations Food and Agriculture Organization. Forestry for Local Community Development, Forestry Paper No. 7, FAO, Rome, Italy, 1978.
- United States Department of Housing and Urban Development. Handbook for Building Homes of Earth. Report for USAID, Washington, D.C., U.S.A., 1979.
- Volunteers in Asia. The Trans-Cultural Study Guide. Stanford, California, U.S.A.: Volunteers in Asia, 1978.
- Volunteers in Technical Assistance. VITA Woodstove Packet: Designs of Wood-burning Stoves. Mt. Ranier, MD, U.S.A.: Volunteers in Technical Assistance, (continually updated).
- Volunteers in Technical Assistance. Wood Conserving Cook Stoves: A Design Guide. Mt. Ranier, MD, U.S.A.: Volunteers in Technical Assistance, 1980.
- Volunteers in Technical Assistance. Woodstove Project Bibliography. Mt. Ranier, MD, U.S.A.: Volunteers in Technical Assistance, (continually updated).