

AT MICROFICHE
REFERENCE
LIBRARY

A project of Volunteers in Asia

Preservation of Foods

Published by:

Agromisa
P.O. Box 41
6700 aa Wageningen
THE NETHERLANDS

Available from:

same as above or
Stichting TOOL
Entrepotdok 68A/69A
1018 AD Amsterdam
THE NETHERLANDS

Reproduced by permission.

Reproduction of this microfiche document in any form is subject to the same restrictions as those of the original document.

preservation

of foods

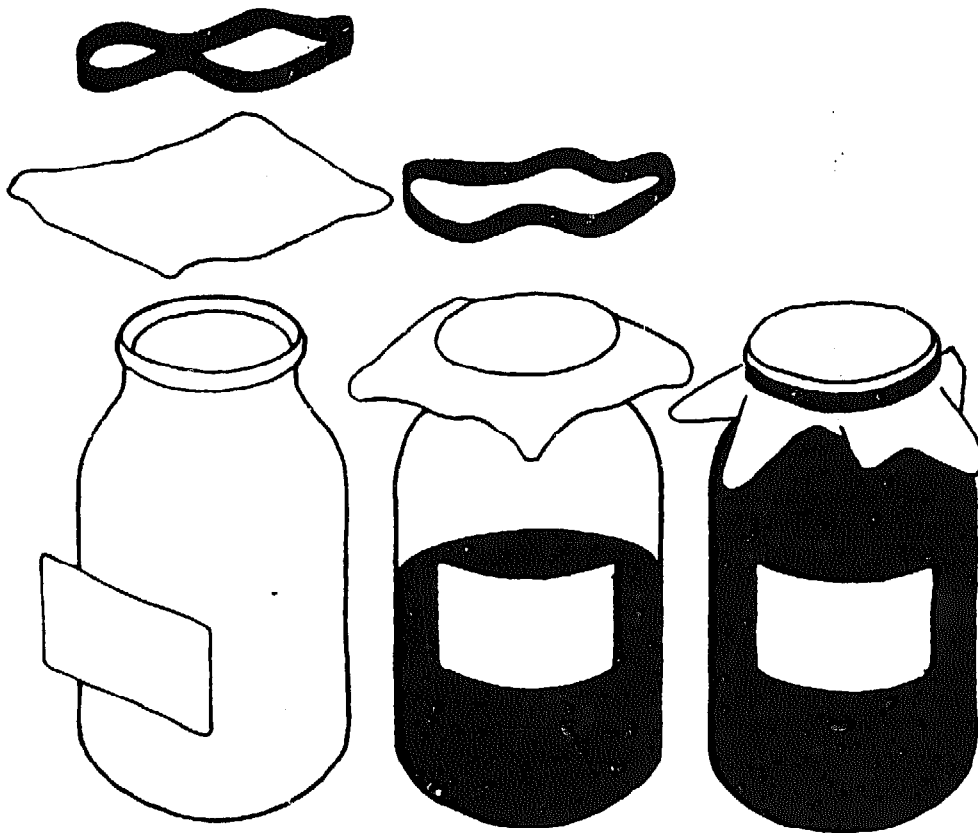

agrodok 3

agromisa, p.o.box 41
6700 aa wageningen,
the netherlands

AGROMISA FOUNDATION

Agromisa is a volunteer organisation of students from the Faculty of Agriculture in Wageningen, the Netherlands. The organisation was established in 1933.

Agromisa aims at improving the position of socially and economically underprivileged groups in developing countries, by transferring agricultural knowledge to those organisations and persons who devote themselves to these groups.

Agricultural knowledge is transferred in the following ways:

- we give answers and recommendations in writing to those who pose questions
- we provide an "entrance" for visitors and those who pose questions, to the different departments of the Faculty of Agriculture
- we publish the Agrodoks
- we publish a Dutch quarterly magazine for development workers: VRAAGBAAK
- we sell practical books on agriculture in the tropics

The second aim of Agromisa is to increase the awareness for development problems among the Dutch people.

Agromisa is a member of the TOOL Foundation (TOOL = Technical Assistance for Developing Countries). In the TOOL Foundation are gathered the agricultural, technical and medical groups in Holland, working to achieve the same aims as Agromisa. ATOL is a sister organisation of TOOL in Belgium.

If you are working with underprivileged groups in developing countries, then the groups participating in TOOL, and ATOL, can give you advice on the following subjects:

Building and building materials	Water power
Machinery	Wind power
Electrotechnics	Solar energy
Chemical technology	Biogas
Roads and waterworks	Fossile energy

continued on back cover

Foreword

This brochure ("dokje", or little document) is meant to give a general view of the simple techniques used to preserve foods. It is a completely revised edition of the old Dutch-language "dokje", "Konserven van Voedingsmiddelen", and includes much new information in extended or new chapters.

The principles of spoilage and spoilage prevention are treated first in the general introduction. Following this, the various methods of preserving will be explained, and the most important points of spoilage specific to the method will be repeated.

The chapters on drying and smoking of fish and meat, and on preserving by jam and juice making have been extended. New chapters pay attention to vegetable and fruit drying, salting of vegetables, and the processing of milk. The chapter on deep freezing has been omitted, as this technique needs facilities not usually available in developing countries.

Comparisons of the cost prices of the various methods is very difficult, as this is dependent on many factors. We have tried to describe every method as practically as possible, so that you will be able to see which materials and techniques are required.

In closing, we would appreciate it very much if you would complete and return the evaluation form on page 84.

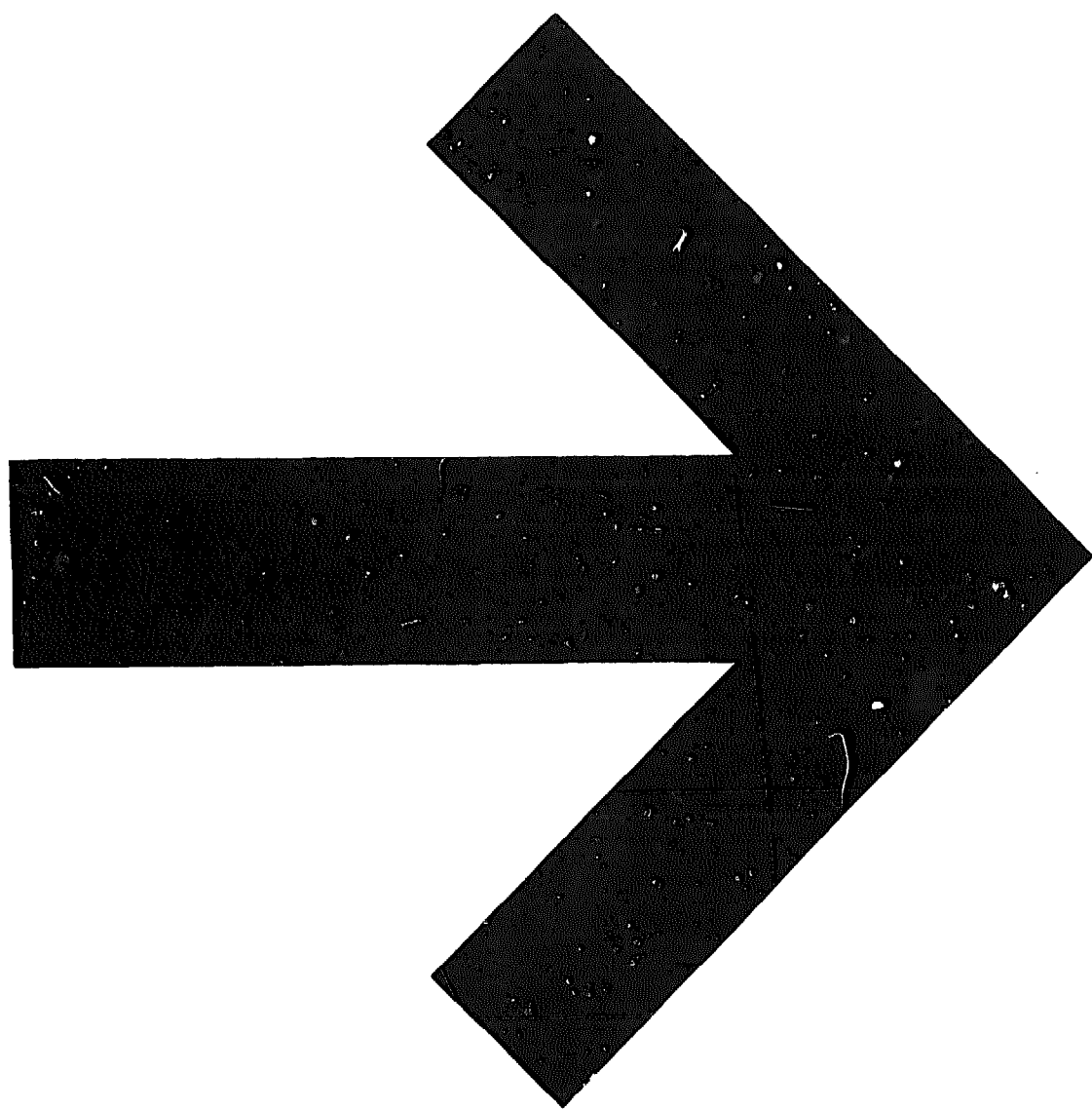

Agrodok 3: PRESERVATION OF FOODS

<u>Table of contents</u>	<u>page</u>
Introduction	1
1. Spoilage: Causes, effects and prevention	2
1.1 What is spoilage?	2
1.2 Prevention of spoilage	4
2. Preserving vegetables, meat and fruit by heat	8
2.1 Introduction	8
2.2 Preparations	11
2.3 Processing techniques	12
2.4 Storage	15
3. Drying of Vegetables and Fruit	26
3.1 Introduction	26
3.2 The quality of the fresh product	26
3.3 Pretreatment	27
3.4 Drying techniques	28
3.5 Packing and storage	25
3.6 Hygiene	36
3.7 Preparing dried foods for use	36
3.8 Remarks on table 4	36
4. Preservation of vegetables with salt	41
4.1 Introduction	41
4.2 Requirements	42
4.3 Preparations	43
4.4 Salting methods	44
4.5 Warning	46
5. Preservation in acetic acid	47
6. Preserving fruit by jam and juice making	48
6.1 Introduction	48
6.2 Making fruit juices	48
6.3 Lemonade concentrates	53
6.4 Fruit jelly preparation	53
6.5 Making candied fruit	54
6.6 Jam making	54
7. Simple techniques for preserving meat and fish	60
7.1 Introduction	60

Table of contents, continued

	<u>page</u>
7.2 Salting and drying of meat	61
7.3 Salting and drying of fish	64
7.4 Smoking of meat and fish	66
8. Dairy products	71
8.1 Introduction	71
8.2 Milking	71
8.3 Preparing milk	72
9. Final remarks and literature	82

List of Tables

1. Preparation of vegetables and fruit and processing times in glass jars	17
2. Preparation of fruit; sterilization times in a boiling water bath	19
3. Preparation of vegetables and meat; sterilization times in a pressure cooker	21
4. Preparation and drying conditions for various products	36
5. Preparation of vegetables for salting	43
6. Juice extraction from various types of fruit	58

List of Figures

1a, b, c Glass jar seals	16
2. An autoclave	16
3. Drying racks	31
4 and 5. Improved sun driers	31
6. Storage bags	31
7. The bush drier	32
8 and 9. Salting vegetables	42
10. Bottle top sealer	57
11. A fruit press	57
12. A juice steamer	57
13. Smoke grill	70
14. Smoke oven	70
15. Smoke house	70
16 and 17. Butter churns	77
	77
	77

List of Figures, continued

page

- 18. Cheese cutting frame
- 19. Curd stirrer for cheese making
- 20. Cheese mold
- 21. A cantilever system for pressing cheese

77

77

77

81

Introduction

Man is dependent for his food on products of plant and animal origin. Because most of these products are only easily available in certain seasons of the year and because food spoils, methods have been developed to preserve foods. Preserved foods can be eaten long after the products would normally have spoiled. With the growth of towns, the need for preserving foods for longer times increased, as people could no longer grow their own vegetables and keep animals.

Preservation is the process by which foods can be kept for longer periods of time.

Preservation must be seen as a means to store excess foods available at certain times, to be consumed in times when food is scarce. Consumption of fresh foods is always preferable as preservation usually destroys some of the nutritional value - in plain language, preserved foods are not as healthy as fresh foods.

Attention is paid in this dokje to a number of simple preservation techniques, meant to preserve on a small scale, such as the household or village level. Special attention is paid to small scale methods, to make it possible for people to process and store their surplus economically.

In times of scarcity preserved foods can be a welcome addition to the diet. Through preservation sales out of season are possible, independent of the normally lower market prices in the harvest season.

This "dbkje" begins with a discussion of spoilage and its prevention. Knowledge of the causes of spoilage is necessary in order to be able to preserve correctly. After this, the principles and the methods of preservation are explained and the advantages and disadvantages of each method are described.

The following methods of preservation are treated with data for various foods: drying of vegetables and fruits, drying, salting and smoking of meat, canning, fruit juice preservation, jam manufacture, dairy product manufacture, pickling and fermenting.

1. Spoilage: Causes, Effects, and Prevention

1.1 What is Spoilage

Spoilage is the deterioration in food which makes it distasteful (sour, rotten, moldy) and/or a carrier of disease germs. Most fresh foods spoil within days when they are stored without care in warm surroundings.

When is food spoiled? If one of the following properties can be applied to the food, it can be considered to be spoiled and is definitely not to be eaten: offensive smell, moldy surfaces, strongly sour or sharp flavor, a different color, gas development (bulging tins) or slimy surfaces. The food, when consumed, can cause such symptoms as diarrhoea, stomach pains, nausea and vomiting, stomach infections and cramps. In very serious cases it can cause death.

Spoilage can be caused by:

- microorganisms: molds, yeasts, and bacteria
- continuation of the various life processes in foods (for example, overripening in fruit)
- reactions in the food itself: chemical reactions leading to changes in the color and taste

Spoilage by microorganisms occurs quickest. This is the most important cause of spoilage and will be the only cause dealt with here. It is also the cause of spoilage most easily combatted. Enzymatic spoilage is usually stopped by heating (blanching, pasteurization, sterilization). Chemical spoilage is of minor importance and is very difficult to prevent. Some preservation methods quicken this type of spoilage.

Which microorganisms cause spoilage in food? Not all microorganisms (m.o.) cause spoilage. Some cause desired changes in foods (cheese and sauerkraut preparation); these are caused by useful m.o., of which there are thousands of types. M.o. are usually not visible with the naked eye, so that serious infections and food poisoning can be caused without the food being visibly changed.

Molds can grow on almost all foods. They usually can be seen directly on the foods and can alter the taste, making a food taste rancid. They often grow at low temperatures, in sour products, and on

dry products such as grain or bread. Some molds can produce poisonous and often carcinogenic substances, called toxins, especially in moist seeds such as peanut, corn (maize) or soy bean.

Yeasts can also cause spoilage. They often multiply at low temperature and in sour products.

Bacteria can grow in fresh foods (meat, fish, milk, vegetables) which are not sour. Some bacteria can cause infection and poisoning as well as spoilage. A number of bacteria can form spores, so that they are less sensitive to preservation techniques and can begin to grow again after an insufficient heat treatment.

When can spoilage and/or food poisoning occur? Food poisoning and spoilage occur only when m.o. have multiplied in the food. Their growth in the food is dependent on:

- the nutrients in the food: Water, proteins, carbohydrates, minerals, and sometimes vitamins must be present. Milk and meat are foods where the mentioned nutrients are present in large quantities and which, consequently, spoil quickly.
- acidity: Most bacteria grow best in neutral conditions such as found in milk, meat, and fish. Molds, yeasts, and some bacteria can still grow in sour products (yoghurt, fruits).
- The amount of water available for the m.o.: M.O. grow poorly in dry products (powdered milk, grains) as compared to watery products (milk, meat, fish, vegetables).
- The presence of substances such as preservatives and some herbs which inhibit the development of microorganisms.
- The temperature at which the foods are stored: The ideal temperature for growth of microorganisms is between 7 and 55°C. Below -10°C molds usually don't develop; at temperatures above 80°C they usually die. Spores and poisons are often resistant to temperatures above 100°C.
- The oxygen level: Some microorganisms need oxygen to grow, while others cannot grow in the presence of oxygen.
- The time between infection and processing of the food (preservation or consumption). Time is needed for new microorganisms to adapt to the new food. In addition, some microorganisms multiply quicker than others, so that the levels of microorganisms or poisons in the food can vary. At 37°C bacteria can multiply from 1000 to 10,000,000 individual organisms in seven hours.

The actual rate at which the bacteria grow is dependent on a combination of the factors mentioned. A watery product at 25°C will spoil

much quicker than a dry, sour product at 5°C.

How does contamination take place? Infection can be caused by people (germs on skin, intestines, cuts, throat or hands) soil, dust, sewage, surface water, manure, and other spoiled foods. Contamination can also take place through badly cleaned apparatus, domestic animals, pets, vermin, or unhygienically slaughtered animals.

Contamination after a preservative treatment is especially disastrous. An example of this is the contamination of cooked meat by placing it on the same plate where the fresh meat was stored.

How to prevent contamination? Hygiene!

- Use good personal hygiene. Wash hands thoroughly with hot water and soap after using the toilet, after handling cuts and infections, after doing dirty work and before touching food.
- Change towels and wash clothes regularly.
- Keep food on smooth surfaces which can be and are washed well (stainless steel kitchen block, smoothly polished wood, tiles, stone).
- Keep the places where food is stored clean by regularly washing with soda water.
- Wash all tools used with foods regularly.
- Cover all foods well.
- Try to keep all pests away from the places where foods are kept.
- Never store left-overs at room temperature.
- Ensure proper hygiene when animals are slaughtered.
- Use clean water. Where necessary boil the water before use.

1.2 Prevention of Spoilage

As already mentioned in the introduction, this "dokje" deals with preservation -- extending the storage life of products which otherwise quickly decay. This preservation can be done in two ways.

1. with retention of the original quality and properties of the foods.
2. with radical changes which result in new products with completely new qualities.

Preservation is based on the delay or prevention of spoilage by microorganisms. The dangers of microorganisms can be avoided in three ways:

1. The microorganisms are removed: This is a very costly method which can only be used with liquids (filtering of drinking water). This method will not be discussed.

2. The microorganisms are killed: This is usually done with heat.

When all microorganisms are killed by the heat treatment the process is called sterilization, and the product can be stored for a long time. When a short heat treatment is given, so that not all microorganisms are killed, the process is called pasteurization, and the product can only be stored for a limited time. The acidity of the food is very important with heat sterilization. Microorganisms and spores die faster by heating in an acid product than in a less acid product, and sterilization in the former is therefore quicker. Microorganisms grow less easily in acid products. A product's sourness is indicated by its acidity, expressed in "pH". The more sour a product is, the greater the acidity and the lower the pH. Food can be divided up into three groups based on their acid content:

<u>group</u>	<u>pH</u>	<u>products</u>
weak acid or neutral	more than 4.5	most vegetables, milk, meat, and fish.
acid	4.0 - 4.5	tomatoes, pears, strawberries, pineapples, apples
strongly acid	less than 4.0	citrus products, rhubarb, sauerkraut

3. Microorganism activity is suppressed: An environment in which microorganisms can no longer grow, or can grow only very slowly; is created. There are various ways to do this:

- a. low temperature: Products remain fresh in the refrigerator (2-4°C) for 4-7 days; they can be stored for much longer periods in the deep freeze (-20°C). Low temperature must be accurately maintained, and high demands are made upon the freezer and energy supply and quality. Because of the high costs of energy needed for freezing, this method will not be discussed further. Extensive information from the manufacturer is usually supplied with the purchase of a freezer.
- b. reduction of the water content: Drying is the oldest method of preserving foods. When sufficient water is removed from a product, microorganisms can no longer grow. The amount of water to be removed varies with the product itself. The simplest and cheapest

method is to dry the products in the open air (with or without sun). Somewhat more expensive and difficult methods make use of driers in which the products are artificially dried with warmed air. Sun-dried products are of slightly less quality due to the breakdown of certain vitamins in sunlight.

- c. Raising the osmotic pressure: In this technique sugar or salt is added to stop microorganism growth. Examples are salting of meats, jam making, and the candying of fruit. These preserved products keep well. The method is less suitable for vegetables. The nutritional value of the final product is low.
- d. Addition of preservatives: Addition of certain substances can partly prevent spoilage. In practice this method is only used as an aid to other methods of preserving, and will therefore not be treated here. Because of the poisonous nature of the substances the accompanying directions must be followed accurately.
- e. Changing the foods: By preserving in liquids or by adding alcohol or acids or by special microbial processes "new" foods can be made. These often have a very specific odor and taste, as for example cheese, yoghurt, sauerkraut, alcoholic drinks, sausage, smoked products, and many local fermented products.

Which method should be chosen?

The choice of a preservation method depends on the product, the desired properties of the stored product, the accessibility of energy (wood, gasoline, oil, electricity, sun), the storage facilities, possible packing materials, and the costs involved in each method. It is sometimes necessary to combine methods, as for example salting and drying meat, or adding acid and then sterilizing. It is also desirable to conform to the local customs if the products are to be accepted.

A number of advantages and disadvantages of several methods are summarized here:

heat treatment: fairly expensive; labor intensive; requires much energy and water; jars or tins with lids are needed; sterilizers and canning machines are needed; packing is expensive; storage is easy (below 25°C) and for long periods; the quality of the product and the nutritional value is good.

low temperatures (freezing): very expensive technique, using much energy; high investments are needed; the quality, nutritional value and length of

storage are good.

drying: inexpensive, no energy (sun drying) or only relatively little energy needed; little equipment needed; dry and/or airtight storage required; quality and nutritional value reasonable with good storage.

high osmotic pressure: inexpensive when sugar or salt are cheap; no energy required; storage at room temperature; salting gives a reasonable quality and food value with meat but poor quality with vegetables; sugar gives good quality for fruit; long storage possible; nutritional value low (excess sugar).

fermentation and pickling: often cheap (native techniques); no energy needed; taste and odor often radically changed; length of storage in general rather short (a few weeks); food value often good.

2. Preserving Vegetables, Meat, and Fruit By Heat

2.1 Introduction

2.1.1 General Information

Heating is one of the commonest preservation methods. Heating is suitable for many types of vegetables and fruit. Fruits can also be preserved as juices. Sterilized meats in tins or jars can also be kept for long periods.

In general, heated products can be stored for a long time (until the next harvest). This is done by closing off the air to a product and then heating this, so that the microorganisms present in the jar or tin are killed and microbial spoilage is stopped. The hermetic seal on the jar makes infections from outside impossible. Chemical spoilage (deterioration in taste and color) continues.

Not all products can be heated in the same way. The timing and the temperature given are dependent on the infection level, the product, the jar or tin, and the storage temperature. Sour products such as fruit can be sterilized in boiling water (100°C), while less sour products such as meats and vegetables must be sterilized by heating in a pressure cooker or sterilizer, where temperatures higher than 100°C can be achieved. Vegetables can be stored longer when heated in a boiling water bath (canning, not sterilizing).

Advantages of heating are:

- longer and safer storage of the product
- the quality of the product is reasonable with vegetables, good with fruit. The best quality is achieved by using fresh, healthy products and by accurately following the heat specifications for that product.

Disadvantages of heating are:

- the high price of the preserved foods due to:
 - a. Glass or tin packing materials must be used, and may be expensive and difficult to obtain. Glass can be reused.
 - b. The processing equipment is, when compared with sun drying, very expensive. The costs for canning in glass jars is less.
 - c. The treatment requires much fuel.
- The process requires more clean water than other methods do.
- The long heating at high temperatures causes taste and vitamin losses, especially with vegetables. The nutritional value of the food is lowered, as a result of chemical conversions and loss of nutrients into the water.

The quality is better than by other methods. It is preferable to eat as much fresh fruit and vegetables as possible during the whole year.

In this chapter the methods are given for sterilization and canning of a variety of vegetables, fruits, and meats. Because the packing materials are very important in this procedure, these will be discussed first.

2.1.2. Packing Materials

Tin-plated cans and glass jars or bottles can be used to hold the products. The shape and volume of the vessels must be chosen according to the quantity to be processed. Big, bulky products such as pieces of meat must be sterilized in small or flat tins or jars which allow the heat to penetrate the center of the product quickly. Small products and products in juices, brine, etc. can be packed in all shapes and types of tins or jars.

The contents of an opened tin or jar must be consumed as quickly as possible (in any case within 24 hours), so that the contents of a tin or jar should be adapted to the quantity of food consumed in one meal or one day. Of course it is true, the larger the tins or jars, the cheaper the packing material per kilo of treated product. In general, bigger tins and jars must be heated longer, so that the quality is somewhat lower than with smaller tins or jars.

a. Tins

These are iron cans which are covered with a thin layer of tin. They are especially used for sterilizing, and are very suitable for sterilizing larger amounts. Unfortunately they can only be used once. There are many different types available; tins with varying capacities and shapes (cylindrical = long and thin; flat= wide and shallow). A few common volumes are:

capacity in liters	0.58	0.85	0.95	3.1
--------------------	------	------	------	-----

Tins can also vary by the presence or absence of a varnish layer on the inside. Unvarnished tins are often good. Tins with special layers on the inside are also available for special products; consult the supplier about these. Highly acid products (cherries, berries, plums) must be put in varnished tins to maintain good color and taste.

With every tin comes a lid, which can be hermetically sealed with the help of a tin sealer. Various types are available, ranging from simple hand-operated tools to new automatic machines. The sealer must

be properly adjusted to prevent leakage. This can be checked by closing the tin with a little water and immersing it in boiling water. If, after a few minutes, air is seen to escape, the sealer must be readjusted.

Tins delivered from the factory are fairly clean, and do not require extra washing. Store them upside down to keep dirt out. If they are not clean, wash them in hot soda water (1.5%), rinse with hot water and let them drip dry on a clean cloth. The lids must also be clean.

b. Glass

Glass jars can be used for sterilizing under pressure and for canning. Glass has the advantage that it can be reused after the product is consumed and that the glass doesn't affect the product. The fragility of glass, and the fact that light can get to the product are two disadvantages.

Use only undamaged lids and jars to get a good seal. Jars differ in size and in the sealing mechanisms. These are:

- jars with ceramic lined zinc lids (figure 1a, page 16). A rubber ring is put between the lid and the jar. Jar and lid are reusable, but the ring must be renewed each time. Wet the ring and put it on the clean rim of the jar. Fill the jar, clean any spills, screw the lid on tightly and then give the lid a quarter turn back. Air can then escape during the process. Immediately after heating, when the jars are still hot, the lids should be tightened again.

- jars with divided lids (figure 1b). In addition to a screw cap there is also a type of disk which fits into the lid and which seals the jar airtight. The disk (made of carton or cork) can be used only once, but the jar and lid are reusable. Fill and close as with other jars,

- jars with caps (figure 1c). On the jar is a lid with a plastic layer on the inside; the lid allows air to escape when the jar is warm and seals it off when the jar is cold. The jars can be reused, but the lids must be new. The lids can be screwed tightly closed before heating.

The jars and lids must be cleaned before using with soap (soda) and hot water. Keep the clean jars in hot water until they are required. Jars come in 0.50, 0.75, 1.0, 1.5 and 2.0 liter sizes. Each manufacturer has their own rings, lids, and sometimes clamps which fit on the jars. Best results are achieved when all parts are of the same make.

2.3.1. Processing Equipment

The items needed for the whole process are:

- tubs for washing and rinsing vegetables, bottles, lids, etc.
- cutting equipment: tables, knives
- kettles for warming, boiling, pre-boiling, processing
- shallow open pans for sterilizing at 100°C.
- hand sealing machines for sealing tins
- a thermometer to check the temperature
- a sterilizer (autoclave) or pressure cooker for sterilizing at temperatures higher than 100°C

A number of important points of the process have already been described. Before beginning the description of the work method a few other important points will be mentioned.

Clean and tidy work pays off in lower levels of microorganisms and more chance of success of the process. The time between filling and sterilizing must therefore be as short as possible, and the temperatures by which the jars or tins are filled and closed may not be lower than that given in the tables. Never use damaged tins and jars.

2.2. Preparations

Specific information is to be found in the tables on the following pages. The general work method is here described.

a. Vegetables and Fruit

For canning use only healthy, unbruised fruit and fresh vegetables. Keep the time between harvest and processing as short as possible in order to get the best quality preserves.

Wash the produce, cut and remove inedible parts, and cut into small pieces. Work as quickly as possible. Cook all vegetables to shrink them and to keep the number of microorganisms as low as possible before canning. Normally fruit is not cooked.

b. Meat and Fish

Processing meat to a preserve is possible, although the danger of growth of pathogenic bacteria is much higher with meat and fish than with vegetables. Therefore bottling of meat is not advised, but sterilizing is possible.

Use only clean fresh pieces of meat; remove bones, cut into smaller pieces (a few cm thick), season where desired. Brown the meat; big pieces

should be partly cooked before frying. Use flat tins, especially for bigger pieces.

Only fatty fish are suitable for heat processing. Start with fresh, healthy fish. Wash them and gut them so that the intestines do not touch the flesh when being removed. Remove the head and tail and, with big fish, the bones, then wash the fish thoroughly in cold water. The fish can be tinned raw, fried, or cooked. Put small fish straight up in suitable jars or tins (sardines); somewhat bigger fish can be put in flat oval tins (herrings). Big fish have to be cut into smaller pieces to go into small tins.

2.3. Processing Techniques

2.3.1. Canning

After the preparations, the products, still warm or heated to the filling temperature, are put into the jars or tins as quickly as possible, and these are then filled to a half centimeter under the rim with hot water, hot cooking broth, hot salt solution, hot sugar solution, or hot oil, as is indicated in the table. With leafy vegetables the liquid is better put first into the tin or jar, before the vegetables. Take care that no air bubbles are sealed in with the product.

A correct composition and temperature of the liquid is very important. Use boiling water. A sugar solution of 40% is not 400 grams of sugar in 1000 ml water but 400 grams sugar in 600 ml water.

Glass jars, bottles, and tins can be sealed after adding the liquid, as long as the sealing temperature has been reached in the middle of the product.

The sealing temperature may never be lower than indicated in the table. If it is lower, the jars and tins must be quickly reheated in a shallow water bath until the temperature in the middle of the tin is equal or higher than the indicated temperature. Always measure the temperature in the middle of the tin.

Seal quickly and apply the recommended heat treatment.

2.3.2. Canning in Glass With Temperatures Up To 100°C

Canning cannot be advised unless the jars can be stored below 20°C. If you live higher than 300 meters above sea level, canning is not possible, and you must sterilize the foods. Canning is done in a large kettle with a perforated rack on the bottom, on which the jars

are placed. The lids are attached with clamps to the jars. Other pans with wooden racks or cloths on the bottom to hold the jars can also be used. Two layers of jars can be used, placed so that the rim of the jars in the lower layer are just above the water. The water in the pan should be warm or the same temperature as the jars. Begin timing when the pan is heated to the proper temperature. The jars are removed from the pan immediately after the time is up and allowed to cool on a shelf or cloth. Leave the clamps on the jars for a few hours. When the jars are closed properly they can be lifted up by the lid without these falling off.

Table 1 gives processing times for vegetables. The canned vegetables should be stored in a cool, dark place at temperatures below 20°C

Before consumption the vegetables should be cooked for 15 minutes. Never eat spoiled food. Never eat from jars which have opened during storage.

2.3.3. Sterilizing In A Boiling Water Bath

The boiling water bath is used to preserve sour products. The acid prevents the growth of any surviving microorganisms.

To prevent the glass jars from breaking, start with hot but not yet boiling water; tins can go straight into the boiling water. The tins and jars should be completely under water. Begin timing the process only when the water boils again, making sure that the water remains at a rolling boil during the entire sterilization period. An open water bath boils at 100°C for altitudes up to 300 meters above sea level. At greater altitudes the water boils at a lower temperature, and the products must be sterilized longer to achieve the same effect, as shown in the table:

altitude	sterilization time in minutes	example
0 - 300 meters	a minutes	a = 10 minutes
300 - 600 meters	a + 1/5 a minutes	a = 12 minutes
600 - 900 meters	a + 2/5 a minutes	a = 14 minutes
900 -1200 meters	a + 3/5 a minutes	a = 16 minutes

After heating the tins can be cooled in cold water, which should be changed occasionally to speed the cooling. Glass jars should only be put into cold water when they are luke-warm. The cooling can be speeded up by gradually adding cold water to the hot water in the sterilizer.

The sterilization times are given in table 2.

2.3.4. Sterilization With an Autoclave

For sterilizing with temperatures higher than 100°C a pressure cooker or autoclave is needed. These high temperatures can be reached only by means of over-pressure.

At sea level water boils at 121°C when the autoclave has one atmosphere over-pressure. At an over-pressure of 0.7 atmosphere water boils at 115°C. In higher areas more over-pressure is needed to get the required temperature. As a rule 0.1 atmosphere extra is needed per 1000 meters above sea level. The temperature in the pressure cooker has to be carefully checked with a thermometer. The principle is the same for a pressure cooker and an autoclave. The general work method is:

- Cover the bottom of the autoclave with water.
- Place the basket with the jars in the autoclave. The holes in the basket must not all be blocked, steam must be able to pass through. Remember to give the jar lids a quarter turn back.
- Seal the autoclave and open the ventilation system. Apply heat.
- After the steam has escaped 10 minutes close the ventilation system (the air has been removed) and let the over-pressure build up.
- When the necessary temperature is reached, the cooking time starts. (see table 3) Keep the temperature and pressure as constant as possible by regulating the heating.
- Tins: After the processing let the steam escape slowly. This can be done quicker with small tins than with bigger ones, but still should be done slowly and carefully as the tins can deform or even burst. When the pressure is again normal the lid can be opened. Remove the tins and immerse in cold water, refreshing this now and then to keep it cold. When the tins are cool (which takes as long as heating them) dry them.
- Glass jars: Wait until the autoclave cools down and the over-pressure is gone before opening the lid. Remove the jars and tighten the lids immediately. The disadvantages of glass jars is that they cannot be cooked quickly. The safest way is to cool them in the open air until

they are hand warm and then to put them in cold water.

A second technique for sterilization with an autoclave uses more energy and water but gives a better product. The autoclave is completely filled with water and the tins and jars are put into this. The process is as above. The cooling can be quickened by slowly removing the hot water and adding cold water to the autoclave after sterilization.

2.4. Storage

Store the canned foods in a cool place. Label them so that one knows the contents. The temperature during storage should stay below 20°C. - the cooler the better, as chemical spoilage still takes place. Don't pile the preserves too tightly; air should be able to move between them. The storeroom should also be dry and with a constant temperature. Only ventilate with dry air; avoid ventilation in warm, humid weather, as the condensation could rust the tins.

Always use the oldest preserves first. Check the product for spoilage.

General Remarks For Using the Tables:

- Use as little herbs and spices as possible. These are often a source of contamination
- Use clean and purified salt. If the salt is not pure, heat it on a dry iron sheet above a hot fire.

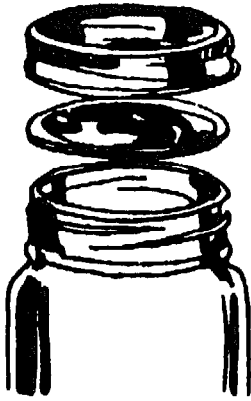

Figure 1a

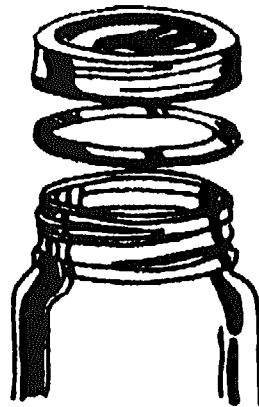

Figure 1b



Figure 1c

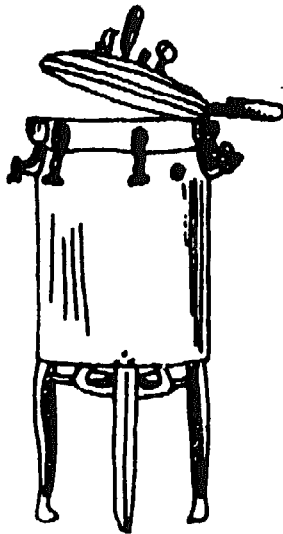

Figure 2
an autoclave

Table 1: Preparation of vegetables and fruit and processing times in glass jars (1-2 liter volume)

product	preparation	canning liquid
strawberries	wash, sprinkle with $\frac{1}{4}$ of the product weight in sugar, let stand two hours before packing	-
apricots	peel, split and remove pits	75% sugar, cold
applesauce	make applesauce, reduce liquid, add no sugar	-
raspberries	wash, sprinkle with $\frac{1}{4}$ of the weight in sugar, let stand two hours before packing	-
cherries	wash, remove stems, pack. Sweet cherries need 25% sugar solution, sour cherries 75% syrup	25% or 75% sugar, cold
pears	hard: cook for $\frac{1}{2}$ hour soft: peel and cut	40% sugar, cold
peaches	peel, halve and remove pits	40% sugar, cold
rhubarb	clean, cut into pieces, sprinkle with $\frac{1}{4}$ of the product weight in sugar. Pack with juices after 2 hours.	-
plums	wash, (peel), halve	40% sugar, cold
currant juice	wash currants, remove stems, boil shortly, simmer one hour, strain if cloudy	-
tomatoes	wash	1% salt solution, warm
tomato puree	wash tomatoes, boil shortly, strain and reduce juice	-
endive	cut, wash, boil for 10 minutes in 1% salt, add fresh boiling water to the jar before packing the vegetables tightly	fresh boiling water
asparagus	strip, cut to jar height, boil for 5 minutes	fresh boiling water
snow peas	remove ends, wash, boil in lightly salted water for 10 minutes	fresh boiling water
turnip tops	wash, boil for 5 minutes, add boiling liquid to the jar before packing	fresh boiling water

table 1, continued

product	preparation	canning liquid
peas	shell, wash, do not boil	fresh boiling water
green beans	wash, break, boil for 10 minutes in lightly salted water	fresh boiling water
spinach	use fresh leaves only. wash, boil without water for 5 minutes with some salt, add boiling liquid to the jar before packing tightly	-
runner beans	remove tops, wash, cut, boil in lightly salted water for 10 minutes	fresh boiling water
broad beans	shell, wash, boil in lightly salted water for 5 minutes	fresh boiling water
carrots	clean and wash, boil in lightly salted water for 5 minutes	fresh boiling water plus salt
cauliflower	cut, wash, boil for 1-2 minutes	fresh boiling water

product	canning times	product	canning times
strawberries	30 min. 80°C.	rhubarb	30 min. 80°C.
apricots	30 min. 80°C.	plums	30 min. 80°C.
apple sauce	30 min. 80°C.	currant juice	20 min. 75°C.
raspberries	20 min. 75°C.	tomatoes	20 min. 80°C.
cherries	30 min. 80°C.	tomato puree	30 min. 80°C.
pears	30 min. 80°C.	endive	1½ hour 100°C.
peaches	30 min. 80°C.	asparagus	1½ hour 100°C.
snow peas	1 hour 100°C.	snap beans	1½ hour 100°C.
turnip tops	1½ hour 100°C.	broad beans	1½ hour 100°C.
peas	1½ hour 100°C.	carrots	1½ hour 100°C.
	repeat after 24 hours	cauliflower	1½ hour 100°C.
beans (fresh)	1 hour 100°C.	spinach	1½ hour 100°C.

Table 2: Preparation of fruit and sterilization times of fruit in a boiling water bath using glass jars of $\frac{1}{2}$ and 1 liter or tins of 0.58, 0.85, and 3 liters. Unless stated otherwise, all products are blanched and sterilized in the boiling water bath.

product	preparation	liquid
apples (whole)	peel, blanch for 3 minutes, fit tightly into tins	boiling water or 20% sugar
apples (slices)	peel, remove core, slice and blanch for 3 minutes in 1% salt	boiling water or 20% sugar
apple sauce	pulp apples, boil for 10 minutes, add 5% weight sugar and fill at 82 ^o C. minimum	-
apricots	remove stalks, wash, halve and fill	25% sugar, boiling
berries	remove stalks and overripe fruit, wash carefully	30% sugar, boiling
cherries	remove stalks, wash (remove pits). with sour cherries add extra sugar	30% sugar, boiling
figs	remove stalks, boil in 30% sugar until the syrup contains 65% sugar, fill at 100 ^o C	boiling liquid
grapefruit	peel, remove seeds, split segments, fill jars first with liquid	40% sugar, boiling
grapes	remove stalks, wash	15% sugar, boiling
mango	steam for 2 minutes, peel, slice, remove seeds, pack into flat jars or tins	40% sugar + 0.25% vinegar, boiling
oranges	peel, remove seeds, split into segments	15% sugar, boiling
papaya	peel, halve or slice	50% sugar + 0.25% vinegar, boiling
peaches	boil for 1 minute in water, peel, halve, remove pits	25% sugar, boiling
pears	peel, halve, keep under water until filling	20% sugar, 80 ^o C.
pineapple	peel, core, cut into rings	30% sugar, boiling
plums	remove any overripe fruit, wash, remove stalks (halve)	30% sugar, boiling
rhubarb	wash, remove unedible bits, cut into chunks, pack tightly into glass or tins	boiling water
sauerkraut	boil for 10 minutes and pack hot	-
strawberries	remove tops, wash	20% sugar, boiling

table 2, continued

product	preparation	liquid
tomatoes	wash, steam 15 seconds, dip in cold water, remove skins, fill	0.5% dry salt + 0.07% calcium chloride
banana	peel, cut into slices, fill immediately	3.5% sugar + 0.5% vinegar + 0.1% calcium chloride, boiling
lychee	peel, (halve)	50% sugar + 0.25% vinegar, boiling
fruit puree	prepare, fill at 70-80°C.	-
artichoke	remove outer parts, blanch hearts for 5 minutes in 1% vinegar	3% salt + 4% vinegar, boiling
sweet peppers	cut, (peel after boiling in 10% lye), blanch for 3 minutes, (puree)	1.5% salt, boiling

product	sealing temperature (°C)	sterilization times in boiling water bath (minutes)				
		glass		tins		
		½ l.	1	0.58	0.85	3.1 l.
apples	60	20	20	15	15	20
apple sauce	82	5	5	5	5	10
apricots	60	25	25	15	20	30
berries	70	20	20	15	20	30
cherries	70	25	25	15	20	30
figs	95	15	15	10	10	10
grapefruit	60	10	10	15	18	20
grapes	77	20	20	12	15	20
mango	95	do not boil		10 minutes, 91°C.		
oranges	77	10	10	15	18	20
papaya	77	20	20	15	20	30
peaches	71	20	20	20	25	40
pears	71	35	35	30	30	30
pineapple	75	20	20	20	30	40
plums	82	20	20	15	22	35
rhubarb	86	10	10	15	18	20
sauerkraut	71	25	30	15	25	35
strawberries	77	10	10	15	18	20
tomatoes	60	45	45	45	55	90
banana	71	15	15	10	12	20

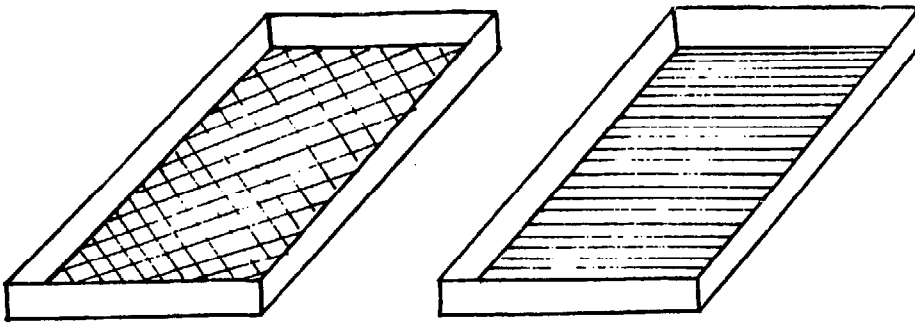

figure 3: drying racks

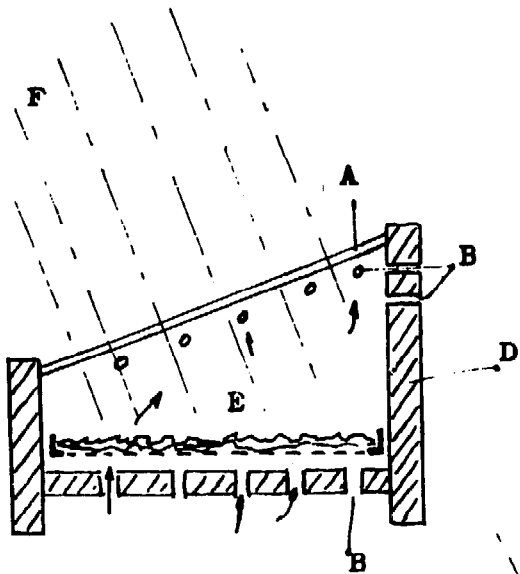

figure 4

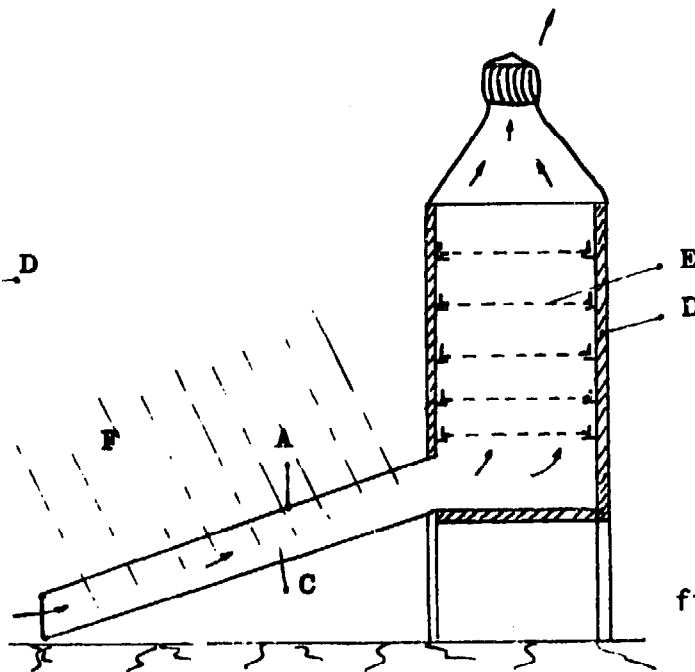

figure 5

improved sun dryers:

A: glass, B: ventilation holes, C: air heater, D: insulation
E: racks with the to-be-dried product, F: angle of incidence of the sun
The arrows show the direction of the air flow.

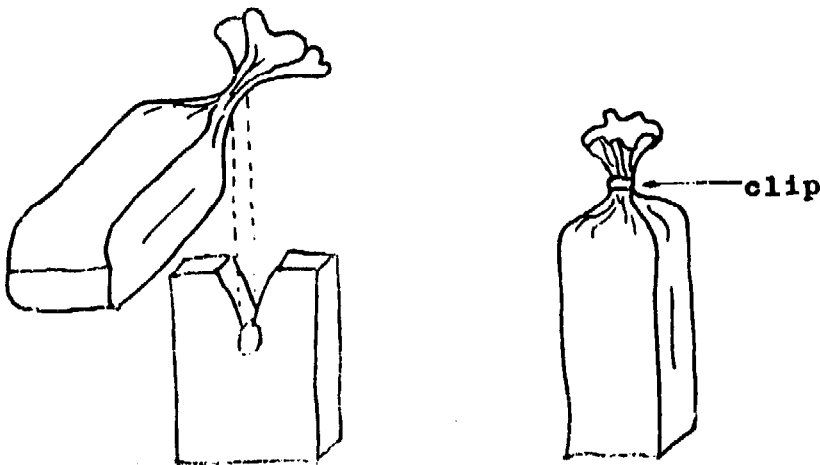

figure 6:
Close bags with a clip

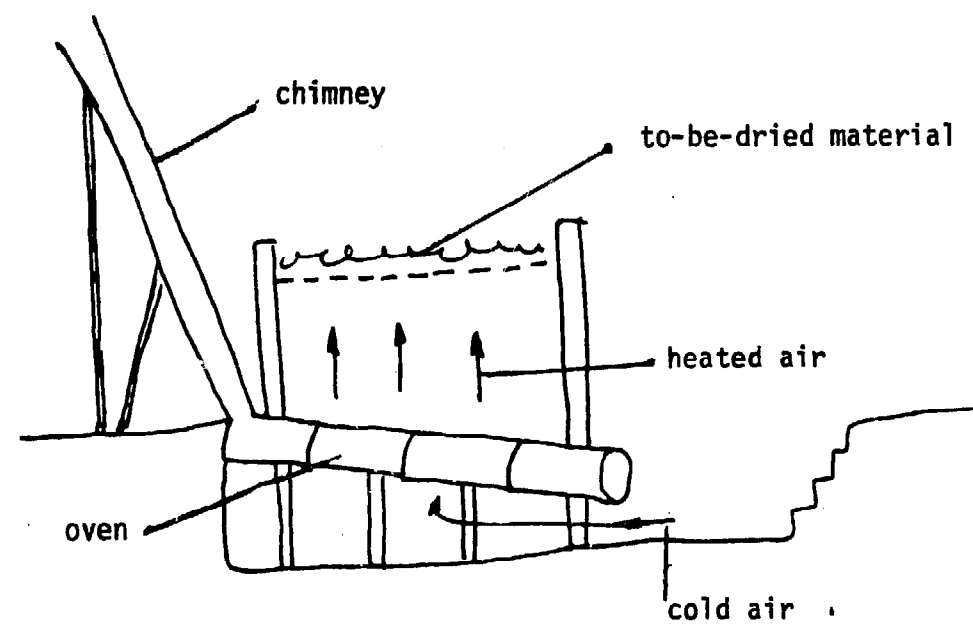
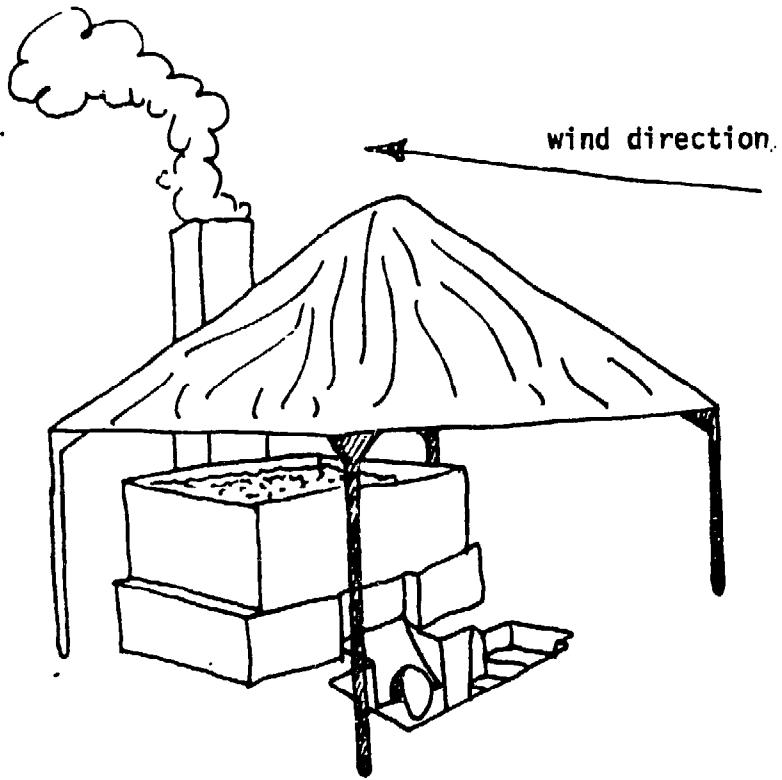

figure 7: the "bush drier"

where it rains often and for long periods, it is a good idea to keep an artificial drier in reserve or to always use an artificial drier.

3.4.3. Artificial Drying

Improved Sundrying

Drying goes quicker when the racks are placed in a structure so that the sun's rays can enter through a glass cover and the warmth is trapped. This raises the temperature to 60-75°C. Over-heating can be avoided by regulating the ventilation (see figure 2). Without ventilation the temperature can reach 90-100°C, especially at the end of the drying process. The ventilation must be good enough to prevent condensation on the glass. It is also possible to heat the air in special boxes before leading it over the product (figure 3). These techniques will speed the sun drying in dry areas (beware of overheating), giving a better product. These techniques also make drying possible in areas with high humidity, as the relative moisture decreases with a higher temperature, as explained in section 3.1. An extra advantage of this technique is that the product is protected from rain. Should you be interested in this method of drying, you can write for specifications for building and using drying boxes. The structure shown in figure 4 is already commonly applied; the technique shown in figure 5 is less common.

Heating With Fuel

In wet climates, or when large quantities (above 100 kg/day) have to be processed, one should consider heating the air with wood or other fuels, especially when the fuel supply is not a problem. Vegetables dry better with this method than in the sun, and the color, odor and taste of the end product is better. Two methods will be briefly described to give an idea of the technique. If you are interested, further information can be obtained from Agromisa or from: Department AO/OPR, Koninklijk Instituut voor de Tropen, Mauritskade 63, Amsterdam, the Netherlands.

1. The Bush Drier (figure 7)

A fire in an oven made from welded tin cans heats the surrounding air. The heated air rises through a thin layer of the to-be-dried product on racks. The fire must be watched at all times and the product has to be shaken or stirred at regular intervals.

capacity: 0.1 to 1 ton/day (24 hours)

material: oil drums, galvanized iron sheets, netting, wire, wood, nails,
one sack portland cement, sand stones.

costs: building costs, material costs, high fuel costs and attendance
construction: accurate work is required. Instructions can be obtained from
Agromisa or the Koninklijk Instituut voor de Tropen (see above).

2. Air Driers With Artificial Ventilation

A motor-powered ventilator is used to blow warm air from the motor (or air warmed by a burner) through the product, which should be spread in a fairly thick layer on a drying floor. The maximum thickness of the layer depends on the air speed and the water content of the product; the air temperature is of lesser importance. Extra heating of the drying air may be necessary during wet periods. (see page 34).

capacity: 1 ton or more in 8 hours (for example for cooperative use)

material: motor (2 or 3 hp is enough), ventilators (can be made of wood)

wood, nails, netting, and, where needed, a paraffin burner

costs: material costs, building costs, fuel costs, attendance

construction: accurate work and technical insight required

information: see above addresses

3.5. Packing and Storage

At the end of the drying period all foreign material (stems, etc.) should be removed, as well as pieces which are not yet dry enough. Dried vegetables can easily absorb water from the surrounding air because of their low water content and packing has to take place in a dry room. It is a good idea to finish drying in the warmest part of the day when the relative humidity is at its lowest. The product can be cooled in the shade and when the work has been done hygienically, the cooled products can be packed immediately.

The packing material must be waterproof, airtight, and insect-proof. The dried products can only remain good when stored in such a way that they are dry and protected against insects. Normal plastic bags (properly sealed) will do for some time, but are not entirely gas and waterproof. It is also possible to use polymer-coated cellophane bags (which are water and airtight). These can be closed with a hot iron or a sealing machine (where electricity is available). This kind of plastic is not so easily obtained, and is not too strong.

A plastic bag of a thicker quality (polyethylen, 0.05 mm thick) is the best. These can be closed tightly with a metal clip or with cellophane tape, although the quality of the closure also depends on the force with which the bag is closed and on the flexibility of the

material (see figure 4). The plastic bags still have to be stored in a cool place and must be protected against rats and mice. It is therefore better to put a number of small bags in bigger jars or tins which can be closed tightly as well. Small bags are useful, as the products will not absorb water despite regular opening of the tin. Each bag can best be filled with a quantity sufficient for one family meal.

Gourds can also serve as packing/storage material. They must be closed well and smeared with linseed oil, varnish, or other sealing material.

To be on the safe side, a desiccant such as slaked lime is sometimes packed with the product in small paper bags. About 100 gr. calcium oxide for 100 kg. product is needed. Ground products absorb water quicker, so it is wise to grind just before use, rather than storing the products in ground form. Properly dried and packed vegetables can be stored for about one year (see table 4). After that the quality can decrease quickly. Cool storage, as in a cellar, makes longer storage possible.

3.6. Hygiene

Drying a product does not make that product sterile. Infections must therefore be avoided. Work hygienically:

- Use only drinking quality water.
- Clean equipment regularly and remove all trash promptly.
- All workers must have good personal hygiene; clothes and hand should be clean.
- Persons who are ill or who have open wounds should not be allowed to touch the food.
- Wash hands often.
- See further remarks about personal hygiene on page 4.

3.7. Preparing Dried Foods For Use

Soak the product in a small quantity of water in a covered pan and using water of good quality. For fruit use one to 1½ times as much water as dried fruit; soak 8 to 12 hours. For vegetables, use 1½ to 2½ times as much water as dried vegetables; soak 30 minutes. Powders do not need to be soaked.

After soaking cook the product in the same water for 10 or 15 minutes (not always necessary for fruit).

3.8. Remarks On The Use of Table 4

The following product information is meant to give an idea of the work method to be followed. Because the drying circumstances always vary somewhat, the numbers should be seen as an indication rather than as absolute instructions. One must experiment to determine the best method for each situation and product. Extra information concerning specific products can be obtained from the authors.

rack capacity: The figures are based on the use of single racks and sun drying. The capacity for artificial drying will be the same or higher, depending on the relative humidity and air flow speed.

characteristics of the final product: A description of the final product has been given to help determine when the product is sufficiently dry, since the moisture content itself is difficult to determine without expensive equipment. When in doubt, use the local standards, especially when these are in contradiction with that given in the table.

maximum temperature: The temperature of the product itself is difficult to measure, but the temperature of the drying air can be measured fairly easily. When the product contains much water the air temperature may be higher than the maximum given in the table, but at the end of the drying process this should be avoided. Measure the air temperature just above the product with a thermometer. Protect the thermometer against direct sunlight.

Table 4: Preparation and Drying Conditions For Various Products

Product	Preparation	Drying Conditions/Remarks
<u>Fruit</u>		
apricots	wash, halve, remove pits	spread on racks one layer thick with the cut side up
peaches and mangos	wash, halve, remove pits	spread on racks with the cut side up
plums	sort by quality and size 10 minutes lye dip,boiling	large plums should be turned occassionally
grapes	no usual pretreatment, sometimes a lye dip given	dip in boiling water before packing
cherries	wash and remove pits (this speeds drying but loses juice)	-

Product	Preparation	Drying Conditions/Remarks
bananas	peel and cut in half in the length or slice	-
figs	partly tree-dried, do not cut	-
apples	wash, peel, quarter and remove the core	-
pears	wash, cut in half, remove the core and stems	spread on racks with the cut side upward. Maximum 2 days in full sun, thereafter shade
pineapple	peel and cut	sulfite treatment advisable (request information from authors); maximum temperature 60°C.

Vegetables

Product	Preparation	Blanching time (minutes)	Remarks
greens (spinach)	select, cut, wash and blanch	2	-
Cabbage	wash, cut (5mm thick) and blanch immediately	3 - 4	moderately long storage
Beans	remove tops and strings wash, break by hand	5 - 8	dried products should not be packed directly in tins or bags
carrots	use fresh, young roots, clean, remove tops and slice	none	cut with a stainless steel knife
potatoes	wash, peel and remove eyes, wash, slice 2-3 mm thick	4 - 6	can be powdered to use as a thickener
sweet potatoes	wash, peel and remove eyes, wash, slice 2-3 mm thick, dip in lemon juice to prevent brown discoloration	6 - 8	blanch 6-8 minutes or boil 20-30 minutes before peeling; can be ground to powder

table 4, continued

Product	Preparation	Blanching time (minutes)	Remarks
onions	peel, cut 3 mm thick	none	can be ground to powder
garlic	peel (not necessary when making powder), cut slices 3mm thick	none	can be ground to powder
tomatoes	wash, dip in boiling water, peel, cut in slices 7-10 mm thick	1.5	rub paraffin oil on the racks to prevent sticking
egg plant	remove stem and flower parts, wash and cut in slices 3 mm thick	2 - 6	-
okra	select, wash, remove stems, slice 6 mm thick	4	after blanching rinse with cold water
chilis (capsicum)	select, remove stems little chilis are not cut, big ones are cut to 5-10 mm pieces	none	sometimes blanched
pumpkin	remove stem and flower parts, cut, remove seeds, peel, slice 3mm thick	3 - 6	need not peel when making powder

table 4, continued

product	rack capacity (kg/m ²)	final product water con- tent (%)	description	max. temp. (°C)	yield per 100 kg.	
					fresh product (kg) pretreated	dried
<u>Fruit</u>						
apricots	4-8	18	leathery	66	90	18
peach and mango	6	14	leathery	68	85-90	15-20
plums	6	15-20	kneadable, pit	74	100	34
grapes	6	10-14	kneadable	71	90	7
cherries	25	25	leathery	74	80	28
bananas	6	12	hard		85	15
figs	6	15-20	kneadable, skin flexible	71		20
apples	6	15-20	bouyant	68	60	10
pears	6	10-15	leathery	65	80-85	15-20
<u>Vegetables</u>						
greens	2.5	4	brittle, crisp	65	60-75	8-10
cabbage	4	4	tough, brittle	55	85	6-9
beans	4	5	brittle, dark	68	90	9-12
carrots	4	5-7	brittle	71	80-85	8-9
potatoes	5	5	hard, brittle	65	74	11
sweet po- tato	5	7-8	hard, brittle	71	80-85	27
onions	4	5-7	brittle	60	90	9
garlic	4		brittle	63		
tomatoes	5	5	tough, brittle	65	70-90	4-5
egg plant	4	5	tough	65	90	10
okra	4	5	brittle	65	90	9-12
chilis	6	5-7	tough, brittle	60-65	85	10
pumpkin	4	5	tough, brittle	71	70	7-12

More information about drying can be found in:

- Solar Drying of Crops and Foods In Humid Tropical Climates, a practical working manual on construction and use of enclosed convection ventilated solar dryers by James McDowell The Caribbean Food and Nutrition Institute, Jamaica, 1973
- Sundrying of Fruits and Vegetables by Th. Jackson and B.B. Mohammed Agricultural Services Bulletin no 5, FAO, Rome, 1969
- How To Dry Fruits and Vegetables by E. Reid, AFPRO, New Delhi, India (gives technical and product information for small scale processing)
- How To Make a Solar Cabinet Dryer For Agricultural Produce, Do-It-Yourself-Leaflet number 6, Brace Research Institute, Quebec, 1966 (also available in French)

Questions can also be sent to:

- Koninklijk Instituut Voor de Tropen (agricultural research dept.)
Mauritskade 63
Amsterdam
the Netherlands
(specialized in artificial drying and specific product information)
- Brace Research Institute
MacDonald College of McGill University
Ste Anne de Bellevue 800
Quebec, Canada
(for more information about sun drying)

4. Preservation Of Vegetables With The Aid Of Salt

4.1. Introduction

One of the oldest methods of preserving food is by salting. This is a simple and cheap method of preserving if salt is plentiful and cheap. However, the method has its disadvantages, especially when large amounts of salt are needed. Vegetables lose much of their nutrients through salting, and should, in fact, only be salted when there are surplus fresh vegetables available, and when other methods of preserving cannot be used. The use of small amounts of salt, for "acid fermentation", can produce good products like sauerkraut, which has good nutritional value. The quality of salt needed depends on the vegetables one wishes to preserve.

Use of large amounts of salt or heavy brine

A 1:5 ratio of salt is added to vegetables to stop microorganism growth. This method of preserving gives the vegetables a very salty taste and they therefore need to be soaked in fresh water several times before being used. This results in the loss of large amounts of nutrients. It's an easy way of preserving and less labor intensive than preserving with small amounts of salt. Large quantities of salt can be added dry or as a salt solution (brine). Vinegar sometimes has to be added as well.

Use of small amounts of salt or light brine

Enough salt is added to the vegetables to create a proper condition for those microorganisms which form acids which preserve the vegetables. The acid gives the product a special, often appreciated taste. The proportion of salt to vegetables is about 1:20, to be added as dry salt or as light brine. When vinegar is also added to this light brine less salt is needed. The brine method is easier than the dry salt method, as brine gives an even distribution of salt and vegetables. This even distribution is a condition for success.

With the dry salt method the product will shrink as liquid leaves the product. The color, odor, and taste are better preserved than with the brine.

The preparation for salted or pickled vegetables is the same as for fresh vegetables, although longer cooking times are sometimes necessary. A description of the equipment needed for salting and the special product data, followed by exact instructions, will be given in this chapter.

4.2. Requirements

Salt: This should be finely granulated and without a drying agent. Disinfect salt which isn't prepacked or which is locally extracted by sprinkling the salt on a metal sheet and heating this over a hot fire.

Vinegar: Use white or cider vinegar with a 4-5% concentration.

Jars and crocks or other vessels: These can be made of wood, plastic, ceramic, glass or stainless steel. Barrels made from pine wood should be avoided as they can change the taste of the vegetables. The jars must be very clean. Wash them in hot soda water and rinse with clean, hot water.

Muslin cloth: This is laid over vegetables and under the pressure plate. The cloth is used to remove the froth from the surface of the vegetables.

Pressure plate: This is a plate or grid of wood, ceramic, glass, stainless steel or plastic. A weight is put on top of this to keep the vegetables under the surface of the liquid (see figure 8). The pressure plate should be slightly smaller than the diameter of the vessel. A pressure plate which catches under the neck can be used with certain jars (figure 9), in which case a weight is not needed.

Weight: This is put on the pressure plate to keep the vegetables under the level of the liquid. The weight can be a clean stone or a water-filled glass jar.

Scales and/or a measuring cup: These are needed to weigh or measure the correct amounts of vegetables, salt and vinegar.

Knives: Stainless steel knives are needed to cut the vegetables.

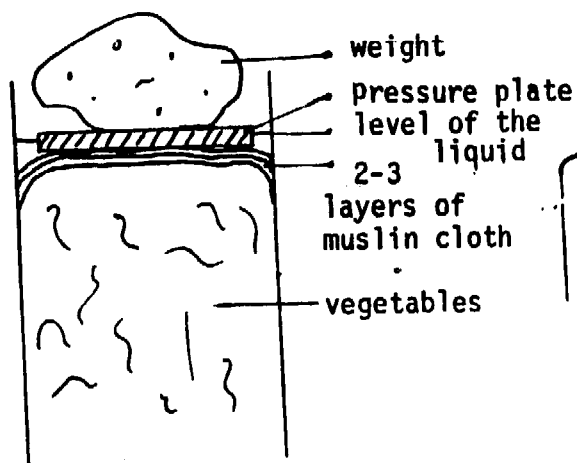

figure 8

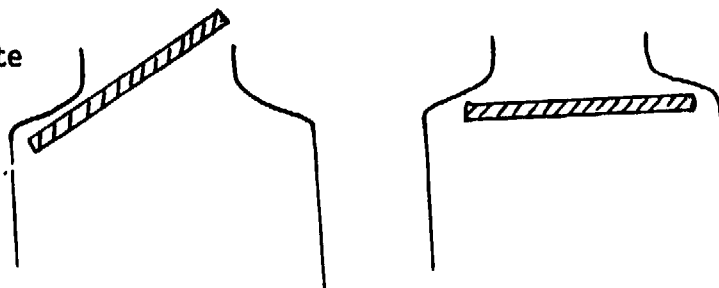

figure 9

4.3. Preparations

The vegetables must be prepared properly before salting. Table 5 gives directions for preparing a number of vegetables and indicates the best salting method for each type of vegetable.

Table 5: Preparation of vegetables for salting and the best salting method for each vegetable type.

Product	Preparation	Method
cabbage	remove outer leaves and stalks; shred	light salting
lettuce	wash, remove outer leaves and stalk; shred	light salting
swedes and turnips	wash well; remove tops and bottoms; cut into small pieces	light salting
green beans	wash; cut off tips; blanch 5 min- utes; cut into short pieces; whole beans can be used with the light brine method	light salting, heavy salting, light brine
sweet corn	boil the cobs for 10 minutes; remove kernels	heavy salting
peas	shell; with the heavy brine method wait until repacking from big vats to small pots before shelling; do not use overripe peas with the heavy brine method; blanch 5 minutes	heavy salting heavy brine
brown beans	see peas	see peas
okra	cut ripe okra into small pieces	see peas
cauliflower	remove stalks and leaves; cut into small pieces; no cutting is needed with the heavy brine method	heavy brine light brine
green toma- toes	wash well, do not slice	light brine
beets	see green tomatoes	see green tomatoes
kale	trim leaves; wash well; use the whole leaves	light brine
beet tops	see kale	see kale
onions	remove dry skins	heavy brine
sweet pepper	cut lengthwise; remove seeds and stem	heavy brine

4.4. Salting Methods

4.4.1. Heavy Salting (20 - 25%)

Mix the vegetables and the salt well, using 250 gram per kilo of vegetables. Fill the crocks with the mixture of vegetables and salt, cover with muslin cloth, the pressure plate, and a weight, as shown in figure 8. Add brine (250 gram salt per liter water) until the pressure plate is just submerged.

After about two weeks the salted product must be repacked into smaller jars. These jars should only be big enough to contain enough for one meal, as infections appear quickly in an opened jar. Pour the remaining liquid from the crocks over the salted product in the smaller jars, until the vegetables are completely covered. Fresh brine may be needed. Seal the jars tightly and store them as cool as possible.

Before using the vegetables the salt has to be removed. Pour off the brine and let the vegetables drain. Soak the vegetables for half a day in fresh water (1 kilo vegetables in 10 liters water). The vegetables loose nutrients during soaking, and this should therefore be avoided where possible, for example, when the vegetables are to be used in soup. Always cook the vegetables before use.

4.4.2. Heavy brine (20%)

Fill the crocks or jars with the prepared vegetables, cover with several layers of muslin cloth, the pressure plate, and the weight (see figure 8). Pour the brine (200 gram salt + 65 gram vinegar per liter water) over the vegetables until the pressure plate is just submerged. The required quantity of brine is about half of the volume of the vegetables. To maintain the proper salt concentration sprinkle 200 grams salt per kilo vegetables over the pressure plate. Store the crocks at 21-25°C and make sure that the vegetables remain under the brine. Add fresh brine (200 grams salt + 65 grams vinegar per liter water) when necessary.

The vegetables have to be packed into smaller jars after about two weeks. Shell peas and brown beans if this hasn't been done yet. After repacking the vegetables add the old brine plus fresh brine where necessary so that the vegetables are submerged. Close the jars tightly.

Before use the vegetables should be soaked for half a day to remove excess salt. Drain and soak one kilo of vegetables in one liter of fresh water. Avoid soaking where possible to limit nutrient loss. Cook the

vegetables before use.

4.4.3. Light Salting (2.5 - 5%)

Mix the prepared vegetables with salt (25 grams salt per kilo vegetables, for green beans 50 grams of salt + 50 ml. vinegar per kilo). Fill the crocks with the vegetables and salt mixture, packing tightly. Cover the vegetables with several layers of muslin cloth, the pressure plate and the weight, as in figure 8. The salt draws the liquid from the vegetables, which should gradually become covered with brine. If this doesn't happen within a few hours, add brine (25 grams of salt per liter water). Brine for french beans should be made from 50 grams of salt plus 50 ml. of vinegar per liter water. Store the crocks at 20-25°C. The vegetables will begin an acid fermentation lasting 2-3 weeks. Skim the froth regularly from the surface of the vegetables, as explained in section 4.4.4.

If the vegetables are to be kept longer they have to be repacked into smaller containers after fermentation. Vegetables fermented in small jars do not need repacking. The fermented product is packed tightly into glass jars of 0.5 - 1 liter with a screw cap. Pour brine over the product until it is covered, using the old brine plus, where necessary, fresh brine made from 25 grams of salt plus 50 ml. vinegar per liter water. Close the jars but make sure that air can escape by twisting the lid closed and then giving it a quarter turn back. Heat the jars in a boiling water bath for 25 minutes (for 0.5 liter jars) or 30 minutes (for 1 liter jars). The jars should be tightly closed immediately after heating. This process will pasteurize the contents and stop fermentation.

4.4.4. Light Brine (5%)

Fill jars or crocks with the prepared vegetables and cover with the muslin cloth, the pressure plate, and the weight, as in figure 8. Add brine (50 grams of salt + 50 ml. vinegar per liter water) until the pressure plate is just submerged. You will need about half of the volume of the vegetables in brine. Keep the jars or crocks in a cool place ($\pm 15^{\circ}\text{C}$.). An acid fermentation will take place during the next 2-3 weeks. Remove the froth regularly (see below). After the fermentation it is best to repack the vegetables from the crocks into smaller jars with screw lids. Pack the glass jars tightly and add brine until the vegetables are submerged. Where necessary fresh brine can be made using 50 grams of salt plus 50 ml.

vinegar per liter water. Close the jars so that air can escape by closing the twist lid and give it a quarter turn back. Pasteurize the contents by heating the jars in a boiling water bath (25 minutes for 0.5 liter jars and 30 minutes for 1 liter jars). Close the jars tightly immediately after heating.

The vegetables need only be drained and rinsed before use.

Removing froth during fermentation

A white layer of froth will appear on the vegetables after a few days when fermenting with the light brine and light salt methods (sometimes with other methods as well). This is caused by the growth of undesirable microorganisms. If this froth is left undisturbed it will use up the acid from the fermentation process and can cause an unpleasant smell and taste in the vegetables.

The froth is best removed by first removing the weight and pressure plate and carefully lifting the muslin cloth, keeping the froth on the cloth. Rinse this, together with the pressure plate and weight, and replace these as shown in figure 8. This treatment should be carried out every other day, especially when the froth is produced in large quantities.

4.5. Warning

Peas, beans, sweet corn and greens preserved with salt always have to be cooked for 10 minutes before use. Do not eat uncooked preserved vegetables, even to test them.

Vegetables that are soft or slimy, or that have a bad smell, must be thrown out.

It is important that the vegetables are always kept submerged below the level of the liquid.

More information can be found in:

Preservation of vegetables by salting or brining

Farmer's Bulletin number 1932, US Department of Agriculture

5. Preserving in Acetic Acid

Foods can also be preserved by pickling in acetic acid. This method of preserving can be done with vegetables (cabbage, beets, onions, cucumber), fruit (lemons, olives) and sometimes with meat and fish (pickled herring, rollmops). To obtain a product which can be stored, the foods first have to be salted and heated before being put into vinegar.

When ordinary vinegar is used (5% acetic acid in water), it has to be heated in a closed pan. Because of this, the utensils should be made of enamel or stainless steel. The high acid concentration of the vinegar corrodes other materials.

The acetic acid should have a minimum concentration of 4%. (The pH has to be lower than 3.5; this can be checked with pH papers). The following vinegars can be used: white or cider vinegar (5% acetic acid) or pickling vinegar (concentrations vary up to 100% acetic acid).

The following method is generally used: The cleaned and prepared vegetables or fruits are put into heavy brine (200 grams of salt per liter water) for several hours, depending on the size and shape of the product. They are next put into a boiling salt solution, brought to a boil, and cooled to 70-80°C. At this temperature the product (with herbs and spices if necessary, but without the brine) is transferred to jars. The jars are filled to 1.5 cm. under the rim and the product is covered with warm acetic acid so that all pieces are covered by at least 1 cm. of the liquid. The jars are filled, therefore, to 0.5 cm under the rim. The vinegar used, either white distilled vinegar or the stronger acetic acid solution, must have a final concentration of about 5% after dilution. Always use clean glass jars (see chapter 2 for information about cleaning and types of jars). Close the jars as quickly as possible and cool quickly in a cool, airy place. Store the products as cool as possible.

Gurkins are sometimes fermented first (lactic acid fermentation) by storing them for some time in a salt-vinegar solution in crocks, after which they are packed into jars (see chapter 4). If there is no experience with this process, caution is advised.

Vinegar can be home-made by fermenting fruit juice with water and sugar. A kind of wine is produced first, which subsequently turns into vinegar. Experiment to find the best way to make wine and vinegar using local ingredients. Information on fermenting fruit juices is available from Agromisa.

6. Preserving Fruit By Jam and Juice Making; preparation of syrups, jellies and candied fruits

6.1. Introduction

There are several possible methods of preserving fruit. Canning, sterilizing and drying have already been dealt with in the preceding chapters.

This chapter concerns the possibilities of making juice, jams and jellies. This can be done with all fruit; fruit mixtures can also be used. A fruit mixture often gives a better, more rounded taste in the final product. Apricots and peaches combine very well with orange or grapefruit juice. Orange and grapefruit juices can also be mixed. Pineapple is often mixed with orange, grapefruit, or apricot juice. The juices are best mixed before preserving, not just before use. Choose the proportion of the fruit in the mixtures according to your individual taste. The proportions have no effect on the storage life of the product. The following methods are based on preserving with sugar or heat or a combination of these two.

It is best to start with fresh, undamaged fruit which is not overripe. Moldy fruit increases the chance of spoiling the product and of causing food poisoning. Overripe fruit results in a tasteless, sometimes slightly musty tasting product. All materials with which the fruit comes into contact, such as knives, pots, kettles, cans, pans, and bottles, should be made of stainless steel, glass, undamaged enamel or good quality plastic. Avoid using aluminum or galvanized tools and kettles, as these will be attacked by the acid in the fruit. The acid can dissolve the aluminum and the zinc layer of the galvanized materials, resulting in a metallic taste and possible zinc poisoning.

6.2. Making Fruit Juices

Preserved fruit juices keep their fresh taste and attractive color when they are not heated for too long or at a too high a temperature. Prolonged boiling or heating changes the taste, except with tomato and apricot juice. Therefore, take care not to heat the juice any longer than is indicated in table 6. The extraction and heating is the same for juices that will be bottled or canned.

Packing materials (see also Chapter 2)

Jars and bottles of 0.5-1 liter are best. Bottles bigger than 1 liter

are less suitable, as they need a longer heating time. One liter bottles are of course cheaper and easier to use than 0.5 liter bottles, as they hold twice as much juice. Clean jars or bottles with soda, sterilize (boil), and keep in hot water (95⁰C -100⁰C) until ready for filling.

Jars: Follow the manufacturers instructions for heating the jars, lids, and sealing rubbers. If no instructions are available, heat the jars and lids in hot water just before use.

Bottles: Use bottles which can be closed with metal tops. Always use clean tops that have never been used. Tops with a plastic layer on the inside are the best. Bottle tops with a cork layer inside can infect the product, while those with metal foil on the inside can give a metallic taste and food poisoning. Bottle top sealers, as shown in figure 10, are available. Make sure that the bottle sealer is properly adjusted, following the instructions from the manufacturer and those in chapter 2.

Sulphured bottles: Bottling in sulphured bottles is a special preserving method. A burning piece of sulphur ribbon is put into the washed bottle and the cork is put into place. When the bottle is full of sulphur vapor the ribbon is removed and doused in a bowl of water. The bottle is closed with the top and is held upside down for 10 minutes to disinfect the cork. The vapor is let out of the bottle, which is then quickly filled.

The juice extraction of fruit can be done in three ways. With all three methods it is important to work as quickly as possible and to expose the juice as little as possible to the open air. Use the juice as quickly as possible after the extraction. Heating the fruit helps the juice extraction and it gives the juices a deeper color. Heating also deactivates the enzymes in the fruit, lengthening the storage life of the juice. Press the fruit as quickly as possible, heat the juices after extraction and filter in a boiling water bath until the desired temperature for sterilization or filling has been reached. (see table)

Heat before extraction		Do not heat before extraction
apricots	rhubarb	apples
berries	tomatoes	morrel (sour) cherries
red cherries	plums	green grapes
peaches	purple grapes	citrus fruit

Method 1

The extraction of fruit juice requires a fruit press or a fruit mill. Figure 11 shows a popular basket press. This method gives cloudy juice. The juice can be cleared by heating it to 60°C and then straining it through a cloth (use a clean, washed, finely woven cloth such as muslin or several layers of cheese cloth). The advantages of this juice is that it retains the smell and nutritional value of the fresh fruit, because the juice is extracted without boiling.

Method 2

Clean the fruit, crush and cut into pieces. Next heat the fruit with very little water until sufficient liquid has been removed. Turn the mass onto a wet muslin cloth, put this into a sieve, and let the juice drip without pressing or stirring. This gives a clear juice. More juice is obtained with squeezing, but this will be cloudy.

Method 3

Steaming of fruit is a labor intensive method which, however, gives a lot of clear juice. Wash and cut fruit into pieces (if necessary remove the pits). The fruit is put into a juice steamer (see figure 12). Bring the water in the kettle to a boil and allow the steam to develop. The steam and the heat extract the juice from the fruit; the juice drips through the cloth and is collected in a small pan. For soft fruit this method takes about one hour, for hard fruit about 1½ hours.

The material needed for a juice steamer is: a kettle or pan with a lid without holes (a wash kettle or sterilizer made of galvanized metal with a cork in the thermometer hole), a plate or grate which is laid in the bottom of the pan; a small enamelled pan or bowl or a dish of glazed pottery, which is put on the plate or grate to catch the juice (glazed pottery can sometimes contain a lead compound which can cause lead poisoning; be sure to enquire before using); two boiled white cloths (muslin where possible), one of coarse weave and one of fine weave, to be pulled over the edge of the kettle or pan; a piece of strong parchment paper (grease-proof paper) to be put over the fruit on the cloth to catch the condensation.

One can use most fruit with all three methods, but as already mentioned, apples, morrel cherries, green grapes and citrus fruit are best squeezed without heating (method 1). The fruit pulp left over after extraction can be used as a spread on bread (add sugar where necessary) or as a base for fruit yoghurt. Before bottling the extracted juices, one can add sugar and/or acid to them, or the juices can be mixed. By mixing sweet with sour juices, no expensive sugar has to be added.

Bottling of Fruit Juices

Sour fruit juices can be kept in cleaned and sulphured or sterilized bottles. Other juices can also be kept this way, but the chance of spoiling is greater. It is better to pasteurize or sterilize these. The juice can be pasteurized or sterilized in two ways. One can first pasteurize and then fill the bottles, or one can fill the bottles first and then pasteurize. This last method is preferable.

Method 1: Pasteurizing before filling

The juice can be heated in a pan or kettle, preferably with a flame divider, where available, on the fire to prevent scorching. The juice is brought to the boiling point, stirring constantly. Juice preserved in this way will have a mildly boiled taste, especially when the juice is cloudy. Better results can be achieved when the pan with the juice is placed inside a larger pan, which contains boiling water. Stir gently but thoroughly and heat to 88°C (check with a thermometer). Remove the pan from the fire and fill the bottles or jars. Tomato juice cannot be treated in this way because of its low acid concentration, and must be boiled and sterilized (see below).

When the juice is ready for filling, remove the bottles or jars from the hot water or reopen sulphured bottles. Fill all bottles or jars immediately to the brim with the hot juice. Remove any froth and add extra juice to fill the bottles again to the top. Keep the juice at the proper temperature (hold above a fire or in a hot water bath). The temperature of the juice mustn't fall below 85°C. If this happens, the juice must be reheated to 85°C. Put the tops on the bottles and invert them immediately for 5 minutes. Close the lids on the jars tightly and invert them for 3 minutes. Do not place the bottles or jars on a cold surface. Cool the vessels after turning (see cooling of bottles and jars, below).

Method 2: Filling before pasteurizing

Remove the bottles from the hot water bath, drain quickly and fill immediately to 2 cm. under the rim. When using jars the neck of the jar must be cleaned well, removing any spills, before the sealing ring and lid are placed on the jar. Ordinary bottles are sealed loosely with sterilized (boiled) corks, which are secured with a piece of string or with a damp piece of cellophane with a hole in the center, again secured with a piece of string.

Fill a kettle or pan with water until it reaches the level of the juice in the bottle or jars. Bring the water to the boil (for sterilizing) or to 75°C. (for pasteurizing) and heat the bottles for 20 minutes. After

this, take the bottles out of the kettle, press the corks securely into the bottles or place a second piece of damp cellophane (without a hole) over the cellophane squares. Cover the bottles with a cloth and let cool to hand temperature ($\pm 60^{\circ}\text{C}$).

Cooling of jars and bottles (for method 1 and 2):

When the bottles or jars are still hot to the touch they can be placed into a big crock or pail with hand warm water. After a few minutes 1/3 of the water is drained from the crock or pail and replaced with cold water. This is repeated once or twice. To remove the last of the heat, the jars or bottles are put into cold running water for 5 minutes, but the flow should not be aimed directly at the bottles.

The cooling takes about 30-40 minutes, but this time can be reduced somewhat by moving the bottles and jars during the cooling process.

Storage of the bottles and jars

Wipe the bottles dry and put them into a dark, cool and dry place. The lower the storage temperature, the longer the juice will keep. If no dark storage is available, the jars and bottles must be wrapped in paper or packed in cardboard boxes.

Hygienically prepared juices will not spoil quickly, even if they are stored in warmer places. However, they will slowly lose taste and vitamins, and their color will change. At higher temperature, for example 20°C ., the loss will be faster than at a lower temperature. Long storage is possible at temperatures of $0-5^{\circ}\text{C}$.

Check the bottles regularly for fungus and remove any bottles which show signs of spoilage. Never use the contents of these bottles.

Preservation of tomato juice

Tomato juice is preserved in a boiling water bath. If the taste is acceptable, add 0.3-0.5% citric acid (quantity depending on the quantity of tomatoes) before boiling. This will increase the chance of success with the juice.

Use only healthy, ripe tomatoes with a deep color. Boil the pieces and press the obtained pulp through a fine colander or sieve to remove the seeds and to soften the mass. Add, to taste, a teaspoon of salt per liter of juice or 3-5 grams of citric acid. The bottling is the same as with the other juices. The boiling juice is poured into the bottles and the bottles are closed. The bottles and jars are placed into a boiling water bath and heated for 15-20 minutes (see chapter 2 for the correct method for using a boiling water bath).

6.3. The Preparation of Lemonade Concentrates

Where storage space is limited or bottles are hard to get, one can still make lemonade concentrates. The disadvantage of this is that much sugar is needed for this.

With most fruits one starts with the juice obtained by method 2 (see section 6.2, juice extraction). The juice is brought to the boil and 1.5 kg sugar per liter of juice is added and dissolved while stirring. The liquid is skimmed (where necessary) and finally cooled. When using citric acid, first dissolve in hot water and let cool. The lemon juice or citric acid is then mixed with the syrup and this is poured into the bottles. Close with corks or cellophane.

Fruits such as berries, cherries, plums, and the like are ground down raw and forced through a sieve; oranges, grapefruit, etc. are squeezed. The juice is sieved, lemon juice or citric acid solution added to taste and 1.5 kilo sugar per liter juice added while stirring. The liquid is then covered, but stirred regularly until all sugar is dissolved. This can take a day or even longer. When the sugar is dissolved, pour the syrup into bottles and close these tightly.

6.4. Fruit Jelly Preparation

Jelly is prepared from fruit juice and sugar (and, where necessary, lemon or citric acid solution). The juice can be from one or more types of fruit. Extract the juice with method 3 (see section 6.2, juice extraction). Apple, grape, red currant, black currant, and elderberry juice are especially good for making jelly. A general recipe is given below:

Reduce the fruit juice to $\frac{2}{3}$ of the original volume by boiling. Slowly add $\frac{1}{2}$ kilo sugar per liter of reduced juice while stirring. Add, if desired, lemon juice or citric acid. Boil the jelly mass until a few drops, when sprinkled onto a plate and cooled, have the thickness of jelly. Skim off any froth from the jelly. Fill well-cleaned jars with the jelly and seal these immediately with cellophane, a metal, glass, or plastic lid, or with greaseproof paper. The jelly can also be covered with hot paraffin wax; after setting, this has to be covered with a second layer to completely seal all sides.

Another recipe for jelly, which uses less fuel but more sugar, is as follows: bring a liter of juice to the boil and add 1.5 kilo sugar (if necessary add lemon juice or citric acid as well). Boil the liquid for

5 minutes (remove froth where necessary). Fill the jars and close as described above. Jelly can also be made with pectin (see directions on the pectin) or with albedo (the white of an orange peel).

6.5 Making Candied Fruit

Preservation with sugar is based on the effect of sugar to increase the osmotic pressure in a product; the sugar withdraws water from the product and the product "dries out". The method is mostly used with fruit (candying or jam making) but can also be used with milk (sweetened condensed milk). The energy and expense needed for this technique depends largely on the product and the circumstances. With candying, the fruit is slowly impregnated with sugar until the sugar concentration is so high ($\pm 65-70\%$ sugar) that decay is impossible.

Fresh fruit, at the most just ripe for picking, is first peeled and cut into pieces or slices 1-2 cm thick. These are boiled in water until they can be easily pierced with a fork. The fruit pieces are then boiled and soaked overnight in a 30% sugar solution (by weight). After this the sugar solution is increased by 10% and the mass is momentarily brought to the boil again before being allowed to stand overnight. This process is repeated until the sugar solution contains $\pm 72\%$ sugar. The sugar concentration can be checked with a sugar refractometer, a small, handy and cheap apparatus, in which the light refraction index is measured in percentage sugar present in the liquid.

The fruits are kept for several weeks in this saturated sugar solution of $\pm 72\%$ and dried afterwards. To prevent crystallization, the sugar solution must consist of glucose as well as beet or cane sugar. If this is not available, "inverted" sugar can be used. This can be prepared by boiling a concentrated solution of beet or cane sugar for 20 minutes with a generous dash of acid (vinegar, lemon juice, citric acid, hydrochloric acid, etc). This converts the saccharose into invert sugar, a mixture of glucose and fructose.

6.6. Jam making

Jam preserves fruit by the sugar action, that "dries" the fruit. A few recipes for jam making are given:

1. Volume Reduction Method:

Clean the fruit, weigh and cut larger pieces of fruit into parts.

Heat the fruit with a small amount of water in a wide pan with a lid until soft. Mash the fruit. Reduce the fruit to 2/3 of its original volume by cooking quickly in an open pan. Stir the sugar (¾ kilo per kilo of fresh fruit) gradually into the fruit mass and boil for another few minutes. When the jam is very sweet add a few drops of lemon juice or citric acid. Boil the jam until a few drops, scattered on a plate and cooled, have the thickness of jam. Skim the mass if necessary. Clean the jars well (see section 5.1) and fill them as full as possible with the jam. Close the jars immediately with damp cellophane and/or a metal, glass, or plastic lid, or a greaseproof paper. The jam can also be covered with a layer of hot liquid paraffin wax. After setting this is covered with a second layer so that all sides are sealed.

2. Extra Sugar Method:

Boil the fruit after cleaning and cutting until soft. Mash the fruit and gradually add 1.5 kilo of sugar per kilo of fresh fruit, plus lemon juice where desired. Boil the mass for another 5 minutes. Follow the instructions for method 1 for filling and sealing.

3. Pectin Method:

Pectin is a jelling agent used to set the jam. It is not, however, a preserving agent. If you buy pectin, follow the directions for use enclosed in the package. Apple pulp (apple sauce) or ground albedo (the white of orange peel) can be used instead of pectin.

4. Light Sugar Method: (chutney, fruit puree)

Boil the fruit until soft and then mash. Add sugar plus, where desired, lemon juice to taste, and boil the mass for a few minutes extra. Clean jars (see section 5.1) and fill with the hot mass to ½-1 cm under the rim. Close the jars with rings, inner metal lids and twist lids, or glass lids. Give the twist lids a quarter turn back after closing; glass lids are clamped down. Place a rack or cloth in a large pan and fill with water until it reaches the neck of the jars. Heat the water ($\pm 70^{\circ}\text{C.}$) and place the jars into the pan. Bring the water to a boil and boil gently for 20 minutes. Remove the jars from the water and cool gradually, using the method described in chapter 2.

The product should be used fairly quickly after a jar is opened.

Preparation of Chutney

With one kilo of fruit (tomato, rhubarb, etc.) use 1 dl. table vinegar (5%), 125 gram brown sugar, onions, spanish peppers, ginger powder and mustard powder to taste. Heat the sugar in the vinegar until dissolved, add the rest and boil the chutney until thick. Complete the preparations using the recipe for jam making.

Marmelade is made from citrus fruit. The peel can also be used, in which case pectin is not needed. When the jam is to be kept for a long time, sodium benzoate can be added as a preservative, using up to 250 mg. per kilo of jam.

Addresses for ordering simple hand equipment and information about their use are:

- Mather and Platt Ltd. Food Machinery Dept., Radcliffe , Manchester, England
- International Machinery Corp., Breedstraat 3, St. Niklaas Waas, Belgium
- James Dole Engineering Co., 1400 Industrial Way, Redwood City, California 94063, USA

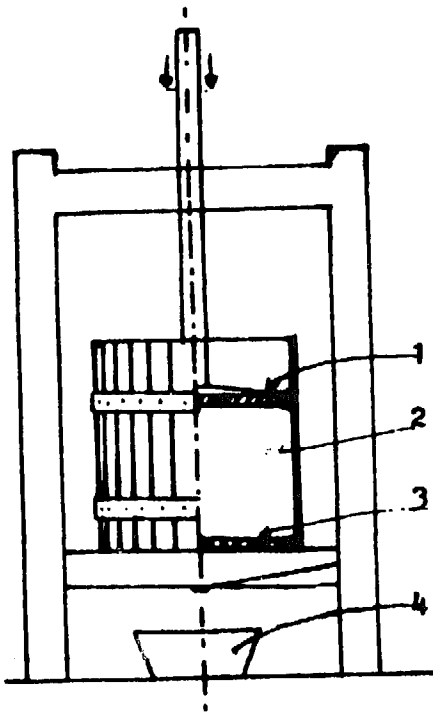

- 1. press
- 2. to be pressed fruit
- 3. sieve and cloth
- 4. juice collector

figure 11: A Fruit Press



figure 10: A metal bottle top sealer

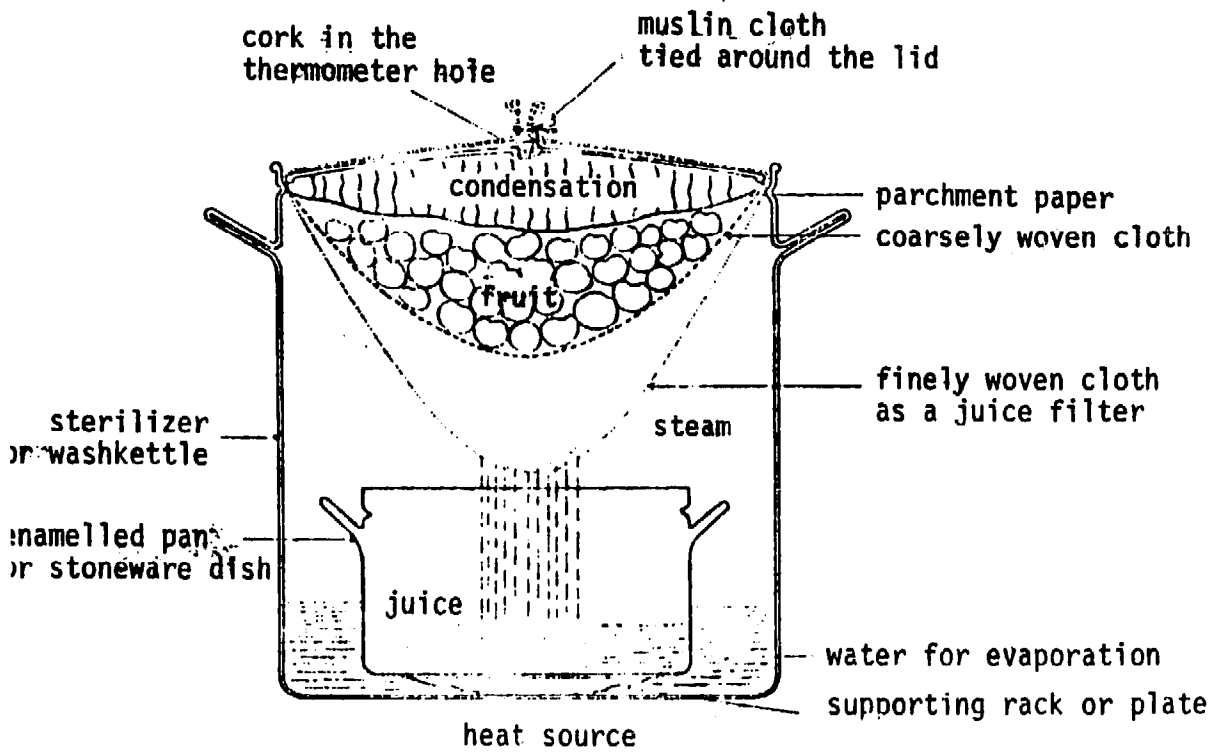

figure 12: A juice steamer

Table 6: Instructions for juice extraction from various types of fruit.
All juice can be preserved without sugar; sugar need only be added when a sweetened taste is desired.

Fruit	Preparation	Extraction	Sugar
Apples	wash; use juice centrifuge, hand press or vegetable mill (fine)	do not heat; press through a clean cloth or bag	none
apricots and peaches	use solid ripe fruit; wash, remove stems	boil in a little water until soft, strain or use a juice steamer	1 part sugar + 4 parts water + .5parts juice or 1 part juice + 1 part citrus juice
berries	wash and crush the ripe berries; heat to 80°C.	press through cloth; filter or use a juice steamer	where desired: 1 part sugar + 1 part juice
straw berries	see berries	see berries	1 part sugar + 3 parts juice
cherries and morrels	wash, remove stems and pits cut, heat to 80°C. (not for morrels)	press through cloth; filter	where desired: 1 part sugar + 9 parts juice
citrus fruit	remove navels and seeds; do not heat	juice steamer; do not press the peel; do not remove pulp; use a coarse sieve	none
tomatoes	use well ripened fruit	press through a fine sieve	none; salt to taste
purple grapes	wash; remove long stems; dip in a muslin bag in boiling water for 30 sec. chop, let stand for 10 min. wash; crush	press through cloth or cloth bag; filter	none
blue and green grapes	wash; remove stems; chop remove seeds; heat blue grapes to 71°C; do not heat green grapes	juice steamer press through cloth or cloth bag; filter	none
plums	use ripe plums; wash and crush. add 1 l. water to 1 kilo fruit; heat to 82°C	press through cloth or cloth bag; filter	1 part sugar + 4 parts juice

table 6, continued

Fruit	Preparation	Extraction	Sugar
plums	until soft or		
(cont.)	wash; cut	juice steamer	
rhubarb	wash and cut into pieces; add 2 l. water per kilo fruit; heat until boiling or	press through cloth or cloth bag; filter	1 part sugar + 8 parts juice
	wash and cut	juice steamer	

7. Simple Techniques For Preserving Meat and Fish

7.1. Introduction

→ For a well-balanced diet it's necessary to have a daily intake of a minimum quantity of protein (among other nutrients). This quantity can come from plant as well as animal origins. When meat and/or fish are available, these high protein sources must be used to the best advantage. One can live on plant protein only. Vegetables or even some vegetable waste should only be used as cattle fodder when there is surplus. It is therefore necessary that one can preserve those animal protein sources which are not needed for immediate consumption. For this, effective but simple preserving methods, which can be used under local circumstances, are necessary. In this chapter we will mention a few of these.

Proper preservation of fish and meat is necessary because these foods are excellent feeding cultures for microorganisms (bacteria, fungi, yeasts, etc.). Through the action of these microorganisms the meat can spoil or can even be poisoned. The preserving technique therefore must stop the growth of these undesirable organisms. The most important rule with preserving is that one must work as hygienically as possible. By preserving one has to kill all microorganisms or else make the circumstances unsuitable or impossible for their growth, or at least strongly slow their growth. Microorganism growth is strongly slowed when water is withdrawn from the meat or fish, as in salting, drying, or smoking. Smoking also releases particles from the fire which enter the meat and impair the growth of the microorganisms. These substances work as preserving agents. Another possibility is to make the meat more acid, to stop the growth of harmful microorganisms. This happens, for example, in some sorts of sausages (like salami) or when meat is kept in vinegar. Harmless microorganisms can also be used to sour (as with yoghurt and cheese). Another possibility to stop the growth of microorganisms is to substantially lower the temperature of the product. The growth of harmful bacteria is stopped by cooling the product below 3°C . For long term storage, temperatures below -10°C . are necessary (deep freezing). Because deep freezing requires a lot of energy and is often too expensive we will not further discuss this method here.

After the preserving process the storage conditions must insure that spoilage cannot take place. This means storing as cool and as dry as possible. If possible make use of smaller packaging (jars, cans, small plastic bags). With larger packaging (sacks, barrels) measures have to be taken against vermin (insects and rodents).

7.2. Salting and Drying of Meat

Best results are obtained with salting and drying of meat when both techniques are used in combination. One can also salt meat by pickling (wet salting). In this case drying is not used. Pickling has a reasonable chance of success if the work and storage is done at temperatures below 10°C. With temperatures above 10°C the storage life is rather short.

First a few comments about salt and salting. One can use ordinary salt. The salt should be fairly pure (chemically as well as from microorganisms). The size of the salt grains can have an effect on the salting process (especially on its speed). Recommended is a mixture of coarse and fine grains, in which 40% of the salt has a diameter smaller than 1.6mm. To kill possible microorganisms in the salt, heat the salt in a thin layer on a metal sheet over a hot fire. Besides using normal salt one can also use coloring salt, which consists of 99.4% ordinary salt and 0.6% nitrite. The nitrite has a preserving action and makes meat keep its red color. The disadvantage of nitrite, however, is that it camouflages any spoiled taste in the meat and that an excess of nitrite is bad for one's health (invisible deterioration). The given ratio should not, therefore, be exceeded. Salting itself is not the same as using a lot of salt! Large concentrations of salt give the meat a very salty taste and extra nutrients will be lost. Good salting means that the salt is rubbed in well. Every piece has to be individually and thoroughly rubbed in. Salt is expensive. That is why excess salt can be reused (after it has been disinfected by heating)

Diagram of possible combinations of salting and smoking or drying of meat:

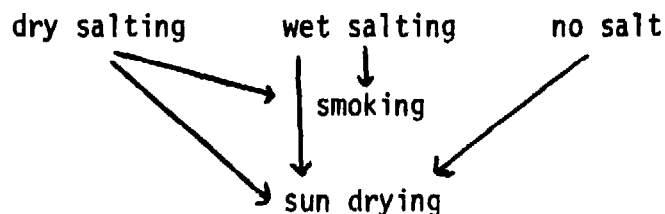

1. Pickling

The pickling process is as follows:

- cut the meat into strips 2-3 cm. thick
- rub the strips thoroughly with salt, using 10% of the weight of the meat in salt
- pack the salted strips tightly in clean vessels, close the vessels with a tight-fitting lid and, where effective, with weights on top
- after one week brine will appear due to the extraction of the liquid from

the meat. The meat has to be kept below the surface of the brine (if necessary push it below this level). After one week the pieces should be rinsed with cold boiled water before being covered again with saturated brine (37%).

- Check the meat regularly. Should froth develop due to fermentation replace the old brine with fresh brine.

The meat needs to be soaked in clean cold water for at least one day before use, and the water should be refreshed periodically. One can also simmer the meat for 2-3 hours on a low fire. If the meat is very salty then soaking as well as simmering is needed before use.

2. An alternative pickling method

Let the brine form during two weeks, as in the method 1. Soak the meat in cold boiled water for 2-3 hours to remove excess salt. Refresh this water 2-3 times. Place the meat in the sun on wire netting. Protect the meat from insects with the aid of mosquito netting or other means. Expose the meat until the surface is dry.

3. Dry salting

The dry salting method is as follows:

- Cut the fresh raw meat into pieces of 1.5-2 kilo, about 1 cm thick and 5 cm long.
- Wash the meat in running water after cutting, and let it drip dry by hanging in the shade for half an hour.
- Immerse the meat in a saturated salt solution (37%) during 1 hour.
- Hang the meat above the brine to drain.
- Rub the meat well with salt, using in total about 30% of the meat's weight in salt. A 1-2 cm. thick salt layer is spread on a wooden plank or, preferably, a plastic plate or a diagonally grooved concrete slab. The meat is put on top of this. On top of this layer put another salt layer (1-2 cm. thick), etc., until a height of 1-1.5 meters is reached. The stack is covered with a few (clean) wooden planks or plastic plates and pushed down with heavy stones. The liquid must be able to drain beneath the pile.
- The next day reverse the layers by putting the top layer on the bottom and use salt again. If after two days and this first reordering of the meat the juices stop dripping from the meat, the process can be ended. If not...keep changing layers. When the meat stops dripping, the drying process can be started. The excess liquid should be pressed from the meat first and the meat flattened. This can be done by putting the meat

through a wringer (two wooden rolls with a gap of 1.2-1.8 cm between them), or with a press. Salt has to be brushed off.

Use drying racks made, for example, of chicken wire or bamboo sticks. The meat should be put onto the racks in such a way that it makes as little contact with the racks as possible. An even better way is to hang the meat on the racks from hooks. If the meat is laid on the racks, it has to be turned regularly, to dry it evenly.

Drying has to be done carefully and evenly. This is best done in warm and dry weather with a lot of wind. Take care that the meat doesn't get so hot that the fat melts or that a crust forms on the surface. Don't put the meat immediately in the full sunlight. During the early morning or late afternoon the meat will stay cool but you may need to shade it during the midday. Experience will tell which way is the best.

During the first day of drying the pieces of meat should be turned every two hours. Later on this can be lengthened to every four hours and in the last part of the process every six hours. The drying racks have to be protected as much as possible against vermin. They should be at least ± 30 cm. above the ground; stand the legs of the racks in pans of water with some oil on top. It is best to wrap the racks with mosquito netting to keep the insects off. A chemical agent can be used to keep the eggs of the blue bottle flies off the meat. Before drying the meat is dipped in a mixture of pyrethrum and piperonyl butoxide called "Faru-Tox Fish Dip concentrate". This contains 5.5% pyrethrum and 11% piperonyl butoxide. According to the manufacturer the chemicals are broken down during the drying process, so that no residue remains. The Fish Dip can be ordered from Kenya Apiaries, Ltd., P.O. Box 252, Nakuru, Kenya.

The meat must be protected against rain and heavy dew forming. The meat can be covered with banana or palm leaves or plastic sheets, or one can put the racks under a roof or in a shed.

Experience will tell you when the meat is dry enough. It shouldn't give when pressed with the finger and it will sound dry when the pieces are slapped together. When a strip is broken in half it should show a uniform structure on the inside. The dried meat can eventually be sprinkled with fine salt to which 10% cornflour or other flour has been added.

Store the meat as cool as possible in a dry, well ventilated dark place. It can be helpful to hang the dried meat in sacks from the ceiling to avoid vermin. It is also possible to store the meat in boxes with ventilation holes, taking care that the holes are covered with mosquito netting to keep out pests.

Before using the meat should be soaked and rinsed in clean water. The length of soaking will be determined by the desired taste.

The meat can also be smoked. Smoking is a form of drying (liquid extraction), by which some elements from the smoke are absorbed. These have a favorable influence on the taste, color, and storage life of the meat. Smoking is done after salting. Because the smoking process is about the same for meat and fish it will be dealt with later on in this chapter for meat and fish together.

7.3. Salting and Drying of Fish

Salting and drying of fish differs only in certain ways from that of meat drying. For good results start with fresh fish, as fresh as possible. It is best to use fish which has been recently caught and which has been kept covered with ice after being caught. Always work as hygienically as possible.

For fish smaller than 10 cm.:

- Wash the fish well and soak for 30 minutes in a 15% salt solution. Drain well. The intestines do not need to be removed.
- Hang the fish by the tails or on a metal or wooden rod which is pushed through the heads. If this is not possible the fish can be spread on a drying table one layer deep. The table can be made of wood or steel, with a table surface of wire netting or concrete metal matting. Cover this with fine wire netting.
- Dry in the open air, where the sun and wind can reach the fish. In dry climates evaporation may cause a crust on the surface of the fish to form. This can hamper further drying. Protect the fish from direct sun when this tends to happen. Experience is needed to learn the best drying schedule (see drying of vegetables and fruit). With sufficient sun and wind the fish can be dried to a sufficiently low moisture content in two or three days. Under these circumstances the fish can remain on the drying tables during the night and do not have to be protected against dew. It is, however, necessary to protect the fish against rain, using banana leaves or plastic sheets.

The dried fish is best stored in strong plastic bags, the edges of which have been folded a few times to keep insects out. Check that no condensation appears on the inside, as this will cause the fish to spoil. The fish can also be wrapped in cellophane bags which can be sealed by melting the edges. Another possibility is storage in airtight containers.

In all cases store the fish as cool as possible in a dry, well-ventilated dark room.

For Fish Bigger Than 10 cm.:

- Remove the hard scales, intestines, and head; let the blood drain through the back next to the backbone. Thick fish can be cut to slices which are left connected at the backbone (like pages of a book).
- Soak the fish in a 15% salt solution for 30 minutes.
- Predry the fish for one day on racks; hang the fish from the tails or laid on horizontal bars. After predrying the fish can be further dried (2-3 days, depending on the weather circumstances) or can be smoked.

Preserving With Large Amounts of Salt

- Clean the fish as described above.
- Cut big fish in slices no thicker than ± 1 cm., but leave the slices connected at the back.
- Rub the fish on all sides with salt, using three parts fish to one part salt.
- Put two or three layers of fish in a watertight vessel. Sprinkle extra salt in between the layers. The salt will extract liquid from the fish, making brine. The fish must be kept under the level of the brine, for example with the aid of clean stones. Keep the brine saturated; less salt will lead to spoilage, but excess salt will change the taste of the fish. The salting process takes 12-15 days when the weather is warm, and ± 21 days when the weather is cold. When the fish is well-salted the meat will be translucent and firm, but still soft enough to press with a finger.
- Wash the fish with fresh brine to rinse off the old brine.
- Flatten the fish as much as possible to remove excess liquid. This will speed the drying process.
- Dry on racks in an open place exposed to sun and wind. On the first drying day the fish should be protected from full sunlight, as this might cause a crust to form. Wait until the second day to put the fish in direct sun. The wind must be able to move freely over the fish. Protect the fish against rain and heavy dew. The drying takes ± 6 days with warm weather and wind. After drying the fish will be difficult to bend; fine salt crystals are present on the surface of the dried fish.

When drying the fish one can have trouble with blue bottle flies who may lay their eggs on the fish (as mentioned with the drying of meat). This can spoil the fish. Flies are especially a problem in damp, wind-still weather with cloudy skies, when the fish does not dry fast enough. The problem can be avoided by spreading mosquito netting over the racks. One can also use a chemical preparation. After the salting the fish is immersed in a watery solution of a mixture of pyrethrum and piperonyl butoxide. The trade name is Faru-Tox Fish Dip concentrate, containing 5.5% pyrethrum and 11% piperonyl butoxide. According to the manufacturer the chemicals are broken down during the drying process, leaving no residues in the fish. The preparation can be ordered from Kenya Apiaries Ltd, P.O.Box 252, Nakuru, Kenya.

It is best to store the fish packed in tightly closed plastic bags; check regularly for signs of condensation in the bags.

Preserving With Salt Without Drying

- Cut the fish so that it can take up the salt better.
- Rub the salt into the meat.
- Put a thick layer of salt in a basket or similar container from which the liquid can drain. Put a layer of fish on top of this, then another layer of salt, etc., until the basket is full.
- Cover the basket with a thick plastic sheet, but do not weigh it down with stones.
- Place the basket on stones or otherwise raise it up so that the extracted liquid can drain freely.

Heavily salted fish has a long life when properly covered.

7.4. Smoking of Meat and Fish

Smoking has several effects on meat and fish. The heat of the smoke grills the meat or fish, and water is extracted (drying). The meat or fish also absorb particles from the smoke which have a favorable effect on the color, taste, and storage life. The best smoke production is from a smouldering fire of wood shavings and hard wood blocks. One can best begin the smoking process by burning damp wood for one day. After that smoke with dry wood. Some kinds of wood (such as oleander) are not suitable for smoking as they contain poisonous particles. All wood from foliage and pine trees are reported to be safe. A disadvantage of smoking is that a lot of wood is needed.

It is not absolutely necessary to salt or brine the meat or fish before smoking; this depends on the local traditions. The use of salt does, however, improve the storage life. The fish can be smoked whole, filleted, cut, etc., again depending on the local customs.

The fish can be smoked either cold or hot. Hot smoked fish is cooked, which means that the fishmeat has coagulated. This product will crumble when it becomes too dry. Because of the relatively high water content, then, of the product, the fish can only be stored for some weeks. Many tons of fish are temporarily preserved in tropical countries with this "smoke-drying". Cold smoked fish is, without technical aids, difficult to prepare in warm countries. The fish is not cooked by this method, and can be dried further. The product has a longer storage life. This smoking and drying method for fresh fish must start below 30°C. The most efficient way is to pre-dry the filleted fish in the sun before smoking. The process is started at ±30°C. As the fish dries out, the temperature can slowly be increased to 55°C. The final product should be translucent brown and with a glassy, hard structure. The product can be eaten dry or after soaking. Cold smoking is very difficult because the temperature has to be controlled. Fresh fish meat starts to coagulate (cook) at 30°C, and the smoke must be cooled. This can be done by increasing the distance between the fire and the fish, for example by leading the smoke to the fish on the grate via a cross corridor. Be sure that the smoke isn't too cold however, as no drying will then be able to take place.

The smoking process works better in a dry environment. It is therefore better to work in a smoke house than in the open air, and smoked fish stays better longer in a smoke house.

A few types of smoking ovens which can be made are described here. The simplest oven is the open grill, on which the meat or fish is put with a smouldering fire underneath. The capacity is small, however, and there is great smoke loss. An improvement is an oven made of dried mud or clay layers, or oil drums, with a grate on top (see figure 13). The grate is best made from wood; steel can scorch the fish. A number of these small ovens can be put in a hut.

The next step is to put a few oil drums on top of each other. The rims must fit well. Over the rim of the top drum a damp sack is placed to stop the smoke from escaping too quickly. The fish (or meat) is hung in the drums. This system uses the smoke much more efficiently. The order of the drums, or of the meat in the drums, must be changed regularly

as the lowest drum gets most of the heat and the smoke (see figure 14). Oil drums and mud ovens can only be used to make smoked products.

The last suggestion is to build a smokehouse. This house should have a floor area of about 2 by 2 meters. Place an oil drum on an earth or stone floor. Fireproof the place where the drum stands with stone walls. Remove the bottom from the drum and build a grate for the fire a little above the bottom. Make a door in the drum to regulate the oxygen flow and cut smoke holes in the top. Build shelves above the drum on which to put the meat. Leave enough room to let the smoke permeate the house. Instead of shelves the walls can have supports to rest removable beams on. The meat and fish can be hung from these beams.

The walls and the roof must be closed so that the smoke cannot escape. Build a ventilation valve or flap into the roof. This can be used to control the smoke circulation (see figure 15). When one builds a completely closed smokehouse the fire can be made directly on the floor. Hang the meat on ropes or hooks above the oven.

Experience will tell when the meat or fish is fully smoked. This can vary from one to five days. Remember, the best results are obtained by experimenting oneself, and by following local customs as much as possible. Smoked fish generally cannot be stored as long as salted and dried fish.

Remarks: It cannot be stressed enough that one must work as hygienically as possible. This means that all knives and other tools should be clean; hands, clothing and water should be clean. Knives and the other tools should be washed with hot soda solution. Slaughter waste and spoiled products must be deeply buried or burned; they must be kept as far away as possible from the products to be preserved.

If you require more information about smoking, or wish to order smoking equipment, two useful addresses are:

- De Jong, St. Vitusstraat 25-27, Hilversum, the Netherlands
- Intermediate Technology Development Group, 9 King Street, London WC 2E 8HN, England

Information about sausage recipes and the preparation of sausages, and supplies of cultures for sausage fermentation can be obtained from :

- CIVO, Dept. of Meat Technology, Utrechtseweg, Zeist, the Netherlands (telephone number 03404-18411)

Information about fish products is available from:

- the Institute for Fish Products, Dokweg 37, IJmuiden, the Netherlands

telephone number 02550-19022

Information is of course always available from members of the food and nutrition group of Agromisa.

Finally, the titles of some, perhaps somewhat dated, pamphlets about meat and fish:

- Meat handling in underdeveloped countries, Rome, 1960. FAO agricultural development paper
- A short guide to fish preservation by G.C.Rawson and F.A.Saj, 1966, FAO
- Equipment and methods for improved smoke-drying of fish in the tropics FAO technical paper 104, 1971
- FAO home techniques, series 1: Food Preservation, fish and meat
- Small-Scale processing of fish, Technical Memorandum no 3, ILO, 1982

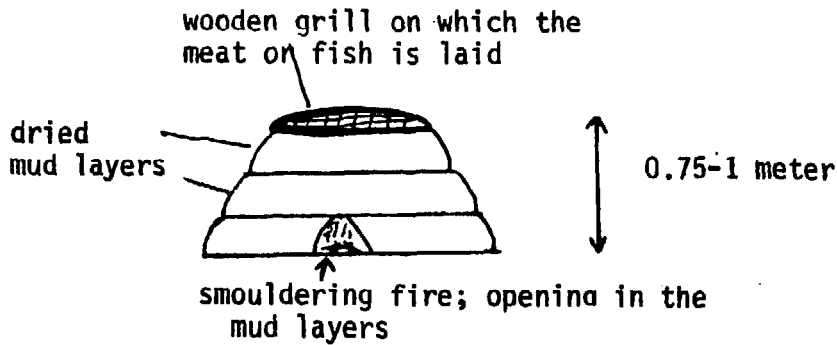

figure 13A: open grill

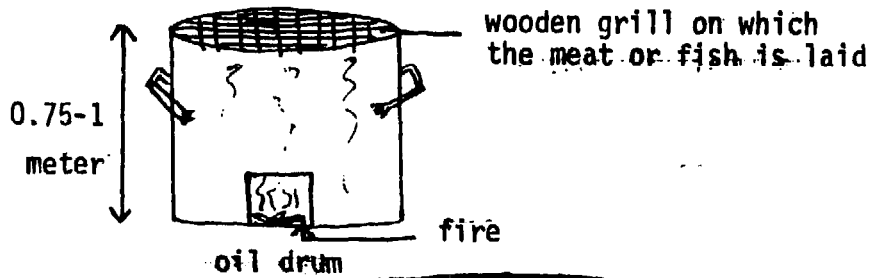

figure 13B: smoke oven

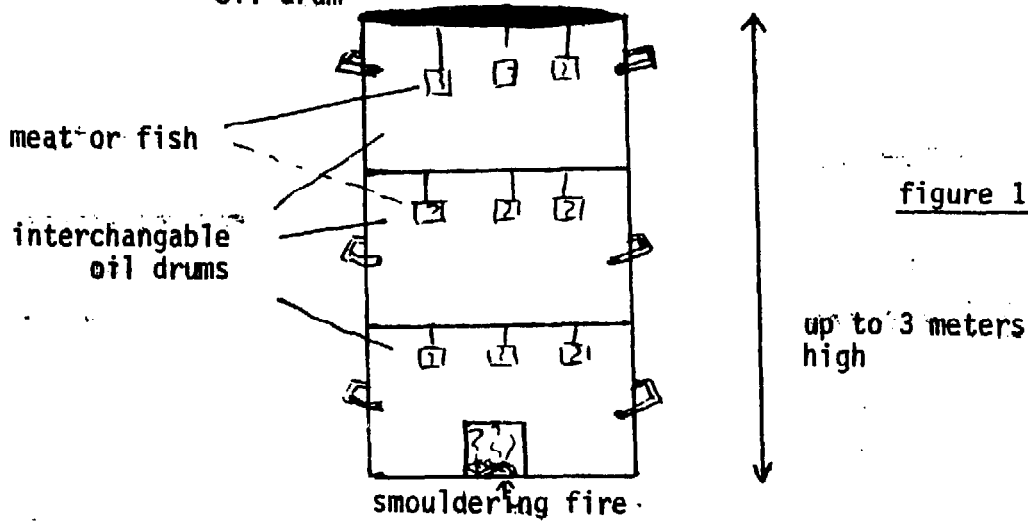

figure 14: smoke oven

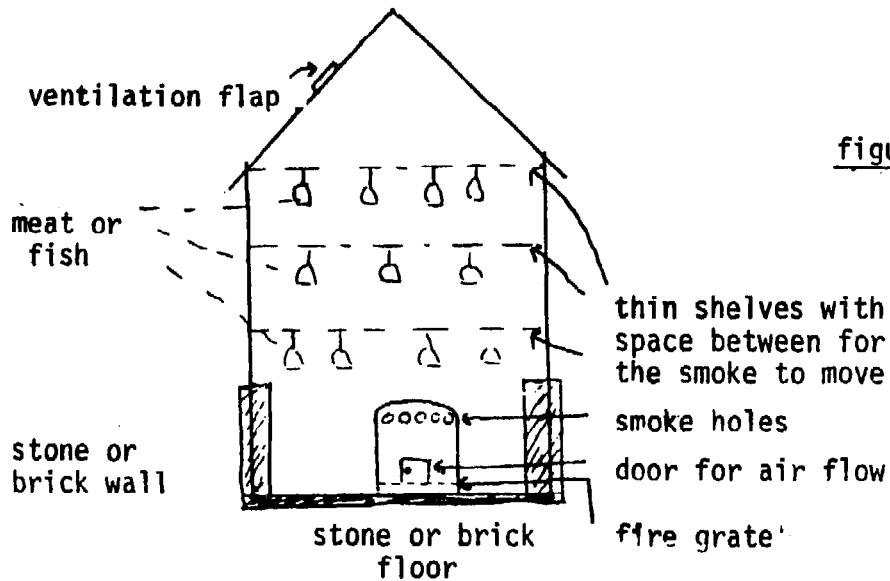

figure 15: smoke house

8. Dairy Products

8.1. Introduction

Milk is a foodstuff with a very high nutritional value and is of special importance to babies and children. It is also of importance for adults. Man uses the milk of cows, sheep, buffalos, goats and camels. Cow milk is most commonly used. Broadly speaking, milk has the following composition (in percentage):

	cow	sheep	goat	buffalo	human
fats	2.5-4.5	7.9	4.2	7-8	3.75
protein	3.3-3.5	5.2	3.5	4.5-6	1.6
lactose (milk sugar)	4.7-4.9	4.8	4.9	4-6	7
vitamins	vitamin A and D in fats, vitamin B in water				
minerals	especially rich in calcium				

Because of these important nutrients and the absence of acid in milk, milk spoils quickly. Spoilage is caused by bacteria, some of which can be harmful. Therefore steps have to be taken to prevent spoilage before milk can be stored. Several methods to achieve this will be described in this chapter. Good results can be obtained by simple means.

Souring by harmless microorganisms is the most common method used. In an acid surrounding harmful bacteria cannot grow. The storage life of milk preserved in this way is, however, not very long.

One must work as hygienically as possible. The hygiene starts with the milking. By making sure that as little bacteria as possible get to the milk, one considerably limits the chances for spoilage.

8.2. Milking

Udder and nipples have to be clean (clean with a dry cloth; if the udder is very dirty clean with a damp cloth). Of course the hands of the milker have to be clean and well washed. The milking place also should be clean and free of dust and manure. The milking tools need special attention. Dirty milking aids are often the cause of bad, quickly souring milk. After use the milk buckets, cannisters, udder cloths and other items have to be cleaned thoroughly. Rinse with cold water, scrub with hot soda water and rinse again with clean water. After this dry them in a dust-free place in the sun to kill the bacteria.

8.3. Preparing the Milk (in principle for all types of milk):

After milking the milk is best filtered through a cotton wool filter or through a clean cloth to remove particles of dirt. This cloth must be cleaned very well after use, after which it should be boiled and then dried in the sun. Milk is best stored at temperatures below 10°C. Cooling facilities may not always be available. One can cool milk by putting a covered cannister of milk in a bowl of cool water and stirring the milk occasionally. Other possibilities include spraying the milk cannisters with water or wrapping them in damp cloths. It is also important that the milk is protected from sun as well as heat. Sunlight causes chemical reactions which change the taste (oxidation taste) and it breaks down vitamins (especially vitamin B).

Never mix morning and evening milk when cooling below 10°C is not possible.

8.3.1. Pasteurizing the Raw Milk:

If the milk cannot be stored cool, than the milk must be used or processed as quickly as possible. The first possibility is heating. Rule: Never drink raw milk. Always boil milk first. Harmful bacteria can grow very well in milk, but these are killed by heating. The milk can be heated in three ways:

- pasteurization
- boiling
- sterilization

Pasteurization is heating the milk to $\pm 70^{\circ}\text{C}$, for example, 20 seconds at 72°C or 30 minutes at 63°C . The advantage of pasteurization is that no boiled taste is produced. Boiled and pasteurized milk can be kept for some time under cooled conditions. Without cooling the milk cannot be stored for longer than one day. Milk is sterilized when it is heated to temperatures higher than 100°C , for example, 20 minutes at 110°C . or 10 minutes at 120°C . or 2 seconds at 140°C . Special equipment is needed for this however, which might not always be available, and which is usually only profitable with large quantities. Milk sterilization is beyond the scope of this booklet. There is, however, a lot of information about it, especially from the FAO.

Another way of increasing the storage life of milk is to make milk products, especially sour milk products such as: soured milk, yoghurt, kefir, buttermilk, cottage cheese, butter, cheese. One can let the milk sour spontaneously, but one doesn't know which bacteria are present then. It is better to sour the milk with the aid of specially selected bacteria

(after pasteurization). One then gets a pleasant fresh taste and a sour aroma.

8.3.2. Yoghurt:

Yoghurt is obtained by souring milk with certain milk-souring bacteria. It is important that no other bacteria are present in the milk, so that the milk-souring bacteria can grow well. Therefore it is necessary to boil or pasteurize the milk first. The souring will go best at temperatures between 30⁰ and 50⁰C. After souring the yoghurt bacteria remain alive, so that when yoghurt is added to milk, yoghurt is made again. To make yoghurt;

- Heat milk to the boiling point
- Cool to ±45⁰C.
- Add 2.5% yoghurt (±3 tablespoons of yoghurt per liter milk)
- Let the milk sour (not in sunlight)

40-45 ⁰ C.	2- 3 hours
35-37 ⁰ C.	15-20 hours
30 ⁰ C.	24 hours

It is not possible to make yoghurt at temperatures below 30⁰C.

- When the yoghurt has the right taste it should be cooled to keep the yoghurt from becoming more sour. Keep a little yoghurt for starting the next yoghurt batch.

The souring stops when the yoghurt is cooled and the taste will remain good longer. Moreover, cooling helps keep the milk-souring bacteria alive, so the yoghurt can be used to make the next yoghurt batch. If the yoghurt cannot be cooled below 20⁰C. then part of the yoghurt must be added to new milk immediately after the yoghurt making, when the yoghurt is just sour enough. The milk-souring bacteria will die because of the high acidity and the culture will otherwise be lost. Yoghurt cannot be stored very long: 10 days at 5⁰C, 3 days at 10⁰C. 20⁰C is really too warm to keep yogurt.

When yoghurt isn't available to start yoghurt making, one can start with a powdered culture of yoghurt-souring bacteria. This powdered culture can also be used once or twice a year to replace the old culture, or when the old culture suddenly doesn't work anymore. It is best to start from local yoghurt-souring bacteria, which should be available in districts where soured milk products are known and made. If this is not the case one can get yoghurt cultures from the Netherlands from: Fa. J.M.E. Snuyf, Ardeweg 28, 7384 SG Wilp, the Netherlands. (telephone number 05761-563) Cultures for buttermilk, butter, cheeses and kefir, as well as information

and directions for use are also available from this address.

It is also possible to make yoghurt from milk made from milk powder. Use boiled water, or boil the milk after mixing.

8.3.3Kefir:

Kefir is a soured milk drink which is made by milk-souring, alcohol and carbonic acid production by bacteria from milk sugar (lactose). The alcohol content is less than 1%. Kefir is made with kefir grains. These are cultures of yeast and bacteria. Kefir grains may be available locally, or can be ordered from the address given in section 8.3.2.

Kefir grains can be stored dry. When one starts with dry kefir grains, they must be activated by soaking them in lukewarm water for 5-6 hours. The water is then drained and the grains are soaked 5 to 6 times in milk (4 hours/ soaking). The grains swell and they will float. It sometimes takes a few days before all grains are floating. The floating grains are suitable for making kefir. A tablespoon of fresh kefir grains is added to half a liter of pasteurized milk, the bottle is closed and is incubated at 16-18°C for 8 to 12 hours. The grains are removed by straining the milk, after which the milk is returned to the bottles and is kept for 1-2 days at 12-15°C. A second fermentation will take place (ripening) which is necessary to give the milk the characteristic qualities of kefir. The final product is a thick, creamy fluid, bubbly, sour smelling and sour tasting. Towards the end of the second fermentation whey separation takes place. The fluid can be stirred to give a homogenous consistency.

A substitute for kefir can be made by adding ±2 teaspoons (10 grams) of sugar to half a liter of buttermilk and infecting the buttermilk with a little active yeast (bakers yeast). Incubate 3-4 days at 18-21°C. Use a strong bottle with a tight lid as the gas pressure can get high.

Storing kefir: The quality of kefir deteriorates with longer storage, as with yoghurt and buttermilk. At 5°C. soured products can be kept ±10 days and at 10°C 3 days. At 20°C. soured products should be used quickly.

Problems: Kefir is too sour or "yeasty" when the balance between the bacterial action and yeast action is wrong. An ammonia taste can result from a protein breakdown by unwanted bacteria, a sign that one was not careful enough during preparation.

It is possible to make good kefir (and good yoghurt), as long as one works hygienically. Don't work at high temperatures, 20°C is best. Use the kefir grains every day for best results.

8.3.4. Buttermilk:

Buttermilk is a byproduct of buttermaking (see also buttermaking, section 8.3.5). It is also possible to make buttermilk as follows:

- heat milk to the boiling point
- add 2.5% buttermilk (3 tablespoons per liter milk) or a powdered culture for buttermilk (available from Fam. Snuyf, see section 8.3.2).
- incubate for 18-24 hours at 18-20⁰C; keep out of direct sunlight
- cool to stop further souring

8.3.5. Buttermaking:

The principle of buttermaking is: Skim the cream from the milk and put the cream into a butter churn (a bottle or vessel with a beater). Churn the cream by beating air into it until small lumps of butter are formed. Separate the butter from the rest (buttermilk), knead the butter by hand (wash hands), and form into a block. When the milk is cooled as soon as possible after milking, the cream will rise after 6-10 hours. The temperature is an important point with buttermaking. This musn't be much higher than 15⁰C. It is therefore best to remove the cream from the milk at the coldest moment of the day, usually early in the morning, and to process it quickly.

The cream and milk have often become sour by the time that the cream has risen. One can process the cream further by churning it. A better method is to pasteurize the cream (heat almost to the boiling point), cool to 10-13⁰C, and then add 10% buttermilk and leave for a night at 15-17⁰C. One can also add a powdered culture from Fam. Snuyf. This last is not necessary, but it does give a more uniform product which can be stored longer.

The milk left after the cream has been removed, is called skim milk. Skim milk can be used for soured milk products like yoghurt, buttermilk, etc.

The cream is turned into butter by churning. With this the air is beaten into the cream, through which the fat drops gather together and become butter pellets. Churning can be done in:

- a vessel with a turning beater (figure 16)
- in a rotating vessel (fill one third full with cream)
- in a cylinder with a perforated plate that moves up and down (figure 17)
- in a bottle which is vigorously shaken

These churns can be easily made.

The churning has to be vigorous enough to beat air into the milk. After 20-60 minutes lumps of the size of peas have been formed. The pellets are separated from the buttermilk by pouring the contents of the churn over a coarse woven cloth. The pellets can be washed where desired

with clean (boiled) cool water.

The butter is then kneaded to a homogenous mass, extracting as much water as possible. The kneading is best done at lower temperatures. Salt can be added during kneading; this gives a butter which can be kept longer. Sprinkle preferably fine salt over the butter (3%=30 gram/kilo), and lightly knead this in by hand. Let the butter rest and cool for some hours to give the salt a chance to penetrate throughout the butter. After that knead the butter again until the butter has an even appearance. The butter can then be put into a pot or jar, pressed down and smoothed out. To prevent mold from growing on the surface, sprinkle some salt on top of the butter. The butter cannot be kept too long.

The butter can also be processed to ghee: heat the butter on a fire until all the water has evaporated. The protein in the butter is then grainy and brown colored. This is filtered off (the grainy protein can be eaten, on bread for example). The fat which is left has a long life and the same properties as butter.

8.3.6. Cheese Making:

Cheese making is an excellent way to process milk, but it is with simple means and little experience difficult to do. Cheese making concentrates most of the protein and fat from the milk and sours this as well. Cheese is also salted. Souring, the salt, and the absence of oxygen in the cheese give the cheese its long storage life. In the dairy industry, cheese is made that can be kept for up to one year. For this, good storing conditions and temperature control is needed. Such preparation demands craftsmanship which must be learnt in a factory or on a cheese making farm. The method of cheese making described here gives a reasonable product that can be made with simple equipment. The cheeses cannot be kept too long, however.

The principle of cheese making is as follows: By adding a curdling agent (rennet) one gets a thick pudding-like mass which can be cut. The pieces (curds) that one gets exude liquids, but one can speed this by stirring. When the pieces have lost enough liquid, the fluid (whey) is poured off. The curds are left to drain and then are placed into a mold in which the cheese is pressed into the desired shape. After that the cheese is salted. The whey can be used as fodder.

For cheese making the milk needs to be warm (30°C.) and needs to be kept at this temperature until it is pressed into the form. For this reason cheese making is best begun directly after milking, when the milk

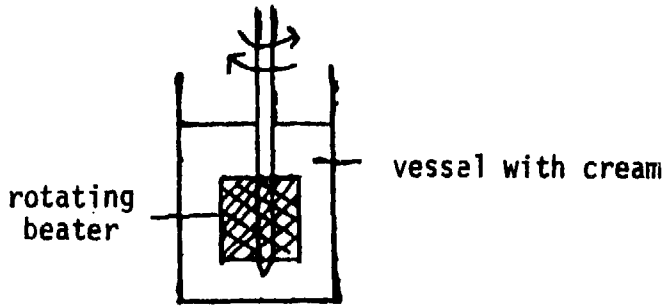

figure 16

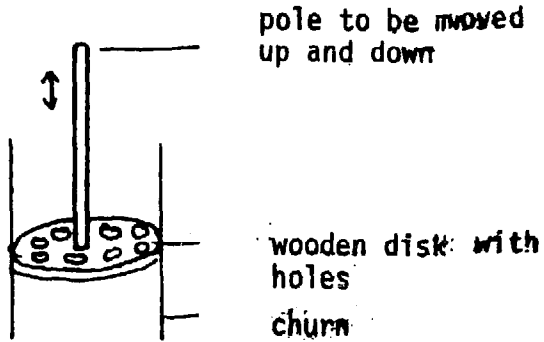
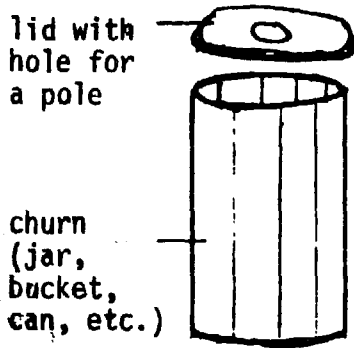

figure 17

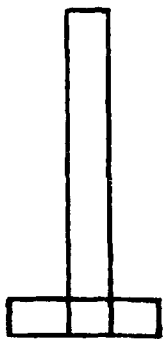

figure 19:
stirrer for cheese
making

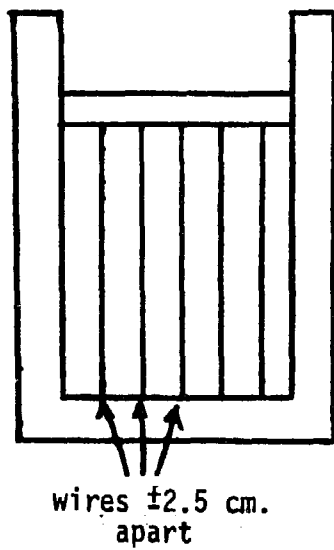

figure 18: cutting
frame

wooden or
metal frame

wires 2.5 cm.
apart

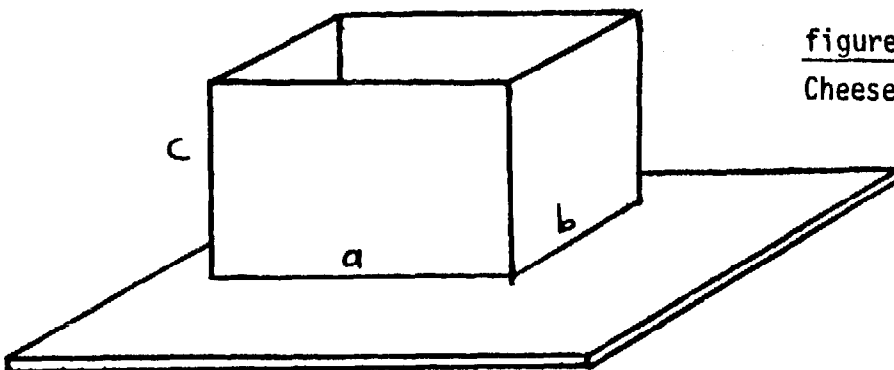

figure 20:
Cheese mold, also for
pressing

a=20 cm.
b=20 cm.
c=12 cm.

is still at body temperature.

The milk is poured onto a bowl and rennet is added. Rennet is needed to curdle the milk. If one starts from powdered rennet, dissolve this just before the cheese making. Powdered rennet can be obtained from the address given in section 8.3.2, or from Chr. Hausen laboratorium A/S, Sankt Annae Plads 3, 1250 Köbenhavn K, Denmark. This powdered rennet is delivered in tins with measuring spoons and directions for use. After adding rennet let the milk stand for ± 1 hour; cover to slow cooling. One hour is needed to curdle the milk fully. It is important to curdle each time to the same degree of solidity. Adjust the curdling time if necessary and check the milk by feeling with a finger. Push a finger diagonally into the curdled milk and move the finger upward so that the curds break. The degree of solidity can be judged by the way the curds break. When the milk is sufficiently solid the spongy mass is cut with a specially made cutting frame (figure 18) into pieces (curds). Do this by pulling the cutting frame quickly through the curdled milk a few times. Let the mass rest for 5 minutes and then stir gently for about one minute with a T-shaped wooden stirrer (figure 19). The stirring helps the whey leave the curds. Let the mass rest again for 5 minutes; the curds will sink to the bottom. Drain the whey, for example by tilting the vessel. Pour the curds on the bottom into a coarse muslin cloth. The cloth with the curds is placed into a square of wooden boards which have been stood on a table or a wooden surface (figure 20). Cover the curds with the corners of the cloth and let the curds drain for one hour. Next turn the bundle upside-down and let the curds drain again. After two hours the bundle is again turned and weights are placed on top of the curds. The weights are best placed on a wooden lid which fits inside the square. Press the curds overnight. The curds have then cooled down and are solid enough to be cut. They will also have soured. The cloth is removed and the square cheese cut, for example into four equal pieces. The pieces are rubbed with salt each morning and evening for 3-4 days, turning them each time they are salted. The cheeses can be kept after this, but bacteria and yeast will grow on the crust, giving a sort of limburg cheese, with a strong smell and taste (not everyone likes this taste). Another solution is to keep the cheese in a salt solution (15% brine) so that the crust will remain relatively clean. Add 1% calcium chloride to the solution to prevent the crust from becoming slimy. Storage in brine needs to be done in as narrow a container as possible, with a lid. The cheese should be stored

in a cool place. A fortnight after the cheese making the cheese can be eaten. The whey left over from the cheese making can be used as fodder.

A few variations on this basic cheese recipe are:

Pickled Cheese:

This cheese can be made from poor quality milk, for example, milk that has started to sour or to curdle (of course no harmful bacteria must be present). 5-15% salt, a souring agent (if necessary) and rennet are added to the milk. After 2-3 hours the curds are cut and stirred and then are sieved through a cheese cloth. The curds are wrapped in cloth and placed in metal or wooden vessels and pressed. The cheeses must be pressed with considerable pressure (5-10 times the weight of the cheese) and they are turned regularly. The cheeses can be used soon afterwards or, if preferred, can be kept in brine ($\pm 15\%$ salt).

Fresh Unmatured Cheese:

2% souring agent is added at 30°C to good quality raw milk or to pasteurized milk (30 minutes at 63°C. or 1 minute at 70°C.) Rennet is then added (in the Netherlands 15-25 ml per 100 liters of milk). If the strength of the rennet is not known, add enough to thicken the milk in 30-60 minutes at 30°C. After this cut the curdled milk into pieces (the size can vary from the size of beans to the size of eggs). If necessary heat the mass to 33-35°C. and stir until enough liquid is extracted from the pieces. Remove the whey and mix the curds with 5% salt (by weight). The cheese can then be pressed into various shapes. Pressing doesn't need much pressure (for example, twice the weight of the cheese). When the cheese can be cooled it can be kept for 7-14 days.

Queso Blanco:

This is a popular cheese in Latin American countries. When making queso blanco an acid is added to hot milk to curdle it. The curds are then separated from the whey, mixed with salt, and formed into a cheese. An important difference from other cheeses is that the milk isn't curdled by rennet but by acid (which is cheaper). A second difference is that one doesn't salt queso blanco by rubbing salt in but by mixing salt with the curds before the cheese forms. A third difference is that queso blanco is very loose; after shaping one has to press very hard to finally get a crust which is strong enough to keep the cheese together. Rennet is rather expensive, while acid is mostly cheaper and easier to obtain, so acid may be preferred. One can use any edible acid (vinegar, lactic acid, or citric acid) or sour fruit juice (lemon juice). The quantities of acid

needed must be established by trial and error. If one uses vinegar of 4% (table vinegar) then about $\frac{1}{3}$ liter per 10 liters milk will be needed.

Queso blanco is prepared as follows: milk is heated in a vessel to 80°C (do not burn the milk). When the milk reaches 80°C the acid is carefully added while stirring steadily; the milk will curdle. Continue stirring carefully for another half a minute. The contents of the vessel are then poured into a cloth to drain the whey. Let the curds cool to 40°C by leaving them open on the table. Whey will continue to drain. When the curds have cooled to 40°C, break the curds and sprinkle salt evenly over them (5% salt to the quantity of curds). Mix the salt thoroughly through the curds. The temperature of the curds must then be about 30°C. The salted curds are then placed into a cloth-lined form, for example a square of wooden boards (see figure 20; a=b=12 cm., c=15 cm.) Cover the curds with a corner of the cloth and let them rest in the form for one hour, during which they should not cool much. After an hour press the curds by placing a weight on the curds, for example by laying a stone on a lid which fits inside the form. Add a little more weight every half hour for the next two hours. Avoid putting on too much weight at once; this would close the crust too quickly and the curds won't lose enough whey. A wet cheese will result. The final pressure on the top of the cheese must be about 0.5 kilo per cm² (this means that if the top of the cheese is 12x12 cm., the pressure must be about 70 kg.). This can be achieved with a cantilever system (see figure 21). Press the cheese overnight, after which the cheese can be eaten or stored. The cheese can be cooked with a rootcrop and herbs for a tasty dish. If one wants to keep the cheese for a while, then it must be stored whole; queso blanco is very brittle. If necessary the cheese can be stored in brine, as described in the basic cheese making section. Use a vessel in which the cheese fits as tightly as possible.

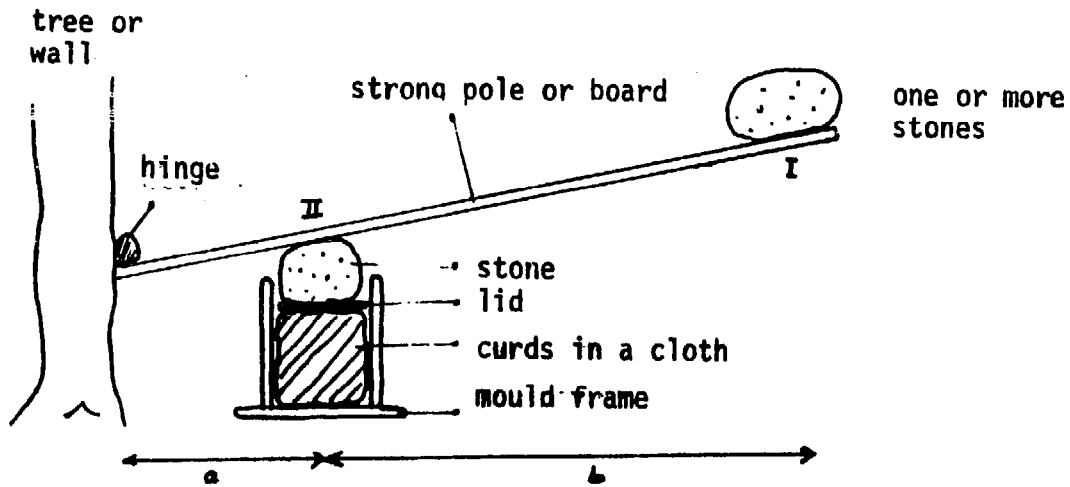

figure 21: a cantilever system for applying extra pressure

If $a:b = 1:4$, then four times as much pressure is applied to stone II than to stone I; 17 kg at point I gives 68 kg at point II.

9. Final Remarks and Literature

In closing it is useful to give some general information and to mention a number of literature sources useful to the general public.

Firstly, there are a number of Agromisa publications that compliment this booklet. These are:

- Agrodok nr. 9: The vegetable garden in the tropics
- Agrodok nr. 10: Soya
- Agrodok nr. 31: The storage of tropical agricultural products

There are also a number of institutes you can write to for information about food technology or appropriate technology:

- Action for Food (AFPRO)
Technical Information Service
C-17 Safdarjung Development Area
New Delhi 110016, INDIA
- The Director of Central Food Technological Research Institute
Mysore 570013, INDIA
- Appropriate Technology Development Association (ATDA)
POB 80
Lae, PAPUA NEW GUINEA
- Bandung Institute of Technology
Development Technology Center
POB 276
Bandung, INDONESIA
- Appropriate Technology Center (UNICEF)
P.O.Box 454
Kisumu, KENYA
- Economic Commission for Africa, United Nations
P.O.Box 3001
Addis Abeba, ETHIOPIA

Agrodok 3: PRESERVATION OF FOODS

<u>Table of contents</u>	<u>page</u>
Introduction	1
1. Spoilage: Causes, effects and prevention	2
1.1 What is spoilage?	2
1.2 Prevention of spoilage	4
2. Preserving vegetables, meat and fruit by heat	8
2.1 Introduction	8
2.2 Preparations	11
2.3 Processing techniques	12
2.4 Storage	15
3. Drying of Vegetables and Fruit	26
3.1 Introduction	26
3.2 The quality of the fresh product	26
3.3 Pretreatment	27
3.4 Drying techniques	28
3.5 Packing and storage	25
3.6 Hygiene	36
3.7 Preparing dried foods for use	36
3.8 Remarks on table 4	36
4. Preservation of vegetables with salt	41
4.1 Introduction	41
4.2 Requirements	42
4.3 Preparations	43
4.4 Salting methods	44
4.5 Warning	46
5. Preservation in acetic acid	47
6. Preserving fruit by jam and juice making	48
6.1 Introduction	48
6.2 Making fruit juices	48
6.3 Lemonade concentrates	53
6.4 Fruit jelly preparation	53
6.5 Making candied fruit	54
6.6 Jam making	54
7. Simple techniques for preserving meat and fish	60
7.1 Introduction	60

<u>Table of contents, continued</u>	<u>page</u>
7.2 Salting and drying of meat	61
7.3 Salting and drying of fish	64
7.4 Smoking of meat and fish	66
8. Dairy products	71
8.1 Introduction	71
8.2 Milking	71
8.3 Preparing milk	72
9. Final remarks and literature	82

List of Tables

1. Preparation of vegetables and fruit and processing times in glass jars	17
2. Preparation of fruit; sterilization times in a boiling water bath	19
3. Preparation of vegetables and meat; sterilization times in a pressure cooker	21
4. Preparation and drying conditions for various products	36
5. Preparation of vegetables for salting	43
6. Juice extraction from various types of fruit	58

List of Figures

1a, b, c Glass jar seals	16
2. An autoclave	16
3. Drying racks	31
4 and 5. Improved sun driers	31
6. Storage bags	31
7. The bush drier	32
8 and 9. Salting vegetables	42
10. Bottle top sealer	57
11. A fruit press	57
12. A juice steamer	57
13. Smoke grill	70
14. Smoke oven	70
15. Smoke house	70
16 and 17. Butter churns	77
	77
	77

4. Which are the most important crops in your part of the country, and in which season are they harvested?

5. Which animals are kept or bred in your area?

Preserving foods:

6. Does the local population use any techniques to preserve food? yes/no
If yes, which are these? (product, method^{**}, desired and real storage life, quality of the final product)

7. Do you have any experience yourself with preserving methods? yes/no
If yes, for which techniques? for which products? how long?

8. Do these methods have certain faults? yes/no
If yes, what are these? What causes these faults, in your opinion?

9. Are you planning to try a certain preserving technique? yes/no
If yes, for which product?
Which technique will you try?
Why?
 for use by the local population
 for sales
 for other reasons,

^{**}= a short discussion of the method is meant. A more extensive discussion on a separate page is always welcome, especially if it is a technique not described in this booklet.

10. Are the following available in your country?
- institutes where information and/or advice can be gained? yes/no
 If yes, which are these?
 - factories which deliver: tins yes/no
 glass jars/bottles yes/no
 pressure cookers yes/no
- If yes, which are these?

11. Are the following available in your country?
- sufficient drinking water yes/no
 - sufficient fuel yes/no
 in what form is this?

 - sufficient (inexpensive) sugar yes/no
 - sufficient (inexpensive) salt yes/no

Plant cultivation
Plant diseases
Soil science & soil fertility
Erosion, prevention and control
Cattle breeding
Forestry

Health and medicine
Nutrition

Small-scale industry
Water supply
Waste-water treatment
Irrigation and drainage

Sociology
Economics
Business management

Do not hesitate in asking our advice !

Please include the following points in your letter:

1. Your name, organization and mailing address.
2. A brief description of the kind of work that you are doing.
3. A brief description of the underprivileged group that is confronted with the problem.
4. A brief description of the relevant aspects of the problem, along with a description of the local surroundings.
5. State the problem in as concrete and specific terms as possible; include sketches and/or photographs
6. Different unconnected problems are best written on different sheets of paper.

In stating your problem and formulating your question, it is useful to put yourself in the place of the person who will answer that question. This will ensure that you will add all the relevant information. Experience has shown that a general and vague question receives a general and vague answer; and that a specific and precise question receives a specific and precise answer.

Send your letter to TOOL or ATOL, who will then forward the letter to one of the different groups. The addresses of TOOL and ATOL are on the back.

AGRODOKS are a series of low priced, simple and practical booklets on agricultural practise in the tropics. The price is between US\$1 and US\$2 plus mailing. The following agrodoks are available:

1. Varkens houden in de tropen
 2. Bodemkunde en een vorm van bodemonderzoek
 3. Konserveren van voedingsmiddelen
 3. Preservation of foods
 4. Kippen houden in de tropen
 6. Landmeten
 7. Bataat
 8. Preparation and use of compost
 9. The vegetable garden in the tropics
 9. Le jardin potager dans les tropiques
 10. Soja
 18. Voorraadbescherming in de tropen
 20. Backyard rabbit farming in the tropics
 26. Rijstziekten en -plagen
 29. Gewasbescherming in de tropen
 31. The storage of tropical agricultural products
 32. Bijen houden in de tropen
 34. Hatching eggs
 35. Bereiding van cassave
- Eenvoudige bedrijfsboekhouding
The Samaka Guide on Homesite Farming.

Agrodoks are published by Agromisa, and can be ordered from:

Agromisa

P. O. Box 41
6700 AA Wageningen
The Netherlands

tool

Stichting TOOL

Entrepôtdok 68a/69a,
1018 AD Amsterdam
The Netherlands.
Tel. (0)20-264409

ATOL

Blijde Inkomststraat 9
3000 Leuven
Belgium