

AT MICROFICHE REFERENCE LIBRARY

A project of Volunteers in Asia

Domestic Grain Storage Bins

Published by:

Farm Information Unit
Directorate of Extension
Ministry of Agriculture
New Delhi, INDIA

Available from:

Out of print.

Reproduced by permission.

Reproduction of this microfiche document in any form is subject to the same restrictions as those of the original document.

DOMESTIC GRAIN STORAGE BINS

FARM INFORMATION UNIT, DIRECTORATE OF EXTENSION, MINISTRY OF AGRICULTURE, NEW DELHI



Price : 50 Paise

April 1973

No.5

This is the fifth of a series of bulletins being issued by the Farm Information Unit, Directorate of Extension, Ministry of Agriculture, on agricultural and animal husbandry subjects. These bulletins are so written as to give an overall picture of the farming practices in vogue in the country, with suggestions on improvements based on research results.

For any further information, and especially on the recommendations suitable for his locality, the reader is advised to contact the local agricultural officer.

EDITOR : RAVI VARMA

ASSOCIATE : P.VISHWANATH RAO

CONTENTS

	Page
Save grain campaign	2
General instructions for the fabrication of types I & II	4
Quality control	6
Detailed instructions on the fabrication of domestic type I "Gharelu Kothi"	7
Specifications and drawings	8
Fabrication procedure for type I bin	8
Detailed instructions on the fabrication of domestic type II "Gharelu Kothi"	19
Specifications and drawings	19
Fabrication procedure for type II bin	20
Annexure I - Capacity of bins for storing various foodgrains	24
Annexure II - Users' instructions	24

SAVE GRAIN CAMPAIGN

Department of Food, Government of India, have launched a programme to extend the knowledge of scientific storage to farmers, traders and all others who store foodgrains at various levels. This programme known as "Save Grain Campaign" is intended to save the colossal loss of foodgrains which generally occurs in the storage due to insects, rodents, birds and micro-organisms.

An Indian Grain Storage Institute has also been set up at Hapur, U.P. with a field station each at Ludhiana (Panjab) and Bapatla (Andhra Pradesh). The Institute is engaged in applied research in the problems of farms and community grain storage practices and as such is developing and testing improved storage techniques and practices. One of the main activities of the Institute is to design and develop suitable structures of all materials, capacities and types for various grains to suit different regions.

The Save Grain Campaign will mainly draw on the research and development work carried out by the Indian Grain Storage Institute and will disseminate this knowledge to all levels.

This guide has been prepared to assist the manufacturer to fabricate the storage bins developed and tested by the Indian Grain Storage Institute. This is only concerned with the fabrication of two types of Grain Storage Metal Bins, viz: Type I with inclined outlet and Type II with horizontal outlet. See Annexure I for their capacity to store various foodgrains.

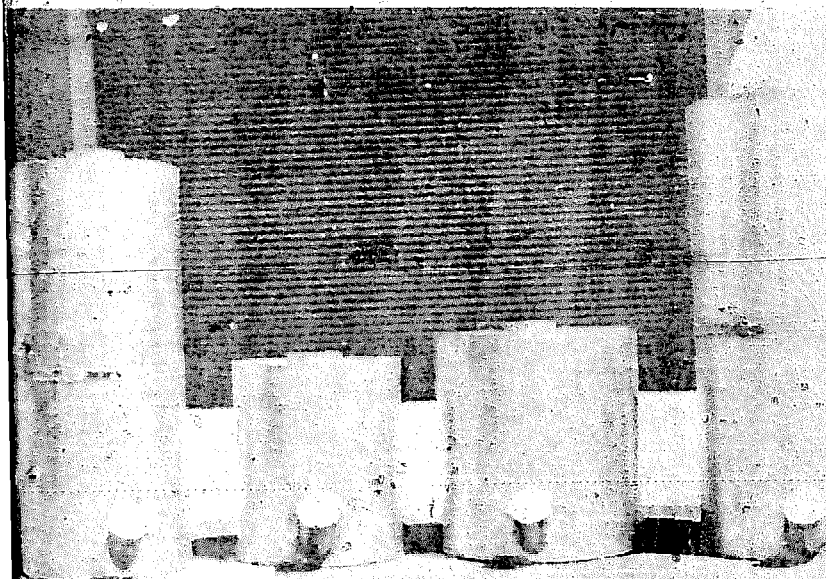

Type I
Domestic Metal Bins
"GHARELU KOTHI"
(Inclined Outlet)

Especially suited
for storing wheat
and other low
moisture foodgrains

Type II
Domestic Metal Bins
"GHARELU KOTHI"
(Horizontal Outlet)

Specially suited for
storing paddy and
other low moisture
coarse foodgrains

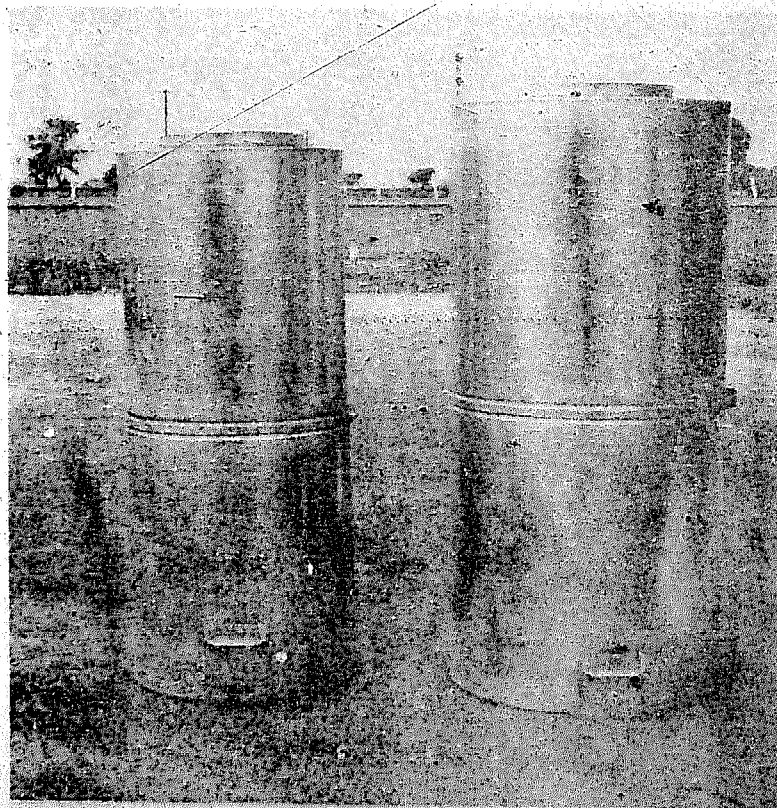

GUIDE TO MANUFACTURERS

THIS Guide has been prepared to assist you to fabricate the storage metal bins developed and tested by the Indian Grain Storage Institute.

FOLLOW the step by step procedure and carry out the work accurately to ensure that the bins you fabricate will be in perfect condition and will conform to the Quality Control Standards.

THESE two types are similar, except for the designs and specifications of the inlet and outlet, etc.

FOR the manufacture of Type I Bin consult the detailed technical drawings listed on page 8, and for the manufacture of type II Bin, consult those listed on page 19.

GENERAL INSTRUCTIONS FOR THE FABRICATION OF TYPES I & II

MATERIAL USED : These two types of bins are made of plain galvanised 'Steel' Sheets. Use sheets according to Indian Standard Institution specifications only. Such sheets are to be free of scratches, gauges, water marks or any signs of lifting of the coating. Edges should be straight and true. Length should be carefully checked against requirements and trimmed as required. Corners should be at 90° . The width of sheets is not critical and if in excess of ISI standard dimensions, the excess may be left on, in lieu of trimming, as this will add slightly to the capacity of bins.

CORROSION PROTECTION: All mild steel parts should be thoroughly cleaned of scale, welding, slag

and oil stains removed. The steel should then be brush-painted with one coat of non-lead base metal primer followed by two coats with synthetic exterior enamel paint before assembly.

CLIPS AND CLASPS: These should be in accordance with those shown on the respective drawings. These are, however, standard purchasable items and consequently other types may be submitted for approval, in which case it will be the manufacturers' responsibility to check and if necessary revise the dimensions for attachment. Clips and clasps should be heavy gauge nickel plated to resist corrosion.

TRANSPORTATION: It is suggested that the domestic bins are required to be transported in fully assembled form for short distances. Attention should be given to provide adequate support to the bin while in transport to avoid any damage.

MAINTENANCE: The manufacturer is advised to give instructions to the users for maintenance of the bins. Such instructions should include the following instructions :

- a) "Keep bin clear of floor to allow passage of air. Check bottom surface at least yearly and if necessary paint with metal primer."
- b) "If after prolonged period of use the galvanising is seen to be lifting, the area should be painted with metal primer and finished with aluminium paint."

RECORDING: After assembling the bin you manufacture, record serial No. and the fact that it is an approved design which could form the basis for transactions through banks or other agencies.

USERS' INSTRUCTIONS: Always attach the Users' Instruction Sheet as at Annexure II to the bin before delivering it to the customer.

QUALITY CONTROL

IF the bins described in the attached specification are manufactured under close engineering control with regard to dimensions, gauges and finish and inspected by persons trained in engineering inspection, further inspection should not be necessary.

HOWEVER, to assist purchasers to check the bins before purchase, the following points are included.

1. Check that the inlet lid fits neatly and that clasps will lock the lid in position.
2. Check that inlet and outlet padlocks are supplied.
3. Check that outlet cover fits neatly and that provision is made for locking.
4. Check that all metal parts have been painted: scrape a little of the enamel to check that the metal has also been primed (underneath colour should be brownish red). Check that metal parts have been painted before assembly.
5. Check that all screws and bolts are tight.
6. Check soldering of outlets/inlets and ensure that surface has been well washed to remove acids. No black staining should be present.
7. Check that all steel rivets have been touched up with paint after assembly.

8. Check that all joints are flat and true and have not been damaged, buckled or bent.
9. Check that instruction sheet has been attached, that it is in language understandable to the purchaser and that he understands the meaning.
10. Check that capacity and name have been stencilled on the side-wall.
11. Check that the manufacturer has given maintenance instructions to the purchaser.
12. Check that the overall dimensions of the bin and the cubic capacity as stencilled on the bin are correct.

DETAILED INSTRUCTIONS ON THE FABRICATION OF DOMESTIC TYPE I "GHARELU KOTHI"

DESCRIPTION: The domestic Type I storage structures developed at the Indian Grain Storage Institute are in four basic sizes. They are constructed of mild steel galvanised plain sheets with folded seam joints. The sheets are standard 2 m x 1 m and 8' x 3' although other standard sizes may be utilized to manufacture the same size bins or by using similar techniques to construct bins of alternative dimensions.

A 225mm diameter inlet is fitted to the top plate and an upward inclined 150mm diameter outlet is fitted in the wall panel near the base. Of the four sizes two are joined at the centre with a clamp ring whereas the other two may be considered as being half of the initial bins with a base added.

SPECIFICATIONS AND DRAWINGS: The drawings for manufacture of Type I bins are as listed herein. Also included thereafter is the suggested manufacturing method. Contact Save Grain Campaign, Ministry of Agriculture, Department of Food, Krishi Bhawan, New Delhi-1 for the drawings.

<u>Drawing No.</u>	<u>Title</u>
IGSI/71/103	Details of domestic bins Type I
IGSI/71/104	Schedule of components for domestic bin Type I
IGSI/71/105	Assembly of domestic bins Type I
IGSI/71/106	Details of inlet and outlet covers for domestic bins Type I
IGSI/71/107	Walls and end plates for domestic bins Type I
IGSI/71/108	Clamp rings for domestic bins Type I
IGSI/71/109	Fabrication of wall section for domestic bins Type I
IGSI/71/110	Seal rings for domestic bins of 0.42 and 0.68 cu. m. Type I
IGSI/71/111	Indicative "Users' Instruction Sheet".
IGSI/71/134	Typical layout of sheets

FABRICATION PROCEDURE FOR TYPE I BIN:
The Domestic Bin of 0.8 cu. m. capacity has been used as an example. (The same procedures apply to the fabrication of other sizes).

Step No. 1. Top Bin Wall Section P/N IGSI-71-109-1.

Select a 24 gauge G.P. sheet of 8' x 3' size. Set out the lines for folding and cutting the sheet as shown on drg. No. IGSI-71/109. Bend the sheet in opposite direction at the two ends along lines set

out after cutting top corners of the sheet. (See Photo No.1). Join the two folded ends hammer it to make a close joint and then drill and rivet at pitch as set out on drg. Take care that tongues of joints are well seated as otherwise the diameter will be affected. (See Photo No.2). Flange the end of bin-wall in beading machine.

Step No.2. Bottom Bin Wall Section P/N IGSI-71/109-2.

Select a 24 gauge G.P. sheet of 8' x 3' size. Follow the same procedure in marking, folding, cutting and joining at the ends as explained in Step 1. Refer to drg. No. IGSI/71/109.

Step No.3. Top Plate P/N IGSI-71/107-7

Select a 24 gauge G.P. sheet. Mark the two circles of correct diameter for cutting and folding as shown in drg.No. IGSI.71/107. Cut the circular plate

Photo No.1 : Preliminary fold at the end of the wall sheets

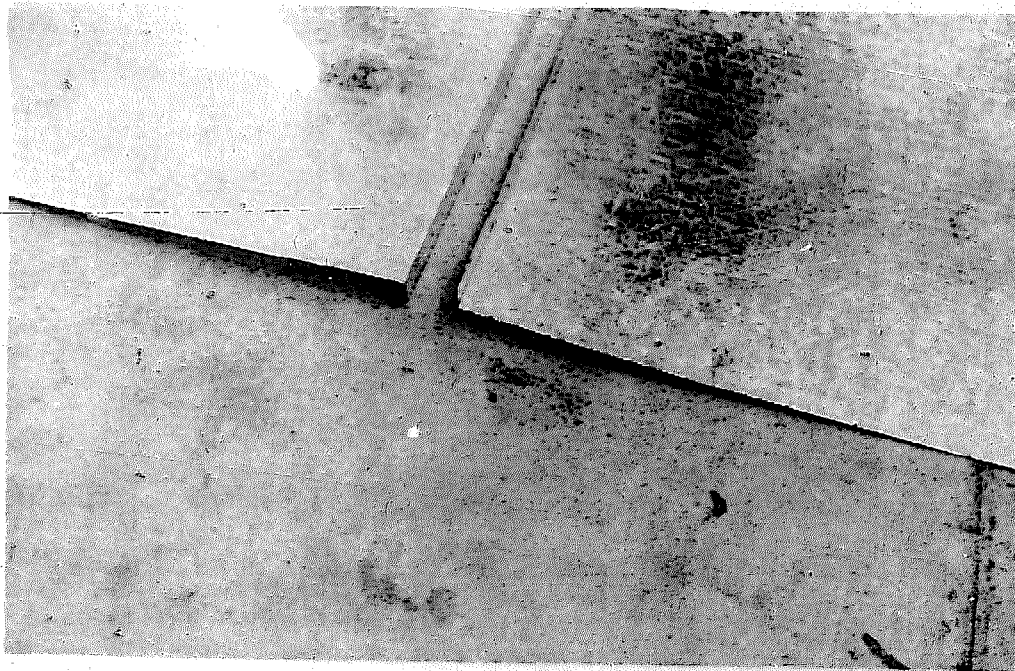

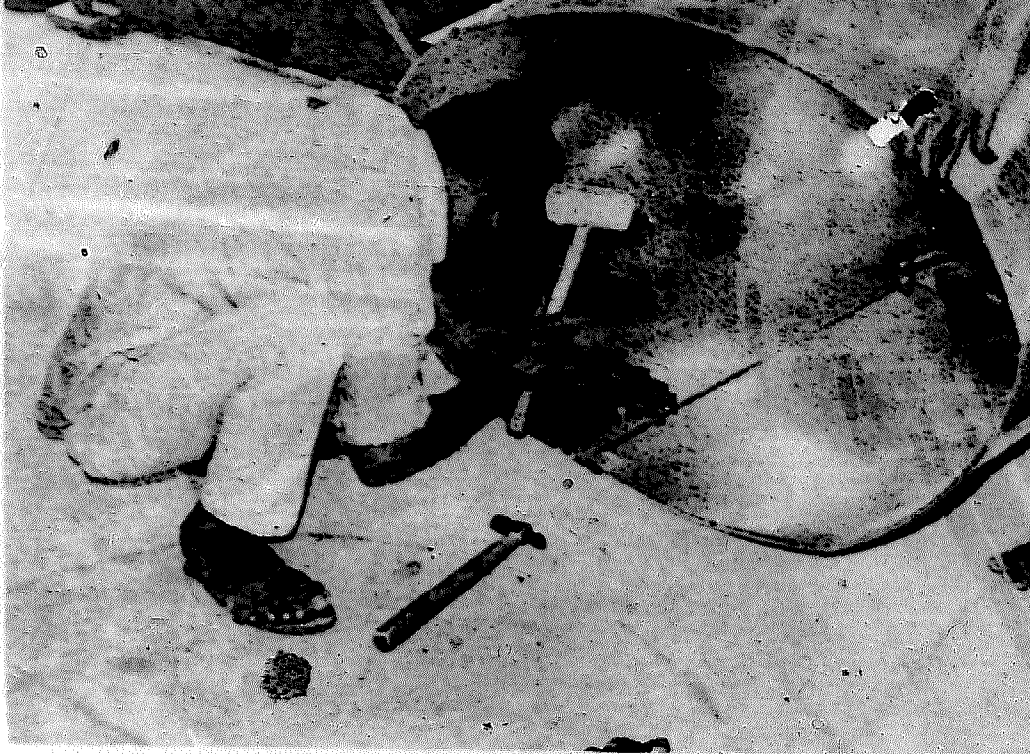

Photo No.2 : Forming bin wall and joining®

along the outer circle as illustrated in photograph No.3. Fold the plate against the inner circle (See Photo No.4). Join the top plate over the upper end of the bin wall section. Follow the method of joining the top plate in four stages as shown in drg. No. IGSI-71/107.

Step No.4. Bottom Plate P/N IGSI-71/107/11

Select a 24 gauge G. P. sheet. Follow the same procedure in marking, folding and joining the bottom plate over the lower end of the bottom bin wall section as explained in Step 3. Refer to drg. No. IGSI-71/107.

Step No.5. Bin Walls P/N IGSI/71/109-1 & 2.

Provide the grooves at the top edges of the bottom wall section and at the bottom edge of the top wall section at specific distance. Refer to drg. No. IGSI-71/109. P/No. IGSI-71/109-1 and P/No. IGSI-71/109-2 (See Photo No.5).

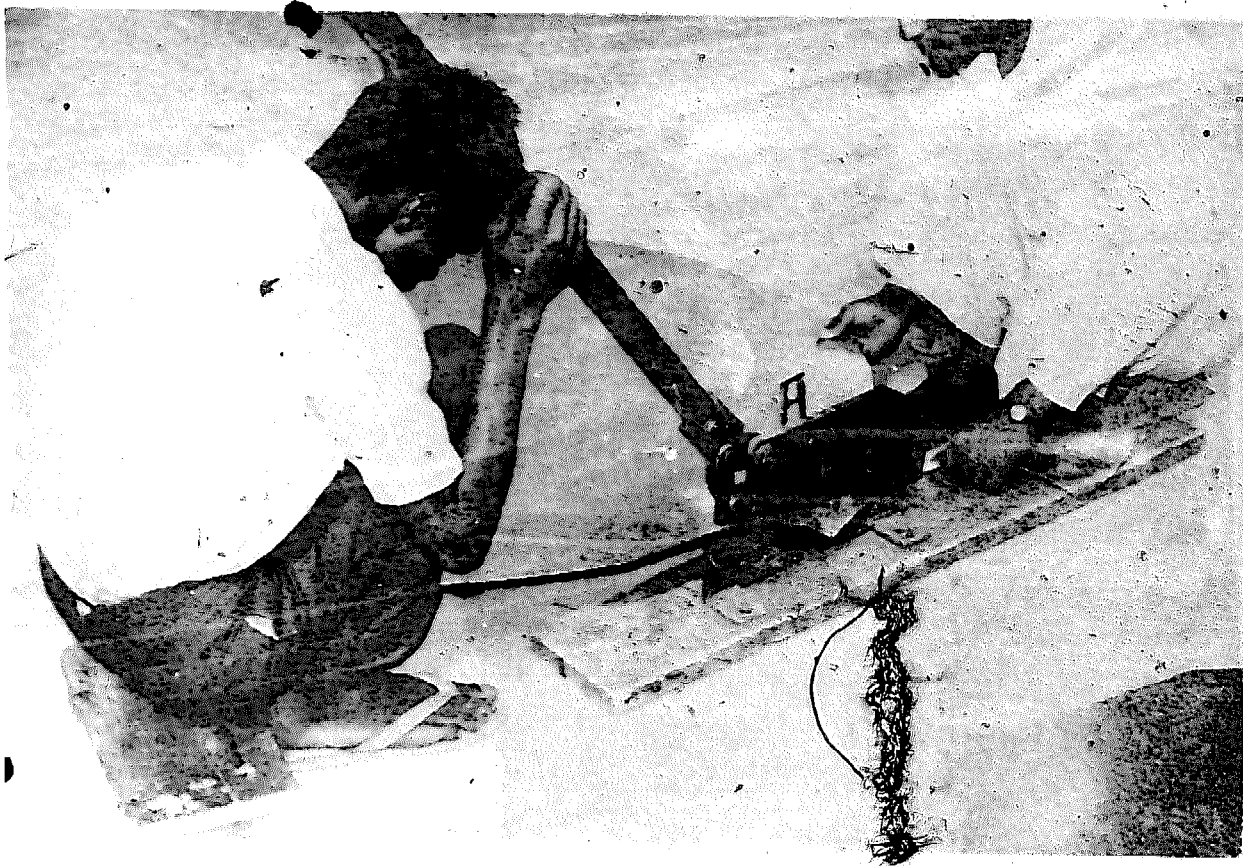
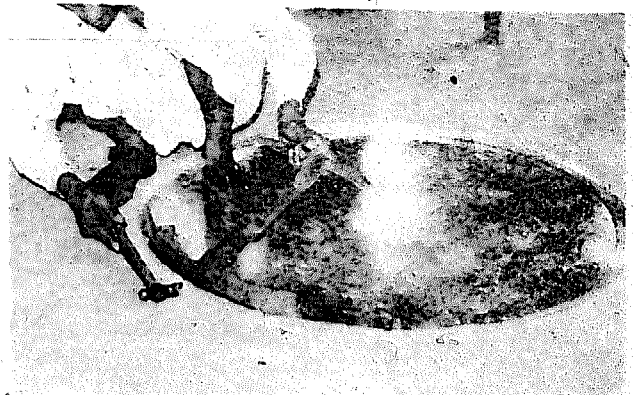

Photo No. 4 : Collecting minor imperfections in lip. Note the lig of angle iron curved to the radius of end plate.



Step No. 6. Inner Ring P/N IGSI-71/107-13

Fabricate M. S. flat bar ring as per drg. No. IGSI-71-107. Check the outside circumference before welding. Apply metal primer and after drying, fit the inner ring into the upper end of the bottom bin wall section P/No. IGSI-71/107-2. Then fold top edge over

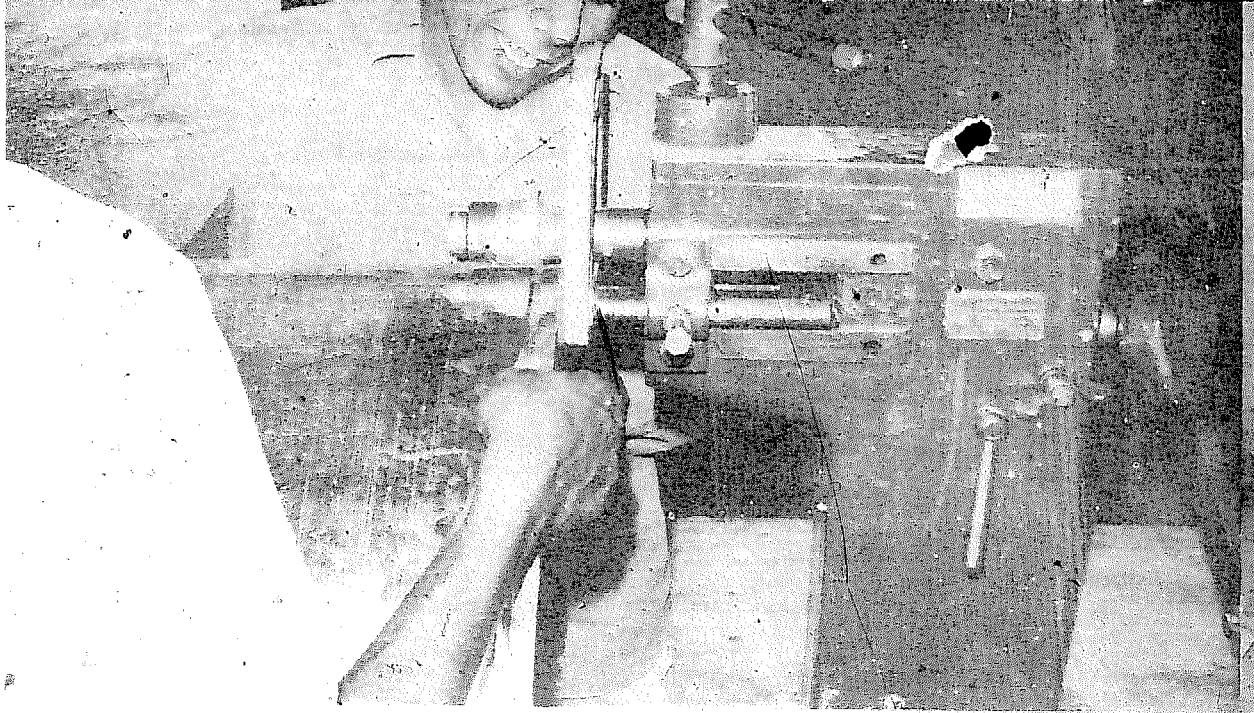

Photo No.5 : Beading the end of bin wall

the ring as shown in drg. No. IGSI-71/107. (See Photo No.6).

Step No.7. Inlet P/N IGSI-71-103-3

Cut the circular opening of specific diameter and at the specified distance from the edge of the top plate of the bin. As shown in drg. No. IGSI-71-103 cut a strip from 24 gauge GP sheet.

Photo No.6 : Inner ring in position and lip of bin being turned over

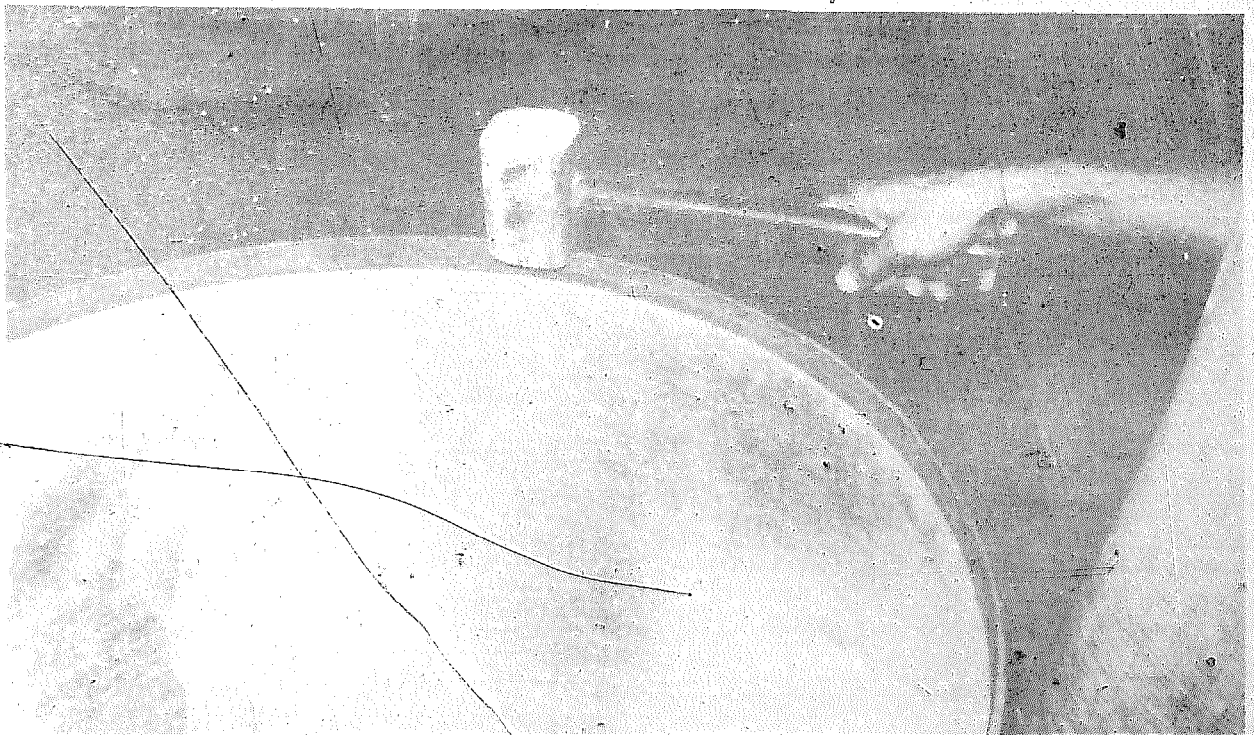



Photo No.7 : Preparing strips for inlet rings

Set out the lines for folding and cut at one end for joining the ends to make a circular ring. Cut tabs along the joining edge 20 mm apart as shown in drg. No. IGSI-71/103 and Photo No.7. Fold outside at the top edge. Now join the two ends to make a circular ring by overlapping and riveting. Fold alternate tabs outward at 90° angle and fix the ring into the inlet opening already cut, in the top plate as shown in the drg.No.IGSI-71/107. The unfolded tabs are required to be hammered from inside to make a close joint. Similarly hammer outside tabs also. Then solder tabs with 60/40/tin/lead solder.

Photo No.8 : Preparing outlet spout after cutting the template shape



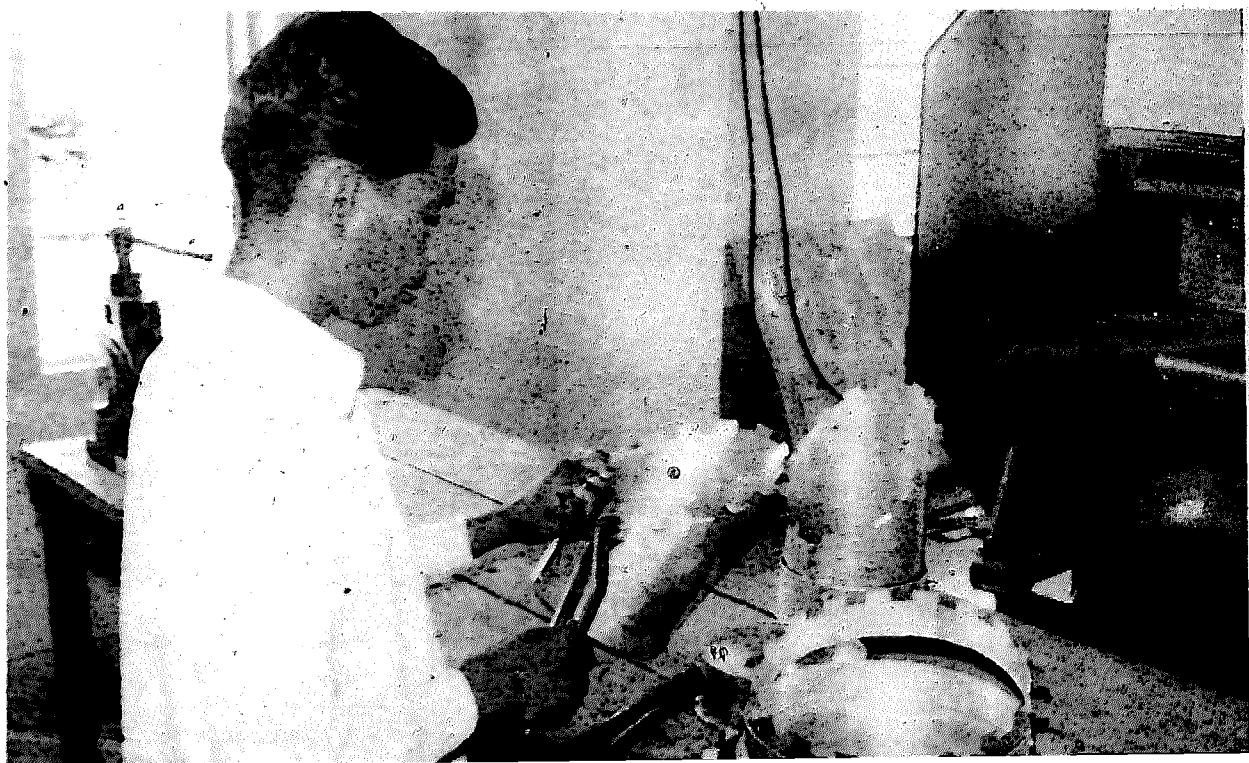

Photo No.9 : Using template to mark out shape to be cut out of lower bin wall for outlet

Step No.8. Outlet P/N IGSI-71/103-2

Select a 24 gauge G. P. sheet and mark the sheet by setting out lines in accordance with drg. No. IGSI-71/103. As the development drg. shown in above drg. is drawn to $\frac{1}{2}$ scale a template should be made for marking on the sheet to full size. Fold at the upper edge and cut the tabs at the joining end of the outlet. (See Photo No.8). Join the two ends by method of overlapping and riveting to form a cylinder.

Photo No. 10 : Turning over tabs of outlet spout



Now use the completed spout to make a template which may be used ultimately for marking the profile of 'cut out' on the bottom bin wall section at appropriate position as shown in drg. No. IGSI-71-109 and Photo No.9 . The spout is required to be fixed in upward inclined direction. Cut out the outlet opening. Fold alternate tabs outwards at approximately 90° angle. (See Photo No.10). Fix the spout into the outlet opening. The unfolded tabs are required to be hammered from inside to make a close joint (See Photo No.11). Similarly hammer outside tabs. Then solder to make air tight and water tight joint.

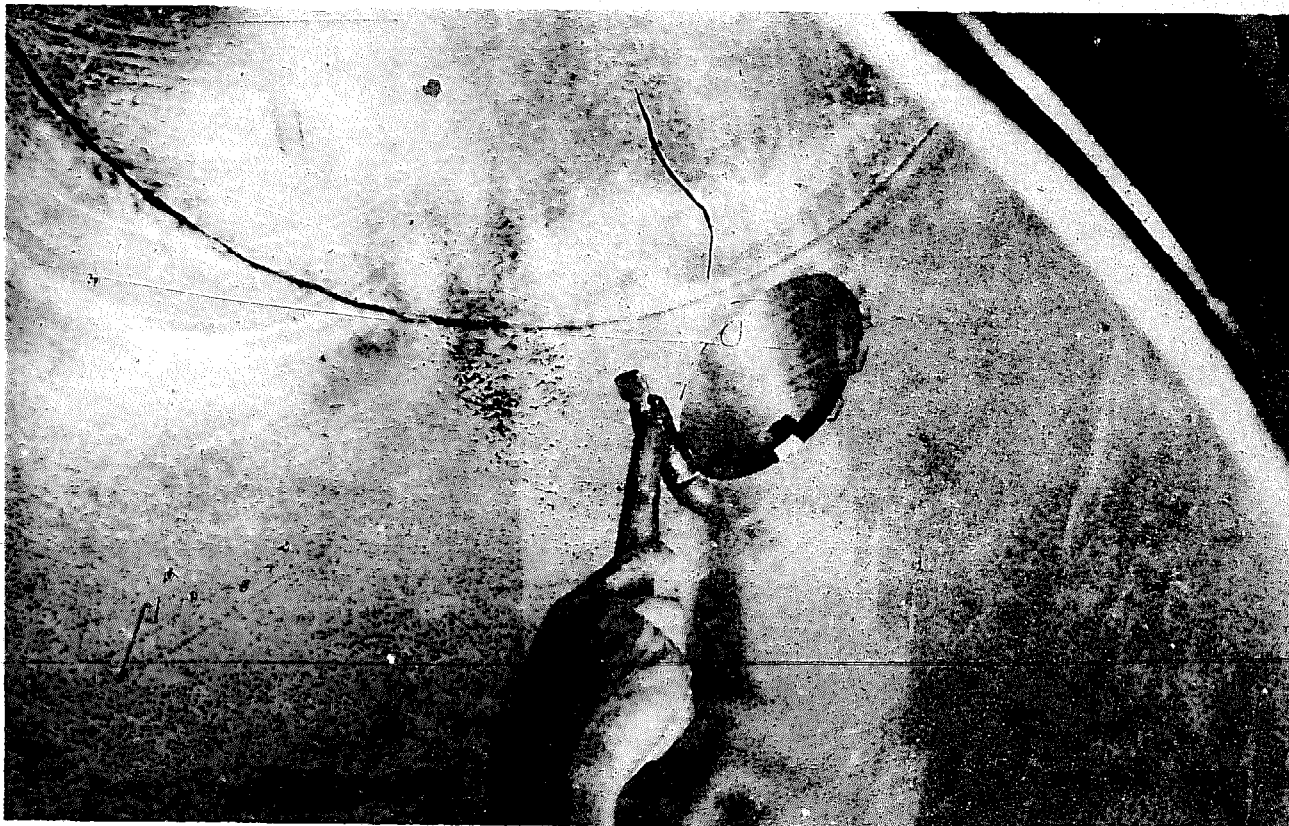

Photo No.11: Hammering tabs flat against the inside of the bin wall

Step No.9. Inlet lid P/N IGSI-71/106-2

Select 24 gauge G. P. sheet. Fabricate the inlet lid as per drg. No.IGSI-71-106. provide two clasps, diagonally opposite each other at specific position so that the lid can be locked in position.

Step.No. 10. Outlet lid P/N IGSI-71/106/1

Select 24 gauge G.P. sheet. Fabricate the outlet lid as per drg.No.IGSI-71/106. Provide two clasps diagonally opposite each other at specified position so that the lid can be locked in position.

Step No. 11. Clamp Ring P/N * IGSI-71-108

Select 20 gauge sheet. Cut a strip of exact length and width. Make two grooves lengthwise at 35 mm CRS apart on beading machine, as shown in drg. No. IGSI-71/108. (See Photo No.12).

To make the two clamps (P/N 71-108-Ib) use 16 gauge G.P. sheet. Cut the pieces of appropriate sizes as shown in above drg. Set the lines for folding and the holes for riveting. Fold each piece at the centre to form a semi-circular groove. Fix the clamps by riveting at the two ends of the clamping strip in the desired position.

Photo No.12 : Preparing grooves for clamp ring

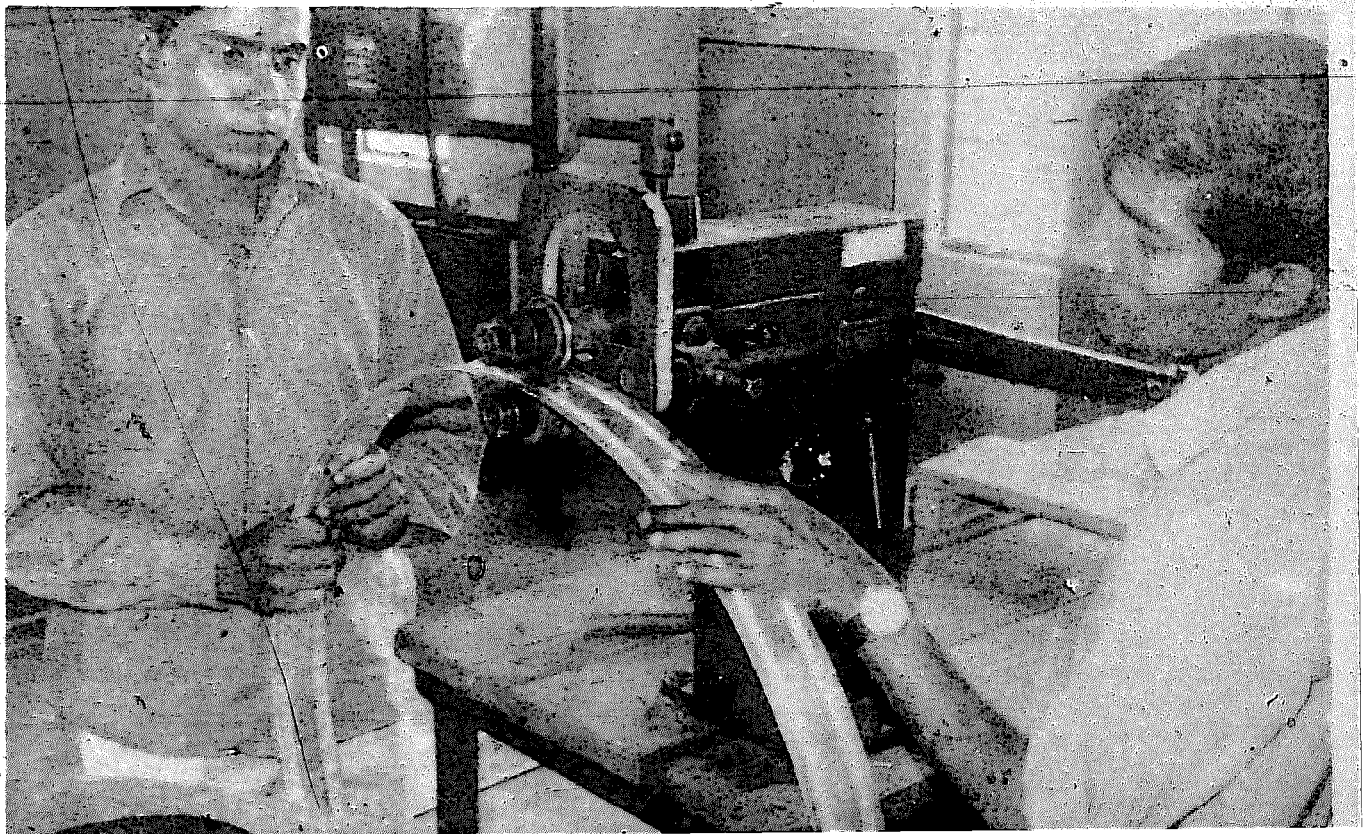

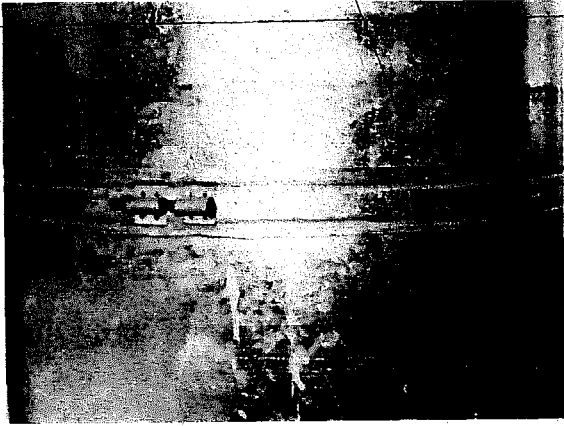

Photo No.13: Clamping ring in position

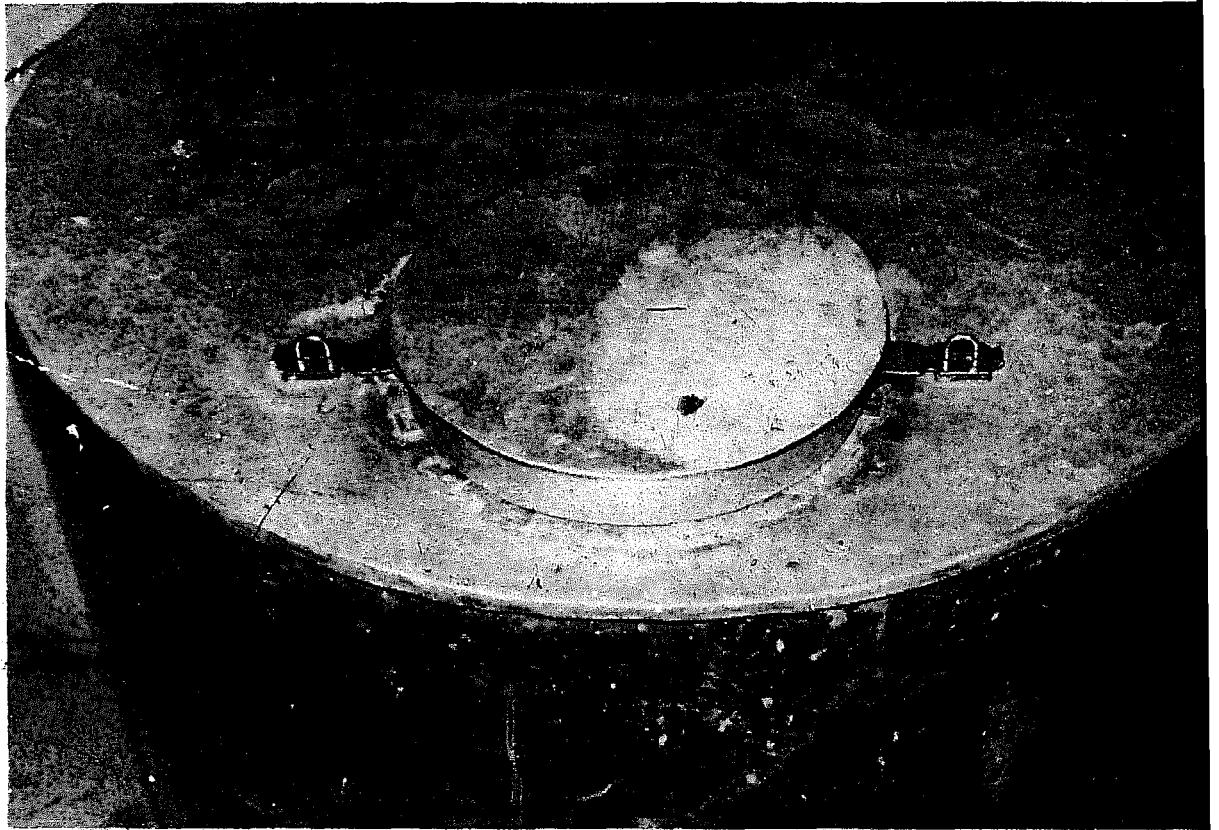

Photo No.14: Inlet lid with locking arrangement

Step No.12. Assembly

The lower end of the top wall section is slipped over the top end of the bottom wall section so that the grooves provided in the top wall section come into contact with stiffening ring. Fix the



Photo No.15 : Outlet lid with locking arrangement

clamping ring with grooves covering the overlap joint and lying into the grooves in the bin walls. Fix deeper groove to bottom. Fix the clamping bolt of correct size and length with metal washers at both ends and tighten. (See Photo No.13). Tap over edges of clamp ring if these tend to stand out from the bin wall.

Step No. 13. Locks

Provide the locking arrangements at the inlet and outlet. (See Photos Nos.14 & 15). Photo on front page shows the 4 sizes of domestic bins.

Step No. 14. Instruction sheet

Attach 'Users' Instructions' in regional language.

Step No. 15. Stencil name and capacity on bin.

DETAILED INSTRUCTIONS ON THE FABRICATION OF DOMESTIC TYPE II "GHARELU KOTHI"

DESCRIPTION: The domestic type II storage structures developed at the Indian Grain Storage Institute are in four basic sizes. They are constructed of mild steel galvanised plain sheets with folded seam joints. The sheets are standard 2 m x 1 m and 8' x 3'. Other standard sizes may be utilised to manufacture the same size bins. Otherwise construct bins of alternative dimensions by adopting similar techniques.

A 450 mm diameter inlet is fitted to the top plate and a horizontal 150 mm diameter outlet fitted in the wall panel near the base. Of the four sizes two are joined at the centre with a clamp ring whereas the other two may be considered as being half of the initial bins with a base added.

SPECIFICATIONS AND DRAWINGS: The drawings for the manufacture of these bins are listed herein. Also included thereafter is a suggested manufacturing method. Contact Save Grain Campaign, Ministry of Agriculture, Department of Food, Krishi Bhawan, New Delhi for the drawings.

To construct the type II bins reference is to be made to the drawings listed under type I Plus the following :-

<u>Drawing No.</u>	<u>Title</u>
IGSI/71-211 (Conversion)	Schedule of Components
IGSI/71-202	Domestic II General Arrangement
IGSI/71-203	Domestic II Inlet and Outlet Covers
IGSI/71-207	Domestic II Inlets and Outlets
IGSI/71-206	Domestic II Instruction Sheet
IGSI/71-210	Details of Conversion from Type I to Type II

FABRICATION PROCEDURE FOR TYPE II BIN :

The Domestic Bin of 0.8 cu. m. capacity has been used as an example. The type II domestic storage bin is basically similar to the type I except that different outlets, slides, inlets, covers and instruction sheets are provided. Many parts are identical and additional drawings are provided to show the variations where applicable.

Step No. 1. Top Bin Wall Section P/N IGSI-71-208

To construct top bin wall section follow the same instructions as in Step-1 under Fabrication Procedure for Type I Bin and details shown for Part No. 71-109-1.

Step No. 2. Bottom Bin Wall Section P/N IGSI/71/208

To construct bottom bin wall section follow the same instructions as in Step-2 under Fabrication Procedure for Type I Bin and details shown for Part No. 71-109-2 except the outlet hole which should be cut to instructions in drg.No.IGSI-71-210.

Step No. 3. Top Plate P/N IGSI-71-209-7

To construct top plate follow the same instructions as in Step-3 under Fabrication Procedure for Type I Bin and details shown for Part No. 71-107-7 except the inlet hole which should be cut to dimensions shown in drg.No.71-210

Step No. 4. Bottom Plate P/N IGSI-71-209-8

To construct bottom plate follow the same instructions as in Step-4 under Fabrication Procedure for Type I Bin and details shown for Part No. 71-107-8.

Step No. 5. Bin Walls P/N IGSI-71/209-13

For grooving follow the same instructions as in Step-5 under Fabrication Procedure for Type I Bin.

Step No.6. Inner Ring P/N IGSI-71/209-13

To construct inner ring follow the same instructions as in Step-6 under Fabrication Procedure for Type I Bin and details shown for Part No. 71-107-13.

Step No.7. Inlet P/N IGSI-71/207-3

Cut the circular opening of specific diameter and at the specified distance from the edge of the top plate of the bin as shown in drg. No. IGSI-71/207. Turn up lip as shown. To fabricate inlet P/N IGSI-71-207-3 cut a strip from 24 gauge G. P. sheet Set out the lines for folding and cut out at one end for joining the ends to make a circular ring by overlapping and riveting. Fold lower 6 mm inwards at 90° angle, fix the ring on to the inlet opening already cut in the top plate. Assemble inlet ring as shown on drg. No. IGSI-71-210.

Step No.8. Outlet P/N IGSI-71-207-2

Select a 24 gauge G. P. sheet and mark the sheet by setting out lines in accordance with drg. No. IGSI-71/207. The development layout shown in the above drawing indicates all dimensions to make a template which should then be used for marking on the sheet. Fold at the upper edge and cut the tabs at the joining end of the outlet. Join the two ends by method of overlapping and riveting to form a cylinder.

Now use the completed spout to make a template which may be used ultimately for marking the profile of 'cut out' on the bottom bin wall section at appropriate position as shown in drg. No. IGSI-71/210. The

spout is required to be fixed in by the tabs. Cut out the outlet opening. Fold alternate tabs outwards at approximately 90° angle. Fix the spout into the outlet opening. The unfolded tabs are required to be hammered from inside to make a close joint. Similarly hammer outside tabs. Then solder to make air tight and water tight joint. Solder on front plate as shown in drg. No. PN IGSI-71-207-lb.

Step No. 9. Inlet Lid P/N IGSI-71-203-2

Select 24 gauge G. P. sheet. Fabricate the inlet lid as per drg. No. IGSI-71-203. Provide two clasps, diagonally opposite each other at specific position so that the lid can be locked in position.

Step No. 10. Outlet Slide P/N IGSI-71-203-

Select 18 gauge G. P. sheet. Fabricate the outlet slide as per drg. No. IGSI-71-203. Provide hole for padlock as shown so that the cover can be locked in position.

Step No. 11. Clamp Ring P/N IGSI-71-204-1

To construct clamp ring follow the same instructions as in Step-11 under Fabrication Procedure for Type I Bin and details shown for Part No. 71-108-1.

Step No. 12. Assembly

The lower end of the top wall section is slipped over the top end of the bottom wall section to come into contact with stiffening ring. Fix the clamping ring with grooves covering the overlap joint and lying in the grooves in the bin walls. Fix deeper groove to bottom. Fix the clamping bolt of correct size and

length with metal washers at both ends and tighten. Tap over edges of clamp ring if these tend to stand out from the bin wall.

Step No. 13. Locks

Provide the locking arrangements at the inlet and outlet.

Step No. 14. Instruction Sheet

Attach 'Users' Instructions' in regional language.

Step No. 15. Stencil name and capacity on bin.

FOR FURTHER INFORMATION ON SCIENTIFIC STORAGE OF FOODGRAINS CONTACT

1. Save Grain Campaign, Ministry of Agriculture, Department of Food, Krishi Bhavan, New Delhi. New Delhi.
2. Save Grain Campaign, Ministry of Agriculture, Department of Food, GIG No.3, Kalyan Street, Masjid, PB 5213, Bombay-7.
3. Save Grain Campaign, Ministry of Agriculture, Department of Food, K.B. Sayad Hasans House, Kadam Kua, M.P. Sinha Road, PB 509, Patna-3.
4. Indian Grain Storage Institute, PB 10, Hapur, District Meerut (U. P.).
5. Indian Grain Storage Institute—Field Station, Punjab Agricultural University, PB 158, Ludhiana (Punjab).
6. Indian Grain Storage Institute—Field Station, Agricultural University, PB 22, Bapatla, Andhra Pradesh.

ANNEXURE-I

Capacity of Bins for Storing Various Foodgrains

Capacity in Cu. m.	PADDY*		MAIZE***		WHEAT*****	
	Kgs	Bags**	Kgs	Bags****	Kgs	Bags****
0.42	230	3	300	3 $\frac{1}{3}$	315	3 $\frac{1}{3}$
0.68	375	5	485	5	510	5 $\frac{1}{2}$
0.82	450	6	580	6	615	6 $\frac{1}{2}$
1.35	745	10	960	10	1015	10 $\frac{1}{2}$

* At the rate of 550 kg/m³ approximately

** At the rate of 75 kg/bag approximately

*** At the rate of 710 kg/m³ approximately

**** At the rate of 90 kg/bag approximately

***** At the rate of 750 kg/m³ approximately

***** At the rate of 95 kg/bag approximately

ANNEXURE II

"USERS' INSTRUCTIONS"

1. Check your bin to find out that
 - a) Lids fit correctly
 - b) Edges are not damaged
 - c) Centre clamp is tight
 - d) Joints are well made.
2. Transport and handle bin carefully.
3. Clean thoroughly the inside of the bin.
4. Keep your bin indoor.
5. Keep the bin on a layer of bricks or wooden batons.

6. Clean your grain by removing dirt, chaff and other foreign matter.
7. Sun-dry your grain well before storage, because grain with high moisture gets spoiled in storage.
8. Do not mix new grain with old insect infested grain while storing.
9. Store insect-free grain. Fumigate with E. D. B. or E. D. C. T. immediately after storage to kill hidden infestation.
10. Inspect your grain fortnightly for possible development of insect infestation. If infestation is found, fumigate with E. D. B. or E. D. B. Ampoules.
11. Always replace lids.
12. Consult your nearest BDO for assistance and advice on your storage problems.

OUR OTHER PUBLICATIONS

Text Books

1. Home Science - Compiled by Dr. R. P. Devadas -
Price Rs. 22.50
2. A Hand book of Animal Husbandry - Price
Rs. 4.00

Farm Bulletins

1. Tips on Better Farming No. 9 75 P per copy.
2. Tips on Better Farming No. 10 40 P " "
3. Tips on Better Farming No. 11 25 P " "
4. Cold Storage of Fruits — 30 P " "
5. Grapevine diseases and their
control 50 P " "
6. High Yielding Varieties of
paddy 40 P " "

Journals (Monthly)

Animals subscription

1. Intensive Agriculture (English) Rs. 5.50
2. Unnat Krishi (Hindi) Rs. 2.25
3. Home Science (English) Rs. 4.50
4. Gharni (Hindi) Rs. 4.50
5. Gosamvardhana (English) Rs. 6.00
6. Gosamvardhana (Hindi) Rs. 3.60

1. For details write and send your subscription/
orders to :

Business Manager
Directorate of Extension
Shastri Bhavan, New Delhi

GUIDE TO THE MANUFACTURE OF METAL BINS

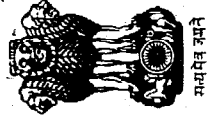

SAVE GRAIN CAMPAIGN
MINISTRY OF AGRICULTURE
DEPARTMENT OF FOOD
KRISHI BHAWAN
NEW DELHI

DOMESTIC BINS TYPE I
GHARELU KOTHILI

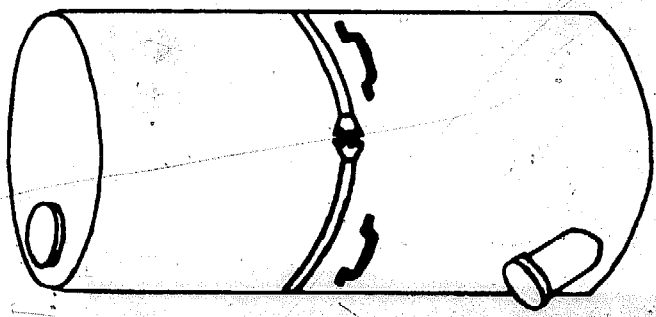

155 40%

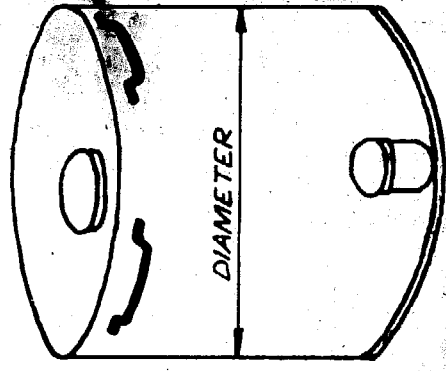

DIAMETER

H

225 ϕ

150
45°

H ₁	1.785	0.900	0.990	1.950
DIA	0.769	0.769	0.938	0.938
M ³	0.820	0.420	0.680	1.350
MT	0.620	0.310	0.510	1.000

CAPACITY FOR WHEAT AT 750 Kg/M³

DRG. No.
I.G.S.I-71-104

DOMESTIC BINS TYPE I

SHEET 2 OF 9.

GHARELU KOTHI I

S.No.	DESCRIPTION	PURCHASE ITEM	PART No OR REF. No.	No. REQUIRED PER BIN.			
				0.82 M ³	0.42 M ³	0.68 M ³	1.35 M ³
1	INLET COVER		71-106-2	1	1	1	1
2	PADLOCK	YES		4	4	4	4
3	TOP WALL SECTION COMP.		71-107-1	1			
4	BOTTOM WALL SECTION COMP.		71-107-2	1			
5	TOP WALL SECTION COMP.		71-107-3				1
6	BOTTOM WALL SECTION COMP.		71-107-4				1
7	BODY SECTION.		71-107-5		1		
8	BODY SECTION.		71-107-6			1	
9	OUTLET COVER		71-106-1	1	1	1	1
10	CENTRAL CLAMP RING		71-108-1	1			
11	TENSION BOLTS.		71-108-1c	1			
12	CENTRAL CLAMP RING.		71-108-2				1
13	TENSION BOLTS.		71-108-2c				2
14	STIFFENING RING LOWER		71-107-15		1		
15	STIFFENING RING LOWER		71-107-16			1	
16	RIVETS			TO DRGS	TO DRGS	TO DRGS	TO DRGS.
17	BIN BASE		71-107-11		1		
18	BIN BASE		71-107-12			1	
19	CLASPS (PLATED)	YES.	71-106-3	4	4	4	4
20	INSTRUCTION SHEET IN REGIONAL LANGUAGE		IGSI-71-111	1	1	1	1
21	LIFTING HANDLES	YES	IGSI-71-107	4	4	4	4

FOR GENERAL ARRANGEMENT REFER IGSI-71-105

GHARELU KOTHI I

JOB No. DPIC 2	ALL DIMENSIONS ARE IN MILLIMETRES.	
SCALE.	DATE	INDIAN GRAIN STORAGE INSTITUTE
DRN	1-6-71	HAPUR-UP-INDIA.
CHD		TITLE
APD	18-6-71	SCHEDULE OF COMPONENTS FOR DOMESTIC BINS OF 0.42, 0.68, 0.82, 1.35 M ³
APPROVED FOR GENERAL ISSUE.		DRG. No. I.G.S.I. 71-104.
SIGNATURE		DATE

DRG. No
I.G.S.I-71-105

SHEET 3 OF 9

DOMESTIC BINS TYPE I GHARELU KOTHI I

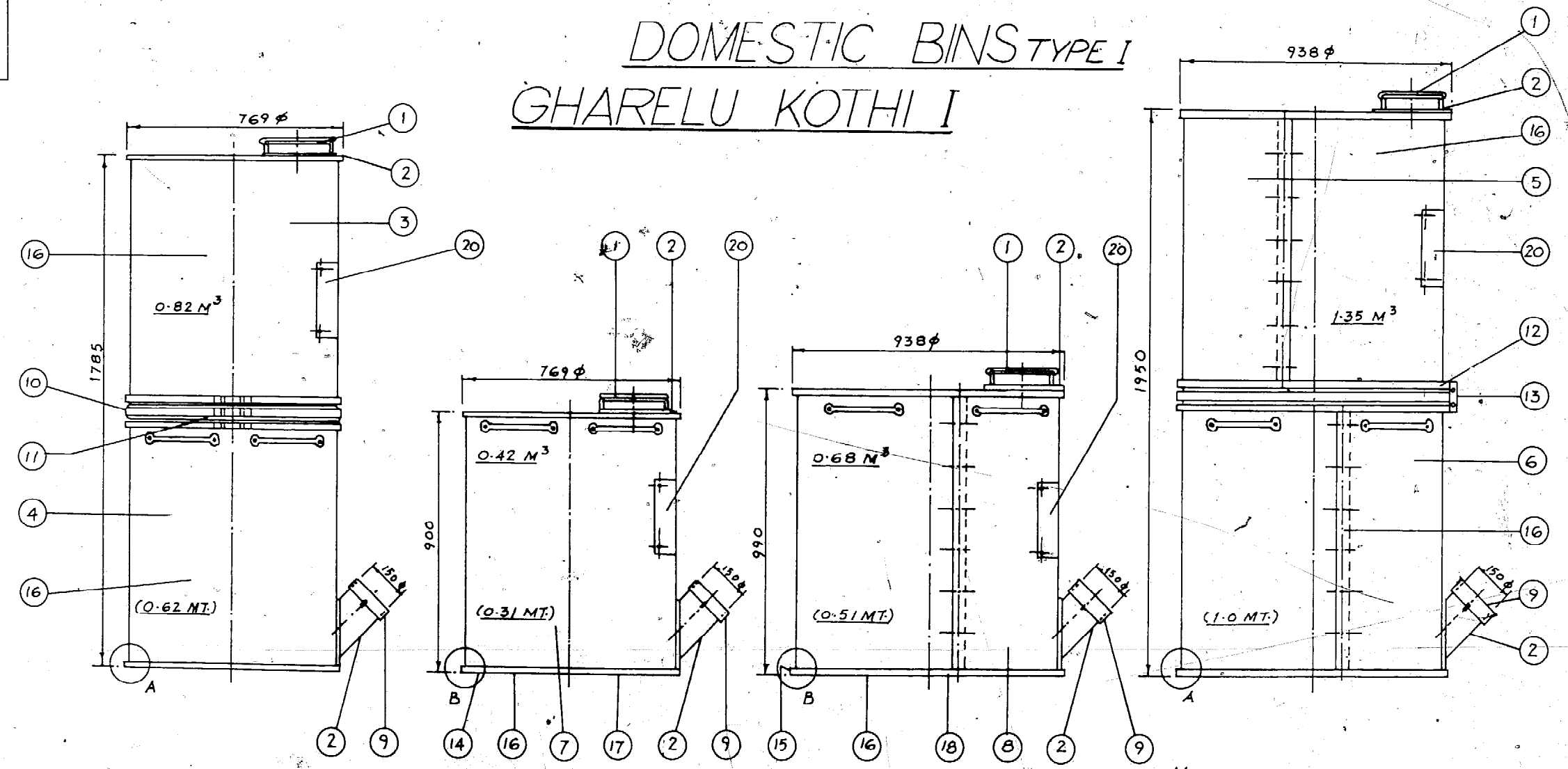

SECTION THROUGH INLET WITH COVER

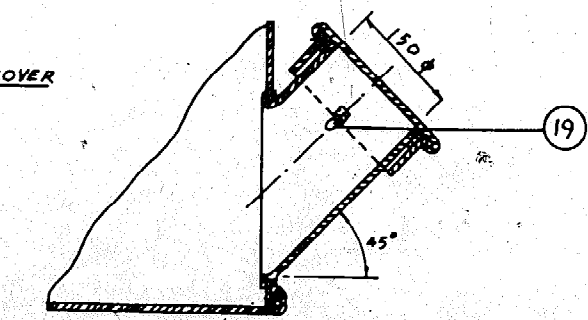
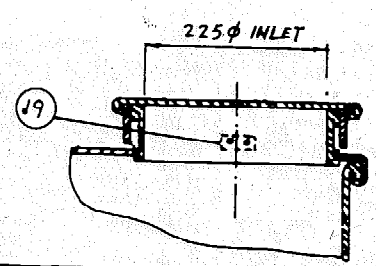

SECTION THROUGH OUTLET WITH COVER

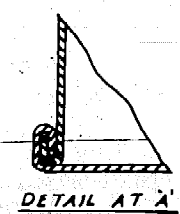

DETAIL AT A

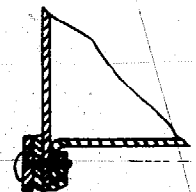

DETAIL AT B

NOTE 1:- STENCIL NAME & CAPACITY AFTER ASSEMBLY (30mm. LETTERS)

APPROX. CAPACITY IN METRIC TONS OF WHEAT AT 750 KG/M³ ARE SHOWN IN BRACKETS FOR EACH BIN.

FOR SCHEDULE OF COMPONENTS REFER DRAWING No. 1651-71-104.

GHARELU KOTHI I

JOB. No. DP162	ALL DIMENSIONS ARE IN MILLIMETRES.
SCALE	DATE
DRH.	INDIAN GRAIN STORAGE INSTITUTE
	HAPUR-UP-INDIA.
QND.	TITLE
APD.	ASSEMBLY OF DOME- STIC BIN FOR-0.42
	0.68, 0.82 & 1.35 CUMTR.
	DRG. No
	I.G.S.I
	71-105.

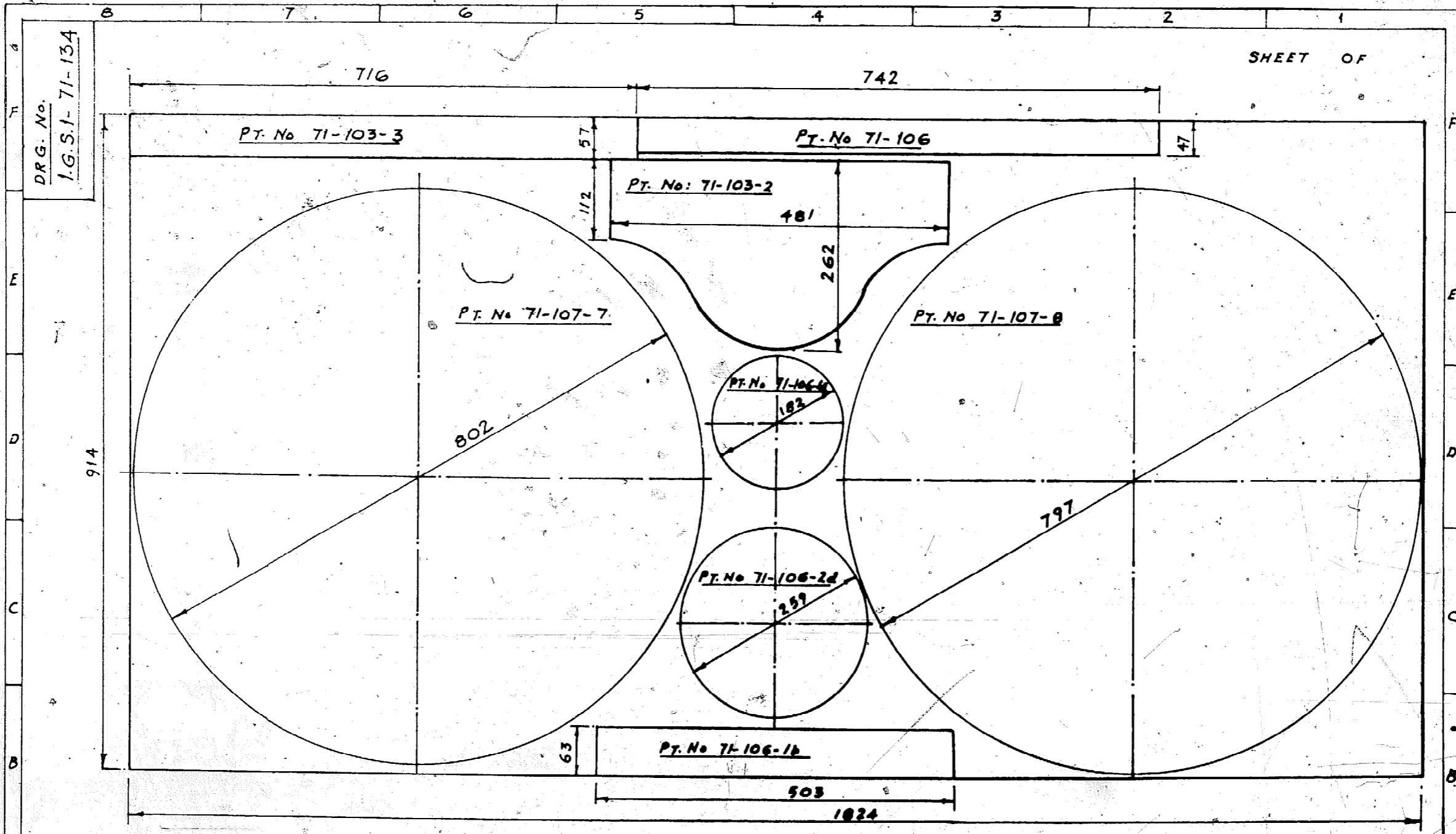

DRG. No.
I.G.S.I- 71-134

SHEET OF

JOB No. DPI&2		ALL DIMENSIONS ARE IN MILLIMETRES.	
SCALE 1:5	DATE	INDIAN GRAIN STORAGE INST.	
DRN.	9-7-77	HAPUR U.P. (INDIA)	
CND.		TITLE:-	DRG. No.
APD.		MAT LAYOUT PLAN FOR	I.G.S.I-
		DOMESTIC BIN OF	71-134.
		0.42 M ³ & 0.02 M ³	
APPROVED FOR GENERAL ISSUE.		SIGNATURE	DATE

GHARELU KOTHLI

DRG. No. I.G.S.I.-71-109

0.82 M³ BIN DETAILS

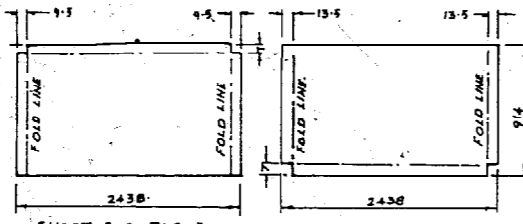

SHEET FOR TOP BIN
2438 x 914 GALV.
No. REED. - 1 OFF

SHEET FOR BOTTOM BIN
2438 x 914 GALV.
No. REED. - 1 OFF

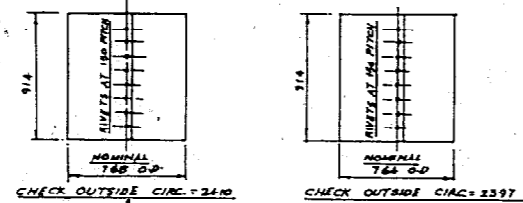

CHECK OUTSIDE CIRC. = 2410

RIVETTING
AFTER FORMING INTO CYLINDER DRILL & FIT
4 DIA 6 M.M. M.S. RIVETS AT 150 PITCH

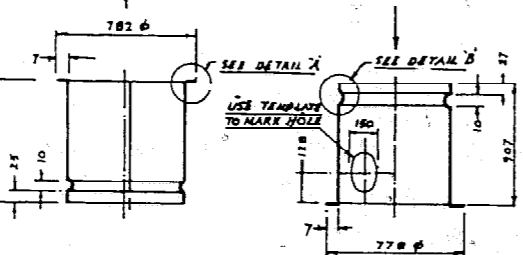

BIN WALL TOP
Pt. No. 71-109-1

BIN WALL BOTTOM
Pt. No. 71-109-2

DETAILS OF CONSTRUCTION

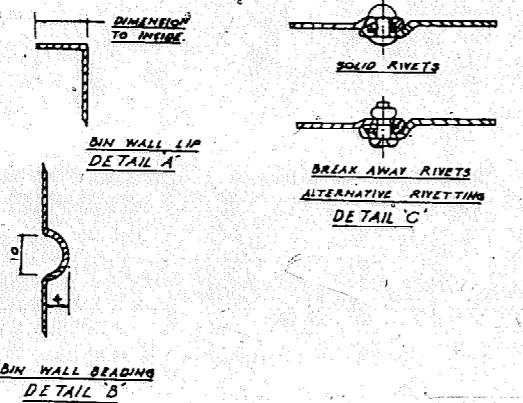

1.35 M³ BIN DETAILS

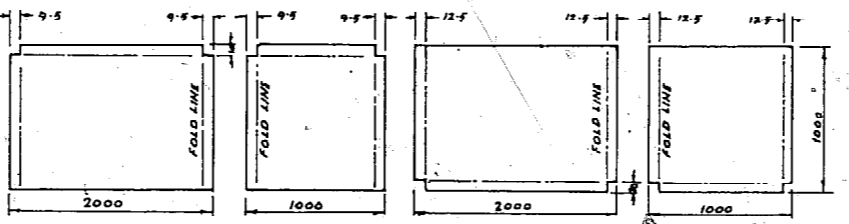

BIN WALL SECTION TOP
2000 x 1000 GALV. SHEET
No. REED. - 1 OFF

BIN WALL SECTION BOTTOM
2000 x 1000 GALV. SHEET
No. REED. - 1 OFF

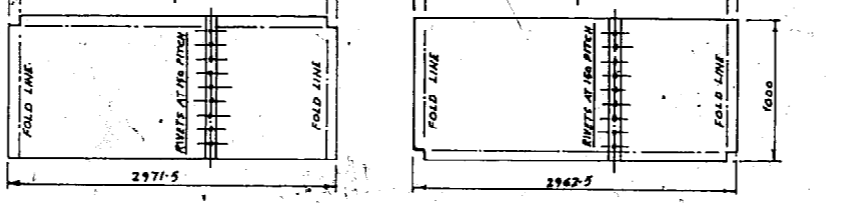

BIN WALL SECTION TOP SUB-ASSEMBLY
CHECK OUTSIDE CIRC. = 2942

BIN WALL SECTION BOTTOM SUB-ASSEMBLY
CHECK OUTSIDE CIRC. = 2928

RIVETTING
JOIN SHEETS WITH LAP JOINT & DRILL & FIT
4 DIA 6 M.M. M.S. RIVETS AT 150 M.M. PITCH

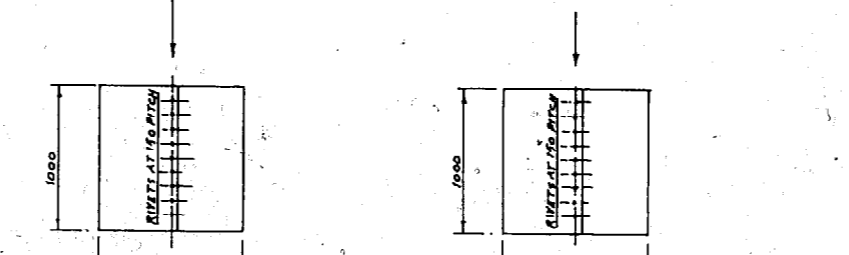

BIN WALL TOP
Pt. No. 71-109-3

BIN WALL BOTTOM
Pt. No. 71-109-4

RIVETTING
AFTER FORMING INTO CYLINDER
DRILL & FIT 4 DIA 6 M.M. M.S.
RIVETS AT 150 PITCH

0.42 M³ BIN DETAILS

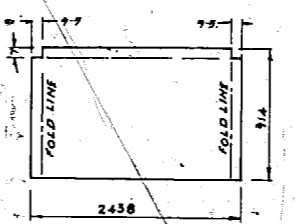

SHEET FOR BIN WALL
2438 x 914 GALV.
No. REED. 1 OFF

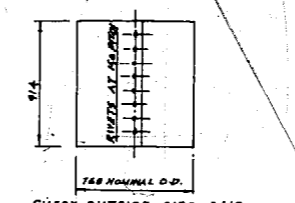

CHECK OUTSIDE CIRC. = 2410

RIVETTING
AFTER FORMING INTO CYLINDER
DRILL & FIT 4 DIA 6 M.M. M.S.
RIVETS AT 150 PITCH

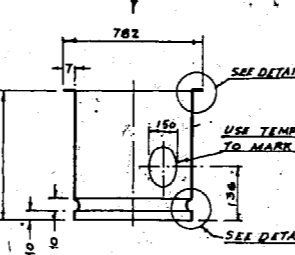

BIN WALL
Pt. No. 71-109-5

0.68 M³ BIN DETAILS

SHEET 7 OF 9

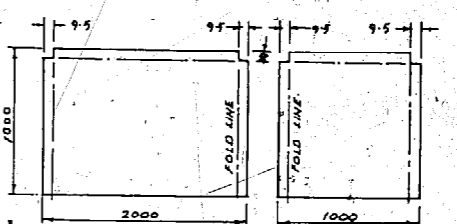

SHEETS FOR BIN WALL
2000 x 1000 GALV. SHEET
No. REED. - 1 OFF

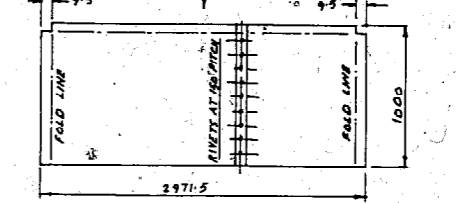

CHECK OUTSIDE CIRC. = 2942

RIVETTING
JOIN SHEETS WITH LAP JOINT & DRILL & FIT
4 DIA 6 M.M. M.S. RIVETS AT 150 M.M. PITCH

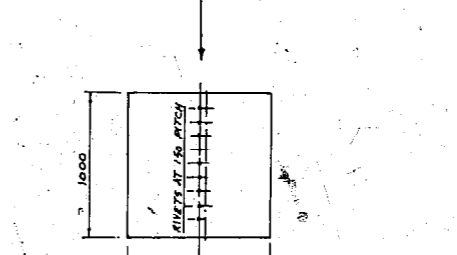

BIN WALL
Pt. No. 71-109-6

RIVETTING
AFTER FORMING INTO CYLINDER DRILL & FIT
4 DIA 6 M.M. M.S. RIVETS AT 150 PITCH

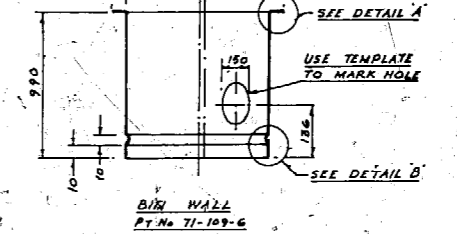

BIN WALL
Pt. No. 71-109-7

NOTE:- FOR GENERAL ARRANGEMENT REFER
DRG. No. I.G.S.I.-71-108
FOR SCHEDULE OF COMPONENTS
REFER DRG. No. I.G.S.I.-71-104

GHARELU KOTHI I

JOB No. DP142	ALL DIMENSIONS ARE IN MILLIMETRES
SCALE: NTS	INDIAN GRAIN STORAGE INST.
DRN: 1.671	HAPUR - O.P. - INDIA
CND:	TITLE: WALL SECTIONS
APR: 82	DOMESTIC BINS OF
	0.4, 0.6, 0.8 & 1.35 M ³
APPROVED FOR GENERAL ISSUE	DRG. No. I.G.S.I.-71-109

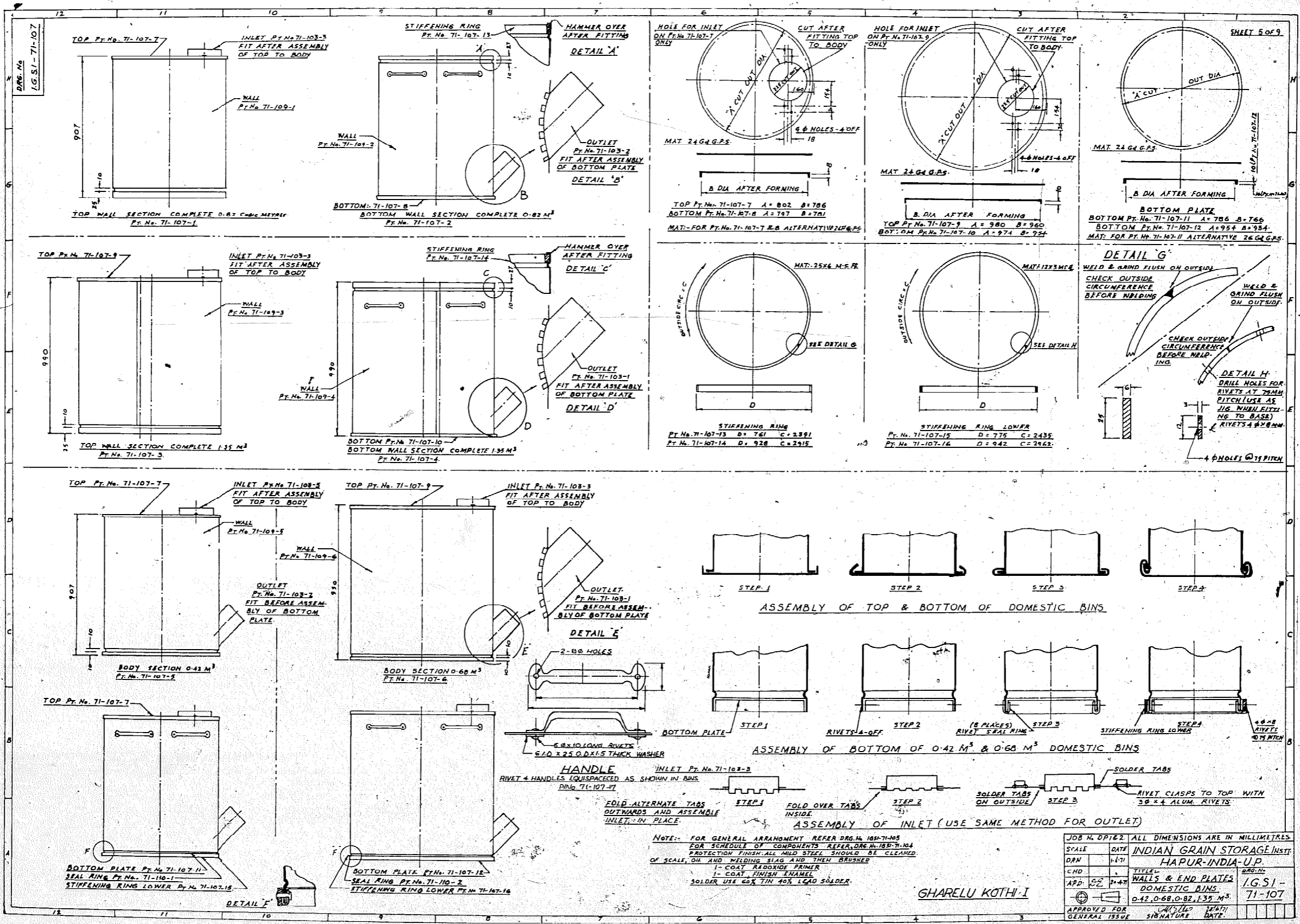

JOB NO. DP1&2	ALL DIMENSIONS ARE IN MILLIMETRES
SCALE	DATE
DRN	INDIAN GRAIN STORAGE INST
CHD	HAPUR-INDIA-U.P.
APP	TITLE- WALLS & END PLATES
APPROVED FOR GENERAL ISSUE	DOMESTIC BINS
	0.42, 0.68, 0.82, 1.35 M ³
	DRG. NO. I.G.S.I-71-107
	DATE

DRG. No.
IGSI-71-103

SHEET 1 OF 9

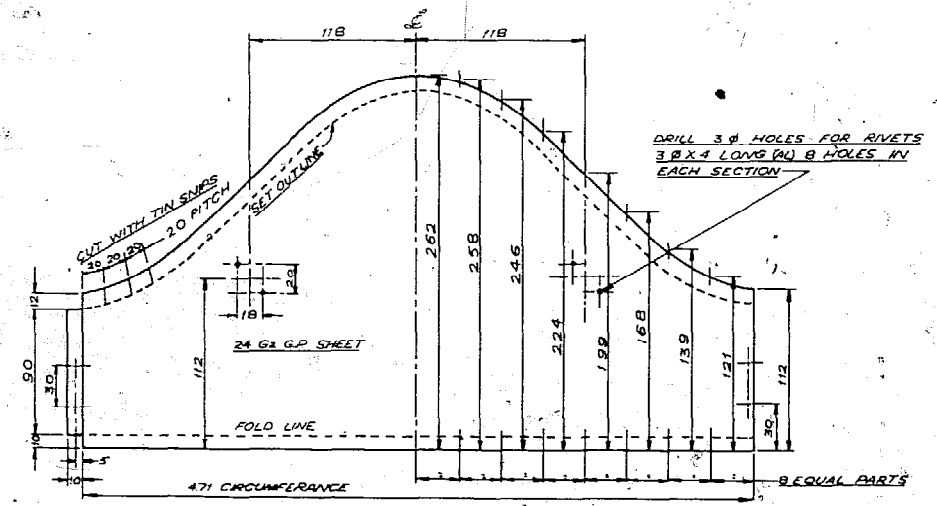

DEVELOPMENT VIEW OF OUTLET
FOR 0.68M³ & 1.35M³ DOMESTIC BINS
P. No. 71-103-1
FOR ASSEMBLY REFER IGSI-71-107 — 0.68M³
IGSI-71-107 — 1.35M³

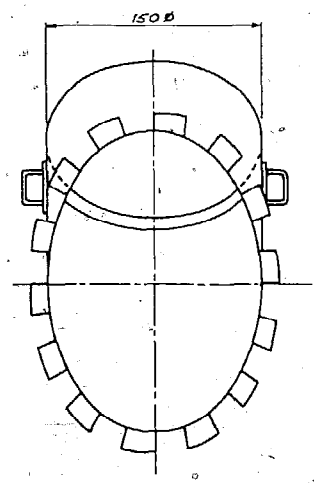

OUTLET

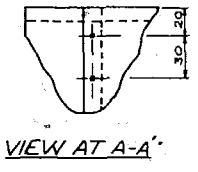

VIEW AT A-A

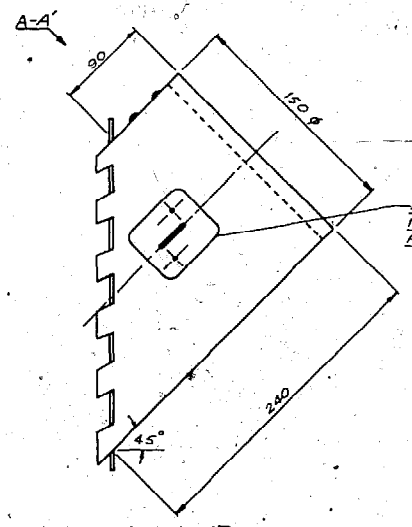

SIDE VIEW OF OUTLET

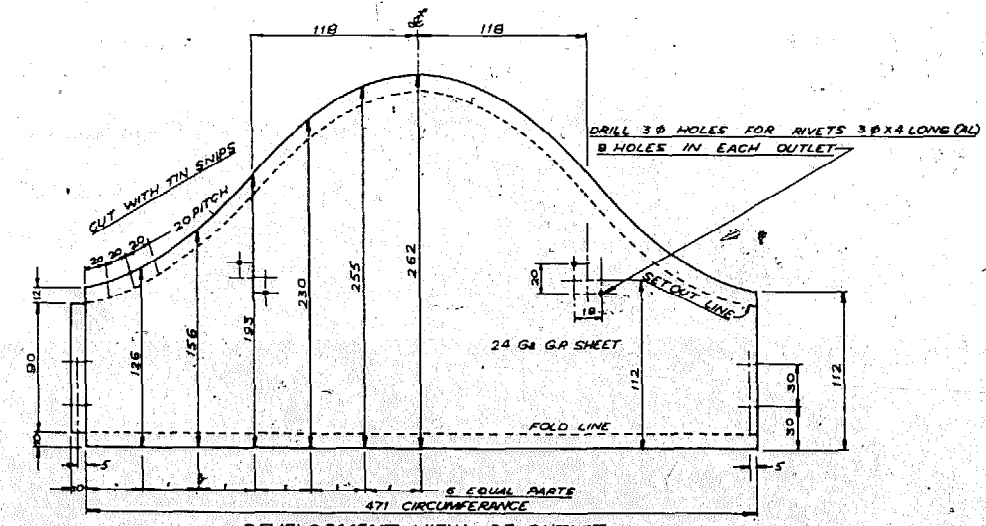

DEVELOPMENT VIEW OF OUTLET
FOR 0.42M³ & 0.82M³ DOMESTIC BINS
P. No. 71-103-2
FOR ASSEMBLY REFER IGSI-71-107 — 0.42M³
IGSI-71-107 — 0.82M³

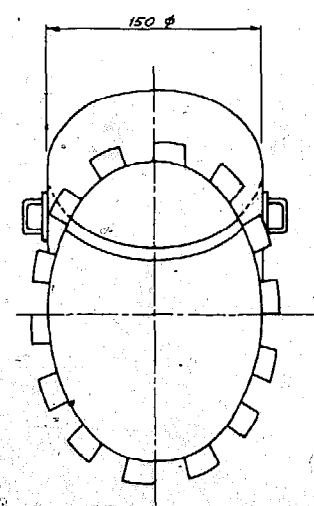

OUTLET

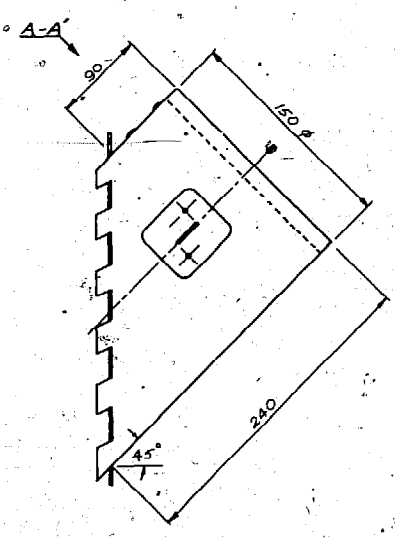

SIDE VIEW OF OUTLET

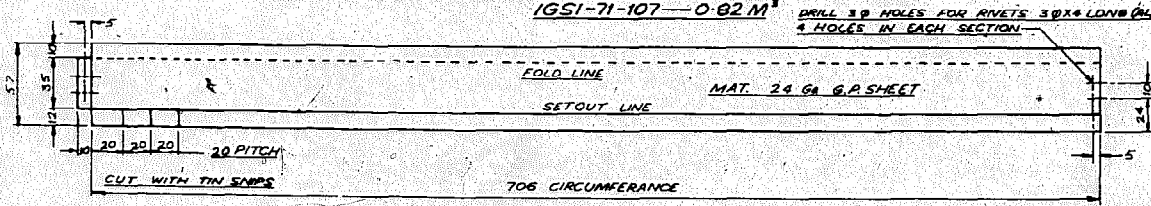

DEVELOPMENT VIEW OF INLET
FOR DOMESTIC BINS
P. No. 71-103-3
FOR ASSEMBLY REFER IGSI-71-107 — 0.42M³
IGSI-71-107 — 0.68M³
IGSI-71-107 — 0.82M³
IGSI-71-107 — 1.35M³

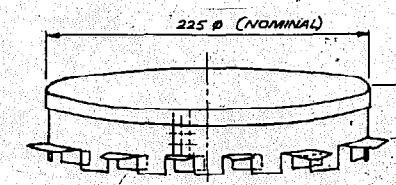

INLET

TURN OUT EACH ALTERNATE TAB

GHARELU KOTHI I

JOB No. DPT 2		ALL DIMENSIONS ARE IN MILLIMETRES	
SCALE	DATE	INDIAN GRAIN STORAGE INST.	
DRN		HAPUR-U.P.-INDIA	
CHD		TITLE	DRG. No.
APD		DETAIL OF DOMESTIC	IGSI-
		BIN FOR 0.42, 0.68, 0.82 & 1.35 M ³	71-103
APPROVED FOR GENERAL ISSUE	DATE	SIGNATURE	DATE

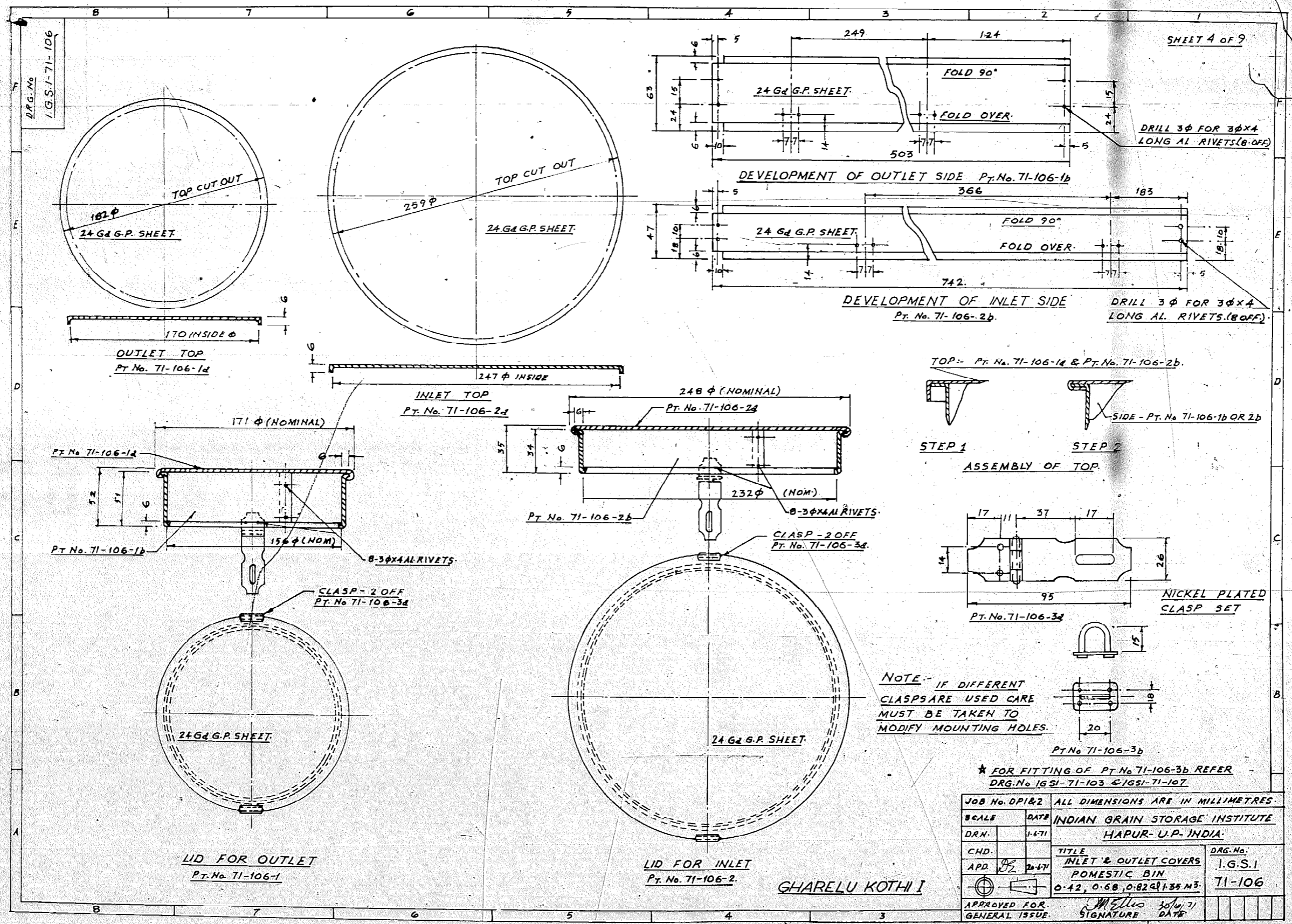

JOB No. DPIR2	ALL DIMENSIONS ARE IN MILLIMETRES.	
SCALE	DATE	INDIAN GRAIN STORAGE INSTITUTE
DRN.	1-6-71	HAPUR- U.P. INDIA.
CHD.		TITLE
APD.	2-4-71	INLET & OUTLET COVERS
		POMEISTIC BIN
		0.42, 0.68, 0.82 & 1.35 M ³
APPROVED FOR GENERAL ISSUE.	SIGNATURE	DATE

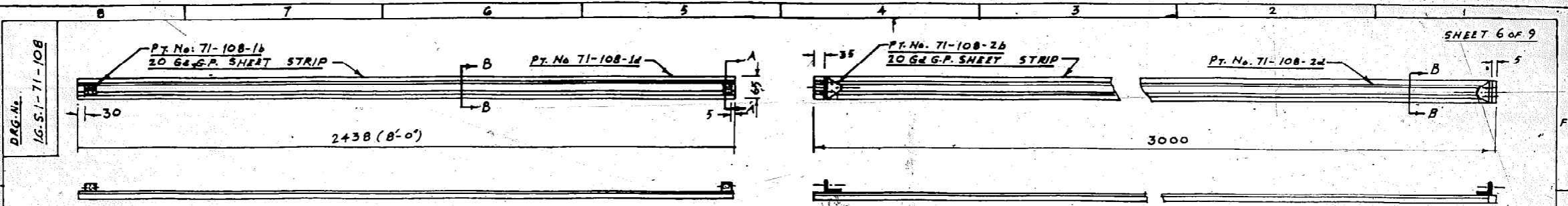

CLAMPING RING
Pt. No. 71-108-1
No. REQD. - 1 OFF
SCALE 1:10

CLAMPING RING
Pt. No. 71-108-2
No. REQD. - 1 OFF
SCALE 1:10

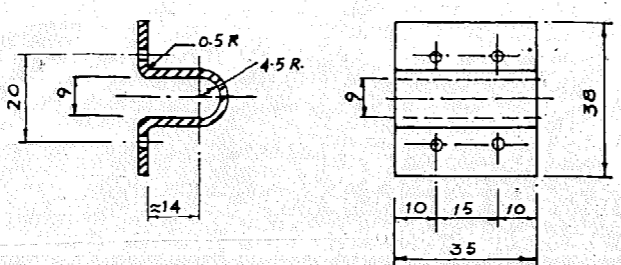
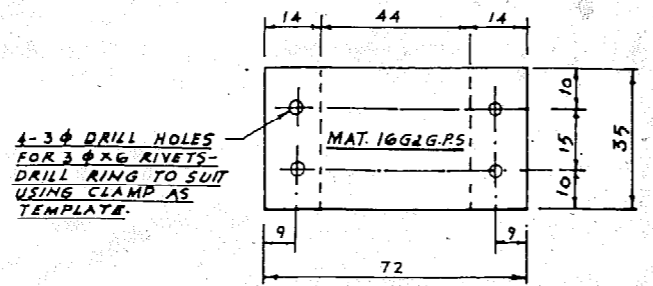
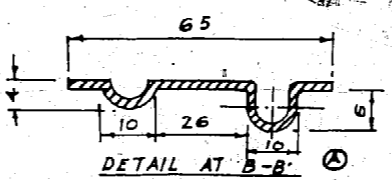

CLAMP FOR CLAMPING RING
Pt. No. 71-108-1b
No. REQD. - 2 OFF
SCALE FULL SIZE

CLAMP FOR CLAMPING RING
Pt. No. 71-108-2b
No. REQD. 2 OFF
SCALE FULL SIZE

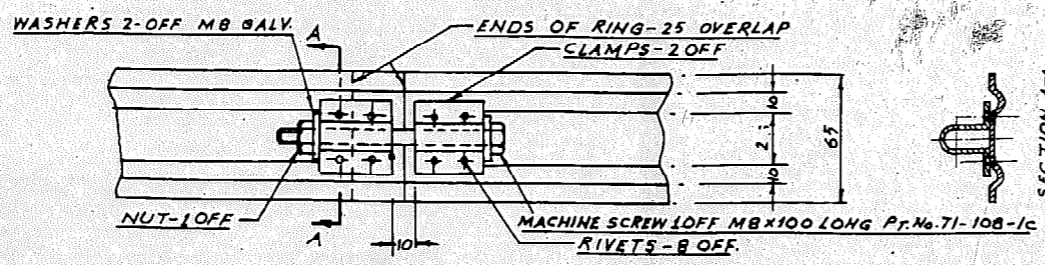
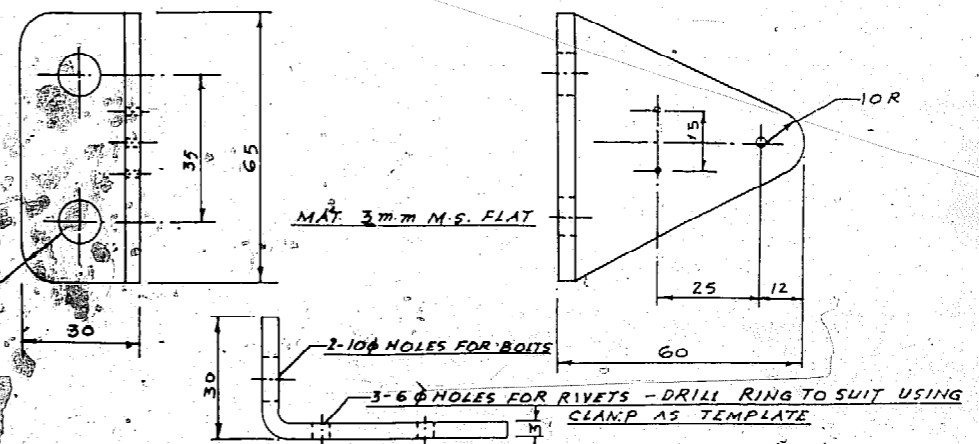

CLAMP RING
Pt. No. 71-108-1
SCALE 1:2

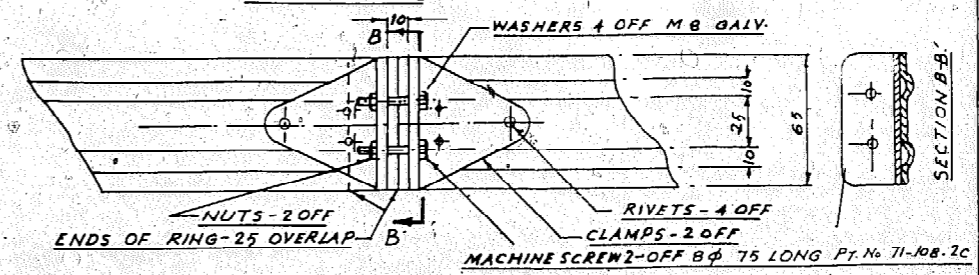

CLAMP RING
SCALE 1:2

NOTE:- FOR GENERAL ARRANGMENT REFER DRG. No. 16S-71-105
FOR SCHEDULE OF COMPONENTS REFER DRG. No. 16S-71-104
PROTECTION FINISH ALL MILD STEEL SHOULD BE
CLEANED OF SCALE, OIL & WELDING SLAG AND THEN BRUSHED
1- COAT REDOXIDE PRIMER
1- COAT FINISH ENAMEL
MODIFICATION(A) CROSS SECTION OF CLAMP MODIFIED

JOB No. DP12	ALL DIMENSIONS ARE IN MILLIMETRES.
SCALE 1:10	INDIAN GRAIN STORAGE INST.
DRN. 1.6.71	HAPUR-U.P.-INDIA.
CKD.	TITLE:
APD. 20.6.71	CLAMP RING
	DRG No
	16S-1
	71-108
APPROVED FOR GENERAL ISSUE	SIGNATURE DATE

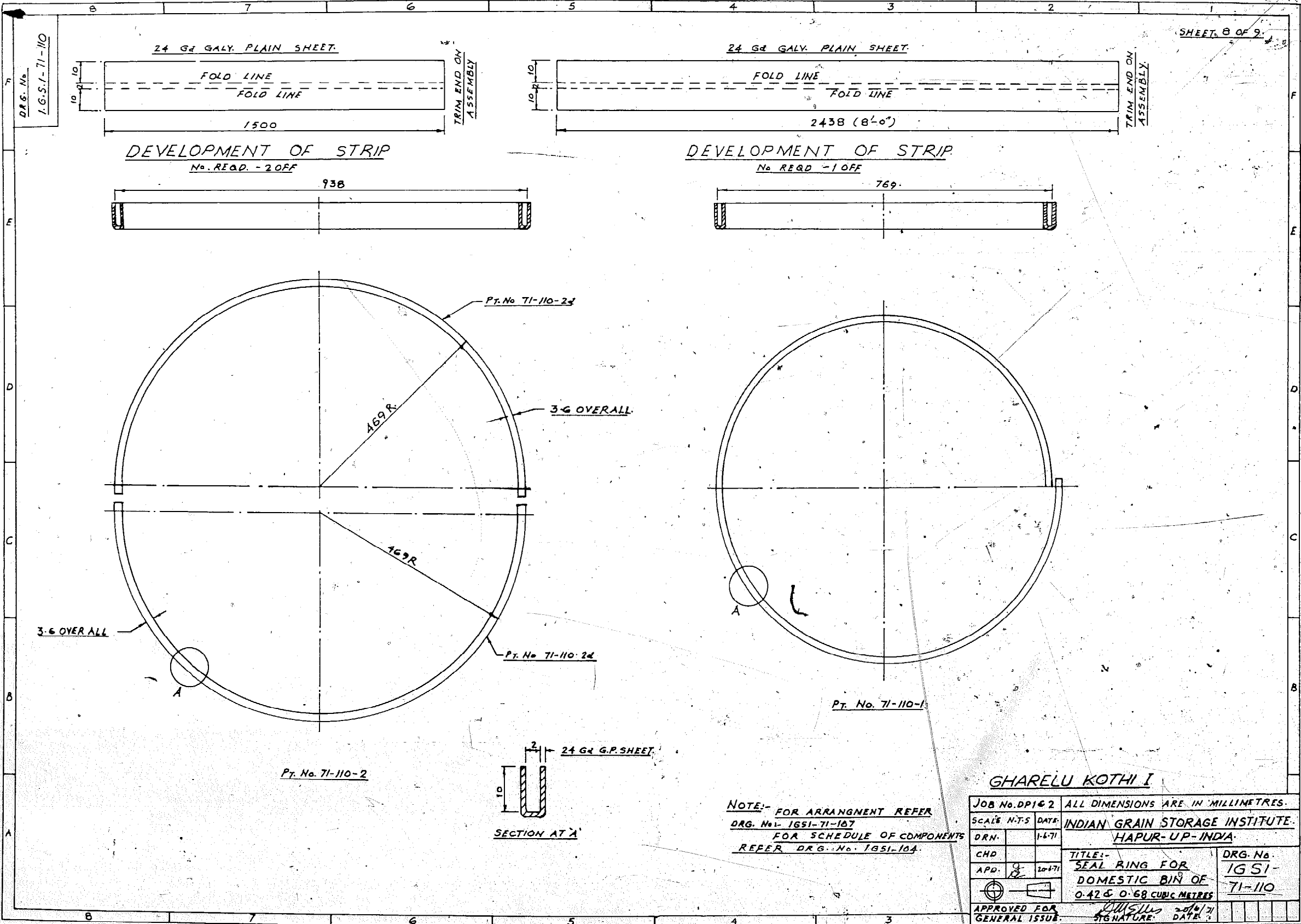

SHEET 8 OF 9

DRG. No. 1-G.S.I.-71-110

DEVELOPMENT OF STRIP
No. RECD. - 2 OFF

DEVELOPMENT OF STRIP
No. RECD. - 1 OFF

GHARELU KOTHI I

NOTE:- FOR ARRANGMENT REFER
DRG. No. 1GSI-71-107
FOR SCHEDULE OF COMPONENTS
REFER DRG. No. 1GSI-104.

JOB No. DP162		ALL DIMENSIONS ARE IN MILLIMETRES.	
SCALE N.T.S.	DATE	INDIAN GRAIN STORAGE INSTITUTE.	
DRN.	1-4-71	HAPUR-UP-INDIA.	
CHD.		TITLE:-	DRG. No.
APD.	20-4-71	SEAL RING FOR	1GSI-
		DOMESTIC BIN OF	71-110
		0.42 & 0.68 CUBIC METRES	
APPROVED FOR GENERAL ISSUE.		SIGNATURE	DATE

**USER'S INSTRUCTIONS
FOR
DOMESTIC BINS TYPE I**

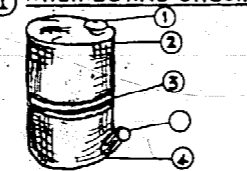
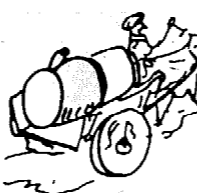
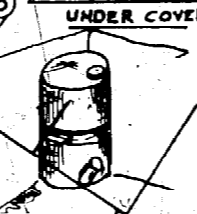
<p>① WHEN BUYING CHECK:</p>  <p>① LIDS FIT CORRECTLY. ② EDGES ARE NOT DAMAGED. ③ CENTRE CLAMP IS TIGHT. ④ JOINTS ARE WELL MADE.</p>	<p>② TRANSPORT GENTLY:</p> 	<p>③ PLACE IN DOOR UNDER COVER:</p> 
--	---	--

<p>④ LIFT BIN FROM FLOOR ON TIMBERS ABOUT 2":</p> 	<p>⑤ GRAIN TO BE STORED SHOULD BE:</p> <p>① CLEAN ② DRY ③ NOT MIXED WITH OLD OR INFECTED GRAIN. ④ INSPECTED REGULARLY FOR INSECTS</p>
--	--

⑥ **FUMIGATION:**
IF YOU FIND INSECTS IN YOUR GRAIN FUMIGATE WITH E.D.B. AMPULES (IF AVAILABLE) OR CONTACT YOUR **BLOCK DEVELOPMENT OFFICER** FOR ASSISTANCE AND GUIDANCE.

DO	DO NOT
ALWAYS REPLACE LIDS.	STORE MOIST GRAIN OR MIX OLD AND NEW GRAIN.

PREPARED AT THE:
**INDIAN GRAIN STORAGE INSTITUTE
HAPUR, U.P.**

200

300

**PROPOSAL
USER'S INSTRUCTION SHEET:
P/No 71-III-1**

MATERIAL: MULTI COLOURED SCREEN PRINT ON ALUMINIUM SHEET 26 GAUGE INSTRUCTION SHEET TO BE RIVETED TO FACE OF EACH BIN.

NOTE:
1. INSTRUCTION SHEET TO BE TRANSLATED INTO REGIONAL LANGUAGE AND PRESENTED TO MANUFACTURER FOR ATTACHMENT TO BIN.
2. SKETCHES AND INSTRUCTIONS SHOWN ARE INDICATIVE ONLY.

GHARELU KOTHI I

JOB No DP 162	ALL DIMENSIONS ARE IN MILLIMETRES.	
SCALE: -	DATE	INDIAN GRAIN STORAGE INSTITUTE HAPUR, U.P. INDIA.
DRAWN D.M.E 26/71	CHECKED	TITLE:
APPROVED [Signature] 18-6-71		DRG. No IGSI 71-III
APPROVED FOR GENERAL ISSUE.	[Signature] 29/6/71	DATE

DRG. No.
IGSI-71-211

DOMESTIC BIN TYPE II

GHARELU KOTHI II

SHEET OF

S.No.	DESCRIPTION	PURCHASE ITEM	PART No. OR REF. No.	No. REQUIRED PER BIN			
				0.82 M ³	0.42 M ³	0.68 M ³	1.35 M ³
1	INLET COVER		71-203-2	1	1	1	1
2	PADLOCK	YES		3	3	3	3
3	TOP WALL SECTION COMP		71-107-1	1			
4	BOTTOM WALL SECTION COMP		71-107-2	1			
5	TOP WALL SECTION COMP		71-107-3				1
6	BOTTOM WALL SECTION COMP		71-107-4				1
7	BODY SECTION		71-107-5		1		
8	BODY SECTION		71-107-6			1	
9	OUTLET COVER		71-203-1	1	1	1	1
10	CENTRAL CLAMP RING		71-108-1	1			
11	TENSION BOLTS		71-108-1c	1			
12	CENTRAL CLAMP RING		71-108-2				1
13	TENSION BOLTS		71-108-2c				2
14	STIFFENING RING LOWER		71-107-15		1		
15	STIFFENING RING LOWER		71-107-16			1	
16	RIVETS			TO DRGS	TO DRGS	TO DRGS	TO DRGS
17	BIN BASE		71-107-11		1		
18	BIN BASE		71-107-12			1	
19	CLASPS (PLATED)	YES	71-106-3	2	2	2	2
20	INSTRUCTION SHEET IN REGIONAL LANGUAGE		71-208-1	1	1	1	1
21	LIFTING HANDLE	YES	71-107	4	4	4	4

*
*
*
*
*
*

DRAWING LIST		
SHEET No.	DRAWING NUMBER	SIZE
1	IGSI-71-211	A3
2	IGSI-71-202	A2
3	IGSI-71-203	A2
4	IGSI-71-108 (REFER DRGS FOR TYPE I)	A2
5	IGSI-71-110 (REFER DRGS FOR TYPE I)	A2
6	IGSI-71-206	A2
7	IGSI-71-207	A1
8	IGSI-71-107&109	A1
9	IGSI-71-210	A2

THIS SCHEDULE IS APPLICABLE WHEN DOMESTIC TYPE II BIN IS BEING PRODUCED USING DOMESTIC TYPE I DRAWINGS PLUS THOSE DRGS APPLICABLE TO CARRY OUT MODIFICATIONS FOR PROCEDURE REFER SPECIFICATION.

FOR GENERAL ARRANGEMENT REFER IGSI-71-202

GHARELU KOTHI II

JOB No.	ALL DIMENSIONS ARE IN MILLIMETRES.	
SCALE	DATE	INDIAN GRAIN STORAGE INSTT.
DRN		HAPUR-U.P-INDIA
CKD		TITLE:
APD		SCHEDULE OF COMPONENTS FOR CONVERSION OF DOMESTIC TYPE I TO DOMESTIC TYPE II
		0.42, 0.68, 0.82, & 1.35 M ³
		DRG. No.
		IGSI-71-211
APPROVED FOR GENERAL ISSUE	SIGNATURE	DATE
		10-5-72

* FOR DETAIL OF THESE COMPONENTS REFER CONVERSION DRG. No. 71-210 & 107

DRG. No. IGS1-71-202

DOMESTIC BINS TYPE II GHARELU KOTHI II

SHEET 2 OF 9

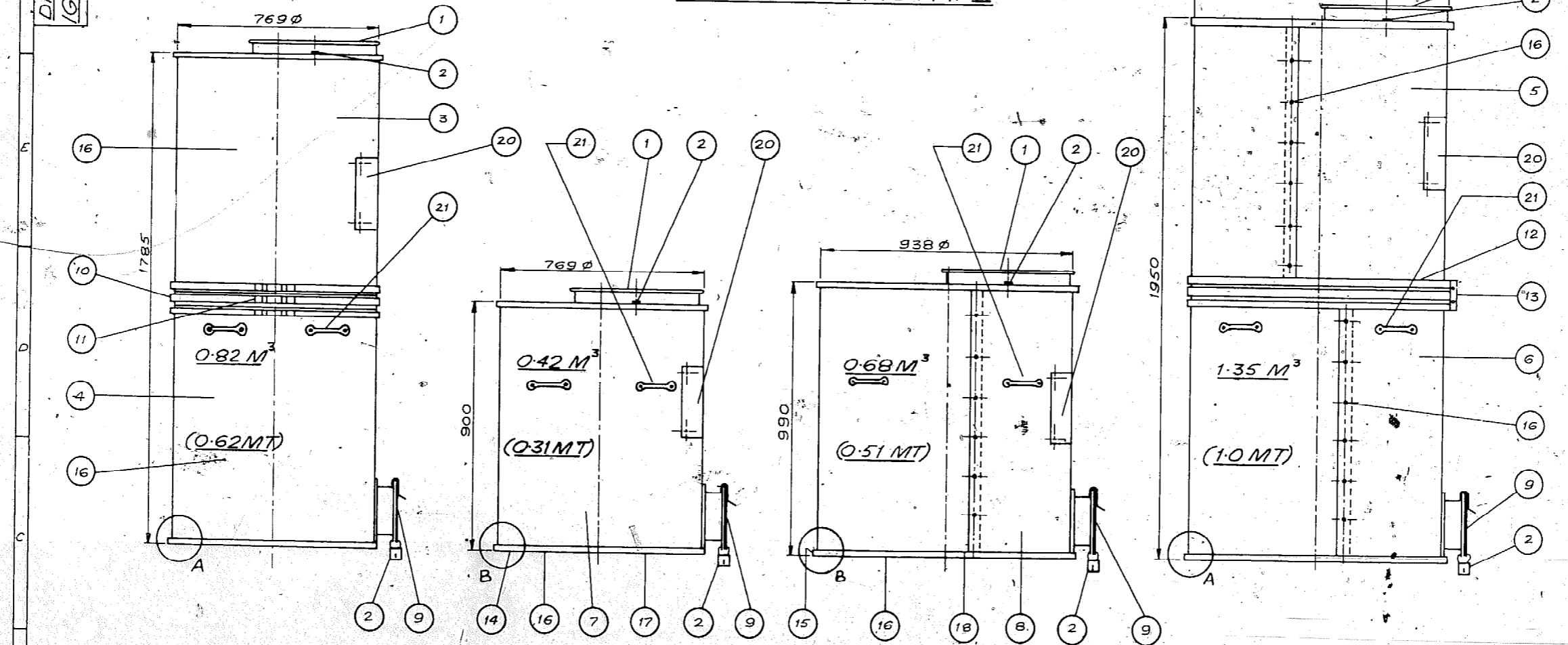

APPROX. CAPACITY IN METRIC TONS OF WHEAT AT 150 KG/M³ ARE SHOWN IN BRACKETS FOR EACH BIN

FOR SCHEDULE OF COMPONENTS REFER DRG. No. IGS1-71-211

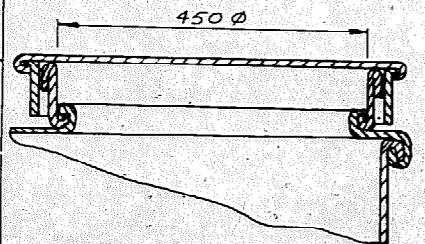

S. THROUGH INLET WITH COVER

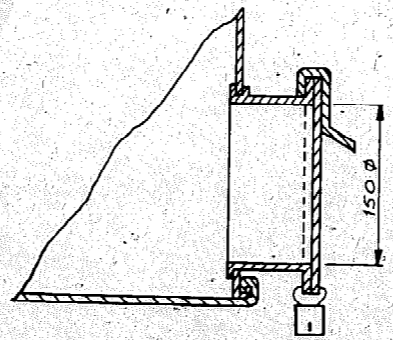

S. THROUGH OUTLET WITH COVER

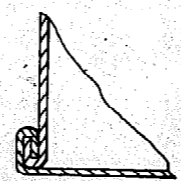

DETAIL AT 'A'

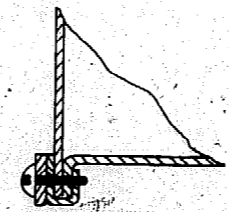

DETAIL AT 'B'

GHARELU KOTHI II

JOB No.	ALL DIMENSIONS ARE IN MILLIMETRES	
SCALE 1:10	DATE	INDIAN GRAIN STORAGE INSTT
DRN		HAPUR-U.P.-INDIA
CKD		TITLE:
APD		GENERAL ARRANGEMENT
		FOR DOMESTIC BIN TYPE
		II; 0.42, 0.68, 0.82, 1.35 M ³
		DRG. No. IGS1-71-202
APPROVED FOR GENERAL ISSUE	SIGNATURE	DATE

DRG. No. IGSI-71-210

DOMESTIC TYPE II BIN - GHARELU KOTHI II

SHEET OF

CONVERSION NECESSARY TO CONVERT TYPE I (INCLINED OUTLET & 225 ϕ INLET) TO TYPE II (HORIZONTAL OUTLET & 450 ϕ INLET).

1. CONSTRUCTION OF BIN WALLS - DETAILS SHOWN ON DRG. IGSI-71-109 ARE TO BE CLOSELY FOLLOWED WITH EXCEPTION THAT HOLE FOR OUTLET IS TO BE SET OUT AS FOLLOWS.

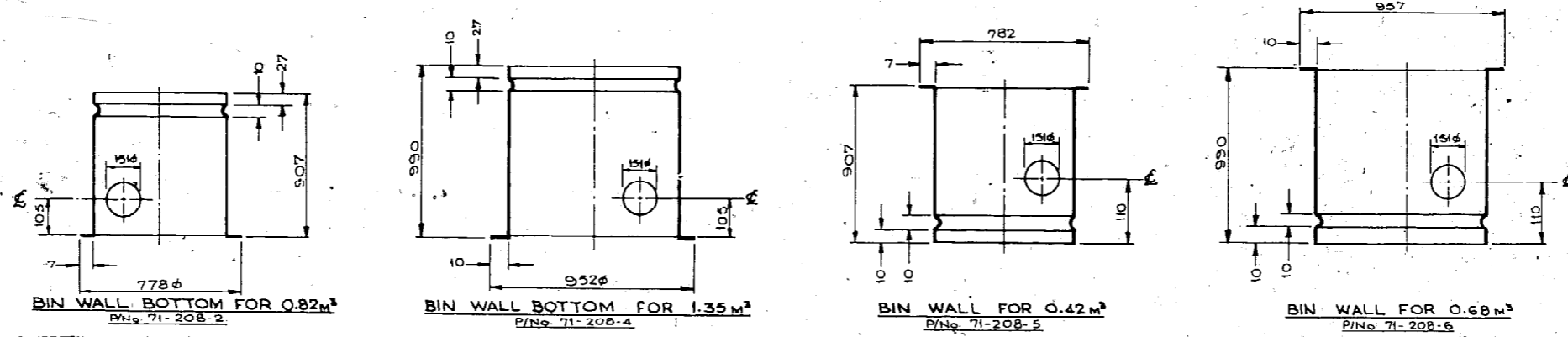

2a. CUTTING INLET - DETAILS SHOWN ON DRG. IGSI-71-107 ARE TO BE CLOSELY FOLLOWED WITH EXCEPTION AS FOLLOWS.

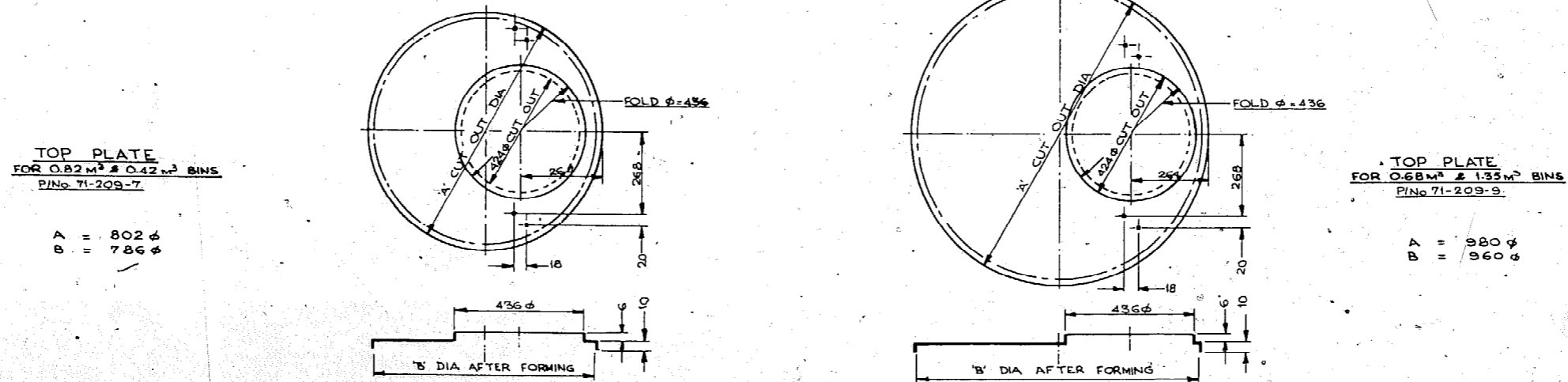

2b. ASSEMBLY - METHOD OF ASSEMBLY IS SAME FOR BOTH TYPES EXCEPT AS FOLLOWS (FITTING OF INLET P/No. 71-207-3)

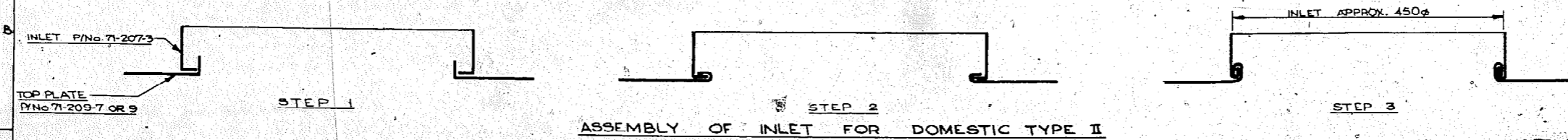

NOTE: THE ABOVE DETAILS ARE EXTRACTED FROM DRGS. IGSI-71-208 & IGSI-71-209 RESPECTIVELY.

GHARELU KOTHI II

JOB No.		ALL DIMENSIONS ARE IN MILLIMETRES.	
SCALE	DATE	INDIAN GRAIN STORAGE INSTITUTE	
DRN.		HAPUR, U.P. INDIA.	
CKD.		TITLE: DETAILS OF CONVERSION FOR DOMESTIC TYPE I TO DOMESTIC TYPE II 0.42, 0.68, 0.82 & 1.35 m ³	DRG. No.
APPD.			71-210
APPROVED FOR GENERAL ISSUE		SIGNATURE	DATE

DRG. No. 1651-71-203

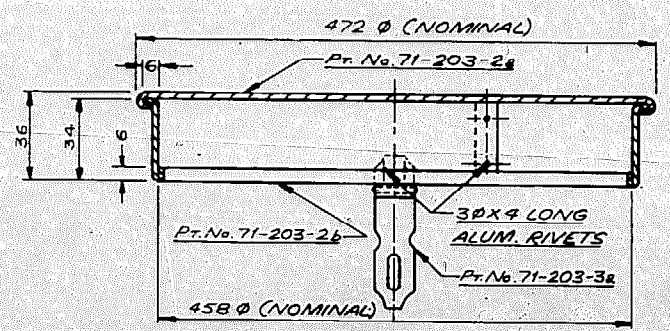
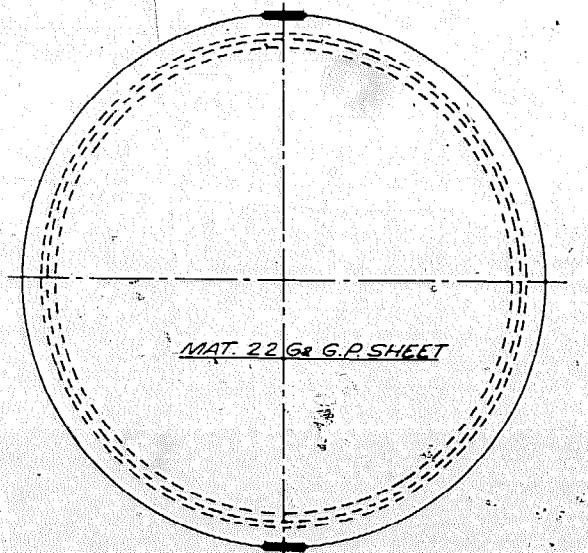
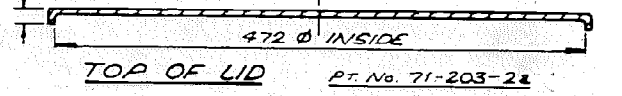
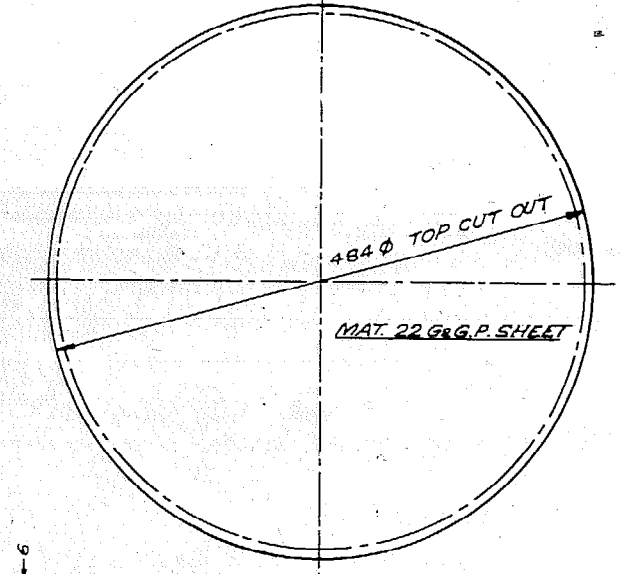

LID FOR INLET
Pt. No. 71-203-2

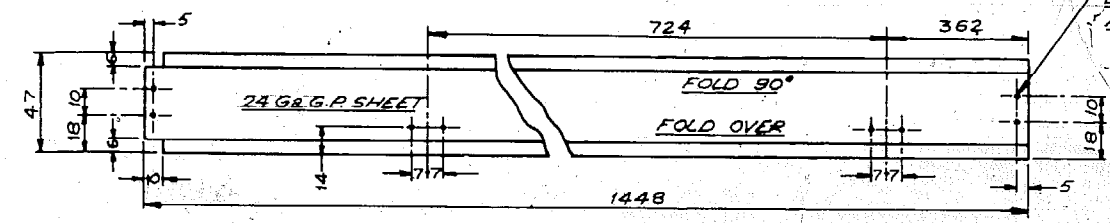

DEVELOPMENT OF SIDE OF LID
Pt. No. 71-203-2b

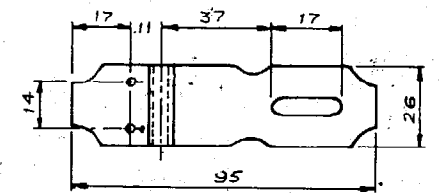

NOTE: IF DIFFERENT CLASPS ARE USED CARE MUST BE TAKEN TO MODIFY MOUNTING HOLES

NICKEL PLATED CLASP SET
Pt. No. 71-203-3a
Pt. No. 71-203-3

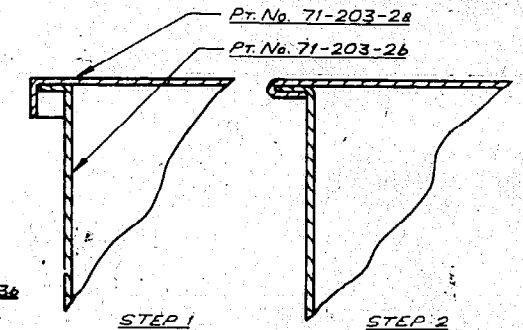
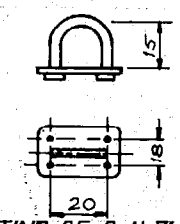

ASSEMBLY METHOD OF COVER

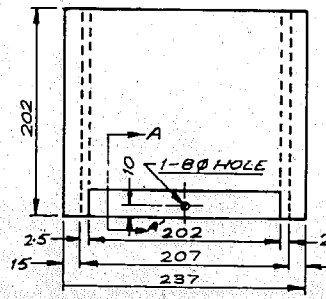

COVER AFTER FOLDING
Pt. No. 71-203-1a

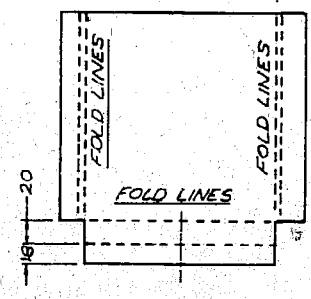

COVER BEFORE FOLDING

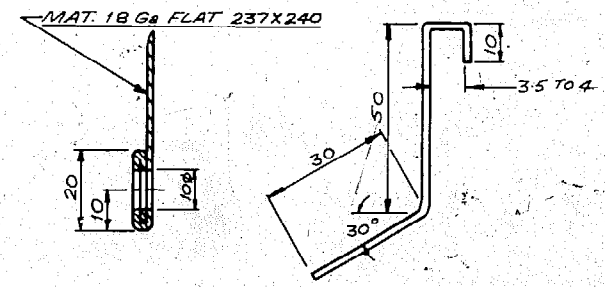

FOLDING OF HANDLE FOR COVER
Pt. No. 71-203-1b

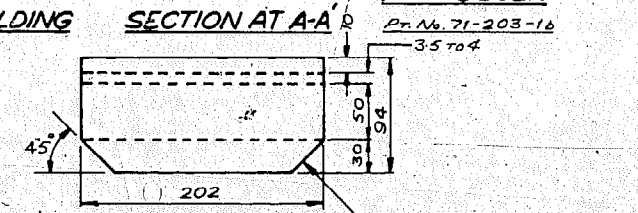

COVER HANDLE
Pt. No. 71-203-1b
REMOVE SHARP EDGES

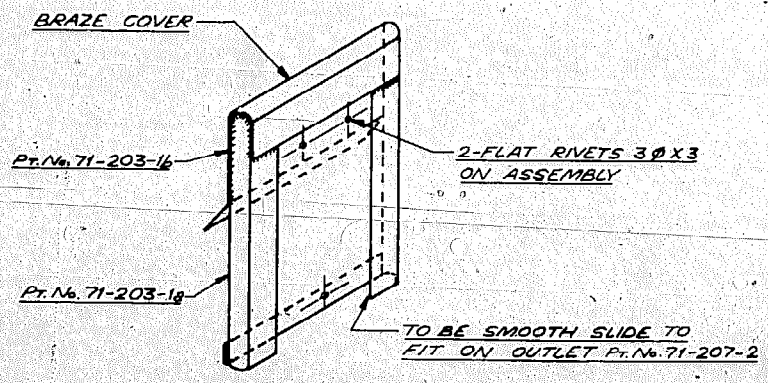

OUTLET COVER
MAT. 18 G&P S. Pt. No. 71-203-1

GHARELU KOTHI II

JOB No.	ALL DIMENSIONS ARE IN MILLIMETRES		
SCALE: NTS DATE	INDIAN GRAIN STORAGE INSTI. HAPUR-U.P.-INDIA		
DRN	6/2		
CKD			
APD			
TITLE	DOMESTIC BINTYPE II INLET & OUTLET COVERS	DRG. No.	1651-71-203
APPROVED FOR GENERAL ISSUE	DATE	SIGNATURE	DATE

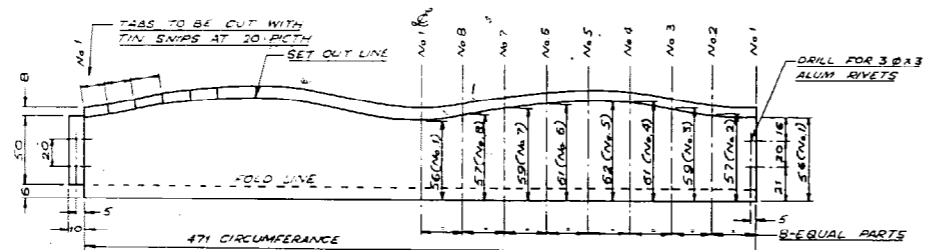

DEVELOPMENT VIEW OF OUTLET
FOR 0.69 M³ & 1.35 M³ DOMESTIC BIN
Pt. No. 71-207-1a

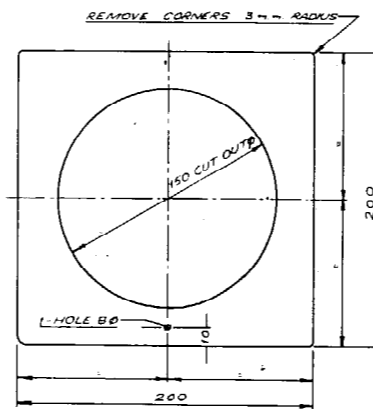

OUTLET FLANGE
Pt. No. 71-207-1b
MAT. 16 GA GALV. M.S. FLAT

NOTE:- THIS PLATE MUST BE
FLAT & TRUE

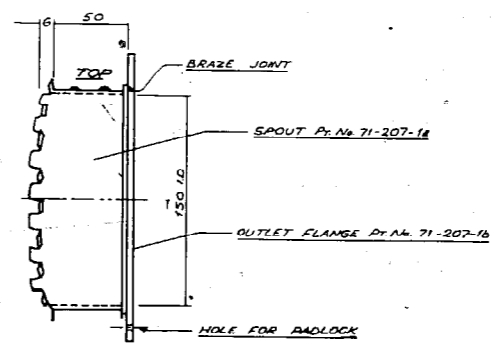

SIDE VIEW OF OUTLET
Pt. No. 71-207-1

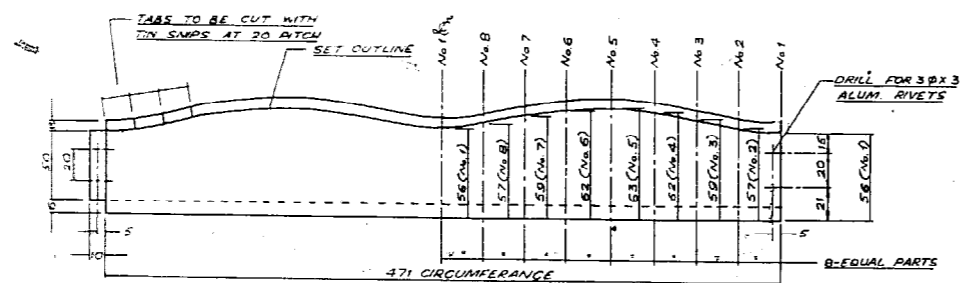

DEVELOPMENT VIEW OF OUTLET
FOR 0.42 M³ & 0.82 M³ DOMESTIC BIN
Pt. No. 71-207-2a

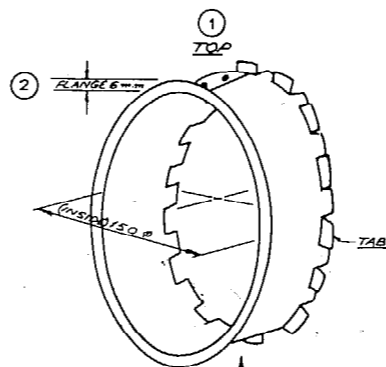

① AFTER FORMING INTO CYLINDER
TAKE OUT ALTERNATIVE TABS (RIVETED
JOINT WILL BE AT TOP) & ② TURN
FRONT FLANGE 6mm

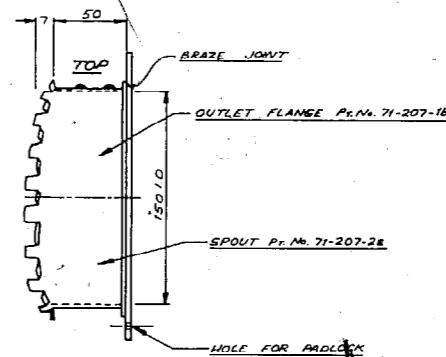

SIDE VIEW OF OUTLET
Pt. No. 71-207-2

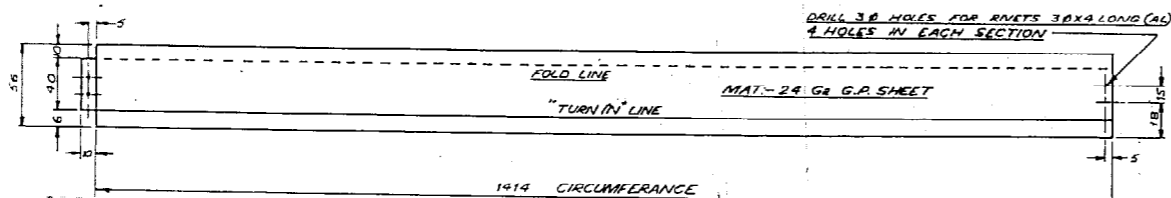

DEVELOPMENT VIEW OF INLET
FOR DOMESTIC BIN
Pt. No. 71-207-3
FOR ASSEMBLY REFER IGSI-71-209

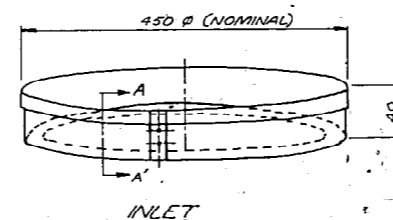

INLET

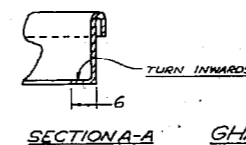

SECTION A-A

GHARELU KOTHI II	
JOB No	ALL DIMENSIONS ARE IN MILLIMETRES
SCALE	INDIAN GRAIN STORAGE INSTT.
DATE	HAPUR-U.P.-INDIA
DRN	
CHKD	
APD	TITLE
	DOMESTIC TYPE II BIN
	DRG. No.
	IGSI -
	DETAILS: INLET & OUTLET
	71-207
APPROVED FOR	
GENERAL ISSUE	

USER'S INSTRUCTIONS FOR DOMESTIC TYPE II BINS

① WHEN BUYING CHECK

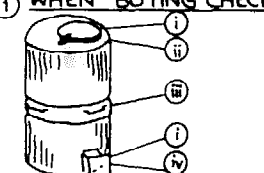

① LIDS FIT CORRECTLY.
② EDGES ARE NOT DAMAGED.
③ CENTRE CLAMP IS TIGHT.
④ JOINTS ARE WELL MADE.

② TRANSPORT GENTLY

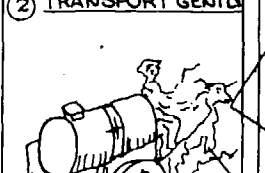

③ PLACE IN-DOOR UNDER COVER



④ LIFT BIN FROM FLOOR ON TIMBERS ABOUT 2"

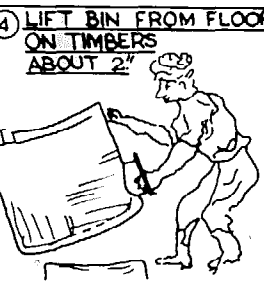

⑤ GRAIN TO BE STORED SHOULD BE.

- ① CLEAN.
- ② DRY.
- ③ NOT MIXED WITH OLD OR INFECTED GRAIN.
- ④ INSPECTED REGULARLY FOR INSECTS.

⑥ FUMIGATION

IF YOU FIND INSECTS IN YOUR GRAIN
FUMIGATE WITH E.D.S. AMPULES (if available)
OR
CONTACT YOUR BLOCK DEVELOPMENT OFFICER
FOR ASSISTANCE AND GUIDANCE.

DO

ALWAYS REPLACE LIDS

DO NOT

STORE MOIST GRAIN OR
MIX OLD AND NEW GRAIN.

PREPARED AT THE:
INDIAN GRAIN STORAGE INSTITUTE
HAPUR, U.P.

PROPOSAL USER'S INSTRUCTION SHEET. P/No. 71-206-1.

MATERIAL: MULTI COLOURED SCREEN PRINT
ON ALUMINIUM SHEET 26 GAUGE INSTRUCTION
SHEET TO BE RWETED TO FACE OF EACH BIN.

- NOTES:
1. INSTRUCTION SHEET TO BE TRANSLATED INTO REGIONAL LANGUAGE & PRESENTED TO MANUFACTURER FOR ATTACHMENT TO BIN.
 2. SKETCHES AND INSTRUCTIONS SHOWN ARE INDICATIVE ONLY.

GHARELU KOTHI II

JOB No.		ALL DIMENSIONS ARE IN MILLIMETRES.	
SCALE: 1:1	DATE	INDIAN GRAIN STORAGE INSTITUTE HAPUR, U.P. INDIA.	
DRN.		TITLE:	DRG. No.
CHKD.		DOMESTIC TYPE II BIN	IGSI
APPD.		USER'S INSTRUCTION SHEET	71-206
APPROVED FOR GENERAL ISSUE	SIGNATURE	DATE	