

AT MICROFICHE
REFERENCE
LIBRARY

A project of Volunteers in Asia

Farm Implements for Arid and Tropical Regions

by: H.J. Hopfen

Published by:

Food and Agriculture Organization of the
United Nations
Via delle Terme di Caracalla
00100 Rome
Italy

Paper copies are \$ 5.95.

Available from:

META Publications
P.O. Box 128
Marblemount, WA 98267 USA

Reproduced by permission of the Food and
Agriculture Organization of the United Nations.

Reproduction of this microfiche document in any
form is subject to the same restrictions as those
of the original document.

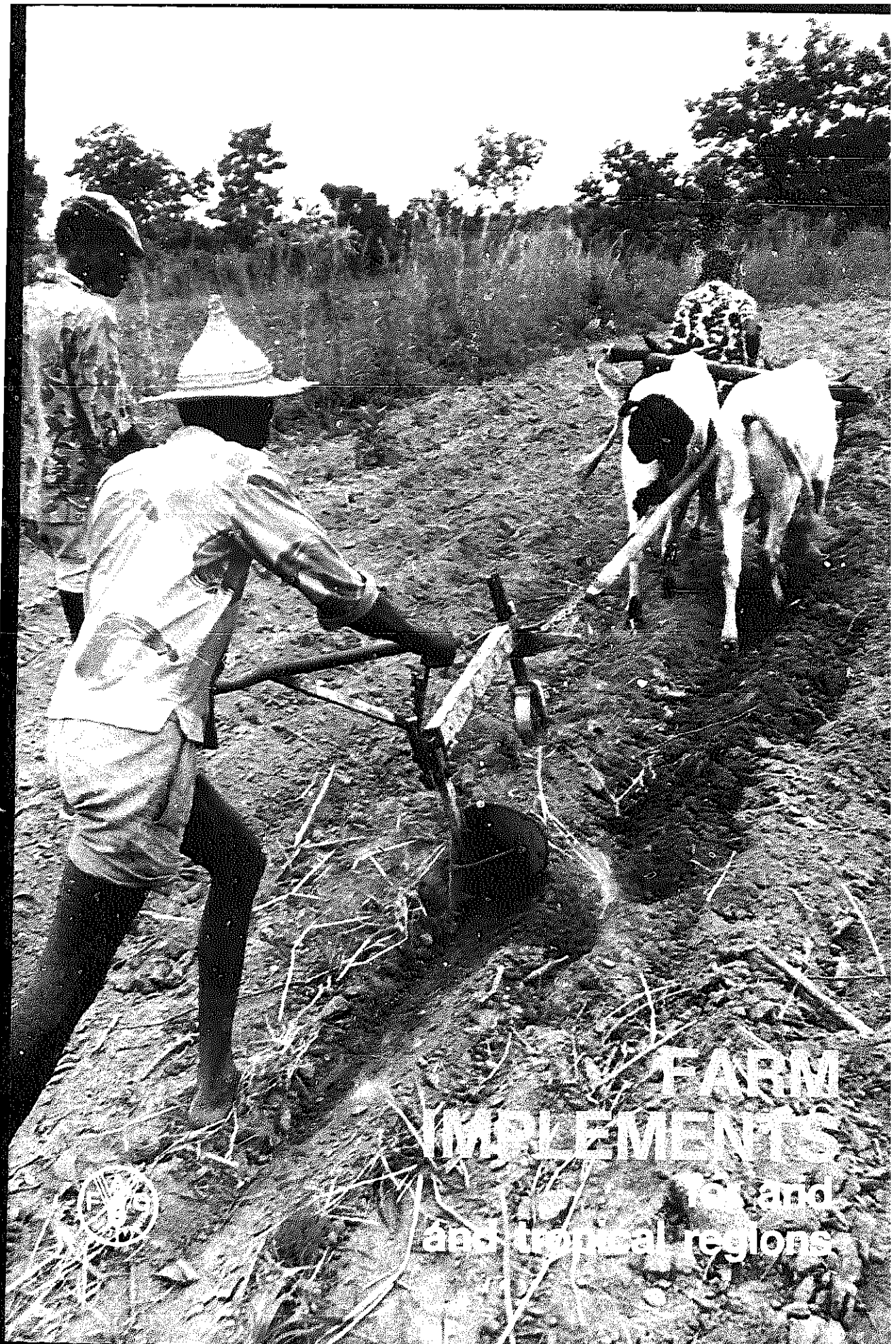

FARM
IMPLEMENT
FOR AND
TROPICAL REGIONS

FAO Agriculture Series
FAO Agricultural Development Paper

No. 13
No. 91

FARM IMPLEMENTS FOR ARID AND TROPICAL REGIONS

Revised Edition

Prepared by

H. J. HOPFEN

Consultant

Agricultural Engineering Service
Agricultural Services Division

FOOD AND AGRICULTURE ORGANIZATION OF THE UNITED NATIONS
Rome, 1969

First edition 1960
Revised edition 1969
Reprinted 1976, 1981

P-05
ISBN 92-5-101527-9

© FAO 1969

FOREWORD

This Agricultural Development Paper is a revised edition of the publication issued by the Food and Agriculture Organization of the United Nations (FAO) under the same title in 1960. It is one of a series of publications financed by generous contributions from the Swedish International Development Authority, through the Freedom from Hunger Campaign. FAO acknowledges with gratitude this further contribution, which has made it possible to produce this revised edition.

The author of both the original and revised edition, Mr. H. J. Hopfen, was for many years in charge of the farm implement work of the former Agricultural Engineering Branch of the Land and Water Development Division. Although there is a considerable amount of literature available in various parts of the world on farm tools and small-scale machinery, Mr. Hopfen has attempted to bring together in this paper a description of the more important hand tools and animal-drawn machinery suitable for arid and tropical regions in developing countries. In this task, he has been assisted by Mr. I. Constantinesco, of the Land and Water Development Division, to whom thanks are due for his contributions.

It is hoped that this revised publication will continue to be useful, particularly to extension workers and farm machinery specialists working with Member Government organizations, FAO and other technical assistance organizations throughout the world, where there is still a need to introduce better hand tools and simple farm implements.

A. D. FAUNCE
Chief, Agricultural Engineering Service

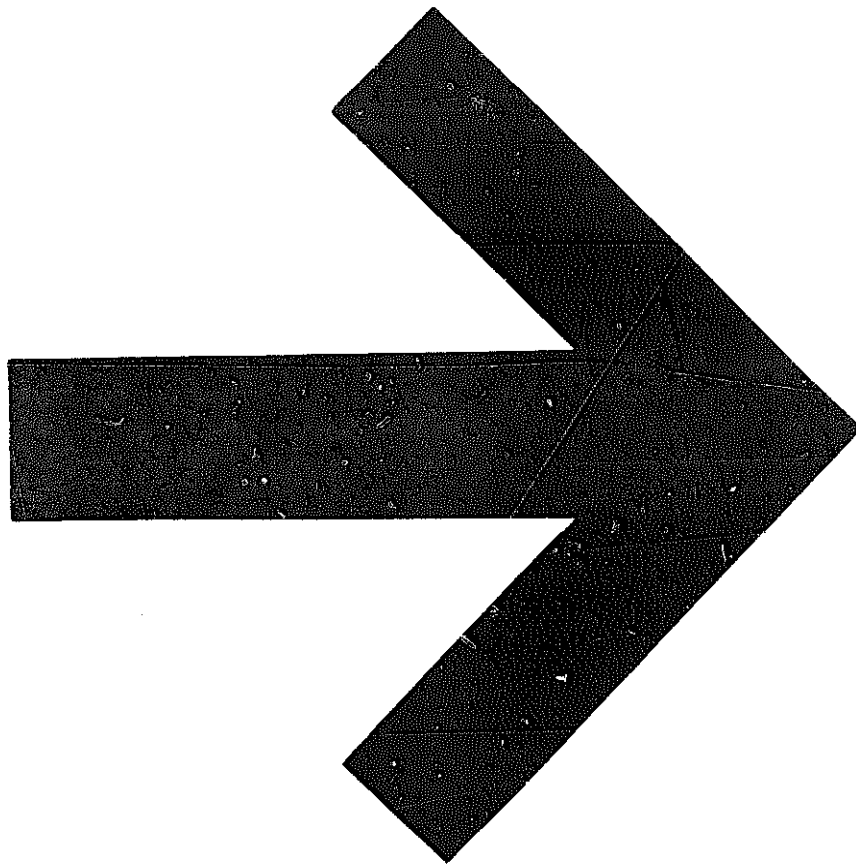

CONTENTS

Foreword	v
Introduction	1
1. Manpower and adaptation of implements to man	4
Man as a source of power	4
Adaptation of implements to man	5
2. Animal power and harness	7
Animal power in relation to the size of animals	9
Training and treatment of animals	11
Animal harness	13
3. General considerations on power machines for small-scale farming	28
4. General considerations on implements and their materials	32
Tool handles and grips	32
Connecting devices between working part and handle	35
Balancing and handling implements and tools	36
5. Tillage implements	40
Spades and digging hoes	40
Ploughs	44
Cultivators	63
Multipurpose implements	64

6. Machinery for seedbed preparation, earth moving and fertilizer spreading	68
Hand-operated implements	68
Animal-drawn harrows	70
Earth-moving equipment	74
Fertilizer distributors	80
7. Sowing and planting machines	81
Broadcast seeding	81
Seed drilling	82
Planting seeds and seedlings	89
8. Implements for intercultivation	91
Hand tools	91
Animal-drawn implements for intercultivation	96
9. Plant protection machines	98
Sprayers	98
Dusters	100
10. Harvesting tools and machines	101
Sickle	101
Scythette	104
Scythe	104
Paddy knife	115
Weed cutters	117
Animal-drawn mower	117
Mower for harvesting cereals	118
Reaper	118
Binder	118
Cutting implements for plantations	119
Potato diggers	120
Sugar-beet harvesting implements	122
Maize harvesting tools and implements	123

11. Threshing machinery	124
Simple threshing methods	124
Threshing sleds	124
Threshing rollers	124
Pedal-operated drum threshers	125
Hand-operated drum threshers	127
Straw bruising and chaff cutters	127
Hand-operated maize shellers	128
Groundnut sheller	129
12. Winnowing machines	130
Winnowing baskets	130
Winnowing sieves	131
Winnowing fan	131
Fanning mill	132
13. Handling and transportation equipment	133
Forks	133
Tedders	135
Rakes	135
Hay loaders	136
Drying stands for forage crops	136
Binding materials	136
Containers	136
Transportation by carrying	137
Transport on sleds	138
Transport on wheels	139
Hand pumps	142
14. Workshop equipment	144
Selected references	147
Conversion tables	151

LIST OF ILLUSTRATIONS

Figure

1. Working positions	6
2. Double neck yokes	12
3. Double neck yokes from Italy	13
4. Yoke harnessing	15
5. Double neck yoke with pads and collars; type used in Iraq and Syria	16
6. Double neck yoke with collars; type used in Portugal ..	16
7. Double head yoke; Spanish type used with strong short-necked cattle	17
8. Double head yoke; when used on long-necked cattle does not fully utilize their strength (Chile)	17
9. Belly yoke from Morocco	18
10. Single neck yoke with rope traces and swingletree for buffalo, Malaysian type	18
11. Single neck yoke with rope traces and swingletree, Chinese type (Kiangsi, southern Mainland China)	19
12. Single neck yoke, Swiss type	20
13. Swingletrees	21
14. Head yokes for single animals	21
15. Collar harness for horses and mules	23
16. The three-pad collar harness for cattle	25
17. Breastband harness	26
18. Animal power gear	27
19. Tempering a hoe	33
20. Handle tops	34
21. Connecting devices	36
22. Hang of a fork	37
23. Setting an implement	38

Figure

24. Right-hand and left-hand work with hand tools	38
25. Long-handled spades	41
26. Short-handled spade (a) and spading fork (b)	42
27. Testing a steel blade	42
28. Deep spading by a team of three men	43
29. Digging and chopping hoes	44
30. Digging and chopping hoes	45
31. Digging hooks	45
32. Beam ards	46
33. Body ards	48
34. Sole ards	50
35. Triangular and quadrangular ards	51
36. Ard shares	53
37. Ard from north Mainland China	55
38. Chinese ploughs	56
39. Chinese farmer carrying plough and single neck yoke	57
40. Japanese ploughs	58
41. Detail of simplified Japanese plough body construction ..	59
42. Kedah plough (Malaysia) with improved share design	59
43. Historical evolution of the western plough	60
44. Western mouldboard plough	60
45. Turn-wrest plough with wooden beam	61
46. Western reversible plough	61
47. Hand-drawn reversible plough	62
48. Improved multipurpose ard	63
49. Animal-drawn cultivator for primary and secondary tillage	64
50. Light multipurpose implement	65
51. Multipurpose implement	66
52. Unibar	66
53. Hand tools for cultivation	69
54. Spike-tooth harrows	69
55. Flexible harrow	70
56. Peg-tooth or comb harrow, Chinese type	71
57. Blade harrow	72
58. Rotary harrows	73
59. Hoe-like shovels	74
60. Common types of shovels	75

Figure

61. Two-man shovel and its animal-drawn version, the shovel board	76
62. Work with the two-man shovel	77
63. Ridger plough	78
64. Animal-drawn earth scoop	79
65. Bund former (India)	79
66. Distribution of fertilizers with hand shovel	79
67. Indian four-row seed drill (<i>goru</i>)	83
68. Ceylonese six-row hand seeder for rice	83
69. Chinese two-row seed drill	85
70. Chinese three-row seed drill at work, followed by press rollers	86
71. One-row hand drills, pushed types	87
72. Four-row seed drill for seeding under dryland conditions .	87
73. Seed planter with interchangeable seed plates and stars for different seeds	88
74. Italian maize planter for seeding by hand in an erect position	88
75. Chopping and pulling hoes	92
76. Pulling hoes	92
77. Chinese pulling hoe	93
78. Sugar-beet thinner	93
79. Pushing and pushing/pulling hoes	94
80. Japanese rice weeder, one-row type, hand pushed	95
81. Expandable horse hoe	96
82. Sprayers and dusters	99
83. Smooth-edged sickles	102
84. Farmer from Terjil, near Kirkuk, Iraq, with reaping sickle and finger guards	103
85. Grain reaping with scythette	103
86. Scythe blades	105
87. Scythe snaths	106
88. Scythe rings	108
89. Chinese cradle from northern Anhwei, Mainland China ..	109
90. Hammer (<i>a</i>) and anvil (<i>b</i>) for scythe hammering; (<i>c</i>) whetstone in container	110
91. Farmer hammering a scythe blade	110
92. Scythe-hammering apparatus	111

Figure

93. Scythe whetting	111
94. Grass mowing	113
95. Reaping against the standing crop	114
96. Reaping away from the standing crop	116
97. Weed and brush cutter with serrated double-edged blade	117
98. Matchets	119
99. Potato digger	120
100. Animal-drawn potato digging plough	121
101. Hand tools for beet harvesting	121
102. Simple threshing devices	125
103. Olpad thresher	126
104. Japanese rice thresher	126
105. Sectional view of drum thresher	126
106. Chinese straw cutter (Shansi Province, Mainland China) ..	127
107. Simple maize sheller	127
108. Simple groundnut sheller	128
109. Sectional view of winnower	131
110. Forks	134
111. Rakes	134
112. Sheaf binding with woolder	134
113. Carrying aids	137
114. Wooden transport sled from Amelia, Italy	139
115. Chinese wheelbarrow	140
116. Italian farm cart (Orte, Italy)	141
117. Italian farm cart	141
118. Sectional view of force pump	143
119. Sectional view of diaphragm pump	143
120. Workshop tools	145

INTRODUCTION

The rapid development of engine-powered agricultural machinery, with its increasing ease in use and adaptation to an ever-widening range of operations, sometimes raises the question whether nonmotorized farm implements are still necessary.

Historically, the emergence of new farming methods in response to the need of growing populations for more food did not supplant existing systems of food production. Thus, the earliest hunter and shepherd stage survives in the desert nomads and modern range farmers of today. The succeeding planting stage, with tree-protected shifting cultivation, persists unchanged in many tropical rainfed areas; it has also developed into horticulture and market gardening in semiarid and temperate zones. The last stage, field crop farming, developed ultimately as highly specialized, uniform crop farming on large areas with powered machinery and chemical methods and has not displaced either of the earlier methods of production.

Each stage came into existence to meet new demands. At the same time the older ones continued to develop. Agriculture is so diversified and so flexible by nature that abundant production can be secured from a variety of systems. The motorization of agriculture will, therefore, not render man- and animal-powered methods superfluous; there is scope for the development of all of them.

Despite the great progress of motorized power in agriculture, manual workers and draught animals will still continue to provide the main source of power for the farmers of many regions where the use of tractors and tractor equipment does not yet pay for itself. One should not forget that the use of power machinery can only be afforded where the farming system provides sufficient cash income to pay for its purchase, operation, maintenance, repair and depreciation. The necessary income can only materialize through increased returns or decreased operating costs in conjunction

with accessible markets for salable products. The advance of motorization can also be delayed when the size of farms is small and the layout of fields is irregular and where there is an abundance of underemployed labour. Other inhibiting factors are insufficient mechanical skill accompanied by a lack of training, maintenance and repair facilities.

Under these conditions the improvement of hand- and animal-operated farm implements is of great importance as it is one of the first steps that can be taken to raise crop yields and the farm income. Unfortunately this is not always recognized and the view is sometimes held that power and speed, being striking expressions of technical advance, make for progress even where they do not justify the expense involved or satisfy any particular needs other than prestige.

It is stressed therefore that, in areas where agriculture will continue to depend for many years mainly on hand and animal power, significant improvements in production can often be obtained by the introduction of better small farm implements and machines. The capital investments required are small but they lead to a strengthening of the farm economy and fuller employment of the rural labour force and the creation of that capital so much needed for larger investments, eventually in more developed forms of mechanization and organization.

A great variety of implements has been developed indigenously all over the world, reflecting the experience handed down for many generations. Frequently, however, they may be rather primitive due to the lack of adequate materials or facilities for construction. In addition, the development of farm implements has often been limited by other factors such as weak draught animals, unsuitable plant varieties, soil or climatic conditions. Both the experience available and the limitations which determine the construction of local farm implements should be studied carefully in order to remove, wherever possible, the main obstacles to their further development. Thus, for example, it is often necessary to combine the improvement of farm implements with measures to increase the strength of draught animals and to grow crops which respond to improved cultural practices. It may also be necessary to instruct local craftsmen in better manufacturing techniques and to seek sources from which suitable raw materials can be obtained.

Research and extension workers undertaking programmes for the introduction and improvement of hand- and animal-powered farm implements should stress that it is not a sign of lack of progress to use improved simple implements under conditions where expensive power machines

cannot be successful. It should be noted also that "simple" is not synonymous with "primitive." Simplicity of design and operation is often the most desirable characteristic in any equipment.

The following points should be borne in mind when attempting to improve tools and implements. These should be:

- (a) adapted to allow efficient and speedy work with the minimum of fatigue;
- (b) not injurious to man or animal;
- (c) of simple design, so that they can be made locally;
- (d) light in weight for easy transportation;
- (e) ready for immediate use without loss of time for preparatory adjustments;
- (f) made of easily available materials.

In conclusion, it should be noted that while a publication of this size cannot be exhaustive it aims to show how improvements in output can be obtained in areas where it is most needed. It is in fact oriented toward dry-farming tools, rice-growing implements and those used for row crop planting in tropical areas. The implements discussed are not necessarily representative of those found in all areas, but have been chosen because they are common in certain countries; some show how simple modifications can be made to improve performance; others provide examples of the more effective types which have been developed and which could profitably be introduced into areas where they are unknown.

Work of this kind has the best chance for success when there is a full appreciation of local conditions and traditions before and during the process of introducing new ideas and improvements on the old ones.

1. MANPOWER AND ADAPTATION OF IMPLEMENTS TO MAN

Man as a source of power

When man is regarded as a source of power for operating implements, his strength and intellectual faculties must be considered as an indivisible whole enabling him to think and act simultaneously. Thus, his capacity to perform work requiring either a rapid succession of quick actions or particular skills without any great effort constitutes an unequalled advantage over other sources of power. This explains why even today on motorized holdings, man still spends two thirds to three quarters of his working time with hand implements. Of course, the length of time spent is hardly commensurate with the amount of work accomplished, but it shows how important hand implements are, not only in developing but also in highly industrialized countries.

A man normally works at a rate of 7 to 10 kgm/s (kilogramme-metres per second),¹ varying from 5 kg at 1.1 m/s (metres per second) with a crankshaft to 64 kg at 0.15 m/s when treading a water ladder with his own weight. Working continuously he produces about 8 kgm/s or roughly 0.1 HP. For short periods he can develop 0.4 HP. The average force a man can exert is equal to about one tenth of his own weight. If several men work together in a line, the power output per man slightly decreases as it is determined by the slowest worker in the row.

A man exerts his physical strength either directly by walking, pushing, pulling, pressing, lifting, carrying, throwing, or indirectly by means of tools which transmit and increase his manual skill in innumerable ways.

¹ See conversion tables.

Adaptation of implements to man

Man is capable of a great variety of natural movements; the more the work with an implement follows his natural movements with regard to direction, speed and frequency, the healthier and less tired he will be. Work requiring the use of only a few muscles causes fatigue sooner than work engaging various parts of the body and various muscles in each part. The more the movements are changed to allow the use of alternative muscles for the work the less fatiguing it will be. So implements should be shaped to obtain:

- (a) working motions which follow man's most natural movements in direction, speed and frequency as closely as possible;
- (b) the use of as many muscles as possible to diminish the load on each single muscle;
- (c) a variety of working motions, engaging different muscles in alternating sequence.

Comparative studies with different types of implements have shown how much, for instance, the shape of a handle is apt to affect the working capacity of an operator, the ease of his work and his health. For example, the results of investigations have led to the use of suitable synthetic materials for handles which become soft when heated to 60 °C, taking the counter-shape of the operator's hand and maintaining it after the temperature has decreased. Handles so shaped have led to better performance. The adaptation of an implement to the operator is at least as important as its adaptation to the task to be performed; it is not only necessary for the preservation of the operator's health but also for greater working capacity.

Damage to health by unsuitable implements generally becomes apparent only after their sole and excessive use over long periods. The constant use of digging hoes can lead to permanent abnormal curvature of the spine and, in juveniles, may arrest their development. The use of digging hoes with very short handles causes pressure on the chest and may lead to respiratory troubles. Similar deformations and troubles may result from the constant use of other implements, particularly when the operator is obliged to work in an uncomfortable position.

As work in a bending position is particularly arduous for most people of Indo-European and Mongolian origin, the tendency for them has been to develop hand tools with long instead of short handles, making it possible



FIGURE 1. - Working positions: (a) erect position, more comfortable in temperate zones; farmer reaping grain with the scythe to which a grain-laying cradle is attached; (b) squatting position, more comfortable for many farmers in hot climates; farmer reaping grain with a sickle.

to work standing up (Figure 1[a]). However, this does not appear to be the most comfortable position for all people; the inhabitants of tropical or subtropical areas prefer to work in a squatting position (Figure 1[b]). The reason for this is not known, but it may perhaps be that in hot climates there is more protection from the sun's rays when crouching. Whatever the reason, this fact has to be taken into account when improvements are undertaken among people accustomed to working in a squatting position.

Recent investigations have shown that work with hand- and animal-operated implements is less likely to upset the workman's health than motorized machines.

2. ANIMAL POWER AND HARNESS

Power needs in agriculture have grown rapidly in the world during the past 15 years. More power, timely power and greater speed are required to cope with the opportunities for increased food and cash crop production offered by high-yielding varieties, fertilizers, double cropping and other modern farming techniques. This has led to an increase in both animal and engine power in Asia, Latin America and Africa and to an increase in engine power alone in North America, Europe and Oceania.

An attempt has been made in Table 1 to assemble data and estimates available for a number of selected countries on the use of animal power for Asia, Latin America and Africa and to compare these with the other sources of power used in relation to cereal production. The table illustrates that animal power continues to maintain its overwhelming importance in the Far East (except in Japan). As much as about 98 percent of the total available agricultural power in China (Mainland), India, Indonesia, Korea and the Philippines is derived from animals. Animals as a source of power are still very important in Latin America also (except in Argentina and Cuba). Furthermore their use in those parts of Africa where field work is done mainly by manual labour holds great potential.

Among draught animals, oxen (including buffaloes) outnumber horses; mules are important, while camels and donkeys, used in North and Central African countries also for pulling ploughs and carts, are normally more suitable for carrying loads.

The idea of using domestic animals for draught power in agriculture appears to have been conceived originally by the Sumerians when they were faced with the need to increase food production for the expanding population. Oxen (including buffaloes) are the main source of animal power in South and East Asia and in the United Arab Republic. Draught oxen are also important in parts of Latin America, particularly in Brazil

TABLE 1. - ANIMAL POWER AND TRACTORS, AND THE PRODUCTION OF CEREALS IN ASIA, LATIN AMERICA AND AFRICA (see also Table 5)

Countries	Horses		Draught oxen (including buffaloes) ¹	Tractors		Garden tractors	Cereal area ²		Cereal production ³	
	1948- 52	1966		1948- 52	1966		1948- 52	1966	1948- 52	1966
ASIA	.. Million heads Million units Million hectares		.. Million tons				
Burma	3.0	4.0	5.0	5.6	6.8	
Ceylon	0.5	0.4	0.6	0.5	1.0	
China (Mainland) ..	5.5	7.6	60.0	99.7	111.2	113.5	176.6	
India	1.5	1.3	78.0	78.4	93.5	56.1	80.3	
Indonesia	0.6	0.9	5.0	8.1	10.9	11.3	17.0	
Iran	0.4	0.5	2.5	3.2	5.8	3.1	5.1	
Japan	1.1	0.2	⁴ 1.5	...	2.6	5.0	4.2	16.5	18.9	
Pakistan	0.5	0.5	19.0	15.3	17.9	17.2	21.7	
Philippines	0.2	0.3	2.0	3.3	5.2	3.5	5.6	
Thailand	0.2	0.2	5.0	5.2	7.4	6.0	10.2	
Turkey	1.1	1.2	4.0	...	0.1	8.5	12.9	9.1	16.5	
Other countries ⁴ ..	0.6	1.0	9.5	...	0.2	19.4	25.5	25.1	42.6	
Asia total	11.7	13.7	190.0	...	0.3	2.6	250.5	300.1	267.5	402.3
LATIN AMERICA										
Argentina	7.3	3.8	...	0.1	0.2	...	8.5	11.1	10.3	17.3
Brazil	6.9	9.3	0.1	...	7.2	13.5	9.3	17.9
Chile	0.5	0.5	1.0	1.0	1.2	1.8
Colombia	1.2	1.0	1.0	1.5	1.2	1.7
Mexico	3.0	5.1	0.1	...	5.1	9.1	4.0	12.0
Peru	0.5	1.1	0.6	0.8	0.9	1.3
Other countries ⁴ ..	3.4	3.4	0.1	...	4.7	6.3	4.4	6.4
Latin America total	22.8	24.2	...	0.1	0.5	...	28.1	43.3	31.3	58.4
AFRICA										
Algeria	0.2	0.4	3.0	1.9	2.0	1.0
Ethiopia	1.0	1.4	4.9	7.0	2.7	4.9
Morocco	0.2	0.3	4.1	4.0	2.7	1.6
Nigeria	0.3	0.4	8.6	11.8	5.3	8.3
South Africa	0.7	0.5	3.0	...	0.2	...	5.0	6.8	3.5	6.1
Sudan	—	—	1.2	2.0	0.8	1.2
Tanzania	1.4	2.5	1.0	2.4
United Arab Rep.	0.1	1.5	1.8	2.0	4.1	6.9
Other countries ⁴ ..	0.7	0.6	0.1	...	18.7	23.5	11.8	18.2
Africa total	3.1	3.7	...	0.1	0.3	...	48.7	61.5	33.9	50.6
TOTAL	37.6	41.6	...	0.2	1.1	2.6	327.3	404.9	332.7	511.3
Europe, U.S.S.R., North America and Oceania ..	39.9	20.9	...	5.8	12.8	1.6	283.1	283.1	358.1	576.2
WORLD TOTAL	77.5	62.5	...	6.0	13.9	4.2	610.4	688.0	690.8	1 087.5

¹ Rough estimates (except for India, Pakistan, Ceylon, Japan which are derived from census figures). The term draught oxen is used for both male oxen and cows. - ² Cereals include: wheat, rye, barley, oats, maize, millet, sorghum, rice (paddy), mixed grains, buckwheat and miscellaneous cereals. - ³ Draught oxen only (draught buffaloes not used). - ⁴ Includes abovementioned countries with figures below 50 000 units.

and Mexico, and in some parts of Africa, particularly Ethiopia. In Europe oxen have lost their former importance as a significant source of power except in a few southeastern areas. Horses are the main source of animal power in Chile; they are also important in Brazil and Mexico, but their importance is, on the whole, diminishing throughout the world.

Mules are much used in mountainous areas of the Near East and Mediterranean countries. Donkeys are the typical pack animals used from Ethiopia, throughout the Mediterranean regions, to west India and China (Mainland). Camels are used for transport in the deserts and arid zones from West Africa to China (Mainland).

Animals either carry or pull loads, pulling being best suited to them. Animal draught can also be converted into rotary power to operate pumps and other machines, and can be used for field puddling and threshing grain by trampling.

Of course the advance of motorized power has had a marked effect on the use of animal power and this trend will continue. It will be used to an increasing extent for heavy work. For small-scale farming, however, where one or two animals can meet the normal power requirements for the operations necessary, draught animals will continue to be valuable and economical in a number of developing countries for many years to come.

Animal power in relation to the size of animals

Animals are a relatively cheap source of power if raised by the farmer himself, particularly if they also provide other services such as milk, meat, manure and hides.

Normally the pulling power of an animal is directly proportional to its weight and corresponds very roughly to one tenth of it. Horses have a higher output than other animals in relation to weight (approximately 15 percent) and for short periods they can produce a force equal to nearly half their own weight.

Small animals develop, comparatively, rather more power than the larger members of the same species. While heavy animals work mainly with their weight, relatively light animals, particularly small horses, substitute this lack of weight by nerve, tenacity and endurance. The relative draught efficiency of smaller animals is better because their line of pull is lower; i.e., the more acute the angle of pull can be made with the ground, the less will be the power required to pull the implement behind.

TABLE 2. - NORMAL DRAUGHT POWER OF VARIOUS ANIMALS

Animal	Average weight	Approximate draught	Average speed of work	Power developed	
 Kg Kg M/s Kg/s HP ..
Light horses	400-700	60-80	1.0	75	1.00
Bullocks	500-900	60-80	0.6-0.85	56	0.75
Buffaloes	400-900	50-80	0.8-0.9	55	0.75
Cows	400-600	50-60	0.7	35	0.45
Mules	350-500	50-60	0.9-1.0	52	0.70
Donkeys	200-300	30-40	0.7	25	0.35

Investigations carried out in the Federal Republic of Germany on the draught power output of different animals in relation to requirements for normal farm tasks showed that small horses (470 kg weight and 137 cm high at the withers) are relatively superior to heavy horses with regard to speed and total work performance, and that the draught oxen from mountain areas are stronger than those from the plains. Table 3 summarizes the maximum drawbar pull obtained in these tests.

A comparison of Table 3 with Table 4 shows that pairs of small light horses and draught oxen provide enough pulling power for most of the work required under small farming conditions. For many operations even single animals will suffice to do the work if kept in good condition. For example in Japan, farming operations, including ploughing, in the past were almost exclusively carried out with single animals. In other regions, however, draught animals do not always match up to the standards set forth in Table 2. The reasons for this vary, but in some cases are due to lack of proper care and feeding of the animals, or to unsuitable breeds or harness.

TABLE 3. - RESULTS OF DRAWBAR TESTS WITH VARIOUS ANIMALS

Animals	Maximum drawbar pull expressed in kilogrammes	
	Two hours of work	Four hours of work
 Kg	
Heavy horses	260-290	240-270
Light horses	180	160
Mountain oxen (draught cows) ..	160-170	140-150
Oxen from the plains (draught cows)	140-150	120

The period during which animals can be used for daily work varies from eight hours and more for horses and mules, six to eight hours for male oxen, and from two to three hours for cows.

TABLE 4. - DRAUGHT REQUIREMENTS OF SOME FARM IMPLEMENTS FOR OPERATIONS ON MEDIUM LOAM SOILS

Operation	Draught requirement
	<i>Kg</i>
Ploughing fallow land with single mouldboard	
11.4 cm wide, 12.7 cm deep	89
14.0 cm wide, 12.7 cm deep	94
16.5 cm wide, 15.2 cm deep	121
25.0 cm wide, 18.0 cm deep	170
Ploughing fallow land with double mouldboard	
30 cm wide, 5.5 cm deep	116
Harrowing ploughed soil	
18-tine peg tooth harrow, 6.3 cm deep	46
5 spring tines, 11.4 cm deep	118
heavy harrowing 165-320 cm wide	80-100
light harrowing 320 cm wide	90
Levelling ploughed soil with a 180-cm-long board ridden by a person of 53 kg weight	90
Rolling	96
Cultivating, 3-tine cultivator, 9 cm deep	53
Seed drilling, 175-200 cm wide, 11-13 openers	90
Wheeled transport of loads up to 1 metric ton on average farm roads	90-120

Training and treatment of animals

The successful use of animals for draught purposes depends on how they are tamed, trained and harnessed. Because of the widespread use of double yoke harness in most countries of the Near and Far East, Africa and Latin America, draught animals are used in pairs. The use of single animals for most work, ploughing included, is practised in China (Mainland and Taiwan), Japan and a few southeast Asian countries where single animal harness with rope traces have been developed.

There are therefore, considerable differences in the way animals are harnessed and guided in various countries. In some regions the harness is used mainly to control the animals and only secondarily to transmit power, with the result that the power output is lower than it could be.

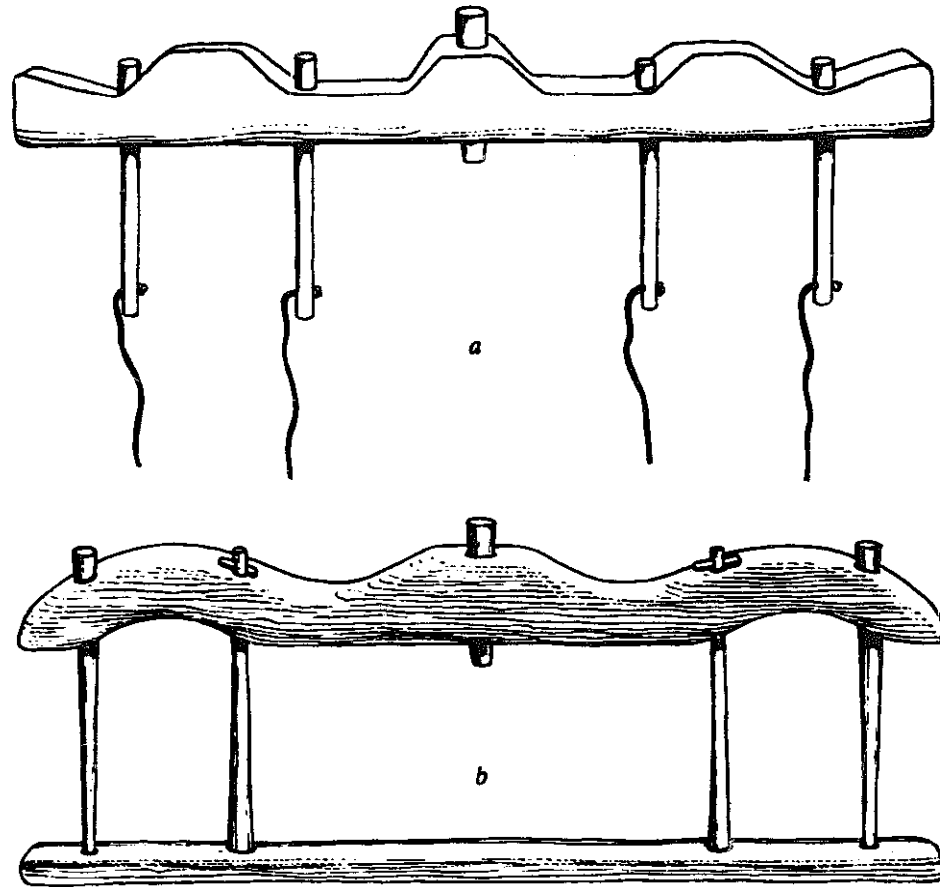

FIGURE 2. - Double neck yokes: (a) Afghan type; (b) Pakistan type.

In other regions the harness is used chiefly for the transmission of power, the animals being steered by simple devices, in some cases only by oral directions.

Horses and cattle are generally trained for draught purposes at about one and a half to two years of age. They are first made accustomed to wearing harness, then to pulling very light weights at a quick pace, side by side with a familiar, well-trained older animal. The loads are increased gradually to avoid any slowing down of the pace. Once trained, the animals have to be kept in training to maintain their strength and skill. Calmness and patience, firmness and consistency are essential attributes for those people who deal with animals.

Animal harness

The power output of an animal is decisively influenced by its harness and the way the implement is attached to it. Hence harness improvement could, in many cases, lead to an increase in the quantity of work done and its quality.

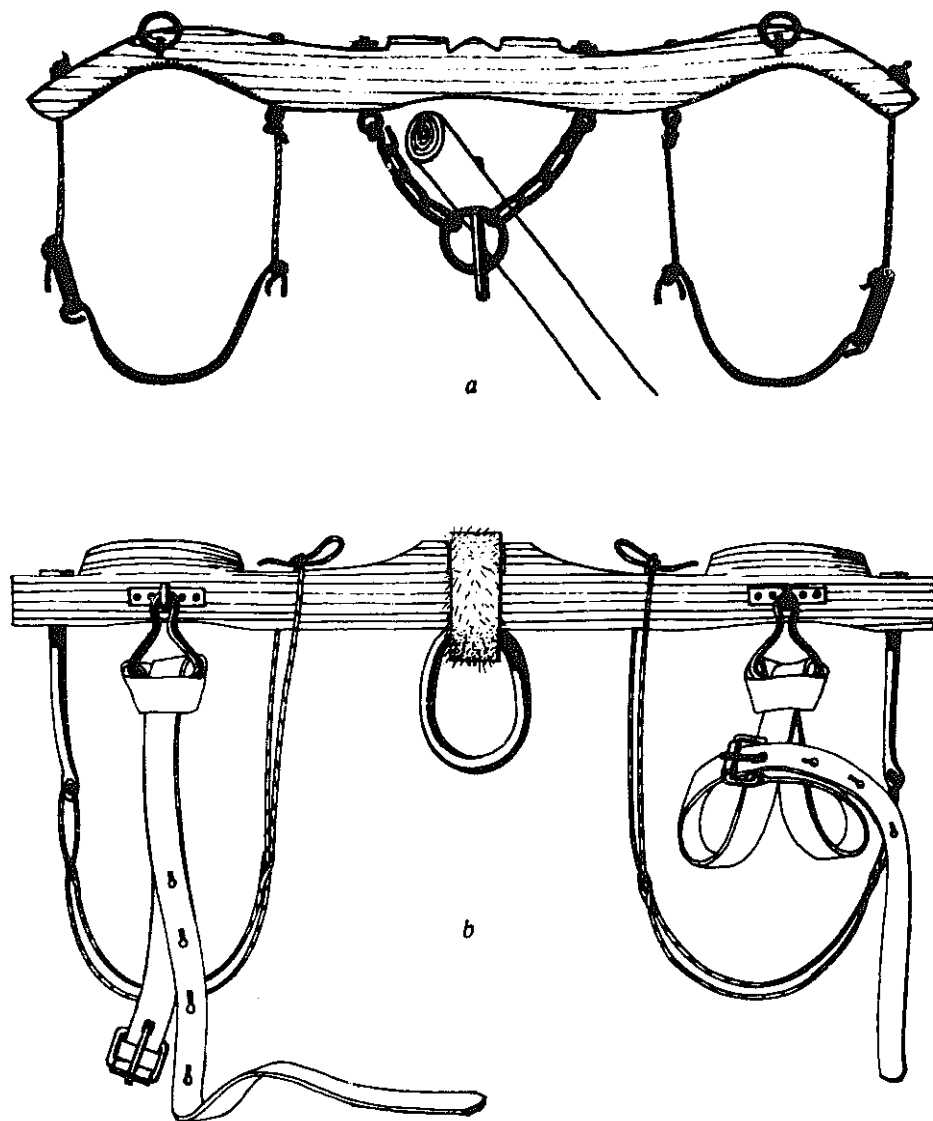

FIGURE 3. - Double neck yokes from Italy: (a) with central chain (Ferrara); (b) with leather straps which serve to fasten the yoke loosely to the horns of the oxen (Orte).

There are various types of harness commonly used: double yokes, single yokes, collar harness and breastband harness. The more ancient types of yokes are primarily designed for a sure and easy control of the animals rather than for the best utilization of their power, whereas in modern harness attention is particularly given to power efficiency, proper guidance being obtained by careful training.

The two most usual ways of hitching an implement to the harness are a long rigid pole or rope attached to the centre of a double yoke, or a short beam hitched to a swingletree with traces. A double yoke harness pulls the implement in a more upward direction than does a trace harness. The great advantage of the trace harness is that it allows also for an implement to be hitched to a single animal, where the work to be done does not require the combined strength of two animals.

DOUBLE YOKE HARNESS

The following is a description of the various types of double yoke harness.

Double neck yoke

This type of harness is the most widespread, being common all over Africa, throughout the Near East, India and Burma, and in the Mediterranean area. (Three basic designs are shown in Figures 2 to 4.) The types shown in Figure 2 are normally used for oxen, but in Iran, Iraq and Syria also for horses, mules and donkeys, where pads for all animals, and pads and collars for horses and mules, are added to the yokes to ease the pressure (Figure 5). A variation of this, with a different design of collar used for mules in Portugal, is shown in Figure 6.

The double yoke consists basically of a beam, which may be shaped to fit the top of the animals' necks. The length of the beam varies from 120 to 180 cm or more, and it is normally held in position with two wooden sticks inserted on both sides of each animal's neck, or by two similarly placed chains or ropes. The centre of the yoke has either a ring or similar device, or a notch, to support long-beam-type implements, which are fixed with a peg or a rope so that they can turn freely in the support without falling out.

Short-beam-type implements can also be attached to the yoke by a rope or chain.

Because of the great simplicity and low cost of the double neck yoke its replacement by more efficient harness would be expensive. However,

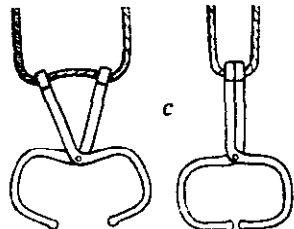
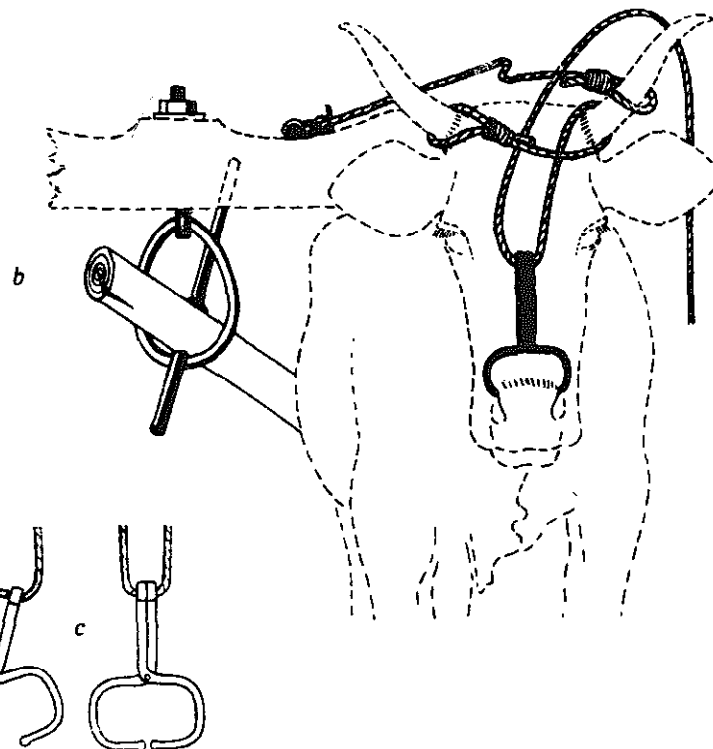
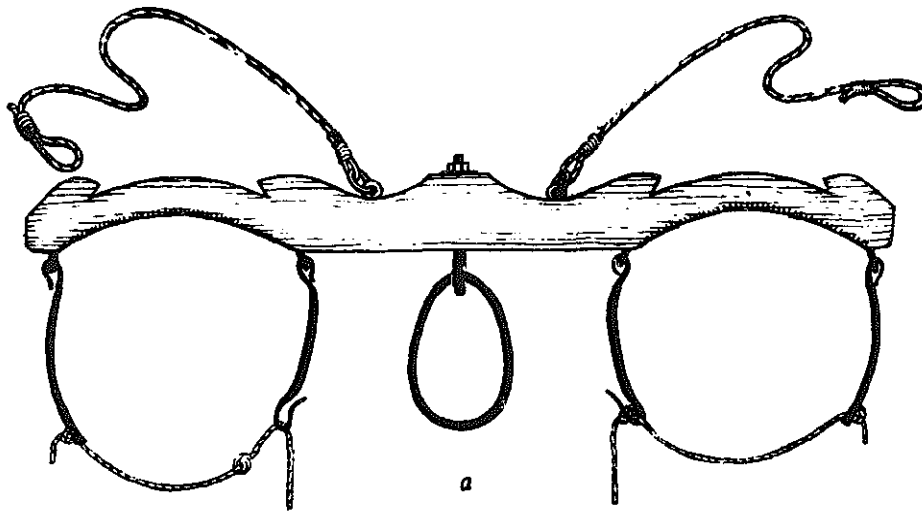

FIGURE 4. - Yoke harnessing: (a) yoke with rope straps, one for each outer horn of the oxen; (b) harnessing of yoke and pincer-type nose ring; (c) pincer-type halter in open and closed position (Florence, Italy).

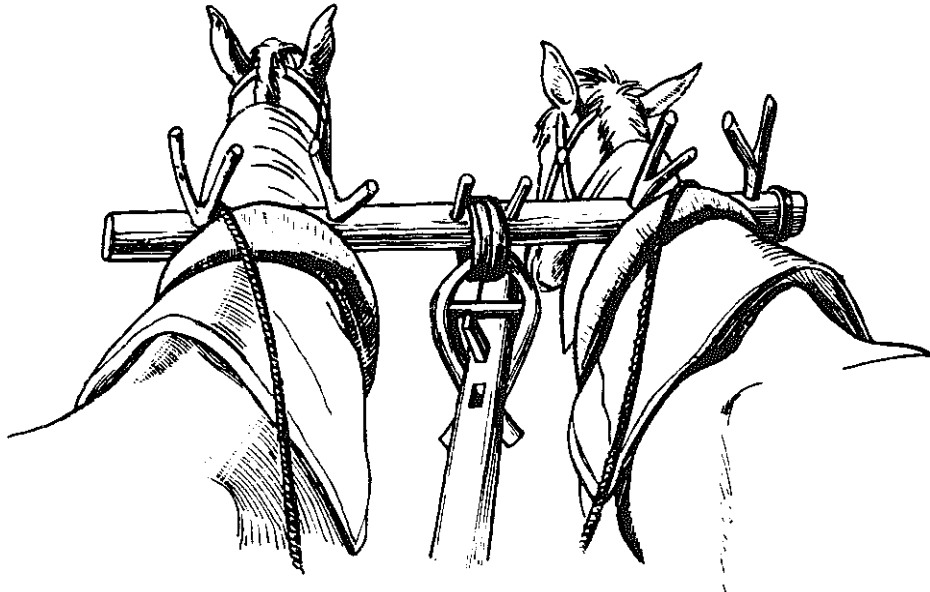

FIGURE 5. - Double neck yoke with pads and collars; type used in Iraq and Syria.

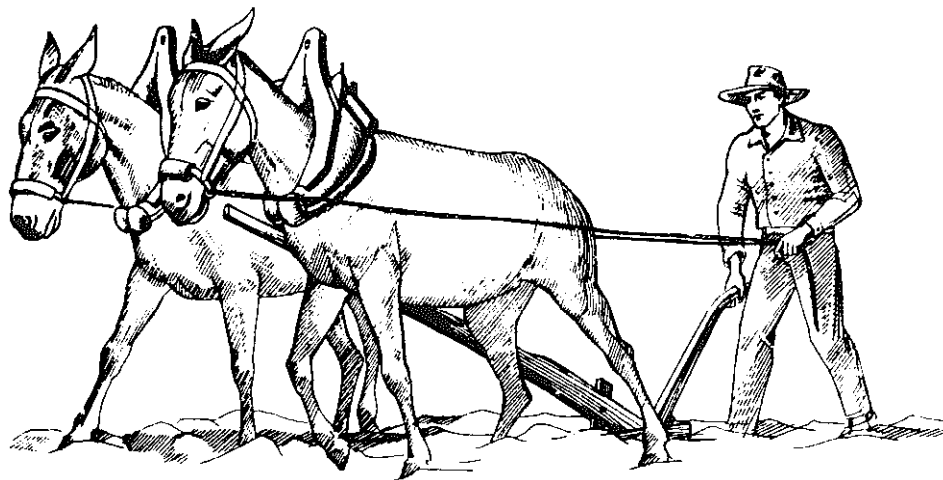

FIGURE 6. - Double neck yoke with collars; type used in Portugal.

the throat fastenings of double yokes tend to choke the animals and decrease their power, especially when they pull heavy loads. This inconvenience can be minimized by providing a loose rope or strap connection between the yoke and the heads of the animals (Figures 3[b] and 4).

Other serious disadvantages of all types of double yokes are that animals of different sizes do not fit into the same yoke. Further, even light



FIGURE 7. - Double head yoke; Spanish type used with strong short-necked cattle.

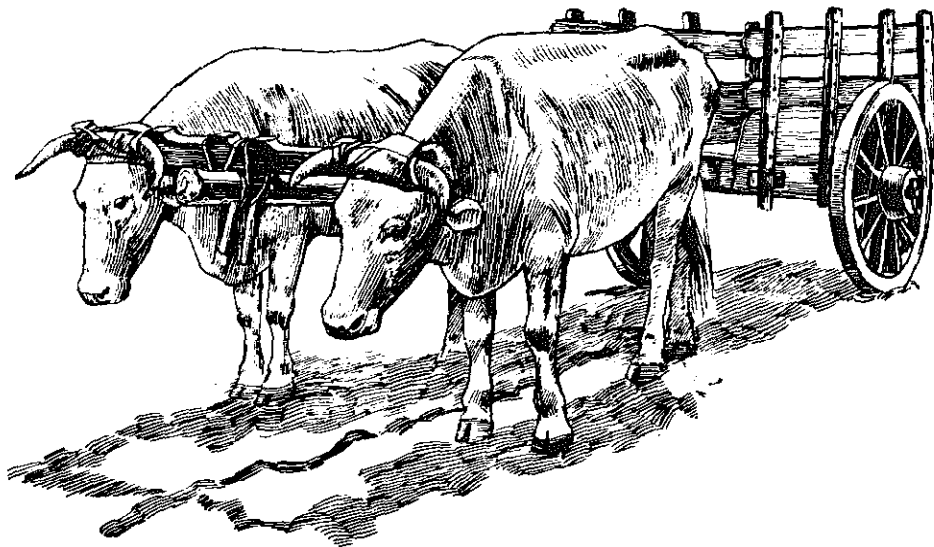

FIGURE 8. - Double head yoke; when used on long-necked cattle does not fully utilize their strength (Chile).

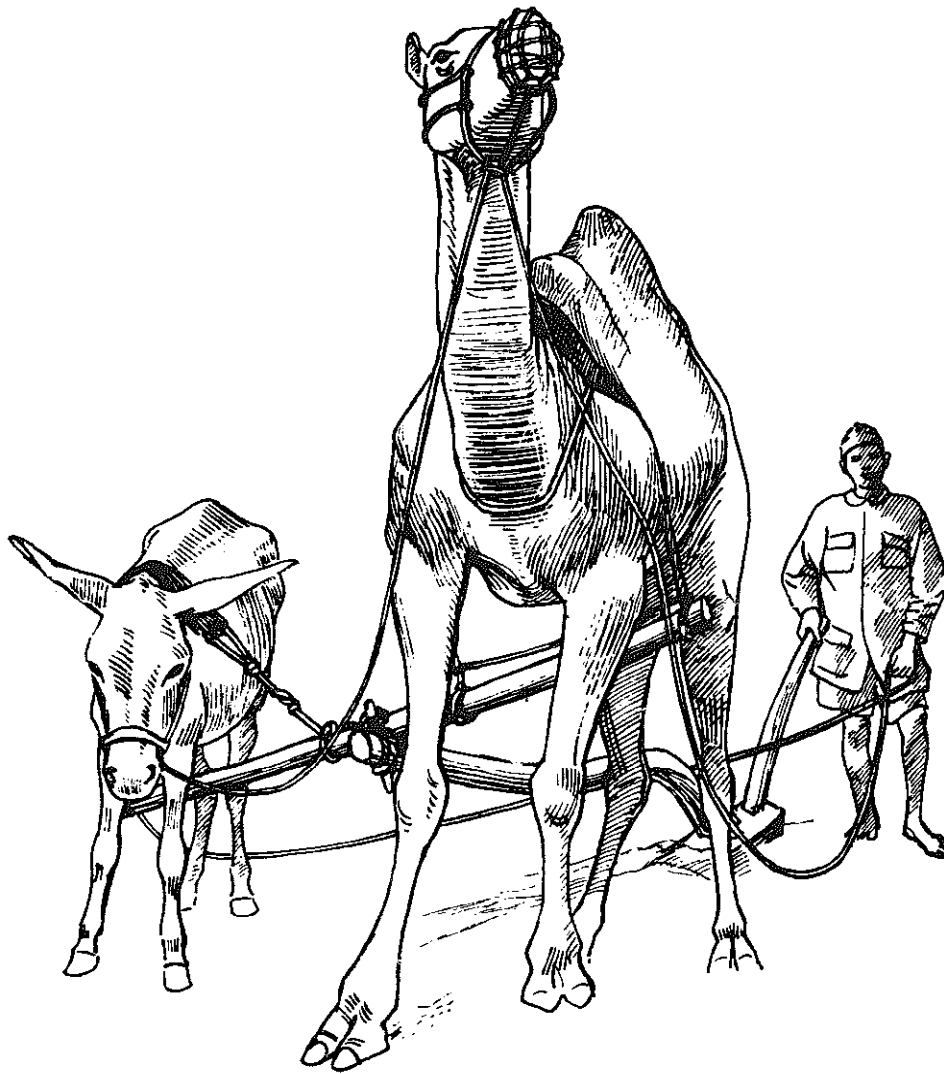

FIGURE 9. - Belly yoke from Morocco.

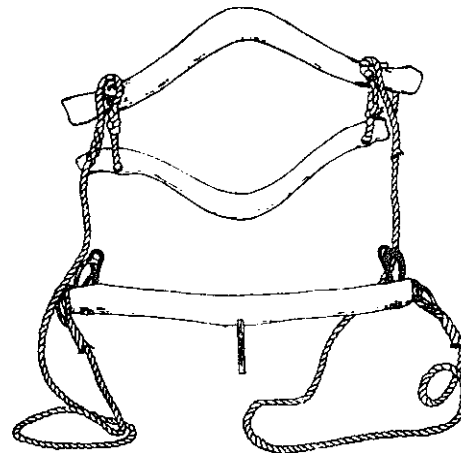

FIGURE 10. - Single neck yoke with rope traces and swingletree for buffalo, Malaysian type.

work must be done with two animals, when it could be more easily and efficiently done by one animal, such as in inter-row hoeing. This is a matter of great importance because in many regions where crop planting and hoeing on small plots is still the backbone of the agricultural economy and where single-animal work has not yet been introduced in a simple, acceptable form, farm operations are almost entirely based on manual labour with a resulting large demand on manpower.

Double head yoke

The double head yoke is perhaps the most ancient type of harness (Figure 7). It is fixed either at the front or the back of the head, and is suitable only for strong and short-necked animals. It originated in Mesopotamia. When it came to be adopted in countries in the east, using zebu cattle with their humps or buffaloes with their turned-back horns, it was no doubt shifted to the animals' necks. In this way it probably also soon replaced the head yoke in its country of origin. The double backhead yoke is still used in Spain and in Latin American countries, where it was introduced by the Spaniards (Figure 8).

The Spanish double head yoke serves the purpose of drawing, pushing backward and, if necessary, braking. It keeps the animals under firm control but must be adapted to them individually. Being tied to the horns, it need not be fastened to the animals' necks. A double head yoke makes harnessing very simple, but it hits the animals on their heads whenever they meet an obstacle, sometimes causing them serious injury unless there is an intermediate device between beam and yoke to absorb shocks. Moreover, the two animals being linked together without being

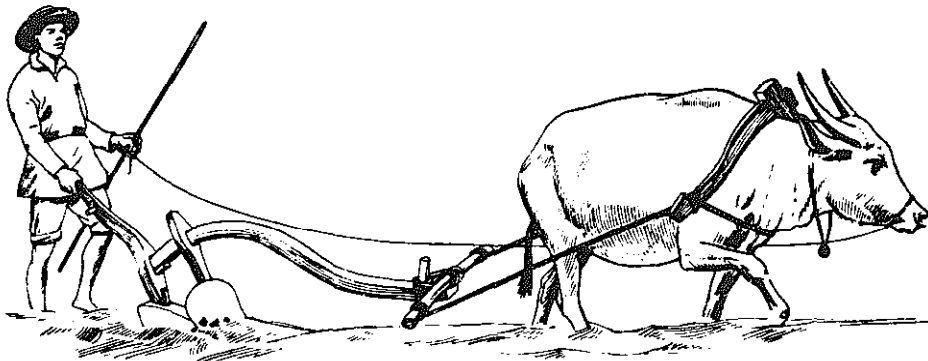

FIGURE 11. - Single neck yoke with rope traces and swingletree, Chinese type (Kiangsi, southern Mainland China).

able to move their heads freely, increase each other's discomfort. The power output of cattle with relatively longer or weaker necks and harnessed to this type of yoke is considerably lower than their potential power (Figure 8).

Belly yoke

The belly yoke harness is a particular type of double harness in which the yoke tree is fastened under the animals' bodies behind their front legs. It is something between a double yoke and a singletree harness and still exists in some parts of North Africa, particularly in Morocco. Two animals of different sizes can be harnessed together with this yoke, such as a donkey and a camel (Figure 9), but it is an inefficient and painful device and can cause the animals severe injury.

SINGLE YOKE HARNESS

The single yoke harness needs two shafts, or two ropes and a singletree for one animal (Figures 10 and 13[a]) and four ropes with or without a central shaft and a double singletree with evener (Figure 13[b]) for animals in pairs. It is impossible to hitch long-beam implements satisfactorily to one animal, although it is sometimes done with a plough attached to one side of a camel.

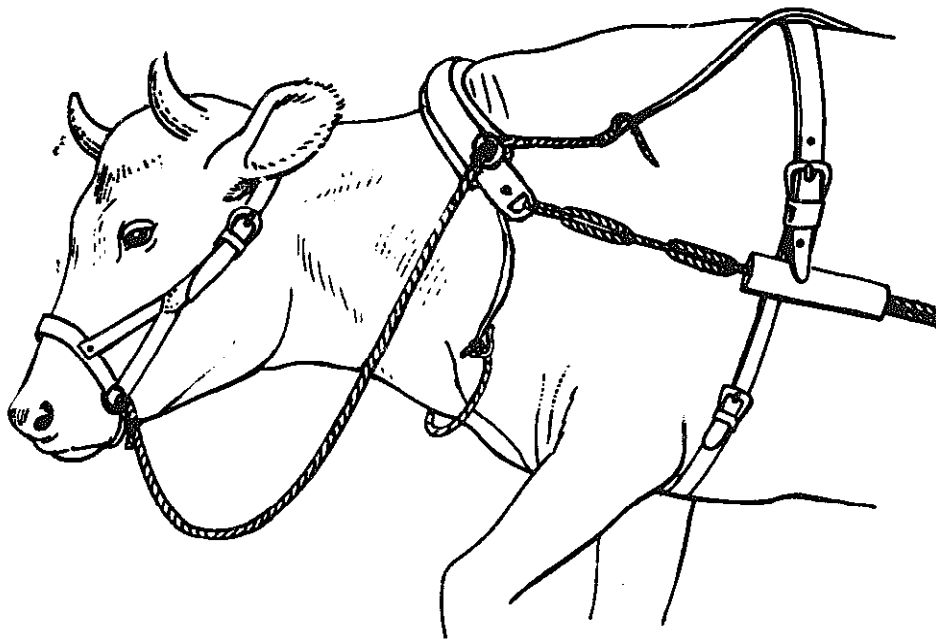

FIGURE 12. - Single neck yoke, Swiss type.

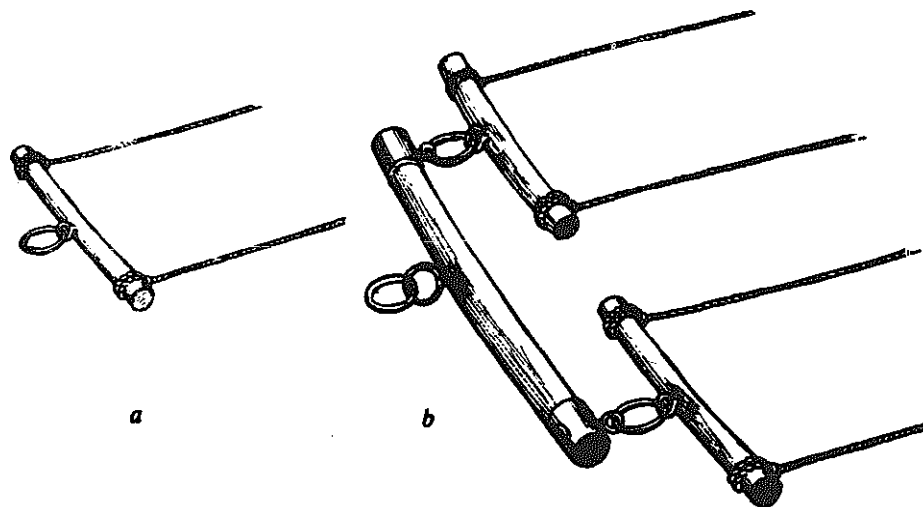

FIGURE 13. - Swingletrees: (a) for one animal; (b) for two animals with two swingletrees and evener.

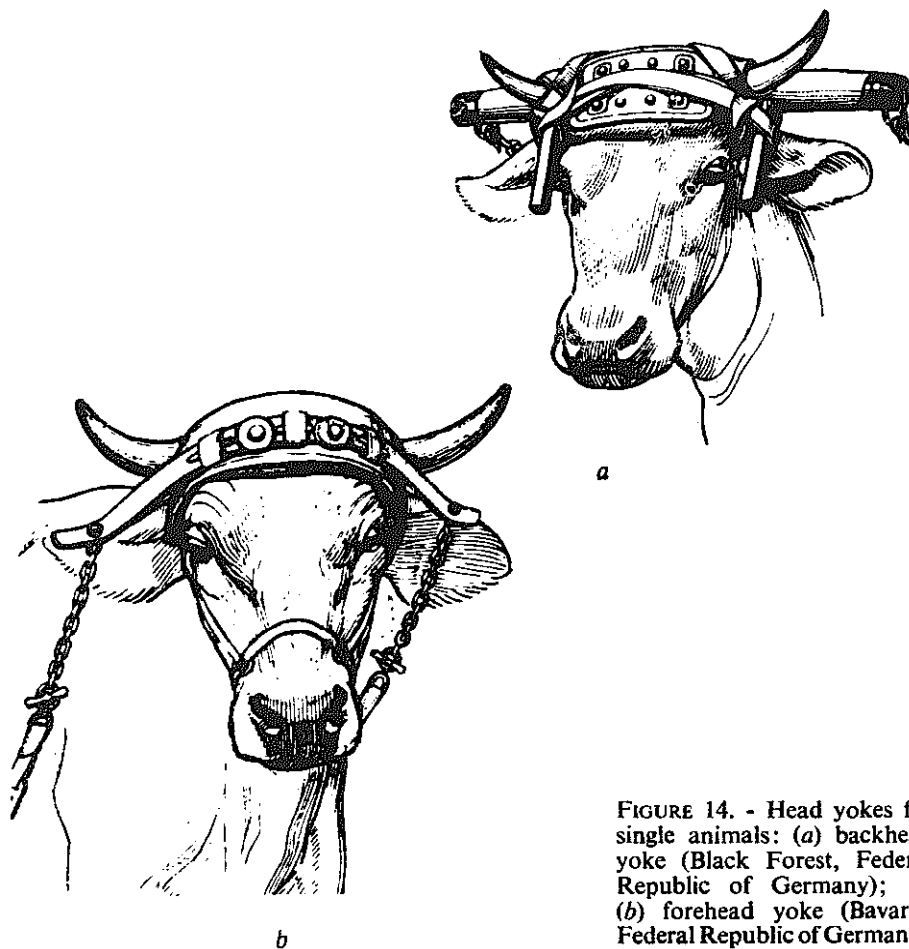

FIGURE 14. - Head yokes for single animals: (a) backhead yoke (Black Forest, Federal Republic of Germany); (b) forehead yoke (Bavaria, Federal Republic of Germany).

Centuries ago the double yoke was changed to the single yoke in China and in central Europe, at first by providing an implement with two shafts and then, when the swingletree was invented, with traces instead of shafts.

This was practicable with tillage implements because there is no need to move backward when ploughing or harrowing, as there is with carts and wagons. For vehicles, the general trend has been to have shorter shafts attached to small saddles on the animals' backs.

This single neck yoke with traces and swingletree, for both single animals and those hitched in pairs, is the main type of draught equipment used in China (Mainland), Figure 11; the Chinese took it to Korea, Japan, the Philippines, Thailand, Viet-Nam, Indonesia and other countries of Southeast Asia. It is also used in some parts of Switzerland (Figure 12), northern Italy and other European countries.

The swingletree was the first decisive step that led to the improvement of the harness. It appears to have been invented independently, first in China (perhaps suggested there by the two-man shovel), and then in central Europe. Figure 13 shows the general construction of the swingletree, the Chinese as well as the western type. It will be seen that for the two-animal swingletree, a beam called the "evener" is provided. With this it is possible to balance the unequal pulls of two animals of different strength by moving the point of attachment of the evener to the implement so as to give the weaker animal a longer lever on which to exert the lesser pull.

Another version of the single yoke is the head yoke with rope traces of which there are two varieties: the backhead yoke for single animals, still used in some parts of Finland, Estonia and in southwestern Germany (Figure 14[a]), and the single forehead yoke not uncommon in some areas of central Europe, particularly Bavaria in the Federal Republic of Germany (Figure 14[b]).

YOKE HARNESS AND THE ANATOMY OF ANIMALS

The efficiency of harness with regard to its power transmission largely depends on how and where it fits the animal's body. Horses, mules and donkeys are built differently from cattle. Cattle have strong shoulders which move more freely when walking, but they are rather weak across the breast. Some breeds of bovines have comparatively long and weak necks, others very short and strong ones. Many breeds have a pronounced hump. The neck yoke allows the shoulder blades to move freely and

this is important for cattle. If there is a natural hump it provides a good seat for the yoke, but fastenings under the throat press on the windpipe.

Yokes are definitely unsuitable for horses, mules and donkeys. Their main strength is in their shoulders and breast, which are well developed, while their withers are weak and may be permanently damaged by yokes. Therefore, collar harness for heavy draught and breastband harness for light work have been developed for these animals.

COLLAR AND BREASTBAND HARNESS

Collar harness probably originated in Siberia, its various names, *gom* (Mongolia), *gam* (Turkestan), *kummet* (Germany), *hame* (England) pointing to its eastern origin. It was brought to the west during the great

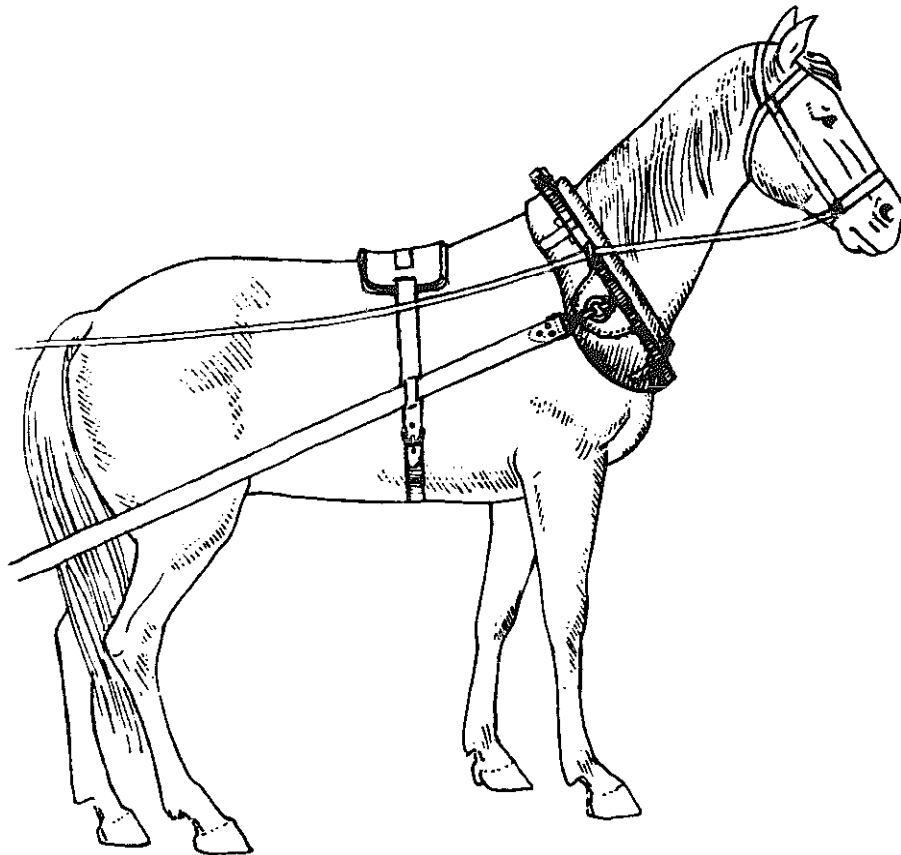

FIGURE 15. - Collar harness for horses and mules.

migrations of the early Middle Ages. All types of collar and breastband harness are suitable for work with single animals, animals in pairs or in larger teams.

Collar harness

For horses and mules this type of harness (Figure 15) has an oval wooden or metal frame around the collar, called the hame. The collar is generally made in one piece which can either be opened or not at the bottom, and should be softly lined and individually adapted to fit the horse's shoulders. For heavy draught a separate collar pad worn under the collar avoids pressure damage. The hame has hooks, rings or holes slightly above the joint of the animal's shoulder-blades to take the draught traces. This point of attachment ensures a good fit of the collar to the shoulder when the horse is pulling. An adjustable back band and halter and, for backing, adjustable breeching (a large strap behind the hind legs kept in place by hip straps) complete this harness. For one-horse vehicles with two shafts, the back band also holds a small well padded saddle to support the shafts. The collar harness is particularly suitable for heavy draught by horses and mules. For lighter work a breastband instead of the collar can be used (Figure 17).

Three-pad collar harness

For cattle the three-pad collar harness was developed in Germany around 1938 and has since then replaced other types of cattle harness in most of the central European countries (Figure 16). It combines the advantages of the neck yoke (free movement of the shoulder-blades) with those of the collar harness (natural straight position of the back when pulling, as opposed to the curved back under the yoke). The three-pad harness consists of two wooden shoulder hames, with a cushion padding the upper parts, to protect the shoulders without impeding their movement. The traces are hooked to the wooden hames in the middle of the shoulder-blades. A third small pad connected to both hames lies on the neck of the animal in front of its withers. The upper parts of both hames are loosely connected by an adjustable leather strap, while the lower ends are joined by a chain and a hook. The traces hooked to the hames are also attached to a band behind the withers which holds the collar in position. The hames are provided with metal rings when two animals pull

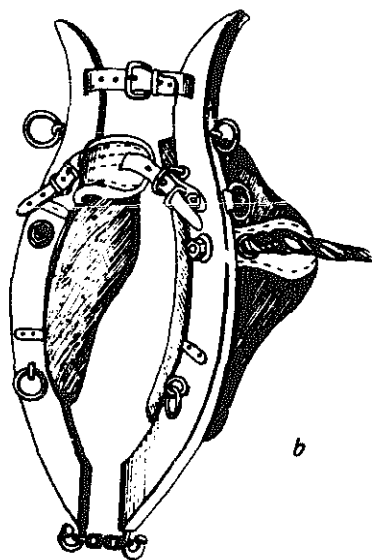
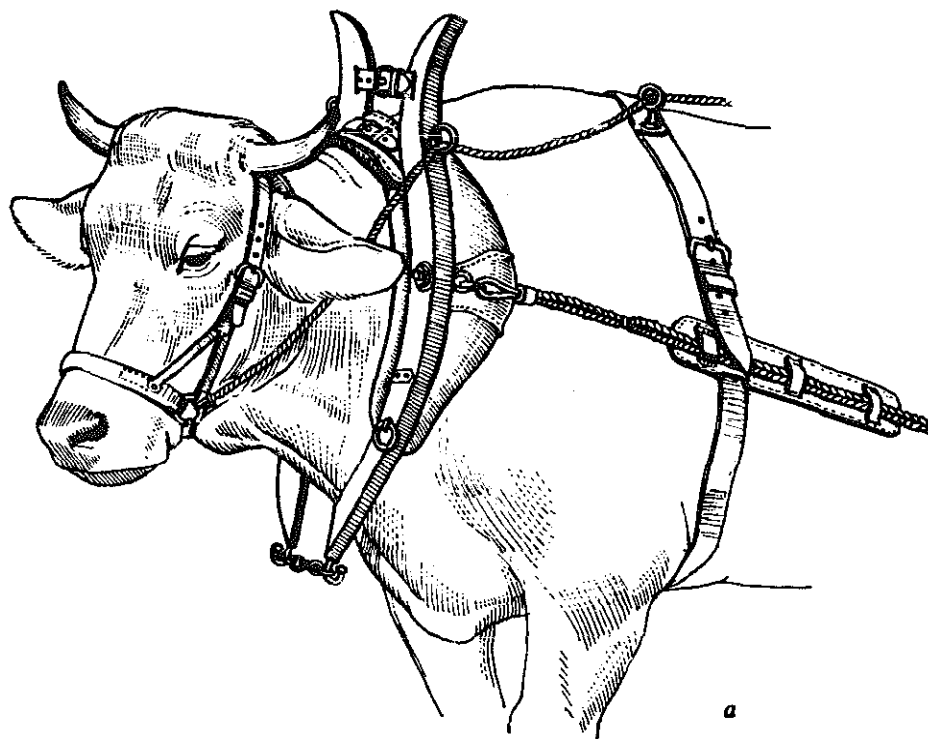

FIGURE 16. - The three-pad collar harness for cattle: (a) side view with halter; (b) detail showing the hames and three pads.

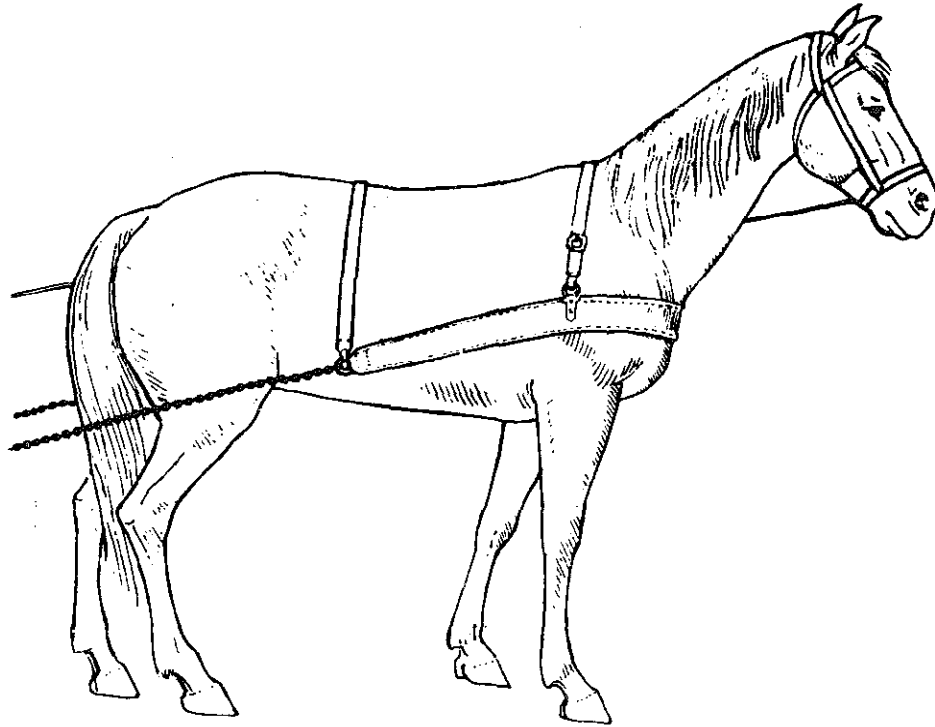

FIGURE 17. - Breastband harness.

a vehicle with a central pole, which has two small chains fastened to the rings to steer the vehicle.

This harness is completed by a simple halter which consists of a leather strap behind the animal's head held by a metal band over the nose and another strap behind the mouthpiece holding the rein. When two animals are harnessed together, only the left rein of the left leading animal is held by the driver. A second rein from the right-hand animal's halter is generally fastened to the centre of the swingletree behind the animal on the left. In western countries the left side is normally the leading side for draught animals. In the east the driver is usually at the right side of the animals.

Breastband harness

On this type of harness — adapted for equines, not cattle — the traces are joined to a large leather or other material strap which takes the pull from the animal's chest. With this exception, the breastband is the same

as the collar harness. The breastband should be large enough and so adjusted to the animal to avoid pressure on its windpipe. It is simpler than the collar harness and well suited for work which does not constrict the animal's chest too much (Figure 17).

ANIMAL POWER GEARS

Manual and animal power can also be used for the operation of stationary machines, such as water wheels, pumps, threshing machines, winnowers, chaff cutters and grinders. Although engines are the best source of power to drive such machines, animal power can be used in regions where fuel or electricity are not available for such purposes. The slow, forward-pulling action of an ox, horse or mule is transformed into rotary motion by means of gears, which in turn operate machine devices. Animal power gears are still widely used in the Near and Far East for water lifting. In the past they were widespread also in Europe for operating threshers, chaff cutters and grinders, but they have since been completely replaced by engines.

The efficiency of the animal power gears is generally low, especially after some use. Improvements could be made by protecting the gear wheels from dust and dirt. For example, a good dust-protected animal power gear can be made from a disused tractor by using only the drive wheels, differential and transmission (Figure 18). The construction is

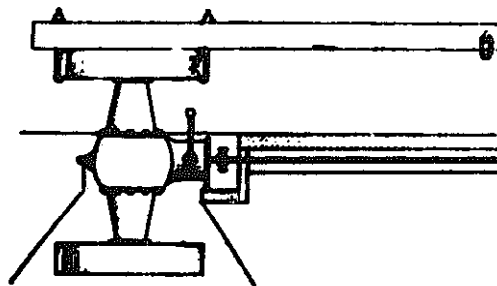

FIGURE 18. - Animal power gear.

simple. One wheel, let into the ground, is imbedded in concrete with the axle in a vertical position. The gear-shifting lever is arranged for control from above. The mainshaft is lengthened to extend beyond the working circle of the animal and fitted with a belt pulley. The speed of the pulley can be changed by the gear lever. The draught beam for the animal is then attached to the wheel above ground.

3. GENERAL CONSIDERATIONS ON POWER MACHINES FOR SMALL-SCALE FARMING

Farmers who depend only on manual labour and animal draught for farm work could derive substantial help from additional engine power for heavier work or greater speed of work during periods of peak labour demand.

Heavy work, of course, needs heavy equipment, which for the small farmer may only be obtainable under some form of multifarm use of machines in areas where this exists. (See *Multifarm use of agricultural machinery*, FAO Agricultural Development Paper No. 85, 1967.)

The timely performance of light work during seasons of short duration or during a rapid succession of work for multiple cropping, often requires only a small engine power source, but this must be at the ready disposal of, and hence owned by the individual farmer.

The cost of tractor work decreases with the increase of utilizable tractor power. Small tractors are relatively more expensive to buy and to run per HP unit and therefore less economical than larger ones. There is a clear tendency in the industrialized countries to continue to increase the power of tractors to serve ever-increasing areas. Tractors with 60 HP or more to cope with 200 ha or so of cereal land are no longer an exception in North America and Europe and will soon be surpassed by even more powerful units. Agricultural motorization, once started in industrialized countries, becomes an irreversible process, with industry helping to provide the training and supply of skilled operators and mechanics and the necessary facilities for machinery maintenance and repair. Table 5 shows the use of power sources in agriculture in industrialized countries; it is characterized by an increase in tractor power, and a decreasing use of horses accompanied by an increase in cereal production and higher yields from the land.

The more distant a country is from industrial centres and the less developed its facilities for transport and communication, the less economical will be its agricultural motorization. Under such conditions agriculture will continue to rely on manual labour and draught animals for field work. A comparison of Table 1 with Table 5 illustrates and confirms this statement.

An exception to the general development trends in tractor use can be observed in Japan where the emphasis until recently was on small power units, mainly rototillers, the use of which had reached 3 million units by 1968 as against 62 000 units in 1948-52. The expansion of rototillers in this country had its special reasons: small farms with small fields prevail and the work is relatively light, but must be done with speed. The small rototiller is relatively light in weight and suitable for work on the irrigated land used mainly for wet paddy production with complete water control. The success of the rototiller in Japan has also been aided by heavy subsidies from the Government and by the natural mechanical skills of the Japanese farmers. Under similar conditions as in Japan the garden tractor is also advancing in China (Taiwan) and in certain as yet restricted areas of India, Pakistan and Ceylon for general farm work. Garden tractors are of course used extensively for intensive market gardening on good friable soils in many other parts of the world. Ordinary four-wheel tractors have so far been little used in Japan but will acquire greater importance in the very near future owing to the new trend toward larger economically viable farm units.

Under some dryland conditions however, and on the heavy soils which prevail in the Near East and in many parts of Africa, garden tractors have not been found to have sufficient power or robustness for the work demanded of them.

Attempts to develop small, very simple, yet sturdy tractors for tough conditions in developing countries have repeatedly been made but so far they have not been very successful. The reasons for this are both technical and economic. They relate to the need to develop sufficient power at the drawbar from a relatively light tractor at a price which is within the purchasing power of the small farmer.

The fact remains that while farm motorization rapidly advances in industrialized countries, it does not make significant progress in most non-industrialized countries. In certain countries of West Africa for example, motorization has been replaced by animal draught, following the use of power equipment for land reclamation and initial periods of production.

TABLE 5. - ANIMAL AND TRACTOR POWER AND CEREAL PRODUCTION
IN EUROPE, U.S.S.R., NORTH AMERICA AND OCEANIA (see also Table 1)

Countries	Horses		Tractors		Garden tractors	Cereal area ¹		Cereal production ¹	
	1948-52	1966	1948-52	1966	1966	1948-52	1966	1948-52	1966
EUROPE	<i>Million heads</i>		<i>.. Million units ..</i>			<i>Million hectares</i>		<i>Million tons</i>	
France	2.4	1.2	0.1	1.1	0.2	8.1	9.0	14.1	26.7
Germany, Fed. Rep. ..	1.6	0.4	0.2	1.2	0.1	3.0	3.8	10.3	14.8
Italy	0.8	0.3	0.1	0.5	0.1	6.9	6.0	11.1	14.4
Poland	2.7	2.6	...	0.1	...	9.7	8.4	12.1	16.1
Spain	0.7	0.3	...	0.2	...	7.4	7.0	7.4	9.2
Sweden	0.4	0.1	0.1	0.2	...	1.4	1.4	2.6	4.4
United Kingdom	0.6	0.2	0.3	0.4	0.1	3.3	3.9	8.1	13.4
Yugoslavia.....	1.1	1.1	...	0.1	...	5.1	5.2	6.2	13.9
Other countries ²	6.2	2.9	0.2	1.4	0.3	29.9	27.5	40.5	60.2
<i>Europe total</i>	16.5	9.1	1.0	5.2	0.8	74.8	72.2	112.4	173.1
U.S.S.R.....	12.8	8.0	0.6	1.7	...	101.2	118.9	76.2	164.2
NORTH AMERICA									
Canada	1.6	0.4	0.4	0.7	...	19.3	19.6	26.0	38.5
U.S.A.	7.7	2.8	3.6	4.8	0.8	81.6	61.2	136.7	183.4
<i>North America total</i>	9.3	3.2	4.0	5.5	0.8	100.9	80.8	162.7	221.9
OCEANIA									
Australia	1.1	0.5	0.1	0.3	...	6.1	11.1	6.6	16.6
New Zealand	0.2	0.1	...	0.1	...	0.1	0.1	0.2	0.4
Pacific Islands	0.1
<i>Oceania total</i>	1.3	0.6	0.2	0.4	...	6.2	11.2	6.8	17.0
TOTAL	39.9	20.9	5.8	12.8	1.6	283.1	283.1	358.1	576.2
Asia, Latin America and Africa	37.6	41.6	0.2	1.1	2.6	327.3	404.9	332.7	511.3
WORLD TOTAL	77.5	62.5	6.0	13.9	4.2	610.4	688.0	690.8	1087.5

NOTE: The use of draught oxen is no longer significant in Europe, U.S.S.R., North America and Oceania, and is therefore not reported in this table.

¹ Cereals include: wheat, rye, barley, oats, maize, millet, sorghum, rice (paddy), mixed grains, buckwheat and miscellaneous cereals. - ² Includes abovementioned countries with figures below 50 000 units.

With the settlement of farmers in the area animal work has become much cheaper (50 percent less). Under such conditions progress can be achieved by improving the strength of the draught animals through better feeding, by improving harness types, by using single animals instead of animals in pairs for light work and by improving the implements for animal draught and hand work by man.

4. GENERAL CONSIDERATIONS ON IMPLEMENTS AND THEIR MATERIALS

A hand tool consists of a working part and a controlling handle, firmly joined together by a connecting device. The working part should be of material resistant to wear and stress and is therefore generally made of steel. Abrasion, in particular, blunts cutting edges and points; so, to reduce the effects of abrasion the materials used must have suitable chemical and physical properties.

Tool steel can be hardened by heating to a high temperature and cooling suddenly, known as "tempering" (Figure 19), and softened by heating and cooling very gradually, which is called "annealing." The blacksmith who sharpens, or otherwise treats a farmer's hand tools, must know the properties of the steel he is handling, otherwise he will ruin its quality. Most of the cutting edges of factory-made tools can be sharpened by the farmer with suitable files, whetstones or by hammering. Both the steel and the wooden parts of implements need care and proper maintenance for efficient use.

Tool handles and grips

The handle of a tool is generally made of wood, round or oval in section, and it either has a specially shaped end or one or two grips so that the tool can be held and managed with the least possible effort. A good handle should be adapted to the size, strength and shape of the hand and to the most convenient working position of its operator. It should be light in weight, strong, smooth and comfortable to hold.

The best handles are generally made from saplings grown on poor soil, the strongest part being that near the roots. The saplings must be thoroughly dry before being fashioned into handles. The root end should be connected to the working part of the tool subject to the greater stress.

FIGURE 19. - Tempering a hoe.



Sap-wood is more elastic and tougher and therefore more suitable for handles than heart-wood. A good quality handle has the grain running along its entire length and in axe handles the grain should also be parallel to the blade. Where curves are necessary they should be obtained by steam bending and not by cutting across the grain of the wood, which weakens the handle. The handle should be smoothed with sandpaper but never painted, because this makes it disagreeable to hold. Flame treatment or waxing gives it a final finish and adds to its quality and life.

WOODS FOR HANDLES

Various woods are used for making handles. Hickory (*Hicoria alba*) and common ash (*Fraxinus excelsior* L.) are the most suitable and versatile. They are tough, elastic and relatively light. Very light but less resistant handles are obtained from willow saplings (*Salix alba* L.). Field maple (*Acer campestre* L.) gives good handles which are comfortable to hold. Handles made from large leaved lime (*Tilia emopea* L.) show similar qualities; they are light but not very resistant. Mulberry saplings (*Morus alba* L.) are frequently used in some eastern countries. Common alder (*Betula almus glutinosa* L.), birch (*Betula alba* L.) and hornbeam (*Carpinus*

betulus L.) are very resistant, of medium elasticity, but shrink easily. Hornbeam, being tough, is generally used for short handles, also for rake teeth, flails, etc. Hazelnut saplings also make very tough and useful handles. The choice of the most appropriate woods for different types and parts of farm implements naturally depends on the supply available. Only a few types of woods suitable for making handles of farm tools have been mentioned; others with different properties, such as oak, beech, olive tree, cypress and robinia, are also used for farm implements or their parts.

HAND GRIPS

The part of the handle actually grasped by the operator is shaped to give a firm and comfortable grip (Figure 20). Thus, the top is either in the shape of a ball, a knob, T, Y, or a D, the better to apply pressure for digging or lifting. It is hoof shaped on axes to avoid slipping from the hand when wielding the tool, or it is bent slightly backward to facilitate pulling. Sometimes there is an auxiliary grip in the middle of the handle to give a better grasp of the implement for heavy pulling, e.g., with hand cultivators or rakes. Or, both the top and the middle part of the handle may have special grips for transmitting complex motions, such as swinging a scythe.

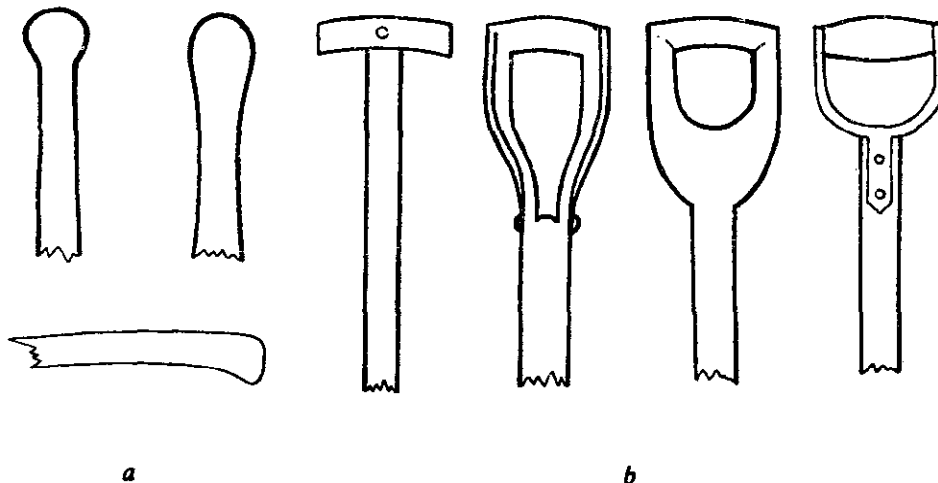

FIGURE 20. - Handle tops: (a) ball point, knob and a simple enlarged top; (b) T, Y and D types.

FOOT RESTS

Foot rests are frequently provided at the lower end of long handles of soil-working implements, which serve to take the pressure of the operator's foot when he pushes the blade or other working part into the ground (Figure 25). For barefoot work, a strong piece of wood with a hole in the middle (through which the handle passes, lying across the top of the blade, and projecting beyond it on either side) comprises the foot rest. Iron foot rests for work with shoes are one sided with a ring at one end; they can be moved around the handle base to any required working position.

Connecting devices between working part and handle

Blade and handle must be firmly connected because a loose handle lowers efficiency and is most irksome to the operator. There are basically three ways of fixing a tool to a handle:

- (a) joining the overlapping parts (Figure 21 [a]);
- (b) inserting a tang on the tool into the handle (Figures 21[b], 21[c]);
- (c) inserting the handle into the blade (Figures 21[d] to 21[g]).

The oldest way of joining overlapping parts, which is still used, is to bind them with rawhide thongs or cords, or with metal rings and wedges (Figure 21[a]).

Later in their development, tools with tangs were driven into the handles in various ways. Figure 21(b) shows a diagonal insertion of a tang into the lower thick part of a sapling, which is cut after further growth and makes a very strong joint. This method is still practised in some parts of Africa, but is gradually being abandoned because it is too slow. Most hand tools for workshops and some cultivating hand tools are driven into the end of the handle lengthwise, the end of the handle being reinforced with a tubular ferrule (Figure 21[c]). A tang and ferrule makes a strong, light and smooth connection, but a broken handle is difficult to repair when so fitted and farmers who make their own handles generally prefer a simpler device.

Another common method is to insert the handle into a socket or a hole which is an integral part of the tool. Figure 21(d) shows the latter and Figures 21(e), 21(f) and 21(g) illustrate three forms of sockets.

The socket probably derived from the method of fixing a spear point to the shaft, and the hole is doubtless a survival from neolithic times when

man had learnt to bore holes in flint implements. A slightly oval-tapering hole is the best.

Balancing and handling implements and tools

Animal power is transmitted to an implement from the centre of power located at the middle of the yoke or hame hooks through the hitch point to the centre of resistance, which might be more of an area than a specific point.

The resistance of an implement to draught depends on the resistance of the material in which it works and on the shape of the implement.

The moving power is exerted in a straight line with pulled implements; in a circle, with crank arms; in complex, mainly semicircular movements, with beating, lifting or swinging implements.

The centre of power, i.e., the centre of motion, is either in front or at the back, lateral to, or at a radial point outside of, or on the implement. Its location is important for the proper guidance of the implement.

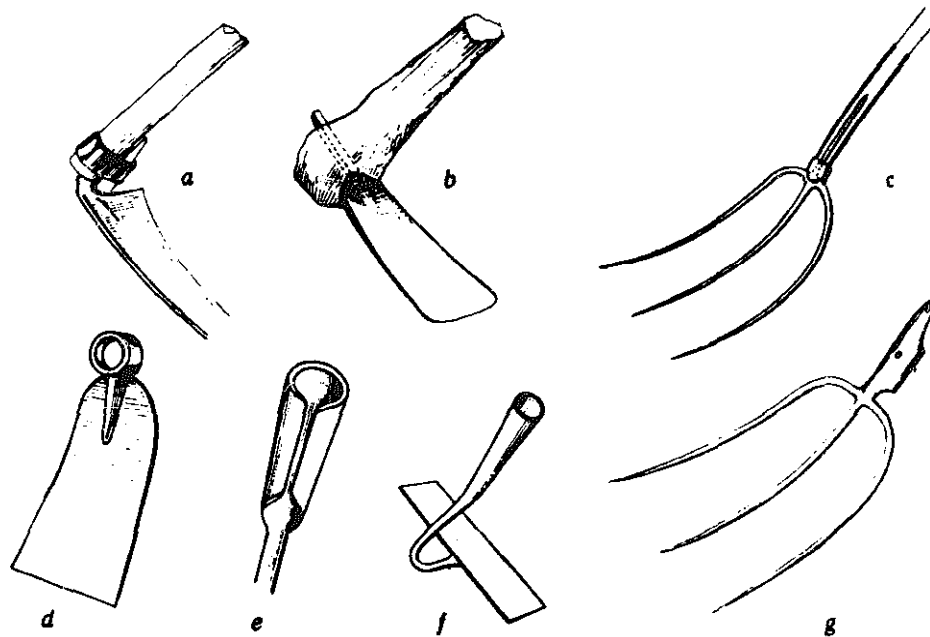

FIGURE 21. - Connecting devices: (a) overlapping joint (scythe blade to snath) by means of a metal ring and wedge; (b-c) inserting the blade tang into the handle (cross-wise and lengthwise); (d-g) inserting the handle into the blade (eye-catch and various types of sockets).

STEERING AN IMPLEMENT

The operator uses one or two handles to steer, and the better the shape of the implement the less effort is needed to guide it and the better it will be balanced. The handles are levers and as such need a pivot or fulcrum. When the power centre is in front of the implement the fulcrum is the centre of resistance, which is nothing but the centre of gravity of the implement in motion. For effortless steering the movement of the handle around this fulcrum should be perpendicular to a straight line between the centre of resistance and the hitch on the implement. This means that the operator inclines the handle to the right to steer the implement to the left and vice versa. Wide implements cannot be steered by simply inclining a handle from its vertical plane toward the right or the left into oblique positions, but have to be moved with two handles toward the right or the left in a horizontal plane, with the centre of movement in the hitch and not at the centre of gravity. For easy steering such wide implements must have the hitch as near as possible to the centre of resistance.

Power is transmitted to a hand tool at one or two points. When both hands are used, one hand mainly transmits the power while the other guides.

The balance of a tool is the position it assumes when it is loosely moved in the working motion. The position should be the same as that to be maintained during actual work. An implement is well balanced if it does not tend to leave its course when working. Balance is influenced by the implement's centre of gravity and its hang. The nearer the centre of gravity is to the actual work, the better will be its balance.

The hang of a hand tool is approximately the angle between a traverse section of the blade at the edge and the projecting upper part of the handle (Figure 22). The intersection point should generally be near the edge or point of the working part and will coincide with the centre of resistance if the implement is well designed.

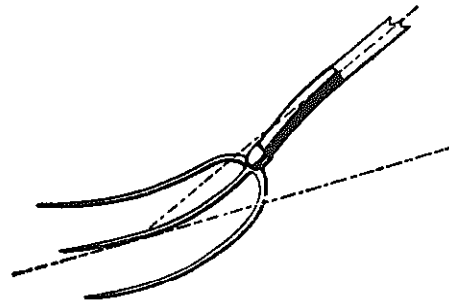

FIGURE 22. - Hang of a fork.

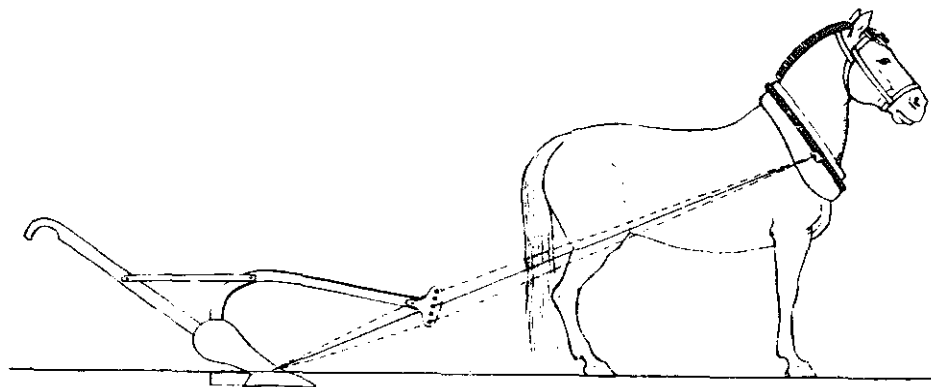

FIGURE 23. - Setting an implement (showing the height adjustment of a plough). The line of hitch should go straight from the centre of pull (midway between both hooks on the hame) through the clevis, or hitch, to the centre of resistance.



FIGURE 24. - Right-hand and left-hand work with hand tools.

The setting consists in those adjustments on the tool which are necessary to achieve the best balance for specific tasks (Figure 23).

RIGHT-HAND AND LEFT-HAND USE OF A HAND TOOL

Most hand tools can be used either with the right or left hand. For right-handed work the right hand guides the tool from the top of the handle (except on scythes, where it does so from the central grip), pushing or swinging mainly toward the left, and pulling toward the right. Left-handed work is performed in the reverse order. Alternating right- and left-handed work relieves the muscles of the operator, but it requires skill (Figure 24).

5. TILLAGE IMPLEMENTS

The main object of tillage is to assist the natural processes which bring about the most favourable soil conditions for the germination of seeds and the growth of plants, in other words, good tilth. Tools are used to break and turn the soil, to control soil moisture, temperature and air circulation, weeds and pests, and to bury vegetation and other matter in the soil.

The great variety of soil and climatic conditions has led to the development of a large range of tillage implements which may be grouped, according to their purpose, for:

- (a) breaking;
- (b) breaking-cutting;
- (c) semiturning;
- (d) cutting-turning.

Spades and digging hoes

The hand-operated tools used for tillage are mainly spades and hoes. Both are universal tools existing in different shapes according to their specific purpose, to the prevailing soil conditions and to local customs. In different regions there is a very definite preference for a specific tool for primary tillage: the spade, for example, in Italy, Iraq, Iran, Afghanistan; the digging hoe in Africa, India, Ceylon, China, Japan and the Far East in general.

Originally, the spade apparently was a spear-like stick, the hoe a scraping stone adapted by planters from the spears and from the scraping and cutting stones of their hunting ancestors. In fact, new stages in the development of agriculture and, consequently, of farm implements, were usually

due to causes which had nothing to do with the previous stage but were brought about by outside events or emergencies. In such cases traditional implements were first adopted without any modification until the nature of the new work and inventive spirit gradually caused them to change their shape.

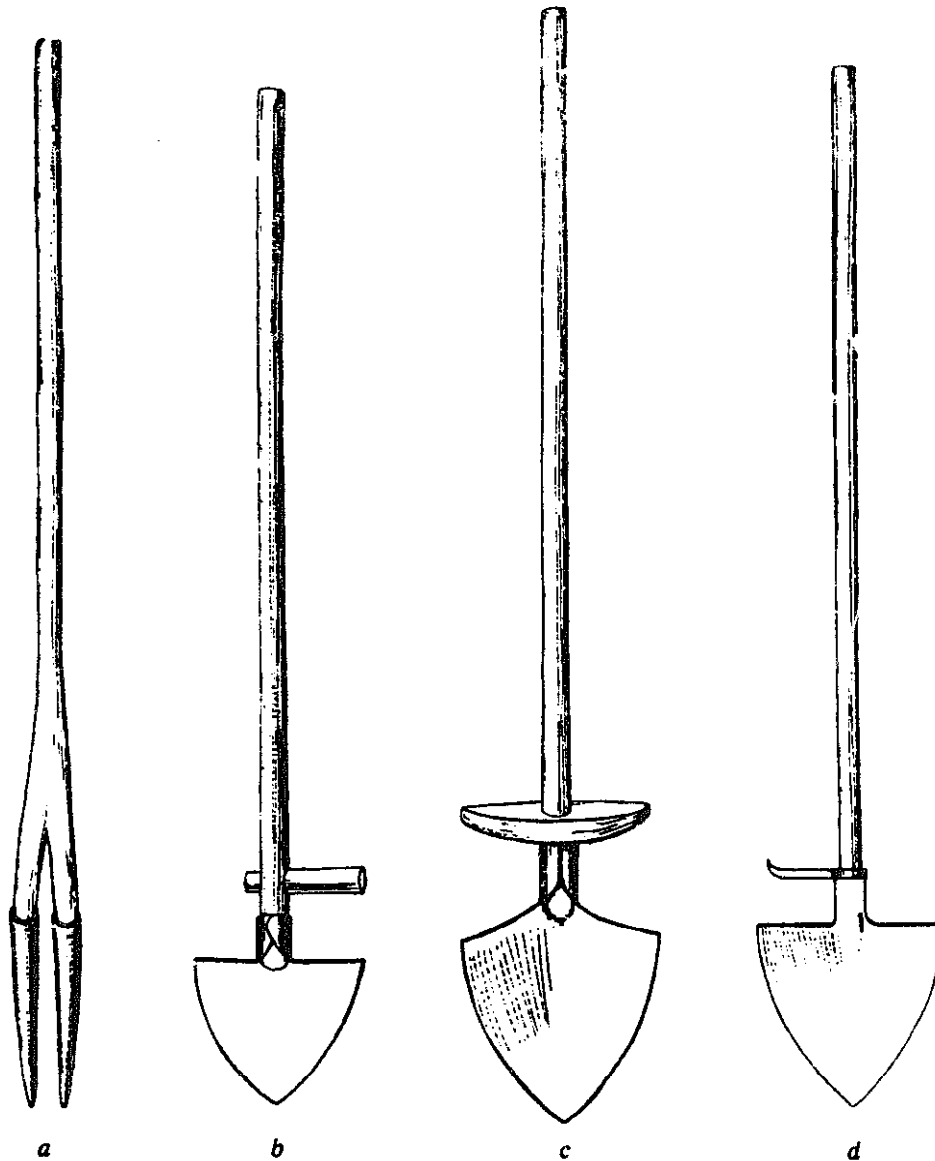

FIGURE 25. - Long-handled spades: (a) double speared from Ethiopia; (b) from Basra, Iraq; (c) from Kabul Province, Afghanistan; (d) from Tuscany, Italy.

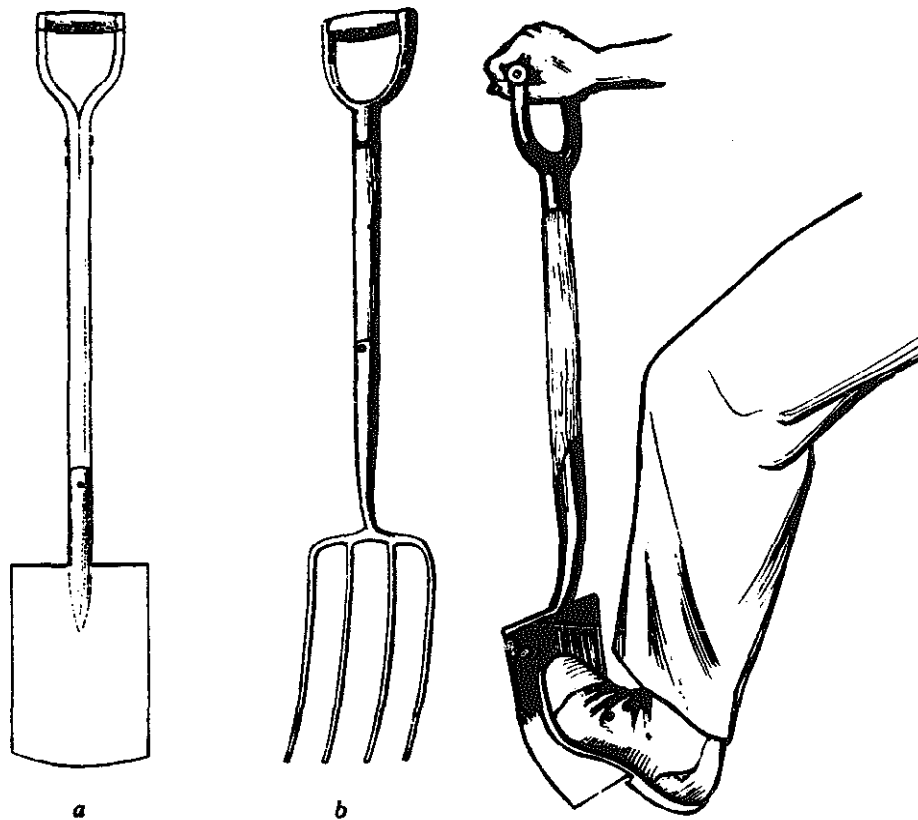

FIGURE 26. - Short-handled spade (*a*) and spading fork (*b*) (central and northern Europe and North America).

FIGURE 27. - Testing a steel blade: after bending, the blade, if correctly tempered, should return to its original shape.

SPADE

The spade is used to dig, lift and turn soil for the preparation of arable land, to make holes and to dig and clean channels or other excavations. For work with spades both hands are usually employed as well as one foot which helps to push the blade into the earth.

The spade in its original form, consisting of a long stick with or without a metal socket point, or with a small blade or, sometimes, with two points (Figure 25[a]), is still used in parts of central Africa, in parts of the Andes in Latin America, and in Sumatra. In countries where the spade became an important tillage implement, such as Italy (Figure 25[d]), Syria, Iraq (Figures 25[b] and 28), Afghanistan (Figure 28[c]), and in parts of Turkey, the blade is mostly triangular with wooden or iron foot rests and

with long handles. Spades with rectangular or trapezoid blades are used in loose soils. Central and northern European and North American horticulturists prefer short-handled spades with top grips and rectangular blades for soft soils, and spading forks with several tines for heavy soils (Figure 26).

Working with the spade is very strenuous. The digging depth, with long-handled spades and a foot rest is between 25 and 35 cm, and sometimes exceeds the length of the blade because the spade can be pushed into the soil up to the foot rest. In some countries spading is done in teams. In southern Iraq, three men spading the same piece of land is characteristic of the date plantations around Basra (Figure 28).

The working depth of short-handled spades is generally about 22 cm. At that depth a man can dig about 20 m² of medium arable soil per hour, lifting approximately 44 m³ or roughly 80 quintals of earth. This shows how strenuous spade work really is. Attempts have often been made to invent devices to relieve the strain of lifting. They consist mostly of lever supports behind the handle, sometimes also spring levers, but they are generally not very suitable being too heavy, complicated and expensive. Moreover, such devices cannot be used for digging holes or trenches but only for the tillage of level fields, while farmers generally require spades for universal application.



FIGURE 28. - Deep spading by a team of three men; typical in the date plantations near Basra, Iraq; (a) first movement; (b) second movement.

FIGURE 29. - Digging and chopping hoes: (a) Chinese digging hoe; (b) western chopping hoe (blade length 22 cm, edge 17.6 cm, weight 1.2 kg, handle length 102 cm).

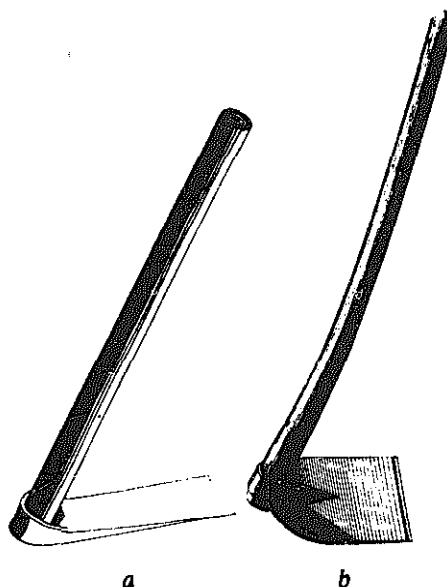

DIGGING HOES AND DIGGING HOOKS

Digging hoes and hooks are used for tilling and for clod breaking. The digging hoe is a more universal implement as it also serves for ridging, surface cultivation and weeding. Its elements are a steel blade, usually with a hole for a wooden handle. The angle between the working part and the handle varies between 85 and 90°.

Blades of digging hoes vary considerably in size, weight and shape according to the user's physique and the soil conditions. They are small for children and women and larger for men, long and narrow and heavy for compact soils and short, wide and light for light soils. They are pointed and rectangular in shape (Figures 29 and 30).

Digging hooks have two or more strong tines instead of a blade and mainly serve for tilling very hard or stony soil and sometimes for digging out root crops, such as potatoes (Figure 31).

The ability of these tools to penetrate the soil increases with the weight and with the slenderness of the blade or of the tines.

Ploughs

The plough came into existence when man first succeeded in taming and harnessing animals for draught purposes. The Sumerians in Mesopotamia appear to have been the first to use the plough about 3600 B.C.

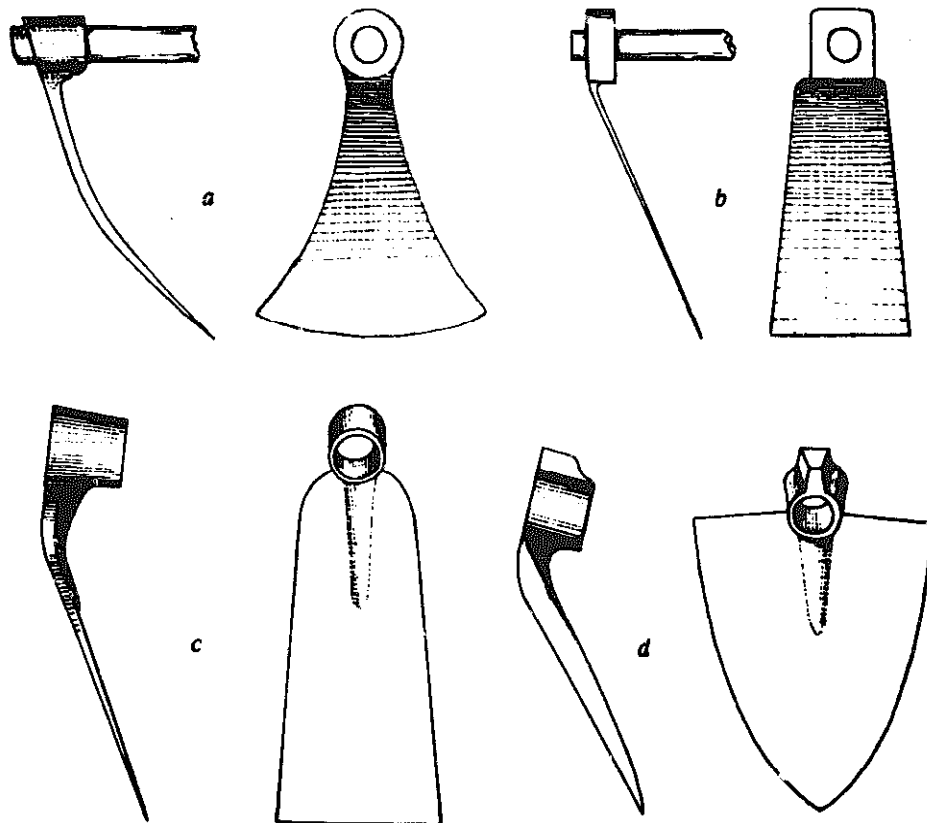

FIGURE 30. - Digging and chopping hoes: (a) Egyptian " Fass " (blade length 27 cm, edge 26 cm, weight 3 kg); (b) another type of Egyptian " Fass " (blade length 29 cm, edge 17 cm, weight 3.6 kg); (c) Spanish digging hoe (blade length 23 cm, edge 12 cm, weight 1.4 kg); (d) digging/ridging hoe with pointed blade (blade length 21.5 to 34.5 cm, weight 0.92 to 2.3 kg, width at head 18 to 28 cm).

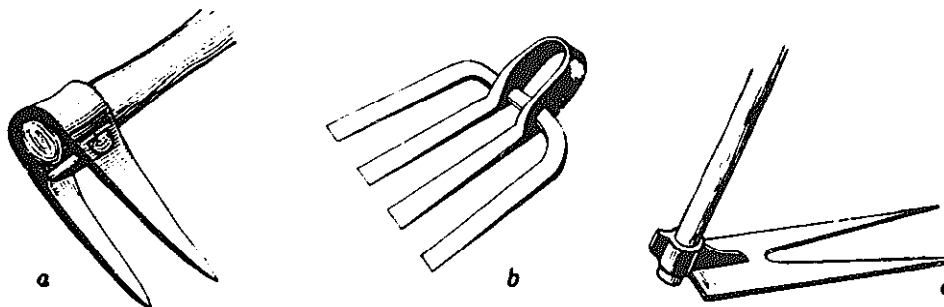

FIGURE 31. - Digging hooks: (a) Chinese two-tined type (length of tines 23 cm, width at point 10 cm); (b) Chinese four-tined type (length of tines 24 cm, width at point 24 cm); (c) Portuguese two-tined type.

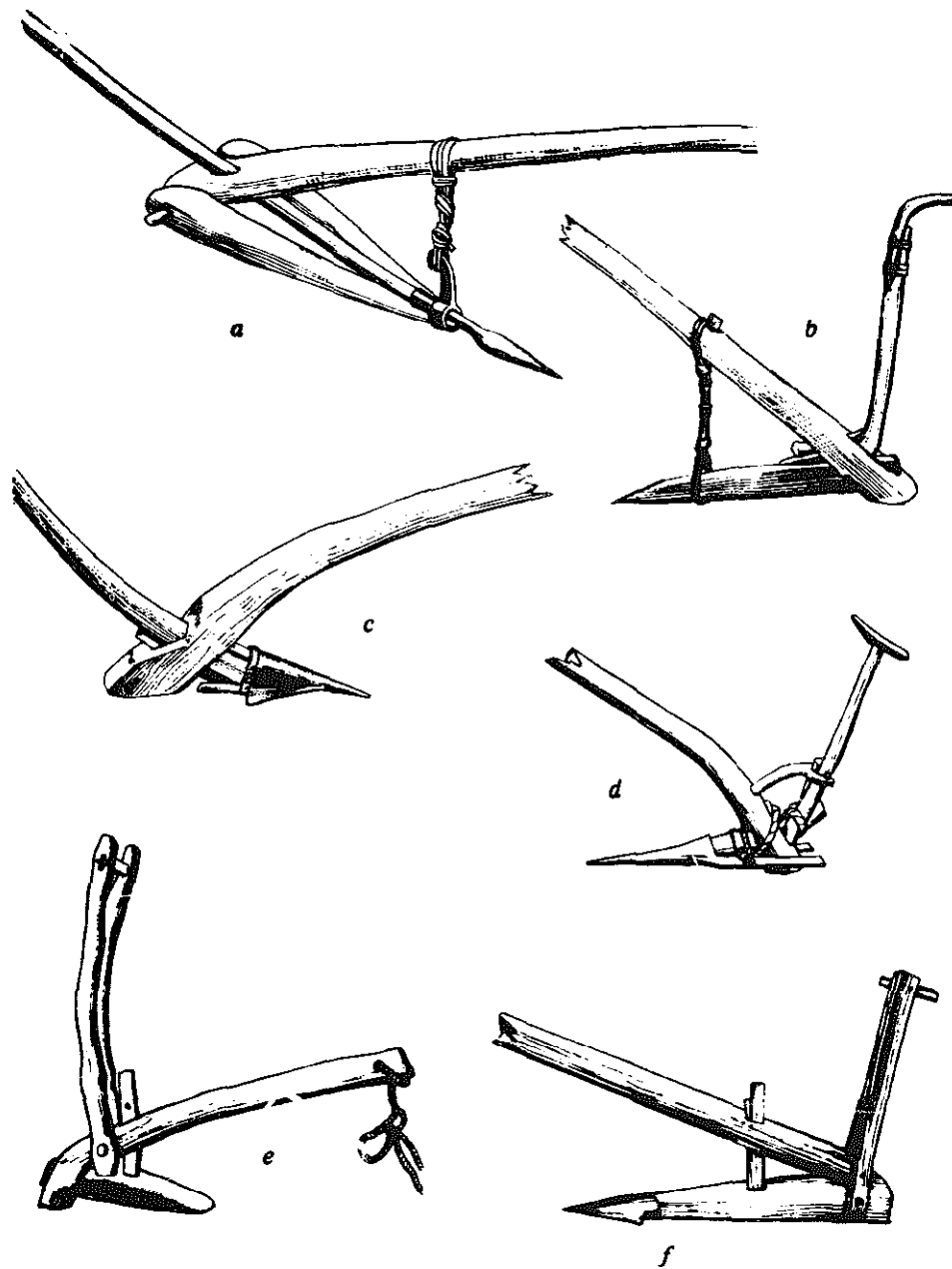

FIGURE 32. - Beam ards: (a) Ethiopian; (b) Chilean; (c) central Iraq; (d) Syria; (e) ard without metal share of the marginal desert area southwest of Basra, Iraq; (f) Egyptian balady plough.

and to have been followed by the Egyptians around 3000 B.C. Prior to that stage hand tools, such as spades and hoes, were used. Probably the first animal-drawn ploughs were adaptations of one or other of the prevalent hand tools.

There are two basic types: the symmetric breaking type and the asymmetric turning (mouldboard) type. The breaking plough more correctly designated with its ancient name "ard" (Swedish: *ard*, German: *arl*, French: *araire*, Latin: *aratrum*, Armenian: *araur*) throws soil to both sides. Its draught line lies in a vertical plane with the beam and share point dividing the implement into two symmetric halves. A turning or mouldboard plough throws the soil toward one side and turns it over. Its draught line does not go through the share point but is slightly toward the side of the inverted soil, dividing the plough into two asymmetrical parts.

BREAKING PLOUGH

The breaking plough or ard consists of a beam, body and handle which are commonly made of wood, the share of iron. It produces a slightly ridged tilth, does not invert the soil and leaves vegetation on the surface of the tilled ground to die. It has either a breaking/digging or a breaking and cutting action. The ard is easy to handle. Depth adjustment is obtained by hitching the beam closer or further from the yoke, or by changing the angle between beam and body. To steer the plough the handle is moved in the direction opposite to the desired direction of steerage.

The ard is basically a shallow tilling implement used in semiarid zones. In sandy soils and under dry conditions it has the advantage of leaving a trash layer on the surface without uprooting perennials, thus preventing excessive wind erosion and soil drifting.

This kind of plough is still widespread in North Africa, southeastern Europe, the Near and Far East and Latin America. Numerous varieties exist in all these regions. If the different types in use are compared with pictures of the most ancient ards on Sumerian seal cylinders it would seem that the plough was never really invented but that its development came about when the idea was conceived to utilize animals as a source of power for drawing implements, at first with the tools then available by adapting them to the new conditions. The necessity to adapt hand tools originally used for spading or hoeing to the draught of animals at first resulted in animal-drawn tillage implements working the soil with nothing

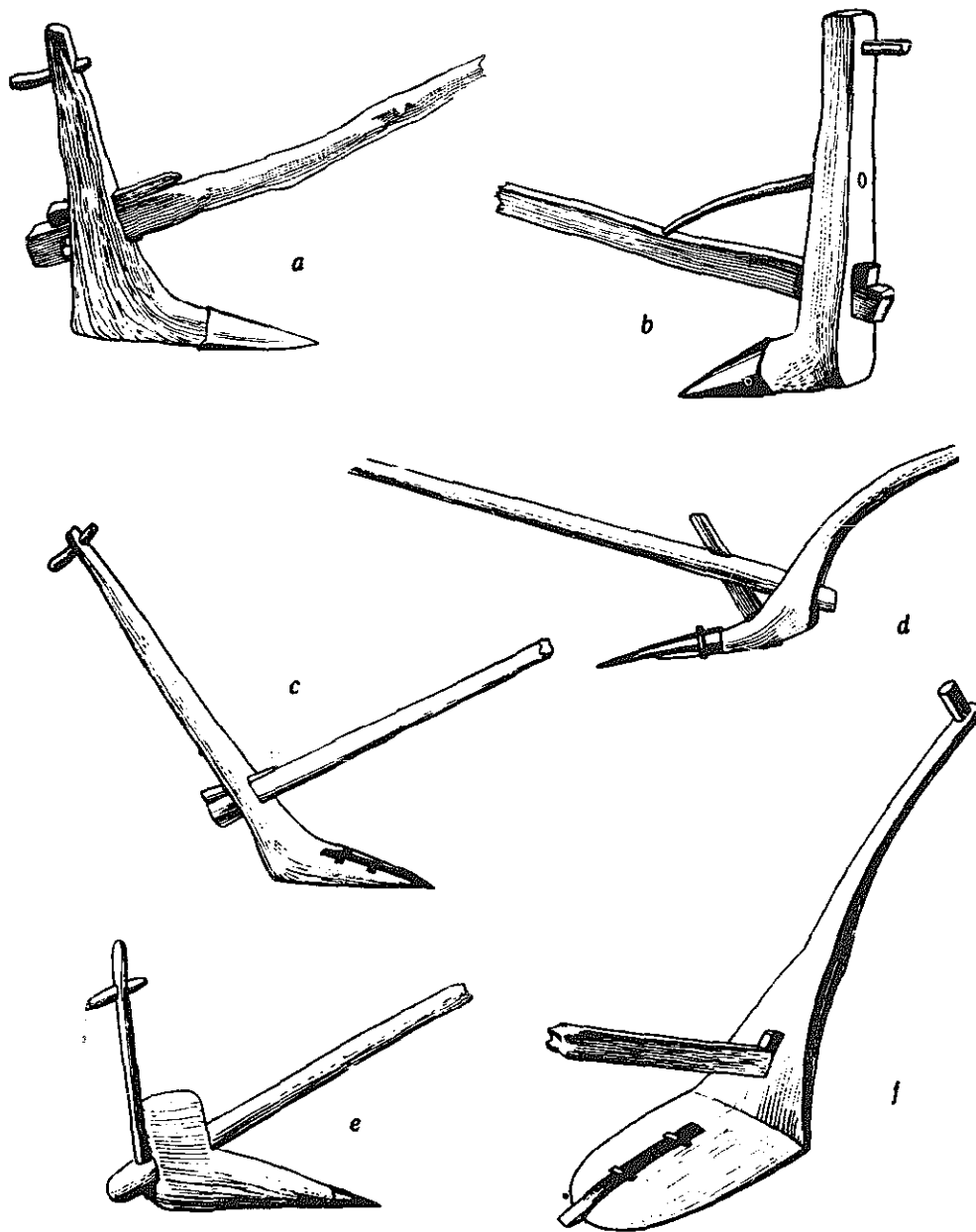

FIGURE 33. - Body ards: (a) Afghan; (b) Syria and central Iraq; (c) Indian; (d) Turkish; (e) another Indian type from the region of Bombay, and (f) Orissa plough for tilling paddy fields.

but the point and without any additional support on the soil, because the main body with the rest of the implement remained above the soil. Gradually the body came to rest on the soil behind the share point to assure work at an even depth.

Two basically different types of ards can be traced back to the dawn of history. They are:

- (a) the beam ard (*araire chambige, arado cama*) usually with a curved beam which originally was pierced by a spear-like body-handle unit, later developing into a separate body and handle inserted into the beam (Figure 32);
- (b) the body ard (*araire manche-sep, arado radial*) with an upward-inclined body tapering off into a handle, and pierced by the beam (Figure 33).

The beam ard being the weaker and narrower of the two favoured the evolution of a long horizontal sole body sliding on the ground, while the body ard (sturdier and heavier for deeper tillage) followed later, a short portion of the body first being made to slide on the furrow bottom and gradually developing into a horizontal body. Both ards led to three further groups:

- (a) the sole ard (*araire dental, arado dental*) with a horizontal sole body holding the inserted beam and handle, both separate from one another (Figure 34);
- (b) the triangular ard (*araire triangulaire, arado triangular*) with a horizontal sole body holding the beam and the handle which cross each other (Figure 35[a]);
- (c) the quadrangular ard (*araire quadrangulaire, arado quadrangular*) with a horizontal sole body connected to a straight, nearly parallel beam by a handle and an additional brace (*étançon, espata*) (Figure 35[b]).

The working part of the ard was originally of hard wood, then it developed into an iron or steel share. This share exists in two basic forms (Figure 36): a socket share which is slipped over the nose of the plough body, and a tang share which fits into a groove where it is held with a clamp on the wooden body.

Beam ard

The beam ard is probably the most ancient type of breaking plough (Figure 32). It is more commonly used for shallow work, normally with a tang share, in dry, stony soils but sometimes it has a socket share for

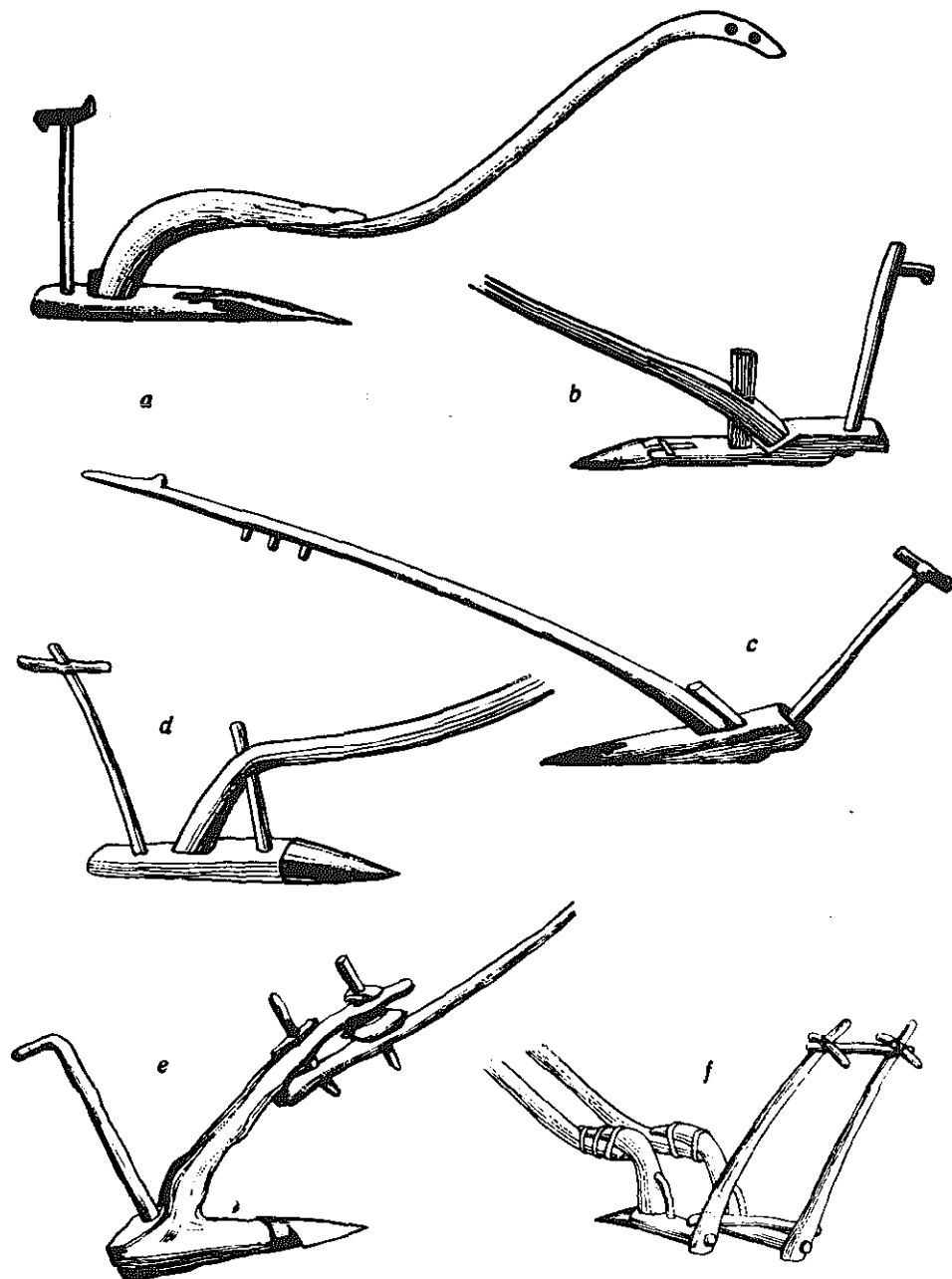

FIGURE 34. - Sole ards: (a) Pakistan; (b) Afghan ard from Kabul Province; (c) Nepal; (d) Cyprus; (e) Kurdistan, Iraq; (f) double-sole ard from Syria.

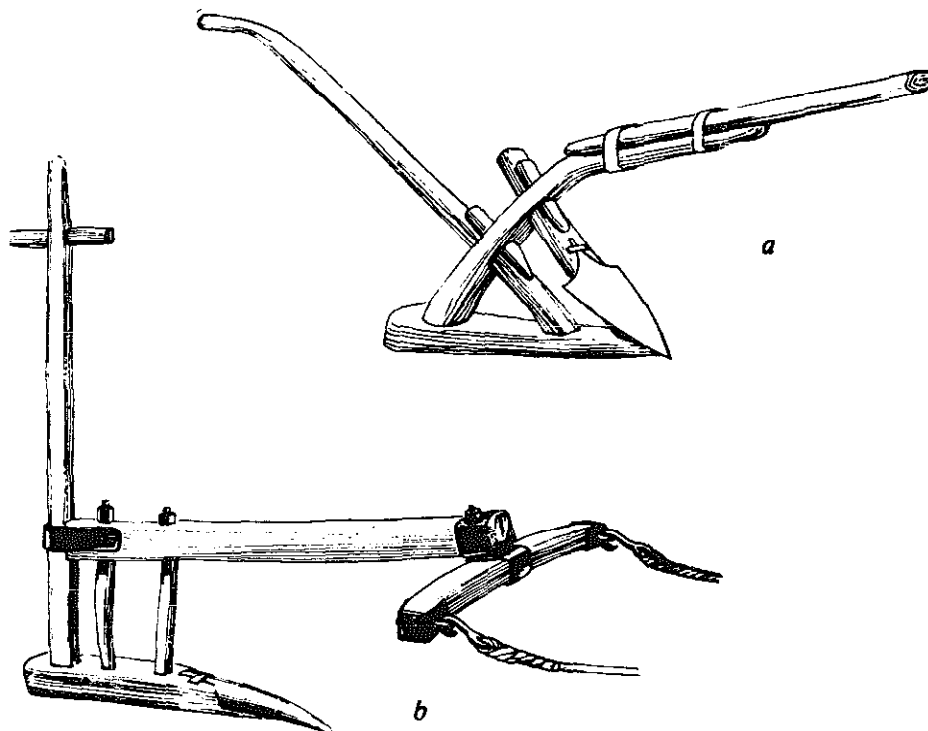

FIGURE 35. - Triangular and quadrangular ards: (a) Mecklenburger Haken; (b) quadrangular ard from Malta.

other soils. At present it is mainly used in central and eastern Spain, northern Tunisia, Ethiopia, northern Greece, southern Bulgaria, western Turkey, Syria, Lebanon, Israel, Jordan, Iran, eastern India and Sumatra.

While the present beam ard and other ards generally have one handle, the first beam ards used by the Sumerians and the early Egyptians clearly show two handles and sometimes also a seed tube. The modification from two handles to one does not appear to be a backward step because two handles are unnecessary for such types of symmetric ploughs. There are still a few beam ards with two handles in Luristan (Iran), southern Iraq near Basra (Figure 32[c]), and in the United Arab Republic (Figure 32[d]) where some plough handles consist of two parallel shafts joined on the upper part by a wooden crosspiece.

Traces still exist of the lower part of the two handles mentioned above in the lateral wings of some ard bodies, as used in the Balkans, Ethiopia, Spain and some North African and Latin American countries formerly under Spanish influence.

The first beam ards, being an adaptation of former hand tools, no doubt showed the deficiencies of an implement made for digging which then had to be pulled. For instance, the narrow body with only the point in the soil and no other support (Figure 32[a]), being badly balanced, could only be used in soils free of obstacles, such as irrigated fields in Mesopotamia. Later, the stress between beam and body was neutralized by a fibre or leather brace between the lower part of the body and the beam (Figure 32[b]). Still later, this brace was made of wood and became an important element in subsequent ard construction.

Body ard

The body ard has an upward inclined body which tapers off into the handle (Figure 33). The beam passes through the upper part of the body. The implement is used for comparatively deep tillage in soils with sufficient moisture. In some parts of Europe with moist soils this ard was preceded by a separate "ristle" (*coutrier, cuchillo*), a coulter-like implement, to achieve a greater depth. The ristle was later combined with, and is now, the coulter of the ordinary plough although it is still used in some parts of Spain and Portugal as a separate implement.

The body ard is stronger than the other implements of this type and normally has a socket share. For better cutting of weeds the metal share is sometimes laterally extended or even provided with serrated wings.

Body ards are the most widespread of the ard group and predominate in Portugal, western Spain, in the Balearic and Canary Islands, the Azores, Morocco, and the more humid eastern parts of Algeria, Yugoslavia, Albania, Bulgaria, Romania, northern and central Greece, northern Turkey and Anatolia, Afghanistan, India, Ceylon, Malaysia, Thailand, Japan, Indonesia, Celebes and most of the Latin American countries, such as Guatemala, Mexico, Peru and Brazil, where they were introduced by the Spaniards and the Portuguese.

As a special feature, in Syria, central Iraq, Turkestan, and Kansu (Mainland China), the ard has a typical wooden brace between its beam and upper handle (Figure 33[b]). In southern India the handle is frequently separate from the body and wedged parallel with its vertical part into an extension of the beam at the rear of the body (Figure 33[e]). In northern India the share is generally chisel shaped and not of the usual socket type.

The above-mentioned wooden wing extensions on both sides of the lower part of the ard, which give better mixing of the soil, are character-

istic in the west, being found in the Balkan countries, Morocco, Portugal and Spain.

The *sokha* is a special type of double body ard. It consists essentially of two body ards, with their parallel beams, forming the two shafts for

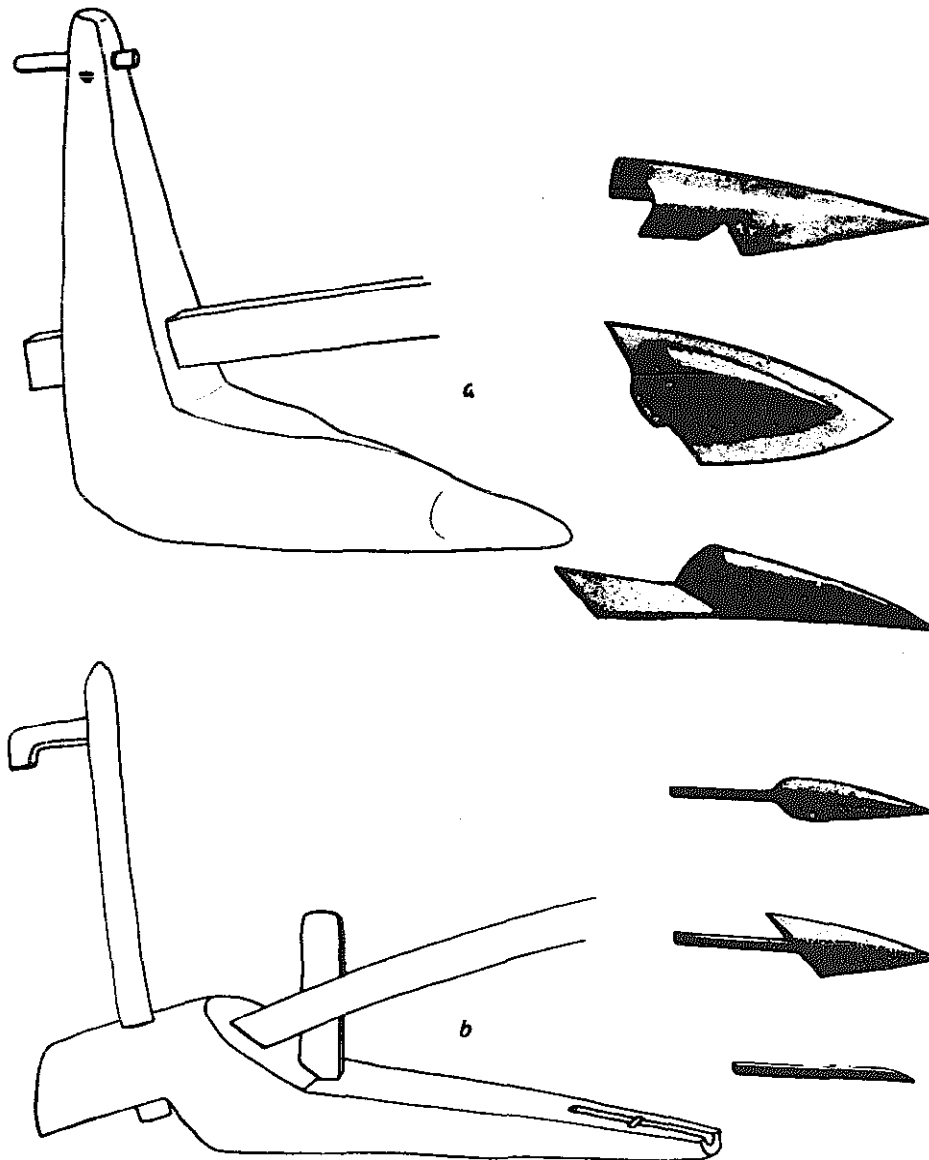

FIGURE 36. - Ard shares: (a) socket shares; (b) tang and chisel types of shares.

a single horse-drawn tillage implement with two socket shares. In later types the double body is combined in one wooden board. A *sokha* shows the adaptation of an old traditional implement to a more recent single-animal harness following the pattern of a shaft-drawn cart. It is still used in some parts of the U.S.S.R. and Finland.

The body ard also came as far as northwest China from the west via Sinkiang Province, and then underwent radical changes. Nevertheless, a long-beam body ard with a knee-like brace still appears to be used in the west of Lanchow Province, which would show its connection with the Mesopotamian body ards.

Sole ard

This is a versatile, easily manageable, light implement of dry zones, generally used by nomads for shallow tillage (Figure 34). It leaves weeds mostly uncut, a not undesirable feature where weeds are grazed on fallow land.

The sole ard generally has a long, narrow, horizontal body, which, in some regions, widens at the rear thus assuming a triangular form. Beam and handle are separately inserted into the sole body, the heel (*talon, espadillo*) of which usually remains clear for the operator's foot when added pressure is necessary. The body has sometimes wooden lateral wing extensions.

The beam of the sole ard consists of one or two joined pieces. The beam is shorter in Malta, Tunisia and Libya where the implement is drawn by a single horse or mule (with collar harness in the first two countries, and breastband harness in Libya).

The sole ard is widespread in Andalusia in Spain, Morocco, western and southern Algeria, southern Tunisia, Libya, the United Arab Republic, Malta, southern Italy, Greece and the eastern Balkan countries, Crete, Cyprus, northern Turkey, Caucasus, northeastern Iraq, western Iran, Afghanistan, northern Pakistan, Kashmir and Nepal.

Triangular ard

The triangular ard with crossed beam and handle inserted into the horizontal sole body was typical of the Mecklenburger Haken in Germany (of beam ard origin) (Figure 35[a]), and is typical of the various Chinese ploughs of body ard origin (Figure 38[a]).

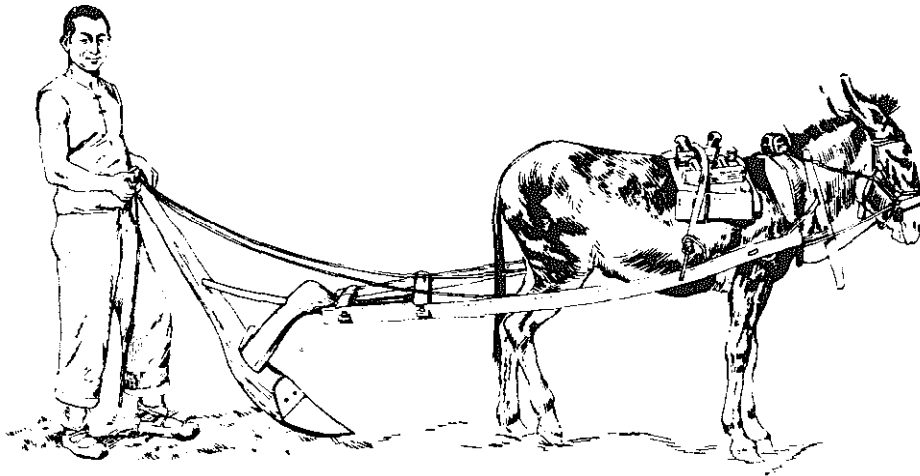

FIGURE 37. - Ard from north Mainland China: this shows the transition from the body ard to the triangular plough.

Quadrangular ard

This implement, characterized by a horizontal body with vertical handle and a vertical brace holding the beam, represents a further step in development. It is used mainly in the Balkan regions and Malta (Figure 35[b]) in the west and in China (Mainland) (Figure 38[b]) in the east. The quadrangular ard has facilitated the transition from the symmetrical ards to asymmetrical mouldboard ploughs.

MOULDBOARD PLOUGH

The mouldboard plough lifts and turns the soil toward one side. Some invert the soil, and others only partially invert it. It differs essentially from the ard by its ability to clear the furrow bottom for the next turn and enables the ploughman to till a field in one operation instead of with repeated cross-ploughing which is necessary with ards.

Chinese plough

The Chinese plough appears to be based on the body ard, coming from Mesopotamia via Turkestan. Subsequently this implement was modified by the addition of a board or plate to protect the wooden body behind the share (Figure 37), which later was evolved into the mouldboard. It was also adapted to single-animal draught.

The Chinese plough is usually quadrangular (Figure 38[b]), although the earlier triangular type is still widely used. It consists of a wooden beam and body with one handle, a steel socket share and a steep curved, cast-steel mouldboard. The beam is often sharply curved with a low hitch point giving a well-balanced draught. It weighs between 14 and 18 kg and is drawn by one or two animals.

The triangular Chinese plough (Figure 38[a]) was introduced into Japan, the Philippines, Viet-Nam, Cambodia and Thailand. It seems to have been brought to Japan at a very early stage in its evolution and to have been developed there quite independently.

Quadrangular Chinese ploughs are also found in Korea and Taiwan. The Chinese influence in mouldboard and share design stretched as far as Malaysia (Figure 41), Java, Bali and the Celebes, but not in the rest of the plough body, which suggests Indian origin.

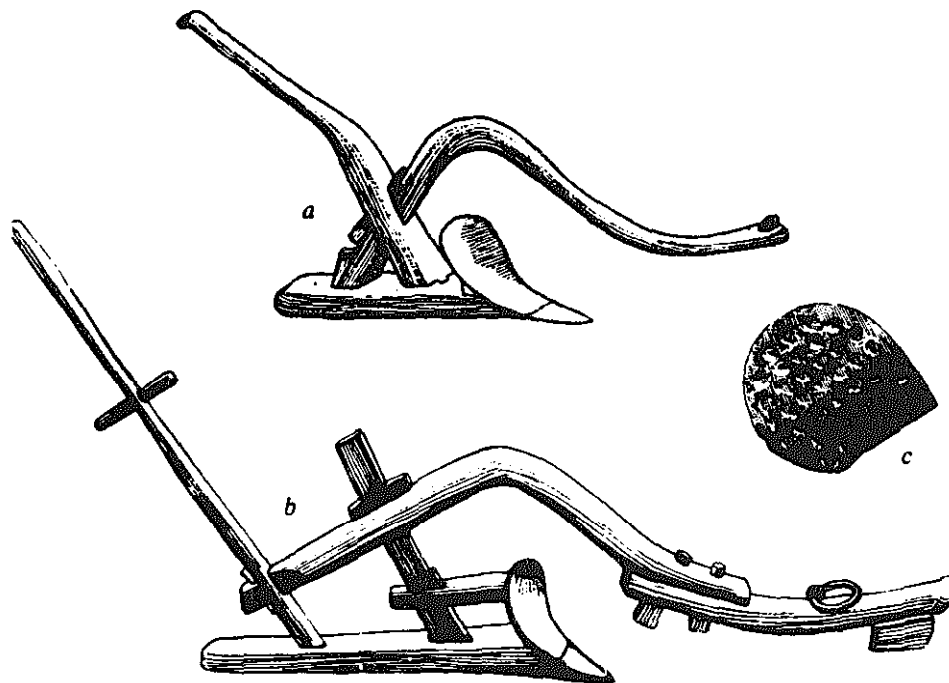

FIGURE 38. - Chinese ploughs: (a) triangular; (b) quadrangular; (c) mouldboard in bottom-like relief for better scouring of sticky soil.

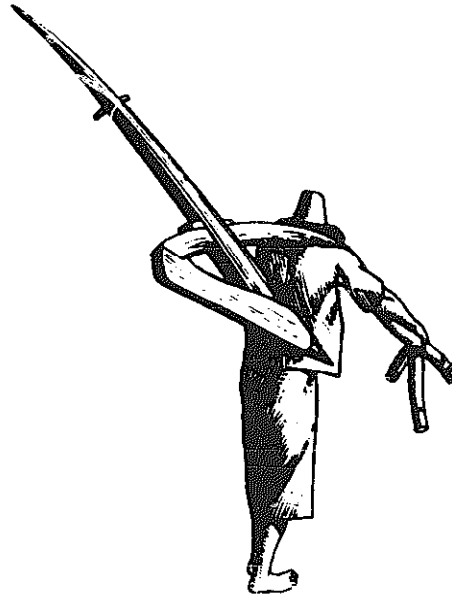

FIGURE 39. - Chinese farmer carrying plough and single neck yoke.

Japanese plough

The Japanese wooden plough (Figure 38) consists of a cigar-shaped wooden body with its upper part tapering off into a handle, and with a steel share and mouldboard attached to its lower part. The share is centre pointed and diamond shaped; the curved mouldboard is made either of one steel plate or it may be slotted (or finger like) for better scouring of sticky soil. Underneath the body is a central knife edge. The Japanese plough has only negligible side draught and therefore no land-side as in western ploughs. A short beam is attached to the body with a joint and a support brace. The support brace allows for the increase and decrease of the angle between beam and body to increase or decrease the depth of work. The free end of the beam is hitched to a swingletree pulled with rope traces by a single draught animal. Besides the main body handle there may be an additional handle or cross-piece at right angles to it for added control from the left or the right. This enables the ploughman to guide the plough accurately and to control the width of cut, which is dependent on the inclination of the plough toward or away from the furrow side.

Separate types of ploughs are made for right-hand (Figure 40[a]) or for left-hand turn of the furrow-slice, and there are also reversible types (Figure 40[b]) with a lever within hand reach of the ploughman to reverse the mouldboard and share assembly. Little effort is required to guide and control a good Japanese plough.

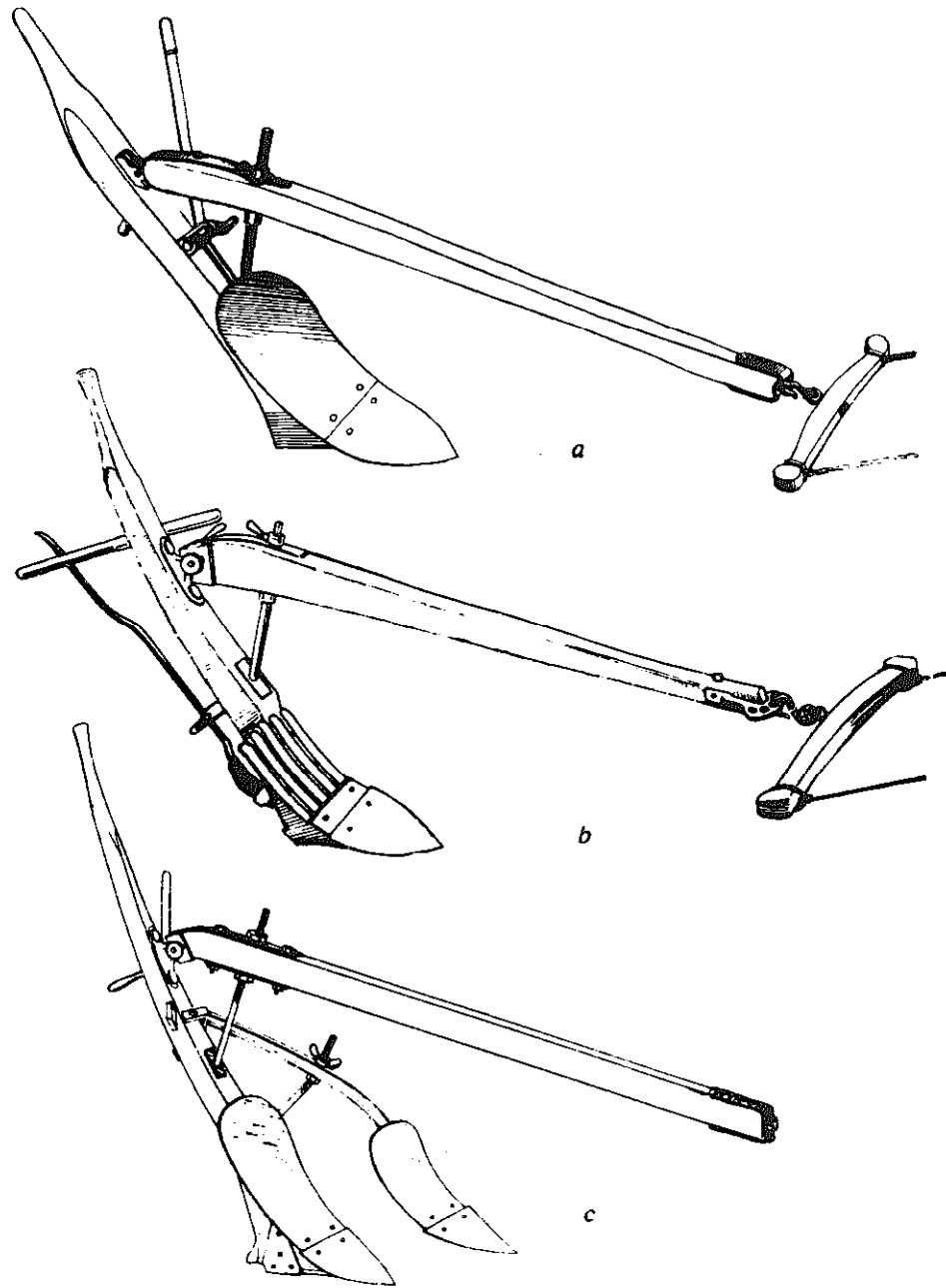

FIGURE 40. - Japanese ploughs: (a) common type; (b) reversible turnwrest type; (c) two-level plough.

Japanese two-level double plough

The two-level plough has a smaller body and share fixed in front and slightly at the side of the main body. The smaller front body cuts off about half of the furrow-slice and throws it into the path of the main body which cuts the lower half of the furrow-slice and turns both soil layers together to the side. The smaller front body enables the principle of planing to be applied, which results in reduced draught. Thus it is possible to plough hard soil in one operation with one animal only (Figure 40[c]).

Western mouldboard plough

The western type of mouldboard plough is the standard tillage implement of temperate zones particularly where there is regular rainfall. It is perhaps a more efficient destroyer of weeds than any other cultivation implement but has a heavier draught than the Chinese and Japanese ploughs. The mouldboard plough of the west is based on a combination of the ard and a two-wheel wagon forecarriage. As such it was reported by the Romans to be used in central Europe. They called it *carruca* from wagon (which became *charrue* in French) to distinguish it from *aratrum*, the ard, the then normal tillage implement. Besides the forecarriage the early ploughs had a vertical flat slide board aslant the share (Figure 43[b]), simply to clear the cut furrow from the untilled soil. Such types are still in use in northern Turkey and in Morocco. The slide-board plough was used in western countries until the eighteenth century, when the Chinese curved mouldboard became known in Brabant in north-western Europe, and from there it led to the development of the western curved mouldboard and to modern plough design (Figure 43[c]).

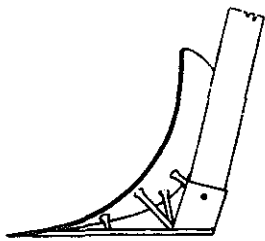

FIGURE 41. - Detail of simplified Japanese plough body construction, adapted to conditions in some Southeast Asian areas.

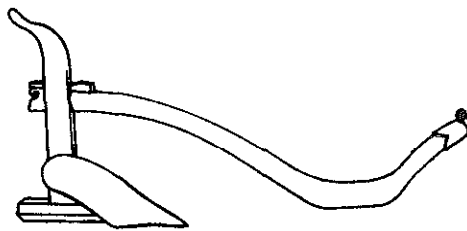

FIGURE 42. - Kedah plough (Malaysia) with improved share design.

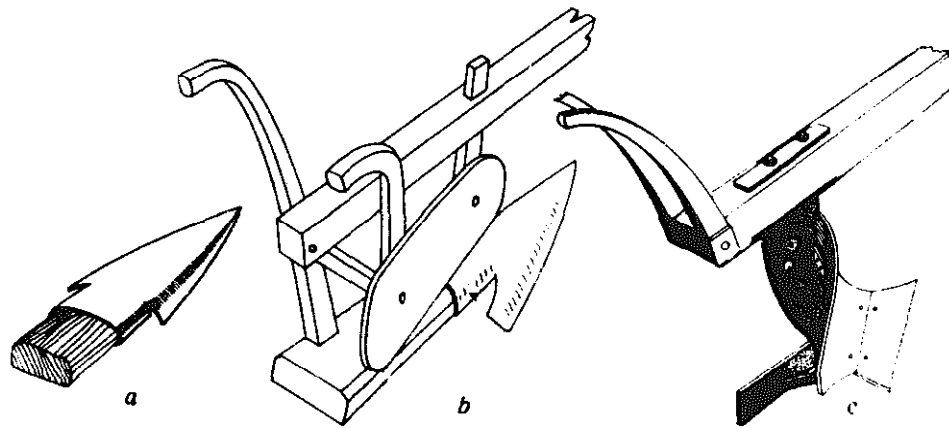

FIGURE 43. - Historical evolution of the western plough: (a) the ard, (b) bisected ard with flat slide board; (c) the plough with share and curved mouldboard.

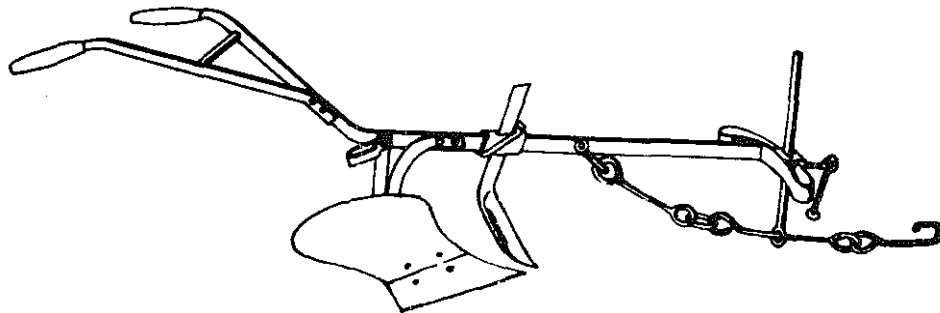

FIGURE 44. - Western mouldboard plough.

The ox-drawn western mouldboard plough (Figure 44) is usually made of steel and cast iron. It consists of a body to which share, mouldboard, landside, sole and beam are attached. The beam carries the handles and the adjustable hitch, sometimes also a coulter and a land wheel (neither of which is ever found on Chinese ploughs) or a skid in place of the wheel. Horse-drawn types may have both a land wheel and a furrow wheel. The share cuts the soil and the mouldboard turns the slice, while the landside takes the side thrust on the furrow wall and the sole the downward pressure of the whole implement on the bottom of the furrow. It is not unusual for the landside and the sole to be combined in one component called the "slade." The weight and sliding action of the plough, in heavy

soils, creates an impermeable layer, a "ploughpan," if the depth of ploughing is always constant on the furrow bottom. This is undesirable in all but wet rice fields where it is an advantage.

The plough is designed with adjustments for width and depth of ploughing and general balance of the implement which, if set correctly, ease the ploughman's work and reduce the draught. Light ploughs turn furrows approximately 22 cm wide and from 12 to 14 cm deep. As with eastern-type ploughs, there are both left-hand and right-hand types, but the majority are right hand. There are also reversible types as described below.

Reversible or one-way mouldboard plough

The western type of reversible plough is designed for the same reason as the eastern type — to turn all the furrow-slices in one direction, to maintain a furrow-free surface on the fields, to work on hilly land, and to enable the farmer to plough the whole field without having to mark out lands. This implement is heavier and more expensive on account of its double mouldboard or single reversible mouldboard. The latter is often known as the "turn-wrest" plough (Figures 45 and 46).

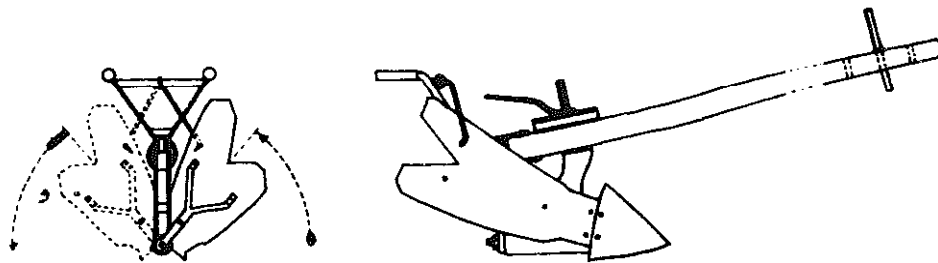

FIGURE 45. - Turn-wrest plough with wooden beam (Florence, Italy).

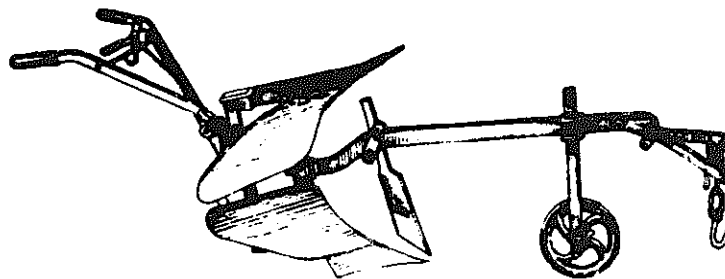

FIGURE 46. - Western reversible plough.

Man-drawn ploughs

Manually-drawn ploughs are used to till previously cultivated plots too large for spading and too small for animal draught. They are used in some parts of China (Mainland) for very small fields and sometimes by gardeners in western countries (Figure 47).

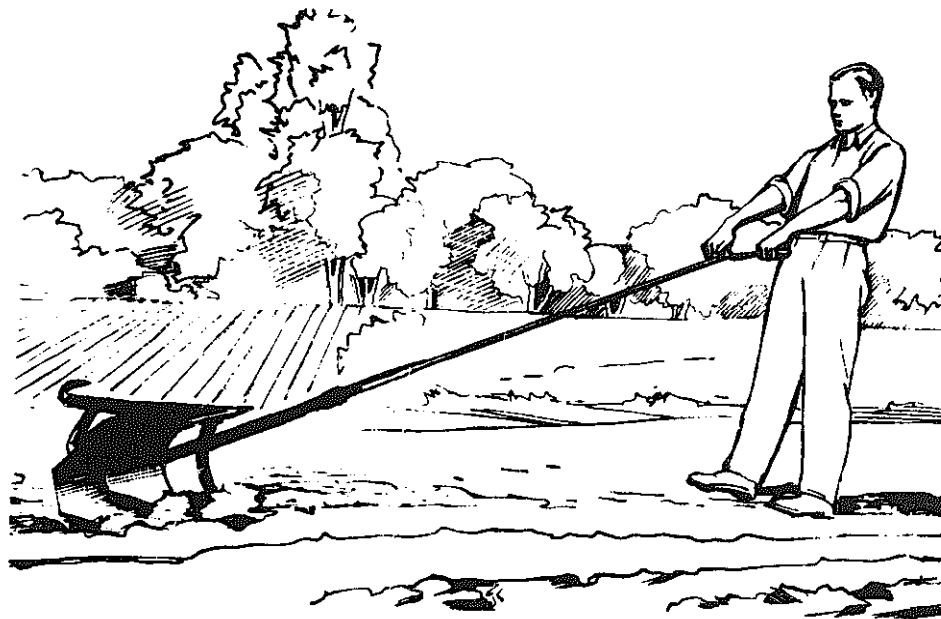

FIGURE 47. - Hand-drawn reversible plough.

IMPROVED ARDS

The technical features, low cost, simplicity of design and ease of operation possessed by breaking ards are advantages which should not be underestimated, especially in hard soils, semiarid areas and regions exposed to wind erosion. Their disadvantages are the slowness of their work, making repeated cross-ploughing necessary to obtain a good tilth, and insufficient capacity to eradicate weeds. Efforts to overcome its disadvantages were made by fitting an improved ard made of steel, with various interchangeable shares and sweeps to ensure better tillage and effective cutting of weeds (Figure 48). A greater width of work is sometimes obtained with ards, for instance in Syria, by hitching two parallel ards to the same yoke with one pair of animals (Figure 34[f]). This development has led to the cultivator and to its use for primary and secondary tillage.

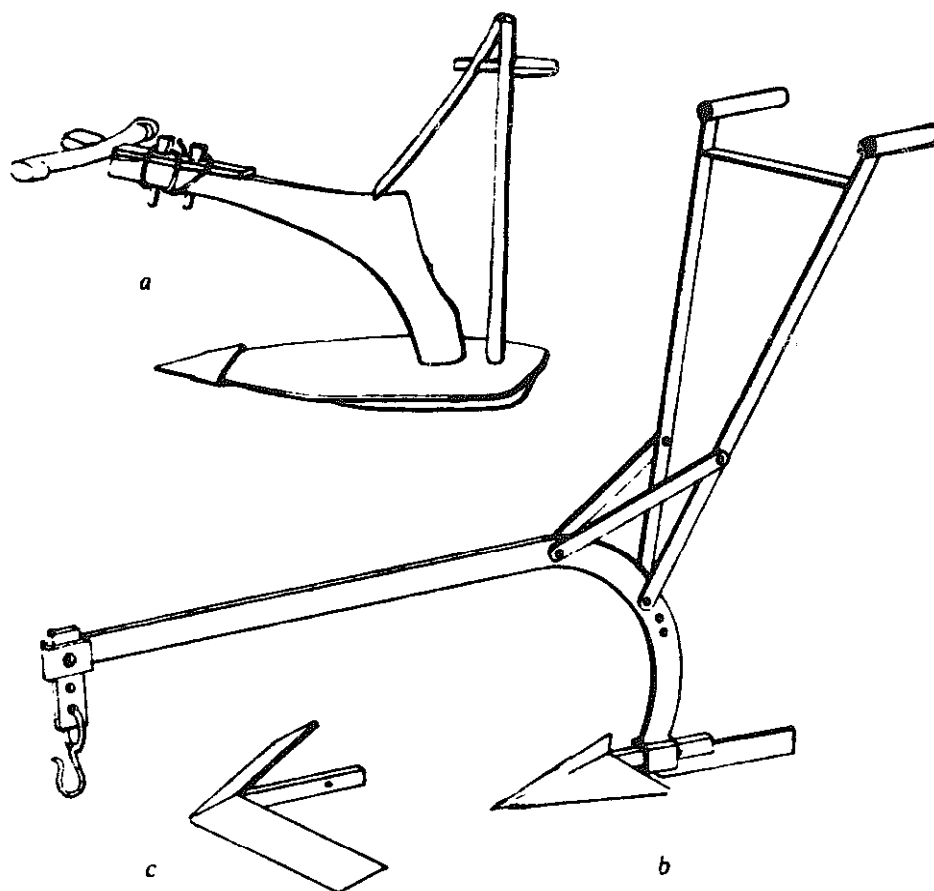

FIGURE 48. - Improved multipurpose ard: (a) traditional Libyan plough; (b) improved version with exchangeable shares for shallow tillage or intercultivation; beam length approximately 75 cm, ground clearance approximately 35 cm; (c) weeding sweep, *mahacha*.

Cultivators

The cultivator is a very versatile implement derived from the symmetric ard by a multiplication of its working part. It is used for tillage as a multiple breaking plough, for clod breaking, stubble mulching, seedbed preparation and seed covering in arid zones either on dry or irrigated land.

A sturdy type of this implement is used in Italy for tillage; it consists of a crossbar with three to seven rigid staggered tines, a double handle, two rings and chain drawn with a rope by a pair of oxen (Figure 49). The same implement is sometimes made with a wheeled forecarriage which has a central pole to facilitate steering and depth control.

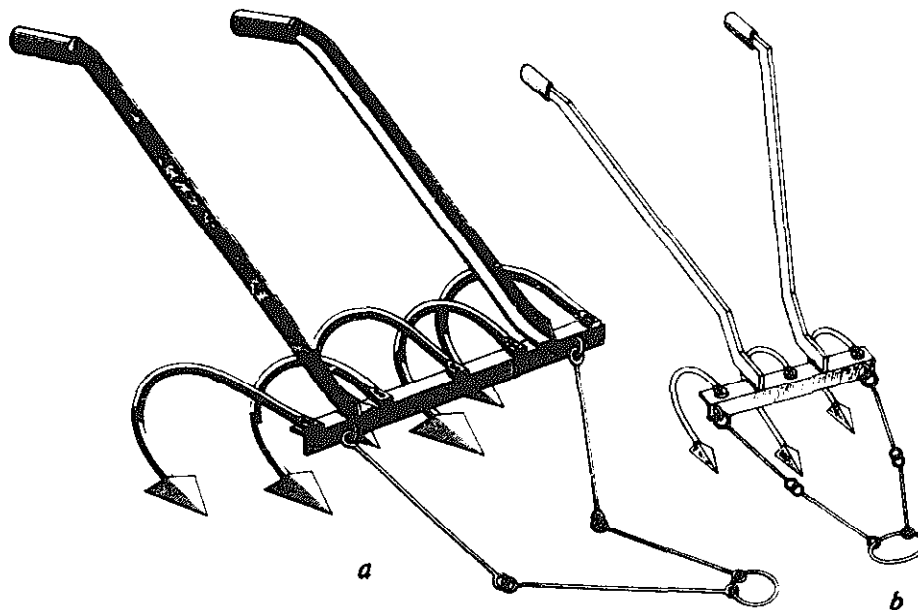

FIGURE 49. - Animal-drawn cultivator for primary and secondary tillage (Casalese type, Italy).

Lighter types of cultivators (also called horse hoes) with spring-type or flexible tines and an expandable, lever-controlled frame are used for intercultivation with one or two animals (see chapter 8).

Multipurpose implements

The name "multipurpose implement" has been coined to include implements which have a basic frame or toolbar to which a variety of tools or sets of tools or mechanical devices can be fixed for different work. To fulfil their task efficiently the devices under draught should keep under control unbalanced component forces such as side draught. The weight of the implement combination should not be so high as to make it difficult to handle in small fields or to transport over country without roads. The cost of the tool carrier with its related tools should also not exceed the total price of the individual implements which it is replacing. The attachment and detachment of the devices for the tool carrier should be easy and fast, and the method of attachment must be firm enough to stand tough conditions and treatment. The idea to combine also a transport

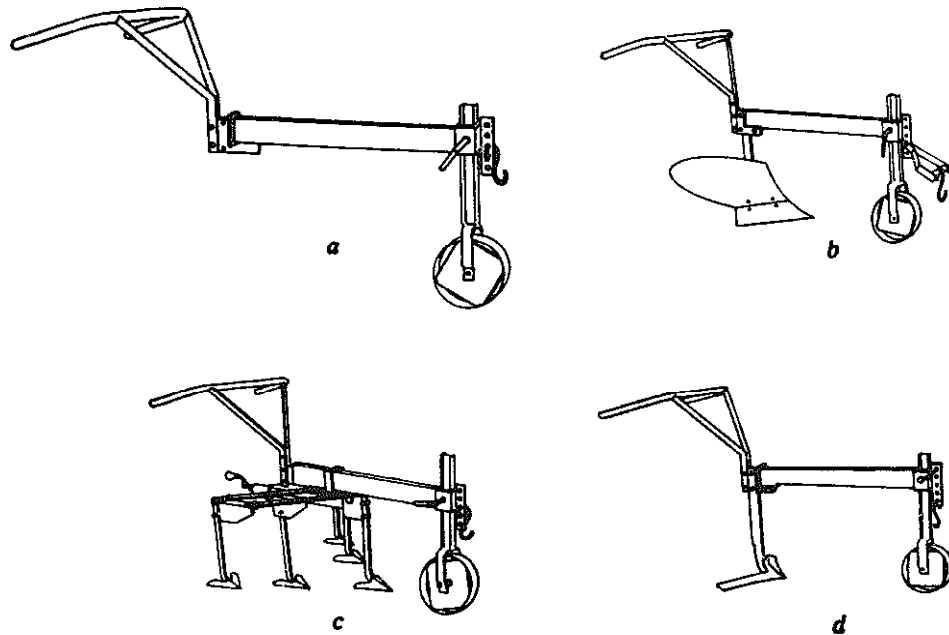

FIGURE 50. - Light multipurpose implement also made in Senegal: with (a) tool carrier; (b) plough body; (c) cultivator tines; (d) sweep for groundnut lifting.

platform with a multipurpose tool has the disadvantage of increasing the cost beyond that of a separate simple cart and a separate set of basic implements. It also has design problems if used with an implement that introduces side draught, such as the western type of mouldboard plough, and thus further increases the cost. The problem is less severe with the eastern type of mouldboard plough, which has negligible side draught.

Significant progress has on the other hand been achieved with the development of lighter multipurpose implements which are not designed to be adapted as a cart and therefore are not built around a wheeled drawbar. A few samples of basic tools of this lighter type are shown in Figures 50 to 52, with some of their combinations. The first one (Figure 50) represents a light basic tool carrier (19 kg) to be combined with a plough body (6.5 to 8 kg), 3 spring-type cultivator tines (16 kg), an expandable 5-tine hoe (28 kg), a ridging body with expandable wings (9 kg), or a groundnut lifting sweep (50 cm width, 5 kg). It can be drawn by one to two donkeys or draught oxen according to soil conditions and work. It is being used with success in West Africa where it is manufactured in

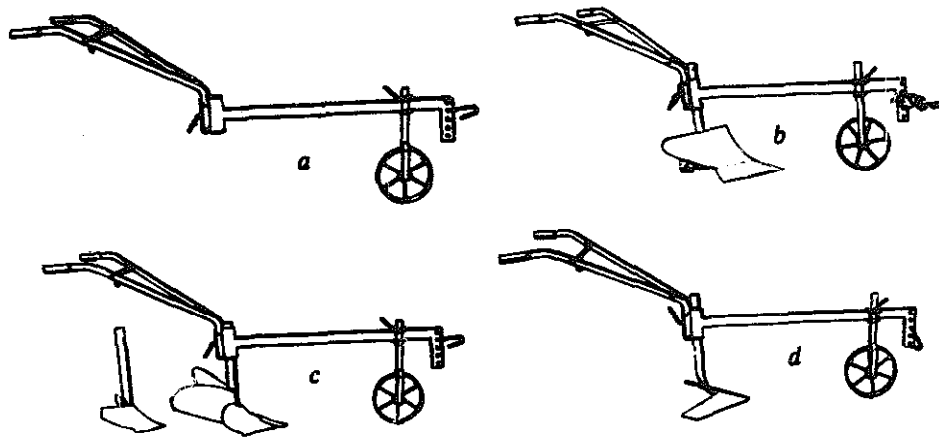

FIGURE 51. - Multipurpose implement, also designed for West African conditions with: (a) tool carrier; (b) plough body; (c) ridging attachment; (d) groundnut lifter.

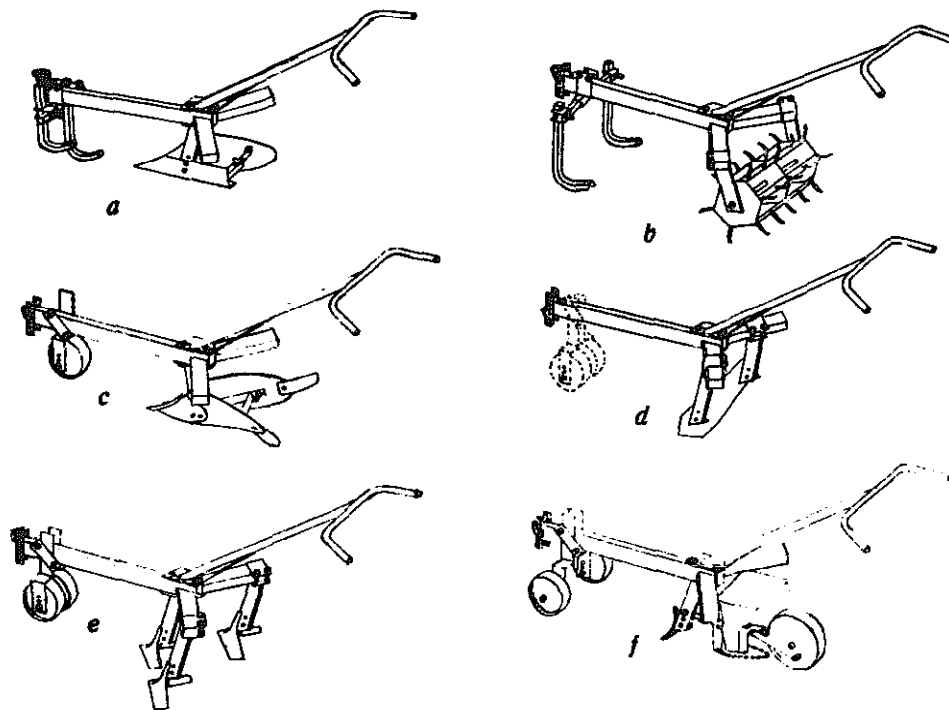

FIGURE 52. - Unibar with (a) plough body; (b) rotary cultivator; (c) ridger; (d) cross-tying blade; (e) cultivator tines; (f) seeding attachment.

Senegal. Also designed for West African conditions is another tool carrier (23 kg) built with attachments for ploughing, cultivating, hoeing, ridging, row marking, two-row seeding, weeding, earthing up, and groundnut lifting (Figure 51). The third so-called "Unibar" shown in Figure 52 was designed to meet the requirements of farmers in the groundnut and cotton farming areas of Northern Nigeria and East Africa, with special regard to the serious problem of weed control in marginal rainfed areas. The full range of operations possible with the Unibar is as follows: ploughing, cultivating (three different ways), rotary harrowing, ridging, ridge splitting, ridge ripping and remoulding (with a centre share ahead of the ridger), hoeing, cross-tying (combined with remoulding and weeding), planting (maize, etc.) with a precision seeder (with or without fertilizer hopper), and groundnut lifting. The weight of the Unibar with a plough is 41 kg, with a ridger 44 kg, with a 5-tine cultivator 47 kg.

6. MACHINERY FOR SEEDBED PREPARATION, EARTH MOVING AND FERTILIZER SPREADING

A good seedbed should promote not only the germination of seeds but also the subsequent growth of the young plant. The main object of seedbed preparation, following primary tillage, is to break large clods, level the field and produce a firm tilth. The higher the humus content of the soil, the longer good tilth can be maintained. In irrigated fields, seedbed preparation in this context also includes levelling, bund forming, ridging and other water-control operations, insofar as they have not been done by the primary tillage operation. In the case of wet paddy cultivation it also includes puddling.

In arid zones where organic matter decays rapidly the humus in the soil may be practically nonexistent. A fine tilth will not, under such conditions, remain firm but will turn into a crust on drying after heavy rainfall or irrigation, thus impeding soil aeration and plant growth. Therefore, under such conditions the soil should be left in a cloddy state.

A selection of hand-operated and animal-drawn equipment commonly used for these tasks is described in this chapter. Where implements have already been described in previous chapters, such as animal-drawn cultivators, they are not mentioned again.

Hand-operated implements

HOES

The same or similar tools and implements as those used for primary tillage are also common for seedbed preparation although the blades of the latter may be wider. Forked hoes should preferably have four tines to give a greater working width for lighter work. Large clods are often broken with the reinforced back of the hoe, but long-handled wooden hammers are still used to do this in some countries of the Near East where digging is done with a spade.

HAND CULTIVATORS

Hand cultivators are useful for loosening the soil and for killing weeds. Simple types consist of three to seven interchangeable tines with duckfoot sweeps, held in a socket by a screw. They are dragged through the soil with one handle (Figure 53[a]).

ROTARY HAND HARROW

Figure 53(b) illustrates an effective type of rotary hand harrow. It consists of two rows of serrated steel plates or "stars" combined with a horizontal blade. It has good pulverizing properties when the soil is not too dry and compact.

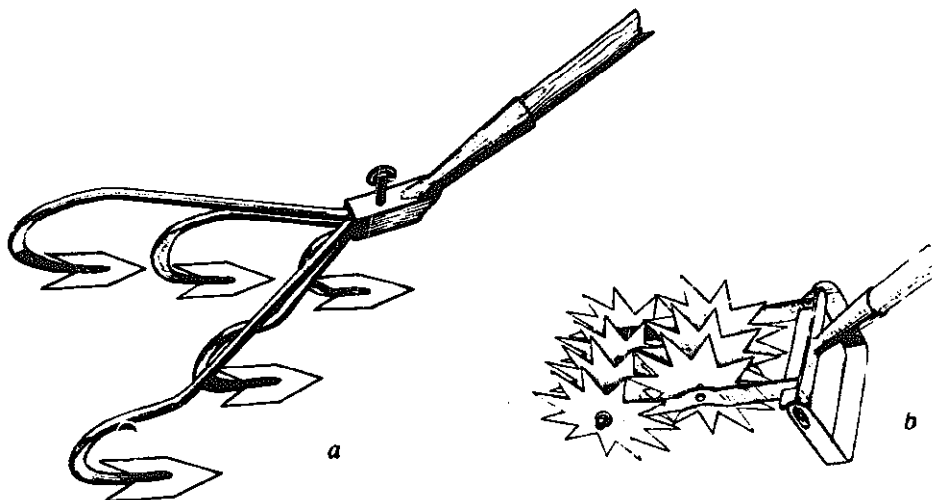

FIGURE 53. - Hand tools for cultivation: (a) cultivator; (b) rotary harrow.

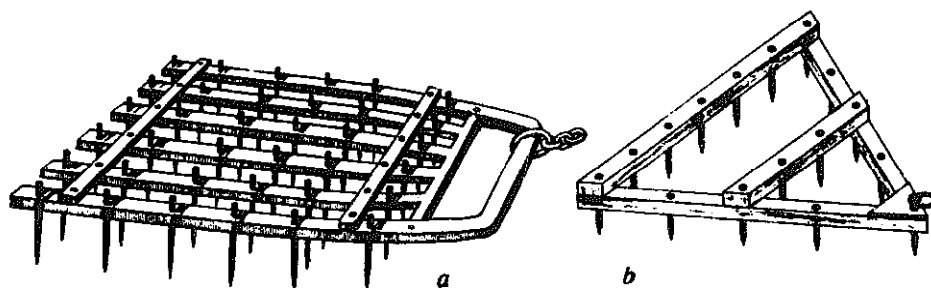

FIGURE 54. - Spike-tooth harrows: (a) trapezoid and (b) triangular.

Animal-drawn harrows

Harrows are used for seedbed preparation, to cover seeds, destroy weeds, to break up soil crusts, and for aerating pastures. Rotary harrows are being used to an increasing extent in rice-growing areas because they have relatively low draught; they are good soil pulverizers and in wet rice fields they puddle well, break up organic matter and compact the subsoil.

SPIKE-TOOTH HARROW

The spike-tooth (or peg-tooth) harrow is one of the commonest implements for seedbed preparation in temperate zones (Figure 54). Simple types consist of a triangular or rectangular horizontal wooden or iron frame with crossbeams to which rigid, straight or slightly bent steel teeth or tines are attached in a variety of ways. For levelling and smoothing tilled fields the implement may be used upside down. The harrow, with four crossbeams, is very common in central and northwest Europe and, with two crossbeams, in China (Mainland).

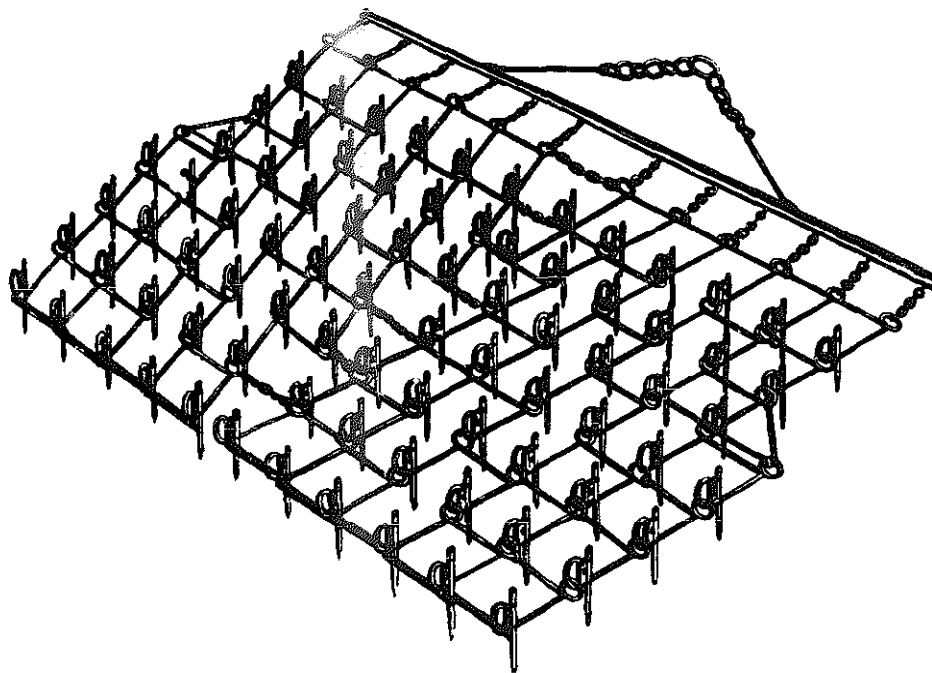

FIGURE 55. - Flexible harrow.

SPRING-TOOTH HARROW

In the spring-tooth harrow the tines are made from spring steel usually rectangular in section and curved. Attached to crossbars, they vibrate as they progress through the soil. The crossbars can be rotated through a small angle with a lever and consequently the penetrating depth can be regulated. Each spring has a renewable working point.

FLEXIBLE HARROWS

There are many varieties of flexible harrows, sometimes called chain harrows. The one shown in Figure 55 is so constructed — steel rods formed into links — that one side of the harrow has larger teeth than the other, thus providing two harrows in one. It is used for weeding and very light tillage during early stages of crop growth, seed covering and spreading manure on pastures. Another type, specially made for renovating old pastures, has carbon steel, renewable, knifelike teeth. Still another type consists only of chain links made up into a grid.



FIGURE 56. - Peg-tooth or comb harrow, Chinese type.

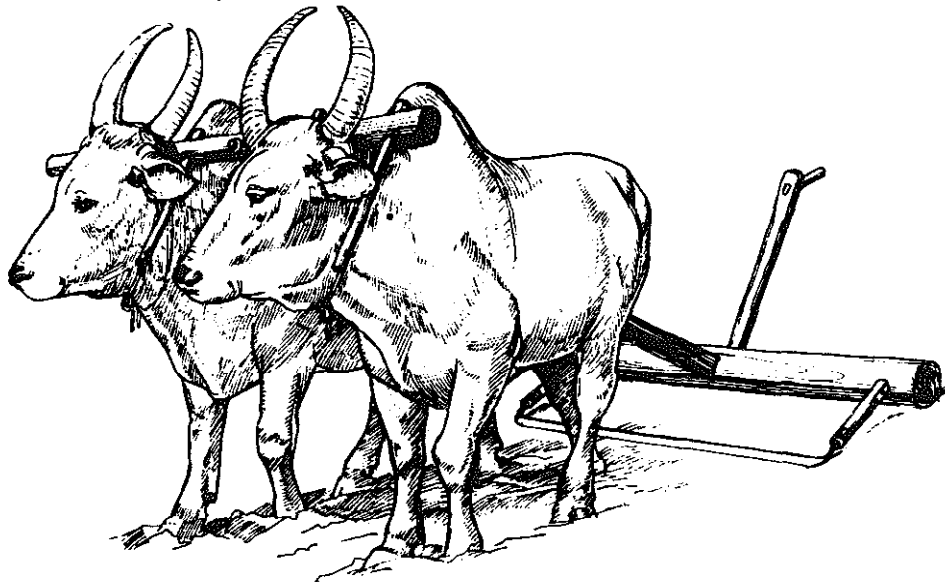

FIGURE 57. - Blade harrow, called bakhar or guntaka, widely used in India and Ceylon.

COMB HARROW

The comb harrow is the most commonly used implement for puddling wet paddy soil in the Far East. It has wooden or iron teeth driven into a wooden beam. In India and Ceylon it usually has one long central pole for drawing animals in pairs. A narrower type with wooden extensions on the beam, drawn by a single animal with a rope harness, is found in China (Mainland) (Figure 56). The comb harrow has a comparatively heavy draught and it is difficult to maintain an even depth while working with it.

BLADE HARROW

The implement shown in Figure 57 is a typical Indian implement (also called either *guntaka* or *bakhar*). It is effective for shallow secondary tillage in dry zones, cutting the roots of weeds below the soil without unduly disturbing the surface, to conserve moisture.

It consists of a sharp steel blade with a working width of about 40 to 60 cm. The blade is carried on two supports fixed to a wooden beam or an iron frame, and has a central pole for two yoked animals.

ROTARY HARROW

An animal-drawn rotary harrow sometimes known as a roller harrow is shown in Figure 58(a). It is a traditional puddling implement of the rice-growing areas of the Far East. Its working parts consist of a wooden cylinder, about 20 to 25 cm in diameter and up to 180 cm in length, holding

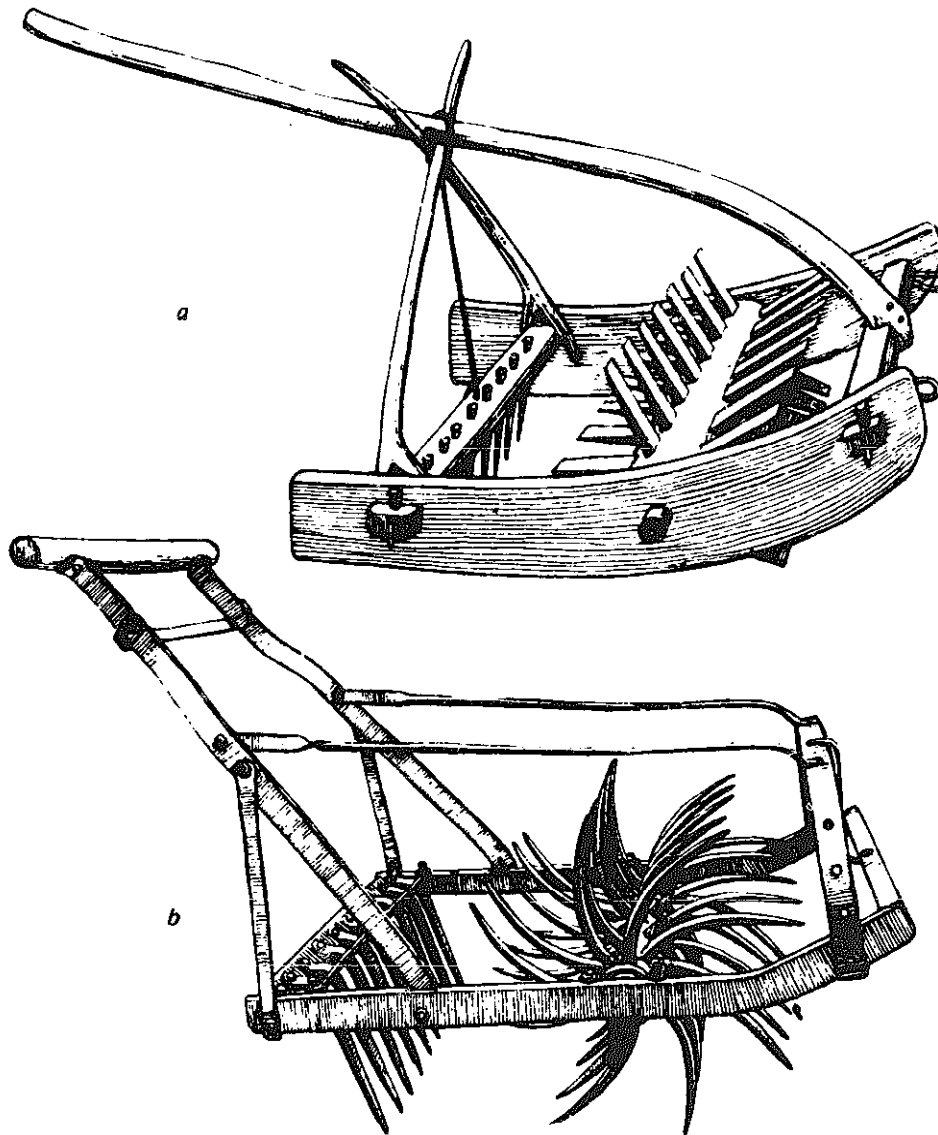

FIGURE 58. - Rotary harrows: (a) wooden type from Malaysia; (b) metal type made in Japan.

tapered wooden lugs or metal blades. The cylinder rotates on two bearings in a rectangular wooden frame. Two or three passes with this harrow after ploughing produce a good puddle in paddy fields.

The rotary harrow, shown in Figure 58(b), also called a rotary hoe, is fairly widespread as a clod crusher and efficient crust breaker on dry land in temperate zones. It consists of a series of metal units each having teeth radially fastened to a solid steel hub. All the units, spaced approximately 15 cm apart, rotate on a solid axle. This is also a popular puddling implement in Japan, the teeth being curved and about 25 cm in length.

Earth-moving equipment

SHOVELS

The chief object of a shovel is to move loose soil or similar material over short distances. The essential parts are the blade, the socket and the handle, with grip.

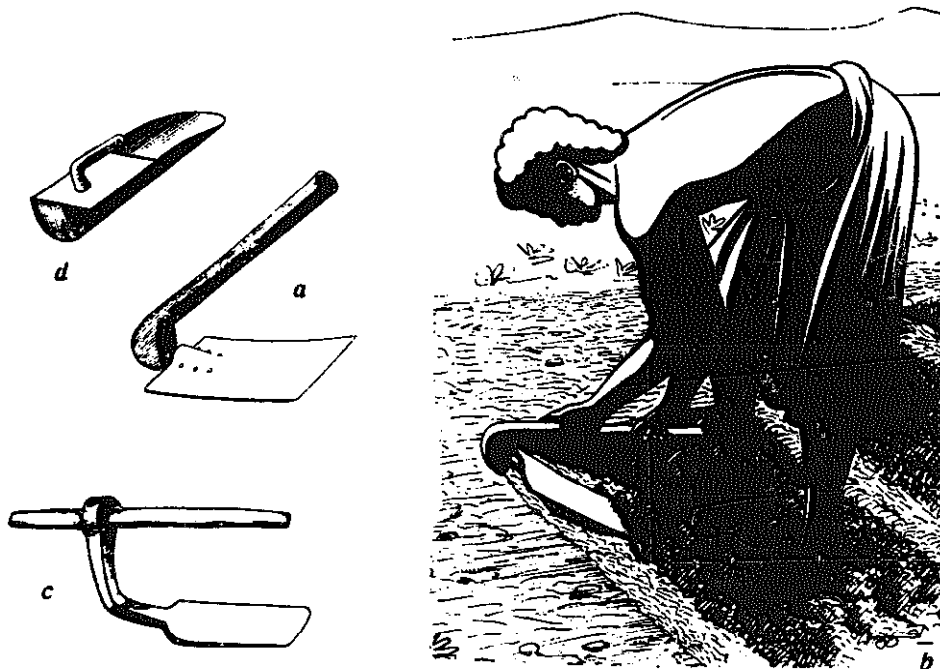

FIGURE 59. - Hoe-like shovels: (a) Ethiopian type for ridging and moving soil; (b) work with the Ethiopian shovel hoe; (c) shovel hoe from Nepal. Similar types are also used in some parts of India, Tunisia, Nigeria and other countries north and south of the Sahara; (d) one-handed scoop.

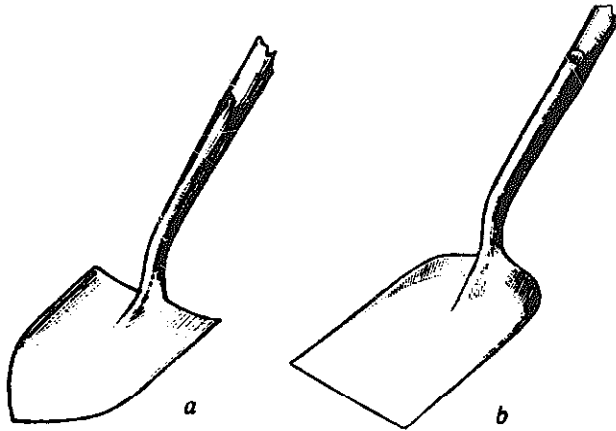

FIGURE 60. - Common types of shovels: (a) Multipurpose type; (b) for use on even ground.

There are long-handled and short-handled shovels for moving material lying on the ground, all operated with both hands, and one-handed scoops (Figure 59[d]) for transferring material from one container to another. On long-handled shovels the angle between the blade and handle is only slightly less than 180° , whereas this same angle on very short-handled shovels is acute, as will be seen in Figure 59(a) to (d). In fact, these shovels, much used in various parts of Africa and the Far East, are sometimes classified as hoes.

Various types of shovel blades have been developed for different working conditions. A good multipurpose shovel blade is concave and slightly pointed (Figure 60[a]). Blades with a straight edge and rounded, raised shoulders (Figure 60[b]) are particularly suitable for picking up material from smooth ground while the pointed ones are better on uneven ground. The handles and the connections between blade and handle are much the same as those used for spades.

Two-man shovel

The two-man shovel serves to prepare alternating ridges and furrows, to form bunds for irrigated crops, and for other shovel work. It consists of a large, slightly concave, flat-sided blade with two rings on the inside. The rings hold the ends of a rope. In use one man pushes and directs the shovel with the long handle while a second man, facing the first, pulls on the rope. This rhythmic action generally results in an output exceeding that of two men with two shovels. It is widely used in Arabia, Syria, central and northern Iraq, Iran, Afghanistan, parts of India and West

Pakistan, Turkestan, China (Mainland and Taiwan) and Korea (Figures 61 and 62).

HAND-LEVELLING BOARD

A hand-levelling board may be used in wet paddy fields to give the final touches to the puddling operation by breaking up, levelling and smoothing the soil. It varies greatly in design. It may be a simple solid board with no teeth or, in some cases, with a saw-tooth design on one side of the board.

HAND RIDGER

This tool draws furrows in tilled soil. Its construction can be seen in Figure 63(c).

ANIMAL-DRAWN SHOVEL BOARD

The implement shown in Figure 61(b) is the animal-drawn version of the two-man shovel. It is made of wooden boards to the lower part of which are fixed either an iron plate or some five or so small iron shovels.

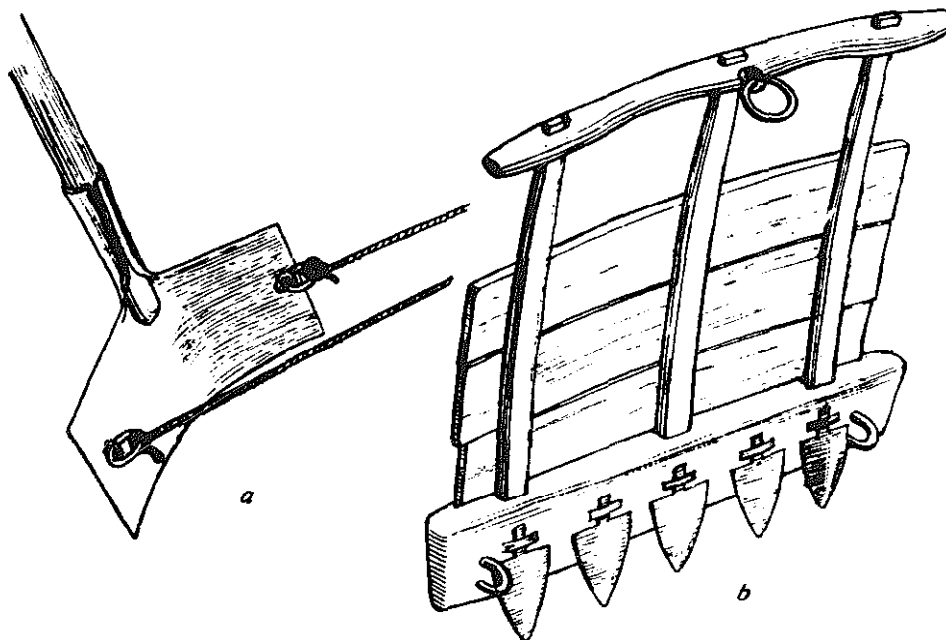

FIGURE 61. - Two-man shovel and its animal-drawn version, the shovel board: (a) two-man shovel; (b) animal-drawn shovel board (*rakol*).



FIGURE 62. - Work with the two-man shovel.

The implement is usually drawn by two oxen and is widely used in Syria, Iran and Afghanistan for moving dry soil over short distances, generally to level fields for irrigation.

ANIMAL-DRAWN EARTH SCOOP

The earth scoop is used to level land for irrigation and to build small dams, and for any other work involving the transport of soil or similar material over short distances. The construction varies, but a common type has a large scoop of mild steel with a reinforced bottom, the whole being controlled by two wooden handles and drawn by a movable U-shaped steel drawbar. The two points of attachment of the drawbar are at the points of best balance for easy draught, filling and tipping (Figure 64).

ANIMAL-DRAWN LEVELLING BOARD

The animal-drawn levelling board is used in many countries to prepare rice fields under flooded conditions. It consists of a wooden plank of

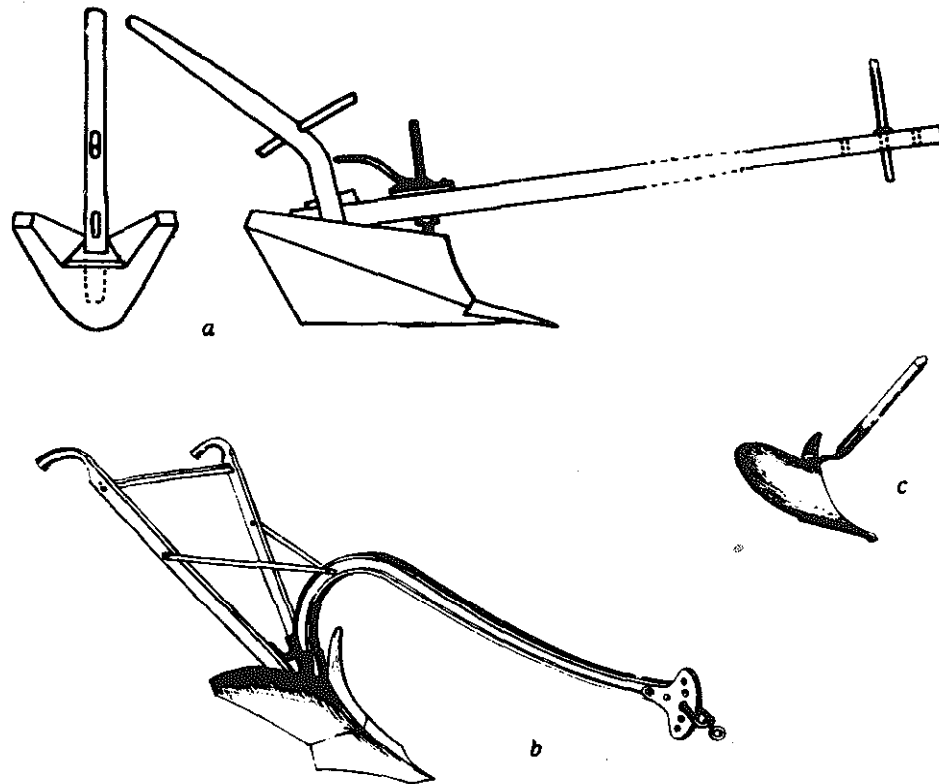

FIGURE 63. - Ridger plough: (a) wooden body (Florence); (b) iron type; (c) its hand-drawn version.

varying dimensions fitted either with a pole for attachment to yoked animals or with two rings for traces. The operator normally rides on the plank to achieve better penetration into the soil. It is also used for clod crushing under dry conditions.

ANIMAL-DRAWN RIDGERS

Animal-drawn ridgers draw furrows and pile up the soil for crops being grown either on the ridge or in the furrow. Conversely, they may split existing ridges, thus forming new ones, and be used for digging out certain root crops for harvesting, such as potatoes (Figures 63[a], [b] and 100).

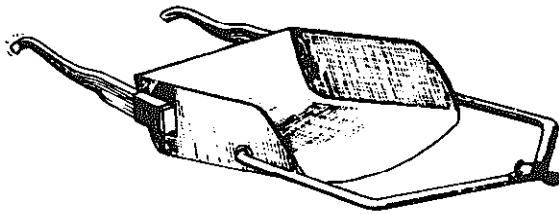

FIGURE 64. - Animal-drawn earth scoop.

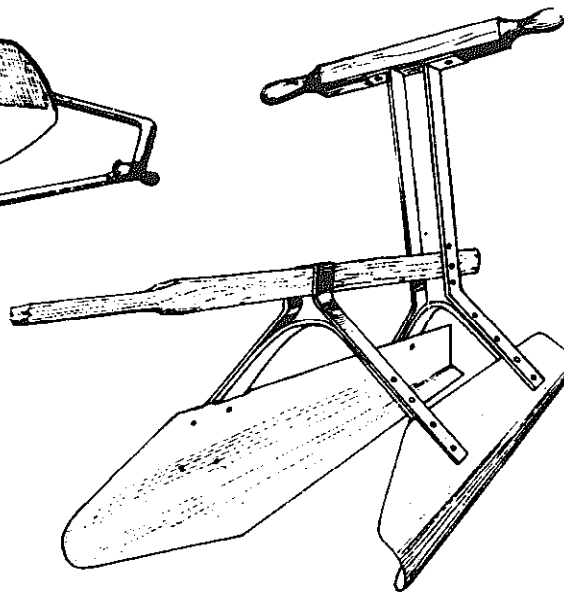

FIGURE 65. - Bund former (India).



FIGURE 66. - Distribution of fertilizers with hand shovel; length of shovel blade from head to edge 7.5 or 8.5 or 11 cm.

BUND FORMER

The bund former serves mainly to prepare contour ridges in irrigated fields. Its main parts are a pair of wooden or metal boards, kept in position by a frame, as shown in Figure 65. The boards are wider apart in front and narrower at the back in order to collect soil while advancing; their concave shape moulds the collected soil into a bund.

Fertilizer distributors

Generally, no special machinery is used on very small farms to distribute chemical fertilizers, the work being done by hand. However, some fertilizers damage unprotected hands. The specially designed scoop shown in Figure 66 may be used in conjunction with a basket suspended from a man's neck. It is a useful aid in that hands do not come in contact with the fertilizer. Also a more uniform distribution may be obtained. Different sizes are used according to the amount of fertilizer to be spread.

7. SOWING AND PLANTING MACHINES

Sowing is one of the most important farm operations after soil preparation because the time of sowing and the way in which it is done decisively influence germination of the seed and the growth of the seedling during its early stages. This in turn affects the subsequent time of weeding and intercultivation and their effectiveness and finally the yield of the crop.

Seed needs an adequate supply of moisture, the right temperature, sufficient air, and a protected environment for good germination.

Three main methods of sowing are used: broadcasting, drilling, planting. Each of these, and the implements used, are discussed below.

Broadcast seeding

Broadcasting is scattering the seed on the surface of the land by hand or with simple implements. Grass, clover and other small herbage seeds are generally broadcast with hand seeders. Broadcasting of cereals is also carried out by hand in some developing countries. It has however a number of disadvantages, in that the seed may be deposited at varying depths in the soil which leads to uneven germination, while inter-row cultivation afterwards is either difficult or impossible. It is also wasteful of seed.

HAND FIDDLE

The hand fiddle is a broadcasting implement consisting of a rotating horizontal disk which scatters the seed, fed from a bag or hopper, by centrifugal force. The disk is mounted on a spindle which is driven by means of a bow and cord. It is used for sowing rice in some countries of the east.

The evenness of distribution is somewhat affected by the reciprocating action of the drive. A more even scatter of seed can be obtained by subsequent cross-sowing. The sowing width is about 600 cm.

CYCLONE HAND SEEDER

The cyclone hand seeder is a crank-driven broadcast seeder similar in other respects to the fiddle. It gives a more uniform distribution and has a working width of about 800 cm.

PUSHED BROADCAST SEEDER

The hand-pushed broadcast seeder consists of a light wooden seed-box, 350 to 400 cm in length, mounted on a wheel and pushed with two handles like a wheelbarrow. The wheel drives a rotating brush which expels the seeds through adjustable openings in the bottom of the box. This machine gives a more uniform scatter of grass and similar small seeds. Its working width is nearly equal to the length of the seed-box.

Seed drilling

The drilling operation consists of depositing seeds in shallow furrows cut in the seedbed and then covering them with soil with the same machine. The uniformity of seed deposition in the furrows depends mainly on the seed ejecting mechanism with which the drilling machine is equipped. A machine that deposits the seed with some regularity is known as a "precision drill." Some seeding machines are specially designed to place larger seeds, such as peas and beans, in furrows at greater distances apart than is necessary with cereals; these are generally called "seed planters," and should not be confused with seedling planters.

The main purpose of drilling in rows is to place all the seed at a pre-determined uniform depth and with the rows equidistant and thus save up to 25 percent of seed as compared with broadcasting. Drilling also facilitates subsequent intercultivation and weeding.

Seed drilling for many centuries was common practice in Mesopotamia, India and China before the western world began to realize its importance. The Sumerians were the first to seed their grain in rows with a seeding tube connected to a plough, a method still used in some eastern countries.

FIGURE 67. - Indian four-row seed drill (*goru*).

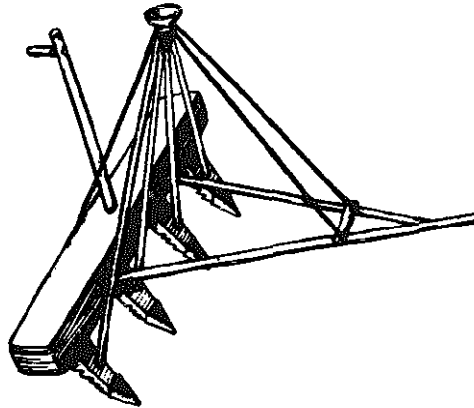

ROW SEEDERS

The most simple type of seed drill is a plough with a seed tube at the rear. A development of this commonly used in India is shown in Figure 67. The seed in the bowl at the top is fed by hand into a number of seed tubes corresponding to the number of pegs or openers. Attempts to make this type of seeder more accurate by substituting a seed-box for the bowl with a mechanical seed metering device driven by a sprocket-wheel rotating on the ground spoiled the simplicity of the original construction without gaining much in practical application.

A hand-operated row rice seeder which has gained some acceptance was developed in Ceylon and is shown in Figure 68. It consists of six seeding tubes held at the bottom by a horizontal bar which also provides the desired spacing, and converges at waist height into a distribution box

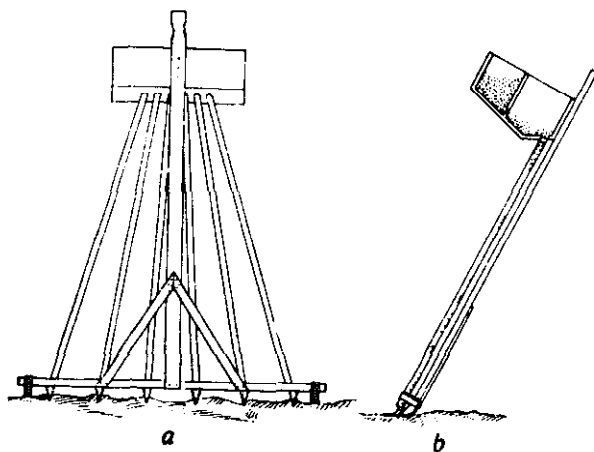

FIGURE 68. - Ceylonese six-row hand seeder for rice: (a) rear; (b) side view.

and a seed hopper. Hopper and distribution box are separated by a vertical board with a sliding outlet at the bottom, through which the seed passes at a controlled rate from the seed container to the distribution box. The operator moves the seed by hand back and forth across the distributing holes at the bottom of the box while pulling the seeder backward. The tube spacing bar is provided with two sliding shoes at its ends for the control of the seed depth. This implement is simple, cheap and practical, although the necessity to walk backward is somewhat tiring in a muddy rice seedbed.

CHINESE SEED DRILLS

Chinese seed drills generally have two or three seed tubes. The ancient feed mechanism possibly dating back to 200 B.C., still in use and illustrated in Figure 69, is of interest in that it shows there was a need even then for an automatic, reasonably selective and positive ejecting device on an implement already in use for drilling seeds in furrows. The principle is ingenious yet simple: it merely consists of an agitator in the form of a vibrating bamboo rod passing through a hopper which, when the drill is swayed slightly, ensures the flow of seed to the tubes with a fair measure of selectivity between first one seed tube and then the other.

The necessary vibratory motion is imparted to the rod by a pendulum in the form of a stone and a cord. Consolidating rollers frequently follow the seed drill (Figure 70).

WESTERN TYPES OF SEED DRILLS

Western drills have become rather complicated machines to ensure precision of work. They are adjustable to the size and shape of the grain, to the rate of seeding and to the depth of placement. Special seed drills for semiarid zones facilitate the collection of moisture around the seed by pressing the furrow bottom immediately after the seed has been dropped and before it is covered with loose soil.

One-row hand drill

The one-row hand drill shown in Figure 71(a) consists of a wheelbarrow frame with a front wheel, a seed-box holding approximately 4 litres of seed, an adjustable feed mechanism, a furrow-opener with depth adjustment, a seed coverer, a press wheel and a marker. The feed mechanism is generally adjustable for spaced drilling (also called "dibbling") in the

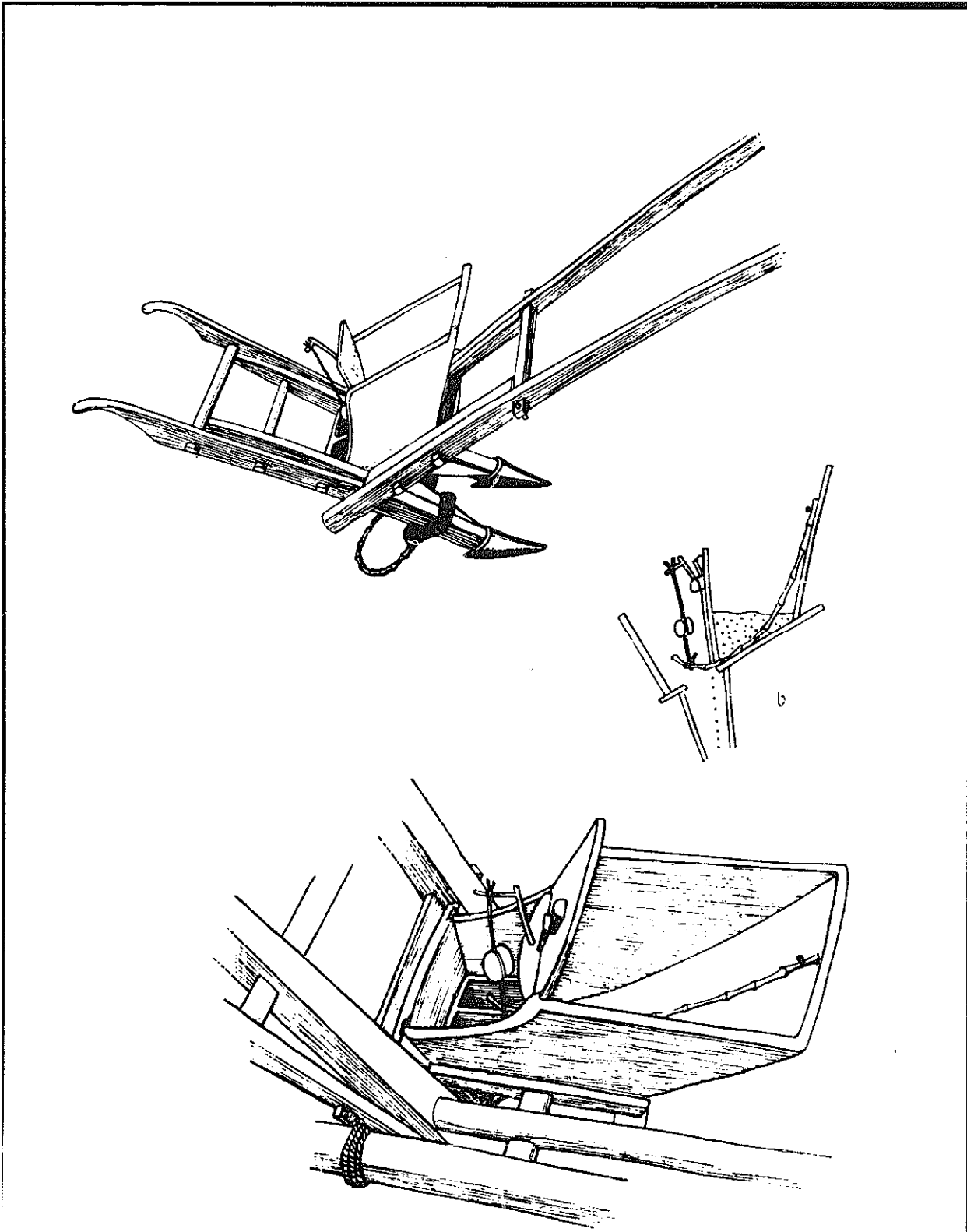

FIGURE 69. - Chinese two-row seed drill: (a) overall view. The bamboo rod behind the furrow openers covers the seed; (b) sectional view; (c) detail of hopper with second double chamber leading to the seed tubes.

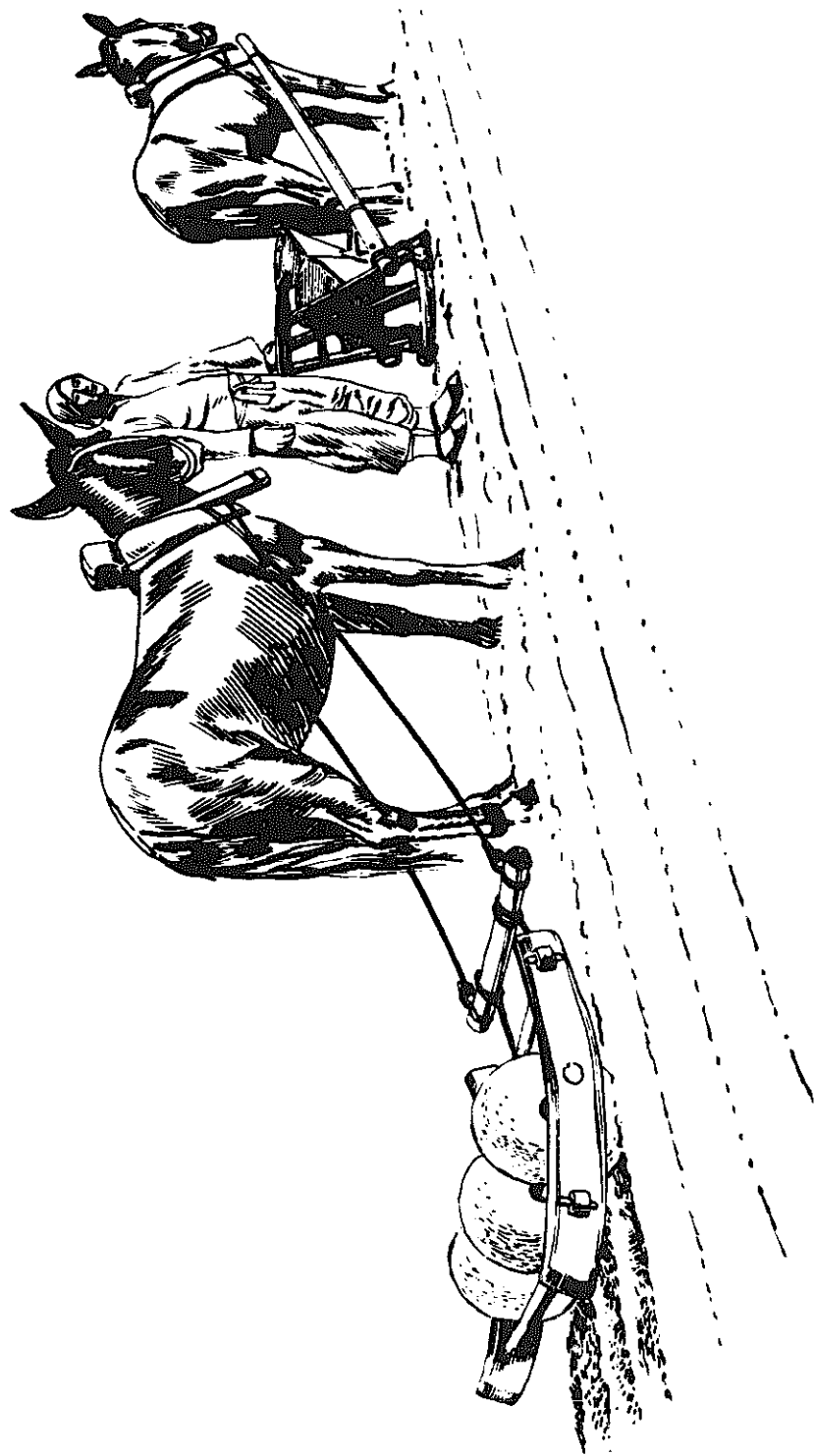

FIGURE 70. - Chinese three-row seed drill at work, followed by press rollers.

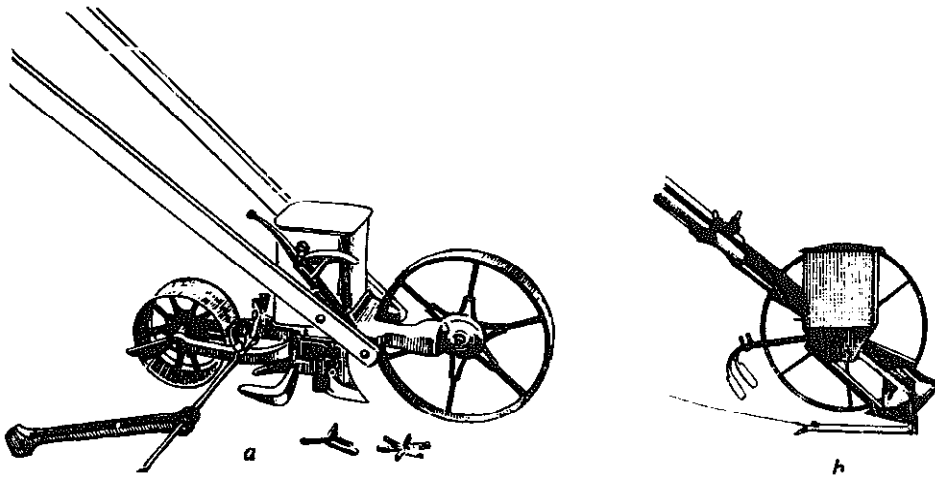

FIGURE 71. - One-row hand drills, pushed types: (a) common type with one wheel in front and a double wheel behind the furrow opener; (b) another type with only one wheel immediately behind the furrow opener, pressing the seed into the furrow before covering it.

row. Most seeds, from large to very small, can be sown with this machine which weighs about 19 kg. A simplified version of this type (Figure 71[b]) has only one wheel behind the furrow-opener, which not only supports the machine but also presses the seed into the soil before it is covered. There are two markers and the drill weighs only 8 kg, so it can easily be carried.

Animal-drawn seed drill

The machine shown in Figure 72 is an example of a typical animal-drawn seed drill. It consists of a seed-box, the feed mechanism and the furrow-openers. The feed mechanism determines the rate and uniformity

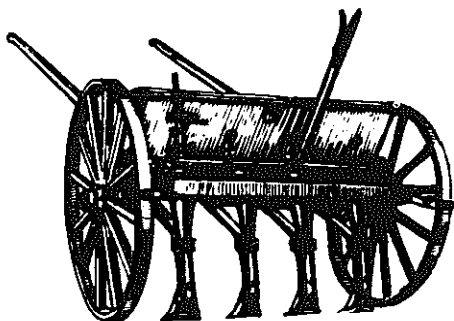

FIGURE 72. - Four-row seed drill for seeding under dryland conditions; width between the wheels approximately 125 cm; spacing of seed tubes about 25 cm; large shoe furrow openers.

of seeding, the furrow-openers the depth of seed placement. Delivery tubes conduct the ejected seeds to the furrows. Feed mechanisms differ considerably in design, but all have the object of metering and ejecting the seed in an even flow and most are gear driven from one of the machine's land wheels. Different types of furrow-openers are used under different conditions. In average soils hoe-type openers are preferred. In cloddy soil or in soil with trash, roots or other organic materials, single-disk furrow-openers generally function best. The working width of animal-drawn drills varies between 100 and 240 cm. While the normal spacing between the rows is 16 to 18 cm for cereals, under dry conditions this spacing must be wider, namely about 25 to 30 cm. If winds are frequent, cereals should be dropped to the bottom of deeper furrows and pressed into the soil with rollers. For protection from the wind and to control wind erosion, the seed rows should lie across the wind and surface trash should remain on top of the ridges.

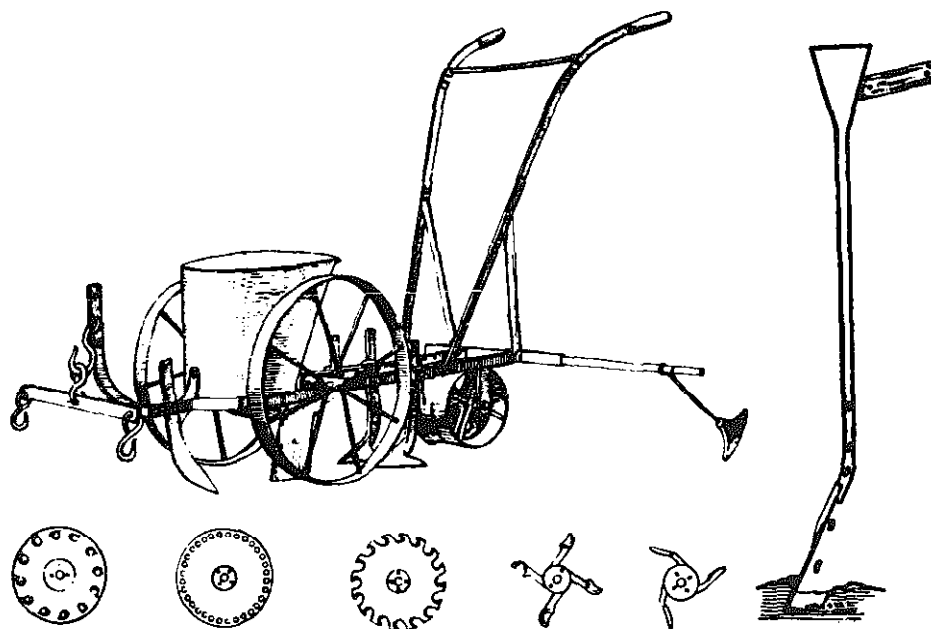

FIGURE 73. - Seed planter with interchangeable seed plates and stars for different seeds.

FIGURE 74. - Italian maize planter for seeding by hand in an erect position.

A hand-controlled forecarriage is a very useful addition to steer the drill in straight lines.

Planting seeds and seedlings

By planting is meant the placing of seeds or seedlings into the ground in rows so that subsequent hoeing and weeding can be done easily. Maize, cotton, groundnuts, sugar-beet and potatoes are some of the crops usually sown in rows; there are, of course, many others. Rice, tobacco, brassicas, onions — to mention a few — are generally raised in special nursery plots and transferred, as seedlings, to the main growing field; this is known as “transplanting.”

Transplanting by hand is a most labour-consuming and arduous job, particularly with crops grown on a large scale such as rice.

It will thus be seen that the implements used for seed planting and for transplanting seedlings are necessarily completely different although both are often called planters.

SEED PLANTERS

Seed planters are one of a series of separate drilling units designed to deposit single seeds in relatively widely-spaced rows. The feed mechanism on some planters can deal with a variety of seeds and on all of them the spacing in the row can be varied.

Figure 73 shows a seed planter which drills different kinds of seeds either into a furrow or onto a ridge. The feed mechanism of this machine consists of a star or plate which, as it slowly rotates, forces single seeds out of the hopper into the seed furrow. The plate can be changed for another of different shape to suit a different seed, a complete set of plates being supplied with each seeder.

HAND PLANTER

A useful form of hand planter has a small hopper with a wedge-like lever device, which is pressed into the soil and then pushed slightly forward, making a hole and releasing seeds into it.

A spade-like maize planter for seeding by hand in an erect position, is made in Italy. It consists of a hopper with a handle, and a seed tube with a small spading blade, as shown in Figure 74.

TRANSPLANTERS

One form of transplanter is a pointed stick which makes a hole and then is used to press the soil around the plant roots. Another type for transplanting rice seedlings, consists of a small iron fork about 45 cm long with a wooden handle. Two or four plants are slipped into the fork and the tool is then pushed into the mud and withdrawn, leaving the seedlings in place. The transplanting rate with this tool is faster than with the hand stick.

TRANSPLANTING MACHINES

A number of rather complicated machines are available for transplanting a variety of seedlings, and they function well, but so far a satisfactory animal-operated machine for rice transplanting in paddy fields has not been produced.

8. IMPLEMENTS FOR INTERCULTIVATION

The main objects of intercultivation are to destroy weeds, aerate the soil, ridge up the plants.

Irregularly spaced crops can only be cultivated with chopping hoes or weeding knives with great expenditure of labour and time. Since timeliness is generally decisive for success, a farmer and his family are able to cultivate only very small plots properly in this way.

Crops planted in rows with regular, sufficiently wide spaces and a soil that is not too cloddy, can be cultivated with labour-saving hand tools, or with animal-drawn implements. Modern methods of intercultivation on larger fields with such implements are speedy and efficient.

Hand tools

CHOPPING HOES

Chopping hoes of various sizes, weights and shapes are the most common weeding tools. They are normally wider and lighter than the digging hoes used for tillage (Figure 75[a]). Weeding sickles, described later, are also used for this purpose in some eastern countries. Chopping hoes, however, are gradually being replaced, where possible, by lighter pulling or pushing tools which allow faster work with less effort. These can be used when the crops are grown in rows and if the soil is fairly friable.

PULLING HOES

Pulling hoes are drawn through the top soil between the plant rows without being lifted (Figures 75[b] to 77). A long handle allows work in an erect position, the operator moving backward. Pulling hoes nor-

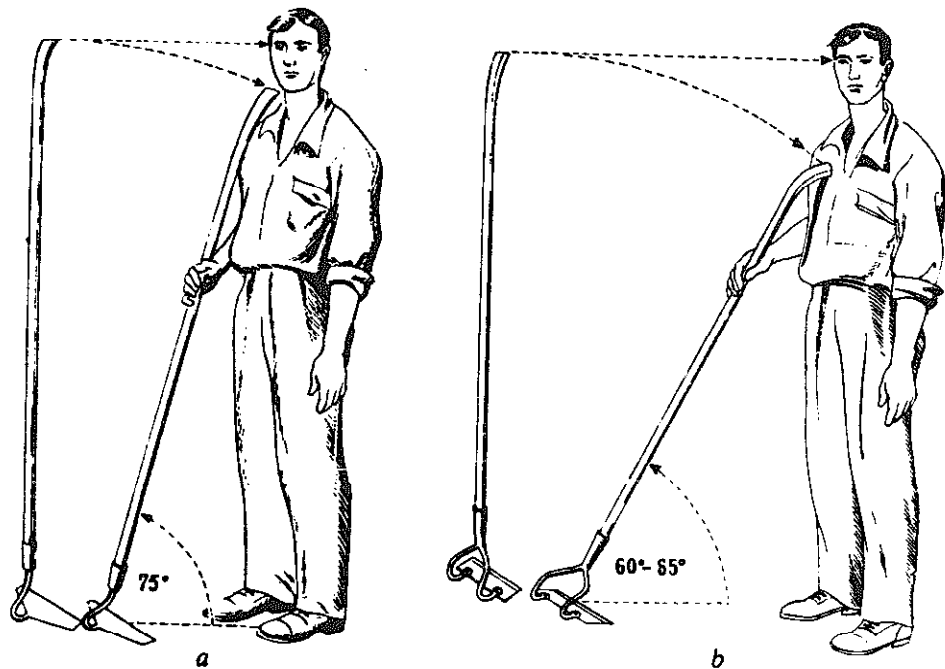

FIGURE 75. - Chopping and pulling hoes: (a) chopping hoe; (b) pulling hoe.

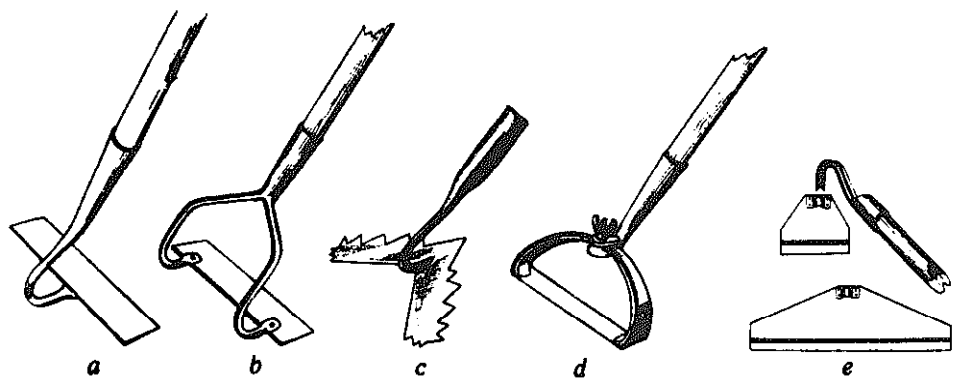

FIGURE 76. - Pulling hoes with: (a)-(b) fixed blades; (c) serrated edge blade; (d)-(e) interchangeable blades.



FIGURE 77. - Chinese pulling hoe: (a) blade and long iron hoe socket; (b) work with the hoe.

mally have a thin blade with working widths from 10 to 30 cm. The handle length is approximately 160 cm. Different types are available, some with interchangeable blades (Figures 76[d] and [e]), others triangular and serrated (Figure 76[c]). The connection between blade and handle is generally either a single or a double gooseneck socket.

Pulling hoes are of relatively recent use in western countries but have spread rapidly; they were known in China in ancient times. The Chinese use two different types: heavy for weeding and soil aeration (Figure 77), and a light one (which the western types resemble) as a weed scraper on light soils.



FIGURE 78. - Sugar-beet thinner.

Pulling hoes for sugar-beet thinning and singling

In many countries, sugar-beet is thinned by two manual operations: first, it is gapped with light chopping or normal pulling hoes, and then singled with small curved knives. The two operations can also be done at the same time with only one beet thinner (Figure 78) which has a sharp steel blade attached to a medium long handle. The unwanted plants are cut by the strokes of this tool which speeds up the work and is therefore gaining popularity.

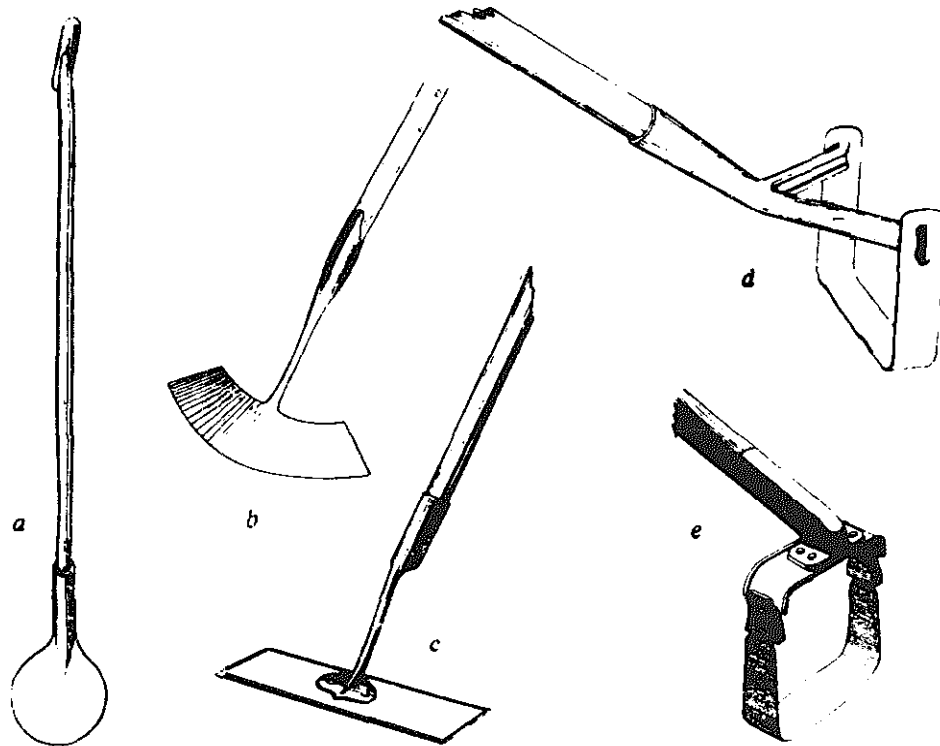

FIGURE 79. - Pushing and pushing/pulling hoes: (a) weeding hoe (*Maloda*) of the Sudan, a kind of scuffle hoe; (b) scuffle hoe, also called Dutch hoe; (c)-(e) pushing/pulling hoes.

PUSH HOES

Push hoes are also called Dutch hoes, and have blades fastened to long handles and are shuffled through the rows to be weeded (Figures 79[a] and [b]). Wheeled types with one or two wheels and two handles give good results in light soils.

PUSH-PULL HOES

These hoes (Figures 79[d] and [e]), consisting of a thin steel blade held by an oscillating frame used with a rocking motion, are efficient weeding implements.

ADJUSTABLE HAND CULTIVATORS

Hand cultivators, already mentioned for seedbed preparation, are less efficient than hoes for weed eradication, with the exception of weeds with rhizomes, like Bermuda grass.

ROTARY HAND WEEDERS

Some of these are made in Europe for use under dryland conditions. Others are manufactured in Japan and are very efficient for weeding rice fields planted in rows and covered by 3 to 5 cm of water. They consist

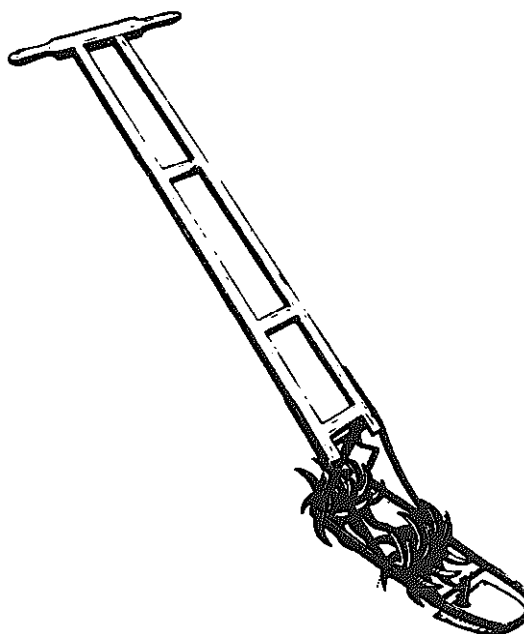

FIGURE 80. - Japanese rice weeder, one-row type, hand pushed.

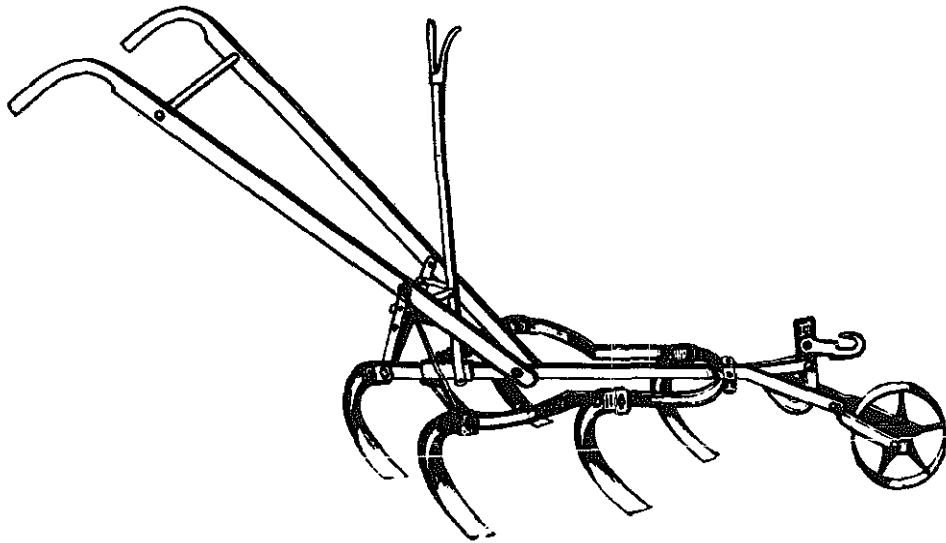

FIGURE 81. - Expandable horse hoe.

of sets of revolving curved teeth, arranged in tandem, mounted inside a sled frame. One- and two-row models are made. The single row type varies in width from 15 to 20 cm (Figure 80).

Animal-drawn implements for intercultivation

Many of the implements described for seedbed preparation can also be used for intercultivation and weeding. More specific implements for these purposes are now dealt with.

ROTARY RICE WEEDER

The rotary rice weeder for flooded fields is similar in design to the hand type. A three-row model is commonly used with one draught animal, which must be well trained, and the rows must be straight and parallel if good work is to be obtained.

EXPANDABLE HORSE HOE

For single rows the expandable horse hoe (Figure 81) is a very common implement all over the world for deep row-crop intercultivation and weeding. Many methods of width adjustment and patterns of tines are used. The implement is steered with two handles at the rear and an adjustable front wheel controls the depth.

STEERAGE HORSE HOE

The steerage horse hoe is a multirow implement which, with a two-wheeled forecarriage and a tool bar carries, as required, tines, sweeps, shares, ridgers, etc., easily attached at adjustable distances. The tool bar can be lowered, raised and steered, independently from the forecarriage. This implement gives very satisfactory results on well prepared ground with precisely spaced rows, but it is rather complicated and expensive. It was the forerunner of the multipurpose tool carriers already discussed under tillage implements.

9. PLANT PROTECTION MACHINES

Cultivated plants are beset by insects, fungus and virus parasites, as well as weeds, all of which are unfavourable to their growth. Weeds can be eradicated by effective cultivation but pests and diseases have to be kept under control with chemical sprays and powders. Chemicals to kill weeds without damaging the crop are now being used to a growing extent, in addition to the weeding tools described in the previous chapter.

Chemicals are either sprayed in liquid form or applied as dry powders, and for these treatments machines are needed. Sprayers and dusters are available in many forms. The requirements of small peasant farmers can be met with relatively low-cost hand-operated, portable or wheeled sprayers and dusters.

Sprayers

Among the many portable sprayers, knapsack types (Figure 82[a]) with easily accessible working parts are perhaps to be preferred in arid and tropical regions. They consist of a container for the liquid carried on the back, either a diaphragm or piston pump, an air vessel, an agitator, a short rubber pipe, lance and spraying nozzle. A piston pump generally produces a higher pressure than one with a diaphragm, and gives a better spray, but more effort is needed to work it.

Another form of sprayer which is also carried on the back like a knapsack relies on compressed air to eject the liquid. In its simplest form this pneumatic machine has no moving parts. The spray fluid is contained in a strong cylinder from which it is forced out via a rubber pipe, spray lance and nozzle by compressed air. The cylinder is charged with both liquid and air at a central station on the farm, thus needing no pumping in the field. Another form has an air pump as an integral part of the

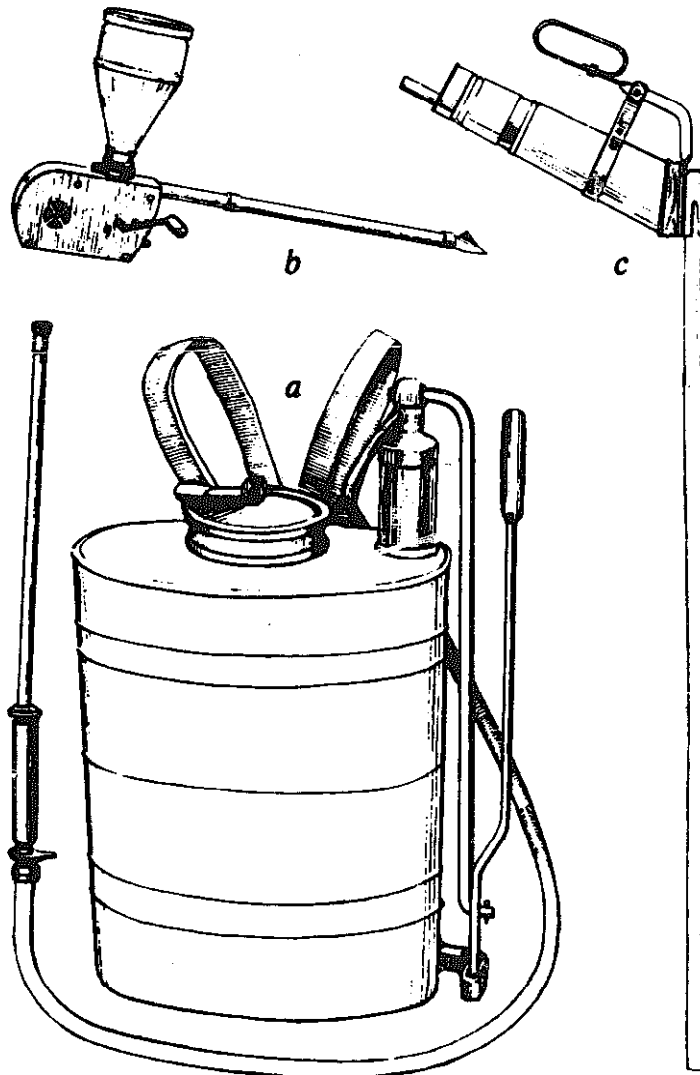

FIGURE 82. - Sprayers and dusters: (a) knapsack sprayer; (b) fan-type duster; (c) bellow-type duster, also used for pollination of date palms.

sprayer to give it the initial charge of compressed air before spraying starts. This type is more complicated in construction and needs more maintenance but it is not reliant on a fairly powerful central charging pump.

The bucket sprayer is not carried on the back but rests on the ground when in operation. The bucket, with a piston pump in it, is held firmly in position by foot pressure applied to a metal stirrup at the side of the

bucket, leaving one hand free to work the pump handle and the other to direct the lance and spray nozzle. Some of these are double acting and give high pressures which drive the spray to the tops of the trees.

When larger areas have to be sprayed by hand labour a machine with a container holding 50 or more litres, mounted on wheels and having a pump manually operated with a lever, can do efficient work. One man works the pump and a second directs the nozzle.

The selection of a sprayer is dependent on a number of factors, such as the area, the crops or trees, the labour available and the maintenance facilities. Most plant pests must be sprayed at a critical period in their life cycle if the chemical is to be effective, which means that the work has to be done quickly and efficiently at the right time.

Dusters

Chemicals to control pests can also be applied in the form of fine powders, and these can be dusted on to affected trees and other crops with machines made for the purpose. Dusters, generally, are used only when there are water supply difficulties, because powders do not have the same pest-killing properties as liquid sprays unless conditions are ideal.

Dusters vary in size from very small hand-operated bellows or fan types (Figure 82[b]) to large engine-driven machines. Small bellow-type dusters, fixed on a long pole and operated in a rocking motion (Figure 82[c]), serve not only for dusting insecticides at tree height but also for the pollination of certain trees, such as date palms when they are in bloom.

10. HARVESTING TOOLS AND MACHINES

Harvesting includes cutting or digging, gathering and handling of crops up to their final removal from the field. Crops growing above the ground, such as cereals, clover, grasses, are cut with knives; those growing in the soil, like potatoes and roots, are lifted with digging tools or implements. Gathering and handling crops grown on a small scale is done with various tined or toothed implements, which are dealt with later in chapter 13.

Sickle

The sickle is one of the most ancient harvesting tools and is mainly used for reaping cereals. It exists in a great variety of forms, with two different types of blade edges: those with a serrated edge and those with a smooth edge (Figure 83). The first is of older origin. Both types are used in many countries. Serrated sickles are more common in the southern Mediterranean regions, in Africa south of the Sahara, in Arabia, southern and central Iraq, southern Iran and in Pakistan and India. Sickles with a smooth edge made of good quality steel are generally used in the northern parts of the Mediterranean, in some parts of Turkey and Syria, in northern Iraq, Iran and Afghanistan. Although both types are used, the smooth-edged pulling sickle is more popular in China (Mainland) and Japan. It has a straight blade fastened approximately at right angle to a handle about 35 cm long (Figure 83[a]).

The form of the sickle further varies in the shape of its blade which may be semicircular (Figure 83[b]), or straight or slightly curved (Figure 83[c]) in the angle of the blade to the handle and in the form of the handle and in the connecting devices. Most blades are inserted into the handle by means of a tang. Sometimes they are attached to an iron shaft with a wooden handle. The most characteristic of the latter smooth-edged

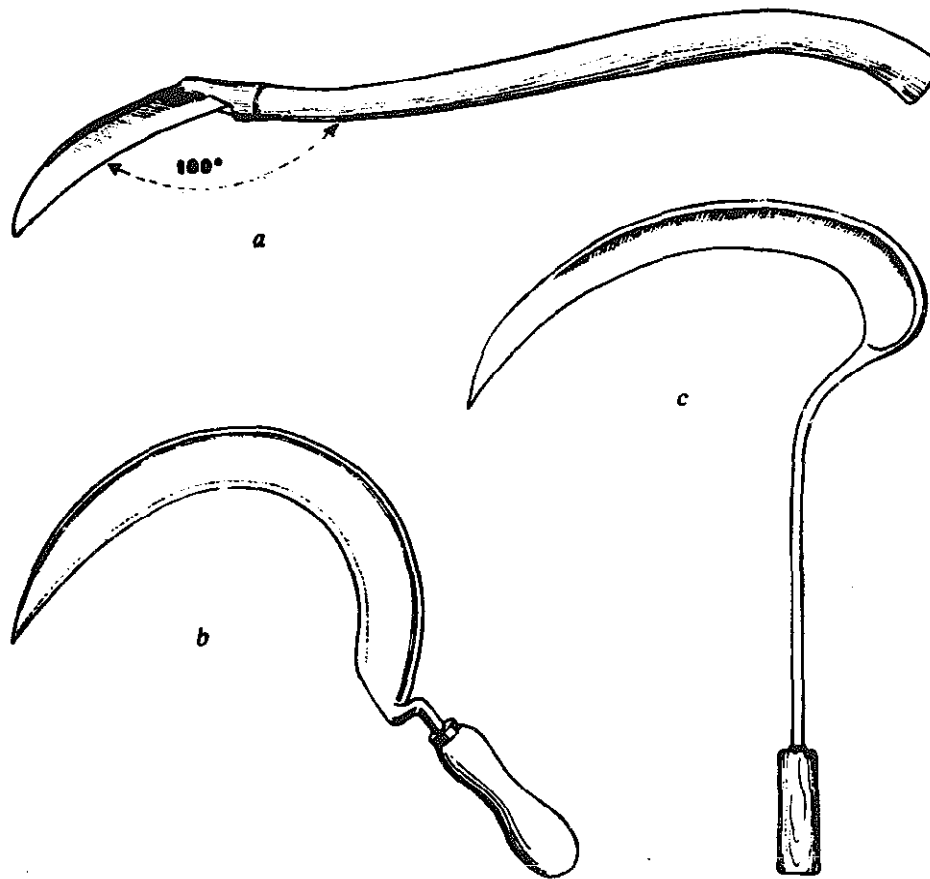

FIGURE 83. - Smooth-edged sickles: (a) Chinese pulling sickle; (b) common sickle with cranked handle shaft; (c) stork's bill sickle from Mosul, Iraq.

sickles resemble a stork's bill (Figure 83[c]) and are used in Turkey (province of Samsun), Syria, northern Iraq, Iran and Afghanistan.

Harvesting cereals with a sickle is very slow, yet it allows careful reaping and prevents the ears from shattering. For this reason and in view of its great simplicity, small size and very low cost, the sickle is still widely used all over the world to reap cereals, particularly paddy rice which has soft but tough straw and is easily shattered.

The sickle is wielded in one hand with either a semicircular or a pulling motion, depending upon its design, while the other hand grasps the ears. Grasping can be facilitated by means of simple finger guards, their purpose



FIGURE 84. - Farmer from Terjil, near Kirkuk, Iraq, with reaping sickle and finger guards.



FIGURE 85. - Grain reaping with scythe.

being to protect the hand or to increase its grasping capacity. These guards also give a better grip of larger grain bundles and are in common use, e.g., in northern Iraq (Figure 84). In some countries, semicircular hooks are used to collect and hold large bundles of grain.

A special type of small sickle for weeding is much used in some Near Eastern countries; the inside and upper outside edges of the blade are sharpened, but the work with such sickles is extremely slow.

For mowing grass in substantial quantities the sickle is too slow and tiring, so it does not encourage any serious effort to cut forage and make hay in regions where it is the only available harvesting tool.

Scythette

The scythette, like the sickle, is essentially a one-handed grain reaping tool. The slightly arched blade is about 60 cm long with a tang bent steeply upward (Figure 85); a handle of 60 to 80 cm in length is fastened to the tang with a ring connector. The handle is bent on the top and it ends in a hoof-shaped hand grip. The scythette is complemented with a hook about 100 cm in length, held in the operator's other hand (Figure 85), which separates the standing crop from that being cut and clears a way for the cutting blade.

Although of ancient origin and once widespread in Europe, the scythette has, to a great extent, been substituted by the more efficient scythe and cradle. It is still used in Belgium and the Netherlands and in the neighbouring regions of northeastern France and northwestern Germany, but even there it is rapidly vanishing.

Scythe

The scythe is essentially a grass-mowing implement, used with two hands. Ancient forms of the scythe suggest that it derived from the sword, when the Celts, during their migrations from the east to central Europe may occasionally have used the sword for grass cutting to speed forage gathering during emergencies, and thereupon may have conceived the idea of developing the sword into a scythe for mowing.

Where the scythe is unknown, the neglect of haymaking for animal feeding during seasons of forage shortage is very common. This applies particularly to the dryland areas of the Near and Far East. Farmers in these areas do collect the so-called tibben, i.e. bruised straw, from cereal threshing and sometimes even pay a high price for it to prevent their animals from starving during the dry season. This straw has very little if any, nutritive value, yet in many instances good nutritive hay could be fed if grass were cut and cured during the flush season. Whichever may be the reasons for the neglect of haymaking the fact is that with the sickle as the only reaping instrument it is impossible to cut sufficient amounts of grass. Haymaking with subsequent better feeding of animals becomes feasible only where the scythe has been introduced for cutting grass, as well as forks and rakes for making hay, and where some sort of transport is available for the haulage of bulky material from the fields to the villages or farms.

The modern scythe for grass mowing consists of a blade joined to a handle, called the "snath," by a ring connector.



FIGURE 86. - Scythe blades: (a) ground blade from the U.S.A.; (b) scythette blade; (c) hammered Austrian blade; (d) short, heavy blade for weed and brush cutting.

SCYTHE BLADES

Two essentially different types of scythe blades (Figure 86) are in use: ground blades, i.e., blades which are sharpened on a grindstone, and hammered blades, i.e., blades which are sharpened with a hammer and small anvil or similar device, thereby drawing out the cutting edge. Both types have the finishing touches given to the edge with a whetstone and are kept sharp in the field by whetting.

Ground blades are still common in most north European countries such as Finland, Sweden, Norway, the United Kingdom, as well as in North America. They are heavier, thicker and made of steel with a higher carbon content than the thinner, hammered mild steel blades.

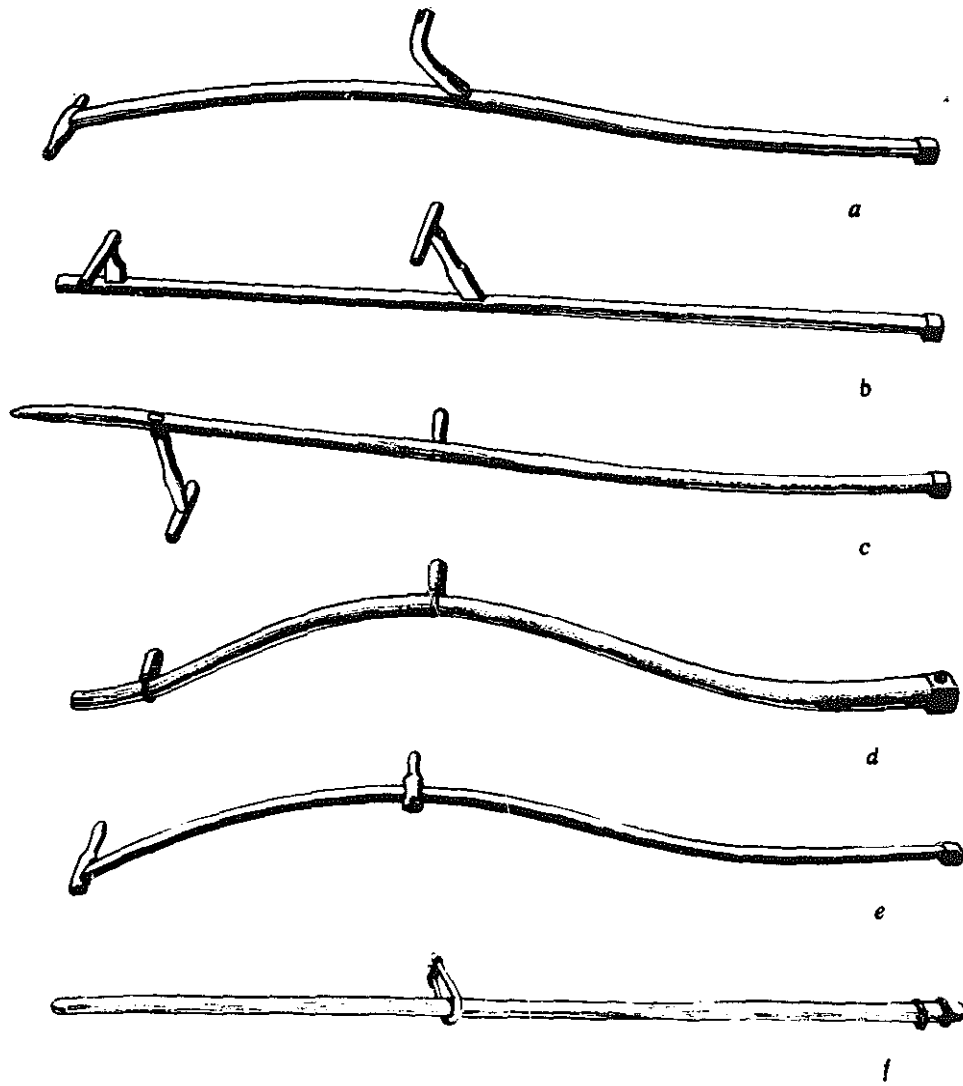

FIGURE 87. - Scythe snaths: (a) type used in some parts of Switzerland and Italy, with hammered blades; (b) Austrian and Bavarian type for hammered blades; (c) type used in northern Germany for hammered blades; (d) United Kingdom and North American type for ground blades; (e) tubular steel snath for hammered blades; (f) U.S.S.R. type of snath used also in the Iraq/Iran border regions and by the Circassian farmers in Syria.

The latter are an improvement on the ground blades and were first produced in Austria several hundred years ago, with improved manufacturing techniques, and rapidly spread over most of the European continent to Russia, Turkey, Spain and Portugal and were taken to Latin America by emigrants.

Hammered blades are not only lighter than ground blades but are also less liable to breakage. The hammer and anvil for sharpening them are much cheaper than a grindstone. They are preferred in most countries, especially in hot climates, although it takes longer to sharpen them than ground blades; they are also less fatiguing to use.

The mild steel blade has a reinforced back ending in a tang to which the snath is connected. The length of a blade for grass and cereal cutting varies between 70 and 100 cm and for brush cutting between 40 and 50 cm. A good length for multipurpose blades for developing countries is 70 to 75 cm. Longer blades require a skilled operator and no stones on the surface of the land. Narrow blades are generally preferable because they are easier to wield and because they maintain their straight edge, while the edge of wide blades may become slightly corrugated when they are hammered. The blade width at the heel should not exceed 10.5 cm for grass and wheat but should be wider for crops with thicker stalks.

SNATH AND RING CONNECTOR

Most scythe snaths are made of wood but light tubular steel is also used. The long handle has a grip in the middle for the right hand, and there is sometimes a second grip at the top. Handles and grips vary considerably but all are designed to enable the operator to work with outstretched arms and both hands at more or less the same horizontal height (Figure 87[a] to [e]). This is achieved either by curving the snath, or on the straight snath by having the middle grip on a separate raised shaft, or with the top grip pendant from a separate shaft pointing downwards. Whatever the arrangement the aim is to allow the operator to swing the scythe through a wide semicircle without undue strain and with the blade always parallel to the ground. Straight snaths with middle grips without shafts and no top grips, however, require a working position with a raised left arm and hence a shorter, more chopping cutting motion. This type of snath is common in the U.S.S.R., Turkey, Syria and Kurdistan (Figure 87[f]).

The middle grip either lies in the same direction as the scythe blade or on the opposite side, depending on the balance best suited to the implement.

A simple type of middle grip used with the straight snaths consists of a U-shaped withy holding the snath in the U bow; the free ends pointing to the left are tied with a string (Figure 87[f]). It has the advantage of being adjustable to the best position for the operator's hand.

The length of the snath and the exact position of the grip are determined by the height of the operator. If the scythe is held in a vertical position with the blade on the ground, its top grip should come up to the nose and its middle grip up to the waist of the operator.

The blade is attached to the side underneath the lower end of the snath with a ring connector; it faces the left if kept in the working position. The D-shaped ring connector (Figure 88) makes it possible to regulate the angle of the blade to the snath. This depends on the crop conditions. The larger the angle between blade and snath, the more material is taken with each cutting stroke and the more strenuous the work; the narrower this angle the less is cut with each stroke. The most suitable position for the blade on the straight handle can easily be checked by standing the scythe on end, the blade facing left against a wall, and marking the position of the heel of the blade on the wall. Keeping the end of the handle on the ground in a fixed position and moving the blade to the right until the blade point approaches the mark on the wall it should be about four fingers below it. The correct position of the blade can also be checked if the scythe is held across the shoulders with the blade to the right and pointing slightly downward, with the middle grip resting against the right side of the neck. In this position the right-hand fingers of the outstretched arm should be able to reach the point and the heel of the blade.

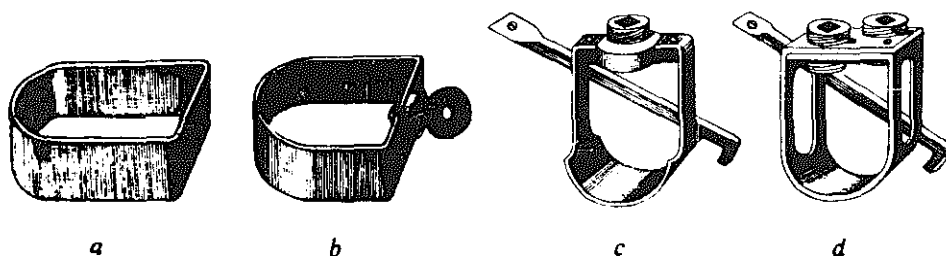

FIGURE 88. - Scythe rings: (a) simple ring to be tightened with a wooden wedge; (b)-(c) rings with one screw; (d) ring with two screws.

CRADLE

The scythe becomes a cereal reaping tool if it is provided with some sort of cradle to hold and collect the crop just cut. Crops of up to 30 cm in height are generally cut without any collecting attachment on the lower part of the snath. When they exceed this height they may be cut with smaller or larger collecting devices, the smaller ones being simply a twig or wire bow while the larger ones — mainly used for reaping cereal crops — consist of a framework, the so-called “cradle” (Figure 1[a]). A cradle is a wooden frame fixed in a vertical position to the lower part of a wooden snath (steel snaths are less suitable for this purpose). The frame may contain a net or long, slightly curved wooden teeth.

In northern Anhwei (north Mainland China) a special type of scythe with cradle is used for cutting wheat with short pulling strokes (Figure 89). The cut grain is thrown with a back swing into a rack on a sled which is pulled by a second man. Another Chinese scythe used for cutting green crops has a blade about 30 cm long, which resembles a double-edged sword, with a socket for a long bamboo handle.

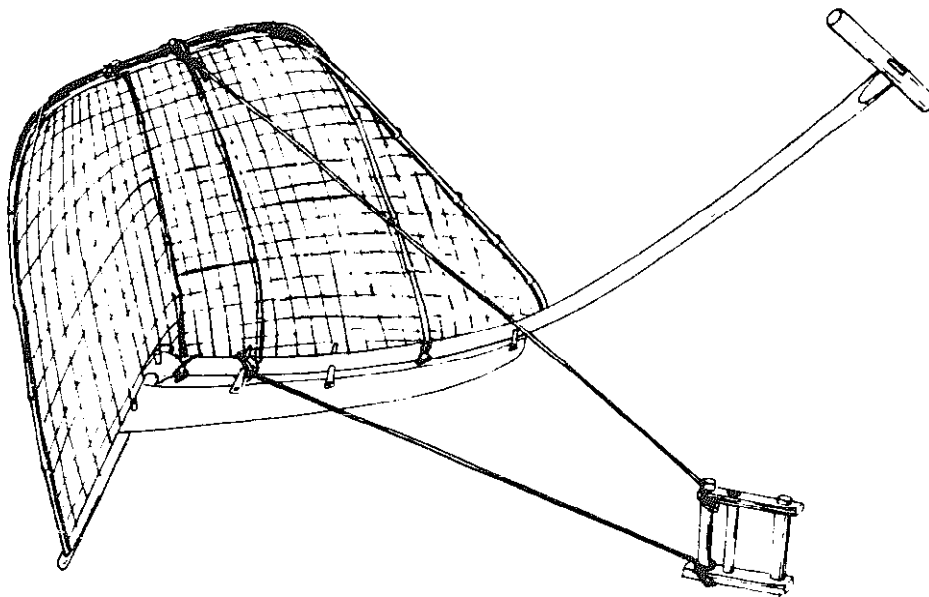

FIGURE 89. - Chinese cradle from northern Anhwei, Mainland China; blade fastened with its whole length on the snath.

FIGURE 90. - Hammer (a) and anvil (b) for scythe hammering; (c) whetstone in container.

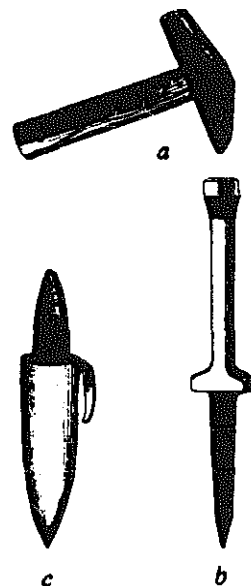

FIGURE 91. - Farmer hammering a scythe blade.

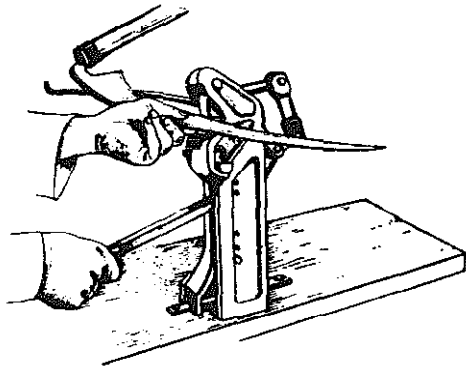

FIGURE 92. - Scythe-hammering apparatus.

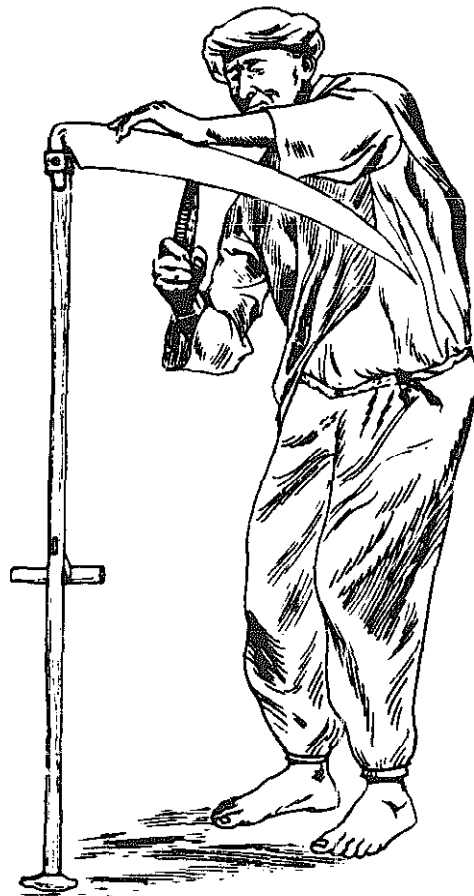

FIGURE 93. - Scythe whetting.

HAMMERING

Mild steel blades should be hammered (Figures 90 [a] and [b] and 91) when whetting no longer provides a razor-sharp edge after roughly 5 to 10 hours of work. It is commonly done with a wedge-shaped hammer on a flat anvil. The reverse system, i.e., flat hammer and wedge-shaped anvil, is also used.

Scythe hammering is difficult and skilled work. Cracks in the edge of the blade should be filed off before hammering. The blade must be held firmly by the operator, with the support of his leg, flat on the anvil (Figure 91). Hammering starts at the heel and moves progressively about 0.1 cm with each stroke toward the point of the blade. The blows should not be too hard, therefore the hammer should not be raised more than 5 cm, or 3 cm if the blade is hard and brittle. A second hammering is sometimes advisable to give a fine edge. It takes about half an hour to hammer a scythe blade properly.

Hammering machines (Figure 92) have largely replaced small hammers and anvils in central European countries. Most of them are operated by a hand or a foot lever.

WHETTING

Whetting refers to the process of sharpening with a suitable stone, called a whetstone of which there are several kinds: some need water, and others are used dry; they are carried in a holder of the type shown in Figure 90 (c). The blade is whetted on both sides of its edge beginning at the heel (Figure 93).

MOWING AND REAPING

Mowing with a scythe requires skill and is a completely different operation from mowing with a sickle. Grass and forage crops are mown with a scythe in wide, semicircular cuts, advancing in a straight line ahead and cutting away from the standing crop (Figure 94). An 80-cm scythe makes a cut of about 200 cm, i.e. two and a half times the length of the blade, if the plant growth is not too dense. With increased density of crop growth the cutting width is reduced. About 500 square metres can be mown in one hour, provided the land is flat and free from stones. Green crops can be cut five times faster with a scythe than with a sickle. This confirms what has been said above, that forage conservation, i.e., hay-

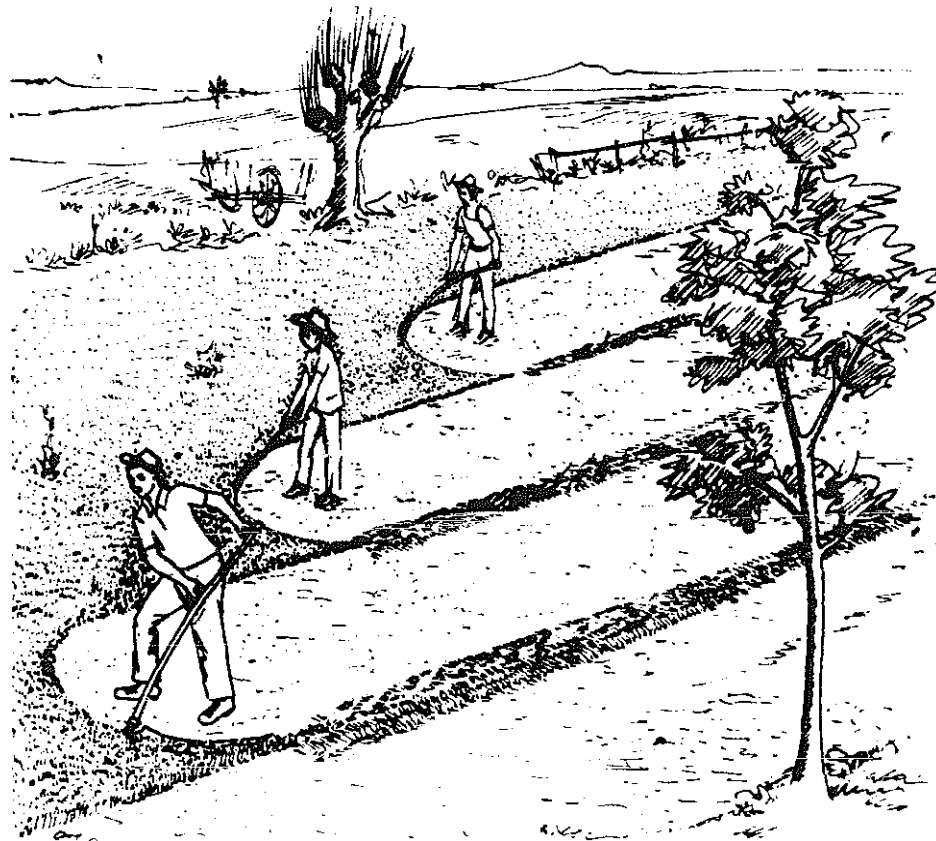

FIGURE 94. - Grass mowing.

making and better animal feeding, becomes possible with the help of a scythe, but not with a sickle.

Cereals can be reaped with a cradle in two different ways: either by cutting against the standing crop, which requires a helper for immediate collection of the grain (Figure 95), or away from the standing crop, leaving the grain in a swath with the ears turned to the left for easy bundling (Figure 96). The first method has the advantage of leaning the cereals against the standing crop which prevents shattering but is applicable only with high, dense crops. The second is used with shorter, less dense crops; it does not need a helper and the whole field can be cut in one operation, the grain being collected after completion of reaping.

When cereals are reaped with a scythe and cradle they are cut close to the ground, i.e., with relatively long straw, whereas farmers who use



FIGURE 95. - Reaping against the standing crop.

a sickle cut their crops higher and with less straw to facilitate threshing by animal treading or with sled or roller threshers. Cutting with the cradle therefore presents certain difficulties in countries where these threshing methods prevail.

The cradle has been tried in many countries for reaping paddy but nowhere has this method been completely accepted. This is due mainly to the high proportion of lodged crops, to the soft and tough paddy straw and to the tendency of the grain to shatter. However, in a good standing paddy crop reaping with a cradle is feasible.

Grain can be reaped with a cradle three times faster than with a sickle on flat fields with uniformly standing crops.

The actual mowing or reaping is done in semicircular sweeps from the operator's right side toward his left. Since the transport of the cut material, not the cutting itself (if the blade is well sharpened), is the tiring part of the operation, the worker should stand with his right foot slightly forward so that this body faces slightly to the left of his advancing direction. He thus achieves the best position toward the end of each cutting sweep when the full grain load is in the cradle of the scythe.

The movement of the feet must be in accordance with the cutting swing. The operator's right foot should move about 20 cm forward and be immediately followed by the left foot during the backward swing of the scythe. Less swing and narrower cuts are used for grain reaping than for grass mowing. After about 120 cutting swings a blade needs whetting, and this gives the operator a short rest.

As the scythe is a rather dangerous implement in unskilled hands, its blade should be protected when out of use.

Paddy knife

A small harvesting knife is used in some parts of Indonesia for collecting paddy. The tool is merely an iron or steel blade, 5 cm long, fixed to a crescent-shaped wooden handle carved to fit the shape of the operator's hand. Individual paddy heads with 8 to 10 cm of stem are clipped off with this tool. Its only advantage would appear to be that individual heads can be harvested as they ripen and that very little loss from shattering occurs. Bundles of grain can be hung up to dry and be threshed later as and when the grain is required, but a great deal of labour is needed with this method.

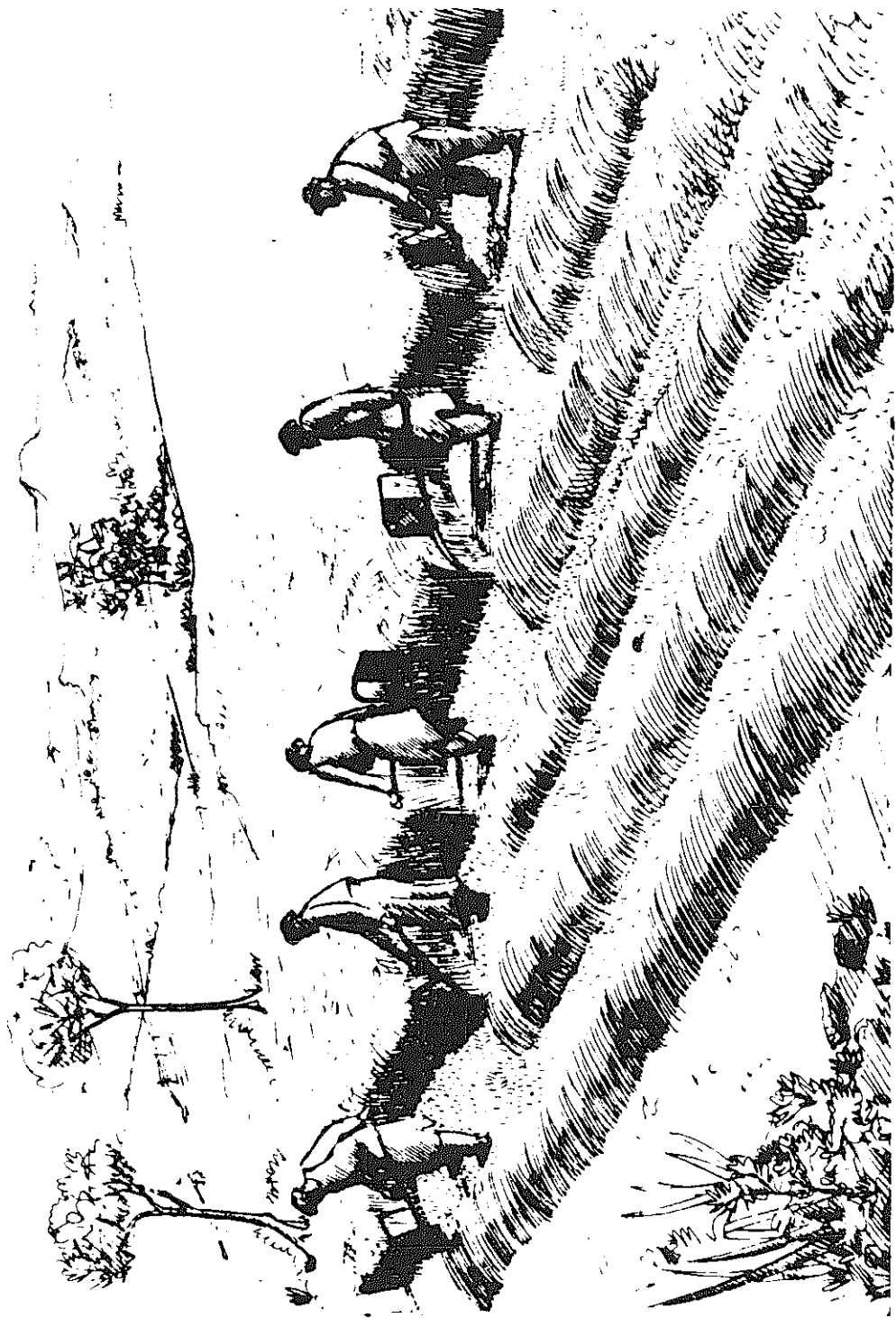
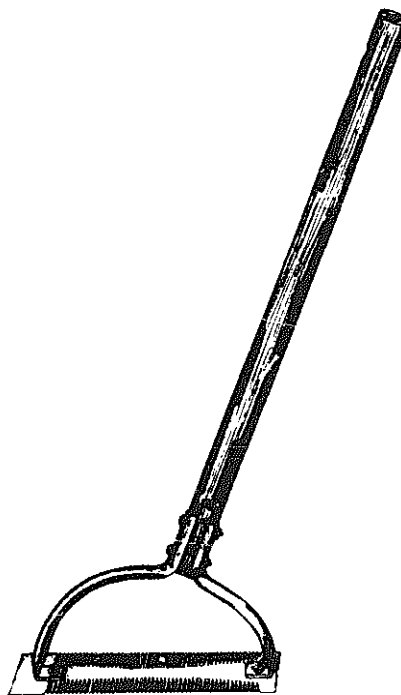

FIGURE 96. - Reaping away from the standing crop. This method is also used for mowing grass.

FIGURE 97. - Weed and brush cutter with serrated double-edged blade.



Weed cutters

Heavy scythe blades, much shorter (40-45 cm long), but wider than the normal ones, are used to sever strong weeds and brush (Figure 86[d]). The snaths are those of ordinary scythes. A special kind of weed cutter has a serrated double-edged steel blade and a handle about 60 cm long (Figure 97). It is used with swinging strokes in two directions.

Animal-drawn mower

Animal-drawn mowers are extensively used for cutting both green forage and hay crops. To work well, the fields where the crops are grown should be free of big stones, tree trunks and other obstacles and have an even surface.

It is a rather complicated machine which requires good mechanical knowledge for proper handling, maintenance and repair. Its main component is an iron framework on wheels, one or both of which drive the cutting mechanism; the operator has a seat from which he guides the draught animals and manipulates the controls. The cutter-bar is the essential working part comprising a substantial steel bar hinged to the frame, a series of slotted fingers or guards, each of which has in the slot

a hard steel plate against the edges of which triangular blades, all riveted to a long strip of steel, cut the crop stalks. The blades, known as the "knife" or "sickle," have a reciprocating motion imparted to them by a crank and connecting rod. The cutter-bar, in the working position, slides on an inner and an outer skid or shoe, both of which are adjustable to vary the height of cut, i.e., the length of the stubble left.

There are three points to ensure the effective functioning of the cutting mechanism: a sharp knife, correct knife register, and the exact amount of clearance between the knife blades and the hard steel ledger plates in the finger slots. The knife is sharpened on a grindstone or with a file; the clearance is controlled by malleable clips — hammered down if slack; and the register, which is the position of each blade relative to its ledger plate, is adjusted with a screw device on the connecting rod.

The mower, although a rather expensive machine, helps to overcome peak labour demands during the haymaking season, particularly if labour is scarce.

Mower for harvesting cereals

To cut cereals the standard animal-drawn mower needs special reaping attachments. The most common of these, a buncher for collecting the cut crop, is a wooden grate fixed to the cutter-bar on to which the grain falls. A second man, on a separate seat, rakes the cut swath off the grate in regular bunches and thus facilitates the work of the team following, who bind the bunches.

Reaper

The reaper is very similar to the mower with the exception that a semi-circular platform is attached to the cutter-bar. The platform is automatically swept clean of the cut crop by windmill-like arms, which deposit the bunches in a windrow behind the machine, to be collected and bound later. One man can handle the reaper. With a cutter-bar 6 ft long (180 cm) and two horses, approximately 0.6 ha of a good standing crop can be cut per hour.

Binder

The combined reaper and binder has largely replaced the reaper for harvesting cereals. The machine cuts the crop, bundles it and binds

the bundles or sheaves automatically, and then deposits them on the ground ready to be stocked, i.e. set up on end in groups for final ripening and drying.

Binders are rather heavy both in weight and in draught. They are complicated machines and good mechanical knowledge is needed to keep them in proper working order.

Cutting implements for plantations

Many kinds of tools are used to cut hard stalks and wood in orchards and tropical plantations. The most important of them are described below.

MATCHET

The matchet is a common chopping tool, widely used in tropical and subtropical regions where the harvesting of plants like sugar-cane, maize stalks, sisal, hemp, requires long and strong cutting tools. The matchet is also used in some tropical areas to dig holes, cut and dress timber. The blade is about 50 cm long with a suitably shaped handle and it is made in a great variety of forms (Figure 98).

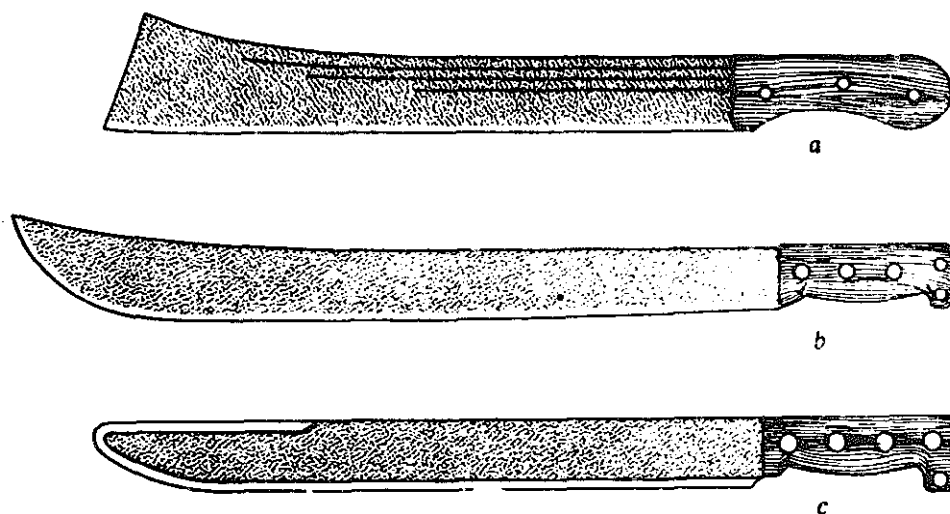

FIGURE 98. - Matchets: (a) African; (b) Latin American; (c) type developed in the Dem. Rep. of the Congo for standardization: overall length 58 cm, blade length 45 cm, blade width 4.5 cm, length of cutting edge on the back 14 cm, weight 650 g.

BILL HOOKS AND HATCHETS

Bill hooks and hatchets are common wood-cutting tools, the first mentioned used for trimming hedges, cleaning trees and cutting branches, the latter for felling small trees and chopping wood.

PRUNING SHEARS

Pruning shears are designed for cutting relatively thin branches of trees and bushes. Most types of shears engage the use of some of the hand muscles and require a pressure which is quite high for continuous work over long periods. The effort required of the muscles can be reduced considerably with shear handles of improved lever action and better shape. (See also page 5: Adaptation of implements to man.)

Potato diggers

Potatoes and similar tuber crops are generally lifted with spades, digging hoes, digging forks or hooks as used for manual tillage, or with animal-drawn potato ploughs.



FIGURE 99. - Potato digger: (a) potato digging with short-handled hook; (b) lanceolated prongs of 19 cm length and 3.5 cm width at largest parts, width at point 13.5 cm, length of handle 60 cm.

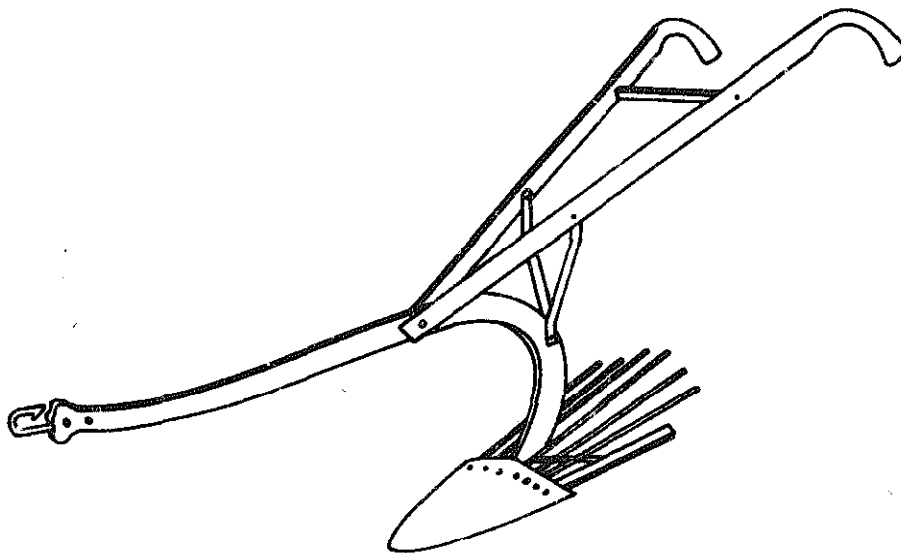

FIGURE 100. - Animal-drawn potato digging plough.

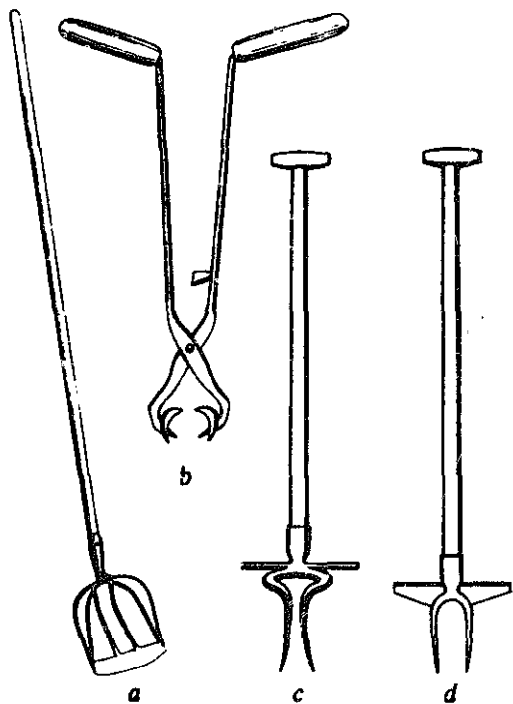

FIGURE 101. - Hand tools for beet harvesting: (a) beet-topping shovel, Dutch type: thin blade 20 cm wide, handle length 150 cm. The bottom of the basket behind the blade must be on the same level as the blade and have a length of 17 to 20 cm. The angle between blade and handle is about 140° ; (b) beet-lifting pincers: total length about 70 cm; jaw shape: six blunt, obliquely placed tines; (c) beet-lifting fork with cranked tines; length of tine 12 cm, width at points 6.4 cm, diameter of upper rounding 9 cm, length of foot rests 24 cm on each side, overall length of lifter 111 cm with a handle of 90 cm; (d) beet fork with support plate.

A special potato-digging hook is widely used in certain parts of central Europe. Although handled in a kneeling position, it is considerably quicker than normal spades or hoes. The design of the tool can be seen in Figure 99. The hook is thrust into the ground beyond the plant mound and drawn with a sudden jerk and a slight upward motion, lifting the tubers and separating them from the soil.

ANIMAL-DRAWN POTATO PLOUGH

This somewhat resembles a ridging plough but instead of two symmetric mouldboards a set of tines behind the share lifts the soil and potatoes. The soil, if friable, falls through the tines and the potatoes are deposited on the surface, ready to be collected (Figure 100).

Sugar-beet harvesting implements

Sugar-beets are harvested in two operations: lifting the roots out of the ground, and cutting the tops off. Which job is done first depends on the machines, implements or tools used. While in the past beets were generally lifted with the leaves and then topped, the modern European method of harvesting is to top the beets with a topping shovel while they are still in the ground and lift them afterwards. Most of the hand, animal- and engine-powered equipment is based on the latter method which saves not only labour but also facilitates the collection of clean leaves and beets.

A great variety of implements exists for lifting the beets with animal draught. In the main these have one or two shares or a pair of tines which either loosen the soil around the roots so that they can be pulled by hand, or lift them completely. With the first method the roots are topped after lifting, whereas they are topped in the ground when the second method is used. Figure 101(a) shows one type of topping shovel for removing the crown and leaves when the beet is still in the ground. There are very many other kinds of toppers in use for both methods.

BEET-LIFTING FORKS AND PINCERS

Two types of lifting forks are illustrated in Figures 101(c) and 101(d). They work well in fairly dry soil. For moist soil the lifter shown in Figure 101(b) has been developed in the Netherlands. It has two sets of fingers which grip the upper part of the beet after having been topped. With a turning and slightly rocking movement the root is loosened and then lifted.

Maize harvesting tools and implements

HAND TOOLS

The whole maize plant can be cut with a machet and the ears husked by hand when they are thoroughly dry, or the ears can be pulled by hand from the standing stalks. A special glove with a metal hook on the palm to open the husks and remove the ears speeds up this latter method of harvesting.

ANIMAL-DRAWN MAIZE CUTTER

A simple implement for harvesting the whole stalk can be made by mounting two blades on a wooden sled slightly aslant to the direction of pull. The blades cut the stalks as the implement advances. The stalks are gathered by the operator standing on the sled, or they are left in windrows for the ears to dry. This implement is also suitable for harvesting sorghum.

11. THRESHING MACHINERY

After collection, cereal grains have to be threshed out from the ears and straw and then separated from chaff and foreign matter. In arid zones the straw has also to be bruised during threshing for fodder and other purposes.

Simple threshing methods

Primitive threshing is done by spreading the ripe crop on a threshing floor where it is beaten either with sticks or flails (Figure 102[a]) or trampled by the hoofs of animals. Where sheaves are made the grain is often threshed out by beating the sheaves against slanting shielded grates.

Threshing sleds

A threshing sled is an animal-drawn implement consisting of two wooden boards, slightly raised in front which are fitted with short pegs, serrated knives or hard stones, inserted into holes on the underside of the boards. The operator stands on the implement, to add weight, and it is dragged over the crop spread on the floor, the knives or pegs rubbing out the grain and bruising the straw.

Threshing rollers

Another way of threshing is to pass ribbed rollers (Figure 102[b]) or two or three parallel sets of disks mounted on a frame over the laid out crop (Figure 103). The disk thresher, known as the *norag* in the Near East, and Olpad thresher in India, has serrated iron disks about 45 cm in diameter and about 15 cm apart, with a seat, and it is drawn by a pair of animals. The crop is spread in layers 30 to 50 cm deep and is turned

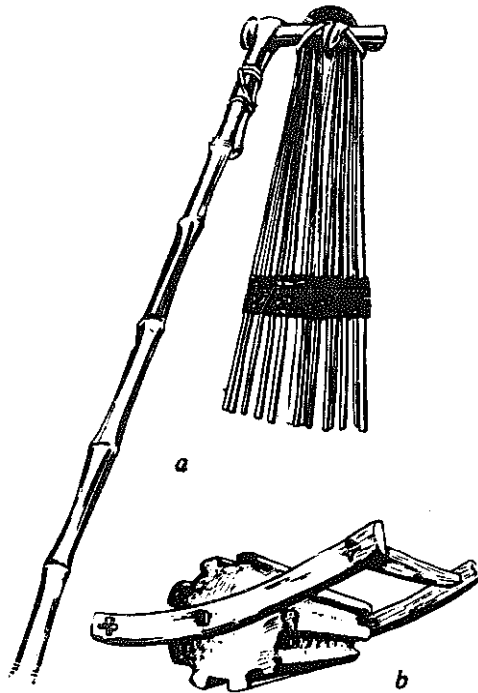

FIGURE 102. - Simple threshing devices: (a) Chinese threshing flail; (b) stone threshing cylinder.

over with wooden forks while being threshed. The grain obtained is not clean and has to be separated not only from chaff but also from dust and dirt. Grain is also likely to be broken and some not threshed, or eaten by the draught animals. The whole process is rather slow, but it has the advantage that the straw is bruised. Threshing rollers are used throughout the Near East and in parts of Spain and Portugal.

Pedal-operated drum threshers

The pedal-operated drum thresher is common in rice growing countries. A revolving threshing drum fitted with wire teeth and driven by a pedal, connecting rod and a crank is mounted in a framework. The sheaf is held at the butt end with the head against the revolving drum until all the grain is beaten out (Figure 104). The drum has a speed of approximately 300 to 400 revolutions per minute, and the output is about 150 kg of grain per hour. Two-man treadle machines with a considerably higher output are also available. These machines are inexpensive and portable, averaging 35 to 70 kg in weight, but are satisfactory only when the grain is easily detachable from the stalks, such as rice, but not wheat or barley.

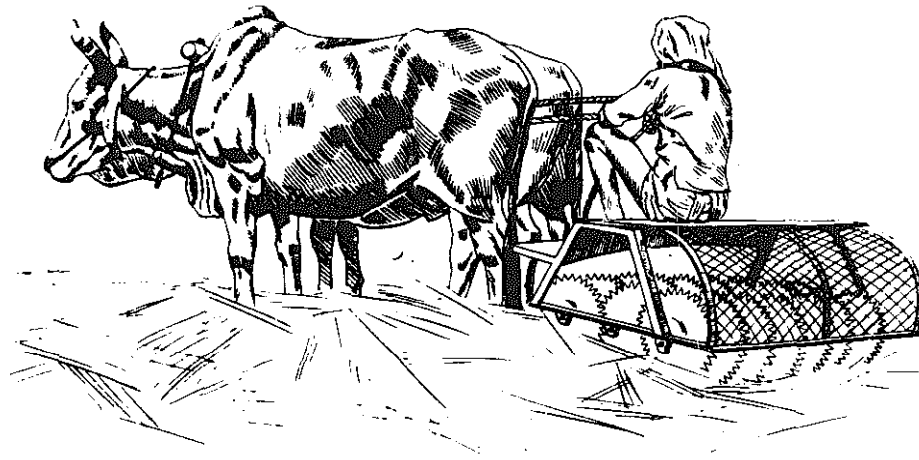

FIGURE 103. - Olpad thresher, made in India on the pattern of the Egyptian Norag thresher; diameter of disks about 45 cm, disk spacing 15 cm, number of disks 20.

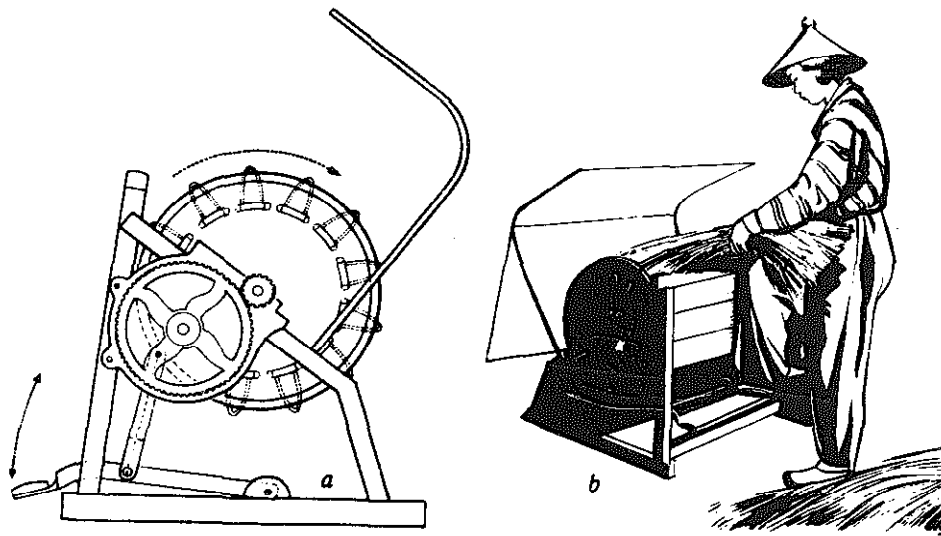

FIGURE 104. - Japanese rice thresher: (a) sectional view of rice thresher; (b) rice threshing with a pedal-operated machine.

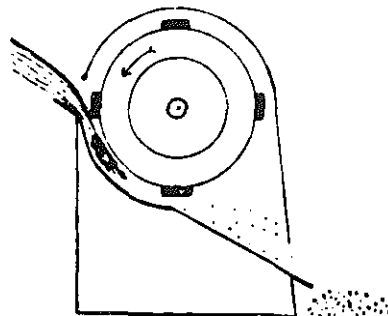

FIGURE 105. - Sectional view of drum thresher.

FIGURE 106. - Chinese straw cutter (Shansi Province, Mainland China), with iron teeth to prevent straw slipping.

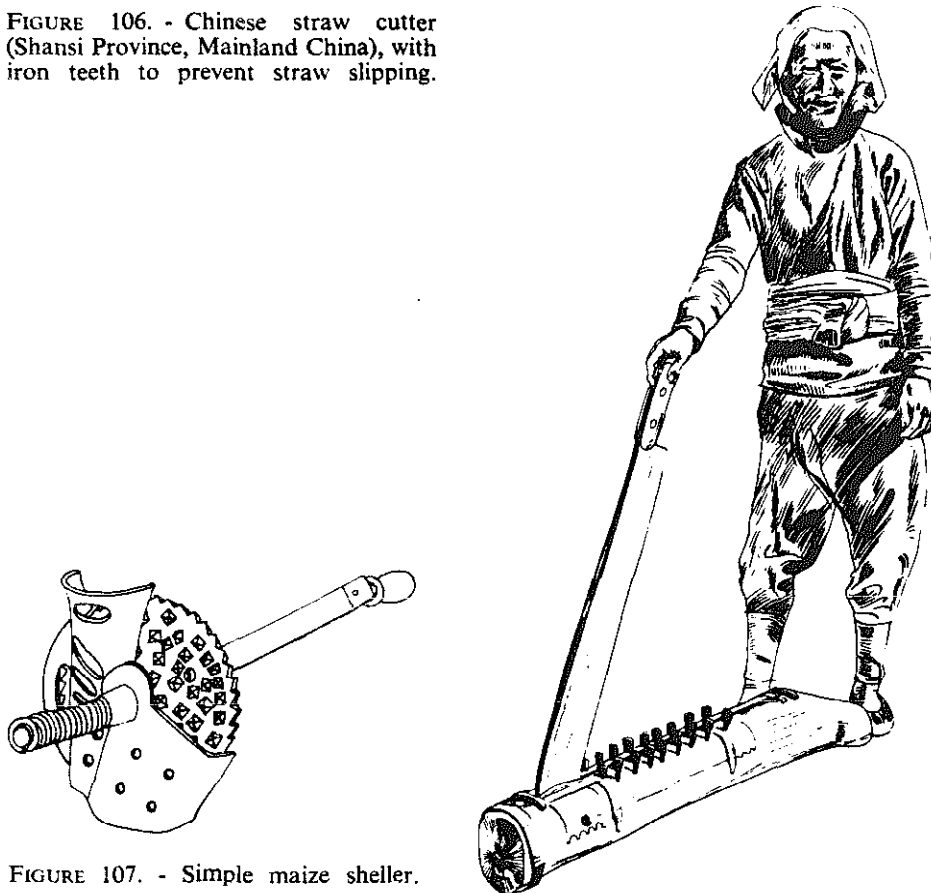

FIGURE 107. - Simple maize sheller.

Hand-operated drum threshers

The hand-operated thresher shown in sectional view in Figure 105 is a type in which the whole sheaf is passed through the machine. The output is 200 to 300 kg of grain per hour according to the proportion of grain to straw. This low output, with two men needed at the drive wheels, makes the machine uneconomical; therefore its manufacture has been discontinued in Europe.

Straw bruising and chaff cutters

In many arid zones straw is the basic fodder for domestic animals during the seasons of forage scarcity. The weak and poor condition of draught animals fed on bruised straw during the dry season is actually the greatest obstacle to improved cultivation at the start of the rains and to the use

FIGURE 108. - Simple groundnut sheller.

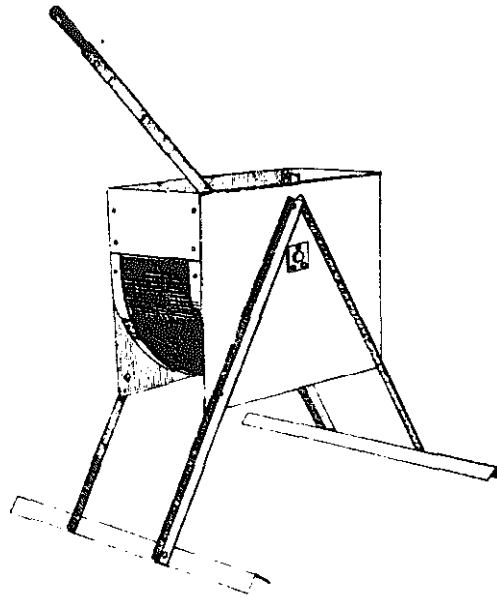

of better implements. This setback could be eliminated if, to begin with, good, otherwise unused grasses growing in many of those areas were cut in the spring with the scythe and made into hay to provide substantial food for the animals during the dry season. Where necessary, chopped straw mixed with hay is better than exclusive feeding on bruised straw.

CHAFF CUTTERS

Figure 106 shows a simple device for cutting straw. A long knife, one end of which is hinged to a slotted wooden beam or curved iron frame, and the other with a handle, cuts against a fixed edge. Iron teeth are sometimes fixed to the beam to prevent the straw getting out of place when the knife is pressed down.

Improved forms of chaff cutters work on the same principle, but they have a feed mechanism and two or more blades, attached to the spokes of a hand-driven fly-wheel, which sweep across a shear plate.

Hand-operated maize shellers

Husked maize ears have to be shelled to separate the kernels from the cob. A simple crankshaft-operated maize sheller (Figure 107) consists

of a feeder, a vertical shelling disk, the picker wheel (with teeth on the inside), a device for holding the ear against the shelling disk and runners for moving it down, a winnowing fan and cleaning sieves.

Groundnut sheller

The simple groundnut sheller (Figure 108) has for its main elements a semicylindrical screen closed at both ends, and a spindle carrying a number of sheller bars. This moving component, worked by hand, shells the groundnuts against the screen.

12. WINNOWING MACHINES

Grain threshed by the simple appliances described in the previous chapter needs considerable additional cleaning before it can be used as food, whole or ground, or used as seed. This process often takes more time and presents more difficulties than the actual threshing.

A primitive method is "wind-grading" for which only simple tools, such as wooden forks, wooden shovels, winnowing baskets, or winnowing sieves are used. This, of course, is dependent upon steady winds. If there is no wind, winnowing can be done by making artificial winds with fans of various kinds.

Winnowing baskets

Winnowing baskets are used when only small quantities of grain are involved. The grain is first put into a flat shell-shaped basket which is shaken either with a circular or slightly forward and upward motion. The chaff and dirt work their way to the upper end of the basket and are discarded, and the heavy grains collect at the lower end. This method provides a clean sample, requires the cheapest and simplest equipment and is not arduous. It is however, extremely slow, the average rate being 45 kg/h.

Baskets are also used in some regions to separate grain and chaff by means of water. Running water is preferable. The full baskets are lowered into the water and the chaff and other light impurities float away. The good grains remaining in the basket are subsequently dried on mats in the sun. The chaff can be collected and dried if needed. This method is faster and gives cleaner grain than wind grading with baskets. However, running water is the limiting factor and the drying causes additional work.

Winnowing sieves

Winnowing sieves are usually open weave baskets, often suspended on tripods and shaken to allow the grain to drop through. Heavy chaff and straw is retained in the basket while light matter is blown away in the breeze.

Winnowing fan

The winnowing fan is a hand-driven revolving fan mounted in a wooden housing which has a horizontal wind duct. The grain, chaff, weed seeds and short straw is fed from a hopper (wooden funnel) into the duct and as it falls vertically the lighter materials are blown away by the blast of air. The strength of the blast is regulated by varying the speed of the fan.

Another type of winnower consists of a fan with two, three or four blades mounted on a simple wooden framework and driven by gears or sprockets and chain actuated by a hand crank or foot pedal. This machine merely supplies an artificial breeze to allow winnowing in periods of calm. The method is rather tiresome and does not grade the grain, that having to be done later with hand sieves of suitable meshes.

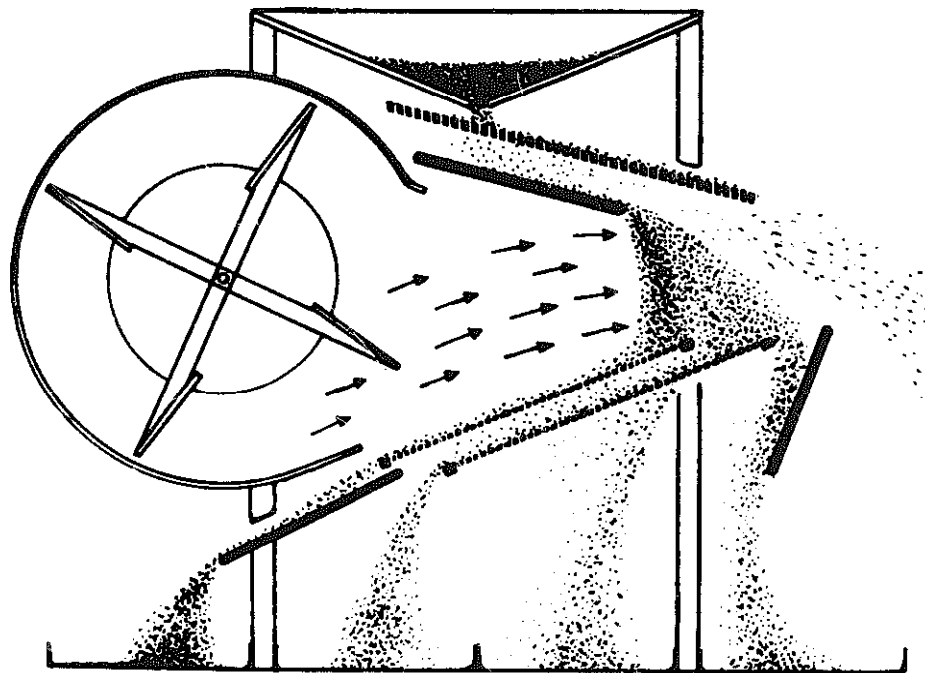

FIGURE 109. - Sectional view of winnower.

Fanning mill

The fanning mill or winnowing machine combines an air blast with sieves and screens for grading according to size. A revolving fan produces the air blast for removing chaff, dust, etc., from the grain. A series of interchangeable vibrating sieves and screens separates the whole grain from the unwanted material and roughly grades the grain. Figure 109 shows a winnower in sectional view with an upper sieve and two lower screens. The sieve is often made of a perforated metal sheet which lets good grain and heavy material fall through its openings, and shakes off bulky material. The lower screens have a smaller mesh than the sieve to retain the grain and eliminate smaller weed seeds and other fine impurities. The grain passes over the screens to a discharge spout where it is collected.

A modern hand-driven winnower running on ball bearings at approximately 200 revolutions per minute, can clean 200 to 1 200 kg of grain per hour. It weighs, according to output, between 70 and 150 kg and produces a very clean sample suitable for seed.

13. HANDLING AND TRANSPORTATION EQUIPMENT

Much of a farmer's time is spent in handling and transporting the crops he grows, the materials and machines he uses to cultivate them as well as other materials — bulky or fluid — produced or needed on the farmstead. For example, crops must be handled in the field; they have to be aerated, collected, loaded, unloaded and further handled during the threshing and cleaning processes. Implements have to be transported to and from the fields; seeds and seedlings, fertilizers and pesticides have to be brought to the fields; harvested crops and other goods have to be moved between the field, homestead, village and the market; liquids have to be conveyed.

There now follows a review of the tools, machines, vehicles and other equipment that facilitate these various operations.

Forks

Forks of many shapes and sizes are used to handle farm produce of various weights and consistencies. In many countries the forks are locally made of wood, but the demand for stronger types with steel tines is increasing. Steel heads may have any number of tines from two to as many as ten.

A three-tine hay and straw fork is illustrated in Figure 110(a) and a four-tine grass and manure fork in Figure 110(b), both very common types. The tines are somewhat curved, round or oval on cross-section, made of spring steel, and so tempered that when their points are forced together until they touch and are then released, they return to their original position. The tines are approximately 32 cm long and 14 to 15 cm apart on three-tined forks, and 11 cm apart on four-tined tools. The handles of grass forks are about 140 to 150 cm long, but longer on hay forks, and should be as light as possible.

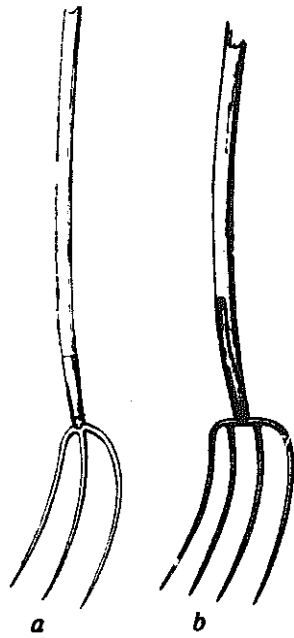

FIGURE 110. - Forks: (a) hay fork; (b) grass or manure fork.

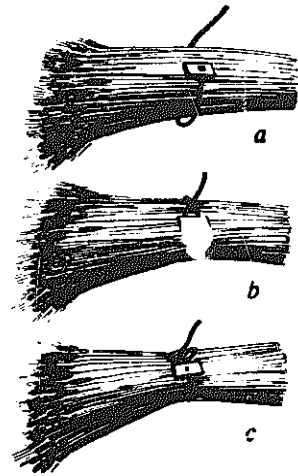

FIGURE 112. - Sheaf binding with woulder.

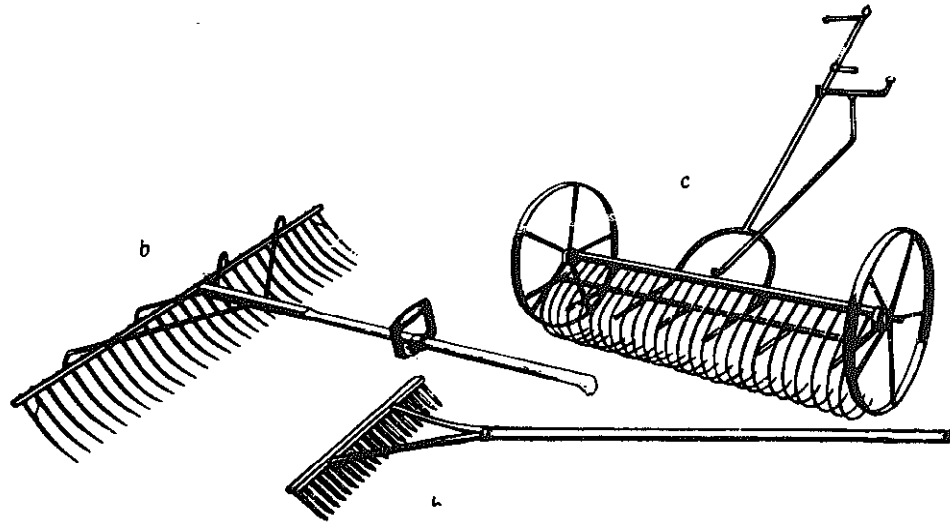

FIGURE 111. - Rakes: (a) common hand rake; (b) hand drag rake; (c) hand-operated wheel rake.

Tedders

The tedder is a horse-drawn version of the fork and it is used for aerating and spreading hay and grass to facilitate drying. A set of rotating spring-loaded forks form the working components. Power is derived from one or both of the land wheels and the machine is animal drawn.

Rakes

The common hand rake is made of wood, steel or aluminium. Wooden teeth are more easily broken, so metal is preferable, especially in arid zones where wooden tines become loose (Figure 111[a]).

A good hand rake has a tubular steel head, 75 to 80 cm wide, with 22 to 24 teeth. The handle must be rather long (185 to 240 cm) so that the operator can draw material from a distant point without excessive body movement.

For windrowing there is a special type of rake which has the head attached at an angle to the handle so that when the rake is drawn along the ground it gathers the hay into windrows to the side.

HAND DRAG RAKE

The hand drag rake has normally 20 long, curved steel teeth with a working width of approximately 100 cm, or 32 teeth with a working width of 140 cm, the handle being 160 cm long with an additional middle grip. It is useful, but rather heavy, for large fields and meadows (Figure 111[b]).

HAND-OPERATED WHEEL RAKE

The hand-operated wheel rake has a working width of about 150 cm. Either 26 or 36 curved, round-sectioned steel teeth are carried on a 150-cm-long bar at a distance of either 4 or 6 cm between the teeth. The bar is mounted on, and parallel to, a wheel axle. A lifting mechanism, operated by a hand lever attached to the handle, enables the operator to dump the hay or straw at will (Figure 111[c]).

HORSE OR DUMP RAKE

Horse or dump rakes are used for collecting hay and dumping it into windrows. They resemble the hand-operated wheel rakes but have a greater working width and are provided with a seat and an automatic lifting mechanism for dumping. They are generally drawn by one horse.

SIDE DELIVERY RAKE

The side delivery rake is designed to gather the crop into a continuous loose windrow sideways, and it can also be used for swath turning. Its action is smooth and it does little damage to dried leaves. It is generally drawn by two horses.

Hay loaders

The hay loader is a rolling elevator, which, hitched to a wagon, picks up the hay from the swath, elevates it and drops it on to the end of the wagon. Two drive wheels operate the elevating mechanism which consists either of a continuous apron conveyer with teeth, rolling on a steel frame, or of a series of long wooden bars, provided with steel teeth, which elevate the hay on an inclined plane.

Drying stands for forage crops

Green forage crops dry out more rapidly if they are off the ground, particularly in wet climates. Large stones, bricks, logs of wood, iron supports, tripods, racks, and strong wire can all be used as drying stands. The object is to have a gap between the ground and the crop through which air can circulate.

Binding materials

The handling of bulky material can often be facilitated by binding it into bales, sheaves or bundles. Chains, wires, ropes (made of hemp, jute, sisal, straw, bast), and bands of willow — in fact anything that can be freely bent around the produce and tied — can be used for this purpose. Detailed descriptions are beyond the purpose of this paper, but the great convenience and saving of labour made possible by binding bulky materials for transportation is emphasized (Figures 112 and 117).

Containers

Liquids loose grain, fertilizers, tubers, fruit and many other such things are carried and stored in buckets, bottles, pitchers, cases, baskets, sacks and nets. Containers are made of materials such as wood, pottery, glass,

metal sheets, rushes, osiers, split saplings, plant fibres. Only a few examples of simple improved containers will be mentioned here.

The common round galvanized iron bucket is larger in diameter at the top than at the bottom. An improved form of bucket has a flat side, i.e., the upper rim is D shaped which makes it more comfortable to carry and easier to pour out liquids than from a normal bucket (Figure 113[a]). Wooden and plastic buckets should have a larger cross section at the middle than at the bottom and at the top rim to reduce spilling of liquids. This is not recommended for metal buckets because it complicates their manufacture and increases the cost.

Transportation by carrying

Transportation by carrying is mainly determined by the weight of the load in relation to the carrying capacity of the person or animal, and less by the surface of the ground to be passed over.



FIGURE 113. - Carrying aids: (a) carrying support with flattened buckets; (b) carrying pole with supporting stick.

CARRYING AIDS FOR MEN

A load should be carried in such a way that its centre of gravity is vertically above the carrier's centre of gravity. This, in fact, means the load should be on the head, but for various practical reasons this is not recommended. Thus, loads are best carried on the shoulders with supports so designed that the ideal carrying position is approached. A modern support is made of a wooden or tubular steel frame with two large straps which pass over the shoulders to distribute evenly the load on either side. Figure 113(a) shows a suitable shoulder support.

A man can carry a load up to his own weight over distances of about 50 m. For long distance carrying, the load should not exceed half the man's weight. Children should not carry anything but very light loads, and women's loads should not exceed 15 kg.

CARRYING POLE WITH SUPPORT

Figure 113(b) shows a carrying pole commonly used in the east. In some parts of China (Mainland) the carrying pole is supported by means of a stick of a length reaching to the man's shoulder when it rests on the ground. The stick has a Y-shaped top, and when the pole is carried on the man's right shoulder the supporting stick is on his left shoulder, with the top end under the carrying pole at the back; the other end is held in front with the left hand. The main load on the right shoulder can be relieved by pressing down the front part of the support with the left hand. If the stick is stood vertically on the ground or leaned against the wall it helps to support the load when changing from one shoulder to the other, or to suspend the load on it to take a rest without having to pick up the load from the ground afterwards.

CARRYING SADDLES

Carrying saddles for animals are generally made of wooden boards held together by two wooden hoops, the boards being padded underneath. The saddle is fastened to the animal by straps. The hoops have holes for ropes to hold the load in place.

Transport on sleds

Sleds are suitable and widely used on smooth ground where there is little friction (snow, grass) and down slopes, particularly in mountain pasture areas of cooler regions (Figure 114).

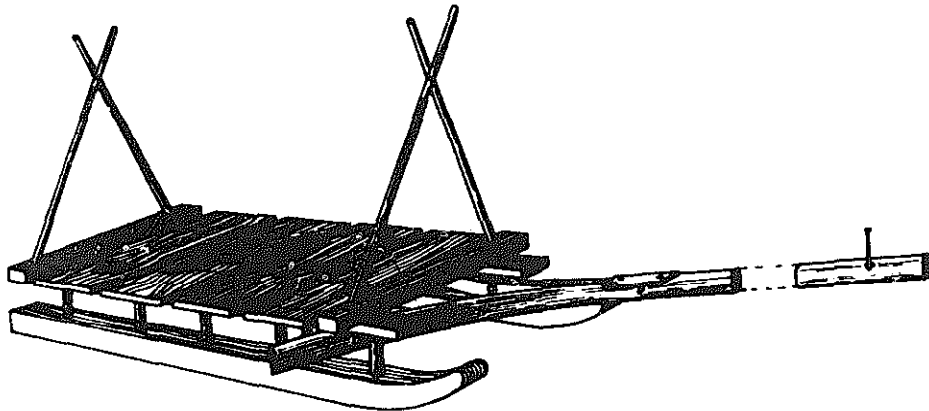

FIGURE 114. - Wooden transport sled from Amelia, Italy. Note the connection of the split shaft with the sled; it ensures sufficient manoeuvrability toward the right and left.

Transport on wheels

The wheel is one of man's most noteworthy inventions. With it he, or his harnessed draught animals, can transport loads far heavier than they carry on their shoulders or backs; and rolling friction being less than sliding friction, far greater loads can be moved on wheel vehicles than on those that slide.

The rolling resistance depends on the formation of the ground. If wheels with iron rims are used on even, hard-surfaced roads it amounts to about 1 to 4 percent of the total weight of the load and its vehicle; on level, stubble fields it is 10 to 15 percent, and on level, soft fields it is as high as 20 to 40 percent of the weight. With pneumatic wheels, still greater loads can be transported. The rolling resistance also depends on the diameter and tread width of the wheels; it is less with large wheels than with those of smaller diameter, particularly on uneven ground. The rim or tread width can be comparatively narrow on hard surfaces, but must be wider on soft ground.

WHEELBARROWS

Wheelbarrows are much used for transport on footpaths or where the road surface is bad. Their great advantage is that they can move on very narrow tracks which are impassable for vehicles with two or more wheels.

A wheelbarrow has one wheel only, two shafts with handles and crossbeams forming a frame to support a platform on which there is a box or some kind of case for the load. The diameter of the wheel should be as large as possible for uneven or soft surfaces as this makes the wheelbarrow roll over the ground easily. A large wheel axle, with relatively wide crossbeams and not too great a weight on the handles, increases the stability and the balance of the wheelbarrow, particularly if the box is fixed between, and not upon, the frame shafts with the gravity point near the ground.

The Chinese wheelbarrow (Figure 115) is well designed for carrying heavy loads over long distances. It has a wheel of about 90 cm in diameter and two shafts, ending in the handles and connected by two crossbeams with the wheel between them. A lattice frame over the wheel holds the load and allows the wheel to revolve freely. A strap fastened to the handle bars and slung over the man's shoulders helps to support the weight and to guide the wheelbarrow. The load is carried on either side, in front, behind and above the wheel so that very little effort is needed to maintain a correct balance. The weight on the handles should not exceed 20 kg.

Western types of wheelbarrows generally have too small a wheel which is very often too far in front of the platform. To correct this defect, platforms of modern wheelbarrows are sometimes extended above the wheel, and the wheel itself has a pneumatic tire.

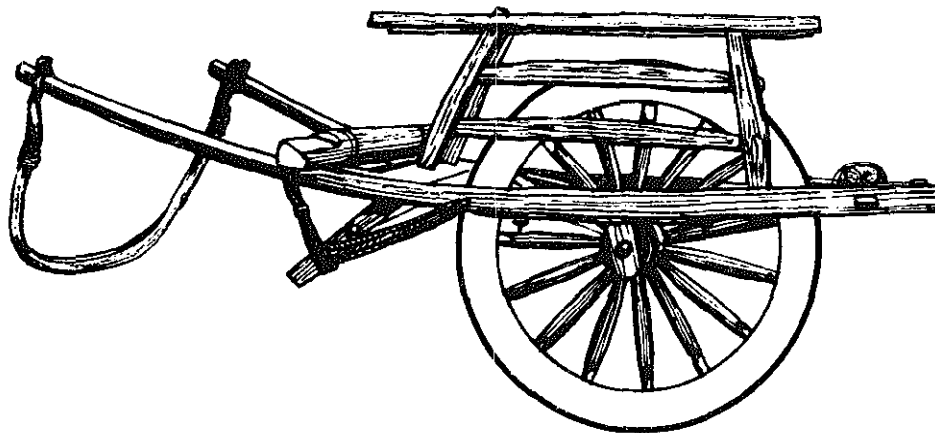

FIGURE 115. - Chinese wheelbarrow.

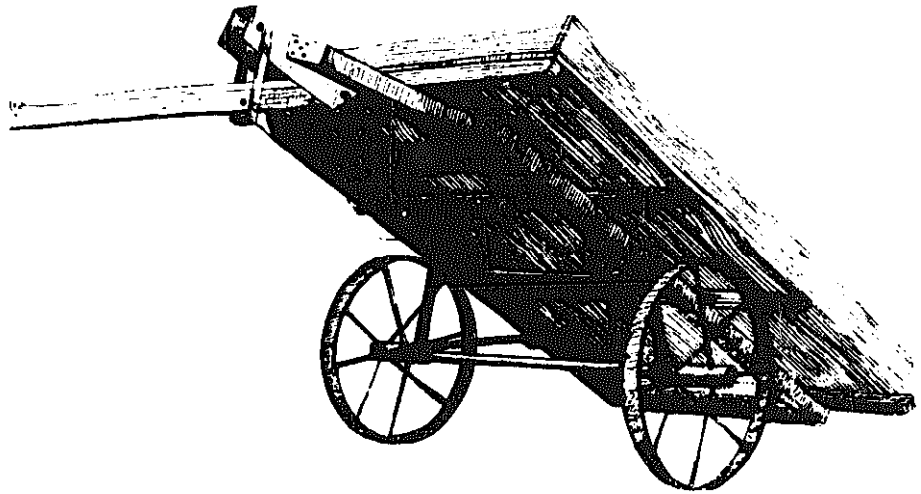
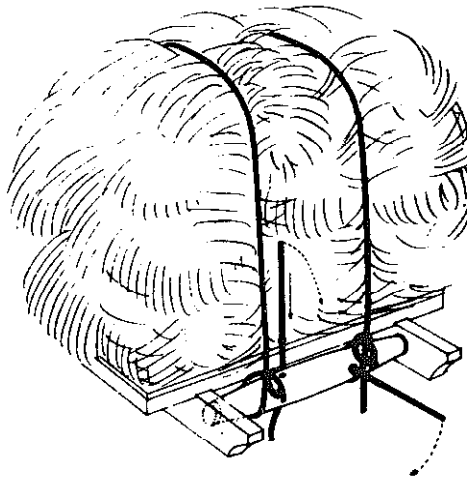

FIGURE 116. - Italian farm cart (Orte, Italy) with tipped platform.

FIGURE 117. - Italian farm cart, details of roller at the rear. The roller serves for tying bulky material. One rope is passed under the central shaft in front of the platform, drawn over the material to the rear, where both ends are fastened to the hooks on the roller. The roller is then turned with the help of two iron bars, one of which is inserted into one of the holes on the roller and pushed down, while the other is pulled out. Both ends of the rope are thus wound around the roller until the rope is tight. One of the bars is left in the roller which cannot unwind until this is pulled out again.



DRAYS AND FARM CARTS

A dray is a relatively heavy vehicle with two wheels, normally drawn by animals in pairs. Farm carts are a lighter version for single animals. Both represent the most widespread types of animal-drawn transport in agriculture.

The most ancient types of drays still in use have both wheels fixed to a live axle on which the dray frame rests, held by two concave pieces with rod extensions to two grooves on it. The frame, which can be lifted from the axle, is triangular with the apex in front. A rectangular platform of

wooden boards is fixed to the rear part of the frame. The pole in front is hitched to the yoke of a pair of animals.

Other drays have a rectangular frame with a central pole, the axle fixed to the frame, and the wheels free to turn on the axle hubs (Figure 116). All drays have large-diameter wheels as they are normally used on rough, uneven ground.

Farm carts usually have two shafts for single animal draught. The frame generally has springs to absorb road shocks and the wheels turn on the axle.

FARM WAGONS

A wagon is a four-wheeled vehicle. Four wheels make for greater stability and better balance: there is no upward or downward pressure of pole or shafts on the draught animals; and there is less road wear than with two-wheeled carts. But carts are easier to drive, particularly on tortuous mountain roads. In fact, the wagon was evolved in the plains, probably in the Ukrainian-Danubian area, by hitching one dray to another, thus obtaining a forecarriage with a turn-table. The wagon came to central Europe from the Danubian region in the Middle Ages. From central Europe it advanced toward the west, the south and the north, gradually displacing drays and carts in some parts of Europe, whereas the cart still remained the chief agricultural vehicle in other regions.

The automobile has influenced the development of the wagon steerage in that the front axle is fixed and the wheels rotate on stub axles, one being hinged to each end of the axle. This type of steerage has great stability when the wagon turns corners. It allows a short turning radius, and the central pole or shafts are not affected by road obstacles as they are with a turn-table, which tends to transmit road shocks to the draught animals. The low loading platform of these wagons is also of great advantage.

Hand pumps

Without water, man, animals and crops cannot grow and live, and on most farms there is a water supply problem. Water often has to be raised from a well, stream or pond and there are many and varied appliances for doing this. Ancient devices used on small farms, such as bucket lifters, well sweeps, foot-power chain pumps, foot wheels and water wheels, are slowly being replaced by modern pumps operated by hand, animal power or engines.

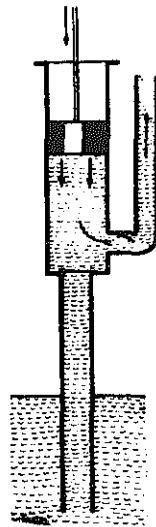

FIGURE 118. - Sectional view of force pump.

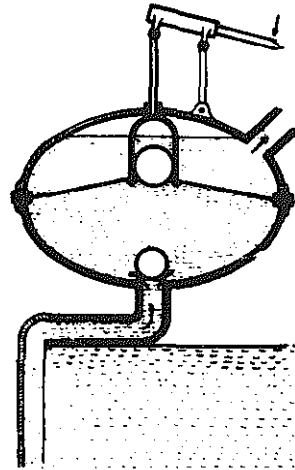

FIGURE 119. - Sectional view of diaphragm pump.

Among the many types of hand-operated pumps three are of particular interest to the small farmer: suction, force and diaphragm pumps, all three being of the reciprocating type. Suction and force pumps are mostly used for clean water, and the third type for pumping muddy water or liquids containing solids or for irrigation.

Suction pumps are common, but they will only raise water to heights not exceeding 6 to 8 m. A force pump (Figure 118) is needed for greater lifts than this. Both these types have a piston reciprocating inside a cylinder, a valve or valves and a delivery spout or pipe. To be effective the piston or plunger must fit air-tight in the cylinder, a condition soon nullified if dirty water is pumped.

The diaphragm pump (Figure 119) having a flexible rubber or leather wall or diaphragm between and completely dividing two halves of the pump chamber, and not having any sliding fit, can deal with liquids containing solid matter in suspension. It, too, can be of the suction or force type and has similar valve arrangements as the piston types.

The capacity of all pumps depends on factors such as volume of cylinder or chamber, length of piston or diaphragm stroke and the number of strokes per minute. A detailed description of pumps is contained in FAO Agricultural Development Paper No. 60, *Water-lifting devices for irrigation*.

14. WORKSHOP EQUIPMENT

Implements last longer and give better service if they are kept in good condition. From time to time they should be thoroughly cleaned and checked; the edges of tools should be kept sharp; and implements should be repaired as soon as possible after a season's work. Minor repairs can be done by the farmer himself with appropriate workshop tools during slack periods. Some of the useful tools given in the following list are illustrated in Figure 120.

- SMALL VICE - width of jaw faces approximately 4 in or 10 cm
- CLAW HAMMER - weight 1 lb or 500 g (a)
- WEDGE HAMMER FOR SCYTHE HAMMERING - weight 1 lb or 500 g (Figure 90[a])
- SMALL SCYTHE-HAMMERING ANVIL - stock type (Figure 190[b])
- HAND-SAW, CROSSCUT - blade length 24 in or 60 cm (b)
- HATCHET - weight 2 lb or 900 g - face 5 in or 13 cm (c)
- ADZE - weight 2 lb or 900 g - face 4 in or 10 cm (r)
- DRAW KNIFE - blade length 10 in or 25 cm
- CARPENTER'S CHISEL - edge width $\frac{1}{2}$ in or 13 mm (f)
- PINCERS - 8 in or 20 cm
- COMBINATION PLIERS - 8 in or 20 cm (s)
- HALF-ROUND RASP - length 12 in or 30 cm (g)
- TAPER FLAT FILE, DOUBLE-CUT - length 10 in or 25 cm (h)
- TRIANGULAR SAW FILE, SLIM TAPER - length 7 in or 18 cm (i)
- BIT BRACE - ratchet type (n) with ball-bearing head, with set of bits (o)
- SCREWDRIVER - blade width $\frac{3}{8}$ in or 19 mm (k)
- COLD CHISEL - length 7 in or 18 cm - edge $\frac{3}{4}$ in or 19 mm (e)
- PUNCH - length 6 in or 15 cm - edge $\frac{3}{16}$ in or 5 mm (d)
- SPANNERS - set of four double-ended spanners, width across flats ranging between $\frac{3}{8}$ and $1\frac{1}{8}$ in or 9 and 28 mm (l)

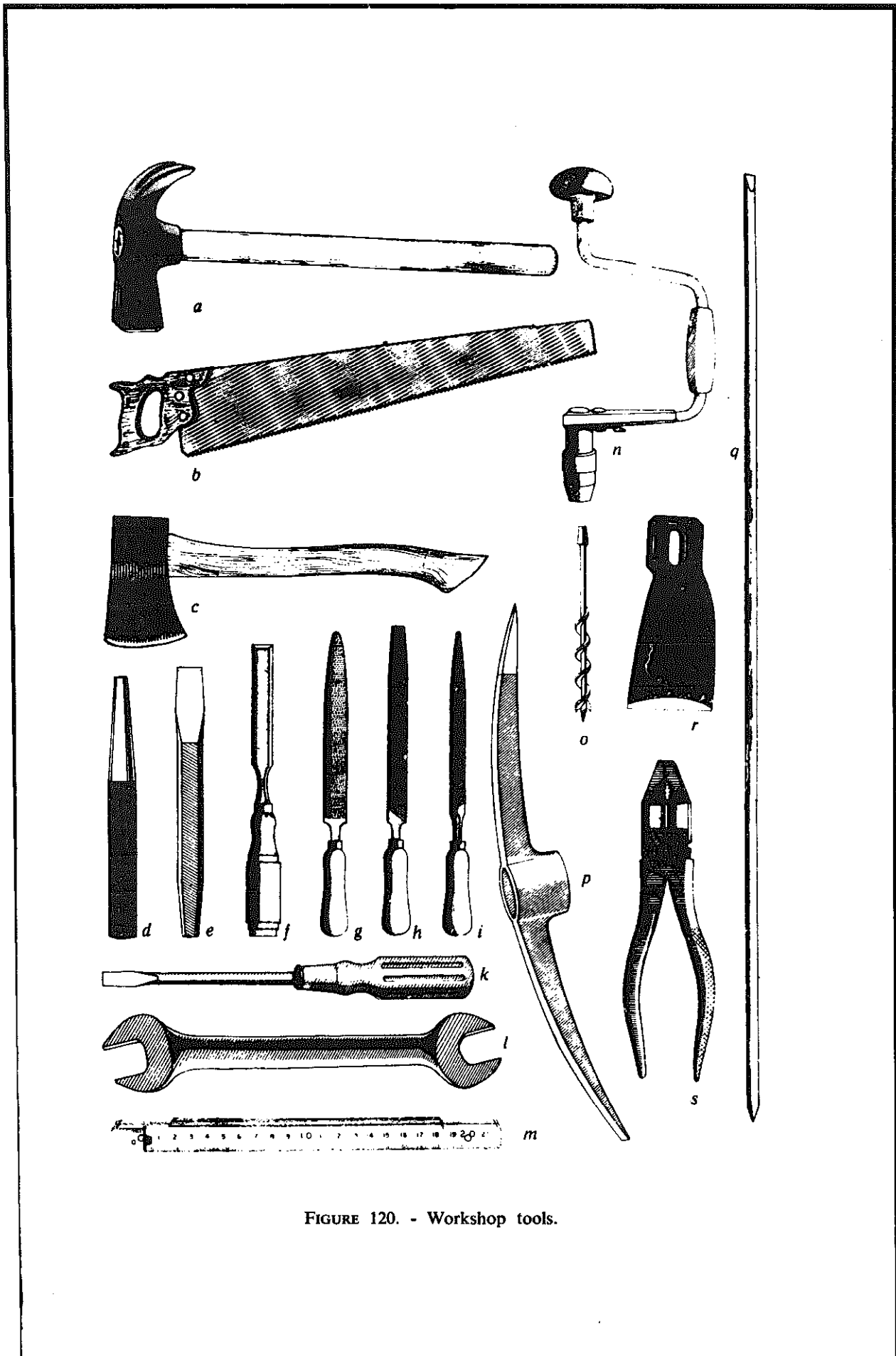

FIGURE 120. - Workshop tools.

ADJUSTABLE SPANNERS – size 10 in or 25 cm with maximum jaw openings of approximately $1\frac{1}{8}$ in or 28 mm

MEASURING RULE – folding type, 6 ft or 2 m (*m*)

WIRE BRUSH

CARBORUNDUM WHETSTONE FOR SCYTHE AND SICKLE BLADES – length about 9 to 11 in or 23 to 28 cm (Figure 90[c])

OILSTONE – combination type, coarse and fine: $8 \times 2 \times 1$ in or $20 \times 5 \times 2$ cm

CROW BAR (*q*)

PICK AXE (*p*)

ASSORTED NAILS, SCREWS, NUTS, BOLTS AND WIRE

SELECTED REFERENCES

- AMANO, M. [The plough in China, its development and role in agricultural economy.]
1956 *Tôhō Gakuhō, Kyoto*, (26): 104-172, 70 illus. (In Japanese)
- AVITSUR, S. *The native ard of Eretz-Israel: its history and development*. Tel-Aviv,
1965 Sifriath Hassadeh. 192 p., 72 illus.
- BAROJA, J. C. *Los arados españoles, sus tipos y repartición*. Madrid, Bermejo. 96 p.,
1949 117 illus.
- BIESALSKI, E. & FULDA, E. *Zweckmässige und erprobte Handgeräte für die Landwirt-
1957 schaft* [Suitable hand tools for agriculture.] Bad Kreuznach, Max-Planck-
Institut für Landarbeit und Landtechnik. 125 p., illus.
- BOZKAYA, E. A. *Anadolunun pamuk-celtik-misir-findik-afyon ve bagcilik bölgelerinde
1936a kullanılan Ziraat âlet ve düzenleri üzerinde araştırmalar* [Agricultural implements
and equipment used in the cotton, rice, maize, hazelnut, poppy and wine-
growing areas of Anatolia, Turkey.] Ankara, Yüksek Ziraat Enstitüsü. 144 p.,
134 illus. (In Turkish and German)
- BOZKAYA, E. A. *Ankara vilayecinde kullanılan pulluklarla tarım âletleri, ve bunların
1936b simdiki tarım durumu ile olan ilgileri üzerinde araştırmalar* [Ploughs and yokes
in the District of Ankara.] Ankara, Yüksek Ziraat Enstitüsü. 106 p., 34 illus.
(In Turkish and German)
- BUCK, J. LOSSING. *Farm implements and machinery for China*. Nanking, Nanking
1945 University. 9 p.
- BURMA. AGRICULTURAL RESEARCH INSTITUTE. *Some investigations about the soil and
1955 paddy cultivation in Burma*, by P. G. de Boer and U Chit Saing. Gyogon,
Insein. 20 p., 11 illus. Report No. 7.
- CHANCELLOR, W. J. *Report of initial phase of program for evaluation and improvement
1961 of small tools in Thai agriculture: survey of indigenous farm implements*. Davis,
Calif., Agricultural Engineering Department, University of California. 84 p.
- CONFEDERAZIONE FASCISTA LAVORATORI AGRICOLTURA. *Indagine sugli attrezzi a mano
1939 in agricoltura* [Inquiry on agricultural hand tools.] Roma, Confederazione
Fascista Lavoratori Agricoltura. 584 p., illus.
- CONSTANTINESCO, L. Research and development towards improved farm implements
1962 for peasant farmers in the tropics. *Journal and Proceedings of the Institution
of Agricultural Engineers*, 18: 135-139.
- DRAWER, K. *Anspannung und Beschirrung der Haustiere* [Harnessing of domestic
1959 animals.] Frankfurt a.M., DLG-Verlag. 92 p., 69 illus.
- FALS BORDA, O. La introducción de nuevas herramientas agrícolas en Colombia.
1958 *Agricultura tropical*, 14 (1): 23-44.
- FAO. *A study of small implements in India*, by M. Vaugh. Rome. (Mimeo)
1951
- FAO. *Report to the Government of Afghanistan on small agricultural implements*, by
1952 W. Sommerauer. Rome. 13 p., 61 illus. FAO/ETAP Report No. 23.
- FAO. *Report to the Government of Afghanistan on small agricultural and farm tools*,
1953a by W. Sommerauer. Rome. 18 p. FAO/ETAP Report No. 195.

- FAO. *Report to the Government of Ethiopia on small agricultural implements*, by K. 1953b Gabathuler. Rome. 14 p., 25 illus. FAO/ETAP Report No. 194.
- FAO. *Report to the Government of Iran on farm mechanization problems and possibilities*, 1953c by M. H. Elerna. Rome. 37 p. FAO/ETAP Report No. 172.
- FAO. *Small farm implements*, by H. J. Hopfen and E. Biesalski. Rome. 79 p., 120 1953d illus. FAO Agricultural Development Paper No. 32.
- FAO. *Report to the Government of Iraq on small agricultural implements*, by H. J. Hopfen. 1954 Rome. 16 p., 55 illus. FAO/ETAP Report No. 328.
- FAO. *Report to the Government of Libya on small agricultural implements and farm 1955 tools*, by W. Sommerauer. Rome. 44 p. FAO/ETAP Report No. 421.
- FAO. *Report to the Government of Egypt on farm implements*, by U. D. Kalverkamp. 1956a Rome. 15 p., 48 illus. FAO/ETAP Report No. 527.
- FAO. *Report to the Government of Syria on small agricultural implements and farm 1956b tools*, by P. A. Wiesmann. Rome. 31 p., 26 illus. FAO/ETAP Report No. 485.
- FAO. *Water-lifting devices for irrigation*, by A. Molenaar. Rome. 76 p., 41 illus. 1956c FAO Agricultural Development Paper No. 60.
- FAO. *Report to the Government of Afghanistan on farm implements and small powered 1958 machines*, by H. H. Buchmann. Rome. 16 p. FAO/ETAP Report No. 836.
- FAO. *Rapport au gouvernement du Maroc sur le petit matériel agricole*, par J. Frauen- 1959 felder. Rome. 37 p., 31 illus. FAO/ETAP Rapport No. 1036.
- FAO. *Report and recommendations to the Government of Libya on farm implements*, 1961 by P. A. Wiesmann. Tripoli. 39 p., 46 illus.
- FAO. *Report on a visit to the Far East to study indigenous and improved farm implements 1962 and machinery for small peasant farmers in the tropics*, by I. Constantinesco. Rome. 33 p., 57 illus.
- FAO. *Report to the Government of Libya on farm implements*, by A. Eberhard. Rome. 1963a 13 p. FAO/EPTA Report No. 1645.
- FAO. *Report to the Government of Saudi Arabia on farm mechanization problems and 1963b services*, by H. Hablützel. Rome. 27 p. FAO/EPTA Report No. 1611.
- FAO. *Interim report on farm mechanization and improved cultural practices for the Ganges- 1964 Kobadak project, East Pakistan*, by I. Constantinesco. Rome. FAO/EPTA Report. (Mimeo No. 29802)
- FAO. *Equipment for rice production*, by B. A. Stout. Rome. 169 p., 91 illus. FAO 1966 Agricultural Development Paper No. 84.
- FAO. *Multifarm use of agricultural machinery*, by H. Lönnemark. Rome. 113 p., 1967a 18 illus. FAO Agricultural Development Paper No. 85.
- FAO. *Rapport au gouvernement du Niger sur le développement de la culture attelée au 1967b Niger*, par H. J. Braun. Rome. 29 p. FAO/PEAT. (Rapport préliminaire)
- FAO. *Rapport sur l'amélioration du matériel agricole et des techniques culturales dans 1968 le nord-ouest de Madagascar*, par H. Hablützel. Tananarive. 20 p., illus. FAO/CMCF Rapport final MAD I.
- FÉDÉRATION SUISSE D'ÉLEVAGE DE LA RACE TACHETÉE ROUGE. *Guide de l'attelage du 1968 bétail bovin*. Berne. 8 p., 7 illus.
- HAUDRICOURT, A. G. & DELAMARRE, M. J. B. *L'homme et la charrue à travers le monde*. 1955 Paris, Gallimard. 506 p., 235 illus. Bibliography.
- HAYNES, D. W. M. *Report on the mechanization of wet padi in the Federation of Malaya*. 1956 Document, International Rice Commission Ad Hoc Working Group on the Problems of Mechanization of Rice Production under Wet Paddy Conditions.
- HEFTI, J. *Untersuchungen über die Sense und das Mähen [Investigations concerning 1948 scythe and mowing.] Die Grüne, 76 (15): 389-419, 37 illus.*
- HEFTI, J. *Die Sense und das Mähen [The scythe and mowing.] Die Grüne, 88 (18): 1960 543-556, 24 illus.*
- HOMMEL, R. P. *China at work*. Doylestown, Penn., The Bucks County Historical 1937 Society. 357 p., 535 illus.
- HOOGENDORN, N. & MOENS, A. *Gereedschap voor het landbouwbedrijf [Implements 1960 for agriculture.] Wageningen, Instituut voor Landbouwtechniek en Rationalisatie*. 85 p., 87 illus.

- INTERNATIONAL RICE COMMISSION. *Report of the Meeting of the Ad Hoc Working Group 1956 on the Problems of Mechanization of Rice Production under Wet Paddy Conditions, Peradeniya, Ceylon, 1956.* Rome, FAO. 57 p.
- INTERNATIONAL RICE COMMISSION. *Report of the first Meeting of the Working Party 1960 on the Agricultural Engineering Aspects of Rice Production, Storage and Processing, Saigon, November 1960.* Rome, FAO. 44 p.
- INTERNATIONAL RICE COMMISSION. *Report of the second Meeting of the Working Party 1962 on the Agricultural Engineering Aspects of Rice Production, Storage and Processing, Kuala Lumpur, September 1962.* Rome, FAO. 36 p.
- INTERNATIONAL RICE COMMISSION. *Report of the third Meeting of the Working Party 1964 on the Agricultural Engineering Aspects of Rice Production, Storage and Processing, Manila, March 1964.* Rome, FAO. 37 p.
- INTERNATIONAL RICE COMMISSION. *Report of the fourth Meeting of the Working Party 1966 on the Agricultural Engineering Aspects of Rice Production, Storage and Processing, Lake Charles, Louisiana, July 1966.* Rome, FAO. 19 p.
- INTERNATIONAL RICE COMMISSION. *Report of the fifth Meeting of the Working Party 1968 on the Agricultural Engineering Aspects of Rice Production, Storage and Processing, Peradeniya, Ceylon, September 1968.* Rome, FAO. 11 p.
- INTERNATIONAL SECRETARIAT FOR RESEARCH ON THE HISTORY OF AGRICULTURAL IMPLEMENTS. *Research on ploughing implements. Reports of the Conference in Copenhagen, 1-5 June 1954.* Copenhagen, National Museum. 171 p., illus.
- JAMAL, AHMAD BIN. *Implements used in rice cultivation in Malaya.* Presented at the 1962 second Meeting of the IRC Working Party on Agricultural Aspects of Rice Production, Storage and Processing, Kuala Lumpur. 9 p.
- JAPAN. MINISTRY OF AGRICULTURE AND FORESTRY. *Agricultural equipments and machinery in Japan. Part 1. Hand and animal-powered equipment and machinery.* Tokyo. 13 p., 26 illus.
- KING, F. H. *Farmers of forty centuries of permanent agriculture in China, Korea and 1948 Japan.* Emmaus, Penn., Organic Gardening Press. 379 p., 209 illus.
- KING, T. OGDEN. *Farm implements in the Yangtze plain.* Nanking, University of 1935 Nanking.
- KING, T. OGDEN. *Farm implements in East Central China.* Nanking, University of 1938 Nanking. 112 p., 26 illus. 65 tables. Bulletin No. 53.
- KOREN, H. *Pflug und Arel, ein Beitrag zur Volkskunde der Ackergeräte [Plough and ard, 1950 a contribution to the history of tillage implements.]* Salzburg, Otto Müller Verlag. 276 p., 27 illus., 2 maps.
- LESER, P. *Entstehung und Verbreitung des Pfluges [Origin and geographical distribution 1931 of the plough.]* Münster, Aschendorffscher Verlag. 676 p., 315 illus. 42 tables.
- MA, FENGCHOW C. *Preliminary study of farm implements used in Vietnam.* Taipei, 1963 Chinese-American Joint Commission on Rural Reconstruction. 171 p., illus.
- MA, FENGCHOW C., TAKASAKA, T. & YANG, CHING-WEN. *A preliminary study of farm 1955 implements used in Taiwan Province.* Taipei, Chinese-American Joint Commission on Rural Reconstruction. 331 p., illus.
- MEMON, A. A. *Indigenous agricultural implements in Bombay State.* Baroda, Govern- 1955 ment Press. 175 p., illus.
- MOROCCO. MINISTÈRE DE L'AGRICULTURE. CENTRE DE RECHERCHES ET D'EXPÉRIMENTA- 1958 TION DU GÉNIE RURAL. *Le petit outillage à traction animale en culture irriguée,* par R. Ringuélet. Rabat. 19 p., illus. Bulletin No. 6.
- RAJU, V. S. & WAGHREY, K. N. *Survey of indigenous agricultural implements in Hyder- 1955 abad State, 1954-1955.* Hyderabad, Department of Agriculture. 22 p., illus.
- RAMIAH, R. V. & SRIVASTAVA, C. P. *Agricultural implements for Indian farmers.* New 1954 Delhi, Indian Council of Agricultural Research. 48 p., 44 illus.
- RUSSEL, J. C. *Tillage practices in Iraq.* Abu Chraib, Iraq College of Agriculture. 1957 44 p. (Mimeo)
- SAITO, M. *Japanese hoes and sickles.* Tokyo, Agricultural Institute for Asia. 10 p., 1951 16 illus. (Manuscript)

- SENEGAL. MINISTÈRE DE L'ÉCONOMIE RURALE. *Les conclusions des journées du machinisme agricole de l'Afrique occidentale française, Bambey, 1958.* Paris, Jouve. 1959 128 p., illus.
- STEINMETZ, H. *Kuhanspannung in Deutschland* [Cow harnessing in Germany.] Berlin, 1936 Reichsnährstand Verlag. 124 p., 58 illus.
- TAHARA, T. & NAKAZAWA, S. [Japanese farm machinery.] Tokyo, Nôgyo Keizai 1955 Shinsha. 154 p., 186 illus. (In Japanese)
- UNITED NATIONS. *Report to the Government of Iran. The production of agricultural machinery*, by A. Lumme. New York. 1958 20 p., 16 blueprints of a special plough design for animal draught.
- VAN DE GOOR, G. A. W. *Agricultural tools and equipment used in rice growing in Indonesia*. Bogor, Agricultural Institute. 1948? 6 p., 10 illus. (Manuscript)
- VAN DER GIESSEN, C. *Verbeterde Landbouwwerktuigen voor den inlandschen Landbouw in Nederlandsche-Indië* [Improved implements for native agriculture in the Netherland East Indies.] *Landbouw, Buitenzorg*, 14: 697-710, 11 illus. 1938
- VIGUIER, P. *L'Afrique de l'Ouest vue par un agriculteur*. Paris, Maison rustique. 1961 133 p.
- VITALI, G. & BARTOLOZZI, E. *Strumenti agricoli indigeni dell'Africa Orientale Italiana* 1939 [Native farm implements in Italian East Africa.] Firenze, Istituto Agronomico per l'Africa Italiana. 79 p., 22 illus. Bollettino No. 52.
- WERTH, E. *Grabstock, Hacke und Pflug* [Spade, hoe and plough.] Ludwigsburg, 1954 Eugen Ulmer. 435 p., 231 illus., 25 maps.
- WHITE, K. D. *Agricultural implements of the Roman world*. Cambridge, University 1967 Press. 232 p., 119 illus., 16 plates.
- YANG, MARTIN C. *A Chinese village: Taitou, Shantung Province*. New York, Columbia University Press. 1945 275 p., 26 illus.
- ZEITLINGER, J. *Sensen, Sensenschmiede und ihre Technik* [Scythes, scythe blacksmiths and their manufacturing techniques.] Special reprint from *Jahrbuch des Vereins für Landeskunde und Heimatpflege im Gau Oberdonau*, Vol. 91. Linz-Donau. 1944 166 p., 54 illus.

CONVERSION TABLES

Linear measurements

Metric system
 1 millimetre (mm) = 0.1 cm
 1 centimetre (cm) = 10 mm
 1 metre (m) = 100 cm
 1 kilometre (km) = 1 000 m

British system
 1 inch (in) = $\frac{1}{12}$ ft
 1 foot (ft) = 12 in
 1 yard (yd) = 3 ft
 1 mile (mi) = 1 760 yd

INCHES AND FRACTIONS INTO MILLIMETRES
 (1 in = 25.39977 mm)

inches	0	$\frac{1}{32}$	$\frac{1}{16}$	$\frac{1}{8}$	$\frac{1}{4}$	$\frac{3}{8}$	$\frac{1}{2}$	$\frac{5}{8}$	$\frac{3}{4}$	$\frac{7}{8}$
0	mm	0.79	1.59	3.17	6.35	9.52	12.70	15.87	19.05	22.22
1		25.40	26.19	26.99	28.57	31.75	34.92	38.10	41.27	44.45
2		50.80	51.59	52.39	53.97	57.15	60.32	63.50	66.67	69.85
3		76.20	76.99	77.79	79.37	82.55	85.72	88.90	92.07	95.25
4		101.60	102.39	103.19	104.77	107.95	111.12	114.30	117.47	120.65
5		127.00	127.79	128.59	130.17	133.35	136.52	129.70	142.87	146.05
6		152.40	153.19	153.99	155.57	158.75	161.92	165.10	168.27	171.45
7		177.80	178.59	179.39	180.97	184.15	187.32	190.50	193.67	196.85
8		203.20	203.99	204.79	206.37	209.55	212.72	215.90	219.07	222.25
9		228.60	229.39	230.19	231.77	234.95	238.12	241.30	244.47	247.65

CENTIMETRES INTO INCHES
 (1 cm = 0.3937 in)

cm	0	1	2	3	4	5	6	7	8	9
0	inches	0.394	0.787	1.181	1.575	1.969	2.362	2.756	3.150	3.543
10		3.937	4.331	4.724	5.118	5.512	5.906	6.299	6.693	7.087
20		7.874	8.268	8.661	9.055	9.449	9.843	10.236	10.630	11.024
30		11.811	12.205	12.598	12.992	13.386	13.780	14.173	14.567	14.961
40		15.748	16.142	16.535	16.929	17.323	17.717	18.110	18.504	18.898
50		19.685	20.079	20.472	20.866	21.260	21.654	22.047	22.441	22.835
60		23.622	24.016	24.409	24.803	25.197	25.591	25.984	26.378	26.772
70		27.559	27.953	28.346	28.740	29.134	29.528	29.921	30.315	30.709
80		31.496	31.890	32.283	32.677	33.071	33.465	33.858	34.252	34.646
90		35.433	35.827	36.220	36.614	37.008	37.402	37.795	38.189	38.583

INCHES INTO CENTIMETRES
(1 in = 2.539977 cm)

inches	0	1	2	3	4	5	6	7	8	9
0	cm	2.54	5.08	7.62	10.16	12.70	15.24	17.78	20.32	22.86
10	25.40	27.94	30.48	33.02	35.56	38.10	40.64	43.18	45.72	48.26
20	50.80	53.34	55.88	58.42	60.96	63.50	66.04	68.58	71.12	73.66
30	76.20	78.74	81.28	83.82	86.36	88.90	91.44	93.98	96.52	99.06
40	101.60	104.14	106.68	109.22	111.76	114.30	116.84	119.38	121.92	124.46
50	127.00	129.54	132.08	134.62	137.16	139.70	142.24	144.78	147.32	149.86
60	152.40	154.94	157.48	160.02	162.56	165.10	167.64	170.18	172.72	175.26
70	177.80	180.34	182.88	185.42	187.96	190.50	193.04	195.58	198.12	200.66
80	203.20	205.74	208.28	210.82	213.36	215.90	218.44	220.98	223.52	226.06
90	228.60	231.14	233.68	236.22	238.76	241.30	243.84	246.38	248.92	251.46

METRES INTO FEET
(1 m = 3.2808 ft)

m	0	1	2	3	4	5	6	7	8	9
0	feet	3.28	6.56	9.84	13.12	16.40	19.68	22.97	26.25	29.53
10	32.81	36.09	39.37	42.65	45.93	49.21	52.49	55.77	59.05	62.34
20	65.62	68.90	72.18	75.46	78.74	82.02	85.30	88.58	91.86	95.14
30	98.42	101.70	104.99	108.27	111.55	114.83	118.11	121.39	124.67	127.95
40	131.23	134.51	137.79	141.07	144.36	147.64	150.92	154.20	157.48	160.76
50	164.04	167.32	170.60	173.88	177.16	180.44	183.72	187.01	190.29	193.57
60	196.85	200.13	203.41	206.69	209.97	213.25	216.53	219.81	223.09	226.38
70	229.66	232.94	236.22	239.50	242.78	246.06	249.34	252.62	255.90	259.18
80	262.46	265.74	269.02	272.31	275.59	278.87	282.15	285.43	288.71	291.99
90	295.27	298.55	301.83	305.11	308.40	311.68	314.96	318.24	321.52	324.80

FEET INTO METRES
(1 ft = 0.3048 m)

feet	0	1	2	3	4	5	6	7	8	9
0	m	0.305	0.610	0.914	1.219	1.524	1.829	2.134	2.438	2.743
10	3.048	3.353	3.658	3.962	4.267	4.572	4.877	5.182	5.486	5.791
20	6.096	6.401	6.706	7.010	7.315	7.620	7.925	8.230	8.534	8.839
30	9.144	9.449	9.754	10.058	10.363	10.668	10.973	11.278	11.582	11.887
40	12.192	12.497	12.802	13.106	13.411	13.716	14.021	14.326	14.630	14.935
50	15.240	15.545	15.850	16.154	16.459	16.764	17.069	17.374	17.678	17.983
60	18.288	18.593	18.898	19.202	19.507	19.812	20.117	20.422	20.726	21.031
70	21.336	21.641	21.946	22.250	22.555	22.860	23.165	23.470	23.774	24.079
80	24.384	24.689	24.994	25.298	25.603	25.908	26.213	26.518	26.822	27.127
90	27.432	27.737	28.042	28.346	28.651	28.956	29.261	29.566	29.870	30.175

OTHER LINEAR CONVERSIONS

1 m = 1.0936 yd
1 km = 0.62137 mi

1 yd = 0.9144 m
1 mi = 1.60934 km

Area

<i>Metric system</i>		<i>British system</i>	
1 square metre (m ²)	= 10 000 cm ²	1 square foot (ft ²)	= 144 square inches (in ²)
1 are	= 100 m ²	1 square rod (rd ²)	= 272.25 ft ²
1 hectare (ha)	= 10 000 m ²	1 acre	= 43 560 ft ²
1 square kilometre (km ²)	= 100 ha	1 square mile (mi ²)	= 640 acres

HECTARES INTO ACRES
(1 ha = 2.47109 acres)

ha	0	1	2	3	4	5	6	7	8	9
0	acres	2.47	4.94	7.41	9.88	12.36	14.83	17.30	19.77	22.24
10	24.71	27.18	29.65	32.12	34.60	37.07	39.54	42.01	44.48	46.95
20	49.42	51.89	54.36	56.84	59.31	61.78	64.25	66.72	69.19	71.66
30	74.13	76.60	79.07	81.55	84.02	86.49	88.96	91.43	93.90	96.37
40	98.84	101.31	103.79	106.26	108.73	111.20	113.67	116.14	118.61	121.08
50	123.55	126.03	128.50	130.97	133.44	135.91	138.38	140.85	143.32	145.79
60	148.27	150.74	153.21	155.68	158.15	160.62	163.09	165.56	168.03	170.51
70	172.98	175.45	177.92	180.39	182.86	185.33	187.80	190.27	192.75	195.22
80	197.69	200.16	202.63	205.10	207.57	210.04	212.51	214.98	217.46	219.93
90	222.40	224.87	227.34	229.81	232.28	234.75	237.22	239.70	242.17	244.64

ACRES INTO HECTARES
(1 acre = 0.40468 ha)

acres	0	1	2	3	4	5	6	7	8	9
0	ha	0.405	0.809	1.214	1.619	2.023	2.428	2.839	3.237	3.642
10	4.047	4.451	4.856	5.261	5.666	6.070	6.475	6.880	7.284	7.689
20	8.094	8.498	8.903	9.308	9.712	10.117	10.522	10.926	11.331	11.736
30	12.140	12.545	12.950	13.354	13.759	14.164	14.568	14.973	15.378	15.783
40	16.187	16.592	16.997	17.401	17.806	18.211	18.615	19.020	19.425	19.829
50	20.234	20.639	21.043	21.448	21.853	22.257	22.662	23.067	23.471	23.876
60	24.281	24.685	25.090	25.495	25.900	26.304	26.709	27.114	27.518	27.923
70	28.328	28.732	29.137	29.542	29.946	30.351	30.756	31.160	31.565	31.970
80	32.374	32.779	33.184	33.588	33.993	34.398	34.802	35.207	35.612	36.017
90	36.421	36.826	37.231	37.635	38.040	38.445	38.849	39.254	39.659	40.063

OTHER AREA CONVERSIONS

1 cm ² = 0.155 in ²	1 in ² = 6.452 cm ²
1 m ² = 10.764 ft ²	1 ft ² = 0.0929 m ²
1 m ² = 1.9599 yd ²	1 yd ² = 0.8361 m ²
1 km ² = 247.109 acres	1 mi ² = 2.5899 km ²
= 0.3861 mi ²	= 259 ha

Volume

Metric system
 1 litre (l) = 1 000 cm³
 1 hectolitre (hl) = 100 l
 1 cubic metre (m³) = 1 000 000 cm³ =
 = 1 000 l
 1 litre water weighs 1 kg

British and U.S. systems
 1 Imperial (British) quart (qt) =
 = ¹/₄ gallon (gal) = 69.36 in³
 1 U.S. qt = ¹/₄ gal = 57.75 in³
 1 Imp. gal = 4 qt = 277.42 in³ =
 0.16054 ft³
 1 U.S. gal = 4 qt = 231 in³ = 0.13368 ft³
 1 bushel (bu) = 8 gal
 1 Imperial gallon water weighs 10 lb

LITRES INTO IMPERIAL (BRITISH) GALLONS
 (1 l = 0.219975 Imp. gal)

litres	0	1	2	3	4	5	6	7	8	9
0	gal	0.220	0.440	0.660	0.880	1.100	1.320	1.540	1.760	1.980
10	2.200	2.420	2.640	2.860	3.080	3.300	3.520	3.740	3.960	4.180
20	4.400	4.620	4.840	5.060	5.280	5.500	5.719	5.939	6.159	6.379
30	6.599	6.819	7.039	7.259	7.479	7.699	7.919	8.139	8.359	8.579
40	8.799	9.019	9.239	9.459	9.679	9.899	10.119	10.339	10.559	10.779
50	10.999	11.219	11.439	11.659	11.879	12.099	12.319	12.539	12.759	12.979
60	13.199	13.419	13.639	13.859	14.079	14.299	14.519	14.739	14.959	15.179
70	15.399	15.619	15.839	16.059	16.279	16.499	16.718	16.938	17.158	17.378
80	17.598	17.818	18.038	18.258	18.478	18.698	18.918	19.138	19.358	19.578
90	19.798	20.018	20.238	24.458	20.678	20.898	21.118	21.338	21.558	21.778

IMPERIAL GALLONS INTO LITRES
 (1 Imp. gal = 4.54596 l)

gal	0	1	2	3	4	5	6	7	8	9
0	litres	4.55	9.09	13.64	18.18	22.73	27.28	31.82	36.37	40.91
10	45.46	50.01	54.55	59.10	63.64	68.19	72.74	77.28	81.83	86.37
20	90.92	95.47	100.01	104.56	109.10	113.65	118.19	122.74	127.29	131.83
30	136.38	140.92	145.47	150.02	154.56	159.11	163.65	168.20	172.75	177.29
40	181.84	186.38	190.93	195.48	200.02	204.57	209.11	213.66	218.21	222.75
50	227.30	231.84	236.39	240.94	245.48	250.03	254.57	259.12	263.67	268.21
60	272.76	277.30	281.85	286.40	290.94	295.49	300.03	304.58	309.13	313.67
70	318.22	322.76	327.31	331.86	336.40	340.95	345.49	350.04	354.58	359.13
80	363.68	368.22	372.77	377.31	381.86	386.41	390.95	395.50	400.04	404.59
90	409.14	413.68	418.23	422.77	427.32	431.87	436.41	440.96	445.50	450.05

LITRES INTO U.S. GALLONS

(1 l = 0.26418 U.S. gal)

l	0	1	2	3	4	5	6	7	8	9
0	gal	0.264	0.528	0.793	1.057	1.321	1.585	1.849	2.113	2.378
10		2.642	2.906	3.170	3.434	3.698	3.963	4.227	4.491	4.755
20		5.284	5.548	5.812	6.076	6.340	6.604	6.869	7.133	7.397
30		7.925	8.190	8.454	8.718	8.982	9.246	9.510	9.775	10.039
40		10.567	10.831	11.095	11.359	11.623	11.888	12.152	12.416	12.680
50		13.209	13.473	13.737	14.001	14.265	14.529	14.794	15.058	15.322
60		15.851	16.114	16.379	16.643	16.907	17.171	17.435	17.699	17.964
70		18.492	18.756	19.020	19.284	19.549	19.813	20.077	20.341	20.605
80		21.134	21.398	21.662	21.926	22.190	22.454	22.719	22.983	23.247
90		23.776	24.040	24.304	24.569	24.833	25.097	25.361	25.625	25.889

U.S. GALLONS INTO LITRES

(1 U.S. gal = 3.78533 l)

gal	0	1	2	3	4	5	6	7	8	9
0	litres	3.79	7.57	11.36	15.14	18.93	22.71	26.50	30.28	34.07
10		37.85	41.64	45.42	49.21	52.99	56.78	60.57	64.35	68.14
20		75.71	79.49	83.28	87.06	90.85	94.63	98.42	102.20	105.99
30		113.56	117.35	121.13	124.92	128.70	132.49	136.27	140.06	143.84
40		151.41	155.20	158.98	162.77	166.55	170.34	174.13	177.91	181.70
50		189.27	193.05	196.84	200.62	204.41	208.19	211.98	215.76	219.55
60		227.12	230.91	234.69	238.48	242.26	246.05	249.83	253.62	257.40
70		264.97	268.76	272.54	276.33	280.11	283.90	287.69	291.47	295.26
80		302.83	306.61	310.40	314.18	317.97	321.75	325.54	329.32	333.11
90		340.68	344.47	348.25	352.04	355.82	359.61	363.39	367.18	370.96

OTHER VOLUME CONVERSIONS

1 l = 0.0353 ft³ = 0.8799 Imp. qt = 1.0567 U.S. qt 1 Imp. qt = 1.136 l
 1 hl = 22 Imp. gal = 26.42 U.S. gal 1 U.S. qt = 0.946 l
 1 m³ = 35.315 ft³ = 220 Imp. gal = 264.18 U.S. gal 1 ft³ = 0.02832 m³

Weight

Metric system

1 gramme (g)	= 0.001 kg
1 hectogramme (hg)	= 100 g
1 kilogramme (kg)	= 1 000 g
1 quintal (q)	= 100 kg
1 ton (t)	= 1 000 kg

British system

1 ounce (oz)	= $\frac{1}{16}$ lb
1 pound (lb)	= 16 oz
1 hundredweight (cwt)	= 112 lb
1 short ton (sh ton)	= 2 000 lb
1 long ton (l ton)	= 2 240 lb

KILOGRAMMES INTO POUNDS
(1 kg = 2.20463 lb)

kg	0	1	2	3	4	5	6	7	8	9
0	lb	2.20	4.41	6.61	8.82	11.02	13.23	15.43	17.64	19.84
10	22.05	24.25	26.46	28.66	30.86	33.07	35.27	37.48	39.68	41.89
20	44.09	46.30	48.50	50.71	52.91	55.12	57.32	59.53	61.73	63.93
30	66.14	68.34	70.55	72.75	74.96	77.16	79.37	81.57	83.78	85.98
40	88.19	90.39	92.59	94.80	97.00	99.21	101.41	103.62	105.82	108.03
50	110.23	112.44	114.64	116.85	119.05	121.25	123.46	125.66	127.87	130.07
60	132.28	134.48	136.69	138.89	141.10	143.30	145.51	147.71	149.91	152.12
70	154.32	156.53	158.73	160.94	163.14	165.35	167.55	169.76	171.96	174.17
80	176.37	178.58	180.78	182.98	185.19	187.39	189.60	191.80	194.01	196.21
90	198.42	200.62	202.83	205.03	207.24	209.44	211.64	213.85	216.05	218.26

POUNDS INTO KILOGRAMMES
(1 lb = 0.45359 kg)

lb	0	1	2	3	4	5	6	7	8	9
0	kg	0.454	0.907	1.361	1.814	2.268	2.722	3.175	3.629	4.082
10	4.536	4.990	5.443	5.897	6.350	6.804	7.257	7.711	8.165	8.618
20	9.072	9.525	9.979	10.433	10.886	11.340	11.793	12.247	12.701	13.154
30	13.608	14.061	14.515	14.969	15.422	15.876	16.329	16.783	17.237	17.690
40	18.144	18.597	19.051	19.504	19.958	20.412	20.865	21.319	21.772	22.226
50	22.680	23.133	23.587	24.040	24.494	24.948	25.401	25.855	26.308	26.762
60	27.216	27.669	28.123	28.576	29.030	29.484	29.937	30.391	30.844	31.298
70	31.751	32.205	32.659	33.112	33.566	34.019	34.473	34.927	35.380	35.834
80	36.287	36.741	37.195	37.648	38.102	38.555	39.009	39.463	39.916	40.370
90	40.823	41.277	41.730	42.184	42.638	43.091	43.545	43.998	44.452	44.906

OTHER WEIGHT CONVERSIONS

1 g	= 0.03527 oz	1 oz	= 28.349 g
1 hg	= 3.527 oz	1 cwt	= 0.50802 q
1 q	= 1.968 cwt = 0.11023 sh ton = 0.09842 l ton	1 sh ton	= 9.07185 q
1 t	= 19.68 cwt = 1.1023 sh ton = 0.9842 l ton	1 ton	= 10.16047 q

Yields per surface unit

KILOGRAMMES PER HECTARE INTO POUNDS PER ACRE
(1 kg/ha = 0.89217 lb/acre)

kg/ha	0	1	2	3	4	5	6	7	8	9
0	lb/acre	0.89	1.78	2.68	3.57	4.46	5.35	6.25	7.14	8.03
10	8.92	9.81	10.71	11.60	12.49	13.38	14.27	15.17	16.06	16.95
20	17.84	18.74	19.63	20.52	21.41	22.30	23.20	24.09	24.98	25.87
30	26.77	27.66	28.55	29.44	30.33	31.23	32.12	33.01	33.90	34.79
40	35.69	36.58	37.47	38.36	39.26	40.15	41.04	41.93	42.82	43.72
50	44.61	45.50	46.39	47.29	48.18	49.07	49.96	50.85	51.75	52.64
60	53.53	54.42	55.31	56.21	57.10	57.99	58.88	59.78	60.67	61.56
70	62.45	63.34	64.24	65.13	66.02	66.91	67.80	68.70	69.59	70.48
80	71.37	72.27	73.16	74.05	74.94	75.83	76.73	77.62	78.51	79.40
90	80.30	81.19	82.08	82.97	83.86	84.76	85.65	86.54	87.43	88.32

POUNDS PER ACRE INTO KILOGRAMMES PER HECTARE
(1 lb/acre = 1.12086 kg/ha)

lb/acre	0	1	2	3	4	5	6	7	8	9
0	kg/ha	1.12	2.24	3.36	4.48	5.60	6.73	7.85	8.97	10.09
10	11.21	12.33	13.45	14.57	15.69	16.81	17.93	19.05	20.18	21.30
20	22.42	23.54	24.66	25.78	26.90	28.02	29.14	30.26	31.38	32.50
30	33.63	34.75	35.87	36.99	38.11	39.23	40.35	41.47	42.59	43.71
40	44.83	45.96	47.08	48.20	49.32	50.44	51.56	52.68	53.80	54.92
50	56.04	57.17	58.29	59.41	60.53	61.65	62.77	63.89	65.01	66.13
60	67.25	68.37	69.50	70.61	71.73	72.86	73.98	75.10	76.22	77.34
70	78.46	79.58	80.70	81.82	82.95	84.07	85.19	86.31	87.43	88.55
80	89.67	90.79	91.91	93.03	94.15	95.28	96.40	97.52	98.64	99.76
90	100.88	102.00	103.12	104.24	105.36	106.48	107.61	108.73	109.85	110.97

Miscellaneous conversion factors

Weight per length

$$\begin{aligned} 1 \text{ kg/cm} &= 5.59973 \text{ lb/in} \\ 1 \text{ kg/m} &= 0.67197 \text{ lb/ft} \end{aligned}$$

$$\begin{aligned} 1 \text{ lb/in} &= 0.17858 \text{ kg/cm} \\ 1 \text{ lb/ft} &= 1.48817 \text{ kg/m} \end{aligned}$$

Weight per area (pressure)

$$\begin{aligned} 1 \text{ kg/cm}^2 &= 14.22329 \text{ lb/in}^2 \\ 1 \text{ normal atmosphere} &= 1.03323 \text{ kg/cm}^2 \\ &= 14.696 \text{ lb/in}^2 \\ 1 \text{ kg/m}^2 &= 0.20482 \text{ lb/ft}^2 \end{aligned}$$

$$\begin{aligned} 1 \text{ lb/in}^2 &= 0.07037 \text{ kg/cm}^2 \\ 1 \text{ lb/ft}^2 &= 4.88244 \text{ kg/m}^2 \end{aligned}$$

Weight per volume (specific weight)

$$\begin{aligned} 1 \text{ kg/cm}^3 &= 36.12710 \text{ lb/in}^3 \\ 1 \text{ kg/m}^3 &= 0.06243 \text{ lb/ft}^3 \end{aligned}$$

$$\begin{aligned} 1 \text{ lb/in}^3 &= 0.02768 \text{ kg/cm}^3 \\ 1 \text{ lb/ft}^3 &= 16.01855 \text{ kg/m}^3 \end{aligned}$$

Speed

$$1 \text{ m/s} = 196.851 \text{ ft/min}$$

$$1 \text{ mi/h} = 0.44703 \text{ m/s}$$

Rates of flow

$$\begin{aligned} 1 \text{ l/s} &= 3.6 \text{ m}^3/\text{h} \\ &= 0.0353 \text{ ft}^3/\text{s (cusec)} \\ &= 2.118 \text{ ft}^3/\text{min} \\ &= 13.205 \text{ Imp. gal/min} \\ &= 15.853 \text{ U.S. gal/min} \end{aligned}$$

$$\begin{aligned} 1 \text{ cusec} &= 375 \text{ Imp. gal/min} \\ &= 448.8 \text{ U.S. gal/min} \\ &= 28.32 \text{ l/s} \\ 1 \text{ ft}^3/\text{min} &= 0.472 \text{ l/s} \\ 1 \text{ Imp. gal/min} &= 0.0755 \text{ l/s} \\ 1 \text{ U.S. gal/min} &= 0.0631 \text{ l/s} \end{aligned}$$

$$\begin{aligned} 1 \text{ m}^3/\text{h} &= 0.5886 \text{ ft}^3/\text{min} \\ &= 3.668 \text{ Imp. gal/min} \\ &= 4.403 \text{ U.S. gal/min} \end{aligned}$$

$$\begin{aligned} 1 \text{ ft}^3/\text{min} &= 1.699 \text{ m}^3/\text{h} \\ 1 \text{ Imp. gal/min} &= 0.272 \text{ m}^3/\text{h} \\ 1 \text{ U.S. gal/min} &= 0.227 \text{ m}^3/\text{h} \end{aligned}$$

Power

$$\begin{aligned} 1 \text{ kilogramme-metre (kgm)} &= 7.23302 \text{ ft lb} \\ 1 \text{ metric horsepower (ch)} &= 0.98632 \text{ hp} \end{aligned}$$

$$\begin{aligned} 1 \text{ foot-pound (ft lb)} &= 0.13825 \text{ kgm} \\ 1 \text{ British horsepower (hp)} &= 1.01387 \text{ ch} \end{aligned}$$

$$\begin{aligned} 1 \text{ ch} &= 0.73528 \text{ kW} \\ &= 75 \text{ kgm/s} \\ &= 542.48 \text{ ft lb/s} \\ 1 \text{ kilowatt (kW)} &= 1.35003 \text{ ch} \\ &= 102.002 \text{ kgm/s} \end{aligned}$$

$$\begin{aligned} 1 \text{ hp} &= 0.74548 \text{ kW} \\ &= 76.04 \text{ kgm/s} \\ &= 550 \text{ ft lb/s} \\ 1 \text{ kW} &= 1.34143 \text{ hp} \\ &= 737.783 \text{ ft lb/s} \end{aligned}$$

Temperature

DEGREES CENTIGRADE INTO DEGREES FAHRENHEIT

Centigrade	0	1	2	3	4	5	6	7	8	9
 Fahrenheit									
-40	-40.0									
-30	-22.0	-23.8	-25.6	-27.4	-29.2	-31.0	-32.8	-34.6	-36.4	-38.2
-20	- 4.0	- 5.8	- 7.6	- 9.4	-11.2	-13.0	-14.8	-16.6	-18.4	-20.2
-10	+14.0	+12.2	+10.4	+ 8.6	+ 6.8	+ 5.0	+ 3.2	+ 1.4	- 0.4	- 2.2
0-	+32.0	+30.2	+28.4	+26.6	+24.8	+23.0	+21.2	+19.4	+17.6	+15.8
0+	+32.0	+33.8	+35.6	+37.4	+39.2	+41.0	+42.8	+44.6	+46.4	+48.2
10	50.0	51.8	53.6	55.4	57.2	59.0	60.8	62.6	64.4	66.2
20	68.0	69.8	71.6	73.4	75.2	77.0	78.8	80.6	82.4	84.2
30	86.0	87.8	89.6	91.4	93.2	95.0	96.8	98.6	100.4	102.2
40	104.0	105.8	107.6	109.4	111.2	113.0	114.8	116.6	118.4	120.2
50	122.0	123.8	125.6	127.4	129.2	131.0	132.8	134.6	136.4	138.2
60	140.0	141.8	143.6	145.4	147.2	149.0	150.8	152.6	154.4	156.2
70	158.0	159.8	161.6	163.4	165.2	167.0	168.8	170.6	172.4	174.2
80	176.0	177.8	179.6	181.4	183.2	185.0	186.8	188.6	190.4	192.2
90	194.0	195.8	197.6	199.4	201.2	203.0	204.8	206.6	208.4	210.2

DEGREES FAHRENHEIT INTO DEGREES CENTIGRADE

Fahrenheit	0	1	2	3	4	5	6	7	8	9
 Centigrade									
0	-17.8	-17.2	-16.7	-16.1	-15.6	-15.0	-14.4	-13.9	-13.3	-12.8
10	-12.2	-11.7	-11.1	-10.6	-10.0	- 9.4	- 8.9	- 8.3	- 7.8	- 7.2
20	- 6.7	- 6.1	- 5.6	- 5.0	- 4.4	- 3.9	- 3.3	- 2.8	- 2.2	- 1.7
30	- 1.1	- 0.6	0	+ 0.6	+ 1.1	+ 1.7	+ 2.2	+ 2.8	+ 3.3	+ 3.9
40	4.4	5.0	5.6	6.1	6.7	7.2	7.8	8.3	8.9	9.4
50	10.0	10.6	11.1	11.7	12.2	12.8	13.3	13.9	14.4	15.0
60	15.6	16.1	16.7	17.2	17.8	18.3	18.9	19.4	20.0	20.6
70	21.1	21.7	22.2	22.8	23.3	23.9	24.4	25.0	25.6	26.1
80	26.7	27.2	27.8	28.3	28.9	29.4	30.0	30.6	31.1	31.7
90	32.2	32.8	33.3	33.9	34.4	35.0	35.6	36.1	36.7	37.2
100	37.8	38.3	38.9	39.4	40.0	40.6	41.1	41.7	42.2	42.8
110	43.3	43.9	44.4	45.0	45.6	46.1	46.7	47.2	47.8	48.3
120	48.9	49.4	50.0	50.6	51.1	51.7	52.2	52.8	53.3	53.9
130	54.4	55.0	55.6	56.1	56.7	57.2	57.8	58.3	58.9	59.4
140	60.0	60.6	61.1	61.7	62.2	62.8	63.3	63.9	64.4	65.0
150	65.6	66.1	66.7	67.2	67.8	68.3	68.9	69.4	70.0	70.6
160	71.1	71.7	72.2	72.8	73.3	73.9	74.4	75.0	75.6	76.1
170	76.7	77.2	77.8	78.3	78.9	79.4	80.0	80.6	81.1	81.7
180	82.2	82.8	83.3	83.9	84.4	85.0	85.6	86.1	86.7	87.2
190	87.8	88.3	88.9	89.4	90.0	90.6	91.1	91.7	92.2	92.8
200	93.3	93.9	94.4	95.0	95.6	96.1	96.7	97.2	97.8	98.3
210	98.9	99.4	100.0							

FAO SALES AGENTS AND BOOKSELLERS

Algeria	Société nationale d'édition et de diffusion, 92, rue Didouche Mourad, Algiers.
Argentina	Editorial Hemisferio Sur S.A., Librería Agropecuaria, Pasteur 743, 1028 Buenos Aires.
Australia	Hunter Publications, 58A Gipps Street, Collingwood, Vic. 3066; Australian Government Publishing Service, P.O. Box 84, Canberra, A.C.T. 2600; and Australian Government Service Bookshops at 12 Pirie Street, Adelaide, S.A.; 70 Alinga Street, Canberra, A.C.T.; 162 Macquarie Street, Hobart, Tas.; 347 Swanson Street, Melbourne, Vic.; 200 St. Georges Terrace, Perth, W.A.; 309 Pitt Street, Sydney, N.S.W.; 294 Adelaide Street, Brisbane, Qld.
Austria	Gerold & Co., Buchhandlung und Verlag, Graben 31, 1011 Vienna.
Bangladesh	ADAB, 79 Road 11A, P.O. Box 5045, Dhanmondi, Dacca.
Belgium	Service des publications de la FAO, M.J. de Lannoy, 202, avenue du Roi, 1060 Brussels. CCP 000-0808993-13.
Bolivia	Los Amigos del Libro, Perú 3712, Casilla 450, Cochabamba; Mercado 1315, La Paz; René Moreno 26, Santa Cruz; Junín esq. 6 de Octubre, Oruro.
Brazil	Livraria Mestre Jou, Rua Guaipá 518, São Paulo 05089; Rua Senador Dantas 19-S205/206, 20.031 Rio de Janeiro; PRODIL, Promoção e Dist. de Livros Ltda., Av. Venâncio Aires 196, Caixa Postal 4005, 90.000 Porto Alegre; A NOSSA LIVRARIA, CLS 104, Bloco C, Lojas 18/19, 70.000 Brasília, D.F.
Brunei	SST Trading Sdn. Bhd., Bangunan Tekno No. 385, Jln 5/59, P.O. Box 227, Petaling Jaya, Selangor.
Canada	Renouf Publishing Co. Ltd, 2182 St Catherine West, Montreal, Que. H3H 1M7.
Chile	Tecnolibro S.A., Merced 753, entresuelo 15, Santiago.
China	China National Publications Import Corporation, P.O. Box 88, Beijing.
Colombia	Editorial Blume de Colombia Ltda., Calle 65 N° 16-65, Apartado Aéreo 51340, Bogotá D.E.
Costa Rica	Librería, Imprenta y Litografía Lehmann S.A., Apartado 10011, San José.
Cuba	Empresa de Comercio Exterior de Publicaciones, O'Reilly 407 Bajos entre Aguacate y Compostela, Havana.
Cyprus	MAM, P.O. Box 1722, Nicosia.
Czechoslovakia	ARTIA, Ve Smeckach 30, P.O. Box 790, 111 27 Prague 1.
Denmark	Munksgaard Export and Subscription Service, 35 Nørre Søgade, DK 1370 Copenhagen K.
Dominican Rep.	Fundación Dominicana de Desarrollo, Casa de las Gárgolas, Mercedes 4, Apartado 857, Zona Postal 1, Santo Domingo.
Ecuador	Su Librería Cia. Ltda., García Moreno 1172 y Mejía, Apartado 2556, Quito; Chimborazo 416, Apartado 3565, Guayaquil.
El Salvador	Librería Cultural Salvadoreña S.A. de C.V., Calle Arce 423, Apartado Postal 2296, San Salvador.
Finland	Akateeminen Kirjakauppa, 1 Keskuskatu, P.O. Box 123, 00101 Helsinki 10.
France	Editions A. Pedone, 13, rue Soufflot, 75005 Paris.
Germany, F.R.	Alexander Horn Internationale Buchhandlung, Spiegelgasse 9, Postfach 3340, 6200 Wiesbaden.
Ghana	Fides Enterprises, P.O. Box 14129, Accra; Ghana Publishing Corporation, P.O. Box 3632, Accra.
Greece	G.C. Eleftheroudakis S.A., International Bookstore, 4 Nikis Street, Athens (T-126); John Mihalopoulos & Son S.A., International Booksellers, 75 Hermou Street, P.O. Box 73, Thessaloniki.
Guatemala	Distribuciones Culturales y Técnicas "Artemis", 5a. Avenida 12-11, Zona 1, Apartado Postal 2923, Guatemala.
Guinea-Bissau	Conselho Nacional de Cultura, Avenida da Unidade Africana, C.P. 294, Bissau.
Guyana	Guyana National Trading Corporation Ltd, 45-47 Water Street, P.O. Box 308, Georgetown.
Haiti	Librairie "A la Caravelle", 26, rue Bonne Foi, B.P. 111, Port-au-Prince.
Hong Kong	Swindon Book Co., 13-15 Lock Road, Kowloon.
Hungary	Kultura, P.O. Box 149, 1389 Budapest 62.
Iceland	Snaebjörn Jónsson and Co. h.f., Hafnarstraeti 9, P.O. Box 1131, 101 Reykjavik.
India	Oxford Book and Stationery Co., Scindia House, New Delhi 110001; 17 Park Street, Calcutta 700016.
Indonesia	P.T. Sari Agung, 94 Kebon Sirih, P.O. Box 411, Jakarta.
Iraq	National House for Publishing, Distributing and Advertising, Jamhuriya Street, Baghdad.
Ireland	The Controller, Stationery Office, Dublin 4.
Italy	Distribution and Sales Section, Food and Agriculture Organization of the United Nations, Via delle Terme di Caracalla, 00100 Rome; Libreria Scientifica Dott. Lucio de Blasio "Aeiou", Via Meravigli 16, 20123 Milan; Libreria Commissionaria Sansoni S.p.A. "Licoso", Via Lamarmora 45, C.P. 552, 50121 Florence.
Japan	Maruzen Company Ltd, P.O. Box 5050, Tokyo International 100-31.
Kenya	Text Book Centre Ltd, Kijabe Street, P.O. Box 47540, Nairobi.
Kuwait	Saeed & Samir Bookstore Co. Ltd, P.O. Box 5445, Kuwait
Luxembourg	Service des publications de la FAO, M.J. de Lannoy, 202, avenue du Roi, 1060 Brussels (Belgium).

FAO SALES AGENTS AND BOOKSELLERS

Malaysia	SST Trading Sdn. Bhd., Bangunan Tekno No. 385, Jln 5/59, P.O. Box 227, Petaling Jaya, Selangor.
Mauritius	Nalanda Company Limited, 30 Bourbon Street, Port Louis.
Mexico	Dilitsa S.A., Puebla 182-D, Apartado 24-448, Mexico 7, D.F.
Morocco	Librairie "Aux Belles Images", 281, avenue Mohammed V, Rabat.
Netherlands	Keesing Boeken V.B., Joan Muyskenweg 22, 1096 CJ Amsterdam.
New Zealand	Government Printing Office, Government Printing Office Bookshops: Retail Bookshop, 25 Rutland Street, Mail Orders, 85 Beach Road, Private Bag C.P.O., Auckland; Retail, Ward Street, Mail Orders, P.O. Box 857, Hamilton; Retail, Mulgrave Street (Head Office), Cubacade World Trade Centre, Mail Orders, Private Bag, Wellington; Retail, 1 F. J. J. Street, Mail Orders, Private Bag, Christchurch; Retail, Princes Street, Mail Orders, P.O. Box 1104, Dunedin.
Nigeria	University Bookshop (Nigeria) Limited, University of Ibadan, Ibadan.
Norway	Johan Grundt Tanum Bokhandel, Karl Johansgate 41-43, P.O. Box 1177 Sentrum, Oslo 1.
Pakistan	Mirza Book Agency, 65 Shahrah-e-Quaid-e-Azam, P.O. Box 729, Lahore 3.
Panama	Distribuidora Lewis S.A., Edificio Dorasol, Calle 25 y Avenida Balboa, Apartado 1634, Panama 1.
Paraguay	Agencia de Librerías Nizza S.A., Tacuarí 144, Asunción.
Peru	Librería Distribuidora "Santa Rosa", Jirón Apurímac 375, Casilla 4937, Lima 1.
Philippines	The Modern Book Company Inc., 922 Rizal Avenue, P.O. Box 632, Manila.
Poland	Ars Polona, Krakowskie Przedmiescie 7, 00-088 Warsaw.
Portugal	Livraria Bertrand, S.A.R.L., Rua João de Deus, Venda Nova, Apartado 37, 2701 Amadora Codex; Livraria Portugal, Dias y Andrade Ltda., Rua do Carmo 70-74, Apartado 2681, 1117 Lisbon Codex; Edições ITAU, Avda. da República 46/A-1/c Esqdo., Lisbon 1.
Korea, Rep. of	Eul-Yoo Publishing Co. Ltd, 46-1 Susong-Dong, Jöngro-Gu, P.O. Box Kwang-Wha-Moon 362, Seoul.
Romania	Ilexim, Calea Grivitei N° 64-66, B.P. 2001, Bucharest.
Saudi Arabia	The Modern Commercial University, P.O. Box 394, Riyadh.
Sierra Leone	Provincial Enterprises, 26 Garrison Street, P.O. Box 1228, Freetown.
Singapore	MPH Distributors (S) Pte. Ltd, 71/77 Stamford Road, Singapore 6; Select Books Pte. Ltd, 215 Tanglin Shopping Centre, 19 Tanglin Road, Singapore 1024; SST Trading Sdn. Bhd., Bangunan Tekno No. 385, Jln 5/59, P.O. Box 227, Petaling Jaya, Selangor.
Somalia	"Samater's", P.O. Box 936 Mogadishu.
Spain	Mundi Prensa Libros S.A., Castelló 37, Madrid 1, Librería Agrícola, Fernando VI 2, Madrid 4.
Sri Lanka	M.D. Gunasena & Co. Ltd, 217 Olcott Mawatha, P.O. Box 246, Colombo 11.
Sudan	University Bookshop, University of Khartoum, P.O. Box 321, Khartoum.
Suriname	VACO n.v. in Suriname, Dominee Straat 26, P.O. Box 1841, Paramaribo.
Sweden	C.E. Fritzes Kungl. Hovbokhandel, Regeringsgatan 12, P.O. Box 16356, 103 27 Stockholm.
Switzerland	Librairie Payot S.A., Lausanne et Genève; Buchhandlung und Antiquariat Heinemann & Co., Kirchgasse 17, 8001 Zurich.
Thailand	Suksapan Panit, Mansion 9, Rajdamnern Avenue, Bangkok.
Togo	Librairie du Bon Pasteur, B.P. 1164, Lomé.
Tunisia	Société tunisienne de diffusion, 6, avenue de Carthage, Tunis.
United Kingdom	Her Majesty's Stationery Office, 48 High Holborn, London WC1V 6HB (callers only); P.O. Box 569, London SE1 9NH (trade and London area mail orders); 13a Castle Street, Edinburgh EH2 3AR; 41 The Hayes, Cardiff CF1 1JW; 80 Chichester Street, Belfast BT1 4JY; Brazennose Street, Manchester M60 8AS; 258 Broad Street, Birmingham B1 2HE; Southey House, Wine Street, Bristol BS1 2BQ.
Tanzania, United Rep. of	Dar es-Salaam Bookshop, P.O. Box 3030, Dar es-Salaam; Bookshop, University of Dar es-Salaam, P.O. Box 893, Morogoro.
United States of America	UNIPUB, 345 Park Avenue South, New York, N.Y. 10010.
Uruguay	Librería Agropecuaria S.R.L., Alzibar 1328, Casilla de Correos 1755, Montevideo.
Venezuela	Blume Distribuidora S.A., Gran Avenida de Sabana Grande, Residencias Caroni, Local 5, Apartado 50.339, 1050-A Caracas.
Yugoslavia	Jugoslovenska Knjiga, Trg. Republike 5/8, P.O. Box 36, 11001 Belgrade; Cankarjeva Založba, P.O. Box 201-IV, 61001 Ljubljana; Prosveta, Terazije 16, P.O. Box 555, 11001 Belgrade.
Zambia	Kingstons (Zambia) Ltd, Kingstons Building, President Avenue, P.O. Box 139, Ndola.
Other countries	Requests from countries where sales agents have not yet been appointed may be sent to: Distribution and Sales Section, Food and Agriculture Organization of the United Nations, Via delle Terme di Caracalla, 00100 Rome, Italy.

