

Helmut Muche/Harald Zimmermann

# The Purification of Biogas

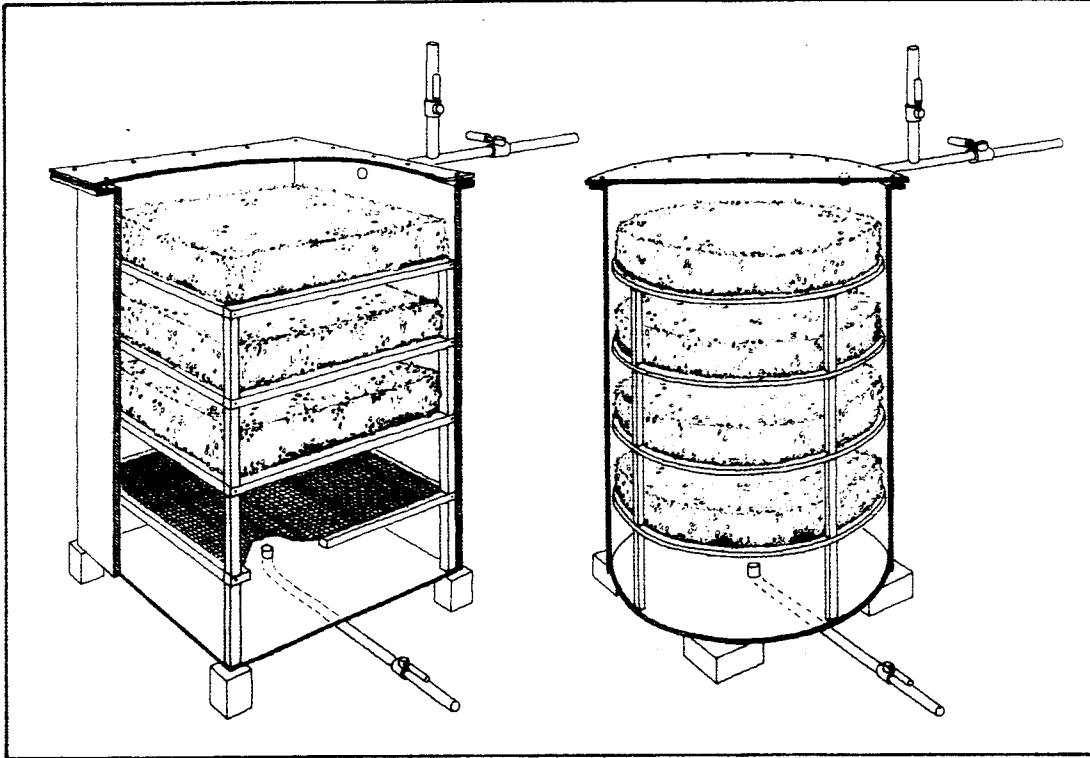

Vieweg

## **Deutsches Zentrum für Entwicklungstechnologien – GATE**

Deutsches Zentrum für Entwicklungstechnologien – GATE – stands for German Appropriate Technology Exchange. It was founded in 1978 as a special division of the Deutsche Gesellschaft für Technische Zusammenarbeit (GTZ) GmbH. GATE is a centre for the dissemination and promotion of appropriate technologies for developing countries. GATE defines „Appropriate technologies“ as those which are suitable and acceptable in the light of economic, social and cultural criteria. They should contribute to socio-economic development whilst ensuring optimal utilization of resources and minimal detriment to the environment. Depending on the case at hand a traditional, intermediate or highly-developed can be the „appropriate“ one. GATE focusses its work on the key areas:

– *Dissemination of Appropriate Technologies:* Collecting, processing and disseminating information on technologies appropriate to the needs of the developing countries; ascertaining the technological requirements of Third World countries; support in the form of personnel, material and equipment to promote the development and adaptation of technologies for developing countries.

– *Environmental Protection:* The growing importance of ecology and environmental protection require better coordination and harmonization of projects. In order to tackle these tasks more effectively, a coordination center was set up within GATE in 1985.

GATE has entered into cooperation agreements with a number of technology centres in Third World countries.

GATE offers a free information service on appropriate technologies for all public and private development institutions in developing countries, dealing with the development, adaptation, introduction and application of technologies.

## **Deutsche Gesellschaft für Technische Zusammenarbeit (GTZ) GmbH**

The government-owned GTZ operates in the field of Technical Cooperation. 2 200 German experts are working together with partners from about 100 countries of Africa, Asia and Latin America in projects covering practically every sector of agriculture, forestry, economic development, social services and institutional and material infrastructure. – The GTZ is commissioned to do this work both by the Government of the Federal Republic of Germany and by other government or semi-government authorities.

The GTZ activities encompass:

- appraisal, technical planning, control and supervision of technical cooperation projects commissioned by the Government of the Federal Republic or by other authorities
- providing an advisory service to other agencies also working on development projects
- the recruitment, selection, briefing, assignment, administration of expert personnel and their welfare and technical backstopping during their period of assignment
- provision of materials and equipment for projects, planning work, selection, purchasing and shipment to the developing countries
- management of all financial obligations to the partner-country.

Deutsches Zentrum für Entwicklungstechnologien – GATE

in: Deutsche Gesellschaft für Technische Zusammenarbeit (GTZ) GmbH

P. O. Box 5180

D-65726 Eschborn

Federal Republic of Germany

Telephone: (061 96) 79-0      Telex: 41 523-0 gtz d      Fax: (061 96) 7948 20

CIP-Kurztitelaufnahme der Deutschen Bibliothek

**Muche, Helmut:**

The purification of biogas : a publ. of Dt.  
Zentrum für Entwicklungstechnologien – GATE in:  
Dt. Ges. für Techn. Zusammenarbeit (GTZ) GmbH /  
Helmut Muche ; Harald Zimmermann. [Drawings:  
Renate Flügge]. – Braunschweig ; Wiesbaden :  
Vieweg, 1985.

Dt. Ausg. u.d.T.: Muche, Helmut: Reinigung  
von Biogas

ISBN 3-528-02015-6

NE: Zimmermann, Harald:

All rights reserved.

© Deutsche Gesellschaft für Technische Zusammenarbeit (GTZ) GmbH, Eschborn 1985

Published by Friedr. Vieweg & Sohn Verlagsgesellschaft mbH, Braunschweig

Printed in the Federal Republic of Germany by Lengericher Handelsdruckerei, 4540 Lengerich/Westf.

ISBN 3-528-02015-6

# Contents

0.	Introduction. . . . .	5
1.	Properties of hydrogen sulphide . . . . .	6
2.	The origins of hydrogen sulphide in biogas plants . . . . .	7
3.	The effect of hydrogen sulphide on the biogas plant and the gas-utilization equipment . . . . .	8
4.	Determination of the hydrogen sulphide content of biogas . . . . .	10
5.	Methods for removing hydrogen sulphide from biogas . . . . .	11
6.	Purifying absorbent . . . . .	13
7.	Requirements on the absorbent/Preparation of the absorbent . . . . .	15
8.	The desulphurizing apparatus. . . . .	18
9.	Operation procedures for gas desulphurization . . . . .	24
10.	Summary . . . . .	30
	Appendix: Calculation method for dimensioning desulphurization units . . . . .	31

# 0. Introduction

This review attempts to set out the procedures for removing hydrogen sulphide from biogas.

Hydrogen sulphide is particularly harmful when biogas is used in internal combustion engines. Its chemical reactions and those of its combustion product – sulphur dioxide, quickly lead to severe corrosion and wear on engines.

The only practical way of removing the hydrogen sulphide on a small scale is by dry desulphurization using ferrous substances. Locally available, iron-containing soil is suitable for use as the purifying agent in Third World countries. This manual con-

tains a detailed description of criteria for designing the purification chamber. It also presents the basic steps for manufacturing the purifying agent or absorbent.

The paper is mainly directed at staff in the various regional biogas advisory services. In particular the colleagues must give assistance in selecting the soils, and sometimes carry out investigations to identify the composition of the substances. Only an optimally applied purification agent can ensure a long life for the gas user, particularly engines, and avoid unnecessary repairs and maintenance on the plant equipment.

# 1. Properties of hydrogen sulphide

## *Physical and chemical properties*

Hydrogen sulphide ( $H_2S$ ) is a colourless, very poisonous gas. It is inflammable and forms explosive mixtures with air (oxygen).  $H_2S$  has a characteristic smell of "rotten eggs". This odour is only apparent in a small concentration range (0.05–500 ppm).

$H_2S$  is soluble in water forming a weak acid. A combustion product of  $H_2S$  is  $SO_2$ . This makes the exhaust gases very corrosive (sulphuric acid) and contaminates the environment (acid rain).

## *Toxicity*

$H_2S$  is very poisonous (comparable to hydrogen cyanide).

## *Lower toxic limit*

10 ppm  $H_2S$ .

## *Lethal dose*

1.2–2.8 mg  $H_2S$  per liter of air or 0.1% kills instantly.

0.6 mg  $H_2S$  per liter of air or 0.05% kills within 30 minutes to one hour.

## *Effect*

$H_2S$  changes the red blood pigment; the blood turns brown to olive in colour. The transport of oxygen is hindered. The person suffocates "internally". The symptoms are irritation of the mucous membranes (including the eyes), nausea, vomiting, difficulty in breathing, cyanosis (discoloration of the skin), delirium and cramps, then respiratory paralysis and cardiac arrest. At higher concentrations immediate respiratory para-

lysis and cardiac arrest are the only symptoms.

Even if a person survives poisoning, long-term damage to the central nervous system and to the heart remains.

## *First aid*

Fresh air, artificial respiration, warmth, rest, transportation in an inclined position. There is a danger of suffocation if the patient is unconscious!

## *Medical care*

Artificial respiration. Analeptics. Further observation of symptoms, particularly the function of the circulatory and pulmonary systems. Beware of oedema of the larynx. Codeine may be administered for bronchitis as soon as the asphyctic stage is past. Oedema of the lungs during the latent period: treat prophylactically with high doses of prednisolone i.v. In addition, infusions of altogether 0.5 g THAM/kg. Absolute rest, warmth, infection prophylaxis, keep breathing passages free. Only small quantities of morphine. Combat anhydremia by peroral administration of fluids or rectoclysis.

## *Chronic effects*

Long-term exposure to very small amounts of  $H_2S$  can lead to chronic poisoning. Symptoms: irritation of the mucous membranes, sensitivity to light, bronchitis, headaches, weariness, circulatory disturbances and loss of weight.

## 2. The origins of hydrogen sulphide in biogas plants

### *Formation*

Hydrogen sulphide is formed in the biogas plant by the transformation of sulphur-containing protein. This can be protein from plants and fodder residues. However, when animal and human faeces are used, bacteria excreted in the intestines is the main source of protein. Inorganic sulphur, particularly sulphates, can also be biochemically converted to  $H_2S$  in the fermentation chamber.

### *Amounts*

Plant material introduces little  $H_2S$  into biogas. On the other hand, poultry droppings introduce, on average, up to 0.5 vol. %  $H_2S$ , cattle and pig manure about 0.3 vol. %  $H_2S$ .

Protein-rich waste (e.g. swill, molasses etc.) can produce large amounts of hydrogen sulphide (up to 3 vol. %). Inorganic sulphates (from salty, stall rinse water or diluting water) also produce considerable  $H_2S$ .

### 3. The effect of hydrogen sulphide on the biogas plant and the gas-utilization equipment

#### *Fermentation inhibition*

Dissolved  $H_2S$  is contained in the fermentation slurry. An equilibrium is set up between the dissolved  $H_2S$  and the  $H_2S$  in the gas phase. The dissolved  $H_2S$  in high concentrations can be toxic to the bacteria in the slurry. It can inhibit the production of biogas and cause its composition to alter.

**Remedies** — put less sulphur-rich material in the plant, dilute with water. In less serious cases stir vigorously (to drive  $H_2S$  out of the slurry).

#### *Corrosion by $H_2S$*

The presence of  $H_2S$  gas in biogas makes it corrosive to metal parts. Iron is subject to surface attack, although not major corrosion. Galvanized parts are similarly subject to surface corrosion.

The effect on non-ferrous metals in components, such as pressure regulators, gas meters, valves and mountings, is much more serious. They are very quickly corroded. These materials also corrode in gas engines (seals and valves).

#### *Corrosion by $SO_2$ from $H_2S$*

The combustion product  $SO_2$  combines with water vapour and badly corrodes the exhaust side of burners, gas lamps and engines. Burning biogas in stoves and boilers can also result in damage to the chimney.

#### *Engines*

The acid which is formed corrodes engine parts in the combustion chamber, exhaust system and in various bearings. This is enhanced by frequent starts, short running times and the relatively low temperatures when starting up and after cutting off the engine. The water cooling system also provides the means (water needed to form sulphuric acid) for corrosion.

#### *Service life*

Running engines with  $H_2S$ -containing gas can reduce the service time to the first general overhaul by about 10–15%.

#### *Engine oil changes*

The sulphur content of biogas used in gas engines shortens the time between oil changes.  $SO_2$  from combustion and water vapour both dissolve in the lubricating oil. The oil becomes acidic and its properties change. It loses its ability to lubricate and sometimes corrodes metal components. Under continuous operating conditions the interval between oil changes is reduced to 200–250 hours.

#### *Cooking stoves*

If biogas is burned for cooking and lighting in poorly ventilated rooms, the occupants



will be burdened by  $\text{SO}_2$  in the air. Indicators are coughing, irritation of the mucous membranes, watering of the eyes and the corrosion of metal surfaces.

### *The odour of biogas*

The adequate desulphurization of biogas causes it to lose its characteristic, warning smell. This increases the danger of an unnoticed leak from pipework or equipment.

### *Environmental pollution*

The  $\text{SO}_2$  formed during combustion pollutes the environment by creating "acid rain". Even small concentrations of  $\text{SO}_2$  in the atmosphere damage plants. Its concentration

in the soil slowly causes land which is lacking in lime to become acidic.

These effects occur primarily in densely populated areas. They should be negligible for the use of biogas in rural areas in developing countries, since only small amounts of biogas are utilized.

### *Which biogas applications require desulphurization?*

The desulphurization of biogas is absolutely necessary for its use in gas engines. Under some circumstances it is expedient to desulphurize for boilers. Desulphurization is also required when the biogas is produced from sulphur-rich materials. If people are not adversely affected, desulphurization is not required when biogas is burned openly.

## 4. Determination of the hydrogen sulphide content of biogas

The  $H_2S$  content of the purified gas can be measured to check the effectivity of the desulphurization process.

### *Laboratory method*

In the laboratory the  $H_2S$  content of gases is usually measured iodometrically using cadmium acetate. However, the necessary techniques are too involved for an application here.

### *Lead acetate method*

A simple way of determining the presence of  $H_2S$  in biogas is a test with lead acetate paper. A piece of paper soaked with lead acetate solution is held in the gas stream for a short time. The presence of  $H_2S$  colours the strip black. The difficulty with this method is its high sensitivity which means that even a very small amount of  $H_2S$  can be detected. A small amount of  $H_2S$ , however, is not an indication of greatly reduced efficiency of the desulphurization. Simple desulphurization plants may still possess an adequate purifying performance.

### *Detection with iodine solution*

Another simple method for detecting  $H_2S$  is with an alcoholic solution of iodine, such as often available in first aid kits. A small amount of biogas is carefully introduced into the iodine solution. If  $H_2S$  is present the reddish brown solution will decolour. The formation of elementary sulphur causes a milky turbidity.

### *The test-tube method*

The test-tube method is a very exact and simple method of determining the  $H_2S$  concentration in biogas. Suitable tubes are available for measuring the concentration in both raw and purified gas. The gas detector apparatus (ca. 450,- DM) and the individual test tubes (ca. 5,- DM each) are relatively expensive. Also, the test tubes can only be preserved for a limited time. This method is only expedient in the regional biogas extension service or similar advisory services. This apparatus could then be used to provide empirical field values for individual plants. The intervals for recharging the purifying agent can then be laid down.

As yet there is no simple, cheap, test method available. For this reason a close control of the desulphurization plant is strongly recommended.

# 5. Methods for removing hydrogen sulphide from biogas

## *General*

Of the many processes traditionally and presently employed, that have been used for large-scale desulphurization of technical gases, only the so-called "dry" process is suitable on a smaller scale for biogas plants. They are acceptable from the point of view of technical complexity and maintenance and the degree of purification is satisfactory.

The desulphurization of biogas is based on a chemical reaction of  $H_2S$  with a suitable substance.

## *The lime process*

The oldest process is the desulphurization of gases with quick lime, slaked lime in solid form or with slaked lime in liquid form. The process using quick or slaked lime has not been applied on a large scale for a long time. The large amounts of odourous residue that are produced cannot be satisfactorily disposed of. The handling of large amounts of dissolved or suspended slaked lime requires elaborate equipment.

Large concentrations of  $CO_2$  which are present in biogas make the satisfactory removal of  $H_2S$  difficult. The  $CO_2$  also reacts with the quick and slaked lime and uses it up quickly. The  $Ca(HCO_3)_2$  formed reacts with  $Ca(SH)_2$  which is formed by the reaction of  $H_2S$  with  $Ca(OH)_2$  thus resulting in the reoccurrence of  $H_2S$ . However, a large-scale biogas plant in Germany with the co-generation of heat and power has recently

been constructed using a lime purifier. The results of long term tests are not yet available.

In as far as enough lump, quick lime is available in the countries concerned, this process could be considered for desulphurization. The apparatus for utilizing quick lime corresponds in construction and function to that used for the desulphurization with iron-containing substances.

## *Ferrous materials*

Ferrous materials in the form of natural soils or certain iron ores are often employed to remove  $H_2S$ .

## *Principle*

The ferrous material is placed in a closed, gas tight container (of steel, brickwork or concrete). The gas to be purified flows through the ferrous absorbing agent from the bottom and leaves the container at the top, freed from  $H_2S$ .

## *Chemistry*

The absorbing material must contain iron in the form of oxides, hydrated oxides or hydroxides. These react as follows:

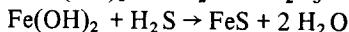
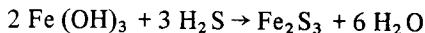

This process terminates, of course, after some time. The greater part of the iron is then present as a sulphide.

## *Regeneration*

However, by treating the sulphidized absorbent with atmospheric oxygen, the iron can be returned to the active oxide form required for the purification of the gas:

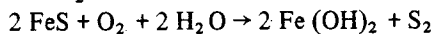
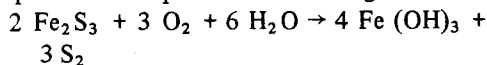

The used absorbent can, therefore, be "regenerated". This regeneration cannot be repeated indefinitely. After a certain time the absorbent becomes coated with elementary sulphur and its pores become clogged. Purifying absorbents in gasworks (coke plants) acquire a sulphur content of up to 25% of their original weight, i.e. 40% sulphur by dry weight.

## **Process techniques**

There are three different, dry desulphurizing processes available.

### *Without regeneration*

The purification chamber consists of a box or drum. The absorbent is placed inside it on several, intermediate trays (sieve floors) to ensure that the depth of the absorbent is not more than 20–30 cm. Otherwise the absorbent would easily press together causing an increase in the resistance to the gas flow.

The biogas is fed in at the bottom of the box, flows through the absorbent and leaves the purification chamber at the top, freed from  $\text{H}_2\text{S}$ . When the absorbent becomes loaded with iron sulphides, the gas leaving the chamber contains increasingly more  $\text{H}_2\text{S}$ . The chamber is then opened at the top and the trays with the spent absorbent are removed. Then fresh absorbent is placed on the trays.

After the air in the purification chamber has again been displaced with biogas, the gas connection to the user is re-opened.

The spent absorbent is disposed of as described under the heading "Disposal of spent absorbent" on p. 25.

### *With regeneration*

The spent, sulphide-containing absorbent can also be regenerated by exposing it to oxygen. This can either be done by taking the used absorbent out of the chamber and exposing it to the air, or inside the purification chamber by simply sucking ambient air through it.

Since regeneration inside the chamber requires precautions against the formation of unwanted and dangerous air-gas mixtures and would require powerful fans, regeneration outside the chamber is usually preferred. The absorbent that is to be regenerated, is spread out on the ground in as thin a layer as possible. From time to time it is turned over with a shovel. After a few days it is ready for use again.

This regeneration process can be repeated up to ten times, after which the absorbent is finally spent.

### *Simultaneous regeneration and loading*

Simultaneous regeneration and loading of the absorbent is a special case. Here a certain, small amount of air is added to the biogas. Then sulphide formation and regeneration occur at the same time and place. As such, the absorbent acts effectively as a catalyst.

Expensive gas-measuring and mixing equipment is required for this process, however, so that it is not suitable for small biogas plants.

## 6. Purifying absorbent

### *General*

The industrial absorbents in Europe are native ores or synthetic materials containing iron hydroxide or hydrated iron oxides. They are employed under such names as "H-Masse", "Lux-Masse", "Wasserwerks-Masse" and "Raseneisenerz".

### *Iron content*

The iron content calculated as the oxide is decisive and should be at least 40–50% by weight. If possible the proportion of "active iron" should be more than 70% of the total iron. "Active iron" is hydrated iron oxide having a particular crystal modification, for instance,  $\alpha$ -FeOOH and  $\beta$ -FeOOH. Certain industrial, iron-containing substances such as iron pyrites and slags etc., do not react with  $H_2S$  even though they have a similar chemical composition. They are "inactive". Under certain conditions they can be activated by grinding or other mechanical processing. This partially destroys the crystal structure.

### *Natural materials*

Some naturally occurring, ferruginous soils are suitable for use as absorbents. Those ores or soils containing large concentrations of hydrated ferric oxides ( $Fe_2O_3 \cdot H_2O$  or  $FeO(OH)$ ) are suitable. Such ores are known

as brown ironstone. There are various subtypes:

goethite (needle iron ore, pyrrhosiderite):  $\alpha$ -FeO(OH),  
lepidocrocite (ruby glance):  $\beta$ -FeO(OH),  
limonite: (by appearance) amorphous.

They occur mainly as conglomerates and are generally classified as limonites.

The ores in question have various local names:

brown haematite (xanthosiderite),  
limonite,  
pea ore,  
conglomerate ore,  
minette (iron ooliths),  
sea ore,  
bog ore,  
stilpnosiderite,  
yellow clay ironstone,  
yellow ochre.

The ores have various appearances and abundances.

### *Deposits*

Laterite soils occur widely in tropical and subtropical areas. The iron content varies according to location: some of these laterite deposits are large enough to be mined for the production of iron.

Since laterite consists mainly of goethite, it is probably suitable for use as an absorbent. It is, of course, necessary to break or grind the material mechanically to achieve the right particle size. Since areas with laterite

soils are usually cultivated for intensive crop production, i.e. the basis exists for a biogas plant, this soil appears likely for the purification agent.

The "terra rosa" found in the Mediterranean region is probably also suitable. It contains 10% of iron, again in the form of goethite.

### *Activation by regeneration*

Some absorbents are less efficient when used for the first time. After they have been regenerated once the purification effect can be improved. The chemical processes involved have activated the material.

## 7. Requirements on the absorbent

### Preparation of the absorbent

The absorbents must fulfil certain requirements in order to show a satisfactory, purifying action.

Alongside the requirements already mentioned concerning the iron content and the chemical composition, the following are important:

#### *Bulk density*

The absorbent must not be too "dense", that is it should possess a certain empty or pore volume. If the absorbent is too fine, the gas flow will be hindered. The resistance pressure in the layers and, thus, in the chamber will be too great. In extreme cases the purification chamber can become blocked.

#### *Grinding, stamping*

The absorbent material will normally be found in the form of soil or as lumps which should be broken up and ground. Stamping with an appropriate tool is a suitable technique.

Comminution increases the surface area (important for the chemical reaction) and secondly, the crystal structure is improved.

#### *Filler*

To obtain the desired porosity, a filler is mixed into the ferrous material. Organic

fillers are suitable. They loosen the texture of the absorbent and bind a certain amount of water into it.

Suitable fillers are:

Sawdust or fine woodshavings, milled straw, chaff, fine peat, milled coconut fibre and similar substances.

A mixture with the ferrous material containing 10–15% filler is to be obtained. Water is added while mixing so that the finished mixture has a moisture content of 20–30%.

#### *The finished absorbent*

The addition of water and the filler should transform the original powdery, ferrous material into a friable, crumbly mass. It should not smear if rubbed in the hand, but should also not pulverize for lack of water.

#### *Bulk density*

The bulk density, which is a measure of the porosity, should be 0.7–0.8 kg/litre.

The bulk density can be measured by taking a tin can, for example, with a known volume, filling it loosely with absorbent and weighing it. The absorbent should not be packed down or pressed – but exactly as it is in the purification chamber.

#### *Particle size*

The particle size should be from 2 to 5 mm.

### *pH value*

The finished absorbent should have a pH of at least 5. A slight alkalinity is better. If the natural soil is acidic due to humic acid or the filler is acidic (peat especially), then the absorbent can be neutralized by the addition of alkaline material.

The pH value can be adjusted with soda or potash. About 2 to 4% is added to the absorbent. As a substitute alkaline wood or plant ash could also be used.

This treatment, however, is not expected to be as effective as guaranteeing the optimal particle size and porosity.



## Preparation of the absorbent

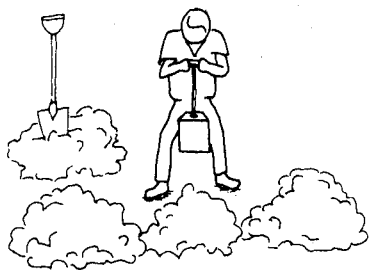

Break up the lumps of soil

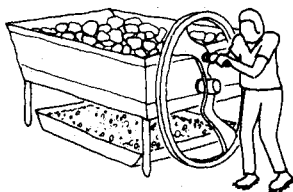
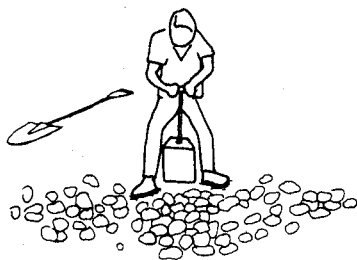

Grind the small pieces



+

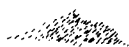

+



55–70% finely ground soil

10–15% sawdust,  
peat, etc.

20–30% water



Mix the fine soil with the filler and the water

## 8. The desulphurizing apparatus

The absorbent described above must be brought into immediate contact with the gas. This takes place in closed purification chambers. They can be made of steel, gas-tight brickwork or concrete.

### *Size of the chamber*

The area perpendicular to the gas-flow or cross section of the chamber is important. If it is too small, the gas will flow too quickly through the absorbent and the contact time is too short. If the gas flow is too fast channels will open in the absorbent. The gas then flows through these channels and is not properly purified.

The volume (if the cross section is fixed then the height) of the chamber is also important. The chamber must contain enough absorbent for the gas to be in contact with the absorbent over a sufficient distance. Apart from this the purification chamber must be large enough so that it does not constantly need to be refilled.

### *Dimensioning method*

A method for calculating the required size of purification chambers is included at the end of this manual.

### *Intermediate trays*

The purification chamber contains several intermediate trays. A layer of absorbent ca.

20–30 cm thick is placed on each tray. This avoids compacting of the absorbent under its own weight.

The intermediate tray floors are permeable to the biogas. They are made from perforated steel sheet or wooden slats. Wickerwork can also be used.

The individual, intermediate trays do not rest upon the absorbent in the tray below, but are supported by small spacers attached to the tray underneath. The layers of absorbent that lie between should not be compacted.

### *Inserting absorbent*

The absorbent should be placed on the trays in such a way that it is not compressed or packed down. It should be piled up higher at the chamber walls to avoid the preferable gas penetration at this position.

### *The chamber cover*

The chamber cover should be designed to give access to the whole chamber cross section. This allows the removal of the intermediate trays from the chamber.

### *Sealing the cover*

The cover must be sealed with the chamber. A rubber seal made from foam rubber, old bicycle inner tubes or a water hose would be suitable.

*Desulphurization chamber for biogas*

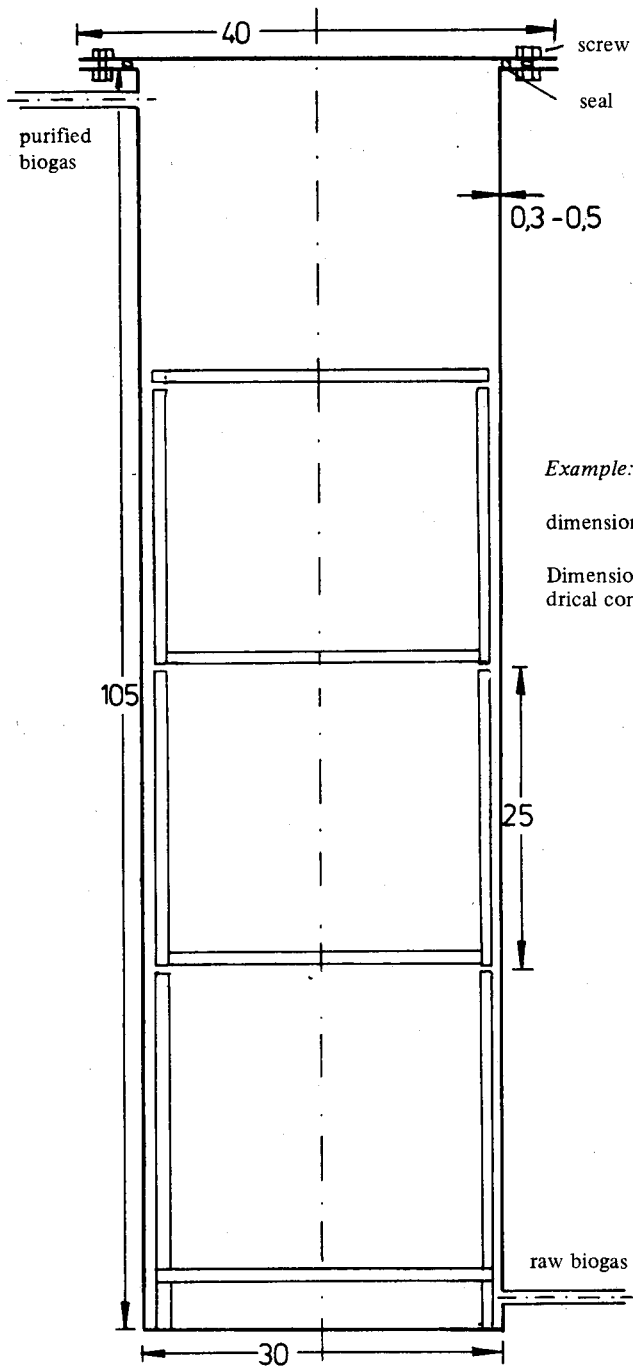

*Example:* 1.25 m<sup>3</sup> biogas/h

dimensions in cm

Dimensions apply to both rectangular and cylindrical constructions (p. 20/21)

*Cylindrical purification chamber*

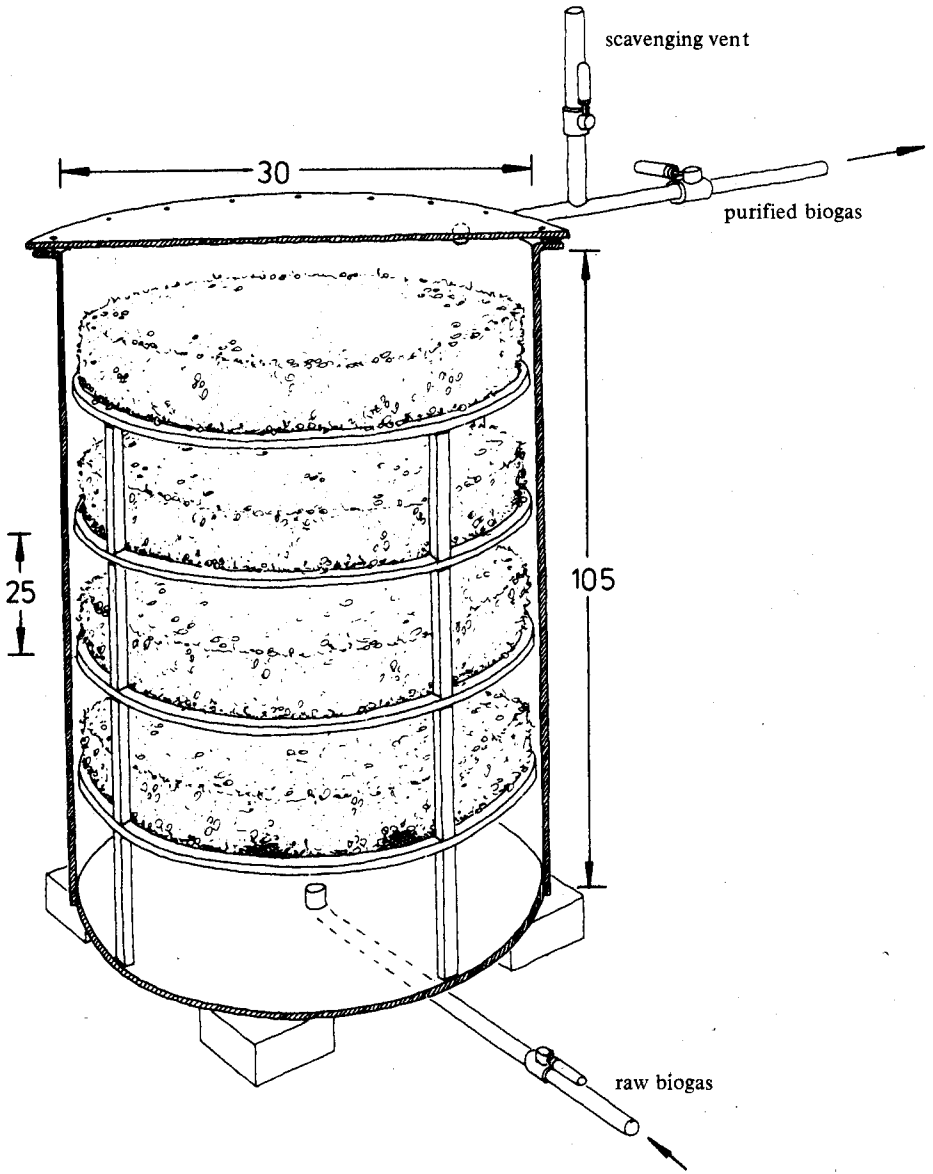

*Example: 1.25 m<sup>3</sup>/h (see dimensioning calculation)*

dimensions in cm

*Rectangular purification chamber*

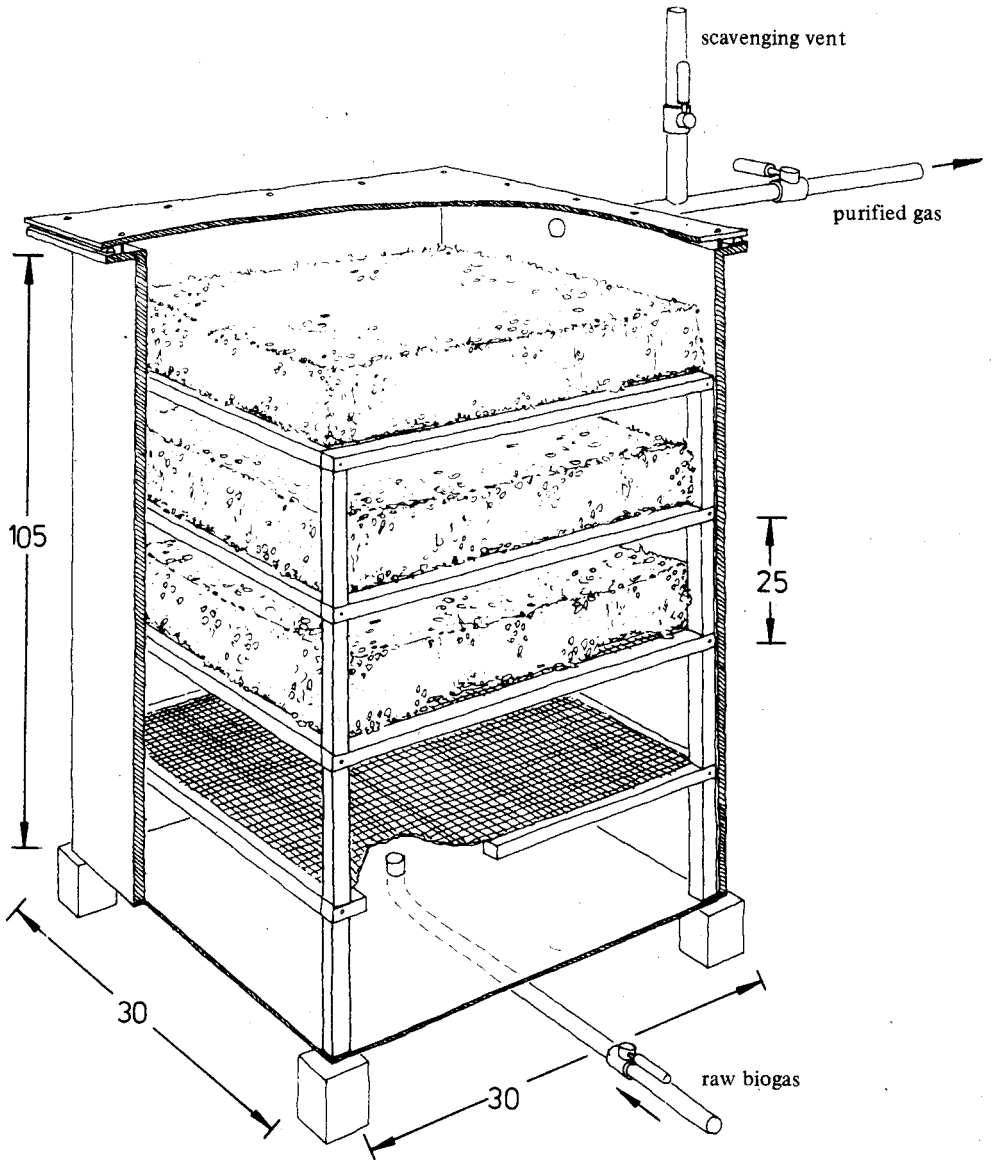

*Example:* 1.25 m<sup>3</sup>/h (see dimensioning calculations)

dimensions in cm

*Construction of intermediate trays, cross section*

*The intermediate trays can be made from*

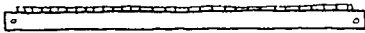

The top tray is only a frame.

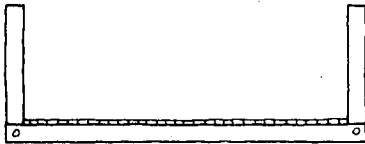
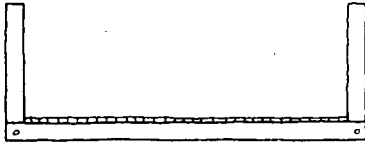

The intermediate trays have spacers extending upwards.

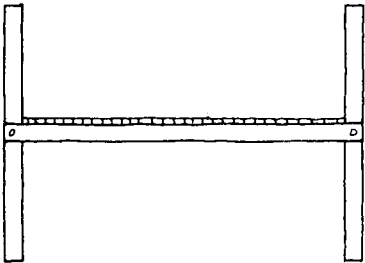

The bottom tray has spacers on the top and bottom.

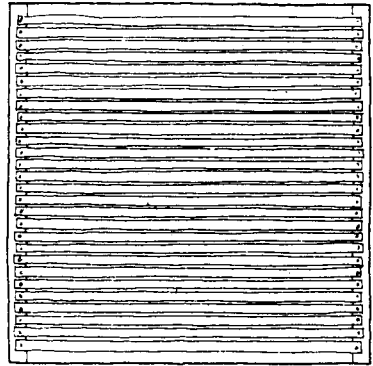

– a frame covered with thin slats,

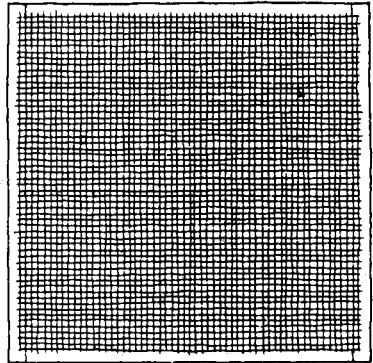

– a frame covered with wire-screening,

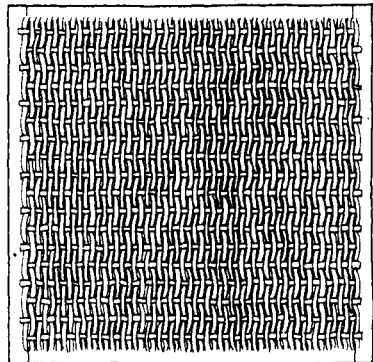

– a frame covered with wickerwork made from rattan or similar material.

### *Fixing*

The cover is fixed on to the chamber with clamps or bolts.

### *Control valves*

Control valves are installed in the feed and exit pipes of the purification chamber. These are used to disconnect the chamber from the gas flow while the absorbent is being exchanged.

### *Scavenging vent*

In addition, a scavenging vent is installed. It is used for flushing air out of the chamber

with new biogas after exchanging the absorbent and sealing the chamber.

### *Caution: Danger of fire and explosion*

When scavenging the chamber there is a danger of fire and explosion, due to the gas emerging from the scavenging vent. For this reason the vent exit should be installed high up and away from buildings. Open flames and smoking must be prohibited during all work on the purification chamber.

When scavenging is completed, that is, when two or three times the volume of the chamber has been vented, the valve to the user can be re-opened.

The  $H_2S$  content of the gas can also be checked via the scavenging vent even during plant operation (see Section 5).

## 9. Operation procedures for gas desulphurization

### *Filling*

Remove the cover of the purification chamber. Put in the bottom tray, which has spacers attached both below and above. Spread a layer of absorbent 20–30 cm thick over it. The absorbent at the edge of the tray is “piled up” against the wall of the chamber.

The material should not be pressed and should be uniformly distributed.

The second, intermediate tray is then placed on the spacers of the bottom one and covered with absorbent. Then the rest of the intermediate trays, which are covered in turn with absorbent, are placed in position.

### *Sealing*

Put the cover on the purification chamber together with the seal and screw it down tight.

### *Scavenging*

Open both the feed valve in front of the chamber and the scavenging vent valve. Leave the control valve to the user closed. Let a volume of gas equivalent to three times the chamber volume escape from the scavenging vent (caution — danger of fire and explosion!). Then close the scavenging vent and open the valve to the biogas user.

### *Emptying the chamber*

When the  $H_2S$  concentration of the purified biogas begins to rise, the absorbent should be exchanged. See Section 5 for the determination of the  $H_2S$  of the gas.

### *Exchanging the absorbent*

Close the control valves (feed and user valves) in front of and behind the purification chamber. Remove the cover of the chamber. Caution — danger of fire and explosion!

Remove the absorbent layer after layer from the chamber. In some cases the individual, intermediate trays can be removed together with the entire layer of absorbent.

Check the trays for damage and, if necessary, repair or replace them. Then the purification chamber can be refilled with fresh absorbent.

### *What to do with the spent absorbent?*

The sulphur-loaded absorbent can either be regenerated by exposure to the air (oxidation) or be discarded if there is an ample supply. See the next section for details.

### *Regeneration*

The absorbent is regenerated by spreading it on the ground in a thin layer and turning it over periodically. It is oxidized again within a few days and can be re-used.



After it has been utilized and regenerated several times the absorbent finally becomes inactive and must be discarded. Spent material highly concentrated with powdered sulphur reacts under certain conditions with the oxygen in the air, to form sulphur dioxide –  $\text{SO}_2$  – which irritates breathing passages and the eyes, as well as being harmful to the environment.

### *Self-ignition*

It is only seldom that the heat of reaction is sufficient to cause spontaneous combustion. The spent absorbent should however be disposed of in a way to avoid these problems.

### *Disposal of spent absorbent*

Discarded absorbent should thus be placed in pits and immediately covered with earth. When this is done the soil bacteria transform the sulphur and sulphides to relatively harmless sulphates.

It might also be possible to mix the used absorbent with the digested sludge. In this way the sulphur, which had been removed, could be fed back through the soil to the plants, thus completing the natural cycle. A decision can only be made after tests under local conditions.

### *Degree of desulphurization*

Since the desulphurization capacity drops with continued use, the efficiency is not constant during the service life of a charge of absorbent. As it becomes loaded with sulphur, that is as the sulphur concentration increases, the  $\text{H}_2\text{S}$  content of the purified gas

also increases. Nearly complete desulphurization can only be achieved when the absorbent is regularly exchanged and then discarded. The absorbent is not completely utilized with this procedure and the time interval between refillings is considerably shortened.

### *Two chambers in series*

Another way of producing a very low  $\text{H}_2\text{S}$  concentration is to use at least two purification chambers in series, that is one after the other.

The first serves as a coarse purification chamber while the second serves as a fine filter chamber. Even when the first chamber allows considerable amounts of  $\text{H}_2\text{S}$  to pass through, the second is capable of reliably binding the remainder. The resulting purified biogas is almost completely free from sulphur.

The absorbent is almost completely utilized. As soon as the first chamber is unable to remove  $\text{H}_2\text{S}$ , its absorbent is exchanged. This chamber is now used as the fine filtering chamber. The second chamber which was the fine chamber is now used as the first, coarse purification chamber. That is, the order of the gas flow has been reversed.

### *Temperature during desulphurization*

The temperature of the gas in the purification chamber should be held as constant as possible to prevent the absorbent from drying out or becoming moist. If necessary the purification chamber should be insulated. The chemical reactions in the purification process operate best at temperatures between  $15\text{--}25^\circ\text{C}$ . A higher temperature is better than too low a temperature.

## *Regeneration of the spent absorbent*



Take the intermediate trays with the used absorbent out of the chamber.



Throw the absorbent onto the ground.



Turn the absorbent over several times . . .



. . . and spread it out evenly on the ground.

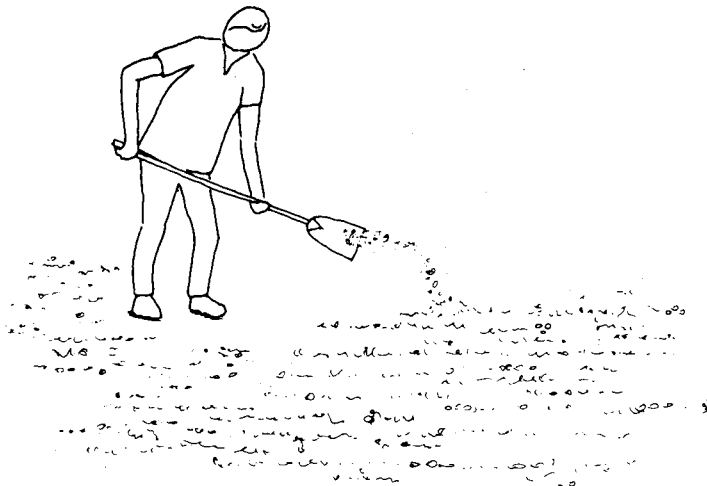

After a time turn the absorbent material over and spread it out again.

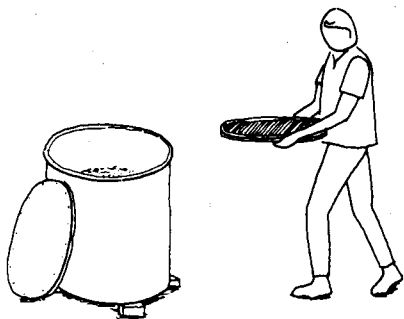

Put the intermediate trays back in the chamber.



Put the newly regenerated absorbent back in the chamber.

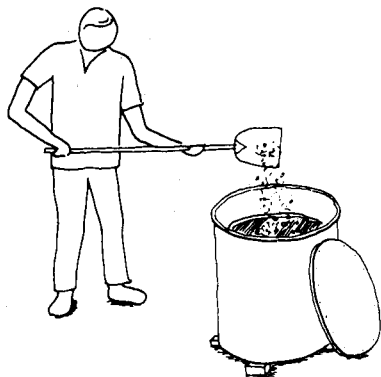

*Starting up the chamber after refilling with regenerated absorbent*

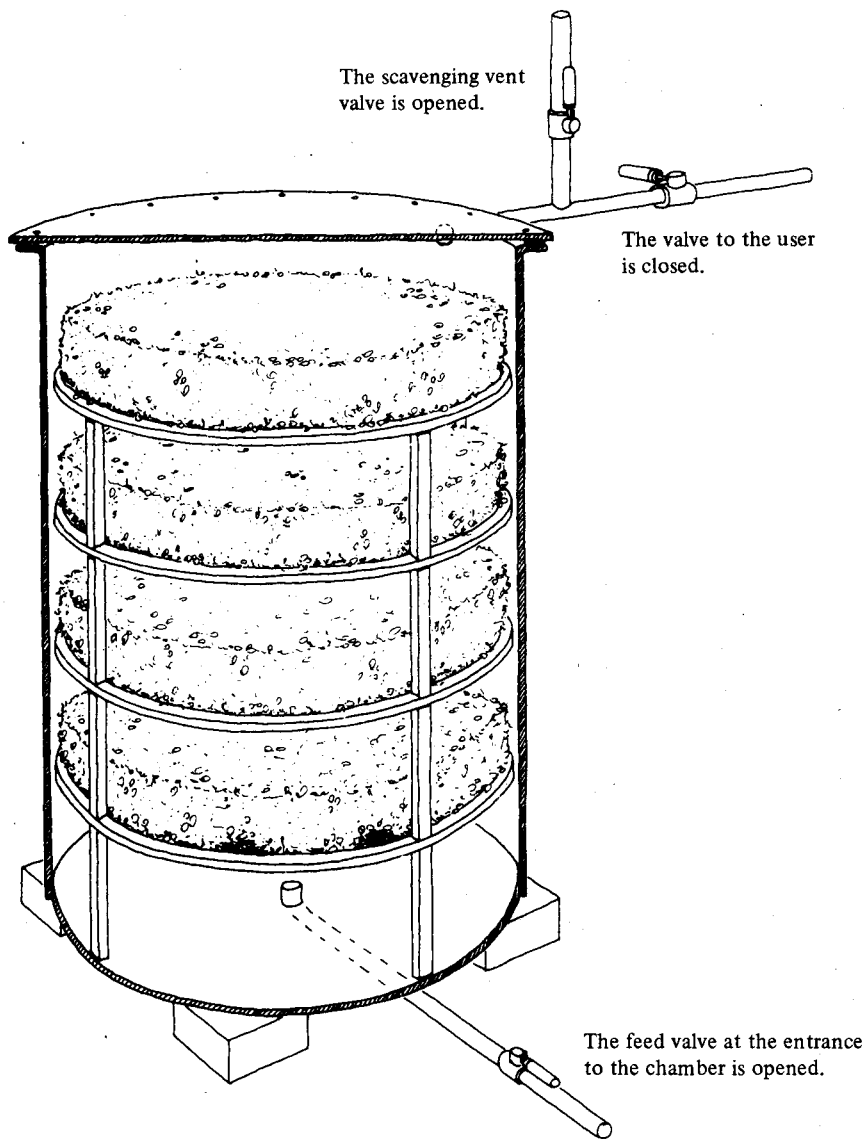

After about 15 minutes the  
scavenging vent valve is closed

and the valve to the user can  
be re-opened.

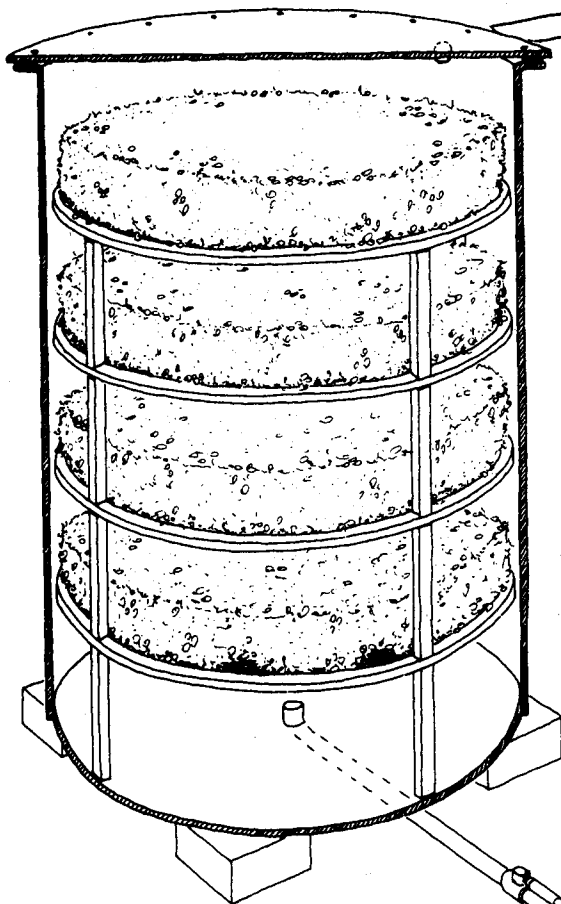

The feed valve stays open,  
of course.

## 10. Summary

Hydrogen sulphide is a natural component of biogas. Its concentration depends on the sulphur content of the raw material being digested and lies in the range 1,500 ppm–5,000 ppm or 0.15–0.5 vol. % or 2.1–7 g  $H_2S/m^3$ . Hydrogen sulphide is responsible for corrosion of various parts of the plant equipment.

The use of biogas in an internal combustion engine causes uncontrollable corrosion problems. Engine components are very susceptible to corrosion by  $H_2S$  and its reaction product  $SO_2$ .

The experience of various manufacturers and users, as well as the (older) literature indicate that with the sulphur concentrations mentioned, the service life of the engines can be reduced by up to 15% of their normal value. Not only are the resulting repair and maintenance costs increased but also the costs for service materials such as spark plugs and lubricating oils. Even with special oils the oil change interval drops up to one-fifth of that under normal conditions. The oil becomes acidic from sulphur dioxide and thus loses its lubricating properties.

Acidic exhaust gases corrode the exhaust systems very severely.

Desulphurizing biogas with acceptable investment and operating costs is only possible employing the dry desulphurization method. Iron-containing materials of specified compositions are utilized as absorbing agents for  $H_2S$ . Alongside the traditional, commercially available absorbents, certain substitutes can be used. Various tropical and subtropical

soils contain sufficient iron in a suitable form. They must be prepared, in order to obtain the proper purifying characteristics. The material must be loose, porous, moist and granular.

The raw soil has to be ground and mixed with a filler and water to obtain a homogeneous texture. The finished absorbent is placed on gas-permeable trays in a purification chamber. The raw biogas is fed in at the bottom and the desulphurized or partially desulphurized gas is extracted from the upper part of the chamber.

Eventually the absorbing agent is saturated with sulphur and can be regenerated either inside the chamber or outside through natural ventilation with air (oxygen). The absorbent material can, therefore, be re-used several times.

Using two or more purification chambers connected in series ensures a continual production of purified gas and allows a good capacity utilization.

The spent absorbent can be disposed of safely by burying it. Various factors must be considered when dimensioning the purification chambers. A certain maximum flow speed should not be exceeded. The gas volume to be purified per unit time determines the cross section of the purification chamber. The chamber volume and, hence, the amount of absorbent determine the operating time for the purification process up to regeneration or exchange of the absorbent. A calculation procedure simplifies the dimensioning of the desulphurization unit.

# Calculation method for dimensioning biogas desulphurization units

## 1. Calculation of the chamber cross section

$$\boxed{\phantom{0000}} \frac{\text{m}^3 \text{ gas/hour throughput} \times 1000 \times 1000}{3600} = \dots\dots\dots \text{cm}^3 \text{ gas/s throughput}$$

or

$$\boxed{\phantom{0000}} \text{m}^3 \text{ gs/hour throughput} \times 278 = \dots\dots\dots \text{cm}^3 \text{ gas/s throughput}$$

The *maximum flow rate* in the chamber is *0.5 cm/s*

The area of the section is then

$$\frac{\dots\dots\dots \text{cm}^3 \text{ gas/s throughput}}{0.5 \text{ cm/s flow speed}} = \dots\dots\dots \text{cm}^2 \text{ cross section of chamber}$$

$$\text{divided by } 10\,000 = \dots\dots\dots \text{m}^2 \text{ cross section}$$

Length of a chamber side with a square cross section:

$$\sqrt{\text{cross sectional area}} = \dots\dots\dots \text{cm or m side-length}$$

Radius of chamber for a circular cross section

$$\sqrt{\frac{\text{cross sectional area}}{\pi}} = \sqrt{\frac{\phantom{0000}}{3.14}} = \dots\dots\dots \text{cm or m radius}$$

## 2. Calculation of the height of the chamber

The height and the cross sectional area of the chamber determine its volume. The volume determines the amount of absorbent that can be put into the unit. The amount in turn determines the operating time of the chamber between absorbent exchanges.

Reference values for the amount of sulphur bound in the absorbent:

without regeneration ca. 15 g sulphur/kg absorbent

with regeneration ca. 150 g sulphur/kg absorbent

The actual values depend on the absorbent used.

m<sup>3</sup> biogas per day throughout

g H<sub>2</sub>S/m<sup>3</sup> biogas (measured) or 3 g H<sub>2</sub>S/m<sup>3</sup> estimate

Number of operating days desired between absorbent exchange or regeneration

..... m<sup>3</sup> gas per day throughout × ..... g H<sub>2</sub>S/m<sup>3</sup> gas × ..... operating days =  
..... g H<sub>2</sub>S/operating period

..... g H<sub>2</sub>S/operating period  
..... g H<sub>2</sub>S/kg absorbent = ..... kg absorbent/operating period until  
exchange or external regeneration

Bulk density of the absorbent

..... kg/l (measured) or estimated at 0.8 kg/l

..... kg absorbent/operating period  
..... kg/l (bulk density) = ..... liter absorbent/  
operating period

Addition for dead volume (base, head and intermediate trays): 25%

Chamber volume

..... l absorbent

+ ..... l dead volume addition

..... l chamber volume or divided by 1,000 = ..... m<sup>3</sup>

Chamber height

chamber volume = ..... m<sup>3</sup>  
cross section ..... m<sup>2</sup> = ..... m chamber height

3. Number of intermediate trays

height of chamber (m) = ..... m  
0.25 m layer depth/tray 0.25 m = ..... trays

However, there should be at least 3–4 intermediate trays.

When two or more purification chambers are connected in series, they should all have the same cross section.



# Example

## Calculation method for dimensioning biogas desulphurization units

### 1. Calculation of the chamber cross section

$$\boxed{1,25} \frac{\text{m}^3 \text{ gas/hour throughput} \times 1000 \times 1000}{3600} = 347,5 \text{ cm}^3 \text{ gas/s throughput}$$

or

$$\boxed{1,25} \text{ m}^3 \text{ gs/hour throughput} \times 278 = 347,5 \text{ cm}^3 \text{ gas/s throughput}$$

The *maximum flow rate* in the chamber is 0.5 cm/s

The area of the section is then

$$\frac{347,5 \text{ cm}^3 \text{ gas/s throughput}}{0.5 \text{ cm/s flow speed}} = 695 \text{ cm}^2 \text{ cross section of chamber}$$

$$\text{divided by } 10\,000 = 0,0695 \text{ m}^2 \text{ cross section}$$

Length of a chamber side with a square cross section:

$$\sqrt{\text{cross sectional area}} = 26,4 \text{ cm or } \phi \text{ side-length}$$

Radius of chamber for a circular cross section

$$\sqrt{\frac{\text{cross sectional area}}{\pi}} = \sqrt{\frac{695 \text{ cm}^2}{3.14}} = 14,9 \text{ cm or } \phi \text{ radius}$$

### 2. Calculation of the height of the chamber

The height and the cross sectional area of the chamber determine its volume. The volume determines the amount of absorbent that can be put into the unit. The amount in turn determines the operating time of the chamber between absorbent exchanges.

Reference values for the amount of sulphur bound in the absorbent:

without regeneration ca. 15 g sulphur/kg absorbent

with regeneration ca. 150 g sulphur/kg absorbent

The actual values depend on the absorbent used.

**30**m<sup>3</sup> biogas per day throughout**3,5**g H<sub>2</sub>S/m<sup>3</sup> biogas (measured) or 3 g H<sub>2</sub>S/m<sup>3</sup> estimate**60**

Number of operating days desired between absorbent exchange or regeneration

... **30** ... m<sup>3</sup> gas per day throughput × **3,4** ... g H<sub>2</sub>S/m<sup>3</sup> gas × **60** ... operating days =

**6300** g H<sub>2</sub>S/operating period

**6300** g H<sub>2</sub>S/operating period = **42** kg absorbent/operating period until exchange or external regeneration

**150** g H<sub>2</sub>S/kg absorbent

Bulk density of the absorbent

... **0,8** ... kg/l (measured) or estimated at 0.8 kg/l

... **42** ... kg absorbent/operating period = **52,5** liter absorbent/operating period

... **0,8** ... kg/l (bulk density)

Addition for dead volume (base, head and intermediate trays): 25%

Chamber volume

**52,5** l absorbent

+ **13,1** l dead volume addition

... **65,6** l chamber volume or divided by 1,000 = **0,066** m<sup>3</sup>

Chamber height

chamber volume =  $\frac{0,066 \text{ m}^3}{0,0695 \text{ m}^2} = 0,95$  m chamber height

3. Number of intermediate trays

height of chamber (m) =  $\frac{0,95 \text{ m}}{0,25 \text{ m}} = 4$  trays

However, there should be at least 3–4 intermediate trays.

When two or more purification chambers are connected in series, they should all have the same cross section.