

AT MICROFICHE
REFERENCE
LIBRARY

A project of Volunteers in Asia

Basic Sewing Machine Repair

by: K. Kiri and S. Kalmakoff

Published by:

South Pacific Appropriate Technology
Foundation
P.O. Box 6937
Boroko
National Capitol District
Papua New Guinea

Paper copies are \$2.30 in the South Pacific area;
\$3.50 in Asia, Africa and Latin America; and \$5.00
in Australia, Europe and North America.

Available from:

South Pacific Appropriate Technology
Foundation
P.O. Box 6937
Boroko
National Capitol District
Papua New Guinea

Reproduced by permission of the South Pacific
Appropriate Technology Foundation.

Reproduction of this microfiche document in any
form is subject to the same restrictions as those
of the original document.

BASIC SEWING MACHINE REPAIR

MARCH 1979

SOUTH PACIFIC
APPROPRIATE TECHNOLOGY
FOUNDATION

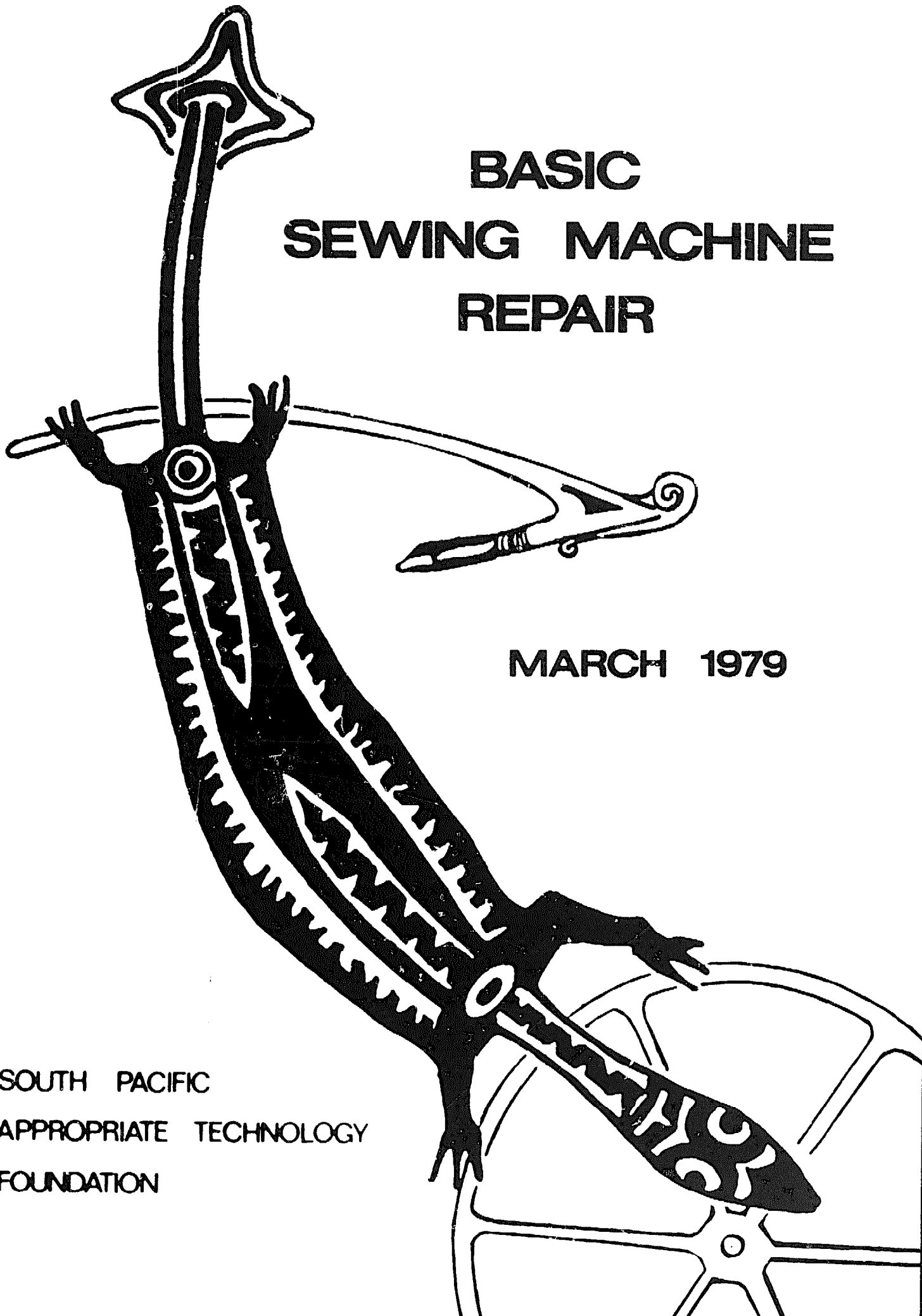

**THE PRINTING OF THIS BOOKLET WAS FUNDED BY GRANTS FROM THE
PRIME MINISTER'S DEPARTMENT OF THE PAPUA NEW GUINEA GOVERNMENT,
THE GOVERNMENT OF NEW ZEALAND AND THE OVERSEAS BOOK CENTRE
OF CANADA.**

**FOR MORE INFORMATION ON THIS AND OTHER SPATF PUBLICATIONS,
WRITE TO:**

**SOUTH PACIFIC APPROPRIATE TECHNOLOGY FOUNDATION
P.O. BOX 6937
BOROKO
PAPUA NEW GUINEA**

**BASIC
SEWING MACHINE
REPAIR**

K. KIRI
S. KALMAKOFF

MARCH 1979

PUBLISHED BY
THE SOUTH PACIFIC APPROPRIATE TECHNOLOGY FOUNDATION (SPATF)

THANKS

SPATF WISHES TO THANK MR. SILI WAKUS OF MADANG TECHNICAL COLLEGE, AND MS. PATRICIA SANGWINE FOR THEIR HELP IN THE PREPARATION OF THIS BOOK.

MANY OF THE DRAWINGS IN THIS BOOK HAVE BEEN ADAPTED FROM INSTRUCTION AND SERVICE MANUALS OF THE SINGER COMPANY, AND THE JANOME SEWING MACHINE COMPANY, LTD. SPATF GRATEFULLY ACKNOWLEDGES THIS ASSISTANCE.

SPATF ALSO WISHED TO THANK THE OVERSEAS BOOK CENTRE, OF CANADA, AND THE GOVERNMENT OF NEW ZEALAND FOR GRANTING FUNDS TO COVER THE COST OF PRINTING THIS BOOK.

FOR MORE INFORMATION ON THIS AND OTHER SPATF PUBLICATIONS,
WRITE TO:

SOUTH PACIFIC APPROPRIATE TECHNOLOGY FOUNDATION
P.O. BOX 6937
BOROKO
PAPUA NEW GUINEA.

CONTENTS

	PAGE
SEWING MACHINE PARTS	4-5
COMMON SEWING MACHINE FAULTS (CHART)	6-9
THE RIGHT WAY TO...	11
TAKING CARE OF THE MACHINE	18
REPAIRING FAULTS	23
DIFFERENCES IN MACHINES	59
TO GET PARTS AND ADVICE	63

SEWING MACHINE PARTS

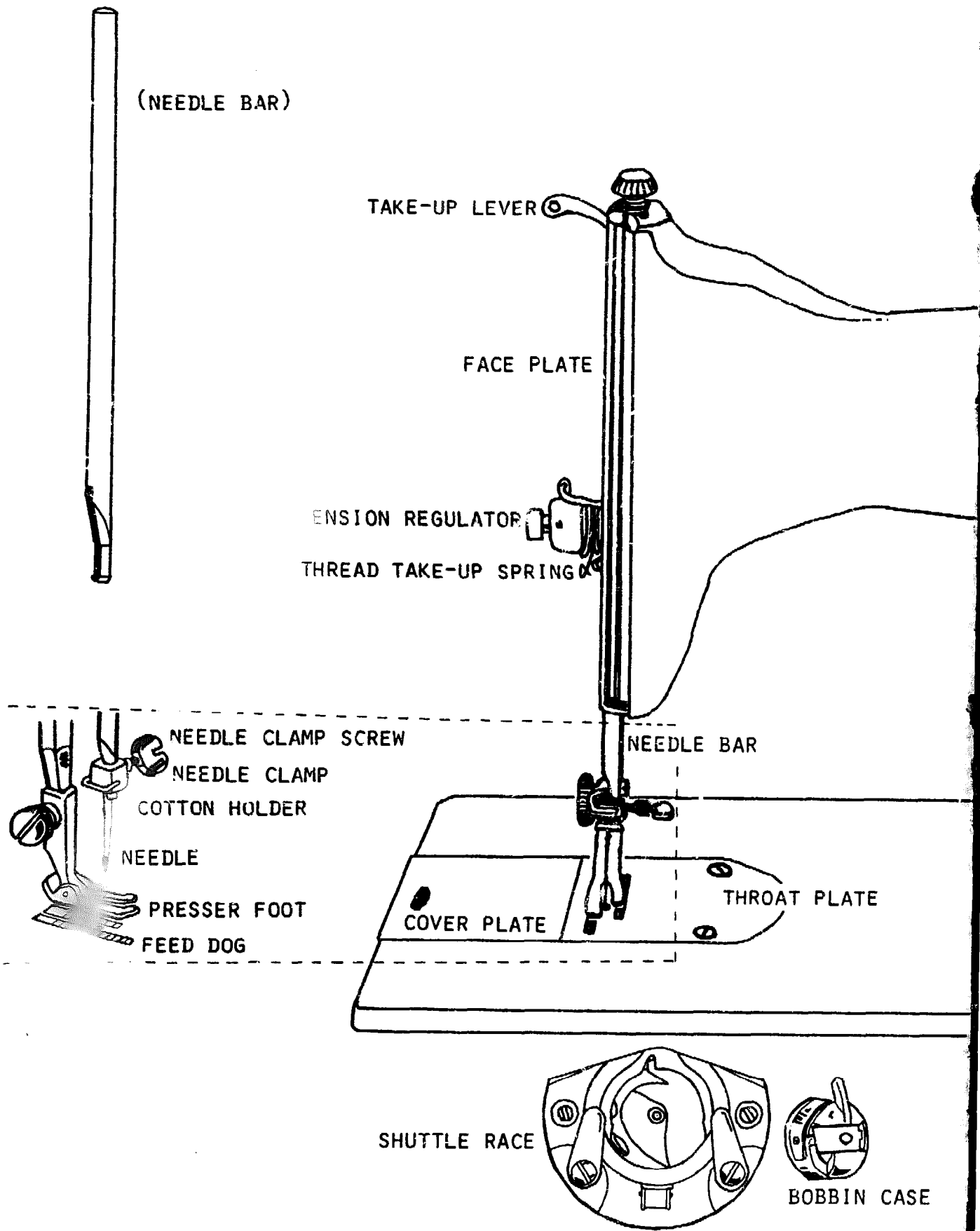

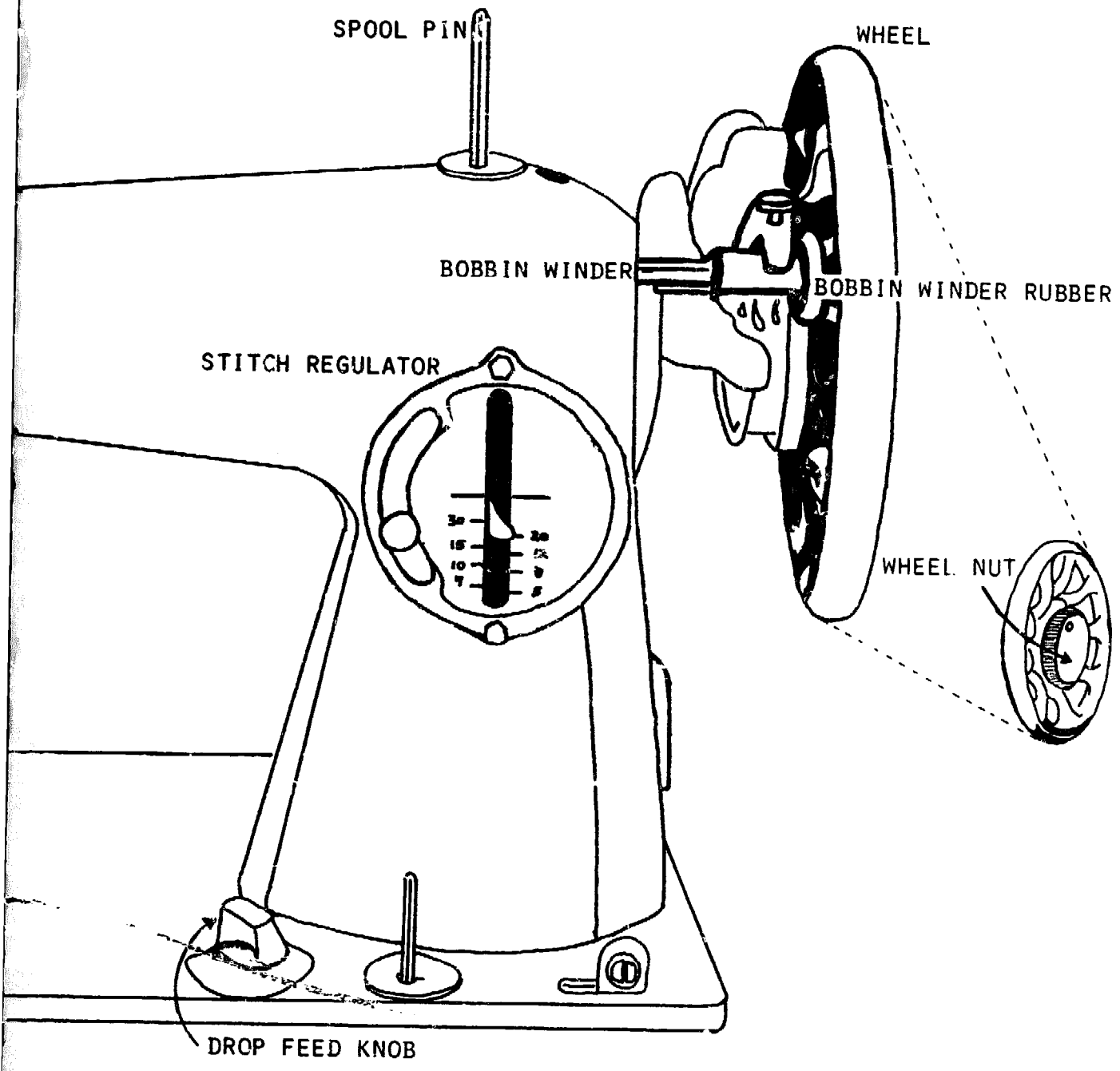

COMMON SEWING MACHINE FAULTS

THE CHART ON THE NEXT PAGES LISTS THE MOST COMMON PROBLEMS OF SEWING MACHINES, SHOWING WHAT GOES WRONG MOST OFTEN. BESIDE EACH PROBLEM, A NUMBER OF POSSIBLE CAUSES OR REASONS FOR IT ARE GIVEN. BESIDE EACH CAUSE THERE IS A SOLUTION (WHAT TO DO).

IF YOUR MACHINE HAS ONE OF THESE FAULTS, TRY EACH OF THE SOLUTIONS GIVEN IN TURN. THE SOLUTIONS ARE DESCRIBED ON OTHER PAGES IN THIS BOOK.

COMMON SEWING MACHINE FAULTS AND HOW TO FIX THEM

PROBLEM	POSSIBLE CAUSE	WHAT TO DO	SEE PAGE
THE UPPER THREAD BREAKS (NEEDLE THREAD)	A) THE MACHINE IS NOT THREADED IN THE RIGHT WAY	THREAD THE MACHINE IN THE RIGHT WAY	11
	B) THE TENSION OF THE UPPER THREAD IS TOO TIGHT	LOOSEN THE TENSION OF THE UPPER THREAD	15
	C) THE NEEDLE IS BENT OR DULL	PUT IN A NEW NEEDLE	14
	D) THE COTTON IS TOO THICK FOR THE SIZE OF THE NEEDLE	USE THINNER COTTON	--
	E) THE UPPER THREAD IS NOT THE SAME SIZE AS THE LOWER THREAD	USE THE SAME SIZE OF SEWING COTTON FOR BOTH THE UPPER AND THE LOWER THREAD	17
	F) THE THREAD TAKE-UP SPRING IS BROKEN	PUT IN A NEW THREAD TAKE-UP SPRING	26
THE LOWER THREAD BREAKS (BOBBIN THREAD)	A) THE TENSION OF THE LOWER THREAD IS TOO TIGHT	LOOSEN THE TENSION OF THE LOWER THREAD	15
	B) DIRT, DUST OR SMALL THREADS ARE IN THE BOBBIN CASE	CLEAN THE BOBBIN CASE	18

PROBLEM	POSSIBLE CAUSE	WHAT TO DO	SEE PAGE
COTTON GETS CAUGHT UNDER THE THROAT PLATE	THE TENSION OF THE UPPER THREAD IS TOO LOOSE	TIGHTEN THE TENSION OF THE UPPER THREAD	15
THE CLOTH PUCKERS OR DOES NOT LIE FLAT	A) THE TENSIONS ARE WRONG	CHANGE THE TENSIONS	15
	B) THE BOBBIN CASE IS NOT THREADED IN THE RIGHT WAY	THREAD THE BOBBIN CASE AGAIN	12
	C) THE NEEDLE IS NOT THREADED IN THE RIGHT WAY	THREAD THE NEEDLE AGAIN	--
THE UPPER THREAD HAS NO TENSION	A) THE TENSION REGULATOR IS NOT WORKING	FIX THE TENSION REGULATOR	37
	B) THE PIN IN THE TENSION REGULATOR IS WORN OUT OR BROKEN	PUT A NEW PIN IN THE TENSION REGULATOR	31
THE TENSION REGULATOR DOES NOT WORK PROPERLY, THAT IS, THE TENSION OF THE UPPER THREAD IS TOO LOOSE OR TOO TIGHT	THE TENSION REGULATOR GOT MOVED WHEN THE PIN OR SPRING WAS BEING CHANGED	FIX THE TENSION REGULATOR	37
THE NEEDLE BREAKS	A) THE PERSON SEWING WAS PULLING THE CLOTH	DO NOT PULL THE CLOTH WHEN SEWING -- GUIDE IT GENTLY	--

	B) THE NEEDLE IS BENT	PUT IN A NEW NEEDLE	14
	C) THE NEEDLE TIMING IS WRONG (THE NEEDLE COMES DOWN AT THE WRONG TIME)	FIX THE NEEDLE TIMING	40
THE STITCHES ARE UNEVEN	THE STITCH REGULATOR IS NOT WORKING PROPERLY	FIX THE STITCH REGULATOR	23
THE CLOTH DOES NOT MOVE ACROSS THE MACHINE PROPERLY (IT DOES NOT "FEED" THROUGH)	A) THE HEIGHT OF THE FEED DOG IS WRONG	CHANGE THE HEIGHT OF THE FEED DOG	52
	B) THE FEED TIMING IS WRONG	THIS IS DIFFICULT TO FIX, IF POSSIBLE, ASK A SEWING MACHINE MECHANIC FOR HELP	55
THE NEEDLE WON'T MOVE UP AND DOWN	A) THE WHEEL NUT IS LOOSE	TIGHTEN THE WHEEL NUT	57
	B) THE NEEDLE BAR HAS WORN OUT AND BROKEN, OR IS BENT	PUT IN A NEW NEEDLE BAR	46
THE BOBBIN WINDER DOES NOT STAY DOWN	A) THE BOBBIN WINDER SCREW HAS COME LOOSE	TIGHTEN THE BOBBIN WINDER SCREW	56
	B) THE RUBBER IS WORN	PUT IN A NEW RUBBER	58

THE RIGHT WAY TO...

TO KEEP YOUR SEWING MACHINE RUNNING WELL, YOU MUST WORK WITH IT IN THE RIGHT WAY. IF YOU FOLLOW THESE STEPS WHEN YOU ARE USING THE MACHINE, IT WILL NOT GO WRONG SO EASILY.

NOTE: THESE ARE NOT COMPLETE INSTRUCTIONS ON HOW TO USE THE MACHINE, BUT STEPS TO TAKE CARE WITH.

THREAD THE MACHINE

1. TURN THE WHEEL TOWARDS YOU TO RAISE THE TAKE-UP LEVER AS HIGH AS IT WILL GO.
2. PUT A SPOOL OF SEWING COTTON ON THE SPOOL PIN.
3. THREAD THE MACHINE LIKE THIS:

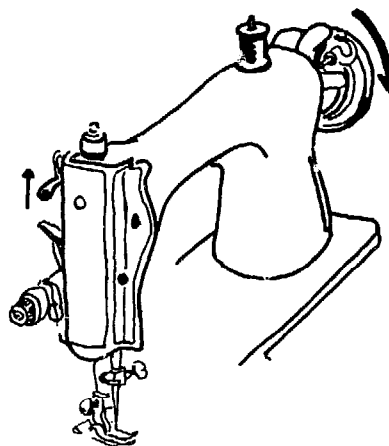

SOME MACHINES

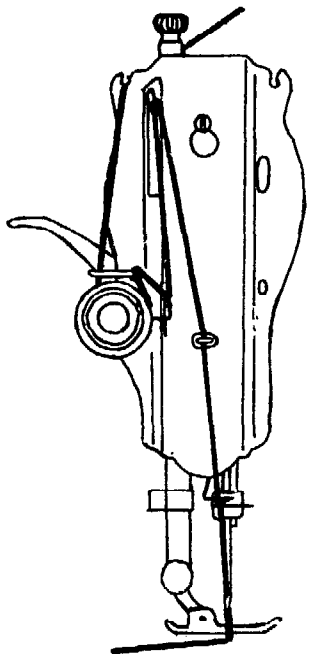

OTHER MACHINES

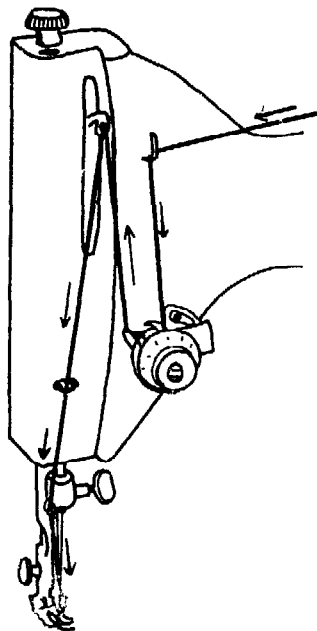

4. MAKE SURE THE COTTON GOES AROUND THE TENSION REGULATOR LIKE THIS:

SOME MACHINES

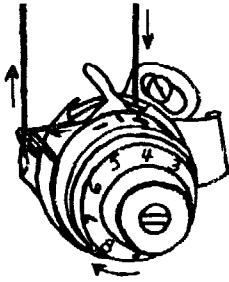

OTHER MACHINES

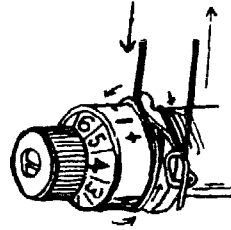

OTHER MACHINES

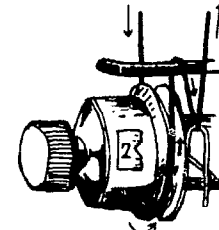

TAKE OUT THE BOBBIN CASE

1. SLOWLY TURN THE WHEEL TOWARDS YOU UNTIL THE NEEDLE IS AS HIGH AS IT WILL GO.
 2. OPEN THE COVER PLATE.
 3. USE TWO FINGERS TO PULL THE LATCH OF THE BOBBIN CASE. PULL THE BOBBIN CASE OUT OF THE MACHINE.
- WHEN YOU LET GO OF THE LATCH, THE BOBBIN WILL DROP OUT.

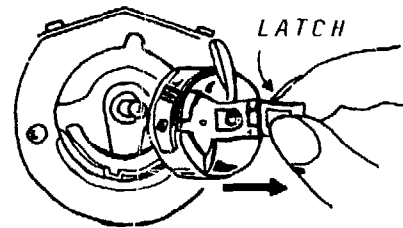
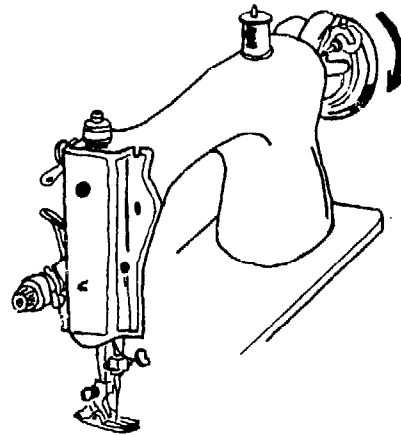

THREAD THE BOBBIN CASE

1. MAKE SURE THERE IS ENOUGH COTTON ON THE BOBBIN.
2. HOLD THE BOBBIN CASE IN ONE HAND, USE YOUR OTHER HAND TO PUT THE BOBBIN INTO IT. PUT THE BOBBIN IN WITH THE LOOSE END OF COTTON HANGING DOWN IN FRONT (FACING YOU).

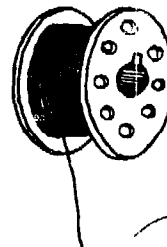

3. PULL THE THREAD INTO THE SLOT
IN THE EDGE OF THE BOBBIN CASE.

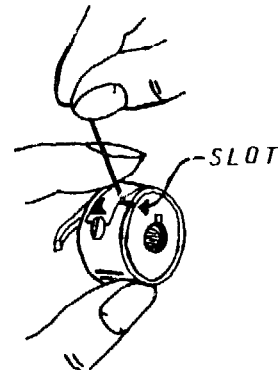

4. PULL THE THREAD UNDER
THE TENSION SPRING AND
INTO THE SMALL HOLE ON
THE SIDE OF THE BOBBIN
CASE.

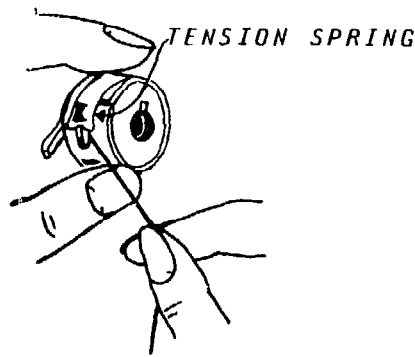

5. PULL THE LATCH, AND KEEP IT OPEN
SO THE BOBBIN WILL NOT FALL OUT.

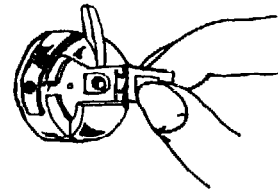

PUT BACK THE BOBBIN CASE

1. HOLD THE BOBBIN CASE BY THE LATCH.

PUT IT IN PLACE, HOLDING IT UP THIS WAY:

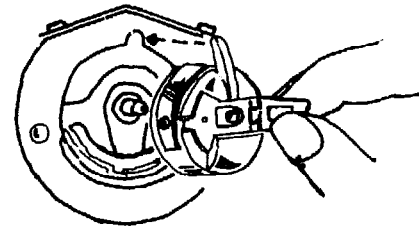

2. LET GO OF THE LATCH, AND PRESS
THE BOBBIN CASE IN, UNTIL YOU
HEAR A SMALL 'CLICK'. THIS
MEANS THE BOBBIN CASE WILL
STAY IN PLACE.

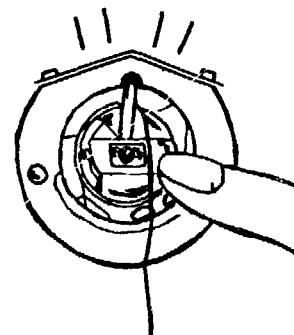

PUT IN THE NEEDLE

1. SLOWLY TURN THE WHEEL TOWARDS YOU UNTIL THE NEEDLE BAR IS AS HIGH AS IT WILL GO.

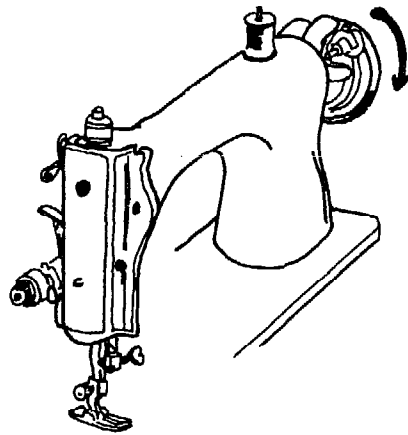

2. LOOSEN THE NEEDLE CLAMP SCREW.

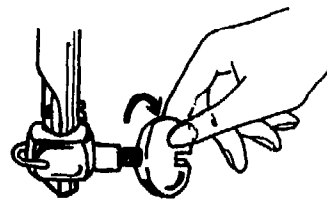

3. HOLD THE NEEDLE WITH THE THICK END TURN IT SO THE FLAT SIDE IS FACING TO THE RIGHT.

NOTE: ON A FEW MACHINES, THE FLAT SIDE OF THE NEEDLE MUST FACE TO THE BACK, SEE PAGE 61.



4. PUT THE NEEDLE INTO THE HOLE AT THE BOTTOM OF THE NEEDLE BAR. PUT IT IN AS FAR AS IT WILL GO.

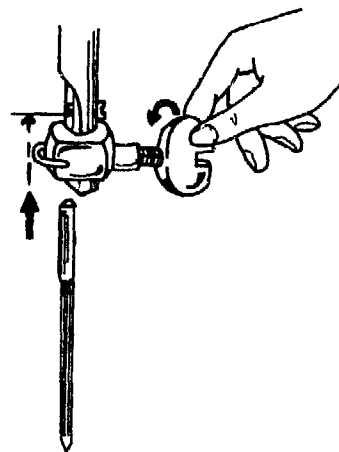

5. TIGHTEN THE NEEDLE CLAMP SCREW.

CHANGE THE THREAD TENSIONS

1. THE TENSION OF THE UPPER THREAD SHOULD BE THE SAME AS THE TENSION OF THE LOWER THREAD.

BOTH THREADS SHOULD FASTEN TOGETHER IN THE CENTRE OF THE SEWN CLOTH,

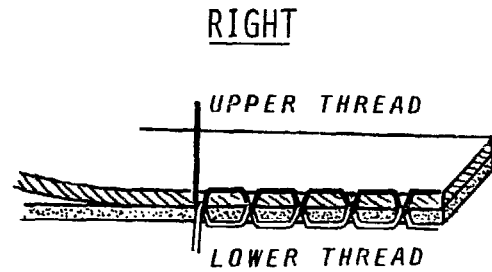

WHEN BOTH TENSIONS ARE RIGHT, THE STITCHES ON BOTH SIDES OF THE SEWN CLOTH ARE THE SAME SIZE,

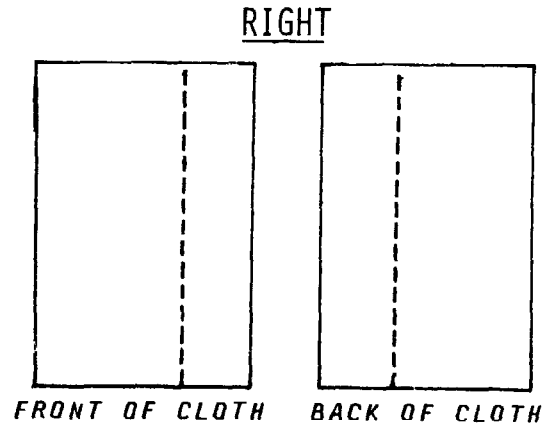

TO GET THE RIGHT TENSIONS, YOU MUST:

- I) BE SURE THE PRESSER FOOT IS DOWN WHEN YOU SEW
- II) USE THE SAME COTTON FOR BOTH THE UPPER THREAD AND THE LOWER THREAD.

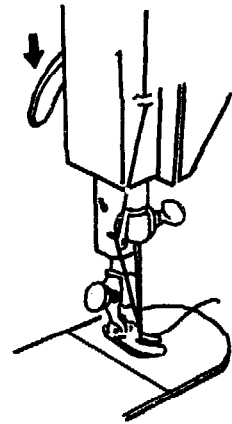

NOTE: THE THICKNESS OF THE CLOTH YOU ARE SEWING MAY AFFECT THE TENSIONS. YOU WILL THEN NEED TO CHANGE THE THREAD TENSIONS, AS SHOWN BELOW.

2. WHEN THE TENSION OF THE UPPER THREAD IS TOO TIGHT,

OR

WHEN THE TENSION OF THE LOWER THREAD IS TOO LOOSE,

THE SEWING LOOKS LIKE THIS:

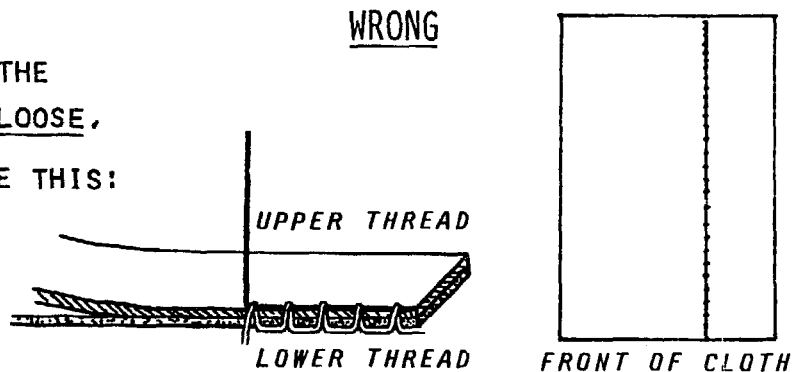

TO MAKE THE TENSION OF THE UPPER THREAD LOOSER, TURN THE TENSION REGULATOR SO A LOWER NUMBER IS ON TOP, (IF THE TENSION REGULATOR IS ON THE SIDE OF THE MACHINE, TURN IT BACKWARDS OR AWAY FROM YOU, IF IT IS ON THE FRONT, TURN IT TO THE LEFT.)

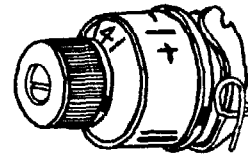
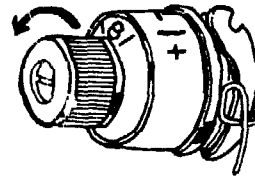

TO MAKE THE TENSION OF THE LOWER THREAD TIGHTER:

TAKE OUT THE BOBBIN CASE, FIND THE SMALL SCREW, USE A SMALL SCREWDRIVER TO TIGHTEN THE SCREW.

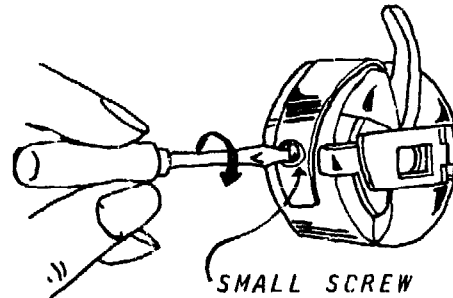

3. WHEN THE TENSION OF THE UPPER THREAD IS TOO LOOSE,

OR

WHEN THE TENSION OF THE LOWER THREAD IS TOO TIGHT,

THE SEWING LOOKS LIKE THIS:

WRONG

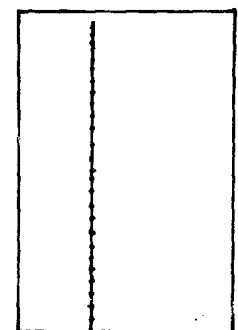
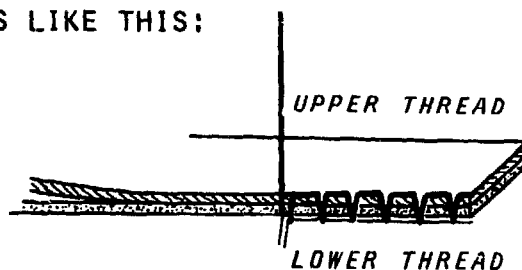

BACK OF CLOTH

TO MAKE THE TENSION OF THE UPPER THREAD TIGHTER, TURN THE TENSION REGULATOR SO A HIGHER NUMBER IS ON TOP, (IF THE TENSION REGULATOR IS ON THE SIDE OF THE MACHINE, TURN IT FORWARD OR TOWARDS YOU, IF IT IS ON THE FRONT, TURN IT TO THE RIGHT.)

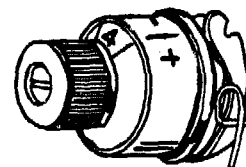
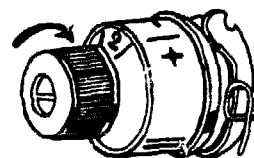

TO MAKE THE TENSION OF
THE LOWER THREAD LOOSER:

TAKE OUT THE BOBBIN CASE,
FIND THE SMALL SCREW,
USE A SMALL SCREWDRIVER
TO LOOSEN THE SCREW.

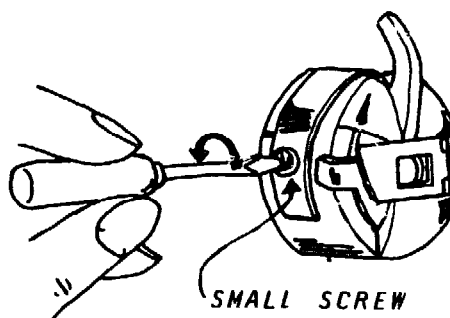

USE THE RIGHT NEEDLE

YOUR SEWING WILL LOOK BETTER AND YOUR MACHINE WILL
WORK BETTER IF YOU USE THE RIGHT SIZE OF NEEDLE.
THIS CHART SHOWS WHICH NEEDLE TO USE WITH DIFFERENT
KINDS OF CLOTH.

KIND OF CLOTH	SIZE OF NEEDLE	
VERY THIN, SOFT CLOTH	11	
ORDINARY CLOTH	14	
THICK, HEAVY CLOTH	16	

THE THREAD TENSIONS MAY NEED TO BE CHANGED
WHEN YOU SEW WITH A DIFFERENT KIND OF CLOTH.

TO CHANGE THE TENSIONS, SEE PAGE 15.

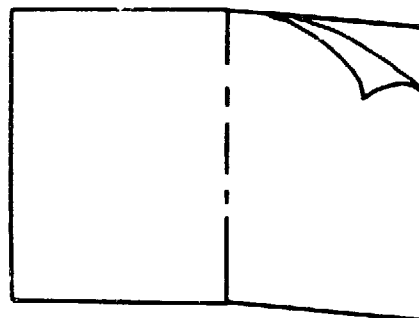

SEE PAGE 15

NOTE: ALWAYS USE THE SAME KIND OF SEWING COTTON
FOR BOTH THE UPPER THREAD AND THE LOWER THREAD.

TAKING CARE OF THE MACHINE

TO KEEP YOUR MACHINE RUNNING WELL, CLEAN IT AND OIL IT AFTER YOU HAVE DONE A LOT OF SEWING, AND OIL IT ONCE MORE BEFORE YOU START SEWING AGAIN.

BE ESPECIALLY CAREFUL TO CLEAN THE FEED DOG AND THE SHUTTLE RACE OFTEN.

TO CLEAN THE MACHINE

TO CLEAN THE MACHINE,
OR ANY PARTS,
DO NOT USE WATER.

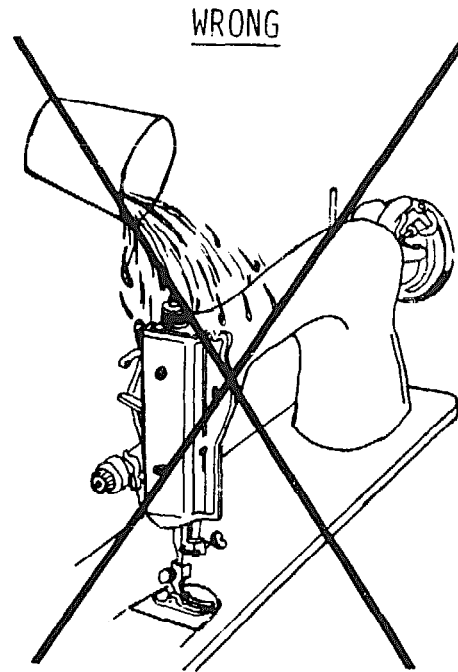

USE KEROSENE

RIGHT



1. SOAK A CLOTH IN KEROSENE.

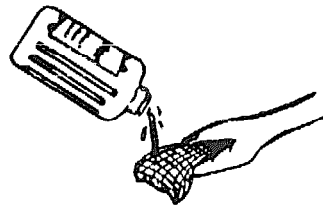

2. USE A CLOTH TO CLEAN ALL PARTS OF THE MACHINE AND MAKE THEM SHINY.

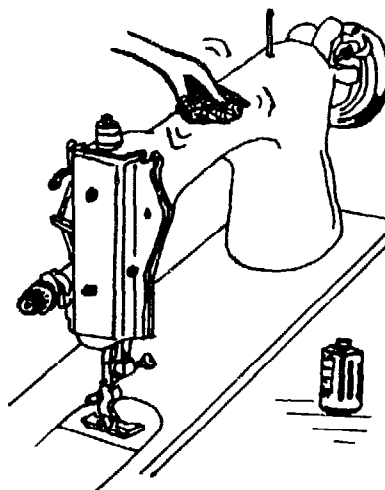

3. WIPE AWAY THE KEROSENE WITH A CLEAN CLOTH.

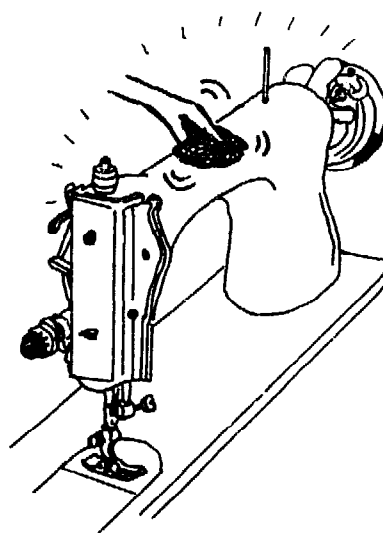

TO OIL THE MACHINE

DO NOT LET THE OIL ON THE MOVING PARTS GET DRY.
THIS OIL MAKES THE MACHINE RUN SMOOTHLY, AND STOPS IT FROM RUSTING.

1. OIL THE MACHINE AT ALL THE PLACES SHOWN BY ARROWS,
OR AT ALL THE SMALL HOLES.

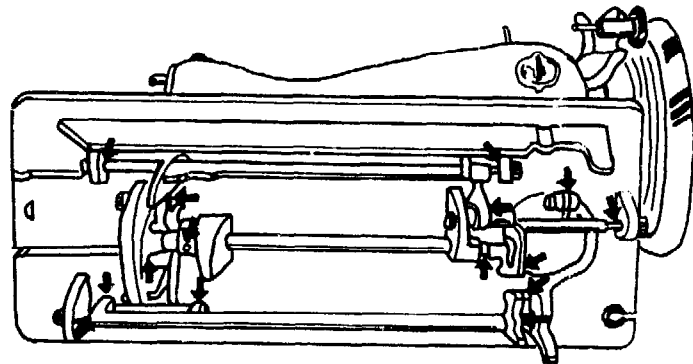
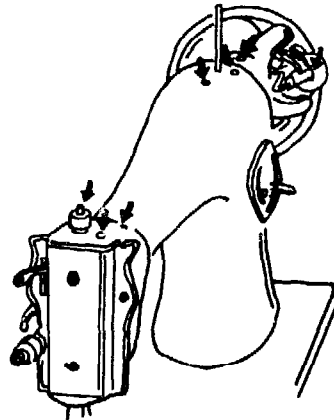
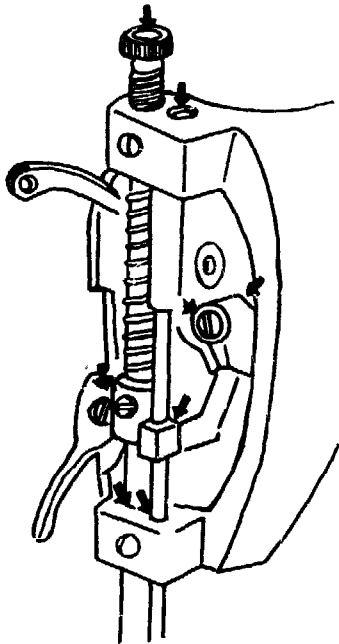

USE SEWING MACHINE OIL.
DO NOT USE ANY OTHER KIND OF OIL.

PUT ONLY ONE OR TWO DROPS OF OIL
AT EACH HOLE. TOO MUCH OIL WILL
GET ON THE SEWING.

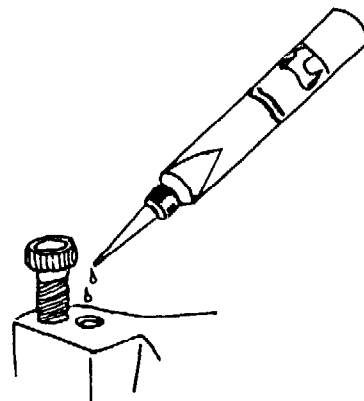

2. WHEN YOU HAVE PUT OIL IN ALL THE HOLES, TAKE OUT THE NEEDLE, AND RUN THE MACHINE VERY FAST FOR A FEW MINUTES SO THE OIL WILL SPREAD TO ALL THE PLACES IT IS NEEDED.

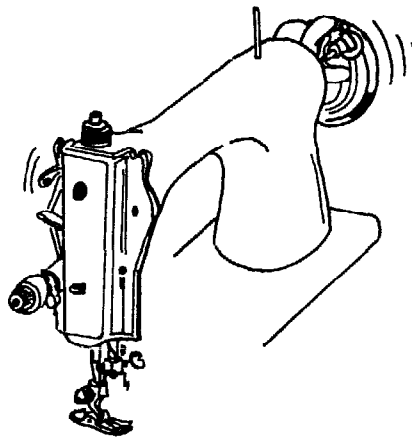

IMPORTANT: WHEN YOU ARE OILING THE MACHINE, DO NOT LOOSEN ANY OF THE SCREWS UNDERNEATH THE MACHINE.

TO CLEAN THE FEED DOG

1. TAKE OFF THE NEEDLE.

TAKE OFF THE THROAT PLATE.

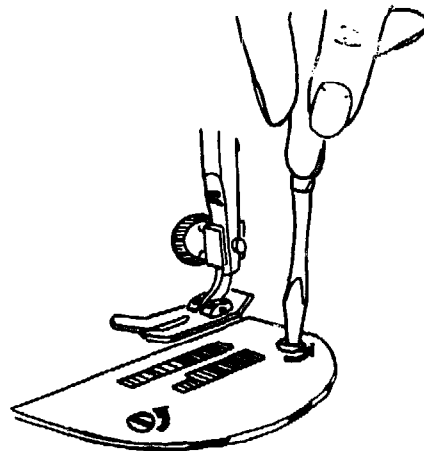

2. USE A SMALL BRUSH TO CLEAN AWAY DIRT, DUST AND SMALL THREADS FROM THE FEED DOG.

OR

CLEAN IT WITH A CLOTH AND KEROSENE.

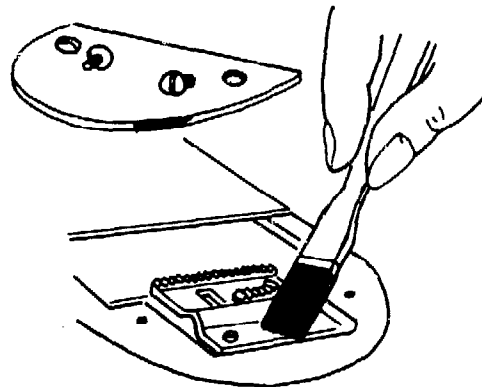

3. PUT BACK THE THROAT PLATE AND THE NEEDLE.

TO CLEAN THE SHUTTLE RACE

1. TAKE OFF THE NEEDLE.

TURN THE WHEEL TOWARDS YOU
TO MOVE THE NEEDLE BAR AS
HIGH AS IT WILL GO.

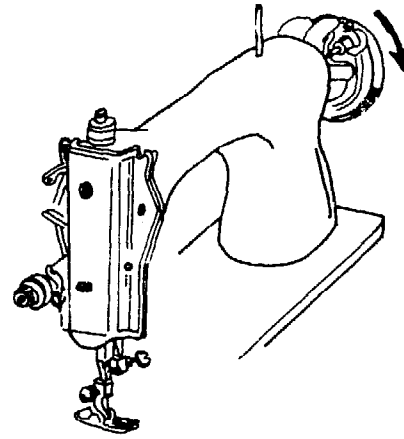

2. TIP BACK THE MACHINE.

3. TAKE OUT THE BOBBIN CASE.

4. MOVE THE SHUTTLE RACE RING.

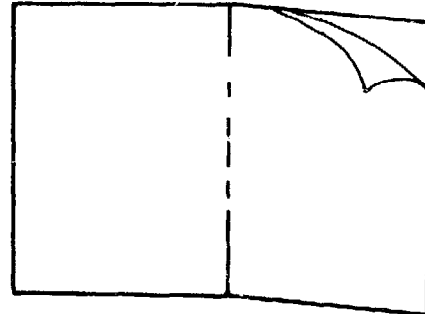

SEE PAGE 40, STEPS 1, 2, 3.

5. TAKE OUT THE SHUTTLE HOOK.

CLEAN IT WITH A CLOTH AND
KEROSENE, OR A SMALL BRUSH.

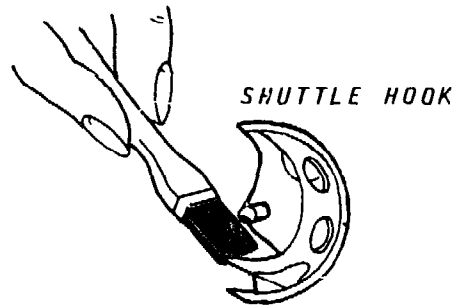

SHUTTLE HOOK

6. CLEAN THE OTHER PARTS
OF THE SHUTTLE RACE.

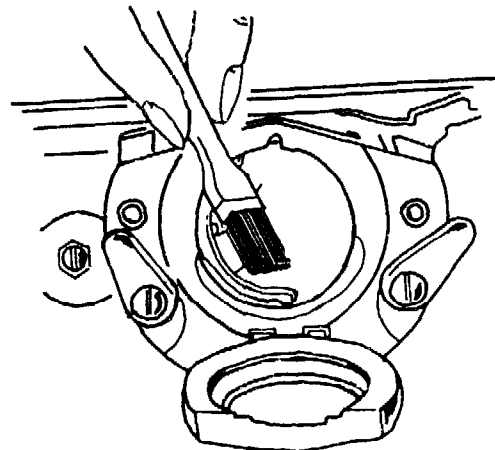

7. PUT BACK THE SHUTTLE HOOK.

PUT BACK THE SHUTTLE RACE RING,

PUT BACK THE BOBBIN CASE AND THE NEEDLE.

REPAIRING FAULTS

NOTE: DO NOT FORCE SCREWS
THAT WILL NOT LOOSEN
OR YOU MAY DAMAGE THEM.

INSTEAD, HOLD THE SCREWDRIVER
AGAINST THE SCREW, AND GENTLY
KNOCK THE TOP OF THE SCREW-
DRIVER A FEW TIMES WITH A
HAMMER OR SOMETHING HARD,
THIS SHOULD STOP THE SCREW
FROM STICKING.

THEN TRY TO LOOSEN THE SCREW
WITH THE SCREWDRIVER.

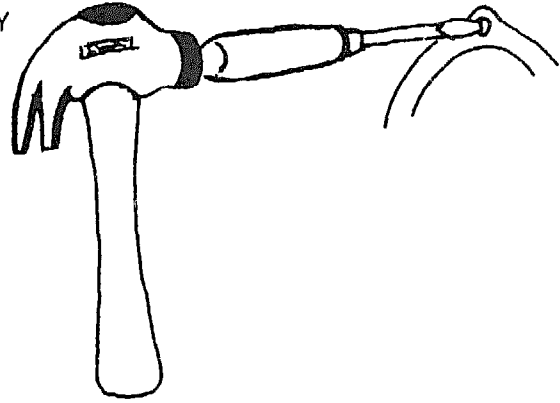

TO FIX THE STITCH REGULATOR

1. TAKE OFF THE TWO SCREWS ON
THE STITCH REGULATOR PLATE.

TAKE OFF THE PLATE.

STITCH REGULATOR PLATE

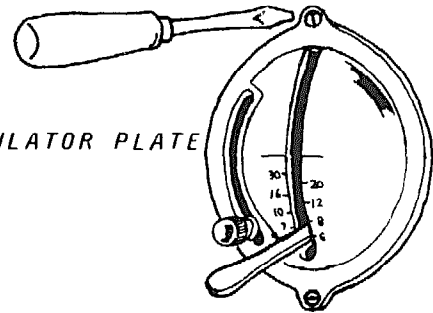

IN SOME MACHINES:

2. PUT THE STITCH REGULATOR LEVER
UP AS HIGH AS IT WILL GO.

STITCH REGULATOR LEVER

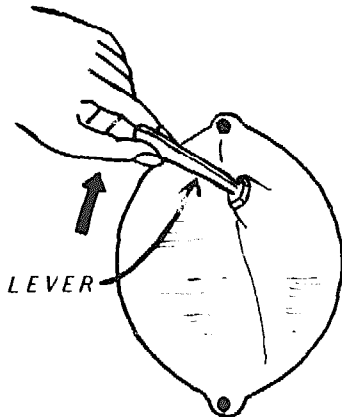

3. TIP BACK THE MACHINE.

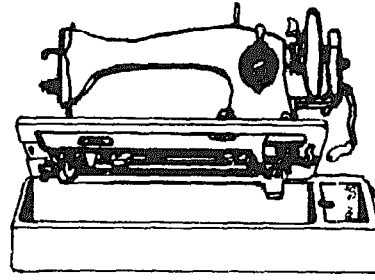

4. USE A LONG SCREWDRIVER
TO REACH THE SCREW
UNDER THE LEVER.

TIGHTEN THE SCREW.

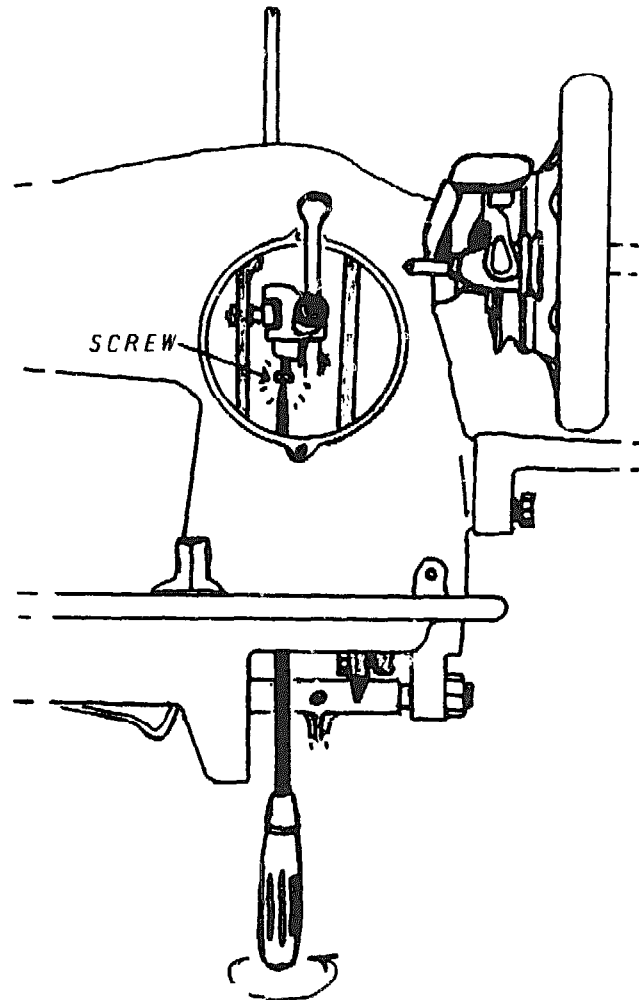

5. TAKE AWAY THE SCREWDRIVER.

PUT THE MACHINE DOWN.

PUT BACK THE STITCH REGULATOR PLATE.

TIGHTEN THE SCREWS OF THE PLATE.

IN OTHER MACHINES:

2. PUT THE STITCH REGULATOR LEVER
AS LOW AS IT WILL GO.

STITCH REGULATOR LEVER

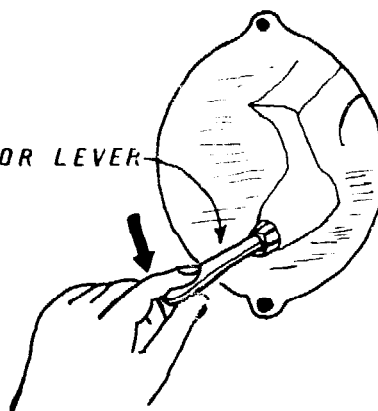

3. TAKE THE ARM SIDE COVER OFF
FROM THE BACK OF THE MACHINE.

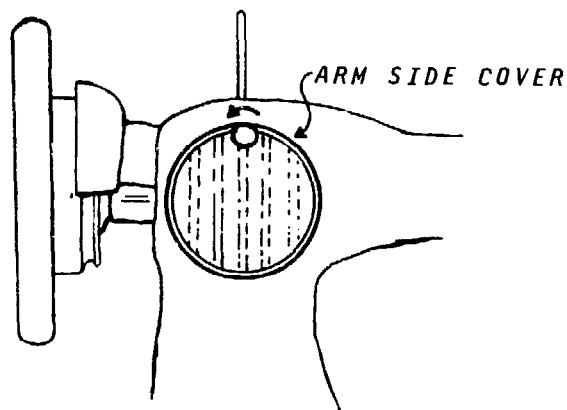

4. USE A SCREWDRIVER TO TIGHTEN
THE SCREW SHOWN.

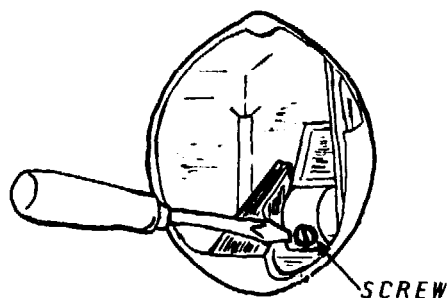

5. TAKE AWAY THE SCREWDRIVER.

PUT BACK THE ARM SIDE COVER.

PUT BACK THE STITCH REGULATOR PLATE.

TIGHTEN THE SCREWS OF THE PLATE.

TO PUT IN A NEW THREAD TAKE-UP SPRING

FOR MACHINES WITH THE TENSION REGULATOR ON THE SIDE:

1. LOOSEN SCREW A,
DO NOT TAKE IT OUT COMPLETELY.

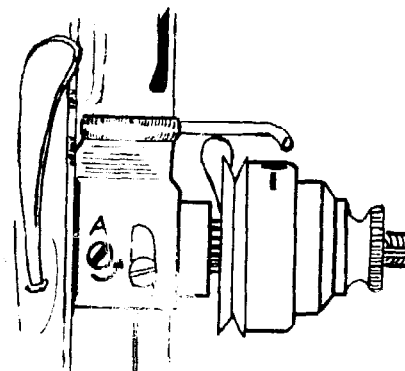

2. TAKE OUT THE TENSION REGULATOR
BY PULLING IT AWAY FROM THE
MACHINE.

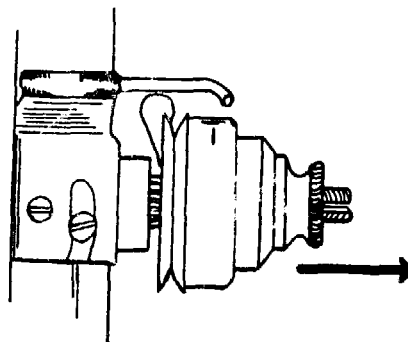

3. TAKE OFF THE OLD SPRING.

(TAIL END)

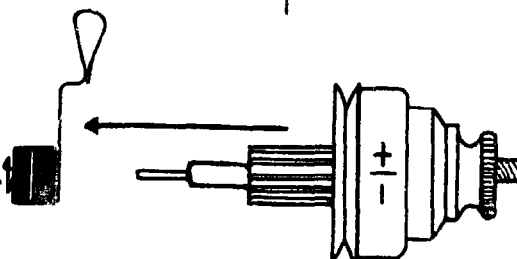

4. PUT THE TAIL END OF
THE NEW SPRING INTO
ONE OF THE GROOVES
ON THE TENSION REGULATOR.

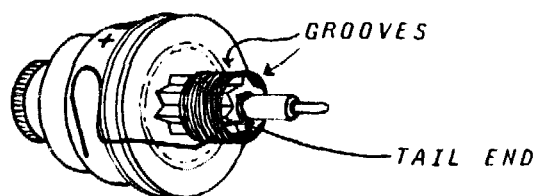

PUT IT IN THE RIGHT GROOVE SO THAT THE SPRING IS IN THIS POSITION:

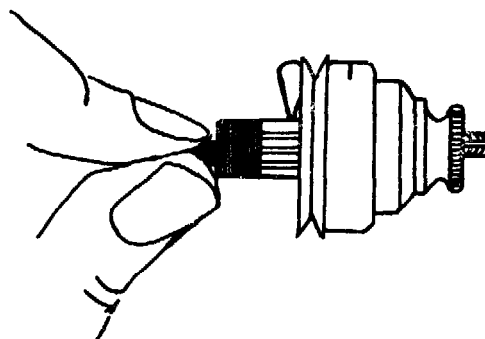
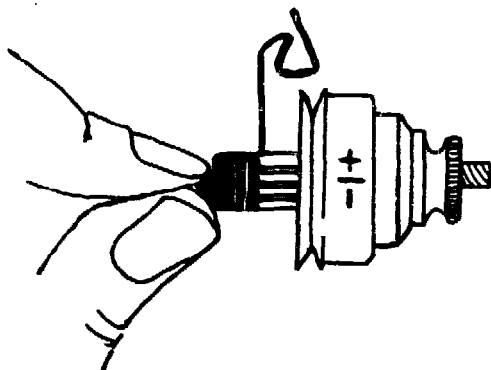

5. PUT THE TENSION REGULATOR
BACK IN THE MACHINE
IN THIS WAY:

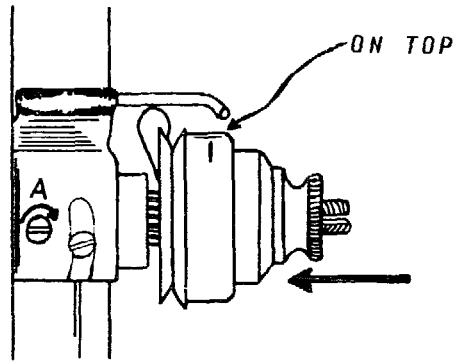

TIGHTEN SCREW A.

6. MAKE SURE THAT THE SPRING IS
SITTING IN ABOUT THIS POSITION:

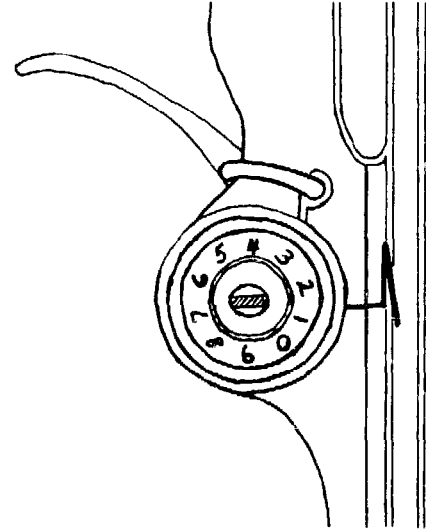

CHECK TO MAKE SURE THAT YOU CAN
MOVE IT WITH YOUR FINGER SO THAT
IT COMES OVER THE THREAD GUARD
LIKE THIS:

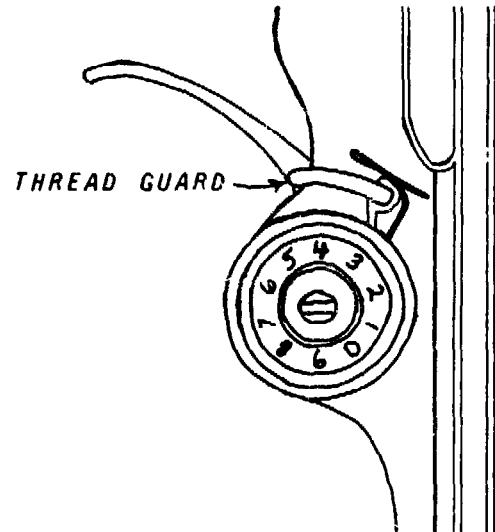

7. FIX THE TENSION REGULATOR
TO MAKE THE TENSION RIGHT.

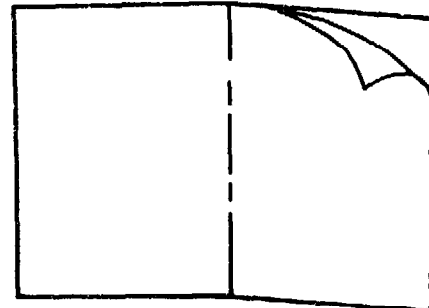

SEE PAGE 37

FOR MACHINES WITH THE TENSION REGULATOR ON THE FRONT:

1. TAKE OFF THE FACE PLATE.

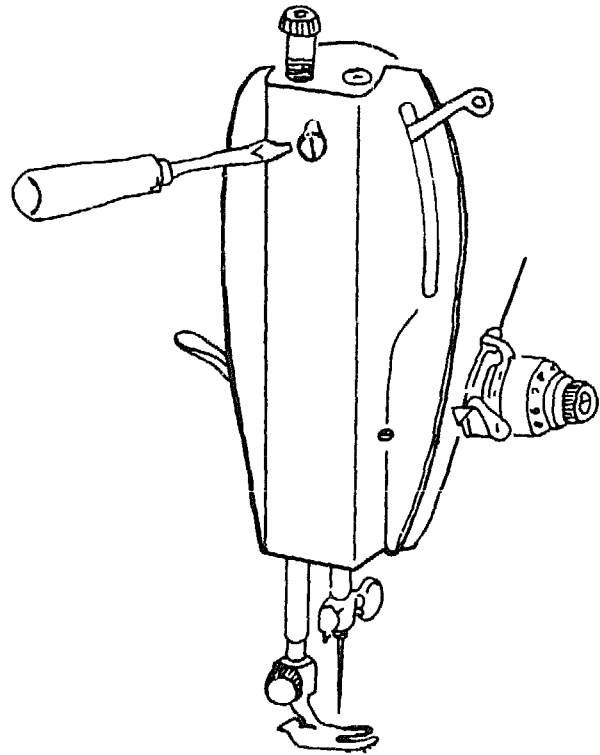

2. LOOSEN SCREW B.

DO NOT TAKE IT OUT COMPLETELY.

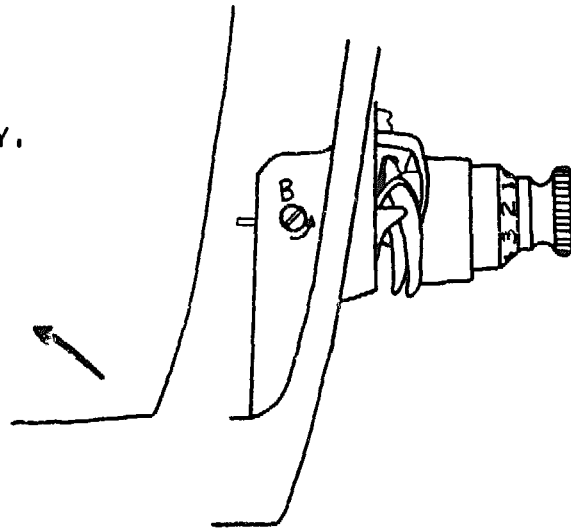

3. TAKE OUT THE TENSION REGULATOR
BY PULLING IT AWAY FROM THE
MACHINE.

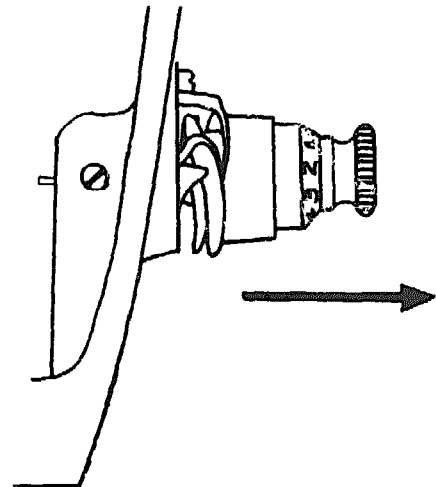

4. TAKE APART THE TENSION REGULATOR BY TAKING OFF THE PARTS IN THIS ORDER:

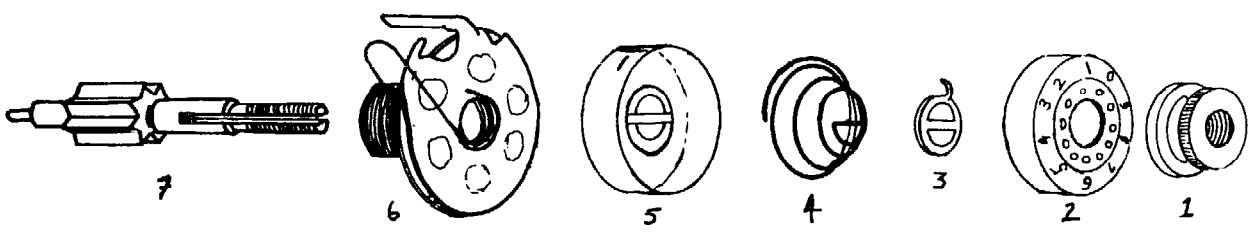

PUT THE PARTS DOWN IN A LINE ON YOUR WORK TABLE.

5. TAKE AWAY THE OLD SPRING.

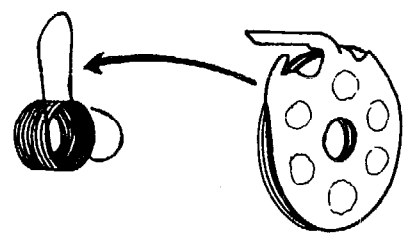

6. PUT THE NEW SPRING IN POSITION AROUND THESE THREE PARTS:

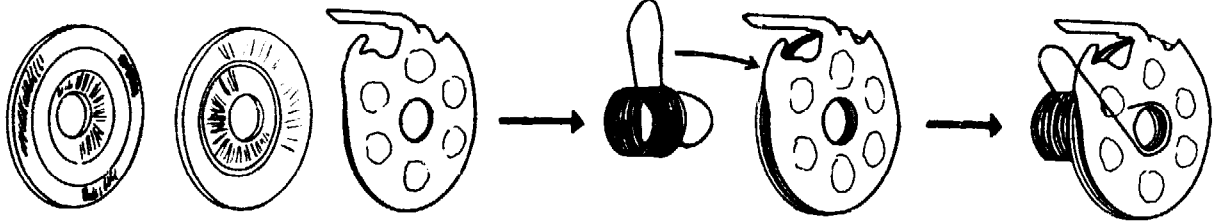

7. FIT THESE PARTS ONTO PART NUMBER 7.

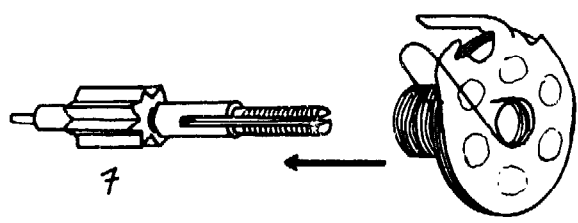

FIT THE TAIL END OF THE SPRING INTO ONE OF THE GROOVES IN PART NUMBER 7, SO THAT IT WILL BE IN THE POSITION SHOWN.

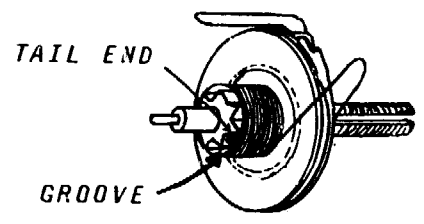

THE THREAD GUARD MUST BE ON TOP.

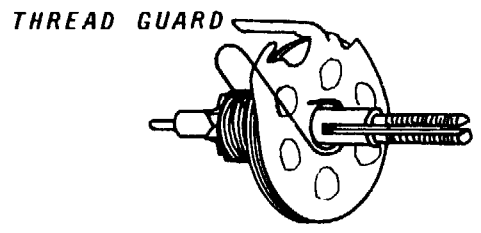

8. PUT ALL THE OTHER PARTS BACK IN THE RIGHT ORDER.

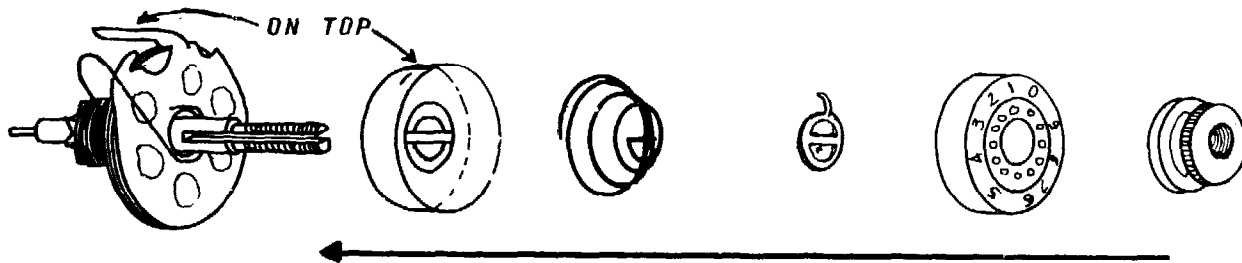

MAKE SURE THE THREAD GUARD IS ON TOP.

9. WITH THE THREAD GUARD ON TOP, CHECK TO MAKE SURE THAT YOU CAN MOVE THE SPRING WITH YOUR FINGER SO THAT IT COMES OVER THE THREAD GUARD.

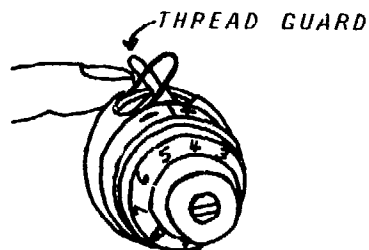

10. PUT THE TENSION REGULATOR BACK IN THE MACHINE IN THIS WAY:

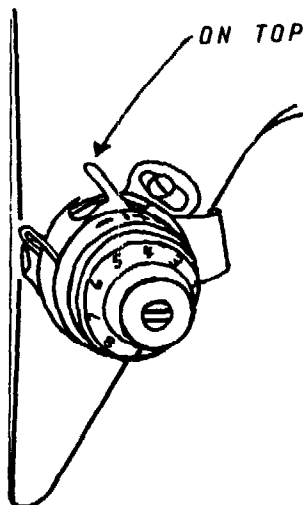

11. TIGHTEN SCREW B.

PUT BACK THE FACE PLATE.

12. FIX THE TENSION REGULATOR TO MAKE THE TENSION RIGHT.

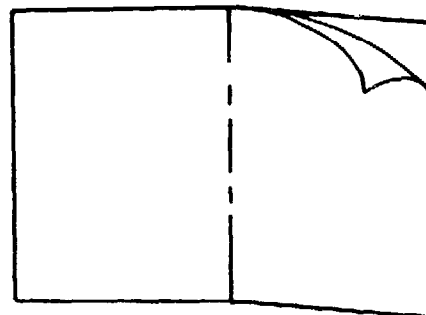

SEE PAGE 37

TO PUT A NEW PIN IN THE TENSION REGULATOR

FOR MACHINES WITH THE TENSION REGULATOR ON THE SIDE:

1. LOOSEN SCREW A.

DO NOT TAKE IT OUT COMPLETELY.

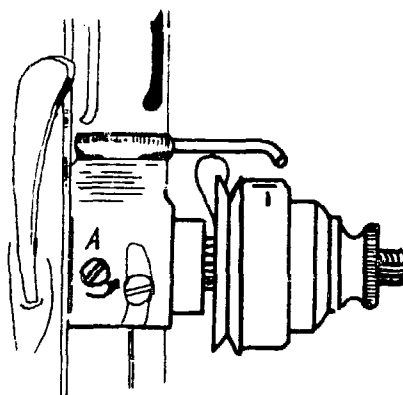

2. TAKE OUT THE TENSION REGULATOR BY PULLING IT AWAY FROM THE MACHINE.

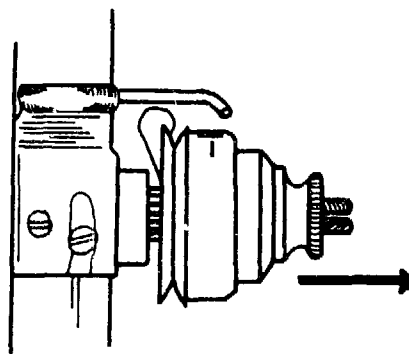

3. TAKE APART THE TENSION REGULATOR BY TAKING OFF THE PARTS IN THIS ORDER:

PUT THE PARTS DOWN IN A LINE ON YOUR WORK TABLE.

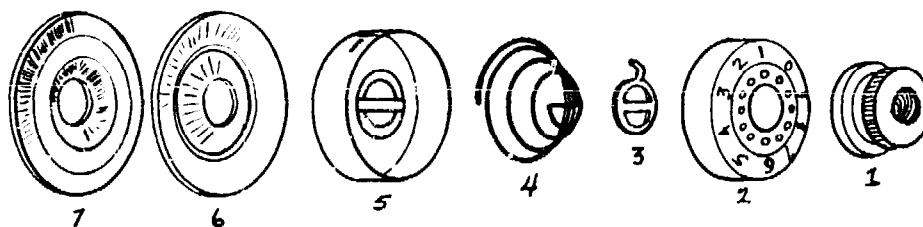
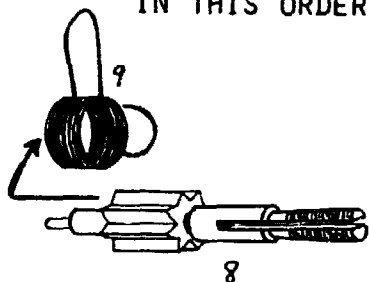

4. LET THE OLD PIN DROP OUT BY HOLDING PART NUMBER 8 UPRIGHT.



5. CHECK TO SEE IF THE PIN IS BROKEN OR WORN DOWN AT THE END.

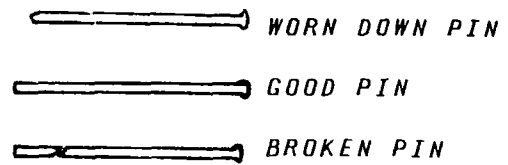

6. MAKE A NEW PIN:

USE A NAIL THAT IS THE SAME THICKNESS AND THE SAME LENGTH AS THE PIN WAS.



CUT OFF THE HEAD OF THE NAIL, USING PLIERS.

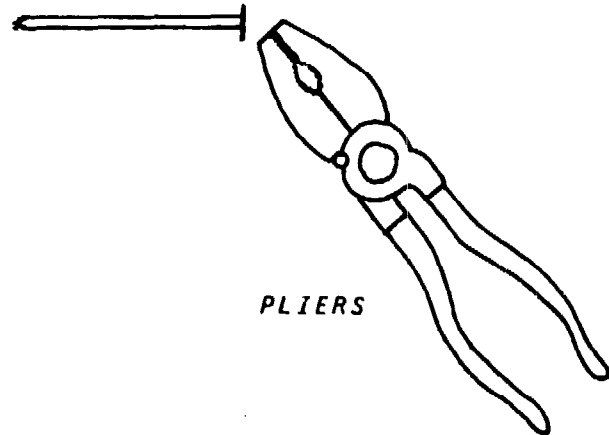

USE A HAMMER TO FLATTEN THE CUT END OF THE NAIL.

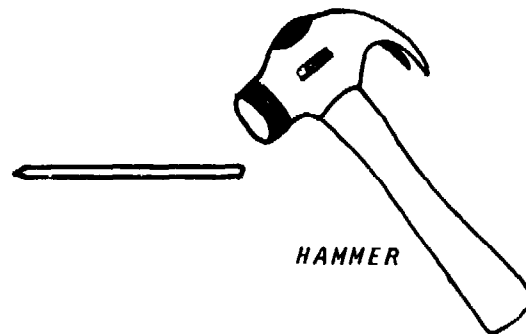

MAKE SURE THAT THE PIN IS THE RIGHT LENGTH BY MEASURING IT AGAINST THE PIECES OF THE BROKEN PIN



OR

SEEING THAT IT IS A LITTLE LONGER THAN THE WORN DOWN PIN.



THIS WILL BE AS GOOD AS A NEW PIN.

7. PUT IN THE NEW PIN.



8. PUT THE OTHER PARTS BACK IN THE RIGHT ORDER.

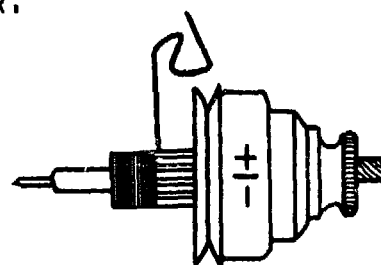

9. MAKE SURE THAT THE THREAD TAKE-UP SPRING IS IN THE RIGHT PLACE.

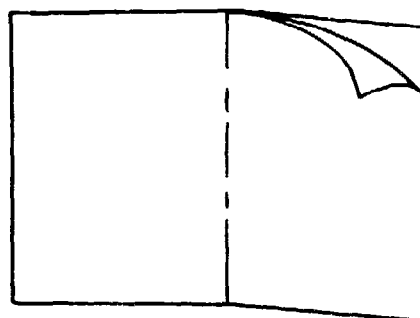

SEE PAGE 26, STEP 4

10. PUT THE TENSION REGULATOR
BACK IN THE MACHINE
IN THIS WAY:

TIGHTEN SCREW A.

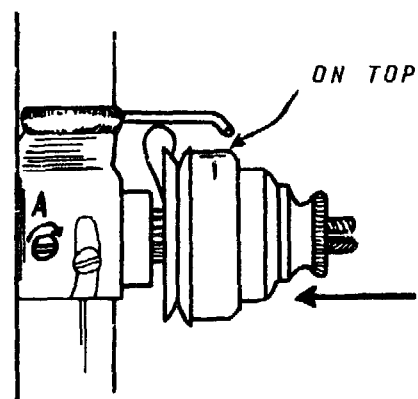

11. CHECK THE POSITION OF THE THREAD TAKE-UP SPRING.

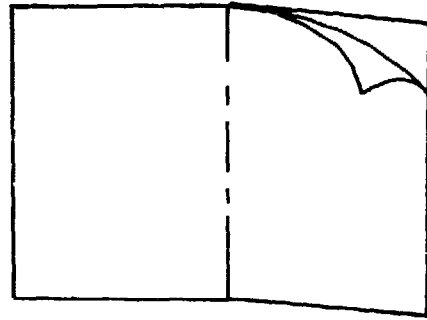

SEE PAGE 27, STEP 6

12. FIX THE TENSION REGULATOR TO MAKE THE TENSION RIGHT.

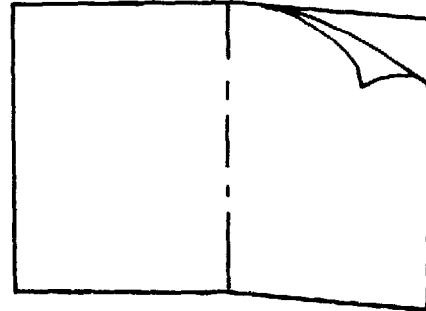

SEE PAGE 37

FOR MACHINES WITH THE TENSION REGULATOR ON THE FRONT:

1. TAKE OFF THE FACE PLATE.

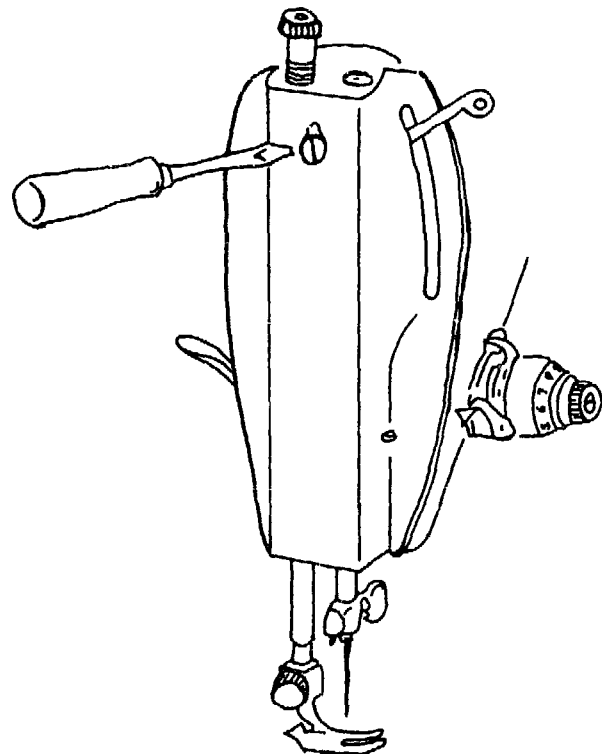

2. LOOSEN SCREW B.

DO NOT TAKE IT OUT COMPLETELY.

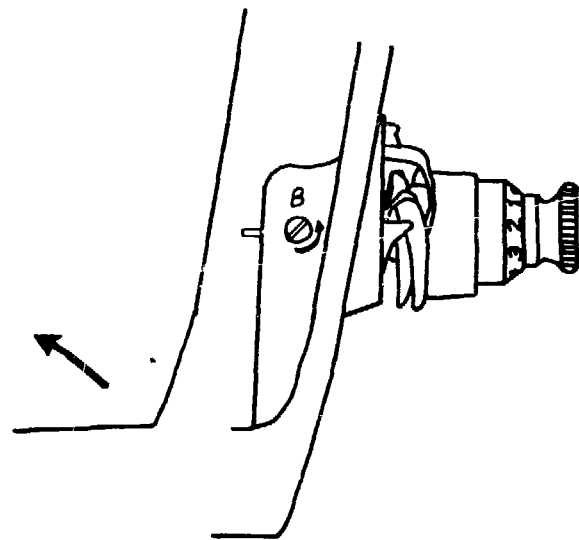

3. TAKE OUT THE TENSION REGULATOR BY PULLING IT AWAY FROM THE MACHINE.

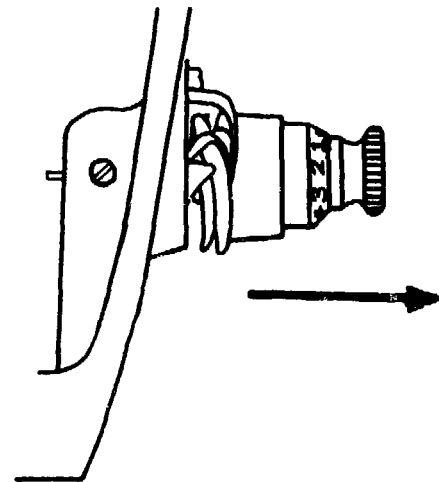

4. TAKE APART THE TENSION REGULATOR BY TAKING OFF THE PARTS IN THIS ORDER:

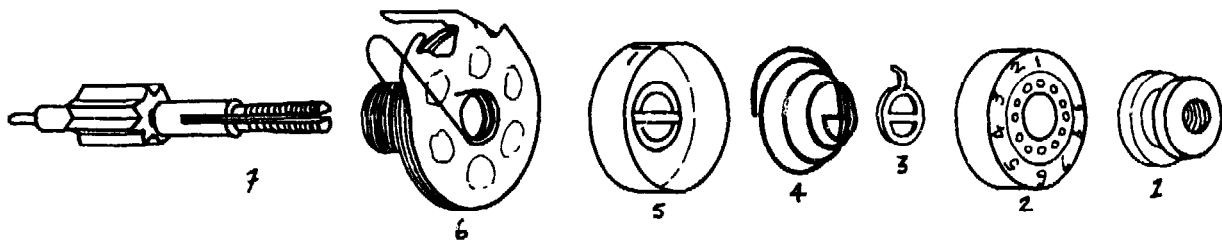

PUT THE PARTS DOWN IN A LINE ON YOUR WORK TABLE.

5. DO STEPS 4, 5, 6 AND 7, PAGES 31-33.

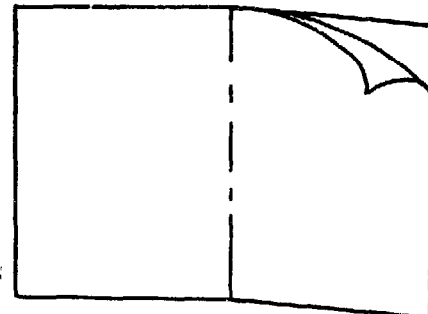

SEE PAGE 31

6. MAKE SURE THE SPRING IS IN POSITION AROUND THESE THREE PARTS:

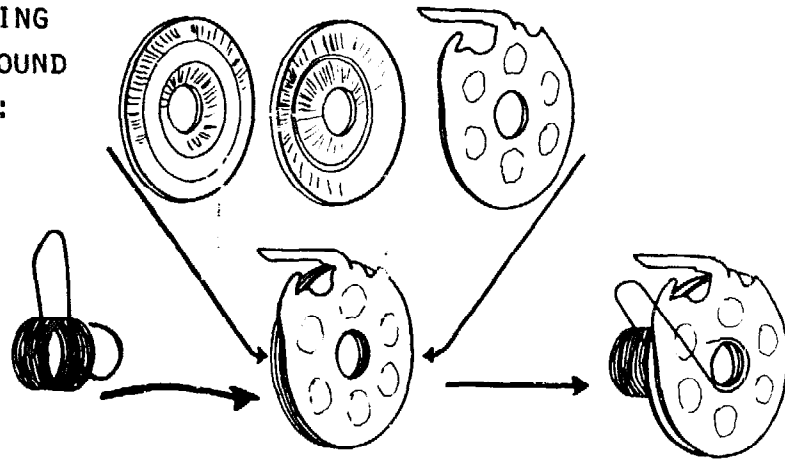

7. PUT ALL THE OTHER PARTS BACK IN THE RIGHT ORDER, AND CHECK THE POSITION OF THE THREAD TAKE-UP SPRING.

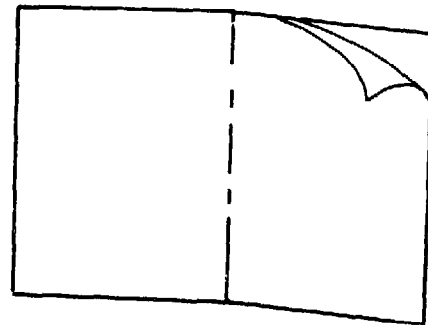

SEE PAGE 29, STEPS 7, 8, 9.

8. PUT THE TENSION REGULATOR BACK IN THE MACHINE, AND FINISH OFF FOLLOWING STEPS 10, 11 AND 12, PAGE 30.

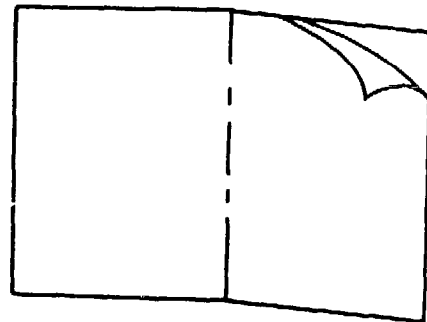

SEE PAGE 30, STEPS 10, 11, 12.

TO FIX THE TENSION REGULATOR

1. WHEN THE NUT ON THE TENSION REGULATOR IS TURNED AS FAR AS IT WILL GO TO THE LEFT, THE 0 SHOULD BE ON TOP.

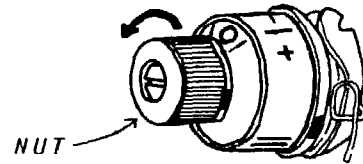

WHEN THE NUT IS TURNED AS FAR AS IT WILL GO TO THE RIGHT, THE 9 SHOULD BE ON TOP.

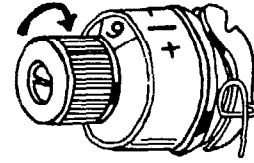

THE NUT SHOULD MAKE ONLY ONE TURN.

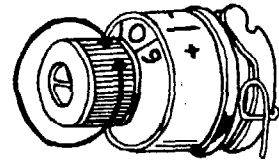

WHEN THE 0 IS ON TOP, THE DISCS SHOULD BE LOOSE.

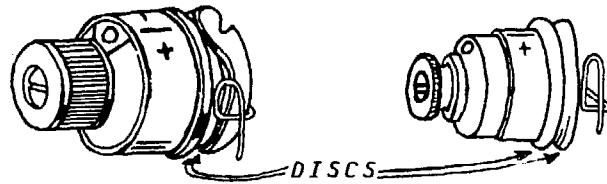

WHEN THE 9 IS ON TOP, THE DISCS SHOULD BE VERY TIGHT.

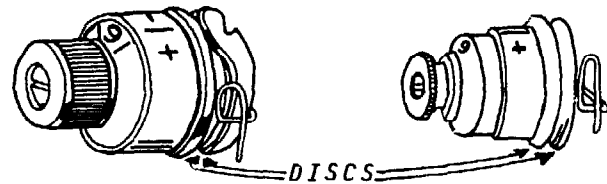

IF YOUR TENSION REGULATOR DOES NOT WORK IN THIS WAY, THEN FOLLOW THE REST OF THE STEPS.

2. TURN THE NUT UNTIL THE 0 IS ON TOP.

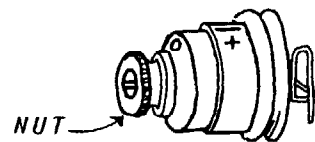

3. WITH YOUR FINGERS, PRESS BACK ON THE NUMBERS DIAL, UNTIL THE NUT CAN TURN FREELY WITHOUT IT.

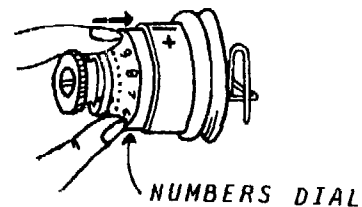

4. TURN THE NUT A LITTLE TO THE LEFT.

MAKE SURE THE PIN IS NEXT TO ONE OF THE SMALL HOLES IN THE NUMBERS DIAL.

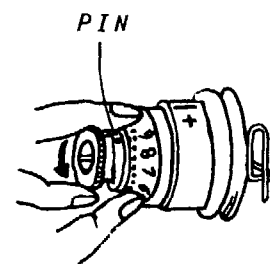

5. LET GO OF THE NUMBERS DIAL.

TRY TURNING THE NUT TO THE LEFT AND TO THE RIGHT, TO SEE IF THE REGULATOR IS NOW TURNING IN THE RIGHT WAY, AND IF THE DISCS ARE LOOSE AND TIGHT WHEN THEY SHOULD BE.

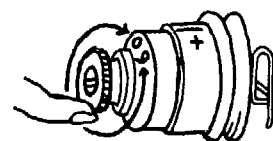

6. IF THE REGULATOR IS STILL NOT TURNING PROPERLY:

TURN THE NUT AS FAR AS IT WILL GO TO THE LEFT.

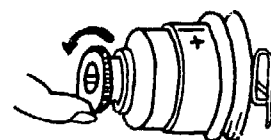

PRESS DOWN ON THE NUMBERS DIAL. TURN THE NUMBERS DIAL WITHOUT TURNING THE NUT, TURN IT SO THE 2 IS ON TOP.

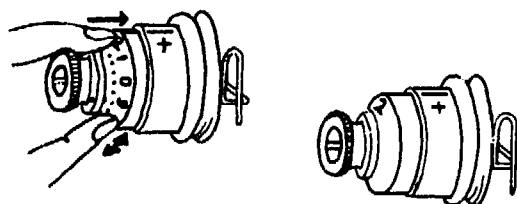

LET GO OF THE NUMBERS DIAL. TRY TURNING THE NUT TO SEE IF THE REGULATOR IS NOW TURNING IN THE RIGHT WAY.

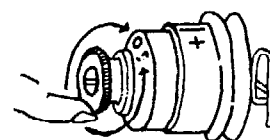

7. IF IT IS STILL NOT RIGHT, KEEP TRYING.

FOR EXAMPLE, IF THE NUMBERS DIAL WILL ONLY GO TO 8 WHEN YOU TURN THE NUT AS FAR AS IT WILL GO TO THE RIGHT (THAT IS, 8, NOT 9, IS ON TOP), THEN:

TURN THE NUT AS FAR AS IT WILL GO TO THE LEFT.

PRESS DOWN ON THE NUMBERS DIAL, TURN IT WITHOUT TURNING THE NUT, TURN IT SO THE 1 IS ON TOP.

LET GO OF THE NUMBERS DIAL, TRY TO TURN THE NUT FROM 0 TO 9.

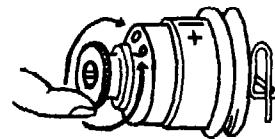
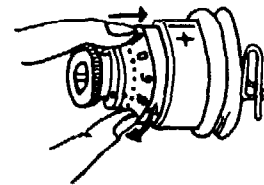
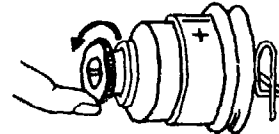
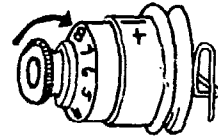

THE TENSION REGULATOR SHOULD NOW BE WORKING IN THE RIGHT WAY.

TO FIX THE NEEDLE TIMING

1. TIP BACK THE MACHINE SO YOU CAN SEE UNDERNEATH.

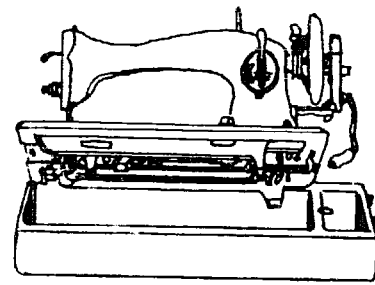

- 2 TAKE OUT THE BOBBIN CASE.

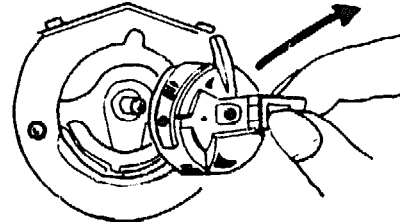

3. MOVE THE SHUTTLE RACE RING.

IN SOME MACHINES:

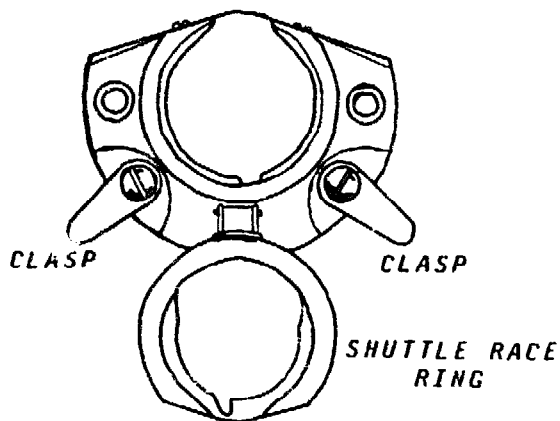

MOVE THE CLASPS.
LOWER THE SHUTTLE RACE RING.

IN OTHER MACHINES:

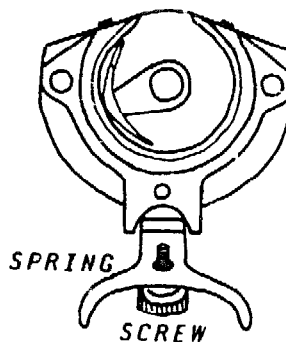

LOOSEN THE SCREW.

PULL DOWN THE SPRING.



TAKE OUT THE SHUTTLE RACE RING.

4. SLOWLY TURN THE WHEEL TOWARDS YOU TO LOWER THE NEEDLE UNTIL IT IS AS LOW AS IT WILL GO.

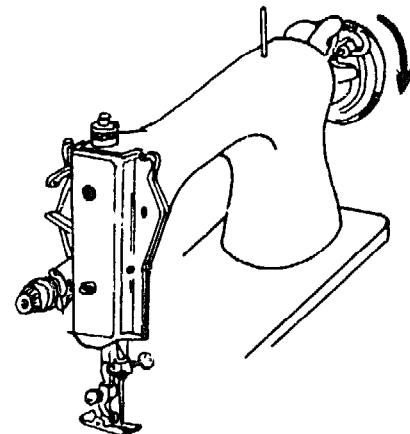

5. LOOK UNDER THE MACHINE.
THE HOLE OF THE NEEDLE
SHOULD BE BELOW THE
HOOK, AND TO THE RIGHT.

RIGHT

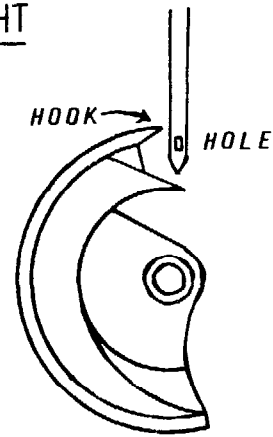

TURN THE WHEEL A LITTLE UNTIL THE HOOK AND THE NEEDLE SEEM TO BE TOUCHING. THE HOOK SHOULD SEEM TO TOUCH THE NEEDLE AT THE HOLE.

RIGHT

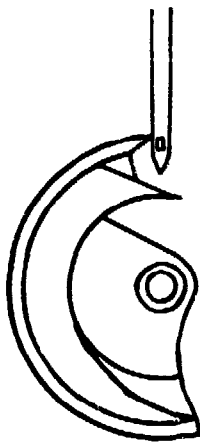

WRONG

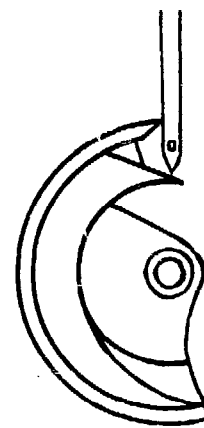

IF THE NEEDLE AND THE HOOK
COME TOGETHER AT THE HOLE
IN THIS WAY, YOU DO NOT
NEED TO CHANGE THE NEEDLE
TIMING.

IF THE HOOK SEEMS TO TOUCH
THE NEEDLE AT A POINT ABOVE
OR BELOW THE HOLE, THEN
FOLLOW THE REST OF THE STEPS.

6. MAKE SURE THE NEEDLE IS
AS LOW AS IT WILL GO,
THEN USE A SHORT SCREW-
DRIVER TO LOOSEN THE
NEEDLE BAR SCREW.

NEEDLE BAR SCREW

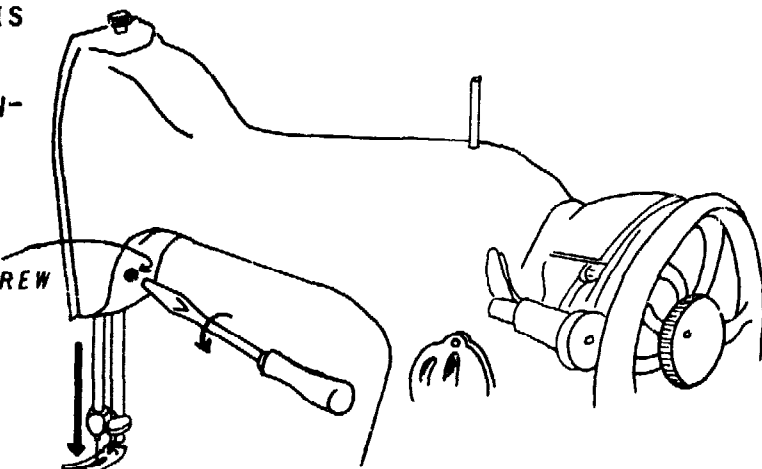

7. TURN THE WHEEL SO THE HOOK AGAIN SEEMS TO TOUCH THE NEEDLE.

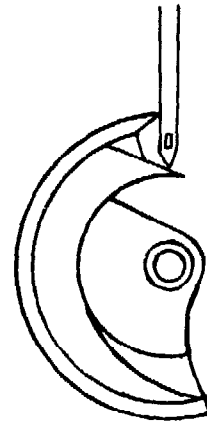

8. HOLDING THE NEEDLE CLAMP SCREW WITH YOUR FINGERS, RAISE OR LOWER THE NEEDLE UNTIL THE HOLE IS NEXT TO THE POINT OF THE HOOK.

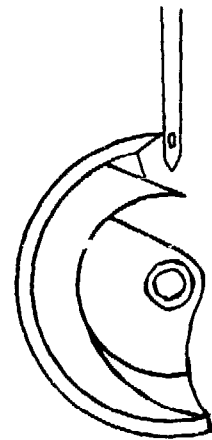
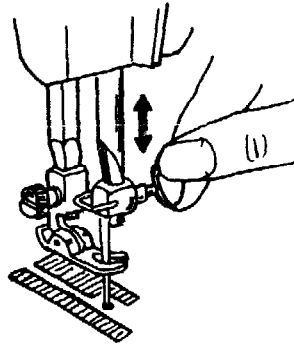

9. MAKE SURE THE GROOVE ON THE NEEDLE BAR IS FACING THE LEFT.

NOTE: ON A FEW MACHINES, THE GROOVE SHOULD FACE THE FRONT (SEE PAGE 61).

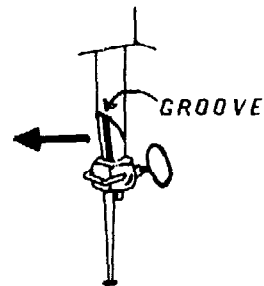

HOLD THE NEEDLE BAR FIRMLY IN PLACE WITH ONE HAND, AND TIGHTEN THE NEEDLE BAR SCREW.

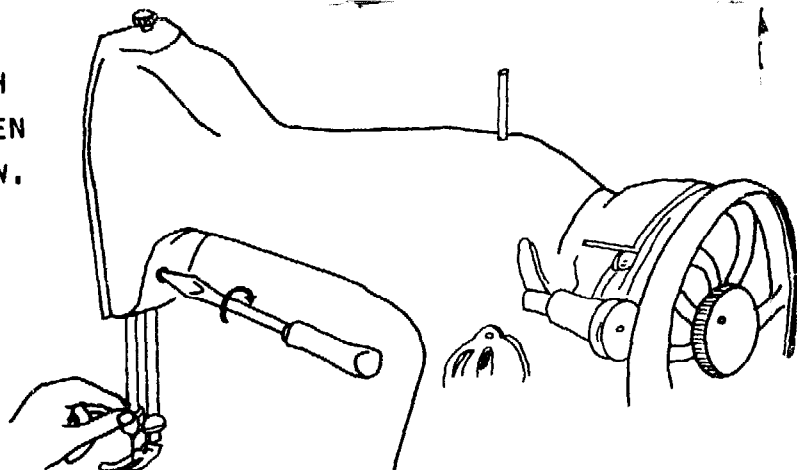

10. CHECK THE POSITION OF THE NEEDLE,
AS IN STEP 5.

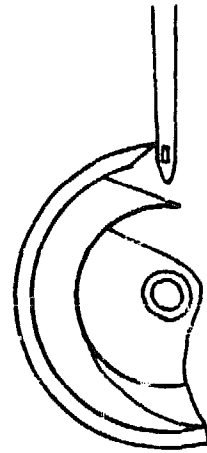

11. PUT BACK THE SHUTTLE RACE RING,

PUT BACK THE BOBBIN CASE,

PUT BACK THE FACE PLATE.

NOTE: IN SOME MACHINES THERE ARE TIMING MARKS ON THE NEEDLE BAR.
TO CHANGE THE NEEDLE TIMING ON THESE MACHINES, FOLLOW
THESE STEPS:

1. TAKE OFF THE FACE PLATE.

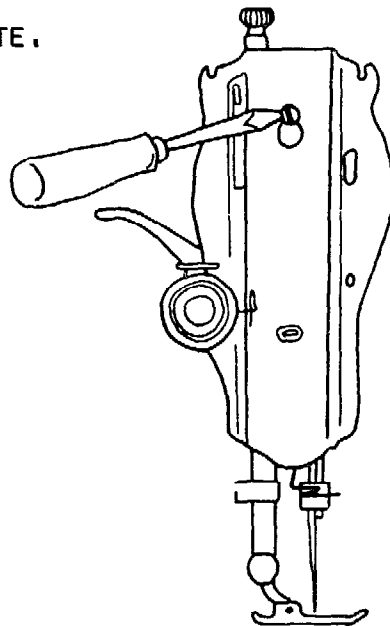

2. SLOWLY TURN THE WHEEL TOWARDS YOU
TO LOWER THE NEEDLE UNTIL IT IS
AS LOW AS IT WILL GO,

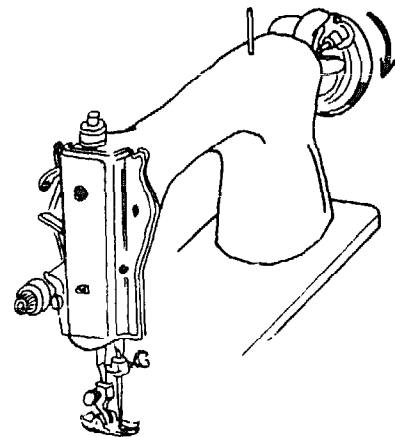

3. USE A SHORT SCREWDRIVER TO LOOSEN THE NEEDLE BAR SCREW.

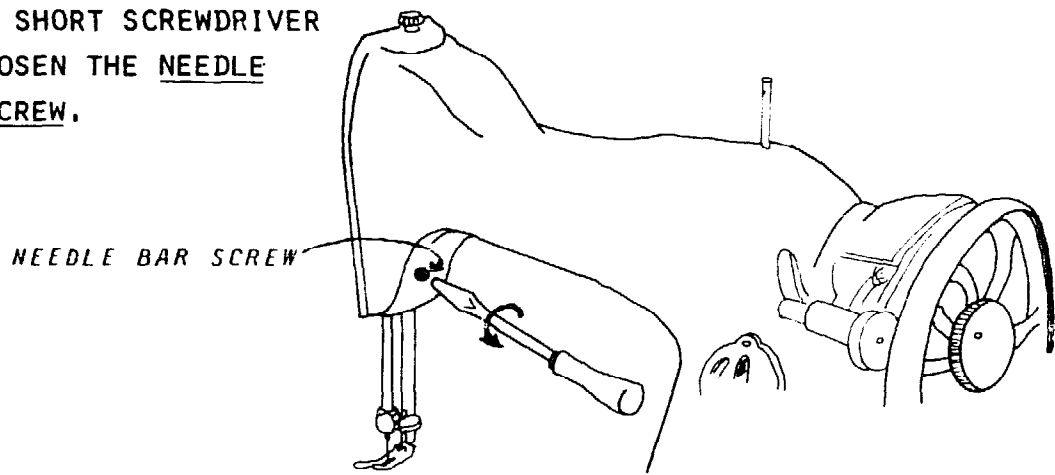

4. USE YOUR FINGERS TO MOVE THE NEEDLE BAR UP OR DOWN SO THAT THE TWO TIMING MARKS ARE HERE:

(THE TOP MARK IS EVEN WITH THE BOTTOM OF THE TUBE.)

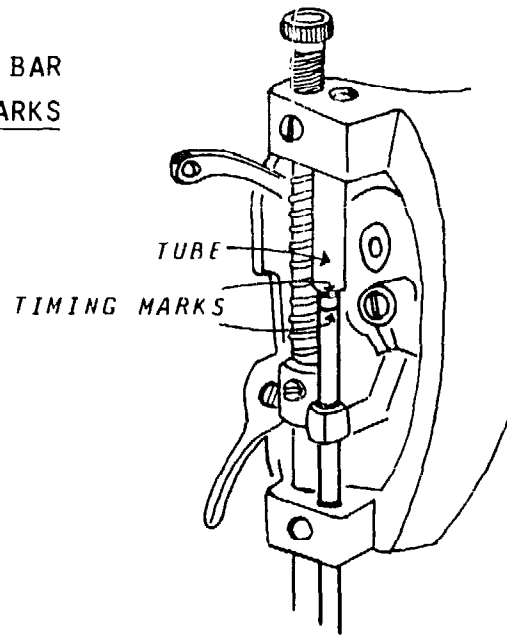

5. MAKE SURE THAT THE GROOVE ON THE NEEDLE BAR IS FACING THE LEFT.

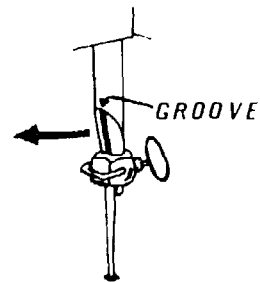

HOLD THE NEEDLE BAR FIRMLY IN PLACE WITH ONE HAND, AND TIGHTEN THE NEEDLE BAR SCREW.

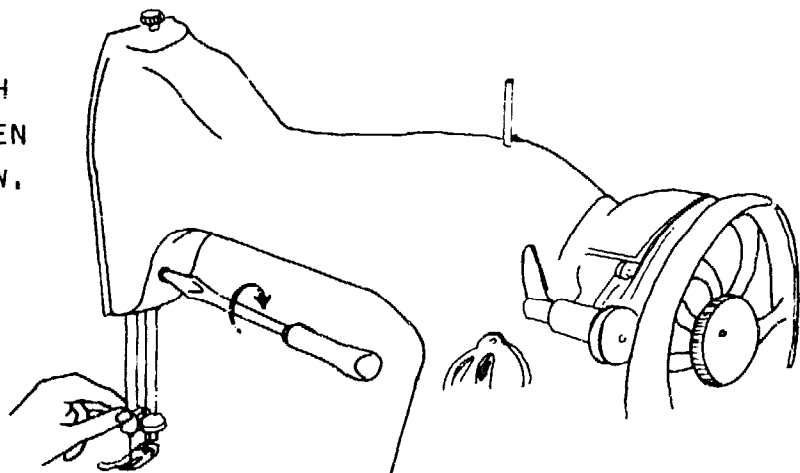

6. CHECK THE TIMING:

TIP BACK THE MACHINE,
TAKE OUT THE BOBBIN CASE,
MOVE THE SHUTTLE RACE RING.

TURN THE WHEEL TOWARDS YOU
UNTIL THE BOTTOM TIMING MARK
IS EVEN WITH THE BOTTOM OF
THE TUBE.

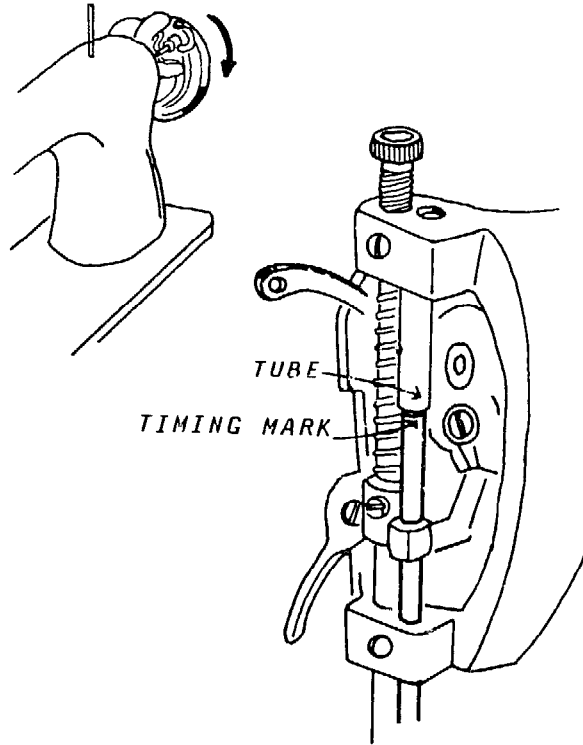

THE HOOK SHOULD NOW SEEM TO
TOUCH THE NEEDLE AT THE HOLE.



IF IT DOES NOT, TRY TO CHANGE THE TIMING AGAIN.

TO PUT IN A NEW NEEDLE BAR

1. TAKE OFF THE FACE PLATE.

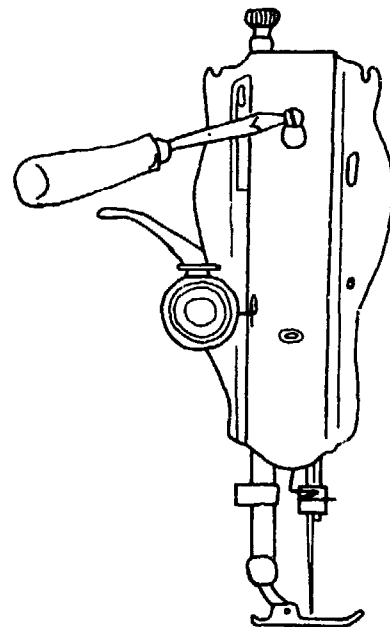

2. TAKE OFF THE NEEDLE, THE NEEDLE CLAMP, THE COTTON HOLDER, AND THE PRESSER FOOT.

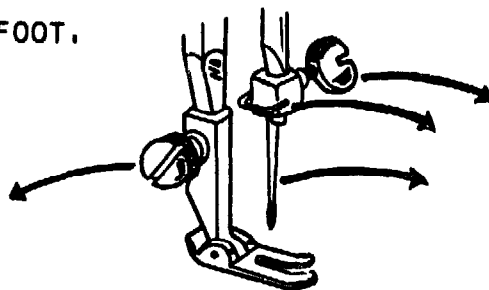

3. SLOWLY TURN THE WHEEL TOWARDS YOU UNTIL THE NEEDLE BAR IS AS LOW AS IT WILL GO.

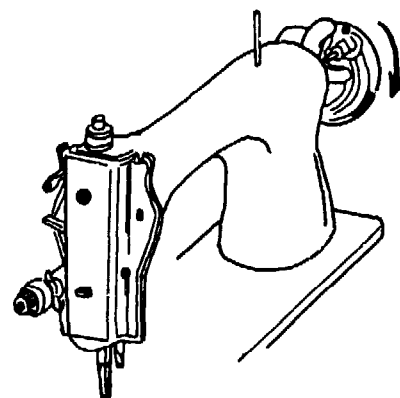

4. LOOSEN THE NEEDLE BAR SCREW.

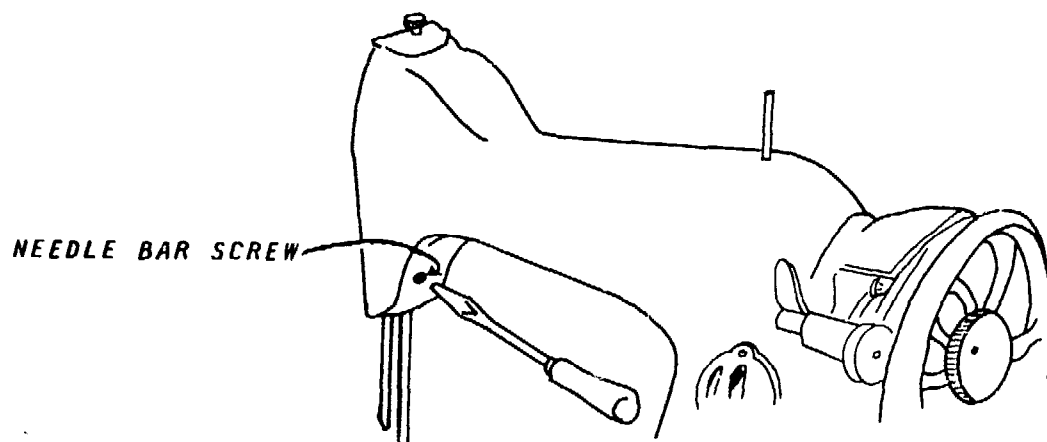

5. PUSH THE NEEDLE BAR UP.

THE NEEDLE BAR WILL PUSH
OUT THE NEEDLE BAR CAP.

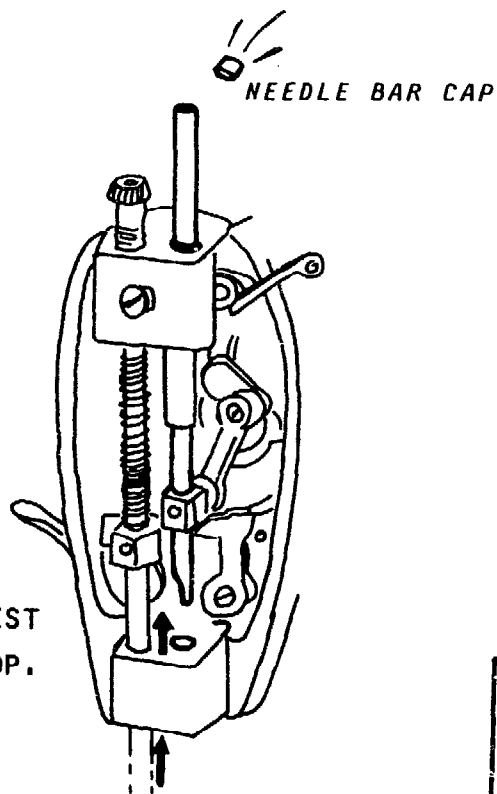

PULL THE NEEDLE BAR THE REST
OF THE WAY OUT FROM THE TOP.

6. PUT IN THE NEW NEEDLE BAR.

PUT BACK THE NEEDLE BAR CAP.

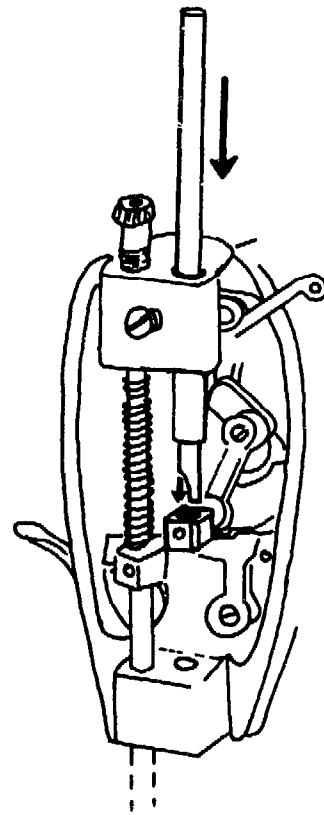

7. PUT BACK THE PRESSER FOOT, THE COTTON HOLDER
THE NEEDLE CLAMP, AND THE NEEDLE.

8. FIX THE NEEDLE TIMING.

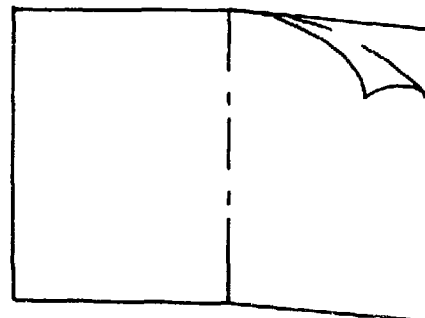

SEE PAGE 40

NOTE: IN SOME MACHINES THERE IS NO HOLE FOR THE NEEDLE BAR TO COME OUT THE TOP OF THE MACHINE.

TO PUT IN A NEW NEEDLE BAR IN THESE MACHINES, FOLLOW THESE STEPS:

1. TAKE OFF THE FACE PLATE.

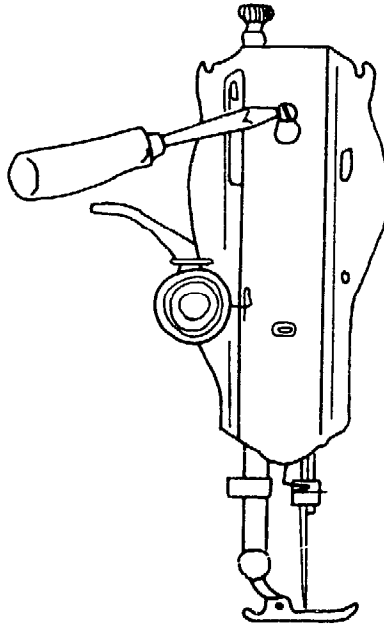

2. TAKE OFF THE NEEDLE, THE NEEDLE CLAMP, THE COTTON HOLDER AND THE PRESSER FOOT.

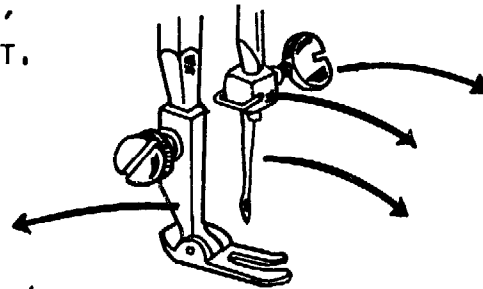

3. TAKE OFF THE THROAT PLATE.

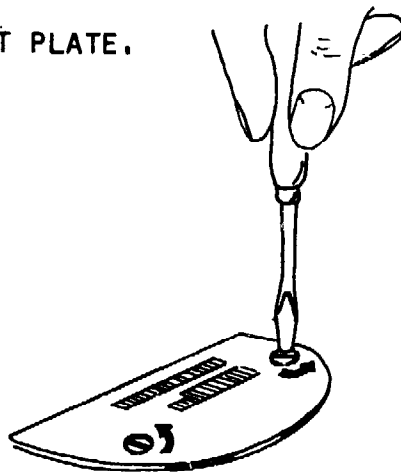

4. TIP BACK THE MACHINE SO YOU CAN SEE UNDERNEATH.

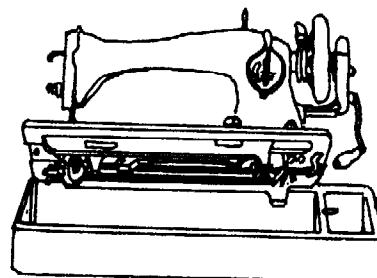

5. TAKE OUT THE BOBBIN CASE.

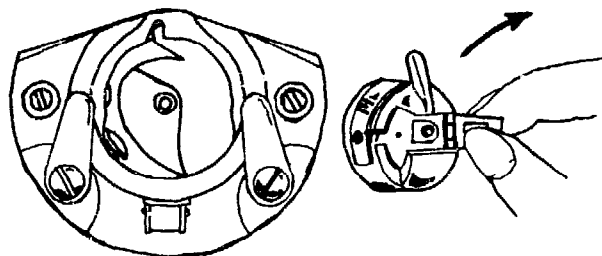

6. TAKE OUT THE SHUTTLE RACE.

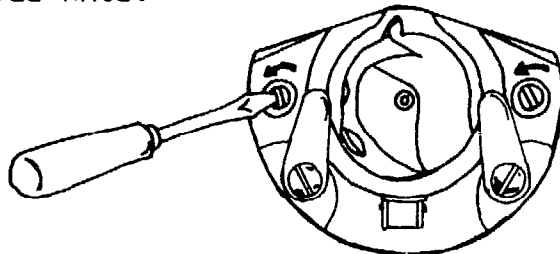

7. PUT THE MACHINE DOWN.

TURN THE WHEEL TOWARDS YOU
TO MOVE THE NEEDLE BAR AS
HIGH AS IT WILL GO.

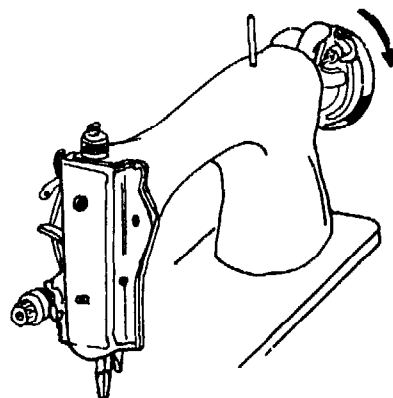

8. TAKE OFF THE FEED DOG BY
UNSCREWING THE TWO SCREWS SHOWN.

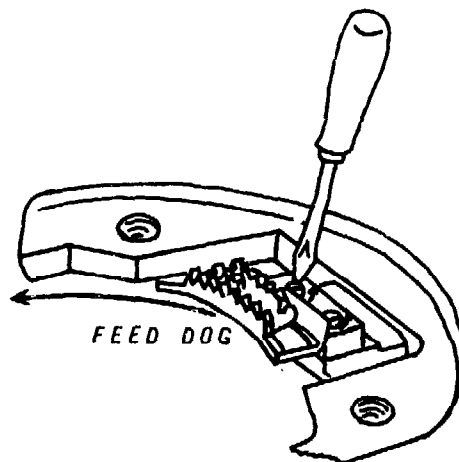

9. TURN THE WHEEL TOWARDS YOU
UNTIL THE NEEDLE BAR IS AS
LOW AS IT WILL GO.

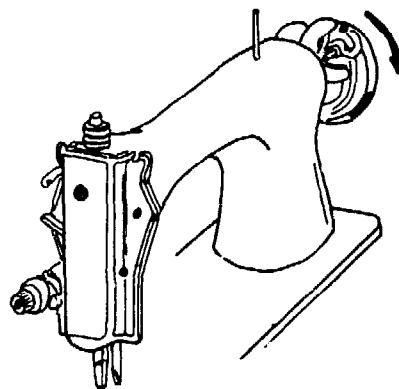

LOOSEN THE NEEDLE BAR SCREW.

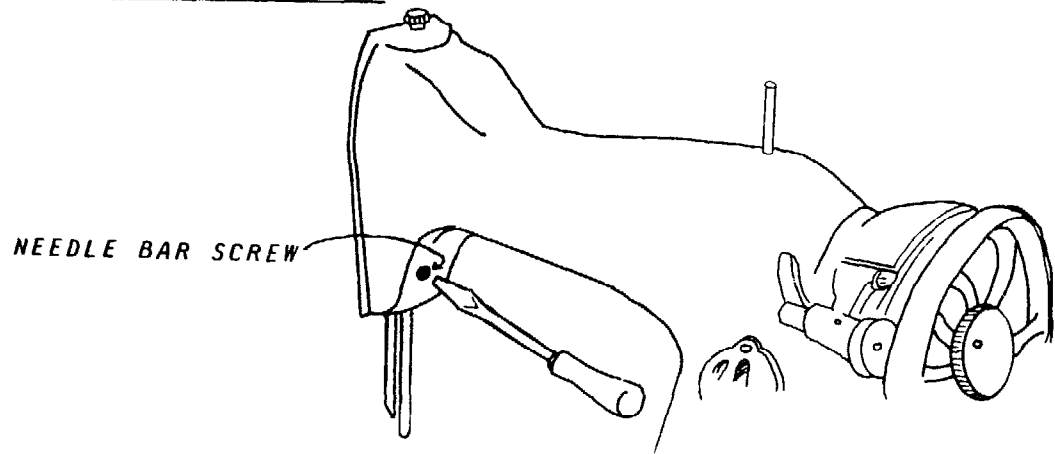

10. TIP BACK THE MACHINE.

PULL THE NEEDLE BAR DOWN,
UNTIL IT COMES OUT THE
BOTTOM OF THE MACHINE.

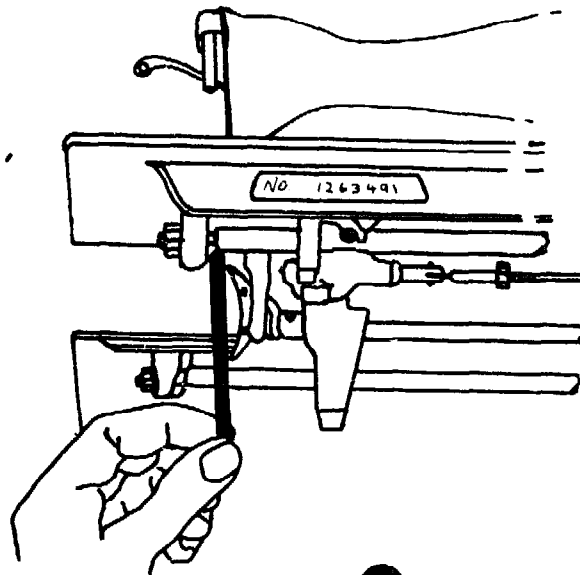

11. PUT THE NEW NEEDLE BAR IN
FROM THE BOTTOM.

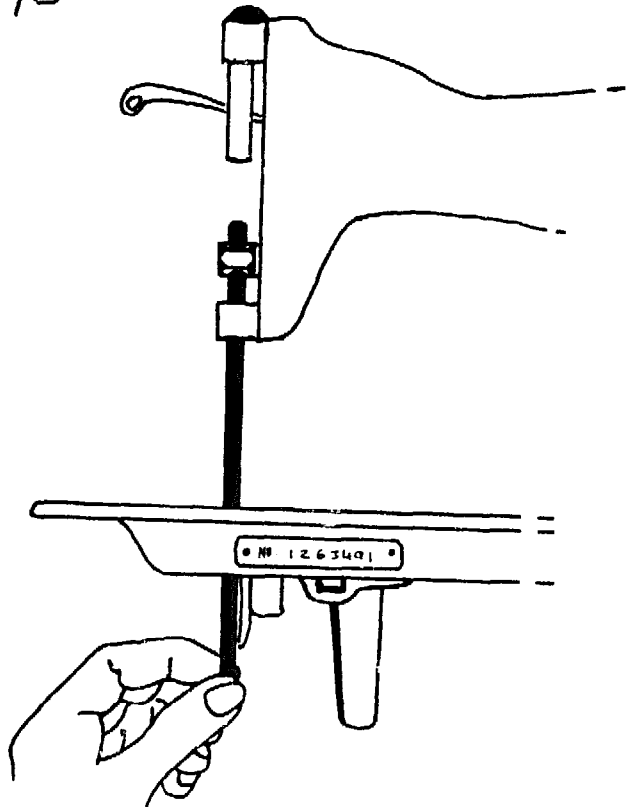

12. PUT THE MACHINE DOWN.

TURN THE WHEEL TOWARDS YOU
UNTIL THE NUT IS AS LOW AS
IT WILL GO.

TIGHTEN IT.

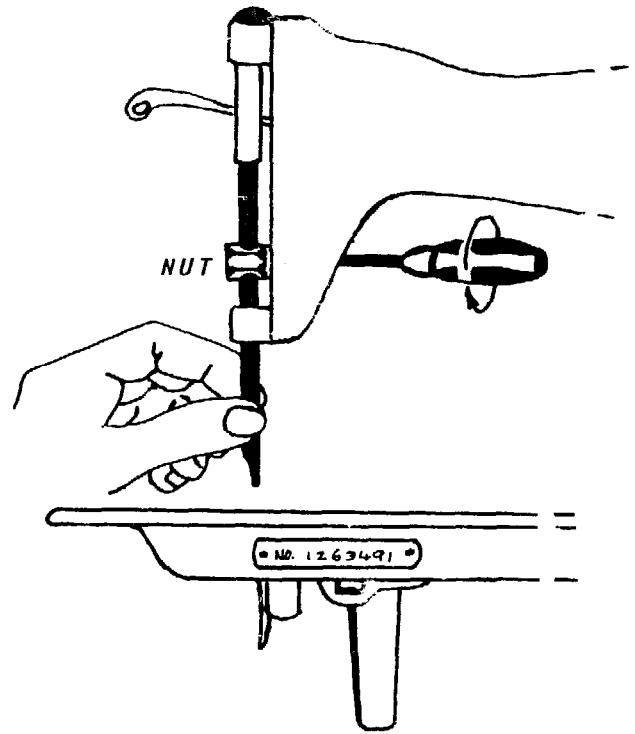

13. PUT BACK THE FEED DOG.

PUT BACK THE SHUTTLE RACE,

PUT BACK THE PRESSER FOOT, THE COTTON HOLDER,
THE NEEDLE CLAMP AND THE NEEDLE.

14. FIX THE NEEDLE TIMING.

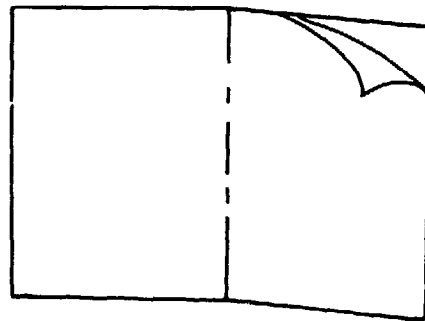

SEE PAGE 40

TO CHANGE THE HEIGHT OF THE FEED DOG

1. FOR ORDINARY SEWING, THE FEED DOG SHOULD BE SET SO THAT WHEN IT IS AS HIGH AS IT WILL GO IT IS IN THIS POSITION:

ALL THE TOP POINTS ARE ABOVE THE THROAT PLATE,
ALL THE BOTTOM POINTS ARE BELOW THE THROAT PLATE.

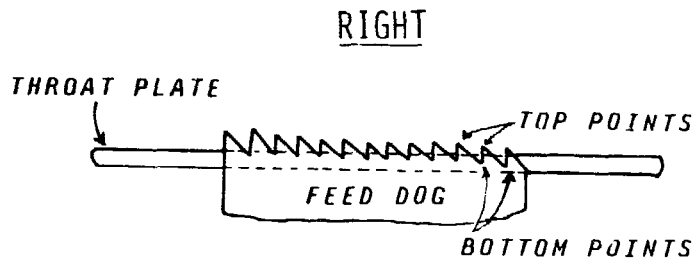

WRONG

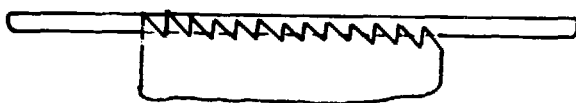

WRONG

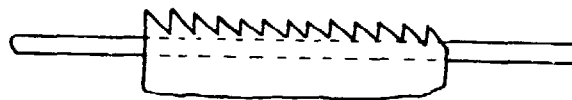

TURN THE WHEEL UNTIL THE FEED DOG IS AS HIGH AS IT WILL GO,
THEN CHECK THE HEIGHT.

IF THE HEIGHT OF THE FEED DOG IS WRONG, THEN FOLLOW THESE STEPS:

2. TAKE OFF THE NEEDLE.

TAKE OFF THE PRESSER FOOT.

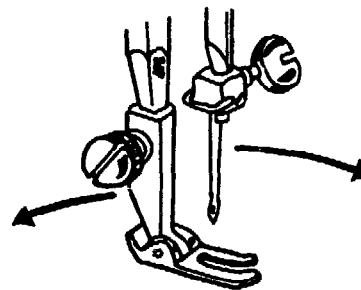

TAKE OFF THE THROAT PLATE.

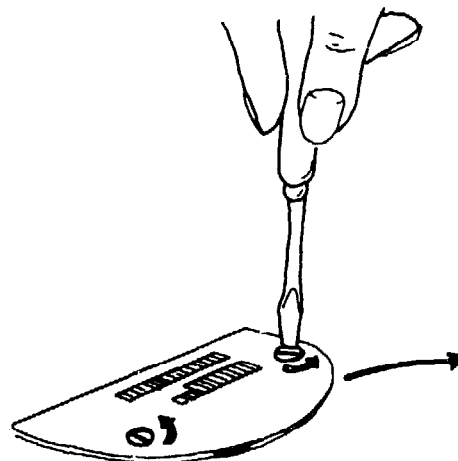

3. TIP BACK THE MACHINE.

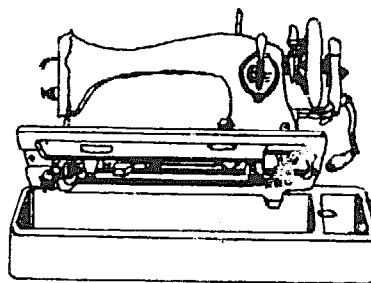

4. LOOSEN THIS SCREW.

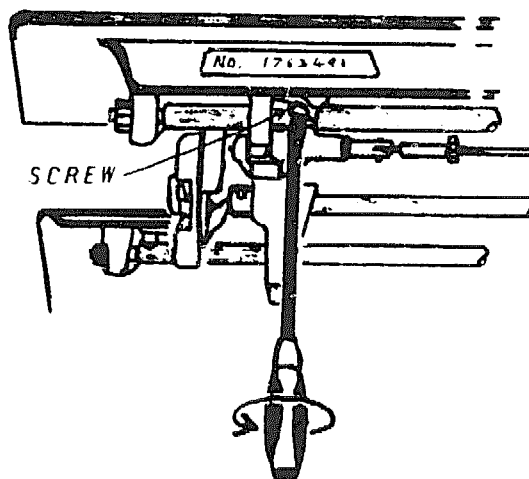

5. MOVE THIS PART WITH YOUR FINGERS
TO MAKE THE FEED DOG MOVE UP OR DOWN.

TO MAKE THE FEED DOG MOVE UP,
PUSH IT BACK (AWAY FROM YOU).

TO MAKE THE FEED DOG MOVE DOWN,
PUSH IT FORWARD (TOWARDS YOU).

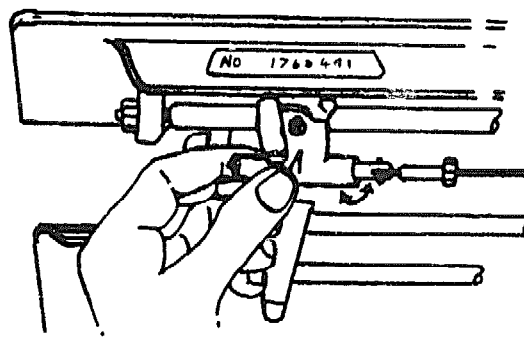

6. TIGHTEN THE SCREW.

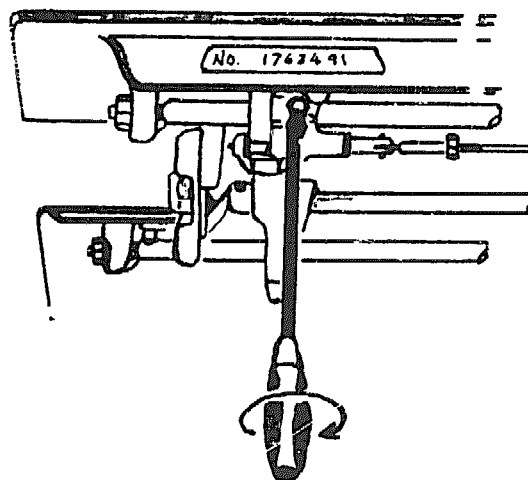

7. PUT THE THROAT PLATE BACK ON.

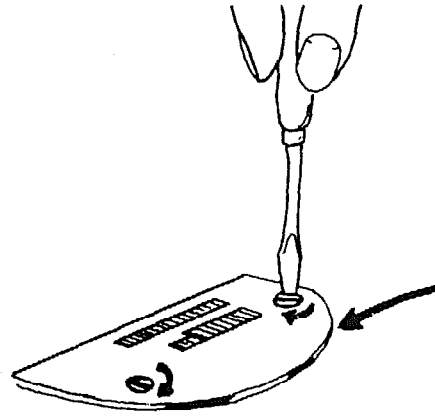

8. TURN THE WHEEL TOWARDS YOU UNTIL THE FEED DOG IS AS HIGH AS IT WILL GO, THEN CHECK THE HEIGHT OF THE FEED DOG, AS IN STEP 1.

IF THE HEIGHT IS STILL NOT RIGHT, THEN:

TAKE OFF THE THROAT PLATE AGAIN, LOOSEN THE SCREW UNDERNEATH THE MACHINE, MOVE THE FEED DOG

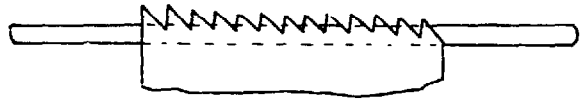

AGAIN UNTIL IT IS AT THE RIGHT HEIGHT.

9. WHEN THE HEIGHT IS RIGHT, MAKE SURE THAT THE SCREW UNDERNEATH THE MACHINE IS TIGHT.

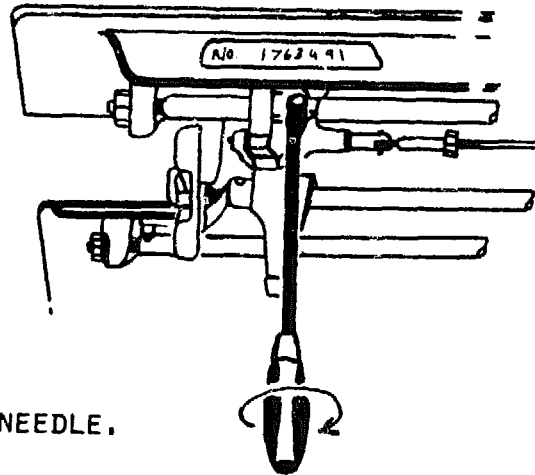

PUT BACK THE PRESSER FOOT AND THE NEEDLE.

NOTE: IF YOUR MACHINE HAS NO DROP FEED KNOB TO LET YOU DO DARNING, LOWER THE FEED DOG UNTIL THE TOP POINTS ARE ALL BELOW THE THROAT PLATE.

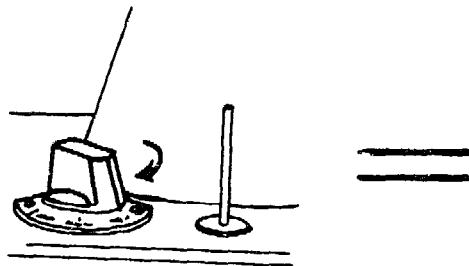

WHEN YOU HAVE FINISHED YOUR DARNING, PUT THE FEED DOG BACK AT THE RIGHT HEIGHT FOR ORDINARY SEWING.

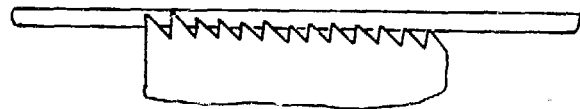

NOTE: IF THE HEIGHT OF THE FEED DOG IS RIGHT,
BUT THE CLOTH IS STILL NOT MOVING THROUGH
PROPERLY, CHECK THE FEED TIMING:

THE FEED TIMING IS RIGHT IF:

- A) THE FEED DOG COMES OUT OF
THE THROAT PLATE AFTER THE
NEEDLE COMES UP ABOVE THE
TOP OF THE THROAT PLATE.

AND

- B) THE FEED DOG STARTS TO
MOVE AWAY FROM YOU AT
JUST THE SAME TIME AS
THE NEEDLE STARTS TO
MOVE DOWN.

AND

- C) THE FEED DOG GOES BELOW
THE THROAT PLATE WHEN
THE NEEDLE HAS COME
DOWN TO JUST ABOVE THE
THROAT PLATE.

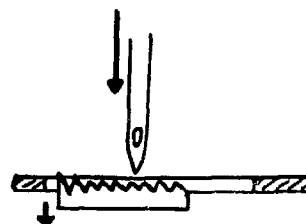
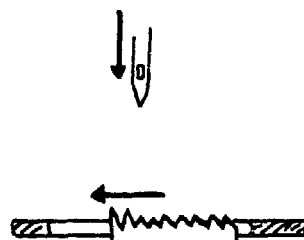
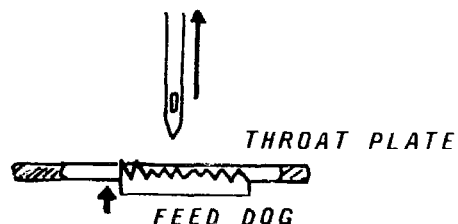

TURN THE WHEEL TOWARDS YOU TO SEE IF THE NEEDLE
AND THE FEED DOG MOVE TOGETHER IN THIS WAY,

IF THEY DO NOT, THEN THE FEED TIMING IS WRONG.
THIS IS DIFFICULT TO FIX. TRY TO ASK A
SEWING MACHINE MECHANIC FOR HELP.

TO TIGHTEN THE BOBBIN WINDER SCREWS

IF THE BOBBIN WINDER DOES NOT STAY DOWN
WHEN YOU WANT TO WIND THE BOBBIN,
FOLLOW THESE STEPS:

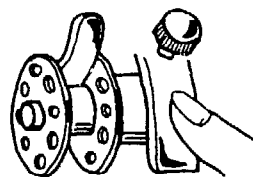

1. TAKE OFF THE HANDLE.

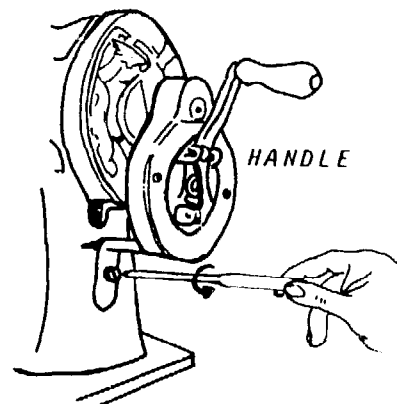

2. LOOSEN THIS SCREW.

THEN LOOSEN THE WHEEL NUT.

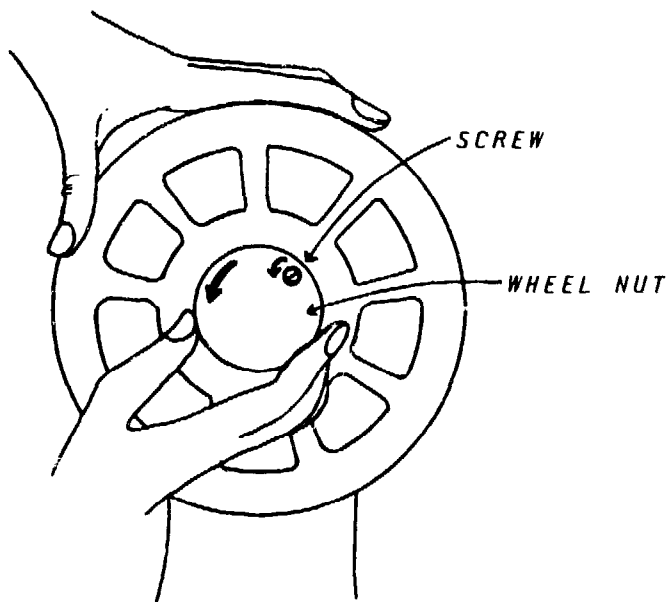

3. TAKE OFF THE WASHER.

THEN TAKE OFF THE WHEEL.

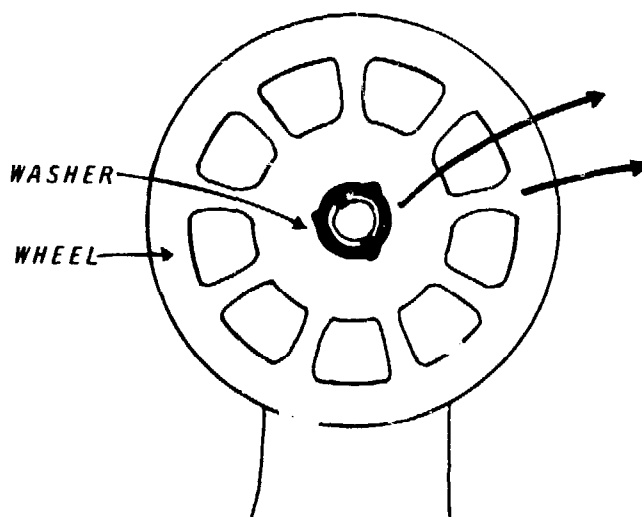

4. TIGHTEN THESE TWO SCREWS.

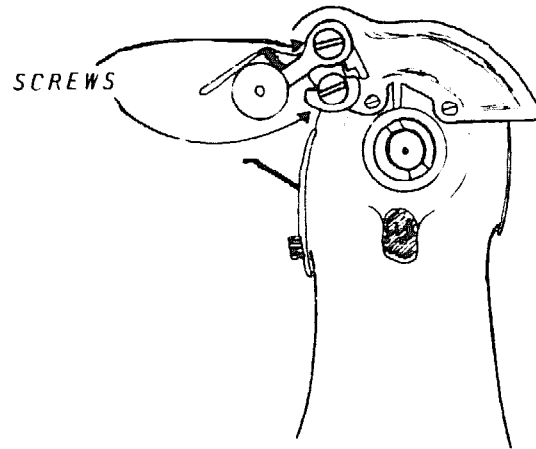

5. PUT BACK THE WHEEL.

PUT BACK THE WASHER.

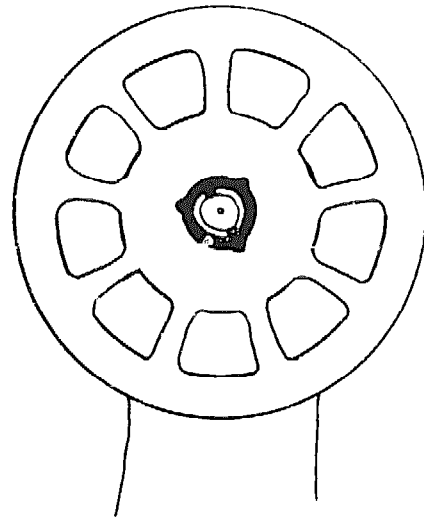

6. PUT BACK THE WHEEL NUT
AND TIGHTEN IT.

TIGHTEN THE SCREW.

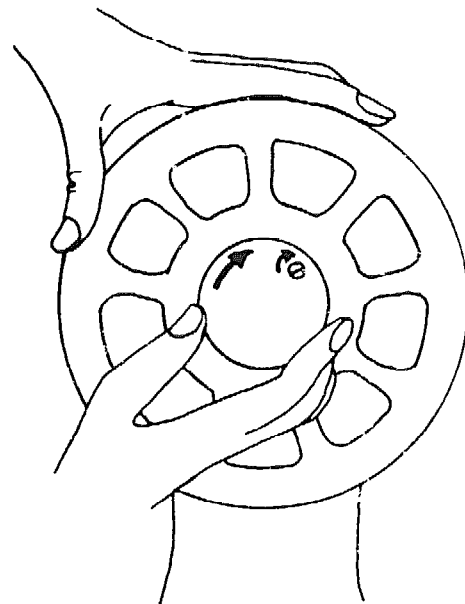

7. PUT BACK THE HANDLE.

TO PUT IN A NEW BOBBIN WINDER RUBBER

1. IF THE RUBBER IS WORN,
TAKE IT OFF THE BOBBIN WINDER
BY PULLING IT TOWARDS THE WHEEL.

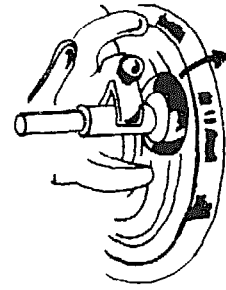

2. PUT A NEW RUBBER ONTO THE
BOBBIN WINDER BY PUSHING
IT GENTLY OVER THE EDGE
AND INTO THE GROOVE.

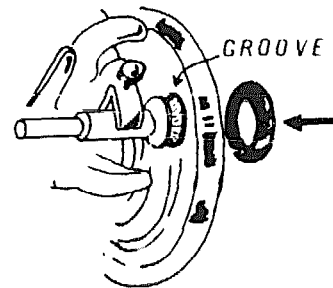

DIFFERENCES IN MACHINES

DIFFERENT KINDS AND MODELS OF SEWING MACHINES ARE BUILT IN DIFFERENT WAYS. YOU WILL PROBABLY FIND THAT PARTS OF YOUR MACHINE DO NOT LOOK EXACTLY LIKE THE DRAWINGS IN THIS BOOK. TO HELP YOU FOLLOW THE INSTRUCTIONS ANYWAY, HERE IS A LIST OF THE MOST IMPORTANT DIFFERENCES AMONG SEWING MACHINES. BESIDE EACH DIFFERENCE IS THE PAGE NUMBER OF THE STEP FOR WHICH IT IS IMPORTANT.

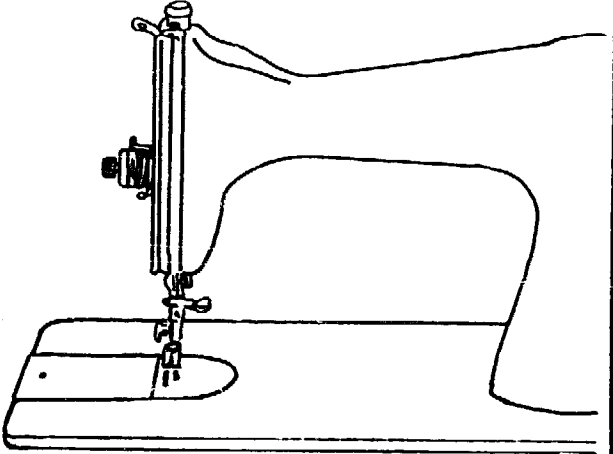
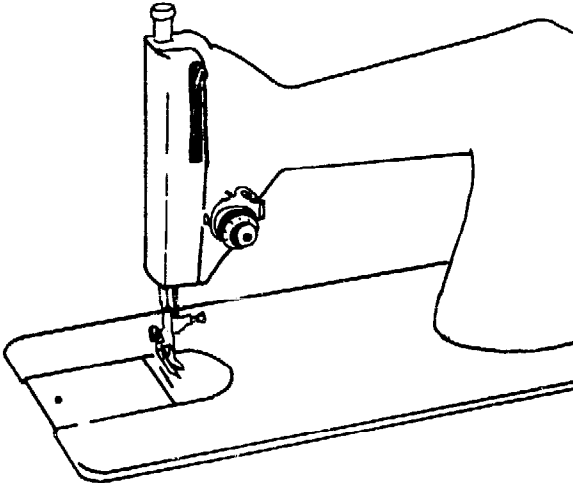
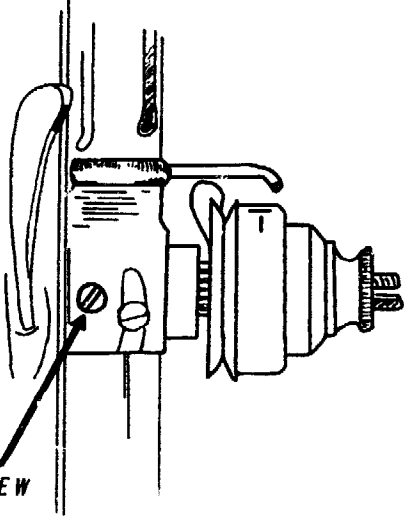
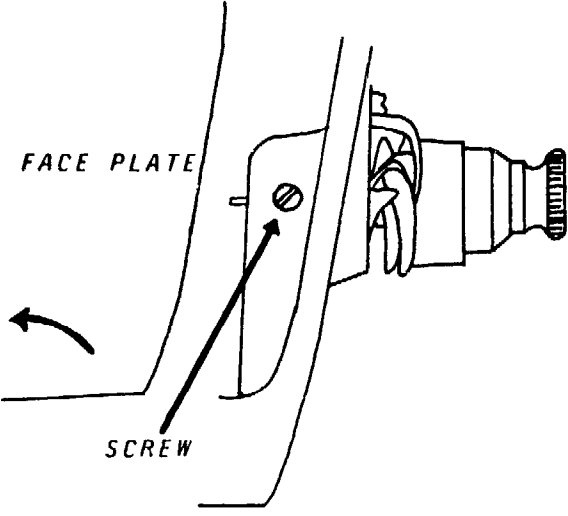
SOME MACHINES	OTHER MACHINES	SEE PAGE
 <p data-bbox="191 1087 732 1209">THE TENSION REGULATOR IS ON THE SIDE OF THE MACHINE. IT IS ATTACHED TO THE FACE PLATE.</p>	 <p data-bbox="805 1045 1365 1209">THE TENSION REGULATOR IS ON THE FRONT OF THE MACHINE. IT IS ATTACHED TO THE BODY OF THE MACHINE.</p>	<p data-bbox="1401 632 1438 772">11 26 28 31 34</p>
 <p data-bbox="207 1717 298 1745">SCREW</p> <p data-bbox="185 1793 732 1959">WHEN YOU LOOK AT THE TENSION REGULATOR FROM THE BACK OF THE MACHINE, YOU CAN SEE THE SCREW THAT HOLDS IT IN PLACE.</p>	 <p data-bbox="808 1394 987 1421">FACE PLATE</p> <p data-bbox="894 1682 985 1709">SCREW</p> <p data-bbox="776 1793 1377 1959">TO FIND THE SCREW THAT HOLDS THE TENSION REGULATOR IN PLACE, YOU MUST TAKE OFF THE FACE PLATE AND LOOK AT THE MACHINE FROM THE SIDE.</p>	<p data-bbox="1390 1503 1427 1644">11 26 28 31 34</p>

SOME MACHINES

OTHER MACHINES

SEE PAGE

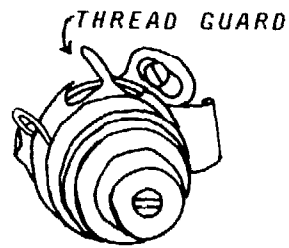
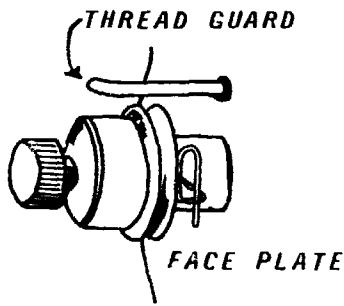

12
27
29

THE THREAD GUARD FOR THE TENSION REGULATOR IS A BAR ATTACHED TO THE FACE PLATE, AND NOT A PART OF THE TENSION REGULATOR.

THE THREAD GUARD FOR THE TENSION REGULATOR IS A PART OF THE TENSION REGULATOR ITSELF. IT IS A BAR OR CURVED PIECE THAT STICKS OUT FROM ONE OF THE PIECES OF THE TENSION REGULATOR.

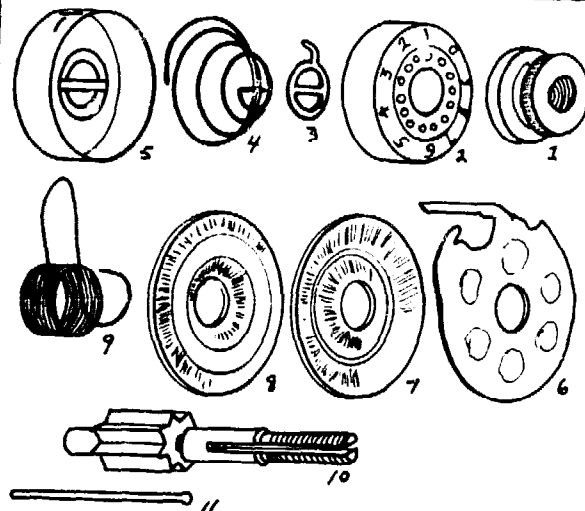
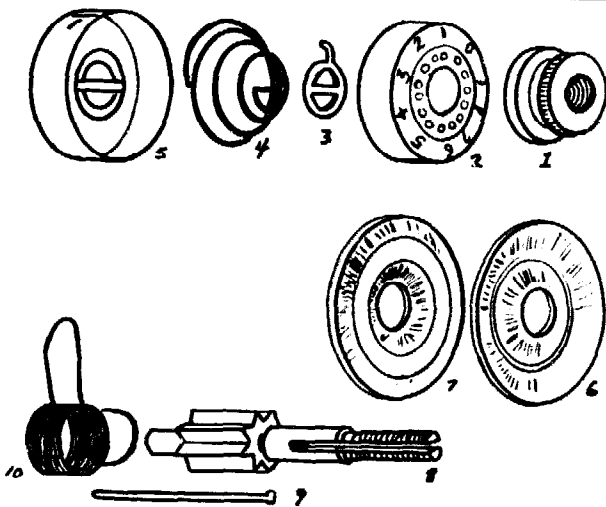

29
31
35

IN THESE MACHINES THE TENSION REGULATOR HAS 10 PIECES.

IN THESE MACHINES THE TENSION REGULATOR HAS 11 PIECES.

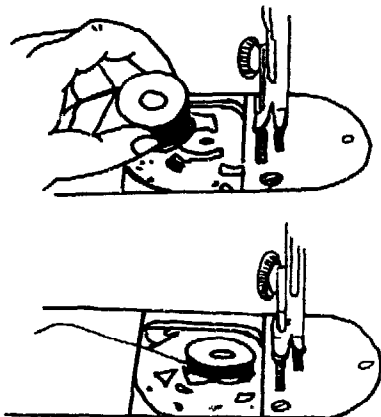

THE SHUTTLE RACE LIES FLAT UNDER THE COVER PLATE. THE BOBBIN CASE IS ATTACHED TO THE SHUTTLE RACE--YOU CANNOT TAKE IT OUT OF THE MACHINE.

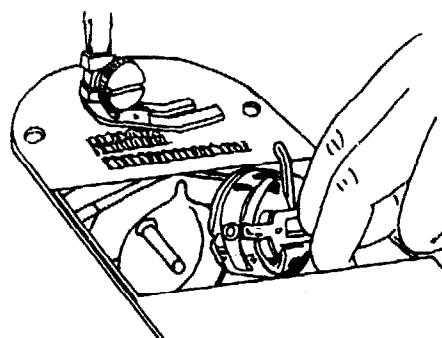

12
13
40
49

THE SHUTTLE RACE STANDS STRAIGHT UP UNDER THE THROAT PLATE, YOU CAN TAKE THE BOBBIN CASE OUT OF THE MACHINE.

SOME MACHINES

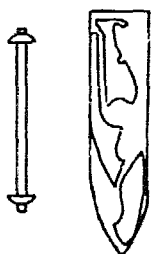

THE BOBBIN IS LONG AND FITS INTO A LONG BOBBIN CASE.

61

OTHER MACHINES

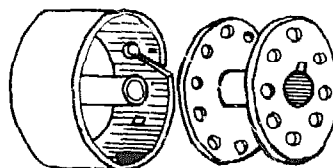

THE BOBBIN IS ROUND AND FITS INTO A ROUND BOBBIN CASE.

SEE PAGE

12
13
40
49

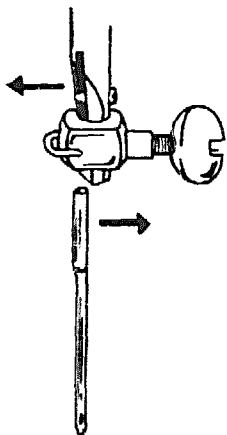

IN MOST MACHINES THE GROOVE IN THE NEEDLE BAR FACES LEFT (WHEN YOU ARE LOOKING AT THE FRONT OF THE MACHINE), AND THE FLAT SIDE OF THE NEEDLE FACES TO THE RIGHT TO FIT INTO THE GROOVE.

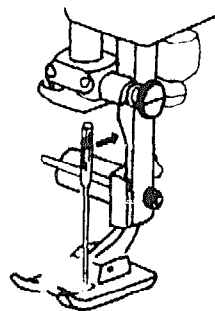

IN A FEW MACHINES THE GROOVE IN THE NEEDLE BAR FACES TO THE FRONT AND THE FLAT SIDE OF THE NEEDLE FACES TO THE BACK TO FIT INTO THE GROOVE.

14

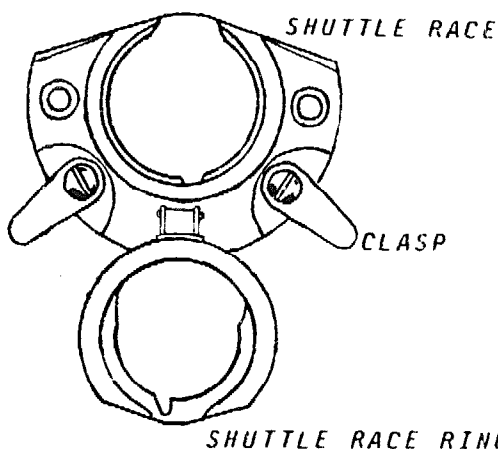

THE SHUTTLE RACE RING IS HELD IN THE SHUTTLE RACE WITH CLASPS. THE SHUTTLE RACE RING IS ATTACHED TO THE SHUTTLE RACE.

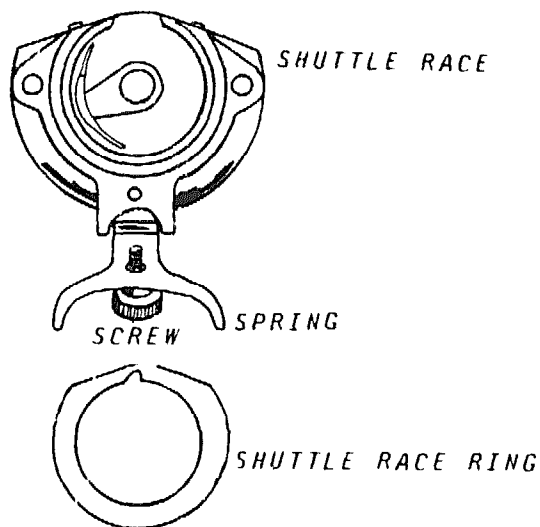

THE SHUTTLE RACE RING IS HELD IN THE SHUTTLE RACE WITH A SCREW AND A SPRING. THE SHUTTLE RACE RING IS NOT ATTACHED TO THE SHUTTLE RACE.

22
40

SOME MACHINES

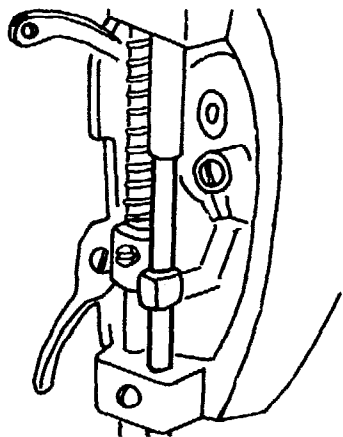

THE NEEDLE BAR HAS NO TIMING MARKS. TO FIX THE NEEDLE TIMING YOU MUST CHANGE THE POSITION OF THE NEEDLE BY SIGHT.

OTHER MACHINES

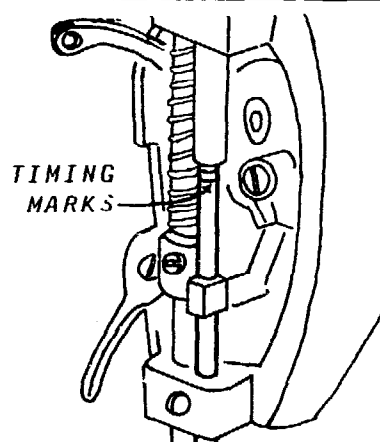

THE NEEDLE BAR HAS TIMING MARKS. THESE MAKE IT A LITTLE EASIER TO FIX THE NEEDLE TIMING.

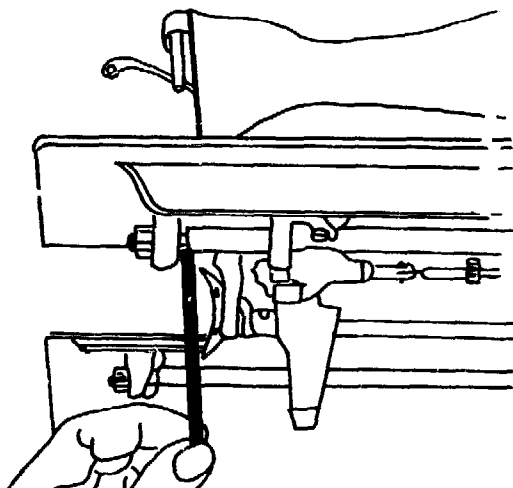
SEE
PAGE40
43

THE NEEDLE BAR CANNOT COME OUT THE TOP OF THE MACHINE. YOU MUST TAKE IT OUT FROM THE BOTTOM. BOTTOM.

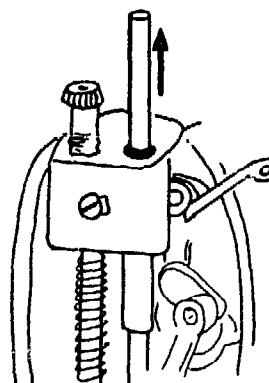

THE NEEDLE BAR CAN BE TAKEN OUT FROM THE TOP OF THE MACHINE.

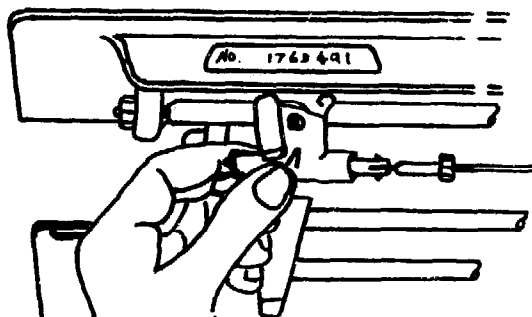
46
48

THERE IS NO DROP FEED KNOB. INSTEAD, YOU CAN CHANGE THE HEIGHT OF THE FEED DOG FROM UNDER THE MACHINE.

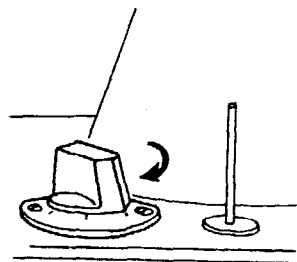

TURNING THE DROP FEED KNOB TO THE LEFT LOWERS THE FEED DOG SO YOU CAN DO DARNING. IT MOVES THE FEED DOG OUT OF THE WAY SO THE CLOTH WILL NOT CATCH ON IT.

54

TO GET PARTS AND ADVICE

PARTS FOR MOST KINDS OF SEWING MACHINES CAN BE ORDERED FROM:

STEAMSHIPS TRADING COMPANY LTD.
P.O. BOX 1
PORT MORESBY
NATIONAL CAPITAL DISTRICT
PAPUA NEW GUINEA.

IN THE NEAR FUTURE, VILLAGE EQUIPMENT SUPPLIERS, SPATF'S TRADING COMPANY, WILL ALSO HAVE SEWING MACHINE PARTS FOR SALE. FOR MORE INFORMATION, WRITE TO:

THE MANAGER,
VILLAGE EQUIPMENT SUPPLIERS
P.O. BOX 2172
LAE
MOROBE PROVINCE
PAPUA NEW GUINEA.

IF YOU CANNOT FIX YOUR SEWING MACHINE USING THIS BOOK, YOU CAN WRITE TO SPATF FOR MORE ADVICE:

SOUTH PACIFIC APPROPRIATE TECHNOLOGY FOUNDATION (SPATF)
P.O. BOX 6937
BOROKO
PAPUA NEW GUINEA.

PRINTED BY HEBAMO PRESS. P.O. BOX 6033. BOROKO. P.N.G.

TO THE USERS OF THIS MANUAL:

THIS IS THE FIRST EDITION OF THIS MANUAL. A SECOND EDITION WILL BE PRINTED IF IT IS FOUND THAT CHANGES NEED TO BE MADE IN THE MANUAL. TO HELP US DECIDE WHAT CHANGES MIGHT BE NEEDED, WE ARE ASKING YOU TO FILL IN THIS QUESTIONNAIRE. PLEASE WRITE YOUR NAME AND ADDRESS AT THE END OF THE QUESTIONNAIRE, SO THAT WE CAN SEND YOU THE SECOND EDITION, IF THERE IS ONE.

SEND YOUR COMPLETED QUESTIONNAIRE TO:

SOUTH PACIFIC APPROPRIATE TECHNOLOGY FOUNDATION
P.O. BOX 6937
BOROKO
PAPUA NEW GUINEA

THANK YOU FOR YOUR HELP.

QUESTIONNAIRE:

1. HAVE YOU REPAIRED A SEWING MACHINE USING THIS MANUAL?

WHAT WAS WRONG WITH THE MACHINE?

DID THE MANUAL TELL YOU CLEARLY HOW TO FIX IT?

IF NOT, WHAT STEPS WERE NOT CLEAR?

2. ARE THE DRAWINGS CLEAR?

WHICH ONES SHOULD BE MADE CLEARER?

ARE THERE ENOUGH LABELS ON THE DRAWINGS?

3. ARE THE PRINTED INSTRUCTIONS CLEAR?

WHICH ONES SHOULD BE MADE CLEARER?

4. ARE THERE ANY IMPORTANT SEWING MACHINE FAULTS THAT HAVE BEEN LEFT OUT?

ARE THERE ANY INSTRUCTIONS THAT SHOULD BE CHANGED IN ANY WAY?

5. WHAT KIND OF SEWING MACHINE DO YOU HAVE?

ARE THE PARTS OF YOUR MACHINE NEARLY THE SAME AS, OR VERY DIFFERENT FROM THE PARTS SHOWN IN THE MANUAL?

6. ANY OTHER COMMENTS OR SUGGESTIONS?

NAME _____

ADDRESS _____
