

**AT** MICROFICHE  
REFERENCE  
LIBRARY  
A project of Volunteers in Asia

Tropical and Sub-tropical Apiculture

By:FAO Agricultural Services: Bulletin 68

Published by: Food and Agriculture Organization of the United Nations  
Publications Division  
Via delle Terme di Caracalla  
00100 Rome  
Italy

Available from: UNIPUB  
4611-F Assembly Drive  
Lanham MD 20706-4391  
U.S.A.

Reproduced with permission.

Reproduction of this microfiche document in any form is subject to the same restrictions as those of the original document.

# Tropical and sub-tropical apiculture

FAO  
AGRICULTURAL  
SERVICES  
BULLETIN

68



FOOD  
AND  
AGRICULTURE  
ORGANIZATION  
OF THE  
UNITED NATIONS

# Tropical and sub-tropical apiculture

FAO  
AGRICULTURAL  
SERVICES  
BULLETIN

68

Food and Agricultural Industries Service  
FAO Agricultural Industries Division

Exclusively Distributed by:

~~BENTON~~ - UNIPUB

4611 - F Assembly Drive

Lanham, MD 20706-4391

(301) 459-7666

Price: \$24.00

F2981



FOOD  
AND  
AGRICULTURE  
ORGANIZATION  
OF THE  
UNITED NATIONS  
Rome, 1986

The designations employed and the presentation of material in this publication do not imply the expression of any opinion whatsoever on the part of the Food and Agriculture Organization of the United Nations concerning the legal status of any country, territory, city or area or of its authorities, or concerning the delimitation of its frontiers or boundaries.

M-21  
ISBN 92-5-102444-8

All rights reserved. No part of this publication may be reproduced, stored in a retrieval system, or transmitted in any form or by any means, electronic, mechanical, photocopying or otherwise, without the prior permission of the copyright owner. Applications for such permission, with a statement of the purpose and extent of the reproduction, should be addressed to the Director, Publications Division, Food and Agriculture Organization of the United Nations, Via delle Terme di Caracalla, 00100 Rome, Italy.

© FAO 1986

## PREFACE

In recent years, governments of many developing countries have been giving greater attention to the production of honey, beeswax and other bee products. Indeed, apiculture offers many advantages such as --

- (a) providing valuable food, especially to rural populations;
- (b) providing remunerative employment;
- (c) earning much-needed foreign exchange;
- (d) requiring no large investment;
- (e) contributing to pollination and thus to crop production;
- (f) requiring practically no space on the farm.

One of the main obstacles to the development of apiculture in developing countries in the tropics and sub-tropics has been the shortage of up-to-date literature designed specifically for those regions. The present volume is particularly designed to help to fill this gap, and also to provide a general introduction to apiculture for agricultural planners.

Suggestions from readers on how to improve subsequent editions would be appreciated. They should be addressed to:

Chief  
Food and Agricultural Industries Service  
Agricultural Services Division  
Food and Agriculture Organization of the United Nations  
Via delle Terme di Caracalla  
00100 Rome  
Italy

M.S.O. Nicholas  
Director  
Agricultural Services Division

## FOREWORD

Apiculture is a valuable tool for helping to meet the urgent needs of the rural population of developing countries: more food, higher income, and greater opportunities for gainful employment. The publication of this comprehensive monograph on "Apiculture and honey production in the developing countries of the tropics and sub-tropics" by FAO is hence timely. This is the first book of its kind, and Dr. Eva Crane and the other authors deserve our gratitude for this labour of love. The book in its geographical coverage is relevant to about half the world's land area. Obviously, therefore, it cannot deal with every region and set of conditions in great detail. Nevertheless, the volume of data and information condensed in this concise book is impressive. Adequate background and operational information has been provided about all aspects of apiculture; hence policy makers and general agricultural experts will find the book an invaluable source of information and an aid in decision-making.

The book brings out the enormous untapped potential for the development of a dynamic apiculture industry in the developing countries. Already, the three largest exporters of honey in the world are China, Mexico and Argentina. Another point which clearly emerges from the various chapters is the great value of considering the tropical/sub-tropical region in an integrated manner. Most countries in these regions are blessed with abundant sunshine, and a rich flora which blooms all the year round. An integrated consideration of the problems and potential of the apiculture industry in the tropics and sub-tropics will therefore help in identifying the constraints responsible for the gap between potential and actual honey production. At the same time, it will help to monitor and regulate the movement of bees and associated pathogens from temperate into tropical areas, where beekeeping is especially vulnerable to setbacks caused by new diseases. We urgently need a mechanism for disease monitoring, and for organizing an early warning system with reference to the spread of new pests and pathogens. Information on marketing opportunities will also be necessary for countries that are substantially increasing their apicultural production.

Much of this book has been written by scientists who are authorities in their respective fields. The book, therefore, serves as an encyclopaedia of information relating to the various aspects of

apiculture. A special appendix, on information resources for beekeepers, shows how the reader can enlarge his knowledge further, and the final chapters suggest how a technology transfer programme can be initiated.

In spite of all global resolutions on food security, several hundred million children, women, and men are going to bed hungry every day, particularly in countries of the "south". Since prospects for a global food security system appear to be small at the present moment, it will be prudent for developing countries characterized by poverty and under-nutrition to build their own national food security systems. In this task, apiculture can play a useful role. At very little expenditure, honeybees will not only provide food and income, but will also enhance the productivity of horticultural and other field crops, by their pollinating activities. The International Bee Research Association, contracted by FAC to prepare the book, hopes that its publication will generate awareness and thereby catalyse action towards a more effective exploitation of natural resources in developing countries, through apiculture. By publishing the book FAO has rendered great service to rural development, a cause to which it is deeply committed through the action plan developed at the World Conference on Agrarian Reform and Rural Development.

M.S. Swaminathan  
Director General  
International Rice Research Institute  
and  
Independent Chairman, FAO Council

## ABOUT THIS BOOK

In 1980, FAO, aware of the importance of apiculture in the tropical and sub-tropical areas of the developing world and of the growing interest in it there and elsewhere, requested the International Bee Research Association (IBRA) to prepare a book on the subject for early publication. As originally conceived, the monograph was to review the current position of beekeeping in the various developing regions, continue with a general introduction to bee management and the management of hive products, summarize the position with regard to plant resources for bees in the tropics and sub-tropics, go into some detail on the resources available for beekeepers in the developing countries, and conclude with an important section setting out proposed measures - both technical and political/organizational - for developing apiculture and increasing its productivity in the regions concerned.

IBRA assembled an impressive roster of international authorities on beekeeping as contributors, and the manuscript was ready for the press by the end of 1981. Authors of chapters or major parts of chapters were as follows: C.E. Bowman (UK), B. Clauss (FRG), Dr. E. Crane (UK), Prof. W. Drescher (FRG), Prof. J.B. Free (UK), Dr. D.A. Griffiths (UK), Huang W.-C. (PRC), Dr. I. Kigatiira (Kenya), D.A. Knox (USA), Prof. N. Koeniger (FRG), Capt. P. Latham (UK), Ma D.-F.M. (PRC), M. Nixon (UK), Dr. R.P. Phadke (India), Dr. A. Popa (France), Dr. H. Shimanuki (USA), Prof. G.F. Townsend (Canada), Mrs P. Walker (UK), G.M. Walton (NZ), and H. Wiese (Brazil). Dr. Eva Crane, then Director of IBRA, planned the book and was its Chief Editor, and Dr. M.S. Swaminathan (India) gave advice and support both as Independent Chairman of the FAO Council and as President of IBRA.

Unfortunately, financial constraints made it impossible for FAO to publish the book without delay, and toward the end of 1983 IBRA kindly undertook to update the manuscript as far as was practicable, time being then too short to consult all the authors. In the meantime, FAO reexamined the scope of the book in light of preliminary comments, and this review, together with the wealth of the new material available, made a complete reorganization and rewriting of the book inevitable. FAO therefore requested its former Chief Editor, D. Jon Grossman, to assume this task, drawing to the greatest extent possible on the valuable contribution of IBRA but also taking into account the documented experience of FAO itself in apicultural development in all the tropical and sub-tropical regions.

Originally a composite work, with the considerable advantage of varied viewpoints of highly skilled, long-time workers in apiculture, the study as now presented has a more limited scope: to provide a general introduction to beekeeping confined to the aspects strictly necessary for an understanding of the problems of apiculture which are specifically applicable to the developing countries of the tropics and sub-tropics. Many technical matters of considerable importance are hardly touched on, and some are not even mentioned, but these are dealt with in good beekeeping manuals written in and for the developed countries; on the other hand, emphasis is laid on certain points which, while of little concern to beekeepers in temperate zones, create acute problems in the tropics.



This book is therefore not a complete manual of tropical apiculture. Since beekeeping methods, as will be seen, must vary widely according to the ecological conditions of each area, and since the tropics and sub-tropics contain an enormous range of such conditions, such a manual would have to assume encyclopedic dimensions. The beginning tropical beekeeper will however find in it much of the background material he needs for a thorough understanding of his art, the more experienced worker with bees may find solutions to some of his problems which have been solved elsewhere, and agricultural planners will find some indications of means by which apiculture can become an element in integrated rural development.

The contribution of IBRA to this book cannot be over-estimated; in particular, the help of Dr. Eva Crane and Mrs. Penelope Walker in answering technical queries was invaluable. It must be emphasized, however, that final decisions on the format and contents of the book were those of FAO alone, and accordingly that the views reflected in it do not necessarily reflect those of IBRA or of individual contributors, except where they are specifically cited.

The Editor

FAO AGRICULTURAL SERVICES BULLETINS

1. Farm planning in the early stages of development, 1968 (E\* F\* S\*)
2. Planning for action in agricultural development, 1969 (E\* F\* S\*)
3. Karakul processing, 1969 (E\*)
4. Bread from composite flour, 1970 (E\* F\* S\*)
5. Drying of fruits and vegetables, 1970 (E\* F\* S\*)
6. Cashew nut processing, 1970 (E\* F\*)
7. Technology for the production of protein food from cottonseed flour, 1971 (E\* F\* S\*)
8. Cassava processing. (New edition (1977) available in E, F and S in the FAO Plant Production and Protection Series)
9. World list of food technology institutions, 1971 (E/F/S\*)
10. Technology for the production of protein foods from groundnut, 1971 (E\* F\* S\*)
11. Technology for the production of protein foods from soybean, 1971 (E\* F\* S\*)
12. Guide for instructors in organizing and conducting agricultural engineering training courses, 1971 (E\* F\* S\*)  
Sup. 1. — Elements of agricultural machinery, Vol. 1, 1977 (E\* S\*)  
Sup. 2. — Elements of agricultural machinery, Vol. 2, 1977 (E\* S\*)
13. Fruit juice processing, 1972 (E\* S\*)
14. Environmental aspects of natural resource management — agriculture and soils, 1972 (E\* F\* S\*)
15. Sericulture manual: Vol. 1. — Mulberry cultivation, 1976 (E\* F\*)  
Vol. 2. — Silkworm rearing, 1973 (E\* F\*)  
Vol. 3. — Silk reeling, 1972 (E\* F\*)
16. Use of aircraft in agriculture. (New edition (1974) available in E, F and S in the FAO Agricultural Series)
17. Airtight grain storage, 1973 (E\* F\* S\*)
18. Flice testing — methods and equipment, 1973 (E\*)
19. Cold storage — design and operation, 1973 (E\* F\* S\*)
- 19/2. Design and operation of cold stores in developing countries, 1984 (E\* F\*)
20. Processing of rural rubber, 1973 (E\*)
- 21 Rev. 1. — Agricultural residues: world directory of institutions, 1978 (E/F/S\*)
- 21 Rev. 2. — Agricultural residues: world directory of institutions, 1982 (E/F/S\*)
22. Rice milling equipment — operation and maintenance, 1974 (E\*)
23. Rice drying (E\*\*)
24. World list of textile research institutes, 1974 (E/F/S\*)
25. Utilization of molasses, 1975 (E\* F\* S\*)
26. Tea processing, 1974 (E\*)
27. Some aspects of earth-moving machines as used in agriculture, 1975 (E\*)
28. Mechanization of irrigated crop production, 1977 (E\*)
29. Non-mulberry silks, 1979 (E\*)
30. Machinery servicing organizations, 1977 (E\*)
31. Rice husk conversion to energy, 1978 (E\*)
32. Animal blood — processing and utilization, 1982 (E\* S\*)
33. Agricultural residues: compendium of technologies, 1982 (E/F/S\*)
- 33 Rev. 1. — Agricultural residues: compendium of technologies, 1982 (E/F/S\*)
34. Farm management data collection and analysis, 1977 (E\* F\* S\*)
35. Bibliography of agricultural residues, 1978 (E/F/S\*)
36. China: rural processing technology, 1979 (E\*)
37. Illustrated glossary of rice-processing machines, 1979 (E\*)
38. Pesticide application equipment and techniques, 1979 (E\*)
39. Small-scale cane sugar processing and molasses utilization, 1980 (E\*)
40. On-farm maize drying and storage in the humid tropics, 1980 (E\*)
41. Farm management research for small farmer development, 1980 (E\* F\* S\*)
42. China: sericulture, 1980 (E\*)
43. Food loss prevention in perishable crops, 1980 (E\* F\* S\*)
44. Replacement parts of agricultural machinery, 1981 (E\*)
45. Agricultural mechanization in development: guidelines for strategy formulation, 1981 (E\* F\*)
46. Energy cropping versus food production, 1981 (E\* F\* S\*)
47. Agricultural residues: bibliography 1975-81 and quantitative supply, 1982 (E/F/S\*)
48. Plastic greenhouses for warm climates, 1982 (E\*)
49. China: grain storage structures, 1982 (E\*)
50. China: post-harvest grain technology, 1982 (E\*)
51. The private marketing entrepreneur and rural development, 1982 (E\*)
52. Aeration of grain in subtropical climates, 1982 (E\*)
53. Processing and storage of foodgrains by rural families, 1983 (E\* F\* S\*)
54. Biomass energy profiles, 1983 (E\*)
55. Handling, grading and disposal of wool, 1983 (E\* F\*)
56. Rice parboiling, 1984 (E\*)
57. Market information services, 1983 (E\*)
58. Marketing improvement in the developing world, 1984 (E\*)
59. Traditional post-harvest technology of perishable tropical staples, 1984 (E\*)
60. The retting of jute, 1984 (E\*)
61. Producer-gas technology for rural applications, 1985 (E\*)
62. Standardized designs for grain stores in hot dry climates, 1985 (E\* F\*)
63. Farm management glossary, 1985 (E/F/S\*)
64. Manual on establishment, operation and management of cereal barks, 1985 (E\*)
65. Farm management input to rural financial systems development, 1985 (E\* S\*)
66. Construction of cribs and storage of maize, 1985 (E\*)
67. Hides and skins improvement in developing countries, 1985 (E\*)
68. Tropical and sub-tropical apiculture, 1986 (E\*)

Availability: July 1986

Ar	— Arabic	* Available
E	— English	** Out of print
F	— French	*** In preparation
S	— Spanish	
Multil.	— Multilingual	

The FAO Agricultural Services Bulletins can be purchased locally through FAO sales agents or directly from Distribution and Sales Section, FAO, Via delle Terme di Caracalla, 00100 Roma, Italy.

## TABLE OF CONTENTS

	<u>Page</u>
PREFACE	(iii)
FOREWORD	(v)
ABOUT THIS BOOK	(vii)
TABLE OF CONTENTS	(ix)
CHAPTER 1 - INTRODUCTION	1
CHAPTER 2 - THE BEE	20
A. Bee Biology in the Tropics and Sub-Tropics	20
1. The Inhabitants of the Hive	20
2. The Queen	21
3. The Workers	21
4. The Drones	22
5. The Dearth Period	23
6. The Major Honey Flow	25
7. Behaviour Characteristics	25
B. Honeybee Species, Races and Strains	30
C. Bee Forage	48
D. The Value and Use of Bees in Pollination	62
CHAPTER 3 - BEE DISEASES, PESTS AND OTHER ENEMIES	69
1. General	69
2. Disease Transmission	70
3. Bee Diseases	70
A. Brood Diseases	71
B. Adult Bee Diseases	79
C. The Mite Diseases	82
D. Other Pests	88
E. World Distribution of Bee Diseases and Pests	90
CHAPTER 4 - HONEY-HUNTING AND TRADITIONAL METHODS OF BEEKEEPING	97
A. Honey-hunting	97
B. Beekeeping with Wild Bees	101
1. Hiving <u>Apis dorsata</u>	101
2. Beekeeping with <u>Apis florea</u>	102
C. Traditional Methods of Beekeeping	104
1. Traditional Beekeeping in Tropical Africa	104
2. The Cylindrical Split Wameru Hive	109
3. Traditional Beekeeping in the Mediterranean Basin	109
4. Traditional Beekeeping in Asia	110
D. Transitional Hives	111
1. The Kenya Top-Bar Hive	112
2. The Modified African Long Hive	117
E. Conclusion	117
F. Further Reading	118
CHAPTER 5 - MODERN APICULTURE	119
A. Hive Bees in the Tropics and Sub-Tropics	119
1. <u>Apis mellifera</u>	119
2. <u>Apis cerana</u>	125
B. The Movable-Frame Hive	126
1. Principles of the Movable-Frame Hive	126

	<u>Page</u>
2. Hive Types	129
3. Hive Construction	134
4. Comb Foundation	136
C. Diseases and Pest Control	136
D. Improved Utilization of the Honey Potential of the Land	137
E. Colony Management	138
1. Seasonal Cycles	138
2. The Seasonal Management Plan	139
3. Swarming	142
4. Robbing and its Prevention	144
5. Frequent Management Errors	144
F. Protection against Bees	145
 CHAPTER 6 - HIVE PRODUCTS	 151
A. Honey	151
1. Obtaining Honey from Traditional Hives	159
2. Obtaining Honey from Modern Hives	159
3. Honey Quality	168
4. Honey Standards and Legislation	171
5. Final Recommendations on Honey	172
6. Further Reading	172
B. Beeswax	173
1. Special Types of Beeswax	175
2. Important Factors in Harvesting Beeswax	177
3. Processing	177
4. Beeswax Production and Trade	182
5. Important Factors in Exporting Beeswax	184
6. Further Reading	184
C. Other Hive Products	185
1. Pollen	185
2. Propolis	188
3. Royal Jelly	189
4. Bee Venom	191
5. Bee Brood	192
6. General Observations	193
7. Further Reading	193
D. Production of Bees for Sale	194
1. Queen Rearing	194
2. Colonies and Packages of Bees	194
3. Hiring Bees for Pollination	195
4. Further Reading	195
 CHAPTER 7 - BEEKEEPING FOR PROFIT IN DEVELOPING COUNTRIES - A BANGLADESH CASE STUDY	 197
 CHAPTER 8 - NATIONAL PROGRAMMES FOR APICULTURAL DEVELOPMENT	 209
 CHAPTER 9 - TECHNICAL ASSISTANCE	 223
 APPENDIX A Important Sources of the World's Honey	 239
 APPENDIX B Codex Standards for Honey	 249
 APPENDIX C Beekeeping with Minimal Cost and Equipment: An Example from the Kalahari Desert	 253

	<u>Page</u>
APPENDIX D Bee Vulnerability to Pesticides	257
APPENDIX E Information Resources for Beekeepers in Developing Countries	263
BIBLIOGRAPHY	271

## LIST OF ILLUSTRATIONS

Fig. 1/1 Approximate distribution of the world's honey-producing bees, honeybees ( <u>Apis</u> ) and stingless bees ( <u>Meliponinae</u> )	
Fig. 1/2 Natural nest of <u>Apis cerana</u> in a tree in India.	3
Fig. 1/3 The regular spacing left by bees when building their combs.	4
Fig. 1/4 Weekly weight changes in a hive at La Plata, Argentina, 1968-69.	7
Fig. 1/5 Average weight changes in three hives at Piracicaba, Brazil.	7
Fig. 1/6 Cylindrical bark hives in Tanzania.	8
Fig. 1/7 Apiary of Langstroth movable-frame, on stands, Papua New Guinea.	9
Fig. 1/8 Beekeeper in Papua New Guinea beginning to open a three-box, eight-frame Langstroth movable-frame hive.	10
Fig. 1/9 Kenya top-bar hives suspended in the shade.	11
Fig. 1/10 Suspending top-bar "bait" hives in trees, in Zululand.	12
Fig. 1/11 Clustered swarm of <u>Apis mellifera</u> on a rhododendron bush.	13
Fig. 2/1 Queen larva cells.	20
Fig. 2/2 A natural migratory swarm of <u>Apis dorsata</u> settled at a resting place.	24
Fig. 2/3 Small colony of <u>Apis dorsata</u> in full defensive action ("aggressivity").	28
Fig. 2/4 Workers of the four honeybee species.	31
Fig. 2/5 Distribution of major honeybee species and races in Europe, northern Africa and western Asia.	32
Fig. 2/6 The spread of Africanized bees in South America.	36
Fig. 2/7 <u>Apis cerana</u> colonies in traditional hives.	38
Fig. 2/8 Single-comb nests of <u>Apis dorsata</u> in a tree in India.	40
Fig. 2/9 <u>Apis dorsata</u> comb, showing the brood nest.	40
Fig. 2/10 Single-comb <u>Apis florea</u> colony attached to a thin tree branch.	44
Fig. 2/11 <u>Apis florea</u> comb, showing the crest above, the central brood area and some larger drone cells below.	44
Fig. 2/12 Colony of stingless bees in India.	47
Fig. 2/13 Section through a pear flower.	48
Fig. 2/14 Foraging honeybee collecting nectar from a borage flower.	49
Fig. 2/15 Honeybee collecting nectar from a dandelion flower and carrying a large pollen load.	50
Fig. 2/16 Droplets of honeydew on leaves of a silver fir ( <u>Abies alba</u> ).	51
Fig. 2/17 Self-pollination and cross-pollination by wind and by a bee.	63
Fig. 2/18 Hives well sited for pollination beside rapeseed crops.	67
Fig. 3/1 American foul brood showing perforated cappings and scattered brood pattern (pepperbox appearance).	73
Fig. 3/2 American foul brood showing "ropy" symptom.	74
Fig. 3/3 World distribution of American foul brood (AFB), by countries, as known in 1982.	75
Fig. 3/4 World distribution of European foul brood (EFB), by countries, as known in 1982.	75
Fig. 3/5 European foul brood.	76

	<u>Page</u>
Fig. 3/6 World distribution of sac brood, by countries, as known in 1982.	78
Fig. 3/7 World distribution of chalk brood, by countries, as known in 1982.	78
Fig. 3/8 World distribution of Nosema, by countries, as known in 1982.	80
Fig. 3/9 World distribution of Amoeba disease, by countries, as known in 1982.	80
Fig. 3/10 World distribution of <u>Varroa jacobsoni</u> , by countries, as known in 1983.	83
Fig. 3/11 World distribution of <u>Tropilaelaps clareae</u> , by countries, as known in 1983.	83
Fig. 3/12 World distribution of acarine disease ( <u>Acarapis woodii</u> ), by countries, as known in 1982.	87
Fig. 3/13 World distribution of bee louse ( <u>Braula</u> spp.), by countries, as known in 1982.	87
Fig. 4/1 Honey hunters' equipment from Riau, Sumatra (Indonesia).	98
Fig. 4/2 Climbing a bee tree in Riau, Sumatra (Indonesia).	99
Fig. 4/3 Preparing an artificial "cave" to receive an <u>Apis florea</u> colony in Oman.	101
Fig. 4/4 Brood part of an <u>Apis florea</u> comb supported in front of an Oman cave entrance.	102
Fig. 4/5 Oman beekeeper removing an <u>Apis florea</u> colony from its artificial "cave".	103
Fig. 4/6 Log hive hung in a shady position in Tanzania.	105
Fig. 4/7 Log hive apiary in a baobab tree, Tanzania.	106
Fig. 4/8 Hive used by Tugen beekeepers, Kenya.	107
Fig. 4/9 Wameru hives, northern Tanzania.	108
Fig. 4/10 Kenya top-bar hive, with Nightingale's improvement.	112
Fig. 4/11 Comb from Kenya top-bar hive, supported by Nightingale's strips.	113
Fig. 4/12 Kenya top-bar hive.	114
Fig. 4/13 Modified African long hive.	116
Fig. 4/14 Modified African hive.	116
Fig. 5/1 Section through a movable-frame, showing suspended frames in place, leaving a bee space all round.	128
Fig. 5/2 Apiary of <u>Apis cerana</u> in Newton hives, on a rubber estate.	131
Fig. 5/3 Apiary of large-bodied <u>Apis cerana</u> in Langstroth hives, in northern India.	132
Fig. 5/4 Apiary of <u>Apis cerana</u> in ISI Type A hives, in a forest in southern India.	133
Fig. 5/5 Bee veil.	146
Fig. 5/6 Beekeeper equipped for working with tropical African bees.	148
Fig. 5/7 Boy in Botswana blowing smoke from a pierced tin into a hive entrance.	149
Fig. 6/1 Removing honey from combs by allowing it to drip through a cloth.	158
Fig. 6/2 Loading pieces of comb into the wire basket of a centrifuge for honey extraction.	160
Fig. 6/3 Charging the wire basket containing comb into the extractor.	161
Fig. 6/4 Plan of a simple honey-collecting centre on a hillside.	164
Fig. 6/5 Baffle tank for settling honey to assist straining.	165
Fig. 6/6 Small single-baffle honey strainer.	166
Fig. 6/7 Pouring the hot mixture of water and melted wax into a cotton bag over a pot.	176

	<u>Page</u>
Fig. 6/8 Squeezing the cotton bag with two sticks, to press all the wax through the bag into the pot below.	178
Fig. 6/9 Solar wax melter.	179
Fig. 6/10 Hot-water wax press.	180
Fig. 6/11 Squeezing wax out of dark combs by means of a hot-water press.	181
Fig. 6/12 Pollen trap, OAC type, fitted to the floorboard of a Langstroth hive.	186
Fig. 6/13 Royal jelly production.	189
Fig. 6/14 Royal jelly collection.	190

## LIST OF TABLES

Table 1/1 Summary of Age-linked Stages in the Life of a Worker Bee in Summer.	5
Table 2/2 Typical List of Honey and Pollen Sources (Japan)	59
Table 2/2 Typical Floral Calendar (from Maymo Apiaries, Burma)	60
Table 2/3 Mean Percentage Yield Increase of Some Economic Crops when Pollinated by the Honeybee <u>Apis cerana</u>	65
Table 2/4 Development of Beekeeping in Relation to Pollination	66
Table 3/1 Comparison of Symptoms of Four Honeybee Brood Diseases	72
Table 3/2 Bee diseases and parasites in islands for which information is available	92
Table 6/1A Major World Producers, Importers and Exporters, 1982	151
Table 6/1B Honey: Developing Country Production, Imports and Exports, 1982	153
Table 6/2 Honey: World Production, Imports and Exports, 1976-83 (5-year running averages)	155
Table 6/3 Honey Production Prices by Plant Source (Japan, 1979)	169
Table 6/4 Beeswax: Major Producers, Importers and Exporters, 1982	174
Table 6/5 Beeswax: Estimated World Production and Trade, 1976-83	183
Table 6/7 Hive Products used as food: Representative composition ranges (%) of major constituents.	187
Table 7/1 Beekeeping in Bangladesh: Estimated Costs and Returns per Colony, 1983	200
Table 7/2 Beekeeping in Bangladesh: 10-Year Theoretical Cash-Flow Analysis	203
Table 7/2A Beekeeping in Bangladesh: 10-Year Theoretical Cash-Flow Analysis - Conservative Receipts Estimates	204
Table 7/2B Beekeeping in Bangladesh: 10-Year Theoretical Cash-Flow Analysis - Catastrophe Receipts Estimates	205

TROPICAL AND SUB-TROPICAL APICULTURE



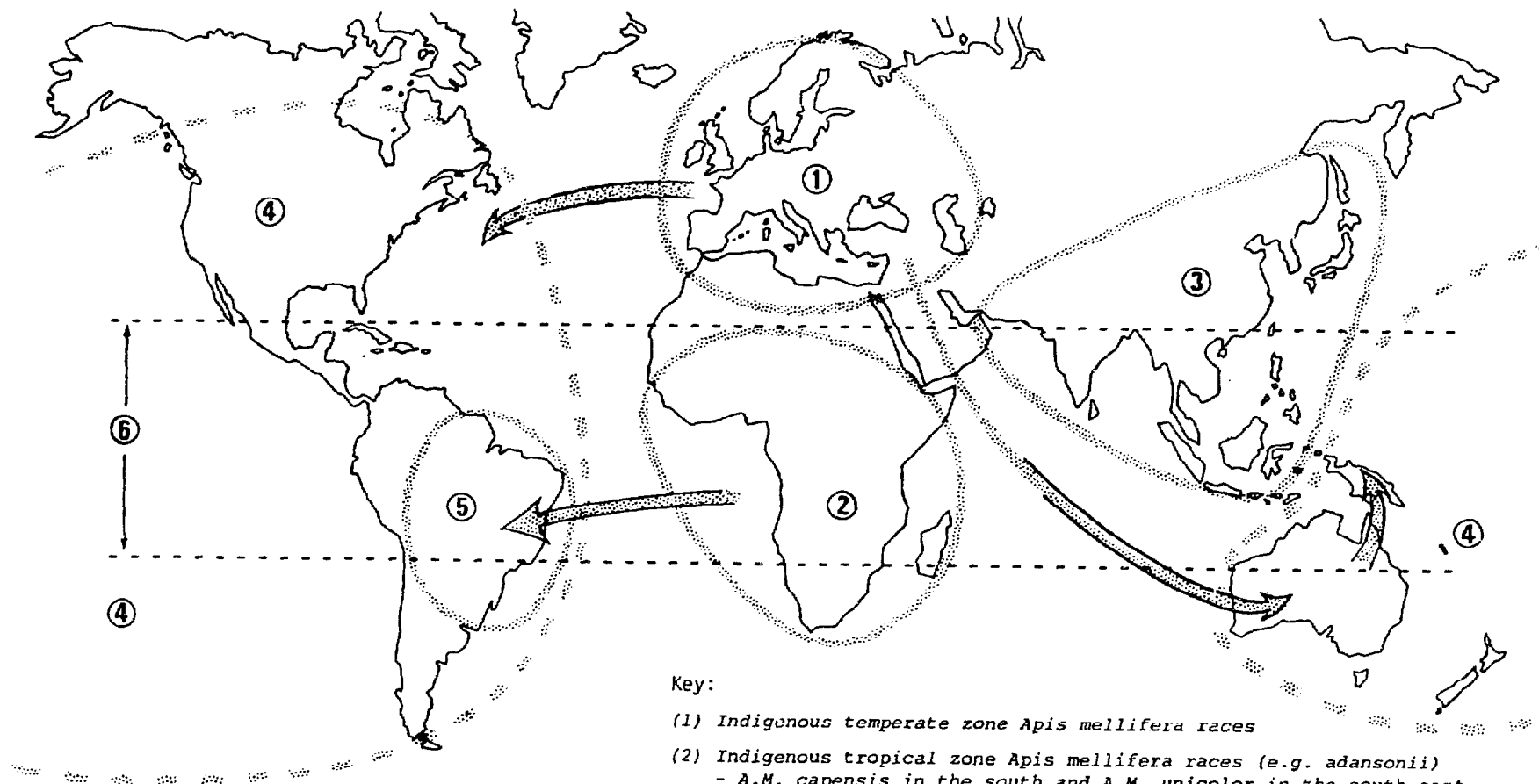

Key:

- (1) Indigenous temperate zone *Apis mellifera* races
- (2) Indigenous tropical zone *Apis mellifera* races (e.g. *adansonii*)  
- *A.M. capensis* in the south and *A.M. unicolor* in the south-east
- (3) Indigenous *Apis cerana*, also *Apis dorsata* and *Apis florea* in the tropics; introduced *Apis mellifera* in some parts
- (4) Introduced temperate zone *Apis mellifera* races from Europe
- (5) Introduced tropical zone *Apis mellifera* races from Africa
- (6) Stingless bees occur in many areas between the Tropics.

N.B. Actual desert and mountain boundaries between (1), (2) and (3) are not yet known, and no attempt is made to define them.

Fig. 1/1 Approximate distribution of the world's honey-producing bees, honeybees (Apis) and stingless bees (Meliponinae).  
Source: E. Crane (1979).

## CHAPTER 1

### INTRODUCTION

Apiculture is not a quaint hobby, or just a way of adding an infinitesimal amount of carbohydrates to the world's food supply. It is a science-based industry which uses bees as micro-manipulators to harvest plant foods from environmental resources that would otherwise be wasted. Further, the bees pollinate crops they visit, thereby increasing yields of fruits and of seeds - notably those of oilseed and fodder crops on which economic harvests of fat and animal protein depend. The bees' housing occupies minimal space, so that practically no other food production has to be foregone in favour of beekeeping.

This is the first book on apiculture in developing countries as a whole. The cooperation of specialists with experience in different regions, and in different branches of apiculture, has been necessary in order to make a useful synthesis to serve as a basis for future development in this rewarding branch of agriculture. The gain is proportionately highest to subsistence farmers, for the produce from a few hives of bees can sometimes give them a higher income than they can earn by a full-time occupation. Not much work is needed to look after the bees, and men, women and children can all take part in it. At the other end of the scale, developing countries of the sub-tropics have already become the main source of honey exported onto the world market: at least 150 000 tonnes a year are exported from developing countries. This is more than three fourths of the world total, and the potential for development is still very great, for reasons which will be indicated.

#### Tropical Honeybees

There are many thousands of species of bees in the tropics, but we are concerned here only with bees which form permanent colonies and store enough honey to be worth harvesting by man: the honeybees Apis and the so-called stingless bees of the Meliponidae. The indigenous European honeybee is Apis mellifera, two of the best known races being the Italian (A.m. ligustica) and the Carniolan (A.m. carnica).

Three land masses (Africa, Asia, America) have tropical regions, which are well separated by oceans or deserts, and the Pacific islands form a large fourth scattered tropical region. Each of these regions has its own distinct characteristics with regard to honey-producing bees.

The Americas and the Caribbean islands have no native honeybees (Apis), but they do have native tropical stingless bees, which build small, rather amorphous nests; these bees are also found, to varying extents, in Africa, Asia and the Pacific (Fig. 1/1). There has been a long tradition of beekeeping with them in the Americas, and the extensive pre-Columbian production of gold castings by the lost-wax method must have relied upon their wax. Hives of Apis mellifera were carried to New England, in North America, in the early 1600s, but there were none in Central or South America until the last century. The deliberate shift to beekeeping with these more productive imported bees is still not complete in the Americas, nor is the change to modern hives. Tropical African honeybees were introduced directly into Brazil in 1956; the shift to the re-

sultant hybrid, the tropical "Africanized" honeybee, has been involuntary in most areas where it has occurred, but it appears to have contributed to increased honey production by forcing the adoption of more modern apicultural techniques more rapidly than might otherwise have occurred.

The sub-tropical Mediterranean region includes the developing countries of North Africa and the Near East, which have a number of native races of A. mellifera, and also rich beekeeping traditions; these factors have given rise to complex problems but have opened wide potentials for development.

Of all the regions under consideration, tropical Africa has the oldest tradition of beekeeping, and the one that survives most vigorously in the main, still with primitive hives. It is the only region with native tropical A. mellifera, of which the best-known variety is A.m. scutellata, formerly referred to as A.m. adansonii.(\*)

Asia has three native tropical species of Apis: the hive bee A. cerana and the wild bees A. dorsata and A. florea. A. cerana is similar to A. mellifera, but smaller; in general it is less productive than the latter, but it is very good at exploiting its native flora and can thrive in zones where some races of A. mellifera cannot survive. The A. cerana bees that colonized high Himalayan valleys, and regions north of the eastern end of these mountains, are able to survive the cold winters by forming a cluster within the nest and regulating the temperature inside it. This characteristic is also highly developed in European A. mellifera, but, apparently, not at all in those in tropical Africa, except possibly at high altitudes. The most productive Asian bee, A. dorsata, builds a single-comb nest in the open. It cannot be kept in a dark hive, and its honey is still harvested from wild nests as in prehistoric times. Finally, there is a very small species, Apis florea, which also builds a single-comb nest in the open. A form of beekeeping is practised with it in Oman and in parts of India.

The Pacific islands have no native honey-storing bees at all, except stingless bees in one small area. European A. mellifera has been taken to many of the groups of islands over the last century, but the remainder are still without honeybees.

At various times men have introduced A. mellifera from Europe into many other parts of the world; it usually thrives in temperate and sub-tropical climates and in some tropical regions where there are no native honeybees, but not, generally speaking, in tropical regions with native Apis species.

#### The Hive and the Colony

Except in modern movable-comb hives, bees construct their nest by building a group of parallel combs vertically downwards from the roof of the hive or nest cavity (Fig. 1/2). The distance they leave between the combs (Fig. 1/3) is an inbuilt characteristic of the bees, and varies slightly for different species or sub-species, according to their body size. The bees observe this spacing very precisely with regard to the combs in which brood is reared; these are normally the central ones, where the temperature can most easily be controlled. There is a greater tolerance to the spacing between the honey-storage combs above and around the brood nest.

(\*) This name still appears in some of the diagrams in this book.



Fig. 1/2 Natural nest of Apis cerana in a tree in India.  
Photo: C.V. Thakar.

The size of a colony depends on the number of worker bees in it, and is lowest at the end of the main dearth period of the year, when no food can be collected, and during which up to half the bees die. The dearth period is usually followed by rapid colony growth, as many plants come into flower, and the colony population increases by four times or more. The approximate composition of a temperate-zone A. mellifera colony is given on page 4: the figures are lower for tropical Africa A. mellifera, and much lower for tropical Asian A. cerana.



Fig. 1/3 The regular spacing left by bees when building their combs. The beekeeper is showing the lid of a movable-frame hive in which bees have inadvertently been allowed to build combs. The centre of the combs, built for brood, is narrow and regular; at the outer edges, the comb, whose spacing is wider and less regular, is intended for honey storage.  
Photo: P. Papadopoulo.

	Seasonal maximum	at onset of dearth period	at end of dearth period
Queen (female reproductive)	1	1	1
Drones (male reproductive)	300 - 3 000	0	0
Workers (female non-reproductive)			
adults	50 000	25 000	13 000
brood (eggs, larvae, pupae)	35 000	500	2 000

TABLE 1/1: Summary of age-linked stages in the life of a worker bee in summer. (Source: Crane (1980).)

The ages entered for the adult bee are examples only. All are flexible in normal colony conditions, and highly flexible in abnormal conditions; an individual bee may show several different behaviour patterns on the same day.

Age (days) Stage	Food required	Other conditions	Behaviour
<b>Brood Stage: Day 0 = DAY EGG IS LAID</b>			
0-3 (egg)	none	temp. c 34° C	none
3-8	bee milk, then pollen + honey	temp. c 34° C	eats, moves in open cell
8-9 (larva)	none	temp. c 34° C	spins cocoon in sealed cell
9-21 prepupa, pupa	none	near 34° C	none
<b>Adult Stage: Day 0 = DAY OF EMERGENCE FROM CELL = DAY 21 OF BROOD STAGE</b>			
0-20 'house bee' i.e. remaining in the hive; preferring darkness to light; subdivided as follows:			
0-5 'young bee'	pollen + honey		cleans cells
5-10 'nurse bee'	honey/nectar	hypopharyngeal glands secrete bee milk	feeds larvae
10-15 'building bee'	honey/nectar	wax glands developed	builds comb, caps cells
15-20 'guard bee'	honey/nectar	venom glands developed	guards hive (a few days only, or not at all)
20-30 'honey-making bee'	honey/nectar	hypopharyngeal glands secrete invertase	elaborates nectar, etc. into honey
20-35 + to death 'field bee'	honey/nectar	flight muscles developed; attracted to light, not darkness	after short orientation flights, forages for pollen, nectar, etc., also (some bees) for water, or for propolis (and works with propo- lis in hive)

The queen lays all the eggs (up to 1000 or 2000 a day) during the active season. The workers do all the other "work" in the colony: Table 1/1 shows their activities, which follow an age-linked sequence.

The seasonal cycle of the bees' work depends on the flowering seasons of the year; Figs. 1/4 and 1/5 illustrate the sequence of honey flows and its influence on hive weights. After a dearth period (whether caused by dry seasons, heavy rains, heat, or cold), plant development starts again, and with the first flowers a pollen and nectar flow begins. The pollen provides the protein the colony needs for rearing brood, and the bee population increases rapidly until the colony has enough bees to forage and collect more nectar than is needed for its immediate energy (carbohydrate) requirements. The bees convert the surplus into honey which, using their wax, they seal into the cells of the honey combs when it is "ripe", i.e. when its water content has been reduced to 18-19%, although in the tropics this low figure is not always attained. The beekeeper harvests the honey, usually at the end of a major nectar flow, leaving enough stores to feed the colony through the ensuing dearth period.

The seasonal cycle of a colony is perhaps best understood by the colony's weight change through the year. In Argentina (see Fig. 1/4) the dearth period is due to cold (autumn/winter), and between mid-April and mid-November (in the northern hemisphere the equivalent period would be mid-October to mid-May) there is a continuous loss in weight due to consumption of stores, the lack of incoming food, and little or no brood rearing to produce new bees. The colony population grows very rapidly once flowering starts in spring and decreases again as the food intake drops off. (Most of the weights shown in the graphs is stored honey, but the size of the colony is linked with this.) In Brazil, closer to the equator (see Fig. 1/5), the dearth period is the wet summer, and the period of colony expansion and honey production is the dry winter. In some tropical regions the cycle is repeated twice in the year.

Tropical honeybees can survive the relatively short, warm dearth periods experienced in their native regions. In some regions A. dorsata colonies avoid dearth periods: the colonies migrate between two areas, each of which provides food resources for part of the year; thus, the colony abandons its nest twice a year, and builds a new one in the other area. The same is true of A. mellifera in parts of tropical Africa, for instance, it has been reported, between the top and bottom of the Rift Valley. A. florea also migrates, and A. cerana shows a similar, but less pronounced, tendency.

Apart from this seasonal migration, a colony of honeybees may abandon its nest if it is excessively disturbed; this is referred to as absconding. An A. florea colony may return to the nest a short time afterwards.

### Methods

Beekeeping started with traditional, or fixed-comb, hives, so called because the combs are attached to the top and sides of the hive itself, and the beekeeper cannot easily remove and replace them.

Traditional hives are usually simple containers made of whatever material is used locally for other purposes: hollowed logs, bark, woven twigs or reeds, coiled straw, baked or unbaked clay, etc. In the most primitive form of beekeeping the bees are killed, or driven out by smoke, once or twice a year when the hive contains the most honey: the honey and wax are taken and the colony is destroyed in the process. During the next swarming season the empty hive will probably be occupied by a new swarm.

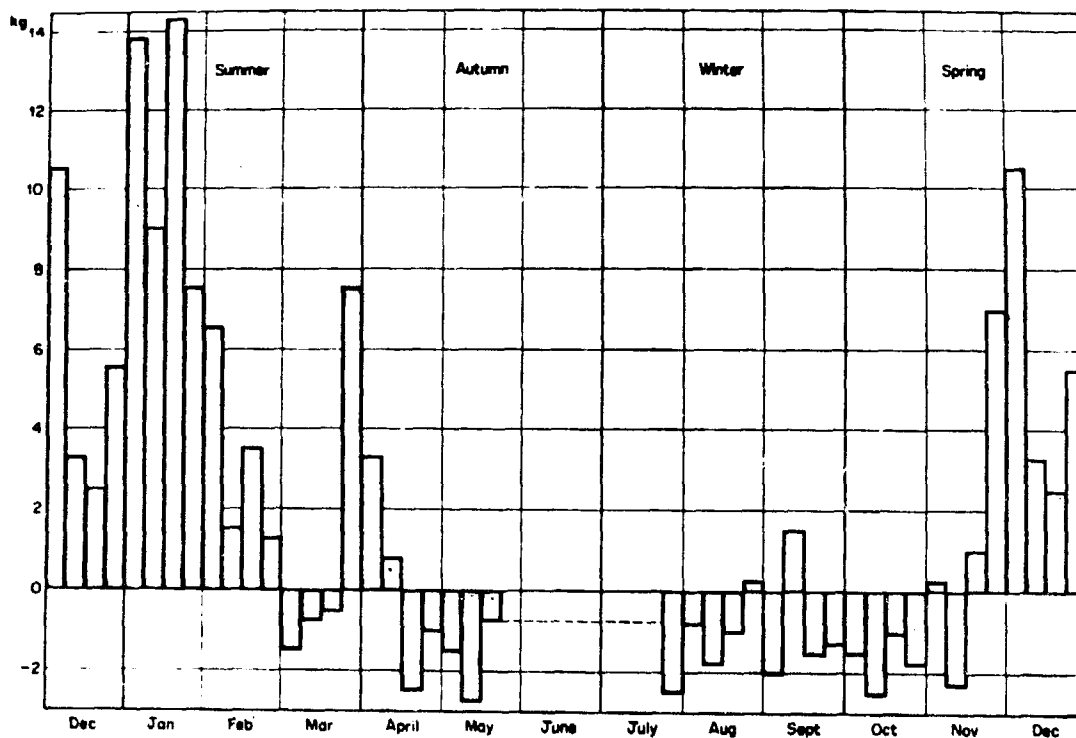

Fig. 1/4 Weekly weight changes in a hive at La Plata, Argentina, 1968-69. (Data from L.G. Cornejo)

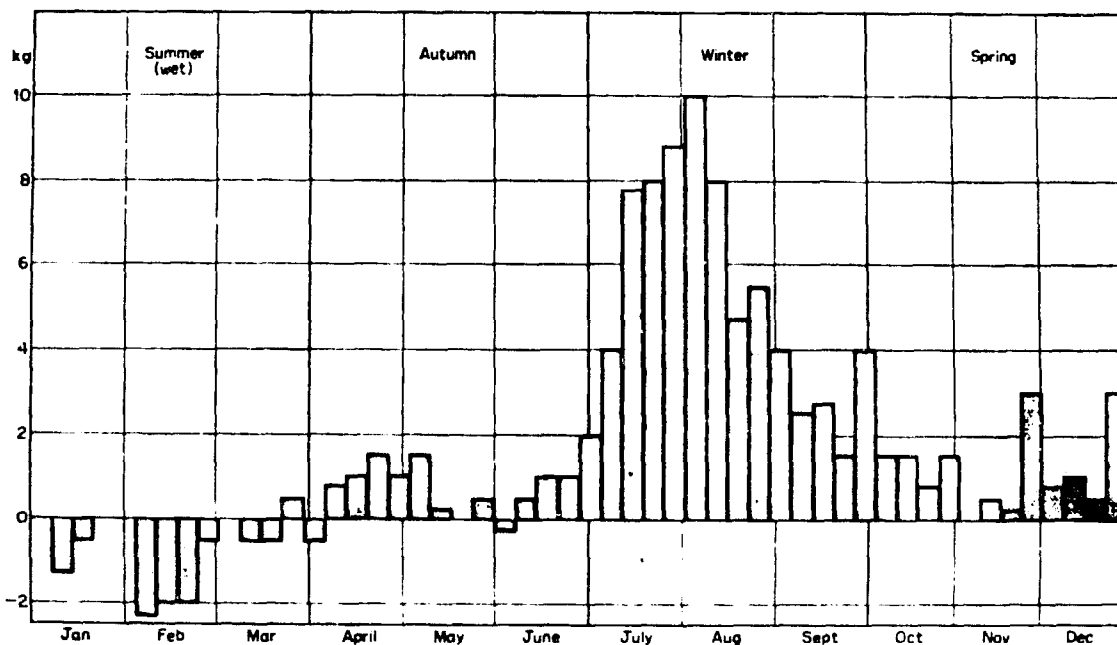

Fig. 1/5 Average weight changes in three hives at Piracicaba, Brazil. (Data from E. Amaral)





Fig. 1/6 Cylindrical bark hives in Tanzania.  
Photo: F.G. Smith

One of the better forms of traditional husbandry, widely practiced with cylindrical hives (Fig. 1/6), is to leave brood combs behind, with the queen and some bees, when the honey is taken. The simplest way of ensuring success in this method is to use hives longer than the reach of a man's arm, so that when he reaches in from one end, he cannot remove all the combs. Measurements of cylindrical hives from widely separated parts of Africa show that most have a very similar length (100-110 cm), which satisfies this condition and also is the maximum length that can be carried easily.

At the other end of the scale are the movable-frame hives used in modern apiaries, and which will be discussed in some detail in Chapter 5. They consist of a tier of accurately manufactured boxes, generally of wood, each fitted out like a filing suspension system and containing a number of frames



Fig. 1/7 Apiary of Langstroth movable-frame hives, on stands,  
Papua New Guinea.  
Photo: G.M. Walton

which hold the combs of the brood and the honey. A movable-frame hive allows frames to be removed for inspection, replacement, or transfer to another hive, and for honey extraction. The most widely - but by no means universally - used pattern of movable-frame hive is the Langstroth hive (Fig. 1/7) with 10-frame boxes. Standard designs differ in minor ways, however, and the number of frames in each box may vary from 4 to as many as 15.

The bottom box of a movable-frame hive is the brood chamber, and a queen excluder can be used to separate it from the honey chambers above, often called supers because they are superimposed (Fig. 1/8). In temperate zones two or even three boxes may be used for the brood chamber, and any number of supers can be added, but in the tropics colonies do not usually grow so large or store so much honey in a short time, so that one brood box and one or two supers suffice. Movable-frame hives are used widely in the American tropics and subtropics, and in Pacific islands. A smaller version is used for A. cerana in India and other Asian countries.

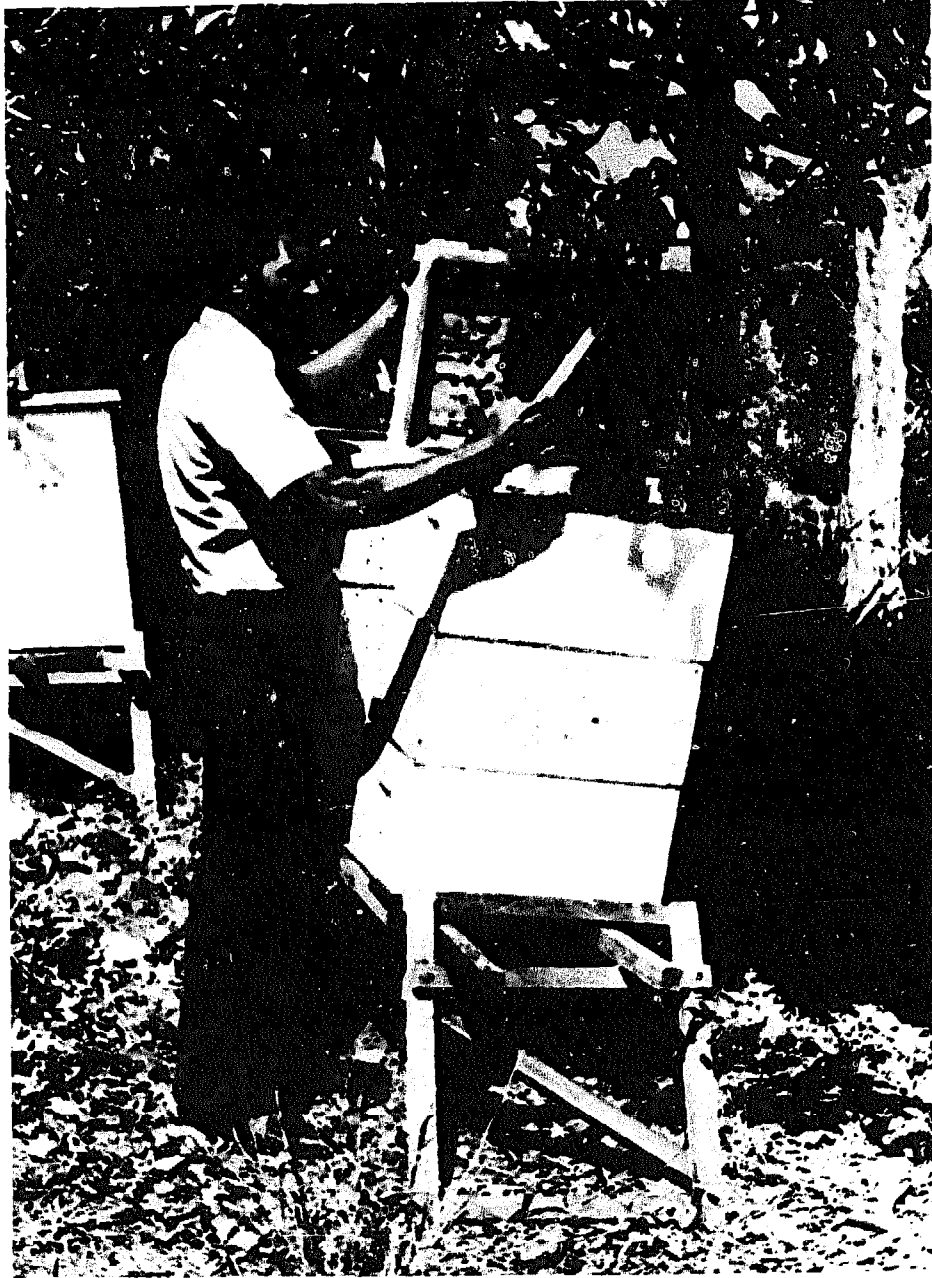

Fig. 1/8 Beekeeper in Papua New Guinea beginning to open a three-box, eight-frame Langstroth movable-frame hive. Photo: G.M. Walton.

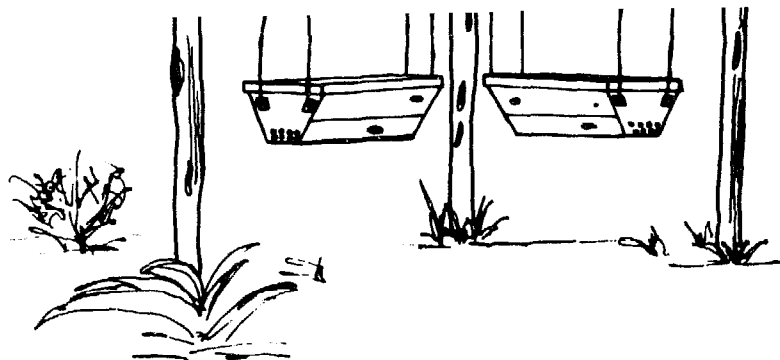

Fig. 1/9 Kenya top-bar hives suspended in the shade.  
Drawing: Stephanie Townsend.

Between the two extremes of a hollow cylinder and a tiered frame hive - each irreplaceable in its context - there are various intermediate or transitional hives that combine some of the advantages of movable-frame beekeeping with a much reduced need for precision. (Precision is always expensive, and unless it is used to full advantage its benefits are lost.) Top-bar hives (Fig. 1/9) are movable-comb hives in which the rectangular frame fitted with wax foundation is reduced to a top-bar only, rounded on the underside and fitted with a narrow strip of wax, or smeared with wax. The top-bars must be properly spaced to attain the bees' natural bee space, but that is the only precision measurement. The two long sides of the hive are often made to slope inward toward the bottom, as the bees' naturally-built combs do, and the bees will not then attach their combs to the sides of the hives. The hive is made extra long instead of being tiered up with supers; the sloping sides would hinder tiering, and without frame bottom-bars the bees tend to join the wax combs between the boxes so that it is difficult to separate them. The bees store honey on each side of the brood nest instead of above it, and these outer combs provide the honey harvest.

With tropical African bees, "bait" hives are usually positioned in trees (Fig. 1/10), for wild swarms to enter and occupy. When this has happened, the hives are taken down and sited near the ground (Fig. 1/9). Where bees of temperate-zone origin are used, the beekeeper usually captures a swarm when it has clustered (Fig. 1/11) and transfers it to a hive; to stock an empty hive he may also divide an existing colony, and either provide a queen for the queenless portion or let it rear a new queen itself.

Harvesting the honey from movable-frame hives involves three basic operations:

- a) removing the honey supers (bee-free) from the hive;
- b) taking off the cell cappings with a knife or other implement;
- c) spinning the honey out of the frames in a centrifugal extractor.



Fig. 1/10 Suspending top-bar "bait" hives in trees, in Zululand. The hives are built to be self-stacking, and their top cross-section is the same as that of a Langstroth hive. Photo: R. Guy.



Fig. 1/11 Clustered swarm of Apis mellifera on a rhododendron bush.  
Photo: IBRA Collection.

The honey is then usually strained to remove particles of wax and other impurities. The fact that the frames can be removed from the hive singly facilitates (a) and (b), and the frames provide support for the combs so that these can be spun at quite a high speed. With intermediate hives without a separate honey chamber, combs must be removed singly instead of in boxes, and can be broken by centrifuging; the honey is therefore usually separated from the wax by straining.

With traditional fixed-comb hives, operation (a) consists of cutting the honey combs out one by one; (b) is awkward, but possible, but (c) is possible only by placing pieces of comb in a specially-made basket; usually the combs are cut into smaller pieces and strained. The strained honey is sold, the wax comb (still wet with honey) often being mixed with water and fermented to make beer. Finally, the wax is melted and strained into containers, in which it sets and from which blocks of solid wax can be removed (although in many areas the wax is in fact thrown away).

The price of beeswax is several times higher than that of honey, but the yield per hive is much smaller. However, the movable-frame hive is designed for producing honey, minimizing any diversion of the bees' energy into wax production. For this reason, the world's requirements of beeswax are largely produced in the tropics, where many hives do not have movable frames.

#### Uses of Apicultural Products

The major part of the honey made by bees is also used by them, and the beekeeper's harvest can only be the surplus they do not require. It has been estimated that this surplus varies from around one-tenth of the total amount in poor honey-producing areas to one-third in the richest areas.

Honey is produced in almost every country, and 90% of the world's production is eaten directly as honey. The remaining 10% is used in baking, confectionery, fermentation to alcoholic drinks, tobacco curing and the manufacture of pharmaceuticals and cosmetics.

In many parts of the developing world honey is a valued food, as an occasional treat or as a standby in times of famine. In some areas it is so highly regarded that it is used as medicine rather than as food, and in other regions, especially parts of tropical Africa such as Ethiopia, it is used largely for making beer (tej).

Because honey is universally valued it can be sold as a cash crop; it can also be kept for future use, since it need not be used quickly like meat and many fruits and vegetables. Beeswax is even more durable, and being solid it needs no container. Pollen is another hive product that can be collected and utilized where it is plentiful. It contains up to 20% or more of protein, and is richer than many plant materials in vitamins B2, B3, B5, B6, C, E and H. Would pollen benefit people not receiving enough protein in their diet? The answer is surely yes. Whether the use of pollen as an additive is feasible, economic and acceptable are separate questions. It is, however, worth bearing in mind that pollen is produced in almost all inhabited parts of the world, and is largely unharvested. In primitive honey-hunting days the whole combs from bees' nests were eaten, the honey, pollen and bee brood together constituting a nutritious and acceptable food.

The economic value of beekeeping is commonly assessed by the market price of surplus honey that beekeepers are able to harvest from their hives. With traditional types of hive the yield is usually low, perhaps 3 to 5 kg per hive per year, but the combs removed from the hive provide a beeswax harvest, usually reckoned as about 10% of the weight of the honey harvest. With modern movable-frame hives the honey yield may be 50 kg or more, or even twice this amount if hives are "migrated" to different honey crops, but beeswax production is likely to be only 1.5% to 2% of the honey yield because the hives are designed to encourage honey, but not wax, production. Other hive products with commercial possibilities are pollen, propolis, royal jelly, bee venom and bee brood.

The number of colonies of bees kept, and total honey production, have been increasing steadily, and incomplete FAO statistics indicate that in 1983, world honey production probably reached a million tons. Yet the developing countries, whose total land area is well over half of the world's total and whose climate, generally speaking, is admirably suited for apiculture, still furnish only about half of the world's total production -- far below their potential.

There are, of course, notable differences between the honey-producing potential of the developing countries and that of countries in temperate zones, and also among the developing countries themselves. Many sub-tropical countries, such as those in Central and South America, have rich bee forage and a long flowering season, and here the yield per hive is high. Lower hive yields elsewhere (e.g. the Mediterranean area and tropical Africa) are partly due to the fact that primitive hives are still generally used there; these yields could be considerably increased over time by the adoption of modern methods. In Asia, the average lies between lower yields from Asian bees in traditional hives and higher yields from organized modern beekeeping with European bees, such as is carried on in China.

Many of the developing countries could increase their honey production at least 10 times, because they have rich honey-yielding plant resources not yet exploited for beekeeping (\*). This rich tropical resource of nectar and pollen may not be available indefinitely, as man destroys his environment, but it is the last of its kind on our finite planet, and most of it is going to waste. The thesis of this book is that it should be harvested by, and for the benefit of, the rural populations, and particularly the subsistence farmers, who can thus obtain a cash crop at little or no cost. At an average price of US\$ 1 per kg, the 20 or 30 kg such farmers can produce in a year may seem negligible, but if it comes from a few home-made hives that cost nothing, then in terms of the return of labour and scarce land resources it can compare favourably with the return from the land, without interfering with normal farming operations.

(\*) In most temperate-zone areas, many such resources have been or are being destroyed as an indirect effect of the modernization of agriculture, and honey yields often depend on agricultural and horticultural crops, rather than on wild plants. Long-term records for the USA, for instance, show that despite the ever-increasing expertise of the beekeepers, average yields per colony have remained stable over the past half-century, an indication that the resources available to the bees are disappearing there.



The value of all the honey produced annually in developing countries is about US\$ 370 million, to which may be added, as a conservative estimate, another US\$ 30 million for beeswax and other hive products, for an overall total of US\$ 400 million. As already stated, it should be possible to increase this production tenfold. While such an increase, occurring too rapidly, would create serious marketing problems, the increasing demand for honey and beeswax indicates that the market could probably keep pace with the expansion of supply.

As a further main factor in the bees' economic importance, it has been calculated that in the United States, crops pollinated by bees are worth about 100 times as much as the hive products produced; in the developing countries this figure is probably no lower, although it will vary widely with the crop and according to many other circumstances. This gives some idea of the present significance of apiculture for the developing countries, and thus of its potential for the future.

### The Plan of this Book

All the matters referred to above will be discussed in much greater detail in the chapters which follow. Chapter 2 is given over to the bees themselves: leaving aside complicated considerations of taxonomy of interest to scientists, it describes their origins, their customs, their feeding, and their incalculable importance as pollinators. Chapter 3 describes their enemies: their diseases and parasites, and man himself, who through indiscriminate use of pesticides kills off untold millions of this useful insect every year. Chapter 4 gives examples of traditional methods of beekeeping around the world, while Chapter 5 - which many readers will consider the key chapter of the entire book - gives details on modern beekeeping techniques, with some indications of what is needed to convert beekeeping from traditional to modern techniques, neither an excessively difficult nor an excessively costly process (\*). Chapter 6, also essential, discusses the handling of the hive products: not only honey and wax, but royal jelly, propolis, bee brood, and live bees themselves. An approach to apicultural micro-economics is made in Chapter 7 which, with the aid of examples drawn from the developing regions, offers some indication of just how profitable beekeeping can be. Chapter 8 offers the case history of a long-term programme for national apicultural development in an African country and discusses such essential inputs as education, training, extension, research and their organization, while Chapter 9 describes international technical assistance projects, with FAO examples from Africa, Asia and Latin America. A special appendix is devoted to the needs of the beekeepers for further information, and the impressive array of resources available to them, many of which will also be of value to planning authorities and technical assistance agencies.

### Further Reading

Crane (1976a) and the same author's introductory chapter (to which the present chapter owes much) to CS/IBRA (1979) provide a background to the factors governing apicultural potential, while USDA (1982) furnishes usually

(\*) Technical details of beekeeping operations which can be found in any general beekeeping manual are not discussed in this book, whose scope is limited to a review of beekeeping problems specific to the developing countries of the tropics and sub-tropics.

reliable numerical data on the production of honey and other hive products. See also Crane (1980b) and Crane (1984b) for more information on the bees used in beekeeping. Crane (1976b), Butler (1974) and Free (1977) describe the bees' activities that result in an economic return for the beekeeper - and some that may cause problems. Dade (1977) describes the honeybees' anatomy fairly simply. Dadant & Sons (1975) is widely useful, although it deals primarily with beekeeping in temperate climates, while Johansson and Johansson (1978) and Bee World (1968) provide detailed information on specific beekeeping operations; the last four mentioned all deal with European Apis mellifera. Crane (1980c), on the contrary, covers all four species of Apis and gives concise basic information about tropical apiculture in general; it is derived from IBRA's Bibliography of tropical apiculture, which appears in the Bibliography as Crane (1978a and b).

## CHAPTER 2

### THE BEE

#### A. BEE BIOLOGY IN THE TROPICS AND SUB-TROPICS(\*)

##### 1. The Inhabitants of the Hive

A normal bee colony consists of one queen, a number of workers ranging from 60,000 to 80,000 in the major honey flow season (in Central America, from October to May) to as low as 10,000 or less in the nectar and pollen dearth period (mid-May to mid-August), and a number of drones ranging from a few hundred to 2000 to 3000. The queen lays eggs and is the mother of all the bees in the colony; the workers collect pollen and honey and execute all the work within the hive; and the drones are males whose task is to fertilize queens from other, distant colonies.

In addition to these three castes of bees, a normal colony contains, in different stages of development, what is referred to collectively as the brood. While quantities may vary considerably, on average there may be about 5000 eggs, 10,000 larvae and 20,000 pupae in the hive. The eggs and larvae are referred to as uncapped brood; when the brood cells are covered with a porous wax cap, the brood is said to be capped.

The hive of a bee colony consists of a series of combs, about 25 mm thick, hanging about 10 mm apart. The combs, built of beeswax, and used to contain the brood and to store honey and pollen, consist of hexagonal cells of three different sizes, one for brood of each caste. Pollen is stored in worker cells, and honey in both drone and worker cells. The brood occupies the lowest part of the combs, near the hive entrance; above and on both sides of the brood is stored a strip of pollen cells, while the honey is stored above these, at the greatest distance from the hive entrance.

The queen lays her eggs at the bottom of the cells, and the eggs hatch after three days, the female larvae (i.e. of queens and workers) from fertilized eggs, and the male (drone) larvae from unfertilized eggs (See Table 1/1). During their first three days, the larvae are fed on royal jelly, produced by nurse workers; after this period, worker and drone larvae are fed on a mixture of honey and pollen, while for two more days the queen larvae receive royal jelly (see Fig. 2/1). Queens can thus be reared from any worker larvae less than three days (preferably one day) old. Queen larvae cells are capped on the fifth day, those of workers on the sixth and those of drones on the seventh; the pupal stage then begins. Queens emerge after 8 days as pupae, workers after 12 and drones after 14 days.

(\*) This sub-section is a condensed version of a training booklet (Woyke, 1980b), prepared under an FAO apicultural development project in El Salvador. The bee discussed is A. mellifera, kept in movable-frame hives, but the general principles involved are equally applicable to A. cerana.

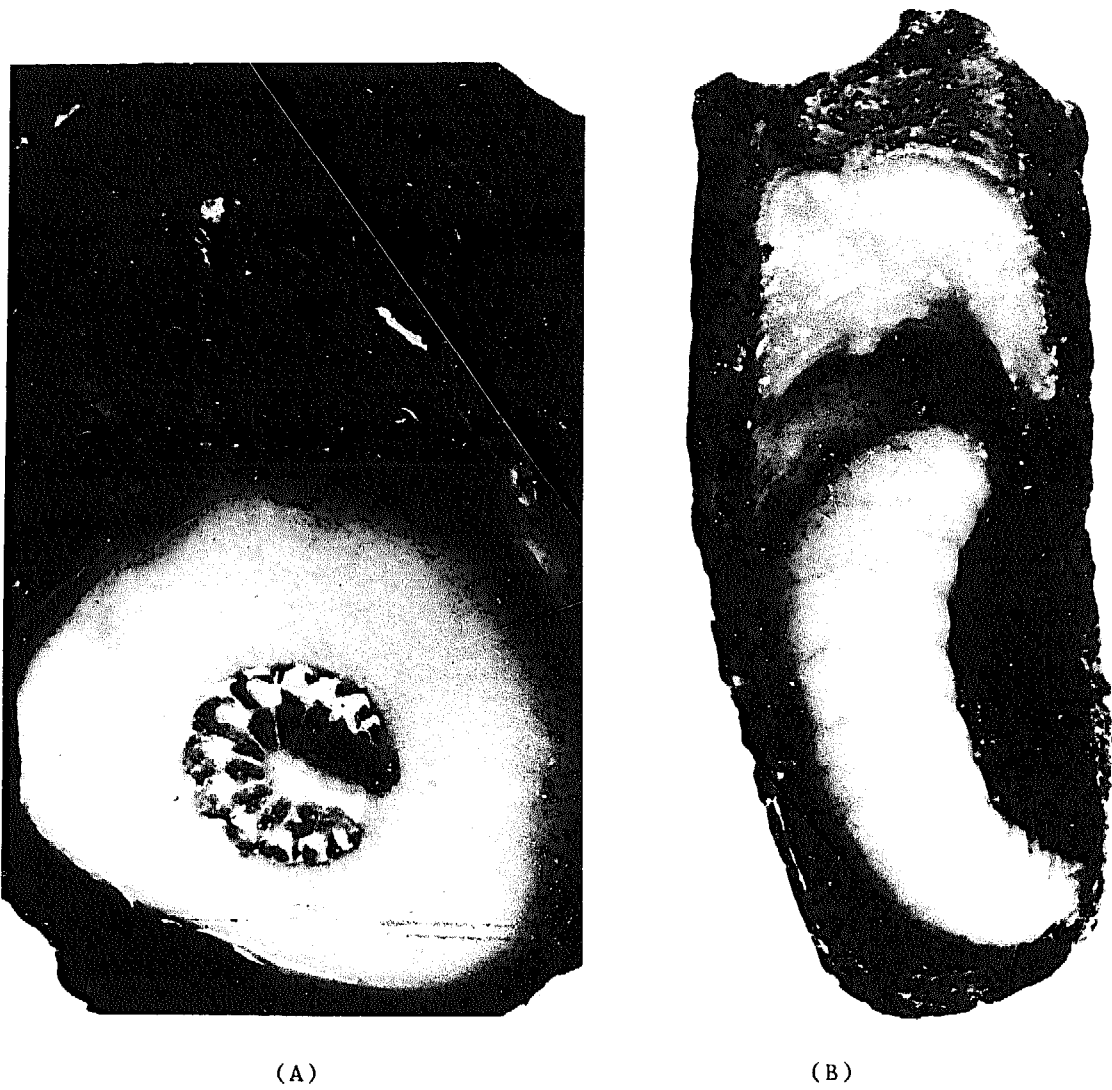

Fig. 2/1 Queen larva cells. (A) Young larva "floating" on royal jelly. (B) Older larva shortly before pupation; royal jelly is seen at the top of the cell.  
Photos: IBRA Collection.

## 2. The Queen

New queens are produced under three circumstances: (a) when the colony is planning a reproductive swarm, the bees build from 10 to 20 royal cells, and the original queen lays an egg in each. The new queens, born after the old queen has departed with the swarm, are called swarm queens; (b) when the queen is over-age and laying badly, or is otherwise failing, the workers build 1 to 3 replacement royal cells, in which the old queen lays her eggs. The new, so-called replacement, or supersedure, queen, lives together in the hive with the old queen for a certain time; (c) when the colony loses its queen through accident or disease, the workers create emergency queen cells from workers' cells containing larvae less than three days old, situated at the central strip of the comb.

During her first day of adult life, the young queen hunts out rivals in order to kill them. When the colony is not about to swarm, the workers destroy the other queen cells by opening them at one end. About five days after emerging, the queen takes short (5-minute) reconnaissance flights, and then leaves on a mating flight of 30 to 45 minutes. When she reaches a zone, 6 to 10 metres above the ground, where drones are concentrated, they recognize her by a characteristic odour given off by a secretion from her body. During a mating flight she is fertilized by about eight drones; if this number is not reached, she makes a second mating flight next day.

During copulation, the drones' sperm is injected into the queen's oviducts, whence the spermatozoids pass into a special cavity which can contain about 5 million of the male gametes. The queen begins laying three days after her last mating flight, and can fertilize the eggs laid to produce workers, or refrain from fertilizing them to produce drones.

When the queen has not been fertilized, for lack of drones or because bad weather has prohibited mating flights, she begins after four weeks to lay unfertilized eggs in worker cells, from which only drones are hatched in most cases.

A good queen lays from 1500 to 2000 eggs a day, and she lives for up to five years, but her best laying period is during her first two years only. When the spermatozoid reserve in her body capacity is depleted, the queen begins to lay both fertilized and unfertilized eggs in worker cells, the unfertilized eggs producing drones.

The queen emits a chemical message known as a pheromone, which controls the biology of the colony and inhibits the ovarian activity of the workers. When the queen dies and pheromone production ceases, this serves as a signal for the workers to produce a new queen from worker larvae, as indicated above. If no young larvae exist, the ovaries of some workers develop and they lay unfertilized (drone) eggs in workers' cells.

## 3. The Workers

The workers are females whose reproductive organs are atrophied; they cannot be fertilized by drones because they possess no sperm reserve capacity. On the other hand, they have organs other than those of the queens and drones, to enable them to execute all the work of the colony. Their tongue is longer than that of the other castes, to enable them to suck nectar from flowers; they

have a special sac for carrying honey and water; on each of the rear pair of legs is a special "basket" for carrying pollen pellets into the hive; their stings are well developed for the defence of the colony; their heads contain glands producing royal jelly to feed the queens and larvae; salivary glands in the thorax produce enzymes which ripen the honey; and four pairs of glands in the abdomen produce beeswax.

In El Salvador, the workers live for about six weeks, the first three within the hive and the last three outside the hive, as foragers. During their first three days, they clean the cells of the honeycomb; from the fourth to the sixth day they nurse the larvae more than three days old, feeding them on a pollen-honey mixture; from their sixth to their twelfth day they feed the larvae of less than 3 days on royal jelly produced by their head glands; from their thirteenth to their eighteenth day they produce wax and build comb, and ripen and store honey, by adding their enzymes to it and evaporating its excess water; on the next two days they act as guards at the hive entrance; and from their twenty-first day onward they collect nectar, pollen, water and propolis(\*).

If at any time a greater number of bees is required for a special type of work, the pattern set out above may be varied; in particular, during periods of major honey flow, workers may begin to collect nectar from 14 to 18 days after emerging, and their life span may be reduced by a week or more.

When a worker discovers a nectar or pollen source, she returns to the hive and, by "dancing" in front of her sisters, she indicates to them the distance and direction of the flowers. The bees' normal flight radius in countries such as El Salvador is 3 km, although distances of 6 km and more have been observed, and the economic flight radius (at which the bees can collect more energy in the form of nectar and pollen than they consume in flight) is only about 1 km. A colony at 1 km from a floral source can however store only 60% of the honey collected by other colonies nearer to the source.

As Crane has pointed out (CS/IBRA 1979), "The performance of bees is truly astonishing. The fuel consumption of a flying bee is about 0.5 mg honey per kilometre, or 3 million km to the litre. In providing 1 kg of surplus honey (for the market), the colony has had to consume something like a further 8 kg to keep itself going, and the foraging has probably covered a total flight path equal to six orbits around the earth - at a fuel consumption of about 25 g of honey for each orbit."

#### 4. The Drones

The drones, which are stingless, are the male bees, whose sole function is to fertilize queens. Their compound eyes, at the top of the head, are twice as large as those of the queen and the workers, and their wings are the largest of those of the three castes; these differences help them to locate the queen in the air and to reach her during the mating flight.

(\*) The amount of honey produced is therefore a function of the length of life of the worker bees; as will be reported in Chapter 5, research in India indicates that Apis cerana indica workers have a longer life than workers of A. mellifera, and this characteristic is potentially one superiority of A. cerana over A. mellifera as a honey producer in some geographical areas.

The workers breed drones only during the heavy nectar and particularly the pollen flow season (in Central America, September-October and April). They are bred in colonies which are more populous, with numerous nurse workers producing more royal jelly than can be used by the worker larvae.

The adult drones are fed by the workers, but in dearth periods the workers cease this feeding and expel the drones from the hive so that they die. Only orphan colonies, or colonies with an unsatisfactory queen, have drones during the dearth period, so that the presence of drones in the hive at that time is an indication to the beekeeper that there is a problem regarding the queen and that the colony needs to be requeened.

The drones reach sexual maturity nine days after having emerged, and in good weather they leave the hive every day in search of a queen. They can localize a queen up to 8 km away; as indicated above, copulation takes place from 6 to 10 metres above the ground, and about eight drones copulate with a queen during a mating flight. During copulation the drone turns his sexual organ inside out as he injects his semen into the queen; he leaves part of the organ at the end of the queen's abdomen, and dies as a consequence.

#### 5. The Dearth Period

In temperate regions, the dearth period coincides with winter, when temperatures fall to 0°C and below. Under these conditions the bees form a cluster and reduce their activity to a minimum; they do not leave the hive, and the queen ceases laying. In tropical areas, on the contrary, the bees remain active all year round and the queen continues to lay, although there are periods of greater or less activity.

The dearth period is a period of reduced activity, during which the flowering of the plants is considerably reduced, or when no plants important for bees come to blossom. In Central America this period lasts for roughly 120 days, from mid-May to mid-September, and while it continues the queen reduces her laying to a great extent. At the beginning of the period, there are honey and pollen reserves for producing royal jelly on which the larvae feed; under these circumstances the nurses feed all the larvae that hatch from the eggs, and as a result the capped brood appears to be very regular.

When the hive's pollen reserves and the nurses' protein reserves are exhausted, however, and when there is an insufficient pollen flow outside the hive, the bees lack the raw materials needed for producing royal jelly, and not all the larvae hatched can be fed in order to develop into capped brood and then reach the adult stage. When this occurs, the nurses eat some of the larvae in order to produce royal jelly on which to feed the queen and the remaining larvae. Consequently, the capped brood appears to be irregular (discontinuous). In irregular brood combs both eggs and larvae at different stages of development are found near capped cells. Many beekeepers, unaware of this phenomenon, believe that the queen is at fault, in that she is laying her eggs irregularly, or else that the brood is diseased, and in the latter case they wrongly begin to apply medicinal remedies.

When the lack of pollen is prolonged, the bees eat almost all the larvae. As a result, during this period the area of irregular brood may show only capped brood originating from an earlier, better time, and cells with eggs, but practically no cells with larvae.



Fig. 2/2 A natural migratory swarm of Apis dorsata settled  
at a resting place.  
Photo: N. Koeniger.



Three weeks after the pollen flow has ceased completely and the nurses can produce no more royal jelly, the last adult bees emerge from the capped cells, and at this stage the cells of the brood contain practically nothing except eggs; the nurse bees eat all the larvae in order to produce royal jelly for the queen.

If the situation fails to improve, there is a lack of the honey needed to produce the energy necessary for heating the hive and for working, and also of the proteins necessary for laying eggs and feeding the brood. In this case the queen ceases laying and all the bees, queen included, migrate from the hive to hunt out a site with better conditions for survival (See Fig. 2/2). This tendency will be discussed in greater detail below.

Often the conditions are not so serious as to force the bees to leave: in some places and at some periods they may find a little pollen or nectar, or else the beekeeper may feed them. When this occurs, the final stage of hunger is not reached, but the earlier phases are very frequent during dearth periods in tropical regions.

#### 6. The major honey flow

During the major honey flow, the bees need a maximum of comb to store nectar and they will store it even in empty queen cells. This space is needed in order to allow the bees to evaporate the excess of water from the nectar. Nectar may contain as much as 80% water, and to convert it into honey, which should only contain about 18% water, the bees are obliged to evaporate the excess by fanning their wings and thus creating a flow of air. Normally, 50% of the weight of the nectar collected during the day is evaporated during the night. This evaporation takes place both in comb cells and in the droplets of nectar which the workers remove and place on their tongue, at the same time adding the enzymes needed for ripening the honey.

Normally, bees store their honey above the brood, at the end of the hive opposite the entrance. When the cells with ripe honey are full, the bees cap them with wax, leaving a little air between the cap and the surface of the honey. Comb with capped honey is ready to be removed by the beekeeper.

#### 7. Behaviour Characteristics

Of great importance to beekeepers are the behaviour characteristics of the bees, i.e. their reaction as a group to certain stresses or other conditions. These traits vary considerably according to the species and subspecies of bee, and they are also affected by temperature, altitude, humidity and other environmental factors. To some extent, however, all the bees show all the characteristics, and it is therefore convenient to review them together here.

a) The most apparent characteristic of the bee is referred to as its aggressiveness, although in fact this behaviour characteristic is more defensive than offensive: when the bees feel themselves attacked, or in danger of attack, they counter-attack without delay (See Fig. 2/3). G.F. Townsend's description of this characteristic in tropical African bees (Apis mellifera scutellata) portrays aggressiveness at its most developed state:

"Tropical African bees can be very 'aggressive', or they can be very mild-tempered, and it has been said that only a beekeeper who knows what he is doing can afford to take a risk with them. They are very sensitive to external disturbances, and, generally speaking, the stronger the colony the more easily the bees in it can be provoked. The attack - on the beekeeper, a bystander or an animal - is usually instantaneous; it is en masse and without warning. No one can stay close to an attacking colony without using smoke or protective clothing, and sometimes not even these are sufficient. Once aroused, colonies remain aggressive for the rest of the day, and it is therefore advisable to work them only in the late afternoon or early evening, after which they will settle down overnight".

b) Of perhaps the greatest importance to the beekeeper is the bees' tendency to abandon the hive, whether temporarily or permanently. This characteristic is given different names, depending on the cause of this departure: reproductive swarming, migration and absconding. The terms are sometimes used rather loosely, and a need for more precise definitions has been felt. In a report presented by Dr. I.K. Kigatiira to the Third International Conference on Apiculture in Tropical Climates (Nairobi, 1985), the following draft definitions were submitted:

"Reproductive swarming comprises the sudden departure of a proportion of the adult worker bees of a colony from its nest, with a queen and sometimes some drones, to form a separate colony elsewhere. (Control methods are as with European bees). The movement of an entire colony, as opposed to its division in reproductive swarming, is usually referred to as either migration or absconding.

"Migration is usually taken to comprise a large-scale movement of a population. It often carries the implication of a movement in one direction during one season and in the opposite direction during another season, as with migratory birds and mammals. But this need not be so; in the locust, for example, migration is the dispersal of part of a population from an epicentre, without any mechanism for the return of components of the population to that centre. The migration of tropical honeybees should be defined as an adaptive seasonal departure by mass flight of a whole colony, which has probably reached a broodless state, from a forage-poor habitat to a different and comparatively forage-rich habitat. This definition does not depend on whether the colony (or its daughter colonies) returns in another season to the former area, when forage conditions there have improved. Migration behaviour has a genetic foundation.

"Absconding should be used to describe the departure of all the adult bees of a colony from a nest, caused by factors other than shortage of forage. These factors may include shortage of water, or damage by overheating of the nest or by pests or predators. 'Hunger swarming' or 'hunger absconding' by European Apis mellifera should be treated as a different behaviour."

i) Swarming

Swarming is the bees' natural method of colony propagation. When the colony becomes overcrowded with adult bees, and there are not enough cells for the queen to continue laying large numbers of eggs, the worker bees select a

number of larvae (usually from 10 to 20), enlarge their cells, and begin to feed them great quantities of royal jelly. As a result, these larvae will develop not into new workers but into queens.

Soon after the first queen cell is capped, the old queen leaves the hive with about half the bees of the colony; the swarm attaches itself to a tree branch for a certain time before flying off to a new nest. This is known as the primary swarm.

The original colony remains queenless until the new queen emerges, about a week after the departure of the primary swarm. If the environmental conditions are good, the workers protect the remaining queen cells against destruction, and two days later, i.e. nine days after the primary swarm, a second swarm leaves the hive with the first young queen to emerge, the next day a third swarm, the following day a fourth, etc. At times, more than one young queen leaves with a secondary swarm; when such a swarm has located itself on a tree branch or in a new home, the queens fight until only one remains alive. When the hive population has been considerably reduced, the workers destroy the remaining queen cells.

The new queen makes her mating flights and begins laying. If she is lost during this time, the colony has no brood and cannot raise an emergency queen. If the beekeeper fails to assist it at this stage by giving it a brood comb with young, a queen cell, or a new queen, egg-laying workers appear which produce only drones, and as a result the colony is lost.

Any circumstances tending to create an imbalance within the colony will provoke swarming. This can occur when the queen finds it impossible to lay her eggs, because either the hive is too small, or the combs are badly built or old and damaged; when the queen is failing and lays fewer eggs; when a hive, standing in the sun, is over-heated, and the hive workers, unable to continue working, leave it and gather around the entrance; or when the colony, stimulated by an early food supply, attains its maximum strength before the beginning of the major honey flow, and has insufficient work to do.

While certain races of bees have a greater tendency to swarm than others, beekeepers can often control the phenomenon. It is first necessary to realize that the immediate cause of swarming is usually overcrowding in the hive, for whatever reason. Preventing overcrowding is therefore in most circumstances the best way of preventing swarming. This can generally be done by ensuring that the colony has a sufficiently large hive, with well-built -- and preferably new -- combs. At times the beekeeper may find it necessary to divide a colony in two before the bees do this themselves, and to install one half in a new hive with a new queen. Beekeepers can also limit swarming by placing wax foundation sheets in the hive to give the workers a base to build comb on, or by removing capped brood comb from the hive and thus decreasing the number of young workers emerging -- although this latter approach has the considerable disadvantage of decreasing the colony's honey-gathering potential.

A colony may also swarm when its queen is old and laying poorly, as was noted above. Such swarming can generally be prevented by the beekeeper who ensures that the colony has at all times a young, well-laying queen.

ii) Migration

In the tropics, colonies may migrate a few kilometres only (e.g. up or down a hill slope) to a place where flowers are in bloom, but one may also move over hundreds of kilometres before it establishes a new nest at a food-rich lo-



Fig. 2/3 Small colony of Apis dorsata in full defensive action ("aggressivity"). The clusters of bees below the lower edge of the comb are typical.  
Photo: N. Koeniger.

cation. Beekeepers there seek to collect the swarms in their hives, where the bees remain until their forage is exhausted; the bees then migrate back to the first location. A classical example is said to be the migration of colonies of tropical African bees between the top and bottom of the Rift Valley.

N. Koeniger has described the migration of Apis dorsata in Asia as follows:

"Migration is a response to seasonal lack of food resources: the whole colony moves to an area where flowering is just starting. One colony builds a new nest and rears brood twice a year, in two different places. In India, Indonesia (Java), Pakistan, Sri Lanka and most other countries, A. dorsata seems to migrate annually: there are no reports of an A. dorsata population staying in the same area for a year or longer. Colonies from one area migrate to another, stay for one flowering season only, then return to the first, to migrate again to the second in the following year, at the beginning of the flowering season there. There are indications that in some parts of Sumatra (Riau) the migratory cycle is completed in only six months, but this stay in the valleys during the colder season, and then migrate to higher elevations where they stay during the warmer season. This behaviour is reported in several other parts of Asia and seems to be typical.

"In February, A. dorsata colonies are spread throughout the coastal plains and the north central region of Sri Lanka. In June-July they migrate to the higher up-country, where they form a very dense population. They leave this zone in October-November, arriving back in the coastal plains in December. The distance between the areas is about 150 km, and observations of the flight speed of migratory swarms have led to an estimate of 20 - 30 km/h, or 5 to 8 hours of constant flight. However, the swarms spend a month or so on the migration, travelling in several stages and remaining for days or even weeks at resting places where they gather nectar, apparently "fuel" for continuing the journey. They do not build combs at these resting places, and freshly settled swarms do not show much defensive behaviour; during the first two days after their arrival, they are as easy to handle as A. mellifera.

"The migratory rhythm of Apis dorsata seems to be an inherited one, and governs the bees' seasonal cycle. A. dorsata colonies kept under constant conditions in Europe stopped rearing brood twice a year and tried to leave their comb, although they were kept in flight cages and there was no possibility of their migrating."

iii) Absconding

A whole colony may also "abscond", i.e. leave its hive or nest - at any time of year, and even if it contains food - as a result of disturbance of almost any kind, including mishandling in management. The most usual sources of disturbances are ants or animals, lack of sufficient shade, or a bout of robbing (see below). It has been said that absconding is by far the greatest problem in management with movable-frame hives, and that the annual absconding rate of colonies from an apiary may be well over 100%. Absconding from traditional hives made of bark or logs seems to be cancelled out by new occupation of empty hives by other swarms. Thus, with the frequent movement of colonies, only half the traditional hives in East Africa may be occupied at any one time, the rest being empty, awaiting a reproductive swarm or a migrating or absconding colony.

c) Another behaviour characteristic of importance to beekeepers is the bees' tendency to engage in robbing, i.e. to invade another colony's hive in order to obtain its honey. If the invading bees are in greater numbers/or physically stronger than the defenders, the latter may abscond, leaving the invaders in possession of the hive, but more frequently the robbers take the honey off to their own hive, leaving the defenders' hive depleted; many bees are killed in such attacks. Robber bees are drawn by the odour of the honey, and will often attack a hive which contains free honey (resulting, for example, from the breaking of a burr comb between frames). They will also attack combs removed from hives for harvesting, and at such times they can represent a real danger for the beekeeper. Such attacks can be prevented, or their effects minimized, by keeping removed frames carefully covered at all times, and by harvesting late in the day, when temperatures are lower and robber bees are less prone to attack.

## B. HONEYBEE SPECIES, RACES AND STRAINS

The genus Apis consists of four main species: A. mellifera, A. cerana, A. dorsata and A. florea (Fig. 2/4); small stingless bees, Trigona spp., belong to the genus Meliponidae.

Bees, like almost all other animals, are by nature wild, but A. mellifera and A. cerana are easily installed in man-made hives. It is this characteristic, in addition to their relative productivity, that makes them important to apiculture. They are often referred to as "hive bees", as opposed to A. dorsata, A. florea, and stingless bees, which cannot usually be brought to live in beekeepers' hives and which are therefore referred to as "wild bees".

### (1) Apis mellifera

The most widely distributed of the honeybee species, and the species most important in modern beekeeping, is Apis mellifera (\*). It is the most productive of the bees, and its name, which means "the honey-carrying bee", is a recognition of this fact. It is believed to have originated in Africa, where it is still indigenous, and to have migrated to Europe in prehistoric times. In addition to its outstanding productivity, an essential characteristic of this bee is its high degree of adaptability: it relatively quickly develops new races suited to differences in climate - temperature and rainfall are the most important - and for this reason, among others, its races are numerous. A. mellifera is fairly aggressive, although this characteristic tends to be attenuated in cooler climates and at higher altitudes. It is less prone to swarm than other species, and absconds less easily; these characteristics are important for beekeepers, who naturally hope to lose their colonies as rarely as possible. A serious disadvantage of this bee, however, is its vulnerability to certain diseases and especially to a parasite, the Varroa mite, which will be discussed in Chapter 3.

(\*) Incorrectly referred to in some countries as Apis mellifica, "the honey-making bee."



Fig. 2/4 Workers of the four honeybee species. From left to right, Apis florea, Apis dorsata, Apis cerana and Apis mellifera. The first three are native to Asia; the specimens shown are from Sri Lanka. The fourth is found in Europe, Africa and the Americas, the sub-species shown, A.m. carnica, is native to the eastern Alps.  
Photo: N. Koeniger.

In the Mediterranean basin, a relatively small area, there are believed to be about 9 million colonies of A. mellifera, the majority being concentrated in the European countries (France, Greece, Italy, Spain and Yugoslavia). Here the main races are A.m. mellifera, called the European black (or brown) bee, A.m. ligustica, the yellow Italian bee, and A.m. carnica, the grey Carniolan bee. A.m. mellifera was carried to North America in the 17th Century and became of economic importance there, although many American beekeepers currently prefer the Italian and Carniolan bees, as being gentler, easier to manage and possibly more productive. Recent attempts at displacing Asian bees (mostly A. cerana) by A. mellifera have concentrated for the most part on A.m. ligustica, better adapted to warmer climates; A.m. carnica; and A.m. caucasica, a race indigenous to southern Russia.

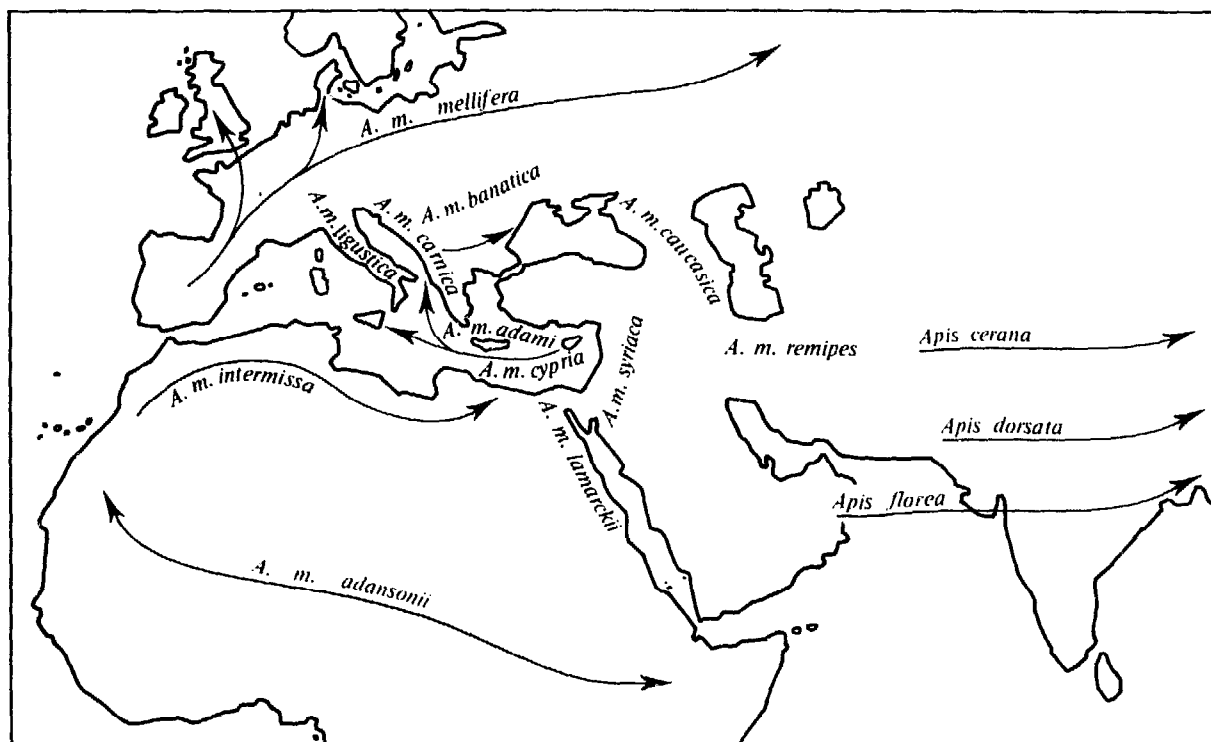

Fig. 2/5 Distribution of major honeybee species and races in Europe, northern Africa and western Asia.  
Map: FAO.

A.m. mellifera has many biotypes, ranging from black in southwestern Europe to brown in northern and central Europe. In its native habitat, it is prolific, industrious, active, slow to swarm and not excessively given to propolizing. Reports as to its aggressiveness differ widely from "gentle" to "fairly aggressive". Its aggressiveness is said to increase notably when it is removed from its native environment; bees from Brittany, for example, are reported to become "unmanageable" when carried to southeastern France.

A.m. ligustica, the Italian bee, is easily recognizable by the three yellow segments on its abdomen and by the "shield" between its wings. It is very gentle and industrious, beginning to collect honey early in the season. It is less vulnerable to attack by wax moth than most other bees. However, it tends to rob hives excessively, does not build queen cells in great quantities, and performs poorly in cooler, rainy climates.

A.m. carnica, the Carniolan bee, originated in Austria and the Balkans. It is slightly larger than the black bee, and is covered with grey hairs which give it a silvery appearance. It is very gentle but swarms easily; the latter characteristic tends to disappear in hybrids between this bee and A.m. ligustica.



A.m. caucasica, the Caucasian bee, is so gentle that it is particularly recommended to "ladies desiring to take up beekeeping" (Caillas, 1974). Smaller than the Italian bee, it is very productive indeed: in one area in southern France poor in honey plants, 130 kg of honey were removed from two of its hives in one season, a further 30 kg having been left in the hive as a reserve. It also produces a very white wax. Its main disadvantage is that it propolizes excessively.

An interesting race of A. mellifera is the banatica, indigenous to the Banat region of western Romania and northeastern Yugoslavia. It is of medium size, brown (mountain biotypes are darker than those of the plains) with two or three yellow bands not as pronounced as in A.m. ligustica, a cross of which it probably is. A.m. banatica is hardy, strong in defence against robbing, and very resistant to storms and to extremes of temperature. It is very gentle, stings little, does not rob, does not swarm excessively and collects honey up to the end of October in its native habitat, although it begins to breed somewhat late in the season.

The developing countries of North Africa and the Near East have about 3.5 million colonies of A. mellifera, of which about 90% are still kept in traditional hives. A unique diversity of races is represented, and these differ among themselves not only in their morphology but in their behaviour. It is difficult to establish the limits of the geographical areas they originally occupied, because they can interbreed, and intermediate forms exist where hybridization has occurred between races.

A.m. intermissa, known as the Punic or Tellian bee, is present in the coastal belt of North Africa bounded on the south by the Sahara, from Morocco through Algeria and Tunisia to Libya, and also in Malta and the Canaries. It is of medium size and at first sight resembles A.m. mellifera, being dark brown, except when the abdominal tergites and the scutellum show a slightly lighter colour. This bee is nervous and moderately aggressive, particularly in unfavourable weather or when colonies are roughly handled. The queen is fairly prolific, and the colonies have a tendency to swarm. In spring, when there is an abundant supply of nectar and pollen, colonies develop rapidly, and those kept in small traditional hives may produce two or three swarms. In modern hives, the bees can be managed as easily as Italians or Carniolans. They are very well adapted to the conditions of North Africa and can produce higher honey yields there than some European bees. They use relatively large quantities of propolis.

In Morocco there is a Saharan bee, isolated between the Atlas mountains and the northern edge of the Sahara, which differs from the Punic bee in its yellow colour, and in its docility and calm behaviour, but these characteristics are insufficient to define it as a separate race. Some specialists regard it as an ecotype of A.m. intermissa developed in the special conditions of the area; others think it may represent a transitional form between A.m. intermissa and A.m. scutellata.

A.m. lamarckii, the Egyptian bee, occupies the Nile Valley north of the Nubian Desert. It is of medium size, with thick hair, light grey in the worker and yellowish in the drone. The bee is somewhat aggressive and has a tendency to swarm; it has evolved characteristics that make it well adapted to conditions in the lower Nile Valley.

A.m. syriaca, the small Syrian bee, is found along the east coast of the Mediterranean (Israel, Lebanon, Syria, southeast Turkey). It is industrious, moderately aggressive, and well adapted to local conditions. In Israel, the beekeepers are replacing it with the less aggressive and more productive Italian bee.

A.m. adami evolved in the island of Crete, at the crossroads between North Africa and Asia Minor, and has characteristics similar to bees from both these regions. It is also found on the islands of Rhodes, Chios and Lesbos. Its pigmentation is variable, from dark to yellowish.

A.m. cypria, the Cyprian bee, is endemic in the island of Cyprus and was introduced into Sicily and Dalmatia in about 1860. Characterized by its small size, it is yellow with a reddish tinge, very aggressive, but industrious; it swarms little. It is related to A.m. remipes, described below.

One of the most easterly of the indigenous A. mellifera races is A.m. remipes, a yellow bee native to an area south of the Caucasus Mountains and distributed in the Georgian SSR, northeastern Turkey and Iran. It is of medium size, and in appearance is somewhat similar to the Italian bee, A.m. ligustica, the differentiating factor being the size of the metatarsus. This bee is inclined to rob, is rather aggressive, and tends to swarm, but it is fairly industrious.

Africa south of the Sahara and East Africa are the areas to which A.m. scutellata, the tropical African bee, is indigenous; since it was accidentally transferred to South America in 1956 its hybrids have taken on major importance there as honey producers. There are several races or strains of this bee, and those occurring at high altitudes have been little investigated. The behaviour characteristics of the different strains are in general similar, but they seem to be more intense at lower elevations and near the equator than outside the tropics proper and at higher altitudes; they also appear to depend on the size of the colony. The aggressiveness of tropical African bees has already been mentioned; a second important characteristic is their great tendency to reproductive swarming. Colonies often swarm when they are small compared with European bees, fewer workers being needed for a viable swarm and for the continuation of the parent colony. This is due partly to the shorter development period of the bees, and partly to the acceptance by swarms of nesting sites too small to allow the development of a populous colony. A number of small swarms often unite, and a swarm may even join with a colony that a beekeeper is manipulating.

Another characteristic of tropical African bees is that they run about excitedly on the comb when the hive is opened, and that queens are difficult or impossible to find. Upon occasion most of the colony takes to the air.

Tropical African bees are much more active in collecting nectar than temperate-zone European bees, and will work early in the morning and late in the evening, when nectar is usually secreted in their native environment. They produce wax readily, possibly as an adaptation to their need to build new nests frequently.

A.m. scutellata is distinguished from European races of A. mellifera in a number of other ways; their management must therefore be somewhat different, and in certain respects it is more difficult. They are very adaptable, and can live in tropical climates ranging from semi-desert to tropical rain-forests.

The queens are very prolific and (given the space) colonies grow much more rapidly than those of European bees. Worker bees mature in 19-20 days, as compared to 21 days for European bees, and this alone gives them an advantage. Their cells are smaller, so that more are packed into a unit of comb, and the combs are closer together (i.e. the bee space necessary is smaller). The African bees are also prolific at rearing queens, and when a colony rears swarm queens, as already noted, it sends off many small swarms rather than a few larger ones.

Much still remains to be learned about the tropical African bees and much more research work is needed. There is some evidence that they do not have the temperate-zone bees' capability of maintaining a constant brood-nest temperature. In Gabon, for example, brood nest temperatures were found to fluctuate widely with the outside temperature, and in Poland it proved difficult to winter colonies from tropical Africa.

The most publicized introduction of bees from one region to another in recent years was the import of tropical African bees from Pretoria, South Africa, to São Paulo, Brazil, in 1956, already referred to. Twenty-six absconding swarms, headed by their queens, escaped, hybridized with local bees, and successfully spread through most of South America. The new hybrid, "Africanized" bee, characterized on the one hand by high productivity but on the other by extreme aggressiveness, created serious problems until beekeepers learned how to manage it and adopted appropriate methods.

The bees' phenomenal rate of spread, involving advances of 200 or even 500 km in a year (Fig. 2/6), was achieved with the help of its very rapid swarming cycle. Under favourable conditions a 1 kg swarm can produce another swarm in 48-50 days, and swarming can occur in nearly all months of the year. Also, the swarms probably make several temporary stops before they finally occupy a nesting site where they build combs and rear brood, many kilometres from the parent colony. As a result, by mid-1985 the bee was reported as far north as Honduras and El Salvador, and in June of that year (Gary et al., 1985) an isolated colony was discovered in Bakersfield, California, USA.

Almost all areas in South America where the Africanized bees have advanced strongly seem to be rather dry, with less than about 1000-1500 mm rainfall a year. In Africa, A.m. scutellata occurs in a wide range of habitats but seems to be most abundant in Central African plateaux at 1000-1500 m, with an annual rainfall of 500-1500 mm. Dr. O.R. Taylor says that "basically A.m. adansonii belongs to semi-arid regions, and it would not be surprising if its greatest population densities and highest productivity in South America are attained in a similar habitat, such as northeast Brazil."

There is evidence to show that in Brazil, where beekeepers have adopted new methods of managing these bees, honey yields have soared, and in many areas surplus honey has been produced for export for the first time in history. But there have been difficulties when the Africanized bees arrive in an area, affecting more people than just the beekeepers; the bees can easily be alerted to sting en masse.

As beekeepers gain experience in handling the Africanized bees, special control measures have been devised which are contributing to minimizing the results of their aggressive nature. For a recent Spanish-language leaflet on the subject, based on the work of an FAO assistance project, see (Mexico, 1985).

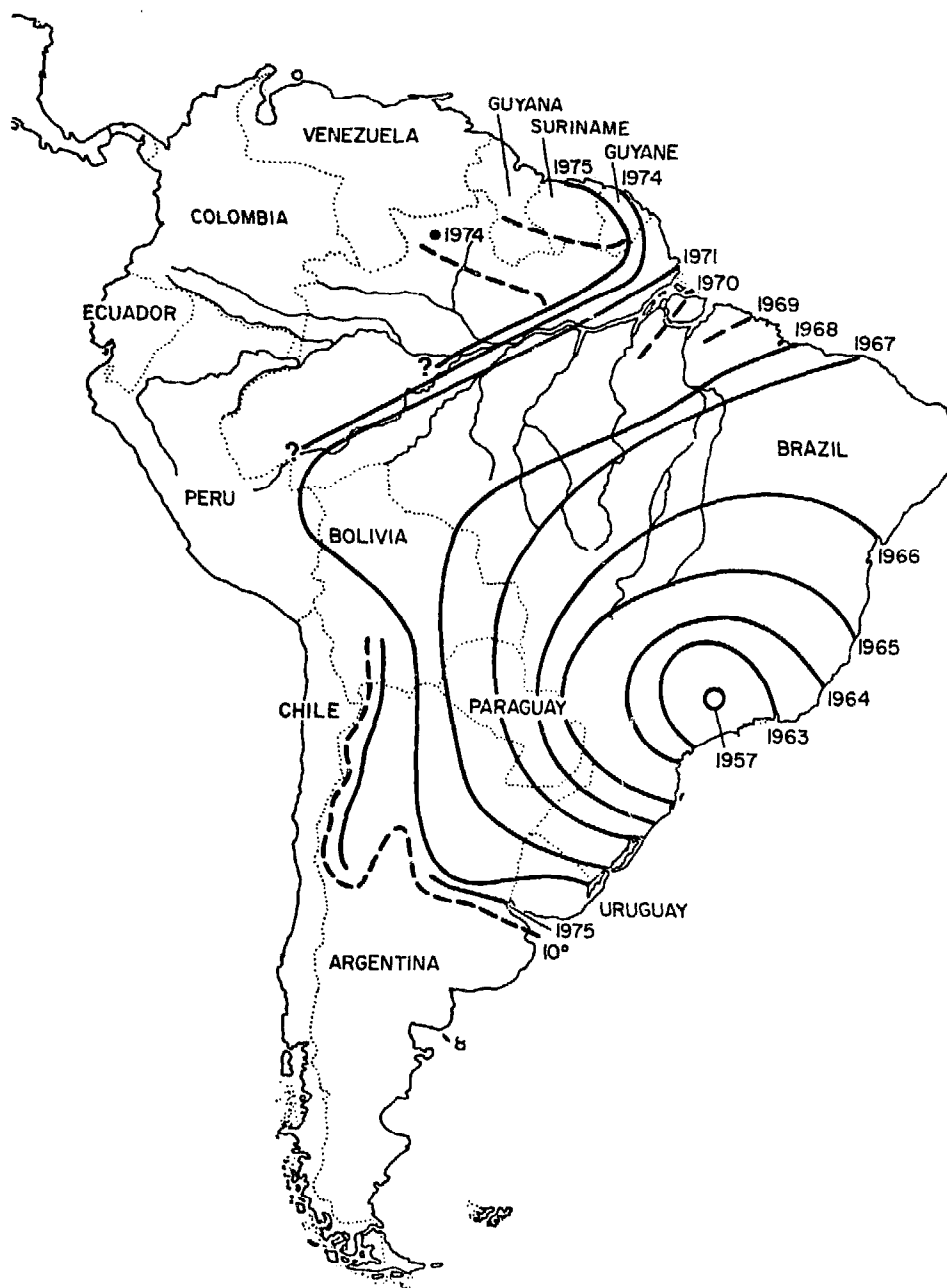

Fig. 2/6 The spread of Africanized bees in South America, 1956-1976. The 10° line represents mean Centigrade temperatures for July, the coldest month. The corridor bounded by broken lines in northern Brazil and the southern Guyanas have lower rainfall than to the north and south; Africanized bees moved through this region rapidly. In April 1976 they were found on the Guyana coast, and in various localities in the triangle formed by the Guyana, Brazil and Venezuela borders. Source: Taylor, 1977.

(2) Apis cerana

The second most important species of Apis, from the standpoint of distribution, is Apis cerana, which is indigenous from Afghanistan to China and Japan. The three major races of this bee are A.c. japonica, A.c. sinensis (or A.c. cerana) and A.c. indica, occasionally but erroneously referred to as A. indica; there are also many sub-races, which have still not been studied in sufficient detail, although work is currently going forward in India on A.c. indica. The bee exhibits wide variations in body size, productivity and behaviour in different parts of its region, depending largely on latitude and altitude.

Generally speaking, A. cerana bees are similar to the European races of A. mellifera, but smaller. They abscond more easily and are more prone to swarm, but are better at defending their colony against wasps and other enemies and are more resistant to mite pests. They are much less active in spring, and more active in winter, than A. mellifera, reflecting an adaptation to climatic differences between the habitats of the two species. They have been kept in hives for centuries: in logs, pots, bamboo baskets, or wall hives (Fig. 2/7). Currently, beekeeping with indigenous A. cerana predominates in eastern Iran, Pakistan, India, Bangladesh, Sri Lanka and parts of Thailand, but with competition from A. mellifera in most of these countries and elsewhere.

Beekeeping with these bees has been practiced for at least 2000 years in India, in China for 1000 years and perhaps for about the same period in Japan. Even today a thriving beekeeping industry exists in India, and great strides in modernizing or introducing beekeeping with A. cerana are being made in Bangladesh, Indonesia, Malaysia, Nepal, the Philippines, Sri Lanka and parts of Thailand. The modernization includes movable-frame hives of various types adapted to local conditions and availability of materials. However, much research is still needed on hive design, improvements of bee strains for traits such as diminished aggressiveness, more honey-hoarding and less tendency to abscond, and in honey extraction, processing and marketing.

A recent report (FAO, 1984) makes it possible to review briefly the current status of A. cerana in many parts of its distribution area. In Afghanistan, A. cerana is limited mainly to three eastern districts, although some small areas in central Afghanistan are also reported to be occupied by this bee. The bees live wild in crevices and hollow trees, but beekeepers also keep them in clay pots or wooden frames, inserted into the dried-mud walls of houses. An attempt to initiate modern beekeeping with A. cerana was made in the 1950s but failed, the bees being unproductive and absconding or swarming excessively. As a result, three colonies of A.m. caucasica were imported; these produced 70 kg of honey per colony the following year, while the native bees produced only 7 kg per colony.

In Pakistan, A. cerana is found for the most part in the northern and western hills and foothills, and for this reason it is known there as the "hill bee". Some 6000 colonies of this bee are currently housed in modern hives, while some 40,000 more colonies of A. cerana are kept in earthenware pitchers, hollow trees and crevices in house walls; of these, about 30% produce little or no surplus honey. The colonies in the northern areas are reported to conflict with A. mellifera, whose introduction is currently being attempted; this results in frequent losses of imported queens and colonies.



(A)



(B)

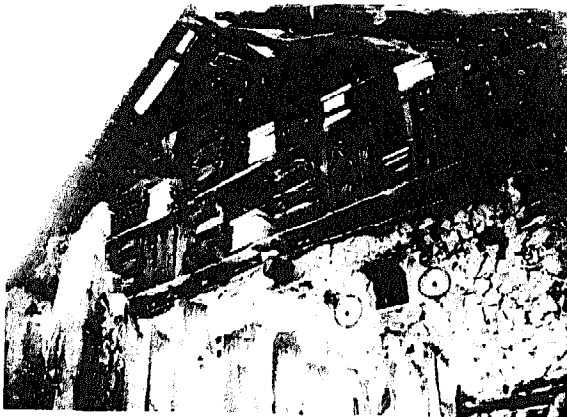

(C)

Fig. 2/7 Apis cerana colonies in traditional hives.  
(A) In a horizontal log hive.  
(B) In a pot hive, in the fork between two tree branches.  
(C) In wall hives (circled), with frame hives in roof eaves, in northern India.  
Photos: N. Koeniger.

As mentioned above, considerable research is being conducted in India on that country's three main biotypes of A.c. indica, Kashmir, Himachal and Manipur (in descending order of size). The finding that workers of A.c. indica have a longer life than those of A. mellifera has already been mentioned. A further finding is that at high altitudes in India A.c. indica performs well, while A. mellifera performs poorly.

In the eucalyptus zone of central Sri Lanka, beekeeping with A. cerana gained popularity in the 1970s. During the honey flow season (August-October), a well-maintained colony can yield 15-20 kg of honey, and it has been demonstrated that with good management and selection of colonies and flow sites, the yield can be increased to 20-30 kg. The country currently produces about 80 tonnes of honey per year, but of this, only about 35% comes from "hive bees".

It is reported from Bangladesh that Apis cerana bangladeshi lives wild but can readily be hived. The bees generally build multi-combed nests in dark, enclosed places, such as hollow tree trunks; they are easy to handle and can be migrated to other areas, either for honey production or as pollinators. A colony produces, on average, 12 kg of honey per year.

A. cerana is the bee kept in Nepal. Farmers house their swarms in hollow logs and wall crevices, and harvest honey by cutting out parts of the combs, which they crush and strain; brood cells are not separated before crushing. The average production is therefore only 2 to 3 kg per colony per year; farmers keep it for their own consumption. There are about 1200 modern hives in the country, from which beekeepers obtain an average of 10 to 15 kg per colony.

In Malaysia, keeping A. cerana in movable frames has been gaining in popularity among coconut growers since the introduction of semi-modern coconut-trunk hives ("gelodogs"). The low cost of the gelodogs and the many wild swarms of A. cerana available are the two main factors responsible for the enthusiastic response by growers to beekeeping with indigenous bees.

Beekeeping with A. cerana is widespread throughout Thailand, where simple hives, some with movable wired frames, are made from bark, coconut palms, hollow logs, wooden boxes or sometimes concrete pipes. The inside of the hives is coated with melted beeswax to attract the wild swarms. Average yields are generally below 10 kg per hive. The most serious problem faced by A. cerana beekeepers is migration; colonies are almost certain to leave, and for this reason some beekeepers prefer to cut all the honeycombs from the hives and recapture the departing colonies later.

A report from Indonesia indicates that the local Apis cerana javanica is very well adapted to tropical conditions and, even more important, is resistant to infestation by Varroa. The size of the bees varies greatly, however, and careful attention must therefore be paid to hive design and comb foundation size.

In China, where A. mellifera has been introduced, local A. cerana have survived better and remained dominant in hill areas, because of climatic conditions, the nature of the nectar resources and bees' natural enemies. Of the 4,000,000 colonies of bees in tropical and sub-tropical China, 1,000,000 are A. cerana, which are kept in modern hives and can produce 20 kg of honey per colony



Fig. 2/8 Single-comb nests of Apis dorsata in a tree in India.  
Photo: C.V. Thakar.

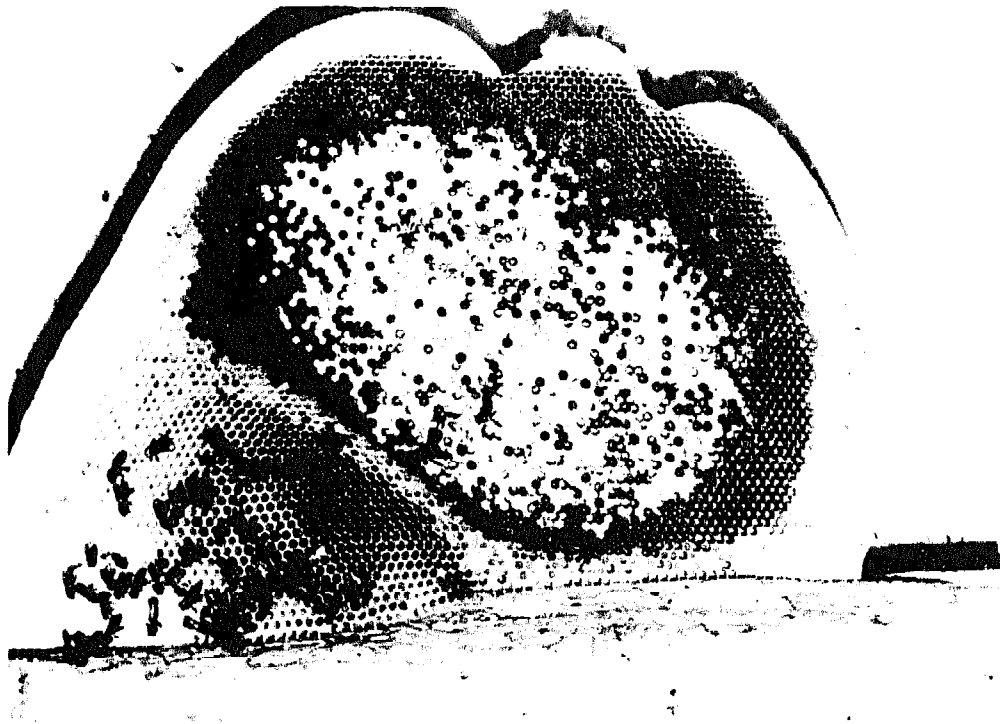

Fig. 2/9 Apis dorsata comb, showing the brood nest (darker central part) with much capped brood, a band of pollen abut it, and uncapped honey.  
Photo: N. Koeniger.



per year in non-migratory beekeeping. A. cerana in China begins its foraging activities at lower temperatures than A. mellifera (8°C); it is efficient at foraging on scattered honey plants, requires less food and is more resistant to heat, dryness, cold and the Varroa mite. It is however poor in colony defence against robbing by A. mellifera and more susceptible to European foul brood and sac-brood disease. It is more aggressive, has a lower egg-laying rate, and swarms more frequently; laying workers appear sooner after the loss of the queen, making queen introduction more difficult.

Statistical data on the Korean beekeeping industry are available from 1928. At that time, there were about 170,000 hives in Korea, of which 84% were of A.c. indica and 16% A. mellifera. Currently, the Republic of Korea has about 400,000 hives, of which about 70% are A. mellifera and 30% A.c. indica. These percentages may indicate that earlier generations of beekeepers are continuing with A. cerana, while almost all the recent expansion has taken place with A. mellifera.

In Japan, A. cerana is considered the most attractive species in the biological sense, especially in its gentle behaviour and its resistance to Varroa, but only a few colonies can be kept in one place, because of their short foraging range.

Owing to the repeated failure of beekeeping with A. mellifera in the Philippines (due primarily to attacks by Varroa and predatory birds), local producers turned in the 1970s to A. cerana, formerly living in the wild in the archipelago. The bees are abundant around the cities and towns, especially in areas where coconut and sugarcane are grown. They were placed in boxes but were heavily fed with sugar solution, to produce 10 to 15 kg of sugar honey per colony per year. A study made between January and April 1981 indicated that the mean yield from A. mellifera, kept in 14-frame hives, was 28 kg during the January-April honey flow, whereas A. cerana, kept in 10-frame hives, produced only 2 kg, and hives of wild A. dorsata produced 10 kg (\*). Migration of A. cerana is very high, most colonies departing within a year of being hived; beekeepers merely rehive a wild colony.

### (3) Apis dorsata

The honeybee Apis dorsata is the largest of the four Apis species. It is distributed throughout the tropical and sub-tropical parts of mainland Asia, and also in Sumatra, Java, the Philippines and other Asiatic islands, but is not found outside Asia.

Without doubt, honey hunters have exploited colonies of Apis dorsata since the dawn of civilization. Its honey is used commercially and is the basis for most of the jungle honey sold all over tropical Asia. The width of the single, open-air combs varies, according to the season and the stage of development of the colony, from 30-40 cm to 100-160 cm. When the colony is attached to a branch, the height is generally about half the width. The bees generally tend to hang their combs high in trees, cliffs and sometimes buildings, suspended from overhanging branches, ledges and eaves (See Fig. 2/8). The colonies are

(\*) The study also found that with supplementary (sugar) feeding, A. cerana could produce an average of 15 kg/colony, and A. mellifera 60 kg/colony. When migratory beekeeping is practiced, reports of 60 kg/hive (December-April) have been received (Capadan, 1984).

vigorous, swift to attack intruders; they produce large amounts of tasty, but somewhat watery, honey. They are sought out by honey-hunters, particularly in forested regions, and the honey is extracted and sold, in large quantities in some places (e.g. the Sunderbans and Chittagong Hills of Bangladesh, in Malaysia, Indonesia, etc.). Some attempts to bring these bees into semi-commercial management have been made, e.g. at the Central Bee Research Institute in Pune, India, but such trials are still in an early stage.

A. dorsata has many characteristics in common with the other honeybees. The construction of its comb (See Fig. 2/9), the placing of brood, pollen and honey on the comb, and the structure of the colony, are basically similar for all species, as are the number of chromosomes ( $n = 16$ ) and many of the pheromones and methods of communication.

While feral A. mellifera and A. cerana nest in hollow trees or other cavities, A. dorsata attaches its single wax comb to branches or horizontal rocks, needing a thick horizontal trunk or branch. In most areas its nesting places are high and exposed, but elsewhere the colonies nest less than 3 m from the ground. In Timor (Indonesia), a nesting site has been observed with more than 100 colonies in a single tree.

The upper portion of the comb, usually containing honey and pollen, is between 10 and 25 cm thick, the cells being made as deep as the thickness of the supporting branch will allow. Below this storage area is the brood nest. The difference between drone and worker cells is not as great as in A. mellifera, but queen cells (constructed when a colony is preparing to swarm) are at the lower edge of the comb, and are similar in shape to those of the other honeybee species. A strong colony has 60,000 to 100,000 workers, and a swarm usually 5000 to 12,000.

The defensive behaviour of A. dorsata against man and the larger animals is very well documented. The outstanding feature of this behaviour, in comparison with other tropical honeybees in Asia and in Africa, is that A. dorsata seems to have much more efficient alarm communication. Colonies in jungle areas can recognize an approaching man at a distance of 50 to 100 m, often before he can see the colony. A single bee is able to alert up to 5000 bees, which then fly out in search of the intruder, who will be covered by defending bees within a minute or so. In this situation a rapid, pre-planned retreat is the only choice, even for a well protected and experienced beekeeper, and incidents are reported in which stinging has led to severe injury or even death. During the alarm, the organization within the colony changes. In an undisturbed colony the comb is completely covered by a well-ordered layer of bees, but in a disturbed colony all activities cease except defensive ones. The smooth curtain of bees dissolves; clusters are formed which hang beyond the edge of the comb. The upper bees in these clusters suddenly leave, and all the bees in them take to the air and participate in the mass defence. The defending bees fly low over the ground and can locate an object that has already been stung by the scent of sting pheromones (isopentyl acetate and decenyl acetate) left on it by the stinging bee(s); it is nearly impossible to hide successfully from A. dorsata after being marked once with a sting. Such defence is very effective. In general, the bees defend their nesting place so well that animals and villagers living nearby avoid any approach; accordingly, the bees do not need to abscond as much as other tropical bees do.

But A. dorsata colonies are also found in large towns and other places with a constant and frequent human presence, and there they behave quite dif-

ferently. They become accustomed to their surroundings, and they do not react to passing people or vehicles, although they defend themselves as soon as the colony is disturbed.

The duration of the defensive behaviour depends on the intensity and duration of the disturbance. One expert sometimes used a cage to protect himself when observing A. dorsata nests. On one occasion the bees reacted to the introduction of the cage with constant defensive behaviour for more than two days; on the third day the colony became calmer, and on the fourth day the observer was able to leave his cage without being stung.

Information on the honey yield of an A. dorsata colony varies very widely, and many writers overestimate it: they see the large size of a colony, and estimate as they would for A. mellifera. N. Koeniger has observed a greater seasonal variation in the amount of honey that can be collected from Apis dorsata than from any other bee. He never found a comb containing more than 20 kg of honey, and many yielded less than 1 kg, or even none. Based on observations in Indonesia, Pakistan and Sri Lanka, he estimates that one can expect about 10 kg of honey per comb at the right season. Similar yields have also been observed in the Philippines and in some parts of India.

(4) Apis florea

A. florea is the smallest of the four species of honeybees. Although it has recently been reported in the Sudan, it occurs generally from Oman and Iran in western Asia through the Indian subcontinent to Indonesia in the east; it is absent north of the Himalayas. It usually inhabits the plains, but survives up to about 1500 m. In many parts of its range it co-exists with indigenous A. cerana and A. dorsata and with imported A. mellifera.

An A. florea colony usually builds a single wax comb, reaching 35 cm wide, 27 cm high, and about 1.8 cm thick. The comb is often attached to a palm leaf, or to or around the branch of a bush or tree, about 3 to 5 m above the ground (Fig. 2/10). Nests are also sometimes built in cavities such as caves and hollow trees, the top of the comb then being attached directly to the roof of the cavity. The upper part forms a "crest" above and surrounding the supporting branch, and contains honey and sometimes pollen. Underneath is a band of pollen cells, and the brood area extends out from the centre of the comb (Fig. 2/11) toward the edges as the colony develops.

Cells in the central part of the crest are two or three times as deep as those below. The upper cells may face slightly upward and the lower cells slightly downward. Most cells below the crest are of the appropriate size for worker brood, about 3 mm wide and about 7 mm deep. At certain times of the year, in mature colonies, drone cells and queen cells are built along the lower edge of the comb or, if this is not possible, at the side. Drone cells are about 4.5 mm wide and 11 mm deep; queen cells are widest at the base (10 mm) and 14 mm deep; when completed they hang down as in A. mellifera combs.

The queen starts to lay eggs at the centre of the comb and expands the brood area towards the periphery, at times laying in newly-built cells only a quarter of the normal depth. When bees have emerged from the central cells, further eggs are laid in them, giving a concentric arrangement of brood stages, often with alternating bands of capped and uncapped cells. Sometimes pupal cells remain uncapped, without apparent detrimental effect. The mean duration of worker development is 20.6 days (egg, 3.0; larva, 6.4; pupa, 11.2).

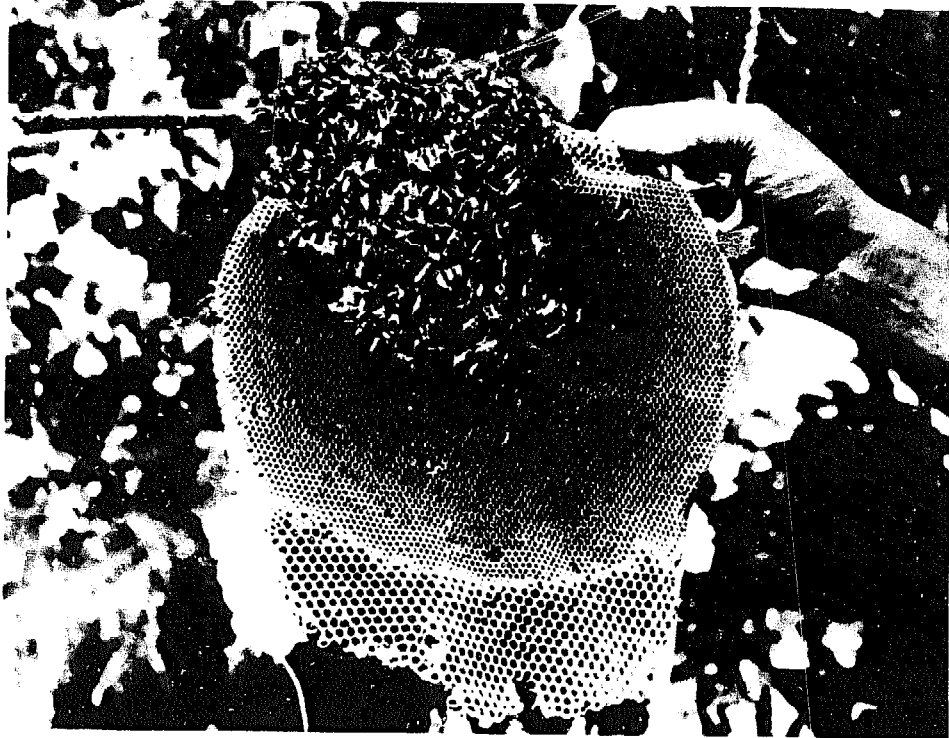

Fig. 2/10 Single-comb *Apis florea* colony attached to a thin tree branch.  
Photo: J.B. Free.



Fig. 2/11 *Apis florea* comb, showing the crest above, the central brood area and some larger drone cells below.  
Photo: J.B. Free.

Brood rearing is closely linked with forage availability and environmental temperature. In India, Iran and Oman, little or no brood is reared in December and January; brood rearing starts to increase in February, reaching a peak in late April and May, when the worker brood may cover 600 cm<sup>2</sup> of comb. When forage is abundant, a newly-initiated colony may attain full size in 6 to 8 weeks. Little brood is reared during the hot summer months (June-August), but a second, smaller, peak is attained in October. Drone production starts at the end of February and continues during March and April, when the colony population approaches its maximum. During the peak of drone production, drone brood may occupy a quarter to a third of the total brood area.

On removal or death of the queen, worker cells containing eggs and young larvae are modified to form emergency queen cells, which do not protrude from the comb surface as in *A. mellifera*, but are slightly sunk beneath the comb surface and are thus better protected from unfavourable temperatures. Most queen rearing is associated with swarming, and a colony may build up to 20 swarm cells at the lower edge of the comb, often in small clusters. The mean duration of queen development is only 16.5 days (egg, 4.0; larva, 5.8; pupa, 7.7).

Swarming is most prevalent during the major period of colony growth in March-April, but may also occur during the secondary growth period in September-October. A large colony may produce up to 8 swarms in a year.

The swarm travels at about 2 m above ground level, and may fly a long or only a short distance (2 to 20 m) before clustering in a shaded bush or tree for 2 to 7 days, while scout bees search for a permanent site. Long-distance movement of the whole colony occurs when it migrates; this may occur two or three times a year. Diminution in the supply of forage is probably the main cause of migration, and it could also be primarily responsible for the seasonal migration that is said to occur from the plains to more abundant forage in the hills.

Wherever it is, the colony needs protection from extremes of heat and cold. Despite the protective curtain 3 or more bees thick, formed by the workers and enveloping the whole comb, environmental temperature changes may provoke a move from one nest site to another, even if only a short distance away. At the beginning of the hot season, colonies move to sites better protected from the sun, in the dense foliage of trees and bushes, or deeper into caves. At the approach of cooler conditions they move to the south sides of trees and bushes, or forward in the cave, where the early morning sun strikes the comb. In winter the comb tends to be built east-to-west, so that the sun strikes the comb face; in summer locations it is more likely to be north-to-south so that the minimum area of the comb is exposed to the sun.

The bees must defend themselves against a variety of enemies, including ants, hornets, other *Apis* species, and man; invasion by enemies such as ants or wax moths can cause a colony to abscond. Sticky bands, 2.5 to 4.0 cm wide, of propolis-like material which they deposit around the branch supporting the comb just beyond its extremities, appear to deter ants from reaching the comb. Wax moths usually attack a comb that does not have enough bees to cover it. Colonies can also be damaged by pesticide sprays when farmers fail to take the necessary precautions.

Greatly varying reports have been published on the aggressiveness of *A. florea* bees. Some authors consider them very mild, while others report that they are easily alerted. When smoke from burning cardboard is blown at a

colony, the bees congregate over the brood and stores, abandoning the lower part of the comb; prolonged smoking causes them to abandon the nest.

A. florea foragers tend to work close to their colonies, within a maximum range of 500 m. They are valuable pollinators of many crops including alfalfa (lucerne), beans, cotton, litchi, sunflower, toria and sarson.

A. florea honey appears not to granulate and has a higher dextrin content than honey of other Apis species. The annual yield from a colony is not great, about 1 to 3 kg. However, the honey is highly esteemed for its quality and reputed medicinal and mystical properties, and in many places the combs are collected for sale at local markets.

(5) Trigona spp.

"Stingless bees" of the genus Trigona are indigenous to Africa, Asia and the Americas, where they may have been hunted and kept more for their wax than for their honey. They are found extensively in the Indo-Malayan area (\*), where they build their nests under the roofs of dwellings, in trunks of trees, wall crevices, logs, etc. (see Fig. 2/12). In the nest there is a group of separate cells for brood rearing, and also large "pots" for honey storage. These bees gather propolis to construct their nest, draw out the tunnel-like entrance to it, and close up crevices. They are very sturdy and can be seen working throughout the day, irrespective of extreme summer temperatures. But the colonies are small, and produce only 20 to 50 g of honey per year.

Trigona is found widely in the sub-tropical region of North America, and for centuries some species have been kept for their honey and wax. Some are still kept in hives in Belize and in Trinidad, where a colony is reported to produce from 1 to 10 litres of honey a year, as well as beeswax.

According to M.T. Chandler (1975, cited in CS/IBRA 1979, p.71) there are probably ten species of Meliponinae in Tanzania, of which one Trigona species is particularly important, having been exploited for honey and wax by traditional methods for many years.

Colonies of Trigona can maintain themselves for years without artificial feeding or inspection, and they seldom desert their nests. They can be kept in simple hives of natural origin - logs, for example - and transferring them to such hives is very easy as compared with the transfer of hive bees. Several colonies can be brought together to a single place and an apiary established; such methods appear to have been used in the Americas in pre-Columbian times.

The insect is important as a pollinator, perhaps because its small body size allows it to have access to many kinds of flowers whose openings are too narrow to permit penetration by other bees. For the best utilization of Trigona as a pollinator, however, much more knowledge of its biology and behaviour is needed; it is known to differ from the Apis species in foraging behaviour, and to show preference for different plants. This may be at least a partial explanation of the fact that Trigona honey is reported (e.g. from the Philippines) to be darker, cloudier and more bitter than honey from Apis spp.

(\*) According to a recent report (FAO 1984), Malaysia has 22 species of Trigona, of which six are of major importance as honey producers.

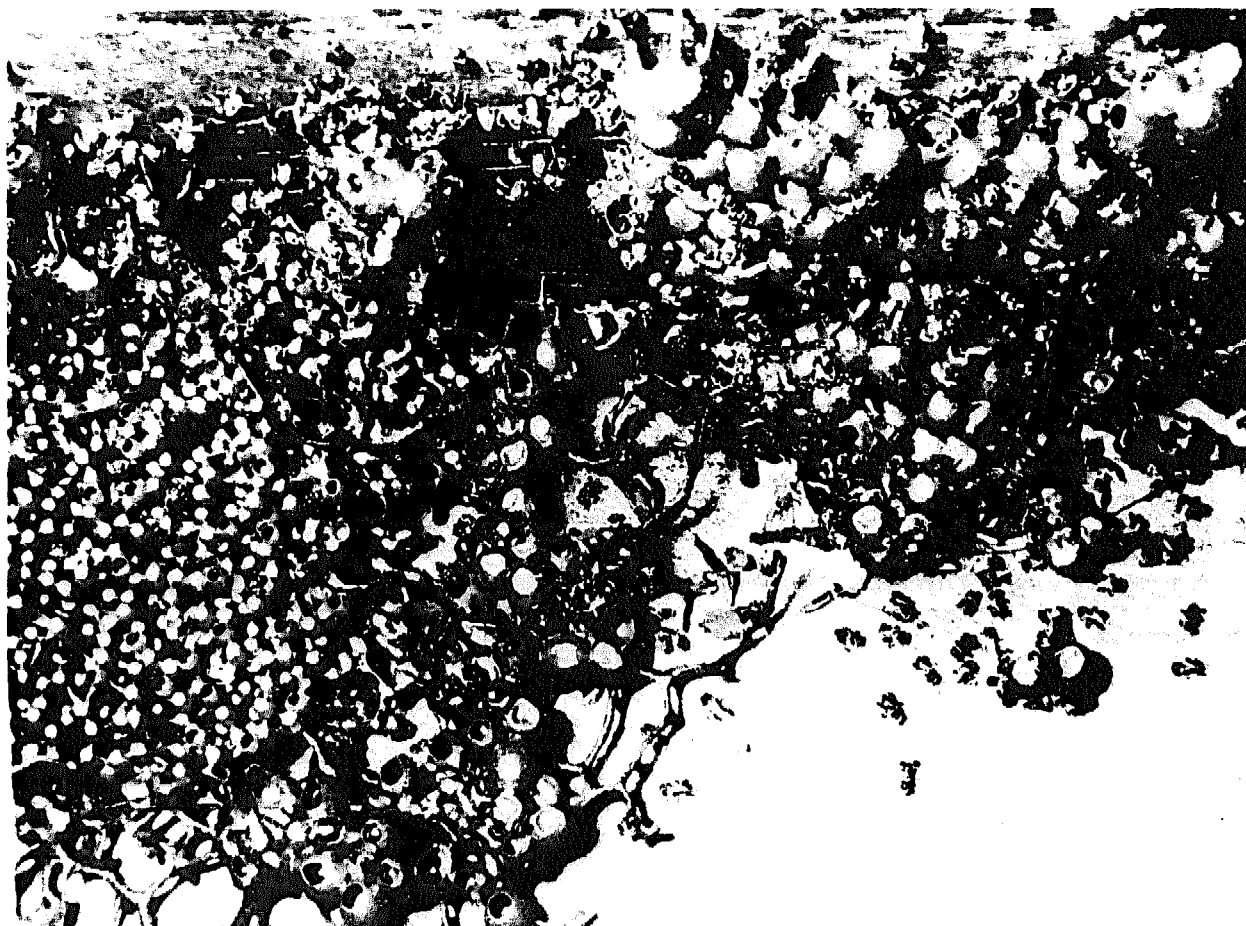

Fig. 2/12 Colony of stingless bees in India. Brood cells are on the left, and the larger honey cells on the right.  
Photo: R.P. Phadke.

(6) Further Reading

Practically every entry in the bibliography touches in one way or another on the material dealt with in this section; a reading list here can therefore hope, at best, only to provide a preliminary introduction to a vast question indeed. Crane (1976a and b), Dadant & Sons (1975) (in English and Spanish), Caillas (1974) (in French) and Wulfrath and Speck (1955, 1958) (in Spanish) are encyclopedic works of reference, although the last-named is somewhat out of date and Dadant and Caillas deal essentially with Apis mellifera in temperate zones. The 1978 IBRA Bibliography of tropical apiculture (Crane, 1978a and b) is an invaluable source: Parts 8 through 13 deal, respectively, with Apis mellifera of European and Asiatic origin in the tropics, A. mellifera native to Africa, "Africanized" bees in America, A. cerana, A. dorsata and A. florea, while Satellite Bibliographies S/32 and S/33 cover laboratory studies of A. cerana and the biology of stingless bees.

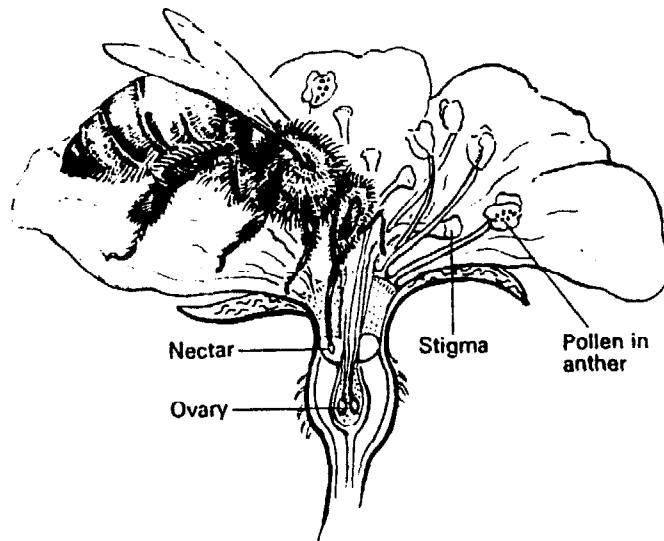

Fig. 2/13 Section through a pear flower, showing the nectary, which is easily reached by a bee standing in the petals.  
Photo: Dorothy Hodges.

#### C. BEE FORAGE

The bees obtain their food, and the raw materials for all the hive products of interest to man -- honey, wax, royal jelly, etc. -- from plants. They make honey from nectar and honeydew, and collect pollen and propolis. They secrete beeswax, which is produced in their bodies by the metabolism of carbohydrates obtained from honey, nectar and honeydew. Similarly, they secrete royal jelly, produced mainly by the metabolism of pollen proteins, as is probably also true of bee venom.

This section explores the availability of plant materials in the tropics and sub-tropics, and attempts to make a quantified comparison between food yields using bees as mediators in cropping the land, and the direct harvesting of grain and other crops. Most of these plant materials go to waste if bees do not collect them, and bees thus extend and enrich man's use of natural plant resources.

In the tropics there is a much greater variety of flowering plants than in the temperate zones, and flowers are available through much of the year. Economically valuable honey crops are not difficult to obtain there, provided that colonies are maintained in suitable places.

The bees must be adapted to local conditions of climate and plant growth, and bees taken outside their native habitat may fail to exploit rich plant resources economically. For instance, the daily rhythm of plants in the new area may be out of phase with the bees' flying rhythm. Thus, in tropical Africa many plants secrete nectar morning and evening, and native honeybees fly during these cooler periods, but bees imported from Europe start flying later and finish earlier, being adapted to the daily rhythm of temperate-zone plants, and thus they search for food in the hot (and unproductive) part of the day.



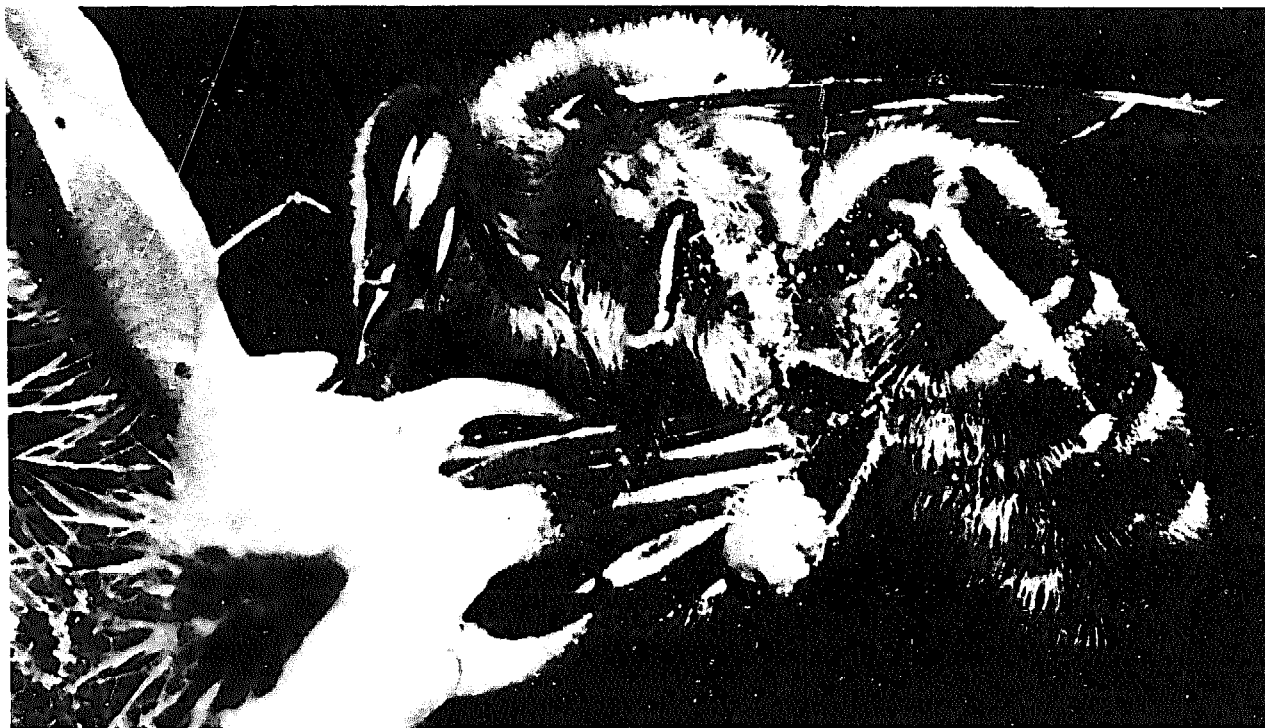

Fig. 2/14 Foraging honeybee collecting nectar from a borage flower, inserting her proboscis deeply into it to reach the nectaries.  
Photo: IBRA Collection.

Dearth periods in tropical regions are relatively short, and races of bees that evolved there tend to store, or need to store, less honey than those from regions with long cold winters, which must amass large honey stores if the colonies are to survive. One of the most productive combinations seems to be the use of temperate-zone bees (good honey storers) in regions of the subtropics - but not the tropics - with a long nectar-producing period. The main honey-exporting regions of the world are in, or approximate to, this category: People's Republic of China, Mexico, Argentina, Australia. Some countries in North Africa have a similar potential, although it has not so far been much exploited.

(1) Nectar

Most honey comes from nectar, a water solution of various sugars, which constitute from as little as 3% to as much as 87% of the total weight, and 90-95% of the total dry matter. Nectar also contains very small amounts of nitrogen compounds, minerals, organic acids, vitamins, pigments and aromatic substances, but sugars are generally believed to be what attract bees to nectar (Fig. 2/14), even if it is the aromatics that communicate to honey its distinctive flavours.

Bees can produce much more honey from nectar if its sugar concentration is high (say 50%) than if the concentration is low (say 15%). And they can

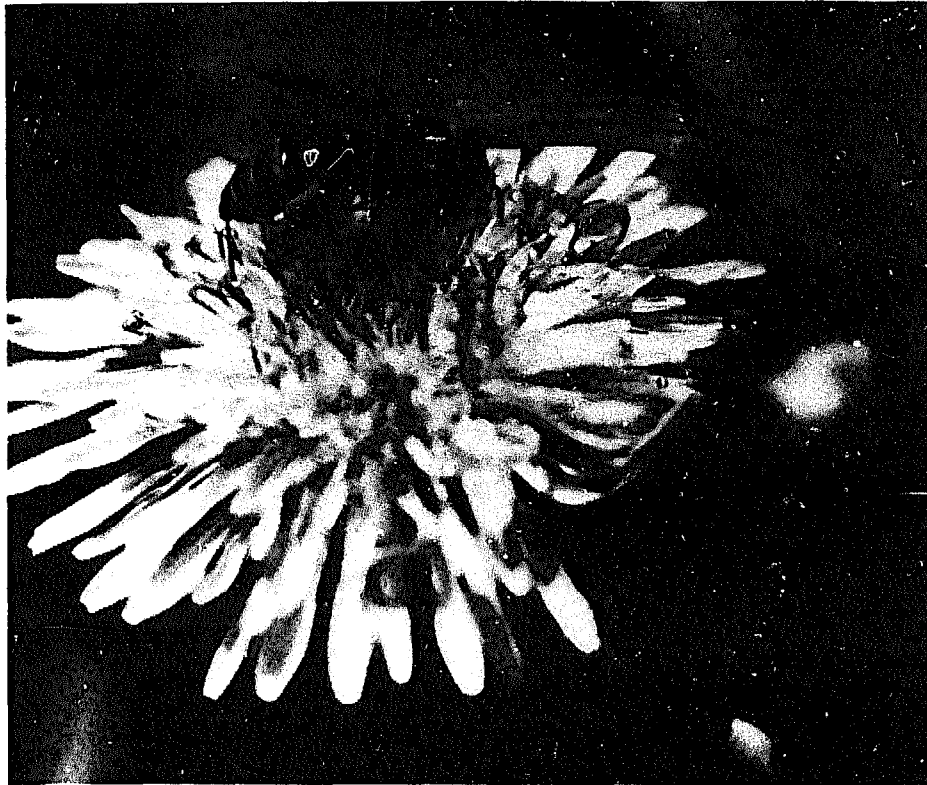

Fig. 2/15 Honeybee collecting nectar from a dandelion flower and carrying a large pollen load.  
Photo: IBRA Collection.

recognize the sugar concentration of different nectars by their sweetness; in the course of their evolution they have developed a good ability to assess the relative "cost-effectiveness" of the various food sources available at any one time, and they forage accordingly.

Most nectar is secreted by glands (nectaries) in flowers. Nectaries are usually deep-seated, for instance at the base of petals (Fig. 2/13), but they can occur elsewhere on plants; for instance, cotton plants have nectaries at three extrafloral locations as well as in the flowers, while in rubber (Hevea brasiliensis) the nectaries are on the stalks at the base of the young leaves.

The naked eye can hardly distinguish the simplest nectaries from surrounding plant tissues. More complex nectaries are often clearly visible, and may have quite striking shapes and colours. The function of all of them is the active secretion of nectar, and they have sometimes been called "sugar valves", because by secreting sugars they regulate the sugar content of the plant sap. Flowers on many plants yield only minute amounts of nectar, but some large flowers may contain half a teaspoonful. Only floral nectaries have developed the secondary function of attracting insects to the flowers, and so initiating pollination.

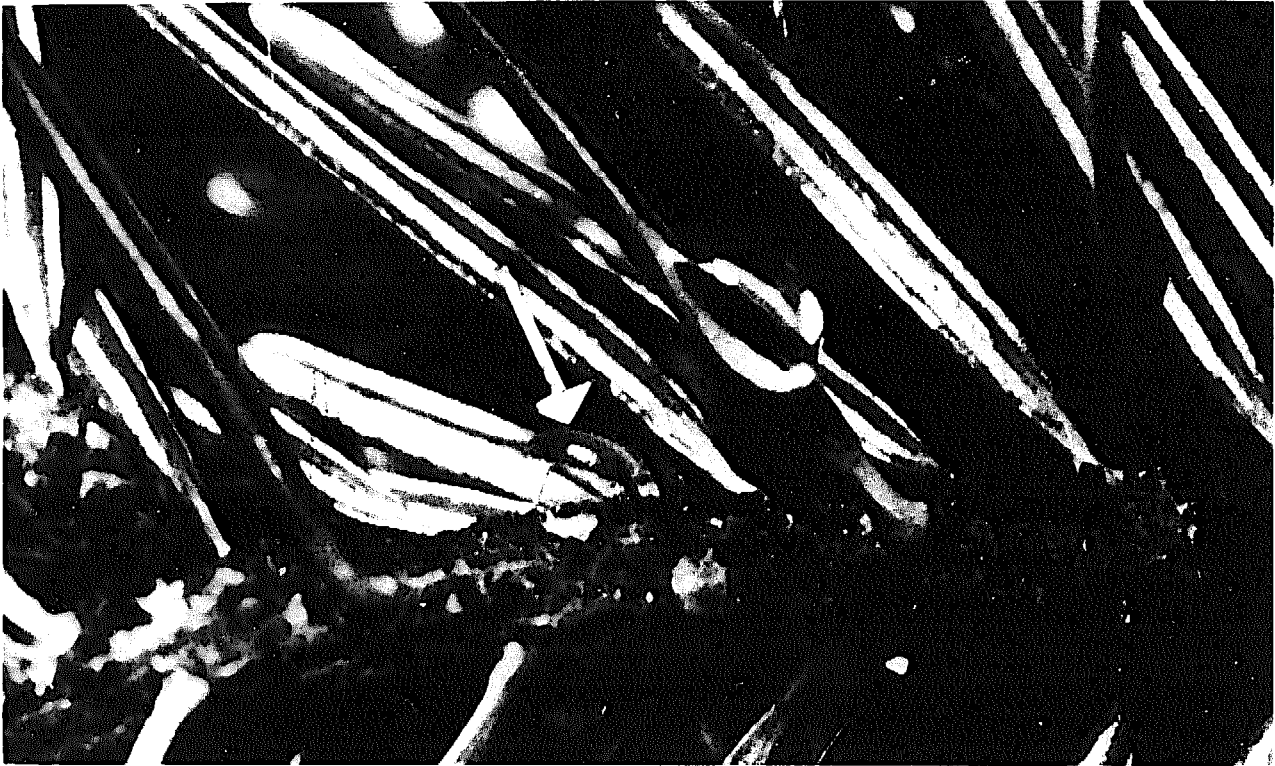

Fig. 2/16 Droplets of honeydew on leaves of a silver fir  
(Abies alba).  
Photo: A. Fossel.

(2) Honeydew

Honeydew, like nectar, is a mainly carbohydrate material which bees collect and convert into honey. Its production involves both plants and the plant-sucking insects of the order Homoptera. Such insects have mouth parts that can pierce plant surfaces, the sap inside the plant then being forced out by the plant's internal pressure and by the insect's own pumping. Excess fluid secreted by the insects is deposited on leaves, twigs, etc. in small droplets (Fig. 2/15), known as honeydew; it is collected by other insects, including bees and ants. Honeydew is often produced high up in the tree canopy, and one is more likely to hear bees working a honeydew flow than to see them.

Honeydew differs in composition from nectar, and honeydew honey therefore has certain constituents and characteristics that are different from those of nectar honey. The most apparent differences are, usually, a more pronounced flavour and a darker colour. Honeydew honey fetches a high price in areas where it has traditionally been produced, and where it therefore enjoys consumer preference. Coniferous forests of northern Europe are one of the main known areas of production. It is likely that honeys in many areas of the world are partly derived from honeydew without beekeepers being aware of the fact, and even prolific sources of honeydew honey may still be unrecognized.

Almost nothing is known about the production of honeydew or honeydew honey in the tropics and sub-tropics. It may be of only trivial importance, or in certain areas, possibly at higher altitudes, it may be a rich resource that should be systematically exploited. Any evidence of a honey flow, without flowering to account for it, should be investigated. Cooperation from botanists and entomologists specializing in plant-sucking insects may be needed, to identify the trees and insects involved.

### (3) Pollen

Pollen, the male element in a plant's reproductive process, is produced by the anthers of a flower; it consists of grains of a diameter between 0.01 and 0.1 mm. The shape and structure of the pollen grain are characteristic of each genus or group of plants. Identification of known pollen grains in honey, using a microscope and a reference collection of known pollen grains of local plants, can help to determine the plant sources of the honey. Such pollen analysis of honey, known as melissopalynology, is complicated, specialized work, but it can be most valuable. Its systematic application to honeys of the tropics and sub-tropics is a task for the future.

Wind-pollinated plants produce light, dry pollen that is easily dispersed by the wind. The pollen of insect-pollinated plants is heavier, and contains adhesive substances which enable honeybees to pack it into clumps (pellets or loads) on stiff hairs on their hind legs. Many bees that do not collect the pollen by packing it in this way may nevertheless transport it from one flower to another, because the grains can become attached to many parts of their hairy bodies as they move about a flower searching for nectar.

Pollen is the bees' protein and lipid source: it enables a colony to rear brood, and hence new generations of adult bees. Without it, a colony dwindles away and dies. In temperate zones, a colony of bees uses some 50 kg of pollen a year; in the tropics and sub-tropics the amount is likely to be of the same order, the more extended brood-rearing season being perhaps compensated by the fact that less brood is reared at any one time.

Flowers of a few plants produce nectar but no pollen, and the pollens of some others are nutritionally deficient for bees. Almost nothing is known about tropical plants in this respect, but some eucalyptus species are involved; for instance, E. sideroxylon produces no pollen and E. albens poor-quality pollen. A few flowers, such as the opium poppy (Papaver somniferum), produce pollen but no nectar, as do plantains (Plantago), also found in tropical regions, and grain crops such as maize and sorghum, which are wind-pollinated but are utilized by honeybees as a pollen source.

### (4) Propolis

Propolis ("bee glue") is a sticky, brown, resinous plant secretion, occurring especially on the buds of certain trees, which bees collect and use for minor building works, e.g. to stop up cracks in the hive, to line and smooth the inner surface of their nest, and on occasion to reduce the size of the hive entrance (hence its name, from the Greek pro-, before, + polis, the city). Not all trees yield propolis, and little is known about their identity and the amounts they produce, even in the temperate zones. Almost nothing has been published about sources of propolis in the tropics, but there is no reason to believe that any large region of the earth lacks them entirely.

It has been reported that in the Caribbean region bees collect propolis from species of Bursera, Calophyllum, Clusia, Ipomoea and Rheedia, and in the Seychelles from the coconut palm and Casuarina. The trunks and branches of the mango and avocado also produce a resin that bees use as propolis.

(5) Important Honey Plants in the Tropics and Sub-Tropics

Many plants from which bees store surplus honey in the tropics and sub-tropics are well known. (\*) Some, such as Eucalyptus and Citrus, have become widespread through introduction from one continent to another, while some wild plants are strictly localized, being of primary importance in one area but perhaps nowhere else; examples are tah (Viguiera helianthoides, Compositae) in Yucatan, Mexico; shain (Plectranthus rugosa and P. spp., Labiatae) in the western Himalayas and also Indonesia; and mascal (Coreopsis abyssinica, Compositae), the main honey source in parts of Ethiopia. Many other plants that are honey sources have not yet been identified, and lack of knowledge about them is one of the major constraints to their effective exploitation.

(a) Crop Plants

Crops grown by farmers often cover large areas, and many of them can give very high honey yields, especially if they flower for a long time. The yields vary according to the soil and also from year to year according to growing conditions. It is, however, often necessary to take hives to the crops for their flowering periods, because the fields are unlikely to produce food for bees at other times and are therefore not suitable as year-round hive sites. Also, there may be danger from pesticides, as pest thrive better in monocultures than where their host plants are thinly scattered. Important honey plants among tropical and sub-tropical field crops include--

Cruciferae: such as sarson, toria, Indian/Chinese mustard, and rape -- giving a variety of extra-sweet honeys that granulate very rapidly;

Compositae: especially sunflower and niger;

Leguminosae: e.g. various clovers, most of which give light mild honeys; vetches, whose honey is usually pleasant but somewhat more strongly flavoured (many, but not all, honeys from clovers and vetches granulate rapidly); groundnut, soybean and other beans, whose honeys are often of indifferent quality;

(\*) Appendix A lists 232 plants that are known to be important sources of the world's honey, and indicates the zone(s) in which there are honey sources in each continent: the tropics and sub-tropics, and the north and south temperate zones. Temperate-zone plants are included in the list because descriptions of them, their honeys and their honey yields, are more likely to be available than those for plants limited to the tropics. Plants are listed under their botanical families, of which the Leguminosae, Myrtaceae, Compositae and Labiatae include the greatest number of plants known to be important honey sources. Common names of plants used in this section can be identified via the family name, which is also cited.

Malvaceae: cotton can also give much honey, usually of good quality although sometimes thin-bodied;

Amaryllidaceae: sisal, another prolific source, yields honey with a rather unpleasant flavour.

(b) Tree Crops

Tree crops can produce large honey yields. Among sub-tropical fruits, the various citrus (Rutaceae) are widespread and give high yields of excellent honey; it is much liked and commands a good price, especially a mixed citrus-coffee honey; coffee (Rubiaceae) itself is a good source. Many tropical stone fruits, including litchi, longan and soapnut (Sapindaceae) give very good honeys, and that from loquat (Rosaceae) is agreeable, but tamarind (Leguminosae) honey is second-grade; honey from avocado (Lauraceae) is dark and heavy-bodied and not liked by everyone. Among other good sources is mango (Anacardiaceae), which gives a heavy early-morning nectar flow and produces a delicious honey. The same family includes two nut trees whose flowers provide a honey source: cashew and pistachio. The coconut palm (Palmaceae) is also important.

(c) Other Trees

Many of the honey sources in the tropics are trees other than those cropped for their fruits or nuts. Some are grown for timber and other purposes, including shade and amenity; many native trees are not planted or cropped at all, except by bees for making honey. Trees grow in a wide variety of habitats, and being deep-rooted can survive drought better than most herbaceous plants. Moreover, their three-dimensional array of flowers can provide large quantities of nectar and pollen from a relatively small area of land.

Among timber trees are logwood or campeche (Leguminosae), whose honey is one of the best in the world, and black mangrove (Verbenaceae), which yields honey with quite a good flavour but fermenting easily. The royal palm (Palmaceae) is much used as an amenity tree whose honey has a characteristic and well-liked flavour and aroma. The rubber tree (Euphorbiaceae), with its extrafloral nectaries has already been mentioned.

There are 250 species of combretum (Combretaceae), and as many of grevillea (Proteaceae), trees and shrubs found in tropical Africa and America; many of these are probably honey sources. In Yucatán, Mexico, the main sources of honey include the native trees ha'bin (Leguminosae) and dzidzilche (Polygonaceae).

The genus Eucalyptus is a very large one, and some species are extremely valuable to bees. Eucalyptus has been introduced widely in the Mediterranean region, especially in North Africa, where there are large eucalypt forests, and there is a growing trend to raise some species for paper pulp in the warmer regions of Europe and elsewhere. Bees collect both nectar and pollen from most species, though some produce no pollen, or pollen that is nutritionally inadequate for bees. Honey of excellent quality is obtained from E. melliodora (said to be the best honey-producing plant in the world), E. camaldulensis, E. albens and E. siderophloia. E. camaldulensis and E. cornuta give an excellent annual flowering in Tunisia, although in Australia, their country of origin, they flower only in alternate years. E. gomphocephala also flowers abundantly each year, whereas in Australia it flowers only once in four years. The flowering

period of some species can last for nine months. Near Sedjenane (Tunisia) there is a eucalypt forest of 10,000 hectares consisting of 80% E. camaldulensis, which flowers in summer, and 36 other species. It gives a very good honey yield; in 1976 an FAO/UNDP project there obtained an average of 35 kg per colony. The flowering periods of the different species in this forest varied so widely that at least eight were flowering during every month of the year. For an analysis of the value of various Eucalyptus species as honey producers, see (FAO, 1979, pages 292-293).

Eucalypts are grown widely throughout the tropics and sub-tropics as amenity trees and windbreaks, for timber, for their oil, and for cellulose production. (For this last purpose they are cropped before flowering, and so are useless as honey plants.) Some eucalyptus honeys imported into Europe, whose colours vary from water-white to quite dark, have acquired a reputation for poor quality, but many others have an excellent flavour and aroma.

The main honey sources throughout much of the miombo in Africa are species of leguminous trees, Brachystegia and Julbernardia, especially J. globiflora and J. paniculata. The honey is fairly light in colour (it is lightest in the copper belt of Zambia), with a medium-to-strong but pleasant flavour. In somewhat drier regions of Africa, a great many species of another leguminous genus of trees and shrubs, Acacia, yield large quantities of delicious honeys. (The false acacia, Robinia pseudoacacia, is also a prolific honey source.)

Another tree genus (Townsend, 1981b) which is receiving increasing attention, not only as a honey source but as a "multi-purpose" tree (to provide feed, food and wood, increase land fertility and help control desertification) in arid tropical areas, is Prosopis, of which over 40 species are known. Various species of this tree meet the requirements of growing quickly in difficult conditions, needing little water and having many different uses. They grow in dry areas, but only where their roots can reach water; they develop a tap-root that may be 20 or even 30 metres long, in order to reach groundwater levels.

The introduction of P. pallida into Hawaii made this area the world's largest producer of honey in the early 1930s. The honey flow from these trees gives annual hive yields of 120-150 kg, and in one zone 230-260 kg have been reported.

P. juliflora is a major honey source in Bolivia, Jamaica, Pakistan, Western Australia and elsewhere, and is also a good source of pollen. It is a particularly hardy, fast-growing species which, like many other members of the genus, produces not only wood for fuel but also a bean that is used for fodder and can be ground into a flour for human consumption. It can be grown from seed, and can also be reproduced from root suckers or stem cuttings. Under ideal conditions it produces seed within three years. During the early weeks of its growth its roots penetrate the soil rapidly, assisting in its establishment. Its honey is light and of good quality.

In a striking example of integrated rural development (Habit et al., 1981), over 1000 ha of P. juliflora were established in the coastal desert of Piura, Chile. Colonies of bees were moved onto the project site for commercial honey production, and the land was also grazed by sheep and goats after the trees had reached a size at which the loss of the small branches grazed did not interfere with pod production. Prosopis taken alone is not a perfect food for livestock, but drought-resistant grasses grew well under the trees, which pro-

vide both humus and nitrogen. There were two seed harvests a year, the principal one in December-March and a lighter one in August; correspondingly, there were two honey and wax crops. In some desert areas, a complete food economy built up around the cultivation of this plant can be envisaged, particularly if drought-resistant grasses can also be grown. In the Chilean programme, the land bearing the trees was turned over to the families living on the project site within three years of its establishment, and was to be in full production by the fifth year.

In grassland areas of the southern United States, some Prosopis species (e.g. P. glandulosa -- called "mesquite" in the area in question --, P. velutina and P. ruscifolia) are considered to be damaging weeds. Others are invasive and should not be introduced into other than desert areas, although they may form trees as large as P. juliflora, particularly if pruned during their first two or three years of growth.

(b) Native ground flora

In contrast to what is true in the temperate zones, native ground flora are still the source of much of the honey in some parts of the tropics. Tropical honeys therefore have an enormously wide range of flavour and aroma.

These plants are often more localized than trees and shrubs, and a few examples must suffice. A number of Compositae are valuable. Two species of Viguiera are important in Mexico's honey exports: tah and acahual; the latter honey has a butter-like consistency and an exquisite flavour. Species of Vernonia (ironweed, etc.), growing in higher tropical wooded grasslands of South America, Africa and Asia, give very light, fine-flavoured honeys. Bidens species are important in the same continents, but some give honeys with a strong, rather disagreeable flavour.

The Labiatae in the drier sub-tropical regions include a number of shrubby aromatic plants that give distinctive and highly-regarded honeys: for instance lavender, sweet basil, marjoram, rosemary, sage, savoury and thyme.

Many plants and trees have been deliberately introduced to new continents by man for use as crops, and many introductions that are not crop plants also yield honey. As already noted, eucalyptus originating in Australia are important honey sources in many tropical and sub-tropical countries. Again, the cardoon (Cynara cardunculus) was introduced from western Eurasia into Argentina, where it spread over vast stretches of the pampas. It grows to a great size, forming large areas of impenetrable vegetation, and is one of the most important honey sources in the country which, it may be recalled, is a major honey producer and exporter.

There have, however, been many problems when a plant introduced into a new region becomes an invasive weed, the new environment lacking the pests that kept it under control in its native habitat. In the Americas, for example, species of prickly pear (Opuntia) provide nectar and pollen in many arid areas in which they have been introduced, but in Australia, where they may have been taken to provide cattle fodder, the cactus spread disastrously, and was a serious pest until successful biological control methods finally became possible.



(f) Directory of important world honey sources

After more than a decade of planning, preparation and experimentation, the International Bee Research Association (IBRA) in 1984 published an important, computer-generated Directory of important world honey sources, including details of over 460 species (listed in the bibliography of this volume under Crane, Walker & Day, 1984). The book is designed to assist a wide range of users:

- honey producers in developing countries who need to identify plant sources of honeys that command premium prices because of their flavour, etc., or, conversely, that are unpalatable or even toxic, or otherwise difficult to handle, since in the absence of such knowledge a small mixture of an undesirable honey may spoil an entire large batch;
- agriculturalists responsible for managing marginal land, especially in arid areas, where suitable planting for cropping by bees may offer the most profitable method of land use;
- specialists in agro-forestry and other disciplines concerned with integrated planting programmes and needing to consider the relative value of candidate species and varieties from all angles, including cropping by bees;
- development programmes, with or without international assistance, seeking to identify plants likely to be the major honey sources of a country and thereby to determine areas in which beekeeping would be most profitable; and
- the world honey trade, which may accept from developing countries honeys, from certain specified plant sources, that can be produced to a uniform standard.

The programme under which the Directory was issued has not reached completion. It is planned to extend greatly the number of plants in the system beyond those included in the Directory as published and to provide a permanent database for searches in response to requests to identify, for example, high-yielding plants, plants that give undesirable or specially desirable honeys, likely honey sources in areas for which firm information is lacking, etc., as well as "spin-off" publications by regions, habitats, etc.

(6) Floral Calendars

A knowledge of what plants provide nectar and pollen is insufficient unless it is supported by knowledge of when the nectar and pollen flow is available. Since bees need food all year round, and the honey in the hive is their food reserve, it is clear that they will produce more honey, and consume less, if they can find natural food most of the time.

A floral calendar, which catalogues the flowers, their value to bees, their abundance and time and duration of bloom, contains essential information for sound management in beekeeping. Floral calendars need to be produced for ecological regions in which beekeeping is practiced. Sometimes, especially in mountainous or hilly country, the ecological regions can be quite small and diverse in terms of their floras.

Floral calendars for several regions can be used to plan for migratory beekeeping. When dearth commences in one ecological region the bees can be moved to another where bee flowers are abundant. In this way, extra honey crops can be harvested.

In preparing a floral calendar, the first step is to draw up a list of all the major honey and pollen sources of the area, together with an indication of their blooming seasons. An example of such a list, from Japan, is shown in Table 2/1. From this list it is possible to assemble a calendar of the blooming periods of the different plants in the area, and to plan to migrate bees accordingly to take advantage of major flows. Such a calendar, from a small area in Burma, is shown in Table 2/2. It will be noted that the Japanese list shows no honey source blooming between early winter and early spring, so that bees will probably have to be fed during the winter. In Burma, on the contrary, with its more tropical climate, one source or another is available throughout the year, and if migration could be properly planned it would probably be possible to maintain production under normal circumstances.

A floral calendar is not however an infallible guide. Under exceptional weather conditions, a plant may bloom before its normal time, or later, or poorly, and this is the main reason why a country's honey and beeswax production, like its agricultural production in general, can show considerable fluctuations from one year to the next. The calendar, if properly prepared, should, notwithstanding this, be reliable most of the time, and if it is complete enough it may offer a basis for taking exceptional migrating measures when blooming periods fail to meet normal expectations.

(7) Cropping by Bees as the Most Efficient Use of Land

There are probably areas in the tropics and sub-tropics where cropping by bees is likely to be the most efficient use of land, but most of the following examples are from temperate zones.

Some marshy areas too wet to be grazed support many honey-rich wild flowers. The Danube delta is one of the rich honey-producing areas of Romania, and boatloads of hives are taken there for the flowering season.

Cleared areas in forests may be difficult of access for men and animals, whereas bees can reach them by flying from several kilometres away. Very large quantities of honey are obtained from fireweed (rosebay willow-herb, Onagraceae) in such circumstances in mountainous areas of British Columbia (Canada), and the Pacific Northwest of the United States, when beekeepers can convey their hives near enough to the sites.

Dry areas that support native flora - perhaps ephemerals - may provide a honey crop, but only very poor grazing for sheep or other animals, even if the native flora is destroyed and grasses or legumes sown. An example is the coastal plains belt of Western Australia.

Mountainous and rocky dry areas that cannot be cultivated, but that support honey plants, are widespread, for example in the Mediterranean area and northern Oman. Some of these are already exploited for bees, especially in the sub-tropics.

Table 2/1: Typical List of Honey and Pollen Sources (Japan)

N1, N2, N3 = major, medium and minor nectar source, respectively.  
 P1, P2, P3 = ditto, as pollen source.  
 Blooming season: Sp (spring), S (summer), A (autumn) and W (winter), modified with E (early) or L (late) seasons, or by name of month.

Species	English name	Notes
<b>Aceraceae</b>		
<i>Acer</i> spp.	(maples)	N3 P2 Sp
<b>Anacardiaceae</b>		
<i>Rhus javanica</i>	(sumac)	N3 P2 S
<i>Rhus succedanea</i>	(sumac, wax-tree)	N2 P2 ES
<i>Rhus verniciflua</i>	(sumac)	N3 ES
<b>Aquifoliaceae</b>		
<i>Ilex pedunculosa</i>	(gallberry)	N2 P2 ES
<i>Ilex rotunda</i>		N2 P2 Sp
<b>Caprifoliaceae</b>		
<i>Weigela decora</i>		N3 P2 May-June
<b>Compositae</b>		
<i>Artemisia vulgaris</i>		P3 S-A
<i>Cirsium</i> spp.	(thistles)	N2 P2 S
<i>Helianthus</i> sp.	(sunflower)	N3 P3 S
<i>Solidago altissima</i>	(goldenrod)	N2 P2 S-EA
<i>Taraxacum platycarpum</i>	(dandelion)	N3 P2 Sp
<b>Cruciferae</b>		
<i>Brassica campestris</i>	(rape)	N1 P1 Sp
<i>Raphanus sativus</i>	(radish)	N3 P3 Sp
<b>Cucurbitaceae</b>		
<i>Cucumis</i> spp.	(cucumber, melon)	N2 P2 S
<i>Cucurbita moschata</i>	(pumpkin)	N2 S
<b>Diapensiaceae</b>		
<i>Clethra barbinervis</i>		N2 P2 S
<b>Ebenaceae</b>		
<i>Diospyros kaki</i>	(persimmon)	N2 June
<b>Fagaceae</b>		
<i>Castanea pubinervis</i>	(sweet chestnut)	N1 P1 ES
<b>Gramineae</b>		
<i>Zea mays</i>	(maize)	P2 S
<b>Hippocastanaceae</b>		
<i>Aesculus turbinata</i>	(Japanese horse-chestnut)	N1 P2 ES
<b>Labiatae</b>		
<i>Elsholtzia ciliata</i>		N2 EA
<b>Leguminosae</b>		
<i>Astragalus sinicus</i>	(Chinese milk vetch)	N1 P1 Sp
<i>Lespedeza</i> sp.	(bush clover)	N2 P2 A
<i>Robinia pseudoacacia</i>	(black locust)	N1 P1 ES
<i>Trifolium pratense</i>	(red clover)	N3 P3 S
<i>Trifolium repens</i>	(white clover)	N2 P2 Sp-S
<b>Liliaceae</b>		
<i>Allium cepa</i>	(onion)	N3 A
<b>Oleaceae</b>		
<i>Ligustrum japonicum</i>	(privet)	N2 May
<b>Polygonaceae</b>		
<i>Fagopyrum esculentum</i>	(buckwheat)	N2 P2 S-EA
<b>Rosaceae</b>		
<i>Eriobotrya japonica</i>	(loquat)	N2 EW
<i>Malus pumila</i>	(apple)	N2 P2 LSp
<i>Prunus avium</i>	(cherry)	N3 P3 Sp
<i>Prunus mume</i>	(Japanese apricot)	N2 P3 ESp
<i>Prunus persica</i>	(peach)	N3 P2 Sp
<i>Pyrus pyrifolia</i>	(pear)	N3 P2 LSp
<b>Rutaceae</b>		
<i>Citrus natsudaiddai</i>	(summer orange)	N2 ES
<i>Citrus unshiu</i>	(orange)	N1 ES
<b>Salicaceae</b>		
<i>Salix</i> spp.	(willows)	N2 P2 Sp
<b>Styracaceae</b>		
<i>Styrax japonica</i>	(snowbell)	N2 P3 May-June
<b>Theaceae</b>		
<i>Camellia japonica</i>	(camellia)	P3 Sp
<i>Thea sinensis</i>	(tea)	P3 LA
<b>Tiliaceae</b>		
<i>Tilia japonica</i>	(linden, lime)	N1 P2 S
<i>Tilia maximowicziana</i>	(linden, lime)	N1 P2 S

Table 2/2: Typical Floral Calendar (from Maymyo Apiaries, Burma)

JULY	AUG	SEPT	OCT	NOV	DEC	JAN	FEB	MARCH	APRIL	MAY	JUNE
Cucurbitaceae plants				Cajanus indicus						Zizyphus	incurva
		Cichorium intybus						Grevillea robusta			
Zea mays			Trigonella foenum-grastum				Citrus reticulatum & C. sinensis			Zea Mays	
Homonia raparia	Wild Cosmos						Hoi paw			Homonia raparia	
	Zizyphus puzuba			Prunus cerasoid				Coffea arabica			
	Eucalyptus tereticornis			Melilotus albus			Litchi chinensis		Schima wallichii		
Albizzia procera			Raphanus sativus						Albizzia procera		
			Guizotia abyssinica				Eucalyptus resiniferous				
			Tithonia tagetifolia				Persea gratissima		Schleichera oleosa		
			Helianthus annuus						Careya arborea		
						Prunus insititia			Albizzia chinensis		
						Eucalyptus camaldulensis			Quercus spp		
Quercus spp									Eugenia spp		
	Sechinum edule					Brassica spp					
								Salmaria malabarica			
	Bidens pilosa									Grewia microcos	
		Sit-paung (Labiatae)					Ageratum conyzoides			Oxalis corniculata	
Oxalis corniculata				Mimosa pudica					Sesamum indicum (Sint-gaing)		
Preparation of bee colonies at Maymyo for Zee honeyflow Treatment against ectoparasitic brood mites	Migrate for utilization of Zee honeyflow at Mandalay			Return to Maymyo for utilization of major honeyflow of niger and wild sun flower			Preparation of bee colonies at Maymyo for citrus eucalyptus and litchi honeyflow	Migrate to Hsipaw or Naung-cho for utilization of citrus or litchi honeyflows or stay at Maymyo for eucalyptus honeyflow		Migrate to Sintgaing for utilization of sesame honeyflow	

Source: FAO, 1984.

(8) Further Reading

Most publications on beekeeping in particular areas, such as FAO (1984), contain lists of honey sources in the countries or areas to which they refer; some of these are sketchy, others very complete and detailed. Crane et al. (1984) is the most complete general study of honey sources, filling many gaps and presenting a much more complete picture than has been heretofore available. Crane (1976b) provides general information on honey plants (and their honeys) of the tropics and sub-tropics, as does Crane (1980a), in English, Spanish and Portuguese, from which Appendix A is reprinted with the kind authorization of the Oxford University Press.

A number of studies of bee plants in specific regions are available:

Central and South America: Ordetx (1952); Espina Perez and Ordetx (1981 and 1983); Kempff Mercado (1980); Ordetx is also the author of separate studies of Cuba, the Dominican Republic, Honduras and Nicaragua which are referenced in Crane (1976b). For El Salvador, see Woyke (1981a).

Mediterranean area: No general study, but for Italy and the UAE see Ricciardelli d'Albore and Persano Oddo (1976) and Kwei and Esmonds (1976) respectively; the latter includes information about salinity tolerances of relevant arid-land plants.

East Africa: Smith (1960); also contains some information on other regions.

West Africa: Gledhill (1972) is useful, although it does not mention honey sources as such.

South and East Asia: FAO (1984) and the further studies referenced therein. The best list for India is Indian Standards Institution (1973), while Singh (1962/1975) includes soil conditions and other details for honey plants.

The eucalypts are probably the best documented genus of honey plants. Penfold and Willis (1961) contains a special chapter on honey-yielding species, while FAO (1979), in English, French and Spanish, prepared in Australia, is the most recent complete study of the genus considered as a utility plant.

For Prosopis, see Habit et al. (1981), a full-scale study of a salt-resistant Chilean species which offers promise for planting elsewhere; unfortunately, it refers only in passing to its value as a honey-producer.

Woyke (1980h) briefly sets out a methodology for determining the honey potential of local plants.

No complete book on planting for bees in the tropics and sub-tropics is known, but Hall et al. (1972) and New South Wales Forestry Commission (1979?), both from Australia, may be helpful in certain areas, while Eisikowitch and Masad (1980) describes a detailed study of the value of planting in semi-arid areas.

Part 15, "Bee forage in the tropics", and Satellite Bibliography S/34, "Bee forage in specific regions of the tropics", of the IBRA Bibliography of tropical apiculture (Crane 1978a and b) lead to many further published sources of information on bee forage in the tropics.

D. THE VALUE AND USE OF BEES IN POLLINATION

Pollination is an essential process in the production of seeds and fruit of flowering plants. It consists of the transfer of pollen grains (the male element in plant reproduction) from a flower's anthers, where they are produced, to the female stigma of the same or another flower, whence they reach and fertilize its ovule.

Many, if not most, agricultural crops need pollination, and the two main pollinating agents are wind and insects (Fig. 2/17). Wind pollinates cereals and other grasses, nut trees and a few other crops whose pollen, light and dry, is easily carried by air currents from one plant to another. Most other crops have heavier, sticky pollen, and insects are their main pollinators. Honeybees are the most important of the insect pollinators, and in countries with advanced and highly mechanized agriculture, the use of bees for pollination is now an integral part of crop production.

The pollination requirements of tropical and sub-tropical crops have thus far been relatively little explored. Insect pollination is known to be essential for such crops as coconut palm, melon, sunflower, litchi, passion fruit and avocado, and it is almost as important, for example, for cashews, coffee, mango, allspice, guava, etc. But studies in temperate climates are not necessarily applicable to tropical regions, and tropical conditions are so diverse that experience in one tropical area will not necessarily apply in another. Most of the information that does exist has been obtained in response to a specific problem, or to an obvious lack of pollination. Systematic beekeeping in Costa Rica began, for example, when the insects were introduced from Europe as pollinators of coffee crops.

In tropical countries, where low soil fertility and/or inadequate water or rainfall may limit production, wild pollinating insects may provide sufficient pollination for the plants' bearing capacity, and for this reason little urgent need has been felt to improve the pollination of tropical crops. With the introduction of irrigation and improved cultivars and cropping methods, pollination may well become a limiting factor in obtaining economic yields, and the commercial use of bees for pollination will then have to be developed.

Many different insects visit the flowers of commercial crops, seeking nectar or pollen or both. Probably most of them transfer a few pollen grains, and so may help in pollination, but relatively few are consistently good pollinators. The most efficient insect pollinators carry large quantities of pollen on their bodies and brush against flowers' stigmas, thus transferring the pollen; they visit several flowers in succession, and move frequently from flower to flower and from plant to plant of the same species. Some insects fail to pollinate because they are unable to release the flower's pollinating mechanism. Bees are the most important group of pollinators, partly because their bodies are covered with branched hairs which pick up many pollen grains. (Various hairy flies carry as much pollen as do bees, but they do not forage as consistently on one plant species). Pollen and nectar are the bees' sole source their immediate needs, bees forage consistently to collect sufficient food for their brood and also to store for future colony use.

In the past, many countries in the tropics and sub-tropics have had small plantations of a variety of crops, growing in close proximity and flowering at different times. There is now a tendency to increase the size of

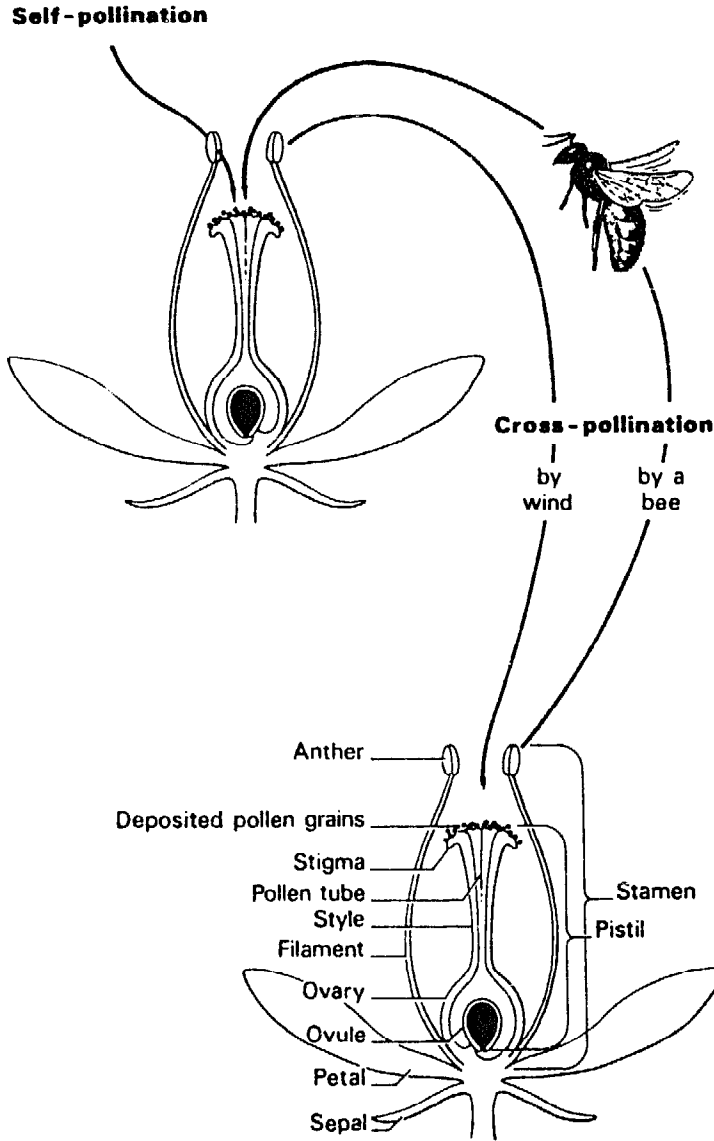

Fig. 2/17 Self-pollination and cross-pollination by wind and by a bee.  
Source: Crane (1980a).

fields and to use larger fruit plantations with fewer varieties, and in these circumstances if the number of wild insect pollinators in an area remains the same, it may become insufficient. Further, the number may have decreased, especially if year-round bee forage has been eliminated to make way for specific crops.

With increasing monoculture, flowering will be concentrated into shorter periods, during which larger pollinator populations will be needed; this is already happening in some locations with some crops. Furthermore,

whereas pollen sources that allow cross-pollination are likely to be present in small mixed farms, a large area of uniform crop needs special provision for cross-pollination.

Modern agricultural practices thus tend to reduce the numbers of wild pollinators but to increase the requirement for pollinating insects.

Pollinating insects can be encouraged to remain in a crop area by making the habitat more acceptable for their nesting and hibernation, or they can be taken to the vicinity of the crop for the flowering period only. Recently, midges pollinating cocoa have been successfully reared on a variety of foods (including rotting fruit and stems, and cocoa pod husks) and then released on plantations where they are needed; the manipulation of fig wasp populations for pollination has long been practised. However, for most crops, a deficit in pollinating insects is usually overcome by using honeybees or other bees.

Many species of solitary bees visit agricultural crops, and they are especially valuable for pollinating legumes; their nest sites should be protected, and the bees guarded from insecticides. Similar efforts must be made to protect and encourage bumble bees and the stingless bees.

In the north temperate zone two species of solitary bees, especially efficient at pollinating lucerne, have been successfully induced to nest and multiply in artificial domiciles near lucerne crops. The success obtained has stimulated a search for suitable bees for other crops, in both tropical and temperate zones. A species of bee used commercially must be gregarious, increase its population rapidly in man-made nests, be easily manipulated and managed, and visit flowers of a commercial crop in preference to other flowers, and its peak of activity and the flowering of the crop must coincide. Finally, it must not be subject to uncontrollable parasites and diseases.

Honeybees are beyond doubt the most important pollinating insects. They are active throughout the flowering season, visiting and pollinating a large proportion of crop species. Even where numerous other insect pollinators occur, honeybees are often the most efficient in transporting pollen and in pollinating. All four species of honeybees are valuable pollinators, but only Apis mellifera and A. cerana can readily be introduced in large numbers where and when they are required, because they can be maintained and transported in hives by well-established techniques.

These observations are borne out by the following report from India, submitted to a recent FAO Expert Consultation (FAO, 1984):

"In view of the importance of bees for increasing the yield of cross-pollinated crops, different species of honeybees and solitary bees are being utilized for this purpose in Northern India. Himachal Pradesh and Kashmir are the principal temperate fruit-growing regions of the country. In Himachal Pradesh more than 75 000 hectares of land are under temperate fruit cultivation and they require more than 200 000 colonies of honeybees, against the present number of 10 000. The population of non-Apis pollinators is declining at an alarming rate, owing to growing deforestation, vast clearance of waste land for cultivation and increased use of pesticides. This makes domesticated hive bees essential for pollination.



TABLE 2/3 - Mean percent yield increase of some economic crops when pollinated by the Honeybee *A. cerana*

Crops	Mean Percent Yield Increase
Cotton (Deltapine 16)	35
Watermelon	74
Squash	89
Bitter gourd (Ampalaya) ( <u>Momordica charantia</u> )	84
Bottle gourd (Upo) ( <u>Lagenaria Siceraria</u> )	85
Dishcloth gourd (Patola) ( <u>Luffa cylindrica</u> )	99
Coconut	20

"In addition to pollinating temperate fruits, both these species are also being utilized for the pollination of vegetables, oil-seed crops and clovers.

"Himachal Pradesh has taken the lead in renting *A. cerana indica* colonies to the orchards for the pollination of apple crops. This programme has helped create awareness among the orchard owners of the importance of honeybees for pollination. However, insecticide spraying at the time of apple bloom is responsible for killing a large number of rented bee colonies."

The same meeting noted a report from the Philippines on preliminary 1981-82 experiments on yield increases due to pollination by *A. cerana* (see Table 2/3).

The number of honeybee colonies needed for pollinating a crop depends on many factors, including the area planted, the crop's pollination requirements, the density of flowers, the amount of nectar and pollen available, their attractiveness to bees, the behaviour of bees on the crop and their ability to pollinate it, the colonies' foraging populations, the number of pollinating insects already present, etc. Whereas the flowers of some species (e.g. lucerne) need to receive only one visit before they set seed, others (e.g. melon) need several visits before enough seeds are set to produce well-shaped, marketable fruit. Often the plant's carrying capacity can be reached, and a commercial crop produced, when only a proportion of the available flowers are pollinated.

Because of the many variables, the grower must determine for himself the effect on his yield of progressively increasing the number of honeybee colonies on the crop. If he can increase the set of a sample of flowers by hand-pollinating them, then pollination has been insufficient and more colonies are needed. On the other hand, over-pollination by foraging honeybees may have a detrimental effect on the native pollinators through competition for their food sources; for this reason, no more honeybee colonies should be imported once enough pollination has taken place, and those present should be removed when the crop has finished flowering.

TABLE 2/4 - Development of Beekeeping in Relation to Pollination

Stage of Beekeeping Development	Harvest	Hives used	Pollinating Value
Initial	Honey for bee-keeper and family	Traditional or transitional	Incidental pollination of crops near hives
Intermediate	Surplus honey and wax to supplement income	Transitional or movable-frame	Increased incidental pollination of crops near hives
Final	Honey and wax main source of income	Movable-frame	Migratory bee-keeping for crop pollination

The beekeeper must be adequately paid for providing bee colonies for pollination, and this requires that the full value of honeybee pollination be recognized. The amount the grower is prepared to pay depends on the extent to which he thinks his net profits will be increased. Payment to the beekeeper will depend partly on his transport costs, but also on the extent to which his potential honey crop will be diminished if the number of bees required for adequate pollination is greater than their density for optimum honey production. Bees on citrus produce a high-quality honey, and therefore beekeepers may not charge for putting bees in citrus orchards, whereas in greenhouse pollination of strawberries in Japan, for example, the colonies die out for lack of pollen, so that the beekeeper obtains nothing from his hives. In some circumstances it is necessary to maintain colonies on artificial diets, and this greatly adds to the expense. Again, while some crops, such as almonds, provide both nectar and pollen for the bees, such great numbers of bees are needed for the pollination service that the colonies compete and cannot build up rapidly enough; there is thus a cost to the beekeepers, whose bees would be more productive elsewhere.

Encouragement of beekeeping for wax or honey in an area will inevitably help to increase pollination there. The more advanced the stage of beekeeping development, the more useful the bees will be for pollination (Table 2/4). But beekeeping should no longer be considered solely as a method of producing honey and wax. In some agricultural systems, bees will be used primarily for pollination, and honey and wax will become by-products. And beekeeping for pollination must continue, whatever the honey and wax harvests may be.

In agricultural areas, insecticides are probably the most serious threat to wild pollinators, and they are also the greatest deterrent to the use of honeybees as pollinators. Pesticide damage to honeybee colonies differs according to many factors, including the insecticide's toxicity, its drift to other sources of forage, the number and frequency of applications, the method and the time of day of application, the proportion of forages visiting the treated crop, the behaviour of bees on the crop, and the structure of the flowers. Meteorological conditions in turn influence several of these factors.

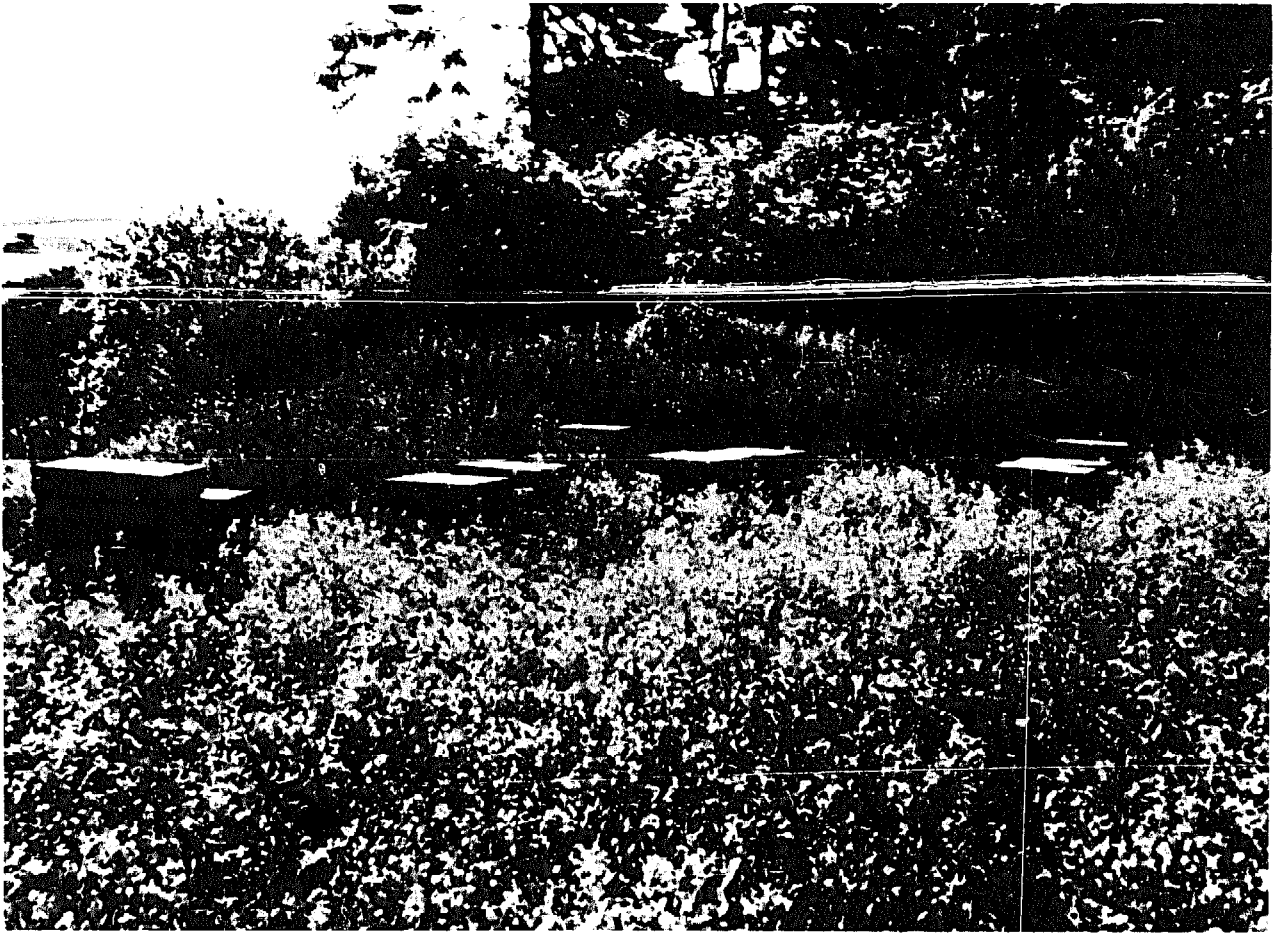

Fig. 2/18 Hives well sited for pollination beside a rapeseed crops.  
Photo: J.B. Free.

Most pesticide poisoning occurs while bees are collecting nectar or pollen, and they sometimes die before they can return to the hive. They may also be poisoned by contaminated water, or while flying through an area currently or recently treated. Bee food imbibed with pesticides may be transported back to the colony and poison both adult bees and brood.

The problem of the pesticide danger to honeybee pollinators will be discussed in greater detail in Chapter 3 of this book.

#### Good Pollination Practice

The following practices have been developed for the effective use of honeybee colonies for pollination:

1. Growers should hire colonies for crops needing pollination and not rely on colonies nearby. Colonies immediately beside a crop (see Fig. 2/18) are much more useful than those even a short distance away from it, because the proportion of bees visiting the crop will be much greater.

2. Colonies should be distributed through a crop in small groups, not kept in one large group. In this way, the bees will forage evenly over the entire crop, and the crop yield will be high over the entire area. In fruit plantations, a group of 5 colonies in the centre of each 2-hectare plot will usually ensure an even distribution of foraging bees.
3. The proportion of foragers visiting a crop can be greatly increased by building up the colonies at places of good nectar and pollen availability some weeks before they are needed on the crop, but moving them to it only when flowering has begun. When colonies are moved to the area before the crop flowers, most of the foragers become conditioned to visiting other flower species in the locality, and will not readily switch to the crop to be pollinated when it comes to flower.
4. On most crops, pollen foragers are more efficient pollinators than nectar foragers, because they carry a greater amount of pollen on their bodies and are thus more likely to transfer pollen to the stigmas. Colonies for pollination should therefore be encouraged to collect pollen rather than nectar. There is more than one way of doing this. Since the presence of brood in the colony stimulates foraging in general, and pollen gathering in particular, colonies for pollination should have plenty of brood. The hive entrance should be so located that returning foragers have to pass through the brood nest before they deposit their pollen loads. Feeding colonies with sugar syrup from containers inside the hive stimulates an internal nectar flow and causes nectar foragers to change to pollen collecting, and this technique alone can more than double the amount of pollen collected.

3. Further reading

Free (1970, repr. 1976) and McGregor (1976) are comprehensive reference works on insect pollination. Free and Williams (1977) provides a working summary of pollination requirements and the management of honeybee colonies, while a general discussion of pollination by bees can be found in Free (1981).

## CHAPTER 3

### BEE DISEASES, PESTS AND OTHER ENEMIES

#### 1. General

Like all animals, bees are subject to diseases, attacks by parasites and pests, and other phenomena endangering their health and life. Some of these are of minor importance, either because they are rare or because their effects are slight, while others, though they attack only individual bees, can so weaken a colony that its very existence is threatened, and its entire population may be killed in a year or two.

In general - although there are many important exceptions - it can be said that bees in their native habitat can meet threats from local sources of infection more easily than from imported diseases. For example, the introduction into India of European foul brood, primarily a disease of Apis mellifera, apparently by way of imported European bees, caused havoc with local beekeeping when the disease entered the A. cerana population. On the other hand, a series of important reports from an FAO/UNDP apicultural development project in Guinea, into which there had been only few introductions of non-indigenous bees, makes no mention of bee diseases, the inference being that such diseases as existed were of little or no consequence. There is however ample evidence to indicate that the introduction of a new bee into an area not only creates the risk of introducing new diseases, but is rendered more difficult because the new bees cannot protect themselves adequately against local pests and diseases to which the indigenous bees were to all intents and purposes immune. (\*)

Further, there seems to be general agreement among observers that combined attacks by two or more different diseases or pests have much more serious effects than the normal effects of each taken singly, because the weakening of a colony by the one makes it more vulnerable to attack by the other. A report from northern India, for example, indicates that combined attacks by the mites Varroa jacobsoni and Tropilaelaps clareae caused much more important losses than were observed in areas where only one of the pests was common. In Tunisia it was found that when American foul brood or bee paralysis took hold of a colony, they produced a biological imbalance within it and favoured the invasion of the hive by the wax moth, which reduced the colony's strength very rapidly. For this reason, diseases which apparently cause little or no damage can still be dangerous and should to the extent possible be controlled.

To whatever extent, however, that a disease or pest can cause losses of bees, honey, and hive equipment, it is essential that the beekeeper be able to distinguish between a healthy and a diseased or infected colony and to take the necessary steps to control the attack and prevent its spread.

In many countries, methods of dealing with bee diseases are subject to legal regulations, and the options for disease prevention and control may then

---

(\*) This point is discussed in greater detail in Chapter 5.

be limited. For this reason, beekeepers should first determine the legality of any chemical treatment before using it.

This chapter presents a short survey of some of the more important bee diseases and pests encountered in the tropics and sub-tropics, and includes maps showing the countries in which they are distributed, as currently known. (\*)

As far as is known, the major pathogens can affect both Apis mellifera and A. cerana, although sometimes to different degrees; the position with regard to A. dorsata and A. florea is not yet clear for all of them.

## 2. Disease Transmission

Diseases are transmitted from one colony to another in two main ways: by adult bees and by the re-use of contaminated combs. Adult nurse bees may become contaminated by robbing or otherwise consuming honey and/or pollen from diseased colonies, and they in turn contaminate larval food. Diseased colonies should therefore be removed from the apiary, or (if the colony is dead) the hive entrance should be closed to prevent bees from healthy colonies robbing honey stores in the contaminated hive. Honey and pollen from unknown sources can be carriers of disease-causing organisms and should not be fed to colonies. Pollen collected for feeding to other colonies should be trapped from colonies (and hives) that are disease-free. Opening colonies during the season when robbing between colonies is likely to occur should be avoided. If it is necessary to expose combs from any colony, this should be done quickly, using a cloth cover or lid of some kind, to reduce access by robber bees to the inside of the hive.

The second main means of contamination is the re-use by the beekeeper of combs contaminated by disease-causing organisms. Apiary hygiene is all important. The natural spread of disease from colony to colony is usually a slow process, but any disease can be spread rapidly when a beekeeper transfers diseased brood or contaminated combs to a healthy colony.

Since package bees and queens may carry diseases, they should be purchased only from reliable sources, and certainly not imported from a source that is not disease-free. A swarm is a potential disease source and, if captured, it should be isolated until its freedom from disease can be established.

Every beekeeper should inspect his own colonies regularly, because early detection of diseases is essential. He should not wait until a colony dies before inspecting the brood chamber of the hive, and of other hives in the same apiary.

## 3. Bee Diseases

Bee diseases are generally classified into two categories, depending on whether they attack bee brood or adult bees. The bee brood diseases are generally considered to be the more important, not only because their effect upon the entire colony is likely to be greater, but also because their control is at the same time essential and more difficult.

(\*) This distribution information is subject to rapid change, as diseases are introduced into new areas or as they are reported from areas in which they may already have existed undetected.

A. Brood Diseases

Brood diseases are generally much easier to recognize as a group than adult diseases, although a close examination of the brood is necessary to identify the disease correctly. Colonies that appear weak or that show little flight activity are suspect, and should be examined closely for disease. On the other hand, a strong and populous colony is not necessarily disease-free.

Brood combs from healthy colonies typically show a solid and compact brood pattern. Virtually every cell from the centre of the comb outward has eggs, larvae or pupae, and only a few cells are empty. In contrast, brood combs from diseased colonies usually have a spotty brood pattern, sometimes called a "pepperbox" appearance: there is a mixture of sealed and unsealed cells throughout (Fig. 3/1). (Sometimes this pattern may also indicate the presence of a failing queen or of laying workers, or the lack of pollen.)

Inspection of brood-cell cappings is also useful in diagnosing brood diseases. Cappings of healthy brood are uniform in colour, and convex (higher in the centre than at the edges), whereas cappings of diseased brood tend to be darker and concave (sunken in the centre), and are frequently punctured. The unfinished cappings of healthy brood may also appear to have punctures toward the centre, but since cells are sealed from the outer edges, any holes are always central, and they have smooth edges.

Another useful diagnostic feature is the presence in cells of the dried remains of larvae or pupae. These remains, called "scales" in American foul brood, European foul brood, and sac brood diseases, are found at the bottom of brood cells, lying lengthwise, and can be seen with the unaided eye.

Since more than one disease can be present in a colony, the entire brood should always be observed, and examination should not be stopped after one diseased individual has been found. Table 3/1 compares the symptoms of the first four brood diseases discussed below.

(i) American foul brood disease (AFB)

This disease is world-wide in distribution; it can be found on every continent and in Pacific islands. (\*) In the Republic of Korea, where it is very common, it is reported (FAO 1984) to cause very serious damage, while in Belize, half a world away, it is less common than other diseases, but where it occurs it usually affects entire apiaries (CS/IBRA 1979).

AFB may not destroy a colony in the first year of its presence, but if it remains undetected and uncontrolled in any area it can reach devastating proportions. This occurred on some islands of the Hawaiian group in the 1930s and resulted in the near-abandonment of beekeeping there for a number of years.

The disease is caused by the bacterium Bacillus larvae, only the spore stage of which is capable of initiating it. The larva of a worker, drone or queen is susceptible to AFB for up to three days after it hatches, but then

---

(\*) See Fig. 3/4 for world map of distribution of AFB by countries, as currently known.

Table 3/1: Comparison of symptoms of four honeybee brood diseases

Symptom	American foul brood	European foul brood	Sac brood	Chalk brood
Appearance of brood comb	Sealed brood. Discoloured, sunken, and punctured cappings.	Unsealed brood. Occasionally sealed brood with discoloured, sunken, and punctured cappings.	Sealed brood. Scattered cells with punctured cappings, often with two holes.	Sealed and unsealed brood.
Age of dead brood	Usually older (stretched) larvae or young pupae.	Usually young (coiled) larvae; occasionally older (stretched larvae in sealed cells).	Usually older larvae (stretched in cells).	Usually older larvae (stretched in cells).
Colour of dead brood	Dull white, becoming light brown, coffee brown to dark brown, or almost black.	Dull white, becoming yellowish white to brown, dark brown, or almost black.	Greyish or straw-coloured, becoming brown, greyish black, or black; head end darker.	White, sometimes mottled with black.
Consistency of dead brood	Soft, becoming sticky or ropy.	Watery, rarely sticky or ropy; granular.	Watery and granular; tough skin forms a sac.	Watery.
Odour of dead brood	Slight to pronounced odour like glue-pot.	Slightly to penetratingly sour.	None to slightly sour.	Slight, not objectionable.
Scale characteristics	Uniformly lies flat on lower side of cell. Adheres tightly to cell wall. Brittle, fine threadlike tongue of dead pupa may be present. Black.	Usually twisted in cell. Does not adhere tightly to cell wall. Rubbery. Black.	Head end prominently curled towards centre of cell. Does not adhere tightly to cell wall. Rough texture. Brittle. Black.	Hard. Does not adhere to cell wall. White or mottled black.



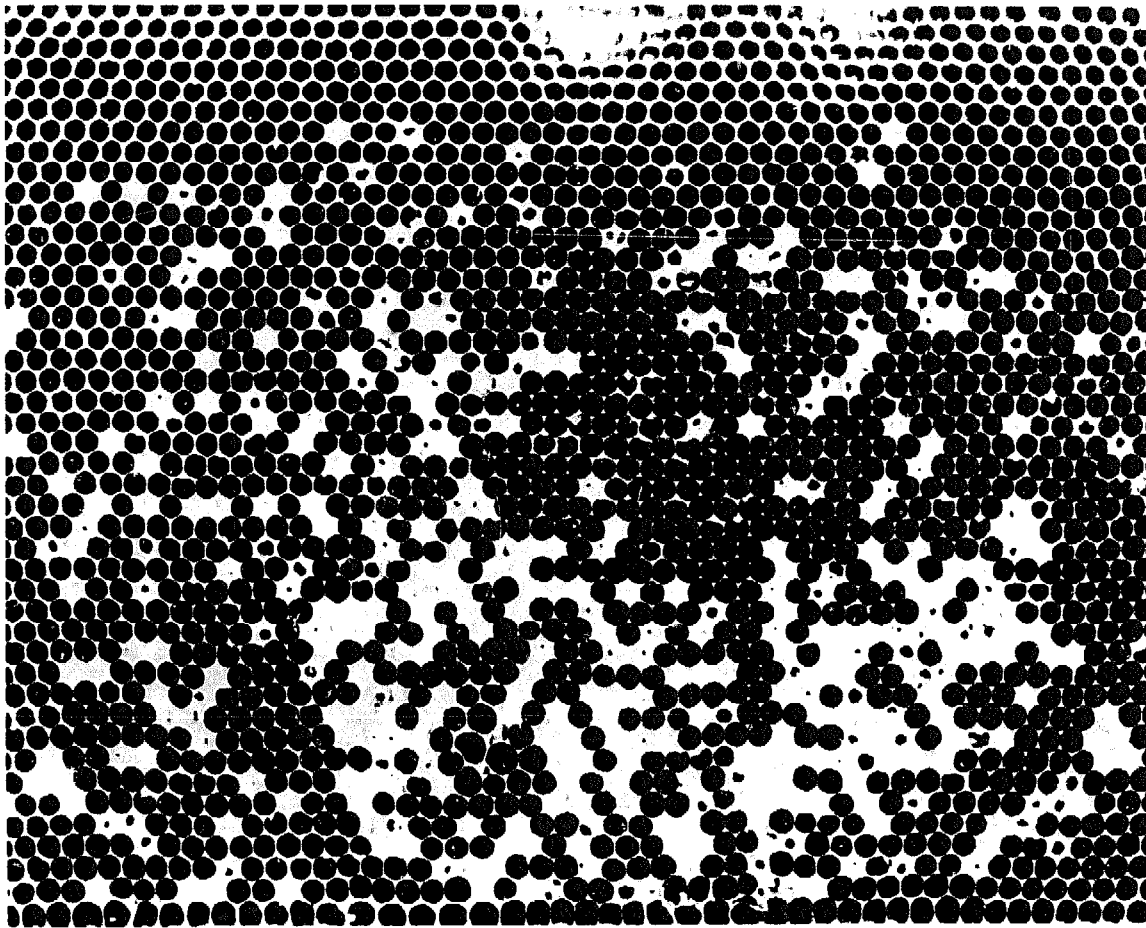

Fig. 3/1 American foul brood, showing perforated cappings and scattered brood pattern (pepperbox appearance).  
Photo: H. Shimanuki and D.A. Knox.

becomes immune to the disease. Infected larvae are not likely to become visibly abnormal until some days later, when they have been sealed in the cells.

Combs with AFB-diseased larvae generally have a pepperbox appearance, although when the infection is slight, this may not be so. Cappings over diseased brood are darker brown than normal, usually punctured, and sunken into the cell. (See Fig. 3/1.)

Healthy larvae look pearly white, whereas diseased larvae show a colour change from dull white to brown, and finally to black, with the progression of the disease. When the larvae are brown, the symptoms of ropiness can usually, but not always, be observed (Fig. 3/2). The suspected brood is probed with a matchstick or twig and carefully withdrawn from the cell. If AFB is present, the brown remains can usually be drawn out like a thread for 2 cm or more.

The final stage of the disease progression is the formation of the scale. If AFB disease kills a pupa, the resultant scale may have the "pupal tongue": a threadlike projection that extends away from the scale and toward the centre of the brood cell.

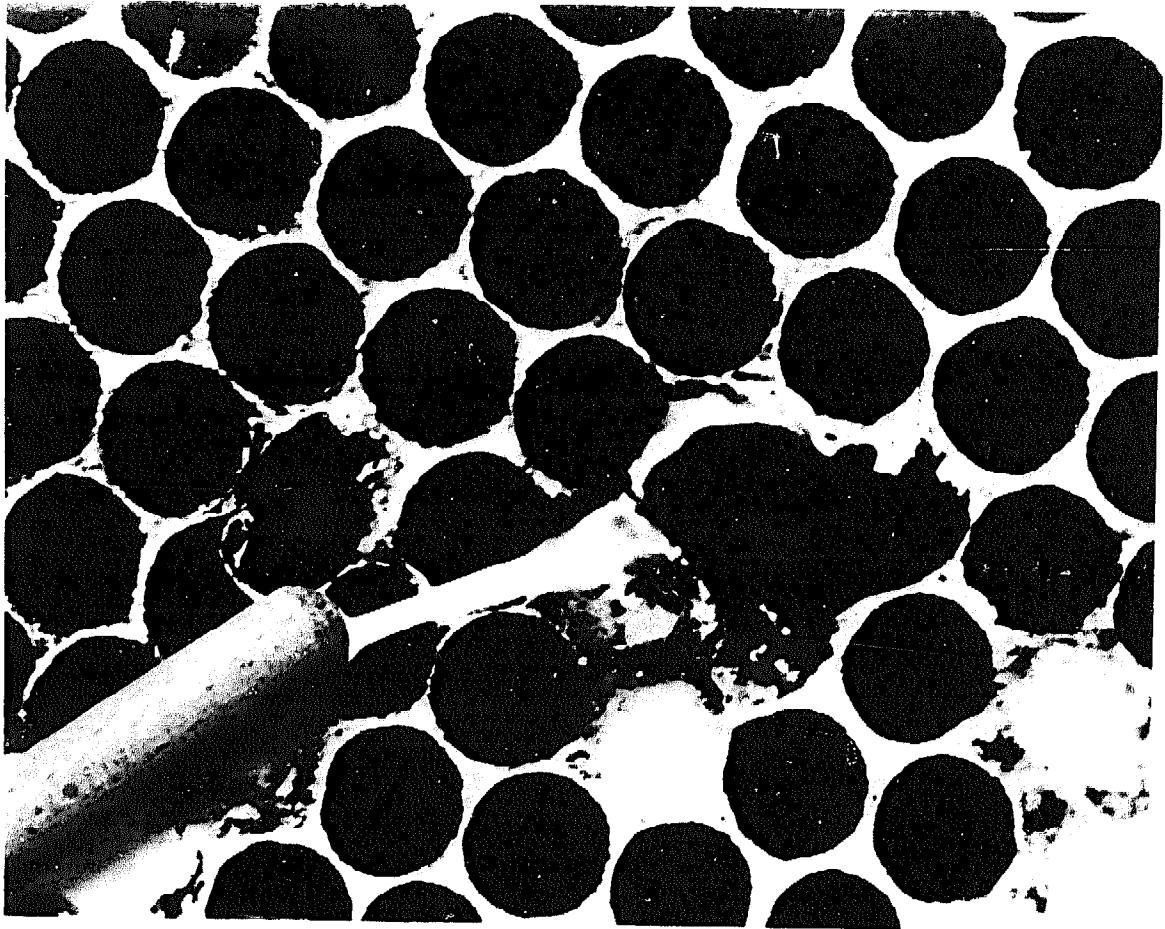

Fig. 3/2 American foul brood, showing "ropy" symptom.  
Photo: H. Shimanuki and D.A. Knox.

No strain of bees is completely immune to AFB, but differing degrees of resistance to it have been demonstrated.

Control. Destruction by fire of colonies with AFB, and of their hives as well, is required in some countries. It is reported (FAO 1984) that about 2500 infected colonies of *Apis mellifera* are burned in Japan every year. In some places beekeepers are allowed to retain the hive boxes, bottom boards, and inner and outer covers (lids), and are required to burn only the frames. The parts to be salvaged are first scraped and then scrubbed with a stiff brush and hot soapy water. Some beekeepers also scorch the inner surface of the hive boxes before re-use. Another option available to some beekeepers is the use of potash or soda lye, a strongly alkaline solution. The wooden equipment is completely immersed for 20 minutes in a boiling lye solution (12 g/litre). Since lye solutions are caustic, appropriate safety equipment should be worn.

Sodium sulphathiazole and terramycin (oxytetracycline) have been used for the prevention and control of AFB, but the former is no longer registered for use with bees in the USA, for example, while the latter is barred in Japan (where, however, it continues to be used illegally from time to time, despite the fact that honey containing residues of antibiotics is prohibited for sale).

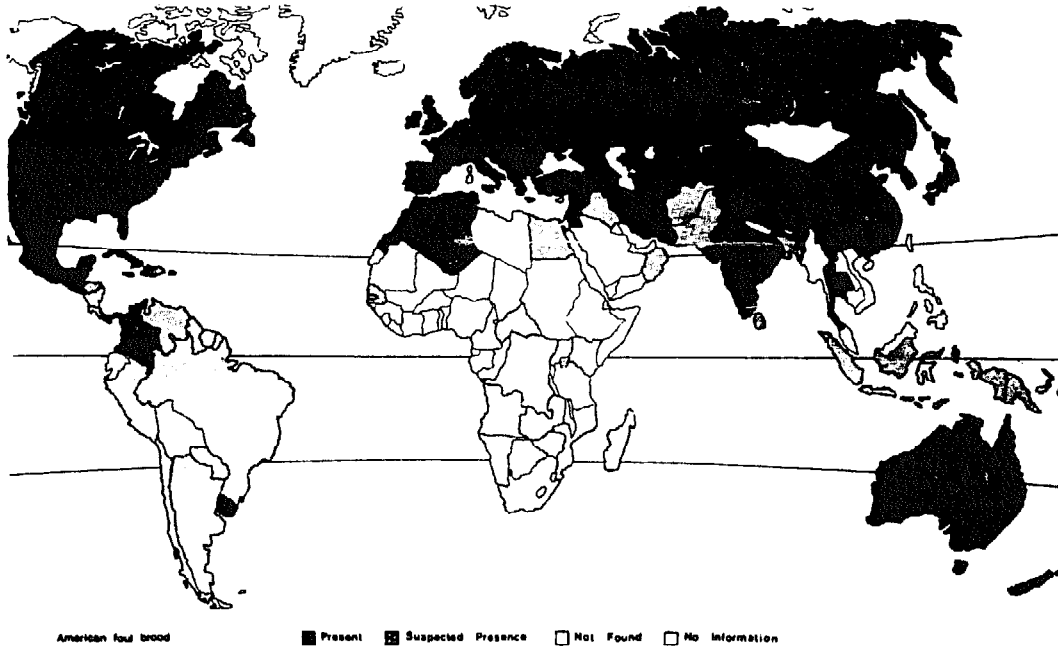

Fig. 3/3 World distribution of American foul brood (AFB), by countries, as known in 1982.  
Map source: Nixon (1982).

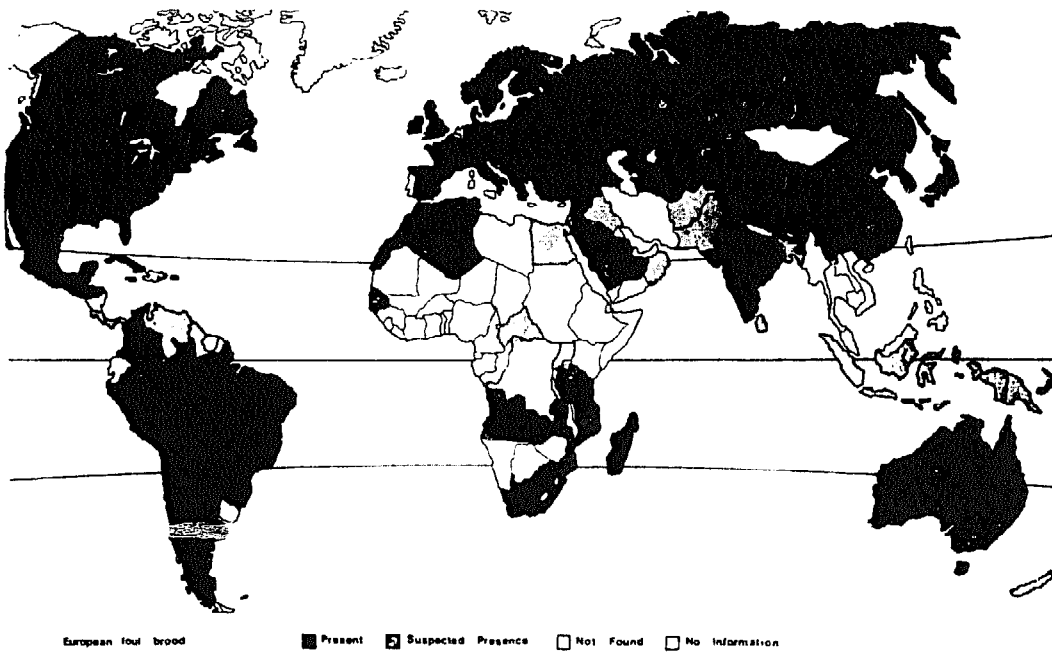

Fig. 3/4 World distribution of European foul brood (EFB), by countries, as known in 1982.  
Map source: Nixon (1982).

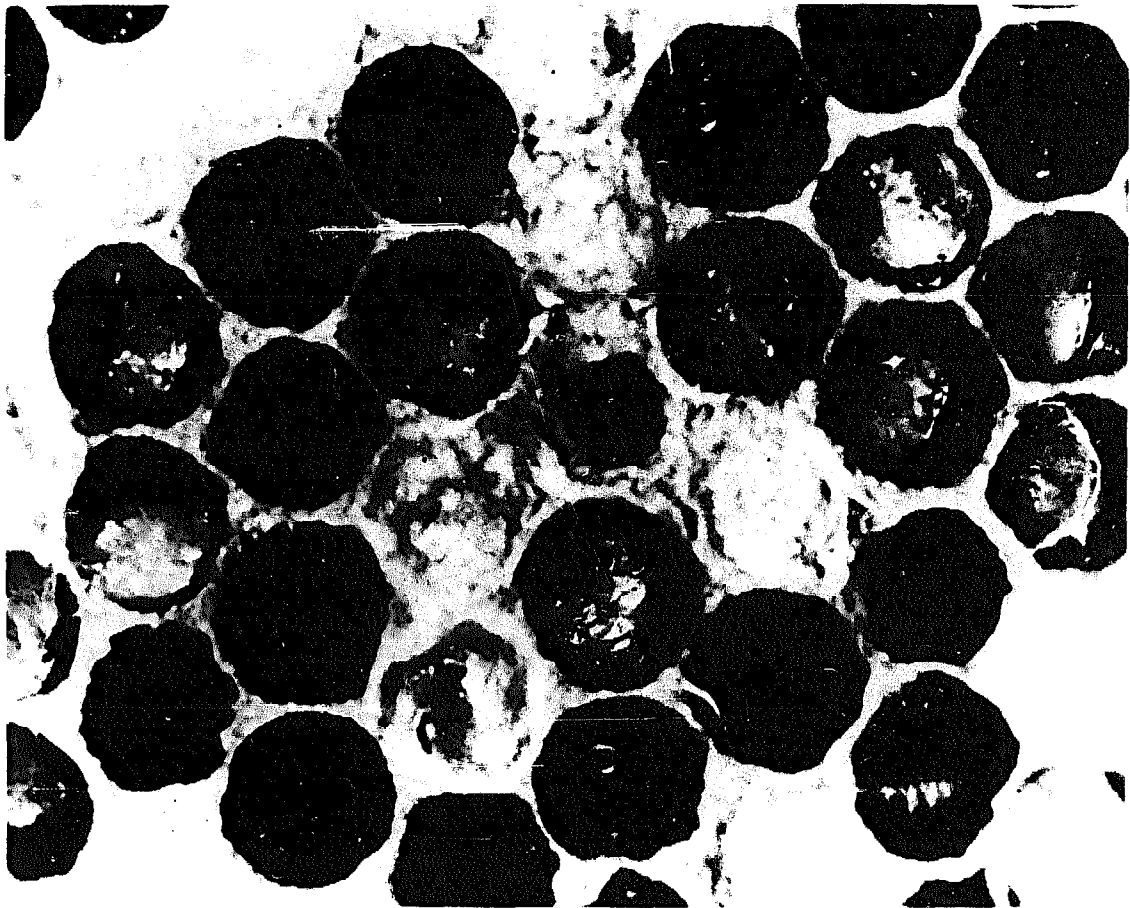

Fig. 3/5 European foul brood.  
Photo: H. Shimanuki and D.A. Knox.

Both drugs are sold in several formulations, and each carries specific instructions. Residues of either drug can occur in honey harvested, if it is not used properly.

With a view to preventing AFB and other bee diseases, Japan subsidizes ethylene oxide fumigating equipment (FAO, 1984).

(ii) European foul brood disease (EFB)

This disease is caused by the bacterium Melissococcus pluton (formerly referred to as Streptococcus pluton). World-wide in distribution, (\*) and in some areas considered to be as serious a problem as AFB, it usually occurs just when colonies are developing their greatest populations. In severe cases, EFB can reduce the population so much that its productivity is lowered, but the disease symptoms usually disappear with the onset of a substantial honey flow.

(\*) See Fig. 3/4 for world map of distribution of EFB by countries, as currently known.

Worker, drone and queen larvae are all susceptible to EFB. Affected larvae usually die about 4 days after hatching, while they are still in the coiled stage in uncapped cells. This is in contrast to AFB, in which the affected individuals die at a later stage, when they are stretched out in the cell.

The general appearance of combs of brood with EFB disease is similar to that resulting from the AFB infection. They may show a scattered brood pattern, and cappings may be discoloured, punctured and/or sunken (Fig. 3/5). Diseased larvae show colour changes from pearly white to yellow, then finally to black. In the yellow stage, the tracheal system appears prominently like a network of silver threads. The larvae usually appear undernourished, twisted and swirled to the cell walls; sometimes they resemble an irregular mass of melted tissue. The diseased larva may show some ropiness, but not to the extent associated with AFB, and the texture of the ropy material is granular. EFB disease is sometimes referred to as "sour brood" because of its odour, which is influenced by secondary invaders associated with the disease.

Scales of EFB are rubbery and much easier to remove than those of AFB. In rare cases, the pupa may show a "false tongue" which is actually the thick, blunt head; it should not be confused with the thread-like "pupal tongue" associated with AFB scales.

(iii) Sac-brood disease

Sac brood is the only known brood disease caused by a virus. Generally it is present in only a small number of larvae, and it rarely, if ever, destroys a colony. Nevertheless, it is important that beekeepers be able to distinguish it from the more serious foul-brood diseases.(\*)

Larvae affected with sac-brood disease change from a pearly white colour to grey and finally black. The larvae dies during the stage when it is stretched out, just prior to pupation, so that affected larvae are usually found in capped cells. The cappings can be sunken and discoloured, and also punctured. Rarely does the disease become serious enough to show the pepperbox appearance observed in AFB.

When an affected larva is carefully removed from its cell, it appears similar to a sac filled with water -- hence the name "sac brood". Head development in diseased larvae is typically retarded, and the head region is usually darker than the rest of the body. In advanced cases, the head region may be bent toward the centre of the cell. The scales in sac-brood disease are typically brittle, but easy to remove. There is no associated characteristic odour.

Control. There are no known chemo-therapeutic agents for the control of sac-brood disease. Requeening of affected colonies may sometimes be helpful. In most cases the disease disappears without causing any serious loss in the colony population, or in its honey yield.

(\*) See Fig. 3/6 for world map of distribution of sac-brood disease by countries, as currently known.

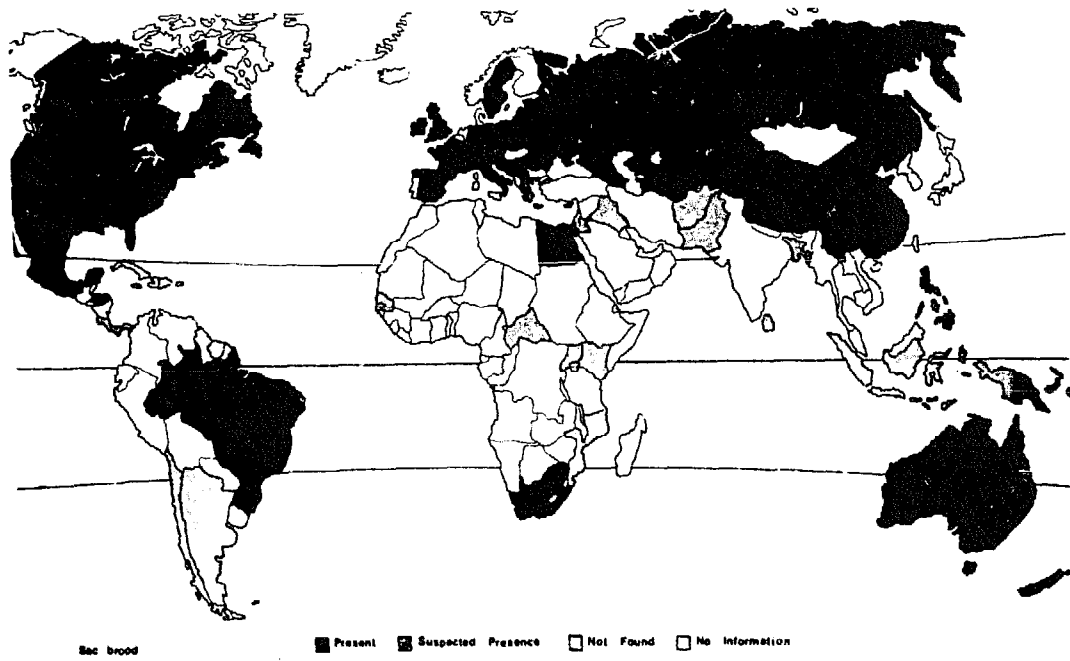

Fig. 3/6 World distribution of sac brood, by countries, as known in 1982.  
Map source: Nixon (1982).

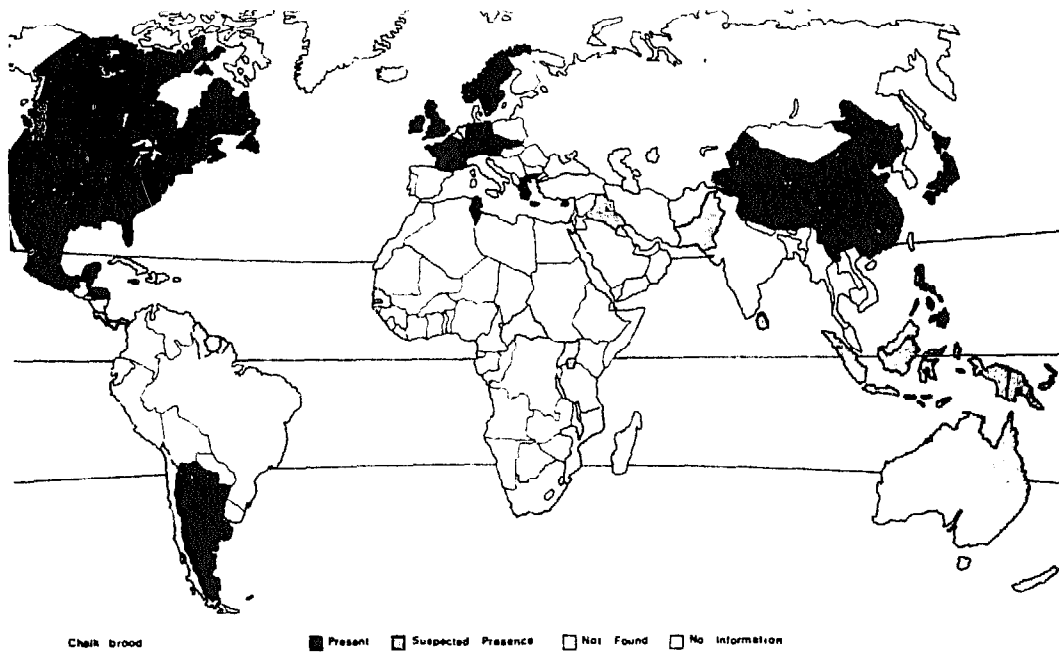

Fig. 3/7 World distribution of chalk brood, by countries as known in 1982.  
Map source: Nixon (1982).

(iv) Chalk-brood disease

Chalk-brood disease is caused by the fungus Ascosphaera apis. Views concerning it tend to differ, indicating that it needs to be investigated further. (\*) One recent opinion, for example, states that "it is rarely serious, although some beekeepers report a reduction in honey production due to this disease. Damp environmental conditions and chilling of the brood were formerly thought to be predisposing factors, but recent investigations tend to discredit this belief." A recent and authoritative report from Burma (FAO, 1984), on the contrary, associates the spread of chalk brood in weak colonies with the monsoon season, and notes that "in the last stage of infestation, bees desert the hive, absconding, or the whole colony dies out." A third report, from Belize (idid.), indicates that the disease is "rarely if ever fatal but potentially debilitating throughout the year."

Chalk-brood disease is found more commonly in worker and drone larvae than in queen larvae. The fungus infests the larva 3 to 4 days after hatching. The infected larva is soon covered with a white cotton-like mycelium which fills its entire cell; finally the mycelium dries up, forming a solid mass referred to as a "mummy". Chalk-brood mummies are usually white -- hence the name -- but colour being due to the presence of fruiting bodies of the fungus.

Mummies can be found at the hive entrance of infected colonies, or on the hive floor (bottom board). Capped or uncapped cells may contain infected brood, and the mummies can be easily removed by tapping the comb against a rigid surface.

Control. No chemo-therapeutic agent is currently available for the control of chalk brood. The most promising factor in its prevention appears to be the maintenance of large strong colonies.

B. Adult Bee Diseases

Most diseases of adult bees are difficult to diagnose, because the gross symptoms are not specific to a particular disease. For instance, inability to fly, unhooked wings and dysentery are general symptoms that can indicate many disorders. A microscopic examination of the appropriate organs is often required in making a diagnosis.

(i) Nosema disease

Nosema disease, caused by a protozoan, Nosema apis, is the most widespread of all bee diseases, and among the most serious. (†) In temperate zones, its occurrence is estimated to cause a loss in honey production of more than 40%, and it also contributes to winter losses of colonies. Workers, drones and queens are equally susceptible, and the disease reduces their life expectancy. The egg-laying of infected queens may be impaired, and they may ultimately be superseded.

(\*) See Fig. 3/7 for world map of distribution of chalk-brood disease by countries, as currently known.

(†) See Fig. 3/8 for world map of distribution of Nosema by countries, as currently known.

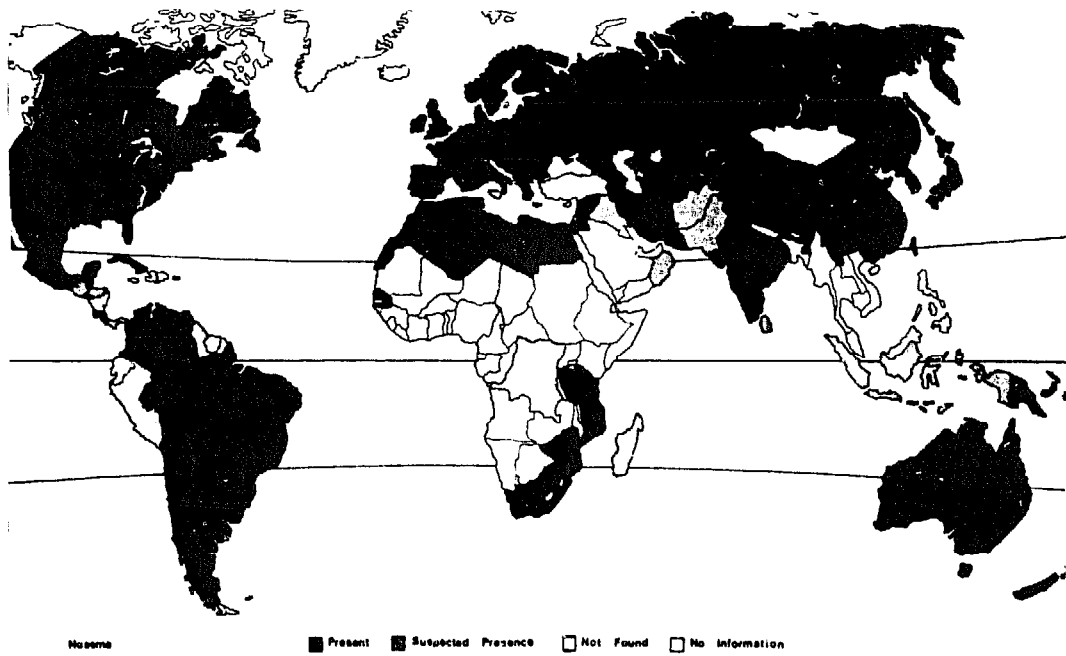

Fig. 3/8 World distribution of *Nosema*, by countries, as known in 1982.  
Map source: Nixon (1982).

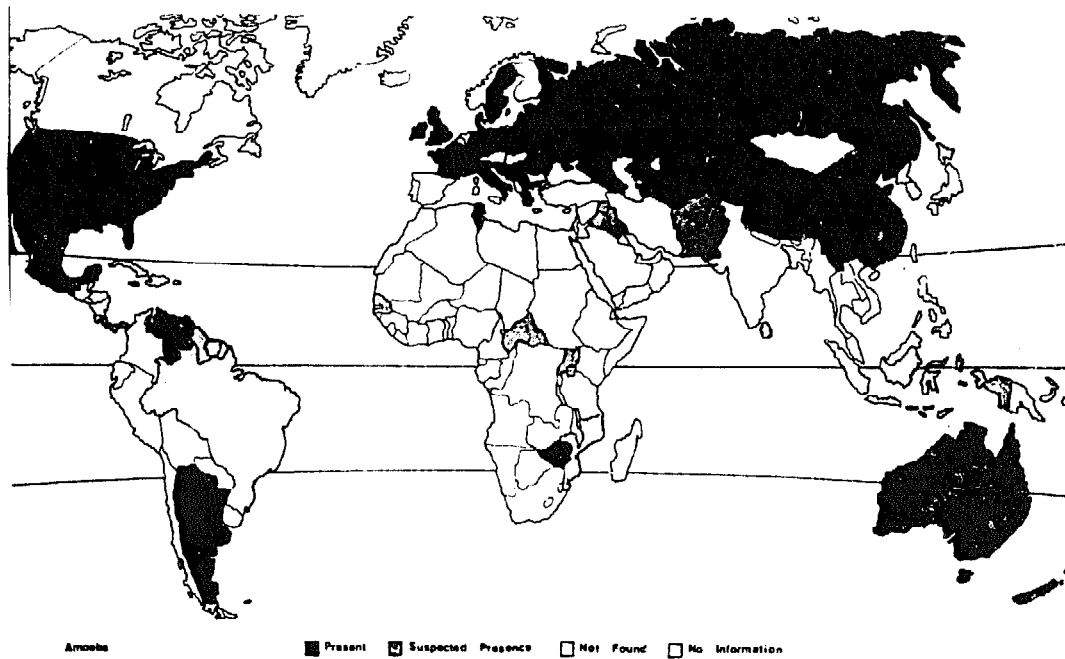

Fig. 3/9 World distribution of Amoeba disease, by countries as known in 1982.  
Map source: Nixon (1982).



The disease cycle is initiated by adult bees ingesting spores which multiply in the epithelial cells of the midgut and then compete with the host bee for nutrients. Positive diagnosis of the disease can be made by microscopic examination of the ventriculus. Since queens cannot be sacrificed for dissection, a coprological examination is used instead.

Control procedures include both medication of colonies with Fumidil-B (fumagillin), effective only when fed in sugar syrup, and heat treatment of empty combs. Nosema disease is spread to healthy bees by contaminated combs, but combs can be decontaminated by heating them for 24 hours at 49°C. The most effective control is attained by combining both operations: heat treatment cleans up the combs, and fumagillin controls the infection in the bees.

(ii) Amoeba disease

Amoeba disease is caused by a protozoan, Malpighamoeba mellificae. Little is known about this disease except that the protozoan is found in the Malpighian tubules of adult bees (hence its name), and that it is assumed to impair the function of the tubules. The disease, most commonly found in worker bees(\*), is generally of little consequence, but when it is combined with Nosema disease, the total impact is more serious than that of either disease alone. No gross symptoms characterize Amoeba disease, and a microscopic examination of the Malpighian tubules for the presence of cysts is necessary for diagnosis.

There is no known control for the disease. Fortunately, infected colonies appear to overcome its effects without assistance from the beekeeper.

(iii) Bee paralysis

A virus is the inciting agent of bee paralysis, although paralysis-like symptoms are also caused by some toxic chemicals. The disease probably occurs frequently in colonies, although it is seldom diagnosed. It can occur throughout the season, but is rarely serious and should not cause the death of the colony.

In severe cases, large numbers of bees appear to be escaping from the hive; they seem to run in circles and are unable to fly. Individual bees with paralysis disease are frequently black, hairless and shiny in appearance.

No known chemicals are effective for controlling the disease. It is believed that susceptibility to it is an inherited character, and that requeening with a queen from a different source can eliminate it from a colony.

(iv) Septicaemia

Septicaemia, caused by a bacterium, Pseudomonas apisepatica, is rarely encountered. The disease results in the destruction of the connective tissues

---

(\*) See Fig. 3/9 for world map of distribution of Amoeba disease by countries, as currently known.

The disease cycle is initiated by adult bees ingesting spores which multiply in the epithelial cells of the midgut and then compete with the host bee for nutrients. Positive diagnosis of the disease can be made by microscopic examination of the ventriculus. Since queens cannot be sacrificed for dissection, a coprological examination is used instead.

Control procedures include both medication of colonies with Fumidil-B (fumagillin), effective only when fed in sugar syrup, and heat treatment of empty combs. Nosema disease is spread to healthy bees by contaminated combs, but combs can be decontaminated by heating them for 24 hours at 49°C. The most effective control is attained by combining both operations: heat treatment cleans up the combs, and fumagillin controls the infection in the bees.

(ii) Amoeba disease

Amoeba disease is caused by a protozoan, Malpighamoeba mellificae. Little is known about this disease except that the protozoan is found in the Malpighian tubules of adult bees (hence its name), and that it is assumed to impair the function of the tubules. The disease, most commonly found in worker bees(\*), is generally of little consequence, but when it is combined with Nosema disease, the total impact is more serious than that of either disease alone. No gross symptoms characterize Amoeba disease, and a microscopic examination of the Malpighian tubules for the presence of cysts is necessary for diagnosis.

There is no known control for the disease. Fortunately, infected colonies appear to overcome its effects without assistance from the beekeeper.

(iii) Bee paralysis

A virus is the inciting agent of bee paralysis, although paralysis-like symptoms are also caused by some toxic chemicals. The disease probably occurs frequently in colonies, although it is seldom diagnosed. It can occur throughout the season, but is rarely serious and should not cause the death of the colony.

In severe cases, large numbers of bees appear to be escaping from the hive; they seem to run in circles and are unable to fly. Individual bees with paralysis disease are frequently black, hairless and shiny in appearance.

No known chemicals are effective for controlling the disease. It is believed that susceptibility to it is an inherited character, and that requeening with a queen from a different source can eliminate it from a colony.

(iv) Septicaemia

Septicaemia, caused by a bacterium, Pseudomonas apisepatica, is rarely encountered. The disease results in the destruction of the connective tissues

(\*) See Fig. 3/9 for world map of distribution of Amoeba disease by countries, as currently known.

of the thorax, legs, wings and antennae. The affected bees fall apart when handled; dead or dying bees may also have a putrid odour. There is no known control for this disease. However, it is not considered serious, and no assistance from the beekeeper is necessary.

C. The Mite "Diseases"(\*)

Infestation of a colony by one of several mites is often referred to as a "disease" (e.g. Varroa disease, acarine disease), but this is, technically speaking, a misnomer. Diseases are in principle caused by micro-organisms, whereas Varroa and the other mite "diseases" are cases of parasitism. The mites of greatest economic importance to beekeepers are Varroa jacobsoni and Tropilaelaps clareae, which attack brood, and Acarapis woodii, a microscopic mite attacking adult bees.

Varroa, which naturally parasitizes Apis cerana, and Tropilaelaps, which parasitizes Apis dorsata, both afflict Apis mellifera in the same way as their natural hosts, infesting the brood, feeding on pupae and killing, stunting or causing malformation of the bees. However, their depredations seem more severe on A. mellifera than on their natural hosts.

(i) Varroa jacobsoni

Varroa is the best known of the mites, perhaps because it has now infested honeybees in Europe; it is also the mite that appears to have created most difficulties in the successful introduction of A. mellifera to replace A. cerana in certain countries or areas of Asia.

It was first described in 1904 as a parasite of the eastern honeybee A. cerana (= indica) in Java. The mite has subsequently been observed as an indigenous, obligate, honeybee parasite throughout most of tropical and temperate Asia. While A. cerana has been recognized as the mite's native host, specimens of V. jacobsoni were collected from A. mellifera brood in Hong Kong in 1962. This was the first report of the utilization of A. mellifera as an alternative host by V. jacobsoni.

V. jacobsoni has been anthropogenically spread to every continent where honeybees are kept, with the exceptions of North America and Australia.(†). Its wide dispersal has been the result of human carelessness in matters involving transcontinental shipment of bees.

The number of mites in an A. mellifera colony may exceed 10 000 individuals. An infested adult worker bee may be host to as many as five mites, a drone up to about 12. Mite populations in individual brood cells are reported to be as high as 12 in worker brood and 20 in drone cells. In the Republic of Korea, Varroa is reported to cause losses of 30 to 40%.

(\*) Sub-sections (i)-(iv) of this section are drawn from a paper by D.M. Burgett and G.W. Krantz (FAO, 1984).

(†) See Fig. 3/10 for world map of distribution of Varroa jacobsoni by countries, as currently known.

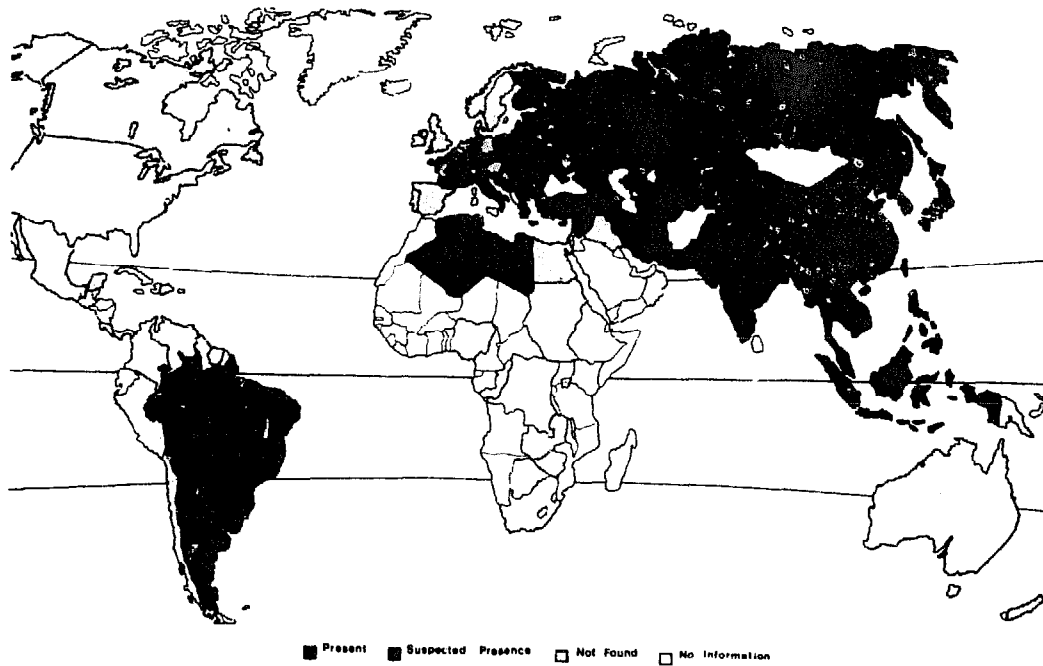

Fig. 3/10 World distribution of *Varroa jacobsoni*, by countries, as known in 1983.  
Map source: Nixon (1983).

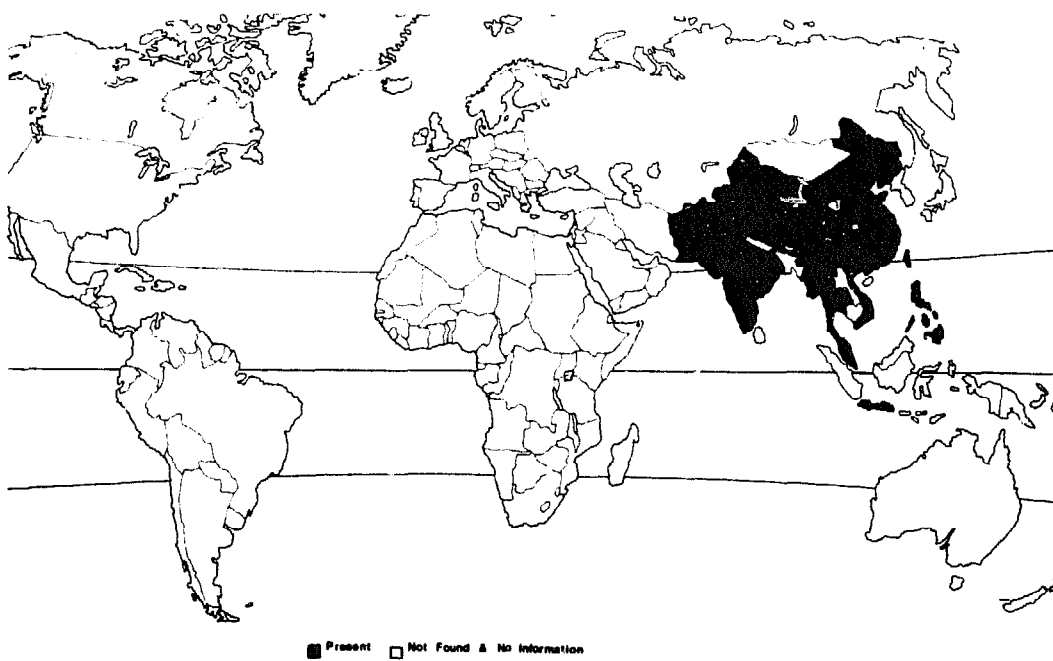

Fig. 3/11 World distribution of *Tropilaelaps clareae*, by countries, as known in 1983.  
Map source: Nixon (1983).

(ii) Tropilaelaps clareae

Tropilaelaps clareae was first discovered in the Philippines and was described in 1961. Although it was initially observed as an obligate brood parasite of A. mellifera, it was later found as a parasite of A. dorsata. It is believed, because of the mite's tropical to sub-tropical distribution, that A. dorsata represents the native host species. A recent paper reports the parasite from colonies of A. cerana. A second species of Tropilaelaps, T. koenigerum, has been reported infesting A. dorsata in Sri Lanka and Nepal, where A. mellifera has also been introduced.

T. clareae is presently limited to India, Pakistan, peninsular southeast Asia and tropical insular areas such as Sri Lanka and the Philippines, although in 1983 it was reported from China<sup>(\*)</sup>. It is widely believed that it is at least as serious a pest of A. mellifera as the better known Varroa. Its importance as a honeybee parasite has been largely unrecognized by the research community for two reasons: (1) there is at present an overriding interest in Varroa, and (2) that while potentially a major threat to the world beekeeping industry, Tropilaelaps is presently restricted to tropical Asia, an area that has historically been relegated to secondary importance as regards large-scale beekeeping. As a result, there are relatively few published works on the mite, and many of these are in the form of short notes describing survey results or attempts at control.

T. clareae is perhaps less likely than Varroa to be transferred out of Asia, as its natural host, A. dorsata, is entirely restricted to tropical Asia, where beekeeping with A. mellifera has not succeeded until recently. Of particular concern is that T. clareae appears to be the more destructive of the two mites. The possibility exists that it could spread northwards out of tropical Asia, through China, if beekeeping with European honeybees is practiced throughout Asia.

(iii) Control of Varroa and Tropilaelaps

Control of these mite pests on A. mellifera is not easy and requires a mixture of chemical and management control. Central to the schemes is the need to break the brood-rearing cycle of the bees, halting the life cycle of the mites by depriving them of immature bees on which to feed. In Burma this is done by caging the queen for about three weeks and fumigating with phenothiazine. In Thailand, brood is removed and allowed to die, and fine sulphur and naphthalene applied as a fumigant in the hive.

Even in temperate countries such as northern China, the Republic of Korea, Japan, Afghanistan and now Europe, where there is a natural break in brood rearing in the autumn, chemical control of the mites is practiced. The intensity of these management techniques and the need for chemical agents for mite control suggest that newcomers to beekeeping with A. mellifera in developing countries with large rural, uneducated and unsophisticated, poor populations in isolated areas may find themselves in difficulty.

(\*) See Fig. 3/11 for world map of distribution of Tropilaelaps clareae by countries, as currently known.

Chemical. According to De Jong *et al.* (1982), "at present there is no accepted, satisfactory chemical means of eliminating Varroa from a colony, though there are many chemicals that will reduce the number of mites." This is an accurate assessment of chemical control not only for V. jacobsoni, but for T. clareae as well. It is appropriate and timely for the apicultural research community and the vocational beekeeping industry to recognize the likelihood that brood mites cannot be eradicated, and control programmes and future research should be predicated on parasite management instead.

The problems involved in chemically controlling an ectoparasitic brood mite are many. Some of the more obvious difficulties are that (1) whenever brood is present within an infested colony, a great number of mites are safely sequestered within sealed brood cells; (2) chemicals tested are often toxic to the host as well as to the pest, so that careful dosage manipulations are required for success; (3) the potential of toxicant residue buildup within the colony matrix is great; (4) the possibility exists for development of toxicant resistance by the target pests; and (5) there is a lack of uniformity in monitoring efficacy of chemical controls on a worldwide basis. A number of successes with chemical controls have been reported in the literature, but some negative factor or combination of factors frequently mitigates the effectiveness of a given compound.

Two major chemical approaches have been stressed for control of ectoparasitic brood mites: fumigants and systemics. Both have had reported successes, although a more long-lasting reduction of mite population is believed to occur with the systemic approach. The use of Galecron (= chlordimeform hydrochloride) as a systemic has shown a great deal of promise in Germany, and in limited experimental trials in Thailand, it is reported to have been effective against both V. jacobsoni and T. clareae. The possible residual effect of systemics such as Galecron in the colony matrix is unknown.

Non-chemical. Most efforts in this area have involved a cultural technique that mimics a break in the brood cycle at some stage of colony growth. This is usually accomplished by caging the queen and/or by removal of all brood. Such methods are used in the hope that they will interrupt the natural reproductive cycle of the mite parasite. While non-chemical methods cannot eliminate mites from colonies, they do appear at least to slow mite population growth. A programme put forward by Nyein and Zmarlicki (1982) is typical of a combined cultural and chemical approach: caging the queen for at least one complete brood cycle (21 days), uncapping the dead brood to facilitate removal by worker bees and the inclusion of a fumigation regimen, in this case phenothiazine. The methodology used was quite labour-intensive and required a high degree of beekeeping skill, but populations of both V. jacobsoni and T. clareae were reduced to what the authors termed non-economic levels.

Natural control systems. Little, if anything, is known as to what defensive systems, mechanisms, or behaviours are employed by the native bee hosts of V. jacobsoni and T. clareae. It seems unlikely, however, that the Apis species are defenceless against mite parasitism. Some of these defences may be obvious, but unrecognized as defences. For example, the seasonal absconding behaviours of both A. cerana and A. dorsata, so often attributed to

movement to areas of more favourable floral resources, may in fact be triggered by the severity of mite infestation. (\*) (†)

(iv) The Constraints of Mite Parasitism

From a global perspective, V. jacobsoni is approaching the status of the foremost honeybee pest. V. jacobsoni and T. clareae certainly are major obstacles to apiculture with A. mellifera in tropical Asia. In the past, authors have projected a dismal future for A. mellifera in areas where the two mite species are endemic, but preliminary reports of successful mite control in A. mellifera colonies in Asia suggest that good bee management in combination with limited chemical prophylaxis may keep mite populations below economic levels. Ensuring the future of A. mellifera in tropical Asia, however, will require a sound mite research programme which focuses on both biology and management. Considerable research is already being conducted on V. jacobsoni on an international scale, and much of this information will be applicable to A. mellifera in Asia. The natural history of T. clareae, a species of great potential worldwide importance, is much less well understood, and deserves the immediate attention of beekeepers and researchers alike.

(v) Acarine "Disease"

Acarine "disease" is caused by the microscopic mite Acarapis woodii. Mites enter the tracheal system (breathing tubes) of young adult bees and multiply there, deriving nourishment from the bee's blood and also interfering with its respiration, ultimately leading to its premature death. Mature female mites then emerge from the tracheae in search of a new host. The disease can be carried to a healthy colony by robbing or introducing infected queens.

No single symptom characterizes this disease; an affected bee can have disjointed wings and be unable to fly, or have a distended abdomen, or both. Positive diagnosis can be made by microscopic examination of the tracheae. Acarine disease can persist in a colony for years, causing little damage, but combined with other diseases and/or poor bee seasons, it can lead to the death of the colony.

According to a report from Pakistan (FAO, 1984), a recent (1982-83) outbreak of Acarapis woodii brought about heavy mortality of A. cerana colonies, and some 9 000 colonies of this bee kept by modern beekeepers succumbed. The disease also attacked colonies of A. dorsata but remained restricted to a few areas. Its incidence on A. mellifera was very low as compared with that on A. cerana. In northern India, also, the mite is reported to cause very serious damage in A. cerana colonies. It has now been reported in most major beekeeping

(\*) In April 1984, J. Woyke expressed the view (FAO 1984), on the basis of experience in Afghanistan, that Tropilaelaps would not reach temperate areas, as the mite cannot tolerate a break in brood rearing. He also noted that bees sense, in some unknown way, when infestation is present and open the brood cells prematurely and remove the larvae.

(†) According to a report from Thailand (FAO 1984), infested native A. cerana absconds, whereas infested imported A. mellifera remains in the hive.

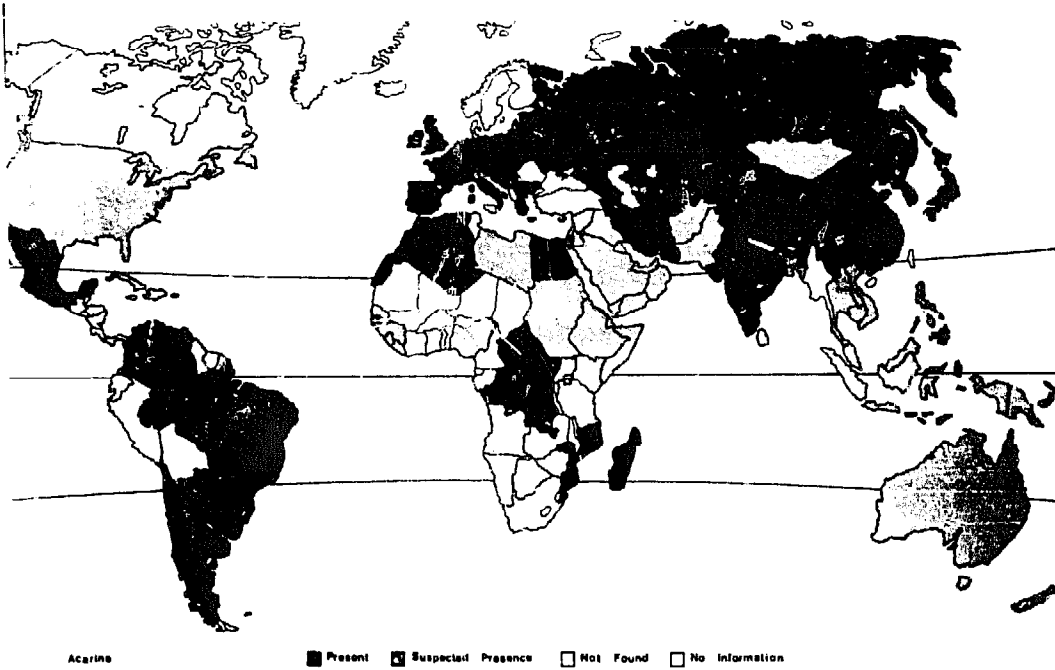

Fig. 3/12 World distribution of acarine disease (*Acarapis woodii*), by countries, as known in 1982.  
Map source: Nixon (1982).

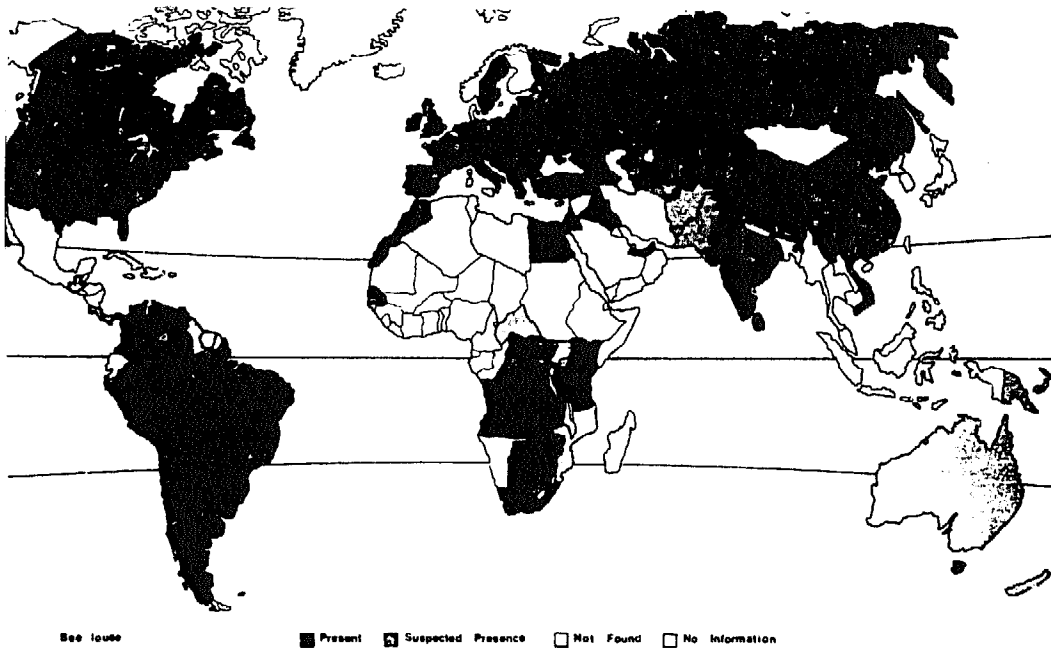

Fig. 3/13 World distribution of bee louse (*Braula* spp.), by countries, as known in 1982.  
Map source: Nixon (1982).



countries, but is absent from Canada, much of southern Africa, Australia and New Zealand, and the Pacific area. (\*)

The most widely used chemical for the control of acarine disease is chlorobenzilate. Menthol has been recently proposed, but it has not been widely tested.

D. Other Pests

(i) Wax moths

The greater wax moth, Galleria mellonella, is the most serious pest of combs, but comb damage is also caused by the lesser wax moth, Achroia grisella, and the Mediterranean flour moth, Ephestia kuehniella. All these moths may present an especially serious problem in the tropics and sub-tropics, where the warm climates favour their rapid development, but the greater wax moth, in particular, is a major pest in all regions. In Pakistan, for example, it is said to cause "fairly heavy losses", destroying from 8 to 23% of the A. cerana colonies traditionally maintained in wall hives in the northern hills; it has been reported to infest 12 to 48% of colonies of A. dorsata in the plains and up to 10% of imported A. mellifera colonies (FAO, 1984). In northern India as well, wax-moth attacks on A. cerana indica colonies are reported (ibid.) as being more severe than those on A. mellifera, because the latter collects more propolis to guard against moth attacks. According to another report (ibid.), wax-moth infestation seems to cause A. dorsata colonies to abscond.

Again, the greater wax moth is reported to be perhaps the most damaging and costly bee pest in the tropical Pacific area; in recent years it has reached plague proportions in New Caledonia, where it has greatly reduced the number of colonies kept by beekeepers and also, apparently, the number of colonies living wild. The lesser wax moth is also present throughout the tropical Pacific area but is reported to be of relatively minor importance.

The female of the greater wax moth lays her eggs in clusters, usually in cracks or between the wooden parts of the hive. After the eggs hatch the larvae feed on the wax combs, and can reduce them to a pile of debris that falls to the hive floor. They obtain their nutrients not from the beeswax itself, but from other materials in the combs: honey, cast-off pupal skins and pollen. Consequently, darker combs that have contained brood are more likely to be infested than light combs or foundation.

Combs stored in dark, warm and poorly ventilated rooms are most likely to be destroyed by the moth. Hives containing colonies that have lost their adult population through disease or pesticide poisoning are also likely to be invaded.

The most effective method of control of wax-moth infestation is to maintain large, strong, healthy colonies in just sufficient comb to meet their needs, as the moth is less likely to occupy combs covered by bees. Combs having suffered minor wax-moth damage should be thoroughly cleaned and repaired before re-use. Combs stored away from bees for any length of time must be protected

(\*) See Fig. 3/12 for world map of distribution of Acarapis woodii by countries, as currently known. According to Townsend (1985), the mite is "now found in the USA and will no doubt be found in Canada soon".

against wax moth; storing them in hermetically sealed buildings is possible, but fumigation is the standard technique. Fumigants such as paradichlorobenzene, ethylene dibromide and phostoxins are sometimes employed, but they should be applied with great caution, and only on stored combs that do not contain honey to be used for food. Treating combs with carbon dioxide, or by the application of low temperatures, does not harm honey in them. Heat treatment can also be used, but only for combs without pollen or honey. In tropical areas, however, as will be seen in Chapter 6, it is usually more cost-effective to render and sell the wax from combs than attempt to protect them.

(ii) Wasps and hornets

Wasps and hornets are also reported from all regions as being pests of some seriousness. Their activity is said to be seasonal, and at its maximum in dearth periods, when their own colonies are large; honeybee losses can then be heavy. In some parts of Papua New Guinea, the predatory attacks of a hornet, Vespa affinis, have been so severe as to force apiary sites to be abandoned. Four species of Vespa are reported as common in Pakistan, where they destroy adult bees, brood, and honey reserves during the crucial July-October floral dearth period. In Thailand, tropical hornets create serious problems during the monsoon months. During peak wasp-predation periods in Malaysia, random hive inspections showed as many as 15 to 30 dead wasps inside a hive; usually at least 3 to 4 bees are killed for every wasp killed, and a weak colony of A. mellifera or A. cerana may even refuse to come out of the hive when it is harassed by several wasps at the entrance. In northern India, five wasp species cause a serious threat to the cottage industry. By means of shimmering and evasive behaviour, A. cerana indica can resist the attack of wasps better than can A. mellifera. Similarly, in Japan, A. cerana is able to defend itself against attacks by the giant hornet Vespa mandarinia, the worst enemy of A. mellifera; it is reported that 20 giant hornets can seriously damage an A. mellifera colony in 2 to 3 hours.

Control methods in Thailand are limited to hunting out the hornets' colonies and destroying them (hornets are considered a delicacy in that country). In the Mediterranean area, control methods are based on the fact that wasps are carnivorous: fish impregnated with pesticides are placed on hive covers. Grids are also used across hive entrances.

(iii) Ants

Ants constitute the final group of insects of economic importance to beekeeping. In tropical Asia, it is reported that an ant attack can destroy a colony in a day. In the Pacific area, the small bee populations used in queen-mating hives make them particularly susceptible to ant attacks; the big-headed ant Pheidole megacephala is widespread, and individuals of this species may invade hives and form a food chain which carries away honey, eggs and larvae, in addition to harassing adult bees. In Africa, the Safari ant can destroy most of a beeyard overnight, unless proper protection is ensured (Townsend, 1985).

There are some grounds for believing that poor management is the cause of most losses from ant predators. The simple device of placing the legs of hive stands in open tins filled with waste oil is known throughout the world to be a generally satisfactory defence; in the Pacific area the stand legs are sometimes smeared with a thick grease (e.g. axle-grease) to which a suitable insecticide has been added, while in the Mediterranean area ants are fended off

by planting tomatoes -- a known ant-repellant -- near the hives. Keeping apiaries free of debris and overgrowth, and destroying nests within the area, are also evident methods of controlling ant populations.

(iv) Bee louse

Braula coeca, known as the bee louse, is not a louse, but a wingless fly that feeds on honey. Adult bee lice can be found on adult workers and queens, but no detrimental effect on the bees has been attributed to their presence. Braula larvae can, however, damage the appearance of comb honey. There are no known control methods for the bee louse, and none are considered necessary(\*).

(v) Birds

The extent to which birds are of economic importance as predators on bees is not clear. They are reported as "troublesome" throughout the world, the bee-eater (Merops spp.) being the most widespread offender, but the damage they cause appears to be limited to isolated cases, even if from 20 to 100 bees have been counted in the midgut of individual bee-eaters. In Asia, the honey buzzard (Pernis apivorus) has been observed landing on a branch supporting an Apis dorsata comb and bending down to grasp pieces of it in its beak. The bees, though trying to sting the bird, were unable to drive it away.

(vi) Miscellaneous

Numerous other pests are reported as causing difficulties to beekeepers, to a varying extent. Termites, mice and rats can damage hive equipment. The ratel, or honey badger (Mellivora ratel), raids hives in Africa, and M. indica in southern Asia. Bears can knock over all the hives in an apiary in a single night. Toads, frogs and lizards are often mentioned as causing problems. For example, the giant toad Bufo marinus was introduced to a number of Pacific islands - including Papua New Guinea, the Solomons, Fiji and Hawaii - ostensibly for insect control in sugarcane plantations. This toad, and Bufo bufo which is also present in the Pacific area, can consume large numbers of bees if hive entrances are within their jumping range. As a preventive measure, hive entrances should therefore be at least 50 cm. from the ground; fencing apiaries with toad-proof wire mesh can also be a successful deterrent.

E. World Distribution of Bee Diseases and Pests

When a developing country is considering the importation of bees and equipment as a step toward improving its apiculture, it is essential that it understand the danger of doing so: the risk of importing new diseases and/or pests that could decimate the local bees. The foul-brood diseases can also be transmitted in contaminated honey or beeswax, and chalk brood in contaminated pollen.

(\*) See Fig 3/12 for world map of distribution of the bee louse by countries, as currently known.

This risk is increased considerably when the bees and equipment originate in an exporting country in which the disease is known to exist, and where adequate sanitary export control regulations are not strictly enforced.

In an effort to collect, from many published sources, all available information concerning the presence or absence of these diseases, country by country, and to present it in a convenient form, the International Bee Research Association compiled in 1982-83 a series of ten world maps showing the distribution of major bee diseases and parasites as currently known; these appear as Figs. 3/3 - 3/4 and 3/6 - 3/13 above.

The maps show only the countries(\*) in which the diseases are present or absent, not the distribution within the country or the severity of the attack. Since the maps are the first of their kind, they are inevitably incomplete, especially those for sac-brood, chalk-brood and amoeba diseases. Further information on country distribution will be welcomed by IBRA.(†)

The tremendous movement of air traffic around the world is creating new problems each year as man accidentally transports pests, predators and diseases of his agricultural crops and animals from one continent to another. In time it can be expected that honeybees on all continents will suffer from the major diseases. Part of the work of beekeepers and bee specialists everywhere is to ensure that this transfer is delayed as long as possible. To this end there is serious need of an effective, quick-acting monitoring system, with the means of collecting and rapidly disseminating not only information on disease and pest outbreaks, but also treatments that have been shown to be effective in developing countries, and updated reports on other bee-production activities at the local, national and international levels.

#### 4. Man

G.M. Walton has pointed out that "the most serious enemy of bees can be man himself. Neglectful hive management can lead to colony starvation, and to the introduction and spread of bee diseases and pests. In some Pacific islands, human irresponsibility has developed to a stage where hives have been used for target practice, or where hive lids and frames have been removed." Similar cases of vandalism - and even theft - are reported by M. Weise from tropical America. A greater danger in southern Asia, because more widespread, is created by collectors of palm sap, from which alcoholic beverages are made. The bees visit the pots in which the sweet liquid is collected, and drown; frequently, as many as 100 to 150 bees are found in every pot.

FAO reports from two Sahelian countries note that the custom of burning bushes, often before the beginning of the rainy season, destroys the vegetation on which the bees feed. As a result, the colonies are weakened even before the beginning of the dearth season, the combs are not completely covered, and the colonies fall victim to insect attacks. The loss of suitable bee pollinators may have an unfavourable effect on crop yields. Further, the bush itself, with

(\*) Table 3/2, derived from the same sources, shows the known distribution of diseases in certain islands too small to be indicated clearly on the maps.

(†) Address: Hill House, Gerrards Cross, Bucks., SL9 0NR, UK.

Table 3/2: Bee diseases and parasites in islands for which information is available.

	AFB	EFB	sac brood	chalk brood	nosema	amoeba	acarine	bee louse
<u>Caribbean</u>								
Bermuda	+	+	-	-	+	0	-	-
Jamaica	?	-	-	-	-	-	-	-
Puerto Rico	-	-	0	0	-	0	-	0
Trinidad and Tobago	-	-	-	-	-	-	-	+
<u>Pacific</u>								
Fiji	+	-	0	0	0	0	-	0
Hawaii	+	+	+	+	+	0	0	0
Niue	+	-	+	0	+	0	-	-
Tonga	+	-	+	-	+	0	-	-
<u>Atlantic</u>								
Canary Islands	+	0	0	0	0	0	+	0
<u>Indian Ocean</u>								
Mauritius	-	-	-	-	+	-	-	+
Réunion	-	-	0	0	+	0	?	0

Key to symbols:

- + present
- ? presence suspected
- reported not present
- 0 no information available

Source: IBRA.

a great diversity of flora, unpolluted by chemical agents, represents a major resource, capable of accommodating many thousands of hives and becoming a true reservoir of honey and other hive products; its burning is the unwitting destruction of a major asset. Finally, honey-hunting, often affecting Apis dorsata hives, can result in the destruction of entire colonies. (\*)

But however important such mismanagement of resources may be from the local point of view, man is the bee's worst enemy primarily because of his indiscriminate use of pesticides, which kill off uncounted thousands of colonies every year and close off wide areas from foraging bees. The following report on the current situation of beekeeping in relation to pesticide use in Thailand is typical of the position in many developing countries:

"Pesticide damage to apiculture in Thailand can be classified in three different categories. The application of herbicides on waste lands in an attempt to control mimosa weed reduces the pollen supply of the honeybee during monsoon months. Insecticide sprays in litchi orchards in the north prevent the migration of honeybee colonies into the orchards to collect honey. The country has vast areas under citrus and cotton which produce enormous amounts of nectar, but apiculture cannot utilize such rich resources, owing to the heavy application of toxic insecticides in citrus- and cotton-growing areas."

Similar reports come from all over the world. In the Mediterranean area, according to A. Popa, "poisoning by pesticides... constitutes a major obstacle to the development of beekeeping in the region, causing heavy losses. Many insecticides (such as DDT and BHC), highly toxic to bees, are used because they are cheaper than more selective products. With traditional hives it is impossible to provide any protection for the bees against pesticides, and the only way to reduce losses is to educate farmers and sprayers to the value of bees in crop pollination." Most countries in Asia use pesticides, so that damage to bees is to be expected, although one observer has pointed out that many Asian apiaries are located in forests, where hazards from pesticides are minimal. In countries where beekeeping is not yet widely practised, it is understandable that reports have not yet appeared in the literature, but there are positive reports of pesticide damage to bees from Bangladesh, China, India, Japan, Malaysia, Nepal, Pakistan, the Philippines, Sri Lanka and Thailand (Crane and Walker, 1983; FAO, 1984). Indiscriminate use of insecticides has caused such great losses of bees in certain developing countries that the insect is said to have completely disappeared from some areas.

Not all pesticides are equally dangerous to bees. Some, such as the rodenticides and fungicides, do not threaten them at all. Others are used only on crops, such as cereals, which bees do not visit; others again are applied to crops only after they have finished flowering; still others can be administered in the evening, after bee foraging has ceased, and have lost their power by morning, when it begins again. Appendix D lists 500 pesticides in common use, classified according to the extent to which they are dangerous to bees.

(\*) N. Koeniger, however, considers that "honey-hunting is not as destructive as it might seem: the queen apparently retains the power of flight at all times, so if the bees are driven from their comb, they can cluster nearby and build another one."

Pest-control measures used on cotton make it the most dangerous of all crops to bees, but with all tropical and sub-tropical crops the killing of bees and other pollinating insects is for the most part due to local lack of knowledge about correct pesticide application. The most effective way of reducing the large-scale killing of bees is therefore through the dissemination of information. The most important measure which should be taken is to integrate into every pest-control undertaking a component for protecting and fostering beneficial insects. (See also Crane and Walker, 1983).

Minimal use of insecticides should be integrated with maximal use of biological and cultural control methods, and the use of insecticides should be limited to preparations that cause least damage to beneficial insects. Growers should learn the toxicity of different pesticides to bees, and should use those that are least toxic, but acceptably effective at killing insect pests. Growers should make every effort to learn the locations of hives in the vicinity of their crop. It is the responsibility of the beekeeper to label his hives, so that he can readily be contacted before any insecticide application, and given the opportunity to move them. However, he cannot always do this at short notice, and the operation can be expensive and detrimental to his colonies. It may be possible, without ill effect, to confine bees to their hives for a short time (e.g. when a short-term residual pesticide is applied at dawn or dusk), but longer periods of confinement are not practicable.

Since weather conditions in the tropics and sub-tropics favour the development and spread of many crop pests, pesticides properly used can greatly assist in increasing food production there. It is however essential for maximum production that beneficial pollinating insects, and bees in particular, should not be killed along with the pest insects. The solution to this problem is likely to be a slow and difficult one, in which patient education and extension work must play a major role.(\*)

As markets for pesticides are opened up in developing countries, materials may be sold and used on crops without an understanding of more than the immediate lethal effect of the pesticide on the target pest itself, and this tendency may be exploited by less conscientious exporters. It is to be hoped that the international code of conduct on pesticide distribution and use recently adopted by FAO will assist in minimizing this danger. In short, it recommends that governments should take action to ensure that pesticide manufacturers and traders and those who use pesticides observe the following practices in pesticide management:

- 1) only pesticides of clearly defined quality, packaged and labelled as appropriate for the specific market should be supplied;
- 2) to meet the needs of small-scale users who individually apply pesticides in developing countries, only tested products of low hazard designed especially for their use should be marketed;

(\*)

Growers in developed countries have -- to some extent at least -- learned to follow the instructions for use which accompany their pesticides, and thus to avoid the irresponsible use of pesticides which kills bees and other pollinating insects; this is the result of education and extension work, and an understanding by growers that they need the bees to pollinate their crops, and must not kill them.

- 3) special attention should be paid to formulations, presentation, packaging and labelling in order to reduce hazards to users who are unable or unlikely to take ordinary precautionary measures;
- 4) information and instruction adequate to ensure safe and effective use of the pesticide should be provided with each package of pesticide;
- 5) each pesticide should be formulated and packaged so that the toxic hazard is reduced to the minimum consistent with the effective functioning of the pesticide;
- 6) Pesticides which require the use of uncomfortable and expensive protective clothing and equipment should be avoided, especially in tropical climates.

5. Further Reading

Most of the books on bee diseases and pests listed below include photographs and drawings that facilitate diagnosis. Morse (1978) gives the widest coverage and includes many tropical diseases and pests, while Bailey (1981) is an authoritative study, with recent information on all known honeybee diseases, including those caused by viruses. Hansen (1980?), in English, French and Spanish, contains close-up colour photographs for the identification of diseased brood. Shimanuki (1981) is a valuable contribution to knowledge of control of the greater wax moth. Ritter (1981) is a complete description of the Varroa mite and its effect on bees.

Crane and Walker (1983) deals with the destruction by insecticide poisoning of both honeybees and wild bees, particularly in developing countries, and the information it contains is supported by over 1000 references.

Part 18, "Bee diseases, enemies and poisoning in the tropics", of the IBRA Bibliography of tropical apiculture, (Crane 1978a and b) and its Satellite Bibliography S/35, "Bee diseases and pests in specific regions of the tropics", cite many more publications useful in these regards.



## CHAPTER 4

### HONEY-HUNTING AND TRADITIONAL METHODS OF BEEKEEPING

#### A. HONEY-HUNTING

Man has hunted bees for their honey since prehistoric times, and certainly for longer than the "hive bees", Apis mellifera and A. cerana, have been managed. Honey collection from colonies of wild bees is still practised in many areas of the tropics and sub-tropics, especially those which are still covered with primary vegetation or where essential elements of the natural vegetation continue to exist, and there is no reason to believe that the methods employed have evolved considerably with the passage of time. In many such regions of Asia, much honey is collected from A. dorsata nests, and a lesser quantity from those of A. florea.

Harvesting A. dorsata honey is very productive in regions with a dense population of the bees, mainly in forest areas where beekeeping with A. cerana has not been very successful. A typical example of the operations is provided by practices in Riau, on the island of Sumatra (Indonesia). The equipment consists of a large funnel-shaped container which can be carried on a man's back, and several long ropes (Fig. 4/1): it is normally kept at the headman's house and is used by all honey collectors in the area. A. dorsata colonies nest in high trees, between 30 and 50 m above the ground. At least two men work together. First, they collect a fair amount of creepers and young, tall saplings (about 4 to 7 cm in diameter), and some straight thinner sticks. The saplings are attached to the trunk of the bee tree by creepers tied around the tree at different heights, and at each such place two sticks are inserted into the knot, to serve as a stand for the next step. In this way one sapling is fixed above another, to form a continuous climbing pole parallel to the trunk of the tree (Fig. 4/2). After a height of about 15 m has been reached, new building material is hauled up on the ropes.

Three hours after starting, the men have reached the crown of the tree. They wait for darkness, and then one man lights a torch made from strips of bark tied tightly together. He fixes the funnel on his back and ties the glowing and smoking torch to a rope so that it swings some 3 m below him. When he reaches the colony, he utters a loud, high-pitched sound and at the same time waves the torch under the comb. Most of the bees leave the comb and cluster on part of the supporting branch out of reach of the smoke, but a good many fly into the torch and are burnt. The honey collector cuts out the brood area of the comb, throws it down, and carefully puts the honey portion into the funnel on his back. Then the next colony in the tree is dealt with in the same way. From three colonies in a single tree, a man can collect nearly 50 kg of honey, which is squeezed through a cloth and filled into empty bottles for sale to merchants. Because of its high water content (34% in one case observed), A. dorsata honey starts to ferment very quickly. This is a major problem with honey from A. dorsata as well as from other tropical bees, and the honey in the local markets is of poor quality. The brood is consumed by the villagers, and the wax sold to merchants.

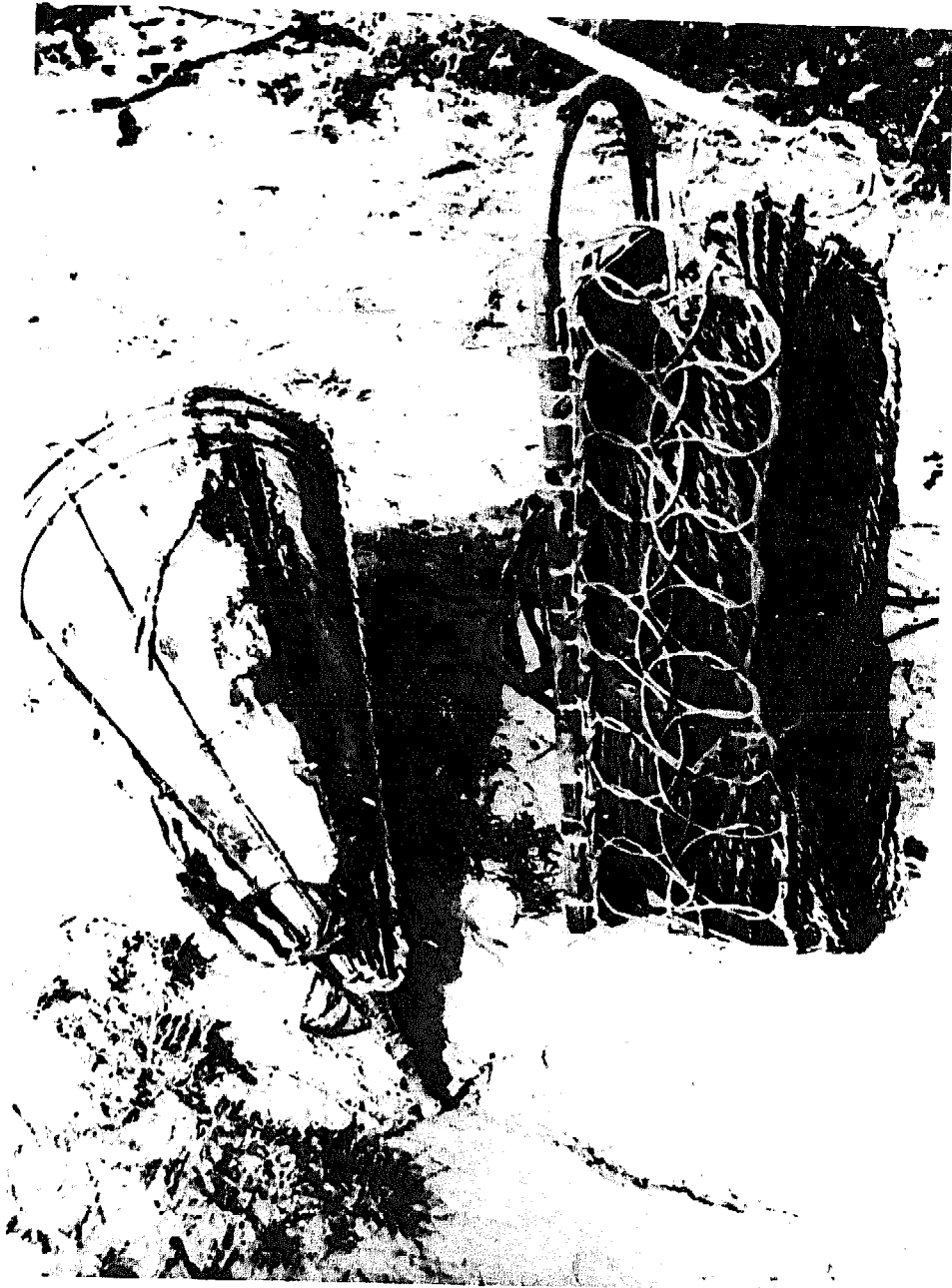

Fig. 4/1 Honey hunters' equipment from Riau, Sumatra (Indonesia).  
The funnel is used to carry the combs down the tree, the  
rope for hoisting the materials for the climbing pole.  
Photo: N. Koeniger.

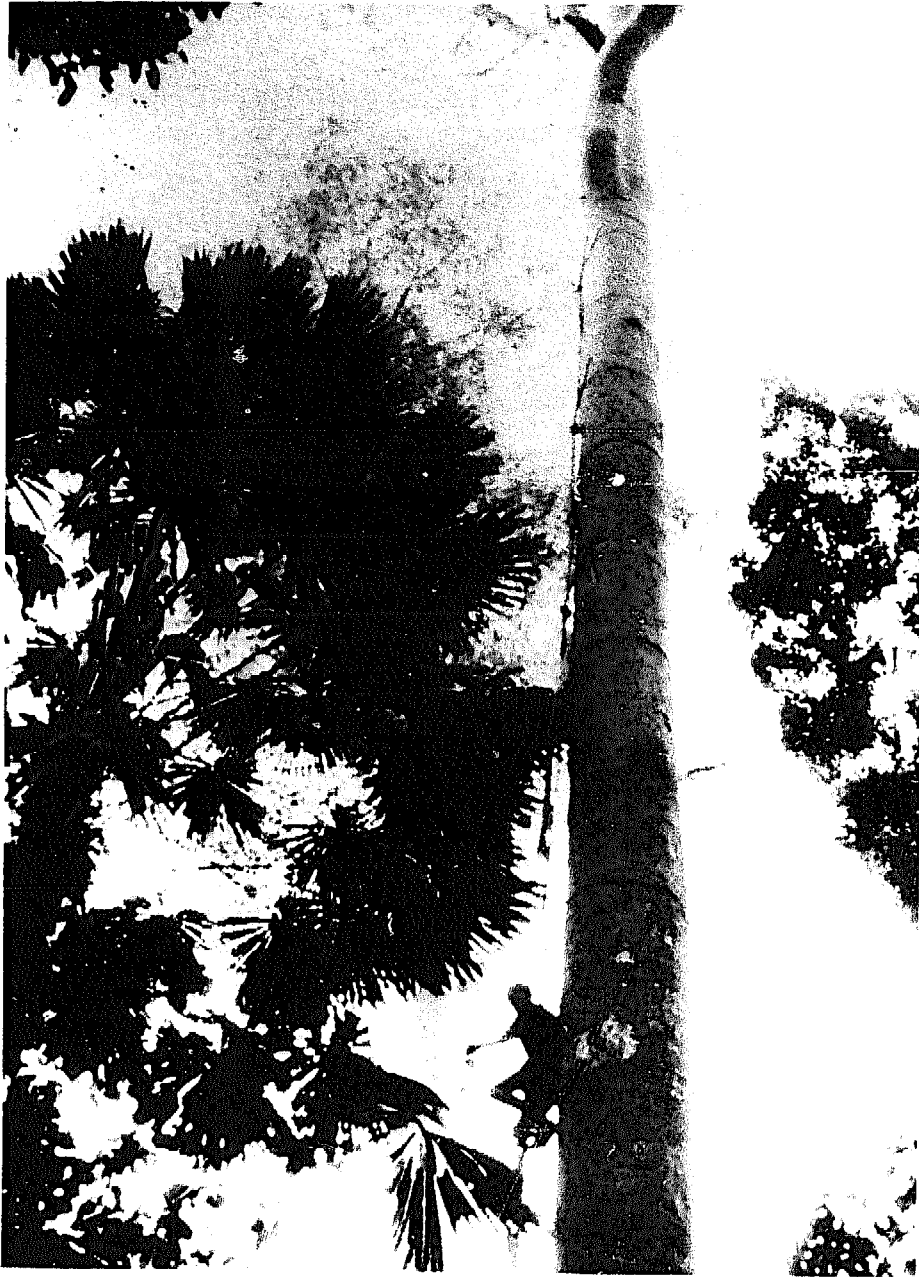

Fig. 4/2 Climbing a bee tree in Riau, Sumatra (Indonesia) with  
the equipment shown in Fig. 4/1.  
Photo: N. Koeniger.

Traditional methods of honey collection are similar in other parts of Asia, although there may be wide variations of detail. Instead of a bark smoker, an earthenware pot with smoking dung or rotten wood may be used. When the nesting site is low, a fire is often lit under the nest to drive away or kill the bees. Sometimes nests on a cliff face may be approached from above, the collector being let down on a rope.

In many countries of tropical Asia, more honey is collected from wild A. dorsata nests than from hives of A. cerana, yet no projects to improve traditional methods of honey harvesting are known, although such an approach would be very promising. A considerable improvement could be achieved by adequately protecting the honey collector against stings - usually he cannot afford an adequate bee-suit - and by devising a method for estimating, from the ground, the amount of honey in a comb.

Improvement of the quality of A. dorsata honey needs urgent attention. Reducing its high water content would prevent fermentation and - together with adequate straining, packing and marketing - could certainly result in a much better payment to the men who collect it; such measures would have a beneficial economic impact on the poor rural populations living in Asian forests where A. dorsata is found, perhaps even greater than improvement of yields from A. cerana.

The techniques used in hunting honey from A. florea are much simpler than those outlined above, because A. florea is less aggressive than A. dorsata, and generally tends to nest lower. Since A. florea is the least productive of the honeybees, however, the results of hunting its honey are not as satisfactory as could be desired, even though the honey is greatly appreciated and eagerly sought after.

When searching for Apis florea colonies, it has been found helpful to look along the ground toward the sun, because sunlight shimmering on the bees' wings is likely to reveal the presence of their colony as they enter or leave it. Often brood and honey are collected together for human consumption, but sometimes the honey collector removes only the crest of the comb and the accompanying honey, leaving the remainder of the comb attached to its support so that the colony can rebuild the comb and replenish the food stores. This practice should certainly be encouraged.

Honey-hunting is not however limited to A. dorsata and A. florea. Although most of the effort with regard to A. cerana and A. mellifera is given over to collecting and hiving entire colonies, these bees' honey is sometimes still hunted for itself. According to a report from Ghana in the mid-1960s (CS/IBRA, 1979), the wild honeybee in the northern part of the country - a strain of A.m. scutellata - generally nests in hollow tree-trunks. Its honey being much relished by the local inhabitants, any bee trees found are cut down; fire is used to kill the bees; and the trunks are chopped open to obtain the honey. No attempt is made to hive the bees, which are highly aggressive.

Again, according to a report from Sri Lanka (op. cit.), the primitive plundering of honey from wild bee colonies still goes on, and honey-hunters do not neglect or ignore colonies of A. cerana, which are as numerous in certain areas as A. dorsata, though somewhat less easy to detect. An illustration of the scope of honey hunting is afforded by the fact that a wholesale dealer in wild honey in a single dry-zone area is able to market as much as 2000 kg of honey in a season.



Fig. 4/3 Preparing an artificial "cave" to receive an Apis florea colony in Oman.  
Photo: J.B. Free.

B. BEEKEEPING WITH WILD BEES

1. Hiving Apis dorsata

Because of the high honey production of A. dorsata, several attempts have been made to use beekeeping methods for the bee similar to those for A. mellifera. So far none has been successful. The first difficulty is in collecting the colonies, normally a dangerous venture involving complicated preparation and equipment. It has been found advantageous to carry out the operation at night, because this both reduces the loss of bees and avoids strong colony defence. If put into any enclosed box like a hive, A. dorsata deserts it at once. Accordingly, for collecting a colony, use has been made of a box or frame open on one or two sides, which were closed with cloth or wire screen while the colony was being transported. Nevertheless, most colonies absconded sooner or later from these boxes after they were opened at their new site, and took most of the honey with them. An attempt to prevent this by the use of a

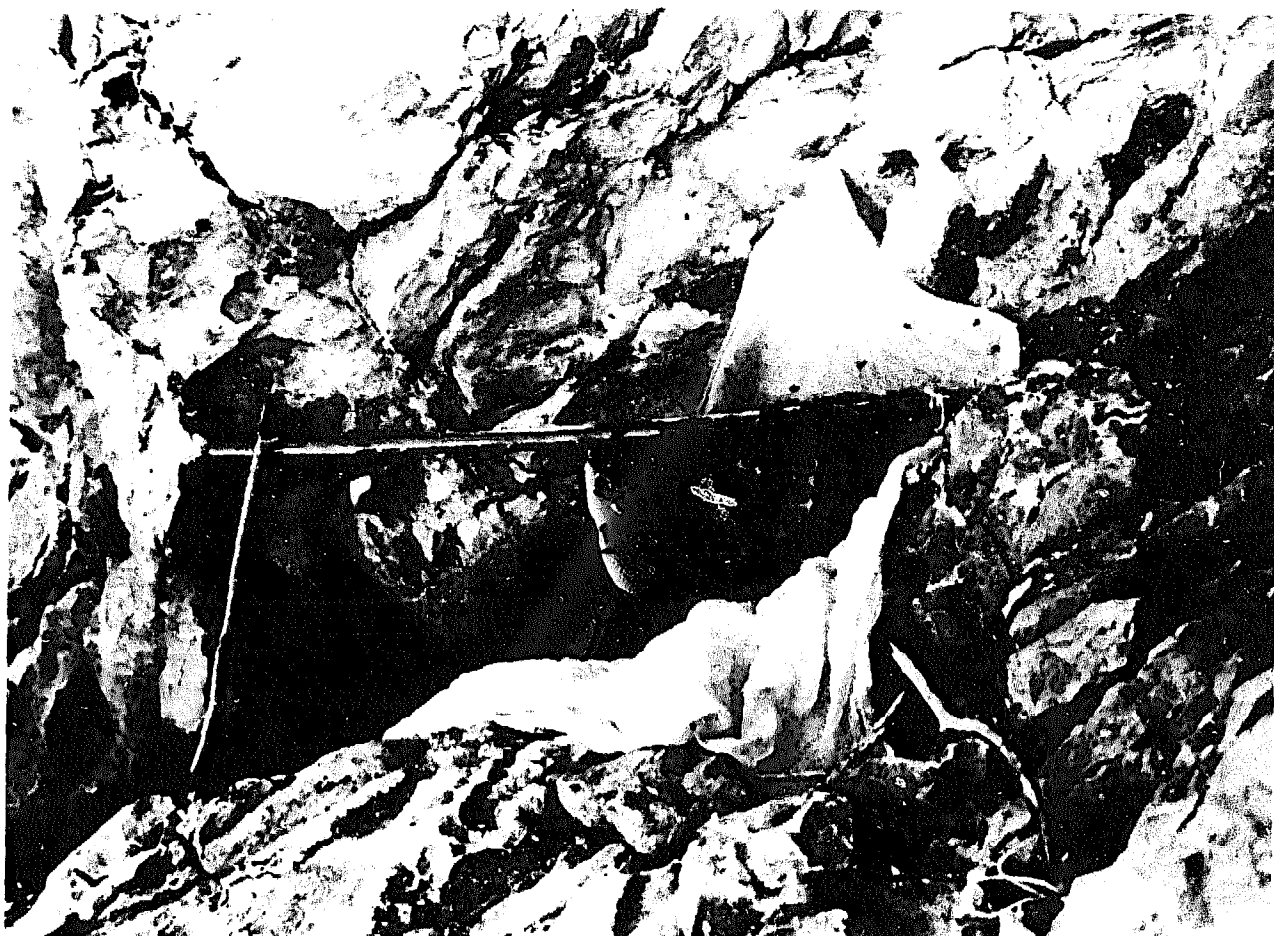

Fig. 4/4 Brood part of an *Apis florea* comb supported in front of an Oman cave entrance. The entrance is draped with muslin to prevent the bees from returning to their old site in the cave and to encourage them to adopt the comb in its new position.  
Photo: J.B. Free.

queen-excluder was ineffective: the bees left without the queen. The conclusion from this experience is that none of the procedures produced enough honey to justify their further experimentation.

## 2. Beekeeping with *Apis florea*

Various degrees of sophistication accompany the change from honey-hunting to beekeeping with *Apis florea*. In India and Oman, some colonies are kept in specially-prepared artificial "caves", in niches in houses and walls, or suspended in the shade of trees (Fig. 4/3). Thorn brushwood is put at the entrance to the cavity to protect the colony from marauding animals. When a colony is collected, the crest storage-area of the comb is removed for its honey, and the upper part of the remainder is then sandwiched between two parts



Fig. 4/5 Oman beekeeper removing an Apis florea colony from its artificial "cave".

Photo: J.B. Free.

of a split stick, or of a palm frond. This comb, with the attached bees, is wrapped in muslin or put in a suitable cage or box, and taken to a prepared site (Fig. 4/4) . At dusk the ends of the split stick are rested on supporting stones, or tied to the branch of a tree, and the muslin removed. The bees do not fly until the next morning.

In some circumstances, it is worth making two visits to a site to collect a colony. On the first visit the comb is cut from its support, sandwiched between two sticks, and left suspended near its original site; then a day or two later, when all the bees have settled again on the comb, the colony is collected, with more of its bees than if the operation had been completed on the first visit.

The bees attach their comb to the sticks. In time, they will elongate cells in the upper part to become the new storage area, and new cells will be built in the lower part of the comb for brood. When the new storage cells are in turn filled with honey, the beekeeper can cut them away, and move the sticks

further down the comb. This simple beekeeping operation is clearly superior to honey-hunting, because the colony is not destroyed and can be used as a known source of more than one honey harvest (Fig. 4/5). It should be encouraged.

A beekeeper can increase the number of his colonies either by discovering and collecting additional natural colonies or by dividing into two halves some of the combs he collected earlier; the bees in the part of the colony without a queen will rear a new one.

Care must be taken to limit the handling of colonies to a minimum, because disturbance tends to cause absconding. Migration when the supply of forage diminishes must also be prevented if possible; attempts to do this have been made by providing colonies with sugar syrup at the proper time. Attempts have also been made to confine colonies in boxes, or in cages whose entrances and walls are covered with appropriate queen-excluder material, so that the workers can forage but the queen cannot leave. The entrances can be kept open during times of abundant forage, to allow ready access by foragers, and closed when forage is scarce and absconding or migration is likely. However, such cages appear to be only partially successful, and there is much scope for improving beekeeping methods with A. florea.

The crest storage area of comb that has been collected by the beekeeper is chopped up and the honey drained into a container. It should be kept warm until wax remnants and other debris have risen to the surface and can be skimmed off. The honey is then ready to be strained and bottled.

### C. TRADITIONAL METHODS OF BEEKEEPING

There can be little doubt that traditional beekeeping was evolved directly from honey-hunting. In all likelihood, forest dwellers observed a colony of bees returning to a hollow tree-trunk that had been emptied of its comb, and found a few weeks or months later that the same "hive" could be hunted again. From then on, it was only a step - but a step which was probably not taken for thousands of years - to setting up a hollow log for a bee swarm to occupy, perhaps in a place more convenient for hunting. The next step, a more difficult and important one which not all honey-hunting peoples have yet taken, was to collect a colony and install it in such a primitive hive; beekeeping in the true sense of the word can be said to have begun the first time this occurred.

Traditional hives are, in general, simple containers made of whatever material is used locally for other containers: hollowed logs, bark, woven twigs or reeds, coiled straw, baked or unbaked clay, plant stems and leaves, or fruits such as gourds. In the tropics and sub-tropics, almost all these hives lie or are hung horizontally. In the most primitive form of beekeeping the bees are killed or driven out of the hive when the honey and wax are taken, the colony being destroyed in the process.

#### 1. Traditional Beekeeping in Tropical Africa

Tropical Africa has a wide variety of forage and climate, and different methods of beekeeping have developed in the different zones. The most common method in the dry zones is to rely on migrating swarms to populate hives, when all adult bees of a colony leave their hive because of dearth conditions and





Fig. 4/6 Log hive hung in a shady position in Tanzania.  
Photo: G.F. Townsend.

move into an area where new blossoms are appearing. Bait hives are set out for the swarms, which occupy them and (in a good season) produce a crop of honey during the next few months. This honey must be removed before the colony migrates again, usually toward the end of the flowering period, and therefore before the honey is ripe; this naturally has a negative effect on honey quality. The combs are often all crushed together, producing a mixture of honey, pollen, brood and beeswax, which is not suitable for marketing as honey; traditionally it is used for brewing honey beer, and much of the beeswax is lost. Where only full combs are harvested in this manner, all the empty combs must still be removed and rendered, or they will be destroyed by wax moth. The equipment is stored until the next season, when the hives are hung out again just before the swarms are due to arrive.

In this zone, hives are suspended high above the ground (Figs. 4/6 and 4/7) for a number of reasons: this system prevents attacks by safari ants and honey badgers; it provides a cool, shady area for the colony; it protects the



Fig. 4/7 Log hive apiary in a baobab tree, Tanzania.  
Photo: G.F. Townsend.

colony from flash grass-fires; and it reduces pilfering. All these factors must be taken into consideration in designing equipment for use with tropical African bees, whether in Africa or in Central and South America.

J.M. Nightingale (1976) has described in interesting detail the hive-making techniques and beekeeping practices of three Kenyan tribes, living in forest areas a few hundred kilometres apart, but at different altitudes and therefore in different conditions of climate; it was noted in Chapter 2 that altitude has a considerable, although still not sufficiently studied, influence on bee behaviour, and this may be a partial explanation of differences in hive construction. To all three tribes, beekeeping is an important traditional craft.

Since it has been found that bees prefer hives hung high above the ground, all three tribes place their hives as high as possible in trees. Among the Wakamba tribe, hives are hung, as far as possible, facing away from the

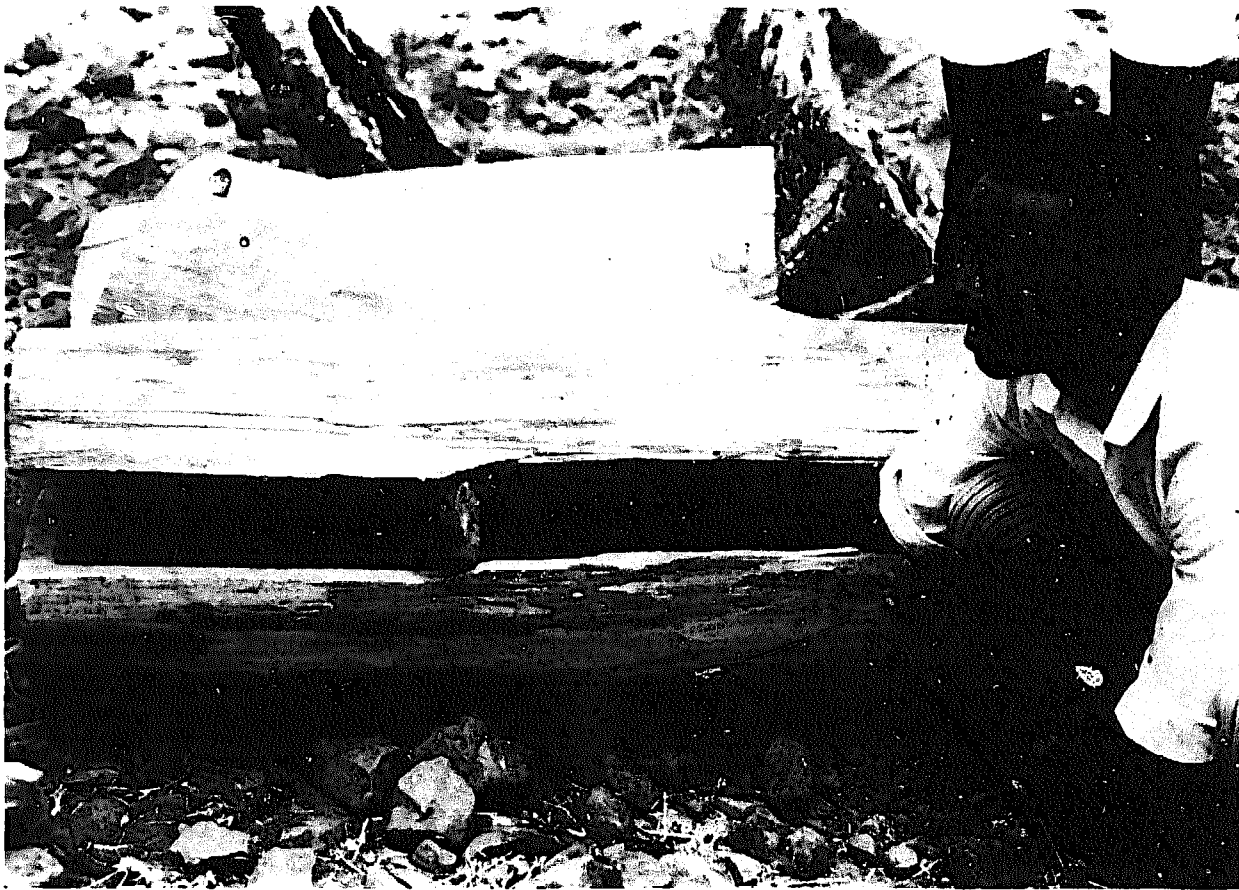

Fig. 4/8 Hive used by Tugen beekeepers, Kenya.  
Photo: G.F. Townsend.

strong prevailing wind, as bees will often abscond if there is a strong draught blowing in at the entrance. The beekeepers work their hives on the ground, usually in the late evening, because they find the bees too fierce during the day. One advantage of working the hive on the ground is that any flying bees tend to go up to the high site in the tree. The bees usually build their brood nest at the lower end of the hive, near the entrance, working up gradually to the higher, wider end, and finally store their honey at the top, so this end is opened to remove the crop, smoke being used quite extensively. After the honey has been removed, the hive is hauled back up and hung in its old place.

The hives of the Pokot tribe, who live in an extremely hot area, are bound with grass or reeds as protection against both the weather and the intense heat. An opening, about 15 x 10 cm, is disposed in the centre of one side of the hive and closed with a cushion of bark fibres. The beekeeper waves his smoke torch around the hive for about ten minutes, removes the cushion and blows smoke through the opening until the bees leave the hive from both ends. The honey is scooped out by hand into a skin bag worn around the neck; by custom, only one end is worked from the opening, so that the brood is preserved. Among

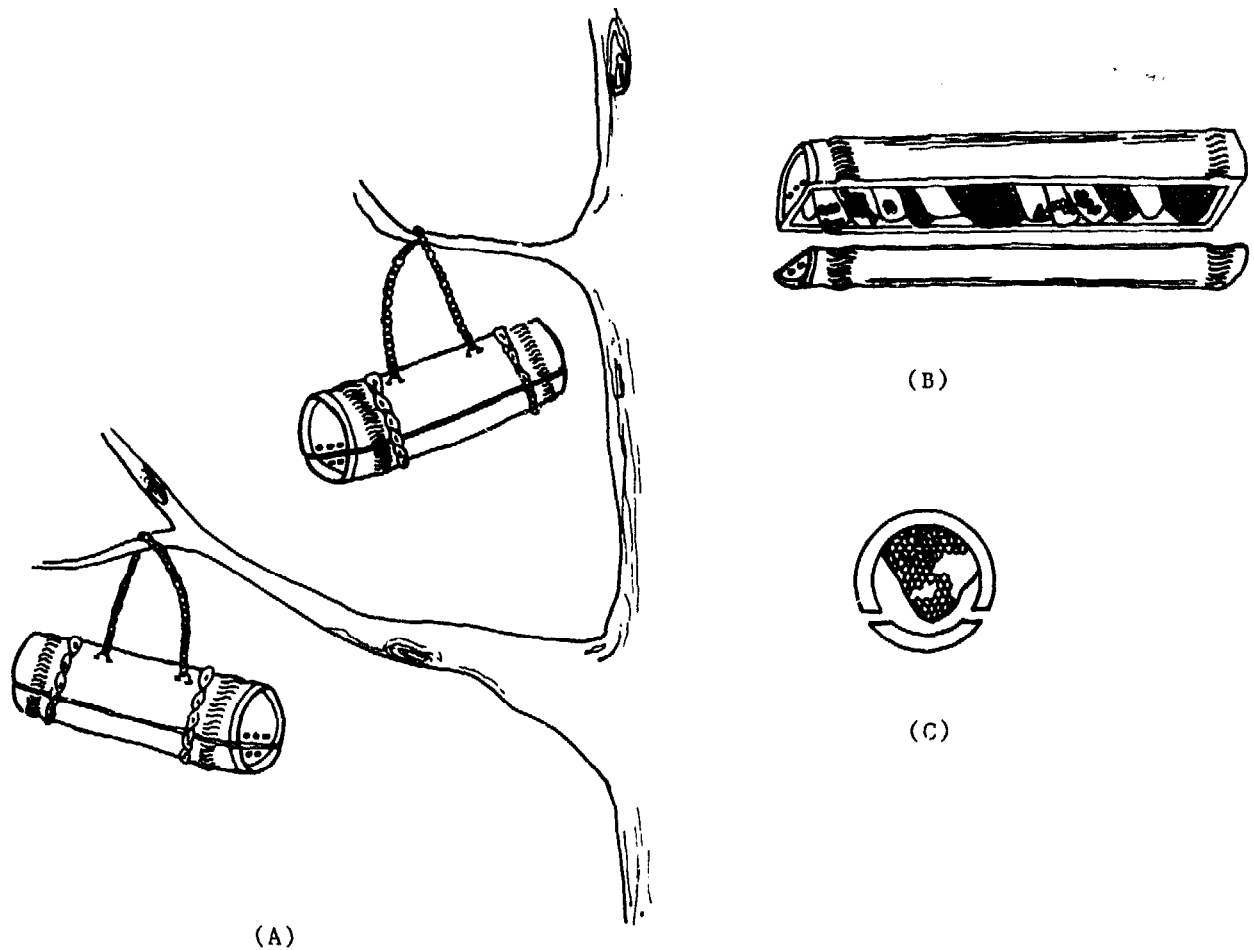

Fig. 4/9 Wameru hives, northern Tanzania.  
Drawings: Stephanie Townsend.

- (A) Hives suspended in tree branches. Note entrance holes at lower ends of hives.
- (B) Hive opened to show comb built in upper part.
- (C) Cross-section of hive, showing that comb is not attached to floor.

the Tugen tribe, the hive is placed level with the ground in the top of a thorn tree, so that usually the operator has a convenient perch to stand on. The hive is opened by levering it apart along one edge and inserting a stone or piece of wood to hold it open until all the honey has been removed (Fig. 4/8). Unfortunately, however, the Tugens' log hives are split so near the centre that the combs are often broken in half when the hive is opened, and the loss of honey at the time of collection is considerable.

## 2. The Cylindrical Split Wameru Hive

The Wameru tribe of northern Tanzania also use a log hive, but they discovered that if their logs are split along one side (less than one fourth along the diameter) rather than down the middle, the smaller piece can form a removable floor to the hive to which the bees do not attach their combs. To harvest the honey, the hive is lowered to the ground, the bees controlled by smoke, and the floor removed (Fig. 4/9). The combs containing honey are removed, the floor replaced, and the hive rehung without damaging the brood comb.

This hive is to be recommended wherever conditions do not permit the introduction of modern or transitional hives. It can be built not only from logs but from bark, clay, or woven reeds, sisal, etc. It should be 90-100 cm long and about 30 cm in diameter. Each end is closed; holes are bored in one end for flight entrances. To attract a bee swarm to a new hive, or in case of absconding, the inner roof of the cylinder is rubbed with beeswax or a mixture of beeswax and propolis.

Attention was first drawn to the Wameru hive in the first (1953) edition of Mann (1973). He suggested that tribes using split-log hives should be encouraged to adopt the split bottom used by the Wameru, but unfortunately this suggestion does not appear to have been pursued. Properly implemented, it could have made, and could still make, a great contribution to improving the quantity and quality of the honey produced by traditional beekeepers. The Wameru hive meets all the requirements for tropical beekeeping in the earliest stages of development. It is cheap, or virtually free for the making, so that the beekeeper may start off with almost no investment except his labour. It makes it possible to produce a good-quality honey, unmixed with brood or pollen, and to harvest beeswax as well. It is large enough to maintain the colony for honey production without leading to swarming, and it is adaptable to the special characteristics of local bees. It is easy to manipulate and has very few openings where bees need to be smoked to keep them under control during the operation.

## 3. Traditional Beekeeping in the Mediterranean Basin

In the Mediterranean area, traditional hives vary locally according to the climate and the materials available. Horizontal cylindrical hives, woven from osier or wicker, and protected by a coating of clay or cow dung, predominate. Others are of fired earthenware or sun-dried mud, cork, a palm or other log or wooden boards. The hive is from 70 to 120 cm long and 20 to 35 cm in diameter, or sometimes more than 40 cm for a palm-log hive. With the exception of the last-named, the traditional hives are too small to allow the bees to store sufficient food to last through a dearth period. The ends of the hives are closed by removable lids of mud, clay, wood or woven plant stems; one or more flight holes for the bees are pierced in one lid of the hive. The hives are laid horizontally in a single tier, or stacked one above the other or in a sloping pyramid; they are often protected from the heat by brushwood.

In Crete and Tunisia, some cylindrical earthenware hives are tapered, much as most log hives are narrower at one end than at the other. Other Cretan hives are upright, made of clay, with top-bars across them, similar to wicker hives of the same shape found in Greece. In North Africa, as one approaches the

Sahara, fewer materials are available for hive-making, while adequate protection against the heat becomes essential. In such areas, therefore, hives may take the form of cavities in the mud walls of houses, or even stone-lined underground cavities.

Beekeeping methods, based on traditions handed down from ancient times, are similar in most respects throughout the Mediterranean area. One of the essential operations is the capture, in the spring, of swarms to populate empty hives and replace colonies that have died or absconded. A captured swarm is kept in the shade, in a bag woven from plant stems and leaves, until it can be placed in a new hive. Early swarms are usually the most profitable, because they have a longer active period in which to store food. Honey is harvested at the end of the flowering period. The combs are carefully cut out from both ends of the hive; combs with brood and pollen as well as honey, in the central part of the hive, are left to maintain the colony. Honey is extracted from the combs by pressing.

The island of Malta was renowned in ancient times for the quality of its honey, and its very name is derived from the Greek word meaning "honey". The traditional Maltese hive is a bottle-shaped earthenware jar, with a neck of a diameter of 7 to 8 cm, and a body of about 25 cm; both ends are open. To the broader end is fitted an open-ended clay cylinder about 45 cm long, which serves as a honey chamber, while the jar serves as a brood chamber and the neck is the hive entrance; its size can be adjusted by lining it with sackcloth. The open end at the base of the hive is usually closed with a sheet of cardboard or wood, held firmly in place by a stone or other heavy object. These earthenware jars, which are still used by some Maltese beekeepers, have the advantages of maintaining an even temperature (24°) day and night, and they are relatively inexpensive. The combs are securely attached to their rough inner surface. Honey is usually extracted by removing the rear cylinder to obtain the combs, which are pressed by hand or with a mechanical press, and then strained.

The traditional Maltese beekeeper still enlarges his apiary by encouraging his colonies to swarm. To attract a swarm to establish itself in a prepared earthenware jar, the inner surface is rubbed with balm extracted from Melissa officinalis and some comb honey or sugar syrup is left inside the jar. If this lure fails, the beekeeper - who at swarming time usually spends every day watching his hives - is always ready to hive any swarm that appears.

#### 4. Traditional Beekeeping in Asia

Traditional beekeepers in Asia generally adopt the log hive or the clay pot, or both, as reported to a recent FAO expert consultation (FAO 1984). In Afghanistan, beekeepers use clay pots or wooden frames (boxes), both inserted into the mud walls of houses. Pakistan has three types of hive, easy to make, cheap, and safe from theft, but their management is difficult and the colony is often destroyed during honey extraction. The first is the wall hive, a cavity built in the wall of the natural stone or mud house, preferably exposed to the south or down-valley. Honey is harvested from the inside of the house after the mud has been removed from the hive entrance. The pitcher hive, a further development of the wall hive, is a cavity in the house wall, into which a clay pitcher is inserted horizontally; a clay lid frequently serves as a covering for the opening inside the house. The third type, a log hive roughly similar to those used in Kenya, is disappearing, as in parts of Kenya, because of the large quantity of wood required for its preparation.

Logs and clay pots were formerly used by beekeepers in Bangladesh and continue to be current among the rural populations of Java and Bali (Indonesia). In Thailand, simple hives are made from bark or coconut palms, hollow tree-trunks, wooden boxes, or sometimes concrete pipes. The inside of the hive is coated with melted beeswax as bait. The beekeeper either waits patiently for a swarm to move into the prepared hive, or else goes hunting for new swarms, clusters of absconding bees, or colonies established in the wild, which he transfers to his hives. At harvesting time, all or parts of the combs are cut from the hive. The honey is squeezed from the combs and strained through wire mesh or a cloth; the crushed combs are then melted together and the beeswax is rendered.

#### D. TRANSITIONAL HIVES

The characteristic common to almost all the hives discussed thus far in this section is that the bees attach their combs to the sides of the hive, so that the hive cannot be opened, and comb removed, without the latter being broken. Such hives are therefore called fixed-comb hives. Their advantage - simplicity of building - is far outweighed by the disadvantages inherent in such a system, and in particular by the fact that it renders impossible the observation of events within the hive, necessary to any rational system of hive management. By lifting a hive and estimating its weight, an experienced beekeeper can judge, to some extent, how much honey it contains, but only visual observation can allow him to know whether the hive is pest-infected, and to determine (by the lack of brood cells and the presence of queen cells) whether the colony is preparing to swarm.

Only relatively recently -- probably in the 17th century -- was it discovered that if rounded bars, baited by smearing with honey or beeswax, are placed at the top of a hive whose sides slope inward toward the base, the bees will build comb downward from these bars without attaching much of it to the sides or bottom of the hive. In such a movable-comb hive, individual combs can be removed for inspection or honey collection and then replaced without damage to the colony.

The spacing of the top bars is of primary importance: if they are too close together, the bees will build unwanted comb between the vertical combs, and if they are too far apart, the comb will be attached to the sides of the hive; in both cases the problem of comb breakage will arise once again. The top-bars must therefore be at the correct distance apart to give the bees' natural inter-comb distance -- the bee space --, but that is the only precision measurement necessary. Honey and beeswax are harvested by simply removing the combs containing fully-capped honey, but no pollen or brood.

In fixed-comb hives, whether hollowed logs, clay pots, or somewhat more sophisticated containers, the attachment of the combs to the inner surface is necessary for their support, but in these so-called "transitional" hives (because they constitute a transitional stage between primitive and modern beekeeping) the long top-bars provide nearly all the support needed under normal circumstances. If the hive is moved without great care, however, as can occur for example in migratory beekeeping, the comb will readily break away from the top-bar; in handling a colony, therefore, the beekeeper must never turn the top-bar with comb so that it is horizontal, lest, lacking the necessary support, the comb break.

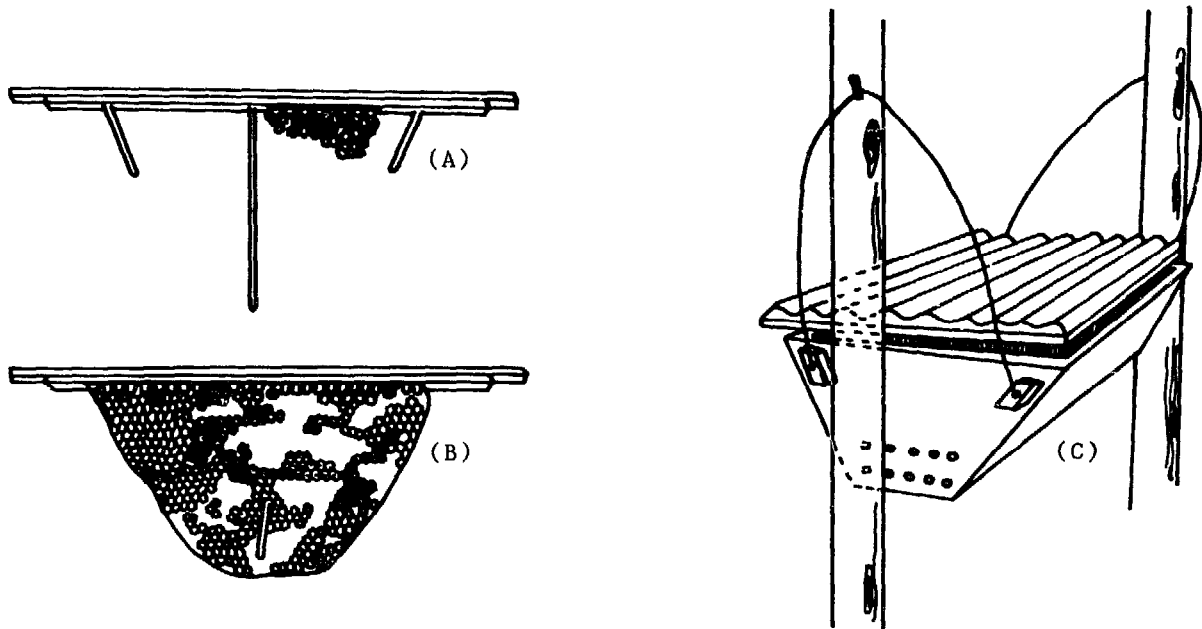

Fig. 4/10 Kenya top-bar hive, with Nightingale's improvement.

Photo: Stephanie Townsend.

- (A) Top-bar, showing support strips.
- (B) Comb built over and supported by strips.
- (C) Top-bar hive suspended between to posts.

A movable-comb hive in the shape of a truncated cone (round waste-paper basket) is known to have been used in Greece as early as 1680, and is still in use there. Bars are placed across the round top at the correct spacing, and each supports a comb. These combs are however not interchangeable, as in more modern versions of this hive, because, owing to the shape of the hive, their dimensions are not uniform. If a rectangular box hive is used, this inconvenience disappears, provided as always that the long sides slope inward toward the base.

#### 1. The Kenya Top-Bar Hive

Such a hive (Fig. 1/9) was successfully tested on a large scale in Kenya by J.N. Nightingale, who more recently introduced an improvement: three small holes ( $\varnothing = 2.5$  to  $3.0$  mm) are drilled through the top-bar, the centre hole being vertical and the others sloping inwards (Fig. 4/10A), and strips of wood or bamboo are pushed tightly into the holes from below. When the bees build comb over these sticks (Fig. 4/10B and 4/11), the comb thus reinforced is strong enough to withstand transportation and can be transferred with its top-bar to another type of hive; if necessary, some of the comb can be cut from the bottom to make it fit. Dimensioned drawings of the hive parts are given in Fig. 4/12.



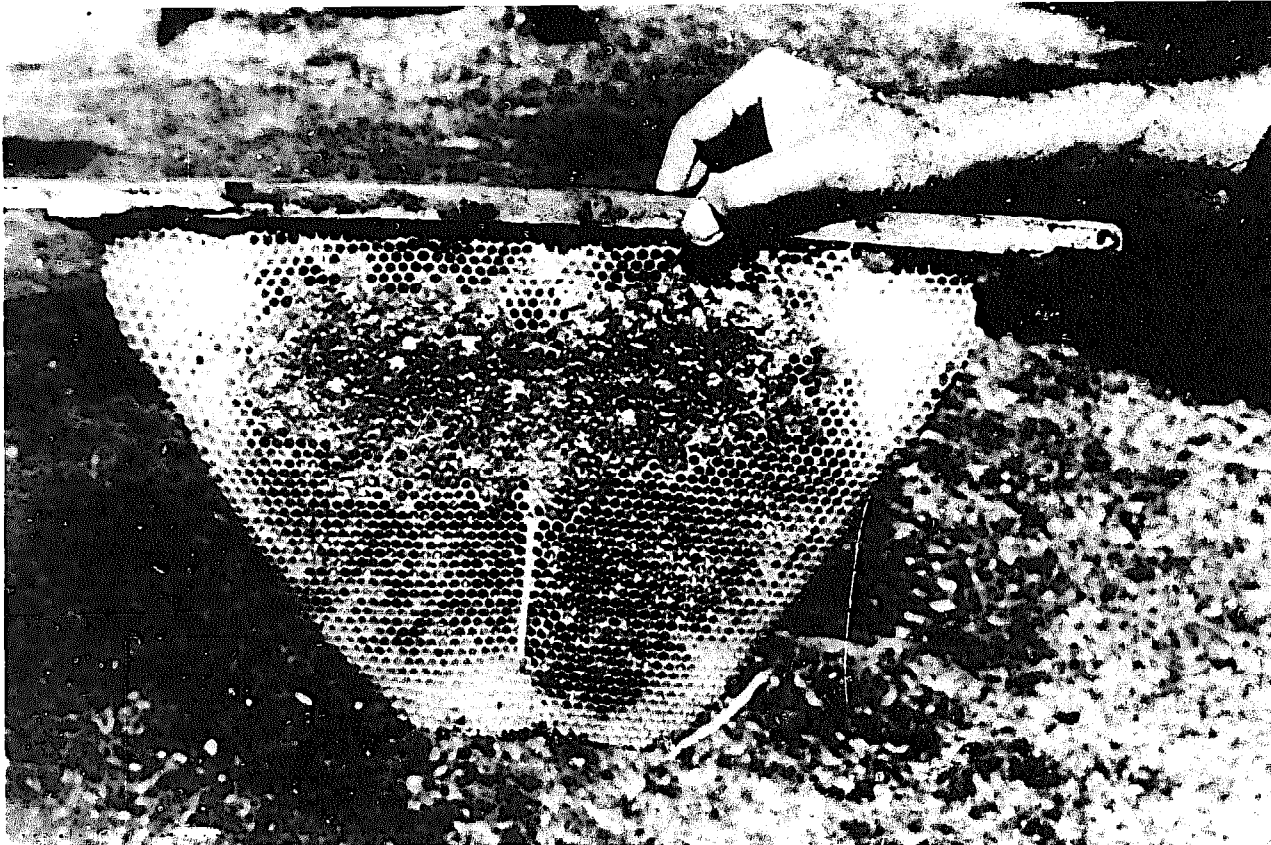

Fig. 4/11 Comb from Kenya top-bar hive, supported by Nightingale's strips.  
Photo: G.F. Townsend.

A queen-excluder made of coffee screen with a 0.5 mm mesh can be placed vertically in the centre of this hive, but there is no real need for it with the management methods suggested. A feeder made in the shape of a comb and suspended from a top-bar can be used if required. If the hive is built carefully from seasoned lumber, all the parts should fit well, so that the top-bars together form a complete cover for the hive. At each end of the row of top-bars, a strip of wood of the same length and thickness as a top-bar, but narrower, is inserted to block off any gap, before the lid is replaced; they can protrude over the end of the box, since the ends of the top-bars are flush with the sides, and they are easily removed, the gap thus left facilitating removal of top-bars with comb attached.

The hive can be suspended from each end by wires (with blobs of grease at intervals so that ants cannot readily travel along them), using posts or trees as supports. The wires should be almost vertical (see Fig. 4/10C), to enable the hive to be lifted slightly in order to estimate the amount of honey it contains. The hanging-blocks on the ends of hive are placed about 10 cm from the top, so as not to interfere with removal of the lid. The hive is hung at a

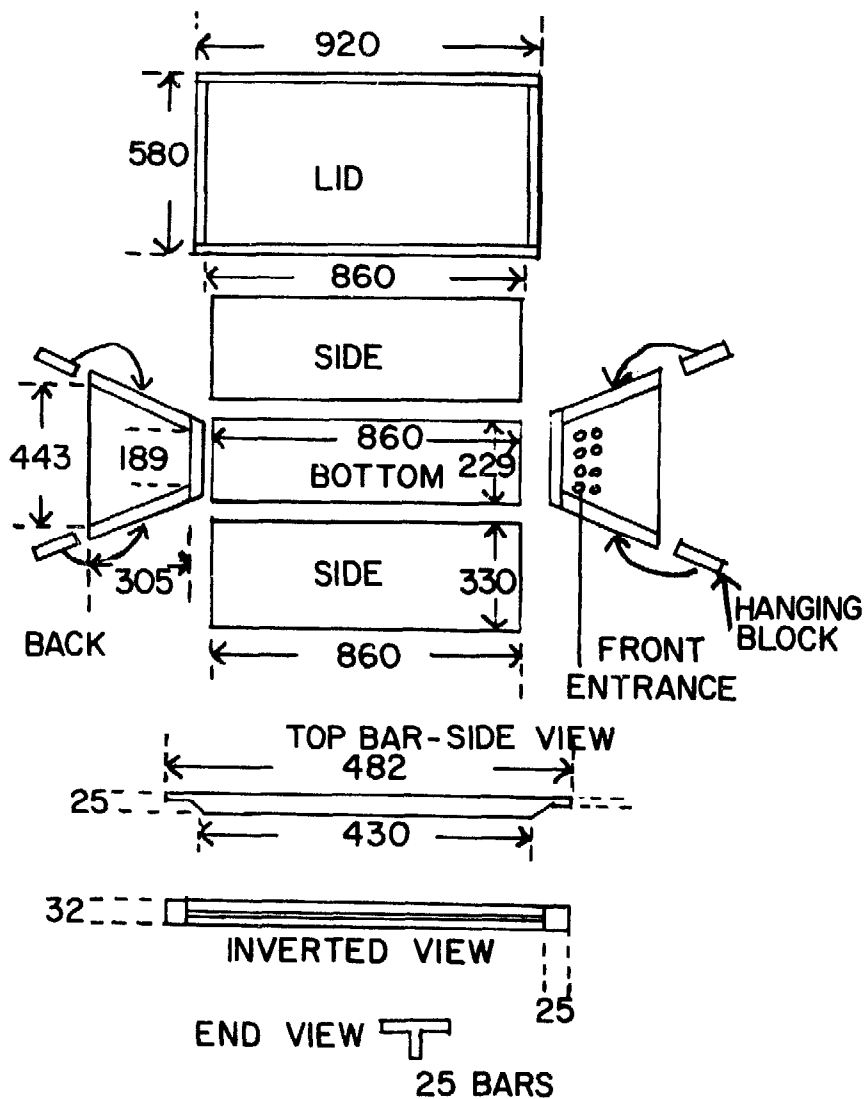

Fig. 4/12 Kenya top-bar hive. Dimensioned drawings based on 19-mm lumber. All measurements in mm. The side panels form an angle of 130° with the base.  
Drawing: Stephanie Townsend.

working height of about 1 m, enough to protect it from honey badgers; if the badgers climb the supporting posts, it may be necessary to wrap the latter with metal sheets. Insect attacks on the hive are controlled by replacing the alighting board by ten 12 mm holes, 25 to 35 mm above the floor of the hive (see Fig. 4/10C); holes of this size will keep out the larger beetles, while the smaller variety appears to need an alighting board to enter the hive.

In selecting materials for the construction of the hive, availability is the most important criterion. Termite-proof, or termite-proofed, wood is the best and easiest material to work with, if it is readily available at reasonable prices, but when it is scarce or expensive, alternate materials should be considered. Thus, in Sri Lanka, where wood is a scarce and very expensive commodity, Dr. N. Koeniger recently persuaded pottery makers to build a clay top-bar hive similar to the wooden Kenya model.

To assist the bees in building their comb, it is desirable - but not essential - to attach a strip of foundation comb, or even a simple strip of wax sheet, known as a starter, to each top-bar. Starters are common in the management of African bees.

Simple management procedures using transitional hives involve siting the hives and attracting swarms; feeding the bees if necessary; and harvesting the crop at the end of the flowering period, before the bees consume all the honey. Colonies should be managed for both honey and beeswax production. Hives should be hung out in areas where and at seasons when honey plants are about to flower. Colonies should be left alone as much as possible, and they should be located where they will not be disturbed by men or animals. In particular, animals should never be tied up near hives. Hives can be kept quite close to dwellings provided they are managed correctly, and animals fenced out. If the area is a good one, swarms will readily enter a properly baited hive. (Work is going forward with considerable success on the use of synthetic pheromone lures to attract honeybee colonies to hives in the tropics (Kigatiira *et al.*, 1986). If there is no honey flow at the time, a feeder(\*) containing a 50% (by weight) sugar syrup should be placed in the hive. If there is no natural water source within 500 m, water should also be provided.

J.M. Nightingale has written the following instructions for harvesting from a Kenya top-bar hive. Two beekeepers are needed, one of whom is essentially responsible for handling the smoker:

"Give a little smoke at the entrance once or twice, until no more attacking bees seem to come out. Shortly the bees will start to cluster near the entrance, and this is the time to open the hive, because returning bees will join the cluster, and attacking bees will also do so, and not try to attack. Remove the lid, tap the bars lightly with a hive tool, and from the sound you can tell which have full or empty combs, or none, i.e. how far along the hive the bees have built combs. Remove the last top-bar with comb, to create a working

(\*)

A frame-type feeder is convenient, with dimensions to fit the hive being used. A frame is boxed with thin wood or hardboard, and the cracks sealed with hot wax. An opening in the hive allows the feeder to be filled with syrup, and the bees enter through this opening; a float must be provided so that the bees do not drown in the syrup.

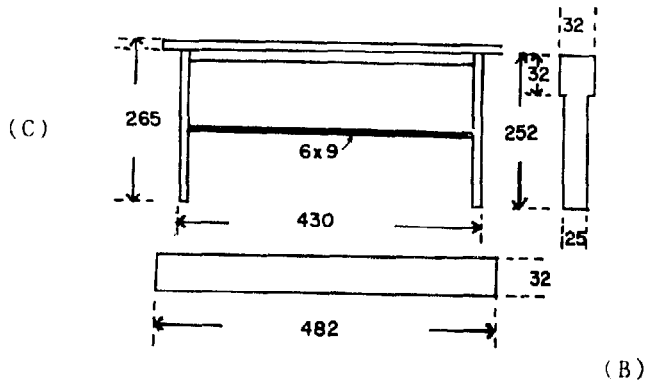
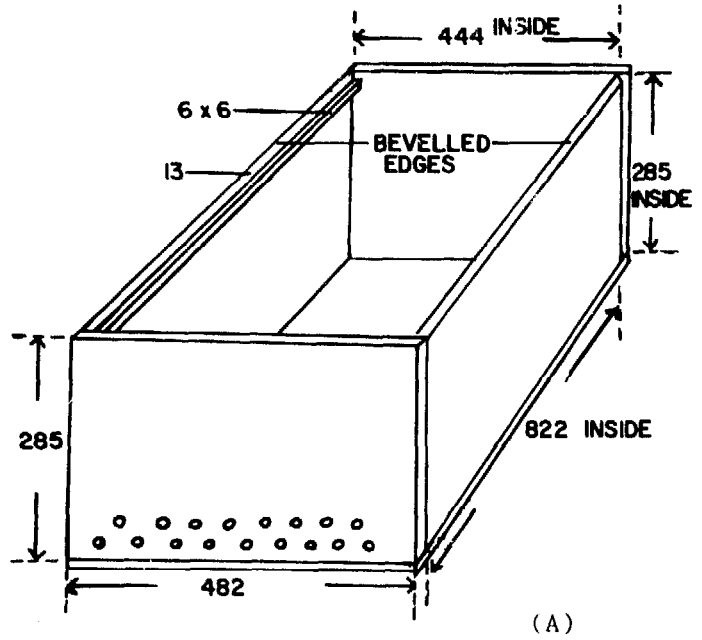
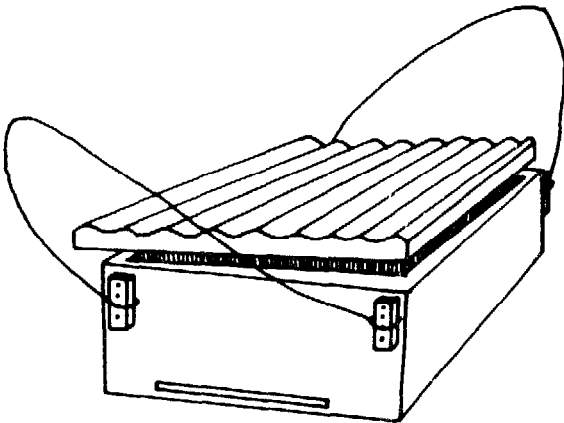
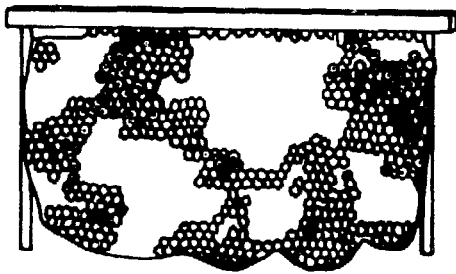
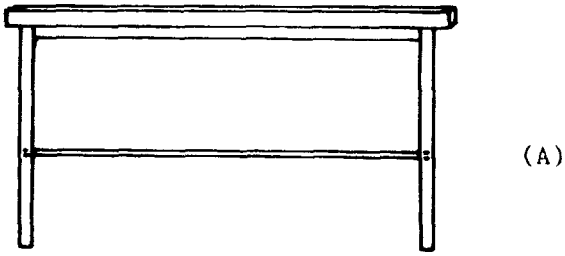

Fig. 4/13 Modified African long hive.  
Drawing: Stephanie Townsend.  
(A) The complete hive.  
(B) Frame, with side-bars and median cross-bar.  
(C) Frame, with comb built.

Fig. 4/14 Modified African hive.  
Dimensioned drawing based on 19-mm lumber.  
Drawing: S. Townsend.  
(A) Body for 25 frames.  
(B) Frame.

space, applying a little smoke also over all the top-bars, and then slowly remove one comb for inspection, and introduce a light amount of smoke. All the time combs are being removed, pass a continuous flow of light smoke over the openings. When each comb is removed, jolt most of the bees off it by a quick blow to the arm, and brush off the rest with a handful of very soft grass. Do not work bees in one apiary for more than 45 minutes; after this time, the first colony operated will start preparing to attack. Do not work them before 1600 hours; a time nearer 1800 hours is preferable, because if robbing starts, darkness will soon reduce it."

## 2. The Modified African Long Hive

The modified African long hive with movable frames (Figs. 4/13 and 4/14) has proved a very useful transition between the top-bar hive and a Langstroth-type, modern movable-frame hive. By providing the frames with side-bars and a median cross-bar (or a thin cross-strip of wood or bamboo), the hive can be transported and the combs handled without breakage. This hive has all the advantages of the Kenya top-bar hive and costs very little more. The dimensions shown in Fig. 4/14 are such that the lid of a Kenya top-bar hive can be used, as can the top-bars themselves.

In building this hive, the upper edge of the box is bevelled to slope down to the outside, so that the box has thin inner edges to serve as supports for the top-bars. A strip of wood 6.5 x 6.5 mm, placed 13 mm below the top-bar supports, is necessary to ensure a correct bee-space at each side for African tropical bees, since there is no bee space at the top. These dimensions must be modified slightly for other bee races. The hive lid is best covered with corrugated galvanized iron, but other waterproof materials can be used. A queen excluder (0.5 cm mesh coffee screen) and a feeder can be used if necessary.

The hive is hung and operated in the same manner as the Kenya top-bar hive. The combs can be cut out and the honey extracted by dripping, or - and this is a real advantage - the honey can be extracted from the combs in a centrifugal extractor designed for frames. The framed combs can then be replaced intact in the hive if the honey flow is continuing; if not, the wax can be cut out of the frame and rendered for sale.

## E. CONCLUSION

It will have been observed that this rapid review of traditional beekeeping around the world is essentially a review of hive construction and use. The reason for this is as clear as it is regrettable: traditional beekeepers - with a few outstanding exceptions - have approached the occupation in a passive manner, contenting themselves with providing bees with an environment as similar as possible to their natural state, and then collecting their honey when it becomes available. There is frequent evidence of efforts to protect the bees and their honey from some of their natural enemies, particularly heat and mammals; the active search for swarms to be installed in hives is not rare; and there are occasional cases of migratory beekeeping, notably in Malta and the Indian hills; but the observation of A. Popa with regard to the developing countries of the Mediterranean basin applies with equal force to Asia and

Africa south of the Sahara, and also, to a lesser extent, to Central and South America: "Traditional beekeeping started very early in this region, and there is evidence of honey-hunting from prehistoric times. As a result, the populations are accustomed to beekeeping, and interested in it, but there has been very little change in methods in the course of the centuries."

Notwithstanding numerous efforts at modernization which will be discussed in Chapter 5, traditional beekeeping remains predominant in all the developing regions; Popa estimates that of the 3.5 million bee colonies in the developing countries around the Mediterranean, 90% are kept in traditional hives, while the total honey production of these countries is less than their potential domestic consumption. It is this last fact, taken together with the considerable export potential for honey, which best justifies current efforts at modernizing this activity or, as one observer has put it, "converting from beekeeping to apiculture."

Nevertheless, it must be recognized that while a true modern apiculture should be the target everywhere, this means for bringing it into existence at all places and in all cultures are still sadly lacking. For this reason, the pragmatic approach is taken in a number of countries: improving traditional beekeeping (and in particular the traditional hives) can in many contexts offer the most promise for rapidly increasing the output of hive products. This "grass-roots" approach should certainly be encouraged, and the work of Nightingale described above is an illustration of what can be done with local resources. Another example is provided by an FAO apicultural development project in Guinea, one of whose medium-term objectives was to create an improved local hive, built with the usual materials and according to usual techniques, requiring no special knowledge for its use but avoiding the destruction of colonies during the honey harvest. It was found possible to prepare such a hive and to develop harvesting methods for it that doubled the output of the original hive and at the same time produced a better quality honey, which after harvesting required no treatment that might reduce its quality (FAO 1980).

#### F. FURTHER READING

Although their primary thrust is the encouragement of modern apiculture, CS/IBRA (1979) and FAO (1984) contain numerous insights into traditional practices, the former in the British Commonwealth, the latter in southern Asia. The Bibliography to this book contains many entries of papers on beekeeping, generally traditional, in individual countries; outstanding among them are Bodenheimer (1942), Mellor (1928) and Singh (1962), which discuss respectively practices in Turkey, Egypt and India; Nightingale (1983), while briefer than one could wish, is fundamental for an understanding of traditional beekeeping among the tribes of Kenya, and of East Africa in general. For a discussion of means of reducing comb attachment to side-walls in transitional hives, see Budathori and Free (1986).

The IBRA Bibliography of tropical apiculture (Crane 1978a and b) is a precious reference source for information on traditional beekeeping; see in particular Part 17, "Indigenous materials, methods and knowledge relating to the exploitation of bees in the tropics", Parts 1 through 6, covering respectively beekeeping in North Africa and the Middle East, Africa south of the Sahara, the Indian sub-continent (with Afghanistan and Iran), Asia east of India, northern Latin America (with Brazil) and southern Latin America; and Satellite Bibliographies S/25 through S/31, on beekeeping and bee research in Egypt, eastern Africa, South Africa, India, Mexico, Brazil and Argentina, respectively.

## CHAPTER 5

### MODERN APICULTURE

The father of modern apiculture, the American Lorenzo Lorraine Langstroth (1810-1895), owes most of his reputation to his invention in 1851 of the two-chamber movable-frame hive, but his contribution to the art is much more extensive than this: he was the first important apiculturist to seek to place beekeeping on a scientific basis, and his early studies of colony management, while they have been supplemented in many ways and corrected in minor details, were fundamental to the creation of apiculture as an industry.(\*)

For while the modern hive is necessary to the success of modern apiculture, it is far from being sufficient. Obtaining the maximum quantity and quality of hive products calls, first of all, for the use of the most productive bee species and races, which may not be the same for all areas; it calls for the optimum availability and use of bee forage, the strict and continuing control of bee diseases and pests, the adoption of satisfactory processing methods, and - perhaps most important because most fundamental - research in all these aspects of beekeeping, adapted to the requirements of each ecological zone. Finally, it calls for a massive dose of humility, even among experts: acceptance of the fact that no one hive type, bee race, forage variety, or management system is ideally suited to all contexts, and in particular that the wide variety of climates and vegetations in the tropics and sub-tropics makes it vital to approach each new ecological situation without bias and preconceptions.

It is beyond the scope of this book to propose integrated solutions to the problem of modernizing beekeeping everywhere in the tropical and sub-tropical world, the range of situations being too large to make such an approach possible. It will be more useful to local beekeepers to familiarize themselves with a few general principles and a few examples of experience already gained elsewhere, which can serve as a basis for their own further investigations.

#### A. HIVE BEES IN THE TROPICS AND SUB-TROPICS

##### 1. Apis mellifera

Apis mellifera is the most widely distributed of the honeybees. A.m. mellifera, ligustica and carnica predominate in Europe, the Mediterranean basin, and North America; A.m. scutellata in Africa south of the Sahara; various local strains in the Middle East, Iran, Afghanistan and the Caucasus; and a hybrid between A.m. scutellata and local strains (the "Africanized bee") has become dominant in Central and South America in the last quarter-century. Many Pacific islands have no indigenous Apis, but European strains were successfully introduced there in the mid-nineteenth century.

(\*) The contribution of his contemporary, the Franco-American Charles Dadant (1817-1902), who developed the Dadant hive, created the first major firm producing beekeeping supplies, and made many contributions to practical beekeeping, was hardly less important, if somewhat less original. Mention should also be made of the pathfinding research in bee biology by the Pole Johann Dzierzon (1811-1906).

The success of A. mellifera among beekeepers is due primarily to its high productivity, combined with its adaptability to differing ecological conditions. The rapidity of the Africanized hybrid's spread through Latin America is a striking demonstration of this adaptability, probably supported by the fact that the "new" bees found ecological conditions highly favourable to their reproduction. Almost all areas in South America where the Africanized bees have advanced strongly seem to be rather dry, with less than about 1000 to 1500 mm rainfall a year. In Africa, A.m. scutellata occurs in a wide range of habitats but seems to be most abundant in Central African plateaux at 1000 to 1500 m, with an annual rainfall of 500 to 1500 mm. This seems to indicate that the successful introduction of a new bee to an area requires that the climate of the new area be compatible with the bee's own preferences; if the 26 queens from East and South Africa that reached Brazil had arrived in a high-rainfall region, they might well not have survived at all. Temperatures are equally important: while the Africanized bees are reported to support short intervals of temperatures as low as -10°C, their spread southward into Argentina was slow, and they appear to have reached little farther south and west than around the 10°C mean temperature isotherm, in the coldest month of the year.

At the beginning of the 20th century, the first known sporadic efforts were undertaken to introduce A. mellifera into the Asian countries, with widely varying results. "Repeated failures" are reported from Malaysia and the Philippines, and "no notable success" from Thailand, while in China, Japan and Korea -- less tropical countries with a history of modern beekeeping with A. cerana -- the experiments were much more successful. The estimated numbers of A. mellifera colonies currently present in certain of the countries, as reported to an FAO expert consultation in 1984, were as follows:

Afghanistan	20 000
Bangladesh	0
Burma	2 000
China	4 000 000
India	3 000
Indonesia	1 000
Japan	320 000
Malaysia	0
Nepal	0
Republic of Korea	280 000
Pakistan	1 000
Philippines	2 000
Sri Lanka	4
Thailand	30 000
Vietnam	16 000

While these figures should not be taken as absolutely accurate (e.g. another report from Vietnam estimates the number of A. mellifera colonies there at 35 000), they furnish a fair idea of a trend: success in China, Japan and Korea, large-scale experiments in Burma, India, Indonesia, Pakistan and the Philippines, some success in Afghanistan, Thailand and Vietnam, and little or no interest in Bangladesh, Malaysia, Nepal and Sri Lanka.

The following summary of a report from Thailand (FAO 1984) is typical of experience in several of the countries of southern Asia: In the early 1950s, the Dean of Agriculture of Kasetsart University introduced a few nucleus colonies of A. mellifera and established the first A. mellifera apiary in the country. The colonies thrived for a few years, but for nearly 25 years there was



no further government research in apiculture. In the meantime, there were several private introductions, mostly to the vicinity of Bangkok, where the honey flow was minimal. None of the introductions was a substantial success, owing largely to pests, diseases, and particularly a lack of understanding of bee biology and colony management. By the early 1970s there were no more than five A. mellifera apiaries in Thailand, with a total of no more than 500 colonies, most of which had been imported, hived, from Taiwan Province, China. About 300 colonies were kept, in or near Chiang Mai, a relatively dry, cool area, in single-story hives using standard frames with comb foundation provided. The success of these operations is difficult to assess: the colonies were heavily fed with sugar syrup all year round, and a few beekeepers were reported to have lost money on their operations. In the early 1970s, therefore, beekeeping with A. mellifera was considered to be a high-risk venture throughout Thailand.

In the late 1970s, however, A. mellifera beekeeping began to succeed in Chiang Mai and neighbouring provinces, thanks to the concerted efforts of researchers, extension workers, and beekeepers. Basic bee research had been undertaken in 1974, and provided valuable background for apicultural development in the country. In early 1978, A. mellifera was introduced in large quantities from California for the establishment of research and demonstration apiaries at Kasetsart University. At an early stage of the project, major nectar sources were identified, and experiments in colony management were conducted which led to the development of a sound model for honeybee colony management. Most of the major problems of seasonal management and disease and pest control were identified and for the most part solved. The experimental colonies thus thrived and were productive, justifying the conclusion that apiculture could be built up in Northern Thailand.

Summarizing the current position in Asia, Kevan, Morse and Akwatanakul have recently written as follows (FAO, 1984):

"Apis cerana is not as productive a bee as A. mellifera, and so considerable efforts have been expended in introducing the latter into various parts of the world. The building of a beekeeping industry with A. mellifera in tropical Asia has been delayed for a number of reasons, many of which are not clear. European honeybees have been introduced repeatedly into all Asian countries .... The bees have always failed in the tropical areas until recently. The fact that large numbers of colonies of A. mellifera are now prospering in Thailand, Burma and parts of India indicates that these problems may be overcome, at least in part.

"Pests, predators and diseases, notably caused by Varroa jacobsoni and Tropilaelaps clareae, have stood high on this list of problems, but may not be the only reasons for the delay in building a successful industry. Predatory birds, insects and other animals are certainly responsible for the loss of a great number of individual bees. The effects of tropical temperatures on bees that evolved in a temperate climate have not been well studied ... The mating behaviour of A. mellifera, which is poorly understood, may have been a problem. There is no question that there is competition for food between Asian and European Apis; pollen shortages may be a greater problem than we suspect. However, we do not know how compatible A. mellifera may be with the Asiatic species in different places and seasons in the tro-

pics. Successful beekeeping is based on having an abundance of nectar and pollen plants in the area. Beekeepers do not plant for honey production. They seek out areas where these plants are in great abundance and build their apiaries in these locations. These are the very places where native bees are likely to be abundant.

"It is obvious that there are still many constraints and unexplored areas as regards beekeeping in tropical Asia. It is important to identify the most important of these and to investigate them thoroughly. From such research will come guidelines that will aid in the building of a sound industry."

Warnings have been sounded, however, to the effect that introducing new bees into an area is not without risk, and a recent article(\*) called for great caution in this respect. It pointed out the greatest dangers in introducing new bees into an area:

- (a) the introduction of diseases and parasites: European and American foul brood, acarine disease and the Varroa mite have been gratuitously introduced into various developing countries in this way, to the lasting detriment of their apiculture;
- (b) the permanent loss of genetic material that could be valuable for beekeeping;
- (c) the introduction of unsuitable bees with a resultant reduction in the productivity of beekeeping;
- (d) the possible reduction of populations of native bees other than Apis (e.g. Trigona), through competition for food.

With a view to eliminating -- or at least reducing -- these dangers, and at the same time ensuring new introductions every chance of success, the article proposes the following guidelines for the introduction of exotic bees (primarily A. mellifera) into new areas:

1. Bees must never be introduced into a new area unless --
  - (a) the characteristics of the native honeybees have been adequately assessed;
  - (b) the bees introduced are perfectly healthy and free of parasites;
  - (c) the bees introduced have no characteristic that is disadvantageous for their use in beekeeping (e.g. inbreeding, poor performance, unacceptable behaviour characteristics such as excessive "aggressiveness").
2. No combs or used beekeeping equipment should ever be introduced, because their potential as disease and pest carriers is high.
3. Bees should be imported only from countries or areas(†) which --
  - (a) are free from serious bee diseases, and have no bees with undesirable genetic characteristics;

(\*) Bee World 63(1) : 50-53 (1982), which includes a list of references.

(†) The article suggests that Pacific islands, including Hawaii, may well be the first choice, then New Zealand, and finally certain careful suppliers in the mainland USA and Canada.

- (b) maintain effective bee quarantine and disease control programmes;
- (c) can certify the health status of export shipments.

4. Bees should be introduced only under rigid quarantine conditions, and import permits should be granted only to institutions and individuals maintaining strict compliance with quarantine requirements.

5. Before any major introduction is undertaken, a pilot scheme should be carried out in an area as isolated as possible. The behaviour of the introduced bees under local conditions should be studied, and if other Apis species are present, any robbing, competition in foraging or other interactions between species should be investigated.

6. Transport questions.

- (a) The most common transport of bees is of a young mated queen in a cage with a few accompanying workers. The cage should be destroyed on receipt, and the workers (labelled by the reference number of the hive into which the queen is introduced) sent to a competent authority for diagnostic examination. Only the queen should be allowed contact with bees or hive materials in the new area.
- (b) The best available way of introducing bees in bulk is to transport package bees, in new boxes having had no previous contact with bees.
- (c) As far as is known, adult bee diseases are not transmitted by immature stages of honeybees, and for this reason methods have been developed for transporting honeybee brood between continents in an incubator, without comb. Drone semen can be deep-frozen and transported without risk of disease transmission, for subsequent use in artificial (instrumental) insemination of queens.

7. Subject to the foregoing general restrictions --

- (a) there is no apicultural objection to introducing bees to an isolated area entirely without honeybees, such as some Pacific islands, although there may be other ecological objections, e.g. if the introduced bees compete for food with endangered native non-Apis species;
- (b) the introduction of European-type A. mellifera into an area where no honeybees are native, but where similar bees have previously been introduced (e.g. Central America), may be permissible. Such introductions may, however, result in hybridization with bees already present, and this may or may not be desirable. In no circumstances should new bees be taken to a "sanctuary" area where previously introduced bees have for some reason been isolated and now form a genetically valuable resource. An example is Kangaroo Island off South Australia, which has purer "Italian" bees (A.m. ligustica) than now exist in Italy or anywhere else;

- (c) where native *A. mellifera* bees exist, there is danger in importing foreign bees of the same species, because new genes may then contaminate the local gene pool, and a genetic breeding resource may be lost. This may not matter if the bees in the area are already very mixed as a result of many past introductions, but if there are isolated populations, genes valuable for breeding may disappear forever; this can be true in particular of parts of Turkey and North Africa;(\*)
- (d) where native tropical *A. mellifera* exist, as in tropical Africa, introductions from temperate zones may well fail to survive, for lack of several adaptations to life in the tropics;
- (e) where *A. cerana* is native, in Asia, introducing *A. mellifera* can have a variety of results. In some areas, both species may co-exist. In others, the introduction may lead to the extinction of the local *A. cerana*; this process is almost complete in Japan, for example. Alternatively, competition between the two species may lead to the extermination of the introduced *A. mellifera* because *A. cerana* is better at exploiting the local food resources; on the other hand, *A. mellifera* can be very productive in areas with introduced agricultural crops that are good honey sources (e.g. *Euphoria longan* in Chiang Mai, northern Thailand) even though *A. cerana* is better at exploiting native honey sources;(†)
- (f) Where *A. cerana*, *A. dorsata* and/or *A. florea* are present, complications arise with the mating of queens of introduced

(\*)

Some successful introductions of European-type *A. mellifera* have been made into the territory of other *A. mellifera* bees that is not too dissimilar from the native region of the introduced bees. Such importations have been on a large scale and constantly repeated, so that hybridization with the local bees was minimized. An example is the introduction into Israel of *A.m. ligustica* to replace the native *A.m. syriaca*, which are rather unproductive, "aggressive" and otherwise difficult to handle. According to Dr. Y. Lensky, "Prior to the large-scale replacement of the native *A.m. syriaca*, observations on the introduction of Italian queens into *A.m. syriaca* colonies were made for several years. Introductions were successful when either mated queens or queen cells were placed in small *A.m. syriaca* colonies. Hybrid queens must constantly be replaced by Italian queens, because of the influx of *A.m. syriaca* drones (from outside the area). To preserve the Italian genes, every year we import several hundred Italian queens from California and Australia and distribute them among queen-breeders and beekeepers..."

Introductions have also been maintained in areas of other countries (e.g. Burma, the People's Republic of China and Thailand).

(†)

Information on the introduction of productive *A. cerana* strains into other tropical countries to replace less productive *A. cerana* strains is insufficient for comment.

A. mellifera, because the sex pheromone that attracts drones to the queen is the same for all species, and the presence of many drones of other species may prevent drones of the same species obtaining access to the queen and mating with her;

- (g) the well-documented results of introducing tropical A. mellifera from Africa into Brazil indicate that under no circumstances should tropical African bees, or Africanized bees from America, be introduced elsewhere.

## 2. Apis cerana

The emphasis placed on Apis mellifera, especially since World War II, has led in certain countries to what is probably unjustified neglect of A. cerana as a hive bee. With respect to one country in particular, it has been observed that "if they had spent as much money and energy on improving Apis cerana as they have spent on introducing Apis mellifera, they would probably have obtained the same results in terms of productivity, or even more." A bee species which has been native to an area for thousands of years will have developed races well suited to its survival and success, and where traditional beekeeping with A. cerana already has a long history, the adoption of modern management techniques -- including the breeding of improved races -- may yield satisfactory results without unnecessary tampering with the environment through the introduction of exotic species.

India offers a striking example of efforts which may in the long run prove to have been misguided, despite some limited initial successes. With its estimated annual production of 18 000 tonnes, India is one of the leaders in world honey production, and almost all of this total is produced by A. cerana indica. According to a report of L.R. Verma, submitted to the 1984 FAO Expert Consultation on Beekeeping with Apis mellifera in Tropical and Sub-Tropical Asia, A. mellifera was introduced in the 1960s into the plains of the Punjab and the lower hills (below 1500 m) of Himachal Pradesh; the area now contains about 2500 colonies of A. mellifera (race not specified) and 30 000 colonies of A. cerana indica in modern hives. The report states that "A. mellifera produces three to four times more honey as compared to A. cerana indica," but that "practically no work on the genetic improvement of A. cerana indica has been done. In fact, information about its biological, economic and morphometric characteristics is needed as a basis for its improvement by selection and breeding." The self-evident first guideline for the introduction of exotic bees cited above ("Bees must never be introduced into a new area unless the characteristics of the native honeybees have been adequately assessed") has thus been neglected, and this may have contributed to the premature introduction of A. mellifera, and thus to some of the difficulties reported as having been experienced: robbing by A. mellifera, infection of A. mellifera with acarine disease as the result of robbing, danger of extinction of A.c. indica in northern India, inbreeding of A. mellifera, etc. Be that as it may, comparing the productivity of selected strains of one species with that of unselected strains of another is not likely to yield scientifically acceptable results which would serve as a valid basis for action in the development of apiculture in the area concerned.

The same meeting received a report from the Republic of Korea along the same lines: "The average honey yield... will probably be increased, especially

with the continued replacement of unproductive native bees (i.e. A.c. sinensis?) with the elite lines of European stock..."

Other countries are adopting a different, and perhaps more realistic, approach. Malaysia, for example, reported that introducing A. mellifera created "unknown risks, such as the long-term effects on the local flora and the risks of accidental importation of diseases not found locally... The aforementioned problems and the concomitant risks posed by the introduction of A. mellifera into the country underscores the need for concerted action in future introduction attempts. However, it is felt that Malaysia should first concentrate on work with the indigenous bees before making any further attempts to introduce the temperate bees. The priority developed by the beekeeping research team is to complete the present research and development programme on A. cerana and later move on to A. mellifera..." Pakistan, again, reports that research being conducted includes "studies on A. cerana (PARC and Swat strains) and on A. mellifera (Caucasian and Italian strains), using the best management techniques at various locations to determine the relative honey production capabilities of these bee species and their strains," and also "the improvement of A. cerana for low propensity to swarming, better ability to develop large populations, reduced aggressivity and production of higher honey yields in different locations."

B. THE MOVABLE-FRAME HIVE

1. Principles of the Movable-Frame Hive

The modern beekeeper, even more than his traditional predecessor, is interested in obtaining the greatest possible yield of good-quality hive products (particularly honey) at the lowest possible investment in labour and capital. The simplest, cheapest hive, operated on a simple honey-gathering basis, does not generally permit the tropical beekeeper to obtain large quantities of honey, and the product he does obtain, mixed with wax, brood and other impurities and often insufficiently ripe, can only exceptionally meet urban commercial standards. Some investment, and some attention to management, is necessary to beekeeping as an industry, even at the village level. The modern movable-frame hive, relatively inexpensive and easy to build and operate, makes it possible to obtain combs of honey, unmixed with brood, that can be fully separated from its wax by centrifuging if desired, and at the same time it also facilitates inspection of the interior of the hive, thus making good bee management possible.

In conception this hive is based on two of the behaviour characteristics of bees; (1) their tendency to install their brood low in the hive, as near the entrance as possible, and their honey reserves above and around the brood, as far from the entrance as possible, and (2) their tendency to maintain an equal space, known as a bee space, between combs (see Fig. 1/3).(\*) L.L. Langstroth found that it was possible to divide the hive physically into two parts, a brood chamber below and a honey chamber above, separated by a grid

(\*) The discovery that this bee space is invariable for each race of Apis is said to have made the design of the modern hive, and therefore modern beekeeping, possible. Indeed, the success of the modern hive depends on the fact that the bee space it provides is calculated according to the bee race used, and is constant for it, although the space in the brood chambers is often less than that in the honey chambers.

whose openings were large enough to let worker bees pass, carrying honey, but too small for the queen. The effect of this queen excluder is thus to allow the workers to store honey in an area which the queen has no access for laying, and which will therefore contain combs of regularly capped honey without brood. The hive, then, generally consists of a roof and cover, a floor, and a series of two or more boxes, the lower one or more for the brood, and the upper one or more, called supers, serving as the honey chamber.

Suspended within each of the boxes, which are fitted out with runners like a suspension filing system, is a series of movable frames (whence the general name of the hive), each carrying a wax sheet which has been pressed into a pattern of hexagons of the size adopted by the queens themselves for lodging their worker brood. The bees accept this man-made contribution and build cell walls out from the foundation sheet provided, using both wax from the sheet and wax they excrete themselves. So that the frames can be removed individually from the hive, they must be precisely built and positioned on all sides by the runners and spacers which maintain a bee space of between 6 and 10 mm all round except where the frames are in contact with the runners and spacers (see Fig. 5/1). Bees will close up any gap round a comb that is smaller than a bee space, attaching the comb to the adjacent surfaces, while if a gap is left that is greater than this critical distance, the bees will use it to build extra burr comb; either will make it difficult, if not impossible, to remove the frames without breaking the comb and thereby damaging the colony or losing a part of the honey crop, as the case may be.

The original spacers were metal pins protruding horizontally from the top of the frames and fitting into notches in the runners. However, when the bees deposited propolis in and around the notches, the pins were easily broken, and in any case the frames had to be handled one at a time to remove them from the notches, lest the pins bend or break. Further, when the hive is transported, a frame suspended from two pins can swing back and forth, crushing the bees. For these reasons, among others, beekeepers today tend to adopt frames equipped with the Hoffman side-bar. In this frame the top-bar is prolonged to bear on the runners, while the upper fourth of the side-bars is broader than the other three fourths, the breadth being calculated to provide the needed bee space. This system also has its critics, however. The protruding edges are said to make decapping the comb somewhat more difficult, and bee strains which tend to propolize heavily can weld two frames together so solidly that it is almost impossible to move them without breaking them.

One of the chief differences among the numerous types of hive is the size of their frames, which directly affects the size and the weight of the entire hive. The interior dimensions of the Langstroth super frame are roughly 430 x 200 mm, but the original Dadant variant of the Langstroth hive had frames of 400 x 300 mm. Most Dadants currently in use employ Langstroth dimensions in the supers and have larger frames (roughly 430 x 270 mm) for the brood.(\*). The

(\*) A Langstroth frame full of honey weighs about 3 kg, so that a full Langstroth super will weigh over 30 kg, including the weight of the box, and even more if the weight of the bees present is taken into account. On the same basis, a full Dadant super will weigh over 40 kg; the difficulty of handling weights of this order manually explains why Dadant supers are relatively little used, especially since it is always possible to use two or more of the smaller, lighter supers, stacked vertically.

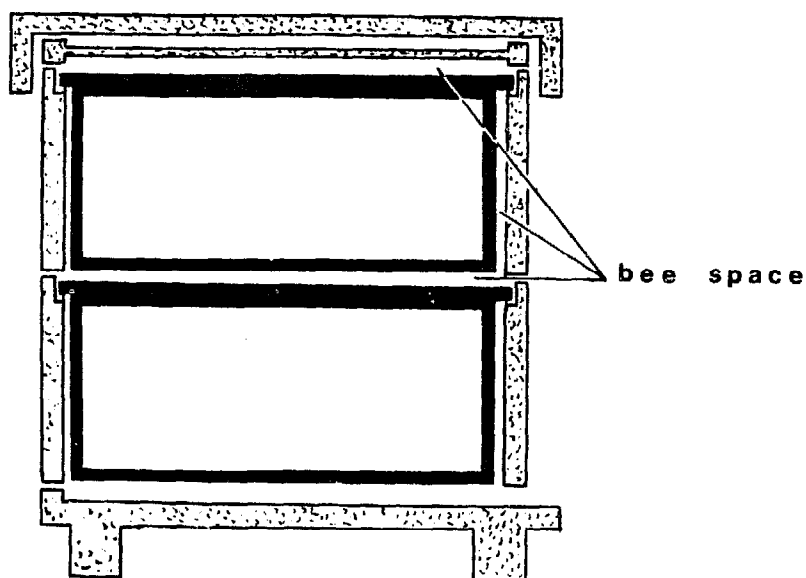

Fig. 5/1 Section through a movable-frame hive, showing suspended frames in place, leaving a bee space all round. The hive shown has two boxes, a floor, an inner cover and a roof.  
Source: G.M. Walton in Bee World 56:109-119 (1975).

Langstroth hive generally contains 10 frames(\*); the Dadant can contain 10, 12, or (exceptionally) even 15, but the 10-frame is often preferred for ease of handling; many Dadant users adopt a pattern of 12 frames in the brood chamber and 10 or 11 in the supers, which have to be moved more often and should therefore be somewhat lighter. Depending on the thickness of the wood used in the hive walls, the overall dimensions of a normal Langstroth box are thus about 51 x 37 x 24 cm, while the Dadant will be about 7 cm higher and somewhat wider; when more than one brood chamber and/or super is employed, the total weight of the hive will be increased correspondingly.

In older hive models, the entrance is provided by shortening the front panel of the brood box, leaving an empty space between the box and the hive floor. More recently, hive floors, or bases, incorporate a special entrance which can be enlarged or narrowed as circumstances command. In most tropical locations, the hive floor must be placed on a hive stand about 50 cm above the ground, as protection against toads, ants, other pests and predators, and the encroachment of vegetation. The stand can also be used as a base on which to strap the hive down during tropical cyclones, etc.

(\*) Eight-frame Langstroths are in use, and giving satisfactory service, in Papua New Guinea. When bees are kept for purposes other than honey production (e.g. queen rearing, pollination, etc.) even smaller hives are often used; in Japan, six-frame and even four-frame hives are employed when colonies are rented as pollinators of crops grown under glass.



Under humid conditions, as has already been observed, bees have difficulty in removing the excess moisture from honey during the ripening process. Unless the moisture-laden air is vented from the hive, condensation can occur within, obliging the bees to evaporate the moisture again and creating an unhealthy, stressful environment for the colony. The roof in tropical countries must therefore be designed not only to protect the colony from the weather, pests and predators but also to allow for ventilation, in particular the escape of hot and humid air. (Bees remaining at the entrance, or clustering loosely on the front face of the hive, indicate colony overheating, although such activity can also be induced by insufficient storage space within the hive or merely by entrance congestion.) A number of roof designs incorporate means of ventilation; according to many beekeepers, the best is a lid with a cavity between a horizontal sheet and two slightly inclined roof boards joined at the top, although this arrangement makes it difficult to stack hives when transporting them.

Efforts to build plastic hives have been made repeatedly over the last quarter-century, but most hives currently in commercial use are still built of wood, which is not too fragile, relatively inexpensive, reasonably easy to work, reasonably light and a poor conductor of heat, an advantage because overheating in the hive is a constant danger, especially in tropical countries. The major disadvantages of wood are its vulnerability to the weather and to ants, termites, etc., its tendency to warp if not properly seasoned, and its relative scarcity in some areas.

In one FAO project in Guinea, three different woods were used in building Dadant-type hives: iroko, a hard wood, weather- and insect-resistant but heavy, was chosen for the hive body and floor, which remain in the field all year round and are never moved except for migration; fraké, lighter, and requiring to be painted or otherwise treated, for the supers and the roof; and samba, a very light deal-type warp-resistant wood, for the frames.

In tropical climates, with their extremes of heat and humidity, it is especially important to ensure that the wood selected is fully seasoned and also, wherever possible, that it be insect-resistant. Where no such woods are available, the wood finally chosen must be painted or treated with a good preservative to protect it. White pine may be more readily available than resistant woods, and lighter to handle than some others, but it must be treated before use, or it will only have a short life. Paraffin wax is an effective preservative completely safe for bees; the equipment is dipped into very hot melted wax (about 158°C) for two minutes. The other wood preservative that is relatively safe for bees is copper naphthenate; equipment can be painted with it, or dipped in it, possibly followed by paraffin wax treatment. Any beekeeping equipment treated with a wood preservative must be allowed to dry well, and air, before use. If a paint only is desired, the best material is an oil-base paint containing aluminium, but it will not protect wood as will paraffin wax.

## 2. Hive Types

Several different basic types of hive exist, and most of them also have variants designed to take different apicultural circumstances into account. This diversity -- as well as the diversity of expert opinion concerning the respective merits and demerits of the different types -- makes it impossible to discuss them more than briefly here.

The beekeeper's choice of hive will depend on a number of circumstances. Thus, as will be seen below in the discussion of seasonal cycles of bee management, the life cycle of the bee is different in temperate and tropical areas, and this has a direct effect on the optimum configuration of the hive: whereas temperate-zone beekeeping may require the use of two, three or even four brood boxes for each colony in spring and summer, a single brood box is usually sufficient throughout the season in the tropics, although in some cases a "Jumbo" brood box, with frames much deeper than normal, is required. The use of a single brood box makes the manipulation of aggressive bees much easier, because only one hive box need be uncovered to examine the brood nest.

Again, since wax moth is a serious problem in much of the tropics, the colony must at all times be confined in a space small enough to be protected against it, and this consideration will clearly affect a decision on hive size. In the tropics, too, many areas have more than one honey flow a year, the production from each of them being less than from a single flow in the temperate zones. For storing these lesser quantities, supers shallower than the normal may be adequate; in addition to limiting the volume of the hive as protection against wax moth, such supers have the advantage that, being lighter, they are easier to handle, and that in them, comb breakage is minimized when hives are hauled over rough trails.

It will be seen, then, that under certain conditions colony management may call not only for adding and removing brood boxes and supers, but even for changing the model used at different times in the seasonal cycle. For this reason alone, no one hive or configuration can be considered as "the best" under all circumstances.

Several dozens of hive types for Apis mellifera exist, but almost all of them are variants of the original Langstroth hive (Figs. 1/7 and 1/8), which is in most general use throughout the world, or of its principal competitor, the Dadant hive, which itself is a variant of the Langstroth with the essential difference that in the brood chamber of the Langstroth, as already mentioned, the frames are smaller than in the Dadant. The result of this difference is striking. The brood-chamber frames of the Langstroth hive are large enough to contain the brood and pollen under normal conditions (or otherwise an additional brood chamber can be installed), but they can contain only very little of the honey the bees need for feeding the brood and for keeping alive during dearth periods. Almost all the honey collected is stored in the supers, where it is easily available to the beekeeper without disturbing the brood chamber. The larger frames of the Dadant brood chamber enable the bees to store a much greater quantity of honey there and to have access to it when needed.

In most tropical and sub-tropical areas, honey flows are not as pronounced as they are in intensely-cultivated areas of the temperate zones, nor are dearth periods as severe; in many places, indeed, minor sources of nectar are often available even during the dearth periods. This being so, less honey-storage space is needed by the colony, and therefore the greatest advantage of the Dadant hive is minimized in such areas, while its major disadvantage (greater size and weight) does not disappear unless it is not planned to move the hive (e.g. for transport to honey flows elsewhere) or unless equipment for moving it mechanically is available. On balance, then, it can be said that while both hives should be tested on the terrain where a major project is contemplated, first preference can be given to the Langstroth hive for smaller-scale A. mellifera operations. It is considered by many experts to be the logical choice where A. mellifera bees of a gentle type are used, where there



Fig. 5/2 Apiary of Apis cerana in Newton hives, on a rubber estate.  
Photo: R.P. Phadke.

are few predators (especially ants), where facilities are available for the precise cutting of hive parts, where good extension services exist, and where subsidies or credit can be obtained. It is also said to be the hive best suited for harvesting hive products other than honey and beeswax, and for some types of research, particularly into queen and bee production and improvement.

In tropical South America, Africanized bees are more prolific than the bees of European ancestry previously there, and the use of two or even three brood chambers is often advisable in areas with abundant forage. Where forage is less abundant, only one brood box is used, with honey supers as required. In the semi-desert zones north of the Sahara in Africa, on the contrary, bee forage is limited, and while in some areas an 11-frame Dadant hive is used for local races of A.m. scutellata, a modified Langstroth frequently appears to be more suitable: either a 5-frame hive so disposed as to make it possible to join two hives together for the major honey flow, or a 10-frame hive with a special vertical divider used to adjust the volume occupied by the colony according to its stage of development.



Fig. 5/3 Apiary of large-bodied Apis cerana in Langstroth hives, in northern India.  
Photo: R.P. Phadke.

In short, the Langstroth hive is the type most commonly used for A. mellifera throughout the world, and particularly in the tropics. It is significant that the top bars of the Kenya top-bar hive are of Langstroth length.

The wide range of body sizes of different races of Apis cerana necessitates the use of different sizes of hives for them; both Langstroth and Dadant are much too large for any but the largest bees. Three types of movable-frame hive have been in common use for A. cerana in India during the past half-century. The smallest, the Newton hive (Fig. 5/2), accommodates seven 203 x 140 mm frames in the brood box and seven 203 x 64 mm frames in the honey super. The Jeolikote, or Villager, hive used in the north takes ten 305 x 178 mm frames in the brood box and ten 305 x 89 mm frames in the super. In the extreme north of the country some use is made of the 10-frame Langstroth (Fig. 5/3), and where this is rather too large for the larger A. cerana there, the British Standard hive is being used experimentally.



Fig. 5/4 Apiary of Apis cerana in ISI Type A hives, in a forest in southern India.  
Photo: R.P. Phadke.

More recently, the Indian Standards Institution (ISI) has defined two standard 10-frame hives, Type A (Fig. 5/4) using 210 x 145 mm frames in the brood box and 210 x 65 mm frames in the super, and Type B, whose frame dimensions are 280 x 175 mm and 280 x 85 mm respectively. Currently, India has about 700 000 A. cerana colonies in ISI standard hives, and about 6 000 in Langstroths(\*).

In Bangladesh and Sri Lanka, variants of the Newton hive are used for A. cerana, while in other Asian countries the design of movable-frame hives for A. cerana is based on the Langstroths in which A. mellifera was first introduced. China reports (FAO 1984) production of 20 kg per colony per year using a standard 10-frame hive whose frame dimensions (420 x 250 mm) are similar to

(\*) Several thousand A. mellifera colonies introduced into the Punjab and Himachal Pradesh are also kept in Langstroth hives, as are most A. mellifera colonies introduced into other Asian countries.

those of the Dadant hive. In Indonesia, on the contrary, "only a few apiaries ... are using movable-frame hives, but without the proper bee space, so in many cases bees build additional combs between the frames. It is almost impossible to pull such combs out of hives for inspection or, if full of honey, to remove them for extraction without destroying them. The advantage of movable-frame hives is therefore completely lost." (It appears likely that the beekeepers in question are attempting to use unmodified Langstroths or Dadants for the smaller local A. cerana.) It is reported from Pakistan that the Langstroth or other modern movable-frame hive is used by professional beekeepers as well as by teachers, professional soldiers, small-scale businessmen and public servants, operating apparently on a "hobby" basis.

Pakistan (FAO 1984) also has two interesting local adaptations of the movable-frame hive, of which the first is derived from the wall hives and pitcher hives mentioned in Chapter 4. Used in Swat and Hazara, "the wall movable-frame hive consists of a cavity containing movable frames in the wall of a house. Sometimes it includes a pitcher with movable frames placed in the wall." Pakistan's cement- or mud-wall movable-frame hive, used by some beekeepers in Hazara, is built like the Langstroth, but its walls are of a mixture of cement and sand (1:3 by weight), clay and chopped wheat straw (16:1 by weight) or "multani mitti", newspapers, fine wheat flour and agave leaves (6:4:2:1 by weight). It would be desirable to have more information on such hives and their suitability; if it is found that such low-cost local materials can be successfully and extensively used in modern hive construction, it would be a very encouraging development indeed.

### 3. Hive construction

A discussion of the theory and practice of hive construction in tropical and sub-tropical countries lies outside the scope of this book. The principles are the same in all zones, and most beekeeping manuals published in the developed countries contain detailed descriptions and scale drawings which apply generally to the basic hives and require only relatively minor modifications to make them suitable for most tropical and sub-tropical beekeeping. Several general points should however be underlined here.

First and foremost, it must be recognized that very few developing countries have enough resources in terms of foreign exchange to enable them to engage in the large-scale import of beekeeping materials; the best that can be hoped for, often with the backing of foreign aid programmes, is to import a minimum of hives and other material for the necessary initial experimentation and research on local bees and other environmental factors. Fortunately, most hives are simple enough that, given adequate supplies of wood and other raw materials, they can be manufactured locally by woodworkers. (Such local manufacture has the added advantage of providing employment and in-service carpentry training in rural areas where they are badly needed.) A final advantage is that local manufacture allows for flexibility in design: if it is found that changes in design to meet local situations are desirable or necessary, they can be made rapidly and simply, and existing hives modified, at minimal cost in labour and capital.

Secondly, it is encouraging to note that successful innovations in beekeeping can be adopted rapidly all over the world. Thus, the pioneer work accomplished in Kenya in developing hives intermediate between local traditional hives and modern types (see Chapter 4) has served as a model for similar work in

Nepal, where transitional hives based on the Kenya top-bar type are being used for Apis cerana (Free, 1985). Prof. F.H. Townsend (1985) writes further, "The example in Kenya is being adopted in other areas where there is a suitable infrastructure and experts who are interested in helping the poorest people rather than developing a commercial enterprise for the already rich. It is already being used extensively in Uganda, Colombia and even in the hills of Kentucky in the USA."

It must be emphasized once again that if movable-frame hives are to give satisfactory service, they require precision in construction, and therefore that suitable woodworking equipment be available and properly used. A recent report (FAO 1984) notes with understandable irony, in regard to one Asian country, "At present, two types of hive are in use: the Dadant and the Langstroth... The frames are built according to the complicated American model. They are very good in the USA, where they are cut on special carpentry machines. Here they are often built with the aid of hand-saws only, and as a result they are crooked, and this raises serious difficulties in handling hives with bee colonies."

A more satisfactory situation is reported (FAO 1980) from an FAO apicultural development project in Guinea. From the outset, one of the essential objectives of the project was the manufacture of modern hives adapted to the local bees, in quantities necessary to meet the needs of the National Apicultural Centre, agricultural training schools, etc. Woodworking machines were ordered as soon as the project was implemented, and a building was constructed to house them. (It was subsequently decided to enlarge the building to provide room for seasoning wood and stocking hives; the final overall dimensions of the building were 40 x 10 m.)

When the building was ready, the machines arrived and preliminary experiments with imported hives took place. An expert installed the machines and set them to work, organized and equipped the workshop, built work-benches, trained staff to use and maintain the machinery, and finally built several prototype hives for testing. A second expert, arriving a year later, pursued the worker-training programme and initiated work on a series of 25 hives, since training in working in series and in using patterns was essential to the production of a sufficient number of hives.

Difficulties were of course encountered: supplies of suitable wood were irregular, the training of personnel to produce precision work on a regular basis was not always easy, and supervisory staff was inadequate, but it was found that a well-organized shop of the type and dimensions foreseen, with a staff of five including the shop foreman, could produce between 1500 and 2000 hives a year.

It is disturbing to observe that the emphasis placed on local hive construction by this project is somewhat exceptional, and that in fact insufficient attention is paid in tropical countries generally to the problem of the hive. It is almost certain that suitable locally-built hives could contribute to a considerable increase in honey production: F.H. Townsend has pointed out, for example, that "a better hive for Apis cerana, possibly of clay, could go a long way toward reducing absconding" (1985). But none of the countries reporting to the 1984 FAO Expert Consultation already referred to mentioned unsatisfactory hives as a major constraint, or appeared to envisage hive improvement as a priority question for research.

#### 4. Comb Foundation

The correct use of beeswax comb foundation ensures that the comb is positioned and built correctly within the frame, and that it is almost entirely composed of worker cells. The cell size on the foundation is determined by the size of the die on the roller or mould used to press it, and varies -- often considerably -- depending on the species and race of bees. Thus, for European Apis mellifera the cell size best suited is 814-857 cells per dm<sup>2</sup>, while the FAO project in Guinea already referred to found, after a series of careful measurements, that the proper size for the worker cells of the local (Fouta Djallon) colonies of A.m. scutellata was 1030-1090 cells per dm<sup>2</sup>, whereas the honey cells in the supers could still be in the 850 range.

Some comb foundation strengthened by embedded wire or a plastic central core is produced by commercial firms, but these sheets must still be secured firmly to the frame, and may require additional wiring support. The most commonly accepted method of wiring is to attach the wire firmly to the frame and then to embed it into the foundation sheet by passing a slight electric current through the wire to heat it momentarily.

Commercially manufactured Hoffman end-bars for frames, designed to maintain the proper bee space between combs, are drilled with three or four holes for wire, spaced 50 mm apart. A frame equipped to receive four strands of wire provides a stronger comb and better support under tropical conditions. The wax foundation sheet must also be held firmly to the top-bar of the frame, and this can be achieved by running molten wax or glue along the groove in the top-bar. Even with the best support, however, frames can sag or collapse completely if exposed to excessive heat.

Like hives, comb foundation for use in the tropical and sub-tropical developing countries should be manufactured locally, once the initial experimentation stage is past. A hand-operated mould, prepared with a die of the proper size for the local bees, is adequate for this work if properly maintained, especially since many reports indicate that beekeepers in developing countries often have great difficulty in procuring imported foundation. If honey is extracted by centrifuging and the comb is then returned to hive (not exposed in the open) for bees to clean, it is not necessary to renew all the foundation after every honey crop, and the wax obtained from decapping will normally suffice to meet the beekeeper's current needs. Needless to add, used comb must be carefully protected against wax moth while it is stored out of use.

#### C. DISEASE AND PEST CONTROL

One of the greatest advantages of the modern hive, as already pointed out, is that it enables the beekeeper to inspect the interior of his hive regularly to determine the health of his colony, and to take any measures he finds necessary. When he fails to do this, he is failing to make the best use of his hive.

In general, the bee diseases and pests are similar in all the climatic zones of the world, and if they are particularly troublesome in the tropics it is often because less effort is made there to control them. Methods of treatment are equally efficacious everywhere, although an increasing number of countries are tending to prohibit the use of antibiotics on bees because of the



implications of such treatment for human health. Otherwise, the beekeeping manuals published in the developed countries usually contain full details on the diagnosis and treatment of bee diseases and mites, and their indications are equally applicable in the tropical and sub-tropical world.

This being so, the point which most needs emphasizing here in this connection is the need for beekeepers to learn to inspect their hives and to recognize the symptoms of any diseases encountered, in order to provide for their rapid treatment. One infected hive is not necessarily in itself a major problem, but when it is considered that one hive can easily infect an entire apiary and thus be the indirect cause of serious losses, it will be seen that disease and pest control is a matter to be taken very seriously. Strict observation of the guidelines on the introduction of exotic bees, set out earlier in this chapter, can be specially useful in impeding the spread of pests and diseases across national and regional frontiers.

#### D. IMPROVED UTILIZATION OF THE HONEY POTENTIAL OF THE LAND

Between 1970 and 1980, in the Gascony region of southwestern France, beekeepers found their average honey crops doubled, as the surrounding farmers gradually abandoned the cultivation of alfalfa and replaced it with rape and sunflower, which are better honey plants. Since beekeeping is only a secondary agricultural activity, and can only under exceptional circumstances be more than that, farmers' year-to-year planting decisions cannot be taken on the basis of the honey-producing capacity of their crops, but this example shows the great extent to which planting decisions can affect honey yields. What did occur, in fact, was that an increasing number of farmers, learning that beekeeping with these crops could, at little cost in labour and capital, provide them with an additional source of income, began to adopt apiculture as an auxiliary activity, with the final result that it became a valuable secondary industry throughout the area.

Another example from the same region illustrates how beekeepers can increase their production by responding to exceptional circumstances. In 1984, as the result of a prolonged dry period, the sunflower crop failed, and the nectar flow lasted only four or five days. One small area, however, was hit by a series of summer storms which reactivated the nectar flow. Several enterprising beekeepers immediately carried their hives to the area in question, and obtained harvests averaging 50 kg of honey per colony, while their less alert colleagues were producing only about 10 kg.

The lesson that can be drawn from these two special cases, for the tropical and sub-tropical regions as a whole, is that one of the most obvious means of using bees to exploit existing plant resources more fully is to increase the number of colonies and hives, particularly in areas rich in bee forage. (Care must of course be taken to limit this increase to the number of colonies that can forage without decreasing the yield per colony.) This activity may be impeded by lack of service roads, especially in forest areas where the hives must be migrated to benefit from specific honey flows.

In very special circumstances it may also be possible -- and therefore desirable -- to increase the plant resources themselves, through the introduction of plants yielding relatively large quantities of honey and that thrive in areas that are accessible. A note of warning must however be sounded in this connec-

tion: many parts of the world have suffered economic loss because plant diseases, parasites or undesirable genetic characteristics have been introduced with new plants. The environment can also suffer: if a vigorous plant is introduced into a new habitat, in which the pests that controlled its spread in its original habitat are lacking, the plant may become, like prickly pear in Argentina, an invasive weed. A decision to introduce a new plant must therefore be made only after full consideration of any dangers inherent in doing so.

Much of the honey produced in tropical areas comes from trees: species of Eucalyptus, Acacia, Brachystegia, Julbernardia and Prosopis are all outstanding examples. Most of these are multi-purpose trees, whose wood is useful for fuel and timber, whose bark may produce tannin and medicinal substances, whose flower pods may be an excellent animal feed, and which may be valuable as windbreaks, as well as for honey production. Here, in deciding between several ecologically suitable species to plant, (e.g. for wood production or as windbreaks) the honey potential of the different species should be taken into account.

#### E. COLONY MANAGEMENT

Every agricultural activity depends for its success on the execution of a series of coordinated operations determined by the cycle of the seasons and by the weather and other conditions prevailing at a particular moment. Land must be ploughed, fertilized and seeded; if the rainfall is insufficient, the crops must be watered, and if it is excessive they must be protected against mildew; pesticides and herbicides may be needed; the time of harvesting must be chosen with care.

In beekeeping, the combination of regular operations is referred to as colony management. Its general purpose is to ensure that the maximum strength of the colony coincides with the maximum nectar flow, in order to obtain a maximum honey production. When no pollen and nectar are available, the colony must survive on its reserves, and economy of operation therefore requires that breeding be reduced to a minimum, to be renewed again in anticipation of the honey flow. Many conditions must be met in order to achieve these purposes, perhaps the most important being a sound knowledge of the dates of the normal flowering periods of the honey plants in the area of operation.

#### 1. Seasonal Cycles

Probably the most significant difference between bee management in temperate zones on the one hand and in tropical and sub-tropical zones on the other lies in the fact that the cycle of the seasons is radically different in these two ecological zones. In temperate zones, with their annual alternance of relatively hot and cold seasons, the bee colony goes through a period of confinement in winter, with little or no brood rearing, and then starts to build itself up rapidly in spring as the days grow longer, in time to produce a crop of honey during a relatively short period that may vary from a few weeks to one or two months. In most tropical regions, on the contrary, brood rearing can continue throughout the year, with only sporadic cutbacks during bad weather or a (usually short) dearth period, and some honey plants will be in bloom practically all year round.

This difference in seasonal cycles imposes a view of bee management in the tropics that differs considerably, in many ways, from practices current in the temperate zones.

## 2. The Seasonal Management Plan

To serve as a reminder for the various management measures he will be obliged to take - changes in hive configuration, swarm control, drug treatments, requeening, migration, etc. - the efficient beekeeper establishes a calendar known as his seasonal management plan, based essentially on his knowledge of the dates when the major honey flows occur and, equally important, the extent to which these dates may vary from one year to the next. (There is much more variation in this respect in the tropical and sub-tropical regions than in temperate climates.) The seasonal management plan tells the beekeeper when changes are likely to occur within the hive or in the environment outside it, allowing him to manipulate his colonies sufficiently in advance of the time when they are actually needed.

Most beekeepers agree that five years' experience is needed to determine both the value of a site for honey production and how much the flow may vary. Building colony populations so that they will be at their maximum at the outset of the honey flow requires that an adequate supply of pollen and nectar be available during the six- to eight-week period before the flow, to foster brood rearing. It often happens that a good honey-producing area does not have sufficient pollen and honey plants in advance of the flow to make this possible. In such circumstances, it may be possible to build colonies to maximum strength in one area, where nectar and pollen are available, and then move them to another site to take advantage of the major flow. Some beekeepers use pollen substitutes to build colony populations, but this approach requires that the necessary substitutes be available, and also calls for close attention to detail in feeding.

The movable-frame hive enables the beekeeper to determine when the production of queen cells is initiated. This takes place well after the bees have begun to rear worker brood, and is the first sign that a colony is becoming congested. Congestion leads to swarming, which must be controlled if a satisfactory honey harvest is to be obtained. The length of the swarming season varies, and this time, too, must be determined. Knowledge of all these factors involved in basic honeybee biology is necessary for a beekeeper in building his management scheme.

Once a management scheme has been developed, it should be adhered to, but at the same time the beekeeper must be alert to respond to special conditions. A case in which an unprogrammed migration of hives led to a major gain in production was cited above. Long-term meteorological forecasts may indicate an early or late spring, an exceptional monsoon, etc., and the skilful beekeeper will be prepared to adjust his plan accordingly.

It is a commonplace that successful bee management depends on so many variable factors - climate and forage availability are probably the most important - that no management scheme for a given area can be adopted without change in another. Even on a relatively small island, or within distances of a few kilometres on the mainland, management requirements may vary radically. Management is affected by the bee races used, by the availability of raw materials for hive construction, by the prevalence or absence of a given bee pest or disease, by local communications infrastructures, by consumer preferences for the final product, etc. For this reason, the management methods set out in many beekeeping manuals, even in the countries most advanced in apiculture, are strictly relevant only to the area for which they were originally intended.

A book of this kind cannot therefore prescribe, or even suggest, a management plan applicable to the tropics and sub-tropics as a whole, or even to a single region or country. The local beekeeper must develop his own plan, largely through a trial-and-error system of research. The principles of colony management in movable-frame hives are however practically the same in all areas of the world, and with all races of Apis mellifera and A. cerana; the major differences arise out of the question of timing. Individual management plans, to be successful, must be based on these principles.

The system set out below, which is of broad general applicability in large areas of southern Asia, is therefore given only as an example of the approach that should be taken when a management plan is being prepared. Like other broad approaches of this nature, it may however be taken as a starting point for further local development where conditions are roughly equivalent to those mentioned.

(a) Monsoon management (June-September)

In May, at the end of the honey-flow season, enough honey must be left in the hive to keep the colony alive during the prolonged monsoon dearth that follows. The colonies must be well protected from rain and wind, from enemies attempting to enter the hive, and from unhygienic conditions that can present great problems. Many colonies may abscond from their hives, like tropical bees in Africa; it is said that this tendency can be minimized by periodically removing combs not covered by bees during the monsoon period.

The major wet spell of the monsoon has generally finished by mid-August, and there are intermittent sunny days; many wild plants and grasses appear, a few trees flower, and the bees start collecting pollen. On a clear sunny day the colonies should be quickly inspected, and any old dark combs not covered by bees and showing fungus or wax-moth damage should be removed, and replaced by wired frames fitted with sheets of comb foundation. Nectar is generally not available during this period, and colonies may be given 300 to 500 ml sugar syrup (50% sugar by weight) in the evening. With the supply of fresh pollen, and this stimulative sugar feeding, bees start constructing new combs. Colony inspection, comb renewal and feeding should be repeated at 10-day intervals. Comb renewal can thus be completed by mid-October; also, by ensuring the continued presence of sealed and unsealed brood in the colonies, this management procedure usually prevents absconding during the period after the summer monsoon.

(b) Post-summer-monsoon management (October-December)

Depending upon the duration of the October-December nectar flows and the severity of winter and of the January dearth, alternative management methods should be followed.

- (i) If the flow period is short, the colonies can be developed to take advantage of such minor honey flows as occur. Some strong colonies may make swarming preparations, but it is not advisable to divide them, in view of the ensuing dearth period. Sealed brood combs from such strong colonies may be removed to reduce the likelihood of swarming, and used to strengthen weak colonies. Supers of fully-built combs, if available, can be given to colonies at the appropriate time. Alternatively, a

super containing frames fitted with comb foundation may be given, enabling the bees to build comb from the new foundation for the next major honey flow. After extracting any surplus honey in these new combs, the super of fully-built combs is stored until the next flow.

- (ii) If the flow period is long, with sufficient pollen and nectar, and if the winter rains are not heavy and the dearth period not very acute, a few selected colonies may be further strengthened by giving them frames of sealed brood and of pollen and honey stores, taken from other colonies. This will induce early drone-rearing and swarm preparations in the selected colonies, and the swarm-queen cells from them can be used either to increase the number of colonies (by dividing existing strong ones), or to requeen colonies that had old queens. In any case, the divided colonies with newly-mated queens must be allowed sufficient time, in the latter part of flow, for brood rearing and for building up pollen and honey stores for the following dearth period.

(c) Winter management (December - January)

The beekeeper will learn by experience how much pollen and honey his colonies need to survive the winter dearth. Hives must be checked to make sure that they have adequate stores; if not, about 300 to 500 ml of 50% sugar syrup may be fed. The hives should be well protected from direct rain and wind, and the legs of the stands should be placed in ant wells (tins containing, for instance, spent machine oil). The colonies can be inspected every two weeks without much disturbance.

In areas where the temperature drops to near freezing or where there is snow, winter packing may be necessary. After honey extraction in October, all empty supers should be removed to help the bees make a compact cluster. Depending upon the strength of the colonies, 3 to 5 kg of 50% sugar syrup should be fed to them for winter stores. The hives may be packed with tar-paper, leaving entrance and ventilation holes open, and should be slightly tilted on their stands to prevent water accumulating inside. The colonies can be unpacked when foraging activities recommence, generally by the end of February or early March.

(d) Post-winter management (February - May)

This is the principal active season for the bees. If the colonies were not developed and requeened during the period after the summer monsoon this may now be done, following the method described in (b) (ii) above. A beekeeper with only a few colonies can use swarm cells, but otherwise it is advisable to use the grafting technique for queen-rearing.(\*). This saves labour and time, and colonies can be developed ready for producing the new honey crop. If colonies are managed as in (b) (ii) during the post-summer-monsoon period, most will develop rapidly and start storing honey. Supers of fully-built combs should be added to strong colonies. A few of these may prepare to swarm, and effective swarm control is necessary; for instance, such colonies may be divided and a swarm-queen cell used to provide a queen for one half.

---

(\*) A discussion of queen-rearing techniques lies outside the scope of this book. The question is studied in most good beekeeping manuals, and a number of specialized works on the question have also been published.

As at least a partial solution to the problem of excess humidity in tropical Asian honeys, to be discussed in Chapter 6, auxiliary ventilation holes may be provided in the hive supers and the top cover, although the bees will frequently propolize such holes, is an indicator that excessive air is passing through the hive. Placing the hives in well-aired surroundings (although not in direct sunlight), rather than in dense shade, may also help to reduce moisture.

Honey is usually ready for extraction when 75% or more of the cells are sealed. Some beekeepers extract honey from the brood frames at the end of the honey flow, but this is undesirable: the honey in the brood chamber must be left for the bees during the summer monsoon period. After the final extraction of honey around mid-May, the empty supers are sometimes put out in the open in the apiary so that the bees clean them: this is not a good practice, as it can encourage robbing, attract wax moth and spread disease. It is better to put some supers on each hive, with no access except by bees in the hive.

The dry supers are stacked, a shallow dish containing 50 g paradichlorobenzene put on the top super as a preventive against wax-moth infestation, and the stack enclosed and made airtight at the top and bottom with a telescopic hive roof. This will preserve the combs until the next flow season.

The management recommended above is for a fixed or stationary apiary. Most commercial or semi-commercial beekeepers undertake local and long-distance migrations, moving the colonies to new pollen and nectar resources in the region. In tropical countries, honey-flow seasons often alternate in hills and plains, and in farmland and forests. Migratory beekeeping is therefore especially profitable in transitional belts between two different habitats.

In summary, the basic principle of seasonal management of colonies in this region is either to increase the number of colonies in the minor honey-flow season (October - November) and keep them ready for major honey-flow, or to produce some honey during the minor honey-flow season and to increase the number of colonies in the early part of the major honey-flow season, so that the rest of the flow is utilized for honey production. With migratory beekeeping, the beekeeper gains the advantage of an additional season in which to build up his colonies and produce honey.

### 3. Swarming

Swarming is one of the most prevalent problems in tropical beekeeping, particularly with tropical African and Africanized bees, but also with many others. Repeated swarming weakens the colony to the point where it may be useless for honey production.

In many parts of the tropics and sub-tropics, reproductive swarms are used as honey-producing colonies. In these areas colonies develop rapidly, often building up during the early part of the honey flow and producing honey only during the latter part, a wasteful situation for the beekeeper. In some tropical areas colony migration from one site to another is a natural phenomenon, the pattern depending upon climate as it affects the availability of water, nectar and pollen. When a colony migrates from an area of poor food resources and re-establishes itself at a better site, it can start producing honey as soon as it has built comb to receive the nectar, because it has built up its population on a previous honey flow at its original site. Advantage of this fact is taken in the traditional beekeeping of many parts of the world. The same prin-

principle is applied in the migratory beekeeping practised in some tropical areas as well as in the more temperate zones. In this case it is the beekeeper who has to transport (migrate) the colonies seasonally to the new flows, but the bees already have their combs and brood at the new site.

(a) Swarm control

There is no way to prevent swarming completely, as it is the natural method by which honeybees reproduce their colonies. However, it can be reduced to an insignificant level by proper management. The beekeeper should ensure that the brood chamber is large enough so that there is no lack of space for brood rearing; if necessary, he will install the colony in a Jumbo box. He must keep track of the timing of the honey flow so as to add sufficient supers, at the right time, to provide plenty of space for the storage and ripening of incoming nectar. When a dearth period approaches he must keep sufficient stores of honey and pollen in the hive, and - especially in dry-zone areas - he must provide a permanent water supply for the bees near the apiary. By knowing the honey plants and when they come into bloom, and by taking weather factors into consideration, it is not difficult to keep swarming under control in most tropical areas, particularly where European Apis mellifera is used.

The most important recent advances in swarm control have been made by genetic methods: selecting colonies with a low tendency to swarm, and rearing new queens from them. This practice should be followed wherever queens can be produced and mated satisfactorily with reasonable control over matings. Like other genetic improvements, however, it is not likely to succeed permanently unless queen breeding is carried out systematically and queens bred by the bees themselves are regularly replaced by selected queens.

(b) Hiving swarms

For some time before swarming, the queen's egg-laying is reduced, and the bees do little or no foraging. When the swarm emerges from the hive, the bees are very easy to handle. If they cluster on an accessible branch of a tree, the branch should be simply cut off and carried carefully, with the swarm, to a hive prepared and baited (preferably with foundation) for the purpose. The branch and swarm should be placed on the ground just in front of the hive, and the bees will enter it; evening is the best time for this. A swarm that clusters on a post or other fixed object is more difficult to capture. The bees may be loosened from a thick tree limb by shaking: if a prepared hive, from which the cover has been removed, is placed directly under the swarm, and the limb is given a jolt sharp enough to dislodge the bees, most of them should drop in or near the hive. When necessary, the bees in the swarms can be brushed off into or near the hive. A lure can also be used.

If the queen enters the hive, the entire swarm will soon follow. An indication that she is there is given when the bees are fanning at the hive entrance. On the contrary, if a cluster of bees begins to form on the ground, this may be a sign that the queen is there; the group of bees should be carefully scooped up and transferred to the hive. The hive cover should be replaced as soon as possible, because bees will go more readily into a dark place. A swarm that alights in an inaccessible place, such as the top of a high tree or building, may have to be abandoned; it is not worth risking an accident trying to climb up to it.

#### 4. Robbing and its Prevention

The instinct to collect and carry sweet substances back to the hive is so strong in honeybees that, when no nectar is available, they will search for other sources. This often leads to robbing: collecting honey from weak colonies and any other accessible places, discussed in greater detail on page 30. Bees from a strong colony will enter the hive of a weak, poorly defended colony, take its honey and carry it back to their own hive. It is clear that this can be very troublesome to the beekeeper, especially since once robbing has begun, it is very difficult to control. Weak colonies may be destroyed and many bees killed by fighting. Further, as mentioned in Chapter 3, robbing is one of the principal causes of the spread of bee diseases from one colony to another.

The best means of preventing robbing is to ensure, through adequate management methods, that all colonies are strong enough to defend themselves. Two or three weak colonies can be combined and brought together in the same hive to make one strong one; this is a normal procedure, for example, when colonies have been weakened by swarming.

The entry of robber bees to other hives can be controlled considerably by reducing the size of the flight entrances, and by making sure that hive covers and supers are bee-tight. Grass can be used to close the entrance of a weak colony being overpowered by robber bees; this will prevent further robbers from entering the hive and give the colony a chance to recover before the robber bees can clear a hole to escape.

In addition to such raids on hives, robber bees are likely to try to collect honey that is exposed in any way, so that they can reach it without having to pass through a narrow hive entrance. Should it be necessary, therefore, to examine a colony at a time when robbing is likely to occur - such as just after the end of a honey flow - the beekeeper should work rapidly and not keep hives open, or combs exposed, any longer than is absolutely needed. He should work late in the day, so that if robbing starts, darkness will soon put an end to it. If robbing does commence when a hive is being worked on, it should be closed quickly, and further operations postponed until a more favourable moment.

The practice of exposing extracted combs still wet with honey for bees to clean up can lead to robbing. Honey supers should never be left exposed, nor should they be placed near a hive, because after the bees have cleaned the supers they may attack the hive.

#### 5. Frequent Management Errors

Most difficulties in bee management arise out of one or more of the following errors made by the beekeeper:

- (a) failure to leave sufficient honey in the hive to maintain the colony during a dearth period, causing starvation or absconding;
- (b) failure to provide sufficient space for colony development and honey storage, causing swarming;
- (c) failure to provide a good source of water, causing inadequate brood rearing and colony development.



F. PROTECTION AGAINST BEES

The unfavourable reputation from which beekeeping suffers among non-initiates is due to the undeniable fact that bees sting. The effect of the stinging on the human organism differs widely among individuals: some, after a few stings, become relatively or totally immunized and no longer have any problem, while at the other end of the scale some individuals develop allergies so severe that the result of a concerted bee attack -- or even of a single sting -- may be fatal. All beekeepers will occasionally be stung, and therefore allergy sufferers should not engage in the activity. The average beekeeper has however a number of resources at his disposal to minimize stinging and its consequences.

One of the first of these may be the choice of a race of bee that is gentler, even if somewhat less productive, in preference to a more productive but more aggressive race. This is not always possible, particularly when beekeeping takes place on a limited scale. The deliberate choice of a race which is not dominant in the area concerned is often over-ridden by the fact that the introduced race hybridizes with the dominant race, with the result that the gentler race is lost and the new hybrid is often more aggressive even than the original bee of the area. Since the breeding of bees in the wild cannot be prevented, the only means of avoiding this situation is the continuous elimination of mated queens and their replacement with imported queens of the gentler race; this is the technique adopted in large-scale operations, as was seen earlier in this chapter, but unless the local bees can be completely superseded -- a long and difficult operation which requires that the area be completely isolated from incursions of bees from outside -- it rarely offers a permanent solution.

For this reason most attention is focussed on precautions to be taken while manipulating bees. Rough handling of a gentle colony can render it more aggressive than a more aggressive race handled gently. The first rule in this regard, and it suffers no exceptions, is that when handling bees, sudden movements should be avoided at all costs. Even the instinctive motion of waving away bees that fly in front of the beekeeper's face can stimulate them to sting. He should make no movement that is not strictly necessary, and he should move slowly and "almost unctuously, like a priest," as Caillias (1974) writes.

Whenever possible, hive manipulations should take place in the early morning, before foraging has begun, or in the late afternoon, when it is finished, because at these times the bees are less excitable; working with them in the midday heat should especially be avoided.

For the beginning beekeeper, however, and for any beekeeper working with very aggressive bees, protective clothing remains the best defence against bees, particularly a veil to cover the head and face. A veil especially made for beekeeping, with a cord or elastic to draw it close in at the bottom (Fig. 5/5), is the best type. If these cannot be obtained, the beekeeper can make a veil out of mosquito netting, in the shape of a bag about 75 cm long, which he slips over a wide-brimmed hat; the lower end is tucked into his clothing. Most mosquito netting is white and therefore allows poor visibility, so the front part of the veil should be stained (e.g. with black or dark blue ink) to make it easier to see through.

The choice of clothing is important in working with bees. Since they are sensitive to smells such as that of human perspiration, clothing should be

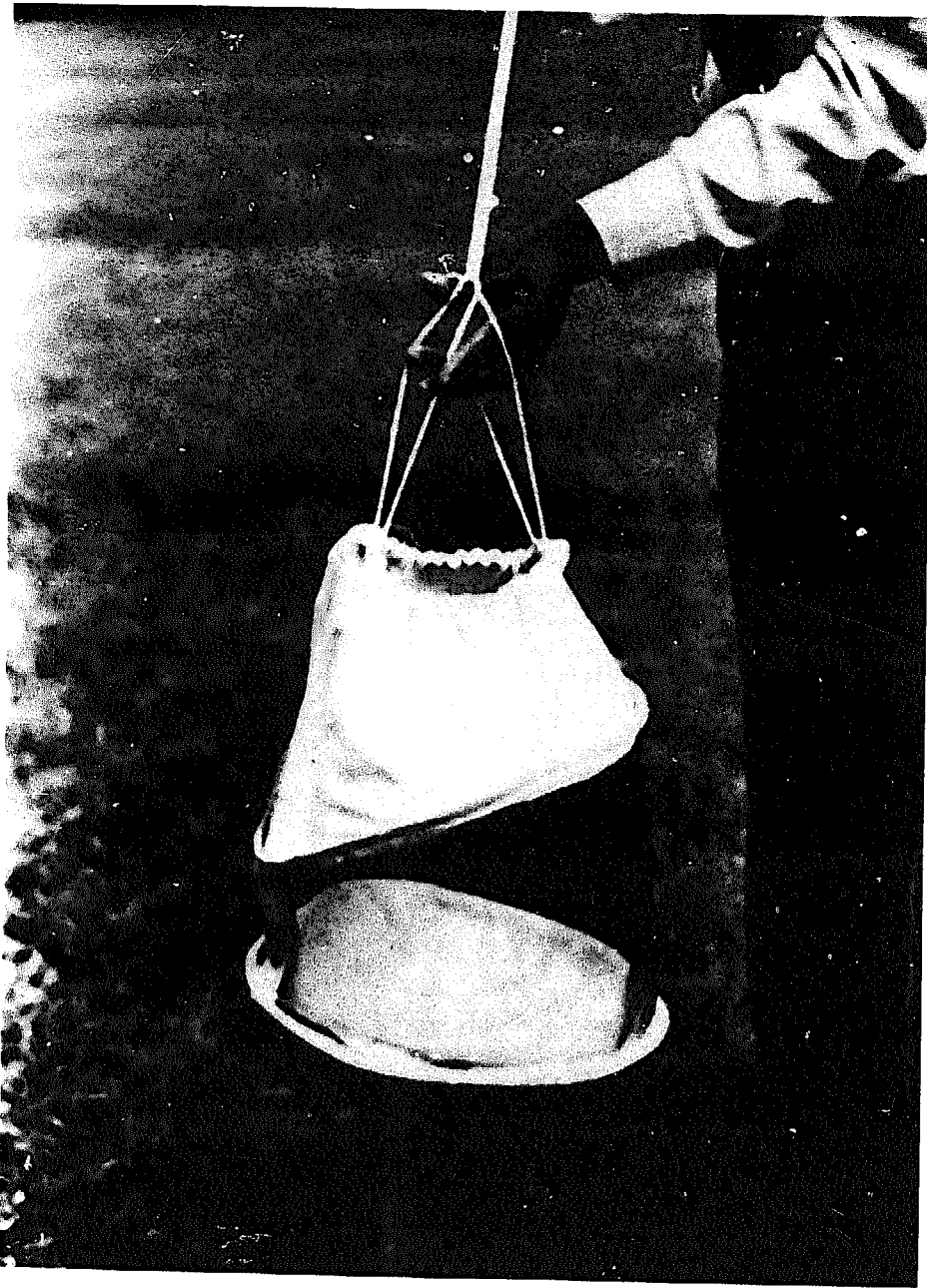

Fig. 5/5 Bee veil. Photo: G.F. Townsend.

washed perfectly clean before being used by the beekeeper. White or light-coloured clothes are the best; black clothes should never be worn for beekeeping, especially with aggressive bee races, because bees are much more inclined to sting black cloth than white.

Especially when working with aggressive bees, it is advisable to wear gloves. They should be long enough to overlap the sleeves, making a bee-tight joint. If they are home-made, e.g. from canvas, they should be soaked in linseed oil, allowed to dry, and then soaked in linseed oil again once or twice; it is then more difficult to sting through them, and some materials become more pliable. Long sleeves should be worn, and trousers tucked into the top of boots: bees often sting bare ankles. Bees will crawl into any openings, and are then likely to move up; for this reason, a useful precaution is to wrap strings around the clothing to bind it tightly to the body.

In practice, many experienced beekeepers find that these precautions are not always worth the trouble involved in taking them, especially in hot zones where the weight and bulkiness of a complete protective outfit make it inconvenient for use over long periods, or when bees are of a gentler race. Fig. 5/6 shows a beekeeper equipped for working with tropical African bees: his equipment is limited to the bee veil and gloves. Fig. 1/7 shows another, working with European Apis mellifera; he has dispensed with gloves. His colleague shown in Fig. 1/8 has abandoned the veil, and is wearing a short-sleeved shirt. As to the Indonesian honey hunters seen in Fig. 4/2 taking nests of the dangerous Apis dorsata, they are practically nude. In fact, skill and experience generally afford better protection against bees than protective clothing, and beekeepers accept the fact that they will be stung occasionally.

The one piece of protective equipment with which no beekeeper dispenses is the smoker. The use of smoke is the most ancient and still the most common means of calming bees and driving them off. Sophisticated smokers are available on the market, but simple ones which are just as efficient can easily be manufactured locally, and home-made smokers can be constructed, for instance a tin with holes in the side and a tube at each end: the beekeeper blows through one tube, and the smoke comes out of the other (Fig. 5/7). Some skill is still required in giving the right amount of smoke: too much smoke or too little may anger the bees more than none at all.

Attention should also be paid to using a suitable smoker fuel. It should be slow-burning and produce sufficient cool smoke. Shavings, rotten wood, sacking, eucalyptus leaves or coir will serve; dried elephant, camel or cow dung is very good. (If sacking is used, beekeepers should ensure that it is not contaminated with poisonous chemicals.) Part of the fuel is lit and placed at the bottom of the smoker; when it is burning well, further fuel is added so that it smoulders slowly and produces a cool, continuous smoke with no sparks.

Remedies against the pain of bee-stings are numerous; their success varies with the individual, but seems to depend largely on rapidity of application. The first step, to be taken immediately because the most important aspect of treatment is to prevent swelling, is to scrape the sting from the wound, in order to interrupt the further flow of venom; removing it otherwise than by scraping will pump more venom into the wound. Many beekeepers prepare and carry with them, or leave at the apiary, a bottle of tincture of marigold, or a 4% solution of potassium permanganate, or simple ammonia or chlorinated water, with which to treat stings. Prof. F.H. Townsend reports (1985) that one of the best treatments is meat tenderizer. In case of severe reactions, an anti-histamine can relieve stress, but a medical doctor should be consulted.



Fig. 5/6 Beekeeper equipped for working with tropical African bees.  
Photo: G.F. Townsend.



Fig. 5/7 Boy in Botswana blowing smoke from a pierced tin into  
a hive entrance.  
Photo: Bernhard Clauss.

## CHAPTER 6

### HIVE PRODUCTS

#### A. HONEY

"Honey", according to one recent definition, "is the sweet substance produced by bees from the nectar of blossoms or from secretions of or on living parts of plants, which they collect, transform and combine with specific substances, and store in honey combs." (Codex Alimentarius Commission, 1981; see Appendix B.) But honey has always been, and continues to be, much more than this. Since the beginning of recorded time it has been a symbol of happiness and prosperity: a happy country was "a land flowing with milk and honey" (Genesis, iii,8). To the ancient Egyptians, honey was a precious ingredient in medicines, reserved for the very rich because of its rarity (Darby et al., 1977), and it is still widely used for its medical properties throughout the Far East. Wherever writing was known, honey was mentioned in the holy books of the peoples, and it often held a place of honour in their rites. Today it is still the only sweetening agent known to some primitive peoples, while it continues to hold its own as a delicacy on the breakfast-tables of millions of families, largely in northern Europe and North America.

Table 6/1 A shows honey production, imports and exports by country in 1982, and Table 6/1 B provides further details with regard to the honey situation in the developing countries. Table 6/2 summarizes this information for the entire world over the period 1976-1983; five-year running averages have been used in order to minimize the effect of considerable annual fluctuations.

Table 6/1 A Major World Producers, Importers and Exporters, 1982(†)  
( '000 metric tonnes)

<u>Country</u>	<u>Production</u>	<u>Net Imports</u>	<u>Net Exports</u>
Afghanistan	4 T		
Algeria	2 F	1 *	
Angola	15 F		
Argentina	33 *		30
Australia	25		13
Austria	10	5	
Belgium/Luxembourg	1 T	3	
Bolivia	1 *		
Brazil	8 F		
Bulgaria	10		4
Cameroon	2 F		
Canada	31		10
Central African Rep.	7 F		
Chile	5		1
China	137		65
Colombia	2 *		
Cuba	10		9
Czechoslovakia	10		
Denmark		2	
Dominican Republic	1 *		1

<u>Country</u>	<u>Production</u>	<u>Net Imports</u>	<u>Net Exports</u>
Ecuador	1		
Egypt	8 F		
El Salvador	3 F		3
Ethiopia	21 *		
Finland	2		
France	25	7	
Germany, D.R.	7		
Germany, F.R.	18	62	
Greece	12		
Guatemala	3		2
Honduras	1		1
Hungary	17		14
India	18 S		
Iran	6 F		
Israel	2		
Italy	8 F	11	
Jamaica	1 *		
Japan	7	28	
Kenya	11 *		
Korea, Republic of	6 F		
Malagasy Republic	4 F		
Mexico	57 *		40
Morocco	3 F		
Netherlands		6	
New Zealand	7 F		1
Norway	2		
Paraguay	1 F		
Poland	19		
Portugal	3	1	
Romania	16		4
Saudi Arabia		2	
Spain	16	4	
Sweden	3	2	
Switzerland	3	5	
Tanzania	11 F		
Turkey	30 F		1
USSR	186		14
United Kingdom	2 F	20	
United States	104	38	
Uruguay	4 *		3
Yugoslavia	5	5	

(†) Includes only countries whose 1982 production, net imports or net exports were 1000 MT or more.

Explanation of symbols:

No symbol = Official data  
 \* = Unofficial data  
 F = FAO estimate  
 T = Trend calculation  
 S = Source: IBRA

Source: FAO Statistics Division, September 1984 (except India)

Table 6/1 B Honey: Developing Country Production, Imports and Exports, 1982 (Metric tonnes)

<u>Country or Territory</u>	<u>Production</u>	<u>Net Imports</u>	<u>Net Exports</u>
<b>I. AFRICA</b>			
Algeria	1 560 F	1 000 *	
Angola	15 000 F		
Botswana		1	
Burkina Faso			3
Burundi	900 F		
Cameroon	2 250 F	7	
Central African Rep.	6 600 F		
Chad	960 F		
Côte d'Ivoire		20	
Djibouti		6 *	
Egypt	7 500 F		78
Ethiopia	21 000 *		37
Gabon		10 *	
Guinea-Bissau	300 F		
Kenya	10 500 *		12
Liberia		5 *	
Libya	549	549	
Malagasy Republic	3 500 F		
Mali	320 F		
Mauritius		45	
Morocco	2 800 F		
Mozambique	250 F		
Nigeria		60 *	
Rwanda	8		
Senegal	190 F	5	
Seychelles		2	
Sierra Leone	600 F		
Sudan	600 F		
Tanzania	10 500 F		50 F
Tunisia	750 F		16 *
Uganda	200 F		
<b>II. CENTRAL AND SOUTH AMERICA</b>			
Argentina	33 000 *		29 873
Bahamas		6 *	
Barbados		10 *	
Belize	230 F		172
Bermuda		31	
Bolivia	1 400 *		
Brazil	7 500 F	251	
Chile	5 000		1 088
Colombia	2 200 *		211
Costa Rica	900 *		200 *
Cuba	10 100		8 984
Dominican Republic	1 300 *		1 058
Ecuador	1 050 F		
El Salvador	2 600 F		2 931



<u>Country or Territory</u>	<u>Production</u>	<u>Net Imports</u>	<u>Net Exports</u>
Guatemala	2 677		2 286
Guyana	65 F		
Haiti	310 F		100 F
Honduras	1 700		1 188
Jamaica	1 000 *		30 F
Mexico	56 500 *		40 024
Nicaragua	105 F		
Paraguay	1 000 F		
Peru			40
Puerto Rico	160 F		
Suriname	70 F		
Trinidad and Tobago	260 F		
Uruguay	3 500 *		2 544
Venezuela	316	259	

III. WEST AND SOUTH ASIA

Afghanistan	3 880 F		
Bahrain		15 *	
Cyprus	800 F		72
India	18 000 S		
Iran	6 000 F	1	
Iraq	50 F	1 500 *	
Jordan	60 F	71	
Kuwait		330 *	
Lebanon	300	800 *	
Oman		105	
Pakistan	680 F		
Qatar		187	
Saudi Arabia		1 878	
Sri Lanka		1	
Syria	600 F	5	
Turkey	30 000 F		1 279
United Arab Emirates		300 *	
Yemen Arab Republic	300 F	340 *	
Yemen, P.D.R.	80 F	269 F	

IV. EAST ASIA AND PACIFIC

Brunei		4	
Burma	4		
China	136 605		65 250
Fiji	5 F	10	
Hong Kong		898	
Indonesia		109	
Korea, Republic of	6 000 F	22	
Macau		50	
Malaysia		471	
Mongolia	340 F		
Niue	20		27 *
Papua New Guinea		24	
Philippines		35	
Samoa	360 *		30 F
Singapore		464	

<u>Country or Territory</u>	<u>Production</u>	<u>Net Imports</u>	<u>Net Exports</u>
Thailand		97	
Tonga	18 F		
Vanuatu		1	
Viet Nam	280 *		
Wallis and Futuna	10 F		

Explanation of symbols:

No symbol = Official data  
 \* = Unofficial data  
 F = FAO estimate  
 S = Source: IBRA

Source: FAO Statistics Division, September 1984 (except India)

Table 6/2 Honey: World production, imports and exports, 1976-83 (5-year running averages) ('000 metric tonnes)

	<u>1976-80</u>	<u>1977-81</u>	<u>1978-82</u>	<u>1979-83</u>
Production	815	829	866	893
Imports	153	196	211	226
Exports	191	204	220	237

Source: FAO Statistics Division, September 1984.

Table 6/2 indicates that world honey production is, roughly speaking, keeping pace with world population growth, whereas international trade in the commodity is expanding much more rapidly. This reflects a steadily increasing demand for honey, particularly in the developed countries, and authorizes the conclusion that investment in honey production in the developing world of the tropics and sub-tropics -- traditionally a major source of honey in international trade -- continues to offer a considerable potential as a source of foreign earnings. Table 6/1B in particular should be studied in this context.

For a clear understanding of a number of notions referred to throughout this chapter, some explanation of the special nature of honey is necessary. Three sugars are of primary concern in the world market. The first and most important of these, sucrose, obtained primarily from sugarcane and the sugar beet, is the sugar in most general use; widespread in nature, it can withstand high temperatures and harsh treatment because it is chemically stable. The second, glucose, obtained in particular from maize, is the least sweet of the sugars; it is preferred by sweetmeat manufacturers because more of it can be consumed at a time. The third, fructose, is the sweetest and most delicate of the three. As its name implies, it is found largely in fruit; it is chemically less stable than the others.

The nectar that honeybees collect is predominantly made up of water and sugars, most commonly sucrose. An enzyme in the bee's body splits this sugar into glucose and fructose, so that the honey it produces contains only about 1% of sucrose. The proportions of glucose and fructose in the honey vary according to a number of factors, and it is largely this fact that accounts for differences in honey sweetness; differences in honey taste, on the contrary, are explained for the most part by the origin of the nectar collected: acacia honey and heather honey, for example, have very different tastes, as will be discussed below.

Honey is a delicate, relatively high-priced, luxury product in the developed countries. Stored properly, it has a reasonably long life and retains its delicate flavour, although after several years the fructose may tend to decompose, and the honey turns black, loses its delicate taste and becomes unsealable.

Honeys in which glucose predominates tend to granulate rapidly, while high-fructose honeys tend to remain liquid. Granulation, which is the formation of hard glucose crystals in the honey, has no effect on honey taste, but this fact is not generally appreciated by consumers, who tend to believe that granulated honeys have been adulterated by the addition of "sugar", i.e. sucrose. This is one reason why high-fructose honeys generally command a higher price on the market in a number of countries. Honeys that are granulated can be reliquified by gentle heating, although care must be taken never to expose honey to direct heat, which burns the fructose it contains and destroys its flavour. Granulation is, indeed, only a real problem because it can be an indirect cause of fermentation.

Fermentation is honey's greatest enemy. It is caused by a yeast, different from those used in baking and brewing, which can grow only in concentrated sugar solutions; in honey the yeast cells grow, fermenting the product, only when the water content of the honey is 19% or more in temperate regions, or about 18% or more in the tropics, where higher temperatures tend to activate them earlier. Honey whose water content lies below these percentages is considered ready for harvesting, and therefore is called ripe honey. The yeast cells remain alive, however, even if they are not active, in honeys with a lower moisture content, and if the moisture percentage increases they begin to grow, and the honey ferments and is lost. (The yeast cells can be destroyed, and fermentation thus prevented, by pasteurizing the honey, just as some brewery and wine products, for example, are pasteurized for the same reason, but the product must thereafter be stored in sealed containers, lest yeast cells in the air enter and reinfect it.)

Granulation is a danger to honey, and can cause fermentation, because the granulated sugar crystals contain only about 12% water. This means that the moisture content of the ungranulated honey in the container can rise to a point where the yeast cells once again begin to grow. The liquid fraction of honeys that granulate uniformly throughout the container is dispersed in such a way that fermentation does not take place, but fermentation threatens honeys that granulate only slowly or partially.

Since fermentation is a direct consequence of the moisture content of honey, it is clear that for the beekeeper this moisture content is honey's most important technical characteristic, and that under normal circumstances honey intended for the trade should only be harvested when it is ripe, i.e. when, in the tropics, it does not contain more than 18% moisture.

The nectar as collected by honeybees may contain from 50 to as much as 90% of water, and as it leaves the bee's honey stomach it still contains an excessive amount of moisture. By evaporating some of this moisture, the bees can reduce the volume needed to store their honey, which they intend to use as their food reserve. This they do by spreading the honey around the storage combs in small droplets and then, acting as a group, by fanning their wings, thus forcing air through the hive. This action can usually reduce the moisture content of the honey to an acceptable level in 24 to 48 hours, although temperature, atmospheric humidity, the amount of honey to be ripened, the surface area and the hive population all have a considerable effect on what actually takes place. Thus, if the relative humidity is high, the water in the honey will evaporate less quickly, while if there are many bees in the hive to fan the honey, it will be ripened sooner than if there are only relatively few. When the honey reaches the necessary concentration, the bees cap the storage cells with wax.

As a general rule, it is said that honey is ripe and ready to extract when two thirds or more of the storage cells of the comb are capped. Like all rules of thumb, this one is convenient, but it does not always hold true. The wall cell cappings are porous, and allow air to pass through to reach the honey. Honey being hygroscopic (i.e. tending to absorb water readily from the air), it can, when atmospheric humidity is high, lose its ripeness and be once again in danger of fermentation. The proper timing of harvesting is thus of the utmost importance, especially in the tropics. It is of course possible to remove some water from honey still in the comb and thus ripen it, by blowing warm, dry air over it, but this is a slow, costly process which should be avoided wherever possible.

It is often said that, in modern beekeeping, some honey can be harvested during a honey flow, and this is indeed true, but it calls for a great deal of care in timing and technique, particularly as regards supering. As the flow of nectar from flowers continues, most modern beekeepers add additional boxes (supers) to those already present and being filled in the hive. In the production of comb honey (honey that is to be sold in the new white wax comb), the new unfilled supers are placed below those already filled or partially filled, immediately on top of the brood nest. This method, called bottom supering, helps to relieve congestion in the hive, as it gives the young, wax-secreting bees a place to go. In top supering, on the contrary, the empty supers are placed above those already filled; producers of liquid honey prefer this method, as it is simpler than bottom supering. It is clear that in top supering, the honey at the top of the hive is the least ripe, and therefore that harvesting must be delayed accordingly.

This emphasis on timing and the importance of harvesting only ripe honey, except for local consumption(\*), is rendered necessary because beekeepers have suffered serious losses as a result of failing to understand all the implications of the problem.

(\*) A recent report from Japan (FAO 1984, p. 164), for instance, states that in that country migratory beekeepers cannot wait until their honey is completely ripened. Accordingly, the country's standard for domestic honey calls for 23% moisture, while imported honey may not contain more than 21%. The report states that this difference is designed "to protect the national beekeeping industry."

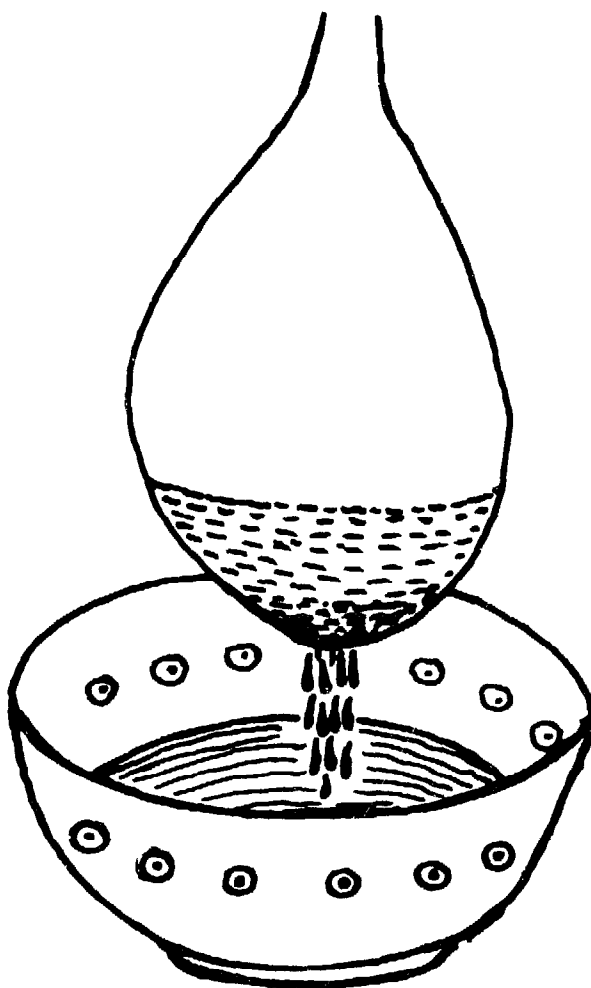

Fig. 6/1 Removing honey from combs by allowing it to drip through a cloth.

Drawing: Stephanie Townsend.

The honey still obtained in Asia and Africa by hunting bee colonies and taking their honey, sometimes under very difficult conditions, often has a high moisture content and is therefore likely to ferment, and it also contains much debris, including large quantities of pollen and brood. Honey so produced must therefore be eaten or sold locally, as quickly as possible before it ferments, and consequently honey-hunters are often exploited by local merchants.

In many tropical countries there is now a growing demand for a higher-quality honey that can be sold in the large towns, or exported. This requires changes in beekeeping and honey-handling practices, which should however be introduced slowly, as they all involve education, training and financial investment in equipment. As production increases, however, and as the honey quality (and, accordingly, the price received for it) improves, beekeepers will be able to make minor investments in equipment, leading to still greater improvements in methods, results and income.

1. Obtaining Honey from Traditional Hives

Using smoke as necessary (Fig. 5/7), the beekeeper removes the combs from the hive, being careful not to crush them. The white combs are usually the ones that contain honey but no brood or pollen. The parts of the comb in which the cells have been capped are chosen, as this honey usually has the lowest moisture content, and they are cut out with a knife. (Brood areas of the comb can be separated in the same way, leaving uncapped honey to be processed later.) The combs are placed in a container, covered, and taken well away from any hives before the next step.

There are several ways in which this honey can be handled. If the beekeeper is some distance from a collection centre, or if none exists and he has no equipment other than a few containers and a cloth for straining, the capped pieces of comb are removed from the container and uncapped with a fork, without crushing them. The broken combs are then put into nylon cloth netting and tied up at the top, supported over a pan in a warm place, and allowed to drip (Fig. 6/1). Some writers have recommended the use of various honey-presses; these work, but they incorporate into the honey small air bubbles which it is impossible to remove and which give the honey a cloudy appearance and cause it to granulate more quickly after it has been put into jars.

It takes about 12 hours for the honey to drain through the cloth; if any still remains after that time it should be squeezed out into a separate container, because its quality will not be as high as that of the dripped honey. Any foam on top of the dripped honey can be readily removed with a spoon. The honey is then strained again, through mosquito netting or nylon mesh, to remove any particles remaining, before it is put into jars or bottles for the market.

If a honey collection centre is nearby, it is likely to be equipped with extracting and straining equipment, and the beekeeper need only put the combs, with as little breakage as possible, into a bee-tight container and take it to the collection centre. At a later stage, as he increases his number of colonies and his income, he is likely to be able to afford his own small two-frame centrifugal extractor; alternatively, several beekeepers may buy one to use in common, and larger models also exist.

The first step in obtaining honey with an extractor is to remove the cappings over the cells with a special fork-type scraper, or uncapping knife. The pieces of comb are then put into a wire basket about the size and shape of a Langstroth comb (Fig. 6/3), which is placed in the extractor (Fig. 6/4). The honey is extracted from the combs by spinning, which throws the liquid honey out to the sides of the extractor, whence it drains down to collect at the bottom. Spinning is then repeated with the opposite side of the comb facing outwards. The honey from the extractor is passed through a strainer made of nylon or other fine-mesh cloth, and then poured into containers.

2. Obtaining Honey from Modern Hives

Since modern hives are generally adopted for the commercial production of honey, it goes without saying that great care must be exercised to ensure that a high-quality product is obtained. This calls for more sophisticated techniques than those used in honey-hunting and traditional beekeeping.



Fig. 6/2 Loading pieces of comb into the wire basket of a centrifuge for honey extraction. The handle used to spin the comb is on the top of the extractor, on the right.  
Photo: G.F. Townsend.

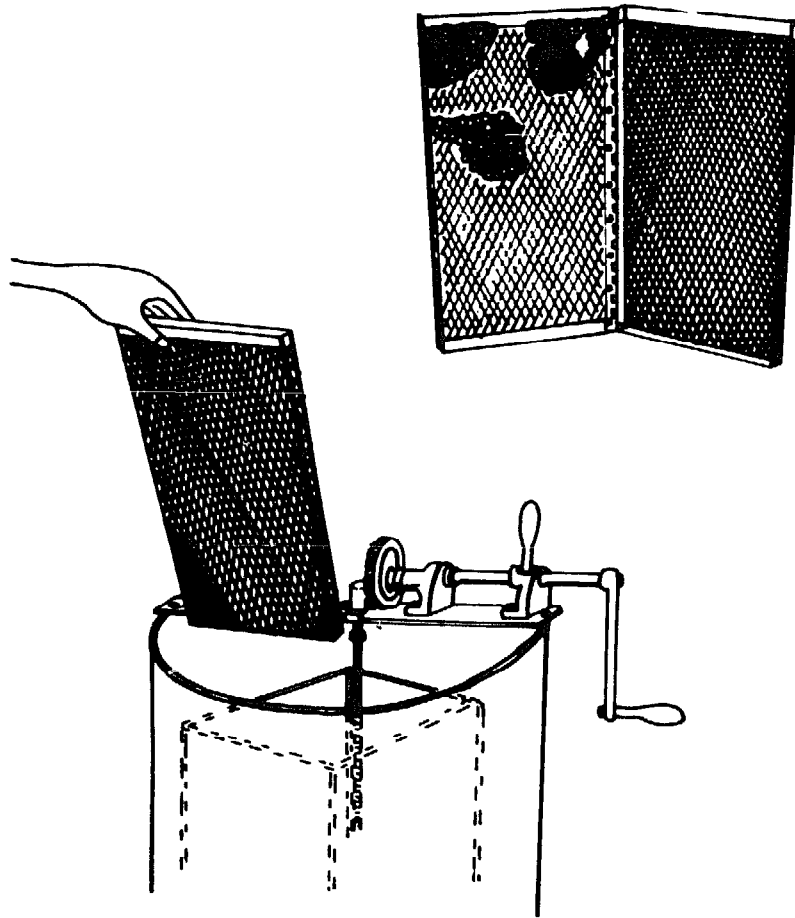

Fig. 6/3 Charging the wire basket containing comb into the extractor. This is a four-frame model, with the handle for spinning on the side, for greater mechanical advantage.  
Drawing: Stephanie Townsend.



(a) Harvesting Methods

In large-scale apiaries in the temperate zones, the most popular methods of removing bees from combs for harvesting are to use bee-repellent or to blow the bees off the comb with a strong current of forced air. Some beekeepers use bee-escapes, and a few continue to smoke the bees heavily and brush them off the individual combs. The fact that so many different methods are in use implies that there is no one perfect, or even "best", method.

Repellents are still little used in tropical regions, not only because of their objectionable odour but also because they are relatively expensive even when they are available, (\*) The latter objection also applies to "bee blowers", a number of models of which have been developed in recent years. The physical action of being blown off the combs does the bees no apparent harm and does not appear to render them any more upset or angry than repellents, even if, when harvesting is done, thousands of lost and drifting bees may remain in the apiary. As a beekeeper develops his apiary and acquires new equipment, a bee blower will therefore often be a desirable acquisition, although it is of course possible for several beekeepers to share ownership of a single blower, perhaps through a cooperative.

In the tropics and sub-tropics, the ancient method of smoking the bees away from the comb continues to be most commonly used (Fig. 6/1). A simple home-made smoker, with its fuel, were discussed in Chapter 5; it is important, whatever the model used, to be able to direct cool smoke to the spots where it is most needed, and for this a smoker with a nozzle offers the best possibilities.

In the early years of commercial beekeeping, smoking was the only method known. It is not a good method, especially for removing large quantities of honey, because it is slow and, more important, because it is obviously disturbing to the bees, which often respond by stinging excessively. Smoking is popular with beekeepers with only few hives, because it is less costly and requires no special equipment. If the operation is carried out rapidly, the amount of stinging that takes place can be minimized; learning to do this is a matter of practice.

The final method, the bee-escape, consists of a board inserted in the hive, immediately below the honey super to be removed. The principle underlying the bee-escape is that bees in the storage area need to be - or at least are - in contact with those in the brood area, so that there is a constant rotation of bees in and out of the storage area. The bee-escape board is fitted with a device (several types exist) enabling the bees to leave the storage area, but not to go up to it again; in time, therefore, the super will be almost free of bees.

One advantage of the bee-escape is that it permits supers to be removed early in the morning, when no bees are flying. Its principal disadvantage is that it requires two trips to the apiary, one to put it in place and another, generally the next day, to remove the super. Home-made wooden bee-escapes which

(\*) A further disadvantage is that tropical high temperatures make the repellent work too quickly, either stupifying the bees on the comb or completely driving them out of the hive, thus creating a greater danger of stinging.

provide improved ventilation are said by some experts to work better than the metal escapes usually sold, which are placed in a hole in the centre of a wooden inner cover. Its economy, simplicity of operation and relative efficiency make the bee-escape board the most suitable method of removing bees in artisanal beekeeping.

The greatest problem when removing honey is to prevent robbing. Since harvesting the crop usually takes place after the honey flow, the foraging force is not occupied, and will soon find an attempt to steal any exposed honey. As supers of honey are removed they must therefore be covered. This can be done by a variety of means ranging from ordinary hive covers to tarpaulins. Some large-scale beekeepers use covered lorries with curtains of heavy canvas to cover the rear opening.

A second, though usually minor, problem when removing honey is to catch that which drips from the supers. When the bee-space between the supers is too wide or too narrow the bees will build connecting combs there, and these are broken as the supers are removed. The result can be dripping honey which, if it can be found by the bees, will cause robbing. Metal or wooden drip pans may be used to catch this honey.

At this point it is well to emphasize that the manipulation of individual combs in a hive should be avoided as much as possible. Whether one is attempting to relieve congestion to prevent swarming, or harvesting honey, one moves and manipulates whole supers insofar as is possible. This speeds up the colony management process and allows the producer to handle a greater number of colonies.

(b) Honey processing in a collection centre

Few individual beekeeping operations in the tropics and sub-tropics are extensive enough to warrant the maintenance and operation of full-scale honey handling and packing equipment. In principle, therefore, honey collection, treatment and packaging can best be dealt with through a collection centre, privately, publicly or cooperatively owned and operated.

The minimal equipment for such a centre consists of accurate platform scales for weighing the product delivered to the centre; collecting tanks, preferably of stainless steel or plastic, but galvanized if these are not available; one or more extractors; a strainer; drums for melting wax and moulds for the final beeswax; and honey-packing equipment if the centre is to supply local markets directly. The simplified plan of such a centre, designed to be placed on a hillside, appears at Fig. 6/4. At the initial stage, the extractors can be hand-operated, taking two or four frames (Figs. 6/2 and 6/3); if the centre grows very large, an extractor taking eight to ten frames and operated by bicycle pedals can be obtained.

During the initial period the centre's strainer should preferably be small, with a single screen and a baffled tank (Fig. 6/6). If the volume increases, a larger model, such as the OAC (Ontario Agricultural College), will be more suitable; it should be associated with a sump tank for settling and warming the honey (Fig. 6/7) before it goes into the strainer. With such equipment a means of heating and circulating hot water would be useful, possibly combining solar and fuel heating. In areas where high-moisture honeys are collected for marketing, a small pasteurizer may be necessary. The centre should

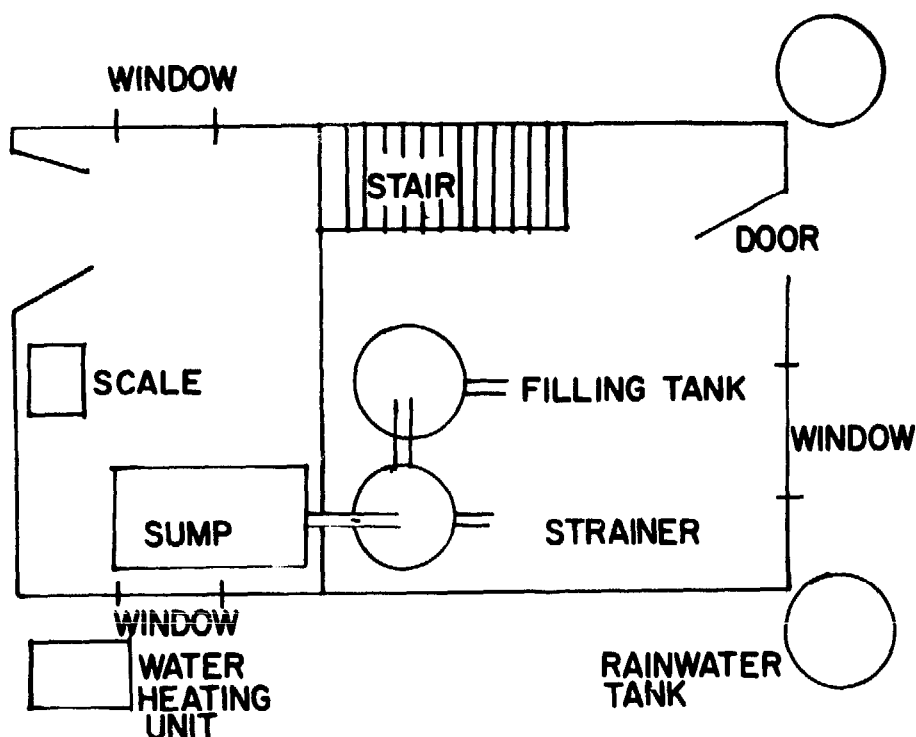

Fig. 6/4 Plan of a simple honey-collecting centre on a hillside. Two rain-water tanks (right) are at the lower end of the building, while the unloading door and scales are at the higher end.  
Drawing: Stephanie Townsend.

also have a bee-proof and ant-proof storeroom, protected against excessive heat, for stocking beeswax blocks and honey in 20-litre (approx. 30 kg) containers before shipping them to the central packing plant or local market.

The site of the collection centre is important: it should be convenient to the area of honey production, be adjacent to or on an all-weather road, have access to an abundant supply of water and stand on well-drained ground. The building should be built of brick or stone and roofed with galvanized iron or similar material. It should be ant-, bee- and vermin-proof, well ventilated and equipped with rainwater tanks, because rainwater is the best for refining beeswax.

In major honey-producing regions, and where distances from apiary sites to the collection centre so justify, the collection centre can be serviced by smaller centres, operated by smaller local groups of beekeepers who share minimal processing equipment; the collection centre can pick up the honey produced, paying for it on the spot, in accordance with a regular calendar.

Since good-quality honey is not highly perishable, supplies of ripe honey brought to the collection centre or the local centre can be held for several days before being refined or shipped to the central packing plant, pro-

Untipe, high-moisture honeys must be handled differently. In certain areas of the tropics, one of the major sources of honey is the rubber plant (*Hevea brasiliensis*), grown commercially for latex production. The honey from this plant is usually light in colour and mild in flavour, but its moisture content is often very high, reaching 25% or even more. A satisfactory practical method for reducing honey humidity to the more suitable 18-19% range is still needed, and attempts are being made to develop equipment of this purpose. Until they succeed, it is necessary to pasteurize this honey by heating it to 70° C, for 10-12 minutes, thus destroying most of the yeasts present and delaying fermentation. Even pasteurized, however, this honey should be marketed as soon as

containers. building with provision for the movement of air under the roof and above the particular, honey stored in the tropics should be kept in a well-ventilated vided that they are adequately protected against pests, heat and theft. In part-

Photo: G.F. Townsend.

if desired. end, into a strainer. The jacket is wired for electric heating debris as it is warmed, and leaves through the bottom of opposite open end and passes over and under several baffles, depositing by circulation. The honey enters or is poured into the wide is double-jacketed, and water in the outer jacket can be warmed The tank Fig. 6/5 Baffle tank for settling honey to assist straining.

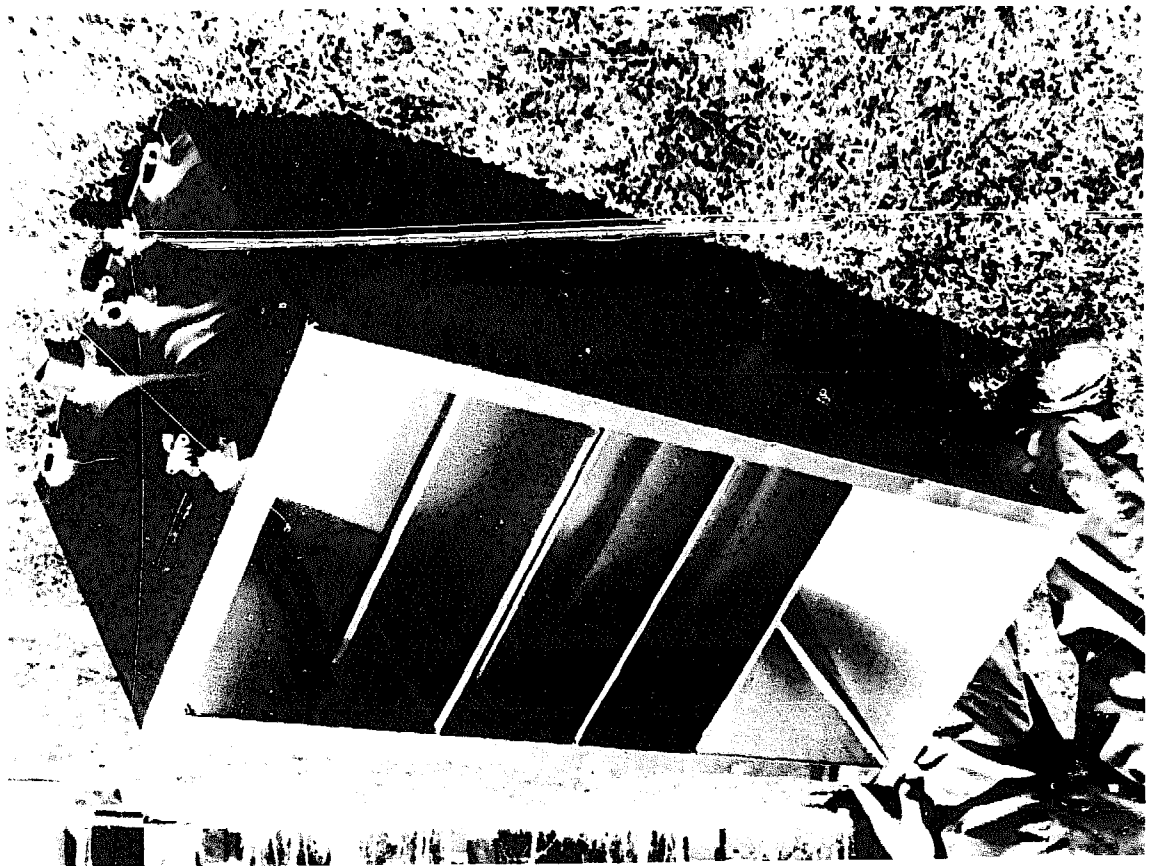

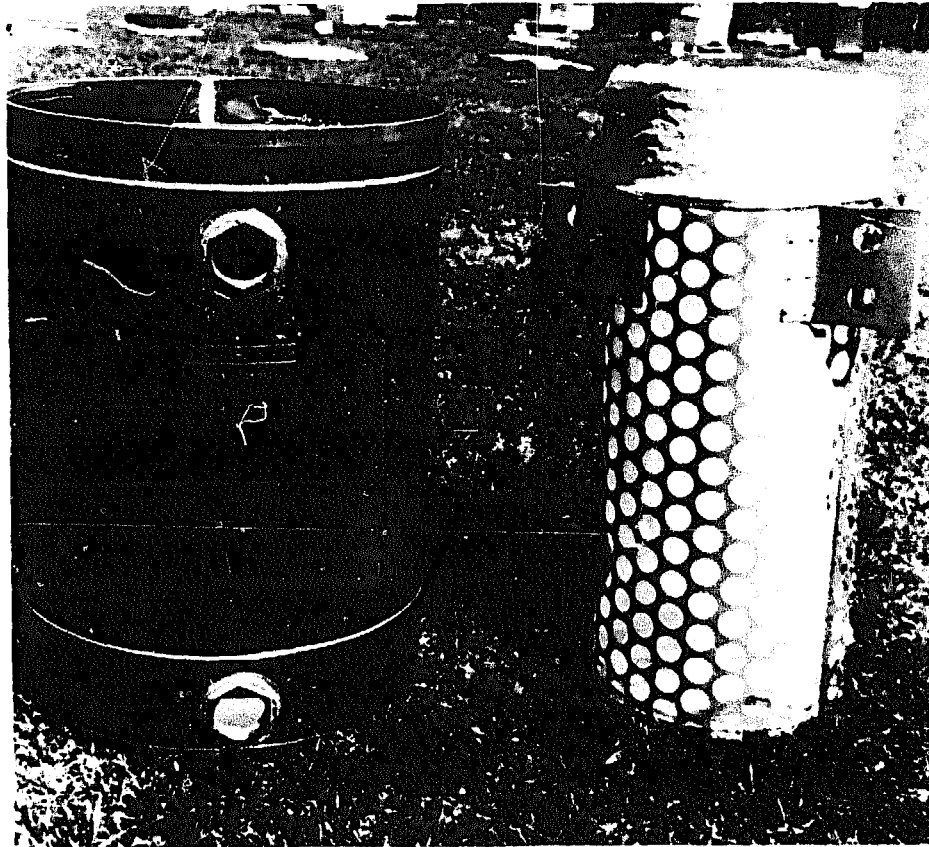

Fig. 6/6 Small single-baffle honey strainer. The straining cylinder (cloth inside a metal supporting grid) on the right is placed in the drum on the left, and the honey is poured into the cylinder. The strained honey can be removed through the opening near the top of the drum, and finally drained through the tap at the base.

Photo: G.F. Townsend.

possible. Most other honeys produced in the rubber-growing areas -- particularly in the drier zones -- have a low enough moisture content when extracted to delay fermentation for some time; they can therefore be stored in order to give priority to moving the honey from rubber onto the market.

It is essential that honey grading standards, applying to colour and, as far as possible, to flavour and moisture content, be established and maintained, and that only one grade of honey be packed under one and the same label. At the collection centre, payment for honey according to grade is extremely important and should be strictly adhered to. In operating a centre it is easy to pay too high a price for unsaleable honeys, but this mistake can be fatal to the centre's financial position. There is no need for elaborate grading standards if the honey is to be sold within the country: care must be taken to

ensure that it is clean, that it is free from larvae, excess pollen and other debris, and that its moisture content is not excessive. The flavour of the honey must be checked: a high pollen content can communicate an unpleasant flavour, making the honey unmarketable for table use. Dirty or off-flavoured honeys should be rejected, or bought in at a very low price if there is a market for them, such as the brewing industry.

Sometimes combs may be brought in just as they are cut out from the hive. If the honey is clean, and no brood comb is mixed with the honey comb, the mixture can be purchased as one lot and processed at the centre. The purchase price would have to be determined by experience.

Batches of honey to be sold on the export market must be uniform. It is therefore always necessary to separate lighter honey from darker batches at the purchasing stage.

If good transportation facilities are available, a major collection centre should be able to handle honey produced within a 200 km radius. At its beginnings, transport over short distances should be by bus, bicycle or ox-cart; a lorry should be purchased only when the volume of honey so justifies, and if a vehicle is occasionally required before that time, it should be rented or shared.

The collection centre can be organized and operated in a number of ways, depending, among other factors, on government policy and the social attitudes of the beekeepers themselves. It can be run as a cooperative, or by private enterprise, or by an agency of the government itself. It must be adequately capitalized or have access to credit, because whatever be the source of its operating funds, they must be available for cash purchase of the honey and wax as they are brought in. Failure of many centres in this regard is the main explanation of the fact that, on the whole, the history of collection centres in the tropics has rarely been a successful one. They seem to thrive for a few years and then disappear, whether for lack of sufficient liquidities, as a result of discouragement in the face of difficulties (often transitory), or because of private conflicts of interest. It cannot be emphasized too strongly that the centre must be in a financial position to purchase honey for cash during the short producing season and to sell it over a much longer period; it must be able to withstand cash-flow pressures between the time it pays for the honey it receives and the time it collects for the honey it sells.

Price differentials established according to honey grade will encourage beekeepers to produce better quality honey by improving their production methods, and possibly by changing to an improved type of hive. To this end, it is desirable to have, associated with the collection centre, a demonstration apiary operated by government extension personnel, who can also provide some teaching and technical assistance.

It is also essential, however, that there be a strong central marketing organization or a government unit responsible for overseeing apicultural developments within the country. Such a structure can both assist the centre in times of difficulty and provide the necessary supervision of its financial and technical operations. Grading methods, price schedules and the handling of funds should be under strict control and supervision at all times. In countries with a tradition of cooperatives, such problems are dealt with successfully by the members themselves, but elsewhere the intervention of the authorities may be required.

b) The central packing plant

The central packing plant should be located near the major market for honey. It is much larger than the collection centre and has more equipment for handling honey, more elaborate heating and cooling facilities, as well as settling and straining equipment. Here the honey is put into retail containers, which should be of standard sizes.

The final phase of honey processing can be operated in many ways: as a cooperative associated with the collection centres, by the government, privately, or through a mission-oriented organization. Financing can best be arranged through a central organization which makes funds available to each collection centre for its purchases. Beekeepers' supplies can be manufactured in association with the central organization, and lorries going to pick up honey at collection centres can carry supplies for sale on their outward journey.

Local collection centres can be provided with containers from the central plant; usually 30-kg containers, which can be handled without special equipment, are large enough. If the local centres bottle and market their own honey, they can use their own label designs, or a standard label can be provided by the central bottling and packing organization.

3. Honey Quality

A fresh look at the question of honey quality is useful, now that honeys are produced for sale in countries all over the world, and honeys from a wide range of climatic zones are candidates for sale on the world market.

Objective criteria that determine honey quality include --

1. purity, absence of adulterants, and conformity with standard definitions of honey;
2. maximum water content of 18-19%, to ensure that the honey is not likely to ferment;
3. no toxicity to man, or impurities such as metals from containers;
4. absence of unhygienic components that might present a health hazard;
5. absence of fermentation;
6. absence of changes in the honey as the bees produce it, resulting from maltreatment.

Other criteria on which honey quality is assessed are more subjective, and largely of traditional and ethnic origin. It is necessary to understand something of this situation in order to work out a programme for promoting sales of developing-country honeys, whether for local consumption or for export. Subjective criteria include --

7. flavour;
8. aroma;
9. consistency, including type and speed of granulation;
10. inclusion of other bee-produced materials such as beeswax.

The reply to the question: "What is the best honey in the world?" is likely to be: "well-produced local honey", for two reasons. Firstly, honey flavour and aroma can be impaired by handling and processing, but are never improved (except perhaps when damaged honey is commercially "deflavoured").

Table 6/3 Honey production and producer prices by plant source  
(Japan, 1979)

<u>Plant Source</u>	<u>Production (MT)</u>	<u>Price (Yen/kg)</u>
Chinese milk vetch ( <u>Astragalus</u> )	2 500	958
Orange + horse chestnut	2 200	667
Linden	1 300	208
Clover	400	667
Black locust ( <u>Robinia pseudoacacia</u> )	300	833
Miscellaneous	800	333

Source: FAO 1984.

Therefore, the closer honey is to the state in which it was produced and (competently) removed from the hive, the better its quality is likely to be. Secondly, flavour preferences are mainly established during the first few years of life, so that honey preferences tend to be passed on from one generation to another, and to be linked with honeys available locally.

As a result, honey-importing countries are willing to pay premium prices in the world market for honeys that they are accustomed to: light in colour and mild in flavour. There are local exceptions: honey from heather has a rather powerful flavour and quite a penetrating aroma, but where it is produced -- for instance in parts of the UK -- it is a premium honey and commands a higher price than the mild honeys. The same is true of honeydew honey from conifers in parts of the Federal Republic of Germany and Switzerland. In Australia, which produces many strongly flavoured honeys, mild honeys are mostly regarded as tasteless and uninteresting. Again, buckwheat honey, which has a pronounced flavour and aroma, can be sold only to ethnic groups accustomed to it, e.g. in (or from) parts of Central Europe and the Netherlands.

It is interesting to note that consumer preferences can dictate producer prices of honey independently of the relative abundance or scarcity of the product. Table 6/3 shows honey production and producer prices by plant sources in Japan in 1979, and indicates that the most abundant honey was also the most sought after, commanding the highest price, while the least abundant was the second most sought after, commanding the second highest price.

Preferences for form and consistency are likewise traditionally determined. For historical reasons, smooth, finely-granulated honeys were promoted in North America in the 1930s, and now over half the honey sold in Canada is finely granulated. In other countries, liquid honey is sold readily, but granulated honey is suspected of being adulterated with "sugar".

As overheating and contamination with metals can darken honey, dark honeys are often suspected in the trade as being damaged, or of poor quality. Sometimes this is quite unjustified: well produced honey is not necessarily of inferior quality because it is dark. Some excellent honeys are by nature light, and others dark.

According to Kevan, Morse and Akrotanakul (FAO, 1984), "There is some argument over how the public views honey flavour and colour. In most parts of



the world, honey that is light in colour and mild in flavour commands a premium price as table honey. There have been no taste studies of which we are aware, but packers will testify that repeat sales depend upon delivering this type of honey for the table market. On the other hand, most of the honey that moves into the bakery trade is dark in colour and strong in flavour. In baked products the stronger flavour is preferred. Price is not the primary consideration when one buys a sweet. It is important to determine what the public wants, not what the beekeeper thinks they want, or what he prefers, and to deliver that product to the market. A portion of the future research effort should be directed at determining what changes might be made in marketing and packaging to take advantage of the best markets and prices. There is no question that consumers are increasingly interested in quality products. This concerns not only the product itself, but the package in which it is presented.

"The question of new honey products is raised periodically and some good thinking and research have gone into this area," the authors continue. The fact is that only a small percentage of honey goes into specialty honey products. Most of the honey in the world is sold for use as such on the table or in the baking trade. However, a number of honey products have been developed and may be produced on a local basis with some considerable success... Some of the honey products that have been developed and about which good literature is available, are as follows: mead (honey wine), honey butter (honey and butter), honey candy (honey as a soft centre or ingredient), honey beer, honey yoghurt, sweetened after-dinner drinks, etc."

In many areas, comb honey sells at a considerably higher price than liquid honey. This fact suggests that consumers prefer physical evidence of non-adulteration, and also that there is no gastronomic or other objection to eating beeswax with honey. (The beeswax passes through the human alimentary tract unchanged; it is not digested or utilized in any way.) Straining or filtering honey removes beeswax particles, and also any other particulate matter from the bees or from the hive that should not be in the honey at all; these may not be harmful, but are commonly regarded in developed countries as unhygienic or unappetizing. Whole comb, containing pollen and bee brood as well as honey, may be eaten fresh from the hive, and is more nutritious than extracted honey. It should not be despised as a food, but it spoils rapidly if stored; it must be eaten soon after harvesting. Honey sold must always conform with the requirements of the buyers, whatever these are, or else consumers must be educated to change their preferences, a difficult proposition.

Honey production in the tropics and sub-tropics has to operate under certain real disadvantages compared with the operation in temperate zones. One inherent disadvantage is that high temperatures can damage honey: they can impair its flavour and aroma, alter its colour (making it darker), reduce the active enzymes it contains, and bring about other chemical changes in it.

Transport and storage of honey in hot climates therefore introduce hazards that do not exist in cooler regions, and present special difficulties in maintaining honey at export-quality levels. In addition, temperatures in the hive itself must be called into question, for the honey stored at the top of a movable-frame hive may be much warmer than that in the brood nest. It can be argued that fully ripened and sealed honey, as it is removed from the hive, is natural honey and therefore satisfactory. But it can also be said, on the contrary, that it is bad beekeeping practice to leave honey in a hive after it has been stored and sealed, if the hive is in a hot place: the quality of the honey may thereby be impaired even before it is removed from the hive.

Another inherent disadvantage in the tropics is that the water content of certain honeys cannot always be reduced to the 18-19% level that protects them against fermentation. If the relative humidity of the air is very high, the bees cannot evaporate sufficient water from the honey. It is possible also that bees native to the tropics, not needing to store honey for long periods, lack the instinctive behaviour of temperate-zone bees to continue evaporating water in the hive until the honey contains only 18-19% water.

#### 4. Honey Standards and Legislation

Honey is understandably the hive product to which most attention has been paid in the matter of legislation, regulations, recommendations, grading schemes and standards. Among the developed countries regulating honey (the legislative status of the regulations differs widely, because of different national legislative techniques) are the following:

Australia	Greece	Poland
Austria	Hungary	Portugal
Belgium	Iceland	Romania
Bulgaria	Ireland	Spain
Canada	Italy	Sweden
Czechoslovakia	Japan	Switzerland
Finland	Luxembourg	United Kingdom
France	Netherlands	United States
Germany (D.R.)	New Zealand	USSR
Germany (F.R.)		

Developing countries with analogous regulations(\*) include --

Argentina	India	Panama
Bolivia	Iran	Peru
Brazil	Iraq	Philippines
Central African Rep.	Kenya	Saudi Arabia
Chile	Liberia	Singapore
Cyprus	Malagasy Republic	Tanzania
Dominican Republic	Mexico	Turkey
Ecuador	Morocco	Uruguay
Egypt	Nepal	

In addition, a number of regional standards exist (see Appendix B for the 1981 European Regional Standard), and the FAO/WHO Codex Alimentarius Commission in 1983 issued a proposed world-wide honey standard.

Governments of developing countries wishing to formulate domestic standards, or to undertake honey export programmes, would be well advised to study the existing standards carefully, in order to profit by experience gained elsewhere and to ensure that their export standards comply with the import standards of their target countries.

(\*) Developing-country regulations on honey are often designed to ensure that export quality is maintained, rather than to protect the local consumer.

5. Final Recommendations on Honey

- (1) For export honey, the requirements of the importing country must be met in full.
- (2) For domestic urban marketing, honey should be handled as discussed above. Only very few developing countries should need to import honey, and home-produced honey should be promoted in its own right. If light-coloured honey is channelled for export, this does not imply that light honey is necessarily better, but that consumers in the importing countries are accustomed to it and prefer it.
- (3) For domestic rural marketing, there is no real need to remove all pollen and particles of wax, if the buyers like honey unstrained and will use it fairly quickly. Pollen can, however, make the honey seem bitter to palates unaccustomed to it and may make it granulate unevenly. Such honey is usually considered to have a less attractive appearance than strained honey. It should not be kept for more than a few months, because fermentation may occur in the liquid part that separates out when granulation starts, and is then encouraged by the materials included in the honey.
- (4) For home use honey should be in whatever form is preferred.
- (5) In times of acute food shortage, honey of any kind should be sought out. It is a subsistence food that is widely available, although not necessarily in large quantities. A poor honey season does not necessarily coincide with crop failure, although droughts affecting crops may well also affect the honey supply.
- (6) As a corollary to Recommendations 1 and 2, more effort should be applied to identifying sources that yield honey acceptable to importing countries and to domestic urban markets. The aim should then be to ensure regular supplies and to sell such honeys under their own special labels.

6. Further Reading

Crane (1976) is the comprehensive book on all aspects of honey, in which Chapter 9, "Processing and storing liquid honey", by G.F. Townsend, is particularly relevant to this section; see also the paper by R.A. Morse, "Honey production, harvesting, processing and marketing", in FAO (1984), intended for Asian countries in particular. Deodikar et al. (1966) describes processing units in tropical Asia, and "Honey processing and collecting centres in East Africa", by G.F. Townsend, in Crane (1976), reprinted in CS/IBRA (1979), processing units utilized in tropical Africa. There is no substantial publication on marketing honey in the tropics, but ITC (1977) was published to provide a guide for would-be exporters of honey from the tropics, who should also consult the standards in EEC (1974) and FAO/WHO (1983), available in a variety of languages. The information in Crane (1980a) (in English and Portuguese) is less technical than that in Crane (1976) mentioned above; "Honey", by J.W. White, in Dadant & Sons (1975) (in English and Spanish) is a shorter general account. VTA (1981) (in English, French and Spanish) has photographs and good working diagrams for a simple extractor built and used in Nicaragua. Part 19, "Honey in the tropics", of the IBRA Bibliography of tropical apiculture (Crane, 1978a and b), and Satellite Bibliography S/36, "Honeys of specific regions of the tropics", cite many more publications relevant to this section.

B. BEESWAX

The origins of the use of beeswax are shrouded in the mists of antiquity, but there is ample evidence to show that primitive peoples and early civilizations were keenly aware of its importance. From ancient Egypt, where it was an ingredient in medicines for the very rich, to Ghana and Latin America, where it was -- and still is -- the basis for the lost-wax technique of brass-casting, its uses are numerous. Among the Tiv of Nigeria it is used as a soldering wax for repairing kitchen utensils, and the modern American electronics industry uses it in computers. In Uganda it is used in tanneries for treating hides and skins, Rome burns it in the fioccoli that illuminate public buildings on festive occasions, France incorporates it into cosmetics, in southern Asia it is sought after for use in batik printing on cotton, and throughout Europe and North America it is a basic ingredient in luxury furniture polishes. Most important, perhaps, is its use for the manufacture of foundation sheets. It is striking to note that when the British administration of what was then Tanganyika planned to launch a beekeeping development programme there in 1958, the programme was placed in charge of a "Beeswax Officer".

Beeswax commands a much higher unit price than honey, (\*) and it requires little investment, handling or special storage. Both short-term and long-term market prospects for the product are good, and it can be an important source of foreign exchange, especially where traditional techniques of honey-hunting and beekeeping still prevail. Much of the beeswax on the world market has always come from the tropics, and today half the imports into the developed countries come from tropical Africa and tropical America (see Table 6/4).

In some developing countries of the tropics, where fixed-comb or transitional hives are used, it would be wise to give as much attention to beeswax production as to honey production, at least in the early stages of beekeeping development programmes, since the bees build new combs once or twice a year, and a kilogramme of easily-handled wax is likely to be produced for every 10 kg of honey, which requires careful handling and processing to be suitable for export. Unfortunately, however, much of the beeswax produced by the bees is still either discarded or mishandled. Thus, a 1979 FAO study of the feasibility of apicultural development in Syria (Popa, 1979) noted that "paradoxically, Syria is an importer of beeswax, despite the fact that the 50 000 colonies in traditional hives should meet domestic requirements and leave a surplus of about 30 t a year for export. In all apiaries wax is scattered indiscriminately and there is at present no collection or extraction of this product."

The indifference of some "experts" to this situation is sometimes surprising. In a 1962 assessment of the apicultural potential of a West African country, it was reported that although "beeswax has a ready international market ... and could be readily exported if the quality was kept high ... a scheme to collect it would necessitate training in extraction of the wax and a marketing service. This would not be worthwhile to set up for the wax from wild bees alone, but would have to await the time when the production from a few thousand beekeepers is available ..." As a result, the country in question continues to expend scarce foreign exchange in order to import between 10 and 30 tonnes of beeswax a year, probably of a standard much higher than is actually needed.

(\*) According to USDA statistics, the wholesale unit price of beeswax in the United States over the period 1939-81 remained slightly above three times that of honey, with minor annual fluctuations.

Table 6/4 Beeswax: Major Producers, Importers and Exporters, 1982  
(Metric Tonnes)(†)

<u>Country</u>	<u>Production</u>	<u>Net Imports</u>	<u>Net Exports</u>
Angola	1500 F		
Argentina	1500 F		143
Australia	482		303
Bolivia	140 F	1	
Brazil	750 F		110
Cameroon	225 F	1	
Canada	1327 F	35	
Central African Rep.	500 F		83
Chile	500		253
China	12 800 F		
Costa Rica	116 F	1 T	
Dominican Republic	350 F		193
Ecuador	128 F		
Egypt	140 F	32	
El Salvador	130 F		
Ethiopia	2 100 F		210
France		421	
Germany (F.R.)		611	
Greece	264	57	
Guatemala	371 F		6 T
Guinea-Bissau	100 F		31
Honduras	120 F		2
Iran		128	
Italy	66 F	211	
Jamaica	230 F		
Japan		533	
Kenya	1 050 F		
Korea, Republic of	600 F	67	
Malagasy Republic	351 F		67
Mexico	9 150 F		
Morocco	350 F		240 T
New Zealand	110 F		123
Paraguay	104 F		
Portugal	375		28
Sierra Leone	100 F		
Spain	730		88
Sudan	100 F		
Switzerland		130	
Tanzania	1 050 F		220 F
Turkey	2 302 T		
Uganda	780 F		
United Kingdom		368	
United States	1 700 F	948	
Venezuela	146 F	20	

(\*) Includes only countries whose 1982 production, net imports or net exports exceeded 100 MT.

Explanation of symbols:

No symbol = Official data

F = FAO estimate

T = Trend calculation

Source: FAO Statistics Division, September 1984.

With modern hives, designed to maximize honey production, the honey/beeswax production ratio falls drastically, to only 1 kg wax per 50 or even 100 kg honey. As an example, between 1973 and 1979, Egypt conducted a beekeeping modernization programme, during which the number of traditional mud-pipe hives was about halved and the number of modern frame hives about doubled, the total number remaining about 900 000. According to official statistics, the traditional hives consistently produced about 10% as much beeswax as honey, but the modern hives only about 0.4%. This latter figure is very low; it is likely that many modern beekeepers do not collect their wax. The net result of the programme was to reduce annual beeswax production from 263 tonnes to 155 tonnes over the six-year period. By the early 1980s production had fallen even farther, to an estimated 14 tonnes, and from a net beeswax exporter Egypt had become an importer.

Beeswax production will be encouraged if honey collection centres purchase beeswax as well as honey, and on the same graded basis. The best quality beeswax comes from the white combs, and beekeepers should be encouraged to separate white from dark combs before melting them down.

In tropical areas, unless special storage facilities are available to protect combs from wax moth, it is not advisable to store them from one season to another: they are almost invariably destroyed and the beeswax lost. It is therefore more cost-effective to render the wax from empty hives and boxes, and sell it.

## 1. Special Types of Beeswax

### (a) Africa

Several African countries, mainly Ethiopia and Tanzania, are large exporters of beeswax to the European and the American market, and there is room for great expansion in beeswax production in tropical Africa. The tropical African bee is a very prolific producer of beeswax, partly because of its frequent swarming, absconding and migration: after each move the colony must build new combs. These bees will use starter strips of wax, placed in the hive to get them to build their combs in a regular pattern. East African beeswax seems to attract a better price on the world market than wax from other areas, perhaps because of the tradition of beeswax exports there, and perhaps too because it is less contaminated from metals, propolis and other adulterants than beeswax from some other sources.

### (b) Asia

In most of southern Asia, the beeswax produced is from Apis cerana or Apis dorsata. The yield from Apis cerana is rather small, but quite large quantities can be collected from Apis dorsata. The wax from these species has somewhat different chemical and physical properties from Apis mellifera beeswax, and is not acceptable on the European export market, mainly because the largest user of beeswax - the cosmetics industry - uses formulae that have been designed for beeswax from Apis mellifera. It is used for foundation for Apis cerana, in the batik industry and others, and in the cosmetics industry in Asian countries which use formulations designed for this wax.



Fig. 6/7 Pouring the hot mixture of water and melted wax into a cotton bag over a pot.  
Photo: G.F. Townsend.

## 2. Important Factors in Harvesting Beeswax

(a) Hives other than movable-frame hives should be regarded as sources of beeswax as well as honey, and combs should be harvested as soon as the bees leave the hive.

(b) Combs from Apis dorsata should be harvested assiduously. A tree may contain many nests which are out of reach, but after the colonies migrate, birds and animals break the combs, taking what they can extract from the cells, while the combs themselves fall to the ground. These combs should be collected, although, since the wax will be dark, it should be rendered and sold separately from other beeswax harvested.

(c) Extension workers, honey cooperatives and all others concerned should make an all-out effort to encourage beekeepers to harvest, render and sell as much of the beeswax produced as possible: this will reduce the waste of natural resources and avoid a considerable loss of potential income, especially for farmers at the subsistence level, where the income is most needed. What is clear is the need for honey-hunters and beekeepers to regard beeswax more highly, to conserve it, and after rendering to store it for subsequent sale.

## 3. Processing

The beeswax should be separated into two types, white comb plus cappings, and dark brood comb; each should be handled separately and in a different manner.

### (a) Rendering white comb

After the honey has been removed from the comb, by either draining or extracting, the comb should be rinsed or soaked in cold water for 1 to 2 hours to remove excess honey. It should then be broken in pieces and covered with fresh water, preferably rainwater. If rainwater is not available and the water is hard, about 1 part commercial vinegar should be added to 1000 parts water. The vessel used could be an earthenware cooking pot, or made of enamelled metal, aluminium or stainless steel, according to what is available in the local area or the household. The vessel containing the wax and clean water is then heated in a double-boiler; direct heat should not be applied to the water-wax mixture. When all the wax has melted, the mixture is poured through a strainer - a long bag of cotton cloth (Fig. 6/7), woven rushes or other suitable material. If three people are available, one holds the strainer over a pot to catch the strained mixture, while the other two stand on opposite sides of the bag, each holding one end of two sticks with which they squeeze the bag, thus pressing out all the wax (Fig. 6/8). The mixture is allowed to cool, and the cake of wax can then be removed from the water. Any dirt at the bottom of the cake is scraped off.

The cake of wax is melted again in the same way, but with only a small amount of water; this time it is best strained through a cotton cloth, and allowed to run into its final mould; it will now be nearly pure wax. The mould should not hold more than about 2 kg; this is a good size for packing into sacks for export. It should have sloping sides so that the wax cake can be removed easily, and it should be smeared beforehand with soapy water or honey to prevent the wax sticking to the sides. If larger cakes are desired, they should be cast in large, wide moulds so that the wax is only about 10 cm thick. (Buyers are





Fig. 6/8 Squeezing the cotton bag with two sticks, to press all the wax through the bag into the pot below.  
Photo: G.F. Townsend.

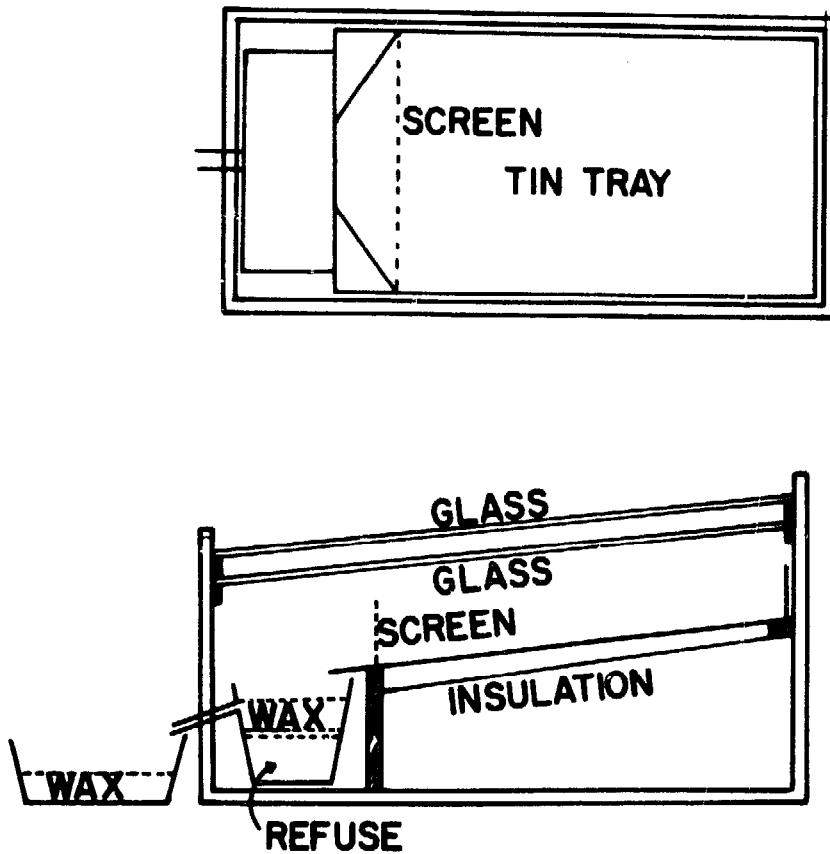

Fig. 6/9 Solar wax melter. Above: Top view. Below: Side view. The pieces of comb are placed on the tin tray lying just above the layer of insulation.  
Drawing: Stephanie Townsend.

alert to any adulteration with stones; if blocks of beeswax are thin, a buyer can check them quickly.) The mould of hot clean wax is covered to keep out dust, and allowed to cool slowly. When the wax is cold, the cake is readily shaken out, and any material remaining at the bottom is scraped or washed off. Beeswax prepared in this manner needs no further treatment before export. Cakes of beeswax of different colours should not be mixed in the same batch sent to the dealer, because a batch consisting of light wax only fetches the best price.

A solar wax-melter is a box with a double glass cover that uses the heat from the sun's rays to melt wax inside (Fig. 6/9). It is satisfactory only for white comb, and should not be used for brood comb. If handled properly, it will produce a light-coloured, clean beeswax which will require only one melting and straining, and can then be poured directly into the moulds.

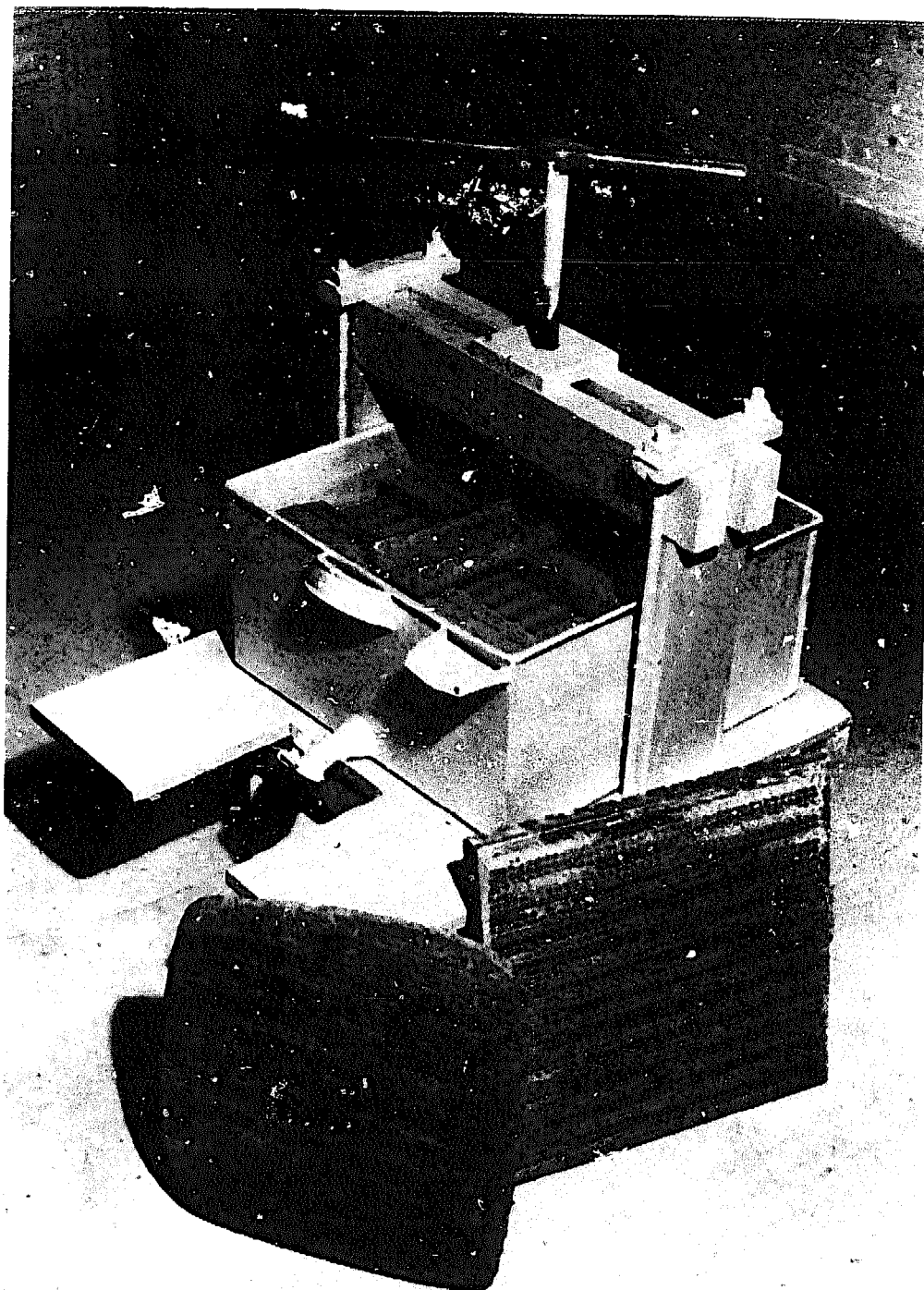

Fig. 6/10 Hot-water wax press. Below, at right, perforated board; at left, cake of residue remaining after wax extraction. Photo: G.F. Townsend.

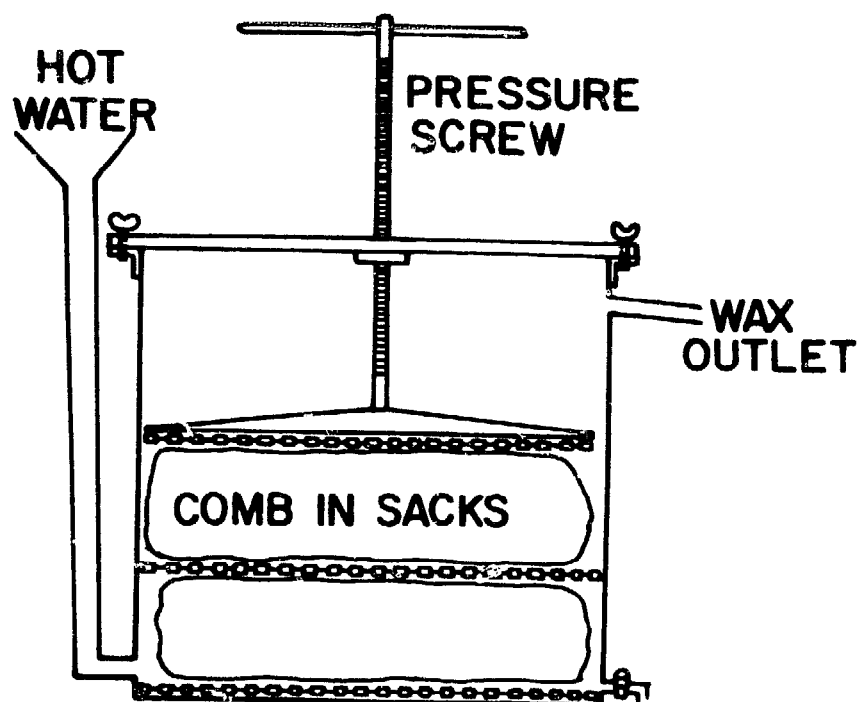

Fig. 6/11 Squeezing wax out of dark combs by means of a hot-water press.  
Drawing: Stephanie Townsend.

(b) Rendering old or dark brood comb

Old brood comb contains the cocoons of the larvae that have been reared in the cells; these colour the wax and also absorb some of it during heating, making it more difficult to render than new white comb. Old comb should be soaked for about 24 hours to allow the cocoons to take up sufficient water so that they will not absorb too much wax. The broken comb is then placed in a sack, along with a heavy rock to hold it at the bottom of a container of water. The water is heated below the boiling point, so that the wax, melted out of the old comb, rises through the sack to the surface of the water. Pressing the sack with a broad stick will help to release the wax through the sacking. The wax that comes to the surface can be either ladled off, or run off, into another container; it is then treated in the same manner as white wax.

A hot-water press (Fig. 6/10), if available, can increase the efficiency of the above process. The sacks of soaked combs are placed between layers of perforated boards (Fig. 6/11), in a container of water that can be heated and continually replenished with fresh hot water added through a side funnel. This container has a screw mechanism by means of which the sacks of wax can be slowly squeezed; the wax pushed out rises to the surface and runs out through the wax outlet. It is usually mixed with a little water after settling, but can be remelted in water and strained through cotton. It will be quite good wax, but probably darker than wax from white comb, so it should not be mixed with the latter. The wax obtained from dark combs in this way can be run into 2-kg moulds as described above, and is ready for market.

Beeswax does not deteriorate to any great extent during storage or shipment, and with proper instructions wax from white comb can be prepared ready for export, without elaborate equipment, in the village where it is produced: dark comb is better rendered at the collection centre or the central packing plant, where more effective equipment can be used.

(c) Important factors in processing beeswax

1. Combs from which honey has been extracted should be rendered before they can be attacked by wax moth.

2. Beeswax is damaged by overheating and should never be allowed to boil. It should never be heated directly over a flame or other strong heat without being mixed with water, because direct heat will darken and spoil it. Since it is very inflammable, heating it directly also creates a real and serious fire hazard.

3. Containers used for melting or cooling beeswax should be made of aluminium, stainless steel, nickel, tinfoil, unchipped enamel or heat-resistant plastic, and never of iron, zinc, copper or brass. Galvanized metal can be used when no other containers are available. A wooden container, or a gourd split in two, is satisfactory as a mould.

4. Adulteration of the wax reduces its value and should be avoided at all times. When comb foundation contains other waxes, combs built from it must not be rendered into beeswax. Moulds should be coated only with honey or soapy water, never with oil or fat, before the wax is poured in: once oil or fat, or any other wax, such as paraffin, becomes mixed with beeswax, it cannot be removed, and the value of the product is permanently reduced.

5. Contamination of beeswax with propolis, lowering its melting point and changing its characteristics, must be prevented; scrapings from frames should never be mixed with cell cappings.

6. Sand or stones must not be allowed to become mixed with beeswax.

4. Beeswax Production and Trade

Figures for beeswax production are too scarce and uncertain to allow useful comparisons or synthesis; those shown in Table 6/4 are known to be not only approximate but fragmentary. As already noted, bees in fixed-comb hives may produce one tenth as much beeswax as honey, but the proportion drops very sharply when modern hives are used; this fact makes it impossible to estimate beeswax production on the basis of honey production, all the more so as by far the greater part of the wax, especially from fixed-comb hives, remains uncollected and is allowed to go to waste. It is certain, however, that the amounts of beeswax reaching the market - and even more the export trade - are only a small fraction of that produced by the bees, and are grossly inadequate to meet the demand.

Figures for international trade in beeswax are more difficult to obtain than those for honey. Table 6/5 summarizes world production, import and export figures for 1976-83, while Table 6/6 presents statistics of 1972-76 exports of

Table 6/5 Beeswax: Estimated world production and trade 1976-83  
(metric tonnes)

	1976	1977	1978	1979	1980	1981	1982	1983
Production	34 557	34 722	36 331	36 108	39 370	41 627	43 400	43 232
Imports	6 178	6 311	6 445	6 616	6 678	6 243	5 518	5 357
Exports	4 987	5 612	5 047	7 107	6 928	4 293	3 777	4 410

Source: FAO Statistics Division, September 1984.  
(Imports corrected to trend.)

Table 6/6 Beeswax: Exports of major African and Latin American  
producers to 7 major importers, 1972-76 (3-year running  
averages) (metric tonnes)

	1972-74	1973-75	1974-76
Ethiopia	530	537	497
Kenya	73	70	86
Malagasy Republic	177	134	128
Morocco	246	190	196
Tanzania	314	286	286
Total 5 African countries	1 340	1 217	1 193
Brazil	256	297	346
Chile	189	224	336
Dominican Republic	200	188	180
Mexico	178	167	178
Total 4 Latin-American countries	823	876	1 040

Source: Derived from ITC (1978).

certain major African and Latin American producers to the seven major importers. The latter table provides no evidence of dramatic changes in the export trade during the period, but certain trends can be observed, particularly a decrease in the African share of the market in favour of Latin America. (Trade figures for the most recent years are still incomplete.)

5. Important Factors in Exporting Beeswax

- (a) Countries desiring to export beeswax must ensure that their product meets the standards of the importing country. The following developed countries, among others, have prescribed standards for beeswax:
- |                |                |
|----------------|----------------|
| Czechoslovakia | Switzerland    |
| Germany (D.R.) | United Kingdom |
| Germany (F.R.) | United States  |
| Italy          | USSR           |
| New Zealand    |                |
- Beeswax is also regulated in a number of developing countries, including Argentina, Dominican Republic, India and Tanzania.
- (b) Export authorities should ensure that the beeswax has been neither contaminated nor discoloured by overheating or by the use of unsuitable metal containers.
- (c) Wax cakes should be thin enough to guarantee that they are free from extraneous material such as stones.
- (d) Beeswax cakes of different colours should not be mixed in the same consignment.
- (e) An officer should be trained to be able to check the contents of beeswax containers before they leave the country, in order to ensure compliance with regulations. At a later stage, as the export industry expands, provision should be made for the analysis of beeswax samples within the country of origin, so that shipping certificates sent with the consignment can include analytical data supporting the description of the product as pure beeswax.

6. Further Reading

Beeswax has been seriously neglected as far as reference works are concerned, and there has been a shortage of up-to-date publications that are really useful. For this reason, Coggs and Morse (1984) will be greatly welcomed. Tropical Africa has been the main world supplier of beeswax, and Smith (1951), though old, still provides sound information; Apimondia (1969), which exists in English, French and Spanish, is widely applicable. The solar wax extractor described in ISI (1977) is suitable for use with wax from any species of honeybees. ITC (1978) is designed as a guide to marketing beeswax from the tropics, and includes information on standards and quality. Tulloch (1980) gives current information on the -- highly complex -- composition of beeswax from A. mellifera, while Phadke (1961; 1975) and Phadke et al. (1969; 1971) provide similar data for beeswax from the Asian Apis species and Trigona. The five bibliographies in Walker (1983) give details of over 500 publications on beeswax and indicate the availability of much information, while Part 20, "Beeswax and other hive products in the tropics", of the IBRA Bibliography of tropical apiculture (Crane 1978a and b) cites many more publications on beeswax, including its handling and marketing.

## C. OTHER HIVE PRODUCTS

Honey and beeswax have been sold commercially for several thousand years. Especially since World War II, beekeepers in technologically developed countries have sought to diversify their production, and there is now some international trade in pollen, propolis, royal jelly, bee venom and bee brood. Table 6/7 shows the composition of some of these materials. In addition, certain beekeepers specialize in producing and selling queen bees, colonies of bees (including small ones known as nuclei), and package bees (young worker bees -- usually 1 kg -- with a young mated queen). Others hire out colonies of bees for pollinating crops.

Storage conditions after harvesting -- even for a short period -- are much more critical for pollen, royal jelly, bee venom and bee brood than for beeswax or honey. Some of these products are good media for the growth of moulds and other micro-organisms, and monitoring by scientifically trained personnel is therefore necessary.

This section assesses the suitability of these specializations for developing countries in the tropics and sub-tropics.

### 1. Pollen

Pollen is the bees' source of protein and other substances they require for rearing brood, and a colony may use up to 50 kg a year. Bees normally collect pollen from flowers that also produce nectar, but sometimes from wind-pollinated plants that do not, such as maize.

The composition of bee-collected pollen varies greatly according to plant source, and its water content also varies with climatic conditions.

Pollen is produced during the flowering season of a plant, which usually lasts a few days or weeks. During such a "pollen flow" it may be possible for the beekeeper to harvest 0.5 or even 1 kg of pollen a day per hive.

Pollen is harvested in a "pollen trap" attached at the entrance of a movable-frame hive and incorporating a single or double grid through which the incoming bees must scramble when entering the hive. The pollen loads on the hind legs are knocked off in the process, and fall into a protected tray below, which the bees cannot enter. Fig. 6/12 shows the OAC trap (named for the Ontario Agricultural College), that has been widely used; improved and more complex versions of it, now produced in several countries, have the flight entrance and the pollen receptacle at the front of the hive, or near the top, and the grid may be vertical or sloping.

The trap does not normally remove more than 50% of the incoming pollen, and brood rearing is not suppressed because more foragers switch to pollen collection. While a yield of 10-15 kg/hive/year can be obtained in good areas in the temperate zones, information for the tropics is sparse; a yield of 2.6 kg/hive/year has been reported from Costa Rica.

Commercial uses of bee-collected pollen include --

- (a) feeding to bees when plant sources of pollen are lacking. Caution is needed because AFB and chalk brood can be transmitted by contaminated pollen;



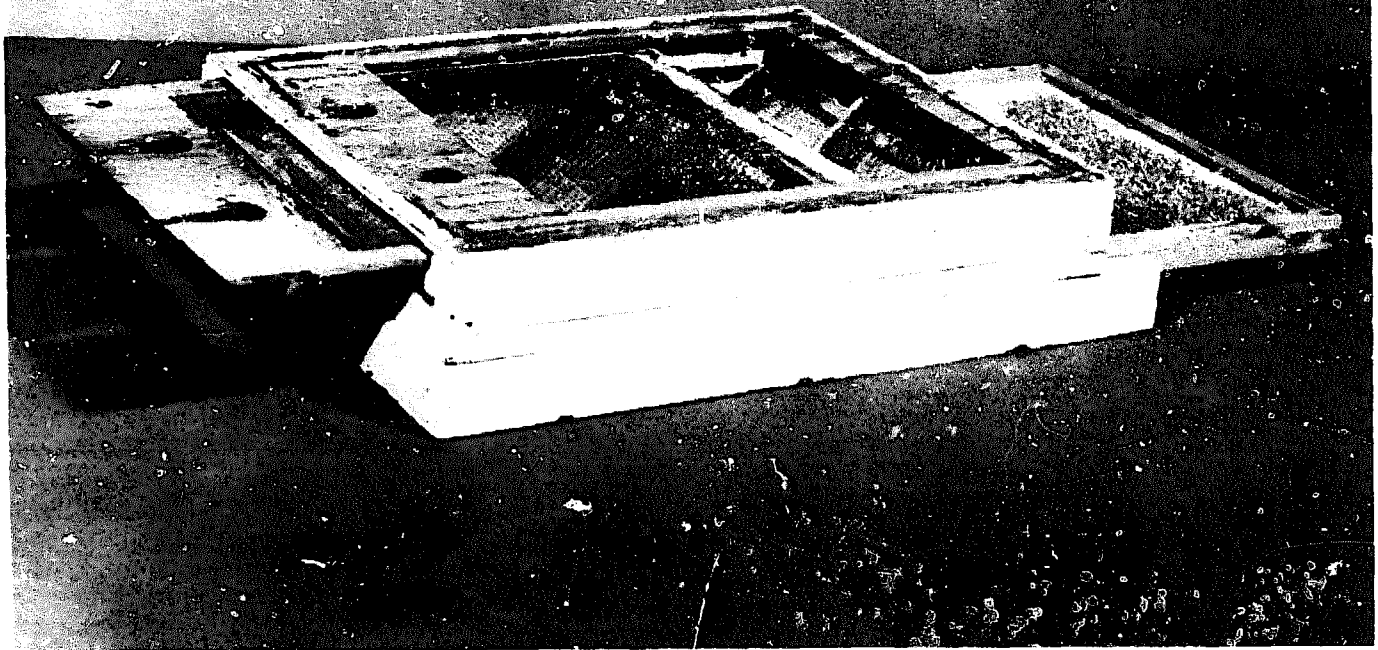

Fig. 6/12 Pollen trap, OAC type, fitted to the floorboard of a Langstroth hive. The floorboard is reversed (front to back), the entire device is placed on it, and the hive boxes are replaced above. Bees enter the trap below the plywood slide at the left and climb up into the hive through the double grid at the top of the trap (2 meshes/cm, separation 6-8). The frame supporting handle for removing them without opening the hive. Pollen falls through a finer screen below the grids, not visible in the figure (2.4 or 2.8 meshes/cm), onto the cloth floor of the collecting tray seen at the right; the cloth allows ventilation. The tray is removed from the back of the hive by sliding it out of the open end of the floorboard; in the figure it is seen partially withdrawn, and bearing pollen pellets. The three pieces of wood placed diagonally below the grids support the lower grid and help the bees to climb up to it. Photo: University of Guelph.

**Table 6/7: Hive products used as food: Representative composition ranges (%) of major constituents**

	Water	Protein	Fat	Carbohydrate	Ash
HONEY (average for 490 USA samples)	17	-	-	80	0.02-1.0
POLLEN, bee-collected (USA)	7-16	7-30	1-14*	21-48	1-6
POLLEN, bee-collected (Egypt)	7-10	20-33	2-6*	not given	3-7
POLLEN, hand-collected (various places)	4-17	11-36	1-18*	1-37	3-6
POLLEN (Scotland) (monthly means)	25-36				
ROYAL JELLY	65-70	14-18	2-6*	9-18	0.7-1.2
BEE BROOD (mature worker larvae)	77	15	4*	0.4	3
-----					
BEEF (Total edible, trimmed to retail level, raw; standard grade)	64	19	16	0	1
MILK (Fluid, raw and pasteurized; US national average on farm production basis)	87.2	3.5	3.7	4.9	0.7

\* Ether extract

**Sources:** Honey: White *et al.* (1962)  
Pollen: Stanley and Linskens (1974)  
Bee brood: Hocking and Matsumura (1960)  
Royal jelly: Johansson (1955); Johansson and Johansson (1958)  
Beef and Milk: USDA/ARS Agr. Hdbk 8.

- (b) as a dietary supplement for domestic animals;
- (c) for human consumption, usually expensive packaged pharmaceutical preparations as nutritional and therapeutic dietary supplements;

In some temperate-zone areas there are seasonal pollen dearths, i.e. periods when colonies can rear brood and/or store honey only if pollen is provided by the beekeeper; feeding with pollen during such dearth periods can double or triple the honey yield per colony. It is, however, useless to feed colonies with pollen when they can collect it. With the rich variety of flora in the tropics, it is unlikely that pollen dearths often impose a significant constraint there, but almost nothing is known on the subject, or on the effects of feeding pollen to colonies in tropical areas. Certain honey flows, including honeydew flows and flows from extrafloral nectaries, are known to be unaccompanied by pollen production.

Pollen is a "free" resource, and much of it is left uncollected and wasted after insects and other animals have taken what they require. There are records of wind-borne pollen, or pollen shaken from plants, being collected for use in folk medicine, but harvesting of bee-collected pollen for animal and human consumption has hardly been explored in the developing countries.

Pollen need not be expensive, and the possibility of its collection and use would seem worthy of study where dietary levels are inadequate. Although this is largely uncharted territory, such a study should also take particular account of possible dangers to health from improperly stored pollen, toxic pollens of any species, and excessive pollen consumption.

## 2. Propolis

Propolis is the latest hive production to have been commercialized, and there has been widespread interest in it only since the 1960s. Most of this interest centres around its content of flavones and related compounds with anti-bacterial and antifungal properties(\*). So far over 30 such components are known; they are present in propolis on the plants, and also (unchanged) in propolis in the hive. The bees' use of it may indeed be part of their hygienic social behavior; for instance they propolize an intruder such as a mouse that they kill in the hive but cannot remove because it is too large.

Many clinical trials have been made with propolis, especially in hospitals in Eastern Europe, but there has so far been little linkage between such trials and individual components of propolis, so a great deal is unclear. There are also reports of injurious effects of some extracts of propolis. About one beekeeper in 2000 (in the UK) is believed to be hypersensitive to propolis, so care is needed in using it.

There is no standard equipment for harvesting propolis. Some beekeepers scrape it off hive walls, frames, etc., wherever the bees deposit it, but this gives a very impure product. The use of propolis in the hive (and therefore the amount harvested) can be increased if wooden or metal grids are inserted which have slots of such a width that the bees will instinctively seal them up. Recommendations for the width of slots vary between 2 and 10 mm, and there may be an advantage in using long angular slots. Fig. 6/14 shows some propolis grids recommended in the USSR and also used in Cuba. In Japan, a piece of wire or nylon netting (10-15 mesh) is placed completely across the top of the frames in a hive as a propolis collector.

Propolis is much easier to handle at lower temperatures, when it becomes brittle. If metal grids are used, and these are frozen after removal from the hives, the propolis can be broken off them by shattering. Recommended temperatures are -10 to -20° C. In hot countries, if this method is impracticable, the propolis can be scraped off the grids, using the inverted end of a metal scraper. The temperature of the grids should be as low as possible for the operation, which should perhaps be carried out at night for this reason.

In another method from the USSR, canvas hive covers are used over the frames, and when they become coated with propolis they are removed and stored.

---

(\*) It is also reported to be used in glues for violin-making.

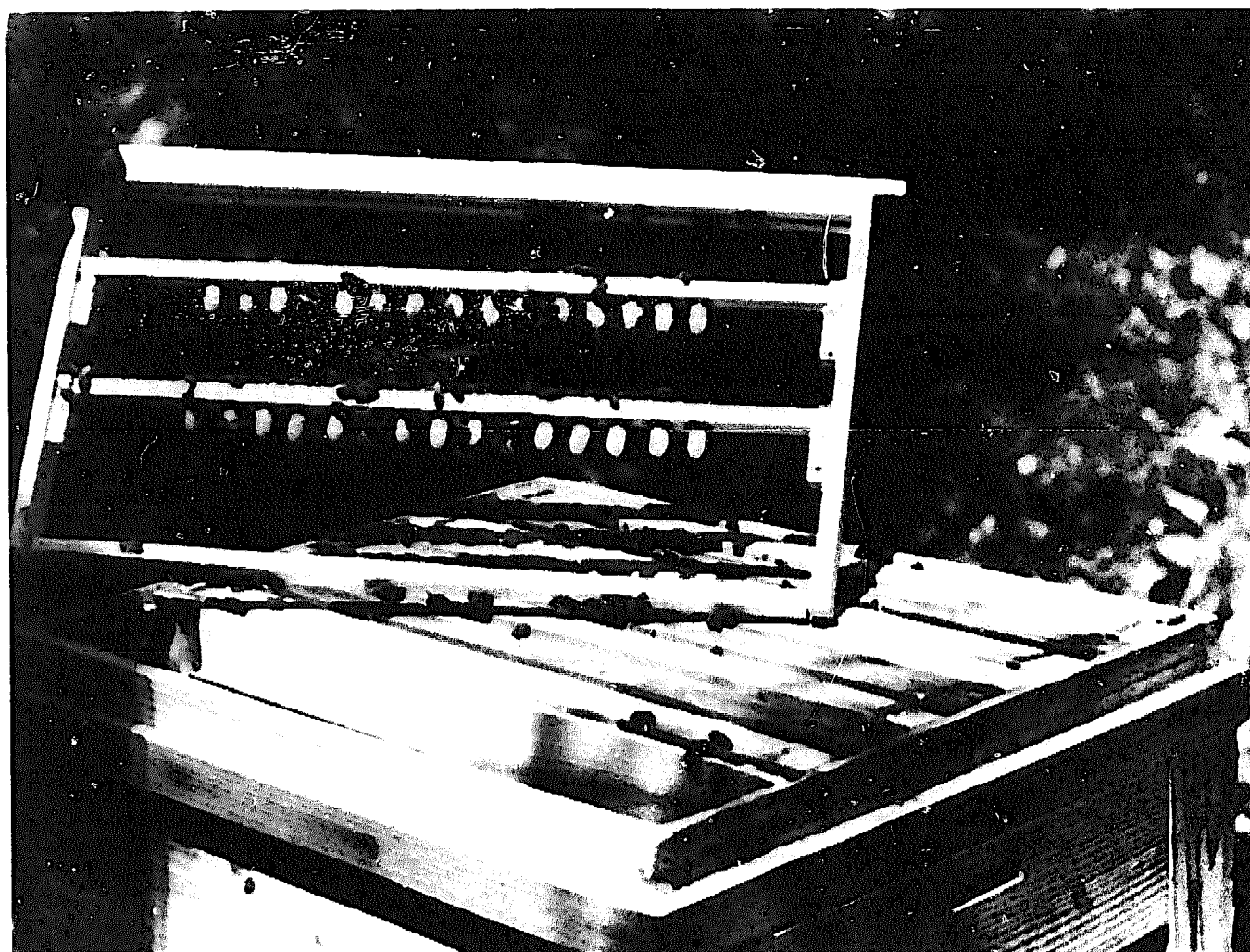

Fig. 6/13 Royal jelly production. Two bars fixed across a brood frame, each carrying 15 artificial queen cells.  
Photo: I. Okada.

In winter (if possible when the temperature is below freezing point) the propolis is removed from them by passing them between rollers; it is then cleaned and formed into briquettes (20, 50 and 100 g) by a hydraulic press. Another system, experimental in the USA, is to insert a slatted bar in one or both side walls of a hive, the bar being protection from the weather. When the bees have propolized the gaps between the slats, the bar is removed (from outside) and put into a freezer, and another clean bar is inserted.

In Cuba 10-20 g is recommended as the maximum to be taken from a hive; in Japan the total yield per hive in the active season is quoted as about 50 g.

### 3. Royal Jelly

Royal jelly is a very rich food, which enables honeybee larvae to grow extremely quickly, more especially queen larvae, which are fed exclusively on

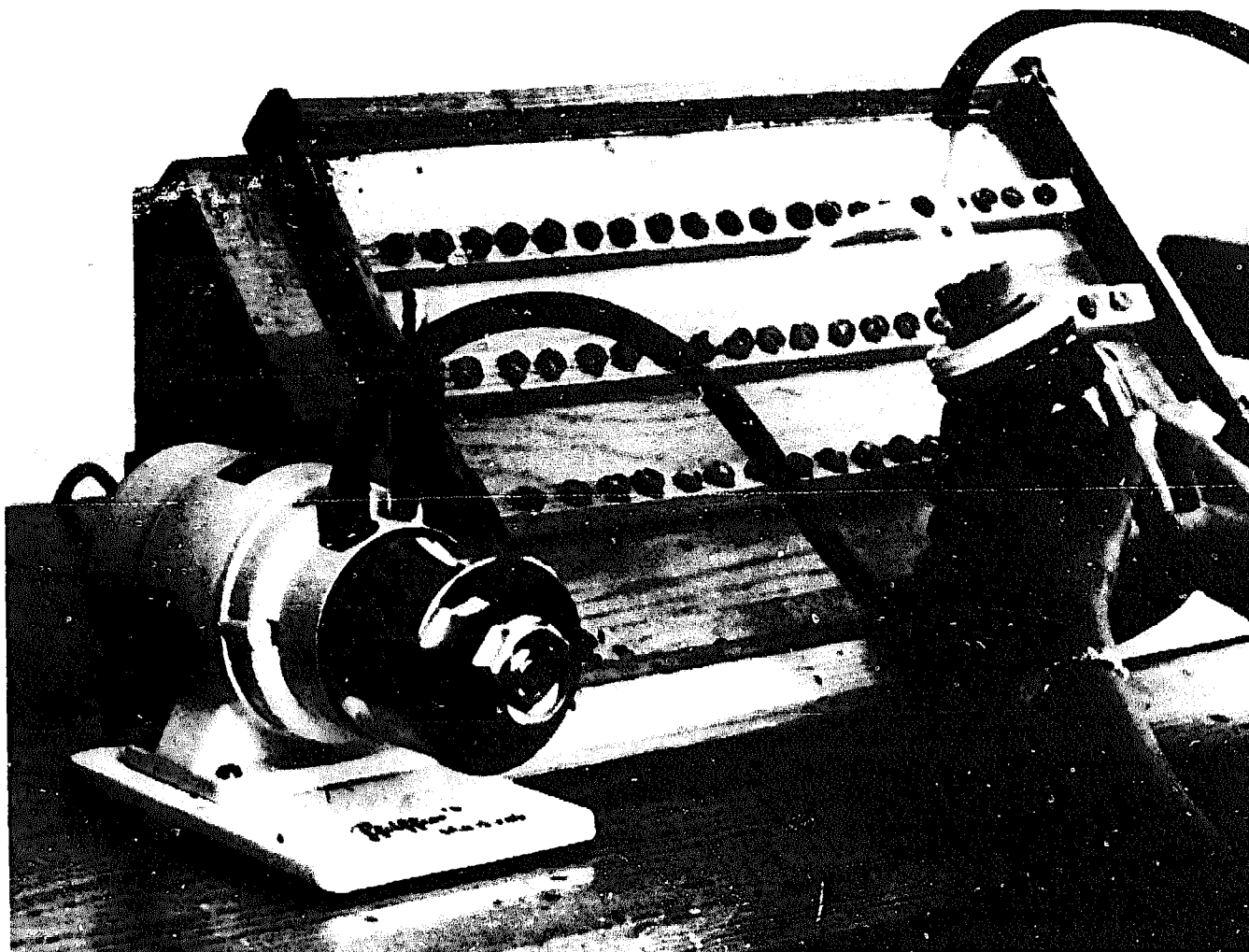

Fig. 6/14 Royal jelly collection. The jelly is being aspirated from artificial queen cells by means of a vacuum pump.  
Photo: IBRA Collection.

royal jelly, workers being fed a mixed and limited diet. Its gross composition is shown in Table 6/7. Royal jelly is used in some countries for treating a wide variety of human diseases and malfunctions, and to promote long life and well-being. Opinions remain divided as to its prophylactic and therapeutic value, a discussion of which lies outside the scope of this book.

Royal jelly is secreted by hypopharyngeal glands in the head of young worker bees. Because it is bee food, it is sometimes referred to as bee milk. The nurse bees deposit small amounts of the jelly in each cell containing a larva, and relatively large amounts (although still less than a quarter of a gram a day) into each queen cell (Fig. 2/1): the method of harvesting royal jelly is based on the latter fact. The beekeeper prepares tiny cups shaped like partly-constructed queen cells, and places in each a very young worker larva; 18-24 hours after hatching from the egg is the best age. This process is called grafting. Up to 40-50 cells are attached to wooden bars fixed across an empty brood frame (Fig. 6/13) and placed in a strong colony of bees. The bees finish constructing the queen cells and stock them up with royal jelly, which the beekeeper harvests by aspirating it into a collection tube (Fig 6/14). The

yield depends on the age of the larva; in one test the average weight of royal jelly extracted per cell was 147 mg if the larva was left in it for 2 days, 235 mg if left for 3 days and 182 mg if left for 4 days - less than after 3 days because during the final day the larva was so large it consumed much more than the workers supplied. Thus, 3 days was the optimal period for harvesting: the yield (235 mg) would give 1 gramme from 4.25 cells, or about 10 grammes per hive.

Not all bees are suitable for royal jelly production. The report of a recent FAO/UNDP project in Guinea (FAO 1981b) for example, noted that the behaviour characteristics of the local bee (a strain of A.m. adansonii) were such that it was not easy to obtain royal jelly from it. Tests were carried out, and the jelly obtained was collected for use by the national apiculture centre, but the disturbance caused by the necessary handling operations caused frequent absconding and high aggressivity. It was felt that further tests were necessary, in an enclosed apiary, but that they were likely to be successful only with imported bees.

Royal jelly production, although profitable, involves the beekeeper in labour-intensive and delicate work, requiring strict adherence to timetables based on the physiology of the developing honeybee larvae. Further, the product once collected must be kept under refrigeration. Producing it is therefore not a suitable activity for tropical and sub-tropical countries starting to develop beekeeping, or for any except those where European bees are kept in movable-frame hives, and where a central organization with specialized technicians can control the work and supervise the handling, storage and transport of the royal jelly produced. (The situation concerning royal jelly production by A. cerana is still unclear.)

Several Asian countries, where these conditions are met, are among the world's largest producers of royal jelly. In China, the province of Taiwan concentrates much of its beekeeping effort on royal jelly production, and produced 120-150 tonnes in 1977. A recent report from mainland China (FAO 1984) indicates a production of about 400 tonnes/year, on the basis of an average of 500 g per colony; the product is sold to the United States, Japan, and countries of southeast Asia. Japan produced 24 tonnes in 1978 and imported a further 99 tonnes. The Republic of Korea, Hong Kong, and some other countries in eastern Asia also produce royal jelly. The wholesale price of royal jelly at the beginning of 1985 was about US\$ 100/kg.

#### 4. Bee Venom

Bee venom, used in medical research, in desensitization treatment for patients allergic to bee stings, and in some countries in acupuncture and for treating certain types of rheumatism, is produced by all worker bees except very young ones. It is secreted by the sting glands, and is injected into the skin of the victim by a pair of lancets with barbs which prevent the sting being easily withdrawn through the tough skin of a human being or large animal. When the bee tries to pull itself away, or is brushed away by the victim, the sting apparatus is torn from its body. Nevertheless its muscles continue to pump venom into the wound; it should be scraped away (not pulled out) by the person stung. The incomplete bee usually dies the same day or soon after. When a bee stings another bee (which it can do only through a soft part of the integument, for instance between two abdominal segments), it can normally retract its sting and live to sting again.

Beekeepers harvest bee venom by attaching to a movable-frame hive, at the flight entrance, a frame supporting a very thin horizontal membrane, with bare copper wires laid horizontally and vertically across it, alternate wires being earthed and attached to an electric battery. The beekeeper puts on the fullest protective clothing possible, and connects the battery so that a small current passes through the alternate wires. The first few bees leaving the hive receive a mild shock, and react by stinging into the membrane. They withdraw their stings and fly off, but they release an "alarm odour" which alerts other bees to come out to defend their colony. The diaphragm thus receives many further stings -- and so does any person or animal near the hive, and even within several hundred metres. Bees can remain alerted to sting for a week after the venom collection.

Tiny droplets of venom, left on the underside of the diaphragm, crystallize if the temperature is high, and can be scraped off. After 5 minutes' operation the yield of dried venom may be 50 mg. The venom needs very careful handling and storage.

Bee venom collection is described here to satisfy readers' curiosity. It is not recommended that attempts be made to harvest bee venom in developing countries, because the danger to human life from many thousands of alerted bees is too great in any but the most carefully controlled conditions. Venom collection should in no circumstances be attempted with tropical African bees, or with Africanized bees in American countries.

#### 5. Bee Brood

Section D of this chapter deals with the production and sale of live bees. Bee brood is included under this heading because, like honey, royal jelly and pollen, it is used for human consumption; the brood does not develop into live adult bees.

Bee brood, harvested as fully mature larvae, has a quite high nutritive value (see Table 6/7). In tropical Africa, honey-hunters normally harvest whole combs (including brood) and eat the brood along with the rest of the combs; both pollen and brood provide protein. The brood is widely regarded as a delicacy by beekeepers in those areas, who may pick the larvae out of the combs to eat. In eastern Asia honeybee brood is similarly regarded, and larvae are sold commercially in tins, whether boiled, fried, pickled or smoked.

Bee brood has also been used for animal feeding, for instance to poultry and hatchery fish; one report, though, says it is "unacceptable to mink if given without other food." In North America as well as in Sierra Leone, it is used as fish bait. A recent report (FAO 1984, p.156) indicates that in Japan, freeze-dried drone pupae are used to feed predatory beneficial insects (e.g. Chrysops and Coccinellidae) employed as biological control agents.

There is no difficulty, and no danger, in producing bee brood for use as food. Drone larvae are often preferred for harvesting because they are larger than worker larvae, and also because they can be mass-produced, unlike queen larvae. Movable-frame hives are used, with drone foundation if required. Frames of brood are cleared of bees, the cells uncapped with a knife, and the frame swung down onto a block with a sharp tap; the brood falls into a tray below. It is preserved by freezing or drying, and may be boiled, pickled or treated in other ways, according to consumer preference.

The annual yield per hive can be high (several kg), but removing the brood, and hence decreasing the number of potential foragers, reduces the honey yield.

## 6. General Observations

Bee brood is sold on its gastronomic merits. Propolis and bee venom are marketed in certain preparations or specifics for pharmaceutical use, as are pollen and royal jelly, except that the latter are often incorporated into preparations sold as improving general health, vitality, well-being, etc. Many accounts of the clinical use of these four substances have been published, and also - separately - reports of their composition: all are highly complex and of considerable biological interest. But there has been relatively little analysis of the physiological effects of individual components of the substances, under controlled conditions and in relation to specific pathological disorders.

In these circumstances, the main markets for these products are currently in developed countries whose food and drug legislation does not prohibit label statements of likely medical benefits of a product. They are relevant to developing countries if their consumption could benefit the people in them. Pilot studies are needed on the possibility of harvesting both pollen and bee brood, and of using them to benefit the human populations in developing countries, both directly and indirectly - e.g. as animal feed.

The products can also be produced for export and thus earn foreign exchange - as is done with royal jelly in eastern Asia, for instance - and this will doubtless continue. Because of the difficulties involved, production of royal jelly is not recommended for wide adoption, and production of bee venom should not be attempted. The future of the propolis market is not very clear; if prices remain high, and the market stable, its production in developing countries could be expanded on quite a large scale. Again, a pilot study to study the possibilities is needed.

## 7. Further Reading

Stanley and Linskens (1974) is a comprehensive work on pollen, and the best currently available. Bee World (1975/76) gives brief details of pollen and pollen traps, with diagrams, while Smith (1963) discusses the original OAC trap. Dany (1978) (in German) also describes pollen collection.

Asis (1979), in Spanish, is the best available guide to propolis harvesting and also deals with its composition and properties, on which Chisalberti (1979) provides more complete information, while Walker (1976) gives a comprehensive bibliography on propolis up to 1975. Smith (1959), Lechman de Enzenhofer (1982) and Inoue and Inoue (1964) discuss royal jelly production and trade; Morse and Benton (1964) bee venom collection; and Hocking and Matsumura (1960) bee-brood harvesting. Donadieu (1981), in French, describes proper storage conditions for pollen, propolis and royal jelly. See also "Other products of the hive", by P.C. Wetherell, in Dadant & Sons (1975).

Part 20, "Beeswax and other hive products in the tropics", of the IBRA Bibliography of tropical apiculture (Crane 1978a and b) cites many other publications on the products dealt with in this section.



D. PRODUCTION OF BEES FOR SALE

1. Queen Rearing

An important specialized part of beekeeping in temperate zones is queen rearing, which has become a thriving industry there for a number of reasons. A young mated queen introduced to a colony to replace an old queen can quickly increase the colony's population and its productivity, and also reduce the chance of its swarming during the next year. A single colony can be split into two during the proper season, and a young mated queen given to the part without the colony's queen; both parts will then build up their populations quite rapidly. New queens can be reared at lower latitudes where spring comes early, and transported to higher altitudes where the season is later, enabling colonies there to develop earlier. Finally, queen rearing can provide queens of better genetic stock than are otherwise available to beekeepers.

Long-distance transport of queens across 20° - 30° of latitude, up to 3500 km, is practised in the two continents where such an area is under common legislation: North America, where queens from the southern USA are sent to the northern USA and also to Canada; and the USSR, where they can be sent from Georgia and Kazakhstan to, for instance, the Moscow region. In theory, a third such route would be from North Africa to northwestern Europe. In the past this trade could not develop because it was unnecessary; currently it is ruled out by import legislation designed to prevent further transmission of bee diseases across national boundaries. Varroa, which is currently present in North Africa, is especially feared.

Queen-rearing operations are not in general a practical proposition in the tropics, because they involve much manipulation of the colonies used, and tropical honeybees react to disturbance by absconding. Tropical African bees are also liable to sting excessively.

The process requires the use of movable-frame hives. It is carried out on a large scale in some sub-tropical developing countries, including the People's Republic of China, Mexico and Argentina, where Apis mellifera of European or Mediterranean ancestry is widely used.

2. Colonies and Packages of Bees

Colonies of bees are produced for sale in many developed temperate-zone countries. They can give a better return from beekeeping than honey production in some locations with a heavy flow of both nectar and pollen soon after the dearth period, followed by much poorer flow periods; large populations of bees, built up on the early flow, may then be otherwise unproductive for lack of nectar sources.

Package bees are more cost-effective for transport than colonies. Light wooden boxes, with screen-ventilated sides, are filled with (usually) 1 kg of young bees, and provided with a young mated queen in a cage, and a container of sugar syrup. Many hundreds of these can be transported in a lorry, and in the USA are taken from the southern, almost sub-tropical states, to the north. In 1981 a first consignment of package bees was successfully sent by air from Australia to the Federal Republic of Germany. Package-bee production is a specialized industry and, because of the danger of disease transmission, it can

operate only within one country (or two closely cooperating countries). Similar arguments apply as to queen production, only more strongly: for instance, the Varroa mite has been spread widely by transport of colonies, although rarely if ever by the transport of queens. This approach is, unfortunately, not one to be followed up at present.

### 3. Hiring Bees for Pollination

This, again, is an important industry in temperate-zone countries with highly mechanized agricultural systems. The fees paid recompense the beekeeper for any reduction in honey crop, and take into account his hive transport and management costs. The grower must ensure that any pesticides he uses do not poison the bees whose services he pays for.

Similar work is starting in the tropics, for instance where insect-pollinated crops are grown as monocultures in newly-irrigated desert land. The first step must be to establish where and when honeybees are needed for pollination, and to educate farmers to the method's possible benefits to them.

### 4. Further Reading

Laidlaw (1979) is a comprehensive modern book on queen rearing and package-bee production; Laidlaw (1971) discusses queen introduction. Woyke (1980d), in Spanish, also deals with queen rearing, in the context of local beekeeping. Similarly, Martinez Lopez (1981), in Spanish, covers queen rearing (and also royal jelly production) in sub-tropical Mexico. Reid (1975) studies the storage of large numbers of young queens until needed. Crane (1984) opens up a new application of the study of bees and their products. See also Chapter 19, "Production of queens and package bees", by H.F. York, in Dadant & Sons (1975).

## CHAPTER 7

### BEEKEEPING FOR PROFIT IN DEVELOPING COUNTRIES

#### A BANGLADESH CASE STUDY(\*)

Once his family's basic subsistence is ensured, the farmer, everywhere in the world, decides what supplementary crops and animals he will raise on the basis of the answer to one fundamental question: What agricultural activity offers me the best promise of maximum income for a minimum input of capital and labour? Readers of this book will already have understood that one outstanding answer to this question can be beekeeping. It requires almost no land, little equipment - all of it light and relatively inexpensive - and little time - on average, an hour a week per hive. Hive products are in demand everywhere, on the local and export markets, and command a good price. This chapter discusses, in simple terms, how a Bangladesh farmer can calculate for himself his chances of success in beekeeping. Elsewhere the figures may change, but the general approach remains valid.

The first thing the farmer needs to know is whether there are enough honey plants in his area for his bees to collect and store nectar. Though Bangladesh is largely a rice-cultivating country, many parts of the country have sufficient and diverse vegetation to make them well suited for bee foraging. Bees are little interested in cereal crops, but the forest areas of Madhupur, Chittagong, the hill tracts and the Sundarbans provide excellent opportunities for beekeeping. The agricultural areas contain litchi, jackfruit, lemon, acacia, albizzia and other legume trees, as well as coconut and date palms, drumstick, blackberry, mango, jambura, eucalyptus, papaya, pomelo, wood-apple, banana, guava and other fruit and shade trees. Large areas are also under cultivation with mustard, cucumber, melons, peppers and pulses. Thus, plant sources for honey are fairly abundant throughout the country. Depending on the availability of supporting services, it may be assumed that a carrying capacity of more than 10-20 hives/km<sup>2</sup> is possible in some areas (Kevan, 1983).

Beekeeping in Bangladesh has only a short history of about 40 years; before that time, the only honey available was obtained from honey-hunting or through commercial imports. Until recently, progress in apiculture was slow, and this indicates the importance of supporting services to the beekeeper. There was little government planning with regard to beekeeping, and little expertise was available in the country; no funds were available to finance research and development and a marketing infrastructure, and coordination among

(\*) The basic facts and methodology presented in the first part of this chapter were kindly furnished by Dr. Ali Mohammad, of the CIDA Agriculture Sector Team, P.O. Box 569, Dhaka, Bangladesh, whose contribution is gratefully acknowledged; see in particular his paper, "The economic impact of beekeeping: A case study of Bangladesh", in FAO, 1984. Necessary modifications have been introduced to make the study more widely applicable. All prices relate to 1983. US\$ 1 = 25 taka (Tk.).

the many agencies involved in promoting apiculture in Bangladesh was poor. More recently, however, several government bodies and foreign organizations have become interested in the question, in particular the government's Bangladesh Small and Cottage Industries Corporation (BSCIC), which has concerned itself with apiculture since 1977, and the Bangladesh Institute of Apiculture (BIA), a non-governmental organization which has been actively involved since 1981. These agencies have concentrated on training, extension, and beekeeping research and marketing.

Beekeepers in Bangladesh are still few in number: estimates range from a conservative 500 to a probably exaggerated 8 000. Only a minority of these practice apiculture on a commercial basis: most have only one or two hives to obtain honey for their private consumption; some have about 10 colonies, a few have 50, and one is known to have 100. The development potential therefore exists, and is growing.

Honey is a popular food in Bangladesh, for both its nutritive and its reputed medicinal value. All the current domestic supply is sold in a relatively short time after collection, and a significant volume is also imported from Australia, Singapore and China. Although reliable data are lacking, domestic production plus imports are estimated at some 400 tonnes, insufficient to meet the demand.

Domestic honey, retailed at Tk. 80/kg, is consumed for the most part in rural and small urban centres, while imported honey is available in major Dhaka and Chittagong hotels and general food stores, retailing at Tk. 120/kg. These relatively high prices do not appear to represent an important constraint on demand or sale. The greatest constraint from the consumer's point of view is widespread adulteration, but with better quality-control measures, this image is likely to improve.

Most domestic honey in the country is still collected from wild colonies and marketed through the Forestry Department, four major private companies and certain non-governmental organizations such as the BIA. Beekeepers in rural areas sell much of their production in local markets (at Tk. 60/kg.) and the remainder, through their associations, to the BIA, at Tk. 45/kg; BIA retails its supplies at 80 Tk./kg, the 35-taka mark-up covering costs of transportation, labour and handling losses. An average producer's price of 50 Tk./kg on honey therefore seems not unreasonable. A survey of beekeepers in Bangladesh indicated that an average production of 15 kg per colony per year could be expected.

An average of 250 g of wax is obtained by Bangladesh beekeepers per colony and per year. Beeswax sells at 60 Tk./kg.

The total potential income per colony and per year can therefore be estimated at Tk. 765.

Estimating probable costs is a more delicate matter. A number of unknown factors are involved, as in all agricultural activities, and this makes it necessary to make assumptions which may or may not all be valid. Above all, it is essential to be careful not to be over-optimistic: many undertakings on the farm fail because of the farmer's discouragement when his results, during the early stages of his apprenticeship in a new skill, are not as good as he had hoped they would be. During the first years of beekeeping, mistakes will be made that the experienced beekeeper can easily avoid, having learned by his

errors. In economic terms, this means that costs in general will be higher, and profits lower, during the apprenticeship period than when the beekeeper has reached a level of expertise such that his operations become a simple matter of routine.

The first set of assumptions to be made concerns the prospective beekeeper's targets and development programme. Taking the efficient range of the local bee (Apis cerana bangladeshi) as 0.5 km, the area covered by a colony is a circle of about 0.75 km<sup>2</sup> in area. It has been seen above that some parts of Bangladesh are rich enough in honey plants to be able to carry 10-20 colonies/-km<sup>2</sup>; on that basis, a bee farm of 10 colonies seems reasonable, and the farmer may well take this as his initial target. (If his results so justify, he can expand later, at proportionately lesser costs.) The wise farmer will not, of course, begin with 10 colonies. In the first place, he has not yet become skilful enough to handle them, and in the second place, part of his later development costs should be covered by income from his earlier years. Assuming a reasonable development period of five years, he will start with two colonies and expand at a rate of two new colonies a year.

In Bangladesh, a 700-gramme colony of bees, including the queen, costs Tk. 100. Well kept, a colony can be maintained indefinitely, and as it expands it can be divided into two or more. The farmer will probably have to buy his colonies during his first three years because handling errors may well lead to excessive absconding; after this time, he should be able to divide existing colonies to cover his needs for expansion and to replace weak colonies, or those which may have absconded.

The movable-frame "bee box" used in Bangladesh is about half the size of the common Langstroth hive. The brood chamber, roughly 25.5 x 23 x 18 cm, contains seven 20 x 15 cm frames, while the super, roughly 25.5 x 23 x 9 cm, holds seven 20 x 7.5 cm frames. Made locally, it costs Tk.350; this low cost is due to the fact that relatively inexpensive raw materials are used, and that labour costs are low. According to the Director of BIA, the Institute can make bee boxes of inferior wood to sell for Tk. 200 to 250. The life of these bee boxes is about 10 years. With each, a queen gate, consisting Tk.20, and a queen excluder, costing Tk. 150, are needed; the life of a queen gate is 2 years, while that of the queen excluder is 5 years.

The beekeeper will need a veil, made locally of metal wire and cloth, at a cost of Tk. 150, with a life of 3 years, and a hive tool, or knife, costing Tk. 20, which can be used for about 5 colonies and has a normal life of about 2 years.

A costly item of equipment, but one which the beekeeper will need during his first year of operations, is the honey extractor. Locally-produced extractors cost Tk. 1000 and have a normal life of about 5 years. A reasonable means of reducing this cost will be discussed below, when possibilities of sources of beekeeping income other than the sale of honey are envisaged.

In order to reduce costs, the normal practice in Bangladesh is to use starter foundation (strips of about 10 x 2.5 cm on each frame) rather than covering the entire frame with foundation. Craftsmanship under such a system is poor, but costs are held down to Tk. 15 per colony and per year, i.e. roughly the amount to be expected as income from the sale of wax. The experienced beekeeper may find with time, however, that the practice of using starter repre-

Table 7/1: Beekeeping in Bangladesh: Estimated Costs and Returns per Colony, 1983 (1)

A. Costs

<u>Item</u>	<u>Price (Tk.)</u>	<u>Life (years)</u>	<u>Cost/year (Tk.)</u>
Bees	100	10(2)	10
Bee box	350	10	35
Queen gate	20	2	10
Queen excluder	150	5	30
Veil(3)	150	3	5
Knife(4)	20	2	2
Honey extractor(3)	1 000	5	20
Foundation	15	1	15
Contingencies(5)	77	1	77
Labour(6)	78	1	78
<b>TOTAL COSTS</b>			<b>Tk. 282</b> =====

B. Returns

<u>Item</u>	<u>Value (Tk./kg)</u>	<u>Amount (kg)</u>	<u>Return/year (Tk.)</u>
Honey	50	15	750
Beeswax	60	0.25	15
<b>TOTAL RETURNS</b>			<b>Tk. 765</b> =====
<b><u>NET RETURN PER COLONY (B-A)</u></b>			<b>Tk. 483</b> =====

NOTES:

- (1) Assuming a 10-colony apiary conducted by an experienced beekeeper.
- (2) The life of a colony should be indefinite; this figure is taken for accounting purposes only.
- (3) To be used for 10 colonies.
- (4) To be used for 5 colonies.
- (5) 10% of gross income (rounded).
- (6) 1 hr/wk at Tk. 15 per 10-hour day.

sents a false economy, since it inevitably leads to greater honey losses due to comb damage, and since the bees, in manufacturing the wax they need, themselves consume energy, and therefore honey; this point will be discussed below, and in the meanwhile the actual 15-taka cost will be taken as a reasonable assumption.

All the above costs can be calculated with reasonable accuracy, but others, likely to arise, are very difficult to estimate. The equipment listed above, for example, does not include a smoker; it is assumed that most beekeepers will prefer to make their own, or be unable to find a commercial smoker (and fuel for it) on the market, but a beekeeper who prefers a commercial smoker and can obtain one will have to include its cost in his analysis. Again, a colony may sicken and need medicines, or it may be fed on sugar to tide it over a low-nectar season, or it may even abscond and have to be replaced - particularly during the early years of the apiary, before the farmer has learned how to prevent absconding. If the beekeeper sells his honey in the local market, he may have to provide containers for it.

Contingencies of this kind constitute a normal cost which must be foreseen, although they are likely to decrease proportionately as the apiary expands and the beekeeper acquires experience. It is assumed in this case study that they will amount to 20% of estimated gross income the first year of the apiary, 18% the second year, 16% the third, 14% the fourth, 12% the fifth, and 10% the sixth and all following years. These figures are probably high, but it is wise to be prepared for them.

A final element of cost is the beekeeper's labour. While no direct cash payment is generally involved, account must be taken of the earnings he might have obtained elsewhere during the time he was taking care of his bees. This "opportunity cost" is based on the local daily wage for a farm labourer (Tk. 15 for a 10-hour day) and the amount of time the farmer needs to spend on each colony. A limited survey of experienced beekeepers in Bangladesh indicated that each colony required, on average, one hour's work a week, but inexperienced beekeepers are likely to need much more at the start. The calculations here are based on 2 hours of work per colony and per week during the first year of the apiary,  $1\frac{3}{4}$  hours the second,  $1\frac{1}{2}$  the third,  $1\frac{1}{4}$  the fourth, and 1 hour during the fifth and all following years.

Once the prospective beekeeper has collected all the information he needs on beekeeping costs and returns in his area, he can begin to calculate whether beekeeping is likely to be profitable for him. In order to see what the results are likely to be once his apiary is fully developed and he has learned to manage it properly, his first step should be to work out how much each colony will cost him to operate each year, and how much it is likely to bring in; Table 7/1 shows such an analysis for Bangladesh, based on the figures set out above. It will be seen that the net profit to be expected from a colony is Tk.483 a year; for a 10-colony apiary, the net profit should be about Tk. 4830, an amount corresponding to the wages of 322 days' labour, for a labour investment of 520 hours, or 52 days. If, in a given area, equipment and labour costs and bee product prices are very different from those used here, this will be an indication that the profitability of beekeeping in the area will also be different to the same extent. In many developing areas, however, the prospects will be found to be generally similar to those shown in Table 7/1.

Before making his final decision, however, the prospective beekeeper also needs to know whether he will be able to cover all his expenses during his first few years of operations, when costs are higher and returns are lower. He

must be sure that he has enough capital to cover all his likely expenses, or that he will be able to obtain enough credit when he needs it. (\*) To do this, he should first calculate (top of Table 7/2) what his total investment is likely to be, year by year, over the first 10 years of the apiary, and then (bottom of Table 7/2) compare the total investment, year by year, with his likely total revenue. What he is considering here is the "cash flow" of the apiary - the amounts of money he will have to lay out and he is likely to receive. Since, as seen above, he is not likely to have to make any cash payment for his labour, the opportunity cost of this labour should not be included in the calculations.

It will be seen from Table 7/2 that during his first year of operations, the Bangladesh farmer taken as an example in this study will have to invest Tk. 2746 before he can expect to receive any return at all. At the end of the year he can expect returns of Tk. 1530, but he will need all this, and Tk. 341 more, to cover his second year's total investment of Tk. 1871. His net outlay during the second year (two years of investment, less the first year's income) will therefore be Tk. 3087, which will be almost covered by his second year's returns of Tk. 3060. He will need a large part of this to cover his third year's investments of Tk. 2124, but his third year's returns will comfortably cover the investments needed in the fourth year, and after that time his profits will begin to increase very rapidly. He knows however that his maximum investment outlay - and therefore the amount of his own or borrowed capital he will need - is Tk. 3087, in addition to any loan-carrying charges. On the other hand, by the end of his sixth year, he will be earning about Tk. 6 000 a year from his apiary. (For the sake of simplification, Table 7/2 disregards the residual value of the apiary's assets at the end of the 10-year cycle; this can be calculated at Tk. 1 700.

All the figures used in this calculation were drawn from actual experience in the operation of an apiary. If he wishes to, the careful farmer can make further calculations, similar to these but based on less favourable assumptions concerning honey production and prices. Tables 7/2A and 7/2B show cash-flow results based, respectively, on honey income reduced by one third and one half, whether because of crop failure or because of a fall in prices. From Table 7/2A, which estimates receipts conservatively (one-third reduction in the basic assumption), it will be seen that the prospective bee farmer will need a total capital of Tk. 3311, that his apiary will not become fully profitable until its fifth year, and that from that time on he can expect a profit of about Tk. 4000 a year. On even more conservative assumptions (the "catastrophe" calculation, which envisages a 50% reduction in beekeeping income), shown in Table 7/2B, it will be seen that the total capital required increases to Tk. 3650, the apiary becomes profitable beginning in its sixth year, and annual profits are somewhat less than Tk. 3000. This amount, on the other hand, still represents the equivalent of 200 days' farm labour, for a labour investment of 52 days.

\*\*\*

(\*) If the farmer needs borrowed capital, loan interest and repayment will be an additional cost item. While this question cannot be discussed in detail here, it seems likely, on the basis of reasonable hypotheses, that all loan capital and interest can be repaid out of the returns of the apiary by the end of the fifth year of operations. The farmer should however consult his usual credit source. (For purposes of simplification, the opportunity value of the farmer's own capital is left out of consideration in the analysis presented here.)



TABLE 7/2: Beekeeping in Bangladesh: 10-Year Theoretical Cash-Flow Analysis (\*)

Year	1	2	3	4	5	6	7	8	9	10
<b>Investment:</b>										
Bees	200	200	200							
Bee box	700	700	700	700	700					
Queen gate	40	40	80	80	120	80	120	80	120	80
Queen excluder	300	300	300	300	300	300	300	300	300	300
Veil	150			150			150			150
Knife	20	20	20	20	20	20	20	20	20	20
Extractor	1000					1000				
Foundation	30	60	90	120	150	150	150	150	150	150
Contingencies	306	551	734	857	918	765	765	765	765	765
	<hr/>	<hr/>	<hr/>	<hr/>	<hr/>	<hr/>	<hr/>	<hr/>	<hr/>	<hr/>
Total year's investment (-)	-2746	-1871	-2124	-2227	-2208	-2315	-1505	-1315	-1355	-1465
Previous year's balance	0	-1216	- 27	+2439	+6332	+11774	+17109	+23254	+29589	+35884
	<hr/>	<hr/>	<hr/>	<hr/>	<hr/>	<hr/>	<hr/>	<hr/>	<hr/>	<hr/>
Accumulated balance out- standing (at beginning of year)	-2746	-3087	-2151	+ 212	+4124	+9459	+15604	+21939	+28234	+34419
Estimated receipts (at end of year)	1530	3060	4590	6120	7650	7650	7650	7650	7650	7650
	<hr/>	<hr/>	<hr/>	<hr/>	<hr/>	<hr/>	<hr/>	<hr/>	<hr/>	<hr/>
Year-end balance	-1216	- 27	+2439	+6332	+11774	+17109	+23254	+29589	+35884	+42069

(\*) For assumptions, see text. All values in Taka (25 Tk. = 1 US\$).

TABLE 7/2A: Beekeeping in Bangladesh: 10-Year Theoretical Cash-Flow Analysis - Conservative Receipts Estimates (\*)

Year	1	2	3	4	5	6	7	8	9	10
Investment:										
Bees	200	200	200							
Bee box	700	700	700	700	700					
Queen gate	40	40	80	80	120	80	120	80	120	80
Queen excluder	300	300	300	300	300	300	300	300	300	300
Veil	150			150			150			150
Knife	20	20	20	20	20	20	20	20	20	20
Extractor	1000					1000				
Foundation	30	60	90	120	150	150	150	150	150	150
Contingencies	204	367	490	571	612	510	510	510	510	510
Total year's investment (-)	-2644	-1687	-1880	-1941	-1902	-2060	-1250	-1060	-1100	-1210
Previous year's balance	0	-1624	-1271	+ 91	+2230	+5428	+8468	+12318	+16358	+20358
Accumulated balance outstanding (at beginning of year)	-2644	-3311	-3151	-1850	+ 328	+3368	+7218	+11258	+15258	+19148
Estimated receipts (at end of year)	1020	2040	3060	4080	5100	5100	5100	5100	5100	5100
Year-end balance	-1624	-1271	+ 91	+2233	+5428	+8468	+12318	+16358	+20358	+24248

(\*) For assumptions, see text. All values in Taka (25 Tk. = 1 US\$).

TABLE 7/2B: Beekeeping in Bangladesh: 10-Year Theoretical Cash-Flow Analysis -  
Catastrophe Receipts Estimates (\*)

Year	1	2	3	4	5	6	7	8	9	10
Investment:										
Bees	200	200	200							
Bee box	700	700	700	700	700					
Queen gate	40	40	80	80	120	80	120	80	120	80
Queen excluder	300	300	300	300	300	300	300	300	300	300
Veil	150			150			150			150
Knife	20	20	20	20	20	20	20	20	20	20
Extractor	1000					1000				
Foundation	30	60	90	120	150	150	150	150	150	150
Contingencies	153	275	367	428	459	383	383	383	383	383
Total year's investment (-)	-2593	-1595	-1757	-1798	-1749	-1933	-1123	- 933	- 973	-1083
Previous year's balance	0	-1828	-1893	-1355	- 93	+1983	+3875	+6577	+9469	+12321
Accumulated balance out- standing (at beginning of year)	-2593	-3423	-3650	-3153	-1842	+ 50	+2752	+5644	+8496	+11238
Estimated receipts (at end of year)	765	1530	2295	3060	3825	3825	3825	3825	3825	3825
Year-end balance	-1828	-1893	-1355	- 93	+1983	+3875	+6577	+9469	+12321	+15063

(\*) For assumptions, see text. All values in Taka (25 Tk. = 1 US\$).

(\*)The experienced beekeeper will be interested in increasing his profits even more. As is true of any profit-making enterprise, this can be done in two ways: by cutting costs and by increasing revenues.

There appears to be little room for reducing costs, but some may still exist. For example, if the farmer takes great care of his equipment, he may be able to extend the life of his bee boxes to 12 years instead of the 10 years taken as a basis in his calculations; on this assumption, his annual cost for bee boxes will be reduced from Tk. 35 to about Tk. 30 each, or a total annual savings of Tk. 50. He can save another Tk. 50 per year by making his queen excluders last 6 years instead of the 5 years taken as the original basis. But he should be sure that the bee boxes and excluders are still in good working order; otherwise, his losses in honey production may be greater than his savings on equipment.

As indicated above, there may be a possibility of reducing the cost of the honey extractor. The beekeeper uses this expensive piece of equipment for only a few days a year at most, although he cannot do without it. If however several beekeepers in the same area agree to share an extractor, they can all save a considerable amount. According to a BIA recommendation, one extractor is enough for at least 10 beekeepers. Shared in this way, the total cost to each, over a 10-year period, is reduced from Tk. 2 000 to Tk. 200, an economy of Tk. 180 per year or Tk. 1 800 for the 10-year cycle; if more beekeepers join in, the savings will be even greater. Conveying the extractor to the different apiaries, or the comb to a centrally-situated extractor, will obviously create an additional cost, but this is practically negligible.

It will be recalled that the figure of 15 kg of honey produced per colony and per year, on which the calculations above were based, represents an average. This means that a number of beekeepers will obtain more than 15 kg, and a number will obtain less. It is likely that poor-producing colonies -- yielding, say 10 kg -- will be found, for the most part, among "hobby" beekeepers who have one or two hives for their own families' consumption. The farmer engaged in beekeeping for profit will obviously seek to increase his per-colony production.

One means of doing this, referred to in Chapter 2, is the use of a floral calendar as a tool for planning the migration of colonies to places and at times when major nectar flows are to be expected. An example was cited of one case in which alert beekeepers were able to multiply their production by five in one exceptional case; even if production can be doubled, however, at only a marginal cost in transport, profits can be increased greatly with a little effort and forethought.

On the other hand, it was seen in Chapter 4 that transporting hives can give rise to considerable comb breakage unless the comb is solidly anchored to its supporting frame. This factor raises the question of the suitability of using relatively small pieces of starter foundation in the hives of professional beekeepers. It will be recalled that by using strips of about 10 x 2.5 cm (i.e. 25 cm<sup>2</sup>) of starter, the costs of foundation are held down to Tk. 15 per colony.

---

(\*) The remainder of this Chapter, much of which is speculative in nature, has little direct relevance to the preceding Bangladesh case study; it has been included here primarily to indicate certain directions that beekeeping for profit can take under specific conditions.

Covering a 20 x 7.5 cm frame (i.e. 150 cm<sup>2</sup>) requires 6 times as much foundation, and therefore increases the cost from Tk. 15 to Tk. 90, per colony and per year. The difference, Tk. 75, represents the sales price of 1.5 kg of honey. In other words, if the beekeeper can increase his honey production per colony by 1.5 kg per year -- a 10% increase over the 15-kg average production -- he will cover his additional cost; any increase over 1.5 kg will represent additional profit. This consideration is valid whether the hives are migrated or whether they are maintained on a single site all year round.

While honey is by far the most important hive product from the economic point of view, it was seen in Chapter 6 that the bees produce other valuable materials, whose sale can under certain circumstances increase the beekeeper's income.

The movable-frame hive is not designed to yield a considerable amount of wax, and it is likely that most beeswax will continue for a long time to come from the hives of wild bees, collected by honey hunters. Some wax is however produced in apiaries, and, as already pointed out, the careful beekeeper should collect, render and sell it, if he does not intend to re-use it for foundation.

There is an important and growing market for royal jelly in a number of countries, and where beekeeping and the sale of hive products is reasonably well organized, collecting this product for sale may be a tempting prospect. It should be remembered, however, that royal jelly has to be kept under refrigeration, especially in hot countries, and this can create problems when maintenance facilities and power supplies do not exist or are unreliable. Before engaging in this activity, the beekeeper should ensure that the return on his refrigeration investment will yield a profit large enough to justify the labour investment that is also involved.

In some cases there is a market for pollen, which however is collected by the bees to serve as their food. If too much is stripped from the hive, and not replaced by another suitable food, the bees are likely to suffer from hunger and to abscond.

Bee venom has useful properties and commands a good price. Collecting it is however dangerous, and only the very experienced beekeeper should contemplate adopting this means of increasing his income.

In areas where beekeeping is an expanding occupation, there may be a market for queens (or queen cells) and even for entire colonies. The enterprising farmer who interests several of his neighbours in beekeeping may thus be able to increase his profits in two ways: reducing his costs by sharing his extractor with them, and increasing his income by selling them their first colonies and queens.

It was seen in Chapter 2 that in some countries, beekeepers earn important sums by leasing their colonies for pollination purposes. This activity is likely to take on more importance as cash-crop agriculture replaces subsistence cropping, and as the importance of bees as pollinators is recognized. When monoculture is practiced, in particular, the decrease in crop varieties and the consequent shortening of flowering periods can compromise the survival of pollinating insects. Under these circumstances, the importation of honeybee colonies during the flowering of the crop is necessary if adequate pollination is to take place. Thus, in Japan in 1980, some 64 500 honeybee colonies were used for

pollinating greenhouse strawberries, 4750 for greenhouse melons, 17 000 for orchard fruits, and 1500 for field crops, mostly melons and pumpkins. Beekeepers rented 4-frame hives for 11 000 yen(\*) and 6-frame hives for 15 000 yen, including maintenance services.

Migratory beekeeping - the practice of moving colonies to areas with good honey sources - is a well-recognized technique for increasing honey production. Migratory beekeeping for pollination is still confined, for the most part, to the developed countries, but the main reasons for this are two: the undeveloped status of beekeeping as an agricultural activity in most tropical and sub-tropical countries and the failure to recognize fully the importance of insect pollination. In the next few years, however, an increasing number of beekeepers are likely to learn how to increase their incomes by adopting this new technique, and at the same time crop yields are likely to increase correspondingly.

Nonetheless, it is likely that in the long run most beekeepers will find that they can best increase their profits by improving and increasing their honey production. On the one hand, they may be able to obtain premium prices by improving their product quality, by migrating their hives to areas with bee plants yielding a honey whose flavour is particularly appreciated by certain classes of consumer, by exercising great care in honey extraction to obtain a more pleasant-appearing product, and by packaging it in a manner to make it more desirable to the luxury trade. All these approaches call for some additional investment, but under most circumstances they can still be profitable.

Finally, if the beekeeper finds that his bees have little difficulty in filling their combs, this is a clear indication that the carrying capacity of his area is great enough to support a larger number of hives. When this situation arises, he can easily expand his operations and increase his profits proportionately. In exceptional cases he may even, in time, be able to convert his beekeeping from a relatively simple side-line activity to the status of a full-time profession.

---

(\*) US\$ 1 = 225 yen (mid-1980).

## CHAPTER 8

### NATIONAL PROGRAMMES FOR APICULTURAL DEVELOPMENT

So many are the advantages of beekeeping to a developing economy, so varied its possibilities, so much promise does it hold, that it is hardly surprising to observe an increasing number of developing countries in the tropics and sub-tropics envisaging national programmes for apicultural development as one means of contributing to a solution of their numerous and serious economic problems.

The advantages of beekeeping cannot be over-emphasized, nor can they be repeated too frequently. Requiring no land but the space to stand (or hang) a hive, very little labour, almost no capital, and practically no inputs other than those that are available locally, it can almost everywhere provide a dietary supplement acceptable to any rural population. With only a slight increase in inputs, it can produce a semi-luxury food much appreciated by urban populations, and thus contribute effectively to increasing rural incomes. At a third stage of development -- admittedly at a higher initial investment, but one which is not unrealistic either in absolute terms or in terms of cost/benefit relationships -- it can yield an export product valuable in developed-country markets, with by-products such as royal jelly that command premium prices the world over and that are labour-intensive, thus counteracting, to some degree, the universal trend toward rural emigration.

At the same time, beekeeping can be a powerful stimulus to local trades and industries such as woodworking and glass manufacture, which again rely chiefly on local materials for their inputs, to the creation of employment in both rural and urban areas, and to the establishment of national and local infrastructures -- particularly cooperatives -- of great value to agriculture as a whole. As an added bonus, the pollinating activity can increase, sometimes to a great extent, the yields of fruits, vegetables, oilseeds and other crops requiring pollination by insects. Finally, countries that are sugar importers can reduce somewhat their calls on foreign exchange by encouraging the production and rural use of honey as a cost-free sugar substitute.

But none of this "just happens": it must be brought about. While private initiatives can frequently accomplish a great deal on a local basis, only governments have the means to act on a wide scale, at the national level, to decide upon a programme, to initiate it, and to provide it at every stage with the support it must have if it is to succeed.

A government's decision to undertake an apicultural development programme will depend essentially on whether the country- - or large area -- concerned has a honey potential, and on whether there is need for the programme. Countries in which there is no honey potential are rare indeed, even if some large areas, such as deserts or cereal-producing zones, are little suited for beekeeping. Hives have been successfully maintained on skyscraper rooftops in large cities, in tropical rain-forests, in semi-desert regions, wherever, in fact, honey plants grow.

The decision whether a given country needs to encourage and develop its apiculture is largely a political one, especially in terms of priorities. It

appears however that wherever rural malnutrition exists, there is a need for beekeeping to provide a valuable dietary supplement; where traditional beekeeping exists, it can usually be improved; where an integrated programme of agricultural and social development is envisaged, it can usefully contain an apicultural element; and where a government wishes to develop its country's agro-industrial potential, particularly with a view to the export market, rational modern apiculture offers an excellent long-term prospect.

Once the basic decision has been taken, the first essential step in the apicultural development process must be careful, realistic selection of targets. In apiculture as in most development programmes -- whether agricultural, industrial or social -- it is almost impossible to move successfully from a zero situation to what might be called Phase III, the agro-industrial system, without passing through preliminary phases. The high-speed approach usually calls for an effort far beyond that which the country is capable of producing: infrastructures must be built up, men and women educated and trained, equipment designed and produced, scientific research carried out. A failure, or even a serious delay, in any of these prerequisites can compromise, perhaps irremediably, the success of the programme.

At the opposite end of the scale is the simple step-by-step approach, introducing and consolidating one improvement before moving on to the next, and thus retracing, while accelerating, the historical process of apicultural development that took place in the developed countries over a number of centuries. The tremendous progress implicit in advancing from primitive honey hunting and beekeeping to the theoretical end of "Phase I" can be clearly observed from the following table:

---

<u>Element</u>	<u>Primitive beekeeping/ Honey hunting</u>	<u>End of Phase I</u>
Bees	Wild	Domesticated to the extent that colonies can be preserved after honey collection
Hive	Hollow log, etc.	Hive not destroyed and colony little disturbed during honey collection
Collection	Hive destroyed to obtain comb	Hive opened to obtain comb and subsequently reused
Colony	Killed or driven off during collection	Available for following crop
Honey extraction	Comb and brood crushed together, quantity and quality poor	Capped honey crushed and strained; quantity and quality improved
Honey use	Consumed as is or fermented	Consumed locally and/or sold in village markets
Wax	Lost	Collected for use or sale

---



Achieving the Phase I targets is for the most part a matter of farmer education and extension. The one technical improvement involved is the development of a hive more rationally conceived than the one originally in use. Bringing the farmer population to adopt such a hive is probably more difficult than designing it, since it is not always an easy matter to overcome the authority of tradition. One means of creating a more receptive attitude might be to begin by showing the farmers that by improving their honey extraction methods they can with little effort obtain a desirable increase in family income, but this illustrates how slow the step-by-step approach must often be.

Phase II targets are more difficult to define. This is the truly revolutionary phase, introducing "transitional" hives whose principles are closer to those of the modern hive than to those of the traditional one, and honey collection and distribution methods requiring fairly extensive infrastructures for marketing in urban centres. Honey quantities obtained will generally be higher, especially where migratory beekeeping is practical (i.e. major honey flows at different periods in areas not too distant from one another, and availability of transport and adequate access roads). To the extent that Phase I has been successful, reluctance to accept new methods can be more easily overcome, but basic lack of familiarity with modern operational concepts can be a major obstacle.

Phase III, with its panoply of modern techniques, is generally the ultimate target. It involves major efforts along all lines: bee improvement and disease protection; millimetric precision in modern hive construction; advanced methods of honey collection and quality control; and a marketing system adapted to export requirements. The capital investment required is usually beyond the capacity of any individual or small group of individuals, and the continuing research effort implied must assume major proportions. Profits to individual beekeepers can increase many times over, but the small farmer, lacking cooperatives or other similar organizations, may often be left behind to the benefit of the large-scale operator or middle-class "hobby" beekeeper with easier access to inputs. (\*)

Such a tendency is not unnatural: one authority has expressed the view that it is easier to teach beekeeping to people who know nothing about it than to change the ingrained habits of those who have been doing things the "wrong" way for generations. To which, however, another expert has replied that experts should not be so arrogant that they do not listen to the experience of local beekeepers even when their techniques seem to be very simple. What is clear, in any case, is that poor farmer-beekeepers who are offered an opportunity to increase their scanty income should be better motivated to accept improvements than a middle-class elite desiring to pick up an extra peso, shilling or rupee at little cost and with little effort. A beekeeping development programme can have the desired impact only if it is designed for and aimed at the small farmer; he must be the ultimate target and the ultimate beneficiary.

The essential ingredients of any apicultural development programme are education, training, extension and research -- all time-consuming, often frustrating, always difficult to evaluate, but nonetheless inescapable. Phase

(\*) Reserving modern hives for "professional beekeepers as well as teachers, professional soldiers, small-scale businessmen and public servants" -- self-defeating where there is any concern for the small farmer -- has already been mentioned in Chapter 5.

III depends more for its success on the human resource than on any other one factor. The beekeeper must rely on an active, efficient extension service for advice and material support; bee extension workers must have special training in what is still a little-known skill; wood- and metal-workers must be trained for precision work in building hives, foundation moulds, extractors, and other equipment; laboratory workers must be educated and trained; and research workers themselves must gain essential experience at one level before moving to the next. From the government's point of view, the most important aspect of Phases I and II, beyond any short-term benefits they may procure, lies in the fact that they are the basis not only for modernizing apiculture but also for establishing the needed human infrastructure. The best extension workers in Phase II will be beekeepers who have themselves been outstandingly successful (which generally implies willingness to learn) in Phase I. Phase I, and even more Phase II, can make it possible to accumulate data serving as a basis for Phase III research. Phase II processing and marketing systems can serve as a basis for the more elaborate systems called for in Phase III, and here again those who have succeeded in Phase II will be best qualified to assume responsibility in the later phase.

An early and successful worker in agricultural development once pointed out that if education, training, extension and research are the four fingers of the development hand, unqualified and continuing government support is the thumb which enables them to be useful. The point cannot be made too often nor too strongly. When a government decides to undertake an apicultural development programme, or any other development programme, its work is not complete: on the contrary, it has just begun. Once a realistic work plan and budget for the programme have been drawn up and approved, it is the government's responsibility to ensure that the programme has the means to carry out its work. In specific terms, this implies, among other things, the prompt assignment of the necessary staff to the programme on a permanent basis, since programmes cannot function efficiently when they are short of staff, or when personnel changes interrupt the continuity of work. It implies the grant and enforcement of the necessary priorities, the prompt release of approved funds, the assignment of vehicles and equipment, and -- perhaps most of all -- the cutting of red tape.(\*)

But all the support of government to a programme in course of execution cannot guarantee its success if the initial objectives were not correctly set, and particularly if they were over-ambitious. It is understandable that the urgent need for economic growth renders governments reluctant to adopt the step-by-step approach, even though it may offer the best chance of success in the long term. There is therefore a tendency to combine Phase I with elements of Phase II, and even in some countries with work on Phase III. The latter is generally of limited value, since the infrastructures required for the success of Phase III operations have not been created, and because the vital but time-consuming work in research and extension has not been carried out; where research has indeed begun, the means of communicating its results to the working level do not exist, and most of its benefits are therefore lost.

A report by G. Ntenga on beekeeping development programmes in Tanzania (in IBRA, 1976) offers an excellent example of a rational approach leading to excellent results (Tanzania is currently one of the largest honey and beeswax producers of Africa). In 1964, a programme initiated before the country became independent was reformulated with the following objectives:

(\*) Work of one recent research project was held up for eight months because of squabbling among officials of three ministries concerning the customs clearance of a six-dollar spare part for a microscope.

- "1. To endeavour to change from primitive beekeeping methods to modern methods, by gradually introducing the movable-frame long hive specially designed for African forest conditions.
- "2. To finalize trials with all types of bee houses, and to publish a report on their usefulness or otherwise to beekeeping...
- "3. To organize beekeepers' associations for receiving technical knowledge and for marketing bee produce.
- "4. To set up apiaries using platform stands, and to find solutions to various problems encountered in this form of beekeeping, with a view to eliminating the hazards of tree-beekeeping methods.
- "5. To finalize queen introduction methods applicable to beekeeping in the country."

It will be noted that objectives 1, 2 and 4 all concern progress over traditional apiculture, while only objective 5 looks forward to more sophisticated techniques. The imaginative concept of objective 3 -- combining extension and marketing functions within beekeepers' associations organized by the government -- may have been sociologically over-ambitious for the context in which it was established, since it was eliminated when the objectives of the national beekeeping development programme were redefined three years later. This 1967 revision distinguished between short-term and long-term projects. The first included modernizing the existing bush and forest beekeeping to the maximum possible through the use of modern hives, improving honey and beeswax collection and processing methods, and organizing honey and beeswax marketing; the long-term projects were research in beekeeping, especially in bee ecology, forage and breeding, and study of the economics of intensive bee farming.

By the mid-1970s, however, it was becoming apparent that the limited objectives of what can be considered "Phase I" would be difficult to achieve. It was assumed that improved beekeeping depends on the use of hives from which the crop can be collected without destroying the colony, but at the same time it was recognized that the use of simple hives would continue for many years, since their advantages in terms of time, labour and money made it difficult to change the ways of the traditional beekeepers. In this respect, therefore, the development programme's immediate objectives were to be to find suitable materials for making hives without debarking live trees and to teach traditional beekeepers how to crop simple hives without destroying the bees. The need for studying traditional beekeeping methods among the different ethnic groups of the country was also recognized, considering that such studies throw light on problems hitherto unobserved, and make it easier to decide on the best line of approach to developing beekeeping in each specific area.

While work on Phase I was pursued with even more limited objectives, the Tanzanian programme therefore concentrated more actively on selected "Phase II" targets: processing and marketing on the one hand, and education, training and extension of the other. One processing and marketing centre in the central part of the country had been in existence for a number of years; organized on a cooperative basis, it was servicing over 3000 beekeepers. A second, developed with foreign aid, had recently been established to service the northeast. Both were fully equipped and applied a system of payment for produce by quality. A

further centre for the southeastern part of the country was planned, and the establishment of smaller units in the west was envisaged, with simple straining equipment in selected areas.

But the most striking aspect of the revised programme was an exemplary emphasis on education and training at all levels. A survey had been undertaken to explore the possibility of promoting beekeeping in primary schools, some of which already kept bees. Beekeeping was one of the activities in the national campaign for agricultural development in secondary schools, and special efforts were directed toward developing school apiaries, to teach pupils how to keep bees and to show them that beekeeping can be a profitable undertaking as well as an interesting hobby.

Basic training in simple beekeeping (12 lectures) had been organized for beekeeping extension staff as early as 1955, but it was considered that much broader knowledge was needed for beekeeping instructors. An eight-week course in frame-hive beekeeping, leading to a "beemaster certificate", was organized in 1958; successful candidates were required to work for two years in the field to gain practical experience before being given further training leading to a higher qualification, similar in standard to the "senior certificate" of the British Beekeepers' Association system. As an essential point in motivating personnel, the highest qualification, the "National Diploma in Beekeeping", similar in standard to equivalent diplomas in other fields, was made compulsory for all senior appointments of beekeeping staff in Tanzania. Two institutes provide training for these diplomas, and the higher-level institute can also receive candidates from other African countries. Training is also arranged at institutions abroad.

In one district, three demonstration centres, each with 300 hives, were established to assist in extension efforts. Beekeepers were brought to the centres for two months of practical training, after which they returned to their villages to look after village apiaries. (Under a special fund for regional development, more than 12 000 modern hives had been distributed to 450 villages, commonly 10 to 50 per village, and some villages also received protective clothing, smokers and honey presses.) To ensure that the staff of these centres remained effective, each was required to build up and maintain his own modern productive apiary.

In addition to these centres, it was also planned to set up bee farms in three different regions, to provide working examples of modern farms where prospective bee farmers could obtain training and practical experience in commercial honey and beeswax production. Finally, articles on beekeeping were regularly published in local newspapers, radio broadcasts on beekeeping were given, and two cinema vans circulated in rural areas throughout the country, showing training films on beekeeping.

The Tanzanian development programme for beekeeping also included a number of other "Phase II" activities: three workshops for hive manufacturing, under the supervision of trained beekeeping officers, had been set up, and two more were under construction, while the setting up of a wax foundation mill was planned for rapid implementation. The central bee farm was to be responsible not only for the training function but also to provide package bees and nuclei for stocking new hives, as well as breeder stocks for a queen-rearing unit. Some initial work in strain selection for gentleness was also contemplated.

It was recognized that such an extensive programme would inevitably encounter problems that must be overcome if it was to be successful: problems associated with man and his traditions, and problems associated with the honeybee and its enemies, requiring a scientific approach. If however the programme received adequate financial support to provide access tracks, hives, buildings, equipment and manpower, it was promising in that it concentrated on those aspects, in the national context, which appeared most likely to yield satisfactory results with minimum inputs. Although the traditional sector had, to some extent, to be sacrificed, it seems nonetheless probable that some of the "Phase II" benefits could reach the lower level and serve as an incentive for its further development. More ambitious schemes involving a high level of equipment sophistication and systematic research were left to a later stage.

Since most honey collected in Tanzania is still consumed locally, it is difficult to quantify the effects of this programme. FAO estimates indicate however that from a basic production of about 7000 tonnes of honey per year in the early 1970s, growth at a rate of about 500 tonnes a year has been taking place, a growth rate about twice that of the country's population. From these data it does not appear exaggerated to say that the increased honey production of the country, stimulated largely by the programme outlined above, is making a significant and badly needed contribution to Tanzania's food consumption levels, at a relatively low cost.

#### Education, Training and Extension

It has already been observed that, education, training and extension are three of the "fingers" of the "development hand". Their common characteristic is that they are all concerned with the communication of knowledge; they differ in the type of knowledge to be communicated, and in the audience to which they are addressed. In simple terms, education is addressed to a broad general public and is confined largely to such simple, abstract ideas as "Honey is good for you", "Beekeeping can be profitable", or "Bees are not as dangerous as many people think". The function of education, thus conceived, is to create among the members of its target audience a receptive attitude toward ideas new to them, as motivation for development in the chosen field. Training, on the contrary, is addressed to a relatively limited audience of people who are to be actively engaged, often on a full-time basis, in the development activity envisaged: researchers, extension workers, managers, senior administrators, etc. Its content is essentially technical in the broadest sense; its function is to provide the intellectual infrastructures necessary for the accomplishment of development tasks. Extension is addressed to workers in the development effort on the operational level: as regards apiculture, and agriculture in general, the target is the individual farmer. Its content is again technical, but limited to what the farmer needs to know in order to carry out his tasks successfully; its function, also, is to enable the farmer to succeed, by furnishing him with the necessary informational backstopping. Finally, it should be borne in mind that education, training and extension have one common operational characteristic: if they are to be carried out successfully, the effort they require is a continuous one: the public is never completely and permanently educated, the technician is never totally trained, the farmer always needs more advice.

Many, if not most, agricultural development programmes are large consumers of equipment, but it has been seen that the equipment required for bee-

keeping is minimal. An apicultural development programme's principal emphasis, at least during Phases I and II, will therefore be placed on the education/-training/extension complex, whose requirements in terms of capital are fortunately less massive than those of equipment-intensive programmes.

The thrust of an apicultural education programme is double: it seeks to create a demand for hive products -- primarily honey -- and at the same time to encourage farmers to engage in beekeeping. With a little imagination, all information media can be called into play, beginning in the primary schools and ending in radio and television. A school apiary can be an excellent means of interesting young people in beekeeping, a way in which school-leavers can earn a living in developing countries when other employment is not available or fails to offer a reasonable income. Latham cites one example of two boys in Uganda who left low-paid jobs in industry and went into beekeeping, to find that with ten hives they earned considerably more than they had in the town.

Traditional honey-hunting does not attract modern youths as it did their forebears: climbing a thorny acacia tree in the middle of the night without protective clothing is not attractive, and most young people who do not come from beekeeping families are often, and understandably, afraid of bees. School can thus be, in many cases, the best place to introduce the subject of modern beekeeping. Pupils will tend to have their options open to some degree, and a reasonable amount of time to consider what interests and skills they can put to work for them after leaving school. If a young farmers' club programme operates through the school, encouraging boys and girls to take up projects of their own at home, this is an ideal method of familiarization with apiculture, especially since such extra-curricular activities draw together a group of young people with similar interests.

It may be possible to identify good local beekeepers who would be happy to act as leaders, helping and encouraging the young people. One young farmers' programme in Kenya, operating along the lines of the 4-H programme in North America, depends on a number of such local leaders, good farmers who, on a voluntary basis, assist a club of young people with their individual projects at home. First, the learners visit the beekeeper and work with him on his own hive. Then, once they have seen what beekeeping is like, the programme may enable them to obtain a hive on loan. (In Kenya, a condition of this loan is that the applicant must have planted or protected a specified number of nectar-producing trees.) At a later stage, the club may be provided with coveralls, veils and a smoker for the young beginners to borrow. It may also have simple processing and marketing facilities available to it, the cost of the equipment being covered from the honey crop produced.

Many young people who have become personally involved in beekeeping in this manner have been able to obtain an income from the practice, even while still at school. This has in turn encouraged them to think seriously about a personal involvement in the occupation after finishing their formal education. This involvement is usually limited to their keeping a few hives for their own use, wherever they live, but a few will move on to gaining their livelihood, or a considerable part of it, from keeping bees and marketing their products.

Reaching adult audiences is the primary role of the most common information media: newspapers, radio and television. The authority of the printed word is, in much of the developing world, almost absolute, and for this reason the newspaper remains, in zones of relatively high literacy and good newsprint availability, the ideal medium for apicultural education. Its principal advan-

tage over its electronic competitors is its permanence: it can be read and re-read, passed from hand to hand for broader dissemination, consulted at the convenience of the reader. The drawings and photographs it contains can be examined with care and in detail; explanations in the text can be studied repeatedly until they have been thoroughly assimilated. While, as stated above, the primary purpose of an apicultural education programme is essentially to motivate rather than to train, the printed word does facilitate a higher level of technical communication than the electronic media. It can communicate not only that "Honey is good for you", but why and how.

The potential of television in an education programme is more limited, not only because in many developing countries television is available, if at all, only to urban populations, but also because its usefulness as an educational medium in such countries is open to question. Reading is an active function; watching television is a passive one, calling for less intellectual participation on the part of the audience. Only simple messages can be assimilated under these circumstances, even if funds are available to cover the high cost of television production. As developing country audiences grow in sophistication, some of these objections will certainly cease to hold true, but -- at least in the short and medium term -- the costs of production and reception will continue to outweigh the benefits of what could otherwise be a most useful supplement to education.

The widespread adoption of the transistor radio has, on the contrary, made this a valuable educational auxiliary, especially in regions where illiteracy is high. Farm broadcasts have obtained high acceptability levels in many areas, and can offer an ideal vehicle for apicultural education. Repeating a message on radio does not create resistance to it to the same extent as is true of television, and the possibility of live broadcasting at little cost makes radio an elastic medium well suited to conveying messages of the desired type.

Other means of education than the better-known media, even though they may reach smaller audiences, can have a more immediate and long-lasting impact. Among these are exhibits at markets, fairs and agricultural shows, which enable the many farmers attending these events to make direct contact with people engaged in beekeeping. An ideal situation can be created by combining such exhibits with a programme of visits to working apiaries, honey and beeswax processing firms, etc. It is in the nature of such visits that they must be confined to a restricted number of prospective beekeepers, but if they are properly organized and carried out they can provide powerful, and often permanent, motivation, enabling the visitors to obtain first-hand information not only on production and processing techniques but also on more general, but equally important, questions such as quality, pricing, marketing, packaging and labelling, and supply and demand trends. The success of such visits depends greatly on the educational skills of the visit conductor, who should usually be a trained extension agent: a well-arranged tour can play a major role in publicizing general ideas about beekeeping.

In some countries, apicultural education can focus usefully on the role women can and do play in beekeeping. In many tropical societies it has traditionally been man's work, particularly in those parts of Africa where log hives are maintained in trees, and in Asia where honey is generally harvested by hunting wild nests. In some societies, on the contrary, beekeeping responsibilities are divided between the husband and the wife; in Haiti, for example, men manage the bees while women market the products. In a few societies beekeeping is traditionally women's work.

In areas of tropical Africa where transitional top-bar hives have been introduced, four to six such hives can be positioned close to the home, or in the bush, and the women can look after them and thus considerably supplement their income. Beekeeping with top-bar hives involves no heavy work, nor need it interfere with other household and gardening activities. In Kenya, more and more of the top-bar hives are kept by women in this way, and in the Kisumu area of Western Kenya, a proposed honey cooperative is to be operated by its 150 women members.

In Asia, Apis cerana hives are very easy for women to handle, because colonies are relatively small and there are no heavy weights to lift. As these bees are fairly gentle, they can easily be kept very close to the home.

It is thus most advisable for development programmes to devote attention to educating and encouraging women to engage in beekeeping and in that way contribute directly to improving the living standards of the family. In the long run, it would not be surprising if much small-scale family beekeeping gradually moved into the charge of women.

Obviously, the training component of a national apicultural development programme is of a nature completely different from the education component, and it must be looked at in a different light. In theory, as mentioned above, training is addressed essentially to the people who will be operating the programme over an extended period, and who in fact will constitute the programme's backbone: the extension workers, the managers, etc. The training such individuals receive will of course have to be adapted to the type of work in which they will be called upon to engage, but a knowledge of the fundamentals of beekeeping will be invaluable even to the administrators, while familiarity with the basic ideas of management will be necessary even for the extension workers.

Training at another, completely different, level may also be required, depending on the human resources available to the programme. For example, if the local manufacture of hives is foreseen under the programme, and if trained woodworkers are unavailable, the programme will have to include an element for training of this nature.(\*). In-service training is often necessary where trained personnel are called upon to exercise certain skills related to their specialities, but where no such persons are to be found, training from the beginner's level will have to be foreseen.

Organizing training at the suitable levels is one of the most difficult and complicated aspects of many development programmes, and a beekeeping programme is no exception to this rule. Study outside the country is only rarely suitable, because of the diversity of beekeeping problems and solutions arising out of ecological differences. Frequently, too, workers in the programme will be called upon to perform other duties at the same time -- this is particularly true of the extension element -- and their training will have to be adapted to the diversity of their responsibilities.

Where circumstances permit, therefore, the establishment of a national beekeeping institute, having training as one of its principal tasks, can offer a useful approach, which will be discussed in greater detail below.

(\*) As was seen in Chapter 5, this case arose in the Guinean apicultural development project, and indeed created certain difficulties.



There is little need to emphasize here the essential role that extension must play in an apicultural development programme. Extension is fundamental to all agricultural backstopping: it is the farmers' main means of maintaining contact with the off-farm world and thus of improving his production and his family's standard of living. Especially when he first undertakes a new activity will he need technical guidance, as well as moral support, at every step, and the extension worker is usually the first, if not the only, source of direct information and counsel available to him.

For this reason, a well-trained corps of extension agents is essential to the success of the programme, and their training therefore takes on critical importance. Since under most circumstances, they will be called upon to deal with beekeeping additionally to all their other agricultural support duties -- the full-time apicultural extension worker will unfortunately be the exception, rather than the rule --, it would be unreasonable to expect them to attain a high level of expertise at the outset. They should however be given a sound theoretical background in beekeeping, and also be enabled to gain as much practical experience as possible over a full year's cycle. Refresher seminars can be valuable, especially if they are held at different points of the cycle and are accompanied by field work. Not only can they enable the extensionist to expand his skills, but they can provide the programme managers with feedback from the farmers themselves, and thus enable them to define and eliminate problem areas.

### Research

Throughout the preceding chapters, such phrases as "little is known about..." and "research is needed on..." have appeared with disturbing frequency. An almost random listing of some of these points illustrates the limits of our knowledge of tropical and sub-tropical beekeeping, and of the scope for future research in all domains of apiculture:

- (1) Characteristics and behaviour of A.m. scutellata
- (2) Characteristics and behaviour of A. cerana species, subspecies and strains
- (3) Breeding A. cerana for improved traits
- (4) A. cerana hive design
- (5) A. cerana honey extraction, processing and marketing
- (6) Superseding non-productive by productive A. cerana strains
- (7) Biological, economic and morphometric characteristics of A.c. indica (much work in this area is already going forward in India)
- (8) Selection and breeding of A.c. indica
- (9) Possibility of commercial management of A. dorsata; if this approach were to be found promising, an entire new area of research would be opened up
- (10) Improvement of A. dorsata honey collection, yields and quality
- (11) Improvement of A. florea beekeeping methods
- (12) Influence of altitude on bee behaviour
- (13) Effect of tropical temperatures on bees evolved in temperate climates
- (14) Compatibility of A. mellifera and A. cerana in different tropical contexts
- (15) Honeydew production and plants in the tropics and sub-tropics
- (16) Determining tropical plants by melissopalynology

- (17) Tropical pollen sources
- (18) Nutritional value to bees of tropical pollens
- (19) Effect on honey production of feeding pollen to bee colonies in the tropics and sub-tropics
- (20) Tropical propolis sources
- (21) Effect of honeybee pollination on tropical crops
- (22) Pollination requirements of tropical and sub-tropical crops
- (23) Seasonal pollen availability in tropical and sub-tropical areas
- (24) Pollen as human food and animal feed
- (25) Chalk-brood disease
- (26) Tropical and sub-tropical bee-parasite management
- (27) Native-host defence mechanisms against mites
- (28) Natural history of Tropilaelaps
- (29) Reducing honey humidity, e.g. from Hevea brasiliensis
- (30) Improvement of honey packaging and marketing to meet consumer preferences
- (31) Production and collection of royal jelly from A.m. scutellata and A. cerana
- (32) Harvesting bee brood
- (33) Bee brood as human food and animal feed
- (34) Propolis production and export marketing
- (35) Beekeeping as an optional land-use system on marginal lands

This list is far from being exhaustive, and some of the items on it may not appear to be of considerable immediate importance. It does however illustrate the fact that modern apiculture in tropical and sub-tropical areas is only at its beginnings; a major breakthrough in only one of a number of areas listed could revolutionize an entire question. It is also important to bear in mind that research findings in one ecological zone will not necessarily agree with those in another: the same studies may have to be made separately in different zones. While international support for bee research may be needed, much of the work itself can best be carried out on a national or even local basis. On the other hand, in many developing countries there is an adequate network of institutions to provide samples of honeys and waxes, for instance, to interested research workers, wherever they live.

Dr. Eva Crane has compiled a list of areas for investigation, some of which are as follows:

- (1) Relationships among coexisting species, including geographical distribution and mechanisms for mating separation. (The sex pheromone being the same for all honeybee species, a queen attracts drones of any species in the locality, although mating can occur only with drones of her own species.)
- (2) Migration from a dearth area to a resource-rich area. While much research has been invested in studying the wintering of honeybees, migration may be regarded as a more interesting and positive behaviour pattern, because it utilizes food resources in two areas and obviates an unproductive inactive season.
- (3) Factors governing the bees' attaching their combs to the sides of hives. The management of bees in top-bar hives depends on the non-attachment of comb, but no systematic study has been made to identify the factors that determine it. They may include the length of the top-bar, hive height, bee-type, season, state of

colony development, etc. There are indications that brood combs are less likely to be attached than honey combs, and that attachments destroyed are not necessarily rebuilt.

- (4) In cooperation with ornithologists, studying the behaviour of birds that prey on bees, e.g. bee-eaters (Merops spp.), swifts (Apodidae) and shrikes (Laniidae), and devising means of obviating their depredations that are consistent with both economic practice and wildlife conservation. Problems with certain mammals need similar treatment.
- (5) Identifying and evaluating sources of nectar, pollen, honeydew and propolis.
- (6) Identifying plants economically worth planting for bees, especially in arid regions.
- (7) Determining the pollination requirements of tropical crops for which this information is still unavailable.
- (8) Exploiting the seasonal migration of colonies on an economic basis; this work must probably wait until item 6) above has been dealt with adequately.
- (9) Establishing whether and when it is of practical economic value to feed colonies on sugar and/or pollen.
- (10) Upgrading honey harvesting from A. dorsata, and finding ways of siting A. dorsata nests to reduce harvesting risks by honey hunters (falls from trees, attacks by wild animals, etc.).
- (11) Trials with A. florea, using the "beekeeping" system current in India and Oman.
- (12) Devising better ways of reducing the high water content of certain tropical honeys to acceptable levels.

Bee scientists with new ideas often have enough freedom in their appointments to be able to try them out directly, and this is how much new knowledge is acquired and many new techniques developed. The apicultural research workers of the world should be regarded as a resource for advancing beekeeping in tropical and sub-tropical countries. They form a small enough group for most specialists in a given branch to know each other and enjoy working together; most are highly dedicated to the bees they study, and to the beekeepers who may apply any findings they obtain. Their help should be actively solicited in ways that will benefit scientific research as well as practical beekeeping in the countries concerned.

#### National Beekeeping Institutes

The diversity of the tasks incumbent upon a government engaging in an apicultural development programme, and the scarcity of staff with the necessary technical expertise, have led several governments to set up national institutes

with broad responsibilities in the execution of the programme. Grouping in a single functional unit a fair number of bee specialists not only facilitates immediate and continuing exchanges of information and encourages coordination among all the activities under the programme but also promotes economy by the elimination of overlapping and the full use of available expertise.

The actual administrative position of such an institute will depend on a number of factors in the internal organizational structure of each country's government. Often it will be attached to a ministry, but this may be the ministry of agriculture, of animal husbandry, of forests, of rural industry or of general development (especially if bee-product exports are a primary target). Where a good agro-technical university exists, it may be incorporated into the university structure. In less centralized countries, it may become an organ of the government of a province in which beekeeping is a major activity. Finally, it may be established as a non-governmental organization (such as a beekeepers' association or a federation of such associations) enjoying direct or indirect government support. More important than its official status is the fact that it should enjoy the broadest possible autonomy and power of decision, and dispose of an adequate, independent budget.

## CHAPTER 9

### TECHNICAL ASSISTANCE

It is a regrettable but inescapable fact that very few tropical and sub-tropical countries are currently in a position to plan and execute, without external assistance, the type of apicultural development programme envisaged in Chapter 8. Even where the necessary funds are available, the lack of trained local personnel can create an insuperable obstacle at the initial stages unless the necessary expertise can be obtained from abroad.

The simplest type of technical assistance can arise, almost by accident, under existing general rural development programmes funded and executed by private organizations or under bilateral assistance programmes. Appendix C is an unedited report from a young German worker in Botswana, where the main aim was the propagation of small-scale and family-based beekeeping in order to raise the subsistence level and to create an additional source of income among poor population groups in rural areas. The worker knew, at the outset, almost nothing about beekeeping; he began to learn, he says, together with some schoolboys in the area. "At that time," he writes, "I was not conditioned by any particular beekeeping technology," and his pragmatic approach to designing hives made, for example, from apple cartons, appears to have been successful.(\*)

Some "experts" express serious reservations with regard to this line of action, and it is indeed true that much can go wrong if the worker is unenthusiastic, or unimaginative, or convinced of his own infallibility. The scope of such mini-projects must obviously be limited, at least in the first instance, to the boundaries of the village in which the worker is operating. But it is not too optimistic to assert that "grass-roots" operations can under favourable circumstances yield astonishingly satisfactory results.

That said, however, there can be little doubt but that a more highly organized effort is necessary if a programme is to have repercussions on more than a limited, local scale. For a national apicultural development programme, or one which envisages covering a large part of a country, the desirable sequence of events, as they concern technical assistance, would be roughly as follows:

- 1) The government decides to explore the possibility of a programme and, assuming that foreign technical assistance is to be required, selects a country or international agency on which it desires to call for such assistance.
- 2) A feasibility survey is made by qualified experts under the technical assistance programme.
- 3) On the basis of the report of the feasibility survey, the government decides on the execution of the programme, setting targets,

---

(\*) Appendix C contains a number of hints that can be useful even to the "experts", e.g. the use of a simple paper-clip as a queen excluder.

defining the resources it intends to make available, and appointing programme managers.

- 4) A preliminary project, with foreign technical assistance, draws up detailed plans for the execution of the programme. Almost simultaneously, the intensive training of the appointed programme managers is carried out, using the resources of foreign technical assistance as necessary.
- 5) When the training of the programme managers is completed, the programme itself is launched, with the collaboration of one or more foreign technical assistance experts. Depending on the scope of the programme, it may be divided into several stages, with interim assessments, and call at different times on different types or levels of expertise.

Many international bodies -- and notably FAO -- have assisted bee-keeping development programmes, and individual countries which have been donors in the past, whether through their governments or through private organizations, include the following:

Algeria	Netherlands
Belgium	New Zealand
Canada	Norway
Denmark	Sweden
France	Switzerland
Germany (Fed. Rep.)	United Kingdom
Israel	United States of America

Donors' priorities are subject to change, however: one country may wish to devote a greater part of its limited development resources to plant breeding, another to the dairy industry, etc. An early informal approach to determine whether a beekeeping development programme would be likely to be well received in principle can thus save much subsequent time and effort.

When a likely donor has been identified, the government's first official step, as in any development project calling for foreign technical assistance, is to submit a project request to the prospective donor. The extent to which this request is well prepared often determines whether it can be accepted, and drawing it up in as detailed and accurate a manner as possible is therefore fundamental to the realization of the programme. Many donors have drawn up general or detailed guidelines for the submission of project requests, and the authorities of the developing countries will do well to follow such guidelines closely.

If the prospective donor's preliminary assessment of the request is favourable -- i.e. if it is prepared in principle to support a promising bee-keeping development project or programme in the applicant country -- its first action will be to attempt to discover to what extent the proposed project is indeed promising. This attempt takes the form of what is called a feasibility study: a process in which an expert or team of experts collects as much information as possible to determine whether, in the existing situation, and within the funds and other resources available, a project such as that contemplated (suitably modified if necessary) is likely to be successful, and makes detailed recommendations to the prospective donor concerning ways and means, time schedules, resources required, etc.

The first rule of conduct in carrying out a feasibility study is to bear in mind at all times what the prospective beneficiary country itself wants, as reflected in its project request, and not necessarily what the advisor thinks it should want. A beekeeping development programme, properly conceived, is only one element of a country's overall development plan, and maintaining a proper balance and a suitable sense of proportion with regard to it is essential. This is why a successful commercial beekeeper from a developed country is not necessarily the best person to carry out a good feasibility study in a developing country: if he fails to take full account of all prevailing local conditions, or if he bases his analysis of technical possibilities on, or recommends, the initial establishment of an industry on a commercial scale such as could be viable in his own country, he may compromise an entire programme at the outset. If he proposes the use of imported bees -- a frequent error which has accounted for many past failures -- he creates the risk of importing unsuitable bee strains or new bee diseases. And if he assumes that his own success in one ecological context makes him an infallible judge of conditions in another, he may make proper programme execution impossible.

In the field, the advisor will first take a complete look at the current indigenous methods of colony management, where they exist: type of hives, bee species and races, brood-rearing cycle, swarming period, harvesting time, bee diseases and predators, aggressiveness, and migrating or absconding behaviour of the local bees. In particular, he will attempt to discover why particular management methods, especially the exceptional ones, have developed; for example, in much of East Africa hives are sited in trees, for two very good reasons: to protect the bees from pests, such as honey badgers, and to keep them cool during the heat of the day. An important element of information is also the number of existing colonies of bees, including an estimate of those living wild, and their distribution in relation to the nectar-yielding flora and to water availability. This information will enable the advisor to make a realistic recommendation concerning the location of the project, or of any pilot project that may be found necessary, since it is always wise to select an area where honeybees are abundant and, unless there is a good nectar flow, where a good local source of water exists: these are usually signs that beekeeping could be possible in the area. The existing nectar sources and periods of nectar and pollen flows will of course also be studied in this connection, and the expert will determine whether there are toxic plants in the area that yield appreciable quantities of pollen and/or nectar. For example, rhododendron poses a serious problem to beekeeping development in certain areas of Nepal, because of the possibility of toxic honey being produced and offered for sale.

In the course of his feasibility study the advisor will also turn his attention to the production aspects of beekeeping. He will determine the average honey yield per colony and compare whatever statistical background material is available with the results of direct observation and sampling in the field. Methods of honey harvesting, storage and use will be attentively observed. Similarly, the advisor will ascertain the beeswax yield per colony -- even if beeswax production is not specifically foreseen in the preliminary plans --, and whether and how the beeswax is collected, rendered and sold, or whether it is allowed to go to waste.

Any existing marketing conditions will also be studied. Current packaging methods will be analyzed, with particular attention to possible sources of containers (paper/cardboard, plastic, glass, metal). The advisor will review existing marketing systems not only for honey but also for other farm

products, including road networks and distances between contemplated production areas and target consumption centres. Since good marketing and a satisfactory pricing pattern will depend largely on the existence of satisfactory quality standards, the expert will determine whether these exist and are enforced.

Suitable local equipment for the entire production and marketing cycle is primordial: only at a very late stage can a beekeeping development programme rely on complicated imported processing machinery. Imported machinery for producing equipment, such as woodworking machinery for hive construction, often creates a training problem, as was seen in Chapter 5. Such machinery can even become a burden to the country after the project has been completed and handed over to the national authorities: it may be damaged through mishandling, allowed to run down, often for lack of spare parts, or otherwise become useless. The feasibility study will therefore envisage the possibility of producing all requisites locally, and with local equipment. Suitable raw materials must be available, and if lumber is to be used there should in principle be an adequate local woodworking industry. If wood is scarce or excessively costly, other hive materials (e.g. clay, cement, or woven wicker) will be needed.

All beekeeping programmes are primarily training, rather than investment programmes, at least at the outset, and staffing and training considerations are therefore of the greatest importance. The advisor will determine the literacy level of the local population, the existence of a rural adult education system, and the number and standard of available instructors, as well as the existence of national institutions for instructor training.

Finally, the delicate question of motivations and attitudes will be investigated, diplomatically but firmly. No beekeeping development programme can succeed without the active interest, and even enthusiasm, of the local population, and it is most desirable that the original thrust behind the proposal come from them. Programmes imposed from above succeed only rarely, with particularly well-disciplined rural groups, and politically-inspired programmes are especially vulnerable to shifts in the political winds. The advisor will therefore attempt to determine the extent to which the local population wants the programme and is prepared to contribute their personal effort to it.

Even more important -- indeed vital -- is the government's commitment to the programme. In making a feasibility study, long and searching discussions with government officials are necessary to determine exactly what their desires are and what effort they are prepared to put into the project, not only in terms of funding (the government's financial participation in the project is usually greater than that of the donor, even if only in non-convertible local currency) but in terms of general moral and administrative support. The advisor will examine how the government carries out its extension programmes, how it makes appointments, how it deals with such administrative and financial matters as vehicle assignment and maintenance, etc.

In writing his final report, the advisor will depend in the first instance on the information he himself has collected, assessed and analyzed, but he will also bear in mind a number of more general considerations:

1. Environment. Beekeeping being completely dependent on the suitability of the environment, deficiencies in this regard cannot be overcome by technical skill nor by capital investment.

2. Trainees. As has already been observed, beekeeping projects are largely concerned with training rural populations. However, since such popula-



tions often tend to be reluctant to change their old working methods for newer ones, it has at times been found easier to build up a sound programme in an area environmentally suitable for beekeeping but not already occupied by traditional beekeepers. If such an area cannot be identified, it is sometimes best to select school leavers and other young people for training, and to encourage them to participate in the programme by adopting its newer methods.

Recommendations regarding the training of technicians will be formulated with great care. In general, beekeeping problems in the tropics and sub-tropics cannot be solved by sending practical beekeepers from such areas for training in temperate-zone developed countries. Only future bee scientists and instructors with an adequate educational background are likely to be able to profit fully from methodological training in certain disciplines, at a suitable bee research laboratory in a developed country. Practical problems in the developing country itself should usually be solved pragmatically on the spot.

3. Time frame. Since the project will be concerned largely, if not primarily, with training local farm populations, a substantial period (at least three years) will generally be allowed for implementing its first phase. One particularly successful project in Kenya required six years before real results became apparent, although after that time it had a wide effect far beyond the area of the pilot scheme.

4. Staffing. As much of the project staff as possible will consist of qualified locals; the main cost of beekeeping development programmes being the remuneration of foreign advisors, their number will be kept to a minimum.

Usually at least three senior staff, together with support personnel, are needed to execute a large-scale national or regional programme:

- a team leader with good academic as well as practical experience in apiculture, who can both organize and teach;
- an assistant with successful experience in extension work;
- an administrator, preferable a local, to deal with all personnel matters, accounting, procurement, and working-level liaison with government departments.

5. Counterparts. If a programme is to succeed in the long term, and if continuity of action is to be ensured after its completion, national counterparts should be available early in its execution, and preferably at the very time of its initiation. The proper selection of counterparts is of the utmost importance. They must have a genuine interest in beekeeping, and be prepared to be stung. (Appointments of personnel from other branches of agriculture, with no real interest in apiculture, have had most unfortunate results. Motivations in this respect are more important even than proved success in other agricultural activities.) Once appointed, counterparts should be replaced only exceptionally, and for reasons directly related to the project itself; otherwise, the essential continuity cannot be maintained. On the other hand, for obvious reasons, it is essential that a new counterpart work on the project for at least six months before being admitted to the permanent staff or being recommended for advanced training.

6. Forecasting output. In preparing financial and economic estimates, it is wise to be moderate in forecasting the honey yield per colony likely

to be obtained during the first years of the project. Excessively optimistic forecasts, when they are not fulfilled, are likely to compromise the entire programme in the eyes of the government, or at best to expose the staff of the project to unfair and unjustified criticism.

A well-prepared feasibility study will indicate clearly, both to the applicant country and to the prospective donor, whether the proposal for an apicultural development programme appears technically and economically promising, to the extent that it warrants both parties' committing to it resources which are not unlimited and which might be better used elsewhere. If it is agreed to proceed with the programme, the government and the donor use the report as their basis for fixing targets, defining resources, etc.

Drawing up detailed plans for the programme do not lie within the responsibilities of the author of the feasibility study, largely because at the time the study is made, a number of decisions cannot yet have been taken. It is for this reason that the next step must be to draw up such plans, and this will usually be done through a preliminary project set up for that specific purpose. The plan will of course draw on the feasibility report for much of its background information, but with a fairly clear view of the resources that will be made available to the programme it will generally be possible to anticipate with some degree of precision just how much can be accomplished within those resources, and the best means of accomplishing it. Persons unfamiliar with the development process tend at times to consider that this entire planning process is over-bureaucratic, and indeed it does appear to be somewhat heavy, but experience has shown, time and again, that the success of a programme depends directly on the quality of its original planning.

This general overview of programme planning for international technical assistance to beekeeping development will assist in the comprehension of the summary of several FAO beekeeping projects, in different regions, discussed in the following pages. It is however essential to bear in mind at all times one of the major points made time and again throughout this book: the almost infinite diversity of ecological conditions prevailing from one area to the next makes it next to impossible for any two projects to resemble each other, except, perhaps, very superficially. Not all the projects described here have been equally successful, owing at times to changes in governmental perspectives and, only too frequently, to the lack of continuity of purpose which is in many ways the most essential ingredient in any development programme. All, however, are of interest as samples of the sort of work that needs to be, and can be, carried out in developing countries in most tropical and sub-tropical zones.

The projects discussed below are far from constituting a complete view of FAO's activities in technical assistance to beekeeping in developing countries. Emphasis has been placed on projects which for one reason or another appear to be of particular interest in some respect, either because of their comprehensive nature or of their specific orientation.

BURMA. Burma has good potential for the development of apiculture. The tropical climate, with varying agro-ecological conditions, ensures the availability of flowers from numerous species of wild and cultivated plants throughout the entire year. Until recently, however, beekeeping was almost non-existent in the country, and the roughly 500 tonnes of crude honey produced each year came from honey hunting of Apis dorsata nests. In developing its agricul-

ture, the Government of Burma planned not only to introduce new crop varieties but also to increase crop yields through improved pollination, and for this purpose it wished to promote apicultural development. At the same time, it was expected that modern beekeeping practices would provide additional farm income, especially as part of crop replacement programmes.

As part of the plan to introduce modern beekeeping, the Government first requested assistance under FAO's Technical Cooperation Programme (TCP) to carry out a pre-investment study in 1979/80. This initial project also included the training of some 160 bee specialists, the selection of suitable localities with high potential for the development of beekeeping, and the import of beekeeping equipment as well as the introduction of colonies of A. mellifera. The cost of the project, in 1979 terms, was US\$ 106 000. Under this first project, the country was surveyed to determine the suitability of the various regions for apiculture. One region could not be surveyed because of communications difficulties, one was found best suited to the native A. cerana and three were found suitable for A. mellifera; despite problems with Varroa, the Government finally decided that the programme should concentrate exclusively on the latter bee.

At the beginning of the project only five colonies of A. mellifera were available to it. A first training apiary was formed at Rangoon with these colonies, and a first eight-week basic beekeeping course was launched a few days later. While localities suitable for beekeeping were still being selected, more colonies were received and distributed to the areas selected, four experimental apiaries being set up; these were tended by trainees who had completed the project's first and second basic beekeeping courses. Other suitable localities were selected, and 200 further colonies were imported and hived in a number of them. By the time the project was completed, nearly 400 colonies had been distributed among seven experimental apiaries, two out-stations and three training apiaries.

Using an imported Langstroth hive as a model, the national timber corporation produced over 600 hives made of teak, which has a life of at least 20 years with proper maintenance. Smokers, bee veils and hive tools were also produced locally for field work and training.

A training, extension and research station, known as "the Bee House", and consisting of a lecture hall, a laboratory room, a storeroom, a practical training room and an office, was constructed in Rangoon, with a small workshop attached for maintaining and repairing hives and other equipment, and in the same vicinity two bee sheds were constructed for the colonies.

Three basic beekeeping training courses were conducted, an eight-week course for 10 trainees, a 12-week course for 30, and a 17-week course for 121. Of the 161 people trained during the three courses, all were to be assigned to beekeeping work, including training and extension services. Eighteen suitable graduates of these courses were sent abroad to temperate-zone developed countries for further on-the-job training in the latest scientific techniques and to gain practical experience in dealing with bees on a commercial scale. It is worth noting in this connection that training courses for farm cadres currently include beekeeping as a compulsory subject.

Finally, this one-year TCP project drew up plans for a three-year follow-up project designed to transfer modern beekeeping techniques from the

research and experimental centres to farmers and the rural population through demonstration, training and extension. This highlights one of the fundamental ideas behind the TCP concept: to assist in preparing major projects requiring a major financial and technical effort.

The follow-up project commenced operations almost immediately after the end of the TCP project in mid-1980, with a contribution from the United Nations Development Programme (UNDP) of about US\$ 442 000 and a corresponding government contribution of the equivalent of some US\$ 657 000, and with a long-range objective of introducing scientific beekeeping and modern equipment and techniques for increasing not only the production of bee products but also crop yields, through bee pollination of agricultural plants. The project's immediate objectives evolved somewhat in the light of circumstances; essentially they included determining the productivity of A. mellifera in Burma (research on A. cerana indica productivity was not completed in view of changing government priorities), establishing a queen-rearing station as well as a beehive and bee-equipment plant, developing the cooperative marketing of hive products, establishing a small honey-processing plant and a workshop for the manufacture of wax foundation, training qualified beekeepers to act as extension agents, building up a beekeeping extension service and developing one further demonstration and training centre.

While the report of the TCP project had suggested caution in the introduction of European bees until the results of several years of preliminary work were known, in view of their susceptibility to Varroa disease, the government chose to accelerate this introduction in order to obtain rapid results. A. mellifera performed well in 1980, but with the monsoon there was a lack of pollen plants for brood rearing, and as a result the colonies were seriously weakened by attacks of both Varroa and Tropilaelaps. After some research, it was found possible to control mite infestation by interrupting the breeding cycle for a 21-day period, isolating the queen, and at the same time by controlling the adult mite population through chemical treatment. American foul brood (AFB) and chalk brood continued to create problems throughout the life of the project.

A workshop to produce hives and other beekeeping equipment was established in Rangoon, and with six woodworking machines it was producing 20 hives a day. The government then requested increased hive production, and six further machines were purchased, but multiplication of bee colonies decreased owing to mite infestation, and a surplus of hives accumulated which were subsequently sold abroad.

Another workshop was built in which, using two manually operated rollers (one plain and one engraved), at least 250 sheets (15 kg) of wax foundation could be produced per day from A. mellifera as well as A. dorsata wax. At the end of the project this output was adequate to meet demand.

Owing to ectoparasitic brood-mite infestation and the priority given to the training of personnel, the project produced honey only on an experimental scale (colonies used for training and demonstration rarely produce much honey and tend often to abscond because of the disturbance). Nonetheless, under favourable weather conditions, uninfested colonies produced a good honey crop, of excellent quality and requiring no processing before marketing; it was strained, filled into glass jars and attractively packed for sale.

At an advanced stage of the project, the government became interested in the utilization of honey and other hive products for the production of foods,

cosmetics and pharmaceuticals, and experiments began on the production of honey wine, honey liqueur and honey vinegar. Following a study tour to China, Japan and Yugoslavia to study the production of other goods based on hive products, research was started on the manufacture of honey soap, honey powder, honey tablets, honey milk powder and tablets, honey candy, and honey preserves with strawberries and pineapple. It was found that the honey from the local bee species could also be utilized in the production of these items.

After initial success in the early stages of the project, queen-rearing with A. mellifera encountered severe problems due to the fact that the drone population had been seriously weakened by parasites, so that the queens actually reared were for the most part unable to mate.

On the basis of observations carried out mainly in the areas where colonies of A. mellifera were kept, a total of 96 honey plants, including agricultural and horticultural plants, wild plants and forest trees, were identified, and 44 of them were evaluated in terms of bee activity, nectar secretion and sugar concentration. This evaluation made it possible to work out a bee-keeping calendar, discussed in Chapter 2, and herbarium sheets of about 100 honey plants were prepared for training purposes.

One of the most significant achievements of the project was in the training of bee specialists. Most of the 160 graduates of the training courses held during the earlier TCP project were engaged in implementing the beekeeping programme, and over 40 of them were sent abroad for further study under various technical cooperation programmes. More than 30 others were responsible for the beekeeping programme at the Bee House training school (where 1 800 trainees completed training in agriculture and livestock breeding, including beekeeping as a major element in the curriculum) and at other training schools throughout the country.

Some 41 training and experimental apiaries, with colonies of A. mellifera, were established in different parts of the country, and training of the staff responsible for these apiaries was a major activity of the project, 173 trainees having participated in 11 short-term training courses. Specialized training in various fields of apiculture was carried out throughout the life of the project, making it possible to assign 44 specialists to bee management and apiary supervision, 32 to extension work (including the training centre), and lesser numbers to queen-rearing, honey handling, beeswax handling and foundation production, equipment production, honey plant evaluation and pollination, bee diseases and hive products. Finally, a small but growing apiculture library was assembled for daily use by project staff.

Striking evidence of the success of this intensive training programme came to light when two trainees accompanied the FAO expert on a five-week mission to Western Samoa, to advise on the development of honey and beeswax in that country, in 1982. At the expiration of his consultancy, the Government of Western Samoa requested that the Burmese participants be authorized to remain on Samoa for two additional months in order to improve the management of bee colonies and the training of Samoans in beekeeping.

It was originally planned to follow up this project with another three-year project, intended essentially to create an active beekeeping industry, with stated capacities beyond what had already been achieved. In the event, the government authorities considered, after reviewing past accomplishments and future targets, that it was not necessary for them to call upon FAO and UNDP for further assistance; they could continue on their own.

EL SALVADOR. In September 1979, the Government of El Salvador requested FAO's assistance in financing and executing a beekeeping development project under TCP. Significantly, the government stated in its request that the proposal had grown out of feedback from field workers whose reports indicated that many people already engaging in beekeeping in the country required increased support in the form of more regular and complete technical backstopping. Not only information on new techniques was needed, but also guidance on the marketing and use of hive products. At the same time, initial resources and inputs were required at prices whose level would encourage beekeeping development. Finally, it appeared that the small producers were unable to obtain reasonable prices for their products, even though beekeeping constituted a major source of their income: an organization of small producers was badly needed.

In its request, the government stressed that while apiculture was already playing an expanding role in the national economy, greater encouragement and an improved orientation could lead to generating higher incomes, offering a permanent source of raw materials for various local industries, obtaining hard currencies and promoting the use of honey in the local diet. This however called for integrated assistance in planning, organizing and executing a broad apicultural development programme, which would also require the continuous training not only of beekeepers themselves but also of the technical personnel who would be directly involved in it. Foreign assistance, as well as foreign study tours by national staff, would be essential for success. While a preliminary programme had been drawn up, it urgently required revision in the light of experience in apicultural development gained elsewhere, and foreign expertise was particularly needed in this area.

On that basis, the Government put forward proposed terms of reference for a one-year TCP project, and FAO assistance to the extent of US\$ 100 000 was requested, most of this sum to be used for recruiting and remunerating foreign experts. The Government envisaged contributing roughly another US\$ 150 000 of its own funds.

FAO was quick to respond. By the beginning of November 1979 the Director-General had approved the project, and the formal agreement with the Government was signed on 22 November. Although there was some delay in recruiting the principal adviser of the project, due to the need to obtain his release from other duties, the project became operational on 1 February 1980. The principal adviser spent 10 months in the country in a series of three visits spread over a 16-month period, and FAO also recruited a bee pathologist for a 2½-month mission with the project. The Government, for its part, made available a project coordinator, four apiculturalists from rural development centres as well as eight field technicians whose work included servicing practising beekeepers throughout the country.

The principal objective of the project as finally defined was to promote beekeeping in El Salvador by introducing technical improvements designed to increase production and thus generate additional farm income. Other objectives included creating new private apiaries, providing continuing training for both technicians and beekeepers, and making maximum use of, and further developing, the country's nectar- and pollen-producing flora. The minimum targets set were to establish five reproduction centres, to organize 10 pilot apiaries, to train at least 300 beekeepers, to provide foreign training for 10 technicians, to hold two training courses for technicians and eight for project beneficiaries, to

produce 400 hives for programme use, to execute eight research projects and publish their results, to increase per colony honey production above its current annual level of 10-15 kg, to draft legislation on the promotion and protection of apiculture, to make an analysis of hive products supply and demand and to define the scope of a broader programme.

Considering the project's time frame and the resources available to it, this was an ambitious programme indeed, but in some ways at least, its results considerably exceeded expectations. Five reproduction centres were set up, representing a total of 370 colonies. Technical guidance was furnished, through eight field workers, to 132 beekeepers with a total of 5567 hives, and the technicians themselves also received individual and collective training. Especially in the northeastern part of the country, the transfer of colonies from elementary to modern hives was promoted. The frames currently in use in existing hives having created numerous difficulties, a simpler frame was designed which could be built by the beekeepers themselves. Thirteen training courses for technicians and 24 for beekeepers were held, and in addition the technicians learned to organize such courses themselves; as a result, a total of over 100 courses could be given. Ten technicians went on two-week study tours to a Mexican apiary with 35 000 hives, and the project coordinator spent nearly a month in Brazil to study the management of Africanized bees, expected to arrive shortly in El Salvador. Eight research projects were carried out, covering year-round brood production, brood survival, internal conditions in the hive, bee plants of El Salvador, the need to feed bees and the influence of the frequency of feeding on colony development, feeding methods, and bee diseases in El Salvador. A production and marketing survey was made. A specially-recruited bee pathologist surveyed 2463 colonies in 41 apiaries, and found that half the colonies of the country were affected by diseases of brood and adult bees, the wax moth being present in nearly 85% of the cases. A small apicultural library was built up.

Finally, and perhaps more important, the project published, through the national ministry of agriculture, a total of 20 information and training leaflets covering a number of points with which technicians and/or beekeepers were found to be unfamiliar, as well as eight containing the results of the research projects.(\*). This unprogrammed result of the project is making it possible to spread needed information much more widely, both inside and outside the country, than would have been possible had it not been published, and the project thus has had an effect which is being felt far beyond the boundaries of El Salvador.

TUNISIA. One of the most significant and valuable beekeeping development programmes ever carried out in a developing country was that which FAO executed in Tunisia, with UNDP financing, over the nine-year period 1975-84. The programme had its origin in a 1971 survey of beekeeping conditions in the country, which found that the potential there was such that 980 tonnes of honey per year could be produced by 1985, covering 100% of Tunisia's honey requirements. This feasibility study, prepared by the International Federation of Beekeepers' Associations (APIMONDIA), recommended the creation of an FAO/UNDP technical assistance programme, which was set up in 1975.

The project was executed in three phases, each of a duration of roughly three years. Phase I was essentially preparatory, focusing for the most part on

(\*) These booklets are listed in the Bibliography under the names of their respective authors, J. Bobrzecki, S. Handal and J. Woyke.

training. Its approaches and results were very similar to those reported above for the apicultural development project of Burma, and therefore need not be set out in detail here. During Phase II, intensive training continued, but the project devoted increasing attention to the creation of a working infrastructure on which a sound beekeeping industry could be based. This work continued during Phase III, but at the same time the project placed increased emphasis on providing technical assistance to the traditional beekeeping sector in the less populated southern central part of the country.

The overall objectives of the programme during the entire period can be summarized as follows: to train beekeeping managers and producers, with special emphasis on teacher training; to carry out applied research on problems arising out of the programme itself; to create an infrastructure for beekeeping research, improvement, production and extension; to increase the number of colonies and thus honey production, in order to satisfy the domestic demand for honey; and to provide extension and modern technology-transfer services for the beekeeping units set up with project assistance and for beekeepers in general.

More than 80% of the total budget of the project was covered by Tunisia itself - largely to meet the costs of counterpart staff - and less than 20% by UNDP. To these expenditures should be added the considerable investments made by the individual beekeepers.

Only a brief overview of the major accomplishments of the project can be given here: the wide range of activities engaged in over a reasonably long period was such that space is lacking to consider them in detail.

The vital training element of the project included the training of the staff of the project itself, international staff (associate experts), primary school teachers (over 300 trained teachers are currently teaching beekeeping in specialized farming schools), extension agents, students at higher-level institutions, etc.

Research in beekeeping, after a somewhat slow start, gained strength with the creation of the necessary infrastructure, the National Tunisian Centre for Apicultural Research. Here, programmes in bee biology, beekeeping technology, chemistry, toxicology, botany, pollination and bee pathology were executed. Experiments were carried out on the hybridization of the local bee (*Apis mellifera intermissa*, whose characteristics were defined in another research programme) with other important races of *A. mellifera*: *A.m. ligustica*, *A.m. carnica*, *A.m. carpatica*, etc. The results of this research programme appear to justify the views expressed in Chapter 5 above: while hybridization appears to yield good results in the short term, its advantages are lost after a few generations: the Tunisian project finally abandoned the use of exotic bees to specialize in breeding local strains for desirable characteristics.

Technological research led to two interesting results, among others. A special, one-box variant of the Langstroth hive was developed for areas in south central Tunisia where bee plants are relatively scarce, and heated, ventilated rooms were developed to reduce honey humidity to the 18% level. Mention may also be made of the development of solar wax melters, which in the Tunisian ecological context make it possible to obtain a wax that is pure, of excellent quality, and preserving all biological properties of the product.

Research in bee botany and pollination was directed largely toward the preparation of a map of Tunisian bee plants, elaboration of a complete method of



pollen analysis and constitution of a reference library of pollen samples. Preliminary studies indicated that fully exploiting the honey-producing resources of the country would require from 80 000 to 100 000 modern hives and 60 000 improved traditional hives, from which could be obtained some 2000 t of honey per year.

Bee pathology research produced excellent results. A method of treating chalk brood was developed which made it possible to eliminate this disease, as a factor of economic importance, throughout the country. A treatment of AFB, based on sulfathiazol or terramycin, was developed and yielded good results, although outbreaks of the disease continue to occur in some areas. Some success was obtained with treatments of *Nosema* and the wax moth, and work continues on methods of combatting *Achroe grisella* by biological means through treatment of the wax by *Bacillus thuringiensis*, harmless to bees but mortal to the moth. Considerable effort, of course, was devoted to research on *Varroa* control, and a camphor-thymol-menthol formula was developed which has yielded excellent results, particularly when administered in accordance with the methodology which the project also elaborated.

Research, however, is most useful if its results can be applied, and the project was particularly active in producing bees and hive products. A queen-rearing and fertilization centre, opened at the Soukra, produced 48 000 queens over the life of the project, and 16 000 of these were fertilized. Some were used for the project's own requirements or by private beekeepers, while others were held in reserve for the difficult summer periods. Attempts at summer drone-rearing for fertilization are continuing, but thus far results have been disappointing; it is believed that artificial insemination of queens during the summer months will require the introduction of long-term sperm-conservation techniques.

Two pilot stations for producing colonies and honey were opened, one in a citrus-growing region where most of Tunisia's modern apiculture is concentrated, the other in a 10 000-hectare eucalyptus forest, where traditional beekeeping predominated. Average honey production was 25 kg per hive, and from 300 to 800 colonies were produced per year. During the life of the project, the two stations produced more than 120 t of very good quality honey, about 4000 colonies, and 10 t of pure wax.

Also at the Soukra was established a technical centre for the production of hives and other beekeeping equipment. When the project began, Tunisia was importing all its equipment; by the time it was completed, the centre was producing 90% of it. In addition to numerous such items as smokers and hive tools, more than 15 000 movable-frame hives and about 50 000 kg of wax foundation had been manufactured.

An assessment of the apicultural situation in Tunisia at the end of the project showed that the country had 100 000 bee colonies, of which 40 000 in modern hives, as against a total of 60 000, of which only about 6000 in modern hives, at the inception of the project. Honey production had doubled; thanks to the introduction of more modern methods of management, productivity had increased, even in the traditional sector, despite several consecutive years of drought and the appearance of *Varroa*. A practical method of feeding and new methods of disease control had been introduced. An estimated 5000 farmers had adopted beekeeping as a part-time activity, and there were about 100 full-time professional beekeepers.

Most striking of all, however - and the aspect which has made of the Tunisia project more than just one more success - is the impact it has had and continues to have in other countries of the region. Throughout the developing countries of the Mediterranean basin and the Near East, apiculture had made little progress, despite the fact that the ecological conditions of many large areas lend themselves well to this activity. News of the success encountered in Tunisia spread rapidly, and Lebanon, Libya, Morocco and Syria all requested the project to carry out consultancy missions in their countries to draw up national plans for apicultural development, and the project in fact undertook to provide courses of specialized training for staff from these countries.

Finally, the continuation of the Tunisian project has taken the form of a regional project, operating in the three countries of the Maghreb (Algeria, Morocco and Tunisia). This project, which is still in its preliminary phase, is most ambitious in its objectives, but the experience gained in Tunisia is a clear indication of what can be achieved. The project is designed to transform apiculture from a marginal sector of animal husbandry into a modern sector of animal production, based on the application of advanced technologies; to create an institutional framework to facilitate the work and training of personnel in management and production, as needed in each of the participating countries; to increase honey production by increasing the number of existing colonies of bees and through the transfer of technologies; to diversify apicultural production through the collection of royal jelly, propolis, pollen and venom in addition to honey and wax; to improve production quality through the introduction of modern processing equipment utilizing advanced methods of extraction and preservation, and through the application of strict quality controls; in the short term, to cover the domestic honey requirements of the participating countries, and in the longer term to produce an export crop; to ensure the efficient growth and exploitation of the region's honey-plant resources; to contribute to increased plant production through more adequate pollinization; and, lastly, to contribute to rural development by providing supplementary income for about 50 000 small-farmer families and new employment for young beekeepers.

\*\*\*\*\*

The lessons that can be drawn from this review of three FAO beekeeping development projects in widely-separated parts of the world are as clear as they are numerous.

- 1) Foreign technical assistance, as well as financial assistance, can be obtained for a rationally planned beekeeping development project.
- 2) The ecological resources of most regions are adequate for such a project to succeed.
- 3) Success is, essentially, a function of the adequacy of the original planning and of the government's continuing commitment to the programme.
- 4) Flexibility in programme objectives and methodologies is desirable to the extent that experience often indicates areas where changes are necessary, while arbitrary changes based on other than technical considerations are usually counter-productive.

- 5) The first requisite for a large-scale programme is the training and guidance of a reasonably large number of managerial and technical staff, and the permanent commitment of such staff, once trained, to the objectives of the programme.
  
- 6) Just as there is no one solution to all the problems of beekeeping which can be applied in the same manner throughout the world, there is no one solution to the problem of beekeeping development. Different social contexts, as well as different economic and ecological contexts, must determine different approaches, but the basic objectives of all must be the same: to improve national dietary levels and small-farm income through the systematic exploitation of an abundant, low-cost resource.

APPENDIX A

IMPORTANT SOURCES OF THE WORLD'S HONEY (\*) (†)

<u>SCIENTIFIC NAME</u>	<u>COMMON NAME</u>	<u>DISTRIBUTION</u>				
		<u>E</u>	<u>AS</u>	<u>AF</u>	<u>AM</u>	<u>O</u>
<u>Acanthaceae</u>						
<u>Carvia callosa</u>	karvi		T			
<u>Dyschoriste</u> spp.				T		
<u>Hypoestes</u> spp.				T	(S)	
<u>Isoglossa</u> spp.				T		
<u>Lepedagathis cuspidata</u>			T			
<u>Monechma</u>				T		
<u>Thelepaepale ixiocephala</u>			T			
<u>Aceraceae</u>						
<u>Acer</u> spp.	maple, etc.	N	N	N	NS	(S)
<u>A. pseudoplatanus</u>	sycamore	N	N		(S)	
<u>Amaryllidaceae</u>						
<u>Agave</u> spp.	agave		T	TS	T(S)	
<u>A. sisalana</u>	sisal		T	T	T(S)	

(\*) Reprinted with permission from A Book of Honey by Eva Crane (Oxford : Oxford University Press, 1980).

(†) The 232 plants listed are in alphabetical order of their botanical families, a common name being inserted where a generally-known one exists. Entries in the five columns on the right indicate the presence of the plant as a honey source in the different continents:

N = north temperate zone  
 S = south temperate zone  
 T = tropics and sub-tropics

Brackets indicate presence of the plant, but not as a recognized major honey source.

The extent of the continents is:

Europe (E)	N			
Asia (AS)	N	T		
Africa (AF)	N	T	S	
America (AM)	N	T	S	
Oceania (O)		T	S	

SCIENTIFIC NAME	COMMON NAME	DISTRIBUTION				
		E	AS	AF	AM	O
<u>Anacardiaceae</u>						
<u>Anacardium occidentale</u>	cashew nut		T	T	T(S)	
<u>Lannea</u> spp.			T	T		
<u>Mangifera indica</u>	mango		T	T	T(S)	
<u>Pistacia vera</u>	pistachio		T	T	T(S)	
<u>Rhus</u> spp.	sumac, etc.	N	NTS	NTS	NT(S)	T
<u>Aquifoliaceae</u>						
<u>Ilex</u> spp.	holly, etc.	N	NTS	NTS	NT(S)	(S)
<u>Ilex glabra</u>	gallberry				N	
<u>Asclepiadaceae</u>						
<u>Asclepias</u> spp.	milkweed, silkweed			NS (S)	N(S) N	
<u>Asclepias syriaca</u>						
<u>Balsaminaceae</u>						
<u>Impatiens</u> spp.	balsam	N	T	T	N(S)	
<u>Impatiens glandulifera</u>	Himalayan balsam	N	T	T	N(S)	
<u>Berberidaceae</u>						
<u>Berberis</u> spp.	barberry	N	N	N	N(S)	S
<u>Bombacaceae</u>						
<u>Ceiba pentandra</u>	silk-cotton tree			T		
<u>Durio zibethinus</u>	duryon			T		
<u>Boraginaceae</u>						
<u>Borago officinalis</u>	borage	N	N	N	NTS	S
<u>Echium lycopsis</u>	purple viper's bugloss, etc.	N	N	N	NS	S
<u>Echium vulgare</u>	viper's bugloss, blueweed	N	N	N	NS	S
<u>Cactaceae</u>						
<u>Opuntia</u> (200 spp.)	prickly pear, etc.	N		N	NT(S)	S
<u>Combretaceae</u>						
<u>Combretum</u> spp.				T	T	
<u>Terminalia</u> spp.			T			

SCIENTIFIC NAME	COMMON NAME	DISTRIBUTION				
		E	AS	AF	AM	O
<u>Compositae</u>						
<u>Arctotheca calendula</u>	cape weed			S		S
<u>Aster spp.</u>	aster	N	NT		N	
<u>Baccharis</u>					T	
<u>Bidens spp.</u>	Spanish needle, etc.		NTS	T(S)	NT(S)	
<u>Calea pinnatifida</u>					T	
<u>Calea urticifolia</u>	jalacate				T	
<u>Carduus spp.</u>	thistles	N	N	T	(S)	(S)
<u>Carthamus tinctorius</u>	safflower	N	N		N(S)	
<u>Centaurea (600 spp.)</u>	knapweed, corn- flower, etc.	N	N		N	S
<u>Cirsium spp.</u>	thistles	N	N	T		S
<u>Cynara cardunculus</u>	cardoon	N			S	
<u>Eupatorium spp.</u>				T		
<u>Guizotia abyssinica</u>	niger		T	T	(S)	
<u>Helianthus annuus</u>	sunflower	N	N	NTS	NTS	(S)
<u>Senecio jacobaea</u>	ragwort, etc.	N	N	S	NTS	S
<u>Solidago spp.</u>	goldenrod	N	NTS		N(S)	
<u>Taraxacum officinale</u>	dandelion	N	N	NS	NTS	S
<u>Vernonia spp.</u>	ironweed		T	T	T(S)	
<u>Viguiera grammatoglossa</u>	acahual				T	
<u>Viguiera helianthoides</u>	romerillo, tah				T	
<u>Convolvulaceae</u>						
<u>Ipomoea spp.</u>	morning glory, campanilla, aguinaldo			(T)		
<u>Rivea corymbosa</u>	aguinaldo blanco		T	T	NT(S) T(S)	T
<u>Cruciferae</u>						
<u>Brassica juncea</u>	Indian/Chinese mustard		T		T(S)	
<u>Brassica napus</u> subsp. <u>oleifera</u>	summer/winter/ swede rape	N	N	T	NS	S
<u>Brassica rapa (B. campestris)</u> var. <u>oleifera</u>	(winter) rape, turnip rape	N	N	T	NT(S)	S
<u>Brassica rapa (B. campestris)</u> var. <u>sarson</u>	sarson		T		(S)	
<u>Brassica rapa (B. campestris)</u> var. <u>toria</u>	toria		T		(S)	
<u>Sinapis alba</u> and <u>Brassica nigra</u>	white/black mustard	N	N		NT(S)	
<u>Sinapis arvensis</u>	charlock, wild mustard	N	N		N	S
<u>Cucurbitaceae</u>						
<u>Cucumis spp.</u>	cucumber, melon, etc.	N	NTS	NTS	NTS	T(S)

SCIENTIFIC NAME	COMMON NAME	DISTRIBUTION				
		E	AS	AF	AM	O
<u>Cunoniaceae</u>						
<u>Weinmannia racemosa</u>	kamahi					S
<u>Weinmannia silvicola</u>	towai, tawhero					S
<u>Cyrillaceae</u>						
<u>Cyrilla racemiflora,</u> <u>Cliftonia ligustrina</u>	ti-ti				NT	
<u>Ebenaceae</u>						
<u>Diospyros virginiana</u> and spp.	persimmon, etc		NT	S		NT(S)
<u>Ericaceae</u>						
<u>Calluna vulgaris</u>	ling heather	N			N	S
<u>Erica</u>	heaths	N		(T)S	(S)	S
<u>Erica cinerea</u>	bell heather	N				
<u>Oxydendrum arboreum</u>	sourwood				N	
<u>Rhododendron ferrugineum,</u> <u>R. hirsutum</u>	alpine rose	N				
<u>Rhododendron ponticum</u>	rhododendron	N	N		(S)	
<u>Vaccinium</u> spp.	bilberry, blue- berry, etc.	N	N	(T)	N	
<u>Eucryphiaceae</u>						
<u>Eucryphia</u> spp.	leatherwood					S
<u>Euphorbiaceae</u>						
<u>Croton</u> (600 spp.)	croton		T	T		NT(S)
<u>Hevea brasiliensis</u>	rubber tree		T			(T)
<u>Ricinus communis</u>	castor		T	T		T(S)
<u>Fagaceae</u>						
<u>Castanea sativa</u>	sweet chestnut	N	N			S
<u>Quercus</u> spp.	oak	N	NT			N(S)
<u>Hippocastanaceae</u>						
<u>Aesculus</u> spp.	horse chestnut	N	N			N(S)
<u>Hydrophyllaceae</u>						
<u>Phacelia tanacetifolia</u> and spp.	phacelia	N	N			N(S)
<u>Labiatae</u>						
<u>Dracocephalum moldavicum</u>	Moldavian balm	N	N			(S)

SCIENTIFIC NAME	COMMON NAME	DISTRIBUTION				
		E	AS	AF	AM	O
<u>Labiatae (contd)</u>						
<u>Lavandula spica</u>	lavender	N		N	S	
<u>Lavandula stoechas</u>	French lavender	N		N		(S)
<u>Metha</u> spp.	mint	N	N	N	NS	S
<u>Nepeta</u> spp.	catmint	N	N	NT	N(S)	(S)
<u>Ocimum</u> spp.			T	T	T(S)	TS
<u>Origanum</u> spp.	marjoram	N	NT		NT(S)	
<u>Plectranthus mollis</u>			N			
<u>Rosmarinus officinalis</u>	rosemary	N		N	(S)	
<u>Salvia</u> (550 spp.)	sage, etc.	N	N	NT	NTS	S
<u>Satureia</u> spp.	savory	N		N	N(S)	
<u>Stachys annua</u>	woundwort	N	N		(S)	
<u>Teucrium scorodonia</u>	woodsage	N			N(S)	
<u>Thymus</u> (150 spp.)	thyme	N	N	N	N(S)	S
<u>Lauraceae</u>						
<u>Actinodaphne angustifolia</u>			T			
<u>Alseodaphne semecarpaefolia</u>			T			
<u>Persea americana</u>	avocado		NT	S	NT(S)	
<u>Leguminosae</u>						
<u>Acacia</u> spp.	wattle, etc.		NTS	NTS	NTS	TS
<u>Albizzia</u>				T		
<u>Arachis hypogaea</u> and spp.	groundnut, peanut earthnut			T	T(S)	
<u>Astragalus</u> spp.	milk vetch	N	N	N	(S)	
<u>Brachystegia</u> spp.				T		
<u>Caragana arborescens</u>	(Siberian) pea tree		N		N(S)	
<u>Dalbergia</u> spp.	rosewood, sissoo		T	T	T(S)	
<u>Erythrina</u> spp.	coral tree		T			T
<u>Gleditsia</u> spp.	honey locust		NT	TS	NT(S)	
<u>Glycine max</u>	soybean		N		N S	
<u>Haematoxylum campechianum</u>	campeche, logwood			T	T(S)	
<u>Hedysarum coronarium</u>	sulla	N			NS	
<u>Julbernardia globiflora</u>	julbernardia,			T		
<u>Julbernardia paniculata</u>	mua			T		
<u>Lespedeza</u> spp.	lespedeza		N		N	(S)
<u>Lotus corniculatus</u>	bird's-foot trefoil	N	N		NT(S)	(S)
<u>Medicago</u> spp.		N	N	NS	NTS	S
<u>Medicago sativa</u>	lucerne, alfafa	N	N	NS	NTS	S
<u>Melilotus</u> spp.		N	N		NTS	S
<u>Melilotus alba</u>		N	N		NTS	S
<u>Onobrychis viciifolia</u>	sainfoin	N	N		N S	(S)
<u>Ornithopus sativus</u>	seradella	N	N	N S	(S)	
<u>Phaseolus</u> spp.	bean (lima, black- eyed, runner, etc.)	N	N	TS	NTS	(S)



<u>SCIENTIFIC NAME</u>	<u>COMMON NAME</u>	<u>DISTRIBUTION</u>				
		<u>E</u>	<u>AS</u>	<u>AF</u>	<u>AM</u>	<u>O</u>
<u>Leguminosae (contd)</u>						
<u>Piscidia piscipula</u>	ha'bin, Jamaica dogwood				T	
<u>Pongamia pinnata</u>			T			
<u>Prosopis (glandulosa)</u> and spp.	mesquite			S	NTS	S
<u>Prosopis juliflora</u>			T	S	NTS	
<u>Psoralea pinnata</u>	blue pine wood, taylorina			(S)	(S)	S
<u>Robinia pseudoacacia</u> (also other spp.)	robinia, acacia, black locust	N	N	NS	NS	S
<u>Sophora japonica</u>	pogoda tree	N	N		NS	(S)
<u>Tamarindus indica</u> (only spp.)	tamarind		T	T	T(S)	
<u>Trifolium spp.</u>		N	N	NT	NTS	S
<u>Trifolium alexandrinum</u>	Egyptian clover, barseem, berseem		N	N	NS	
<u>Trifolium hybridum</u>	alsike clover	N			NTS	
<u>Trifolium incarnatum</u>	crimson clover	N			NTS	S
<u>Trifolium pratense</u>	red clover	N	N	N	NTS	S
<u>Trifolium repens</u>	white clover	N	N	N	NTS	S
<u>Trifolium resupinatum</u>	Persian clover	N			N(S)	
<u>Vicia spp.</u>	vetches	N	N	N	NTS	(S)
<u>Vicia faba</u>	field/broad bean	N	N	N	NTS	(S)
<u>Vicia villosa</u>	hairy vetch	N	N	N	NS	
<u>Liliaceae</u>						
<u>Allium spp.</u>	onion, leek, etc.	N	N	NS	NTS	S
<u>Aloe spp.</u>	aloe			TS	(S)	
<u>Asparagus officinalis</u>	asparagus	N	N	N	NT(S)	S
<u>Lythraceae</u>						
<u>Lythrum salicaria</u>	purple loose- strife	N	N	N	N(S)	S
<u>Magnoliaceae</u>						
<u>Liriodendron tulipifera</u>	tulip tree, tulip poplar	N	N		N(S)	
<u>Malvaceae</u>						
<u>Gossypium hirsutum</u> and spp.	cotton	N	NT	NT	NT(S)	
<u>Musaceae</u>						
<u>Musa spp.</u>	banana, plantain, etc.		T	T	T(S)	T

SCIENTIFIC NAME	COMMON NAME	DISTRIBUTION				
		E	AS	AF	AM	O
<u>Myrtaceae</u>						
<u>Eucalyptus</u> spp.		N	N	NTS	NTS	TS
<u>Eucalyptus albens</u>	white box			S	TS	S
<u>Eucalyptus calophylla</u>	marri			S	S	S
<u>Eucalyptus camaldulensis</u>	(river) red gum	N		TS	TS	S
<u>Eucalyptus citriodora</u>	lemon-scented gum			NTS	TS	S
<u>Eucalyptus cladocalyx</u>	sugar gum			S		S
<u>Eucalyptus diversicolor</u>	karri			S	S	S
<u>Eucalyptus globulus</u>	Tasmanian blue gum					T
<u>Eucalyptus gomphocephala</u>		N				T
<u>Eucalyptus grandis</u>		N	NT	NTS	NTS	TS
<u>Eucalyptus hemiphloia</u>	grey box		NT	NTS	NTS	TS
<u>Eucalyptus leucoxylon</u>	blue gum etc.			S	(S)	S
<u>Eucalyptus loxophleba</u>	York gum					S
<u>Eucalyptus maculata</u>	spotted gum			TS	(S)	S
<u>Eucalyptus marginata</u>	jarrah				S	S
<u>Eucalyptus melliiodora</u>	yellow box			TS	S	S
<u>Eucalyptus obliqua</u>	stringy bark				S	S
<u>Eucalyptus paniculata</u>	grey ironbark			NTS	TS	S
<u>Eucalyptus platypus</u>	moort					S
<u>Eucalyptus robustus</u>	swamp messmate			TS	TS	S
<u>Eucalyptus rudis</u>	flooded gum	N			(S)	S
<u>Eucalyptus siderophloia</u>	broad-leaved iron-bark				(S)	S
<u>Eucalyptus sideroxylon</u>	mugga, red iron-bark			TS	(S)	S
<u>Eucalyptus tereticornis</u>	forest red gum	N		TS	TS	S
<u>Eucalyptus viminalis</u>	mannum gum, white gum	N		TS	TS	S
<u>Eucalyptus wandoo</u>	wandoo					S
<u>Leprospermum scoparium</u> and spp.	manuka, ti/tea tree					S
<u>Melaleuca leucadendron</u>	cajeput		T		T(S)	S
<u>Metrosideros excelsa</u>	pohutukawa					S
<u>Metrosideros umbellata</u>	rata					S
<u>Myrtus communis</u>	myrtle	N	N		(S)	
<u>Tristania conferta</u> and spp.	scrub box				(S)	S
<u>Syzygium</u> spp.			T			
<u>Nyssaceae</u>						
<u>Nyssa</u> spp.	tupelo		T		N(S)	
<u>Onagraceae</u>						
<u>Chamaenerion angustifolium</u>	fireweed, rosebay willowherb	N	N		N	S
<u>Palmaceae</u>						
<u>Cocos nucifera</u>	coconut palm		T	T	T(S)	T

SCIENTIFIC NAME	COMMON NAME	DISTRIBUTION				
		E	AF	AS	AM	O
<u>Palmaceae (contd)</u>						
<u>Roystonea regia</u> and spp.	royal palms		T	T	T	(T)
<u>Serenoa repens</u> and spp.	saw palmetto				N	
<u>Pedaliaceae</u>						
<u>Sesamum indicum</u>	sesame		T	T	T(S)	
<u>Pinaceae</u>						
<u>Abies alba</u>	silver fir	N			(S)	
<u>Abies bornmuellerana</u>		N				
<u>Larix decidua</u>	larch	N			(S)	
<u>Picea abies</u>	spruce	N			(S)	
<u>Pinus halepensis</u>		N			S	
<u>Pinus mugo</u>	mountain pine	N			S	
<u>Pinus nigra</u>	Austrian pine	N			S	
<u>Pinus sylvestris</u>	Scots pine	N			S	
<u>Polygonaceae</u>						
<u>Antigonon leptopus</u>	coral vine				T(S)	
<u>Eriogonum fasciculatum</u>	wild buckwheat				N	
<u>Fagopyrum esculentum</u>	buckwheat	N	N	S	NT(S)	
<u>Gymnopodium antigonoides</u>	dzidzilche				T	
<u>Polygonum spp.</u>	bistort, etc.	N	N	NT	NT(S)	S
<u>Proteaceae</u>						
<u>Banksia</u>	banksia					S
<u>Banksia menziesii</u> , <u>Banksia prionotes</u>	orange banksia					S
<u>Dryandra sessilis</u> and spp.	parrot bush					S
<u>Grevillea robusta</u> (and 230 spp.)	grevillea			T(S)	NTS	S
<u>Knightea excelsa</u>	rewarewa, New Zealand honeysuckle					S
<u>Protea spp.</u>	protea			TS		
<u>Rhamnaceae</u>						
<u>Frangula alnus</u>	alder buckthorn	N	N		N(S)	
<u>Rhamnus spp.</u>	buckthorn	N	N		N(S)	
<u>Rosaceae</u>						
<u>Crataegus spp.</u> and <u>Crataegus oxycantha</u>	hawthorn	N	N		N(S)	S
<u>Eriobotrya japonica</u>	loquat		T		T(S)	
<u>Malus/Pyrus/Prunus</u>	pome and stone tree fruit	N	N	(S)	NT(S)	S
<u>Rubus fruticosus</u>	blackberry	N	N		N	S
<u>Rubus idaeus</u>	raspberry	N	N		NS	S

<u>SCIENTIFIC NAME</u>	<u>COMMON NAME</u>	<u>DISTRIBUTION</u>				
		<u>E</u>	<u>AS</u>	<u>AF</u>	<u>AM</u>	<u>O</u>
<u>Rubiaceae</u>						
<u>Calycophyllum candidissimum</u>	dagame				T(S)	
<u>Coffea arabica</u> and spp.	coffee		TS	T	T(S)	
<u>Rutaceae</u>						
<u>Citrus aurantium</u>	orange	N	NT	NTS	NTS	S
<u>Citrus</u> and spp.	lemon, lime, gratefruit, etc.	N	N	NT	NTS	S
<u>Salicaceae</u>						
<u>Salix</u> (500 spp.)	willow	N	N	S	N(S)	S
<u>Sapindaceae</u>						
<u>Euphoria longan</u>	longan, lengeng		T		T(S)	
<u>Nephelium litchi</u> ( <u>Litchi chinensis</u> )	litchi, lychee		T	T	(S)	
<u>Sapindus mukorossi</u> (possibly other spp.)	soapnut		T		(T)	
<u>Scrophulariaceae</u>						
<u>Scrophularia</u> spp.	figwort	N	N		N	
<u>Simarubaceae</u>						
<u>Ailanthus altissima</u>	tree of heaven		T		N(S)	
<u>Sterculiaceae</u>						
<u>Dombeya rotundifolia</u> and spp.	dombeya		T	T	T	
<u>Tamaricaceae</u>						
<u>Tamarix</u> spp.	tamarisk	N	N	N	N(S)	
<u>Tiliaceae</u>						
<u>Tilia</u> spp.	lime, linden, etc.	N	N		NS	S
<u>Tilia americana</u>	basswood				N(S)	
<u>Triumfetta rhomboidaea</u> and spp.	triumphetta			T	T	T
<u>Umbelliferae</u>						
<u>Anthriscus cerefolium</u>	cow parsley	N	N	N	N(S)	
<u>Daucus carota</u>	carrot	N	N	N	N(S)	
<u>Faeniculum vulgare</u>	fennel	N			(S)	S

<u>SCIENTIFIC NAME</u>	<u>COMMON NAME</u>	<u>DISTRIBUTION</u>				
		<u>E</u>	<u>AS</u>	<u>AF</u>	<u>AM</u>	<u>O</u>
<u>Umbelliferae (contd)</u>						
<u>Heracleum sphondylium</u>	hogweed, cow parsnip	N	N	N	N(S)	
<u>Verbenaceae</u>						
<u>Avicennia nitida</u>	black mangrove				T	(S)
<u>Citharexylum</u>	fiddlewood, etc.				T(S)	
<u>Lippia</u>	carpet grass, etc.		N	T	NTS	
<u>Vitex</u>			T	T	NT	(S)

## APPENDIX B

### CODEX STANDARD FOR HONEY(\*)

(European Regional Standard)

#### 1. DESCRIPTION

##### 1.1 Definition of Honey

Honey is the sweet substance produced by honey bees from the nectar of blossoms or from secretions of or on living parts of plants, which they collect, transform and combine with specific substances, and store in honey combs.

##### 1.2 Description

Honey consists essentially of different sugars, predominantly glucose and fructose. Besides glucose and fructose, honey contains protein, amino acids, enzymes, organic acids, mineral substances, pollen and other substances, and may include sucrose, maltose, melezitose and other oligo-saccharides (including dextrans) as well as traces of fungi, algae, yeasts and other solid particles resulting from the process of obtaining honey. The colour of honey varies from nearly colourless to dark brown. The consistency can be fluid, viscous or partly to entirely crystallized. The flavour and aroma vary, but usually derive from the plant origin.

##### 1.3 Subsidiary Definitions and Designations

###### 1.3.1 According to origin

Blossom or nectar honey is the honey which comes mainly from nectaries of flowers.

Honeydew honey is the honey which comes mainly from secretions of or on living parts of plants. Its colour varies from very light brown or greenish to almost black.

###### 1.3.2 According to mode of processing

Comb honey is stored by bees in the cells of freshly built broodless combs, and sold in sealed whole combs or sections of such combs.

Extracted honey is honey obtained by centrifuging decapped broodless combs.

Pressed honey is honey obtained by pressing broodless combs with or without the application of moderate heat.

(\*) CODEX STAN 12-1981

2. ESSENTIAL COMPOSITION AND QUALITY FACTORS

2.1 Compositional Criteria

2.1.1 Apparent reducing sugar content, calculated as invert sugar:

Blossom honey, when labelled as such: not less than 65 percent

Honeydew Honey and blends of Honeydew  
Honey and Blossom Honey: not less than 60 percent

2.1.2 Moisture content: not more than 21 percent

Heather Honey (Calluna) not more than 23 percent

2.1.3 Apparent sucrose content: not more than 5 percent

Honeydew Honey, blends of Honeydew Honey  
and Blossom Honey, Rubinia Lavender  
and Banksia menziesii Honeys: not more than 10 percent

2.1.4 Water-insoluble solids content: not more than 0.1 percent

Pressed Honey: not more than 0.5 percent

2.1.5 Mineral content (ash): not more than 0.6 percent

Honeydew Honey and blends of Honeydew  
Honey and Blossom Honey: not more than 1.0 percent

2.1.6 Acidity: not more than 40 milli-  
equivalents acid per  
1000 grams

2.1.7 Diastase activity and hydroxymethylfurfural content

Determined after processing and blending  
diastase figure on Gothe scale: not less than 8

provided the hydroxymethylfurfural  
content is: not more than 40 mg/kg

Honeys with low natural enzyme content,  
eg. Citrus, diastase content on  
Gothé scale: not less than 3

provided the hydroxymethylfurfural  
content is: not more than 15 mg/kg

2.2 Specific Prohibitions

2.2.1 Honey must not have any objectionable flavour, aroma or taint absorbed from foreign matter during the processing and storage of honey.

2.2.2 Honey must not have begun to ferment or be effervescent.

2.2.3 Honey must not be heated to such an extent as to inactivate greatly or completely the natural enzymes it contains (see 2.1.7).

2.2.4 The acidity of honey must not be changed artificially.

3. FOOD ADDITIVES AND ADDITIONS

3.1 None permitted.

4. HYGIENE

4.1 It is recommended that the product covered by the provisions of this Standard be prepared in accordance with the appropriate sections of the General Principles of Food Hygiene recommended by the Codex Alimentarius Commission. (Ref. No CAC/RCP.1-1969, Rev 1).

4.2 Honey should, as far as practicable, be free from inorganic or organic matters foreign to its composition, such as mould, insects, insect debris, brood or grains of sand, when the honey appears in retail trade or is used in any product for human consumption (see 2.1.4).

5. LABELLING

In addition to Sections 1, 2, 4 and 6 of the General Standard for the Labelling of Prepackaged Foods (Ref. No. CODEX STAN 1-1981) the following specific provisions apply:

5.1 The Name of the Food

5.1.1 Subject to the provisions of 5.1.4 only products conforming to the standard may be designated "honey".

5.1.2 No honey may be designated by any of the designations in 1.3 unless it conforms to the appropriate description contained therein.



5.1.3 Honey may be designated according to colour, and according to floral or plant source if the predominant part of the honey originates from the floral or plant source or sources so designated and if the honey has the characteristics of the type of honey concerned. Honey may be designated by the name of the geographical or topographical region if the honey was produced exclusively within the region referred to in the designation.

5.1.4 Honey not complying with the requirements of 2.1.7, 2.2.1, 2.2.2 or 2.2.3 of this Standard must, if offered for sale, be labelled "baking honey" or "industrial honey".

5.1.5 Honey complying with the provisions of this standard may be sold under designations which describe its physical characteristics, e.g. "creamed", "whipped" or "set".

## 5.2 Net Contents

The net contents shall be declared by weight in either the metric ("Système International" units) or avoirdupois or both systems of measurement, as required by the country in which the product is sold.

## 5.3 Name and Address

The name and address of the manufacturer, packer, distributor, importer, exporter or vendor of the honey shall be declared.

## 5.4 Country of Origin

The country of origin of the honey shall be declared unless it is sold within the country of origin, in which case the country of origin need not be declared.

## 6. METHODS OF ANALYSIS AND SAMPLING

[...]

## APPENDIX C

### BEEKEEPING WITH MINIMAL COST AND EQUIPMENT:

#### AN EXAMPLE FROM THE KALAHARI DESERT

by

Bernhard Clauss

#### Simple and Unaggressive Beekeeping in Botswana

Though I had previously studied a little about bees, and had watched German beekeepers at work, I gained my first practical experience of beekeeping in Botswana in southern Africa, in 1977. At that time I was not conditioned by any particular beekeeping technology, nor was I aware that tropical African bees were "vicious". All I remembered was the coolness with which honey-hunters, for instance in the Okovango Delta, dealt with wild colonies. I had watched them using a piece of smouldering buffalo dung as their only protective measure for keeping the bees under control all the time they were taking honey combs from a nest.

I realized the potential of beekeeping, as an activity to improve the subsistence level of groups of the poor rural population, and as a source of additional cash income for them. Botswana is, however, a country without any tradition of beekeeping. So I looked for a smooth transition from the "gentle" honey-hunting I had watched, to an unaggressive and simple method of beekeeping - assuming that beekeeping would not then seem basically different from this honey-hunting, to people already familiar with bees.

Fortunately I got hold of a drawing of a top-bar hive designed in Tanzania. I began to learn beekeeping, together with some Kalahari schoolboys. It was a bit rough during the initial stage, but at last we became certain that the best way to prevent aggressiveness by the bees was to handle them in a friendly way. And this goes well with an uncomplicated top-bar type of hive.

- 1) The length of the hive provides sufficient working space for the colony to build its combs, and for the beekeeper to shift each top-bar and its comb during inspection.
- 2) Before the hive is opened, smoke is blown into the entrance holes of the hive - up to eight times. A moderate puff of smoke is applied before each successive step below.
- 3) The five or six top-bars at the empty end of the hive are removed, providing the beekeeper with a working gap.
- 4) The bees below the top-bars at the other (full) end of the hive are not exposed to direct light, and stay calm.
- 5) The beekeeper, standing behind the hive, shifts any further empty top-bars to the empty end of the hive, thus approaching the first top-bar that has a comb attached.

6) The combs are removed and inspected, and shifted along, one by one; bees are not crushed when top-bars are pushed together.

7) There is only one working gap during the whole operation, and most of the bees are in the dark most of the time, so they are not disturbed unnecessarily. All the occupied combs remain inside the hive, and this minimizes the chance of robbing by other bees.

8) Because we have no protection beyond our ordinary clothes (except a hat and a tin smoker) we can feel the occasional single sting, and can scratch it out and smoke it immediately, thus preventing a large-scale attack.

9) The combination of the top-bar hive and unaggressive handling can help to change the behaviour of "aggressive" colonies. One European farmer had two colonies, in movable-frame hives, that were "vicious". They were "tamed" after transference to top-bar hives, and since then the farmer has abandoned his frame hives.

We have encountered one particular problem, due to the fact that a new swarm needs hardly any smoke for a period after it is hived. This may lead a beginner to relax his precautions, thinking that his bees know him, and will behave well towards him. As the colony grows larger its behaviour changes, and the result is likely to be a severe blow to the beekeeper's confidence; it may even cause him or her to give up. The "friendly" method can thus seduce a beginner into becoming careless and lazy. We learned that a certain mutual adaptation is possible between a beekeeper and his colonies, although they never know him personally. On the beekeeper's side, this adaptation leads to a kind of respect, but also to a reduction of fear.

This simple method of beekeeping, as a continuation of gentle honey-hunting practices, is a suitable way of introducing beekeeping into a non-beekeeping society. For this reason in particular, we want to recommend the use of the simplest and most inexpensive equipment, in addition to normal (tight) clothing, such as a T-shirt and shorts:

- 1) broad-brimmed hat;
- 2) smoker made from perforated tin;
- 3) knife for separating top-bars before removing them;
- 4) feather for brushing bees off combs;
- 5) pieces of queen excluder, for use across the entrance for the first few days (only) after hiving a swarm. One beekeeper discovered that a paper clip with an inner measurement of 4 mm can be used across a flight hole as a queen excluder;
- 6) matchbox as queen cage.

#### First Experiences with Home-made Top-bar Hives

Our main aim in Botswana is the propagation of small-scale and family-based beekeeping, in order to raise the subsistence level and to create an additional source of income among poor population groups in rural areas. When we started beekeeping at Kagcae, among inhabitants of a rural area (mostly San) in the central Kalahari, we were faced with the problem that the number of colonies kept could not be increased unless we could devise a hive that cost absolutely nothing.

We therefore transferred from commercially-made top-bar hives imported from Tanzania to top-bar hives using home-made boxes of cheap or scrap material. After some experimentation we had to accept the necessity for accurately made top-bars (simple wooden strips, later provided with wax strips as starters), and these had to be purchased from carpenters with adequate tools. Our first attempt to use scrap containers as hives failed: empty paraffin cans, even when well insulated, did not provide a satisfactory home for bees. Other types of hive were, however, more successful. Some beekeepers use plywood tea boxes with insulation made of sacking material stuffed with dry grass or sawdust. Others build their hives from scrap wood.

Four types of top-bar hives that cost practically nothing to make are described below.

During a shortage of wooden hives in 1978 we used cardboard apple-boxes as temporary hives; they were 50 x 32 x 30 cm and accommodated 16 top-bars. If protected from the rain they lasted for several months.

In order to make more durable hives, apple cartons were plastered with two layers of a mixture of cow-dung and clay, and then with a third layer of fresh cow-dung. These hives have proved to be quite durable and rigid, provided they are well protected against rain. One has now been in operation for three years. The climate inside this hive seems to be very suitable for our bees. Although they continually gnaw the cardboard material, this does not seem to affect the rigidity of the box. One empty hive was occupied by a swarm, apparently attracted by the smell of the beeswax strips along the top-bars. The shortness of the apple carton makes it rather small for a hive, and this can cause problems. In 1980, colonies in six out of nine hives extended brood-rearing up to the thirteenth comb, and only a little honey was stored; the other three colonies did not extend their brood nest beyond the eighth comb, and they gave 6 to 10 kg of honey each.

In the eastern and northern parts of Botswana the apple-carton hive generally becomes over-crowded within half a year unless continued and drastic management measures are taken, which is more than can be expected from our average beekeepers. In southeast Botswana, beekeepers overcame this difficulty by constructing a long hive from two apple cartons, fastening them together on a rigid wooden board or metal sheet. Both the boxes and the board were plastered with the cow-dung and clay mixture. These were called tswaragano ("bound-together") hives; four were still in operation six months after they were made.

"Noah's hive", another home-made hive, was developed in 1980 by a young Motswana. A framework of straight sticks was tied together with wire or terminalia bark and then plastered with cow-dung and clay. This hive is about 1 m long and has a similar cross-section to the cardboard-box cow-dung hive described above. The beekeepers can therefore transfer top-bars with their combs from one type of hive to the other.

APPENDIX D

BEE VULNERABILITY TO PESTICIDES

(Source: Johansen, C.A. (1979).)

Symbols:

EC = emulsifiable concentrate	S = solution
D = dust	SP = soluble powder
F = flowable	ULV = ultra low volume
G = granular	WP = wettable powder
MA = concentrate applications at mosquito abatement rates	

1. PESTICIDES EXTREMELY DANGEROUS TO BEES

The following pesticides can kill bees up to 10 hours after application. They should never be applied to any flowering crops or weeds.

Accothion (fenitrothion)	Brachlene (dicapthon)
acephate	Bromox D (naled)
Agrothion (fenitrothion)	calcium arsenate
Alderstan (aldrin)	carbanolate
aldicarb G (applied 4 weeks before bloom)	carbaryl
Aldrex (aldrin)	Carbicron (dicrotophos)
aldrin	carbofuran F
Ambush (permethrin)	carbophenothion D
aminocarb	chlorpyrifos
arprocarb (propoxur)	chlorthion
Astex (aldrin)	chlorxylan (carbanolate)
azinphosethyl	Cidial (phenthoate)
azinphosmethyl	Ciodrin (crotoxyphos)
Azodrin (monocrotophos)*	Colep
Banol (carbanolate)	crotoyphos
Basanite (dinoseb)	Curater F (carbofuran)
Basudin (diazinon)	Cyflor (famphur)
Baygon (propoxur)	Cygon (dimethoate)
Baytex (fenthion)	Cythion D or ULV (malathion)
Baythion (phoxim)	Dasanit (fensulfothion)
benzene hexachloride	DDV <sup>®</sup> (dichlorvos)
BHC, gamma-BHC (benzene hexachloride)	De-fend (dimethoate)
Bidrin (dicrotophos)	diazinon
Bladafum (sulfotep)	Diazitol (diazinon)
Bolstar (sulprofos)	dicapthon
Bomyl	dichlorvos
	Dicofen (fenitrothion)

\* Can cause serious problems if allowed to drift onto vegetable or legume seed crops.

Dicron (phosphamidon)  
dicrotophos  
dieldrin  
Dilstan (dieldrin)  
Dimecrono (phosphamidon)  
dimethoate  
dimethoxon (omethoate)  
dinitrocresol  
dinoseb  
dithio or Ditiufos (sulfotep)  
DN-289 (dinoseb)  
DNC or DNOC (dinitrocresol)  
DNSBP or DNOSBP (dinoseb)  
Draza (methiocarb)  
DTMC (aminocarb)  
Dursban (chlorpyrifos)  
Elgetol (dinitrocresol)  
Elsan (phenthoate)  
EPN  
Ethyl Guthion (azinphosethyl)  
Ethyl-methyl Guthion  
Famophos (famphur)  
famphur  
fenamiphos  
fenitrothion  
Fenstan (fenitrothion)  
Fensulfothion  
fenthion  
Folidol (parathion)  
Folimat (omethoate)  
Folithion (fenitrothion)  
Furadan F (carbofuran)  
Gammexane (gamma-BHC)  
Garrathion D (carbophenothion)  
Gusathion A or K (azinphosethyl)  
Hamidop (methamidophos)  
HCH (benzene hexachloride)  
HEOD (dieldrin)  
heptachlor  
HHDN (aldrin)  
Imidan (phosmet)  
isobenzan  
Ivosit (dinoseb)  
Lannate D (methomyl)  
lead arsenate  
Lebaycid (fenthion)  
lindane (gamma-BHC)  
Lirothion (parathion)  
Lorsban (chlorpyrifos)  
malathion D  
malathion ULV  
maldison (malathion)  
Matacil (aminocarb)  
mercaptodimethur (methiocarb)  
mercaptothion D or ULV (malathion)  
Mesurol (methiocarb)  
Metacide (methyl parathion + parathion)  
metaphos (methyl parathion)  
metathion (fenitrothion)  
methamidophos  
methidathion  
methiocarb  
methomyl D  
methyl-carbophenothion  
methylnitrophos (fenitrothion)  
methyl parathion  
Methyl Trithion (methyl-carbophenothion)  
mevinphos  
mexacarbate  
Monitor (methamidophos)  
monocrotophos  
naldrin (aldrin)  
naled D  
Nemacur (fenamiphos)  
Nemafos (thionazin)  
Nogos (dichlorvos)  
Nudrin D (methomyl)  
Nuvacron (monocrotophos)  
Nuvan (dichlorvos)  
omethoate  
Orthane (acephate)  
oxydimethoate (omethoate)  
Paphthion (phenthoate)  
paraoxon  
parathion  
Penncap-M (methyl parathion)\*  
permethrin  
phenthoate  
Phosdrin (mevinphos)  
phosmet  
phosphamide (dimethoate)  
phosphamidon  
phoxim  
phthalophos (phosmet)  
Pounce (permethrin)  
Prolate (phosmet)  
propoxur  
Pydrin (over 0.1 kg/ha)  
Pyramat  
Rebelate (dimethoate)  
resmethrin  
Rogor (dimethoate)  
Sevin (carbaryl)\*  
Sevin ULV (over 0.5 kg/ha)  
Sinox (dinitrocresol)  
Sinox General (dinoseb)

\* Can cause serious problems if allowed to drift onto vegetable or legume seed crops.

Soprocide (BHC)	thinonazin
Strykol (gamma-BHC)	thiophos
sulfotep (p)	thioteps (sulfotep)
sulprofos	Tiguvon (fenthion)
Sumithion (fenitrothion)	TRI-ME (methyl-carbophenothion)
Supersevtox (dinoseb)	Trithione D (carbophenothion)
Supracide (methidathion)	Ultracide (methidathion)
Swat (Bomyl)	Uden (propoxur)
Tamaron (methamidophos)	Valexon (phoxim)
Telodrin (isobenzan)	Vapona (dichlorvos)
Temik G (aldicarb) (applied at least 4 weeks before bloom)	Warbex (famphur)
Terracur (fensulfothion)	Wofatox (methyl parathion)
thinonazin	Zectran (mexacarbate)
	Zinophos (thionazin)

## 2. PESTICIDES VERY DANGEROUS TO BEES

The following pesticides should be applied only during late evening. They are then not likely to kill bees next morning (8 hours later).

Bromex WP (naled)	mercaptothion EC (malathion)
Cythion EC (malathion)	naled WP
Dibrom WP (naled)	phorate EC
malathion EC	Pydrin (0.1 kg/ha or less)
maldison EC (malathion)	Thimet EC (phorate)

## 3. PESTICIDES DANGEROUS TO BEES

The following pesticides are not likely to kill bees 3 hours after application. They should be applied only during late evening, night, or early morning.

Abar (leptophos)	benzophosphate (phosalone)
Abate (temephos)	binapacryl
Acrex (dinobuton)	Birlane (chlorfenvinphos)
Acricid (binapacryl)	Bladan (TEPP)
amidithion	Bromex EC (naled)
amiton or amiton oxalate (Tetram)	Camphechlor (toxaphene)
Aphox (primicarb)	carbaryl ULV (0.5 kg/ha or less)
Aramite D	carbophenothion
arprocarb MA (propoxur)	Carzol (formetanate)
Aspon (propyl thiopyrophosphate)	chlordan
Asuntol (coumaphos)	chlorfenvinphos
Baygon MA (propoxur)	chlorfos or chlorophos (trichlorfon)
Baytex G or MA (fenthion)	chlorpyrifos or chlorpyriphos MA

Citram (Tetram)	Lethane 384 Special
Co-Ral (coumaphos)	Lorsban MA (chlorpyrifos)
DDD	malathion MA
DDT	maldison MA (malathion)
DDVP MA (dichlorvos)	Malonoben
Delnav (dioxathion)	menazon
demeton	mercaptothion MA (malathion)
demeton methyl (methyl-demeton)	Metasystox (methyl-demeton)
Derris D (rotenone)	Metastox-R (oxydemeton-methyl)
dialifor or dialifos	methomyl S,SP
Dibrom EC (naled)	methoxychlor
dichlofenthion or dichlorfenthion	methyl-demeton
dichlorvos MA	MNFA (Nissol)
dieldrin G	Mobilawn (dichlofenthion)
diethion (ethion)	Morocide (binapacryl)
difos (emephos)	naled EC
Dilan	Nankor (fenchlorphos)
dimetilan	Neguvon (trichlorfon)
Dimetilane (dimetilan)	Nemacide (dichlofenthion)
dinobuton	nendrin (endrin)
dioxathion	Nialate (ethion)
Dipterex (trichlorfon)	Nissol
disulfoton EC	Nogos MA (dichlorvos)
Di-Syston EC (disulfoton)	NPD (propyl thiopyrophosphate)
Dursban MA (chlorpyrifos)	Nudrin S,SP (methomyl)
Dyfonate (fonofos)	Nuvan MA (dichlorvos)
Dylox (trichlorfon)	Octachlor (chlordan)
endosulfan	oil sprays (superior type)
endrin	oxamyl
Eradex (thioquinox)	oxydemeton-methyl
ethion	Parasolan EC (disulfoton)
ethylan (ethyl-DDD)	Perthane (ethyl-DDD)
ethyl-DDD	Pestox III (schradan)
fenchlorphos	phorate G
fenthion G or MA	phosalone
Fernos (pirimicarb)	Phostex
fonofos	Phosvel (leptophos)
formetanate	pirimicarb
Gardona (tetrachlorvinphos)	Pirimor (pirimicarb)
Garrathion	polychlorcamphene (toxaphene)
Granyulox EC (disulfoton)	primin (isolan)
HEOD G (dieldrin)	propoxur MA
heptachlor G	propyl thiopyrophosphate
isobornyl thiocyanate	Proxol (trichlorfon)
isodrin	quinothionate (thioquinox)
isolan	Rabon (tetrachlorvinphos)
isopropyl parathion	Rhothane (DDD)
Korlan (fenchlorphos)	ronnel (fenchlorphos)
Kroneton	roneton D
Lannate S,SP (methomyl)	sabadilla
Labaycid G or MA (fenthion)	Sapecron (chlorfenvinphos)
Larvin	Saphi-col (menazon)
leptophos	Sevin ULV (carbaryl (0.5 kg/ha or less))



Shirlan (sabadilla)	Thiodan (endosulfan)
Sintox (ethion)	thiodemeton ECi(disulfoton)
Solvigran	thioquinox
Solvirex EC (disulfoton)	Tiguvon G or MA (fenthion)
stirofos (tetrachlorvinphos)	Torak (dialiofor)
Strobane	toxaphene
Supona (chlorfenvinphos)	Tranid
Sydane 25 (chlordan)	trichlorfon
Syfox (menazon)	trichlorphon (trichlorfon)
Systox (demeton)	Trithionf(carbophenothion)
TDE (DDD)	Trolene (fenchlorphos)
temephos	Tugon (trichlorfon)
TEPP	Uden MA (propoxur)
tetrachlorvinphos	Vapona MA (dichlorvos)
Tetram	Vydate (oxamyl)
Thanite (isobornyl thiocyanate)	Wotexit (trichlorfon)
Thimet G (phorate)	Zolone (phosalone)
Thiocron (amidithion)	

4. PESTICIDES LEAST DANGEROUS TO BEES

Acaralate (chloropropylate)	Dasanit G (fensulfothion)
Acarol (bromopropylate)	Derris EC (rotenone)
Akar (chlorobenzilate)	dicofol
Akaritox (tetradifon)	dienochlor
allethrin	diflubenzuron
Altozar (hydroprene)	Dikar
amitraz	Dimilin (diflubenzuron)
aprocab G (propoxur)	Dimite (chlorfenethol)
BAAM (amitraz)	dinex
Baygon G (propoxur)	dinitrocyclohexylphenol (dinex)
bromopropylate	dinocap
butoxy thiocyanodiethyl ether	disulfoton G
carbaryl G	Di-Syston G (disulfoton)
carbofuran G	DMC (chlorfenethol)
chinomethionat (quinomethionate)	DN-111 or DNOCHP (dinex)
chlorbenside	entocone (hydroprene)
chlordecone	fenazaflor
chlordifon (tetradifon)	fenbutatin-oxide
chlordimeform	fenson
chlorfenethol	fensulfothion G
chlorfenson	Fendal (chlordimeform)
chlorfensulphide	Furadan G (carbofuran)
chlorobenzilate	Galecron (chlordimeform)
chloropropylate	Genite 923 or Genitol 923
Chlorparacide (chlorbenside)	Granulox G (disulfoton)
chlorphenamidine (chlordimeform)	hydroprene
Crotothane (dinocap)	Karathane (dinocap)
cryolite	Kelthane (dicofol)
Curater G (carbofuran)	Kepone (chlordecone)
cyhexatin	Largon (diflubenzuron)
Cythion G (malathion)	Lethane 384 (butoxy thiocyanodiethyl ether)

Lime-sulphur or lime-sulfur	propoxur G
LovozaI (fenzaflor)	pyrethrum
melathion G	Qikron (chlorfenethol)
maldison G (malathion)	quinomethionate
mercaptothion G (malathion)	Rospin (chlorfenethol)
Micasin (chlorbenside)	rotenone EC
Milbex (chlorfensulphide)	ryania
mirex G	Ryanodine (ryania)
Mitox (chlorbenside)	schradan
Morestan (quinomethionate)	Sevin G (carbaryl)
Neoron (bromopropylate)	sodium fluosilicate baits
Neotran (oxythane)	Solvigran or Solvirex G (disulfoton)
nicotine sulfate	Sulphenone
Omite (propargite)	sulphur or sulfur
OMPA (schradan)	Sytam (schradan)
ovex or ovotran (chlorfenson)	Tedion (tetradifon)
oxythane	Terracur G (fensulfothion)
oxythioquinox (quinomethionate)	tetradifon
Parsolin G (disulfoton)	thiodemeton G (disulfoton)
Pentac (dienochlor)	Uden G (propoxur)
Plictran (cyhexatin)	Vendex (fenbutatin-oxide)
propargite	

## APPENDIX E

### INFORMATION RESOURCES FOR BEEKEEPERS IN DEVELOPING COUNTRIES

#### 1. GENERAL

The lack of good, complete manuals of apiculture in local languages, accessible to the rural communities of the developing countries, creates a major constraint on beekeeping in the tropics and sub-tropics. While the bibliography to this volume contains more than 250 entries, the large majority of them are given over to specialized topics rather than to the basic information every beekeeper needs. Further, most of the general manuals are restricted in scope to discussions of beekeeping with Apis mellifera in temperate climates, and this in itself limits their usefulness to the developing world. The major exceptions to this general rule are Indonesia, whose publishing industry has shown a lively interest in apiculture; Latin America, where the matter is reasonably well covered; and, to some extent, India, where publications in Hindi and Urdu, as a start, are beginning to appear.

In both the developed and the developing countries, another difficulty arises out of the fact that - with some notable exceptions - most beekeeping publications are produced by small, specialized publishers whose production is not generally available through normal trade channels. One partial solution to this problem is offered by the International Bee Research Association (Hill House, Gerrards Cross, Bucks, SL9 0NR, UK), which in addition to publishing a wide range of beekeeping materials, also acts as distributor of a number of the publications listed in the bibliography of this volume.

With the financial support of the International Development Research Centre, IBRA has prepared ten leaflets to provide information often sought by beekeepers in developing countries. These leaflets, forming a series entitled Source Materials for Apiculture, are available in English, French and Spanish. They are as follows:

- No. 1 Suppliers of equipment for tropical and subtropical beekeeping 6 pages  
Suppliers in 23 countries, also suppliers of specialized equipment such as pollen traps, propolis harvesters, top-bar hives, apparatus for instrumental insemination, queen-rearing equipment, bee blowers, protective clothing.
- No. 2 Marketing bee products: addresses of importers and agents 10 pages  
Addresses of 119 importers and traders in honey, 58 in beeswax, 28 in pollen and 15 in propolis, with other useful information for would-be exporters.
- No. 3 Planting for bees in developing countries 10 pages  
Details of 31 plants especially selected as worth growing for honey production.
- No. 4 Opportunities for training in apiculture world-wide 10 pages  
Details of both scheduled and tailor-made courses organized by 55 institutions, in 25 countries, that accept students from elsewhere.

- No. 5 Sources of voluntary workers for apicultural development 4 pages  
Lists of agencies providing voluntary workers, and advice to individuals seeking work in developing countries.
- No. 6 Sources of grant-aid for apicultural development 12 pages  
Information on 56 agencies, with indications that will help in selecting agencies to be approached, and in making an application.
- No. 7 Obtaining apicultural information for use in developing countries 6 pages  
Addresses of libraries in developing countries with books on apiculture, and others from which information on a specific subject may be sought.
- No. 8 Apicultural reference books for developing countries 8 pages  
Special selection of books and other publications, with additional recommendations for Asia, Africa, the Mediterranean region and the Americas. Prices and sources are included, and a list of publications available free.
- No. 9 Educational aids of apiculture 6 pages  
Selected wall charts, posters and colour prints, with prices and illustrations. Also sets of colour slides, films and audiovisual material.
- No. 10 Writing about apiculture: guidelines for authors 6 pages  
Covers writing for the general public and for an international audience; writing instruction leaflets, research papers, reports to read at a meeting, and labels for an exhibition.

IBRA has thus far issued three leaflets in another series, Information Sheets on Tropical Apiculture, in English and Spanish. These are as follows:

- ISTA-A: Wax moths and their control
- ISTA-B: Selection of visual aids
- ISTA-C: Correspondence and honey study courses

## 2. BEEKEEPING JOURNALS

The following partial list of periodicals dealing exclusively with apiculture is abstracted from IBRA's Reference List L20: World list of beekeeping journals, annual reports and other serials currently received by IBRA (1983), which gives names and addresses of 236 journals published in 42 countries:

### A. JOURNALS PUBLISHED IN THE TROPICS AND SUB-TROPICS

#### Argentina:

- Ciencia y Abejas. Calle 13 esq. 32, 1900 La Plata. (Spanish) Irregular.
- Gaceta del Colmenar. Sociedad Argentina de Apicultores, Rivadavia 717 - Piso 8º, 1392 Buenos Aires. (Spanish) 12/year.
- Panorama Apicola (Supplement to Delta). Perú 655, 1068 CF. (Spanish) 12/year.

Brazil:

Api-Divulgações. Rua Prof. João Doetzer 56, Jardim Santa Barbara, CP 2536, 80.000 Curitiba, Paraná. (Portuguese) 6/year.

Boletim Técnico e Informativo, Confederação Brasileira de Apicultura, CP 428, 88.000 Florianópolis, Santa Catarina. (Portuguese) 12/year.

(in 1983 CBA announced the future publication of an official journal: Revista da Apicultura Brasileira.)

Boletim Capel. Cooperative dos Apicultores de Pernambuco Ltda, Av. Caxanga 2, 200 Recife-PE. (Portuguese) 3/year.

Correio do Apicultor. Rua Dosé Zappata 404, 1940 Ibitinga, SP (Portuguese) 6/year.

Zum-Zum. Associações de Apicultores de Santa Catarina, CP 428, 88.000 Florianópolis, Santa Catarina. (Portuguese) Irregular.

China, People's Republic of:

Zhongguo Yangfeng. Institute of Apiculture of the Chinese Academy of Agricultural Science, Xiang Shan, Beijing. (Chinese) 6/year.

Ghana:

Ghana Bee News. Technology Consultancy Centre, University of Science and Technology, Kumasi. (English) 2 or 3/year.

India:

Indian Bee Journal. All-India Beekeepers' Association, 817 Sadashiv Peth, Pune 411 030. (English) 4/year.

Indian Honey. Indian Institute of Honey, Martandam, Kuzhithurai 629163, Kanyakumari Dist., Tamil Nadu. (English, Tamil, Malayalam) 4/year.

Madhu Prapancha. D.K. Beekeepers' Cooperative Society Ltd., No. L. 386, Puttur 574 201 D.K. (Kannada) 4/year.

Patrika. Uttar Pradesh, Mannapal Sangh, PO Jeolikote, Dist. Mainital, UP. (Hindi) Irregular.

Suriname:

Imker Koerier. Imkersvereniging Surinam, K.v. Deursen, Boma Serie 7, no. 6 (Dutch) Irregular, about 6/year.

Zimbabwe:

Bee Line. Zimbabwe Beekeepers' Council, PO Box 743, Harare (English) 3/year.

B. IBRA JOURNALS

Apicultural Abstracts reports the world's literature on new advances in beekeeping technology and bee research;

Journal of Apicultural Research publishes research papers from all over the world;

Bee World discusses subjects of topical significance and importance, in authoritative articles and shorter features, and gives beekeeping news of international interest.

C. OTHER JOURNALS

The following journals publish articles of international interest in all or most issues:

American Bee Journal. Dadant & Sons Inc., Hamilton, IL 62341, USA. (English) 12/year.

Apiacta. Apimondia, Str. Pitar Mos 20, 70152 Bucuresti 1, Romania, or Apimondia, 101 Corso Vittorio Emanuele, Rome, Italy. (English, French, German, Russian and Spanish editions) 4/year.

Apidologie. Service des publications de l'Institut national de la recherche agronomique (INRA), 149, rue de Grenelle, 75341 Paris Cedex 01. (French, English, German) 4/year.

Australasian Beekeeper. Pender Beekeeping Supplies Pty Ltd., P.M.B., 19 Gardiner St., Rutherford, NSW 2320, Australia. (English.) 12/year.

Gleanings in Bee Culture. A.I. Root Co., P.O. Box 706, Medina, OH 44258, USA. (English) 12/year.

New Zealand Beekeeper. National Beekeepers' Association of New Zealand, P.O. Box 4048, Wellington, NZ (English) 4/year.

3. BEEKEEPING LIBRARIES

A. IBRA LIBRARIES

Within certain limits, the IBRA libraries can furnish photocopies free to applicants from developing countries, and against a charge to applicants from other countries; personal use of these libraries is restricted to IBRA members.

Main IBRA Library: International Bee Research Association, Hill House, Gerrards Cross, Bucks. SL9 0NR, UK

Branch IBRA Library for Africa: Inter-African Bureau for Animal Resources, P.O. Box 30786, Maendeleo Ya Wanake House, Monrovia Street, Nairobi, Kenya

Branch IBRA Library for Tropical Asia: Central Bee Research and Training Institute, Khadi and Village Industries Commission, 839/1 Deccan Gymkhana, Pune 411004, India

Branch IBRA Library for Eastern Asia: Institute of Honeybee Science, Tamagawa University, Machida-shi, Tokyo 194, Japan

B. OTHER LIBRARIES

The following institutions in developing countries hold collections of apicultural books presented by the Commonwealth Foundation or by the Overseas Development Administration and the British Council, UK. It may be possible for outsiders to consult these books on prior application.

Bangladesh:

Appropriate Agricultural Technology Cell, Bangladesh Agricultural Research Council, Farmgate, Dhaka 15.  
Library, Bangladesh Agricultural University, Mymensingh.

Belize:

National Beekeeping Centre, Ministry of Agriculture and Lands, National Agricultural Showgrounds, Belmopan.

Botswana:

Ministry of Agriculture, Private Mail Box 003, Gaborone.

Colombia:

Departamento de Biología, Universidad Nacional, Apartada Aereo 3840, Medellin.

Egypt:

Faculty of Agriculture, Ain-Shams University, Shobra-Kheima, Cairo.

Ghana:

Technology Consultancy Centre, University of Science & Technology, Kumasi.

Guyana:

Library, University of Guyana, Tuckeyen Campus, P.O. Box 10 1110, Georgetown.

Honduras:

Proyecto Apicola, Recursos Naturales, El Progreso, Yoro.

India:

Department of Zoology and Entomology, Haryana Agricultural University, Hissar 125004, Haryana.  
Department of Biosciences, Himachal Pradesh University, Simla 171005, Himachal Pradesh.  
Department of Zoology, University of Kashmir, Srinagar 190006, Jammu & Kashmir.  
Shivaji University, Kolhapur 416004, Maharashtra.

College of Agriculture, Punjab Agricultural University, Ludhiana, Punjab.

Tamil Nadu Agricultural University, Coimbatore 641003, Tamil Nadu.  
Department of Entomology, University of Agriculture, Pantnagar, Dist. Nainital, Uttar Pradesh.

Department of Zoology, University of Lucknow, Lucknow 226007, Uttar Pradesh.

Indonesia:

Pusat Studi Pengembangan Biologi Terapan, Yayasan pembina masjid salman, Institut Teknologi Bandung, Jalan Ganesa 7, Bandung.

Kenya:

Embu Institute of Agriculture, P.O.Box 6, Embu, via Nairobi, Eastern Kenya.

Provincial Animal Production Officer, Ministry of Livestock Development, P.O. Box 530, Nakuru.

District Agricultural Office, Box 974, Kisumu, Nyanza Province.

Malaysia:

Agricultural Research Centre, Semorgok, P.O. Box 977, Kuching, Sarawak.

Library, University of Pertanian Malaysia, Serdang, Selangor.

Mauritius:

Ministry of Agriculture, Agricultural Services, Réduit.

Nepal:

Lumle Agricultural Centre, P.O. Box 1, Pokhara, Gandaki Anchal.

Pakistan:

Agricultural Research Institute, Tarnab.

Ayub Agricultural Research Institute, Faisalbad.

Pakistan Agricultural Research Council, 13 Al-Markaz, F-7, P.O. Box 1031, Islamabad.

Papua New Guinea:

Library, University of Papua New Guinea, P.O. Box 4820.

Philippines:

Philippines Bee Research, Alaminos, Laguna 3724.

Sudan:

Shambat Library, University of Khartoum, P.O. Box 32, Khartoum North.



Tanzania:

Beekeeping Division, Ministry of Natural Resources and Tourism, P.O. Box 65360, Dar-es-Salaam.  
Beekeeping Research Centre, Njiro Wildlife Research Centre, P.O. Box 661, Arusha.  
Beekeeping Training Institute, Ministry of Natural Resources & Tourism, P.O. Box 62, Tabora.

Thailand:

Bee Research Laboratory, Department of Biology, Kasetsart University, Bangkhen, Bangkok 9.

Zambia:

Beekeeping Division, Forest Department, P/Bag Mwekera, Kitwe.

Zimbabwe:

Department of Conservation & Extension, P.O. Box 8117, Causeway.

4. MISCELLANEOUS INFORMATION

Requests for information from developing countries may be sent to the Information Officer for Tropical Apiculture of IBRA. Specific enquiries can be dealt with, but not comprehensive requests such as for "all information about honey". Contact addresses in different countries can often be indicated, but not sponsors for beekeeping training employment.

Other useful addresses are:

International Federation of National Beekeepers' Associations  
(Apimondia)  
Str. Pitar Mos 20, 70152 Bucharest 1, Romania, or  
101 Corso Vittorio Emanuele, Rome, Italy

International Agency for Apiculture Development (IAAD)  
3201 Huffman Bld.,  
Rockford, IL 61103, USA

## BIBLIOGRAPHY

- ADAM, Br. (1980) A la recherche des meilleures races d'abeilles. Paris: Courrier du livre. 174 p. + 17 pl. (Transl. of first German ed.) In French.
- ADAM, Br. (1983) In search of the best strains of bees. Hebden Bridge, UK: Northern Bee Books. 206 p. (Transl. of second German ed.)
- ADJARE, S. (1985) The golden insect: a handbook on beekeeping for beginners. Kumasi, Ghana: University of Science and Technology. (2d Ed). 104 p.
- AHMAD, R. (1981) A guide to honeybee management in Pakistan. Islamabad: Pakistan Agricultural Research Council. 38 p.
- APIMONDIA (1969) Handling the wax from honey combs. Bucarest: Apimondia Publishing House. 8 p.  
French translation: Traitement et conditionnement de la cire des rayons. Bucarest: Apimondia Publishing House. 8 p.  
Spanish translation: La labra y el condicionamiento de la cera de los panales. Bucarest: Apimondia Publishing House. 8 p.
- ARAGON LEIVA, P. (rev. ESPINA, D., & ORDETX, G.S.) (1958) Apicultura moderna. (Modern beekeeping.) Mexico, D.F.: Trucco. 537 p. 3rd ed. In Spanish.
- ASIS, M. (1979) El propóleo, un valioso producto apícola. (Propolis, a valuable bee product) La Habana: Ministerio de la Agricultura. 124 p. In Spanish.
- ASOCIACION APICOLA ARGENTINA, Ed. (1973) Manual de apicultura. (Beekeeping manual.) Buenos Aires: Asociacion Apicola Argentina. 193 p. In Spanish.
- ASSOCIATION FRANÇAISE DES VOLONTAIRES DU PROGRES (1983) Apiculture. (Beekeeping.) Paris: Revue de l'Association française des volontaires du progres No. 36. 48 p. In French.
- ATKINS, E.L. (1975) Injury to honey bees by poisoning. In: DADANT & SONS, Ed. (1975) The hive and the honey bee. Hamilton, IL: Dadant & Sons. Chap. 22, pp. 663-696. For Spanish translation, see main entry.
- ATTFIELD, H.H.D. (1981?) A beekeeping guide. Arlington, VA, USA: Volunteers in Technical Assistance. ii + 45 p.
- BAILEY, L. (1981) Honeybee pathology. London: Academic Press. x + 132 p.
- BAILEY, L. (1982) Viruses of honeybees. IBRA Reprint (M11) from Bee World. 9 p.
- BAILEY, L.H. (1971) Manual of cultivated plants. New York: Macmillan. 1116 p.
- BARBIER, E. (1973) L'état et avenir de l'apiculture au Maroc. (Beekeeping in Morocco, present and future.) El Koudia, Morocco. 14 p. In French.
- BEE WORLD (1968) Clearing bees from honey supers. Bee Wld 49(2): 55-63.
- BEE WORLD (1975/76) Pollen and its harvesting. Bee Wld 56: 155-158; 57 : 20-25. IBRA Reprint M86.
- BOBRZECKI, J. (1982) Enfermedades de las abejas en El Salvador. (Bee diseases in El Salvador.) San Salvador: Direccion General de Ganaderia. In Spanish.
- BODENHEIMER, F.S. (1942) Studies on the honeybee and beekeeping in Turkey. Istanbul: Numune Matbaasi. 179 p. In Turkish and English.
- BRADBEAR, N. (1983) Laws and regulations (world-wide) relating to the importation of bees, the control and notification of bee diseases, and the registration and siting of hives. Biblyphy Int. Bee Res. Ass. No. 35. 27 p.
- BUDATHOKI, K., & FREE, J.B. (1986) Comb support and attachment within transitional beehives. (Unpublished.)
- BURGES, H.D. (1978) Control of wax moths; physical, chemical and biological methods. IBRA Reprint (M96) from Bee World. 10 p.

- BUTLER C.G. (1974) The world of the honeybee. London: Collins. xii + 226 p. + 42 pl. 3rd ed.
- CAILLAS, A. (1974) Le rucher de rapport, les produits de la ruche. Paris: Synd. nat. apiculture. 515 p.
- CALE, G.H., BANKER, R., & POWERS, J. (1975) Management for honey production. In: DADANT & SONS, Ed. (1975) The hive and the honey bee. Hamilton, IL: Dadant and Sons. Chap. 12, pp. 355-412. For Spanish translation, see main entry.
- CAPADAN, E.P. (1984) Private communication.
- CHURCH, L.J., & WHITE, R. (1981) Beekeeping and honey production in Cyprus. In: Proceedings of 2nd International Conference on Apiculture in Tropical Climates, New Delhi. In press.
- CHANDLER, M.T. (1975) Meliponiculture in Tanzania. In: Termination Report submitted to CIDA, App. II. Olmotony, Tanzania: Forest Training Institute.
- CLAUSS, B. (1982) Beekeeping handbook. Gaborone, Botswana: Ministry of Agriculture. 2nd ed. iv + 76 p.
- CLAUSS, B. (1983) Bees and beekeeping in Botswana. Botswana: Ministry of Agriculture. v + 122 p.
- COGGSHALL, W.L., & MORSE, R.A. (1984) Beeswax: Production, harvesting, processing and products.
- CORNER, J. (1976) Beehive construction. Canada Department of Agriculture. 21 p.
- CRANE, E. (1971) Frameless movable-comb hives in beekeeping development programmes. IBRA Reprint (M60) from Bee World. 4 p.
- CRANE, E., Ed. (1976a) Apiculture in tropical climates. London: IBRA. x + 208 p.
- CRANE, E., Ed. (1976b) Honey: A comprehensive survey. London: Heinemann in cooperation with IBRA. xvi + 608 p. (Reprint of 1975 ed. with corrections.)
- CRANE, E. (1977a) The shape, construction and identification of traditional hives. IBRA Reprint (M90) from Bee World. 9 p.
- CRANE, E., Ed. Dictionary of beekeeping terms with allied scientific terms. Bucarest: Apimondia, in collaboration with IBRA. Vol. 5 (1977b): English-French-German-Spanish-Russian. 206 p. Vol. 8 (1979): English-French-Italian-Spanish-Portuguese-Romanian. 252 p.
- CRANE, E. (1978a) Bibliography of tropical apiculture. In 24 parts, as below. London: IBRA. 380 pp.
- Parts
1. Beekeeping in North Africa and the Middle East
  2. Beekeeping in Africa south of the Sahara
  3. Beekeeping in the Indian sub-continent (with Afghanistan and Iran)
  4. Beekeeping in Asia east of India
  5. Beekeeping in northern Latin America (with Brazil)
  6. Beekeeping in southern Latin America
  7. Beekeeping in the Pacific area
  8. Apis mellifera of European and Asiatic origin in the tropics
  9. Apis mellifera native to Africa
  10. Apis mellifera hybrids, known as Africanized bees, in America
  11. The Asiatic hive bee Apis cerana
  12. The giant honeybee Apis dorsata
  13. The little honeybee Apis florea
  14. Beekeeping in the tropics with stingless bees
  15. Bee forage in the tropics
  16. Beekeeping management and equipment in the tropics
  17. Indigenous materials, methods and knowledge relating to the exploitation of bees in the tropics
  18. Bee diseases, enemies and poisoning in the tropics

19. Honey in the tropics
20. Beeswax and other hive products in the tropics
21. Descriptions of pollen grains in tropical honeys
22. Bees for pollination in the tropics
23. Cancelled
24. Miscellaneous, indexes, acknowledgements, etc.

CRANE, E. (1978b) Bibliography of tropical apiculture - Satellite bibliographies. 14 bibliographies, as below. London: IBRA. 238 pp.

- S/25 (to Part 1) Beekeeping and bee research in Egypt
- S/26 (to Part 2) Beekeeping and bee research in eastern Africa
- S/27 (to Part 2) Beekeeping and bee research in south Africa
- S/28 (to Part 3) Beekeeping and bee research in India
- S/29 (to Part 5) Beekeeping and bee research in Mexico
- S/30 (to Part 5) Beekeeping and bee research in Brazil
- S/31 (to Part 6) Beekeeping and bee research in Argentina
- S/32 (to Part 11) Apis cerana: laboratory studies
- S/33 (to Part 14) Biology of stingless bees (Meliponinae)
- S/34 (to Part 15) Bee forage in specific regions of the tropics
- S/35 (to Part 18) Bee diseases & pests in specific regions of the tropics
- S/36 (to Part 19) Honeys of specific regions of the tropics
- S/37 (to Part 21) Descriptions of pollen grains of further tropical plants
- S/38 (to Part 22) Bee pollination in specific regions of the tropics

CRANE, E. (1979) Bees and beekeeping in the tropics, and trade in honey and beeswax, with special reference to the Commonwealth. In CS/IBRA (1979) Beekeeping in rural development. London: Commonwealth Secretariat. p. 1-19.

CRANE, E. (1980a) A book of honey. Oxford: Oxford University Press x + 198 p. Portuguese translation: O livro do mel. Sao Paulo: Livraria Nobel S.A. 226 p. Spanish translation: El libro de la miel. Mexico, DF: Fondo de Cultura Economica. 289 p.

CRANE, E. (1980b) Apiculture. In: CAB (1980) Perspectives in world agriculture. Farnham Royal, UK: Commonwealth Agricultural Bureaux. Chap. 10, pp. 261-294.

CRANE, E. (1980c) The scope of tropical apiculture. Bee Wld 61(1): 19-28. IBRA Reprint M102.

CRANE, E. (1982) The archaeology of beekeeping. London: Duckworth. 364 p.

CRANE, E. (1983) Surveying the world's honey plants. Lect. Cent. Ass. Beekprs: 12 p.

CRANE, E. (1984a) Bees, honey and pollen as environmental indicators. Bee Wld 65(1): 5-6.

CRANE, E. (1984b) Honeybees. In Anon. (1984) Evolution of domestic animals. London: Longman. Chap. 65, pp. 403-415.

CRANE, E., & WALKER, P. (1983) The impact of pest management on bees and pollination. London: Tropical Development and Research Inst. ix + 232 p.

CRANE, E., & WALKER, P. (1984) Pollination directory for world crops. London: IBRA. 184 p.

CRANE, E., WALKER, P., & DAY, R. (1984) Directory of important world honey sources. London: IBRA. 384 p.

CS/IBRA (1979). Beekeeping in rural development. London: Commonwealth Secretariat. vi + 196 p.

- DADANT, C.C. (1975). Beekeeping equipment. In: DADANT & SONS, Ed. (1975) The hive and the honey bee. Hamilton, IL: Dadant & Sons. Chap. 10, pp. 303-328. For Spanish translation, see main entry.
- DADANT & SONS, Eds. (1975) The hive and the honey bee. Hamilton, IL: Dadant & Sons. xviii + 740 pp. Revised ed. Spanish translation: (1979) La colmena y la abeja melífera. Montevideo: Editorial Hemisferio Sur. 936 p.
- DADE, H.A. (1977) Anatomy and dissection of the honeybee. London: IBRA. xviii + 158 p. + 20 pull-out pl. (Reprint of 1962 ed. with additional notes and corrections.)
- DANY, B. (1978) Pollensammeln heute. (Modern pollen harvesting). 2nd ed. Munich: Ehrenwirth Verlag. 56 p. In German.
- DARBY, W.J., GHALIOUNGUIP, P., & GRIVETTI, L. (1977). Food: the gift of Osiris. London: Academic Press. Vol. 1.
- DE JONG, D., MORSE, R.A., & EICKWORT, G.C. (1982) Mite pests of honey bees. Ann. Rev. Entomol. 27: 229-252.
- DEODIKAR, G.B., PHADKE, R.P., & SHENDE, S.G. (1966) A design for honey processing unit. Indian Bee J. 28(1): 1-10.
- DONADIEU, Y. (1981) La bonne conversation des produits de la ruche. (Satisfactory storage of hive products.) Revue fr. Apic.: 278-279, 334, 383. In French.
- DRAZ, O. (1954) Some desert plants and their uses in animal feeding (*Kochia indica* and *Prosopis juliflora*). Publ. Inst. Désert. Egypte No. 2: 95 p.
- DRESCHER, W., & CRANE, E. (1982) Technical cooperation activities: beekeeping. A directory and guide. Eschborn, FRG: GTZ. 172 p.
- DURON AVILES, E. (1982) La abeja Africanizada en el area de OIRSA. (The Africanized bee in the OIRSA region). San Salvador: Organismo Internacional Regional de Sanidad Agropecuaria. Boletín Técnico 14. ii + 37 p. In Spanish.
- DUTTON, R.W., MJENI, A.M., & WHITCOMBE, R.P., Eds. (1982) Honeybees in Oman. Muscat, Oman. Office of the Adviser for Conservation of the Environment. 39 p. In Arabic and English.
- DUTTON, R.W., & SIMPSON, J. (1977) Producing honey with Apis florea in Oman. Bee Wld 58(2): 71-76.
- EACHEVERRY A.R., & PATRUNO, Q.A. (1975) Proyecto para el desarrollo de la industria apícola en la zona cafetera. (Project for the development of beekeeping in the coffee-growing area.) Bogota: Federacion Nacional de Cafeteros de Colombia. xiv + 194 p. In Spanish.
- ECKERT, J.E., & BESS, H.A. (1952) Fundamentals of Beekeeping in Hawaii. Ext. Bull. Univ. Hawaii No. 55 : 59 pp.
- EISIKOWITCH, D., & MASAD, Y. (1980) Nectar-yielding plants during the dearth season in Israel. Bee Wld 61(1) : 11-13, 18.
- ESPINA PEREZ, D., & ORDETIX, G.S. (1981) Apiculture tropical. (Tropical apiculture.) 2ns ed. Cartago, Costa Rica: Editorial Tecnológica de Costa Rica. 482 p. In Spanish.
- EUROPEAN ECONOMIC COMMUNITY (1974) Council directive of 22 July 1974 on the harmonization of the laws of the Member States relating to honey (74/409/EEC). Official Journal of the European Communities (12.8.74). No. to L221: 10-14.
- FAO (1979) Eucalypts for planting. Rome: FAO. 677 p. Also in French and Spanish.
- FAO (1980) De la conception à la construction d'une cadres adaptée à l'abeille de Guinée, Apis mellifica adansonii. (Principles and construction of a frame hive suitable for the Guinean bee, Apis mellifera adansonii.) Rome: FAO. Document AG:DP/GUI/74/023, Rapport technique 1. 19 p. In French.
- FAO (1981a) Des caractéristiques écoéthologiques de l'abeille du Fouta-Djalon à la conduite des ruchers. (The ecological and ethological character-

- istics of the Fouta-Djalou bee and their influence on hive management.) Rome: FAO. Document AG:DP/GUI/74/023, Rapport technique 2. 44 p. In French.
- FAO (1981b) Pour une valorisation des produits apicoles guinéens. (Improvement of Guinean bee products.) Rome: FAO. Document AG:DP/GUI/74/023, Rapport technique 3. 28 p. In French.
- FAO (1984) Proceedings of the Expert Consultation on Beekeeping with Apis mellifera in Tropical and Sub-Tropical Asia held in Bangkok/Chiang Mai, Thailand, 9-14 April 1984. Rome: FAO. v. + 238 + 4 annexes.
- FAO/WHO (1983) Proposed draft Codex standard for Honey (World-wide standard). Rome: Joint FAO/WHO Food Standards Programme (CX/PFV 84/13) : 9 .
- FARRUGIA, V. (1978) Beekeeping in the Maltese islands. In: CS/IBRA (1979) Beekeeping in rural development. London: Commonwealth Secretariat. Pp. 43-46.
- FAS (1982) World honey situation in 1982. Washington: USDA Foreign Agric. Service. Foreign Agric. Circ. FS 3-82. 16 p.
- FLETCHER, D.J.C., Ed. (1977) African bees: taxonomy, biology and economic use. Apimondia. ix + 207 p. + 11 pl.
- FREE, J.B. (1970 repr. 1876) Insect pollination of crops. London: Academic Press. 544 p.
- FREE, J.B. (1976a) Insect pollination of tropical crops. Lect. Cent. Ass. Beekeepers. 10 p.
- FREE, J.B. (1976b) Beekeeping and pollination in developing countries. Span 19.2.76:73.
- FREE, J.B. (1977) The social organization of honeybees. London: Edward Arnold. 68 p.  
French translation: L'organisation sociale des abeilles. Paris: Librairie Vuibert. 96 p.  
Portuguese translation: A organização social das abelhas (Apis). São Paulo: Editora Pedagógica e Universitária. xiii + 79 p.
- FREE, J.B. (1981a) Bees and mankind. London: Allen & Unwin.
- FREE, J.B. (1981b) Biology and behaviour of the honeybee Apis florea, and possibilities for beekeeping. Bee Wld 62(2): 46-59. IBRA Reprint M105.
- FREE, J.B. & WILLIAMS, I.M. (1977) The pollination of crops by bees. Bucarest: Apimondia and IBRA. 14 p.
- FRY, C.H. (1983) Honeybee predation by bee-eaters, with economic considerations. Bee Wld 64(2) : 65-78. IBRA Reprint M112.
- GARY, N.E. et al (1985) The Africanized honey bee: ahead of schedule. Calif. Agric. 39(1-2):4.
- GHATGE, A.I. (1956) A scientific approach to (wild) rock bees. Ujjain (Madhya Bharat): All-India Khadi & Village Industries Board. 17 p.
- GHISALBERTI, E.L. (1979) Propolis: a review. Bee Wld 60(2) : 59-84. IBRA Reprint M99.
- GLEDHILL, D. (1972) West African Trees. London : Longman. vii + 72 p.
- GOCHNAUER, T.A., FURGALA, B., & SHIMANUKI, H. (1975) Diseases and enemies of the honey bee. In: DADANT & SONS, Ed. (1975) The hive and the honey bee. Hamilton, IL: Dadant & Sons. Chap. 21, pp. 615-662. For Spanish translation, see main entry.
- GOYAL, N.P. (1974) Apis cerana indica and Apis mellifera as complementary to each other for the development of apiculture. Bee Wld 55(3) : 98- 101.
- GRIFFITHS, D.A., & BOWMAN, C.E. (1981) World distribution of the mite Varroa jacobsoni, a parasite of honeybees. Bee Wld 62(4). 154-163. IBRA Reprint M107.
- GUY, R.D. (1976) Commercial beekeeping with Apis mellifera adansonii in intermediate and movable-frame hives. In: CRANE, E., Ed. (1976a) Apiculture

- in tropical climates. London: IBRA. Pp. 31-37.
- HABIT, M.A., et al. (1981) Prosopis tamarugo: fodder tree for arid zones. Rome: FAO. FAO Plant Production and Protection Paper 25. 110 p. Also in French and Spanish.
- HADIWIYOTO, S. (1980) Pedoman pemeliharaan tawon madu. (Guide to beekeeping.) Jakarta: Pradnya Paramita. xiii + 125 p. In Indonesian.
- HALL, N. et al. (1972) The use of trees and shrubs in the dry country of Australia. Canberra: Austral. Govt. Publ. Serv. 558 p.
- HANDAL, S. (1980) FAO Project TCP/ELS/8903. Field Documents. San Salvador: Dirección General de Ganadería. In Spanish.  
(1980a) Alimentación artificial de las abejas. (Artificial feeding of bees.)  
(1980b) Cosecha de miel de abejas. (Bee honey harvesting.)  
(1980c) Laminado y estampado de la cera. (Wax pressing and stamping.)  
(1980d) Métodos para fundir los opérculos y los panales. (Methods of rendering cell caps and comb.)  
(1980e) Traslado de colmenas. (Hive transport.)  
(1980f) Unión o fusión de dos colmenas. (Combining two swarms.)  
(1980g) Uso de la cera estampada y colocación del alza. (Use of wax foundation and installation of sheets.)
- HANSEN, H. (1980?) Honey bee brood diseases. Copenhagen: L. Launs, Biavlernes Etiketkontor. 28 p.  
French translation: L'abeille domestique: maladies du couvain. Copenhagen: L. Launs, Biavlernes Etiketkontor. 32 p.  
Spanish translation: Enfermedades de la cría de la abejas. Copenhagen: L. Launs, Biavlernes Etiketkontor. 32 p.
- HARNAJ, V., & WEISE, H., Eds. (1979) Apicultura em clima quente: Simpósio internacional, Florianópolis, SC, Brasil, 19-28/10/1978. (Apiculture in hot climates: International symposium, Florianópolis, Brazil, 19-28 October 1978.) Bucarest: Apimondia Publishing House. 255 p. + 41 pl.
- HOCKING, B., & MATSUMURA, F. (1960) Bee brood as food. Bee Wld 41(5) : 113-120.
- INDIAN STANDARDS INSTITUTION (1970) Specification for bee hives. Indian Standard No. IS:1515-1969 : 19 p.
- INDIAN STANDARDS INSTITUTION (1973) Code for conservation and maintenance of honey bees. Indian Standard No. IS:6695-1972 : 28 p.
- INDIAN STANDARDS INSTITUTION (1977) Specification for solar wax extractor. Indian Standard No. IS:8524-1977 : 6 p.
- INOUE, T., & INOUE, A. (1964) The world royal jelly industry: present status and future prospects. Bee World 45(2) : 59-64
- INSTITUTO NACIONAL DE MEDICINA VETERINARIA (1981) Instructivos técnicos apícolas-veterinarios. (Technical instructions for apicultural veterinarians.) La Habana : Centro de Información y Divulgación Agropecuario. 58 p. In Spanish.
- INTERNATIONAL BEE RESEARCH ASSOCIATION (1977) Honey standards, laws and regulations (world-wide). Biblphy Int. Bee Res. Ass. No. 19 : 17 p.
- INTERNATIONAL BEE RESEARCH ASSOCIATION (1979) World-wide standards for hive products except honey, and for equipment used in beekeeping and in processing hive products. Biblphy Int. Bee Res. Ass. No. 24 : 13 p.
- INTERNATIONAL BEE RESEARCH ASSOCIATION (1982a) Directory of institutions in developing countries known to be concerned with apiculture. List L17. 18 p.
- INTERNATIONAL BEE RESEARCH ASSOCIATION (1982b) Directory of suppliers of beekeeping equipment world-wide. London : IBRA. List L18. 15 p.
- INTERNATIONAL BEE RESEARCH ASSOCIATION (1983a) Laws and regulations (world-wide) to protect bees from pesticide poisoning. Biblphy Int. Bee Res. Ass. No. 29 : 11 p.

- INTERNATIONAL BEE RESEARCH ASSOCIATION (1983b) World list of beekeeping journals, annual reports, and other serials currently received by the International Bee Research Association. London : IBRA. List L20. 30 p.
- INTERNATIONAL CONFERENCE ON APICULTURE IN TROPICAL CLIMATES, 2nd (New Delhi, 1980). Proceedings. New Delhi : In press.
- INTERNATIONAL CONFERENCE ON APICULTURE IN TROPICAL CLIMATES, 3rd (Nairobi, 1985). Proceedings. London: IBRA.
- INTERNATIONAL TRADE CENTRE, UNCTAD/GATT (1977) Major markets for honey: openings for quality supplies from developing countries. Geneva : ITC UNCTAD/GATT. xiv + 120 p. Also in French and Spanish.
- INTERNATIONAL TRADE CENTRE, UNCTAD/GATT (1978) The world market for beeswax: a high-value product requiring little investment. Geneva: ITC UNCTAD/GATT. viii + 105 p. Also in French and Spanish.
- JEAN-PROST, P. (1979) L'apiculture. (Beekeeping). Paris: J.-P. Baillièrè. 497 p. In French.
- JOHANSEN, C.A. (1979) Honeybee poisoning by chemicals: signs, contributing factors, current problems and prevention. Bee World 60(3): 109-127. IBRA Reprint M100.
- JOHANSSON, T.S.K. (1955) Royal jelly. Bee Wld 36: 3-13, 21-32.
- JOHANSSON, T.S.K., & JOHANSSON, M.P. (1958) Royal Jelly II. Bee World 39: 254-264, 277-286.
- JOHANSSON, T.S.K., & JOHANSSON, M.P. (1978) Some important operations in bee management. London : IBRA. 145 p.
- JULIANO, J.C. (1975) Montagem de um perfil tecnologico para o Estado do Rio Grande do Sul. (Technological profile for [250 hives in] the State of Rio Grande do Sul). Anais 3 Congr. Bras. Apic., 1974 : 233-244 + 3 pl. In Portuguese; English summary.
- KELLY, S., CHIPPENDALE, G.M., & JOHNSTON, R.D. (1977) Eucalypts. Vol. 1 Melbourne : Thomas Nelson. xiv + 82 p.
- KEMPF MERCADO, N. (1980). Flora apícola subtropical de Bolivia. (Sub-tropical bee plants of Bolivia). Santa Cruz, Bolivia: Departamento de Publicaciones de la UBGRM. ii + 96 p. In Spanish.
- KEVAN, P. (1983) The potential for beekeeping in Bangladesh. AST/CIDA Report.
- KIANGSI PROVINCE BEEKEEPING RESEARCH INSTITUTE (1975) (Manual of beekeeping.) Beijing: Agricultural Publishing House. 480 p. + 16 pl. In Chinese.
- KIDD, L.J. (1979) Introduction and spread of honeybees in mainland Papua New Guinea. In: CS/IBRA (1979) Beekeeping in rural development. London: Commonwealth Secretariat. Pp. 127-136.
- KIGATIIRA, K.I. (1976a) Beekeeping development programmes in Kenya. In: CRANE, E., Ed. (1976a) Apiculture in tropical climates. London: IBRA. Pp. 143-146.
- KIGATIIRA, K.I. (1976b) Keeping bees in fixed-comb and movable-comb frameless hives. In: CRANE, E., Ed. (1976a) Apiculture in tropical climates. London: IBRA. Pp. 9-13.
- KIGATIIRA, K.I., BEAMENT, J.W.L., FREE, J.B., and PICKETT, J.A. (1986). Using synthetic pheromone lures to attract honey bee colonies in Kenya. (Unpublished.)
- KOENIGER, N., & KOENIGER, G. (1980) Observation and experiments on migration and dance communication of Apis dorsata in Sri Lanka. J. Apic. Res. 19 (1) : 21-34.
- KWEI, T., & ESMONDS, T. (1978) Landscape plants in the United Arab Emirates. New York: Teresa Kwei. 133 p.
- LAIDLAW, H.H. (1979) Contemporary queen rearing. Hamilton, IL: Dadant & Sons. x + 199 p. + 1 plate.
- LAIDLAW, H.H., JR. (1981) Queen introduction. Bee Wld 62(3) : 98-105.



- LECHMAN DE ENZENHOFER, L. (1982) Un método para producción de jalea real. (A method for the production of royal jelly.) Gac. Colmen 44(6) : 272-274, 276, 278-279. In Spanish.
- LOUVEAU, J., MAURIZIO, A. & VORWOHL, G. (1978) Methods of melissopalynology. IBRA Reprint (M95) from Bee World. 19 p.
- MACKISACK, J.B. (1968) Beekeeping on Niue Island. N.Z. Beekpr 30(3) : 18-21
- MAHINDRE, D. (1968) Apis dorsata - the giant bee of India. Glean. Bee Cult. 96(2) : 102-108.
- MAMMO, G. (1976) Practical aspects of bee management in Ethiopia. In: CRANE, E., Ed. (1976a) Apiculture in tropical climates. London: IBRA. Pp. 69-78
- MANN, I. (1973) Nyuki ni mali. (Bees are wealth.) 2nd ed. Nairobi: East African Literature Bureau. 115 p. In Swahili and English.
- MARTIN, E.C. (1975) The use of bees for crop pollination. In: DADANT & SONS. Ed. (1975) The hive and the honey bee. Hamilton, IL: Dadant & Sons. Chap. 20, pp. 579-614. For Spanish translation, see main entry.
- MARTINEZ LOPEZ, J.F. (1979) Apicultura. (Beekeeping.) 7th ed. Mérida, Mexico: Productos Martinez. 218 p. In Spanish.
- MARTINEZ LOPEZ, J.F. (1981) Cría de reinas y jalea real; inseminación artificial. (Queen rearing and royal jelly; artificial insemination.) Merida, Mexico: Productos Martinez. vii + 85 p. In Spanish.
- MCGREGOR, S.E. (1976). Insect pollination of cultivated crop plants. Agric. Handbook 496, Washington: USDA. viii + 411 p.
- MELLOR, J.E.M. (1928) Beekeeping in Egypt: Part 1. An account of the baladí craft, that is to say the craft native to the country; with observations made upon it from September 1926 to January 1928. Bull. soc. r. ent. d'Egypte: 17-33.
- MICHENER, C.D. (1963) The establishment and spread of European honeybees in Australian New Guinea. Bee Wld 44(2) : 81.
- MICHENER, C.D. (1974) The social behaviour of the bees: a comparative study. Cambridge, Mass.: Belknap Press. 404 p.
- MEXICO. SECRETARIA DE AGRICULTURA Y RECURSOS HIDRAULICOS (1985). Las abejas africanas y su control. Mexico, DF: 84p.
- MORSE, R.A. (1970a) Annotated bibliography on Apis dorsata. IBRA Bibliography no. 9. 25 p.
- MORSE, R.A. (1970b) Annotated bibliography on Apis florea. IBRA Bibliography no. 10. 16 p.
- MORSE, R.A. (Ed.) (1978) Honeybee pests, predators and diseases. Ithaca, NY : Cornell University Press, 430 p.
- MORSE, R.A., & BENTON, A.W. (1964) Notes on venom collection from honeybees. Bee Wld 45 : 141-143, 68.
- MORSE, R.A., & DE JONG, D. (1979) Annotated bibliography on Varroa jacobsoni, Tropilaelaps clareae and Eugarroa sinhai. IBRA Bibliography no. 15. 36 p.
- MORSE, R.A., & LAIGO, F.M. (1968) Beekeeping in the Philippines. Fm Bull. Univ. Philippines Coll. Agric. No. 27 : 56 p.
- MORSE, R.A., & LAIGO, F.M. (1969) Apis dorsata in the Philippines (including an annotated bibliography). Monogr. Philipps. Ass. Ent., Inc. No. 1 : 96 p.
- NDIAYE, M. (1976) Beekeeping in Senegal. In: CRANE, E., Ed. (1976a) Apiculture in tropical climates. London: IBRA. Pp. 171-179.
- NEW SOUTH WALES FORESTRY COMMISSION (1979?) Tree planting for beekeeping. New South Wales, Australia : Forestry Commission. 3 p.
- NIGHTINGALE, J.M. (1976) Traditional beekeeping among Kenya tribes, and methods proposed for improvement and modernisation. In CRANE, E., Ed. (1976a) Apiculture in tropical climates. London: IBRA. Pp. 15-22.

- NIGHTINGALE, J.M. (1983) A lifetime's recollections of Kenya tribal beekeeping. London: IBRA. 38 p.
- NIXON, M. (1982) Preliminary world maps of honeybee diseases. Bee Wld 63(1) : 23-42. IBRA Reprint M108.
- NIXON, M. (1983) World maps of Varroa jacobsoni and Tropilaelaps clareae, with additional records for honeybee diseases and parasited previously mapped. Bee Wld 64(3) : 124-131.
- NOGUEIRA-NETO, P. (1970) A criação de abelhas indigenas sem ferrão (Meliponinae). (Beekeeping with indigenous stingless bees (Meliponinae)). 2nd ed. Sao Paulo: Chacaras e Quintais. 365 p. In Portuguese.
- NTENGA, G. (1976) Beekeeping development programmes in Tanzania. In CRANE, E., Ed. (1976a) Apiculture in tropical climates. London: IBRA. Pp. 147-154.
- NYEIN, M.M., & ZMARLICKI, C. (1982) Control of mites in European bees in Burma. Am. Bee J. 122: 638-639.
- ORDET, G.S. (1952) Flora apícola de la América tropical. (Bee plants of tropical America.) La Habana: Editorial Lex. 334 p. In Spanish.
- OWENS, C.D., & MCGREGOR, S.E. (1964) Shade and water for the honeybee colony. USDA Leaflet. 530 : 8 p.
- PATRA, K., & SANTOSA, S. (1980) Membangun dan mengembangkan peternakan lebah madu di Indonesia. (Building and developing beekeeping in Indonesia.) Bandung: Karya Inti Nusantara. xii + 92 p. In Indonesian.
- PELLETT, F.C. (1976) American honey plants. Hamilton, IL: Dadant & Sons. 467 p.
- PENFOLD, A.R., & WILLIS, J.L. (1961) The eucalypts. London : Leonard Hill, 550 p.
- PHADKE, R.P. (1961/1975) Some physico-chemical constants of Indian beeswaxes. Bee Wld 42(6) : 149-153 (1961); Indian Bee J. 37(1/4) : 15-18 (1975)
- PHADKE, R.P., NAIR, K.S., & NANDEKAR, R.U. (1969/1971) Indian beeswaxes. Indian Bee J. 31 : 52-55; 33 : 3-5.
- POPA, A. (1975-81) Rapports techniques. (Technical reports.) Rome: FAO. Project FAO/TUN/75/005. 12 issued. 10-30 p. In French.
- POPA, A. (1978a) Rapport de mission FAO au Liban. (Report of an FAO mission to Lebanon.) Rome: FAO. 5 p. In French.
- POPA, A. (1978b) Rapport de mission FAO en Algérie. (Report of an FAO mission to Algeria.) Rome: FAO. 12 p. In French.
- POPA, A. (1978c) Rapport de mission FAO en Libye. (Report of an FAO mission to Libya.) Rome: FAO. 14 p. In French.
- POPA, A. (1979) Rapport de mission FAO en Syrie. (Report of an FAO mission to Syria.) Rome: FAO. 7 p. In French.
- POPA, A. (1980) Beekeeping in Tunisia - its impact on other developing countries of the Mediterranean basin. Wld. Anim. Rev. (FAO) 34: 29-34. (French and Spanish versions published simultaneously in Revue mond. Zootech. (FAO) and Revista mond. Zootec. (FAO) respectively.)
- RAWAT, B.S. (1979) Successful beekeeping 2nd ed. Almora, UP: Rawat Apiaries. 366 p. In Hindi.
- REID, M. (1975) Storage of queen honeybees. Bee Wld 56(1) : 21-31. IBRA Reprint M83.
- RICCIARDELLI D'ALBORE, G., & PERSANO ODDO, L. (1978) Flora apistica italiana. (Italian bee forage.) Florence: Istituto Sperimentale per la Zoologia Agraria. 286 p. In Italian.
- RICHES, H.R.C. (1982) Hypersensitivity to bee venom. IBRA Reprint (M109) from Bee World. 16 p.
- RITTER, W. (1981) Varroa disease of the honeybee Apis mellifera. Bee Wld 62(4): 141-153. IBRA Reprint M106.
- ROBINSON, W.S. (1981) Beekeeping in Jordan. Bee Wld 62(3): 91-97.
- RUTTNER, F. (1976) Apiculture in the past and present in Crete - model of a successful development project. Apiacta 11(4) : 187-191.

- SAMMATARO, D., & AVITABILE, A. (1978) The beekeeper's handbook. Charlevoix, MI, USA: Peach Mountain Press. vii + 132 p.
- SAUBOLLE, B.R., & BACHMANN, A. (1972) Beekeeping: an introduction to modern beekeeping in Nepal. Kathmandu, Nepal : Sahayogi Prakashan. 52 p.
- SCHWARZ-HANSEN, B. (1966) (Bees and beekeepers of Rhodes.) Tidsskr. Biavl 100: 174-177, 192-193. In Danish.
- SHAH, F.A. (1977) Beekeeping. Srinagar: Shah Beekeepers. 312 p. In Urdu.
- SHIMANUKI, H. (1980a) Diseases and pests of honeybees. Agric. Handb. U.S. Dep. Agric. No. 335 rev.: 118-128.
- SHIMANUKI, H. (1980b) Identification and control of honeybee diseases. Frms' Bull. U.S. Dep. Agric. No. 2255 rev.: 18 p.
- SHIMANUKI, H. (1981) Controlling the greater wax moth: a pest of honey combs. Frms' Bull. U.S. Dep. Agric. No. 2217 rev.: 12 p.
- SILDERRAD, R.E.M. (1976) Beekeeping in Zambia. Bucarest: Apimondia. 76 p.
- SIMCINTHOMAS, R.T., & SIMONTHOMAS, A.M.J. (1980) Philanthus triangulum and its recent eruption as a predator of honeybees in an Egyptian oasis. Bee Wld 61(3): 97-107.
- SIMPSON, B.B. Ed. (1977) Mesquite: its biology in two desert scrub ecosystems. Stroudsburg, PA: Dowden, Hutchison and Ross. xxii + 250 p.
- SINGH, S. (1962, repr. 1975) Beekeeping in India. New Delhi: Indian Council of Agricultural Research. 214 p.
- SKILLMAN, G.J. (1979) Queen bee imports - a trial run. Anim. Quarant. 6(2) 12-16.
- SMITH, F.G. (1951) Modern methods of rendering beeswax. Pamph. Dep. Agric. Tanganyika No. 49: 21 p.
- SMITH, F.G. (1960) Beekeeping in the tropics. London: Longmans. 265 p.
- SMITH, F.G. (1964) The hive environment in hot climates. J. apic. Res. 3(2) : 117-122
- SMITH, F.G. (1966) The hive. Bull. Dep. Agric. West. Aust. 3464 : 56 p.
- SMITH, M.V. (1959) The production of royal jelly. Bee Wld 40(10) : 250-254.
- SMITH, M.V. (1963) The O.A.C. pollen trap. Canad. Bee J. 74(4): 4-5, 8. French translation: La trappe à pollen O.A.C. Ontario Agricultural Collge unnumbered report: 3 p.
- SOERODJOTANOJO, S. KARDJONO (1980) Membina usaha industri ternak lebah madu Apis mellifica. (Establishing a beekeeping industry with Apis mellifera.) Jakarta: Balai Pustaka. 57 p. In Indonesian.
- SPENCE, J.D. (1980) La apicultura: guía práctica. Cómo trabajar con las abejas. (Beekeeping: a practical guide. How to work with bees.) Nebaj, Guatemala: Proyecto Desarrollo Apícola. x + 222 p. In Spanish.
- STANLEY, R.G., & LINSKENS, H.F. (1974) Pollen: Biology - biochemistry - management. Berlin: Springer-Verlag. ix + 307 p.
- SUMOPRASTOWO, R.M.; SUPRAPTO, R.A. (1980) Beternak lebah madu modern. (Modern beekeeping.) Jakarta: Bhratara Karya Aksara. xii + 217 p. In Indonesian.
- SWANSON, R.A. (1976) The case for beekeeping development programmes in West Africa. In: Crane, E., Ed. (1976) Apiculture in tropical climates. London: IBRA. Pp. 191-197.
- TAYLOR, O.R., Jr. (1977) The past and possible future spread of Africanized honeybees in the Americas. Bee. Wld 58(1) : 19-30. IBRA Reprint M89.
- THAKAR, C.V. (1976a) Practical aspects of bee management in India with Apis cerana indica. In: CRANE, E., Ed. (1976) Apiculture in tropical climates. London: IBRA. Pp. 51-59.
- THAKAR, C.V. (1976b) The beekeeping development and research programme of the Khadi and Village Industries Commission, India. In: CRANE, E., Ed. (1976) Apiculture in tropical climates. London: IBRA. Pp. 125-134.

- TOWNSEND, G.F. (1975) Removing the crop and extracting the honey. In: DADANT & SONS, Ed. (1975) The hive and the honey bee. Hamilton, IL: Dadant & Sons. Chap. 13, pp. 413-428. For Spanish translation, see main entry.
- TOWNSEND, G.F. (1976a) Honey processing and collecting centres in East Africa. In: CRANE, E., Ed. (1976a) Apiculture in tropical climates. London: IBRA. Pp. 85-92.
- TOWNSEND, G.F. (1976b) Transitional hives for use with the tropical African bee Apis mellifera adansonii. In: CRANE, E., Ed. (1976a) Apiculture in Tropical Climates. London: IBRA.
- TOWNSEND, G.F. (1976a) Processing and storing liquid honey. In: CRANE, E., Ed. (1976a) Honey: a comprehensive survey. London: Heinemann in cooperation with IBRA. Chap. 9, pp. 269-292.
- TOWNSEND, G.F. (1978) Preparation of honey for market. Publ. Ont. Ministr. Agric. 544. 28 p.
- TOWNSEND, G.F. (1981a) Introductory apiculture. Guelph, Canada: University of Guelph in cooperation with the Ontario Ministry of Agriculture and Food. iii + 105 p. + 23 filmstrips (300 frames) + 2 cassettes.
- TOWNSEND, G.F. (1981b) Honey producing trees in the tropics. ICRAF Newsletter 5:1 July 1981.
- TOWNSEND, G.F. (1985) Private communication.
- TULLOCH, A.P. (1980) Beeswax - composition and analysis. Bee Wld 61(2) : 47-62. IBRA Reprint M103.
- VOLUNTEERS IN TECHNICAL ASSISTANCE (1981) Centrifugal honey extractor. Tech. Bull. VITA No. 51035-BK : 9 p. Revised ed. Also in French and Spanish.
- WALKER, P. (1976) Annotated bibliography on propolis, 1976. Bibliophy IBRA No. 16 : 14 p.
- WALKER, P. (1983) Bibliophy IBRA Nos. 30-34
- |        |  |       |
|--------|--|-------|
| No. 30 | <u>Beeswax: secretion and use by bees.</u>             | 15 p. |
| No. 31 | <u>Beeswax: processing.</u>                            | 11 p. |
| No. 32 | <u>Beeswax: composition, properties, adulteration.</u> | 19 p. |
| No. 33 | <u>Beeswax: uses and commercial aspects.</u>           | 17 p. |
| No. 34 | <u>Beeswax: publications of historical interest.</u>   | 9 p.  |
- WALSH, R.S. (1968) The development of beekeeping in the South Pacific. Pacif. Isl. mon. 39(10): 147, 149, 151, 153.
- WALTON, G.M. (1976) Beekeeping development programmes in the tropical and subtropical Pacific. In CRANE, E., Ed. (1976a) Apiculture in tropical climates. London: IBRA. Pp. 159-164.
- WHITCOMBE, R.P. (1980) (Honeybees in the Sultanate of Oman.) Oman : Directorate of Agriculture. 20 p. In Arabic; IBRA English translation E1570.
- WHITE, J.W. (1975) Honey. In: DADANT & SONS., Eds. (1975) The hive and the honey bee. Hamilton, IL: Dadant & Sons. Chap. 17, pp. 491-530. For Spanish translation, see main entry.
- WHITE, J.W., Jr., RIETHOF, M.L., SUBERS, M.H., & KUSHNIR, I. (1962) Composition of American honeys. Washington: USDA. Tech. Bull. 1261. 124 p.
- WIESE, H. (1977) Apiculture with Africanized bees in Brazil. In: FLETCHER, D.J.C., Ed. (1977) African bees: taxonomy, biology and economic use. Pretoria: Apimondia. Pp. 67-76 + 4 pl.
- WEISE, H. (1981) Apicultura migratória - projeto pesquisa convênio FIPEC-SAA-SC. (Migratory beekeeping - research project FIPEC-SAA-SC.) Florianópolis, Brasil. 35 p. In Portuguese.
- WIESE, H. (1983) Nova apicultura. (Modern apiculture.) 4th ed. Porto Alegre, Brazil: Livraria e Editora Agropecuaria Ltda. 485 p. In Portuguese.
- WINSTON, M.L., TAYLOR, O.R., & OTIS, G.W. (1983) Some differences between temperate European and tropical African and South American honeybees. Bee Wld 64(1): 12-21.

- WOYKE, J. (1980-81) FAO Project TCP/ELS/8903. Field Documents. San Salvador: Dirección General de Ganadería. In Spanish.
- (1980a) Alimentación de las abejas en las zonas tropicales. (Bee feeding in tropical regions.) 5 p.
  - (1980b) Biología de las abejas en las zonas tropicales. (Bee biology in the tropical regions.) 11 p.
  - (1980c) Colocación de la cera estampada en los cuadros. (Installation of wax foundation in frames.) 8 p.
  - (1980d) Cría de las abejas reinas. (Queen rearing.) 20 p.
  - (1980e) División de las colonias de las abejas. (Division of bee colonies.) 7 p.
  - (1980f) Estudio comparativo sobre el manejo de las abejas melíferas durante todo el año en zonas moderadas y tropicales. (Comparative study of honeybee management throughout the year in temperate and tropical regions.) 7 p.
  - (1980g) Inseminación artificial de las abejas reinas en beneficio del desarrollo de la apicultura. (Artificial insemination of queen bees for apicultural development.) 10 p.
  - (1980h) Instrucciones para realizar observaciones y conducir registros sobre la floración de las plantas apícolas. (Instructions for making observations and maintaining registers on the flowering of bee plants.) 3 p.
  - (1980i) Principios de la construcción de la colmena moderna tipo standard. (Principles of construction of the standard-type modern hive.) 16 p.
  - (1980j) Que se hace en El Salvador para evitar el peligro de las abejas asesinas. (Action in El Salvador to avoid the danger of Africanized bees.) 6 p.
  - (1980k) Trasiego de las colonias de abejas desde las cajas rústicas a las colmenas modernas. (Transferring bee colonies from primitive boxes to modern hives.) 6 p.
  - (1981a) Flora apícola salvadoreña. (Bee plants of El Salvador.) 13 p.
  - (1981b) Tablas para determinar las cantidades de cría en las colonias de abejas. (Tables for determining quantities of brood in bee colonies.)
- WOYKE, J. (1980-81) FAO Project TCP/ELS/8803. Report of research results. San Salvador: Dirección General de Ganadería. In Spanish.
- (1980L) Investigación sobre factores internos de las colonias de abejas de los cuales depende la producción de la miel en El Salvador. (Research on internal factors in bee colonies affecting honey production in El Salvador.) 29 p.
  - (1981c) Apicultura en El Salvador. (Beekeeping in El Salvador.) 16 p.
  - (1981d) Investigación sobre influencia de la frecuencia de alimentación de sosten sobre desarrollo de colonias de abejas en El Salvador. (Research on the influence of the frequency of sustenance feeding on the development of bee colonies in El Salvador.)
  - (1981e) Investigación sobre métodos de alimentación de estímulo a las colonias de abejas en El Salvador. (Research on methods of stimulation feeding of bee colonies in El Salvador.)
  - (1981f) Investigación sobre necesidad de alimentación de sosten a las abejas en El Salvador. (Research on sustenance feeding requirements of bees in El Salvador.)

- (1981h) Sobrevivencia de la cría de la abejas en El Salvador. (Bee brood survival in El Salvador.) 7 p.
- (1981i) Investigaciones apícolas en El Salvador. (Beekeeping in El Salvador.) FAO Project TCP/ELS/8903: San Salvador: Ministerio de Agricultura y Ganadería. 149 p. In Spanish.
- WULFRATH, A., & SPECK, J.J. (1955, 1958) Enciclopedia apícola (Beekeeping encyclopedia.) Mexico, D.F.: Editora agrícola Mexicana. Vol. 1, 479 p. Vol. 2, 540 p. In Spanish.
- ZAMBIA FOREST DEPARTMENT (1979?) An introduction to frame-hive beekeeping in Zambia. Ndola, Zambia: Forest Department. 60 p.

\*\*\*\*\*