

AT MICROFICHE
REFERENCE
LIBRARY

A project of Volunteers in Asia

Illustrations for Development

edited by George McBean

Published by:

Afrolit Society
P.O. Box 72511
Nairobi
KENYA

Available from:

same as above

Reproduced by permission.

Reproduction of this microfiche document in any form is subject to the same restrictions as those of the original document.

ILLUSTRATIONS FOR DEVELOPMENT

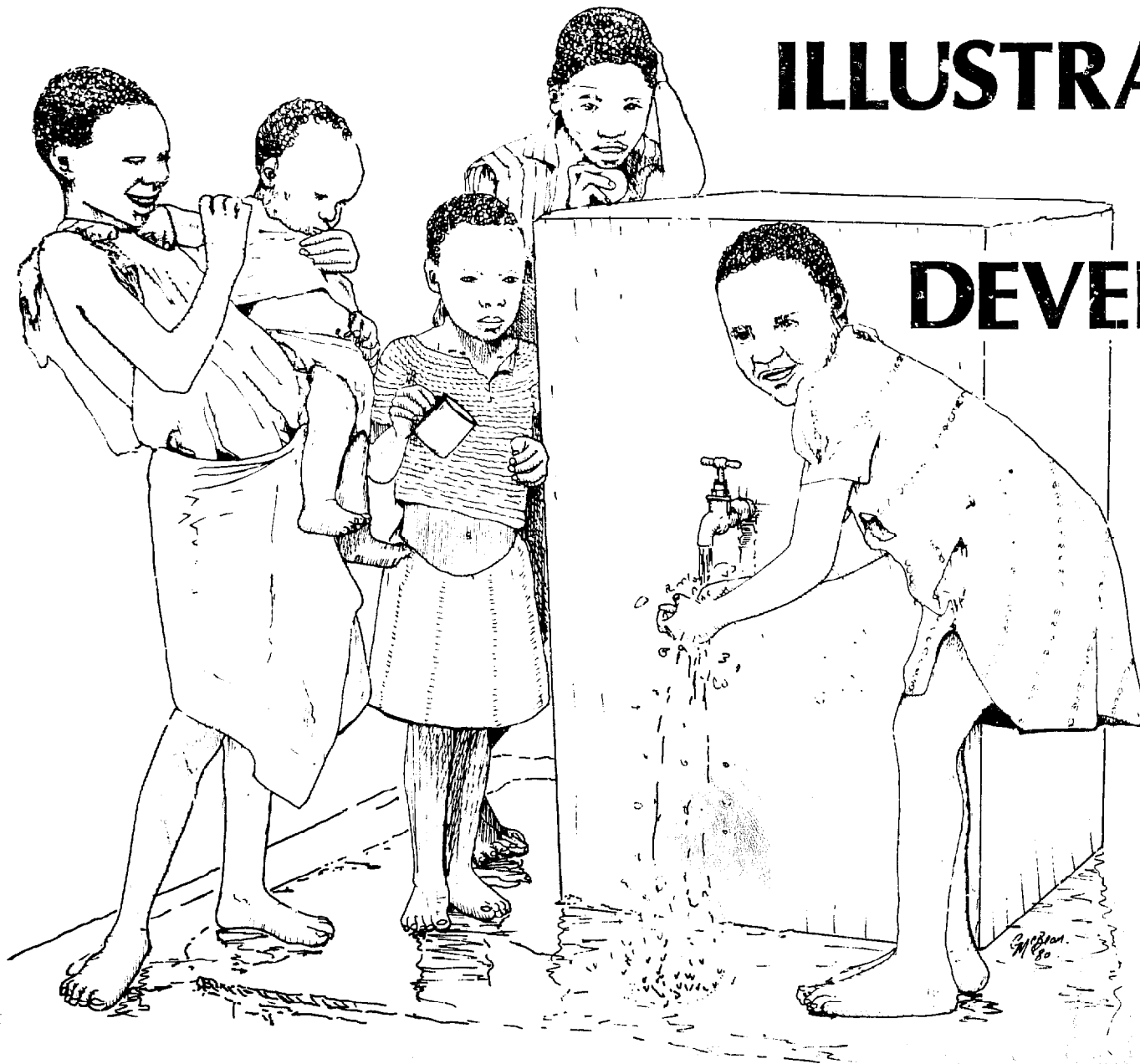

EDITORS: GEORGE McBEAN
NORBERT KAGGWA
JOHN BUGEMBE.

ILLUSTRATIONS FOR DEVELOPMENT

A Manual for Cross-Cultural Communication through Illustration
and Workshops for Artists in Africa.

Text prepared by members of the Illustrations for Development Workshop, April 1980, arranged by Afrolit Society with the help of UNICEF Eastern Africa Regional Office. Mr. Norbert C. Kaggwa Chairman National Literacy Committee of Uganda, Coordinator.

PHOTOGRAPHS SUPPLIED BY UNICEF.

Design and Final Editing by George McBean



Copyright © 1980 Afrolit Society
P.O. Box 72511
NAIROBI, KENYA.

All rights reserved under latest restriction of the 1979 copyright law of the United States of America and International Copyright Convention.

Full credit is gratefully acknowledged to the members of the Illustrations for Development Workshop of Afrolit Society for Artwork and Text as indicated below.

JOHN BUGEMBE – UGANDAN PUBLISHING HOUSE LTD.
WILLIAM GATAMA – K.I.E. MINISTRY OF HIGHER EDUCATION, KENYA
MORGAN JOHNSON – AFRICA LITERATURE CENTRE, ZAMBIA
NORBERT KAGGWA – DEPT. OF DESIGN, KYAMBOGO, UGANDA
MURIITHI KINYUA – GRAPHIC DESIGNER, D.A.E., NAIROBI
BRUNO MACHALA – ARTIST & ILLUSTRATOR OF MIN. EDUCATION, TANZANIA
SEVERINO MATTI – MINISTRY OF CULTURE, JUBA, SUDAN
GEORGE McBEAN – ART AND DESIGN OFFICER, UNICEF, EASTERN AFRICA
MUTHAMA MUTHIANI – GRAPHIC ARTIST, MINISTRY OF AGRICULTURE, KENYA
CHARLES MUTHIKE – PROJECT CO-ORDINATOR FOR AFROLIT
BILLY NKUNIKA – UNIVERSITY OF ZAMBIA
ALICE REGGY – UNITED BIBLE SOCIETIES
DAVID WARR – EXTENSION AIDS MINISTRY OF AGRICULTURE, MALAWI
CHARLES T. HEIN – AFROLIT SOCIETY KENYA

Produced with the Assistance of
The United Nations Children's Fund
Eastern Africa Regional Office
P.O. Box 44145
Nairobi, Kenya

ILLUSTRATIONS FOR DEVELOPMENT

CONTENTS

Preface and introduction4

CHAPTER 1. WHAT THE ARTIST NEEDS TO KNOW

 Part 1. The communications team 7

 Part 2. Visual literacy research findings 11

CHAPTER 2. PREPARATION FOR WORK.....

 Part 1. The topic..... 19

 Part 2. The audience..... 24

CHAPTER 3. WHAT THE ARTIST NEEDS TO BE ABLE TO DO...

 Part 1. Learning to draw better..... 29

 Part 2. Learning to draw round objects..... 31

 Part 3. Learning to draw square objects 38

 Part 4. Learning to draw figures 43

CHAPTER 4. COMPLETING THE WORK

 Part 1. How to pretest drawings 51

 Part 2. Has the planning process been followed 55

 Part 3. Final layout and reproduction techniques..... 56

 Part 4. Meeting the deadline..... 62

CHAPTER 5. ILLUSTRATIONS FOR DEVELOPMENT AS A CAREER..... 65

APPENDIX 1. WORKSHOP FOR ARTISTS FORMAT 69

The image features two large, detailed black and white illustrations of tsetse flies. They are positioned on either side of the central text, facing each other. The flies are shown from a dorsal perspective, highlighting their long, segmented bodies, large compound eyes, and prominent proboscis. The wings are intricately detailed with fine lines representing veins and texture. The overall style is that of a technical or scientific illustration.

THE TSETSE FLY STORY

Wherever the subject of visual literacy is brought up, anywhere in Africa one is very likely to hear the following story: In a village somewhere, in a rural area of Africa, communicators were trying to explain the problems related to the tsetse fly. For their talk, the communicators used illustrations of a large tsetse fly, to which the villagers responded by saying, "we cannot have these problems here because there are no flies that big in our village."

This is by far the most over-used story connected with visual literacy research and it is hoped that because of this illustration training manual the story may never be told again.

Introduction

The Artist as a Development Communicator

Illustrations, whether on posters, flip-charts, in pamphlets or books, play a major role in national development projects. Yet it is unfortunate that the artist in Africa is often unaware of the new set of demands which must be made on his talent when he becomes involved in such a development project.

Even if Africa has many artists, very few have directed their energies to illustrate for development. Worse still, those who have been interested and involved have usually lacked the necessary technical skills to produce effective communication materials. We can see their work on the many poorly drawn posters and booklets conveying health, agriculture, literacy, and appropriate technology messages. In the rare cases where an artist has had the required technical ability, his illustrations have often been made with hardly any reference to the people who are supposed to receive the message and benefit from it. Hence this training manual. The manual is an attempt to improve visual development communications by suggesting to artists in Africa ways and means of producing more communicative illustrations.

Perhaps you are already a trained and qualified artist? Then no doubt you already have a wealth of professional experience related to your field. However, you might still find in this manual a lot of interesting subjects for reflection.

If you are still under training you may have already selected one of the many "arts" to specialise in; but did you know about illustrations for development communication before you made the selection?

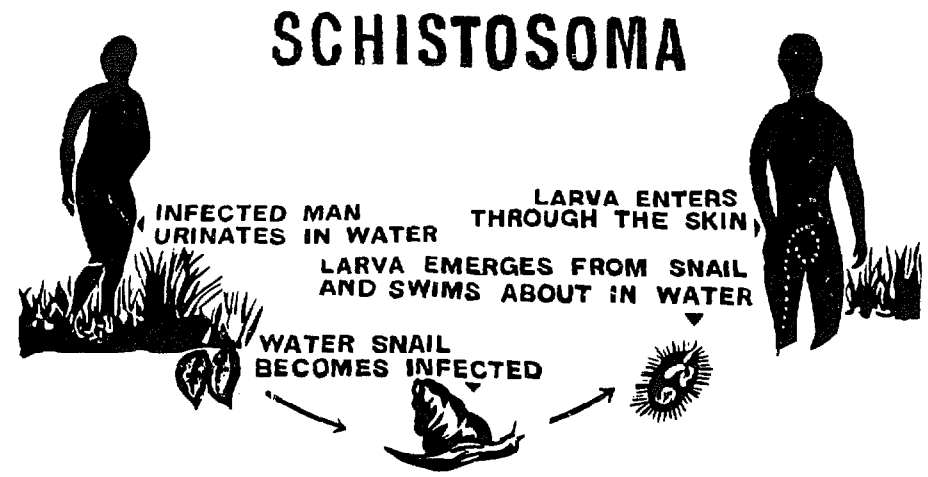

*How effective are these illustrations for adults of limited education?
What maybe difficult to interpret correctly?*

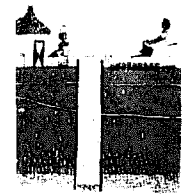
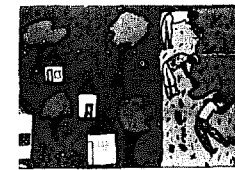



Illustrations are important in helping the viewer to visualize the message.

On the other hand, if you are merely an intending artist, you may now have realised how vast the field of choice can be, each area requiring specialised training. Perhaps you may wish to train as an illustrator for development? It is anticipated that the exercises and approaches suggested in this manual will help you improve your drawing skills and provide a foundation for further practice in this exciting and useful field of illustration.

If you are a communicator in the academic sense, with responsibilities to organise project support communications, then this manual may be of extreme value to you. How often do communicators struggle to find that the work produced is not quite as good as expected, but because of time limitations it is printed anyway? This manual may help you to:

1. Understand better why and how to adopt art work to the visual experience of the intended audience;
2. Recognise the need for good quality professional illustration at all levels of communication materials;
3. To be able to brief an artist more precisely as to the work required and the audience who will see it;
4. To be able to conduct a simple workshop for local artists, stripping away unnecessary art teachings and focusing only on the skills required in illustrating for development;
5. To assess the final professional work of the artist more confidently;
6. Thereafter, to evaluate the success and effectiveness of both the illustrations produced and of the workshop conducted.

Finally, it is the hope of the authors of this manual that no matter what category of reader you are, you might appreciate henceforth the necessity and value of working as a team in the task of message design and communication.

CHAPTER 1

WHAT THE ARTIST NEEDS TO KNOW

Part 1

The Communication Team

Artists are usually unaware of themselves as part of a communication team, but if they are employed to illustrate development messages they are most definitely part of a team. Too often, they involve themselves only in the execution of their work, they are reluctant to change drawings, and generally take the attitude that their skill is a gift from God and should not be criticised. Yet long before a communications project reaches the artist for illustration, there are many other people who have worked creatively on it. These people vary in accordance with the nature of the project, but in most cases:

The team consists of:

1. Message designers, government or agency officials involved in any of the fields from Health to Information;
2. Authors who are asked to define the message in appropriate terms for a given audience;
3. **THE ARTIST**
4. Printers who work to produce the illustrated message many times in the form of a poster, pamphlet or book;
5. Teachers and extension workers in the field who use the illustrated material to convey the message to the people for whom it is intended;
6. The audience is also part of the team since ideally the original request for information on how to solve a particular community problem came from them.

The communication process takes place through teamwork and the artist is an important member of the team.

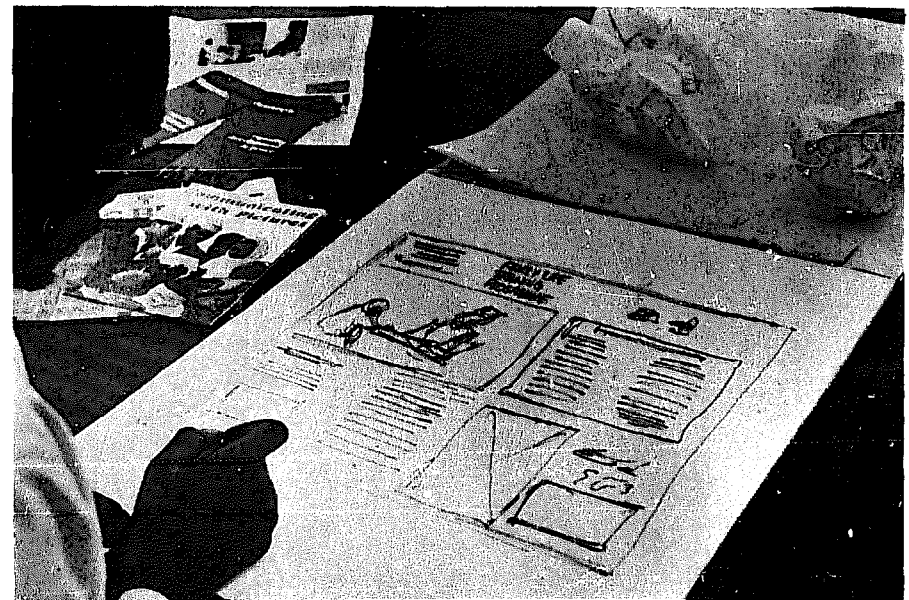

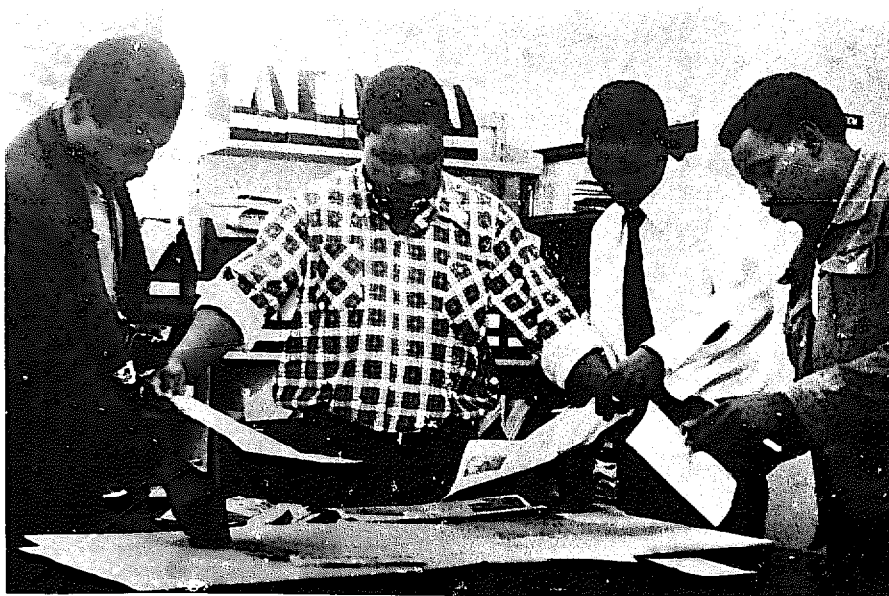

If the artist works closely with his colleagues in producing teaching materials, the field worker or teachers' job will become easier and more interesting. (see over)

This is only a rough guide. In practise it can vary widely. Some projects may also require editors, photographers, dramatists, researchers or other specialists to join the team. Other projects may be mainly conducted by only two persons: the initiators and the artist. Sometimes, projects may be largely carried out by a single person taking on all the roles. Thus the artist may find himself as a small part of a large team, or be virtually his own boss.

The important thing is that the artist's work is understood as part of the total communication exercise. Each member of the team has a professional skill which should be understood by the other members.

The artist working on illustrations for development is not just an artist engaged in producing beautiful pictures; he is a communicator of messages aimed at enhancing peoples' lives. The development artist must produce functional pictures; and his criteria for judgement should be that if they fulfill their function and the audience learns from them, then they are beautiful.

Working on illustrations for development, the artist must possess the basic skills of drawing, painting and visual design. These skills will enable the illustrator to present objects, events and ideas visually in his two-dimensional form.

However, in addition to these fundamental skills there is another range of skills which the artist should always bear in mind. These "skills" are difficult to define, but they refer to the artist's ability to work with other people, to process information in an attractive visual way, and to select appropriate styles and medium for a given job.

When message designers decide to provide information intended to solve a community problem, one of the first questions they must ask is: "What is the best way to convey this message to the people?" For example, does the intended audience have access to television or radio? Is there a popular magazine in circulation? Could these vehicles

be used to get the message across? Or do they miss the intended viewer?

In Africa, the traditional method of "passing on messages" was through the spoken word, music and song. As "communication methods" these were certainly slow, and probably hampered by the 2,500 or more spoken languages which still survive across the continent today.

These days, television still only serves about 1% of the population of most African countries and is therefore rarely suitable as a channel for development messages. Radio holds a wider appeal, but this form is limited in the type of message it will convey effectively. There are few magazines or newspapers found in rural areas; so we find that travellers, teachers, or in many countries the official community extension workers are the main sources of new information to a rural audience. This being so, the materials used by these teachers or extension workers (which are generally printed and should invariably require the hand of an artist in their production) probably provide one of the most effective mediums for development messages.

Development is aimed at helping the individual to improve his or her way of living. Most development messages are therefore concerned with teaching new skills to individuals or small groups. One important branch of development focuses on literacy and language; that is it aims to teach people to read and write. Increasingly literacy work is integrated with other development work which is concerned with helping people to acquire certain knowledge, attitudes and practices which may improve their standard of living. For example, some projects aim at improving crop yields, or improving the health of the people, or encouraging them to develop a spirit of self-help and a feeling of belonging to the community. When these areas of development involve a community which is largely unable to read and write, the work of an artist is virtually indispensable. Since about 70% of the population of sub-Saharan Africa is estimated to be illiterate, or only semi-literate, the potential demand for development artists is very considerable.



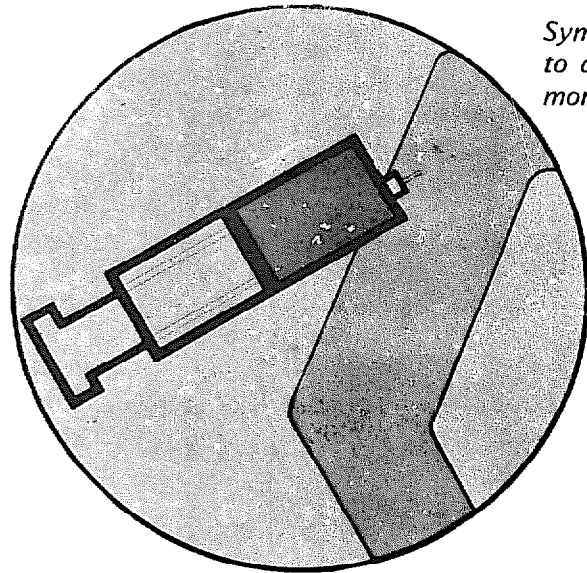

Symbolic illustrations are easier to do but they are some times more difficult to recognise.



Full figure illustrations promote greater interest in the subject and the message is more clearly understood.

From now on we shall concern ourselves solely with the work of the artist and how he can enhance his role in the communications team. His primary task is to draw, so let us begin by asking: "How does the artist know what to draw?"

To be an effective illustrator for development the artist needs to carry out some research in order to discover how his drawings are perceived, and what types of representations are best understood by the specific group of people he is trying to communicate with. In this, it is not necessary for the artist to confine himself to his own research, for a welter of investigation into visual literacy has already been conducted. Rather, he should use the existing research findings as a basis for his own very necessary supplementary research.

Part 2

Visual Literacy Research Findings

Let us look at some of the common research findings. The most common conclusion among visual literacy researchers working in Africa is that most rural communities have had very little exposure to printed materials in any form. Pictures or illustrations are new experiences for them, and the idea that one can learn something of use from a picture is very new. The belief is also prevalent that many illustrations delivered to rural audiences are either ignored or misinterpreted. It appears there has been a gap in communication between researchers and artists involved in producing these illustrations. Work is still sent out which does not take account of the level of visual perception in the community concerned. There is also a growing feeling among artists that many of these illustrations are not executed as professionally as they could be.

The following short list of research conclusions should be taken into consideration by a development artist when illustrating for an audience with little experience of two-dimensional representations.

1. Close up illustrations which cut off any part of the body (e.g. head or hands) are difficult to comprehend.
2. Full-figure drawings are usually understood, and provide a useful starting point for educating and introducing an audience with a low visual literacy level to picture communication.
3. Superfluous detail in the background should be omitted for the new viewer, who may find it confusing and unattractive.

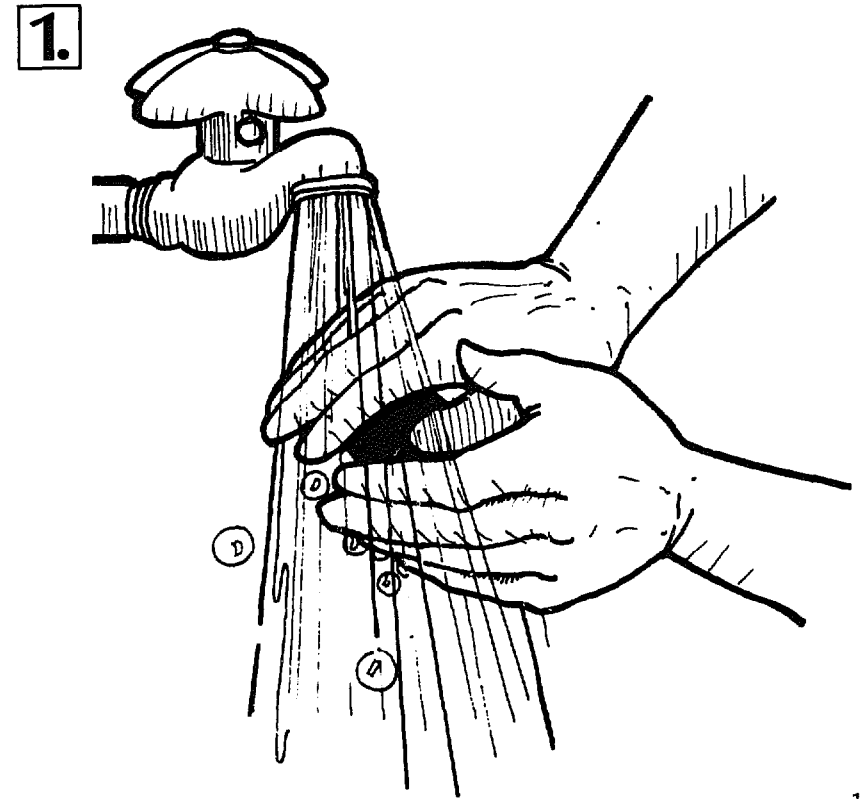

- 4. Photographs with the background taken out are recognised as easily as drawings but often reproduction techniques for printing photos clearly only exist in capital cities. The photograph of a black face in bright sunlight can block-in easily when printed and so become unrecognizable.
- 5. Symbols such as ticks, crosses, arrows, pain symbols, lines for speed, or movement for heat or fever, shaky lines for chills, dotted lines for flight, are not understood by the new viewer and must be introduced slowly and patiently.
- 6. Complicated messages with too many items in the illustration cannot be comprehended.

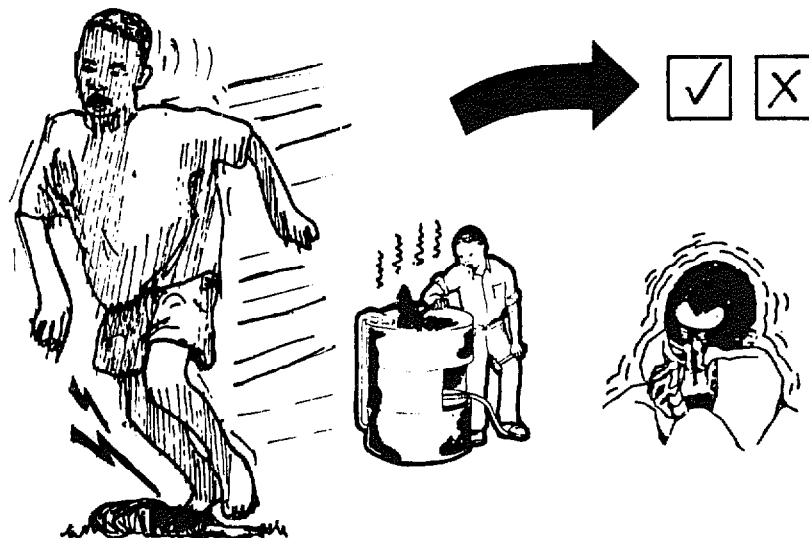
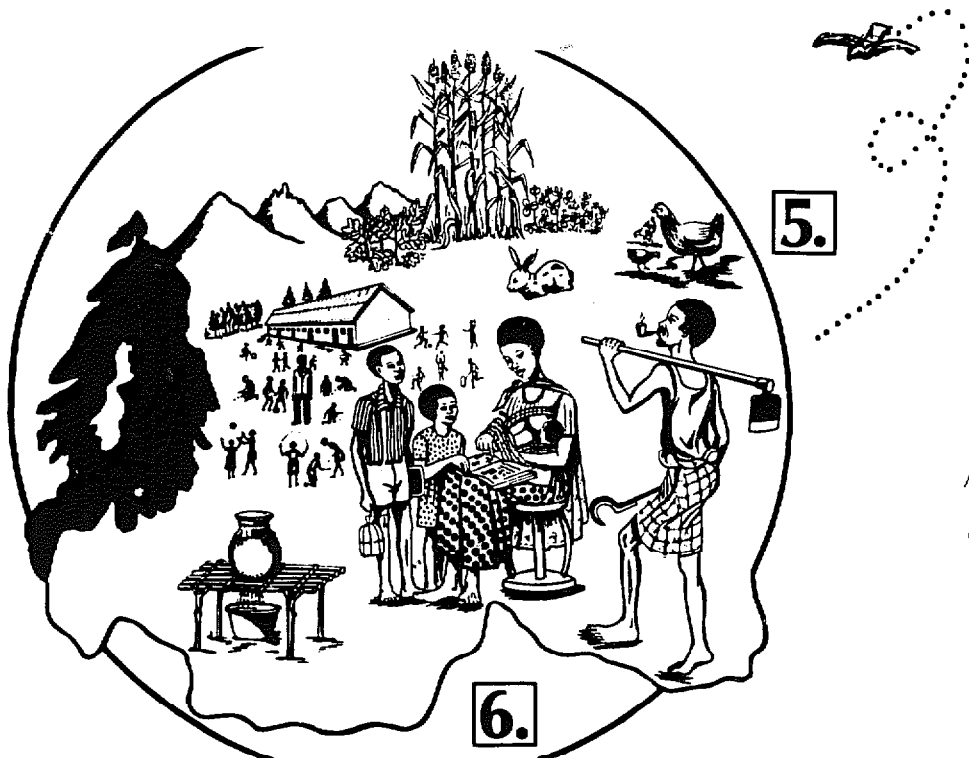



- 7. Single message illustrations are the best introduction to a rural viewer.
- 8. Cartoon strips with full figures can carry more elaborate messages when the viewer has been taught how to read pictures. But the professional skill of the drawings must be high so that people identify the character as the same man in the next box—and not as a separate illustration.
- 9. In a literate audience stories and illustrations together are very effective in conveying messages provided the story refers directly to the illustration and makes the reader examine it.

The results of visual literacy research are often not passed on to the artist, so there is not as yet a new generation of teaching materials which takes into account the research already made.



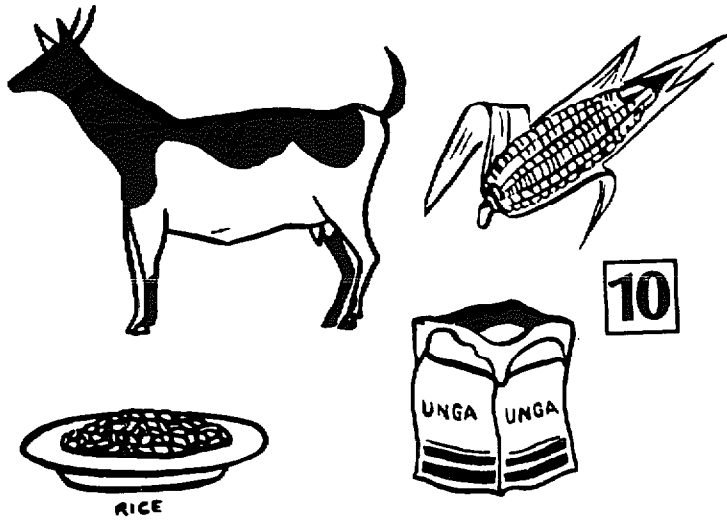

- 10. Food, animals and items around the village are more difficult to recognise than figures and take time to be learned.
- 11. Colour can be added effectively to food to enhance recognition.
- 12. Rural people are more interested in pictures if they can recognise people like themselves in them. Figures should be dressed appropriately, and facial resemblance to members of the community is often an advantage.



- 13. Mannerisms, ways of dress, facial expressions, which are familiar to the audience, all help to communicate the message more effectively.
- 14. Posters do not last long in rural settings.
- 15. Flip-charts or flash cards, used and explained by extension workers, are the most effective way of teaching people to learn through pictures.
- 16. Illustrated booklets left with the audience are only effective in areas where visual perception is high.
- 17. In schools, childrens' books which contain puzzles like "spot the difference" or "spot the mistakes" are important tools in increasing their visual awareness.



Spot the ten differences

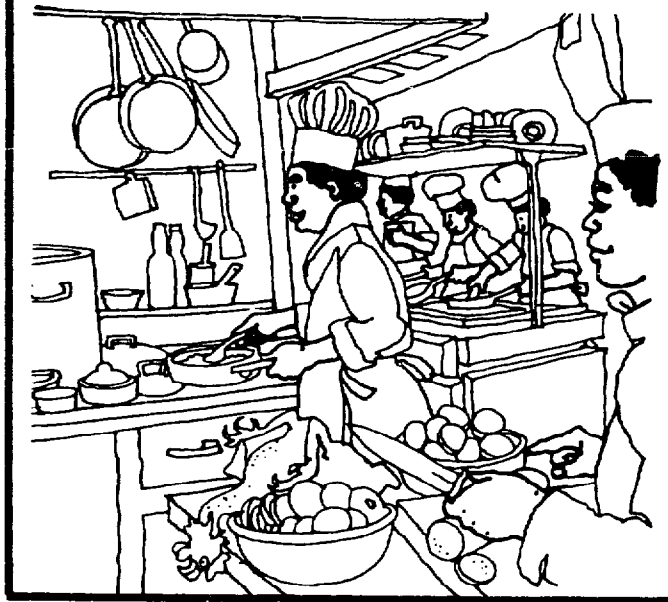

17

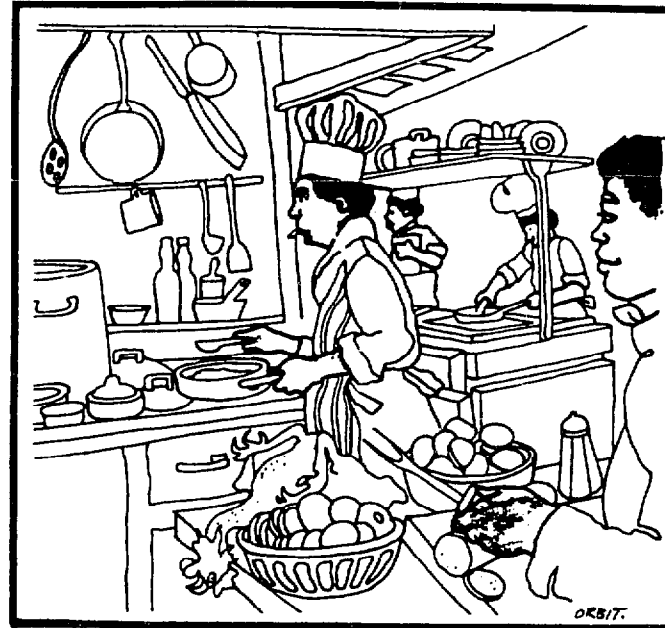

In some societies the people will only relate to visual aids which portray their own culture.

19

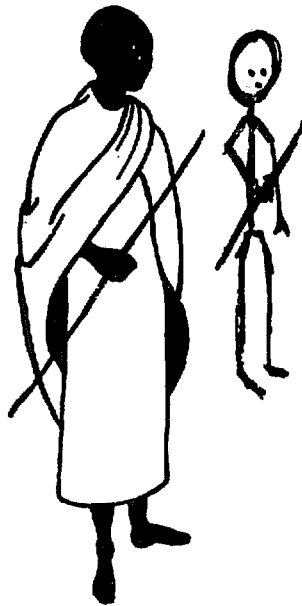

- 18. Small flash cards enclosed in polythene can survive the elements in a rural area.
- 19. Blocked out figures, stick figures and outlined figures are not as recognisable as line drawings toned in.
- 20. If words are used in comic strips or on posters for newly literate people then upper and lower case letters should be used. Capitals used throughout are more difficult to understand. Avoid any fancy lettering styles.
- 21. The scale of items in a drawing should be like daily visual experience. Large illustrations should not be used to depict small items such as insects.
- 22. Studies are favourable to the realistic use of colour unless it is likely to distract the viewer. But there is little evidence that the increased costs of using colour are justified since the corresponding increase in comprehension is usually slight. Black and white will usually suffice.

20



23. Once a rural viewer has confidence that something has been learned from a picture there is much more interest in the medium.

Although general research aims at providing information which can apply to many situations, each individual communications project remains a unique exercise and requires further investigation. The necessary additional research could be carried out by the artist himself (together with other members of the communications team) or by a special research unit. It may be informal research, as when an artist visits a village and talks to some residents in order to get the feel of his audience. Alternatively it may be more systematically organised and involve formal interviews, discussion groups, and randomly distributed questionnaires. Of course, systematic research takes more time, costs more money and needs more qualified staff, but it can increase the effectiveness of communication.

Finally, the artist should realise that since he is working in the field of development communications, he must necessarily become an advocate of visual communications among his people. He should therefore have a clear understanding of his work and its importance in the community.

There is no recipe for becoming an outstanding illustrator, but it is somehow wrapped up in the artist's ability to express his feeling or message in drawing; in the skill with which the drawing is executed; in the materials he chooses; in the way he presents himself to his audience and lastly his confidence in his position as communicator in his society.

Once a new generation of visual aids has been produced more research can reveal ways of refining and enhancing the messages.

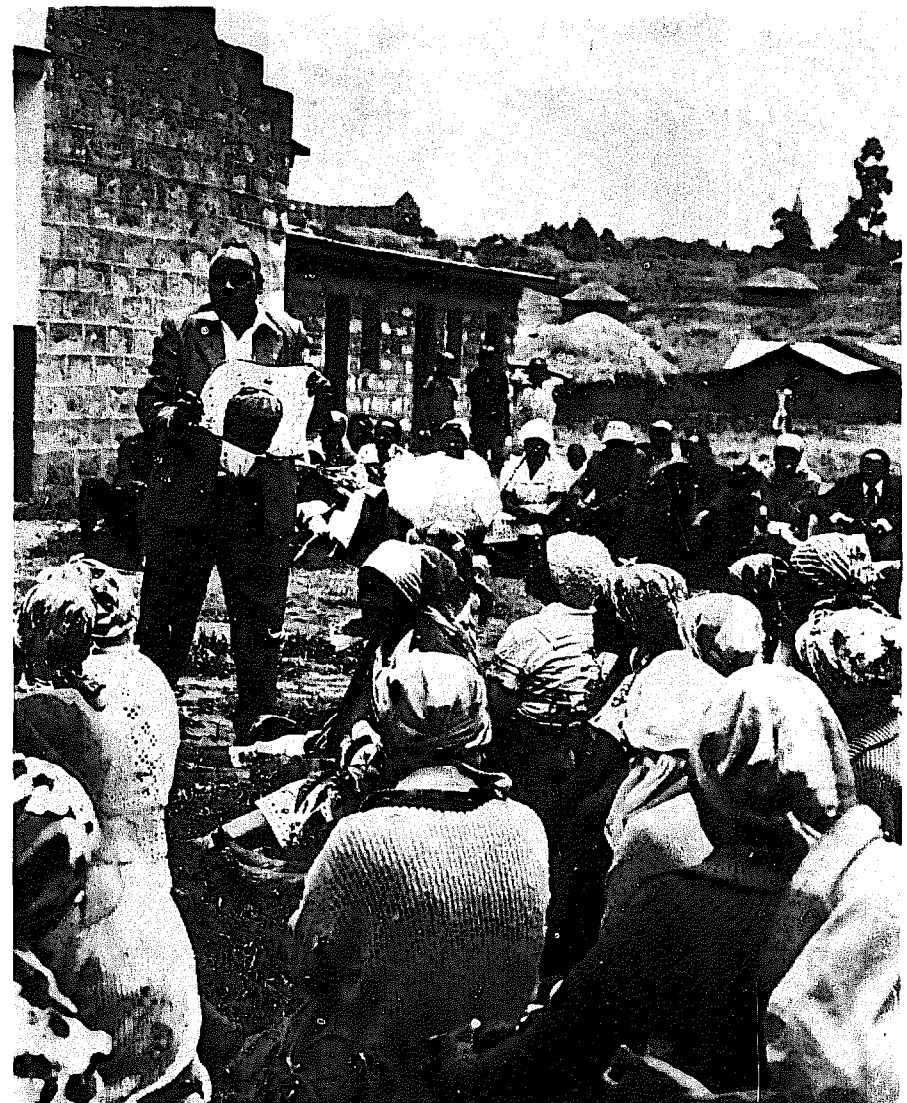

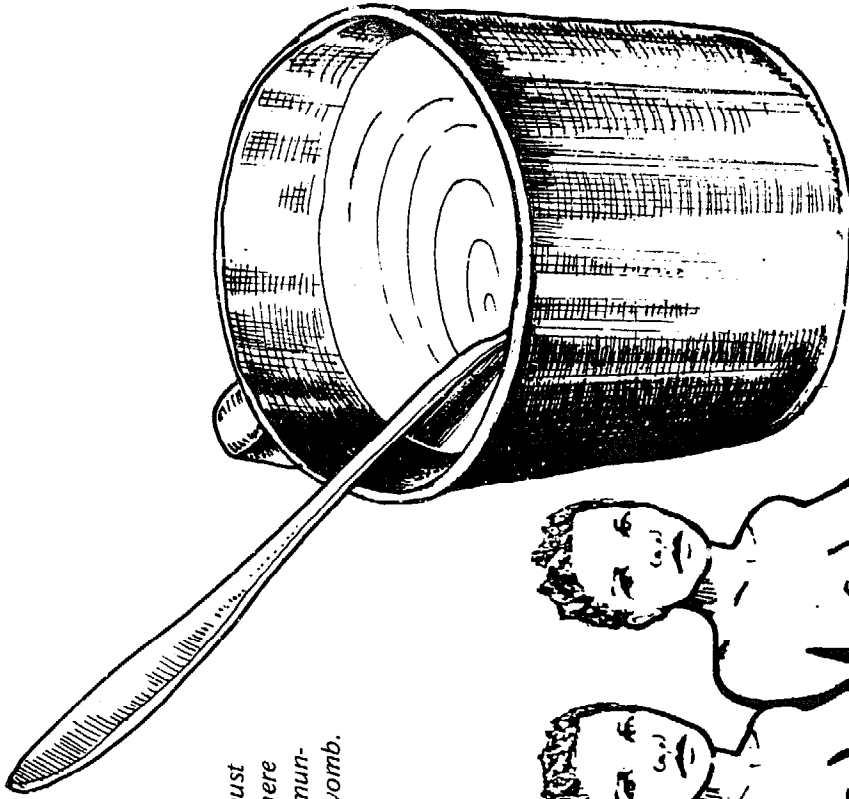

Whether the message is simple or complicated the artist must illustrate it well enough to be understood. In a society where the visual literacy level is high illustrations can help to communicate the unseen. Such things as the growth of a child in the womb.

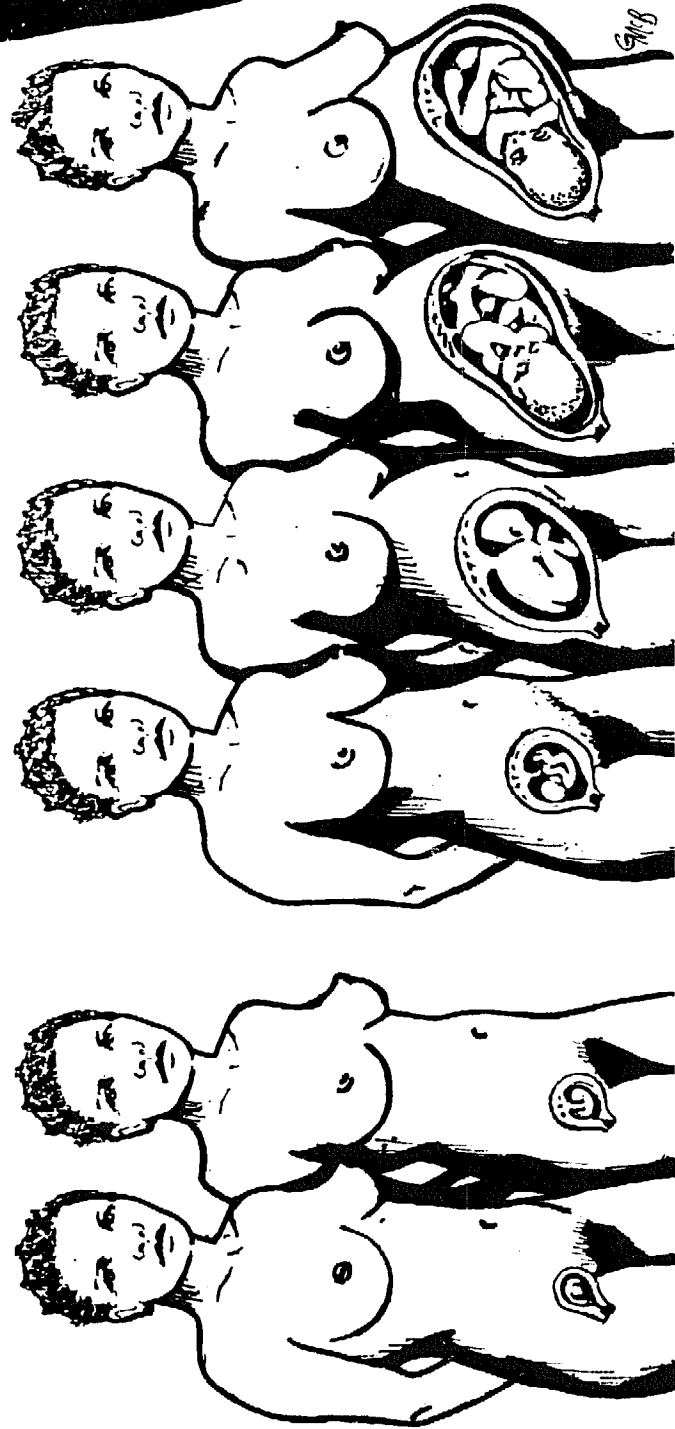
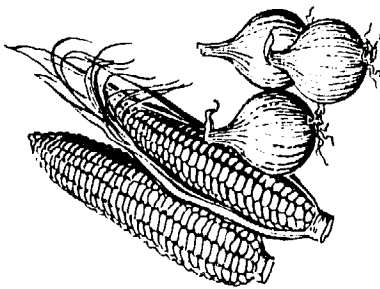

CHAPTER 2

PREPARATION OF WORK

Part 1

The Topic

While the artist may possess the skills which allow him to draw widely recognisable people and objects, he may still have little knowledge of what sort of "development messages" he may be called upon to illustrate. Assignments may come from any of the following areas:

- Health Education
- Agriculture
- Education
- Literacy
- Community Development
- Public Information
- Religion
- Family Planning and Family Life Education
- Road Safety
- Village Technology
- Conservation

The topics to be covered can vary widely: from bilharzia control to methods of constructing storage granaries, to fishing techniques. Whatever the topic it is important for the artist to become familiar with its broader aspects.

We cannot communicate effectively unless we thoroughly understand exactly what we are trying to communicate and why. For example, if the topic concerns bilharzia control, it will be necessary for the artist to understand something about the nature of the disease, as well as how it is passed on from person to person, what the best methods

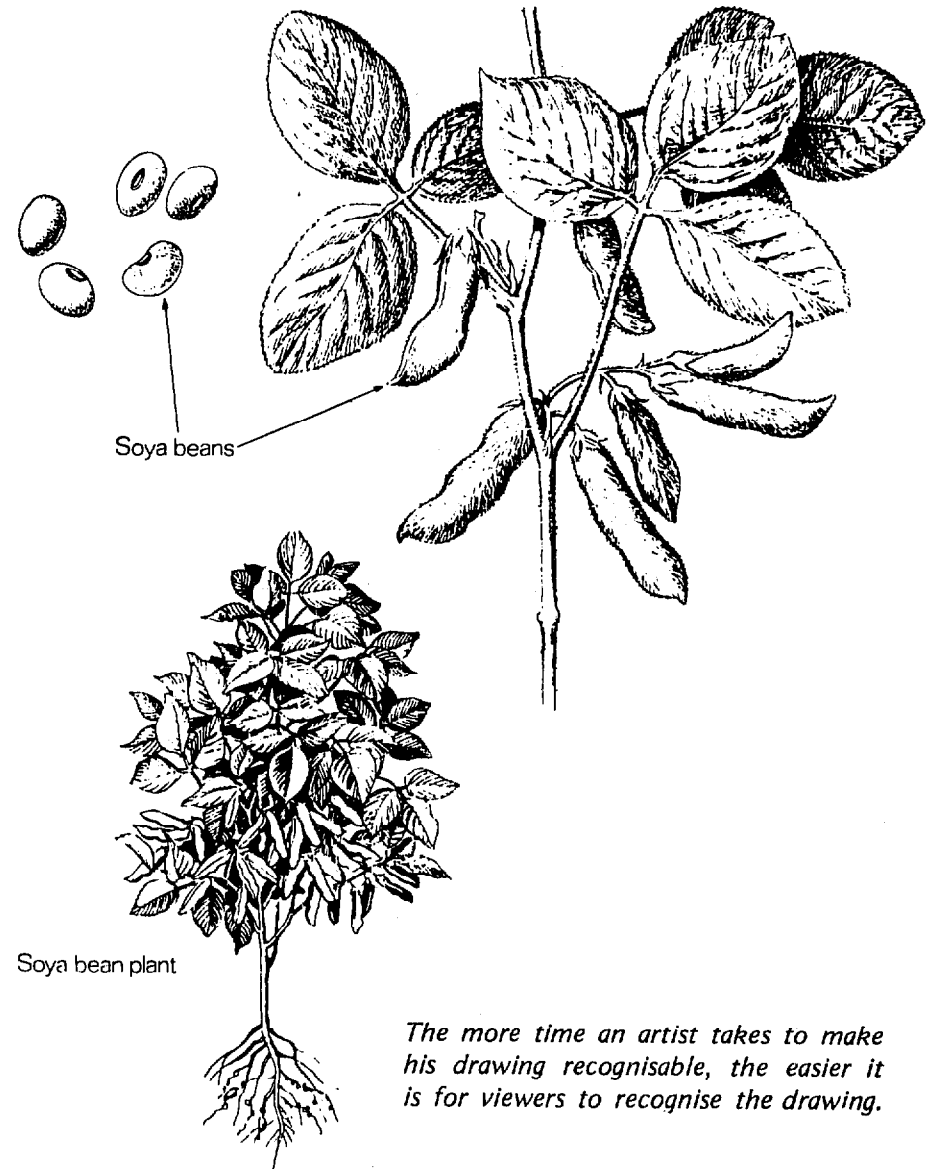

The more time an artist takes to make his drawing recognisable, the easier it is for viewers to recognise the drawing.

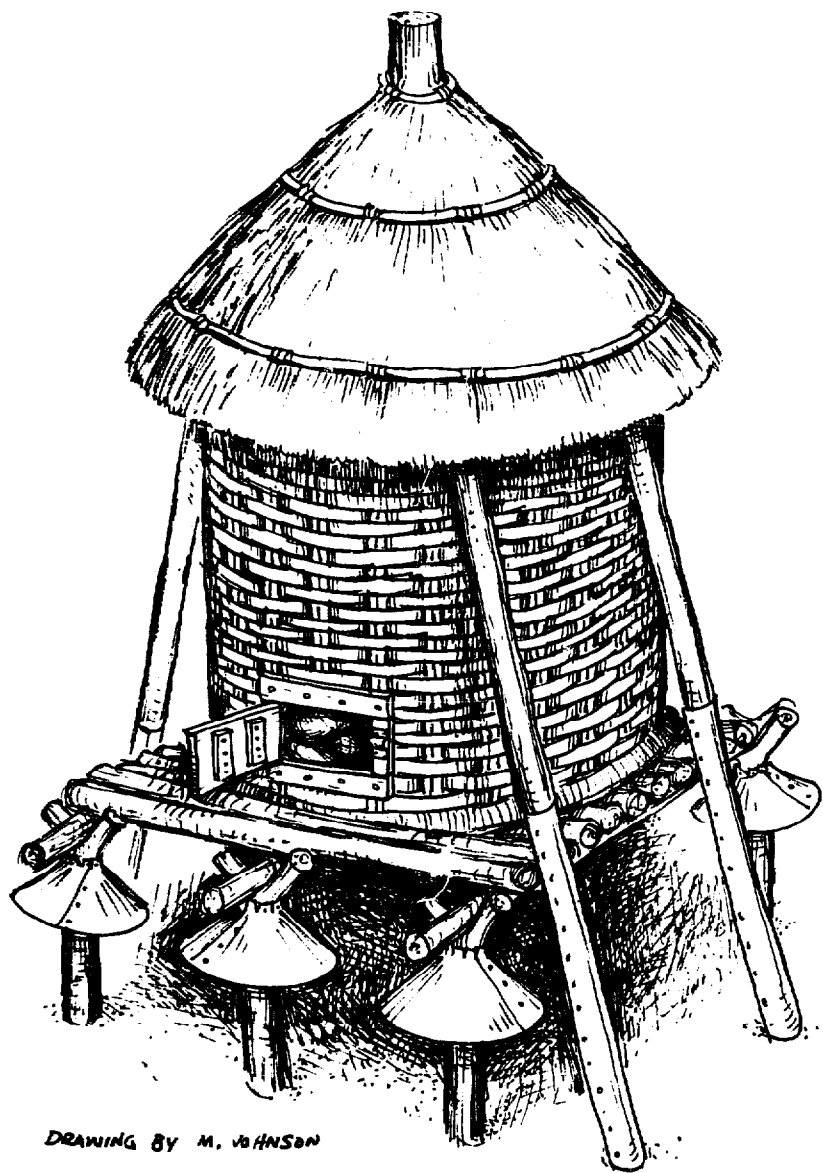

for controlling the disease are, and how all of this can be best communicated to the audience concerned. For instance, should the message be a positive demand for the audience to “DO THIS”, or should it be a negative instruction to “STOP DOING THAT”, or should it be mainly informative and explanatory, “THIS IS WHAT HAPPENS”. Which of these messages would work best in illustrative terms? Are any of these likely to be more easily understood and acted upon by the audience?

It will probably be necessary therefore for the artist to become something of an “expert” in many fields. The artist who is engaged to illustrate a booklet on grain storage methods will have to become familiar with farmers’ problems in protecting their surplus stored grain from rats and weather. The artist involved in illustrating a literacy project aimed at fishermen will have to be knowledgeable about the tools of a fisherman’s trade — so that they can be used to illustrate the lessons.

In order to gain the necessary knowledge the artist should hold frequent discussions with recognised experts in the field concerned. In order to check that the illustrations he intends to produce will be accurate, as well as to find out more about the topic he should preferably meet people in their own habitat. The communications team will also need to seek assistance from those specialists with practical experience at the field management level, for example, a game warden if the topic concerns the protection of wildlife.

The communications team may also need to consult books, films, magazines, journals and a host of additional documentary sources in order to improve their knowledge of the topic. Since a project will often involve the introduction of some new piece of equipment or a new procedure, it may be necessary for the entire communication team to visit the establishment where the new technology is being developed (such as a village polytechnic) in order to make an accurate visual record as well as to improve their general knowledge.

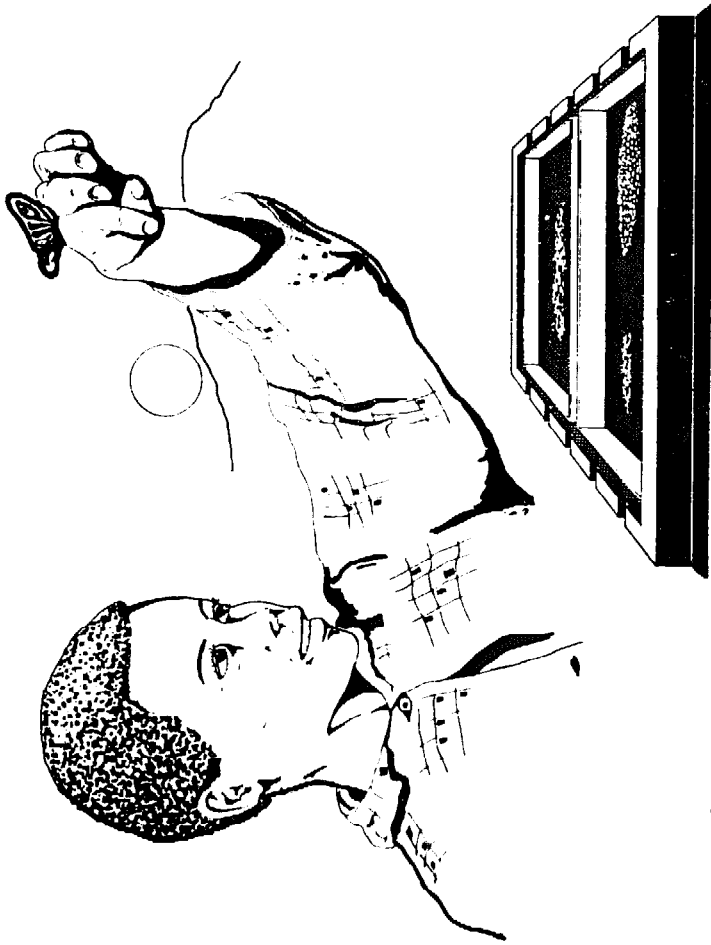
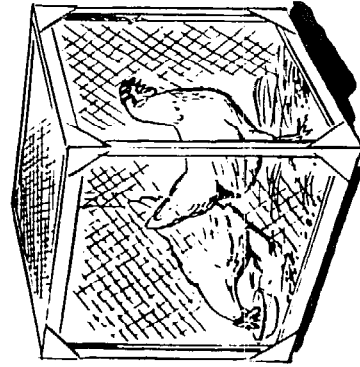
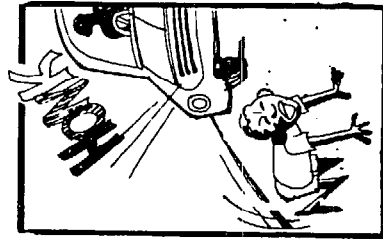
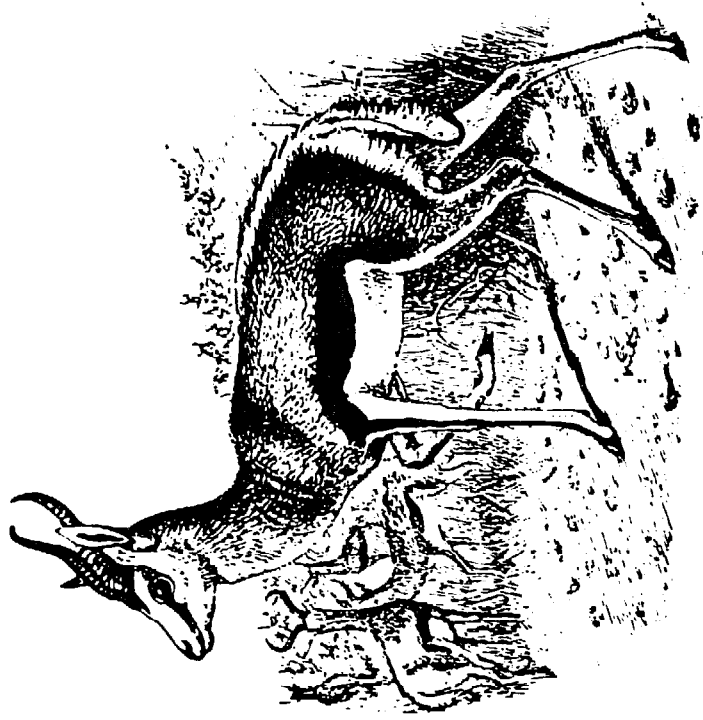

Development messages require the skill to draw many different subjects.

Once the topic has been understood, the artist should give greater attention to his audience.

WHO ARE YOU DRAWING FOR?

FOR
INTERNATIONAL
ART LOVERS?



FOR
ARTIST
FRIENDS?



M. JOHNSON.

FOR
THE BOSS ?

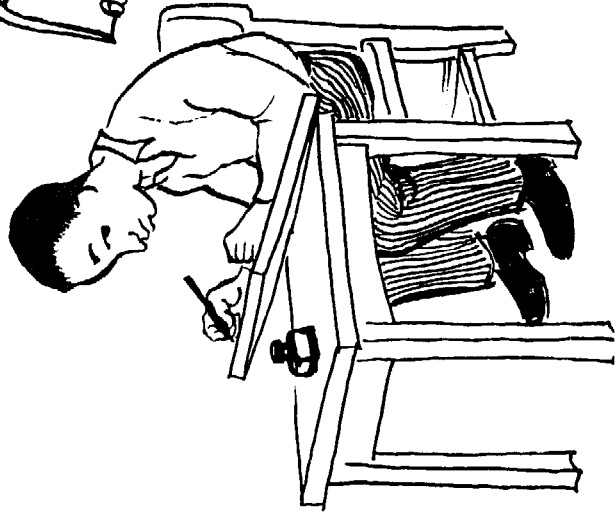

OR FOR THE
TARGET AUDIENCE ?

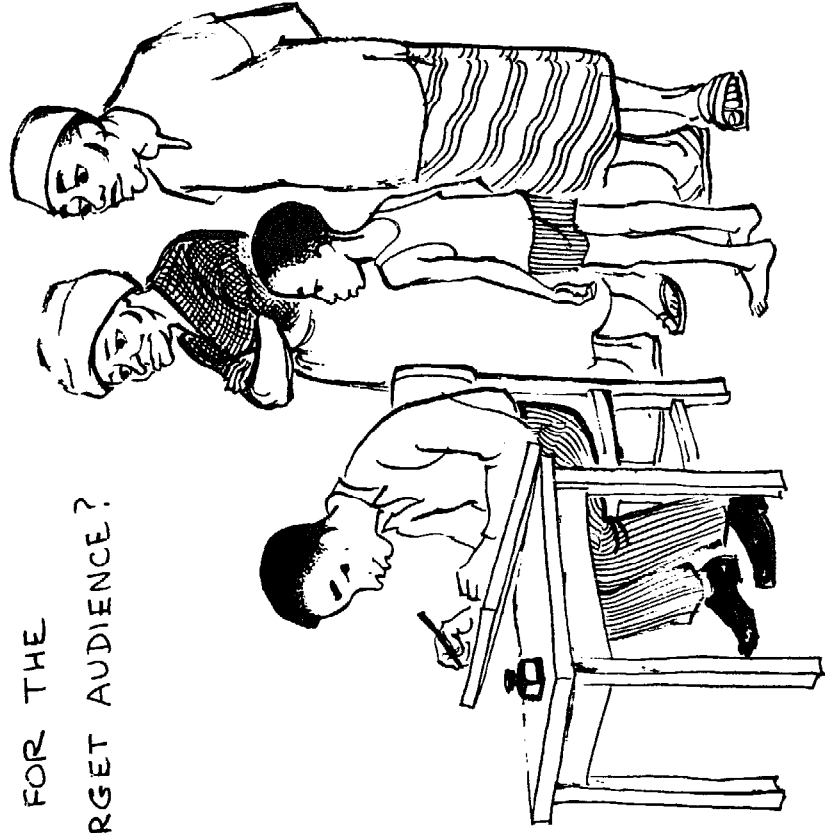



Part 2

The Audience (Adapting the Message to the Community)

The term "target audience" is frequently used to designate the specific section of the community which is intended to receive, understand, act upon and hopefully benefit from a particular development message. In the past, the term "target audience" has been criticised for implying only a one-way communication process. Some communicators have suggested that it sounds like the community is being "ordered" to change lifestyle, attitudes, beliefs or behaviour. We will continue to use the term in this chapter since it is too useful to be easily discarded. However, it is important to recognise that a dictatorial approach in the communication of development messages is neither useful nor productive. Too often, the superior attitudes taken by members of some communication teams towards their target audiences have hampered their understanding of the community, and have therefore prevented setting the development message in terms which are acceptable and reasonable to the community.

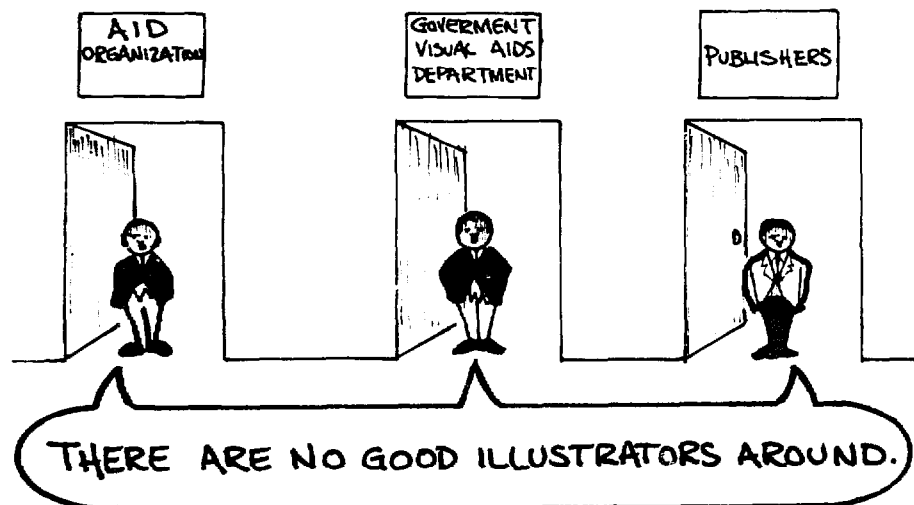

CONTINUED—

The first thing the development artist needs to know about the target audience concerns their level of visual perception. The more people are used to looking at pictures, the more they are readily capable of learning from them. The reverse is also true. The artist must ask: How much have they seen pictures before? In what context have they looked at pictures? Do they like looking at pictures? Have they learned something before by looking at pictures? Do they understand symbols used in pictures—i.e., arrows, ticks or crosses?

If the answer is that the visual perception level of the target audience is low, then the artist must make his drawings accordingly. The drawings will have to be simple. They will have to contain full-figure images since these are most easily understood. The artist may even have to

produce several drawings to illustrate one simple message. It is important for both the artist and the project designer to understand this. When the target audience is unfamiliar with the visual representation of ideas, then each drawing should contain just one point of information. A progression of ideas (such as might be suggested for illustrations dealing with "how bilharzia is transmitted" or "the mosquito cycle" for example) should never be presented in a single drawing to such an audience.

If the answer is that the audience are mostly literate and/or are used to seeing pictures, then more complicated illustrations may be drawn to help communicate messages. However, it should be remembered that the visual perception level is unlikely to be uniform throughout any community, and may differ according to age, sex and level of education. Frequently women have least exposure to educational media. If the target audience is broadly based e.g., consisting of men, women and children then either the lowest represented level of visual perception should be taken as the guide for drawing illustrations, or different illustrations may need to be produced for different sections of the target audience. This will vary according to the type of message and audience concerned.

Next, the artist needs to learn about the dress, customs and traditions of the target audience. People usually resist too many changes at one time. If a new idea can be related to traditional ways of behaviour, the development message might appear less threatening, and could be made more acceptable.

For example, any figures appearing in illustrations should be wearing the usual dress of the target audience. This will help closer identification with the aims of the message. Moreover, if illustrated figures do not appear in familiar dress some members of the target audience may ignore the message altogether, as having no relevance for them.

Further, if illustrated figures can be made to closely resemble certain

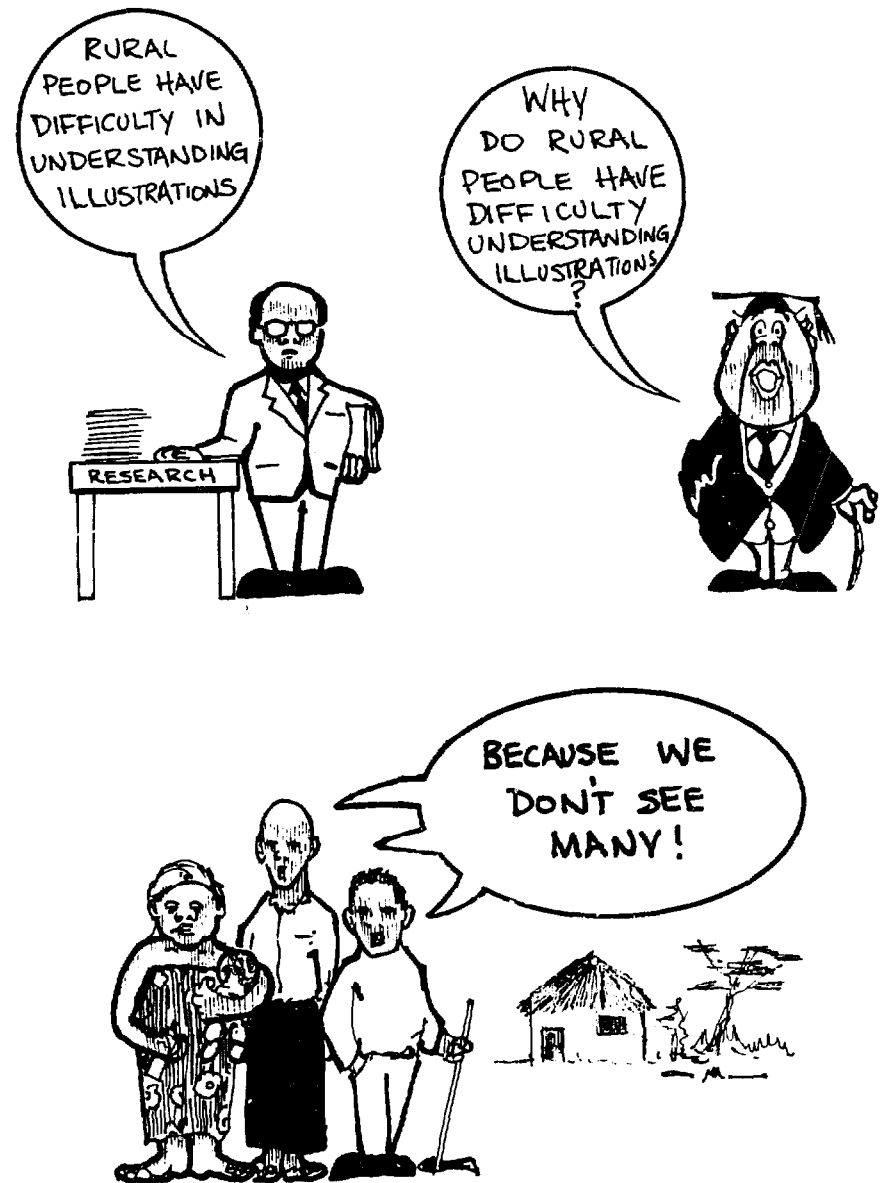



respected members of the community, then the effectiveness of the drawing is likely to be enhanced. If the figure is recognisable to the target audience it is almost certain to arouse more interest; and this may prove particularly valuable in a community which generally has a low level of visual literacy. It may be useful for the artist to learn whether the community possesses any traditional purveyors of new ideas—such as teachers, priests, store keepers, or successful local farmers who might be prevailed upon to lend their support to the message by appearing in illustrations.

The artist must be sensitive to any customs in the community which could have bearing on how the target audience interprets the development message. For example, if an artist is engaged in the production of an illustration dealing with the kinds of foods a pregnant woman should eat, he needs to be aware of any food taboos in the community concerned. Some communities, for example, maintain a taboo against women eating eggs. For such a community it might be meaningless, and perhaps offensive, to show a pregnant woman eating eggs in a development illustration. On the other hand, there would probably be many other foods with the required nutrient value which would be more familiar to the target audience.

Care needs to be taken with grouping in the illustration. For example, some communities have strict ideas about which family members eat together, or which members of the community may be seated while others stand. To offend against such standards of politeness and correct behaviour could invalidate the development message. In some instances, it may be offensive to present a man as being "shorter" than a woman, and whether this is due to the demands of perspective or merely because the man is seated might be irrelevant.

The environment must be illustrated in such a way that the audience can identify it. For example, a group of people who usually bathe in a river would not relate bathing to a drawing of a bucket of water, and the message of keeping the body clean would not be conveyed. The

artist must study the target audience to see how they go about their daily tasks, what types of tools they use and how they use them, what kinds of clothes they wear, what kind of houses they live in, the entertainments they enjoy and the relationships they have with each other.

Finally, the artist must be aware of how much the audience already knows about the topic he intends to communicate. Wherever possible, development illustrations should begin by building upon knowledge already existing within the community. Begin with a known quantity before moving into the unknown. A scheme to introduce new fertilisation methods, for example, should use more traditional farming practices as a starting point. In this way, an opportunity may be established right at the beginning for discussion, and through this to greater understanding.

It should be clear from this that the visual materials for each target audience will require different and specialised treatment if the intended messages are to be effectively conveyed. It is correspondingly important that the target audience is as closely defined as possible in the beginning, so that the maximum value can be extracted from the materials produced.

To sum up this section, the team should marry the topic to the target audience and from this will emerge the final aims, the media, and the individual messages.

Is it important to know whether children eat alone or with their parents when you are designing a nutrition poster?

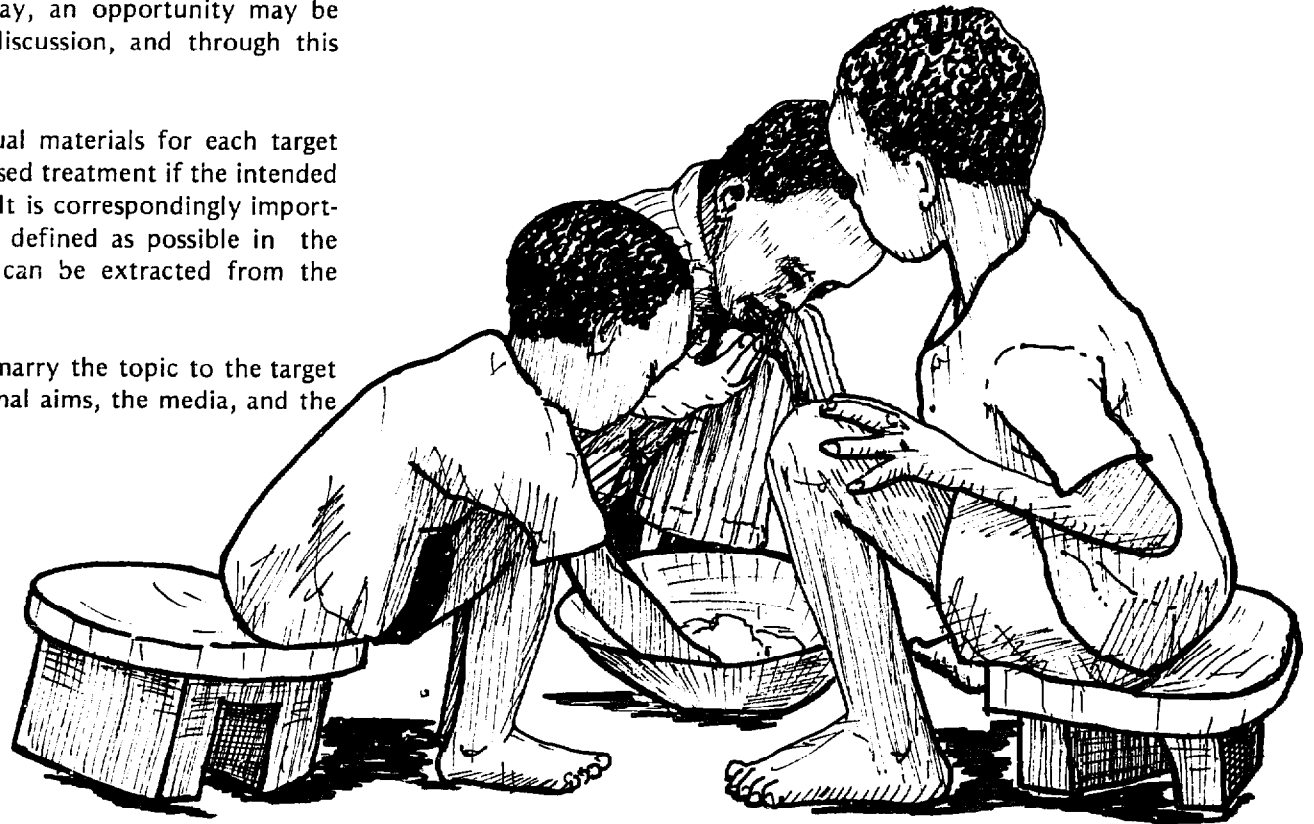

WHILE THE ARTIST BEGINS WORK

Points to Consider before Making Illustrations

Before the artist can start actual illustration he should remind himself:

- (i) that the illustration he is about to make will stimulate active learning.
- (ii) that the illustration are in line with the development goals.
- (iii) that the learners will be able to interpret the responses to them.
- (iv) that the illustrations will bring about expected changes.
- (v) that his illustrations will complement the message in the book or poster.

To arrive at the right decision the team may have to address itself to a number of questions among which are the following:

1. Which parts of the topic are likely to be already familiar to the target audience, and which parts will be new to the majority?
2. Which parts are similar to existing practices, and which will require major innovations?
3. Which aspects of the topic are likely to be accepted within the framework of existing tradition and social structure?
4. Are any aspects likely to meet with suspicious or other negative attitudes?

Answers to the above questions could lead the communicators to reconsider the aims of the project and even to suggest that they be changed.

CHAPTER 3

WHAT THE ARTIST NEEDS TO BE ABLE TO DO

Part 1

Learning to Draw Better

This chapter is designed to improve the technical skills required to produce illustrations for development. The artist must know in addition to other things how to make recognisable pictures and to communicate development ideas (messages) through them. He must be able to distinguish between a development message and an ordinary one. He must know development expression and how to achieve it through simplification and simplicity. The experience of development workers and the findings of research favour developmental materials produced in a realistic style.

The following exercises in object drawing, figure drawing and picture composition have been included in this manual to help mainly artists with little or no art training to develop the skills needed in realistic drawing and also to learn to treat and to present their drawings simply and logically such that the illustrations and messages become readable and more communicable. These exercises can in no way be considered a complete programme in learning to draw realistically. It is only hoped that they will help give a beginner a start.

For the experienced artist, they may help to make him realise the subtle difference in treatment and presentation between ordinary illustrations and illustrations for development. Particularly, they may help to indicate to him the kind of realism we advocate and why we recommend it.





We would recommend that even the experienced artist tries these simple exercises, especially the compositions, and checks on the relevance of his style, interpretation and presentation to visual communication requirements as well as to his intended audience. The highly trained fine artist, however, might have some difficulty in producing the desired kind of illustrations because, for years, he might have been producing works for art galleries and for sophisticated art patrons who are far removed from the experiences and understandings of the people with whom he must communicate in developmental projects. But, as he would have already developed the general professional skills and feeling, he would only have to learn the specialised treatment and presentation of drawings (illustrations) as suggested above, and in the exercises in this book.

As we said earlier for the development messages to be fully and effectively understood all images in the illustration must be easily recognisable by the viewer. A nutrition poster, for example, may include a series of images (pictures) of the kinds of foods that make up a balanced diet. If the viewer of the poster cannot recognise the precise foods pictured in the poster, the illustrations and consequently the whole poster is a failure.

In the following exercises, which have been arranged in progression so as to provide progressive skills in drawing objects, we have attempted to stage some do's and don'ts of drawing curvilinear forms as well as angulated ones. In each case we have started with simple basic forms like a pot for spherical forms, an oil drum for cylindrical forms, a brick or box for rectilinear forms, and progressively moved to complex and compound forms, like vegetables, tables and other such complex forms both natural and artificial. It should be remembered that the main aim of all these exercises is to help you learn how to describe the different basic forms of objects simply, clearly and logically and in a recognisable style such that they express the desired development messages.

Part 2

Learning to Draw Round Objects

There are many shapes that can be developed from a circle, sphere, or a cylinder. Try to list down the commonest ones in your locality, in your culture, in your country, which might be used in developmental activities. The list is infinite isn't it? However, let us pick out a water pot because it provides a circular shape as well as a spherical form. Moreover it is one of the commonest African objects.

Exercise 1. Drawing a Water Pot

Find various local water pots and place them in front of you preferably on the ground or on a low table. For a start, choose a place where the light will reveal the spherical forms and the appearances of the pots fully and clearly. Remember that the aim of this exercise is to practice making the pots appear globular using light and texture or any other means, in a manner that would not make the drawing confusingly vague.

Note: Whichever way you plan to develop your drawing, whether in line or by shading, you should interpret the object as a form, a full form which has got shape in volume. You should avoid separating them. Practise feeling and expressing the shape and volume (form) simultaneously as you draw. Even if you are a beginner, train yourself to see both at once; you will find it very useful.

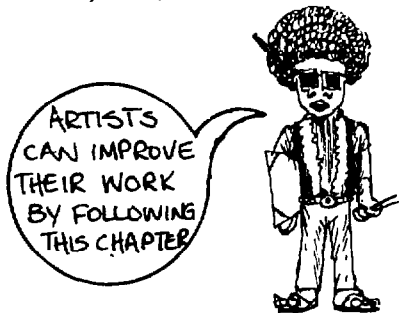
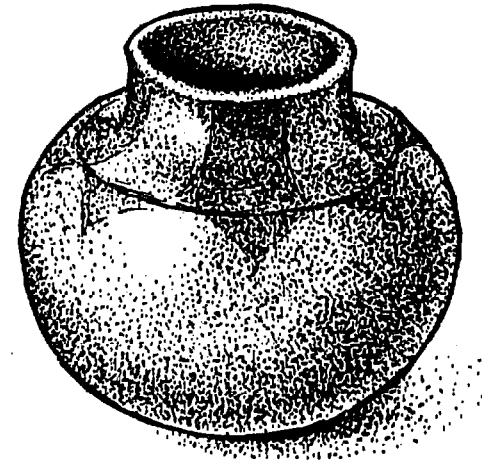
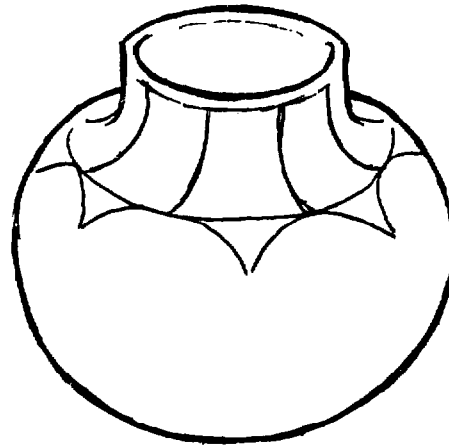
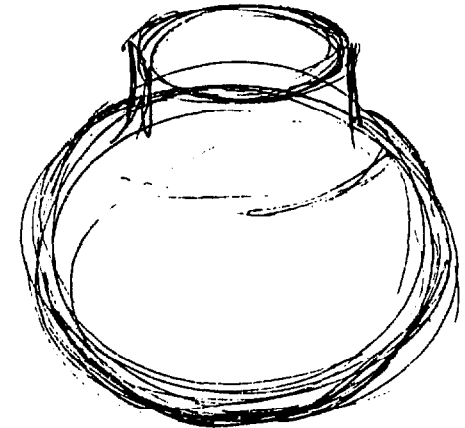
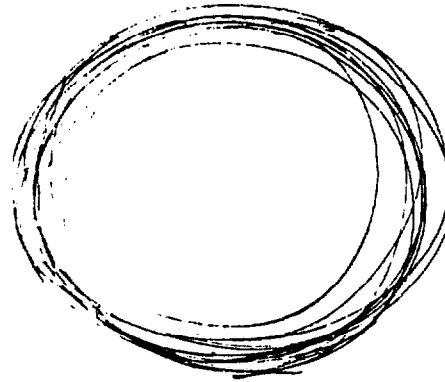

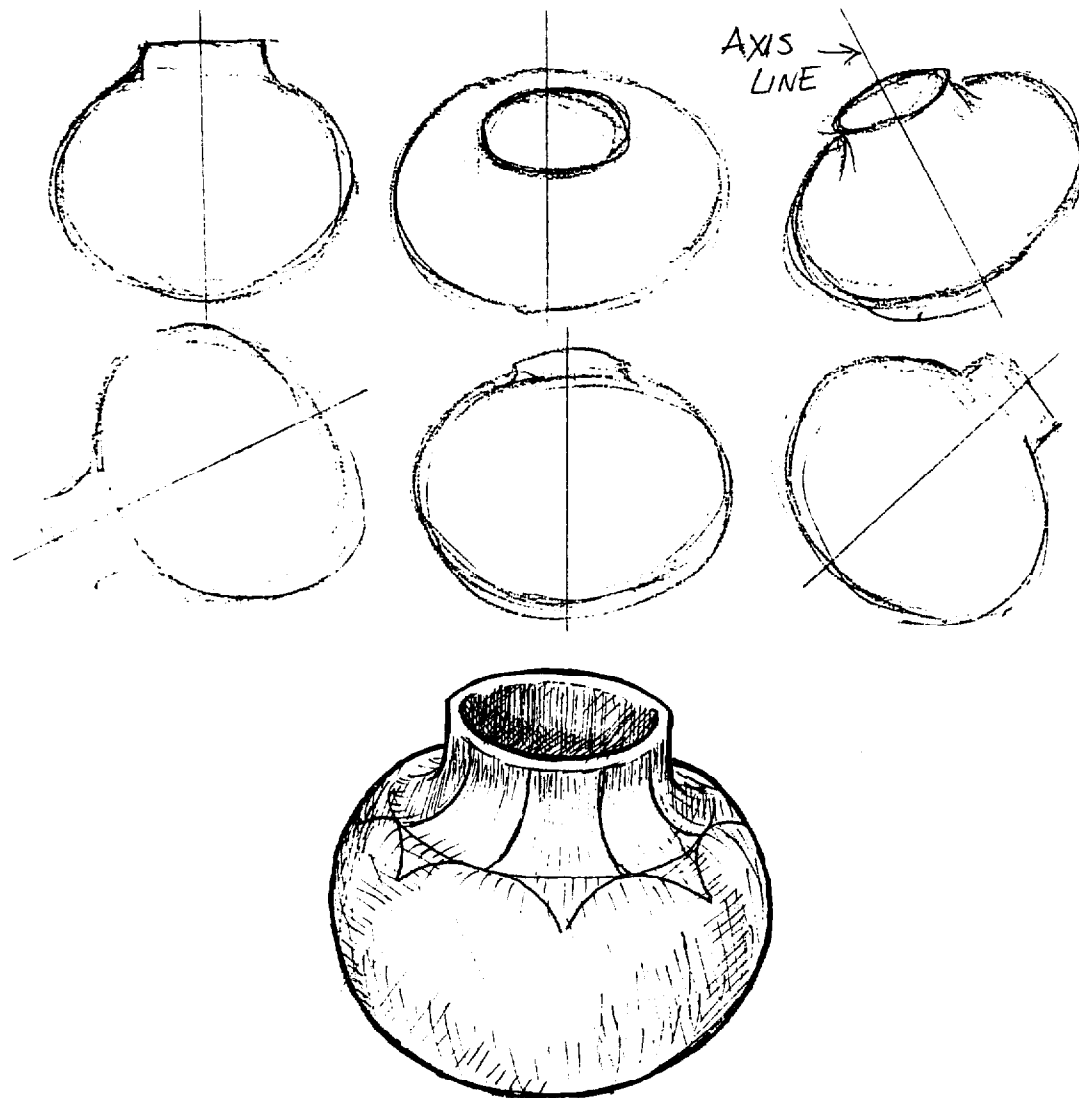

Step 1: Observing the Object

Observe the pot in front of you. Discover its overall form, that is its shape and volume. Is it globular or spherical? Look at its mouth. What shape is it? Is it circular or round? If so, what kind of circle – from where you are viewing it? Is it the normal regular circle, is it oval or what does it look like? What is its relative proportion to the body of the pot? How does its far side differ from the nearer side? How much of the interior space can you see through it and what shape does it assume? What does its out surface (the neck surface) look like or feel like? Is it patterned? Is it coarse? How does the pattern run? What repeat formula does it follow? What is the exterior appearance of the rest of the pot; plain or patterned? Find out how it is illuminated, that is, how the light falls on it. Which side of the pot does light come from? Does it come from the top, from the left hand side, from the right hand side, from where? Does it appear as if there are two or more sources of light? Where does the other light come from? Which of the two appears to be the stronger light and therefore the main light? How does it affect the pot surface – the texture, the patterns, or the general tone or colour of the surface? What happens to the texture, pattern or colour of the pot in the light and shadow areas of the surface. Are the other minor lighting necessary for my drawing. What happens if I ignored them? What effect do they cause if I included them? Does the pot cast (throw) a shadow on the ground? In what direction does it fall? What shape does it assume; does it really look like the pot shape? How dark is it in relation to the pot and base surface? Is it uniformly dark? Which end is darkest? Does it have a distinct edge?

Finally, discover the angle which the vertical axis of the pot makes with the supporting base ground. The axis line is the imaginary line which runs vertically through the centre of the pot and the base making an angle of 90° with the flat horizontal supporting surface if the pot is placed upright. That angle may vary in size according to the inclination of the pot. Every object in nature will always have an axis line. You should always discover it and also use it when drawing. Discovering the axis line of the pot will help you to get its position correctly reproduced on the paper when you start drawing.* After making those and other observa-

*N.B. An axis line is not necessarily the gravity line.

tions about the pot, you will be ready to move to the next step, that is sketching or planning. A lot of space has been given to this step because it is the key step in realistic drawing especially for developmental materials (visuals). Once you succeed to train yourself in accurate purposeful observation, you have succeeded to solve a bigger part of your training problems. What remains would be to learn to interpret and reproduce those observations visually on paper. Although the guide questions may appear to be many, the whole exercise or process of observation itself may be accomplished in a single glance or a minute's glance depending on the amount of guided training one receives. It will also depend on the extent of one's individual practice.

Step 2: Establishing the Figure

This step will include interpretation and presentation of the object (the pot) although, sometimes, each may be treated separately.

It is recommended that you use soft pencil for a start and change to the indelible media like ball pen, pen and ink or such other media only after you have gained sufficient confidence and skill. Soft pencils range from "B" to "6B". You will find those numbers marked on the pencils. The average recommended series are the "2B" and "3B" pencils. Although any light coloured paper may be used for practice drawing, you should try as much as possible to find white paper. It provides better contrast.

The whole drawing procedure may be summarised under one statement that, draw what you observe and in a way you see it; keep your drawing as closely as possible to the actual form (shape and volume) of the object and as correctly as possible. Strive to train yourself that way to be able to synchronise your hand movements to your observation. Learning to draw realistically is learning to observe, see and understand and learning to reproduce visually and accurately on paper what you see and understand. Remember that as much as possible you should see the object (pot) in its totality as a form, that is, shape, texture, colour, or tone and volume all combined.

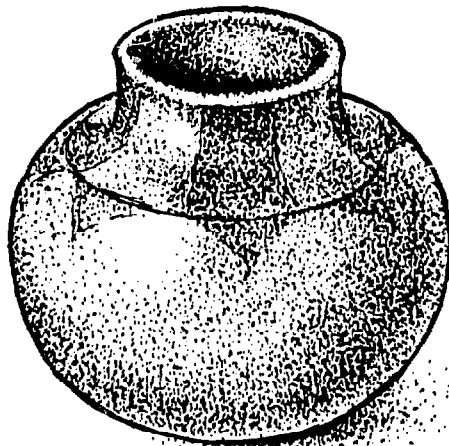
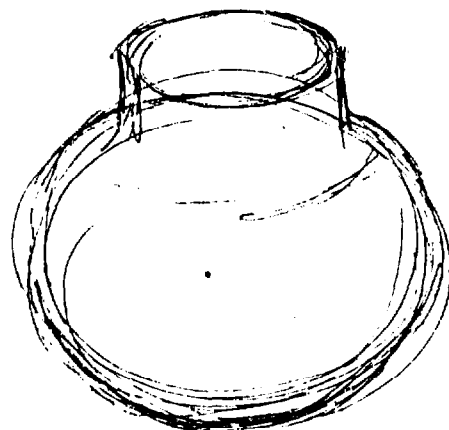

Use the pencil with precise strokes or lines as if you were using pen. This might help you to master the techniques of using a pen even before you begin to use it. Vary the hand pressure on the pencil and consequently vary the thickness of the line according to the characteristic changes in the appearances or feel of the part of the object you draw. Sometimes, those variations may record or represent differences in the nature of the substance of the object. Sometimes they may indicate simply the behaviour of light on the object surface. Do not rub any constructional lines out until after you have reached the final stages of your study.

Step 3: Developing and Drawing

A drawing is developed by adding in more descriptive details either with line or with shading. Shading is normally associated with representation of light and shadow of the object. Yes, probably true. But purposeful shading, especially for development illustration, should be aimed at describing the exterior features of the object in as much as they aid in building up that object's form. Of course in order to be able to see those appearances, there must be a source of illumination (light). But the effect of that light takes its form from the form of the object as well as from its exterior features, particularly texture. Therefore, when shading, choose a method of representation which is appropriate to the characteristic appearance of the object and then vary the intensity of your shading exactly as the appearance of the actual object varies and changes with the light. If successfully done, shading would make your drawing look almost like the real pot in front of you.

Ways of Shading

You may have realised by now that light causes two basic effects. It reveals the volume and form of an object and also produces a cast shadow of the object it illuminates. If you shade to represent its effect on the object you are said to be "modelling" or using direct shading. Sometimes you will find that shading the cast shadow or the background behind and around the object will give you much better and more effective results. In this case you would be described as using indirect shading or the cast shadow method. So,

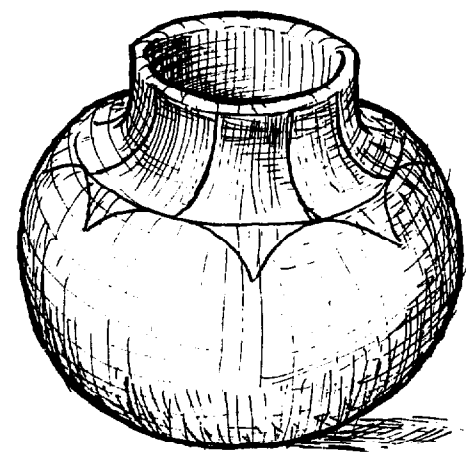
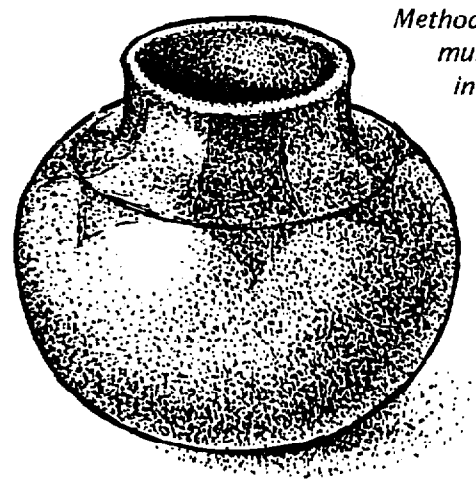
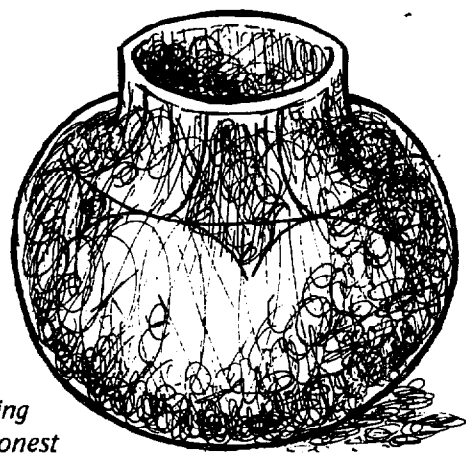
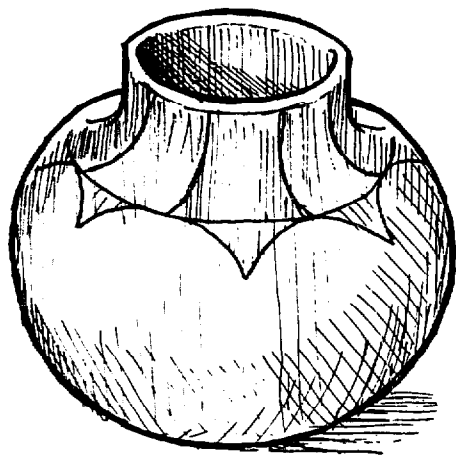

*Methods of shading
must be an honest
interpretation
of the way
light falls
on the pot*

modelling is the shading of the object itself to describe its surface appearance and also to represent the changes in light resulting from the nature of the surface and the form of that object. The cast shadow method is shading the shadow cast on the supporting surface or any other surface mainly to bring out or increase the contrast between the object and that background. Sometimes it is done merely to score visual reality by establishing spatial illusion.

Shading Techniques:

Shading may be done in various ways. You may use dots, or scribbles or crosshatch, or any other technique provided it is clear and meaningful. The levels at which you are beginning to learn development illustration and of course the nature of the object you are drawing will determine largely the appropriate shading techniques to use. Check the shading technique you used in your drawing of the pot and find out whether it is the most appropriate and most effective one. Of course if that is the only technique you can use confidently so far, then feel satisfied with that one for the time being. Try other techniques later and compare their different effects. When you have mastered these shading techniques you may wish to experiment with more representational techniques using, say, curved lines, straight lines, etc. Whichever technique you use, you should remember all along that shading is done mainly to describe the object and not simply to indicate the changes of light on that object. You should achieve the gradual darkness of your shades by increasing the number of the pencil strokes over the area.

One trick in modelling a spherical or cylindrical object form is to avoid shading the darkest part of the object right up to the outline. The effect of leaving a lighter portion next to the outline is derived from the presence of reflected light; light that bounces off other surfaces onto the dark side of the object. We touched on this kind of light in the observation section. Study the pot in front of you and see if you detect the reflected light thereon. It is not always visible; it will become more evident if you place the pot on a white surface. The trick related to cast shadows is to make the shadow darkest at its point of contact with the object base and to avoid making a sharp edge to it.

What has been said about drawing spherical forms or round shapes applies equally to drawing cylindrical and many other forms, natural or artificial. If it varied at all, it would vary slightly.

Constant Practice

The exercises suggested in this manual will not and cannot turn you into a skilled illustrator for development. They are intended simply to start you off, hoping that you would feel sufficiently inspired to find more suitable topics of your own choice and continue practising. You might realise that the more you study life around you and around your audience the easier you might find the job. It is appropriate to point out that you do not always have to produce full and laboriously finished illustrations. Some of your drawings, in fact most of them, should be individual sketch studies of nature or any possible development topics. You may produce repeated studies of the same object with a view, say, to find out the extent to which you could simplify that object before you could make it unrecognisable to your audience. Alternatively, you may repeat the study merely for the sake of experimenting with a particular expression, movement or mood. The more you practice the more you will realise that there are more possibilities of simplifying natural objects effectively than you would have so far tried.

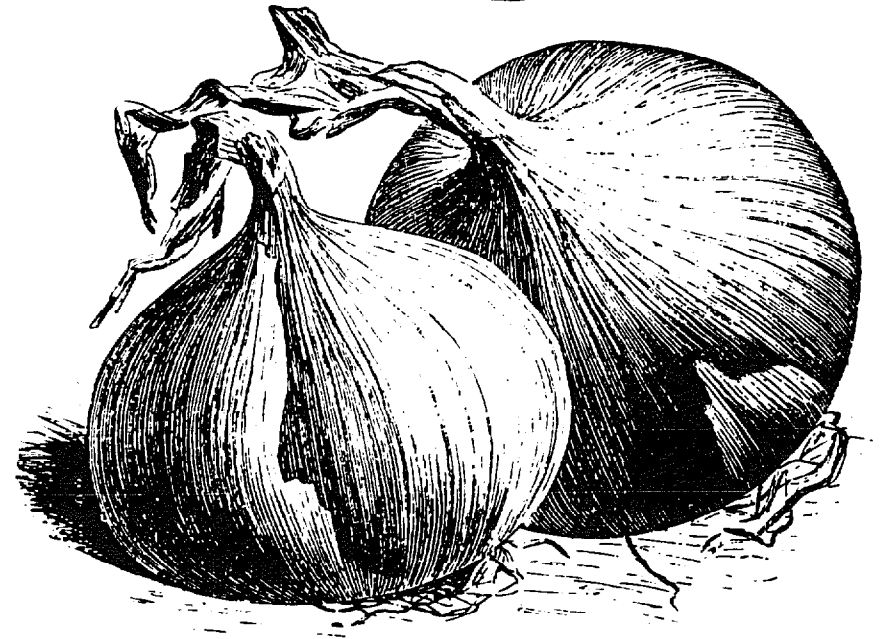
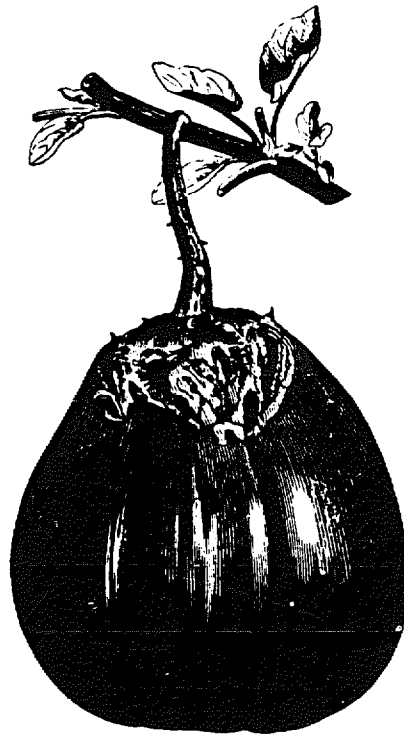
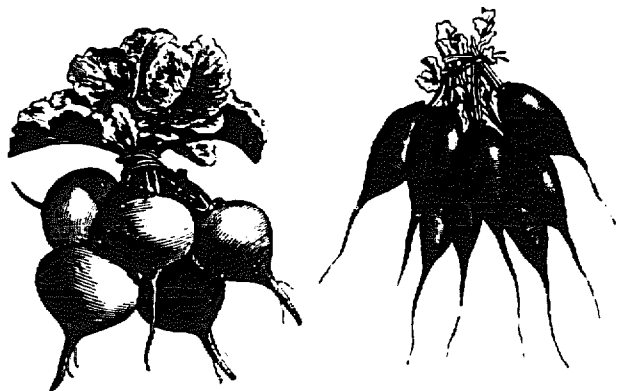
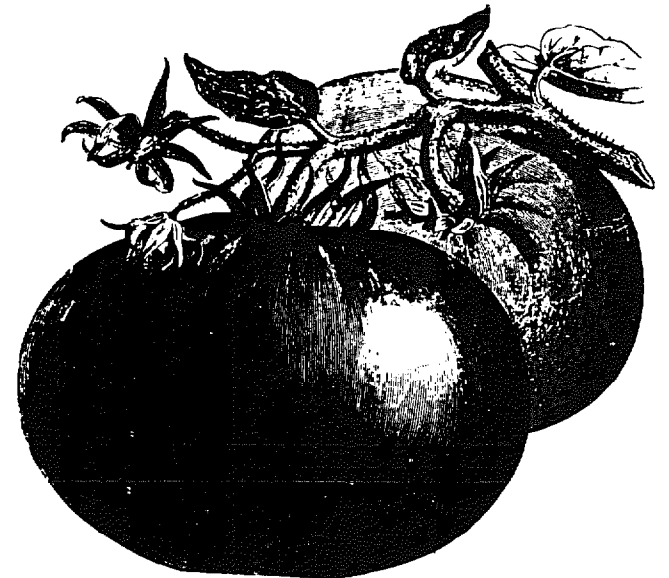
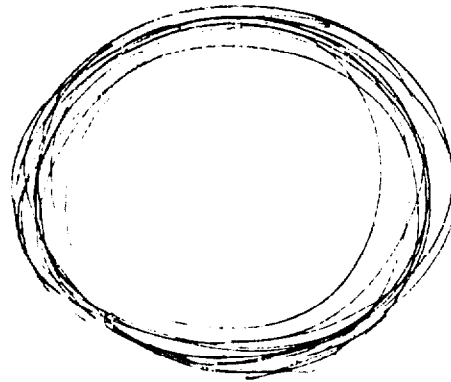

Exercise 2. Drawing Cylindrical Objects

Topic: Drawing an oil drum or some other cylindrical structure. As most of the general and basic requirements for realistic drawing have been covered in exercise one, I will mention here just only those points which might help the artist, particularly the unskilled artist, to make a logical construction and development of a cylindrical structure.

Step 1. Observing the Object

After you have placed the drum in position under suitable lighting, position yourself as you wish ready for the exercise. You may work while sitting down or standing up. From the position you select, find out where your eye-level (horizontal axis) line passes in relation to the drum. Does it pass above the drum? Does it pass through a point on the surface of the drum between the top and bottom ends, or where does it pass? An eye-level line is the imaginary horizontal line which marks off a point in space or on an object along which your eyes travel left or right before they are raised or lowered.

After fixing that eye-level line, now observe the behaviour of the edges and any other linear feature of the drum, in relation to the eye-level line. What is their formation if the eye-level line is above the drum? Do they seem to ascend towards the eye-level line? How do they change if the eye-level line passes in the middle of the drum between the top and bottom ends? Where does each end appear to curve towards? When can you see the top side of the drum and when can you not see it? These are but a few guide questions which might lead you to establishing the structure of the drum.

Step 2. Establishing the Figure

Having observed that strange behaviour of the structural lines (edges) of the drum all you have to do now is to synchronise your eye movements with the hand movements and let the pencil follow those lines or edges wherever they may lead the eye. If they tend to ascend, you also let yours in the drawing ascend; if they curve downwards, let yours also curve likewise. Do not forget to plot your vertical axis line of the drum.

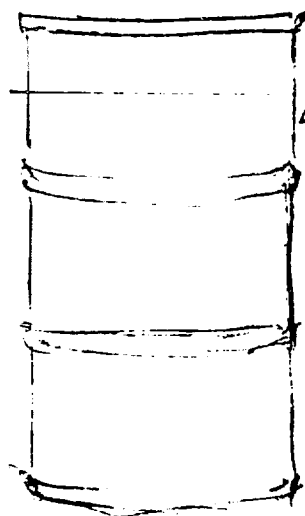

EYE
LEVEL.

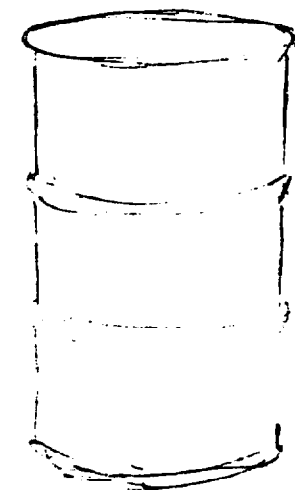
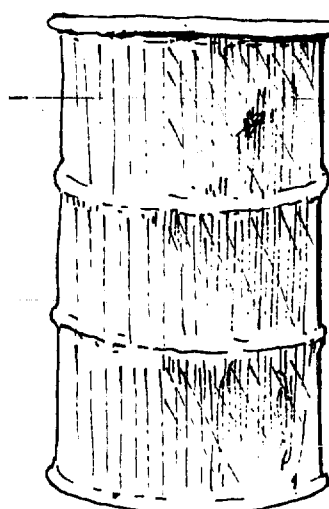
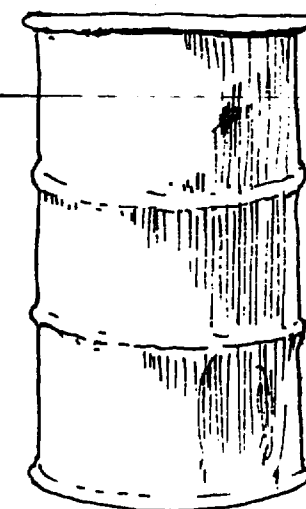

EYE
LEVEL.

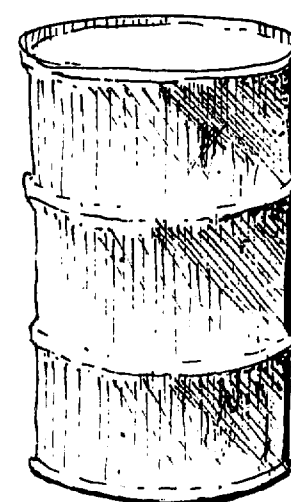

Step 3. Developing the Drawing

Shade as described in exercise 1. You should watch for the highlights on the top edge of the drum as well as for the reflected light on the surface. What is the formation of the cast shadow like?

Additional exercises: After completing the above exercise, set yourself more similar exercises but this time with surfaces carrying labels, lettering or patterns. These exercises will help you to discover the form each of those features takes if it appears on a curvilinear surface.

Exercise 3: Drawing Fruits and Vegetables

You might have realised now that the exercises are becoming harder and harder. They are beginning to require more skills than have so far been employed. This particular exercise is intended to introduce the artist to natural structures of basically similar forms to those so far drawn. The aim of the exercise is to help the artist to learn, in addition to capturing form, how to express correctly the different characteristic feels and appearances of the various natural objects so that the viewer can recognise them. Use texture to build up the forms and also to indicate light. Try a variety of fruits and vegetables. For example, draw a cabbage head. While developing the details of its leaves strive to build up and maintain the basic spherical shape characteristic of cabbages. You should also attempt drawing a massing of smaller units like beans and groundnuts. Leafy vegetables also provide useful subjects for study. Try them. The main objective behind drawing most of these objects is learning to handle the details of a complicated structure without losing its form and freshness.

At this stage you should be able to attempt drawing any object you find. You should attempt drawing woven materials and objects like baskets, deep as well as shallow ones. Your aims in this exercise would be to learn to use texture (the weave) to express form. It is hoped that you would also be able to learn their correct construction on paper; they should look stable. The list of possible topics is endless. It is up to the inspired and enthusiastic artist to keep a growing list of them. Care must be taken, as much as possible, to choose mainly those topics or objects with

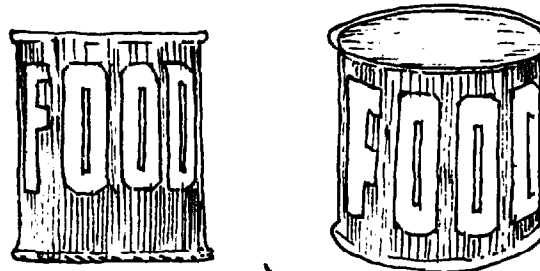

close relevance to development communication, development activities or development messages.

Assuming you have gained sufficient technical skills and experience in representational realistic drawing, let us now attempt some proper development illustration assignments. We shall try one related to curvilinear natural forms.

Assignment 1: Design a Poster Illustrating a Well-Balanced Diet.

Use black ink on white paper. Before starting to make your poster, study the contents of your illustration. What are the types of foods that make up a balanced diet? Consider who will be your target audience. Choose those foods which are easily obtainable by the target audience and which conveniently but accurately illustrate the well-balanced diet. You may need the help of a health expert to do this. Consider the form of the food most easily recognised by the target audience, i.e., fresh or cooked? Make a layout of your poster being careful to leave a good margin around the poster and good space between each food illustration and between the illustrations and the written text. Watch the size and nature of the letters you choose to use on the poster. They should be fairly big, simple and legible. Pretest when you finish your poster; take it to a target audience. Ask them to identify the objects in the poster. Note especially any objects that are not identified or wrongly identified. Do not try to argue with the persons you use to test the pictures; try to analyse with someone else the illustrations that presented difficulty and try to find out why. Was it the shape, or the shading, or the texture, or the proportionate size of the object compared to other objects pictured on the poster? Or was the object simply unfamiliar to the target audience? Try to redraw the poster to eliminate the difficulty and test with the same or another target audience. Your willingness to draw again the illustrations which are not quite acceptable is an important part of your training as an illustrator for development. The first drawing may be beautifully executed, but if it cannot be identified by the target audience, it is not a successful drawing. (In a workshop or classroom situation the testing session with a target audience may be followed by a group criticism directed by the drawing tutor).

Part 3

Learning to Draw Square Objects

Drawing Angulated Objects:

Again, most of the techniques mentioned in the previous sections apply equally to drawing angulated objects. For instance, the methods of observation and establishment remain the same. Even in the development step, some of the development techniques remain exactly the same. However, you are likely to notice two new and peculiar behaviours about angulated structures (objects). You might notice that their planes which lead away from you, especially if the objects are big or long, tend to narrow up at their far ends. In other words, the objects tend to become smaller and smaller as they push away from you. You are likely to notice also, that each of the sides (planes) of the objects carries a slightly different but uniform tone. That behaviour of the planes gives rise to what is technically known as perspective, which I am going to discuss here briefly. But before I do so, I would like to remind you that correct observation leads to correct proportions or relationships. It also leads to correct perspective.

Perspective: (The behaviour of lines and planes in space.) The representation on a flat paper of a cube and all its rectangular derivatives introduces the complex field of linear perspective. Linear perspective is a mechanical system perfected during the Renaissance in Europe and is familiar to the trained artist and the architectural draftsman. It is a system which is built on the optics of the human eye (and its mechanical derivative, the simple camera). It is a system of drawing which attempts to reproduce by mechanical means the image produced on the retina of the eye (or on the film in the camera). It is a system that ignores the stereoptic mechanism of two-eyed human beings which involves simultaneous double perspectives. It also ignores the mental images from a series of retinal images. Even when the human being is sitting quite still, his eyes are very active, constantly refocusing and supplying a series of perspective-images to the mind. The mind constructs a stable perception from this series of retinal images reported to the brain. Further-

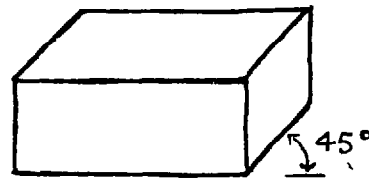

OBLIQUE PROJECTION

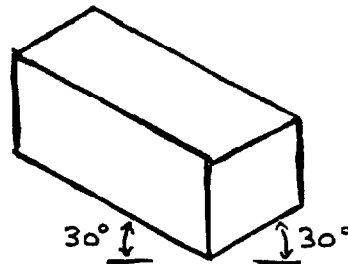

ISOMETRIC PROJECTION

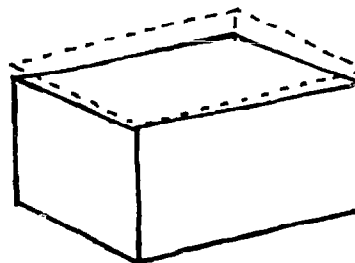

DRAWING ADJUSTED FOR PERSPECTIVE

more, human beings seldom sit still for long. Even when they walk around and pick up an object to examine it from several sides, there is a continuity of perception which is not tied to a single perspective. The artist's skill in producing realistic illustrations for development must include the ability to make pictures which are true to this mental perception of objects and their setting. It is not a skill in making a picture that simply represents a moment's glance (or snap of a camera) which may appear quite strange to persons who are not accustomed to the imaginative search for the unusual viewpoint which is typical in the contemporary world of photography and illustration. Rather it is the ability to present nature in a way that compromises between the realities of nature and the visual perception experience of the audience. Illustrations built up correctly according to the system of linear perspective may sometimes be 'unrealistic' for purposes of illustrations for development.

For the purposes of this manual, no attempt will be made to describe the system of linear perspective. In so doing we do not mean to reject its use in illustration for development. It is a very useful system for building up and correcting realistic drawings. In its place we are describing a simpler system more closely related to the system of observation.

THE FARTHEST LEG OF THE TABLE APPEARS THE SHORTEST

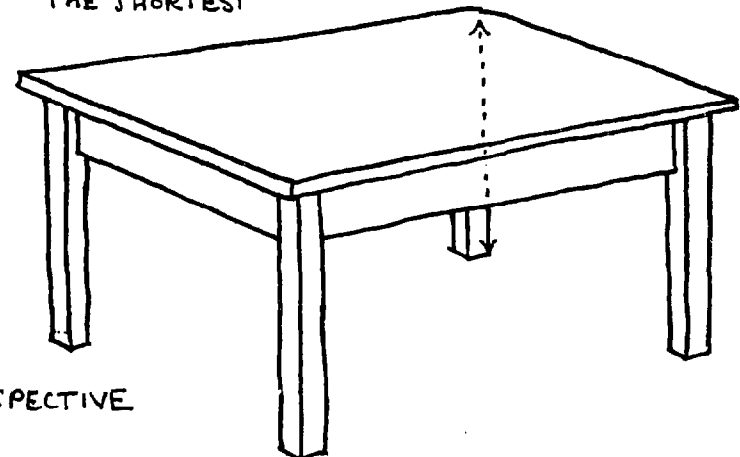

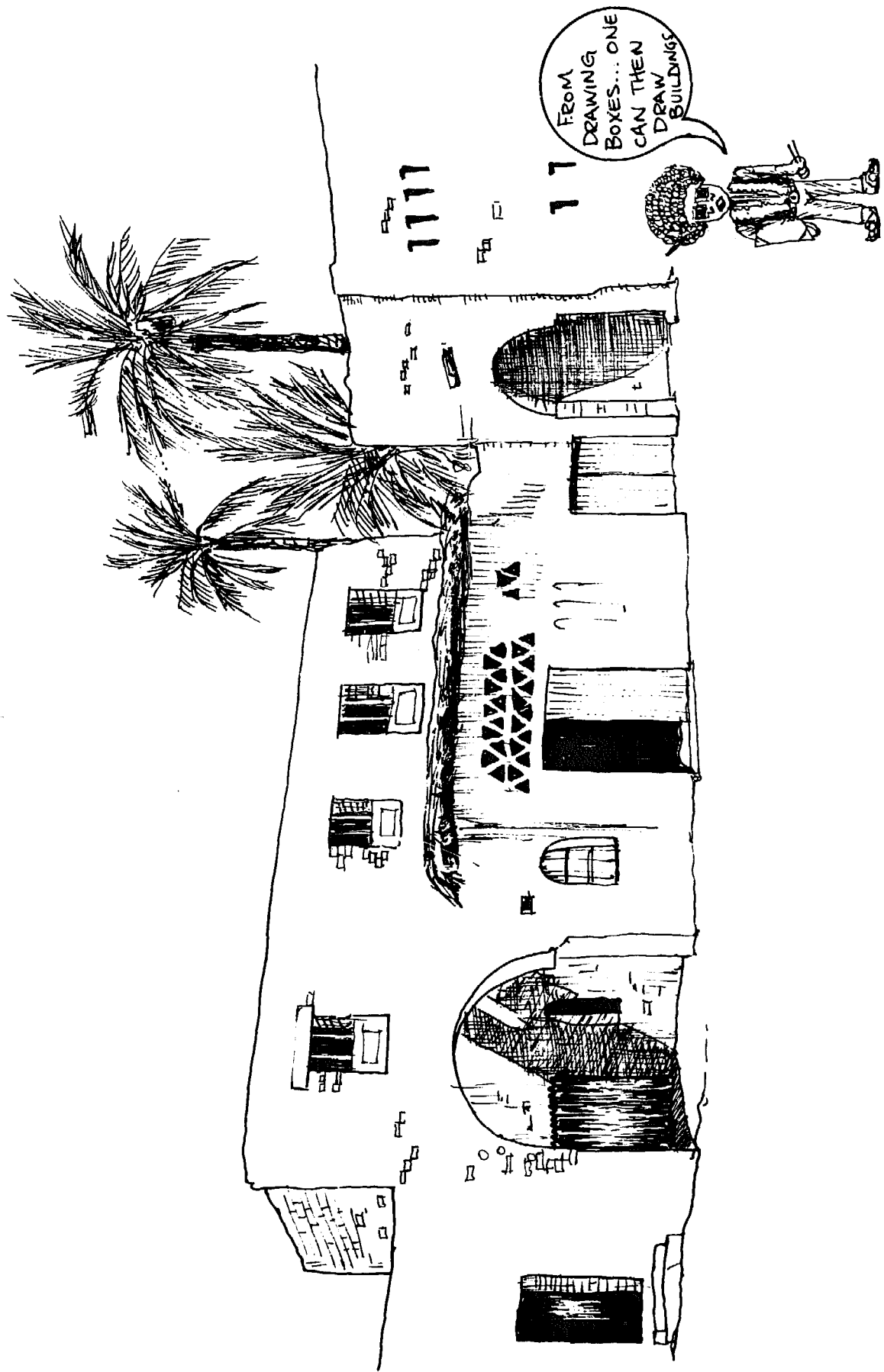

Observing Perspectives

Like other drawing exercises, perspective drawing requires correct observation and perfect relation of the hand movements to the eye movements. Basically, lines tend to ascend or descend according to the position of the viewer's eye-level line. That is to say, all lines of construction above the eye-level line tend to slant downwards towards the position of the imaginary eye level line. This is true with all lines leading away (left, right and forward) from the viewer. Lines below the eye-level line, on the other hand, tend to slant upwards towards the same position of the eye-level line. Observe this on the buildings or other construction around you. So, if the lines above and below the eye-level line were to continue indefinitely, they would tend to meet together in the distance at a certain point along the imaginary eye-level line. But, unfortunately, there are not yet long enough constructions in life to enable each one of us to observe this behaviour. That behaviour of edges (lines) is not easily noticeable on small angulated objects; but, it always applies.

You may probably have noticed yourself by now that all those edges (lines) which are placed squarely parallel to your eye-level line remain unaffected by this principle; they retain their original normal spacing. You may have realised also that there is another imaginary line, this time running vertically, which cuts through a point on the horizontal eye-level line where your eyes focus before you turn them left or right. For your information that is known as the vertical axis line, sometimes called the principal axis. Now, find a building or any construction again. Look at it and fix your eye-level horizontal line as well as your vertical axis line. Watch the constructional lines running to the left and right of the vertical axis line. What do you notice about them? Where do they seem to start slanting from? Now turn to those lines (edges) pointing forwards and observe them in relation to the vertical axis. Look at those on the left and right of the axis. Where do they seem to converge. Is it towards the vertical horizontal axis? What can you then deduce from your observation? Draw a simple diagrammatic representation of your observations. It might help you to understand this peculiarity better.

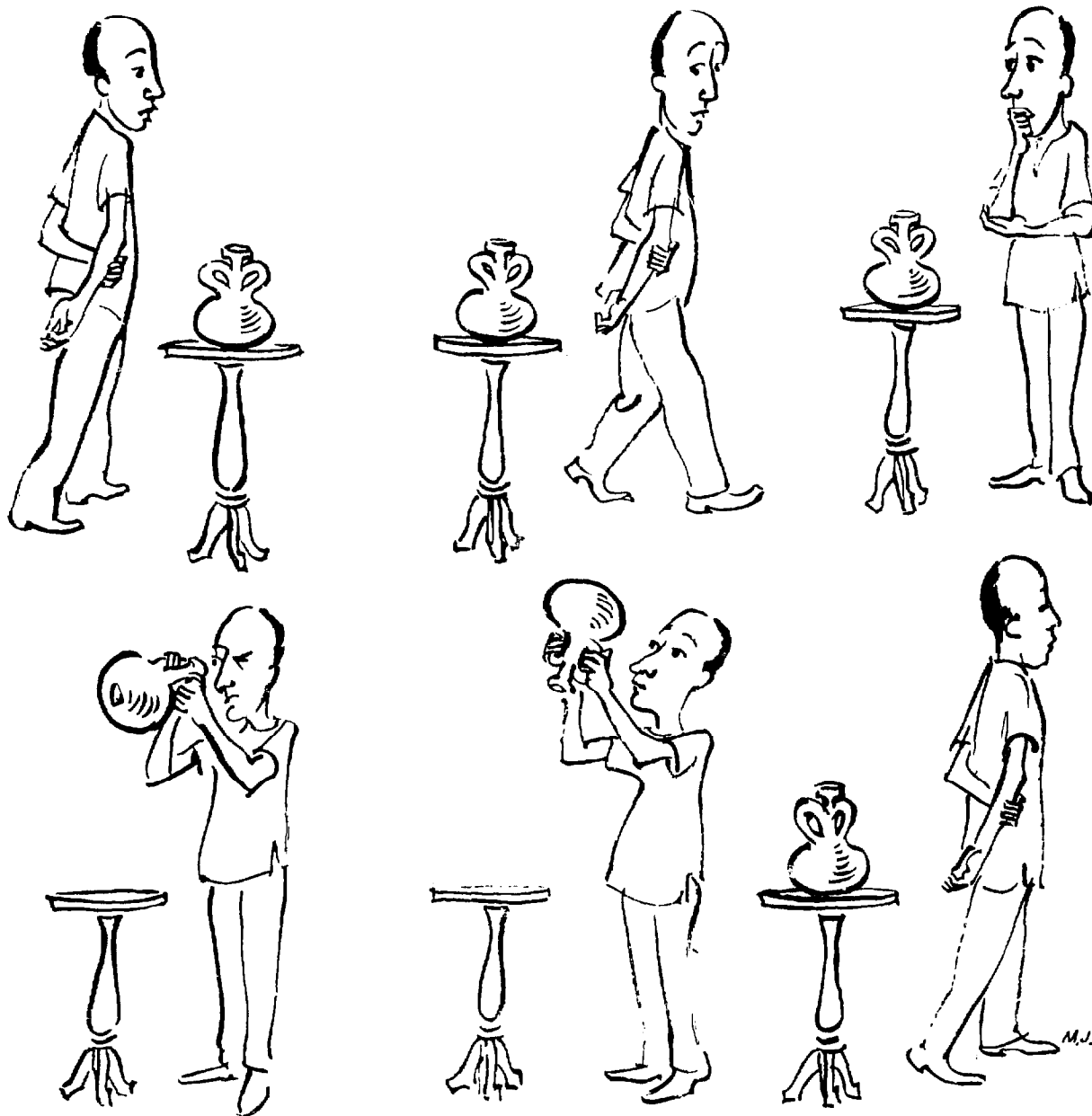

Establishing Perspective

After receiving all this information and simplified guidance about perspective, you should be sufficiently ready to make a simple perspective construction.

Exercise 4: Draw a Picture of a Brick

Note: You may substitute the brick with any similar rectangular object such as a block of wood or a closed box. For a start, you are advised to select an object that has sharp edges and corners and which is not irregular in shape.

Before you begin to draw, observe the brick from several views. Placed directly and squarely in front of you along your horizontal line of vision or eye-level line you will only see one side of the brick and this image can be represented by a simple rectangle in the proportion of the side of the brick seen. If the brick is lowered below the level of the eye you will see the same side and also the top. From this perspective we can acknowledge the fact that as an object moves away from the eyes it appears to be reduced in width and ultimately in size. (This is the basis of the system of linear perspective). The first side appears the same size as the first view, but the top appears flattened since it is turned away from the observer (in the same manner as the mouth of the pot and the top of the oil drum appeared as flattened ovals rather than the round shape that it is seen to be when viewed from above). It will also be observed that the far edge is slightly shorter than the near edge of the top. What do you deduce from this behaviour and exercise. (Is there need for adjustment? Draw what you observe and deduce).

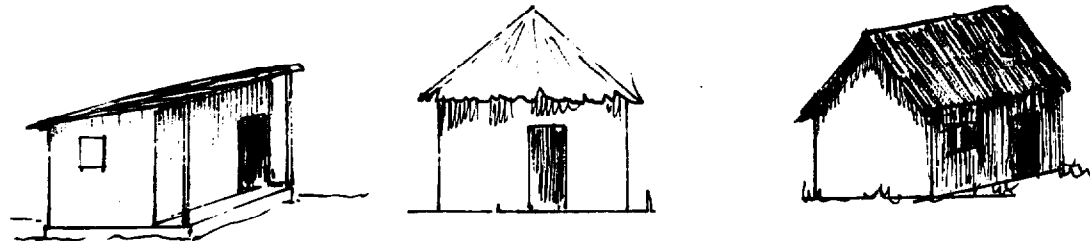
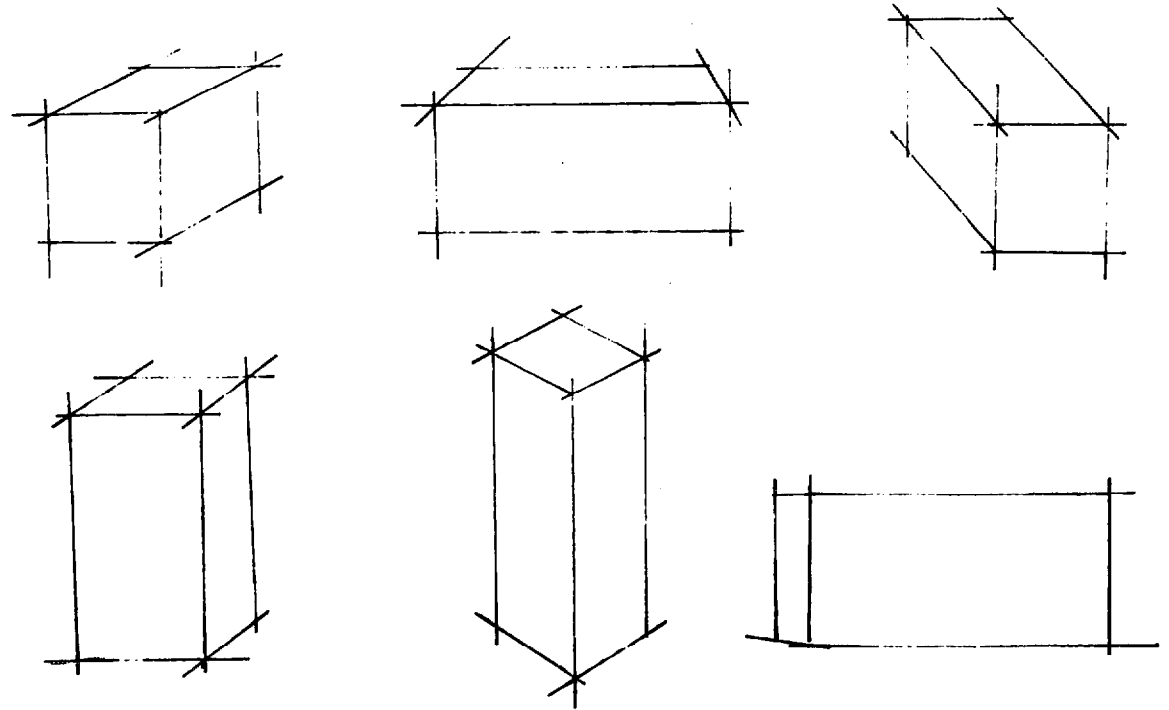

Assignment 2: After drawing the brick, make a series of drawings of more complex structures like an opened match box, a table, a drying rack, a cattle dip, local buildings, etc. The list can be indefinite. Remember that the main objective is to discover the behaviour of the parts of each of these objects and thereafter to be able to determine a reasonable modification which would make your visual reproduction (illustrations) more understandable to the audience, thus appropriate for developmental communication purposes. When drawing constructions with legs, determine the relative lengths of their legs by using faint construction perspective lines to join their bottom ends. But the simplest and somewhat more assured method is to observe the legs and compare the relative lengths of the hind legs to those of the front ones. Everything will work itself out almost automatically. Just let the pencil follow faithfully the directions of the lines and the eye.

Exercise 5: Though modern buildings do not commonly feature in developmental communication materials (visuals), it might be useful to you to try to apply your knowledge of the principles of perspective, now gained, to the construction of such big complexes. The trick remains the same.

Conclusion: The system of perspective drawing we recommend for this manual therefore is a modification of the basic academic perspective principles and also of the normal behaviour of the objects in reality such that there is a slight and purposeful reduction in size and dimension for the sides and edges that move away from the viewer. That modification should be just enough to make the illustrations more easily recognisable, communicative and understandable to the audience or viewer.



Assignment 3: Produce a poster showing the construction and use of a local storage device, like a potato storage box. The poster should show how the device is constructed, how it holds the contents, and can be emptied and cleared. It is hoped that those different positions will present you with most of the major perspective problems you need to learn to overcome in realistic drawing for development communication. After you have produced the poster, test it on a target audience, analyse the results, rectify the faulty points, then retest as detailed in assignment 1.

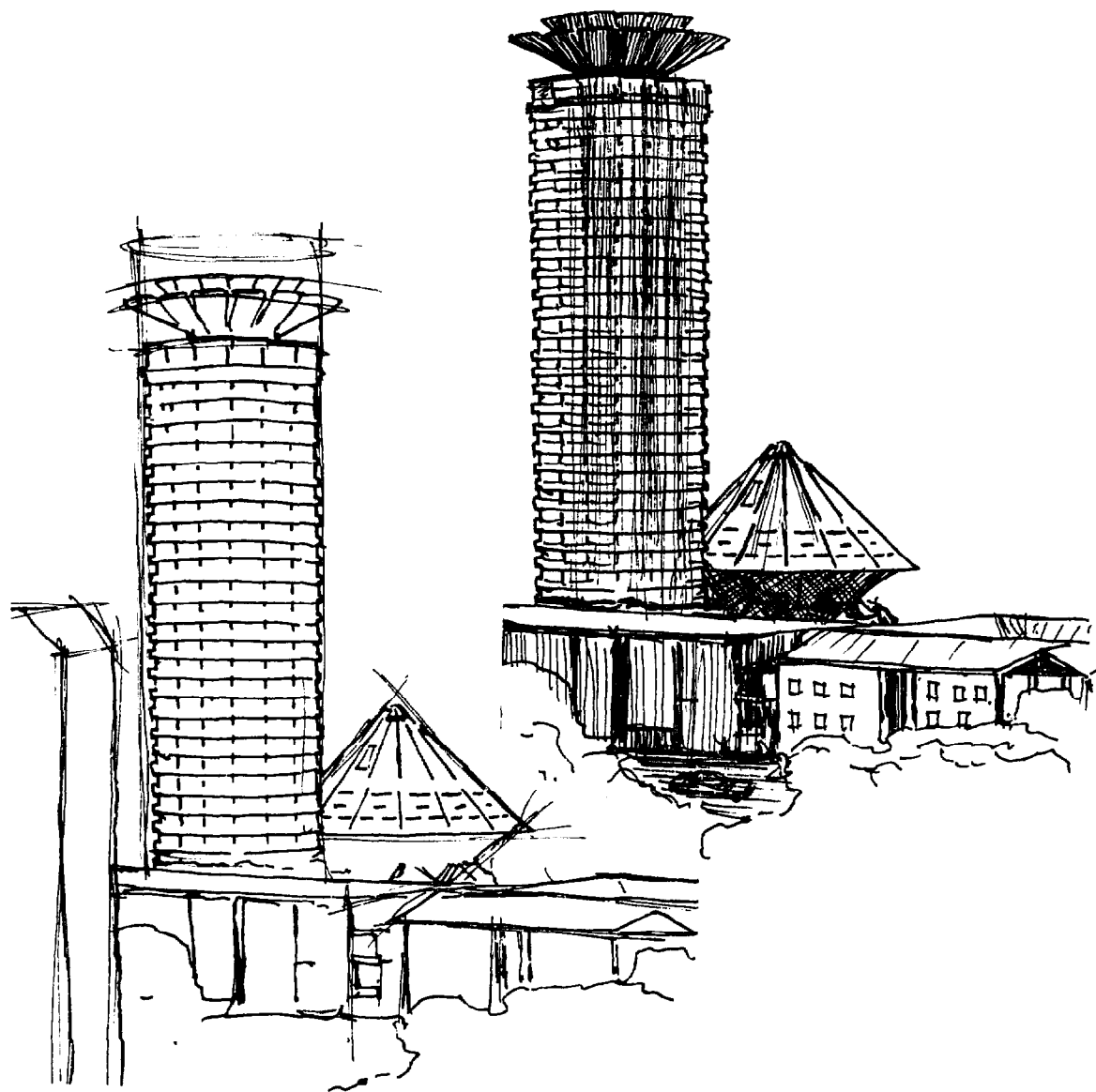

Part 4

Learning to Draw Figures

FIGURE DRAWING:

One of the most important skills of an illustrator for development is skill in figure drawing. In the previous sections of this chapter we discussed drawing as it applied to studying inanimate (non-living) objects. We called that kind of drawing "object drawing", sometimes, objective study. In art, a study of living objects, (creatures and animals) is called "figure drawing or figure study". You might find however, that some creatures come under both types of study, objective and figure studies.

Human Figures:

In this section, emphasis has been placed on human figure drawing because it is the commonest figure in developmental communication visuals. Moreover, it is the most complicated and most difficult figure to draw. However, an artist should make every effort to learn animal figure drawing also. The skills needed for human figure drawing are the same as those needed for animal figure drawing.

Age Levels:

A human being, like all living creatures, exists in various stages. He exists as an infant, a child, a youth, an adult and an old person. I have probably left out one stage, the stage where he exists as a foetus in his mother's womb. Though right from birth a human body regains the same basic component parts, it assumes different characteristics at each of those stages above resulting from the steady and typical physical changes; also, from the varied experience a person gains at each of those stages. At each stage the physical features look different, the proportions are different, the behaviour is different, the expressions are different, the interests are different, the experience is different, altogether, life becomes different.



S.M.B.
80.

NOW
WE COME TO
FIGURES...
THE MOST
DIFFICULT
PART





The Illustrator Needs Special Skills:

It follows, therefore, that an artist who aspires to become an illustrator for development must be able to adjust himself to each of these stages, visualise its characteristics, identify himself with it and finally, be able to interpret its characteristics visually and convincingly on paper for the desired developmental purposes. That is where the problem arises, it is where developing extra skills and perfecting the basic ones (observation, interpretation and presentation) becomes really necessary.

Figures Must Be Recognisable.

Field experience and research have both confirmed the value of pictures of people whom the audience can recognise and with whom they can identify. Field experience and research have also pointed out difficulties in interpreting pictures in which parts of the body are hidden from view either deliberately by a weak illustrator or due to overlapping, foreshortening or perspective. It is thus clear that the artist producing illustrations for development must be able to make clear and realistic drawings of the full human figure in many different poses, and activities, and also with different expressions and moods. (Some successful artists lack confidence when it comes to figure drawing.) The exercises in this section have been designed with a beginner in mind. But a practising artist who was not properly trained in figure drawing may also try them. The few illustration assignments that have been set should be done by every artist because they set problems which might challenge even the experienced illustrator. Remember that the final test of your figure drawing is successful communication of a desired message to the target audience.

Observation: (Observing the Model)

Four things, among others, make a human body very difficult to observe and consequently to draw;

1. Being a living body, it can move and change positions (poses) any time; the illustrator must be sufficiently quick and experienced to be able to capture the original pose and expression before the body moves into new positions.
2. A person has got reason and will power; he can therefore decide to change expressions and moods as he likes, even if he did not necessarily move out of position. (Illustrator) If capture of expression or moods is what you are interested in, you must possess highly developed drawing skills to be able to record those expressions promptly.
3. Again, being a living body capable of reasoning intelligently and controlling his body purposefully, a person can decide intentionally to carry certain messages through certain intended expressions. You must be able to get those expressions correctly.
4. A person conceals his body under coverings like dress, thus making it hard for the illustrator to discover the true form and behaviour (articulation) of the body structure. So, you must know the human body structure and articulation sufficiently well to be able to follow the body through the coverings. Moreover drapery, which is one of the commonest coverings, is very difficult to draw properly.

In this section, we will suggest some simple ways of learning to draw a human figure properly. But we would like to remind you that the only effective means of learning figure drawing is accurate observation and constant practice.

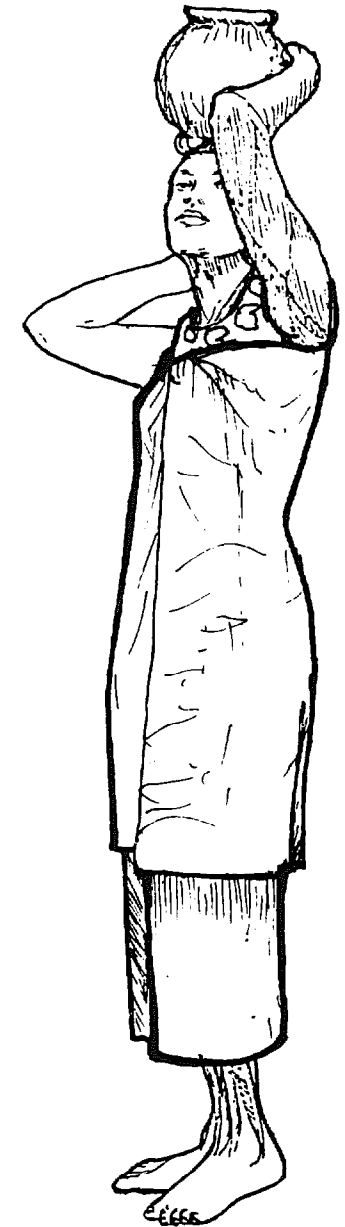
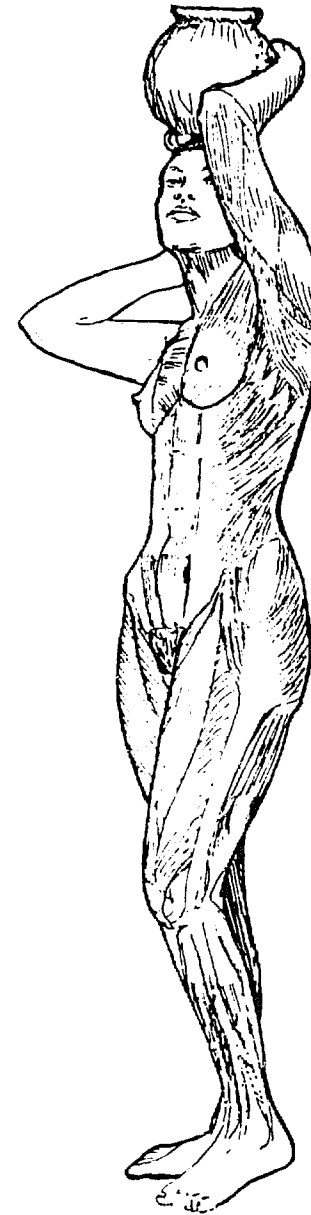
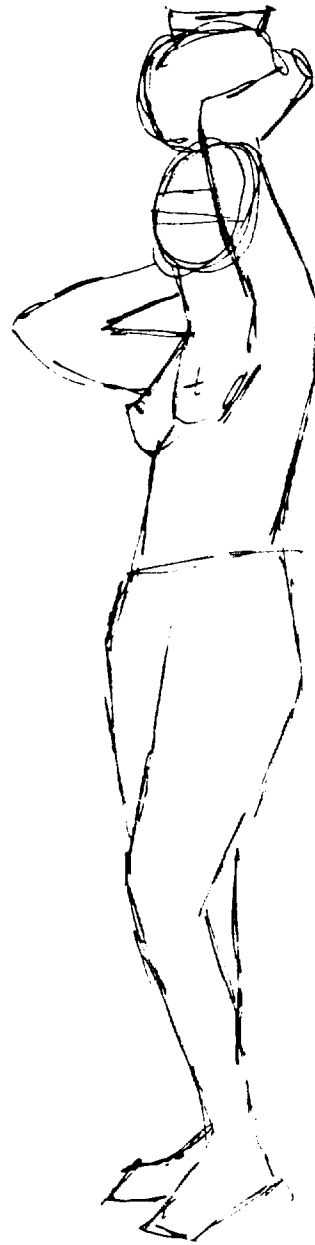

Proportion:

The artist must understand the basic human proportion if his figure drawings are going to appear realistic. This is not to say that he may not choose to distort human proportion in the interest of humour (cartoon style) or emotional impact (emotive messages) involving anger or grief, for example, an artist's distortions will be more convincing if they are a result of purposeful alteration of what is known rather than a hopeless or naive effort to hide his inability or weakness to do so. It does not take a trained artist to tell the difference.

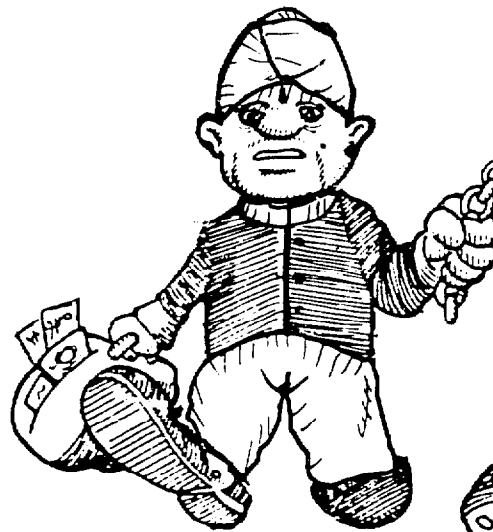
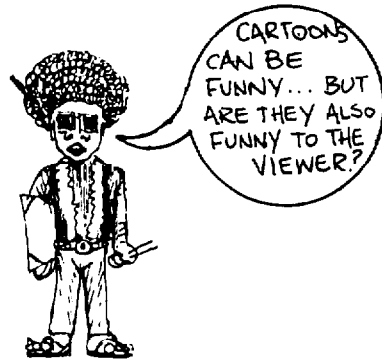

Conventional Proportions:

The following proportions have been mentioned simply for your information. We would not expect you to use them slavishly as they are likely to weaken your power of observation, cause undesirable stiffness in your figures, as well as make your figure drawing become somewhat stereotyped and dry. You are likely to discover also that they apply to very limited cases particularly in an African context.

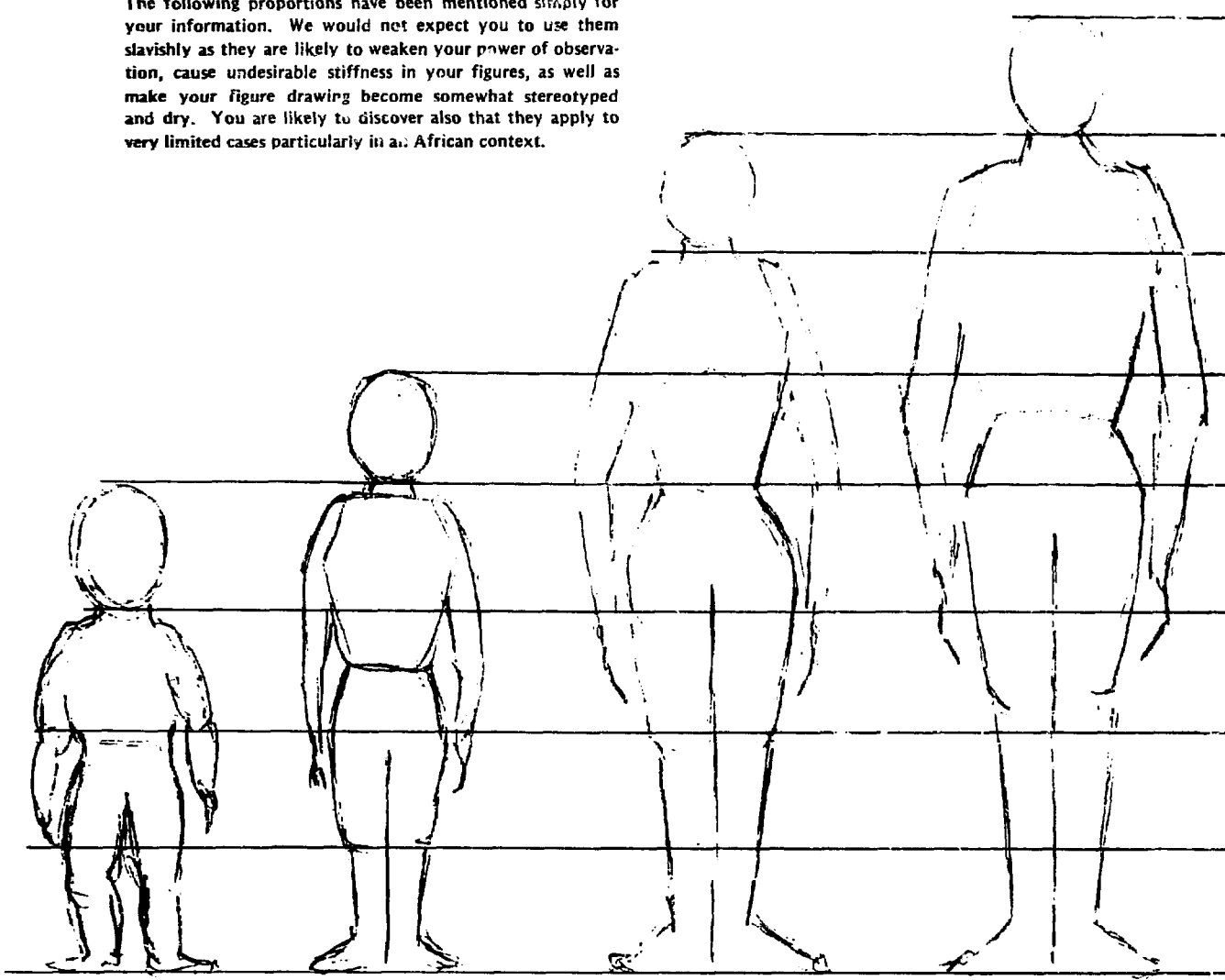

Adults : standard height 7½ heads; varies from 6½ to 8½ heads.

Youth (12 years and over) : standard height approximately adult proportions.

Child 9 – 12 years old : standard height 6 heads

Child 4 years old : standard height 5 heads

New-born child : standard height 4 heads

The head length is used as the artist's standard traditional unit to measure human proportion.

General Observations:

Adult : hips are roughly halfway from top of the head to the soles of the feet;
: finger tips nearly touch the knees in the standing position;
: elbows are located approximately at the waist;

Male Adult : shoulders are normally square and slightly wider than the hips;

Female Adult : shoulders are normally lower and smaller than the hips
: the muscles are less pronounced;

Child (infants) : the spinal curvature is very slight. The head normally appears disproportionately big for the body. The younger the infant or baby the more the head looks disproportional.

Head Proportions. Front View:

The shape and proportions of the head and face are of special importance because human beings meet most frequently "face to face" and it is thus with the face that we identify and relate. The front of the head has been compared to an egg standing on its small end. The front view may be divided with a horizontal line in the middle which will locate the eyes. The nose nostrils are located almost halfway from the eye line to the bottom of the chin. The mouth lies slightly above halfway between the nose nostrils and the bottom of the chin. The ears may be located from a line just above the eyes to a line across from the nostrils. These are the normal proportions for an adult. For a small baby the eye line may be drawn about two-thirds down from the top of the head and about one-third from the bottom of the chin.

Side View:

The side of the head can be constructed from two ovals. A flattened oval includes the top of the head, the back of the head, the bottom of the ears, the forehead, and the cheek bones. An elongated oval includes the face from the top of the forehead to the bottom of the chin. As the head turns (making what is called a three-quarter view) the shape is a combination of the two figures.



Gesture Drawings

Some artists begin with a "gesture drawing" when drawing figures. The gesture drawing consists of free-flowing, bold, continuous lines which quickly indicate the full pose, the "gesture", of the figure. If started very lightly, the artist can build up his figure by strengthening the lines as the drawing becomes better defined. Whatever method is used, the purpose of this step is to begin sketching the whole figure before concentrating on the details.

Figure Balance

It is important to make your figure stand or move convincingly. We call it articulation. It is important to check the placement of the figure in relationship to the sides of the paper. In a drawing of a figure standing erect, a line from the head straight down to the feet, or between the feet should be parallel to the sides of the paper and perpendicular to the base side. If this is not so the figure will incline and appear to be falling.

The line of weight is important to any figure postures if the figure is to stand. On the other hand if the figure is slanted so that the line of weight is outside the feet (or other points of support such as knees or hands) then it is possible to represent movement such as falling or running. This convention may not be effective with the target audience not accustomed to looking at pictures and must be pretested if used.

However, sometime figures showing action convey messages more meaningfully to the audience than unnecessarily static ones.

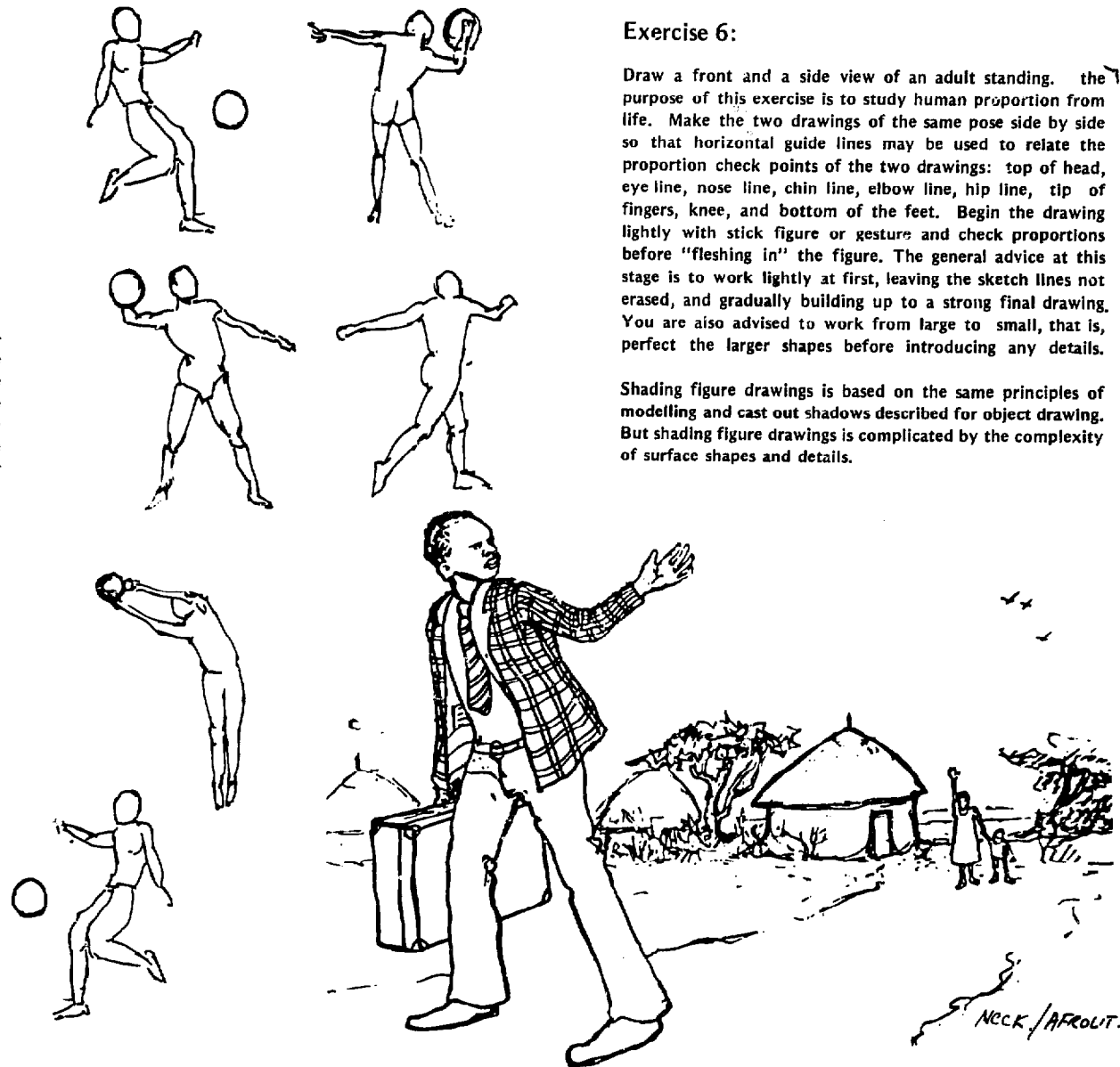

Exercise 6:

Draw a front and a side view of an adult standing. the purpose of this exercise is to study human proportion from life. Make the two drawings of the same pose side by side so that horizontal guide lines may be used to relate the proportion check points of the two drawings: top of head, eye line, nose line, chin line, elbow line, hip line, tip of fingers, knee, and bottom of the feet. Begin the drawing lightly with stick figure or gesture and check proportions before "fleshing in" the figure. The general advice at this stage is to work lightly at first, leaving the sketch lines not erased, and gradually building up to a strong final drawing. You are also advised to work from large to small, that is, perfect the larger shapes before introducing any details.

Shading figure drawings is based on the same principles of modelling and cast out shadows described for object drawing. But shading figure drawings is complicated by the complexity of surface shapes and details.

Exercise 7:

Make a series of figure drawings of a variety of persons built up from a collection of rapid sketches. The illustrator for development must frequently produce pictures that distinguish between old and young, man and woman, child and adult, healthy and sickly, fat and thin. He is also called upon to draw figures hoeing, digging, running, sleeping, feeding a baby, applying first aid, going to the toilets, bathing, and endless number of activities necessary for communication of developmental messages. This assignment may begin with a series of short poses by a model, or better you may carry paper and pencil to places where there are a lot of people and sketch them as quickly as you see them. You may begin with gesture drawing. After you have made at least 20 of these, choose several of them and work them into full drawings. You may ask someone to pose in the manner of your sketch. But try to preserve the freshness of the original sketch, avoiding the stiffness of the longer pose. As soon as possible begin experimenting with drawing ink either as a final completion of the drawing begun in pencil, or as a drawing developed entirely in ink. Put in more emphasis on constant sketching or study, with particular emphasis on pose/articulation, expression and dress (coverings) or exterior appearance.



Photography and Realistic Drawing:

Some artists have found photographs a good resource for developing figure drawings. The artist may wish to build up resource files not only from his own sketches, but also clippings and photographs that will be a source of information for clothing and hair styles as well as aids to construct figures doing a series of tasks. One method of building appropriate figures for specific illustrations is the following procedure:

A developmental project may require illustrations picturing members of a target audience solving some developmental problem. The illustrator presents the problem to a target audience community and encourages them to act out the problem and possible solutions. While the group is acting out the situation the illustrator photographs them as they act. These photographs then provide material for the illustrations he draws. In this manner the target audience actually participates in the design of the visual materials.

The important thing to remember is that a good photograph does not automatically become a good drawing. The selection and elimination of detail, and the modification and simplification of figure construction and the composition of the picture may require as much creative effort and skill as working life. The test of the illustration is the success of the message and not the method used to produce it.

Assignment 4:

Make a poster that illustrates ways to prevent a bedridden patient from developing bed sores. Illustrate the following directions:

- (a) Turn the sick person every hour—face up, face down, or from one side to the other.
- (b) Put cushions under the person in such a way that the bony parts rub less.

Assignment 5:

Pretest, analyse responses, and redraw the assignments as previously directed.

CHAPTER 4

COMPLETING THE WORK

Part 1

How to pretest drawings

For effective communication to take place the intended message must be presented clearly to the recipient. We cannot claim fully to have communicated the message until the recipient of the message responds positively to his expectation. An illustrator generally finds it difficult to communicate because his illustrations are always left to the audience to visualise and interpret them. The interpretation of illustrations largely depends on the particular audience's perception and understanding of the picture. It is therefore important that an artist should pretest his work before introducing it on a large scale to the target audience.

(a) The Use of Pretesting

Pretesting will enable the illustrator to:

- (i) Ascertain that his illustrations are appropriate and relevant to the target audience.
- (ii) Determine as early as possible whether the illustrations will produce the expected behavioural changes.
- (iii) Determine what is to be deleted or whether modification can improve the illustrations for an effective communication of the message or not.





(b) Methods of Pretesting

There are various ways in which an illustrator can find out whether the message is being communicated to the audience as designed.

For example, consumers of the message and other people involved in the literacy campaign exercise may be requested to give their judgement, opinions and reactions to particular illustrations. Such information may be gathered in the form of interviews, questionnaires and direct questioning. Here is an example of some of the direct questions:

- (i) Can you tell what this picture is about?
- (ii) Do you think other people will understand this picture?
- (iii) Is there anything in this picture that will offend your friend or you?
- (iv) What do you think the message in the picture is trying to put across?
- (v) What kind of people will be most interested in looking at this kind of picture?
- (vi) What did you learn from this picture?
- (vii) Describe what is happening in this picture.

(c) Involvement of Communication Team

Members of the communication team can be requested to observe the reactions of the target audience in response to a particular illustration. In their observation, the team members could be asked to record their findings objectively. Examples of such records could be:

- (i) The target audience was excited by the picture.
- (ii) The target audience can interpret the message.
- (iii) The target audience can relate the learning experience from the picture in an accurate way.
- (iv) The target audience needs are fulfilled by the illustration.
- (v) The message intended is easily communicable.

- (vi) The illustration is offensive.
- (vii) The picture is understood but the message is too controversial to be accepted.

The team may also be asked to make personal judgements and recommendations as how the facilities to develop particular concepts, skills, abilities and attitudes can be improved in a particular learning situation.

The target audience with the help of the extension workers, local leaders and adult educators can be asked to speak openly on their understanding of a particular illustration.

For example:

1. Give a short description of the message contained in this picture. An oral discussion in an informal setting between the artist and the consumers of the message can greatly assist in identifying where the communication barriers exist.

“Is the illustration feasible and practicable for use by the target audience?”

“From the given illustrations, how accurate do you perceive the intended message to be?”

“How relevant is the illustration in relation to the intended message?”

“What suggestions can you make in correcting errors or the inadequacies that you may perceive?”

2. Take an illustration that does not fully carry the message you intend to communicate and ask the target audience to fill in more information in it.

“Do the target audience need more explanations in order to interpret the message correctly?”

“Does the artist need extra training to improve his skills in order to facilitate communication for development?”

Compare this picture to the same one on the next page.





“Does the artist need extra skills to interact with the target audience?”
“Is the language used in the caption simple and clear for the target audience?”

“Is the illustration at the right level of the target audience’s ability to interpret, that is, is the illustration too technical or unnecessarily detailed?”

“Is the target audience likely to find the illustration appealing?”

“Are there any special problems the artist should have catered for in the illustration for his target audience in order to facilitate easier communication of the message?”

“How relevant is the illustration in relation to the target audience’s interests and aspirations?”

(d) The Need to Modify and Change

It is in the light of the answers to the above questions that the need for modification, change and revision will come. It is important that the revision method should reflect the desired change of behaviour that is expected when the message reaches the consumer.

For the message to reach the audience effectively, a proper feedback system that has proper and well co-ordinated continuity to enable easy flow and outflow of the message must be established and adhered to. Constant review of this feedback system is necessary so as to keep up with changes in attitudes, interests and aspirations of the target audience.



CORRECT.
YOUR WORK
BEFORE FINAL
PRINTING.

Part 2

Has the planning process been followed?

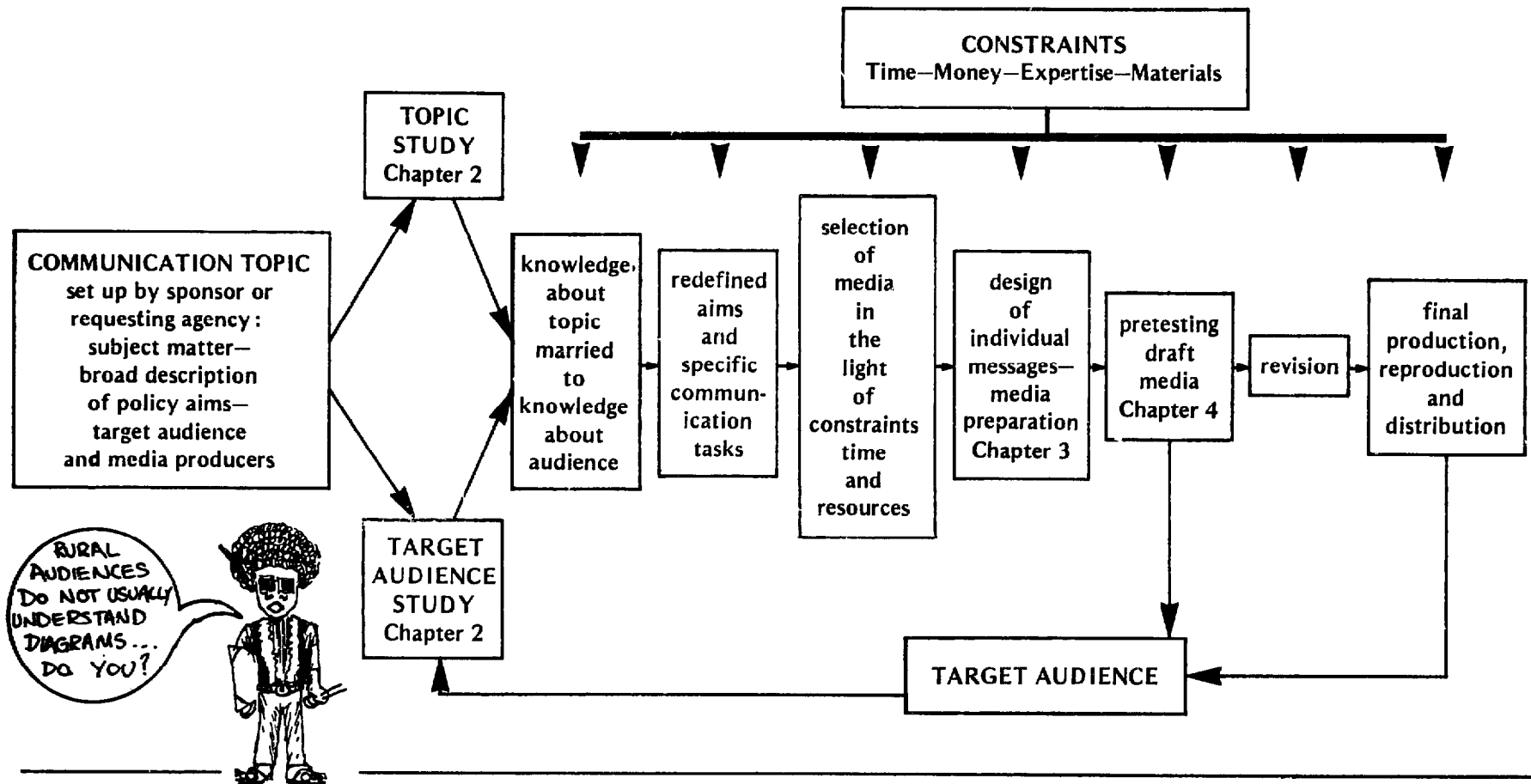

Part 3

Final Layout and Reproduction Techniques

The artist's last job is to hand over his work to a printer so that it can be reproduced in large numbers. But although it is his last job it must be among his first considerations while working.

There are many books written on printing techniques, so we will not go into detailed descriptions in this manual. However it is important to remember that the artist should familiarise himself with the techniques which are available for him to use in his area of work.

Line drawings are the easiest forms of art to reproduce. They can be traced onto stencils which are used on the simplest of printing machines. But if you have shaded your artwork with water colour, charcoal or pencil then it needs to be reproduced through a screen. However it requires a high degree of skill from the printer to screen and print wash drawings nicely, since he does this in the same way in which he prints photographs.

A "halftone" is made by screening the wash drawing or a photograph. The screen is placed over the artwork and breaks it up into small patterns of dots, just like the dots you added yourself in the drawing exercises earlier. A plate is made and then used for printing the image onto paper.

To make it easier for the printer the artist can do line drawings in pen and ink, shading in the necessary parts with dots or hatching and presenting to the printer an image which can be reproduced looking exactly the same.

If any other technique is used by the artist such as pencil, charcoal



The Artist must now learn about straight lines and Lettering.

or wash drawing he must first inquire whether or not the intended printer has the facilities and skills to reproduce his work. He needs to check if the cost is within the budget.

Layout involves the positioning of illustrations beside written text. For posters it is a fairly easy task but it becomes more difficult for pamphlets and books. However the principles remain the same.

The artist may be responsible for final layout. This means his drawings and illustrations are pasted up next to captions or text for the printer. At this stage the artist needs to become more aware of straight lines and neatness. Let's go over some of the simple points to consider when laying out or lining up for final layout.

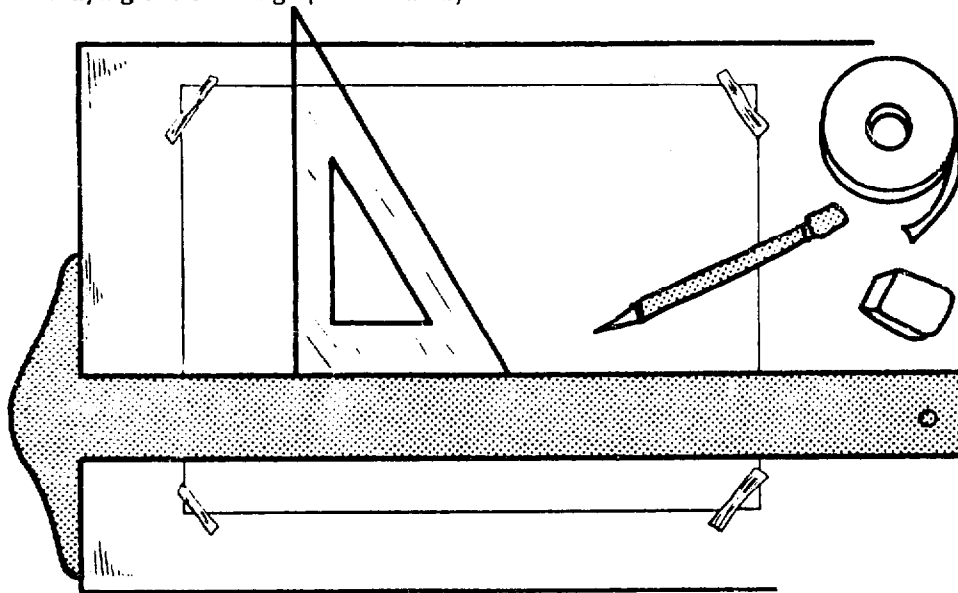

The first consideration in lining it up is to decide what size and shape you want your artwork or lettering to be. The size and shape you choose will depend on how you plan to use the visual. There are no

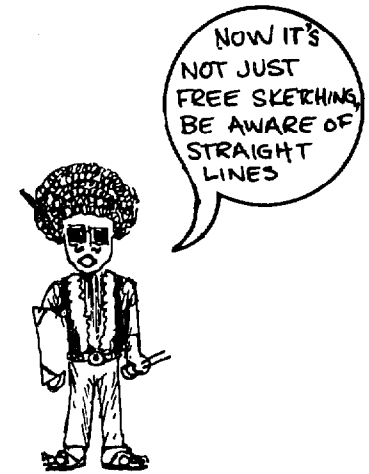
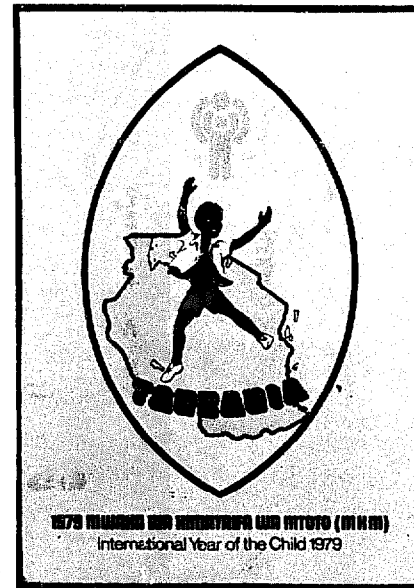

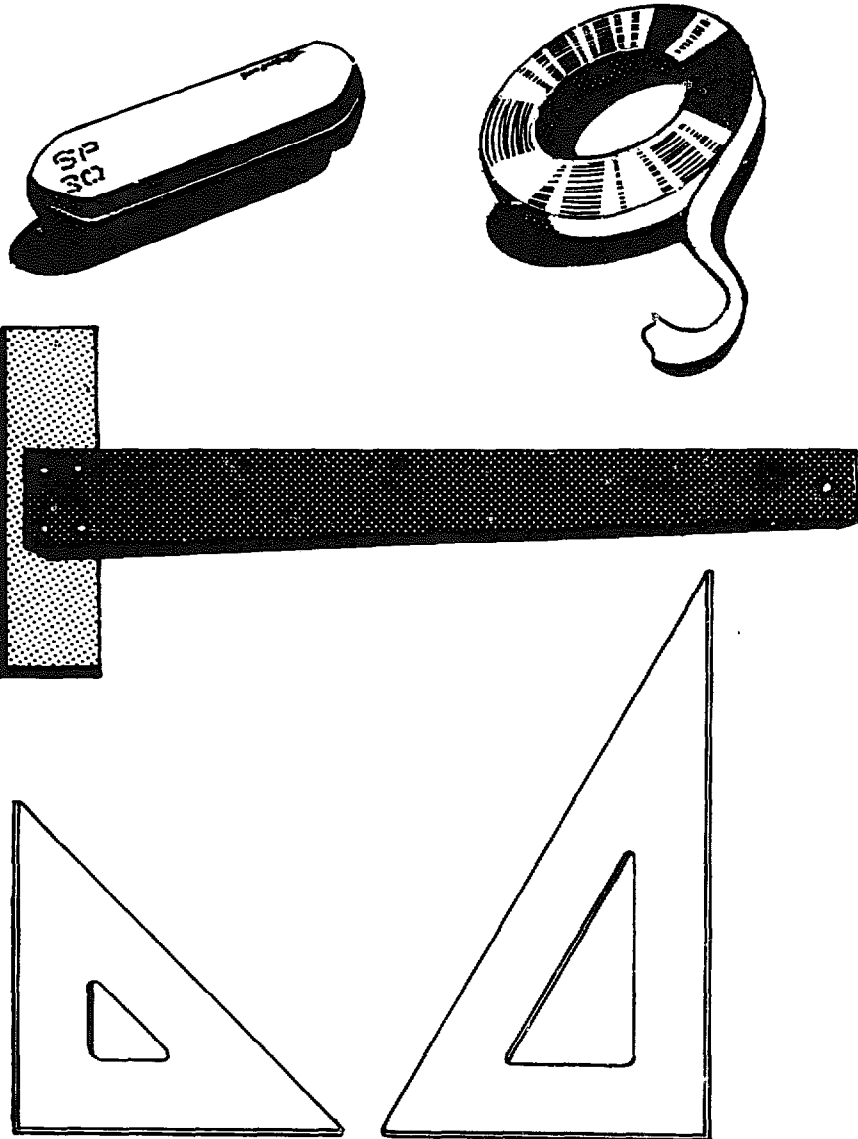

rules to follow except the obvious one that people must be able to see it. (The greater the viewing distance, or the older the viewer, the the larger the print will need to be to be readable).

Basic tools include:

MASKING OR DRAFTING TAPE for securing paper. Do not use scotch tape since scotch tape tears paper when it is lifted off the backing.

ERASER for removing smudges and unwanted lines. Guidelines for artwork which are not to be printed will need to be erased.

T-SQUARE for making a true horizontal edge. The curved end fits snugly over the desk, table or drawing board surface. Make sure the top to the T-square fits evenly against the side of the desk or drawing board so that you get an accurate line.

TRIANGLE for making a true vertical or diagonal line. It sits on the ruling edge of the T-square.



OPEN SPACES give viewing eyes relief. Don't feel you have to fill up every corner of a visual to get your time and money's worth. Simplicity is much more sensational than complexity.

CLEAN COPY means keeping heavy, smudgy hands from touching or rubbing the paper surface.

Lettering

Lettering can be hazardous for some people; therefore, this section will introduce you to various means of lettering and hopefully direct you to a satisfying, unfrustrating future.

Letters are either:

SERIF (curly or decorative end) or **SANS-SERIF** (straight, no curls) Letters are made in various styles called Faces. Optima is a modern Face which is Sans-serif. Book faces are usually made with serifs. Times Roman has an open serif easily read. Generally, serif lettering is hard to read if it's as ornate as Old English. Use straight, open letters for your visuals, and you will have better response from viewers.

Letters come in a variety of point sizes (heights). It's important to know the differences when purchasing transfer letters or getting something typeset for printing. Standard textbook type is usually 10 or 12pt. Primer type is usually 16 pt, or 18 pt in a few languages.

There are 72pts in one inch. So 36pts is a half inch high type face. For good visuals from a distance, type needs to be at least 48pt for easy readability.

Legibility in Typefaces for Layout

1. Use a type style familiar to the majority of readers: Sans-serif for primary school readers;
2. Use shorter rather than long lines—general rule not less than 35 or more than 55 characters per line of type;
3. Use 2pts between lines to increase legibility—Don't type solid for inexperienced readers;
4. Separate paragraphs with at least one line of space, indent 2cms whenever possible in text to increase legibility.



P SERIF.

P SANS SERIF

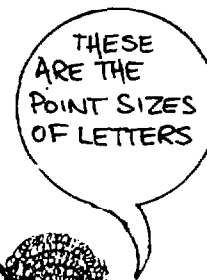

6 ABCDEFGHIJKLMNOPQRSTUVWXYZABCDEFGHI
8 ABCDEFGHIJKLMNOPQRSTUVWXYZ
10 ABCDEFGHIJKLMNOPQRSTU
12 ABCDEFGHIJKLMNOPQR
14 ABCDEFGHIJKLMNOP
18 ABCDEFGHIJKLM
24 ABCDEFGHI
30 ABCDEFG
42 ABCDE
48 ABCD
60 ABC

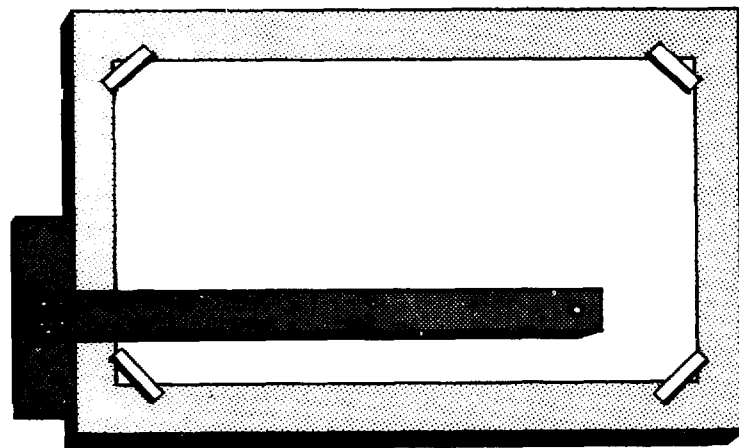
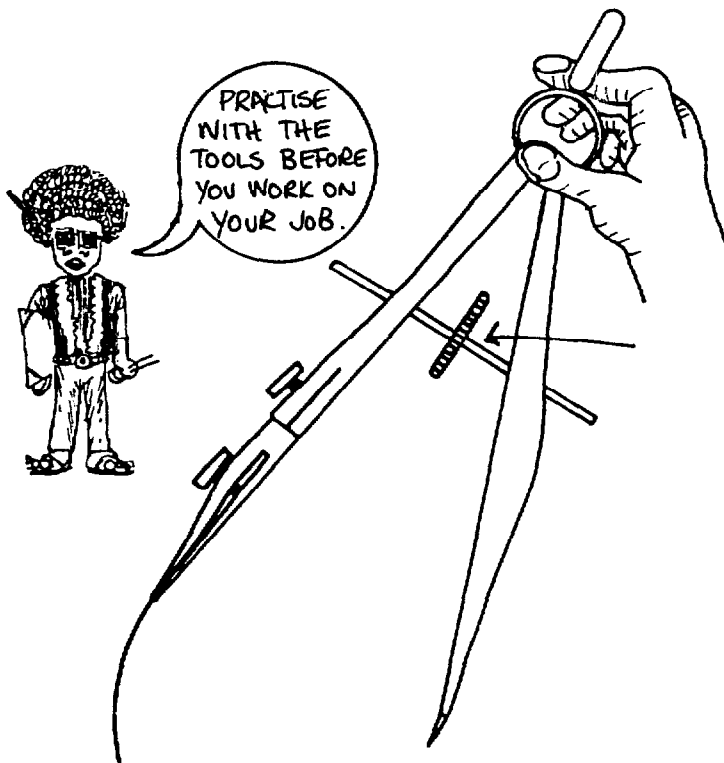

OTHER USEFUL TOOLS

COMPASS — Although a circle template gives you a fair choice of different sizes, a compass will handle every size you're likely to need. Get at least a 6-inch compass with both inking and penciling points, if you are only going to buy one. You can also get an extension arm that allows you to make circles up to 14 inch in diameter.

The inking point fits into the same position as the pencil point.

If you don't feel you can justify all these tools, often, you'll find something sitting around the office which has just the right edge. Hole punchers and staplers have nice curved edges which make attractive corners. Bottles, glasses, ashtrays, jar tops ... just look around and use a little imagination.

The next step is squaring your paper on the drawing surface and making your guidelines.

The drawing surface can be any smooth-topped desk or table. Portable drawing boards which can be placed on top of another table are available.

Line up your paper or artboard by placing the bottom edge evenly on the T-square's ruling edge and taping at least two corners to keep it from slipping around. Now you can use the T-square and Triangle to draw your guidelines. Accurate guidelines cannot be over-emphasised. You will need good straight parallel guidelines when you:

- Set margins.
- Align columns.
- Place illustrations in an appealing relationship to verbal content.
- Keep lettering straight.
- Balance information to achieve maximum visual or message impact.

Consider the following when designing your materials:

HAND LETTERING

It's quick. Beauty and artistic talent are not requirements. Just legibility and simplicity. Use black ink or black flair pen for materials to be xeroxed or printed. Magic markers are useful for posters.

TRANSFER LETTERS

These provide the professional look. Great for headlines or key words on posters, pamphlets.

Numerous (rub-off) type faces (styles) are available. Chartpak, Velvet Touch, Letraset, Normatype, Press-type and Artype are some of the brand names.

These are mostly available in black or white but some styles are available in red, green, yellow and blue. They are sold in art stores, book stores, blue print companies and office supply stores.

PRE-CUT ALPHABETS

Good for titles or short sentences on cork boards or poster boards. Quick way to make directional signs or notices.

LETTERING STENCILS

Available in plastic or thin card stock paper. Use as you would a template with pencil, flair pen or ink. You can purchase ink pens with flat or dull points just for use with stencils. (Wrico and Rapidograph are two brand names.)

Among your art supplies, you will want to have a sharp pair of SCISSORS, an X-ACTO KNIFE and the availability of a CUTTING BOARD

HAND LETTERING IS QUICKLY DONE.

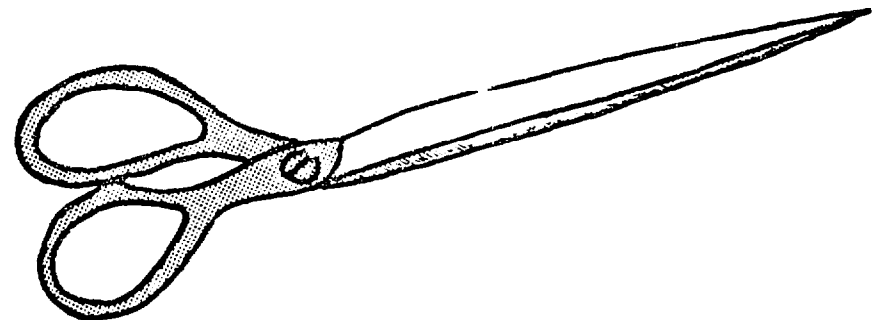
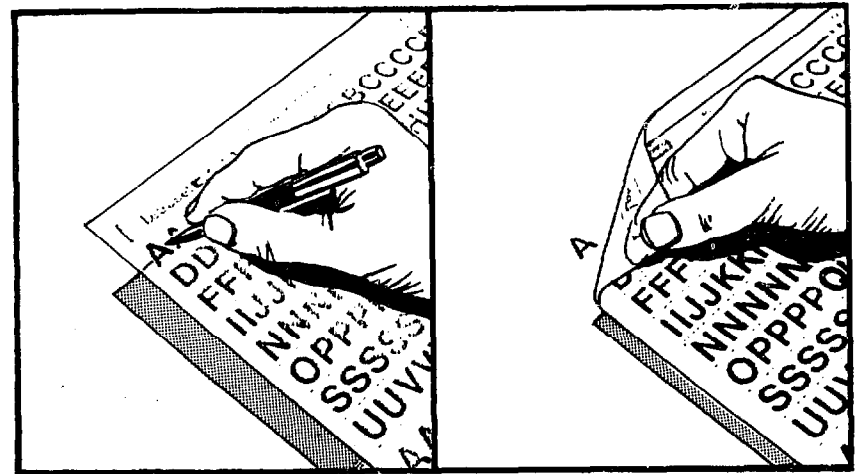

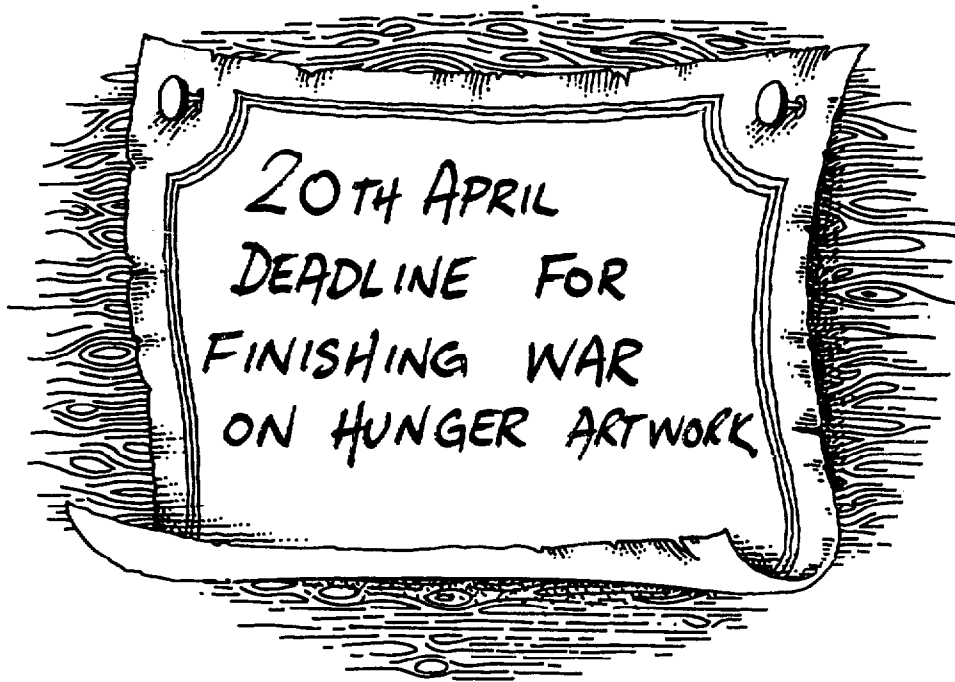
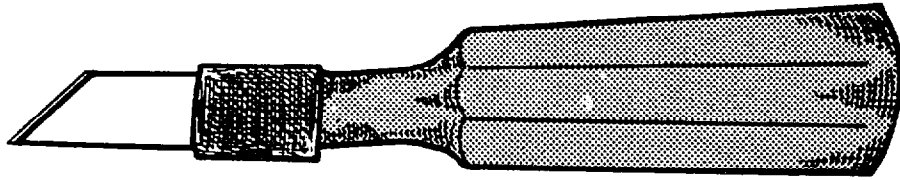

if possible. The cutting board is great for cutting large mat boards for displays, since these colored poster boards often come in 30" x 40" sizes.

X-acto knives are necessary for cutting adhesive colored papers or screens and can be used for many other tasks:

1. cutting a straight line;
2. cutting a circle;
3. cutting colored tapes for maps, slides, displays or transparencies;
4. cutting a picture mat or frame, but this takes patience if the frame is mat board or something heavier.

Part 4

Meeting the deadline

(a) The Need for Clarity in Setting Deadlines

When the initiator takes his work to the artist, he should discuss with him the date of delivery of the illustrations. This deadline must be acceptable to both of them and should allow the illustrator ample time to do the job properly. The need for clarity in setting deadlines can be seen in the example below:

Mr. Omenge, an administrator of the War on Hunger Programme has set 24th April as the day to launch this year's anti-hunger campaign in his home town. In January, he consulted an artist in the area to assist him to make illustrations for his project. The artist agreed. He told him that bright colourful wall posters, a few billboards and bumper-stickers with catchy slogans would fit the situation. But April 15th has arrived, Mr. Omenge is waiting impatiently. The artist is trying hard to finish the work, but he has had many interruptions: his children are sick, his uncle died and he took some time off for the mourning, and supplies for the studio were hard to find. All these

problems made it difficult for him to finish the work, but he hoped he would do it when the situation improved. So there are no illustrations. Mr. Omenge will launch the campaign without fanfare.

What went wrong? Is anyone to blame? Who? Why? If you faced the same problems, what would you have done?

(b) Compromise on Deadlines

It is necessary for the artist and the sponsor to discuss the deadline. The deadline should allow the artist sufficient time. Some sponsors having no idea how long it takes an artist to finish a poster or an illustration, may set a three weeks' deadline for work which would take an artist about six weeks to produce. Only the artist will know how long it will take him to finish a piece of work. The deadline represents a compromise between the artist and the sponsor. It should also make allowance to give the printer enough time to finish the work in time.

The artist must also take care to finish the work and deliver it to the sponsor on time. He must gauge (estimate accurately) the time he needs to do certain kinds of work. His reputation will suffer if his work is late. Even a masterpiece is of no value if it is prepared after the campaign is finished or after the book is printed. An artist should always contribute to the setting of the deadline. If the sponsor fails to bring up the matter, he should ask: What deadline do you have in mind? Each artist has his own way of arranging family matters, etc., so as to meet the deadlines. But what we all have in common is the need to be right on time with the work.

Fortunately in most cases, an artist can meet the deadline. But how can he do it? The best way is for him to be prepared to work long hours and include weekends in his working week. It may sometimes be difficult if the house where he stays is small. This problem can be overcome if he converts one of the corners of his house into a "studio".

War on Hunger



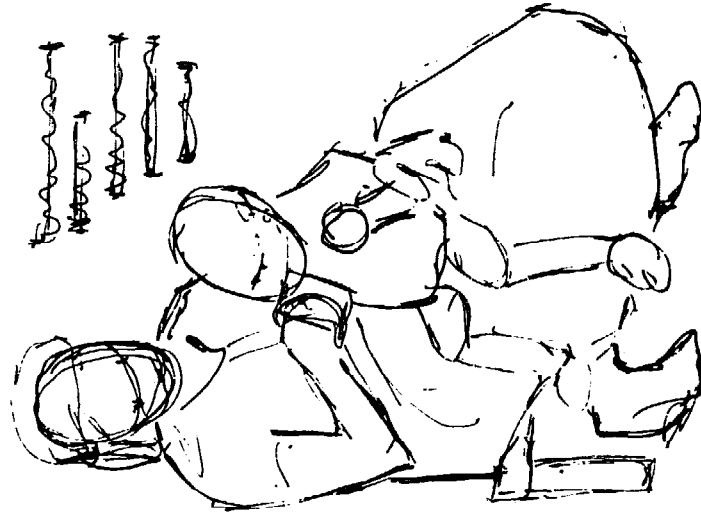

Bottles are difficult to clean.

It is safer to cup-feed your child.

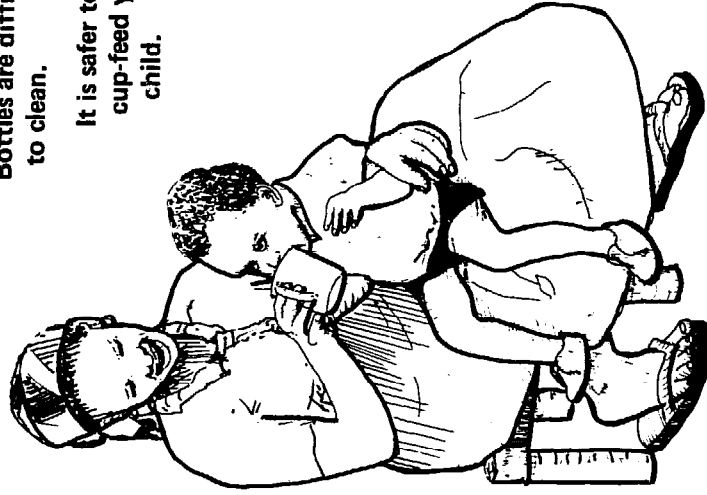

Getting started is perhaps a bigger problem in meeting a deadline than "getting finished". Usually the artist puts on and off his start at the beginning of the work because, let us face it, a blank piece of paper is frightening to even the most experienced illustrator.

Some artists visualise their ideas and put them down in rough form. An experienced artist may walk with a small sketch book in his pocket so as to make rough sketches as he waits for a bus, sits in a pub, etc.

CHAPTER 5

ILLUSTRATIONS FOR DEVELOPMENT AS A CAREER

Drawing is still one of the best disciplines an artist can learn: it serves the memory of the would-be observers, and once you have drawn something you will remember it.

Before students leave art training institutions, they should be able to draw well both figures and objects, to work in a media that will easily reproduce, and to illustrate an idea in an attractive way. It is up to each individual student on an art course to see that he has enough command of the technique by practising the discipline of drawing. Dress and fashions change rapidly in the developing world but the basic skills do not.

Can the institutions do more to help the newly trained illustrator? There are many stories from students who leave art training institutions, including universities, with none of their work; as a result they cannot immediately find the resources to make themselves a portfolio. It seems crazy that art institutions should keep the work of their students only to leave it rotting in a cupboard after the yearly show. If an artist is to survive as an artist, he must have a portfolio of his work he can show to his prospective clients as credentials.

To Sell Yourself as a Development Illustrator

Keep your portfolio as up to date as you can. Your line work is most important since clients will view it as cheap to reproduce. Show some of the more controversial messages that you have attempted to illustrate, but be sure that the illustrations will be understood by the intended audience. Clients will most likely believe what you say, but failure in communicating the clients message could mean fewer commissions.

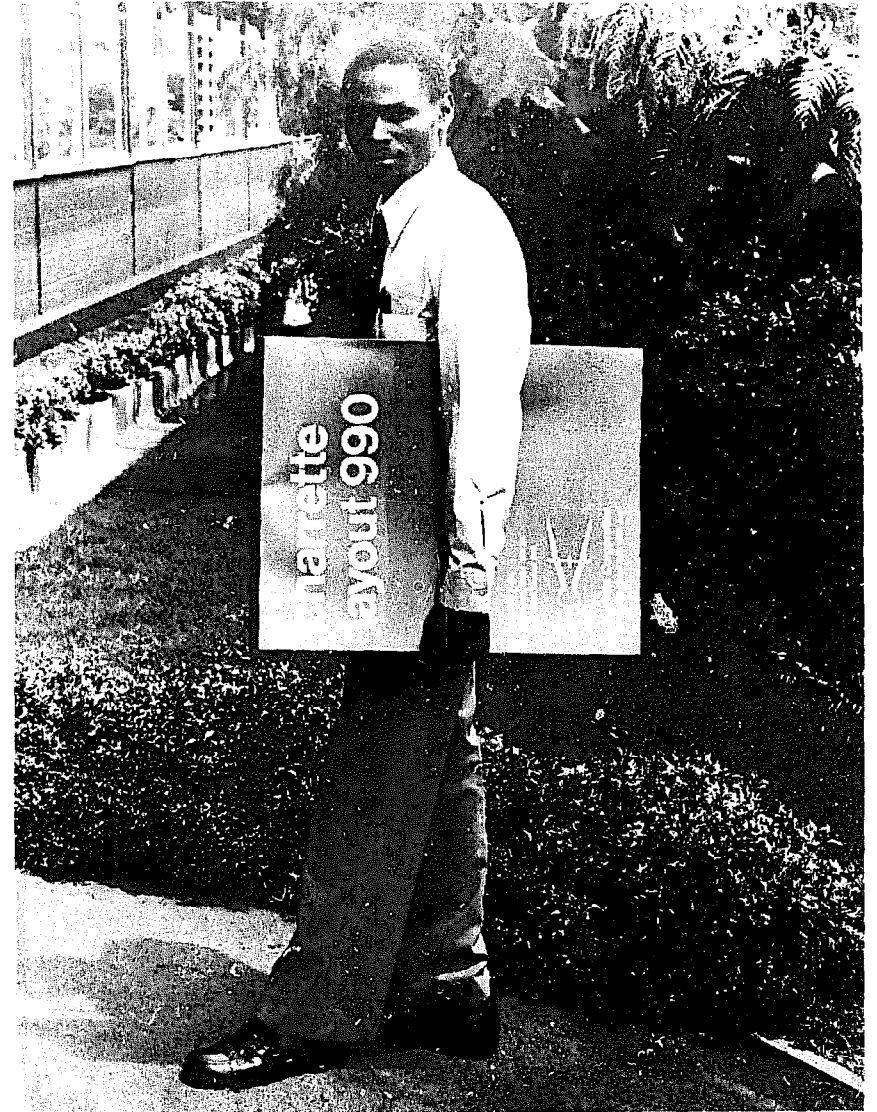



The commercial sector as well as the urban and rural areas are potential markets for young artist's products. If you can show you can communicate with rural people, you may well have a job.

Initial Expenses

The movement towards realism in African Art must begin with the artist and his skill, and in the beginning he may have to meet the expense himself. Once he can show what he can do, more people will become interested in his work. Collect posters produced by various ministries of health, agriculture, and also those for general information messages and improve them.

Mount an exhibition on the subject "illustrations for development" and show your expertise. It may also be an idea to have visiting cards you could leave with potential clients for future contacts.

Advice to Improve Illustrations

- (i) Constantly experiment—as a rule you are only asked to do work which you have already done. So if you want to progress and expand your scope it must come from experimenting with new messages which you feel have never been tackled before.
- (ii) Do not always do work which you feel compromises your artistic standards. You should take pride in your work, but never be satisfied with your standard as an artist.
- (iii) Take an active interest in what other artists in the field are doing.
- (iv) Re-appraise your work, think about it, talk to others about it, try to define your strength and weakness.
- (v) Remember the work of artists you admire; study what it is about their work you admire. Try and relate to the element in their work which attracts you. Then find out from your audience what they like about your own work and develop it.



Fwanya



A group of boys came along to watch. Fwanya told them that Patrick was learning the secret of wood-chopping.



The boys begged to try using the axe and Fwanya finally agreed to give each one a turn.



Soon all the wood was chopped. Fwanya's mother asked how he had finished all the work so quickly.



"I have a secret way," said Fwanya. "Some day I will show you. Now may I visit Joseph?"

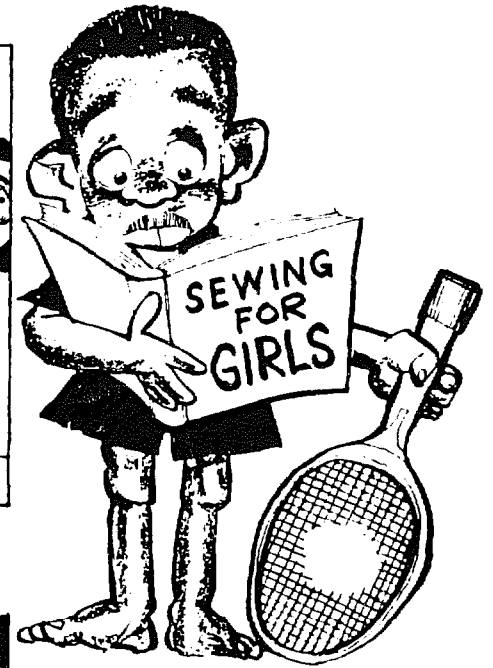

Here are some good examples of Artwork. Artist Feliciano Bwalya who works for Orbit Children's Magazine in Zambia is among the best cartoonists in Africa today.

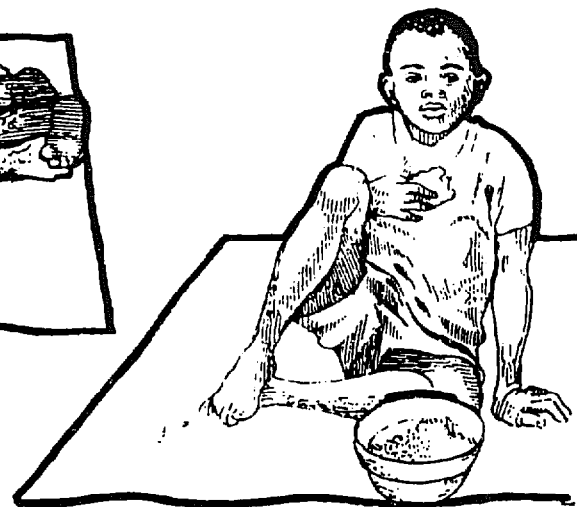
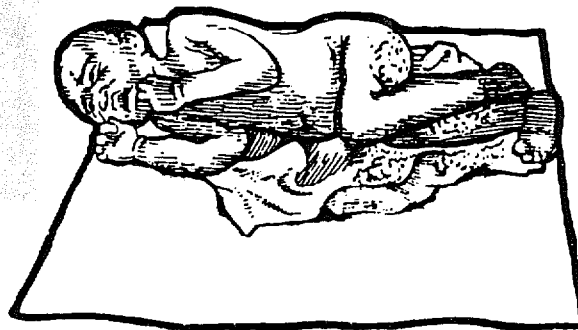

The Development Illustrations of Artist Marina Maspero who is working for PBFL in Swaziland should also be mentioned as exceptionally good.

APPENDIX I: WORKSHOP FOR ARTISTS FORMAT

The training of Artists can take place in a number of ways. There can be pre-service training workshops for newly employed artists or in-service training for those already employed. Artists can come for one day's training every week over a period of time or they can attend a full-time residential course. The "way" and the "how long" really has to be decided by whomever is sponsoring the workshop.

However the content of an Artists' Workshop could be based on the chapters of this manual, expanded to meet the needs of participants.

When planning an in-service workshop establish a suitable venue with the facilities which an Art Class require. The selection of participants should be kept to a manageable size. Participants can be drawn from the production departments of various Ministries, NGOs and Literacy Agencies. Permission for the release of the artists should be sought in advance, and the experience and capabilities of the workshop participants should be considered in the content and timetable of the workshop.

The workshop should contain as much practical work as possible. The testing and evaluation of the work produced should be done in a rural setting. So it may be necessary to arrange trips into the rural setting in advance. An accurate timetable can be made after these considerations.

The success of any workshop can be measured in a few ways; the visible improvement of professional ability in the artist; the increased awareness amongst the community of the visual media; and the recognition of illustrated materials and their messages by the community.

More difficult to measure would be the adoption of the ideas conveyed in the messages by the community.