

AT MICROFICHE
REFERENCE
LIBRARY

A project of Volunteers in Asia

How to Make Tools

Peace Corps ATFD Reprint No. R-35

by: Per Christiansen and Bernard Zubrowski

Published by:

Peace Corps
Information Collection and Exchange
806 Connecticut Avenue, N.W.
Washington, DC 20525 USA

Available from:

Peace Corps
Information Collection and Exchange
806 Connecticut Avenue, N.W.
Washington, DC 20525 USA

Reproduction of this microfiche document in any form is subject to the same restrictions as those of the original document.

APPROPRIATE TECHNOLOGIES FOR DEVELOPMENT

How To Make Tools

Peace Corps

INFORMATION COLLECTION & EXCHANGE

REPRINT NO. R-35

INFORMATION COLLECTION & EXCHANGE

Peace Corps' Information Collection & Exchange (ICE) was established so that the strategies and technologies developed by Peace Corps Volunteers, their co-workers, and their counterparts could be made available to the wide range of development organizations and individual workers who might find them useful. Training guides, curricula, lesson plans, project reports, manuals and other Peace Corps-generated materials developed in the field are collected and reviewed. Some are reprinted "as is"; others provide a source of field based information for the production of manuals or for research in particular program areas. Materials that you submit to the Information Collection & Exchange thus become part of the Peace Corps' larger contribution to development.

Information about ICE publications and services is available through:

Peace Corps
Information Collection & Exchange
Office of Programming & Training Coordination
806 Connecticut Avenue, N.W.
Washington, D.C. 20525
(202) 254-7386



Add your experience to the ICE Resource Center. Send materials that you've prepared so that we can share them with others working in the development field. Your technical insights serve as the basis for the generation of ICE manuals, reprints and resource packets, and also ensure that ICE is providing the most updated, innovative problem-solving techniques and information available to you and your fellow development workers.

Peace Corps

HOW TO MAKE TOOLS

by

PER CHRISTIANSEN

and

BERNARD ZUBROWSKI

This publication was prepared in conjunction with Preserving Food by Drying, Manual M10, and has been designed to assist you in producing tools and equipment that can be used by both yourself and members of your community. Some of the items in this publication were published originally as "Tools for the Classroom" by Per Christiansen, Bernard Zubrowski and others through the Education Development Center of Newton, Massachusetts under US/AID contract csd-772.

Peace Corps

Information Collection and Exchange

Reprint R 41

July 1980

September 1981

CONTRIBUTORS

Per Christiansen served as a Peace Corps Volunteer in the Philippines, 1963-1966 after several years in engineering. Later, he was involved with the science education program for Africa (SEPA) in rural Kenya. He has worked in Peace Corps training programs for countries on every continent. In the U.S., he has taught science education both in public schools and at the college level.

Bernard Zubrowski was a Peace Corps Volunteer in Bangladesh, 1962-1964. Later, he worked as a curriculum developer in rural Kenya for SEPA. Since then he has been involved in community and non-formal education in the Boston area.

Thanks to Sally Barb Landry, Arnulfo Barayuga and Lance Hellman for photography and art work.

TABLE OF CONTENTS

<u>Section</u>	<u>Page</u>
A. A Temporary Hammer	1
B. A Chisel	3
C. A Drill	5
D. Saw Made with Two Pieces of Wood	7
E. Saw Made with Four Straight Pieces of Wood and String	11
F. Permanent Hammer with Bamboo Handle	14
G. Permanent Hammer with Wood Handle	17
H. Tin Can Drill	18
I. Holding the Wood with a Bench Hook	22
J. Another Wood Holder	24
K. Knife from Metal Packing Strip	26
L. Combination Saw and Knife	27
M. A Screwdriver	28
N. Tongs	31
O. Tweezers	35
P. Cutting Tin Using the Chisel or a Tin Cutter	37
Q. A Heating Stand Made from a Tin	39
R. How to Make a Round Hole in a Tin	40
S. Making an Equal Arm Balance	40
T. Detecting Changes in Temperature Without a Thermometer	44
U. Making a Set of Weights	47
V. Conversions Between Metric, British and American Weights and Measures	49

Section A. A TEMPORARY HAMMER

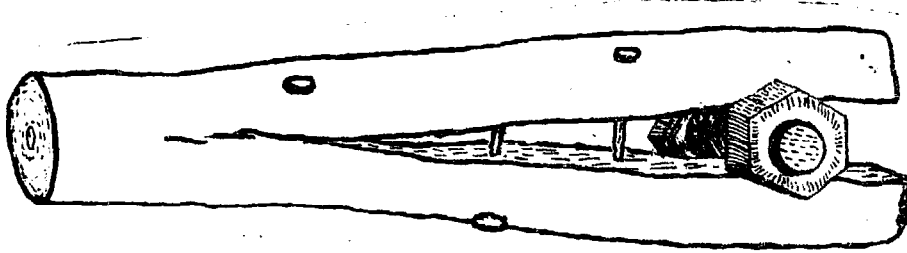

One tool which you will need in making almost all the other tools mentioned in the following pages is a hammer. If you can borrow one or a suitable substitute for a day or so, you can move on to the next section. If not, you can make a temporary hammer quickly.

You will need the following materials:

One large nut and bolt to the dimensions shown

One piece of wood, such as a thick branch of a tree

Length: Not less than 35 cm (cm = centimeter)

Circumference: Between 21 cm and 23 cm

One nail, $7\frac{1}{2}$ cm long

Three nails, 5 cm long

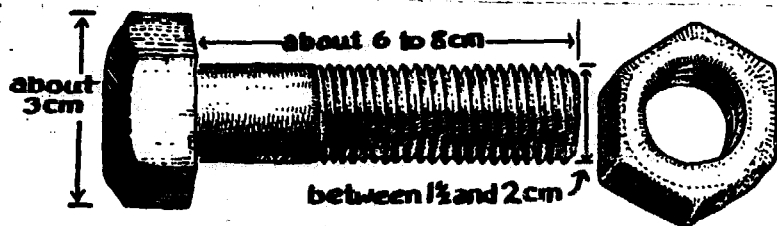

To measure the circumference of the wood, wrap a piece of string around the wood as shown and mark the string. Then measure the distance between the marks. This distance should be between 21 cm and 23 cm.

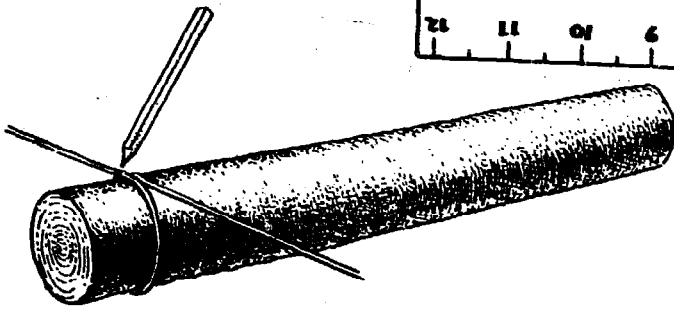
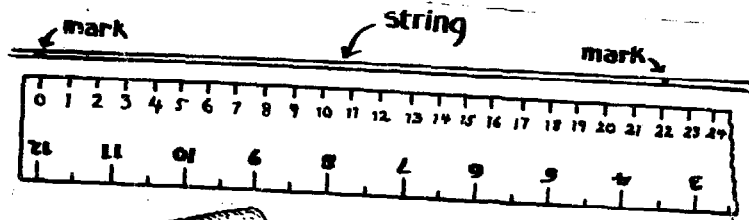

With a large knife, slice the piece of wood down the middle to a distance of 16 centimeters. Force the bolt into the slit and down four centimeters from the top. Place the nut on the bolt.

centimeters from the top. Place the nut on the bolt.

To keep the bolt in place and the wood from splitting further, you will need to hammer a few nails as shown in the diagram. A heavy stone can be used to drive in the nails.

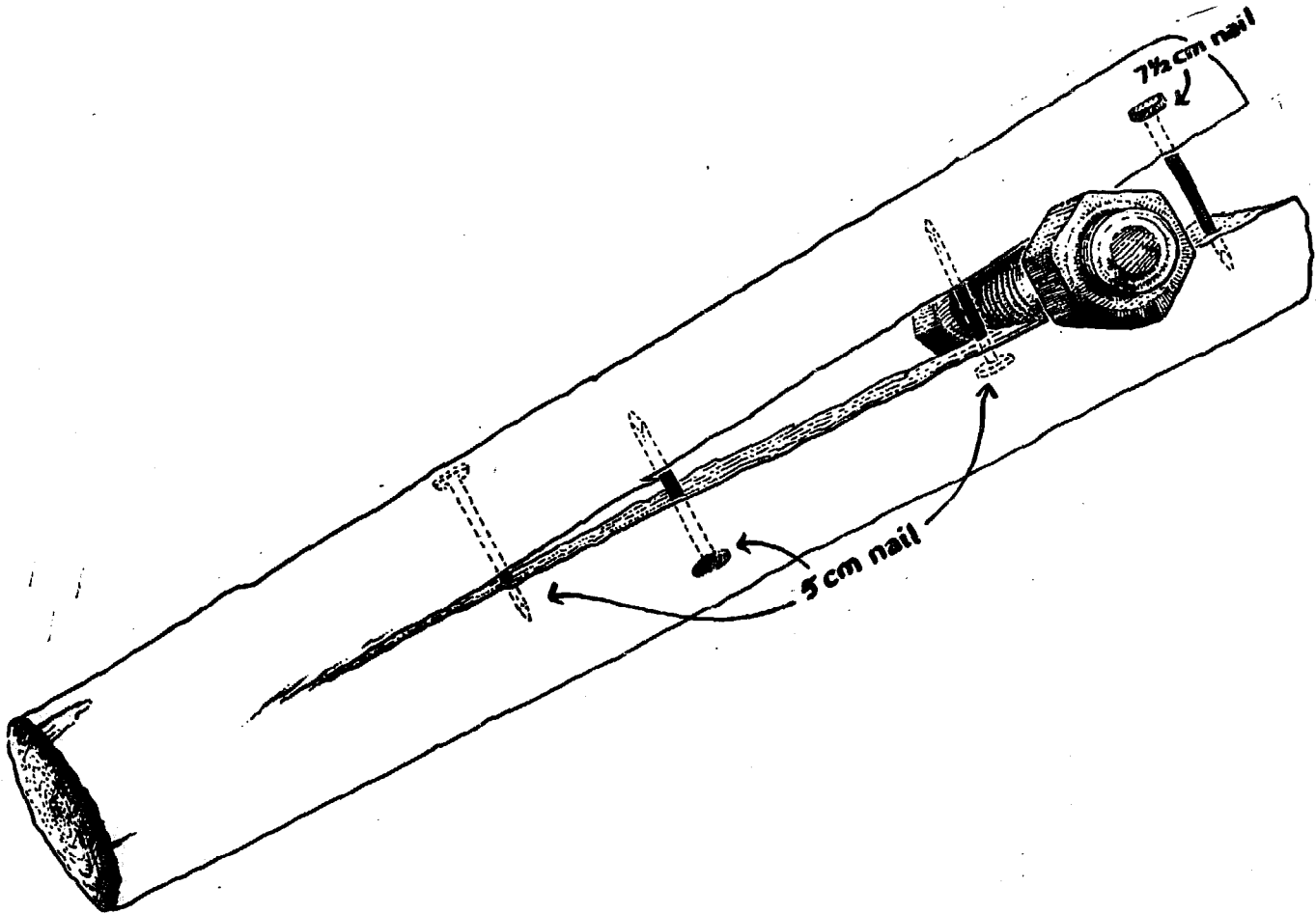

Section B. A CHISEL

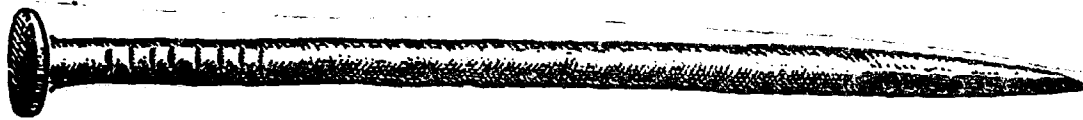

You will often need to cut off small pieces of wood from a large piece, or cut a tin. The chisel will help you do these things, as well as many other kinds of cutting work.

To make a chisel you will need:

One nail, 15 cm long

Hammer

You will also need a very hard surface to work on. You could use a piece of iron from an old automobile, or any other kind of scrap iron. Sometimes a heavy piece of metal is around the school compound, such as metal that is banged to make a sound calling the pupils together for assembly.

Put the nail on the piece of iron and, with the hammer, hit the pointed end of the nail until it is flattened. The following three diagrams show (A) a 15 cm nail before hammering, (B) the hammered nail from a top view and (C) the hammered nail from a side view, showing how it has been flattened.

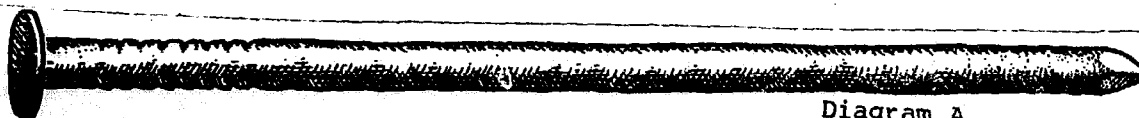

Diagram A

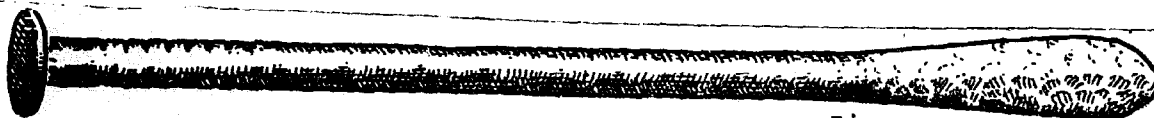

Diagram B

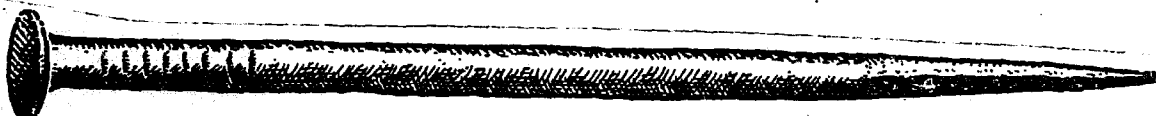
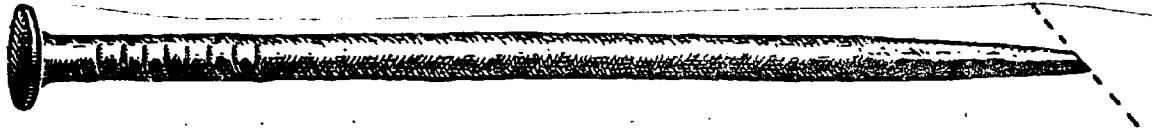
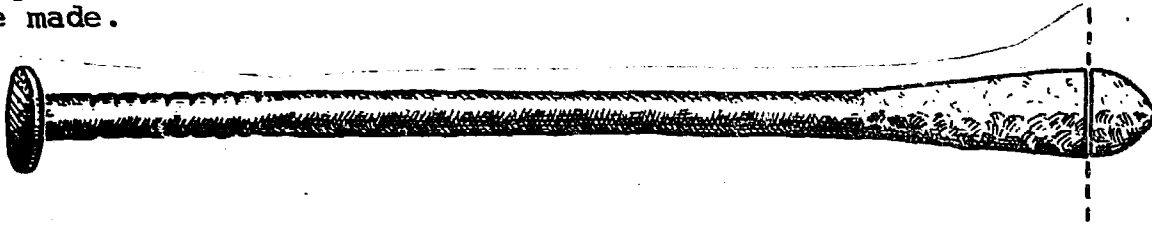
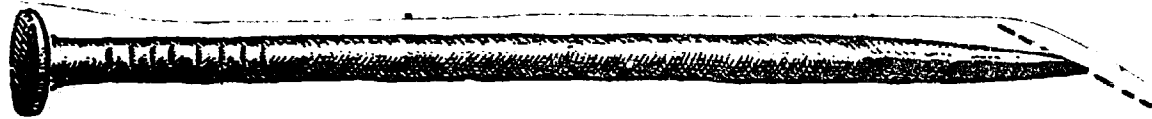

Diagram C

The nail is then cut with a hacksaw blade to get a flat edge. The following diagrams show the angle of cut to be made.



After cutting, the edge needs to be sharpened by rubbing it against a hard rock. If a hard rock cannot be found, you can buy a small file. After sharpening the edge should look like the one in the following diagram.



Remember that files are made of metal which will rust easily. Rust destroys the sharp edges on the teeth of the file. A small amount of cooking oil or fat can be put on the file after it is used each time and this will prevent rust.

Most nails you buy will probably be made of soft metal. When you use the chisel it will become damaged or blunted quickly. You can harden the tip by the following procedure. Make a fire and place the end of the nail in the fire, keeping it there until it is glowing red. Then drop it quickly into a tin of cold water. Repeat this procedure several times.

Using the Chisel

The chisel is very useful in shaping wood or cutting holes in wood. When pupils make holes in wood, they usually try to chip out big pieces of wood. It will be easier if they cut only small pieces at a time. This practice will also preserve the chisel. There will be occasions when you or your pupils will want to chip away part of a piece of wood to get a certain width. Again, chip off small slices at a time until the desired thickness is reached.

Another use for the chisel is the cutting of tins.

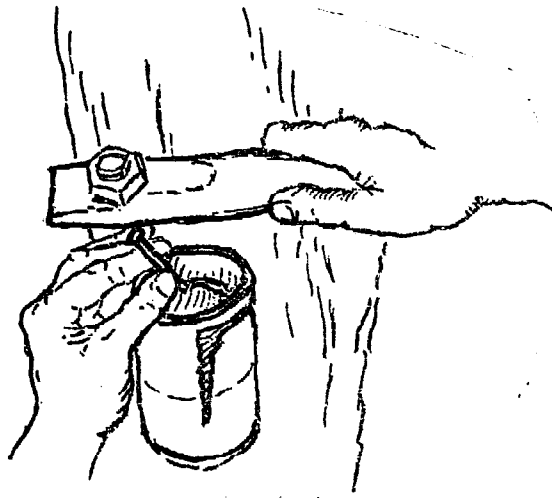

Cutting on a hard surface will damage the point of the chisel. Be sure to place the tin on a wooden surface such as a thick tree branch. When you cut through the tin, the point will go into the wood and the chisel will need to be pulled out before making the next cut.

Remember that the chisel cuts best when it is sharp. Keep a hard stone or file around the classroom and encourage the pupils to use these sharpening tools often.

Section C. A DRILL

Sometimes you may need to make a small hole through a piece of wood. The following tool will help you do this.

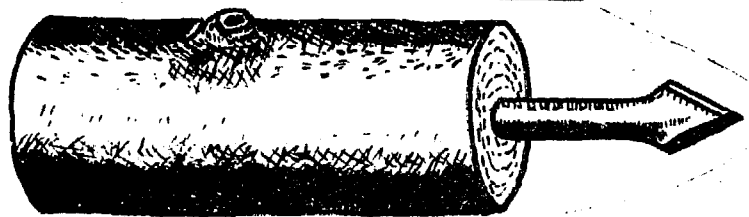

You will need these materials to make the drill:

One nail, 8 cm long

One piece of wood such as a branch of a tree
 The wood should be very hard
 Length: about 12 cm
 Thickness: between 10 and 12 cm (See page 1 for
 instructions on measuring the thickness.)

Hammer

The first step is to flatten the point of the nail as you did when making the chisel. Hammer the point until flattened as shown in the diagram.

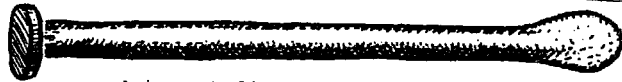

The flattened point is then hammered into the center of the end of the piece of wood as shown in the following diagram. Cut the head off the nail with a hacksaw blade. This exposed end of the nail is hammered until it is flattened.

Nail with head off before being flattened:

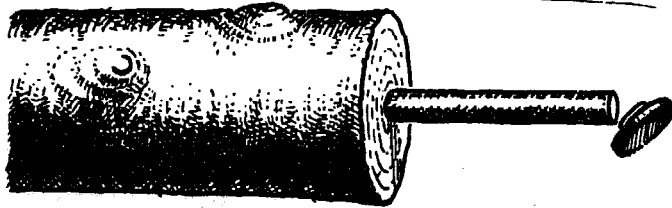

Nail after being hammered:

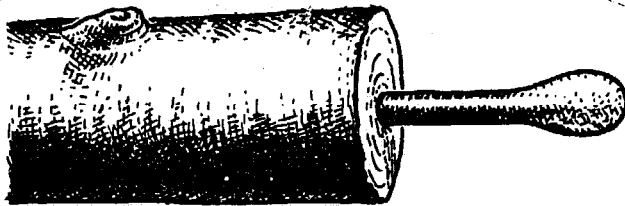

Finally, sharpen the end using a hard stone, or by rubbing it on a hard cement floor until the point looks like this:

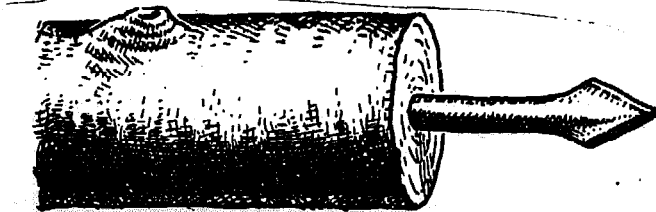

The same procedure can be used to make drills of various sizes, using different sized nails. When using large nails, make sure the wood for the handle is thick enough in diameter so that it will not crack or split when the drill is being used.

To use the drill, grasp the butt of the handle with the palm of the hand as shown in the diagram. Press down as you twist the nail back and forth through the wood.

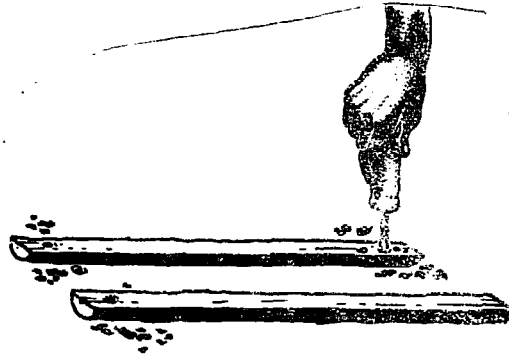

The drill also can be used to prepare a piece of wood for a nail. If a hole is made in a piece of wood before a nail is pounded into it, the wood will be less likely to split. Choose a drill which will make a hole that is slightly smaller in diameter than the nail that you want to use. Drill the hole not quite through the other end. When joining two pieces of wood, do this for both pieces. Then bang the nail through the holes in the two pieces.

Section D. SAW MADE WITH TWO PIECES OF WOOD

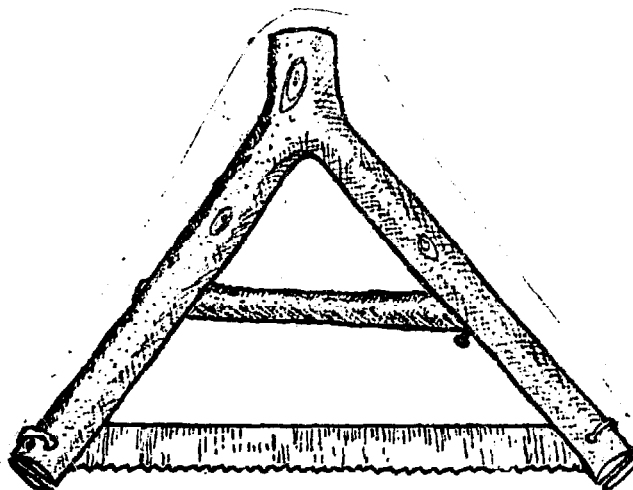

You will need the following materials:

One hacksaw blade which can be of either of the two types shown in the diagram. The length can be 25 or 30 cm.

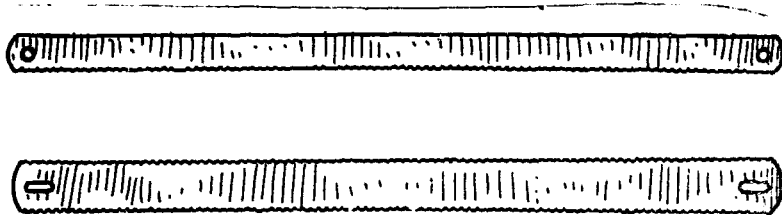

One small tree branch

A branch which divides into two branches of about equal thicknesses should be found. The blade can be used to cut it from the tree.

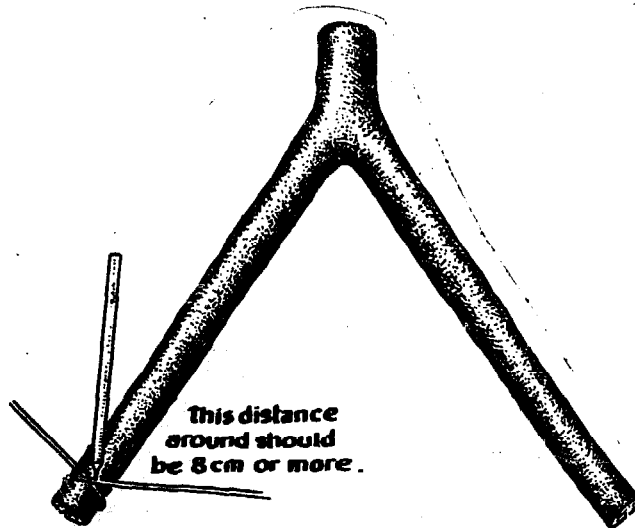

The thinnest part of this piece of wood should be measured to make sure it is thick enough. It should be at least 8 cm around. The wood must be strong enough so that the hacksaw blade remains tight. If the wood is too thin, it will bend when the saw is being used, and the blade will also bend. The blade will last longer the less it bends.

You will also need:

One straight piece of wood, about 18 cm long

Four Nails

For most pieces of wood, it is best to use three nails that have a length of 4 cm and one nail that has a length of 2 to 3 cm. For pieces of wood that are much thicker than the measurements shown above, nails that have a length of 5 cm are needed.

Hammer

Drill

Making the Saw

If necessary, cut off the two bottom ends of the piece of wood so that the distance between the two ends is the same as the length of the hacksaw blade.

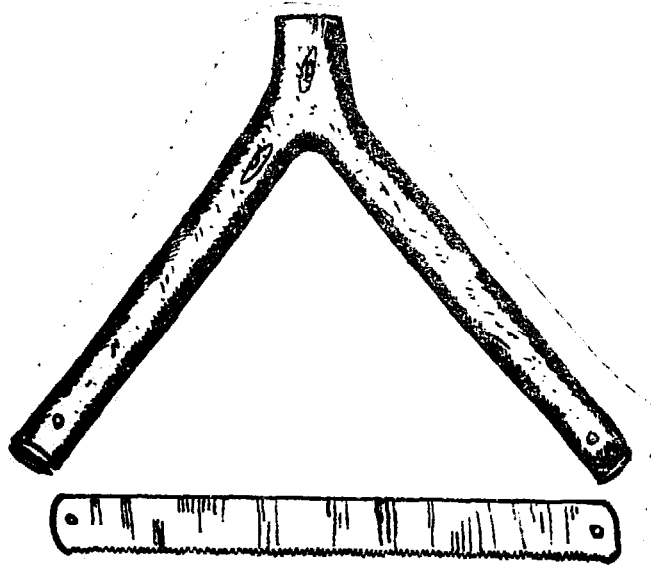

The hacksaw blade is used to make a cut in each end of the piece of wood. These cuts should be aligned with each other so that the blade can be placed into the cuts without becoming bent. The cuts should be about as deep as the width of the blade.

Before putting the blade into the cuts, use the drill to make a hole at each end where the nails will be placed. Now the blade can be put into each slot and a 4 cm nail put through each hole in the wood and each hole in the blade. The nails are then bent over with a hammer. The straight piece of wood should now be cut so that it fits into the saw as shown in the diagram.

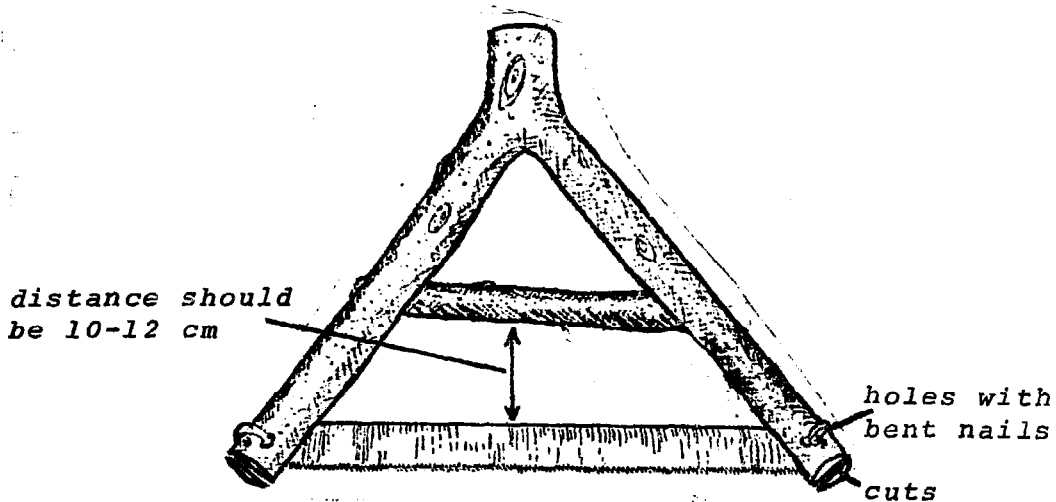

Next, hammer a 4 cm nail through one side of the piece of wood and into the end of the straight piece of wood as shown in the diagram at A. Pull the short piece of wood upwards to tighten the blade and hammer the smaller nail (2 or 3 cm) just below the end of the short piece as shown in the diagram at B.

The saw is now ready to use. Caution the pupils not to bend the blade while sawing for if it is bent at too much of an angle, it may break.

You should check the tightness of the blade in this kind of saw every few weeks. If you find a saw with a loose blade, ask the pupil who owns the saw to pull the movable end of the short piece upwards and hammer the short nail in a new place. By repositioning the brace in this way, the blade will be tightened. Have the pupil ask a friend to help since one person must usually hold the short piece while another hammers.

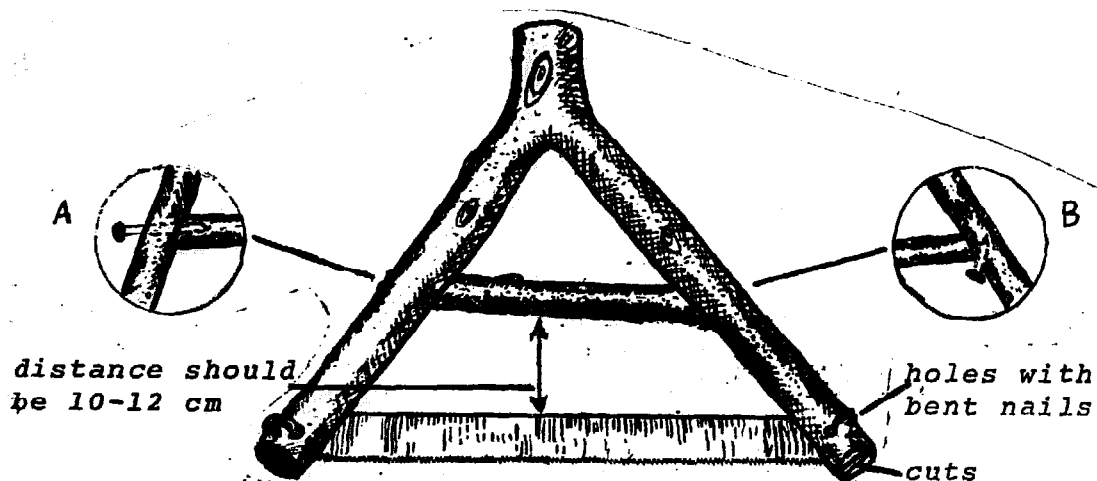

Section E. SAW MADE WITH FOUR STRAIGHT PIECES OF WOOD AND STRING

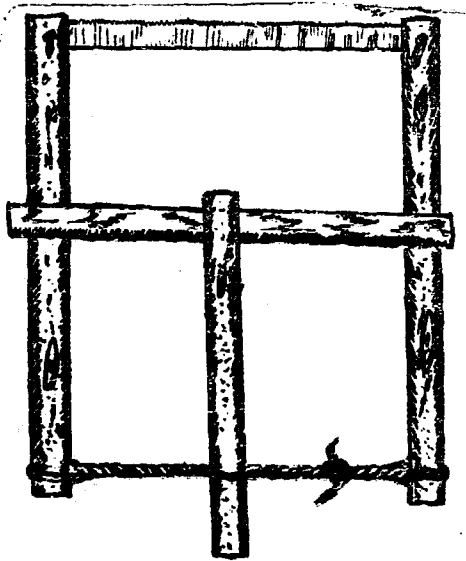

The materials you will need are:

One hacksaw blade which can be either of the two types shown in Section D. The length can be 25 or 30 cm.

Four straight pieces of wood from tree branches.
 Length: larger than 36 cm but less than 38 cm
 Circumference: between 8 and 10 cm
 One of these pieces is split along its length into two equal pieces.

One piece of string which measures more than 200 cm but less than 250 cm

Two nails, 4 cm long

Two nails, 6½ cm long

Hammer

Drill

Chisel

A heavy knife can also be used. (Sometimes called a machete, panga, bolo in various countries.)

Making the Saw

First, a hole is made near each end of the two split pieces of wood using the drill. Drill the holes wide enough for a $6\frac{1}{2}$ cm nail to be hammered through without splitting the wood. The holes should be 3 to 5 cm from the ends of the sticks. This procedure is shown in Diagram A. Next, drill one hole in each of two of the other pieces of wood. Each hole is 12 to 15 cm from one end of the wood. This procedure is shown in Diagram B.

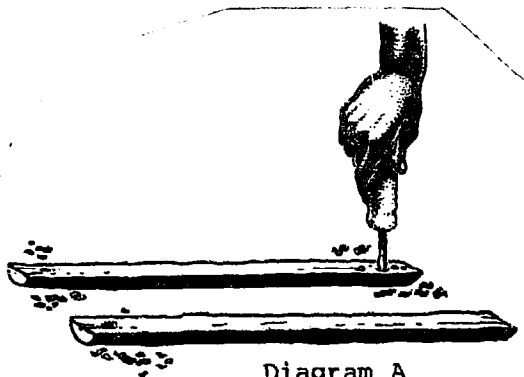

Diagram A

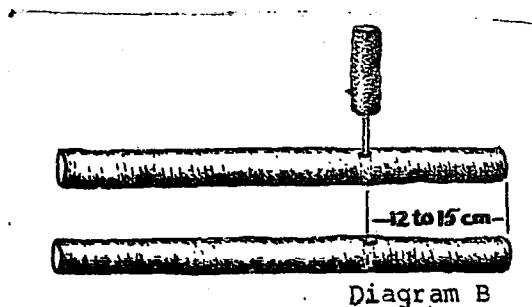

Diagram B

The four pieces of wood are then joined together using $6\frac{1}{2}$ cm nails as shown in Diagram C. The ends of the nails are bent using a hammer. Do this carefully so that the pieces of wood do not split.

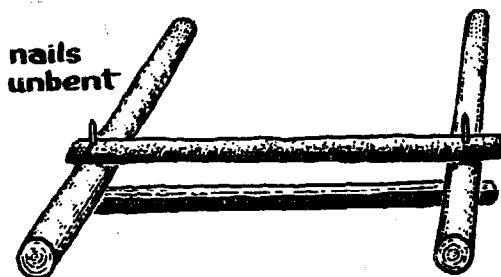

Diagram C

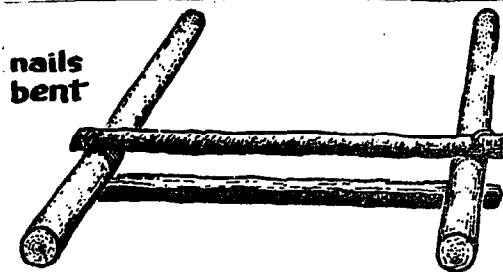
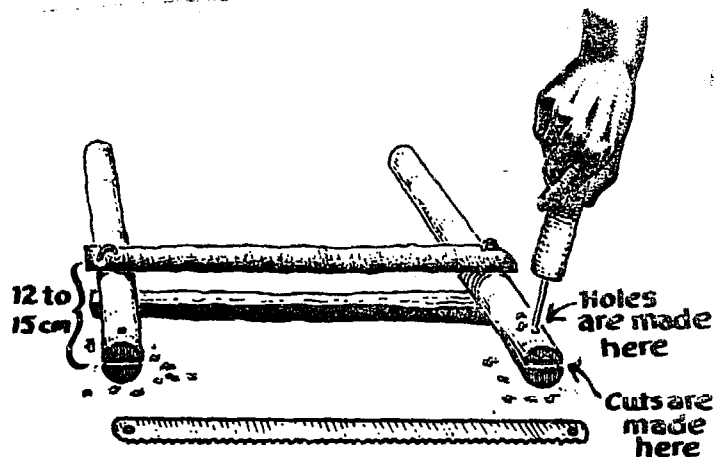

Diagram D

A cut is now made in the ends of the two pieces of wood where the blade is to be attached. The blade should be able to fit into the two cuts without it becoming bent.

A hole is now made near each end of the pieces of wood where the cuts have just been made. Each hole is placed so that the nail will go through both the hole in the wood and the hole in the end of the blade. Use a hammer to bend the nails which hold the blade. Do this carefully to avoid damaging the wood or the blade.



Notches are then made between 3 and 5 cm from the ends of the pieces of wood where the string is to be attached.

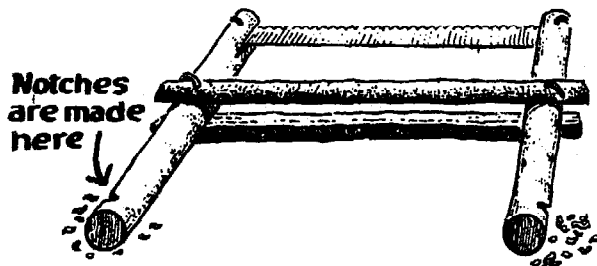

Attach the string by wrapping it around the two pieces of wood at the notches. The string should be wrapped 2 or 3 times and then tied together. Put the last piece of wood through the string and turn until the string twists enough to tighten the blade.

The saw is now ready to use.

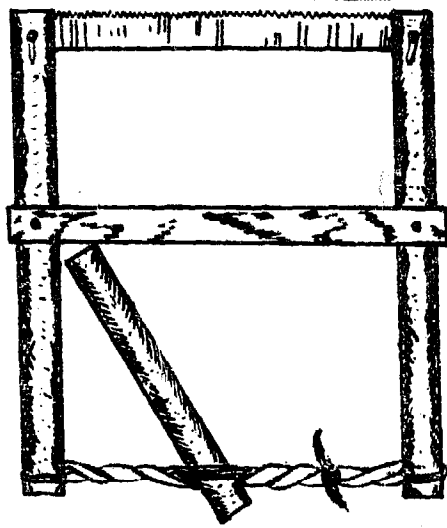

You can check the tightness of the blade in this kind of saw by the tightness or looseness of the strings. If a pupil has tightened his or her saw too much and the string has broken so that most of it is lost, it may no longer be possible to tighten the blade properly. Sometimes pupils will attempt to use their saws with no string, or with a broken piece of wood. If you find a saw that needs a part replaced, ask the pupil who owns the saw to replace the broken string or piece of wood before using the saw again. Remind the pupils that if they do not do this, their blade will soon become broken and it is expensive to replace a blade.

Section F. PERMANENT HAMMER WITH BAMBOO HANDLE



Bamboo can be used to make a handle for a permanent hammer. It is a good material for making the handle if a strong type is available. It is also very easy to make a handle using this material.

You will need the following materials:

One piece of bamboo which is between 30 and 40 cm long and with a circumference between 12 and 16 cm.

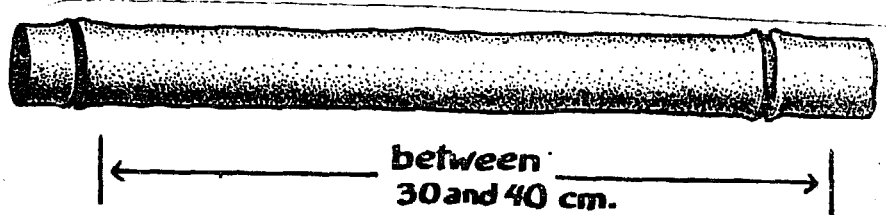

One large nut and bolt (See Temporary Hammer for dimensions)

Saw

Temporary Hammer

Chisel

Making the Hammer

Saw the bamboo as shown in Diagram A. Make two small cuts in the bamboo 2 cm apart as shown on diagram. These two cuts should be near the end which includes the joint (where the branches once grew). Use the chisel and hammer to remove the piece of bamboo so that there is a hole. Now do the same thing on the other side of the bamboo so that the bolt can be put through the opening and the nut tightened.

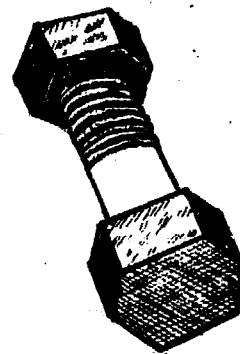
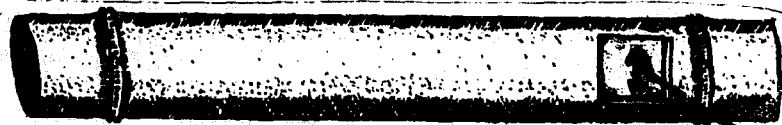

chisel out
this area

Diagram A

After the bolt has been put through the bamboo handle, and the nut screwed on until the bolt is not loose, the hammer is ready for use.

Making the Hammer into a Nail Remover

Sometimes when hammering nails into wood, it is necessary to stop and remove the nail because it is bent or will not go into that particular spot. You can cut a slot in your bolt which will enable you to use it as a nail remover. You can only make the nail remover if the bolt is sticking out about 1 cm or more from the nut.

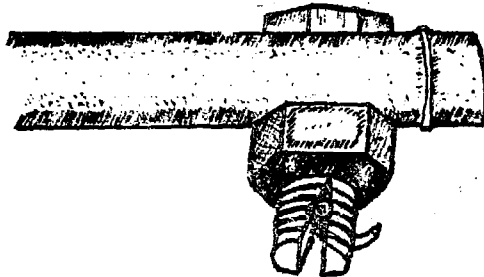

In cutting the bolt with the hacksaw, first make a vertical cut about 1 cm deep. Then cut between 2 and 3 mm away from the first cut. (mm = millimeter; a millimeter is one tenth of a centimeter.) This second cut should be a diagonal one. It is important that the cut be made no larger than 3 mm. If the cut is wider, it will be difficult to remove any nails.

The slot should be wide enough so that a $6\frac{1}{2}$ cm nail can fit into it, but not wide enough for a $7\frac{1}{2}$ cm nail to fit. If the slot is wider than this, the heads of smaller nails will not be caught by the slot. Since the pupils work mostly with 4 and 5 cm nails, this is very important.

If the piece of metal does not come out after you have made the cuts, move it back and forth until you can force it out with a nail or other small pointed object.

make
vertical cut
1 cm deep

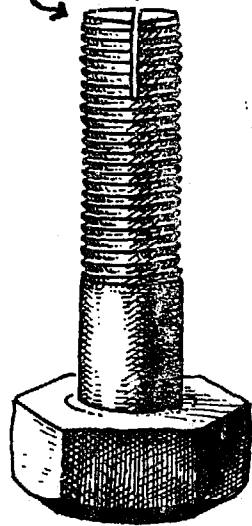

cut
diagonally

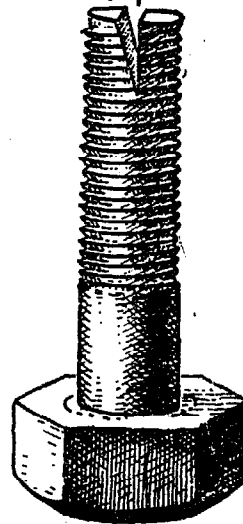

Section G. PERMANENT HAMMER WITH WOOD HANDLE

If bamboo is not available in your area, you can make a permanent hammer using a thick branch from a tree.

You will need the following materials:

One piece of wood, 30 cm long and 12 to 16 cm around

One large nut and bolt

Chisel

Temporary hammer

Heavy knife

Making the Hammer

With a heavy knife, such as a panga or machete, shape the lower part of the branch so that it has the form shown in the following diagram.

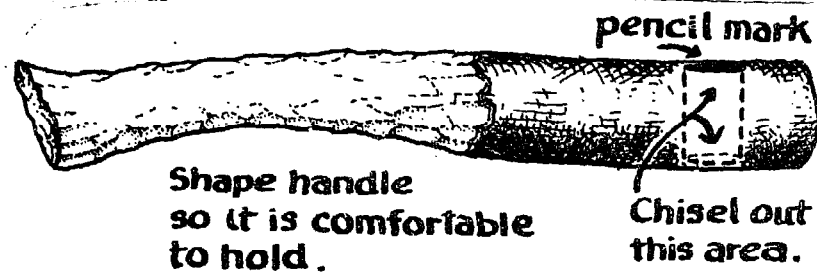

Mark off the area at the thick end of the handle where the bolt will go. With a chisel and a hammer, cut through the wood inside the pencil mark until you have made a hole completely through the thickness of the wood. Remember to cut away small pieces at a time. When you think the hole looks big enough, try forcing the bolt through. If it does not fit, keep cutting with the chisel until it does. Try to cut the hole so that the bolt will fit tightly. Finally, push the bolt through, and place the nut tightly on the end of the bolt. A nail remover can also be added to this type of hammer (See Section F).

Section H. TIN CAN DRILL

The tin can drill is a tool which is relatively easy to make. Drilling holes with this tool is quicker and takes less effort than drilling holes with the manual drill described earlier.

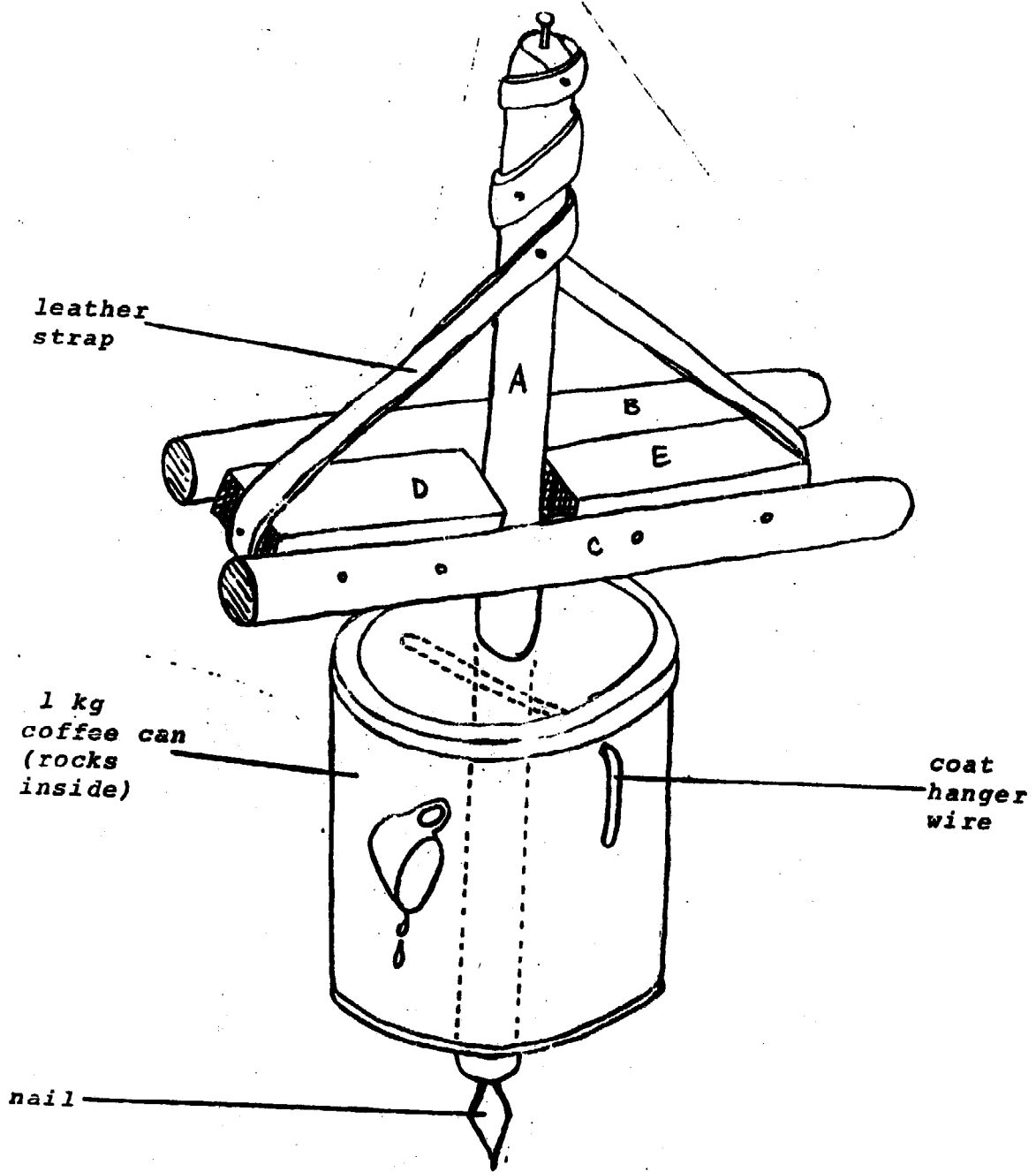

DIAGRAM A

You will need the following materials:

One large coffee tin with fitting lid

Pole (dowel or piece of branch) 1 meter long, 6-8 cm around

Two blocks of wood 3 cm wide, 10 cm long and about as thick as the rod

Leather strap or strong twine which is approximately 7 decimeters long

One piece of wire approximately the same thickness as a coathanger, a little bit longer than the diameter

Eight nails, 4 cm long

Nine nails, $2\frac{1}{2}$ cm long

One nail, 5 cm long

Saw

Drill

Hammer

Method for Making the Drill

Cut a rod which is approximately 1 meter long and 6-8 cm around. Cut this rod in half to form two pieces which are 5 decimeters each. One of these forms the center pole (A) and the other piece needs to be cut in half again to form pieces B and C.

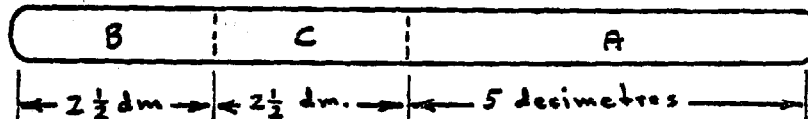

Diagram B

Now cut two blocks of wood (D and E) which are approximately 10 cm long, 3 cm wide, and about as thick as the rod. These blocks will secure B and C in place to form the handle. B and C should be just far enough apart to allow the center pole (A) to slide easily through as shown in Diagram C.

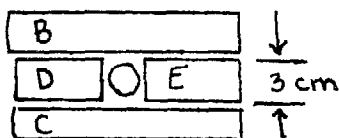

Diagram C

Cut holes in the top and bottom of the 1 kilogram coffee can which are just big enough for the pole (A) to fit snugly through. These holes need to be in the very center of each end.

The next step is to wire the rod to the can near the top of the can. Punch two holes in opposite sides of the can near the top using a nail. Now drill a hole through the pole. To determine where you want the hole, hold the pole next to the can with the bottom end of the pole extending approximately 3 cm below the bottom edge of the can. Mark the point on the rod which is between the two small holes in the can. At this point drill your hole. Now pass a wire through the hole in the pole and both holes in the tin. Bend each end of the wire where it comes out of the can. The center of the wire passes through the hole in the pole.

Nail the middle of the leather strap to the top of pole A. Nail the ends of the strap (or twine) to the ends of blocks D and E as shown in Diagram A. The strap (twine) should be just long enough to hang the handle approximately 3 cm from the top of the can at its lowest point. Secure the strap, by lashing, taping or tacking, to the top of the pole.

The next step is to attach the point of the drill. Flatten the end of a 5 cm nail. Pound the 5 cm nail into the bottom of pole A. At least 3 cm of the nail should be showing. Cut off the head of the nail (as described in Section C). File the end of the nail to a point. The nail will need to be resharpened from time to time. The size of the nail will determine the size of the hole that can be drilled. You may want to make different drills with different sized points. Fill the can with rocks, sand, or some other heavy material. Your drill is now ready to use.

To use the drill, first twist the handle so that the strap is wound up all the way, then pump the handle up and down giving the can a back and forth rotary motion.

I. Holding the Wood with a Bench Hook

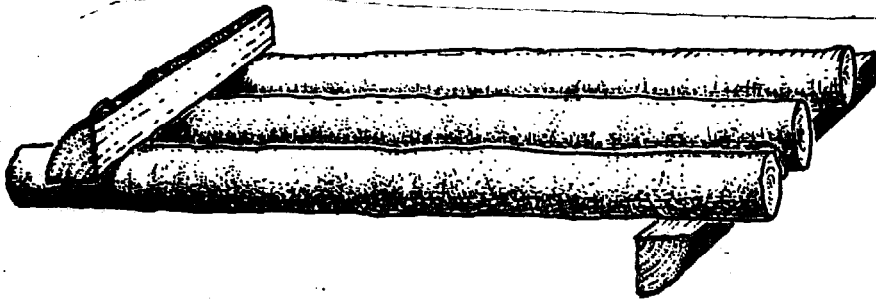

When sawing or drilling wood it is often a problem to hold the piece of wood so that it does not move. This is especially true when a person is working without another person to help. A simple piece of equipment to hold a branch is shown in the diagram above. The following diagram shows this support being used. This is called a bench hook.

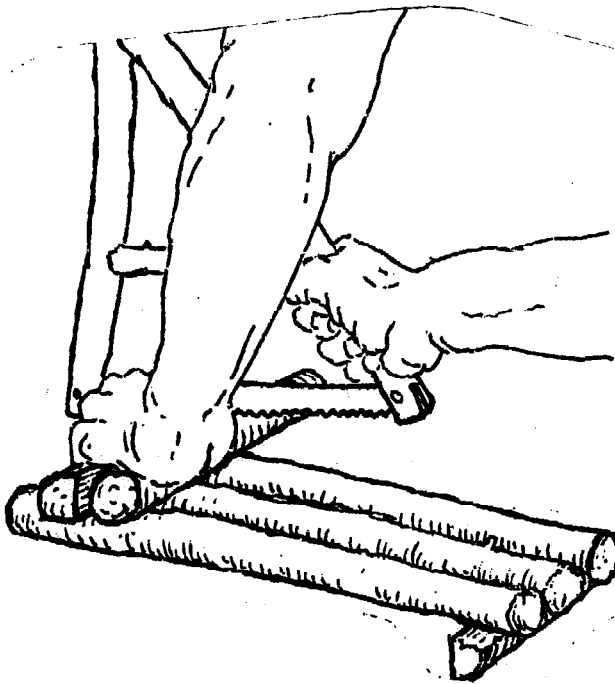

You will need the following materials:

Three pieces of wood more than 30 cm but less than 36 cm long and between 6 and 8 cm around

Two pieces of wood which are between 11½ and 13 cm long and are between 6 and 8 cm around

Six nails, 5 cm long

Saw

Hammer

Drill

Chisel

The three longer pieces of wood are used as they are. The two smaller pieces of wood are chiseled so that they have the shape shown in the diagram below.

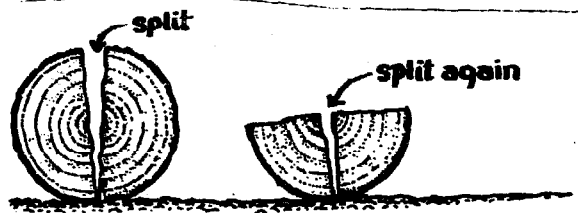

Drill three holes in each of the two smaller pieces of wood, in the places shown in the diagram below.

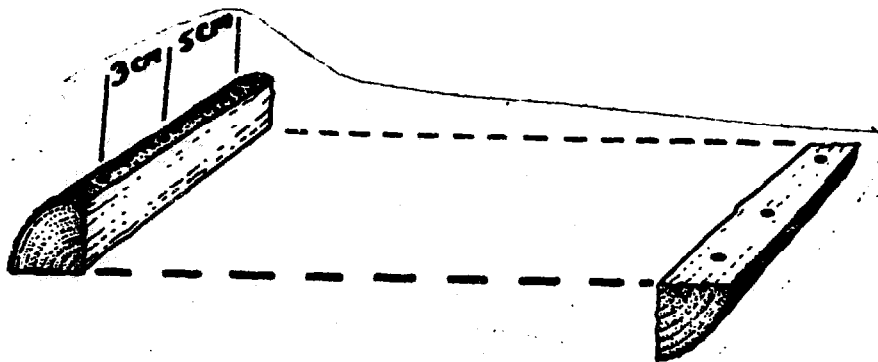

Attach one small piece of wood to the top of one end of the three longer pieces, and the second small piece underneath the other end of the three longer pieces. This can be done by putting a nail into each hole in the short pieces and hammering each nail through and into a long piece. To secure, hammer the points of the nails so they are bent back. The bench hook is then ready for use; it looks like the one shown in the diagram at the beginning of this section.

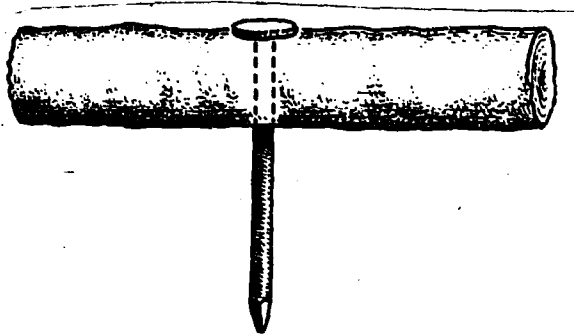
Section J. ANOTHER WOOD HOLDER

Four wood holders are usually needed to hold a piece of wood vertically for sawing. See Diagram B on page 25.

To make the wood holders you will need the following materials:

Four pieces of wood

Length: more than 8 cm but less than 10 cm

Circumference: If a string is put around the wood and marked, the marks on the string should be between 6 and 8 cm apart.

Four nails, 5 cm long

Hammer

Saw

Drill

Bench Hook

Making a Wood Holder

Use a drill to make a hole in the center of a piece of wood. Choose a drill which will make a hole that is slightly smaller than the nail that will fit into it. Drill the hole almost through the other side of the wood. Diagram A shows the wood supported by a bench hook while being drilled. Then hammer the nail through the hole until the head of the nail reaches the wood. The best place to do this is on soft ground from which the nail, attached now to the wood, can easily be removed.

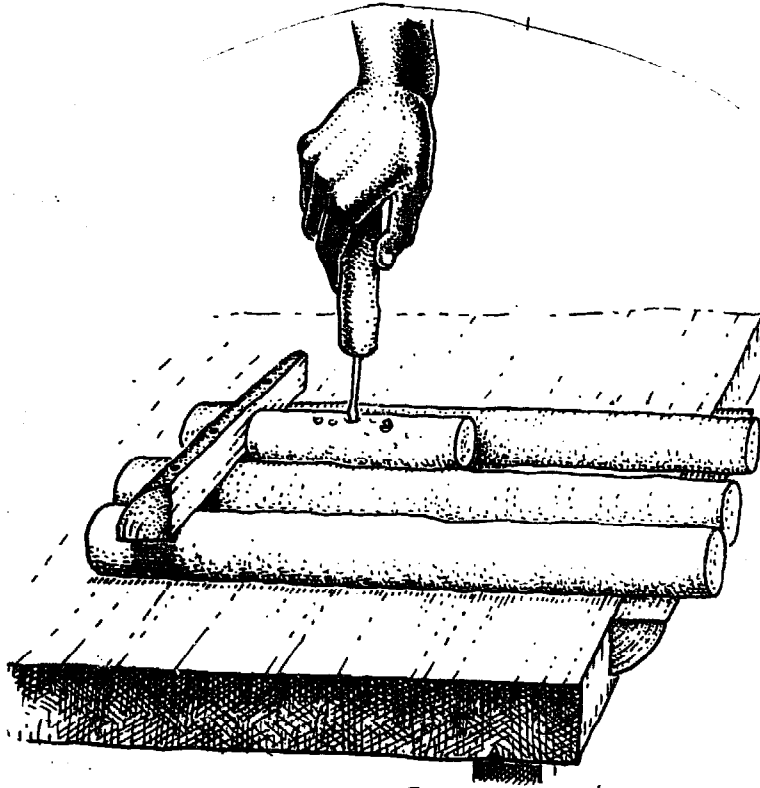

DIAGRAM A

Four of these wood holders can be used to hold what you are sawing securely against a log or large piece of wood as shown.

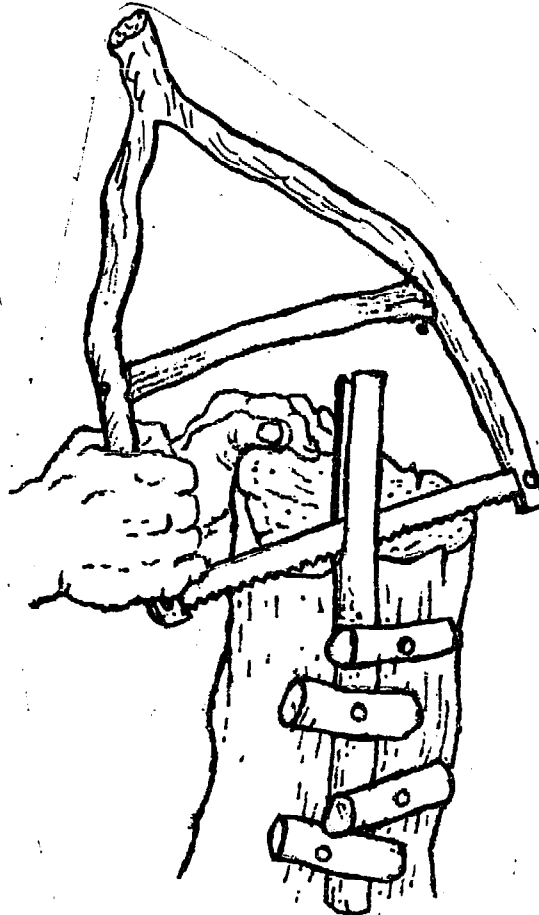
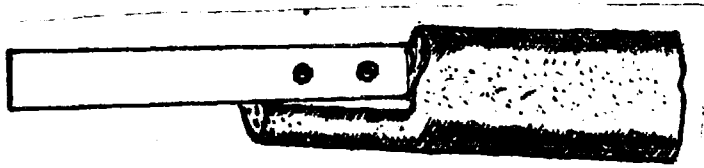

DIAGRAM B

Section K. KNIFE FROM METAL PACKING STRIP



Materials for the knife:

One piece of metal strapping from an old packing crate.
The metal strip should be of a kind that is thick and does not bend easily.

Length: about 10 cm

Width: about 2 cm

Two nails, 4 cm long

One nail, 15 cm long

One piece of wood 12 cm long and 10 cm around

Hammer

Saw

Making the Knife

Put holes in one end of the metal strip. Use the 15 cm nail to make the holes. The holes should be placed in the metal strip as shown in the diagram.

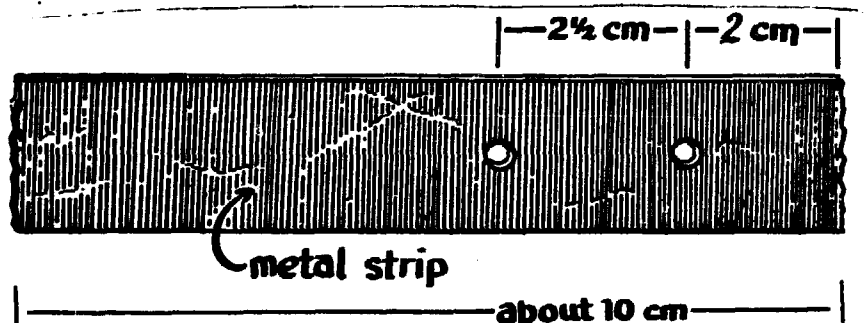

If the piece of wood is a branch of a tree, cut out one part as shown in the diagram.

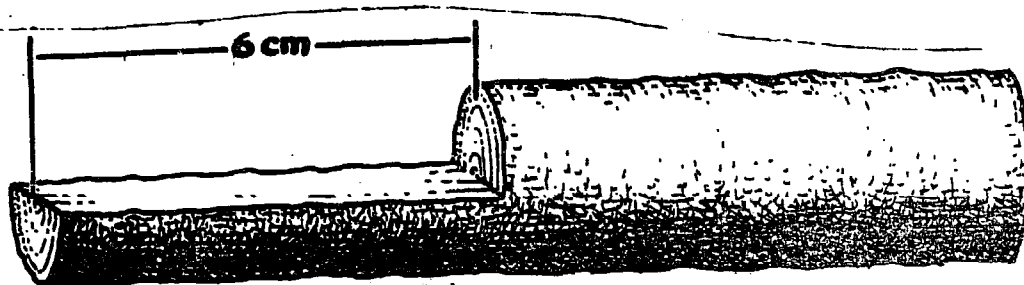

Hammer the two nails through the holes in the metal and through the wood. Use a saw to cut off the ends of the nails. Sharpen one edge of the metal on a hard stone or with a file. The knife is now ready to use.

Caution your pupils about using these knives. Some children will use the knife so that the sharp edge is coming towards them. This is dangerous. Tell them to carve away from themselves. They can also carve on a table.

Section L. COMBINATION SAW AND KNIFE

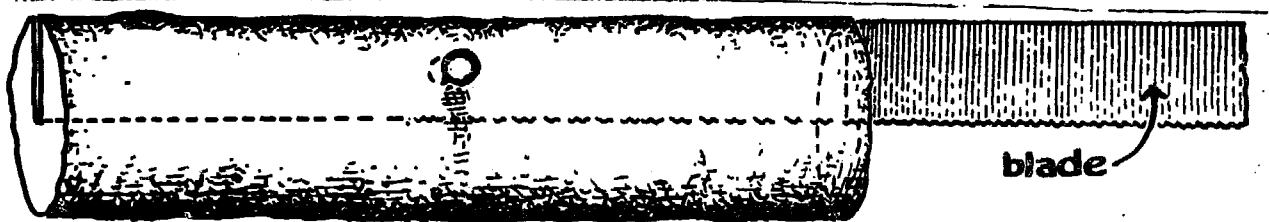

Materials you will need to make the combination saw and knife are:

One broken hacksaw blade between 12 and 14 cm long

One piece of wood

Length: between 10 and 12 cm

Circumference: between 9 and 10 cm (as measured by string)

One nail, 5 cm long

Saw

Drill

Making the Combination Saw and Knife

The piece of wood is cut along the length of the stick as shown in the following diagram. The depth of the cut should be equal to the width of the blade.

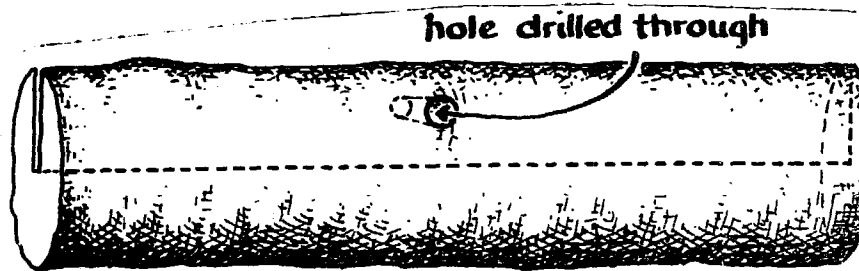

Drill a hole with a small diameter in the middle of the stick as shown. The broken hacksaw blade is inserted into the slot until the hole in the blade is lined up with the hole in the wood. The nail is then inserted. Bend over the nail which sticks out of the other side.

The edge of the blade that does not have teeth should be sharpened on a hard stone or with a file. You now have a tool which can be used as a knife or as a small saw.

Section M. A SCREWDRIVER

In certain schools, children may be able to use screws, instead of nails, for joining pieces of wood. If screws are available in your school, your pupils will find this screwdriver useful.

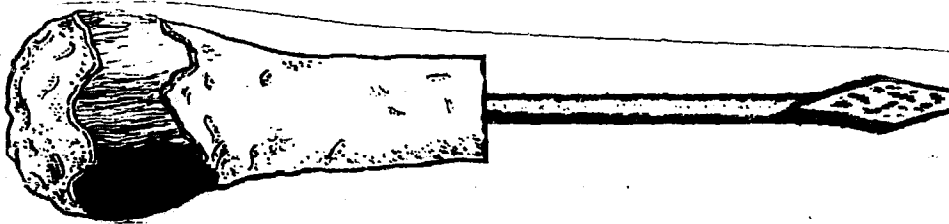

You will need the following materials:

One piece of wood

Length: more than 9 cm but less than 14 cm

Circumference: If a string is put around the wood and marked the marks should be more than 12 cm but less than 15 cm

One nail, 10 cm long

Saw

Hammer

Chisel

Bench Hook

Drill

Making the Screwdriver

Use the bench hook as a support. Then, with a chisel and hammer or a heavy knife, shape the piece of wood so that it looks like the handle shown in the diagram.

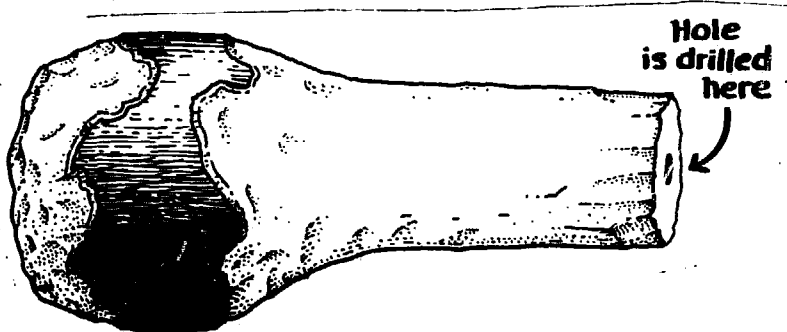

Use a drill that will make a hole a little smaller than the nail. Make a hole in the end of the handle as deep as it is possible to make with the drill. Use the saw to cut the nail near the head of the nail, as shown in the diagram.

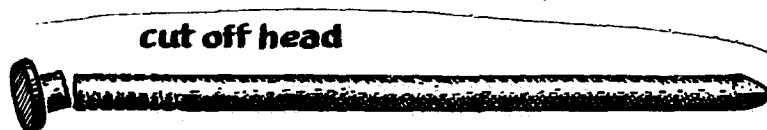

Flatten the part of the nail where you have cut it until it looks like this:

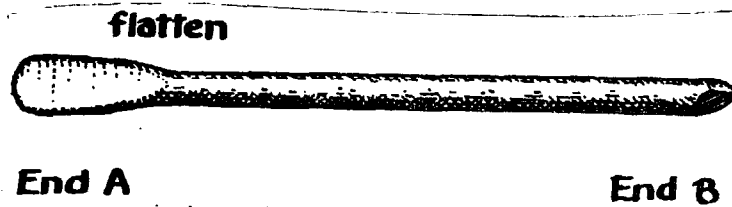

This end will be the one which is banged into the wooden handle. Flatten the other end of the nail (End B) until it looks like this:

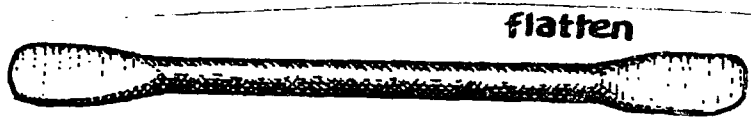

Decide how thick the point of the screwdriver will be. This controls where you will cut off the flattened part of the nail. Use a saw to cut off the end of the nail.

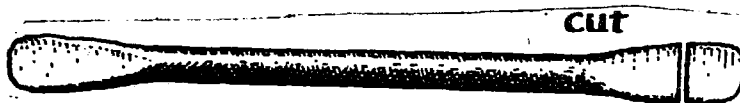

A little rubbing on a piece of stone, or some filing, may be needed to remove sharp pieces of metal.

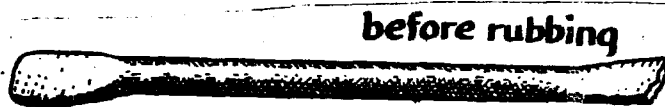

When the point of the screwdriver is complete, it should look like this:

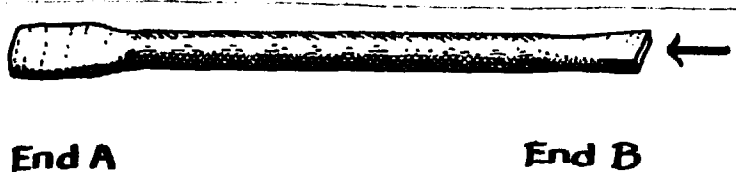

Too much rubbing on a stone can destroy the usefulness as a screwdriver; if the point looks like this, it is not good.



Most nails that you will buy are probably of a soft metal. When you use the screwdriver, the point of it will become damaged or twisted quickly. You can harden the point by using the method which is described in making the chisel point hard (Section B).

It is only necessary to harden the end of the nail which will be the blade of the screwdriver. The other end, which has been roughly flattened, does not need hardening.

Now put the blade of the screwdriver on a large piece of soft wood and hold the handle so that the flattened part of the nail (End A) is in the hole in the handle. Use a hammer to hit the other end of the handle so that the flattened end of the nail goes into the hole in the handle. When the nail seems firmly attached in the handle, stop hammering. Twist the screwdriver gently to remove the blade from the large piece of soft wood. The screwdriver is now ready to use.

Section N. TONGS

There may be occasions when you need to remove hot objects from a fire such as a hot nail or pot. A useful tool for this purpose is a pair of tongs. These can be made easily from a tree branch.

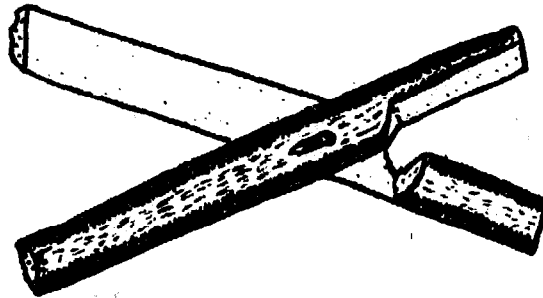

You will need the following materials:

- One straight branch
Length: Not less than 17 cm
Circumference: Between 8 and 9 cm
- One nail, 4 cm long
- Saw

Hammer

Chisel

Four wood holders

Bench Hook

Making the Tongs

Secure the branch to a tree or log with wood holders. Make a cut 13 cm in length in the branch, as shown.

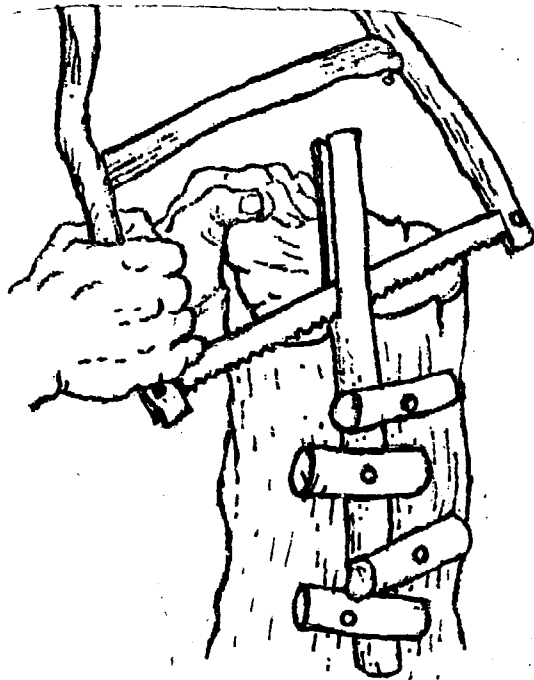

1. Now remove the branch from the wood holders. Cut off the extra wood at the other end, so your piece is 17 cm long. Again, hold the branch with wood holders this time with the end with the 13 cm cut down. The end that is up should now be cut to a depth of 4 cm at right angles to the 13 cm cut. The diagrams illustrate these cuts.

Actual Size

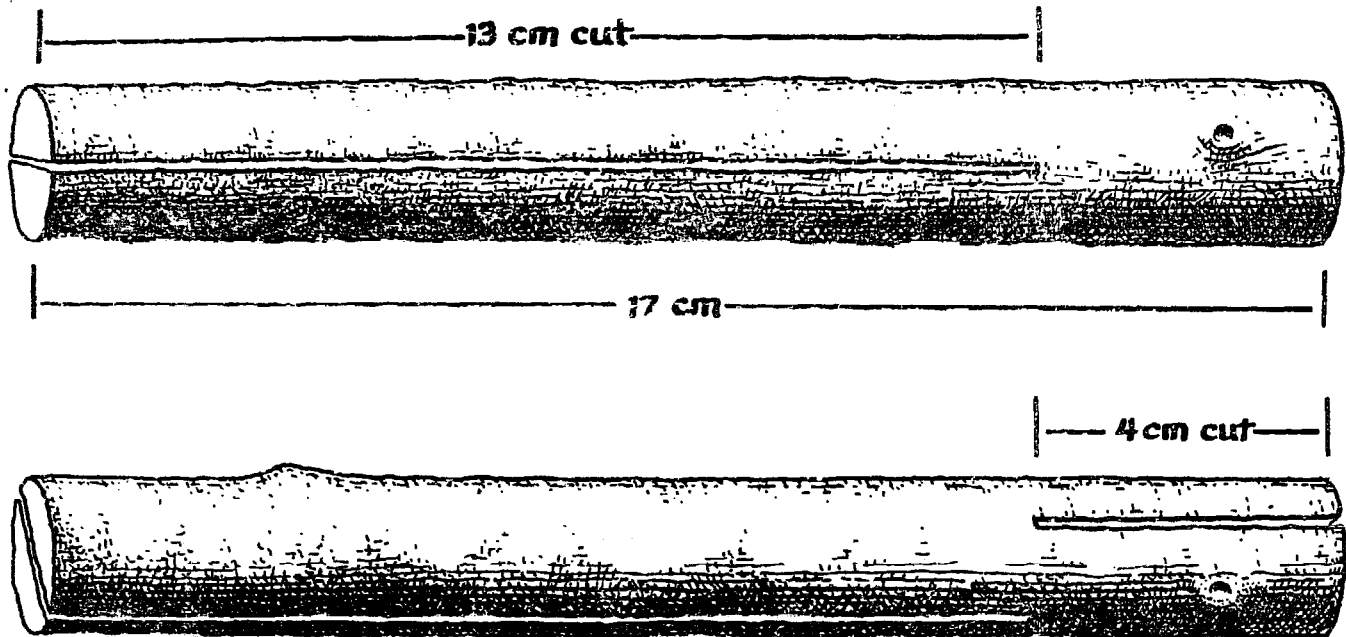

Use your chisel and hammer to chip away at point "A" as shown in the diagram. Chisel a little away at a time. Do this until the cuts are connected. Turn the branch over and do the same thing to connect the two cuts on the other side.

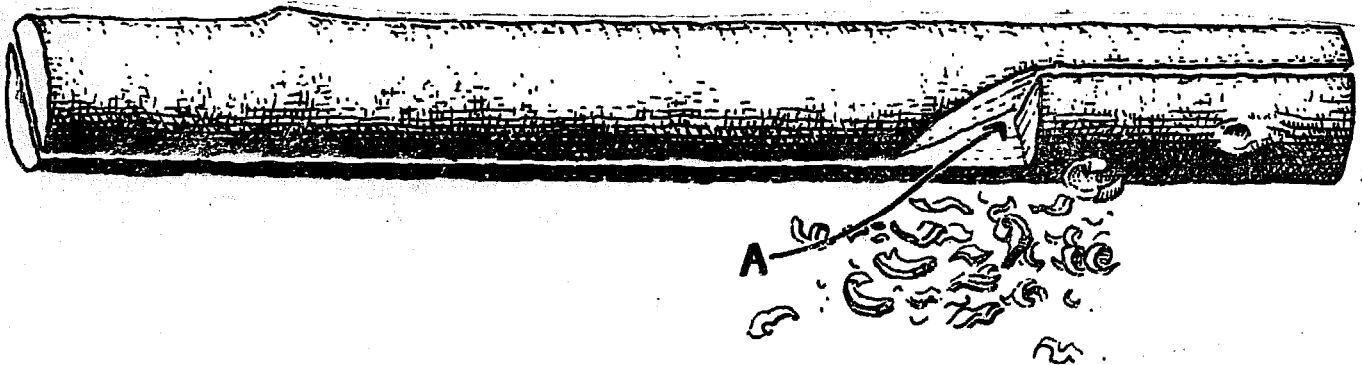

At this point you should be able to pull the branch apart into two pieces as shown in the diagram.

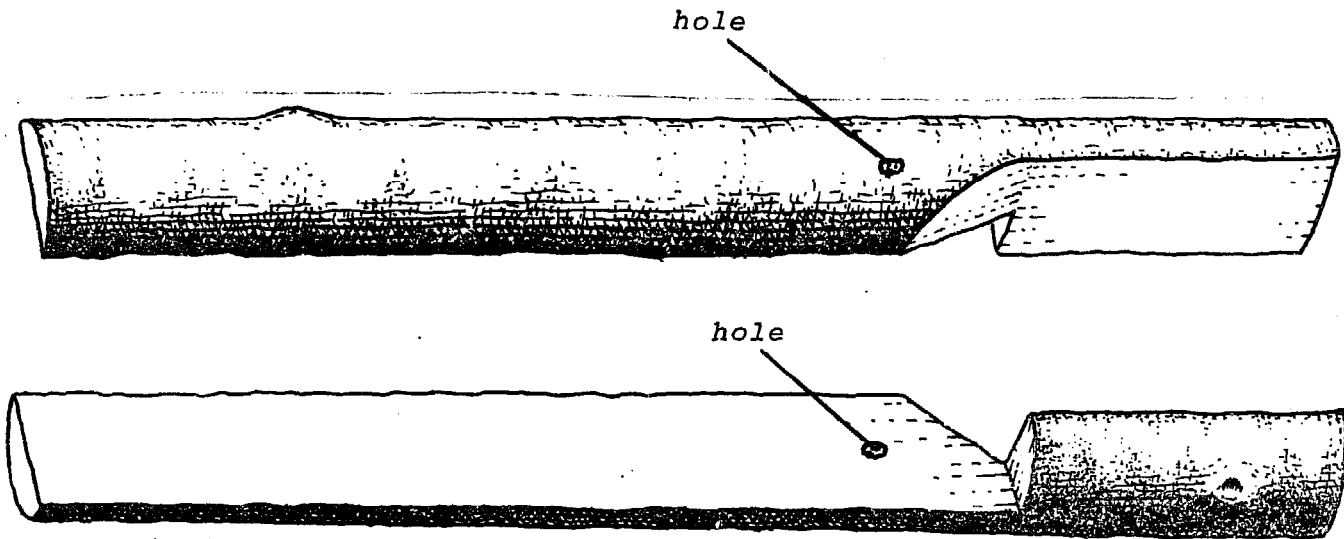

With a drill, make a hole through both pieces. Put a nail through these two holes. Bend the pointed end of the nail. Your tongs are now completed.

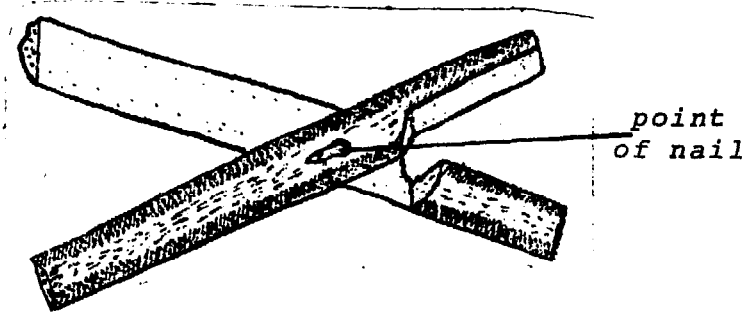

Section O. TWEEZERS

There will be some occasions when you will be working with small objects. It may be difficult to handle these objects. There may also be times when you want to pull out some small object which is inside a certain device, and you cannot get at it with your fingers. In these situations you can use tweezers.

Tweezers from a Branch

Find a small branch of a tree which is "Y" shaped. Cut off the bigger branch so that it is of a size which will fit nicely in the palm of your hand. Make sure it is flexible. That is, squeeze the two arms until they touch each other. When you let go, they will spring back to their original position.

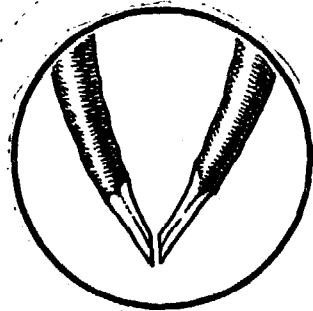

With a sharp knife, cut the ends so that they are thin and tapered. Any small object, such as a nail or pin, can be picked up.

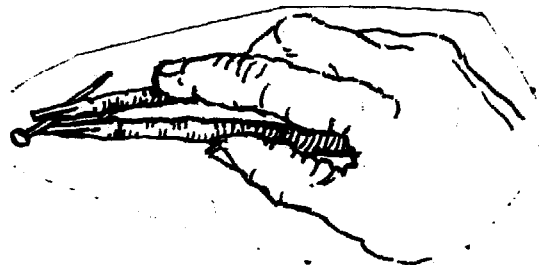

Metal Strapping Tweezers

Use a piece of metal strapping from an old packing crate to make these tweezers. Try to get a strip thick enough to be a bit rigid but still somewhat flexible. Its length can be between 20 and 24 cm. Round off the two ends by rubbing the metal on a hard stone. Bend this piece in half.

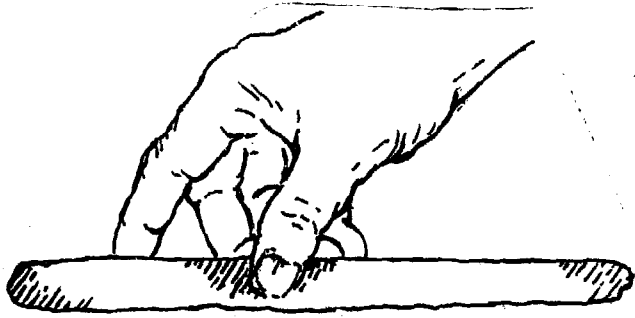

The two arms should spring back to their original position when your fingers are not pushing them together.

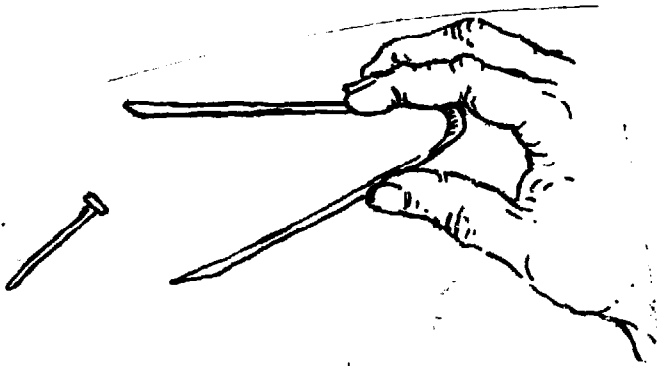

Bamboo Strip Tweezers

Find a piece of bamboo that is about 28 to 30 cm in length. With a heavy knife, cut a 1 cm wide piece from the large bamboo. If the strip is very thick, cut some of the inside away with a knife until it is about $\frac{1}{2}$ cm in thickness. With the shiny side down, make two small cuts on the rough side.

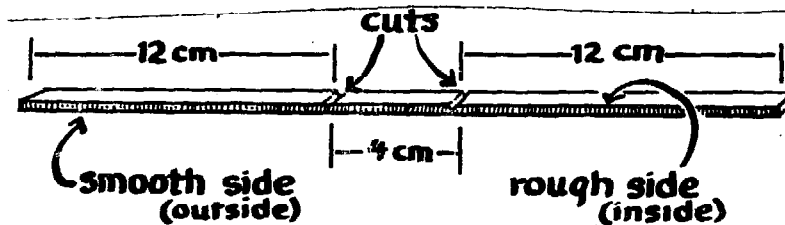

Carefully bend the strip at the two cuts so that the shiny side is inside. With a knife, shave the two ends so that they are thin and come to a point.

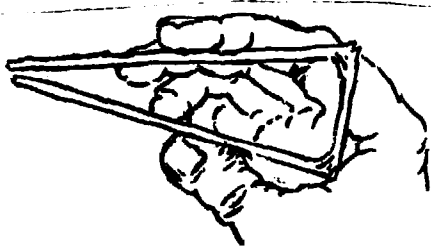

Section P. TIN CUTTING USING THE CHISEL OR A TIN CUTTER

A convenient way to cut tins is to nail a pole into the top of a work table. The board shown in Diagram A has been rounded near its end and has been nailed into the table. About 15 cm of the board are beyond the edge of the table. A tin can be put on this part of the pole, and then cut with a chisel and a hammer as shown in Diagram B. In this way, a useful square or rectangular piece of metal can be cut out of each tin. The remaining tin is also useful as a stand for heating things.

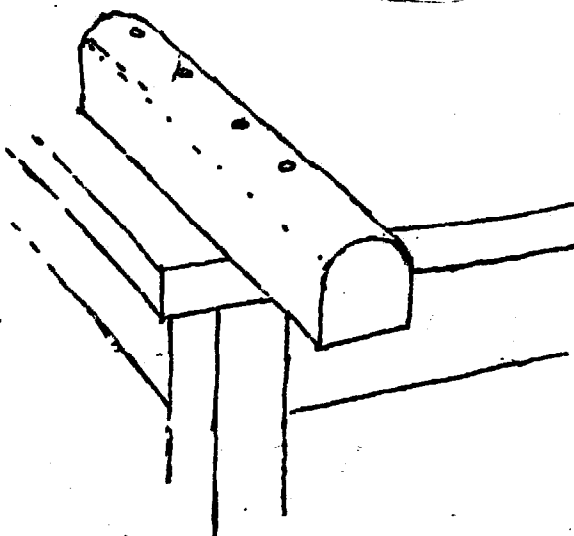

DIAGRAM A

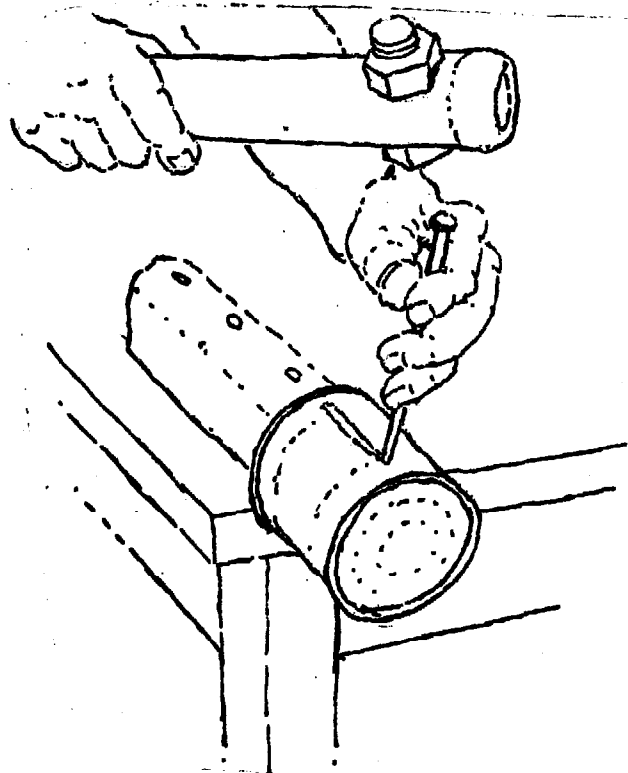
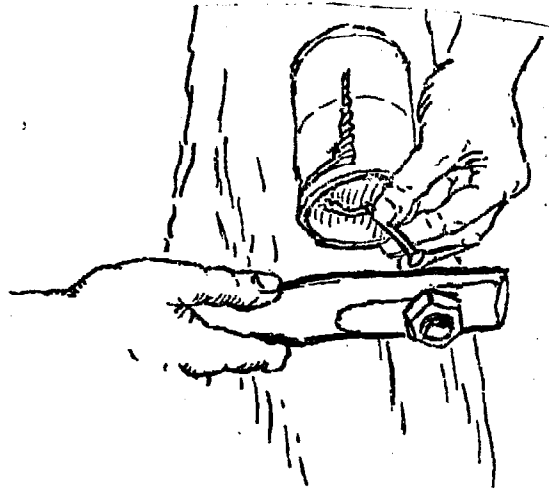

DIAGRAM B

It is also possible to cut a piece of metal from a tin without nailing a pole onto a table. This method, shown below, is much more difficult.



A special tool for cutting the top out of a tin can be made with a 15 cm nail. Rub the head of the nail on a rough stone or rough cement floor until it has the shape shown in Diagram C.

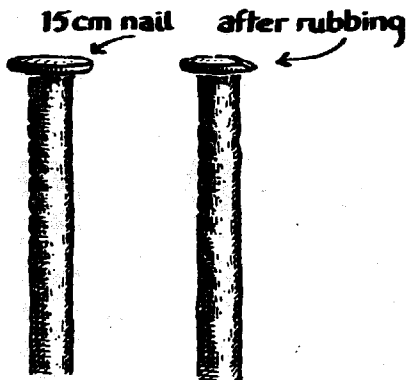

DIAGRAM C

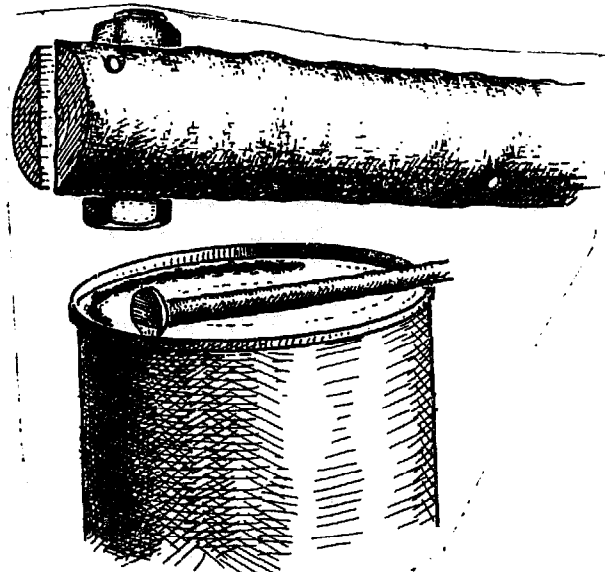

DIAGRAM D

The sharpened edge of the nail is now placed at the edge of the tin, and the other part of the head is hit with a hammer as shown in Diagram D.

Each time the hammer hits the nail, a small part of the tin is cut. Move the nail and hit it again. Do this until the top of the tin is removed.

Section Q. A HEATING STAND MADE FROM A TIN

Using one of the methods of cutting a tin shown previously, you can make heating stands while you obtain rectangular pieces of metal to use for other purposes.

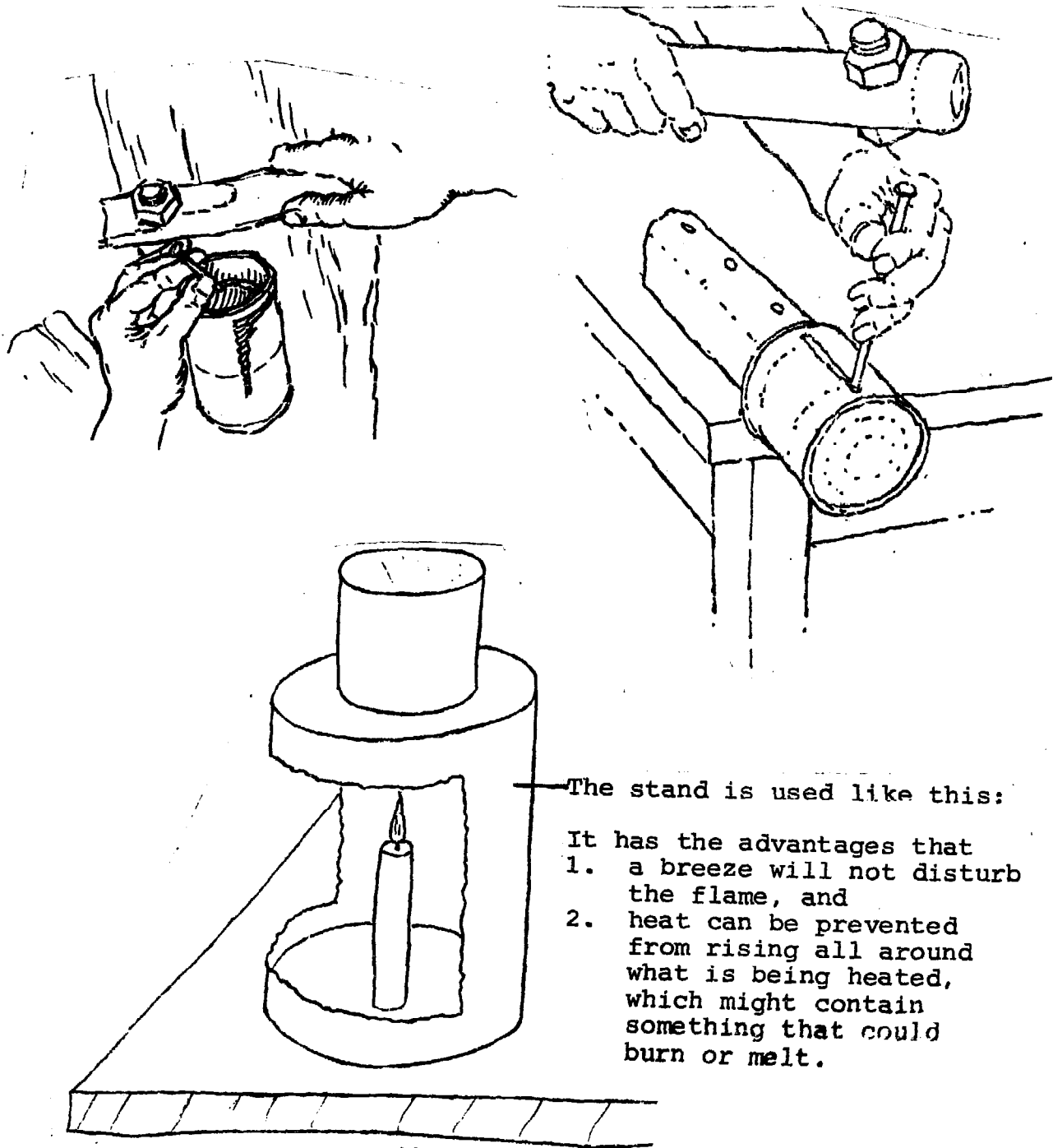

The stand is used like this:

- It has the advantages that
1. a breeze will not disturb the flame, and
 2. heat can be prevented from rising all around what is being heated, which might contain something that could burn or melt.

Section R. HOW TO MAKE A ROUND HOLE IN A TIN

In cases where one wants to insert a tube into a tin tightly so that there is no leakage between the tube and the hole it fits into, it is necessary to make a round hole in the tin. If the hole is large enough to be able to fit the case of a Bic pen into (or a very small hollow bamboo branch) use the following method. First, make a tiny hole with a nail having a length of 5 centimeters. Then enlarge the hole with a 6½ cm nail, followed by a 10 cm nail, and lastly by a 15 cm nail. It is important that these four nails be used in this way. If only the largest nail is used, it will make a square hole because the point of the nail has four sides.

Section S. MAKING AN EQUAL ARM BALANCE

Many science lessons can be improved by having weighing equipment available for the students to use. Often there is only one triple arm balance or weighing scale in the science room, and the teacher is apprehensive that it may become broken if students are allowed to use it.

Simple designs for equal arm balances that can be made from easily available materials are shown here.

Several details of design affect how sensitive a balance is:

1. Friction at the center point.
2. Whether the center hole is placed above or below the end holes.
3. The weight of the beam and where the center of gravity of the beam is located compared to the center hole.

Friction at the center point can be kept very low as long as the pivot uses rolling instead of sliding friction. Using a nail that rolls on the edges of tins is one effective way to keep friction at the pivot from being a problem, and is the method used in the diagrams that follow.

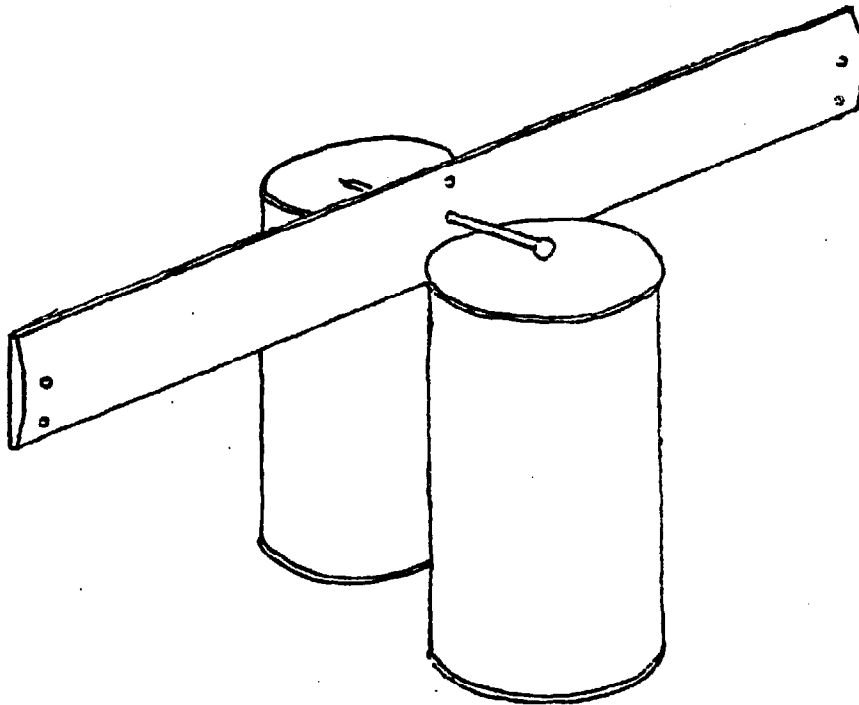

To investigate the effect of having the end holes
a. below the center hole, and
b. in line with the center hole,
make the holes shown in the following diagram in a
wooden ruler.

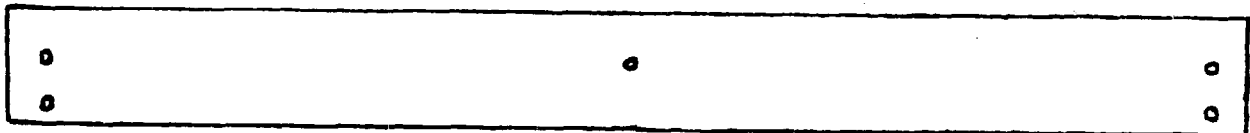

Put a nail in the center hole, which is approximately at the center of gravity of the ruler. Then hang a hook or light-weight container from the lower holes at each end of the ruler. Get many small objects that all have the same weight. These could be common pins, paper clips or staples. One of these objects should be enough to unbalance the ruler. (If the ruler does not hang level at first, put an elastic band around the portion of it that is higher, and use its position to adjust the ruler so it is level.)

Then put five pins on each side. Add a sixth to one side. Does the ruler move? Add five more pins to each side, so you have ten on each side. Add an eleventh to one side. Does the ruler move? Continue this procedure for fifteen and twenty pins.

Now hang your hook or light weight container from the upper holes at each end of the ruler. Do the same thing, testing the sensitivity to detect the weight of one pin when there are zero, five, ten, fifteen and twenty other pins already in each container.

You will find that in one case, the sensitivity decreased greatly when many pins were already on each container. This characteristic is useful when you want students to quickly compare objects that are approximately the same weight with other objects that are very different in weight, such as being only half as heavy. Too much sensitivity might make every object seem different in weight from every other object, and the students would get bogged down. Measuring the potato cubes in Part I of *Preserving Food by Drying* is an activity where the balances purposefully should not be very sensitive.

Now make one more hole in the center of the ruler, so it looks as follows:

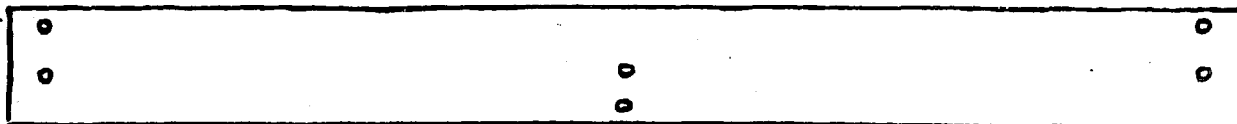

In this explanation, the weight of the beam is staying the same - it is the weight of a ruler. If you need to make an extremely sensitive balance, the same principles described here can be used with a light weight beam made from thin cardboard. Similarly, if a more rugged balance is needed for heavier weights, a design using parts of a tree could be made, similar to the diagram at the end of this explanation.

Now put the nail in the new hole you have made near the edge of the ruler. First put it on the pivot with the hole near the lower edge of the ruler. You will see that it does not balance when it is used this way. This is because the center of gravity of the ruler is above the pivot. The ruler tries to fall to a position where its center of gravity is below the pivot.

Now put the ruler on the pivot so the new hole (with a nail through it that rests on the edges of the tins) is near the top edge of the ruler. Repeat the same procedure of testing the sensitivity of the balance by putting one pin on one side, when you have zero, five, ten, fifteen and twenty pins already in the containers at each end of the beam.

You now have seen how the sensitivity varies according to where you make the holes at each end, and the hole in the center that the pivoting nail goes in. Now you will be able to make a balance where you can design what the sensitivity will be, even if you use materials such as shown in the following diagram:

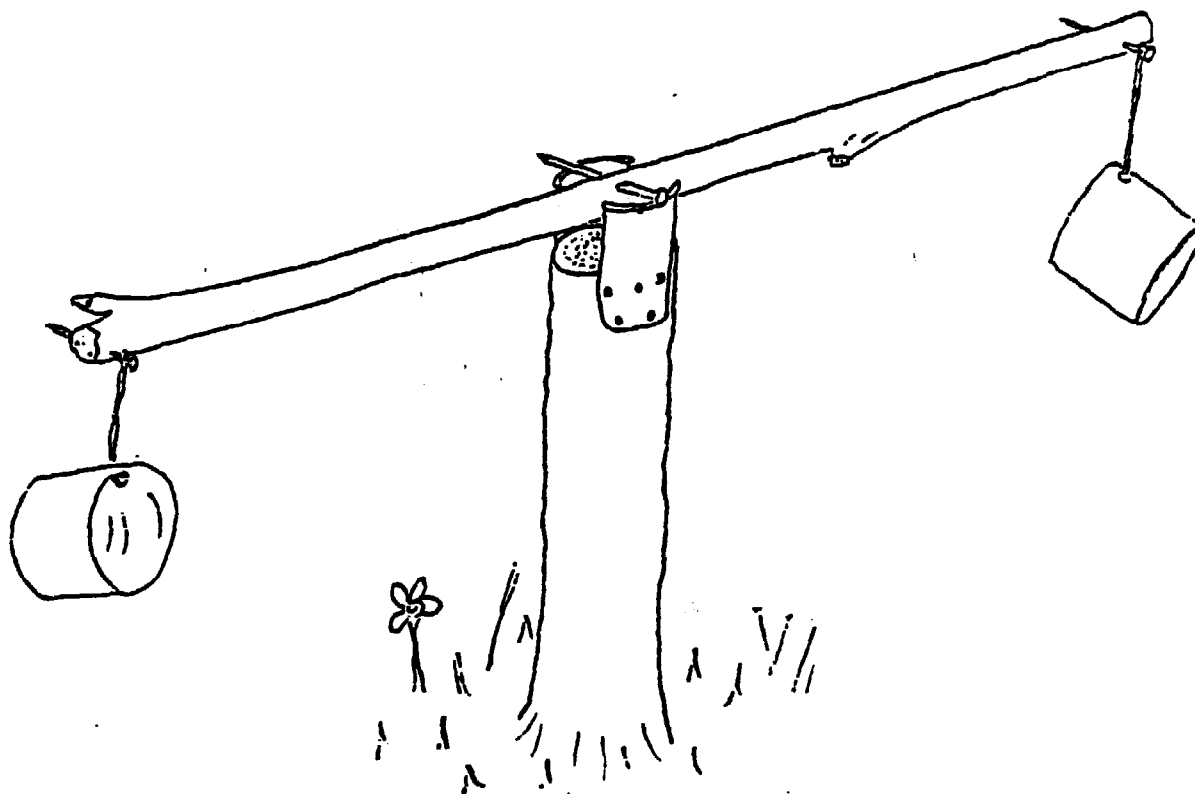

Section T. DETECTING CHANGES IN TEMPERATURE
WITHOUT A THERMOMETER

In a number of the activities* where an increase of temperature takes place, it can be felt with your hand. These are Activities I-3B, I-4C, I-4C *Further Study*, I-5A and I-10.

In several other activities, the increases in temperature can be noted the same way, but it would be desirable to improve both measuring skills and understanding of the situations by making a somewhat more quantitative measurement. The approaches suggested here apply to these activities: I-5B, I-7, I-7 *Further Study*, I-8B, I-11A, I-11B and II-2.

In the *Further Study* following Activity I-3A, a laboratory thermometer which can measure temperatures up to 100° C is needed. This is a difficult requirement to meet with improvised temperature measuring devices, but perhaps you can invent one or locate an existing design that is easy to make and works well. If you do, please communicate it to the Information Collection and Exchange office. Also, please let us know about your successful or unsuccessful attempts to measure temperature in any of the lessons.

In many industrial applications, temperatures are measured using pieces of material that melt at known temperatures. For example, in Activity I-7, three tiles are placed in the sun. They are all horizontal. One is black, one is earth colored, and the other one is white. On each tile, you could put a piece of margarine and a piece of wax. Whether both of these melt on each tile, and how long it takes could be noted. Maybe in your locality, both of these melt too easily. Can you find another material that melts at a higher temperature?

*

*

*

*The classroom activities referred to here are those described in Peace Corps ICE manual M10, Preserving Food by Drying: A Math-Science Teaching Manual.

The following device can measure small and medium changes of temperature.

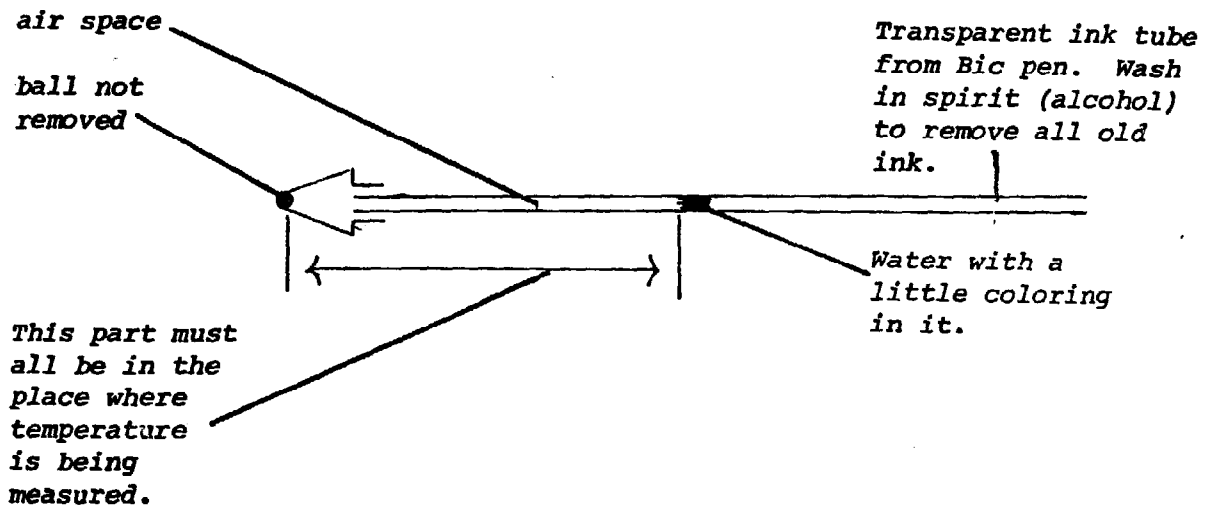

The air trapped in the tube expands as the temperature rises. Experiment with the size of the air space. A small air space gives less sensitivity, but a higher temperature can be measured without the water spilling out the end of the tube. The range has an upper limit near the boiling point of water because too much water vapor forms in the air space. Positions along the tube can be marked, or it can be glued to a piece of paper, pasteboard, plastic or wood, and that can be marked.

*

*

*

The following device is useful for measuring relatively small changes in temperature. Air in the body of the pen expands to move the colored water. Air must be free to leave or enter the tip. Water getting in it will impair its operation.

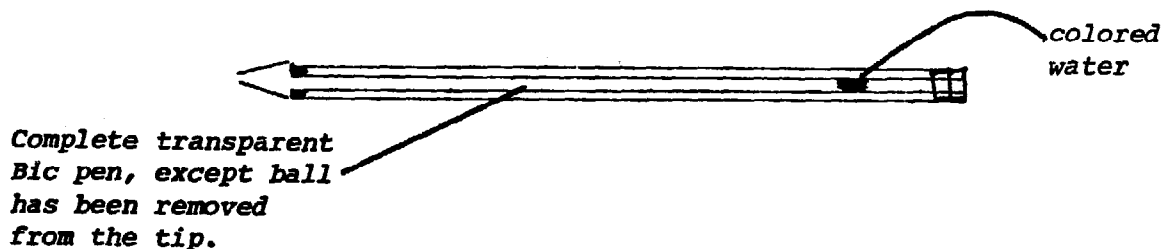

All connections must be sealed, including the small hole on the side of the pen. When the air is warmed and expands, it pushes the colored water. It must not escape elsewhere. The whole device is sensitive to change of temperature. Either the whole thing should be put in the place where temperature is being measured, or the same length must be used for all measurements which are to be compared. It also responds to your warm fingers, and thus must be held some other way.

As you can see, these devices have some merit, and we are anxious to hear of your efforts to use them. However, they also have limitations. Perhaps they can be adapted in some way to become better.

The conditions of measurement in the various activities are as follows:

Activity	Wet or Dry	Amount of temperature change	Temperature present over a large or small area	Calibration of device needs numbered uniform intervals	Temperature too hot to touch by hand for very long
I-5b	wet	slight	can be either	no	no
I-7	dry	moderate to large	large area	no	maybe
I-7	wet	moderate	large area	yes	no
I-7 Further Study	dry	moderate to large	large area	yes	maybe
I-8b	dry	moderate to large	large area	no	maybe
I-7,11a I-11b II-2	dry	moderate	depends on size of equipment	no	no
I-3a Further Study	wet	very large	depends on size of equipment	yes	yes

Section U. MAKING A SET OF WEIGHTS

Without a set of weights, an equal arm balance can be used to see whether various objects are equal in weight or not. This is done in Activity I-6,* where the equal arm balance shows that if one of the cubes is cut into several pieces, the pieces still weigh the same as the other cube that was not cut.

If the objects are to be weighed with the equal arm balance, a set of weights is needed. This is necessary where the weight of a piece of fresh food is to be compared with the weight of the same piece of food after it has been dried. The equal arm balance can be used for weighing by putting the piece of food on one side of the balance and by putting enough weights on the other side to balance the food.

The set of weights should be based on some easily available objects that all weigh about the same. In Section S, things like staples, common pins, and paper clips are suggested for testing the sensitivity of the balance. However, these are too light to be useful for weighing the food pieces. They also have the disadvantage that unless they are all bought from the same source, they may not all have the same weight. Washers also do not make suitable weights, because they are made from scrap pieces of sheet metal, and although the diameter may be the same, the thickness varies tremendously.

Bottletops from Coca-Cola, Fanta and beer bottles are quite uniform in weight. These are probably the best things on which to base your set of weights. They have the added advantage of being obtainable for free.

The set of weights can consist only of bottletops. For example, a piece of food might weigh 130 bottletops fresh and 47 bottletops after being dried. This gets to be a lot of bottletops to pile on the balance, however.

Somewhat heavier objects that are quite uniform are batteries of the kind used in flashlights and radios. The weights may vary between batteries from different makers, but all batteries of a certain type made by the same company should weigh about the same. Consider that you have some small batteries that each weigh 14 bottletops, and some large batteries that each weigh 55 bottletops. To weigh the fresh food in the example, two large batteries would equal 110 bottletops, one small battery would add 14, and 6 bottletops would add the rest, to reach the total of 130 bottletops of weight. To weigh the dried fruit, three small batteries would equal 42 bottletops, and 5 bottletops would be added to balance the food's weight of 47 bottletops.

* Peace Corps ICE Manual M10, Preserving Food by Drying, p.51

Objects such as these can be used to make sets of weights suitable for all the food drying activities in this book.

	Fresh Food				Dried Food			
	Objects on balance	x	Object weight	= Equivalent weight	Objects on balance	x	Object weight	= Equivalent weight
Large Battery	2	x	55	= 110	0	x	55	= 0
Small Battery	1	x	14	= 14	3	x	14	= 42
Bottletops	6	x	1	= 6	5	x	1	= 5
Total weight (bottletops)				130				47

Section V. CONVERSIONS BETWEEN METRIC, BRITISH AND AMERICAN WEIGHTS AND MEASURES

These conversions have been rounded to produce values that are easy to work with and to remember. However, they are all within 2 percent of the exact values.

LENGTH

<u>Metric</u>	=	<u>British and American</u>
1 centimeter	=	4/10 inch
1 decimeter	=	4 inches
1 meter	=	40 inches
1 kilometer	=	5/8 mile
<u>British and American</u>	=	<u>Metric</u>
1 inch	=	2.5 centimeters
1 foot	=	3 decimeters
1 yard	=	9/10 meter
1 mile	=	1.6 kilometer

AREA

<u>Metric</u>	=	<u>British and American</u>
1 square decimeter	=	15.5 square inches
1 square meter	=	10.8 square feet
1 square meter	=	1.2 square yards
1 hectare	=	2.5 acres
<u>British and American</u>	=	<u>Metric</u>
1 square inch	=	6.5 square centimeters
1 square foot	=	9.3 square decimeters
1 square yard	=	5/6 square meter
1 acre	=	4/10 hectare

VOLUME

<u>Metric</u>		<u>British</u>		<u>American</u>
100 milliliters	=	3.5 ounces	=	3.4 ounces
500 milliliters	=	17.5 ounces	=	17.0 ounces
1 liter	=	0.88 quart	=	1.06 quart
5 liters	=	1.1 gallons	=	1.3 gallons

<u>British</u>		<u>Metric</u>		<u>American</u>		<u>Metric</u>
1 cubic inch	=	16.4 milliliters		1 cubic inch	=	16.4 ml
1 ounce	=	28.0 milliliters		1 ounce	=	30.0 ml
5 ounces ($\frac{1}{2}$ pint)	=	140.0 milliliters		4 ounces ($\frac{1}{2}$ cup)	=	120.0 ml
10 ounces ($\frac{1}{2}$ pint)	=	280.0 milliliters		8 ounces (1 cup)	=	240.0 ml
1 pint (20 ounces)	=	560.0 milliliters		1 pint (16 ounces)	=	480.0 ml
1 quart (40 ounces)	=	1.1 liters		1 quart (32 ounces)	=	960.0 ml
1 gallon (4 quarts)	=	4.5 liters		1 gallon (4 quarts)	=	3.8 l

MiscellaneousMetric

1 bottletop (Coca-Cola, etc.)	=	3.5 milliliters
1 usual teaspoon	=	4 to 5 milliliters
1 measuring teaspoon	=	5 milliliters
1 tablespoon, eating	=	8 to 10 milliliters
1 tablespoon, serving	=	14 to 16 milliliters
1 measuring tablespoon	=	15 milliliters

Note: 40 British ounces - 1 British (Imperial) quart, and 32 American ounces = 1 American quart. The ounces are almost the same size but this relationship creates a difference of about 20 percent in the size of pints, quarts and gallons between British and American measurement of volume.

<u>WEIGHT</u>		
<u>Metric</u>	=	<u>British and American</u>
10 grams	=	7/20 ounce
100 grams	=	3.5 ounces
1 kilogram	=	2.2 pounds
<u>British and American</u>	=	<u>Metric</u>
1 ounce	=	28 grams
1 pound	=	450 grams
10 pounds	=	4.5 kilograms

Note: The British and American units of weight shown above are the ones in common use, the "Avoirdupois" system, which has 16 ounces in a pound. Another system exists in both Britain and America, the "apothecary" or "troy" system. Its pound, which equals about 370 grams, contains 12 ounces. This system is only used in certain specialties.

3

Since 1961 when the Peace Corps was created, more than 80,000 U.S. citizens have served as Volunteers in developing countries, living and working among the people of the Third World as colleagues and co-workers. Today 6000 PCVs are involved in programs designed to help strengthen local capacity to address such fundamental concerns as food production, water supply, energy development, nutrition and health education and reforestation.

Loret Miller Ruppe, Director
 Everett Alvarez, Jr. Deputy Director
 Richard B. Abell, Director, Office of Programming and Training Coordination

Peace Corps overseas offices:

BELIZE
 P.O. Box 487
 Belize City

FIJI
 P.O. Box 1094
 Suva

MALAYSIA
 177 Jalan Raja Muda
 Kuala Lumpur

SEYCHELLES
 Box 564
 Victoria

BENIN
 BP 971
 Cotonou

GABON
 BP 2098
 Libreville

MALI
 BP 85
 Bamako

SIERRA LEONE
 Private Mail Bag
 Freetown

BOTSWANA
 P.O. Box 93
 Gaborone

GAMBIA, The
 P.O. Box 582
 Banjul

MAURITANIA
 BP 222
 Nouakchott

SOLOMON ISLANDS
 P.O. Box 547
 Honiara

CAMEROON
 BP 817
 Yaounde

GHANA
 P.O. Box 5796
 Accra (North)

MICRONESIA
 P.O. Box 336
 Saipan, Mariana
 Islands

SWAZILAND
 P.O. Box 362
 Mbabane

CENTRAL AFRICAN
 REPUBLIC
 BP 1080
 Bangui

GUATEMALA
 6a Avenida 1-46
 Zona 2
 Guatemala

MOROCCO
 1, Rue Benzerte
 Rabat

TANZANIA
 Box 9123
 Dar es Salaam

CHILE
 Casilla 27-D
 Santiago

HONDURAS
 Apartado Postal
 C-51
 Tegucigalpa

NEPAL
 P.O. Box 613
 Kathmandu

THAILAND
 42 Soi Somprasong 2
 Petchburi Road
 Bangkok 4

COSTA RICA
 Apartado Postal
 1266
 San Jose

JAMAICA
 9 Musgrove Avenue
 Kingston 10

NIGER
 BP 10537
 Niamey

TOGO
 BP 3194
 Lome

DOMINICAN REPUBLIC
 Apartado Postal
 1414
 Santo Domingo

KENYA
 P.O. Box 30518
 Nairobi

OMAN
 P.O. Box 966
 Muscat

TONGA
 BP 147
 Nuku'alofa

EASTERN CARRIBBEAN
 Including: Antigua
 Barbados, Grenada,
 Montserrat,
 St. Kitts-Nevis,
 St. Lucia, St.
 Vincent, Dominica
 "Erin Court"
 Bishops Court Hill
 P.O. Box 696-C
 Bridgetown, Barbados

LESOTHO
 P.O. Box 554
 Maseru

LIBERIA
 Box 707
 Monrovia

PAPUA NEW GUINEA
 c/o American Embassy
 Port Moresby

TUNISIA
 6, Ave. Louis
 Braille
 Tunis

MALAWI
 Box 208
 Lilongwe

PARAGUAY
 c/o American Embassy
 Asuncion

UPPER VOLTA
 BP 537-Samandin
 Ouagadougou

ECUADOR
 Casilla 635-A
 Quito

PHILIPPINES
 P.O. Box 7013
 Manila

WESTERN SAMOA
 P.O. Box 880
 Apia

RWANDA
 c/o American Embassy
 Kigali

YEMEN
 P.O. Box 1151
 Sana'a

SENEGAL
 BP 254
 Dakar

ZAIRE
 BP 697
 Kinshasa