

AT MICROFICHE REFERENCE LIBRARY

A project of Volunteers in Asia

A Model Health Centre

Published by:
Council for World Mission
British Council of Churches
Edinburgh House
2 Eaton Gate
London SW1W 9BL
England

Paper copies are 4.50 British pounds.

Available from:
Teaching Aids at Low Cost
Institute of Child Health
30 Guilford Street
London WC1N 1EH England

Reproduced by permission of the Council for World Mission, British Council of Churches.

Reproduction of this microfiche document in any form is subject to the same restrictions as those of the original document.

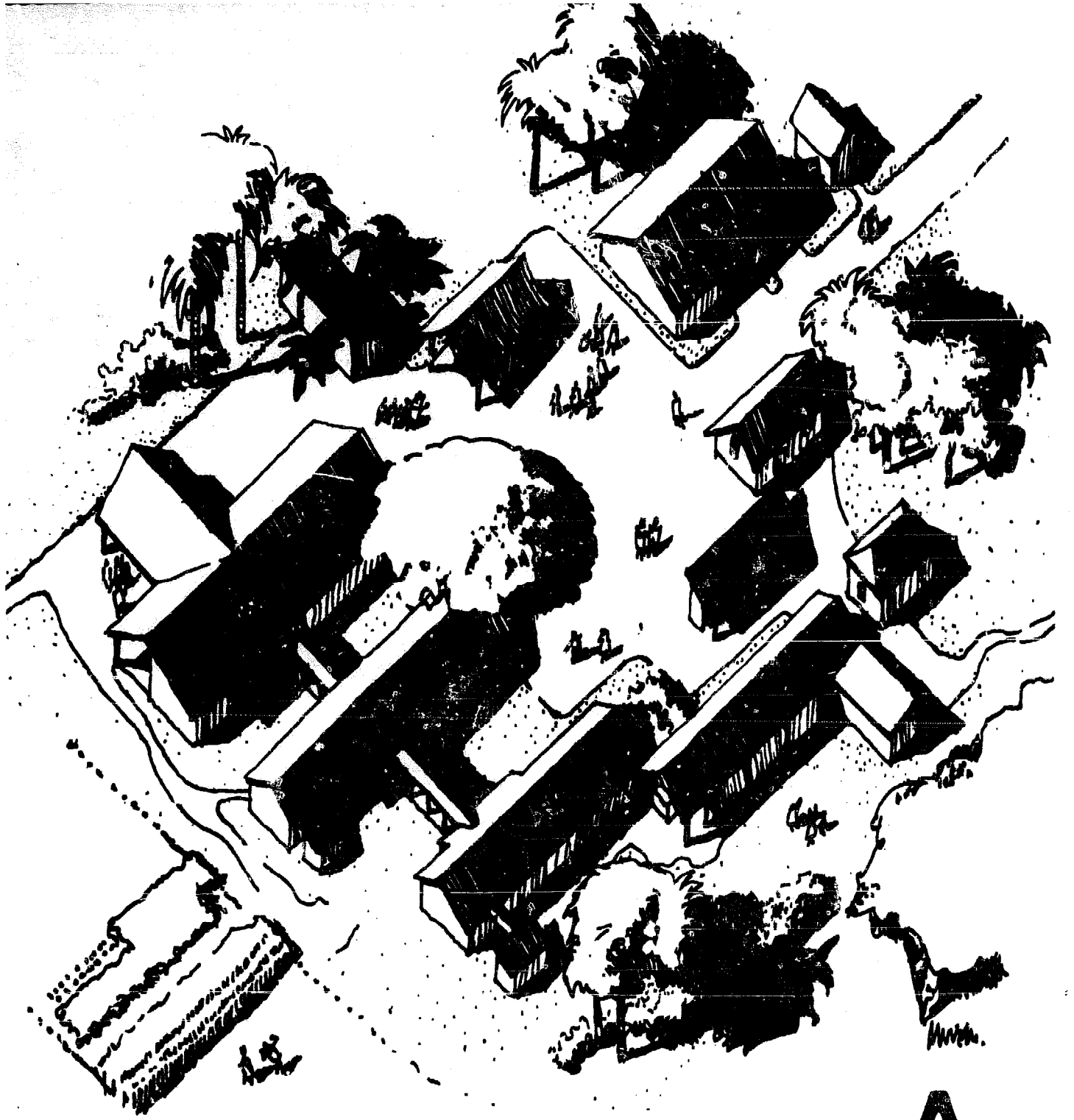

**A
MODEL
HEALTH
CENTRE**

A MODEL HEALTH CENTRE

**A Report of the Working Party appointed in 1972 by the Medical Committee
of the Conference of Missionary Societies in Great Britain and Ireland**

Conference of Missionary Societies in Great Britain and Ireland.

1975

Copyright © 1975 The Chairman of the Medical Committee of the Conference of
Missionary Societies in Great Britain and Ireland, Edinburgh House, 2 Eaton Gate,
London SW1W 9BL.

Permission must be sought should any of the material be used for the purpose of
financial or other gain.

The purpose of this copyright is particularly to protect the design of the Model
Health Centre from copyrighting by others so that reasonably open access to the
material may be maintained.

Printed in the United Kingdom by R.K. Hudson, 53, Elmfield Road, London SW17 8AF

CONTENTS

	<i>Page</i>
Contents	iii, iv
Foreword	v
Members of Medical Committee	vi
Members of Special Committee	vi
Introduction	vii
Chapter I. The background, the Model, important areas for further study and the future	1
Chapter II. A description of the Model plan	5
Chapter III. The drawings	9
	Appendix
Social area and kitchens	1
Under fives clinic	2
Ante-natal clinics and family planning	3
General outpatients	4
Waiting areas	5
Pharmacy or dispensary	6
Laboratory	7
Central facilities	8
Reception and office	9
Clerical work	10
Admissions	11
Wards	12
Hostels	13
Staff housing	14
Sterilizers and sterile supplies	15
Notes on an immunization area	16
Disposal	17
Stores and store-keeping	18
Equipment lists	19
Extended room list and expansion options	20
Treatment types	21
Part-time workers	22
Communications and responsibilities	23
Duties of the doctor in relationship to the Health Centre	24

	Appendix
Teaching and staff training	25
Some teaching aids and their use	26
Home visiting	27
School visiting	28
Evaluating the work of the Health Centre and the use and design of records	29
Some examples of patient retained records	30
The use of school children for record making	31
Community hygiene	32
Nutrition and food	33
The nature of disease	34
Costs and materials	35
Foundations and roads	36
Flexibility, expandability, mass production and standardization of buildings	37
Latrines and sewage disposal	38
Water supply, purification and storage	39
Energy and plant	40
Site sizes	41
Urban clinics	42
Very small clinics	43
Numbers of people served, the distribution and grouping of Centres and some wider planning problems	44
The design of simple operating theatres	45
Producing, handling and assessing statistics	46
Setting up a Centre	47
Orientation of buildings, their construction and environmental considerations	48
Reference reading in relation to a Model Health Centre	49
Examples of diagnostic and treatment routines serialized for use in Health Centres	50
A description of a small rural Health Centre	51
Further drawings	52

FOREWORD

At the International Hospital Federation's Seventeenth International Hospital Congress held in Dublin in June, 1971, one session considered the value of standardizing buildings and methods when planning for the provision of health care in developing countries. Those involved in the medical work of voluntary organizations expressed immediate interest. Several of the architects present offered their help in making a detailed study of this approach to health care.

The idea of a Model Health Centre was presented by Dr. D. A. Andersen to the meeting of the Medical Committee of the Conference of Missionary Societies in Great Britain and Ireland (CBMS) on 27th October, 1972 and found such favour that a special committee was appointed, under Dr. Andersen's chairmanship, to bring in expert opinion.

At the first meeting of this special committee a working party was set up to prepare a report describing the buildings of a Model Health Centre, its staff, equipment and the work which should be undertaken from and in it. The names of members of the Medical Committee, special committee and working party are given on page vi.

The working party met on twelve occasions and, in presenting its report, would like to express its appreciation for the valuable advice and criticism received from many persons with special knowledge and experience in the field of health care in developing areas.

Acknowledgements

The Medical Committee, in receiving the report, gratefully acknowledges the special contribution of Mr. Mark Wells in undertaking the major share of the work involved in the preparation of both text and diagrams. It also expresses its thanks to Mrs. Phyllis Head who served as secretary to the working party, to Mr. James C. McGilvray who produced the reading list, to Mr. Graham Stone who made the fair copies of the diagrams, to the Witney Press who printed the large diagram at the end of the report, to Mrs. Gladys Hunt who read the proofs, to Mrs. Louisa Grant, Lt. Cdr. Roland Hudson and Mr. George Moore who provided the ways and means for typing, printing and binding the final document and to the many people, too numerous to mention individually, who have read drafts of manuscripts and given helpful advice and criticism. It gratefully acknowledges the financial assistance received from the Christian Medical Commission, the Medical Institute at Tübingen and MISEREOR at Aachen.

The special committee records with deep regret the sudden death of Dr. D. A. Andersen on 4th December, 1973. He had made a major contribution to the work involved in the preparation of this report and guided the committee with unfailing skill, tolerance and good humour.

Members of the Medical Committee

Dr. D.A. Andersen (Chairman to 2.12.73)	Canon A.S. Neech
Dr. Kathleen G. Wright (Chairman from 3.12.73)	Rev. T.C. Patterson
Rev. C.B. Firth (Secretary)	Miss R.E. Rankin
Dr. I.S. Acres	Dr. Nancye M. Ridley
Mr. A.D. Askew	Miss J.M. Sharp
Dr. H.H.W. Bennett	Dr. Elizabeth G. Sloan
Dr. W.R. Billington	Dr. H. Souster
Dr. S.G. Browne	Miss B. Spanner
Miss C. Cheal	Dr. J.L. Tester
Miss D. Dykes	

Members of the Special Committee

In addition to the members of the Medical Committee who attended the Special Committee meetings, the following consultants were invited:

Dr. W.A.M. Cutting, London School of Hygiene and Tropical Medicine
Dr. W.J. Maelor Evans, Foreign and Commonwealth Office, Overseas Development Administration
Professor N.R.E. Fendall and Dr. David Stevenson, Department of Tropical and Community Health, Liverpool School of Tropical Medicine
Mr. G.H. Franklin, Department of the Environment, Building Research Establishment
Mr. G. McRobie and Miss Pamela J. Logie, Intermediate Technology Development Group Ltd.
Mr. A.E. North, Architecture Department, Polytechnic of North London
Dr. P.N. Swift, Children's Department, Farnborough Hospital

Members of the Working Party

Dr. David Morley and Miss Margaret Woodland, Institute of Child Health
Mr. Mark Wells and Mr. Brian Brookes, architects
Dr. Kathleen Wright and Dr. Daniel Andersen, Missionary Societies
Miss M. Lethbridge, formerly Institute of Child Health
Dr. William Cutting, London School of Hygiene and Tropical Medicine

INTRODUCTION

This report is a contribution to the study of the problems associated with the provision of health care services in developing areas. Such services usually have their outreach into the community by means of small clinics, sometimes in isolated positions. Shortage of money and staff preclude the establishment of any larger units, at least in the first instance. The small clinic is fully described in the Appendices to the report.

From such small beginnings it may be that a site on which a small clinic has been established will become well placed for the care of a growing community. The report shows how, with careful forethought in the siting of the first buildings and the allocation of land, such a clinic may be developed into a Health Centre. In the opinion of the working party the Health Centre, a Model of which is described in detail, should be the most efficient unit upon which to plan the health care of a population of up to 20,000 people within a radius of from 10 to 20 miles.

Further growth of population or the improvement of communications and transport facilities may show that one of the Health Centres is so well located that it should be developed into a District Hospital. This development is also described in the relevant Appendices.

Every aspect encountered in the course of the studies (including training of staff, staff duties, equipment, construction of buildings, provision of essential services) has been set out in the Appendices some of which are in detail, others in a more cursory outline, it being hoped that persons with greater experience will improve upon the report where detail is lacking. Whilst full use has been made of the knowledge and experience gained from the reports of other groups, there are some fields in which further studies are essential. These include the training programmes for staff at all levels, with emphasis on the value of the auxiliary health worker, and the services of the Health Centre, as envisaged, in the health education of the community.

It is emphasized that the Health Centre as presented in the report is a Model which must be adapted to meet the needs of each individual location. Only by translating the proposals carefully into practice can their value be tested. All plans must be subjected to continuous revision in the light of experience.

The Medical Committee would welcome contributions and criticisms which would improve the contents of this report, which is now offered as a design primer and reference book for those engaged in planning, developing and operating health services whether at a national or local level.

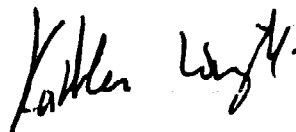

Chairman, Medical Committee
Conference of Missionary Societies in Great Britain and Ireland

9th June, 1975

A MODEL HEALTH CENTRE

Chapter I – The background, the Model, important areas for further study and the future.

The Background

The need for the study

Increasingly, the Health Centre is being seen as an instrument of forward-looking medical policy. So now seems to be a good time at which to clarify attitudes to Health Centres, and to take a look at why they are needed, how they work, what they are supposed to do and what they should look like.

The medical need and how it can be met

Those concerned with health care in the developing world recognize that health delivery based mainly on patients in need coming to hospitals must fail to meet more than a small fraction of total health needs. The problem is vast and no expansion of traditional facilities can in practical terms hope to meet the demand. A policy is needed which is capable of coping with this expanding problem: this policy will have to be radical and must take account of economics, available manpower and medical possibilities.

Economics

Costs must be kept to the 'morally' acceptable minimum. The setting of this threshold is a very major problem. Economically there is also the problem that people living in rural areas practising subsistence agriculture are difficult to reach, which puts up costs; and by definition contribute little to the national purse from which their health care is to be paid for. Morals and economics dictate the need for a reasonably even spread of care-facilities.

Manpower

There is no possibility in the foreseeable future of a sufficient number of medical and nursing graduates being available to deal directly with medical needs. It must be clear that planned delegation of duties to auxiliary workers is inevitable and no one should be required continually to perform a task which someone less qualified can readily be taught to do competently. How this is to be done in the longer term is a massive problem, and many proposed solutions offend established medical opinion. This report accepts the need for auxiliaries. It is particularly noted that age-structure in developing countries, with a remarkably high percentage of young children, encourages a start on younger patients, and that this type of care can be made to tie in with maternity care, implying in turn a population increasingly protected by immunization; auxiliary workers are particularly appropriate in these fields.

Implementation

We know a great deal more about the causes, prevention and treatment of diseases than we put into practice. Several diseases can be eradicated, prevented or treated comparatively economically and by less skilled people. It seems reasonable to suggest that such diseases and their treatment should take high priority in the policy.

A balanced approach

A balanced approach is needed, a balance between prevention and cure, a balance between use of the highly qualified in some areas and over use of the less qualified in others, between sophisticated care benefitting a limited number and much less sophisticated care for the majority, between 'applying' health to people with a hospital and teaching people in the community to help themselves, between a medical profession rightly proud of its overall health care history and a system of delivery that notes the importance of agriculture, nutrition and hygiene in the health of the community.

The value of the auxiliary

The pressure on skilled manpower, the high cost of traditional facilities and delivery and the huge problems of delivery in a dispersed population may appear to drive practical solutions into the realm of second class medicine peddled by auxiliaries, the retail outlets being cheap pseudo-hospitals. But in examining this problem the positive desirability of planned community-based preventive medicine, tied in with the essential basic needs of communities for adequate nutrition, hygiene, etc., suggest that in fact auxiliaries, supported by and communicating regularly with qualified staff, can do an immensely valuable job extremely well, and in doing so may reduce the hard core medical problems to a scale where, with reasonable forecasts of availability of skilled staff, we can hope to deal with them. This report adopts this cheerful view cheerfully.

The need for early action

Ideally, fairly detailed evaluations of current medical facilities, current disease prevalence patterns and population spreads should be carried out by trained teams before programmes are put in hand. This requires the training of teams to carry out such evaluations in order that future programmes can be precisely aimed at specific problems. This report accepts that such surveys are not yet available and that there is a shortage of people who could carry them out. This is not seen as an adequate reason for delaying action, and it is noted that many Centres must be built before the problem has become so reduced and refined that precise aiming is necessary and practicable. It is also noted that training programmes must be instituted to train the people who will do the surveys.

The Model

The aims of the study

This study illustrates a Health Centre and describes it and its workings in some detail. The study is offered as a design primer and reference for people faced with planning problems in the field. In some cases, the plan may be suitable as it stands. In others, additions or omissions will be necessary. To assist in adapting the plan, much of the preliminary work behind the design is offered for examination in the Appendices.

Using the Model

The study was initially restricted to a single model plan. As work progressed, and as discussion widened, the need for a range of facilities became increasingly clear, the range extending downwards to smaller units. The Model is therefore shown in the drawings both complete and broken up into smaller pieces. A specific layout is proposed even in small buildings to allow for future expansion. Any arrangement or rearrangement can be made. Planners inspecting the Model may feel it does not suit them at all, but it is hoped that this consistent volume of information can still be a 'companion' in the planning process. As most developing countries compared with the West have twice the number of under fives and half the working population, this report stresses a preference for the larger under fives clinic as the smallest desirable unit.

The general place of Health Centres in the spectrum of health care buildings

In most developing countries, five main categories of health care facilities exist:

1. The larger, often teaching, hospital (a Regional Hospital)
2. The smaller hospital (a District Hospital)
3. The Health Centre
4. The smallest reasonable clinic
5. Mobile services

This study is primarily set in category 3, but areas of high or low density will need special consideration. It must never be forgotten that a Centre is part of a network of care facilities. The references between Centres and the mutual responsibilities of more and less skilled staff, the links between Centres and District Hospitals and sub-centres need careful thought, definition and firm implementation. It is not

intended to cover urban centres, although examination might show the fundamental theory to be the same in the town as in the countryside.

The staffing of the Model Centre

The medical job to be done by the Centre can probably be best described by referring to what could be seen as a near ideal level of staffing as set out below:

- (a) Two principal staff: hospital trained nurses, midwives, medical assistants.

The principal staff will have a full nurses' training or a full medical assistants' training within the terms of the country in which they serve. It must be borne in mind that present-day training may not be wholly appropriate. Three years is seen as a current minimum for formal training.

- (b) Four auxiliary staff: small hospital or Health Centre-trained nurses, midwives, medical assistants, dispensers, dressers, laboratory workers, etc. with a one to two year in-service training.
- (c) Two local assistants: locally recruited and trained.

These assistants can be expected to be useful workers in the Centre team within a year.

- (d) One household assistant: locally recruited and trained for domestic duties.
- (e) Clerk-storeman-driver-mechanic-handyman.

Added to category (a) or within category (b) should be a health assistant trained in teaching and community medicine and familiar with the agricultural problems of the locality. One person in this group must also have a minimum approved laboratory training. Additionally, teachers and farmers can be given part-time training and can be part-time health workers and may be unpaid. Whilst in different places different stresses will be laid on the exact duty and meaning of each of these categories, it seems essential to see all the staff as having interlocking responsibilities. Thus, for instance, the household assistant can be expected to draw the attention of the medical staff to the arrival of a very sick child. Ideally all staff should also take part in community teaching and home visiting.

The staff listed should be capable of dealing with up to 200 'outpatients' per day and ten beds, supported by hostel accommodation for 'inpatients' not requiring bed care. Similar Centres to that illustrated work reasonably well with a considerably lower staffing level than that described here.

Consistent with local customs, availability and suitability of accommodation, staff can be male or female, single or married.

Two-way communication

Regular visits by doctors and two-way communication between the Centre and the local hospital must be seen as absolutely crucial to the Centre's being.

The Centre in the community

The Centre is to be embedded in the community it serves. Not only are the staff to go out into the community, but also the community is to have facilities within the Centre; these facilities being the main new idea generated by this study. Two-way communication between the Centre and hospital is to tie the Centre into the nationwide health delivery network.

Expansion of the Model

Chance or policy may dictate that a particular Centre will grow. The Model is therefore proposed as an expandable unit with a specific layout judged against turning the Centre into a small hospital at some future date. Such expansion is illustrated in outline, but should not be seen as being in any way essential to the establishment of a Centre.

Important areas for further study

Evaluation of intention and effect in planning

The problem of evaluating buildings and organizations and services is one receiving much attention at the present time. The aims of these evaluations are threefold: firstly, to see whether a facility is living up to expectations in use so that when the next run of facilities is planned the ideas behind the first run can be adapted to give a better result; secondly, to measure the effect of the service in simple health improvement terms as opposed to testing the organization used; and thirdly, as a method of locating gaps in the service so that they can be filled in future.

Evaluation of results in the field

This problem particularly affects the worker in a Health Centre in relation to medical records. This is too wide a field for the working party to begin to cover in any detail. We note some problems and some proposed solutions in the Appendices.

Teaching and communicating

This report lays emphasis on teaching, training and communication. People have to be taught to teach in addition to being taught the discipline in which they are going to work. This is another field which we have been unable to cover in any detail as insufficient is known about the techniques involved.

A framework for progress

The working party feels very strongly that a framework for progress should be drawn up in both these fields which might serve to co-ordinate all the work that is currently being done. We outline such a possible framework in relation to an ideal large scale organizational unit described in Appendix 44 as a macro-unit, the proposal being based partly on the proposition that centralized training runs against the precept of dispersed community-based medicine.

The future

Trying to locate the problems

The precise position that Health Centres should occupy in a particular country's health delivery network, the precise job the Centres are to do in that country, how they are to be staffed, run and financed, etc., will depend on factors too numerous and too varied for any specific comments on the wider organization of health units to be very useful. However, the working party, in considering staffing and training, the distribution of Centres and hospitals, and the annotation of community health responsibilities, has found it necessary to build wider ideas against some sort of framework. This framework is discussed in Appendix 44 (Numbers of people served and the distribution of Centres).

The 'macro-unit'

The macro-unit we have used is large, consisting of one Regional Hospital relating to ten District Hospitals, each District Hospital relating to ten main centres and a number of sub-centres. An organization proposed on this scale makes a useful analytical tool for breaking a national planning problem down into a limited number of parcels, each parcel being of a comprehensible size. Each parcel is big enough to cover such a wide variety of geographic and population conditions that it becomes reasonable, in setting the ideal into an actual situation, to propose a substantial but still acceptable loss of efficiency from the ideal pattern: if enough people are included in one macro-unit, then the precise proportional differences between town and country dwellers, reasonably accessible and virtually inaccessible terrains, good and poor communications, and varying population densities, become less relevant, giving initial theoretical planning a better chance of being realistic.

The use of the macro-unit

The macro-unit attempts to give an overall organizational map on to which Health Centres of smaller and larger size, with their supporting network of hospitals, can be plotted with some confidence in the resulting requirements for staff of all sorts, for buildings, and for the organization of training.

Chapter II – A description of the Model plan.

(This description is supported by a number of Appendices. Many of these overlap, but the working party have preferred duplication within different subjects to complex cross-referencing. Each Appendix aims to cover a particular subject constituting in effect a check-list for that subject.)

Basic format

Principal inter-relationships

Fig. 1 shows how the main parts of the Centre relate to each other.

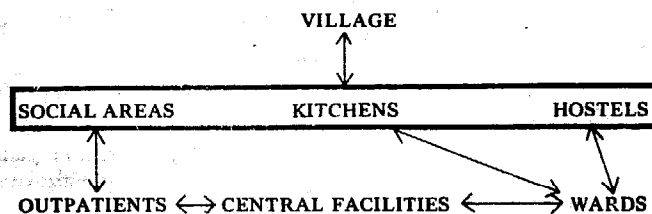

Fig. 1. The principal inter-relationships in the Model Centre

The social area

The social area, kitchens and hostels are placed between the village and the Centre. This position demonstrates that the area is as much village-territory as Centre-territory. The buildings are to be improved local buildings, using materials and techniques available to the community and within their financial resources. The buildings will be silent teachers throughout their life, and will provide a place where two-way communication between staff and patients, between people and people, takes place. These areas are discussed in Appendices 1 and 13.

Where problems of malnutrition could be alleviated by garden cultivation on a small plot such a plot should form part of the social area. It should be worked by a member of the Centre staff, using no more time or money than a member of the community could afford.

Basic organization

Fig. 2 expands the relationships between the main parts.

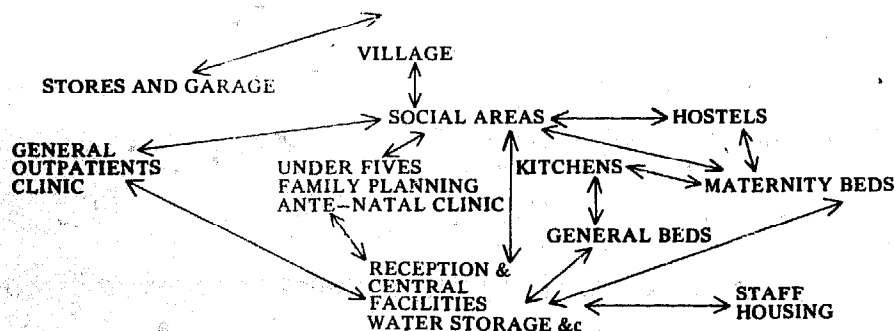

Fig. 2. Expanded inter-relationships in the Model Centre

The Model Plan

Fig. 3 shows a simplified outline plan of the Model Centre with the outline accommodation shown in Fig. 2 distributed round the buildings. Fig. 4 opposite shows a bird's eye view of the plan looking from the direction of the black arrow.

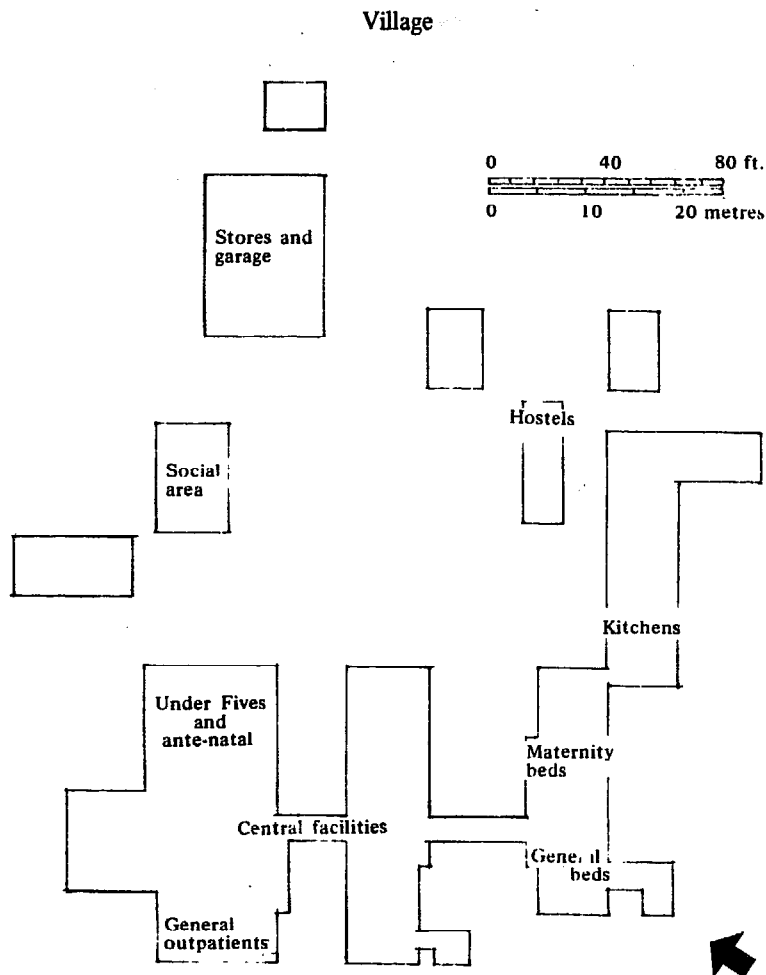

Fig. 3. Outline plan with basic organization shown

Additional governing factors

Points about the Model Plan

It is essential to remember that:

1. Only part of the Model may be appropriate for a small Centre.
2. More accommodation than shown may be required in large Centres. Some Centres may even turn into hospitals and this expansion has been planned for.
3. The buildings are laid out assuming that there is a best orientation for climatic reasons (see Appendix 48) so they are set parallel to each other in the Model.
4. The buildings are designed so that they can be built with unsophisticated means and simple materials. The distance between walls or columns has therefore been kept as small as is practical. Where a bigger room is wanted or extra space is needed the roof is pulled out a little. This gives a complicated outline.

Description of the plan

General description of the layout

Fig. 4 below shows a bird's eye view of the plan with the accommodation numbered and the names of the parts given underneath. The parts are numbered clockwise from the top.

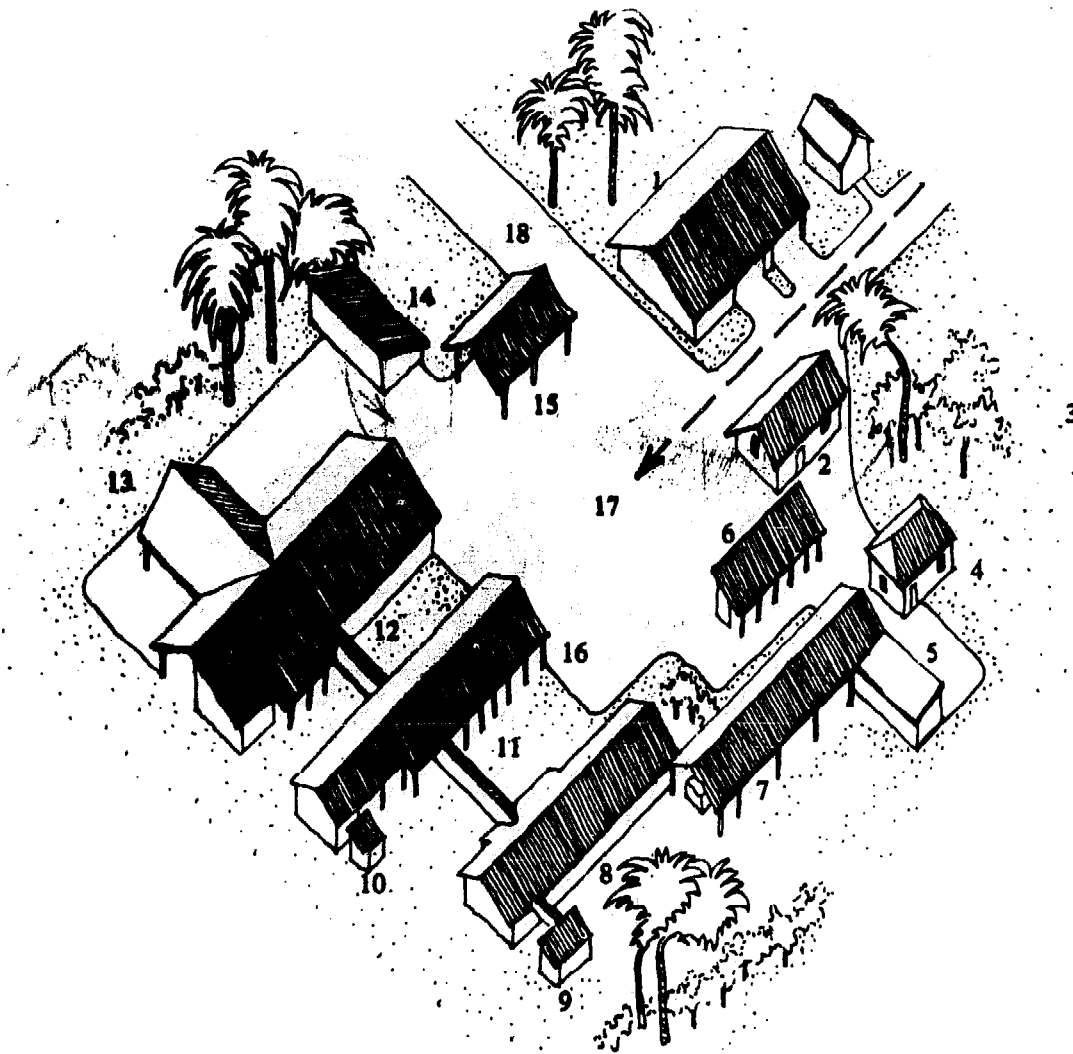
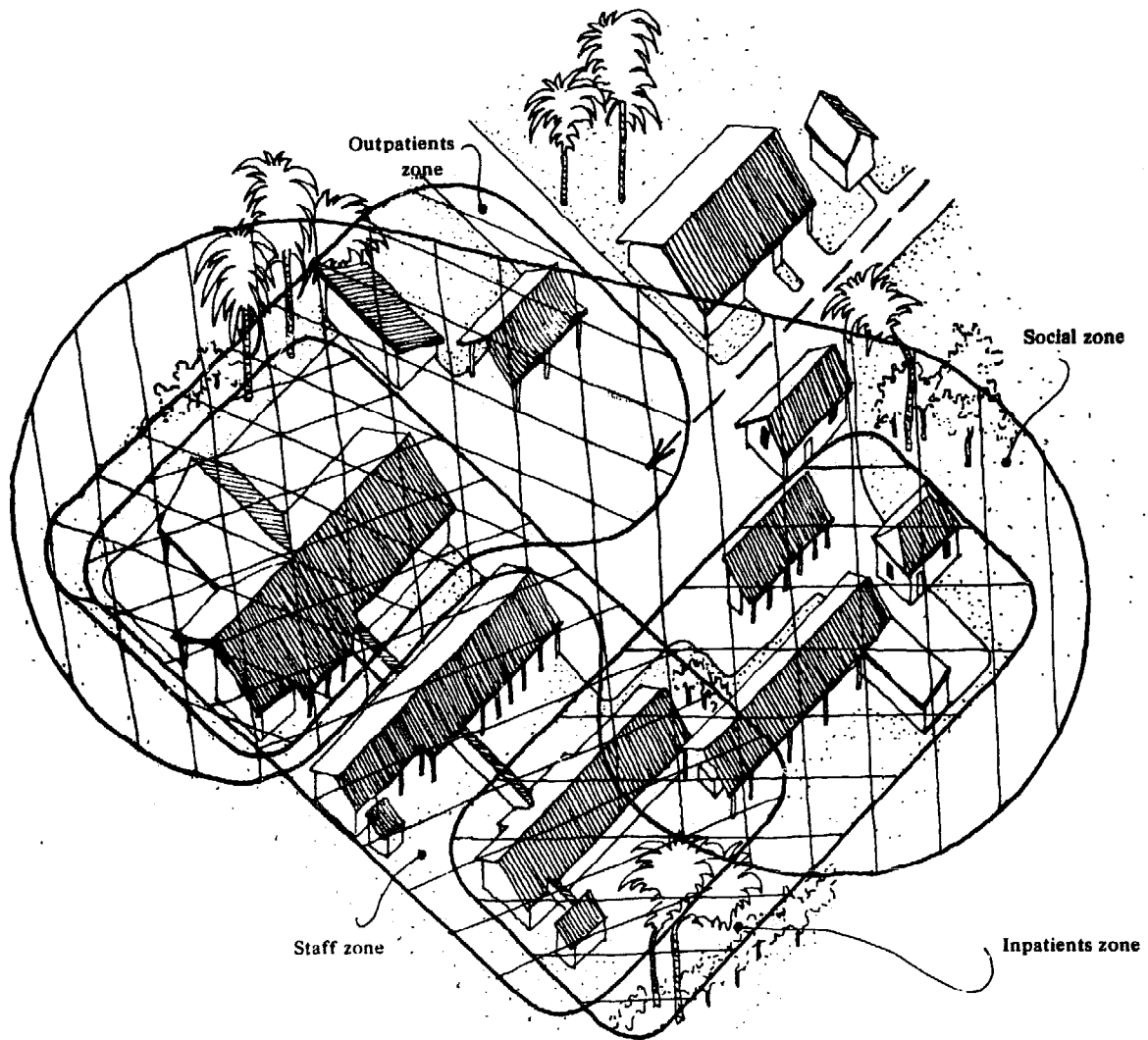

Fig. 4. A typical Centre on the Model plan. The arrow indicates the main approach.

1. Stores and garage placed near the entrance to simplify early construction, to cut down traffic and to achieve a public position rendering theft more difficult
2. Hostel or dormitory
3. Garden
4. Hostel
5. Women's latrines (inpatients) and hostel latrines
6. Kitchens and washing (hostels and social area)
7. Kitchens and washing (inpatients)
8. Ward
9. Men's latrines (inpatients)
10. Staff latrines
11. Central facilities
12. Outpatients including under fives etc
13. Pharmacy (dispensary) and laboratory
14. Latrines for social area and outpatients
15. The social area, prominent in the middle of the plan
16. Reception (and information) set opposite the entrance
17. There is an open area at the centre of the plan. This should be well planted with trees for shade
18. An alternative entrance position is shown from the left.

Fig. 5. The main zones of interest in the Model Plan



There is no reason why the Plan cannot be turned any way round or up. There are, however, fairly precise relationships which allow for growth and change. These should not be upset if this can be avoided. Where sites slope, changes will have to be made, but should be restricted to the minimum.

Covered ways are shown linking the main buildings, but not to the social area which is thereby given its own territory. The social area shown is smaller than the working party would like to see. If it is made any smaller it will not shelter sufficient people to make the building worthwhile. In some situations the social area could double as a sleeping shelter. (see Appendix 13 on Hostels).

Chapter III – The drawings

Drawings and how to use them

Folded into the back of the report is a scale plan of the whole Centre. This can be opened out to lie beside the report. The plan shows detailed dimensions which can for the moment be ignored. The plan shows columns as black dots and walls as thick lines. Roof overhangs are shown in a dash-dot-line, the ground floor is outlined in a single line, windows are shown as two parallel lines. The lines away from the buildings with numbers by them locate the dimensions and have no other meaning. Immediately in front of the plan at the back is Fig. 15 showing the cross section of the building and a possible roof structure. This may be ignored for the moment.

Preceding Fig. 15 at the back of the report is Fig. 14 which shows details of latrines and possible sewage lines. Earth latrines have to be moved periodically so a 'line of march' must be allocated. Where piped sewerage is installed the lines of the pipes must be laid to avoid possible future extension. These are for later reference.

Preceding Fig. 14 is Fig. 13 which shows the Model Centre with its possible extension to a substantial hospital outlined. Fig. 12 shows the extension to a 25-bed hospital. These last two drawings may also be ignored at this stage.

Fig. 6 which follows the next section (How the buildings are to be built) shows the Centre as a roof plan with letters on. These letters refer to the main blocks of accommodation. They do not relate to the numbers on Fig. 5. Below Fig. 6 is Fig. 7 which shows a plan of the rooms in the main buildings. The plan shows numbers and also the same letters as Fig. 6. The numbers refer to the key giving the room names. The names can be found on the room list immediately opposite Fig. 7. This list groups the rooms by letter, some rooms overlapping into two groups, and notes the area of each room. Circulation and covered ways are not noted on this list. A skeleton extended list for a small hospital is given in Appendix 20.

Following the room list is a series of drawings in two parts much as Figs. 6 and 7 where the roof plan is shown at the top of the sheet, the detail plan below. Each can be referred to the main fold out plan. Not all the possible alternatives are shown.

How the buildings are to be built and selecting the right size

Appendix 48 shows the basic thinking behind the plan and is written in non-technical terms. A short 'span' has been used to keep the structure simple, the span being the distance between walls or columns. Details of windows and doors have not been given as they will vary so much from place to place. If there is a local solution that works (such as solid shutters instead of glass windows) it should be considered.

Appendix 35 looks at materials and costs. Again these vary very widely.

Selecting the right size for a unit is a relatively simple matter providing either available staff or available money is known and providing an approximate cost per square foot or metre is known. The smallest unit recommended by the working party is unit C, the under fives clinic (see Appendix 2). This will give enough space for a tolerable social area where resources are very slight.

Actually going about setting up a Centre is described in Appendix 47.

Where only a very small clinic is required following the overall layout and selecting a site (see Appendix 41 on site sizes) may be totally irrelevant. It may also be wise to adopt a simpler structure that can be built by the local people without drawings. The approximate sizes needed can, however, be taken from the Model plan.

Figs. 12 to 15 are in Appendix 52

Room list and some comments on rearranging the Model plan

This room list should be read in conjunction with Fig. 6 or 7 and/or the fold out plan at the end of the report. The numbers are not the same as for Fig. 4. The rooms are grouped with a letter reference which is used to describe smaller units than the Model, for instance A+B is outpatients (A) plus laboratory, dispensary and clean and dirty treatment (B). The letters do not show all the possible groupings and combinations. It is convenient and practical to carve the plan up on column lines. One could have A + room 4 + a combined laboratory and dispensary in the outpatients waiting area in front of 4. 4 would then combine the functions of 4 and 5. The same sort of thing could happen taking C but using it as the only clinic, and making 10 into the office and reception. The social area might be built first where 23 and 24 are on the Model. It could be moved later, the old area becoming the office accommodation. F and G could be built first, room 23 being used for room 9, room 24 for rooms 10 and 4/5. Room 22 would be used for rooms 11 and 12. Room 15 is a suitable place for immunizations. Room 8 could double as a social area.

An extended room list is given in Appendix 20.

Possible extensions are illustrated in Appendix 52, Fig. 13.

Group	Room No	Room	Size in ft.	Area in sq. ft	Total Room areas in sq. ft	Add or corridors and overhangs	Area for costing in sq. ft	Area for costing in sq. m.
A. Outpatients	1	Store	5x16	80	784*	15%	900	83.5
	2	Examination	12x16	192				
	3	Waiting	16x32*	512*				
B. Treatment area	4	'Dirty' treatment	10x13	130	1106*	30%	1435	133.5
	5	'Clean' treatment	13x16	208				
	6	Laboratory	8x16	128				
	7	Dispensary	8x16	128				
	8	Additional waiting if required	16x32*	512*				
C. Treatment area. As B, but room 4 moves to room 13								
D. Under fives and Ante-Natal	9	Under fives consulting room	16x20	320	1292*	20%	1550	144
	10	Examination/Ante-Natal	12x16	192				
	11	Corridor and weighing station	4½x40	180				
	12	Waiting	12x50*	600*				
	13	Additional waiting for treatment	13x16*	208*				
E. Ward	14	Men's beds	16x16	256	1358	20%	1630	152
	15	Stores	10x13	130				
	16	Women and Children's beds	12x26	312				
	17	Nurses' centre of activities	8x15	120				
	18	Store	8x8	64				
	19	Cleaners' store	5x8	40				
	20	Delivery	12x15	180				
	21	Labour	16x16	256				
F. Offices	22	Store	16x16	256	816	30%	1050	97.5
	23	Staff/conference	16x20	320				
	24	Reception/clerk	12x20	240				
G. Goods area	25	Disposal	5x8	40	480	25%	600	56
	26	Clean up for sterilizing	8x11.	88				
	27	Sterilizing	8x11	88				
	28	Linen store	8x11	88				
	29	Laundry	8x11	88				
	30	Dirty linen	8x11	88				
		Covered links		490				
Total including 13					6534		7955	740

* Area shown has additional space available under overhangs or extended eaves.

These figures do not include:

Latrines, kitchens and laundry
Store and garage
Social area
Hostels
Staff housing

See Appendix 13 for Hostel plans and Appendix 14 for Staff Housing plans.

See also fold out plan at end of Report and extended room list, Appendix 20.

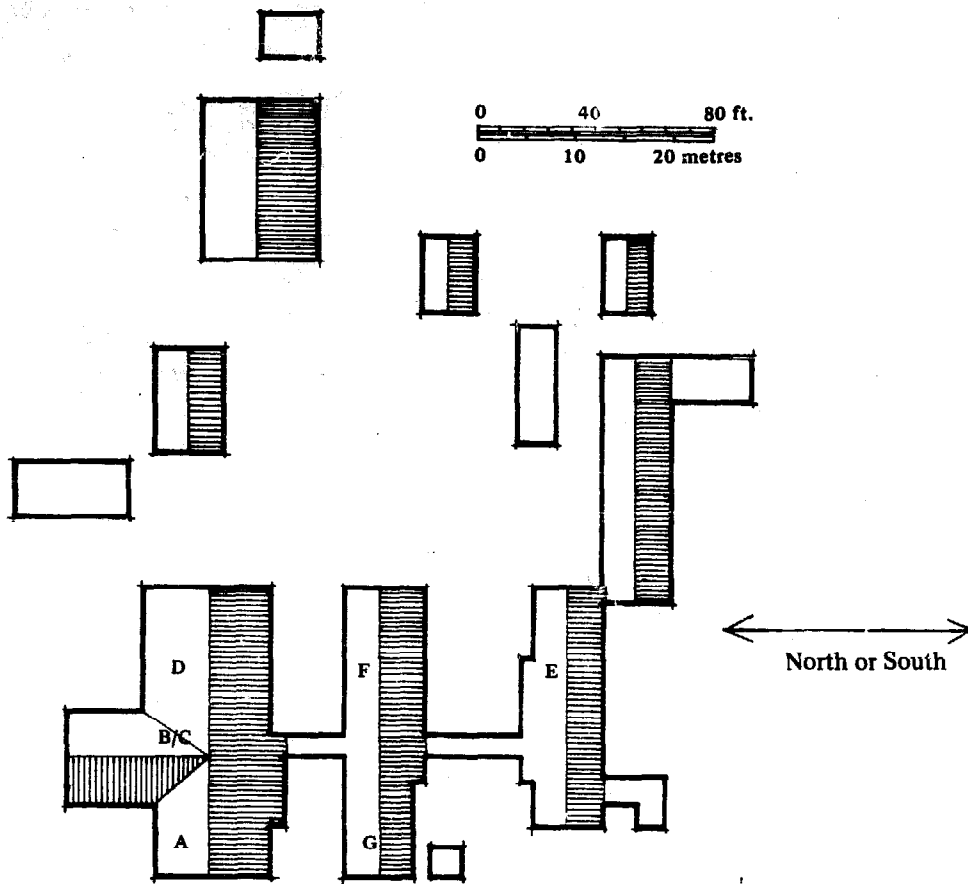

Fig. 6. The Model Plan related to letter groups for reference to room list.
(roofs shown shaded as in fig. 4.)

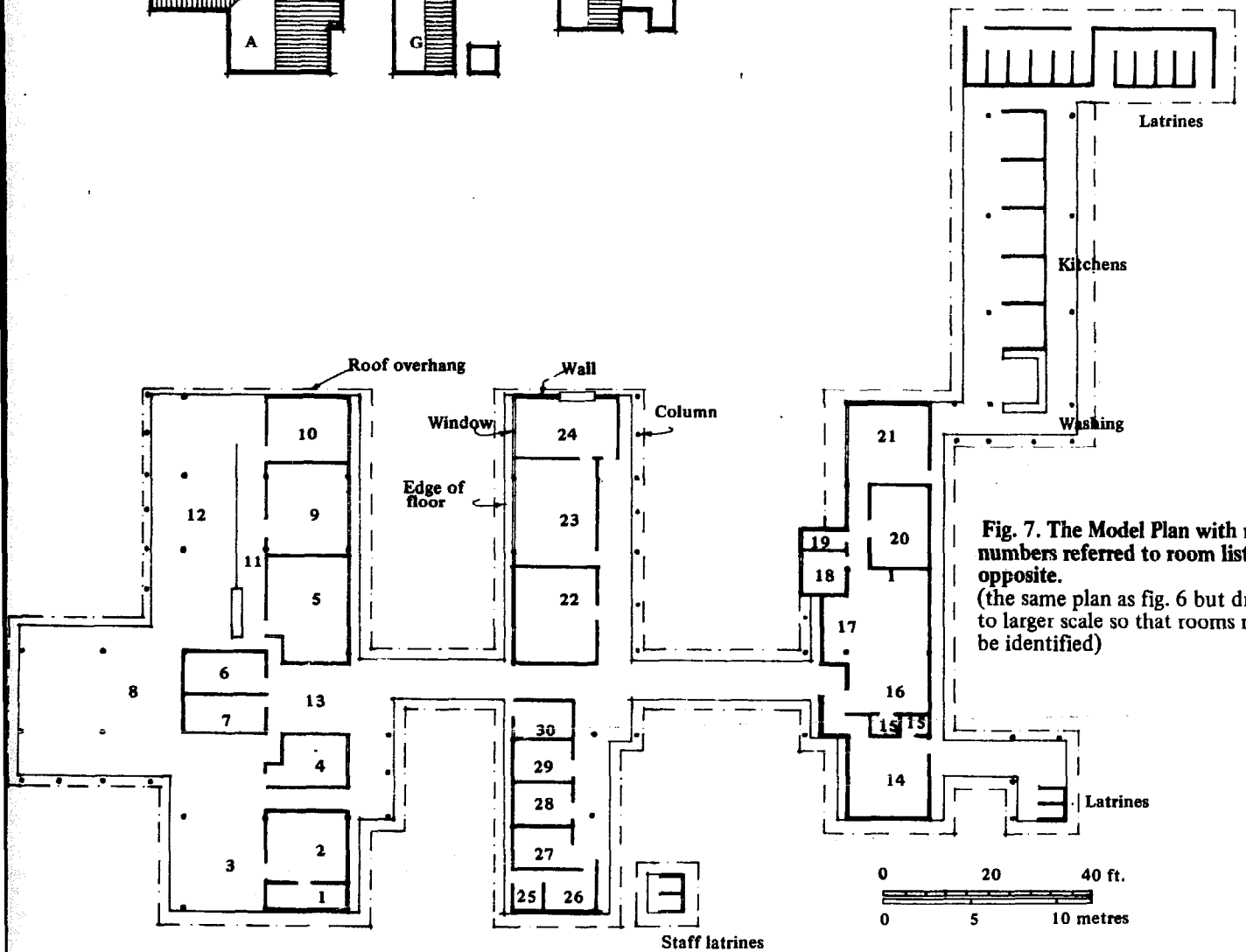

Fig. 7. The Model Plan with room numbers referred to room list opposite.
(the same plan as fig. 6 but drawn to larger scale so that rooms may be identified)

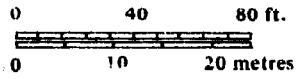
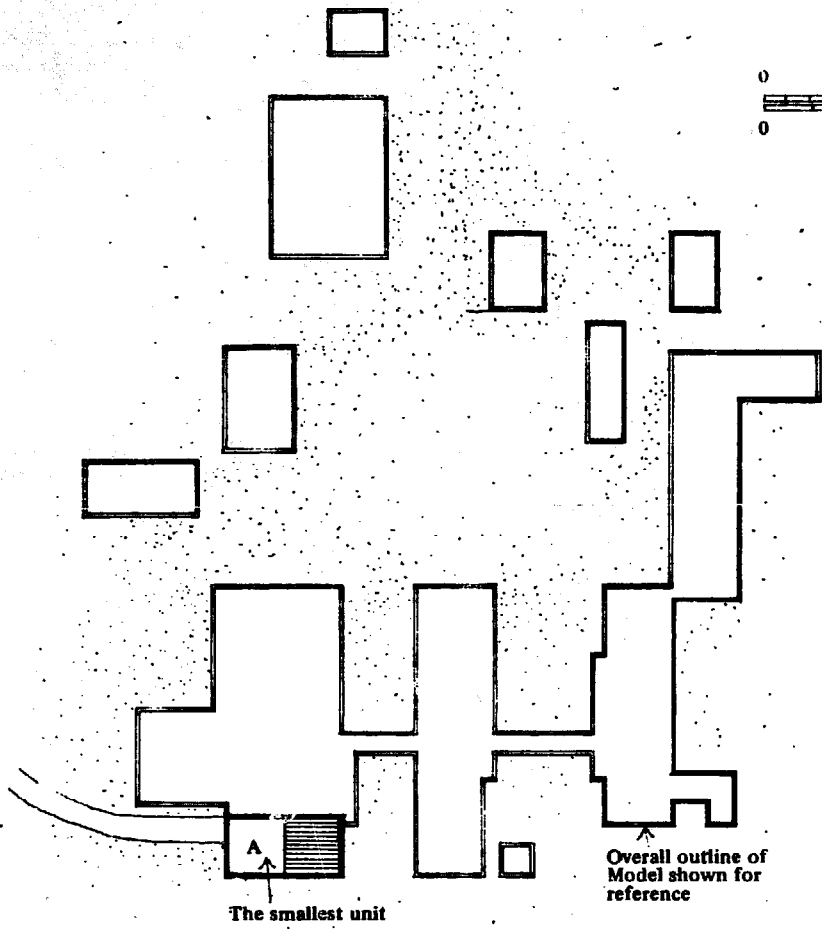
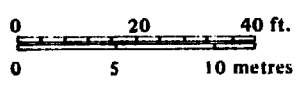
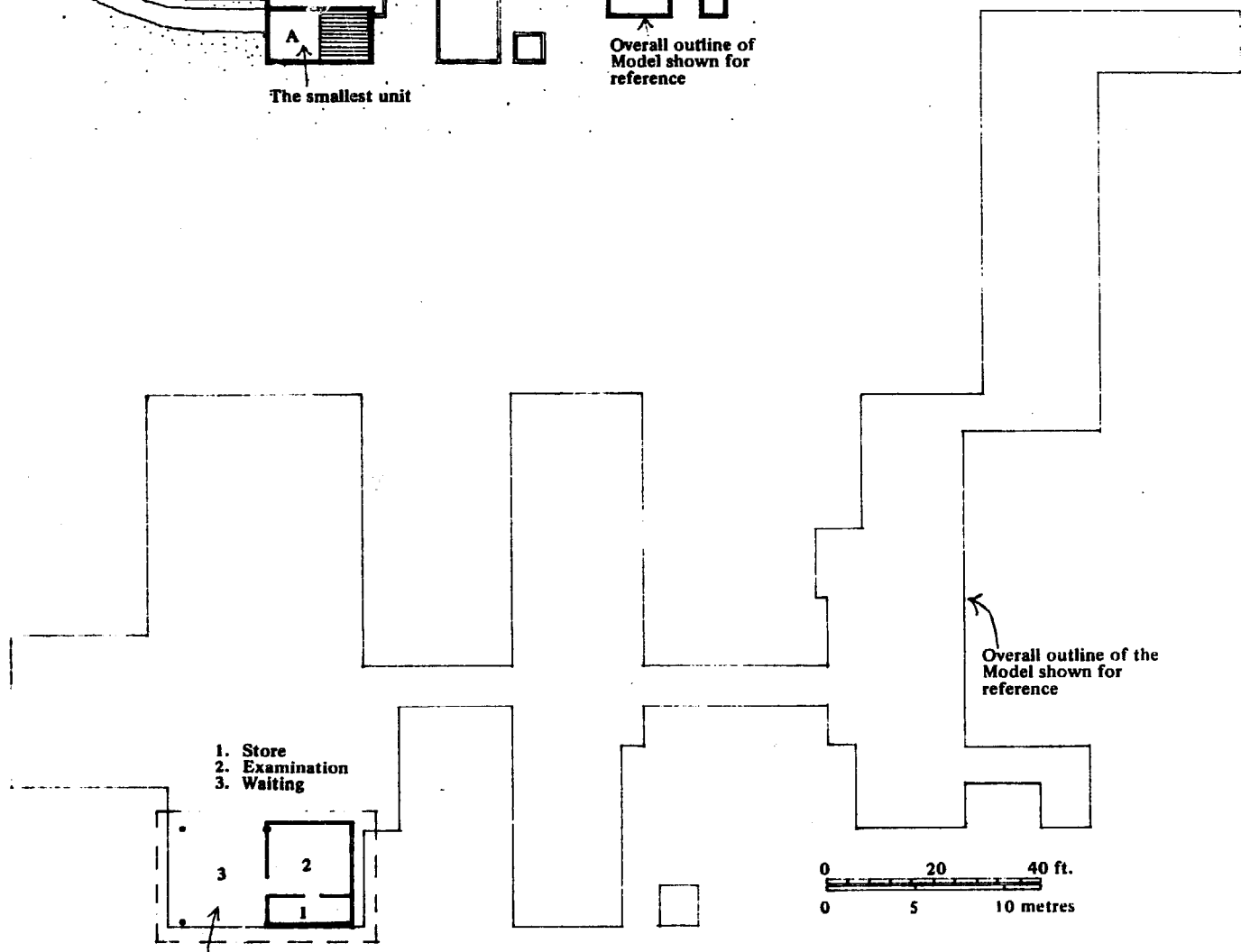

Fig.8. The smallest unit
A - general clinic



The smallest unit

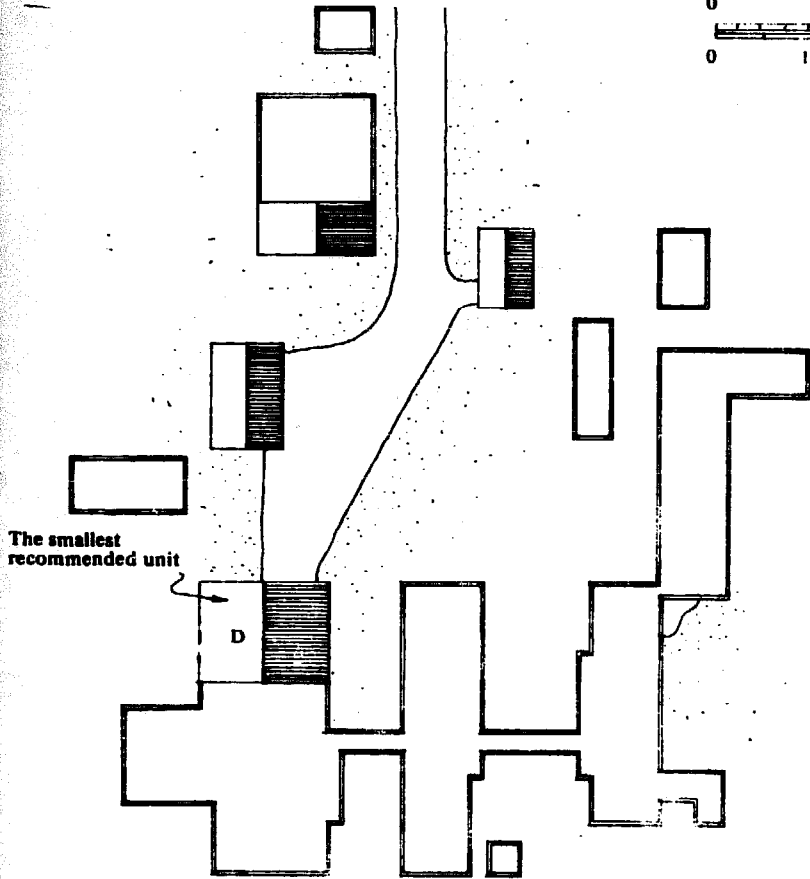
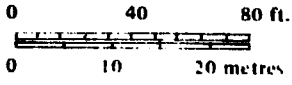
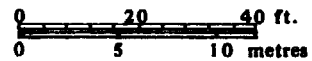
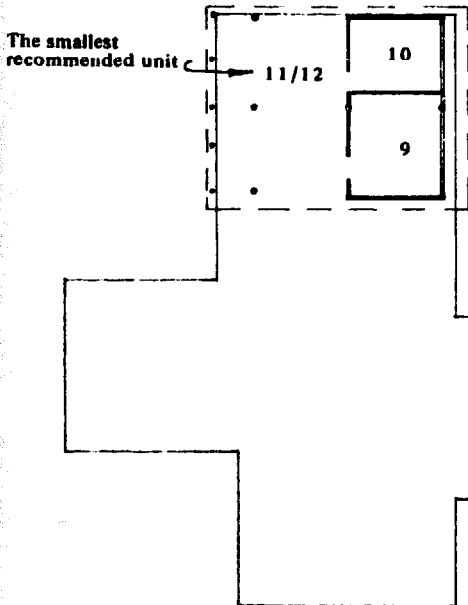

Fig. 9. The smallest recommended unit.

D - An under fives based general clinic

- 9. Consulting room
- 10. Examination/ante-natal
- 11. Weighing station
- 12. Waiting

Plus - social area
stores
hostels



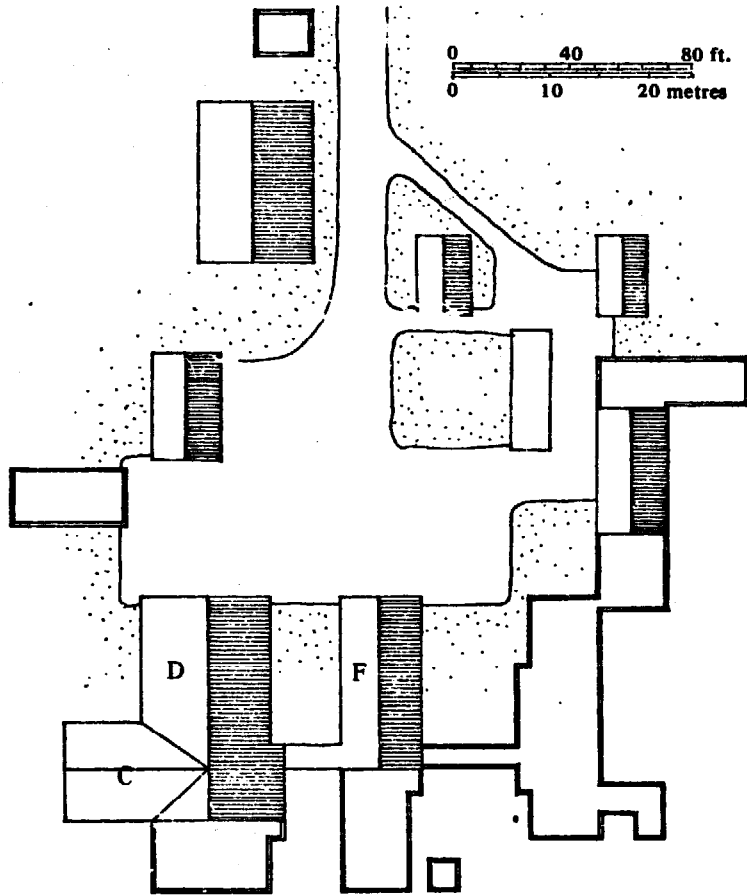
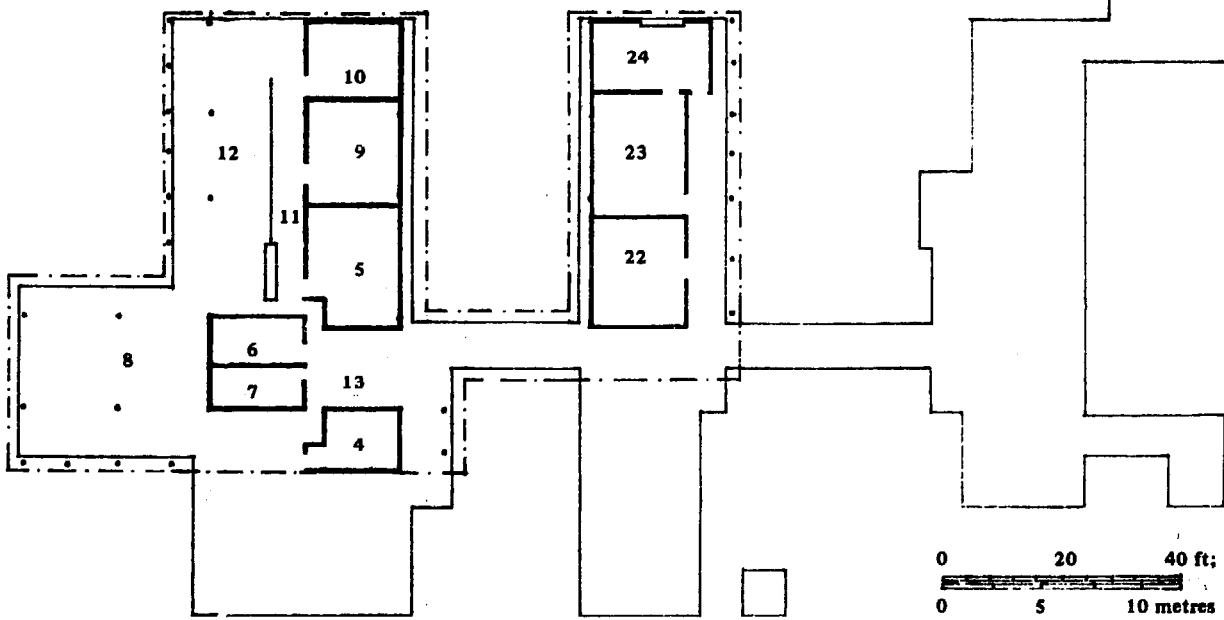

Fig. 10. A well supported clinic unit.



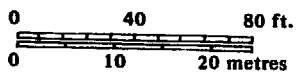
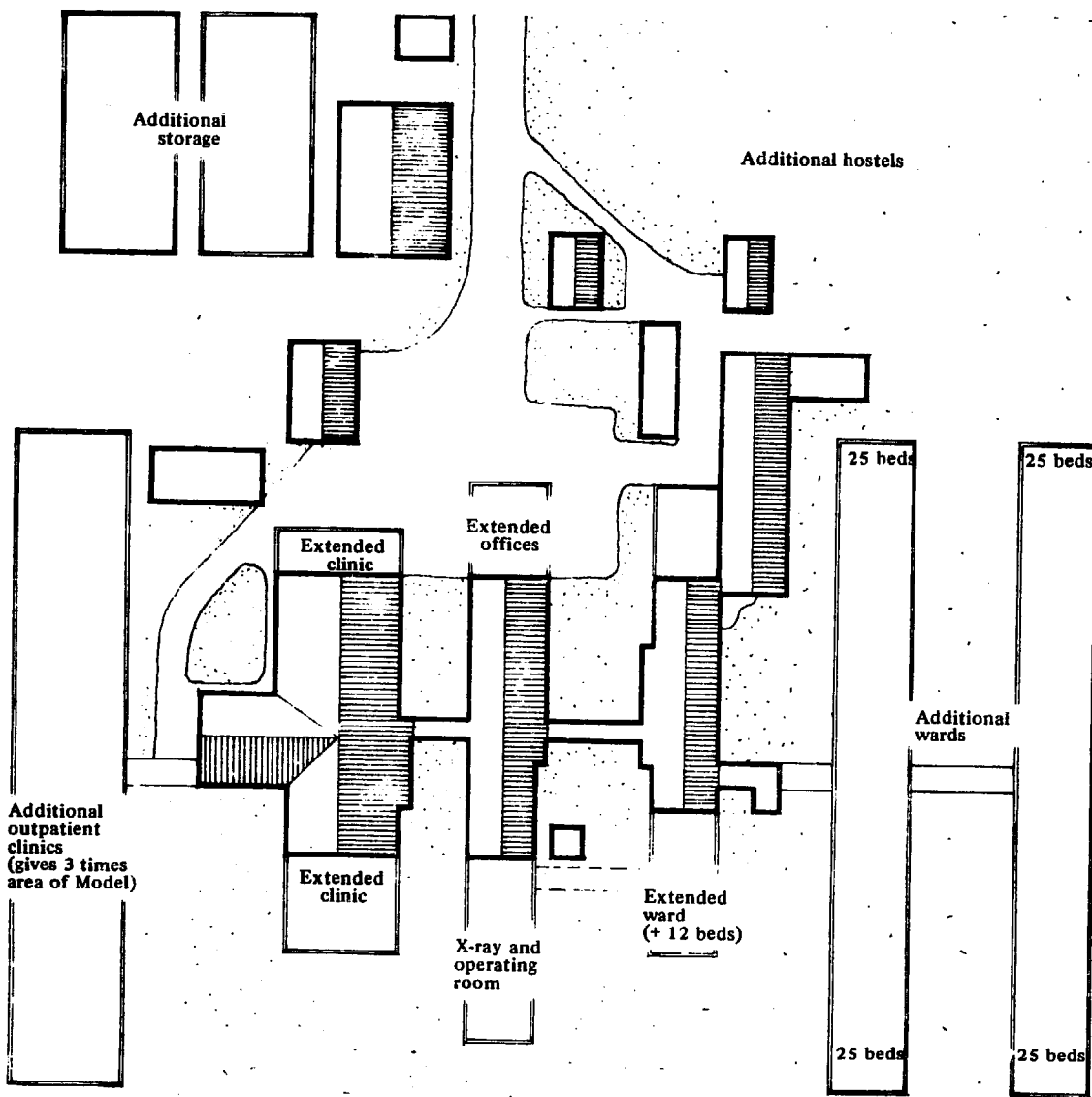

Fig. 11. Possible extensions of the Model.

See also Appendix 20 and Figs. 12 and 13 in Appendix 52 at the back of the report.

SUMMARY

These notes suggest how a Health Centre might look and how it might work. It could be built and run this way but the intention of this report is not to lay down hard and fast rules, but to put forward only one solution to the problem of how to set up a Centre which would be a flexible vehicle for health delivery in the community and to state in broad outline the operational policy for a Centre of the size proposed in the basic Model. Only those with local knowledge and experience can make the right decisions on distribution, operational policy and built form.

A report which is so generalized that it will not offend specialist opinion must inevitably suffer from many limitations and result in the exclusion of any reference to some specialist areas. At least half of the Appendices could be expanded to provide papers each being longer than the whole of this report. We would, however, like to feel that the report will provide a useful check list of important attitudes and ideas and will help others to arrive at what may be quite different solutions.

Social area and kitchens

The social area is the point where the Centre meets the community and vice versa and is essential as a health education facility. Displays, demonstrations, talks, films, slides, etc., should be allowed for and should cover:

- Personal hygiene
- Community hygiene
- Water treatment, conservation and storage
- Nutrition and nutritional rehabilitation
- Food growing and preparation, and agricultural and gardening practice
- The nature of diseases
- Baby and child care and family planning

The area should be roofed and will also be used as a waiting area. It should be prominently sited on the principal entrance route and could be seen as a gate-house.

It may contain an 'ideal home' built in improved local construction as a permanent teaching display.

It may be shut within the Centre compound by night. It should be built and maintained by the community. Community development people should be drawn into the life of the Centre and the social area, and should be approached at the earliest planning stages for advice, and later for assistance. Where possible, it should have a drinking water point.

At least 10 kitchens in the local manner should form part of the social area, for teaching and for ward and hostel use. We are not planning to provide or prepare any food except for special diets prepared by the nurses: relatives will feed patients.

The area should have some aspects of a market. A small number of local women can be offered the opportunity to sell bottles, para-medical kit, local weaning foods and approved foods such as Hyderabad Mix. This facility is to be absolutely under the Centre's control. The area should be clean, dry and shaded, and supervised from a reasonable distance by, for instance, reception. It must be clear to the vendors that they are there under direction.

A garden is to be used to demonstrate husbandry, including small animals, irrigation and the use of fertilizers on the household scale.

The area should have associated latrines under the control of the community. Other Centre latrines could be used.

Intentions regarding the use of and access to the area, what it is for and what it will offer, when and by whom it may be used, and who will build, maintain and clean it must be made clear in each case with the local people before a project is started.

Ideally Centre staff will be available for discussions of matters of current interest at times which come to be recognized. This is preferable to a programme of talks. Similarly, visiting doctors should be persuaded to turn up and join in occasionally, treating the event literally as a social event, but one to which a special contribution can be made. Local people will also ideally turn up and discuss things of relevance, possibly asking questions etc. This kind of non-meeting would be a good time to start new projects by trying out the idea and testing enthusiasm.

The social area shown on the plans is small. The bigger the area the better – within reasonable limits.

The problems of the social area in cold countries need a separate study.

APPENDIX 1

SOCIAL AREA AND KITCHENS

Under Fives clinic

The working party strongly recommends close integration of the Under Fives Clinic with the Ante-Natal and Family Planning Clinic. (see Appendix 3).

The Under Fives Clinic in the Model doubles with the Ante-Natal and Family Planning Clinic. Where there is only one clinic in a small Centre it is reasonable to suggest it should be the Under Fives Clinic. Some laboratory facility should be provided in or very near to the clinic.

The full theory of the workings of an Under Fives Clinic can be found in 'Paediatric Priorities in the Developing World', by Dr. David Morley (Butterworth, 1973).

The essential principles can be simply summarized. Children from birth to five, accompanied by their mothers, regularly attend the clinic whether the child is ill or not. Weight is entered on a chart which gives early visual warning of malnutrition or other maladies resulting in weight loss. Staff trained in the recognition and treatment of the childhood diseases see mothers and children in groups, so that mothers learn about the problems which their own children may later present. Ante-natal advice forms part of this group system, general discussion and comments being possible, experiences being shared as discussion topics rather than as confidences. Nutrition, hygiene, etc., can also form part of these group sessions. Some dispensing, injections and treatment are normal during a session. Some clinics see groups (of six to eight mothers and children) as a group and work through until everyone is 'seen'. Others have six to eight mothers in at a time, each family leaving as it is seen, and a new family coming in.

About 80 children is the maximum number a nurse can see in a day.

The plan

The plan of the clinic has three main parts, a waiting area (see Appendix 5), a corridor behind a 'fence' and the consultation room or rooms. When the unit doubles as an ante-natal clinic an examination room is necessary. Built into the 'fence' is the weighing counter, which should be at a convenient height for standing mothers to be able to put babies on the scale. Height is also measured in some clinics. Mothers going to consultation following weighing, etc. are let through a gate in the fence. Mothers leaving consultation also pass through the gate. This controls the flow of patients and ensures adequate documentation.

Patients' activities

The diagram opposite shows patients moving through the clinic taking full advantage of all its services. Every patient will not necessarily go through the full routine. This kind of diagram occurs elsewhere in the report and attempts to summarize the activities involved with people using the clinic and may also show goods (e.g. 'disposal' meaning 'goods to disposal') and links to other rooms or departments (e.g. 'treatment' means 'patient goes to treatment' when on a side shoot, but means 'treatment is part of clinic routine' where it is in the main stream). Words in brackets mean the activity will not always happen. These sequences make useful check lists during planning — the plan must satisfy them.

The key features of this clinic are regular attendance whether the child is ill or not, and continual two-way communication between patients and staff. Teaching is a continuous process. Advantage may be taken of waiting periods for formal teaching.

Groups of mothers and children are seen together so that training in the recognition and treatment of the common childhood diseases forms part of each visit irrespective of the symptom for which a particular child is brought to the clinic.

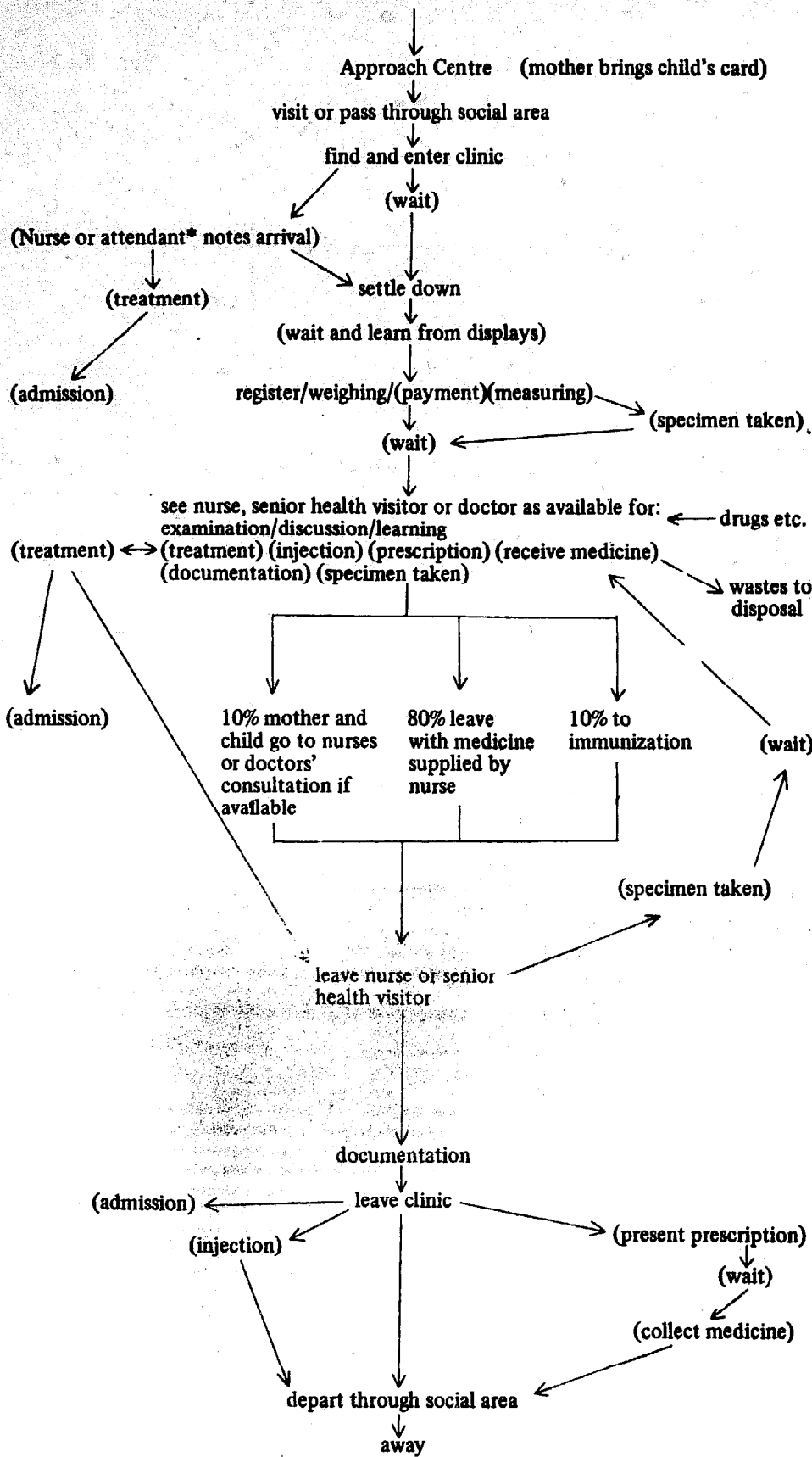

TEACHING IS INTRODUCED WHEREVER THE OPPORTUNITY ARISES

* attendant could be a school child. Arrival can be noted in 30 seconds. This system means queues can be avoided. Attendants should be trained to recognize children needing immediate attention, hence the introduction of (treatment) at this point.

Nurse's activities

The nurse's activities, following the patient's registration, are described below.

The nurse starts her 'consultation' by checking the correct name on the weight chart and uses this name (unless it is culturally unacceptable).

Nurse enquires about the child's health, or if he is obviously well she congratulates the mother on her child's health. Symptoms and their duration are recorded.

Opens chart and quickly notes:

1. Reasons for special care
2. Present weight in relation to previous weight
3. Gains a picture of child's progress and past illnesses
4. Notes parents' attitude to birth interval
5. Sees if any immunizations have not been given, and whether they are due.

Asks about food given the previous day and frequency of meals.

Praises mother on at least one point in the diet she has given before suggesting even minor alterations.

Proceed with examination as follows:

Child with symptoms		Child symptom-free
Nurse observes and examines relevant part of child. If the condition is:		Nurse enquires as to happiness of the child, and his development. Follows up any lead given in conversation by the mother on family or other difficulties.
Severe or not understood	Mild	
Accompanies child to see senior health worker or doctor if available.	Nurse gives treatment or Anti-malarial tablets or Arranges or gives immunization or Food supplement if required or Family planning advice if required etc.	Turns conversation to improving health. May draw other waiting mothers into this conversation and, for example, get their opinion on the most suitable birth interval. Aims to be a sympathetic and patient listener. Makes entries on card.
Mother and child leave		

ANTE-NATAL CLINICS
AND FAMILY PLANNING**Ante-natal clinics and family planning**

Integration of the under fives clinic, ante-natal clinic and family planning clinic is strongly recommended. Records can be constructed in a way which shows that the health of both mother and children deteriorates as families get larger, and that the shorter the birth interval, the quicker the deterioration.

Conception, pregnancy and childbirth are surrounded by many folk-traditions and taboos, and an understanding of these is essential before planning a teaching campaign. An understanding is also necessary of the reasons for frequent pregnancies in any given community. These may include a high infant mortality rate with the consequent need to have x number of babies to ensure one son living to adulthood; the need for a succession of herd-boys, water-carriers, etc; as proof of virility in the male or fertility in the female; or simply that the woman does not 'feel right' without a baby.

With this background knowledge, the optimum birth interval may be worked out: this will vary in different cultures, but will probably be in the region of two to two and a half years. A family planning campaign can then be introduced as the way to ensure optimum spacing of children and not as a means of limiting family size. Family planning will not bring to an end misery, ill-health and starvation, but it should lead to a noticeable improvement in the well-being of a noticeable number of families. It is very much the job of Health Centre staff to annotate and point out the improvements.

Ideally, motivation for family planning is best discussed with both parents together. Next best is to have separate sessions with men and women and the least successful method is to have only the women attending.

The contraceptive method of choice will depend on many factors, and it is essential that both parents understand and accept the method recommended. Specific instruction on contraceptives may well be combined with the work of the ante-natal clinic.

Attendance at the ante-natal clinic should be monthly up to 28 weeks, then fortnightly up to 32 weeks, then weekly. Only rarely will this ideal be achieved; most patients will attend only three or four times and at irregular intervals. The first visit will include history-taking, physical examination, weighing, pathological investigation (Hb, urine, tests for parasites), and these investigations may be separated at future visits. All visits will include prescriptions for vitamins, iron pills, anti-malarials and appropriate immunization as indicated.

Any visit may reveal complications requiring more frequent attendance, coming on a special day to be seen by the doctor, referral to the base hospital, or admission to the Centre.

The Centre must have a clear policy on admitting for delivery, which will depend on local circumstances. In the village situation with reasonable housing conditions and a reliable co-operative 'folk' midwife, a high proportion of home deliveries may be possible. With a scattered population, very poor housing, or bad communications, delivery at the Centre should be encouraged. This may mean that the mother must move nearer to the Centre well in advance of the expected date of delivery and use could be made of the hostel area for this purpose. Mothers will probably bring their other children with them, and it must be remembered that this is an excellent opportunity for teaching, especially on food values, cooking and home budgeting.

It must always be remembered that an apparently straightforward delivery can become complicated in a very short time, and this is often given as a reason for admitting every mother for delivery. Health Centre staff should not attempt full cover with insufficient funds and facilities available, but adhere to the agreed policy over admissions and accept the fact that unpredictable last-minute complications are not their fault.

The composite labour graph devised by Professor R.H. Philpott ⁽¹⁾ for use at Horari Hospital, Salisbury is easy to use both for home deliveries or at the Centre and is a good 'early warning' system of impending complications.

Post-natal care can be limited to one visit six weeks after delivery and the importance of attending for this examination should be stressed. It is also hoped that mothers will bring the new baby to the under fives clinic at regular intervals.

(1) 'Obstetrics, Family Planning and Paediatrics' by R.H. Philpott, K.E. Sapire and J.H.M. Axton, published by the Family Planning Association of Rhodesia.

General Outpatients

A separate set of rooms for general outpatients is best, but where the clinic is very small and only one room is possible, it is better to plan this for use as a UFC and use it for general outpatients also, rather than the other way round.

Categories of patients attending clinics will be:

- a. Adult male
- b. Adult female – non-maternity
- c. Adult female – maternity (where clinics are combined)
- d. Children from five to sixteen
- e. Under fives (where clinics are combined)

In countries where men and women may wait together, a, b, and c, can use the same clinic. Where strict segregation is necessary, the general outpatient area will be used for men, and all women and children will be seen in the UFC clinic area.

It is also recommended that school-children be treated during visits of Health Centre staff to schools (see Appendix 28).

Immediate attention and treatment for all patients is obviously the ideal, but will rarely be achieved. Waiting time should be kept to a minimum, and a simple method of preventing queue jumping is advisable. This could be done by issuing numbered discs on arrival, or by collecting patient-retained record cards and calling them in rotation. It is not a good method to have patients doing a 'bench shuffle' every time one of them is called. Where large numbers of patients attend a clinic, patients for treatment may have to be 'pooled' and treated in batches. Ideally there should be one senior staff member seeing patients, and another supervising the treatment area.

The pharmacy should be near the clinic, but preferably with a separate waiting area. Routine medicines (e.g. iron tablets, anti-malarials, vitamins) should be held and issued in the clinic room, particularly for the under fives.

The best record documents are those carried by the patients themselves in a strong plastic bag (see Appendix 30). Local or national government may also require the keeping of other and separate records.

In some areas, special clinics might be run on different days, e.g. ulcer clinics, TB, leprosy etc. It may also be convenient to see patients for repeat treatments at a different time of day, provided this is acceptable locally as well as to the clinic organization. Nevertheless, any patient coming from a distance should always be seen and treated irrespective of whether he has come on the 'right' day. Also, all clinic staff should be constantly alert to spot the arrival of very ill patients and ensure that these are not kept waiting.

Statistics offered to us from various sources indicate that the breakdown of attendances will be about 10–15 per cent adult male, 30–40 per cent adult female; 40–60 per cent children. Daily attendances may vary from 50–250. An average of not more than two visits per year per adult may be expected, and a high proportion of visits will be connected with maternity care. It is an open question whether this pattern of attendance is a reflection of the care offered or of the potential demand. An urban hospital outpatient department, excluding UFC and ANC will see 25 per cent adult male, 30 per cent adult female and 45 per cent children. On the face of it the statistics given above are therefore realistic, since the imbalance shown reflects the concentration on under fives and maternity care at the Health Centre.

Waiting areas

Facilities are required for:

Standing

Sitting

Drinking – clean, obvious, well-drained tap in view of the staff

Disposal of rubbish

Latrines

High shelves for belongings where they can be easily seen

Low seating is to be preferred where there are mothers with small children

The social area can act as a 'waiting reservoir', and proximity to the social area is important for children's and ante-natal clinics, for teaching and demonstrations purposes. Plenty of space is required, well shaded.

Children may have to be dressed and undressed in the waiting area. Male and female areas should be separate if a waiting room is to be made a part of the clinic for interviews or examinations. Teaching displays in a locally digestible manner are important throughout all waiting areas.

The position of the clinic and its waiting areas must be obvious and once patients are involved with the clinic it should be clear where they must go to receive treatment. In the Model plan patients pass through to the 'back' of the clinic for treatment where a small waiting area is provided.

Pharmacy or Dispensary

The object of the pharmacy is to get the right drug to the right patient conveniently and efficiently and to make sure that the patient knows how to use it.

The drugs themselves must

- a. Effectively treat the relevant disease
- b. Be reasonably economical
- c. Be stable in available storage conditions

Humidity and temperature can ruin drugs very quickly in store: the best drug, even the cheapest, may be useless for this reason. There is a particular problem of cool storage, particularly of vaccines, which needs study.

Requirements have to be predicted, drugs ordered, checked and stored, the bulk-packaging broken down for use, the prescribed doses issued in a suitable manner for the patient to hold and use them, and stocks replenished. The key-notes up to issue are tidiness and forethought. Counting out pills during a session is irritating and a waste of time. Batching should be done before the session, and if possible about twice a week. A suitable set of open pigeon-holes of varying sizes can then be filled, and the required drugs taken out and issued quickly, re-stocking needs being obvious to the eye. It must be noted that pigeon-holes should not be re-filled until all the packets are used, or care must be taken to ensure that new packets are placed behind or below the old ones.

Batches must be prepared in packaging which is reliable. Plastic sachets made up with heat-sealing machines from plastic sheeting appear to work well in many cases, but interactions between plastic and drugs need checking. If patients bring their own bottles or jars, these should be rejected unless scrupulously clean.

The pharmacist should sit in public view – patients will be more tolerant if they can see him working – and a counter at a good height is more human than a hatch. The higher counter will also give more storage space to hand. Patients should not be able to reach in and grab drugs.

Instructions on use and instructive labelling are essential. It has been suggested that pictures be drawn to describe use. Two examples are given below from the Dabou Hospital in the Ivory Coast. Clearly these pictures are ambiguous, but are better than mere writing or verbal instructions.

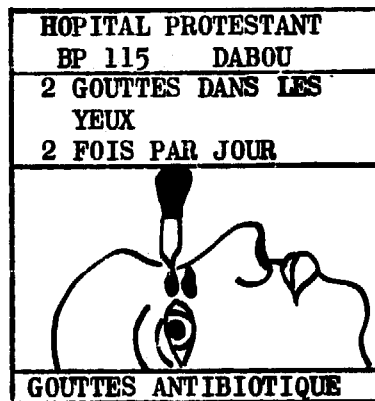
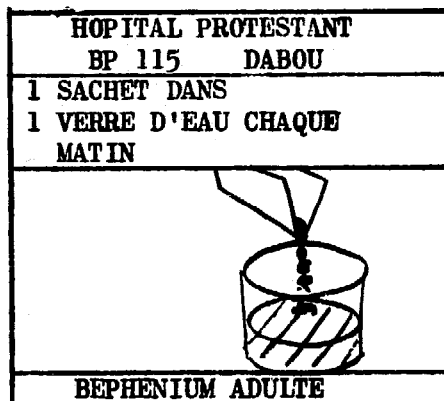

Two examples of explanatory labelling for drugs

Where a folk-medicine parallels the Health Centre system it is advisable to check that the drugs used do not resemble folk-medicine in appearance. A brownish syrupy liquid may have very different actions and method of use in the two circumstances, and even if a patient may not misuse the drug, a relative might.

A consistent prescribing policy is necessary. It is better to give one patient one pack for a short course and another patient two packs for a longer course of the same drug rather than making up different sized packs. This saves time and reduces the possibility of mistakes. Details like half spoonfuls should be obviated by making up weaker solutions.

Where drugs are made up on a fairly large scale at a National or Regional Service Centre, packs can (with advantage) be made up for use before issuing to the Health Centres. This saves time in the Centre and means that machinery may be used economically, with better hygiene and fewer mistakes. Labelling will also be more economical if carried out centrally.

Where outstations are supplied from the Health Centre, staff must realize the total dependence of the outstation on their services. Stocks should be ready well in advance of delivery time, documenting must be clear, packaging and labelling clear and simple, and dated. For liquids it is better to return a partly full container and issue a new full one, washing the old one at the Centre, rather than to go in for messy 'topping-up', which can lead to the progressive dilution of ineffective old stock.

Theft can be controlled by keeping well-locked and supervised stores laid out so that the progressive diminution from the back of a pile which can occur is stopped. Thieves should be instantly dismissed. Accessible stocks must be kept to the useful minimum.

Laboratory

Laboratories for Health Centres are covered in detail in a book, 'A Medical Laboratory for Developing Countries' ⁽¹⁾ by Maurice King with the assistance of UNICEF. We reproduce opposite one of his illustrations showing a laboratory. The main feature of the laboratory is a work bench about 10 feet long at a good working height (in this case 30 inches) and 30 inches deep. Some people will prefer a higher bench to work at, with a small lowered area for writing, as 30 inches may be too low for working standing up when the worker wants to move around, whilst being somewhat too high for writing sitting in a chair.

The work that will be done in the laboratory will depend on the skill of the assistant concerned, available equipment and the prevalent disorders in the community. A microscope in a good case is a must, the instrument to be well maintained and admired and inspected regularly by senior staff. Teaching of the existence of microscopic organisms is greatly eased if people can and are encouraged and allowed actually to see them under a microscope.

The laboratory has a major role in the working of the Health Centre. Training and encouragement are essential for recruitment and the improvement of the service.

With the staff described for the Model Centre the range of work that can be undertaken will include but will not much exceed the following:

- Testing urine for albumen, sugar and acetone
- Identifying malaria and filaria parasites in blood
- Simple test for sickle cells
- Identification of more common parasites in stool specimens
- Haemoglobin estimation.

In some areas other investigations, as for instance filaria or leprosy tests will be essential. An outline equipment list is given in Appendix 19.

⁽¹⁾ A MEDICAL LABORATORY FOR DEVELOPING COUNTRIES, Maurice King, MA Cantab., MRCP Lond. Edition assisted by UNICEF (Oxford University Press) Illustration reproduced by permission

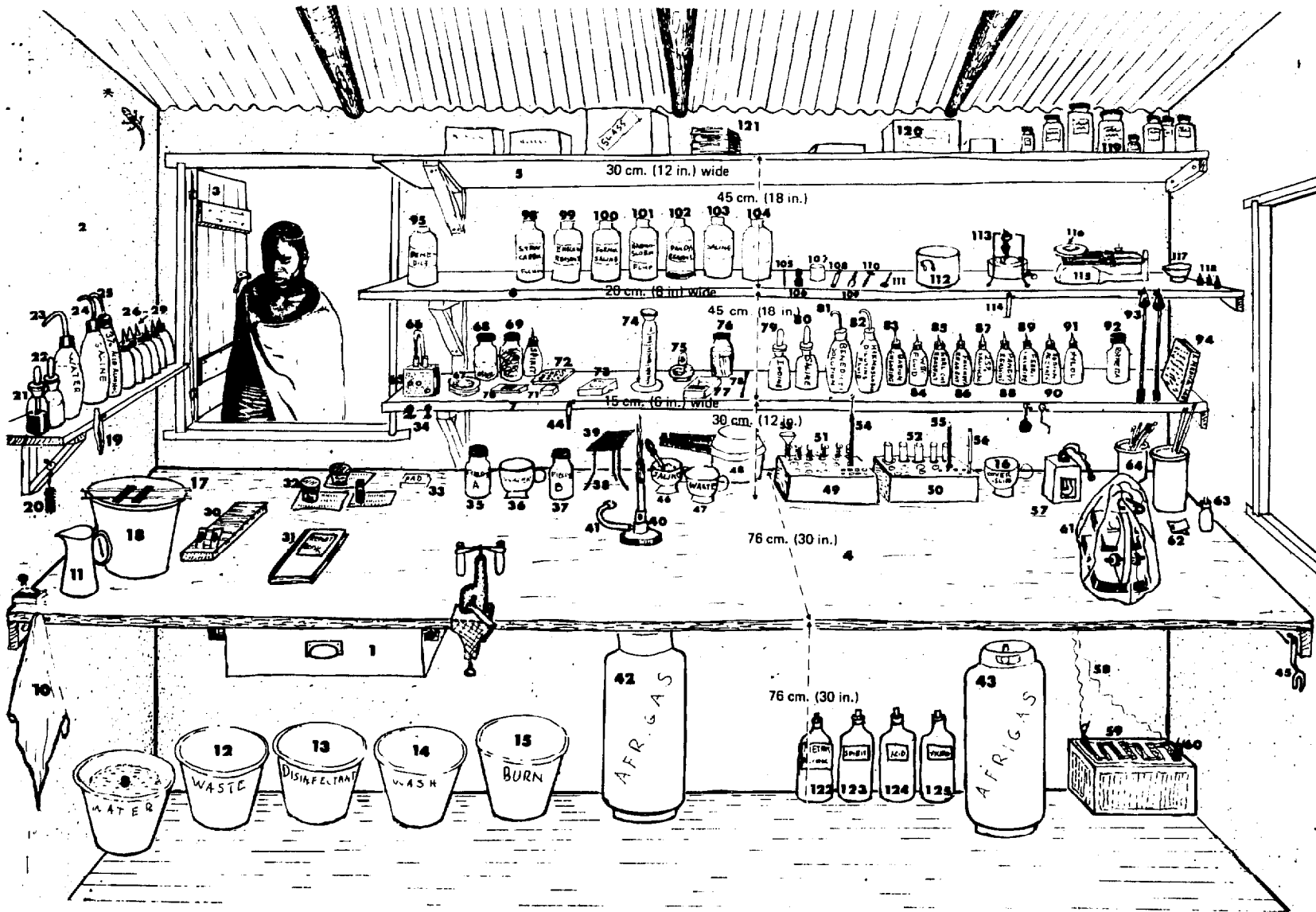

A health centre laboratory

Central facilities

The Model is based on the principle of avoiding duplication to achieve maximum efficiency and economy. The Model has no X-ray facilities and no operating theatre. A better description of 'Central facilities' might be shared facilities, shared between inpatients and outpatients. There are three main groups of rooms:—

1. A treatment/injection sequence
2. Laboratory and pharmacy
3. Staff accommodation

The treatment, injections etc., rooms are designed with an eye to staff economy. The inter-relationships may be seen below:—

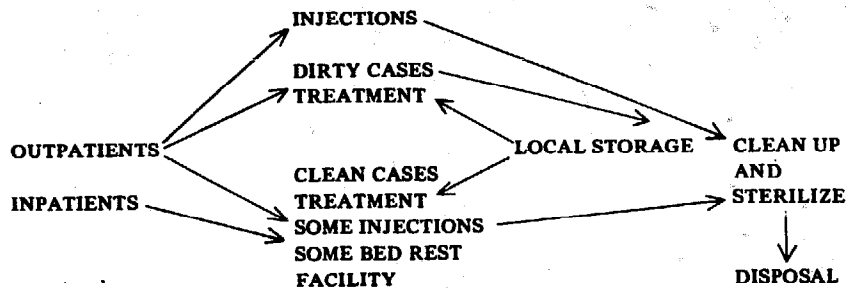

Where a 'dirty treatment' room is provided, sunlight should be allowed to enter the room as it has a beneficial sterilizing effect. A high seat for patients with leg dressings saves staff much bending. The treatment centre will also be used by 'inpatients' and may in some cases act as a follow-up dressings clinic. Injections facilities will receive highest call from the under fives clinic.

The clean room is also to be used for re-hydration, injections and possibly also for bed rest.

The principal call on laboratory and pharmacy will be from outpatients, but inpatients will also need their services. Additionally, the pharmacy may in some cases need direct access from outside the compound where the compound is shut at night. Money may also be taken at the pharmacy.

All these facilities and staff accommodation are discussed in their separate Appendices.

APPENDIX 8

CENTRAL FACILITIES

App. 8. Fig. 1. Inter-relationships in the shared facilities

Reception and office

The reception area and office should be clearly visible from the entrance, should be both an enquiries and a direction post, and those working in it should be able to see the main parts of the Centre for giving directions. It will also be the clerical and documentation centre, and may well need a safe for cash payments.

In the Model plan reception is shown between outpatients and inpatients rather than as part of outpatients as suggested by several authorities. The position shown is preferred by the working party as it allows a space within the Centre where record making, collating, and the preparation of progress charts &c. can take place.

See also clerical work (Appendix 10).

APPENDIX 9 RECEPTION AND OFFICE

Clerical work

A clerk may be necessary in some Centres.

The following types of documentation are noted as probable:

- Requisitions for supplies, probably on a monthly or quarterly basis. A requisition book will be normal (See Appendix 18 – Stores and Storekeeping)
- Simple accounts for petty cash
- Accounts of incoming sums, i.e. fees, and outgoing sums, i.e. local payments. Fees should be standardized as much as possible, to avoid complications and to make checks easier.
- Government monies, if applicable, to be accounted separately, probably involving receipts.
- Correspondence
- Referral notes from satellite clinics and area hospital
- Register of notifiable diseases
- Ante-natal register and births
- Centre deaths
- Records

Some local statistics, e.g. census information, should not be part of the Centre's duties.

When a patient is being 'documented', staff should be set at a high counter so that their eye level is similar to that of the patients. The staff should also be trained and encouraged to be welcoming and friendly.

The outpatient aspect of the Centre will make the greatest call on records and offers the major load of paper work. Wherever cards can be held by the patient, this should be encouraged. Records of all sorts should be as few and simple as possible.

See also Appendices 29 and 30 on record-making and patient-retained records.

Admissions

The documentation required for an admission may be largely dictated by government. Whether the acceptance of a patient as a temporary hostel resident constitutes an admission at law will need clarification in each country. The basic rules for documentation must be that they are:

- As simple as possible
- Designed to do the job in hand
- Useful as a guide to the progress of the Health Centre
- Useful for national statistics
- Useful for forward planning

Once decisions have been made as to what kind of treatment a Centre is to carry out on admitted patients it becomes possible to decide on routines. In general terms and taking very bald figures provided from working party experience admissions are currently divided up as follows:

- 5 per cent adult male
- 25 per cent children
- 70 per cent adult female

These figures reveal again the bias of current Centres to maternity and child care. A most important decision is whether this tendency is to continue or whether the Centre is to take on more work in fields other than maternity.

The majority of admissions in most situations are non-elective, that is to say that there is an element of emergency. This will apply even for deliveries if a policy of dealing only with abnormal deliveries is adopted. Whilst it may be accepted that mothers will accompany children through most of the routines in the Centre the following attempts to summarize the activities that must be satisfied in the Centre by its plan, staff and policy.

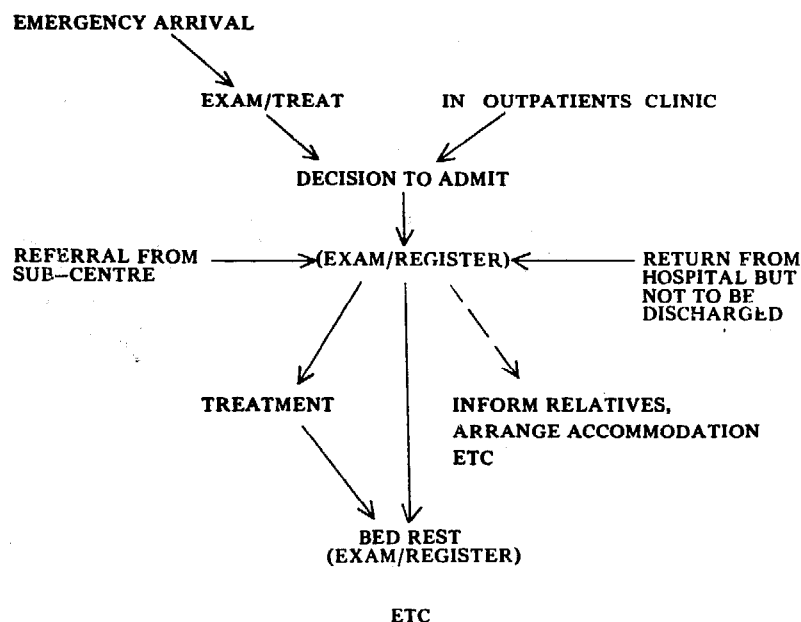

In the Model plan we see initial examination and treatment being made in the 'back' of the outpatients block, in the treatment rooms as appropriate. Documentation can then be completed in the Central Facilities block before the patient goes to the ward. Patients from the outpatient clinic may need no further examination, but admissions documentation will only disrupt the clinic. Some patients should be got into bed immediately and documented etc. at their, rather than the staff's, convenience.

The secure and proper storage of belongings, the informing of relatives or village, the accommodation of relatives in hostel or local village lodgings – all these are jobs which if they are well done by the Centre, will ease everyone's burden.

Once a patient is admitted it is best if time can be found for someone to explain what is involved in terms of daily routine, facilities, whether different food can be ordered, whether relatives can stay etc. This is a job which can be done well by any interested person. If it is Centre policy to allot some kind of housekeeping jobs to patients this should be explained early to make it clear what goes on, although the patient may be in no sort of state to take up duties immediately.

Admissions policy will depend on staff and facilities. The technique of being humane is a matter of attitude. There is a sense in which staff can relax once the patient is admitted. The staff can then control virtually everything that happens. Staff must always try to remember that the more familiar and routine something is to them, the stranger it probably is to a patient. Some mutual understanding on admission helps the patient and the patient's family enormously.

It has been suggested that patients should be admitted in order that they can be held until a doctor's visit. This seems an inappropriate use of facilities. If accommodation is available in the hostels this would seem to be a better place for patients to stay pending a doctor's visit.

Wards

This Appendix relates to the Model plan which shows what is probably an absolute minimum bed accommodation. In some cultures men and women will have to be kept entirely separate. This can be done most simply by having a link covered way split down the middle with a wall. The women then have access to the hostel area and kitchens, the men's wards being approached from the clerical block. This simple idea can be carried through into the outpatient area.

The wards should have easy access to their surroundings, must relate closely to kitchens and hostels, and can with advantage relate to the social area. The ward must also relate to central facilities for laboratory treatment, clerical and staff latrine purposes.

Animals must be kept out.

Plenty of good bench seating is desirable.

Wash basins should be of generous size, although depth is not important: one in each 'bay'.

The labour room is to be big enough for two beds, must have a sink, and should be a room more or less separated from children's beds but under good observation by the nurse. An instrument cupboard is required.

A cooking facility is included in the nurses' centre for cooking by nurses. In some Centres patients may be allowed to use these facilities.

Storage for patients' belongings, and as much general storage as possible should be included: the Model plan shows a minimum. A ventilated cleaners' cupboard is an advantage.

At least one relative should be anticipated as accompanying each mother or child. Relatives may have to be accommodated in the hostels.

Clothes washing and drying facilities are provided in relation to the female part of the ward. These should accord with local customs, must be well drained, should not be too close to latrines and drying area, and should be reasonably secure against theft.

The diagram below shows the proposed layout of the bed area:

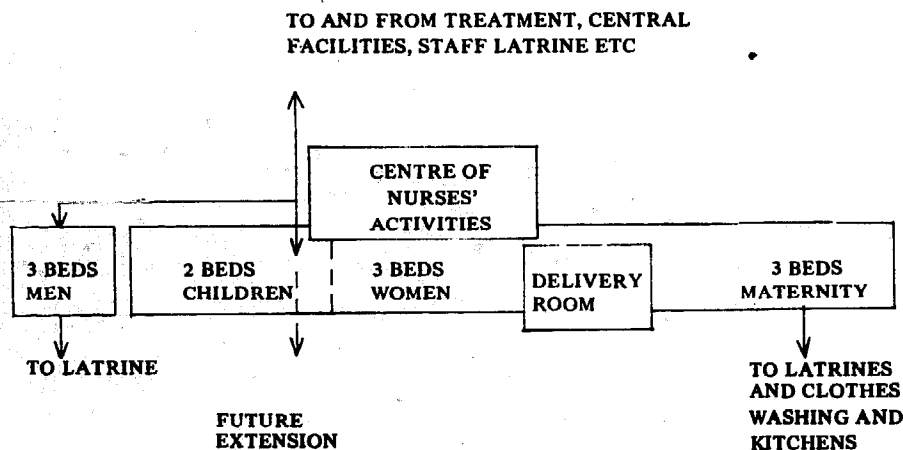

APPENDIX 12

WARDS

App. 12. Fig. 1. Organization of the ward

Hostels

Two categories of accommodation may be provided:

1. A sleeping shelter only for relatives of inpatients and outstation patients not requiring bed care.
2. Hostels in the form of local houses (made in the local manner incorporating suggestions for improvement) for rehabilitational patients and waiting mothers. At least two hostels will be required, one for men and one for women and children.

The improved houses and the sleeping shelter should be built and maintained by the community and are to be a community responsibility, including sweeping and cleaning latrines, but under the direction of the Centre, and are sited near the social area and compound entrance.

Hostel residents use the improved local kitchens in the social area and should have access to clothes washing facilities. Women could use the maternity ward kitchens and latrines, but some Centres may wish to keep ward kitchens and latrines entirely for the use of inpatients. In some villages residents who might otherwise use the sleeping shelter may be able to find accommodation in the village.

The furnishing of the hostels should reasonably accord with local customs. Some staff should have the duty of visiting the hostels every day, however briefly, to check they are being kept clean and free of, particularly, insect pests. Storage space for belongings, food, fuel for fires and lamps, and possibly also water will be required.

The hostels should be big enough to accommodate up to twelve people each in reasonable conditions, probably five partitioned or partly partitioned areas being acceptable. The local house style may not be big enough, so a simple plan is shown below for a dormitory:

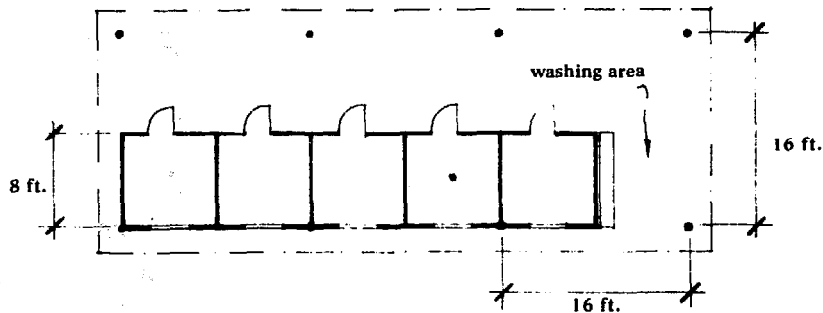

A dormitory

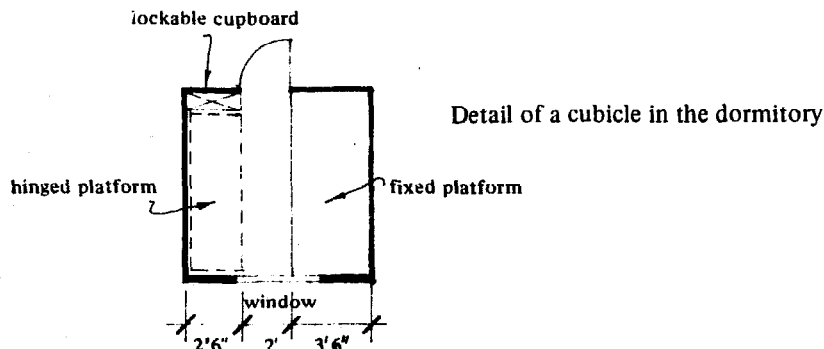

Detail of a cubicle in the dormitory

Hinged sleeping platforms attached to the walls will allow for day-time use of the spaces. These sleeping cubicles would each allow space for two adults and two children, and should be sufficiently 'flexible' for most centres. This type of dormitory should be used to supplement hostels built in the style of local houses, the buildings of which in an improved manner is part of the Centre's teaching function and should not supplant improved local house hostels entirely.

App. 13. Fig. 1.
A simple dormitory

Staff housing

The Model Centre requires two houses for principal staff who may have families: these houses should be within the compound. Ideally, houses for the auxiliaries should also be built within the compound. Staff housing should be of good quality in local terms and should ideally be 'improved local construction'.

It is currently easier to raise capital finance than running finance for externally sponsored schemes, which suggests that it is advantageous to build initially and save rental later.

Staff may be male, female, married or single, with or without children, and possibly, where married, both husband and wife will work in the Centre.

The same building criteria apply to houses as to any other kind of building. An extremely simple plan is given below for a small two-bedroom house based on the same structural bay size as the other buildings.

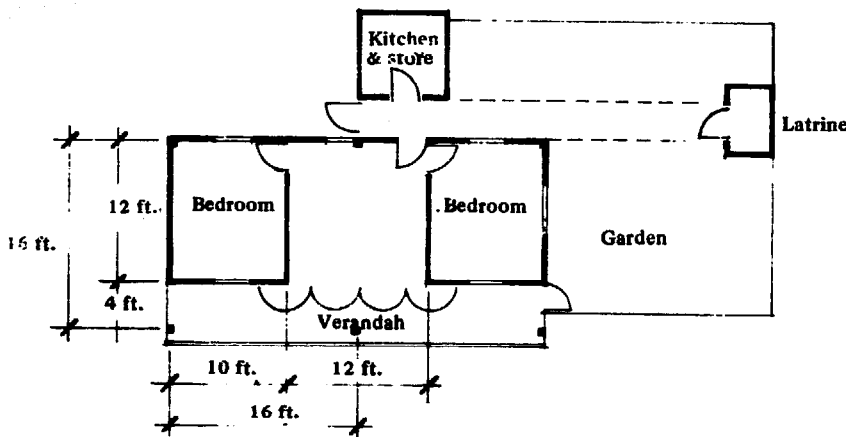

App. 14. Fig. 1.
A small two-bedroom house

This basic plan can be made larger by putting on a higher roof and pulling the eaves well out.

In hot countries the demands for privacy are frequently much less stringent than in colder countries as the need for ventilation makes for little 'noise' privacy. High level ventilation slots are an excellent idea.

An extremely simple house plan, and one which can be extended easily is shown below. Kitchen and latrine as in fig. 1.

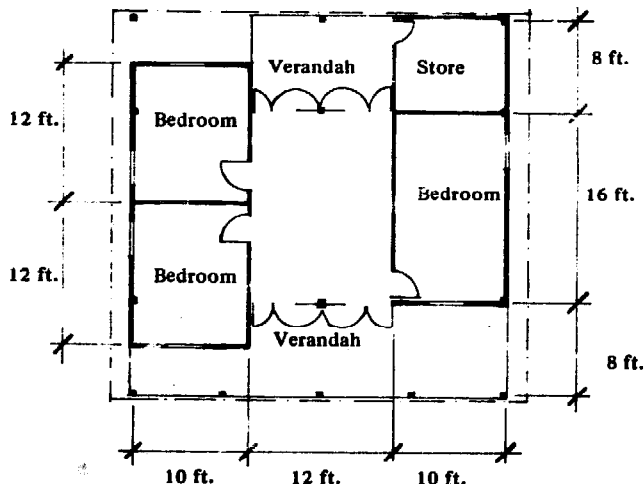

App. 14. Fig. 2.
A simple house plan

Introduction

In sterilizing it is not better to travel hopefully than to arrive. A practical routine for the treatment of goods in any given situation is a routine which can be followed without mistake and with confident knowledge of the result in all foreseeable circumstances.

Much is misunderstood about sterilizing, sterility, sterilizers and sterile areas. One can read 'the whole unit is sterile, but some parts have a different degree of sterility'. What does this mean? It means, presumably, that the whole unit is a great deal less likely to cause infection as an environment than somewhere else (in the hospital), and that extra care has been taken in particular places within the unit. The chances are that continuing total sterility in clinical work in hospitals or Health Centres is impossible. It is all a matter of degree.

The aim of sterilizing

The aim of sterilizing is to kill off as many organisms as possible in the circumstances, to reduce infection risks as much as possible. If a cloth dampened with antiseptic and used to wipe things over is all that is available in a particular place, then that is the practical sterilizing routine there. 'Sterilization' does not therefore relate to sterility, but only to a degree of cleanliness. There are further subdivisions of practicality. A smooth surfaced simple metal object with no cavities can be dealt with with confidence. Hollow or complex jointed instruments, syringes, etc. are harder to deal with. Also, some goods such as gloves have to be handled with special care as the sterilizing routine, whatever it is, leads to deterioration. Finally, the best sterilized article in the world stops being 'sterile' when it is exposed to 'non-sterile' air.

Grading 'sterility'

This sloppiness in the use of terms hides the real problems. Three gradings are needed:

1. Highly sterile
2. Hospital sterile
3. Kitchen clean

These grades can be defined as follows:

Highly sterile. Special procedures at all stages for the production and/or presentation of goods to environments with special provisions for maximum practical sterility in areas where persons are required to use special routines when entering, etc., etc.

Hospital sterile. Based on the use of properly wrapped or packed and properly handled instruments etc. passed through pressure-steam or similar sterilizers.

Kitchen clean. Based on the use of routines and equipment other than pressure-steam or similar sterilizers.

The need for understanding sterile routines

There is theoretically no upper practical limit to 'High sterility' until total sterility is achieved, but standards need to be set in the other two grades. These notes are particularly concerned with 'Kitchen clean' but some reference is necessary to sterilizers of the pressure-steam and similar sorts. The notes obviously cannot be comprehensive, but will hopefully serve to establish a basic understanding of the problems. If all concerned have a reasonable idea of what they are supposed to be doing the chances of success are much better.

Pressure-steam and similar sterilizers

Equipment using dry steam at high pressures with pumps for drawing vacuums should be called pressure-steam autoclaves and can produce 'highly sterile' goods. Pressure-steam autoclaves are discussed in more detail at the end of this Appendix.

Ethylene Oxide Sterilizers and Formalin cabinets can also produce highly sterile goods but can be more safely considered as producing hospital sterile goods.

Infra-red ovens can produce highly sterile goods providing the goods are packed properly. Their use is usually restricted to syringes.

For hospital use, hot air ovens should not be considered as producing hospital sterile goods.

Ultra-violet radiation has good sterilizing properties but no practical application in hospital goods sterilizing.

No other equipment can be considered as producing highly sterile or hospital sterile goods.

Kitchen clean

Hospitals are notoriously reservoirs of infection and breeding grounds for inventive new organisms which have an apparent passion for defeating manoeuvres made against them. Health Centres, being smaller and less complex and attempting fewer procedures exposing patients to a high risk, actually need less complex defences against organisms and can reasonably accept less complex 'sterilizing' routines.

Defences against infection

Clean buildings, minimum dust, nothing to attract insects, protection against animals, clean water, good cross ventilation with sun-washed air, well spaced buildings, clean staff and clean patients, well maintained latrines, well washed and sun-dried linen and uniforms are all first line defences against infection and must be seen to all the time.

Early recognition of infections in patients, staff and visitors and their prompt treatment in a suitable manner is the second line of defence.

The third line is the actual processing and handling of goods. The goods can be broken down into two types:

1. Goods exposed to known infection
2. Goods which may have been exposed to infection

Both must be treated the same in the end, but goods in category 1 should be dealt with immediately and handled carefully.

Kitchen clean 'sterilizing'

The essence of sterilizing is the exposure of harmful organisms to an environment which kills them. Such an environment can be found inside a sterilizer (even a 'boiling water sterilizer', providing the organisms are exposed to enough heat for long enough, and providing there are no 'sophisticated' organisms present). The basic killer of organisms is heat. As goods can be sterilized in boiling water it follows that sterilizing them in a pressure vessel (such as a pressure cooker) is a better method, as the temperature inside is higher. Sterilizing by exposure to high temperature is known as pasteurization and this report recommends ten minute pasteurization of goods in a pressure cooker as the minimum acceptable standard. Box jointed instruments will need fifteen minutes; dismountable box jointed instruments are preferable and need only the shorter time.

Cleaning goods before sterilizing

Goods must be cleaned before sterilizing. A good scrub with a scrubbing brush, perhaps a preliminary boil to loosen any adhering material, 'flue' brushing of syringe barrels and the cleaning of needle lumens with a wire are essential. This will allow maximum heat to get to all the surfaces of the goods. Needles in particular need careful rinsing in clean water before 'sterilizing'.

Linen, bowls, etc.

Scrupulously washed and sun-dried linen is adequately clean for Health Centre

purposes. But the storage area (and preferably the drying area) must be fly free. Bowls may be washed in clean water with a good disinfectant (see below) but must be dried with clean linen and stored covered in a fly free area. Dressings, if it is essential to re-use them, must be pressure cooked, then rinsed and sun-dried. Some form of linen drying cabinet may be essential in areas with prolonged monsoons.

The handling of sterilized goods

A 'sterilized' item starts losing its comparative cleanliness as soon as it is removed from the sterilizing container. Goods left in more or less open containers in the water in which they have been boiled are particularly at risk. Wet goods will pick up airborne infection more quickly than dry goods. Unwrapped but covered goods will pick up more infection than wrapped goods. Clean goods placed on trays with uncleaned tongs, or placed on uncleaned trays or in uncleaned containers, or covered with a previously used cloth are soiled goods. Goods laid on a clean tray and covered with a clean cloth which is then lifted periodically are soiled goods. The ideal aim is to 'cook and use fresh', handling as little as possible.

A practical routine for a Health Centre

Returned used goods should be washed and then sterilized by the best available method. Keep the washing area well away from the sterilizing area. Goods should be taken from washing to sterilizing on clean trays by clean staff to avoid undue contamination of the sterilizing area. This care is not so important in modern sterilizing units where packing protects goods but is most important in less sophisticated practice. Do not store unsterilized goods in the sterilizing area. At the end of the day it is better to wash and hold goods in the washing area than to put them in the sterilizing area until morning as they can carry and then spread infection. Goods can be sterilized, then stored, then sterilized again before use but this double handling is wasteful. Goods sterilized but not used must be re-sterilized before re-issue unless well wrapped.

Sterilizing containers, following whatever sterilizing routine is employed, should be emptied with tongs included in the container on to a double thickness of sound linen, on a smooth tray well wiped with a strong antiseptic agent. The linen should then be carefully folded over the top of the goods and the bundle turned over on the tray. Do not touch the face of the linen that will be in contact with the instruments; do not let the linen lie on unclean tables. Turning the pack over secures the wrap with minimum fuss, makes it difficult to raid the pack, and will mean that the goods are adequately covered and protected. Smaller sets are better than larger ones. A local method of identifying contents may be necessary; do not stick pins through the wrappers.

Goods prepared and wrapped in this way will maintain a reasonable degree of cleanliness for some hours, but the wraps must be kept dry. Heaf guns with magnetic heads which can be sterilized should be purchased and used in preference to syringes where possible.

Wrappings and trays

Wraps can be made from old bed sheets. Trays can be any kind of metal tray, but smooth. If no wrappings and no trays are available, carry the goods to the site of use in the sterilizing container, open the container when the goods are needed, use small loads for quicker use. The site for use is the principle source of contamination.

Drums

Much faith and many instruments have traditionally been placed in drums. In the early days of steam sterilizers drums with open ports in their sides were placed in what amounted to sealed steam chambers. Steam filled the chamber and the drum, settling and condensing on the instruments, creating high temperatures which were then more or less maintained by pressure and more heat. At the end of the cycle the chamber was opened and as soon as practical the ports were snapped shut. As the drum and its contents and the air inside it cooled so unclean air was sucked in unfiltered. Linen is better, drums are dangerous. Linen or paper wrapped goods placed inside a drum which has had the ports pulled off and drainage holes cut through the bottom can be safely sterilized in a modern autoclave (see notes at end

of this Appendix), the drum then making a good container for the wrapping, the wrapping protecting the instruments. Drums may be convenient containers but they are not in any sense sterilizing apparatus.

Antiseptic fluids and disinfecting

Inadequately mixed antiseptic solutions which are too weak and have not been allowed to stand (so that the agent can disinfect the water into which it is poured) and which have been mixed in unclean buckets which have been left around empty without covers on may smell comforting but do not do any other useful job. Using antiseptic solutions which are too weak is a totally false economy, being in fact a dangerous waste of a valuable resource.

Goods to be placed in antiseptic solutions should be cleaned and rinsed first, and the solution should not be used for longer or more often than recommended by the manufacturer.

Where disinfectant is being used on a cloth to wipe surfaces or goods, do not rinse the cloth in the disinfectant between wipes. This makes for an infection reservoir in the solution, the infection in the end being laboriously spread. A second container for rinsing and even a third for wringing makes more sense however tiresome. This method prolongs the supply of active agent and is wasteful only of water.

Dust

Airborne organisms frequently travel on dust particles from bed linen and clothes. Brisk, efficient people rustling round wards expertly twitching bed linen are people stirring an unnecessary aerial soup of harmful organisms. Bed making should be quietly carried out without linen touching the floor. The counting of linen on the ward is an unforgivable health hazard. Frequent floor sweeping accompanied by much whisking of dust is harmful. Slow sweeping with a soft paddy brush into a container is perfectly acceptable providing the brush is not then shaken out of the window and the container dumped just round the corner.

Dust and organisms stirred in these ways will travel into the sterilizing area, on to the goods and into the patients.

Sunshine and ventilation

Sunshine and sky glare contain radiation that is an effective sterilizing agent. Sun should be let into latrines and dirty areas. Well spaced buildings without enclosed links allow the sun to keep infection down. A balance between shade trees and sterilizing sunshine must be kept.

Air that has been blown across a field will be virtually sterile. Clear cross ventilation will allow this air to flush out buildings.

Modern sterilizing practice

Larger Health Centres may well have sophisticated sterilizers. This last section of this Appendix is long but is only attempting to clarify what sterilizers are and what they are supposed to do.

Modern sterilizing practice is based on the use of goods wrapped in steam permeable wrappings; linen, cardboard or special paper and special celluloid. These are placed in a fairly complicated autoclave and sterilized with heat from steam. The autoclave must be in good working order, and new ones should not be bought without fool-proof guarantees and maintenance contracts. Malfunctioning autoclaves are a dangerous waste of money and effort.

Wrapping is essential as in any normal circumstances unwrapped goods cease to be sterile as soon as they leave the sterilizing chamber, being then exposed to non-sterile air. Further, properly wrapped or packed goods can be stored for quite long periods (up to 20 days in a good double linen wrap) and can be carried round and handled in safety providing they are kept dry. Adequate packing before sterilization is the root of modern sterilizing practice.

Modern sterilizers have complicated cycles. First a partial vacuum is drawn, then steam is let in, then the partial vacuum re-drawn a few times. This is known as pulsing and replaces air in the chamber and in the packs with water vapour. After

this flushing, steam is pushed into the chamber under pressure, the temperature of the steam being raised by the pressure. This pressure then has to be held, as does the temperature, for the right length of time. The pressure is then released and an after-vacuum drawn which dries the load. Filtered air is then let in to bring the chamber to atmospheric pressure. The sterilizer can then be opened.

Without pulsing the first steam entering may rush towards instruments in a pack (training) trapping air inside the pack, which air may insulate the goods from the sterilizing action of the live steam and from the very high temperatures reached when steam condenses on the goods releasing latent heat. The air itself may remain unsterilized. (This has in the past been called 'the small load effect'). A post-vacuum is necessary to dry the goods, otherwise moisture in the wrapping or coming out through it will open a path for the ingress of harmful organisms through the inevitable movements of the moisture in the process of the pack drying out.

It will be seen from the foregoing that unwrapped goods in traditional drums with ventilating ports are dangerous, that opening the sterilizer door as soon as possible to assist in cooling and drying is dangerous, and that safe routine modern sterilizing requires comparatively complex apparatus which needs attention and maintenance if it is to do its job properly.

In sterilizing it is necessary to establish a practical standard, acknowledge its effectiveness, work out practical routines related to the degree of sterility obtainable and stick rigorously to these routines.

Autoclaves come in large, medium and small sizes. Modern Western practice has favoured the large autoclave as it is more amenable to factory line type processing of goods and, when filled efficiently and used with a rapid turnover, it shows good results. Where a factory line process seems irrelevant (usually because the unit throughput is small) smaller sterilizers are much more appropriate, having shorter cycles (the cycle may have to be varied for different goods) and therefore allowing for a sporadic presentation of goods for sterilization. Well organized, a somewhat larger number of very much smaller sterilizers can fulfil the demands of very large units extremely well, and there is the additional advantage that breakdowns are less disruptive. Units have been built with one large sterilizer capable of doing all the necessary work in a few cycles. The fallacy in this economy is revealed at the first malfunction. Robust pumps, a suitable and limited range of cycles, accurate and unfussy instruments, simple easily repeatable and replaceable door sealing gaskets and suitable water pre-processing units are essential. Demand pulsed pre-vacuum, and a drying after-vacuum. Demand realistic cycle times and capacities, and resist loading, racking and stacking gadgets until it is found that they are needed. Much can be achieved by building wood and cardboard mock-ups of autoclaves on offer. These can then be trial packed and compared. Senior staff resisting this idea maintain their dignity at the risk of their patients' health. An essential of any well run unit is a senior staff member with direct and known responsibility for performance.

Small, so called 'flash sterilizers' are available. These work for unwrapped metal or glass or polypropylene goods set on a mesh tray. Bowls etc. must be placed upside down (this is not entirely satisfactory). Steam is admitted which rushes to the goods, condensing and producing a high temperature. The chamber is then pressurized for a short time, the pressure released, the door opened and the hot instrument taken out. Flash sterilizers have a definite place in hospital sterilization. Placed immediately adjacent to an operating or treatment room in a clean and well ventilated lobby, the ventilation source cleanable and as far as possible from any infection source, these sterilizers are extremely useful for dropped or unrepeatable instruments. Somewhere to wash the instruments is essential.

Most sizes of sterilizers come with doors at both ends for pass-through work. This means twice the number of gaskets, hinges and locks to go wrong. Double-ended sterilizers have their uses, but big double-enders are trouble sources.

Downward displacement autoclaves where steam 'soaks' down through a load driving the air out at the bottom, the air cock then being closed and the pressure built up have been superseded by high pre-vacuum autoclaves. They should be seen as big pressure cookers.

Syringes, gloves and rubber goods are always a problem. Gloves can be carefully wrapped (well powdered) and sterilized on a suitable cycle in most good autoclaves.

Syringes can be dealt with on a standard cycle. Rubber goods and anaesthetic equipment need careful and particular consideration. Ethylene oxide sterilizers which can be used for these goods need careful maintenance and exceptionally careful handling, being liable to explode. It seems reasonable to site them away from work areas and other machinery. Formalin is both the sterilizing agent and the main drawback of formalin cabinet sterilization.

Hot air cabinets may be useful for drying goods, but their effectiveness as sterilizers is very doubtful.

Syringes can well be sterilized in infra-red conveyor ovens, packed in metal capsules. These capsules are convenient to handle, properly sealed have a very long sterile life, are robust, easily identified and are near ideal. It seems very doubtful whether capsuling is truly effective in a pre-vacuum autoclave. With the growth of the use of disposables and jetspray guns ovens are no longer made as standard equipment.

Sterile fluids and lotions can be sterilized in standard autoclaves on appropriate cycles. There is no ideal capping system. Rapid cooling systems are available. In these the vessels in the chamber are sprayed to cool the fluids which would otherwise boil off violently as the chamber pressure was reduced. An alternative is to programme fluids for the end of the day and allow them to 'cook' quietly through the night.

Ointments and linen can also be put through suitable cycles.

Bowls of all sizes can be wrapped or stacked single or in pairs (pairs being separated by a small folded towel, otherwise they seal together) and used as occasion demands. Big outer wraps on bowls can be used to drape stands. Bowls with lips turned out over and down should be avoided as moisture can be trapped in the rims when the bowls are sterilized inverted. They are best sterilized laid on their sides and should not be sterilized right way up.

Operating theatre instruments can be made up in standardized laparotomy kits laid up in linen on cafeteria trays. Specials for individual doctors' preferences or extras to extend the range of the possible procedures are added as a separate bundle. Eye surgery calls for delicate and very special instruments and it is recommended that the specialist be allowed complete freedom of decision on the handling of these goods.

Sterilizing techniques and routines and sterilizing area layouts do not appear, by and large, to be as simple and uniform as the basic routines involved would seem to indicate. Common sense does not seem to be the keynote of design. The basic activity sequence for a large or small, complex or simple unit is as shown on page vii.

The demands of this sequence of activities can be met with a very simple plan. Complex partitioning is unnecessary as the goods are to be wrapped. Some authorities prefer to see separate stripping areas, washing areas, several packing areas and a sterilizing area, all linked by doors which are usually propped open as soon as the designer leaves. The partitions cut down air circulation in hot countries and hinder the passage of goods and people. If the goods are wrapped it does not matter where the air goes. Where mechanical ventilation is practical, heavy extract at the stripping area will draw air away from the 'cleaner' parts. So often one sees extract at the sterilizers to cut down heat. This, of course, sets up the wrong direction of air flow. In a simple building the stripping and washing area could be separated from the main work room by a completely open lobby. The goods themselves will still have some contamination on them, but sterilizing before wrapping is not necessary.

Complicated 'work stations' are often designed for packing goods. They are totally unnecessary; ordinary table tops with a formica or similar surface are practical and adaptable. Cardboard boxes do well for carrying goods round in the unit.

Spray racks are needed for testing needles, foam blocks for carrying them round (they are stuck into the block). A capsuling machine is necessary if syringes are being sterilized in metal tubes in an infra-red conveyor oven. Otherwise they can be wrapped in linen in tin boxes (or beer cans with the top removed and sharp edges blunted, these to be sterilized upside down).

Taps with suitable nozzles are needed to flush out tubing. Big low level sinks are needed for washing bowls, galleys etc.

Washing machines are a problem. Good agitation, hot water and a good squeeze of lemon juice produce bright and apparently clean instruments. A converted domestic or commercial washing machine may do the trick and will be at least as effective as and more easily serviced than an ultrasonic cleaner. Goods should be packed in a wire box packed with rubber netting so they do not rattle and break.

Wire boxes are good for issuing goods. They can be locked against theft between issue and arrival at the use point.

There is much to be said for wrapping lots of smaller sets and making up bigger packs after sterilizing. This means that someone can sit down and wrap fifty galleys with swabs in, then do spatulas, then do something else rather than having to collect all the items first, then wrap them in a thoroughly complicated manner.

Glove powdering can well be done in a separate cubicle to stop the spread of dust.

These notes have tried to strike a note of homely common sense. There is no substitute for this commodity in designing and running sterilizing units. Two days spent in a large room or a car park with tables and packing cases to represent equipment, with an experienced staff member getting a complete 'mock-up' day worked through, will solve very many design problems very satisfactorily.

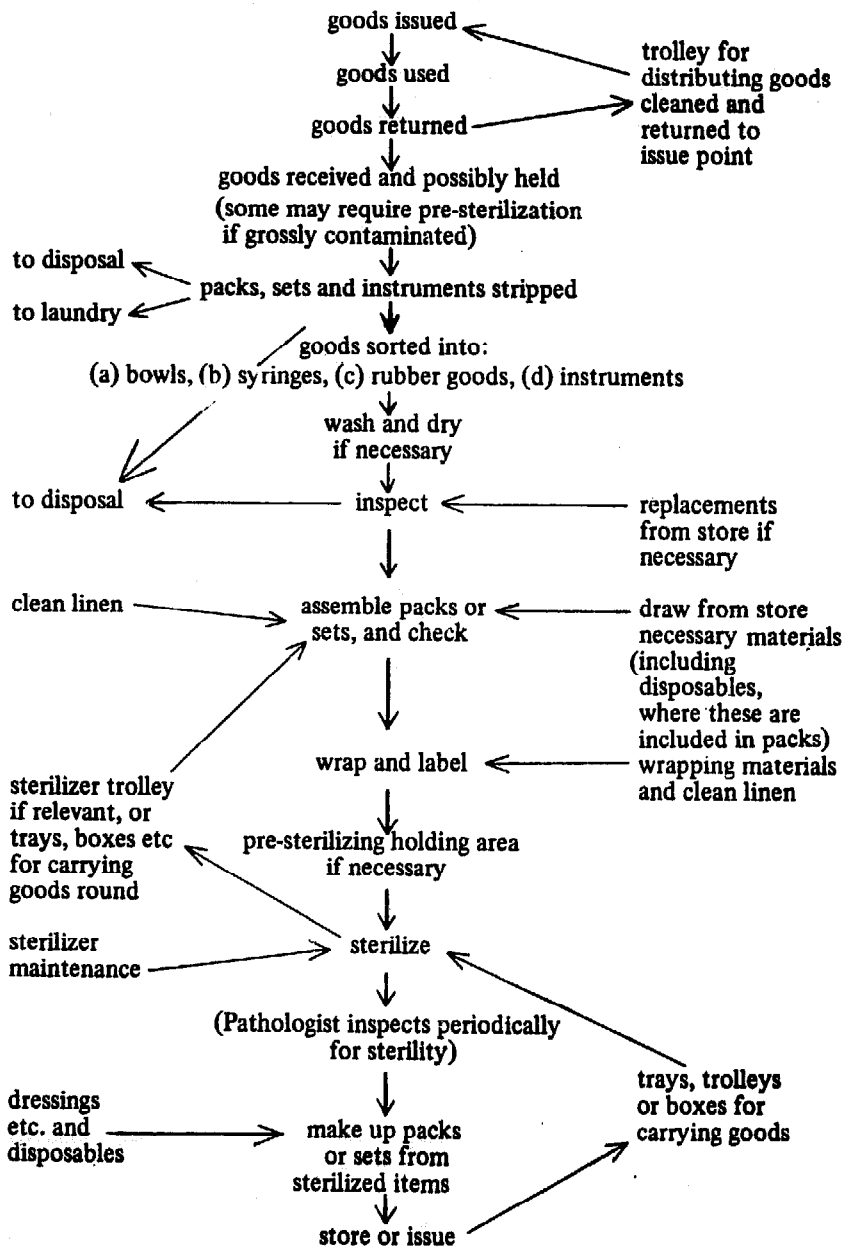

App. 15. Fig. 1. Activities in a Sterilizing Unit

Notes on an immunization area

This Appendix illustrates an immunization room layout. Such a room is not included in the Model. If a separate room were required it could be placed between the laboratory and the dispensary. This would mean an increase in the size of the treatment room's waiting area, but this would probably be a good idea as only a fairly large Centre would have the need or the staff for a separate room. The aim is to immunize all children who attend the Centre. The room is in use every day from 7.00 a.m. to 3.00 p.m., except Sunday, and has the following main features:

1. Vaccines are kept cold and away from light. Vaccines must be protected from strong light during a working session. A cold box is advised for holding during a session.
2. Two sets of syringes and needles are in use. one set sufficient for a day's work (one set in use and one being sterilized).
3. A sterile needle (or multiple puncture 'blade') is used for each immunization given. Syringes are used eight times. A bifurcated needle is available free from the WHO for SP vaccine. The needle controls puncture depth.
4. Magnetic head Heaf type multiple puncture guns are used for smallpox vaccination (freeze dried), BCG and HT. The 'Pan-Jet' (previously named 'Dermo-Jet') available from Schuco International London Ltd., Halliwick Court Place, Woodhouse Road, London N. 12, England, is recommended for administration of soluble drugs by intra-dermal infiltration. The instrument can be sterilized by boiling. Partial disassembly, rinsing and test filling with distilled water is recommended once a week or every 500 shots.
5. A helper receives the patient's card, records it and stamps the card, as the vaccination is given. Patients' cards are kept on side trolley away from the actual work bench, but near by.

Reminder charts

Charts on the wall at the back of the work bench show Heaf test reaction numbers, sites and methods for the various immunizations and dosages.

Suggested arrangement for the work bench (see diagram following)

1. Refrigerator
2. Cold box with opened vaccines actually in use; one vial only of each type of vaccine
3. Covered tray with magnetic headed multiple puncture 'guns' (two) (Heaf model).
4. Folded sterile towel with dry sterile 'gun' blades ready for use
5. Polythene tray with syringe for Triple Vaccine
6. Polythene tray with syringe for Tetanus Toxoid
7. Polythene tray with syringe for ATS
8. Polythene tray with disposable syringes for measles vaccine
9. Tray with spare syringes, tins of sterile needles and scissors
10. Covered tray with syringe for rabies vaccine
11. Small jar with dissecting forceps (sterile)
12. Squeeze type polythene bottle of spirit
13. Cotton wool swabs
14. Tin of sterile needles in use
- 15)
- &) Small bowls of water to receive used needles and 'blades'
- 16)

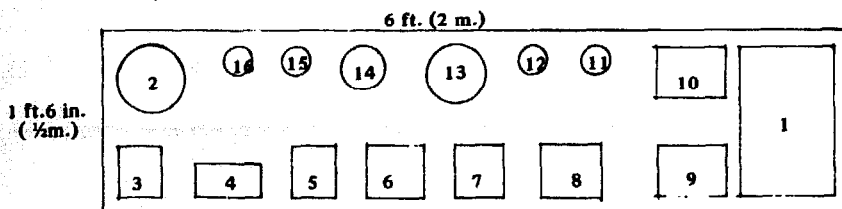

Disposal

All dressings which cannot be washed and re-used must be burned under supervision. Heavily soiled linen should be soaked in a bucket and rinsed as thoroughly as possible, then boiled for at least ten minutes before being processed through the usual wash.

Syringes, needles, etc., must be thoroughly broken up under supervision. No drugs of any sort should be disposed of in any form in which they could be taken.

Paper boxes, cardboard, etc., should be collected and burned periodically. A large bin is suitable for this, but it should have a perforated bottom, a lid with a 'chimney' with a hood, and the bin should stand on a plinth. Rubbish which cannot be burned, such as tins, should be collected in closeable bins, the contents being periodically compressed as much as possible and buried. Bins smell less if shaded. It is a mistake to put them out of sight and out of mind. If there is a security enclosure in the central facilities area, the bins should be within it to discourage scavenging.

Waste which can be used as garden waste should be properly composted, and should not be left around as it will become a fly nuisance source. Composts should be covered with fresh earth every two days.

Food waste can often be used by a local farmer, who should be under a direct obligation to remove it frequently and to keep the collection point clean. Excreta, vomit, blood, pus, etc., can be emptied into a latrine or pit or flushed down a WC where running water is available.

A disposal room is shown on the Model plan. The intention is that supervised treatment of rubbish can be made periodically from the disposal room, which should have a door opening to the outside and a hose point (where there is adequate water). The floor and walls should be impervious and cleaned regularly. Fly screening, sun and ventilation are advantages.

Following disposal routines, hands must be washed.

Stores and store-keeping

The storage building in the Model is sited at the entrance to the site for ease of access, for ease of supervision, and for initial use as the storage shed during construction. Additionally, in this position, there is room for considerable expansion without marked expansion of site size.

The building must be rat-proof. A building on stone or concrete mushrooms deals with this problem very well, but the mushrooms must be high enough for effective clearing of undergrowth and rubbish from underneath the building, as this space might otherwise attract snakes, mosquitoes, rats, etc.

The size of the store will depend on frequency of delivery of goods and the possibility of irregular bulk donations. A separate store for inflammable goods such as petrol and kerosene is essential; it should be placed sufficiently far enough away from the main storage building for fire spread to be unlikely in the event of accident.

Closed bins, metal or concrete shelves, and possibly a separate area for linen etc., are advisable. Avoiding storage on the floor makes cleaning easier. The store must be adequately ventilated, but a ceiling is unnecessary.

Doors must be big enough to allow large packing cases to be carried in easily. The store may be used as a garage, in which case some fire precautions are necessary.

A simple form of store-keeping book will be essential in order to maintain a reasonable ordering system. The minimum information to be shown in the book will be:

1. Date of receipt (entry to be made on day of receipt)
2. Nature and quantity of goods
3. Condition of goods on receipt
4. Price of goods (can be filled in later from invoices sent by post)
5. Any special storage requirements

A system is also needed which shows when remaining stocks will shortly be reduced to the point where they will be finished before a new batch can be ordered and delivered. This means that normal order and delivery times and consumption rates should be known and recorded. In its simplest form the amount of any given stored item which will last through the order and delivery delay period should be clearly shown at the storage area so that any staff member can check.

The issue of goods must also be carefully recorded on the day of issue. The record should show amount issued, date issued and to whom issued. Notes requisitioning stores should be checked periodically and matched with the issue book.

Periodic stock-taking is necessary. This involves totting up the total of goods received, adding in amount in stock at last check, checking the amount issued, checking that the difference is still in store and checking the state of the goods.

Where goods deteriorate or get broken they should not be thrown away before inspection. Drugs, syringes etc., must be thoroughly broken up and rendered unusable before disposal.

The placing of goods in the store should be clear and systematic as the storeman may be ill or away and someone else may have to take over. It is best not to stack goods against a wall and to have an aisle on both sides of stacks. In this way systematic pilfering from the backs of piles can be avoided. Anyone caught pilfering should be instantly dismissed.

It is unlikely that a storeman will be kept busy enough by a Health Centre to work in the store full-time.

Equipment lists

The Appendix notes items of furniture, equipment, drugs etc. It is not comprehensive, particularly in the matter of drugs. It does not show quantities, nor are all the items listed required to run a Centre, and there is some duplication, i.e. in sterilizing equipment where a sophisticated autoclave will make more primitive equipment unnecessary.

EQUIPMENT LISTS

The list is offered as a check list. Depending on many varying factors the lists may be greatly reduced or widely extended.

Cooking equipment, plates etc.

Not listed

Domestic and cleaning equipment

Soap, including babies' soap
Toilet rolls
Matches
Uniforms, footwear, headgear
Buckets and bowls
Children's potties
Beakers
Razors

Detergent
Brooms, brushes, mops, cloths,
scrubbing brushes
Baby bath and stand
Jugs and measuring jugs
Hot water bottles
Funnels
Razor blades

Scouring powder
Nail brushes
Aprons
Washing bowls
Latrine buckets
Bedpans, urine bottles
Insect sprays
Stretchers

Larger equipment which needs consideration in building

Autoclave (sterilizer)
Refrigerator - kerosene, gas
or electric
Generator

Incinerator
Drying cabinet
Washing machine
Steam plant

Gas bottles and boiling rings for
sterilizing
Cans of kerosene
Heat sealer for packing drugs

Sterilizing equipment

Wire boxes
Tongs
String, labels
Needle sharpener and magnifying lens
Steam resistant sticky tape

Pressure cookers
Wraps
Photographs of standard packs
'Bripac' cardboard boxes
Autoclave test phials

Boiling water and sterilizers
Trays for set-ups
Instrument cleaning equipment
Steam permeable paper
Autoclave cycle recording paper

Some suggested sterilizing packs (these are offered for thought only. The range of possible packs is enormous, the secret is to work out the fairly complicated ones that are needed in emergency, or packs needed for outstation visits or sets frequently used as a matter of routine. Examples are given below).

1. Maternity (gloves not included)

a. Delivery pack:

2 Towels (absorbent paper or
'J' cloths or material)
Swabs
4 Maternity pads

b. Cord dressing:

Swabs
Cord dressing
Cord ties

c. Maternity emergency pack:

Swabs
2 Rolls of packing (i.e. cotton wool)
2 Towels

d. Maternity additional:

Parts of vacuum extractor and/or
forceps
Towels

e. P.P. Repair: (compare with 1.c. There may be unnecessary duplication here)

Speculum
Needles and sutures
Pads
Swabs (gauze and cotton wool)

2. Burns and Wounds etc.

a. Burns:

Selected dressing plus 2 autoclaved plastic bags. The old dressing is removed by putting the hand inside a bag, grasping the dressing and turning the bag inside out over it. The new dressing is applied by the hand inside the second and clean bag. The dressing can be sterilized inside the second bag if a pressure steam autoclave (see Appendix 15) is used and provided the dressing is left protruding from the bag so that steam can get in and out. The protruding dressing will be protected by the pack wrapping.

b. Wounds

Ribbon gauze
Sinus forceps

Swabs

Gauze and cotton wool dressing

c. Stitch up sets

Selection of needles stuck in a lint pad
Swabs

Sutures
Gauze dressings

Stitch scissors

d. Incision sets

Bard Parker scalpel, handle
and blades
Curved scissors

Spencer Wells artery forceps,
2 large, 2 small
Swabs

Sinus forceps
Cotton wool and gauze dressings

e. Sore dressings

Folded gauze

Swabs

From the foregoing it may be seen that a pack containing swabs, gauze dressings, packing and towels might suit all 'soft goods' requirements, so that **only** instruments had to be added; unused soft goods to be returned for repacking. Careful thought and strong decisions are needed on these subjects.

Linen and bed requirements

Adult mattresses and washable covers
Pillows and washable covers
Blankets (antibac or cotton cellulose),
cot blankets
Towels (mothers and babies)
Towels (hand)

Cot mattresses and washable covers
Sheets, cot sheets
Polythene sheets 6ft. x 2 ft. (cut
from rolls) or rubber sheets
Plastic aprons
Mosquito nets

Crib mattresses and washable covers
Draw sheets
Mothers' gowns
Babies' gowns, nappies
Polythene bags
Containers for bed linen

Stationery etc.

Account books
Store-keeping ledgers
Exercise books for:
ward reports
daily registration of outpatients
register of deliveries
Adult cards in polythene envelope
Required report forms and statistical
return forms
Envelopes
Ink pads
Ball-point pens, pencils
Large sheets of graph paper, etc
for maps and charts
Typewriter
Screen
Visitors' book
Map of district to large scale mounted
on soft board (for putting in pins) and
covered in spray-on or stick-down plastic
(for visiting rosters, community projects
etc. to be kept on display)

Receipt books
Temperature charts
Under fives weight charts in
polythene envelope
daily consultation cards to
go with same
Notepaper
Carbons
Referral forms for patients transferred
to hospital
India rubber
Files
Containers for paper etc.
Film projector
Card index boxes and refills
(for recording community
projects etc.)
Map pins or pegs

Requisition books
Labour ward charts
Maternity cards in polythene
envelope (this pregnancy only)
(disposable)
summary of obstetric history to
be retained and added to
(permanent)
Date stamps
Stapler and staples
Felt tip pens
File boxes
Bill spikes
Slide projector
Large stiff cardboard folder
(home made) for maps and
charts. (See also Appendix 26,
Teaching Aids.)

Drugs list (i)

(During the preparation of this report a list of drugs has gradually been built up and commented on by different authorities. The working party put forward the results for thought. Some of the entries will cause raised eyebrows, others annoyance and/or worry. We have chosen to put forward the list for discussion rather than suppress it from fear of causing argument.)

Tablets and powders

Vitamin capsules
Yeast tablets or B complex
Sulphadimidine
Aspirin
Welldorm
Thiacetone + INH

Iron tablets
Chloroquine
Tetracycline or choramphenicol
Codeine
Bephenium or tetrachlorethylene
Other specific anthelmintics

Folic acid tablets
Daraprim or substitute
Penicillin v
Phenobarbitone
Piperazine

Local applications and antiseptic solutions

Appendix 19 (ctd.)

Surgical spirit
Kaolin
Sterzac powder
Hibitane lotion
Eye drops
Triple dye

Gentian violet
Arachis oil or local equivalent
Tinct. benz. co.
Eusol powder (for making lotion)
Eye ointments

Benzyl benzoate
Vaseline
Hibitane cream
Ear drops
Copper sulphate crystals

Others

Disinfectant

Insecticide fluid

Mixtures, syrups

Cough mixture
Iron mixture (infants)
Simple mixture

Syrup of chloral (infants)
Vitamin preparation (infants)
Purgative

Elixir piperazine
(Antepar elixir)

Injections

Streptomycin
Syntometrine amps I ml.
Sterile giving sets (disposable)
Ringer lactate

Procaine penicillin
Intravenous saline (disposable packs)
Half strength Darrow's solution

Crystalline penicillin
Intravenous dextrose (disposable packs)

Urine testing strips

'Albustix'

'Uristix'

Clinitest tablets or acidify, boil
and use Benedicts solution

Vaccines

As available and can be stored

Gases

Oxygen

Trilene or penthrane

'Locked Cupboard' drugs

Anaesthetic ether
Pethidine
Nikethamide
Pentothal

Ethyl chloride spray
Morphia
Lethidrone

Atropine
Lignocaine 1 per cent
Vit. K. injection

Family Planning supplies (if relevant)

Pill

I.U.D.'s

Drugs list (ii)

(The drugs list below was prepared for a group of Centres in 1965. We reproduce it to show the kind of list that can be prepared at a specific time for specific circumstances. It is the availability and cost of drugs and their ability to withstand storage conditions that will dictate choice as much as anything else.)

Benzyl Benzoate Emulsion
Chloramphenicol Ear drops
Sulphur ointment
Magnesium Trisilicate
Flavine Solution 0.1 per cent
Aspirin Tablets gr. 5
Cascara Tablets gr. 5

Sulphanilamide Powder
Chloramphenicol Eye ointment
Gentian Violet Jelly
Cetavlon Solution 10 per cent
(to be diluted to 1 percent before use)
Ferrous Sulphate Tablets gr. 5
Chloroquine Tablets (150 mg. base)

Dusting Powder
Turpentine Liniment
Kaolin Light Powder
Iodine Solution
Methylated Spirit
Yeast Tablets
Bradosol Lozenges

Dressings etc

Cotton wool
Gauze
Elastoplast
Splints
Sutures

Lint
Bandages open wove
Dermicel or micropore
Towels
Maternity pads (which may also be
sold to mothers)

Cellulose
Bandages crepe
Triangular bandages
Linen

General equipment

Cold boxes for vaccines
Height measurement scale
Boiling water sterilizers
Polythene sheeting and bags

Adults' weighing scales
Pedal bins for soiled articles
Drip stands
Trolleys

Appendix 12 (ctd.)

Children's weighing scales
Primus stove for local boiling
Angle-poise type lights

Furniture

Chairs: stacking
normal
low (for mothers)
arm
Beds: cots, cribs, beds, delivery,
divans, local type
Chart and map racks
Shelving: solid, slatted, washable

Stools: high for e.g. lab
normal
small (for children)
Exam couch
Cupboards: lockers for staff
general
lockable (e.g. drugs)
bedside lockers

Benches
Tables
Work benches: working height
writing height
Towel rails on walls
Blackboards
Curtains and blinds
Bowl stands

Sanitary fittings (where running water is available)

Wash basins (hands)
Sinks
Long bath
Bucket sinks (low level)

Surgeons' basins (deep with wrist
or elbow taps)
Drinking fountains (with unsuckable
delivery pipes)

Baby baths
W.C.s: as appropriate and
including urinals

Medical equipment

Heaf gun
UNICEF kit for home delivery
(emergencies)
Nylon syringes: 2 ml, 5 ml, 10 ml
(reboilable, for IM injections)
Lotion thermometer

BCG intradermal vaccinator
Sphygmomanometers on stands
Foetal stethoscopes
Metal hypodermic needles No. 1, No. 12
Pulsometers
Thermometers for refrigerators and cold
boxes for vaccines

Bifurcated needles
Binaural stethoscopes
Tape measures
Thermometers, clinical and low
reading, oral and rectal

Delivery sets

Artery forceps
8 inch bowl with lid (polypropylene)

Scissors (7 inch)
Gallipot

Receiver with lid (polypropylene)

Instruments for outpatient dressings

Dressing forceps
Sinus forceps
Container for sterilized instruments
Gallipots
Suture scissors
5-6 inch toothed forceps

Dissecting forceps
Probe
8 inch dressing bowls with lids
Receivers with lids
Scalpel handles
5-6 inch nontoothed forceps

Scissors
Cheatles forceps
Cheatles container
Needle holder
Scalpel blades

For care of unconscious or anaesthetized patients

Mouthgag
Sponge-holding forceps

Tongue forceps
Rubber wedge

Metal spatula
Adult sucker (pedal variety or home
made model with Higginson's
syringe to provide suction)

Other sundry items

Ear syringe
Auriscope
Syringes: 20 ml for doctors' use
(disposable)
needles for same (disposable)
tuberculin
Wooden spatulas
Test tubes, rack and spirit lamp,
urine test reagents

Assorted polythene connectors
Pipettes, supply
Mucus extractors (disposable, can be
sterilized two or three times)
Disposable polythene gloves
Resterilizable gloves (see Appendix 15)
'Orange' sticks

Polythene tubing or rubber tubing
Polythene catheters:
urethral size 8
baby feeding (can be reesterilized
two or three times)
Enemas: equipment as selected
Bottles and containers for:
medicines, mixtures, ointments,
specimens, used goods, sterile
goods, syringes, instruments,
thermometers

Additional equipment

Appendix 19 (ctd.)

The Health Centre may hold equipment for anaesthesia for use during doctors' visits. Similarly vacuum extractors, destructive instruments etc. may be held for or brought by the doctor.

Laboratory

(With the equipment given below a laboratory assistant could undertake the jobs noted in Appendix 7 and could collect, prepare and pack specimens to be sent elsewhere for inspection.)

Spring loaded microscope	Microscope slides and cover slips	Blood pipette with rubber tubing
Pipettes	Drop bottles	Blades or substitute for finger pricking
Hagedorn needle or substitute	Scissors	Plastic rods
Small dissecting forceps	Wire loop	Test tubes, 125 x 16mm and stand
Spatula	Containers, various	Funnel
Urine collecting glasses	Polythene wash bottle	Primus stove, gas ring, electric heater
Measuring jug	Spirit lamp	Sulphosalicylic acid
Haemoglobin measuring device	Vaseline	Acetic acid
e.g. Lovibond Comparator complete	Benedict's solution	Methyl alcohol
Leishman's stain and buffer	(alternatively Clinistix range)	Sodium acetate
Methylated spirit	Sodium chloride	Report forms
Litmus paper	Filter paper	Labels
Chinagraph pencils	Record book	

EXTENDED
ROOM LIST
AND
EXPANSION
OPTIONS

This Appendix suggests further rooms that could be added to the various groups and shows typical possible extensions. Fig. 12 at the back of the report in Appendix 52, Additional Drawings, shows the Centre expanded to a 25-bed hospital. If the extension was for surgical work, option H would be taken, if for maternity option I. Any X-ray or operating room facilities would be placed in extension J. These would again be accessible from option K, extension of the general clinic. J will also be accessible from group D (under fives and ante-natal) down the back of A, B and C and across a new link.

Fig. 13 (Appendix 52) shows the Centre expanded to 125 beds. Women's, children's and maternity beds will tend to be in options L, men's surgical and medical beds in M. Ante- and post-natal and children's clinics will be in option N and men's and surgically based clinics in O. A will then be well positioned for allocation to orthopaedic work, being also accessible from the bedded areas. Option J will displace the incinerator. Option N will mean the removal of the latrines from the social area.

Referring to the numbered plan at the back and to the room list on page 10, extra office accommodation can be made in option P and by changing room 22 (store) into an office. Room 26 will be conveniently placed for theatre goods, rooms 28 and 29 (men) will go elsewhere and will become sterilizing, storage and work space. Option Q, extension of the under fives, will probably be sufficient to deal with any likely work load as the rooms then available (9, 10, Q and possibly 5) would cope with over 200 children a day.

Combination of rooms 6 and 7 will give an adequate laboratory for a large unit, a new dispensary being made in N or O. Either could be extended into room 8, (additional waiting space). The latrines by the social area, earlier noted for removal, could be made into specimen-taking latrines, under which use they would have a long life. Additional hostels would be built in the hostels area, new kitchens being made here, and new latrines if necessary.

Outline room lists for these options are given below, comments on simple theatres and comments on sterilizers and sterilizing areas are given in Appendices 45 and 15 respectively.

H. Surgery related ward:	Area for costing purposes
Clean store with sink and lockable cupboard	
Disposal room	1,345 sq. ft
Nurses' desk	125 sq. m
Bed spaces (12)	
Additional latrines and washing places	
Covered link to E	(+ 224 sq. ft, 21 sq. m)
 I. General store	 1,345 sq. ft
Nurses' desk	125 sq. m
Bed spaces (12)	
One or two small rooms for children with mothers	
Covered link to E	(+ 224 sq. ft, 21 sq. m)
 J. X-ray room	
Dark room and store	1,920 sq. ft
Rearrange sterilizing suite	178.5 sq. m
Small operating room	
Room with half partition for scrubbing, anaesthesia and recovery	
Additional staff latrines and shower and associated changing	
Covered link to H (if applies)	(+ 224 sq. ft, 21 sq. m)
Covered link to K (if applies)	(+ 224 sq. ft, 21 sq. m)
 K. Increase room 1 to bigger store, make clerk's desk between 1 and 3	
New exam room as room 2	640 sq. ft
Additional waiting	59.5 sq. m
Covered link to O (if applies)	(+ 224 sq. ft, 21 sq. m)

L.	Rooms as H or I	
M.	Rooms as H	
N.	Two exam rooms Store and clerk's room as K Possible re-location of dispensary and associated extension of laboratory	
	Waiting space	1,920 sq. ft
	New latrines	178.5 sq. m
O.	As N, but include room for changing dressings accessible from N, much as rooms 4 and 5 are accessible from A and D in the Model	1,920 sq. ft 178.5 sq. m

Each additional 12-bed ward will call for accommodation as H. The wards are calculated as having a 16 feet (5m) width between columns, one wall being flush with the columns and having three beds per bay, the other wall being 4 feet outside the columns with two beds per bay. This will give very close bed spacing. A 25-bed ward would need double the area given for H and I, although a 30 to 32-bed ward would need a clear one bay less than three times the H and I area.

Each additional clinic as N. Clinics with only one exam room are very inflexible. If one room clinics are planned within the Centre, then make it possible to open through waiting areas so that wider use can be made of the space.

Except in respect of two exam rooms per clinic these suggestions are minimal. A generally accessible treatment room in the ward area would be a great advantage. Centrally placed additional storage may be thought necessary, in which case a new sterilizing suite should be made outside room 26, the operating room being displaced further out, rooms 25 to 30 then being available for storage. Where an operating room is included, consideration should be given to a space with two to four beds, centrally located, where post-operative cases, particularly children, can be given special care. A room for mothers should be located close by or mothers given a divan in the room.

If a nursery is required E or L are well located.

The area figures given for costing purposes are only approximate. They do not include latrines or additional washing spaces, nor do they include additional staff housing, hostels or any extension of the social area or main stores.

All the groups are summarized in Appendix 20, fig. 1 which shows the Model extended to a 125-bed hospital.

Appendix 20, Fig. 1.
Extension options
(See also room list
page 10)

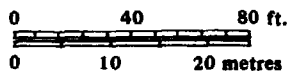
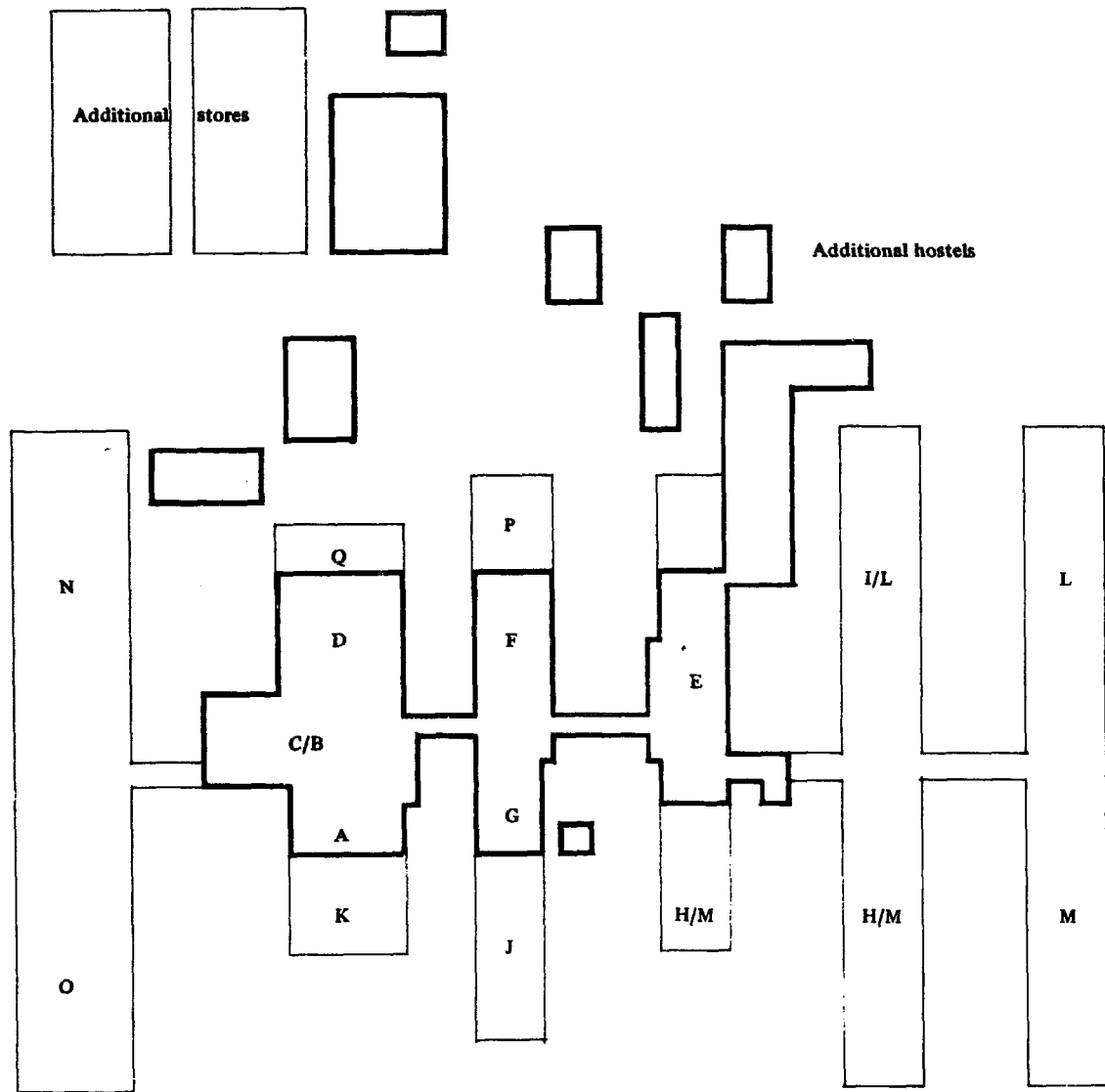

Treatment types

The working party has spent much time attempting to establish the outlines of treatment programmes. Only very general conclusions have been reached. The table immediately following shows the kind of actions that medical and para-medical staff can take and where. It is not comprehensive.

Likely treatments – graded into three groups

In O.P. clinic during interview	<p>Giving of tablets and medicines. Taking temperature. Small cleaning (wiping nose, external ear, small blister, application of GV – mouth cleaning).</p> <p>Showing mother how to clean and drop ears/eyes of child.</p> <p>Showing mother how to spoon feed. Removal of 'easy' foreign bodies from nose/ear. Showing oral giving of fluids. Minor dressing changes.</p> <p>Prescribing. Issue of safe medicines.</p>
Special place set aside in clinic or bed area	<p>Cool sponging for convulsions and/or hyperpyrexia. Dressing of most sores and wounds. Cleaning and dropping ears/eyes. Urine testing.</p> <p>Injections – therapeutic and immunization. Simple laboratory procedures (either collection of specimen or simple tests). Small burns. 'Easy' fractures. Taking blood pressure. AN exam. Re-hydrating children – oral, sub.-cut, intra-peritoneal, and scalp vein.</p> <p>Helping mother with engorged breasts and re-establishing breast feeding.</p> <p>Preparing and demonstrating foods for malnourishment. 'Day' or emergency care of sick child or adult. (Decision later to send for hospital care or home). Small incisions and repair of lacerations.</p> <p>Removal of jiggers, tumba. Delivery. Issue of medicines.</p>
Hospital – transfer or if Centre has hospital facilities	<p>Severe illness. Severe burns. Large bleeding lacerations. More difficult and adult fractures and injuries. Tests and investigations that cannot be done in Health Centre. Difficult removal of foreign bodies.</p> <p>Large incisions. Complicated AN – labour – PN cases.</p>

Some authorities suggest and many existing Centres demonstrate that many treatments normally considered to be within the sole capability of doctors and hospitals can be carried out by auxiliaries in Health Centres.

Given an unlimited supply of staff, time and money there is virtually no end to the range of treatments that can be undertaken and the range of rare diseases that can be looked for with sophisticated apparatus; there is virtually no end to the possibilities of prophylactic and preventive medicine. As staff, money and time are all limited goals must be set. The general system followed in most countries at the present time is esoteric medicine practised in a limited number of sophisticated institutions, the sophistication in facilities and treatment trailing off to, in too many cases, no treatment at all. Health Centres aim to spread care, and are intended to be staffed by auxiliaries.

The range of treatments that can and should be carried out in Health Centres by auxiliaries will need separate consideration and decision in each country and often in each locality. Where there are fewest doctors auxiliaries will have to carry the biggest responsibility. The selection of treatments suitable for auxiliary based Health Centre management is a crucial factor in planning, surveying, training, recording etc., etc.

Health Centre treatment must deal with common local ailments successfully if the Health Centre and its staff are to gain local respect and confidence.

Treatment and education must always go hand in hand; ante-natal, maternity and child care aspects of the Centre's work are crucial and excellent pathways into community co-operation.

Treatments undertaken should always include two or three diseases which can be expected to show positive response to available treatment. This is as much for the benefit of the staff as of the community. Selecting main areas for efforts in staff training, treatment and close documentation will depend on:

1. Treatability
2. Ability to show results
3. National decision
4. Local necessity
5. Available staff
6. Available drugs
7. Available equipment
8. Available facilities
9. Available money
10. Available transport

In Appendix 29, Evaluating the work of the Centre and the use and design of records, it is suggested that the work programme of the Centre should be organized to some degree with the main intention of making record making and evaluation feasible with simple means. The key to the whole record making problem lies in defining medical goals. One then knows what is to be recorded. Goal selecting will also define staffing levels, necessary equipment, building, transport and training; the placing of units etc., etc. This problem of selection lies on the battle lines drawn between Health Centres and hospitals, between doctors and auxiliaries, between high cost care for the few and too little care for the many, between country based medicine and institutional medicine.

Firm and very difficult decisions are needed. The working party has not managed to reach any sort of agreement.

Part-time workers

There are many aspects of a Health Centre's work which can be coped with by part-time workers. The workers can be of almost any grade and can work in the Centre or in a sub-Centre or even where there are no formal facilities or organization at all. They may be radio telephone operators with some ability to recognize diseases or farmers who have grasped the ideas being offered and are willing to help their neighbours. It could be that a member of the community understands well digging or some similar craft and will help others on request. They can all become part of the Health Centre armoury. Alternatively someone may be requested to get word round that a doctor is visiting, that an immunization team will be through the district on a particular day etc. It is helpful if the Health Centre can call on someone to get word round.

Similarly, if bullock carts or some similar vehicles are to be used as ambulances someone will have to be willing to lend his or to produce one from his friends or village.

In selecting part-time workers the Centre accepts quite a responsibility. Character judgment is obviously important. Where village health committees (see Appendix 23) exist they could be approached for advice.

In general terms it does not seem unreasonable to suggest that it may not even be necessary to pay part-time workers. Providing the tasks are not onerous and providing the worker receives recognition for what he is doing there may be no need of payment.

It is proposed in Appendix 31 that school children can be used as part-time record makers. Similarly there is evidence that in many countries school leavers are willing to do community work of one sort or another.

The essence of this problem is the motivation of those who might help and defining areas in which help will be useful. Surveying and the preparation of information, such as crops being grown, are areas in which inexperienced but intelligent workers offering themselves on a voluntary basis can be used. The information coming in must be dealt with. This is another area in which a large scale comprehensive map of the Health Centre's area could be extremely useful for both defining problems and storing information. It is again a matter of finding need and proposing a solution which is stated in terms of possible staff. Part-time workers may be able to do very well some of the jobs which might otherwise fall to over-qualified staff.

Communications and responsibilities

The importance of two-way communications throughout the structure of a health delivery service cannot be overstressed.

The Centre communicates with the people of the villages and district, with the schools, with public health and agricultural services, with the government and sponsors, with visiting doctors and the District Hospital and with other Centres.

Nothing is gained by isolation.

Perhaps the most important stream of communication is between District Hospital doctors and the Centre. Much of the confidence of the Centre staff and the quality of care offered depends on these doctors' visits, and from this confidence should spring a meaningful network of care centres, which centres should inter-communicate.

Repetition of the words and the links cannot adequately stress the importance of this central notion.

It is easy to say that every Centre of any size should have a vehicle with a high clearance, four-wheel drive and a robust frame and body; capable of carrying stretchers and goods; able to travel in very wet or very dusty conditions; supported by a maintenance system — and it must be said. Mobile clinics, home visiting, the support of small peripheral units, hospital referrals, the carrying of supplies and the general mobility of staff are the jobs the vehicle is to be used for. The extra expense of this transport and the extra problems of maintenance are far outweighed by the enormous advantages.

Isolation can also be effectively combatted by radio telephone. An isolated semi-skilled auxiliary, living perhaps within his family group in terrain inaccessible in real terms, can ring up for advice, support and if necessary, transport.

Similarly, Centres can ring up each other and can ring their District Hospitals. Small peripheral clinics can keep in touch with larger organizations. Isolation will be greatly reduced. Diagnostic, or rather disease recognition skills can, in this way, spread care.

Each unit in an area will be responsible to the District Hospital. The doctors will carry a people and health management responsibility as well as a strictly clinical responsibility. As team leaders they will need to understand the cultural background of the peoples in their area. They will need training and practice in dealing with local social hierarchies and must have some instruction in management disciplines.

This Appendix has drawn the working party close to a discussion of how this extra burden of training can reasonably be imposed on doctors, who is to plan it and do it, etc. Part of the answer must be in some of a doctor's training period being in a District Hospital, and this period must include Centre visiting.

Traditionally, young doctors, at the end of a sophisticated training period, quite possibly in a foreign country, are thrown into an isolated rural situation where the facilities they have been trained to use, and the staff they have been trained to rely on are not immediately available. Simple contemplation of this apparent absurdity may result in suggestions for alleviating the problem of overburdening an already packed course. The doctor's duties are further expanded in Appendix 24.

As well as communication with other medical organizations, schools, agricultural advisers, etc., the Centre must communicate with the population it serves. One method of doing this is through the village health committee. Typically such a committee would have the village chief or other influential person as chairman, the local teacher as secretary and a member of the Centre staff as initiator or organizer. The principal object is the improvement of sanitary and water facilities in the village. Thereafter improved husbandry, tree planting if relevant, goat control and similar projects can be taken on. Improvements in animal slaughter, the condition of any market, improved housing can all be implemented through the committee.

Starting fifty village committees in all the villages in a Health Centre's orbit all at once would put an intolerable burden on the Centre staff. It is probably best to start in two or three villages near the Centre and to wait for requests to come in from other villages. The organizer or initiator will have the job of putting up ideas

about what can be done, including some idea of costs, controlling wilder and over ambitious schemes and keeping up a map or other form of record of activities so he or she can make introductions between committees where self help can be useful. This should not be seen as a full-time job for the health worker concerned. Either the committee will get on with the job with a reasonable minimum of help and advice or the health worker concerned will need a large secretariat to do the job for them. As the second option is out of the question the committees must be supplied with basic information, their specific questions should be answered and much encouragement given; but they must do the job and must see that as their aim.

A successful village health committee will include women and representatives of every type of household. Members of the Centre staff must make a point of visiting the committees, the visiting doctor must be persuaded to show lively interest and annual or more frequent gatherings of representatives held whether in a village or at the Centre — even at the District Hospital if it is well placed.

In some areas there may be a taxation system for the support of rural improvement programmes. There is something to be said for giving to the 'haves'. As a village improves itself so it is given more money for further improvement.

In the village in which the Centre is located different problems may appear. If the village has been most helpful in building the Centre they may feel quite proprietorial towards it. They may feel that all their village's deliveries should have priority over other villages' complicated deliveries, etc. It must be made clear early that it is not only theirs but everyone else's as well.

The two-way communication system must be started as it is intended it should be carried on.

Duties of the doctor in relationship to the Health Centre (see also Appendix 23)

The doctor's duties are as follows:

1. To see patients referred for his opinion
2. To educate and encourage staff and patients
3. Trouble shooting at all levels
4. Responsible for maintaining standards and reviewing progress
5. Responsible for instigating and maintaining changes and improvements
6. Responsible for introducing any younger doctors or students in his sphere of influence to the theory and practice of Health Centre work.
7. Responsible for maintaining the major links between Centres and District Hospitals, other disciplines and the local Health Centre committees.

When visiting the Health Centre the doctor should have aims similar to those of the Centre staff when visiting a local home, i.e. to advise and encourage, support and teach, to note progress and suggest improvements, etc. These duties impose an extra burden on the doctor beyond those he carries by virtue of his medical qualifications, and they call for a flexibility of teaching approach which one could reasonably expect to find only in a limited number of suitably gifted people. This problem could be lessened if the doctor could learn to think of all the staff of the Centre as trusted colleagues who will inevitably benefit from any advice he can give: even if the advice is not understood by the person to whom it is given, at least a feeling of confidence in their job may result.

A curriculum of lecturettes with very simple content would offer a good basis for this essential inter-communication between the doctor and the Centre staff. A three to five minute talk, preferably supported by slides or other visual presentation, should be sufficient to promote immediate discussion and questions. There is no reason why these discussions should not be developed in further meetings. A set of twenty lecturettes taken in rotation, some of the subjects being followed up in two or three discussion meetings, would provide an adequate cycle for the average Centre without wasteful repetition. The Centre staff should be encouraged to continue reading on and discussion of these subjects.

These notes have continually suggested that the local community must be brought into the 'power structure' of the Health Centre. It is suggested that the local 'committee', which should of course include Health Centre representation, should be 'in charge' of the Centre excepting specifically any medical power and with only a limited involvement. From the earliest stages it should be clear within the committee that they will be asked to accept advice on all medical matters and on financial matters over which they have control where these are involved with medical problems, but it is essential that all these matters be fully discussed in the local committee. It is suggested that the visiting doctor should have the right of final decision and direction in these matters, it being assumed that any decision will have involved full discussion with representatives of the community and the Health Centre staff.

APPENDIX 24

**DUTIES OF THE DOCTOR
IN RELATIONSHIP TO
THE HEALTH CENTRE**

Teaching and staff training

Doctors will teach nurses, nurses will teach auxiliaries and other nurses, all three will teach patients and visitors. The teaching function of the Centre cannot be overstressed. Seminars at the local hospital are also essential for the maintenance of standards and morale.

The basis of good teaching is two-way communication, which is often helped by good teaching aids which are discussed in Appendix 26. Simple answers to questions from an interested audience will go a long way to establishing confidence in both staff and visitors in the teaching sequence.

Most 'teachers' will not have the opportunity of a spell of specialized training in teaching. Further study of this problem is needed and proposed solutions must be phrased in locally understandable terms. Further, it seems essential to stress that any proposed teaching training should aim at the possible and practical and should not assume that all the students are gifted teachers, or even quite good ones. Simple rules are needed like 'If you've talked for ten minutes you've talked for too long.'

Regular visits from the area hospital staff are the principal foundation of staff instruction. Visiting doctors must explain any new techniques and accept the help of auxiliaries.

Week-end refresher courses for staff are recommended at least once a year. Gatherings of staff with similar problems should be encouraged. As a principle, it should be stated that gatherings and seminars should take place in Health Centres and District Hospitals in rotation.

Once every two years a fortnight's refresher course and in-service training in a hospital is very greatly appreciated by Health Centre staff.

Auxiliary staff training for higher grades needs specific study and recommendations for Health Centre work. Appropriately tailored training programmes could, it is believed, reduce the formal training period to two years. This can be partly in-service training. Training centres must not be centralized in a capital city, should if possible move round the country periodically, and should be closely linked with the Health Centre net-work as well as the District Hospitals.

Training programmes need early establishment and careful design. They are perhaps the most essential feature of the whole Health Centre idea. Intense and early effort is needed in this area. Further notes on this subject can be found in Appendix 44.

**SOME
TEACHING AIDS
AND THEIR USE**

Some teaching aids and their use

The problems of communicating information are described in Appendix 25, teaching and staff training. This Appendix puts forward ideas for teaching aids where these are appropriate. Staff should be able to understand charts and pictures so teaching aids, well prepared, can be used in staff training sessions.

Teaching aids have the following aims:

1. Clear presentation
2. Memory aids for the teacher
3. Visual material is always better than just talking
4. They give confidence to a teacher who is perhaps not very experienced.

A military lecturer asked the secret of his evident success replied that his technique was, 'First I tell them what I'm going to tell them, then I tell them, then I tell them what I've told them.' This technique is very useful and no amount of teaching aids will make up for a lack of clear, firm, simple presentation. Visual aids will either help in explaining something very complicated or will punch home a simple point. If possible a complicated picture should be preceded by a related simple one and followed by another related simple one (possibly the first one back again) so that the idea is remembered even if the detail is forgotten.

Aids fall essentially into the following categories:

1. Ready-made (commercially produced or home-made)
2. Kits that can be put together and taken apart and used again
3. Pictures or displays arranged during the talk or just before and probably not used again
4. Things used in demonstrations which go back to their original use later

Ready-made aids

Commercially produced or home-made charts, books, pamphlets, pictures, posters etc., films, film strips, tapes, slides, transparencies etc., projectors, overhead projecting drawing tables etc., notice boards, pin boards etc., kitchens and buildings in the local manner; all these are teaching aids. They are all fairly expensive except for home-made work on paper. They all have storage problems in hot, damp countries and the more elaborate equipment is subject to theft.

Drawing pins and felt tip pens, slide containers, film spool tins and paper are also needed. The essence of these aids is that talks are built around them, and must follow their demands. The material cannot be changed during a talk. Very experienced teachers can stop half way through a set of slides and still make sense. Most people, if delayed before or during a talk, find it very hard to shorten it or change emphasis. Ready-made aids should therefore be prepared for presentation in short batches. Two or three batches can be strung together with questions in between where a longer session is appropriate. If a film is being shown try to run it through first and see that it is in one piece, makes sense and says what you think it says. Make sure equipment is there and working before you start. Make sure slides are in order and that the projectionist knows which way up they are. If you want a slide repeating ask for it to be taken out while it is still on the screen so the projectionist does not get lost.

Try not to talk to the pictures or to the apparatus. Face the audience, try to look at individuals and move your eyes around the whole group. If you want to pick something out on a picture stand to one side of it and nearly behind the screen or board, and use a pointer. In the dark use a torch with most of the beam blacked out as a pointer.

The audience should be arranged for the presentation in mind. A small group looking at charts or pictures could squat or sit in a half circle, or could possibly sit on beds or on a tree trunk. Try to involve the audience by asking questions, but make sure they have a reasonable chance of answering them. In small groups members of the audience can be asked to pick out things on a picture. Children can sometimes be encouraged to shout out the answers to questions.

Where charts or pictures are pinned up on a board on long term display, for instance in a waiting area, it is helpful if a routine can be established. A member of staff can go into the waiting room and talk briefly about an item and answer

questions. The aim will be to put one or two points over only, the points closely related to the picture or chart. Done regularly this will be acceptable and expected. This implies a planned rota of material with programmed changes of pictures. A limited number used in rotation is more valuable than having a permanent display which quickly loses interest. The same technique can be used in staff teaching.

Flip stands are very useful. An easel blackboard can be converted to a flip stand with drawing pins. Using this technique one starts with the charts in reverse order pinned by their tops to the top of the blackboard with the pictures facing the back of the blackboard. The first picture is then flipped (pulled gently!) over the top of the board and then faces the audience. Practice is needed, particularly in pinning the pictures together.

Big rolled up charts and maps can be stored on pegs set into strips of timber. The pegs should be about 3 inches apart and stuck into the backing timber at a slight upward angle. The backing timbers plus pegs are then fixed to the wall and the charts laid across the pegs. This makes them less susceptible to mildew, cockroaches and termites. Charts to be used on the flip stand should not be rolled up as they will not lie flat on the board when flipped.

Kits that can be taken apart

Flannelgraphs are a good example of this kind of aid. The base is flannel (felt) and bits are made of felt. The bits are made to any required shape. Sets are commercially available but can be home-made. Any felt or lint-like material which will stick to itself will do. The base board is set up at an angle so adhesion does not have to be too strong. The advantage of the flannelgraph is that the pieces made help the teacher to organize material but the pieces can be used in any order, members of the audience can help put the pictures on and many different uses can be made of the pieces. Flannelgraphs particularly suit story telling for children (with a suitable teaching point).

Plastic models are available for teaching anatomy, the way babies grow etc. These are useful because, again, the student can do the disassembly and assembly which greatly aids memory. Where models of this sort are used that are not at the right scale care must be taken to explain this. There is the classic story of the community which, when shown a big scale and beautiful model of a tsetse fly, expressed relief that their tsetse flies were very small, so they did not really have a problem.

Blackboards fall into the category of re-useable aids as the pictures and diagrams drawn can be rubbed off and the board used again. Coloured chalks can be used, and if not available white chalk can be coloured with ink. This is not totally satisfactory as the chalk goes soft if thoroughly soaked. The chalk can however be tinted so there is a visible colour difference. Blackboards can of course be other colours; green boards with yellow chalk are a common alternative. Blackboards on easels have two sides, so complicated pictures can be drawn on the back before a talk, and not produced till the appropriate moment. Students should be encouraged to help in preparing pictures during a talk.

Overhead light table projectors are very useful. Transparent sheets or a continuous roll of transparent material are laid over a light. Drawings made in felt pen on the sheet are then projected by a lens on to a wall or screen. The drawings can be done during the session whilst talking, students can have a try, a pointer is not necessary as the pen shows on the screen and can be used as a pointer, and successful pictures or rolls can be kept and used again. Sheets can be prepared beforehand and used much like slides. This aid can be used for large gatherings and is perhaps the most useful available for general teaching purposes. It will be found particularly useful for seminars for more advanced students as part of their training must be to learn how to put over information.

Fixed displays for single talks

Staff may wish on occasion to set up exhibition displays. This may be as part of a seminar, as a feature for a particular effort in propaganda or as part of the Health Centre's co-operation with schools etc.

Displays of this sort are best set up in a sequence, to start at one end and work along to the other. Charts, pictures, objects and models can all be linked, literally with coloured tape or string or with some other more complex reference system such as writing or symbols. Horizontal and vertical surfaces can be used, thus a

screen on a table could have a picture of the school, and a picture of the Centre could be on the table. A ribbon from each might then go to a third panel showing the two working together. If a cookery display is being set up, take care to be realistic. Attaching raw food stuffs to an empty pan on a table with ribbon, and then attaching a picture of a healthy and satisfied baby to the pan from the other side could be interpreted in many hilarious ways, none of them as intended. If a progression in food preparation is to be shown then each stage must be shown. A simple display on these lines changed reasonably often will attract interest where a permanent display will rapidly become 'part of the wallpaper'.

Things used in demonstrations

Stress has been laid on the need to have a demonstration kitchen in the local manner but exhibiting any improvements that would be within the local means and genuine improvements. When this kitchen is used for demonstration purposes the utensils used must be the same as those used locally, unless a change is being proposed in which case this must be made clear. Joining in is important here.

If the care of a baby's mug and spoon is being demonstrated ask someone who does it properly to bring theirs rather than using a spanking new demonstration set. Get mothers to demonstrate spoon feeding as soon as you can rather than doing it yourself. A demonstration in which everyone can join in is worth many words.

Sticks, stones, leaves and marks in the sand can be used for teaching. 'Here is a house on this hill (a stone), here is the latrine (a piece of stick) and here is the well (a hole in the sand). And here is the water going from the latrine to the well and here is the owner after using the well (drop a leaf). The latrine must be away from the well (move the stick). It must be at least 60 paces away and more if it is uphill.' Anyone can learn this kind of routine and repeat it time and again, anywhere, and without teaching aids.

Summary

There is no use pretending that all Centres are going to be staffed by people who handle pens, glue, string, paper etc., and are experts in presentation. In the same way no single set of answers will do as different communities will understand different presentations. Co-operation with any local school will help. There they must know what is understood.

Highest grades of staff will learn from the more sophisticated methods and will take in more complex information. Junior staff will have less sophisticated learning methods. Villagers may need something very simple. People who are going to have to teach with no aids or facilities must be taught to use mud and sticks because that is all they will have. People taking on lots of teaching may need a journal or card index box in which they note what they have done with each collection of people, and will need programmes to organize their subjects.

Staff will need to make notes, for which purpose précis of talks, but not full notes, can be issued. These help students to remember what was said without making it unnecessary for them to make the effort of remembering.

A typewriter, or simple sign writing set or big rubber stamps with coloured ink pads and some form of duplicating machine, or periodic access to one, will complete a useful set of aids.

Fig. 1 over illustrates a useful kit which can be carried round and used for several purposes.

Fig. 2 illustrates the construction of the kit. This drawing is 'cut down' to show the details. The box should be made to the overall sizes shown in Fig. 1, or somewhat larger than any charts which may be used. A very much simpler version can be made with stiff cardboard and linen hinges.

A Travelling Teach-box

To use as blackboard, open out box and stand up.
 For flannelgraph, reverse lid and stand up.
 For flip charts, take off lid, lay out charts, put back lid.

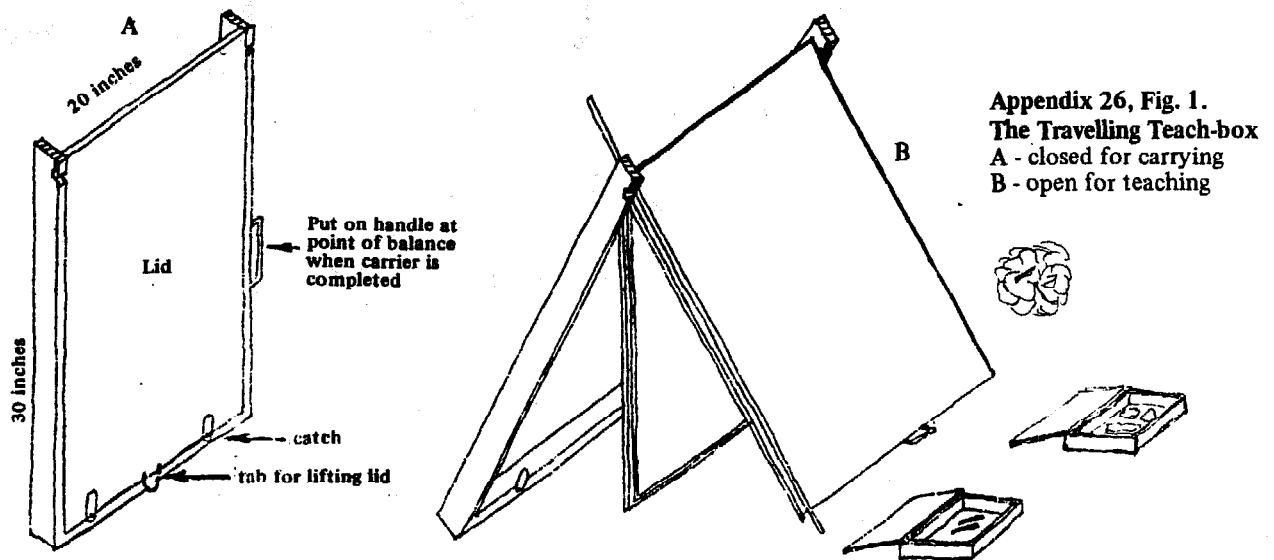

Appendix 26, Fig. 1.
 The Travelling Teach-box
 A - closed for carrying
 B - open for teaching

Width of box inside to be at least width of charts plus 1½ inches

Depth of box clear inside to be thickness of charts plus thickness of flat box, like cigar box. Such boxes are useful for chalks and for flannel pieces etc. .

Keep board duster in a bag as chalk dust will spoil flannel

When box is opened for standing up charts will hang down, so make box 4 inches longer than charts at bottom and 3 inches longer at top to give space for hinge, chart hanger, etc.

Make a pointer, to lie diagonally in box.

Key to Appendix 26, Fig. 2.

- A Hinge made from long strong screw set deep in lid
- B Flannel surface
- C Blackboard surface
- D Tab for lifting lid
- E Bottom of lid angled
- F Metal plate such as a hinge cut in half
- G This dimension to be half the thickness of the lid
- H Line of lid hinge (A)
- I Lid thickness
- J Lid closes on this ledge
- K Split paper clip goes through hole in wooden batten to hold on flip charts
- L Catch
- M Rail ledge angled to push lid back into socket at other end when lid is closed
- N Strong rail at bottom
- O The box will be much longer than this. The drawing has been pushed together so that it will fit on the page
- P Plywood or thin timber back
- Q Tacks
- R Strong cloth for hanging flip charts over back (lid to be taken off whilst this is done)

Appendix 26, Fig. 2.
Details of the construction
of the Teach-box
Key on page iv.

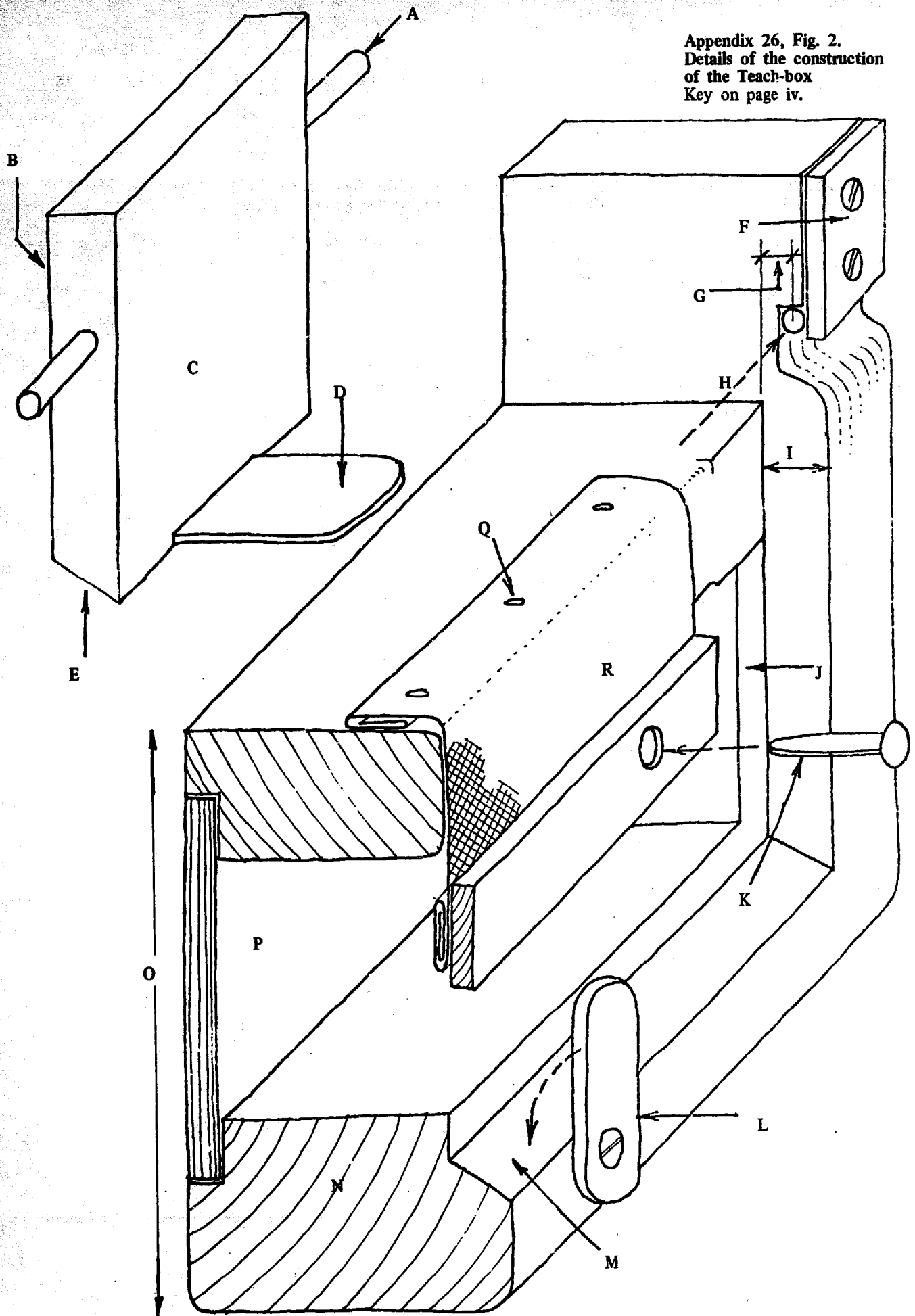

Home visiting

Home visiting is an important feature of two-way communication in health delivery.

Which member of the staff will be responsible for the overall home visiting programme will depend on qualifications, availability and programming of the work of the Centre.

Where school children assist in the collation of records by visiting homes (as proposed in Appendix 31), home visits should be related to this record making programme.

In an area of dispersed population, home visiting may in fact mean visiting a small population sub-group. In some areas home visiting may become indistinguishable from a mobile clinic situation. The idea is, however, not the offer of curative medicine but the cementing of co-operative relationships.

The object of the home visit is to check on the health of the family visited, to encourage them to use the facilities of the Centre and to try to ensure that they are following advice and instructions given to them during visits to the Centre. The visit should be as informal as possible. Suggestions for improvement of diet and improvement of the home, hygiene, childcare, etc., are part of the duty of the home visitor but such advice must clearly be given slowly and carefully, and the need for change should preferably be brought out in discussion on a basis of friendship. Local customs of greeting, methods of entering houses, the politeness of sitting and standing etc., should be studied in the area, as cultural clumsiness does not assist in the transfer of information.

A map of the area to be covered should be prepared with the house visiting schedule on it. In this way the schedules are more likely to be met. Local committee centres should be marked on to this map, also zones of interest of government advisers on agriculture, sanitation, etc., and schools. Home visiting is the clearest expression of the two-way health delivery process. All the more senior members of the Centre staff should have home visiting duties.

The keynote of home visiting must be the avoidance of criticism.

School visiting

The Health Centre will have a teaching and caring role towards the school or schools in its area. Friendly and co-operative contacts with teachers are important. Attendance at sports days, prize-givings etc. whilst time consuming will assist in cementing relations.

Appendix 31 discusses the role school children can play in record making. This can form an integral part of the curriculum having a valuable teaching content in maths, graphs, presentation methods and co-operative team work.

The school should have sanitary facilities of a good standard whose proper use should be taught. Personal hygiene, agricultural and garden care should also be taught in conjunction with the staff using the Centre as a local base. These efforts are essential to the preventive programme.

The Centre may also be responsible for school health. Height and weight can be recorded by children before the medical team arrives. Sight and hearing can be checked by children under proper supervision. Glands, general physique, feet, skin and any definite defects or abnormalities are medical team problems. The teachers' advice should be sought on any children having apparent medical problems.

All children seen should be checked for immunization. Local immunization drives can be run with the school's help. The children have free access to their own homes and can be used to disseminate information. It will be seen that, when a new Centre is being established, early co-operation with schools is of great importance, and the teacher should be drawn into and should understand the programme.

An older pupil can be made a 'dispensary assistant' being given some responsibility in the weighing, measuring and record-making field. Similarly 'sanitary prefects' appointed in rotation could carry responsibility for maintaining standards of hygiene.

The visiting doctor should visit the school occasionally to back up the Centre staff's efforts. Community teaching programmes can be started in the schools, the children preparing displays etc.

As much as five days a year may be spent in inspections and immunization sessions at each school. Probably three evenings a year should be set aside for discussions with teachers either at the school or the Centre, and three or four evenings a year spent in some form of school-orientated social gathering. Any special programmes will need further involvement.

Evaluation of the provision of health care in the more developed countries of the world has depended on data such as the lowering of death rates and the diminution of diseases such as tuberculosis.

In developing countries communications are poor. Systems of registration of births and deaths usually do not exist, and if they do are frequently not sufficiently accurate to be a satisfactory guide.

For this reason, the Health Centre must and does attempt to keep records of the work undertaken. Records may be either quantitative, such as the number of patients and their age grouping, or qualitative, in terms of the actual health of those seen. Whatever kind of record is kept it needs to be very simple, and it is generally not considered necessary to record a patient's name, or even his number. We do, however, need to know whether he has attended before, and clear records of the most common diseases need to be kept. However, records organized on the basis of a detailed breakdown of diseases are rarely satisfactory.

The type of record developed in Malawi and Zambia is described in the chapter on Under Fives Clinics, in 'Paediatric Priorities in the Developing World', by David Morley, published by Butterworth. Such simple records have proved effective and useful. In assessing the nutritional status of the children, the proportion who fall below a certain line on a chart which is used throughout the country can be noted and this gives a useful indicator of progress both qualitatively and quantitatively. In assessing the success of a clinic in its preventive policy, the proportion of children who have completed all their immunizations — the so-called 'protected children' — is probably the best guide. Some similar system for adults is needed.

The working party has discussed records at length and has found no answers. We distinguish three different aims and find them in conflict.

1. Patients' records kept to assist in treatment.
2. 'Centre' records kept to:
 - a. assist in setting targets
 - b. check the progress of the Centre for the satisfaction and information of the staff which we consider to be very important and readily show the visiting doctor how the Centre is doing
 - c. assist in changing directions in treatment etc. if necessary
 - d. include community hygiene projects etc.
3. District, regional or national records kept to:
 - a. assist in planning
 - b. give a basis for comparative evaluation of different Centres and programmes
 - c. demonstrate the progress of, for instance, national immunization programmes
 - d. provide national statistics on birth rates etc.
 - e. Provide a basis for annual accounting and budgeting.

At some stage the records must also begin to indicate the kind of things that must be looked for in an initial survey before establishing a new Centre and its programme.

Patient retained records (see Appendix 30 for examples) are strongly recommended by the working party. Field experience suggests that losses of records are low once the patient understands their importance. The loss rate is said to be very much lower than the loss rate in a hospital system. The under fives card is a classic example of this kind of record. The card shows precisely the information needed, demonstrates when something is going wrong even before it is otherwise obvious, gives a running check list of supporting treatments, carries additional information on the family and can be understood by the family. The problem is that someone sitting in the Centre cannot see the records. Some authorities therefore keep the records in duplicate, one in the Centre, one for the patient. This does not seem economical. The alternative is the use of some other agency for general statistical analysis. One such method is described in Appendix 31, The use of school children for record making.

Design is a major stumbling block in record keeping. The under fives card is designed to show progress, to illustrate developing problems and to be readily

understandable. The design of adult cards for the same purposes is more difficult. This problem is discussed further in Appendix 21 on Treatment types.

When a Centre patient is referred to a hospital he may be X-rayed. Who is to keep the plate? If it is kept at the Centre, who will ensure it is brought back to the hospital if the patient appears there again? On the other hand, will not a visiting doctor want to see the plate if he sees the patient during a Centre visit?

Storekeeping and requisitioning problems also affect the running of the Centre and record keeping. Thus if, say, 1000 units of a particular drug are requisitioned then the books must show:

1. balance remaining at any given moment
2. batches drawn from store and dates
3. use of the batches to check proper issue etc.
4. whether the requisition was correct for the time span considered
5. whether the 'book' balance remaining has been checked in the store to check theft, deterioration etc.

Item 3 is on a patient's record. Is that record designed to help in following up drug issue information? If not, then work is being duplicated and the chances of error are increased. In this connection a standardized prescribing policy and central prepacking of drugs (see Appendix 6, Pharmacy or Dispensary) help as 1000 units can appear as, say, 10 packs. This reduces accounting and the checking of remaining supplies. If a patient retained record has a serial number and if the dispenser notes that number on his batch slip for a particular drug when it is issued by him then:

1. the recipient can be checked
2. the marking in of the serial number denotes issue
3. the completed slip can, by reference to the serial number register, give information on the age, sex and geographical use distribution of that drug
4. if the drug is used only for one condition the incidence of that condition can be plotted and followed and
5. home visiting will help to find out if the drug has been properly used, if used at all.

Fairly precise record keeping on drugs is essential anyway, so the burden of marking in a serial number is not so great. Similar marking in of serial numbers in a clinic could become burdensome. Thus, quite commonly, the total number of people seen is noted by putting on to a piece of paper a vertical stroke for each of the first four attendances, crossing them through for the fifth and so on. Thus each crossed batch is five attendances and totting up is fairly simple. Splitting attendances down into conditions requires several sheets of paper. Unless forms are provided that are specifically designed to give, in effect, a proportional forecast of conditions, the results must be a daily pile of largely blank paper which wastes time, money and storage space. Splitting down into conditions and marking in serial numbers could take ten to fifteen seconds a time, sorting out and counting up and recording the results from each source in the Centre could take half an hour a day, storing so that a particular condition could be statistically traced over a period of time without having to go through the lot would take another half hour, and getting the information into a form that will be useful in showing the progress of the Centre will take another half hour. This represents two man hours a day spent, essentially, in pushing paper around. This problem is discussed further in Appendix 21.

This report burdens the doctor visiting a Centre with duties of advice, checking of progress, medical work and supervision, encouragement of staff, some home visiting, teaching, checking on the progress of latrine building in the district etc., etc. It seems reasonable to suggest that some form of aide memoire cum report sheet cum progress record cum major problem annotation will be essential for him. The staff can prepare such a form before the doctor's arrival, and, if the same format is used each time, the doctor can, with a little practice, bring himself fully up to date in a matter of a few minutes. The doctor can spot check the information given to him by making a few well chosen home visits, possibly on his way to or from the Centre. The implication is that daily recording of attendances etc. should be made in such a way that the information required for the doctor's check list is instantly available. It also follows that this check list should be usable as a periodic return from the Centres, and that it would well include goods requisition information. If the Centre has a vehicle then the form should also show if it is due for servicing and

whether maintenance has been carried out. Clearly, such a visit form cannot be comprehensive.

The institution of community hygiene and food improvement programmes also needs recording and progress needs checking. If possible such records should be understandable and readily checked. One answer would be a large wall map of the area served. Coloured bamboo pegs could be stuck in to show where improvement schemes have been started, one colour each for gardens, field culture, latrines, rubbish disposal, water supply and animal management. Publicly displayed such a map will show how different villages are getting on and could be a powerful propaganda agent. Each community could have its own display showing proportional progress using the same colours. If school children are taught how this works they can both explain the system to their elders and do the surveying, reporting and marking up. Such a system will:

1. show need - no pegs
2. indicate progress - not enough pegs
3. record results - how many pegs?
4. encourage action - why haven't we got any pegs?

A simple refinement would be to put beside the map a space for each village with, for instance, a latrine peg for each household. A peg is moved on to the map when a latrine is built. This system would also serve to indicate the need for further survey. Medical maps could be prepared on the same system. Periodic records can be made photographically. Well prepared 'records' of this sort will encourage, plan, show progress, show need and give simple and accurate results, the photographs giving a full and understandable permanent record. Once the general idea has been understood progress can be demonstrated in the community by showing slides beside the map.

The bones of a programme are clear. Each patient needs a medical record. The Centre needs records made in such a way that information can be simply extracted in a form which will show progress. The doctor needs a time saving check. Requisitioning of goods etc. should be tied in if possible and regional and national statistics should be reasonably accessible. Fully comprehensive records are an intolerable time burden. If you know what you want to do with what you have recorded designing the record form becomes possible. Otherwise it is paper for paper's sake and a terrible waste of time.

Some examples of patient retained records

Records have traditionally been held in the Hospital, and this system is logically transferred to Health Centre work. However, experience shows that where patients keep their own records the loss rate is less than 10 per cent. This is an excellent performance, and considering the savings in time, staff and space resulting from holding only a minimum of records in the Centre, a performance worth investigating.

Where an entirely new kind of record, such as an under fives road-to-health weight chart, is introduced there is no backlog of tradition to be overcome. If adults' records for the patients' retention are to be introduced it may be necessary to prove that the new scheme works better than the old. A competition between the old and new systems must produce false results as the Centre record staff will be put on its mettle and will make a special effort. The first step therefore is to note the general record loss rate over a period of time and before introducing the new scheme. Patient retained records should then be introduced for a specific disease, preferably one requiring reattendances. After a period of use the loss rate can be compared directly to indicate preference; but additionally the reattendance patterns can also be examined to see whether the patient, holding his own record, is persuaded to reattend to programme.

Where patient retained records are used statistical analysis is a problem. Visits to homes are necessary. This can have advantages as the statistics can be set into a social background, disease incidence being related to socio-economic position, status of housing etc. School children can be used for some aspects of assessment (see Appendix 31).

The cards are given out in strong plastic bags. The patient should be told to keep all the family's records and to keep them together. The record must be explained to the patient.

Three examples follow:

- Fig. 1 page (ii) Chest clinic card
- Fig. 2 page (iii) The reverse of chest clinic card (Fig. 1)
- Fig. 3 page (iv) A children's card (the reverse is lined across like the lower part of the front)
- Fig. 4 page (iv) A children's tuberculosis card (the reverse is blank)

This subject is discussed at length in 'Patient Retained Health Records', Co-ordinating Agency for Health Planning, (C/45 South Extension, Part II, New Delhi 110049), printed by Parnassus Publishers and Printers Pr. Ltd., (H.S., 30 Kailash Colony Market, New Delhi 110048). 1973.

SOME EXAMPLES OF PATIENT RETAINED RECORDS

Appendix 30, Fig. 1
Chest clinic card

ILESHA WESLEY GUILD HOSPITAL

CHEST CLINIC CARD OF _____ O. P. No. _____

WEIGHT

Date	Streptomycin Gm/dy.	P.A.S Gm/dy.	I.N.H.	Tabs/dy.
	1st. Two wks. Dly. injection	Visit to Doctor 1 2 3 4 5 6	Medicine 7 8 9 10	Tablets. 11 12
	2nd. Two wks Dly. Injection	13 14 15 16 17 18	Visit to Doctor 19 20 21	Medicine 22 23 24
	3rd. Two wks Dly. Injection	25 26 27 28 29	Sputum Test 30 31 32 33	Medicine 34 35 36
	4th. Two wks Dly. Injection	37 38 39 40 41 42	Visit to Doctor 43 44 45	Medicine 46 47 48
	5th. Two wks.	Sputum Test (X Ray Chest)	Medicine	Tablets.
	6th. Two wks.	Visit to Doctor	Medicine	Tablets.
	7th. Two wks;	Sputum Test	Medicine	Tablets.
	8th. Two wks.	Visit to Doctor	Medicine	Tablets.
	9th. Two wks.	Sputum Test	Medicine	Tablets.
	10th. Two wks.	Visit to Doctor	Medicine	Tablets.
	11th Two wks.	Sputum Test	Medicine	Tablets.
	12th. Two wks.	Visit to Doctor	Medicine	Tablets.

13th. Two wks.	Sputum Test (X Ray Chest)	Medicine	Tablets
14th. Two wks.	Visit to Doctor	Medicine	Tablets.
15th. Two wks.	Sputum Test	Medicine	Tablets.
16th. Two wks.	Visit to Doctor	Medicine	Tables.
17th. Two wks.	Sputum Test	Medicine	Tablets.
18th. Two wks.	Visit to Doctor	Medicine	Tablets.
19th. Two wks.	Sputum Test	Medicine	Tablets.
20th. Two wks.	Visit to Doctor	Medicine	Tablets.
21st. Two wks.	Sputum Test	Medicine	Tablets.
22nd. Two wks.	Visit to Doctor	Medicine	Tablets.
23rd. Two wks.	Sputum Test	Medicine	Tablets.
24th. Two wks.	Visit to Doctor	Medicine	Tablets.
25th. Two wks.	Sputum Test (X Ray Chest)	Medicine	Tablets.
26th. Two wks.	Visit to Doctor	Medicine	Tablets.

YOU HAVE TUBERCULOSIS

Tuberculosis can be cured if treated regularly,
People with tuberculosis usually die from it if they are not treat,
Your Sputum is dangerous to others.
Tuberculosis is dangerous to small children.
Let the doctor see small children from your house.
He can protect them against tuberculosis.

DO NOT EAT CASSAVA OR PLANTAIN

EAT BEANS EVERY DAY.

O NI EGBEKỌ

Egbekọ le san ti aba toju re dede.
Egbekọ ma npa awon ti o ba ni aisan na lai toju re.
Ewu ni kelebe Iko Egbẹ yi je fun awon olomiran.
Iko Egbẹ je ewu nla fun awon omode.
Jeki Onisegun ri awon omọ wewe ile yin, O le dabobo
won lowo Iko Egbẹ.

MAŞE JE GARI TABI OGEDE AGBAGBA.

MA JE EWA ERE LOJOJUMO

ILESHA WESLEY GUILD HOSPITAL
SCHOOL CHILD'S CLINIC
 (Up to 14 years)

No _____ Name _____

Year of Birth _____ Address _____

Date, Weight, Height, Symptoms and their Duration, Treatment

Fig. 3 A children's card

ILESHA WESLEY GUILD HOSPITAL
CHILDREN'S TUBERCULOSIS
TREATMENT CARD

Name _____

O. P. No. _____ Dose _____

Date	Doctor	No. of Tabs	Dispenser
/ / 1st Month			
/ / 2nd Month			
/ / 3rd Month			
/ / 4th Month			
/ / 5th Month			
/ / 6th Month			

Your child has a form of Tuberculosis. It is not dangerous to others. The child will get well and strong if you give the tablets regularly and feed him good food.

Good Food: Any food made from beans: Ewa Ere, Ofe, Gbẹgiri, Ekuru.

Feed one of these at least once a day.

Also: Rice, Yam, Eko.

Do not Feed: Gari, Ebi, Oka-Ogede tabi Ogede-Agbasha (Ipekere).

Fig. 4 A children's tuberculosis card

**THE USE OF
SCHOOL CHILDREN
FOR
RECORD MAKING**

The use of school children for record making

Where patient retained records are used information which may be needed for statistical research or future planning surveys may be in the homes in the villages and not on the Health Centre shelves. It is important that this information should be available. Rather than sending out members of the Health Centre staff it is proposed that this collection of information can usefully and interestingly be made by school children.

In addition to the mere collection of information this system will serve to introduce the children to community service, to the range of facilities available in the Centre and to the methods and progress of community development.

This system will not work unless records are designed with this kind of data collection and collation in mind. It seems reasonable to suggest that a fairly limited number of diseases will be widespread in a particular community and that these could be given a code number and a simple treatment reference. Thus for instance an appropriate mark in a box numbered 15 and an associated box C could indicate an upper respiratory infection treated with a palliative mixture. At the end of that line could be a series of date boxes to show years of incidence. Such a record would be very limited in scope and application but would be extremely useful. Rarer diseases would need more complex annotation which the Centre could easily handle.

A system for collecting information from under fives weight charts is described in outline below. It is obviously important that information which might be considered confidential or embarrassing should be kept off records that are to be used in this way.

The senior school children start with some instruction using typical charts in the classroom. When they understand the chart and what they are to do they visit all the houses in the community or a sample of them.

After introducing themselves and discovering whether there are children under five in the household, they ask if they may see the growth charts: from these they would extract information on to a spare chart, or a paper copy of one. On the spare chart they would use one line across for each child and thus be able to use one chart to extract records from ten charts in the houses visited.

It is most important that the information to be extracted is simple. An example is given on the charts which follow of how simple this information can be.

Chart A. (Fig. 1): This is an example of a chart they might find.

Chart B. (Fig. 2): This is the chart on which they will extract the information.
Line 1 refers to Chart A

↑ refers to a weight being recorded in that month

↓ refers to the month in which they are carrying out their study

On the accompanying Chart B the following has been recorded:

- Child 1. Attended 4, 5, 7, 8, 9, 14, 15, 16 months and was 18 months old
- Child 2. Never attended and was 11 months old
- Child 3. Attended 1, 2, 3, 4 months; 4 months old
- Child 4. Lost card; 5 months old
- Child 5. One month old, not attended
- Child 6. Attended 1, 2, 3, 6, 7, 8 months; 29 months old

The school children, probably working in pairs, will collect information on ten children. On return to the school they can work out tables giving:

1. Proportion of children aged 0-1-2-3 registered at a clinic at any time
2. Proportion of children aged 0-1-2-3 attending a clinic in the last three months

More complex information can be extracted if other symbols are used:

- Weight below lower line

CHART A.

Birth-1 year

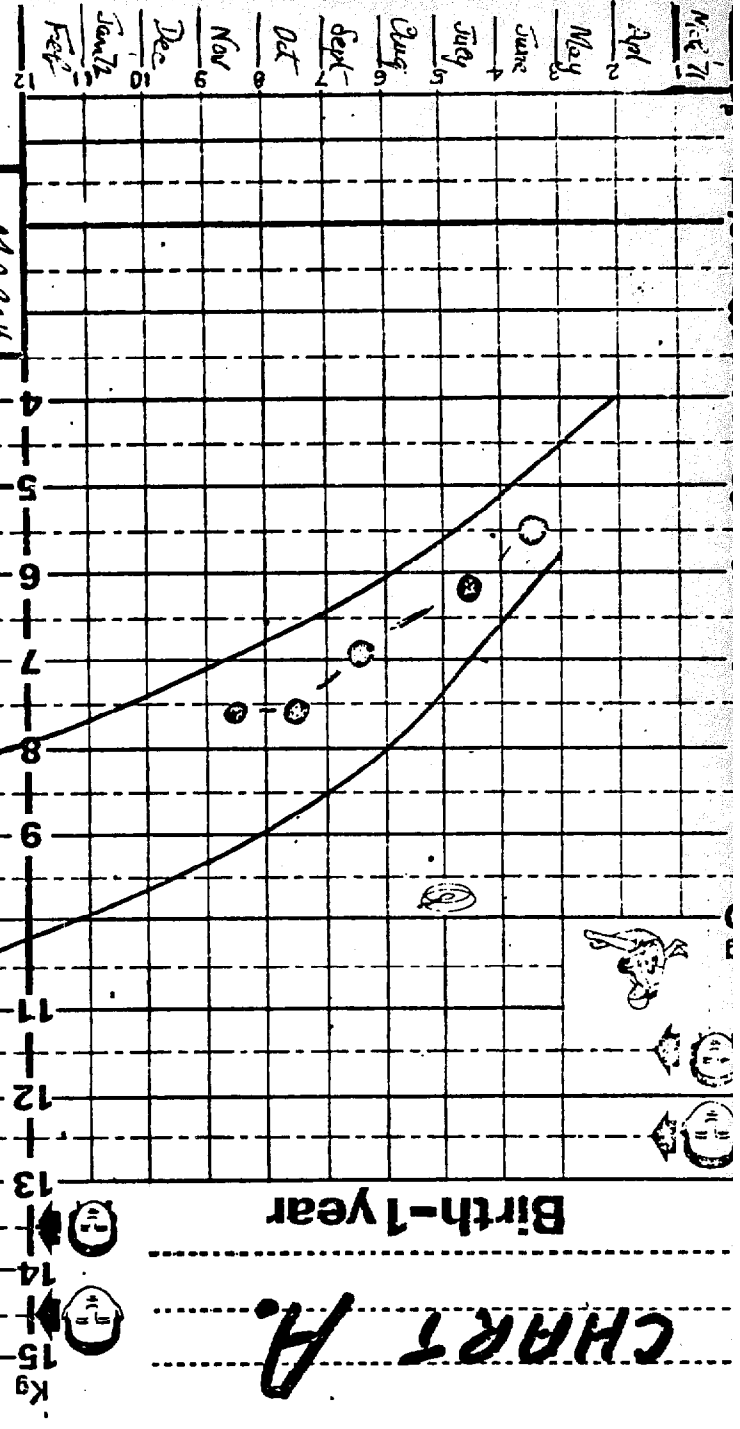

1-2 years

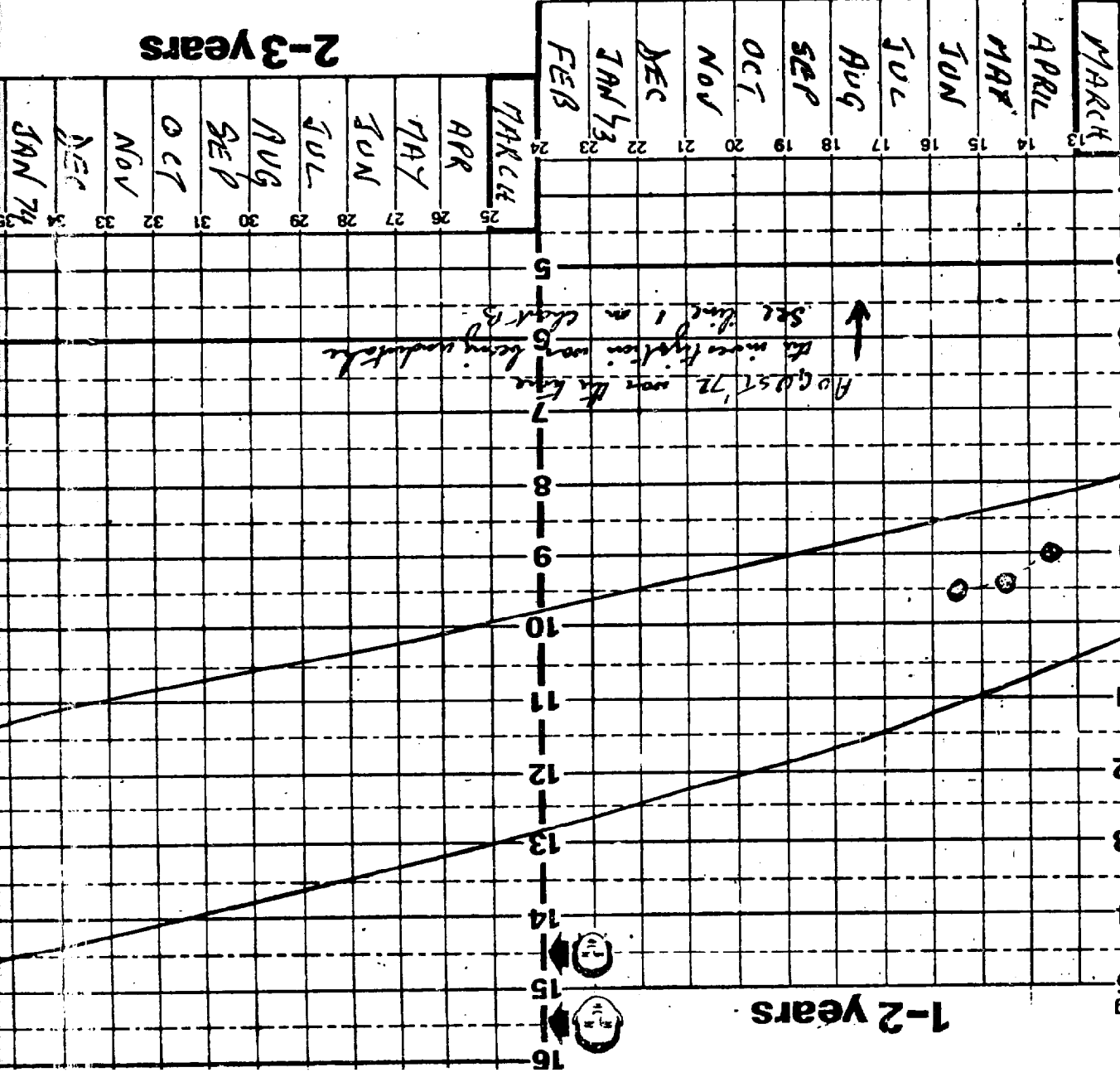

*At 60st '72 was the time
the investigation was being undertaken
see line 1 on chart B*

2-3 years

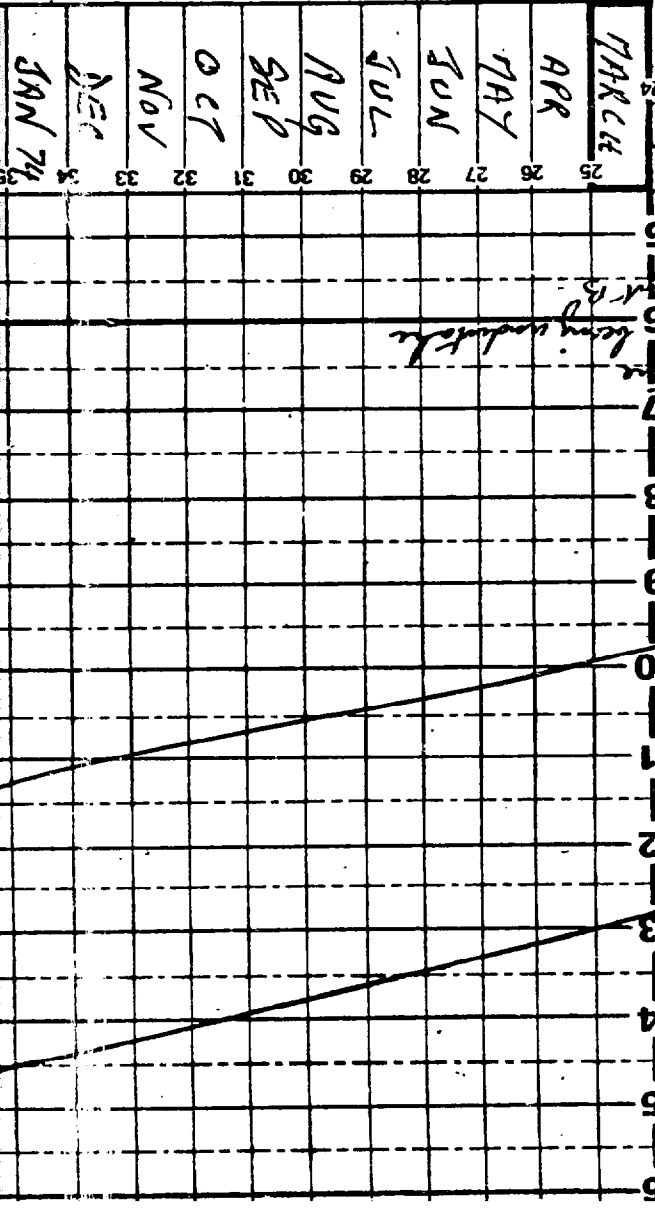

Upper Line: 50th centile Boys
Lower Line: 3rd centile Girls
(International Children's Centre Study, U.K. Children)
Further Information: TALC, Institute of Child Health

Appendix 31, Fig 1

Reasons for special care

CHART B.

Birth-1 year

1-2 years

2-3 years

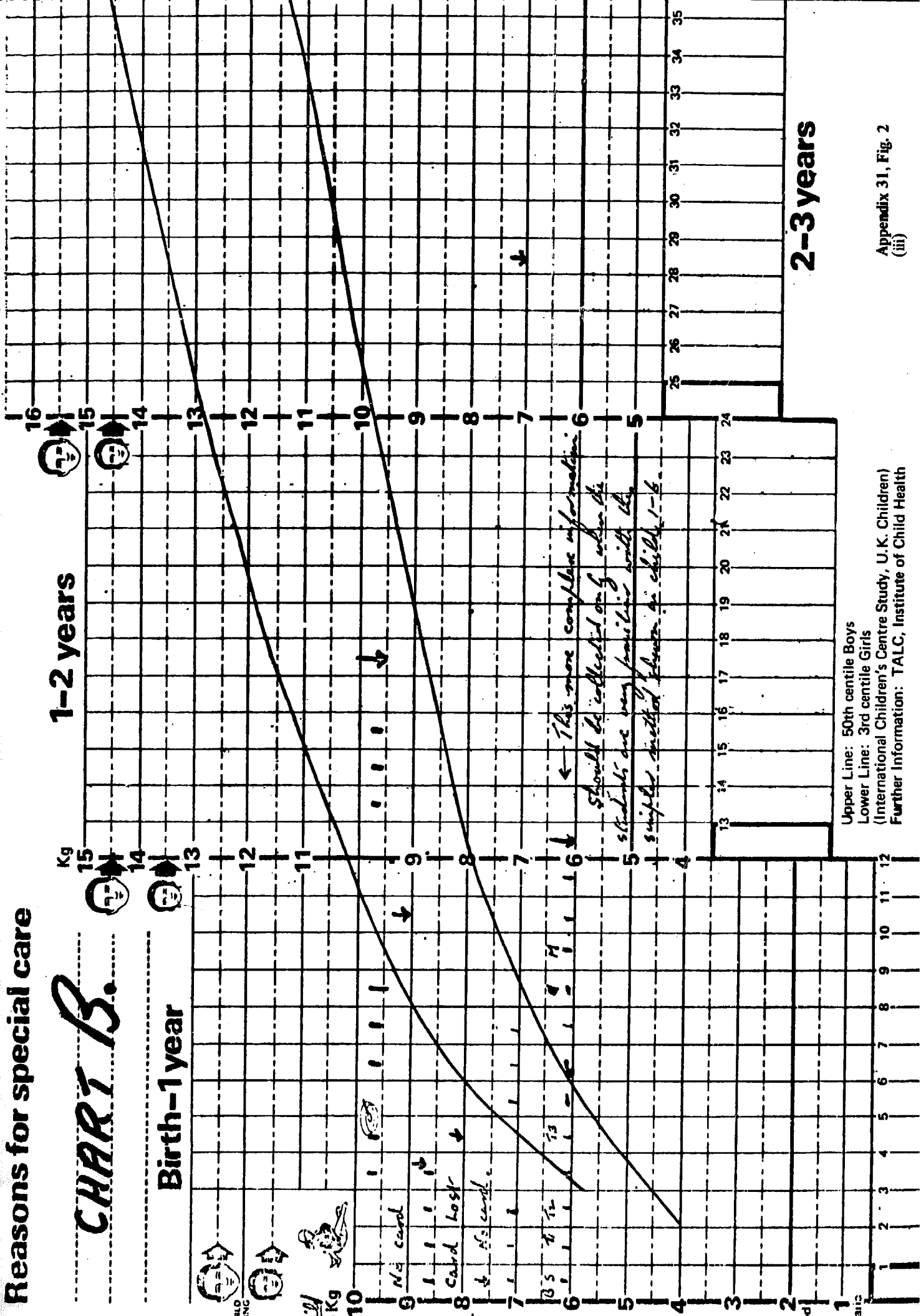

Upper Line: 50th centile Boys
 Lower Line: 3rd centile Girls
 (International Children's Centre Study, U.K. Children)
 Further Information: TALC, Institute of Child Health

B = BCG given S = Smallpox T = Triple Antigen M = Measles

Child 7. Attended 2, 3, 4, 5, 6, 7, 8, 9, 10, 11, 12 months. 13 months old.
His weight was shown below the lower line in 6, 7 and 9 months.

Child 8. BCG and Smallpox in first month, Triple Antigen 2, 3 and 5 months.
Measles vaccine in 10 month.

Working with this information tables can be prepared giving proportion above and below the lower line and at what age they cross the line (that is, have a reduced velocity of growth).

Detailed tables can also be prepared on the age of immunization and proportion of children immunized. Preparing these may seem complex but will not be so once a routine has been established. Problems that would arise over calculating the ages of children are largely removed by setting them out on a chart.

More detailed information on the under fives system can be found in Appendix 2.

Examples of other patient retained records are given in Appendix 30.

Community hygiene

Programmes to encourage smaller, healthier families will not work if infant mortality rates remain at the horrific levels that obtain in some developing countries. Gastro-enteritis, worm infestations and diseases carried by flies are problems that can be literally buried.

Adequate latrines, soakaways for fluid wastes, pits for the rotting down of manure (covered with earth every two days), a pit for the burial of refuse, or an incinerator, soakaways associated with animal pens (particularly in areas with non-porous soils), and the reasonable management of water resources can be expected to have dramatic results in the reduction of disease.

The Health Centre has two roles to play in this connection:

1. The method by which it controls its own sanitation problems must serve as an example for the community at large. Even where running water is available at least one earth latrine must be built, used and maintained. The provision of a wheelbarrow and a spade for a village sweeper, the sweeper to have clearly defined duties and a possibly nominal reimbursement in cash or kind, preferably drawn from the community, should also assist very materially in the reduction of disease. The implementation and successful continuing use of community hygiene facilities will depend on a change in the understanding of disease. Improved hygiene should be part of the responsibility of the local health committee.
2. The staff at all levels must know the necessary size, method of construction, time taken and cost of making latrines relevant to the local terrain; must know how to keep them in reasonable order; and must include the family's management of its latrine in the home visiting programme. The advice given must relate directly to local conditions. Similar details must be known for soak pits for fluid wastes. It may be possible to position soakaways so that adequately filtered run-off will water kitchen gardens. The Centre staff must also know the rudiments and cost of well digging although the siting of wells is best left to a visiting expert. Some knowledge of local geology is essential in selecting sites for latrines. Run off from latrines must not be allowed to contaminate water sources.

Schools in the zone of influence of the Centre must have latrines and soakaways and the children must be taught why they are there and how they are to be used, not as a matter of something special but as a matter of course.

It does not seem unreasonable to suggest that money spent on village sanitation might show at least as good a return in terms of community health as would the same money spent on a Health Centre. It is proposed that the community by communal effort can make this contribution without direct cost to anybody else. Ideally, government might offer a cash award for the improvement of a communal water supply to every village achieving a given percentage of private sanitation.

Tied in with this sanitation programme there should be a parallel programme for the teaching and encouragement of personal hygiene, this programme being judged against the practical possibilities within the community concerned.

The member of the Health Centre staff primarily responsible for home visiting should co-ordinate community hygiene projects at least to the extent of knowing where they are going on. The visiting doctor should be kept informed of progress and encouraged to visit sites.

Home visiting staff will have the opportunity of first contact at a personal level, and should attempt to find out about sanitary facilities, if any, in a particular house or compound, and could make a note on fly problems, general cleanliness, etc. This should obviously be a confidential note, and should be expressed in terms of 'a useful place to start' rather than 'filthy house'.

Community action is best taken through the local village committee. There is little to be gained from attempting to by-pass the local social power structure. The health committee should be visited by someone from the Centre, and should periodically be represented by at least one of its members at a meeting of committees at the Health Centre. Here ideas can be exchanged and progress noted and, possibly, joint action between villages taken.

Whilst these notes suggest that all the Centre staff members should have a working knowledge of solutions to local problems, there is obviously a practical and useful limit to the spread of this knowledge. One staff member should be the local 'expert' if there is no government official available. Alternatively, school teachers could well be brought into this arena.

There may be culture-based objections to people showing an active interest in sanitation. This is most likely to happen in a caste divided society. At least initially more may be achieved by using the caste system than attempting to change it.

Appendix 32 (ctd.)

Proper feeding is very important to health in developing countries. In particular it is important in the weaning or transition phase (which can be long-lasting) and in early childhood.

In India many of the problems of malnutrition could be overcome simply by more food. In other countries the bare food supply may be sufficient to fill the stomach but may not be well-balanced. Investigation of locally grown food-stuffs may lead to the discovery of all that is needed for a balanced diet contained quite literally in the (unfortunately) despised 'weeds'. In most cases crop strains will have to be improved or new food crops introduced altogether. Four things are needed for growing crops:

Topsoil Water Care Plants

Without topsoil there is not much to be done. Where there is topsoil three years' rains can wash away 40,000 years of the accumulated matter which forms topsoil, so conservancy is essential. The basic weapons in conservancy are contour ploughing so that water and rain-washed soil are trapped, leaving wind-breaks in the form of trees, and nourishing the soil by any available means. In a sense, one uses fertilizer in year 1 to ensure the existence of the soil in year 3. Year 2 crops may well grow without it. In primitive jungle-clearing cultures the felled trees are left to rot, the crops being planted between them and shaded by them. This is good sense: the more efficient clearing and burning is highly destructive. This year's 'efficiency' may be next year's erosion.

Re-afforestation is an excellent conservancy method but is very expensive. On the other hand if everyone planted a tree a week the eventual effect would be dramatic.

Topsoil without water is useless. Where water is very limited conservancy is essential. Ground water can often be reached by digging wells. If the ground water has accumulated over generations of rains there is a fair chance that it will be exhausted in two generations of irrigation. Modern irrigation throws tons of water in the form of sprays over the crops. The spray is partly subject to evaporation before it hits the ground, much of it sits quite uselessly on the leaves and evaporates. Often the water is delivered in cuts or canals, these again being subject to evaporation. Seepage from canals may well re-establish ground water, on the other hand where canals are available, wells probably are not used. Or, wells may not have been used because the ground will not hold water, so seepage water is lost. Whole rivers can be lost by wasteful irrigation, depriving others, living down river and away from its rain-source, of this essential resource. The cash cost of this squandering cannot be equalled by the apparent increase in the value of the irrigated crops.

Care in planting, watering and shading of plants may be the best tool available. A small quantity of water delivered from a can to the shaded root area of the plant may be all that is required. Why use more? Additionally, a well-tended small patch may be labour intensive and may not yield a 'cash crop' but may be it will feed the family well. Mixed planting of shade plants with food plants may also be a good answer.

The selection of plants is of paramount importance. The only answer is to find the best authority available and ask, bearing in mind that the growers concerned must be willing to eat the recommended crop. Demonstration is the main propaganda weapon. Grow your own garden. If a member of the Centre staff or a villager is employed to work the garden, then it must not be bigger in size or labour requirements than everyone else can manage. Rip out flower-beds and put in food, and tend it and use it. If the proposition is that one can live off a small patch — then prove it, and cut food bills.

Livestock, usually cattle and goats, are a desperate menace in many communities. Goats promote deserts. It is argued that only goats can use the desperately poor vegetation, but in fact they are often kept as cultural or cash, rather than culinary, assets. They do not convert plants to animal proteins efficiently and usually do not even give milk. They do destroy the only remaining vegetation and shade. The alternative to a total goat massacre (which is the best answer) is the introduction of a strain of goat that will give meat and milk when kept in a pen. Where insufficient plant material or water is available to feed a penned goat, the only practical solution is to shoot the existing goat population. This is not a job

for Health Centres at a practical level, but it is a propaganda job for the Centre staff.

National agricultural authorities are usually not geared to small garden agronomy, which is what is needed. An official ally in garden culture is valuable. Government for its own good reasons will look after cash-crop land owners. People with tiny bits of land need help, advice and encouragement, and the Centre staff must do all they can in this effort.

Establishing food values, improvement programmes etc. is a subject well covered in various books. Alternatively someone will know the answers and will be keen to help. Four problems remain in the Centre's responsibility:

- Establishing a well-balanced and locally practical diet
- Cooking the food while preserving its value
- Transitional foods for weaning
- Food storage

Any proposed new foods will need to be popularized, and existing inadequate methods of cooking improved. The only starting point is an understanding of local taboos, preferences and available time for cooking. Taboos and preferences can be altered in the course of time with patience, understanding and example. Do not attempt to introduce methods of cooking and food preparation which are not possible in the time available, or which use unfamiliar utensils. If the cook cannot do the new method in the same time and with the same effort as the old, then it will not get done. Careful observation and planning are required.

Transitional or weaning foods are important. If possible infants should have the same diet as adults; this will probably give them the widest range of foods. Experiment may show that, for instance, manioc (or cassava) leaves properly prepared and then chopped very small will give a child the food it needs. Un-chopped they are indigestible. Similarly, curry is fine for a child, but desperately hot curry is destructive. The key is to examine the local diet and attempt to adapt it so that it serves the child well without additional cost to the family, without extra expenditure of time (the cook is a very busy person and cannot lose time in the daily round) and without being based on an imported ingredient which may cease to be available. The Centre must have a demonstration kitchen in the local manner, stocked in the local manner, and used in the local manner, and the food should be eaten by the Centre staff. If it seems to be possible to improve the local kitchen design without additional cost, then the demonstration kitchen should show such improvements.

Food storage is an important factor in the household economy. Study what is done locally, make clear notes and ask advice. It may be that certain food is not stored because it rots or is eaten by insects, and there may be simple ways of overcoming these problems. The answers should again be demonstrated, but all in the local manner and within local pockets.

Recent studies have shown that in Mozambique liver cancer kills one man in every 40 households; about 50 times as many deaths as in Britain. This is now known to be related to a liver poison, aflatoxin, produced by the mould *Aspergillus*. This fungus can attack staple foods such as groundnuts or maize if they are stored in warm, humid conditions. (South African Medical Journal 2,508,48 : 1974.)

Vitamins B and C are frequently lacking or in short supply. C can be made up with fruit and a suitable variety must be sought and grown if none is available. B can be made up with, for instance, unpolished rice. Advice on the best source of these vitamins in the area concerned should be sought.

The best laid schemes for food improvement can founder on drought, insect or disease attack. This is obviously a pity but the local farmers will be familiar with this problem. Schemes that founder because a crop will not grow well in the locality are not well laid and will be counter-productive.

The best-fed national animals are probably intestinal parasites, and the worst-used food that which passes through intestines that cannot absorb it because of diarrhoea. Both these problems are very much in the Health Centre's orbit.

In a very wide sense efficient modern agriculture is destructive. With machinery it is possible to reduce landowners' costs; the people who then worked the land

and also supported themselves to a certain extent with livestock and gardens are driven away to the towns where they cannot produce anything for themselves, but consume the bulk of the increase in the crops resulting from irrigation etc. In other words, the assessable effect of modern methods may be an increase in human misery. Should supplies of the fuels needed to work the machinery fail, disaster will be total. The same materials that go to make the fuels also make the fertilizers necessary for modern methods.

Nutritional education has three aims, first to break down harmful local beliefs, secondly to encourage a better diet and thirdly to show how the improved food-stuffs can be produced and existing food-stuffs improved. It is important to remember that the food customarily eaten is eaten because it grows reasonably well and is reasonably resistant to fungi etc; that there may not be a practical or economical alternative; that talk of irrigation etc. must be linked to the practical possibility of irrigating; that the best run programmes can founder on prolonged drought, etc. Additionally, the important people in the area may be healthy, strong, energetic, vital and intelligent, and are children from very many generations of people built on the same diet. It is people like this who do the convincing in the community, and nutritional education has to convince them first. 'My wife was a weak woman and had weak children but I now have a new strong wife' is a statement solidly based on observation and evolutionary probability, and 'Why should I waste extra food on someone who was weak anyway?' may not be a romantic reply to suggestions about increased diet, but it is a reply packed with logic in a community with a subsistence agriculture.

Nutritional rehabilitation can be a very useful weapon in food propaganda. A malnourished child responding to a changed diet is a great teacher. It is vital that the family knows what is going on. It is no good 'doctor' waving bowls and pills and medicine at the child which 'miraculously' recovers. The family must be taught to do it all themselves with locally available foodstuffs. Pills that are given should be the same as those given to others anyway and everyone should know it. Nutritional rehabilitation closely associated with the Health Centre is an excellent teaching point and morale booster. But the impossible should not be attempted or the end result will be a loss of confidence.

Pregnant mothers given additional iron, folic acid or protein during the last trimester of pregnancy produce babies with significantly increased birth weights. This is encouraging in view of the relationship between low birth weight and perinatal mortality. In some cultures heavy feeding during pregnancy is associated with big babies and consequent difficult births. This coldly logical proposition must be overcome in discussions about feeding.

Lactating mothers need as much if not more food than pregnant mothers. This is often overlooked and sometimes contradicted by cultural custom. This problem is substantially hidden by the wonderful ability of the mother's body to provide highly nutritious milk from poor materials, but this miracle is wrought at the mother's expense.

Infants in the first months and throughout the first year need good food to support growth. Skull and brain development is prodigious; inadequate feeding can lead to brain deficiency. Encouragement, exhortation, psychological pressure, any means of encouraging mothers to breast feed for a year should be used. Advertisements for artificial substitutes should be quietly removed from the district, and television or other advertisements ridiculed. But breast feeding must be supplemented with solids from six months, and the aim must be for balanced solids, until by one year the infant should be able to eat most of the normal family foods. Highly spiced and coarse foods may be rejected by infants. This does not necessarily mean they are not ready for solids.

Toddlers and infants up to the age of five make up the most obviously malnourished groups in many countries. In transition from mother dependence to independence this problem is particularly noticeable. Toddlers benefit twice from continued breast feeding, first from high quality protein, second from the decreased chance of competition from a further pregnancy and birth. Underfed children respond well to just more food than they have been getting. Calories are often the main deficiency.

Staples and pulses, leafy and 'coloured' vegetables, animal and vegetable protein and oil should all be viewed as essential additions to basic diets.

People in rural communities have what is often called 'natural dignity'. Thus, when encouraged to eat more of an unusual and possibly flavourless food they may not reply 'Well, why don't you eat it instead of tinned tomato soup?' but they may well think it. Example is very important in teaching. Food preservation and storage and cooking are important items. Most will be learnt as a result of demonstration. Demonstrate improvement in a child, demonstrate a good diet, demonstrate cooking. Talks and pictures are indispensable but talks should be very short and have a simple theme like 'Well fed mothers of healthy children'. Questions and answers need to be kept simple. Pictures need to be explained and then used as memory aids. 'Protein', 'vitamin' and similar words are only tags for convenient concepts and are meaningless in themselves. Perhaps analogy would be most potent. A bullock cart is the protein, the bullock is the calories, the driver iron and other salts, the prodding stick the vitamins. It is near enough to be accurate and wholly understandable. The idea here is to tag the message to something which is readily understood and sufficiently complicated to hang the whole idea onto.

With inadequate nutrition we have unhealthy and dead children and mothers, so family planning teaching will be difficult until nutrition is improved. Food is understandable, so it is a good pathway into understanding. Agriculture is important and a good basis for co-operation, and can show quite positive results in a fairly short time.

An understanding amongst the Centre staff of local nutritional problems and answers in practical terms seems to be very important. It also seems to be important that school teachers be taught nutrition exactly as they will have to teach it. Biochemistry is obviously less relevant than the communication of basic facts.

The nature of disease

People in a rural community may find it as difficult to understand the nature of disease as most well educated people do. 'Virus', 'bacteria', 'germ', 'infection' are words which are used to describe mechanisms and organisms we barely understand. The idea that the air, the water, the Health Centre, the hospital, the lungs etc. are full of germs which can strike a strong man down is not very sensible to a strong man who is not being struck down, never has been and quite probably will not be. It is probably obvious to him that weaker people get sick more often because they are weak, not because of anything else, and it is an arguable idea. Attempting to explain the lowering of defence mechanisms will not clarify the discussion.

A medical training may blind its recipient to the simple problem of believing that these invisible micro-organisms exist. Further, the life cycles of some of the more improbable parasites are more likely to be taken as an elaborate joke than as vital fact.

It is no good growing a culture to show that germs are present in a particular disease unless the audience understands the nature of culturing and germs. The teaching of ritual defensive actions such as washing and the use of latrines to children is the starting point in this field, but cannot be expected to have much demonstrable effect as successful hygiene leads to reduced infection – a medically desirable result but not a very startling one to the untutored observer.

The essential messages relate to the need to get rid of flies, to build a strong body and to practise hygiene. Malaria mosquito eradication could be used as an example in the insect field as the results are dramatic providing an initial survey is done and the improvement pointed out. Nutritional rehabilitation will demonstrate the importance of diet. From the resulting interest and confidence and willingness to believe may come the necessary willingness to believe and interest in the more complex mechanisms of diseases.

Much effective basic teaching could be done through the medium of dance and song. 'This is the way we wash our hands (even) on a cold and frosty morning' is an example of this method. Similarly, a three team dance, one team being 'bacteria', one being 'toothpaste', one being 'teeth' could demonstrate the effects of oral hygiene very effectively and with maximum involvement. Dances showing 'fly and disease' and 'unprotected food' and 'protected food' will not be difficult to organize.

APPENDIX 34

THE NATURE OF DISEASE

Costs and materials

From three sets of identical and detailed documents and drawings builders will often tender three widely different prices. On the other hand, when some kinds of buildings are tendered for where either the usual and acceptable cost is known or there is a government imposed budget limit for that kind of building, nearly identical tenders will be received requiring careful study in order to select a best buy. In other cases there may be no builders as such or perhaps only one. Further, two buildings in the same town built by the same government agency more or less at the same time and more or less the same size may vary widely in cost per square foot depending on siting, materials, standards of finish and possibly air conditioning etc.

The Model Centre suggests a roof structure only, but makes this structure on a set of columns or walls close enough together for most traditional building materials to be effective. One Centre may be built with bricks and mortar, plastered or rendered inside and perhaps outside, with steel windows etc., another may be built with a bamboo roof over painted woven timber walls. The planning principles of the Model stand firm in each case, but the cost will be subject to very wide variation.

It is therefore unrealistic to offer a single cost guide. However, the working party has received the following information on various building costs which may assist in estimating costs. The costs should be taken as being comparative and must be treated as very low in view of price rises in the last two years.

1. Kerala (July 1973)

For rubble walled buildings with reinforced concrete roofs
To include internal walls
To include latrines, doors, windows and lights
Rs. 35 per square foot*

For an un-subdivided building
Rs. 30 per square foot

This is approximately £2.00 per square foot.† At the time of writing the cement and iron rods needed were rising rapidly in cost.

2. Lagos (July 1973)

For concrete block walled buildings with iron or asbestos roofs
For a simple structure
Nigerian £5.00 to £7.00 per square foot

This is between £2.50 and £3.50 per square foot. Cement prices are noted as continually rising

3. Lahore (July 1973)

Building not described
Rs. 28 to Rs. 30 per square foot.

This is approximately £2.00 per square foot. City buildings are noted as being of higher quality and more expensive

4. Madras (July 1973) (Rural areas)

(Building costs for structure and finishes but not services, i.e. water and electricity not included.)

Schools and Offices:

For stone walls and concrete roof, foundations at 4 feet 6 inches below ground level and cement floor
Rs. 24 per square foot

As above but tiled roof (noted as subject to frequent repair)
Rs. 20 per square foot

As above but asbestos roof and false ceilings on tabular trusses
Rs. 18 per square foot

* Multiply cost per square foot by ten to get cost per square metre.

† Unless otherwise stated £ is £ sterling at 1973 rates of exchange.

This is a variation from £1.50 to £2.00 (not including services)

Hospitals (rural and urban):

As above but with tiled dado to 4 feet 6 inches above floor level and mosaic floors

Rs. 40 per square foot

As above but without dado and mosaic

Rs. 35 per square foot

As above but tiled roof

Rs. 30 per square foot

As above but tiled roof with dado and mosaic

Rs. 32 per square foot.

(Asbestos roofed quoted at Rs. 28 but finishes not noted)

This shows a range of £3.00 to £4.00 without services

Houses:

Concrete roof

Rs. 32 per square foot

Tiled roof

Rs. 27 per square foot

Asbestos roof (false ceiling not noted)

Rs. 22 per square foot

This is £2.00 to £3.00 per square foot (services not specified as included)

All costs noted as rising continually and steeply. (Costs can probably be assessed as about £4.00 to about £4.50)

5. Bandung, Indonesia (August 1973)

Using own concrete blocks (office building)

Rp. 1000 per square foot

(Public works estimate Rp. 3000 per square foot)

Using own concrete blocks

Rp. 2000 per square foot.

This is between £1.00 and £2.00 per square foot. (It is noted that the buildings are now complete, and that building materials have risen 100 per cent since last year.) It is understood that direct labour was also partly used, structure, services and finishes not stated as included or excluded.

6. Rhodesia (July 1973)

Building in rural areas, using local materials

\$7.00 per square foot

This is approximately £3.00 per square foot and is presumed complete

7. Ghana (July 1973)

Cement block building, with good quality iron roof

¢ 15.00 per square foot

This is approximately £5.00 current costs. Cement is noted as having nearly trebled in the last year

Conclusions

The cost of a unit can not reasonably be below £1.00 per square foot. £5.00 is mentioned as an upper limit, but only in rural areas. Costs are noted as rising

steeply and continually nearly everywhere — there is an international shortage of timber, steel and cement. Further, the amount of 'services' — latrines, electricians, water — is not specified; equipment is not included; proportion of direct labour is not noted; establishment costs, e.g. travel, are not noted; South America is not mentioned at all. The following advice is therefore offered to people trying to work out a budget:

1. Attempt to assess the proper size for the unit.
2. Get a friendly person — architect, engineer, quantity surveyor, contractor, artist, surveyor, estate agent — to trace the appropriate accommodation off the Model plan. It does not have to be the actual layout you intend to use — size is what counts here.
3. Send the plan to the inter-ied country or ask around if you are there and try to find out:
 - a. Approximate square foot cost to include sanitary and water arrangement if appropriate
 - b. Appropriate materials for:
 - Floors
 - Walls
 - Ceiling (if any)
 - Roof structure
 - Roof finish
 - Windows
 - c. Approximate cost per electrical outlet if appropriate
 - d. Foundation depths usual
 - e. Outline of sewerage work
 - f. How long will it take to build
4. This will establish budget possibilities
5. Proceed with scheme as appropriate
6. Allow for 15 per cent per annum increase in cost throughout the building period.

Local building regulations must also be consulted. Requirements may lead to up-grading of materials for, for instance, reasons of fire resistance. Ceiling heights, water channel sizes, water storage requirements, sewage disposal proposals may also be subject to these regulations.

Concrete blocks made in wooden, metal or rubber moulds or pressed in proprietary machines are an important resource. Blocks stacked under polythene sheeting in humid climates 'cure' in about three weeks although up to three months is preferable. Otherwise the blocks will shrink if used too quickly. An equally good curing system is immersion in a pond, pool or river for some weeks. A simple mould can be made with a timber box split up with crossed dividers slotting over each other. Concrete is poured in, then a timber grid with tapered plugs sticking down from it is put on top. The plugs, when withdrawn, leave holes in the blocks which lighten them and save concrete. The plugs are oiled before being put in so they do not stick to the concrete and are lightly nailed to the grid. The grid is raised when the concrete has hardened, then the dividers are taken out by stages, the plugs being tapped out last of all. The dividers and the main box should also be oiled. Individual moulds can be used on the same principle. A mixture of mud and cement may be useful and saves cement, but experiment is necessary including spraying with a hose for some time to test for reasonable stability. Further, mortar for jointing earth-and-cement blocks and render for finishing will have to be made in a weak mix, i.e. extra sand should be put in and the render applied somewhat drier than usual. Blocks containing earth must be well protected with eaves overhangs. If buildings are to be painted the paint must be tested on the specimen blocks.

Presses for concrete blocks called the 'Cinva Ram' are referred to in 'Recent Approaches to Malnutrition in Uganda'. Ed. Dr. J. Paget Stanfield. Monograph No. 13 (issued in conjunction with The Journal of Tropical Paediatrics and Environmental Child Health, Vol. 17, No. 1, March 1971.) ref. p. 69. (Plates 33 and 34.)

Traditional building methods should not be scorned. Thick walled houses with a limited number of doors and windows are the ideal environment in many countries with hot days and cool nights, or very cold spells.

Wattle and daub, made from mats of woven shoots plastered with mud, can also be used. The wood-work should be treated against termites and the mat panels well protected from rain.

Mud can be beaten into moulds, then lifted out and left to dry in the sun, making building blocks which, if protected from rain, will last for generations. Some mud can be mixed with straw and sun dried. The straw has to be stirred into the mud so it gets well tangled up. Anti-termite fluid must be mixed in where termites are a problem. Mud and straw balls can also be dropped into timber formwork held together with wire or bolts and held apart by small size pieces of timber. The mixture is then rammed with a pole, the formwork taken off and raised up, the spacing timbers knocked out, the holes thus left being filled with more mixture rammed in. Each 'lift' of formwork overlaps the previously laid piece of wall, the formwork standing on the spacing timbers. At corners a small box is set in the formwork to make a notch in the wall. The return to make the corners is rammed into this notch. The walls are brought over the corner and notched alternately.

A long piece of timber is sometimes rammed into each lift at the top of the formwork in the middle of the wall. The timber is then lifted out, which leaves a groove into which the next lift is rammed to tie the two lifts together. Local experiment is the only guide to satisfactory action.

Rammed walls can sometimes be made from straight mud. An alternative is mixing earth and cement; either fairly wet to make building blocks or fairly dry and rammed.

The traditional British names for these methods of wall making are:

Cob:	earth and straw
Pise:	rammed earth or earth and straw
Stabilized earth:	earth and cement mixed

Reference books on these methods of building can be found.

In many countries simple lapped boarding walls with shutters instead of windows will work very well. In hilly country with a good covering of trees very simple buildings without ceilings are cool and comfortable provided that they are shaded by trees from direct sun.

Woven and painted bamboo will last well in many areas, but all such materials must be raised out of the ground to avoid rotting and to avoid irresistibly attracting termites.

Powdered termite hill material mixed with water is said to make an effective plastering material, but experiments are needed before committing to its use.

Bundles of quite small stones can be made up in chicken wire and given a reasonably square shape. These can be put in place on a mortar bed then rendered inside and out and wet cement mortar poured in. With experiment it will be found that controlled pouring will make the bundles stable. High walls and load bearing walls should not be made in this way, and the bundles need to be about 12 inches thick although they can be tapered towards the top of the wall.

The essential feature of the Model plan is its use of a 16 feet span between columns or walls. It is believed that most countries will provide materials that will cope with this span. Wide overhangs on roofs are stressed both for coolness and to protect the walls. Roofing materials are referred to in Appendix 48.

Foundations and roads

These notes are prepared for people with limited access to professional advice.

The ideal foundation is good, solid, more or less flat rock at about 2 feet depth, but this is also about the worst possible condition for drains or pit latrines etc.

The worst possible foundations are loose, dry sand, soft 'vegetable' earth, clay which is subject to drying out periodically or soils with moving underground water springs.

Work can be built up from solid rock foundations. Cracks or fissures in the rocks or gaps between them must be solidly bridged either with reinforced concrete or stone, or brick arches.

For single storey buildings on most soils, rock or 'strip' foundations are satisfactory. For rock foundations dig a trench say 3 feet deep and place (not throw in) good size rocks for about 2 feet, then place smaller stones, top with gravel and 'blind' with concrete (blinding is a thin layer of concrete over the gravel) and build up from the blinding. 'Strip footings' require a trench about 2 feet 6 inches deep, about 9 inches of concrete being laid into the bottom. As a general rule the width of the strip will be three times the wall thickness. Where there is frost the footings should be deeper. Where there are soft pockets in the footing base they should be excavated and filled with rocks. If an old wall or rock ridge is found underground, then the obstruction must be reduced about 1 foot below the bottom of the footing and earth filling put in and rammed thoroughly.

On very soft soils or sand the concrete floor of the building must have steel reinforcing mesh put in it, and the edges must be turned down about 2 feet below the underside of the floor slab. This inverted tray effect holds the soft material under the building. The building should be kept as light as possible.

On very soft, very wet soils some kind of piling may be needed. Often there will be a local method of piling construction. Sometimes rows of poles are driven into the ground with stones, platforms having first been erected to enable those driving the poles to reach their tops. The foundation is then made of timber, laid in mats on the top of the poles which are driven to ground level. An alternative is to build on stilts.

If a building starts to move or subside, action must obviously be taken. Dig a narrow trench at right angles to the building up to what seems to be the point of subsidence. Cut in a 3 feet deep trench under the foundations as far as seems safe, say 3 or 4 feet, then fill the trench with concrete equally inwards and outwards from the centre of the wall. Let the concrete set, then do the same on one side of the new footing; when that has set do the other side. (see Fig. 1).

APPENDIX 36 FOUNDATIONS AND ROADS

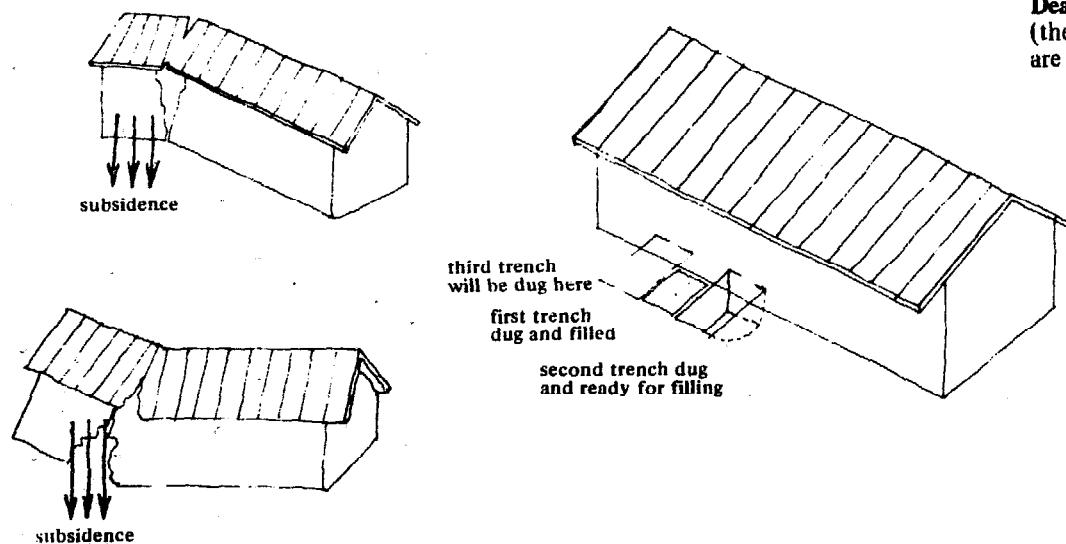

Appendix 36, Fig. 1
Dealing with subsidence
(the cracks shown are
are very much exaggerated)

Building on a slope can be difficult. Cut a platform out of the hillside and build wholly on the cut part unless there is an engineer's design for a retaining wall, in which case you can fill out at the front to make a wider platform. The cut slope at the back should have an adequate angle so that the soil stays up (this angle will depend on the soil) and it should be planted quickly with grass or any other close growing plant with good roots. Make a curved drainage ditch set back from the top of the slope to carry surface water running down the hill away from the new cut face. (See Fig. 2)

Appendix 36 (ctd.)

Appendix 36, Fig. 2
Building into a slope

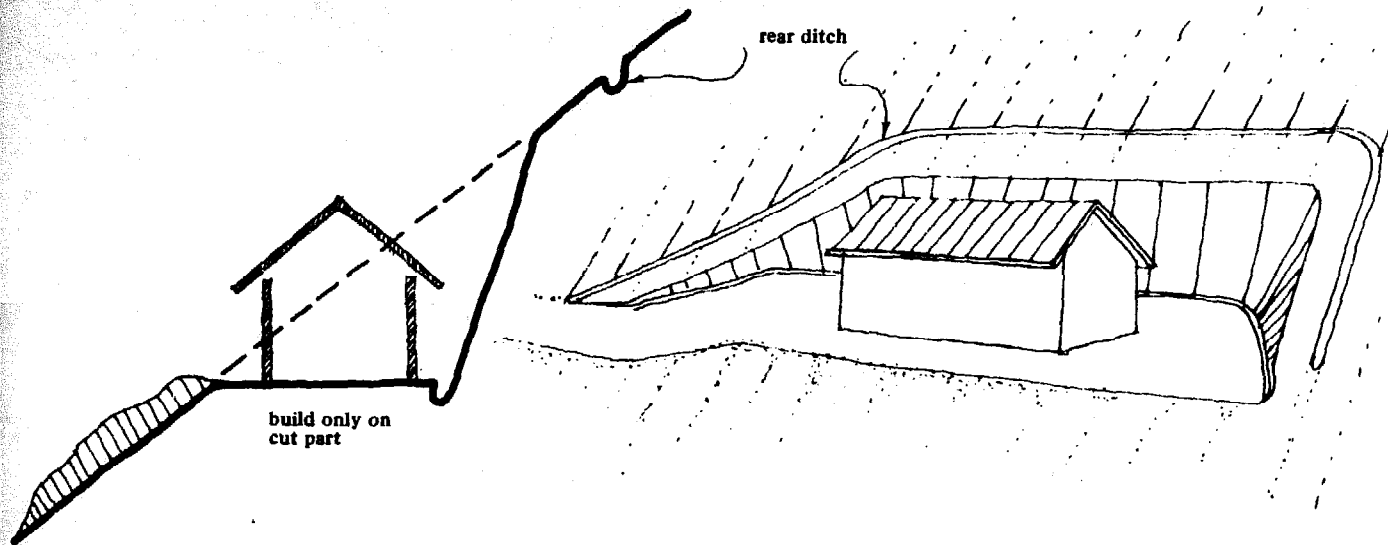

Roads

Roads on hills should not be steeper than 1 in 6 and for ambulance use a slighter slope is desirable. A reasonable road can be made with two concrete strips laid in trenches 3 feet 6 inches wide and 15 inches deep with a 2 feet 6 inches gap between. Lay in 12 inches of stones, then blinding, then 6 inches of concrete. Fill the gap in with gravel. Where roads are cut into slopes build only on the cut part unless there is an engineer-designed retaining wall. Tilt the road back towards the hillside and make a drain at the foot of the new cut slope and line it so that water will not erode the slope. Get rid of the water at the next corner, continuing the drain lining well beyond the road surfacing and preferably spill the water on to a large boulder so that the splashing disperses the water and stops the drain cutting back on itself and undermining the road. A similar two strip road will do on the flat very well, but drainage ditches filled with stones are advisable on either side set about 4 feet outside the strips so that the ground does not become soggy. Adequate drainage is an essential in road building. Light reinforcement in the concrete strips greatly prolongs the life of the road. Some authorities recommend making short reinforced concrete 'legs' into the soil on steeply sloping roads about 15 feet apart, about 12 inches square and about 2 feet deep. These legs should have reinforcing rods stuck into them. The idea is to stop the pavement slithering down the hill if it is undermined by water. (See Fig. 3)

Appendix 36, Fig. 3
Some principles of road
building on hills

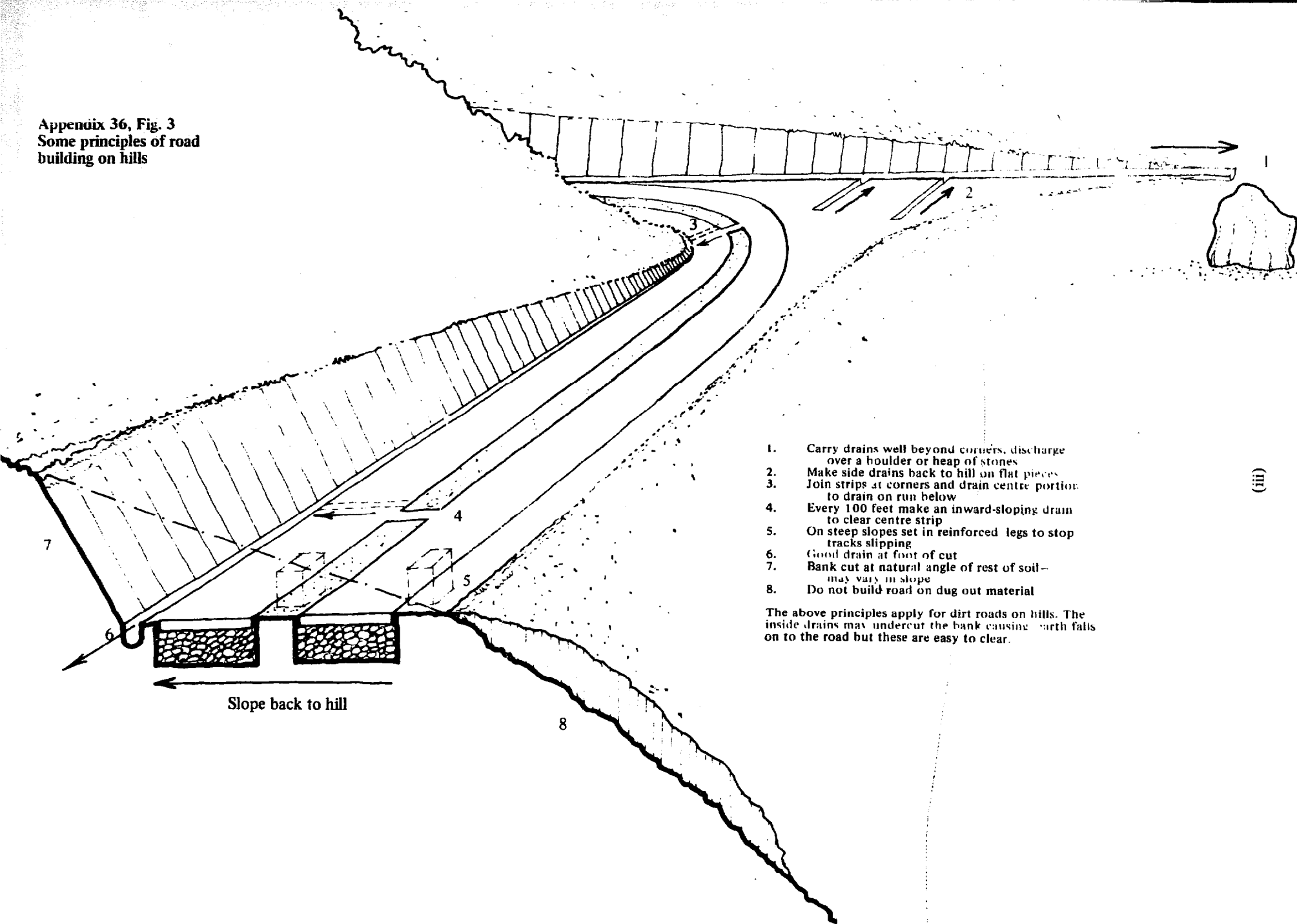

1. Carry drains well beyond corners, discharge over a boulder or heap of stones
2. Make side drains back to hill on flat pieces
3. Join strips at corners and drain centre portion to drain on run below
4. Every 100 feet make an inward-sloping drain to clear centre strip
5. On steep slopes set in reinforced legs to stop tracks slipping
6. Good drain at foot of cut
7. Bank cut at natural angle of rest of soil—may vary in slope
8. Do not build road on dug out material

The above principles apply for dirt roads on hills. The inside drains may undercut the bank causing earth falls on to the road but these are easy to clear.

Flexibility, expandability, mass production and standardization of buildings

Quite complicated Health Centres are often planned as a series of separate buildings that can be arranged in almost any order being linked together with covered ways. The Model which is the subject of this report puts forward definite relationships so that the buildings can be expanded, to a programme, into larger Centres and even to small hospitals.

The report does not suggest a 'standardized' building, that is to say one made up from a mass produced kit of parts. Buildings made like this can be cheaper than locally made buildings of the same sort providing there are enough of them, providing there is good transport to deliver the parts and providing the buildings are not so complicated that special gangs have to be brought in to put them together.

It is generally thought that at least 150 pieces of a particular sort must be built before it is worth mass producing which is why there must be enough buildings in the programme. On the other hand it is no use making 500 roof trusses cheaply by mass production methods if it is going to cost an enormous amount to deliver them. If the trusses are heavy enough to need a crane the whole idea of mass production becomes irrelevant.

A standardized mass produced building is not automatically expandable. It can obviously be designed to be expandable, but if the required expansion is very small and the parts have to be brought a long way small expansions are very expensive.

It is often said that standardized buildings are more flexible than other kinds of building because the parts can be taken apart and put together again in different ways when something needs changing. This is true in systems like office block partition walls, but these systems are either very expensive or flimsy. If the pieces of wall are light enough to move they will be thin and possibly unsuitable for a rural Health Centre.

As architects, engineers and designers spend a lot of time thinking about mass production, etc. it is worth looking at the basic problems. If the idea is to mass produce, a system of making all the pieces fit has to be found. In simple terms, if a column stands in the middle of a wall it will stick out from the wall if it is thicker than the wall. Also, the wall between two such columns will be a certain length: but on the floor above where the columns carry less weight and can therefore be smaller the wall between two of them will be longer than the same sort of wall below. Making enough pieces of wall to fit every case means making smaller pieces which is tiresome: making the columns bigger so the wall is always the same length is wasteful. In the same way windows need to be in a restricted range of sizes, and they have to be built into walls or lined up together with pieces between them. So two windows and a piece between them have to relate to wall sizes, the walls have to relate to columns and inside division walls have to come up to columns or outside wall joints and cannot hit a window.

Making it all work out is an intriguing game, but the results are usually fairly complicated. Also, rooms have to be the right size for the chosen dimensions for the parts which may not be the right size for the use of the room: as the room cannot be too small one has to make it too big — another piece of built in waste. Finally, it all has to be put together very carefully as it is almost impossible to change the sizes of the parts; if you are $\frac{1}{4}$ inch out in the wrong place you get a lot of problems.

With all these points in mind the working party has decided to go for a small span building that uses simple materials, suggests pulling parts of the roof out to get more space, and puts the different parts into different buildings so that they can be expanded without interfering with each other. We are putting forward a plan which suggests standards rather than a standard plan.

FLEXIBILITY EXPANDABILITY MASS PRODUCTION AND STANDARDIZATION OF BUILDINGS

Latrines and sewage disposal

This report continually refers to the need for Health Centre staff being familiar with sanitation etc. We therefore set out below the principles of rural sanitation. There will be very many local variations of use. Detailed reference can be made to 'The Ross Institute Information and Advisory Service', Bulletin No. 8, reprinted April 1972, which is thoroughly comprehensible. The WHO also has useful publications.

Human sewage is dealt with hygienically in two basically different ways:

1. water based sewerage
2. more or less dry decomposition

Water sewerage

1. Sewage is dropped straight into, or carried by pipe to a 'septic tank'. In the septic tank bacteria break down the sewage, making an effluent which is then allowed to soak away into the ground
2. Sewage is flushed (or 'pour flushed' from a 2 gallons minimum can) down a pipe to a pit or septic tank
3. Sewage is flushed down a pipe to a sewage disposal plant
4. Sewage is flushed down a pipe to a waste stabilization pond in which bacterial action and algae decompose the sewage giving an effluent which is lead to a soakaway, can sometimes be fed into a fish pond or can be used for irrigation

More or less dry decomposition

5. Dry pit latrines
6. Pit latrines which get down to the ground water level
7. Latrines are now being produced which compost faecal matter making usable gas at the same time.
8. Buckets

Both waterborne and dry sewerage are discussed at the end of this Appendix.

Communal facilities

Privies using all these methods except 7 can be used as communal facilities. But the usual unbeatable social rule applies that the more people there are to use a facility the more it will be misused and broken up in every possible way. Sanitary attendants are a concomitant of facilities for public use. If attendants are not obtainable do not build communal privies. Senior staff members must accept a responsibility for regular and spot check inspections. Doctors visiting Centres must inspect latrines. This is the only way in which the resident Centre staff can be persuaded to do the same. The better facilities are kept the less unpleasant is the prospect of an inspection. All latrines in a medical compound must be inspected regularly and if instructions are given for work to be done then the work must be done.

Flies

It is almost impossible to control flies in pit latrines and in latrines with no water seal on the pans. Where insecticides are used, insecticide-resistant flies rapidly multiply in ideal non-competitive conditions; one is better off not using them. Cleanliness and a closeable cover are the best defences. Antiseptics must not be used as they interfere with the bacterial action.

Water seals

There are two common types of water seal, P traps and S traps as below. Choice of traps depends on required direction of outfall, either more or less level (P) or straight down (S).

A further type of trap can be used for pour-flush latrines. These are shown in Fig. 1.

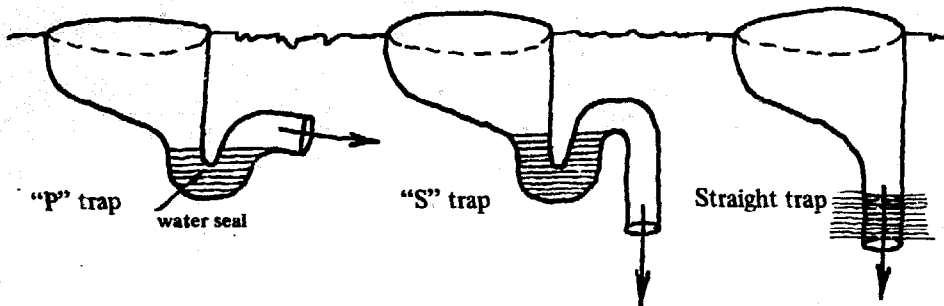

Appendix 38, Fig. 1
Types of trap on lavatory
pans

Cleaning materials

Many communities use leaves, grass, stones or similar materials for personal cleansing. Such materials can make a nonsense of waterborne systems in a very short time. An adequate provision of big inspection chambers (manholes) and rodding eyes (holes for poking flexible canes through) for unblocking drains is essential. Man-hole covers must be concrete, not metal or they will be 'borrowed' very quickly which is unhygienic and downright dangerous in the dark.

Ventilating systems

Flushing or flush pouring systems have to have a ventilating pipe otherwise the load of material going down the pipe sucks air behind it which empties the traps on the fittings. The ventilating pipes must be carried up above roof level and protected with a gauze balloon to keep out flies and mosquitoes.

Light and air

Sun and air must be let in to privies. This may lead to rain getting in during storms but the sterilizing advantages of sun outweigh slight flooding. Ventilating slots must be fly-screened, and doors should be made self closing with a string over a peg or pulley with a weight on the end. The doors should fit well. It is tempting to prop doors open to ventilate the privy but this only encourages flies. Low level slots left open all round so the floor can be flushed over with a bucket are tempting but bad practice as mesh screening rots, collects dirt, gets broken and then animals and insects can get in.

General cleanliness

Experience in any country where 'Asiatic' or squat type pans are used indicates that their use is not simple. The wall at the back is frequently heavily soiled to a height of two feet or more, flushes can empty pans on to the floor and not down the drain, and the feet are frequently soaked by a flush swirling up out of the pan. General spraying can also be a problem. Frequently the area of water in the pan is far too small and quite out of the range of children; this leads to heavily soiled pans. Walls are frequently also soiled. A small shelf for putting belongings on is a great advantage, also a raised area of floor which is slightly tilted so it drains dry quickly after washing. Flushing pipes must not be lead down wall faces and particularly not across floors as they give impossible cleaning problems. Where wooden superstructures are used and also on bottoms of door frames the bottom 4 inches must always be made in smooth concrete, the timber standing on top. Otherwise the timber soaks up moisture and rots. Two coats of 5 per cent silicate of soda will increase the water resistance of the cement flooring and 4 inches upstand. In some countries water is indispensable in the personal cleansing

routine. Small tin cans can be used as containers, but big tubs from which water is dipped should be absolutely banned as they can become infection soups very quickly. Taps are often abused, being left on. A sanitary attendant could deal with this problem, but a male and a female attendant would then be necessary in most cultures.

The squat pan and its surroundings

Flush pipes are best lead to the front end of the pan where the water flow concentrates on the floor of the pan, but water should also swirl round the bowl. Foot rests should be tilted forwards about 1 inch in their 12 inches length, never, never backwards, and should be smooth (for cleaning purposes) unless made in glazed fireclay in which case they can have a criss-cross pattern (with smooth edges and valleys) on the foot rests so that they can dry more quickly. The pan needs to be reasonably deep and long and benefits from a long water area. A reasonable depth and a slight undercutting at the front are good points. The surroundings must be smooth and without dimples and must drain into the pan. Impervious skirtings should be carried at least 4 inches up the wall with an easy sweep. The sweep can be formed by running a bottle round between the floor and the wall whilst the cement is still wet. The wall behind the pan should be impervious for at least 2 feet 6 inches in height and should be as continuous with the floor as possible. A raised area and a shelf have already been mentioned. Many commercially produced squat type pans do not have these features. (See Fig. 2)

Research

Research is needed to establish whether easier use would lead to what can only be described as better aim. This is a perfectly serious, indeed important subject. It may be that people, particularly older people, might find the pan easier to use if some form of hand grip, projecting from the side wall near the right hand were available. The hand grip would have to project well so that it was as near as possible to the middle of the body for balancing. Some form of projection on the left hand side and quite well back so that it could be used as an elbow rest but not a hand rest might also be helpful. The question is whether these aids would lead to extra cross infection possibilities, or whether a sufficient compensating increase in general cleanliness would be achieved.

Compartment size and layout

The back wall should not be less than 19 inches away from the back of the foot rests, the front wall or door not less than 32 inches from the back of the foot rest. This gives a compartment length on the long axis of the pan at 4 feet 3 inches. 4 feet 6 inches is therefore a reasonable minimum length. A 3 foot width gives adequate free elbow (literally) room. The overall depth can be made up by hanging the door on the outside wall face which will give a few extra inches where fairly thick walls are used. Doors can open from the side or the front. The pan should be set centrally in the free width. Doors usually open inwards so that people who do not like to lock doors or forget to do so have a chance of increased privacy.

Flushing

Two gallons is the minimum flush size either for pouring or cistern flushing. Smaller flushes can be used with pressure cisterns. Cisterns should be mounted high enough up to give a good flush but not so high that they flood the floor. Front end flushing gives the best results.

Combined shower and privy

A shower can be installed in a privy compartment using cistern or pour flushing, but the floor area must be increased by at least 3 feet x 3 feet either in width or length, the pan in the former case no longer being in the middle of the overall width or someone will fall down it. Further, the shower should be in a lowered area of floor otherwise dropping the soap is disastrous. Sometimes showers are put straight over pans and a loose duckboard provided for laying over the pan for standing on. The duckboard quickly gets foul and rotten, and breaking slats can lead to unpleasant accidents. Somewhere to hang a towel and put belongings and clothes is also necessary. In a combined shower and privy the driest end is over the pan. Clothes falling off pegs over pans can get into an unpleasant state. Some form of partition to protect clothes is therefore necessary. These points are

Some pans are made so that the drain can be turned to point in any direction. This is convenient but as the joint should be above the water level the water area may be too small for cleanliness.

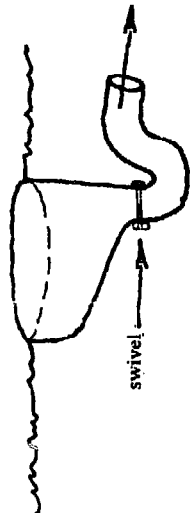

Separate foot rests, foot rests forming part of the casting and foot rests made up in the floor are all used.

The diagram below shows points to look for when choosing a commercially made latrine pan. Many of the same principles apply in pedestal (sitting) type pans. Many commercially made pans do not have these features. All these points apply equally to 'S' and 'P' traps.

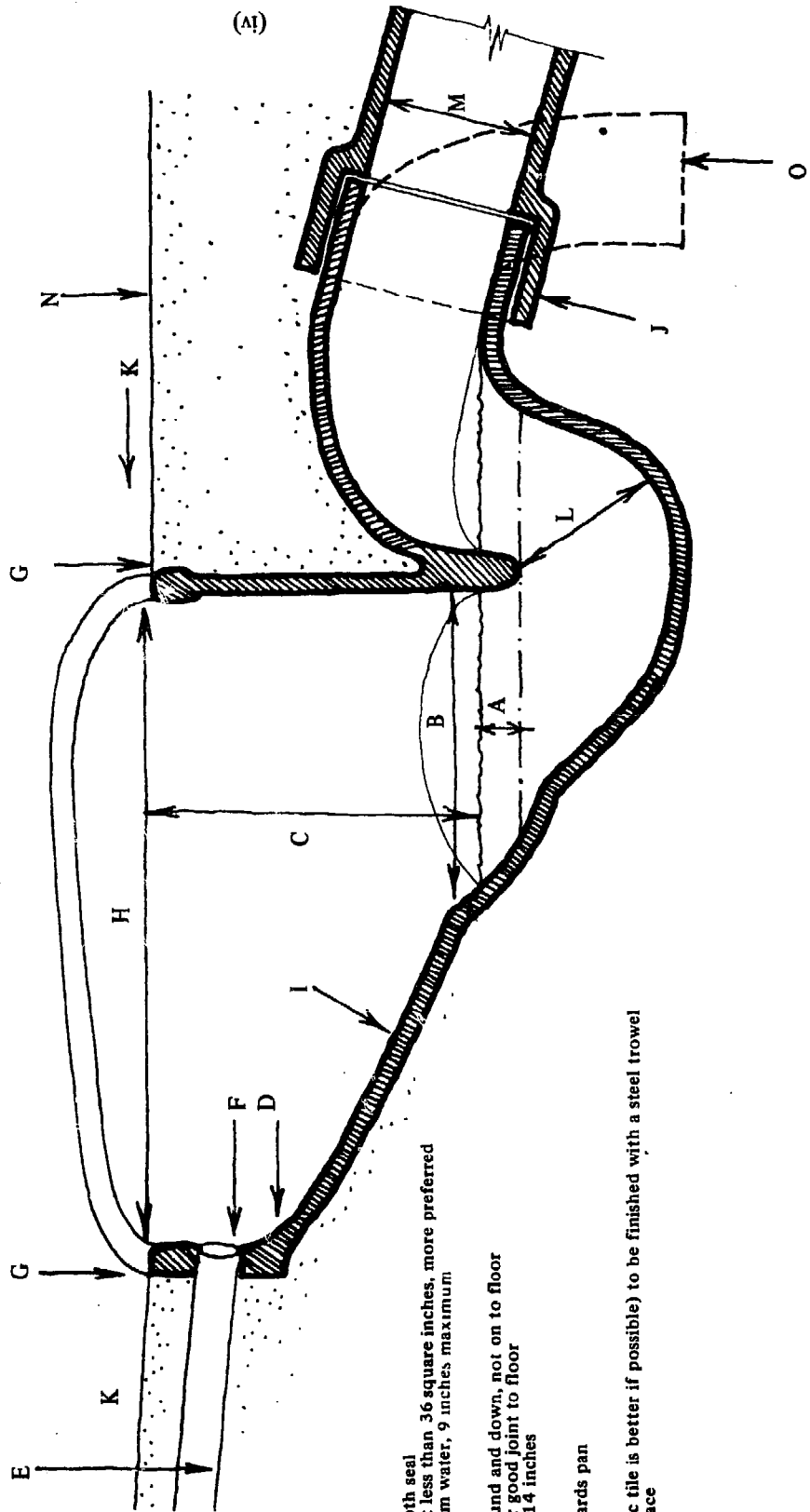

Appendix 38, Fig. 2
The squat pan: features to look for

- A. At least 1 inch water depth seal
- B. Generous water area, not less than 36 square inches, more preferred
- C. Not too great height from water, 9 inches maximum
- D. Hollowed out at front
- E. Flush pipe below floor
- F. Flush outlet to squirt round and down, not on to floor
- G. Unglazed square edge for good joint to floor
- H. Top width not less than 14 inches
- I. Durable glaze
- J. Unglazed joint to pipe
- K. Floor tilted inwards towards pan
- L. Usually about 3 1/4 inches
- M. Usually about 4 inches
- N. The cement floor (mosaic tile is better if possible) to be finished with a steel trowel to give a smooth surface
- O. Outline of 'S' trap

obviously over fussy in cultures where the same sarong or similar is worn to the shower, used as a flannel and then for a wet rub down (getting washed at the same time) then worn away wet, but in cultures and climates where more clothes are worn the essence of hygiene teaching can be totally undermined by the thoughtless design of facilities.

Deciding on a system

Bearing in mind earlier comments about communal facilities, the principal matter bearing on decisions about sanitation systems is water supply. The possibilities are tabulated below, water supply being discussed immediately after the table.

Very little water	Some water	Adequate water	Plenty of water
Big installations			
Pit latrines	Direct Aqua privies	pour flush to pits or aqua privies pour flush to septic tanks	cistern flush to septic tanks, sewage disposal plant or stabilization pond.
Small installations			
Pit latrines	Direct Aqua privies	pour flush to pits or aqua privies pour flush to septic tanks	cistern flush to septic tanks

The alternatives are shown in Fig. 3.

Water supplies

Cistern flushing calls for about ten gallons of water per user resident per day. Thus the Model Centre will require for waterborne sanitation:

Two principal staff and families, say	6 people	
Four auxiliaries and families	12	
Two assistants and families	6	
Assistant and clerk/handyman and families	8	
Inpatients	10	
Inpatients' families	10	
Hostel residents, say	<u>12</u>	
Total at 10 gallons per head per day	64	640 gallons

To this must be added at three gallons per head per day:

say 200 outpatients	
+ say 100 dependents	
a total at three gallons per head per day	300 = <u>900</u> gallons
	1540 gallons

The equivalent amount will be used for general purposes, the equivalent allowed for outpatients should cover the extra requirements for a Health Centre. A Centre with an assured supply of over 3000 gallons per day therefore qualifies for water based sewerage. More than 3000 gallons per day is, in this respect 'plenty of water.' If irrigated farming land or gardens are attached the requirements for the irrigation must be added.

Pit latrines will be constructed of timber for ease of moving. Other privies may be of brick.

See also page (vii) et seq. of this appendix for further information.

Appendix 38, Fig. 3
Alternative privies

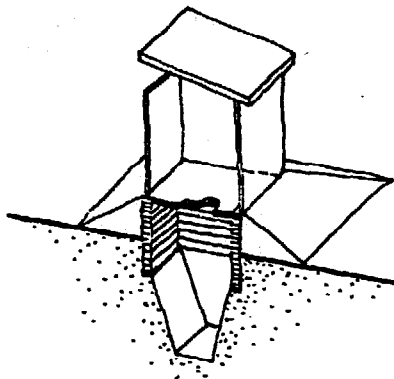

Pit latrine on mound with sealed brick to 2 feet below ground level. Useful in wet ground.

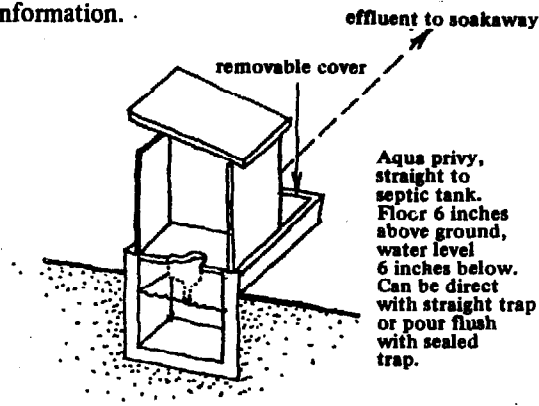

Aqua privy, straight to septic tank. Floor 6 inches above ground, water level 6 inches below. Can be direct with straight trap or pour flush with sealed trap.

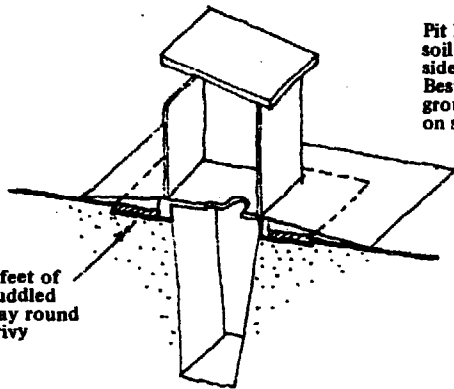

Pit latrine where soil is strong or sides reinforced. Best in dry ground or on slope.

2 feet of puddled clay round privy

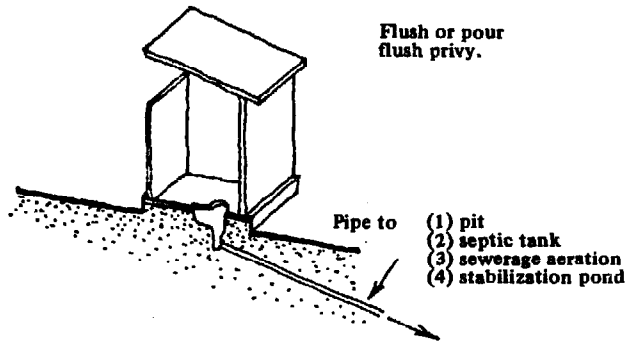

Flush or pour flush privy.

- Pipe to
- (1) pit
 - (2) septic tank
 - (3) sewerage aeration
 - (4) stabilization pond

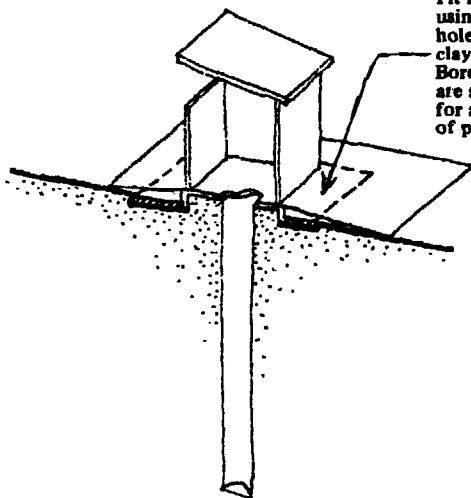

Pit latrine using boxed hole. Puddled clay band. Bored holes are safest for a group of pit latrines.

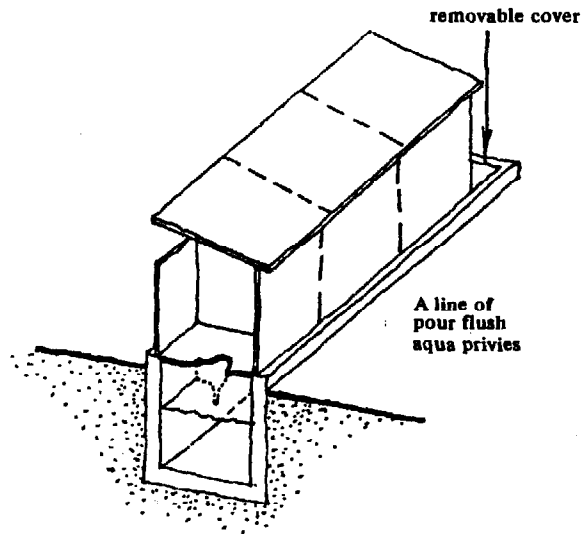

A line of pour flush aqua privies

For pour flushing to pits or septic tanks, about four gallons per head per day is required, the general consumption remaining the same. This gives:

Residents

64x4 pour flushing	256 gallons
64x10 general	<u>640 gallons</u>
say	900 gallons

Outpatients

300x2 pour flushing	600 gallons
300x3 general	<u>900 gallons</u>
	1500 gallons
Total	2400 gallons

This means that say 2400 gallons guaranteed per day is 'adequate water' for pour flushing. If no public facilities are offered then 1500 gallons per day would allow for resident pour flushing to septic tanks and piped water with 600 gallons over for general purposes and outpatient restricted general purposes – essentially controlled drinking water points.

Very little water can be accounted as more than the rock bottom tolerable which is 64 residents at three gallons per head per day, is say 200 gallons a day. Pit latrines are the only answer here.

Aqua privies, possible on the borderline of an adequate water supply, require very little water except for initial filling, each privy needing only one or two bucketfuls of water a day. Periodically more water needs to be added, but the extra fill might not even be necessary during a dry season. For residents' sanitation only 60 gallons per day for pour flushing + 640 gallons for general use + 300 gallons a day for medical and very limited outpatient use, i.e. a total of 1000 gallons is sufficient. A further 200 odd gallons would justify public aqua privies, the extra allowance being made for extra cleaning. Water used for flushing should be clean but not necessarily drinking-clean.

Descriptions of the different systems

Local experience is invaluable and should always be consulted. These notes are offered to act as a check list and to help in establishing standards.

Pit latrines

These are holes in the ground into which faeces drop directly. If there is water in the pit disintegration will be faster, better and the pit will last longer, becoming, in effect, a septic tank. Disinfectants, insecticides etc. must be kept out of the pit. About 2 cubic feet of pit per resident person per year plus 2 cubic feet per 10 visitors plus about 2 feet at the top is needed. The 'life' of a pit and the number required can thus only be calculated from the practical hole that can be dug. When grass, rubbish, sticks etc. are likely to be thrown in then the size of the pit must be increased by at least half, i.e. a third of its life will be lost. When the material in the pit is between 2 feet and 18 inches from the top the pit must be filled with earth and the privy moved, so obviously it should be as light a structure as possible. About a year after moving the pit can be dug out and the contents used as fertilizer.

Holes should be as big as practical, as the bigger the hole the less often must the pit be re-dug and the structure moved. Holes which will fill with water should be 10 feet deep from top to bottom; this being sometimes achieved by building the privy on a mound. Mounds should not exceed about 2 feet 6 inches in height, the whole of the height above ground level being built in impervious material. All holes should be lined with impervious brick for 2 feet from ground level down. If privies are built on a slope this lining should be deeper, say 2 feet below a point 6 feet down the surface of the hill (not 6 feet vertical drop).

In strong stable soils a hole 15 to 20 feet deep can be bored about 18

inches in diameter. The next step, where an auger is not available or a bigger pit is required, is a hole 8 feet to 15 feet deep and as small as can be practically dug — say 3 feet in diameter. A platform the size of the privy will cover these holes. Bigger holes will need structurally designed covers. Wooden floors on wooden beams are used, but must be termite resisting. Falling into a pit latrine is a pretty unhappy experience. Timber is not as easy to clean as smooth concrete.

The floor plate for a latrine is placed on a base which can be the impervious lining carried up to give a finished floor at 9 inches above ground level, or on puddled clay, stabilized earth or mud brick (see Appendix 35 on costs and materials), concrete, stone, brick etc. Excavated material can then be spread round the privy and rammed down firm, ready for shovelling back when the pit is used up, and also serving to carry rain water away from the pit where regular seepage could cause collapse of the walls.

If the walls of the pit are likely to cave in they must be lined with bricks (not mud bricks) or blocks or even stone, but with lots of open joints to let moisture out. Timber and bamboo can be used but will not last so well; a thorough tarring before placing will prolong their life. A circular hole is very much stronger than a square one. Lining is particularly important with large wet holes. **Do not take chances.** Find out what size of hole can be safely dug and left for say two years including through two years' wet seasons. More holes are better than too big holes.

Concrete cover plates can be made in wooden shuttering or in sand or clay (or mixed sand/clay) moulds. In shuttering the 'hole' shape is made in wood, inverted in a shallow box and concrete then poured in. For the mould the positive shape is made in wood which is then stamped and packed into the ground, removed and its impression filled with concrete, the 'hole' standing as an island in the concrete. No one makes a rubber mould for this purpose, which is a great pity. Fibreglass will not do as it loses its surfacing very quickly and breaks up. Plastics tend to distort and dimple. The plate will ideally have a turned up edge for a skirting round three sides, and will be firmly dished towards the middle. Foot rests are needed, canted forward, and are an integral part of the plate. The slab will be about 2½ inches thick at the edges, and will have a 1½ inch thick rim 4 inches high round three sides, will be at least 4 feet 3 inches x 3 feet internally, will need reinforcing and will be heavy, weighing at least 375 lbs. Four loops of reinforcing can be left sticking up from the skirting, one at each corner. They are used for pushing poles through for carrying and placing the plates, and can also be used for fixing down timber superstructures. The reinforcing rod must be painted to combat rust.

Many authorities recommend smaller plates, but the action of bending forward and then squatting down needs at least the 4 feet 3 inches length for taller people, though something could be sacrificed on width, 2 feet 6 inches being an absolute clear internal minimum. The hole should not exceed 8 inches in diameter or children can fall down it easily. A good shape is a keyhole shape, an 8 inches diameter circle with a tapering slot not less than 4 inches wide leading forward from it to give an overall absolute minimum length of say 1 foot 6 inches, a greater length, say 2 feet being preferable. Where houses have older people a bar could be put in, hinged from a simple bracket on one wall and dropping into a slotted bracket on the other. This would be just away from the front wall or door, about 2 feet high. This is not recommended for hygienic reasons in communal facilities, and should only be used with inward opening doors if the door can be lifted off from the outside in case an occupant collapses. See Fig. 4. Simpler set ups are almost universally used; these suggestions aim at ease of cleaning, convenience and security.

Sitting type privies can be made by setting a strong termite resisting timber shelf across the pit with an oval hole cut out, 14 inches above a hole of at least 2 feet diameter in the floor plate. A timber panel fills the gap between shelf and floor. The inside of the panel needs to be part lined with an impervious panel. This type of privy can be exceptionally dangerous for children, so the hole needs a child-size liner as well as a lid: better still, keep the door locked with an outside key well out of child reach and do not let children in unsupervised.

Aqua privies (Direct)

These are basically similar to pit latrines but the hole leads by a 'funnel' to a tank directly below full of water (in effect a septic tank which will be described later). The bottom of the funnel is a 4 inches diameter pipe about 8 inches long whose bottom

is 4 inches below water level. The walls of the funnel are flushed once or twice a day from a bucket or can of about two gallons capacity. See Fig 1 for trap.

Pour flush aqua privies

These are as direct aqua privies, except that they use S or open ended traps (not P traps) and are flushed with two gallons of water from a can after each use.

Pour flush pits

P trapped pans can be flushed with a two gallon can of water down a pipe to a pit which is treated as a pit latrine. Useful with porous soils.

Pour flush to septic tank

As above but to a septic tank not a pit.

Cistern flush to septic tank

The cistern discharges sufficient water to carry the reasonable contents of a pan down a pipe to a septic tank.

continued on page (xi)

Key to Appendix 38, Fig. 4

Some ideas for hygienic latrine construction

- A. Fly screening to ventilation slots
- B. Weight on string over pulley (peg with cardboard tube sleeve) as door closer to keep flies out
- C. A strong handle at low level to assist older people
- D. Concrete or similar washable upstand at back held on with wooden toggle
- E. 4 inches high skirting all round
- F. Wooden posts to stand on skirting to reduce rot and termite attack
- G. Floor plate to slope towards hole
- H. Footrest
- I. Hole
- J. Pit. No sizes are given here or elsewhere for pits. **Dig only what you know to be safe and make sure it is safe when the walls of the pit are thoroughly wet.**
- K. Spread soil from the mound round the privy and compact. This keeps rain out of the pit
- L. Base of puddled clay, 5 per cent cement, 95 per cent earth, or brick well sealed with mortar. This keeps parasites in the pit, particularly hook worm.
- M. Some form of hard surface or path to prevent puddles. N. Stones to catch drips
- O. Lifting handles sticking up from plate, can be used for attaching walls to plate
- P. In a privy with flush a front flush to the pan is best
- Q. Front flush pipe means side door
- R. The cistern on the wall can feed a sink
- S. Sink. **No grease, disinfectants or detergents to go into septic tanks**
- T. Sink tap
- U. The sink will need a trap on it made by bending the pipe to form a 3 inches deep 'U' shape
- V. A gutter will feed rain water to the cistern
- W. Pipe from gutter to cistern
- X. Septic tanks need ventilating so put in a 2 inches pipe and put a fly screen 'balloon' on top to keep out mosquitoes (not needed for pit latrine)
- Y. Access cover to septic tank makes good hard-standing by sink
- Z. Extending the roof sideways increases the covered area and is better for hygiene

Appendix 38, Fig. 4
Some ideas for hygienic
latrine construction

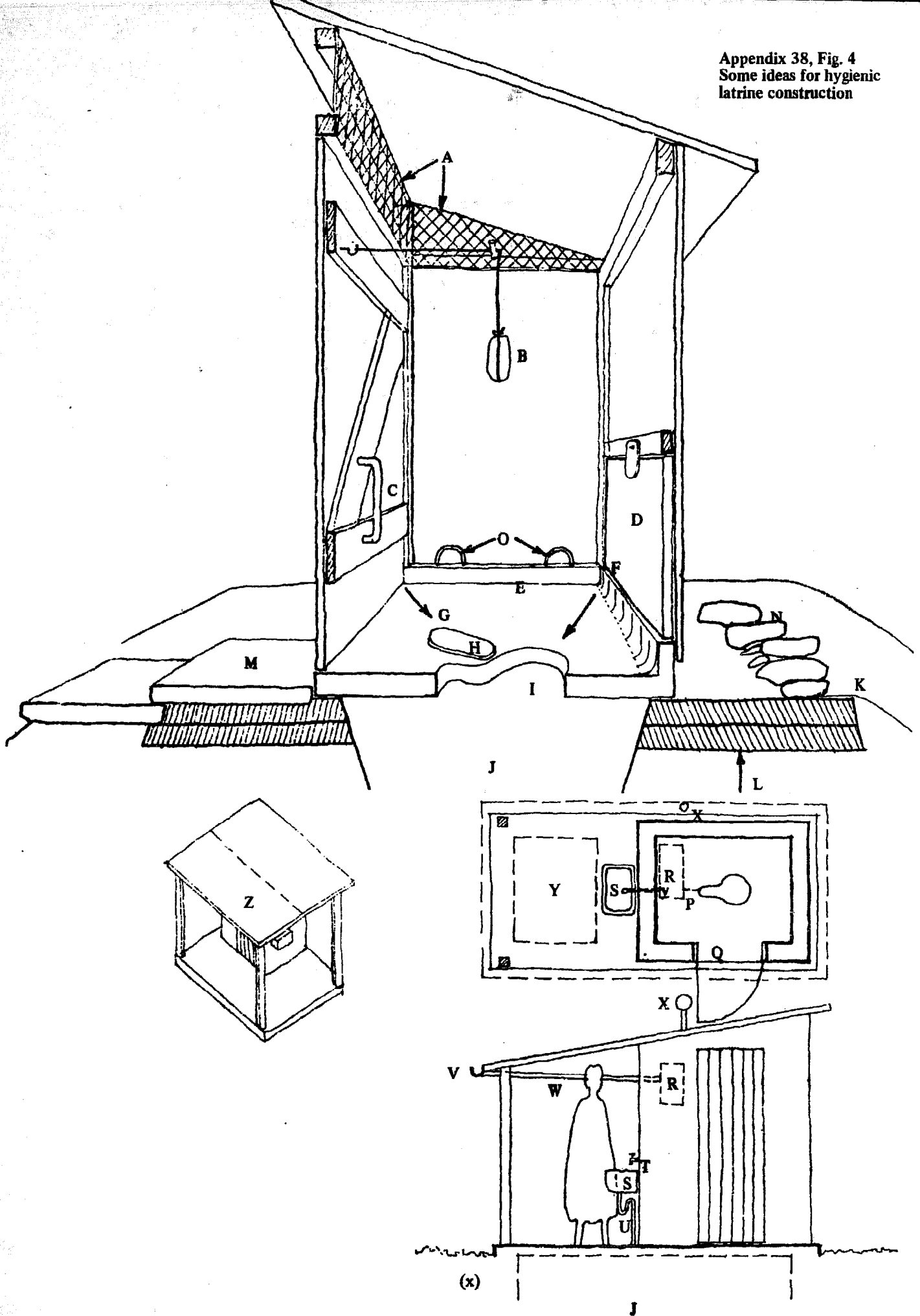

Septic tanks

Septic tanks are impervious tanks, usually built or placed in the ground. They are sometimes available in pre-cast concrete or fibreglass. The tanks have an inlet and an outlet, and usually some form of baffle. Tanks can be quite simple or quite complicated. Bacterial action within the tank liquifies solid matter which then drains away. The effluent that drains away is not pure, will probably contain infectious organisms such as typhoid, may not be used for irrigation and will smell offensively. It is therefore led to pits filled with stones (soakaways) or down spreading fan shapes of permeable pipes in ground through which the water can soak away.

Aeration beds

Septic tank effluent can be put through aeration beds which are heaps of rough stones in openwork brick boxes with collection and run-off troughs. These turn the effluent into a harmless but by no means 'clean' fluid. The beds smell and must be at least 150 feet away from buildings and down wind. They attract their own moth-like flies genus *Psychoda* which can get blown into buildings where they are a serious nuisance.

Grease traps

Where kitchen wastes are run to a septic tank a grease trap must be put in between the sink and the tank in the pipe run. It must be accessible for cleaning and it must be cleaned regularly.

Sewage disposal plants

These need careful maintenance, construction and insect control. Definitely a specialist subject.

Stabilization ponds

Stabilization ponds treat raw sewage or preferably effluent from septic tanks or aqua privies in two ponds. Slight daily maintenance is needed, and the resulting water can be used for irrigation. It may even be possible to have a fish pond between the second pond and the irrigation system. These should not however be attempted without local government approval.

Areas for further study

Stabilization ponds appear to offer a simple re-cycling system for water. A simple do-it-yourself publication with full details for community co-operative construction is needed. This publication should include notes on laying out new villages so that they can take advantage of this re-cycling in areas where water is a problem. Further, it seems reasonable to suggest that studies should be made for modified field septic tanks.

Siting

Comments on siting are given in Appendix 52 where there is a drawing showing pipe layouts at given 'falls'. The fall is the slope at which the drains are laid. English practice differs greatly from, for instance, French practice. In the latter drains are laid at much greater angles and fewer manholes are used. In general bigger pipes have lesser falls, but big pipes with insufficient material going down them block up quickly.

Very wet areas

Waterborne disease, so often associated with limited water supplies which become contaminated as there is so little dilution, can be a very bad problem during wet seasons. Latrine pits may flood, effluents cannot run away in the sodden ground and so back up or rise to the surface; streams and rivers may overflow and broadcast any muck they may be carrying. Paradoxically some form of closed composting container may be the best answer where there is so much water. Containers are being developed which not only compost but make usable gases. They are at the present time expensive as in temperate climates they have to be kept warm electrically and this is expensive. Alternatively impervious tanks of sufficient capacity could be constructed below ground, used during the wet season and

emptied into pits or soakaways in the dry season. Septic tank effluent from buildings or high ground should be put into soakaways in the high ground in areas subject to flooding, the soakaways being big enough to cope with rain getting in. from run-off down the slope.

Summary

People wishing to do complicated installations should write to the Ross Institute, or should take advice in the country concerned. If writing off for advice include the following information:

1. A site plan, either to scale or with dimensions marked on, and to include slopes across the site and how much the slope is.
2. A sketch map of the locality showing wells, water sources, streams etc.
3. Proposed or existing layout of buildings and where latrines are required.
4. Amount of water available and number of people
 - a. resident
 - b. visiting.
5. Information about rainfall and flooding.
6. Information about soil depth, whether it is impervious or porous, and what size holes can be dug without the ground falling in.
7. Information on whether a fish pond would be acceptable.
8. An indication of whether a good builder is available.
9. Is a rock-bottom cost installation required or can a more sophisticated system be built?

A household with running water and flushing cistern septic tank drainage will use something over 20 gallons of water per head per day. Half of this is required for sewerage.

About 10 gallons per head per day will suffice for normal use exclusive of sewerage. About 10 gallons per head per day plus 4 gallons will suffice for normal use plus a pour flush aqua privy or pit latrine.

But aqua privies are more expensive than pit latrines, therefore the following is recommended:

1. 10 gallons/day or less/head – pit latrine
2. More than 10 gallons but less than 20 gallons/head/day – pour flush to pit latrine (or aqua privy if money available)
3. More than 20 gallons/head/day but very little money – pour flush to pit latrine (not cistern flush – the pit will be flooded) or to a soak pit away from the latrine.
4. More than 20 gallons/head/day – cistern flush to aqua privy or septic tank. Supply is adequate for communal privies.

Water supply, purification and storage

Particular reference is recommended to Ross Institute Bulletin No. 10, Small Water Supplies, obtainable as noted in Appendix 38 and to WHO Monograph Series No. 42.

WATER SUPPLY PURIFICATION AND STORAGE

Water can be gathered from underground, the ground surface, springs and rain.

Underground water can be collected from wells, hand lifted, pumped or gravity fed from artesian wells.

Surface water is collected from streams, lakes or rivers, or from catchments made on the ground.

Springs must be 'captured'.

Rain water must be caught by catchment or by guttering from roofs.

Having been gathered water must be stored for use. Underground, surface and high level tanks can be used. Underground tanks are cooler than surface tanks but must be guaranteed impervious, as small leaks are difficult to locate. If they are likely to be emptied underground tanks must be 'tied down', or they may 'float' out of the earth. High level tanks are usually only feed tanks, the main storage being at low level, the water being pumped from main store to feed tanks.

Stored water may need treatment. The methods used for large quantities are filtration and chemical treatment. Small quantities may be boiled. There is no point in purifying water used for lavatories only unless this water is an infection source. Water used 'medically' or for drinking should be treated suitably.

In a Centre the size of the model with about ten staff and ten beds and assuming a four month dry season, at three gallons of water/person/day the storage would have to be 7320 gallons plus allowance for evaporation, say 9000 gallons in order that the utter minimum supply be maintained from a cistern throughout the dry season. This amount would allow, with very careful farming, for survival conditions for staff and inpatients but no more. This same volume would maintain a Centre using water quite lavishly and allowing visitors, outpatients etc. free access for three days. Unless a certain minimum of 3000 gallons of water a day is available, waterborne sewage should not be attempted. 40 residents (including hostel patients, staff and inpatients) flushing a lavatory four times a day each, and 200 outpatients plus 100 accompanying people flushing a lavatory once each will get through approximately 1400 gallons using a standard three gallon flush. As a three day supply is a good safeguard, it seems that 9000 gallons is both the upper and the lower limit of acceptability for main tank storage. If it is felt that 30,000 gallons a year cannot be gathered by one means or another a Centre will have appalling water problems. A fully water supplied Centre will use 1,000,000 gallons all in, but this is more safely viewed as an available supply of 90,000 gallons in the worst month.

Where careful control of water is essential an indicator of the amount in a tank is needed. Two versions are shown in Fig. 1., one for tanks above ground, one for tanks below. The principle is that a float in the tank is attached to a string. The string passes over a pulley, a weight on the end rising and falling against a scale with suitable markings on it. Full is at the bottom of the scale, empty at the top.

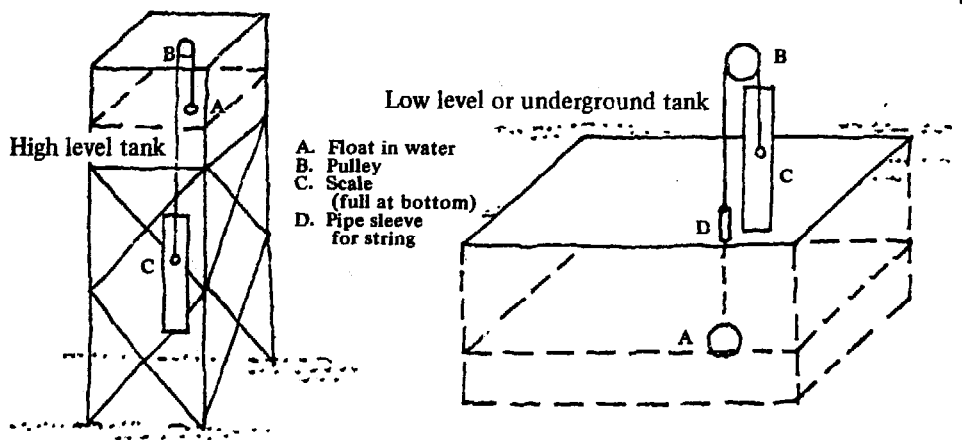

Appendix 39, Fig. 1
A simple water level indicator

Rain water can be collected from roofs by gutters and pipes, the rain being collected in cisterns. A method of collecting which also gives a ready supply above ground is shown in Fig. 2. Rain from the roofs passes through a tank with a tap. When the tank is full the overflow allows the water to pour into the cistern below. Fig. 3 shows this in diagram form. This diagram is not supposed to show any sizes. Sizes will depend on the amount of water available. Water can be pumped from the cistern back to the top tank or dipped from the cistern with a bucket when the top tank is empty. Dipping can be unhygienic and is better avoided.

Appendix 39 (ctd.)

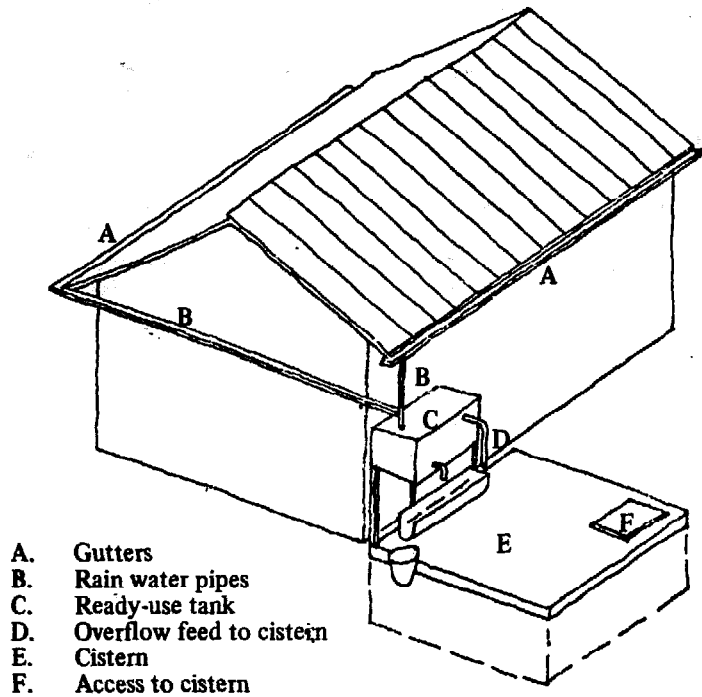

Appendix 39, Fig. 2
A rain water collecting and storage system

- A. Gutters
- B. Rain water pipes
- C. Ready-use tank
- D. Overflow feed to cistern
- E. Cistern
- F. Access to cistern

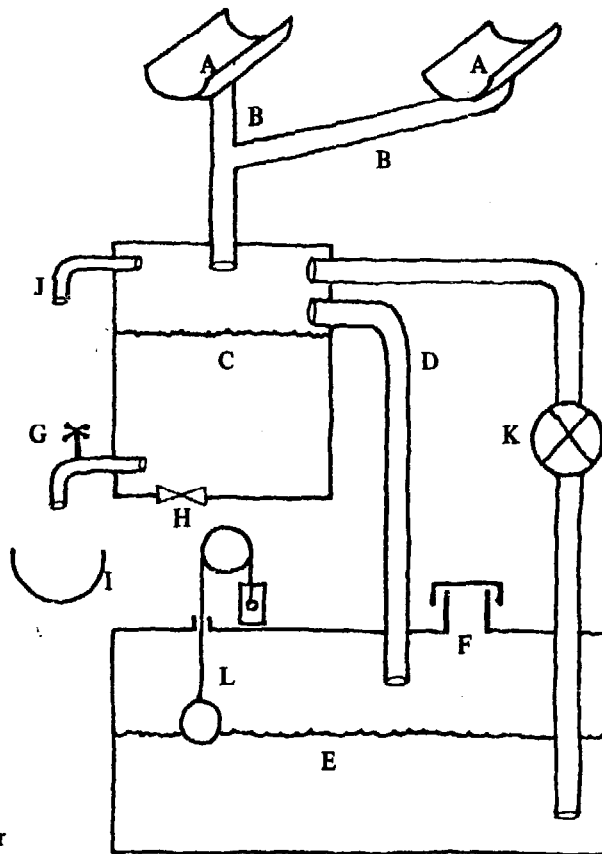

Appendix 39, Fig. 3
Details of the rain water storage system

- A - F as Fig. 2
- G. Tap
- H. Tank drain for cleaning
- I. Trough to catch drips where water is scarce, leading to bucket
- J. Emergency overflow
- K. Pump to refill top tank
Can be locked to conserve supply
- L. Indicator as in Fig. 1.
Cistern need not be opened to check water level

Fig. 4 shows the system applied to the Model Centre, the gutters that can be easily used (including using the covered way gutters as a high level water carrier) being shown in a dark line, extra pipes being necessary across the end of the outpatients' block. The cistern is near the outpatients as this building has the biggest roof, and the cistern will not be too close to the staff latrine. **Underground collecting pipes are not recommended.** The garage and store area should have its own ready-use tank. A collection system to a tank which must be above ground, as the latrines are so numerous, is shown by the laundry.

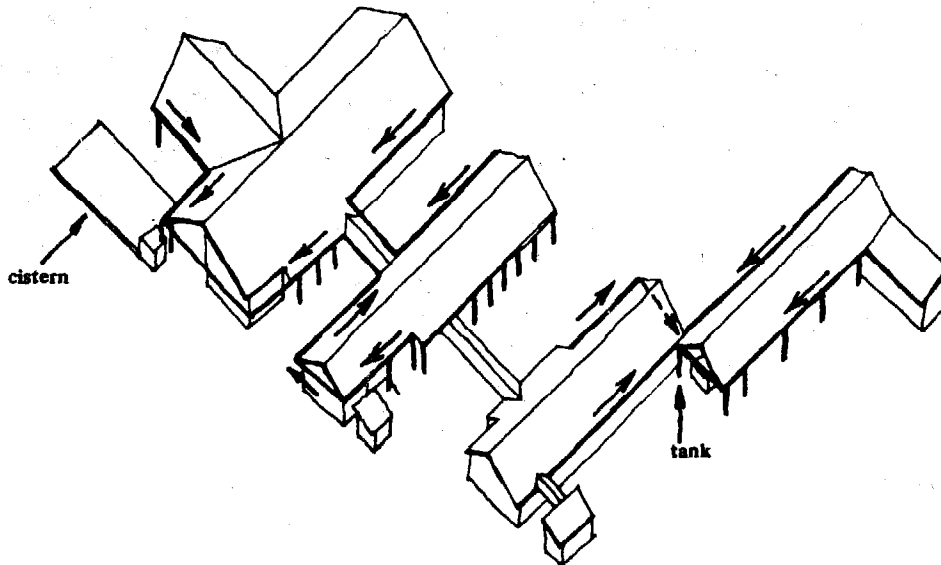

Appendix 39, Fig. 4
Placing a cistern and tank on the Model Plan
The usable gutters are shown in thick line with arrows to show direction of flow.

The gutters will have to be big to collect all this water, and will have to have a very slight slope (fall) otherwise they will obstruct headroom at the eaves. **A consideration in siting buildings on a slope will be to keep the latrines downhill from cisterns.**

Rain water should not be collected in open barrels or drums and then dumped into a cistern. Collecting vessels must always be securely covered.

Water from a cistern can be pumped daily or more often up to a high level tank from which a piped water system can run. On the Model the tank will be placed by the end of the goods area block. The pipes can be run under the roofs but over the ceilings, and can go from building to building under the covered ways. Every long run should have an elbow bellows in it, see Fig. 5, to allow for expansion and contraction in the pipes.

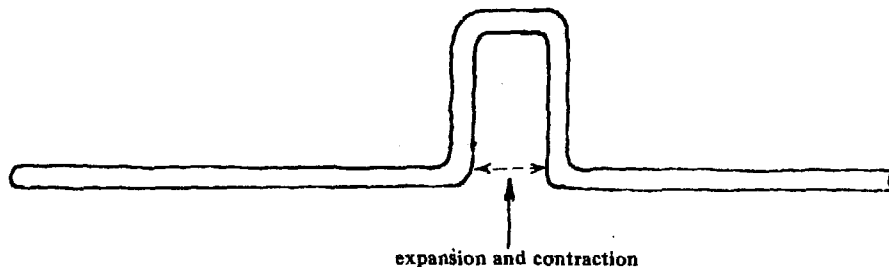

Appendix 39, Fig 5
An elbow joint
(to be made horizontally)

Pumps can either be automatic, worked with a float switch, or turned on by hand when necessary. It is easier to conserve water with a hand-switched pump. The bottom of a high level tank must be at least 3 feet above the highest fitting, a greater height is preferable. Water tanks must be closed and if possible shaded.

Water can be collected from hillside catchments. An area is cleared, covered in stones, blinded with gravel and cement then covered in smooth cement. A low wall is made at the bottom in a shallow V shape, water being run off by pipe. The catchment must be fenced against animals and cleaned regularly. Dew will sometimes form on this kind of catchment, and will run off if the slope is steep enough.

Well digging needs the attention of an expert, whether a local artisan or an engineer. This subject is therefore not covered in this Appendix. Amateur well-digging is to be discouraged.

Water from streams should be taken from deep turbulent parts of the stream; from rivers from the middle, from lakes well out from the bank. Where there is a good slope water may be taken by putting an open-ended pipe into the stream or river and allowing water to flow through. Water can also be taken from reservoirs made with dams.

If the water is muddy it must be cleared, in which case a filter is needed. If the water is very muddy or has a fine suspension then a settling tank must be put between source pipe and filter. In general terms the filter will pass two gallons of water per hour per square foot. 3 feet by 3 feet is the minimum recommended plan size; a filter of this size will only pass about 375 gallons in 24 hours. This should satisfy two or three households, or more if water is short and therefore used sparingly.

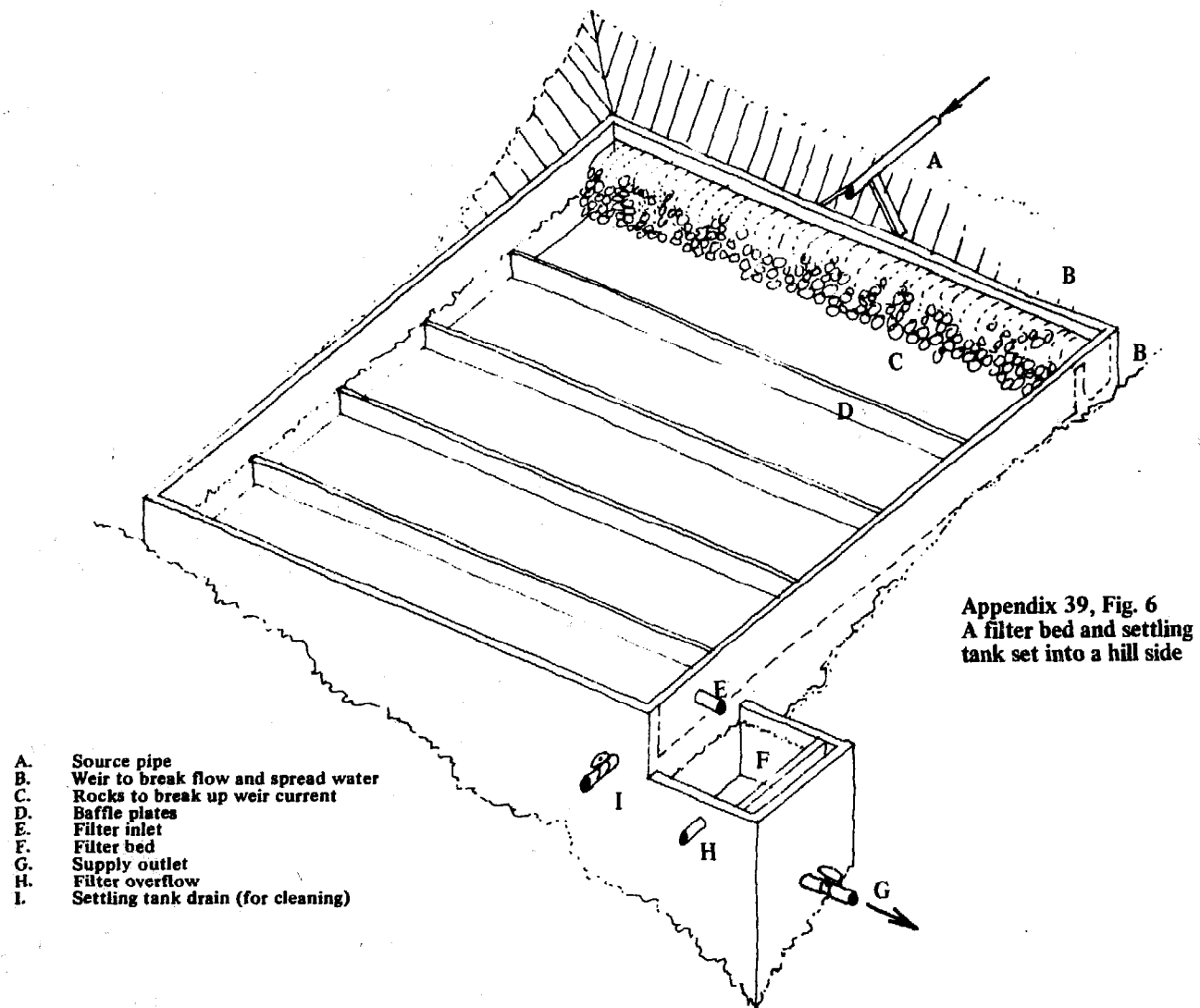

Appendix 39, Fig. 6
A filter bed and settling
tank set into a hill side

- A. Source pipe
- B. Weir to break flow and spread water
- C. Rocks to break up weir current
- D. Baffle plates
- E. Filter inlet
- F. Filter bed
- G. Supply outlet
- H. Filter overflow
- I. Settling tank drain (for cleaning)

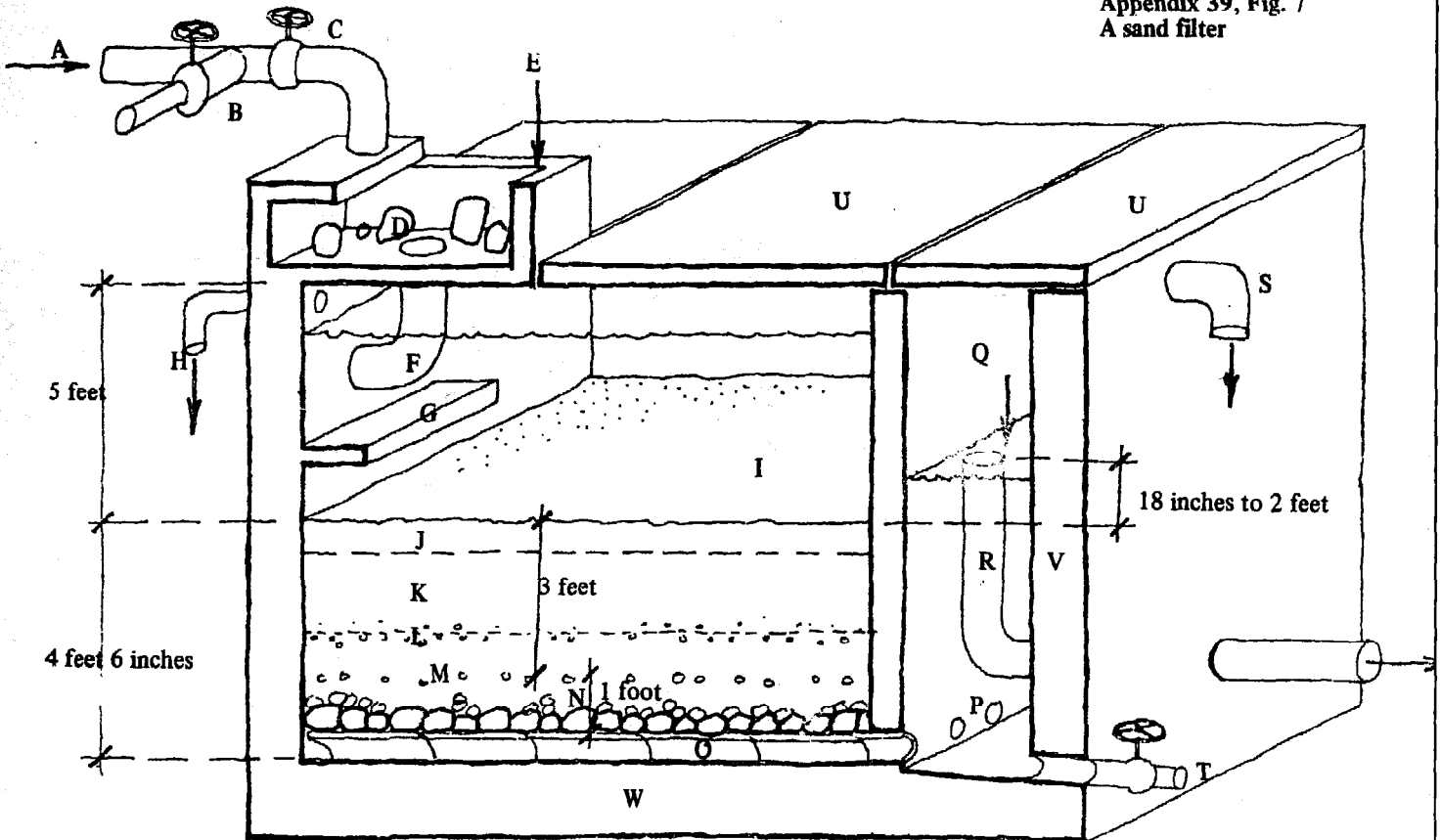

- A. Source pipe (water supply)
- B. Bypass if filter faulty. water will run away
- C. Tap to be closed when bypass is opened
- D. Coarse filter box, full of stones (only a few are shown) to catch any big debris
- E. Position of coarse filter lid (lid not shown)
- F. Pipe, bigger than A, from coarse filter to filter bed, pointed at, but not touching, the filter-bed wall. Inflow hits the wall and does not disturb the sand bed
- G. Baffle to break further the inflow
- H. Overflow
- I. Fine sand
- J. A layer of algae which will grow on the sand. Algae are beneficial, but after they have occupied the top 3 inches or so they will block the flow. The top sand should then be removed, cleaned and replaced.
- K. Fine sand
- L. Fine gravel
- M. Small stones
- N. Stones up to 3 inches round or square
- O. Loose jointed porous tiles
- P. Holes from tile lines to outlet chamber
- Q. Water level to outlet chamber must remain at 18 inches to 2 feet above sand bed to keep filter wet
- R. Outlet pipe. Height of open end sets water level
- S. Overflow
- T. Drainage pipe and tap
- U. Removable covers, watertight if possible
- V. The walls can be brick, rendered at least twice inside with ½ inch strong render each time
- W. Concrete base

Regular cleaning of coarse filter and regular maintenance of the bed are essential

Filters of this design may remove as much as 90% of bacteria in the supply, if well maintained. Animals must be kept off the lids.

Items B, C, D, E, F, G and H, S and T may be omitted, but are all recommended, particularly T and G.

Summary

No water should be assumed usable until proved usable. Regular testing or suitable chemical treatment is necessary. No guidance is given in this Appendix as each case must be taken as it comes. **Some authorities state that rain water collected from roofs should be filtered.** It is certain that roofs and gutters should be regularly cleaned, the supply pipe being disconnected whilst the cleaning is carried out.

Perhaps the worst danger to water supplies occurs at times of very heavy rain (be it annual or unusual) and flooding. Water from the ground may then contaminate wells and cisterns, may flood out latrines and cause the wide spread of infection. Under these circumstances only fresh rain water collected in closed containers should be used. If a dusty season comes before the rains then the collecting system must be flushed out before collection starts. If there has been a threat of contamination wells and cisterns must be emptied and cisterns particularly cleaned. **No wells or cisterns should be used intermittently.** If rain is plentiful for part of the year, a cistern necessary for the rest of the year, then the cistern must be regularly used and refilled during the rainy season.

Health Centres are not big power users. Where mains electricity is available electric powered steam autoclaves can be used, but most Centres will have only a petrol (gasolene, petroleum) or oil fueled generator used only for lighting. Kerosene (paraffin) may be used for fueling primus stoves for cooking and for sterilizing equipment.

Generators are usually run between sundown and an early lights-out time. If water is pumped with an electric pump the generator will be used to allow for pumping enough water for the night during the day, being turned over to lighting in the evening. Where operating or high consumption inspection lamps are used these may be wired on a priority circuit for daytime use or the generator may be started for emergency work.

New ways of using natural power such as the wind, the sun and water power are now under study. Wind and water mills can make electricity by turning generators, the sun can be used for water heating and for space heating (central heating). Organic wastes can be rotted down to make gas which can be burned. Water mills may give a steady supply of electricity but sun (solar) heating systems and wind mills usually vary in their output. The energy made from simple wind and water mills will be much less than that made by petrol driven generators. Every bit of energy made must be stored if not used. A method of storing enough electricity for a night lighting system is set out below. The system can also be charged from an ordinary generator.

A night lighting system

The idea is to charge a battery or batteries when the generator is running, with enough electricity to run a number of very small bulbs in halls and bathrooms for the rest of the night.

The only problem is to balance the amount of current put into the batteries with the amount taken out, remembering that batteries are like leaky baskets, and will seldom give as much as 75 per cent of what is put into them.

The set-up (see Fig. 1 below) consists of:

- A battery charger, connected to the mains or generator
- An accumulator battery, of the type used in cars, usually 12 volts
- A special circuit incorporating a switch and all the night-lights in parallel

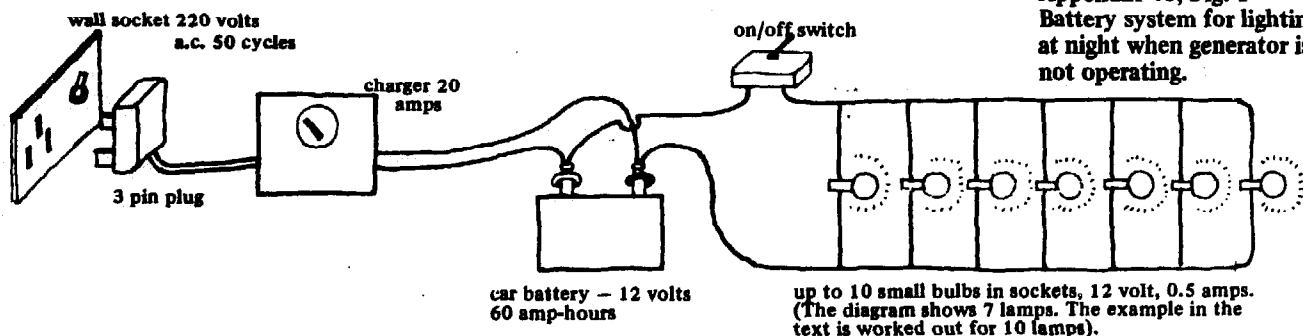

Appendix 40, Fig. 1
Battery system for lighting at night when generator is not operating.

Battery charger. Its capacity will depend on the number of night-lights used, and also the number of hours that the main Electric Generator is run every day on an average.

Example: Suppose we want to have ten night-lights and use small bulbs like flash-light bulbs, but rated for 12 volts, 0.5 amperes. Let us further suppose that the electric generator runs from 7 p.m. until 10 p.m. (three hours) and the night-lights are needed from 10 p.m. until 7 a.m. the following morning. A total of nine hours.

The amount of electricity needed for the night-lights is then:
 $10 \text{ bulbs} \times 0.5 \text{ amperes} \times 9 \text{ hours} = 45 \text{ ampere-hours.}$
 This is what we need get out of the battery, but the battery only gives back approximately 75 per cent of what you put in, therefore you must put in:

$$\frac{45 \text{ amp-hours} \times 100}{75} = 60 \text{ amp-hours}$$

If the electric generator is only run three hours a day, the charger only works during that time, and must therefore supply: $60 \text{ amp-hours} \div 3 = 20 \text{ amperes}$. The usual electric generator (East Africa) is 220 volts, D.C. 50 cycles. So in this case the charger should be:

Battery charger for 12 volts batteries
 Input: 220 volts, D.C., 50 cycles
 Capacity: 20 amperes

Battery. In this case a fairly large car battery would be required, 15 or 17 plates, 12 volts. Minimum of 60 amp-hours.

Circuit. Ordinary electric wire (double core 3/029) and switch will do, as in this example, only 5 amperes are to be dealt with. The sockets for the bulbs would have to be chosen according to the type of bulb chosen. In this example the bulbs could be ordinary bulbs, screw-base type, used in panel boards of cars: 12 volts, 0.5 amp (or approximately 6 watts).

Attention must be given to keeping the battery filled with water to about $\frac{1}{4}$ inch above the top of plates, and keeping all terminals clean. Smearing the two posts of the battery with vaseline helps keeping them free from corrosion.

If appreciably more than ten bulbs are required, for example ten each in two or three different wards, it might be advisable to have a complete and independent system in each ward.

Solar heating

Solar water heating is described by Maurice King in his book 'Medical Care in Developing Countries':*

'A black-painted metal plate on the roof of a building can, in suitable climates, collect enough heat to provide a useful quantity of hot water. Such a plate is set at a slight slope, covered by a glass sheet and backed by an insulator. To it is brazed a small bore brass pipe; the water in this pipe collects heat from the plate and rises by convection to be stored in a tank. This device is satisfactory in a wide range of tropical climates and collects heat radiated from the clouds as well as direct from the sun. Where dull weather might mean a period of cold water an electric booster can be fitted, but this is a luxury.'

'Such a system would not be expensive to instal and should pay for itself in a few years.'

There are other kinds of collectors. Old radiators painted black will work where there is lots of sun, or black polythene bags of water. More sophisticated collectors such as those described by Maurice King will take heat from the sun when the air is cold. Most collectors will work when the sun is covered in cloud. A very simple form of solar water heater is a water tank painted black with a sheet of glass over the top.

Where hot water is wanted the panels and the tank can be on the roof. If a pump is not installed space heating systems must be set out to allow gravity to push the hot water round. (It is very difficult to explain this, but the hottest water must go in at the top and must be allowed to fall all the way round the circuit as it cools. It must not be made to go uphill at any point.) Where water is supplied to the system under pressure precautions must be taken. All these points are illustrated in figs. 2, 3 and 4 following.

Summary

As conventional fuels get more costly more effort is being made to use natural power. In the next few years efficient, reliable equipment should become available. At the moment trial and error is the main method of research.

* See Appendix 49, page (i).

Appendix 40, Fig. 2
Solar water heating.
Can also be used for
space (room) heating

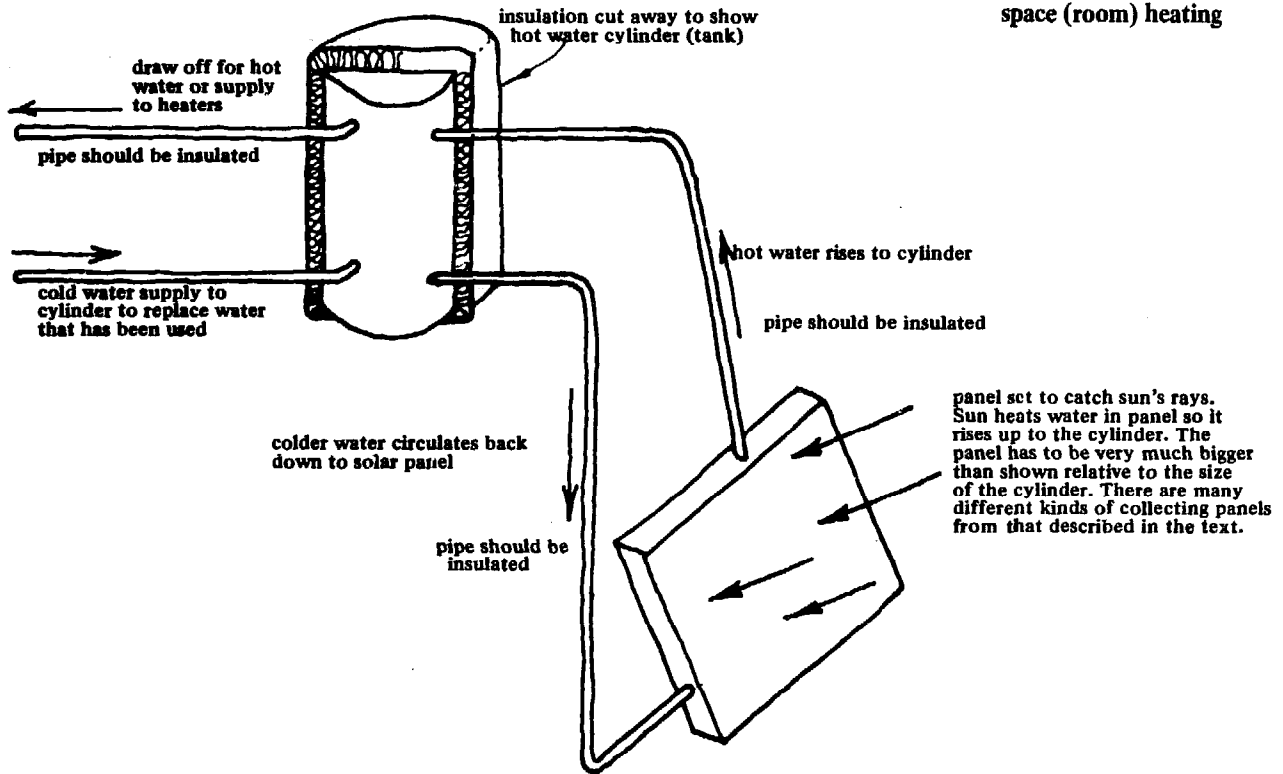

Appendix 40, Fig. 3
Water circulation under 'gravity' (the difference in weights between hot and cold water for the same volume)

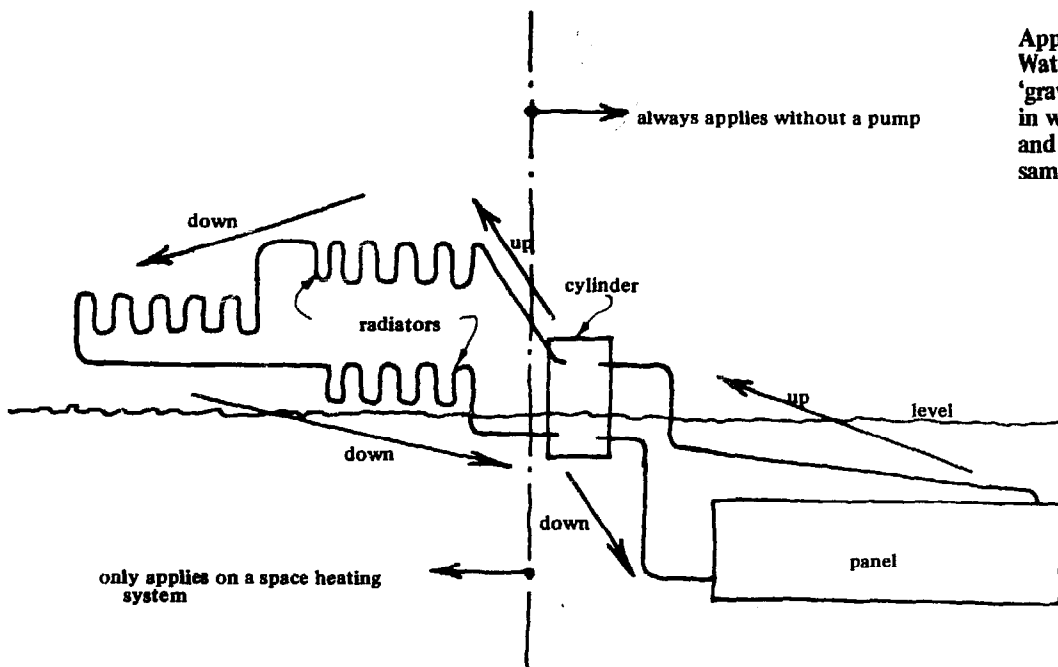

Where no pump is used the hot UPFLOW must be UP only, and the cold DOWNFLOW must be DOWN only. The cold return downflows must finish at and not below the re-entry levels. A 'last little jump of only 3 inches up' will stop the gravity circulation. Where a pump is used the levels can be ignored.

Appendix 40, Fig. 4
Precautions against pressure
build up

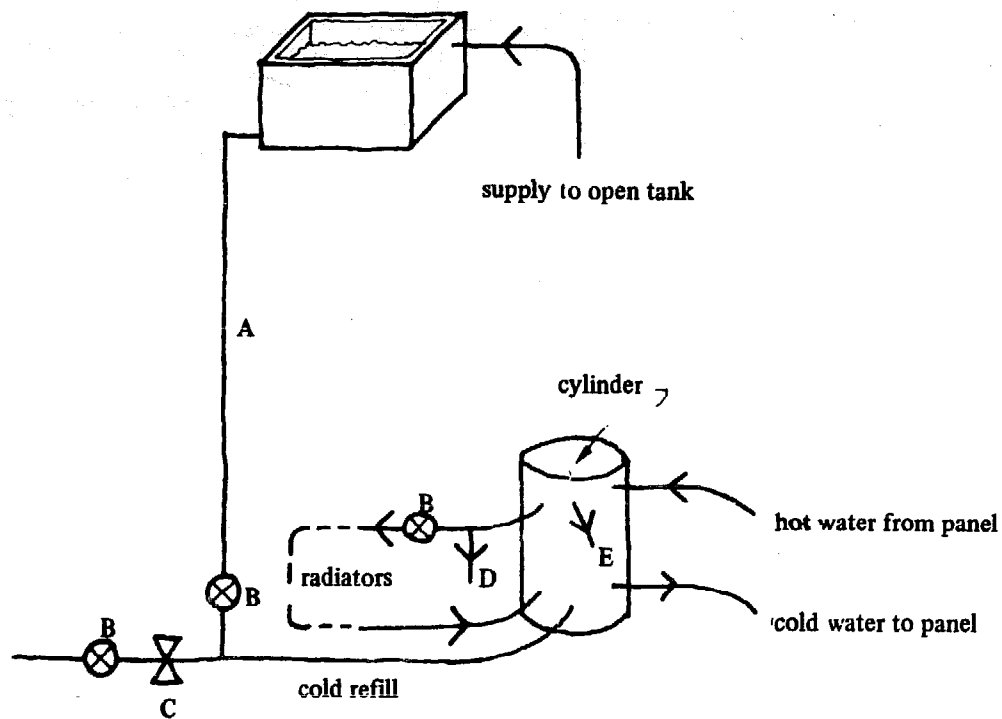

- A. Cold supply from high level tank. Highest tap to be 3 feet below bottom of tank. Water escapes up this pipe if pressure builds up.
- B. Taps to cut off supply or radiators.
- C. Pressure cut off valve if fed direct from mains and not tank (as A). May let out water if pressure builds up.
- D. Draw off for taps where radiators are installed for heating.
- E. Draw off for taps where no radiators or radiator piping is installed.

Site sizes See diagram below.

APPENDIX 41
SITE SIZES

Selecting a site is described in Appendix 47, 'Setting up a Centre'. The overall site size needed for the Model Centre is shown on the fold-out drawing at the end of this report.

The Model plan site does not include:

1. extensive car parking
2. helicopter landing pad or air strip
3. sewerage works
4. extensive garden or demonstration area for husbandry
5. fish pond etc.
6. staff housing

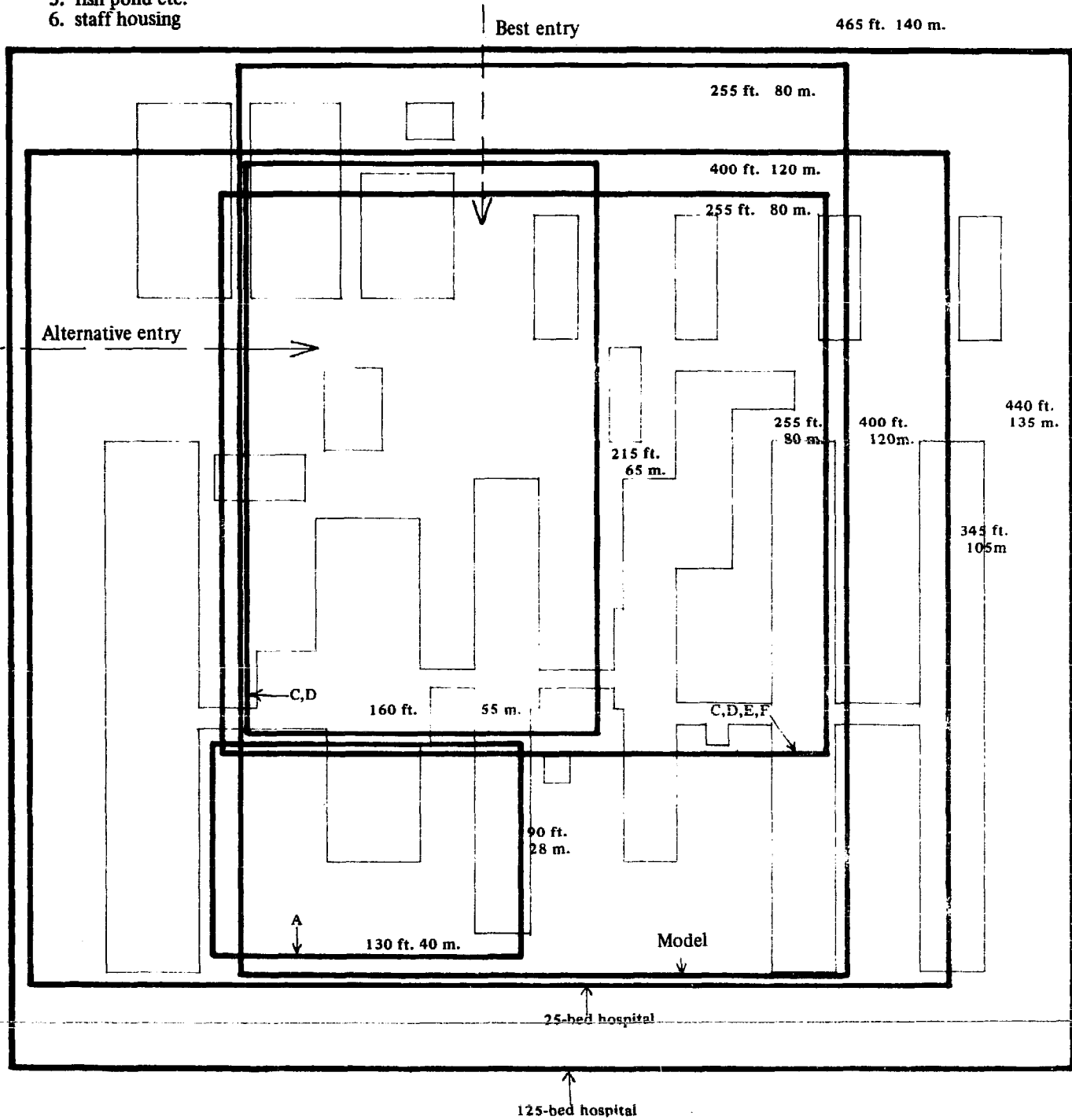

The above dimensions can only be taken as a general guide. Soil conditions, contours, site shape, orientation and access points will all require consideration. See room lists for explanation of letters.

Urban clinics

Centres in large towns will differ from those under study. Where, however, towns are effectively agglomerations of large villages, a Centre run on the same lines as in a village appears suitable.

Assuming there is an area hospital, urban Centres should be small and scattered through the town rather than centralized. Staff will probably be one nurse and one midwife and auxiliaries. A few maternity beds must be provided. The Centre could with advantage be sited close to a school. The medical job will be the same as for a rural Centre.

The clinic should be visited by the area hospital medical staff at least once a month.

The social area is seen as being of great importance; but owing to pressure of land shortage, double use may have to be made of a waiting area. The urban social area will need more sophisticated teaching aids. Storage areas can be reduced to cope with regular monthly supplies where the area hospital holds bulk stores.

Apathy, disease, poverty, filth, hopelessness, lack of food, opportunities, recreation, etc., etc., are typical of the problems in slums. If conditions are improved the towns become more attractive and the pressures build up again until improvements are swamped. No one has an answer to these problems, official action may be inaction, any improvement may lead to a worse problem. The provision of jobs is well outside the powers or possibilities of Health Centres, but they may be able to assist in making a community focus, providing an environment in which hope may grow.

Ideally, auxiliaries will be drawn from the community that is to be served. They should also be trained as much as possible in the community, and the community should be drawn into the work of the Centre as possible. Liaison with any government social workers is obviously essential. Food, hygiene and family planning remain the key areas for action. Sanitation and water supplies are problems that will only respond to government or municipal action.

Very small clinics

'One-room' and 'lock-up' clinics are popular notions, but it must always be remembered that two-way contact is essential. Doctors must visit the smallest clinic regularly. A waiting area, a 'consulting room' of some size for group visits and staff training sessions (this room also having some laboratory and treatment facilities) will be needed. A latrine and a water point are very desirable.

Good communications should come high on the list of priorities (see Appendix 23. Communications, where it is suggested that some 'clinics' will need no other facilities than a radio telephone).

It has been found that farmers can be given the necessary basic training to look after a small clinic on a part-time basis in an isolated area provided they have communication facilities. The part-time worker will bear the local responsibility for hygiene and sanitation, will be the main channel through which diet improvements will be made and will be required to have a good idea of the general state of health of his community including new births, immunizations etc. He will report to visiting doctors or other qualified staff, having a vital role in lessening the introductory problems on each visit, thereby extending the usefulness of the visit.

Numbers of people served, the distribution and grouping of Centres and some wider planning problems

The working party has repeatedly been asked to suggest how many people the Model Centre can serve, and how many Centres will be needed to reach a population. The following is offered as a guide but needs free interpretation.

Numbers of people

We have felt throughout this study that the Centre will probably serve about 20,000 people at ideal staffing level, that is to say two principal staff and three out of the four auxiliaries seeing patients, the fourth auxiliary being much involved outside the Centre.

We attempted first to justify this more or less intuitively as follows, taking as a guide the field experience of members of the working party:

1. Probably between three and four visits a person a year on average to the Centre – bearing in mind one is used to seeing families as opposed to individuals only. This figure is very suspect.
2. Principal staff can see between 40 and 60 people a day if 'meaningful contact' is to be made.
3. Auxiliaries, involved more with return patients, immunizations, dressings etc., see between 60 and 80 people a day, 10 per cent being passed to the principal staff, this 10 per cent to be included in the principals' figures.
4. Assistants do not see patients in the terms of this calculation, being involved with assisting the other staff.
5. Allow one and a half principals only to account for involvement elsewhere in the Centre.
6. Assume Sundays are not worked, that a fortnight is spent training, that a fortnight is spent on holiday and that one week a year is lost through sickness or other causes.
7. Assume that two principals' days a month are spent seeing return cases with the doctor.
8. Assume that the equivalent of a quarter of one auxiliary's year is lost through recruiting.

Then

Principal 1

365 days, less 52 Sundays, less 12 days training, 12 days leave,
12 days with doctor, 6 days sickness, say 270 days

Principal 2

Half as above 135 days

Total for principals 405 days

Auxiliaries 1 and 2

As principal 1, but 12 extra working days not lost with doctor,
282 days each, total 564 days

Auxiliary 3

As auxiliaries nos. 1 and 2 less 25 per cent loss on
recruitment 212 days

Total for auxiliaries 776 days

Numbers of people served, the distribution and grouping of Centres, and some wider planning problems

Contacts made by principals
 405 days — between 40 and 60
 people seen per day = 16,200 to 24,300
 average = 20,250

Contacts made by auxiliaries
 776 days — between 60 and 80
 people seen per day = 46,560 to 62,080
 average = 54,320
 less 10 per cent = 48,888

Total contacts, average 69,138, say 70,000.

At between three and four visits a year this shows between 23,300 and 17,500 population served, an average of about 20,400 per annum.

This figure confirmed our conviction, but was based on an average visit per annum figure we could not support.

We therefore tried again as follows:

20,000 people may well include as many as 4,000 children under five. The under fives visiting ten times a year will give 40,000 visits. This leaves 30,000 visits from the total contact figure of 70,000, that is to say, two visits per annum average from each of the remaining 16,000 people. This seems to be reasonable. These figures indicate, incidentally, six trained people per 20,000 population.

Alternative calculations run as follows:

1. Assume each family has eight people in it

1 grandparent
 1 dependent adult
 2 parents
 3 children over five
 1 child under five

2. Allowing ten visits per annum to the child under five and one per adult gives seventeen visits per family. With 70,000 visits available we could serve $\frac{70,000}{17}$ families = 4,100, which at eight to the family is nearly 33,000 people served.

3. The same family but with two of the children under five gives 26 visits per family is $\frac{70,000}{26} \times 8 = 21,500$ people served.

4. The same family as in (2) with two adult visits per annum gives 24 visits is $\frac{70,000}{24} \times 8 = 23,300$ people served.

5. The same family as (3) with two adult visits per annum gives 34 visits per annum is $\frac{70,000}{34} \times 8 = 16,500$ people served.

6. The family with two less adults, at one adult visit per year and one child under five gives $\frac{70,000}{15} \times 6 = 17,500$ people served.

These calculations point to two important facts:

1. The proportion of under fives in a population is very important in assessing sizes and populations covered.
2. If an increase in survival rate of children can be tied to reduction in family size, and as a population gets older, Centres originally established on an under fives calculation will be too big. This 'loose fit' should allow for an expanding trade in adult outpatients. As outpatient treatment takes longer for adults

than for under fives it is not unreasonable to hope that these varying factors will keep themselves in balance.

Other factors

High or very low population densities, difficult terrain, and difficult communications, the existence of supporting units or existing Centres, seasonal variations causing, for instance, flooding which may annually sever communications, have all to be taken into account in addition to the availability of staff and funds, when setting a Centre into a countryside and into a population; and a suitable size has to be judged against population density.

Cultural patterns, personalities, training and training responsibilities are further variables which will act principally on the number of people who can be seen in a day.

Reasonable travel distances

In reasonably open, reasonably flat country a high proportion of the population will travel three miles to a Centre and good cover will be achieved in this area.

Within five miles in reasonably open, reasonably flat country experience shows that cover is adequate in the general terms of the current reasonable possibilities of health delivery.

Beyond five miles, attendance is sporadic. Theoretically, therefore, a Centre is required in every ten mile square where the country is reasonably open and flat.

Referrals from Centres

It has been tentatively suggested that a rural population of 50,000 people seen by Centres of the type offered in the Model will keep one referral doctor busy. This suggests one doctor to every two-and-a-half Centres of the Model size, that is to say one doctor to every fifteen trained Centre staff. Five Model Centres could be served by two doctors in a District Hospital. Better still, four doctors in a hospital could serve ten Centres. It seems reasonable to state as an absolute rule that one-doctor hospitals must not be allowed.

Travel time

We note that a bullock cart can be readily adapted to a stretcher vehicle, and can travel at 3mph without halt for six hours giving an 18 mile radius of travel by this form of transport. We note later that 20 miles from a Centre to a District Hospital seems to be an average practicable distance. Whilst every Centre would ideally have a faster transport system, it may be that groups of Centres should be 'pushed out of balance' so that as many Centres as possible fall within the 18 miles, the others then being too far for a bullock cart and needing some other form of transport.

A further feature offered for consideration is that a time of six hours between emergency referral and reception at a hospital is reasonable in practical terms.

Density of population

The Model Centre ideally lies at the centre of a ten mile diameter circle within which the population is 20,000 people, i.e. something over 200 people to the square mile. As densities rise above this level more staff must be added until the point where more buildings are needed. Similarly, in areas of lower population density the Centre staff will first reduce and then at a certain point fewer buildings will be needed. Some communities, for instance those spread along river banks, pose their own special problems.

Land form

The Model Centre ideally lies in reasonably open, reasonably flat countryside. As terrain gets more difficult so the distance that people will be willing to travel will reduce. Mountains, forests, swamps and rivers are all factors that will discourage attendances at the Centre. The worse the terrain the more Centres will be needed.

Existing roads, railways, navigable rivers and coastal waters which are reasonably navigable will alter the ideal even spread of Centres over the country.

The relationship between the District Hospital and the Centres it serves

The District Hospital must be located with an eye to the same problems of land form and travel. It may be that the District Hospital will not be in the most easily accessible place but in the place that is equally accessible from everywhere in its catchment. This principle could obviously be taken too far, but it should be borne in mind.

Mobile clinics and radio telephones

In a region of open countryside but very low population density the catchment area needed to give a Centre enough patients to justify the Centre might be ridiculously large. In the same way a population living in a region of mountainous jungles might be so restricted in its travel that a ridiculous number of Centres would be needed. In these cases any built facility may be meaningless, and a helicopter or aeroplane service may be essential. Such services work best where the population served can communicate with the base unit. Radio telephones work well in this context. The most distant units need the most complex communication systems.

Inversion of sophistication

The principle that the most inaccessible units need the most sophisticated communications can be developed further. Health Centres near the supporting hospital should be the least sophisticated as they can expect most support. This idea seems contrary to most development practice where development is outward from the centre of gravity of existing facilities, the sophistication of the units decreasing as the distance from the middle increases. The implication is that, instead of being used to hurry people round the towns in the district concerned, the available vehicles will have most effect where the longest distances of travel are found. The more densely populated towns and their surroundings could be adequately served over the relatively short distances by bullock carts or similar slower methods of transport.

Dealing with the variable factors

As each country may well adopt quite different staffing levels, grades and numbers; as each country builds different sizes and numbers of Centres with different distribution criteria; as the form of the land varies; as population densities vary; as disease patterns vary; as so many different factors vary in themselves and in relation to each other so it seems to be extremely difficult to come up with any formula which will be of significant use in assessing the number of Centres needed and their distribution. The working party in considering this problem have attempted to treat it in a very broad manner.

The macro-unit

We feel that a District Hospital with four or so doctors is a worthwhile medical unit. If one doctor will be kept busy by referrals from Health Centres at the approximate rate of one doctor per 50,000 people, and if each Centre serves 20,000 people then ten Centres will need the support of a hospital. Taking ten such district groups (quite arbitrarily) and relating the ten groups to a Regional Hospital we have a macro-unit which covers so large an area and is so generalized in its structure that it may be a useful planning tool.

The structure of the macro-unit

The Regional Hospital will not necessarily be in the middle of its macro-unit. Its siting will be subject to the same pressures of land form etc. as are District Hospitals and Health Centres. Taking the layout of the macro-unit as an ideal circle, we might find the very generalized layout shown in Appendix 44, Fig. 1.

At the centre is the Regional Hospital. Ring A is a ring of Health Centres relating to the Regional Hospital. Ring C is ten District Hospitals with their dependent Centres in rings B and D. The Regional Hospital and each ring of Centres and District Hospitals has its own satellite system of sub-Centres, not shown here.

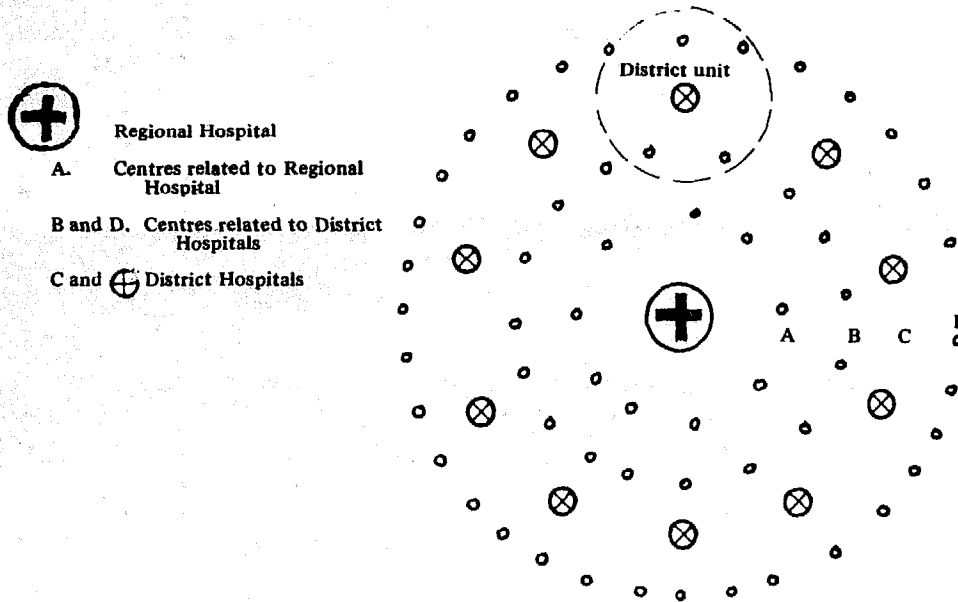

Appendix 44, Fig. 1.
An idealized macro-unit.
Sub-Centres not drawn in.

The sub-Centres

Sub-Centres (very small clinics, see Appendix 43) have been introduced as a major component of the macro-unit for the following reasons:

1. The 'ideal density' of 200 persons to the square mile is unlikely to hold good over the large areas we are discussing with the macro-unit. Higher densities can be coped with by making bigger Centres or more of them: the travel problems are probably slight. Lower densities or difficult terrain will force solutions away from the ideal, making smaller units essential. Our conceptual pattern must include these smaller units.
2. The macro-unit is so generalized that it must be allowed to develop its own rules. Thus where the circles, within which the various units conceptually lie, meet, gaps are left. Sub-Centres can fill these conceptual gaps.
3. As sub-Centres will inevitably be built, it seems to be advisable to take account of them.

The district groups

Ten district groups make up a macro-unit. Referring to Appendix 44, fig. 1 and looking at rings C and D, and assuming that a sub-Centre will attract people from 2½ miles away it becomes possible to start plotting sizes on the macro-unit, see Appendix 44, fig. 2.

Appendix 44, Fig. 2
Distances in the district unit.

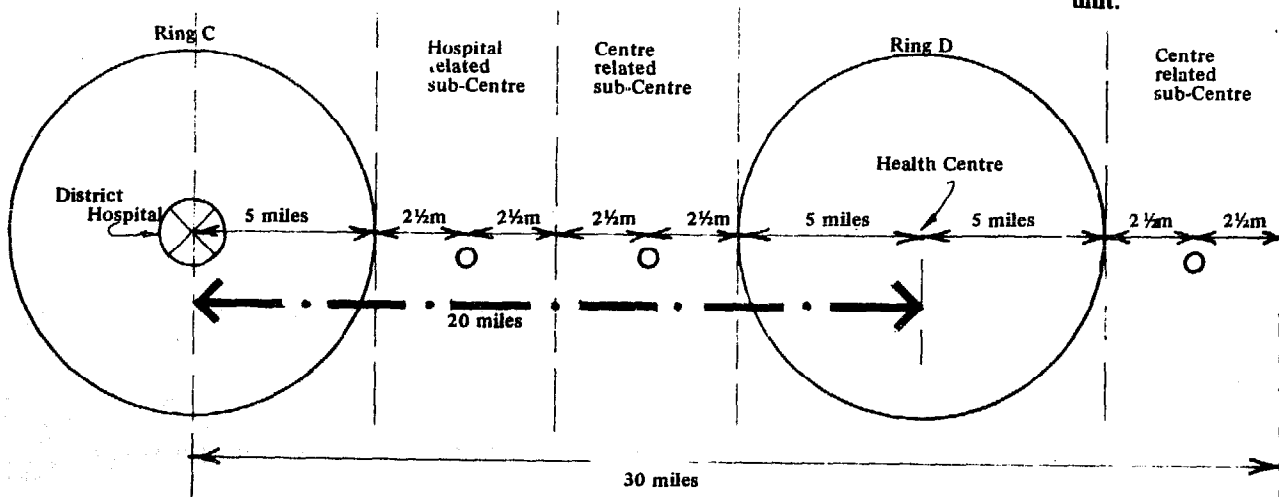

These sizes give us a District Hospital centred circle diameter 60 miles which is an area of approximately 2,825 square miles. We are still assuming four doctors each servicing 50,000 people. We must therefore assume that a number of the Health Centres and sub-Centres indicated will not exist because there is a mountain or a river or a desert in the way, or the doctors will be overloaded.

Appendix 44 (ctd.)

Again, higher densities mean a bigger cash and manpower problem but a simpler planning problem. Allowing the geometry of the circular district group to take over we can draw Fig. 3 which sets the actual number for the sub-Centres.

Where the ten circles that make up the macro-unit about, sub-Centres will be 'shared' or 'lost'. We therefore account 40 in each district group.

Appendix 44, Fig. 3.
Number of units in a district unit

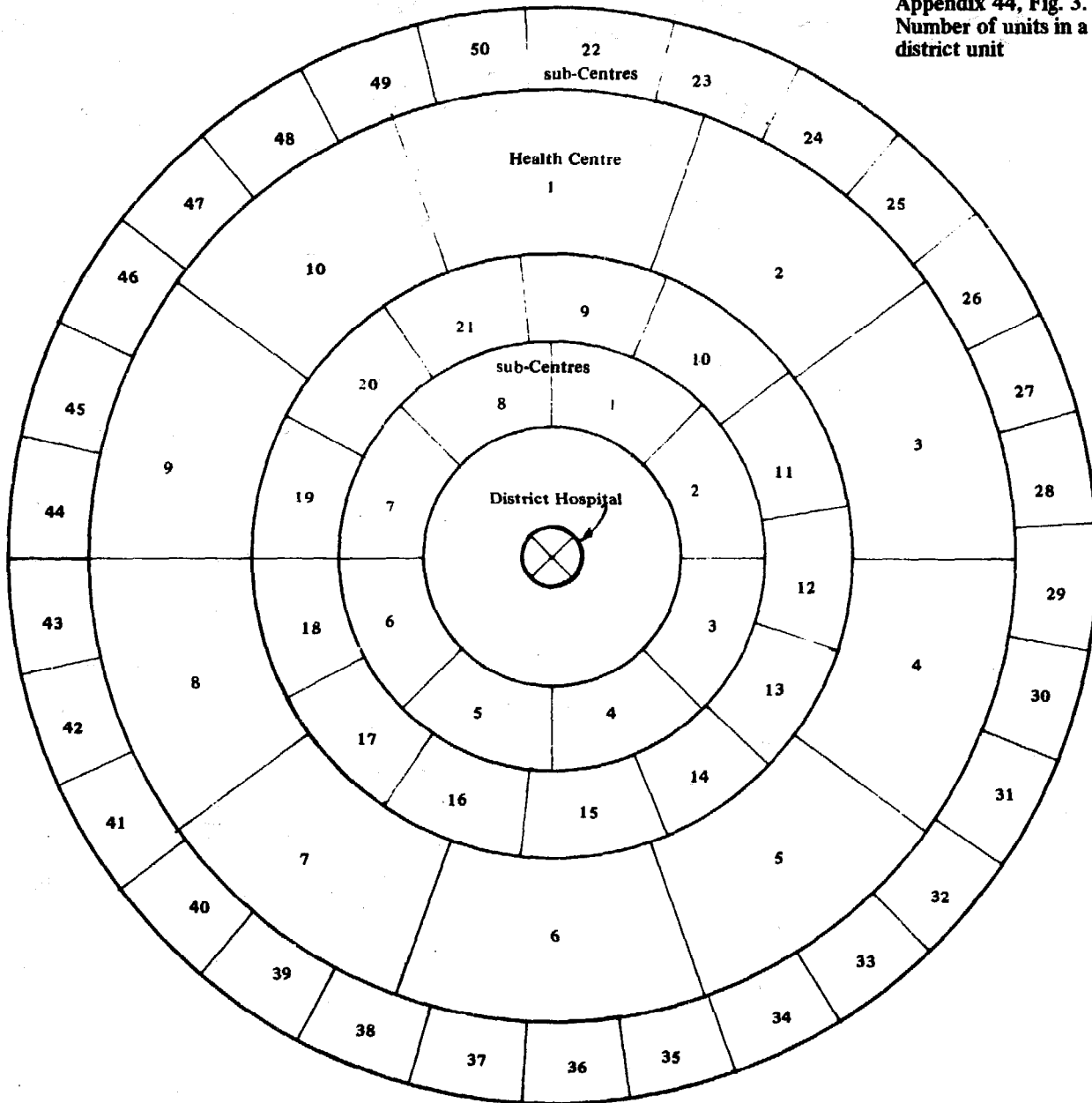

In areas of high population many more people will be reached, which means that the hospital will have to be bigger, and that it will need more staff. We can see no point in making the district unit smaller and multiplying hospitals. This whole report is promoting Health Centres as a good solution providing they are supported by hospitals, not the reverse.

Numbers of people served by the macro-unit

Each district unit has

10 Centres
+ 1 Centre based on the hospital
and 1 hospital

The macro-unit therefore has

110 Centres
and 11 hospitals
and 1 Centre based on the Regional Hospital

As each district unit covers 2,825 square miles, each macro-unit will cover 28,250 square miles. Allowing for a zone of influence round the Regional Hospital, and for other units that may be in the area, the macro-unit can be considered as covering say 30,000 square miles.

The basic unit in our calculation is the Model Centre serving 20,000 people. As we have 110 in each macro-unit, each macro-unit can serve 2,200,000 people.

Taking one district unit, we have 220,000 people in 2,825 square miles, an average density of 77.7 per square mile (see Appendix 46, Some general statistics.) This is the average density the macro-unit can serve.

Staffing requirements of a macro-unit

Each Centre has six trained staff, and there are approximately 40 sub-Centres in each district unit each needing two trained staff. Assuming that each District Hospital has five doctors (this is discussed later) each macro-unit needs 50 doctors plus the Regional Hospital doctors, each Regional Hospital needing fifteen doctors (this is discussed later). This is a total of 65 doctors. We thus have one doctor for every 33,846 people, and one auxiliary for every 1,500 people. As the minimum time it would take to establish a macro-unit is probably ten years this forecast does not seem too impossible.

Moreover, the macro-unit is proposed on a density only 30 per cent of the Model Centre density. It must therefore follow that the trained auxiliary and nursing staff requirements can actually be reduced. Further, the 50 District Hospital doctors could attend to 2,500,000 people, not the 2,200,000 proposed. On the face of it, therefore, at this level one doctor per 35,000 people seems to be the target. There will then, however, be doctors almost wholly involved in research, training and complex procedures serving very few people. It will be seen that 25 doctors in a National Central Hospital are going to reduce the 'available doctors' to population figures to a very great extent indeed in a small country.

On the other hand, to maintain the 'correct' doctor to population ratio a country with an average population density of 200 to the square mile is going to need three times the number of doctors per macro-unit, and will therefore have fifteen doctors based on each District Hospital, each District Hospital servicing a population of 750,000 people. It must be stressed again that this whole fabric relies on communications. It is not so much doctors' training and attitudes that need changing as politicians' and planners' attitudes to national spending. **It is our purpose in introducing the macro-unit to give a health facility network framework for establishing communications patterns, based on health care, which will make Health Centre based community care an assessable reality.**

The staff of the District Hospital

We have suggested that four doctors can see patients from ten Centres. We have also suggested that these doctors will have substantial duties outside the hospital.

Each four-doctor District Hospital has following in its orbit —

10 Centres
40 sub-Centres

not including mobile clinics.

This means 50 visit points to be serviced in a working year, (which can be judged as having 250 days), and implies, (at twelve visits/centre/year maximum, assuming that a visit can be made in a day), 600 doctor visiting days taken from a total of 1000 doctor days, i.e. each doctor has 100 days per annum or two days a week in the District Hospital.

This gives eight total working doctor days per week per hospital, which indicates a maximum of say 120 beds tolerable, which at 70 per cent occupancy is 90 beds. This indicates a load of 60 patients/doctor/day. Assuming a five day average stay we can expect $\frac{365}{5} \times 90$ i.e. 6,510 admissions from 200,000 people, say one

admission from every 30 people at 75 per cent occupancy.

Carrying this calculation further, at 60 patients/doctor/day, with say 30 medical and 30 surgical patients, if each of the surgical patients has an operative procedure of some form (some will have two or more, some none) then, on a five day average stay we have $\frac{30}{5} = 6$ procedures a day, i.e. up to 9 per day with a 50 per cent

fluctuation, which is not impossible but would probably prove intolerable for one doctor with no houseman, no registrar, no anaesthetist, but possibly two students assisting.

This indicates a very clear need for good theatre auxiliaries. Without such auxiliaries the system cannot work at all. There is an area for manoeuvre in these calculations which is that it may be possible to visit more than one Centre or sub-Centre a day.

However well the visiting roster was organized we see sickness, bad weather, leave and recruiting spoiling the doctor/day/occupation calculation, and believe that it is essential to add a fifth doctor.

If in a densely populated area the basic four doctor unit becomes a twelve or sixteen doctor unit, then it may not be necessary to add a fifth doctor to each unit of four.

The District Hospital

It seems to be necessary to point out that the District Hospital we are being forced to consider will have some novel features.

1. It is closely associated with its 'home' Health Centre, but will have no out-patients department.
2. It may have a high proportion of 'hostel' type beds to traditional ward type beds. It may be very like a chalet hotel.
3. It is going to receive patients from all sorts of places and may need isolation admission routines. It is fairly certain that patients coming in will have to be given a fairly thorough diagnostic session. History taking may be a prolonged and interrupted business, one which could well be done by trained auxiliaries.
4. Patients are going to arrive in a fairly bad state. It may be that quite sophisticated diagnostic and life support apparatus will be called for. We should not think of these hospitals as being primitive and second class. Nothing quite like what is needed yet exists, but we urgently need to know what we need. In ten years' time — about the time it would normally take to get up an 'experimental' unit sponsored by some collection of international bodies — we are going to need several hundreds of these hospitals worldwide, and they will need staffing, equipping and running. We have to work out what we have to do and start doing it within the next two to three years. Otherwise Health Centre building is only going to build up worse problems than we have

now — a diagnosed but untreatable population conditioned to expecting health care.

5. Average hospital population figures are likely to be quite useless. Seasonal demands on the hospital will be made and will have to be met. Perhaps training programmes will be organized 'out of season'.
6. All hospitals are training establishments in effect, but the District Hospital is going to have heavy and specific training duties for nurses and auxiliaries.

Much of the work done over many years by many people in promoting the idea of the Health Centre has been prompted by the unsuitability of big Western type teaching hospitals to the problems of developing countries. The effect has sometimes been that people coming new to the field, reading the available literature and talking to those with experience assume that all hospitals are a bad thing. We write on page one of this report 'no one should be required continually to perform a task which someone less qualified can readily be taught to do competently'. The new District Hospitals should similarly be planned and established to do only that which cannot be competently done in Health Centres.

Hospitals traditionally have a full and expensive complement of equipment and staff which is inefficiently used to deal with minor work. The majority are established to do nearly every medical job from treating a small cut to major surgery, from complex diagnostic routines to prolonged minimal care convalescence. Very much more precise definition of aims is needed so that the new hospitals can do their job unencumbered by unsuitable traditions.

The wider implications of training programmes for Health Centre staff

Doctors, it is clear, need new things added into their current 'standard' (i.e. Western based) training. It seems that these extra matters can only be built into the already long course by pruning the standard curriculum. Also, as the new system takes effect a whole generation of doctors may have to be retrained.

Nurses and auxiliaries will need carefully tailored training. We are going to need many different kinds and in each of the disciplines we are going to need teachers.

We are going to need district and regional organization and co-ordination, and some form of central diagnostic reference, organizations for training rosters, etc.

We indicate below how these various things could be tagged, in balanced batches, to each of the ten District Hospitals in each district group, each hospital having its own distinctive responsibility and character. The aim is to recruit, train and use local people locally.

Some possible training groups for District Hospitals

1	2	3	4	5						
Auxiliaries, dressers Building planning Midwifery	Nurses Sterilizing Communications	Theatre auxiliaries Anaesthesia	Hospital auxiliaries Group library and diagnostic reference	Pharmacists and Dispensers Cardiology						
<p>Possible training responsibilities for Regional Hospitals</p> <table border="0" style="width: 100%; border-collapse: collapse;"> <tr> <td style="width: 50%;">Radiotherapy</td> <td style="width: 50%;">Advanced surgery</td> </tr> <tr> <td>Immunology</td> <td>Ophthalmology</td> </tr> <tr> <td>Neurosurgery</td> <td>Etc.</td> </tr> </table>					Radiotherapy	Advanced surgery	Immunology	Ophthalmology	Neurosurgery	Etc.
Radiotherapy	Advanced surgery									
Immunology	Ophthalmology									
Neurosurgery	Etc.									
6	7	8	9	10						
Auxiliaries, general Projects centre Paediatrics	Laboratory assistants X-ray assistants Traumatology Neurology Mental	Teaching hygiene Water supply Ante-natal etc. Family planning Nutrition Schools involvement	Nurses Agriculture Sanitation Public health assistants Community development workers	Records Administration Maintenance Burns Planning co-ordination Statistical analysts and surveyors						

We propose that consideration be given to the basic training of auxiliaries in one sub-discipline plus a general basic familiarization course. Thereafter, and perhaps partly by correspondence courses, 'specialist' courses are added, the total number of courses taken and passed being the qualification of the auxiliary, his salary being qualification related. The better qualified auxiliaries will, presumably, go to the small Centres where their wider experience will serve best.

Doctors, people and beds

Within the rural network only, not including regional and central facilities, the figures for the Model and the macro-unit are:

1 doctor/34,000 people
1.05 beds/1000 people

Ignoring the fact that the bed spaces in each Centre could be increased, we can reasonably expect that the Regional Hospital, drawing patients from its own immediate orbit, will have twelve beds for these patients, and will have referrals from ten District Hospitals with 120 beds each, i.e. 1,200 beds in the group. With ten per cent referrals and a longer stay this means 240 referral beds plus 120 local is a minimum of 360 beds. We believe the Regional Hospital should also support at least one National Speciality Unit. This will bring the total of beds to say 550 (these figures can only be very sketchy). This hospital can hardly run properly including specialization, training and research with less than fifteen doctors, allowing them to have no outside duties.

Including the Regional Centre within the macro-unit we find

111 Centres with 10 beds each	1,110
10 District Hospitals with 120 beds each	1,200
1 Regional Hospital with 550 beds	550
Total	<u>2,860 beds</u>

111 Centres serving 20,000 people each	2,220,000 people
10 District Hospitals with 5 doctors each	50
1 Regional Hospital with 15 doctors	15
Total	<u>65</u>

This is 1 doctor/34,150 people
1.29 beds/1000 people

We have figures which suggest that the current average figures for twenty developing countries in Africa show

1 doctor/17,400 people
and 2.2 beds/1000 people

The macro-unit must therefore be seen as proposing a skeleton service. The number of doctors and the number of beds could be doubled without the unit becoming luxurious unless existing average African conditions can be considered luxurious. On the other hand, figures are not available for auxiliaries. How many 'auxiliaries' are 'worth' one doctor? This question must be answered somehow if statistics are to remain useful in community medicine.

Setting a Centre into the countryside

Appendix 47, on Setting up a Centre notes some of the detailed problems of actually getting a Centre built. Before a site can be selected however the right general area for the Centre has to be located. Appendix 44, Figs. 4, 5 and 6 attempt to show some of the factors that could act on a district group to distort its simple flower-like ideal form.

The maps cannot be comprehensive, but they illustrate that the District Hospital may be sited better if at the focal point for travel facilities rather than in the centre of the area.

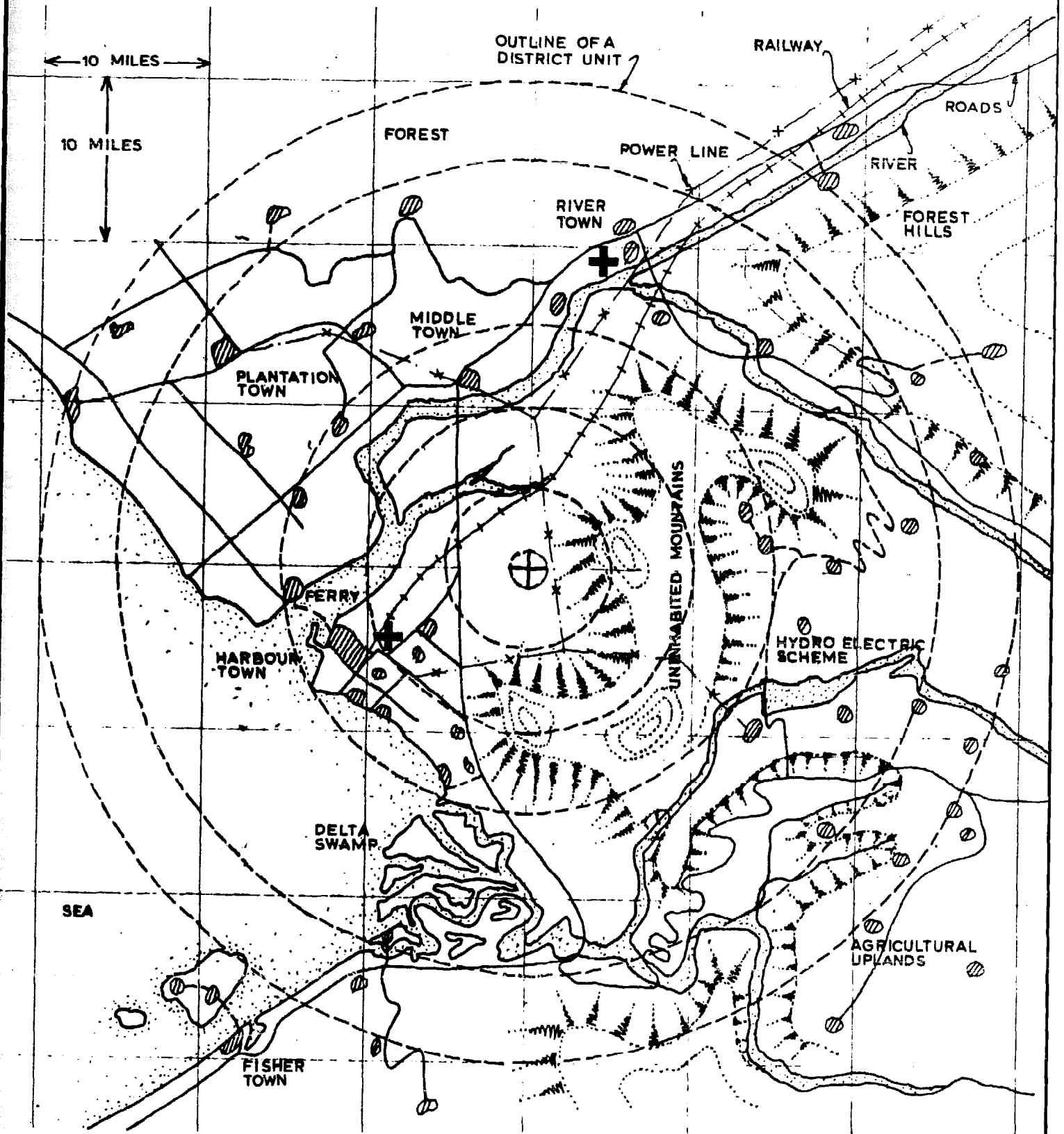

Appendix 44, Fig. 4
 Shows part of an imaginary country. It can be assumed that there will be an existing hospital in Harbour Town, a small hospital existing or proposed in River Town, and clinics existing or proposed in Plantation Town and Fisher Town. Drawn over the map are ten mile squares and also a 'district unit'. It is assumed that the district unit has appeared on this piece of map as a result of moving a series of district units drawn to scale on transparent material round on a map of the whole country.

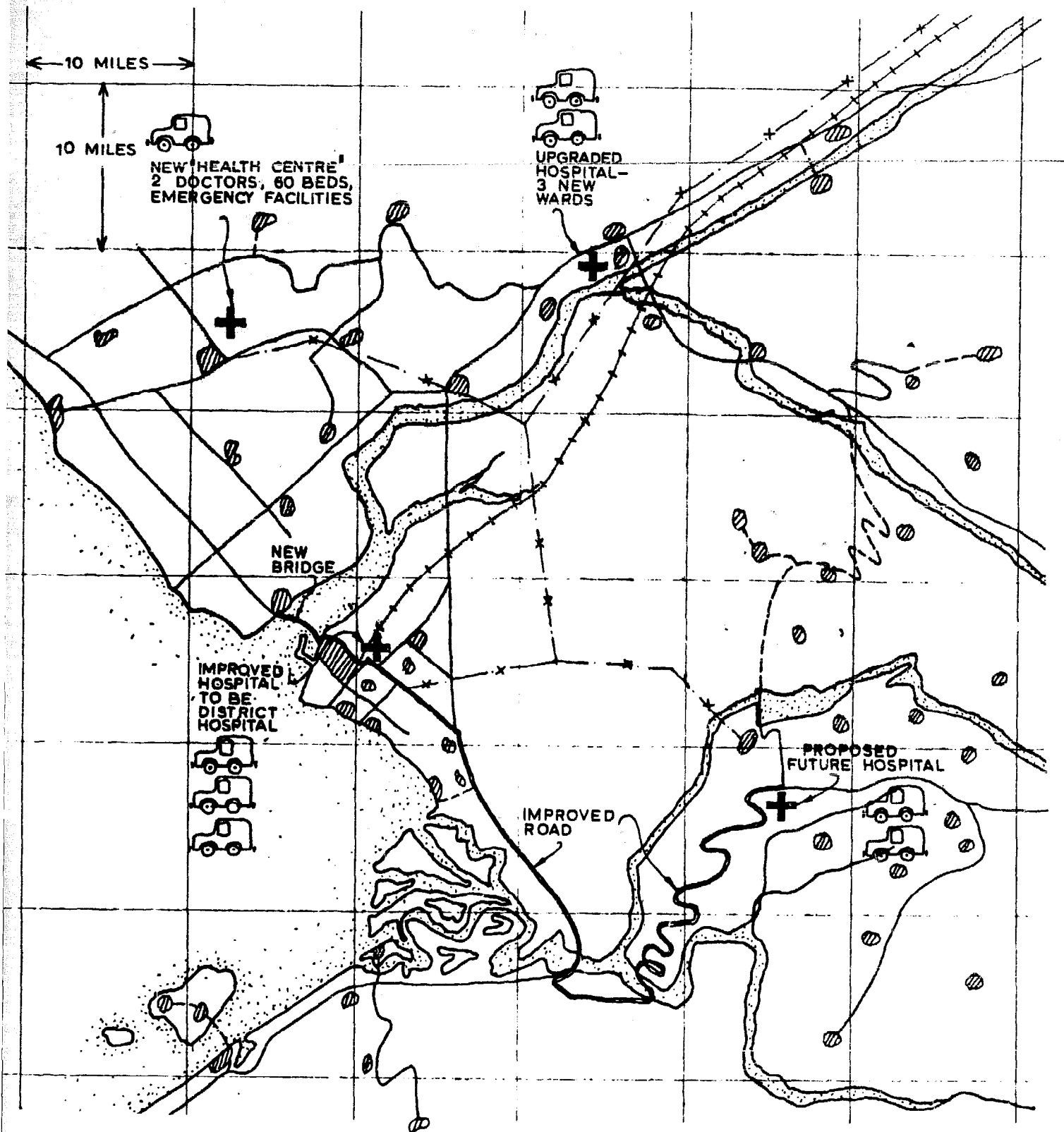

Appendix 44, Fig 5

Shows a possible development plan on traditional lines for increasing health facilities and also shows an improved road between the Delta Swamp and the Agricultural Uplands. This road is proposed so that the new hydro-electric scheme is more accessible, and associated works will relate Fisher Town and Harbour Town more closely. The main development in medical terms will be in Harbour Town or in River Town, probably in the former as it is bigger and has more people to justify the development. Such a development will not favour River Town over Plantation Town.

18 MILE RADIUS FROM DISTRICT HOSPITAL

SUB CENTRES
(TOTAL 36)

HEALTH CENTRES

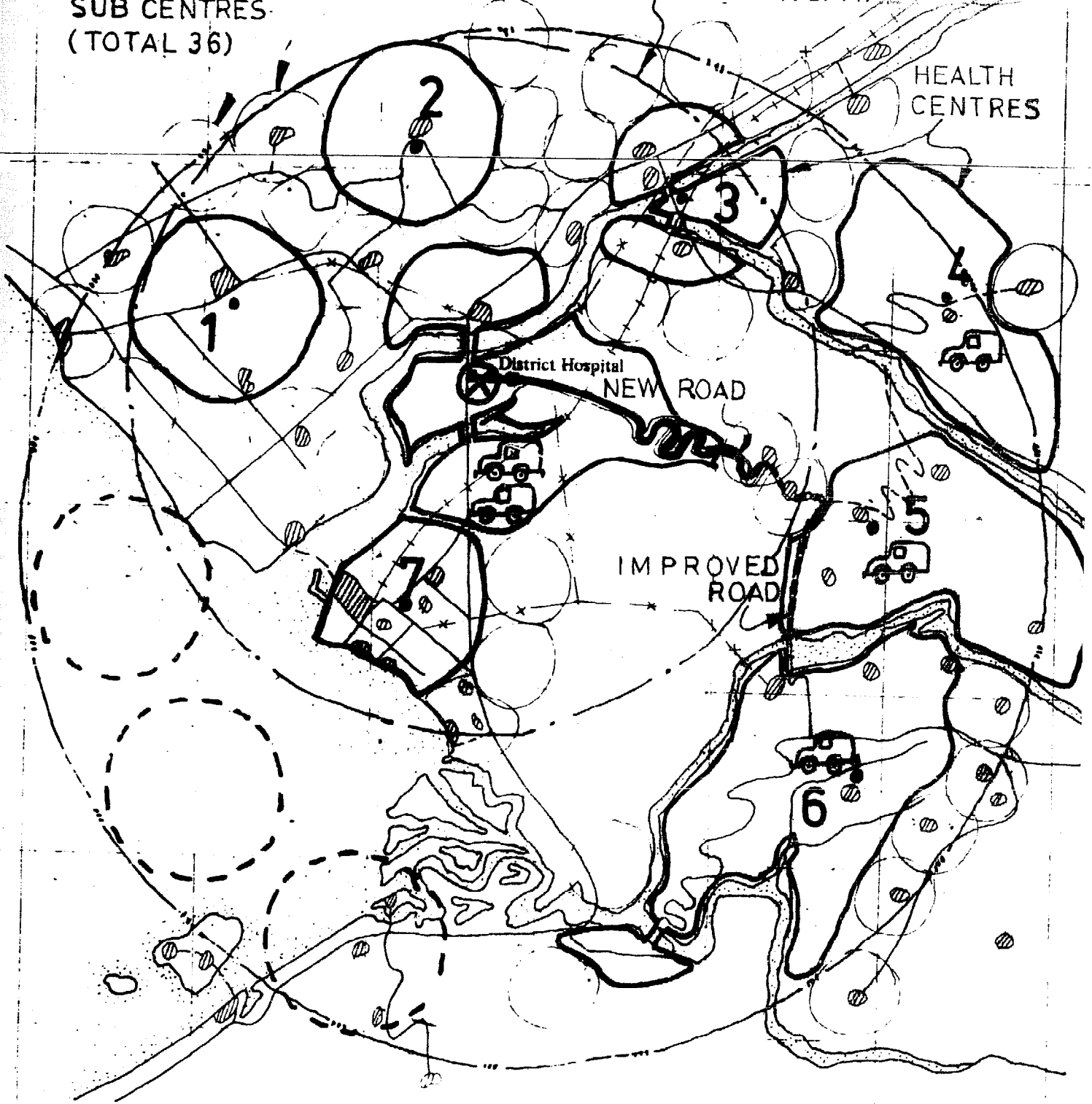

Appendix 44, Fig. 6

Shows a solution arrived at by following the principles discussed in this Appendix. This solution means a new road between Middle Town and the Hydro-Electric Scheme and Agricultural Uplands. The cost of the traditional scheme against the cost of the macro-unit scheme can be worked out, the cost of the new road against the improved road in Fig. 5 can be worked out, and the cost benefit to the community of the new road can also be worked out. It must be seen from this example that the macro-unit solution is very greatly preferable to the traditional solution.

at least in this case. Fisher Town is not well served, but it is right on the edge of the area, so the next door district group may offer an answer. River Town is also near the edge but is very well served by the new hospital. If the district unit is shifted so that the centre lies over Harbour Town so the existing hospital (which is obviously a problem) can become the District Hospital, then the Agricultural Uplands are badly served and the improved road is still needed and a new bridge will be needed to the plantation area. River Town is 35 miles away by road, Fisher Town is 50 miles away and Plantation Town, even with the new bridge, is still 30 miles away.

This example attempts to show that the macro-unit and the district unit can be used as a method of thinking about planning in real terms without expert knowledge. It is suggested that interested readers should copy the map in outline, but assume that it is at half the scale shown, i.e. that each square is 20 miles by 20 miles. Four district units will then be needed to cover the map, and the problem becomes quite different. Alternatively it could be assumed that four district units had come to rest, centred one on each corner of the map, leaving a gap in the middle. This again gives a completely different problem. The solutions to these problems are always stated in medical terms.

Approaches to planning

When setting out to produce any form of overall plan at a national level planners have a range of planning methods from which they can select. They can start from a certain point, usually the existing facilities, and expand outwards, they can start from a whole series of such points and fill in the gaps, or they can make some form of idealized statement and adapt it to existing circumstances. The method chosen is more a matter of emphasis than anything else as each of the systems must take account of the others. The approach of this report emphasizes the third method.

It is currently believed to be essential to conduct surveys before beginning to plan. The results of these surveys will, it is hoped, indicate the nature of the problem that is to be solved. The fallacy of this approach is obvious: the results of the survey will depend on the skill of the surveyors, how the questions are phrased, asked and answered, and how the resulting answers or lack of answers are processed. To give an obvious example, the answer to the question 'Is leprosy a problem in your district?' could be 'No' for four totally contradictory reasons:

1. 'There is no leprosy in the district.'
2. 'It is rife, always has been, we have no methods of treatment for it and no interest in attempting to treat it.'
3. 'We have a leprosy problem, the disease is not widespread, we have it contained and are doing very nicely, thank you.'
4. 'Yes, we do have leprosy, we think we ought to be treating it although we are not and have no intention of telling you about this failure.'

In countries with very well developed health systems reasonably precise surveying to establish reasonably precise ends is important, but in any country with a less well developed system it can usually be said that any facility will be welcome. The question then is, what kind of facility can we afford in staff and money terms? This question can only be answered securely when someone has said how much money can be afforded and how many staff are likely to be available. We hope to have put forward in this Appendix in the form of the macro-unit the bones of a complete organization which can be applied at a national level. Poorer countries will be forced to build smaller Centres with fewer staff than we propose: richer countries may build more elaborate Centres with more staff. But the object remains the same in all cases, and we stress and re-stress that the planning problem at the root is not one of money and staff but one of travel and communications and geography.

Few national plans are produced initially entirely in ideal terms. The planners' instructions are likely to read, 'How many Health Centres can we have in the next so many years for so much money in such and such an area?' The idea of more or less public forward commitment to very large plans is not one that is received with joy in political situations. In the medical planning field this thoroughly practical tendency to drag the feet receives apparent support from the often repeated idea that it is actually rather a waste of time planning anything in the medical field because everything is going to have changed so much by the time it is built that it

will not really be worth building it anyway unless it is 'flexible and amenable to change'. If adequate forward policy planning is carried through this problem can be greatly diluted.

The first question remains; where between walking and helicopters are we to set our communications systems over the next fifteen or so years, and can we relieve our medical problem by tying it in with other programmes such as roads, land reclamation and the siting of industrial areas?

We try to show that health is very much bound up with education and note that health and education absorb very high proportions of most national budgets. We are in fact suggesting that health planning and management can and should be seen as the principal social function of the state.

Using the macro-unit to establish an overall outline plan

People with limited experience in developing countries or an entirely theoretical understanding should understand that the solutions to the problems discussed in this Appendix are very, very complicated. The complication works two ways. Fig. 7 below shows the mainland of the British Isles 'satisfied' by two macro-units. A country the size of England 'needs' only twenty four hospitals. This is obviously nonsense in terms of population density, but in terms of a much smaller density this suggestion should bring home the appalling communication problems in terms of simple distance alone. Two district units side by side would reach from the centre of Bristol to the centre of London.

Fig. 8 shows the same number of units in the bottom part of India. In terms of covering the ground the problem in India is immense. India, like the UK, has areas of high density; but also huge tracts of wilderness. One cannot squeeze solutions from the macro-unit like toothpaste from a tube.

Fig. 9 shows the same units on a sketch map of Africa. Here the problem is very often one of very sparse populations which complicate the issue by being nomadic. The macro-unit works as an idea down to an average density of 77 people to a square mile, and can therefore be used overall as a calculator, but the average results must be readjusted area by area to the facts of geography and population, people and money.

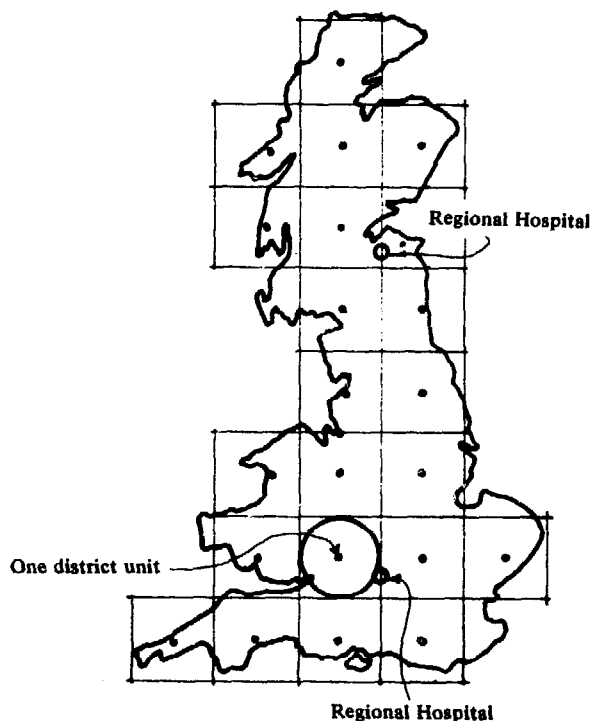

Appendix 44, Fig. 7
A map of England and Scotland 'satisfied' with 22 district units (i.e. 2 macro-units)

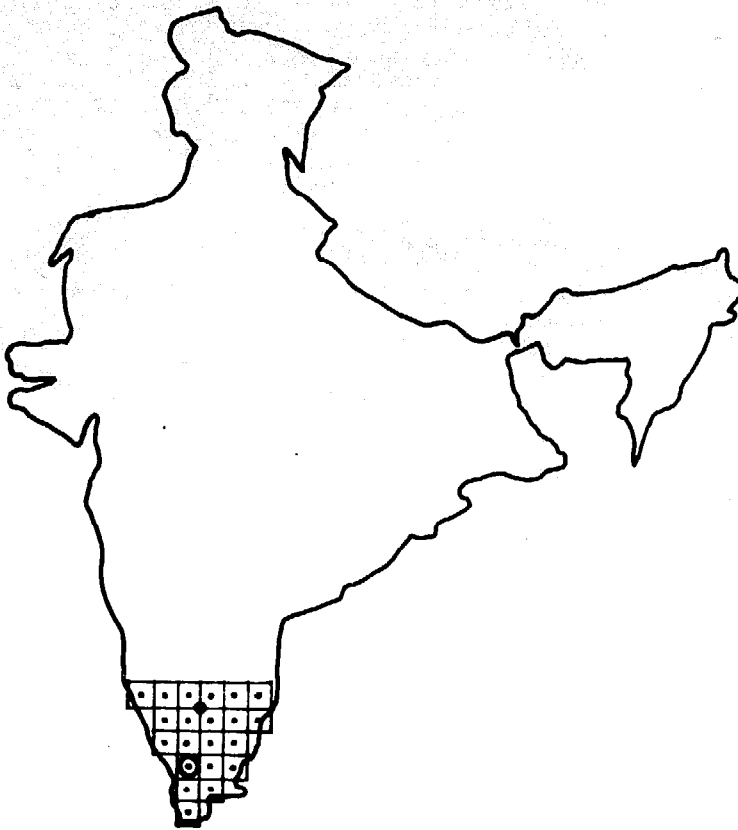

Appendix 44, Fig. 8
A map of India with the
same number of units
superimposed as in
Fig. 7.

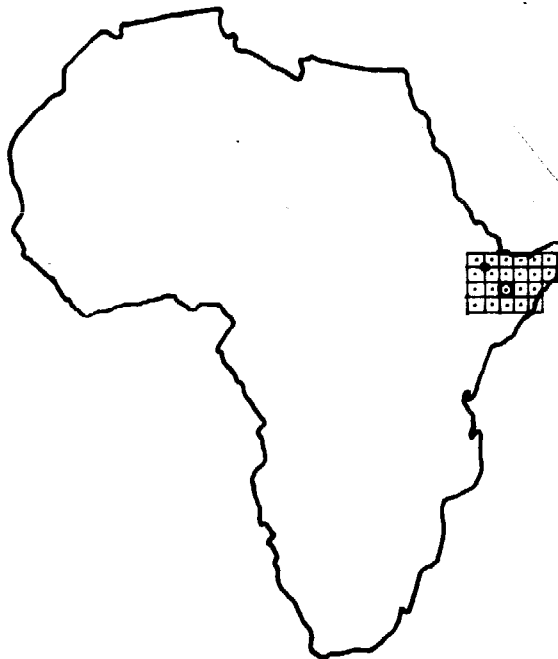

Appendix 44, Fig. 9
A map of Africa with the
same number of units
superimposed as in
Figs. 7 and 8.

A series of macro-units could be drawn on transparent material to the same scale as a map of the country concerned, and then laid over that map allowing not more than 30 per cent wastage for overlapping, or for parts of the tracing overlaying the sea or neighbouring countries. Used with a good will these tracings could give a rapid and tolerably accurate prediction in general terms or in some detail of almost any aspect of the health delivery network. The figures resulting from such a study would have to be adapted by reference to approximate densities but these can be further adapted to any particular country by adjusting the working party's base figures to suit the desired or practical staffing conditions for a given country.

The results of an initial exercise carried out in this way may be very unhelpful. The implications may be that many Centres and hospitals are needed in totally unpopulated areas or in virtually inaccessible mountains. By removing the tracings from such areas and reshuffling the remainder to cover gaps, better results may be obtained. It may be found that geography dictates one-and-a-half macro-units in one place and one-third of a unit only somewhere else. This still gives an answer of some sort and some use, this answer being phrased in terms of a medical organization and not in terms only of pre-existing facilities.

Without attempting the immensely complex task of positioning, sizing and working out individual Centres, then working out staffing and then finding the resulting proposals give requirements that cannot be met, the tracing approach may offer useful initial general answers. The macro-unit covers population densities averaging 77.7 persons/square mile. It appears to work 30 per cent down, i.e. at an average of 50/square mile and 400 per cent up, an average of 200/square mile. As the basic Model Centre works best in its own immediate orbit at 200 persons to the square mile the macro-unit will clearly cover very wide variations of population without the basic maths becoming useless. In these terms the macro-unit can be seen as a predictive tool.

As a planning tool the macro-unit requires very thoughtful handling. It may propose a District Hospital fifteen miles away from an existing hospital, and a Regional Hospital in an inaccessible area.

The existing hospital obviously calls for an intelligent compromise, but if the Regional Hospital seems, in medical and organizational terms, to be in the right sort of place although currently inaccessible, it may be that the place should be made accessible. In view of the high proportion of a national budget that health delivery absorbs this otherwise silly-sounding proposal might repay study.

Clearly there are many parts of many countries where the macro-unit is quite useless. Widely dispersed desert communities or extended river bank communities are special problems. What we have attempted is the production of a planning tool which will allow for the plotting on to a map of health facilities which will make overall as opposed to piecemeal development a reality!

At least the macro-unit sets an overall standard which, if it cannot be met by other means, should obviously be adopted. Moreover, it may form a basis for useful international discussion. Even if no one likes it at least everyone could discuss the problem in the same terms.

It must be remembered that nothing in this report attempts to account for mobile clinics, including for instance flying doctors, or for qualified medical staff of any sort whose time is principally involved in (1) teaching their disciplines, or (2) specialization benefitting a limited number of patients, or (3) research, or (4) medical ancillary services such as blood product work. In a country with a comparatively small population accepting a high ratio of patients to fully qualified doctors these latter groups can make an alarming reduction in the number of doctors available to serve a population.

Community conservation in planning

Throughout the more highly developed countries there is a growing attempt to establish a new balance 'between man and nature'. Whether this is to do with 'identity' or with the dignity of appearing to be self-supporting or with a mere wish to escape from the crushing machines into which our cities are turning it is impossible to say. But it seems possible that the 'backwardness' of rural communities

may be their major asset. It is to be hoped that health planners will respect the structure of communities and not try to drag them into the middle of that kind of 'civilization' we are learning to mistrust.

Where towns are salubrious, reasonably affluent and can offer good job opportunities there seems to be no point in attempting to keep people out of them. Where towns are overcrowded and unpleasant and unhealthy, then anyone interested in the overall health of a rural community will want to offer to members of that community good reasons for not leaving the community and going to the towns. This means providing an income equal in overall terms to that available in the towns, and distractions that at least equal the apparent distractions of the towns. Sports, agricultural improvements and the encouragement of local crafts and manufacturing are all that one can suggest. We should think about these subjects and attempt to extend the range. In many countries these problems and the possibility of dealing with them must seem many years away. In others, however, action can be taken now.

Problems in the future : ongoing care

Rural health services will need at least ten years to reach maximum effectiveness, which gives ten and probably twenty years to cope with the bones of the problem. During this time communications should improve and the overall picture will alter generally. But specifically, as the less complex aspects of the health problem are dealt with, the general standard of care will have to rise. Training programmes must look forward to this happening.

As child health and family planning make their impact, the problem for Health Centres will shift from maternity and child care to more standard adult problems. This shift must also be anticipated.

Further, as communications improve so the posting of patients to larger hospitals becomes easier. There can be no doubt that the District Hospitals we are looking at may be small and could at least double in size before becoming at all unwieldy. They should be planned to accommodate this expansion, and doctors should be trained to work in this kind of hospital.

Reducing families and increasing general health breaks the poverty bonds that stick families together. This, classically, results in a movement to the towns by the younger people, leaving incapables, the aged, the infirm and the mentally disturbed on the hands of the community. What will be the District Hospital's responsibility then?

Will Health Centre staff be trained eventually to cope with this problem of changing social structure? Will the reliance on the Health Centre for so many forms of guidance we are encouraging lead to an emasculated population unable to cope with its own problems? It seems likely that the Health Centre should disengage to some extent from the population it serves as the quality of health care increases. The current tide of opinion in favour of Health Centres may possibly be seen as a passing phase. The success of the Centres should lead to their progressively losing importance.

The next phase is the extension of our thinking into making an on-going community health care structure. This is a complex subject much involved in politics. But it seems worth while asking if there is anything we can do now to ease into this next phase. First, there is the expression of the community as a community - the making of a social environment to which one not only belongs but of which one is proud. The social area is the beginning of such a transfer of community from a ritual to a more formal basis. Immediately one must think of a 'Youth committee' whose useful object is to engage and maintain the interest of school children in the kind of service to the community to which we hope they will become conditioned.

There is also a responsibility in food growing. Well managed crops mean cash, cash is mobility. Mobility is important in a society changing from a family structure to an individualistic structure. Subsistence agriculture can be improved, but making people stick to fairly hopeless land where there is an alternative is not acceptable. A national layout of health facilities should rightly take account of possible rural resettlement.

The design of simple operating theatres

It is common knowledge that the ideal operating theatre is a new table of some sort in a fresh sunlit field on a cool summer day, using new instruments and apparatus and throwing everything away at the end of the procedure, moving to a new field for the next procedure.

Each successive patient in an operating theatre is a danger to himself and the next patient, and is exposed to infection risk from the previous patients and the staff, the goods in the theatre, the fabric of the theatre itself and the air. The more theatres there are in a group, the more complex the layout, the greater the risk of infection, cross infection and re-infection.

The ideal theatre does not exist. The best theatre for an unsophisticated hospital is an easily cleanable room with good cross ventilation from a non-infected area, well separated by an open lobby from infective sources but closely related to an area where patients recovering from anaesthesia or surgery can be visited by the anaesthetist or his equivalent without breaking what the organization in question decides is a reasonable and safe scrub routine.

Traffic in and out of the room during a procedure should be kept to the absolute minimum. One sees attendants walking from theatre to theatre with a jug of 'sterile' water topping up bowls. This is a lethal practice. One sees the floor sparsely mopped with a mop from an inadequate bucket of disinfectant between procedures. No mopping would possibly be preferable. One sees air conditioners recycling air through filthy 'filters', concentrating and broadcasting organisms through the unit. If air conditioning is used it must be very simple, the plant must be duplicated against breakdown where the plan relies on the air conditioning, the air must only be used once and drawn from a clean source (just above the roof or at the eaves is very wrong - wind pressure causes concentrations of organisms in these areas) and the air conditioners must be kept going all the time at low speed so that organisms cannot get into the ducts and breed 'out of hours'. No air conditioning is infinitely safer than an incompetent amateur installation. In particular, air conditioning cools the building fabric. When the machine is turned off there can be bad condensation.

The best possible operating room in a small hospital or Health Centre will stand more or less on its own in a clean part of the site, well surrounded by air that will disperse incoming and outgoing infections.

An acceptable method of cooling is a moveable floor-standing fan outside the theatre blowing in through the window in the same direction as any breeze.

A reasonable size for a theatre is 15 feet x 18 feet, a good size 18 feet x 18 feet; 20 feet x 20 feet is a big operating room. 10 feet is a good height, and the height for which most lamps are designed. Quartz iodide lamps are cooler than traditional lamps. Beams supporting lamps from high 'cool' ceilings catch dirt and infection. Big spreading overhanging roofs outside the cleanable space will promote a large shade volume and make a cooler theatre.

Anti-static boots are better than anti-static flooring as the latter, in all its forms, is difficult to lay. Anti-static flooring plastics may not stand up to rough wear in primitive practice. High humidity renders explosions unlikely. Well laid terrazzo is very satisfactory, but dense and well laid cement screed with a proprietary anti-dust additive is easy to repair and replace and can be ripped up if not satisfactorily laid in the first place. Smooth cement-rendered walls and ceilings with washable good quality paint are very acceptable. Tiles have joints which get dirty. Very finely jointed marble is available cheaply in some countries. This makes a good impervious wall finish, but it must be put up with no hollows behind it (find out by tapping with the knuckles and listen for a hollow sound) and should be thoroughly tested first with the proposed cleaning compound.

Sterile supplies can safely come in simple packs in linen on cafeteria trays providing there is a pressure-steam autoclave to the specifications noted in Appendix 15 on sterilizing. They can be carried in this way safely and over reasonable distances but must be kept dry. If there is no pressure-steam autoclave a flash sterilizer (see Sterilizing Appendix) can be used but wrapped goods are safer. If there is no autoclave of any sort a large stock of infrequently used instruments prepared with very great care may give adequate results, but procedures attempted must be kept uncomplicated and well spaced, three or four in a day probably being a maximum

in any given room. A doctor visiting and anticipating he will have to do operations could carry hospital prepared theatre packs with him. With care very few instruments are needed.

These notes may appear to be offensively simple, but if there is almost nothing to go wrong less things can go wrong. Modern operating theatre design attempts to pack lots of theatres into a manageable area with the object of feeding lots of patients through the system with an acceptable infection rate. These criteria are totally irrelevant in Health Centres and rural small hospitals.

Isolation, good natural ventilation from a clean source, radical simplicity and common sense are the principle features of unsophisticated theatre design.

Figures in themselves may be 'true' or not. 'The average population density of somewhere is 180 people to the square mile' may be true if the count was right, if the area was measured right (did they include lakes?) and if the maths was done correctly. Only in the broadest terms is the figure any use. We need to know the proportion of urban against rural population, any virtually uninhabited areas and their size and how many big towns there are before the figure becomes truly useful. Setting up comparisons is useful. 'The average population density of somewhere is 180 per square mile, and somewhere else which is similar geographically is only 105': if the reader knows one he knows a lot about the other from the simple figures. Alternatively 'somewhere, a grassland economy, has an average rural population density of 10 persons to the square mile whereas somewhere else, a plantation economy, has 105 average rural population density' tells us a great deal that could be useful without reference to the countries concerned. Faced with the lack of the most basic organized statistics for all the countries where the Model might be used the working party has evolved the macro-unit to cover a big enough area and sufficiently widely varying population densities to make the theoretical planning exercise 'realistic' (see Appendix 44). We list at the end of this Appendix the kind of generalized figures we have used, or, in some cases, guessed at. We have found it encouraging that the auxiliary based Health Centre network we discuss responds to changes in situations in a way which traditional hospital based care systems will not.

We have found that some studies which would, we thought, be helpful in putting together a list of useful figures have not been helpful. Too often the studies, however well intended, have not been planned or published in a form which stands questioning. It is no good setting out to study 'The Effect of Auxiliaries on Health Care Delivery'. The study would take far too long and is lacking in definition. 'A study of four same sized areas with similar problems of malnutrition and similar populations to compare the effects on the problems of malnutrition introducing:

1. a hospital based system to area one
2. a mobile clinic system to area two
3. a resident auxiliary to area three
4. leaving area four without care (in order to establish control conditions)

the comparison to be made with reference to cost (which is taken to include.....), to efficacy, which shall be judged against improvements in deficiency and apparent number of new cases of the following diseases....., and with reference to long term benefit over the next years which does not form part of the present study but has been allowed for in planning the study' is precise if complicated. Such a study would have to indicate why the areas chosen are similar, would have to define 'cost' (does it include costs of training personnel?) What the current deficiencies are (not might be) and how the diseases that are to indicate progress are to be categorized and what constitutes a 'new case' and what the incidence is at the beginning of the study in all four areas. The method of treatment should be the same in each area, as should teaching methods and the methods of collecting information. Specially clever people and extra special efforts and equipment should not be used. The study is set to test the comparative effectiveness of auxiliaries in the community as opposed to visiting teams or hospitals. All three groups would have to do everything in their areas - not just deal with nutritional problems. The study would cost quite a lot and would have to run for at least two years, but at the end of the study clear if limited answers would be available.

The study outlined above might have useful side effects. It might be found that the hospital and doctor orientated areas did much better with some conditions and not so well with others. This might indicate the lines for a further study, but should not confuse the limited aim of the study. The answer to the study might be that results were equally good in the chosen fields but that the auxiliary did the job at a much lower cost. This would, in the terms of the study, show a preference for the auxiliary. If, on the other hand, the auxiliary did desperately badly on other matters such other matters should be reported in the published results so that the reader can have a chance of interpreting the results.

Another kind of statistic we have met is 'Fluctuations in admissions to hospitals by age, disease etc. throughout the year.' Such figures are very interesting if you know the country, how travel is affected by rains, when is seed-time and when is harvest, when are most children born, is there a migratory population etc. This

kind of statistic should be the starting point of a study entitled 'Would treating the following conditions at village level stop the annual peak of hospital admissions in such and such a place and culture and would such prior treatment be more or less expensive than dealing with the peak at hospital level'.

Doctors in hospitals have traditionally set out to treat almost every known condition. Only facilities and qualifications have limited the range of work that can be done. It has therefore been possible to build a hospital and open its doors to whoever comes with whatever condition. Auxiliaries will have more limited aims and facilities. When a new Centre is opened it is very important to set clear aims for it. Unless clear aims are set it will not be possible to judge the Centre's effect. Within each set discipline measurable aims are needed, and the possible effect should be assessed before the Centre starts work. If a detailed prior survey cannot be carried out, then an experienced person or team must sit down and list probable problems and possible solutions and means for putting the solutions into effect. The costs and resources should be listed and numbers of staff and their appropriate training estimated. These lists then form the statistical basis for the future internal evaluation of the scheme - is it running behind or ahead of forecast? Ideally a scheme of a different sort serving the same kind of population will be recorded and analysed in very much the same terms. Given these conditions it is possible to ask 'are we doing all right, are we doing the right thing, and perhaps we ought to try so and so?' Unless statistics can serve these purposes they are not much use.

Finally, statistics can be bent. The bending can vary from 'auxiliaries 100 per cent successful in surgical work' (what were they doing?) to 'major study reveals that auxiliaries caused more deaths in certain fields than malnutrition' (what fields - brain surgery? or how does an auxiliary cause malnutrition? or does an auxiliary not trained to remove appendixes 'cause' the death of a patient he cannot treat?) Insufficient information is given. Graphs can also be used to make points that do not exist or else the graph itself can be described as opposed to the subject. Thus a graph showing survival rates will dip when deaths increase in number and frequency giving the possible interpretation 'killer disease - dramatic drop shown in Ministry tables'. Similarly, a graph with two lines, one showing national birth rate the other specific treatments given could lead to 'treatment fails to keep up with growing population' when the fact is that progressively fewer treatments are needed because the condition is well under control. Graph scales can also be used to dramatic effect. This is shown in Fig. 1 following, where the last 20 items in say 10,000 cause a 'dramatic rise'. Fig. 2 puts the same rise into proper perspective. The statistics given in this Appendix are very broad indeed. We hope this will make it difficult to prove things with them that they were never meant to prove.

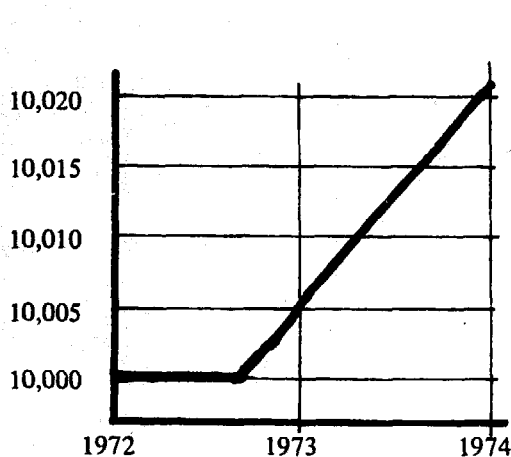

Appendix 46, Fig. 1
'Dramatic Rise!' achieved by starting at 10,000, then going in fives.

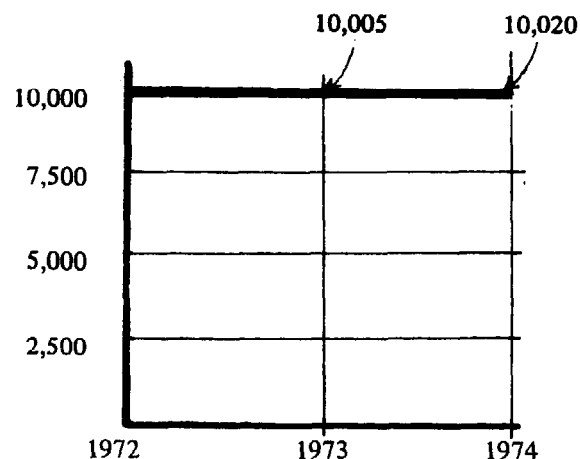

Appendix 46, Fig 2
The truth behind the 'Dramatic Rise' in Fig. 1.

Some general statistics

1. Sizes of 'Health Care Blocks'

India from 80,000 – 200,000 people depending on density

Nigeria (1965) 1 dispensary per 15,000 – 25,000 people
1 maternity home per 30,000 people
1 leprosy village per 100,000 – 300,000 people

This report 1 Centre per 20,000 people
1 'district group' per 200,000 people

2. Size of population seen by auxiliaries in Health Centres whose referrals will keep one doctor acting traditionally busy – 50,000

3. Acceptable travel distances for patients to Health Centre and hospitals:

This report to Health Centres, 5 miles in reasonably open, reasonably flat countryside

Zambia to hospitals

1 patient in 2 from 3 miles average distance
1 patient in 3 from 4 miles average distance
1 patient in 5 from 12 miles average distance
1 patient in 17 from 16 miles average distance
1 patient in 46 from 23 miles average distance
90 per cent of patients came from within 20 miles
8 per cent of patients came from within 30 miles
2 per cent of patients came from within 100 miles
(most, but not all, were referrals)

4. Travelling speeds

This report Allowing six hours for referral trip by available transport:

Walking at 3 miles per hour – 18 miles (very good walking!)
Bullock cart, 3 miles per hour – 18 miles
Vehicle – 30 to 300 miles depending on roads etc.

Where the terrain is very difficult these figures will be very much reduced. In high altitude mountainous country in a cold season three miles might be an impossible journey for a sick person on foot. River travel will depend on craft and current. Travelling down a swift flowing stream a canoe or dugout may achieve 12 – 15 miles per hour but might find the return journey impossible.

5. Population distributions

Generalized Developing countries – urban 25 per cent rural 75 per cent
Europe – urban 75 per cent rural 25 per cent

6. Age distribution

Generalized Developing countries:

under fives 20 per cent
five to fifteen 25 per cent
adults 55 per cent

Europe:

under fives 5 per cent
five to fifteen 15 per cent
adults 80 per cent

Zambia under fives 40 per cent
five to fifteen 15 per cent
adults 45 per cent

7. Attendances and Admissions

Outpatient attendances at typical Centres:

adult male	approximately 10 – 15 per cent
adult female	approximately 30 – 40 per cent
children including under fives	approximately 40 – 60 per cent

Inpatient admissions at typical Centres:

adult male	approximately 5 per cent
adult female	approximately 70 per cent
children including under fives	approximately 25 per cent

These figures reveal the bias to maternity and child care in existing Health Centres and should prompt hard questions about training and intentions.

Attendances at urban hospitals in developing countries:

adult male	25 per cent
adult female	30 per cent
children including run	under fives where such clinics 45 per cent

Admissions to urban hospitals in developing countries:

adult male	30 per cent
adult female	40 per cent
children including exist	under fives where adequate facilities 30 per cent *

* This figure can be very misleading. Exported Western practice takes little account of children, with well under 20 per cent of the population qualifying for a potential place in a children's hospital (see section 6). In some developing countries about half the population are potential children's bed occupiers.

8. Proportion of patients seen at hospitals that 'could have been dealt with by auxiliaries if seen earlier'.

India ('Contact', 17th October 1973)

Outpatients	\pm 50 per cent
Inpatients	\pm 45 per cent

N.B. These are hospitals under great pressure. Also note that this study, as published, did not define either what the auxiliary was to do or what proportion of those diseases which auxiliaries could have treated earlier (called 'preventable') could have been further reduced by sanitation projects etc. But note further that approximately 50 per cent (in very round terms) of the patients going to the hospital needed, in the terms of the study, to see a doctor. Given a wider spread diagnostic net more doctors' cases (called 'non-preventable') would appear. Clearly hospitals are of vital importance unless auxiliaries are to be given wide ranging skills. Conversely, some authorities claim that curative work in hospitals has only a negligible effect on national mortality figures, quoting figures as low as one-and-a-half per cent which is ridiculously low when set against the cost of the hospital service and the figures quoted above. Where does propaganda end and fact begin?

9. Ratios of doctors to patients

Generalized	world-wide	1 : 2500
	better off countries	1 : 1000
	worst off countries	1 : 500,000

These figures are often used to show the imbalance and injustice of the world-wide distribution pattern of doctors. Whether the facts are 'fair' or not, it is certain that many countries must either accept nil effective health delivery or go for an auxiliary system.

10. Beds per 1000 population:

world-wide	- 2.5 to 3 beds per 1,000
better off countries	- 8 to 9 beds per 1,000
worst off countries	- 0.5 to 1.5 beds per 1,000

Bearing in mind the admission figures given in 7 where 70 per cent of Health Centre beds are essentially for maternity work and bearing in mind that the worse off countries tend to rely on Health Centres it will be seen that the fact is much worse than the figures reveal. Something like 5 per cent to 15 per cent only of the beds per 1000 shown will provide for the adult male population. In these countries there is no possibility of a hospital based care structure.

11. Training times in developing countries

6 - 7 years training from 18 years old	- Doctors
5 - 6 years training from 16 years old	- Nurses, Radiographers, lab technicals etc.
4 years training from 16 years old	- Midwives *
3½ years training from 16 years old	- Assistant nurses
3 months to 1 year training from 16 years old	- Junior lab. assistants, auxiliaries etc.

*Midwife training is being lengthened in many countries at the present time.

Doctors' training does not necessarily mean 'fully qualified'.

It is very difficult to believe that 7½ months average training from 16 years will adequately qualify an 'auxiliary'. 'Principals' in this report are experienced nurses in most cases, with a five or six year training.

Traditionally, governments providing health facility buildings tend to send officers to a place (possibly having asked some questions some time before) to start erecting a building. When it is finished the equipment arrives, then the staff arrive and open the doors. This approach is wasteful of the human resources in the neighbourhood. It clearly makes budgeting more difficult if local people are going to help, but it seems doubtful whether the extra administrative costs which may arise will exceed the possible direct money saving, and it is probable that this early constructive involvement will form a good basis for future co-operation between staff and patients. This kind of co-operation becomes essential as the emphasis shifts from curative to preventive and community medicine.

Staff can get a Centre going well before the buildings are completed. Early local contacts can be made, the schools having a particular role to play here, and the staff can get to know the district and its problems, meet agricultural advisers and establish contacts with the local hospital if one exists.

Ideally we would like to see some of the eventual staff starting right in at the beginning of the project. To this end the following notes have been prepared bearing in mind people with restricted building experience and limited access to professional advice. As some people working for non-government bodies may wish to establish Centres, the notes go into some detail.

Available resources

You will be working with, or will need, the following:

- Existing Public Health Services
- Agricultural Advisory Services
- The Social Structure and the Community
- Schools
- Knowledge and understanding of the problem
- Examples to be adapted or followed
- Land
- Building materials
- Water
- Roads
- Bridges
- Accessibility
- Money

Avoid

- Too small sites – see Appendix 41.
- Sites with a high water table, that is to say with standing water in the soil to within two feet or three feet of the ground surface. To test for this dig a hole in the wetter season (not when it is raining) and see how it fills up. Drainage is a problem with a high ground water table.
- Sites that will or may flood.
- Sites close to an existing fly source or, for instance, just downstream from a village latrine point.
- Sites unduly shadowed from the sun by hills.
- Sites near the most difficult river crossing.
- Disputed land and land which is unacceptable in the local culture.
- Sites hemmed in with hills where a radio-telephone would not work.
- Inaccessible sites, however jolly the view 'from just a little higher up'.

Good sites are:

- At a centre of communications.
- Associated with an 'organized' village with a clear social organization, a sense of responsibility and a school.
- Slightly elevated.
- Well drained.
- Having a good water source or possible catchment or piped water.
- With a good disposal, burning and possibly a sewage treatment area down the prevailing wind.
- With its longer axis suited to the layout proposed.
- Big enough for an airstrip if possible or near a piece of road that can be used for this purpose.
- With access to mains electricity if available.

When resources — money — need — staff — have been ascertained:

1. Work out site size
2. Sketch a plan and put sizes on it in general terms; use squared paper for this and allow 20 per cent minimum over what seems to be a good size.
3. Look for a good centre of communications, or at least the best available — do this on a map with someone, anyone, who knows the catchment area.
4. Rough on to a map approximate population spread and density. Inspired guesswork is better than siting a Centre by a stab in the dark.
5. Go to the area that seems to be best and review the villages and the people, the chiefs, the schools, the local agricultural advisers.
6. Choose a reasonable site in or by a village that is somewhere near the bottom of a list of villages headed by the 'nicest and best run village', but one that you think will be reasonably co-operative. The best villages will help themselves.
7. Check for water resources, then work back up the list of possible sites till you find adequate water by drilling, by spring or by run-off and storage.
8. Use any local advice you can.
9. Check land ownership, cost and availability, then have a meeting with the locals.

The first 'site meeting'

This is to be a community effort and a community responsibility.

Having made a preliminary selection of the site, the possibility of a Centre should be discussed with chiefs, teachers, agricultural advisers, and other leading members of the communities. It may be advisable to include any 'folk' doctors in these discussions, and it is clearly extremely important that any representatives of the government in the area should be fully informed of what is going on and should be given every chance to comment. The ideal object of this site meeting is to get the local people actually to ask for the Centre to be in their area, to tell them in simple outline what the Centre will do and what the community must do and to leave behind information in some suitable form for the local community to discuss within itself.

You should then take home with you answers to questions like 'How much does the river flood?' or 'How much rain can be expected?' Ideally you will know the area in wet and dry seasons.

At this stage you should also stress that the Centre may well be built, not that it positively will; you should avoid promises on programmes if you possibly can. Few communities can maintain long-term enthusiasm about a project which is to them highly theoretical. There is perhaps some advantage in getting things moving on the ground at a comparatively late stage when you are sure of finance, staff, programme, etc.

The planning stage

Following initial site selection you must establish legal ownership of land, costs, available money and staff, plans, equipping, availability of builders etc.

It is suggested that at this stage you can use the Model plan or part of it. Whilst it may not be what you intend to build, it gives you something concrete to discuss with government, donors, builders and friendly people in the medical and building design professions.

When you know more about the project, you should return to the site again and give it a cold reappraisal to see if it really suits your needs, which you should be beginning to know in very much more detail.

Implementation of the project

Having worked out your requirements from the Model plan and having decided either to use the Model or having drawn up your own version, it is time to return to the site and work up local enthusiasm. The site should be pegged out and cleared; leave as many good trees as possible, remembering that some very attractive large old trees may drop branches on your new building. Clearly this setting out should

be done with local help. The social area and the hostel area, which are very much the community's contribution, should be given prominence in the ritual of setting out, and it is important that an adequate approach road be secured. The sinking of wells, the draining of land, and the digging of sewage lines can well be put in hand early as they require limited technology and are very visible achievements.

If water is to be collected by catchment, the catchment area must be cleared and suitably prepared, and cisterns or water towers erected early as water will be needed during the building process.

We have sited the store on the Model plan at the entrance to the site so that it is easy to get at without having to go through what may well be a rather muddy site, and suggest that this is the first building that should be built as cement, building materials, block processing etc. can be stored securely and dryly. Additionally, if mud bricks are being used, they must be stored out of the rain.

If the building period is to extend through a rainy season, you should programme pessimistically so far as works in the ground are concerned, otherwise the soil in trenches gets very wet and loses its strength leading to later subsidence of foundations and the caving in of trenches.

The following sequence of building has much to recommend it:

1. Secure delivery of cement and stones, dig foundations, lay in foundations and stones over the area of the building putting smaller stones on top and finishing with cement. This initial finishing cement can be quite thinly and unevenly spread providing it has a reasonably sound top surface. It does not matter if it cracks. Do not forget to put into the groundwork any pipes that you need for electricity, water and drainage.
2. If you are going to have a steel or wooden frame building, make the small bases in stone, brick or cement on which the columns will stand up to their proper level. Towards the end of these works secure delivery of the frame and roofing finish.
3. Now erect the frame and the roof structure and put the roof on. If you are going to hold the roof up with walls and not columns, use temporary timber or bamboo struts to hold the roof up and complete the walls up to it later.

From this point on the building sequence is very much a matter of choice. The following points should be borne in mind:

1. If concrete blocks are used they benefit greatly from being soaked in water for not less than three weeks and if possible longer, the same applying to pre-cast reinforced concrete lintels over doors and windows.
2. If you are using a cement screed floor, lay it on at least two inches thick and preferably thicker, lay it all in one go, and turn the edges up as a skirting not less than four inches. As soon as the cement is reasonably hard, pour water over it to the full depth of the skirting and leave the water for at least three days and preferably longer. This 'cures' the cement. You will obviously have to block up outside doors to stop the water pouring out and you will have to build internal partitions to at least skirting height before laying the screed.
3. All timber should be treated with an anti-insect fluid. It is essential that a coloured fluid be used, and if the only available fluid is clear, then put ink or dye in it so that everyone can see what has been treated and it becomes unnecessary to ask. Where the ends of timbers are being built into the walls it is necessary to stand the timbers on their ends in buckets of preservative.
4. The Building Research Station in England has suggested that a concrete sill sticking out all round the building, six inches to nine inches off the ground, protruding four inches or five inches with a substantial rounded groove in its under side, will discourage termites.
5. No wood should be left in the ground.
6. Drains at ground level round buildings that do not have gutters are essential as they catch water running off the roof and stop it churning up muddy

puddles. If the pre-cast concrete variety, common in most countries, or some equivalent local product cannot be afforded, lay bands of stones and gravel around the building in trenches, the bottoms of the trenches sloping away to soak pits or surface drains.

7. Where you think there will be a lot of traffic on a particular line, there is much to be said for laying some form of hard surface in wet countries. A simple form is a trench with a cross sloping floor filled up with stones and gravel.
8. If you have a thin roof material you must ventilate the roof space, and aluminium faced foil, either plastic, paper or thin metal sheet should be laid over the top of the ceiling. This reflects heat very efficiently. Insulation, such as fibreglass quilt, unless it is foil-backed, is useless. Occasional boards should be laid over the foil so that dust can be swept off it periodically with a feather duster. Where climates have a wide range from hot to cold, insulation to keep the heat in will be necessary during the cold season. The ideal material is foil-backed fibreglass quilt over the ceiling foil side up. Fly screening to keep out insects and birds, bats, rats and mice, must be put up to cover the ventilating slots at the eaves.

Summary

In general terms the most important thing to achieve is community co-operation. This will cut the initial and maintenance costs radically and lead to a more meaningful delivery of health care. In practical terms, the most important person is the builder or the person in charge of the building work and unless he is obviously a rogue, his advice on structure, timber sizes, drainage etc. should be sought and followed. The sooner you can get the builder or building supervisor involved in the planning stage, the better.

Orientation of buildings, their construction and environmental considerations

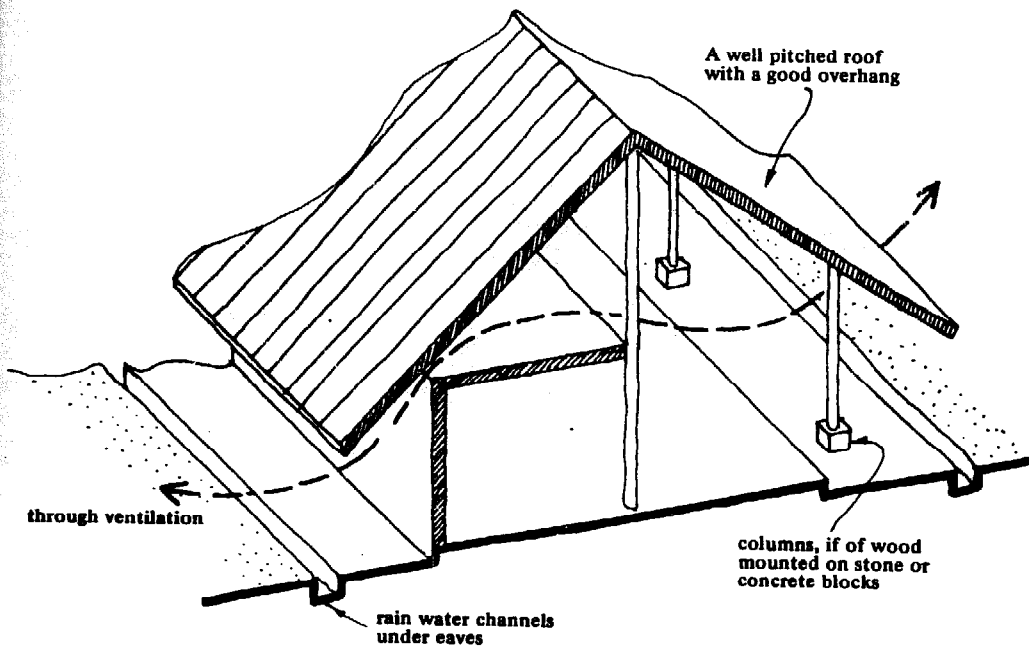

**Appendix 48
Orientation of buildings,
their construction
and environmental
considerations**

**Appendix 48, Fig. 1
The main features of
a building in a hot
country**

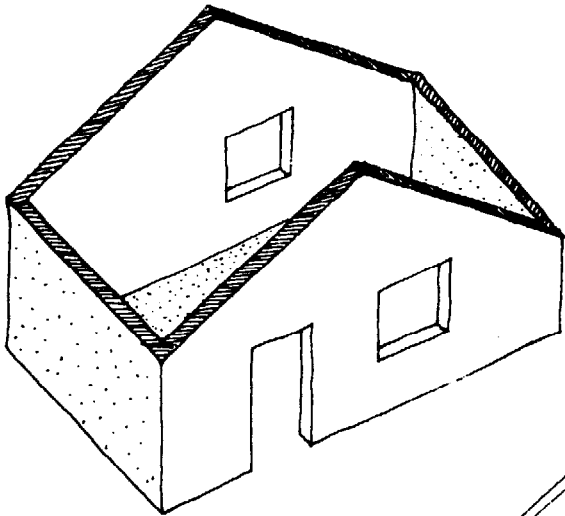

Fig 2. Roof supported on walls

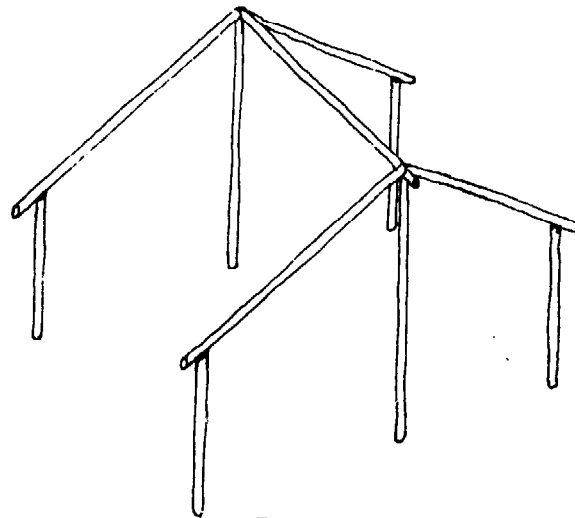

Fig. 3 Roof supported on columns

**Appendix 48, Figs. 2 and 3
Alternative means of
roof support**

Many simple materials such as bamboo or other types of wooden pole will span up to 16 feet, but not much more

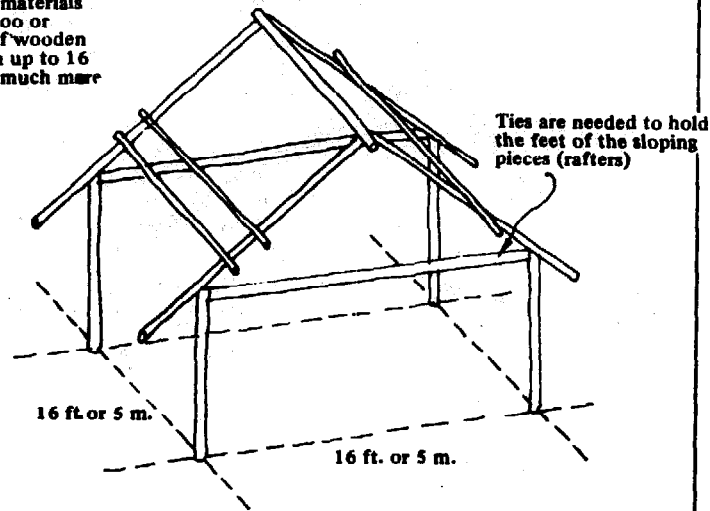

Fig. 4

16 ft. or 5 m.

16 ft. or 5 m.

Main walls can be erected at the same spacing

Appendix 48, Fig. 4
Sizes and materials
for simple structures

Alternatively fairly simple roof trusses can be made up to span longer distances. Trusses cost more and require more skill to construct. The simplest roof truss will give a span of about 24 feet, 7 metres, which is not really sufficient for a more complicated building. A truss can have an overhang beyond the supporting column or wall.

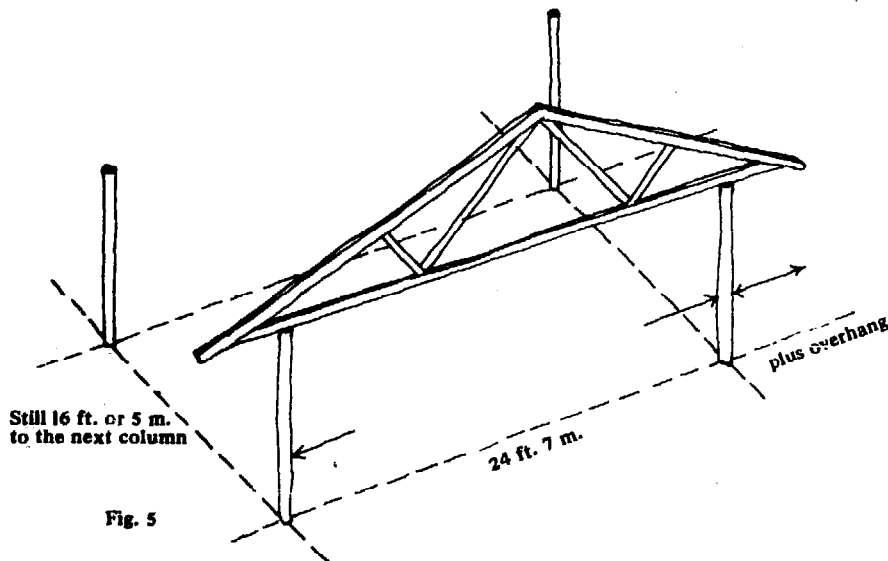

Fig. 5

Still 16 ft. or 5 m. to the next column

24 ft. 7 m.

plus overhang

Appendix 48, Fig. 5
Roof trusses

If buildings are being mass produced, steel trusses, which will span 32 feet, 10 metres, will simplify construction, but will be more expensive than local building methods.

Dimensions in the Model

The Model is designed with columns every 16 feet along the outside walls and is 16 feet or 32 feet wide. Walls could be put in instead of columns. The clinics building is 32 feet wide, the wards and central facilities are 16 feet wide, as shown in the diagrams below. Trusses are not needed.

Appendix 48 (ctd.)

Fig. 6 Wards and central facilities

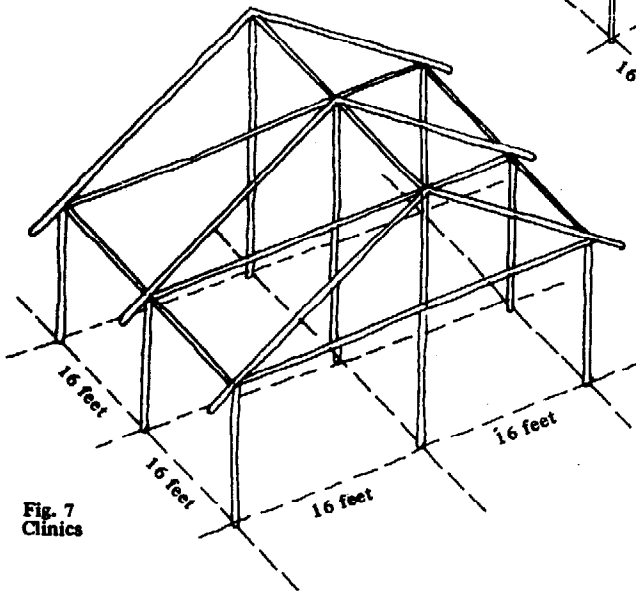
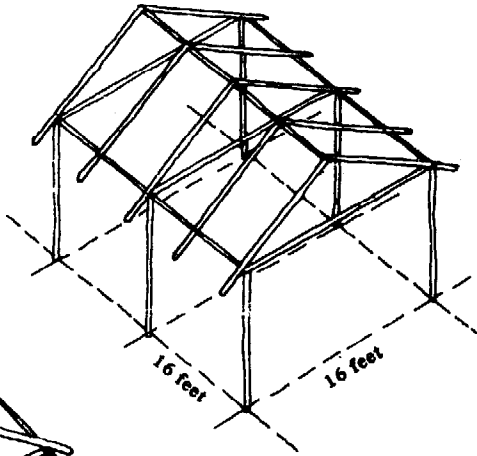

Fig. 7 Clinics

Appendix 48, Figs. 6 and 7
Dimensions in the Model

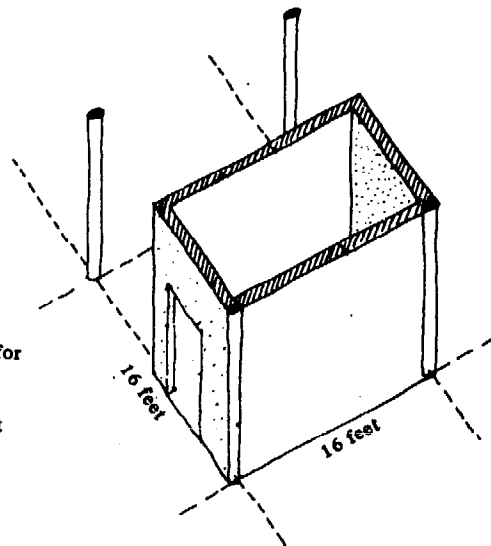

Fig. 8 The size chosen for the Model gives a good size examination room. On this sketch the columns are shown built into the walls.

Appendix 48, Fig. 8
An examination room

Fig. 9. 16 feet gives a very generous room width for beds down one side only, but is too narrow for beds down both sides.

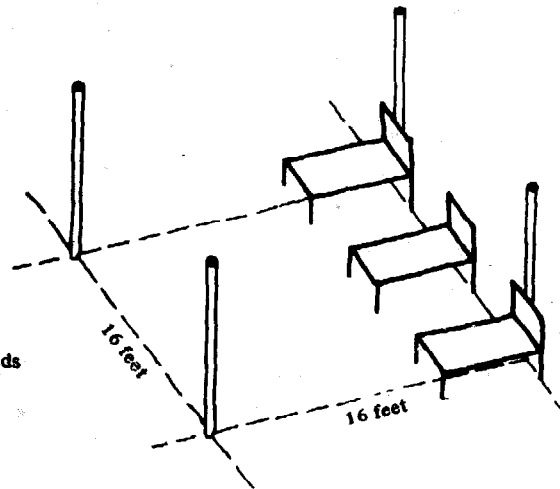
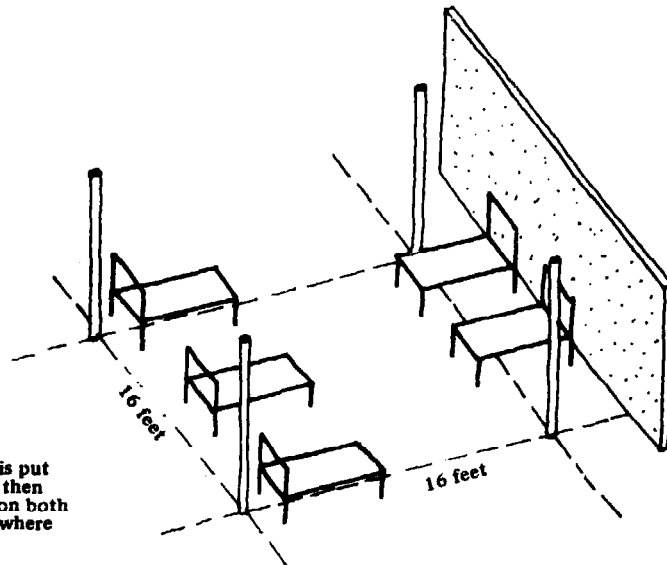
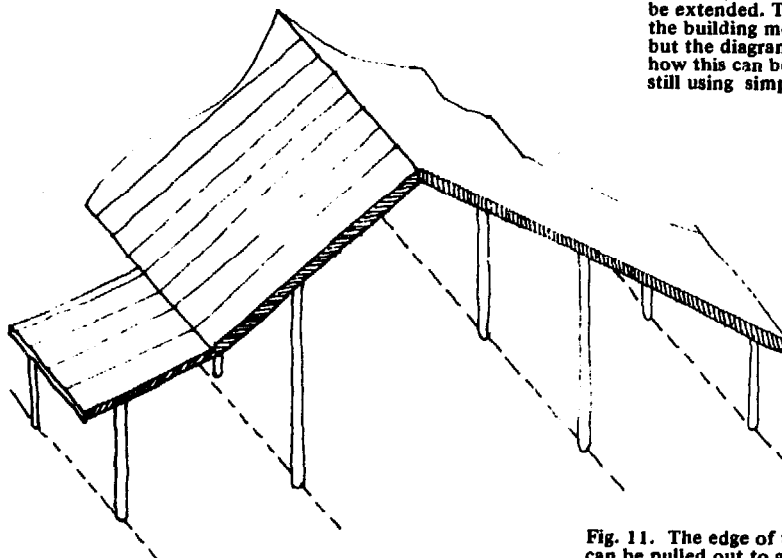

Fig. 10. If one wall is put outside the columns then the beds can be put on both sides, omitting beds where necessary.



If it is necessary to move the walls outwards the roof must be extended. This makes the building more complicated but the diagram below shows how this can be done whilst still using simple materials.



Extensions can also be made at a lesser angle than the main roof to give better height at the outer edge

Fig. 11. The edge of the roof can be pulled out to give extra shade or extra space inside as required in Fig. 10. A row of small extra columns will be needed to carry the extension.

Appendix 48, Fig. 11
Roof extensions

Fig. 12. A ceiling with a ventilated space over it makes a building very much cooler. Aluminium foil laid over the ceiling supports reflects heat very effectively. The ceiling adds to the cost but makes a big difference to living and working conditions. Good ventilation of the roof space above the ceiling is essential.

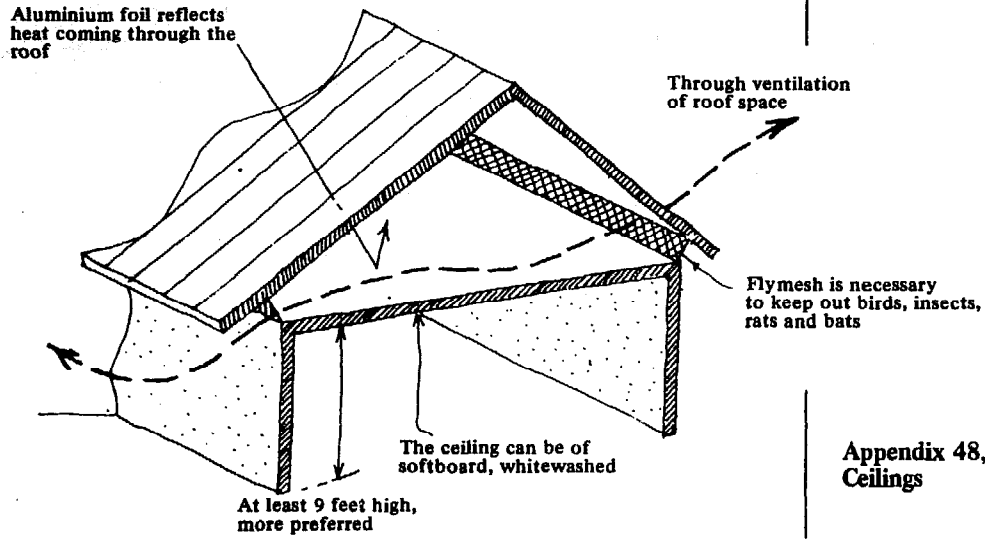

Appendix 48, Figs. 12 and 13
Ceilings

Screening may be necessary where small rooms abut a bigger space

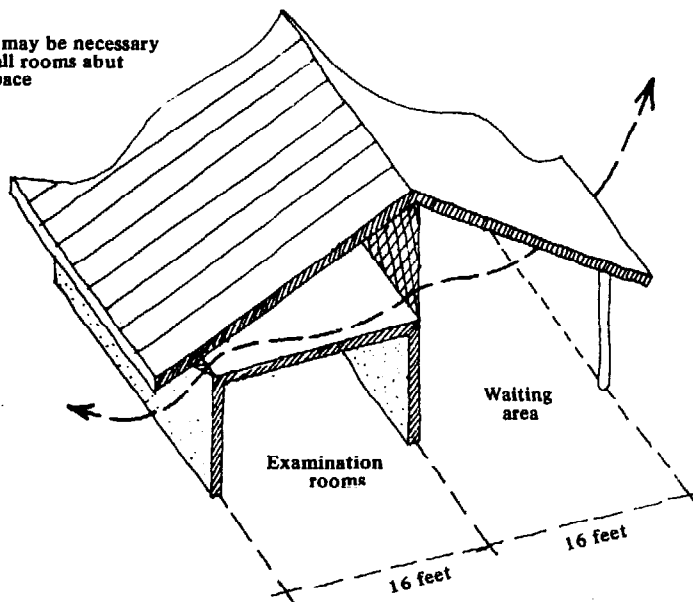
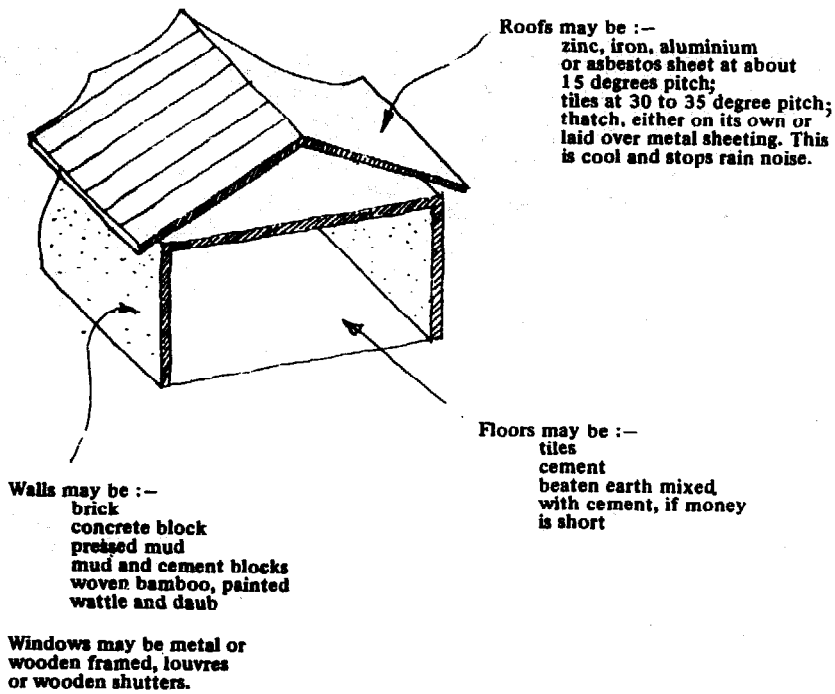
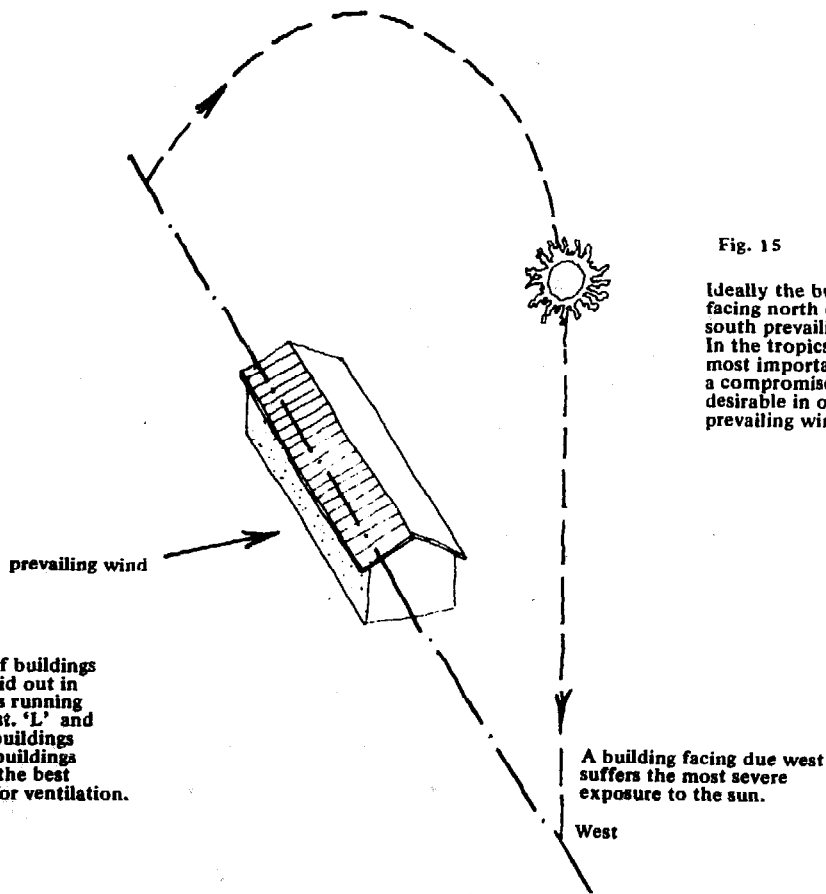

Fig. 13. Where a big space abuts a number of smaller rooms, as in a clinic, screening may be necessary to protect the ceilings of the smaller rooms.

Fig. 14



Appendix 48, Fig 14
Materials used in
construction.



Appendix 48, Fig 15
Orientation and
ventilation

Fig. 15

Ideally the buildings are aligned east and west, facing north or south, and have a north or south prevailing wind blowing through. In the tropics the east - west alignment is most important to keep the sun out, but a compromise in alignment may be desirable in order to make use of the prevailing wind for ventilation.

A number of buildings should be laid out in parallel rows running east and west. 'L' and 'U' shaped buildings and square buildings do not give the best conditions for ventilation.

Shade and environment

Unless air conditioning or other artificial cooling is installed, shade temperature is the lowest temperature available. Trees planted round the buildings increase the 'shade pool', but they can encourage insects. Grass round the buildings stops the reflection of the sun into them, but it must be kept well cut to discourage insects and animals.

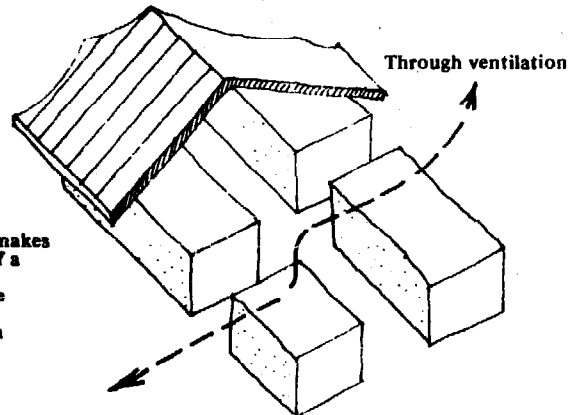

Fig. 16. Where the need for rooms makes it necessary to build on both sides of a central corridor the building will be poorly ventilated. Ventilation will be improved by leaving an unenclosed space here and there, to give through ventilation.

Appendix 48 (ctd.)

Appendix 48, Fig. 16
Through ventilation

Summary

The Model Plan is based on a very simple structural 'grid' of 16 feet by 16 feet so that simple materials can be used. The choice between walls or columns, whether trusses are to be used or not, the selection of materials for roofs and walls etc. can only be made after seeing what is available in a given place.

There is a detailed drawing at the end of the report showing a roof structure. The dimensions shown are for middle quality sawn timber. Poor timber will have to be bigger. Good quality timber could be smaller. A local carpenter should know the strengths of his own kinds of timber.

Reference reading in relation to a Model Health Centre

Appendix 49 Reference reading in relation to a Model Health Centre

General

CUSCO READINGS IN HEALTH. A collection of articles, including all CONTACTS (CMC paper) related to basic health care and incorporating project reports. Compiled by Canadian University Services Overseas, (151 Slater Street, Ottawa, Canada K1P 5H5) 1973. Sections II - IV inclusive are particularly relevant. Topics included are: nutrition; maternal and child health; family planning and population control; education and training projects.

COMMUNITY HEALTH AND THE CHURCH. Edited by J.H. Hellberg, MD. Christian Medical Commission, (World Council of Churches, 150 Route de Ferney, 1211 Geneva 20, Switzerland), 1971.

HEALTH AND THE DEVELOPING WORLD. By John Bryant, MD. Cornell University Press, Ithaca & London, 1969.

* **MEDICAL CARE IN DEVELOPING COUNTRIES.** Edited by Maurice King, MD. Oxford University Press, 1966.

FAMILY SERVICE CENTRE PROGRAMME. Description and analysis by Salwa Khuri-Otaqui, MD. Near East Ecumenical Committee for Palestine Refugees, 1971.

AUXILIARIES IN HEALTH CARE PROGRAMMES IN DEVELOPING COUNTRIES. By N.R. Fendell. John Hopkins Press, Baltimore and London, 1972. (Published for the Josiah Macy Foundation.)

NOTES ON STERILIZATION AND DISINFECTION. By J.C. Kelsey and I.M. Manser (Mission Hospital Bulletin No. 38, May 1971).

* **CLINICAL MEDICINE IN SOUTHERN AFRICA.** By G.D. Campbell, Y.K. Seedat, G. Daynes. Churchill Livingstone, Edinburgh.

SMALL WATER SUPPLIES, Bulletin No. 10. The Ross Institute, London School of Hygiene and Tropical Medicine (Keppel Street, London WC1E 7HT).

THE ARMY MANUAL ON HYGIENE AND SANITATION

RURAL SANITATION IN THE TROPICS. Bulletin No. 8. The Ross Institute.

* **OXFORD POCKET DICTIONARY**

* **BAILLIERE'S NURSES' DICTIONARY** Bailliere, London.

HOW TO BUILD SERIES by A.E.S. Alcock and H.M. Richards. Longman.
How to build to size and shape, Reading Plans,
How to build for climate,
How to plan your market,
How to plan your village.

Nutrition

MANUAL ON FEEDING INFANTS AND YOUNG CHILDREN. By M. Cameron and Y. Hofvander, Protein Advisory Group of the United Nations System. PAG Document 1. 14/26, 1971. For application in the developing areas of the world with special reference to home-made weaning foods.

CHILD NUTRITION IN DEVELOPING COUNTRIES. By D.B. Jelliffe, US Department of Health, Education and Welfare, Washington, D C, 1968.

* **NUTRITION IN DEVELOPING COUNTRIES.** By Maurice King, MD. Oxford University Press, (PO Box 72532, Nairobi, Kenya), 1972.

CONTACT NO. 23 - A GUIDE TO NUTRITION REHABILITATION. By Joan Koppert, SRN, SCM. Published by the Christian Medical Commission,

The field of nutrition is a very extensive one. In addition to the above, material may be obtained from:

OXFAM, 274 Banbury Road, Oxford OX2 7DZ, England.

FOOD AND AGRICULTURE ORGANIZATION, United Nations, Villa delle Ferme di Aracalle, 00100 Rome, Italy.

CARIBBEAN FOOD AND NUTRITION INSTITUTE, University of the West Indies, Mona, Kingston 7, Jamaica.

CANADA/DEPARTMENT OF AGRICULTURE, Information Division, Ottawa K1A 0C7, Publications 1973.

WORLD NEIGHBOURS (Newsletter) 5116 North Portland, Oklahoma City, Oklahoma 73112, USA.

THE VISUALIZER (Newsletter) US Department of Agriculture, Federal Extension Service, Washington D C 20250, USA.

This material is of background use for specific areas.

ENERGY AND PROTEIN REQUIREMENTS. WHO Chronicle Vol. 27, No. 11, Nov. 1973.

NUTRITION PRIORITIES. The Journal of the Christian Medical Association of India Vol. XLVIII, April 1973.

*NUTRITION IN TROPICAL COUNTRIES. By H.F. Welbourn. Oxford University Press.

Maternal and Child Health

MOTHER AND CHILD HEALTH - DELIVERING THE SERVICES. By Cicely Williams and Derrick B. Jelliffe. Oxford University Press, 1972.

*PEDIATRIC PRIORITIES IN THE DEVELOPING WORLD. By David Morley, MD, MRCP. Institute of Child Health, University of London, 30 Guilford Street, London WC1N 1EH Butterworth and Co., Publishers, 1973.

*CHILD HEALTH CARE IN RURAL AREAS - A MANUAL FOR AUXILIARY NURSE-MIDWIVES. Asia Publishing House, 420 Lexington Avenue, New York, NY, USA.

*CHILD HEALTH MANUAL FOR COMMUNITY HEALTH NURSES. Department of Public Health, Papua, New Guinea. (Published 1958 and revised by D.P. Bowler, 1970')

*PRACTICAL MATERNAL AND CHILD HEALTH PROBLEMS IN TROPICAL AFRICA. By G.J. Ebrahim. East African Literature Bureau, Nairobi, Kenya, 1972.

*OBSTETRICS, FAMILY PLANNING AND PAEDIATRICS - a manual of practical management for doctors and nurses. By R.H. Philpott, K.E. Sapire, J.H.M. Axton, Family Planning Association of Rhodesia.

*CHILD HEALTH IN THE TROPICS. By D.B. Jelliffe Arnold, 2nd Ed. 1965.

*AIDS TO GYNAECOLOGICAL AND OBSTETRIC NURSING. By J.V. McNiven and B.E.M. Warne. Bailliere.

Training and Utilization of Personnel

INTERMEDIATE TECHNOLOGY DEVELOPMENT GROUP - HEALTH, MANPOWER AND THE MEDICAL AUXILIARY. General editor Oscar Gish. Published by Intermediate Technology Group, 1971. Parnell House, Wilton Road, London SW1

*ABC OF FIRST AID. A manual of instruction with illustrations arranged in alphabetical order. Published for the British Red Cross by Educational Production Ltd., London, 1968.

*MANUAL FOR VILLAGE HEALTH WORKERS. Health Development, Ministry of Health, Republic of Vietnam.

*METHODS MANUAL FOR COMMUNITY HEALTH WORKERS. Department of National Health and Welfare, Canada, 1970.

*MEDICAL ASSISTANTS MANUAL. By G.B. Wyatt and J.L. Wyatt. McGraw-Hill International Book Company, Singapore.

HOW MUCH OF THE DOCTOR'S WORKLOAD CAN BE TAKEN OVER BY THE A.N.M.s. UNICEF/WHO.

INDO-DUTCH PROJECT FOR CHILD WELFARE. By Dr. Helen Gideon. UNICEF/WHO, 1973.

*OXFORD HANDBOOK FOR MEDICAL AUXILIARIES:

a) Medicine. By F.J. Wright and J.C. Gould

b) Surgery. By W.G. Kerr

c) Midwifery. By M. Fenson

d) Anaesthetics. By J. Vaughan
Oxford University Press.

*AIDS TO SURGICAL NURSING. By K.F. Armstrong and N. Jamieson. Bailliere.

*AIDS TO TROPICAL HYGIENE AND NURSING. By W.C. Fream. Bailliere.

*AIDS TO PRACTICAL NURSING. By M. Houghton. Bailliere.

*AIDS TO MEDICAL NURSING. By M. Houghton and M. Whitton. Bailliere.

*MIDWIFERY MANUAL FOR COMMUNITY HEALTH NURSES. Maternal and Child Health Section, Department of Public Health, Papua, New Guinea, 1958 (Third Revision).

- **MANUAL FOR TEACHING MIDWIVES.** Illustrated by A.M. Jones. Federal Security Agency, Social Security Administration, Children's Bureau, 1948. This book is now considered almost a classic as it was written for nurse-midwives to instruct the traditional midwives. It has been adapted for several communities, including Alaska and Haiti. Use of language is reduced to a minimum. Captions and illustrations tell the story.
- **MIDWIFERY MANUAL - A GUIDE FOR AUXILIARY MIDWIVES.** By H. Cox. McGraw Hill International Health Series, Singapore, 1971.

GUIDE FOR THE TRAINING OF NURSING AUXILIARIES IN LATIN AMERICA. Scientific publication No. 98, Pan-American Health Organization, Regional Office of WHO, (52 W 23rd Street, Washington D C, USA).

THE HEALTH AIDE. By J.H. Slotten and A. Elman. Little, Brown and Co., Boston, 1972.

MANUAL FOR COMMUNITY HEALTH WORKERS. Published by Department of Social and Preventive Medicine, University of the West Indies, Mona, Kingston, Jamaica.

Some sources of Teaching Aids and Audio-Visual Material which might be helpful:

TALC, Institute of Child Health, University of London, 30, Guilford Street, London WC1N 1EH

CATALOGUE OF FILMSTRIPS FOR RURAL DEVELOPMENT. Edited by Langford Danziger, MD, 1971. Order from Peace Corps Development and Training Centre, Escondido, California, 92025, USA.

FAO FILMS AND FILMSTRIP CATALOGUE. Prepared by the Food and Agriculture Organization of the United Nations, 1968. Film and TV Section, (via delle Ferme di Caracalla, 00100 Rome, Italy).

INTERMEDIATE TECHNOLOGY DEVELOPMENT GROUP, Rural Health Panel, Materials for auxiliary teaching, Cameron David Morley, published by ITDA Ltd, Parnell House, Wilton Road, London SW1

Records and Evaluation

EVALUATION OF PAEDIATRIC CARE FROM ROUTINE HOSPITAL RECORDS. By P.N. Swift and P.J.S. Hamilton. *Journal of Tropical Medicine and Hygiene* Vol. 76, Dec. 1973.

OBSTETRIC CARE. An ante-natal record card for use in developing countries. By V.J. Hartfield. *Tropical Doctor*, No. 4, 1973.

PATIENT RETAINED HEALTH RECORDS. By Murray Langesen. Co-ordinating Agency for Health Planning (c/45 South Extension, Part II, New Delhi 110049)

Laboratory and Dispensary

• **A MEDICAL LABORATORY FOR DEVELOPING COUNTRIES.** By M. King. Oxford University Press.

TROPICAL DISPENSARY HANDBOOK. By C.C. Chesterman. Lutterworth.

AN INTRODUCTION TO MEDICAL LABORATORY TECHNOLOGY. By F.J. Baker. Butterworth.

A LABORATORY HANDBOOK OF BLOOD TRANSFUSION TECHNIQUES. By A.D. Farr. Heinemann.

* These publications should be available in the Model Health Centre.

The Publishers would welcome any information which would improve the accuracy and adequacy of the above list of reading material.

Examples of Diagnostic and Treatment routines serialized for use in Health Centres

Reproduced below are two examples of a method of teaching and reaching diagnostic and treatment sessions designed to assist auxiliaries. These sheets illustrate the benefits to be obtained from stating a problem precisely and setting about solving it. The limit to the auxiliaries' competence is set by the 'send to doctor' entries.

These sheets have been prepared by and are obtainable from Management Sciences for Health, 1 Broadway, Cambridge, Mass. 02142, USA.

- Examples: 1. Severe dehydration
2. Nutrition

As the originals use colour they have been adapted for single colour printing in this report. The originals are easier to read. The series has been further refined and developed since the examples shown here were produced.

APPENDIX 50
Examples of Diagnostic and Treatment routines serialized for use in Health Centres

Key to symbols :

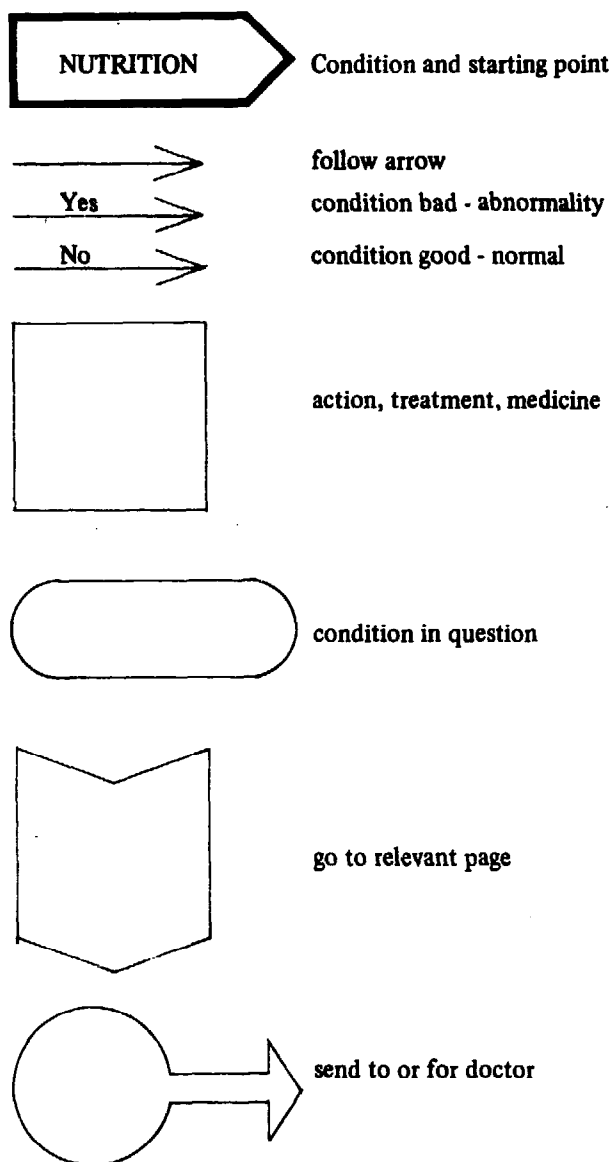

MODERATE DEHYDRATION

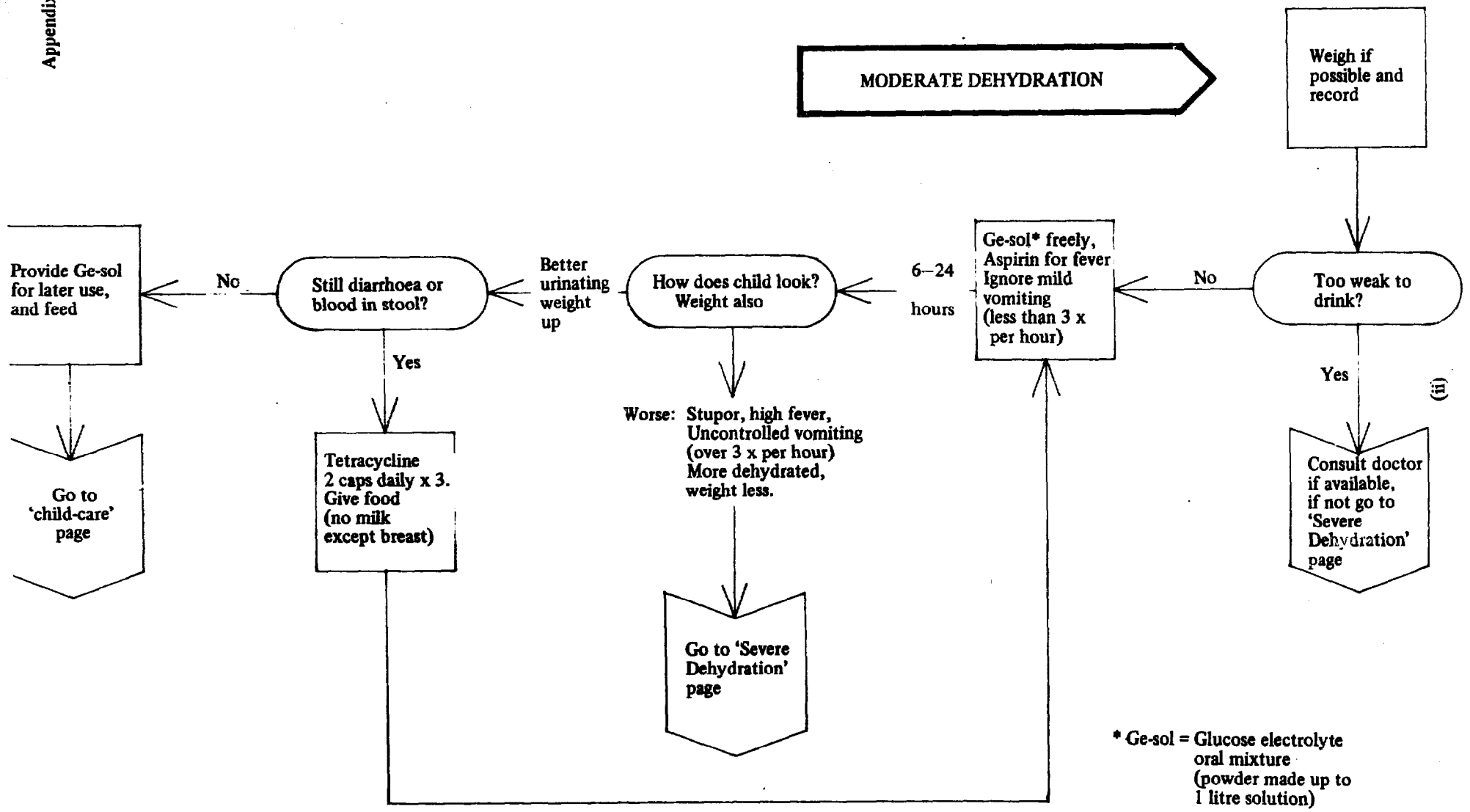

* Ge-sol = Glucose electrolyte oral mixture (powder made up to 1 litre solution)

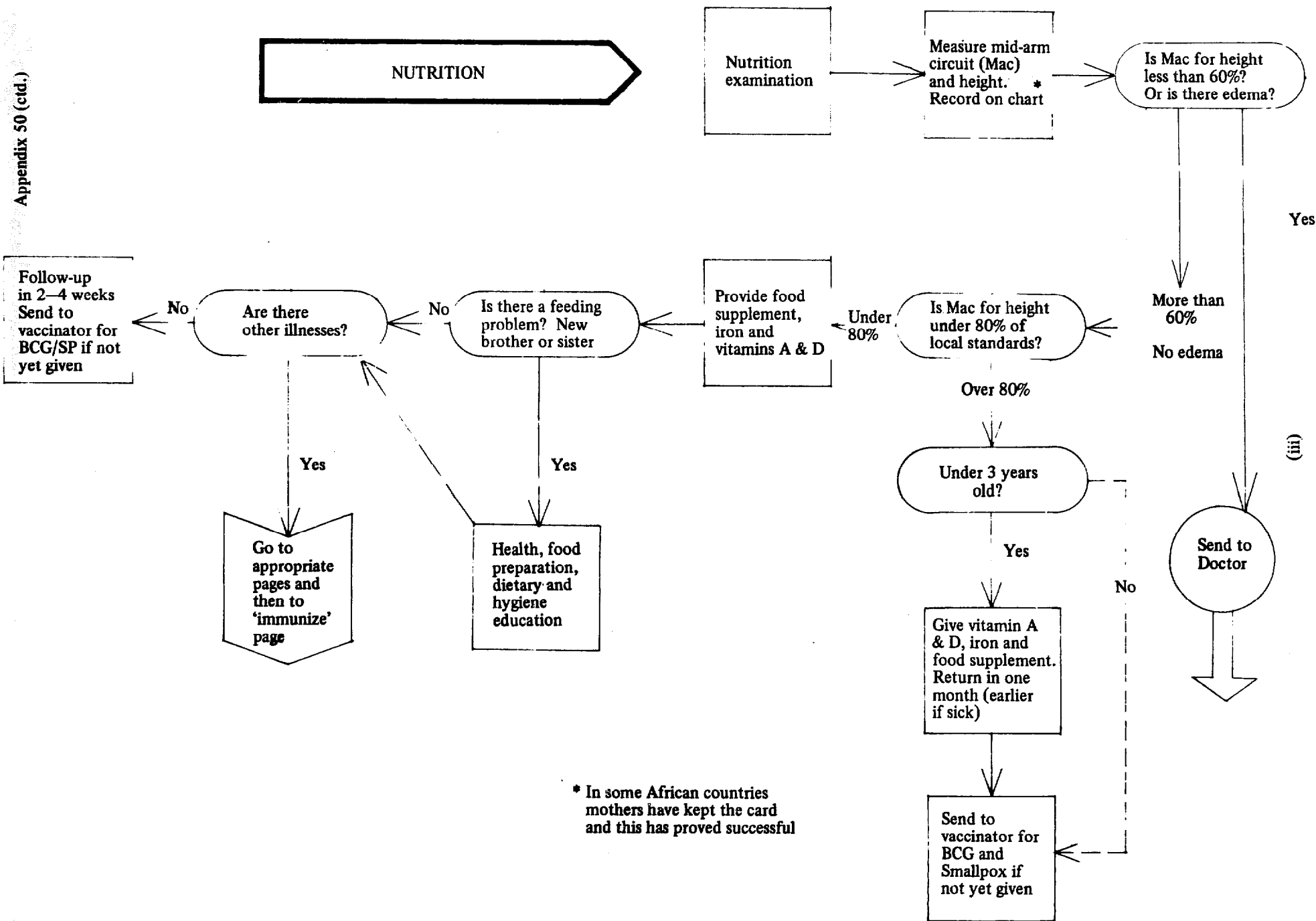

* In some African countries mothers have kept the card and this has proved successful

A description of a small rural Health Centre

APPENDIX 51 A description of a small rural Health Centre

This report concentrates on a description of the Model Centre. We have noted that some Centres are run with smaller staff complements, and also note that smaller Centres are a necessary part of the macro-unit (see Appendix 44). This Appendix describes a small Centre, its staffing, the work it was established to do, its equipment and construction. The description is included without comment beyond pointing out that more than twenty years ago the foundations for modern interest in Health Centres were being firmly laid.

The small rural Health Centre

In many countries of the Third World, particularly those in which the density of the population is of the order of 10 to 25 per square mile, a small rural dispensary or Health Centre has to provide both curative and preventive treatment for about 5,000 people. Such a Centre may be in the charge of a medical auxiliary who has from one to five years of training.

Supervision is undertaken by a doctor or qualified nurse working from a central hospital, clinic or office. Few dispensaries can count on such a supervisory visit more frequently than once a month.

Drugs and dressings are supplied from government or mission stores. The variety available, and the regularity of replenishment, vary enormously.

Accommodation: In an area of about 6,000 square miles in the former Belgian Congo, complete coverage of the population was ensured by a programme of 18 central Health Centres/dispensaries, to which were attached 36 rural treatment clinics. Most of the former developed from small and unpretentious wattle-and-daub clinics, situated in the principal village of each group, and originally served for the control of sleeping sickness and yaws. They were built and maintained by the local communities, under the inspiration and supervision of the paramount chiefs. They were transformed into buildings of brick and iron roofing sheets; the brick presses were lent by the mission hospital (the medical supervisory agency) and all local labour was supplied by the able-bodied men whose families would be the first and obvious beneficiaries of the Centre. When the Congo Welfare Fund was created, grants were made for the transformation of ten of these dispensaries into rural Health Centres.

Population served at a typical Health Centre would number about 5,000 most of them living within a radius of five miles.

Staff. One 'infirmier diplome' who had had a training of five years at the Yakusu Hospital. His wife was often an 'aide-accoucheuse', with a government diploma given after a supervised training at Yakusu of two years' duration. Each satellite treatment centre was under the care of a helper who had had a training of three months at the Health Centre and regular periods of in-training subsequently.

Programme. The 'infirmier' was responsible for the implementation of the general medical policy as applied to the rural areas. This comprised:

- a) Treatment of common diseases
- b) Diagnosis and treatment of endemic transmissible diseases (e.g. yaws, leprosy, tuberculosis, venereal disease)
- c) Investigation of suspected cases of possible endemic diseases (e.g. typhoid, smallpox, poliomyelitis)
- d) Weekly clinics for:
 - i. babies under two years old, or under ten kg. in weight
 - ii. toddlers' clinics for children of three to five years
 - iii. ante-natal clinics
- e) Education and lecture demonstrations at the clinics, in the outpatient departments, and in the nearby elementary schools; cookery classes for the women
- f) Demonstration of gardening methods, composting, new varieties of seeds, etc.
- g) Encouraging the construction of more hygienic dwellings, latrines and rubbish dumps

Buildings. Several plans were followed, according to the availability of money to

Furnishings:

Waiting hall	Benches Wall-charts
Consulting room	Table Chairs Examining couch Cupboards Shelving (for records)
Laboratory	Microscope (complete with oil-immersion lens) for blood, sputum, skin smears, gland puncture, etc. Stains Reagents
Operating theatre	Table Chairs Primus stove for sterilizing instruments and dressings Syringes, etc. for intra-muscular and intra- venous injection
Delivery room	Delivery bed Primus for sterilizing dressings and instru- ments
Maternity ward	6 iron bedsteads (complete with sponge rubber mattresses, blankets, etc.)
General ward	20 iron bedsteads and bedding, as above.

Such a Health Centre served its purpose admirably: it was

- a) Inexpensive to build (twenty years ago it would have cost about £2,500)
- b) Cheap to maintain: it needed no resident guard, or boundary wall, or netting
- c) Convenient for consultations, clinics and demonstrations
- d) Conformable to the type of building that was becoming acceptable in the villages
- e) Not obviously imposed from above, or from outside
- f) Large enough to deal with the patient-load

Volume of work. The Health Centre would see and treat an average of 100 patients daily. This figure takes account of the special clinics for leprosy, yaws, etc. The average number of mothers and babies attending the infant welfare, toddlers' and ante-natal clinics would range from 50 to 100 a week.

The common laboratory examination would include: blood (malaria parasites, trypanosomes, haemoglobin, blood counts); stools (intestinal worms); sputum (for *M. tuberculosis*); skin smears (for *M. Leprae*, *Sp. pertenuis*, fungi); urine (chemical and microscopic); gland puncture (for trypanosomes, *M. Leprae*).

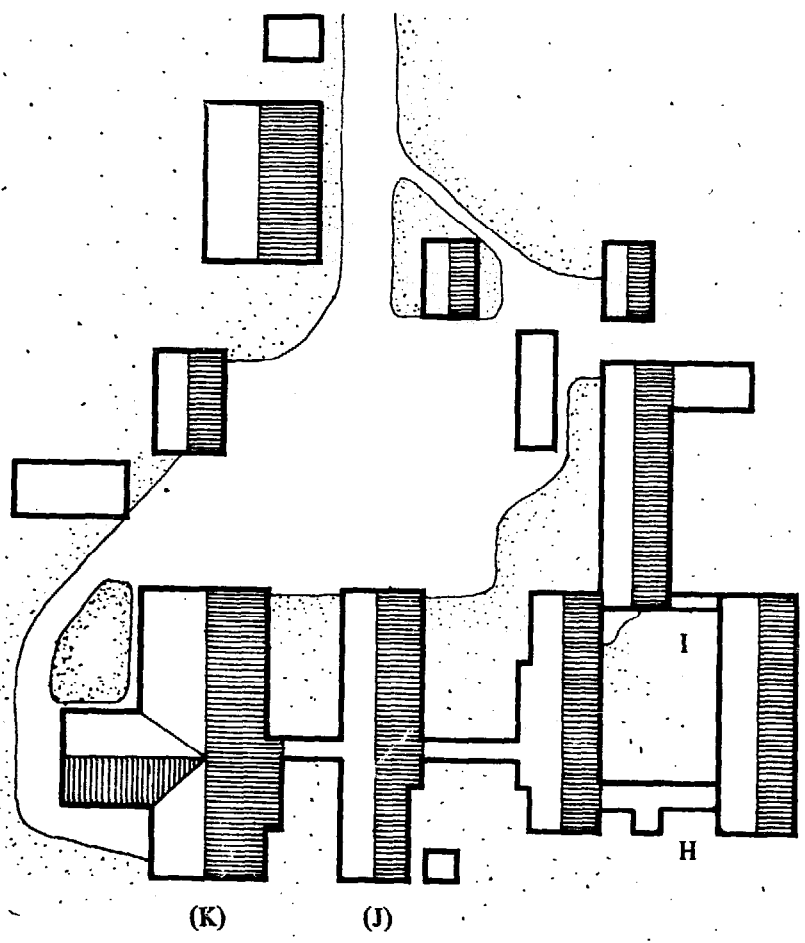

Appendix 52, Fig. 12
The Model as a 25 bed
hospital

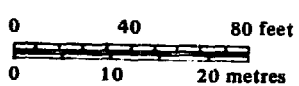

See room lists on page 10 and in Appendix 20 for explanation of letters.

Appendix 52, Fig. 13
The Model extended to a
125 bed hospital

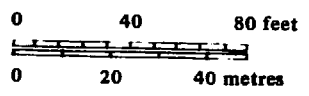
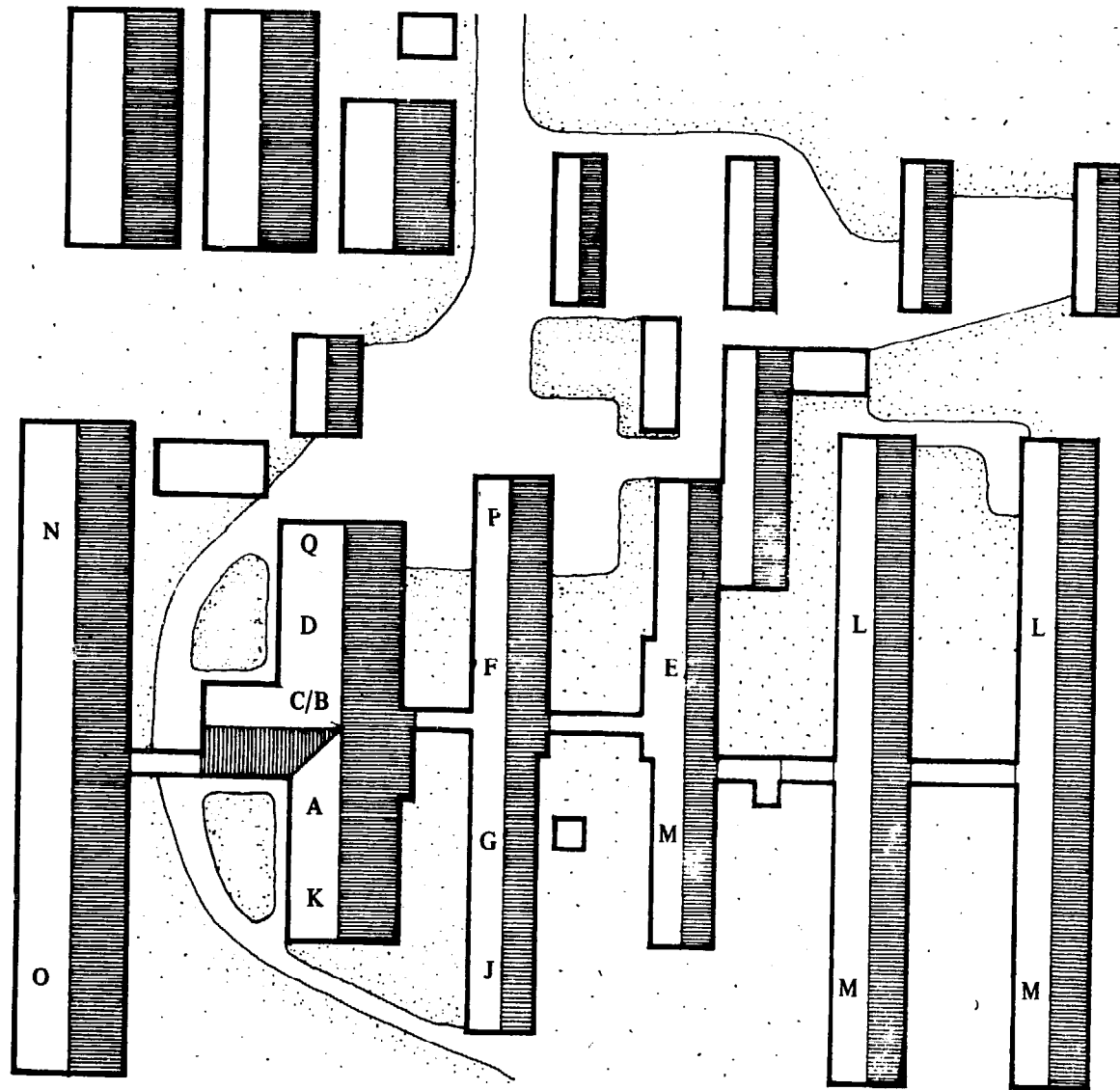

See room lists on page 10 and in Appendix 20 for explanation of letters.

Appendix 52, Fig. 14
Drains, sewers, and
sewage disposal area.

See also appendix 38

Where water is available for water-borne sewerage, the disposal area (pond, septic tank, sewer plant) will have to be down hill, and preferably down prevailing wind. On this plan two of the main possible disposal areas are indicated as A and B. The necessary slope from the furthest manhole (M/H) to the disposal point dictates the fall over the whole length.

Earth closets shown, plus areas for moving to new pits. A good pit 18 to 20 feet deep with reasonably porous ground will last for 2 years.

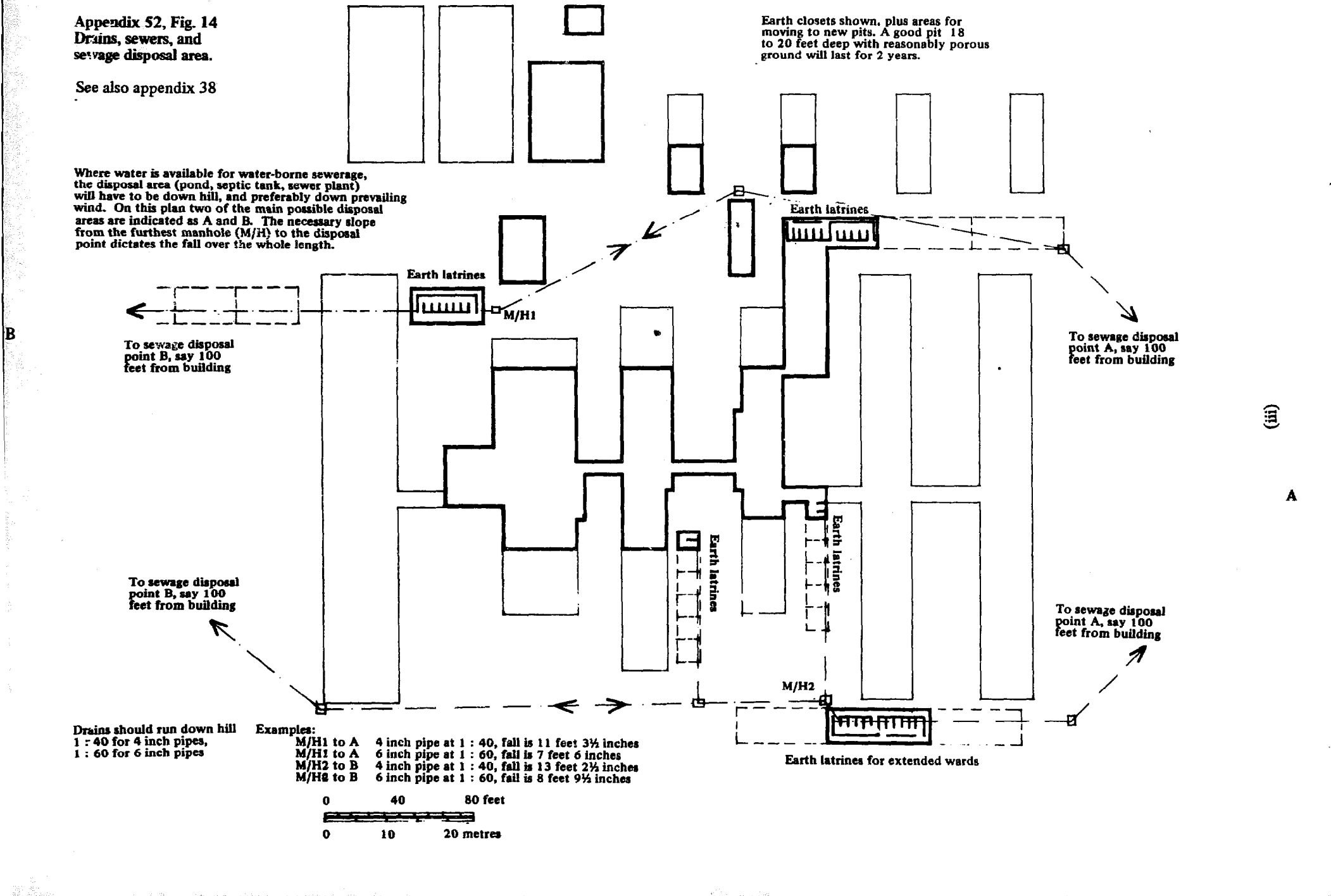

(iii)

A

Drains should run down hill
 1 : 40 for 4 inch pipes,
 1 : 60 for 6 inch pipes

Examples:

M/H1 to A	4 inch pipe at 1 : 40, fall is 11 feet 3½ inches
M/H1 to A	6 inch pipe at 1 : 60, fall is 7 feet 6 inches
M/H2 to B	4 inch pipe at 1 : 40, fall is 13 feet 2½ inches
M/H2 to B	6 inch pipe at 1 : 60, fall is 8 feet 9½ inches

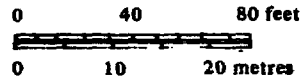

TREAT ALL WOOD AGAINST TERMITES, CARPENTER BEES ETC.

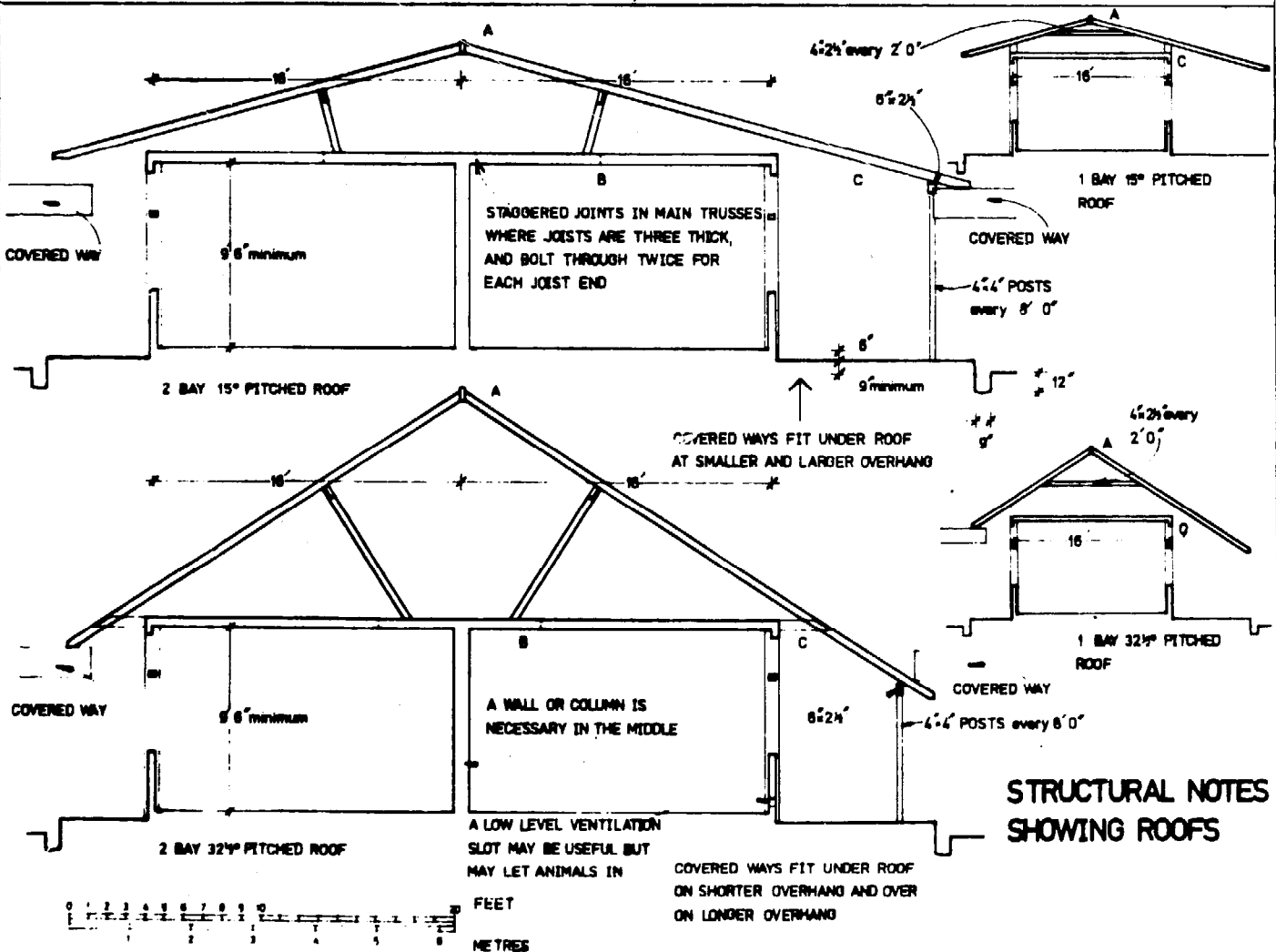
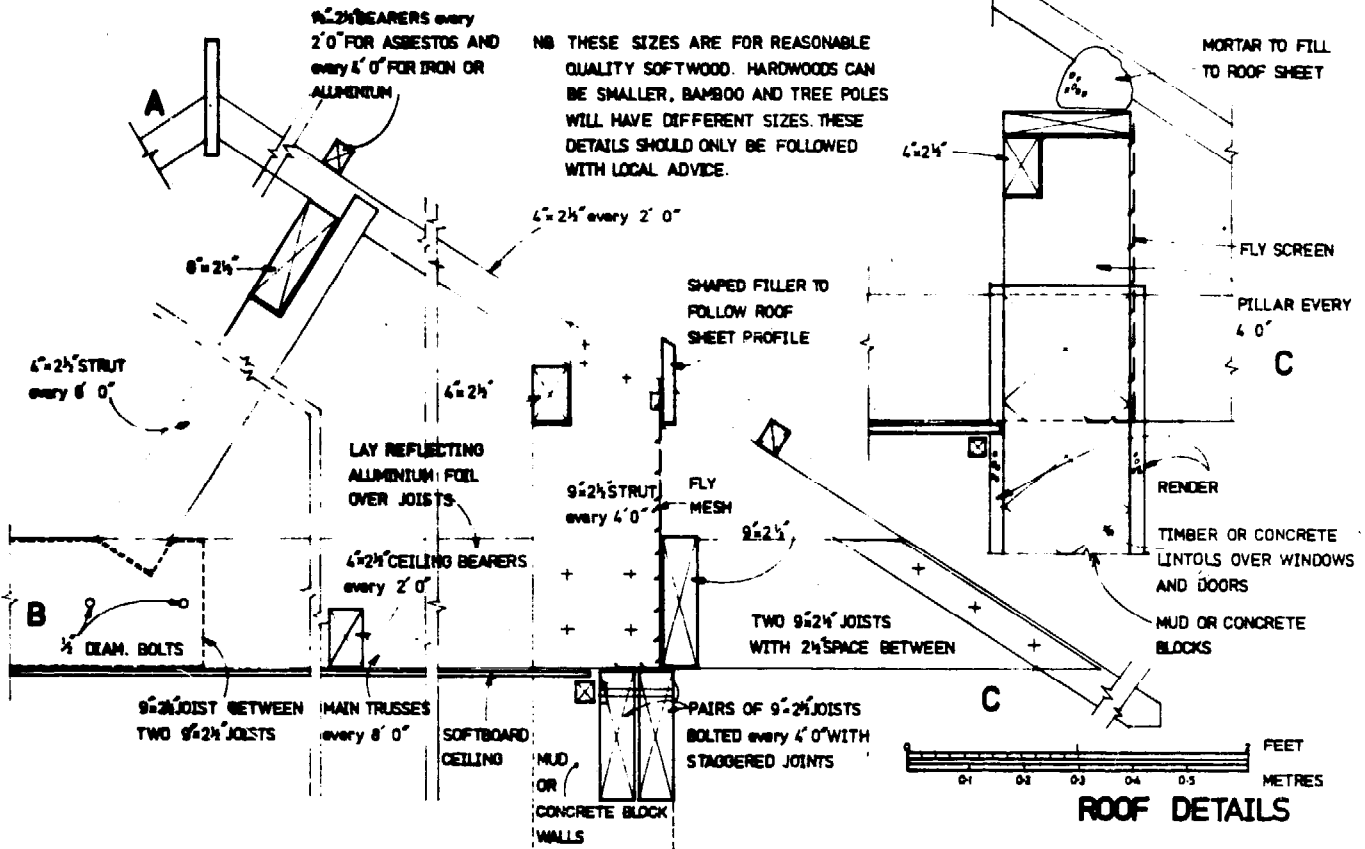

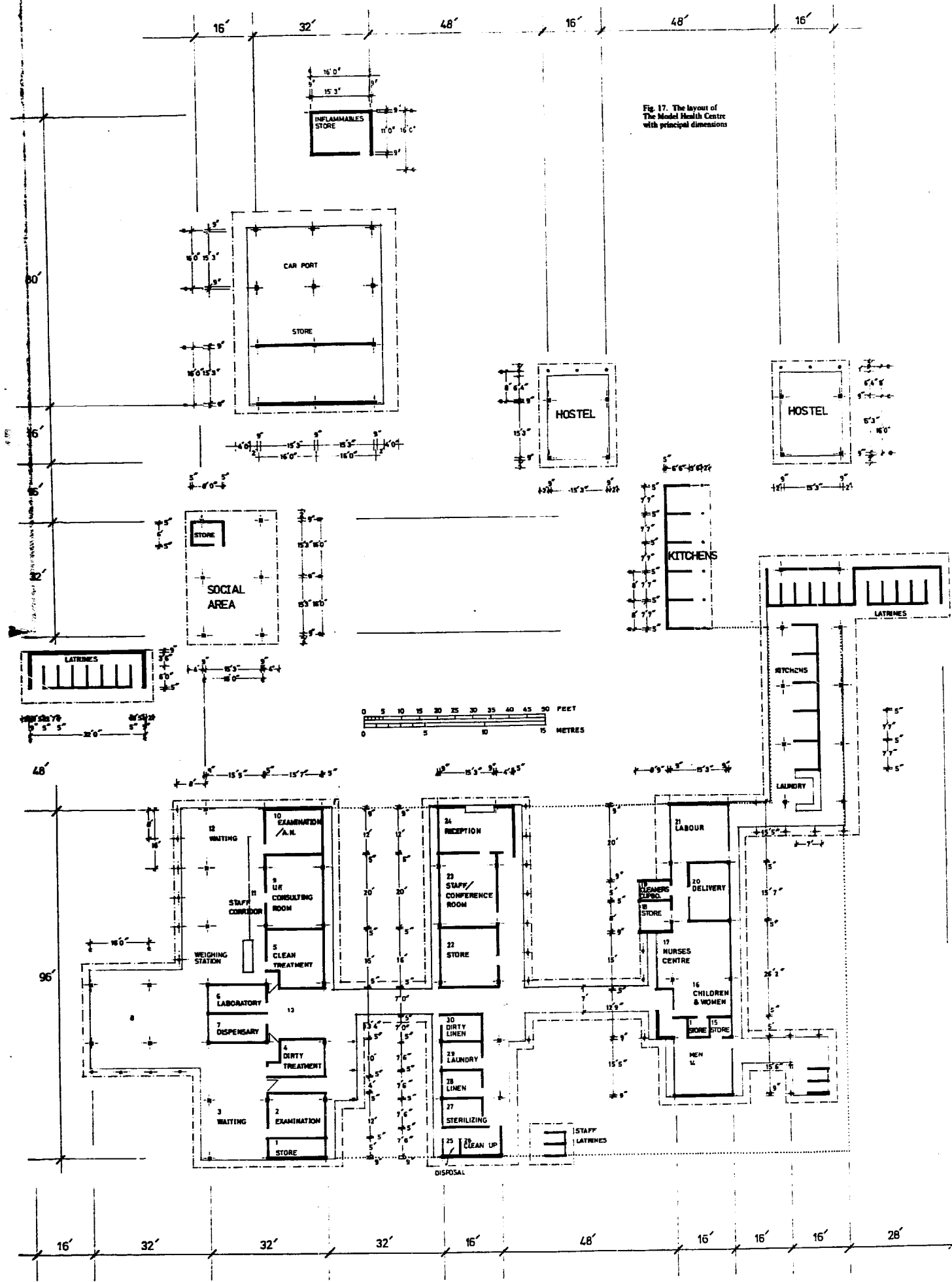

Fig. 17. The layout of The Model Health Centre with principal dimensions