

AT MICROFICHE
REFERENCE
LIBRARY

A project of Volunteers in Asia

A Medical Laboratory for Developing Countries

by: Maurice King

Published by:

Oxford University Press/East & Central Africa
P.O. Box 72532
Nairobi, Kenya

Paper copies are \$22.50.

Available from:

Oxford University Press
16-00 Pollitt Drive
Fair Lawn, NJ 07410 USA

Reproduced by permission of Oxford University
Press, East and Central Africa.

Reproduction of this microfiche document in any
form is subject to the same restrictions as those
of the original document.

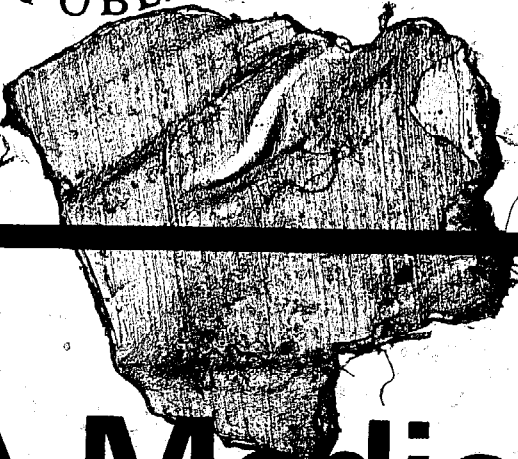

A Medical Laboratory for Developing Countries

This book aims to bring the minimum level of pathological services within the range of everyone in developing countries and is written especially for laboratory and medical assistants who work in health centres and district hospitals. Each piece of equipment needed in a medical laboratory is fully described and illustrated in detailed drawings. Every step in the examination of specimens is simply explained and the method of performing it illustrated; the methods chosen are those that give the greatest diagnostic value at the minimum cost. Ways of obtaining specimens are given, and where it might prove helpful some anatomy, physiology and a brief account of treatment is included. The last chapter contains a detailed equipment list.

This book goes a long way towards defining a complete 'health case package' in an important and neglected field.

net

in



**Oxford
University
Press**

ISBN 0 19 264910 8

OXFORD MEDICAL PUBLICATIONS

**A Medical Laboratory
for Developing Countries**

To all those who might so
easily be diagnosed and
treated if only someone knew how.

A Medical Laboratory for Developing Countries

MAURICE KING

M.D. (Cantab.), F.R.C.P. (Lond.)

WHO Staff Member, the Lembaga Kesehatan Nasional, Surabaya, Indonesia.

*Lately Professor of Social Medicine in the University of
Zambia and Visiting Professor in Johns Hopkins University*

LONDON

OXFORD UNIVERSITY PRESS

DELHI KUALA LUMPUR

1973

Oxford University Press, Ely House, London W.1

GLASGOW NEW YORK TORONTO MELBOURNE WELLINGTON

CAPE TOWN IBADAN NAIROBI DAR ES SALAAM LUSAKA ADDIS ABABA

DELHI BOMBAY CALCUTTA MADRAS KARACHI LAHORE DACCA

KUALA LUMPUR SINGAPORE HONG KONG TOKYO

Hardbound edition ISBN 0 19 264916 7

Paperbound edition ISBN 0 19 264910 8

© Oxford University Press, 1973

All rights reserved. No part of this publication may be reproduced, stored in a retrieval system, or transmitted, in any form or by any means, electronic, mechanical, photocopying, recording or otherwise, without the prior permission of Oxford University Press

*Filmset in Photon Times 10 pt. by
Richard Clay (The Chaucer Press), Ltd., Bungay, Suffolk
and printed in Great Britain by
Fletcher & Son, Ltd., Norwich*

First Preface in Standard English

This book has a critical purpose. It aims to bring a minimum level of pathological services within the range of *everyone* in the developing countries. It is thus firstly for the laboratory assistants and medical assistants who work in health centres and district hospitals, for it is they who must investigate and treat such common and important conditions as anaemia, malaria, leprosy, tuberculosis, trypanosomiasis, and a variety of helminth infestations. Unless such diagnoses as these are routinely confirmed in a laboratory, the medical care that is provided for the millions who suffer from them must inevitably be inadequate.

But it is not enough to know how to take and examine a skin scraping for leprosy. All the necessary equipment, most of which is very cheap, has to be available—the mere provision of a microscope alone is not enough. Hence the last chapter contains a list of everything that a health centre laboratory requires, so that it can be inserted in a medical stores catalogue and packed as a complete kit that *may* be obtainable through UNICEF.

If the doctors of the developing countries are to rise to their challenge, which is to care for *all* the people, they must lead and teach the other members of the health team. Medical students must thus also become expert in the methods described here, so that they can both do them themselves, and later hand on their skills to others; for these same methods are required in ward side rooms, in the consulting rooms of general practitioners, and also in the laboratory that should be an integral part of every outpatient department.

Many readers will not have had much education; so this text has been made as complete as it can be, and written with a strictly limited vocabulary in the simplest possible way. A count of 5,000 words chosen from randomly distributed sections showed only 550 different ones, and it is probable that its entire vocabulary contains less than fifteen hundred. Even so it is hoped that the more learned reader will not be offended by its style. If he will only bear with the way in which it had to be written, he may be able to make good use of what it has to say.

Laboratories have to be numerous and cheap if every anaemic child is to have his stool examined for hookworms, when there is perhaps only about a dollar a year to be spent on health services of all kinds. The methods have therefore been chosen to be of the greatest diagnostic value for the limited funds available; the total cost of the equipment in the basic list given here being about \$500, including the microscope. This then is a medical laboratory at the level of an 'intermediate technology', which is in sharp contrast to the costly and increasingly automated laboratories of the industrial nations.

Because laboratory methods are only part of the clinical process, they have been set here in the practice of which they form part. Thus the indications for doing many of the methods have been given, as have ways of obtaining the specimen and interpreting the result. This has sometimes led to a brief account of treatment, and, where this might help, some anatomy and physiology have been included.

This text is one of the components of what is coming to be known as a **health care package**. By this is meant 'an integrated series of components assisting the application of a particular group of interventions for the improvement of health care under specific socio-economic conditions'. In this case the interventions are the laboratory methods applicable to health centres and district hospitals, while the socio-economic conditions are those of the developing countries. Other components include the kit of equipment, and the associated teaching aids and examination methods described in Section 13.15c. The importance of such packages is that *the combined usefulness of their components is likely to be more than merely additive*. Thus this text and its associated kit of equipment are of little value by themselves, but it is hoped that together they will be very useful indeed.

Preface

There is believed to be a need for a work of this kind, and if the present printing sells out, it is hoped that an improved second edition will follow. *The writer will therefore be pleased to hear from anyone with criticisms or suggestions for improvements.** Colour transparencies for further plates will be particularly welcome.

Many kind helpers have commented on the experimental edition of this manual, of which 5,000 copies were duplicated before this version went to press, and it is not possible to mention all of them; but especial gratitude is due to Dr. Felicity Savage, now my wife, Ken Lewis, Sister Darrah Degan, and to Doctors David Morley, Stanley Browne, and A. H. Van Soest, as well as to Gordon MacGregor, Wilfred de Souza, and Lionel Billows, from whom I hope I have learnt 'Easy English'. Several technicians have contributed valuable criticism, and particular thanks are due to David Staples, Peter Ward, and especially to Aleco Zangousa, Martyn Linton, and George Mwale. I am also indebted to Judith Mitchell for the intelligence and devotion with which she typed the manuscript and to Peter Cheese for so willingly developing the transparencies from which the plates were made.

Lastly, I should like to thank Mr. Johnson, our departmental cleaner at Makerere for his care in reading part of the manuscript. It was from him I first learned how difficult was the task I had so lightheartedly embarked upon.

February 7th 1972

MAURICE KING

* All correspondence should be addressed to Oxford University Press, 37 Dover Street, London W.1., United Kingdom.

Second Preface in Easy English

For laboratory assistants and medical assistants

I have written this book first of all for you. Let me start by telling you why I have written it.

When a patient is sick, he comes for help to a doctor or medical assistant. Let us say that he comes to see a doctor and that you are a laboratory assistant. The doctor must first find out why the patient is sick, so he starts by listening to what the patient says—he takes his patient's **history**. Next he looks at or examines the patient. From the history and **examination** it is possible to find out or **diagnose** what is wrong with most patients. But very often it is not possible to diagnose a patient by only listening to him and looking at him. A doctor needs the help of the X-ray department, where they take special pictures of patients, or of a medical laboratory. For example, a doctor may think that his patient has got weak (anaemic) blood. He will need a laboratory assistant to find out how weak it is and to help him find out why it is weak. I have therefore written this book to tell you about a medical laboratory and how you can use the equipment in it to help doctors, and medical assistants, to diagnose their patients. Your job is to find things out about patients and to **report** (tell) what you have found to the person who is looking after them. If the right diagnosis is made, patients can be given the right treatment and will get well. The reports that you make are therefore important, and they must be right. If you give a wrong report, the wrong diagnosis will be made, the wrong treatment will be given, and the patient may not get well. Your work is thus very important.

I have also written this book for medical assistants who may be working in health centres on their own with nobody to help them in the laboratory. If you are a medical assistant you will have too much to do to be able to spend much time in the laboratory. You should, however, learn how to do the methods described here well, so that you can do them on some of your patients, where they will be of great help in diagnosis and treatment.

If you are going to be able to do your job properly, you must have the right equipment and chemicals. If you do not have what you need—ask for it, and, if necessary, go on and *on* asking. In the end you will probably get what you want. If you do the methods in this book well and give true reports, you will be very useful indeed. You will be a great help to many sick people.

Yours sincerely,
Maurice King

Contents

Chapter 1. INTRODUCTION

1.1 How to use this book. 1.2 Honesty and responsibility. 1.3 Some special words. 1.4 Solutions and suspensions. 1.5 Centrifuging and filtering. 1.6 Acids, alkalis, and salts. 1.7 pH and buffers. 1.8 Indicators. 1.9 Cells. 1.10 Proteins and enzymes. 1.11 Micro-organisms. 1.12 Parasites, commensals and infection. 1.13 How organisms are named. 1.14 The different kinds of parasites. 1.15 Putrefaction or rotting. 1.16 Stains. 1.17 Serum and plasma. 1.18 Isotonic solutions. 1.19 Disinfectants and antiseptics. 1.20 Sterilization. 1.21 The pressure cooker. 1.22 Using sterile equipment. 1.23 Laboratory infection. 1.24 Controls.

Chapter 2. EQUIPMENT AND CHEMICALS

2.1 The equipment described. 2.2 Special equipment in the main list. 2.3 Ordinary equipment in the main list. 2.4 Chemicals. 2.5 The choices. 2.6 Stock and spares.

Chapter 3. MAKING THE LABORATORY READY

3.1 Benches and shelves. 3.2 Sinks and staining. 3.3 Water. 3.4 Bottled gas. 3.5 The Bunsen burner. 3.6 Electricity. 3.7 Using the battery of a Land-Rover. 3.8 Using a spare car battery. 3.9 Making and using Pasteur pipettes. 3.10 The loop. 3.11 Some practical details. 3.12 Washing equipment. 3.13 Routine. 3.14 Time and motion study. 3.15 Stains and reagents. 3.16 Acid alcohol. 3.17 Barium chloride. 3.18 Benedict's reagent. 3.19 Brilliant cresyl blue. 3.20 and 3.21 Buffers. 3.22a 'Cellophane' coverslips. 3.22b Carbol fuchsin (hot method). 3.23 Carbol fuchsin (cold method). 3.24 Dilute carbol fuchsin. 3.25 Crystal violet. 3.26 Dichromate cleaning fluid. 3.27 Ehrlich's reagent. 3.28 Field's stain. 3.29 Formol saline. 3.30 Fouchet's reagent. 3.31a Haemoglobin diluting fluid. 3.31b Drabkin's solution. 3.32 Lugol's iodine. 3.33 Leishman's stain. 3.34 Malachite green. 3.35 Methylene blue in acid alcohol. 3.36 Occult blood reagent. 3.37 Pandy's reagent. 3.38 PAS test strips. 3.39 Rothera's reagent. 3.40 Saline. 3.41 Saturated sodium acetate. 3.42a Sodium citrate solution. 3.42b 20% Sodium hydroxide. 3.43a Sulphone test papers. 3.43b 3% Sulphosalicylic acid. 3.44 20% Sulphosalicylic acid. 3.45 White cell diluting fluid. 3.46 A health centre laboratory described.

Chapter 4. RECORDS AND SPECIMENS

4.1 Records and reports. 4.2 Records for health centres and outpatient departments. 4.3 Records for hospitals. 4.4 The plus notation. 4.5 Preventing mistakes. 4.6 Specimen

Contents

containers. 4.7 Capillary and venous blood. 4.8 Cross infection and syringe jaundice. 4.9 Syringes and 'needles and tubes'. 4.10 Sending specimens to a central laboratory.

Chapter 5. WEIGHING AND MEASURING

5.1 Weight. 5.2 The Ohaus triple beam balance. 5.7 Pipettes and measuring cylinders. 5.8 Percentages and parts. 5.9 Why and how we measure colour. 5.10 The Lovibond comparator. 5.11 The Grey wedge photometer. 5.12 Filters for light. 5.13 The Haldane scale. 5.14 Using the Grey wedge photometer. 5.16 The EEL colorimeter. 5.17 Getting the EEL ready. 5.18 Learning how the EEL works. 5.19 Standards for the EEL. 5.20 The cyanmethaemoglobin method. 5.21a Oxyhaemoglobin methods. 5.21b Using a graph with the EEL. 5.22 When the EEL goes wrong. 5.23 Focusing the bulb of an EEL. 5.24 Changing the bulb in an EEL. 5.25 Changing the selenium cell in an EEL.

Chapter 6. THE MICROSCOPE

6.1 The μm . 6.2 How a microscope works. 6.3 The mirror and the condenser. 6.4 Centering the condenser. 6.5 The filter holder. 6.6 The condenser stop. 6.7 The objectives. 6.8 The eyepiece. 6.9 The tube, the coarse and fine adjustments. 6.10 The mechanical stage. 6.11 Lights for the microscope. 6.12 The Olympus model K microscope. 6.13 Knowing your microscope. 6.14 Using your microscope. 6.15 Specimens of poor contrast. 6.16 Troubles with microscopes. 6.17 Some 'Do's' and 'Don'ts' in microscopy. 6.18 Looking after microscopes in warm, wet countries.

Chapter 7. BLOOD

7.1 Haemoglobin. 7.2 The haematocrit. 7.3 The MCHC. 7.4 An anaemia chart for the 'under-fives clinic'. 7.5 Anaemia. 7.6 Iron deficiency anaemia. 7.7 Folic acid deficiency anaemia. 7.8 Anaemia caused by protein deficiency. 7.9 Haemolytic anaemias. 7.10 When to measure the haemoglobin. 7.11 The thin blood film. 7.12 Leishman's method. 7.13 Faults in a thin blood film. 7.14 Normal white blood cells (leucocytes). 7.15 Platelets. 7.16 The white cell percentages in normal blood. 7.17 How blood cells are formed in the marrow. 7.18 Abnormal cells in the blood. 7.19 Abnormal red cells. 7.20 Abnormal white cells. 7.21 Some further blood pictures. 7.22 The differential white cell count. 7.23 Reticulocytes. 7.24 What a haemoglobinopathy is. 7.25 Sickle cells. 7.26 Two solubility methods for haemoglobins A and S. 7.27a Sickle-cell anaemia and the sickle-cell trait. 7.27b Thalassaemia. 7.28 A simple guide to anaemia. 7.29 Counting white cells. 7.30 What an abnormal total white cell count means. 7.31 Why a thick film is so useful. 7.32 Malaria. 7.33 A diagram of the human plasmodia. 7.34 The meaning of a positive thick film in malaria. 7.35 Relapsing fever. 7.36 Trypanosomiasis. 7.37 Filariasis. 7.38 A concentration method. 7.39 The ESR. 7.40 The formol gel method. 7.41 The serum urea. 7.42 The blood sugar. 7.43 Measuring the plasma acetone with Acetest tablets.

Chapter 8. URINE

8.1 A clean specimen of urine. 8.2 Why we test the urine. 8.3 Testing the urine for sugar and protein. 8.4 The meaning of proteinuria. 8.5 Routine urine testing. 8.6 Diabetes and the blood sugar. 8.7 Acetone. 8.8 Jaundice and some tests for bile pigments. 8.9 Testing for INH and

PAS. 8.10 Testing for sulphones. 8.11 Pus cells in the urine. 8.12 The meaning of pyuria. 8.13 Looking at the centrifuged deposit. 8.14 Three kinds of movement. 8.15 Looking for the ova of *Schistosoma haematobium*.

Chapter 9. THE CEREBROSPINAL FLUID

9.1 Where the cerebrospinal fluid comes from. 9.2 The importance of lumbar puncture. 9.3 Diagnosing meningitis. 9.4 Equipment for lumbar puncture. 9.5 Doing a lumbar puncture. 9.6 Two specimens of CSF. 9.9 Cells. 9.10 Pandy's method. 9.11 Stained films. 9.12 A combined method of examining the CSF. 9.13 The CSF protein. 9.14 Trypanosomes. 9.15 Sugar in the CSF. 9.16 Suppurative or bacterial meningitis. 9.17 Virus meningitis. 9.18 Tuberculous meningitis. 9.19 Head injury. 9.20 Cerebral malaria.

Chapter 10. STOOLS

10.1 Why we examine the stools. 10.2a The saline stool smear. 10.2b The 'Cellophane' thick smear for ova. 10.3 The formol-ether concentration test. 10.4 The 'Sellotape' swab for *Enterobius*. 10.5 Some common ova. 10.6 Some more ova. 10.7 *E. histolytica* and *E. coli*. 10.8 Bacillary and amoebic exudates. 10.9 Identifying *E. histolytica*. 10.10 *Giardia lamblia* and *Trichomonas hominis*. 10.11 Occult blood. 10.12 Measuring the pH of a stool and testing for lactose. 10.13 When to examine the stools.

Chapter 11. SOME OTHER SPECIMENS

11.1 AAFB and the Ziehl-Neelsen method. 11.2 Preventing false positive reports. 11.3 Harmless mycobacteria. 11.4a Finding cases of tuberculosis. 11.4b Examining the sputum for helminth ova. 11.5 Gram's method. 11.6 Urethral smears for gonococci. 11.7 Some less common uses of Gram's method. 11.8 Looking for *Trichomonas vaginalis*. 11.9 Testing the gastric juice for free acid. 11.10 Examining the seminal fluid. 11.11a Classifying leprosy. 11.11b The skin scraping. 11.11c Nasal smears. 11.11d Examining and reporting on smears for *Myc. leprae*. 11.12 Lymph node puncture for trypanosomes. 11.13 The rectal snip for *Schistosoma mansoni*. 11.14 The skin snip for *Onchocerca volvulus*. 11.15 Skin scrapings for fungi.

Chapter 12. BLOOD TRANSFUSION

12.1 Blood groups and agglutination. 12.2 Transfusion. 12.3 Antisera. 12.4 Washing red cells. 12.5 Blood grouping. 12.6 Cross-matching. 12.7 Rhesus grouping. 12.8 Eldon cards. 12.9 Equipment. 12.10 Sharpening needles. 12.11 The pilot bottle. 12.12 Taking blood. 12.13 The Uganda mobile team. 12.14 Storing blood. 12.15 Making blood transfusion safer.

Chapter 13. FOR PATHOLOGISTS, STORES OFFICERS, AND MEDICAL ADMINISTRATORS

13.1 A standard manual. 13.2 The scope of this manual. 13.3 The equipment list. 13.4 Build up peripheral services first. 13.5a Some chemicals and equipment discussed. 13.5b Upgrading peripheral laboratories. 13.5c Teaching. 13.6 The supply of complete kits by UNICEF. 13.7 The addresses of suppliers. 13.8a General stores required. 13.8b Special equipment in the main list. 13.9 Ordinary equipment in the main list. 13.10 Chemicals. 13.11 Prepared reagents. 13.12 Choices. 13.13 Choice 1, The M.R.C. Grey wedge photometer. 13.15 Choice

Contents

2, The EEL colorimeter. 13.16 Choice 3, Silica gel as a desiccant for microscopes. 13.17 Choice 4, Electric centrifuges. 13.18 Choice 5, A Fuchs-Rosenthal counting chamber. 13.19 Choice 6, INH in the urine. 13.20 Choice 7, The cyanmethaemoglobin method. 13.21 Choice 8, Sodium azide. 13.22 Choice 9, Ammonia for the oxyhaemoglobin method. 13.24 Choice 11, Dichromate cleaning fluid. 13.25 Choice 12, Additional chemicals for preparing certain reagents. 13.26 Choice 13, 'Dextrostix'. 13.27 Choice 14, Rothera's test. 13.28 Choice 15, 'Ictotest' tablets. 13.29 Choice 16, The 'Cellophane' thick smear. 13.30 Choice 17, 'Labogaz'. 13.31 Choice 18, This manual. 13.32 A table of choices. 13.33 References.

Epilogue

Vocabulary Index

Plates

- 1-9 Thin blood films, Leishman stained
- 10-17 Blood grouping and sickle cells
- 18-29 Malaria thin blood films, Giemsa stained
- 30-41 Malaria blood films, Giemsa stained
- 42-50 Parasites in thick and thin blood films
- 51-55 Blood microfilariae
- 56-64 Urinary deposits
- 65-85 Ova in the stools
- 86-95 Protozoa, etc. in the stools
- 96-100 CSF and sputum
- 101-107 Gram's method and the Ziehl-Neelsen method

1 | Introduction

1.1 How to use this book

This is the most important chapter of all. It tells you some of the things you must know before you can understand the methods in the rest of the book. First, you must learn how to use a book like this. This is more important than learning all the methods, because, if you can use this book and have it with you, you can easily read how to do the methods in it. Try, therefore, to get a copy of this book for yourself.

The first twelve chapters of this book are written in easy English with as few new words as possible. You will find all these new words at the back of the book in a special list called the **vocabulary index**. You can read what these new words mean, and you will also see where you can find out more about them. If there are still words you cannot understand, get a dictionary. A good dictionary to get is *An English-Reader's Dictionary* by A. S. Hornby and E. C. Parnwell published by Oxford University Press. Some people are helped if they say the new words they find to themselves. The important new words have been written in **thick black type like this**. Learn these new words very carefully. When you have finished reading a chapter, look back over it and make sure that you know all the new words.

This book is made in parts or **sections**. Each section has a number which is written with a dot in it. For example, this is the first section of the first chapter, and you will see 1.1 (one *point* one) written at the top right hand corner of this page. Section 3.12 means the twelfth section in Chapter Three.

The drawings in this book are called **figures**. These figures also have numbers, but these have a dash (a short line) in them. For example, **FIGURE 2-6** (two *dash* six) is the sixth figure in Chapter Two. The coloured pictures at the end of the book are called **plates**. Some things are shown in the black and white figures and in the coloured plates. When this happens the number of the coloured plate has been put beside the black and white picture.

Some sections and figures have a or b after them, 13.8a and 13.8b, for example. 13.8b was added to the book after the numbering was done, but it is just the same as any other section. Some sections and figures

were taken away after the numbering was done, and you will find that they have gone. You will, for example, find no Section 5.3. Some people do not like books numbered in sections and like the pages numbered instead. Books numbered in sections are, however, much easier to make.

Very often it is not possible to explain everything at once, and you will have to look at other sections to understand things. You are often asked therefore to look at a section or a figure in another part of the book—*be sure you do this*. You may not always find what you want at the beginning of a section you turn to; so be sure you look right through a section when you are looking for something. Sometimes you will find the words 'see below'. This means that you can find more about something further on in that section.

This book has been written to teach you. **IF YOU ARE GOING TO LEARN, YOU MUST DO EXACTLY WHAT THE BOOK SAYS**. You will not learn if you do not do what the book says. For example, if in Chapter Six you read the words, '*Look carefully at the Picture C in Figure 6-4 and find the iris diaphragm*', **YOU MUST LOOK IN FIGURE 6-4 AND FIND THE IRIS DIAPHRAGM IN PICTURE C**. To help you do this, instructions like '*Look*' and '*Find*' have sometimes been written like this. These instructions tell you to **DO** something. Don't read any more until you have done what you have been told.

If a piece of equipment is being described in a chapter, try to find it in your laboratory and look at it while you are reading about it. For example, have the Ohaus balance beside you when you are reading Section 5.5. Have the microscope beside you when you are reading Chapter Six.

Large pieces of this book are in thick black writing with the word '**Method**' on top of them. The method sections give you instructions (orders) which tell you what to do. Follow these methods with great care.

There are many figures, and they are all drawn in the same way. At first you may find them difficult to understand. **FIGURE 1-1** will help you. In each figure there are several **pictures**. In **FIGURE 1-1** picture A is a test tube. Picture B is a test tube full of water. Picture C is a test tube which is being shaken (moved about). In Picture D

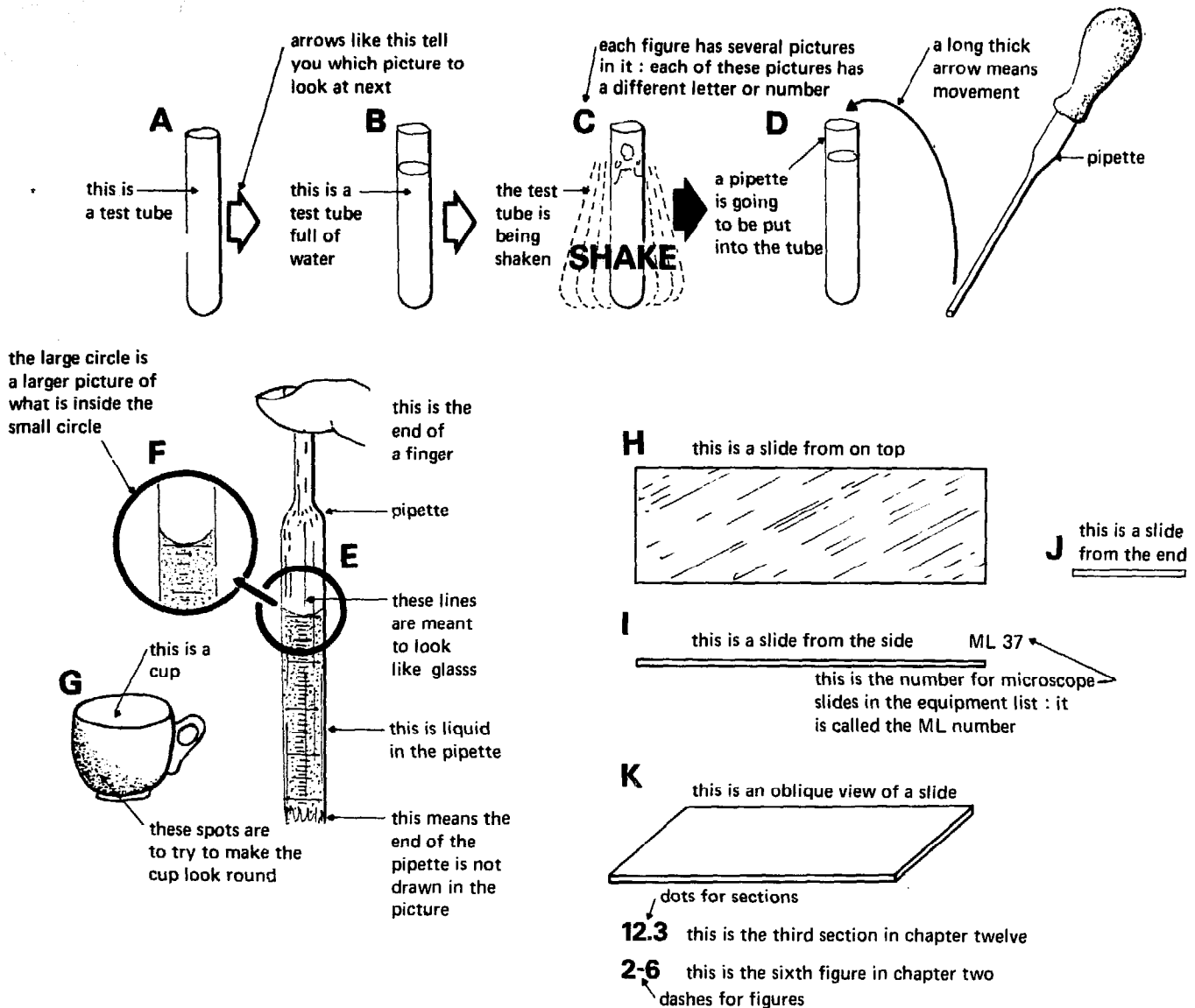

Fig. 1-1 Understanding diagrams

the Pasteur pipette (see 3.9) is going to be put into a test tube. A long arrow shows that something is being moved somewhere. A short thick arrow tells you which picture to look at next. The short thick arrows in FIGURE 1-1 tell you to look at Picture A, then at Picture B, then at Picture C, and then at Picture D. Some arrows are black and some are white. They both tell you what picture to look at next.

In some figures part of a piece of equipment is drawn again larger. For example, the part of the pipette inside the small circle in Picture E is drawn again larger inside the big circle in Picture F.

Spots are sometimes used to show the shape of something. The spots in Picture G, for example, have been used to show that the cup has a round shape.

Pictures H, I, J, and K are all pictures of the same glass microscope slide. Picture H is drawn looking down from on top. Picture I is drawn looking from one side. Picture J is drawn looking from the end of the slide. Picture K is

drawn looking partly from on top, partly from the side and partly from the end. It is called an **oblique** view. In other figures you will see many microscope slides drawn this way.

In some pictures, things are drawn as near as possible to what they really look like. These pictures are **drawings**. Other pictures give only the idea of something. These pictures are **diagrams**. FIGURE 10-5 is a drawing and FIGURE 10-4 a diagram.

To make drawing easier the parts of a figure are sometimes not drawn to **scale**. This means that they are not drawn the right size compared to one another. For example, the finger in Picture E, FIGURE 1-1, is much too big compared to the cup in Picture G. You will soon learn to understand the figures and not get the wrong scale of what you see.

The number beside the picture of a piece of equipment is its **ML** or **Medical Laboratory** number. You will read about these numbers in Section 2.1. The number 37

beside Picture K, for example, is the ML number for microscope slides.

The cost of equipment is in American dollars which are written \$. There are 100 cents in a dollar. For example, a universal container costs about \$0.08, which is eight American cents. This has been done because every country has different money, and it is only possible to give costs in one kind of money.

Here are some more ways in which you can make better use of this book.

METHOD

USING THIS BOOK

Don't learn it by heart.

Don't try to read it from beginning to end all at once.

Make good use of the vocabulary index.

Don't read about equipment you do not have or are not likely to get.

If you are new to laboratory work, read Chapter One as far as the end of Section 1.20. Read Chapter Two as far as the end of Section 2.4. Read Chapter Three as far as the end of Section 3.15. Only read about the reagents in Sections 3.16 to 3.45 when you want to make them. Read Section 3.46 carefully. Read those parts of Chapter Five which describe the equipment you have. Read all about the microscope in Chapter Six. Then, in the other chapters, read about the methods that you are going to use most often. After you have done this you can read anything else which interests you.

Don't worry because this book is so big—you will soon learn to use most of it.

1.2 Honesty and responsibility

On an earlier page you read about how very important it is to be honest—to tell the truth at all times. But there are other things that you should know about the right way to work in a laboratory. The easiest way to tell you about them is to write them down like this.

METHOD

HONESTY, AND PROFESSIONAL RESPONSIBILITY IN A LABORATORY

Always tell the truth. NEVER guess what the answer should be on a specimen you have not examined. A wrong result may make a patient die. Any laboratory worker found doing this deserves to lose his job immediately. He cannot be trusted to work in a hospital or a health centre.

If you are not sure what to report, *say you are not sure*. If you are not sure about something, go and talk to the person who is looking after the patient. If you are looking at a specimen for a doctor, he will think better of you for saying you are not sure. If you have forgotten to do something you have been asked to do, say you have forgotten. If you have made a mistake, say so. The

mistake may be important, and you will be respected for telling the truth.

If you are given so much work that you cannot finish it, say it is too much. Ask which are the most important specimens. Do these. If reports on the other specimens are really wanted, keep them, if you can, until the next day.

Doctors often write 'URGENT' or 'VERY URGENT' or 'IMMEDIATELY' on a request form. Doctors *mean* what they say, so *do* what they say.

Sometimes one method leads to another. Do these methods, even though they are not asked for. If, for example, you have found that a patient is very anaemic, do the other methods for anaemia, such as looking at a blood film, or measuring the MCHC.

Don't work with broken equipment, such as a broken microscope with which you cannot give the right report. It is better to give no report than a wrong report.

Equipment and reagents cost money. Look after all equipment carefully. Try to use the least amount of a reagent needed by each method, so that none is wasted.

All the equipment and chemicals in the laboratory belong to the hospital or health centre. This includes needles, tubes, knife blades, syringes, and spirit. Don't take them home with you. To do so is to steal them. Do all you can to stop other people stealing equipment.

If you cannot go to work because you are ill or for some other reason, send a message to say so. The person you work for will then know what has happened. When you do come back to work go immediately to see the person you work for and tell him why you were away.

Most people work for somebody else. If you do not agree with the person you work for, you have the right to see or write to the person above him. If you do this it is only fair to tell the person you work for first. Many people do not understand this, and it can cause much trouble.

Don't try to experiment and to make new methods for yourself. This wastes chemicals and equipment and may be dangerous.

If you are a laboratory assistant, don't think you are a doctor or a medical assistant. You are not. *Don't therefore treat patients yourself*. If patients ask for the result of a method, don't tell them, even if the patient is a nurse. Laboratory reports are for doctors or medical assistants *only*.

When sick people are to be cared for, the day's work does *not* start with reading the newspaper. Work does not end at 4 p.m. or at any other time! Work in a hospital or health centre only ends when everything that can be done for the patients has been done. This care and interest in the job, and what it means to the patients, is what makes you into a professional person, like a doctor or a judge.

If you have finished looking at the specimens before it is time to go home, don't do nothing. There is *always* work to do in a good laboratory. Make up new reagents,

tidy up, read your textbook, and try to make your laboratory better.

Many patients cannot be treated until their reports are back from the laboratory. If these reports are late, patients cannot be treated as soon as they should be. Patients are often anxious to start treatment, so that they can soon go home to their work and their families. Their beds may also be needed for other patients. Try hard to send all reports back to the ward the same day as the specimen was sent to the laboratory.

Patients are often worried and anxious. Talk to them, explain things to them. If you have to hurt patients by putting a needle into them, explain what you are going to do and tell them why. *Most important of all, be kind to patients, think what they need and do all you can for them.* One day you too may be a patient and you will know how much this means.

If you follow these rules people will rely on you. They will think of you as being kind, honest, reliable, and hard-working. To be thought of like this is precious.

1.3 Some special words

Most of the words you will want to know about are explained in the vocabulary index. Here are some of the difficult ones. Several of them are pairs (twos) of words with opposite meanings. Some of them can mean several different things and only some of these meanings are given here.

Accurate and inaccurate

Accurate means exact. For example, to say that there are about 360 days in a year would be **inaccurate**. To say that there are 365 days would be more **accurate**. You will often have to weigh or count things accurately.

Acute and chronic

These words are used to describe diseases and have special meanings. An **acute** disease, such as pneumonia (a disease of the lungs), is a short-lasting one from which a patient dies or gets better quickly. A **chronic** disease lasts a long time, and a patient dies or recovers slowly. Tuberculosis and leprosy are chronic diseases.

Adjust

To adjust a machine is to alter or fix it so that it works better. If the brakes on your bicycle do not work, they must be **adjusted** so that they do work.

Average

Let us take an example. Say that there are ten boys in a class and that three are aged 12, two are aged 13, two are

aged 15, and three aged 16. We find their **average** age by adding up the ages of all the boys and dividing this sum by the number of boys there are. The ages of all the boys added together come to 140 years. There are ten boys in the class, so we divide by ten and the average age is 14 years. You may want to give the average answer to a method, as in Section 5.14. Take several readings and get several answers. Add them up and divide by the number of readings you took. The result will then be the average answer. It will usually be the answer you get most often. Ten is a good number of readings to take because it makes dividing much easier—you just change the place of the decimal point (see Section 5.2). Five readings will not take so long to do but division is not so easy. Let us take an example. Suppose you are measuring the haemoglobin on the Grey wedge photometer and you get five readings of 40, 41, 43, 43, and 42. Added up these come to 209. Divide this by five and the average is 41.8, say 42. If you cannot understand averages, do not worry—they are not important for most of the methods in this book.

Case

In medicine the word **case** has a special meaning. A patient with a disease is often called a case of that disease. For example, we talk about a case of tuberculosis, meaning a patient with tuberculosis.

Clear, transparent, opaque, and turbid

Clean water is **clear** or **transparent**; that is, we can look through it very easily. We cannot see through milk, and we say it is **opaque**. When we can see little particles (small pieces) floating about in liquid (see below) we say it is **turbid**. Muddy water is turbid.

Detergent

A detergent is a very strong soap. 'Teepol', 'Tide', and 'Surf' contain detergents.

Discharges or exudates

These are fluids which come from some part of the body, such as a wound, a diseased place (a lesion), or from the inside of one of the hollow organs of the body, such as the intestines. Many **discharges** and **exudates** contain pus (see Section 7.14).

Graduated

This word can be used in several ways, but when used here it does not mean getting a B.A. degree! A ruler is **graduated** into inches or centimetres, and the lines on it are called **graduation marks**. A measuring cylinder is graduated in millilitres. Graduated therefore means divided up by marks or lines into spaces of a special size (such as inches or millilitres) that can be used to measure

with. A row of graduation marks is a **scale**. There is a scale on a ruler or a thermometer (see FIGURE 6-3). As you have already read, the word **scale** can also be used to mean the size of the things drawn in a picture. A weighing machine is also sometimes called a scale.

Instrument

An **instrument** is a laboratory machine. A balance, a microscope, and a centrifuge are all instruments.

Male and female

Male means man or belonging to a man. **Female** means woman or belonging to a woman.

Mature and immature

Like many words, these two can be used in several ways. As used here, **immature** means young and not fully grown. **Mature** means fully grown. An **adult** is a fully grown man or woman. An **infant** is a young child.

Membrane and film

The word **membrane** is used for something very thin. Cells are covered by cell membranes. The thin plastic of a plastic bag could be called a membrane. As used here the word **film** means something spread very thinly on a glass slide, such as a blood film or a film of sputum.

Normal and abnormal

If something is seen in most healthy people, we say it is **normal**. If it is only seen in people who are sick, we say it is **abnormal**. For example, healthy people have a few epithelial cells in their urine. We say therefore that it is normal to find epithelial cells in the urine. Healthy people do not have protein in their urine. It is therefore abnormal to find protein in the urine.

There can also be normal or abnormal numbers of something. It is normal for a person to have one or two white cells in a cubic millimetre of cerebrospinal fluid (CSF). It is abnormal for him to have as many as 100.

Percent

'Cent' means a hundred, so **percent** means per hundred. A schoolboy who gets 61 percent marks of the marks in an examination gets 61 marks in a hundred. A patient who has a haemoglobin of 5 g percent has five grams of haemoglobin in 100 ml of his blood.

Positive and negative

You will often find the words **positive** written + and **negative** written -. In this book we use the words positive and negative like this. Say we are looking for protein in the urine, and we find protein. We say that the test for

protein is positive. If we find no protein in the urine, we say that the test for protein is negative. A test may be slightly positive or strongly positive. Read about this in Section 4.4. on the 'plus notation'.

Plastic

Many things we use every day are made of what is called plastic, so also is much laboratory equipment. Almost all pens are plastic, so are the soft kinds of buckets and cups. There are many kinds of plastic; some are hard and some are soft. **Polythene** is a very commonly used plastic. It is opaque, it bends easily, and it becomes very soft in boiling water. **Perspex** is another plastic. It is hard and completely clear (transparent) like glass or water. **Polypropylene** is a very strong plastic that can be boiled or autoclaved (see Section 4.6).

Rod

You will often read the word rod in this book. A rod is something long and thin like a pencil. A shaft is a rod which turns.

Symptoms and signs

A **sign** is something in a patient that a doctor or medical assistant sees, hears, feels, or tests for. This may be spots (seen), noises in the chest (heard), a lump (felt), or protein in the urine (tested for). A **symptom** is something that a patient complains of, such as pain or a sore throat.

Test

To test something is to see if it is there or to see if it is working. We **test** a car to see if it is working and we test the urine to see if there is any sugar in it. The words 'test' and 'method' can sometimes be used in the same way.

Typical and atypical

Typical means what is ordinarily seen. **Atypical** means unusual or extraordinary. Men typically have five fingers; they are atypical if they have six. Patients with pneumonia typically have a fever. It is atypical for a patient with pneumonia to have no fever.

Vertical and horizontal

A high tree stands straight up and is **vertical**. The surface of water is flat or **horizontal**. Something which is sloping and is neither vertical nor horizontal is said to be **oblique**.

Zero and infinity

Zero is another name for '0', nought, or nothing. **Infinity** is the opposite to zero and means the biggest number there is.

1.4 Solutions and suspensions

A **substance** is anything which is the same all through and which can be divided without being spoiled. Water, sugar, earth, ink, and wood are all substances. A **liquid** is something like water or milk which flows and can be spilt. A liquid will fill the bottom of a cup or bottle and will spread over the floor. As used in this book a **fluid** is the same as a liquid. A **solid** is something like wood or glass which stays in the same shape when it is moved. A **powder** is something like earth or sand. A powder is dry and a liquid is wet. Powders are like liquids because they fill the bottom of whatever they are in. But a powder does not flow as easily as a liquid, and if you look at a powder carefully you will see that it is made of many small solid pieces. Small pieces like this are often called **granules**, or **particles**. If all the pieces of a solid have the same simple shape we call these pieces crystals. Sugar and salt make **crystals**, so do many other chemicals.

If a spoonful of sugar is put into a cup of tea the sugar seems to be lost. But we know it is not really lost, because the tea tastes sweet. We say the sugar has **dissolved** in the tea. Sweet tea is a **solution** of sugar in plain tea. If there is much sugar in the tea and the tea is very sweet, the sugar solution is said to be **concentrated** (strong). If there is little sugar in the tea and the tea is not very sweet, the solution of sugar in tea is said to be **dilute** (weak). The concentration of the solution is the amount of sugar that there is in the tea. If there is so much sugar in the tea that it will not dissolve any more, we say that the tea is **saturated** with sugar, or that there is a saturated solution of sugar. A solution of salt in water is called **saline**. Something like salt, which easily dissolves in water, is said to be **soluble** in water. Sand does not dissolve in water and is said to be **insoluble** in water.

Many of the methods in this book use solutions of solids in liquids. The solutions used in the methods are called **reagents**. Most of the reagents are solutions of chemicals in water. Most chemicals are powders or liquids that are made specially pure (that is they have only one kind of thing in them). Blood, earth, and urine have many different things in them and are not chemicals. Sugar is one thing only, so is salt. They can be bought in bottles as pure **chemicals**. When ordinary sugar is bought as a pure chemical, it is given the chemical name 'sucrose', and ordinary salt is called 'sodium chloride'. Unlike salt and sugar most chemicals are not used in homes and have not got ordinary names. For example, there is no ordinary name for the chemical called sodium citrate.

When tea is stirred, tea leaves move in the tea. We say they are suspended (hanging) in the tea, or that there is a **suspension** of tea leaves in the tea. But when the tea in the teacup is still the tea leaves soon fall to the bottom of the cup. The tea leaves form a **deposit**. The tea above the leaves is called the **supernatant fluid** or the **supernatant**. One difference therefore between a solution and a suspension is that in a suspension the solid falls to the bottom. In a solution it does not.

In Section 8.8 you will read about testing the urine for bilirubin. In this test urine is mixed with a clear solution of barium chloride. The mixture of urine and barium chloride goes white (or yellow) and milky. We say a **precipitate** has formed. If the mixture is left to stand this white or yellow precipitate will fall to the bottom of the tube. This is what the word precipitate means—something solid which is made when two chemicals in solution are mixed and which will fall to the bottom if the mixture is left to stand. A precipitate can also be removed by centrifuging or filtering—read about this in the next section. The words deposit and precipitate are often used to mean the same thing.

When wet clothes are left in the hot sun, the water soon disappears and goes into the air. We say the water **evaporates**. If water is boiled we can see it turning into steam, and it will evaporate fast. Some liquids like spirit, methyl alcohol, xylene, and especially ether, evaporate more easily than water. We say they are **volatile**. Methyl alcohol and ether are very volatile. Spirit, methyl alcohol, xylene, ether, and petrol will all burn. We say they are **inflammable**. Ether is very inflammable indeed. Take great care when you use these chemicals that they do not light and cause a fire.

1.5 Centrifuging and filtering (FIGURE 1-2)

Blood is a suspension of very small particles called red cells and white cells in a liquid called **plasma** (see Section 1.17). If a few drops of blood are added to a test tube of saline they will form a suspension as in Picture A. If this suspension were left for a day the cells would slowly fall to the bottom of the tube to make a deposit, and leave clear supernatant saline on top. A deposit with a clear supernatant is shown in Picture E. Blood cells take a long time to deposit when they are left to stand. But we can make blood cells deposit much faster if we make them **spin** (move) round very fast. A machine for spinning tubes round fast is called a **centrifuge**. There is a centrifuge that can be turned by hand in the main equipment list. Look for it in FIGURES 2-1 and 3-11. Picture B, FIGURE 1-2, shows the parts of a simple centrifuge. The tube to be spun or centrifuged, such as the tube of blood cells in saline in Picture A, is put into a bigger metal tube called a **bucket**. These buckets hang in a holder called a **trunion**. The trunions fit into the **head** of the centrifuge. The head turns round on a **shaft**. The centrifuge drawn in FIGURE 1-2 has two buckets to hold two tubes. Many centrifuges have four buckets, and some have more than four buckets.

When the head of a centrifuge turns round the buckets in their trunions are thrown outwards. When the centrifuge is spinning very fast, the tubes are horizontal as in Picture C. As the centrifuge slows down and stops the buckets swing down again as in Picture D. If the tube of red cell suspension is taken out of its bucket, as in Picture E, the cells will be seen as a deposit on the bottom of the tube. There will be supernatant saline on

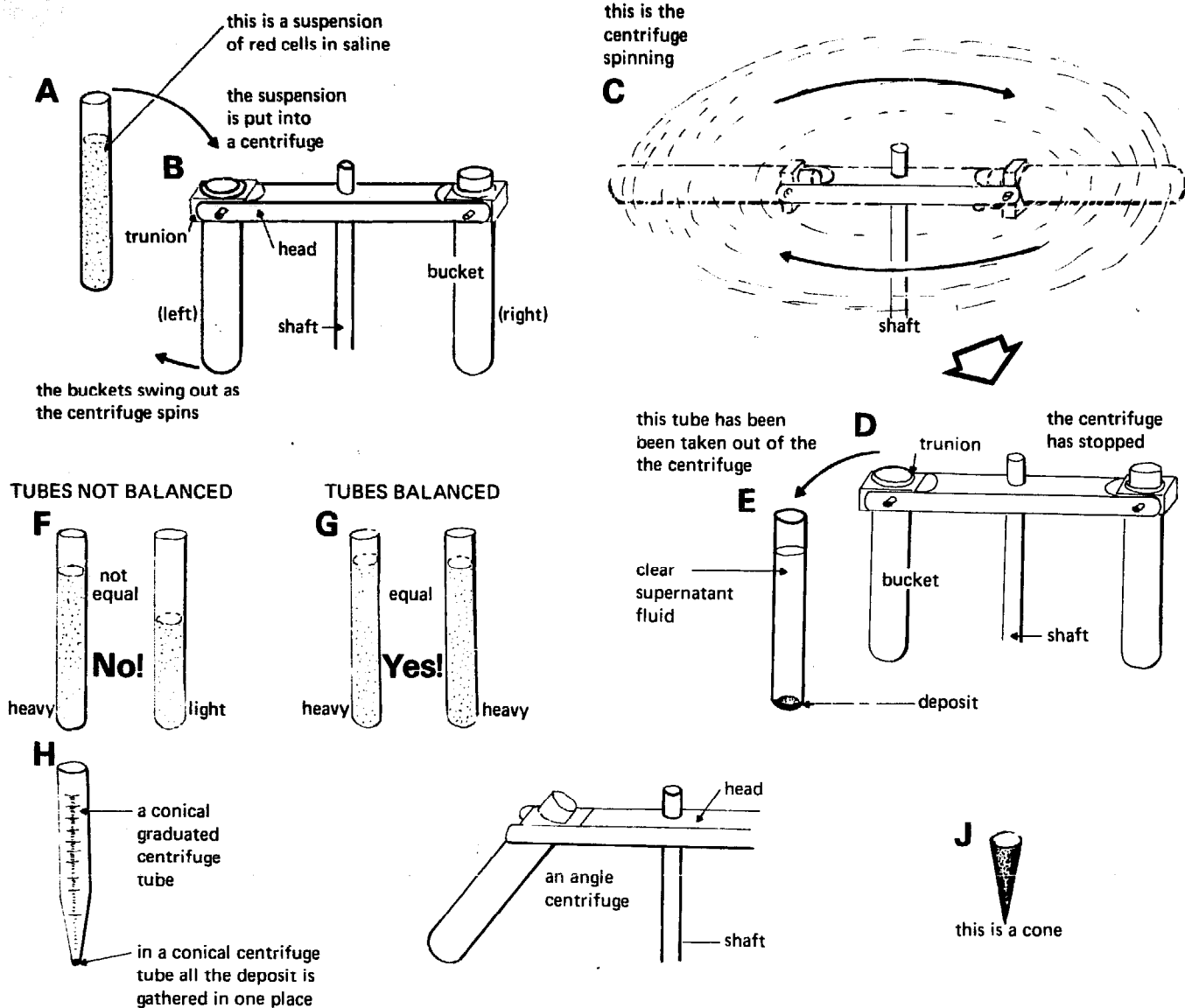

Fig. 1-2 The centrifuge

top. Centrifuging has made the cells deposit in a few minutes—the cells have been thrown to the bottom of the tube. These cells would have taken many hours to deposit if they were left on their own.

If you stop a centrifuge quickly by holding the shaft, the liquid in the tubes is shaken. This often mixes up the deposit and the supernatant. To stop this mixing, let the centrifuge stop slowly by itself.

There are two ways of taking the supernatant fluid away from the deposit. A quick and easy way is to pour off the supernatant. But this mixes up the deposit in the bottom part of the supernatant. So, when you want to take *all* the supernatant away from the deposit, you should use a Pasteur pipette (see Section 3.9).

The tubes in a centrifuge must balance exactly. That is, the tube at one side of the head of a centrifuge must be exactly as heavy as the tube at the opposite side of the head. If the tubes do not balance the centrifuge will shake (move about) as it turns. It will make a noise and may be

spoiled. In Pictures A to E, FIGURE 1-2, only one tube of suspension is being centrifuged. It is put into the left-hand bucket in Picture B. To balance it a tube filled with the same amount of liquid is put into the right-hand bucket. Tubes which contain the same amount of liquid will balance. Tubes which do not contain the same amount of liquid will not balance. Two badly balanced tubes are shown in Picture F. Two well-balanced tubes are shown in Picture G. Not only must the tubes on opposite sides of the head be equally full, but they must also be the same size and weight. In very fast centrifuges pairs of opposite tubes have to be weighed on a special balance to be sure they are the same weight (the word balance can also mean a machine for weighing). In the centrifuge described in this book it is enough to use tubes of about the same size and weight and to make sure they are equally full.

There are several kinds of centrifuge tube. Picture H shows a **conical (cone-like) graduated centrifuge tube**. A

cone is something shaped like the end of a sharp pencil. Conical centrifuge tubes are useful if there is only a very little deposit, because all the deposit comes together at the very bottom of the tube. Graduated centrifuge tubes (tubes with lines or marks on them) are useful for measuring—see Section 5.7. A tube of this kind is shown in Picture H. Some centrifuges have buckets which are fixed at an angle, as in Picture I. These are **angle centrifuges**.

Filtering. Centrifuging is only one way of taking away or separating the particles from a suspension. Another way of separating the particles from a suspension is to **filter** it. If a suspension of red cells in saline is poured through a special kind of paper, called a **filter paper**, the saline will go through and the red cells will be left behind on the paper. The clear saline is called the **filtrate**. In Picture 3, FIGURE 8-3, you will see the precipitate made by mixing urine and barium chloride being removed by filtration. The precipitate is left behind on the filter paper and the clear filtrate is passing through. Remember that a **filtrate** is the clear liquid made by filtering and that a **supernatant** is the clear liquid made by centrifuging.

Filter papers are circles of a special white paper like blotting paper. They are sold in boxes of 100 papers and are shown in FIGURE 2-2 (ML 22). A filter paper becomes soft and easily breaks when it is wet. Filter papers are therefore always held in a funnel and have to be folded in the special way shown in Picture B, FIGURE 3-8.

Filter papers are expensive, so only use them for filtering. *Filter papers are not for cleaning benches or making notes!*

Other things can be filtered, besides particles suspended in liquids. Pieces of coloured glass can be used to filter light. This is described in Section 5.12.

1.6 Acids, alkalis, and salts

As you have just read, the chemical name for the salt we eat is sodium chloride. It is a harmless substance, but it can be made by mixing one kind of 'burning' chemical called hydrochloric acid, with another kind of burning chemical called sodium hydroxide. By burning we do not mean that these chemicals will catch fire like petrol, but that if they touch your skin or your eyes they will harm you as if you had been burnt. If therefore you get these burning chemicals on your skin or into your eyes, wash them off quickly with plenty of water.

Hydrochloric acid is an **acid**, and sodium hydroxide is an **alkali**. Mixed together in the right amounts, an acid and an alkali make a **salt** and water. This can be a dangerous experiment, so don't try it! Salts are not burning because the acid and the alkali have stopped each other from being able to burn. As we shall see in the next section, they are said to have neutralized each other.

Let us take another example. The salt called potassium sulphate can be made by mixing together the right amounts of sulphuric acid with the alkali called potas-

sium hydroxide. There are several acids in the list of chemicals. Hydrochloric acid, sulphuric acid, and trichloroacetic acid are **strong acids**. Tartaric and acetic acids are **weak acids**. Sodium hydroxide and ammonia are **strong alkalis**. Sodium carbonate is a **weak alkali**. There are also many salts, such as sodium citrate, potassium iodide, and ferric (iron) chloride.

1.7 pH and buffers

When a solution of an alkali is slowly added to a solution of an acid, the alkali will begin to use up the acid to make a salt and water. When only a little acid has been added, there will still be some extra acid in the solution. The solution is said to be acid. When all the acid has been used up there will only be salt and water in the solution. The solution has no extra acid or alkali and is said to be **neutral**, but if more alkali is added, there will be extra alkali, and the solution is said to be **alkaline**. The amount of extra acid or alkali is measured by **pH**. Don't worry about what pH stands for. Remember that pH 1 is very acid and that pH 14 is very alkaline. pH 7 is half-way in between pH 1 and pH 14 and is neutral. Pure water has a pH of 7.

If acid or alkali is added to an ordinary solution of salt and water, the pH will change, and the solution will become more acid or more alkaline. However, there are some special solutions of salts made from weak acids and alkalis which can use up extra acid or alkali without changing their pH. These special solutions are called **buffers**. Buffers can be made with any pH, and each buffer has its own special pH. A buffer is useful for keeping a solution at this special pH, even when some acid or alkali is added. The buffer in Section 3.21a, which is used for Leishman's stain, has a pH of 6.8. Because 6.8 is nearly 7, this buffer is nearly neutral and is only very slightly acid. The buffer used for Leishman's stain is a mixture of two different phosphate salts. It is used for keeping the pH of Leishman's stain fixed at 6.8 during staining.

The buffer for gastric washings, which is described in Sections 3.20b and 11.4, is used to neutralize the hydrochloric acid in the stomach. By neutralize (make neutral) we mean that the pH is brought nearer to 7. The hydrochloric acid in the stomach is very strong and has a pH of about 3.5. This strong acid with its low pH would kill the *Mycobacterium tuberculosis* if it were not soon neutralized by a buffer.

1.8 Indicators

In the list of chemicals there are some small books of a special paper called **Universal Indicator Test Paper, pH 1 to pH 11**. If this paper is put in a strong acid, such as hydrochloric acid, it will go red, showing that the pH is about 1. If the paper is put in a strong alkali, such as potassium hydroxide, it will go a deep blue, showing that

the pH is about 11. At pH 4 the paper is orange and at pH 8 it is green. By putting a piece of indicator paper in a solution we can easily see what pH the solution is. Paper which changes colour when the pH changes is called **indicator paper**.

There are many kinds of indicator paper. Most of them have only two or three colours and can only tell you two or three different pH's. For example, Congo red indicator paper is blue at pH 3 and red at pH 5. Litmus paper is red at pH 5 (acid) and blue at pH 8 (alkaline). Universal indicator papers are more useful because they have many colours and can tell you many different pH's. There are several kinds of universal indicator test paper, and you may be given a paper which changes colour in a different way from the one we have just described. The cover of the book in which these papers come is usually printed with several differently coloured squares. On each square is written the pH that that colour shows. Universal indicator test paper is easy to use. Put one end of a piece of paper into the solution you want to test and match (compare) its colour with one of the coloured squares on the cover of the paper.

The use of universal indicator test paper for measuring the pH of the stools is described in Section 10.11. Its use for measuring the pH of the gastric juice is described in Section 11.9. It can also be used for testing the urine.

1.9 Cells (FIGURE 1-3)

Houses are often built with bricks, and a very big house can be built with quite small bricks. In the same way the bodies of all except the smallest living things (micro-organisms—see Section 1.11) are made of millions of very small **cells**. Cells are so small that they can only be seen with a special machine called a microscope (see Chapter Six). There are many different kinds of cells, and they are joined together in different ways to make the **tissues** of the body. Skin cells are joined together to make skin tissue. Liver cells are joined together to make liver tissue. (The word tissue is also used to mean a thin piece of paper. Lens tissue is a special thin paper used for cleaning microscope lenses.) A piece of liver is liver tissue. The whole liver is called an **organ**. A whole eye is an organ, so is a whole heart or stomach. In this way cells make tissues, tissues make organs, and organs make the body. This is shown in Pictures A, B, and C.

Cells have a very thin outer coat called the **cell membrane**. Inside the cell membrane is something called the **cytoplasm**. The cytoplasm is a mixture of many things, especially proteins in water, and contains many small particles. In the middle of the cell there is a large ball or bag called the **nucleus** which is usually round or egg-shaped. When we talk about more than one nucleus we say **nuclei**—for example, one nucleus or two nuclei. Sometimes we use the word **nuclear**, which means belonging to the nucleus. The nucleus contains a substance which is easily coloured (stained) and which is called the **nuclear chromatin**. Chromatin means coloured

material (chrom = colour). In some cells the chromatin is spread more or less evenly all through the nucleus, but in the nuclei of some protozoa it is gathered into larger particles or lumps called **karyosomes** (Picture O). Around the nucleus and between it and the cytoplasm is another thin coat called the **nuclear membrane**. If you think of a cell as a sac or bag (the cell membrane) full of cytoplasm, then the nucleus is a smaller bag inside the cytoplasm. The parts of a cell are shown in Picture A.

All cells are made from other cells. Cells divide (become two) in various ways. The usual way is for the nucleus to divide first to make two nuclei. After this the cytoplasm divides to make two daughter cells with one nucleus in each of them, Pictures H to N show how this happens. Most of the cells in the bodies of animals and man stay close together where they divide. In this way there come to be more cells in a tissue, which is how tissues, organs, and people grow. The amoeba in Picture O and the bacteria in Pictures P to T are made of only one cell. When one celled micro-organisms divide, the daughter cells usually separate from one another and one amoeba becomes two daughter amoebae. Similarly, when a bacterial cell divides two daughter bacteria are formed.

There are many different kinds of cells. Picture D shows a cell called a **lymphocyte**. A lymphocyte is one of the white cells in the blood. Picture E is an epithelial cell from the inside of the bladder. Picture F is a red blood cell or erythrocyte (erythro = red, cyte = cell). A lymphocyte is round like a ball, and the kind of epithelial cell in Picture E is thin and flat. But a **red blood cell** has a special shape. It is like a ball which has been pressed together in the middle. Picture F shows the red cell from the top, and the picture underneath it shows you what it would look like if it were cut in half along the dotted line X-Y. A red cell is thin in the middle and thick at the edges. Red cells are unlike other cells because they have lost their nuclei. A red cell is about $7\frac{1}{2}$ μm across (see Section 6.1). Red cells are red because they are filled with a very important red substance containing iron called **haemoglobin**.

Picture G shows the epithelial cells which come from the inside of the trachea. The trachea is the tube in our necks which takes air to our lungs. You will see that the epithelial cells from inside the trachea are fixed closely together, side by side. These cells form a membrane or **epithelium** all over the inside of the trachea. There are other kinds of epithelium inside the bowel (gut, intestine) and the urinary tract (the organs concerned with urine).

The word cell can be used in several different ways. Besides its use to mean a living cell, a cell can also be a special glass box for putting liquids in, part of an electric battery, part of a counting chamber, or something which makes electricity when light falls on it.

1.10 Proteins and enzymes

Cells are mostly made of many different kinds of substances called **proteins**. The proteins in our cells are

CELLS FORM TISSUES, TISSUES FORM ORGANS

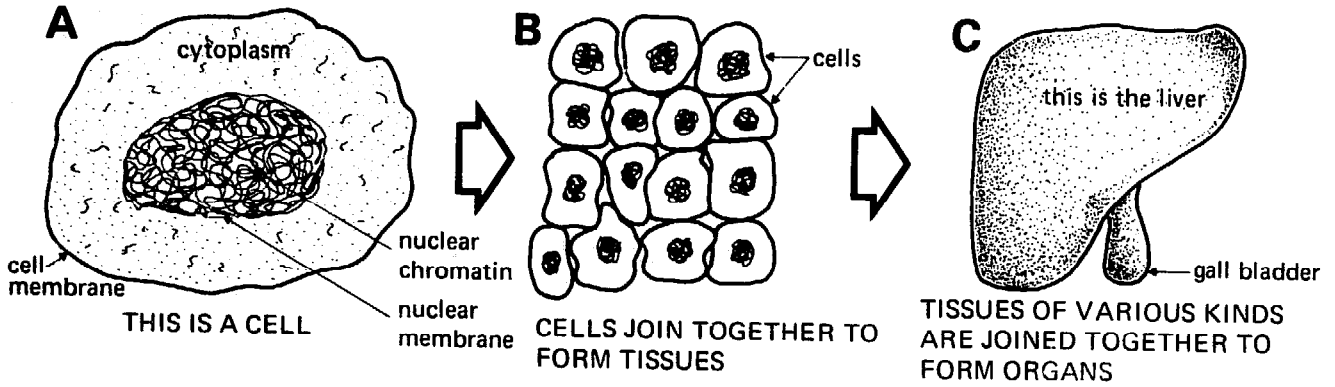

SOME CELLS FROM OUR BODIES

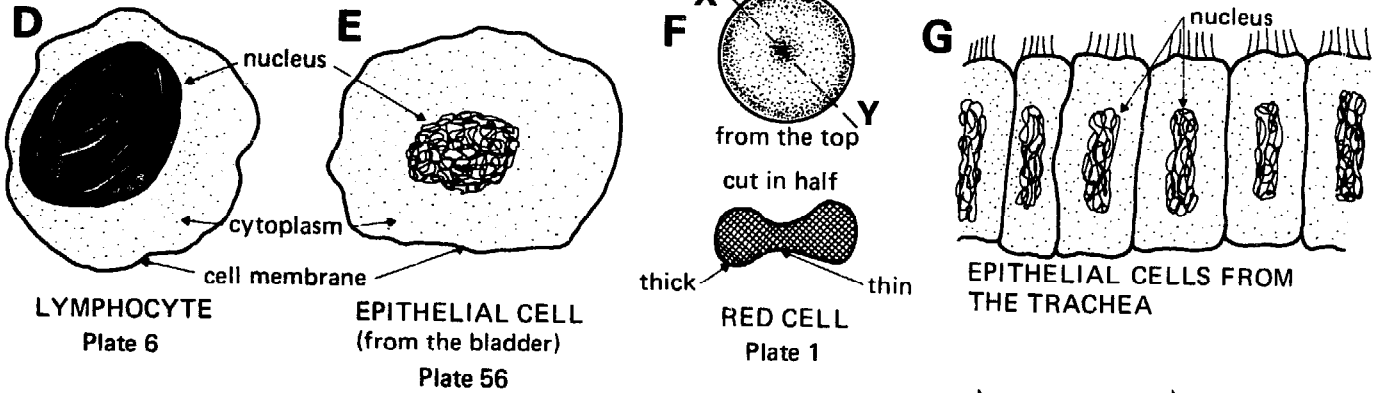

CELLS DIVIDING

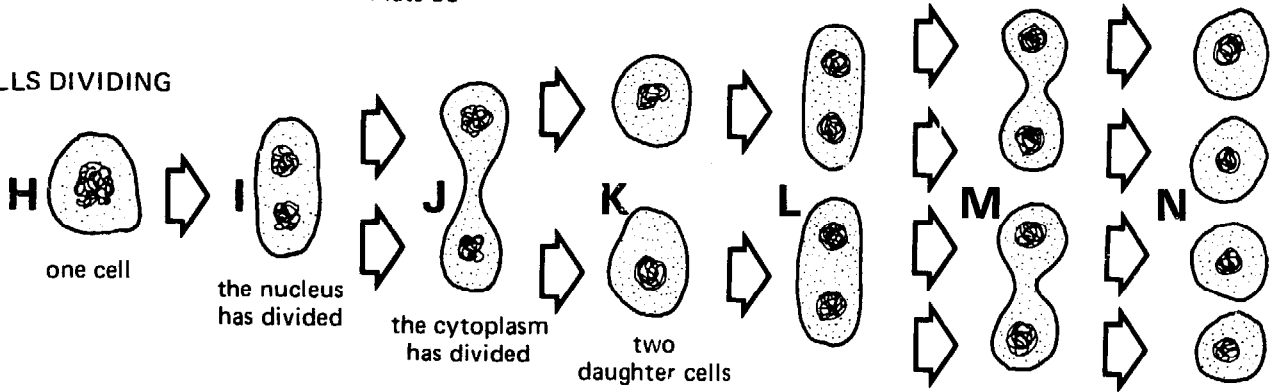

SOME MICRO-ORGANISMS

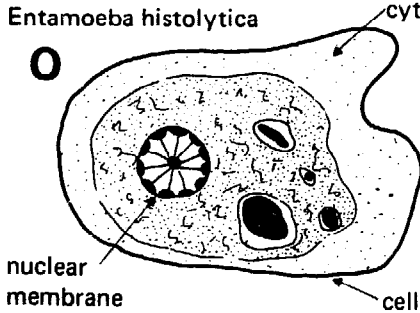

ENTAMOEBE HISTOLYTICA
 protozoal trophozoite

Plate 87

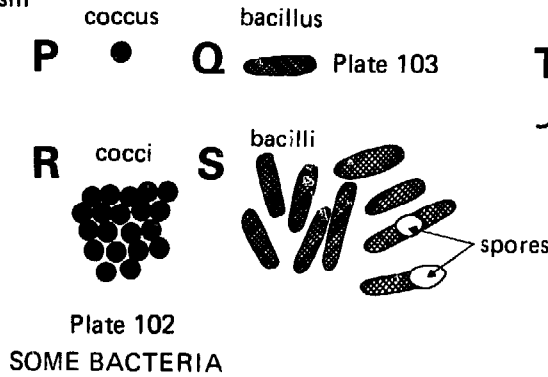

SOME BACTERIA

Fig. 1-3 Cells

made from the protein foods we eat, such as beans or fish. These proteins help to form the cell membranes and the nucleus. They are also some of the many important things in the water of the cytoplasm. Proteins also form the **enzymes** inside the cell which make the cell work. Enzymes are special proteins for making the things that cells need. If you like, you can think of enzymes as being the machines of the cell which make the cell alive. In Section 7.41 you will read about the enzyme called **urease** (all enzymes end with the word '-ase'—for example, lactase, amylase). Urease turns a substance called urea into other substances called ammonia, carbon dioxide, and water. It is only one of the many thousands of enzymes that cells have with which to make the substances that they need to live and grow.

Most of the protein of the body is in its cells, but some proteins are outside the cells and are dissolved in the blood plasma (see Section 1.17). These are the **plasma proteins**. There is no protein in normal urine, but, when the kidneys are diseased, the plasma goes into the urine. In Section 8.3 you will learn how to test the urine for protein.

1.11 Micro-organisms

In the world around us there are many other living things besides men, women, and children. Living things are called **organisms**. Cows and dogs and trees and grass are organisms, so are birds and snakes. Some of these organisms are very big, like elephants or big trees, and some of them are very small, like small insects. But, as well as the living things we can see, there are many more living things which are so small that we cannot see them. These very small living things are called **micro-organisms** (micro means small). They are so small that they can only be seen with a microscope. The smallest micro-organisms are made of one cell only. Micro-organisms are also called germs or microbes. A micro-organism can grow and divide into two micro-organisms in as short a time as twenty minutes. If it has the right food, one micro-organism can grow into millions of micro-organisms in a few hours. Most micro-organisms live in the soil or in water where they do no harm. Many micro-organisms are useful and some help the soil. There are micro-organisms almost everywhere. They are on this book, on your hands, in your nose, on tables, on floors, and on the equipment in your laboratory. There are also micro-organisms in the air. Most micro-organisms are harmless.

1.12 Parasites, commensals, and infection

Many organisms live on or inside man and animals. Those which cause no harm are called **commensals**. Those which cause harm are called **parasites**. One of the reasons why parasites are harmful is that one parasite may grow into millions. When someone has many harm-

ful parasites inside him, he becomes sick and may die. When a person has a parasite of a certain kind living inside him he is said to be **infected** by that parasite, and to be the **host** for it. People can be infected by dangerous micro-organisms, and so can things such as loops (see Section 3.10), test tubes, and specimen containers. If a loop or specimen container has micro-organisms on it, we say that it too is infected.

Each parasite has its own way of getting into the body. Some go through the skin, some get into food, and some use other ways. Parasites can spread from one person to another. When this happens, one person is said to infect another. For example, when someone is sick with the disease called tuberculosis, he is sick because a parasitic micro-organism called *Mycobacterium tuberculosis* is growing inside him and infecting him. Some patients with tuberculosis of the lungs cough sputum containing *Mycobacterium tuberculosis* out of their lungs into the air. Sputum is the thick white or yellow substance that people cough up. A healthy person may breathe in the *Mycobacterium tuberculosis* from the little drops of infected sputum in the air and become infected. He might become sick and die.

Many of the patients coming to a health centre or hospital are diseased because there are parasites growing inside them. Most of these patients will have been infected by another person. A few will have got their parasites from animals. Diseases caused by parasites which can be caught from other people or animals are called infectious diseases. These include leprosy, tuberculosis, ancylostomiasis (hookworm infection), schistosomiasis (bilharzia), malaria, trypanosomiasis (sleeping sickness), and onchocerciasis (river blindness). You will see that many infectious diseases end with the word '-iasis'. If you see a word ending in this way, you can be sure it is an infectious disease. Many diseases are not infectious, sickle-cell anaemia for example.

Many of the methods in this book are for finding parasites in infected people. If we can find which parasite a patient has, we know what disease he is suffering from (why he is ill), and we can give him the right treatment. If a patient is given the right treatment, he will probably get well.

Many parasites and the infectious diseases they cause are common in almost all the warmer countries of the world. Some of these diseases which are seen almost everywhere are tuberculosis, leprosy, hookworm infection, *Ascaris* infection, gonorrhoea, and malaria. Other diseases are only seen in a few countries. For example, there is trypanosomiasis in Zambia but not in India. *Ask what parasites and what diseases are found in your country and learn all you can about them. Don't waste time learning about diseases you will never see.*

1.13 How organisms are named

You may have asked yourself why we write the names of micro-organisms like this—*Mycobacterium tuberculosis*,

Entamoeba histolytica, or *Borrelia duttoni*. We do this because all living things are named in this way. For example, man is *Homo sapiens*, the house fly is *Musca domestica*, the maize plant is *Zea mais*. The first word in each name is the tribe or **genus** of the organism. When there is more than one genus, we say **genera**. The genus always starts with a capital (big) letter. The second name is the name for that special organism; we call it the **species** of that organism. The name of the species always starts with a small letter. In printing both names are always written in special italic writing like this—*italic*. In typing or handwriting both names are underlined. You will meet two species of the genus or tribe *Mycobacterium*. You will meet one species called *Mycobacterium tuberculosis*, which causes tuberculosis, and another species, *Mycobacterium leprae*, which causes leprosy. The word for the genus is often shortened. Thus *Mycobacterium leprae* is often written *Myc. leprae*, and *Entamoeba histolytica* is written *E. histolytica*. There are special shortenings for each genus, and we must not make our own.

1.14 The different kinds of parasites

We shall describe these kinds of parasite:

Nematodes (roundworms)	} Usually big enough to see
Cestodes (tapeworms)	
Trematodes (flatworms)	
Fungi—one or more cells	} Can only be seen with a microscope
Protozoa—one cell	
Bacteria—one cell	
Viruses—less than one cell	

Viruses are the smallest kind of micro-organism. Viruses are very much smaller than a cell and can only grow inside the cells of other organisms. All viruses are therefore parasites. Viruses are difficult to study, and we cannot study them with the equipment in our laboratory.

Viruses cause measles, poliomyelitis (polio), chickenpox, smallpox, and many other diseases.

Bacteria are larger than viruses. Each bacterium is one complete cell, but it has no separate nucleus. The nucleus of a bacterium is mixed up with its cytoplasm. A round bacterium like a ball is a **coccus** (Picture P, FIGURE 1-3). When there is more than one coccus, we say cocci (Picture R). A coccus usually measures about 1 μm . A long rod-shaped bacterium is called a **bacillus** (Picture Q). When there is more than one bacillus, we say bacilli (Picture S). Some bacteria are long, thin, and curved like a snake. *Borrelia duttoni* shown in Picture T is a bacterium of this kind. Some bacteria have strong seeds or spores (Picture S) which are hard to kill with heat or chemicals. Tuberculosis, gonorrhoea, and many other diseases are caused by bacteria.

Protozoa are larger than bacteria and measure about 10–20 μm . They are made of one cell which has a nucleus.

We say protozoon when there is only one organism and protozoa when there is more than one. An amoeba is a protozoon which moves slowly by putting out feet or **pseudopodia**. An amoeba called *Entamoeba histolytica* has been drawn in Picture O. You will see the cell membrane, the cytoplasm, and the nucleus. Many protozoa can live in a larger, active moving form called a trophozoite, as well as in a smaller, 'sleeping', still form called a **cyst**. Trophozoites are easily killed by dryness, sunlight, and chemicals, but cysts can often live through these things, and so infect new hosts. The amoeba drawn in Picture O, FIGURE 1-3, is a trophozoite. You will see cysts in Pictures E and K, FIGURE 10-8. Some protozoa move very fast by waving 'hairs' or **flagella** which stick out of the cell. Protozoa of this kind are called **flagellates** (see Section 10.8). Organisms which move on their own are said to be **motile**. Many protozoa and bacteria are motile. Protozoa cause malaria, trypanosomiasis (sleeping sickness), and amoebiasis.

Fungi are very simple plants. Most fungi are single celled (one celled) micro-organisms, but some fungi contain many cells and are large enough to see. Single celled fungi are about as wide as protozoa (about 5 μm), but they may be long and thin. Their cells have nuclei and often branch or divide into two. Unlike the protozoa, fungi are never motile; we say they are **non-motile**. Fungi cause many skin diseases, such as ringworm.

Most worms or **helminths** are large enough to be seen easily. Many live in the gut (intestines, 'stomach') and lay eggs or ova which we look for in the stool. If we find ova in the stool, we know the patient must have the parent worm in his gut. Worms cause schistosomiasis (bilharzia) and ancylostomiasis (hookworm infection).

1.15 Putrefaction or rotting

If meat, milk, blood, or urine are left in a warm place, they soon start to smell and go bad. They are said to **putrefy** or rot. This is because micro-organisms, especially bacteria, grow in the meat, the milk, or the blood and destroy or spoil them. Some reagents, such as antisera or bovine albumen (see Sections 12.3 and 12.6) also putrefy and spoil if they are kept warm. One way to stop things putrefying is to keep them cold in a refrigerator. Micro-organisms cannot grow when it is cold, or they only grow very slowly. Micro-organisms seldom grow well enough in ordinary chemicals and reagents to spoil them, because most reagents do not contain the right things for micro-organisms to eat. Micro-organisms will, however, grow in a solution like sodium citrate. Citrate solutions should therefore be kept in a refrigerator.

1.16 Stains

Because the cytoplasm of cells is a mixture of things in water, living cells are clear and watery and are often

difficult to see. We usually therefore colour cells with **stains**. We say we stain them. A stain is a coloured liquid like ink. In Picture D, FIGURE 1-3, the nucleus of the lymphocyte has been stained and looks black; so also have the bacteria. But the epithelial cell in Picture E is drawn unstained. Several stains are used in the methods described here. These stains are Gram's stain, Leishman's stain, crystal violet, and carbol fuchsin.

1.17 Serum and plasma (FIGURE 1-4)

When blood comes from the body it is a thick red liquid. Picture B, FIGURE 1-4, shows blood coming from a finger prick. The finger has been pricked with a glass chip—see Section 4.7. If blood is put into an empty tube, as in Picture A, it soon goes solid as in Picture C. It is said to **clot** or **coagulate**. If the blood clot is left for some hours, you will see that a clear yellow liquid comes out of the clot and that the clot retracts (gets smaller) as in Picture D. This clear liquid that comes from clotted blood is called **serum**.

We can easily stop blood clotting by adding a special

chemical to it. Chemicals for stopping blood clotting are called **anti-coagulants**. The anti-coagulants used in this book are **sequestrene** (Section 4.6), sodium citrate (Section 7.39), and heparin (Section 7.2). Sequestrene has many names. It is also called potassium EDTA, potassium ethylene-diamine-tetra-acetic acid, and sequestric acid potassium salt—don't learn these names, but remember that you may see any one of them on a bottle. You must have the potassium salt; plain sequestric acid will not work. If a very little sequestrene is put in the bottom of the tube, as in Picture E, FIGURE 1-4, and blood mixed with it, as in Picture F, the blood will stay liquid and will not clot. It can easily be poured into another tube as in Pictures G and H. If the blood is left until the following morning, it will remain liquid. The red cells will fall to the bottom of the tube. The slightly cloudy yellow liquid on top is called **plasma**. On the top of the red cells is a thin dirty white layer. Most of the white cells are in this layer: it is called the **white cell layer**. Some people call it the buffy coat. Although plasma and serum are both yellow liquids and both come from blood, they are not the same. *Serum comes out of a blood clot. Plasma is the liquid part of blood which has been prevented from clotting.*

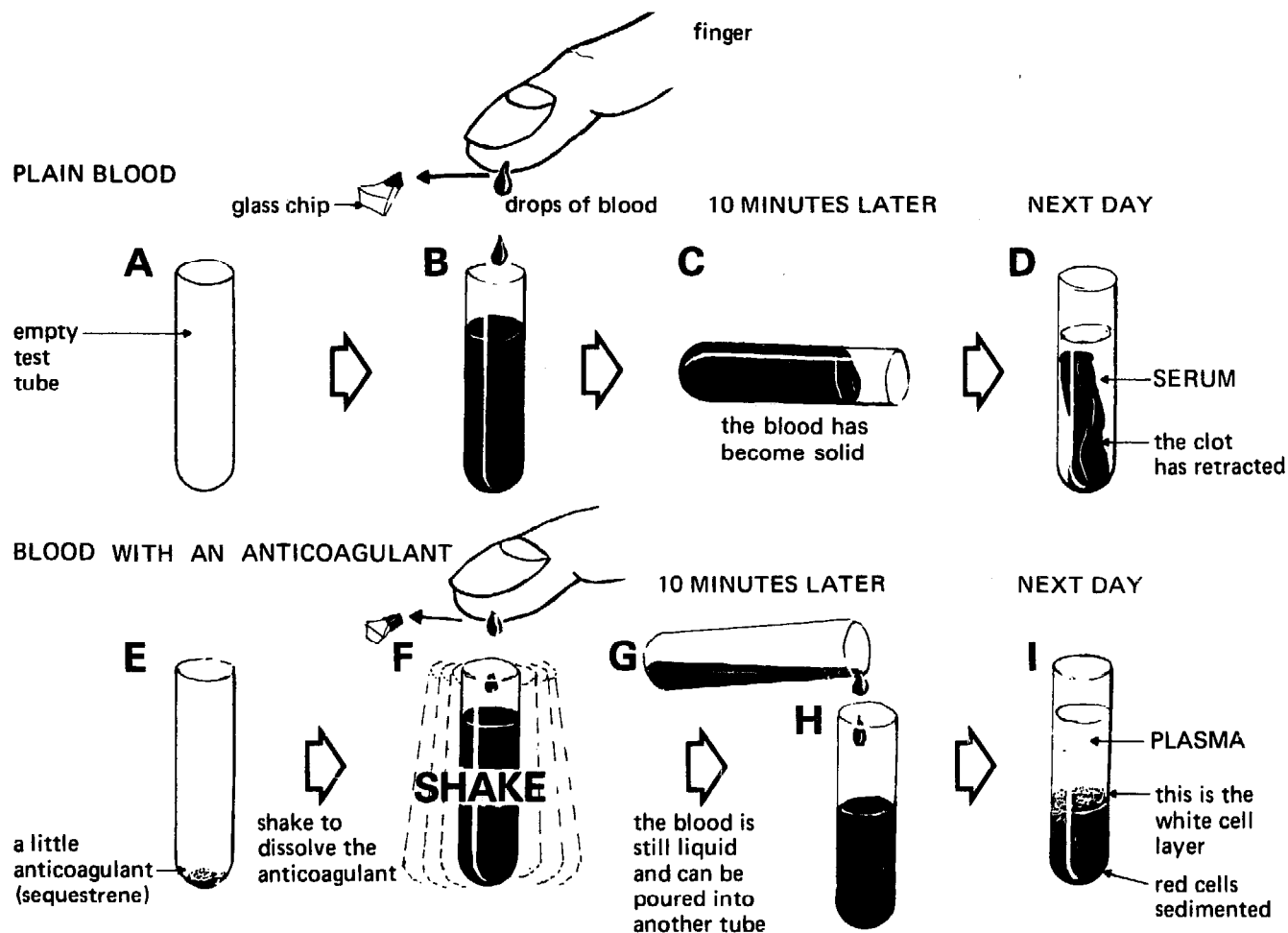

Fig. 1-4 Serum and plasma

In most methods for blood in this book unclotted specimens in sequestrene are used. But in blood grouping, for example, clotted blood is always used. In some methods, such as the serum urea, either clotted or unclotted blood can be used. Because it is important to have either a clotted or an unclotted specimen, whichever the method says, blood must be taken into the right kind of bottle or tube. Laboratories therefore give the wards plain empty bottles for clotted blood and bottles with sequestrene in them for unclotted blood. Making these specimen bottles or tubes is described in Section 4.6.

1.18 Isotonic solutions

As you have read, the cytoplasm inside the cell membrane is a mixture of many different things in water. One of these things is salt. In a living healthy cell there is always just the right amount of salt in the cytoplasm. Some cells, especially some bacterial cells, do not mind how much salt there is *outside* the cell membrane in the solution around them. These cells will live quite well when there is a lot of salt in the water around them or when there is very little. If there is much salt outside them, they can stop too much getting in through the cell membrane. If there is little salt outside them, they can stop too much getting out.

But the red cell is different. The red cell can only live in a solution in which there is just the right amount of salt. If there is too much salt in the solution around a red cell the water inside it goes out through the cell membrane. The cell therefore gets smaller because it has lost water and shrivels up (folds up). Shrivelled up red cells are said to be **crenated**—look at *Picture C, Figure 7-15*. If there is too little salt in the solution around a red cell, the water outside comes in through the cell membrane. Because water has come in the red cell swells (gets bigger), it becomes round and then bursts or **lyses** or **haemolyses** (breaks open). If red cells are going to stay their right shape, there must be the same amount of salt outside them as there is inside them. We call a saline (salty) solution of just this right strength **isotonic** saline (iso = equal, tonic = strength). An isotonic solution has the same salt concentration as the cell cytoplasm. Weaker saline solutions, which make the red cell swell up and burst are called **hypotonic** (hypo = less). Stronger solutions which make the red cell shrivel up and crenate are called **hypertonic** (hyper = more). A hypertonic saline solution will make red cells crenate. An isotonic solution keeps red cells healthy. A hypotonic saline solution will make red cells swell up and burst. An isotonic saline solution for red cells contains 0.85% of sodium chloride (common salt). That is, it contains 0.85 g of salt in 100 ml of solution (see Section 3.40). This isotonic solution is sometimes called physiological saline or normal saline. Often, as in this book, it is just called 'saline'. The saline you read about therefore means 0.85% of sodium chloride in water. It is mostly used for washing red cells for blood grouping.

Don't muddle up *normal saline*, which is for washing red cells and which is only salt and water, and *formol saline*, which is salt, formalin, and water. Formol saline is for fixing or preserving tissues (stopping them putrefying or rotting).

As you have read, when red cells break open and the haemoglobin inside them comes out, they are said to lyse or haemolyse. Many substances will make red cells haemolyse besides water or a hypotonic solution. Soap, or a detergent such as 'Teepol', will make blood haemolyse. For some methods, such as the serum urea, it is important that blood does not haemolyse before it is examined. When we measure the haemoglobin we want to lyse red cells, so that the haemoglobin comes out of them. We do this by putting a little blood into a much larger volume of a very dilute alkaline solution made of sodium carbonate or ammonia.

1.19 Disinfectants and antiseptics

When patients have micro-organisms inside them that are causing disease, we kill these micro-organisms by giving the patient **drugs** (medicines). These drugs are carefully chosen so that they kill the micro-organisms but not the patient. For example, if the patient is infected with *Mycobacterium tuberculosis* he may be treated with drugs called streptomycin, PAS, thiacetazone, and INH. These drugs kill the mycobacteria inside the patient's body. Often we want to kill harmful micro-organisms outside the body. For example, we must kill *Mycobacterium tuberculosis* in sputum bottles that are going to be washed. We want to kill any parasitic micro-organisms that we have found in a patient's sputum. If we do not do this we might ourselves be infected with a parasitic micro-organism and suffer from a disease. We cannot use drugs to kill these micro-organisms, because drugs are too expensive. Also, they only kill some micro-organisms. Instead we use chemical solutions called **disinfectants**. To disinfect something means to kill the harmful micro-organisms in it, or to remove the infection from it.

Disinfectants kill *most* organisms. They will kill us too, if we drank them. So they cannot be used as medicines. Most disinfectants would harm the skin if they touched it. There are many disinfectants. A common one is a brown oily liquid called **lysol**. Keep a jar of lysol on your bench and put into it anything you have finished with and which might be infected and might therefore be dangerous. Keep a bucket of lysol under your bench and put infected specimen bottles into it. Make the lysol solution for the bucket by adding half a cupful of pure lysol to a bucket about three-quarters full of water.

Some people like to keep a pressure cooker on their bench with a little water in it. They put everything which is infected into it, such as sputum pots. When the cooker is full it is quickly heated on a paraffin pressure stove.

This kills all the harmful organisms, and the things inside the cooker can then be safely washed.

Antiseptics are half-way between drugs and disinfectants. Antiseptics kill micro-organisms and may kill you if you drink them. But antiseptics do not harm the skin, so they can be used quite safely to kill micro-organisms on the skin. Antiseptics are used to kill micro-organisms on the skin before a surgical operation. This stops them getting into the patient's wound. **Spirit, iodine, and cetrimide** are antiseptics.

1.20 Sterilization

There are other ways of killing micro-organisms. One way is to heat them so hot that they die. By heating something in the right way we can kill *all* the micro-organisms in it, including all the bacterial spores. All micro-organisms can be killed by heat, not only most of them as in disinfection. When we kill *all* the micro-organisms in or on something we say we sterilize it. Something in which all the micro-organisms have been killed is said to be **sterile**. In our laboratory the thing that we sterilize most often is a wire loop (look at Picture C, FIGURE 3-2). A loop is usually sterilized in the flame of a Bunsen burner or a spirit lamp. The end of a Pasteur pipette or the surface of a slide can also be sterilized by heat in a flame. When we sterilize something by putting it through a flame, we say we are **flaming** it. When a loop has been flamed all the micro-organisms on it will have been killed and it will be sterile.

Another way of sterilizing things is to put them into boiling water. All hospital wards have special **boiling water sterilizers** for sterilizing such things as bowls, scalpels (the knives surgeons use), and scissors. Boiling water is not a good way of sterilizing things because it is not hot enough. But we cannot make a pan of boiling water any hotter. If we heat the water more it only boils away faster and does not get any hotter. The boiling water turns into steam and goes into the air. If water is to be made hotter than boiling water the steam must be stopped from getting away. To stop the steam getting away, the water must be heated in a special strong pan with a strong tight cover (lid). The steam tries very hard to force (push) its way out and would burst a weak pan open or push the lid off. When the steam pushes strongly in this way but is stopped from getting out, we say the steam is under pressure.

Pressures are measured in pounds per square inch which is often written lb. sq. in. Pounds is shortened to lb., square to sq., and inches to in. In the next section, for example, you will read about a pressure of 15 lb. per sq. in. This means that on every part of the inside of the pan and its lid one inch long and one inch wide (one square inch) the steam is pressing just as if it were a weight of 15 lb. When something is heated in pure steam at 15 lb. for 15 minutes, all the micro-organisms in it will usually be killed, and it will be sterile. '15 lb. for

15 minutes' is an easy sterilizing pressure and time to remember.

The harmful micro-organisms in specimens of stool, sputum, etc., will be killed by steam at a pressure of 15 lb. for 5 minutes. So we need only autoclave for 5 minutes to disinfect specimen containers and make them safe to wash. They will not be sterile (some micro-organisms will be left, including most bacterial spores), but they will be safe to wash (the harmful micro-organisms will have been killed).

A pan for sterilizing with steam under pressure is called an **autoclave**. In a boiling water sterilizer the things to be sterilized are kept under the water. In an autoclave the things to be sterilized are kept in the hot steam above the water. Every hospital has a big autoclave for killing the micro-organisms, including the spores, in the towels and dressings (bandages, gauze, etc.) that are used for doing surgical operations. Spores are very dangerous in surgical dressings because one kind of bacterial spore can cause a disease called **tetanus**. Large laboratories also have big autoclaves. The best kind of small autoclave for a small laboratory is called a **pressure cooker**. Don't muddle up a pressure cooker which is a small autoclave and a **pressure stove** (ML 71) which is a stove using paraffin or kerosene under pressure. A paraffin pressure stove is also called a 'Primus stove'. Pressure cookers are made for cooking food in kitchens, because cooking, like sterilizing, goes faster in steam under pressure.

1.21 The pressure cooker (FIGURE 1-5)

The pressure cooker in the main equipment list is called the Prestige 'Hi-Dome' pressure cooker. A small book comes with the cooker which tells you how to use it for cooking food. This section tells you how to use the cooker for sterilizing equipment in a laboratory.

In Picture A you will see that there are two main parts to the cooker: a **body** (the pan) and a **cover** (the lid). The pan and the cover both have long handles. The cover fits tightly on to the pan, and between them there is a rubber ring called the **gasket** (Pictures A and Q). On top of the lid there is a **3-way control valve** (a valve is a tap) and a **safety plug** (a plug is a cork or stopper).

Footnote. When this book went to be printed the Prestige 'Hi-dome' pressure cooker was still being made with weights that measured pressure in pounds per square inch, and not in kilograms per square centimetre. This is why pounds per square inch have been used throughout this book. If you have a pressure cooker that measures pressure in kilograms per square centimetre, you will need to know the following:

- 15 pounds per square inch is nearly equal to one kilogram per square centimetre (kg/cm^2).
- 10 pounds per square inch is nearly equal to 0.7 kilograms per square centimetre.
- 5 pounds per square inch is nearly equal to 0.3 kilograms per square centimetre.

A THIS IS THE PRESSURE COOKER CUT IN HALF

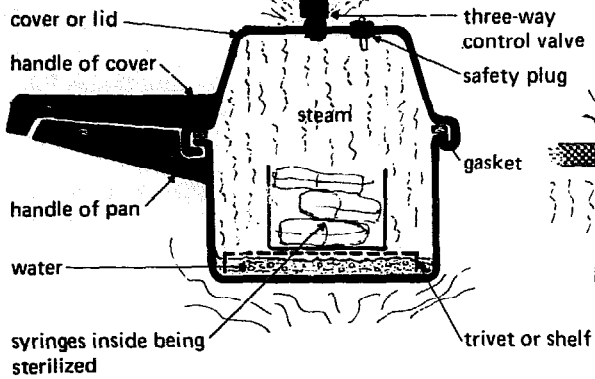

B THREE-WAY CONTROL VALVE

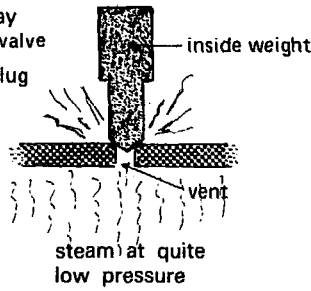

C

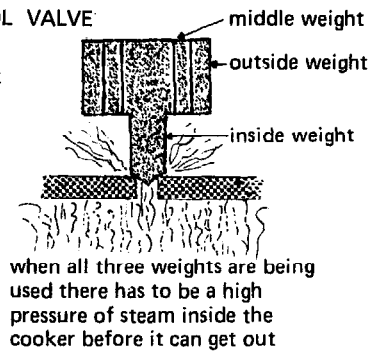

D



ALL THREE WEIGHTS SCREWED TOGETHER (this is the same as in Picture, C)

E



INSIDE AND MIDDLE WEIGHT SCREWED TOGETHER

F



INSIDE WEIGHT (this is the same as Picture B)

G THE PRESSURE COOKER HAS BEEN CUT IN HALF TO SHOW WHAT IT LOOKS LIKE INSIDE

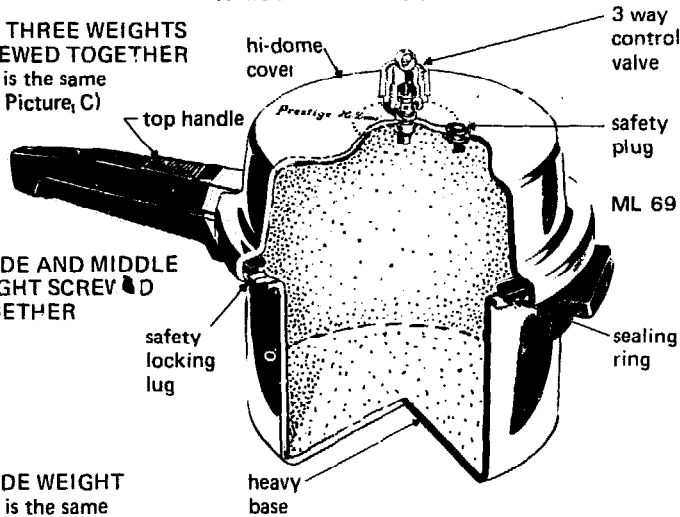

H SAFETY PLUG IN (as in normal use)



I SAFETY PLUG OUT (steam is getting out)



J HOW TO PUT THE LID ON

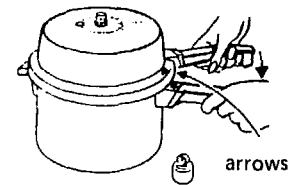

HOW TO FIT THE HANDLES TO YOUR PRESTIGE PRESSURE COOKER

K

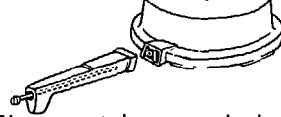

Insert the longer of the two handles into the bracket on the lid. Insert screw-end rod into handle and screw up tightly.

L

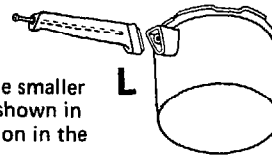

Now repeat the process by inserting the smaller handle in the bracket on the body, as shown in diagram (B) and secure firmly in position in the same way as (A)

REPLACEMENTS

M

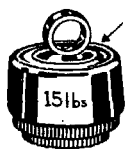

three-way control valve

N



upper handle

P



front handle

O



lower handle

Q



gasket

R



safety plug

Fig. 1-5 The pressure cooker

The 3-way control valve controls (adjusts) the pressure of the steam in the cooker. It is called 3-way because it can control the steam at three different pressures. It is made of three weights which screw together. There is an inside weight (Pictures B and F) and two weights like rings which screw on to it. Picture E shows the inside and middle weight screwed together. Pictures C and D show the inside, the middle, and the outside weight screwed together. A rod on the inside weight blocks (shuts) a small hole in the lid of the cooker. This hole is called the vent. The steam has to lift the rod and the weights before it can get out of the vent. If the weights are heavy (as in Picture C) there has to be a high pressure of steam in the cooker before the steam can lift the rod and the weights and get out of the vent. By using the three weights of the 3-way control valve we can control the pressure of the steam inside the cooker at 5, 10, or 15 lb. per sq. in. In Picture B only the inside weight (Picture F) is being used, and the steam can get out of the cooker when it is only at a pressure of 5 lb. per sq. in. When the middle weight is screwed on to the inside weight the steam can get out when it is at 10 lb. per sq. in. In Pictures C and D all three weights are screwed together, and the steam can only get out when it has got to a pressure of 15 lb. per sq. in. *Whenever you sterilize things in a cooker use all three weights together—that is, at 15 lb. per sq. in.* and keep this pressure for 15 minutes. It is possible to **disinfect** things by killing the more harmful micro-organisms and so making them safe to wash, by keeping a pressure of 15 lb. for only 5 minutes.

If the vent becomes blocked (shut off so that steam cannot get out), the pressure of steam in the cooker might get so high that the cooker would burst (explode or suddenly break open). This would spoil the cooker and might hurt you. A safety plug (Pictures H, I, and R) has therefore been put on the cooker to let out the steam when the pressure becomes too high. In this way a safety plug stops the cooker bursting. The safety plug is a piece of round black rubber with a hole in it. A specially shaped metal rod sticks into this hole. When the cooker is being used this rod sticks into the hole, as in Picture H, and keeps the steam in the cooker. But, if the steam pressure rises too high (that is, much higher than 15 lb. per sq. in.) the rod of the safety plug comes out (as in Picture I) and lets out the steam. When the steam has come out the rod can easily be pushed back again. The cooker will not work with the rod sticking out because the steam will get out too easily. This is why Picture I is crossed out.

Three little baskets, the separators, come with the cooker, and are useful in the laboratory. There is also a metal circle (disc) with holes in it. This is the **trivet** (a trivet is a shelf for holding things while they cook). You will see that the trivet has a rim or edge on one side only. Always use the trivet with the edge down. In this way the trivet will keep the things you are sterilizing from being wet by the water.

Steam is much better than hot air for killing micro-

organisms. When you start sterilizing it is therefore very important to let the steam from the boiling water blow away all the air. *Wait until the steam is coming out of the vent in a steady flow before you put on the weights.* When the steam is coming out in a steady flow it will have blown away the air and then there will be pure steam inside the cooker. This pure hot steam will kill the micro-organisms. When the air has been blown away you can put on the weights and let the pressure in the cooker rise to 15 lb. per square inch. A little steam will escape while the pressure is rising. When 15 lb. pressure has been reached steam will again start escaping fast. You can then turn the heat down a little and *start timing 15 minutes.*

You now know enough about the cooker to be able to use it. Perhaps you want to sterilize some syringes, as described in Section 4.9. Before you start you must remember one thing. This is that **THERE MUST ALWAYS BE SOME WATER AT THE BOTTOM OF THE COOKER.** This water makes the steam for sterilizing. If there is no water the equipment in the sterilizer will burn and the cooker will be spoiled.

METHOD

USING THE PRESTIGE 'HI-DOME' PRESSURE COOKER

Unpack the cooker. Screw the handles on to the pan and the cover, as shown in Pictures K and L.

Put the trivet in the cooker with its rim (edge) downwards. Put two cupfuls of water in the cooker. The top of the trivet should be *just dry.*

Put the syringes, or whatever else is to be sterilized, into the cooker. Put them in an empty tin without a lid, so that they keep as dry as possible.

Loosen the lids of any bottles so that air can get out and steam can get in. Take the plungers out of the syringes as in Picture F, Figure 4-3. If you don't do this the barrels of the syringes may break.

Put the cover on the pan. Put it so that the arrow you will see on the edge of the cover is in line with the arrow you will see on the handle of the pan, as shown in Picture J. *Move the handle of the cover to the left until both handles are together as shown in Picture G.* The cooker is now closed.

Make sure you have removed the weights of the pressure control valve.

Put the cooker on a paraffin pressure stove and heat it strongly. In a few minutes steam will start coming out of the control valve. *Wait until steam is coming out in a steady flow and has had time to blow away all the air from inside the cooker.*

Screw together all three weights of the 3-way control valve (as in Picture D) so that it works at 15 lb. per sq. in. Put the weights of the 3-way control valve on the vent and push them down. Steam will stop coming out, except perhaps for a very slight hiss (a hiss is the noise steam makes when it is coming out of a hole). Leave the cooker for 2 or 3 minutes with the

heat still high. During this time the pressure will rise to 15 lb. per sq. in.

As soon as the steam comes out fast and starts to make a really LOUD hissing noise turn the flame *low* by opening the tap on the stove a little. Start timing 15 minutes with your watch. *Adjust the heat so that there is a SLIGHT hissing noise throughout the 15 minutes.*

At the end of 15 minutes take the cooker off the stove. Leave it on the bench to cool. You will know when it is cool because no steam will come out when you lift the weights. Always let the cooker cool slowly when you are sterilizing liquids in bottles. If you want to cool the cooker fast, hold it under a tap so that water runs over it, or cover it with a very wet cloth. This will turn the steam inside the cooker back to water again. Lift up the weights of the 3-way valve a little after about half a minute. This will tell you if there is any steam still left. If there is, put the cooker back in the water for a few more minutes.

When there is no steam left, take off the weights of the 3-way control valve. Next take off the cover by moving the top cover handle to the right.

All the micro-organisms inside the cooker will have been killed, and the syringes will be sterile.

SOME IMPORTANT THINGS TO REMEMBER

Use your cooker either for sterilizing clean things such as syringes, or for disinfecting dirty things such as sputum containers. Don't try to sterilize and disinfect at the same time.

Keep a spare gasket and a spare safety plug. As with all rubber equipment, keep them in the dark, or they may spoil. There are other spare parts you can get. These spares or replacements are shown at the bottom of Figure 1-5.

NEVER LET THE COOKER BOIL DRY. Unless a lot of steam is lost, two cupfuls of water will be enough. Don't let the cooker lose too much steam, or it will boil dry and spoil.

Start heating with the 3-way control valve OFF. Don't put it on until there is a steady flow of steam. This is very important. The flow of steam blows away the air so that things can be sterilized in pure steam. '15 lb. for 15 mins.' will only sterilize if all the air has gone and pure steam is left.

Don't start timing 15 minutes until you have put the 3-way control valve on.

Make sure that both handles are together and the rod of the safety plug is in before you start heating.

Don't try to open the cooker after heating until you have let down the pressure of steam by cooling it in water.

Never use the cooker more than half full of liquid or two-thirds full of solids.

Keep the vent clean.

Equipment inside a tin will probably sterilize better if you lay the tin on its side to let out the air. Never sterilize anything in a tin or bottle with the lid on.

1.22 Using sterile equipment. Aseptic precautions

In larger laboratories autoclaves and pressure cookers are used for sterilizing many different kinds of equipment. But with the methods in this book the pressure cooker is only used for sterilizing syringes and needles (Picture G, FIGURE 4-3), 'needles and rubber tubes' (Picture E, FIGURE 4-3), bottles of sodium citrate solution for the Westergren ESR, and buffer for gastric washings. The cooker is also used for sterilizing Pasteur pipettes (Section 3.9) and specimen bottles (Section 4.10), and for making infected specimen containers, etc., safe to wash up. A pressure cooker can also be used for sterilizing syringes and needles for use in a clinic or health centre. If you are going to use a pressure cooker to sterilize plastic syringes, sterilize only one syringe to begin with. Many kinds of plastic are spoilt in a pressure cooker, but things made of strong plastics, such as nylon or polypropylene, will not spoil.

'Aseptic precautions'

In the laboratory this means doing something with sterile equipment while taking great care to keep the important part of it sterile. **Aseptic** means sterile or without infection. For example, in Section 4.10 you are told to separate serum from clotted blood aseptically. You are asked to put it into a sterile bottle and send it to a central laboratory. Because you have touched the outside of the bottle there will be micro-organisms on the outside. These micro-organisms must not get inside the bottle into the serum. In the wards using aseptic precautions means doing something, like dressing a wound, without getting micro-organisms into the wound. If micro-organisms get into the wound, it may become infected or septic. Aseptic precautions are especially important in lumbar puncture which is described in Section 9.5.

The first thing to remember is that there are micro-organisms *everywhere*, except where they have been killed by sterilization. There are micro-organisms on your hands, on the bench, and on every piece of equipment which has not been sterilized. *When you touch something sterile with your fingers the part which you touch is no longer sterile. This part is now covered with micro-organisms from your fingers.* This means that when you use a sterile bottle, Pasteur pipette, or syringe, you must touch one part only and leave the other parts sterile. You may only touch the outside of a syringe. You must not touch the plunger (piston or inside part), and you must not touch the nozzle (the place where the needle goes). If you touch

the plunger, micro-organisms will get from your fingers on to the plunger and so into the patient's blood.

You will learn what we mean by 'aseptic precautions' from the following example. We will describe how blood can be taken from a patient and the serum separated from it aseptically.

METHOD

TAKING A BLOOD SPECIMEN AND SEPARATING THE SERUM ASEPTICALLY

With a pressure cooker sterilize a syringe (Section 4.9), some plugged Pasteur pipettes (Section 3.9), and some bijou bottles or universal containers. The bottles and the syringe must be dry if the serum is not going to haemolyse (Section 1.18).

TAKING BLOOD ASEPTICALLY

Tie a rubber tube round the patient's arm and choose a good vein as shown in Figure 12-7. Put a piece of cotton wool or gauze in spirit or iodine and swab (paint) the skin where you are going to put the needle. The iodine or spirit is being used as an antiseptic to kill micro-organisms on the skin.

Carefully unwrap the syringe from the paper. Pick up the plunger by its handle. Don't touch the main part of the plunger. Put the plunger into the barrel without touching the nozzle (the place where the needle fits). Pick up the needle by its adapter (thick part). Put the needle on to the syringe without touching anywhere the blood might go.

Put the needle into the vein, as shown in Figure 12-7, and fill the syringe with blood. Don't touch either the point of the needle or the plunger of the syringe as you do so. Take out the needle when the syringe is full of blood. Press over the hole that you have made in the vein with a piece of cotton wool and ask the patient to keep pressing it for a minute or two. This will stop the blood from the vein bleeding into the tissues of the arm.

Take the needle off the syringe.

Loosen the cap of the bottle with your index finger and thumb (look in Figure 3-6 if you do not know the names of your fingers). Take hold of the cap of the bottle in the little finger of your right hand. Turn the bottle round with your left hand. This unscrews the bottle from the cap.

Put the blood into the bottle without touching any part of the bottle with any part of the syringe.

Still holding the cap in your right hand, screw the bottle back into it. By doing this the blood has touched nothing which has not been sterilized. Nothing unsterile has touched anywhere where the blood will go. The outside of the bottle and cap will be covered with micro-organisms, but the blood inside will be sterile.

Leave the blood until the serum has separated (Figure 1-4).

SEPARATING SERUM ASEPTICALLY

Take a sterile plugged Pasteur pipette (Picture K, Figure 3-5) and break off its closed end. Fit a teat to it. Loosen both the cap of the bottle with the blood in it and the cap of the empty bottle into which the serum is going to be put.

Hold the cap of the empty bottle in your little finger as described above, and unscrew the bottle from it with your left hand.

Take off the cap of the bottle with the clotted blood in it.

Flame the end of the Pasteur pipette and quickly let it cool. Suck up the serum from around the blood clot. Put it into the empty bottle.

Flame the neck of the bottle which now contains serum and screw it back into the cap which is still held in your right little finger.

When you use a sterile Pasteur plugged pipette you have first to flame it because only the inside is sterile. When they take blood aseptically, many people flame the nozzle of the syringe and the needle before they put them together. This kills any micro-organisms there may be on the nozzle or on the needle. They also flame the nozzle before they put the blood into the bottle and the neck of the bottle before they screw on its cap. The flame of a spirit lamp is often the easiest one to use.

This is one of the few aseptic methods that are described in this book. It is one of the few methods where you have to stop the ordinary and usually harmless micro-organisms on your fingers getting into a specimen or bottle. But, in many methods you must stop the harmful micro-organisms in a specimen getting out of a specimen and around the laboratory. Dangerous micro-organisms may make you ill, or possibly even kill you. We will say more about this in the next section.

1.23 Laboratory infection

Many dangerous micro-organisms come into the laboratory in specimens from patients. *Mycobacterium tuberculosis* comes into the laboratory in sputum coughed up by tuberculous patients. There are also many dangerous micro-organisms and worms in patients' stools. Cerebrospinal fluid (CSF—see Section 9.16) may contain a dangerous micro-organism called the meningococcus. All these micro-organisms and others may infect a laboratory worker. How then can you stop yourself catching diseases from the specimens that you look at? Prevent yourself being infected by following these instructions very carefully.

METHOD

HOW TO STOP CATCHING DISEASES FROM INFECTED SPECIMENS

Keep all specimens in the bottles in which they came or on the slides, wire loops, or tubes that are meant for

them. Don't get specimens on to the floor, the bench, your hands, your clothes, or on to the outside of any equipment that is not meant for them. If you spill a specimen, cover it with lysol or some other disinfectant. Keep a bowl of lysol on your bench for this purpose. One part of lysol in nine parts of water is enough.

Don't eat, drink or smoke in a laboratory. If you put a cigarette on the bench and then in your mouth, you will deserve any disease that you get.

Never pipette a specimen of CSF with the kind of pipette that you put into your mouth. You may by mistake get the CSF into your mouth. Some specimens of CSF are very dangerous. Always pipette CSF with a Pasteur pipette and a teat.

Always wash your hands when you leave the laboratory to go home, and especially before you eat. So, keep towels and soap in your laboratory.

Put all infected specimens, such as sputum or stools, into a bucket of disinfectant before their containers are washed. You can, if you wish, put them straight into a pressure cooker.

Remember that even blood from a healthy person may be dangerous. It may contain micro-organisms that cause jaundice. So be just as careful with blood specimens as you are with specimens of stool or CSF. Try not to get blood on your hands and do not spill blood about the laboratory.

Don't leave uncovered specimens on the bench. Flies may get into the specimen and carry micro-organisms from the specimens to food that is going to be eaten.

1.24 Controls

Sometimes it is difficult to know if a method is working or if it is not working. The way to find out is to do 'control tests' or **controls**. By control tests we mean tests on specimens that we know are positive (a positive control) and tests on specimens we know are negative (a

negative control). For example, if you are not sure if your sickle-cell method is working, do the sickle-cell test on a specimen you are sure is positive and on one you are sure is negative. If you get the right answer, your method is working well. If you get the wrong answer, there is something wrong with your method. Controls are only talked about for some methods in this book, such as those for sickle cells and blood grouping. *But you may want to do controls for any method!*

QUESTIONS

1. Give two examples each of an acid, an alkali, a salt, a buffer, and an indicator.
2. Which of the following pH's would mean that the solution was acid—pH3, pH10, pH7, pH8, pH6, pH4? At which of these figures would the pH be neutral?
3. What are the differences between viruses, bacteria, and protozoa?
4. What parts of a cell do you know? Draw a picture of a cell.
5. Describe the more important ways in which you can prevent yourself becoming infected in a laboratory.
6. Draw a pressure cooker and describe how you would use it to sterilize some syringes.
7. What is sequestrene, and why is it used?
8. What are 'aseptic precautions'? Describe one method, either in the laboratory or in the ward, in which aseptic precautions are used.
9. What is the difference between (a) serum and plasma, (b) an antiseptic and a disinfectant, (c) genus and species, (d) an organ and a tissue, (e) a coccus and a bacillus.
10. What is the difference between (a) a filtrate and a supernatant fluid, (b) a symptom and a sign, (c) a fungus and a helminth, (d) zero and infinity, (e) the way in which sections and figures are numbered in this book.

2 | Equipment and Chemicals

2.1 The equipment described

In this chapter you will read about the smaller pieces of equipment and the chemicals you will need. The balances and the measuring instruments are described in Chapter Five and the microscope in Chapter Six. Chapter Thirteen describes all this equipment more fully and is for the storekeepers who must order it.

There is a picture of almost every piece of equipment in the figures in this chapter, and many pieces of equipment are also shown in other parts of the book. The complete set of equipment is for a small hospital laboratory. A few things will not be needed by a health centre and have been marked 'Hospitals Only'.

To help with ordering, each piece of equipment has been given an 'ML number'. ML stands for 'Medical Laboratory'. Because the equipment list changed as this book was written some numbers had to be left out and others added. You must not therefore expect the numbers to be complete. In some figures in other chapters ML numbers have been put beside pieces of equipment. This will help you to find the equipment in the list. Beside each piece of equipment in the figures in this chapter is written the number that should be ordered for supplying a health centre. Hospitals need more of most things.

There is an **asterisk** (an asterisk is a star like this *) beside the pictures of some pieces of equipment. This asterisk means that the equipment is only made by one maker, and that no other equipment should be supplied.

The equipment is not in alphabetical order in the figures here, because in this chapter we have called things by their ordinary names and not by their **catalogue** names. In Chapter Thirteen the equipment is in alphabetical order by its catalogue name. As used here a catalogue is a book which describes equipment. For example, the piece of equipment numbered ML 12 is called a hand centrifuge in FIGURE 2-1. It is called a 'CENTRIFUGE, hand, ...' in Section 13.8.

As in many other figures the equipment is not drawn to scale. Thus, although two things may be drawn the same size in the figures in this chapter, they may not be the same size when you see them.

The more important equipment is in the **main list**, both in this chapter and in Chapter Thirteen. This has been divided into a **special list**, which is equipment that has to be bought from makers of special laboratory equipment, and an **ordinary list**. The ordinary list is equipment like buckets and cups that can be bought in ordinary shops. Sometimes you will be expected to use other equipment and other chemicals. These have been put in a **list of choices** in Chapter Thirteen. We shall describe the main list first and then the choices.

2.2 Special equipment in the main list (FIGURES 2-1, 2-2, 2-3)

ML 1, 2, 3 are the **Ohaus balance** and the things that go with it. The balance is described in Section 5.5.

ML 4 is the Westergren blood sedimentation tube, or **ESR tube**. It is the long thin tube shown in Picture 10, FIGURE 7-33. These Westergren sedimentation tubes are used with the Westergren stand ML 11.

ML 5 is a polythene **dropping bottle**. It holds about 125 ml and has a top with a spout (tube). When you hold the bottle upside down the liquid inside falls out drop by drop. This is often very useful. Many of the reagents for the methods in this book are kept in polythene dropping bottles. Sometimes, in a new bottle, you will find that the hole in the spout is blocked. If it is, make a hole in the end of the spout with a pin or needle. Use dropping bottles for these reagents: 10% barium chloride, strong carbol fuchsin, dilute carbol fuchsin, white blood cell diluting fluid, crystal violet, Ehrlich's reagent, Fouchet's reagent, Lugol's iodine, 3% salicylsulphonic acid, 20% salicylsulphonic acid, malachite green, Pandey's reagent, ferric chloride solution, and saturated sodium acetate, etc.

ML 6 is a litre (1,000 ml) polythene **reagent bottle**. Ordinary glass bottles can be used, but they are often difficult to find in health centres. These special plastic bottles have therefore been put in the list. They are for reagents that are needed in larger volumes than will go into the dropping bottles (ML 5). Use these reagent bottles for Benedict's solution, strong carbol fuchsin,

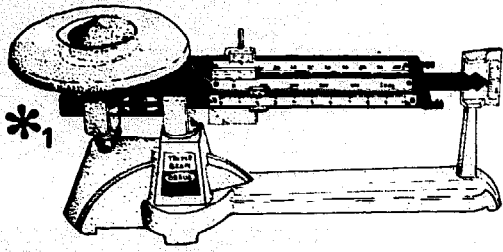

ML 1 The Ohaus balance.

* this means that a piece of equipment is made by one supplier only

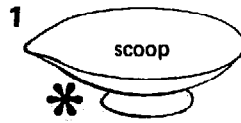

ML 2 A scoop and counterweight for the Ohaus balance



counterweight

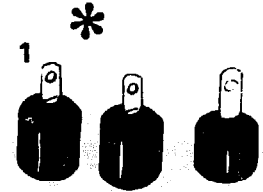

ML3 Attachment weights for the Ohaus balance

these are the numbers of each thing that you will need

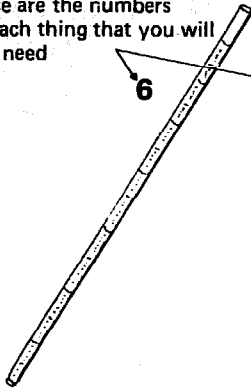

ML 4 Westergren blood sedimentation tubes

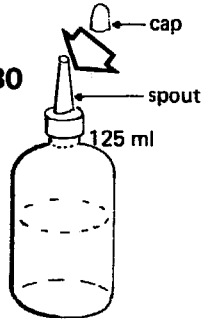

ML 5 Polythene dropping bottles

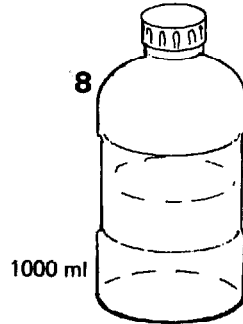

ML 6 Polythene reagent bottles

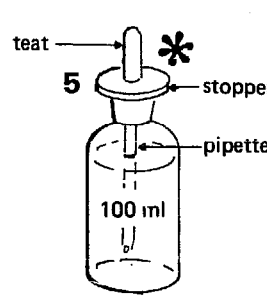

ML 7 'Polystop bottle'

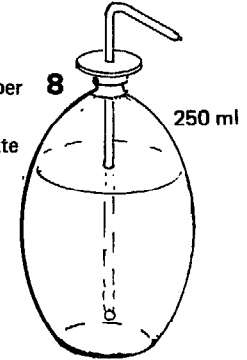

ML 8 Polythene wash bottle

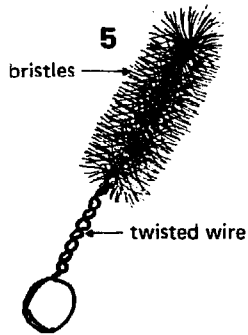

ML 9 Test tube brush

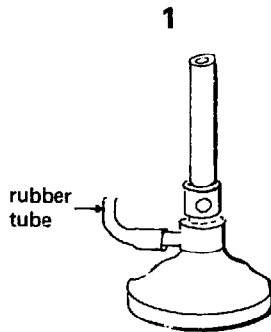

ML 10 Bunsen burner

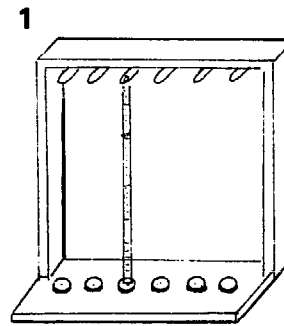

ML 11 Westergren stand

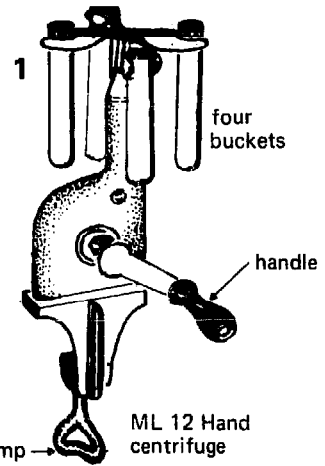

ML 12 Hand centrifuge

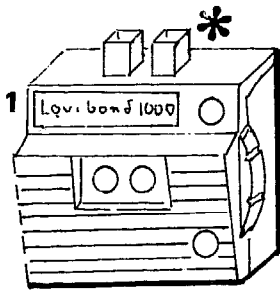

ML 13 Lovibond comparator

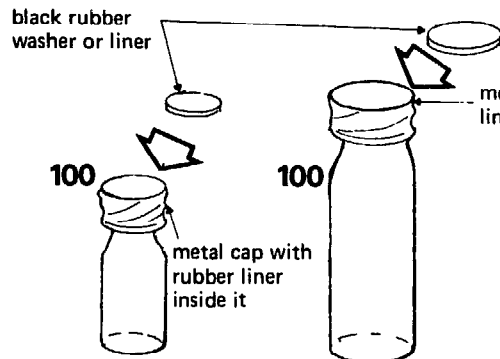

ML 14a Bijou bottle

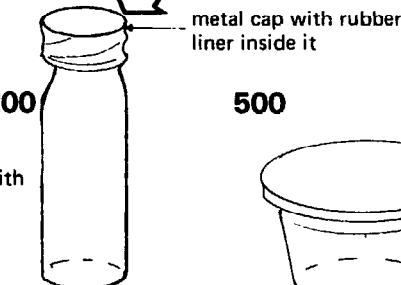

ML 14b Universal container

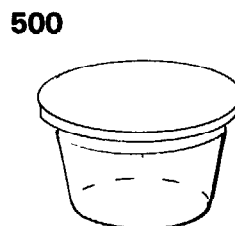

ML 14c 'Polypot'

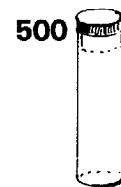

ML 14d 'Polytube'

Fig. 2-1 Special equipment in the main list—one

Ehrlich's reagent, *formol* saline, *normal* saline (don't muddle up these last two reagents—see Section 1.18), haemoglobin diluting fluid, and Pandey's reagent. You will find that it is sometimes useful to keep a small volume of reagent for daily use in a dropping bottle, and a larger volume in reserve in a reagent or stock bottle.

ML 7. A '**Polystop**' bottle is a 100-ml glass bottle fitted with a polythene stopper. A stopper is a cap or cork. The stopper of a Polystop bottle fits the bottle very tightly. A glass tube goes through the stopper and down inside the bottle. This tube is called a **pipette** (a pipette is a small pipe or tube). It has a little rubber bag on it called a **teat**. Liquid can be taken out of the bottle with the pipette and teat and dropped out of the pipette one drop at a time. You will need four Polystop bottles, one for Leishman's stain, one for Leishman buffer, one for normal saline, and one for Lugol's iodine.

ML 8. This is a polythene bottle with a tube going through the cap. When you squeeze the bottle (press it between your fingers and thumb), liquid comes out through the tube in a stream and not in drops as it does in a dropping bottle. This kind of bottle is called a '**wash bottle**' or a '**squeeze bottle**'. Use wash bottles for water, 3% acid alcohol, Benedict's solution, dilute Leishman buffer, haemoglobin diluting fluid, and normal saline.

ML 9 is a **test tube brush** for cleaning test tubes. It is made of twisted wire with stiff bristles (hairs).

ML 10 is a **Bunsen burner**. It burns gas from a cylinder. A cylinder is a heavy steel bottle (ML 60) which can be refilled with gas when it gets empty. Cylinders are refilled in a factory. The Bunsen burner is joined to the cylinder by a rubber tube (ML 50). If you have no gas you will have to use a spirit lamp (ML 39) or a paraffin pressure stove (ML 71).

ML 11 is a stand for the Westergren sedimentation tubes described under ML 4.

ML 12 is a **hand centrifuge** with buckets for four tubes. It is described in Section 1.5.

ML 13 is the **Lovibond comparator**, which is described in Section 5.10. The tubes for it are ML 48d and the discs for it ML 21a, b, c, d, e.

ML 14a, b, c, d. These are **containers**. A container is a bottle, tube, or box for putting something into. The containers here are mostly for putting specimens into. The first two are glass and have metal caps with rubber discs or **liners** inside. The smaller glass container is a **bijou bottle**, and the larger glass container is a **universal container**. ML 14c and ML 14d are containers made of plastic and have plastic caps. The **polypot** is for sputum and stools and the **polytube** for blood. Read about them in Section 4.6.

ML 15 is a double-celled **counting chamber**. It is used for counting cells in the blood and CSF. Look at Sections 7.29 and 9.9. It is very carefully made and is therefore expensive. A counting chamber costs \$7.2.

ML 16 is a spare **cover glass** for the double counting chamber ML 15.

ML 17 are **coverslips** for ordinary microscope slides. *Cover glasses* for counting chambers are bought one by one and are expensive, costing \$0.47 each. *Coverslips* for microscope slides are bought in boxes of half an ounce. There are many coverslips in a box; so each coverslip is cheap. Cover glasses are thick; coverslips are thin. *Don't mix them up, and always keep cover glasses very carefully.*

ML 18 is a **glass measuring cylinder**. It is a high narrow glass bottle with graduation marks on the side—look at Picture L, FIGURE 5-2. It holds 100 ml and has a plastic stopper. You are given two cylinders in case one breaks.

ML 19 is a **plastic measuring cylinder** which holds 1,000 ml or one litre. It therefore holds ten times as much as the glass measuring cylinder ML 18.

ML 20 is a **diamond pencil**. It is like an ordinary pencil, except that it has a very small diamond instead of a lead. A diamond is a very hard, very expensive jewel or precious stone. A diamond can be used for writing on glass. Use it for writing on microscope slides that are to be stained by the Ziehl-Neelsen method. You can write with a grease pencil, but grease pencil marks come off easily, and it is better to use a diamond.

ML 21 is a **Lovibond disc**. Only one disc is shown in this picture—the one for haemoglobin called 5/37X. This is the only one you will need in a health centre, but in a hospital you will want four more. Two are for the blood urea (5/9A and 5/9B), and two are for the blood sugar (5/2A and 5/2B). You will not need them if you have the Grey wedge photometer or the EEL colorimeter.

ML 22 is a **filter paper** and the box in which you buy 100 papers. There are very many kinds of paper and many sizes. The kind you have is the ordinary kind for general use and is called Whatman No. 1. You are given two sizes. One size is 5.5 cm in diameter, and the other is 11 cm in diameter. The smaller one is for the blood sugar method (Section 7.42), for the filtration method for haemoglobins A and S, and for Fouchet's test (Section 8.8). The larger one is for filtering stains.

ML 23 is a **filter pump**. It is a machine for sucking in air and is used for cleaning pipettes. It is described in Section 3.3. A filter pump has to be fixed to a tap. If you are to use a pump of this kind you must have running water and the right kind of tap. Many laboratories will not be able to use a filter pump, because they will not have running water under enough pressure.

ML 24 is a pair of **forceps**. Forceps are used for holding slides or swabs which you do not want to hold in your fingers.

ML 25 is a plastic funnel for holding filter papers. It is 6.3 cm across the top and holds both the 5.5 cm and the 11 cm filter papers.

ML 26 is a square of wire **gauze** (cloth) made of iron wire. In the middle of the gauze is a circle of asbestos. Asbestos is a special kind of wool which cannot be burnt.

Don't mix up these two!!

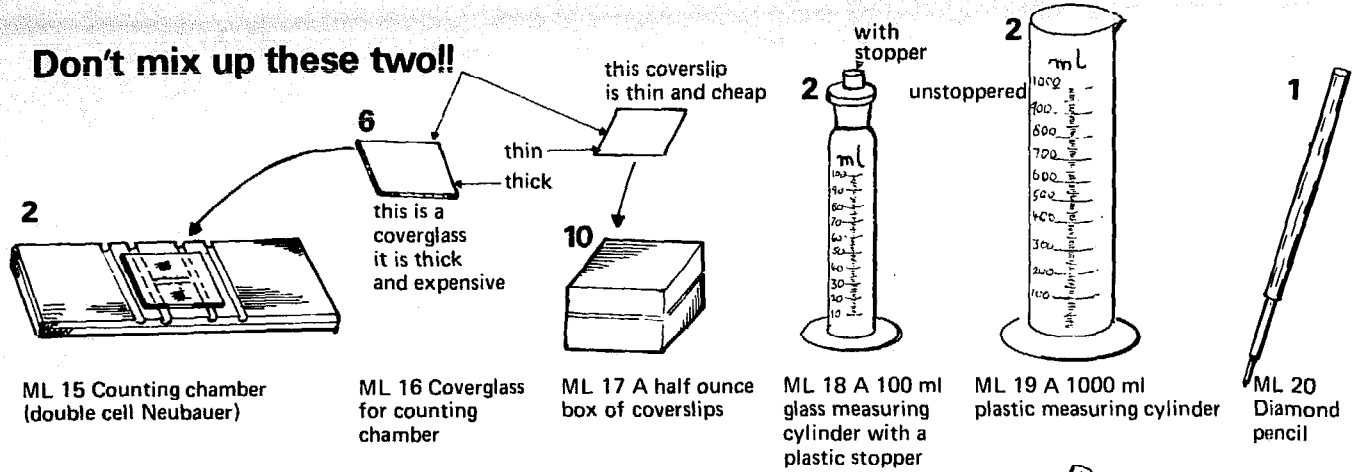

ML 15 Counting chamber (double cell Neubauer)

ML 16 Coverglass for counting chamber

ML 17 A half ounce box of coverslips

ML 18 A 100 ml glass measuring cylinder with a plastic stopper

ML 19 A 1000 ml plastic measuring cylinder

ML 20 Diamond pencil

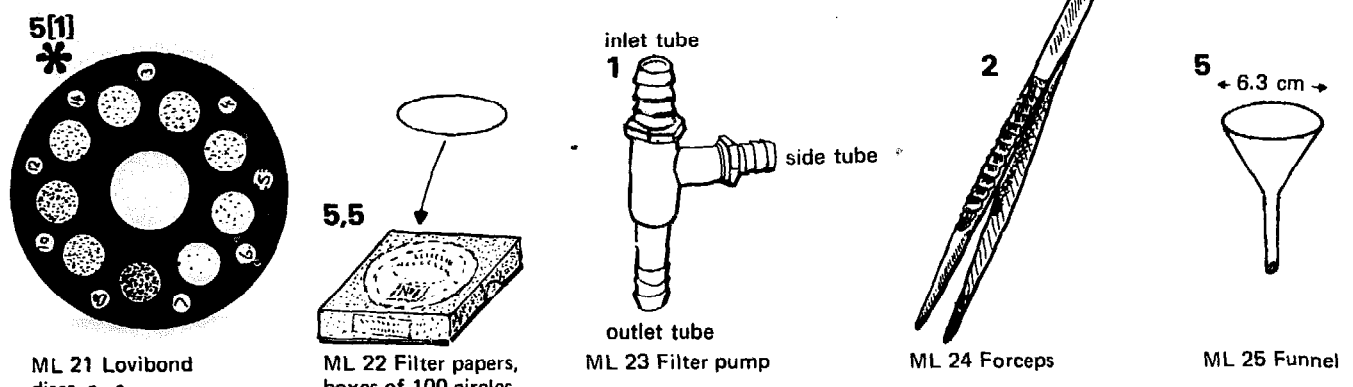

ML 21 Lovibond discs, a-e. Only the disc 5/37x for haemoglobin is wanted in a health centre

ML 22 Filter papers, boxes of 100 circles in two sizes, 5.5 cm and 11 cm

ML 23 Filter pump

ML 24 Forceps

ML 25 Funnel

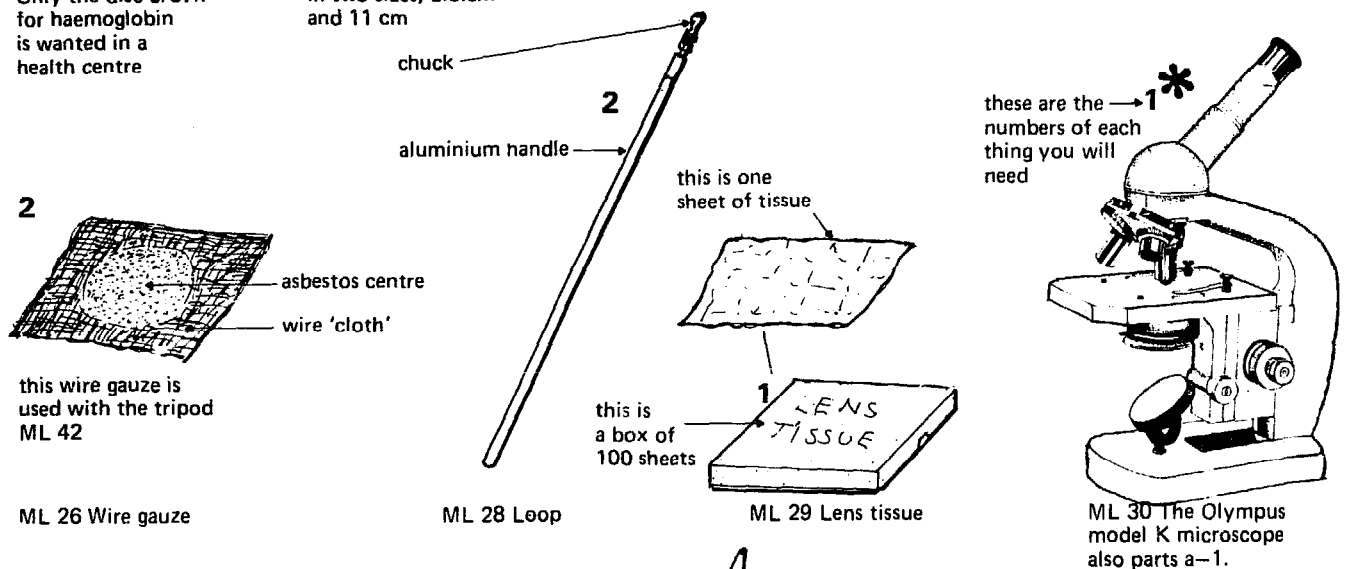

ML 26 Wire gauze

ML 28 Loop

ML 29 Lens tissue

ML 30 The Olympus model K microscope also parts a-1.

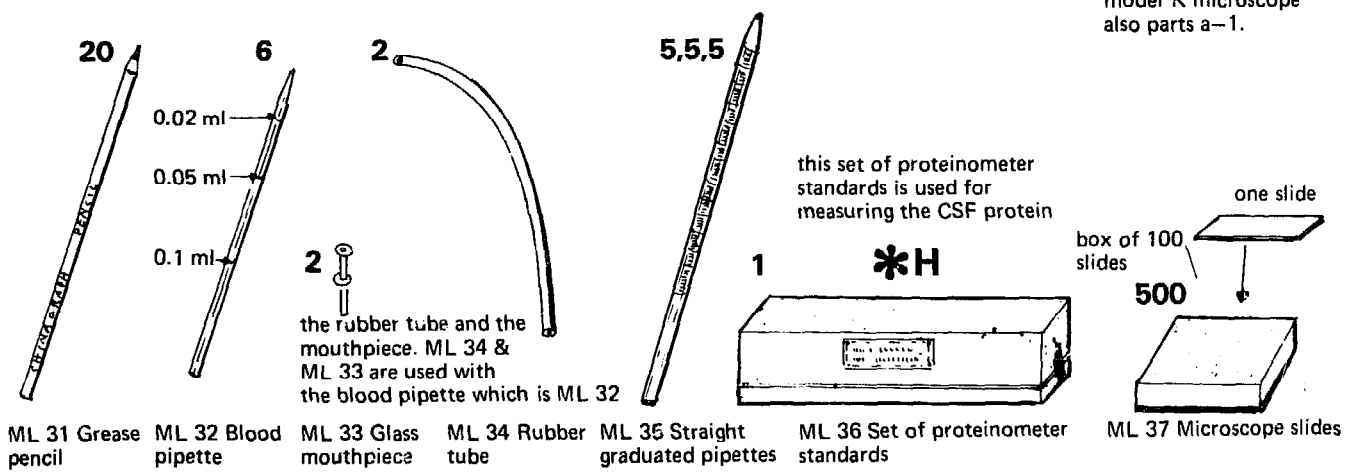

ML 31 Grease pencil

ML 32 Blood pipette

ML 33 Glass mouthpiece

ML 34 Rubber tube

ML 35 Straight graduated pipettes

ML 36 Set of proteinometer standards

ML 37 Microscope slides

Fig. 2-2 Special equipment in the main list—two

The wire gauze and the asbestos do not get burnt in a flame. The wire gauze is put on top of a tripod (ML 42) when a glass beaker (cup) is being heated with a Bunsen burner. The gauze stops the glass breaking. You are told to use a tin in Section 7.42 instead of a beaker, and a gauze square is not needed with a tin. But a square of wire gauze goes with a tripod, and you have been given one in case you have a beaker and want to use it.

ML 28 is a **loop holder**. It is a rod of aluminium with a chuck at one end for holding a wire loop (see Section 3.10) or a needle (see Section 11.11).

ML 29 is **lens tissue**. This is a special kind of very soft paper for cleaning the lenses of microscopes—look at Sections 6.16 and 6.17, also Picture Y, FIGURE 6-20. Lens tissue is sold in a box of 100 tissues which you must cut up and make into booklets (little books). You can buy lens tissue in booklets, but it is much cheaper to buy it as a box of sheets and make the booklets yourself.

ML 30 is the **Olympus Model K microscope** which is described in Chapter Six.

ML 31 is a **grease pencil**. This is a special pencil with a greasy lead which will write on glass. A 'Chinagraph' pencil is one kind of grease pencil. You can also write on glass with a diamond pencil (ML 20) or a spirit pen (ML 66), or with paint and a small paint brush (ML 56). Grease pencil writing is easily rubbed off. Spirit pen writing lasts longer but can be removed by spirit, xylol, or washing.

ML 32 is a **blood pipette**. This is a special glass tube for measuring small volumes of fluid. This blood pipette measures 0.02 ml, 0.05 ml, and 0.1 ml of blood. You will have to use it with a rubber tube (ML 34) and a glass mouthpiece (ML 33).

ML 33 is a **glass mouthpiece**. It is a little glass tube which goes into your mouth and joins on to a rubber tube. The other end of the rubber tube is fixed on to a pipette. It is easier to suck fluid into a small pipette if you use a mouthpiece and rubber tube. Look at Picture 6, FIGURE 7-1.

ML 34 is a **rubber tube** for the mouthpiece described in the paragraph above.

ML 35a, b, c, are **graduated pipettes**. These pipettes are like the blood pipette (ML 32), but they are larger. They are all described in Section 5.7. The three kinds of pipettes listed here hold 2, 5, and 10 ml.

ML 36 is a set of **proteinometer standards**. Proteinometer means 'protein measurer'. This is a row of small tubes in a black box. Each tube is for a different amount of protein. They are used for measuring the CSF protein and are described in Section 9.13. This set of standards will only be needed by hospitals. If you have a Grey wedge photometer, you can use it to measure the CSF protein, so you will not need these proteinometer standards.

ML 37 are microscope **slides**. You will use many microscope slides. Slides are used for making films of a specimen.

ML 38 is a **spatula** or spoon for taking chemicals out of bottles. A knife blade or a teaspoon can be used, but it is better to use a spatula. This spatula is made of nickel which is a metal that does not rust and is not easily harmed by chemicals.

ML 39 is an ordinary lamp which burns spirit—a **spirit lamp**. It is cheap and has been put in the list in case you run out of gas for your Bunsen burner. Use methylated spirit which gives a clear hot blue flame. Don't use paraffin which will give you a smoky cool yellow flame. Don't use petrol because this may be dangerous. This lamp has a cap. Put the cap on when you are not using the lamp. This will stop the spirit evaporating (drying up) and will make it easier to light the lamp the next time you want to use it. A spirit lamp is not large enough to make Pasteur pipettes, and you will have to use a paraffin pressure stove (ML 71) (see Section 3.9) or a Bunsen burner.

ML 40 and 41. You are given two kinds of **test tube rack**. The aluminium one holds small tubes and goes in the water bath (ML 53). It is used in blood transfusion and will only be needed in hospitals. The other test tube rack is made of polythene and is kept on the bench. The aluminium one holds Kahn tubes and cross-matching tubes. The polythene one holds ordinary test tubes as well. It has pegs (short rods) on which wet tubes can be left to drain after washing. A test tube has been shown draining in the picture. By draining we mean letting drops of water run out so that air can dry the inside of the test tube more easily. Always wash out your test tubes when you have finished and let them dry on the pegs.

The plastic test tube stand can be replaced by the wooden test tube block shown in Picture E, FIGURE 3-8.

ML 42 is a **tripod**. This is a stand with three feet (tri = three, pod = foot). It is used for holding things while you heat them with a Bunsen burner. You will use it for measuring the blood sugar in Section 7.42. The tripod holds a tin of boiling water.

ML 43 is a **rubber teat**. Teats are little rubber bags which fit the glass tube ML 51. With a specially pointed glass tube they make a Pasteur pipette. You are told how to make Pasteur pipettes in Section 3.9.

ML 44 is a **thermometer** (therm = heat, meter = measure). A thermometer is used to measure how hot something is—its hotness or temperature. The thermometer here is a glass tube with a **bulb** (small empty ball) at one end. This bulb is filled with a liquid metal called **mercury** which runs up and down the tube. When the mercury is cold it contracts (gets smaller) and only fills the bulb and the bottom part of the tube. When the mercury gets hot it expands (gets bigger) and moves up the tube. The coldest this thermometer will measure is the temperature at which water freezes or 0°C. ° stands for degrees and C for Centigrade. Water boils at 100°C, and the difference between freezing and boiling is divided into a hundred parts. Each part is one degree. 'Cent' means one hundred, and so we have 'Centigrade'. This

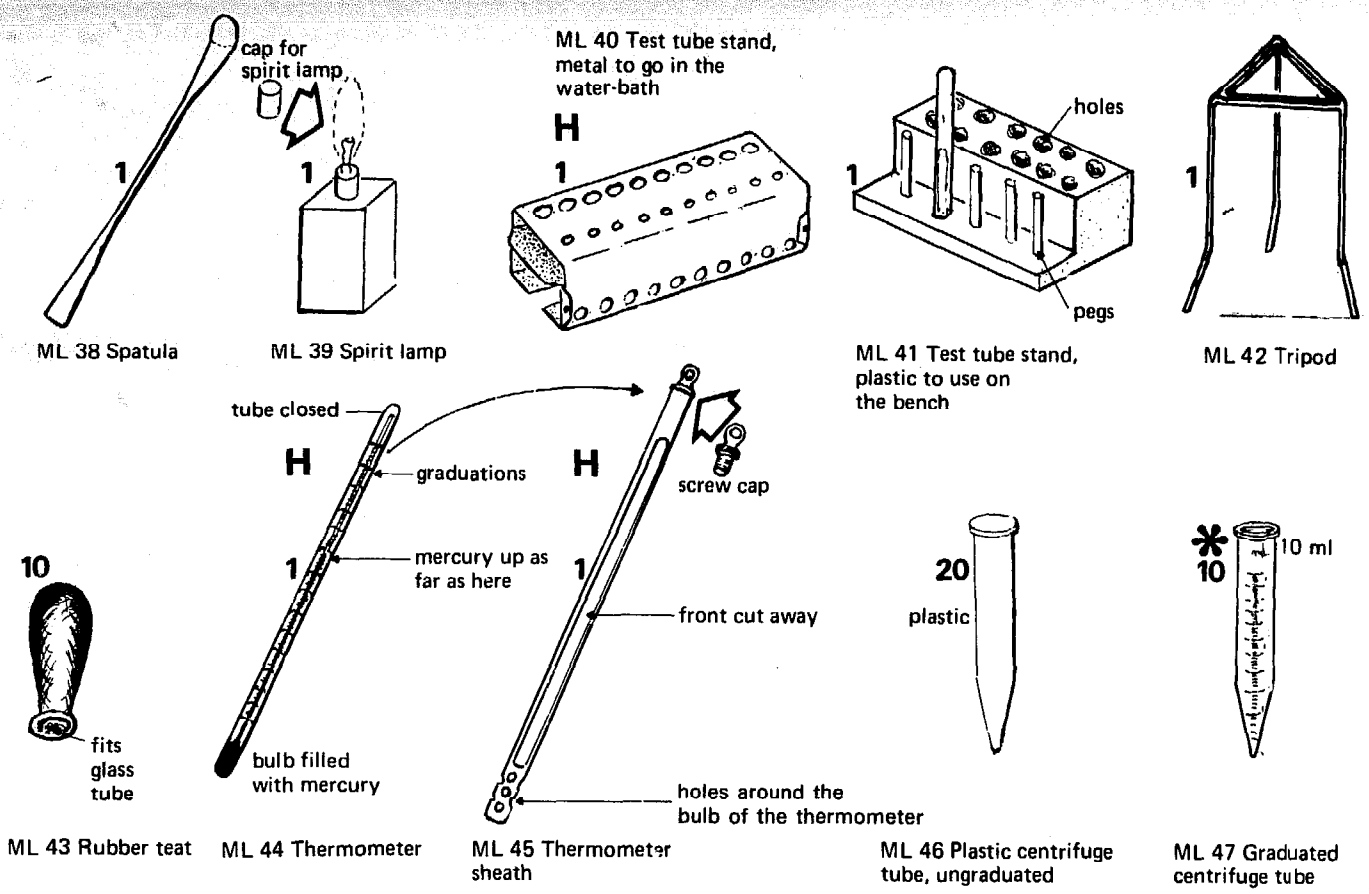

try hard to get ALL the equipment you need !!

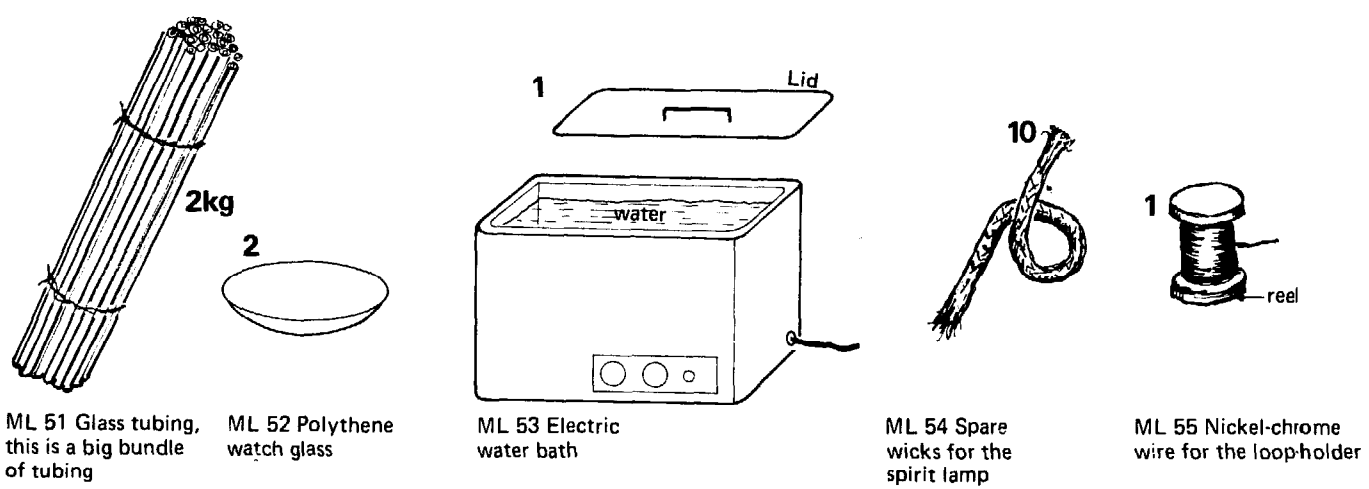
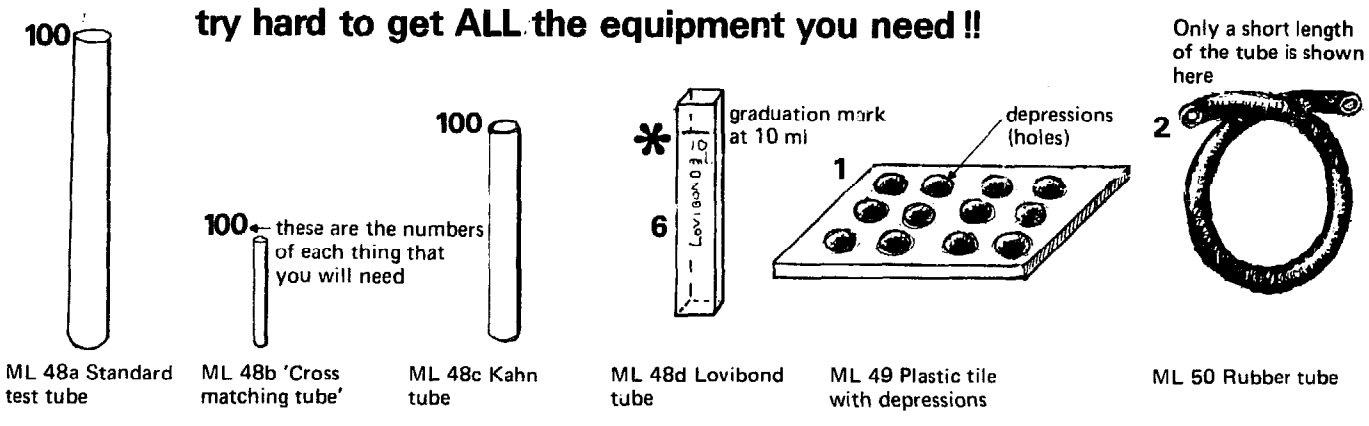

Fig. 2-3 Special equipment in the main list—three

thermometer will measure as high as 50°C, and 50°C is at the top of the tube. It will measure 37°C, which is an important temperature, because this is the temperature of the human body. A waterbath at 37°C is used for blood transfusion methods. You will use the thermometer to measure the temperature of this waterbath. Centigrade is an old word and you will often find the newer word Celsius used instead.

ML 45. A glass thermometer is easily broken. ML 45 is therefore a **thermometer sheath** to stop your thermometer getting broken. A sheath is a covering which protects the thing inside it. This sheath is a metal tube with part of its front cutaway. There is a cap at the top which unscrews. Unscrew the cap and gently push the thermometer down inside the sheath with its bulb first. Put the cap back. Turn the thermometer round so that you can see the graduation marks on the scale. Always keep the thermometer in its sheath. It will be safer this way. But, even so, be careful not to drop it. A thermometer can still break, even inside its sheath.

ML 46 and 47 are **plain and graduated centrifuge tubes**. They are made of polypropylene or nylon, which are strong kinds of plastic. They have conical bottoms and are made to go into the buckets of a centrifuge. One tube is plain and the other has graduation marks on it up to 10 ml. These centrifuge tubes are described in Sections 1.5 and 5.7.

ML 48a-d are **test tubes**. A test tube is a short glass tube with thin sides and a round bottom. You are given four kinds of test tubes. ML 48a is the ordinary test tube and is most often used for testing the urine. ML 48b is a short narrow test tube which is only used for cross matching blood—look at Section 12.6. In this book it is called a **cross-matching tube**. ML 48c is a very useful size of tube in which to 'wash' red cells for blood grouping, and it is called a **Kahn tube**. ML 48d is the special Lovibond tube or cell. It is square and fits the newer 'Lovibond 1000' comparator. The older kind of Lovibond comparator had round tubes (ML 48e). When getting tubes for your Lovibond comparator, *make sure you get the right ones*. These tubes are expensive and the square kind cost about \$1.1 each. Both tubes have the word LOVIBOND written on them and must not be used for anything except comparing liquids in the comparator. Never heat a Lovibond tube, or put it in a centrifuge.

ML 49 is a **tile** or spotting plate. It is a square of white plastic with some shallow holes in it. It is used for blood grouping and for testing the urine for INH (Section 8.9). A white builders' tile can also be used for blood grouping, so can a piece of plastic sheet, such as the clear kind of plastic called 'Perspex'.

ML 50 is two metres of **rubber tube**. This is for the water pump and the Bunsen burner. You may be lucky and have running water and the right tap to make it work—see Picture F, FIGURE 3-1.

ML 51 is a parcel of many long pieces of **glass tube**. This is the glass tube from which you can make the Pasteur pipettes described in Section 3.9. It is between 6 and 7 mm across. This is the external or outside dia-

meter, and each piece is about one and a half metres long. Glass tubing is bought by the kilo. You are given two kilos of glass tubing.

ML 52 is a **polythene watch glass**. There is a round glass on the front of a watch. This is a watch glass. The watch glasses you are given are much bigger than those on wrist-watches and are made of plastic, not glass. They are really dishes or plates. They are used for weighing chemicals on a balance.

ML 53 is an **electric water bath**. It is made so that it will keep water at any temperature between that of a room (about 20°C) and 100°C (boiling temperature or boiling point). You will use it at 37°C.

ML 54 are spare **wicks** for the spirit lamp ML 39. A wick is the cloth in a lamp that is soaked in oil or spirit and burns at one end.

ML 55 is **wire** for making loops which go in the loop-holder ML 28. Section 3.10 tells you how to make these loops. It is called nickel-chrome wire because it is made of two metals which are rather like iron called nickel and chromium. Wire of this kind is not easily burnt away in a Bunsen burner. This wire is called '22 SWG' nickel chrome wire. 22 SWG measures how thick it is. SWG means Standard Wire Gauge.

2.3 Ordinary equipment in the main list (FIGURE 2-4)

So far all the equipment that we have described has been equipment that has to be ordered specially. But there are many ordinary things, like cups and jars which are useful in a laboratory. These can be bought in most ordinary shops. You may say that it is not worth drawing pictures of all these things. Perhaps it is not, but it may help you to get them. This ordinary equipment is just as important as the special laboratory equipment.

ML 56 is a small **paint brush**. It is used with the quick drying paint to label bottles as is shown in Picture C, FIGURE 3-8. A spirit pen can be used, but paint looks much better. Carefully labelled bottles will help you to be proud of your laboratory.

ML 57 is a **bucket** with a handle. You will want six of these. Two of them should be metal. They are shown under the bench in FIGURE 3-11.

ML 58 are ordinary **plastic cups** with handles. They can be used instead of glass beakers for everything except heating. Because they are plastic they do not break as easily as glass beakers.

ML 60 is a **gas cylinder**. This is a big iron bottle of gas. It is used to provide gas for a Bunsen burner as shown in Picture A, FIGURE 3-2. There are many shapes and sizes of cylinders, and you will have the kind which is sold in your country. The cylinder must have a machine on it called a **reducing valve**. This lets the gas out of the cylinder slowly and is shown in Picture F, FIGURE 3-2. The reducing valve is joined to the Bunsen burner by a piece of rubber tubing (ML 50a). You will need two cylinders. Keep one in use. *As soon as it is*

2 | Equipment and Chemicals

empty send it away to be filled up. While it is being filled up use the second one.

ML 61 is a **hammer**. You will find it very useful in a laboratory.

ML 62 is a **glass jar** with a wide mouth and a plastic screw cap. They are for Field's stains, A and B, and for Rothera's reagent. These are very necessary, and if they cannot be bought locally they may have to be ordered with the equipment in the main list.

ML 63 is an **oilstone** for sharpening the needles on blood transfusion equipment. It can also be used to sharpen other needles.

ML 64a, b, and c are small tins of quick-drying enamel **paint** which are used to label bottles and polytubes with paint brush ML 56. You want three colours: black for bottle labels and red and yellow for polytubes —see Section 4.6.

ML 65 is a **metal pan** with two handles and is used for

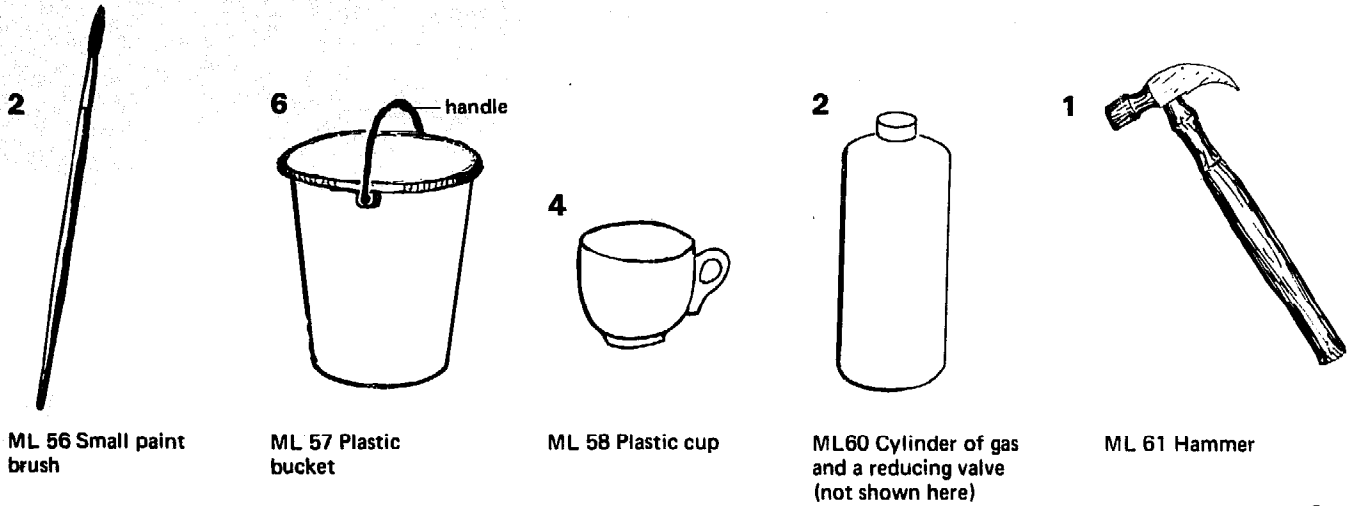

these wide mouthed bottles may have to be ordered specially

you will want three colours of paint, black, yellow and red

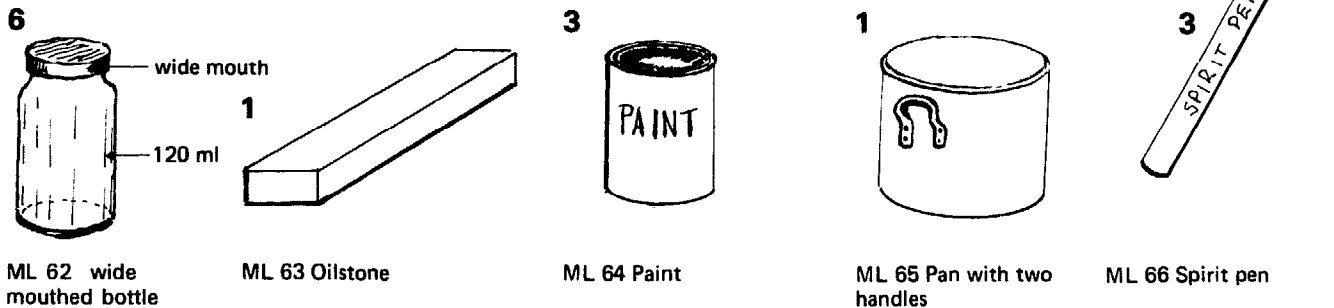

all these things are just as important as the special laboratory equipment!!

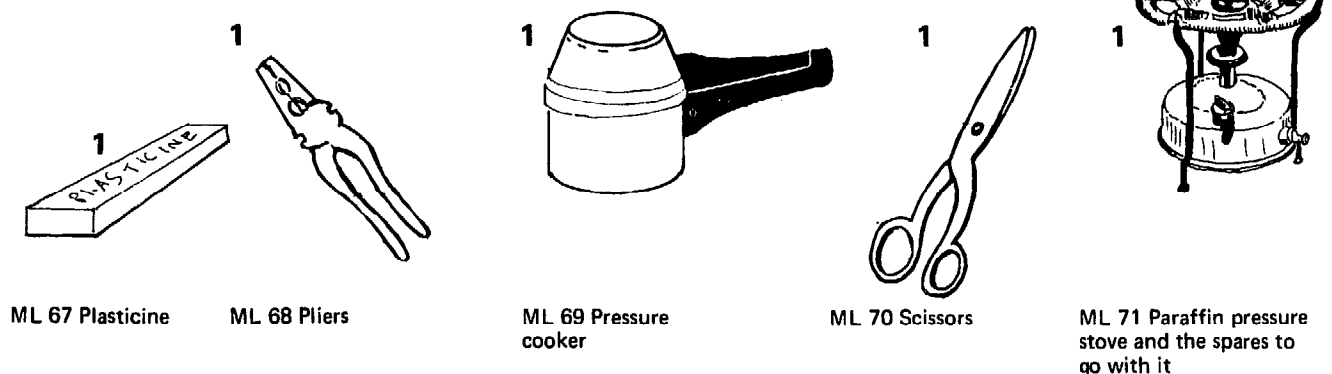

Fig. 2-4 Ordinary equipment in the main list

heating things on the pressure stove. It is especially useful for boiling slides that are covered with oil.

ML 66 is a **spirit pen** for marking. It is useful for marking bottles.

ML 67 is **plasticine**. This is a special kind of clay which does not dry up. It is useful for fixing and holding things in a laboratory. It makes a good slide holder if you have not got the wooden one shown in Picture F, FIGURE 3-8.

ML 68 is a pair of **pliers**. These are used for making wire loops and are very useful in the laboratory.

ML 69 is the Prestige 'Hi-Dome' **pressure cooker**. It is described in Section 1.21. You should have a spare **gasket** and a spare **safety plug** for your cooker.

ML 70 is a pair of **scissors**.

ML 71 is a **paraffin pressure stove**; it is often called a 'Primus stove'. Pasteur pipettes can be made on a paraffin pressure stove if there is no gas. With the stove there should be a bottle for spirit and some '**prickers**' for keeping the jet clear. The jet is the little hole out of which the paraffin vapour (gas) comes.

You will also want **syringes**, **needles**, conical **urine specimen glasses** (as in Picture 3, FIGURE 8-6), **cotton wool**, **surgical gauze**, **lysol**, **paraffin**, and **matches**, **rubber stamps** (see Section 4.2), and a **stamp pad**. The urine specimen glasses are ordinary hospital equipment. Glass breaks easily, so plastic ones are better.

2.4 Chemicals

You will need about forty chemicals. These are listed in Section 13.10.

The following chemicals are white powders, many of which look like one another. They are: tartaric acid, salicylsulphonic acid (also called sulphosalicylic acid), barium chloride, barium peroxide, ortho-tolidine (also called o-tolidine), sequestrene (this is also called sequestric acid potassium salt, and EDTA or ethylene-diamine-tetra-acetic-acid potassium salt), potassium fluoride, potassium iodide, sodium acetate, sodium carbonate, sodium chloride, sodium citrate, and the two kinds of potassium phosphate. Trichloroacetic acid easily takes water out of the air. It is said to be **hygroscopic**, and it may even take enough to make a solution. Keep the lid on carefully to stop this. Copper sulphate forms beautiful blue crystals or big blue lumps. Ferric chloride forms dark brown crystals. It too is hygroscopic. Iodine forms small deep brown-black crystals. Phenol forms crystals when it is cold, but when the weather is warm phenol forms an oily liquid. Sodium chloride is the ordinary table salt that we eat with our food. Sodium hydroxide is best bought as small **pellets** (little balls). It is very hygroscopic indeed. If you leave the lid off the bottle, sodium hydroxide quickly forms a hard lump and is difficult to get out of the bottle. Keep the lid on.

The several kinds of phosphate are more difficult to understand. There are two kinds of potassium phosphate in the list of chemicals. There is *di-potassium* hydrogen

phosphate which is written K_2HPO_4 . K stands for Kalium, which is another name for potassium, H stands for hydrogen, and PO_4 for phosphate. Notice the ₂ after the K. Di means two. There is also potassium *dihydrogen* phosphate which is written KH_2PO_4 . Notice the ₂ after the H in this phosphate.

In the same way there are two main kinds of sodium phosphate. There is disodium hydrogen phosphate Na_2HPO_4 , and there is sodium dihydrogen phosphate NaH_2PO_4 . Na stands for Natrium which is another name for sodium. These two sodium phosphates are not in the list of chemicals, but you may have them, and they can be used instead of potassium phosphates for some methods.

But difficulties do not end there. Both sodium phosphates can be **anhydrous** or without water in them ('an' means without, 'hydrous' means watery). These anhydrous phosphates are written Na_2HPO_4 and NaH_2PO_4 . They can also have different amounts of water in them. The chemical way of writing water is H_2O . The different **hydrated** (watery) phosphates are $Na_2HPO_4 \cdot 2H_2O$ which has some water, $Na_2HPO_4 \cdot 12H_2O$ which has a lot of water, and $NaH_2PO_4 \cdot 2H_2O$ which also has some water.

One kind of disodium phosphate can usually be used instead of another kind of disodium phosphate, but you will want a different weight of it, depending on how much water there is in it. Similarly one kind of sodium dihydrogen phosphate can usually be used instead of another kind of dihydrogen phosphate. You will also need a different weight of it, depending on how much water there is in it. But a disodium phosphate will never work instead of a dihydrogen phosphate. Nor will a dihydrogen phosphate do instead of a disodium phosphate. The right kinds of sodium and potassium phosphates can however be used together. *Read the method and the label on the bottle carefully, and use only the right kind of phosphate.* Section 3.20 describes how these phosphates are used to make buffer solutions.

Acetic acid, hydrochloric acid, sulphuric acid, formaldehyde (also called formalin), 'Teepol', methanol, spirit and xylol (also called xylene), and ether are all liquids. If you have no ether, petrol can be used instead for the method in Section 10.3. Most of these liquids have smells which you will soon come to know.

Concentrated hydrochloric acid and concentrated sulphuric acid are dangerous. Don't pipette them with a pipette in your mouth. If you get them on your hands, wash your hands immediately. *Never add water to sulphuric acid.* The mixture will get hot and spit. It will blind you if it gets in your eyes. When you dilute sulphuric acid, add sulphuric acid *gently* to water. There are more instructions for doing this in Section 3.26.

Methanol is the same as methyl alcohol. Ethanol is the same as ethyl alcohol. Ethyl alcohol is the alcohol in beer; methyl alcohol is very poisonous. 'Spirit' is about 95% ethyl alcohol and 5% water. There are several kinds of spirit, some have poisonous chemicals (including methyl alcohol) added to them to stop people drinking

them. The purple methylated spirit is spirit of this kind. Surgical spirit is a purer kind of spirit, but it too is poisonous. When you read about 'spirit' in this book, this means either methylated spirit or surgical spirit. It is better to use surgical spirit. Spirit is a mild antiseptic and a useful fuel. It is used in the spirit lamp. Absolute alcohol is pure ethyl alcohol with no water and no poisonous chemical in it. It is very expensive, and it is not used for the methods in this book. But, if you have absolute alcohol it can be used for any of the methods that require spirit.

Alcohol, acetone, spirit of any kind, and xylene are all **inflammable**: they will burn like petrol. **TAKE CARE**. Ether is especially inflammable, so take very special care. *Never put ether near a flame*. Never have ether on the same bench as a flame, because the vapour (gas) from ether may roll along the bench and cause a fire or an explosion (a big bang). Besides being inflammable these liquids are also very **volatile**. This means that they easily **evaporate**, disappear and go into the air if the top is left off the bottle. Ether is especially volatile. **KEEP THE CAP ON**.

Ammonia is a very dangerous liquid with a very strong burning smell. A little ammonia in air or water can spoil Nessler's solution and the blood urea method, so keep ammonia and Nessler's solution well apart (see Section 7.41).

You will want the following dry stains. They are all deeply coloured crystals—basic fuchsin (purple, a mixture of blue and red), brilliant cresyl blue, crystal violet (violet is a kind of very deep blue), Field's stain A (blue), Field's stain B (red), malachite green, and methylene blue.

Immersion oil is a special thick, clear oil. The 250 ml you are given is to fill up the oil bottle that is supplied with your Olympus microscope. You can also make an oil bottle (see Section 6.7).

You should have some universal indicator test paper and also a bottle of 'Acetest' test tablets for testing acetone in the urine (see Section 8.7).

The last group of chemicals are called **biologicals**. These are chemicals which come from living organisms, such as man or animals. *All biologicals must be kept in a refrigerator*. If they are not stored in the cold, they soon stop working. Bacteria may grow in them, and they may putrefy (see Section 1.15). The biologicals you will need are anti-A serum, anti-B serum, and bovine albumen. These may be given you as powders or as liquids. They will not be wanted in a health centre. **KEEP THEM IN A REFRIGERATOR**.

2.5 The choices

So far we have described only the main list of equipment. Some people may want to change this list. The changes they might want have been described here as choices. The methods for all these choices are described in later chapters. You can find out more about this equipment in the sections from 13.12 onwards.

What can you do if you cannot get everything you want? Most things are essential—you have got to have them. But there are some things for which there are substitutes (a substitute is something which will do instead of something else). Petrol (it is sometimes called gasoline) can be substituted for ether in the formol-ether concentration test. Liquid paraffin, which is often used in hospitals, works nearly as well as immersion oil. Soft toilet paper can be used instead of lens paper. Small squares of 'Cellophane' or polythene can be used instead of coverslips. None of these things, however, work as well as the right thing!

Choice 1. Replacing the Lovibond comparator by the Grey wedge photometer

If you have the Grey wedge photometer you will not need the Lovibond comparator or its tubes and discs. You will not need the set of proteinometer standards (ML 36) either. Read about the Grey wedge photometer in Section 5.11.

Make sure you have spare bulbs and spare cells—see Section 13.13.

Choice 2. Replacing the Lovibond comparator with the EEL colorimeter

You will not need any of the Lovibond equipment, but you will need the proteinometer standards set. You will want all the EEL equipment you see in FIGURE 5-13. You will want the three Ilford filters 625, 608, and 622, a set of EEL tubes, and preferably a spare selenium cell. You will also need one of the standards for haemoglobin described in Section 5.19. There are other spares also which may be needed—see Section 13.15.

Choice 3. Silica gel

In very warm wet countries fungi grow on the lenses of microscopes and spoil them. Microscopes should thus be kept in a tightly closed box or bag with silica gel to take water out of the air and keep them dry, so that fungi cannot grow on them. See Section 6.18.

Choice 4. Electric centrifuges

There is a hand centrifuge (ML 12) in the main list of equipment. If you have electricity there are several electric centrifuges you can use. There is a cheap plastic one called the 'MSE Minette'. There is also a bigger one called the 'MSE Minor' on which you can do the microhaematocrit. There is also a special one, the 'Model X', which will run on 220-volt main electricity and also on a car battery. You may also have the Bickerton-Eaves microhaematocrit centrifuge.

Choice 5. A deep counting chamber

Counting chambers are discussed in Section 7.29. In the main list there is a Neubauer double-celled counting

chamber 0.1 mm deep. But it is also useful to have a Fuchs-Rosenthal chamber 0.2 mm deep.

Choice 6. Testing the urine for INH

It is sometimes useful to be able to test the urine of tuberculous patients for the drug called INH. Two extra chemicals are needed, chloramine-T and potassium cyanide. Potassium cyanide is so poisonous (so likely to kill you if you eat it) that it has not been put on the main list. Read about the care you must take in using it in Section 8.9.

Choice 7. The cyanmethaemoglobin method

This is a more accurate way of measuring haemoglobin, the equipment for it being listed in Section 13.20.

Choice 8. The use of sodium azide

Sodium azide can be used to preserve (keep) samples of serum to be sent to a central laboratory (see Section 4.10).

Choice 9. Using ammonia to measure the haemoglobin

It is usual to use ammonia rather than sodium carbonate for measuring the haemoglobin.

Choice 11. Dichromate cleaning fluid

Most glassware can be cleaned with soap and water. But if it is very dirty a mixture of potassium dichromate and sulphuric acid will help to clean it. Sulphuric acid is dangerous and caustic. Sections 3.12 and 3.26 will tell you how to make and use dichromate cleaning fluid.

Choice 12. Making some reagents locally

Some reagents are best made up in a central laboratory and given to you ready made. Section 13.25 will tell you the chemicals you need as well as how to make these reagents if you have to.

Choice 13. 'Dextrostix'

This is a special paper test for measuring blood sugar. It is very quick and easy to use, but it is not accurate enough to replace the method in Section 7.42.

Choice 14. Rothera's test

The older and slightly cheaper way to test for acetone in the urine is to use a mixture of sodium nitroprusside and ammonium sulphate. This is Rothera's method. The 'Acetest' tablet method is in the main list, but you may want to do Rothera's method. Both methods are described in Section 8.7. Sodium nitroprusside forms deep purple crystals.

Choice 15. 'Ictotest' tablets

These tablets are used to test the urine for bile pigment. Fouchet's method is the older way of doing this, and the chemicals needed for it are in the main list (see Section 8.8).

Choice 16. The 'Cellophane' thick stool smear

The materials for this very useful way of examining the stools for helminth ova are described in Section 13.29.

Choice 17. 'Labogaz'

Gas is being used more and more often and can be bought in tins that can be used with a special kind of Bunsen burner. 'Labogaz' is gas of this kind and is described in Section 3.4.

Choice 18. This book

The easiest way to make sure that the people who need to read this book can do so may be to put it in the equipment list and give it an ML number. It is therefore included here as Choice 18 and called ML 151.

The choices you will use in your hospital or health centre will be decided by the people in charge of your medical service. There is a table in Section 13.32 where these choices can be written down.

2.6 Stock and spares

Try very hard to keep enough chemicals to last you at least 6 months. *Don't wait until something is finished before ordering some more.* You should always have enough of anything in stock so that if any order fails to come you have time to order again before running out. Note how much of a thing you use, and take special care over things that are soon finished, such as spirit, gas, paraffin, immersion oil, and slides.

Some equipment needs spare parts. For example, keep a spare gasket for the pressure cooker, spare bulbs for the EEL, and a spare cell for the Grey wedge. Never rely on one of anything that is easily broken, one pipette for example. *Make a list of all the spares you need, and try to get them—NOW.*

QUESTIONS

1. What kinds of bottle do you know? Describe one use for each kind.
2. What kinds of pipette do you know? How are they used?
3. What is the difference between a cover glass and a coverslip?

2 | Equipment and Chemicals

4. A spirit lamp is easy to use, but how would you look after it?

5. What figures are there on your thermometer, and what do they mean?

6. What different kinds of phosphate are there, and how do they differ?

7. What do copper sulphate, iodine, ferric chloride, sodium nitroprusside, and phenol look like?

8. Formaldehyde, xylol, methanol, and ethanol all have other names. Do you know them?

9. What are the differences between absolute alcohol, surgical spirit, and methylated spirit?

10. What specially important things must you remember when you are working with (a) ether, (b) potassium cyanide, (c) sulphuric acid?

3 | Making the Laboratory Ready

3.1 Benches and shelves

There are many things to do before specimens can be looked at in a laboratory. This chapter tells you how to do them.

The first thing to think about is a room for the laboratory. This should be a special room where only laboratory work is done, but, if you have no special room, you can use part of a room which is used for something else. Many health centres have no special room for a laboratory; but almost every health centre can find space for a short bench, and there is always plenty of room for shelves. An important part of a laboratory is its bench. This is a big table and is shown in FIGURE 3-11. The bench must be wide enough and the right height. 75 cm is a good width and is also a good height for a bench. If you have not got a bench use a table. You can do all the tests described here on quite a short bench or table, *but you must have plenty of shelves on which to put the equipment. Keep everything you can on shelves so that your bench or table is clear to work on.* Just above the bench the shelves should be narrow, say, 15 cm for the first shelf. Further above the bench shelves can be wider, say, 20 cm for the second shelf and 30 cm for the third. The first shelf should be 30 cm above the bench and the three shelves 45 cm apart. Under the bench there is room for a drawer, and there is also space for another shelf if you want one. The length of the bench needed depends upon how many laboratory workers there are. Each worker only needs about 6 feet of bench.

Before you use a new bench always see that it is well covered with polish. If you have nothing else use a mixture of candle wax and paraffin. A well-polished bench will not stain or get marked so easily.

3.2 Sinks and staining (FIGURE 3-1)

You will want two sinks, one on the bench for staining and one somewhere else for washing up specimen bottles, etc. The best kind of sink for staining is the special square laboratory one that you will see in Picture F. But you can use a bucket as shown in Picture C and in FIGURE 3-11. Some people use an enamel basin set in the

bench with two pipettes across it joined by rubber tubes. A four-gallon petrol tin cut in half can also be used, as shown in Picture B. If a tin or bucket is used for staining slides it will only fill up slowly.

Put two pieces of glass tube (ML 51) across the sink, the tin or the bucket to make a staining rack for slides. These tubes are to hold slides while they are being stained and must be about two inches apart. If you want to know how to cut glass tube, look at Section 3.9. *These tubes must be horizontal*, so that the stain is the same depth all over the slide, as shown in Picture A, FIGURE 3-1. The best way to hold these tubes is to use special metal bars with levelling screws which rest on the bench at each side of the sink. These are shown in Picture F, but they are not really necessary. You can use sticking plaster (surgical adhesive tape or 'strapping') or a wooden block, or two nails. If you are using a tin as a sink, cut the edges of the tin so that the tubes lie flat as shown in Picture B. You will have to borrow a pair of tin shears (tin scissors) to cut the tin. With these cut holes or notches in the edge of the tin so that the tubes can rest in them and lie flat. Cut away the front of the tin so that you can get a spirit lamp or a lighted swab underneath the slides to warm them in the Ziehl-Neelsen method (see Section 11.1). If you use a plastic bucket, cut the edge of the bucket with a knife in the same way so that there is a place for the tubes to lie in. Stick the rods to the bucket with a piece of sticking plaster as in Picture D. If you have many slides to stain by the Ziehl-Neelsen method you may find it useful to put more than two bars across your sink or your tin.

You can wash up dirty glassware (anything made of glass) in any sink. Washing up can also be done in a bucket out-of-doors.

3.3 Water (FIGURE 3-1)

You must have water, but it need not be running water. All the methods in this book can be done with water from a bucket. Underneath the bench in FIGURE 3.11 are two buckets, one is for clean water and the other is for dirty water. Water is taken from the clean bucket with a

3 | Making the Laboratory Ready

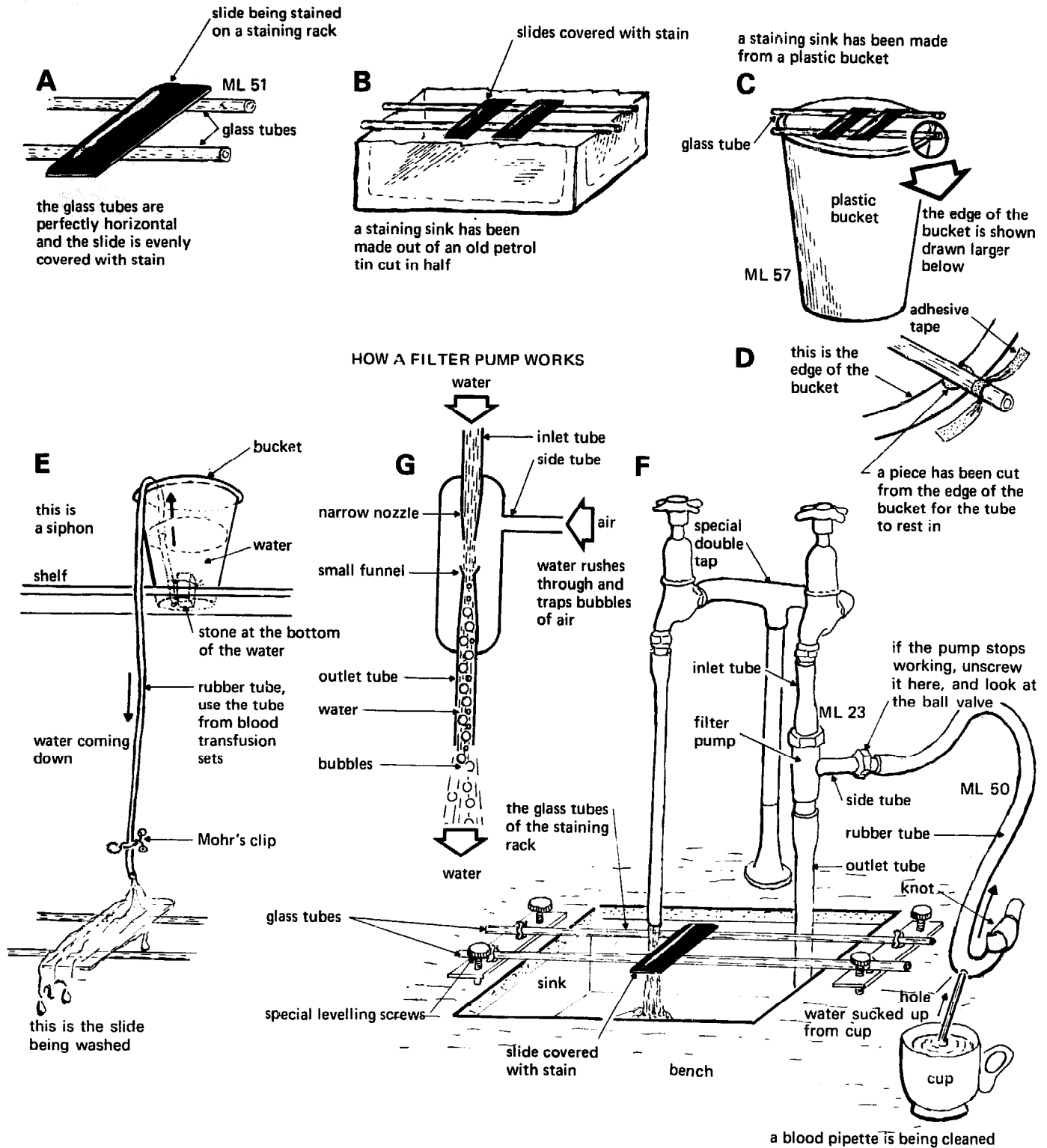

Fig. 3-1 Sinks and staining

jug and poured over the slides. A wash bottle filled with water is also useful.

Another way of getting water to a sink for staining is to use a bucket on a high shelf, a **siphon**, and a clip, as shown in Picture E. A siphon is a way of making water run upwards before making it run a longer way downwards. The flow of water in the siphon has to be started.

The best way to start it is to put all the tube under the water in the bucket and to fill it with water by moving it about in the bucket until no more air bubbles out. Then pinch (close) the lower end of the tube and quickly bring it over the side and well below the bottom of the bucket. Stop pinching the tube and water will start flowing. You can then put on the clip. Water will start flowing once

more as soon as you open it again. Use the clip from a blood transfusion set if you cannot get a proper Mohr's clip. Fix the top end of the tube in the bottom of the bucket by tying it to a stone.

A better way of getting water to your staining rack is to use an **aspirator jar**. This is a very big bottle with a tap on the bottom to which you can fix a rubber tube. Put the aspirator jar on a shelf above the staining rack. A tin with a nozzle soldered on can also be used.

The best way of getting water to the staining sink is to use a high double tap. This is shown in Picture F. One of the double taps can be fitted with a piece of rubber tube which hangs over the slides on the staining rack. This rubber tube can be moved so as to wash any of the slides. A filter pump (ML 23) can be fitted to the second of the two taps. Push a piece of rubber tube on to the tap and on to the top of the filter pump. Push another piece of rubber tube on to the outlet tube at the bottom of the pump. Filter pumps suck better if there is a piece of rubber tube fixed to the outlet tube in this way. Push a third piece of rubber tube on to the side tube of the pump. When you turn on the tap and put your finger over the end of this tube, you will feel the air sucking in. You can now put a pipette on to the end of this rubber tube and dip it into a cup of water. Water will rush up the pipette and clean it. This is a very good way of cleaning pipettes. All this is shown in Picture F.

A filter pump can be used to dry blood pipettes by sucking water through them, and then sucking a little acetone to remove the water. Acetone washes away the water and then rapidly evaporates as air is sucked through. This leaves the pipette dry. Dry pipettes measure blood more accurately than wet ones. If your rubber tube is too big to fit a small blood pipette, tie a knot in the end of the tube and then push the end of the blood pipette through a small hole in the tube just above the knot.

Picture G shows you how a filter pump works. Water under pressure comes out of a narrow nozzle and is caught in a small funnel. As it rushes from the nozzle to the funnel it catches and traps air. This sucks air from around the nozzle and so from the side tube.

The side tube has a valve on it which is not shown in Picture G. This valve is made from a small rubber ball on the end of a pin. This ball may swell and stick and stop the pump working. When this happens unscrew the nut on the side tube and take out the rubber ball with its pin. For most uses the pump works perfectly well without its valve. Put the valve back with the pin the same way round as it came out.

3.4 Bottled gas (FIGURE 3-2)

The Bunsen burner (ML 10) burns bottled gas. There are several kinds of bottled gas each with different cylinders and valves (taps). We shall describe 'Afrigas'. **OTHER KINDS OF CYLINDERS AND VALVES ARE DIFFERENT FROM THOSE FOR AFRIGAS, SO BE**

CAREFUL. Afrigas can be bought in small metal bottles or in big cylinders. One of these big cylinders and a Bunsen burner are shown in Picture A. The gas in the cylinder is under pressure (it is very tightly pushed into the cylinder). So a special valve, called a **reducing valve**, has to be used to let the gas out of the cylinder slowly. In Picture I you will see a reducing valve fixed to the top of a cylinder. Pictures E and F show the top of the cylinder and the reducing valve separately. The reducing valve is fixed to the top of the cylinder with a big nut (a nut is something that turns on a screw). When the reducing valve is not fixed to the cylinder, a **cap** is fixed to it instead—look at Picture D. This cap keeps dirt out of the place where the reducing valve fits. There is a tap on the top of the cylinder to turn the gas on and off. A little rod sticks out and fits a key. *Turned to the left the tap is on; turned to the right the tap is off.*

In Picture A the Bunsen burner has been shown fixed straight to the cylinder with a rubber tube. Very often a cylinder is fixed to metal pipes which go under a bench and bring the gas to taps on the top of the bench. Gas can then be turned on and off at these taps on the bench. Wherever possible cylinders of gas should be *outside* a building so that if gas escapes it will blow away and not cause a fire. When gas escapes inside the laboratory it will mix with air. If there is a light in the laboratory this mixture of gas and air may explode and destroy the laboratory.

Gas may leak slowly from pipes and valves, so it is wise to *turn off gas at the cylinder at the end of a day's work*. Gas smells and you can usually smell it in a room if there is a leak. *Look out for the smell of gas*, and if necessary find the leak.

METHOD

CHANGING A CYLINDER OF 'AFRIGAS' FIGURE 3-2

MAKE SURE THAT THERE ARE NO FLAMES AROUND WHEN YOU CHANGE A CYLINDER.

Use the special key to turn the tap of the cylinder to the right—**OFF**.

Unscrew the nut on the bottom of the reducing valve, and take the valve off the cylinder.

Make quite sure that the tap of the new cylinder is also turned to the right—**OFF**.

Unscrew the cap on the new cylinder.

Make sure that the tap on the cylinder and the place where the reducing valve fits it are both clean. If necessary, fit a new washer.

Screw the nut on the reducing valve into the tap on the new cylinder.

Turn the tap on the cylinder to the left—**ON**. Gas will come out of the reducing valve.

'Labogaz'

This is another useful, but more expensive kind of gas. It is shown at the bottom of FIGURE 3-2. The gas comes in

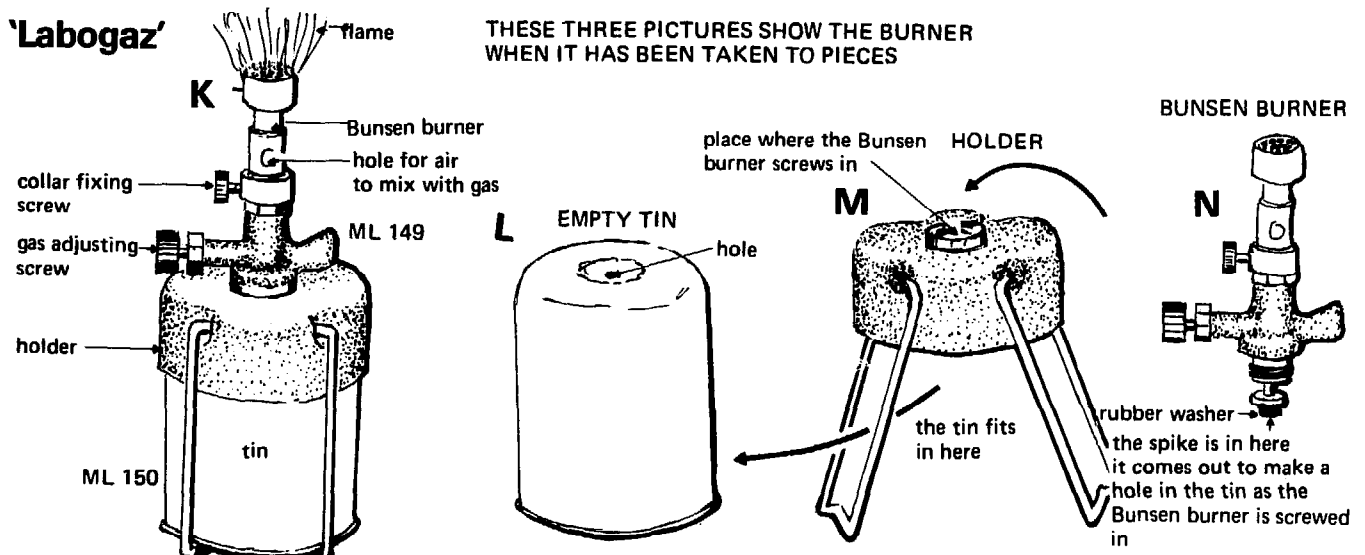
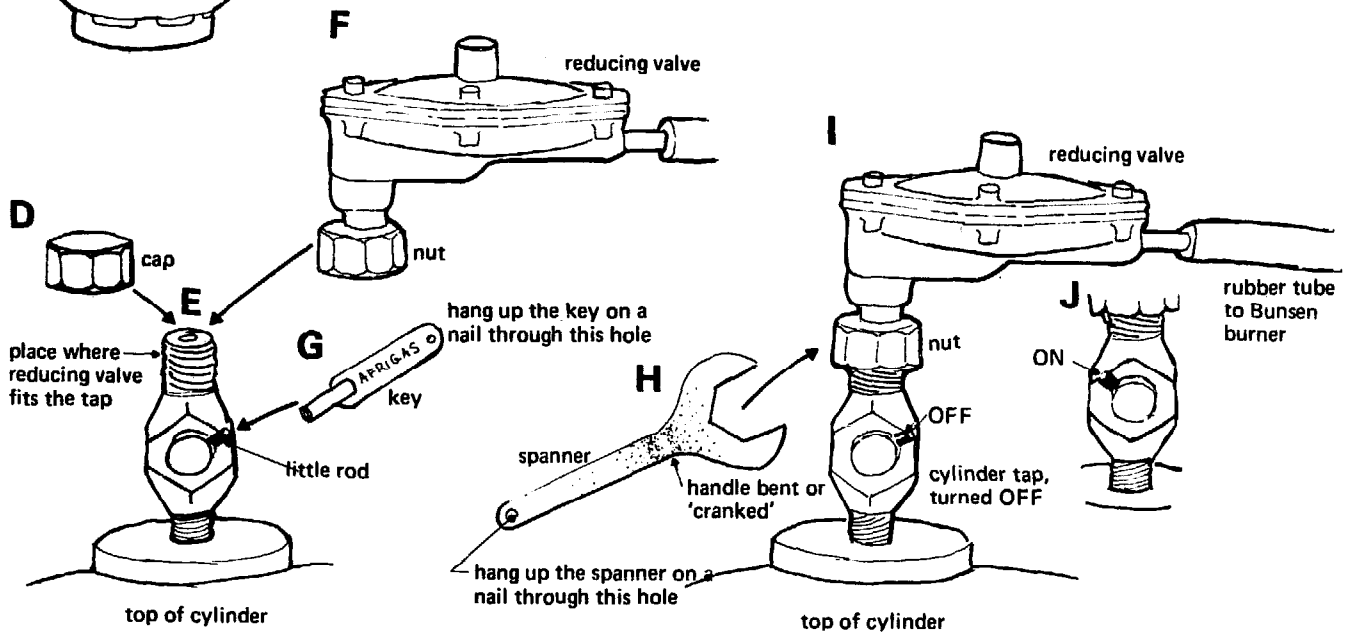
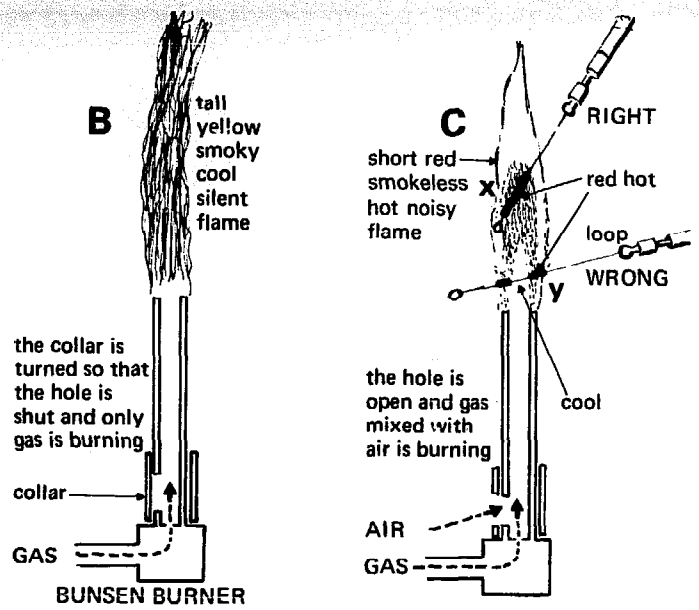
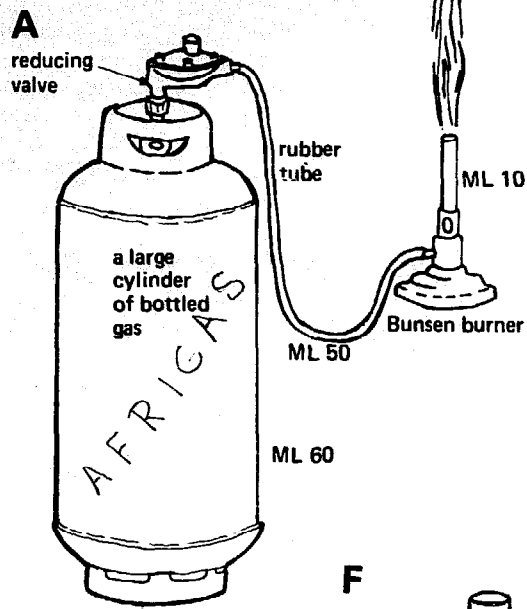

Fig. 3-2 Gas and the Bunsen burner

the tin drawn in Picture L. These tins are full of liquid gas under high pressure. They fit into the holder drawn in Picture M and are held by the arms. The Bunsen burner drawn in Picture N screws into the top of the holder. At the bottom of the Bunsen burner is a black rubber washer, and in the middle of this washer is a sharp steel spike or point. As the Bunsen burner is screwed into the holder the spike comes out of the washer and makes a hole in the tin. The rubber washer stops the gas getting out and keeps it inside the burner. The gas adjusting screw adjusts the height of the flame and turns the burner off completely when it is not being used. The collar has a hole in it to let air mix with the gas, just as in the Bunsen burner described in the next section. The collar is fixed with a collar-fixing screw.

There are three things to remember in using the 'Labogaz' burner.

ALWAYS UNSCREW THE BURNER BEFORE FITTING A NEW TIN OF GAS INTO THE HOLDER. Screw the Bunsen burner into the holder *after* the tin has been put inside it. If the Bunsen burner is screwed into the holder before you put the tin of gas into it, all the gas will come out. It may catch alight and be very dangerous.

DON'T TAKE A TIN OUT OF THE HOLDER UNTIL THE TIN IS EMPTY. DON'T UNSCREW THE BUNSEN BURNER UNTIL THE TIN IS EMPTY.

3.5 The Bunsen burner (FIGURE 3-2)

Look for the Bunsen burner in Pictures A, B, and C. You will see that it has a metal collar with a hole in it. A collar is something that goes round something, just as the collar of a shirt goes round your neck. This collar can be turned round the main tube of the Bunsen burner. At one position (place) the hole in the collar comes opposite a hole in the main tube of the burner. This hole lets air go into the main tube of the burner to mix with gas coming from the cylinder. The mixture of air and gas burns at the top of the main tube. Picture B shows the Bunsen burning with the hole shut. No air is getting to the main tube, and the pure gas is burning with a tall, smoky, yellow, silent, cool flame. Picture C shows the collar turned with the hole open. Air is getting into the main tube, and the mixture of air and gas is burning with a short, smokeless, clear, noisy, hot flame. If the hole is half open the burner will be silent, but otherwise the flame will be like that in Picture C. *Adjust your Bunsen burner by turning the collar until the flame is hot, clean (no smoke), and silent.*

In Picture C you will see that there are two wire loops in the flame. These loops are described in Section 3.10. Loop Y is near the bottom of the flame, and you will see that there is a cool piece of the wire in the middle of the flame. This part of the loop is cool because it is in the cool mixture of gas and air which has not yet burned. At both sides of this cool piece a short piece of the wire is

red hot. These red hot places have been drawn deeply black in this picture.

Loop X is sloping and is higher up in the flame of the Bunsen burner. It is red hot right through, and there is no cool place in the middle. *Whenever you flame your loop, put it towards the top of the Bunsen flame where loop X is, or a bit higher.* You will read more about how to flame your loop in Section 3.10.

3.6 Electricity

It is useful to have mains electricity to provide light for the laboratory. Mains electricity is electricity which comes from outside the laboratory. As well as lighting the laboratory, it can be used to provide light for a microscope lamp, a Grey wedge photometer, an EEL colorimeter, or an electric centrifuge. Many laboratories will not have mains electricity and will have to get electricity from a car battery instead. This can also be used to run an electric centrifuge (Model X, ML 121, Choice 4, Section 13.17). Microscope lamps are described in Section 6.11 and the Grey wedge photometer in Section 5.11.

3.7 Using the battery of a Land-Rover (FIGURE 3-3)

The easiest way to use the electricity of a car battery is to take it from the battery of a car which is standing still. This is especially useful when a Land-Rover takes a doctor or medical assistant to hold a clinic at a distant place—a mobile (moving) clinic. The Land-Rover has special sockets (holes) on its dashboard where metal plugs can be put in to use the electricity of the 12 volt battery. A plug is something which can be pushed into a hole. The dashboard is the place where the instruments are in a car. A volt is a measure of the strength of electricity. A microscope or a centrifuge can thus be used very easily at a mobile clinic. Special plugs can be bought, but the bare ends of wire can be pushed into these sockets and held there with matchsticks. FIGURE 3-3 shows the sockets on the dashboard of a Land-Rover. Plugs have been pushed into the sockets, and wires are leading outside the window into a hut. The driver of the Land-Rover is using an Olympus microscope to look at the stools for hookworm. He is using a 12-volt bulb in his microscope lamp (ML 30k). The medical assistant and the two nurses he brought with him are looking at the patients.

The battery of any car can be used, but the wires will have to be joined up specially because most cars do not have sockets on their dashboards.

3.8 Using spare car batteries. The Honda generator

It may be impossible to use the battery of a car which is standing still. But it may be possible to use a spare

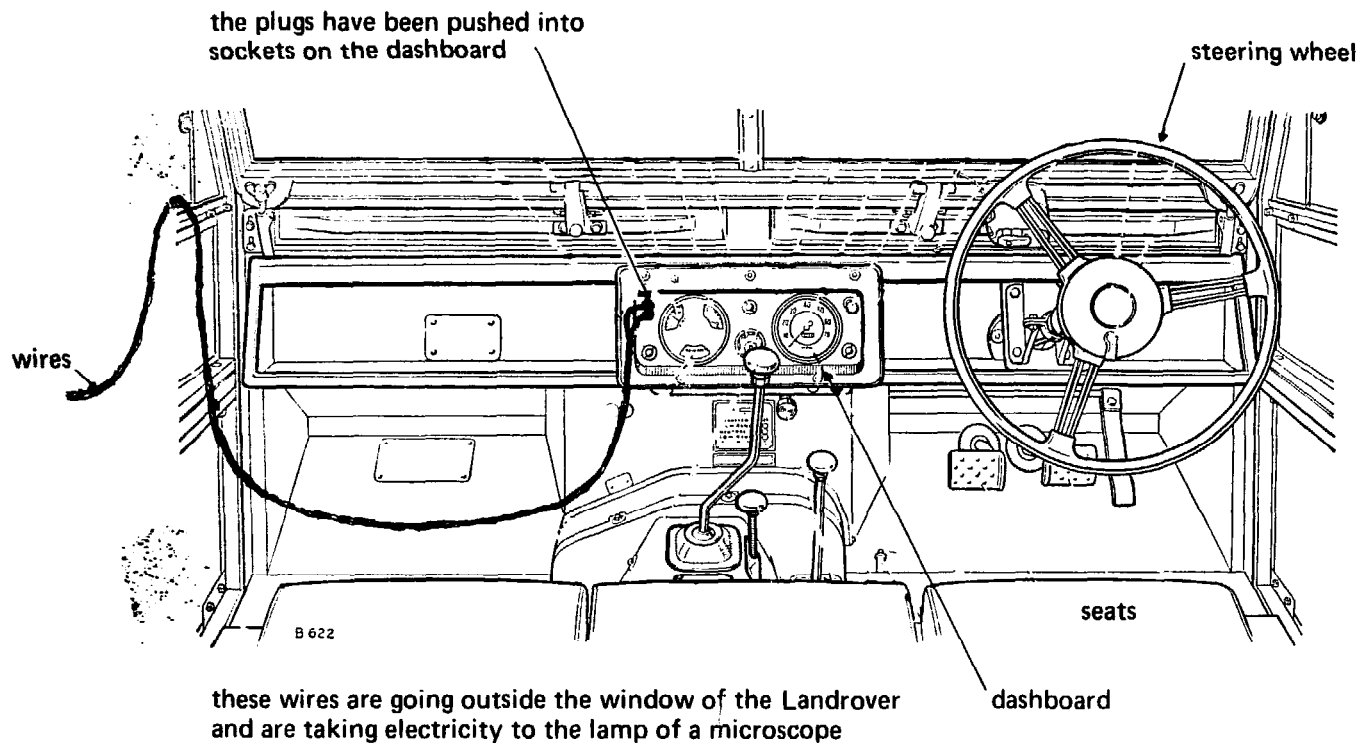

Fig. 3-3 Using the battery of a Land-Rover

battery and charge (fill) it in a car while it is moving. Batteries can also be charged with a **trickle charger**, or a **Hc: 'a generator**.

A car can be used to charge a battery by first making a special place for a second battery. The car can be started on its own battery and then changed over to the second battery while it is running. This second battery can then be charged during a journey. A garage may be able to fit a place for a second battery together with the wires and switch for charging it.

A trickle charger is a machine which will charge a battery using mains electricity. Many hospitals have mains electricity for part of the day only. A battery can be charged with a trickle charger during the time that the mains electricity is on. When the mains are off the electricity that has been stored in the battery can be used. Remember to turn off a trickle charger as soon as the mains electricity is shut off. If this is not done the battery may start discharging (emptying) itself.

A Honda generator is a small petrol engine that generates (makes) electricity. The smallest generator makes a little 'mains' electricity (220 volts AC) for lighting a few lamps. It can also make 12 volt (DC) electricity for charging a battery. Honda generators are not expensive and may be the easiest way of providing a laboratory with electricity. However, if they are going to last a long time Honda generators must be looked after very carefully. Read the instruction book with great care.

Car batteries also need looking after. They are filled with dilute sulphuric acid, which slowly dries up. *They must be 'topped up' (filled) to just above the plates with distilled water (see Section 3.15) once a week. If ordin-*

ary water is used batteries will slowly spoil. If you have no distilled water use rainwater.

Batteries must always be recharged as soon as they are empty. If they are left discharged for any time they will hold less electricity next time they are charged. In this way they are soon spoiled.

3.9 Making and using Pasteur pipettes

A **pipette** is a glass pipe or tube which is used to take a little liquid from one place to another. One of the most useful pipettes is named after a great Frenchman, Louis Pasteur—the 'Pasteur pipette'. Pasteur pipettes are made

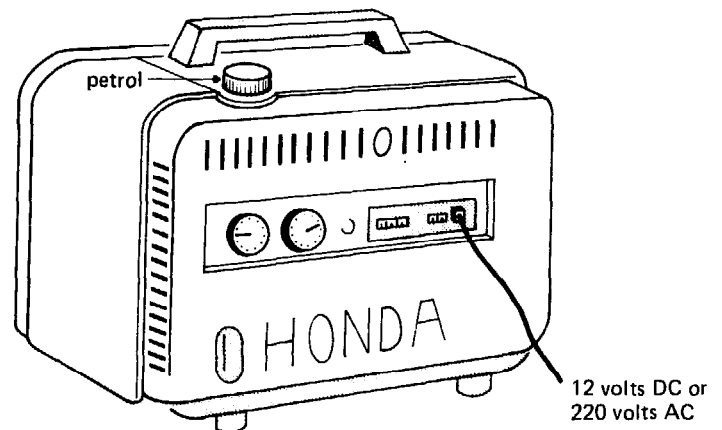

Fig. 3-4 The Honda generator

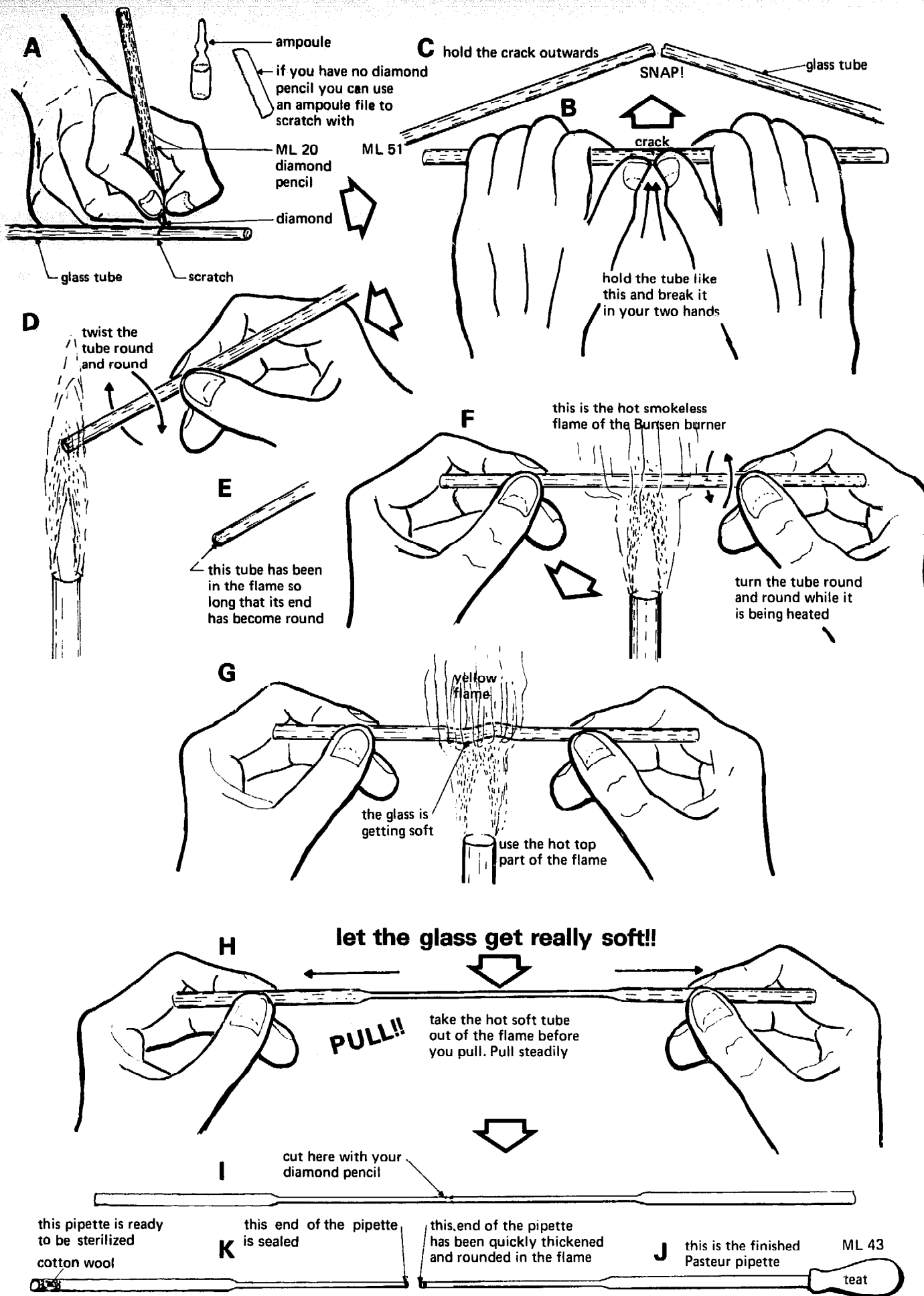

Fig. 3-5 Pasteur pipettes

from glass tubing (ML 51) and use the rubber teats (ML 43).

To make a Pasteur pipette we take a piece of glass tube about 15 cm long and hold it in a hot flame until the middle part is soft. *We then take the tube out of the flame and pull the two ends apart.* The hot soft glass is pulled thin and then cools and goes hard. We break the glass tube in the middle and put a rubber teat on each end. In this way we make two Pasteur pipettes. Either a Bunsen burner or a paraffin pressure stove (a 'Primus stove') can be used. Make Pasteur pipettes like this, but before you make them you must learn how to cut a glass tube and round its ends.

METHOD

MAKING PASTEUR PIPETTES, FIGURE 3-5

CUTTING A GLASS TUBE

Take a piece of glass tube and put it down flat on the bench.

Take a diamond pencil and make *one scratch across* the glass tube in the place where you want it to break. The scratch need only be quite a short one. Look at Picture A. Take the glass tube and break it in your two hands as shown in Picture B. Hold the scratch *outwards* and put your two thumbs behind it. The tube will snap (break) neatly in half as shown in Picture C.

If you have not got a diamond pencil, use one of the little metal files that are used for opening ampoules. A *file* is a tool for shaping something, and an *ampoule* is a very small glass bottle for drugs. Any hospital dispensary can give you an ampoule file. Look at the ampoule and ampoule file in Picture A.

ROUNDING THE END OF A GLASS TUBE

When a glass tube has been cut its ends are sharp and can easily cut your fingers or spoil a rubber teat. To stop this happening the sharp ends of a glass tube should be made round and smooth.

Hold the sharp end of the tube in the hot part of a flame, as shown in Picture D. Turn the end round in the flame a few times. When it is cool you will see its end is smooth. If you hold the end of the tube in the flame too long it will close up completely, as in Picture E.

PULLING THE PIPETTE

Take a piece of glass tubing 15 cm long. Hold it in both hands towards the top of the flame of a Bunsen burner.

Keep turning the tube round in your hands. In a minute or two the tube will become soft and start to bend, and the flame will become yellow, as in Picture G. *Wait until the glass is really soft.*

WHEN THE GLASS IS REALLY SOFT, TAKE THE

TUBE OUT OF THE FLAME AND PULL THE ENDS STEADILY APART.

The faster you pull the thinner will be the pipette. The slower you pull the thicker will be the pipette. As you pull, the hot soft tube goes cold and hard, and you cannot pull it out any more. By the time the tube goes cold the thin part of it should be about 20 cm long.

As soon as the tube is cold, cut it into two Pasteur pipettes, each with about 10 cm of narrow tube.

Quickly pass the end of the pipette through the flame. This will make the cut end strong and smooth. Don't hold the cut end in the flame too long or it will seal (close) up and you will have to cut or break the sealed end off.

Unsealed pipettes are more often used, but it is sometimes useful to make sterile **plugged** Pasteur pipettes with sealed ends. Plugged means blocked or closed. A pipette of this kind is shown in Picture K. You will see that the thin end has been held in the flame until it is sealed. The other end has been plugged with cotton wool which will let air go through but stop micro-organisms getting in. If the pieces of cotton wool stick out of the end of the pipette after you have plugged it, burn them off in a flame. These plugged sealed pipettes can be sterilized in a pressure cooker which will kill all the micro-organisms on them and inside them. The inside will remain sterile because one end is plugged with cotton wool and the other end is sealed. When these sterile plugged and sealed pipettes are wanted, the thin end is broken off and the thin part of the pipette is flamed. Read how to use them in Section 1.22.

If you have not got a Bunsen burner, make Pasteur pipettes on a paraffin pressure stove like this.

METHODS

MAKING PASTEUR PIPETTES ON A PARAFFIN PRESSURE STOVE, FIGURE 3-6

Take off the ring on top of the stove. Take off the metal cup that spreads out the flame (the flame spreader).

Hold the glass tube as shown in Picture A and make a Pasteur pipette just as you would if you were making a Pasteur pipette on a Bunsen burner.

The ends of Pasteur pipettes often break, and it saves glass to be able to make new ends.

MAKING NEW ENDS ON PASTEUR PIPETTES, FIGURE 3-6

Take two Pasteur pipettes with broken ends, as in Picture B.

Heat the ends. When the glass is hot and soft, push them together so that they stick, as shown in Picture C.

Take the joined part out of the flame and heat the

glass next to it as shown in Picture D. Use this soft glass to make a pipette in the usual way, as in Picture E.

Make a new end on the other pipette by heating and pulling the glass at place 'X' in Picture E.

Don't throw away any pieces of glass tubing out of which you could possibly make a Pasteur pipette.

PRACTICE HOLDING A PASTEUR PIPETTE PROPERLY THE VERY FIRST TIME YOU COME TO USE IT.

WASHING A PASTEUR PIPETTE, FIGURE 3-6, PICTURE G

Always keep two plastic cups on your bench, one labelled 'saline', the other 'waste'. Waste is the dirty saline you are going to throw away. It is best to have cups of different colours. You may be given plastic beakers instead of cups.

To wash your pipette, take up some clean saline and blow it into the waste cup. Blow it out keeping the end of the pipette always ABOVE the surface of any dirty saline there may be in the waste cup. Don't let the pipette dip into the waste saline. Try to get all the saline out of your pipette. You will find this easier if you touch

HOLDING A PASTEUR PIPETTE, FIGURE 3-6

It is important to hold a Pasteur pipette properly. Hold the teat between your thumb and index finger and the pipette itself between your middle finger and ring finger. If you don't know which these fingers are, look at Picture F. Your thumb comes first on your hand, your index finger comes second, your middle or forefinger third, your ring finger next, and your little finger comes last.

MAKING PASTEUR PIPETTES ON A PARAFFIN STOVE

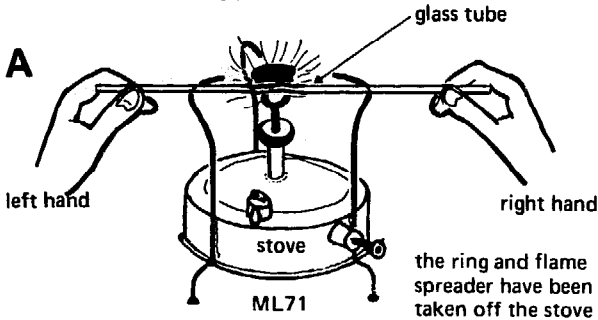

MAKING A NEW END ON A PASTEUR PIPETTE

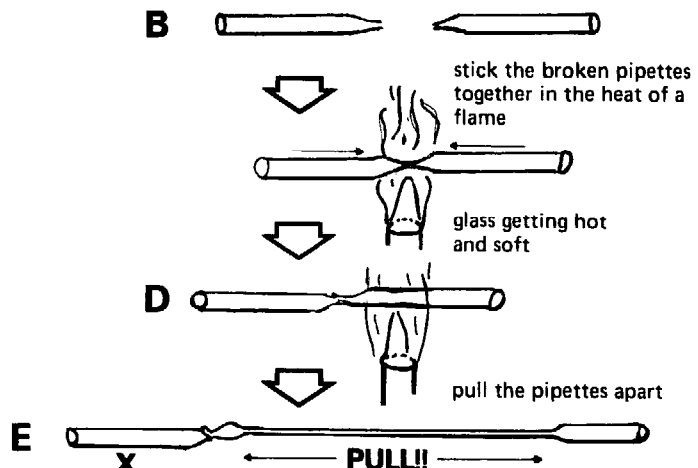

HOLDING A PASTEUR PIPETTE

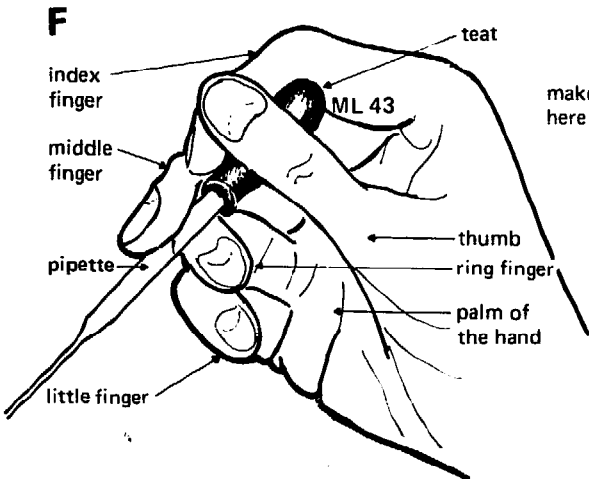

make another pipette here

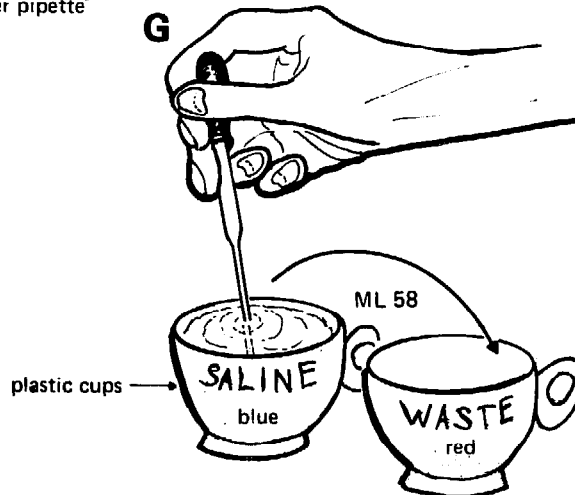

keep the saline and waste cups close together

label these cups

SQUEEZE THE BULB BETWEEN YOUR THUMB AND INDEX FINGER, HOLD THE PIPETTE BETWEEN YOUR MIDDLE AND RING FINGERS

Fig. 3-6 Making Pasteur pipettes on a pressure stove

its end against the side of the cup as you blow out the last drops of saline.

Take up and blow out several pipette-fulls of saline in this way.

Keep the saline and waste cups close together. Keep your pipette in the clean saline cup after use.

ALWAYS BLOW OUT INTO THE WASTE BOWL—NOT INTO THE SALINE CUP. In this way you will keep your saline clean.

Keep your pipette and waste cup for liquids that are not infected, such as the washings from blood cells. *Put all liquids or pipettes that may be infected, such as stools, urine, or CSF, etc., straight into lysol. Don't use an infected pipette again until you have sterilized it.*

Different methods often need different sizes of pipette, so make pipettes of the size that your method needs. Pipettes need not always be made of glass and plastic drinking straws make good pipettes for many purposes.

MAKING A STIRRING ROD

It is sometimes useful to be able to stir a liquid with a glass rod. You can stir with a glass tube, but liquid gets inside the tube, and the end of the tube scratches the bottom of whatever the liquid is in. To make a stirring rod, get a glass tube and seal up both ends completely as in Picture E, Figure 3-5. Cool the tube slowly or it may crack, and don't make the ends too thick. Keep this rod for stirring and mixing.

3.10 The loop (FIGURE 3-7)

In the main list there are two loop-holders (ML 28) and some nickel-chrome wire (ML 55). Take some of the wire, put it into your loop-holder and make a loop. These

loops are used in many methods and are shown in many figures—look at FIGURE 11-1. Loops are mostly used for taking a little of a specimen, such as stool or urine, and making a film on a slide. A loop is useful because it can easily be flamed *both before and after* it is used. The flame will kill any micro-organisms on the loop. A loop which has been flamed is therefore sterile. Flaming an infected loop also stops micro-organisms getting on to the bench, your fingers, or about the laboratory. If you let organisms from specimens spread about the laboratory they may infect you and make you ill. This is especially important with *Mycobacterium tuberculosis*.

One end of your loop-holder is larger than the other. This large end is the **chuck** (a chuck is a tool which holds something). You will find that part of it will unscrew—this is the **collar**. Unscrew the collar, and you will see that the screw inside has been cut into four pieces. The nickel-chrome wire is put into the middle of these four pieces. The screw has been drawn bigger in Picture C, so that you can see where to put the wire.

METHOD

MAKING A LOOP, FIGURE 3-7

Take a piece of nickel-chrome wire. Bend it *once* round a middle-sized nail as shown in Picture F.

Take the loop off the nail, as shown in Picture G.

Cut the end so as to make a loop. Use a pair of pliers.

You will now have made a loop, but it will be at one side of the piece of wire as shown in Picture H. Bend the loop so it is in the middle of the wire as in Picture I. Make sure the loop is closed.

Cut the wire so that it is 6 cm long, including the loop.

Unscrew the collar. Put the wire through the collar

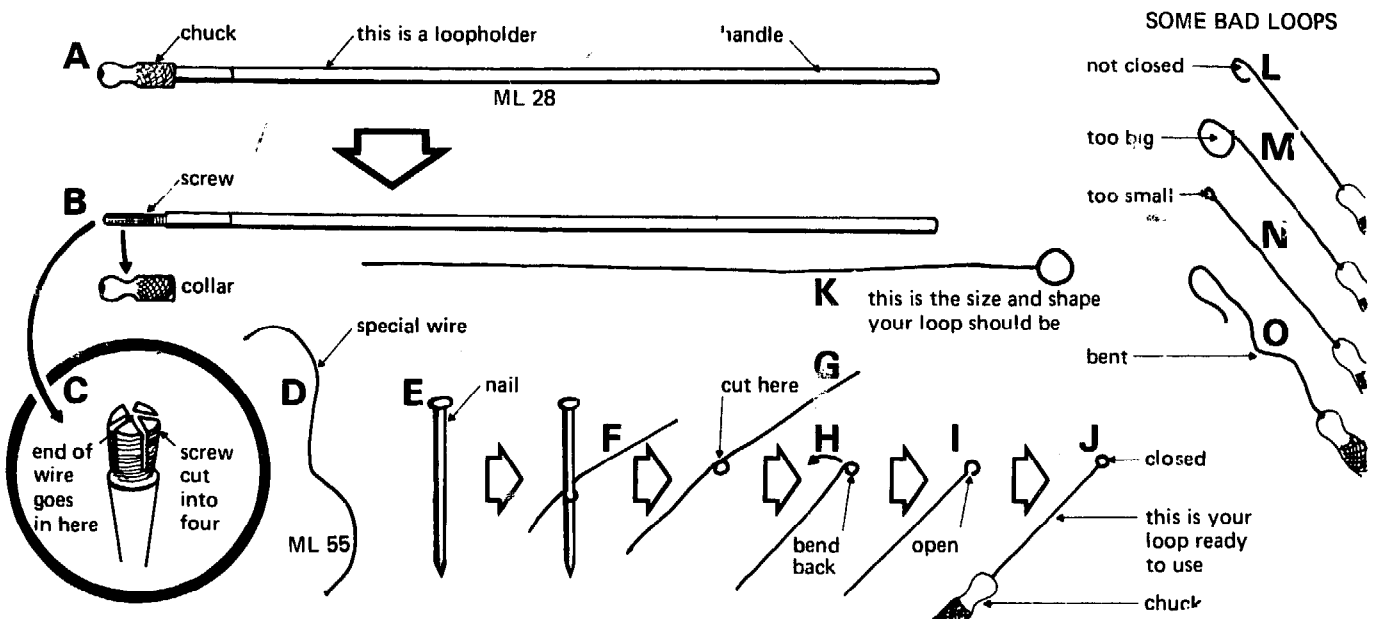

Fig. 3-7 The loop

and into the middle of the four cuts on the chuck. Screw up the collar, and your loop is ready to use.

Look at the full-size picture of a loop that has been drawn in Picture K. Put the loop you have just made on top of this loop. Is your loop the same size and shape? Pictures L, M, N, and O are some bad loops—your loop should not be like these. Loop L is not closed up, nor is loop I, but J is closed up well. If your loop is not closed up it will not hold a drop of fluid. Loop M is too big. Loop N is too small. Loop O is very bad indeed.

Look at Picture C in FIGURE 3-2 to see how to flame your loop.

METHOD

FLAMING A LOOP, PICTURE C, FIGURE 3-2

If there is something on your loop, like a big piece of sputum or stool, try to get this off first. Dip your loop into the edge of the disinfectant in the disinfectant bucket, or into a jar of disinfectant on the bench. This will clean it. If you flame a large bit of sputum it will bubble and spit, and micro-organisms may fall on to the bench without being killed.

Use the top hot part of the flame, and flame the whole loop. There is no need to leave the loop in the flame for more than a second or two, nor need it become red hot.

Many people flame the chuck quickly, but don't leave the chuck in the flame for more than a moment, or you will spoil it.

Help to stop harmful micro-organisms spreading around the laboratory. **ALWAYS FLAME YOUR LOOP AFTER YOU HAVE USED IT ON AN INFECTED SPECIMEN AND BEFORE YOU PUT IT DOWN ON THE BENCH.**

Help to stop organisms from getting from one specimen to another. **ALWAYS FLAME YOUR LOOP BEFORE YOU PUT IT INTO ANY SPECIMEN.**

3.11 Some practical details (FIGURE 3-8)

You have already read about some of the more important things in the laboratory. But there remain a few useful things to tell you.

METHODS

HOLDING A HOT TEST TUBE, PICTURE A, FIGURE 3-8

If you don't want to burn your fingers, the easiest way to hold a hot test tube is to use a piece of paper. This is very useful when doing Benedict's test.

1. Take a piece of paper.
2. Fold it into a strip (a strip is something long, thin and flat).
3. Fold the strip around the test tube, and pinch (hold) it between your finger and thumb close to the tube.

FOLDING A FILTER PAPER, PICTURE B, FIGURE 3-8

- 1 and 2. Fold the paper in half.
3. Fold the paper in a quarter.
4. Open out one of the folds in the paper. Put the paper into a funnel.

Filter papers are very useful in a laboratory. Water and solutions go through them easily, but bigger things do not go through and are left behind on the paper (see Section 1.5). We often filter stains before putting them on a slide, because a filter paper stops pieces of solid stain that have not dissolved from getting on to a film and spoiling it. In Section 7.42 you will read how the proteins in the blood are removed by filtering before the blood sugar is measured.

As you read in Section 2.3, the tidiest way of labelling a bottle is with paint. But it is difficult to paint the label of a bottle so that the letters are straight and it looks well. You will find it helpful to draw a line on the bottle with grease pencil first.

METHOD

LABELLING A BOTTLE, PICTURE C, FIGURE 3-8

Put the grease pencil on something firm which is at the same height as the bottom of the letters, such as a tin as shown in Picture C. *Hold the pencil still and firmly turn the bottle round.* This will make a straight line on which you can paint. Afterwards you can easily rub out the grease pencil line.

Paint a box on the bottom of the bottle. Used like this the word 'box' means the place on a form where you write. Into part of the box put the date the reagent was made, and into the other part put your initials. Use a grease pencil so that you can rub it out when the bottle is filled up again.

Careful labelling like this is very important, because anybody can tell exactly what reagent is in a bottle, who made it, and when he made it.

There is a useful way of making an old bottle into a beaker. The bottom of a bottle can easily be cut off and used as a cup, as shown in Picture D. Don't heat these beakers made from bottles, or they will break.

METHOD

CUTTING OFF THE TOP OF A BOTTLE, PICTURE D, FIGURE 3-8

Make a small scratch on the bottle just where you want to cut it in half. Get some long strips of blotting paper about 2½ cm wide. Wet them and wrap them round the bottle about an inch apart above and below the scratch.

Hold the bottle above a Bunsen burner, and turn it round in the flame. As the glass gets hot between the cold wet blotting paper it will crack in half.

A FOLDING A PIECE OF PAPER TO HOLD A TEST TUBE

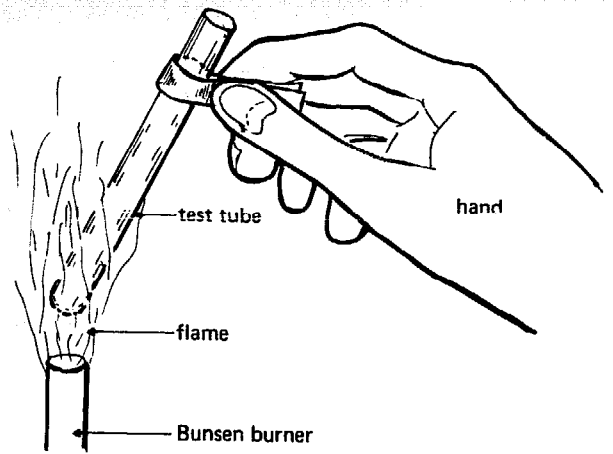
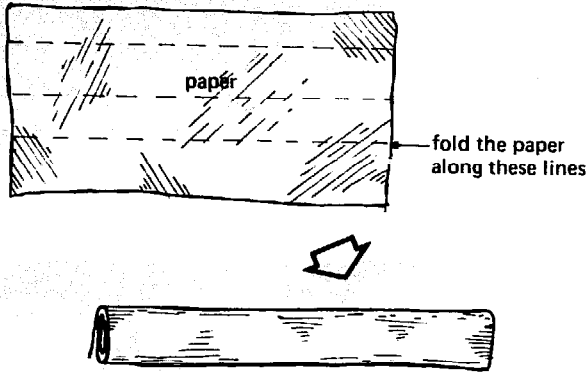

B

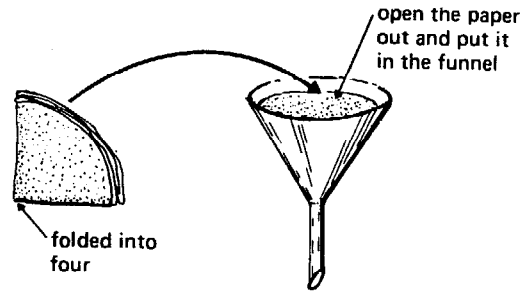
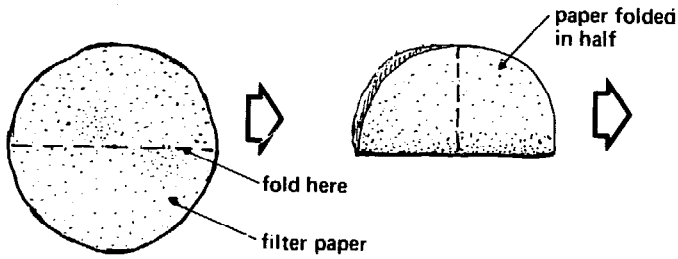

C PAINTING A LABEL ON A BOTTLE

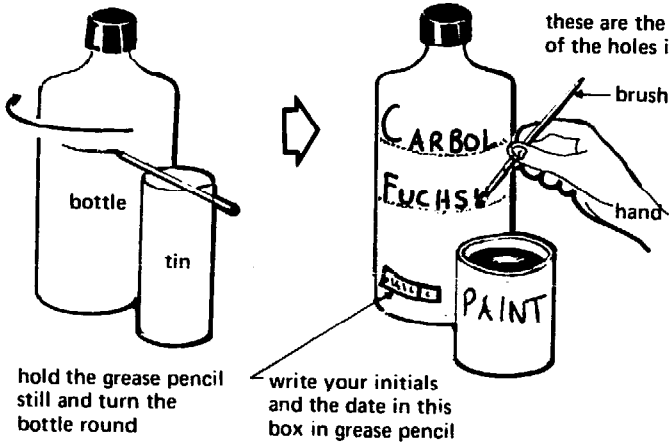

E A LOCALLY MADE TEST TUBE BLOCK

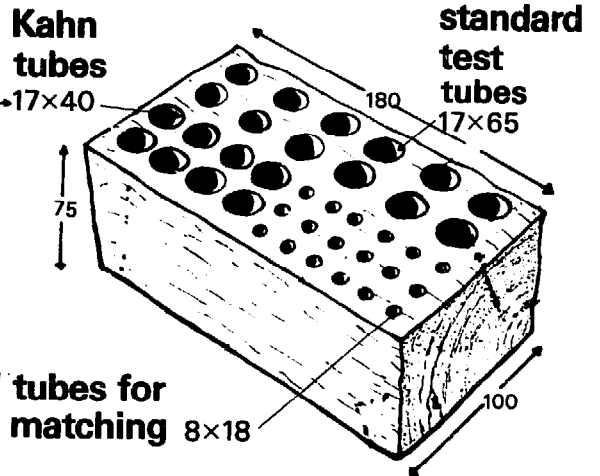

D MAKING A BEAKER OUT OF A BOTTLE

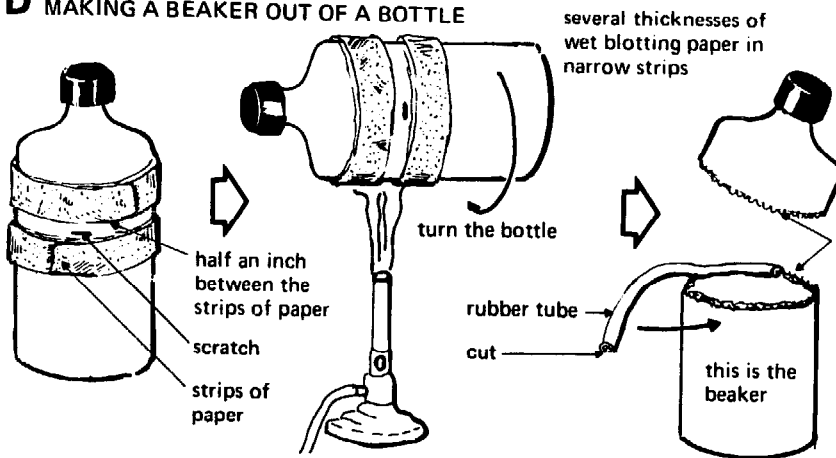

F A SLIDE RACK

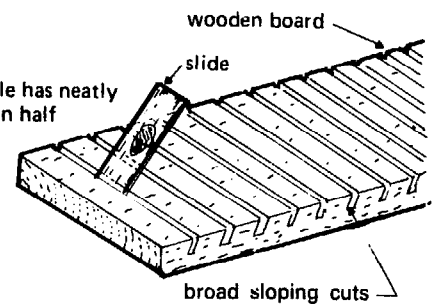

Fig. 3-8 Some practical details

Find a piece of rubber tube which is just long enough to go round the bottle. Cut it from one end to the other with a pair of scissors, keeping the cut on the same side of the tube. Put the rubber round the edge of the bottle, and you will have a useful beaker. A beaker like this can be used for keeping slides and coverslips in before they are washed. These beakers are shown holding pipettes in Figure 3-11.

The test tube block shown in Picture E, FIGURE 3-8, is easily made from any hard wood. It can be made with ordinary carpenter's tools, but it is best made with an electric drill (a post drill). A drill is something for making holes. The block takes the three sizes of test tubes given in the equipment list.

You will need a *slide rack*. Ask a carpenter to make one from hardwood as shown in Picture F, FIGURE 3-8. Ask him to make slots (cuts) with a saw into which the slides can fit. The slots must be sloping (leaning) a little, and they must be wide enough to hold the slides. These racks have to be made because they cannot be bought. If you cannot make a rack, stick your slides into a lump of plasticine to hold them upright while they dry.

3.12 Washing equipment

This is very important. Even in a small laboratory it is useful to wash most things separately.

Disinfecting and washing specimen containers

Many kinds of plastic or paper containers are destroyed by being autoclaved. These containers should be burnt. But polypropylene polypots (ML 14c) can be autoclaved and washed many times.

If you have to wash stool containers, try to wash as little stool as possible. There will then be less smell while autoclaving and the washing up water will not get so dirty. Try therefore to remove as much stool or sputum from a container as you can before it is autoclaved. The best way to do this is to put a piece of toilet paper or newspaper in the containers before they are sent to the wards to be filled with stool or sputum. After a specimen has been examined remove the paper from the container with a pair of forceps. Put it into a paper bag in a kerosene tin. Later, burn the paper bag. If there is no paper, remove as much of the specimen as you can with a stick before it is autoclaved.

When you have removed what stool or sputum you can, you can either disinfect the containers in a bucket or in a pressure cooker.

If you use a bucket, put all infected specimen containers into a metal bucket of lysol (half a cupful of lysol to a bucket three-quarters full of water). Everything to be disinfected *must be covered with the lysol solution*. If bottles or containers are to be disinfected in lysol, it must be able to get to every part of the inside of them. So be sure to remove the cap of every bottle or container you

are disinfecting in lysol. When the bucket is nearly full, put it on top of a paraffin pressure stove and boil it for 15 minutes. This is why the bucket must be metal and not plastic. You can wash infected specimen containers after they have been several hours in lysol without first boiling them, but this is not really safe. You can also boil containers without first putting them in lysol. But this too is not really safe, because the infected water may be spilt before it has been boiled.

If you use a pressure cooker, put two cupfuls of water into it and see that the trivet is inside it. Put infected specimen containers into the cooker as soon as you have finished with them. If they smell, put the lid on. Each morning, or whenever the cooker is full, autoclave the containers to kill all the dangerous micro-organisms. There is no need to put lysol in the water, because there is so little liquid in a pressure cooker that it cannot get to the specimens in their containers. The harmful micro-organisms will be killed by the heat of the steam, and the containers will be safe to wash. Five minutes at 15 lb. will be enough to kill the harmful micro-organisms. It will not, however, be enough to kill the spores of every micro-organism and make the contents of the cooker completely sterile. To do this and to *sterilize* syringes, etc., you must use 15 lb. for 15 minutes.

When you have made infected things safe by sterilizing or autoclaving, they will still be dirty. Wash them with soapy water, rinse them with clean water, and let them dry.

Test tubes

Always wash them out immediately they have been used. Don't leave dirty test tubes in a test tube rack.

Blood slides

These will be covered with oil. Put them into a detergent solution (a teaspoonful of detergent in a pan of water). There is a special pan (ML 65) in the equipment list so that you can do this.

Stool slides

Keep these in a jar of lysol and wash them when the jar is full.

Slides for AAFB

Unless you are keeping all positive slides for someone to check, break them so that they cannot be used again—see Section 11.2. If you have to use them again, wash them well, and boil them in an enamel pan in dichromate solution. Then use them for other methods, such as those for stools. This solution is described below.

Coverslips

Put these into a small jar or cup of lysol. Many laboratories throw used coverslips away, but this is wasteful and they can easily be used several times.

Counting chambers

Wash these with soapy water. Be very careful of the ruled area, or it may be scratched. Blot it dry with filter paper or a soft cloth.

Syringes

Put these in water as soon as they have been used. Squirt (push) water through them to remove the blood. Wash them in soapy water and rinse very well to remove all the soap.

Blood pipettes

Wash these in water. Then, if possible, using a filter pump (see Section 3.3) suck water through them to remove the blood. Next, suck a little acetone through to remove the water. Last of all suck air through to remove the acetone.

Many laboratories do not have enough pipettes to use a clean pipette on each patient, nor do they have acetone or a filter pump. The best thing then is to rinse (wash) out a pipette with water and to use it as dry as possible by blowing out the water—see Section 7.1.

If pipettes get dirty or blocked, push a thin wire down them or use dichromate cleaning solution.

Dichromate cleaning solution

Chemicals for this solution are listed in Choice 11 (see Section 13.24), and the way to make it is described in Section 3.26. It is a deep orange caustic solution and is used for cleaning any kind of glassware and some plastic equipment which cannot be cleaned in any other way. It is probably not really necessary in either health centres or district hospitals. If you have dichromate cleaning solution, use it like this.

METHOD**USING DICHROMATE CLEANING FLUID**

Put pipettes in a cylinder of the solution. Put blood pipettes in a test tube of solution. Test tubes, slides, etc., can be put in a polythene bowl or bucket of solution. Let the glassware stand for at least a day. Then, take it out and wash it well with water. You will find that it will now be clean and shining.

Dichromate cleaning fluid will keep for months. Use it with the care it deserves. Only throw it away when it finally goes green. Don't dilute it with water. Don't add any soap or detergent to it. Don't keep it in a metal or enamel bucket because it may eat through the bucket. Don't clean anything except glassware in it. Don't put your hands in it—use a rubber theatre glove or, better still, a thick post-mortem-room glove. When you finally throw it away, pour it on to some waste ground and not down the sink—it may spoil the drains.

3.13 Routine

A daily routine is the way in which you do the things that have to be done every day. If your laboratory is going to work well, it is very important that this routine should be right. It will be different in different laboratories, but here is a routine for the beginning of the day that you might find useful.

If you can, find a servant to do the washing-up in the afternoon so that you can start work in the morning. When you first come to work, if you are doing all the cleaning yourself, light the pressure stove. This will heat water to wash slides and bottles—see Section 3.12. While the water is heating, sweep the floor, then dust the bench and polish it. When this is done the water will be hot enough for you to start washing. By the time you have finished washing there will probably be enough specimens in the laboratory for you to start looking at them.

By having a regular daily routine like this you can be sure that the ordinary things like washing and polishing are always done.

3.14 Time and motion study

In most laboratories there is much work. Very often there is so much work that it is only possible to do part of it. If you are going to do as much work as you can as well as you can, you must try to save yourself time. This is what 'time and motion study' means. It is the study of the time it takes to do jobs and the movements that are needed to do them. Using time and motion study we can often do more work with less trouble. Here are some of the things you can do to make your work quicker and better.

METHOD**TIME AND MOTION STUDY IN LABORATORY WORK**

When you have several tests to do, try to do them together, not one by one. Let us say, for example, that you are asked to stain films of sputum from twelve different patients. First put all twelve specimens in a row with their labels to the front so that you can see them. Next put twelve clean slides in a row, one in front of each specimen. Label each slide. Then make films from each specimen in turn and fix them. Try to have a big enough rack to stain them all together. By doing each step on all the slides together you will save time. This is not possible with every method. Gram's stain, for example, must be done one slide at a time (see Section 11.5).

Try to make large numbers of things at a time. If you are making specimen containers, make many. If you need much of a particular reagent, make a large volume to save the trouble of having to make more soon afterwards.

Keep all the things you use often as close as you can to the place where you use them. Try to walk or get up from your seat as little as possible.

Try to make all your apparatus as easy to use as you can. If, for example, you can get an aspirator jar to store water, this will be easier to use than a bucket and jug (see Section 3.3).

MAKING REAGENTS

3.15 Stains and reagents

Most of the reagents used for the methods in this book are solutions of chemicals in water. If the chemical is coloured and the solution is to be used to stain (colour) something, we call it a stain.

Every reagent or stain must have in it the right amount of each chemical. Each chemical must therefore be weighed, and the volume of the whole solution must be measured. *Read in Chapter Five about weighing and measuring before you make any reagent.* Weigh chemicals in a plastic watch glass and use the Ohaus triple beam balance (see Section 5.5). Most reagents are made in a 100-ml stoppered measuring cylinder and are used in polythene dropping bottles. Use the stopper to close the cylinder while you shake it to dissolve the chemical. Small volumes of reagent (up to 10 ml) can be made in a graduated centrifuge tube. Hold your thumb over the end of the tube when you shake to dissolve the chemical. Scrape your thumb on the edge of the tube to remove the reagent when you have finished shaking (see Pictures 8 and 9, FIGURE 7-36). Make large volumes (up to 1,000 ml) in a litre measuring cylinder. Except when using strong acids and alkalis, hold the palm (flat part) of your hand over the top of the cylinder when you shake.

Some kinds of chemical are purer and more expensive than others. By pure we mean that there is nothing in a bottle besides that chemical. A pure reagent contains no dirt or impurities. The purest and most expensive reagents are often called AR reagents (analytical reagents, or special reagents for exact testing). Next come the GPR or General Purpose Reagents. Lastly come the cheapest and least pure. GPR reagents are good enough for all the methods in this book.

Never let any chemical get from one bottle into another. Always put a *clean* spatula into a bottle of chemical. If you have not got a spatula, use a slide or a plastic spoon. Some chemicals spoil metal spoons, and these spoons may spoil them. Put the right lid on the right bottle, because a little chemical may get from one bottle to another on the lid. Keep all lids on tight, because some chemicals easily get damp (wet).

Tap water or rain or well water can be used for the reagents and methods in this book. In larger laboratories reagents are always made with specially pure water called **distilled water**. Distilled water is made by boiling ordinary water to make steam and then condensing the

steam (turning it back into water again). Water made from steam in this way is pure. If you have distilled water you should use it.

METHOD

MAKING 100 ML OF A REAGENT, FIGURE 3-9

1. Weigh out the amount of the chemical you need in a plastic watch glass. If your watch glass is not large enough, use scrap paper, or plastic cups.

2. Fetch a stoppered measuring cylinder (ML 18).

3. Tip the chemical from the watch glass into a 100-ml stoppered cylinder. It may help to use a funnel or a piece of folded paper and a spatula. Many reagents need more than one chemical, so you may have to weigh out several chemicals.

4. Using water from a wash bottle, wash the chemical on the watch glass through the funnel and into the cylinder.

5. Fill the cylinder up to the 100-ml mark. This is called 'making it up to 100 ml'. You can, if you wish, fill it to about 90 ml from a tap and then exactly to the mark with a wash bottle or a Pasteur pipette. Look at the cylinder from the side when getting the top of the solution (the meniscus) to the 100-ml mark (see Picture V, Figure 5-3).

6. Put back the stopper and shake the cylinder to dissolve the chemical.

7. When the chemical is all dissolved, pour the reagent into a bottle. This will often be a polythene dropping bottle, which holds about 100 ml.

8. Label the bottle and write your initials and the date in the box at the bottom.

There are many reagents to be made up in this way. They are not all exactly the same, and you will have to change what you do slightly in the methods that follow.

METHODS

3.16a MAKING 3% ACID ALCOHOL—250 ML

Measure 7.5 ml of concentrated (strong) hydrochloric acid into a graduated centrifuge tube—you will find a Pasteur pipette useful. Don't use a graduated pipette, because you may get acid in your mouth. It is dangerous. Tip the acid into a 1,000-ml cylinder. Add spirit to 250 ml. Shake with the palm of your hand over the top of the cylinder. Pour this mixture into a 250-ml wash bottle.

You can also make 3 ml of hydrochloric acid up to 100 ml with spirit and keep the mixture in a dropping bottle. But you will probably use enough of this reagent to make it worth making up 250 ml at a time.

3% acid alcohol is used for the Ziehl-Neelsen method for staining sputum for *Mycobacterium tuberculosis*. Look at Section 11.1.

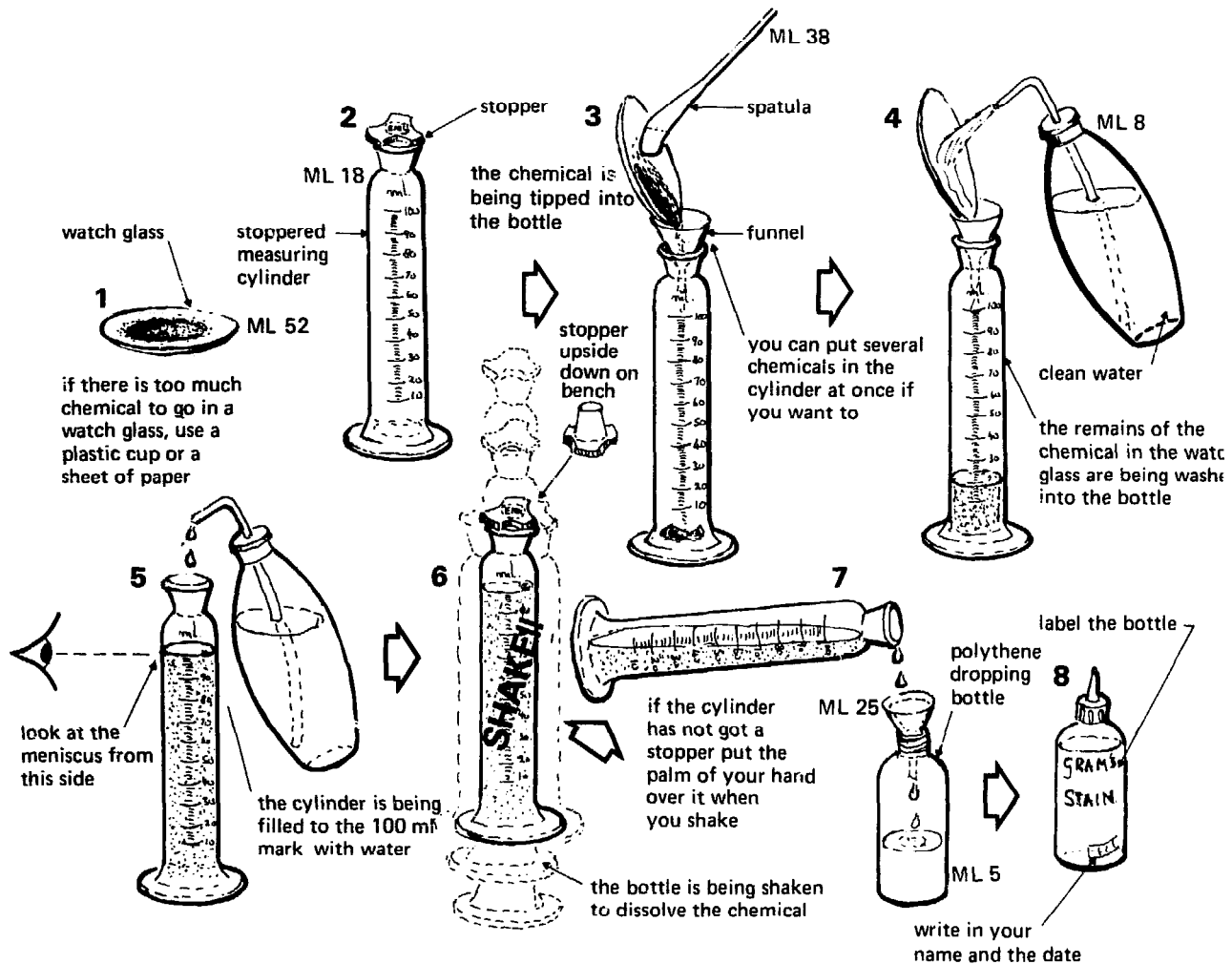

Fig. 3-9 Making a reagent

3.16b MAKING 1% ACID ALCOHOL—250 ML

Make this in exactly the same way as 3% acid alcohol described above, but make 2.5 ml of hydrochloric acid up to 250 ml with spirit, or 1 ml of acid up to 100 ml with spirit.

1% acid alcohol is used for the Ziehl-Neelsen method for staining skin smears for *Mycobacterium leprae* as in Section 11.11b. 3% acid alcohol can be used for *Mycobacterium leprae*, but 1% acid alcohol is better.

3.17 MAKING 10% BARIUM CHLORIDE—100 ML

Weigh 10 g of barium chloride into a 100-ml measuring cylinder. Make it up to 100 ml with water. Shake to dissolve and keep the solution in a polythene dropping bottle.

This reagent is used for testing for bilirubin by Fouchet's method—see Section 8.8.

3.18 MAKING BENEDICT'S REAGENT—1,000 ML

Weigh 17.3 g of copper sulphate. Copper sulphate forms deep blue crystals. Put it in a 100-ml measuring

cylinder. Add about 100 ml of water. The exact volume of water does not matter. Shake the cylinder to dissolve the copper sulphate.

While the copper sulphate is dissolving, weigh 173 g of sodium citrate and put it into a 1,000-ml cylinder. Weigh 100 g of sodium carbonate. Add this to the 1,000-ml cylinder. There is too much sodium citrate and too much sodium carbonate to weigh on a watch glass. So, if you are using the Ohaus balance, weigh these chemicals in a plastic cup.

Fill the 1,000-ml cylinder to the 600-ml mark with water and shake it to dissolve the sodium carbonate and the sodium citrate. When the sodium carbonate and the sodium citrate have all dissolved, add the copper sulphate solution in the 100-ml cylinder a little at a time. Shake the 1,000-ml cylinder each time you add some copper sulphate solution. The mixture may go cloudy as you add the copper sulphate solution. But it will go clear again as you shake.

When you have added all the copper sulphate solution, there will be about 700 ml of liquid in the 1,000-ml cylinder. Fill the cylinder to the 1,000-ml mark with water. Mix well. Keep some of the Benedict's solution in

a wash bottle and the rest in a 1,000-ml polythene reagent bottle (ML 6).

This reagent is used for testing the urine for sugar—see Section 8.3.

3.19 MAKING BRILLIANT CRESYL BLUE SOLUTION—250 ML

Weigh out 0.2 g of brilliant cresyl blue and dissolve it in 100 ml of saline. Keep it in a polythene dropping bottle. This will last a very long time, but it is not easy to make up a smaller volume, as it is not possible to weigh out less than 0.2 g with the Ohaus balance.

Cresyl blue solution is used for staining reticulo-cytes—see Section 7.23.

3.20a Buffers

Read about buffers in Section 1.7, about gastric washings in Section 11.4, and about the various kinds of phosphate in Section 2.4. The list of chemicals contains two kinds of potassium phosphate. These are potassium dihydrogen phosphate (KH_2PO_4) and dipotassium hydrogen phosphate (K_2HPO_4). If you have not got these phosphates you can use sodium phosphate for two of the three buffers you will need. On most bottles of chemicals you will see a number after the name and the formula, such as, for example, potassium dihydrogen phosphate, KH_2PO_4 , 136.09. This number is the molecular weight, and it may help you to recognize the right phosphate.

The buffer for gastric washings is best made into a solution, but the buffer for Leishman's stain is best made as a powder by mixing two of the phosphates. When you make buffer powder for Leishman's method take any *one* phosphate from the list A of acid salts and any *one* other phosphate from the list B of alkaline salts. You will probably use 13.9 g of KH_2PO_4 and 17.2 g of K_2HPO_4 . The buffer for gastric washings only requires any one of the alkaline salts from list B.

METHODS

3.20b MAKING THE BUFFER FOR GASTRIC WASHINGS—50 ML

Choose one of the alkaline phosphate salts from list B in the section above, and weigh it into a measuring cylinder. Add water to 50 ml. Shake hard—the water will get cold as the phosphate dissolves. Put 0.5 ml of this solution into each of several universal containers. Sterilize these in the pressure cooker (ML 69) with their lids on loosely. As soon as the bottles come out of the cooker, screw their lids down tight. They will be sterile—that is all the micro-organisms inside them will have been killed. Don't open them until you want to use them, or micro-organisms may get in and contaminate them (make them unsterile again). If you have any solution left over, put it in a glass bottle with a metal screw cap and sterilize it in the cooker. You can then fill and sterilize other universal containers when you want them.

This buffer is used for adding to gastric washings when they are to be cultured for *Myco. tuberculosis*—see Section 11.4a.

3.21a MAKING THE BUFFER POWDER FOR LEISHMAN'S METHOD—ABOUT 30 g

Choose *one* of the acid phosphates from list A in Section 3.20a. Choose also *one* of the alkaline phosphate salts from list B. Look to see if they are in very fine powders. If they are you can weigh them as they are. But, if they are lumpy, you will first have to grind them into a powder. KH_2PO_4 is usually a fine powder, but K_2HPO_4 is often lumpy. The best way to grind a lumpy chemical into a fine powder is to use a *clean* pestle and mortar; so get one if you can. Dispensaries usually have them. If you have not got a pestle and mortar, tip some of the chemical on to a clean newspaper and roll and crush it with a clean bottle. Lumpy K_2HPO_4 can easily be crushed into a fine powder this way.

Weigh each of your two finely powdered chemicals into a clean wide-mouthed jar, ML 62. Mix and shake them well. Label the jar 'Leishman buffer powder'.

For use, add a *little* on the end of a spatula, about

A. Take the weight shown of any one of these acid salts:

- Potassium dihydrogen phosphate anhydrous, KH_2PO_4 136.09
- Sodium dihydrogen phosphate anhydrous, NaH_2PO_4 119.98
- Sodium dihydrogen phosphate hydrated, $\text{NaH}_2\text{PO}_4 \cdot 2\text{H}_2\text{O}$ 156.01

B. Also take the weight shown of any one of these alkaline salts:

- Dipotassium hydrogen phosphate anhydrous, K_2HPO_4 174.18
- Disodium hydrogen phosphate anhydrous, Na_2HPO_4 141.97
- Disodium hydrogen phosphate hydrated, $\text{Na}_2\text{HPO}_4 \cdot 2\text{H}_2\text{O}$ 178.0 (also called Sorenson's salt)
- Disodium hydrogen phosphate hydrated, $\text{Na}_2\text{HPO}_4 \cdot 12\text{H}_2\text{O}$ 358.16

	For making 100 ml of buffer for gastric washings	For making Leishman's buffer powder
Potassium dihydrogen phosphate anhydrous, KH_2PO_4	not needed	13.9 g
Sodium dihydrogen phosphate anhydrous, NaH_2PO_4	not needed	12.2 g
Sodium dihydrogen phosphate hydrated, $\text{NaH}_2\text{PO}_4 \cdot 2\text{H}_2\text{O}$	not needed	15.9 g
Dipotassium hydrogen phosphate anhydrous, K_2HPO_4	24.5 g	17.2 g
Disodium hydrogen phosphate anhydrous, Na_2HPO_4	20.0 g	13.9 g
Disodium hydrogen phosphate hydrated, $\text{Na}_2\text{HPO}_4 \cdot 2\text{H}_2\text{O}$	25.0 g	17.6 g
Disodium hydrogen phosphate hydrated, $\text{Na}_2\text{HPO}_4 \cdot 12\text{H}_2\text{O}$	52.0 g	35.5 g

3 | Making the Laboratory Ready

250 mg, to each 100-ml 'polystop' bottle of water you use to make Leishman buffer. If you were not to use finely powdered phosphates, your 250 mg might be a lump of one kind of phosphate only.

This buffer is used for Leishman's method for staining thin blood films—see Section 7.11.

3.21b MAKING BUFFER FOR THE SOLUBILITY METHOD FOR HAEMOGLOBINS A AND S—100 ML

Carefully weigh out exactly 13.5 g of potassium dihydrogen phosphate (anhydrous KH_2PO_4). Put most of it into a 100-ml measuring cylinder with a spatula and wash the rest in with a wash bottle of water through a funnel (see Figure 3-9, Picture 4).

With equal care weigh out exactly 23.7 g of dipotassium hydrogen phosphate (anhydrous K_2HPO_4) and add this to the cylinder in the same way.

Then without using a funnel add 1 g of white saponin a little at a time. Shake each time you add some. You will get a soapy frothy solution. Brown saponin does not work.

Wait until most of the froth has settled. Make up the volume with water to exactly 100 ml, and again shake hard to dissolve. Keep the buffer in a 100-ml dropping bottle with a cap on the spout. Keep it in a refrigerator if possible. Make up fresh working solution each day, as described in Section 7.26.

For this method the phosphates must be anhydrous—that is they must be dry, so keep the lids of the bottles screwed on tight.

3.22a MAKING 'CELLOPHANE' COVERSLEIPS FOR THE THICK STOOL SMEAR

Measure 50 ml of glycerol into a screw-capped jar (ML 62). Add 30 ml of water, 10 ml of the malachite green solution described in Section 3.34, and 10 ml of formalin solution (not formol saline).

Get the 'Cellophane' sheet described as ML 148a under Choice 16 in Section 13.29. Put several sheets together and cut them into strips just narrower than a slide (22 mm), using a slide as a guide. Then cut the strips into pieces about 30 mm long. The cellophane sheets easily slide over one another as they are cut together, so, if you have a stapling machine, staple them together while cutting. This 'Cellophane' sheeting may be sold in rolls 22 mm wide, which will make your job much easier.

Soak the coverslips you have made in the malachite green solution for at least a day before they are used.

These coverslips are used in the 'Cellophane' trick smear method in Section 10.2b. Both the malachite green and the formalin can be left out if necessary. The formalin has been put in as an antiseptic to make the slides safer to handle.

Carbol fuchsin is used for staining the sputum for *Mycobacterium tuberculosis* by the Ziehl-Neelsen

method. It is also used for staining skin smears for *Mycobacterium leprae*. Two ways of making up strong carbol fuchsin are described. One is for the older 'hot method'. The other is for the newer 'cold method'. The word 'hot' refers to the way it is used, not the way it is made. Make up the reagents for only one of these methods. It is probably best to choose the hot one.

METHODS

3.22b MAKING CARBOL FUCHSIN FOR THE HOT ZIEHL-NEESEN METHOD—ABOUT 675 ML

Find a tin which will hold at least 600 ml. Put it on the pan of an Ohaus balance. Balance it with the tare weight. Set the weights to 25 g. Add phenol until the pointer is at '0' again. Set the weights to 30 g. Add basic fuchsin until the pointer is at '0' again. You will now have a mixture of 25 g of phenol and 5 g of basic fuchsin in the tin. Heat the mixture *slowly* over a flame until the phenol is melted (has become liquid) and the basic fuchsin has dissolved. All the fuchsin need not dissolve, but most of it should dissolve. Stir the heated mixture with a spatula. A little 'steam' may come off the mixture, but it must not boil. Let the mixture cool. Add 50 ml of spirit and 500 ml of water. A greenish yellow scum (a scum is anything on the surface of a liquid) will come on the surface of the liquid in the tin. Pour this liquid into a litre polythene reagent bottle. Label it 'Strong Carbol Fuchsin—hot method'. Filter some of it through a filter paper and a funnel into a polythene dropping bottle. Stain your slides with stain from this dropping bottle. When the dropping bottle is empty, refill it from the 1,000-ml plastic reagent bottle, *filtering the stain through filter paper and a funnel as you do so*.

Keep the tin and the funnel for carbol fuchsin only. Don't try to wash them: they are very difficult to clean.

3.23 MAKING STRONG CARBOL FUCHSIN FOR THE COLD ZIEHL-NEESEN METHOD—500 ML

Make this stain in the same way as for the hot method. But use 50 g of phenol, 25 g of basic fuchsin, 25 ml of spirit, and 500 ml of water. Last of all add 15 drops of 'Teepol'. Teepol is a detergent. If you have not got any Teepol (or any Tween 80, which is another detergent), use whatever detergent you have—it will probably work. Some people do not use any detergent at all.

3.24 MAKING DILUTE CARBOL FUCHSIN—100 ML

Measure out 6 ml of strong carbol fuchsin (either kind) in a graduated centrifuge tube. Pour it into a polythene dropping bottle. Add 94 ml of water to the dropping bottle.

Dilute carbo! fuchsin is used for Gram's stain (see Section 11.5).

3.25 MAKING CRYSTAL VIOLET STAIN—100 ML

Weigh out 0.5 g of crystal violet. Tip it into a 100-ml measuring cylinder and make it up to 100 ml. Shake to dissolve and pour it into a polythene dropping bottle.

Crystal violet stain is used for Gram's method (see Section 11.5).

3.26 MAKING DICHROMATE CLEANING FLUID—1,000 ML

Fill a litre polythene measuring cylinder to the 900-ml mark with water. SLOWLY add 100 ml of concentrated sulphuric acid. Use 'commercial' or 'technical' impure sulphuric acid and not the more expensive pure kind. *Add the acid slowly*, a little at a time, and keep your eyes away from the top of the cylinder. There will be a noise as you add the acid and the mixture will get hot. Add 20 g of 'commercial' or 'technical' potassium dichromate. Make this into a fine powder before you add it and it will dissolve more easily. If necessary stir the mixture with a long glass tube. Pour most of it into an ungraduated polythene measuring cylinder, and keep some of it in a test tube. It is dangerous—so be careful!

Dichromate cleaning fluid is used for cleaning glassware (see Section 3.12).

3.27 MAKING EHRlich'S REAGENT—250 ML

Weight out 0.7 g of para-dimethyl-aminobenzaldehyde and tip it into a 1,000-ml polythene reagent bottle. You will probably find it easier to tip it through a funnel as in Picture 3, Figure 3-9. Pour into the bottle 150 ml of concentrated hydrochloric acid and 100 ml of water. Shake to dissolve. Pour some into a polythene dropping bottle for daily use.

Ehrlich's reagent is used for testing urine for urobilinogen (see Section 8.8).

3.28 MAKING FIELD'S STAIN A OR B—100 ML

Weigh out 2.5 g of the blue Field's stain A. Tip it into a 100-ml measuring cylinder and make it up to 100 ml with water. Shake to dissolve and filter the stain into a 120-ml wide-mouthed jar with a screw cap (ML 62).

After some days or weeks a scum will form on the top of the stain. This will spoil the stain, so you must filter it regularly—say every Monday morning. *Keep the bottle filled up with stain*, or you will not be able to reach it with your thick blood film. Throw away the stain once a month and make new stain. If you stain many films, throw it away more often than this.

Make up Field's stain B in exactly the same way as you make up Field's stain A.

Field's stains A and B are used for staining thick blood films (see Section 7.31).

3.29 MAKING FORMOL SALINE—1,000 ML

Fill a litre cylinder to the 100-ml mark with 'Formaldehyde solution' or, as it is sometimes called, 'Liquor

Formaldehyde, B.P.'. Add to it 8.5 g of sodium chloride. Sodium chloride is the ordinary salt that you put on your food. If you have no GPR sodium chloride, use any kind of ordinary salt. Make up to 1,000 ml with water. Shake to dissolve. Store in a polythene reagent bottle.

Formol saline is used for preserving specimens for histology (see Section 4.10).

3.30 MAKING FOUCHET'S REAGENT—100 ML

Weight out 1 g of ferric chloride and tip it into a graduated centrifuge tube. Fill the centrifuge tube to the 10-ml mark with water. Shake to dissolve. While it is dissolving, weigh out 25 g of trichloroacetic acid and tip it into a 100-ml cylinder. Fill the cylinder to the 50-ml mark with water. Shake to dissolve.

Tip the ferric chloride solution into the trichloroacetic acid solution. Mix and make up to the 100-ml mark with water. The mixture is Fouchet's reagent. Keep it in a polythene dropping bottle that lets the reagent come out slowly drop by drop.

Fouchet's reagent is used for testing the urine for bilirubin (see Section 8.8).

3.31a MAKING HAEMOGLOBIN DILUTING FLUID—1,000 ML

1. USING SODIUM CARBONATE

Weigh out 10 g of sodium carbonate. Tip it into a litre measuring cylinder. Make up to the 1,000-ml mark with water. Mix well. If you are using the Lovibond comparator, pour some of the solution into a polythene wash bottle. Keep the rest in a litre polythene reagent bottle. Choose a wash bottle with a small hole in its tube. This will make it easier to fill a Lovibond cell to the 10-ml mark exactly. If you are using the Grey wedge photometer or the EEL colorimeter, keep all the solution in a litre polythene reagent bottle. Using a 10-ml pipette, measure several 10-ml volumes into universal containers. Use these for the tests.

If you have ammonia in your laboratory, always use the ammonia solution described below instead of the sodium carbonate solution. Ammonia is included as Choice 9, Section 13.22.

2. USING AMMONIA

Fill up a litre cylinder to the 1,000-ml mark with water. Add 0.4 ml of concentrated ammonia. This is also called SG 0.880 or SG 0.910 ammonia. Measure this with a Pasteur pipette in a graduated centrifuge tube. *Strong ammonia is dangerous. Don't pipette it by mouth*, because it may make you cough. Put the ammonia solution in the same kind of bottle, and use it in the same way as you would the sodium carbonate solution. You can also make up this solution by adding five drops of concentrated ammonia to 250 ml of water in a wash bottle. This may be easier.

This highly alkaline solution does not keep well. In time it takes up an acid gas called carbon dioxide from

3 | Making the Laboratory Ready

the air and comes to have a more neutral pH. Such solutions may not work, so *don't keep ammonia solutions for more than a week.*

3.31b MAKING DRABKIN'S SOLUTION—1,000 ML

Drabkin's solution is the diluting fluid for the cyanmethaemoglobin method for measuring haemoglobin. It can be made either from special tablets (see ML 127(b), Section 13.20) or from potassium cyanide and potassium ferricyanide. Drabkin's solution is very dilute, and very small quantities of these chemicals are needed. If you are careful you can weigh them on the Ohaus balance.

Weigh 200 mg (one-fifth of a gram) of potassium ferricyanide and 500 mg (half a gram) of potassium cyanide, and make up to 1,000 ml with water.

3.32 MAKING LUGOL'S IODINE—100 ML

Weigh out 1 g of iodine. Tip it into a 100-ml measuring cylinder. Weigh out 2 g of potassium iodide. Tip this also into the measuring cylinder. Mix them well. Add a little water and mix again. Fill the measuring cylinder to the 100-ml mark with water. Shake to dissolve. Keep the solution in a polystop bottle.

Lugol's iodine is used for Gram's stain (see Section 11.5). Iodine spoils metal, so don't let it touch metal, and *don't get it on the balance.*

3.33 MAKING LEISHMAN'S STAIN—100 ML

Take a polystop bottle and fill it with 100 ml of water. Make a mark on it where 100 ml comes. Take a second clean DRY polystop bottle, and make a mark on it at the same height as on the first bottle. Weigh out 0.2 g of powdered Leishman's stain and add it to the second bottle. Fill it to the mark you have made with methyl alcohol. You will have added 100 ml and will not have wet and spoilt the methyl alcohol by measuring it in a wet measuring cylinder.

Put the stopper on the bottle and shake hard. Shake several times during the rest of the day and leave the bottle overnight. It will be ready to use in the morning.

Never let the smallest amount of water or buffer get into the stain. If you do the white cells will not be fixed and will not stain. *Even if you measure methyl alcohol in a wet cylinder, it will be spoilt.* This is why we have told you to measure methyl alcohol straight out of the stock bottle to a measured mark on a polystop bottle.

When you need to make more stain, add more powdered Leishman's stain and more methyl alcohol to the same 100-ml mark on the bottle.

Leishman's stain usually works better as it matures (gets older). It is thus useful to make some stain and let it mature in another tightly stoppered bottle before you use it.

Methyl alcohol evaporates much quicker than water, so keep the bottle tightly stoppered.

Leishman's stain is used for staining blood films (see Section 7.12).

3.34 MAKING MALACHITE GREEN SOLUTION—100 ML

Weigh 0.3 g of malachite green. Tip it into a 100 ml measuring cylinder. Make up to the 100 ml mark with water. Shake to dissolve and keep the stain in a polythene dropping bottle.

Many people like using malachite green instead of methylene blue for the Ziehl-Neelsen method (see Section 11.1).

3.35 MAKING METHYLENE BLUE IN ACID ALCOHOL—500 ML.

A. 8% ACID FOR *MYCO. TUBERCULOSIS*

Take a 1,000-ml measuring cylinder. Fill it to the 170-ml mark with spirit.

WITH GREAT CARE AND VERY SLOWLY fill the cylinder to the 210-ml mark with concentrated sulphuric acid. You will be adding 40 ml of acid. *Add the acid a little at a time.* The mixture will get hot and spit. But, because it is at the bottom of a big cylinder, it will not spit much if you only add the acid slowly.

Let the mixture cool.

Fill the cylinder to the 500-ml mark with water. While the mixture is cooling, weigh out 3 g of methylene blue. Tip this into a litre reagent bottle. Pour the mixture of acid alcohol and water into the bottle. Shake to dissolve the methylene blue. Use the methylene blue acid alcohol in a polythene wash bottle. Malachite green cannot be used instead of methylene blue for this method.

B. 1% ACID FOR *MYCO. LEPRAE*

Make up this weaker acid for *Myco. leprae* in the same way that is described above except that 5 ml of concentrated sulphuric acid are added and not 40 ml.

Label your bottles '8% acid-alcohol methylene blue for *Myco. tuberculosis*' and '1% acid-alcohol methylene blue for *Myco. leprae*'. These solutions are for the cold Ziehl-Neelsen method (see Section 11.1).

3.36 MAKING OCCULT BLOOD REAGENT

Weigh out 1 g of *ortho-tolidine* (also written *o-tolidine*). *O-tolidine will not work.* Tip it into a universal container. Weigh out 8 g of barium peroxide. Tip this into the universal container. Put the lid on the container and shake it well to mix these two dry powders.

Find a cork which fits the container as in Picture X, Figure 10-13. Using a pair of strong scissors or tin shears, cut a strip of tin about two inches long and half an inch wide. Cut points at both ends as shown in this picture. Bend the strip down the middle and stick one end into the cork. The other end makes a useful small spoon or spatula.

You will want 200 mg of powder each time you make

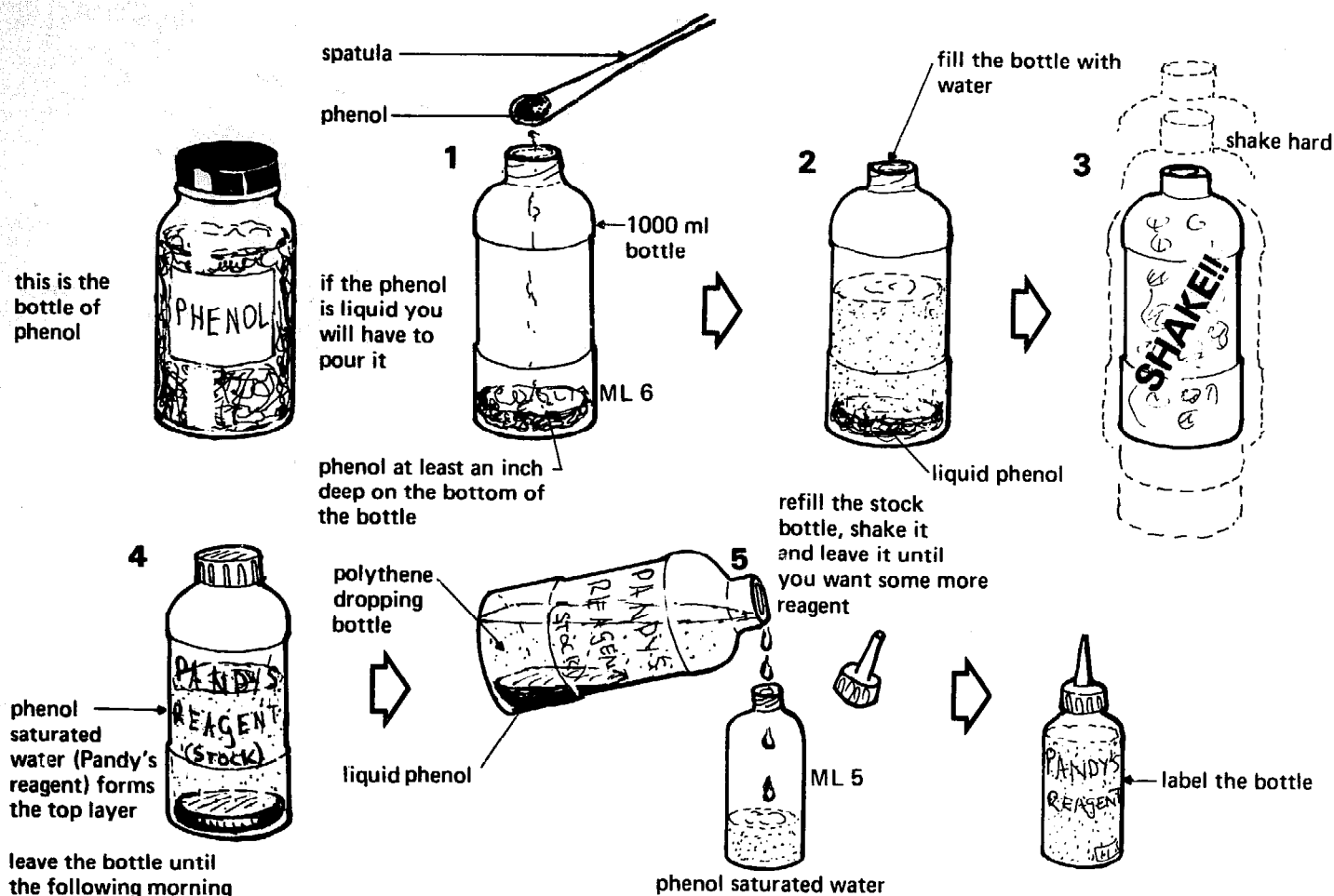

Fig. 3-10 Making Pandey's reagent

up the reagent. Take up what you think is 200 mg and weigh it. Are you right—is it 200 mg? If it is not about 200 mg, try again. You will soon be able to guess 200 mg quite well. It is not easy to weigh 200 mg on the Ohaus balance, but it can be done accurately enough. Make sure the beam is exactly at '0' when you start and when you finish.

This reagent is used for testing for occult blood in the stools—see Section 10.10. Ortho-tolidine is dangerous, so wash your hands after you have used it and don't spill it around the laboratory.

3.37 MAKING PANDY'S REAGENT, FIGURE 3-10

1. Put some phenol into a 1,000-ml polythene bottle. Make a layer about an inch deep on the bottom of the bottle.

2. Fill the bottle half full with water.

3. Put the cap on the bottle and shake the mixture hard for about 5 minutes. The mixture will become turbid (cloudy, milky). Leave the bottle until the next day.

4. You will see a layer of liquid phenol at the bottom and a clear watery layer at the top. This watery layer is a saturated solution of phenol in water and is Pandey's reagent.

5. Carefully pour some of the watery layer at the top of the stock bottle into a polythene dropping bottle. Don't pour off the layer of liquid phenol at the bottom of the stock bottle. Don't shake the bottle before you pour off the reagent. Label the watery layer you have poured off 'Pandey's reagent'.

When the watery layer in the stock bottle is nearly finished, add more water, shake it, and leave it until the next day.

Pandey's reagent is an easy way of measuring the CSF protein—see Section 9.10.

3.38 MAKING PAS TEST STRIPS

Cut filter paper or blotting paper into strips about 1 cm wide and about 5 cm long.

Weigh 1 g of ferric chloride and dissolve it in 25 ml of water in a 100-ml measuring cylinder.

Soak the filter paper strips in the ferric chloride solution—they will go bright yellow. Keep the unused ferric chloride solution in a polythene dropping bottle until you need it again. Leave the strips to dry in the sun. Keep the dry strips in a box or tin until you want them.

These strips are used for testing the urine for a drug called PAS (see Section 8.9).

3 | Making the Laboratory Ready

3.39 MAKING ROTHERA'S REAGENT

A. STANDARD ROTHERA'S REAGENT

Put a few crystals of sodium nitroprusside on a sheet of clean newspaper and crush them to a fine powder by rolling them with a clean dry glass bottle. Weigh out about half a gram (0.5 g) of the fine powder and mix it well with about 100 g of ammonium sulphate. Store the pale pink powder you get in a screw-capped jar (ML 62). The powder goes dark blue after a few weeks and may not work so well, so do not make up too much of the reagent at a time.

Rothera's reagent is used for testing the urine for acetone—see Section 8.7.

B. MODIFIED ROTHERA'S REAGENT

Weigh 3 g of sodium nitroprusside into a plastic cup. Grind it into a fine powder with the bottom of a test tube. Add 100 g of ammonium sulphate and 50 g of anhydrous sodium carbonate. Mix well and keep the mixture in a wide-mouthed screw-capped jar.

Modified Rothera's reagent is used for testing the urine for acetone—(see Section 8.7).

3.40 MAKING SALINE—1,000 ML

Weigh 8.5 g of sodium chloride and tip it into a litre measuring cylinder. Add water to 1,000-ml mark. Shake to dissolve. Pour the saline solution into a litre reagent bottle.

Saline is mostly used for blood grouping and cross matching (see Section 12.4) and for examining the stools (see Section 10.2). Keep some saline in a wash bottle, some in a polystop bottle, and some in a cup with a Pasteur pipette in it—see Figures 3-6 and 3-11.

3.41 MAKING SATURATED SODIUM ACETATE SOLUTION—ABOUT 100 ML

Fill a polythene dropping bottle with sodium acetate. Then fill it with water. Shake hard. About half the sodium acetate will dissolve in the water and give you a saturated solution of sodium acetate on top of a layer of crystals. Pour off the saturated solution as you need it. When the bottle empties, add more water and shake again. Remember, the solution will only be saturated as long as there is a layer of solid sodium acetate at the bottom of the bottle.

This reagent is used for testing the urine for urobilinogen (see Section 8.8).

3.42a MAKING 3.8% SODIUM CITRATE SOLUTION—50 ML

Weigh out *very carefully* 1.9 g of sodium citrate. Tip it into a 100-ml cylinder. Add water up to the 50-ml mark. Shake to dissolve. Measure 0.5-ml volumes into several bijou bottles.

Micro-organisms easily grow in sodium citrate solu-

tion; so only make up a little at a time, and don't keep it too long. Keep it in a refrigerator if you have one. You can also sterilize the bijou bottles of sodium citrate solution in a pressure cooker, just as you do with the buffer for gastric washings (see Section 3.20). Sterilizing the solution will kill the micro-organisms in it so that it will keep for ever.

3.8% sodium citrate solution is used for the Westergren ESR (see Section 7.39).

3.42b MAKING 20% SODIUM HYDROXIDE—100 ML

Weigh out 20 g of sodium hydroxide into a 100-ml measuring cylinder. Add water to the 100-ml mark. Let the sodium hydroxide dissolve and pour it into a polythene dropping bottle. Keep the cap on the dropping bottle and on the stock bottle of sodium hydroxide pellets. Sodium hydroxide easily absorbs water from the air and becomes wet.

This solution is used for examining skin scrapings for fungi (see Section 11.15). Sodium hydroxide is a strong alkali, so handle it with care.

3.43a MAKING SULPHONE TEST PAPERS

Weigh 2 g of para-dimethyl-amino-benzaldehyde into a 100-ml measuring cylinder. Fill it to 15-ml mark with hydrochloric acid. Mix and then fill it to the 100-ml mark with distilled water.

Pour this mixture into a 100-ml bottle with a cap and label it 'Strong reagent for Sulphone test papers'.

When you want to make some test papers, put 2 ml of this strong reagent in the bottom of a measuring cylinder. Fill to the 100-ml mark with water. Wet some 11-cm filter papers (ML 22b) with this solution, let the excess solution drop off, and let them dry. Keep the papers in a tin with a lid away from light until you want to use them.

These papers are used for testing the urine for sulphones (see Section 8.10a).

3.43b MAKING 3% SULPHOSALICYLIC ACID—100 ML

Weigh 3 g of sulphosalicylic acid. Sulphosalicylic acid is the same as salicylsulphonic acid. Tip it into a 100-ml measuring cylinder. Add water to the 100-ml mark. Shake to dissolve. Keep the solution in a polythene dropping bottle.

This 3% solution is used for measuring the CSF protein (see Section 9.13).

3.44 MAKING 20% SULPHOSALICYLIC ACID—100 ML

Weigh 20 g of sulphosalicylic acid. Tip it into a 100-ml measuring cylinder. Add water to 100 ml. Shake to dissolve. Keep the solution in a polythene dropping bottle.

20% sulphosalicylic acid is used for testing the urine for protein (see Section 8.3).

3.45 MAKING WHITE CELL DILUTING FLUID—100 ML

Add 2 ml of glacial acetic acid or 1 ml of concentrated hydrochloric acid to 100 ml of water. Add two or three drops of crystal violet stain to colour the fluid a pale violet. Keep the fluid in any bottle. Some people like to keep it in a bottle with a 1 ml pipette going through the cork.

This fluid is used for counting white cells (see Section 7.30).

A HEALTH CENTRE LABORATORY DESCRIBED**3.46 A description of Figure 3-11**

Let us imagine that FIGURE 3-11 is a picture of your laboratory and that you work in a health centre. The laboratory is on a long bench, and it could be part of a room that is also used for something else. It has been drawn very carefully and shows most of the things described in the main equipment list. You will probably not keep all the equipment in exactly the same places in which it is shown here. For example, it might be best to keep many of the smaller things in the drawer (1). *Go through this section and Figure 3-11 very carefully to see if you have all the things you need.* If you have not got them ALL, try very hard indeed to get them. Do EVERYTHING you read in this section to get your laboratory ready.

Health centres are needed in very large numbers, so they have to be made for little money. You will see that the health centre in FIGURE 3-11 has a tin roof and no ceiling. Its walls (2) are made of whitewashed mud and poles (sticks). The mud has been mixed with an insecticide (a chemical to kill insects) to kill the termites (white ants). There is no glass in the windows, and the shutters (3) are made of wood.

There is a window in the right-hand wall of the laboratory. This is so that light from a bright sky can be used for the microscope. Many laboratories will have to use this kind of light for their microscopes. In this laboratory a car battery is also used to light the microscope lamp.

A long bench (4) runs along one wall. Above the bench are three shelves (5, 6, 7). There is no running water, so water is brought from a well in a bucket (8). This water is for the general use of the laboratory and is also for washing hands. For this there is soap (9) and a towel (10). Because there is no running water, clean water is taken out of one bucket with the jug (11) and poured over the hands into a waste bucket (12). Three more buckets are needed. One bucket (13) holds a disinfectant solution (see Section 1.19), such as lysol, and is for infected specimen bottles and slides. Half a cup of lysol has been added to half a bucket of water. The caps of specimen bottles are unscrewed and care is taken to see that the bottle (or whatever else is infected) is covered by the disinfectant solution. To kill the harmful microorganisms the infected bottles and slides must stay in the bucket *under the disinfectant solution* for at least one day

before they are washed. Bucket 14 is empty and is for things to be washed which are not infected, such as blood slides. Some people like to have a bottle for infected slides on the bench. Bucket 15 is for things to be burnt such as cotton wool swabs, etc. Notice that all these buckets are labelled so that they can be used the right way.

Infected coverslips are kept separate from infected slides when they are washed. When a saline smear of stool has been looked at, the coverslip is pushed off the slide with a loop into the cup of lysol (16). The coverslips are then washed separately from the slides. If the slides are difficult to wash they should be boiled in a detergent solution in the pan (112) (ML 65).

Because there is no sink, slides are stained across a bucket (18) (see Section 3.2). The slides rest on two glass tubes (17). There is a pair of forceps (19) hanging on a nail. These are used to pick up stained slides so that stain does not get on the fingers. A test tube brush (20) hangs near this bucket.

The stains are on a shelf on the left-hand wall. There are 'Polystop' bottles with Leishman's stain (21) and Leishman buffer (22). There are also wash bottles of water (23), saline, Benedict's reagent (24), and 3% acid alcohol (25). Next come several reagents in dropping bottles, dilute carbol fuchsin (26), crystal violet (27), and malachite green (29).

On the bench there is a slide drying rack (30), a report book (31) and several specimens (32). These specimens are on top of the patients' treatment cards. Near the specimens is a rubber stamp pad (33), and on the edge of the shelf just above it are some rubber stamps (34). These are held between two nails hammered into the front of the shelf. On the front edge of the bench is a hand centrifuge. On the back of the bench near the middle is the equipment for Field's stain. There is Field's stain A (35), a cup of water (36), Field's stain B (37). Near by there is a tripod (38), a square of gauze (39), and a Bunsen burner (40). The Bunsen burner is joined by a rubber tube (41) to the reducing valve on a cylinder of 'Afrigas' (42). The rubber tube goes through a hole on the bench. There is a spare cylinder of 'Afrigas' under the bench (43). Both cylinders of gas should, if possible, be outside the room. If the gas leaks inside the room there may be an explosion (see Section 3.4). The 'on-off' key for the 'Afrigas' is hanging on a nail on the bottom shelf where it is easily found (44). The spanner for changing the 'Afrigas' cylinder is hanging up out of the way (45).

In the middle of the bench are two cups: one is for saline (46) and one is for waste (47). There is a Pasteur pipette in one of them. These cups are mostly for blood transfusion methods, but they are also useful in health centres (see Picture G, FIGURE 3-6).

Behind the cups of saline is a pressure cooker (48). Many people prefer to put all infected things into this rather than into the bucket of lysol disinfectant (14).

Next come two test tube blocks (49 and 50) of the locally made kind shown in Picture E, FIGURE 3-8. In

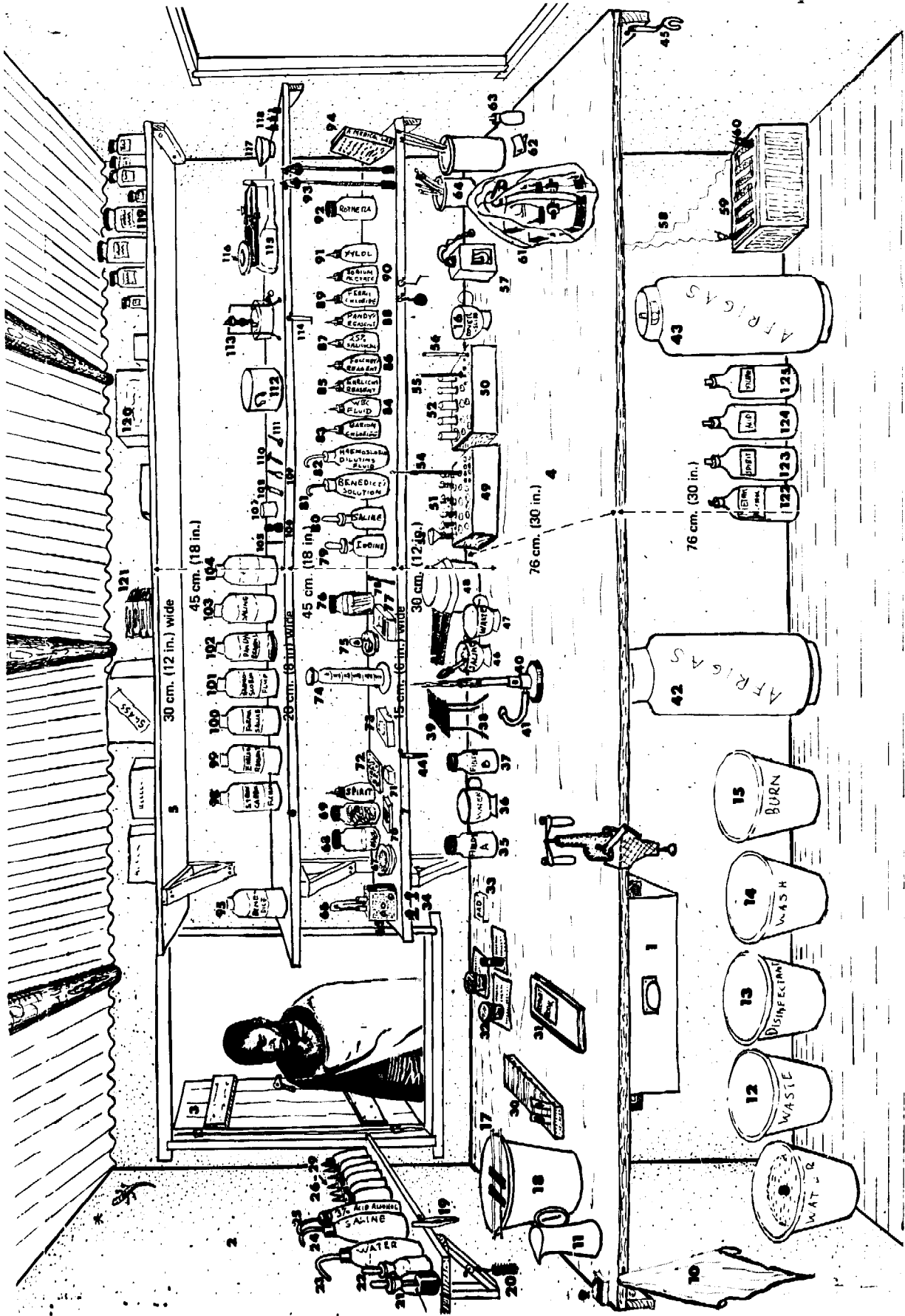

Fig. 3-11 A health centre laboratory

them are some centrifuge tubes (51), some test tubes (52), a funnel (53), a loop (54), a grease pencil (55), and a diamond pencil (56).

Near the end of the bench is a microscope lamp (57) of the kind described in Section 6.11. This has a 12-volt bulb inside it and is joined by wires (58) to a car battery (59) underneath the bench. This battery is charged in the ambulance belonging to the health centre. The wires are joined to the battery by big clips (60). There is an Olympus Model K microscope under a plastic cover (61). Beside it is a booklet of lens paper (62) and a bottle of immersion oil (63). Right at the end of the bench are two of the locally made beakers described in Section 3.11. One of them (the taller one) holds graduated pipettes, the other (64) holds Pasteur pipettes.

At the left of the bottom shelf is the Lovibond comparator (65), and in it are two Lovibond tubes. In one of these tubes there is a blood pipette (66) with a rubber tube and mouthpiece. Next to it is the haemoglobin disc (67) in its plastic box. The disc is kept in its box so as to keep the glass standards clean and free from dust. It should be kept in the dark in a drawer in case its glass standards fade in the light. On the back of the shelf is a glass jar containing glass chips in spirit (68). These are pieces of broken slides and are for taking blood from the ear or finger (see Picture B, FIGURE 4-3). Next to it is a jar full of pieces of cotton wool (69). These are used to stop bleeding from the hole made by the chip. There is also a dropping bottle filled with spirit. This is for cleaning a finger or ear before it is pricked with a glass chip. Near by is the counting chamber (70) with its cover glass on top. Some people store their counting chambers in a dish of spirit. Beside it there is a box of ordinary thin coverslips (71). At the back of the shelf is the plastic tile (72) with depressions. In the health centre this is used for testing the urine for INH. In a hospital it is also used for blood transfusion. There is a box of filter papers (73), a 100-ml stoppered measuring cylinder (74), a spirit lamp (75), and a jar of slides in spirit (76). The 1,000-ml unstoppered plastic measuring cylinder is not shown. The slides in spirit are new ones and are mainly for making blood films and films for AAFB. In front of the jar of slides in spirit there is a box of old and scratched slides for making stool films (77). In the middle of the shelf is a spatula (78).

The first two bottles of the row on the right of the bottom shelf (7) are 'polystop' bottles. One contains Lugol's iodine (79) and the other saline (80). Then come wash bottles with Benedict's solution (81) and haemoglobin diluting fluid (82). In a hospital where blood transfusion is done a wash bottle of saline would also be very useful. The dropping bottles contain 10% barium chloride (83), white blood cell diluting fluid (84), Ehrlich's reagent (85), Fouchet's reagent (86), 20% sulphosalicylic acid (87), Pandy's reagent (88), ferric chloride (89), saturated sodium acetate (90), and xylol (91). At the right-hand end of the bottom shelf are a bottle of Rothera's reagent (92) and two Westergren ESR tubes hanging up on cup hooks (93). Some laboratories do

their ESR's by hanging them on hooks. You are provided with a stand (ML 11). Next to them is a copy of this book (94). Hanging on the right of the front of the bottom shelf are a little tin of paraffin wax and vaseline and a piece of bent wire. These are for sealing the edges of coverslips.

On the middle shelf are 1,000-ml polythene reagent bottles of Benedict's reagent (95), strong carbol fuchsin (98), Ehrlich's reagent (99), formol saline (100), haemoglobin diluting fluid (101), Pandy's reagent (102), and saline (103). Next come several small things. There is a small paint brush (105), a bottle of ink for the spirit pen (106), a tin of quick-drying paint (107), the spirit pen itself (108), a pair of pliers (109), a hammer (110), and a pair of scissors (111). The best way to keep tools is to hang them from hooks on a board on the wall. Paint the shape or shadow of the tool behind the place where it hangs. If someone takes the tool away the shadow will tell you immediately that it has gone.

At the right hand end of the middle shelf is a metal pan (112), a paraffin pressure stove (113), and the pricklers for it (114). Next comes the Ohaus balance (115) with one of the plastic watch glasses on its pan (116). Near it is the scoop (117) that goes on the pan and the extra weights (118).

On the top shelf in alphabetical order are the bottles of chemicals (119) that you will find listed in Sections 2.4 and 13.10. There are boxes of test tubes and specimen bottles (120) and several old record books from last year and the years before (121). Smaller bottles of liquids, such as immersion oil, can be kept on a high shelf. Bigger bottles of liquids such as methyl alcohol (122), spirit (123), hydrochloric or sulphuric acid (124), and xylol (125) are best kept near the floor. They are less likely to get knocked over if they are on the floor.

In this chapter we have tried to describe most of the things that you will need. You will, however, find other things useful, so try to get them. These include small jars, paraffin, matches, urine specimen jars, toilet paper, newspaper, etc.

QUESTIONS

1. Describe the ways in which you can supply water to your laboratory bench.
2. What is a filter pump and how would you use it?
3. How does a Bunsen burner work, and what kinds of flame does it give?
4. How is it possible to make use of the electricity from a car in a laboratory?
5. How would you make a Pasteur pipette on a paraffin pressure stove?
6. How do you make a wire loop? In what ways is a good loop different from a bad loop?
7. How do you (a) hold a hot test tube; (b) fold a filter paper; (c) label a bottle neatly?
8. What kinds of phosphate do you know? What are they used for?

3 | Making the Laboratory Ready

9. What are the following chemicals, reagents or test strips used for: (a) Pandy's reagent; (b) Lugol's iodine; (c) Methylene blue in acid alcohol; (d) 20% sulphosalicylic acid; (e) 3.8% sodium citrate solution; (f) saturated sodium acetate; (g) PAS test strips; (h) Congo red test

paper; (i) ortho-tolidine; (j) sodium carbonate; (k) formalin; (l) para-dimethyl-amino-benzaldehyde; (m) phenol; (n) copper sulphate; (o) 'Teepol'?

10. What is distilled water? How is it made and what kind of water can be used if it is not available?

4 | Records and Specimens

4.1 Records and reports

When you have found something out about a patient, say, for example, that he has hookworm ova in his stool, this knowledge must be written down or it will be forgotten. You must write it down and so keep a **record** in the laboratory of the hookworm ova that you have found. This record has to be kept in a record book, or record file. Used like this the word file means a special way of keeping papers, and is either a box, a drawer, or a book. As well as making a record in the laboratory, you must also **report** what you have found to the person who is looking after the patient, so that he can be treated. Reports are usually sent out of the laboratory on small pieces of paper called **report slips**. These report slips have then to be stuck or stapled to the patient's notes (a staple is a small wire clip). This is better than copying the report slips on to the patient's notes, but, whatever is done it should be done the same day. Only by doing this can we be sure that a laboratory report will always be in a patient's notes, and will not be lost.

Specimens are often sent to the laboratory with another small piece of paper called a **request slip**, which tells you what methods to do on the specimen. Sometimes the same kind of slip is used for both the request and the report, as in Picture A, FIGURE 4-1.

4.2 Records for health centres and outpatient departments

Patients who are treated in a health centre or a hospital outpatient department usually have medical notes that are written on a sheet of paper or card. We will call this the outpatient or health centre card. This is often so small and thin that there is no place on it to stick a report slip. The laboratory report has therefore to be copied on to it in ink or stamped on to it with a rubber stamp.

In small laboratories, when there are few specimens to examine, it may be convenient if patients leave their outpatient or health centre cards with their specimens in the laboratory. The laboratory report can then be stamped on these cards and in the report book. Patients can call later for their cards and find the report

already written on them. This is what is being done at the health centre shown in FIGURE 3-11.

In larger laboratories, where many specimens are examined from outpatients, it may be best if the outpatient leaves his specimen in the laboratory with a request slip. The report is stamped in the report book, and the request slip is thrown away. Next day, when the patient comes back he hands his outpatient or health centre card into the laboratory. While the patient waits, a clerk looks up the report in the report book and copies or stamps it on to the outpatient or health centre card. *It is very important for the laboratory report to be written or stamped on the health centre or outpatient card by the laboratory staff.* If the report slips described below are used, they soon become separated from the outpatient or health centre cards and are lost.

The laboratory in a health centre or outpatient department can use the rubber stamps that are described below. These rubber stamps can be stamped on the patient's notes and in the report book. But, because no request slips are filed, the report book (Picture 31, FIGURE 3-11) must be ruled with enough space in it to stamp in the report on each specimen.

4.3 Records for hospitals (FIGURE 4-1)

The medical notes of patients in a hospital ward (inpatients) are usually written on several larger sheets of paper and are kept in a file like that in Picture D (here a file means a thin book). Because the medical notes of inpatients are much larger than those of outpatients the laboratory reports of inpatients can be kept differently from those of outpatients.

What usually happens is this. When a doctor wants a test done on one of his patients in the wards, he writes it down on a request slip. This request slip is then sent to the laboratory with the specimen. The specimen is examined in the laboratory, and a report is sent back to the wards written on a report slip.

Some hospitals use a different slip for the request and the report, but it is easier to use the same one. *Report slips must be small*, so that they take up little space in the patient's file of medical notes. A combined slip of this kind for the request and the report is shown in Picture A.

THESE ARE SOME OF THE RUBBER STAMPS THAT YOU SHOULD HAVE MADE FOR YOUR LABORATORY

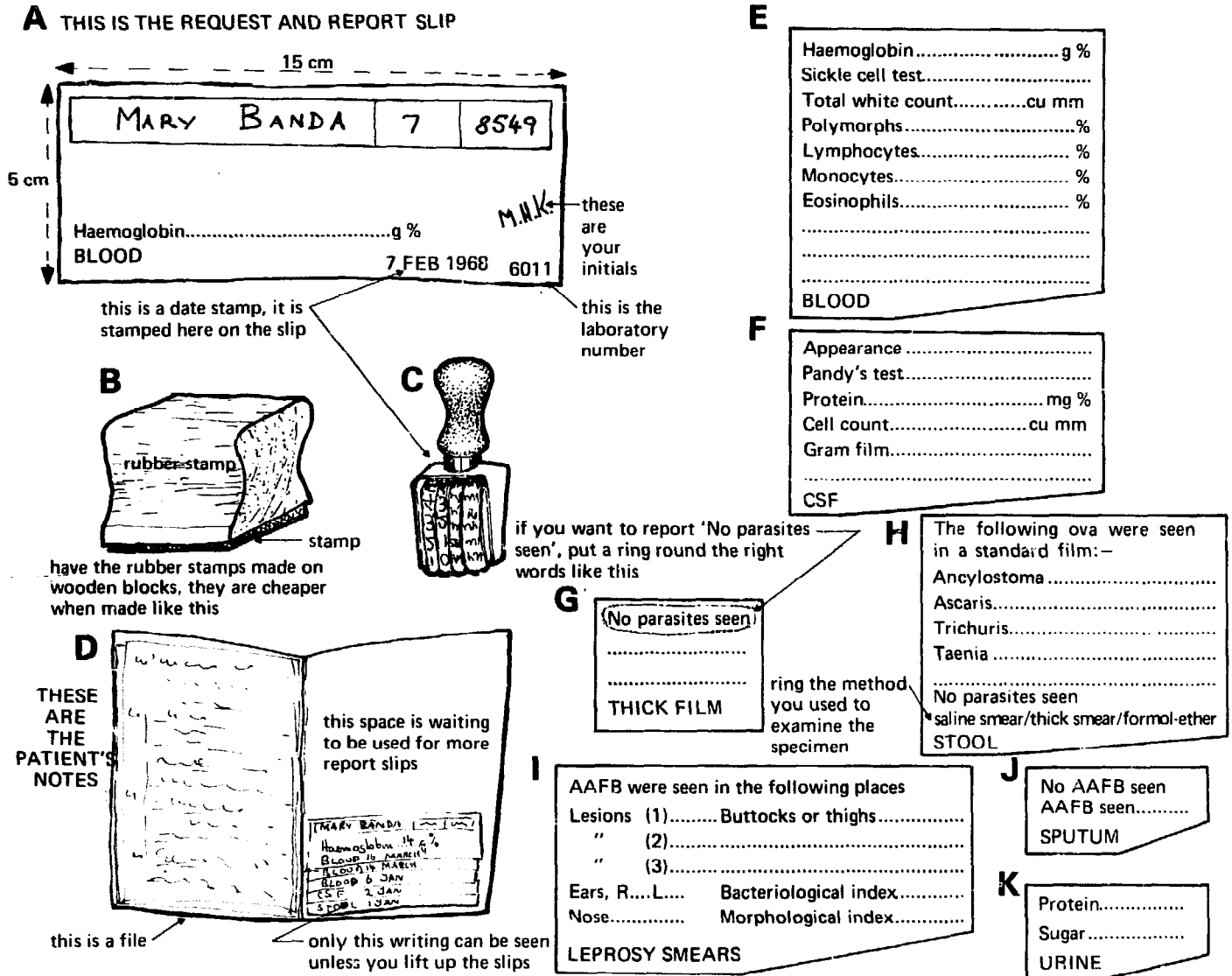

Fig. 4-1 Rubber stamps for records

It is a piece of paper about 15 cm long and 5 cm wide. Printers will often give away free the small pieces of coloured paper (offcuts) from which you can make these slips. If possible use a different colour for each kind of specimen, say red slips for blood, blue for CSF, etc. On the top of the slip there are boxes for the patient's name, his ward, and his hospital number. Underneath there is an empty place for stamping or writing the report. If you cannot get these boxes printed on the slips, have a rubber stamp made and stamp them on with this. Rubber stamps save much writing, and some of the stamps you should have are shown in FIGURE 4-1. Only the figure for the answer is written. All other words are on the stamp.

The date can be stamped on the slips with a date stamp. The best way to put the laboratory number on the slips is to use a **paging numerator** (page numberer). This is a special rubber stamp which can be adjusted to stamp a number, one, two, three, or more times, before it moves

on by itself to stamp the next number. Laboratory numbers help to stop specimens being muddled and are especially useful if the laboratory is a large one.

The ward staff should stick report slips into the patient's notes one on top of the other, so that only their bottom edges can be seen. You will see that the kind of specimen (BLOOD, CSF, etc.) is on the bottom of each stamp, so that it sticks out below the bottom edge of the next slip. The date and the laboratory number are also stamped at the bottom. In this way the slip for a particular specimen can be found very easily.

If your laboratory is big enough to have several people working in it, a good way to keep your records is the way shown in FIGURE 4-2. We will take a request for the haemoglobin as an example. Specimens come into the laboratory with their request slips through a hatch (Picture A—a hatch is a window for putting things through). The first thing to do is to make sure that the

specimen is labelled and that the name on the specimen is the same as the name on the form. The name and the ward of the patient are written in a record book and on a report slip (Picture B). The kind of specimen is also written in the report book. The laboratory number is then stamped on with a paging numerator (not shown in the figure). This is set (adjusted) to stamp the same number three times (once on the request slip, once on the report slip, and once in the record book). The paging numerator will then move itself on one number and be ready for the next specimen. If you have no paging numerator, the laboratory number can easily be written in with ink, but this takes more time.

The request slip and the report slip are then stamped with the right rubber stamp for that particular kind of specimen, dated with the date stamp and clipped together (Picture C). The date is only put into the record book once at the beginning of each day's work. The specimen and two forms then go to the bench where the test is

being done (Picture D). The haemoglobin of the blood specimen is measured (Picture E), and the answer is written in on both slips (Picture F). Both slips then go back to the record bench and are separated. The report slip (Picture H) is placed on a nail in a special rack where a nurse from the ward can fetch it. The request slip (Picture G) is filed alphabetically in a special box made to fit it. Pieces of card are put between the slips of names of patients which start with a different letter.

There are two boxes for request slips, one for specimens examined 'this month' (Picture I) and one for specimens examined 'last month' (Picture J). On the first day of every month the forms in the older of the two boxes of slips are tied up with string and put away in a parcel (Picture K). If they are wanted (which is seldom) they can always be found. The empty box is then used to file slips for the coming month.

Records of this kind are simple and cheap. There is little writing to do, recent reports are easily found, and a

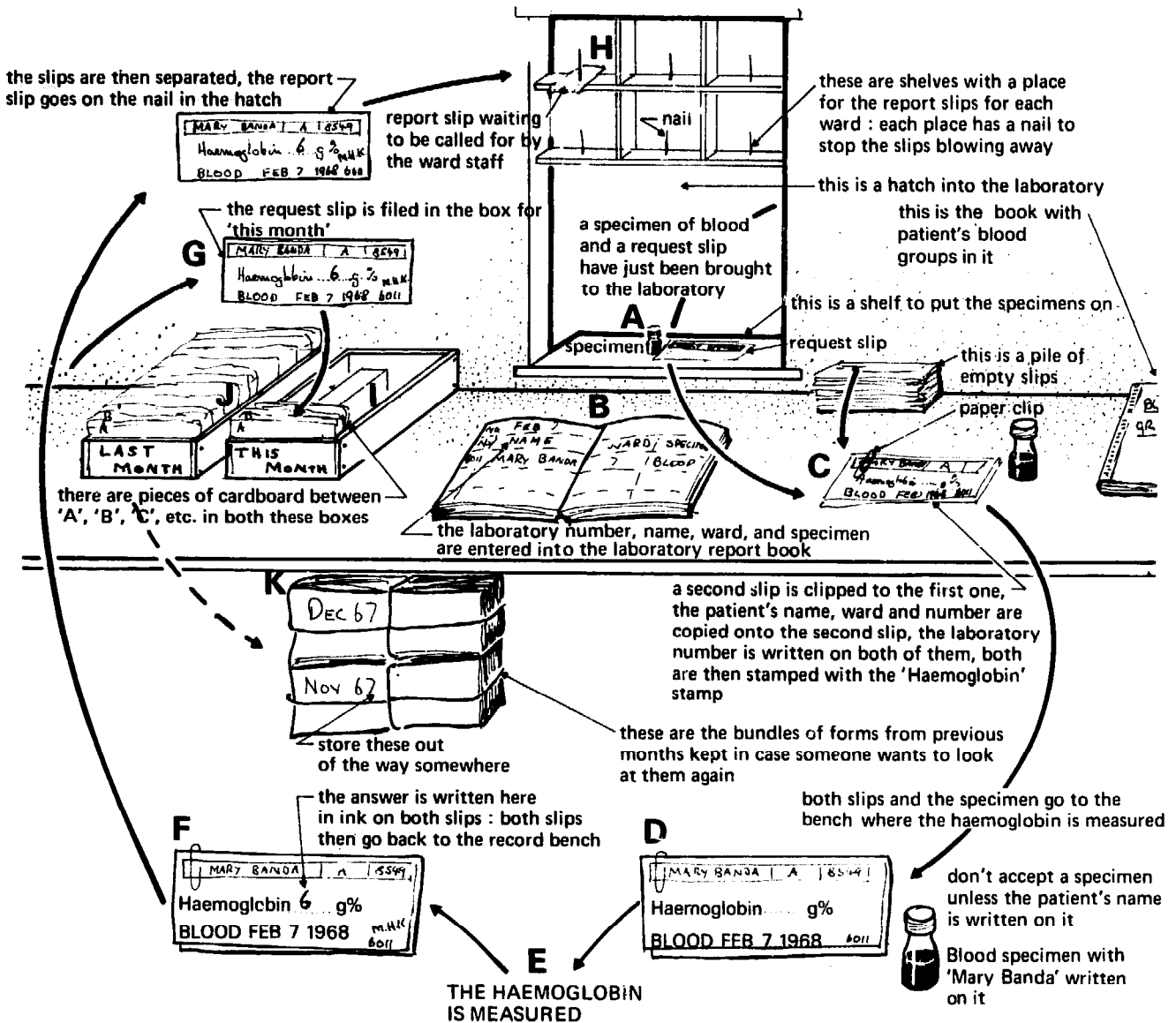

Fig. 4-2 Records for hospitals

report slip can be sent to the ward as soon as the answer is known. The only reports that should be copied into a book are the reports of blood groups. These are sometimes asked for months or even years later.

If the laboratory has a telephone, the record bench is the place to put it.

Never send a report out of the laboratory without keeping a record of it in the laboratory.

4.4. The plus notation

In some of the methods in this book we measure something and give the report in numbers. For example, we might report a patient's haemoglobin as being 10 g %. But very often we do not measure anything. For example, we do not measure the protein in a patient's urine. But in some specimens there is much protein and in others only a little protein. We need some way of reporting this, so we use what is called the **plus notation**. Notation means 'way of writing'. Instead of using words like little, much, scanty, a few, or very many, etc., the report is given like this:

- = Negative	++ = Moderate
± = Doubtful	+++ = Severe
+ = Mild	++++ = Gross

The meaning of the words 'positive' and 'negative' is described in Section 1.3. Report - or negative if you find none of the thing you are testing for or looking for. Some people do not like putting a dash or '-' sign for negative, and prefer to write 'neg.', or to put a ring round the dash sign instead. Report ± or doubtful whenever you are not sure if you have found what you are looking for. If you get a doubtful answer it is often wise to do the method again. *When you are sure you have found what you are looking for*, but there is very little of it, report +. When there is a very large quantity indeed of what you are looking for, report +++. Use ++ and +++ when there are amounts in between + and +++. These have to be judged, and different people will not always report the same result in the same way. Even so, this is a useful way of reporting many of the methods in this book. Here are some examples:

AAFB +++++ means that there are very very large numbers of acid fast bacilli in the film (see Section 11.1).

Malaria parasites + means that you are quite *sure* that there are malaria parasites in the film, but there are very few.

Bilirubinn ± means that you are not sure what the colour you see on the filter paper with Fouchet's method means. You have done the test again and are still doubtful and don't know whether to report the test positive or negative (see Section 8.8).

Formol gel test - or neg., means that the serum remained clear and did not go solid when you added formalin (see Section 7.40).

Pandy's test ++ means that the CSF became cloudy when you added Pandy's reagent. The mixture is more than just cloudy +, so you report it ++ (see Section 9.10).

Trypanosomes +++ means that there are many trypanosomes on the film, but that you have seen films where there were even more of them (see Section 7.36).

The plus notation is a useful way of reporting things. *But always give your report as a number if you can.* For example, it is better to make a standard faecal smear and count the number of hookworm ova than it is to report 'Hookworm ova +'.

4.5 Preventing mistakes

Earlier in this book you read about how important it is to tell the truth. It is also very important to try to prevent mistakes. There are many reasons for mistakes, but here are some of the things you can do. Many of them are about records.

METHOD

PREVENTING MISTAKES

Always label any slide or tube with the patient's name before you start a method. Never accept an unlabelled specimen from the ward or bring an unlabelled specimen into the laboratory yourself. When a specimen is brought to the laboratory, check that the name on the request slip is the same as the name on the specimen. Check this before the person who brought the specimen leaves the laboratory. If they are wrong, hand them back. Never accept a specimen without a request slip.

Be very careful not to mistake names, especially common names like Patel in parts of India, Musoke in Buganda and Banda or Phiri in Zambia. Try to use two initials or two names for patients with common names, such as K. Y. Patel, A. B. Musoke, Y. N. Banda, L. S. Phiri.

One of the main uses of a hospital number is to prevent mistakes from muddled names. Whenever you can, try to use the hospital number, or at least the last three figures of it.

All these rules are especially important with specimens for blood transfusion. Blood of the wrong group may kill the patient.

4.6 Specimen containers

Sometimes patients come to the laboratory themselves, and you can take specimens from them yourself. More often specimens are taken from the patients by nurses in the wards and are sent to the laboratory in containers (bottles or boxes). A laboratory must therefore get these empty containers ready and send them to the wards.

Several kinds of containers can be used for specimens. Some are shown in FIGURE 2-1 as ML 14 a, b, c, and d. ML 14a is a small glass bottle called a **bijou bottle**. It has a metal cap and a rubber washer or **liner**. 14b is a larger glass bottle called a **universal container**; it has the same kind of cap and liner. ML 14c is a plastic container called a **polypot**. ML 14d is another plastic container called a **polytube**. Bijou bottles cost \$0.06, and universal containers cost \$0.08: so they are both quite expensive. But polypots only cost \$0.023, and polytubes only cost

MAKING A SEQUESTRENE POLYTUBE

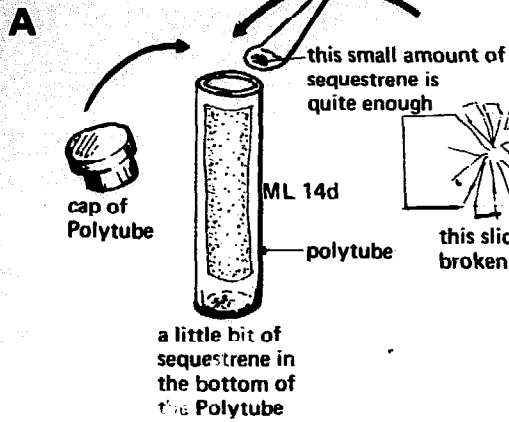

MAKING GLASS CHIPS

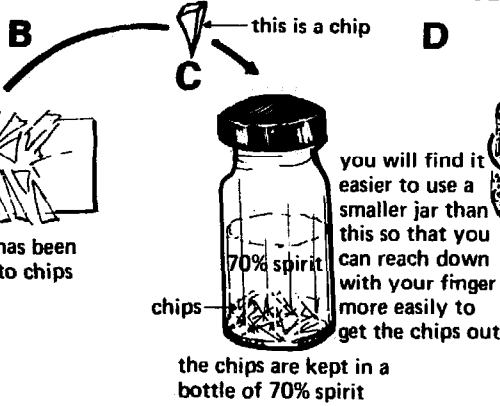

STERILE NEEDLES WITH RUBBER TUBE

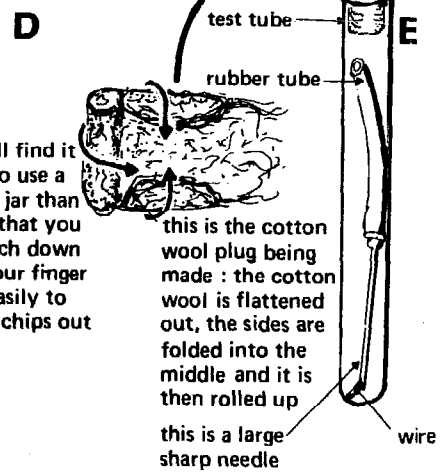

WRAPPING UP A STERILE SYRINGE AND NEEDLE

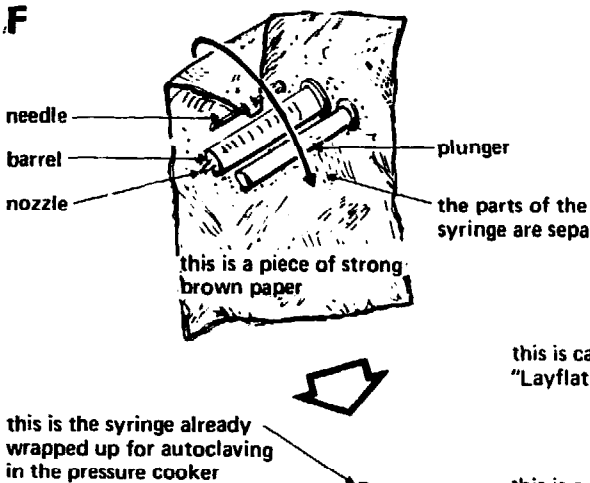

SEALING A TISSUE SPECIMEN INSIDE A POLYTHENE BAG

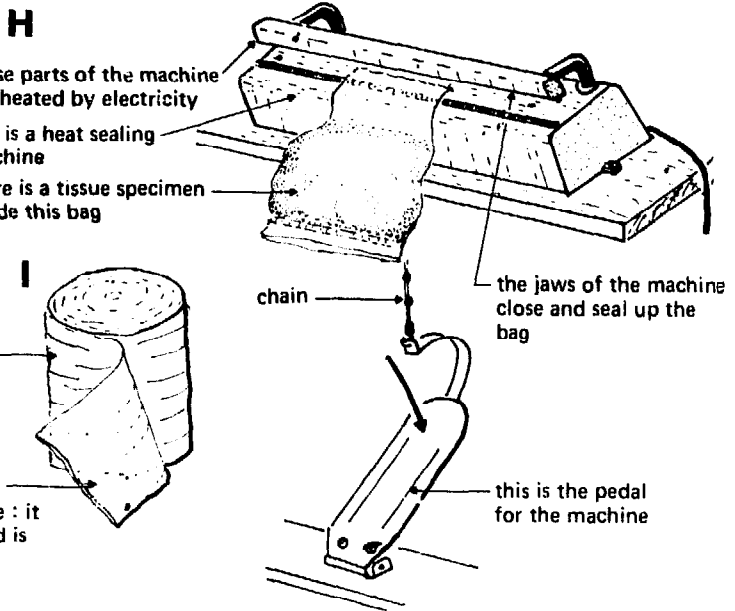

I

this is called "Layflat" tube

this is a roll of polythene tube: it is very thin and is rolled up flat

TAKING BLOOD FROM A FINGER

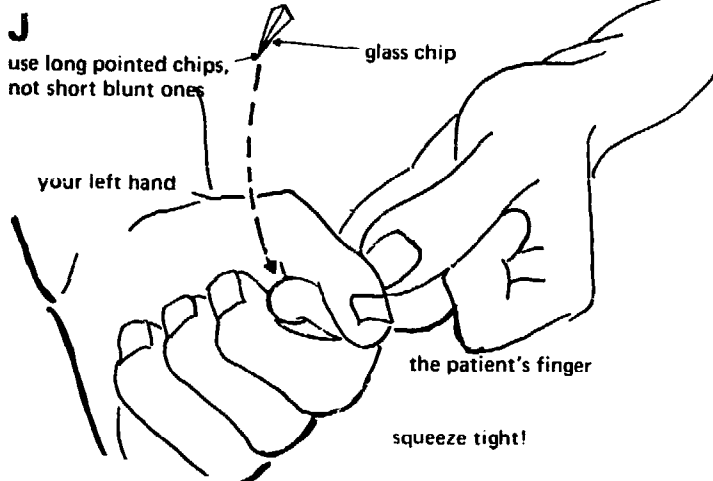

TAKING BLOOD FROM AN EAR

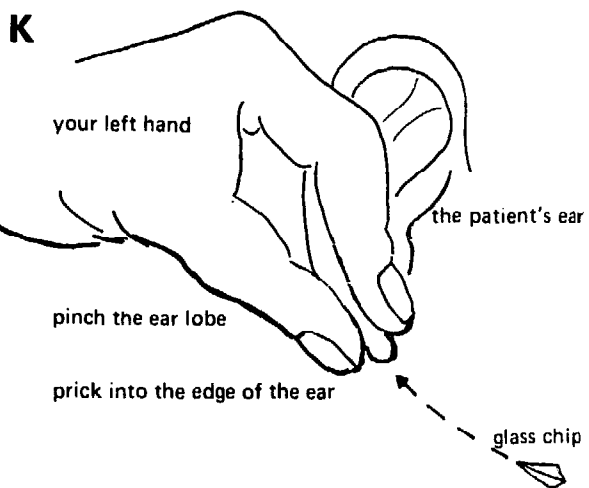

Fig. 4-3 Specimen containers

\$0.0075; so they are both quite cheap. Because all kinds of container so often disappear in the wards, *keep expensive glass bottles in the laboratory*. Send cheap plastic containers to the wards, so that if they are lost they will cost less to replace. Polypots can be boiled and autoclaved because they are made of a special kind of plastic called polypropylene—see Section 1.3. The polytubes listed in this edition can only be boiled.

Polypots are used for stools, urine, and sputum. Three kinds of polytubes will be needed for blood.

Plain empty polytubes. These are used for clotted blood. This is mostly used for blood grouping and cross matching. These are not very common methods, so few empty polytubes will be needed.

Sequestrene polytubes. These are for anticoagulated (unclotted) blood, and many will be wanted. They should have a very *small* quantity of sequestrene in them, as shown in Picture A, FIGURE 4-3. Sequestrene is an anticoagulant which will stop blood clotting—see Section 1.17. If you have no sequestrene you may be able to use Wintrobe's mixture instead. Weigh 12 g of ammonium oxalate, mix it very well with 8 g of potassium oxalate. Make sure the mixture is finely powdered and use it just as you would sequestrene.

Potassium fluoride polytubes. Potassium fluoride stops the cells of the blood or CSF using up sugar. These polytubes are therefore only used for measuring the sugar in specimens of blood or CSF. As with sequestrene, only a very small quantity of potassium fluoride is required.

The easiest way to tell one kind of polytube from another is to mark them with a spot of paint. It does not matter what colour is used, but it is helpful if all hospitals in a country use the same colour. If you can choose, leave plain polytubes unpainted. Put a spot of yellow paint on the sequestrene polytubes, and put a spot of red paint on the fluoride polytubes. There are tins of red and yellow paint for this in the main list of equipment (ML 64). Spirit pens can also be used.

Polytubes, polypots, and slides can be labelled with a grease pencil, but the wards may not have grease pencils, so you should stick a paper label on to each tube with paste or gum. Polytubes can be bought already labelled and filled with potassium fluoride or sequestrene (MBO), but they are more expensive than making your own.

The nurses in the wards will want to know which specimen to put into which bottle; so put a notice in each ward to tell them. It will also help if you put notices in the wards about any other things you think the ward staff should know, such as when to send specimens or how to make thick blood films.

Here are some instructions for you to copy out and put on the ward notice boards. They are given you as a method.

METHOD

A NOTICE FOR THE WARD NOTICE BOARDS

Plain Poly tubes (no paint spot). Use these for the blood grouping, cross matching, and the formol gel test.

Red spot Poly tubes (fluoride). Use these for the blood sugar and CSF sugar.

Yellow spot Poly tubes (sequestrene). Use these for the haemoglobin, the white cell count (total and differential), and the sickle-cell test, the ESR, concentration tests for microfilariae and trypanosomes (send the blood to the laboratory *immediately*), the blood urea, and the reticulocyte count.

Thick films. Make your films like this (stick a good thick film to the notice board, as described in Section 7.31 and cover them with polythene sheet to keep away the flies).

Please send your specimens to the laboratory early in the day.

4.7 Capillary and venous blood

First you must learn a little about how blood goes round the body. Blood carries food and oxygen (from the air) to the tissues of the body. Without this they cannot grow and work. Blood is pumped (pushed or sent) by the heart along tubes with thick walls called **arteries**. When we feel a patient's pulse, we can feel the blood being pumped along an artery by the heart. The blood in an artery is under pressure and will rush out (bleed) very fast if the artery is cut. Blood from an artery goes into many very thin-walled tubes called **capillaries**. These are so small that they can only be seen with a microscope. There are very many capillaries in every tissue of the body including the skin. While blood is in the capillaries it gives oxygen and food to the tissues and takes waste substances from them. If any part of the body is cut, it bleeds because these capillaries have been opened.

Capillaries join together to form larger thin-walled tubes called **veins**. You can easily see the veins of the skin, especially those in the arm and on a warm day. Blood goes along the veins back to the heart. Blood is not under much pressure in the veins, and they easily go flat and empty. Blood coming in the veins from the tissues of the body is pumped by the heart through arteries to the capillaries of the lungs. Here it takes up oxygen from the air and gives up a waste gas called carbon dioxide. Blood comes back from the lungs to the heart in veins. The heart then sends this blood full of oxygen through the arteries to all parts of the body.

Often, by testing a patient's blood, we can find out more about his illness. It is difficult to get blood from arteries, but it is easy to get blood from veins and capillaries. Blood can easily be taken from one of the veins in a patient's arm. A rubber tube is tied around his arm to press on the vein and shut it. Look at FIGURE 12-7. This tube stops blood in the vein getting back to the heart and makes it fill up with blood and swell (get bigger). A swollen (big) vein like this can easily be seen, and you can easily feel it with your finger. Blood can be taken out of a swollen vein with a syringe and needle or with a rubber tube and needle. Blood from a vein is called **venous blood**, and many millilitres can be taken. Venous

blood is also taken for blood transfusion and is described in Section 12.12.

Some patients, especially children, do not have veins which are easy to see and big enough to put a needle into. It is often useful therefore to take **capillary blood** instead. Capillary blood can be taken from any part of the body, but the easiest place to take capillary blood from is the ball (end) of a finger or the lobe of an ear (see FIGURE 7-1). The ear is less painful than the finger, and the patient cannot see what you are doing and is thus less frightened. The heels of very young babies are also used. Special small knives called lancets can be used, so can glass chips (a chip is a small piece, see below). It is usually only possible to get a few large drops or about a tenth of a millilitre (0.1 ml) of capillary blood. But this is enough for many methods.

Glass chips are cheap, easy to use and safe. They do not make quite such a clean cut as the special sterile lancets that can be used, but they are safer and draw more blood than the prick (puncture, stab) of a needle. If you have these special small lancets, they can be sterilized and used again.

METHOD

GLASS CHIPS FOR CAPILLARY SPECIMENS, PICTURES B AND C, FIGURE 4-3

MAKING GLASS CHIPS

Break slides in the middle so that there are as many long-pointed chips as possible. If you do not get good-shaped chips, try hitting the middle of the slide with a hammer. Make good use of all old broken slides in this way. Collect the pointed chips and put them in a small wide-mouthed screw-capped jar of 70% spirit (spirit 70 ml, water 30 ml). This jar is shown as number 68 in Figure 3-11. Use a *small* jar so that you can easily get the chips out.

TAKING CAPILLARY SPECIMENS

Take a piece of cotton wool and put spirit on it. Keep a dropping bottle of spirit for doing this. Clean the patient's ear, or his finger, or the ball of his heel if he is a baby.

Squeeze, or flick the ear, finger, or heel a few times before you prick them. This will make more blood come to the capillaries. Make sure that the skin is dry before you prick it, and if necessary dry it with clean cotton wool. Make one short sharp prick as shown in Pictures J and K in Figure 4-3. Blood will start to come and will soon make a large drop. Try not to squeeze the finger or ear *after* you have pricked it, because this spoils the specimen for some methods.

Make a blood film straight from the drop of blood or fill a blood pipette with it.

Throw away the chip.

It is sometimes easier to put a *very, very little* sequestrene in the bottom of a small test tube (a 'cross-matching

tube', ML 48b) and catch the blood in this as it drops out of the prick on the ear or finger. Let each drop of blood flow down the same side of the tube. They will reach the bottom of the tube more quickly and dry less readily. A blood pipette can then be filled more easily from the drops of blood at the bottom of this tube.

4.8 Cross infection and syringe jaundice

There is one very important thing to remember when taking blood specimens from patients. It is this. *Never put a needle or glass chip into one patient and then into another patient unless you have sterilized it first.* As you have read, sterilizing something means killing all the micro-organisms on it, especially those which cause disease. If a needle is taken out of one patient and put into another without being sterilized, micro-organisms in the blood of the first patient may go on the needle into the second patient and cause disease. *Washing a needle does not remove the micro-organisms.* Only a very small amount of blood need be left on the needle to make it dangerous—so little blood that you cannot see it. Many harmful micro-organisms can be taken from one patient to another with a dirty needle in this way. Malaria parasites are one, but the worst micro-organism of all is a virus which causes a disease called **syringe jaundice** (serum hepatitis). Hepatitis is a disease of the liver. Jaundice is a disease in which the patient's body goes yellow. Patients often die from this disease. To prevent patients being infected in this way **NEVER PUT A NEEDLE INTO A PATIENT UNLESS IT HAS BEEN STERILIZED FIRST. NEVER, NEVER, NEVER PUT THE SAME UNSTERILIZED NEEDLE INTO MANY PATIENTS.** Some people use the same syringe for each patient but use different sterile needles. This too is dangerous because blood from one patient left in a syringe can go up an otherwise sterile needle and into another patient. When one patient infects another in a hospital or health centre, the second patient is said to have been cross infected. **Cross infection** must be prevented. Dirty syringes and needles are one important way in which it can happen.

4.9 Syringes and 'needles and tubes'

The best way to sterilize syringes and needles that are going to be used for taking blood is to autoclave them. For this a pressure cooker is very useful. Autoclaving not only kills the micro-organisms but leaves the syringe dry. Dry syringes are important because the water in a wet syringe lyses some red cells and makes the specimen useless for many methods. But syringes that have been sterilized by boiling can easily be used for giving injections, because it does not matter if a patient is injected with a little sterile boiled water as well as his drug.

Syringes for taking blood must not be kept in spirit, because spirit in the syringe is even more likely to cause haemolysis than water. Spirit can, however, be used for storing glass chips. 70% spirit is an antiseptic and will

kill the micro-organisms on the chips. Spirit soon dries from the chip and does not get into the blood.

Most glass syringes and some plastic syringes can be autoclaved in large test tubes, in special metal tins, or wrapped in paper. The next method tells you how to sterilize syringes wrapped in paper. Syringes made only of glass ('all glass syringes') are the best, but they are expensive. If you have some, look after them carefully.

METHOD

STERILIZING SYRINGES. PICTURE F, FIGURE 4-3

Make sure that the needle is sharp and not blocked (Pictures O, P, and Q, Figure 12-6) and that the syringe is clean and dry. Dip (put) the end of the *plunger* (the plunger is the inside part of the syringe, the *barrel* is the outer part) into a little liquid paraffin. Liquid paraffin is a thick clear medical oil. This oil will lubricate the plunger in the barrel (make it move easily).

Cut sheets of thick brown paper into pieces of the right size to wrap a syringe. Put the needle into one corner of the paper; fold this corner towards the middle of the paper. Take the plunger out of the barrel and wrap it up separately as shown in Picture F. If the plunger is sterilized while inside the barrel, the barrel may crack.

Tie the parcel up with string and sterilize it in the pressure cooker by the method in Section 1.21.

When sterilizing is finished, write 'sterile' on the parcel. Also write the date.

Syringes are expensive and are often broken, lost, or stolen. There are thus too few of them in many hospitals. Fortunately they are not always necessary, and it is often possible to use a 'needle and tube' like that shown in Picture E, FIGURE 4-3. A large needle is fixed to a short piece of rubber tube. The needle and tube are then put inside a test tube. The test tube is plugged (closed or corked) with a plug of cotton wool and sterilized in a pressure cooker. Cotton wool plugs let air through, but they keep micro-organisms out. After the tube has been sterilized no micro-organisms will get in unless the plug is removed.

METHOD

MAKING NEEDLES AND TUBES. PICTURES D AND E, FIGURE 4-3

Take a large needle—a 5-cm No. 21 gauge needle is a good size, but any large sharp needle can be used. Fix about two inches of *rubber* tube on to it. Plastic tube will probably melt in the pressure cooker. Put a piece of bent wire into the end of the needle and put it *point downwards* in a test tube. New needles are usually supplied with pieces of wire in them. The end of the wire will stop the point of the needle getting blunt on the bottom of the tube. Cotton wool in the bottom of the tube can also be used.

Take a piece of cotton wool. The size of the piece is important, and only practice will show you how much

cotton wool you need to make a good tight plug. Open it out flat. Fold the sides to the middle, as in Picture D. Then roll it up. This will make a tight cork or plug for the tube. Autoclave the plugged test tube with the needle inside it in a pressure cooker, as described in Section 1.21.

To use this kind of needle, take out the plug and gently shake the needle part of the way out of the tube. Take hold of the needle where it is covered by the rubber tube between your finger and thumb. Don't touch the point of the needle. Put the end of the rubber tube into the bottle or tube that is to hold the blood. Put the needle into the patient's vein as shown in Figure 12-7.

These needles and tubes are not so easy to use as syringes, but they are much cheaper. Keep some of them ready to use. Wash them as soon as they have been used, and make sure that the points of the needles are sharp. As soon as they get blunt, sharpen them by the method shown in FIGURE 12-6.

4.10 Sending specimens to a central laboratory

Some specimens can be sent from a health centre or district hospital to a central laboratory. If specimens are not to be spoilt before they arrive, it is very important that they are packed and sent properly. This section tells you how specimens should be packed and sent. Some of these instructions are for doctors.

Histology (the study of tissues)

Histology specimens are pieces of a patient's tissues which are to be cut into sections (very thin slices) and looked at with a microscope. A doctor takes these specimens from his patients in an operating theatre, but you may have to wrap them up and send them to the central laboratory. Histology is usually only done in big central laboratories.

As with all specimens, see that the patient's name, age, sex, village, and tribe are put on the request form, as well as something about his illness.

All tissue for histology has to be **fixed**. That is, the cells from which it is made must be killed. The tissue must also be prevented from putrefying (see Section 1.15), and the cells from which it is made must be kept looking just as they did when they were alive. Tissues are fixed by putting them in a fixative solution. Formol saline is the most commonly used fixative for tissues (see Section 3.29). Other methods of fixation used in this book are methyl alcohol, as used in Leishman's stain, and heat. Heat is used to fix the cells and micro-organisms in films of sputum and pus.

The most important thing to remember when fixing tissues in formol saline is to use enough formol saline. *Use at least five times as much formol saline as there is tissue.* Formol saline must also be able to get into the middle of the tissue. If a piece of tissue is small formol saline can easily get to all the cells. But, if a piece of

tissue is large, it must either be cut in slices, or special parts of it must be cut off for sectioning. These special parts are called **blocks**. Knowing where to cut these blocks on a large piece of tissue, or how to slice it up, is a job for a doctor. Only he will know where to cut the blocks. He should cut several blocks $3 \times 2 \times 1$ cm from different parts of the tissue. If the whole of the tissue is to be sent, it must be cut into slices, but they should be left joined together at one edge. Put the slices together again and leave them for several days in a bucket of formol saline, if possible in the cool of a refrigerator. Several large specimens can easily share the same bucket of formol saline while they are fixing. Tie a string to each of them, and put labels on the ends of the strings hanging outside the bucket.

Send small specimens in small, watertight (not leaking), screw-capped bottles. Universal containers can be sent through the post in a strong envelope. Specimens can also be sent in a polypot. Fix them first and pack them in the polypot with some cotton wool made a little wet with formol saline. Polypots may leak; so there should be no liquid inside them. Don't send large screw-capped jars, because they often leak and break in the post. If big specimens have to be sent, cut them in slices and fix them well as described above. Then wrap them several times round in a polythene bag. Seal this bag with adhesive tape (sticking plaster). Don't use staples because these make holes in the bag. Pack the tissue wrapped in its polythene bag in a cardboard box. You can also send small specimens in a polythene bag like this, but put a piece of cotton wool soaked in formol saline in with them. This will stop them getting dry.

The best way to pack and send tissues to a central laboratory is to seal (close) them inside a polythene bag with a heat-sealing machine like that shown in Picture H, FIGURE 4-3. This sealer has two jaws (parts of a mouth) heated with electricity. When the hot jaws are closed, they make the polythene soft so that it sticks together and seals the bag. You will need the thin, flat polythene tube in a roll that is shown in Picture I. Cut off a short length of tube. Seal one end of this with the sealer. This will make a bag. Put the tissue into the bag with some formalin, and then seal the other end of the bag.

Some central laboratories supply district hospitals with labelled wooden blocks. Each block holds a universal container filled with formol saline. This universal container holds the specimen. These blocks have square lids which pivot on a nail. The lids are fixed with 'Sello-tape' (plastic sticking tape) and the blocks are sent off unwrapped to the central laboratory. They are a very good way of sending specimens. *Put a pencil and paper note of the patient's name and the date with each specimen.* Pencil writing will not wash off in the formol saline, but most kinds of ink will.

Serology (the study of sera)

There are many methods for examining serum which can only be done in a central laboratory. The best way to

send a serum specimen is to take blood aseptically (see Section 1.22) into empty sterile bottles and pack these bottles with small pieces of ice in a **vacuum flask**. A vacuum flask is a bottle with two walls. The air between these two walls has been taken away leaving nothing. Where there is nothing, not even air, we say there is a vacuum. Heat cannot get across a vacuum. So if there is something hot inside a vacuum flask, it stays hot for a long time because the heat cannot get out. If there is something cold, such as ice, inside a vacuum flask, it stays cold for a long time because the heat cannot get in. Because the inside of the vacuum flask stays cold for several days micro-organisms do not grow, and clotted blood specimens keep well.

There is another way of keeping specimens cold. This is to use a box made of thick, light, white plastic called **expanded polystyrene**. The box is made cold with special cold bags which are made cold in a refrigerator and are used instead of ice. Expanded polystyrene lets heat into the box very slowly and the cold bags can be used many times. These boxes do not break so easily as vacuum flasks. *Vacuum flasks are very easily broken, so look after them with great care.*

If you have no vacuum flask or cold box, and the serum is going to take some days to get to the central laboratory, it should be preserved (kept as it is) with an antiseptic (see Section 1.19). The best antiseptic for preserving serum is sodium azide. If possible separate the serum aseptically with a sterile Pasteur pipette and add to it a *very few* crystals of sodium azide. You can use a solution of sodium azide instead. Dissolve 0.5 g (500 mg) of sodium azide in 25 ml of water. Add one drop of this solution to every ml of serum you want to preserve. Write on the form that you send with the specimen that you have added sodium azide.

Bacteriology (the study of bacteria)

The specimen that you will want to send most often is sputum for the culture of *Mycobacterium tuberculosis*. A central laboratory may be able to find mycobacteria by culturing them (growing them in a special way) when you have failed to find them by the Ziehl-Neelsen method (see Section 11.1). A central laboratory can also find out which drugs can be used to kill the mycobacteria that are infecting a patient. This is called **sensitivity testing**.

Send the sputum in a universal container inside a strong envelope, or wooden block (see above).

Haematology (the study of the blood)

Haemoglobin can be measured in quite old specimens of blood. But white blood cells are soon destroyed. If therefore you want to send blood away to be looked at, make a thin blood film and fix it with methyl alcohol. This is easy—pour a few drops of methyl alcohol over the film as soon as it is dry. By the time the methyl alcohol has

dried up the film will be fixed. When you write out the request form, say that the film has been fixed. If you have no methyl alcohol, stain the film with Leishman's stain, and send the stained film instead.

Films of the bone marrow can be sent in the same way. But, if you send thick films for blood parasites, send them unfixated.

Biochemistry (*the study of the chemistry of living things*)

The only biochemical methods for blood in this book are the blood sugar and the blood urea. There are many other biochemical methods. Most specimens for biochemistry do not travel well in the post. You can, however, send serum for the measurement of the serum proteins and the serum calcium. These specimens travel well.

Parasitology

The word parasitology is usually used to mean the study of worms and protozoa. It does not usually mean the study of bacteria and viruses even though these are parasites. Put large parasites in formol saline. Preserve stools in two or three times their volume of formol saline.

SEND CAREFULLY FILLED IN REQUEST FORMS WITH ALL THESE SPECIMENS.

QUESTIONS

1. Why are records and reports so important?
2. Describe the 'plus notation'.
3. How can mistakes be prevented in the laboratory?
4. What kinds of specimen container do you know? What is good and bad about each kind?
5. What uses do you know in a laboratory for: (a) potassium fluoride; (b) liquid paraffin; (c) sodium azide; (d) a broken glass slide?
6. Describe the ways in which tissue for histological examination can be sent to a central laboratory.
7. What is meant by a capillary blood specimen? How would you take such a specimen? For what sort of methods is capillary blood especially useful?
8. Why is it so very important not to put the same needle into many patients without sterilizing it properly between one patient and the next patient?
9. What is meant by the words 'cross infection'? What part can the staff in a laboratory play in preventing it?
10. How can venous blood be taken without using a syringe? How would you prepare the equipment for doing this?

5 | Weighing and Measuring

WEIGHT

5.1 Weight

When we buy something in a market we want to know how much of it we are buying, how much fish perhaps, or how much oil. We need some measure for the weight of the fish and for the volume of the oil. Only if we use weights and measures can we be sure that we are getting the right amount of fish, or the right amount of oil. In the laboratory we also want to know how much of something we are using. We use the **gram** for measuring weight and the **millilitre** for measuring volume. Grams and millilitres are part of the **metric system**. The metric system is easy to use because everything is in tens, hundreds, or thousands. Thus there are a thousand milligrams in a gram, and a thousand millilitres in a litre ('mille' means a thousand).

The most important weight is the gram, which is often shortened and written 'g'. Five grams, for example, is written 5 g. The gram is quite a small weight. A new pencil, for example, weighs about five grams. When you weigh out the chemicals for the methods described in this book, you will weigh perhaps 2, 10, or 20 grams. The gram is thus a very useful size of weight for a laboratory like ours.

But sometimes we want to weigh something smaller than a gram, say half a gram or a fifth of a gram. At other times we want to use a weight that is in between whole numbers of grams. For example, we might want to weigh something between three and four grams, say three and a half grams. We could use fractions, like a half ($\frac{1}{2}$) or a quarter ($\frac{1}{4}$) of a gram, but it is easier to use what are called decimals. The word decimal means tenths, and a decimal is only a fraction made into tenths. Thus a half is made into five tenths, and a fifth is made into two tenths. To make it easier to write these decimals we leave out the ten and write a dot called the decimal point instead. Two-tenths become .2 and five-tenths become .5. For example, forty-three and two-tenths becomes 43.2. In front of the decimal point are the whole numbers of grams, such as 43 in this example. After the decimal point come the tenths of a gram, such as .2 and .5 in these examples. When there are no whole grams '0' is usually put in front of the decimal point. Half a gram is

thus written 0.5 g and two-tenths of a gram, or 'point two of a gram' is written 0.2 g.

It is often useful to use a smaller weight than a gram. The weight that we use is the **milligram**. There are a thousand milligrams in a gram. Milligrams are written 'mg'. Thus half a gram, or 0.5 g is the same as 500 milligrams or 500 mg. A fifth of a gram or 0.2 g is the same as 200 mg. A tenth of a gram or 0.1 g is the same as 100 mg. The methods in this book sometimes require 500 mg or 100 mg of a chemical, but we do not need smaller quantities than this.

5.2 The Ohaus triple beam balance

The balance shown in FIGURE 5-1 is called the Ohaus balance after the factory where it is made. As you will see it has a large round pan for holding things, and three arms or beams—triple means in three parts. At the back is an extra beam, or fourth beam, called the **tare beam**. It is used for balancing the watch glass, cup, or paper that are used to hold a chemical while it is being weighed. On each beam there slides a weight and at the end of the beams there is a pointer. The beams and the pan move on a hinged part of the balance called the pivots. When the balance is adjusted the beams swing so that the pointer comes to rest opposite a line on the pillar of the balance marked '0'. Before anything is weighed the balance must be adjusted so that the weights on the front three beams are set at '0', and the pointer also points to '0'. This can be done by turning the **poising nut** in and out until the pointer points to '0'.

In this balance weighing is done by sliding three weights along the three beams. The front weight is for weighing things up to 10 g. The back weight is for weighing things up to 100 g. The middle weight is for weighing things up to 500 g. These weights are often used together. If you look at the front beam you will see that the space between each whole gram (the space between 1 and 2 g, for example) is divided into ten parts. The balance can thus weigh tenths of a gram or 100 mg. If you look at the front beam in Picture B you will see that the front pointer points to 1.1 g (one gram and 100 mg). Because it is not very easy to see this in Picture B, the front weight has been drawn again much bigger in

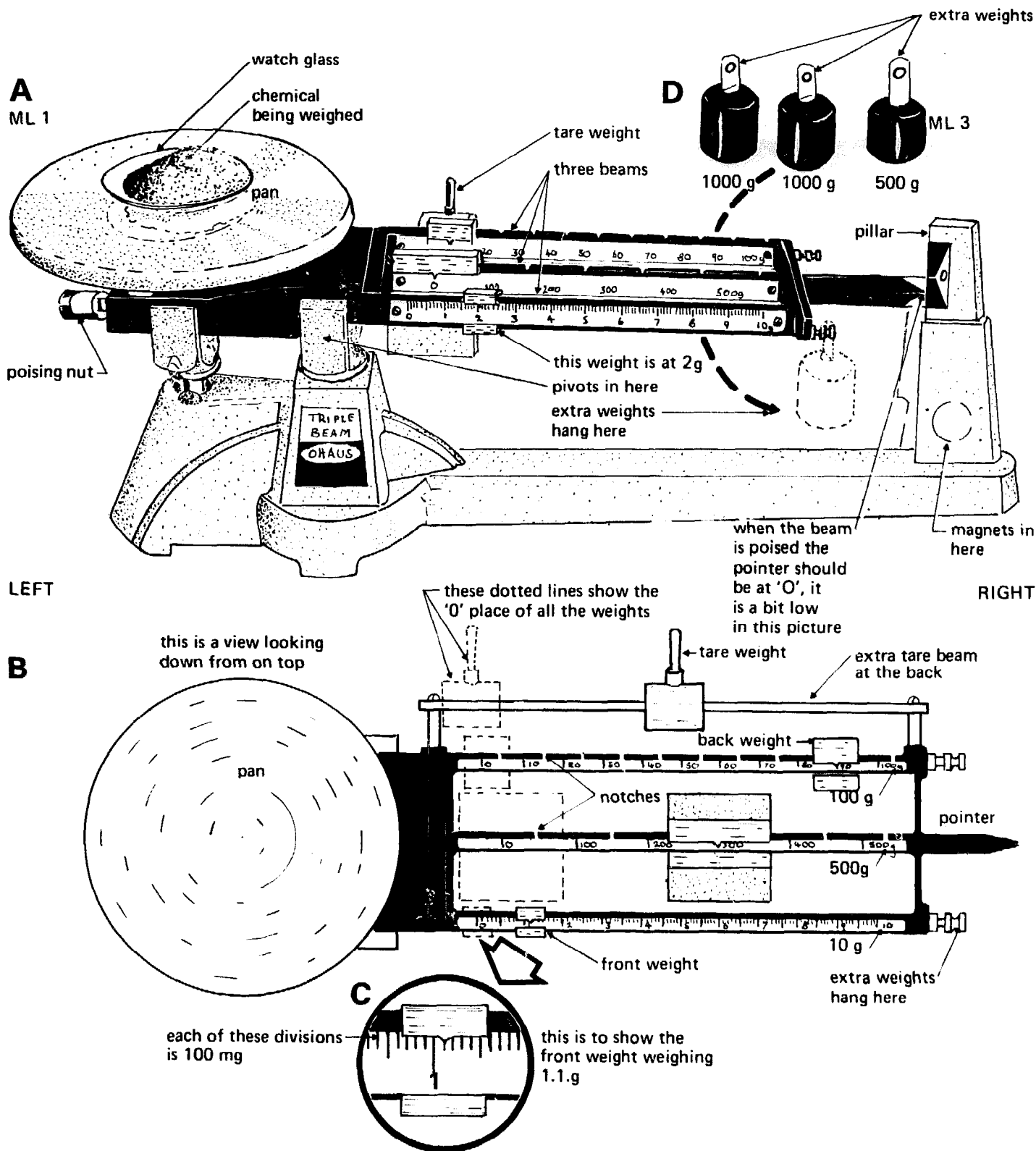

Fig. 5-1 The Ohaus balance

Picture C. The back weight points to 90 g. The middle weight points to 300 g. If there was something in the pan and the beams were poised, the balance in Picture B would therefore be weighing $300 + 90 + 1 \cdot 1 = 391 \cdot 1$ g.

In Picture A the front weight points to 2 g exactly. The back and middle weights are at 0. This balance will therefore be weighing 2 g exactly.

You will see that the front weight can slide anywhere up and down its beam. But the back beam has notches (pieces cut out of the beam) for each ten grams, and the middle beam has notches for each hundred grams. *The back and middle weights must always be in these notches.* If you want to weigh 150 g, put the middle weight in the 100 g notch and the back weight in the 50 g notch. Don't put the middle weight half-way between 100 and 200 g and think that it will weigh 150 g. This will not be accurate.

Chemicals must never be put straight on to the pan of a balance, because this might spoil it. They have to be weighed on a watch glass, or on a piece of paper, or in a cup. Because a watch glass, or a cup, or even a piece of paper weigh something, it is useful to have the tare weight to adjust the pointer to '0' with.

The balance is magnetically damped. By this we mean that magnets are used to slow the swinging of the pointer and bring it to '0' more quickly. These magnets are in the pillar and a piece of metal fixed to the beam swings in between them. It must not touch these magnets, and if it does touch them, gently bend it away from them.

METHOD

USING THE OHAUS BALANCE, FIGURE 5-1

(a) UNPACKING THE BALANCE

Take the balance out of its box. The weights are packed in another part of the box. Make sure you find them. Several pieces of rubber called the beam retainers (holders) are fixed to the balance to hold the beam while it is in the box. Take the beam retainers off the balance and keep them. You may want to pack the balance again.

Put the large weight on the middle beam. Put the small weight on the back beam.

(b) POISING THE BALANCE

Make sure that the pan is empty and clean and that the balance is on a flat level surface.

Move the poising nut to the middle of its screw.

Push all the weights, including the tare weight, as far as they will go to the left. They will be in the places shown by the dotted lines in Picture B. They should all be at '0'. The back and middle weights must be in their notches.

Make sure that the pointer swings easily and is not touching the side of the stand. You may have to move it forward a little.

Move the poising nut until the pointer swings to '0' on the scale. The balance will now be poised. **ALWAYS MAKE SURE THE BALANCE IS POISED BEFORE YOU WEIGH SOMETHING.**

(c) USING THE TARE BEAM

Make sure that all the weights are at '0' and that the balance is poised. Make sure the pan is clean.

Put a watch glass on the pan (you may sometimes find it useful to use a plastic cup instead of a watch glass). Move the tare weight along the tare beam until the pointer swings to '0' and the balance is again poised. You will now have 'tared' the watch glass.

(d) WEIGHING A CHEMICAL

As an example, let us say that you want to make Benedict's reagent as described in Section 3.18. You will want 17.3 g of copper sulphate.

Poise the balance.

Tare a watch glass as described above.

Make sure the middle weight is in its '0' notch. Move the back weight to 10 g and see that it is also in its notch. Move the front weight to 7.3 g. This will be 17.3 g in all. The beam will go down while you do this.

With your spatula put some copper sulphate in the watch glass. Go on adding more and more until the pan falls and the beam rises. Then take some copper sulphate off the watch glass little by little until the pointer swings around '0'. By adding more copper sulphate or taking it away you will be able to get the pointer to swing on '0'. The beam will now be poised once more, and you will have weighed out exactly 17.3 g of copper sulphate.

(e) USING EXTRA WEIGHTS

If you are weighing something which is more than 610 g, you will have to use the extra weights which are shown in Picture D, Figure 5-1. These weights weigh 1,000 g and 500 g on this balance, but their real weight is much less, because they are being used at the end of a long beam. They will not weigh 1,000 g or 500 g on any other balance. Hang them in the places shown by the dotted line in Picture A. Add the weights shown by the three beams to the extra ones you add on. The heaviest thing you can weigh is 2,610 g. This will be using the two extra weights of 1,000 g each and all three weights right at the end of their beams. You will not need to use the extra weights for the methods in this book, but they have been put in the equipment list because they make the balance more useful. You may want to use them for other things in a hospital or health clinic. A *scoop* has also been put on the list. It is really only like a very big watch glass and is for weighing things which are too big to go in a watch glass or a plastic cup. Tare (balance) the scoop with the special counterweight for it, and use it just as you would a watch glass.

(f) LOOKING AFTER THE BALANCE

When you are not using the balance, keep the pan empty.

Keep the balance clean.

Never oil the balance.

When you move the balance, move it carefully and make sure it is not hit or dropped.

5 | Weighing and Measuring

A TWO EVERYDAY MEASURES

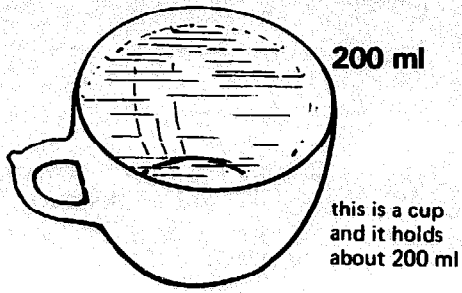

B

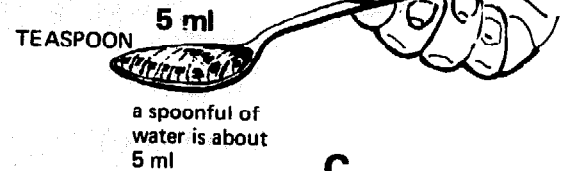

C

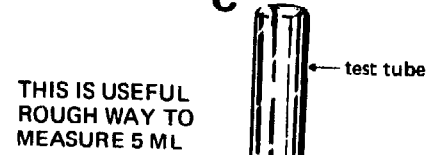

GRADUATED PIPETTES

these are all made of glass

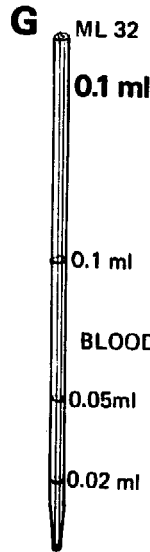
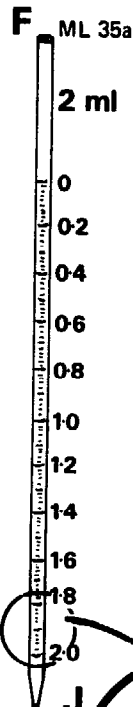
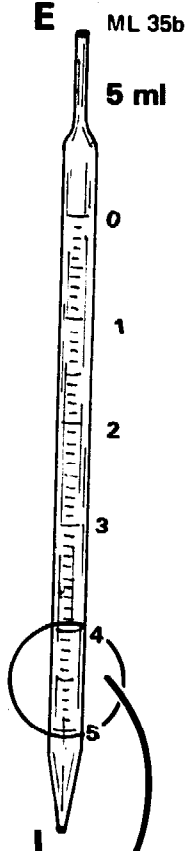
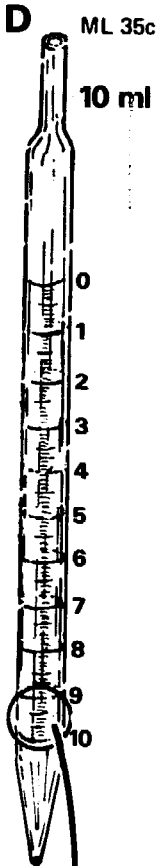

fill a test tube as deep as two of your fingers and it will hold about 5 ml

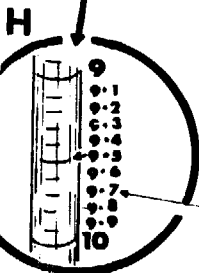
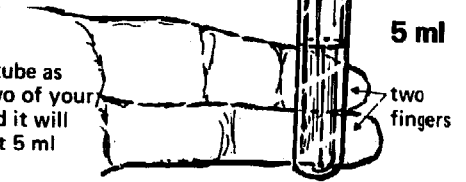

THESE ARE THE BOTTOM PARTS OF THE PIPETTES DRAWN LARGER

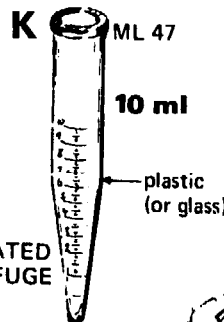
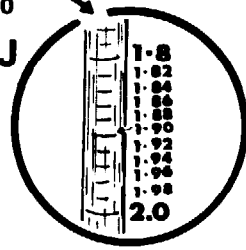
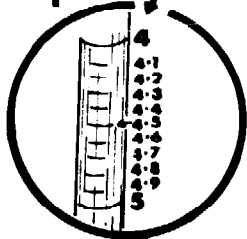

MEASURING CYLINDERS

a glass 100ml measuring cylinder with a stopper

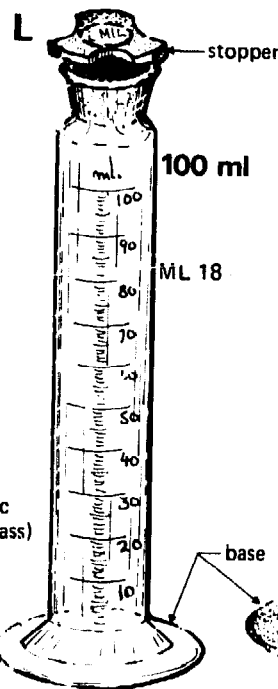

a plastic 1000 ml measuring cylinder without a stopper

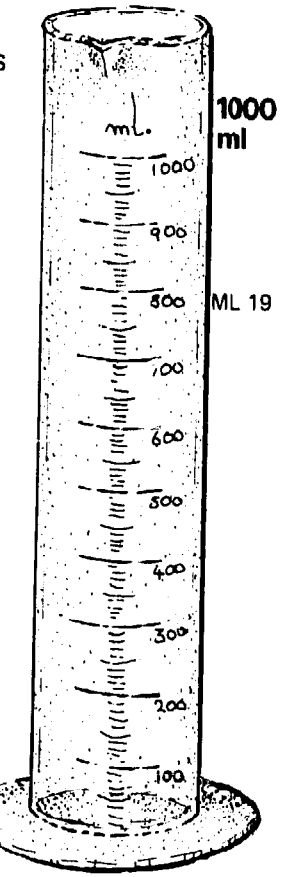

Fig. 5-2 Measuring the volumes of liquids

If your laboratory has shelves like those in FIGURE 3-11, keep the balance on the lowest of them, not on the middle one, as shown in this figure. You will be able to use it while it is on the shelf, and it will not take up any room on the bench.

VOLUME

5.7 Pipettes and measuring cylinders (FIGURE 5-2)

We measure volumes for two reasons. Sometimes we want to find out how much space or volume is filled by some liquid we already have. More often we want to take a special volume of some liquid, so that we only have exactly as much liquid as we want. This is the reason why we measure liquids in the methods in this book. In the first section of this chapter you read that the volumes of liquids are measured in millilitres or ml. Some people use the word cc or cubic centimetre. A cc is almost the same as an ml, but it is much better to use ml. A cup holds about 200 ml, and a teaspoon holds about 5 ml. If you take an ordinary test tube and fill it as deep as two fingers are wide, it will also hold about 5 ml. These useful but inaccurate ways of measuring liquids are shown in Pictures A, B, and C.

In a medical laboratory we measure liquids by putting them into special bottles or tubes which are made to hold exact volumes. These have graduation marks (see Section 1.3) on their sides to show how much liquid is in them when the top of the liquid is at the graduation mark. Some of the measures we use have only one graduation mark on them, some have many graduation marks. We use **measuring cylinders, graduated pipettes, and graduated centrifuge tubes.**

There are two measuring cylinders in the main equipment list. One is a glass measuring cylinder with a plastic stopper which holds 100 ml. This is shown in Picture L. The other measuring cylinder is made of plastic and holds 1,000 ml or one litre. It is thus a litre-measuring cylinder. The graduated centrifuge tube in Picture K is a useful way to measure volumes from half a ml to 10 or sometimes 15 ml.

Measuring cylinders and centrifuge tubes are not a very accurate way of measuring very small volumes of fluid; so we often use special graduated glass tubes called graduated pipettes. The pipettes in FIGURE 5-2 are called straight graduated pipettes and are different from the Pasteur pipettes that were described in Section 3.9. There are four kinds of straight graduated pipettes in the main equipment list. Three are quite big pipettes and are for measuring 10 ml, 5 ml, and 2 ml of fluid. They are shown in Pictures D, E, and F. The fourth pipette is used for measuring small volumes of blood— $\frac{1}{10}$ ml, $\frac{1}{20}$ ml, or $\frac{1}{50}$ ml. It is shown in Picture G. It is not marked as $\frac{1}{10}$ ml, $\frac{1}{20}$ ml, or $\frac{1}{50}$ ml, but as 0.1 ml, 0.05 ml, and 0.02 ml. $\frac{1}{10}$ ml is the same as 0.1 ml. $\frac{1}{20}$ ml is the same as 0.05 ml, and $\frac{1}{50}$ ml is the same as 0.02 ml. These decimals of a millilitre are like decimals of a gram. If you do not understand

them, turn back to Section 5.1. Fill the larger straight graduated pipettes by putting the top end into your mouth and sucking (taking in air) as shown in Picture R, FIGURE 5-3. Fill the blood pipette by sucking through a rubber tube and mouthpiece as shown in FIGURE 7-1.

Measuring cylinders are easy to use. Fill them to the graduation mark you want and then pour out the liquid.

Pipettes are not so easy to use. You will see that the pipettes in Pictures D, E, and F have '0' at the top and are marked at 10, 5, or 2 ml near the bottom. Several other kinds of pipette are also made, and you may be given them. Some have 10, 5, or 2 ml at the top and 0 at the bottom. *Other kinds of pipette are used in different ways, and the methods which follow may not work with them.* In most pipettes some of the volumes are written beside the graduations. But other volumes are not written, and you have to work them out. To help you to do this the bottom part of the 10-ml pipette has been drawn larger in Picture H, and the meaning of the graduation marks has been shown. The bottom part of the 5-ml pipette has been drawn larger in Picture I, and the bottom of the 2-ml pipette has been drawn larger in Picture J. A circle on the pipette shows the part of it which has been drawn larger. *Look at your pipettes carefully with Figure 5-2 beside you.* If you can understand the bottom graduations, you will easily understand the others.

METHOD

USING A GRADUATED PIPETTE. FIGURE 5-3

Practise using your pipette with water.

Look at the graduations on the pipette carefully. Make sure before you start that you know which graduations you are going to use.

Put the blunt end in your mouth. Put the sharp end into the liquid you are going to measure. This is shown in Picture R. (The person in this picture should be holding the pipette with his right hand in the position shown.) Suck the liquid up to just above the '0' mark on the pipette.

Take the blunt end out of your mouth and quickly put your index finger over it so that no air can get in. The liquid will fall a little and then stop as shown in Picture S.

Move your index finger a little, so that some air gets into the pipette. The liquid will start falling back into the bottle. Let the liquid fall until it has got to '0' at the top of the pipette as shown in Picture T. The top of the liquid in a pipette is never flat. It is always curved. This curved top of the liquid is called the meniscus. Get the lower part of the meniscus opposite the graduation you want, as shown in Pictures T, U, and V. If the meniscus falls below '0', start again.

When you have got the level of the fluid to '0', touch the end of the pipette against the inner side of the bottle that holds the liquid. This will let any drops of liquid on the outside of the pipette drain away.

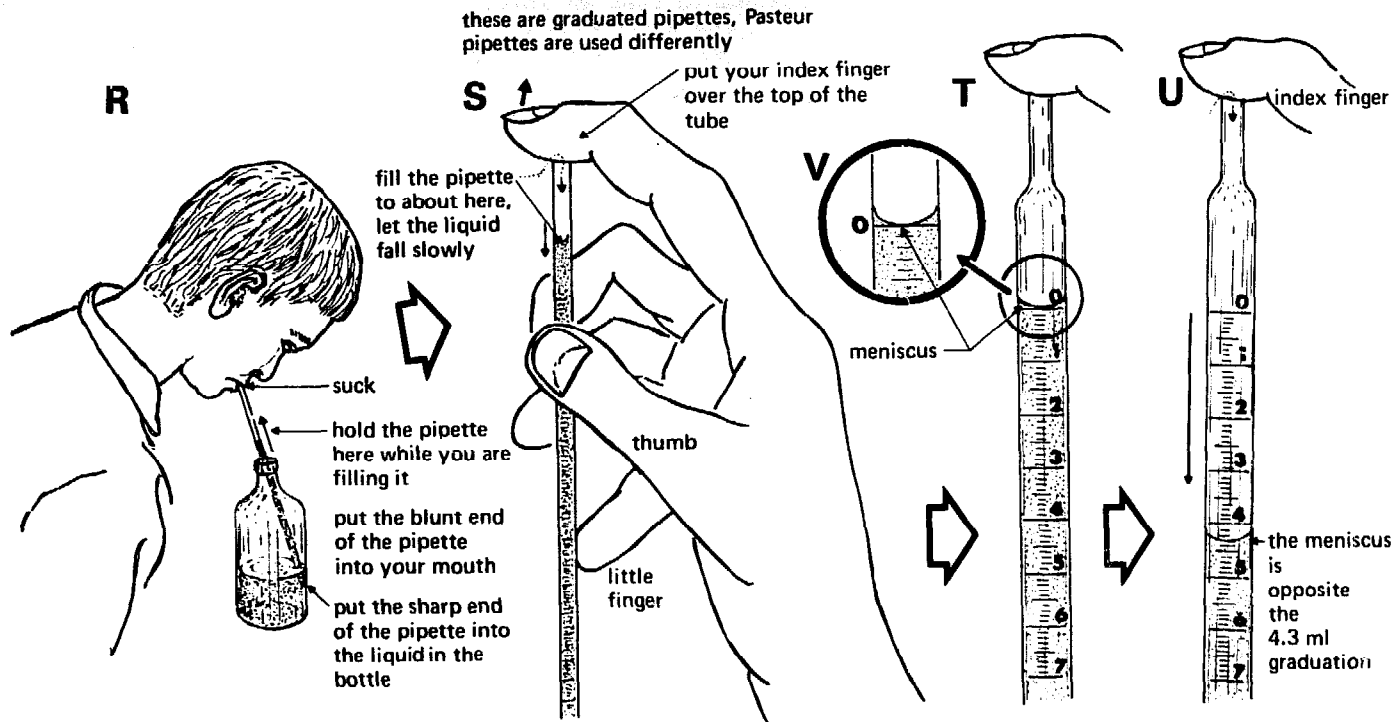

Fig. 5-3 Using a graduated pipette

Take the pipette to where you want to put the liquid. Move your index finger again just a little. Let the fluid fall to the graduation you want. The person using the 10-ml pipette in Picture U wanted to measure 4.3 ml. He has let the meniscus fall to 4.3 ml.

Touch the end of the pipette against the side of whatever you are putting the liquid into. This will let the last drop of liquid drain from the end of the pipette.

Put any liquid you have not used back into the bottle where it came from.

Don't put the point of the pipette into any liquid except when you are filling it up.

The blood pipette, shown in Picture G, FIGURE 5-2, is used differently from the ordinary straight pipettes. Read how to use it in Section 7.1, where the method of measuring the haemoglobin is described.

Pipettes easily get dirty, especially if they are not properly looked after. Read about how to clean them in Section 3.12.

Remember these things when you use pipettes.

NEVER PIPETTE ANY SOLUTION OF CYANIDE. Cyanide is very poisonous and may kill you. Potassium cyanide is used in testing the urine for INH.

Take great care in pipetting strong acids or alkalis such as hydrochloric acid or ammonia. Even their fumes may burn your mouth. Don't pipette these until you are well practised. If you can, measure them in some other way. It is often possible to use a Pasteur pipette and a graduated centrifuge tube instead of a straight pipette. ALWAYS OPEN BOTTLES OF STRONG ACID OR

AMMONIA WITH GREAT CARE. Don't let them spill.

Wash pipettes with water after you have used them. This is very important with blood pipettes. NEVER LEAVE BLOOD IN A PIPETTE. If you do it will become blocked.

5.8 Percentages and 'parts'

As you have read, the word cent means 100. A percentage means the number of something that there is in a hundred of something else. 3% acid in alcohol means that there are 3 ml (or pints or cupfuls) of acid in 100 ml (or pints or cupfuls) of solution. You could make this by mixing 3 ml of acid and 97 ml of alcohol. You could NOT make it by mixing 3 ml of acid and 100 ml of alcohol. The final volume of the solution of acid in alcohol must be 100 ml (not 103 ml). The easiest way to make this solution is to measure 3 ml of acid and put it into something which can hold 100 ml, such as a measuring cylinder. Alcohol can then be added up to the mark which measures 100 ml. In this way we add 97 ml of alcohol and make a solution which contains 3 ml of acid in 100 ml of solution.

Percentage solutions of solids in liquids are made in the same way. In Section 1.18 you read that 0.85% sodium chloride (common salt) in water was called physiological saline or 'saline'. To make this solution we can weigh 0.85 g of sodium chloride and put it into a 100-ml measuring cylinder. We can then pour water into the cylinder to exactly the 100-ml graduation mark and dissolve the salt. There will then be 0.85 g of sodium

chloride in 100 ml of solution—we will have made a 0.85% solution.

Percentage solutions are easy to work out if you are making up 100 ml of a solution. Most of the solutions in this book are made up in 100-ml volumes. Other volumes may not be so easy. For example, to make up 50 ml of 3% acid alcohol we could put $1\frac{1}{2}$ ml of acid in 50 ml of solution (50 is half 100; $1\frac{1}{2}$ is half 3).

We have said that we could have 3% acid in alcohol by putting 3 ml (or pints or cupfuls) of acid in 100 ml (or pints or cupfuls) of solution (97 ml or pints or cupfuls of alcohol being needed). This can also be written as 3 *parts* of acid in 100 *parts* of solution (97 *parts* of alcohol being needed). 'Parts' is only another way of saying any weight or volume we like. But, if we use parts, *they must be the same parts by weight or volume for everything we measure*. Parts are not used in this book, but you should know what they are.

You will often see the letters mg %. In this book they mean the number of milligrams of a substance in 100 ml of plasma. Thus a blood sugar of 150 mg % means that there are 150 milligrams of sugar in every 100 millilitres of the patient's plasma.

COLOUR

5.9 Why and how we measure colour (FIGURE 5-4)

In the first part of this chapter you read about measuring weight and volume. You had to understand this before you could make any reagents. In the rest of this chapter you will read about measuring colour. You will have to understand this before you can understand some of the methods that are described later in this book. But, first of all, you must understand why we need to measure colour.

The blood of healthy people contains many different chemical substances. In sick people there are sometimes more or less of these substances than there should be. It is often useful to measure how much more or how much less of a substance there is. One of the things we measure is the red substance called haemoglobin (see Section 1.9). In the blood of a few patients there is more haemoglobin than there should be. But many patients have less haemoglobin than they should have. We say these patients are **anaemic** (an = without, aemia = blood). Sometimes we measure the sugar in the blood to see if there is too much sugar or too little sugar. Sometimes we measure the urea in the blood to see if there is too much or too little urea.

Haemoglobin, sugar, and urea are all measured with the help of colour. So you must learn how we can use colour to measure them.

We will start by taking blood as an example. If something is coloured red like blood, and we put a few drops of it into a test tube of water, the water will go red. If we add more blood, the water will get more deeply red. If we could measure how deeply red the water was, we would know how many drops of blood had been added to it.

Let us say, for example, that we have a tube of blood and water. We do not know how many drops of blood there are in it and we want to find out. We call this tube of blood and water our **test solution**—it is drawn in Picture A, FIGURE 5-4. What we could do is to take several more tubes of water and put one drop of blood into the first tube, two drops of blood into the second tube, three drops of blood into the third tube, and so on. These tubes have been drawn in Picture B and are called a **set of standards**.

We could then take our test solution and put it beside each of the standard tubes in turn. We would find that one of these standards had the same depth of redness as our test solution. The tubes of test solution and standard solution have been drawn side by side in Picture C. When we find two coloured things are the same, we say that they *match* one another. The two tubes in Picture C match one another in colour.

In this example we found that our test solution had the same depth of redness as the fourth standard tube—that is, the tube with four drops of blood in it. We can therefore say that our test solution had four drops of blood in it because it had the same depth of redness as the fourth standard tube (it *matched* the fourth standard tube).

THE LOVIBOND COMPARATOR

5.10 The Lovibond comparator (FIGURES 5-4 and 5-5)

If possible, find a Lovibond disc and a Lovibond comparator before you read this section. It is difficult to make a set of standard tubes each time we want to compare something, and it is easier to use pieces of coloured glass instead. Instead of using tubes of a watery solution, we use coloured glass standards which are held in the windows of a special black plastic disc (circle, ring). This set of glass standards in a plastic disc is called a **Lovibond disc** and is drawn in Picture F, FIGURE 5-4. Lovibond is the name of the man who first made this kind of disc. Each glass window in a Lovibond disc has a different depth of redness, just like our row of standard tubes. Unlike a set of tubes which cannot be kept for more than a few days, the glass standards of the Lovibond disc last for ever.

The Lovibond disc is used inside the **Lovibond comparator** (comparer or something for comparing or matching things). The Lovibond comparator is a black plastic box with two square holes in the top and four round holes in the front. Look at Picture D, FIGURE 5-4, and Picture A, FIGURE 5-5. The four holes on the front are on a door which opens. Behind it is the Lovibond disc. The Lovibond disc sticks out at the edge of the door, and you can turn it round with your fingers. If you turn the disc you will see that the glass standards go round behind one of the holes in the door of the comparator. This is the **standard hole**. Beside it is the **test hole** which is in front of the empty place in the middle of the Lovibond disc. The square holes in the top of the comparator are for special *square* tubes called **Lovibond cells** (ML 48d), one

PROBLEM This tube of water has some drops of blood in it. How many drops of blood are there? This is the 'test solution' A

METHOD Take a row of tubes of water. Put one drop of blood into the first tube, two into the second tube, three into the third tube and so on. This row of tubes is the 'set of standards'

Put the test solution beside each standard in turn until you find a standard that matches the test

ANSWER Because the test matches the fourth standard, the test must have had four drops of blood in it

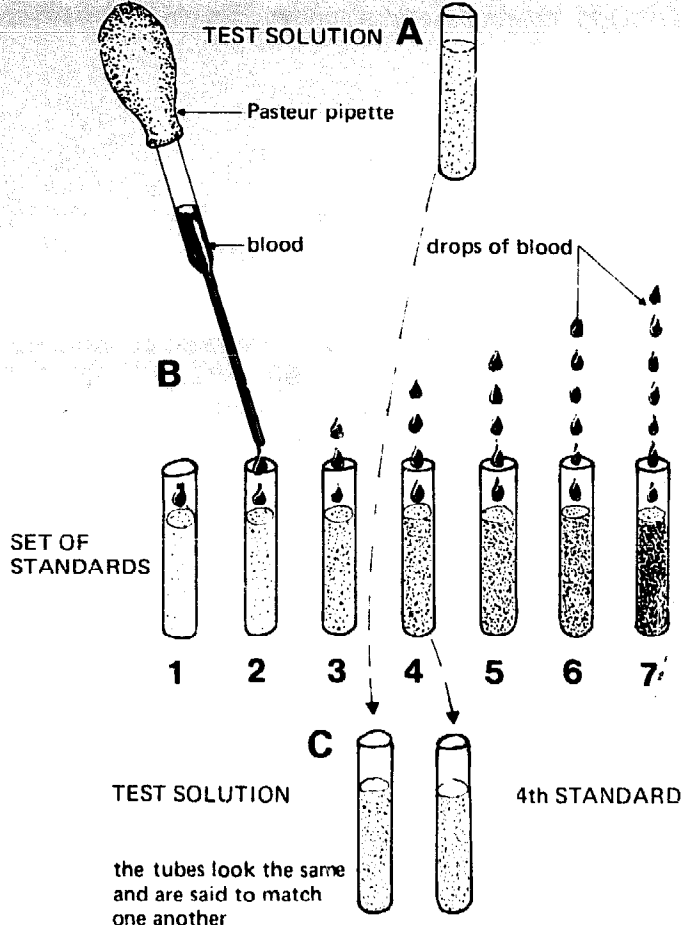

THE LOVIBOND COMPARATOR

E Liquid standards

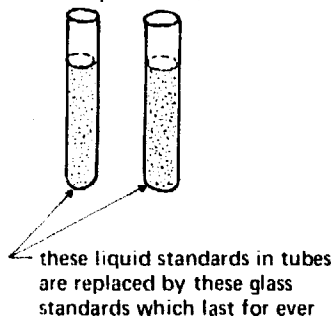

F Lovibond disc ML 21 a-e

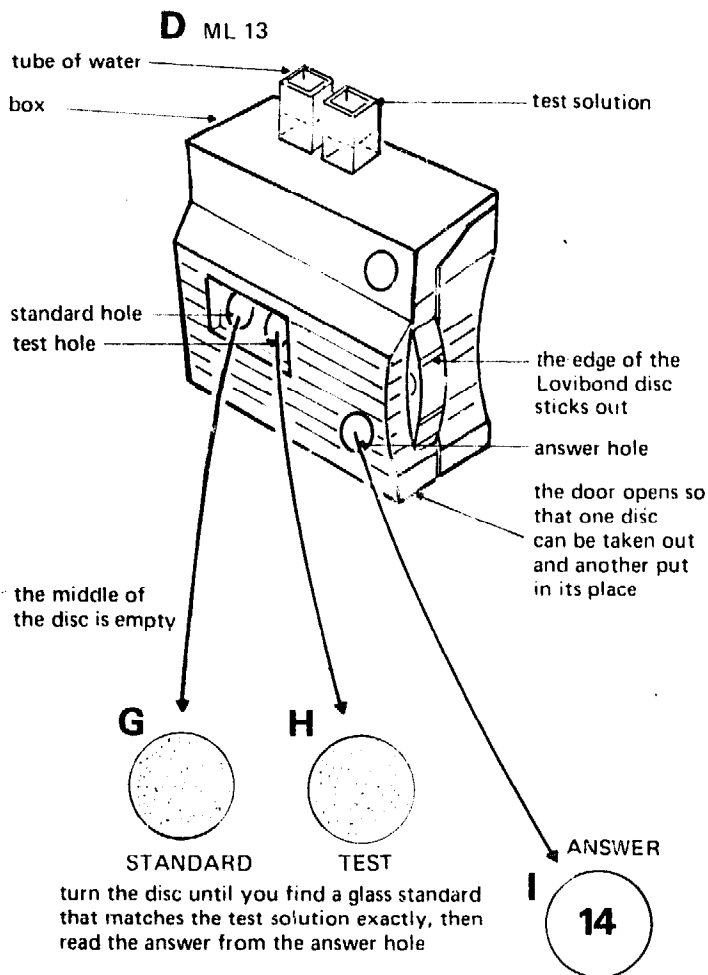
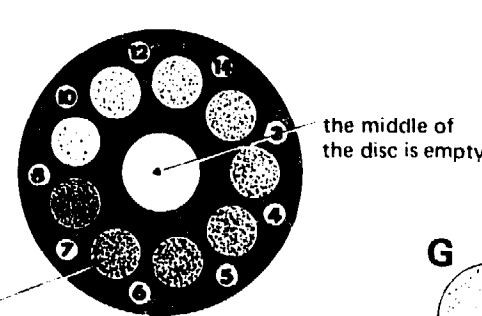

Fig. 5-4 Why and how we measure colour

THE LOVIBOND COMPARATOR OPENED

USING THE LOVIBOND COMPARATOR

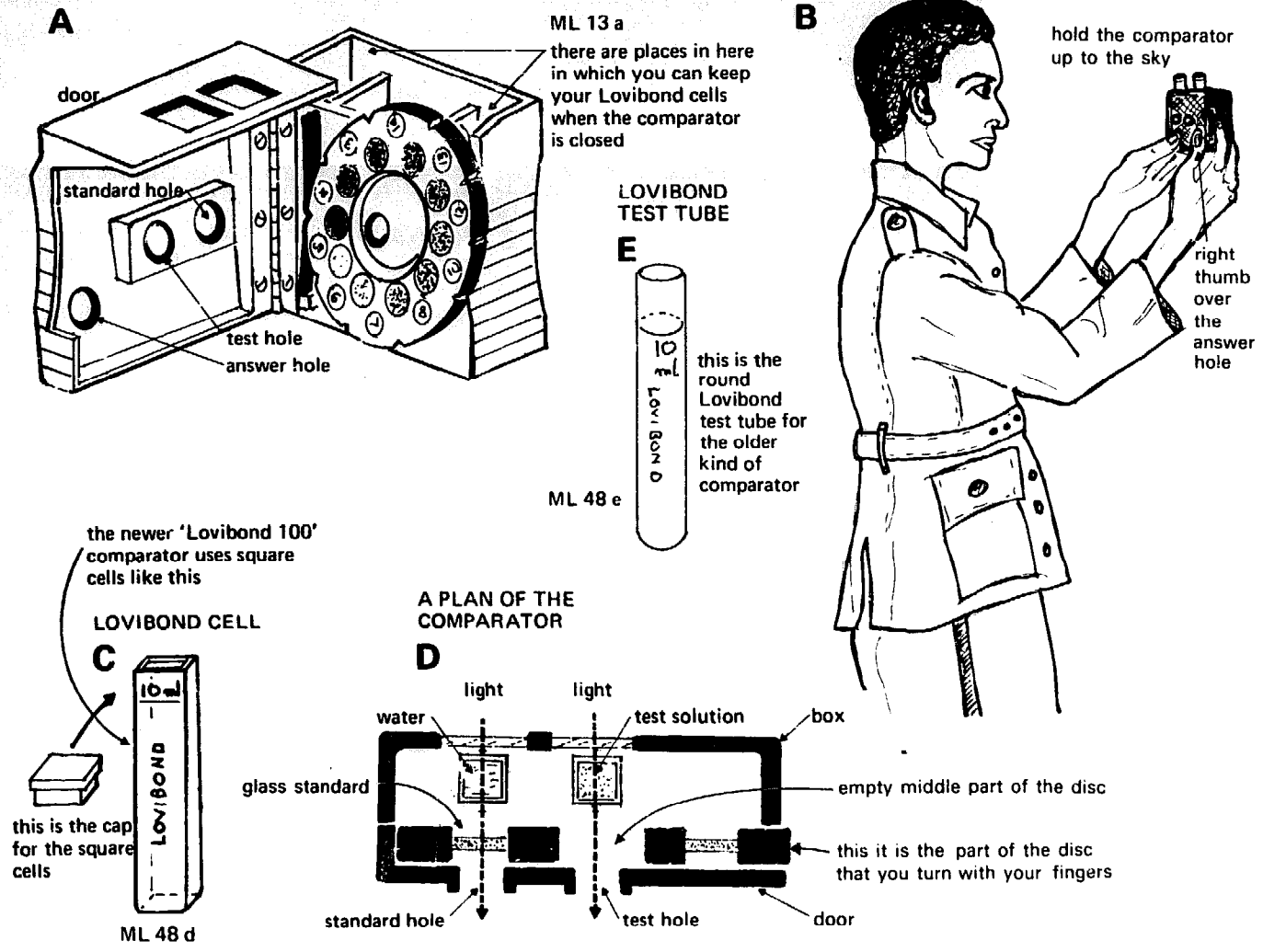

Fig. 5-5 The Lovibond comparator

on the right hand and one on the left. When you shut the comparator, you will see that the left-hand cell comes behind the glass standards in the disc and the standard hole in the door. The right-hand cell comes behind the empty place in the middle of the disc and the test hole in the door. At the back of the box are two round holes covered with white glass through which light gets into the box.

The comparator we have been describing is the newer kind called the 'Lovibond 1,000' comparator and has square glass cells. The older kind of comparator uses special *round* test tubes called **Lovibond tubes** (ML 48e). If you have the older kind of comparator, make sure that you ask for these round tubes to fit it, and not the newer square cells.

Now that we know about the parts of the Lovibond comparator, let us see how we can use it to find out how many drops of blood there are in a test solution. We start by putting the test solution into a Lovibond cell in the right-hand hole. *Remember the test solution always goes into the right-hand hole.* In the left-hand hole we always place another Lovibond cell full of plain water. This cell

of water is called the **blank**. The water blank and the coloured glass standards work together in the same way as the liquid standards in their tubes. Hold the comparator up to the light and turn the Lovibond disc round until you find one of the glass standards that has exactly the same depth of redness as the test solution—that is, until you have found a standard which matches the test solution. When you have found a glass standard that matches the test solution, read what the 'answer' is through the answer hole on the front of the comparator. Through the **answer hole** you will see a number or answer written on the front of the disc. There is an answer for each glass standard.

Forget the fourth hole in the front of the comparator, it is not used with the methods in this book.

Before we explain what the 'answer' means you must remember that we have only been taking tubes of water and drops of blood as an example. In our laboratory we do not want to know the number of drops of blood that have been added to a tube of water. *We do want to know how much redness there is in our patient's blood, because the redness is made by the haemoglobin in his blood.* If

we can measure the redness of a patient's blood, we will know how much haemoglobin there is in it. We do not use several drops of blood. *We measure instead the redness made by one drop of blood.* If it is normal blood, it will make a deeply red solution. If it is anaemic blood, it will have little haemoglobin and only make a pale red solution.

To measure the haemoglobin we take a cell containing a carefully measured amount (10 ml) of a special solution (haemoglobin diluting fluid), and add one carefully measured drop of blood. *This is our test solution.* We don't measure the blood as a drop. We measure it instead in the special glass tube called a blood pipette which you read about in Section 5.7 and which measures exactly $\frac{1}{20}$ or 0.05 of a ml of blood. The same amount of blood from different patients will contain different amounts of haemoglobin. In healthy people 0.05 ml of blood will contain plenty of haemoglobin, but in anaemic people it will contain little haemoglobin. In healthy people the test solution will therefore be deeply red, but in anaemic people it will be pale. We compare the redness of this test solution with the redness of the glass window standards on the Lovibond disc. When we find a glass standard that exactly matches the test solution, we read the answer that this standard means from the numbers we see through the answer hole. These numbers tell us how many grams of haemoglobin the person has in every 100 ml of his blood—how many 'g%' of haemoglobin. This is what we want to know about our patients, and this is the way in which their haemoglobin is reported. Measuring haemoglobin in blood has merely been taken as an example of the way in which we can measure things by their colour in the Lovibond comparator. The complete way to measure haemoglobin is given in Section 7.1.

It is easy to measure something red like haemoglobin, but how do we measure something which is white like sugar? What we do with colourless things is to make a colour with them. We add chemicals to a specimen of blood so that the sugar in it makes a blue colour. We measure the depth of this blue colour in the same way that we measure the depth of a red haemoglobin solution. The more sugar there is in the blood, the deeper will be the blueness. In the same kind of way we make a brown colour with the urea in the blood and measure the depth of the brown colour. The deeper the brown colour the greater must be the blood urea.

We can use a Lovibond comparator to measure the blood urea and the blood sugar. There are two Lovibond discs with blue glass standards for measuring the blood sugar. There are also two discs with brown glass standards for the blood urea. Two Lovibond discs are used with each of these methods, because there are not enough glass standards in one disc alone. One disc in each pair has glass standards for the lower amounts of sugar or urea. The other disc has glass standards for the higher amounts of sugar or urea. The Lovibond comparator is quite cheap and is the best machine for health centres and most outpatient departments.

The following method tells you how to use the

Lovibond comparator after you have made the test solutions for haemoglobin, sugar, or urea. These are described in Section 7.1 (haemoglobin), Section 7.42 (sugar), and Section 7.41 (urea).

METHOD

USING THE LOVIBOND COMPARATOR

Put the test solution in the right-hand hole of the comparator. Put a Lovibond cell full of water in the left-hand hole.

Hold the Lovibond comparator up to the sky or to a bright window to read it—look at Picture B in Figure 5-5.

When trying to find a glass standard to match the test solution, put your thumb over the answer hole and *don't look at the answer until you have found a match.* You will then get the right answer, not the answer you think you want. When you have found an answer, try to get a match again, and see if you get the same answer. If you don't, try a third time. You may have to give an average of several answers.

Sometimes you will find that your test solution is darker than one standard and paler than another. For example, it might be darker than the 5 g% standard and paler than the 6 g% standard. When this happens give the answer as half-way between them—5½ g%.

Keep the Lovibond discs clean. They come in plastic boxes. As soon as you have finished using a disc, put it back in its box. You will not get a good match with a dirty disc. If the glass standards get dirty, clean them with a clean cloth.

USE ONLY LOVIBOND TUBES; OTHER TUBES WILL GIVE THE WRONG ANSWER.

THE GREY WEDGE PHOTOMETER

5.11 The 'Grey wedge' (FIGURES 5-6 and 5-7)

The full name for this instrument is the MRC (Medical Research Council) grey wedge photometer (light measurer). We will call it the 'Grey wedge'. Look at it in Picture A, FIGURE 5-6.

In the Lovibond comparator the test solution is put in a Lovibond cell or test tube. In the Grey wedge the test solution is put in a glass cell. Look at these in Pictures D and E, FIGURE 5-6. In the Lovibond comparator the standards are round pieces of coloured glass. In the Grey wedge the standard is a grey ring or wedge. This is how the Grey wedge gets its name. This grey wedge is on a circle of glass inside a metal wheel. Look for this wheel in Picture F, FIGURE 5-6. You can see the wheel as if it were cut in half. In Picture B, FIGURE 5-7, this wheel has been taken out of the instrument. You can see the glass circle in the middle of the wheel. On the edge of the glass circle you can see the wedge. One part of the wedge is nearly white, but, as you go round the ring, it gets darker and darker until it gets nearly black. A wedge is something which is thin at one end and thick at the other.

The wedge here is an optical or light wedge. It is 'thick to light' (very dark grey or opaque) at one end and 'thin to light' (nearly clear or transparent) at the other end. The dark end and the light end of the wedge have been bent round in a ring or circle until they meet.

Light goes to the cell full of test solution through the clear middle part of the glass circle. Light goes to a cell full of water through part of the grey ring. The light from the test solution and the light from the water are brought together by a prism and lenses (see Section 6.2). You look at this light through an eyepiece. The view through this eyepiece is shown in Pictures B and C in FIGURE 5-6. The light from the test solution is at the left of the field

of view, and the light from the grey ring is at the right. In Picture B, FIGURE 5-6, the two halves of the field of view through the eyepiece do not look the same: the right is darker than the left. If you turn the wheel and look through a different part of the grey ring, the two halves of the field of view can be made to look the same. This has been drawn in Picture C. The wheel has been turned so that a less dark part of the ring is behind the water cell. The right hand half of the field of view is lighter and is now the same as the left. Notice that the light from the test solution goes to the left in the eyepiece, and light from the wedge goes to the right. This is because light crosses over in the prism—look at Picture F, FIGURE 5-6.

A A GENERAL VIEW OF THE GREY WEDGE PHOTOMETER

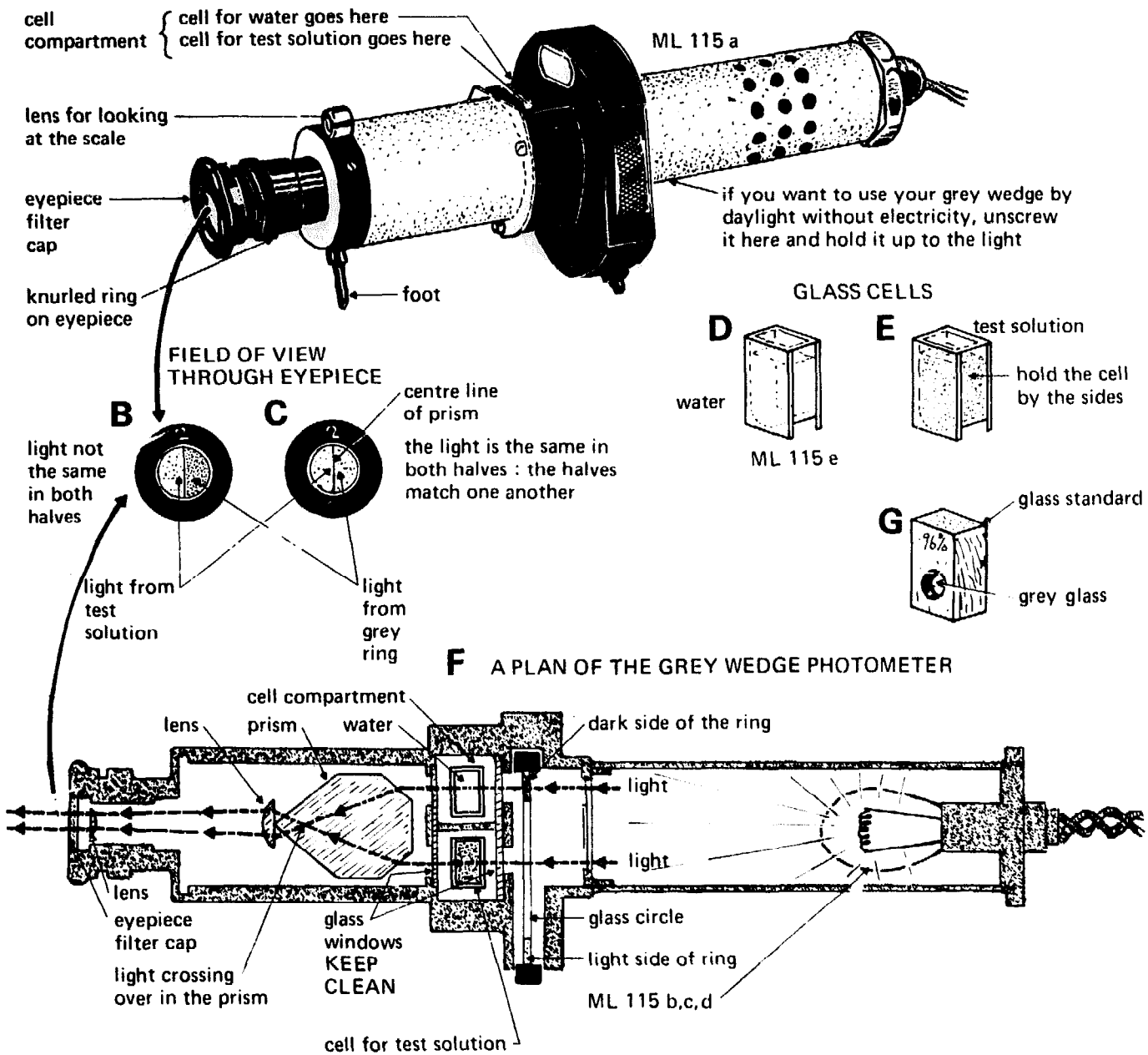

Fig. 5-6 The Grey wedge photometer

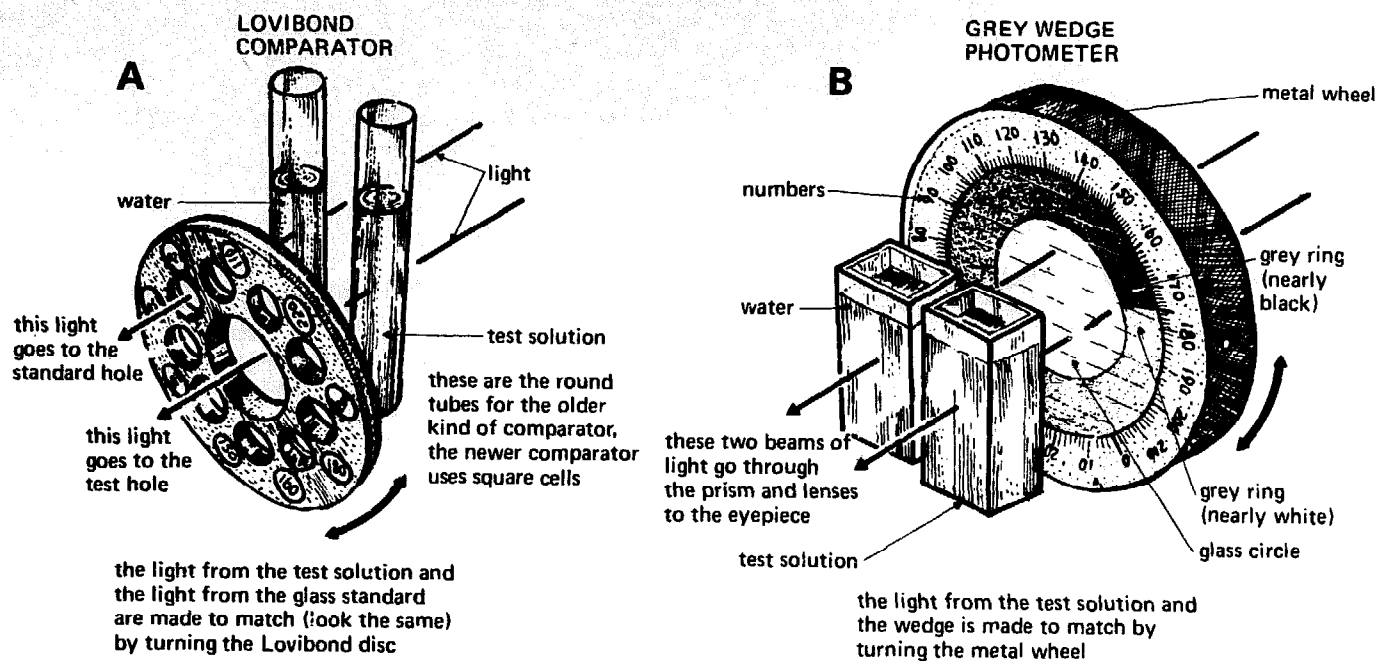

Fig. 5-7 The instruments compared

In the Lovibond comparator the meaning of each glass standard (the 'answer') is written on each Lovibond disc. In the Grey wedge what each part of the wedge means is written on the edge of the wheel—look at Picture B, FIGURE 5-7. There are many Lovibond discs—one or two for each method. But there is only one wheel for the Grey wedge, and the numbers that are written on it are for measuring the haemoglobin and the protein in the CSF. When the Grey wedge is used for measuring the blood sugar or the blood urea, the numbers on the wheel have to be changed (converted). Ways of changing these numbers to give the answer for the blood sugar and the blood urea are given in FIGURE 7-35. The numbers on the wheel and the ways you are given to convert them are **ONLY** for the methods given here. *The numbers on the wheel will only give you the right answer if you do EXACTLY what you are told in each 'Method'.*

5.12 Filters for light

Blood is red, and the glass standards on the Lovibond disc for measuring haemoglobin are also red. It is easy therefore to find a red glass standard which matches a red haemoglobin test solution. But the grey ring of the Grey wedge is grey. How can we match a red solution and a grey ring?

In trying to answer this you must understand that the white light from the sun that we see in the day (daylight) is a mixture of several colours. These are the colours of the rainbow or the colours of the **spectrum**. The rainbow is the curved line of colours that you sometimes see when the sun shines on rain as it falls from a cloud. White light from the sun is split into colours by drops of water in the cloud. The colours of the rainbow or the spectrum are red, orange, yellow, green, blue and violet. All these

colours mixed together in the right amount make white daylight. If we look at a test solution of haemoglobin in white daylight, it looks red because red light gets through the solution. The other colours, yellow, orange, green, blue, and violet, have all been held up (stopped or **absorbed**) by the haemoglobin solution. The more haemoglobin there is in the solution (the greater the concentration), the more will these other colours be absorbed. We want to measure the haemoglobin in the test solution; so *we measure the light which is absorbed, not the light which goes through (is transmitted)*. We must therefore measure light of some other colour, not red. We choose green light and use a piece of green glass called a **filter** in the eyepiece of the Grey wedge. Look for this eyepiece filter cap in Pictures A and F, FIGURE 5-6. A filter is called a filter because it lets light of only one colour go through (in our example green). It holds back light of the other colours of the spectrum (in our example red, orange, yellow, blue, and violet). When we look through the eyepiece, the view is green. When we turn the wheel and match the two halves of the field of view, we are finding a piece of the grey ring which is going to absorb the same amount of green light as the test solution of haemoglobin. Each place on the grey ring absorbs the same amount of green light as a certain concentration (amount) of haemoglobin. This haemoglobin concentration is written on the edge of the wheel.

When measuring the haemoglobin the numbers on the wheel have been worked out for one kind of green light only. This is the No. 2 green eyepiece filter. This filter is also used with a method given here for measuring proteins in the CSF. Two other eyepiece filters are also provided with the Grey wedge—they screw into the inside of the lid of the box that holds it. One is the red No. 1 filter which is used for the blood sugar. The other is the No. 3 filter which is a different kind of green and is

used for the blood urea. **THE RIGHT FILTER MUST BE USED FOR EACH METHOD. THE WRONG FILTER WILL GIVE YOU THE WRONG ANSWER.** This is also true for the EEL colorimeter.

5.13 The Haldane scale

The Lovibond haemoglobin disc (Number 5/37X) has the 'answers' 3, 4, 5, 6, 7, 8, 10, 12, and 14 for its nine glass standards. These are the number of grams of haemoglobin in 100 ml of blood (g%). But the wheel of the Grey wedge has numbers from 0 to 260 on it. What do they measure? The numbers on the wheel of the Grey wedge measure the patient's haemoglobin as a percentage of normal. This is called the **Haldane scale**. Normal on this scale is 14.6 g%; so a person who is 100% normal has 14.6 g of haemoglobin in 100 ml of his blood. The percentage way of measuring haemoglobin is an older way of doing it, and most people now use g%. There is a scale in FIGURE 7-1 with which you can change percentage on the Haldane scale into g%—or g% into percentage Haldane.

5.14 METHOD

USING THE MRC GREY WEDGE PHOTOMETER

FOCUSING ON THE CENTRE LINE

Turn on the light in your Grey wedge. Take out the cells from the cell compartment and turn the wheel to '10'.

Look at Picture A in Figure 5-6 and find the 'knurled ring on eyepiece'. Turn the knurled ring on the eyepiece one way and then the other. You will see the line in the middle of the field sharply (it will be '*in focus*'—see Section 6.7). As you turn the knurled ring more, the line in the middle of the field of view will get hard to see again (it will go 'out of focus'). Turn the eyepiece one way and the other until the centre line is sharply in focus. **WHENEVER YOU USE THE GREY WEDGE, MAKE SURE THAT THE EYEPIECE IS FOCUSED ON THE CENTRE LINE IN THE MIDDLE OF THE FIELD OF VIEW.**

CHECKING THE READINGS ON THE WHEEL

With every Grey wedge there is a little block of wood with a hole in it. This is the *standard block* and is shown in Picture G, Figure 5-6. Inside the hole is a little circle of grey glass. This grey glass is a standard to help make sure your Grey wedge is accurate. On the block is a percentage figure. In the block that has been drawn in Picture G this is 96%, but your block may be different. If the Grey wedge is accurate this standard should always read 96%. Put your standard *in the right-hand cell compartment*. **LEAVE THE LEFT-HAND CELL COMPARTMENT EMPTY.** Use the No. 2 eyepiece. Take the average of several answers. Is this average answer the same as that on the grey glass standard? If it is not

the same, always add on or take away the difference from every answer you get. If your average is 98%, you are reading 2% too high. Take away 2% from all your haemoglobin answers. If, for example, you read 37%, report 35%; if you read 82%, report 80%. If you should get an answer of 98% with your standard block and you get an average answer of 96%, add 2% to every answer you get.

MAKING A READING

Fill the left-hand cell with water. If possible use distilled water—see Section 3.15.

Put the test solution in the right-hand cell. **MAKE SURE YOU ARE USING THE RIGHT FILTER** (Haemoglobin No. 2, CSF protein No. 2, sugar No. 1, urea No. 3).

Look through the eyepiece. Match the right and left halves of the field of view by turning the wheel with smaller and smaller movements until both halves look exactly the same. Where possible take the average of several answers. Make some readings by starting with the right hand of the field too bright and others with it too pale. If, for instance, you get the answers 84, 83, 85, 86, 87, report the average which is 85 (see Section 1.3).

Don't look at the scale until after you have made your reading—this will help you to get the true answer and not the answer you think you should have.

SOME FURTHER POINTS

KEEP THE CELLS CLEAN. If cells get dirty, clean them inside with a swab of cotton wool on the end of an applicator stick.

Hold a cell by its sides. This will help to keep its back and front clean.

ALWAYS PUT THE CELLS INTO THE CELL COMPARTMENT WITH THEIR OUTSIDES DRY.

Keep the glass windows at the back and front of the cell compartment clean. If these get dirty, you will get the wrong answer. The best way to stop them getting dirty is to put only *clean* cells into the cell compartment. To see these glass windows, look into the cell compartment from the top. They are shown in Picture F, Figure 5-6. Are they clean?

Make sure that the cells are always nearly full, especially the water cell on the left. Light must go through water or solution in the cell, and not through air.

WASH AND DRY THE CELLS AS SOON AS YOU HAVE FINISHED WITH THEM. Never leave a cell full of test solution in the cell compartment of the Grey wedge.

Put your Grey wedge on a shelf, or on a box on the bench at a height that is easy for you to use when sitting down.

If you have not got electricity, use daylight. Unscrew the lamp house and hold the Grey wedge up to a brightly lit window.

Keep your Grey wedge in its box away from the dust, or make it a cover of plastic sheet to keep the dust off.

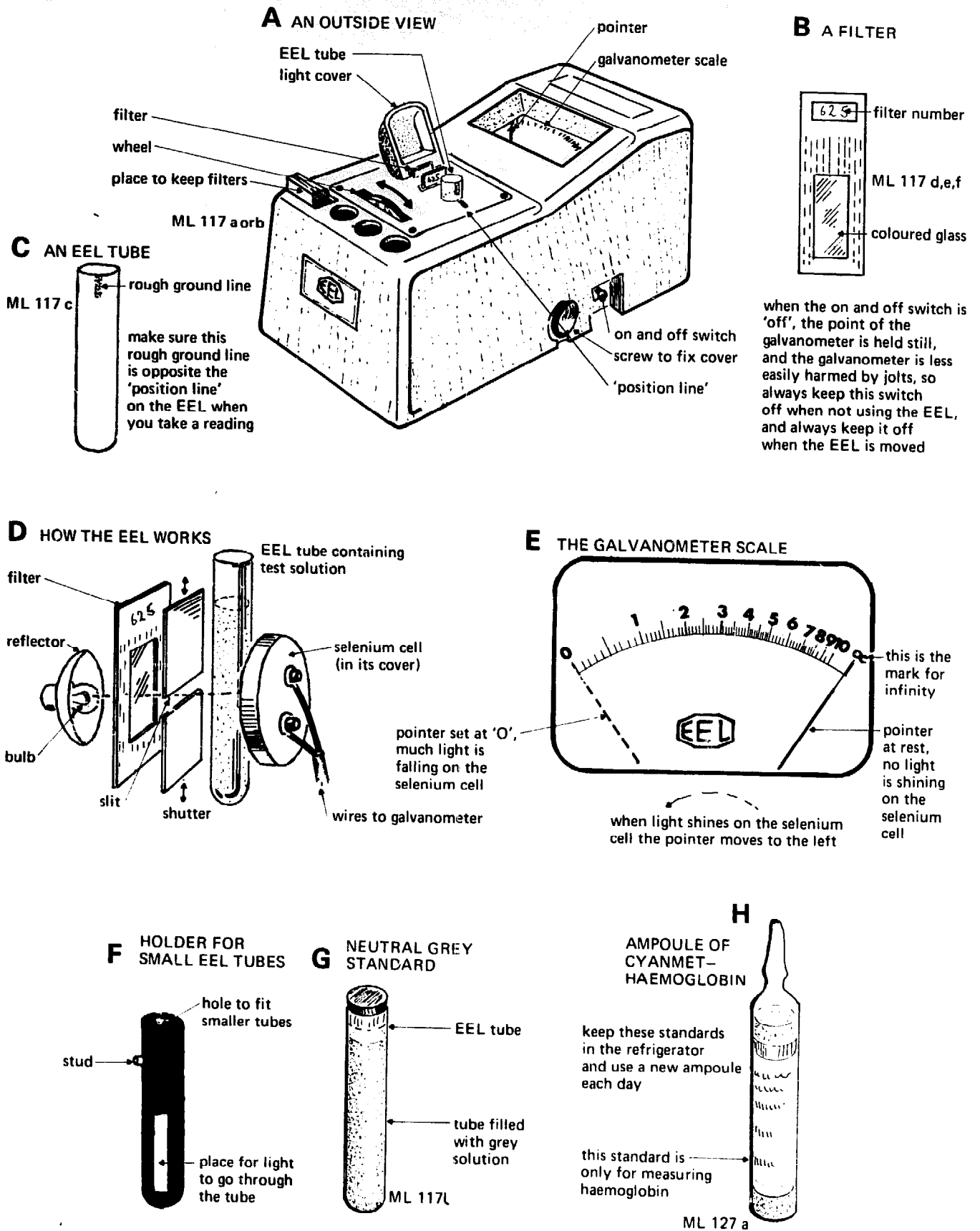

Fig. 5-8 The EEL colorimeter

THE EEL COLORIMETER

5.16 Measuring colour with electricity (FIGURE 5-8)

With an EEL colorimeter (colour measurer) we can measure the depth of the colour of any coloured solution. The measuring is done with electricity, and there is nothing to be matched by eye (unlike the Lovibond comparator or the Grey wedge). The instrument is called the EEL colorimeter after the people who make it (Evans Electro Selenium Limited). We will call it 'the EEL'. The Lovibond comparator cannot go wrong. The Grey wedge seldom goes wrong, but the EEL does sometimes go wrong. This is one of the difficulties with the EEL, but if you have spare parts, you may be able to mend it. When the EEL is working properly, it is quick and easy to use and is more accurate than either the Lovibond or the Grey wedge.

The important part of an EEL is a flat piece of metal called a **selenium cell**—look at Picture D, FIGURE 5-8. (This is yet another use of the word 'cell'.) When light shines on a selenium cell, some of it is made into electricity. The more light that shines on the selenium cell, the more electricity will it make. When it is dark the selenium cell makes no electricity. Electricity from the selenium cell goes along two wires to a machine called a **galvanometer**. The galvanometer measures electricity. It has a hand or **pointer** and a curved line of numbers and graduations called the **scale**—look at Picture E, FIGURE 5-8. When no light falls on the selenium cell, it makes no electricity, and the pointer stays resting at the right-hand side of the scale: this is marked **infinity** or ' ∞ '. But when light falls on the selenium cell it makes electricity. This electricity goes to the galvanometer and makes the pointer move towards '0' at the left of the scale. With a selenium cell and a galvanometer we can therefore measure light. But how do we use them to measure the depth of a coloured solution?

Inside the EEL light comes from a bulb like the bulb of an electric torch—look at Picture D. Light from the bulb goes between two pieces of metal called the **shutters**. These shutters can be opened and closed like the shutters on a window. Between the shutters is an empty place called the **slit**. By moving the shutters we can make the slit big or small. The shutters can be opened and closed by turning the **increase light wheel** on the top of the EEL. Turning the increase light wheel to the right opens the shutters wide and makes the slit wide. Much light will go through the slit to the selenium cell. When the shutters are nearly closed (the increase light wheel turned to the left) the slit will be narrow, and little light will go through. Light from the slit goes through a special test tube called an **EEL tube**. Light which has gone through the EEL tube then goes through a coloured glass filter like that on the eyepiece cap of the Grey wedge (see Section 5.12). This filter lets light of only one colour fall on the selenium cell. The selenium cell turns this coloured light into electricity which moves the pointer across the scale of the galvanometer.

Now that you know something about the EEL, you

can learn more about how it works. First, you must get it ready to use.

5.17 METHOD

GETTING THE EEL READY

Unpack your EEL carefully. You will see a 'Warning notice' under the glass of the galvanometer. Take this out of the EEL by unscrewing the 'screws to fix cover' (Picture A, Figure 5-8). Read this notice carefully.

USING THE EEL WITH MAINS ELECTRICITY

You will see a large thick wire coming out of the EEL. Inside it are three small wires: a green and yellow wire, a blue wire, and a brown wire. Join the green and yellow 'earth wire' to the big brass (metal) pin at the end of the plug. The blue and the brown wires can go to either of the other two pins. See that the mains/battery switch on the right at the front of the EEL is turned to 'mains'.

USING THE EEL WITH A BATTERY

Fix two wires to each of the two screw terminals (a terminal is something an electric wire is fixed to) at the back of the EEL. Fix the other ends of these two wires to a *two volt battery*. You can use a 2-volt dry battery or one cell of a car battery (used like this a cell is one of the parts of which a battery is made).

It is also possible to use a special battery for the EEL (ML II7k) which can be charged with a trickle charger (ML II7j) from the mains—see Section 3.8. Two kinds of battery can be recharged in this way. One is the *lead-acid* kind which is filled with dilute sulphuric acid and must be kept charged and topped up with water, just like a car battery. The other kind is a *nickel-iron alkali* battery, which is filled with caustic soda (sodium hydroxide) solution. This will not spoil if it is not kept charged. Fill whichever kind of battery you have with the right solution, and use it the way the instructions say.

Now that you have got your EEL ready, you can see how it works.

5.18 METHOD

LEARNING HOW THE EEL WORKS

Put the green filter Ilford No. 625 into the EEL. Ilford is the maker's name. Open the shutters wide by turning the increase light wheel to the right. Turn on the light and put a tube of plain water into the EEL. This tube of plain water is called the *blank* tube. Plenty of light will now go through the wide open shutters, through the blank tube, and fall on the selenium cell. The selenium cell will make plenty of electricity, and the pointer of the galvanometer will go rapidly beyond '0' at the left of the scale.

Close the shutters a little by turning the increase light

wheel to the left. The pointer will move to the right. Move the increase light wheel just enough for the pointer to come to '0' (this is shown by the dotted line in Picture E, Figure 5-8). *Like this the EEL is ready to use—light on, tube of water in place, filter in place, and the increase light wheel turned to bring the pointer to '0' on the scale.*

Take out the blank tube of water. Put a weak test solution of haemoglobin into the EEL: the pointer will leave the '0' mark and stop somewhere on the scale, say at 2. The dilute solution has absorbed (taken up or stopped) some of the light, and too little of it now reaches the selenium cell to make enough electricity to push the needle to '0'. Take out the pale coloured solution and put back the blank tube of water: enough light will again reach the selenium cell to send the needle to '0'.

Next put a strong solution of haemoglobin into the EEL. This solution will absorb more light than the dilute solution. Less light will fall on the selenium cell; it will make less electricity, and the needle will stop even further to the right at, let us say, 5 on the scale. *Therefore, the higher the scale reading, the greater must be the depth of colour of a haemoglobin solution, and the more haemoglobin there must be in it (the more concentrated it must be).* With the EEL colorimeter we can measure the concentration of any coloured solution, not only haemoglobin.

The numbers on the scale, from '0' at the left to 10 on the right, are placed to give a true measurement of the amount or concentration of the substances we are measuring. The numbers are far apart near '0' on the left and close together near '10' on the right. This kind of scale is different from the scale on a ruler where all the numbers are the same distance apart. A ruler has a 'linear' scale; the EEL has a 'logarithmic' scale.

5.19 Standards for the EEL

In the Lovibond comparator the 'answer' is written on the Lovibond disc. In the Grey wedge photometer the 'answer' is written on the edge of the wheel. These instruments are easy to use because they have standards inside them with which the test solution can be compared. In the Lovibond comparator these standards are the coloured glass windows on the Lovibond disc. In the Grey wedge the grey ring or wedge is the standard. But the EEL has no standard inside it. The EEL can only tell us that one solution is more deeply coloured than another and thus has more of a coloured substance in it. The EEL can also tell us exactly how much more: a solution for which the pointer reads 40 has twice as much of a substance in it as one for which the pointer only reads 20. But the EEL cannot by itself tell us what the figure 20, for example, means in grams percent of haemoglobin. Before we can use the EEL with any method we must have a standard whose value we know. *It is not possible to use the EEL without a standard.* The best standard to use for measuring haemoglobin is a solution of a kind of

haemoglobin called **cyanmethaemoglobin** (ML 127a, Picture H, FIGURE 5-8). In the same way it is possible to use standard solutions of sugar and urea when measuring the blood sugar and blood urea. But all these standards have difficulties and none of them keep well. We have thus to use another kind of standard called a **neutral grey standard** (ML II71, Picture G, FIGURE 5-8). This is a grey chemical solution which is sealed into an EEL tube and can be kept for many years. This neutral grey standard can be used for measuring the haemoglobin, the blood sugar, or the blood urea. The cyanmethaemoglobin standard can, however, only be used for measuring the haemoglobin.

The neutral grey standard is grey, not red like haemoglobin, but this does not matter because its job is to let through a standard amount of green light when used with a green filter. This green light is equal to that which would get through a tube of standard haemoglobin if we were to use one. All the methods for measuring haemoglobin on the EEL use the same green Ilford 625 filter.

Once you have understood how to use the EEL with one method it is easy to use it for other methods. We shall describe the measurement of haemoglobin as an example. What haemoglobin is and how the specimen is taken is described in Section 7.1.

All the methods for measuring haemoglobin in this book use 0.05 ml of blood added to 10 ml of solution. The blood and solution together measure 10.05 ml. This makes a dilution of one in 201 ($10.05 \div 0.05 = 201$). We usually forget the 'one' and say we have a dilution of 'one in two hundred'.

5.20 The cyanmethaemoglobin method

It is not easy to use the ordinary haemoglobin of blood for a standard for the EEL because it does not keep well. But, when haemoglobin is changed into cyanmethaemoglobin, it keeps better and can be used as a standard. These cyanmethaemoglobin standards are bought already diluted and sealed into ampoules, each box of ampoules having a slightly different value. These ampoules are labelled with their haemoglobin values in milligrams of haemoglobin per 100 ml. Most standards are about 60 mg per 100 ml.

0.05 ml of the patient's blood is taken into 10 ml of a special solution called **Drabkin's solution** (Section 3.31b). Drabkin's solution contains a little potassium cyanide and some potassium ferricyanide. It can be made up from chemicals or from special tablets (ML 127b). Drabkin's solution changes the haemoglobin in the patient's blood into cyanmethaemoglobin. The cyanmethaemoglobin in the test solution is then compared with the standard.

The cyanmethaemoglobin method is the most accurate one for measuring haemoglobin but has several difficulties. One of them is that, once an ampoule of standard has been opened, it only keeps for a day. At the end of a day it must be thrown away. The unopened ampoules only keep for a few months and have to be stored in a

refrigerator. Also, Drabkin's solution is made with cyanide, and, although it contains so little cyanide that it is not dangerous by itself, the solid cyanide from which it is made is *very dangerous indeed* (see Section 8.9).

METHOD

MEASURING HAEMOGLOBIN USING THE CYAN METHAEMOGLOBIN STANDARD

Make Drabkin's solution either by dissolving one of the special tablets in water, or by the method described in Section 3.31b.

Measure 10-ml volumes of Drabkin's solution into universal containers or EEL tubes.

Add 0.05 ml of the patient's blood to the Drabkin's solution, following the method described in Section 7.1.

Mix well and let the mixture stand for ten minutes. During this time the red cells will lyse, and the cyanide and ferricyanide in Drabkin's solution will make the patient's haemoglobin into cyanmethaemoglobin.

Take an ampoule of standard from the refrigerator and let it get warm in the room for ten minutes. Make a small scratch on the neck of the ampoule with a file. Break open the ampoule and pour it into an EEL tube. This is your standard solution.

Put a green Ilford 625 filter into the EEL.

Put an EEL tube of plain Drabkin's solution into the EEL. This tube is called the 'blank'. Adjust the increase light wheel to bring the pointer to '0' with the 'blank' in place.

Quickly take out the blank tube and put in the standard. Take a reading. Put the blank back and bring the pointer to '0' again.

Put back the standard—Do you get the same reading? If you do, go on to the next step. If you do not, take the average of several readings (see Section 1.3).

Do exactly the same thing with the test solution—set the pointer to '0' with the blank tube of Drabkin's solution, and take the average of several readings if necessary.

You will now have a reading for your standard solution and a reading for your test solution. Work out the answer in the following way:

$$\text{Patient's haemoglobin in g \%} = \frac{\text{Test reading}}{\text{Standard reading}} \times \frac{\text{Figure on ampoule}}{5}$$

Say your standard reads 40, your test reads 20, and the figure on the ampoule reads 59.8 mg of haemoglobin per 100 ml. Your calculation would be:

$$\frac{20}{40} \times \frac{59.8}{5} = 5.98 \text{ g \%}, \text{ say } 6 \text{ g \%}, \text{ of haemoglobin.}$$

We get the figure '5' in the working out above like this:

$$\frac{\text{Haemoglobin value of the standard in grams \%}}{\text{Haemoglobin value on the ampoule in milligrams \%}} = \frac{\text{Haemoglobin value on the ampoule in milligrams \%}}{1,000} \times 201$$

201 can be divided into 1,000 very nearly five times. 201 is what is called the 'dilution factor' and is the number of times that you are going to dilute the blood to make the test solution. If you are using other blood pipettes than the 0.05-ml pipette we describe here and volumes of Drabkin's solution other than 10 ml, you will have to work out a different dilution factor.

Answers are more easily worked out with the help of the graph described below. To make this graph you will need the value of the standard. Get this by dividing the haemoglobin value in mg % found on the ampoule by 5. *It will probably be different with each box of ampoules.*

5.21a Oxyhaemoglobin methods

In these methods 0.05 ml of blood is taken into 10 ml of dilute sodium carbonate or ammonia solution. These chemicals lyse the red cells and let out their haemoglobin into the solution. Oxygen (a gas from the air) turns the haemoglobin into oxyhaemoglobin. This oxyhaemoglobin is usually just called 'haemoglobin' and can be measured with the Lovibond comparator, the Grey wedge, or the EEL (see Section 7.1).

METHOD

MEASURING OXYHAEMOGLOBIN USING THE EEL AND A NEUTRAL GREY STANDARD

Make your test solution from 0.05 ml of blood and 10 ml of sodium carbonate or ammonia made as described in Section 3.31.

Take readings of the standard and the test solutions exactly as described above, using an Ilford 625 filter and a water blank

$$\text{Patient's haemoglobin in g \%} = \frac{\text{Test reading}}{\text{Standard reading}} \times 14.6$$

This will be easier to work out if you use the graph described in the next section.

5.21b Using a graph

It wastes time to do a sum every time we measure a patient's haemoglobin, and it is easier to use a graph like that in FIGURE 5-9. A graph is a special picture for doing arithmetic. This graph is drawn on squared paper, but in case you have not got any squared paper, FIGURE 5-10 has been drawn for you. It is at the end of the book with the other figures you can tear out. There is nothing on the back of this Figure, so that you can cut it out of this book and use it in your own laboratory. FIGURE 5-10 is rather small, and it is better to find a larger piece of graph paper and use that. There are more accurate ways of making a graph for the EEL, but this is the easiest way.

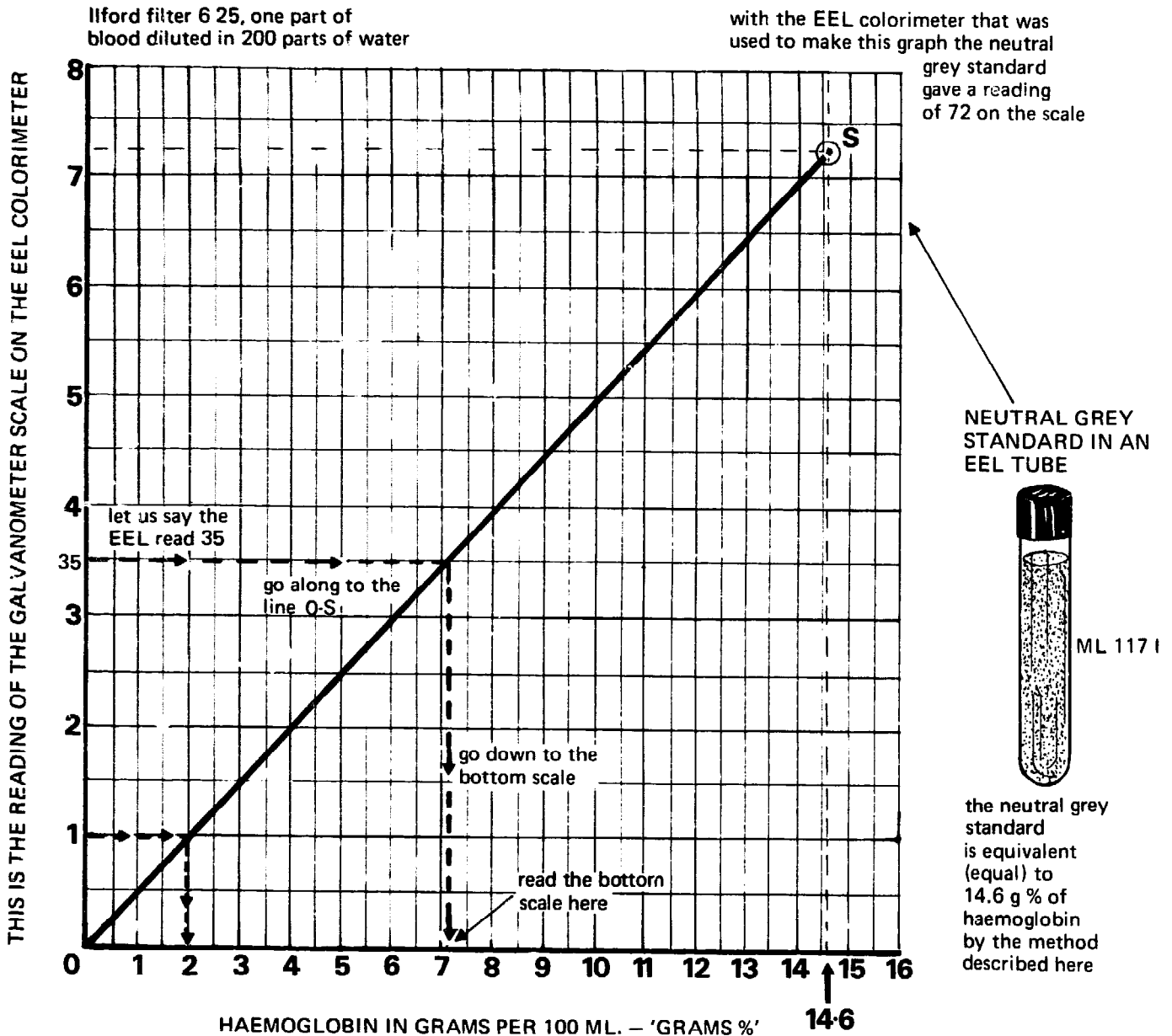

Fig. 5-9 A graph for the EEL

METHOD**MAKING A GRAPH**

Take a piece of squared paper. Make a scale along the bottom to show the haemoglobin in grams from 0 to 16. Make a scale up the side from 0 to 8 for the EEL reading.

The cyanmethaemoglobin standard, and the liquid grey standard can both be used to make a graph. Let us say, for example, that you are using the liquid grey standard which is equal to 14.6 g % of haemoglobin. Using the Ilford 625 filter, you find perhaps that this standard gives a reading of 72 on the scale of the EEL. Find the 14.6 line on the bottom scale of the graph and find the 72 line on the scale at the side. Make a point (a dot) called S (S for standard) at the place where these lines cross. Join S to 0 on the scale.

Using this graph is very easy. Let us say your test

solution gives a reading of 35 on the EEL. Find where 35 comes on the scale at the side. Go along to the 35 line until you get to the line from 0 to S. When you come to this line go down to the bottom scale. This will give you the haemoglobin in your test solution in g %.

Used like this your graph (FIGURE 5-10) will soon get dirty. It is better to get an old X-ray film and wash off the emulsion with hot water—the emulsion is the 'paint' on the film that makes the X-ray picture. The film will go clear. Cut a piece of cardboard and a piece of film the same size as FIGURE 5-10. Put the figure between the cardboard and the film and put sticking plaster round the edge. Mark point S with grease pencil. Draw the line from S to 0 with grease pencil. Better still, get a strip of X-ray film about one inch wide. Scratch a line on it and use this instead of grease pencil as your line from 0 to S.

This is narrower than a grease pencil line, and you can move it if the place of your S moves. Fix the strip where you want it with surgical tape or drawing pins.

The reading given by a standard may change, so, **CHECK THE READING GIVEN BY ANY STANDARD YOU USE OFTEN—AT LEAST EVERY DAY.** If it changes, move point S on your graph, and join a new line from 0 to S. This is another reason why it is better to cover FIGURE 5-10 with X-ray film and use a strip of film with a line on it for the line from 0 to S.

METHOD

MAKING THE BEST OF YOUR EEL

Don't keep your EEL on the same bench as a centrifuge. The continual shaking of the bench will harm the EEL. Keep it on a bench where it will not be shaken. If this is not possible, keep it on a soft thick rubber mat, or on several layers of blanket.

Before you use an EEL, switch it on for about 5 minutes and leave it with the shutters closed (the increase light wheel turned as far as it will go to the left). An EEL is more accurate if it has been warmed up like this.

Make sure that there is enough test solution or water in an EEL tube to cover the path of the light going through it. *This means that EEL tubes must be at least two-thirds full.*

Keep the EEL switched on all the time when several tests are being done. Don't switch it on and off each time a tube is put into it. Do switch it off if you are not going to use it for more than about 15 minutes. Don't leave the EEL on when you go for lunch!

After every reading with a test or standard solution, always make sure that the pointer still reads '0' when the 'blank' tube is put back into the EEL.

Read the place where the needle comes to rest rapidly. Don't spend too long watching the needle before taking a reading.

Close the light cover (Picture A, Figure 5-8) when taking a reading. This stops light from the room getting to the selenium cell.

Keep the light cover closed when the EEL is not being used.

EEL tubes have a rough (ground) mark on them. Look at Picture C in Figure 5-8. Turn an EEL tube so that this ground glass line always comes opposite the 'position line' on the top of the EEL. Look at Picture A, which shows this. You will get a more accurate answer if you always keep an EEL tube turned to the position line like this.

Make sure the EEL tubes are clean and that there are no bubbles on the sides of the tube when you take a reading. Hold tubes by their tops, and put them into the EEL dry.

Unless you are using the EEL, keep the ON-OFF switch turned OFF. This protects the moving parts of the galvanometer. Don't put the needle to the right

merely by closing the shutters. **ALWAYS CARRY OR TRANSPORT AN EEL WITH THE SWITCH TURNED OFF.**

THE EEL IS AN EXPENSIVE INSTRUMENT AND EASILY BREAKS. LOOK AFTER IT CAREFULLY.

5.22 When an EEL goes wrong

You will need some spare parts or spares. The most important of these are spare bulbs. There are special clips (holders) to hold these spare bulbs inside the EEL at the back of the galvanometer. Some bulbs give much more light than others. You should also keep a spare selenium cell because you will probably have to put a new selenium cell in your EEL about once every 18 months. Make sure your spare cell is kept well wrapped up in a dark place. It is also useful to keep a spare galvanometer. But this is expensive, and there is no need for every laboratory to have one. If there are three or four in a medical Store or Central Laboratory, they can be used as they are needed. Galvanometers which do not work can usually be mended by the makers.

Here are some of the things that can go wrong with an EEL.

The pointer does not move when the light is switched on.

Is any light coming from the bulb? Look down the hole in the top of the EEL and see.

1. There is no light.
 - (a) Is the EEL plugged into the mains? Or joined to the battery?
 - (b) Is the bulb loose? Screw it in (see Section 5.23).
 - (c) Has the bulb broken? Put in a new bulb (see Section 5.24).
 - (d) Has the fuse in the mains plug fused (broken)? Put in a new fuse.
 - (e) Is the 'mains-battery switch' rightly switched?
2. There is light.
 - (a) Is the stud (a stud is a short rod) of the tube holder in its slot (hole)? If it is not, the tube holder may be turned round and may be blocking the path of the light from the bulb to the selenium cell. See that the rod is in the slot. A tube holder is used for holding smaller sized tubes, and is shown in Picture F, FIGURE 5-8.
 - (b) Are the 'contacts for the selenium cell' loose? Tighten them up (see Section 5.25).
 - (c) Is the selenium cell working? Put in a new selenium cell (see Section 5.25).

The pointer does not reach '0' with a blank EEL tube of water in place, or the pointer moves very slowly.

- (a) Is the EEL tube full of water? Fill it up.
- (b) Is the filter clean? Clean it.
- (c) Is the reflector clean? Clean it with a soft cloth.
- (d) Is the stud of the tube holder in its slot? See that it is.

(e) The bulb may not be giving enough light. Try using a new one.

(f) Is the selenium cell working? See if you can focus the light better (see Section 5.23). If this does not work, change the selenium cell (see Section 5.25).

The pointer does not move back to infinity (Picture E, Figure 5-8).

The pointer should always be at ∞ when the switch is ON, the light cover closed, and the EEL not joined to the mains or the battery. If the pointer is not at ∞ , it needs adjusting. Look at FIGURE 5-11. Turn the infinity adjusting screw until the pointer comes to infinity. If the pointer sticks and does not come to infinity, change the galvanometer. The EEL will not work accurately unless the pointer comes back to infinity.

The EEL sometimes works well and sometimes does not.

The wires and the terminal screws of the bulb, selenium cell, or battery may be loose. Tighten them up, and if necessary change the bulb or the selenium cell.

The pointer sticks, stops, or moves in jerks.

The galvanometer is not working. Try very gently tapping the infinity adjusting screw with your fingers. The pointer may become free. If the pointer does not become free, change the galvanometer.

Here are some other things you can do to mend EEL.

You never seem able to get the same reading twice.

If you have a mains EEL it may be because the (strength) of the mains electricity keeps changing, a common cause of trouble, and the only way to fix it is to use a battery. You can use a large 2.5-v battery. Even better is an accumulator (ML 117k trickle charger (ML 117j). An accumulator stores electricity and can be charged (filled up) from the mains by the trickle charger. This is described in Section 3. Mains electricity may alter but the electricity from a battery will be constant (the same) and will give a steady reading.

Another reason may be that there is a loose contact somewhere. So, see that the lamp is firmly screwed that the contacts for the selenium cell are not loose and that the wires to the mains or battery have not come loose.

5.23 METHOD

FOCUSING THE BULB OF THE EEL, FIGURE 5-11

Unscrew the knobs holding the cover and take the cover off. Turn on the light; put in the filter you want.

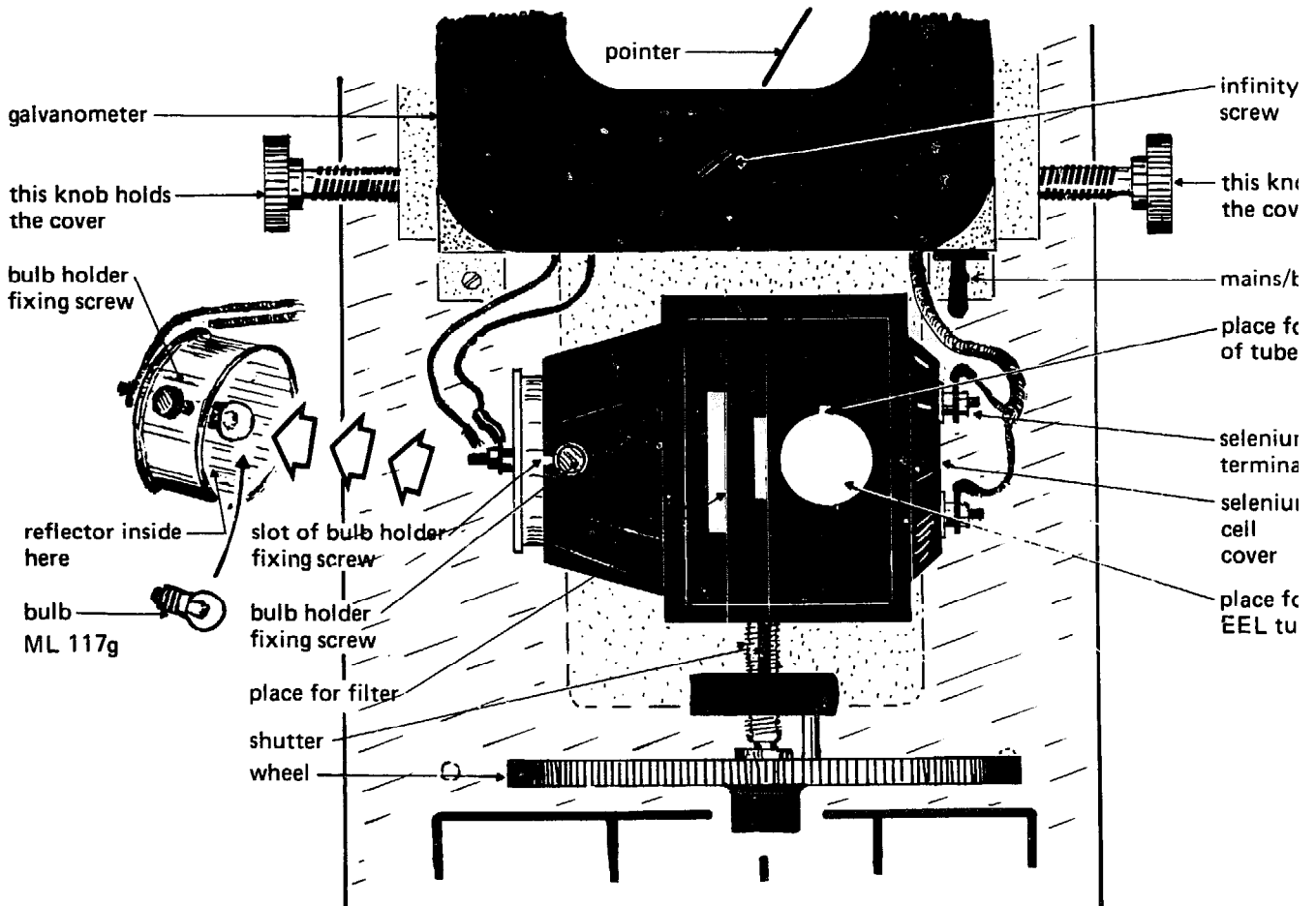
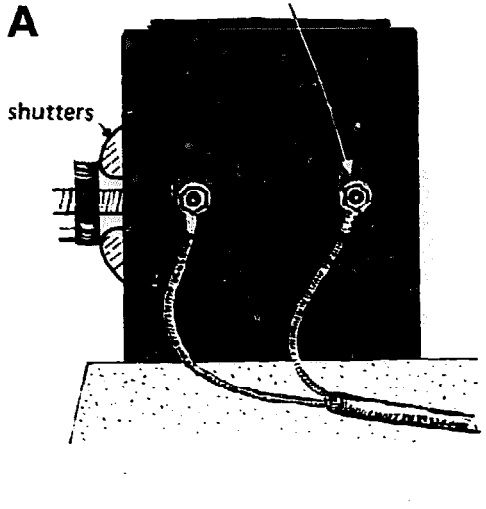
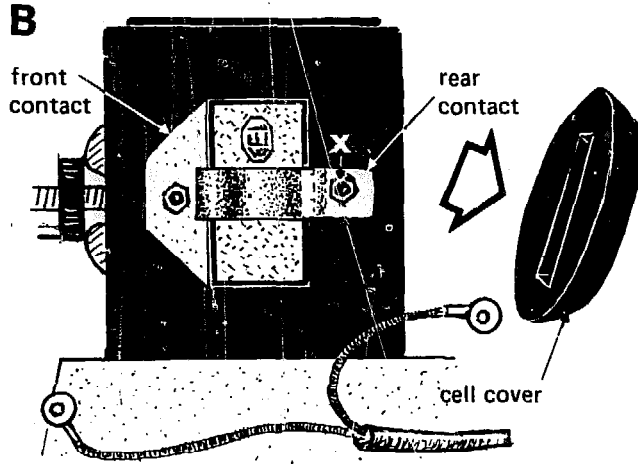

Fig. 5-11 Changing a bulb on the EEL

BEFORE STARTING
selenium cell terminal screws



WITH THE CELL COVER REMOVED



WITH THE SELENIUM CELL REMOVED

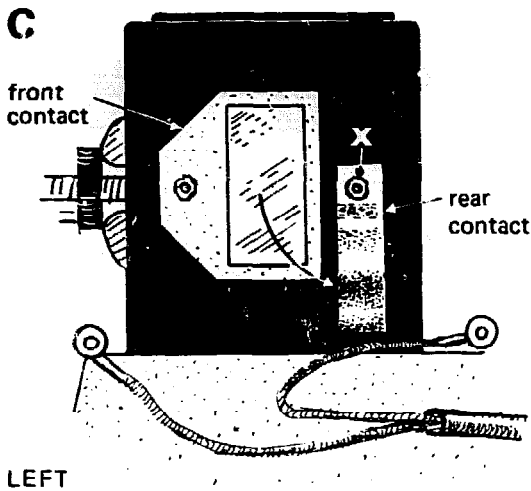

THE SELENIUM CELL TAKEN OUT

D ML 177h

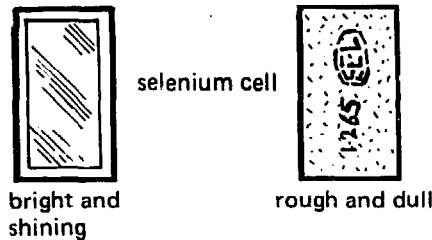

LEFT

RIGHT

Fig. 5-12 Changing a selenium cell on the EEL

use and also a tube of water. Turn the wheel as far as it will go to the left to open the slit. Loosen the 'bulb holder fixing screw' and move the bulb holder in and out of the 'slot' shown in the figure until the pointer is furthest to the left. There will be one place in the 'slot' where the bulb will be focused on the selenium cell and where the pointer will move furthest to the left. When you have found this place, tighten up the bulb holder fixing screw.

5.24 METHOD

CHANGING THE BULB IN THE EEL, FIGURE 5-11

Unscrew the knobs holding the cover and lift it off. Loosen the bulb holder fixing screw and gently pull out the bulb holder as shown. Put in a new bulb. Screw it tight. If this is your last bulb, order some more. Put back the bulb holder. Tighten up the bulb holder fixing screw and put back the cover. If necessary, focus the bulb as described in the method above.

5.25 METHOD

CHANGING THE SELENIUM CELL OF THE EEL, FIGURE 5-12

Take off the cover of the EEL as described above. Find the selenium cell cover and see which coloured wire is going to the terminal screw on the right and which to the terminal screw on the left. Remember these colours. Unscrew the 'selenium cell terminal screws'. Take the wires, nuts, and washers off the 'selenium cell terminal screws'. Take off the 'selenium cell cover'—Picture B. Loosen the nut 'X' on the 'rear contact'. Move the 'rear contact' downwards, as shown by the arrow in Picture C. Take out the selenium cell.

Put in a new selenium cell—the shining front side must be next to the glass. Put back the rear contact and tighten up the nut 'X'. The selenium cell must be tightly held between the contacts. You may have to bend the rear contact so that the selenium cell is tightly held. Put back the selenium cell cover and the nuts and washers of the selenium cell terminal screws. Put the wires back

exactly as you found them. First there is the cover, then a washer, then a nut, then the wires, and then, last of all, the second nut. Tighten the nuts—but not too much or you may break the cover. Put back the cover.

QUESTIONS

1. Give some examples of fractions and decimals of a gram.
2. Name and draw diagrams of the various pieces of equipment that can be used to measure the volumes of liquids.
3. Describe the way in which we can use colour to measure the concentration of a substance in a solution.
4. What must you do to get accurate readings with an EEL? In what ways can an EEL go wrong, and how can it be put right?
5. How would you use the Ohaus balance to weigh 31 g of sodium carbonate?
6. Why do we measure 'depth of colour' in a medical laboratory?
7. Describe the Lovibond comparator and the way it works.
8. What must you do to make sure you get an accurate reading with your Grey wedge photometer?
9. What is a filter? Why are filters used on the Grey wedge photometer and the EEL colorimeter?
10. What are the advantages and disadvantages of the liquid grey standard that can be used with an EEL colorimeter?

6 | The Microscope

6.1 The μm

The microscope is the most important machine in a medical laboratory: it is often the most expensive machine also. If you are going to make the best use of

your microscope, you should read this chapter very carefully several times. Most of the pictures are of the Olympus Model K microscope, which is shown in FIGURE 6-1. But most of what is said in this chapter is true for all microscopes. Olympus is the name of the

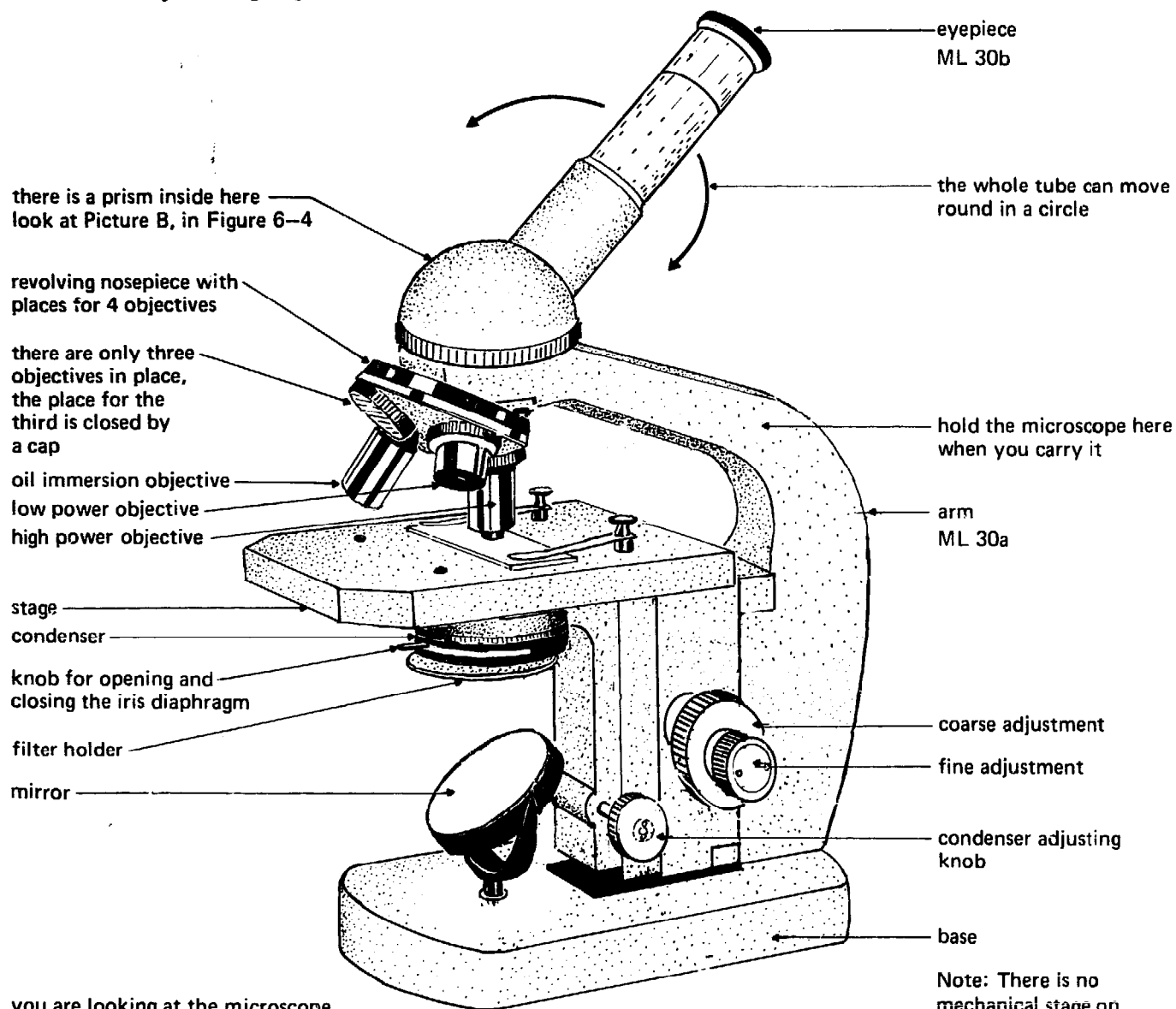

you are looking at the microscope from the left hand side : make sure you put your own microscope the same way round as this picture

Fig. 6-1 The Olympus Model K microscope

maker of the microscope. It is not easy to learn about the microscope. But it will help you to learn if you have your microscope beside you when you read this chapter. **WHEN YOU READ THIS CHAPTER, PUT YOUR MICROSCOPE THE SAME WAY ROUND AS THE MICROSCOPE IN THE PICTURES.** The person in FIGURE 6-2 is reading this chapter, and he has his Olympus Model K microscope beside him on the bench. He has put it round exactly the same way as the picture of the microscope in FIGURE 6-1. In this way he can easily find the places which all the arrows in FIGURE 6-1 point to.

But, first of all, why do we use a microscope in a medical laboratory? We need a microscope because many of the things that we want to find in our patients are too small to see with our eyes. We need a machine with which we can see very small things. This is what a microscope is: 'micro' means small; and scope means 'something for looking with'.

How small are the things that we see with a microscope? To think about this it is best to start with the size of something we know. We will choose an ordinary foot ruler. This has been drawn in FIGURE 6-3. One side of this is divided by many short lines into inches, and the other side is divided into 'centimetres'. Each of these

sides is a scale. One scale is in inches and the other in centimetres. Centimetres are called centimetres because there are a hundred of them in a metre—the word 'cent' means a hundred. A metre is about three feet, but we are not interested here in anything as long as a metre. On our ruler a centimetre is divided into ten 'millimetres', which are the smallest graduations or divisions (little black lines) you can see. They are called milli because 'milli' means one thousand. There are a thousand millimetres in one metre.

The smallest thing that we can see with our eyes is about a fifth part of a millimetre across. But with a microscope we can see much smaller things than this. We cannot use millimetres to measure these small things, because even millimetres are much too big. Instead we use the ' μm '. 'm' is short for a metre. ' μ ' is short for the word 'micro', which, when used like this, means 'a millionth'. As we have just seen, 'micro' can also be used to mean 'small'. A μm is thus a millionth part of a metre. Because there are a thousand millimetres in a metre, a μm is also a thousandth part of a millimetre (a thousand times a thousand makes a million).

One thousand μm are thus equal to one of the millimetre divisions on our ruler. With a microscope we can see things as small as one-fifth of a μm ! The idea of a μm

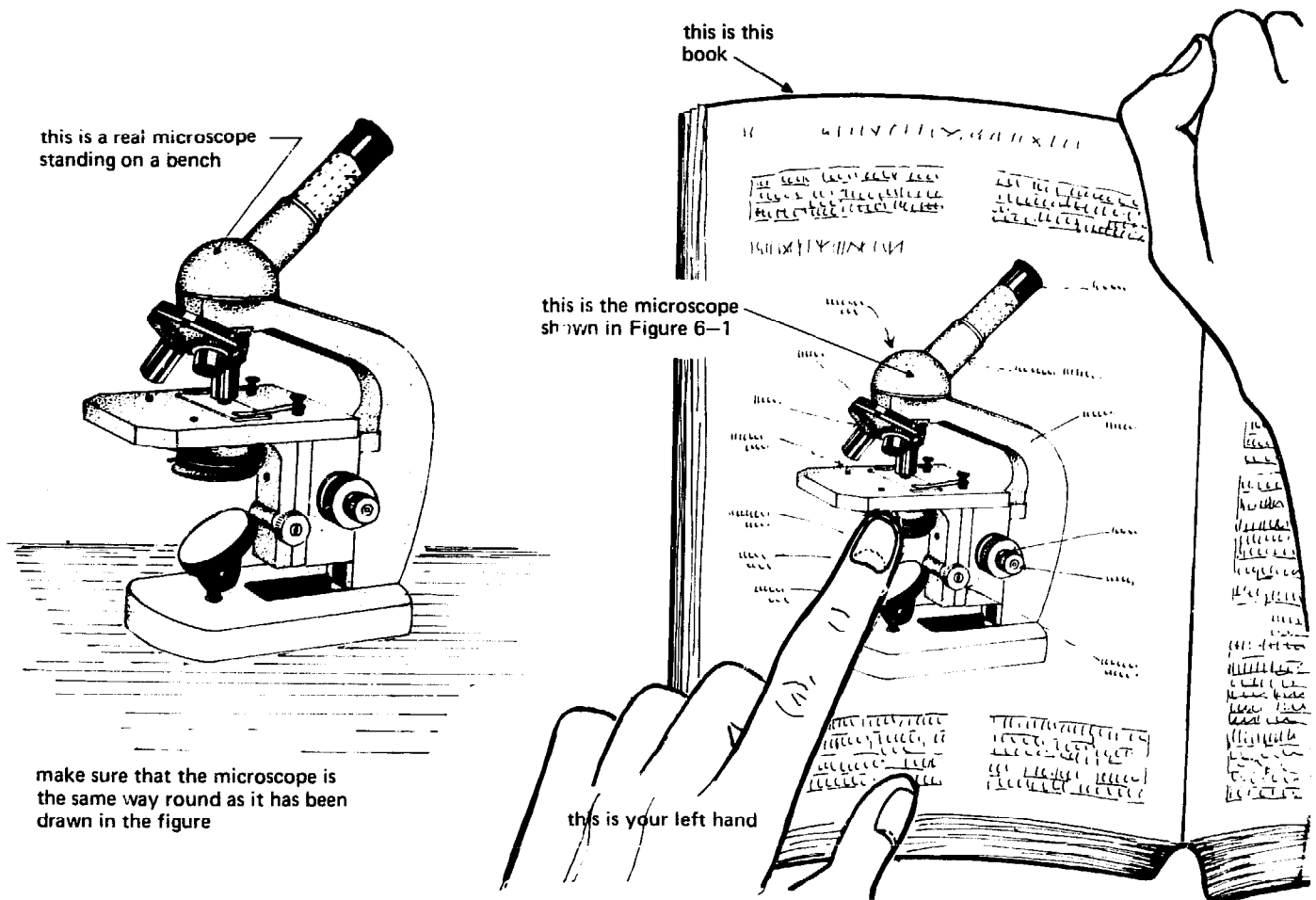

make sure that the microscope is the same way round as it has been drawn in the figure

Fig. 6-2 Finding the parts of the microscope

may not be easy, but unless you know about them it will not be easy to tell you about the things that can be seen with a microscope. We shall meet the μm in many of the chapters of this book.

Do your best to remember that the red blood cell is $7\frac{1}{2}$ μm across and that a coccus (see Section 1.14) is about $1 \mu\text{m}$ across. We should have to put a thousand bacteria side by side to make a line as long as one millimetre! These are very useful sizes to keep in your mind.

6.2 How a microscope works

A microscope is made of several lenses held together in metal tubes. A lens is a piece of smooth round glass. There are two lenses in a pair of spectacles. A microscope is like many spectacles held together in a special way.

The thing we want to look at under a microscope, such as a drop of our patient's blood, is called the **object**. The object is put on a piece of clear glass called a **slide**. The slide rests on the **stage** of the microscope. Light from a **lamp** shines on to a **mirror**. Light next goes into a part of the microscope called the **condenser** and then through the slide and on to the object. Light from the object goes

into a part of the microscope called the **objective**. This light then goes up a long empty **tube**, through something called the **eyepiece** and into your eye. The objective is near the object, and the eyepiece is near your eye. Look at the microscope in FIGURE 6-1 and in Picture A, FIGURE 6-4. Find the lamp, the mirror, the condenser, the slide, the object, the objective, the tube, and the eyepiece. Don't muddle up the *object* and the *objective*. The object is the thing that we look at with a microscope. The objective is the group of lenses that does the looking.

In describing the microscope we will follow the light from the lamp through to the eyepiece. We will leave the lamp until later in this chapter.

6.3 The mirror and the condenser

We put the object, such as a drop of blood, on a glass slide, because we want to shine a bright light on to it from underneath. This light is needed because the things we are looking at are very small. If they are not very brightly lit, we shall not be able to see them clearly. The light comes from a lamp or sometimes from the sky. It is made to shine on the object by going through several lenses in the condenser. Some microscopes have a lamp

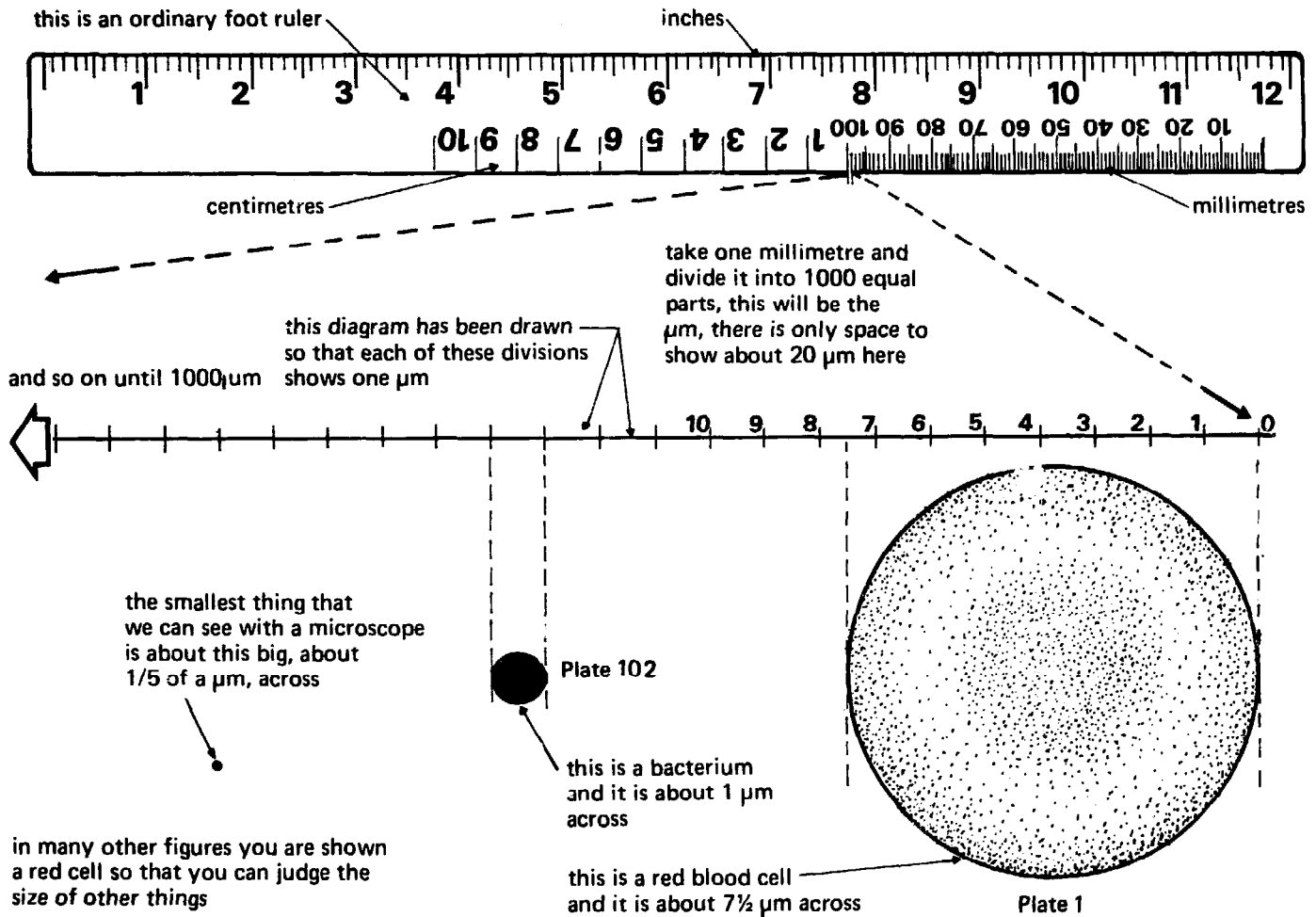

Fig. 6-3 The μm

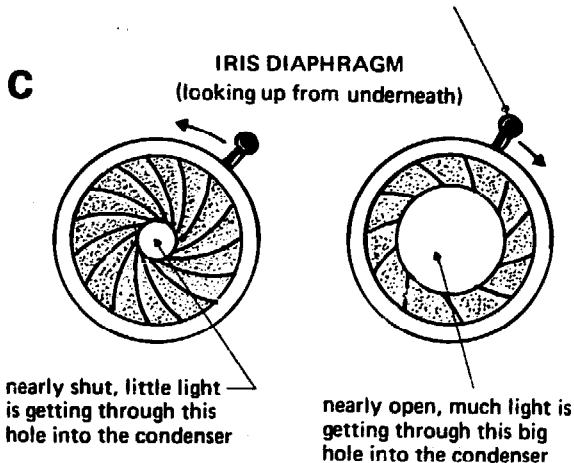
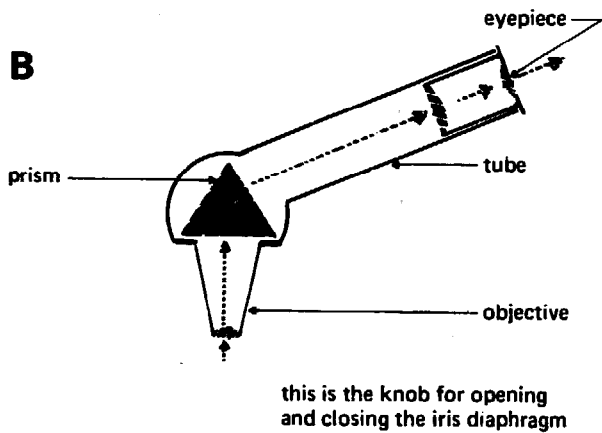
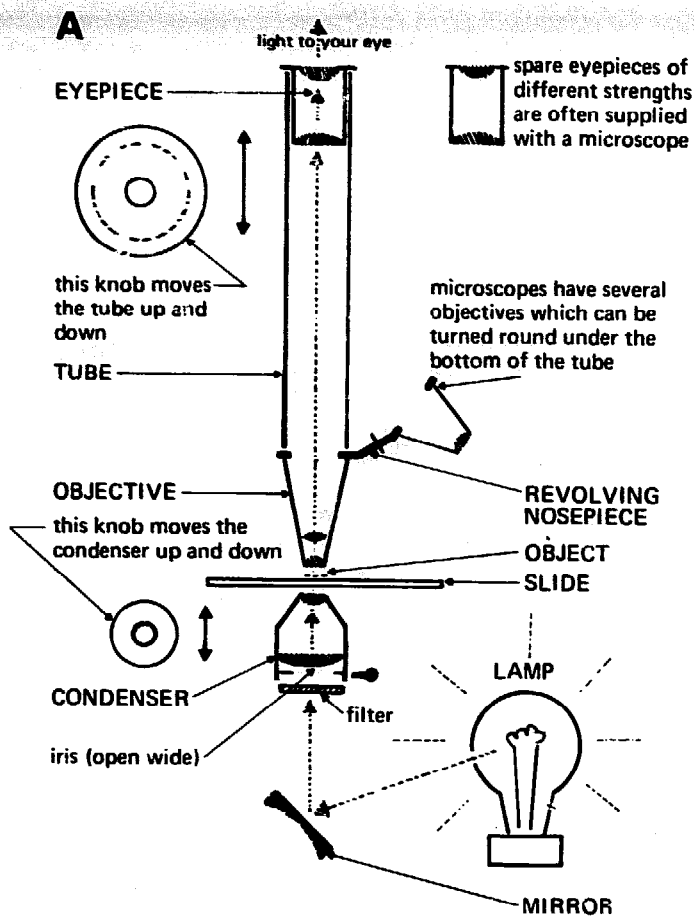

Fig. 6-4 How a microscope works

fixed just under the condenser so that the light can shine straight into it. Other microscopes have a separate lamp, and the light from this lamp shines first on to the mirror and then into the condenser. Because the lamp and the microscope are not always in the same place the mirror is made so that it can move. By moving the mirror we can shine light straight from the lamp into the condenser. The mirror has two sides. One side is flat (a 'plane' mirror); the other side is rounded and hollow (empty, a 'concave' mirror). *Look at your own microscope and see if you can find the plane and concave sides of the mirror.* You can take out the mirror by lifting it out of the hole it fits into in the base of the microscope. **AS A GENERAL RULE USE THE FLAT SIDE OF THE MIRROR.** If you use the light from the sky, use the concave side of the mirror.

Sometimes the object has to be very brightly lit; at other times less light is needed. The light shining on the object can be altered in two ways. The light can be made brighter by moving the condenser upwards until it almost touches the slide. The light can be made darker by moving the condenser downwards further away from the slide. All microscopes have a special knob for raising and lowering the condenser. *Find this knob for raising the condenser in Figure 6-6 and on your microscope. Turn it first one way and then the other way.* The condenser will go up and down.

The other way of shining more or less light on the objective is to open or close the 'iris diaphragm' (pronounced 'diafram'). *Find the 'iris diaphragm' in Picture C, Figure 6-4, in Figure 6-6, and on your microscope.* The iris diaphragm is at the bottom of the condenser. *Look at the condenser from below.* You will see the iris diaphragm better.

The iris diaphragm can be opened or shut by turning a special knob or ring on the condenser. *Find this 'knob for opening and closing the iris diaphragm' in Figure 6-6 and on your microscope. Move this 'knob for opening and closing the iris diaphragm' first one way then the other.* Look at the condenser from underneath and watch the iris diaphragm opening and shutting as you move this knob. When the iris is open, a lot of light goes into the condenser. When the iris is shut, only a little light goes into the condenser.

It is very important whether the condenser is high or low, and whether the iris diaphragm is open or shut. We shall say more about this later in Section 6.15. But we can say now that the iris is usually kept wide open, unless we are using low-powered objectives with a very bright lamp, or looking at very faint (hard to see) objects. The important thing is to raise and lower the condenser and to open and shut the iris until you get *exactly* the light you want. Then you can see the object as clearly as possible.

6.4 Centering the condenser

In the Olympus microscope shown in FIGURES 6-1 and 6-6 you can only do two things to the condenser. You

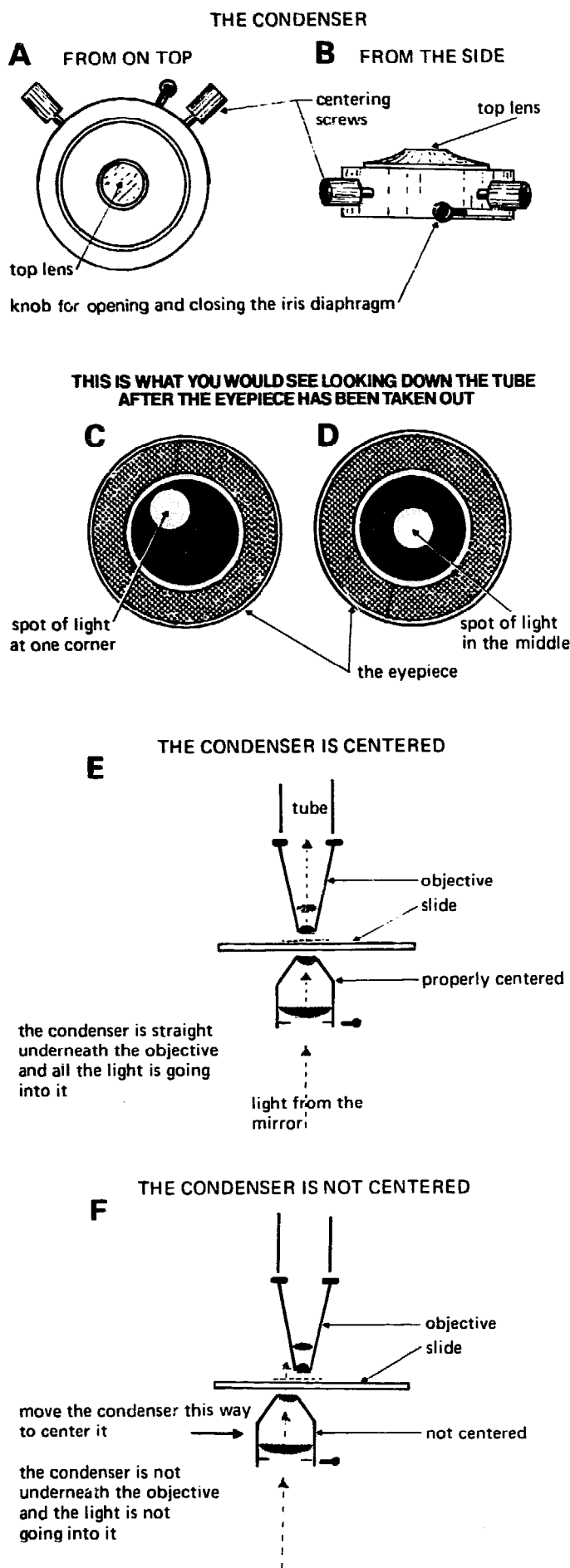

Fig. 6-5 Centering the condenser

can raise and lower it, and you can also open and close the iris diaphragm. In some microscopes, especially older ones, there are two **centering screws** on the side of the condenser so that you can also 'center the condenser'. Find the 'centering screws' that have been drawn on this kind of condenser in Pictures A and B in Figure 6-5. When we say 'centering the condenser' we mean moving it so that it is exactly underneath the objective. Only when the condenser is exactly under the objective will the microscope work as it should. Find Picture E in Figure 6-5. A correctly centered condenser has been drawn, and the light from the condenser can be seen going straight into the objective. In Picture F, FIGURE 6-5, the condenser is a long way away from the center of the objective, and very little light is going into it. The condenser of the Olympus microscope is centered in the factory where it is made. Find the 'centering screws' in Figure 6-6 and on your microscope. They can only be turned by a very small screwdriver, and you will not need to alter them. Don't try to center the condenser of the Olympus microscope. But if your microscope is not an Olympus microscope and has knobs for centering the condenser, center it like this.

METHOD

CENTERING THE CONDENSER (IN SOME MICROSCOPES ONLY). FIGURE 6-5

Turn to Section 6.14 and go as far as the end of step 12. You will then have adjusted the light, the low power objective will be in position, the condenser will be raised and will have focused on a slide. Find Figure 6-5 and look at Pictures C and D.

Close the iris diaphragm. Raise or lower the condenser until you see a sharp spot of light. You may see what has been drawn in Picture C—a spot of light at one side of the field of view. If you see this, turn the centering screws on the condenser one way and the other until the spot of light is in the middle, as shown in Picture D. The condenser will now be centered, and, unless you move the centering screws, it will not need to be centered again. Check the centering of your microscope from time to time.

Microscopes are made so that the condenser can be taken out. In the Olympus microscope the condenser is held in place by a **condenser holding screw**.

METHOD

REMOVING AND REPLACING THE CONDENSER ON THE OLYMPUS MICROSCOPE, FIGURE 6-6

Remove the mirror.

Find the 'condenser holding screw' in Figure 6-6 and on your microscope. Unscrew the 'condenser holding screw' a few turns until it is loose. Don't take it out. Gently push the condenser down until it comes out of the ring that holds it.

To put the condenser back, put it into the ring that

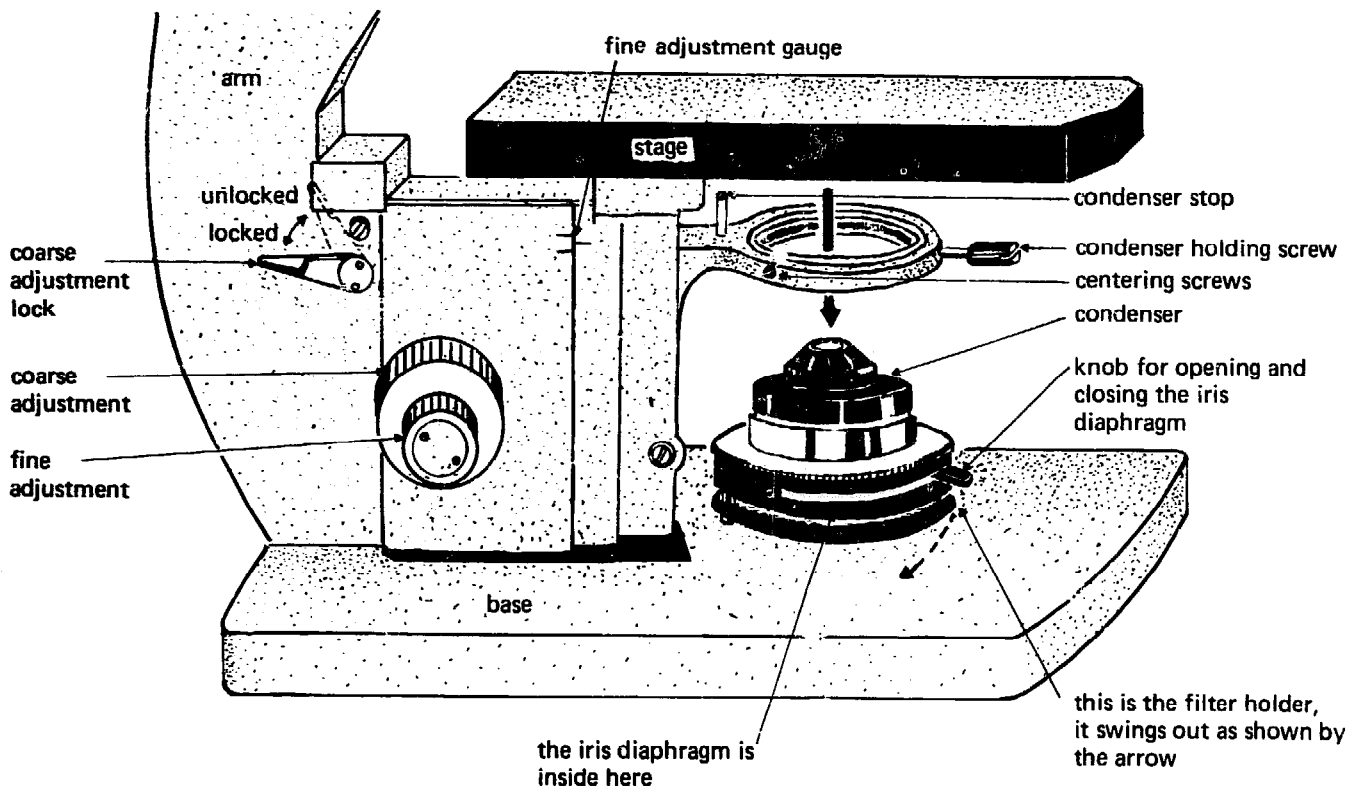

Fig. 6-6 Removing the condenser

holds it. Push it up as far as possible. Tighten the 'condenser holding screw'.

6.5 The filter holder

At the bottom of the condenser of the Olympus microscope is a ring which holds a circle of blue glass. The ring is the **filter holder**, and the circle of blue glass is the **filter**. Find the 'filter holder' in Figure 6-6 and on your microscope. Turn it out to the side and back again. The filter holder is made to swing out from underneath the condenser, so that the filter can be put in and taken out.

A blue glass filter changes the yellow light of an electric lamp into white light: like the light of the sun. Don't use a blue filter with the special lamp for the Olympus microscope (Picture A, FIGURE 6-15), because this lamp already has a blue filter on top of the bulb.

6.6 The condenser stop

It is very important that the condenser does not come above the stage of the microscope. If it does, it will move the slide and push it up out of its proper place. The Olympus microscope has a special screw, the **condenser stop**, to stop the condenser coming up too high. Find the condenser stop in Figure 6-6. Turn the condenser as high as it will go, and you will see the condenser stop hit the bottom of the stage. The condenser stop of the Olympus microscope was adjusted in the factory, so don't alter it. If you have an old microscope, it may have no condenser stop, or it may be badly adjusted; so be careful not to raise the condenser above the level of the

top of the stage. When the condenser is raised as far as it can go it should be just under the slide as shown in Picture M in FIGURE 6-7.

The condenser must not come too high, as has been drawn in Picture N in this Figure. If the condenser does come too high, it will move the slide, and the microscope will not work well.

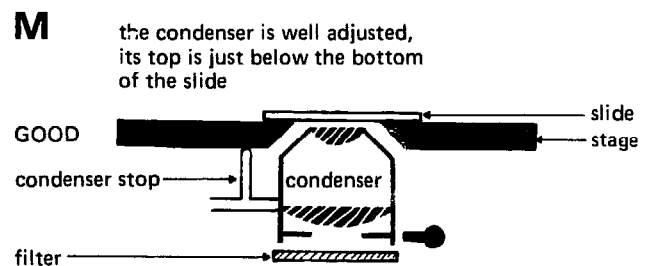

the condenser stop of the Olympus microscope is adjusted at the factory, don't try to alter it

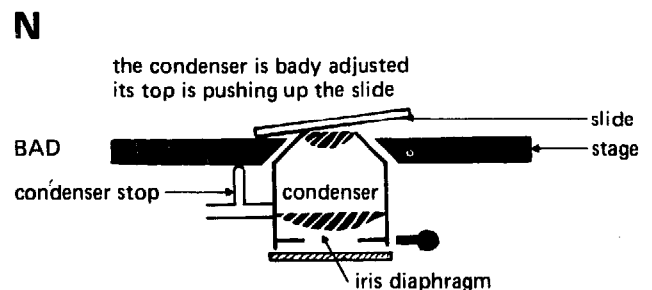
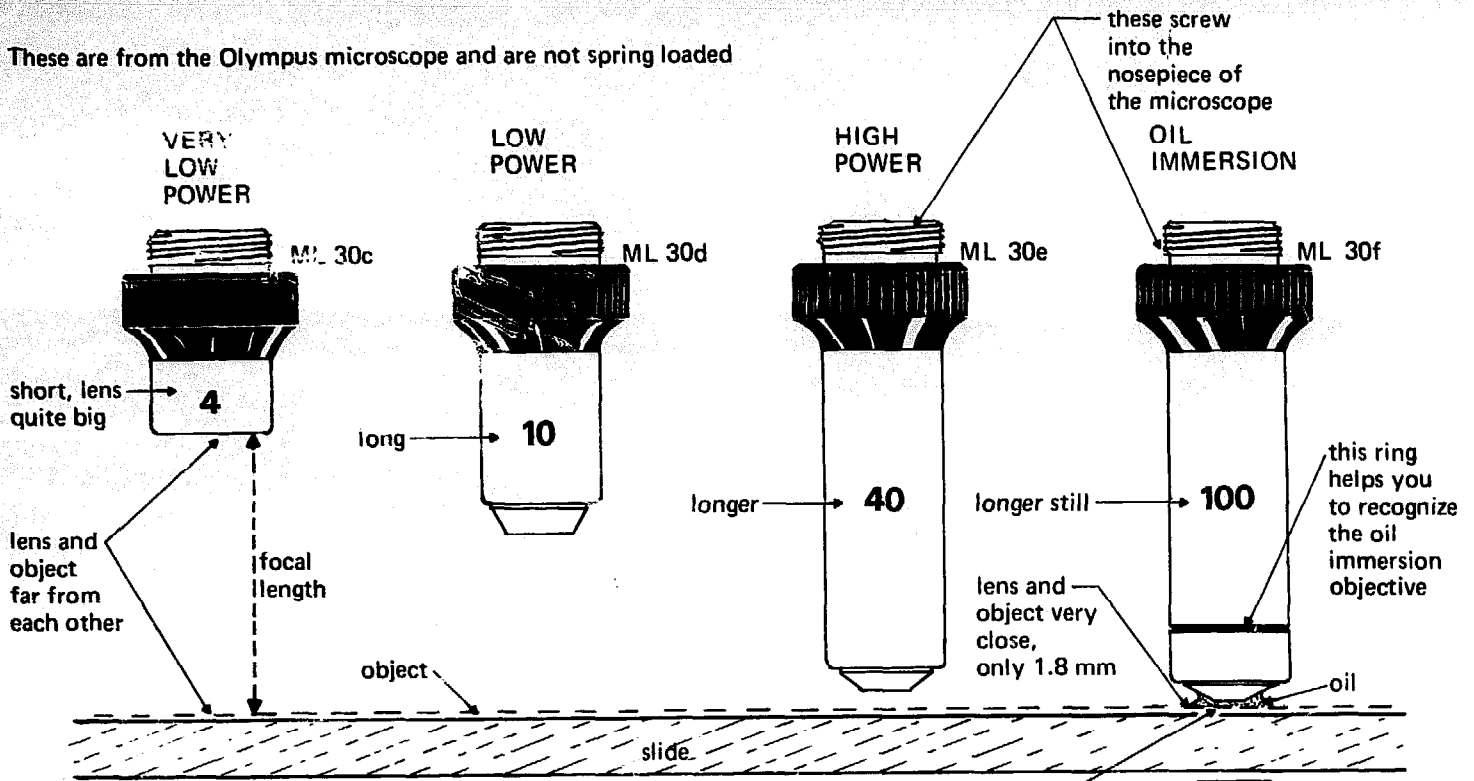
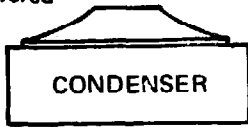

Fig. 6-7 The condenser stop

These are from the Olympus microscope and are not spring loaded



condenser lowered



with the middle two objectives the condenser is sometimes raised and sometimes lowered

the lens of the oil immersion objective is very small indeed



condenser always close up against the slide

THESE ARE VIEWS OF THE OBJECTIVES FROM THE BOTTOM

large lens



middle sized lenses



very small lens

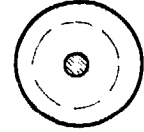

THESE ARE THE FIELDS OF VIEW THAT YOU WOULD SEE THROUGH THESE OBJECTIVES

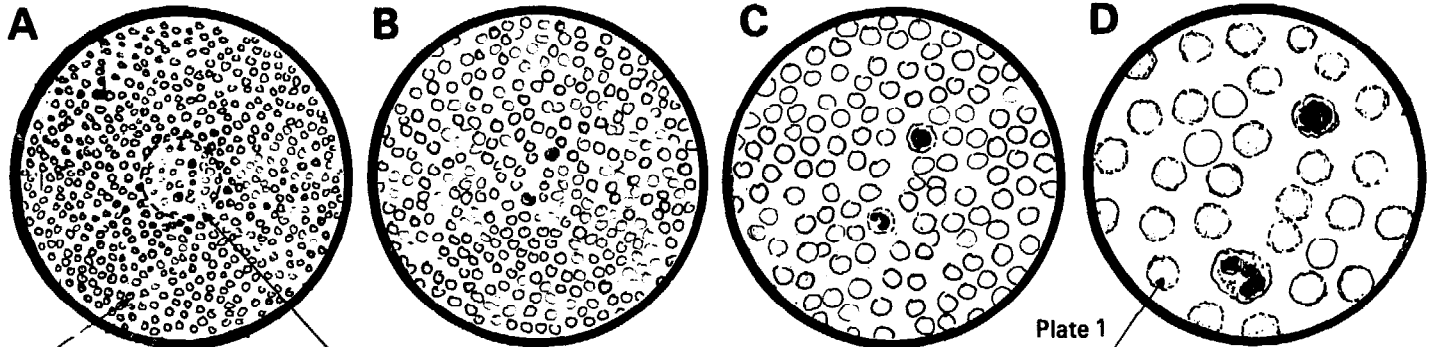

very low power objective, the cells look very small

this is the field of view that you would see through the oil immersion objective, see how small it is

YOU ARE LOOKING AT A BLOOD FILM

oil immersion objective, the cells look very large

Fig. 6-8 The objectives

6.7 The objectives

So far we have only explained how we put our object on its glass slide and how it is brightly lit by the condenser with light from the lamp. The parts of the microscope which make the object look bigger (the parts which magnify it) are the objective and the eyepiece. Like the condenser, these are also groups of lenses in metal tubes.

Sometimes, when we look at our object, we want to make it look very big and sometimes not so big. We want to change this **magnification** of our microscope. By magnification we mean the number of times bigger the object is made to look. To help us to do this microscopes are made with objectives of several different strengths or 'magnifying powers'. Most microscopes have three objectives, but the Olympus microscope has four objectives. They are shown in FIGURE 6-8 and are listed below.

1. The '**very low power objective**' which makes things look four times bigger ($\times 4$).
2. The '**low power objective**' which makes things look ten times bigger ($\times 10$).
3. The '**high power objective**' which makes things look forty times bigger ($\times 40$).
4. The '**oil immersion objective**' which makes things look a hundred times bigger ($\times 100$).

This last objective is the most powerful of all. *It is called the oil immersion objective, or, often, just the 'oil immersion', because its tiny little lens always looks at the object through a drop of oil. All the other objectives look at the object through air.* **IT IS VERY IMPORTANT TO REMEMBER THIS.**

To find the magnification you are using multiply the magnifying power of the eyepiece by the magnifying power of the objective. For example, if you have a $\times 8$ eyepiece and a $\times 4$ objective, you are using a magnification of 32. If you have a $\times 10$ eyepiece and a $\times 100$ objective, you are using a magnification of 1,000.

To make it possible to change quickly from one objective to the other the objectives are fixed to a metal wheel which turns round (revolves). This is the **revolving nosepiece**. When one objective is being used the others are out of the way. As you turn the revolving nosepiece, you will hear a click (a little sound) as each objective comes into position under the tube. This click is made by the **click stop**. *Find the revolving nosepiece in Figure 6-1 and on your microscope. Turn it round. You will hear a 'click' and feel the objective stop as it comes underneath the end of the tube.*

It is very important to be able to recognize these objectives easily; so look at your microscope and make sure you can tell one objective from another. The oil immersion objective of the Olympus microscope has a ring round it so that you can tell it from the others more easily. *Look at the objectives of your microscope.* You will see that the bottom lens of the very low power objective is the biggest. The lens of the oil immersion

objective is very small indeed. The lenses of the other objectives come in between these two in size.

The distance between the object and the bottom lens of the objective is very important. For every objective there is *only one distance* at which the object is clearly seen or, as we say, in **focus**. When the object is in focus, the distance of the objective from the object is called the **focal length** of the objective.

FIGURE 6-9 will help you to understand this. This Figure shows a high power objective, but other objectives are the same. An object will only be seen clearly if it is where the dotted line AB is in Picture W. If the slide is too close, as in Picture X, nothing will be seen. If it is too far away, as in Picture Y, again nothing will be seen. If, as in Picture Z, the object is exactly where the line AB is, the object will be in focus, and you will see it clearly. The views you would see through the eyepiece have been drawn at the bottom of the figure. In this figure the object is a blood film, and blood cells have been drawn. In Picture Z the blood film is sharply (clearly) in focus, as you can see the blood cells easily.

With the very low power objective the focal length is quite long—29 millimetres (mm). But the focal length of the oil immersion objective is very short—only 1.8 mm. The focal lengths of the other objectives are in between these two.

The focal length of an oil immersion objective is so short that it will not focus on a film, if a slide is put film surface down on the stage of a microscope. This is because the slide is so thick that the objective cannot get close enough to focus on the film. This is shown in Picture D, FIGURE 6-18.

When you come to use the objectives you will see that an oil immersion objective looks at a very small part of the object. The very low power objective looks at a large part of the object. We call the area of the object we can see the **field of view**. The higher the magnification of the objective, the smaller its field of view and the smaller the area of the specimen that can be searched. This is well shown in the pictures at the bottom of FIGURE 6-8. The field of view is always upside down and left to right compared with the object. This never matters, and you will soon get used to it.

We have already said that the oil immersion objective, which comes close to the object on the slide, looks at the object through a drop of oil. This is a special kind of oil made only for oil immersion objectives. It is called **immersion oil**, and no other kind of oil can be used instead. *There will be no clear view unless the oil immersion objective and the slide are joined by a drop of oil.* The oil immersion objective will not work without oil. Because oil immersion objectives need this oil, the object has usually to be dry. If the object is wet, it has to be underneath a glass coverslip, with a drop of oil on top of the coverslip. You will not see a clear view through a mixture of oil and water.

A **coverslip** is a small square of very thin glass which is a little narrower than a slide. A slide is 25.4 mm (1 inch) wide and 76 mm (3 inches) long. A coverslip is

all these are the SAME objective

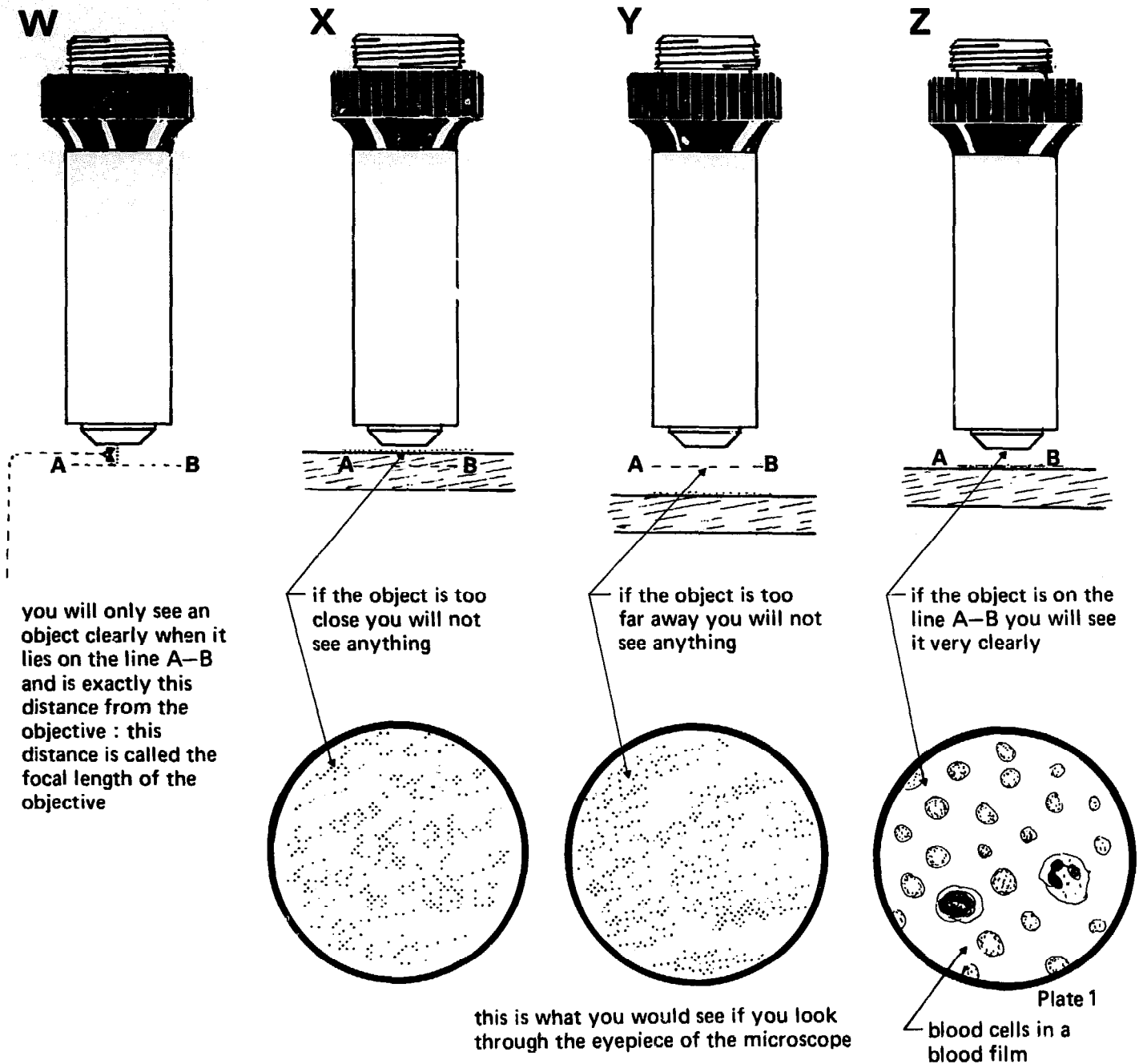

Fig. 6-9 The focal length

usually 22 mm (seven-eighths of an inch) square. A coverslip is put on top of a wet object and makes a flat glass surface that can be looked at through an objective. The wet objects studied by the methods in this book are wet films of stools, urine, and sometimes blood. *It is better to look at wet objects through a coverslip, especially if the high power objective is being used. ALWAYS USE A COVERSLIP WHEN YOU LOOK AT A WET OBJECT WITH AN OIL IMMERSION OBJECTIVE.* Picture B in FIGURE 6-10 shows an oil immersion objective looking at a wet object under a coverslip. Because the oil immersion objective comes very close to the

coverslip, it may cause the coverslip to move on the slide and make the object that you are looking at move out of sight. To keep a wet object still and to stop a wet smear drying up, put a ring of vaseline (a kind of grease) and paraffin wax (what candles are made of) round the edge of the coverslip. This vaseline is shown in Picture B. How to put it on is described in Section 7.23. It is not easy to look at wet objects with an oil immersion objective, so wait until you are well practised with a microscope.

In Section 10.2b you will read about the use of 'Cellophane' coverslips for examining the stool. If they are

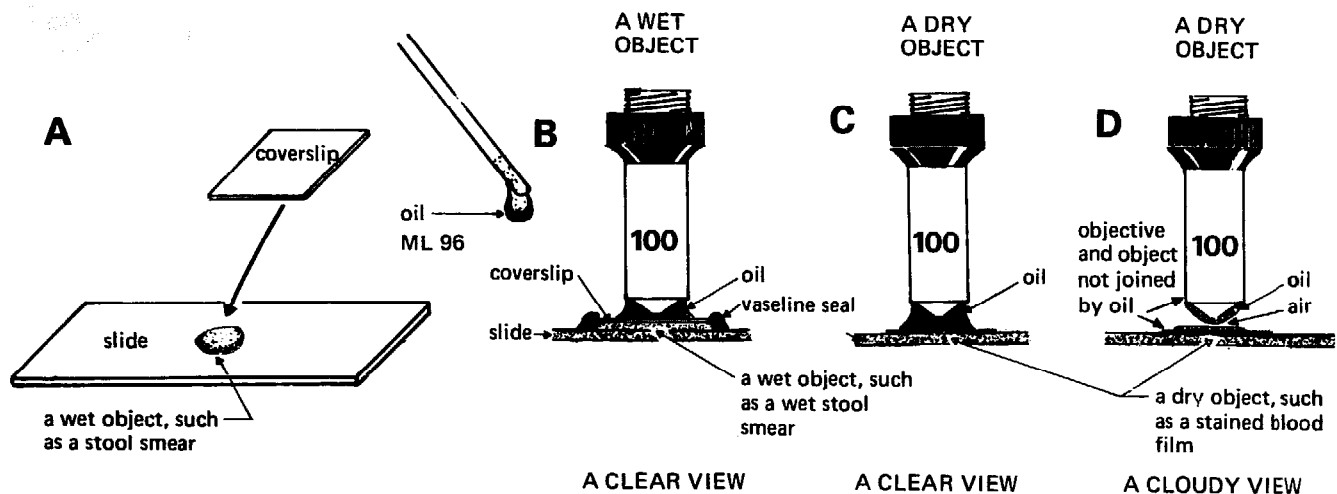

Fig. 6-10 Using an oil immersion objective

soaked in saline first these 'Cellophane' squares can be used for other methods. They even work fairly well with an oil immersion objective.

Picture C, FIGURE 6-10, shows an oil immersion objective looking at a *dry* object such as a blood film. *The film must be quite dry before the oil is put on.* The film is smeared (covered) with oil, and the objective dips straight into the oil.

The objective and the slide must be joined by oil. In Picture D, FIGURE 6-10, there is oil on the objective, and there is oil on the film. But the oil does not join, and there is air between the slide and the objective. The view through this objective will not be clear. Make the oil on the objective touch the oil on the slide. The oil on the objective will join the oil on the slide, as in Picture C, and you will be able to see clearly.

As you have read, an oil immersion objective looks at the object through oil. *All other objectives must look at the object through air.* You cannot put a drop of oil under the high power ($\times 40$) objective and expect it to work as a ($\times 100$) oil immersion objective! You will not see an object clearly in this way. *If, by mistake, oil or any other liquid gets on to the lenses of the high power, the low power, or the very low power objectives, CLEAN THE OIL OFF.* If you cannot see an object clearly through one of these objectives, it is probably because there is oil on the lens. The lens of an objective must be perfectly clean. Even a fingermark will spoil the view. Read how to clean an objective in Section 6.16 and FIGURE 6-19.

It is difficult to keep a high power objective clean and free from oil because the high power objective comes very close to the slide (its focal length is very short). When you turn the revolving nosepiece to change objectives, it is easy to make a mistake and to let the lens of the high power objective touch the oil. This spoils the view that can be seen through it. When this happens, unscrew the high power objective from the nosepiece and clean its lens.

You will find it much easier to keep the high power

objective free from oil if you keep the objectives in the right order in the revolving nosepiece. If you have four objectives, always keep them in this order: very low power, low power, high power, oil immersion. If you are changing from the low power to the oil immersion objective, don't let the high power objective pass over the oil on the slide. *Turn the nosepiece the other way round so that the high power objective does not touch the oil.* If the oil on the film is thin, the high power objective would probably not touch it, but it would almost certainly touch a big drop of oil.

A special plastic oil bottle is supplied with the Olympus microscope. If you have not got a special oil bottle, put some oil in a bijou bottle and dip a clean stick into it. A drop of oil will remain on the end of the stick and can be put on to the slides. An opened out paper-clip can also be used. Bend one end into a little loop to hold the oil, and bend the other end into a handle.

It is usually easy to make another slide, but it is not easy to get another objective. **BE CAREFUL.** For this reason some objectives are made with a spring inside them. Then, if the end of the objective touches the slide, it

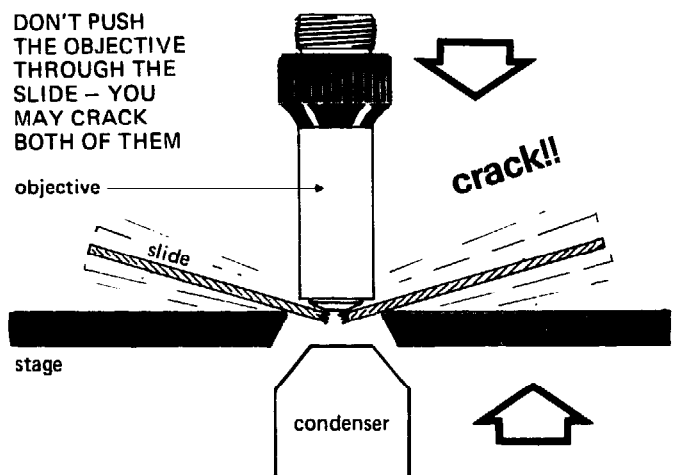

Fig. 6-11 A warning!

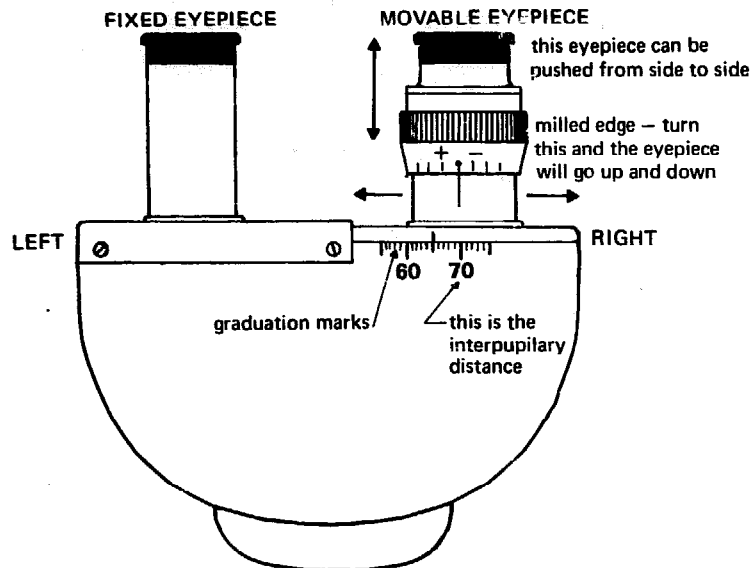

Fig. 6-12 A binocular eyepiece

in some microscopes the left eyepiece is the movable one

springs back and does not get broken. We say these objectives are **spring loaded**. The objectives drawn in FIGURE 6-9 are not spring loaded but those in the equipment list are.

The objectives of the Olympus microscope have been carefully made so as to be **parfocal**. This means that, if something is carefully focused with one objective, it will also be in focus when the nosepiece is turned and it is looked at with another objective. Very little further focusing will be needed. With other microscopes which are not parfocal you may have to alter the focusing quite a lot when you turn from one objective to another.

6.8 The eyepiece

We have seen that the objectives of the microscope are fixed to the revolving nosepiece. They are at the end of an empty tube called the **tube of the microscope**. At the top of this tube are two more lenses in another short tube. These make the eyepiece. It is called the eyepiece because it is close to your eye.

Just as there are objectives of different power, so there are also eyepieces of different power. The Olympus microscope is supplied with a single eyepiece which makes the object look ten times bigger—a $\times 10$ eyepiece. Some microscopes are supplied with two eyepieces: a $\times 10$ and a $\times 5$. *Take the eyepiece out of your microscope.* You will find it easily comes out of the top of the tube. You will see it has two lenses: one lens at the top and one at the bottom.

The Olympus microscope in FIGURE 6-1 has one eyepiece: it is **monocular** (mono = one, ocular = eye: one-eyed). More expensive microscopes have two eyepieces: they are **binocular** (bin = two: two-eyed). Because it strains (hurts) the eyes less, a binocular microscope is easier to use, especially if it has to be used for many hours at a time. You may have a binocular microscope. If you have a binocular microscope, it is important that you use it in the right way.

Look at the binocular head of your microscope. You will see that it is like the one in FIGURE 6-12. The left eyepiece is fixed (it will not move), but the right eyepiece can be moved in two different ways. The right eyepiece can be moved in and out by turning it one way or the other by its milled (rough) edge. It can also be pushed from one side to the other side. Binocular microscopes are made to move like this because the eyes of any two people are never quite the same. People's eyes are different distances apart. It is also common for one eye to focus a little differently from the other eye. By pushing the right eyepiece to one side or the other the person who uses a microscope can make the distance between the eyepieces the same as the distance between his own eyes. This distance is called the '**inter-pupillary distance**' (the distance between the **pupils** or dark middle parts of the eyes: inter = between). In most people it is about 65 mm, but it may be as short as 55 mm or as long as 75 mm. The right eyepiece has been made so that it can be adjusted to the right focus for the user's eye. Turn the milled edge on the movable eyepiece of your microscope, and you will find that it moves. If you have a binocular microscope, adjust it like this.

METHOD

ADJUSTING A BINOCULAR MICROSCOPE, FIGURE 6-12

Focus on some object such as a blood film. Look at Section 6.14 to see how to do this.

ADJUSTING THE INTER-PUPILLARY DISTANCE

Push the movable eyepiece from side to side until you can see the same object comfortably with both eyes. Read your inter-pupillary distance from the scale. Remember it and use it to adjust your microscope after it has been used by someone else.

ADJUSTING THE FOCUS

Close your right eye. Look through the fixed eyepiece with your left eye and bring the object into the sharpest possible focus with the fine adjustment. Then close your left eye and look through the movable eyepiece with your right eye. Don't alter the coarse or fine adjustments, but bring the object into sharp focus by turning the movable eyepiece. Open both eyes. The object should be sharply in focus for both eyes. Always adjust the focus of the movable eyepiece after you have adjusted the inter-pupillary distance. Do this because the right adjustment of the movable eyepiece depends in part upon the inter-pupillary distance.

A well-adjusted binocular microscope will be much more comfortable to work with than one which has not been well adjusted.

6.9 The tube, the coarse and fine adjustments

The microscope drawn in Picture A, FIGURE 6-4, has a straight empty tube. But the tube of a modern microscope is always bent to bring the eyepiece to a better place to look through. A microscope of this kind has been drawn in Picture B in FIGURE 6-4. The Olympus Model K is a microscope of this kind. A special piece of glass called a **prism** is put into the middle of the tube to bend the light. All binocular microscopes have a prism in the tube so that the light coming from the objective can be cut in half to go to both eyes.

The tube of the Olympus microscope is made so that it can move round in a circle. By moving the tube round another person can look down it without moving the microscope.

Microscopes are made so that the objective and the object can be moved closer together or further apart. In some microscopes, like the one in Picture A, FIGURE 6-4, the tube and its objectives move up and down. In other microscopes, such as the Olympus, the tube and the objectives stay still and the object moves up and down. This means that the slide carrying the object has to move. The **stage** (the part of the microscope on which the slide rests) must therefore be made to move also. In microscopes of this kind the condenser moves up and down with the stage.

In most microscopes the moving is done by two kinds of knobs—the **course adjustment** and the **fine adjustment**. Find the coarse and fine adjustments in Figure 6-1 and on your microscope. The coarse adjustment makes big movements; the fine adjustment makes fine (little) movements. The fine adjustment is used for getting the object sharply into focus when it has been put nearly into focus with the coarse adjustment. Sometimes the knobs for the coarse and fine adjustment are separate. Sometimes, as in the Olympus microscope, the knobs are together and are said to be **co-axial** (sharing the same shaft or axle).

When you are using a microscope *always keep your left hand on the fine adjustment* (your right hand works the mechanical stage). It is one of the signs of the good

microscopist that he is always moving the fine adjustment to get a clearer picture.

6.10 The mechanical stage

There are often so many slides to be looked at, that time is wasted if the same part of a slide is looked at twice. It is useful therefore to be able to move the slide about in a regular careful way. This can be done with a **mechanical stage** like the one in FIGURE 6-13. A mechanical stage has two knobs: one knob moves the slide along the stage; and the other knob moves the slide across the stage.

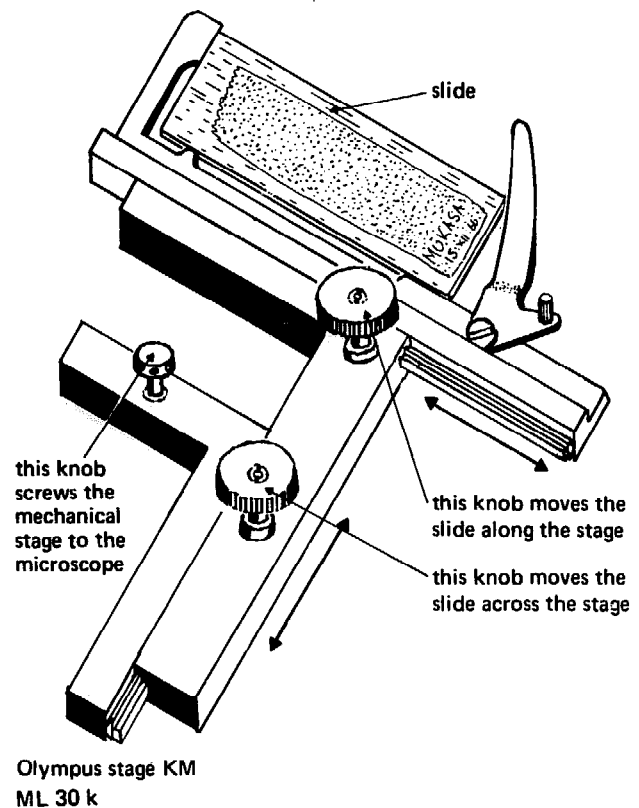

Fig. 6-13 A movable stage

Sometimes it is important to search the *whole* of the specimen under a coverslip for something. It might be CSF for trypanosomes (see Section 9.14) or urine for schistosomes (see Section 8.15). FIGURE 6-14 shows you how to do this.

METHOD

SEARCHING THE WHOLE OF A SPECIMEN UNDER A COVERSGLIP. FIGURE 6-14

The thick black line round the outside of Figure 6-14 is a coverslip. Start looking in the top left-hand corner. It will really be the bottom right-hand corner, because the microscope turns things upside down and right to left. With your microscope you will be able to see everything inside a circle marked A. With the mechanical stage move the slide so that the objective goes along the line with the arrows marked B. You will be able to search an area of the coverslip between lines C and D.

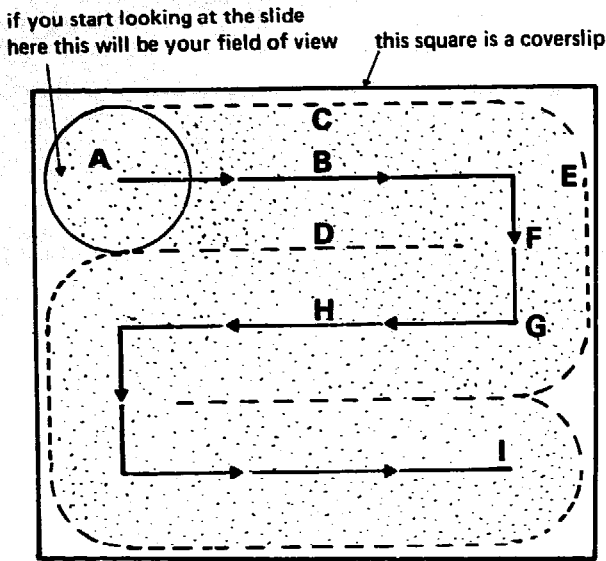

Fig. 6-14 Searching a specimen

Soon you will get to the right-hand end of the coverslip marked E. When you get to E, move exactly one field down so that something marked F, which was at the bottom of your field of view, is brought to the top. When F is right at the top of your field of view, G will be in the middle of it. You can now follow the line A and go back in the direction you started.

In the end you will get to the place marked I in the bottom right-hand corner. You will then have looked at every part of the slide except a little area round the edge.

FIGURE 6-14 has not been drawn to scale (to size), and the area you could see with your microscope would be much smaller than the area shown as A in this figure.

You would therefore have to go backwards and forwards across the slide many more than the three times shown here. The very low power objective looks at an area of slide about 4 mm in diameter. A slide 25 mm across can thus be almost completely covered by going backwards and forwards across it about six times ($6 \times 4 = 24$). When you are searching in this way, always use the lowest powered objective with which you can easily see the thing you are looking for. This will save time. Look for schistosome ova, for example, with a very low power objective.

If you have not got a mechanical stage you can hold the slide with **slide clips**, and move it with your fingers. These clips are shown in FIGURE 6-1 and are not so easy to use as a mechanical stage.

6.11 Lights for the microscope (FIGURE 6-15)

Microscopes are often used badly because the people using them do not understand how important it is to have the right kind of light and to use it well.

Light for a microscope can come from a bright sky, or from some kind of lamp. Don't use the sun, it is too bright. This lamp is often made to fix into the base of the microscope as in Picture A. It can also be separate as in Picture B.

It is sometimes possible to use an ordinary bulb on the mains electricity of the laboratory; this will be either 220 or 110 volts. It is also possible to use a car battery and a bulb from the headlamp of a car; this will be either 12 or 6 volts. It is usually best to have this battery inside the laboratory, but the battery of a car parked outside the laboratory can also be used. If a car battery is to be used in this way, long wires will have to be taken from the car in through the window or door of the laboratory. You will have seen in FIGURE 3-3 how a Land-Rover has a special place (plug sockets) on its dashboard for fixing up

A
A LAMP WHICH FITS THE MICROSCOPE

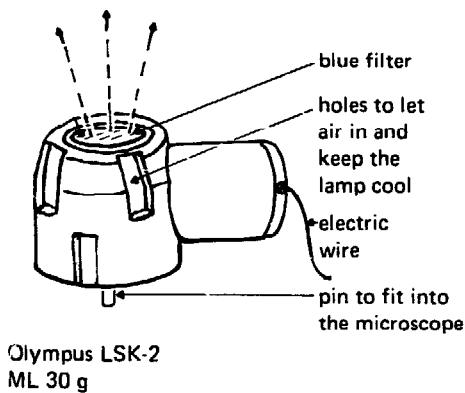

B
A LAMP WHICH YOU CAN MAKE FOR YOURSELF

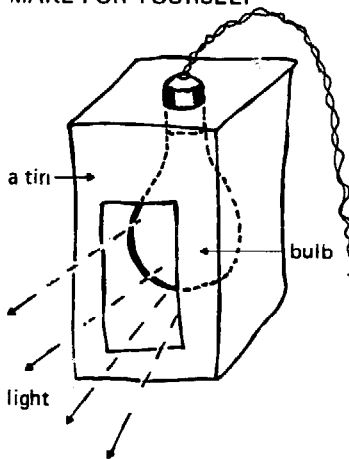

C
A LAMP UNDER THE BENCH

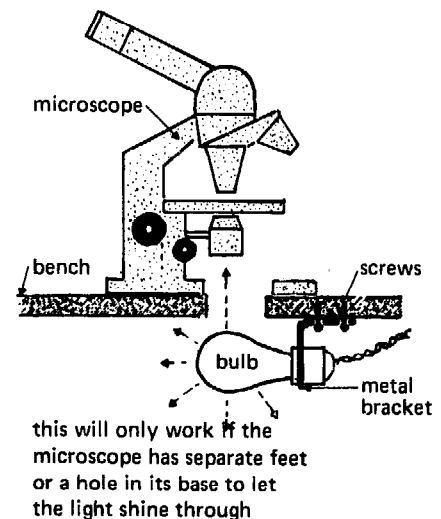

Fig. 6-15 Lights for the microscope

a light like this. If a separate battery is to be used, it will have to be charged up in some way when it runs down. This is discussed in Section 3.8.

What can be done if there is no electricity of any kind? By day it may be possible to use the sky. By night a big torch or a paraffin lamp can be used—either the kind with a wick or a pressure lamp (a "Tilley lamp") with a mantle (a mantle is the 'cloth' part of a pressure lamp which gets white hot). Point the mirror at the flame or the mantle and use it just as you would on an electric lamp—follow the directions in Section 6.14. Most health center laboratories will have to use the sky.

6.12 The Olympus Model K microscope

The Olympus Model K microscope has been put into the equipment list because it is the cheapest and best microscope for our kind of laboratory. There are some things about it which are special.

For example, the Olympus microscope has three little lines called the **fine adjustment gauge**. You will see this in FIGURE 6-6 and in FIGURE 6-16. If you turn the knob of the fine adjustment you will see that the line on the right goes up or down. This line is on a part of the microscope which holds the stage, so that the stage goes up and down when you turn the fine adjustment. Go on turning the fine adjustment as far as you can, first one way and then the other. You will find that the right-hand line finally stops either opposite the top line on the left-hand side (Picture S) or against the bottom line on the left-hand side (Picture U). There is very little movement in the fine adjustment, and these lines have been drawn to help you to use it well. Before you start to use the microscope, make sure that the right-hand line is in the middle between the two lines on the left, as shown in Picture T. You will then be able to focus up or down with the fine adjustment as much as you need.

There is something on the Olympus microscope which you will not find on other microscopes. This is the **preset**

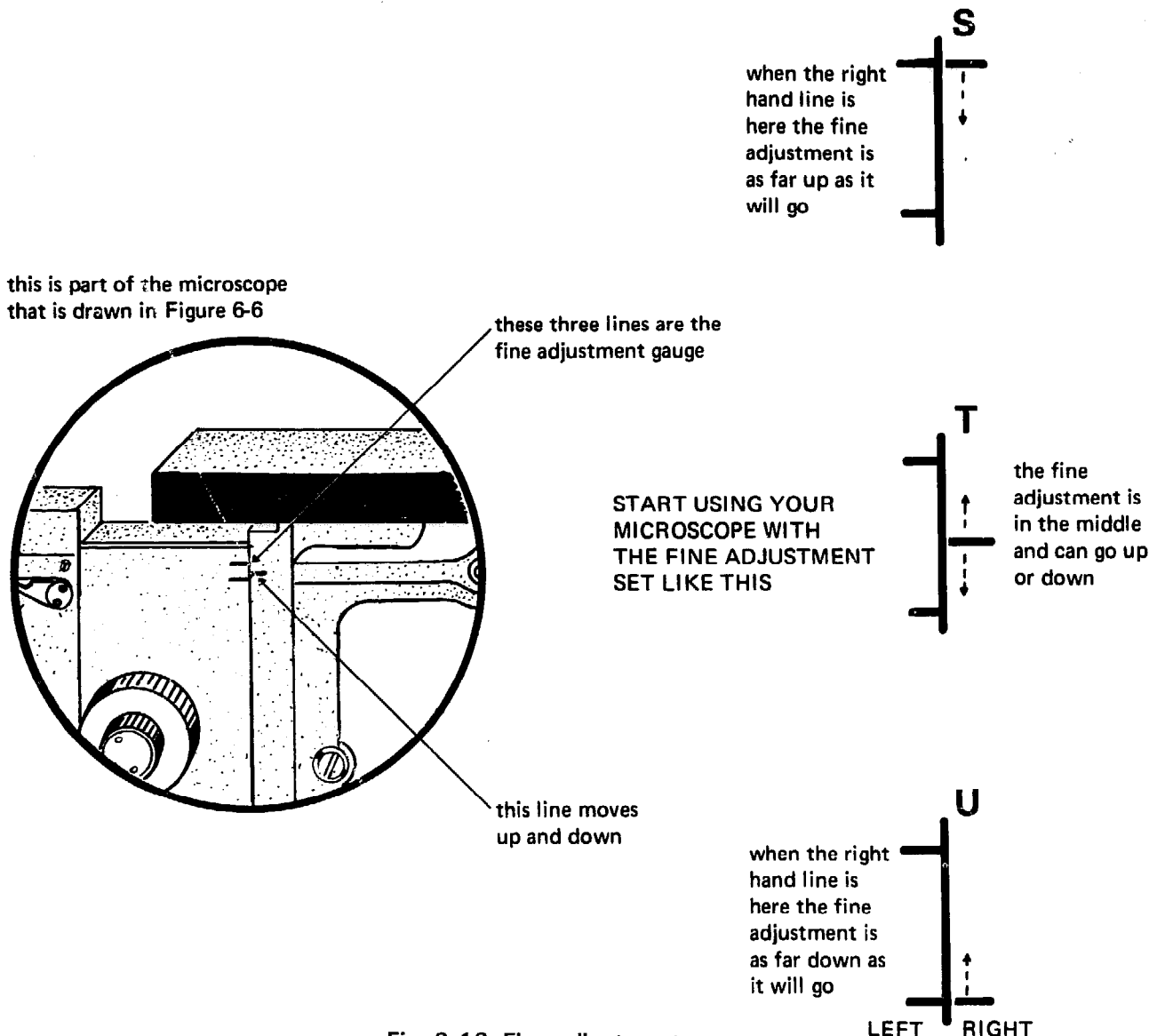

Fig. 6-16 Fine adjustment gauge

focus lock. This locks (stops) the coarse adjustment but leaves the fine adjustment free to move. If you look at FIGURE 6-6 you will see that there is a **locking lever** on one side of the microscope. It is shown here pointing down in the locked position. The dotted line shows it pointing up in the unlocked position. The preset focus lock is very useful for getting a slide into focus quickly. Use it like this.

METHOD

USING THE PRESET FOCUS LOCK ON THE OLYMPUS MODEL K MICROSCOPE, FIGURE 6-6

Turn the fine adjustment so that the right-hand line of the fine adjustment gauge is in the middle of the other two.

Start with the lever unlocked, that is with the lever *up* against the stop in the position shown by the dotted line.

Take a slide, such as a blood film, and bring it sharply into focus with the coarse adjustment.

Lock the lever by pushing it down. Lower the stage with the slide on it. When you raise it again, it will always stop sharply just where you locked it before. When you look at the slide, it will still be sharply in focus. If your slides are of the same thickness you will be able to bring another slide into immediate focus in the same way. The fine adjustment is still free, and you can do the final focusing with this.

To change the position of the lock, raise the lever. You will then be able to move the stage up as far as it can go. You can lock it again in any position you like.

6.13 Knowing your microscope

Before you start to use your microscope you will have to get to know it. You will find it helpful to do these things.

METHOD

GETTING TO KNOW YOUR OLYMPUS MICROSCOPE

First, have a good look at it. It is not the same on the right-hand side as it is on the left-hand side. Only on the left-hand side of the Olympus microscope is there a knob to raise the condenser. The focusing lock and the fine adjustment gauge are only on the right-hand side. With the help of the pictures in this chapter find all the following parts of the microscope. The most helpful picture is put in brackets after the name of the part. The base (6-1), the arm (6-1), the tube (6-1), the eyepiece (6-1), the revolving nosepiece (6-1), the four objectives (6-1, 6-8), the stage (6-1), the mechanical stage (6-13), the coarse adjustment (6-1), the fine adjustment (6-1), the mirror (6-1), the condenser (6-6), the condenser stop (6-6), the condenser adjusting knob (6-6), the iris diaphragm (6-4), the knob for opening the iris diaphragm (6-6), the filter holder (6-6), the fine adjustment gauge (6-6, 6-16), the preset focus lock (6-6). *Only when you*

are quite sure what all these parts are should you read the rest of this method.

Take hold of the eyepiece and pull it out. You will find that it comes out of the tube quite easily. Look down the empty tube. Put it back.

Move the tube round, following the arrow in Figure 6-1; you will find that it goes right round the microscope.

Turn the nosepiece round. Every time an objective comes into place under the tube you will feel a click from the click stop.

Turn the coarse adjustment as far as it will go one way, and then as far as it will go the other way. Make sure the objectives are not going to hit anything as you do this.

Turn the fine adjustment as far as it will go one way, and then as far as it will go the other way. You will see the right-hand line of the fine adjustment gauge move up and down.

Turn the condenser adjusting knob as far as it will go one way, and then as far as it will go the other way. The condenser will move up and down.

Find the knob for the iris diaphragm and move this one way and the other way. The iris diaphragm will open and close.

Unscrew the condenser holding screw. The condenser will come loose and can be gently lowered out of the ring that holds it. Take the condenser out. Put it back and screw up the condenser holding screw to hold it tight. You are shown how to do this in Section 6.4 and Figure 6-6.

Find the lever of the preset focus lock. Move it backwards and forwards. You will find, when you try to move the coarse adjustment with the lever down, that the coarse adjustment is locked and that the stage will not move as far as it will when the lever is up.

Move the mirror about. Take it out and put it back. If the microscope has a light, take this out and fit the mirror into the hole in the base.

DO ALL THESE THINGS WITH CARE. DO NOT BREAK OR STRAIN ANYTHING.

6.14 Using your microscope

Only when you are sure what all the parts are and how they move and work should you go on to the method below. Read this next section over very carefully before you begin. When you really understand the method, you can begin to do what it says. Follow the instructions carefully and don't move to a new instruction until you have completed the one you are doing.

METHOD

USING THE OLYMPUS MICROSCOPE TO LOOK AT A BLOOD FILM WITH THE OIL IMMERSION LENS, FIGURE 6-17

Stain a blood film by the method in Section 7.12. Put it on the stage with the film side up.

1. If you can, put the microscope in a dark corner of the room. You will not see well if the microscope is in a

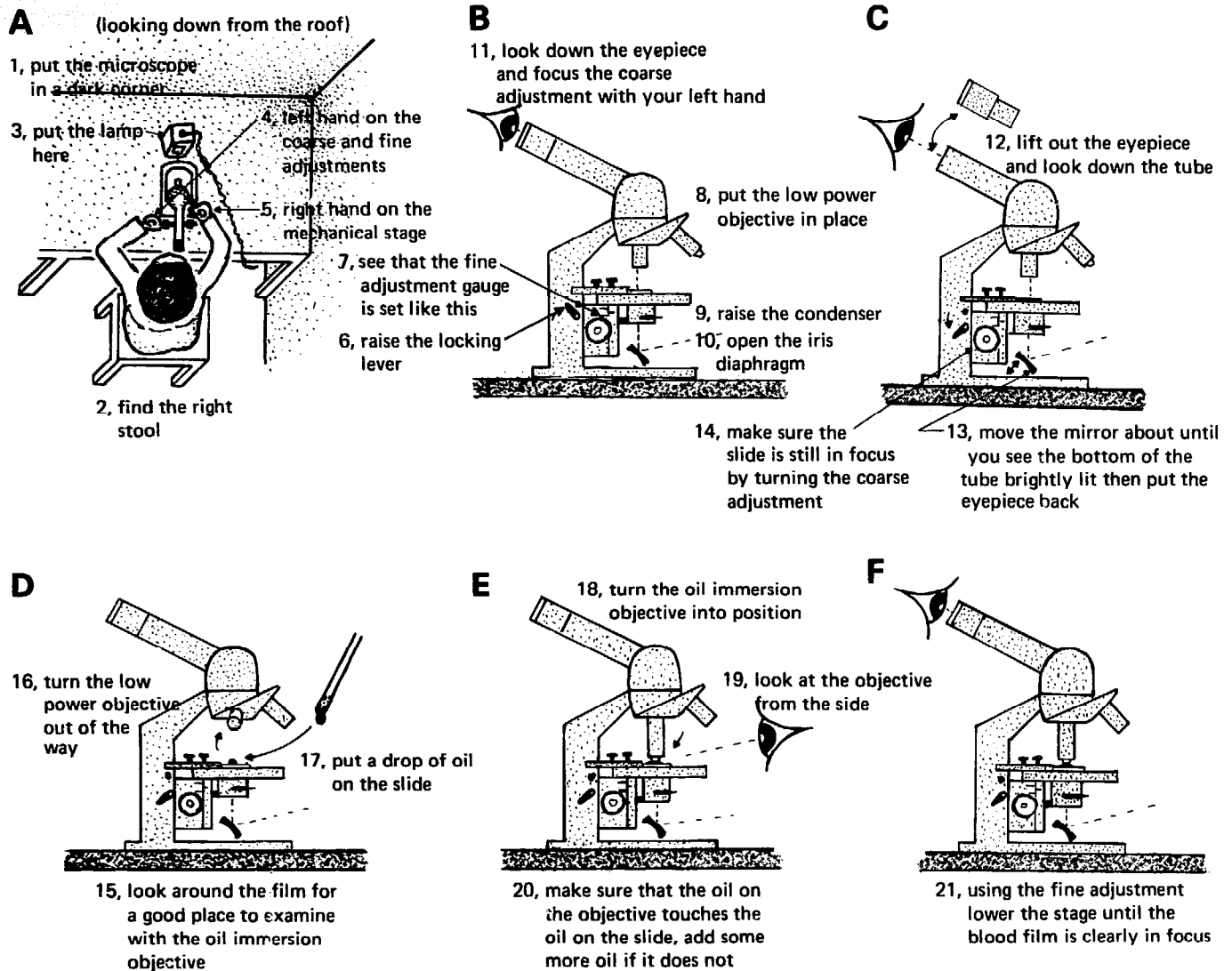

Fig. 6-17 Using an Olympus microscope

place where there is much light. If you have to use the sky you will have to use a bright place under a window, as is shown in Figure 3-11.

2. Find a stool that brings your eyes to the same height as the eyepiece of the microscope with your back straight. You will not be comfortable if you use your microscope for a long time with your back bent because your stool is too high.

3. Put the lamp close in front of your microscope. Put the blood film you have just made on the stage of the microscope.

4. Rest both your forearms on the table. Use your left hand to turn the coarse and fine adjustments.

5. Use your right hand to work the mechanical stage.

6. See that the locking lever of the preset focusing lock is raised (unlocked).

7. Turn the fine adjustment until the right-hand line is in the middle in between the other two on the left, as in Picture T, Figure 6-16.

8. Turn the low power ($\times 10$) objective under the tube. Make sure it has clicked into position.

9. Raise the condenser as high as it will go.

10. Open the iris diaphragm wide.

11. Look down the eyepiece. **CAREFULLY** turn the coarse adjustment (the large outer knob) one way and the other with your left hand until you see a sharp clear picture of the object. You will only see a clear picture when the film is exactly the right distance away from the objective. As you read in Section 6.7 this is called focusing. When the picture is clear it is said to be in focus. When your blood film is in focus you will see something like Picture B in Figure 6-8 except that the cells will look very much smaller.

Even though you are looking through a monocular (one-eyed) microscope, keep both eyes open. This will soon become easier than trying to shut the eye you are not using. You will soon learn to 'forget' about what this eye sees. Use one eye for a time and then use the other eye, so as to give the first eye a rest. Try to look at something far away when you first look into a microscope. Try to look 'through the microscope, not into it'. It is very important how near the eyepiece you put your

eye. Start with your eye far from the eyepiece and bring it closer until you see clearly.

12. Take out the eyepiece. Look down the empty tube.

13. Make quite sure that the flat side of the mirror is on top. Move the mirror around until the whole of the bottom of the tube (the top lens of the objective) is filled with light. If there is light in the middle but not round the edge, lower the condenser until there is light all over the bottom of the tube. Put back the eyepiece. **FROM NOW ON DON'T MOVE THE LAMP OR THE MIRROR**, or you will have to adjust them again. You may find the light too bright to use the low power objective in comfort. If so, close the iris diaphragm a little by moving the knob which closes it.

14. Make quite sure that the slide is still in focus by turning the coarse adjustment. Lock the preset focusing lock by pushing the lever downwards.

15. Turn the knobs of the mechanical stage and look around the film until you find the part you want to examine with the oil immersion objective. It will not be possible to focus the oil immersion objective on a patch of clear glass. The best part of the film to look at will not be the same in all slides. Only practice will tell you which it is.

16. Turn the low power objective ($\times 10$) out of the way of the slide.

17. Put a drop of oil in the centre of the slide just where the oil immersion objective will be when it is turned into position. A spot of light shining on to the slide from the condenser will show you where this is. Use only the special immersion oil described in Section 6.7.

18. Turn the oil immersion objective into position and make sure it has clicked into the right place. *In doing this turn the nosepiece so that the high power objective does not pass over the oil.* It may touch the drop by mistake and have to be cleaned. Look at Section 6.7 to see how important it is to keep the lens of the high power objective free from oil.

19 and 20. Look at the microscope from the side. Has the drop of oil on the oil immersion objective touched the drop of oil on the slide? If the oil drops have not joined up, move the fine adjustment until they touch. When they touch the oil will 'light up'.

If there is already a drop of oil on the tip of the oil immersion objective, it will usually join up with the drop you have just put on the slide as shown in Picture C, Figure 6-10. But there may be no oil on your objective already, and the drop you have put on the slide may be thin and it may spread out rapidly. Then the two drops of oil will not join but will stay separate as shown in Picture D, Figure 6-10.

21. Bring the film into focus with the fine adjustment. Turn the fine adjustment one way and then the other until you see a clear sharp picture. **DON'T RAISE THE SLIDE TOO MUCH, OR YOU WILL PUSH IT AGAINST THE OIL IMMERSION OBJECTIVE AND BREAK IT.** The objective may also be spoilt.

If you cannot focus, look from the side again and bring the slide close to the objective. Then look through the eyepiece and gently lower the slide with the fine adjustment. If you do this you will not spoil the objective or the slide. If you still cannot focus with the oil immersion objective, go back to instruction 14 and try again. Is the film on top of the slide?

As soon as you have focused the slide, lock the focusing lock.

When looking at another slide, look at it first with the low power objective, bringing the stage up sharp against the focusing lock. Focus it with the fine adjustment and then use the oil immersion objective, following the instructions from 15 onwards.

If you use the lamp which fits into the microscope, lighting will be easier, and you will not have to adjust the mirror.

All these instructions may look difficult, but they are not really so hard as they look. Three things are very important.

(i) Before using the oil immersion objective, always first search for a good part of the specimen with the low power objective.

(ii) Until you have had a lot of practice, always look from the side when you bring the slide and the oil immersion objective together.

(iii) Be careful about the light—if it is not as bright as you want, take out the eyepiece and move the mirror until the bottom of the tube is flooded with light.

6.15 Specimens of poor contrast

So far we have only thought about one kind of object—a stained slide. This is a common kind of object to look at with a microscope. But there is another kind of object which needs to be looked at differently. This is the unstained specimen with **poor contrast**. By 'poor contrast' we mean that there is little difference as far as light is concerned between the object and the liquid in which it is. In other words, the object is pale and watery and not easy to see. Examples are cells in an unstained specimen of CSF, cells in the urine, and the smaller parasites in a saline smear of the stool. Such objects need to be looked at differently with a microscope. Follow these instructions.

METHOD

LOOKING AT SPECIMENS OF POOR CONTRAST

Follow exactly the same steps as in the method above except that you **WILL NEED MUCH LESS LIGHT**. The best way to do this is to make the light less bright. One way of doing this is to move the lamp further away. Another and not so good way is to lower the condenser. With higher powered objectives, especially the oil immersion objective, you may have to close the iris diaphragm until you get just the light you want.

THE FIELD OF VIEW THROUGH THE LOWER POWER OBJECTIVES IS NOT AS CLEAR AS IT SHOULD BE

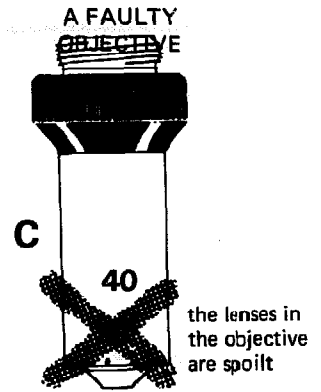
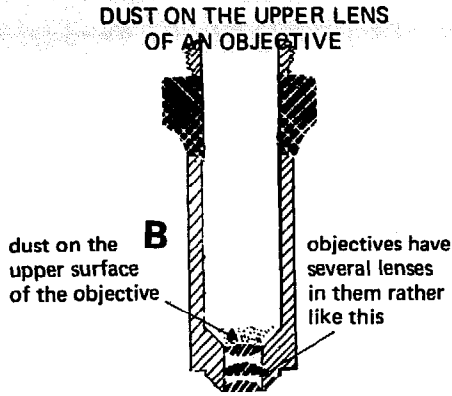
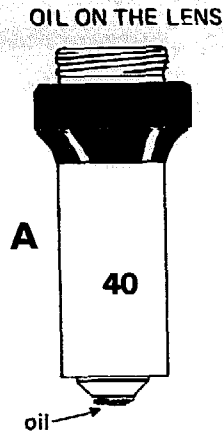

NOTHING CAN BE SEEN THROUGH THE OIL IMMERSION OBJECTIVES OR THE IMAGE IS NOT AS CLEAR AS IT SHOULD BE

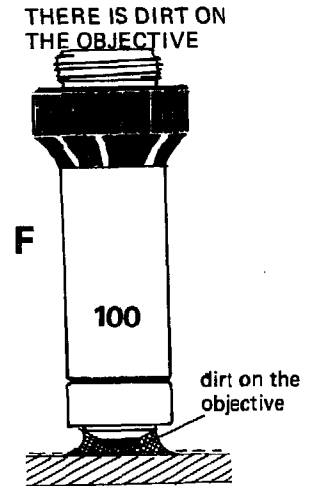
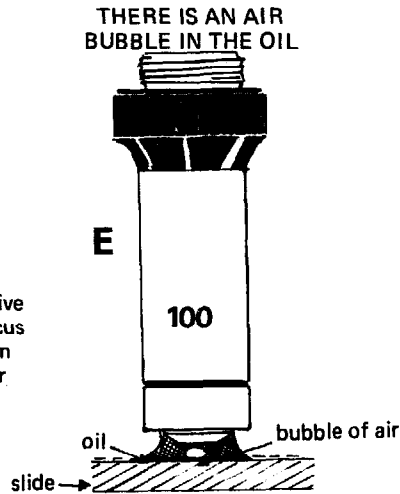
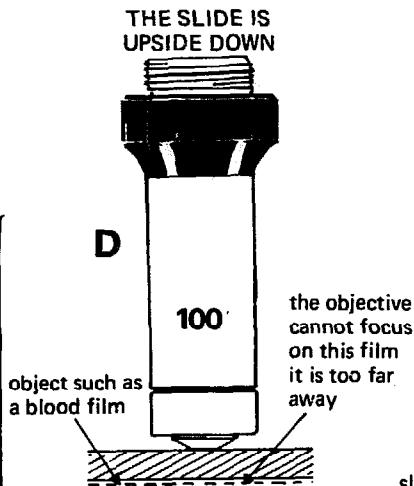

THE COVERSLIP OR THE OBJECT ARE TOO THICK

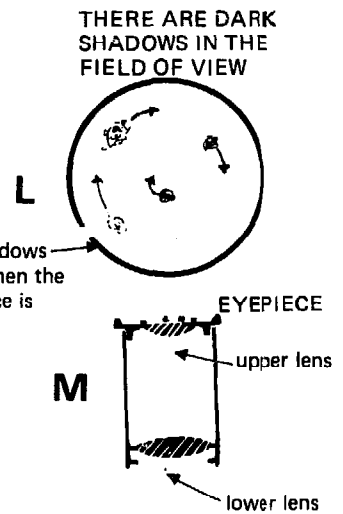
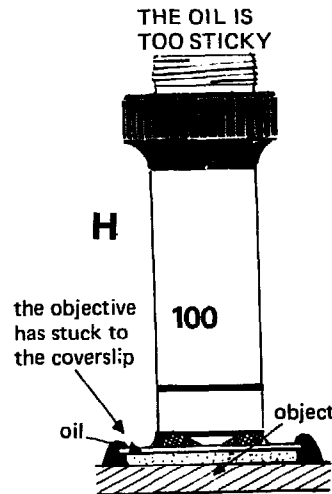
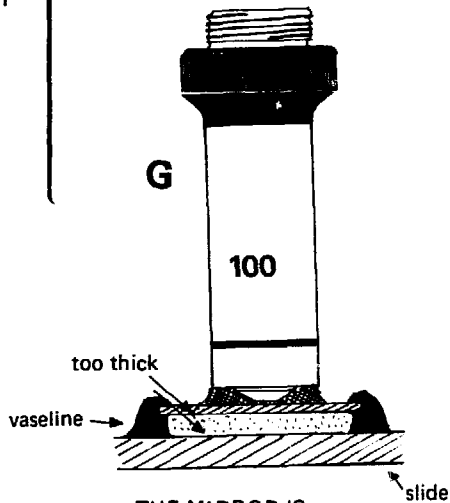

THE LIGHT IS POOR OR THE FIELD COMPLETELY DARK

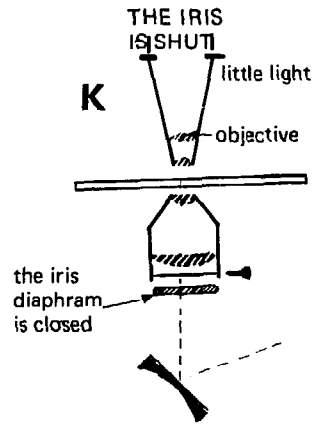
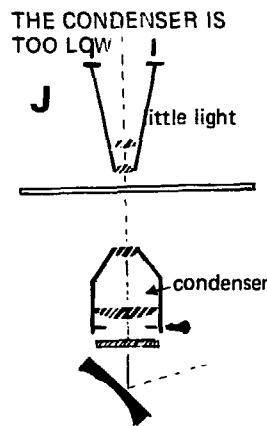
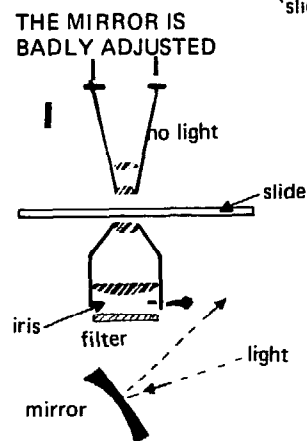

Fig. 6-18 Troubles with microscopes

6.16 Troubles with microscopes

Several things can go wrong with microscopes, especially when they are old. These instructions will help you to put some of your troubles right. They are all shown in FIGURE 6-18.

(i) THE FIELD OF VIEW THROUGH THE LOW OR THE HIGH POWER OBJECTIVE IS NOT AS CLEAR AS IT SHOULD BE.

There are several causes for this.

A. *Is there oil on the lens?*

There are several ways in which you can clean an objective or an eyepiece. The best way to remove dust is to brush it off with a small soft, *very clean* paint brush. There must be no grease (fat or oil) on the brush; so wash it in a very little ether first. If you cannot get the lens clean with a brush, use lens tissue as described below. If you have no lens tissue, use a clean, soft cloth which has been very well washed. Breathe on a lens before you wipe it. Little drops of very clean water will form on the lens from the water in your breath. If you cannot clean a lens in any of these ways, use lens tissue or a clean, soft cloth like this.

METHOD

CLEANING THE SURFACE LENS OF AN OBJECTIVE. FIGURE 6-19

Unscrew the objective from the nosepiece of your microscope.

1. Hold it up to the light. Let light shine on the lens not through it. If it is clean and shiny, put it back in the microscope: a dirty lens is not the cause of the trouble. If the lens is oily or dirty, do the following things.

2. Take a 5-cm square of lens tissue and hold it between the thumb and forefinger of your left hand. Lens tissue is best kept in booklets as described in Section 2.2, ML 29.

Put two or three drops of ether or xylol on a corner of the tissue over your left middle finger.

3. Gently touch the objective on the tissue where it is wet with xylol under your middle finger.

4. Touch the lens on a dry patch of tissue against one of your other fingers. Do this immediately before the xylol has time to dry off the surface of the lens. *When drying an objective like this, always touch it on a fresh dry bit of tissue.*

Hold the objective up to the light again, as in instruction 1, to see if it is clean. If it is not clean, start again. As soon as the objective is clean, put it back in the microscope.

Throw away the lens tissue, and don't use it again.

This instruction is only for objectives which do not dip into oil and which must have dry clean lenses. These are the $\times 4$, $\times 10$, and $\times 40$ objectives. Clean oil does not

matter on the lens of an oil immersion objective, but dirt on the lens will spoil the view through it.

B. *Is there a layer of dust on the upper surface of the objective?*

To find this out, unscrew the objective, hold it up to the light, and look down it from the top. Dust may be seen as in Picture B. Take away the dust with a small paint brush or a bit of cotton wool on the end of a stick. It is to prevent dust gathering here that no microscope should ever be left standing without an eyepiece or an objective.

C. *Will the microscope work if it is used with another objective?*

If the microscope works well with another objective, and nothing that has been said makes any difference, then the first objective is spoilt and must be sent back to the makers. A faulty (broken or spoilt) objective has been drawn in Picture C.

(ii) NOTHING CAN BE SEEN THROUGH THE OIL IMMERSION OBJECTIVE, OR THE IMAGE (PICTURE) IS NOT AS CLEAR AS IT SHOULD BE.

There are many causes for this. Here are some of the more important ones.

D. *Has the microscope slide been put on the stage the wrong way up?*

If the slide is upside down you will never focus clearly with the oil immersion objective because the thickness of the slide may be greater than the focal length of the objective. This is drawn in Picture D. Make quite sure that you put the slide into the microscope with the film on top next time.

E. *Is there a bubble of air or a bit of dirt in the oil underneath the objective?*

This is a common cause of trouble, and the bubble can sometimes be seen moving. Move the oil immersion objective quickly from side to side. The bubble will soon slip out of the way.

F. *Is the lens of the oil immersion objective dirty?*

Take the objective out and look at it against the light as in FIGURE 6-19. Clean it. If the microscope is an old one and the lens has been badly used, it may be deeply scratched and pitted (there may be holes in it). A new objective may be needed.

G. *Is the coverslip or the fluid object (a stool smear, for instance) underneath it so thick that the objective cannot get near enough to the object?*

Use a thinner coverslip or a thinner layer of fluid underneath it.

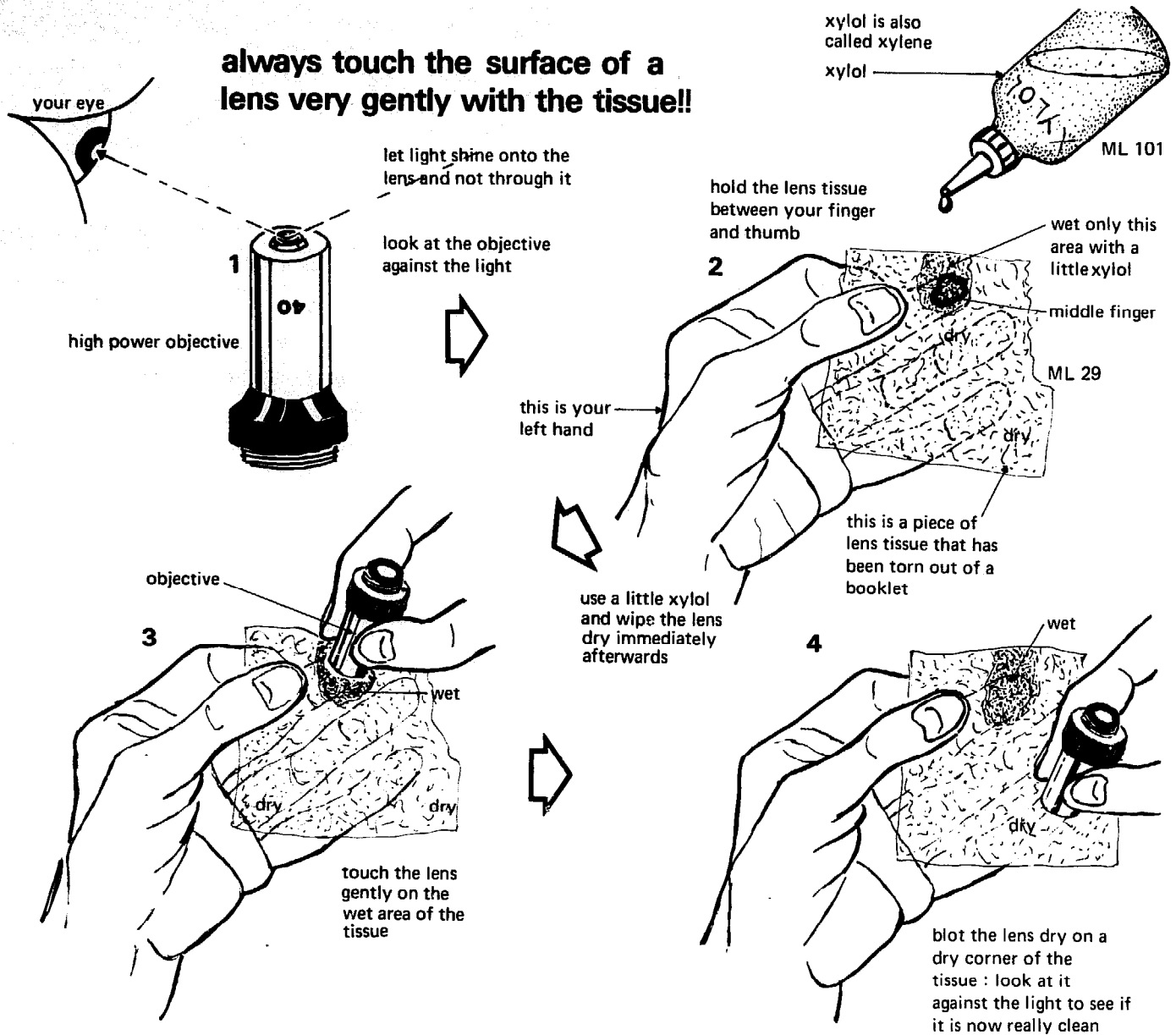

Fig. 6-19 Cleaning an objective

H. Is the immersion oil so sticky that the objective sticks to the slide and they move up and down together?

Use thinner immersion oil.

(iii) THE LIGHT IS POOR OR THE FIELD (VIEW) ALMOST COMPLETELY DARK.

Most of the causes for this are easily put right.

I. Is the mirror adjusted as it should be?

Focus on a slide with the low power objective. Take out the eyepiece and look down the tube. Is the bottom of the tube evenly flooded with light? If not, adjust the mirror as in Section 6.11. Make sure you are using the flat side of the mirror.

J. Is the condenser close up near the slide?

Perhaps you have forgotten to raise it. In Picture J the condenser is too low.

K. Is the iris diaphragm shut?

Perhaps you have forgotten to open it.

(iv) THERE ARE DARK SHADOWS IN THE FIELD OF VIEW, PICTURES L and M, FIGURE 6-18.

If these shadows move round when you turn the eyepiece round, they are due to dirt or scratches on the lenses of the eyepiece. If they move when you turn the upper lens, they are due to dirt on the upper surface of the top lens, as shown in Picture M. If they only move when you turn

the lower lens, they are due to dirt on this lens. Clean the dirty lens very gently with lens tissue and xylol just as you would an objective. The eyepiece of the Olympus microscope cannot be taken to pieces; so don't try. The common place for dirt to collect is on top of the top lens.

(v) THE FIELD OF VIEW LOOKS OVAL AND IS NOT ROUND AS IT SHOULD BE.

Perhaps the objective is not properly held in place by the click-stop? Turn the objective into its proper place under the tube until it is held by the click-stop. Perhaps the filter holder is not properly in place?

6.17 Some 'Dos' and 'Don'ts' in microscopy (FIGURE 6-20)

Finally, here are some practical points to remember. Some of them are shown in FIGURE 6-20.

staple them between two bits of cardboard as shown in Picture Y. This will keep the tissue away from any dust that may scratch the lenses.

Use ether or xylol (xylene) for cleaning the lenses. Don't use spirit or alcohol because you may dissolve the cement (glue) with which the lenses are stuck into the objectives. *Spirit or alcohol may spoil your objectives completely.*

Don't clean lenses with your tie, an ordinary handkerchief, or your coat. Use *only* the special lens tissue, or if this is not available, use soft paper cleaning tissues instead.

DON'T RUB THE SURFACE OF A LENS HARD—touch it with the least possible force that will remove dirt. If there is even a tiny bit of grit (sand) and you rub hard, this will make a scratch and spoil the lens.

Be careful when you take a slide or a counting cham-

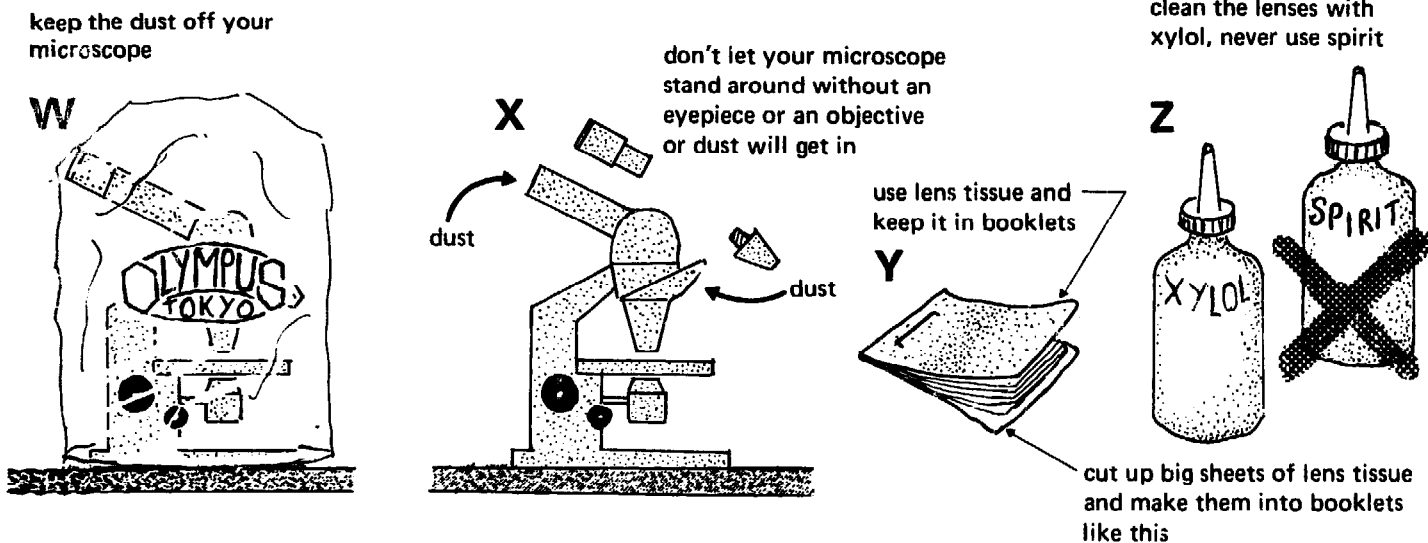

Fig. 6-20 Some 'Dos' and 'Don'ts' in microscopy

Dust is a great enemy of microscopes; so keep dust off your microscope when you are not using it. Many microscopes are supplied with a plastic cover as is the Olympus microscope drawn in Picture W. If your microscope has not got a cover, either keep it in the box in which it came or make it a cover of plastic sheet or cloth.

Keep the tube of the microscope closed. If you leave a microscope without an eyepiece or an objective for any length of time, dust will get in and may cause trouble—see Picture B, FIGURE 6-18. If you have not got an eyepiece or an objective to put in the microscope, close up the hole where they go with a bit of tape or cotton wool. Better still, use one of the special caps or plugs that are made to close these holes. In Picture X, FIGURE 6-20, dust has been drawn getting into a microscope through the holes left by an eyepiece and an objective.

Use lens tissue and keep it in booklets about 6 cm square. Cut up the big sheets in which it is supplied, and

ber from the stage of the microscope. Don't rub them against the objective—it may be scratched. Always raise the objective before removing the slide. Don't leave slides or counting chambers on a microscope.

Keep the objectives in the right order in the revolving nosepiece—very low power, low power, high power, oil immersion.

Make sure that your microscope works. *If you cannot mend it and make it work, try very hard to get a new one.* In some microscopes the coarse adjustment is so loose that the tube falls down and lets the objective touch the slide. Such a microscope cannot be used.

When you put your microscope away always see that the low power objective is in place under the tube. This will stop the oil immersion objective being pushed against the condenser by mistake.

Clean the oil immersion objective with lens paper before you put your microscope away at the end of the day.

6.18 Looking after microscopes in warm, wet countries

In dry countries microscopes are usually quite safe. But, if the air round a microscope is warm and wet, fungi may grow on the lenses and spoil them. Polished glass lenses become cloudy and you will not be able to see through the microscope clearly. In some very warm, wet countries a microscope may be badly spoilt in a few weeks. What can be done? The best way of looking after a microscope in warm, wet places is to put them in a thick polythene bag with a desiccant, such as silica gel. A desiccant is a chemical which takes up water from damp air and makes it dry. Fungi do not grow on lenses if the air is dry, or nearly dry. Silica gel is listed as Choice 3, ML 118a in Section 13.16. When this kind of silica gel is dry, it is blue. When it is wet it goes pink. Use it like this.

METHOD

LOOKING AFTER A MICROSCOPE IN A WARM, DAMP CLIMATE

Get a thick polythene bag (ML 118b). Thick bags keep out the water better than thin ones. Make sure it is airtight, by closing the top and squeezing it gently. Close any holes there may be. You may be able to close them with adhesive tape (sticking plaster).

If your silica gel is pink (wet), heat it in a clean pan over a stove, mixing it all the time. It will soon go blue. Do not overheat it.

Put plenty of dry blue silica gel (not less than 250 g) into a shallow dish or tin (ML 118c). Put this dish into the bottom of the bag. Put the microscope into the bag on top of the dish of silica gel.

Fold over the top of the bag several times, and keep it closed with a clip such as a large paper clip. Test that the bag is airtight by squeezing it gently.

Keep your microscope in this bag whenever it is not being used.

As soon as the silica gel goes pink, heat it up until it goes blue again.

Your microscope will be safer if you always keep its lenses clean. If you have not got a bag and silica gel it will be safer out on a bench than shut in its box, or under its plastic cover. It will also be safer near a fan. Another way of looking after a microscope is to keep it warm in a cupboard over an electric light bulb that is always on. There should be holes in the cupboard so that the air can move freely. Yet another way is to keep a microscope under a metal cover or hood which is heated by an electric light bulb that is kept burning. But none of these ways seem to be as good as keeping a microscope in a polythene bag with silica gel as a desiccant—but only provided it is kept dry and blue.

QUESTIONS

1. What is a μm ? How wide is a red blood cell?
2. Make a list of all the parts of a microscope through which light shines as it goes from a lamp to your eyes.
3. What is the condenser of a microscope? What adjustments can you make to it? Why are they made?
4. What differences are there between a high power ($\times 40$) objective and an oil immersion ($\times 100$) objective? What differences are there in the way these objectives are used?
5. How would you clean the surface of a low power ($\times 10$) objective that had got oil on it?
6. Why is a binocular microscope so useful? What adjustments can be made to the head of a binocular microscope?
7. How is the preset focus lock of the Olympus microscope used?
8. What different adjustments to a microscope are needed when looking at an unstained specimen of CSF, as compared with a stained blood film?
9. What might be wrong if the field of view through an oil immersion objective is cloudy?
10. How can you light your microscope if you have no mains electricity?

7 | Blood

ANAEMIA

7.1 Haemoglobin

This is the red substance in the blood cells that makes blood red. When people have less haemoglobin in their blood than they should have, their blood is pale and they are said to be **anaemic**. Anaemia is very common, so it is useful to be able to measure it. We can see if a patient is anaemic in two ways. We can measure how much haemoglobin there is in his blood and we can also measure what is called the **haematocrit**. Let us first think about ways of measuring the haemoglobin.

Haemoglobin can be measured in two ways. We can measure it as **oxyhaemoglobin**, which is haemoglobin made bright red by the oxygen in the air. We can also measure it more accurately, but with slightly greater difficulty, when we change it into a substance called **cyanmethaemoglobin**. The cyanmethaemoglobin method is described with the EEL colorimeter and the standard for it in Sections 5.19 and 5.20.

Three methods of measuring oxyhaemoglobin are described here. They have all been partly explained in Chapter Five, where the measuring instruments were described. *If you are still in doubt when you have read this section, look back to Chapter Five.* All three methods start in the same way. 0.05 ml ($\frac{1}{20}$ ml) of blood is added to 10 ml of haemoglobin diluting fluid as described in Section 3.31. Blood can be taken from an ear prick or from a finger prick—these are capillary specimens. Blood can also be taken from a vein—a venous specimen (see Section 4.7).

Take blood with the special blood pipette (ML 32). This has three marks on it, one at 0.02 ml, one at 0.05 ml, and one at 0.1 ml. For all the haemoglobin methods *0.05 ml of blood is added to 10 ml of diluting fluid.* Sometimes it is difficult to get 0.05 ml of blood out of a patient's ear or finger, and it may be convenient to add *0.02 ml of blood to 4 ml of diluting fluid.*

The blood pipette must be clean and should also be dry before you use it. The best way to clean a blood pipette is to use an inflammable and volatile liquid called **acetone**. If you have acetone, use it like this. Put some acetone in a small bottle or tube, and fill another tube with water. First clean the pipette by sucking the water

up and down. Then, when the pipette is clean, suck up some acetone. Last of all suck air through with a filter pump until the pipette is dry.

If you have no acetone, you will have to use your pipette wet, which will give you a less accurate answer. When you use a venous blood specimen it is possible to overcome some of the inaccuracy of a wet pipette by filling it once or twice with the blood specimen. In this way the blood can be used to remove the last drop of water in the pipette before it is filled. In the same way blood can be washed out of the pipette into the diluting fluid.

METHOD

MEASURING HAEMOGLOBIN BY THE OXYHAEMOGLOBIN METHOD

A. USING THE LOVIBOND COMPARATOR, FIGURE 7-1

1. Fill a Lovibond tube to exactly the 10-ml mark with haemoglobin diluting fluid—*no other tube will do.* Making this fluid is described in Section 3.31. If you find it difficult to get the meniscus of the fluid to exactly the 10-ml mark, put in a little too much and then use a Pasteur pipette to remove the extra fluid.

Haemoglobin diluting fluid does not keep well, so don't keep it more than a week or so and don't make up more than 100 ml at a time.

2. Using one of the glass chips described in Section 4.7, and a piece of cotton wool soaked in spirit, take blood from a patient's finger (3), or from his ear (4). You can also use a venous specimen (5), but remember to mix the bottle before you do so, because the red cells may have sunk to the bottom. When you take a capillary specimen remember to wipe away the first drop, and to fill your pipette from the next drops. The first drop may not be a true sample of the patient's blood.

6. Put a rubber tube and mouthpiece on to the dry pipette. Dip the end of the pipette into the blood specimen. *Hold the pipette sloping slightly downwards as in Picture 7.* If the tip of the pipette is slightly higher than the other end, blood will go in by itself, and there is no need to suck. Don't hold the pipette vertical (upright) as in Picture 8.

9. Don't get any bubbles into the blood in the pipette.

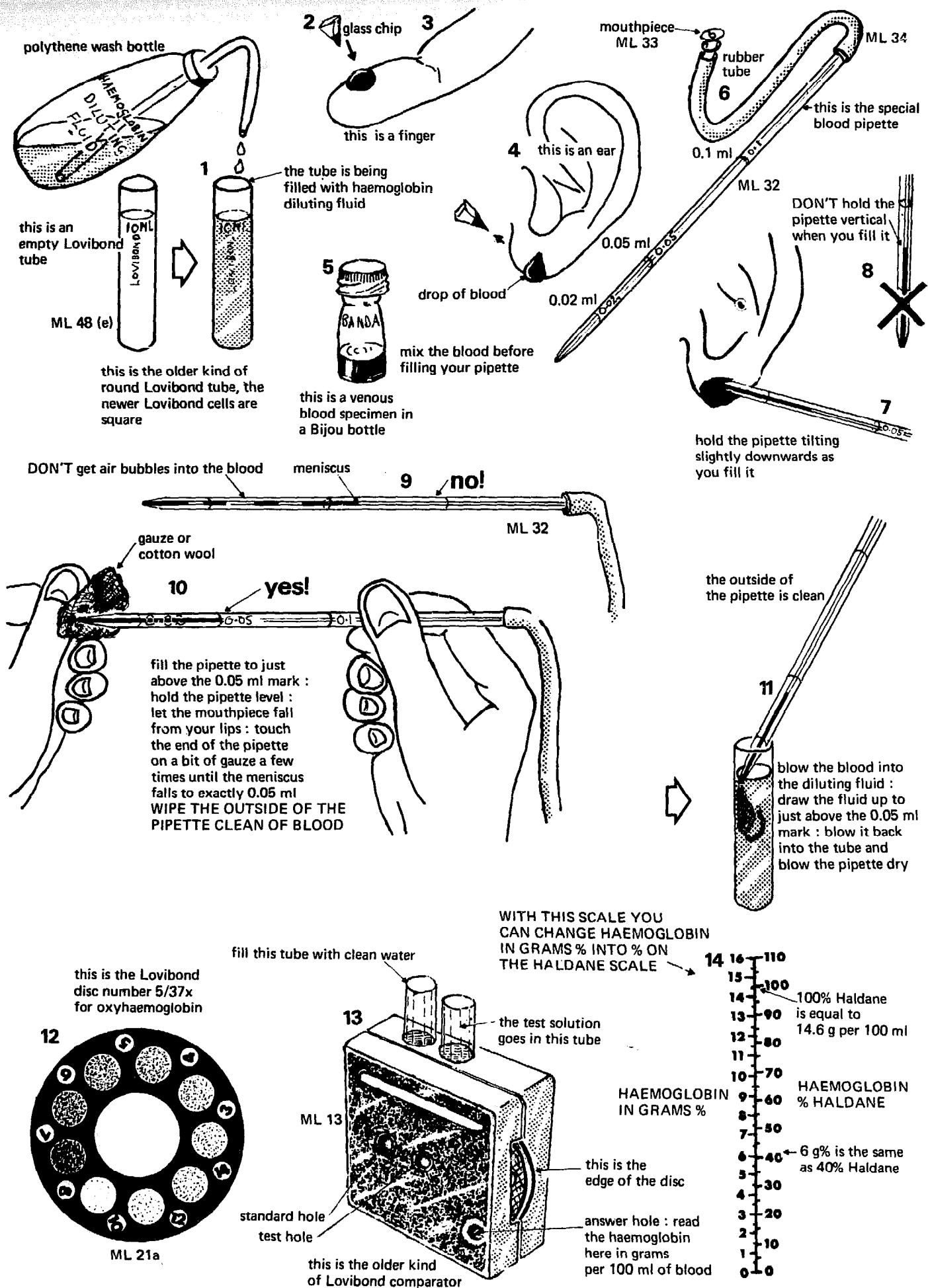

Fig. 7-1 The haemoglobin

If you do, you will not measure the right volume of blood, and your answer will not be accurate. If you get bubbles into the blood, blow them out and start again. Fill the pipette to just a little beyond the 0.05-ml mark. Then carefully clean the outside of the pipette. If you leave any blood on the outside, it will be washed off into the Lovibond tube, and the answer will be too high.

10. Then, still keeping the pipette flat, touch its end with a piece of gauze or cotton wool. This will suck a little blood out of the pipette, and the meniscus can easily be brought to the 0.05-ml line exactly. *Make sure that the outside of the pipette is clean.*

11. Blow the blood into the fluid in the Lovibond tube. Suck some fluid back into the pipette to just above the 0.05-ml mark, but no further. Blow it out again two or three times, because the pipette is made to be used in this way. This will wash out the blood sticking to the inside of the pipette. It will make sure that all the blood is in diluting fluid and will clean the pipette at the same time. This is the haemoglobin test solution.

Hold your thumb over the tube and mix it gently.

12. Make sure that the Lovibond haemoglobin disc marked 5.37 \times is in the comparator, and that the white circles with the answers on them are looking towards you.

13. Hold the comparator up to the daylight and turn the disc until the view through the holes looks the same. Read the answer through the answer hole. This will tell you the number of grams of haemoglobin the patient has in each 100 ml of his blood. For short we write this 'grams per cent' as 'g %'.

14. This picture has a scale on it with which you can change g % into 'per cent Haldane'. Thus 6 g % is almost exactly 40% Haldane. The scales do not match exactly, and you will have to look carefully when changing one into the other. Thus 2 g % is a little less than 15% Haldane, say 14% Haldane.

More is said about the Lovibond comparator in Section 5.10. *Follow these instructions carefully.*

B. USING THE GREY WEDGE PHOTOMETER

Using a 10-ml straight pipette (ML 35 c) put 10 ml of haemoglobin diluting fluid into a universal container (ML 14b). Add 0.05 ml of blood as described above. Mix well and pour the mixture into one of the cells of the Grey wedge photometer. *Wipe the outside of the cell clean.* Put it into the right-hand place in the cell compartment of the photometer. Fill the left-hand cell with clean water. Make sure that you are using the green No. 2 eyepiece. Match the two halves of the visual field. Read the scale reading on the wheel. Either report this as 'per cent' or change it into g % using the scale in Picture 14, Figure 7-1.

More is said about the Grey wedge photometer in Section 5.11. *Read these instructions carefully, and don't forget to check with the grey glass standard.*

C. USING THE EEL COLORIMETER

Dilute 0.05 ml of blood in 10 ml of haemoglobin diluting fluid, exactly as described in part B above. Measure the haemoglobin as described in Section 5.20, using the liquid grey standard, the green Ilford 625 filter, and the calibration graph shown in Figure 5-10.

There may be a hundred women or more at an antenatal clinic who all need their haemoglobin measured on the same morning. What is the quickest and best way of measuring so many haemoglobins? A good way is to get many universal containers and to fill them with 10 ml of diluting fluid before the clinic starts. Hand each mother in the queue a bottle of diluting fluid for her haemoglobin and then go down the queue measuring their haemoglobins using a Lovibond comparator, or a Grey wedge photometer (this can be used with daylight). Try to get someone else to help you, and write a mother's haemoglobin on her card immediately you have taken it. Have some bottles with 4 ml of diluting fluid ready, so that if you cannot get the full 0.05 ml of blood, you can put 0.02 ml of blood straight into 4 ml of diluting fluid.

7.2 The haematocrit

This is another way of testing for anaemia. If you have the right instrument it is easier and more accurate than measuring the haemoglobin, and can often be used instead of it.

In Section 1.17 you read how, when blood is prevented from clotting and left to stand for some hours, the red cells fall to the bottom and leave clear plasma on top. In Section 1.5 you also read how red cells and plasma can be separated much more quickly by centrifuging. If blood is centrifuged very fast the red cells are soon packed (pushed) tightly together at the bottom of the tube. When you look at normal blood after centrifuging, you will see that the packed red cells (they are usually called **packed cells**) take up slightly less space than the plasma. In every 100 ml of blood from a healthy person there will be about 45 ml of packed cells and about 55 ml of plasma. Another way of saying this is to say that the volume of the packed cells is 45% of the volume of the blood. The volume of packed cells is called the **packed cell volume** or **PCV**. The **haematocrit** is the same as the PCV and is the word we will use here. The normal haematocrit is therefore about 45%.

If we take some anaemic blood and centrifuge it, we will find that the haematocrit is less than normal, perhaps only 30% or even only 10%. We can therefore measure anaemia by measuring the haematocrit as well as by measuring the haemoglobin. An anaemic patient has less than the normal amount of haemoglobin. He usually also has a haematocrit which is less than normal.

We shall describe two instruments for measuring the haematocrit. One is the MSE Minor Centrifuge and the pieces of equipment that go with it. This centrifuge is useful because it can be used as an ordinary centrifuge for urine, as well as for the microhaematocrit. The other

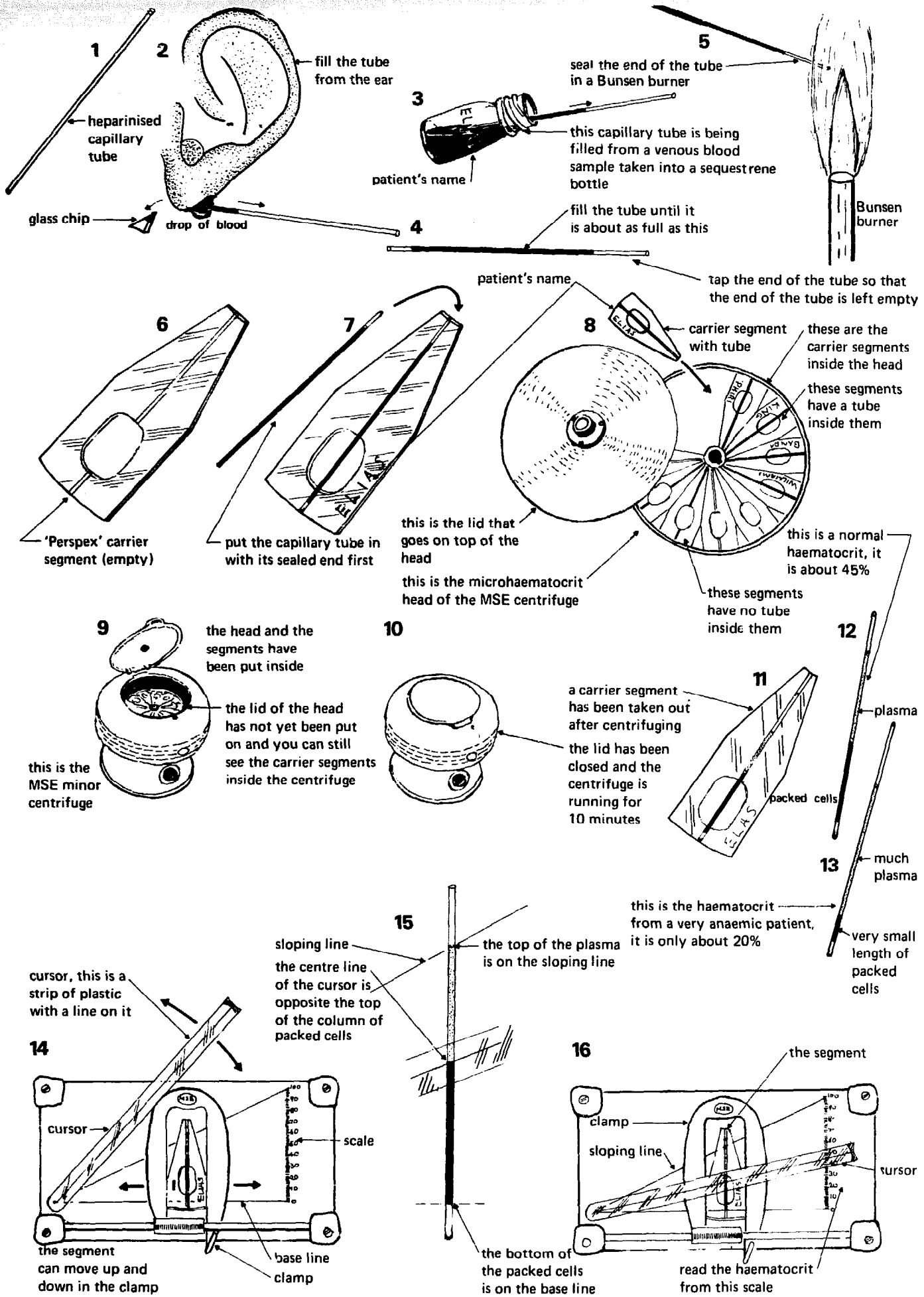

Fig. 7-2 The haematocrit

instrument is the Taylor-Eaves microhaematocrit, which can only be used for this method, but which is much cheaper.

The MSE Minor centrifuge

Besides the centrifuge itself (ML 122), you will need the special head for it (ML 122b), heparinized capillary tubes (ML 122f), and the MSE haematocrit reader (ML 122c). The heparinized capillary tubes are thin pieces of glass tube which have a small quantity of heparin inside them. Heparin is an anticoagulant, and, like sequestrene, it stops blood from clotting. The microhaematocrit reader is shown in Pictures 14 and 16.

METHOD

THE MSE MICROHAEMATOCRIT, FIGURE 7-2

1. Take a heparinized capillary tube and put its end into a drop of blood taken either from the ear (2) or from the finger. The tube can also be filled from a venous blood specimen taken into a sequestrene bottle (3). The tube may fill more easily if you hold it on its side as shown in this picture.

4. The tube should be about three-quarters full. Tap it gently on one end so that the column of blood comes clear of either end, and is closer to one end than the other.

5. Hold the more empty end of the tube for a moment in a flame so that its end seals up. Don't hold it in the flame too long or the tube will bend. The end of the tube will seal, and as soon as it does so, the blood will move along the tube a little. This is a sign that the tube is sealed.

6 and 7. Put the sealed end of the capillary tube into the carrier segment. Write the patient's name in grease pencil on the side of the segment. The tube lies in a ditch or groove in the top of the segment and in a hole at its bottom.

8 and 9. Put the carrier segment with its tube inside into the head of the centrifuge. Make sure that the head is full of carrier segments, with or without blood in them. Put on the lid. **IF THERE ARE LESS THAN TWELVE SEGMENTS INSIDE THE HEAD BEFORE IT IS STARTED, THE CENTRIFUGE WILL NOT RUN SMOOTHLY AND IT WILL BE SPOILED.**

10. Run the centrifuge as fast as it will go for ten minutes.

Footnote. The designs of both centrifuges were changed by the makers as this book was printing. The equipment listed in Section 13.7 has been altered, but it has not been possible to change Figure 7-2. Carrier segments are now no longer used in the MSE Minor centrifuge. Instead, the filled capillary tubes are placed in slots in the rotor, which is closed by a cover. Also, a better way of sealing the capillary tubes can be used with both instruments. Instead of sealing the tubes in a flame, their ends can be pressed into a thin (5 mm) layer of a plasticine-like sealing compound held in a special tray (ML 122e). This fills the ends of the tubes with sealing compound and seals them. These sealed ends then press against a plastic sealing strip or gasket at the edge of the rotor.

11. Take the carrier segments out of the centrifuge. You will see that there is a column (line) of packed red cells at the bottom of the tube, and at the top of the tube there is a column of clear plasma. In normal patients there will be nearly as much red cells as plasma, as in Picture 12. In anaemic patients there will be much plasma and only a short column of red cells, as in Picture 13. These pictures are only to show you what you might find—don't take the capillary tubes out of the carrier segments.

14. Put the carrier segment with its capillary tubes inside into the clamp (holder) of the microhaematocrit reader. Move the carrier segment up and down until *the bottom of the red cell column* is opposite the base line of the reader. Move the clamp along the reader until the top of the column of plasma is opposite the sloping line of the reader.

16. Without moving the clamp, move the cursor so that its centre line is opposite the top of the column of red cells. The cursor in this reader is only a strip of clear plastic with a line on it. Look along the centre line of the cursor, and read off the haemoglobin from the scale. Be careful not to move the clamp while doing this. Picture 15 shows this in more detail. You can see the base line opposite the top of the column of plasma. The centre line of the cursor is opposite the top of the column of packed cells.

The Bickerton-Eaves microhaematocrit

This is a simple instrument made of an electric motor to which is fitted a plastic head or rotor. It is housed in a metal box with a lid and has a time switch which turns off the motor after any time up to 15 minutes. This instrument will take up to 24 capillary tubes and is listed as ML 123a in Section 13.17. There is also a 12-volt model which can be run from a car battery.

METHOD

THE BICKERTON-EAVES MICROHAEMATOCRIT, FIGURE 7-3

1. Fill and seal heparinized capillary tubes exactly as described above.

2. Lift the cover of the case. Place your sealed capillary tubes in the numbered slots in the rotor.

3. Close the lid and turn the time switch to 15 minutes. The machine will run and then turn itself off at the end of this time.

4. Raise the lid. Read each tube by sliding it along the chart that is supplied with this machine and shown in Figure 7-3. If you have no chart, use the one at the end of the book which you can tear out. Put the bottom of the column of blood on the line marked 0. Slide the tube along the chart until the top of the column of plasma just touches the sloping line marked 100%. Read which of the other sloping lines the top of the column of packed cells touches. This is the haematocrit reading.

Never run the machine with the lid open.

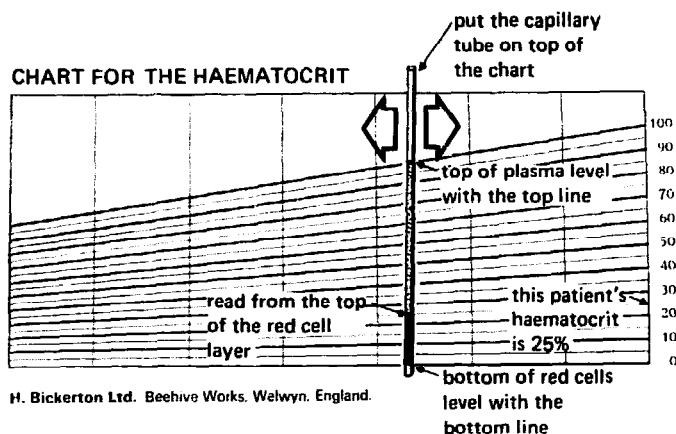
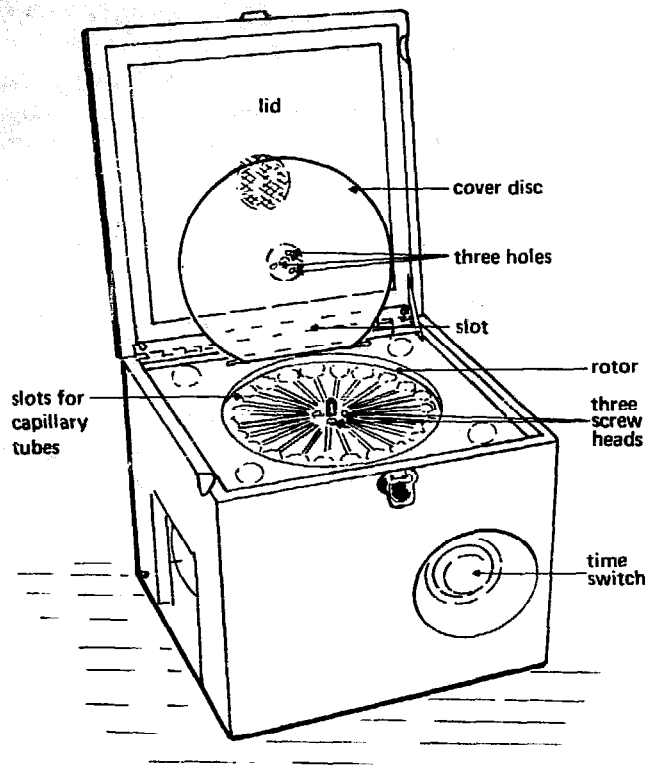

Fig. 7-3 A cheaper instrument for the haematocrit

7.3 Working out the MCHC from the haemoglobin and the haematocrit

We have just seen that there are two ways of finding if a patient is anaemic—we can measure his haemoglobin, and we can measure his haematocrit. These methods are both measures of anaemia, but they measure different things. When we measure the haemoglobin, we measure how much of the red substance called haemoglobin there is in 100 ml of blood. When we measure the haematocrit, we measure the percentage of the blood that is taken up by red cells. Different kinds of anaemia alter the haemoglobin and the haematocrit in different ways. Thus, in many kinds of anaemia there are fewer red cells than there should be, but these few red cells are well filled with

haemoglobin and have a normal pink colour on a stained film. These are the **normochromic**, or normal-coloured anaemias, in which the haemoglobin and the haematocrit have fallen in proportion to one another. But, some anaemic patients lack the iron they need to make the haemoglobin to fill their red cells. The haemoglobin in these patients thus falls more than the haematocrit and their red cells are pale and partly empty of haemoglobin. Red cells which are pale and partly lacking haemoglobin in this way are said to be **hypochromic**. As you will read in Section 7.19, it is possible to see if red cells are hypochromic by staining a blood film and looking at them under a microscope. But this is not always easy, especially if hypochromia is mild, and a better way to measure it is to combine the haematocrit and the haemoglobin together and work out a special measure of how much haemoglobin there is in red cells called the **MCHC**.

The MCHC stands for the Mean (average) Corpuscular (a red corpuscle is a red cell) Haemoglobin Concentration and is worked out like this:

$$\frac{\text{Haemoglobin in g \%}}{\text{Haematocrit \%}} \times 100 = \text{MCHC \%}$$

The MCHC of a normal person is therefore:

$$\frac{14.8}{45} \times 100 = 33\%$$

Any MCHC between 32 and 36% is normal. Normal red cells are already as full of haemoglobin as they can be, and if you get a figure of over 36%, one of your methods must have been wrong. Either the haematocrit is too low, or the haemoglobin is too high. Any figure below 32% means that the patient's blood is hypochromic. To help you find the MCHC a special diagram called a nomogram has been drawn in FIGURE 7-4. To use this nomogram first find the patient's haemoglobin on the top scale. Then find his haematocrit on the bottom scale. Join them up with a ruler. Find where the ruler crosses the middle scale—this is the patient's MCHC. The dotted line in the figure gives you an example. The patient's haemoglobin was 8.1 g % and his haematocrit 34%. The dotted line crosses the MCHC scale at about 24%, so his MCHC was 24%. There is a special nomogram for you to tear out at the end of the book.

It is important to be able to measure hypochromia, because it is common, and it means lack of haemoglobin in the red cells due to lack of iron. Iron medicines are cheap and hypochromic anaemias are usually easy to treat.

Hypochromia can be measured in another way. This is with a special chart. The next section describes such a chart for children.

7.4 An anaemia chart for the 'Under Fives Clinic'

An under fives clinic is a special clinic to which mothers bring their children from the time they are born until they are 5 years old. Many of the children who come to

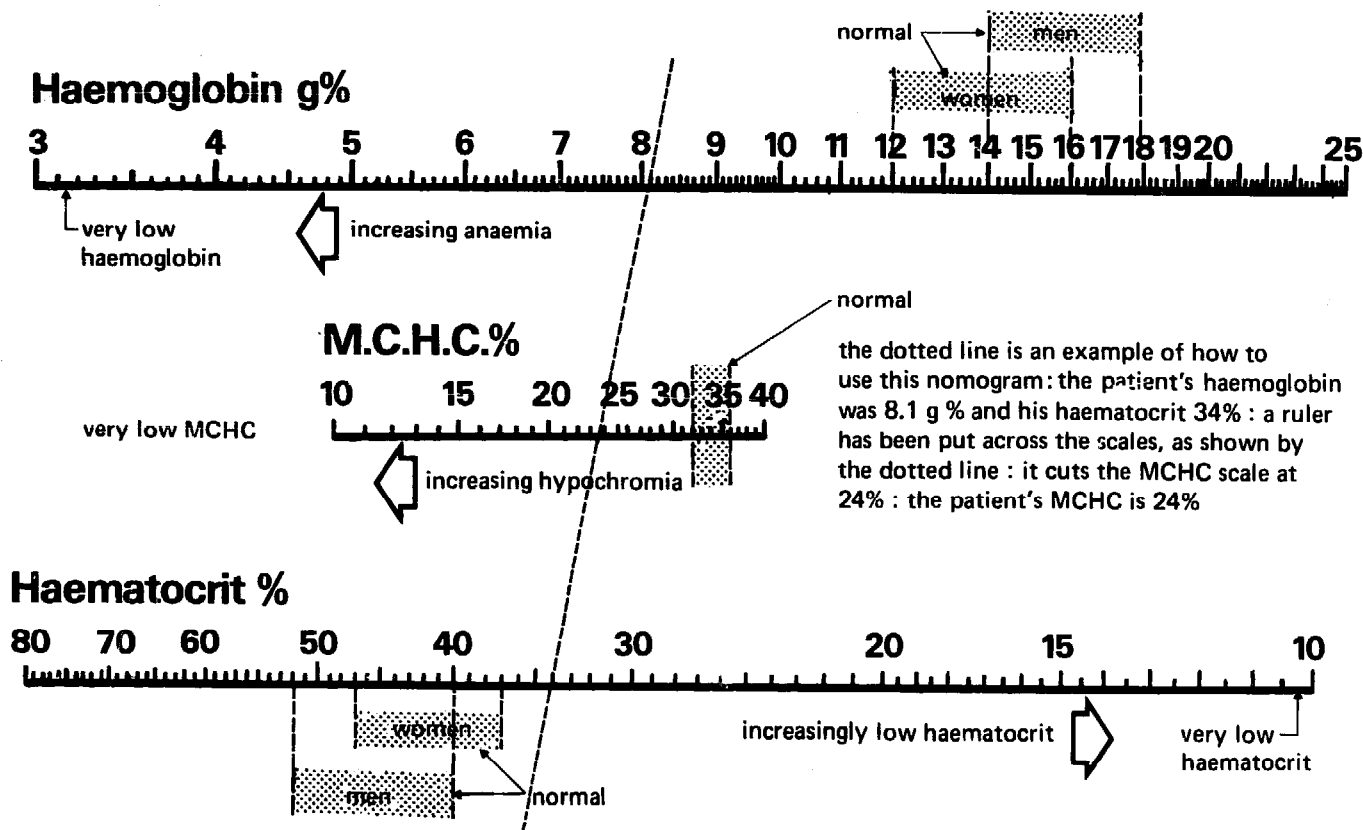

Fig. 7-4 A nomogram for the MCHC

these clinics are anaemic. The cause of their anaemia has to be diagnosed by the methods in this book, after which these children must be treated. Because treatment may take some weeks, or even months, it is useful to have a chart on which a child's haemoglobin or haematocrit can be recorded. The person who is treating the child can then see if his anaemia is improving as it should. FIGURE 7-5 shows an anaemia chart which a mother can keep with the weight chart that she brings with her child to these clinics. You will see that the inside is divided into three parts—one part for each of the first 3 years of a child's life. The parts for his fourth and fifth years are on the outside. Along the bottom of the chart are five rows of twelve boxes. There is a box for each month of a child's life. The first box of each row has a thick black line around it and is for the month of his birth. The other boxes are for the months after that. You will see that the chart in the figure has been filled in for a child born in March 1971.

These charts have the haemoglobin written down the left-hand side, and the haematocrit written down the right-hand side. They can thus be used with either of these methods, the haemoglobin being recorded with a spot, and the haematocrit with a cross. But it is even more useful to do both these methods on an anaemic child. If the cross for the haemoglobin is in about the same place as the dot for the haematocrit, his anaemia is normochromic, and he does not need iron treatment. But, if the cross for the haemoglobin comes below the dot for the haematocrit, his red cells are poorly filled with

haemoglobin, he has a hypochromic anaemia, and he needs iron treatment. This is what was wrong with the child John in the figure who had quite a severe hypochromic anaemia due to hookworm infection that was treated with iron. When he was given iron his red cells filled with haemoglobin, became normochromic, and his anaemia improved. You can see this happening on the chart which shows the crosses for the haemoglobin climbing up and joining the dots for the haematocrit.

We have seen that when the crosses for the haemoglobin and the dots for the haematocrit close together the cells are normochromic. We have also seen that when the haemoglobin is below the haematocrit, the cells are poorly filled with haemoglobin and are hypochromic. However, the haemoglobin can never lie much above the haematocrit, because healthy normochromic red cells already contain as much haemoglobin as they can, and cannot contain any more. If, therefore, the haemoglobin comes much above the haematocrit on the chart, something is wrong, and either the haematocrit is too low, or the haemoglobin is too high. When this happens check your methods.

Children have lower haemoglobins and haematocrits than adults. Both the haemoglobin and the haematocrit are high at birth, but they fall quickly at first, and then more slowly after that, so that by the time a child is a year old his haemoglobin is only about 10 g % and his haematocrit about 33%. From the age of one year onwards they slowly rise again. The normal values for

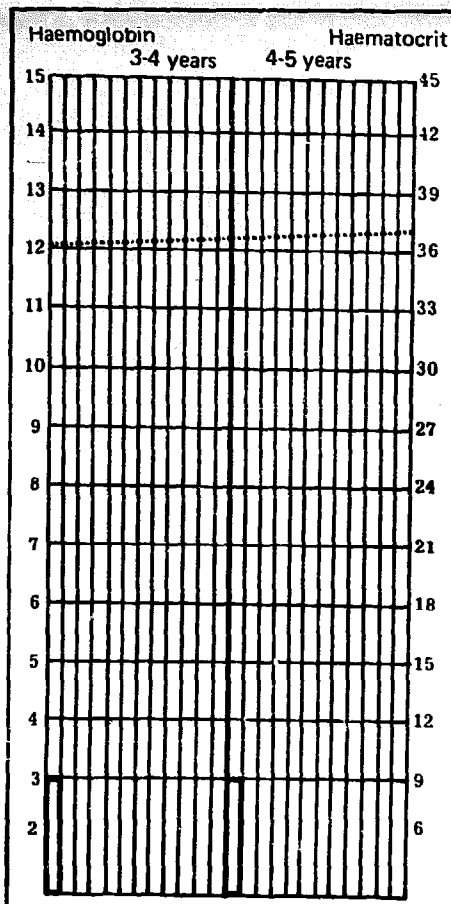

Under fives clinic

ANAEMIA CHART

CHILD'S NAME & ADDRESS	CHILD'S NO.
JOHN BANDA	8135

TO COMPLETE CHART

Fill in the first box (with the thick border) with the month of the child's birthday. Repeat every year and then fill in all the other months.

Example: A child born in April, 1970

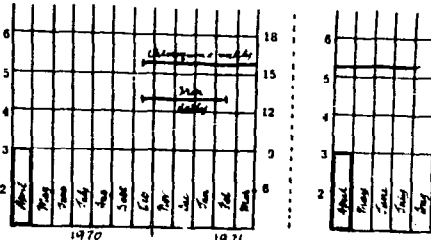

Test the child for anaemia every month by measuring his haemoglobin and/or his haematocrit. In a busy clinic only one of these tests need be made.

Make a cross in that month's column for the child's haematocrit. Make a spot for his haemoglobin. Join the spots and crosses month by month.

Use the rest of the card to record the treatment given to a child. An example is shown of a child having iron and antimalarial treatment.

Normal values

The average normal haemoglobin and haematocrit are shown by the dotted line on the chart. After the first few months of life a haemoglobin below 10 g% shows that a child has anaemia

Normochromic anaemias

The haemoglobin and haematocrit results overlap.

Hypochromic anaemia

The haemoglobin result falls well below the haematocrit

Note. An ordinary weight chart from an under fives clinic can be used. Plot haemoglobin in g% on the kilogram scale. The corresponding haematocrit value can be found from the graph below. Thus 10 kg, a haemoglobin of 10g%, and a haematocrit of 30% all use the same line.

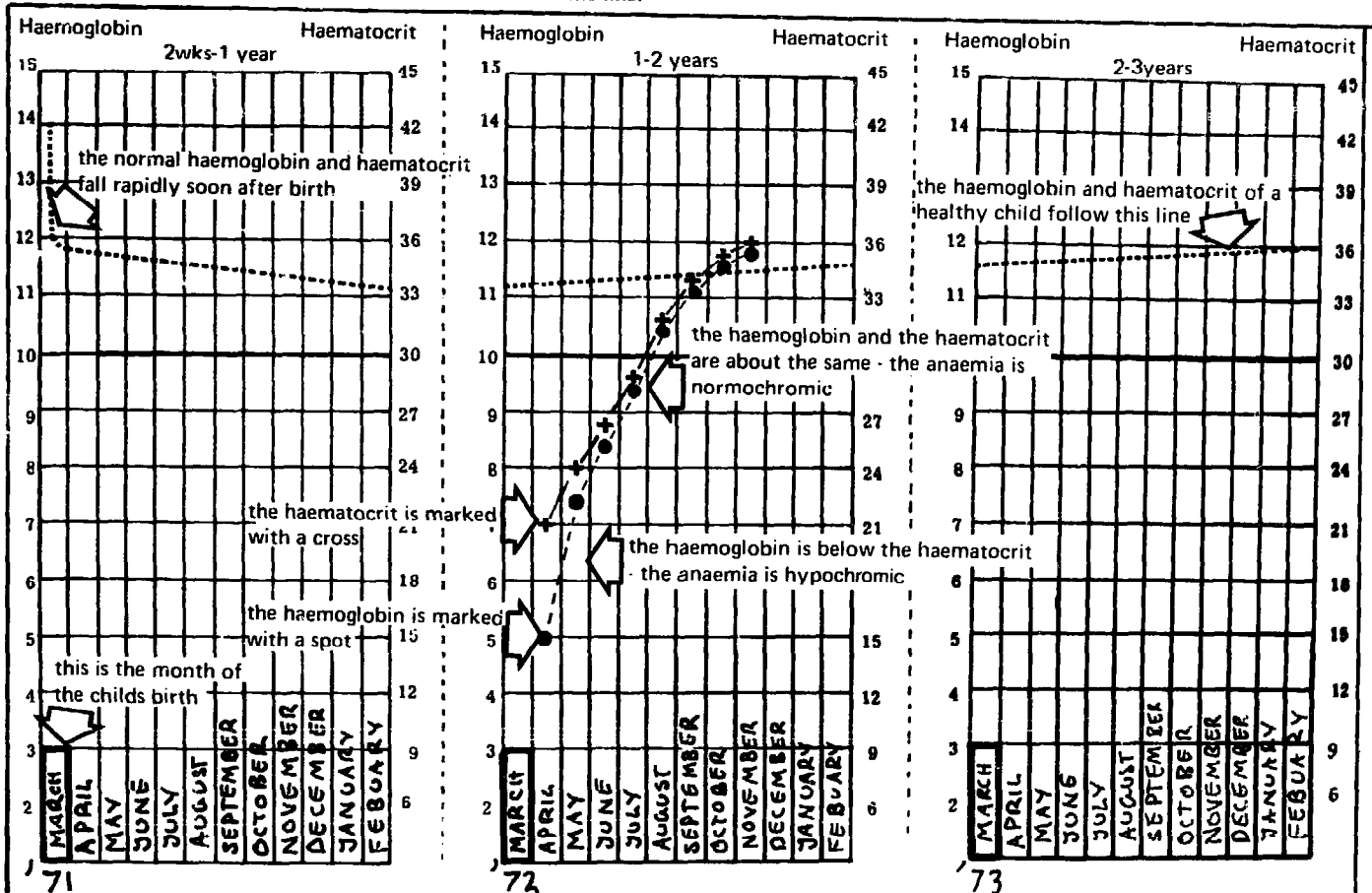

Fig. 7-5 An anaemia chart for the 'Under-Fives Clinic'

both the haemoglobin and the haematocrit are shown by a dotted line on the chart.

These are useful charts, both for the haemoglobin alone and especially for the haemoglobin and the haematocrit together. But, if they are going to be used as a measure of hypochromia, both the haemoglobin and the haematocrit must be accurately measured. This may not be easy in a busy clinic.

7.5 Causes of anaemia

Normal men have between 14 and 18 g of haemoglobin in 100 ml of their blood and a haematocrit of between 42 and 54%. Normal women have about 2 g less haemoglobin, and a haematocrit which is about 5% smaller than men (a haemoglobin of 12 to 16 g % and a haematocrit of 36 to 48%). In normal people the haemoglobin is thus about three times the haematocrit ($3 \times 15 = 45$). 14.8 g % of haemoglobin is often taken as an average normal and is discussed in Section 5.13. Patients who have less haemoglobin than this are said to be anaemic. A very anaemic patient would have less than 5 g % of haemoglobin and a haematocrit of about 24%. A mildly moderately anaemic patient would have about 8 g % of haemoglobin or a haematocrit of about 24%. A mildly anaemic patient might have a haemoglobin of 10 g % and a haematocrit of 30%.

What causes anaemia? A patient may become anaemic because too few red cells containing haemoglobin are being made by the body. If the body is to make enough haemoglobin it must have the right things to make haemoglobin with. Some of the more important things that the body needs to make haemoglobin are **iron**, **protein**, a vitamin called **folic acid**, and a vitamin called **vitamin B₁₂**. A vitamin is a food which the body must have but only needs in small amounts to keep healthy. If there are not enough of these things in the food, or if they are not properly absorbed (taken up) by the body, the patient will have a **deficiency anaemia**. A deficiency means a lack of something, or that something is missing.

A patient may also become anaemic because too many blood cells containing haemoglobin are being lost by bleeding *outside* his body or because they are being destroyed (lysed) *inside* his body. Patients sometimes lose blood into their gut, as when they have hookworms which bite the wall of the gut and cause bleeding. Even though this blood is being lost into the gut, it is being lost outside the body, and leaves the body in the stools. Blood may be lost by bleeding or by lysis faster than it is made, so making the patient anaemic. The two places from which blood is most often lost outside the body are the gut (intestine) and the **uterus** (womb). When there is bleeding into the gut, blood is found in the stools and can be tested with the occult blood test in Section 10.10. When blood is being destroyed inside a patient, he is said to have a **haemolytic anaemia**. As you read in Section 1.18, haemolysis means the destroying, breaking open, or lysis of red cells.

7.6. Iron deficiency anaemia

In many places this is the commonest kind of deficiency anaemia. Sometimes the anaemia is due only to the patient not having enough iron in his food. More often a patient is anaemic partly because there is not enough iron in his food, and partly because he is losing iron because his body is bleeding. The commonest reasons for this loss of blood are hookworm infection and abnormally heavy monthly periods.

As we saw in Section 7.3 iron deficiency causes the red cells to be poorly filled with haemoglobin and thus to be hypochromic with an MCHC below 32%. As we shall see in Section 7.19, the red cells of iron deficiency anaemia are often smaller than normal or microcytic. Iron deficiency therefore causes a hypochromic microcytic anaemia.

Hookworm anaemia

Hookworms are small nematodes or round worms which live in the small intestine (small gut). They hold on to the wall of the small intestine with their mouths. The wall of the intestine bleeds a little where each worm bites it. From the bite of each worm the patient will lose about $\frac{1}{20}$ ml of blood each day. A few hookworms will therefore cause little bleeding and no anaemia. But a heavily infected patient may have several hundred worms in his gut, and thus loses much blood. With the blood he will lose much haemoglobin and thus much iron. He may lose more iron than he eats and therefore easily becomes anaemic. The importance of hookworms as a cause of anaemia depends upon how many of them there are in the gut. Many worms in the gut produce many ova in the stool, so by counting the ova in the stool we can get some idea about how many worms there are in the gut. This is described in Section 10.3.

Hookworm anaemia is common in children, so all anaemic children must have their stools looked at for hookworm ova and these ova must be counted. It is very important to diagnose hookworm anaemia, because it is cheap and easy to treat. A moderately anaemic child is one who has a haemoglobin of between 5 and 10 g %. A child with an anaemia of this kind can easily be treated at a health centre with a drug called **tetrachloroethylene** ('TCE') which will kill hookworms in his gut. Bephenium ('Alcopar') is also used to treat hookworm infection. A child will also need iron to replace the iron he has lost and so help his body make more haemoglobin. Sometimes this iron is given as tablets and sometimes as an injection. Iron injections such as 'Imferon' are expensive, but they are useful because all the iron needed by the body can if necessary be given at one time, or over a few days. When iron tablets or an iron medicine are given, children may not take them as they should. Children with a haemoglobin of less than 5 g % are very anaemic indeed and must be treated in hospital where they can have a blood transfusion as well as iron. Read about blood transfusion in Chapter Twelve.

Very heavy infection with the worms called *Schistosoma haematobium* or *Schistosoma mansoni* can also cause an iron deficiency anaemia. But anaemias of this kind are only common in a few countries, and there must be many worms before the anaemia is severe.

Anaemia due to very heavy monthly periods

Just as many hookworms may together cause much blood to be lost into the gut and make a patient anaemic, so a woman who loses a lot of blood with her monthly periods may also become anaemic. A woman with very heavy monthly periods is said to suffer from **menorrhagia**. She usually knows that she is bleeding too much. Like patients with hookworm anaemia, women who are anaemic from heavy monthly periods also need iron. But most women can be given iron tablets which are cheaper and easier than the iron injections which children often need.

Although iron deficiency is the commonest cause of a hypochromic microcytic anaemia in most areas, there are some places in which a disease called **thalassaemia** is the commonest cause of this kind of anaemia—see Section 7.27b. Thus, although most iron deficiency anaemias are hypochromic, not all hypochromic anaemias are due to iron deficiency.

7.7 Folic acid deficiency anaemia

In some parts of the world this is a very common cause of anaemia, especially in antenatal and nursing mothers. Antenatal means before the birth of the child. So an antenatal mother is a mother with a child in her womb. A nursing mother is a mother who is giving milk to her child. These mothers become anaemic because they do not get enough folic acid in their food with which their bodies can make haemoglobin. A child in his mother's womb (uterus) or sucking from her breast also needs folic acid. Often there is not enough folic acid in a mother's food for both a mother and her child. The mother therefore becomes anaemic. The anaemia due to folic acid deficiency is a macrocytic kind of anaemia and is described in Section 7.19. It is important to recognize folic acid deficiency anaemia because it is easily and cheaply treated with folic acid tablets. Antenatal and nursing mothers also often lack iron. Their anaemia may therefore be due to a double deficiency of iron and folic acid. Antenatal mothers are therefore often given tablets of both iron and folic acid.

Folic acid deficiency is also common in haemolytic anaemia and in anaemia due to infection. Patients with both these kinds of anaemia may therefore be helped by folic acid.

A much less common kind of deficiency anaemia is that due to lack of vitamin B₁₂.

7.8 Anaemia caused by protein deficiency

Patients with protein-joule malnutrition or 'PJM' often become anaemic because they do not eat enough protein

with which their bodies can make red cells. The red cells are often slightly larger than normal as well as being hypochromic.

7.9 Haemolytic anaemias

This kind of anaemia is due to red cells being destroyed or lysed inside the body. In areas where malaria is seen, this is the commonest cause of a haemolytic anaemia, especially in children between the ages of 3 months and 5 years. This is because, when malaria parasites grow inside red cells, they destroy them, and the patient becomes anaemic. When a patient's anaemia is due to malaria, parasites can usually but not always be seen in a thick or thin blood film, as described in Section 7.31. If malaria parasites are seen in large numbers it is probable that they are causing most of his anaemia. If there are only small numbers of malaria parasites in the blood of an anaemic patient there is likely to be some other cause of the anaemia also. So, don't be satisfied by diagnosing malaria alone as the cause of anaemia, especially in a child, without looking for other causes also. When the anaemia is due to malaria you may see large numbers of mononuclear cells, as described in Section 7.14.

Sickle-cell disease is another common cause of haemolytic anaemia in areas where this disease is seen (see Section 7.24).

In haemolytic anaemias, and especially in sickle-cell anaemia, polychromasia is often obvious (see Section 2.27a). At the same time many reticulocytes may be found (see Section 7.23). Abnormal amounts of a substance called urobilinogen are usually found in the urine of patients with haemolytic anaemias—but not with anaemia due to bleeding (see Section 8.8). Finding many reticulocytes in the blood and urobilinogen in the urine are therefore useful ways of telling if a patient has a haemolytic anaemia.

Several causes often combine to make a patient anaemic. For example, a patient's anaemia may be partly due to malaria, partly to hookworm infection, and partly to a deficiency of protein.

There are many other causes of anaemia, and it is often difficult to tell why a patient has anaemia without special methods which are not described in this book. Some other causes of anaemia, such as uraemia and leukaemia, are shown in Figure 7-17.

7.10 When to measure the haemoglobin

Because we cannot measure the haemoglobin or haematocrit of all patients coming to a clinic, an outpatient department, or a health centre, we have to choose only those patients who are most likely to be anaemic. But how do we know which ones they are? When any patient is examined, one of the things that must be done is to look at his tongue, and at the red skin inside his lower eyelids—his **conjunctivae**. The tongue and conjunctivae of healthy people are a deep pink colour, but in anaemic patients they are pale. Patients with a pale tongue and

pale conjunctivae are probably anaemic and must have their haemoglobin measured. When you have had some practice, it is quite easy to find anaemic patients by looking carefully at their tongue and conjunctivae. *Whenever you think someone has anaemia you must measure his haemoglobin or haematocrit.*

It is especially important to examine children and women for anaemia. Anaemia is common in young children, because they are growing fast and do not get the right things in their food. Because of this their bodies cannot make enough blood. They often suffer from hookworm infection and malaria which also make them anaemic.

Anaemia is common in women because they have to give food (especially iron, protein, and folic acid) from their own bodies to make their children's blood. They also lose blood with their monthly periods and at childbirth. Women are most likely to be anaemic during pregnancy or soon after delivery. Measure the haemoglobin or haematocrit of mothers four times, if possible:

1. When they come to the antenatal clinic;
2. When they are 32 weeks pregnant;
3. When they are 38 weeks pregnant;
4. When they come to the postnatal (after birth) clinic.

Any patients who say they feel tired and lack energy should have their haemoglobin measured, because anaemia often makes people feel tired.

One more thing must be said about anaemia. If you measure the haemoglobin of a patient just after he has bled a lot suddenly, you will find that the little blood he has left will still be normal. He will not be anaemic. If, however, you look at his blood a day or two later, you will find that he will now have become anaemic. This is because he will then have had time to dilute his remaining blood, so that its volume is increased. Blood which has been diluted by the body in this way becomes anaemic. The body works better with a larger volume of diluted anaemic blood than it does with a smaller volume of normal blood. But for the body to work in the best way it can, and for the patient to be healthy, the anaemia must be cured by more red cells being made.

When you have found an anaemic patient, the next thing to do is to look at a thin film of his blood.

THIN BLOOD FILMS STAINED WITH LEISHMAN'S STAIN

7.11 The thin blood film

As you will remember from Section 1.17, normal blood contains millions of red cells and smaller numbers of white cells in a liquid called plasma. It is very useful to look at these cells with a microscope to see whether they are normal or abnormal. If the cells are abnormal we have to find out what is wrong with them. Before blood cells can be looked at with a microscope they have to be spread out very thinly on a glass microscope slide. A

slide covered very thinly with blood is called a thin blood film. The cells in a thin blood film cannot be seen unless they are first stained. The stain we use is called **Leishman's stain**. Someone who is well practised in examining thin blood films can find out many useful things about a patient's blood. But it will only be possible here to tell you a few of the more important things that can be seen in a thin blood film. First you must learn how to make the film.

The stain and the buffer

Read how to make Leishman's stain in Section 3.33 and how to make Leishman buffer in Section 3.21. The methyl alcohol from which Leishman's stain is made soon goes into the air and dries up—that is, it rapidly evaporates. Leishman's stain must therefore be kept in a bottle with a stopper or lid that fits tightly. It is also useful if the bottle has a pipette in the stopper with which the stain can be measured. To make it easy to do this, some special bottles, called Polystop bottles, have been put in the equipment list (ML 7). One Polystop bottle is for the stain and another is for Leishman buffer. *Don't put the pipette for the buffer into the bottle for the stain, because, if any water or buffer gets into the stain, it will not work.* No water or buffer must ever get into Leishman's stain—it must be kept dry, or free of all water which easily gets into it from the air.

A buffer was described in Section 1.7 as being a mixture of special salts which helps to keep the acidity or alkalinity (the pH) of a solution fixed (the same). Leishman buffer is made from two kinds of phosphate which are powdered, weighed, and then mixed together. A little of the powdered mixture of salts (about 200 mg) is added to a Polystop bottle full of water to make the buffer.

When plain 'dry' water-free Leishman's stain is put on the film, the methyl alcohol in the stain fixes (kills and preserves) the cells—see Section 4.10. When buffer is added, the wet mixture of stain and buffer then stains the cells. Unfixed cells will not stain well and wet stain will not fix well. This is why it is so important to keep Leishman's stain dry.

7.12 Leishman's method

It may look easy to spread blood on a slide so as to make a good thin blood film. But it is not so easy as it looks. The only way to learn how to make good films is to do everything you read here very carefully. You must go on trying until you really can make good films. *Don't be content with bad ones!*

The first thing to know is what a good thin blood film should look like. This is shown in Picture A, FIGURE 7-7. The film should start close to one end of the slide; it should very nearly reach the other end and come close to but not touch the edges of the slide. The film starts at the *head* and ends at the *tail*. The blood cells must lie evenly on the slide. This means that there must be no holes in the film, and no lines across the film, or down its length.

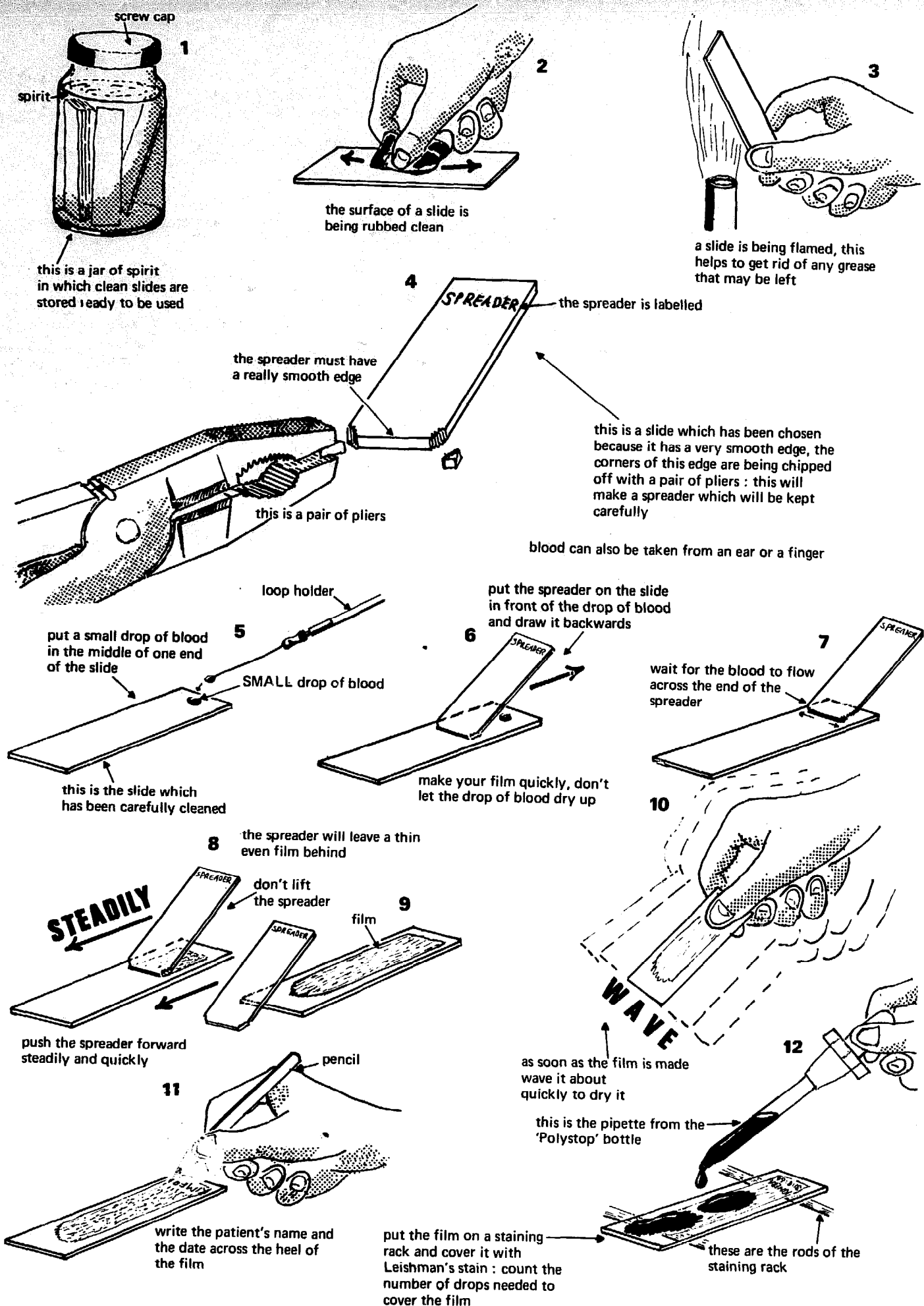

Fig. 7-6 The Leishman blood film—one

A film is always too thick near its head and is usually too thin at the end of its tail. In a good thin blood film the cells are just separated from one another towards the tail in the place shown by the dotted lines in Picture A, FIGURE 7-7. But, if the film is made too thin the cells will be too far apart. Try to make the film of the right thickness for as much of its length as possible. The films drawn in FIGURE 7-11 are the right thickness. The cells are not touching, and yet they are not too far apart. The patient's name should be written in pencil across the head of the film, and when stained a good thin film should be an even pink colour.

You can only make a good film if you do *exactly* what you are told in the method which follows.

METHOD

MAKING A THIN BLOOD FILM, FIGURES 7-6, 7-7, and 7-8

1. Choose your best slides for making thin blood films; keep old scratched slides for stools. Wash the slides well with a detergent or with soap and water. Dry them and keep them in a screw-capped jar filled with spirit. If you still cannot get clean slides with which to make good films, try cleaning them with dichromate as described in Section 3.12.

2. When you want to use a slide, take it out of the spirit jar and rub it dry with a piece of clean cloth or paper. Use toilet paper.

3. Quickly put the slide through a flame and allow it to cool. All these things help to make quite sure that the slide is clean and free from grease. They may not always be necessary, especially with new slides. But, if you follow them, you will at least start with a slide on which it is possible to make a good film.

4. You need a slide to spread the blood with. This is the spreader. Look through your slides until you find one which has a very smooth edge, without any chips. The edge of a spreader should be a little narrower than a slide. So take a pair of pliers and carefully break off the corners of the spreader. Break off very small pieces of glass with each bite of the pliers. When you have made a good spreader, look after it carefully. Make a new spreader every few days, because new spreaders seem to make better films than old ones.

5. Put the slide down on the bench. Using a wire loop or a Pasteur pipette put a *small* drop of fresh or sequestrenated blood in the middle of one end of the slide, close to its edge.

6. Immediately hold your spreader so that it slopes backwards. Put its spreading edge just in front of the drop of blood.

7. Move the spreader backwards so that it touches the drop of blood. When the blood touches the spreader it will flow across between the edge of the spreader and the slide. If it does not spread, lower the spreader a little.

8. As soon as the blood has spread right across the slide, push the spreader forward steadily and rapidly. By

steadily we mean without stopping. The blood will then be left behind on the slide as a thin even film.

9. If the drop of blood was the right size the film will end just before the end of the slide in a nice thin even tail.

10. Immediately pick up the slide by one end and wave it about rapidly until it is dry. This will stop the red cells forming rouleaux—see Picture F, Figure 7-11, and Section 12.6.

11. Write the patient's name and the date across the head or side of the film. Use an ordinary pencil. The writing will stay if it is written on the film.

12. Put the film flat across the two bars of the staining rack.

13. Cover the film with a few drops of Leishman's stain, putting the drops in different places on the film until the whole film is covered. This plain dry stain fixes the cells.

14. Immediately add twice as many drops of buffer. Thus, if five drops of stain were needed to cover the blood film, add ten drops of buffer. Some people wait one minute before adding buffer to the stain. But, if you wait too long, the methyl alcohol in the stain will evaporate and leave pieces of blue stain on the finished slide—see Picture F, Figure 7-11.

15. Because the stain is made with methyl alcohol, and the buffer is made with water, they do not mix easily by themselves. They have to be mixed. So, mix the buffer and the stain by sucking them in and out of the *buffer pipette*. Don't use the stain pipette, because buffer will get into the stain and make it wet. This will spoil the stain.

16. Another way of mixing the stain and buffer is to blow gently up and down the slide, from one end to the other. Don't blow too hard or you will spill the mixture.

17. Wait about 5 minutes while the wet mixture of stain and buffer stains the cells.

18. Flood the stain-buffer mixture off the slide with more fresh buffer. Pick up the slide with forceps rather than with your fingers as shown in the pictures. Wash the slide with a little more buffer.

19. Leave the buffer on the slides for about 3 minutes. The slide should now be a good pink colour and not blue or purple. If it is not pink enough leave some more buffer on it for a bit longer.

20. Tip off the buffer and leave the slide upright in a rack (21).

22 and 23. As soon as the film is dry put a drop of oil on it and smear it all over with the rod of the oil bottle—some people use their fingers. Others put a coverslip over a drop of oil. Unless the film is covered with oil, cells will not be seen clearly.

7.13 Faults in a thin blood film

Look over the film with a low power objective. This will show you what it looks like and will let you find a good place to look at with the high power objective. You will seldom need to use an oil immersion objective, and

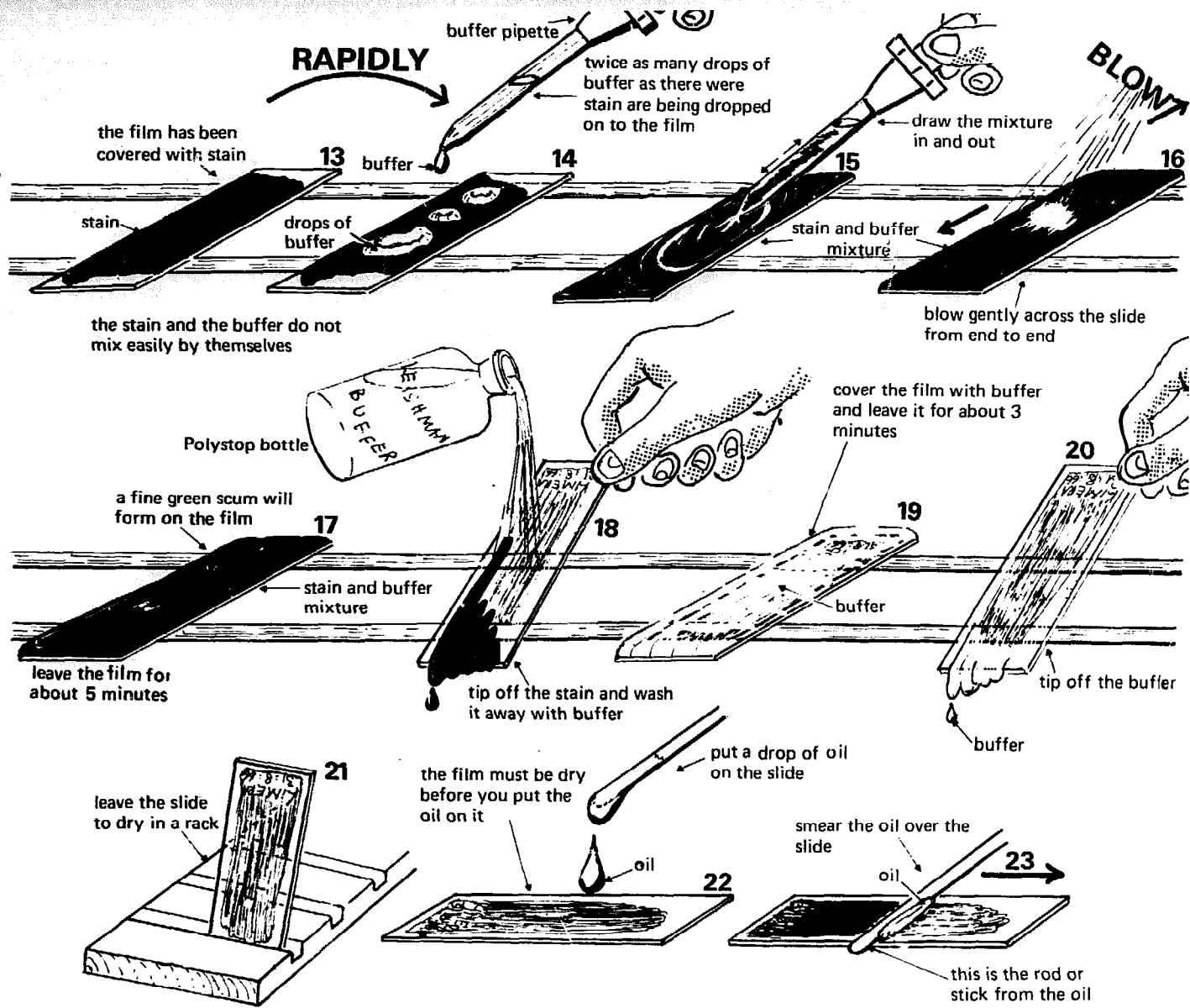

One good film and six bad ones

when you do a differential white cell count follow this line

this is the head of the film. it is always too thick here, this is the place to write the patient's name and the date: use a pencil

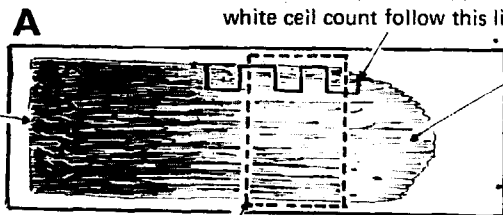

the film will be the right thickness to look at inside this square

this is the tail of the film, it is usually too thin here

GOOD

there are more polymorphs along the edge of the film and in the tail

there are more lymphocytes in the middle of the film

B BAD



the film goes off the end of the slide

E



the slide was greasy and there are holes in the film

C



the spreader has been lifted up here

F

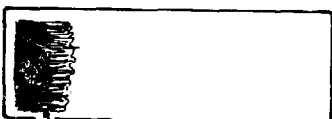

the film is much too short and thick

D BAD

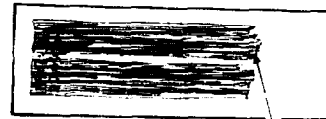

there was a chip in the spreader

G



there are marks across the film: the spreader was pushed forward jerkily

Fig. 7-7 The Leishman blood film—two

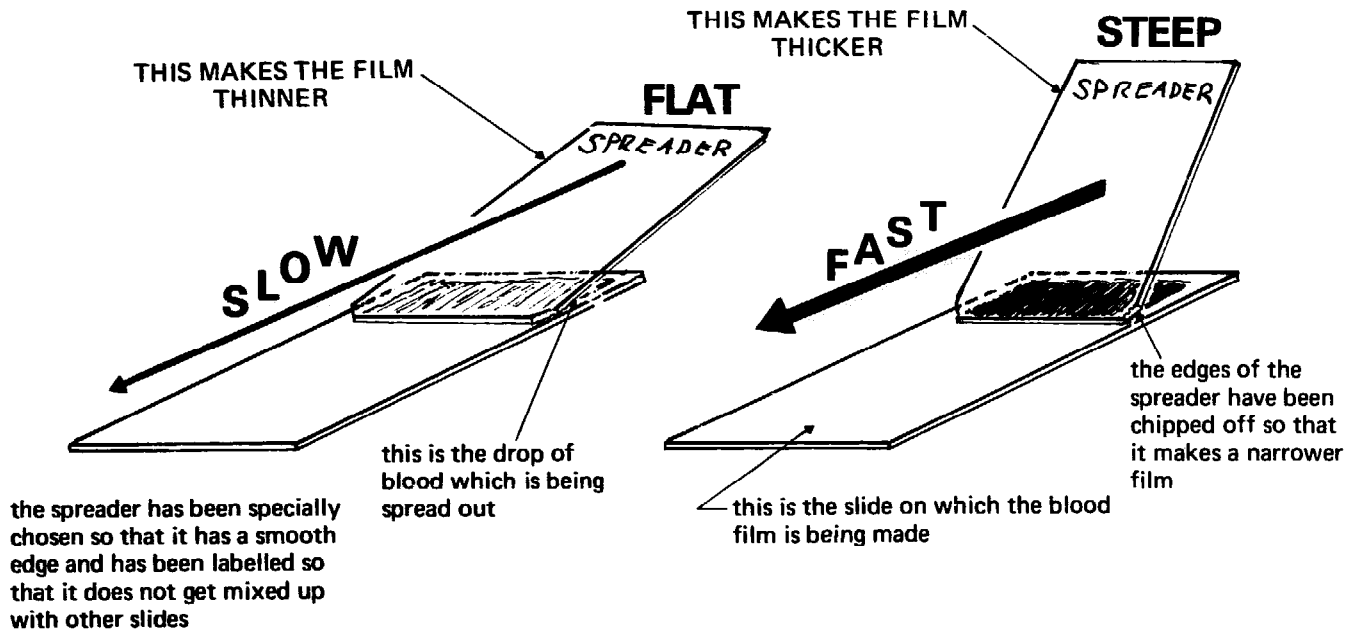

Fig. 7-8 Adjusting the thickness of a blood film

should not use one for a differential white cell count. The best place to look will probably be towards the tail of the film. This area is shown with a line round it in Picture A, FIGURE 7-7. Here the cells should lie evenly without touching or lying on top of one another.

It is more difficult to make a good film with anaemic blood because the film easily becomes too thin. Stop this by holding the spreader more steeply and by pushing it faster. The steeper the spreader is held and the faster it is pushed, the thicker will be the film. The flatter the spreader is held and the slower it is pushed, the thinner will be the film. When a film of anaemic blood is made thicker in this way it is especially important that it be dried quickly by being waved about, as in Picture 10, FIGURE 7-6.

When you have finished looking at the blood films for the day, stand them upright on end in a box. Wipe the films clean with soft or toilet paper and put a piece of paper between the films for one day and those for the next day. Make the piece of paper stick out between one day's films and the next and write the date on it. When the box is full, throw away the oldest ones and put the newest ones in their place. If you keep blood films like this, you will be able to find the films you have made during the previous few weeks very easily. This is often useful.

Some of the common faults in blood films have been drawn in Pictures B to G, FIGURE 7-7. A good film is shown in Picture A. All the other films are bad ones. In Picture B the film reaches right to the end of the slide because the drop of blood used was too big. In Picture C the film ends in a sharp line because the spreader was lifted off the slide before it had reached the end. In Picture D the film looks as if it is cut into two, because there was a big chip in the edge of the spreader. There are holes in the film in Picture E. This is because the slide

was greasy. In Picture F the film is much too short and thick. The spreader must have been held too steeply or pushed too fast, or both. There are lines across the film in Picture G because the spreader was pushed along it in a jerky way—stopping and starting.

Other faults in blood films are shown in Picture F, FIGURE 7-11. On the left-hand side is a heap of red blood cells that have come together in *rouleaux*. Red cells lying on top of one another in this way are like a pile of coins. The way to stop this happening and to make sure that the cells lie evenly as in Picture A, FIGURE 7-11, is to make the film *immediately* you have placed the drop of blood on the slide, not to make it too thick, to make the film thinner, and to wave it dry rapidly *as soon as it is made*. Picture F, FIGURE 7-11, also shows what happens if you let the stain dry up on a slide before it is mixed with buffer. When this happens the dried stain is seen as many little round dots. Much the same thing may happen when the green scum that forms on top of the stain is not washed off with buffer as it should be.

Sometimes you will find that white cells do not stain well. This is usually because the stain has got wet, but it may be because the methyl alcohol was wet to start with. Some kinds of methyl alcohol do not work well with Leishman's stain.

If the blood has been taken into sequestrene, remember to make the film quickly and to mix the blood before you do so. The cells will spoil if they are left in sequestrene for more than an hour before the film is made.

If the film looks a little too blue, it may be made more red by washing it with more buffer. But if the film is much too blue it is because the buffer was too alkaline (see Section 1.7). If the film looks too red, it is because the buffer was too acid. When this happens make new buffer.

Finally, *never blot a blood film*. Always add stain and

buffer to one film at a time. Don't be content with bad films. Go on making films until you have got one which is good enough to stain. Bad films can always be washed and the slides used again.

Leishman blood films are useful for seeing if the white cell or platelet counts are very high or very low, for doing a differential white cell count, for looking at red cells, and for finding parasites. These are discussed later in this chapter. Leishman's stain can also be used for staining the bone marrow. Marrow is obtained by putting a special short, sharp, strong needle called a marrow biopsy needle into a bone and sucking out a few drops of thick red liquid marrow with a syringe. This can be difficult and is only done by doctors. Marrow films can be stained in the same way as blood films.

Remember a medical laboratory can be judged by the quality of its thin blood films—make sure yours are good!

LOOKING AT A LEISHMAN STAINED THIN BLOOD FILM

7.14 Normal white blood cells (leucocytes)

You will remember that normal blood contains red cells, which are round and without nuclei, and white cells and platelets. These next sections describe the normal and abnormal kinds of cell that you will see in a film.

There is only one kind of red cell (erythrocyte) in normal blood, but there are several different kinds of white cell (leucocyte). These are shown in FIGURE 7-9. Some of them have been drawn again in FIGURE 7-10 which also shows some of the cells of the bone marrow. FIGURE 7-9 is a careful drawing. FIGURE 7-10 is a diagram. Both show the cells as you can see them when they are stained with Leishman's stain. Cells E, F, and G are the same in both these figures.

In every hundred white cells in normal blood there are about seventy white cells called **polymorphs** (this is a short way of saying polymorphonuclear leucocytes). These cells are called polymorphs because their nuclei have many shapes (poly = many, morph = shape). When they are very young the nuclei of the cells are round (Pictures A, B, C, D, FIGURE 7-10). But, as these cells get older, their nuclei become folded and twisted. The nucleus of mature (older) polymorphs is twisted into several **segments** (pieces). The older a polymorph grows, the more segments it has. Most of the polymorphs in normal blood have two or more segments, like the cell shown in Picture G, which has three. A few polymorphs in normal blood are like the one drawn in Picture F, and a very few are like that shown in Picture E.

All polymorphs have many granules (very small pieces or particles) in their cytoplasm, which is pinker than the cytoplasm of a lymphocyte. Some polymorphs have very small purple granules—these are called **neutrophil polymorphs**. It is often difficult to see the granules, because they are so small and pale. Neutrophil

polymorphs are much the commonest kind of polymorph, and when people talk about polymorphs, this is the cell they mean. Other polymorphs have much bigger red granules in their cytoplasm—these are the **eosinophil polymorphs** or 'eosinophils'. Sometimes you will see polymorphs with big blue granules in their cytoplasm—these are the **basophil polymorphs** or 'basophils' which are rare (not common).

Neutrophil polymorphs can leave the blood and go into the tissues to fight and eat micro-organisms which come there. If there are many polymorphs together they make a thick yellow liquid called **pus**. Polymorphs in pus are often called **pus cells**. Pus cells are also found in abnormal urine, sputum, CSF, and stools. When something looks like pus, we say it is **purulent**.

There are two other kinds of white cells. Both have more rounded nuclei which are often indented. By indented we mean that they have a dent or a notch in them. They are sometimes grouped together as mononuclear cells because, unlike polymorphs, they have only one lobe to their nucleus (mono = one). Both have few granules in their cytoplasm which is more blue than the cytoplasm of the polymorphs. These cells are the **lymphocytes** and the **monocytes**. There are two kinds of lymphocyte—large lymphocytes and small lymphocytes. The polymorphs and the red cells are made in the bone marrow, but the lymphocytes are mostly made in the **lymph nodes** (lymph glands).

The small lymphocyte is easy to recognize: it is small, its nucleus is round, or nearly round, and it has little cytoplasm (often it appears to have none). The substance from which the nucleus is made, the nuclear chromatin (see Section 1.9), is dense (solid) and deeply staining. The large lymphocyte is larger; it has more cytoplasm in which are a few small pink granules; and its nuclear chromatin is less dense. In the nuclear chromatin of both kinds of lymphocyte you will sometimes see one or two nearly empty 'holes'. These are the remains of similar holes or **nucleoli** in the cells from which lymphocytes are formed. These holes are normal in the nuclei of lymphocytes, but in other white cells nucleoli usually mean that the cell is immature (too young) and should still be in the bone marrow. Cells are often seen which are half-way between small lymphocytes and large ones. We don't usually try to distinguish them. Instead, we count all lymphocytes together.

A monocyte also has cytoplasm with very few granules, but its nucleus is different from the nucleus of a lymphocyte. Instead of being round it is often shaped like a kidney or bean—see Picture B, FIGURE 7-9. The lymphocyte has clear blue cytoplasm, but the monocyte has cloudy or 'smoky' blue cytoplasm. This cytoplasm often has round white holes or vacuoles in it. A vacuole is a small space which looks empty. The nuclear chromatin of lymphocytes and monocytes is also different. The chromatin of the lymphocyte is dense (thick) and is nearly the same all over. But the chromatin of the monocyte is more open and looks as if it is made of strings.

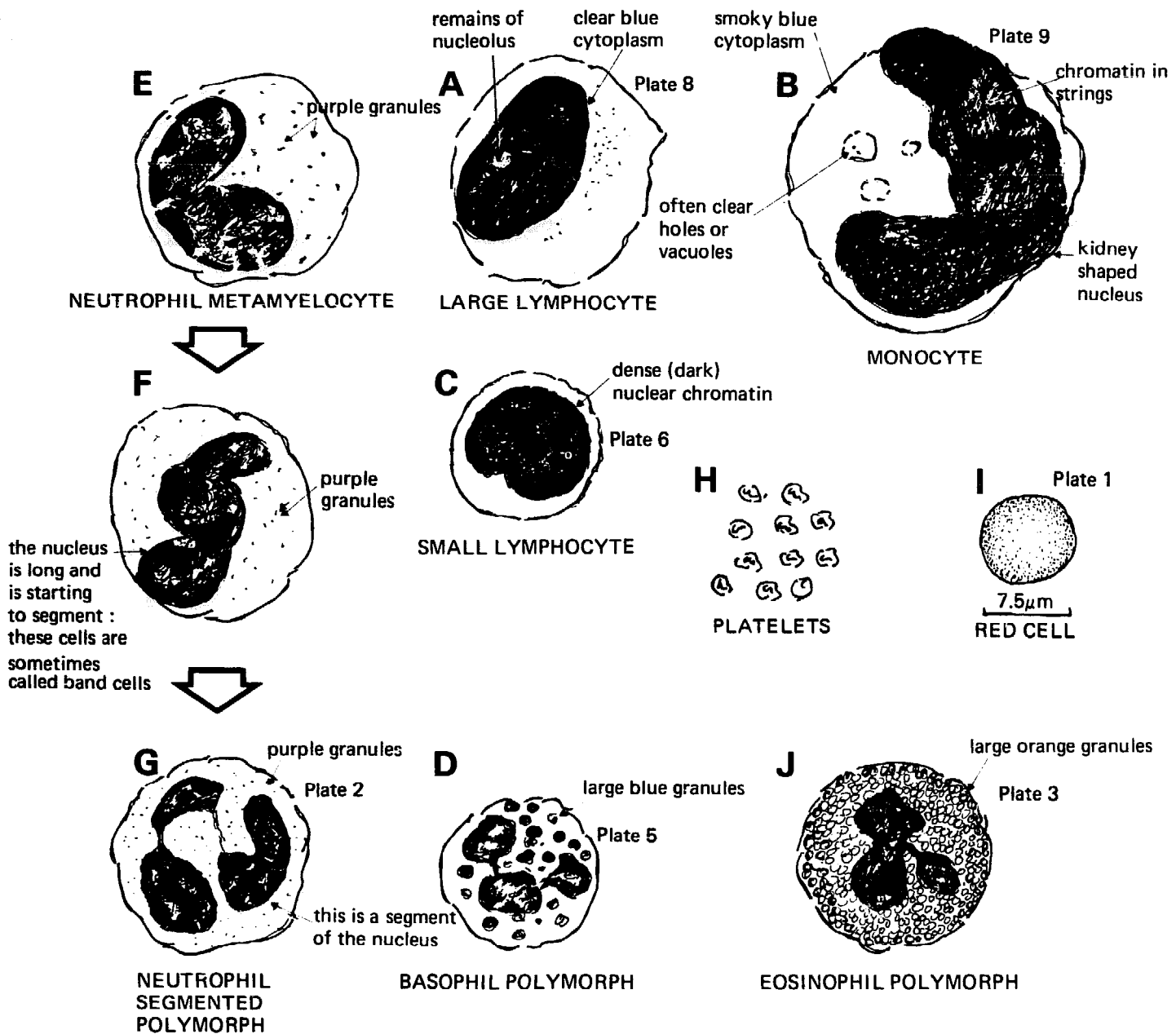

Fig. 7-9 Normal white cells in the blood

7.15 Platelets

Platelets (or thrombocytes) are not whole cells. They are parts of cells. They are needed to help blood clot. They are very small—only about 2 μ m across—and have a purple middle part and a paler outer part. They are made by large cells in the marrow called **megakaryocytes**. The blood of healthy people contains between 250,000 and 500,000 platelets per cu mm. They are easily seen in a Leishman stained blood film and are shown in Picture H, FIGURE 7-9. When there are fewer platelets than normal, the patient is said to have a **thrombocytopenia**. A patient with thrombocytopenia bleeds too easily. You can tell severe thrombocytopenia by looking at the blood film and finding few or no platelets. This is important and should always be reported when you find it.

7.16 The white cell percentages in normal blood

When we look at a blood film from a healthy person, we see white cells scattered all over the film. After we have looked at a few blood films we can quite easily tell if the total numbers of white cells are greatly increased or decreased. A more accurate way of doing this is to do a total white count as is described in Section 7.29. But, when we look at a blood film we should always comment on whether we think that there are more or less white cells than there should be.

After looking at the total number of white cells in a film, the differential count is made by counting the number of white cells of each different kind that are seen in looking at a hundred white cells.

If you were to look at the blood film of a healthy

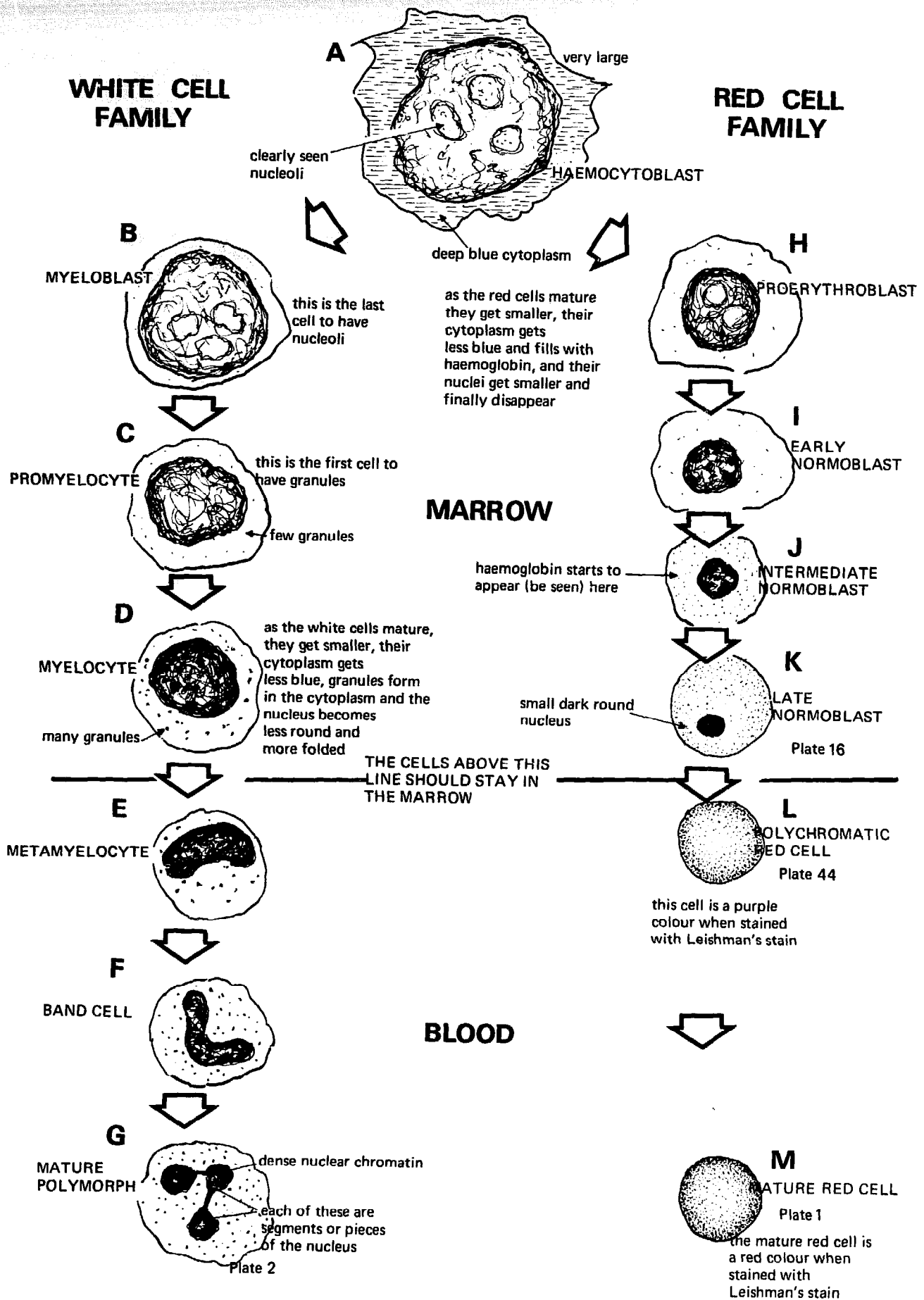

Fig. 7-10 How the blood cells are formed in the marrow

person and count the first hundred white cells you saw, they might be like this:

Neutrophil polymorphs	70
Lymphocytes	25
Monocytes	3
Eosinophils	2

You might or might not find a basophil, because basophils are rare. This is blood from a normal person, and this percentage of the different kinds of cell (this number of white cells in every hundred) is what we mean when we say a person has a normal **differential white cell count**. The normal differential white count is not always exactly like this, and in adults we usually take any figure within those shown below as being normal.

Neutrophils	40–75%
Lymphocytes	20–45%
Monocytes	2–10%
Eosinophils	1–6%
Basophils	Less than 1%

For example, a film with only 5% of neutrophils or a film with as many as 20% of eosinophils would not be normal. It is to find out things like this that we do a differential white cell count.

Normal people have differential white counts within these figures. They also have no abnormal red cells or abnormal white cells in their blood. To understand these abnormal cells, you must first learn how cells are formed in the marrow. When you have learned a little more about white cells, you will be able to do a differential white count. This is described in Section 7.22.

7.17 How blood cells are formed in the marrow (FIGURE 7-10)

New cells have to be made all the time to replace old cells which wear out in the blood as it goes round the body. Polymorphs and red cells are both made in the red marrow, which is inside some of the bones. Only when cells are fully mature should they leave the marrow and go into the blood. You will see this red marrow if you look at animal bones which have been cut up in a butcher's shop. Marrow is the soft red substance in the middle of a bone. If we look at this marrow under the microscope we see that it is made of cells of many different kinds. The less mature of these cells can divide into (make or cut themselves into) two daughter cells. Because many cells in the marrow can divide in this way, there are always more cells to come into the blood. The immature cells which can divide all have big round nuclei and little cytoplasm and stay in the marrow. It is their mature daughter cells which leave the marrow to go round the body in the blood.

The cells of the marrow have been drawn in FIGURE 7-10. At the top of the picture is the parent cell (**haemocytoblast**). This divides to make polymorphs as shown on the left and red cells as shown on the right. In a healthy person all the cells above the line stay in the

marrow, and only those below the line leave the marrow and come out into the blood. The haemocytoblast is a large cell with a big nucleus and little cytoplasm. As cells mature they get smaller and their nucleus gets much smaller and more solid looking. At the same time their cytoplasm gets less blue. Cells which are going to become red cells lose their nucleus altogether, and haemoglobin forms in their cytoplasm. Thus cell A changes into cell H, then into cell I, and so on until the mature red cell M is formed. Cell I is the first to have haemoglobin and therefore stains pink. It is an **early normoblast**. Cell J is in between the two, and is an **intermediate normoblast**. Intermediate means in the middle.

Similarly, as they mature, the nucleus of the cells that are going to become polymorphs gets narrower as well as smaller. The nucleus soon gets so narrow that it twists or cuts into segments, and the mature segmented polymorph G is formed. The **promyelocyte C** is the first cell to have granules and the last cell to have nucleoli.

FIGURE 7-10 only shows how red cells and neutrophil polymorphs are formed. But eosinophils and basophils are formed in just the same way, and there are eosinophil and basophil cells like cells C, D, E, F, and G.

7.18 Abnormal cells in the blood

So far we have only talked about the normal cells in the blood. In sick people many kinds of abnormal cells are seen in the blood. Cells can be abnormal in two ways. They may be abnormal because they are badly made. We shall describe several kinds of badly made cells. Cells can also be abnormal because they are too immature (too young) to be in the blood. As you see in FIGURE 7-10 the immature cells above the line in this figure should stay in the marrow. They are abnormal if they are found in the blood. Some cells are both badly made and immature. We shall first describe abnormal red cells and then abnormal white cells.

7.19 Abnormal red cells (FIGURE 7-11)

The normal red cells of a healthy person are all nearly the same size ($7.5 \mu\text{m}$ across) and they are almost perfectly round. They have no nucleus. When stained with Leishman's stain, they are a good pink colour with only a small pale area in the middle. As we have already seen, normally coloured red cells like this are said to be **normochromic** (normally coloured). They have been drawn in Picture A.

We shall first describe abnormalities due to the cells being badly made and then abnormalities due to the cells being immature.

Badly made red cells The red cells of anaemic patients are often of different sizes. Some cells are small and some are large. When red cells are of different sizes like this, they are said to show **anisocytosis** (unequal-sized cells) and are shown in Picture B. Anisocytosis is common in many blood diseases.

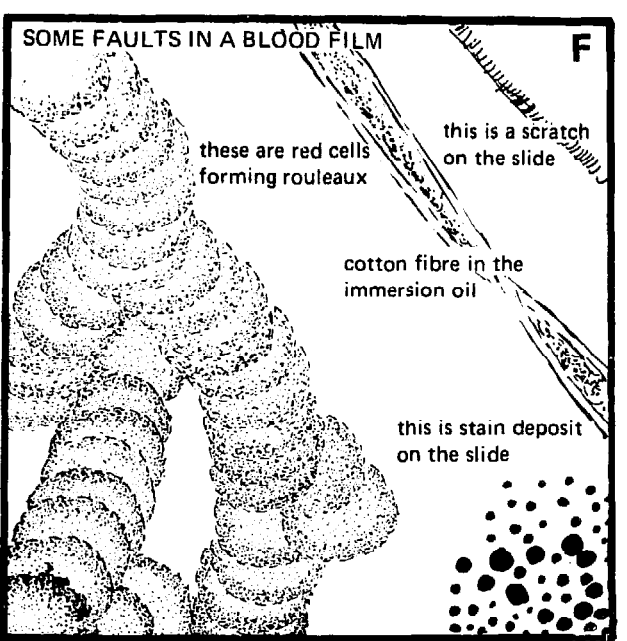
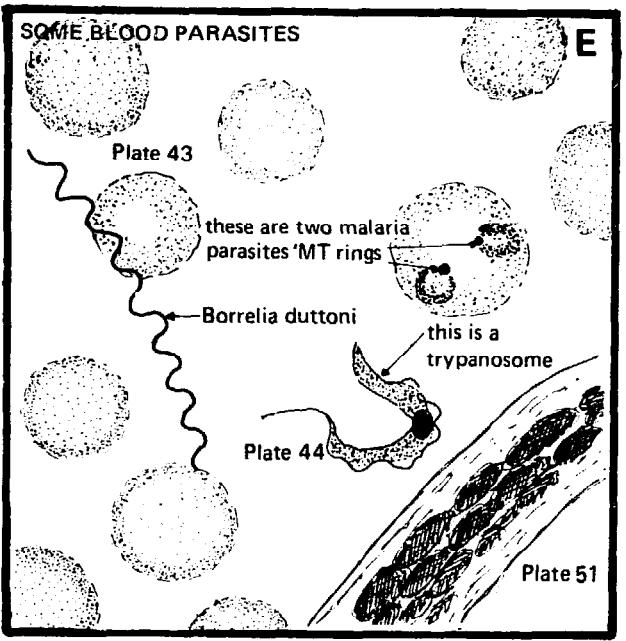
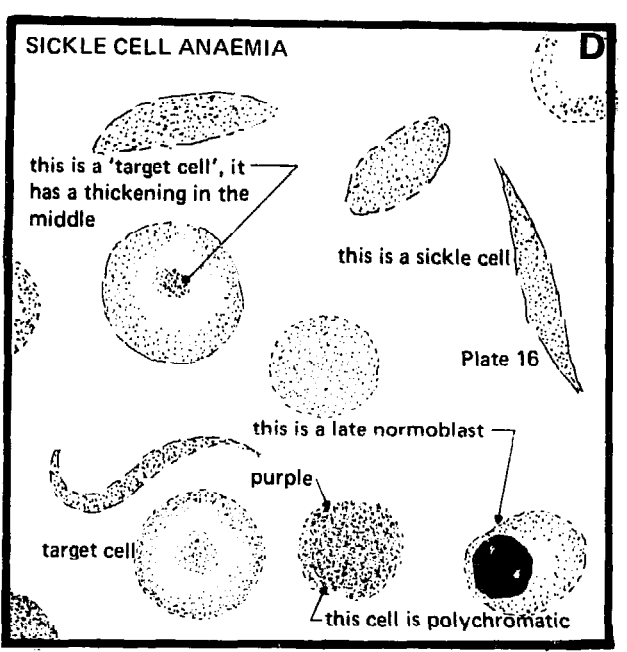
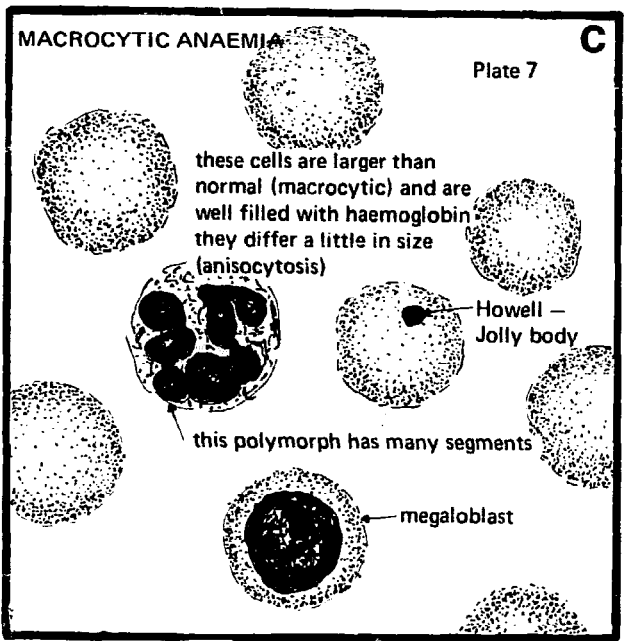
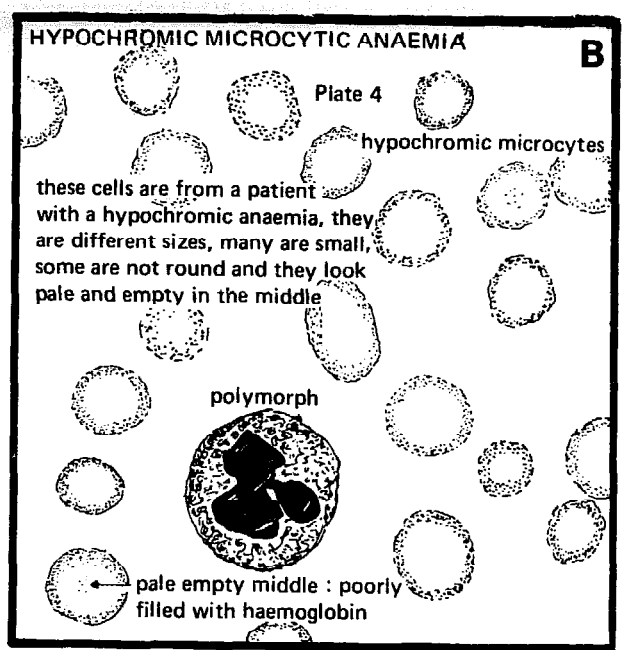
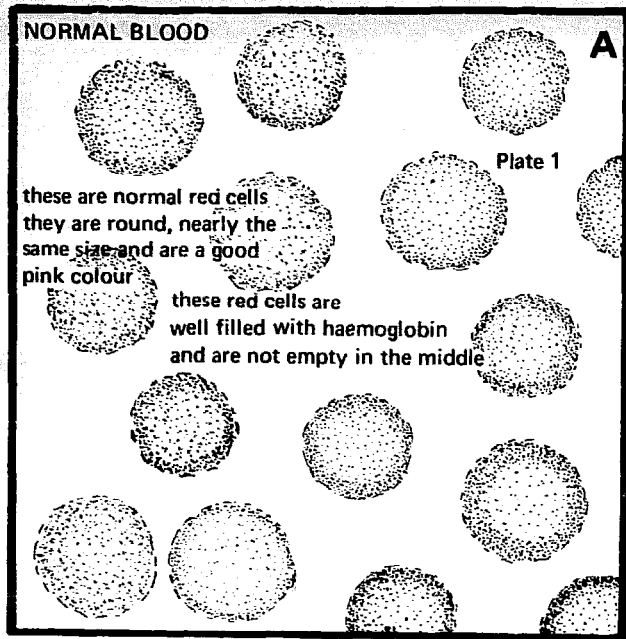

Fig. 7-1 Some blood films

The red cells of anaemic patients are often of many different shapes instead of being round. Red cells of different shapes are said to show **poikilocytosis**, and are shown in Picture D. If poikilocytosis is mild, the red cells are just not quite round. If poikilocytosis is severe, the red cells may have very strange shapes indeed. If you see poikilocytoses, report it.

Another kind of badly made red cell is the **target cell**. These are cells which are thickened in the middle and are said to look like a target. A target is a piece of cardboard with a spot on it which people shoot at with guns to see how well they can shoot. A thin film showing both target cells and sickle cells is shown in Picture D. Target cells are often seen in sickle-cell anaemia.

Often the red cells of anaemic patients are too pale, because they have too little haemoglobin in them. They have large pale areas in the middle, and there is only enough haemoglobin to make a thin ring around the edge of the cell. This is usually due to the patient not having enough iron to make enough haemoglobin to fill his red cells. As we saw in Section 7.3, patients like this are said to have a **hypochromic anaemia**. By this we mean an anaemia with an MCHC of less than 32%. As well as being partly empty of haemoglobin the cells of such patients are also usually smaller than normal. These small red cells are called **microcytes** (micro = small).

Because hypochromic anaemias can be so easily treated with iron, it is important to recognize them. *But, if hypochromia is to be recognized in a blood film, the film must be well made.* But even if the film is well made, it may not always be easy to judge hypochromia, especially if it is mild. This is why the MCHC is so useful.

There are some kinds of anaemia in which the red cells are larger than normal, but there are very few of them. These large cells are called **macrocytes** (macro = big) and these are the **macrocytic anaemias**. The cells are big and full of haemoglobin, so they stain a good pink colour and are not small and pale, like the cells from the hypochromic microcytic anaemias. A film from a patient with macrocytic anaemia is shown in Picture C. In some macrocytic anaemias a special kind of immature red cell may be seen in the bone marrow and sometimes in the blood. This is the **megaloblast**. The nucleus of a megaloblast is much less mature than its cytoplasm. For example, you may see a cell in which the cytoplasm is full of haemoglobin, but the nucleus may be like that of an early normoblast which has no haemoglobin. Large polymorphs with many segments and sometimes Howell-Jolly bodies (see below) are also seen in the blood films of macrocytic anaemia. These anaemias may be due to a deficiency of folic acid, or less often to a deficiency of vitamin B₁₂. Macrocytic anaemias due to folic acid deficiency are very common in countries where people's food contains too little folic acid. Vitamin B₁₂ deficiency is seen all over the world, but it is rare. The blood films of folic acid and vitamin B₁₂ deficiencies look the same. One way to distinguish these deficiencies is to test the gastric juices for free acid, as is described in Section

11.9. There is never any free acid in the gastric juice of patients with the disease called pernicious anaemia which is due to vitamin B₁₂ deficiency. Thus, if free acid is found, this disease can be ruled out.

Immature red cells. Late normoblasts are often seen in the blood of patients with severe anaemia. They look like normal red cells except that they have a small dark nucleus. A normoblast of this kind is shown in Picture D.

Before it matures to become a normal red cell, a normoblast changes into a cell called a **polychromatic** red cell. 'Poly' means many, and 'chromatic' means coloured. When stained by Leishman's stain a polychromatic red cell is purple. The purple colour is made by the remains of the nucleus dissolved in the cytoplasm. Because polychromatic red cells contain the remains of the nuclear chromatin, *polychromatic red cells are young red cells.*

When a young red cell is stained with a stain called brilliant cresyl blue, the remains of the nuclear chromatin are seen as a deeply staining blue net, and the cell is called a **reticulocyte** (net cell). *Polychromatic red cells and reticulocytes are the same cells stained in different ways.* Both a **reticulocytosis** (many reticulocytes in the blood) and **polychromasia** (many polychromatic cells in a Leishman-stained blood film) mean that the blood contains many young red cells. They mean that the marrow is busily making many young new red cells. This is usually to replace those that have been lost by bleeding or haemolysis. A few normoblasts are also seen when there is severe polychromasia or reticulocytosis. This is because, when the marrow is pushing many young red cells into the blood very fast, it pushes out a few very young red cells indeed—those red cells which are so young that they still have whole nuclei (normoblasts).

Polychromatic red cells are not usually counted (we count reticulocytes instead), but you must always report that you have seen them in a film. A normal blood film has very few polychromatic red cells. If you find polychromatic red cells, be sure to report them, because this is of help in diagnosing a haemolytic anaemia.

Sometimes, particularly in sickle-cell anaemia and in folic acid deficiency anaemias, you will see red cells with what looks like a very small nucleus in them. This is the remains of the nucleus and is called a **Howell-Jolly body** after the people who first described them. There is a Howell-Jolly body in Picture C. A red cell with a Howell-Jolly body in it is both young and abnormal. They are not important, but as you will probably see them you should know what they are.

7.20 Abnormal white cells

Abnormal lymphocytes and monocytes are seen, but they are not common, and we will not describe them here. Several kinds of 'abnormal polymorphs' are seen. Most of them are abnormal because they are too young. What it means to find these abnormal white cells in the blood is described in the next section.

haemocytoblast

this is the youngest and most immature cell in the marrow from which the others are formed, it is also shown as cell A in Figure 7-10

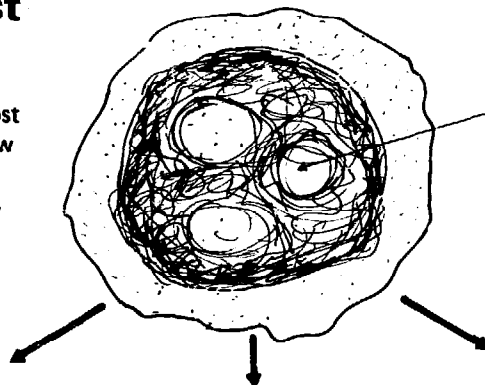

these 'holes' in the nucleus of very young cells are called nucleoli

there are several intermediate cells here, which have not been drawn: they are the cells shown H, I, and J in Figure 7-10

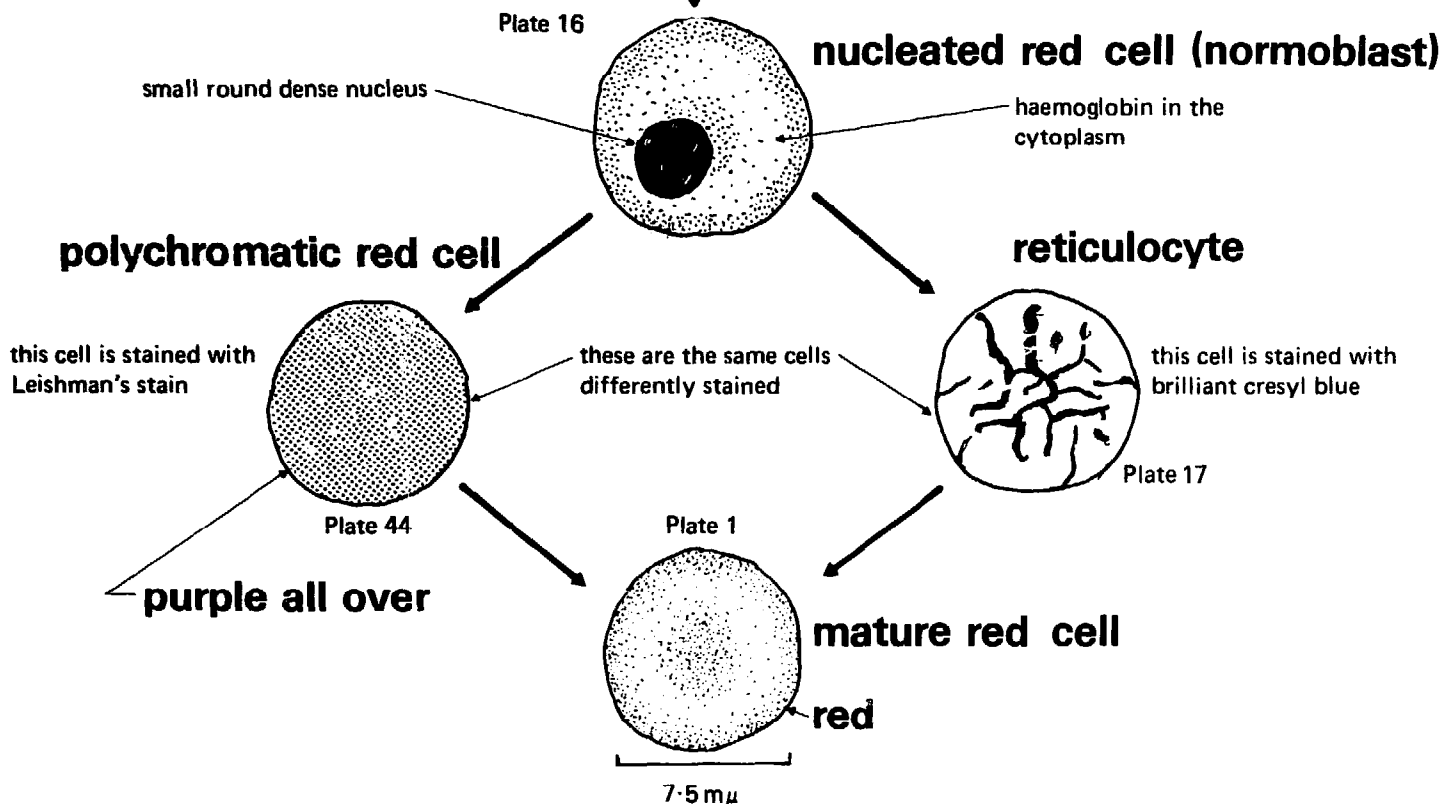

Fig. 7-12 Polychromasia and reticulocytes

Metamyelocytes and myelocytes are 'young polymorphs'. They have cytoplasm containing the same kind of granules (neutrophil, eosinophil, or basophil) as mature polymorphs. But the nucleus of a myelocyte is round or nearly round, and the nucleus of a metamyelocyte is kidney- or bean-shaped. The nucleus of a myelocyte is the same shape as the nucleus of a monocyte, but its chromatin is more dense (thicker and darker). You can easily tell them apart by looking at their cytoplasm. The cytoplasm of a monocyte is quite different—it is a smoky blue with hardly any granules in it.

Promyelocytes and myeloblasts are even younger cells. Neutrophil promyelocytes have a clear or very pale

blue cytoplasm and very few purple granules. They have holes in their nuclear chromatin (nucleoli). Myeloblasts have large round nuclei, no granules, and very clear nucleoli.

In macrocytic anaemias, you will sometimes see large badly made polymorphs with many segments. One of these has been drawn in Picture C, FIGURE 7-11.

7.21 Some further blood pictures

Many diseases have special blood films, or 'blood pictures' as they are sometimes called. Several of these have already been mentioned. Here are a few more.

Diseases caused by bacteria

Many bacteria, when they multiply in the body, cause the marrow to produce many neutrophil polymorphs. There may perhaps be 15,000 or 20,000 white cells per cu mm (see Section 7.16 for the normal values). Most of these will be neutrophil polymorphs. Apart perhaps from a few metamyelocytes, the cells will not be immature. This is a **polymorph leucocytosis**. One of the main uses of a differential white cell count is to see whether or not a patient has such a polymorph leucocytosis. If there is a polymorph leucocytosis, the patient probably has a bacterial infection. Patients with whooping cough often have a leucocytosis (perhaps 40,000 cells or even more). Whooping cough is caused by a bacterium, and the cells causing the leucocytosis are lymphocytes.

Infections with parasites

Many kinds of parasitic worm may cause the marrow to produce many eosinophil polymorphs. Sometimes 20% of the white cells in a blood film may be eosinophils. If you find an **eosinophilia** like this the patient is probably infected with parasitic worms. In malaria the proportion of mononuclear cells may be increased.

Leukaemias

These are rare diseases which make patients anaemic and often kill them within a few months. Sometimes you will see patients with very many white cells—perhaps 100,000 or more. These may be lymphocytes (**lymphatic leukaemia**) or cells from the marrow (**myeloid leukaemia** or marrow leukaemia). In leukaemia many of the cells may be very immature. Thus, in myeloid leukaemia, as well as seeing mature polymorphs, you will see myelocytes, promyelocytes, and myeloblasts. There are two more kinds of leukaemia—acute leukaemia (lymphatic or myeloid) and chronic leukaemia (this again may be lymphatic or myeloid).

7.22 The differential white cell count

Now that you have learned how to make a Leishman-stained blood film and how to recognize the blood cells, you will be able to do a differential white cell count. In the method described below we include any nucleated red cells we see, as well as the white cells. This is convenient, but some people prefer to report having seen so many nucleated red cells for every hundred white cells they have counted.

METHOD

THE DIFFERENTIAL WHITE CELL COUNT, FIGURE 7-13

Make a blood film and stain it with Leishman's stain. Take a piece of paper and write down underneath one another the words: neutrophils, lymphocytes, mono-

cytes, and eosinophils. If you come across any other cells write the names of these down also.

Find a place on the edge of the film where the cells are spread out evenly as shown in Picture A, Figure 7-7. With most microscopes it is best to look at the film with the high power objectives and the x10 eyepiece, but in some microscopes it may be necessary to use the oil immersion objective. Even if your microscope is one with which it is possible to use the high power objective, you may find it useful to have a closer look at a few of the cells with the oil immersion objective.

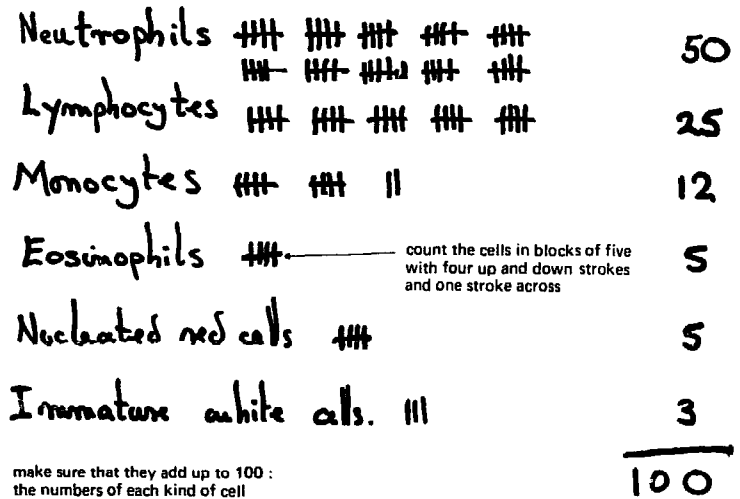

make sure that they add up to 100: the numbers of each kind of cell that you have counted will then give you the percentage without any calculation

use an odd piece of paper to count the cells on

Fig. 7-13 A differential white cell count

For each cell of a particular kind you see put a stroke on the paper. When you have got five cells of a kind, put the fifth stroke across the other four. Start in a separate place when you come to the sixth cell and the sixth stroke. In this way you count the cells in groups of five. This will make it easier to add them up at the end. When you have counted the cells in one field move on to the next one. Move across and down the slide as shown in Picture A, Figure 7-7. It is important to move across the slide like this because there are more lymphocytes in the middle of the film and more polymorphs along the edge. If you are going to get a true count you must look at as many fields in the middle of the film as you do along its edge.

When you have got 100 cells, count up the number of each different kind and report them as a percentage. It is better to count 200 cells and divide the answer by two.

Find a place where the red cells are evenly spaced, and look at them carefully. Report any abnormalities. If you see any malaria parasites, trypanosomes, or microfilaria, be sure to report them. Try to find the species of malaria parasite as explained in Section 7.33. Last of all look at the platelets. If you always look at the platelets in a blood film you will soon be able to recognize when there are fewer platelets than there should be.

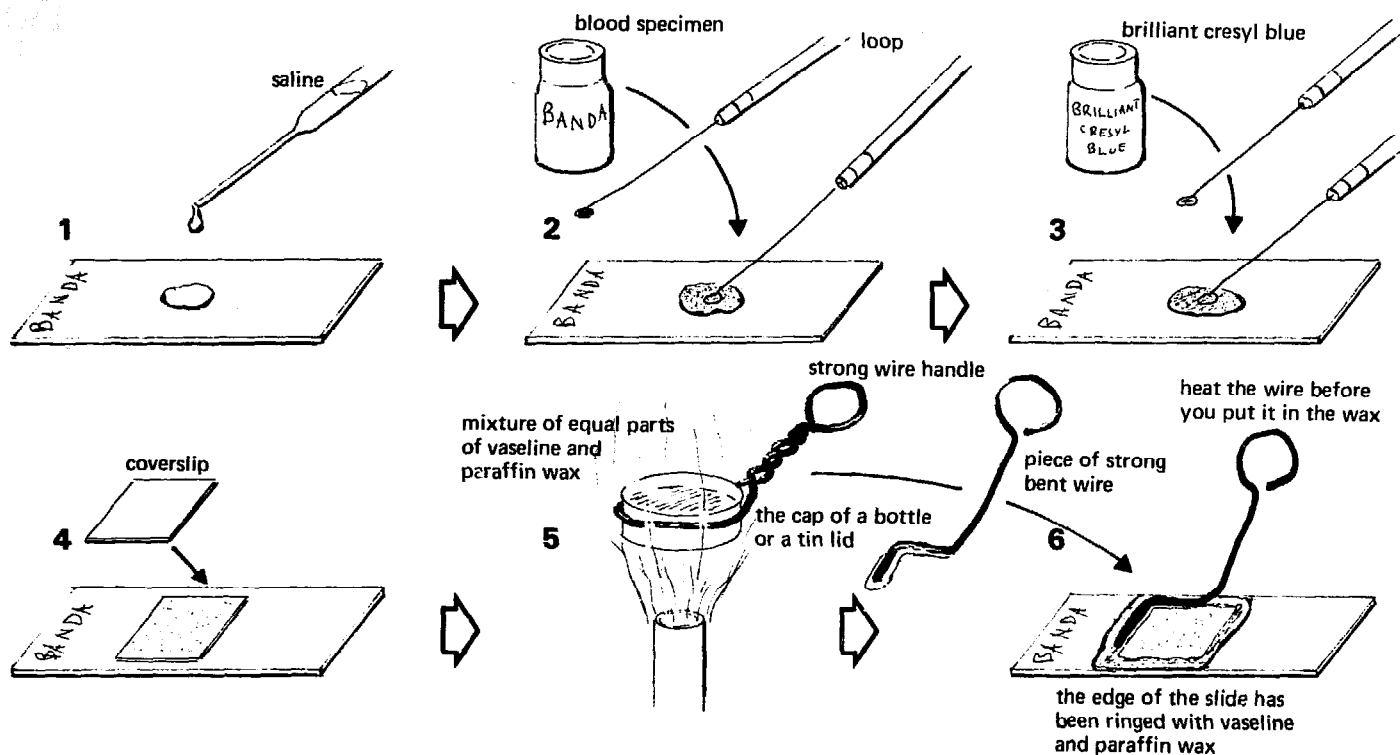

Fig. 7-14 Staining for reticulocytes

They may be very irregularly distributed. By this is meant that there may be many in one part of a film, but few in another.

7.23 Reticulocytes

Earlier on you read that in a Leishman-stained blood film we sometimes see purple or polychromatic red cells. These, we said, were the very young red cells. Reticulocytes are only these young polychromatic red cells stained in another way. They are stained with a stain called brilliant cresyl blue while they are wet under a coverslip. The remains of the nucleus, which was spread all over the polychromatic red cell with Leishman's stain, looks like little bits of purple string when stained with brilliant cresyl blue. These purple strings or threads often look like a net. This gives the cell its name—reticulocyte means 'net cell'. When a patient has too many reticulocytes he is said to have a reticulocytosis.

Like polychromasia, a reticulocytosis means that there are many young red cells in the blood and that the bone marrow must be working very hard to make them. In other words a reticulocytosis means that the marrow is very active (busy). Most patients who have a normal haemoglobin have a marrow which is only ordinarily active. They do not, therefore, have a reticulocytosis either. If an anaemic patient has a reticulocytosis it means that, even though his marrow is very active, he still does not have enough blood. This can either be because his body is losing blood to the outside (bleeding) or because his blood is being destroyed inside his body—a haemolytic anaemia. A reticulocytosis, or poly-

chromasia, usually means that either an anaemic patient is bleeding or that he has a haemolytic anaemia.

METHOD

THE BRILLIANT CRESYL BLUE METHOD FOR RETICULOCYTES, FIGURE 7-14

1. Put a drop of saline on a slide.
2. Take a loopful of blood and mix it into the saline.
3. Take a loopful of brilliant cresyl blue solution and mix it into the saline and blood.
4. Put a coverslip on top of the drop of saline, blood, and brilliant cresyl blue.
5. Make a little cup out of the lid of a tin, and make a handle for it out of thick, bent wire. Bend another short piece of *thick* wire. A paper clip can be used. Into the dish put about equal amounts of candle wax and vaseline (vaseline is a medical grease). Heat the dish so that the wax and vaseline melt (become liquid). *Heat* the thick bent wire. Dip the hot wire into the melted vaseline-wax mixture. Put the end of the wire along the edge of the coverslip. Some of the melted wax mixture will come off the wire and go solid along the edge of the coverslip. Do the same to all four edges of the coverslip. In this way the blood under the coverslip will be completely closed or sealed. The wax holds the coverslip and seals the mixture underneath. Sealing a coverslip is useful for several other methods besides this one.

Here is another method, which takes slightly longer, but which makes a dry stained film that can be kept. This was the way in which Plate 17 was made.

METHOD**ANOTHER WAY OF STAINING RETICULOCYTES**

Dissolve 3 g of sodium citrate in 100 ml of water. Take 20 ml of this solution and add it to 80 ml of saline. Dissolve 1 g of brilliant cresyl blue in the mixture. This will give you 1% brilliant cresyl blue in a solution of citrate-saline.

Put three drops of this solution in a Kahn tube. Add between six and twelve drops of the patient's blood from a sequestrene bottle. The number of drops of blood to be added depends on how anaemic the patient is. If he is very anaemic add twelve drops. If he is not anaemic, add only six.

Mix and leave the tube in a warm place (37°C) for 20 minutes.

Mix by gentle shaking. Make a blood film in the usual way and look at it *unstained*. Reticulocytes will be seen, like those in Plate 17.

The blood of a normal adult has less than 2% reticulocytes; a normal child has up to 5%. We are not interested in a patient having too few reticulocytes but only in his having too many—a reticulocytosis. With practice it is possible to see if there is a reticulocytosis by looking at the film, but reticulocytes can also be counted. To do this it is important that there are not more than about fifty red cells in an oil immersion field. When there are too many red cells it is difficult to count the reticulocytes. Count *all* the red cells (including the reticulocytes) in the same field. Count at least 200 cells altogether and look at as many fields as are necessary. Then do this sum:

$$\frac{\text{Total number of reticulocytes seen}}{\text{Total number of red cells seen}} \times 100 = \text{Percentage of reticulocytes}$$

SICKLE CELLS**7.24 What a haemoglobinopathy is**

When the red cells of some patients are kept without oxygen for some hours they change their shape. Instead of being round and slightly empty in the middle, they become sharply pointed and are called **sickle cells**. They are called this because one of the many strange shapes they form is said to look like a sickle. A sickle is a curved knife that is used in some countries for cutting grass. A sickle cell is shown in Picture D, FIGURE 7-15. Cells sickle because they have in them a special kind of haemoglobin called haemoglobin S (S for sickle). This haemoglobin is different from the haemoglobin of normal adults which is called haemoglobin A (A for adult). When we examine blood for sickle cells we are looking for haemoglobin S. When someone has haemoglobin S in his blood, we say he has **sickle-cell trouble**. There are two kinds of sickle-cell trouble, a mild kind called the **sickle-cell trait**, and a severe kind called **sickle-cell anaemia**.

Haemoglobin S is **inherited**. That means that it is

passed from parent to child in the same way that a child is said to look like his parents. Half a child's haemoglobin is given him by his father, and half by his mother. A normal child gets haemoglobin A from both his parents, and his haemoglobin is said to be AA. Sometimes only one parent gives a child normal haemoglobin A, and the haemoglobin given him by his other parent is the abnormal haemoglobin S. When half the child's haemoglobin is haemoglobin A and half haemoglobin S the child has the mild kind of sickle-cell trouble called the sickle-cell trait. We say his haemoglobin is AS. In many African countries about one person in five has the sickle-cell trait; so it is very common. If both parents have themselves got the sickle-cell trait, they sometimes (one quarter of the times) both give the child haemoglobin S. All the child's haemoglobin will then be abnormal and will be haemoglobin S. We say his haemoglobin is SS. These children are often ill and anaemic, and many of them may die while they are still young. This disease is called sickle-cell anaemia. It is much less common than the sickle-trait—about 1% of all births in areas where 20% of people have the sickle-cell trait.

Diseases due to inherited abnormal haemoglobins are called **haemoglobinopathies**. There are many kinds of haemoglobinopathy, but sickle-cell disease is the most important. Cells containing some abnormal haemoglobins, and especially haemoglobin S, may not live long in the blood and soon break or lyse. When many cells lyse the patient becomes anaemic. Abnormal haemoglobins, and particularly haemoglobin S, are thus important causes of haemolytic anaemia. Haemoglobin C is the cause of another haemoglobinopathy, which is common in parts of West Africa.

7.25 Sickle cells

As you have read, sickle cells got their name from their sickle shape. But red cells containing haemoglobin S may show many other abnormal shapes besides that of a sickle. One of these is **holly leaf** shape. Holly is a tree with sharply pointed leaves. There are many other shapes which have no names: two of them have been drawn in Pictures F and G, FIGURE 7-15. Together all these shapes are called sickle cells. The important thing to remember is that all sickle cells have long, sharp points.

Sickle cells must not be muddled up with **crenated** red cells. Crenation is described in Section 1.18 and means crumpled, shrivelled, or folded up. All red cells will crenate (whether they come from a sickle-cell patient or not) when the plasma or saline in which they are lying starts to dry up. When this happens the salt in the saline or plasma around the red cells gets too strong (hypertonic) and sucks the water out of their cytoplasm. As this water comes out, the cells shrink (get smaller), but the red cell membrane stays the same size. Just as a big coat crumples and folds on too small a person, so the red cell membrane crumples and folds when the inside of the red cell gets smaller. Any red cell can crenate in this way. *Sickle cells have long sharp points, but crenated*

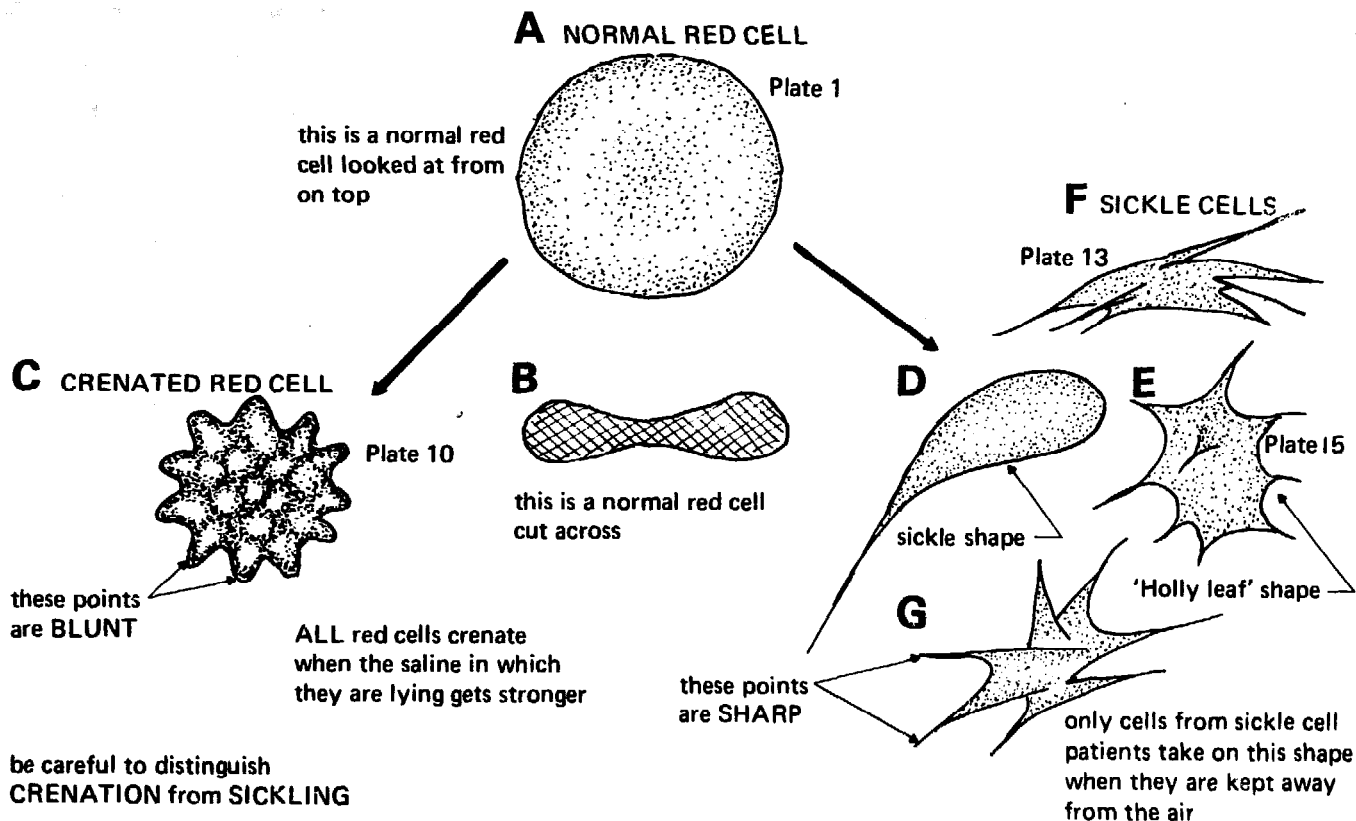

Fig. 7-15 Crenation and sickling

cells have many short points. Once you have seen them both you can easily tell sickle cells from crenated cells.

We can make red cells sickle by putting some undiluted blood from a sickle-cell patient under a coverslip, and sealing the edges with wax. This will keep out the air, the cells will use up the oxygen under the coverslip, and the following morning sickle cells will be seen. But a whole day is a long time to wait, and it is helpful to make cells sickle more rapidly by putting a chemical under the coverslip with the blood. The chemical has the effect of using up the oxygen under the coverslip. Chemicals which use up oxygen like this are called **reducing agents**. Chemicals which can add oxygen are called **oxidizing agents**. If we use a reducing agent, such as sodium dithionite, sickling may be seen in as short a time as 20 minutes. Several chemicals may be used as reducing agents, but sodium dithionite (also called sodium hydrosulphite) is probably the best. Sodium metabisulphite can also be used.

There are some difficulties in using sodium dithionite (or metabisulphite). *It must be kept dry, so the lid of the bottle in which it is stored must be kept tightly shut.* Also the solution must be made up fresh each day, because a solution older than this may not work. If you are not sure if your dithionite is working, dissolve some in a little water and see if it will decolorize litmus paper which is left in it for a few minutes. Another way of testing it is to add a few drops of Lugol's iodine to water and to see if a little of your dithionite will decolorize this. If the dithionite at the top of the bottle does not work,

remove the top layer and see if it works a bit lower down. If you are using sodium metabisulphite, look after it and test it in the same way, if you think it may not be working. Best of all, do a control test (see Section 1.24) with the blood of someone whom you know has sickle-cell anaemia, or the sickle-cell trait.

METHOD

TESTING FOR SICKLING WITH A SOLUTION OF SODIUM DITHIONITE (OR METABISULPHITE)

Make sure that the sodium dithionite that you are going to use has been stored dry. Weigh 500 mg (0.5 g) of sodium dithionite powder into a measuring cylinder. Add 25 ml of water. This will make a 2% solution. **USE THIS SOLUTION FOR ONE DAY ONLY.**

Put a small drop of blood in the middle of a clean microscope slide. Add to it two drops of 2% solution of sodium dithionite that has been freshly made that day. Stir the mixture with the corner of a slide. Put a coverslip over the mixture, seal it with vaseline and paraffin wax, and wait for 30 minutes. Lower the condenser to cut down the light and look for sickle cells with a high power objective. If you find no sickle cells look again 30 minutes later. Keep the slide in a warm place while you are waiting. If you can, keep it at 37°C (body temperature) in an incubator (a special warm box). With practice you will be able to find sickle cells with the low power ($\times 10$) objective and need only use the high power ($\times 40$) to make quite sure. When looking for sickle cells

be sure to look along the edges of the coverslip where slight drying often helps the sickling. *Don't muddle sickle cells with crenated cells!*

Here is another way of looking for sickle cells in which bacteria from the stool use up the oxygen under a coverslip.

METHOD

TESTING FOR SICKLE CELLS WITH BACTERIA FROM THE STOOL

Fill a test tube half full of saline. Add to it a piece of normal stool about the size of a pea (about a gram). Mix the stool in the saline. Let the mixture stand for a few minutes until the supernatant fluid is nearly clear. Put a drop of the supernatant fluid on to a slide and mix in a loopful of blood. Cover the mixture with a coverslip, and either seal it with vaseline and paraffin wax or leave it in a tin containing some damp paper with the lid shut. Wait for half an hour and look for sickle cells. If the test is negative, look again two hours later. This is not such a good test as the one using sodium dithionite, because bacteria in the stools sometimes haemolyse red cells.

There are several difficulties with these methods for showing sickle cells. The blood must be fresh, and it must not be allowed to dry up too much under the coverslip. The coverslip should thus be sealed. The concentration of the sodium dithionite must not be more than 2%, it must have been freshly made up, and the powder must have been stored dry. Sickle cells must also be carefully distinguished from crenated red cells and from poikilocytes. The test also occasionally gives false positive and false negative results, especially in the first few weeks of life (as may the next test also). More importantly the sickle cell method does not tell blood which is AS from blood which is SS. That is, it does not tell the blood of patients with the sickle-cell trait from the blood of patients with sickle-cell anaemia.

It is for some of these reasons that the next methods are now being used which work in quite a different way.

7.26 Two solubility methods for haemoglobins A and S

If we add normal blood containing only haemoglobin A (AA blood) to a strong phosphate buffer containing a reducing agent, such as sodium dithionite, the reduced haemoglobin A will dissolve in the buffer and make a deep purple solution. Because the haemoglobin A is soluble, the solution will be clear, or nearly clear. We can see through a tube of the solution well enough to read a newspaper through it. Also, because the haemoglobin A is soluble, we cannot remove it by filtering the solution through a filter paper. When we try to do this, the reduced haemoglobin A comes through the paper and colours the filtrate a *deep purple*.

But, if we do the same thing to the blood from a sickle-

cell anaemia patient (SS blood), we find that the reduced haemoglobin S will not dissolve in such a buffer. It makes a turbid solution that we cannot see through or read a newspaper through. Because reduced haemoglobin S is insoluble and makes a precipitate in this buffer, we can remove it by filtering the solution through a filter paper. The insoluble haemoglobin S remains on the filter paper as a dark purple precipitate, and the solution coming through the paper is a *clear yellow* (or only the very faintest pink).

If the blood that we add to the buffer contains some haemoglobin A and some haemoglobin S (AS blood from a patient with the sickle-cell trait), the haemoglobin S in the blood will make the solution turbid and we will not be able to read a newspaper through it. When we filter the solution, the haemoglobin S will be left behind on the paper, and the haemoglobin A will come through and stain the filtrate *pink*.

The insolubility of haemoglobin S can thus be used in two ways. We can see if a mixture of blood and working solution is clear or turbid. We can also filter it to see what colour the filtrate is. It is useful to do the turbidity method first as a screening (searching) method. If the solution is turbid and we cannot read a newspaper through a tube containing it, we know that the patient has some haemoglobin S in his blood. He is either AS or SS. We then find out which of these he is by doing the filtration method.

Many of the patients on whom we want to do these methods are anaemic with a low haematocrit (packed cell volume or PCV) and a low haemoglobin. Anaemia spoils these methods so we start by centrifuging a tube of the patient's blood and, if necessary, pipetting off enough plasma so as to leave an equal volume of plasma and packed cells. By doing this we concentrate the red cells and correct or make up for the patient's anaemia.

There is no picture of the turbidity method and only the filtration method is shown in Figure 7-16.

METHOD

THE TURBIDITY SCREENING METHOD FOR HAEMOGLOBIN S

1. Centrifuge the patient's blood. Take the tube out of the centrifuge being careful not to disturb the deposit of packed cells. With a Pasteur pipette carefully remove some of the plasma so that there is an equal volume of plasma and packed cells left in the tube. If the patient is not anaemic and has a normal packed cell volume, you will not need to remove any plasma. But, if he is very anaemic, you may have to remove quite a lot of plasma for there to be left an equal volume of plasma and packed cells. By doing this we are making sure that all specimens start this method with a more or less normal packed cell volume, and that anaemia is corrected for.

2. Make up the working solution as described in Steps 1 and 2 below.

3. Pipette 1.9 ml of the working solution into a Kahn tube.

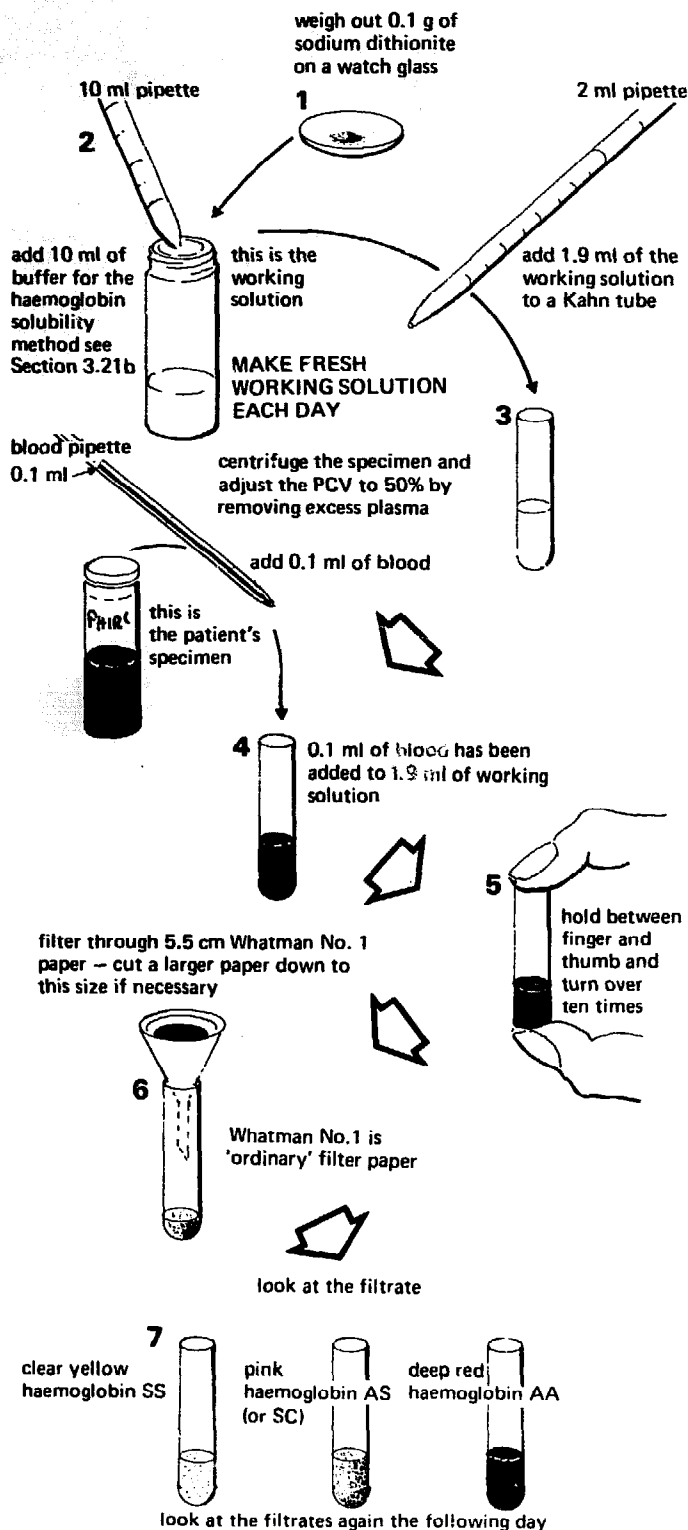

Fig. 7-16 The filtration method for haemoglobin S

4. Add 0.02 ml of blood. Note that this is a smaller quantity than the 0.1 ml of blood needed for the next method.

5. Put the Kahn tube containing the mixture of blood and working solution in front of the ordinary writing of a newspaper. Can you read the writing through the purple tube of solution?

If the solution is a clear purple and you can read through it, there is no haemoglobin S in the specimen, and the patient's haemoglobin is AA. The filtration method below is not needed.

If you cannot read a newspaper through the solution, because it is turbid, some haemoglobin S is present, and the patient is either SS or AS. It is not possible with this method to tell which of these he is and you will have to go on to the filtration method.

This method occasionally gives false positive results when the patient has abnormal plasma proteins (dys-proteinaemias), but this is rare.

If the mixture is turbid by the above method, find out if the patient has haemoglobin AS or SS like this.

METHOD

THE FILTRATION METHOD FOR HAEMOGLOBINS AA, AS, AND SS, FIGURE 7-16

If you have not already done so, centrifuge the specimen and remove excess plasma to correct for anaemia by doing Step 1 above.

1. Weigh out 0.1 g of sodium dithionite into a universal container. A small test tube marked at the 0.1 g level will save you the need to weigh the sodium dithionite each time.

2. Add 10 ml of the 'buffer for haemoglobin solubility methods' (see Section 3.21b) to the container with the sodium dithionite in it. Mix the dithionite with the buffer until it is dissolved. This is the *working solution* and is enough for five tests. Be sure to make up this solution fresh each day. If there is any over at the end of the day, throw it away. This working solution is also used for the turbidity method above.

3. Pipette 1.9 ml of this working solution into a Kahn tube.

4. Add 0.1 ml of the patient's blood that you have corrected for anaemia, to the working solution in the Kahn tube.

5. Mix well by holding the tube between your finger and thumb, and turning the tube upside down ten times. The dithionite will turn the haemoglobin in the blood a deep purple colour. Specimens with haemoglobin S in them will become turbid from the haemoglobin that has precipitated in the buffer.

6. Filter immediately through a 5.5-cm Whatman No. 1 filter paper. If your paper is larger than this, cut it down to this size. Too large a paper will soak up too much of the solution. It may also be useful to cut down one or two of your plastic funnels to fit this size of paper. If you have difficulty in finding somewhere to stand your Kahn tubes, stand them in a lump of plasticine.

7. Look at the colour of the first millilitre of the filtrate.

- Filtrate deep purple with no dark red deposit on the paper — haemoglobin AA
- Filtrate pink with some dark red deposit on the paper — haemoglobin AS

Filtrate clear yellow (or only the palest pink) with a dark red deposit on the paper

— haemoglobin SS

Take the paper out of the funnel after the first millilitre of filtrate has come through. Do this because oxygen from the air oxidizes the insoluble reduced haemoglobin S, and makes it soluble again. When this happens it may start coming through the paper and make the clear yellow filtrate from an SS specimen slightly pink.

If you are in doubt whether a pale pink filtrate is from an SS or AS specimen, leave it until the following morning. If any haemoglobin S has got through the paper and made an SS filtrate pink, it will form a fine feathery precipitate overnight, and leave a perfectly clear supernatant fluid. The filtrate from an AS patient may have a precipitate, but the supernatant will still be pink.

If you still have any doubt about the result of the filtration test, do this control test. Mix 0.9 ml of working solution and 1 ml of water. Do the test in the usual way. Both haemoglobin S and haemoglobin A are soluble in this diluted working solution, so the filtrate using it contains both these haemoglobins. If the filtrate from the test using the undiluted buffer is paler than this, some haemoglobin S must have been left behind on the paper, and the patient must be either AS or SS. He is not AA. This is a useful control to do when seeing if a patient has AS or AA blood.

These last two methods are new ones and it has not been possible to try them out in many hospitals and clinics before this book was printed. However, they will probably be a very useful way of telling AS blood from SS blood in areas where this is the commonest haemoglobinopathy. They may also be useful screening methods in larger laboratories where other methods are also used.

Two more things need to be said about these methods. One is that they may not give the correct results in patients less than about 9 months old. This is because very young children may have another kind of haemoglobin (haemoglobin F) in their blood, which may be confused with haemoglobin S by this method.

Also, haemoglobin C behaves like haemoglobin A in these methods. However, patients with AS blood usually have normal films, provided that there is nothing else wrong with them, such as iron deficiency. Patients with SC and CC blood have abnormal blood films.

If you are in doubt with these methods, you may find it useful to do both of them together and to do the sickle-cell test as well. Both these last two methods were kindly given to us by Doctors Huntsman, Barclay, Canning, and Yawson (see references Section 13.33).

7.27a Sickle-cell anaemia and the sickle-cell trait

These are important conditions, and it is useful to say a little more about them.

The sickle-cell trait

Someone with the sickle-cell trait is healthy and may be of any age. His blood will sickle and give a pink filtrate with the solubility method. Unless there is something else wrong with him he will not be anaemic, and he will have a normal blood film.

Sickle-cell anaemia

Most patients with sickle-cell anaemia are children, who are usually very anaemic. Many of them die. Their blood will sickle and give a yellow filtrate with the solubility test. Their blood films show target cells, polychromasia, and sickle cells. Normoblasts are also often seen.

Patients with sickle-cell anaemia suffer from crises. A crisis is the time of an illness when the patient suddenly gets much more ill and often dies. The more common kind of crisis is the vascular (blood vessel) occlusive (blocking or closing) crisis in which sickle cells block some of the small blood vessels of the body. The child usually has painful bones and joints and may have painful, swollen fingers (dactylitis). He may have pain in the chest and abdomen. He has severe anaemia, fever, and jaundice, and usually has a large spleen. Another and much less common kind of crisis is called the aplastic crisis. The child's marrow becomes tired of making blood cells and becomes aplastic or stops working. The child thus becomes much more anaemic. The third kind of crisis called the sequestration crisis is seen most commonly in children between 1 and 3 years old. Many red cells become trapped (sequestered) in the spleen, which makes the child very anaemic.

Sickle-cell anaemia cannot be cured, but a blood transfusion will often save a child's life during an aplastic or sequestration crisis. A good diet also helps these children, and so does folic acid treatment, as it does all haemolytic anaemias. Sickle-cell crises are often caused by infections. It is thus important to prevent infections and to treat them properly when they occur. It is also most important that sickle-cell patients should not suffer from fever or dehydration, because if they do their anaemia gets worse. Some clinics give their sickle-cell patients drugs to prevent malaria and penicillin to prevent some other infections.

7.27b Thalassaemia

This is another group of inherited diseases in which the body is unable to make haemoglobin in the normal way. The red cells are therefore poorly filled with haemoglobin, and the MCHC is low. The red cells are hypochromic, and there is microcytosis and poikilocytosis. Even though their blood films look very like those of iron deficiency anaemia, they are not cured by iron. In some parts of the world thalassaemia is a common cause of hypochromic anaemia. One of the easiest ways of distinguishing between the hypochromic anaemias of iron deficiency and thalassaemia is to treat them with iron. If the

hypochromia is due to iron deficiency, the anaemia will improve with iron treatment, but if it is due to thalassaemia iron will do no good. There are other ways of finding out if a patient has thalassaemia, but we cannot describe them here.

7.28 A simple guide to anaemia

FIGURE 7-17 will help you to find out why patients are anaemic. When you find that someone's lips, tongue, and conjunctivae are pale, the first thing to do is to measure his haemoglobin and if possible, his haematocrit. If his haemoglobin is more than 10 g % and his haematocrit more than 30%, there is usually no need to treat him. If his haemoglobin and haematocrit are less than these figures, work out his MCHC and stain a film by Leishman's method.

If the red cells are hypochromic and the MCHC is less than 32%, look at the stool for hookworm ova and test it for occult blood. If the patient is a woman, ask her about her periods. She may be bleeding too much from her uterus (womb) and be suffering from menorrhagia.

If the red cells are normochromic and the MCHC is above 32% the patient may have a haemolytic anaemia. Look for polychromasia in the blood film, see if there is a reticulocytosis, and look for urobilinogen in the urine. If you find these things the patient has a haemolytic

anaemia. In many areas, malaria or sickle-cell anaemia will be the most common causes of such an anaemia, so look for sickle cells and use the solubility method to look for haemoglobins A and S. A thick blood film will tell you if a patient has malaria, if you have not already seen parasites in the thin film.

The patient may have a normochromic anaemia because he is malnourished (badly fed), or because he has had an infection for a long time. A few patients will be uraemic. Uraemia often causes anaemia.

If many of the cells are larger than normal and are well filled with haemoglobin, the film is macrocytic. The patient probably has a folic acid deficiency anaemia. He may possibly have pernicious anaemia due to vitamin B₁₂ deficiency. If you can, test to see if there is free acid in the stomach. Patients with pernicious anaemia have no free acid in their stomach. But, if folic acid deficiency is causing the macrocytic anaemia, free acid will usually be found in the stomach. This is thus a useful test. If patients have free acid in their stomach they cannot have pernicious anaemia.

Very occasionally you will find that leukaemia is the cause of an anaemia.

Some anaemias cannot be diagnosed (explained) by the simple methods that we have described, and some anaemias have more than one cause. Even so, these methods will probably be enough to diagnose most anaemias in most places.

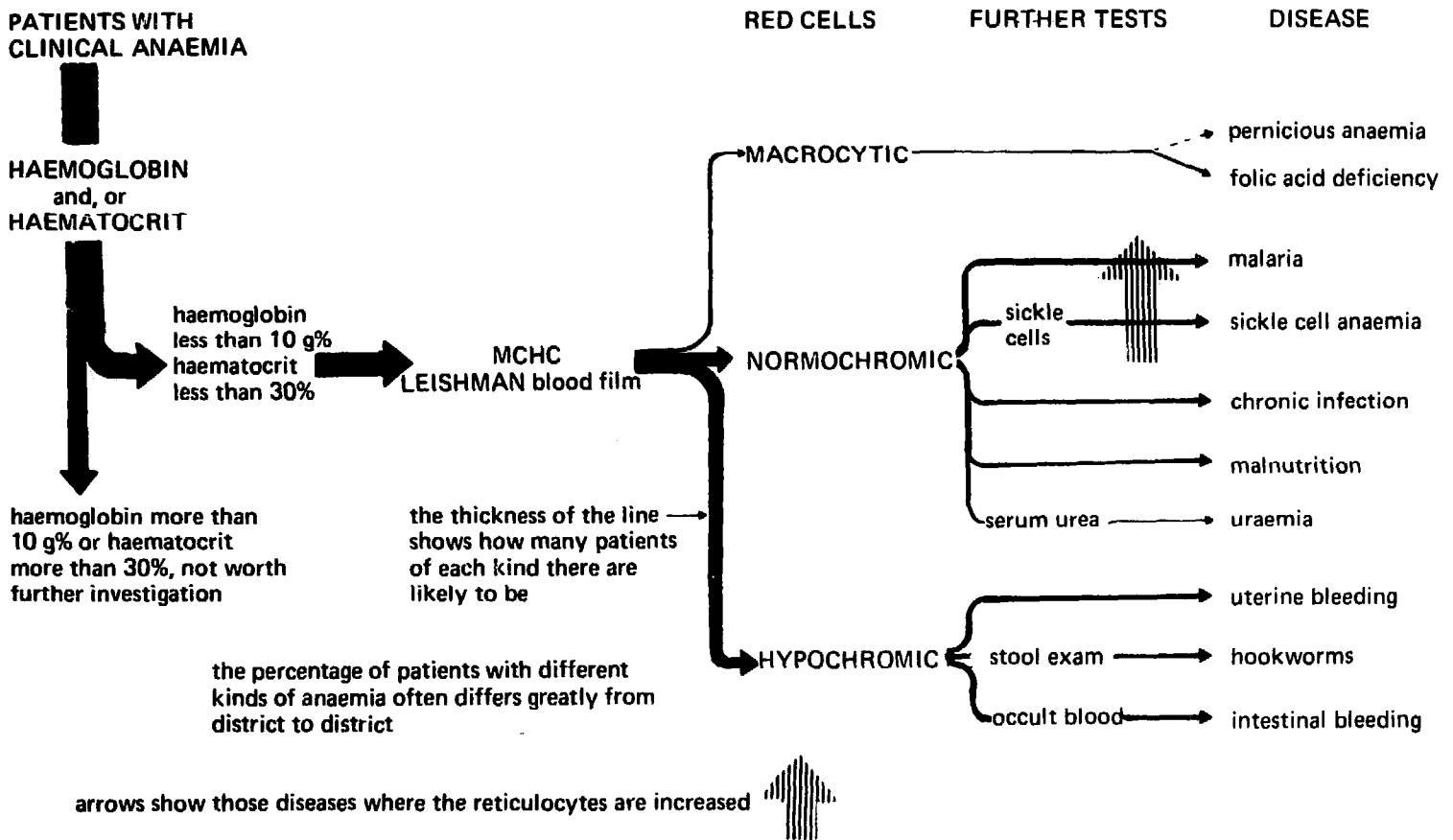

Fig. 7-17 A simple guide to anaemia

THE TOTAL WHITE CELL COUNT

7.29 Counting white cells

Healthy people have between 5,000 and 9,000 white cells in each cubic millimetre (cu mm) of their blood. It is often useful to know if patients have more or less white cells than they should have. To find out how many white cells there are, we take 0.05 ml of blood and add it to 1 ml of white cell diluting fluid. 0.05 ml is $\frac{1}{20}$ ml and is the same volume that we use for measuring haemoglobin. White cell diluting fluid contains acid which will lyse the

red cells without harming the white cells. It also contains a few drops of Gram's stain. This stains the white cells, which would otherwise be colourless, and makes them blue and more easily seen. We add a little blood to a much larger volume of white cell diluting fluid, so that we can make a dilute stained suspension of white cells without any red cells in it. By adding 0.05 ml ($\frac{1}{20}$ ml) of blood to 1 ml of white cell diluting fluid we have diluted our blood specimen 20 times (really 21 times, but we forget about this).

We put this dilute cell suspension into a glass

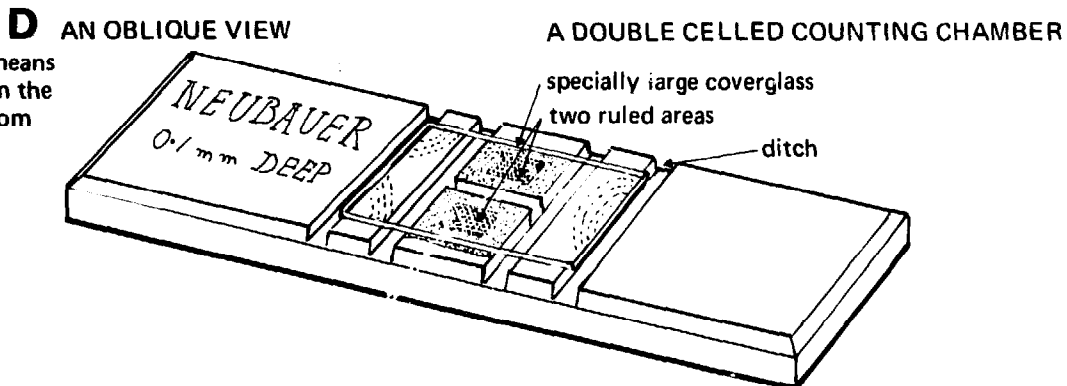
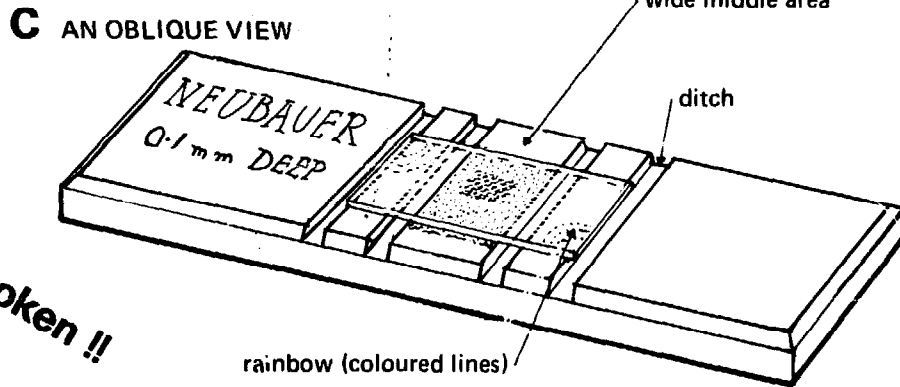
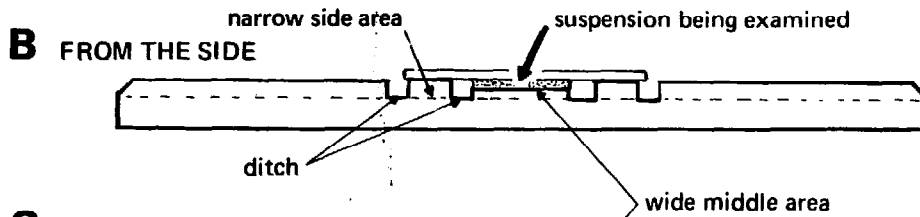
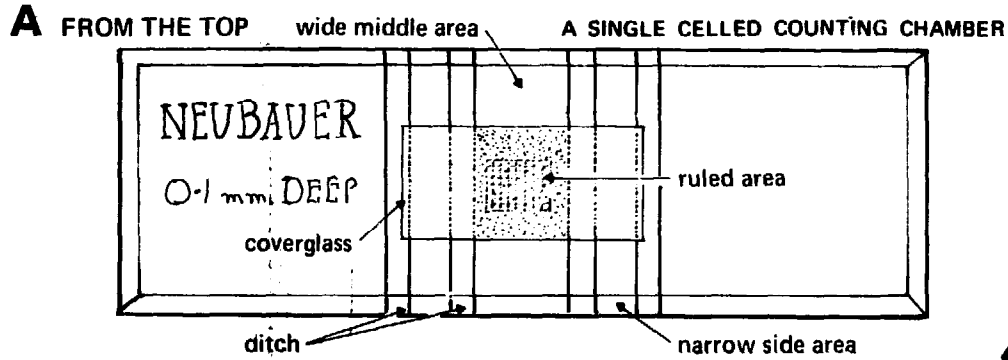

an oblique view means a view partly from the side and partly from on top

EXPENSIVE!!

handle with care!!

easily broken !!

Fig. 7-18 Counting chambers

Neubauer counting chamber (chamber means a little room). This is like a thick microscope slide, but it is very carefully made and is much more expensive. A counting chamber has three special flat areas (places) on it: two narrower ones on either side and one wider one in the middle. The middle area and the side areas are separated by ditches (rivers). The wide middle area is exactly 0.1 mm ($\frac{1}{10}$ mm) below the areas at the sides. A special thick, flat coverglass is put across the chamber and rests on the two side areas. The coverglass makes a bridge over the middle area which is exactly 0.1 mm underneath it. There is thus a very carefully made space exactly 0.1 mm deep between the top of the middle area of the counting chamber and the bottom of the coverglass. We put our white cell suspension into this space.

Many very thin lines are drawn in the middle area of the counting chamber. These lines cross one another and make many small squares. These small squares are shown in FIGURE 7-18 and are called the **ruled area**. The ruled area can just be seen if the chamber is held up to the light and looked at very carefully, but it can be seen much more easily with a microscope.

Some counting chambers have two ruled areas separated by a ditch as shown in Picture D, FIGURE 7-18. These double counting chambers need a specially large coverglass like that shown in Picture G, FIGURE 7-23.

The ruled area of the Neubauer chamber is shown in FIGURE 7-19. For the total white count we use the four corner blocks each of 16 small squares. These have been lettered A, B, C, and D in this figure. The very small squares in the middle of the cross are marked Z and are for counting red cells. In our laboratory we do not count red cells, except sometimes in the CSF, and we do not use these squares. The rulings marked X in this figure are never used.

Each of the corner blocks of 16 corner squares is exactly one millimetre (mm) square. So, if the coverglass was one mm above the ruled area there would be one cubic millimetre (cu mm) above each corner block of 16 small squares. But the coverglass is only $\frac{1}{10}$ mm above the ruled area; so there is therefore only one-tenth of a cu mm over each corner block of 16 small squares. We usually count the white cells in two corner blocks—that is, two-tenths or one-fifth of a cu mm. To find how many cells there are in 1 cu mm we therefore multiply the number of cells we find by five. We also multiply by twenty, because the blood specimen was diluted by twenty to make the cell suspension. $5 \times 20 = 100$; so we count the cells in two corner blocks and multiply the number we find by 100. This is easy: all we do is to add two 0's to the number of cells we find in two blocks of 16 small squares. For example, if there are 22 cells in block A and 28 cells in block B, the count is $22 + 28 \times 100$. This is the same as 50×100 , or 5,000 cells per cu mm.

When you look at the ruled area of a counting chamber you will see that some of the cells are in the middle of the small squares, and some touch the lines at the sides.

count the 16 small squares in the order shown in block A that is 1,2,3, ... : you will then follow the 'snake' that has been drawn in block B

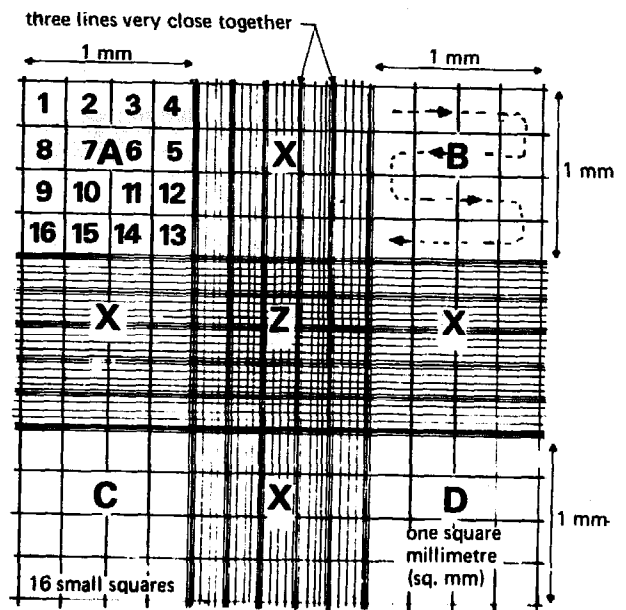

THIS IS ONE OF THE SIXTEEN SMALL SQUARES DRAWN MUCH BIGGER

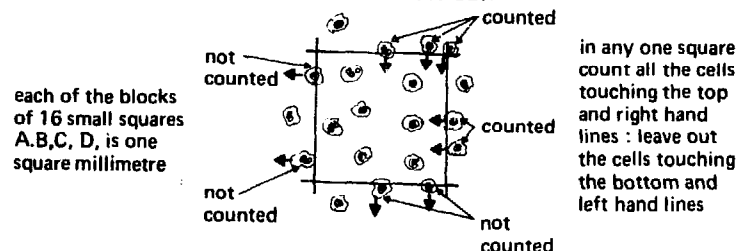

the small squares marked 'z' are used for counting the red blood cells: this method is not described in this book: the parts marked 'x' are not used at all

Fig. 7-19 The ruled area on a Neubauer counting chamber

When you count the cells in a square, it is a useful rule to *count only those cells which touch the top and right-hand lines round a square, and not to count the cells which touch the lines at the bottom and left-hand edges of a square*. If a cell touches the left-hand edge, it will be counted with the cells in the square next to the left. If a cell touches the line at the bottom of a square, it will be counted with the cells in the square below.

When doing a white cell count the important thing to learn is the right way to put a coverglass on to a counting chamber. The coverglass and the narrow side areas must touch one another closely, and there must be no dust between them. Only if they do this, will there be exactly 0.1 mm between the coverglass and the middle area. Follow the instructions for putting on the coverglass on the chamber very carefully. Remember especially never to press on the coverglass except over the narrow side areas. If you press on the coverglass in the middle, it will break.

THESE ARE BOTH VIEWS OF THE RULED AREA LOOKING FROM THE TOP AND THE SIDE

If the coverglass was 1 mm above the ruled area there would be 1 cu mm on top of each of the corner blocks of 16 small squares, but the coverglass is only 1/10 mm above the ruled area, so there is only 1/10 cu mm above each of the corner blocks of 16 small squares

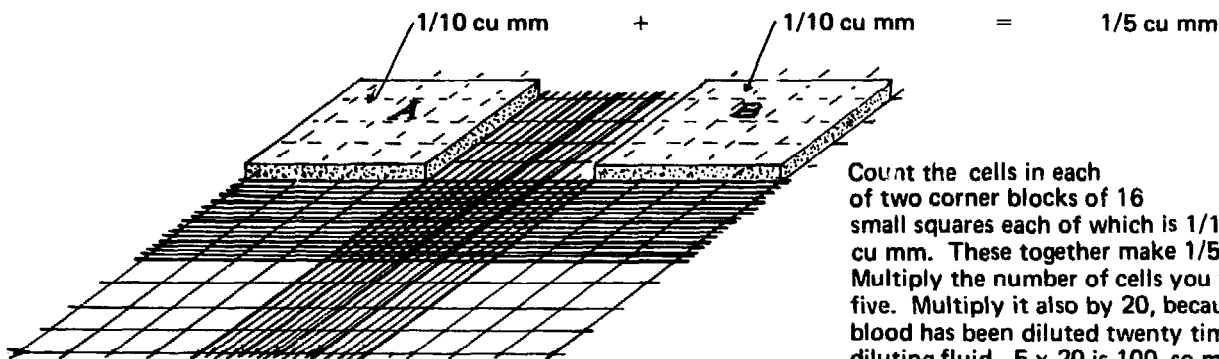
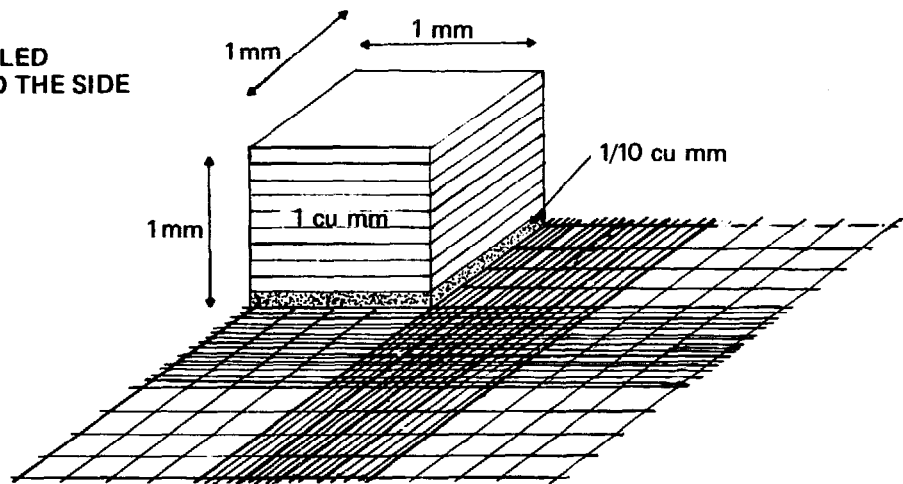

EXAMPLE,

If there were 22 cells in block A and 38 in block B the answer would be:—

$$22 + 38 \times 5 \times 20 = 60 \times 100 = 6,000 \text{ cells per cu mm}$$

Fig. 7-20 The volume of a Neubauer counting chamber

METHOD

THE TOTAL WHITE CELL COUNT, FIGURE 7-21

1. Make sure that both the coverglass and the counting chamber are really clean. If necessary wash them with soap and water and dry them with a soft cloth.

Put the counting chamber on the bench. Put the coverglass on top of it. Put your index finger on top of the coverglass. Very gently, *without pressing*, move the coverglass round and round. This will make any dust between the coverglass and the side areas fall into the ditches. The coverglass and the side areas will then touch one another closely and leave exactly 0.1 mm between the coverglass and the ruled area.

2. Put the coverglass towards one side of the chamber. Put one of your thumbs on each edge of the coverglass. Press gently over the narrow side areas and, while still pressing, push the coverglass into the middle of the counting chamber, as shown in Picture A at the top of Figure 7-23. As you have read, *always press over the narrow side areas as in Pictures 2 and 3. Never press over*

the middle of a coverglass. If you do the coverglass will break, as in Picture 4.

When the coverglass is properly in place you will see the coloured lines of the rainbow or spectrum between the narrow side areas and the underneath of the coverglass. These are shown in Picture A, Figure 7-23.

These coloured lines mean that the coverglass and the narrow side areas are touching each other closely. You will find, when you pick up the counting chamber, that the coverglass will have stuck to it. On some counting chambers the narrow side areas are rough (ground), so you will not see rainbow colours, and the coverglass will not stick to them.

5. Measure 1 ml of white blood cell diluting fluid into a bijou bottle. You may find it useful to keep a 1-ml pipette in the cork of the stock bottle of diluting fluid.

6. Fill the blood pipette to the 0.05-ml mark. Take blood from the ear or finger or from a venous specimen. *Make sure you mix the specimen bottle well before taking the sample.* Fill your blood pipette as described in Figure 7-1.

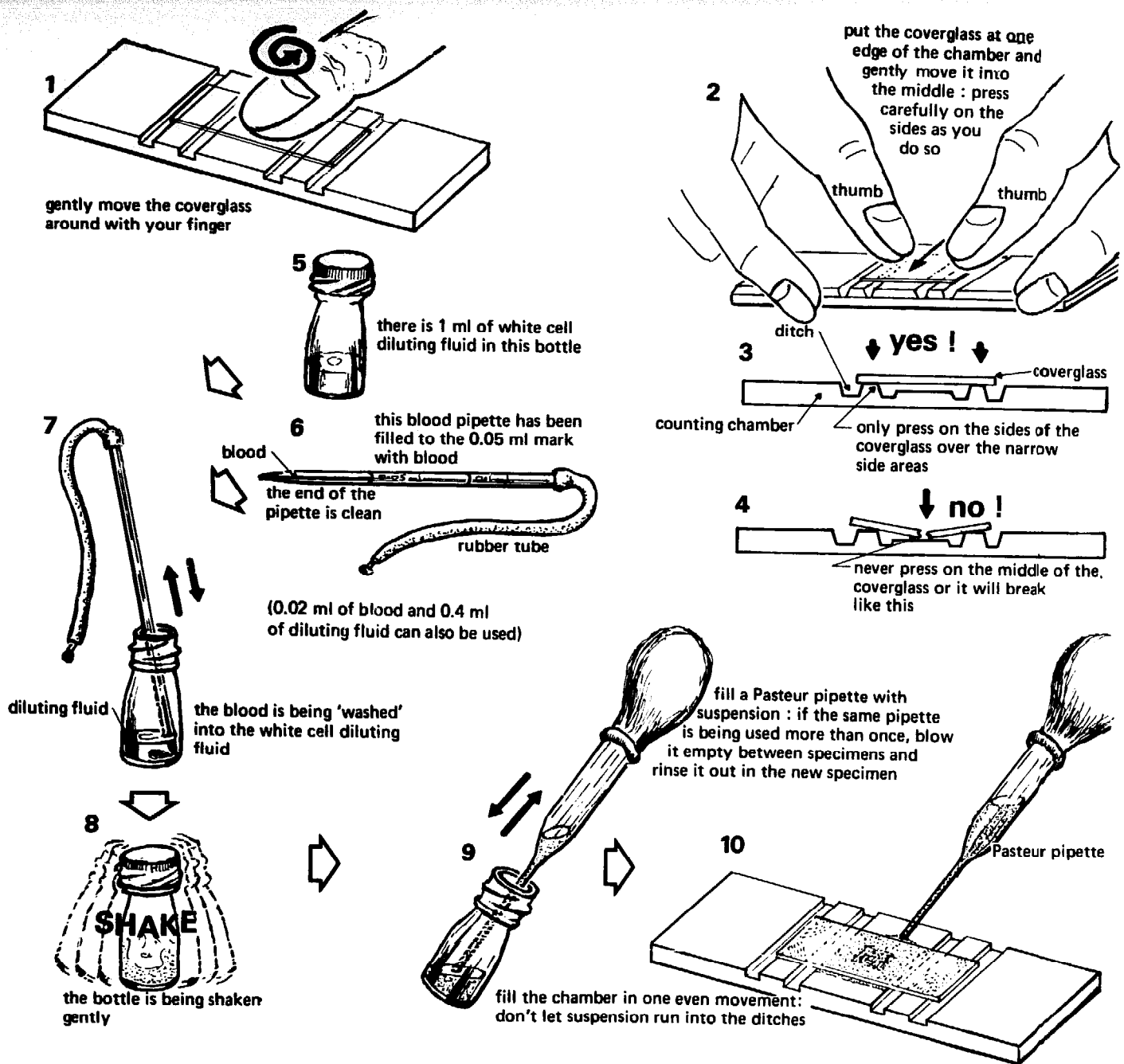

Fig. 7-21 Filling a counting chamber

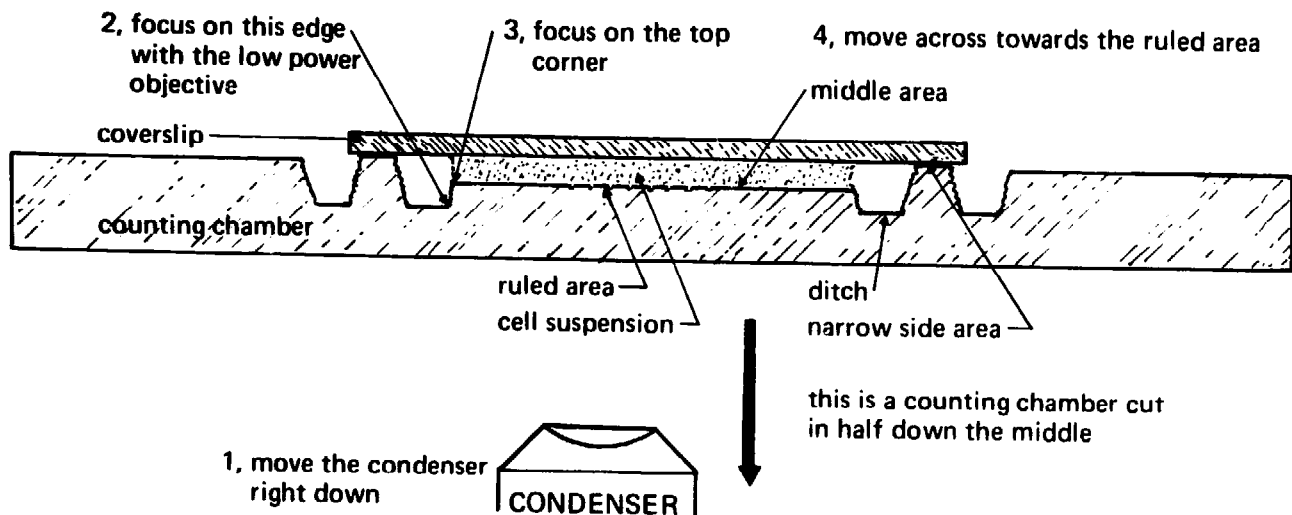

Fig. 7-22 Finding the ruled area on a counting chamber

7. Wipe the outside of the pipette clean and blow the blood into the 1-ml bottle of white cell diluting fluid. Rinse the blood pipette once by drawing up the fluid to just above the 0.05-ml mark and blowing it out again.

8. Put the cap on the bottle and shake it gently.

9. Take a clean Pasteur pipette and draw the white cell suspension in and out of it once or twice.

10. Using the pipette, fill the space between the coverglass and the middle part of the counting chamber with the white cell suspension. *Fill the chamber in one steady movement.* There must be no bubbles and no suspension in the ditches. You will find that the suspension will flow into the chamber on its own.

Turn to Figure 7-22.

1. Move the condenser down. Look for the ruled area with the low power objective.

2. If you cannot find the ruled area, find the edge of the ditches.

3. Focus upwards until you see the top of the ditch and the surface of the wide middle area.

4. Move across the wide middle area until you find the ruled area.

Count the cells in two corner blocks of the 16 small squares. When counting a corner block move through the 16 small squares following a snake-like path drawn in block B in Figure 7-19. Add together the number of cells found in each block. Add on two 0's. The figure you get will be the number of white cells in 1 cu mm.

Picture A, FIGURE 7-23, shows you what a well-filled counting chamber should look like. The coverglass is in the middle. You will see the coloured lines of the spectrum over both side areas; there are no bubbles in the suspension; and no suspension in the ditches. All the other pictures show badly filled counting chambers. In Picture D the coverglass is at one edge of the counting chamber. In Picture B the coverglass is not straight and there are bubbles in the suspension. In Picture E suspension has run into the ditches. In Picture C a coverglass that was meant for a single celled chamber has been put on a double chamber. You will see that it is too small and that the ruled areas are not completely covered. The ruled areas must be well inside the edge of the coverglass. You will see that the double coverglass in Picture G is much bigger than the single coverglass in Picture F.

7.30 What an abnormal total white cell count means

By an abnormal white count we mean one with more than 9,000 or less than 5,000 white cells per cu mm. When a patient has too many white cells (leucocytes) he has a **leucocytosis**. When he has too few white cells he has a **leucopenia** (penia means few). Many infections with bacteria produce a leucocytosis. Very rarely you will find a patient with a white count of 100,000 or even more. This may mean that the patient has a very bad disease of his blood called leukaemia.

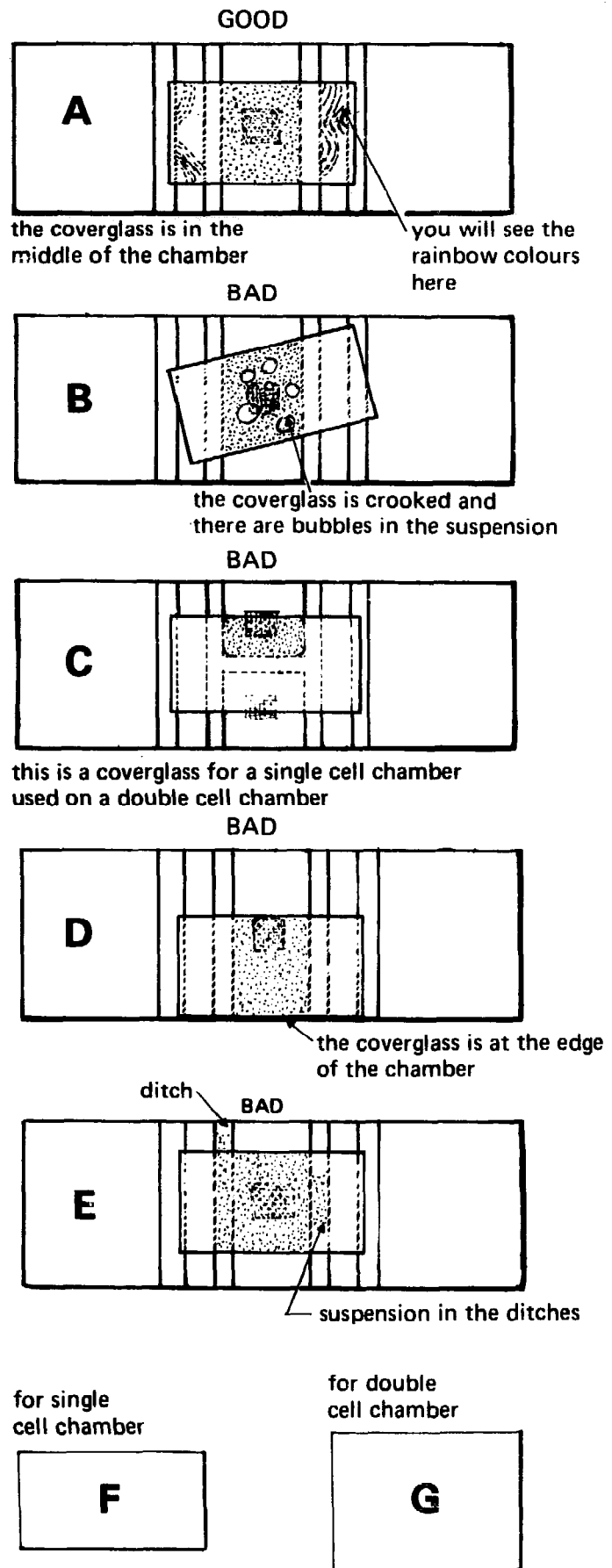

Fig. 7-23 Well and badly filled counting chambers

Leucopenia is much less common than leucocytosis. Typhoid fever is an important cause of a moderate leucopenia, say, 4,000 cells per cu mm. Sometimes there may be very few white cells indeed because the marrow is diseased. As you have read, a diseased marrow which produces very few cells or none at all is said to be aplastic.

Nothing more than this can be said here about the meaning of an abnormal total white cell count. Be prepared therefore to find a few patients with very high counts and a few with very low counts. If you find an occasional very unusual count, your method is probably right, and the patient's white cell count is probably very abnormal.

Total white cell counts will seldom be needed in health centres. But they will often be wanted in hospitals to help find the cause of a fever or, less often, the cause of an anaemia.

FIELD'S STAIN FOR THICK BLOOD FILMS

7.31 Why a thick film is so useful

Field's stain was first made to show malaria parasites in the blood, but it will also show trypanosomes, microfilaria, and *Borrelia*. Because these can all be seen in a thin blood film, you may wonder why we need thick blood films. This is the reason. In a thin film the blood is spread out so thin that, unless there are very many parasites in the blood, we are unlikely to find them. This is because we can only look at a very small volume of blood with an oil immersion objective, unless of course we search for a very long time indeed. In a thick film we can search a much larger volume of blood and have a better chance of finding parasites when there are not very many there.

Leishman's stain contains methyl alcohol which fixes the blood cells. You will remember that by fixing we mean that the methyl alcohol kills the cells and keeps them looking the same as when they were alive. Field's stain is made with water and contains no methyl alcohol. So, when a thick film of blood is put into Field's stain, the water in the stain lyses (breaks open) the red cells and washes the haemoglobin out of them. But the malaria parasites inside the cells are left behind when the haemoglobin is washed away and are stained, so also are the white cells. If *all* the haemoglobin is washed away the red cell membranes (coverings) are also stained, and the field of view in the finished film will be full of purple debris (rubbish). This makes it difficult to see the parasites. But, *if some of the haemoglobin is left in the film, you will see parasites and white cells stained blue and purple against a CLEAR orange-brown background, which is the remaining haemoglobin.* This clear background makes it easy to see the parasites and is explained in FIGURE 7-24.

Thick films are not easy to make. If the film is stained badly too much haemoglobin may be washed away, and the film may even be washed off the slide completely.

Only with care and practice is it possible to make a good thick film every time. But, when a good film is made, it is beautiful, and it gives a sure diagnosis easily and rapidly. The main points to watch are the thickness of the film, how dry it is, how long it is stained for, and how much it is moved about in the jars of stain and water.

METHOD

FIELD'S STAIN, FIGURES 7-25 AND 7-26

THE STAIN

Keep Field's stain A and Field's stain B in two jars with caps that are wide enough for a slide to go through them—150-ml screw-capped jars work very well. Jars of this kind are listed as ML 52. Keep them very nearly full; otherwise it will be difficult to reach the stain with the film. *Put the caps back on the jars when they are not being used.*

MAKING THE FILM

This is very important. The film should be about the size and shape of a postage stamp—say, 2 cm × 1½ cm. It should be thick enough so that the writing in a newspaper or the hands of a watch can *only just be seen through it*. Use the corner of another slide to spread out the blood. A common mistake is to make thick films too thin. Thick films must be *thick!* They are usually made in the wards; so, show the ward staff, and particularly the student nurses, how to make good ones. *If very bad films are sent to the laboratory, don't look at them, because it will be impossible to give a true answer. Ask for another film, or, better still, go to the ward and make another thick film yourself. Show the person who made the bad film how to make a good one. One way of teaching the ward staff is to stick films, good and bad, to a card, to label them and to leave them on the ward notice board as examples.*

The film must be dry enough. A few minutes in a warm place, such as on top of the microscope lamp, will make the film dry enough to stain. *Films that are too dry do not stain well.* You will also find that fresh films stain better than old ones. Use a big enough drop of blood and be sure that the film is flat (horizontal) while it is drying.

STAINING

1. Dip the slide in the blue stain A for one or two seconds, moving it about *gently*. Let it drain for a moment, by touching the bottom of the slide on the top of the jar.

2. Wave the slide *gently* in a cup of clean water. 2–3 seconds is usually enough, by which time the stain will usually have stopped flowing from the film.

3. Dip the slide for one second into stain B. Let it drain for a moment by touching the bottom of the slide on the top of the jar.

4. Wave the slide *gently* for 2–3 seconds in clear

A THIN FILM

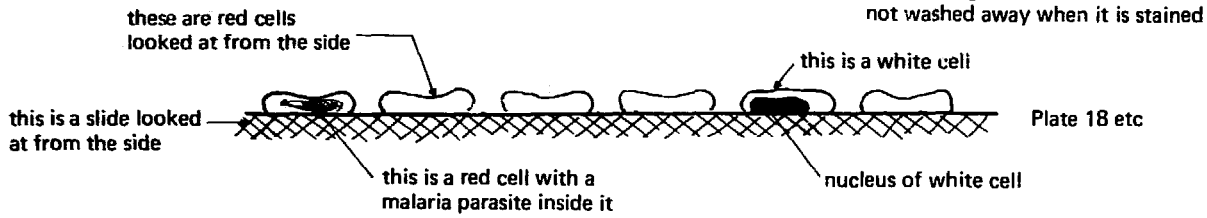

A THICK FILM unstained



this is a heap of red cells, some of them with malaria parasites inside them and some of them without

in Field's method of staining a thick blood film we try to leave some haemoglobin in the film : in Giemsa's method of staining a thick film we wash it all away : Giemsa's method is not described here

stained

GOOD

BAD

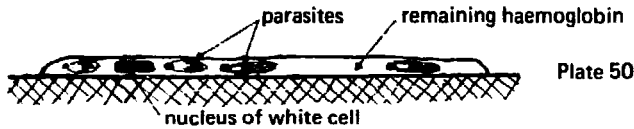

if the film is well stained the parasites are left in a clear layer of haemoglobin

if the film is overstained and all the haemoglobin is washed away, much debris is also stained and the parasites are hard to see

Fig. 7-24 Thick and thin blood films

size

thickness

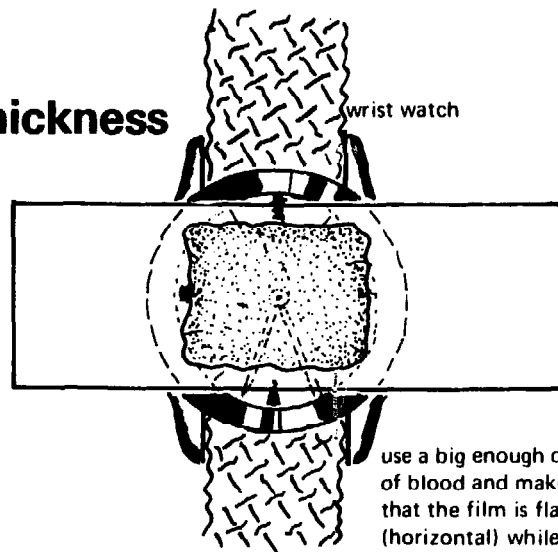
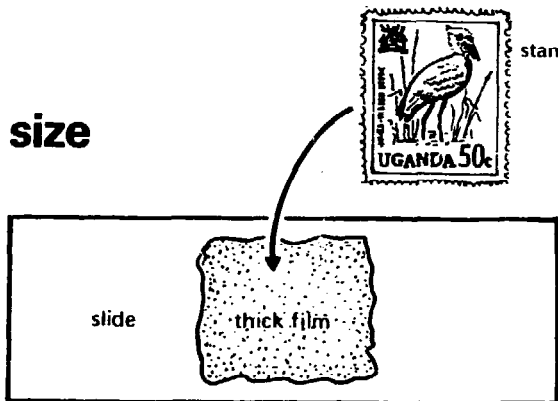

A GOOD THICK FILM IS THE SIZE OF A POSTAGE STAMP AND SO THICK THAT YOU CAN JUST SEE THE HANDS OF A WATCH OR NEWSPRINT THROUGH IT

use a big enough drop of blood and make sure that the film is flat (horizontal) while it dries

Fig. 7-25 A good thick film

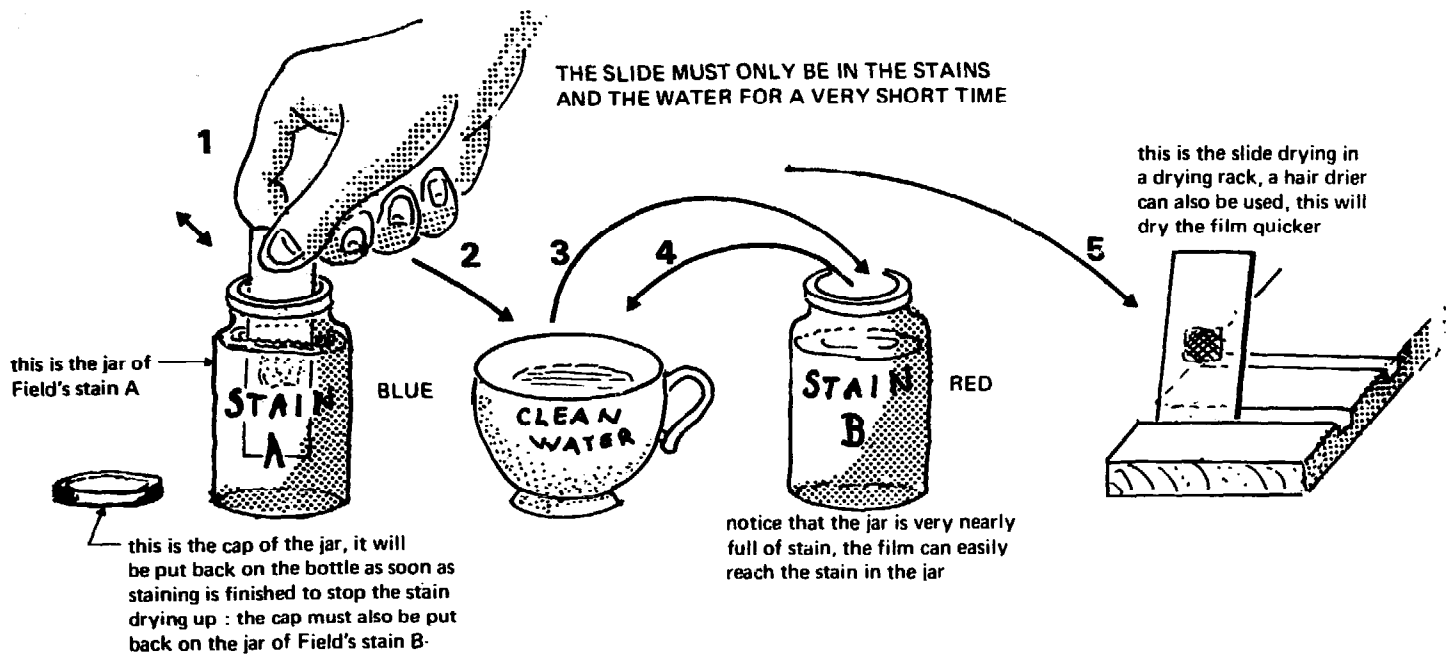

Fig. 7-26 Field's stain

water again. While the film is in the water and the stains, most, *but not all*, of the haemoglobin should wash away, and the film should become much clearer.

5. As soon as the film is stained leave it upright in a rack to dry, or dry it with a hair drier (see below).

When the film is quite dry smear the whole film with oil. Using the low power objective look all over the film for the best place to look at with the oil immersion objective. The place to look should be a clear orange-brown colour and will probably be thick enough to have cracked as the film dried.

There are many important details. The first is that the staining and washing times are very short indeed. Dr. Field himself said that the film should be one second in both stains A and B and one second in the water for the first time. He said it should be 2-3 seconds in the water the second time. The film must not be so long in either the water or the stains that all the haemoglobin washes out. Too long in the stains and water will stain the red cell membranes, and the field will be full of purple debris against which it will be hard to see the parasites. Jars of stain differ in the times that films need to give a really good result. Very dry old films need a longer time for both staining and washing than do moist (not quite dry) fresh ones. When you have made a new batch of stain try staining a film for the times given above. Lengthen these times if you do not make a good film the first time. Filter the stains when they are first made and again when a scum forms on the surface.

A good way of drying films rapidly is to use a domestic (for the home) hair drier. A hair drier is much better for drying films than a Bunsen burner. It blows hot air and dries films almost immediately. A hair dryer makes it possible for someone to bring a thick film into the laboratory and to stain it, dry it, and look

at it all in about 5 minutes. He need waste no time waiting.

If the film is well made, white cells are easily seen, and it is sometimes possible to tell the various kinds of white cell—neutrophils, eosinophils, and lymphocytes. These white cells and any parasites there may be in the film should be seen against an almost empty clear orange-brown background. Platelets also stain as small bluish objects with a pink centre.

7.32 Malaria

Malaria is caused by four species of parasitic protozoa belonging to the genus (tribe) *Plasmodium*. These plasmodia spend part of their life in man and part of their life in certain kinds of mosquito. In man the plasmodia (malaria parasites) live and grow inside the red blood cells and destroy them. *Plasmodium falciparum* causes malignant tertian or MT malaria. *Plasmodium vivax* causes benign tertian or BT malaria. Benign (not serious) tertian (three day) and malignant (very serious, killing) tertian are old names for malaria fever, but they are still used. Malaria is also caused by *Plasmodium ovale* and *Plasmodium malariae*. The word *Plasmodium* is often shortened to 'P.'; so we have *P. vivax*, *P. falciparum*, etc. Some species are common in some countries and some species in other countries. In some places only one species of parasite is seen; in other places two or three species are seen, and in a few places all four species are found.

Not only are there four species of malaria parasite, but each species grows through several stages inside the red blood cells. Each stage of growth has a special name, such as *merozoite*, *trophozoite*, *schizont*, or *gametocyte*. Each stage of each of the four species differs a little from the others.

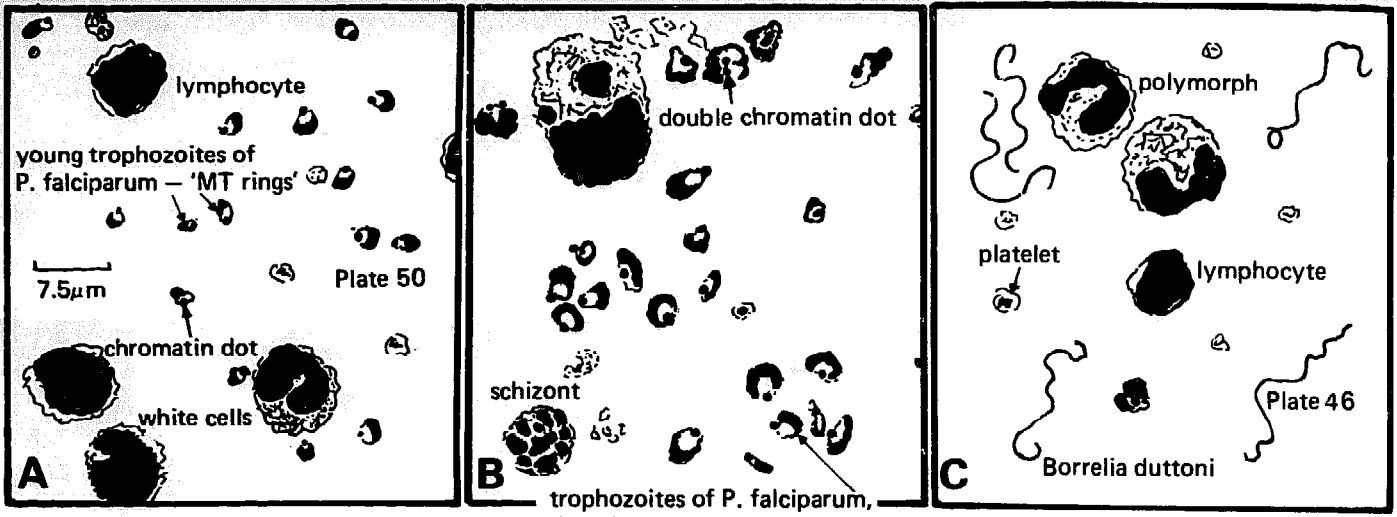

trophozoites of *P. falciparum*, these have grown slightly larger than those shown in Picture A

These are all oil immersion views.

this gametocyte has rounded ends and diffuse chromatin so it must be male

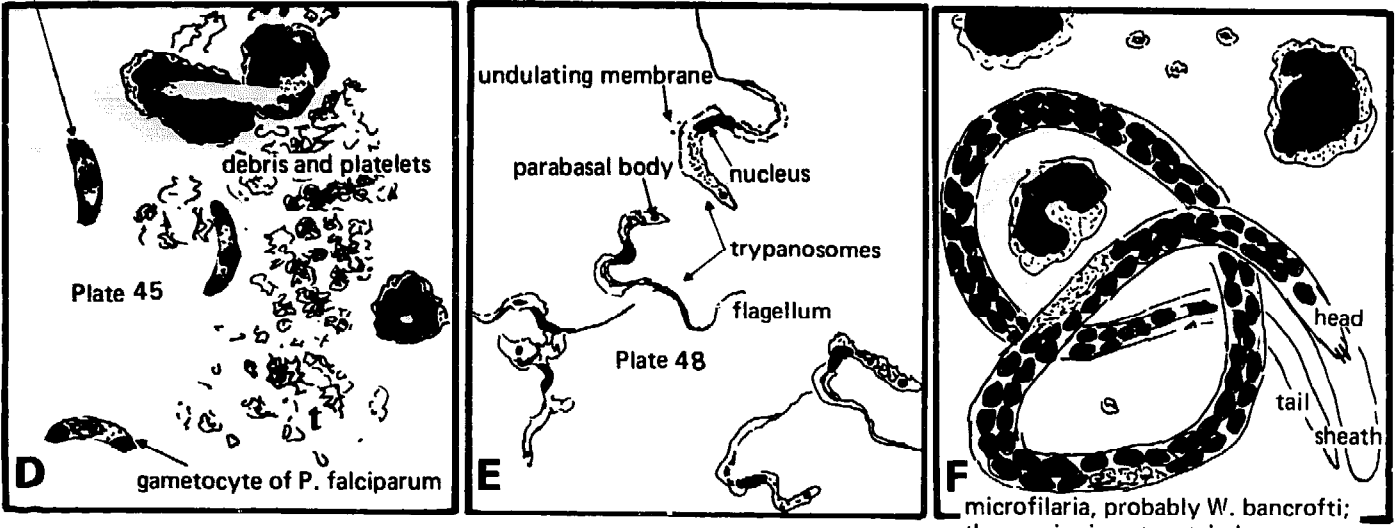

microfilaria, probably *W. bancrofti*; the species is not certain because the tip of the tail is hidden behind part of the body.

Fig. 7-27 Some thick films stained with Field's stain

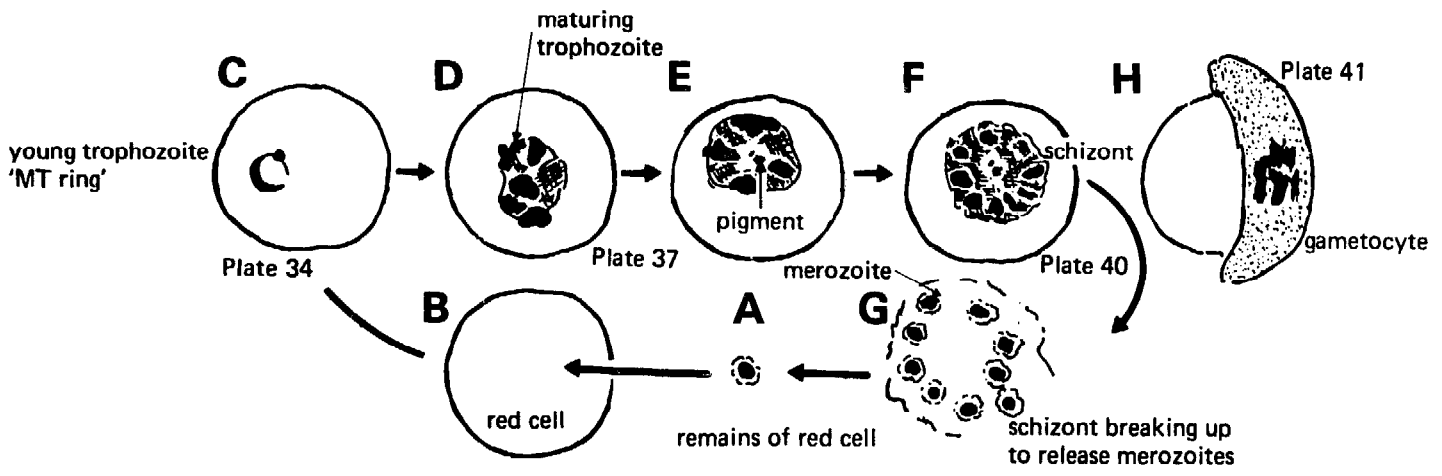

Fig. 7-28 *Plasmodium falciparum* in the blood

FIGURE 7-28 shows the stages through which *P. falciparum* grows. The smallest and youngest form is the merozoite, which is shown in Picture A. This then goes into a normal red cell (Picture B) and grows to become a trophozoite (Picture C). The trophozoite of *P. falciparum* is like one of the rings that people wear on their fingers. It is circular with a stone at the edge of the circle. The stone in the ring is called the **chromatin dot** and stains a deep reddish purple with Field's stain; the rest of the ring stains a pale blue. These rings are very small and are about the same size as platelets. It is easy to distinguish a young trophozoite of *P. falciparum* from a platelet, because a trophozoite has a ring and a chromatin dot, while a platelet has neither.

As the parasite matures (grows) it passes through the stages shown in Pictures D and E. The trophozoite gets bigger, and the vacuole (hole) inside the ring disappears. The chromatin dot grows larger and then breaks up into several pieces as shown in Picture F. A parasite that is about to break is called a schizont. Each piece of the schizont has a little ring of blue cytoplasm around it. When the schizont breaks, the red cell also breaks (Picture G). These broken pieces of the schizont become the merozoites which infect several new red cells. This is one way in which plasmodia multiply (become many). It is part of what is called the **life cycle** (life circle) of the parasite. The life cycle is completed in the mosquito which transmits (takes) malaria from one person to another.

Some of the merozoites don't become schizonts but grow into gametocytes. One of these gametocytes is shown in Picture H. Some of these gametocytes are male (like a man) and some female (like a woman). Inside the mosquito they mate (marry). The gametocytes of *P. falciparum* are shaped like a new moon—'crescent shaped'—but the gametocytes of the other species are round. MT crescents are therefore very easy to recognize. Three of them are shown in Picture D, FIGURE 7-27.

MT malaria caused by *P. falciparum* is a common and serious kind of malaria. One of the most common reports on a thick film is therefore MT rings +++. This means that there are many young trophozoites of *P. falciparum* in the film. You can see these in Pictures A and B in FIGURE 7-27. In Picture B the trophozoites have grown a little larger than those shown in Picture A.

7.33 A diagram of the human plasmodia (FIGURE 7-29)

When you look at a blood film it is always very important to make quite sure when there are malaria parasites in it and when there are none. Often, it is also important to tell which species of Plasmodium a patient has, because the treatment for the various species of Plasmodium is different. Chloroquine and drugs like it kill all four species of Plasmodium when they are in the red cells. They also cure a patient's fever. But, after an attack of fever, *P. vivax*, *P. malariae*, and *P. ovale* may stay in the tissues where they are not killed by chloroquine. *P. falciparum* does not go into the tissues after an

attack of fever; so chloroquine kills all the *P. falciparum* parasites in the patient's body.

If the parasites stay in the tissues and are not killed, they may go back into the red cells later. If they do this, the patient will relapse. That is, he will get another attack of malaria fever some time later.

When patients have malaria caused by *P. vivax*, *P. ovale*, and *P. malariae* they should thus be given chloroquine. They should also be given primaquine for 14 days to kill the parasites in their tissues. The rule is this:

<i>P. falciparum</i> malaria	:	chloroquine alone is enough.
<i>P. vivax</i> , <i>P. malariae</i> , <i>P. ovale</i> malaria	:	give chloroquine and primaquine.

In some countries there are so many infected mosquitoes around that a patient is more likely to get another attack of malaria from another mosquito bite than he is from the parasites remaining in his own tissues. In these countries patients are often not given primaquine, even though *P. vivax*, *P. malariae*, or *P. ovale* is causing their malaria.

In countries which are trying to drive out or eradicate malaria, it is especially important to find out which species of Plasmodium a patient has, so that he can be given the right treatment to kill all the parasites in his body. If every patient with malaria can be properly treated, malaria can be driven out of a country.

FIGURE 7-29 will help you to recognize the four species of Plasmodium. Row A shows the young trophozoites of each species. Row B shows the mature trophozoites. Row C shows the plasmodia as they are about to divide—the schizonts. Row D shows the male malaria parasites—the male gametocytes. Row E shows the female gametocytes. The first column is *P. vivax*, the second is *P. malariae*, the third is *P. falciparum*, and the fourth is *P. ovale*. Here are some of the more important things to look for with each species.

P. vivax is the only species which makes the red cell get bigger and still keeps it round (Pictures 1, 5, 9, 13, 17).

P. ovale makes the red cell bigger and also often makes its edge irregular (rough). The red cell of *P. ovale* is often oval (egg-shaped) like its name—*ovale* (Pictures 4, 8, 12, 16, 20).

Only *P. ovale* and *P. vivax* make round red dots (spots) on the red cell (Pictures 5, 9, 13, 17 and 4, 8, 12, 16, 20). These dots are called **Schuffner's dots**. Schuffner's dots are more often seen with younger (smaller) trophozoites with *P. ovale* (Picture 4) than with *P. vivax* (Picture 5).

Multiple infections (more than one trophozoite in a red cell) are quite often seen with *P. vivax* (Picture 1). They are very often seen with *P. falciparum* (Picture 3).

As you have read, all malarial trophozoites have a dark purple dot called the chromatin dot. This dot is usually large in *P. malariae* (Pictures 2, 6). In *P. falciparum* the chromatin dot is small and is often double (there are two dots side by side, Pictures 3, 7).

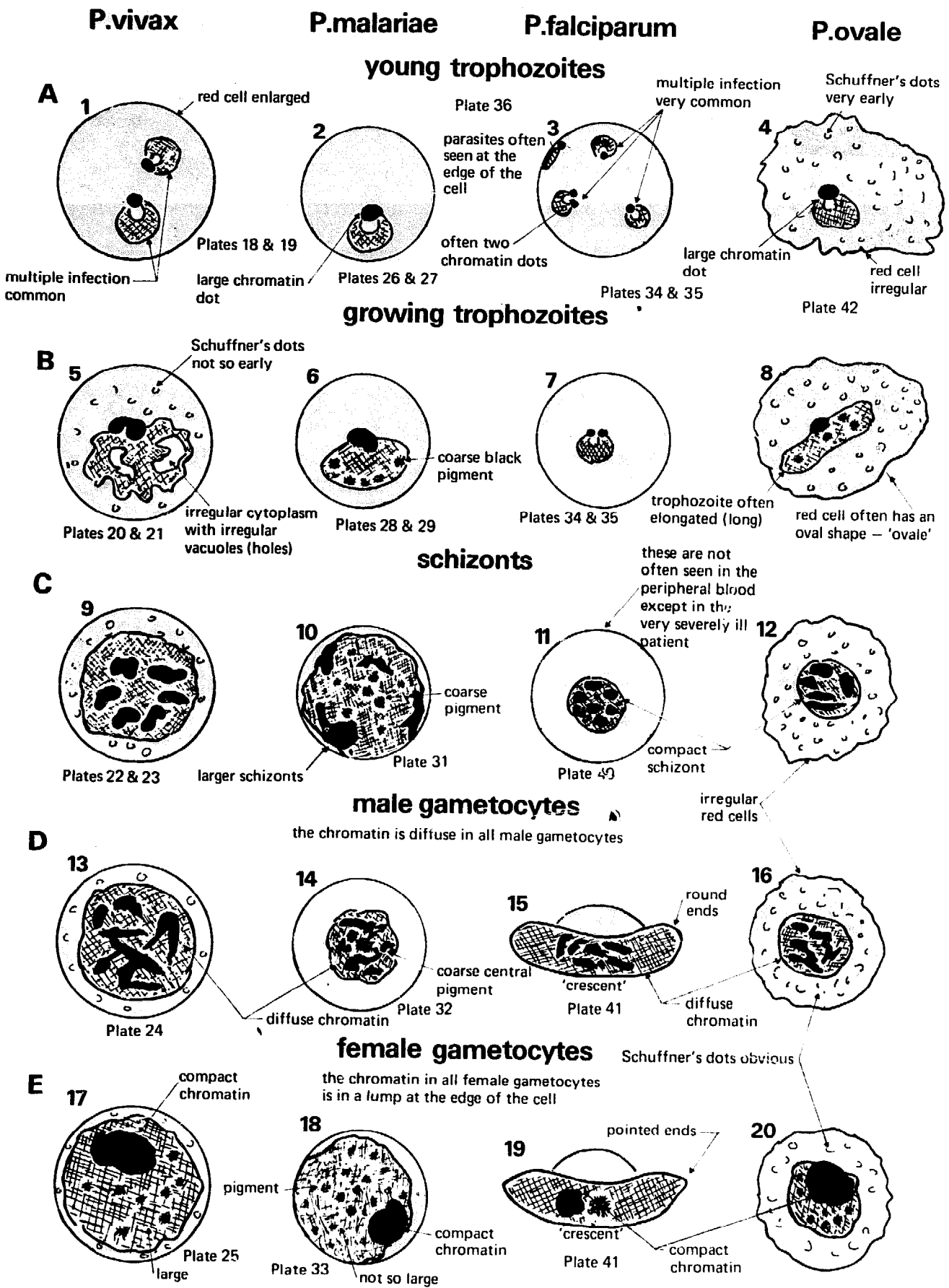

Fig. 7-29 A diagram of human plasmodia

All species make tiny granules of a blackish material called **malarial pigment**. *P. malariae* makes more pigment, makes it earlier, and keeps it in larger lumps (Pictures 6, 10, 14) than do the other three species.

The chromatin of the male gametocyte breaks into pieces in the cytoplasm (Pictures 13, 14, 15, 16). The chromatin of the female gametocyte is in one lump, which is usually at one side of the cell (Pictures 17, 18, 19, 20).

The gametocytes of *P. falciparum* (Pictures 15, 19) are shaped like a new moon (crescent shaped) and are thus very different from the round gametocytes of other species. It is not important to be able to tell a male gametocyte from a female one.

Diagnosing the species of malarial parasite from a thick film is usually easy, but it can be difficult, especially when there are only young forms in the film. Look carefully at several parasites. Sometimes a patient has more than one species of Plasmodium in his blood, so be careful. It is usually easier to tell the species of malaria parasite in a thin film than in a thick one.

If you think that a patient has malaria, but you cannot find any malaria parasites in a blood film, look again some hours later. All the parasites may be at the merozoite or early (young) trophozoite stage and may be hard to find. Some hours later, when they have grown, they may be easier to see. *One negative thick film does not mean that the patient has not got malaria.*

7.34 The meaning of a positive thick film in malaria

Wherever there are many trophozoites in a blood film, the patient is ill and needs treatment. The drug that he is usually given is chloroquine. Chloroquine is quite expensive; so patients who are not very ill are sometimes given mepacrine, which is cheaper, but not quite as good in severe cases.

There is a very serious kind of malaria called **cerebral malaria** (malaria of the brain) which is always caused by *P. falciparum*. The patient usually has a high fever. He often has fits and usually loses consciousness (he seems to be asleep but cannot be woken up). These patients must be given an injection of chloroquine or quinine or they will die. It is thus very important to be able to diagnose cerebral malaria quickly and certainly. This is one of the most important uses of Field's stain.

Blood cells infected by *P. falciparum* become 'sticky' and stick to the inside of the capillaries and block them. It is this blocking of the capillaries of the brain that causes the signs and symptoms of cerebral malaria. The schizonts of *P. falciparum* (Picture 11, FIGURE 7-29) are very seldom seen in a blood film—they are stuck to the inside of the blood vessels. But, when the schizonts of *P. falciparum* are seen in a blood film, they mean that the patient has a very bad attack of malaria. Schizonts in a blood film usually mean that a patient has cerebral malaria.

People who live in countries where malaria is common may have a few malaria parasites in their blood and seem

to be healthy. For example, you may see a gametocyte of *P. falciparum* (a crescent) in the blood of someone, particularly a child, who has no fever and looks healthy. These patients are fighting the malaria parasites quite well, and they do not usually need any treatment. But the malaria parasites may start to win at any time (they may start multiplying). When they do the patient will have fever and needs treatment.

A patient may also have malaria and another disease, pneumonia for example. If you find malaria parasites this does not therefore always mean that they are the most important cause of a patient's illness.

Malaria in the placenta

Malaria parasites sometimes infect the placenta or 'after-birth' and harm it so that a baby is born smaller than he should be. This can easily be prevented by giving all mothers malaria tablets while they are pregnant. This will only be necessary if there is much malaria in a district and many new-born children are underweight because their placentae are infected. The best way to find out is to examine the placentae from a group of mothers, especially those who have given birth to small babies.

METHOD

EXAMINING THE PLACENTA FOR MALARIA PARASITES

Find the rough or mother's side of the placenta which joins on to the inside of the womb. Cut off a small piece with a pair of scissors. Hold it in forceps and 'dab' (touch) it on to a clean slide. Be careful only to touch the slide once or the film will be too thick. One touch with a piece of placenta will leave enough cells to stain and will not distort (spoil) them.

Stain and examine your film by Field's method. You will find malaria parasites, as you would in a blood film.

7.35 Relapsing fever

Relapsing fever is much less common than malaria, but in places where it is seen it is likely to be one of the most important reasons for looking at a thick blood film. The micro-organism that causes relapsing fever is a long, thin, curved bacterium called *Borrelia duttoni*. It looks like a snake and has been drawn in Picture C, FIGURE 7-27. Relapsing fever is called relapsing fever because the patient has fever for about a week and then gets better for a few days, and then after this he gets worse again or 'relapses'. During the days when the patient feels well the *Borrelia* disappear from the blood and cannot be found in a thick film. It is especially important therefore to make the films when the patient has a fever. If you do not find *Borrelia* the first time you look, make several films on several days when the patient has fever. *Borrelia* can also be found in a wet blood film.

7.36 Sleeping sickness or trypanosomiasis

These are two names for the same disease. Trypanosomes are flagellates (protozoa with flagella) which swim actively in the blood. A trypanosome has been drawn very large in FIGURE 7-30, as you can see from the size of the red cell. A trypanosome has a long tail or **flagellum** and a long fin like a fish down one side (a fin is the 'arm' of a fish). This fin is called the **undulating membrane** because it goes up and down or undulates. FIGURE 7-30 shows the undulating membrane and also what a trypanosome would look like if it were cut in half. In a living, active trypanosome the undulating membrane

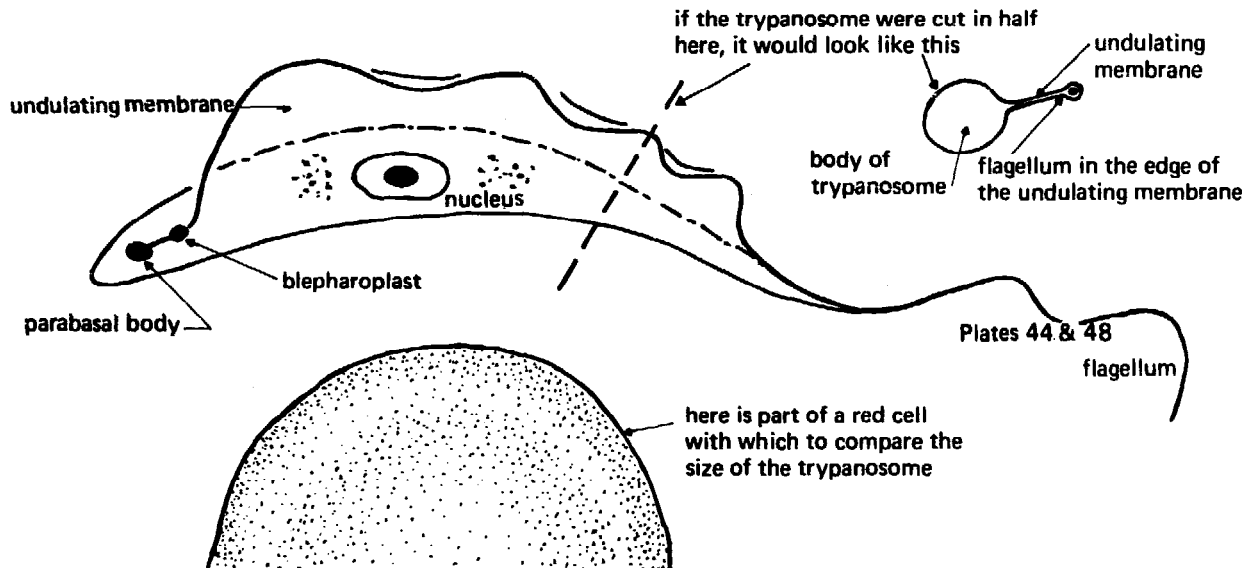

Fig. 7-30 A trypanosome in the blood

moves too fast to be seen. But, as a trypanosome dies, its undulating membrane moves more slowly and can be seen quite easily with an oil immersion objective.

Because trypanosomes move so actively when they are alive, it is usually easier to find them moving and unstained in fresh blood, than it is to find them dead and stained in a thick film. This is because something which is moving is easier to find than something which is still—it is much easier to see a moving animal in the bush than it is to see a still one. Because we so easily see something moving we can search for trypanosomes with a high power objective instead of an oil immersion objective. In this way we can search more blood for trypanosomes and are more likely to find them than when there are only a few in the blood. Trypanosomes can be found by looking for something moving in a drop of fresh blood under a coverslip, but it is better to use the concentration method described in Section 7.38. This method concentrates (gathers together) the trypanosomes so that they are more likely to be found. The concentration method combines the advantages of both concentration and the search for movement.

In Africa two species of trypanosomes cause disease in man: *Trypanosoma rhodesiense* and *Trypanosoma*

gambiense. But they both look exactly the same in the blood. We therefore report a positive film as 'trypanosomes present' and use the plus notation (see Section 4.4) to say how many there are.

If trypanosomes are found in a patient's blood he needs immediate treatment in hospital for several weeks. Suramin and melarsoprol are two of the drugs that he might be given.

7.37 Filariasis

Several kinds of worm live in the tissues. They live in the skin, in the veins, or in the lymph vessels, and not in the

gut like the hookworm. The most important group of worms which live in the tissues are called **filariae**. They cause a disease called **filariasis** and produce young worms called **microfilariae** (little filaria). Most of these microfilariae can be found in the blood, but the microfilariae of *O. volvulus* are an exception. These microfilariae are found in the skin and are described in Section 11.14. Blood microfilariae are easily found in a blood film, or with a concentration method.

Part of a microfilaria is drawn in Picture E, FIGURE 7-11, and a complete microfilaria is drawn in Picture F, FIGURE 7-27. As you will see, microfilariae are *much larger* than plasmodia, *Borrelia*, or trypanosomes.

Microfilariae have a head, a body, and a tail. These join on to one another, as in a snake, and it is difficult to tell where the tail begins and the body ends. Some microfilariae also have a **sheath** (loose outer coat). This is like the dead skin of a snake. You will see that the microfilaria in Picture F, FIGURE 7-27, has a sheath which is longer than the worm itself and that this sheath sticks out beyond its head and its tail.

At least five species of microfilaria can be found in the blood, but in any one place you are unlikely to have to distinguish more than two or three species. In Uganda,

Three harmful species – sheathed

Wuchereria bancrofti

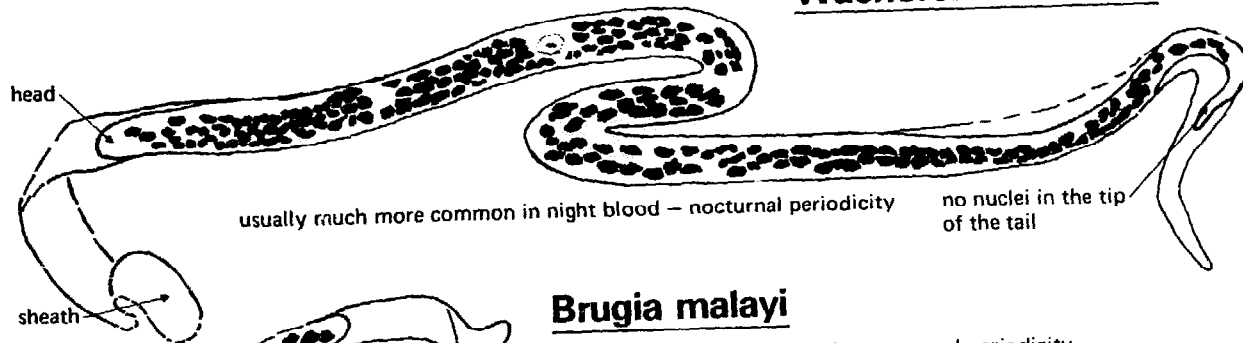

Brugia malayi

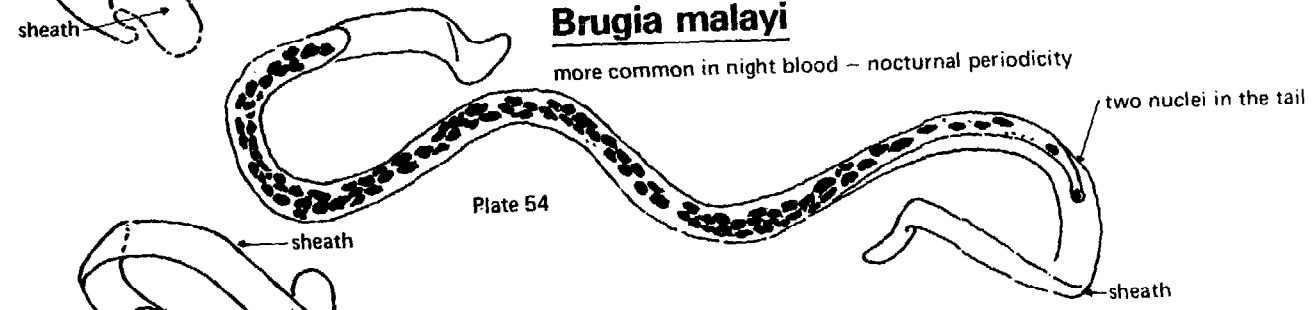
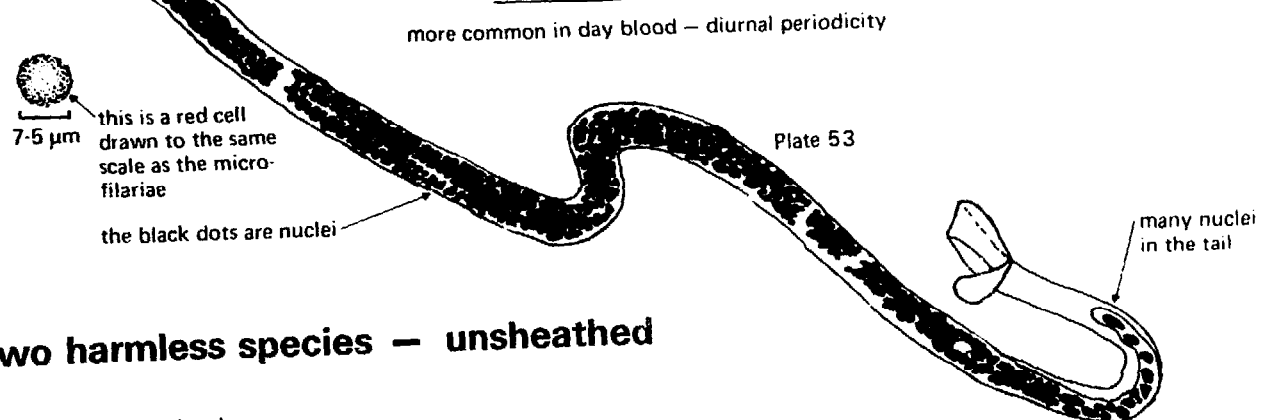

Plate 54

Loa loa



Two harmless species – unsheathed

Dipetalonema perstans

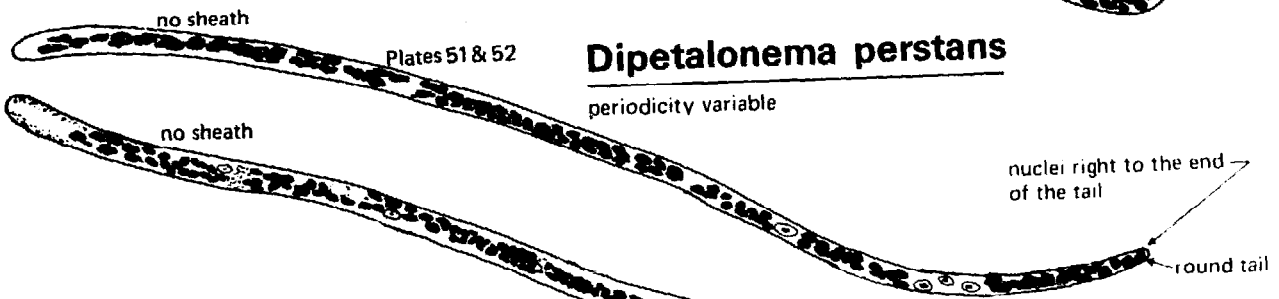

Mansonella ozzardi

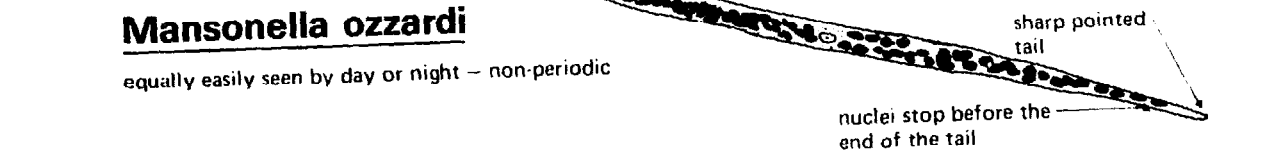

Fig. 7-31 Microfilariae in the blood

for example, only two species are found—*D. perstans* is common and *L. loa* is rare. Find out which species are found in your country and learn to recognize them.

When you are trying to find the species of a microfilaria, first see if it has a sheath. If a microfilaria has a sheath, it is either *W. bancrofti*, *B. malayi*, or *L. loa*. If it has not got a sheath, it may be either *D. perstans* or *M. ozzardi*. It may also be a normally sheathed microfilaria which has temporarily lost its sheath and is growing a new one. Next look at the end of the tail because each species of microfilaria has a slightly different tail. See how far the nuclei go towards the end of the tail and how they are placed at the end of the tail. The five species of microfilariae commonly found in the blood have been drawn in FIGURE 7-31. The sheaths and the different tails of each species are well shown.

All the species of worm which produce sheathed microfilariae cause disease in man. The two which produce microfilariae without sheaths are closely related to one another and cause no disease. *If therefore you see a microfilaria with a sheath it must be harmful.* If, however, you see a microfilaria without a sheath it may be harmless or it may be harmful, because it may be a harmful microfilaria which has lost its sheath and is about to grow a new one. Look carefully at the tail and try to base your diagnosis of the species on several microfilariae. Perhaps you will find one with a sheath. In most parts of the world it is uncommon for a patient to have more than one species of microfilaria in his blood.

W. bancrofti and *B. malayi* are close relatives and both have sheathed microfilariae. They are closely related to one another and cause the same kind of disease. The adult worms of these two species live in the lymph vessels and block them. The lymph vessels are very small, thin tubes which take a watery fluid called lymph from the tissues back into the blood stream. When the lymph vessels are blocked the lymph stays in the tissues and the tissues swell up (get bigger). A patient's legs may swell until they look like the legs of an elephant. This gives this kind of filariasis its name—**elephantiasis**.

The third species of adult worm which has sheathed microfilariae is *L. loa*. This worm causes soft, warm, short-lasting swellings on the skin which are not usually harmful.

Because the unsheathed microfilaria, *D. perstans* and *M. ozzardi* are quite harmless, the patient in whom they are found needs no treatment. But, if any of the sheathed microfilariae, such as *W. bancrofti*, *B. malayi*, or *L. loa* are found, the patient should be sent to hospital and treated. He will probably be given tablets of a drug called hetrazan.

Some microfilariae are more common at special times of the day or night, and are said to show **periodicity**. *W. bancrofti* is usually much more common at night and is said to show **nocturnal** (night) periodicity. *B. malayi* is also more common at night. *L. loa* is mostly seen by day—**diurnal** or daily periodicity. In some people and in some places *A. perstans* shows diurnal periodicity, and in others it shows nocturnal periodicity. *M. ozzardi* may be

found equally easily at any time and is said to be **non-periodic**. When you are looking for particular microfilariae, take blood at the best time to catch them.

When microfilariae are alive they move about in the blood like very active snakes. It is best to look for them moving about in fresh blood in the same way as trypanosomes. The next section tells you how.

7.38 A concentration method

Blood is taken from the patient and put into a solution to stop it clotting (an anticoagulant solution). The blood is then centrifuged. This separates the blood into a layer of plasma on top and a layer of red cells at the bottom. In the middle there is a thin, dirty white layer of white cells. Some of this white cell layer is removed with a Pasteur pipette and looked at under a microscope. You are more likely to find microfilariae or trypanosomes in this layer than you are to find them in plain blood. The parasites will have been concentrated or gathered together into one part of the blood. This is what we mean by a concentration method.

METHOD

CONCENTRATING MICROFILARIAE AND TRYPANOSOMES, FIGURE 7-32

USE FRESH BLOOD AND DON'T WASTE TIME

1. Take about 3–5 ml of blood and add it to 0.5 ml of sodium citrate to stop it clotting. This sodium citrate solution has been made for the Westergren ESR—look at Section 3.42a. You can also use solid sequestrene as an anticoagulant, but a liquid anticoagulant solution is better.

2. Centrifuge the blood for 10 minutes. If you are looking for trypanosomes, centrifuge it as fast as you can. If you are looking for microfilariae centrifuge the blood at about 1,000 revolutions (turns) a minute. One thousand revolutions a minute is about as fast as you can turn a hand centrifuge, or about a third as fast as an electric centrifuge will go. At full speed most ordinary electric centrifuges turn at about 3,000 revolutions a minute.

3. After centrifuging you will see three layers—a layer of plasma, a layer of white cells, and a layer of red cells.

4. Using a Pasteur pipette take off the supernatant plasma until you get to the white cell layer.

5. Take as much of the white cell layer as you can and put it on a slide under a coverslip. If you are looking for microfilariae take some of the red cell layer also and put this under the coverslip too. Some people like to seal the coverslip by the method shown in Figure 7-14.

6. Look all over the coverslip by the method shown in Figure 6-14. Don't use too much light—see Section 6.15. Use a low power objective for microfilariae and a high power objective for trypanosomes. Look for something moving about very actively like a fish. If you see something moving around like this which is about as

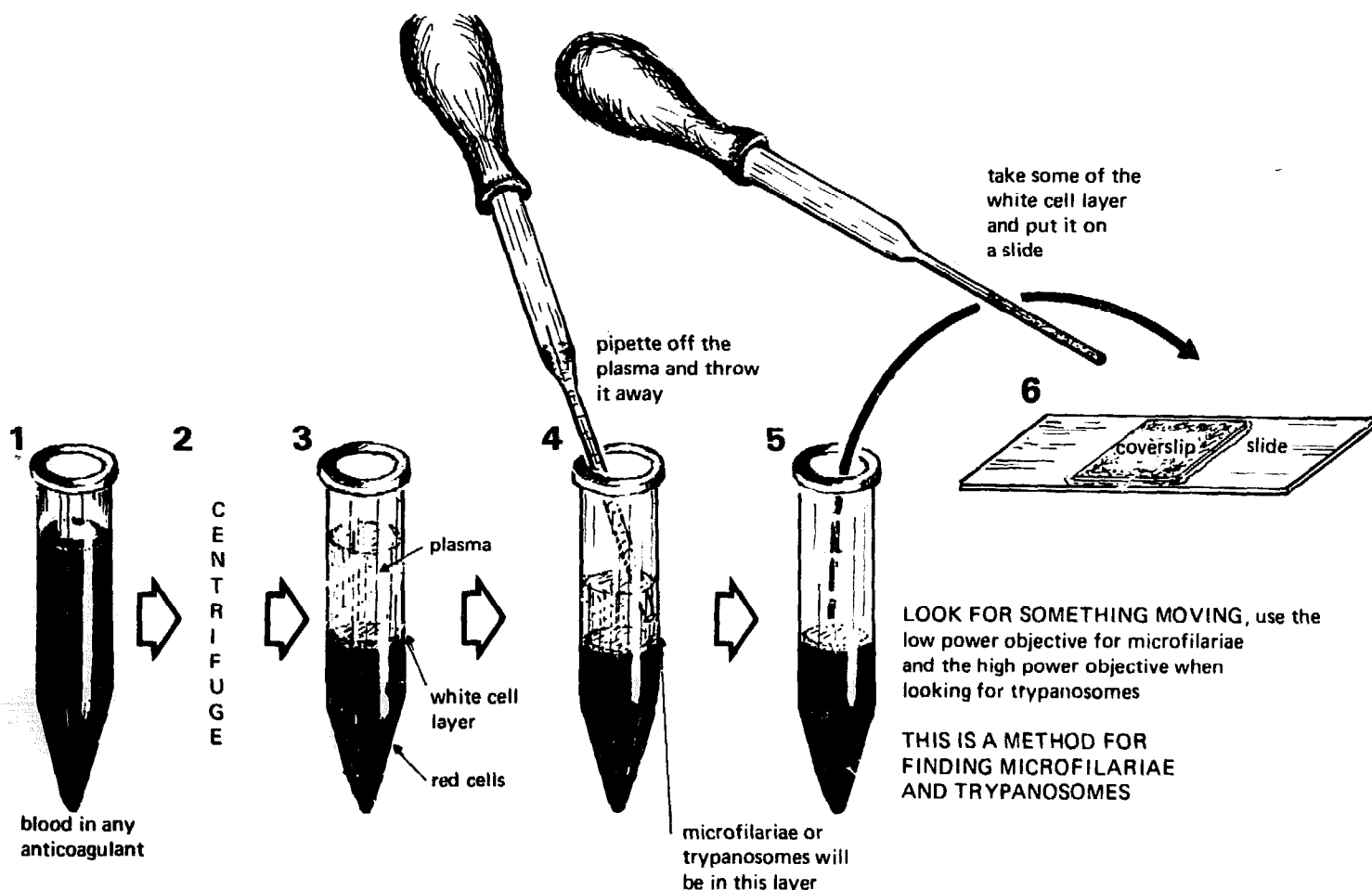

Fig. 7-32 A concentration test for microfilariae and trypanosomes

long as two red cells, it must be a trypanosome. If it is moving about in the same way but it is as long as, say, twenty or thirty red cells, it must be a microfilaria.

You will not be able to tell one species of microfilaria from another while they are moving about in wet blood. If you want to find which species a microfilaria belongs to, you will have to stain a blood film, preferably a thin blood film. Search the whole film with a low power objective.

Blood must be looked at quickly, before the trypanosomes die. Make sure that blood is taken straight from the ward to the laboratory. Do the concentration method quickly. You should be searching the film before the blood has been taken from the patient 20 minutes.

7.39 The ESR

If blood is taken from someone and prevented from clotting, the red cells will slowly fall and leave clear plasma on top of them (see FIGURE 1-4). The rate (speed) at which the erythrocytes (red cells) sediment (fall) is called the 'Erythrocyte Sedimentation Rate' or ESR. It is also sometimes called the blood sedimentation rate or BSR. It is the distance in millimetres that the red cells fall in one hour.

Blood must be taken into a special anticoagulant solution, and the cells must be allowed to fall in a special tube (ML4). There are several ways of measuring the ESR. We shall describe the Westergren ESR, which uses 3.8% citrate solution and the Westergren tube. The tube of blood is put into a special Westergren rack (ML II).

The red cells of a healthy man fall less than 10 mm in one hour in a Westergren tube. The red cells of a healthy woman always fall less than 14 mm in one hour, unless she is pregnant. But in many diseases a patient's red cells fall faster than this. The fall is greater in some diseases than it is in others. For example, the ESR is very high in leishmaniasis and trypanosomiasis and is normal in most mental diseases. An ESR is thus a useful help in finding out if a patient has diseases of a certain kind. The ESR also helps us to know if a patient is getting better. A patient's red cells usually fall more slowly as he gets better.

The ESR is probably one of the least useful tests in this book. But it is sometimes wanted and is cheap and easy to do. The important thing to remember is that the *blood and the sodium citrate solution must be mixed together in the right proportions.* By this we mean that the right amount of blood must be mixed with the right amount of sodium citrate solution.

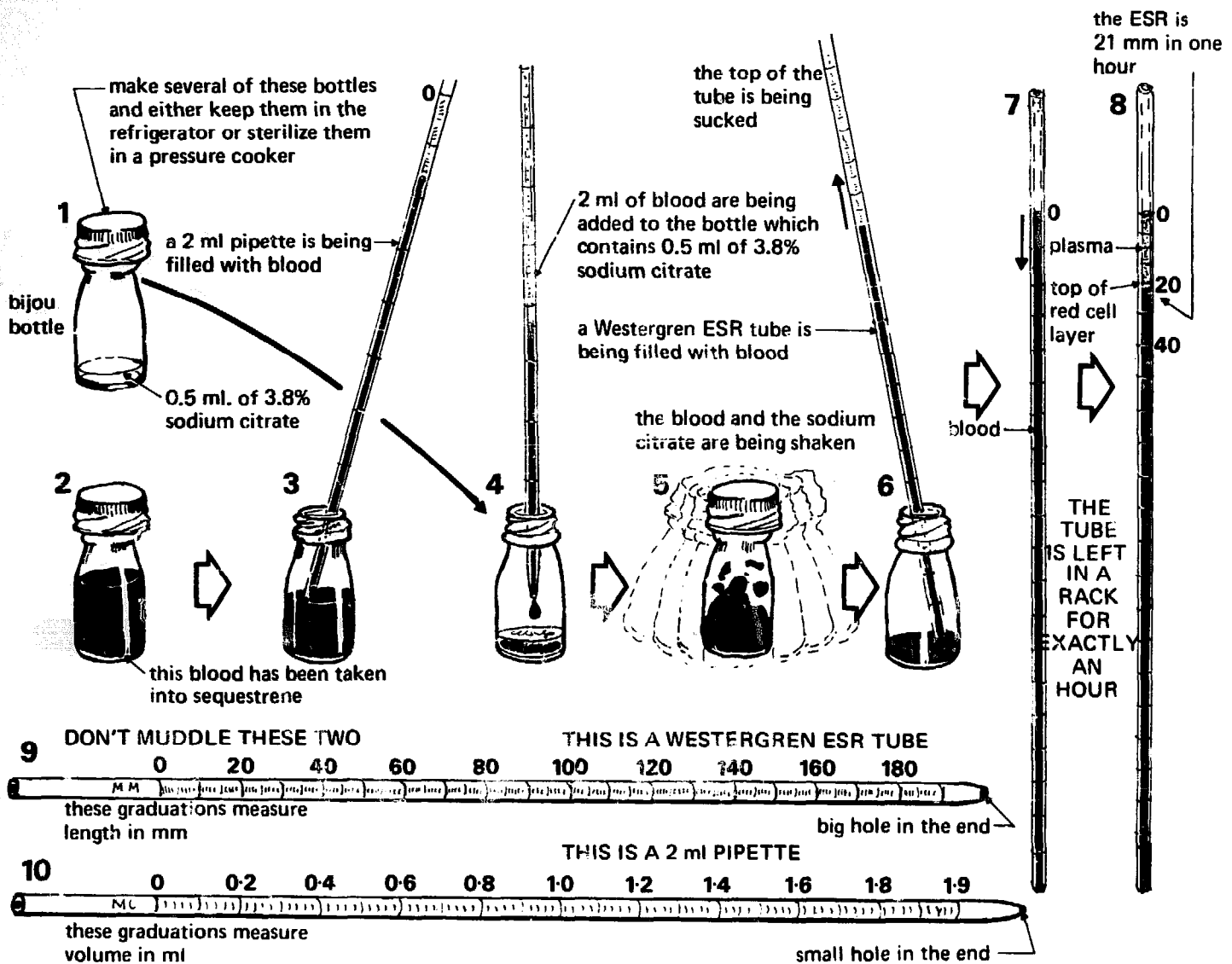

Fig. 7-33 The erythrocyte sedimentation rate or ESR

METHOD**THE WESTERGRN ESR, FIGURE 7-33**

1. Fill bijou bottles with 0.5 ml of 3.8% sodium citrate solution by the method described in Section 3.42a.
2. Take blood into a sequestrene bottle.
3. Measure 2 ml of the sequestrenated blood as described in Sections 1.17 and 4.6. Use a straight 2-ml pipette and put it into the sodium citrate bottle (4). Be careful not to muddle up a Westergren tube and a 2-ml pipette. Look carefully at Pictures 9 and 10 and read what is said below.

Instead of taking blood into sequestrene bottles, you can, if you wish, take blood from the patient's vein with a syringe and measure 2 ml of fresh blood straight into the sodium citrate solution. But it is sometimes difficult to measure 2 ml of blood with a syringe, especially if air gets into the syringe with the blood. It is usually easier to put blood into a sequestrene bottle and measure 2 ml with a pipette, as is shown here.

5. Mix the blood with the sodium citrate solution.
6. Fill a Westergren ESR tube in the same way as you fill a pipette. Fill the tube to just above the '0' mark and let the meniscus fall to the '0' mark exactly.
7. Put the tube in a rack. Take the time by a clock and write it down.
8. Look at the tube exactly one hour later and measure how far the red cell layer has fallen. The tube is like a ruler and graduated in millimetres (mm). The centimetres are written as numbers. The number of mm the red cells have fallen in one hour is the ESR. The best way to measure an hour is to use an alarm clock or a special timer.

Don't muddle a Westergren tube with a 2-ml pipette. A Westergren tube is shown in Picture 9. It has a blunt end with a big hole in it and is marked from 0 to 180. These numbers are *millimetres* and measure *length*. The red cell layer has fallen 21 mm in one hour in Picture 8, so the ESR is 21 mm an hour.

A 2-ml pipette is shown in Picture 10. It has a pointed end with a small hole in it and is marked from 0 to 2.0. These numbers are *millilitres* or ml and measure *volume*. The top end of the tube is marked 'ml'.

7.40 The formol gel method

This is another easy method. A drop of formalin is added to a millilitre of the patient's serum and the mixture is left for 24 hours. If the serum is normal nothing happens. But, when the formol gel method is strongly positive (++++), the mixture of serum and formalin goes solid and white like the white part of a boiled egg. When the serum goes solid like this we say that it gels. The liquid serum has turned into a solid gel. Serum only gels when it contains a greatly increased quantity of a kind of protein called **globulin**. Normal serum contains a little globulin, and in many diseases the globulin is slightly increased. Only in a few diseases, and only when they have lasted for several months at least, is there enough globulin for the serum to gel when formalin is added, and so give a positive formol gel test. The formol gel method cannot by itself tell us which disease has caused the greatly increased globulin in the serum. But in some parts of the world almost all the patients with a positive formol gel test will have one particular disease. For example, in some areas of India a disease called **visceral leishmaniasis** (*kala azar*) is common. This disease often

causes a positive formol gel test. Therefore, if a patient in these areas of India has a positive formol gel test, he probably has visceral leishmaniasis. The formol gel test is therefore a useful presumptive (probable) test for diseases of this kind in areas where they are common.

METHOD

THE FORMOL GEL TEST, FIGURE 7-34

1. Take some blood and put it into a clean, empty bottle.
2. The blood will clot.
3. Leave the clot until the next day. The clot will retract and clear, yellow serum will form.
4. With a Pasteur pipette take about 1 ml of this clear serum and put it into a Kahn tube (5). The exact volume does not matter. You will soon learn what 1 ml looks like in a Kahn tube.
6. With a *clean* Pasteur pipette take some formalin (7) and add one drop to the 1 ml of serum in the Kahn tube (8).
9. If the test is very strongly positive (++++) the serum will gel (go solid) in as short a time as 20 minutes. If it is only just positive (+) it will not gel for 24 hours. If the serum is still liquid the following day the formol gel test is negative.

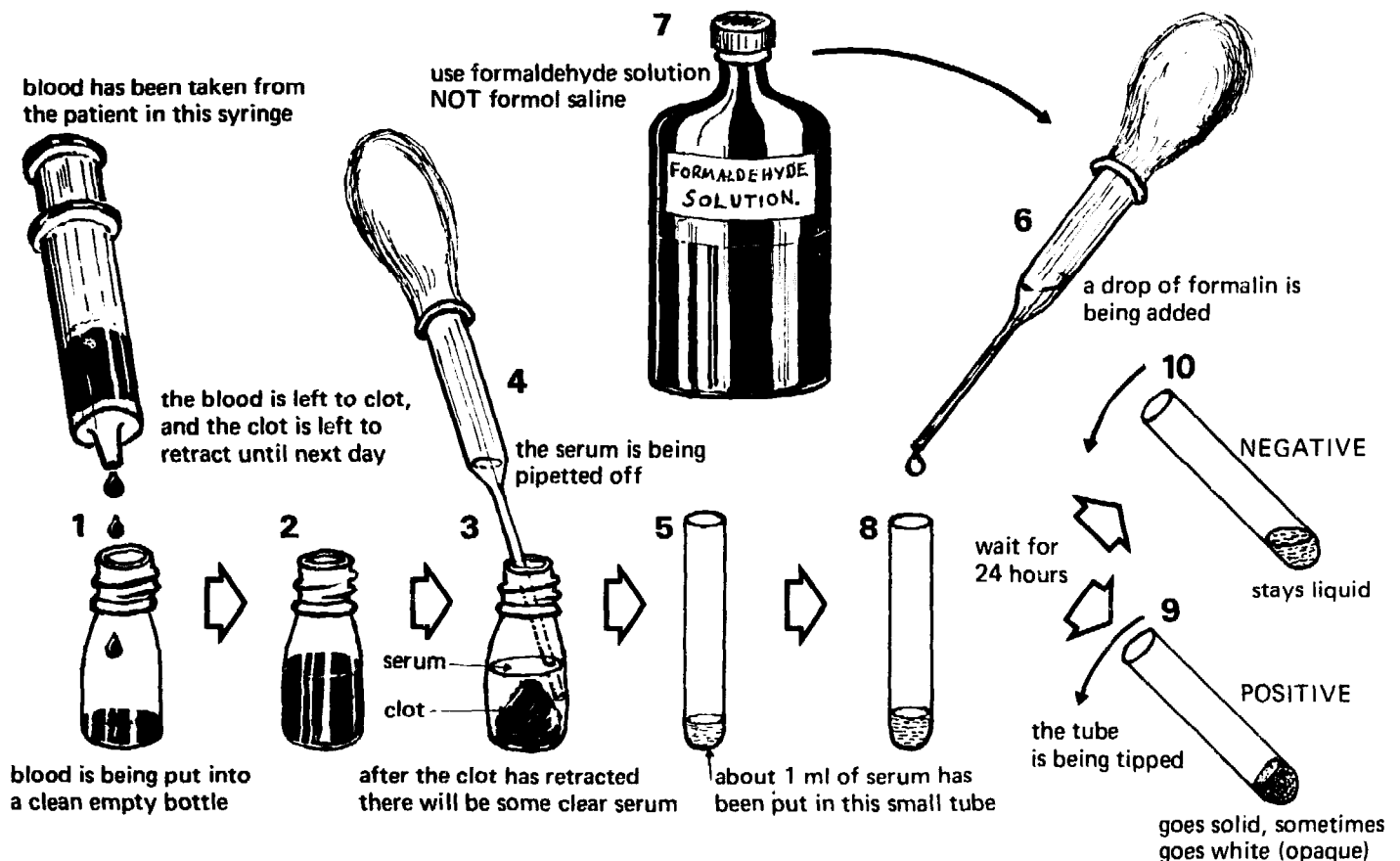

Fig. 7-34 The formol gel test

Make sure you use 'Formaldehyde solution' or 'Liquor Formaldehyde BP'. Don't use formol saline. The formalin in formol saline is too dilute for this test.

7.41 The serum urea

The methods for measuring the blood urea and the blood sugar are both chemical methods for measuring substances in the blood. They are not likely to be needed in health centres; so the equipment for them has been put in the main equipment list as being for hospitals only.

In everybody's blood there is a substance called urea. In healthy people there is always less than 40 mg of urea in every 100 ml of blood—less than 40 mg %. Urea is made as the body uses up proteins and is excreted (got rid of) by the kidneys. When the kidneys are diseased urea may not be excreted properly and may stay in the body. When there is too much urea in a patient's blood he is said to be **uraemic**. A very uraemic patient may have a blood urea of several hundred mg %. Measuring the blood urea is therefore a very useful way of finding out how a patient's kidneys are working.

Urea can be measured in whole blood, in serum or in plasma. The method described here uses serum or plasma. It is very easy. 0.1 ml ($\frac{1}{10}$ ml) of serum or plasma

is put in the bottom of a graduated centrifuge tube. Two drops of a **urease** solution are added. Urease is an enzyme which breaks down urea into ammonia and water. Urease solution should be bought ready made, but it can be made from a special kind of bean (the jack bean), as described in Section 13.25. After about 5 minutes, when the urease enzyme has had time to work, a reagent called **Nessler's solution** is added. Nessler's solution makes a brown colour with ammonia. The more urea there was in the blood, the more ammonia will be made and the deeper will be the brown colour when Nessler's solution is added. This brownness is measured with the Lovibond comparator, the EEL colorimeter, or the Grey wedge photometer. Nessler's solution should also be bought ready made, although it too can be made in a laboratory as described in Section 13.25.

METHOD

MEASURING THE SERUM UREA. FIGURE 7-35

1. Take a clean graduated centrifuge tube. In the bottom of it put 0.1 ml of *clear* serum or *clear* plasma from a *sequestrene* bottle. By 'clear' we mean that the serum should be a clear yellow and not cloudy or red. Measure

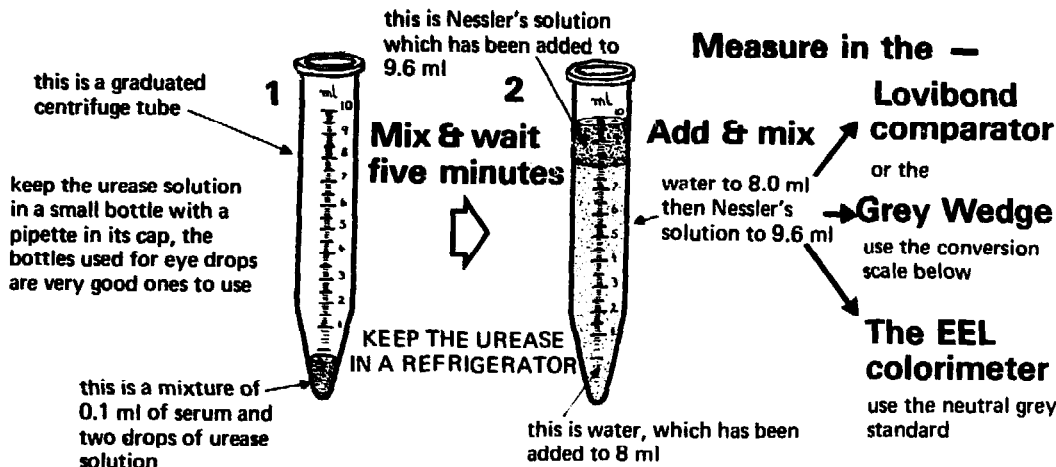

Conversion scales for the Grey Wedge Photometer

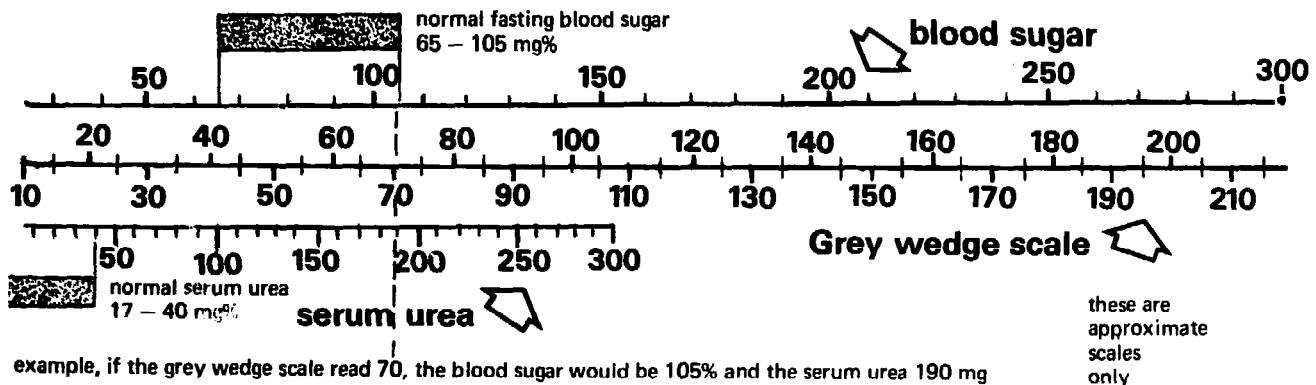

Fig. 7-35 The blood urea

the serum with the blood pipette ML 32, and fill the pipette to the mark which measures 0.1 ml. If you have not got a 0.1-ml pipette you may use the 0.1-ml graduation on the bottom of the centrifuge tube, but this will not be accurate.

Add two drops of urease solution. Picture 1 shows the serum and the urease solution in the bottom of the centrifuge tube.

Mix the serum and the urease solution by gently tapping the bottom of the tube with your finger. Wait 5 minutes while the urease solution breaks down the urea and changes it into ammonia.

2. Using a Pasteur pipette fill the tube to exactly the 8.0-ml mark with water. This must be pure water—see what is said about this below. Again using a Pasteur pipette fill the tube to exactly the 9.6-ml mark with Nessler's solution. The mixture will go brown. Hold your thumb over the tube and turn it over once or twice so that the solution is well mixed.

Measure the depth of brownness of the solution with any of the following three instruments.

THE LOVIBOND COMPARATOR

Use the Lovibond comparator exactly as in Section 5.10, but use the blood urea discs 5/9A and 5/9B. This is probably the best instrument to use with this method.

THE GREY WEDGE PHOTOMETER

Use the Grey wedge photometer exactly as described in Section 5.14, but use the green No. 3 eyepiece. Change the number you read from the wheel of the Grey wedge into mg % by using the scale in Figure 7-35.

THE EEL COLORIMETER

Use the EEL colorimeter with the neutral grey standard exactly as described in Section 5.20, except that you must use the blue filter Ilford 622. Find the reading on the galvanometer scale and then work out the answer like this:

$$\text{Serum urea} = \frac{\text{Scale reading of test solution}}{\text{Scale reading with liquid grey standard}} \times 135 \text{ mg \%}$$

A graph can also be made for this method—see Figure 5-9.

There are several important things to remember. The water you use must not have any ammonia in it. Ordinary tap water often has enough ammonia in it to go brown with Nessler's solution, even without adding any serum or urease. Distilled water should be used, but

Footnote. As this book goes to press arrangements are in progress for revising the scale in FIGURE 7-35. This will employ the same methods described here, but it is hoped that a new filter will make possible a longer scale for the blood urea. This will be incorporated in a pamphlet issued with new Grey wedges, or available from the makers (KEE).

some kinds of tap water may work. If tap water does not work, try clean rainwater. To see if your water and urease solution are pure enough, do a 'blank' test like this. Take a clean, empty centrifuge tube. Don't add any serum, but add two drops of urease solution and fill the tube to 8 ml with water. Then add Nessler's solution to 9.6 ml. The solution should stay almost as clear as water. See what this blank test measures. If you find the blank measures more than about 10 mg % of 'urea', the water is not pure enough, and you must find some water which is pure and has less ammonia in it.

Keep any ammonia or any ammonium salt (such as ammonium sulphate) well away from this method or the reagents for it. This method will not work with plasma made using ammonium oxalate as an anticoagulant.

Keep the urease solution in a refrigerator all the time. If kept cold it will stay active for many months. If it is left on the bench for too long the urease enzyme will soon stop working.

The Nessler's solution must be made exactly as described in Section 13.25. When Nessler's solution is bought it must also have been made in this way. Keep Nessler's solution in a brown bottle. A brown deposit will form at the bottom of the bottle, but this does not matter—use the clear supernatant solution on top of it.

7.42 The blood sugar

Read about the blood sugar and why we measure it in Section 8.6.

Measuring the blood sugar is the most difficult of the methods described here. It has only been included because it is so useful in treating patients with diabetic coma.

A measured amount of blood (0.1 ml) is diluted in a measured volume of water. Two chemicals (sodium tungstate and sulphuric acid) are then added which will deproteinize the blood (take away the proteins by precipitating them) and leave a clear supernatant fluid without any protein. A measured amount (2 ml) of this clear protein-free fluid, which has in it some of the sugar from the blood, is then heated with an alkaline solution containing copper. The sugar alters the alkaline copper so that, when a solution of phosphomolybdic acid is added, the mixture goes blue. The more the sugar in the blood, the more will the alkaline copper be reduced and the deeper will be the blue colour of the final solution. The depth of this blue colour is measured and tells us the patient's blood sugar.

METHOD

MEASURING THE BLOOD SUGAR, FIGURES 7-36 AND 7-37

1. Put a tin of water on top of a tripod and bring it to the boil while you are doing the first part of the method.

Take blood into a bottle containing a little potassium (or sodium) fluoride. This stops the blood cells using up the sugar before the test—see Section 4.6.

2 and 3. Fill a graduated centrifuge tube to exactly the 3.5-ml mark with water, preferably distilled water.

4 and 5. Using the blood pipette (ML 32) add 0.1 ml of blood to the water. Rinse the pipette once in the water.

6 and 7. Add 0.2 ml of 10% sodium tungstate—see below for the best way to measure this.

8. Mix by putting your thumb over the tube and turning it upside down.

9. When you have finished mixing, dry your thumb by scraping it on the edge of the tube.

10 and 11. Add 0.2 ml of 10% sulphuric acid.

12 and 13. Mix and dry your thumb as before.

14. The mixture will go brown.

15. Let the tube stand for 10 minutes while the protein forms a brown deposit with a clear supernatant. After this the mixture can either be centrifuged or filtered.

If the mixture is to be centrifuged, centrifuge it as fast as you can for 5 minutes.

16. If the mixture is to be filtered, filter it through a small filter paper. A Whatman No. 41 filter paper is best, but a Whatman No. 1 paper can be used.

17. Using a 2-ml straight pipette take exactly 2 ml of the clear fluid you have got by centrifuging or filtering and put it in a clean test tube (18).

19. Using another 2-ml straight pipette add 2 ml of alkaline copper solution.

20. Put a piece of cotton wool into the top of the tube

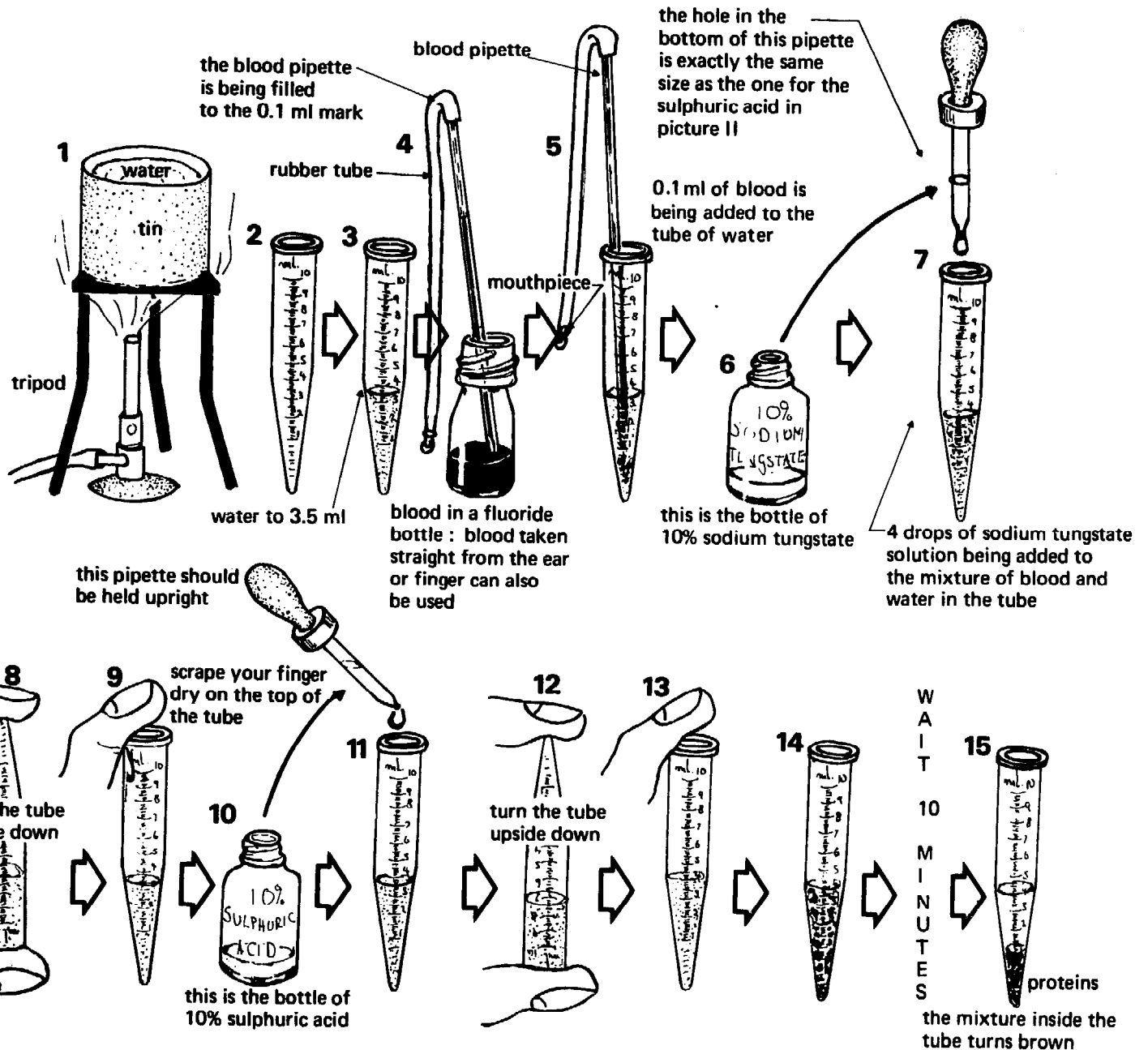

Fig. 7-36 The blood sugar—one

and put the tube into the tin of boiling water (21). *Make sure the water is boiling hard all the time and leave it in the tin for EXACTLY 6 minutes.* If the blood sugar is high the mixture will go slightly brown.

22. After exactly 6 minutes take the tube out of the boiling water and put it into a cup of cold water (23).

24. Using another clean straight 2-ml pipette add 2 ml of phosphomolybdic acid solution. The mixture will bubble and turn blue. Shake the tube gently to get rid of the bubbles.

Measure the depth of the blue colour in the Lovibond comparator, the Grey wedge photometer, or the EEL colorimeter.

THE LOVIBOND COMPARATOR

26. Fill a Lovibond tube with the blue test solution. Use Lovibond discs 5/2A and 5/2B and follow the instructions given in Section 5.10.

THE GREY WEDGE PHOTOMETER

Use the Grey wedge exactly as described in Section 5.14 but use the red No. 3 eyepiece. Change the number you read on the wheel of the Grey wedge into the blood sugar in mg % by using the scale in Figure 7-35.

THE EEL COLORIMETER

Use the EEL colorimeter with the neutral grey standard exactly as described in Section 5.20, except that you should use the red filter Ilford 608. Find the reading the blue solution gives on the galvanometer scale and then work out the answer like this:

$$\text{Blood sugar} = \frac{\text{Scale reading of test solution}}{\text{Scale reading of neutral grey standard}} \times 145 \text{ mg \%}$$

A graph can be made for this method like that in Figure 5-9.

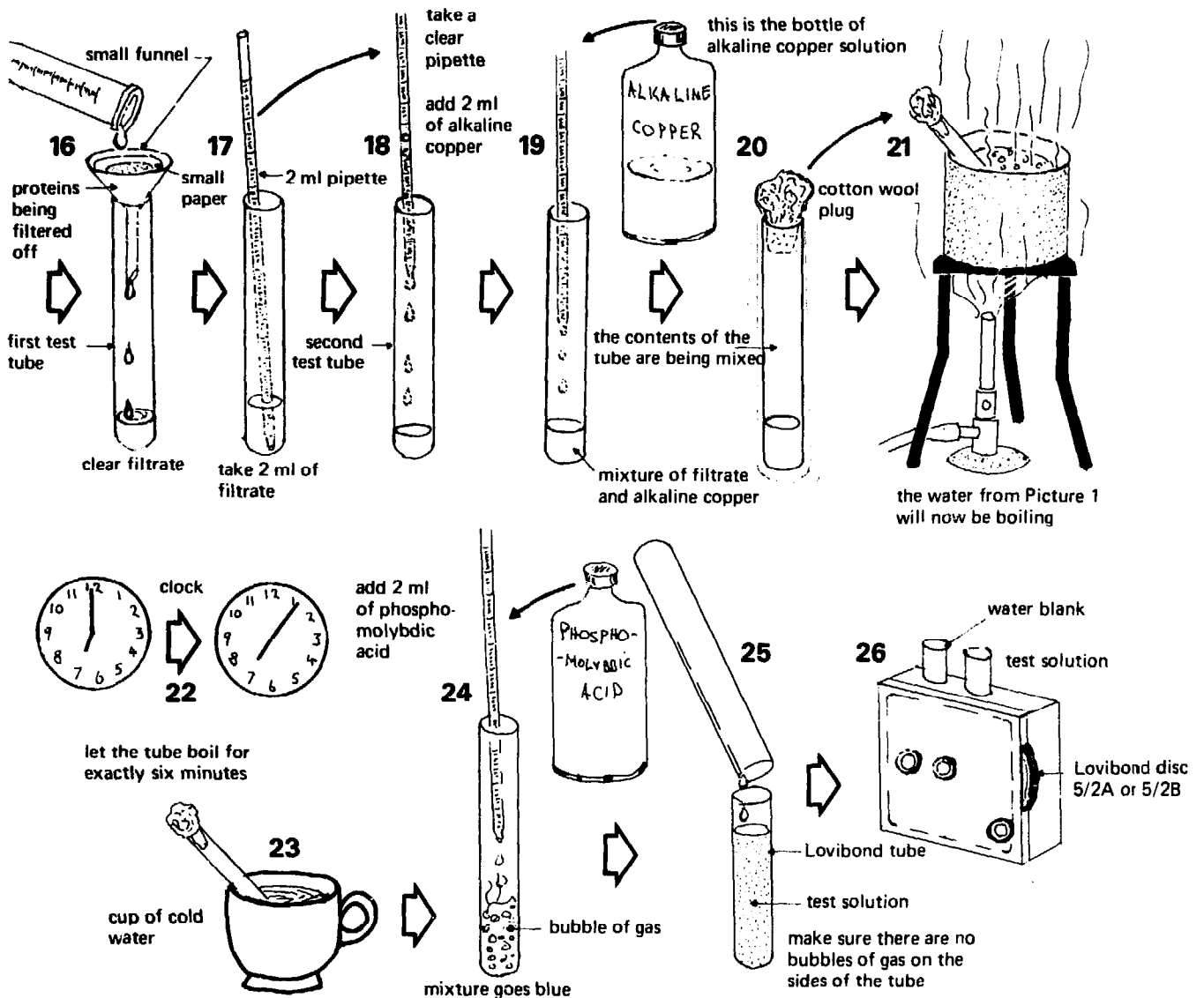

Fig. 7-37 The blood sugar—two

There are many important details. One is the way in which the solutions of sodium tungstate and sulphuric acid are measured. One way is to use 2-ml pipettes. Another way to measure these solutions is to keep them in small bottles with teats and pipettes. See how many drops from each pipette are needed to fill an empty graduated centrifuge tube to 1 ml. Divide the number of drops needed to make 1 ml by five. This will be the number of drops needed to measure 0.2 ml and will be about four drops. It is more important to add the same amounts of sodium tungstate and sulphuric acid than it is to add exactly 0.2 ml of each solution. Choose pipettes with exactly the same-sized tips for both reagents.

You may find it difficult to get enough clear supernatant or filtrate to make 2 ml. Centrifuge the mixture hard, and if you are filtering use a *small* paper. A large paper will soak (drink) up too much filtrate.

The tubes must be *exactly* 6 minutes in water which is boiling very hard. You will get the wrong answer if the time is wrong or if the water is not boiling hard.

If you work in a small laboratory it is better to buy the solutions or get them made in a big laboratory. Wherever they come from, the solutions must be made exactly as described in Section 13.25.

'Dextrostix'

This is another method of measuring the blood sugar which is included as Choice 13 in Section 13.26. It is a special kind of very carefully made test paper. Although it looks easy to use, it must be used in exactly the right way if it is to give the right answer. Even though 'Dextrostix' and other paper tests look as if they are only pieces of paper, they are delicate (easily spoiled) instruments which must be used exactly as the makers say.

Store 'Dextrostix' in a cool dark cupboard. Don't store it in the sun beside a window or beside a sterilizer. Always keep the lid tightly screwed on, because damp spoils 'Dextrostix' quickly. Immediately you have taken a 'Dextrostix' out of its bottle, screw on the cap. Try to use a bottle within 6 months, for it may not keep very long. If you have several bottles, be careful to use the older bottles first, and in this way to rotate (turn over) your stock.

METHOD

THE BLOOD SUGAR WITH 'DEXTOSTIX'

1. Start with a good-sized drop of blood.
- 2 and 3. Let the drop of blood touch the paper and start timing one minute.
- 4 and 5. *Lift* the patient's finger off the 'Dextrostix' so as to leave behind a good-sized drop of blood.
6. Let the drop of blood stay on the paper for exactly one minute.
7. Hold the 'Dextrostix' upright and wash off the blood with a short sharp jet of water from a wash bottle. Don't hold it under the tap.
8. Immediately compare the 'Dextrostix' with the

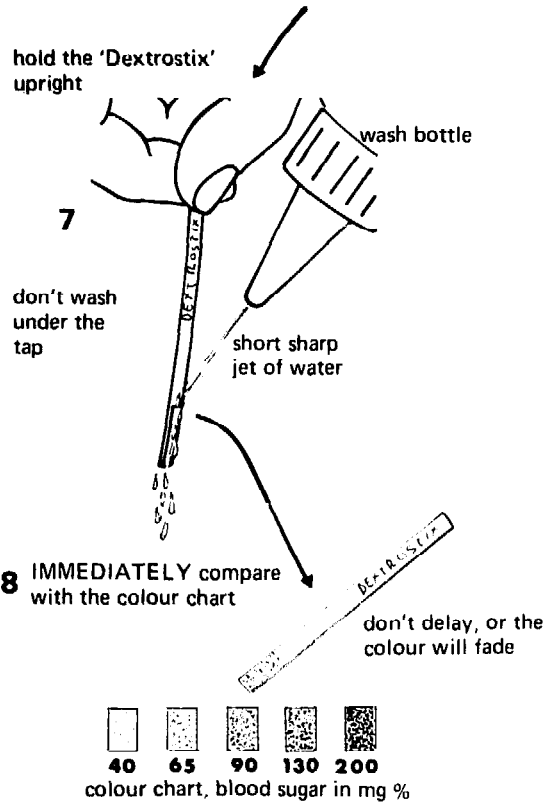
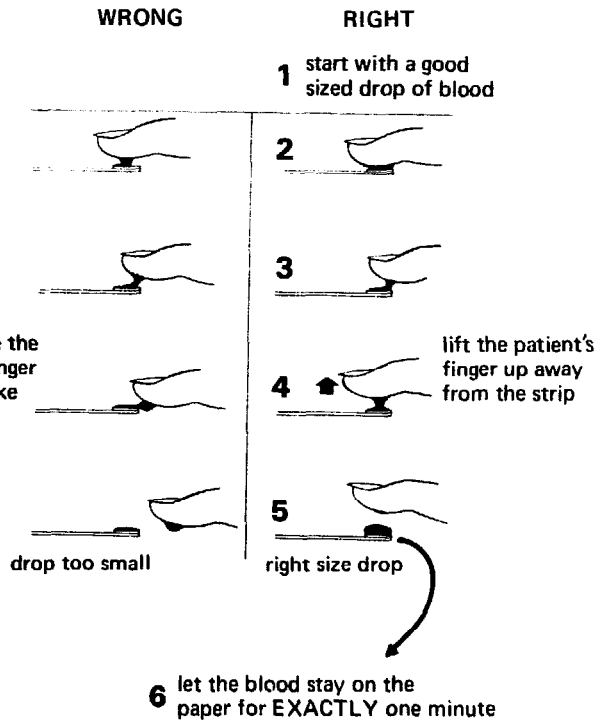

Fig. 7-38 'Dextrostix'

colour chart. This will give you the blood sugar in milligrams per cent.

7.43 Measuring the plasma acetone with 'Acetest' tablets

In Section 8.6 you will read how difficult it is to know how much insulin to give to a patient in diabetic coma.

The usual way to judge this is to measure his blood sugar. But, when a patient's blood sugar is greatly increased, the acetone in his blood is also increased. This means that we can measure the acetone in a patient's blood and use it to judge his probable blood sugar and how much insulin to give him. The plasma acetone can easily be measured by using 'Acetest' tablets. You may be asked to do the method, but the insulin will only be given on the instruction of a doctor.

METHOD

THE PLASMA ACETONE

Take about 5 ml of blood from the patient and put it in a sequestrene bottle. Either allow the red cells to fall to the bottom of the bottle by themselves, or spin the blood to obtain some clear plasma.

Take some of the clear plasma and put two drops into each of four clean test tubes. Label the tubes 1, 2, 3, 4.

Put two drops of saline into tube 2, six drops into tube 3, and fourteen drops into tube 4. Tube 1 will contain undiluted plasma; tube 2 a 50% dilution of plasma; tube 3 a 25% dilution; and tube 4 a 12% dilution of plasma.

Test each dilution with an 'Acetest' tablet as exactly shown in Picture A, Figure 8-2.

Do the test every 2 hours with fresh plasma as long as the patient is in coma.

Wash the pipette well in saline between each dilution of plasma.

If there is a strongly positive test (++++, dark blue) with the diluted plasma in tubes 3 or 4, the patient's blood sugar is over 600 mg %, and he needs at least 100 Units of soluble insulin. If the test is the same 2 hours later, another 100 Units will be needed. When only the first tube gives a ++++ test, don't give any more insulin for the moment, but test again 2 hours later.

Test the urine at the same time. Provided the bladder

is emptied each time, and the kidneys are working properly, the results of the urine test for sugar will reflect the blood sugar, and help to avoid the patient being given too much insulin with resulting severe hypoglycaemia.

QUESTIONS

1. How much haemoglobin has a healthy person? Why might you think that a patient had less haemoglobin than this? List as many reasons as you can for a patient having less haemoglobin than normal.

2. What is the most commonly used and also the cheapest treatment for anaemia? This treatment is only suitable for some patients. How could you find out which patients it is suitable for?

3. Why will a patient who has suddenly lost much blood not become anaemic immediately?

4. What should a good thin blood film look like? List some of the things you should do in making a good thin blood film.

5. When we count the white cells in a Neubauer counting chamber, we count the cells on two corner blocks each of sixteen small squares and add two '0s' to the number of cells we find. Can you explain *why* we do this?

6. Draw pictures of the different kinds of white cells that can be found in normal blood. List the various things that you would look for in distinguishing three different kinds of white cells from one another.

7. How are the red cells formed? What abnormal red cells might you find in a blood film?

8. What kinds of abnormal blood picture do you know and what diseases cause them?

9. What is the difference between the sickle-cell trait and sickle-cell anaemia?

10. What common kinds of anaemia do you know? How would you tell one kind of anaemia from other kinds of anaemia?

8 | Urine

8.1 A clean specimen of urine

Urine may seem the easiest specimen to get. Very often it is, and for many methods, sugar for example, any urine specimen can be used. But for some methods, especially those for pus, protein, red cells, and bacteria, it is important to get a clean specimen of urine. By clean we mean pure urine as it is in the bladder and without any discharge from the vagina or urethra added to it. Discharges often contain protein, pus, red cells, or bacteria. So, if we find any of these in the urine, we cannot be sure if they were in the urine in the bladder, or were added to it in a discharge from the vagina, or the urethra. A specimen of urine without any discharge is called a clean specimen of urine. Clean specimens are taken in different ways in men and women. In women clean urine is sometimes taken by putting a special rubber tube called a **catheter** into the bladder. This is dangerous because bacteria may go into the bladder on the catheter and infect the urinary tract. The urinary tract is the **kidneys** which make urine from the blood, the **ureters** (the tubes joining the kidneys to the bladder), the **bladder** (the bag which holds the urine), and the **urethra** (the tube which joins the bladder to the outside world).

METHOD

TAKING A CLEAN SPECIMEN OF URINE

MEN

Fetch a clean jar with a wide mouth or a specimen glass (Picture 3, Figure 8-1). If the urine is for culture, the jar must be sterile.

Pull back the skin (the foreskin) over the patient's penis (sex organ) and swab (clean) the opening (meatus) of the urethra with a sterile swab.

Ask the patient to pass *some* of his urine. Throw this away but catch some of the rest of his urine into the bottle or specimen glass. Any discharge in the urethra will have been washed away by the first part of the urine, and the rest of the urine will be clean. This is sometimes called a mid-stream specimen or MSU.

WOMEN (this must be done by a nurse)

Sit the woman down on a toilet with her legs wide apart. Fold back the lips (labia) at the side of her urethra. Swab the opening of her urethra as in a man. Throw away the first part of the urine and keep the middle part.

PROTEIN, SUGAR, AND ACETONE

8.2 Why we test the urine

The kidneys excrete (get rid of) water and many of the waste substances in the blood that the body does not want. This mixture of water and waste substances is called urine. One of the more important waste substances is urea (see Section 1.10).

Substances which are not waste substances sometimes go into the urine. They go into the urine because something is wrong with the body or the urinary tract. One of the abnormal substances in the urine is the sugar called glucose (see Section 8.6). When we are talking about testing the urine the words sugar and glucose usually mean the same thing. Sugar in the urine is called **glycosuria**. Glycosuria is found when a patient has diabetes.

Protein is also found in the urine of some patients—**proteinuria**. It comes from the plasma into the urine when the urinary tract is diseased.

We can easily test urine for protein and sugar. If much sugar is found the patient probably has diabetes. If protein is found, the patient has some disease of his urinary tract.

Don't forget to look at a urine specimen as well as testing it, and to report anything abnormal you may see. Urines are sometimes red with blood, or a deep brownish green with bile pigments, and they may also be coloured by drugs.

8.3 Testing the urine for sugar and protein

A few drops of urine are boiled with some Benedict's reagent. Benedict's reagent is a deep blue colour. If the urine is normal and there is no sugar in it, the Benedict's

solution will stay blue. But if there is sugar in the urine it will change the colour of Benedict's solution. The colour that is formed depends upon how much sugar there is in the urine. If the urine has a lot of sugar (++++) in it, the mixture of urine and Benedict's solution will change from deep blue to a deep red-brown colour like burnt bricks. If there is not quite so much sugar in the urine (+++) the mixture will only go orange. If there is less sugar still (++) the mixture will go yellow. If there is only a very little sugar in the urine, the mixture will go green. As well as changing colour, the mixture of urine and Benedict's solution also becomes turbid (cloudy), and, as it stands, a precipitate falls to the bottom of the tube. Some other substances besides sugar will change the colour of Benedict's solution, but we will not discuss them here.

There are several things to be careful about when you do this test. One is the volumes of urine and Benedict's solution you should use. *Use much more Benedict's solution than urine.* Eight drops of urine and 5 ml of Benedict's solution are usually used, but it is both quicker and cheaper to use smaller volumes of both urine and Benedict's solution as described below.

The sulphosalicylic acid test for protein is very easy. A few drops of 20% sulphosalicylic acid are added to the urine. If there is protein in the urine, the sulphosalicylic acid will precipitate it and make the urine cloudy. In the urine protein and sugar are often tested for together; so we will describe both tests together.

METHOD

TESTING THE URINE FOR PROTEIN AND SUGAR, FIGURE 8-1

1. Take two clean test tubes A and B.
2. Fill tube A one third full with urine. In the Picture tube A is shown being filled from a special urine specimen glass (3).
4. Tip the urine in tube A quickly into tube B. *Don't wait for tube A to drain completely*, but put it back in the rack. Four or five drops of urine will collect in the bottom of tube A (5).

SUGAR

6. Fill tube A with Benedict's solution as deep as your thumb is wide. It is best to keep the Benedict's solution in a wash bottle (7).

8. Hold tube A in a piece of paper which has been folded into a strip as described in Section 3.11. Shake the tube gently and boil it for a few minutes. Point the tube away from your face and hands in case the mixture jumps out of the tube. The mixture will be less likely to jump out if you shake the tube gently while it is boiled. Another way to stop the mixture jumping out is to boil only the upper part of the tube, and to look for the colour changes in this part of the tube only. The tube should be boiled for about 5 minutes, but most people usually boil it for about 2 minutes only. The best way of heating a

tube is to put it in a tin of boiling water for about 5 minutes. Many tubes can be boiled at once in this way, but they must be labelled carefully, and you will need a rack to hold them. This can easily be made of wire, or from a piece of wire netting, such as 'chicken wire'.

9. Put the tube in the rack and report the colour of the urine—'red' or 'green', or whatever its colour may be. Some people prefer to use the plus notation like this:

Blue	—
Green (no precipitate)	±
Green (with precipitate)	+
Yellow	++
Orange	+++
Red	++++

PROTEIN

10. Add two or three drops of 20% sulphosalicylic acid to tube B. If the urine is normal, nothing will happen (11). If protein is present the mixture will go milky (12). Report your answers with the plus notation (see Section 4.4).

Another test for protein

If you have no sulphosalicylic acid you can test for protein using dilute acetic acid and heat.

METHOD

ANOTHER TEST FOR PROTEIN IN THE URINE

Fill a test tube nearly to the top with urine. Hold the tube by the bottom and heat only the *top part* of the urine in a flame until it boils. Take the tube out of the flame and add two or three drops of 3% acetic acid. If the urine becomes turbid when it is heated and stays turbid when acid is added, the test for protein is positive. The test is also positive if the urine stays clear when heated but goes turbid when acid is added. But the test is negative if acid removes the turbidity made by heating. This turbidity made by heating and dissolved by acid is caused by phosphates and not by protein and is normal.

Measuring protein in the urine

A common way of measuring the amount of protein in the urine is to use a method called Esbach's method. This has not been described here because you can measure the urine protein in the same way that you can measure the CSF protein. Use the proteinometer standard, or the Grey wedge photometer as described in Section 9.13. Protein in the urine is usually measured in grams per litre and not in mg % like the CSF protein. But it is easy to change one way of measuring into the other. 100 mg % (100 mg in 100 ml) is the same as 1 g (10 times 100 mg, 1,000 mg, or 1 g) in one litre (10 times 100 ml, 1,000 ml, or 1 litre). If there is so much protein in the urine that it goes beyond the end of the scale (100 mg %

with the proteinometer standards, or about 150 mg % with the Grey wedge), you may have to dilute the urine before you add the sulphosalicylic acid. If, for example, you dilute 1 ml of urine with 1 ml of water, you will have diluted the urine in twice its volume (1 ml into a total of 2 ml). You will therefore have to multiply the answer you get by two. If there is much protein in the urine you may have to dilute it even more.

8.4 The meaning of proteinuria

Many diseases cause proteinuria. Here are some of the more important ones.

Fever

Many patients with a high fever have a little protein in their urine. When their fever stops their proteinuria stops also. This is a common cause of mild proteinuria.

Bacterial infection of the urinary tract

Urinary infections are common in women. When bacteria grow in the urinary tract and infect it, there is usually protein in the urine. A patient with an infection of the lower part of his urinary tract usually passes his urine more frequently than normal (**frequency**). He has

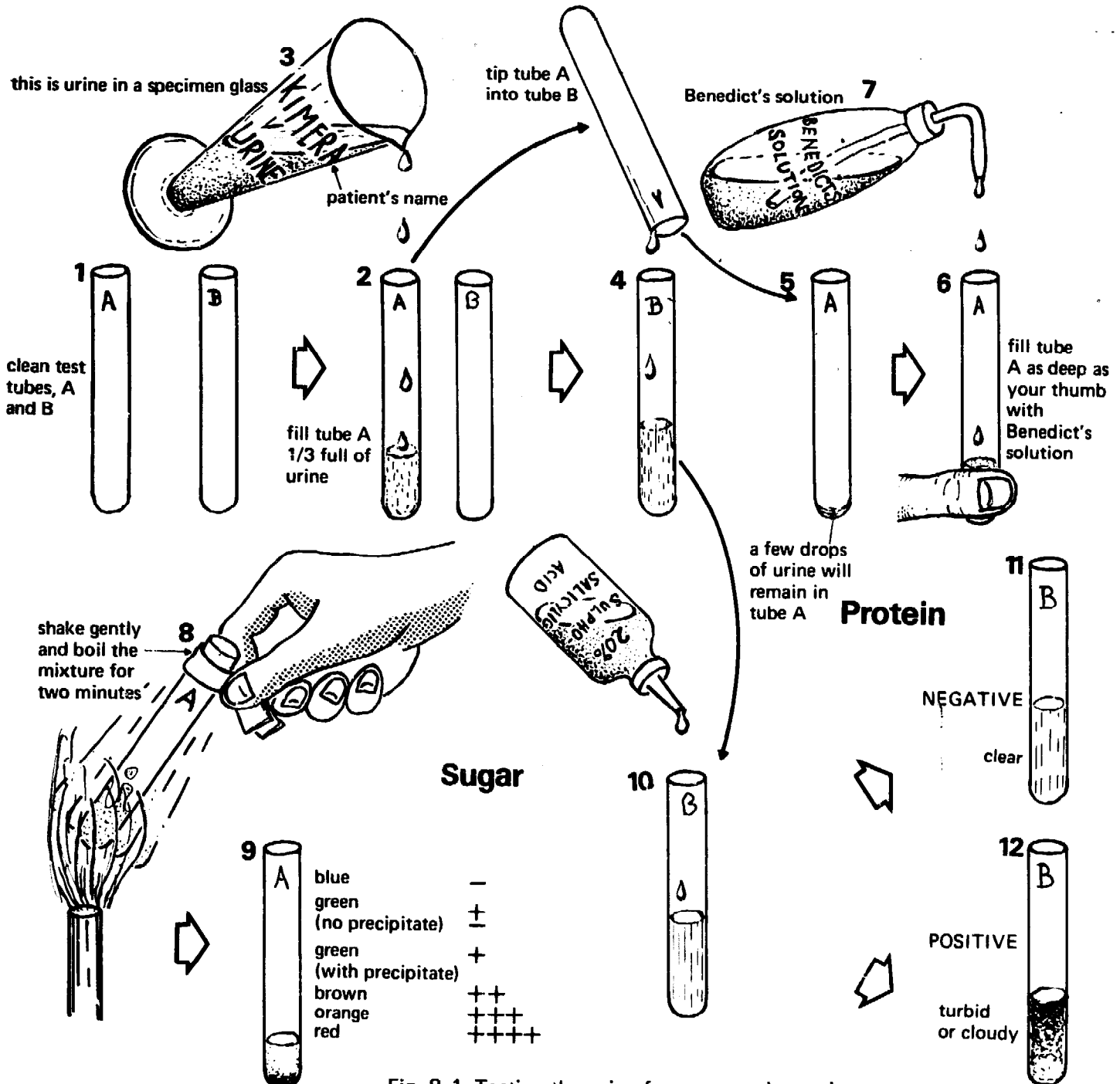

Fig. 8-1 Testing the urine for sugar and protein

often to pass it in a hurry (**urgency**) and usually has pain on passing it (**dysuria**). When a patient has an infection of the *upper* part of his urinary tract (his kidneys and the upper parts of his ureters) he may have no urgency, frequency, and dysuria, but only fever, and perhaps pain in his kidneys. When a patient has any kind of urinary infection, protein and pus cells can usually be found in his urine (**pyuria**, pus in the urine). These pus cells are polymorphs (see Section 7.14) that have come out of the blood to fight bacteria invading the urinary tract. They can easily be found and counted by looking at the urine with a microscope (see Section 8.11) and are very useful in diagnosing urinary infection. Bacteria may also be seen when infected urine is looked at with a microscope.

Urinary infections can often be treated quite easily at a health centre; so it is important to be able to diagnose them. Patients are usually given tablets of a sulphonamide drug to kill the bacteria in their urinary tracts.

Schistosomiasis (bilharzia or bilharziasis)

As you will read in Section 8.15, there is a worm called *Schistosoma haematobium* which lives in the veins in the walls of the bladder and ureters. The urine of infected patients usually has protein and red cells in it besides the ova of *S. haematobium*. In areas where schistosomiasis is common, it will be much the commonest cause of proteinuria. If schistosomiasis is common where you work, always look for the ova of *S. haematobium* whenever you find protein in the urine.

Vaginal and urethral discharges

When patients have infections of the vagina (a woman's birth passage) and urethra they have discharges from these organs. A discharge is an abnormal liquid and is often pus. These discharges contain protein and may contain pus cells and red cells. If vaginal and urethral discharges get into the urine, patients may seem to have proteinuria, pyuria, or **haematuria** (blood in the urine) when really they have not. If you find protein, pus cells or red cells in an ordinary specimen, it is often necessary to take another specimen of urine and this time to make sure that no urethral or vaginal discharge gets into it. Taking a clean specimen of this kind is described in Section 8.1. Blood often gets into the urine during menstruation.

Toxaemia of pregnancy

This is a disease which some pregnant mothers get. Their legs swell, they get protein in the urine, and their blood pressure (the pressure of blood in their arteries) gets abnormally high. If the toxaemia gets very bad the mother may have fits and her baby may die. *One of the earliest signs of toxaemia of pregnancy is protein in the urine. This is why all mothers must have their urine tested for protein at every antenatal visit.*

Nephritis

Some kinds of kidney disease (nephritis) are a less common, but important cause of proteinuria. In nephritis there is often much more protein in the urine than there is in either fever or in urinary infections. There are many kinds of nephritis, but we will describe only three, acute nephritis, chronic nephritis, and the nephrotic syndrome.

Acute nephritis

This is a short-lasting condition which often follows about 10 days after a sore throat. There are red cells and granular casts (see Section 8.13) as well as protein in the urine. There may be so many red cells that the urine looks quite red. The patient's blood pressure and blood urea are often raised, and his face and ankles may be swollen with fluid in the tissues (oedema). Most patients get well in a few weeks. A few patients go on to have chronic nephritis.

Chronic nephritis

The word chronic means long-lasting, and these patients usually have their kidney disease for a long time. They may not know they are ill, and many cases of chronic nephritis are only found on routine urine testing. Even so, after feeling fairly well for some months or years, the blood pressure and blood urea of these patients rise, and they die.

Patients with chronic nephritis have protein and granular casts in their urine.

Nephrotic syndrome

These patients have much protein (+++ or +++) in their urine and too little in their blood, because their kidneys let much protein leak from the blood into the urine. Their legs become swollen with fluid—they are said to become **oedematous**. Some casts may be seen in the urine, but the most obvious signs are the severe proteinuria and the oedema. These patients may be quite common, most of them are children.

Heart failure

When the heart cannot pump the blood round the body properly, the patient is said to have heart failure or cardiac failure. Most patients with heart failure have a little protein in their urine. But patients with heart failure are not usually common; so you will not find this to be a common cause of proteinuria.

Diseases which do not have proteinuria

Children with kwashiorkor and severe hookworm anaemia do not have proteinuria. This is useful, because there may be oedema in both these diseases. A patient with oedema and heavy proteinuria is therefore unlikely

to have kwashiorkor, or severe hookworm anaemia. He is more likely to have nephritis or the nephrotic syndrome.

8.5 Routine urine testing

When a patient is examined and his history is taken, there may be no reason for thinking that he has diabetes or that he has any disease of his urinary tract. Therefore, unless a patient's urine is always tested for sugar and protein, diabetes and disease of the urinary tract may easily be overlooked. By overlooked we mean that these diseases will not be diagnosed when they should be. *Therefore, the urine of all patients who are ill enough to be in hospital must always be tested for sugar and protein.* Some kinds of outpatient should also have their urine tested routinely. By routinely we mean always or as a general rule. It is easy to test the urine routinely because the tests are quick, simple, and cheap. Test the urine of the following patients routinely for protein and sugar:

1. All patients in the wards, especially those who are very ill.
2. Any outpatient with the following symptoms: loss of weight, great thirst or passing too much urine (suggests diabetes), frequency, urgency, dysuria (these three suggest a urinary infection), oedema (suggests nephritis or heart failure).
3. Patients with the last four symptoms are likely to have only proteinuria, but it is best to test routinely for both protein and sugar.

Whenever you find protein, examine the spun deposit for red cells, pus cells, casts, and the ova of S. haematobium as described below. If necessary, count the pus cells.

Whenever you find much sugar (++ or more) test the urine for acetone. These methods are described in the next sections, but, before you can understand why they are used, you must learn more about diabetes.

8.6 Diabetes and the blood sugar

We all have some sugar in our blood. This sugar is called **glucose**, and it is different from the sugar we put into our tea, which is called **sucrose**. There is more sugar in our blood soon after a meal. This is because part of our food (the carbohydrate part) is made into sugar in our gut (stomach, intestines) and absorbed (taken into our blood). Some hours after a meal there is less sugar in our blood, because some of it has been used or stored by our body. The blood sugar measured at this time is called the **fasting (without eating) blood sugar**. The fasting blood sugar of normal people is between 65 and 105 mg per 100 ml. But, about an hour after we have had a meal our blood sugar may rise as high as 150 mg per 100 ml. Because meals alter the blood sugar so much, we usually try to measure the fasting blood sugar. The easiest time

to measure it is in the early morning, when a patient has had no food since the evening before and no breakfast.

In the disease called **diabetes** the cells of the body are unable to use sugar properly, and there is too much sugar in the blood (**hyperglycaemia**: hyper = too much, glyc = sugar, aemia = blood). A diabetic may have 500 mg % and more of sugar in his blood. Because there is so much sugar in the blood, some of it is excreted (goes out of the body) into the urine. This is why we test the urine for sugar. If we find sugar in a patient's urine, he probably has diabetes. We can also see if a patient has diabetes by measuring his fasting blood sugar. This is sometimes useful, but it is not as easy as testing his urine. A patient may have diabetes if his fasting blood sugar is more than 105 mg %. If a diabetic patient is not treated he may get thin and weak. He will be thirsty, he will drink much water, and he will pass much urine. His body may become **dehydrated** (de = without, hyd = water, lacking water), and he may go into a **coma** and die. A patient in a coma seems to be asleep but cannot be woken up. This kind of coma is called **diabetic coma** or **hyperglycaemic coma**.

If the high blood sugar of a diabetic can be lowered to normal he will stay well. This is usually done by giving him injections of a drug called **insulin** once or twice a day for the rest of his life. Some fat patients with mild diabetes get better when they eat less, and other diabetics are given tablets. If a diabetic is being treated with insulin he needs just the right amount of insulin to bring his blood sugar to normal but not below it. If a diabetic is given too much insulin his blood sugar will fall too low, and he will have **hypoglycaemia** (hypo = too little). A hypoglycaemic patient feels ill and weak and is cold and sweaty. If a diabetic is given too much insulin his blood sugar may go so low that he may go into another sort of coma and may die, unless he is quickly given some sugar. This kind of coma is called **hypoglycaemic coma**.

Diabetics differ from one another, and each diabetic needs different treatment. That is, they need different amounts of insulin, starving or tablets if their blood sugar is to be brought down to normal but not below it. It is too difficult to measure the blood sugar of a diabetic each time we want to see if he is being properly treated. Instead, we test his urine for sugar. If the urine of a diabetic is blue with Benedict's method, his blood sugar is probably too low. If it is green, his blood sugar is about right. But, if his urine is yellow with Benedict's method, and especially if it is red, his blood sugar is too high. It is seldom possible to treat a diabetic so carefully that his urine is always just green, but this should be the aim.

As you have read, the blood sugar is low before meals and high soon afterwards. The dose of insulin is adjusted so that a specimen of urine passed just before meals is 'green' or 'blue'. It does not matter if the urine is 'yellow' or 'red' after meals. Benedict's method is thus a useful way of diagnosing diabetes and of adjusting the way it is treated.

8.7 Acetone

As you have read, if patients with severe diabetes are not treated, they may first become sleepy and then go into a coma. These patients have a very high blood sugar and pass much sugar in their urine. They also pass a substance called acetone in their urine, and breathe it out in their breath. Diabetic coma is difficult to treat, and patients sometimes die. It must therefore be prevented. Acetone in the urine is a sign that the patient is about to go into a coma and needs treatment quickly. *The urine of a diabetic must be tested often. If it is yellow or red by Benedict's method, ALWAYS TEST FOR ACETONE.* If you find acetone, the patient needs treatment quickly. If the patient is already being treated with insulin, but still has acetone in his urine, he is not getting enough insulin, and the dose must be increased.

Patients in a diabetic coma need much insulin. It is sometimes difficult to know how much insulin to give them, and it is useful to know what their blood sugar is during treatment. This is the main reason why a method for measuring blood sugar has been described in Section 7.42.

Acetone is sometimes found in the urine *without sugar*, particularly after a patient has been vomiting and especially in children. It may also be found if a patient has been without food for a long time, or in women who are very tired after spending a long time in labour (giving birth). There is seldom much acetone in the urine of these patients and it has nothing to do with diabetes.

There are several ways of testing the urine for acetone. The simplest way uses 'Acetest' tablets which are in the main equipment list. Two other methods will also be described. One is the standard (usual) Rothera method using ammonia. The other is an altered Rothera method which uses sodium carbonate instead of ammonia. It is much the best.

METHOD

TESTING URINE FOR ACETONE, FIGURE 8-2

A. WITH 'ACETEST' TABLETS

1. Put an 'Acetest' tablet on a piece of clean white paper.
2. Put one drop of urine on the tablet.
3. Wait for half a minute (30 seconds) and look at the colour. If possible use a watch to measure 30 seconds. If there is no acetone in the urine, the tablet will stay white or be coloured yellow from the urine (4). If there is acetone in the urine, the tablet will change colour. If there is only a little acetone (+) it will go a pale purple colour. If there is much acetone in the urine (++++) the tablet will quickly go a deep purple colour (5).

B. MODIFIED ROTHERA METHOD

1. The modified (altered) Rothera's reagent used here is a mixture of ammonium sulphate, sodium carbonate,

and sodium nitroprusside and is described in Section 3.39. Using a spatula (2), put a small quantity of powder in a test tube, say just enough to cover the round bottom of the tube (3).

4. With a Pasteur pipette of urine (4), just moisten the powder at the bottom of the tube. Three or four drops of urine will probably be enough (5).

6. Wait one minute—time it if possible with your watch. Hold the tube against a sheet of white paper, so that any colour change can be seen more easily.

7. If there is no acetone in the urine, there will be no change in colour.

8. If there is acetone in the urine, a purple colour will be seen. If there is much acetone in the urine, a deep purple colour will form rapidly.

There are various ways of reporting the colour. Here is one which can be used both with this way of doing Rothera's test and with the next one:

No colour change	—
Very slight purple colour	±
Definite purple colour	+
Slow-forming medium purple	++
Slow-forming deep purple	+++
Rapid-forming deep purple	++++

C. STANDARD ROTHERA METHOD

1. The standard Rothera's mixture contains sodium nitroprusside and ammonium sulphate—see Section 3.39.

2. Use a spoon or spatula to fill the bottom half inch of a test tube with Rothera's mixture (3).

4. Just cover the layer of powder with urine (5).

6. Shake gently. Most of the powder will dissolve in the urine, which will become saturated with ammonium sulphate.

7. Add strong ammonia. This must be 22% or 25% ammonia with a specific gravity of 0.92 or 0.88. The exact amount of ammonia to add is not important, but try to add about a third as much ammonia as urine (8).

- 9 and 10. Mix, and report the colour change exactly as in Method B above.

BILE PIGMENTS

8.8 Jaundice and some tests for bile pigments

A pigment is a coloured substance. The liver does many jobs for the body. One of them is to make the fluid called **bile** and send it into the gut along tubes called the **bile ducts** (tubes). Bile is a thick greenish-yellow fluid which contains many substances. One of them is a yellow substance called **bilirubin** which helps to give bile its yellow colour. Bilirubin is formed from the haemoglobin of broken down (lysed) red cells. In some diseases the yellow bilirubin does not get into the gut as it should, but stays in the blood which then has an abnormally high concentration of bilirubin. When this happens, some bilirubin gets out of the blood into the rest of the body

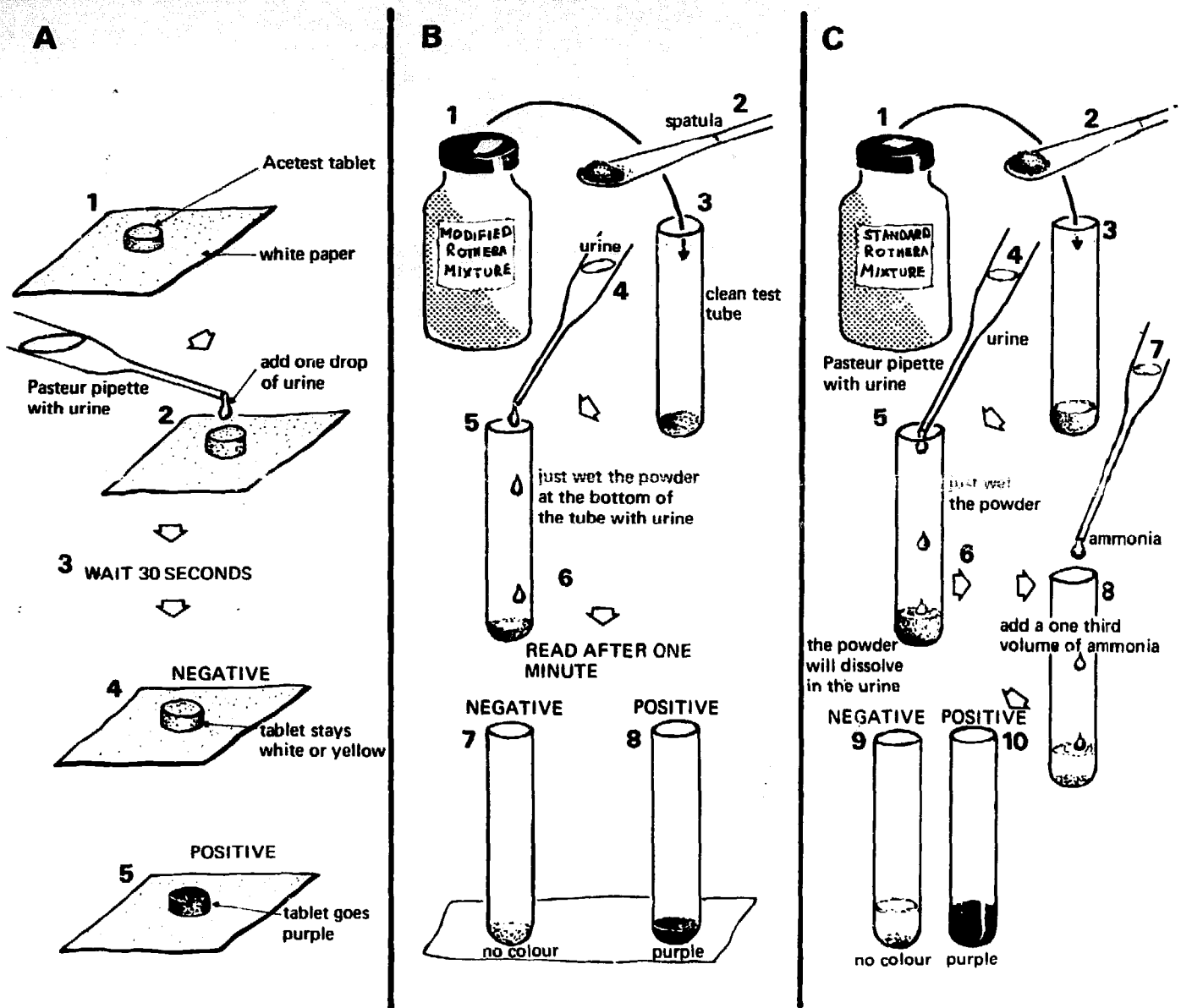

Fig. 8-2 Testing the urine for acetone

and stains it yellow. When a person is stained yellow with bilirubin in this way he is said to be **jaundiced** (icteric). It is easy to see when white-skinned people are jaundiced, but jaundice is not so easy to see in dark-skinned people. The best way to see if a dark-skinned person is jaundiced is to look at the white part (sclera) of his eyes which stain yellow with bilirubin.

In diabetes there is so much sugar in the blood that some leaks out into the urine. In jaundice, too, there is so much bilirubin in the blood that some leaks into the urine and can be tested for with Fouchet's test (spoken 'foushay'). You may say, why test the urine for bilirubin to see if a patient is jaundiced, if it is so easy to look at his eyes (or his skin if he is white)? The answer is that we can often find bilirubin in the urine before a patient's eyes become obviously yellow. This is especially useful in the early days of a liver disease called infectious hepatitis (hepatitis means inflammation of the liver). Sometimes also there is doubt as to whether a patient's eyes

are yellow or not. This doubt can be settled by testing his urine for bilirubin.

There is another bile pigment in the urine which it is easy to test for. This is **urobilinogen**, which we test for with Ehrlich's test. Bacteria in the large gut make urobilinogen from bilirubin. Urobilinogen is partly absorbed from the gut into the blood and excreted in the bile. As with sugar and bilirubin, if there is more urobilinogen than there should be in the blood, some of it will go into the urine.

There are two main reasons for increased urobilinogen in the urine.

1. When red cells are being haemolysed extra fast (in sickle-cell anaemia or malaria for example), much haemoglobin is produced. Much bilirubin is formed from it and passes into the bile. Much urobilinogen is formed from this bilirubin in the gut. Some of this is absorbed into the blood stream and excreted by the kidneys into the urine. If therefore much urobilinogen is found in the

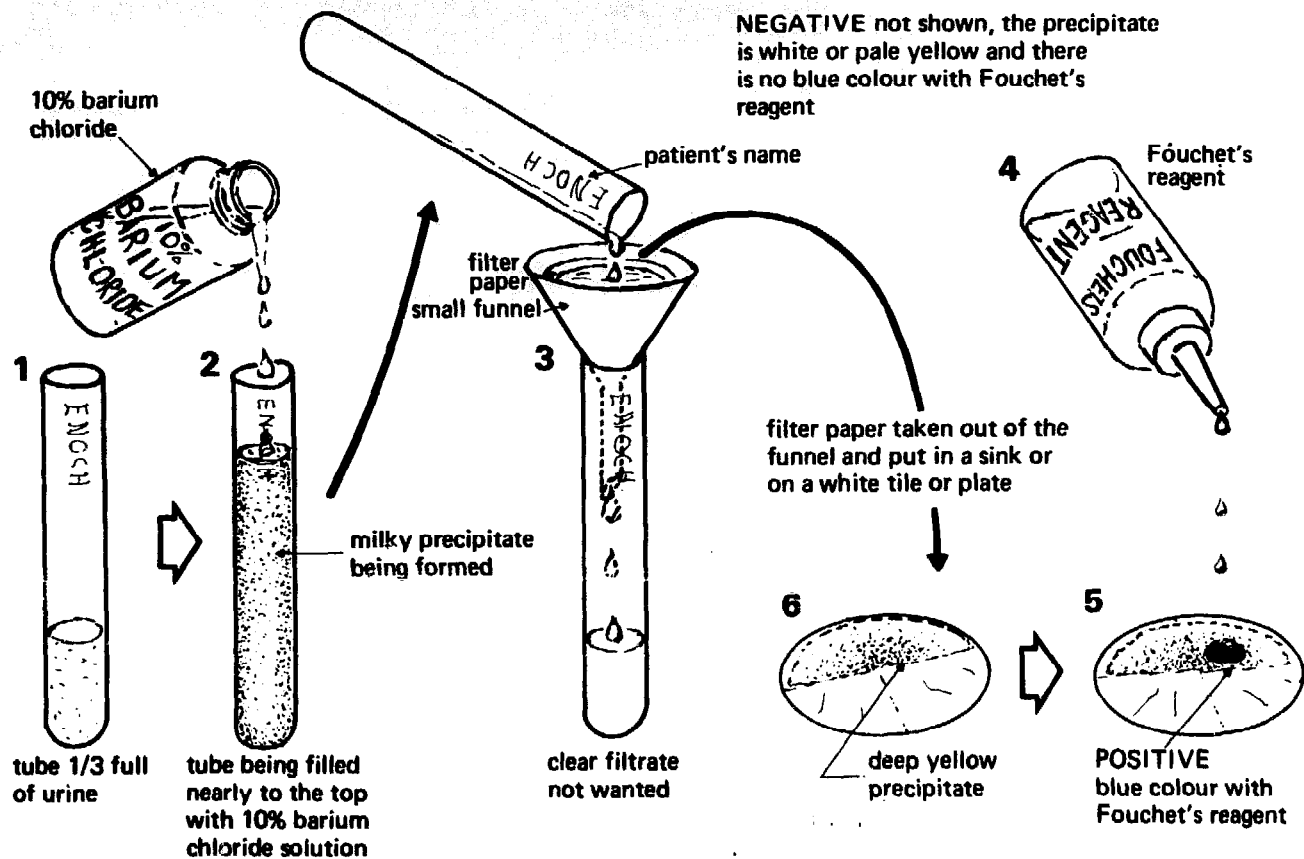

Fig. 8-3 Fouchet's test for bile pigments

urine it may mean that there is increased destruction of red cells. If a patient is anaemic and has much urobilinogen in his urine he may have a haemolytic anaemia (see Section 7.9).

2. Urobilinogen is secreted into the bile by the cells of the liver. When the liver cells are diseased they may not be able to excrete urobilinogen as they should. Urobilinogen therefore increases in the blood and goes into the urine. An abnormal amount of urobilinogen in the urine may mean that the liver is diseased.

Nothing more will be said about the meaning of these tests here. They will mostly be asked for by doctors in hospitals who will understand their meaning.

Look at the colour of the urine. The pale yellow colour of normal urine is not due to bile pigments but to other substances. It is not possible to tell the yellow colour of a concentrated (strong) normal urine, from the colour due to small amounts of bile pigments. This is why we have to test it. But, if there is much bile in the urine, it is easily seen to be abnormal, for it will be a dark brownish green with yellow bubbles (foam) when it is shaken.

METHOD

FOUCHET'S TEST FOR BILIRUBIN, FIGURE 8-3

1. Take a test tube one-third full of urine.
2. Fill it nearly to the top with 10% barium chloride. It will go milky, with a white or yellowish precipitate.
3. Pour the milky mixture through a small filter paper

held in a small funnel. If you don't know how to fold a filter paper, look in Section 3.11. When all or nearly all the liquid (filtrate) has passed through, take the paper out and lay it in a sink or on a white tile. If the patient is jaundiced, the precipitate will be yellow; otherwise it will be white or nearly white.

4. Add two drops of Fouchet's reagent (see Section 3.30) to the precipitate on the paper.

5. If bilirubin is present the precipitate will go blue-green, either a pale blue-green (+) if there is only a little bilirubin present, or a darker blue-green (++++), if there is much bilirubin there.

6. If the test is negative there will be no blue colour.

METHOD

EHRlich'S TEST FOR UROBILINOGEN, FIGURE 8-4

1. Fill a test tube to the depth of two fingers with *fresh* urine. There will be 5 ml in the tube, and it will be about one-quarter full. The urine must be fresh. If the urine is more than about an hour old the test will not work.

2. Add an equal amount of Ehrlich's reagent. The tube will now be about half full.

3. Wait 10 minutes.

4. Fill the tube nearly to the top with a saturated solution of sodium acetate.

5. If there is only a normal amount of urobilinogen in the urine it will be yellowish in colour.

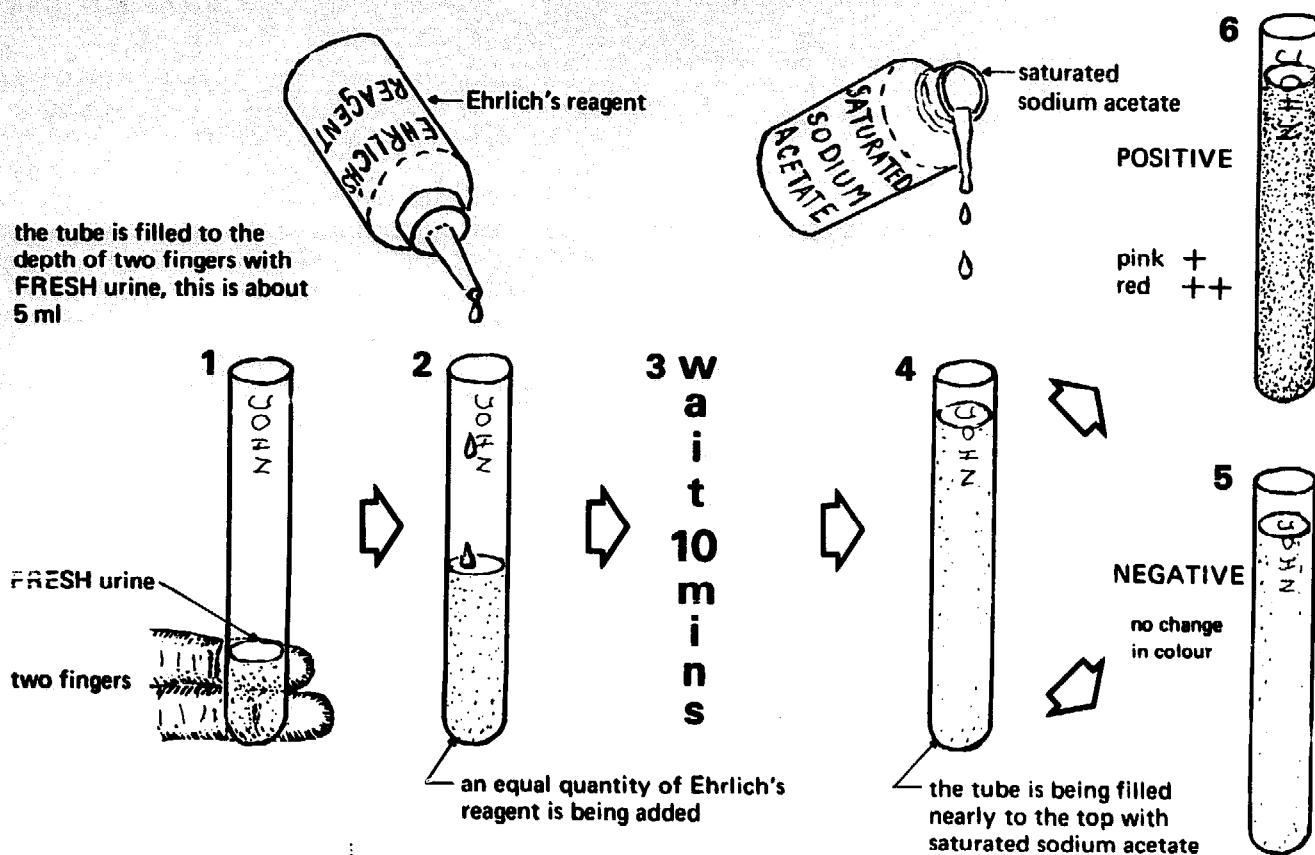

Fig. 8-4 Ehrlich's test for urobilinogen

6. If there is more urobilinogen than there should be in the urine, the mixture will go pink (+) or red (++) . A pink colour is also produced by some other substances, but we will say no more about these here.

The next three methods are different from those we have just described. They are useful in health centres to find out if patients with tuberculosis or leprosy have been taking their drugs as they should.

TESTING THE URINE FOR DRUGS

8.9 Testing for INH and PAS

It is sometimes helpful to know if a patient is taking the drugs that he has been given. This is especially useful if the drugs taste bad, or if they have to be taken daily for many months, as for example in tuberculosis. Many drugs leave the body in the urine, either just as they were eaten or injected, or after they have been altered in some way by the body. The easiest way to see if a patient is taking a drug may be to see if it can be found in his urine. Methods of testing the urine for two drugs are described here. One method is for the drug called INH or 'INAH' (often called 'eyenah') or isonicotinic acid hydrazide. The other method is for the drug called PAS or para-aminosalicylic acid (often called 'pas'). The test for PAS is very easy and uses ferric chloride. The test for INH is

nearly as easy, but it needs special chemicals. One of them is chloramine T which must be got from a special maker (EAS). The other is potassium cyanide which is a DEADLY POISON. For this reason these chemicals are not on the main list but are included as Choice 6, Section 13.19. When chloramine T is some years old, it becomes less soluble and may not work.

There are some very important rules for working with potassium cyanide. Here they are.

METHODS

RULES FOR WORKING WITH POTASSIUM CYANIDE

NEVER pipette any solution of potassium cyanide by mouth—you might suck some into your mouth by mistake and kill yourself. Always use a Pasteur pipette.

NEVER add any strong acid (such as hydrochloric acid or sulphuric acid) to potassium cyanide (in the solid or in solution) because a poisonous gas will form.

Only make up 10 ml of potassium cyanide solution at a time, and throw away what is left over when you have finished.

Always keep potassium cyanide in a locked cupboard. Never touch it with your fingers but always use a spatula. Wash any equipment that may have held potassium cyanide with much water.

TESTING THE URINE FOR INH. FIGURE 8-5

1. Take two 10-ml graduated centrifuge tubes. Label one tube 'cyanide' and the other tube 'chloramine T'. Into one tube weigh 1 g of potassium cyanide. Into the other tube weigh 1 g of chloramine T.
2. Fill both up to the 10-ml mark with water. Both substances will be in 10% solution.
3. Dissolve the chloramine T by shaking the tube with your thumb held over the top.
4. DISSOLVE THE CYANIDE BY DRAWING THE MIXTURE IN AND OUT WITH A PASTEUR PIPETTE.
5. Wash the pipette with clean water. It is convenient to keep the water in a plastic cup and to keep another empty cup next to it into which to empty the pipette (see Picture G, Figure 3-6). NEVER DRINK OUT OF

THESE CUPS OR OUT OF ANYTHING IN A LABORATORY.

6. Place four drops of urine in one of the holes in the plastic tile. Let the urine fall from a pipette. It is better to keep the pipette straight up (vertical); it is shown sloping here, so as to take up less space in the drawing.
7. Wash out the pipette again.
8. Add four drops of the 10% solution of potassium cyanide you have just made. Don't let the pipette touch the liquid already in the hole.
9. Wash out the pipette again.
10. Add nine drops of chloramine T solution to the hole. Don't let the pipette touch the liquid already in the hole. Don't mix the solutions in the holes between adding one reagent and the next.

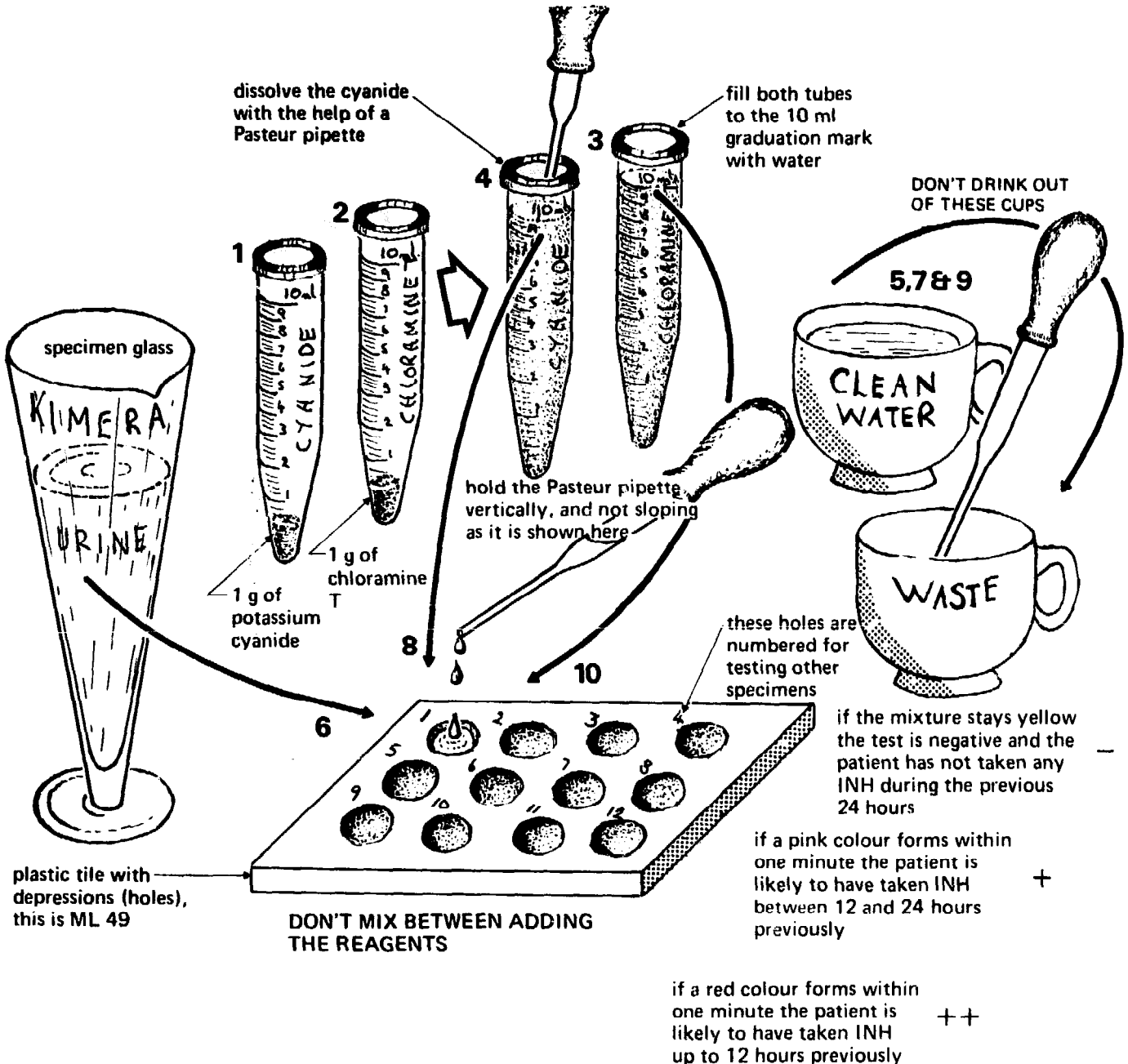

Fig. 8-5 Testing the urine for INH

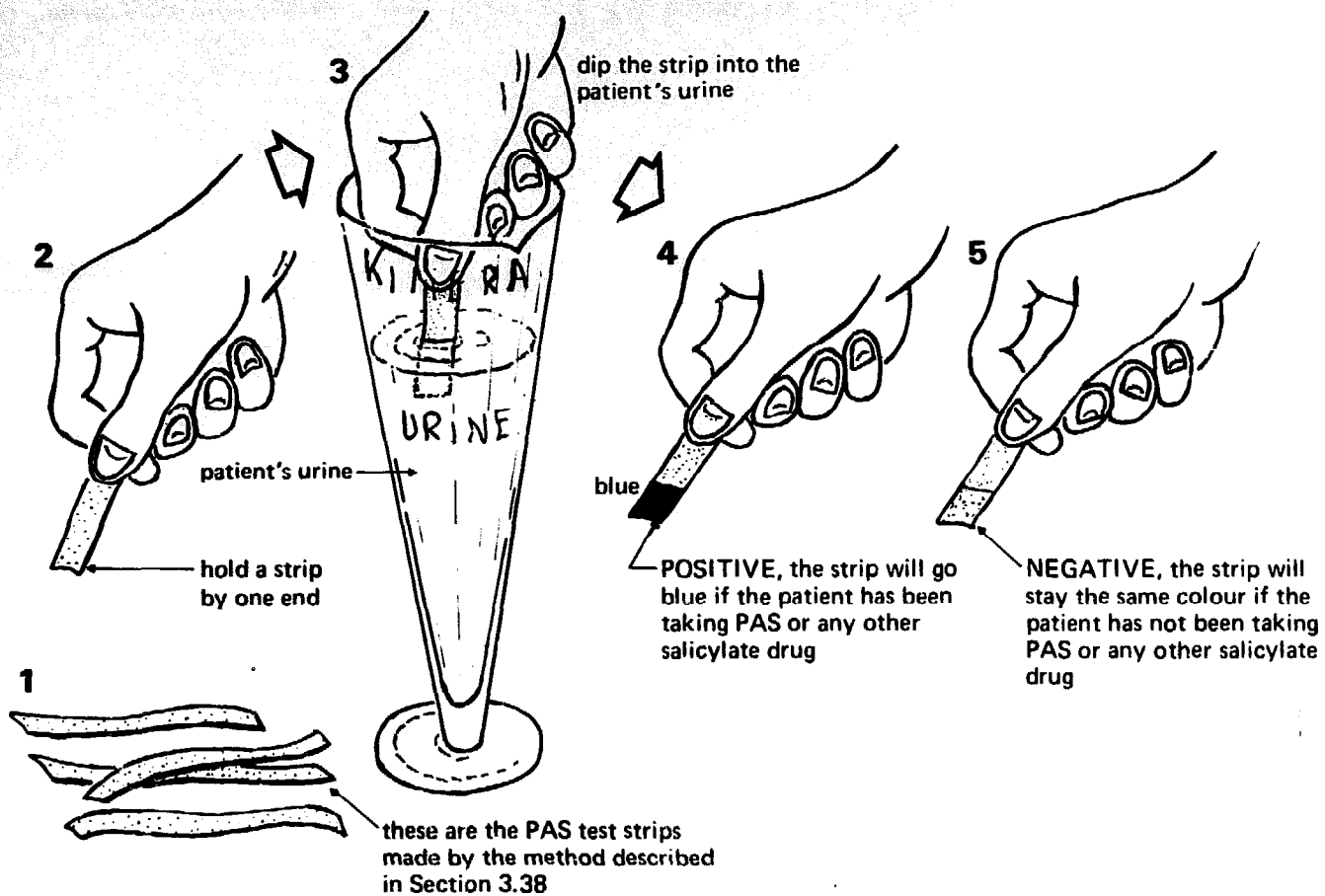

Fig. 8-6 Testing the urine for PAS

If a red colour forms within one minute, the patient is likely to have taken INH up to 12 hours before.

If the urine only goes pink within one minute, it is likely that the patient took his INH between 12 and 24 hours previously.

If the urine remains yellow, the patient has not taken any INH during the previous 24 hours.

There may be many urines from the tuberculosis clinic to be tested. When there are, number the specimens and number the holes, as shown on the tile in FIGURE 8-5. First put the four drops of each of the urines in the tile into their right holes. Next add the four drops of cyanide, then the nine drops of chloramine T.

This test will only work with INH that has been through the body and has been altered by it. It will not work with a solution of INH tablets.

METHOD

TESTING THE URINE FOR PAS. FIGURE 8-6

1. Make PAS test strips as described in Section 3.38.
2. Take hold of a paper by one end.
3. Dip the other end of the paper into the urine.
4. If the paper goes a brownish purple, there is PAS in

the urine. Some other drugs such as aspirin and the other salicylates also give this colour.

5. If the strip does not go brownish purple, there is no PAS (or aspirin or other salicylate) in the urine.

8.10 Testing the urine for sulphones

Sulphones, such as DDS (Diamino Diphenyl Sulphone), are drugs used to treat leprosy. It is often useful to know if leprosy patients are taking their sulphones, and the following method is a very easy one.

METHOD

URINE SULPHONES. FIGURE 8-7

1. Take one of the papers prepared in Section 3.43a.
2. Put a drop of urine in the middle of the paper.
3. If the test is positive, there will be a strong yellow ring within 10 seconds. If the yellow ring comes *after* 10 seconds, it is not due to sulphones.
4. If the test is negative, there is no yellow ring.

Don't make the papers too small, or the drop of urine too big. If you do, the coloured ring will go over the edge of the paper. By this method sulphone can be found in

the urine 60–90 minutes after 100 mg of DDS has been taken by mouth. This method is usually only positive if patients have been taking their sulphones regularly in doses of not less than 50–100 mg daily. If, however, they have been on these doses for a very long time, sulphones may be found in their urine for up to a month after they have stopped treatment.

MICROSCOPY OF THE URINE

8.11 Pus cells in the urine

Infection of the urinary tract was discussed in Section 8.4. You learnt that, when the urinary tract is infected,

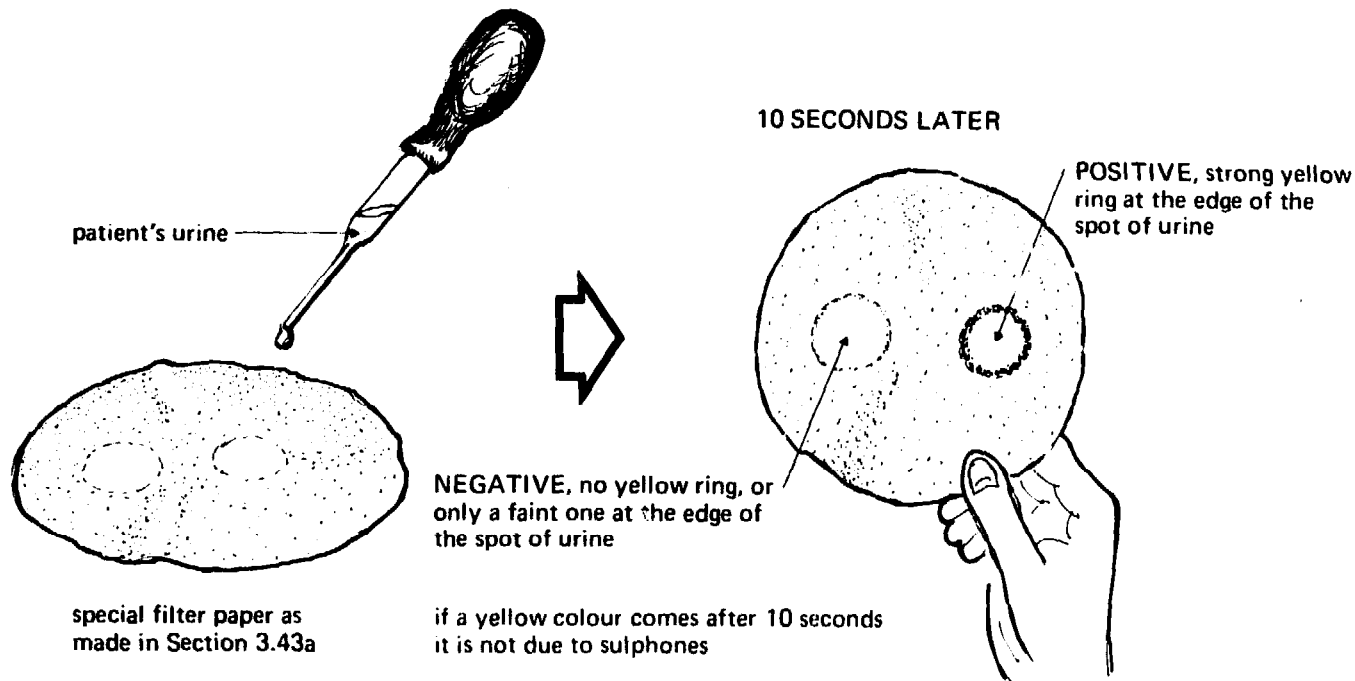

Fig. 8-7 Testing the urine for sulphones

protein, bacteria, and pus cells are usually found in the urine. Finding pus cells in the urine (pyuria) is a much more certain sign of urinary tract infection than finding protein. It is important therefore to be able to look at the urine for pus cells. This is easily done. Put a drop of the urine in a counting chamber, and then count the cells in it just as if you were counting cells in the blood (see Section 7.29) or the CSF (see Section 9.9).

METHOD

PUS CELLS IN THE URINE. FIGURE 8-8

1. Get a clean or mid-stream specimen of urine in a universal container as described in Section 8.1.
2. Mix the specimen well by shaking the bottle with the lid on. If the urine is not well mixed, all the pus cells may stay at the bottom of the bottle.
3. Put a coverslip on a counting chamber—look at Section 7.29 and Picture 2, Figure 7-21, to learn the

right way to do this. A Fuchs–Rosenthal chamber is best, but a Neubauer chamber can be used.

4. Fill a Pasteur pipette with the urine. Fill the counting chamber.

5. If a Neubauer chamber is being used, count the cells in one corner block of sixteen small squares and multiply by ten.

6. If a Fuchs–Rosenthal chamber is being used, count the number of pus cells in one corner block of sixteen small squares and multiply by five. In this way you will get the number of pus cells in 1 cu mm.

7. Some of the more important things to be seen in the urine are drawn in this Picture, which shows a high power view of urine in a counting chamber. Pus

cells are larger than red cells. They have many granules of different sizes which may look faintly greenish. Several segments of the nucleus can usually be seen, and there is often a clear area at the edge of the cell. Red cells are faintly yellowish-red; they are often crenated and have short points sticking out of them (see Section 7.25). Epithelial cells are much larger and flatter. They usually have a nucleus that is easily seen.

If at first you have difficulty in being sure about what blood cells and pus cells look like, put a loopful of blood or pus in a drop of urine, and look at it with a microscope.

8.12 What it means to find pus cells in the urine

In some countries healthy men seldom have any pus cells in their urine. In other countries a mild infection of the urethra (urethritis) is so usual that to have some pus cells

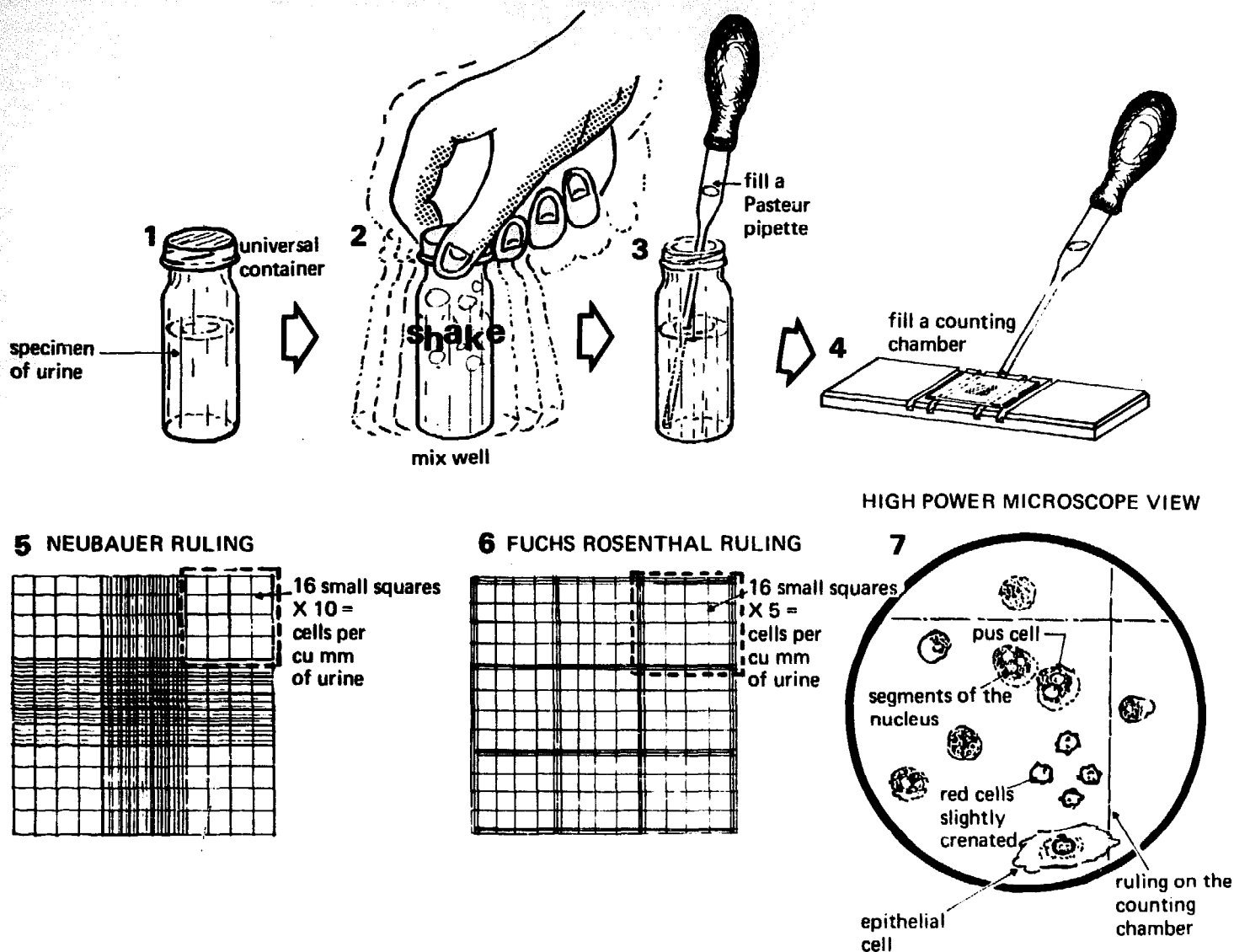

Fig. 8-8 Counting pus cells in the urine

in the urine may be more common than to have none. A few pus cells are also often found in the urine of healthy women everywhere. Because of this, it is usual to take some figure for the number of pus cells in the urine below which patients are said to be normal, and above which they are said to be abnormal, and to have an infection of their urinary tracts. Fifty pus cells per cu mm is a common figure to take. Patients with less than 50 pus cells per cu mm are thought to be normal. Patients with more than 50 pus cells per cu mm are thought to be abnormal, and to have a urinary tract infection. This is only a guide, but it is a useful one. In some countries 10 pus cells per cu mm is taken as the upper limit of normal.

8.13 Looking at the centrifuged deposit

In the last method, when we counted pus cells in the urine, we took care to make sure that the urine was well mixed. We looked at the urine itself and not the deposit.

In this method we look for several things in the spun deposit of urine.

METHOD
EXAMINING THE CENTRIFUGED DEPOSIT OF URINE

- Mix the specimen of urine.**
- Fill a centrifuge tube with urine.**
- Centrifuge for about 3 minutes with an electric centrifuge, or about 5 minutes with a hand centrifuge.**
- Pour away the supernatant urine.**
- Using a Pasteur pipette suspend the deposit in the last drop of urine and put it on a slide under a coverslip. Search the whole area of the coverslip with a low power objective. Then look at some fields with a high power objective.**

Be careful not to pour away the deposit as you pour away the supernatant urine. If a hand centrifuge has been used and the deposit is not well packed at the

bottom of the tube, pour away only the top part of the supernatant. Remove the last inch of supernatant urine with a Pasteur pipette, and mix the sediment with the last drop or two of urine.

Some of the things that can be seen in a urine deposit have been drawn in FIGURE 8-10. They have all been carefully drawn 'to scale'. That is, they have all been drawn the right size compared to one another. To show how big things are a line has been drawn at the bottom of the figure and marked in μm (see Section 6.1b). Beside it is a red cell, which you will remember is about $7.5 \mu\text{m}$ across. One of the most important things to look for are casts.

Casts

In the kidney there are millions of tubules (small tubes) through which the urine goes on its way to the bladder. These tubules are shown in Picture A, FIGURE 8-9. In many kinds of kidney disease these tubules become blocked with protein or the remains of dead cells (Picture B). Very often the solid substance blocking the tubule becomes loose and goes down the tubule and into the urine (Picture C). This material which was blocking the tubule and has come loose is called a cast. Because it was formed inside a tubule a cast has the shape of the tubule from which it came. Casts are usually shaped like the one drawn in Picture D. This is a diagram of a cast, and some drawings of casts can be seen in FIGURE 8-10.

Casts are seen in several kidney diseases, and there are several kinds of cast. To make things simple we shall consider only two kinds of cast—hyaline casts and granular casts. Hyaline (like glass) casts are clear or transparent (light can shine through them). They either have no granules in them or only a few granules. Normal urine often has some of these hyaline casts, and they do not mean that the kidney is diseased.

As their name says, granular casts are made of coarse granules. A granule is something very small and round like a small seed. Granular casts are not found in normal urine, and if they are found in the urine they mean that the patient has diseased kidneys. Very often this disease is serious. Granular casts are only found when there is protein in the urine. *All urines in which protein is found (++ or more) should be centrifuged, so that the deposit can be searched for casts under a microscope.* The finding of protein and granular casts may mean that a patient has chronic nephritis (see Section 8.4).

Two sorts of casts are shown in FIGURE 8-10: some granular casts in Picture 10 and some hyaline casts in Picture 11. The granules in Picture 10a are especially big. Casts often look as if they are partly empty inside as in Picture 10b. In Picture 10c there are the remains of a nucleus. The end of the cast in Picture 10d is twisted (turned) on itself and has nearly broken off.

The cast in Picture 11a is very nearly completely hyaline—that is, it is clear like glass. Those in Pictures 11b and 11c have many tiny granules, but even so these are very different from the big dark granules of the true granular casts in Picture 10. Nevertheless casts are sometimes seen which are partly granular and partly hyaline. If in doubt it is best to report them as granular casts. Other kinds of casts are also seen—cellular, waxy, and pigment casts; but these are not so common, and they will not be described here. It is probably best if you report all casts which are not hyaline as granular casts.

Other findings in the centrifuged deposit—Figure 8-10

The first four pictures in FIGURE 8-10 show the ova of *Schistosoma haematobium* which are described in more detail in Section 8.15.

The next pictures show various kinds of cell. Red cells

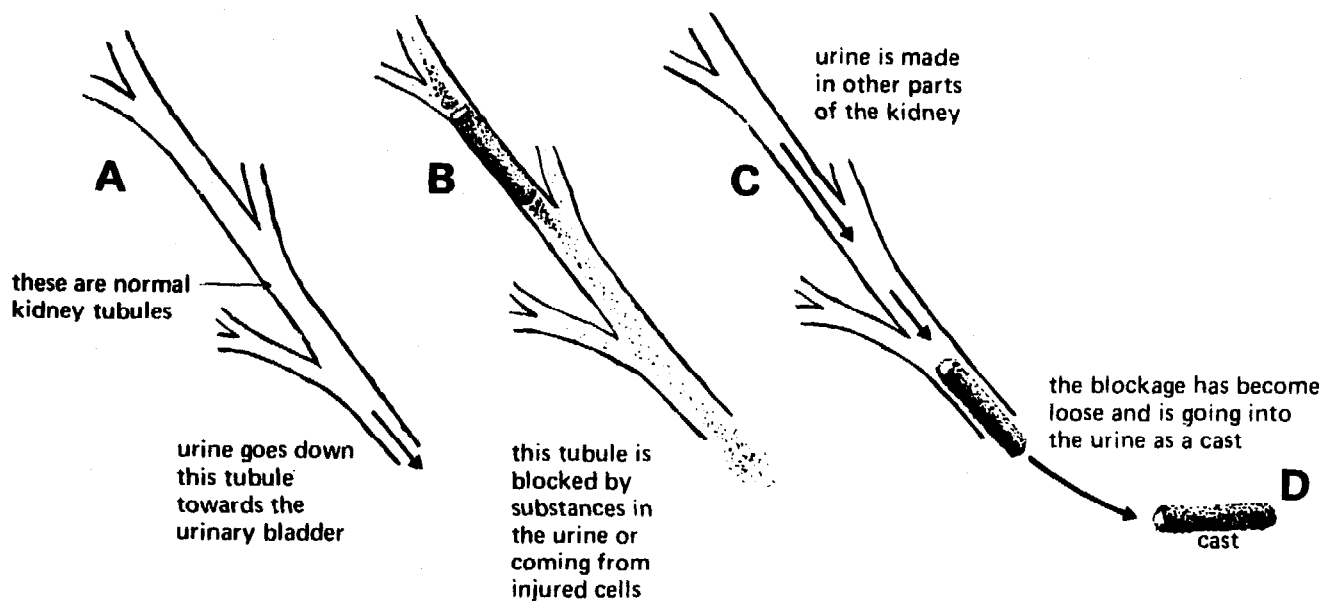
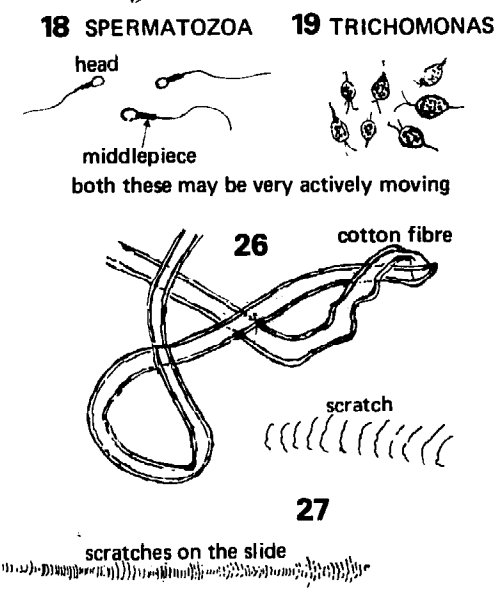
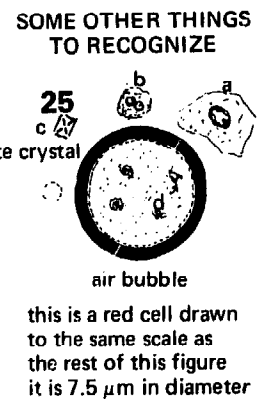
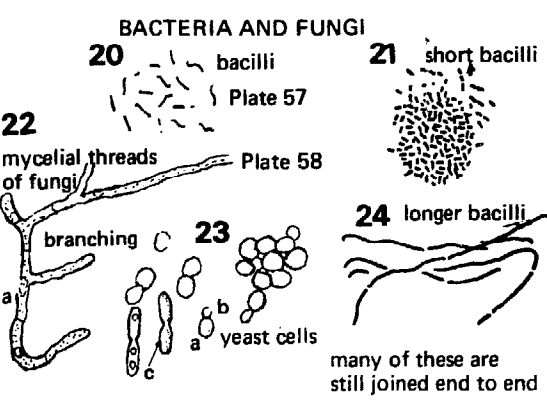
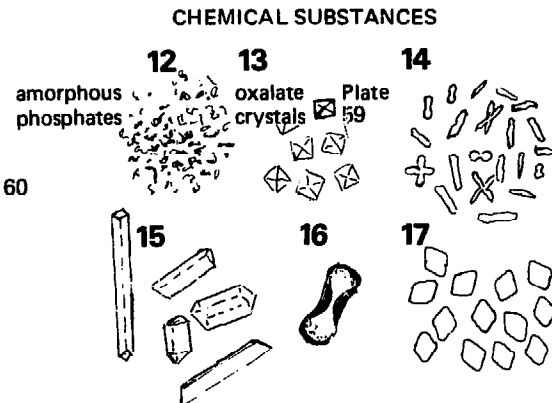
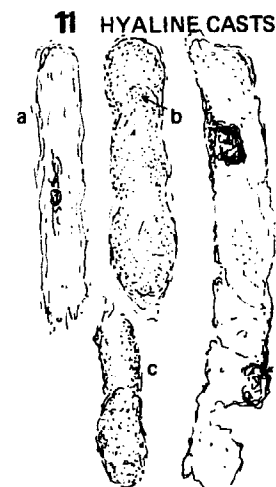
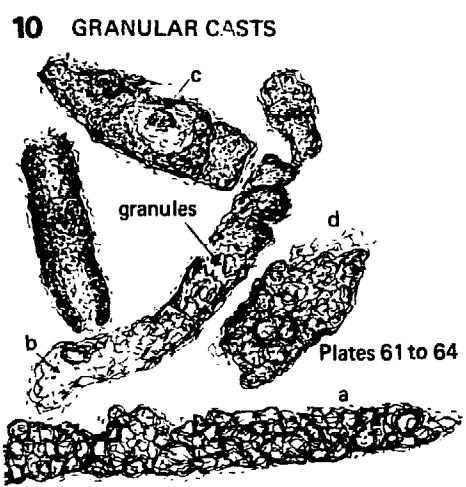
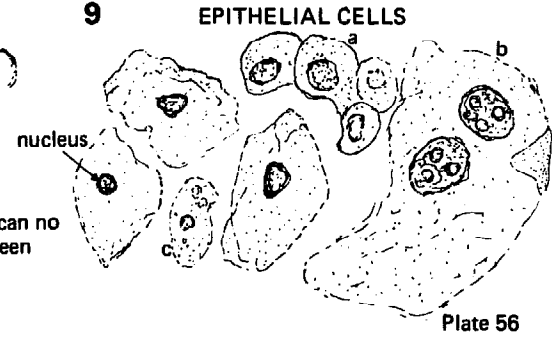
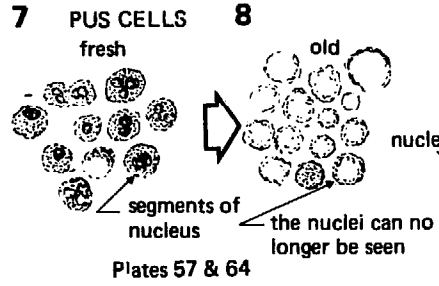
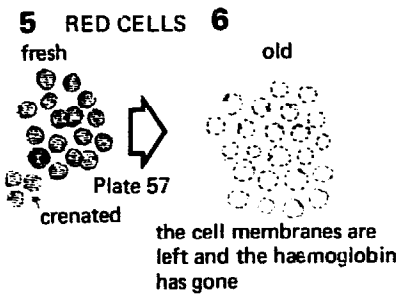
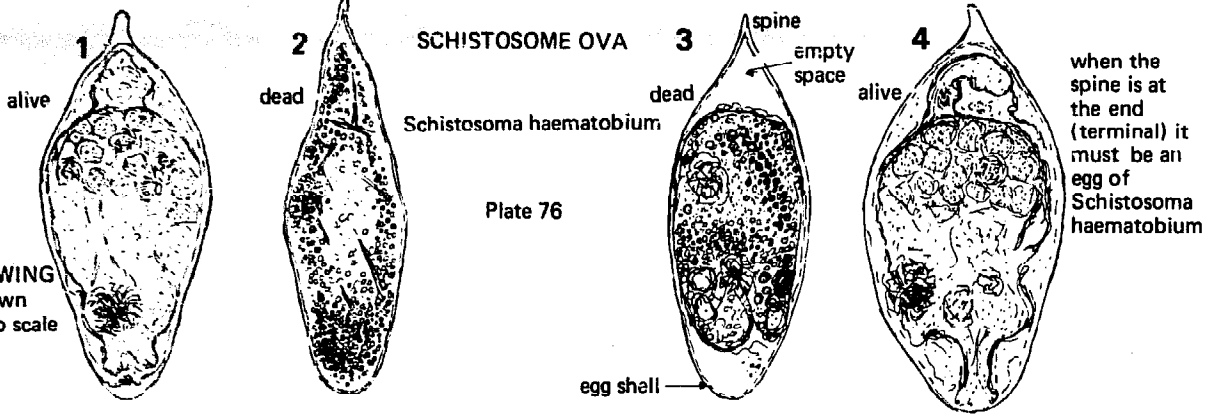

Fig. 8-9 Casts

THIS IS A DRAWING
everything is drawn
approximately to scale



if you find protein in the urine
always look at the spun deposit

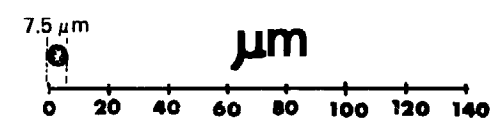

Fig. 8-10 Urinary deposits

are drawn in Pictures 5 and 6. The red cells in Picture 5 are fresh and would look slightly yellowish-red. The three cells at 'a' at the bottom of Picture 5 are slightly crenated (see Section 1.18), and their edges, instead of being smooth, are slightly rough. Crenated red cells are also drawn in FIGURE 7-15. In this figure they are drawn larger and their shape will be understood more easily. The red cells in Picture 6 are old and are being destroyed; the haemoglobin has mostly gone, and all that is left is the coat of the cell—its membrane or envelope. Partly destroyed red cells like this are often seen in the urine.

Patients who pass red cells in their urine are said to have **haematuria**. If there is enough blood in the urine it will be turbid, 'smoky', or even obviously red. Red cells are sometimes destroyed in the circulation, and haemoglobin rather than red cells may be passed in the urine. The patient is then said to have **haemoglobinuria**. His urine will be red and clear, and there will be no red cells to be seen in the spun deposit. Sometimes there are both haemoglobin and red cells in the urine.

Pus cells are drawn in Pictures 7 and 8. In Picture 7 they are fresh, and the nuclei can be seen quite easily. Pus cells are polymorph leucocytes which have come from the blood. They have a nucleus with several segments (see Picture G, FIGURE 7-9). These segments can often be seen with a high power objective. As pus cells are broken down and destroyed in the urine, their nuclei disappear and only the cell membranes remain. This has happened in Picture 8.

Epithelial cells are shown in Picture 9. These are large flat cells with a nucleus that can usually be seen quite easily. They come from the epithelium or 'skin' on the inside of the ureters, bladder, and urethra. Epithelial cells are usually single—that is, there is only one cell at a time. But groups of several epithelial cells are sometimes seen. A group of several epithelial cells is shown in Picture 9a and a very large epithelial cell with two nuclei in Picture 9b. Sometimes epithelial cells are more or less egg-shaped, as in Picture 9c. A few epithelial cells are found in normal urine. In this they are unlike red cells and pus cells, which are abnormal and only found in urine when there is some disease of the urinary tract.

When urine is formed in the kidney all the chemicals in it are in solution. But, after it has left the kidney, some of these chemicals may become solid and form a urinary deposit. Sometimes they form small solid granules without any special shape, as in Picture 12. Deposits of this kind are said to be **amorphous** (without shape). These deposits are very common. Often, however, these chemicals, as they become solid, take on the shape of crystals. When seen from on top the crystals in Picture 13 are square with a cross on them like the envelope in which you post a letter. These are oxalate crystals. Other kinds of crystal are shown in Pictures 14, 15, 16, and 17. But there are many other shapes also which have not been drawn here. The shape of the crystals often tells us what they are made of. But crystals in the urine seldom matter. They will not therefore be described any more here.

Picture 18 shows you what spermatozoa look like. Spermatozoa are the male sex cells which join with the egg inside a woman. From their joining a baby grows. Spermatozoa are often found in a man's urine and are quite normal. After sexual intercourse they may be found in a woman's urine.

Picture 19 shows you *Trichomonas vaginalis*. This protozoon is described in Section 11.8. It is often seen in the urine and gets into the urine from vaginal discharges. If you see a moving protozoon in the urine, it is almost certainly *T. vaginalis*.

Many micro-organisms are seen in the urine. Bacteria are common. Like all the very small things in this figure, bacteria are only seen well with a high power or oil immersion objective. Many bacteria are motile—that is, they move. The different kinds of motility are very important and are described in the next section.

Bacteria are very important *but only in fresh urine*—this is in urine which has been passed by the patient not more than an hour before, or which has been in a refrigerator for not more than 6 hours. Bacteria often grow in normal urine if it is left in a warm room. They get into the urine from a dirty jar, or from the air, or from the patient's skin. Finding bacteria in old urine therefore means nothing. But, when bacteria are found in fresh urine, this means that the patient has a urinary infection. When bacteria are seen in fresh or refrigerated urine, they must be reported. Usually there will be pus cells and protein present also.

A common kind of bacteria found in the urine is called *Escherichia coli*. It is a thin motile rod like a very small pencil. The bacteria drawn in Picture 20 might be *Escherichia coli*.

Other kinds of micro-organisms can often be seen in urine that has been left to stand in a warm place. The bacteria in Picture 21 are growing in a group (or colony) of many hundreds together. Another group of bacteria has been drawn in Picture 24. In this picture the place where the end of one bacillus joins the end of another has been left as a space, but they are really stuck together.

The threads or mycelium of a mould or fungus have been drawn in Picture 22 (see Section 11.15). The mycelium of moulds are longer and thicker than a bacterium, and they branch, as in Picture 22a. Some yeasts have been drawn in Picture 23. When yeasts grow, a parent cell 'a' often makes a daughter cell 'b', which is smaller and grows from one end. Some fungi can grow either as yeasts or as moulds. In Picture 23c two yeast cells have been drawn which look as if they are going to grow in the form of a mould.

Pictures 25, 26, and 27 in FIGURE 8-10 show some of the things which may muddle you if you do not know what they are. Picture 25 shows a small bubble of air, and around it is the urine with an epithelial cell 'a', a pus cell 'b', and an oxalate crystal 'c'. Inside the air bubble on the surface of the slide are some small bits of debris (dirt) 'd'. Picture 26 is a piece of cotton thread that has got into the urine. Picture 27 shows two scratches on the slide.

8.14 Three kinds of movement (FIGURE 8-11)

You will see three kinds of movement in a wet film of urine, stool, or blood. The first kind of movement is the movement of living micro-organisms themselves. We shall call it **motility** (movement). Motile bacteria in the urine, like *Escherichia coli*, can be seen swimming *from one place in the field to another*, as in Picture 1, while everything else stays still. Some other micro-organisms, such as trypanosomes, microfilariae, and amoebae, have their own special kinds of motility. Microfilariae and trypanosomes move very fast. Amoebae move very slowly (see Section 10.7).

The second kind of movement is called **Brownian movement**. If you look at *any very small particle* lying free in a liquid, you will see that it is always moving and

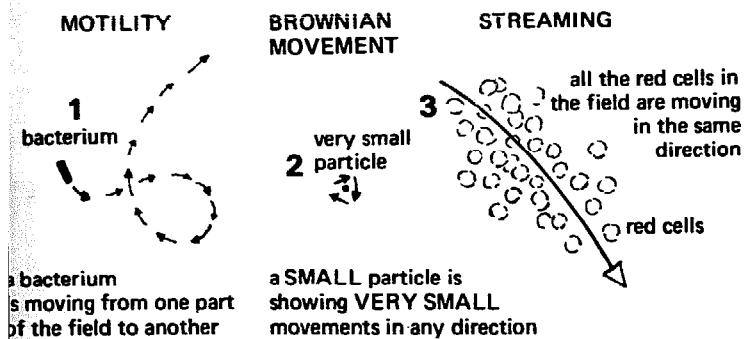

THESE ARE THREE MICROSCOPIC FIELDS

Fig. 8-11 Three kinds of movement seen under the microscope

is never quite still. These movements are very small and quite fast. They are in any direction (towards any place), and they can only just be seen. A small particle in the middle of Picture 2 is showing Brownian movement. Because the movements are very small and in any direction, *the particle does not move from one place to another*, but only shakes about.

The third kind of movement we will call **streaming**. If the coverslip over a wet film has not been properly sealed, the liquid dries up at the edges. This makes liquid move or stream out from the middle of the coverslip to the edges. In this streaming movement you will see a stream or river of particles moving in the same direction, and the rest of the field may be still. At other times everything in the field will be moving towards the same place. Streaming makes it difficult to look at things in a film. Some red cells are streaming across the field in Picture 3. Stop films streaming by sealing the edges of the wet film with vaseline and paraffin wax as shown in FIGURE 7-14.

8.15 Looking for the ova of *Schistosoma haematobium*

In some parts of the world one of the most important things to be found in the spun deposit of the urine are the ova of a worm which lives in the veins around the blad-

der. This worm is called *Schistosoma haematobium*. It lays eggs that go through the side of the bladder into the urine. The disease that it causes is called **schistosomiasis** or **bilharziasis**. With the ova in the urine there are usually also protein, red cells, and pus cells. Most pus cells are neutrophil polymorph leucocytes that have come from the blood. In schistosomiasis many of the pus cells may be eosinophils.

The ova of *Schistosoma haematobium* have been drawn in the first four pictures of FIGURE 8-10. In Pictures 1 and 3 the embryo (the little schistosome inside the egg-shell) is alive and is partly grown. It will soon be ready to leave the egg-shell and swim free in the water. In Pictures 2 and 4 the embryos are dead, and the egg-shells contain granules of different sizes. In Picture 4 the remains of the embryo have come away from the shell at each end. Notice that *S. haematobium* has a spine at the end of its shell—a terminal or end spine. In this it differs from *S. mansoni*. *S. mansoni* is almost always found in the stool and has a spine on one side (a lateral or side spine—look at Picture 5, FIGURE 10-7). The ova of *S. mansoni* with their spines at the side are sometimes seen in the urine, but this is rare.

When you are looking for the ova of *S. haematobium* you should take a specimen that has been passed by the patient between midday and two in the afternoon. It is in urine taken at this time that the ova of *S. haematobium* are most likely to be found. If it is not convenient to take an afternoon specimen, take any specimen and examine that. If you find the ova, well and good. If you don't, look at an afternoon specimen. There are more ova in the beginning and end parts of a specimen; so always take the first and last parts of a specimen whenever you look for the ova of *S. haematobium*.

The complete method is shown in FIGURE 8-12. Very often 10 ml of a well-shaken 2 p.m. specimen will show the ova, and the method can start at Picture 9, FIGURE 8-12. In this diagram the deposit has been drawn as if it was large and easily seen. This makes the diagram clearer, but when doing the method there is likely to be much less deposit than is drawn here. Even if no deposit can be seen, follow the method just the same, and do all the steps just as if you could see a deposit. Schistosome ova are very small, and even if you can see no deposit with your eye you may still be able to find ova with a microscope.

METHOD

EXAMINING THE URINE FOR THE OVA OF *S. HAEMATOBIMUM*. FIGURE 8-12

1. Ask the patient to pass his urine into a large bottle at two o'clock in the afternoon.
2. Shake the bottle well.
3. Fill a specimen glass with it.
4. Let the specimen glass stand for at least 30 minutes.
5. At the end of this time any schistosome ova will have fallen to the bottom of the specimen glass.

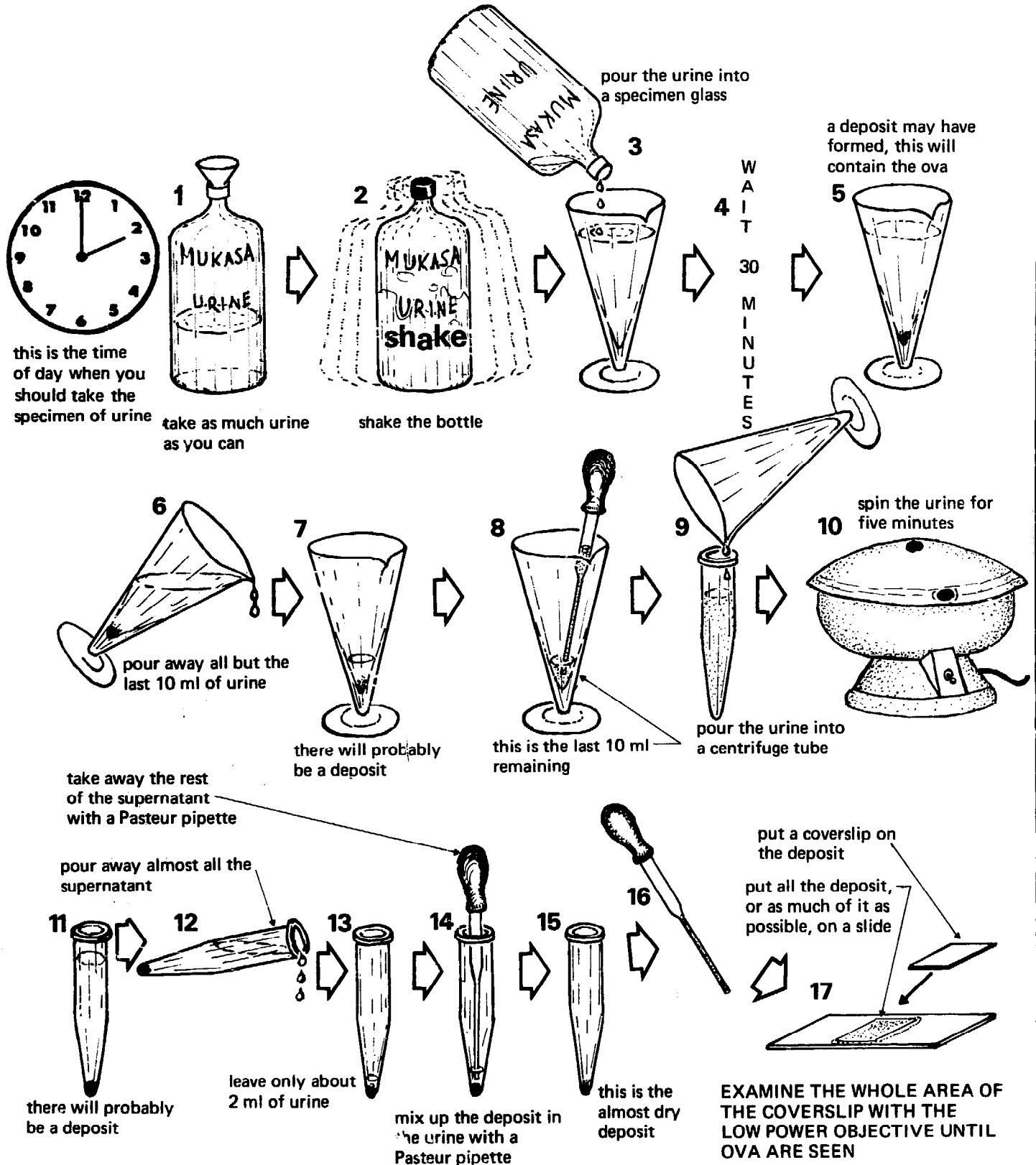

Fig. 8-12 Examining the urine for *Schistosoma haematobium*

6. Without disturbing the deposit, carefully pour away the supernatant urine so that only 10 ml is left (7).

8. With a Pasteur pipette carefully mix the deposit with the last 10 ml of urine.

9. Pour this urine, which has the deposit mixed in with it, into a 10-ml centrifuge tube.

10. Centrifuge for at least 2 minutes. An electric centrifuge is shown in this diagram, but a hand one will do very well.

11. A deposit will usually be seen at the bottom of the tube.

12. Pour off all but the last 2 ml of urine (13).

14. With a Pasteur pipette remove and throw away all but the last drop of urine above the deposit (15).

16. Mix the deposit in the last drop of urine, and take it all into a Pasteur pipette.

17. Place the last drop of urine with the deposit on a slide. Cover it with a coverslip. Using the low power of the microscope, search the whole slide until ova are found. Follow the method shown in Figure 6-14.

Count and report the number of ova you see. Report also how much urine you looked at. Reports might read like this:

'5 ova of *S. haematobium* found in a deposit from 10 ml of urine.'

'About 50 ova of *S. haematobium* found in the deposit from about 100 ml of urine.'

'Over 1,000 ova of *S. haematobium* found in the deposit from 200 ml of urine.'

In countries where *S. haematobium* is found, look for their ova in the urine of any patient who says he is passing blood in his urine, or who has proteinuria, dysuria, or frequency.

QUESTIONS

1. What is a pus cell? Where might you find them? What do they look like?

2. What different kinds of movement can you see when you look at a wet film with a microscope?

3. What is a cast? How would you look for them, and what does it mean if you find them?

4. Why do we test the urine for sugar? What does the finding of much sugar and acetone in the urine mean?

5. List six things that might be found in a urinary deposit. What do they mean?

6. What is PAS? Why and how do we test the urine for it?

7. What is bilirubin? What is it formed from? Where is it found? How may it leave the body?

8. What does it mean to find protein in the urine?

9. How can urinary schistosomiasis be diagnosed?

10. What micro-organisms are found in the urine?

9 | The Cerebrospinal Fluid

Lumbar puncture is usually done only on seriously ill patients. If the wrong reports are sent the wrong treatment may be given and the patient may die. Specimens of CSF are therefore some of the most important specimens ever sent to a medical laboratory.

THE CSF AND HOW IT IS OBTAINED—SOME HELP FOR MEDICAL ASSISTANTS

9.1 Where the cerebrospinal fluid comes from

The spinal cord is a big nerve which joins on to the bottom of the brain. It is about as thick as the end of your little finger and goes down the back inside the many bones (vertebrae) which form the spine. The spine is also called the vertebral column or backbone. The brain and spinal cord are soft and easily hurt and are protected by being covered with several coverings or membranes. These coverings are called the **meninges**. When they are infected by micro-organisms the patient is said to have **meningitis**. Close around the brain and spinal cord is a thin membrane called the **pia mater**. Around this is a loose membrane rather like a spider's web. This is called the **arachnoid mater**. Outside this is a thick membrane called the **dura mater**. This lies close inside the bones of the skull and the spine.

We have said that the arachnoid mater is a loose membrane like a spider's web. From this you might think that there would be air between the threads of the web. Instead of air there is a clear, saline solution called the **cerebrospinal fluid** or **CSF**. The CSF is everywhere between the threads of the arachnoid mater and washes all round the brain and the spinal cord. The space filled with CSF is called the **subarachnoid space**. When the brain or the membranes covering it are diseased, it is useful to take a specimen of CSF from the patient and look at it. This can be done by putting a needle into the subarachnoid space and letting some CSF come out. The needle is put

Footnote. The first few sections of this chapter on the diagnosis of meningitis have been written in the belief that meningitis is too often missed and that lumbar puncture is not done nearly often enough or well enough. It is in line with other chapters which describe how specimens are obtained, as well as how they are examined, and is intended primarily for those parts of the world where health centres are run by medical assistants.

into the lower part of the back or lumbar region, and putting it in is called **lumbar puncture**.

FIGURE 9-1 will explain all this more clearly. On the left, in Picture A, is the skull (the bones of the head) and underneath it is the spine. In Picture B the skull and the spine have been cut down the middle. The brain can be seen inside the skull and the spinal cord inside the spine. Between the brain and the skull, and between the spinal cord and the spine, you will see the subarachnoid space filled with CSF. You will see that the spinal cord ends before it reaches the bottom of the subarachnoid space. In Picture B the lower part of the subarachnoid space has been drawn as if it were nearly empty, but in a living person it is full of spinal nerves which leave the spinal cord through holes between the vertebrae. To make the picture simpler only one of these nerves has been drawn.

If a needle is put into a patient's back between the vertebrae and pushed into the subarachnoid space, the CSF will flow out. Such a needle has been drawn in Picture B. When the spine is straight the vertebrae are close together, and it is difficult to put a needle into the subarachnoid space. The patient's spine must thus be bent if the needle is to get into the subarachnoid space. This is easier if the patient lies on his side. In Picture C such a patient has been drawn lying on his side with his back bent and his knees close up under his chin. There is a needle in his back, and CSF can be seen dripping out of it. In Picture D such a patient has been cut in half. The needle can be seen going into the subarachnoid space in between the spinal nerves.

The most common reason for doing a lumbar puncture is to see if a patient has meningitis.

9.2 The importance of lumbar puncture

Meningitis in babies and young children is different from meningitis in older children and adults. Babies and young children get meningitis more often. They get different kinds of meningitis. They are affected differently by it and are diagnosed in different ways. Babies are also more easily lumbar punctured. *Much of what you will read in the next sections depends upon these differences.*

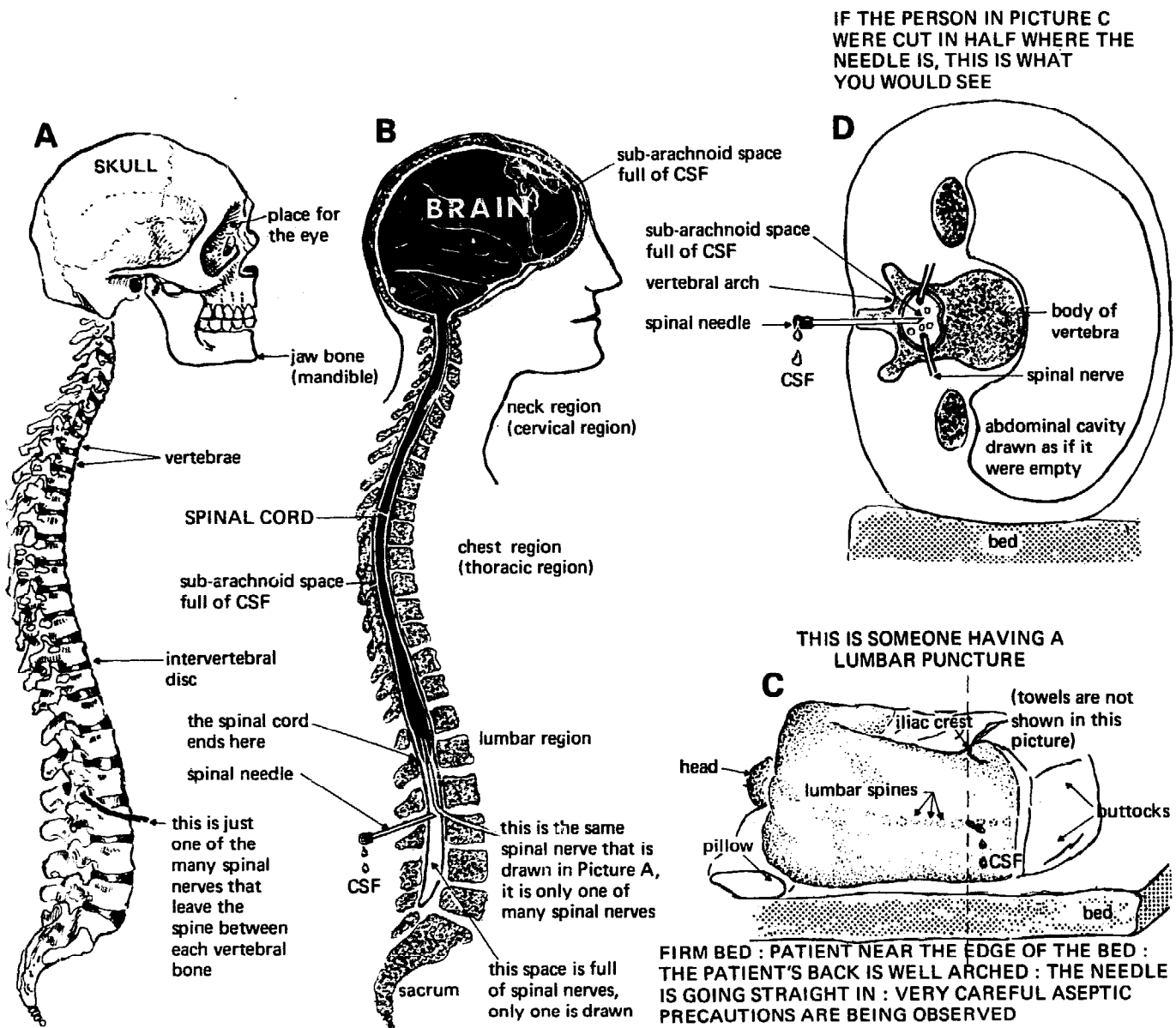

Fig. 9-1 Where the CSF comes from

If a patient is thought to have meningitis the first part of the diagnosis is to make sure that he really has got meningitis and not some other disease. The second part of the diagnosis is finding out what kind of meningitis he has. In adults and older children the history and examination of the patient will usually tell us if a patient has meningitis, even without a lumbar puncture. In babies and young children we have often to do a lumbar puncture before we can tell that they have meningitis and not some other disease. After meningitis has been diagnosed we must know what kind of meningitis it is. For this, lumbar puncture is always necessary.

Meningitis is easily diagnosed in adults and older children. Such patients are not common and can usually be admitted (taken) into a hospital ward for lumbar puncture. *But there are almost always too many young children and babies for all those who might have meningitis to be admitted to a ward. If meningitis is to be diagnosed*

these children must therefore be lumbar punctured in health centres and outpatient departments. Medical assistants in health centres must thus be taught how to diagnose meningitis by lumbar puncture. This means that health centres must have the right equipment, both for the puncture itself and for looking at the CSF afterwards. It is also useful to be able to examine the CSF in an outpatient department.

9.3 Diagnosing meningitis (FIGURE 9-2)

It is usually easy to tell if an adult or older child has meningitis. He looks ill, he lies with his head back and his eyes shut, and he does not want to be moved. If he is old enough, he may tell you he has a headache. But a baby or young child may show none of these things. All he may show is fever (for which there is no other cause), fits, abnormal sleepiness, or, if he is very young indeed,

A HEALTHY PERSON

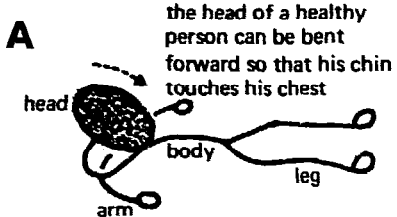

diagnosis

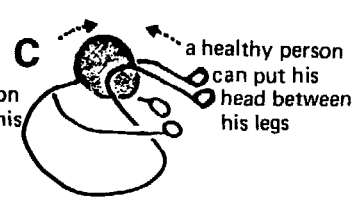
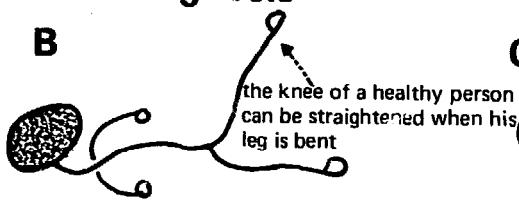

A PATIENT WITH MENINGITIS

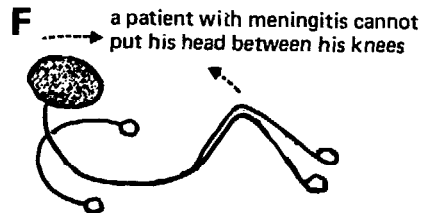
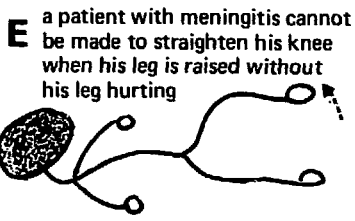
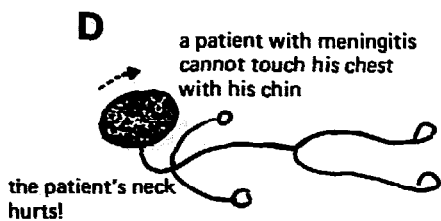

a baby's skull

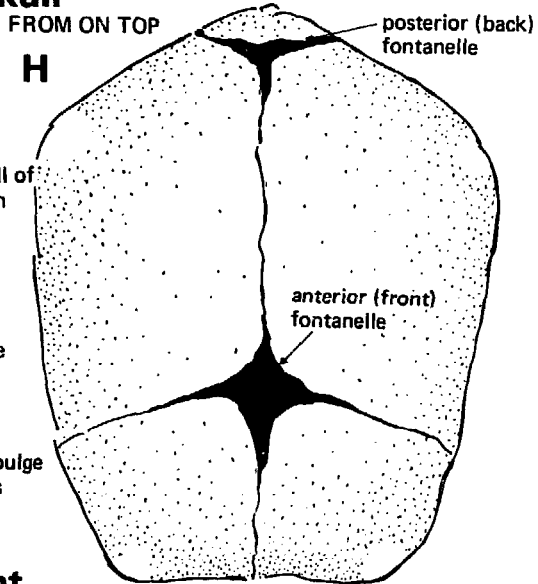
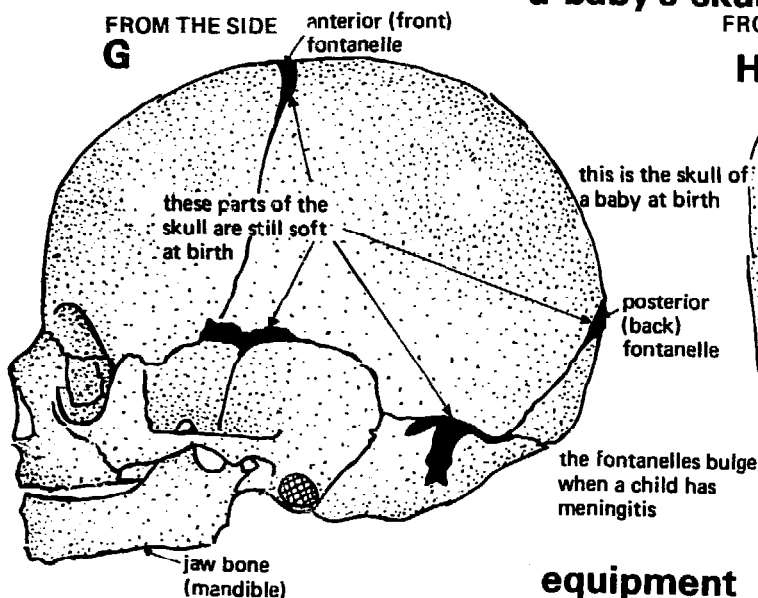

equipment

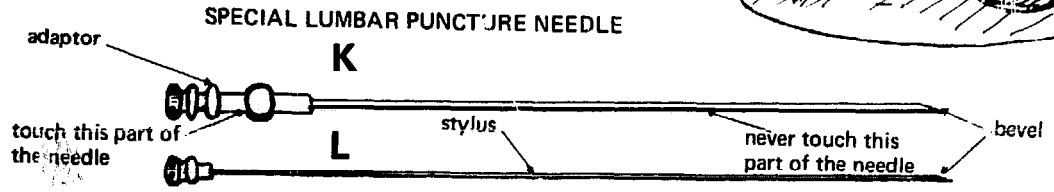
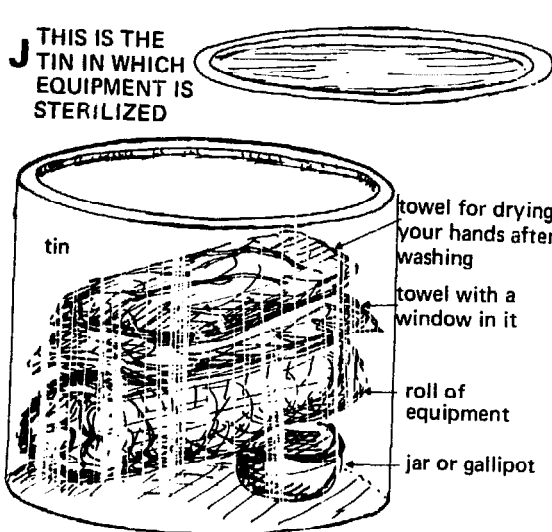
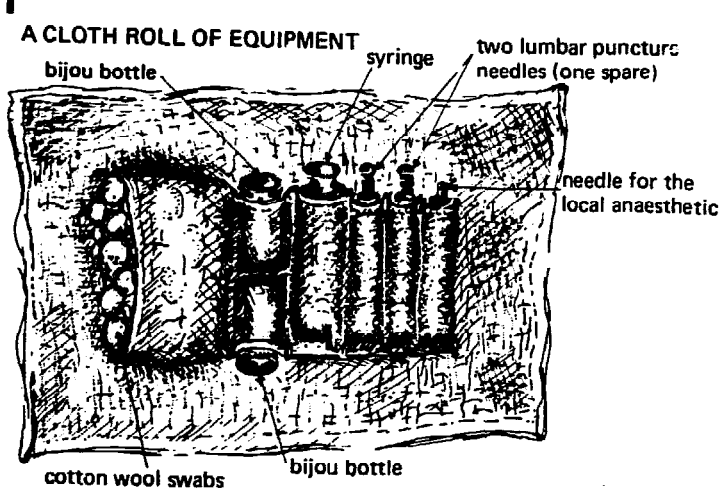

Fig. 9-2 The signs of meningitis

he may just stop suckling. *These are the children who need lumbar puncture.*

There are three useful ways of examining an adult or older child to see if he has meningitis. In the first way lie the patient on his back. Put your hand behind his head and lift it so that the patient's chin touches his chest. You will find that you cannot do this because the patient's neck feels stiff and hurts when it is moved (Picture D). The chin of a normal person or of a patient who has not got meningitis can easily be made to touch his chest (Picture A). Most older patients with meningitis have this 'neck stiffness'.

The second way is a similar one that you can do with the legs of patients who you think might have meningitis. If you lie a normal person on his back, and bend one of his legs forward over his abdomen (stomach), you will still be able to straighten his knee quite easily (Picture B). If, however, the patient has meningitis you will be unable to straighten his knee when his leg is bent forward over his abdomen. If you try, the muscles at the back of his leg will feel stiff and will hurt as they are pulled on (Picture E). When this happens the patient is said to show a positive Kernig's sign and is likely to have meningitis.

The third method is to try to get a patient's head between his knees. If the patient has not got meningitis you will probably be able to do this quite easily (Picture C). If the patient has meningitis you will be unable to get his head between his knees, because the meningitis will make his back too stiff (Picture F).

Young children and babies may show none of these signs. They have, however, a special sign of their own. This is the 'bulging fontanelle'. Bulging means swelling or sticking out. The fontanelles are the soft places between the bones of a baby's skull and are shown in Pictures G and H. The fontanelles bulge because the pressure inside the skull is increased. Meningitis is the most important cause of an increased pressure inside the skull. The fontanelles close up as a child grows older; so a bulging fontanelle is not seen in older children and adults. To find this sign put your hand on the baby's head and feel for these fontanelles. Are they normal or are they bulging?

9.4 Equipment for lumbar puncture

In adults and older children a special lumbar puncture needle is necessary. This is longer and stronger than the needles that are used for giving injections and has a stylet inside it. A stylet is a wire that goes down inside the needle and closes its end. This needle and its stylet are shown in Pictures K and L, FIGURE 9-2. When the needle is in the subarachnoid space, CSF will only come out when the stylet has been removed.

In babies a thin sharp intramuscular needle can be used for lumbar puncture, but it is better to use a special small lumbar puncture needle and stylet. Intramuscular means 'between the muscles' and is the name given to the kind of needle that is used for giving injections. A stylet is not needed.

A LUMBAR PUNCTURE NEEDLE MUST BE STERILE. If the needle is not sterile, or if micro-organisms get on to it from your hands while lumbar puncture is being done, *the patient may get meningitis from the needle.* If you are not careful the micro-organisms on the needle may infect the patient's meninges. *Lumbar puncture can therefore be very dangerous* and **MUST** be done with very good aseptic precautions like those described in Section 1.22. There are two ways of sterilizing lumbar puncture needles. They can be sterilized in boiling water, or they can be autoclaved in a pressure cooker (see Section 1.21).

The equipment for lumbar puncture can also be prepared in two ways. The complete equipment can be sterilized in a cloth roll with pockets like that in Picture I, FIGURE 9-2, and kept sterile until it is needed. This is often very useful. In a young child lumbar puncture can also be done with nothing more than a sterile intramuscular needle. We will describe both ways, but, before describing them, here is one very important word of warning.

Before you first do a lumbar puncture, you must ask someone who knows how to do it to show you. Watch how he does it. Then ask him to watch you doing a lumbar puncture on at least one adult and one child. After that you may be able to do a lumbar puncture with only an assistant to hold the patient.

Until you have done many lumbar punctures, always read the method again before you start.

METHOD

PREPARING A SET OF LUMBAR PUNCTURE EQUIPMENT, PICTURES I and J, FIGURE 9-2

Prepare a cloth roll like that shown in Picture I. Make pockets for two lumbar puncture needles, two thin intramuscular needles, some swabs, a syringe, and two bijou bottles for the CSF.

Find a tin with a lid that will both hold the roll and go into the pressure cooker. Put a small bowl or jar (a 'gallipot') into the tin. Put the roll of equipment on top of it. Find a theatre towel and cut a round hole or window in the middle of it about 10 cm across. This is to put across the back when you do the lumbar puncture. Fold this towel and put it on top of the roll of equipment. On top of this put a small towel to dry your hands. Put the things in the tin in this order, because this is the order in which you will want them.

Put the tin with the equipment and towels *on its side* in the cooker. This will allow the air to be driven away by the steam more easily—see Section 1.21. Put the lid beside the tin but not on it.

Autoclave the tin at 15 lb for 15 minutes.

Take out the tin without touching anything inside it and immediately shut its lid. Put a piece of adhesive tape across the edge of the lid. Write the word 'Sterile' on it and the date. This roll can be kept until it is wanted. It should be sterilized each month, even if it has not been used.

9.5 Doing a lumbar puncture

Now that you have prepared the equipment you can do a lumbar puncture.

METHOD

DOING A LUMBAR PUNCTURE. PICTURE C, FIGURE 9-1

Lay the patient on his side on the edge of the bed. Ask a nurse to put one hand behind his head and the other hand behind his knees. *Ask her to bend his back as much as possible so as to open up the spaces between the vertebrae.*

Swab the lower part of the back (the lumbar region) three times with iodine, using a fresh piece of gauze each time. Use tincture of iodine, which is a solution of iodine in spirit, not Lugol's iodine.

Open the lid of the tin, but don't touch anything inside it.

Scrub your hands well with soap and water, if possible under a running tap. From now on your hands are sterile and must not touch anything unsterile until lumbar puncture is finished. Dry your hands on the sterile towel in the tin.

Put the second sterile towel with the 'window' in it across the patient's back, so that the window is over the lower part of the back where you want to put in the needle.

Feel for the iliac crest through the towel. The iliac crest is the top part of the pelvic bone. Follow a line from the iliac crest down across the back. This line is shown in Picture C. This will cross the fourth lumbar spine or the space between the third and fourth spines. You can easily feel the lumbar spines and the spaces between them through the skin. You can put your needle into any space provided it is below the second spine.

Wet the ends of your fingers with iodine and keep them wet while you touch the needles.

Inject about 1 ml of local anaesthetic, such as 2% lignocaine or procaine solution into the skin in the middle of the space where you want to put the lumbar puncture needle. If possible, take the local anaesthetic from an ampoule, not from a rubber-capped bottle.

Take the lumbar puncture needle and push it between two spines through the place where you have injected the local anaesthetic. Push the lumbar puncture needle straight forwards. Some people try to point it at the umbilicus. You will feel the needle suddenly go in more easily as it goes into the subarachnoid space.

Take out the stylet. CSF should come out of the needle. If no CSF comes out, turn the needle round, put back the stylet, and take it out again. If still no CSF comes, ask the patient to strain so as to raise his CSF pressure.

If the needle hits bone, pull it out a little, make sure its direction is right, and push it in again. If you still cannot get any CSF try the next space.

As soon as CSF flows, put about 5 ml into each of the two bottles.

If the child is under 3 years you can do a lumbar puncture like this.

METHOD

LUMBAR PUNCTURE WITH AN INTRAMUSCULAR NEEDLE

Choose a long, thin, sharp intramuscular needle. *Boil it together with a small bowl for at least 5 minutes in fast-boiling water.* Lift the bowl out of the boiling water with a pair of sterile forceps. Lift the needle out of the boiling water with the sterile forceps and put it in the bowl. Touch only the adaptor with the forceps.

Wash and have the child held as described above.

Hold the intramuscular needle by the adaptor and push it into the space between the vertebrae. It will go in very easily. You will need only 2 or 3 ml of CSF.

Watch these points very carefully. If you do not watch them carefully, you may give your patient meningitis by putting the micro-organisms on your hands or a dirty needle into his CSF.

KEEP THE NEEDLE STERILE. Never touch any part of a needle except the adaptor with your fingers. Never put the needle anywhere unsterile before you put it into the patient. If you are using a sterile roll of equipment, put little glass tubes or test tubes in the pockets of the roll for the needles. If you want to put a needle down before putting it into the patient again, put it into one of these sterile tubes.

Dip your fingers into iodine before you touch the needle. If micro-organisms remain on your fingers after you have washed them, this will help to kill them. Some people like to use spirit or an antiseptic called Cetrimide, but iodine is a better antiseptic.

If you can, wear sterile surgical gloves and a surgeon's mask.

If you are putting a needle into a patient's CSF, take it straight out of boiling water. Don't let it stay at the bottom of a wet dish where it may become infected again before you use it. A freshly boiled needle is safer than one which has been badly autoclaved or stored too long.

If lumbar puncture is going to be easy, the patient must be held properly. His back must be bent as much as possible and must be right on the edge of the bed. The bed or bench should be firm and flat.

Put the needle into the *middle* of the space between the vertebral spines. Put the needle in straight. It must not be sloping, either upwards or downwards or towards the legs. Some people point the needle *very slightly* towards the head as they put it in.

Each lumbar puncture needle has its own stylet. Don't mix them up.

HOW THE CSF IS EXAMINED

9.6 Two specimens of CSF

Two specimens of CSF should be sent to the laboratory for each patient. Specimen One is the first few millilitres

of CSF to flow out of the lumbar puncture needle. Specimen Two is the CSF that comes next. Sometimes a doctor or medical assistant has difficulty in getting his lumbar puncture needle between the vertebrae into the subarachnoid space. He may have to try several times, and the patient may bleed a little from the needle hole into the CSF. This is often called a 'bloody tap'. When it happens the first specimen of CSF will probably contain most of the blood, and the second specimen may contain little or none. If there are two specimens, try to do as many tests as possible on the second one.

Clear or turbid?

The first thing to do with a specimen of CSF is to look at it. Normal CSF is perfectly clear—like pure water. When there are about a hundred cells per cu mm in the CSF it will look very slightly turbid. Hold the specimen up to the light—if it is not clear like water it is likely to contain at least a hundred cells per cu mm.

Colour

Next look at the colour of the CSF—some specimens of CSF are yellow. If there is blood in the CSF the yellowness may only be seen in the supernatant fluid after the specimen has been centrifuged. Yellowness of the CSF is called **xanthochromia**.

9.9 Cells (Normal, less than 5 per cu mm)

White cells are looked at in two ways. We count the number of cells per cu mm of CSF. If necessary, we also spread the cells in the centrifuged deposit on a slide and stain them with Gram's stain or Leishman's stain.

Cells in the CSF are counted in the same way as cells in the blood, but, because there are fewer cells in the CSF, it is best to use a deeper chamber which will contain more CSF. A Fuchs–Rosenthal chamber 0.2 mm ($\frac{1}{5}$ mm) deep is therefore better than a Neubauer chamber which is only 0.1 mm ($\frac{1}{10}$ mm) deep. But a Neubauer chamber can, if necessary, be used for both blood and CSF. So as to save money it is the only chamber in the main list of equipment. There is, however, a Fuchs–Rosenthal chamber in Choice 5, Section 13.18. These chambers are described very carefully in Section 7.29. Ways of using both chambers for CSF are described in FIGURE 9-3. This shows drawings of the three different kinds of counting chamber that you may have. You will see that in each chamber there are several blocks of sixteen small squares.

When there are many cells in the CSF

If there are many cells, say more than fifty in each cu mm, it will be enough to count the cells in one block of sixteen small squares. With the Neubauer chamber, multiply the number you find by ten. With the Fuchs–Rosenthal chamber, multiply the number you find by five

because it is twice as deep. This is shown in Pictures A and B, FIGURE 9-3.

When there are few cells in the CSF

If there are a few cells in the CSF, a larger area of the chamber must be counted. This is especially important if there are about five cells per cu mm because this is the number that divides the normal from the abnormal.

If there are few cells in the CSF, and you are using the Neubauer chamber, count the cells in the whole ruled area and then count one more block of sixteen small squares a second time (it does not matter which). This will be $9 \times 0.1 \text{ cu mm} + 0.1 \text{ cu mm} = 1.0 \text{ cu mm}$. This way of counting is shown in Picture C. Provided the CSF has not been diluted, this will be the number of cells in 1 cu mm and no multiplying will be needed.

It is because counting the whole ruled area of a shallow Neubauer chamber takes so long that the deep Fuchs–Rosenthal chamber is used. With this chamber you need only count five blocks of sixteen small squares. This is $5 \times 0.2 = 1.0 \text{ cu mm}$. It is shown in Picture D. Provided that the CSF has not been diluted no multiplying is needed. The ruled area in the modified (altered) Fuchs–Rosenthal chamber (Picture D) is smaller than that in the standard Fuchs–Rosenthal chamber (Picture E). The modified chamber is the one in the main list of equipment.

The cells in the CSF can be counted by putting CSF straight into a chamber undiluted and unstained. This may be the best thing to do if one single-celled chamber is all you have. But, if you have a double-celled chamber (or can use two single-celled chambers), it is best to dilute the CSF with an equal volume of white cell diluting fluid. This is the same fluid that is used to count the white cells in blood (see Section 7.29). This fluid destroys (haemolyses) any red cells present and stains the white cells blue. Staining makes the white cells easier to see. If you are looking at plain CSF in a single chamber and you find it difficult to decide what kind of cells you are seeing, it may help if you clean the chamber and look at more CSF, this time diluted with white cell diluting fluid. *If CSF has been diluted with an equal volume of white cell fluid, the number of cells counted must be multiplied by two to make up for this dilution.*

It is important to know what kind of white cells there are in the CSF. Are they polymorphs or lymphocytes? It is usually easy to see which they are by looking at them carefully in a counting chamber with a high power objective. If the CSF has been diluted with white cell diluting fluid, you will easily see the nuclei of the white cells. The nucleus of a polymorph has several segments. The nucleus of a lymphocyte is round or nearly round. Always look at white cells in a counting chamber carefully in this way. You can also tell if the cells are polymorphs or lymphocytes by looking at them in a Gram-stained film (a Leishman film is better), but this is not usually necessary. The main use of a Gram film is to stain bacteria.

In normal blood there are about 5,000,000 (five mil-

A NEUBAUER RULING

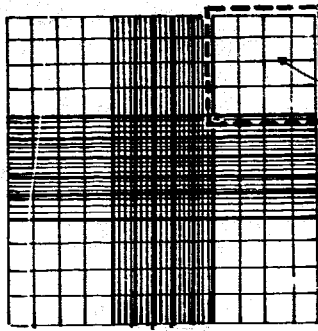

many cells

for undiluted CSF count the cells in 16 small squares and multiply it by 10

B MODIFIED FUCHS-ROSENTHAL RULING

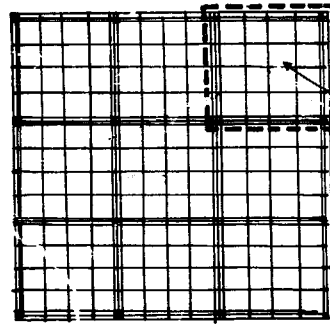

for undiluted CSF count the cells in 16 small squares and multiply it by 5

C NEUBAUER RULING

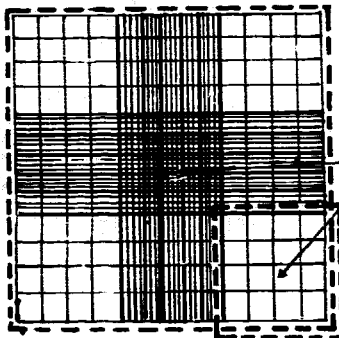

few cells

for undiluted CSF count the cells in all parts of the ruled area and in one extra block of 16 small squares : this will be one cubic mm and there is no need to do any multiplying

D MODIFIED FUCHS-ROSENTHAL RULING

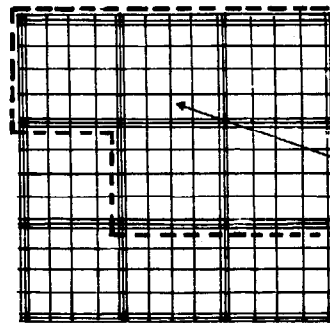

for undiluted CSF count the cells in five blocks of 16 small squares : this is one cubic mm and there is no need to do any multiplying

E STANDARD FUCHS-ROSENTHAL RULING

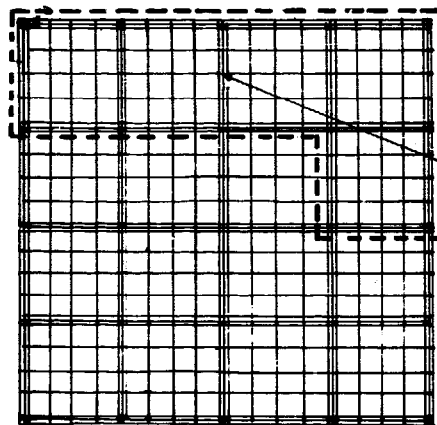

these dotted lines are in the diagram only : they are not ruled on the chamber

some Fuchs-Rosenthal chambers are made like this : five blocks of 16 small squares are one cubic mm.

F MICROSCOPIC VIEW THROUGH THE HIGH POWER OBJECTIVE

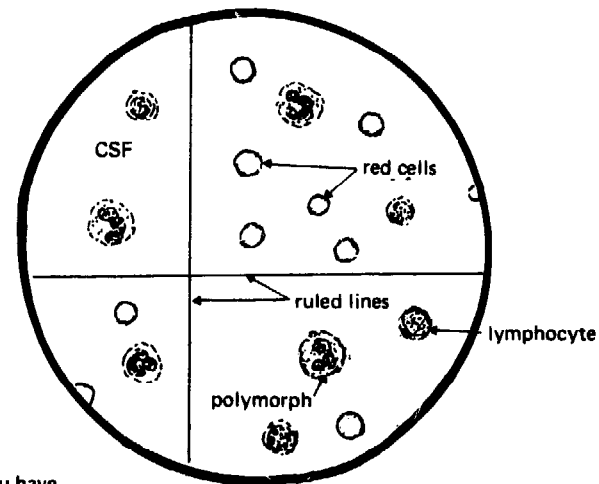

remember to multiply your answer by two if you have diluted the CSF with white cell diluting fluid

Fig. 9-3 Counting cells in the CSF

lion) red cells and 5,000 (five thousand) white cells in each cu mm of blood. If blood from a 'bloody tap' gets into the CSF there will therefore be about 1,000 red cells for every white cell. In a 'bloody tap' the CSF protein will also rise about 1 mg for every 1,000 red cells. It is useful to know this, because you may be sent a specimen of CSF which has some blood in it. The person looking

after the patient will want to know if all the white cells and protein in the CSF specimen are due to the blood, or if there were white cells and protein in the CSF before the blood got in. You will be able to tell him by counting the red cells. Allow one white cell for every 1,000 red cells and 1 mg of protein for every 1,000 red cells. By doing this it is usually easy to tell if the white cells and

protein that you find in a specimen of CSF have been caused by a 'bloody tap'. This is the only reason for counting the red cells.

9.10 Pandy's method (Normal CSF protein less than 35 mg %)

The CSF protein is examined in two ways.

A rough measure of the CSF protein can be found very easily by using Pandy's method. One or two drops of CSF are allowed to fall into a little tube of Pandy's reagent (see Section 3.37), which is a saturated solution of phenol in water. If there is less than 25 mg % of protein there is never any turbidity. If there is more than 35 mg % of protein in the CSF, the mixture of protein and Pandy's reagent always goes milky. When there are between 25 and 35 mg % of protein the CSF mixture sometimes goes milky and sometimes stays clear. When there is more than 35 mg % of protein in the CSF it is abnormal. Pandy's reagent is thus a very quick and useful method of telling whether the CSF protein is normal or abnormal. If CSF is abnormal in any way Pandy's test is almost always positive.

The other way of measuring the CSF protein is more accurate. One ml of CSF is mixed with 3 ml of 3% sulphosalicylic acid. Protein in the CSF makes the mixture turbid. The more protein there is, the more turbid will the mixture become. This turbidity is measured with a set of proteinometer standards, or with an MRC Grey wedge photometer, which is described in Section 9.13.

9.11 Stained films

It is usual to count the cells and measure the protein in all specimens of CSF sent to a laboratory. Very often, a film of the spun deposit is also stained by Gram's method. Gram's method stains the bacteria in the CSF which cause bacterial meningitis. Some people also stain a film of the spun deposit by Leishman's method (see Section 7.12). This makes it easier to see if cells are lymphocytes or polymorphs. Films can also be stained by the Ziehl-Neelsen method (see Section 9.18).

9.12 A combined method of examining the CSF

The combined method which follows and which is described in FIGURE 9-4 may look difficult because several methods are combined—cells, Pandy, protein, film, and culture. It is worth following very carefully because it saves much time. A combined method also makes the best use of a small quantity of CSF. There is usually enough blood, stool, or urine in a specimen for all the methods we want to do. But there is never more than about 5 ml of CSF; so it has to be used very carefully.

In some laboratories it is possible to culture the CSF—that is, to grow the bacteria in it. A method for culture has therefore been included. This will not be possible in most of the hospitals and health centres where this book will be used, but the extra steps for culturing the CSF can easily be left out. In some of the steps in the

following method it is important not to get any organisms into the CSF—that is, not to contaminate it. These steps are marked sterile. In the method which follows the use of a double-celled chamber is described. But it can easily be altered for use with a single-celled chamber.

METHOD

LOOKING AT THE CSF—A COMBINED METHOD, FIGURE 9-4

In a test tube rack put a sterile plugged centrifuge tube (Picture 5; an unsterile centrifuge tube can be used if no culturing is being done), a graduated centrifuge tube (Picture 24), a small test tube such as ML 48b (Picture 13), and a Kahn tube full of Pandy's reagent (Picture 9). Put the coverslip on the counting chamber (Picture 14). If the CSF is to be cultured you will need two Pasteur pipettes—these have been marked 'A' and 'B'. If you are not going to culture the CSF you will only need one Pasteur pipette.

1. If you have been sent two bottles of CSF, do as many tests as you can on the second bottle.

2. Mix the CSF well if it has stood for more than a few minutes.

3. If the CSF is to be cultured flame a Pasteur pipette.

4. Using 'aseptic precautions' if the CSF is to be cultured (that is, taking care not to let any organisms that may be on your fingers or elsewhere get into the CSF), put *most* of the CSF in the second specimen bottle into the sterile plugged centrifuge tube (Picture 5). If a glass centrifuge tube is being used it is wise to leave a little CSF in the specimen bottle in case the tube breaks in the centrifuge. If you have been sent two specimens of CSF, the CSF in the first bottle can be looked at if the tube containing all the CSF from the second bottle breaks in the centrifuge. Plastic centrifuge tubes do not break; so you will not have this trouble.

6 and 7. If you have an electric centrifuge, put the plugged centrifuge tube on to spin while you get on with the method as far as Picture 21. Besides having a little CSF in reserve (in case the tube in the centrifuge breaks while spinning) you should have enough CSF left in your pipette (8) for Pandy's method (starting in Picture 9) and the cell count (starting in Picture 13). Once you have filled the plugged centrifuge tube there is no need to worry about aseptic precautions until you get to Picture 23. When making a plugged centrifuge tube, make sure the plug is well made, or spinning will send it to the bottom of the tube.

10. Put two drops of CSF into the tube of Pandy's reagent. Normal CSF produces no turbidity (Picture 11). If there is an abnormal amount of protein in the CSF the Pandy's reagent will go turbid (Picture 12). Record the turbidity with the plus notation.

13. Put two more drops of CSF into the small test tube.

14. Fill one side of a double counting chamber with the CSF remaining in the pipette.

15. If there is any CSF left in the pipette, throw it away into the lysol jar.

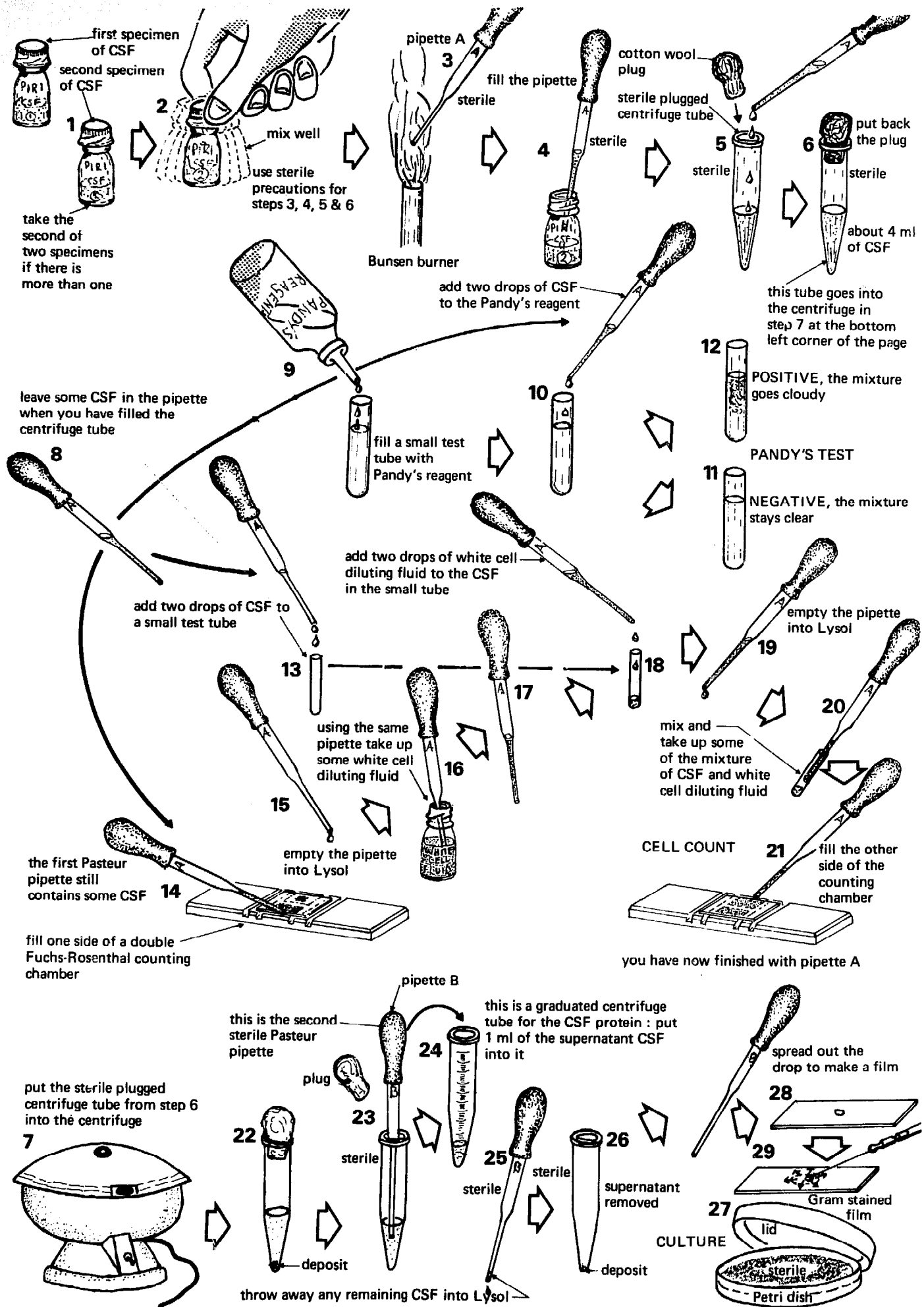

Fig. 9-4 A method for examining the CSF

16 and 17. Take some white cell diluting fluid into the pipette.

18. Add two drops of white cell diluting fluid to the two drops of CSF in the small test tube.

19. Throw away any remaining white cell fluid into the lysol jar.

20. Mix the CSF and the white cell diluting fluid in the small test tube—draw it in and out of the pipette. The mixture will be half CSF and half white cell diluting fluid. Any red cells there may be will be lysed, and the white cells will be stained a pale blue.

21. Fill the second half of the counting chamber with the mixture of CSF and white cell fluid. If you are culturing the CSF put aside pipette A. Count the cells according to the diagram in Figure 9-3. Sometimes it may be useful to count the red cells also. For this, see Section 9.9.

While you have been doing all this, the CSF in the plugged tube that you put into the centrifuge in Picture 7 will have been spinning. It may have a deposit (22) after spinning.

23. Flame a second sterile Pasteur pipette, and, taking care not to touch the pipette with anything unsterile, put 1 ml of the supernatant fluid into a graduated centrifuge tube (Picture 24). This is used to measure the CSF protein in the next method.

25. If you are going to measure the CSF sugar by the method in Section 7.42, keep some of the supernatant for this. Throw away any remaining supernatant into the lysol jar so that only the deposit remains.

26. Mix the deposit with the last remaining drop of supernatant.

27. If the CSF is being cultured put a few drops of the deposit on Petri dishes of blood agar and chocolate agar and spread them out.

28. Put a drop or part of a drop of the deposit on two slides—only one is shown here.

29. Spread out the deposit with a loop to make a film. Flame the film and stain it by Gram's method (see Section 11.5). If necessary, stain another film by Leishman's method (see Section 7.12).

9.13 The CSF protein (FIGURE 9-5)

As we saw in Section 9.10, protein in the CSF can be measured with the Grey wedge photometer, or with a set of proteinometer standards. These instruments only give an accurate answer if the CSF is clear to start with. This means that if it is turbid with red cells or white cells to start with, *it must first be centrifuged*.

In both methods, 1 ml of CSF is mixed with 3 ml of 3% sulphosalicylic acid. The collection of 1 ml of centrifuged CSF has already been described as part of the combined method of looking at CSF. The graduated tube in which the mixing is done is shown in Picture 24 in FIGURE 9-4. The rest of this section describes how to use this specimen to measure the CSF protein.

When we described how haemoglobin is measured, we said that it is possible to do this with a row of tubes with

differing amounts of haemoglobin in them (FIGURE 5-4). These tubes were called standards. It is also possible to use a set of standards of milkiness or turbidity to measure the turbidity of a mixture of CSF and sulphosalicylic acid, and thus the amount of protein in the CSF. The higher the CSF protein, the greater will be the turbidity.

Haemoglobin standards can be made as pieces of coloured glass in a Lovibond disc, but standards for measuring protein are made as a row of test tubes which have been carefully sealed (corked or closed). Such a set is drawn in FIGURE 9-5. There are several things to remember when using it. One is to use the same kind of tube as that in which the standards are made. A tube of a different size will not give a good comparison and will give the wrong answer. Try therefore not to lose the special tubes for doing this test that are supplied with the proteinometer. If you do happen to lose these tubes, use a tube which is as nearly like them as possible, such as a Kahn tube. It is also important to match the test solution with the standards in the rack while light is coming over your shoulder as in Picture 8. This will make it easier to find which of the standards has the same turbidity as the test solution. Another important point is to wait 5 minutes before comparing.

The Grey wedge photometer was made for measuring the haemoglobin in blood, but by a fortunate chance it is also possible to use it to measure protein in the CSF. The mixture of 1 ml of CSF and 3 ml of 3% sulphosalicylic acid is poured into a cell, and, using the green No. 1 filter, the wheel of the Grey wedge is turned until the two sides of the field of view through the eyepiece are equal. The figure in the window of the Grey wedge gives the CSF protein in mg % and no tables are needed to work out the answer.

METHOD

MEASURING THE CSF PROTEIN, FIGURE 9-5

1. Using a Pasteur pipette fill a graduated centrifuge tube to the 1-ml mark with CSF. This has been done in Picture 24, Figure 9-4.

2. Fill the tube to the 4-ml mark with 3% sulphosalicylic acid as prepared in Section 3.43b.

3. Mix gently and wait for 5 minutes.

4. Fill either a glass cell for the Grey wedge photometer or, as in Picture 5, one of the special tubes for the set of proteinometer standards. Make sure that the cell for the Grey wedge is clean, and that its outer surface is dry.

USING THE GREY WEDGE

5. Put the cell with the turbid mixture of CSF and 3% sulphosalicylic acid into the right-hand place in the cell compartment of the Grey wedge photometer.

6. Put a cell filled with water in the left-hand place. See that the green No. 1 filter is screwed into the eyepiece. Turn the wheel of the Grey wedge until the two

9 | The Cerebrospinal Fluid

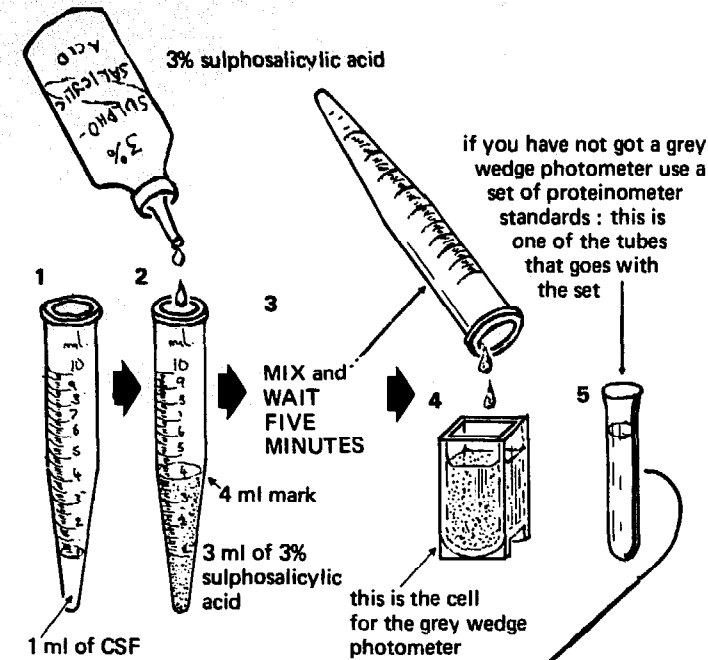

another way of measuring 1 ml of CSF and 3 ml of sulphosalicylic acid solution is to use the special pipettes that come with the set and clip in behind the standards

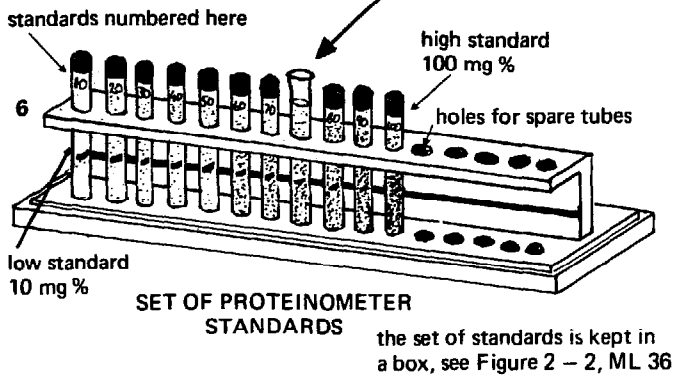

compare the test with the standards with light coming over your shoulder

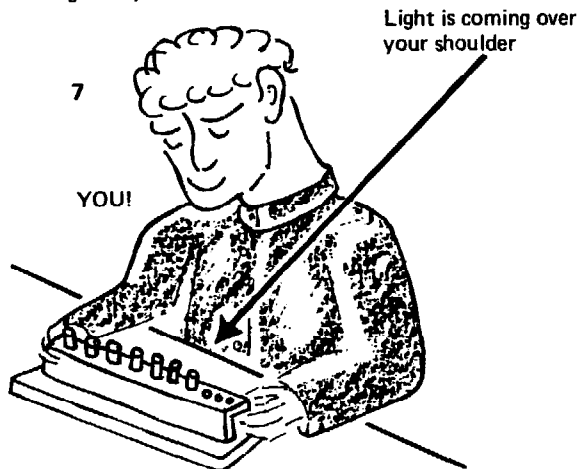

Fig. 9-5 Measuring the CSF protein

halves of the field of view look exactly the same. The number on the scale in the window will be the CSF protein in mg %. Sometimes there will be so much protein in the CSF that the two halves of the field of view cannot be matched. When this happens, dilute some more CSF, as described below.

USING THE SET OF PROTEINOMETER STANDARDS

7. You will see that the set of proteinometer standards has ten small tubes, each of which is equal to a different amount of protein in the CSF. The lowest tube is equal to 10 mg % of protein, and the highest to 100 mg %. Put your tube of CSF and sulphosalicylic acid in the rack and see which of the standards is most like it. In Figure 9-5 it is shown in between the tubes containing 70 and 80 mg % of protein. It was a little more turbid than the tube with only 70 mg % and a little less turbid than the tube with 80 mg %. It thus had about 75 mg % of protein.

What should you report if the test solution is more turbid than the 100 mg standard. When this happens all that is usually needed is a report which says 'CSF protein more than 100 mg %'. Another thing to do is to put only $\frac{1}{2}$ ml of CSF in the graduated centrifuge tube, add $\frac{1}{2}$ ml of saline and then add the usual 3 ml of 3% sulphosalicylic acid. It may well be possible to find a match, but the answer found must be multiplied by two. Sometimes there may be so much protein in the CSF that even further dilution may be needed. *Diluting the mixture of CSF and sulphosalicylic acid when it is already turbid will not give you an accurate answer.*

9.14 Trypanosomes

In Section 7.36 we said that the best way of finding trypanosomes in the blood is to look for *moving* organisms in fresh blood. The same is true of CSF. If you are asked to look for trypanosomes in CSF, look for them like this.

METHOD

TRYPANOSOMES IN THE CSF

Spin some *fresh* CSF as shown in Pictures 5, 6, and 7 in Figure 9-4. *Spin it for at least 5 minutes as fast as you can.*

Take off all the supernatant as shown in Pictures 23, 25, and 26, Figure 9-4. There may be very little deposit—only a tiny white piece at the bottom of the tube. Take care not to disturb this small deposit when removing the supernatant. *Using a very fine (thin) Pasteur pipette (if need be, pull it out in a flame to make it finer) mix what deposit there may be in the smallest possible amount of supernatant CSF. Put all the deposit on a slide. Cover it with a coverslip. Using the high power objective and the condenser racked down a little, search the whole area of*

the coverslip until moving trypanosomes are seen. When searching, follow Figure 6-14 so that no part of the coverslip is missed.

If you are in a country where trypanosomiasis is seen, it is especially important to examine every specimen of CSF plain and not diluted with white cell diluting fluid. This is because white cell diluting fluid kills trypanosomes, and you will not see them moving. A doctor may not think that his patient might have trypanosomiasis and may not ask you to look especially for trypanosomes. If you look at undiluted CSF you may see them moving in the counting chamber. But if you dilute the CSF with white cell diluting fluid, the trypanosomes will be dead and not moving; so you may not see them.

9.15 Sugar in the CSF

Measure this in the same way as you measure the blood sugar (see Section 7.42), except that when you use the Lovibond comparator take four times as much CSF and divide the answer by four. Thus, take 0.4 ml of CSF and not 0.1 ml. When the Grey wedge or EEL colorimeter are used it is best to take only twice as much CSF—0.2 ml and divide the answer by two. Greater volumes of CSF are taken because there is less sugar in the CSF than there is in the blood. CSF should be taken into a fluoride bottle in the same way as blood (see Section 4.6).

Diseases alter the CSF in several ways. Here are some of the diseases you will meet and the changes they cause.

ABNORMALITIES OF THE CSF

9.16 Suppurative or bacterial meningitis

Suppurative means pus-making, and the CSF from a patient with suppurative meningitis often looks like pus. It is often obviously turbid and may be green or yellow. There are usually over 500 cells per cu mm, but there may be as few as 15 or 20 cells per cu mm. Most of the cells are usually polymorphs and the rest lymphocytes.

Suppurative meningitis is caused by bacteria growing in the CSF and meninges. Many species of bacteria can cause meningitis, but three species of bacteria cause most cases. These bacteria can usually be seen when a film of the CSF is stained by Gram's method. Because each species looks different in a Gram-stained film, it is usually easy to tell which of the three is causing the meningitis. The three species of bacteria are *Streptococcus pneumoniae* (the 'pneumococcus'), *Neisseria meningitidis* (the 'meningococcus'), and *Haemophilus influenzae*. We shall not say anything here about the less common bacteria which cause suppurative meningitis. *Streptococcus pneumoniae* and *Neisseria meningitidis* are round bacteria or cocci, but *Haemophilus influenzae* is a rod-shaped bacterium or bacillus. *Streptococcus pneumoniae* is Gram positive (see Section 11.5), *Haemophilus influenzae* and *Neisseria meningitidis* are both Gram negative. We are therefore

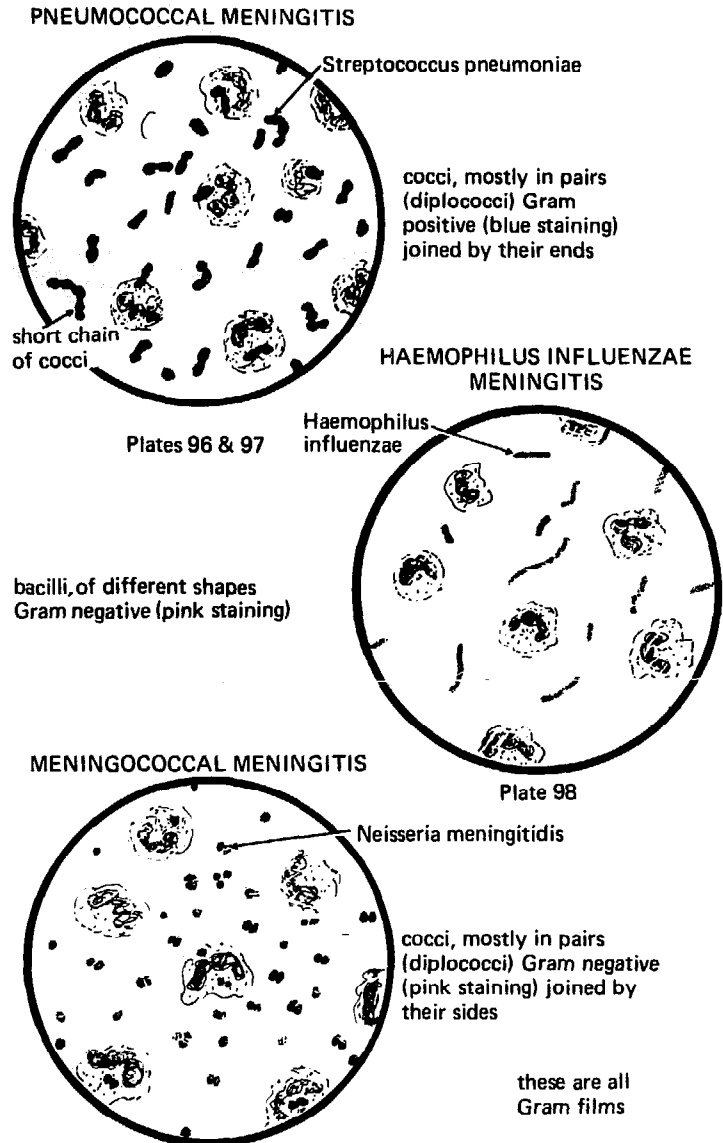

Fig. 9-6 Three kinds of bacterial meningitis

able to tell what the likely species of bacterium is by seeing whether it is Gram positive or Gram negative, and whether it is coccus or bacillus. All three species of bacteria cause the same kind of suppurative meningitis in a patient, but it is important to tell which species is causing the meningitis because they are killed with different drugs. Films from each of the three types of meningitis are drawn in FIGURE 9-6. You will see that, even though *Streptococcus pneumoniae* and *Neisseria meningitidis* are both cocci, they are not quite the same shape. *Neisseria meningitidis* is bean-shaped with the flat sides of the bean together, but *Streptococcus pneumoniae* is a different shape with its short sides together. Both *Streptococcus pneumoniae* and *Neisseria meningitidis* are often seen in pairs. *Streptococcus pneumoniae* often forms short chains. The word streptococcus means a chain of cocci. *Haemophilus influenzae* is often of many different shapes, some long and thin, some short and fat (it is said to be pleomorphic, or many-shaped). In some cases of suppurative meningitis you will see bacteria

which do not look like any of these three. Report exactly what you find.

Haemophilus influenzae meningitis is not seen before a child is 3 months and is rare after he is 3 years old. Other kinds of bacterial meningitis are seen at any age. Meningococcal meningitis is often seen in epidemics—that is, many cases are seen at the same time.

If a specimen of CSF looks like pus there is little point in counting the cells—if you do you will certainly find thousands of cells, mostly polymorphs. CSF from a patient with suppurative meningitis will also have more protein than normal, perhaps 100 mg % or more. There is seldom any need to measure it, and the kind of bacteria seen in a stained film is what really matters. There is usually very little sugar (perhaps less than 10 mg %) in the CSF of these patients.

Unfortunately some patients with suppurative meningitis may have been partly treated with drugs before a lumbar puncture is done. This may kill some of the bacteria infecting a patient without curing him properly and make them very hard to find in his CSF. This often makes the right diagnosis of suppurative meningitis impossible, because we cannot find out which species of bacteria is infecting the patient. As you will read below, meningitis is sometimes difficult to diagnose, and the only way to make sure is to do a lumbar puncture *before you start treatment*.

9.17 Virus meningitis

You will remember from Section 1.11 that a virus is the smallest kind of micro-organism. Many viruses can infect the brain and the meninges, but most of them alter the CSF in the same way. The virus causing poliomyelitis or 'polio' is one of them. In a virus meningitis the CSF protein is raised and may perhaps be 50 or even 100 mg %. There are also an abnormal number of white cells in the CSF. Some of these may be polymorphs, but most of them are lymphocytes. The CSF sugar is normal, and there are no bacteria. All we can say when we see a report like this is that the patient has meningitis, and it is probably caused by a virus. Very special methods are needed to find out which virus is causing the meningitis. There are no commonly used drugs with which we can treat patients with virus meningitis, and most of them get better without special treatment.

9.18 Tuberculous meningitis

Mycobacterium tuberculosis often infects the meninges and causes a very serious meningitis. Tuberculous meningitis is, however, much less common than pulmonary tuberculosis (tuberculosis of the lungs). It is important to diagnose tuberculous meningitis, because most patients can be cured if it is diagnosed early and they are treated properly. If patients with tuberculous meningitis are not properly treated they always die.

In tuberculous meningitis the CSF protein is raised, and there are many cells, just as in virus meningitis.

More than half the cells are usually lymphocytes, the others are polymorphs. The kind of cell is therefore little help in telling whether a patient has tuberculous or virus meningitis. The most useful test is the CSF sugar. If the CSF sugar is above 40 mg % the patient probably has a virus meningitis; if it is below 40 mg % the meningitis is probably tuberculous—except when it is suppurative, when the sugar may be very low indeed. The low sugar of suppurative meningitis should not cause any difficulty, because the diagnosis of suppurative meningitis is usually made easy by finding bacteria.

AAFB can also be found in the CSF in almost all cases of tuberculous meningitis. But this is not nearly as easy as finding them in the sputum. Look for AAFB like this.

METHOD

FINDING AAFB IN THE CSF

Centrifuge as much CSF as you have as fast as you can for at least 10 minutes. Soften the end of a Pasteur pipette in a flame and pull its end out so that it is very thin. Use the pipette to remove all the supernatant CSF except for the last half drop. Mix the deposit in this very small volume of remaining supernatant CSF. Spread the deposit on a slide so that the film you make covers a *small area* on the slide—say a circle not more than $\frac{1}{2}$ cm across. Let it dry. Fix and stain the film by the Ziehl-Neelsen method, as in Section 11.1. Counterstain lightly with malachite green so that the film is a *very pale green*.

Using an oil immersion objective search the *whole* of the film for AAFB by the method shown in Figure 6-14. This may take several hours.

The important points are to take a lot of CSF (at least 5 ml), to centrifuge fast for a long time, to remove almost all the supernatant, to re-suspend the supernatant in a very small volume of supernatant, to make a small, rather thick film, to counterstain very lightly, and to search the whole film very carefully. You are unlikely to find more than one or two AAFB. This is not an easy method and it requires much practice, skill, time, and patience. Finding AAFB in the CSF is, however, very useful, because it makes the diagnosis of tuberculous meningitis certain. Because it is so difficult, only the best laboratories regularly find AAFB in the CSF. You have the equipment; so, do your best. But be quite sure that, when you report 'AAFB+', they really *are* AAFB!

9.19 Head injury

When a patient has been hit on his head, some blood vessels on the surface of his brain may be torn and may bleed into his CSF. Sometimes one of these blood vessels bursts on its own (a cerebral or brain haemorrhage). When this happens there will be many red cells in the CSF. You will remember that blood may also get into the CSF from a 'bloody tap'. It is sometimes difficult to tell if

blood has got into a specimen of CSF from a torn vessel in the brain or from the hole made by a lumbar puncture needle.

When red blood cells have been in the CSF for some days they start to break down, and the yellow substance bilirubin is formed (see Section 8.8). This stains the CSF yellow and it is said to be xanthochromic. If you see that a specimen of CSF is xanthochromic, you should always report it. Besides old blood, a very high concentration of protein will also make the CSF slightly xanthochromic.

9.20 Cerebral malaria

It is sometimes difficult to tell if a patient has meningitis or cerebral malaria (see Section 7.34). In such patients a thick blood film and a specimen of CSF are usually sent to the laboratory. The CSF is usually normal in cerebral malaria, but the thick film will show malaria parasites.

QUESTIONS

1. What is CSF and where does it come from?
2. Why is lumbar puncture so important? Why is it necessary to do lumbar puncture very carefully?
3. How much protein is there in normal CSF? In what diseases is the CSF protein raised?
4. Why is Pandy's method so useful? How would you do it?
5. What are the common kinds of suppurative meningitis? How can you diagnose them?
6. How would you look for: (a) Trypanosomes, (b) *Mycobacterium tuberculosis* in the CSF?
7. What is a 'bloody tap'?
8. What is xanthochromic CSF?
9. What changes would you expect to find in the CSF in a patient with virus meningitis?
10. What are the signs and symptoms of meningitis in: (a) a young child, and (b) an older child or adult?

10 | Stools

10.1 Why we examine the stools

Stools are some of the commonest specimens that come to a laboratory. We usually look at stools to find parasites. These can be worms, or their ova, or protozoa (see Section 1.14). Often the best way to find out which kind of worm a patient has is to look for its ova in his stool. We do this by looking at the stool with a microscope. We mix a little of the stool on a slide with a drop of saline and look at it under a coverslip. This method is called a saline stool smear.

As with other specimens, the first thing to do with a stool is to look at it carefully. You will see some things that you will not see with a microscope. A stool from a healthy person is brown and formed. By formed we mean that the stool has some shape. An unformed stool has no shape. Abnormal stools may be yellow, green, black, or even almost white. They may be soft (not formed) or may even be liquid. A useful way of describing stools is to use these words:

Formed
Soft
Diarrhoeic
Watery

There is no blood or mucus on a normal stool. Mucus is the sticky white substance that comes from your nose when you have a cold. It is made by the epithelial cells covering the inside of the nose. Mucus is also made by the cells covering the inside of the gut. A little mucus is made by a normal nose or gut. But, if much mucus is made, it means that the nose or gut is diseased. Whenever you examine a stool, *report whether you find it normal or not, and describe any abnormalities you may see.*

There are no pieces of undigested food in a normal stool, and there are no worms. Some of the worms that you may see in an abnormal stool have been drawn in FIGURE 10-1. Picture A shows *Ascaris lumbricoides*, or the roundworm. *Ascaris* is a large worm and may be 25 cm long or more. It is smooth and white without any segments, and, as its name suggests, it is round. You will also see from Pictures E and F that both the hookworm and *Trichuris* are very small, thin, round, white worms. *Trichuris* is also called the whipworm. You will see

that one end of it is thin and the other end of it is quite thick.

The tapeworm, or *Taenia*, may be a metre or more in length, and is so long that only parts of it have been drawn in Picture B. At one end it has a very small head which is fixed by hooks or suckers to the wall of the gut. The tapeworm is made of many segments (pieces) which are all the same and which grow from behind the head. Close to the head the segments are very small, but as they go down the worm they get larger. Mature segments are always breaking off from the end of the worm, either one at a time or several at a time, and are found in the stool. These mature segments have been drawn larger in Pictures C and D. You will see that the two species of tapeworm, *Taenia saginata* and *Taenia solium*, are slightly different. You can see these differences by taking a mature segment, pressing it between two slides, and holding it up to the light. You will see that most of the segment is filled by the ovary, or egg sac, which has been drawn black in these pictures. The ovary of *T. saginata* is shorter, straighter, and less branched than the ovary of the *T. solium*. The eggs of both these tapeworms look exactly the same. They are shown in Picture 4, FIGURE 10-7.

You may see any of the worms in FIGURE 10-1 in the stool, and you are especially likely to see them when the patient has been given some drug to kill them. Dead worms are unable to hold on to the gut and are easily passed in a stool. Other worms are sometimes seen, but these are the important ones.

First of all we shall describe the saline stool smear, which is the simplest way of finding parasites in the stool. Then come the 'Cellophane' thick stool smear, the formol-ether concentration method, and the 'Sellotape' swab for *Enterobius*. *When you write a report, say which method you have used.*

Four ways of finding parasites in the gut

10.2a One—The saline stool smear

It is easy to make a saline stool smear, but it takes a long time to learn how to look at it well. Looking at a saline stool smear is difficult because there are so many differ-

ent things to be seen in a normal stool. Many of them come from the food that the patient ate. It is often difficult for someone who is learning to be sure if something he sees is a parasite, or if it is only a piece of the patient's food. We shall try to make this easier with many pictures.

METHOD

THE STANDARD SALINE FAECAL SMEAR, FIGURES 10-2 AND 10-3

1. When you ask an adult for a specimen of stool, give him a 'Polypot' (ML 14c), a sheet of newspaper to put in the latrine, and a stick or a strip of strong cardboard with which to put his specimen into the pot. Don't give patients universal containers for their stools. They get lost and they are too expensive to lose. Use 'Polypots'

which can be boiled or autoclaved and used again, as described in Section 3.12.

An easy way to get a stool specimen from a child is to put a smooth-ended glass tube into his rectum. This should be 8 cm long and 7 mm in diameter and have its edges smoothed in the flame as described in Section 3.9. If a child has diarrhoea, the tube will soon fill with faeces which can be looked at microscopically. Keep a supply of such tubes, and wash and boil them after use. Pieces of drinking straw or pieces of plastic tubing from a blood-giving set can also be used.

If you have been asked to look for amoebae or *Giardia*, make sure that the stool you examine is so fresh that it is still warm. You will not find motile amoebae in a cold stool.

Look carefully at the stool. Choose the most abnormal-looking part of the stool to make your smear.

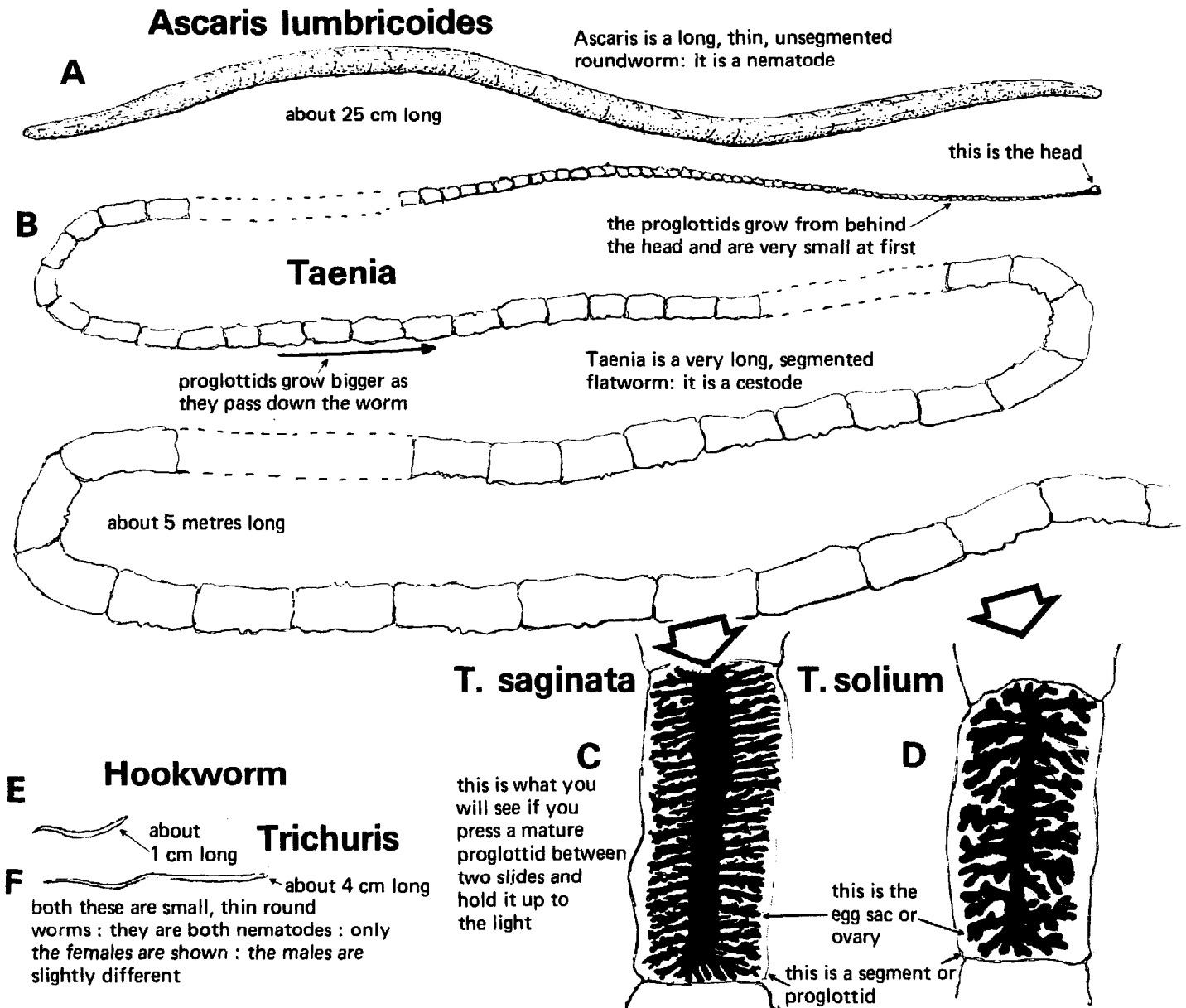

Fig. 10-1 Some worms in the stool

If there is mucus or blood on part of the stool, take some of this part and make sure you report it.

Put a drop of saline on a slide. It will be easier to measure out the right size of drop if you keep the saline in a 'Polystop' bottle.

2. There are several ways of mixing the stool with the saline. A wire loop can be used, so can an applicator stick (orange stick), so can the stick that forms the middle of a palm leaf. If the stool is hard and difficult to mix with saline, the best thing to use is a straightened paper clip with one end hammered flat. This makes a little spatula, with which it is easy to break up the hardest stool. Make many of these 'paper clip spatulae', put used ones in a little jar of lysol, sterilize them, and use them again.

3. Mix the stool in the drop of saline. Stir (mix) until the smear is an even mixture of stool and saline. The smear must not be too thick or too thin. One way of judging the thickness of a smear is to put it on a newspaper. The smear should be so thick that you can *only just* read the ordinary small writing of a newspaper through it. A smear of this thickness under a 22-mm square coverslip is called a *standard faecal smear*. The smear is too thick if you cannot read the newspaper through it. The smear is too thin if you can read the

newspaper through it very easily. Look at Figure 10-3. A standard faecal smear contains about 2 mg of stool.

4. Put a coverslip on the smear. A polythene or 'Cellophane' coverslip can be used as described in the next method, but glass ones are better for thin films.

5. Add a drop of Lugol's iodine to one edge of the smear. It will slowly run underneath. Iodine makes the nuclei of protozoa easier to see. Like saline, Lugol's iodine is best kept in a dropping bottle. You can leave this out, and many people only use Lugol's iodine when they specially want to look at protozoa. Other people always make two smears whenever they look at a stool, one in a drop of saline and the other in a drop of Lugol's iodine.

6. Seal the edge of the coverslip with a mixture of hot vaseline and paraffin wax. This is also shown in Figure 7-14. Both the wire and the paraffin wax must be hot.

BEGIN BY LOOKING ALL OVER THE SMEAR WITH A VERY LOW POWER (×4) OBJECTIVE. Search it by the method shown in FIGURE 6-14. You will easily see ova with a very low power objective. Then search *part* of the smear with a low power (×10) objective. With this objective protozoal cysts look like little round bubbles or balls of glass. You will know that they

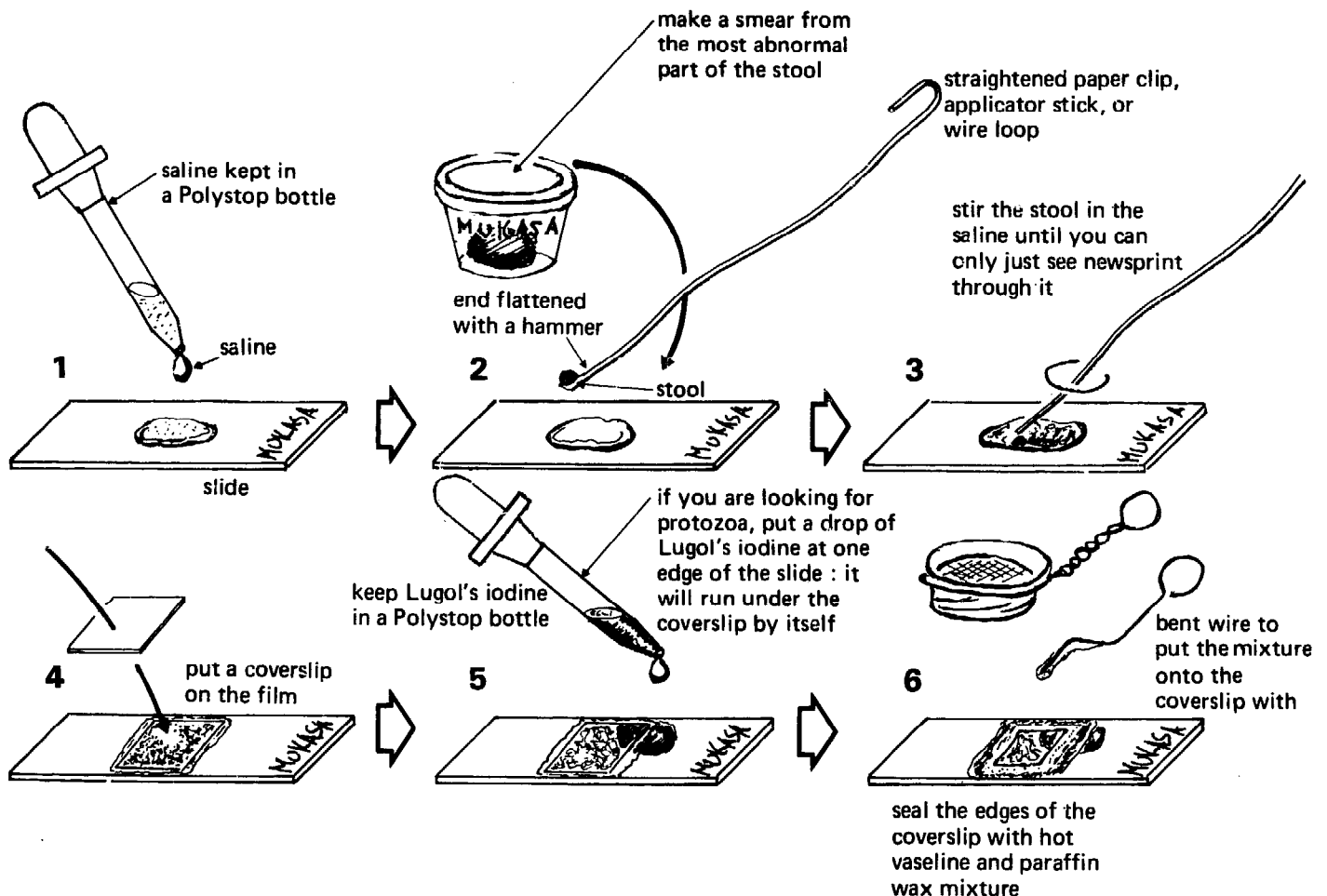

Fig. 10-2 Making a saline stool smear

are not bubbles because there will probably be many of them, all of about the same size. When you have found something that might be a cyst, look at it with a high power (x40) or an oil immersion objective (x100). Under a low power objective trophozoites (see Section 1.11) may look rather like cysts, but they are not so round.

WHEN YOU LOOK AT UNSTAINED THINGS LIKE PROTOZOA, BE CAREFUL NOT TO USE TOO MUCH LIGHT. CLOSE THE IRIS DIAPHRAGM AND LOWER THE CONDENSER UNTIL YOU GET JUST THE LIGHT YOU WANT.

Many people do not seal their coverslips with paraffin wax, but this is a good thing to do. Sealing stops the smear drying, it stops things in the smear streaming about (see Section 8.14), and it keeps the coverslip still, so that an oil immersion objective can be used.

smear—60 mg instead of only 2 mg. The more blood or stool that we are able to search, the more likely are we to find parasites.

A special kind of plastic sheet or film called 'Cellophane' is needed. This is perfectly transparent, and unlike many other kinds of film it can be wet with water and soaks it up. It is listed as ML 148a under Choice 16 in Section 13.29. This 'Cellophane' sheet is cut into pieces about the size of a coverslip and left to soak for a day in a mixture of glycerine and malachite green, as described in Section 3.22a. Some stool is put on a slide and one of these wet green pieces of 'Cellophane' is then pressed down on top of it. The stool spreads out under the 'Cellophane' coverslip, and the glycerol makes it clear, so that ova are easily seen.

METHOD

THE 'CELLOPHANE' THICK STOOL SMEAR, FIGURE 10-4

1. Put a clean slide on top of something soft, such as a pile of newspaper squares, so that it will not break when pressed on. Take an applicator stick ('orange stick'), a loop or, better still, a straightened paper clip with its end hammered flat to make a little spatula. Put about 60 mg of stool on a clean slide. There is no need to weigh the stool. It can be guessed by knowing that 60 mg of stool forms a cube of about 4 mm, that is a quantity of stool about

10.2b Two—The 'Cellophane' thick smear for ova (FIGURE 10-4)

This is a quick and very easy method for finding ova, especially the ova of *Ascaris*. You will remember from Chapter Seven that a thick film stained with Field's stain allows us to search much more blood for parasites than a thin film stained with Leishman's stain. In the same way the 'Cellophane' thick smear allows us to search much more stool for ova than does the standard saline stool

H I J
this is newsprint : it is part of a newspaper

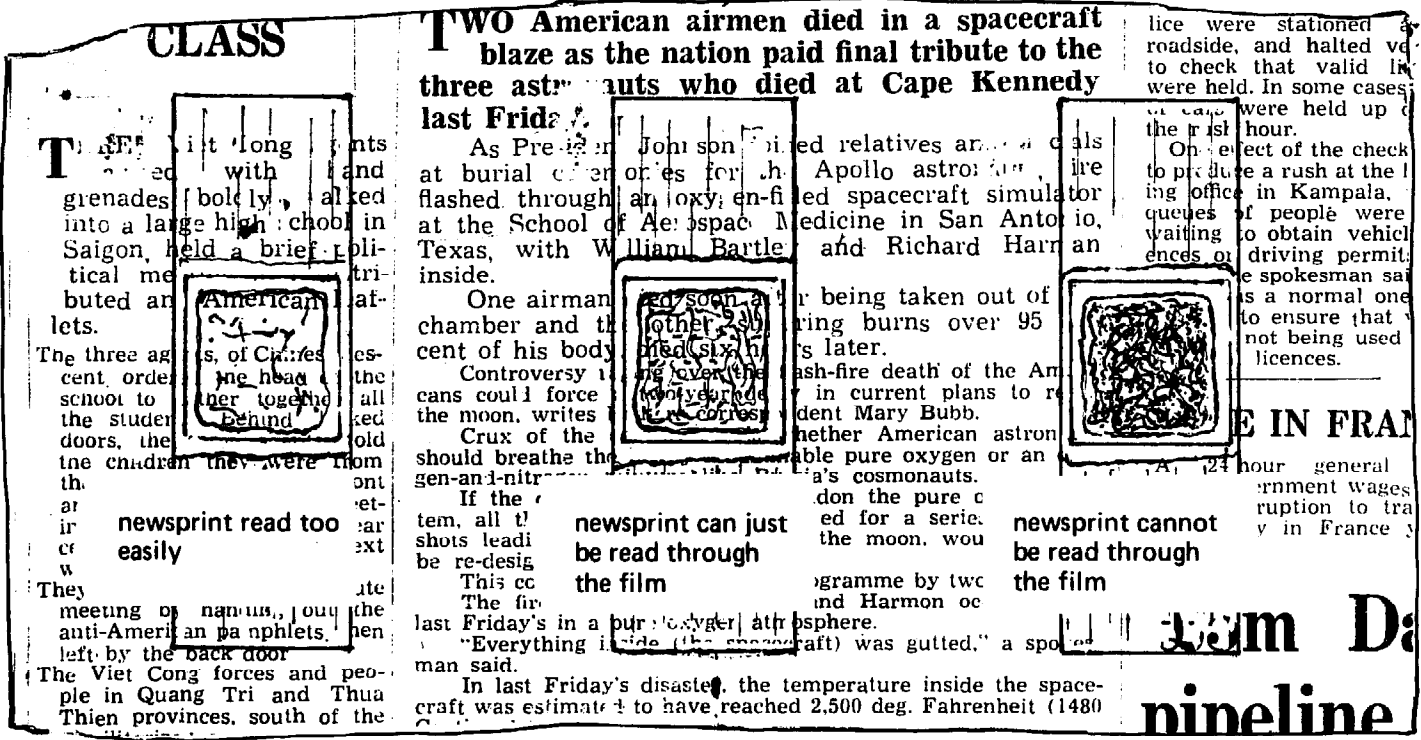

TOO THIN

JUST RIGHT

TOO THICK

Fig. 10-3 A standard stool smear

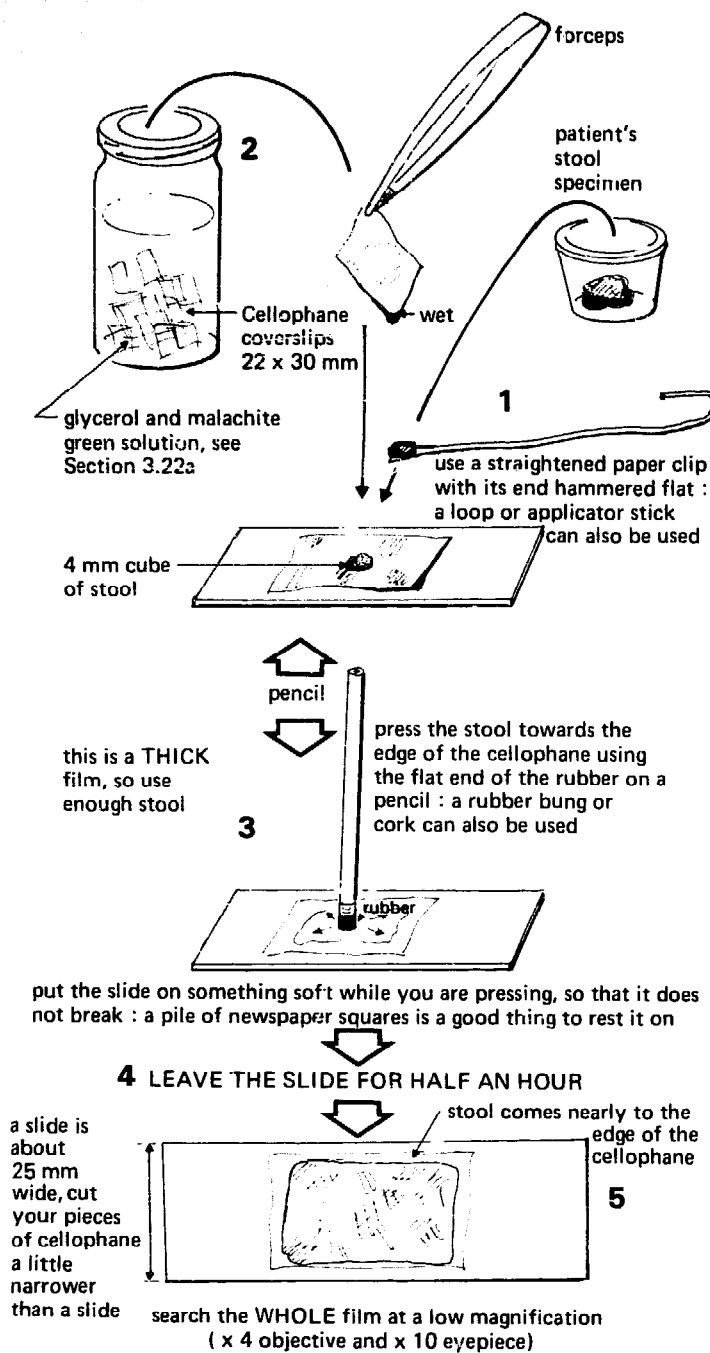

Fig. 10-4 The 'Cellophane' thick stool smear

4 mm × 4 mm × 4 mm. The important thing is that much more stool is needed than for a standard saline smear.

2. Using a pair of forceps take one of the soaked 'Cellophane' coverslips out of the stock bottle (see Section 3.22a), and put it down on top of the stool.

3. Press the 'Cellophane' down firmly on the stool with the rubber on the end of a pencil. A rubber bung or cork can also be used. Carefully spread out the stool under the 'Cellophane'. It should reach nearly to the sides of the 'Cellophane', but need not get to the end. The best thickness for the smear is important, and you will have to learn it with practice. Glycerol clears quite a thick smear.

4. Leave the smear for about half an hour in a warm dry place. A dry incubator is best. Some of the water in the smear will evaporate, and the stool will clear in the glycerol.

5. Search the *whole* film with a low power ×4 objective and a ×10 eyepiece. Count the number of each kind present.

This is a method for ova, and it is not good for protozoa, because the glycerol kills them and stops them moving. If you want to find protozoa, make a standard faecal smear in saline.

There is no point in sealing these 'Cellophane' coverslips with vaseline and paraffin wax, because they are soft, and it will not hold them. They can, however, be used with an oil immersion objective. But because they cannot be held by sealing with vaseline, objects move during focusing. 'Cellophane' coverslips can also be used instead of glass ones for other methods. If used dry, they curl up, so soak them in saline first.

The important part of this method is to have the right kind of film. It must be 'Cellophane' of the right thickness. Thin, unscratched polythene film from an ordinary polythene bag can be used, but it is not nearly so good. Because it is not wettable (water runs off it), you will have to mix the glycerol with the stool on the slide before putting on a polythene coverslip. If you run out of glass coverslips, try using polythene ones.

10.3 Three—The formol-ether concentration test

If there are only a very few parasites in a stool it takes a very long time to find them even in a thick stool smear. Parasites can be found more easily by doing a concentration test. This takes away most of the normal parts of a stool and leaves the parasites. We shall describe the 'formol-ether concentration test'. Ether is expensive and often difficult to get. Fortunately petrol can be used instead and seems to work equally well. This method concentrates both the eggs of worms and the cysts of protozoa. It does not, however, concentrate protozoal trophozoites.

METHOD

THE FORMOL-ETHER (OR PETROL) CONCENTRATION TEST, FIGURE 10-5

1. Add a few ml of water or saline to the container (bottle or box) in which the stool was sent to the laboratory.

2. Stir the stool and the water together with an applicator or clean glass rod (see Section 3.9). By stirring the stool in this way you will get a thin suspension of stool and saline.

3. Put two layers of surgical gauze (pieces of gauze one on top of the other) in a small plastic funnel. Surgical gauze is the thin white cotton cloth that is put on wounds. Pour the stool suspension through this into a centrifuge tube. The large pieces will be left behind on

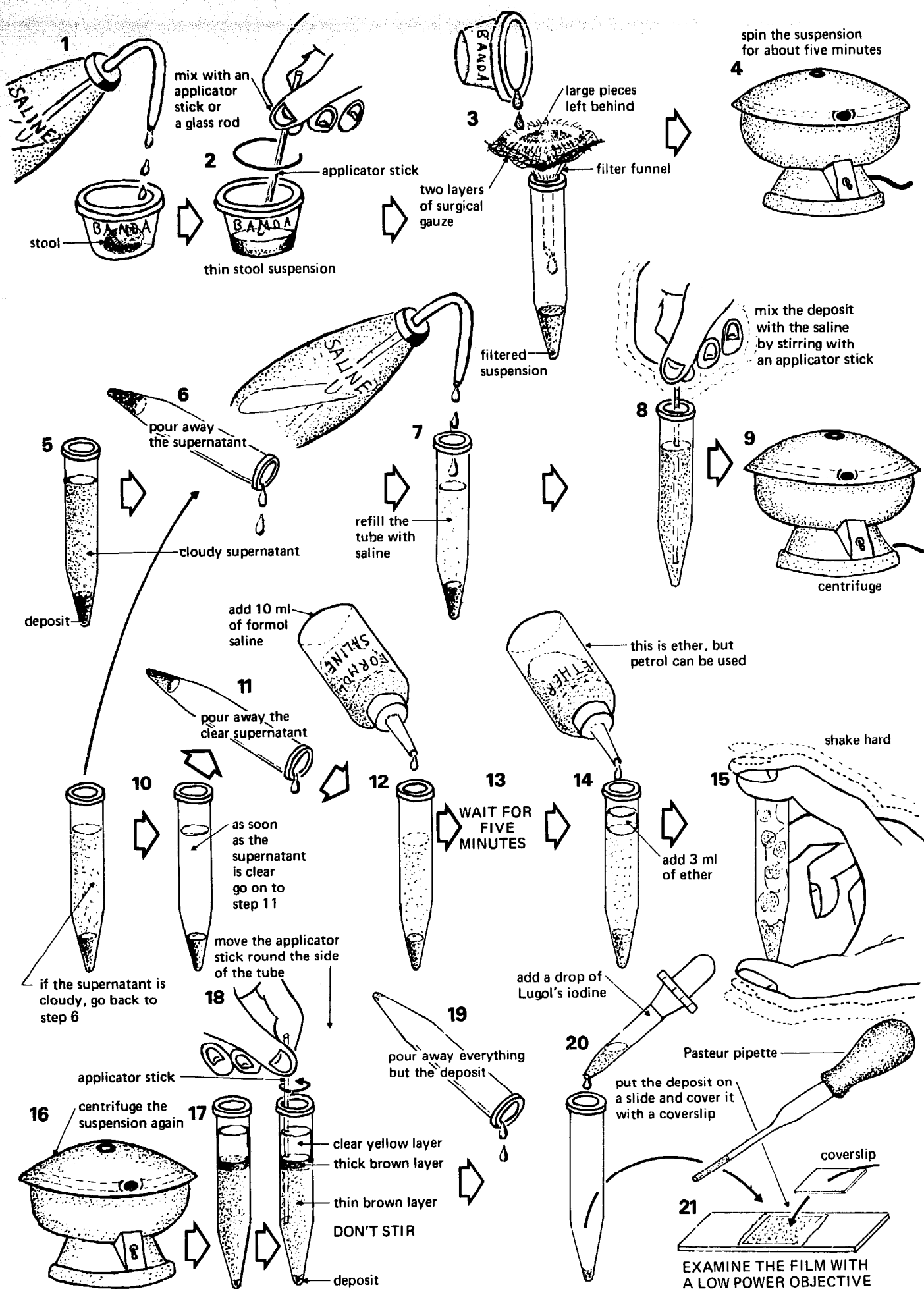

Fig. 10-5 The formol-ether concentration method

the gauze, and a thin stool suspension will go through into the centrifuge tube.

4. Spin the centrifuge tube for about 5 minutes. An electric centrifuge is shown in the drawing, but a hand centrifuge will do.

5. You will be left with a brown deposit and a brownish cloudy supernatant fluid. If you have used the right amount of stool there will be about $\frac{1}{2}$ ml of deposit after centrifuging.

6. Pour away the supernatant fluid into lysol.

7. Fill up the centrifuge tube with saline or water.

8. Mix up the contents, either by stirring with the applicator stick or by shaking with a cork in the top of the tube.

9. Centrifuge again.

10. If the supernatant is not clear, go back to step 6, pour away the supernatant, add more water or saline, and centrifuge once more. If, after this, it is still not clear, go back to step 6 a third time. If the supernatant is then clear, go on to step 11.

11. Pour away the clear supernatant.

12. Add 10 ml of formol saline.

13. Wait 5 minutes.

14. Add 3 ml of ether (or petrol).

15. Shake hard.

16. Centrifuge for 2 minutes. This should be at 1,500 revolutions (turns) a minute. You will not be able to measure this, but it is about as fast as a hand centrifuge or a simple electric centrifuge will go.

17. You will see four layers in the tube: a top, clear, yellowish, ether or petrol layer; a narrow, middle, thick brown layer; below this there is a thin, brown layer; at the bottom is a little layer of deposit.

18. Put an applicator stick (or a loop) into the tube and move it round the inside wall—this stops the middle, thick brown layer from sticking to the side of the tube.

19. Tip away the supernatant, except for the deposit at the very bottom of the tube.

20. Add a drop of Lugol's iodine to the deposit.

21. Using a Pasteur pipette put the deposit on a slide and look at it under a coverslip. You will see many more ova and cysts than there are in an ordinary saline smear of the same specimen, but you will not see any protozoal trophozoites. Search the whole of the specimen as in Figure 6-14.

10.4 Four—The 'Sellotape' swab for *Enterobius vermicularis* (FIGURE 10-6)

Enterobius vermicularis is also called the threadworm. It is a small, thin, white worm which lives in the large intestine. At night the female threadworm crawls (moves) out of the anus (the opening through which the stools are passed) and lays her eggs on the skin in the fold between the buttocks (the parts of our bodies that we sit on). The eggs of this worm are thus more easily found on the skin round the anus than they are in the stool. The easiest way to find them is to use a 'Sellotape' swab. 'Sellotape' is the

transparent (clear) sticky tape (a tape is a long, thin, flat piece of paper or cloth) that is used to stick parcels and letters. If a piece of this transparent sticky tape is pressed on the skin round the anus the eggs of *Enterobius* will stick to it. This tape is then stuck to a slide and looked at with a microscope. The tape works like a coverslip, and the eggs of *Enterobius* can be seen through it clearly. They are shown in Picture 6 in FIGURES 10-7 and 10-8.

METHOD

THE 'SELLOTAPE' SWAB FOR *ENTEROBIUS VERMICULARIS*, FIGURE 10-6

1. Take a strip of 'Sellotape' and fold it round the bottom of a test tube or tongue depressor with its sticky side outwards.

2. Press the *sticky* surface of the 'Sellotape' firmly on the skin round the anus. Flatten the folds of skin as you press. The eggs on the skin will stick to the 'Sellotape'.

3. Cut off the middle part of the strip of 'Sellotape' which has been pressed on the skin.

4. Put three or four drops of xylol on the slide and stick the middle part of the tape sticky side down on top of it. Look at the strip with a low power objective, and you will easily see the ova of *Enterobius vermicularis*.

Enterobius vermicularis is not a very harmful worm. It is usually found in children and makes a child's anus itch, so that he wants to scratch it, especially at night.

MOSTLY ABOUT HELMINTHS

10.5 Some common ova (FIGURES 10-7 and 10-8)

In FIGURE 10-7 the common parasites are drawn as diagrams. These diagrams show what you might or could see, and the parts of the figure are not always drawn to scale (the right size compared to one another). In FIGURE 10-8 these same ova are shown as drawings. They have been drawn as nearly as possible to the same scale, and were made using the Olympus Model K microscope; so you should be able to see everything in these drawings with your own microscope. FIGURES 10-7 and 10-8 are numbered in the same way.

This section describes the parasites that are common in Africa. In the place where you work other parasites may be common, and you will have to ask other laboratory workers which these are likely to be.

Hookworm

There are two species of hookworm called *Ancylostoma duodenale* and *Necator americanus*. Although the adult worms look different, their ova look the same. They have thus been labelled 'hookworm'. The adult hookworm lives in the small intestine where it is hooked on to the mucosa by its mouth. As you read in Section 7.6, the

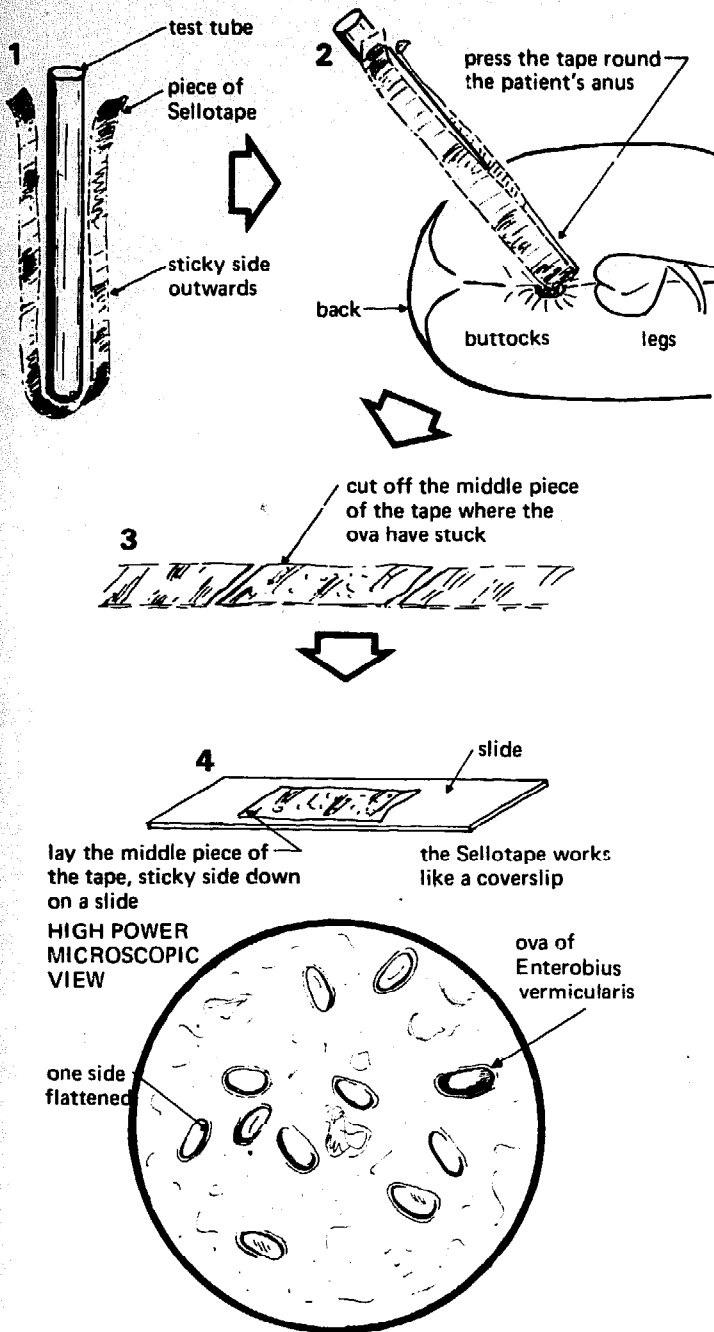

if you have difficulty seeing the ova because there is so much debris, let a drop of xylol run under the Sellotape

Fig. 10-6 The 'Sellotape' swab for *Enterobius vermicularis*

mucosa bleeds a little where the hookworm bites it. The female hookworm lays many ova. Just after they are laid these ova look like Picture 1a and have one large round cell in a thin, clear shell. The cell soon divides into two (Picture 1b), and then into four (Picture 1c). After a few more divisions it becomes a ball of small cells (a morula) as in Picture 1d. The ball becomes empty, as in Picture 1e, and a depression (hole) forms in one side. A rod of cells grows into the middle of the ball, and, after further growth (Picture 1f and 1g), the completed embryo (very

young worm) is formed (Picture 1h). This then bursts out of its shell (Picture 1j) and becomes the free larva. This is the first stage larva. An embryo is said to become a larva when it bursts out of its shell.

Most of the hookworm ova that you will see will be in the early morula stage (Pictures 1b, c, d). This is because there is not usually enough time before you look at the stool for the hookworm ova to grow to the stages shown in Pictures 1g, h, and i. But, if the stool has been waiting in a warm place before you look at it, you may find the stages shown in Pictures 1h and i. The hookworm larva (Picture 1i) is very like the *Strongyloides* larva (Picture 7). For this reason both the hookworm larva (Pictures 8 and 1i) and the *Strongyloides* larva (Picture 7) have been drawn together for comparison at the bottom of both FIGURES 10-7 and 10-8. We shall say more about the difference between the hookworm and *Strongyloides* larvae when we come to describe *Strongyloides*.

A few hookworms do not harm a patient, but many hookworms cause so much bleeding that they may give him a severe hypochromic anaemia. It is thus important to find out, not only that the patient has hookworms, but also how many he has. This can be done quite easily by making a standard thin faecal smear as shown in FIGURE 10-3 and then counting *all* the hookworm ova seen in the film. This means searching the *whole* area of the coverslip, as shown in FIGURE 6-14. It also means that the film must be standard—that is it should only *just* be possible to read newsprint through it. If a child only has 20 ova in a standard film, his infection is mild and it may not be necessary to treat him. Above 20, and certainly above 40, he should certainly be treated. When there are more than 70 ova in the standard film, there are so many hookworms in the gut that they cause enough bleeding to make the occult blood test positive (+) (see Section 10.10). When it is strongly positive (++) there will never be less than this number of ova in the stool, if hookworms are the only cause of the bleeding. If therefore the occult blood test is strongly positive (++) and yet there are less than 70 ova in a standard film, some other cause for the bleeding must be looked for.

Ascaris lumbricoides

As you will see from FIGURE 10-7, the ova of *Ascaris* are about the same size as those of the hookworm. But, instead of having a thin, smooth, clear shell like hookworm, *Ascaris* ova have a thick, rough, dark shell. Picture 2a shows what the ovum looks like from on top—thick, dark, and rough. If you focus on the middle of the ovum you can see it as if it were cut in half as in Picture 2b. This is a fertile ovum—that is, one which is going to grow into an *Ascaris* worm. It has a thick shell, and there are few granules in the ovum itself. Some ova are not fertile—that is, they will not grow into an adult worm. These infertile ova are longer and narrower than the fertile ova and have a thin shell and many round bright granules (little round balls) inside them. These are shown in Picture 2c. There is one more kind of *Ascaris* ovum:—

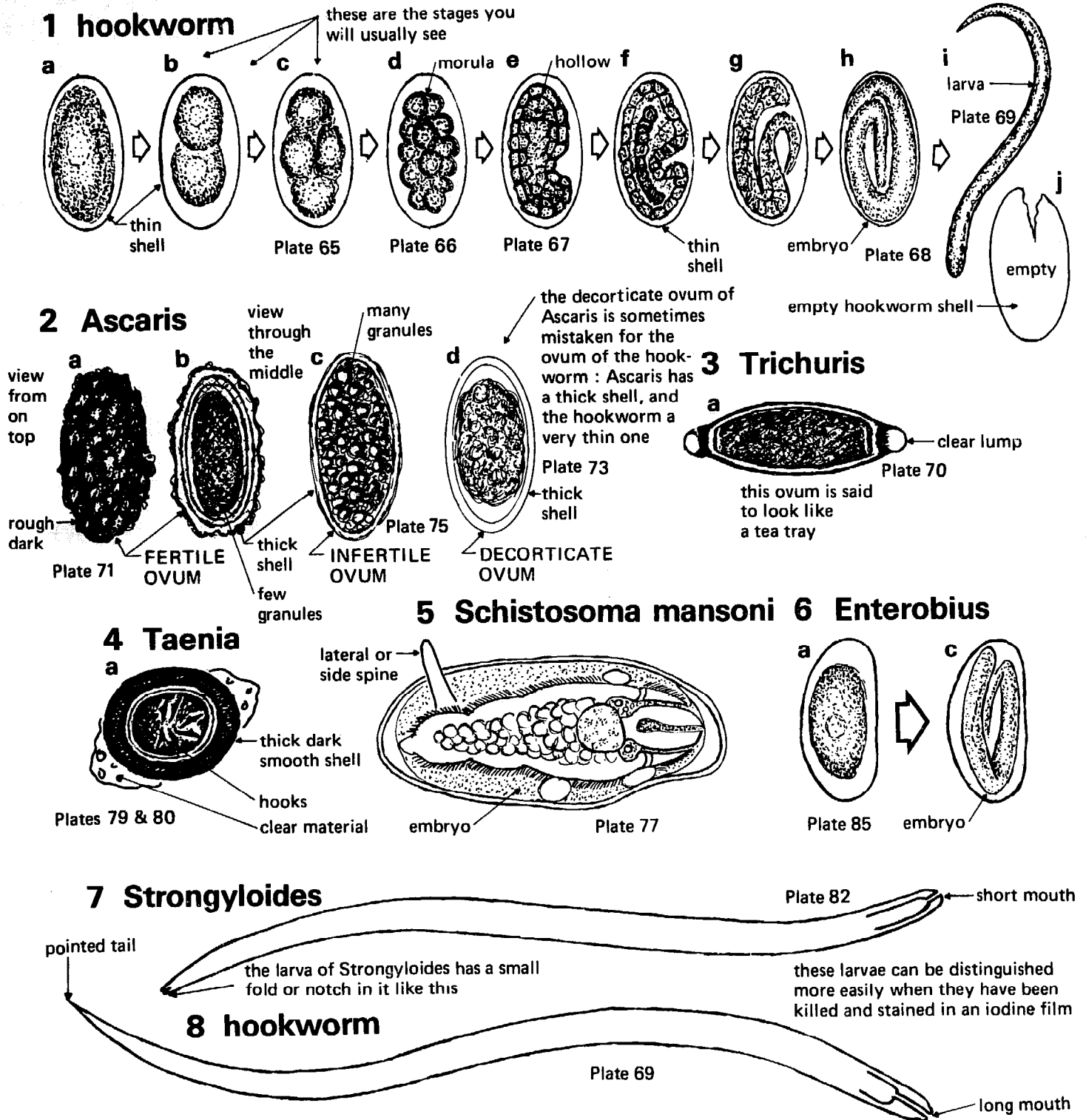

this is the hookworm larva in Picture 1i above drawn much larger so that it can be compared with the larva of Strongyloides

Fig. 10-7 Some common ova—a diagram

the decorticated ovum. Decorticated means that the ovum has lost its skin or cortex. It is like an orange without its skin and is shown in Picture 2d. All these ova are reported together as 'Ascaris ova'; there is no need to distinguish one kind from another.

With the hookworm we saw that the ovum started as a

single cell (Picture 1a) and grew through many stages to become a larva (Picture 1i). We said that all these stages may be found in the stool, but that the later ones are not very common. Ascaris grows through the same stages, but it grows so slowly that only the single-cell stage is found in fresh stools.

Trichuris trichiura

This is a very easy ovum to recognize—it is longer and narrower than the other ova and has clear lumps at each end. It is sometimes said to look like a tray, the lumps being the handles. Like the *Ascaris*, it is only seen in the one-celled stage. Unlike both hookworm and *Ascaris*, there is only one kind of *Trichuris* ovum. This is shown in Picture 3a.

Taenia

There are two common kinds of tapeworm: *Taenia solium* and *Taenia saginata*. Like the two kinds of hookworm, both their eggs look the same. They are nearly round with a smooth, dark, thick shell. Inside the ovum are six little hooks. When the worm grows these will be the hooks of the head with which it fixes itself to the wall of the intestine. These hooks have been drawn in Picture 4a. You can usually see the hooks if you look carefully with a high power objective.

Schistosoma mansoni

This is the largest egg you will find in the stool. As you see from Picture 5, the ova of *S. mansoni* differ a little in shape, but they all have a sharp spine (a thorn or spike) sticking out of one side. The egg of *S. mansoni* is very like the egg of *S. haematobium* (Picture 1, FIGURE 8-10) except for the place of its spine. *S. mansoni* has its spine at one side (a lateral spine); *S. haematobium* has its spine at one end (a terminal spine). *S. mansoni* usually lives in the gut, and its ova are found in the stool. *S. haematobium* usually lives in the bladder, and its ova are found in the urine. Therefore you will usually find lateral spined ova (*S. mansoni*) in the stool and terminal spined ova (*S. haematobium*) in the urine. But you will occasionally find *S. mansoni* in the urine and *S. haematobium* in the stool.

In Picture 5, FIGURE 10-8, you will find that the ova of *S. mansoni* have been drawn just as they are seen in the stool, and it is difficult to find the various parts of the embryo schistosome. But, in Picture 5, FIGURE 10-7, the parts of the embryo are shown as a diagram, and you can see them more clearly.

Enterobius vermicularis

This worm is also called the threadworm, and its ova are not commonly seen in the stools. They are better seen by the 'Sellotape swab method' which is described in Section 10.4. The ovum of *Enterobius* is thin and clear like that of the hookworm, but, unlike the hookworm, it is flat on one side. As with the hookworm, many stages of development are seen, but only three are drawn here. The single cell ovum has been drawn in Picture 6a, the morula (ball of cells) stage in Picture 6b, and the larva about to hatch in Picture 6c.

Strongyloides stercoralis

This worm lives in the small intestine, and *the larvae hatch very soon after the female has laid her ova*. By the time the stools are passed they have had time to hatch. This means that *Strongyloides* are not seen in the stool, but *Strongyloides* larvae are seen. If actively moving larval worms like those drawn in Pictures 7 and 8 are seen in the stool, they are either hookworms or *Strongyloides*. They will only be hookworm if the stool has stood about on the bench and the hookworm eggs have had time to hatch. Larvae in the stools are thus usually *Strongyloides*. It is quite easy to tell hookworm from *Strongyloides* by looking at their mouths. *Strongyloides* has a short mouth, and the hookworm has a long mouth. To see the mouths more clearly, use the high power objective and not too much light. *Strongyloides* also has a notch in its tail.

Some other things

Some of the other things that may be seen in a stool have been drawn in Picture 11, FIGURE 10-8. The little dots and rods that are seen all over this picture are the normal harmless bacteria that are seen in all stools. Pictures 11a, b, c, d, e, f, are all parts of plants, such as cabbage or banana that the patient has eaten as his food. There are also many other parts of plants with quite different shapes which there is no space to draw here. Some pieces of plants, such as those drawn in Pictures 11a, c, and f are so big that only a part of them has been drawn. Spiral (spring-like) cells, such as those in Picture 11d are often seen. Picture 11g is an air bubble; this is a small one—they can be very big.

Pictures 11h and 11i are both fibres (little threads) of meat that the patient has eaten but which have not been completely digested. A few meat fibres are often seen. But, if many meat fibres are seen, this is abnormal because it means that the patient is not digesting his meat as he should. If you see many meat fibres, report 'many meat fibres seen'. Meat fibres are easy to recognize. They are brownish-red like meat, and they have rounded corners where they have been partly digested. Meat fibres also have 'cross striations': that is, they have many small lines going across the fibre. Look for cross striations with the high power objective.

Little drops of oil or fat are often seen in the stool; these are shown in Picture 11j. They are very 'bright' (refractile), completely round and of varying sizes. Oil droplets are often muddled up with cysts. Some cysts have been drawn in Picture 11k. You will see that cysts are not quite so 'bright', and they are not quite so round. This is an unstained saline smear; so you cannot see the nuclei easily. If they were stained with iodine they would look like Picture 9. An amoebic trophozoite has been drawn as Picture 11l. Red cells, white cells or pus cells, bacteria, yeasts, and *Blastocystis* are also shown.

Something more must be said about *Blastocystis hominis* which is a common and harmless yeast. The

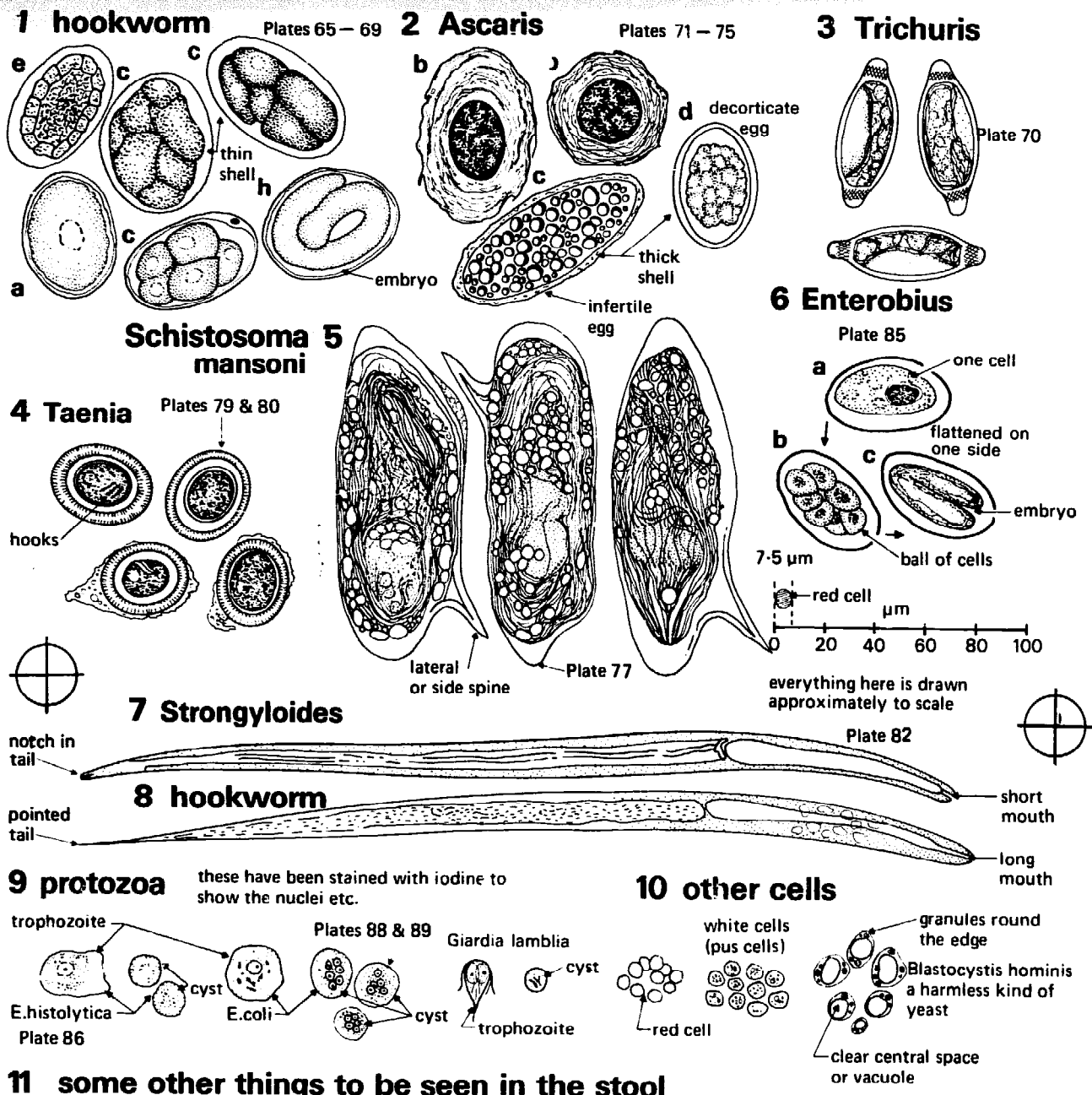

Fig. 10-8 Some common ova—a drawing

important thing about these organisms is that they can easily be mistaken for protozoan cysts. They are more or less round and of varying size. The smallest are about the size of a red cell and the largest several times as big. Most of the organism is filled with a large, clear, empty-looking, spherical (ball-like) space or vacuole. This large vacuole pushes the nucleus and the rest of the cytoplasm to the edge of the cell. *Blastocystis* has been drawn in Pictures 10 and 11 in FIGURE 10-8. Learn to recognize *Blastocystis*, and you will not muddle it up with protozoan cysts.

10.6 Some more ova (FIGURE 10-9)

Most of the parasites and their ova we have described so far are common in Africa, and many of them are also common in other parts of the world. Some of the ova described in this section are rarely, if ever, seen in Africa, although they may be very common in other countries, especially countries in the Far East. You should ask which ova you are likely to see and should not waste time learning to recognize ova that are not found in the place where you work.

The first four are the ova of *flukes*. A fluke is a kind of trematode worm (see Section 1.14) which is short, flat, broad, and thin, and is shaped rather like a leaf.

Picture A, *Fasciolopsis buski*. This is a large fluke which lives in the liver and is common in Eastern Asia and in the South-West Pacific. The egg is very large and has an operculum at one end. An operculum is a

door or weak part of a shell through which the embryo can escape when it is mature and ready to leave the egg.

Picture B, *Heterophyes heterophyes* and *Metagonimus yokogawai*. Both these flukes live in the intestine, and, as their eggs are almost exactly the same, they are described together. *H. heterophyes* is found at the mouth of the Nile, in Turkey, and in the Far East. *M. yokogawai* is common in the Far East. These ova are small, light brown, and have an operculum.

Picture C, *Clonorchis sinensis*. This fluke lives in the bile passages and is found in the Far East, especially in the region of the China Sea. The ova are small and have a thick, light brown shell with an easily seen operculum. The ova of this species may be hard to distinguish from those of *H. heterophyes* and *M. yokogawai*.

Picture D, *Paragonimus westermani*. This fluke is found in the lung, and its ova are seen in the sputum. It is found in the Far East and Western Pacific and also in West Africa. The ova are large and brown with a thick wall and flattened operculum.

Picture E, *Schistosoma japonicum*. This trematode lives in the intestine and is found in parts of the Far East. Its ovum is smaller than that of *S. mansoni* and has a small curved spine at one side. The spine is in a slight depression (hole or cup) and may not be easy to see.

Picture F, *Hymenolepis nana*. This is the dwarf (very small) tapeworm and is common in many parts of the world. Like *Taenia* its ova have a thick shell, but its walls appear double. Between the inner and outer walls are some thin twisted threads. Inside are three pairs of hooks.

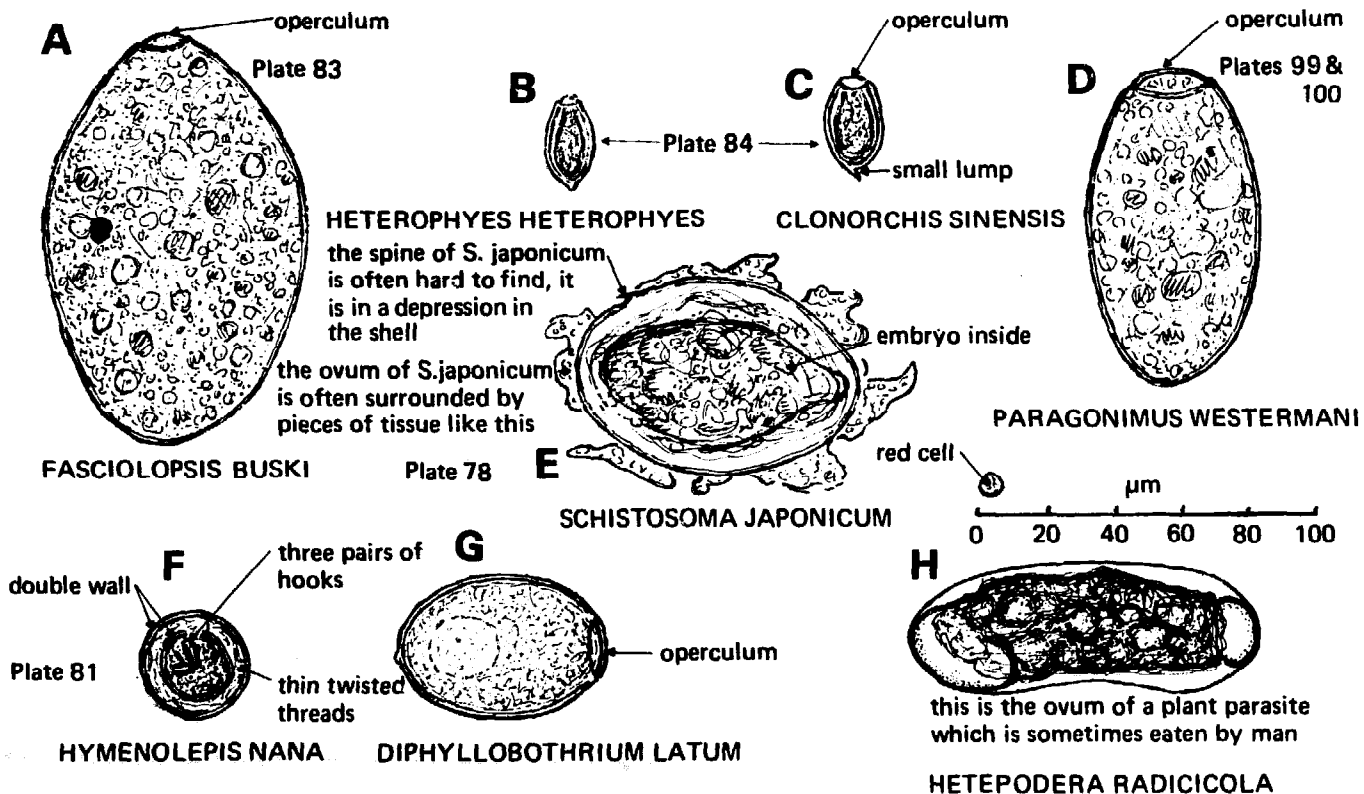

Fig. 10-9 Some less common ova

Picture G, *Diphyllobothrium latum*. This is the fish tapeworm which is found in parts of Russia, Central and Southern Europe, the Middle and Far East, Latin America, and Australia. It is quite a large, yellow-brown ovum with thick walls and an operculum.

Picture H, *Heterodera radicum*. This nematode is a parasite of plants and is only found in the stools when a patient has eaten plants which are infected with it. It is quite harmless.

PROTOZOA

10.7 *E. histolytica* and *E. coli* (FIGURE 10-10)

Protozoa are very much smaller than the helminths, so they are described separately and drawn larger on a different scale.

There are many protozoa in the gut, but the two which cause disease are *Entamoeba histolytica* and a flagellate called *Giardia lamblia* which is described in Section 10.10. The harmless amoebae are *Entamoeba coli*, *Dientamoeba fragilis*, *Endolimax nana*, and *Iodamoeba butschlii*. We shall describe *Entamoeba coli* in some detail because this is the organism which is often confused with *Entamoeba histolytica*. Earlier on you read about *Escherichia coli*, which is often shortened to *Esch. coli*. This is a bacterium, not a protozoon, and is thus quite a different organism. 'Coli' means belonging to the large gut or colon, which is where both these organisms are most often found.

Entamoeba histolytica may invade (harm and go into) the wall of the colon and cause a kind of bloody diarrhoea called *amoebic dysentery*. The stools of such patients will contain actively moving trophozoites with red cells inside them. In many people, however, *E. histolytica* seems to cause no disease and to live harmlessly in the upper part of the colon. The stools of these patients look normal and contain only cysts. There is, however, every intermediate stage between a very sick patient with severe diarrhoea caused by many trophozoites and a person who passes a few cysts and seems perfectly well. Thus a patient might be only mildly ill and pass soft stools containing a few trophozoites of *E. histolytica*.

FIGURE 10-8 shows you what the trophozoites and cysts of *E. histolytica* look like in a saline smear of the stool (Picture 11 in this figure). In FIGURE 10-10 these organisms have been drawn very large as diagrams—see how large a red cell is by comparison (Picture f). The trophozoites of *E. histolytica* and *E. coli* (Pictures a and g) are at the top of the figure. You will see that the cytoplasm of the trophozoite of *E. histolytica* has a clear outer part or **ectoplasm** and an inner **endoplasm** which contains small granules. In this it is unlike the trophozoite of *E. coli*, the cytoplasm of which is the same all over and is much less clear and more full of granules. Many of these granules are the remains of bacteria which the amoeba has eaten and which are more obvious in *E. coli* than in *E. histolytica*.

In both species the nuclear chromatin is spread round the edge of the nuclear membrane and is also gathered into one or more small lumps or **karyosomes**. *Entamoeba histolytica* has finer chromatin round the edge of the nucleus, and its karyosome is usually in the middle. *Entamoeba coli* has coarser chromatin round the edge, and its karyosome is usually towards one side. The *Entamoeba* kind of nucleus is quite different from the nuclei of other species of amoeba, which have their nuclear chromatin arranged in different ways, as shown at the bottom of FIGURE 10-10. If you want to see the detail of the nuclear chromatin, make an iodine film, seal it with vaseline and paraffin wax, and use an oil immersion objective.

Pictures b and h in FIGURE 10-10 show the amoebae turning into cysts. It is not easy to tell one species from the other at this stage. The lower three pictures (Pictures c, d, e and i, j, k) show the cysts. The mature cysts shown in Pictures e and k are commonly seen. Young cysts are less common. The cysts of *E. histolytica* seldom have more than four nuclei; the cysts of *E. coli* usually have more than four nuclei and may have eight. The young cysts of both species sometimes have bars or rods inside them. These are called **chromidial bars**. The chromidial bars of *E. histolytica* are large, rounded, and easily seen; the chromidial bars of *E. coli* are smaller and pointed. It may sometimes be difficult to tell the cysts of *E. coli* from those of *E. histolytica*. The number of nuclei and the shape of the chromidial bars (if there are any) are the things to look for—they can easily be seen when the film is stained with iodine.

There are two important ways of telling the trophozoites of *E. histolytica* from the trophozoites of *E. coli*. Only *E. histolytica* ingests (eats) red cells, and only *E. histolytica* moves in the way shown in FIGURE 10-11. In Picture A in this figure an *E. histolytica* trophozoite has been drawn as if it was about to cross a line X-Y on the slide. Inside it are two red cells. In Picture B it has put out a clear pseudopodium (a foot) as shown by the arrow. In Picture C the inner granular part of the cytoplasm (the endoplasm) has moved into this foot and with it one of the red cells. In Picture D the amoeba has moved in its 'tail' as shown by the black arrow, and at the same time it has put out a new pseudopodium, as shown by the white arrow. In Picture E the amoeba has moved in its 'tail' once more. In this way *E. histolytica* changes its place—it will soon have crossed the line X-Y on the slide. The way *E. histolytica* moves has been called the 'progressive directional crawl'. A crawl is a slow way of moving. It is a good name because *E. histolytica* moves as if it wanted to get somewhere. *E. coli* does not move in this way—it slowly puts out small pseudopodia, which are not clear like those of *E. histolytica*. It does not change its place, and it does not ingest red cells. 'Progressive directional crawl' is a very important way of distinguishing *E. histolytica*, but you will only see it in a fresh warm stool very soon after the patient has passed it. This is why warm stools are so important in looking for this organism.

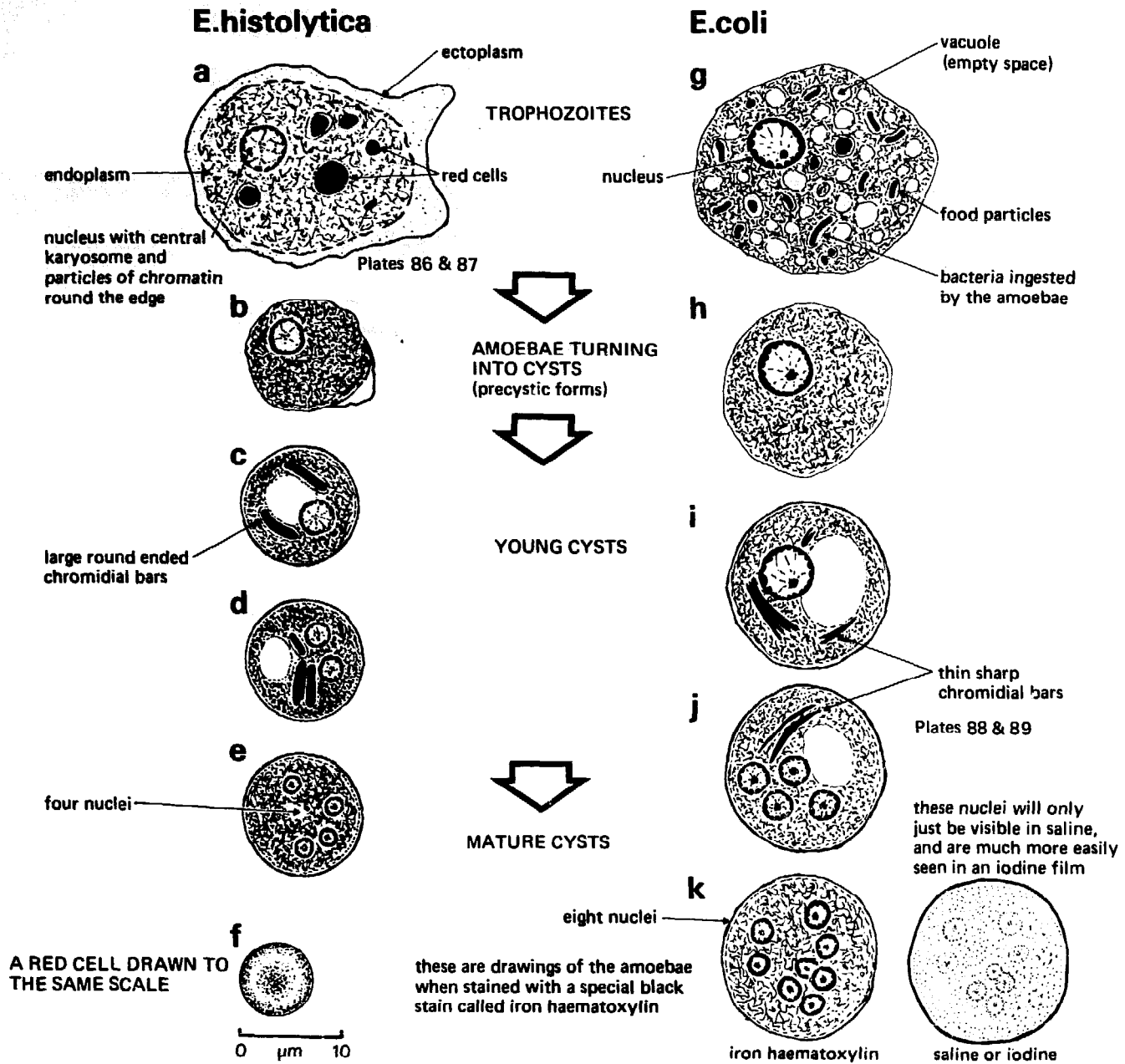

redrawn after Belding

DIFFERENT SPECIES OF AMOEBAE HAVE DIFFERENT NUCLEI

to see these details, make an iodine preparation, seal it with vaseline and wax, and use an oil immersion objective

these are diagrams and are not to the same scale as the figure above

Don't worry about identifying these species, the important thing about them is that they are not *Entamoeba histolytica*

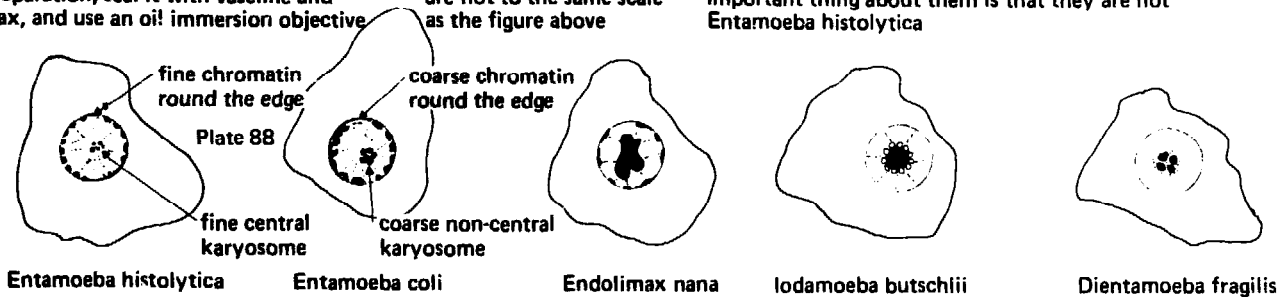

Fig. 10-10 *Entamoeba histolytica* and *Entamoeba coli*

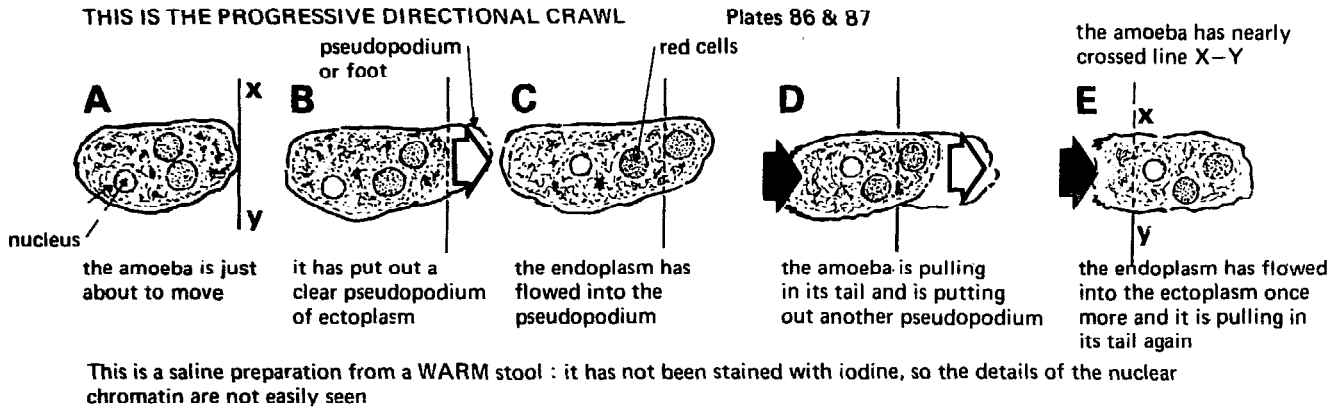

Fig. 10-11 The 'progressive directional crawl' of *E. histolytica*

If you are wondering what something is and it has red cells inside it, it might be *E. histolytica*, and it might be a macrophage. It could not be *E. coli*. A macrophage is usually a monocyte that has come from the blood. Macrophage means 'big eater', and macrophages may eat red cells. But macrophages do not put out pseudopodia. They do not move like *E. histolytica*, and they do not have nuclei with chromatin round the edge like the entamoebae.

10.8 Bacillary and amoebic exudates (FIGURE 10-12)

Very bad diarrhoea with blood in the stools is called dysentery. There are several kinds of dysentery, but the two most important kinds are **bacillary dysentery** and **amoebic dysentery**. Bacillary dysentery is caused by bacteria of the genus *Shigella*. As we have seen, amoebic dysentery

is caused by *E. histolytica*. The stools of these two kinds of dysentery are different and show different exudates.

A stool from a patient with bacillary dysentery is usually watery and is stained with blood. If the dysentery is very bad the stool will have in it pieces of the mucosa of the gut. The mucosa of the gut is its inside surface. When a saline smear is made and looked at with a microscope, it will look like Picture A, FIGURE 10-12. There will be many red cells, many pus cells (polymorphs), and probably some macrophages. Some of these may have red cells inside them, but, unlike *E. histolytica*, they will not be motile (moving).

A stool from a patient with amoebic dysentery will probably be soft. You may see blood in it, and you will almost always find red cells when you look at a saline smear with a microscope. A saline smear of an amoebic exudate has been drawn in Picture B, FIGURE 10-12. You will see the trophozoites of *E. histolytica* with red

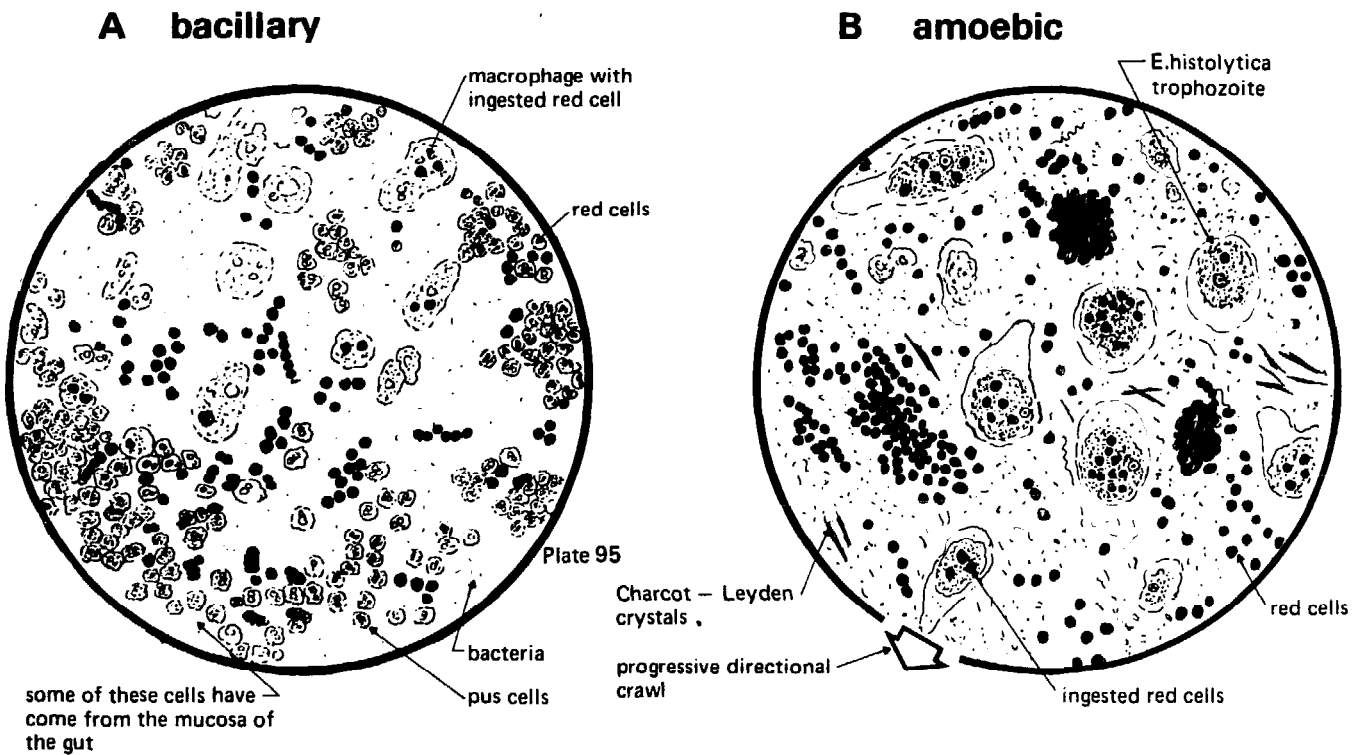

Fig. 10-12 Bacillary and amoebic exudates

cells inside them. There may be a few pus cells, but there will not be nearly so many as in a bacillary exudate. If you watch carefully you will see the 'progressive directional crawl' described in Section 10.7. Sometimes you will see small sharp-pointed crystals called Charcot-Leyden crystals. These are more often seen in amoebic dysentery than in any other disease. This is a typical amoebic dysentery exudate, but in many patients with amoebic dysentery all you will see are a few amoebae and some red cells.

10.9 Identifying *E. histolytica*

This means finding and being able to say with certainty that an organism is *E. histolytica*. As we have seen, this may not be easy, so here are some rules to help you.

Always look at a fresh warm stool as soon as it is passed, and make smears from several parts of it, especially those with blood or mucus on them. If the diagnosis is in doubt, look at several stools, if necessary, after the patient has been given a purge. Don't report on one parasite only, but look at several before making up your mind what they are. Make a smear in iodine so that you can identify the *Entamoeba* kind of nucleus more easily. Try to find the size of any trophozoites or cysts you see. This is best done with a special eyepiece micrometer (size measurer), but you will have to do as best you can by comparing the organisms you see with red cells.

By using these methods you may report *E. histolytica* as being present if you find any of the following:

1. Trophozoites showing a 'progressive directional crawl' and also containing red cells inside them.
2. Trophozoites bigger than $12\ \mu\text{m}$ with a fairly clear cytoplasm and a progressive directional crawl or the *Entamoeba* kind of nucleus (or both).
3. Cysts bigger than $10\ \mu\text{m}$ containing not more than four of the *Entamoeba* kind of nucleus. They are even more likely to be *E. histolytica* if they contain rod-shaped chromidial bars.

When you report on a specimen which you have examined for *E. histolytica*, describe what the stool looks like, give the genus and species of the parasite found, say whether you found trophozoites or cysts, record whether the trophozoites contained red cells or showed the 'progressive directional crawl', or whether the cysts contained chromidial bars. Say what kind of exudate you found. The person who is looking after the patient will then be able to tell if the amoebae are causing disease or only living harmlessly inside the colon. As always, if you are not sure what you have found, say so.

10.10 *Giardia lamblia* and *Trichomonas hominis*

Amoebae move by putting out pseudopodia, but other kinds of protozoa can move in other ways. Some protozoa have a few long hairs or flagella which they move about very fast like a whip. The word flagellum means whip. Protozoa which move with flagella are called flagellates. The trypanosome described in Section 7.36

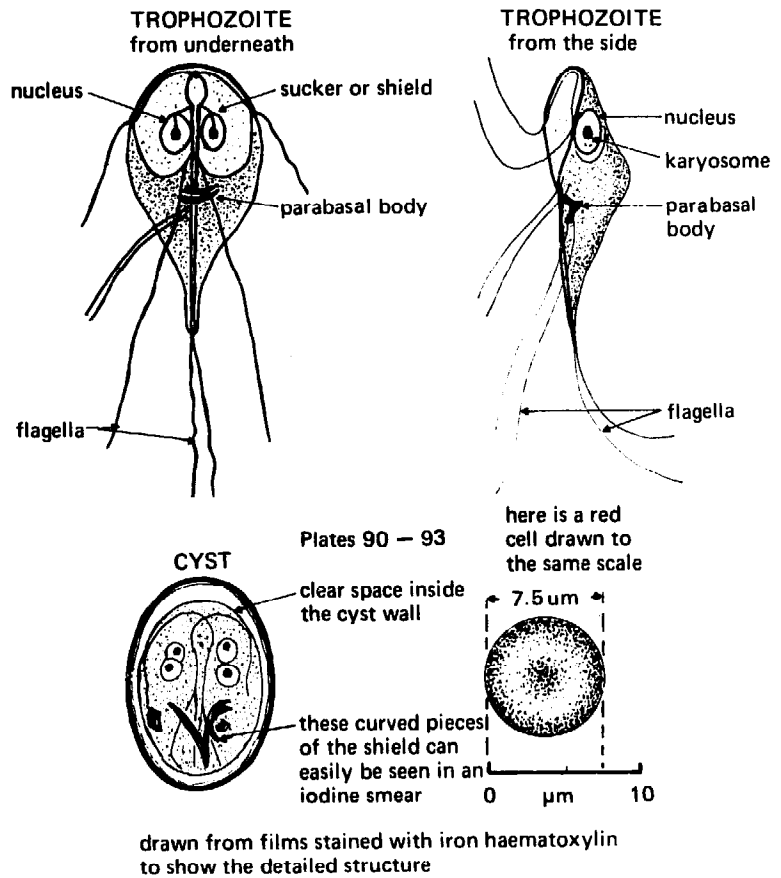

Fig. 10-13 *Giardia lamblia*

is a flagellate; so is *Trichomonas vaginalis* described in Section 11.8. Several flagellates are found in the stools. The most common and the most important stool flagellate is *Giardia lamblia*, which is shown in FIGURE 10-13. Even though it is only one cell, this flagellate has several different parts and is a very special shape. You will see that it has several flagella and a flat area or sucker at one end. Inside it are two curved rods and also two nuclei. *Giardia lamblia* forms oval (egg-shaped) cysts with a thin wall. Inside the cyst there are four nuclei and some curved bars which can easily be seen in an iodine film.

Giardia lamblia is the only intestinal (gut) flagellate which causes disease in man. It lives in the small intestine and can cause diarrhoea. This diarrhoea is usually of a special kind called a fatty diarrhoea or **steatorrhoea**. The stools of a patient with steatorrhoea are said to be 'pale, bulky (there is a lot of them), and offensive' (they smell especially bad). They are also often frothy (they contain bubbles of gas). The stools are like this because large numbers of *Giardia* in the small intestine stop food and especially fat from being absorbed properly. It is this unabsorbed food in the stools which makes them 'pale, bulky, and offensive'. Other diseases can also cause this kind of stool, but giardiasis (the disease caused by *Giardia*) is an important disease to recognize because it can so easily be treated with mepacrine tablets.

Two other flagellates may be seen in the stools. They are *Chilomastix mesnili* and *Trichomonas hominis*, neither of which are believed to cause disease. Both move

about very actively and may be mistaken for *G. lamblia*. One way to tell them apart is by the way they move. *G. lamblia* moves in a rapid, jerky progressive way and moves from one part of the field to another. It is sometimes said to move by turning over and over like a falling leaf. *C. mesnili* moves in rather a similar way, whereas the movement of *Trichomonas hominis* is irregular in that it does not move across the field of view. *Chilomastix mesnili* forms cysts, but *Trichomonas hominis* does not. If therefore you see a flagellate and are not sure what it is, look for cysts. The cysts of *G. lamblia* are very special, and once you have seen them you will not mistake them for anything else. Look for the oval shape, the thin cyst wall, and the curved bars. You will need a high power or an oil immersion objective, and you must carefully adjust the condenser to give the best light. The

cysts will be easier to examine if you seal the coverslip with vaseline and paraffin wax mixture while you are using the high power, or the oil immersion objectives.

It is easy to say if a micro-organism is a flagellate, because flagellates are the only common small protozoa that move around fast in the stools. If you know that something is a flagellate but are not sure if it is *G. lamblia*, *T. hominis*, or another flagellate, report 'Flagellates present'. If the patient has diarrhoea and you report 'Flagellates present', the patient should be given mepacrine tablets. He probably has giardiasis.

10.11 Occult blood

When a patient bleeds from his skin or his nose, the blood is easily seen. But when a patient bleeds a little into

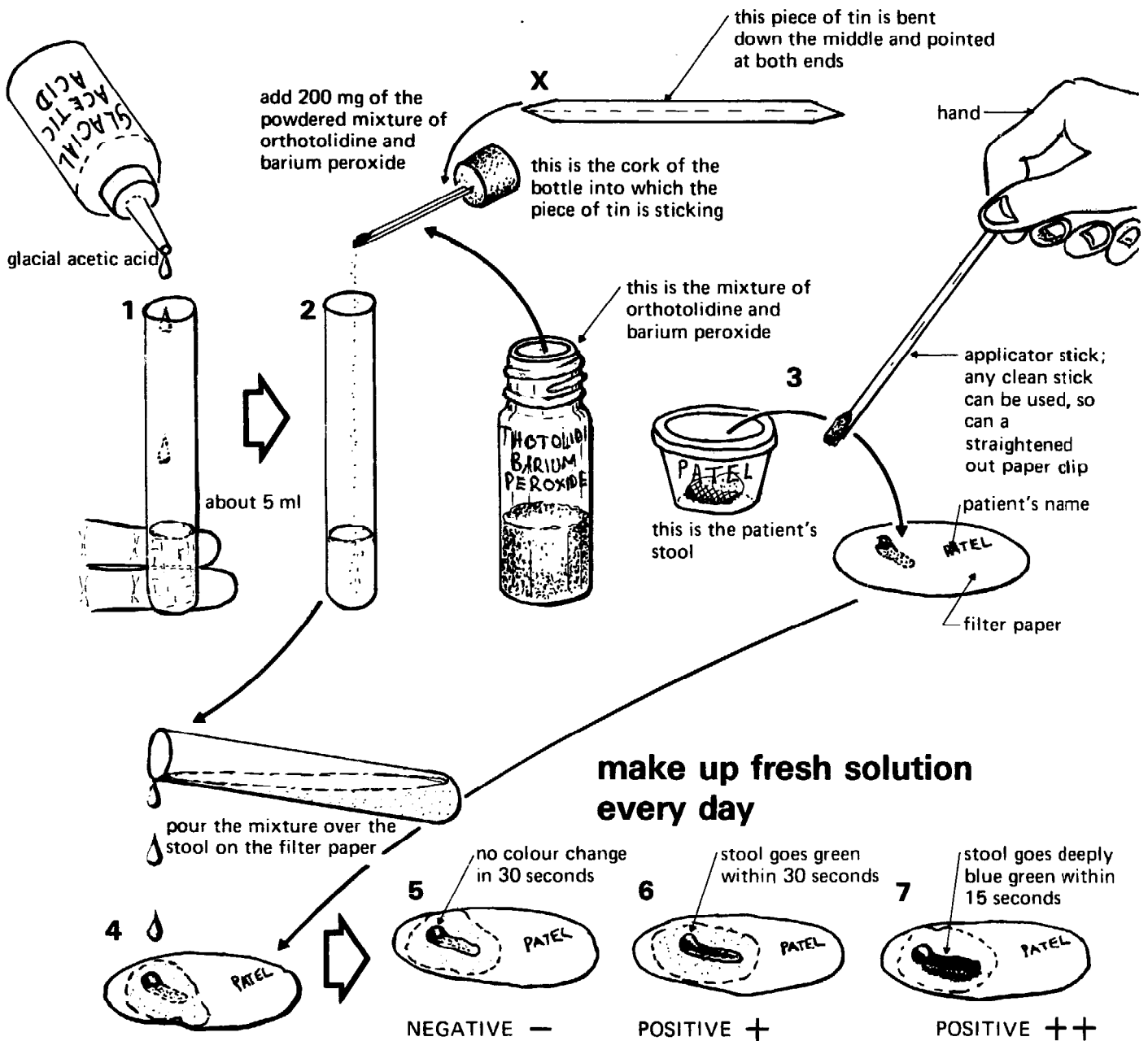

Fig. 10-14 The orthotolidine method for occult blood

his gut (stomach and intestine) the blood may not be seen. This is because it is digested and mixed up with the stool. Bleeding into the gut that cannot be seen is called **occult bleeding**. Occult means hidden. When we test for occult blood we test for hidden blood that cannot be seen by simply looking at the stool.

Bleeding is not always occult. When a patient bleeds from near the bottom of his gut, the blood is not digested, and bright red blood is seen in the stool. Also, if there is much bleeding high up in the gut, the blood may not be digested before it leaves the body. Here too, bright red blood may be seen in the stool. Sometimes there is heavy bleeding high up in the gut and the blood is partly digested before it leaves the body. This half-digested blood is black. A black stool like this is called a **melaena stool**.

METHOD

TESTING FOR OCCULT BLOOD IN THE STOOL. FIGURE 10-14

1. Pour 5 ml of glacial acetic acid into a test tube. Five millilitres is two finger's breadth deep.

2. Add to it 200 mg of ortho-tolidine-barium peroxide mixture (see Section 3.36). The best way to measure this out is to keep the mixture in a bottle with a little tin scoop pushed into its cork. When you first make the scoop, weigh out 200 mg of mixture and see what it looks like on the scoop. Remember what this looks like and add the same amount next time. Dissolve the ortho-tolidine-barium peroxide mixture in the glacial acetic acid. The mixture will go green.

3. Put a piece of filter paper in the sink, or on to a tile or dish. Smear some stool on to it.

4. Pour some of the glacial acetic acid mixture over it.

5. If there is no colour change in 30 seconds, the test is negative (—). The paper will of course stay pale greenish where it was stained by the reagent.

If the stool goes green after 30 seconds, the test is weakly positive (+).

If the stool goes deeply blue-green within 15 seconds, the test is strongly positive (++). It is not possible to judge '+++' and '++++' with this method.

Ortho-tolidine is under suspicion as a dangerous chemical, for it is thought that, if small quantities are taken into the body over a long time, they may cause cancer. In some countries its use has been stopped by law. However, it is not certain that the small amounts used in a medical laboratory have ever caused this disease, and there is no other suitable test for occult blood. This test has therefore been described here for use in those countries where ortho-tolidine may still be used. However, don't spill it round the laboratory, or it may get into the dust, into the air, and so into you. Don't get it on to your hands, and wash them after you have been using it.

10.12 Measuring the pH of a stool and testing for lactose

In Section 1.7 you read how we use pH to measure the acidity or alkalinity of a solution. pH 1, you will remember, was very acid, and pH 14 was very alkaline. pH 7 is in the middle; it is neutral and is neither acid or alkaline. Pure water has a pH of 7. The pH of a stool is easily measured and is a useful way of telling if diarrhoea is probably due to a bacterial infection or to **lactose intolerance**. Lactose is a sugar which is found in milk. Used like this, intolerance means being unable to digest and absorb something. All the lactose in the food of healthy people is digested in the gut by an enzyme called **lactase** and is absorbed into the body. But in some patients, especially those with **kwashiorkor** (see below), there is too little lactase in the gut and lactose is not properly digested and absorbed. It stays in the gut and is made into lactic acid by the normal bacteria of the gut. This lactic acid causes diarrhoea with an acid stool which has a pH of less than 6. In a bacterial diarrhoea (such as a shigella infection—see Section 10.8) the stool is alkaline with a pH of more than 7. By testing the pH of a patient's stool we can therefore tell if his diarrhoea is more likely to be due to intolerance to lactose (or some other sugar) or to bacterial infection. There are of course other causes of diarrhoea, such as the diarrhoeas caused by *Giardia* and amoebae, where the pH of the stool does not help us.

When children do not get enough protein or enough joule-containing (energy-containing) foods, they do not grow properly and become sick. They are said to have **protein joule malnutrition** or **PJM**. A child with severe PJM suffers either from a disease called kwashiorkor, or from another disease called **nutritional marasmus**. In some countries these are both common and important diseases which kill many children. PJM can be prevented by proper feeding, especially feeding with protein. A commonly used protein food is dried skim milk, which is about half protein and half lactose. This gives some children diarrhoea. If it gives a child diarrhoea with an acid stool of pH less than 6, he probably has lactase deficiency. The way to get over this is to ask his mother to add a little dried skim milk to all his food, and especially to his porridge. Given in this way it is less likely to give him diarrhoea. Another and usually less easy way is to give the child another protein food, which does not contain lactose.

METHOD

MEASURING THE pH OF A STOOL

Take a piece of universal indicator test paper and dip one end of it into the stool.

Where the paper is covered by stool you will not be

Footnote. The energy in foods used to be measured in calories. The modern way is to measure it in joules which are part of the SI or International System of units. There are 4.18 joules in a calorie.

able to see its colour, but the water in the stool will soak into (move into) the paper and change its colour. Universal indicator test paper is a dirty yellow colour. If the stool is alkaline, as in a bacterial diarrhoea, the paper will go green or even blue (pH 7 and above). If the stool is acid, as in lactose intolerance, the paper will go brown (pH 5). A pH of 6 or less in the stool of a child taking milk in his food usually indicates lactase deficiency.

These are the colours for the universal indicator test papers listed in Section 13.10. Other kinds of universal indicator test paper may change colour in different ways.

It is also possible to test for lactose directly by testing the stool with a test tablet that is usually used for testing the urine for sugar. This is the 'Clinitest' tablet (AME). This is a much better test for lactose intolerance than the pH of the stool.

METHOD

TESTING FOR LACTOSE IN THE STOOL WITH A 'CLINITEST' TABLET

Collect the stool by putting a piece of polythene sheet inside the baby's napkin. This is important because the lactose is in the watery part of a stool which is absorbed by a cloth napkin.

Make a short, wide Pasteur pipette. Put about half an inch of the diarrhoeal stool in a test tube. Add twice as much water. Mix the stool and the water by drawing it in and out of the pipette. Add fifteen drops of this stool and water mixture to a second test tube. Add a 'Clinitest' tablet. If there is lactose in the stool, the liquid in the tube will go green, yellow, or brown, just as if the tablet were being used to test urine for sugar. If a child is taking milk and his stool goes yellow or brown by this test (more than 0.5% lactose), he probably has lactose intolerance.

10.13 When to examine the stools

Now that you know what abnormal things can be found in stools, you can understand when to examine them.

Look at the stools of all patients with diarrhoea that

does not get better rapidly, especially if there is blood in the stools. You may find amoebae or the ova of *Schistosoma mansoni* or *Giardia lamblia*. You may also be able to tell if the patient has an amoebic or bacillary exudate.

Look at the stools of all anaemic patients to see if you can find hookworm ova. As you read in Section 7.6, hookworms are a very common cause of hypochromic anaemia. Look for occult blood in the stools of all patients with a hypochromic anaemia and no obvious cause for bleeding, such as many hookworms in the gut or heavy bleeding from the womb (menorrhagia). The patient may be bleeding into his gut from some other cause, such as a peptic (stomach) ulcer.

Look at the stools for ova in any patient who has had abdominal (stomach) pains some days or weeks. Many worms cause abdominal pains, and many patients have abdominal pain; so you will often have to examine stools for this reason.

If children are thin and not growing well, look for ova in their stools. Sometimes their thinness is caused by worms. More often it is because they do not get enough good food to eat.

QUESTIONS

1. Which worms can be seen in the stool? Describe each of the species of worm that you might see.
2. What is a standard faecal smear? How would you make one?
3. In what way do the ova of *S. mansoni* differ from the ova of *S. haematobium*?
4. How would you look for the ova of *Enterobius vermicularis*?
5. How would you distinguish *Entamoeba histolytica* from *Entamoeba coli*?
6. What is meant by a bacillary and an amoebic exudate?
7. What flagellates do you know? How do you look for them?
8. How may blood be found in the stool?
9. What is the importance of lactose in a diarrhoea stool?
10. What are the advantages of the formal-ether concentration method? How is it done?

11 | Some Other Specimens

SPUTUM

11.1 AAFB and the Ziehl-Neelsen method

There is an important genus (tribe) of rod-shaped bacteria or bacilli called the mycobacteria. *Mycobacterium tuberculosis* causes tuberculosis or 'TB', and *Mycobacterium leprae* causes leprosy. They are often called tubercle bacilli and leprosy bacilli. Tuberculosis is usually a disease of the lungs, and tubercle bacilli can often be found in the sputum. Leprosy is usually a disease of the skin and nerves, so we look for leprosy bacilli in smears made from a small cut in the skin.

Even though tuberculosis and leprosy harm different parts of the body they are like one another in several ways. In both of them the infection may start when the patient is a child. Both are usually chronic diseases lasting many years which cause severe disability if they are badly treated, or if treatment is started too late. By disability we mean that the patient is unable to lead an active life and particularly that he is unable to work. Patients seldom die from leprosy, but they often die from tuberculosis. Both diseases can usually be cured if patients are diagnosed early and if they take their drugs regularly and for long enough. In leprosy infection always takes place from one person to another. This is also the usual way in tuberculosis, but there is a less common kind of tuberculosis called bovine tuberculosis in which infection is caused by drinking infected milk from an infected cow. Bovine means from a cow.

Both *Myco. tuberculosis* and *Myco. leprae* can be stained by the Ziehl-Neelsen method, which is named after the two people who first invented it. This method uses a solution of a bright red stain called basic fuchsin in a mixture of water, phenol, and spirit. Phenol used to be called carbolic acid, which explains why the mixture is called 'strong carbol fuchsin'. Dilute carbol fuchsin is used for Gram's method. The specimen is spread on a slide to make a thin film. This is then fixed by being passed quickly through a flame, after which it is covered with strong carbol fuchsin. The carbol fuchsin is then gently heated for 5 minutes. All bacteria stain a deep red, so do the cells in the specimen. The hot stain is next poured off, and the slide is covered with a mixture of acid

and alcohol called acid-alcohol. This washes away the red stain from the cells in the specimen as well as from most of the bacteria. It is said to decolorize them. But the acid-alcohol does not wash the red colour away from mycobacteria, which stay a deep red when everything else on the slide goes pale. Because mycobacteria hold on to the red stain in this way they are said to be 'Acid and Alcohol Fast'. When used like this the word 'fast' means 'able to hold on to a stain'. When we look at sputum that has been stained by the Ziehl-Neelsen method we may see bacteria that have stayed red when acid-alcohol has been poured on them. We see Acid and Alcohol Fast Bacilli or AAFB. We thus report AAFB present or absent in the specimen. *Myco. leprae* is slightly less acid fast than *Myco. tuberculosis*. Films from leprosy patients are therefore stained for a longer time with carbol fuchsin than films from patients with tuberculosis, and are decolorized with a weaker acid-alcohol.

A film is easier to look at if the cells in it are coloured. Red mycobacteria are also easier to see when the cells in the film are stained a different colour. But acid-alcohol washes the red fuchsin away from the cells of the sputum or skin smear which become pale, colourless and hard to see. If therefore the cells are going to be coloured, they must be stained again. Either malachite green or methylene blue can be used. Stains like this, which are used to stain the less important parts of film (the cells rather than the mycobacteria), are called **counterstains**. If you use malachite green as a counterstain in the Ziehl-Neelsen method, you will see red mycobacteria and green cells.

We shall describe two ways of doing the Ziehl-Neelsen method. One is the 'hot method' which has been used for many years. The other is the 'cold method' which is newer and uses only two solutions (instead of three with the hot method) and no heat. With most stains films are best stained one at a time, but with the Ziehl-Neelsen method several films can easily be stained together. The strong carbol fuchsin stain for the two methods is slightly different and is described in Sections 3.22b and 3.23. The stronger acid meant for tubercle bacilli can be used for leprosy smears, but it is better not to and to use a weaker acid instead.

METHOD**ZIEHL-NEELSEN STAIN****A. THE HOT METHOD. FIGURE 11-1**

1. Look at the sputum carefully. If it is in a wide polypot it will be easier to look at than if it is in a narrow bottle. Find a piece of sputum which is thick, yellow, and purulent (pus-like). A piece of sputum like this will be more likely to have mycobacteria in it than will other parts of the specimen. If the specimen is frothy and watery, it is probably only saliva from the mouth, and it is better to ask for another one.

2. Flame your loop well. When it is cool take hold of a purulent piece of sputum. When the sputum is very sticky and tough, you may find it easier to use two loops.

3. The purulent piece of the specimen chosen for staining must be *small*—a little smaller than the head of a match.

4. Spread or smear the small piece of sputum on a clean slide. *Spread it very thinly*. As you spread the sputum it will dry and stick to the slide. By the time it has been spread out completely, the film will probably be very nearly dry. Let the film dry completely. **FLAME YOUR LOOP OR LOOPS AGAIN BEFORE LAYING THEM ON THE BENCH**. If there is a lump of sputum on the end of your loop, get it off before flaming by dipping the end of the loop in a little dish of pure lysol which you should keep on your bench. This will stop mycobacteria spitting out of the flame on to the bench.

5. With the film towards the flame hold the slide in a Bunsen burner or spirit lamp for a *very short time*—only a second or two. This kills the mycobacteria and the cells and is said to 'fix' the film (see Section 4.10).

6. Place the slide on a staining rack and move the rods of the rack so that the slide is quite flat or horizontal. The film can then be covered with stain more easily.

7. Pour on strong carbol fuchsin for the hot Ziehl-Neelsen method (Section 3.22b), *not* dilute carbol fuchsin, until the slide will hold no more—that is, until stain just does not run off the slide. *The whole of the slide must be covered with stain*. If carbol fuchsin starts to dry up in the bottle and a yellow scum comes on the surface, add a little spirit to the stain. This will dissolve the scum.

8. Heat the slide until the stain *just* starts to steam, but no more. **THE STAIN MUST NOT BOIL**. If the stain boils or dries, there will be lumps of solid fuchsin all over the finished slide. Use a Bunsen burner, a spirit lamp, or a swab soaked in spirit. A cotton wool swab soon burns, and a better swab can be made from asbestos wool on the end of a piece of wire, the other end of which is stuck into a cork (9). Asbestos is a soft substance like ordinary cotton or wool, but it is not burnt by a flame. An asbestos swab of this kind is often the easiest thing to use. When it is not being used, keep it in a jar of spirit (10).

When the flame is taken away the hot stain on a slide will go on steaming for about a minute and then stop.

Warm it again carefully a second time until steaming starts once more.

11. When staining for *Myco. tuberculosis* leave the warm stain on the slide for 5 minutes. When staining for *Myco. leprae* leave it on for 10 minutes. Use a pair of forceps to tip the stain off the slide and keep it away from your fingers. The film will now be stained a deep red.

12. Wash the slide in water.

13. Put the slide back in the rack and cover it with acid-alcohol. Use 3% acid-alcohol for *Myco. tuberculosis* and 1% for *Myco. leprae*. The acid-alcohol will take the stain out of the film which will become much paler.

14. Wash the film in water rapidly once again. After 3% acid-alcohol it will be almost colourless, but after 1% acid-alcohol it should still be a very faint pink colour.

15. Lay the slide on the rack and cover it with malachite green. Only a few drops will be needed—just enough to cover the film. Leave this on for about 15 seconds. Use 0.3% methylene blue if you have no malachite green.

16. Wash the slide with water for the third time.

17. Leave the slide to dry in a rack.

B. THE COLD METHOD

Make your films, fix them in a flame and put them on the staining rack just as in the hot method.

Cover the films with strong carbol fuchsin for the cold Ziehl-Neelsen method (Section 3.23). **SHAKE THE BOTTLE** before pouring on the stain. Pour the stain on to the slides through a filter paper held in a small funnel. Keep the funnel and the paper for this stain only. There is no need to wash the funnel each time you use it. The stain need not cover the whole slide as is so important with the hot method.

Leave the stain on the slides for 10 minutes for *Myco. tuberculosis* and for 30 minutes for *Myco. leprae*.

Wash the slides well with water.

Tip off the water.

Cover the slides with 'Methylene-blue-acid-alcohol' (see Section 3.35) and leave them for 3 minutes exactly. Use 8% acid for *Myco. tuberculosis* and 1% for *Myco. leprae*.

Wash the slides well with water. Leave them to dry in a drying rack.

If you have many slides to stain, label them with a diamond pencil so that they do not get mixed up. Another way of labelling a slide is to label it in grease pencil on the underneath where the writing will not get washed away by the stain. Keep the stains in wash bottles. You can easily stain many slides at once, but be careful not to have so many that you should be washing the first slides before you have finished staining the last ones.

Look at a film with a low power objective for a good place to search with an oil immersion objective. With practice you will soon learn how to find a good place,

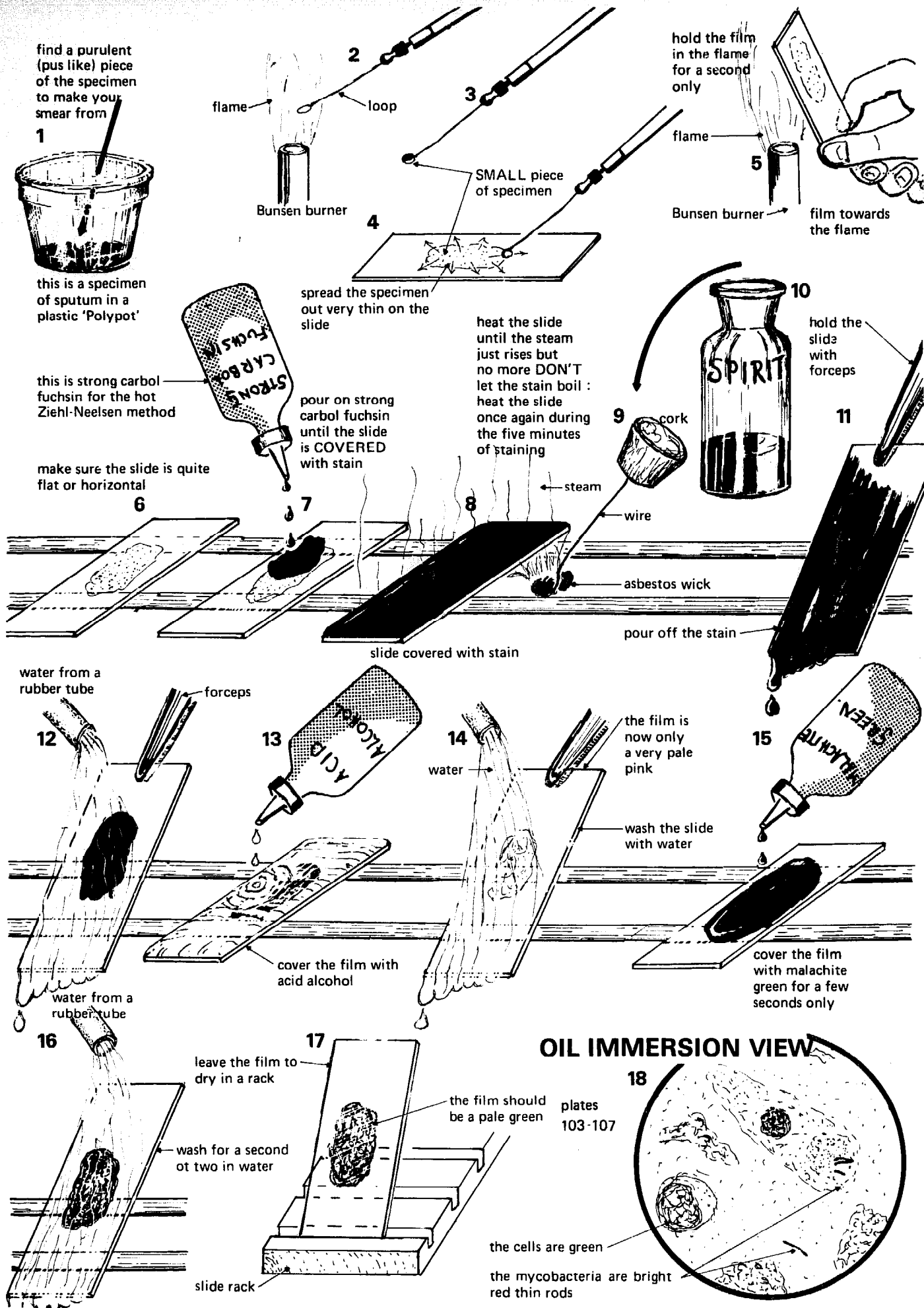

Fig. 11-1 Ziehl-Neelsen's method

which must not be too thick, or too thin. When methylene blue has been used as a counterstain, as in the cold method, you will see deep red bacilli and blue cells. When malachite green has been used, the cells will be green. Mycobacteria often have granules on them so that they look like a string of beads. Mycobacteria may also lie in groups of several bacilli together.

If there are many bacilli in the sputum you will find them quickly. But if there are only a few bacilli in the sputum you may have to search for a long time. How long should you search before stopping and saying that a slide is negative? This will depend upon how many slides there are and how much time you have. If possible search a slide for 10 minutes before reporting it as negative, and don't look at less than about 100 fields.

It is usually easy to decide if something you see is an acid-fast bacillus or if it is not. If you see something you are not sure about, don't report it as positive, but look at other parts of the film to see if you can find bacilli you are sure about. If you are still doubtful, even after you have searched the slide very carefully, report 'AAFB doubtful', and ask for another specimen of sputum from the same patient.

11.2 Preventing false positive reports

Because the right diagnosis of tuberculosis or leprosy is so important to the patient, you must not make false positive reports. A false (not true) positive report is a report which is given as positive when it should be negative. A false positive report will cause a patient to be treated for tuberculosis or leprosy when he is really suffering from some other disease. He will therefore be given the wrong treatment and will not be cured. How do false positives happen, and how can they be prevented? You have already read about one reason for false positive reports—saying something is an acid-fast bacillus when you are not sure about it. Such a report should really be doubtful (\pm).

A common cause of false positive reports is bacilli getting from a positive film on to a negative one. This may happen if a positive film is badly washed, and then used for another film. Stained mycobacteria from the first film may be left on the slide and cause the second specimen to be falsely reported as positive. The best way to prevent this is to *break every positive AAFB slide so that it cannot be used again*. It is much better to waste a few slides than to run the risk of false positive reports. If you have very few slides and must use every one, keep those from positive Ziehl-Neelsen films and use them for other methods. Try to use new slides for leprosy smears, especially if you are doing the bacteriological and morphological indices.

Another cause of false positive reports is to carry bacilli from one slide to another with the rod of an oil bottle. If your oil bottle has a rod, don't touch the surface of the slide with it. Instead, let a drop of oil fall from the rod on to the slide (see Picture 22, FIGURE 7-7). Don't use jars of stain because bacilli may go into the stain and

stick to negative films. These films will then be falsely reported positive.

11.3 Harmless mycobacteria

Until now you have only read about two kinds of mycobacteria, *Myco. leprae* and *Myco. tuberculosis*. But there are other species of mycobacteria, and most of them do not cause disease. They live on the skin, in water, and in the soil. These harmless mycobacteria are acid fast like *Myco. tuberculosis* and *Myco. leprae*, but some of them are not alcohol fast. They are therefore decolorized (made colourless) by the alcohol in acid-alcohol and do not stain red by the Ziehl-Neelsen method. Even so, when we stain the sputum by the Ziehl-Neelsen method, it is possible that the bacilli we see are not *Myco. tuberculosis* but some harmless species from somewhere else. We thus always report 'AAFB present' and not '*Myco. tuberculosis* or *Myco. leprae* present'. To tell if AAFB are really *Myco. tuberculosis* we have to grow them and see what they look like. We cannot do this in our laboratory. Even so, we almost always treat patients as if the AAFB found in their sputa by the Ziehl-Neelsen method were certainly *Myco. tuberculosis*. Harmless mycobacteria are uncommon. If more than one specimen is found with AAFB, it is almost certain that the patient has tuberculosis.

11.4a Finding cases of tuberculosis

Patients with AAFB in their sputum are said to be **sputum positive**. Those without AAFB are said to be **sputum negative**. When you find AAFB in the sputum of a patient this means that he has tuberculosis of his lungs—pulmonary tuberculosis. It also means that his pulmonary tuberculosis is both 'active' and 'open'. By 'active' we mean that mycobacteria are growing, that they are destroying the patient's lungs and that he is getting more ill. By 'open' we mean that mycobacteria are getting out of the patient and may infect someone else. Mycobacteria from someone with open pulmonary tuberculosis can spread in the air in little drops of sputum when he coughs or spits. In this way they can spread from a patient to a healthy person, who may then get tuberculosis and become ill. This is the most common way in which tuberculosis spreads from one person to another. If a patient has tuberculosis but has not got AAFB in his sputum, he is probably not infectious and is said to be a 'closed' case.

If tuberculosis is to stop spreading in a town or village, all cases of open tuberculosis must be found and treated. An important way to find cases of open tuberculosis is to remember that *any patient may have tuberculosis who has a cough which has lasted more than one month and is coughing up sputum*. A patient with a cough who is producing (coughing up) sputum is said to have a **productive cough**. If there is blood in a patient's sputum, he is even more likely to have tuberculosis. Coughs lasting less than one month are usually due to

mild infections of other kinds and are not important. As well as having a productive cough which has lasted more than one month, a patient with tuberculosis is often thin (he has lost weight) and may feel unwell. You will find AAFB in the sputum of about one patient in twenty with a cough, so you must look carefully to find cases of tuberculosis.

If a patient has tuberculosis of his lungs very badly, there will be many AAFB in his sputum, and it will be easier to find them than when he only has it mildly. Milder cases of tuberculosis do not cough up AAFB in every specimen of sputum, so it is necessary to examine several specimens to have a fair chance of finding AAFB. *Always examine three, and better six specimens, before telling a patient who has had a cough for over a month that he has not got tuberculosis.* One or two negative sputa are not enough.

Patients with tuberculosis often spread it to their families and to the people they work with. We call these people close to the patient his **contacts**. *If the contacts of a tuberculosis patient have coughs and are coughing up sputum, this sputum must be examined.* These contacts are usually traced (looked for) by health assistants or nurses, and not by laboratory assistants. But laboratory assistants must stain the sputum from these contacts and look for AAFB. Looking at the sputum of tuberculosis patients and their contacts is one of the most useful things a laboratory assistant can do. This is because tuberculosis will go on spreading until these cases can be found, shown to have AAFB in their sputum and treated. Once a patient is sputum negative, he will no longer be a danger to other people, and tuberculosis will stop spreading.

Children are especially likely to catch tuberculosis when there is a case of open tuberculosis in the family. But children swallow their sputum and seldom cough it up. Because of this, tuberculosis in children has therefore to be diagnosed in a different way.

If sputum is to be obtained from a child, it has usually to be sucked up and washed out of his stomach with a rubber tube through his mouth. This is how it is done.

METHOD

GASTRIC WASHINGS IN YOUNG CHILDREN

Ask the child to swallow the end of a rubber stomach tube before he has had anything to eat in the morning.

Suck up any liquid there is in his stomach. Put this in one of the universal containers containing buffer that are described in Section 3.20a.

If there is not enough fluid to fill the container half full, put a little water into the stomach through the syringe. Suck this out and put it into the universal container.

Send the specimens to a central laboratory as soon as possible. The central laboratory will try to grow *Myco. tuberculosis*.

Treatment

Tuberculosis is usually cheap and easy to treat. But patients must understand that they should take their treatment regularly for at least a year and sometimes for 2 years. They are often given an injection of a drug called streptomycin for about 6 weeks. They are also usually given tablets of a drug called INH for at least a year, and with it either a drug called thiacetazone (also called TB 1), or another drug called PAS. Tests for some of these drugs in the urine are given in Section 8.9.

11.4b Examining the sputum for helminth ova

Sputum can be examined for many micro-organisms. Much the most important is the Ziehl-Neelsen method for AAFB that has just been described. The only other one that we shall describe here is a concentration method for helminth ova, and particularly for the ova of the trematode *Paragonimus westermani* that is commonly found in some parts of the world. This trematode lives in the lungs and its ova are coughed up in the sputum. You may be able to find them by looking at a saline smear of the sputum under a coverslip. Occasionally the ova of other helminths may be found by the same method. As with *Myco. tuberculosis*, look at the thick yellow or blood-stained parts of the sputum. If you cannot find the ova in a saline smear look for them using this concentration method.

METHOD

A CONCENTRATION METHOD FOR HELMINTH OVA IN THE SPUTUM

Mix the sputum well with about a quarter of its volume of 20% sodium hydroxide (see Section 3.42b).

Let the mixture stand for about 10 minutes.

Centrifuge and examine the deposit under a coverslip for helminth ova—see Figure 10-9.

PUS

11.5 Gram's method

This is one of the oldest stains for bacteria. It is also one of the best. A film is made from the specimen. This film is then quickly fixed in the heat of a flame and stained with a violet stain called crystal violet (violet is a special kind of blue). After this a few drops of Lugol's iodine solution are dropped on to the film. Spirit is next poured over the film, which is then washed in water and counter-stained (see Section 11.1) with dilute carbol fuchsin.

All bacteria and all cells stain a deep violet with the crystal violet followed by the iodine. Some bacteria stay this deep blue colour when the spirit is poured over them. Bacteria which stay a deep violet are said to be **Gram positive**. Spirit washes away the violet colour from all cells and from many bacteria and makes them colourless again. Bacteria which are decolorized by spirit are

said to be **Gram negative**. These colourless bacteria and cells are then stained red with the dilute carbol fuchsin counterstain.

In the Ziehl-Neelsen method a counterstain (malachite green or methylene blue) is used to stain cells or bacteria that have been decolorized in acid-alcohol. A counterstain is also used in Gram's method, but this time it is the red stain, *dilute* carbol fuchsin. Gram positive bacteria are therefore violet, because they hold on to the violet stain when treated with spirit. Gram negative bacteria are red, because they are decolorized by the spirit and are then stained again with the red carbol fuchsin.

There are very many species of bacteria. About half of them are Gram positive and half Gram negative. Gram's stain can thus be used to divide bacteria into two large groups of about equal size, the Gram positive species and the Gram negative ones. In this Gram's method and the Ziehl-Neelsen method differ from one another. With the Ziehl-Neelsen method only one genus, the mycobacteria, is acid fast. All the many other genera are non-acid fast. The Ziehl-Neelsen method thus divides bacteria into two groups of very unequal size. There is a small group of acid-fast bacteria and a very large group of non-acid-fast bacteria. The words 'Ziehl-Neelsen positive' and 'Ziehl-Neelsen negative' might have been used, but instead we use the words 'acid fast' and 'non-acid fast'.

METHOD

GRAM'S STAIN, FIGURE 11-2

1. Take a loopful of pus (2) or the centrifuged deposit from a specimen of CSF (3). Smear it on a clean slide (4). Make a *thin* film which will dry as it is spread on a slide.

5. Fix the film in a flame for a moment, making sure that the film faces the flame.

6. Hold the slide in your hand over a sink, a dish or a bucket. *Don't put it on the rack as is done with the Ziehl-Neelsen method.* Drop a few drops of crystal violet stain over the film (Section 3.25). Cover the film with the crystal violet, and take care to keep the stain away from your fingers.

7. Pour a few drops of Lugol's iodine (Section 3.32) over the film.

8. Make sure you have plenty of water ready. If you have a tap, turn it on. *Pour spirit over the film until the blue stain just stops running from it but no longer.* This will take longer in some slides than in others, but it is usually about 5 seconds.

9. *Immediately* the stain stops running from the film, wash it in water. If there is no running water, pour a cup of water over the slide.

10. Still holding the slide over the sink, pour a few drops of *dilute* carbol fuchsin over the film.

11. Without waiting, rapidly wash the film in water.

12. Leave the slide to dry in a rack.

13. Using a low power objective find a good part of the film to look at with an oil immersion objective.

Gram positive bacteria will be a deep violet. Gram negative bacteria and all cells will be red. If the cells and especially their nuclei are still violet, the film has not been treated for long enough with spirit. *Don't continue to pour spirit over a film after the violet stain has stopped running from it.* If you do, you may decolorize it too much, and even some Gram positive bacteria may be decolorized, and be stained red instead of violet in the finished film.

Gram's method can be used for specimens of several kinds. Its use in meningitis is described in Section 9.16. It is also very useful for diagnosing gonorrhoea.

11.6 Urethral smears for gonococci

A venereal disease is a disease which spreads from one person to another through sex. One of the venereal diseases is called gonorrhoea. It is caused by bacteria called *Neisseria gonorrhoeae*, *N. gonorrhoeae*, or gonococci. When a man has gonorrhoea pus comes from his urethra. This pus is called a **urethral discharge**. The urethra is the tube inside the penis (a man's sex organ) through which urine flows. This pus can be stained with Gram's stain to show *Neisseria gonorrhoeae*.

METHOD

URETHRAL SMEARS

Make films of pus by taking a clean slide and holding it against the drop of pus at the end of the patient's urethra. Spread the pus to make a thin film. Wave the film dry and fix it quickly in a flame. Write the patient's name on the slide and stain it by Gram's method.

Neisseria gonorrhoeae is a species of Gram negative diplococcus very like *Neisseria meningitidis* (see Section 9.16). Diplococci are cocci which are seen in pairs (di means two)—that is, two cocci are usually found close together. The *Neisseria* are shaped like a bean, and the long sides of a pair of cocci touch one another as shown in Picture E at the bottom of FIGURE 11-2. In a urethral discharge from a patient with gonorrhoea gonococci are usually seen inside pus cells or **intracellularly** (intra means inside), as in Pictures A to D at the bottom of FIGURE 11-2. If Gram negative intracellular diplococci are seen in a patient's urethral smear he probably has gonorrhoea. Just as we report 'AAFB seen' (not *Mycobacterium tuberculosis* seen), so we report 'Gram negative intracellular diplococci seen' (not *N. gonorrhoeae* seen). We do this because we cannot be quite certain without special methods that the Gram negative intracellular diplococci we are seeing are really *N. gonorrhoeae*. Harmless species of *Neisseria* are found in urethral discharges, but they are not usually found intracellularly inside pus cells. When looking at a urethral smear, always look for Gram negative diplococci *inside* pus cells and take no notice of Gram negative diplococci *outside* pus cells. These may be *N. gonorrhoeae* or they may be harmless species. Send

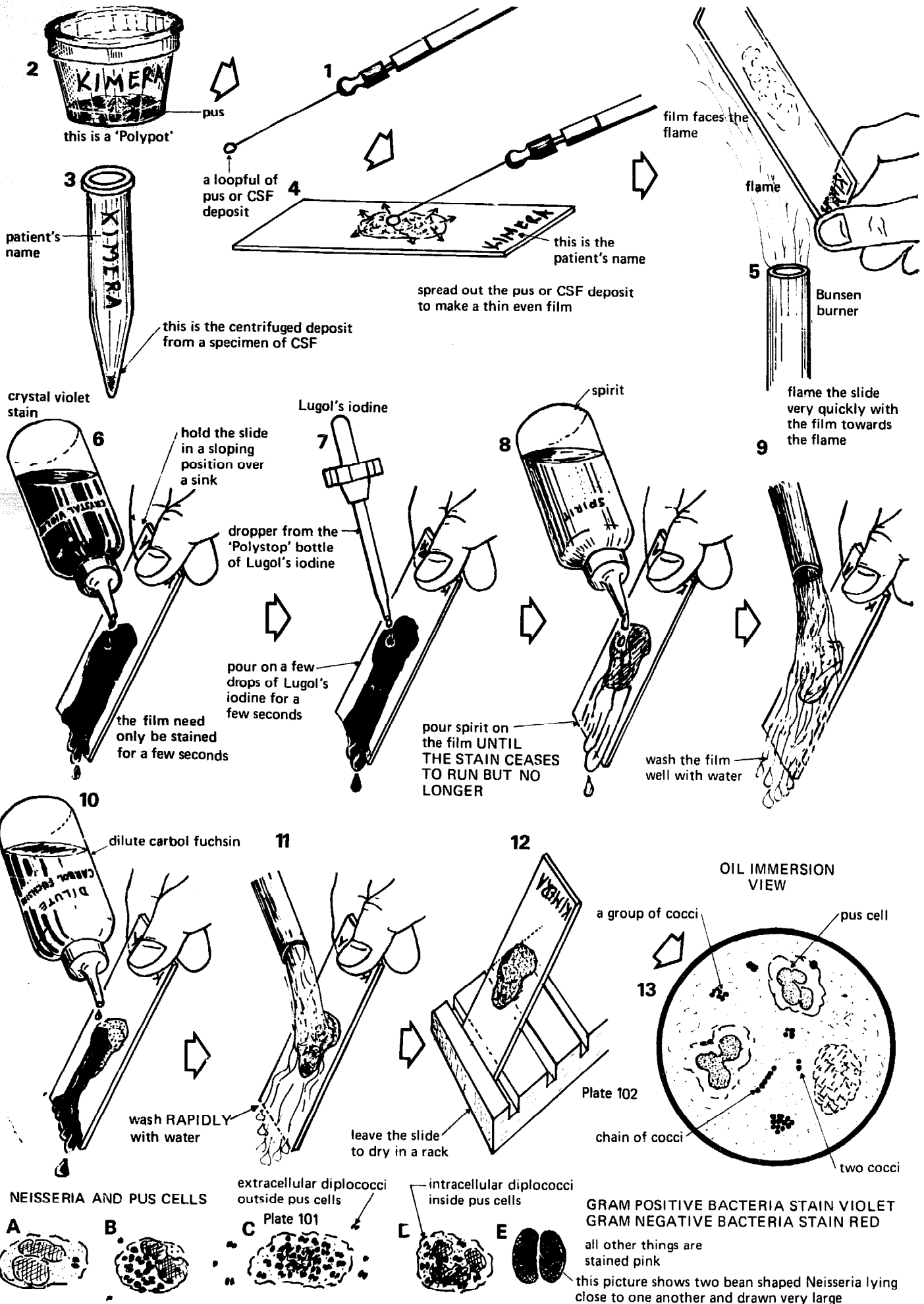

Fig. 11-2 Gram's method

out positive reports like this 'Gram negative intracellular diplococci seen'.

Women may also have gonorrhoea, but it is less easy to diagnose in them. This is partly because a vaginal discharge in a woman (the vagina is the passage through which a child is born) is less easy to see than a urethral discharge in a man. Also, there are often so many different bacteria in the vagina that it is hard to find *Neisseria*.

11.7 Some less common uses of Gram's method

In our laboratory the main use of Gram's method is to stain the CSF and diagnose gonorrhoea. There are however some other less common uses for it.

If pus from an abscess is stained with Gram's stain, Gram positive cocci may be seen. An abscess is a place in the body containing pus. These cocci have been shown in Picture 13, FIGURE 11-2. Cocci are often seen in a chain like a necklace of beads or close to one another in a group or clump. Two main genera of Gram positive cocci cause disease in man—streptococci and staphylococci—but it is difficult to tell one from the other without culturing (growing) them.

There is an uncommon disease called anthrax which men catch from cows, sheep, and other animals. It is caused by a big Gram positive bacillus (*Bacillus anthracis*). These bacilli can be found in fluid from the anthrax lesions (diseased places) in the skin.

There is another uncommon disease called plague. The lymph nodes in the groin get big, and pus forms abscesses inside them. If some of this pus is taken from them with a needle and stained by Gram's method, small fat Gram negative bacilli can be seen. These bacilli often stain more strongly at their ends. They are called *Yersinia pestis*.

VAGINAL DISCHARGES

11.8 Looking for *Trichomonas vaginalis*

This is a protozoon which lives in the vagina of women and sometimes in the urethra of men. In women it often causes a vaginal discharge, and in men it may cause a urethral discharge. Any moving protozoon you find in the discharge from the vagina or urethra is almost sure to be *Trichomonas vaginalis*.

METHOD

LOOKING FOR *TRICHOMONAS VAGINALIS*

Using a Pasteur pipette put a drop of fluid from the vagina on to a slide. Cover the drop of fluid with a coverslip and look for moving protozoa.

When looking for *T. vaginalis* in men put a drop of the urethral discharge on a slide. Look at it wet under a coverslip and examine it for moving protozoa.

Look at these slides quickly before the protozoa die and stop moving. It is much better to look at these

specimens in the outpatient department than to send them to the laboratory. If specimens have to be sent to a laboratory, take a few drops of fluid into a Pasteur pipette and put the pipette into a test tube. Take it to the laboratory quickly and look at it immediately.

GASTRIC JUICE

11.9 Testing gastric juice for free acid

In Section 7.19 you read about macrocytic anaemias. In one kind of macrocytic anaemia called pernicious anaemia the acid in the stomach is very weak. We say that there is 'no free acid in the gastric juice' (the gastric juice is the liquid made by the stomach). A specimen of gastric juice should be taken in the ward on the instruction of a doctor. This is what he will ask the nurses in the ward to do.

METHOD

FREE ACID IN THE GASTRIC JUICE

Give a fasting patient 100 mg of mepyramine (*Anthisan*) intramuscularly. Half an hour later give him 0.04 mg/kg of histamine subcutaneously. Half an hour after that ask the patient to swallow the end of a rubber stomach tube. Suck up some of the juice in his stomach. Put a piece of universal indicator test paper into the juice (see Section 1.8). If there is 'free acid' in the juice the universal indicator paper will show a pH of less than 4. Not all universal indicator papers change colour in the same way, but the paper described in Section 13.10 should become a deep orange-red colour. Congo red paper is a better test of free acid. It goes blue if there is free acid in the gastric juice.

SEMINAL FLUID

11.10 Examining the seminal fluid

Husbands and wives are often worried because they want children and do not have them. Sometimes this is because of the wife, and sometimes it is because of the husband. One way of finding out whether the husband or the wife is the cause is to look at the husband's seminal fluid (his seed). If there are not enough spermatozoa or 'sperms' (the special highly motile male cells) in the husband's seminal fluid, the lack of children is probably due to him. Spermatozoa have been drawn in Picture 18, FIGURE 8-10. There are several methods of examining the seminal fluid, but we shall only consider two. One is to count the total number of spermatozoa in each millilitre of fluid. They are counted in a counting chamber in the same kind of way as white cells in the blood or CSF. The other method is to examine the motility or movement of the spermatozoa. This is very easy. A drop of seminal fluid is looked at under a coverslip with a high power objective.

In normal seminal fluid motile spermatozoa can be seen moving about very actively.

METHOD

EXAMINING THE SEMINAL FLUID

THE TOTAL SPERM COUNT

Give the patient a clean, dry container and explain to him how he is to bring a specimen of seminal fluid as soon as he has passed it. Seminal fluid is a liquid when it is passed. It soon clots and then goes liquid again. Measure 10 ml of water into a universal container. Measure 0.05 ml of seminal fluid in a blood pipette. Add it to the water. Mix well. Using a Pasteur pipette fill a Neubauer counting chamber with the diluted seminal fluid suspension. Count all the *complete* spermatozoa you see in two blocks of 16 squares (0.1 mm). By complete we mean those with heads and tails. Multiply the number you find by a million (add 000,000 to it). This will give you the number of spermatozoa in 1 ml of seminal fluid. A normal man has more than 40,000,000 sperms in each millilitre of seminal fluid. So you should find at least forty sperms in two blocks of sixteen small squares. Report the number of spermatozoa you find.

MOTILITY

Put a dropful of very fresh seminal fluid on a slide. Put a coverslip on it and look at it with a high-powered objective with the condenser moved down a little. In normal seminal fluid at least 80% of the spermatozoa will be actively moving.

If there are no spermatozoa the man is said to suffer from *azoospermia*. Azoospermia is a common cause of a man's failure to have children. Sometimes spermatozoa can be seen but there are fewer than there should be. There may perhaps be only 5 million per ml instead of 40 million.

METHODS FOR LEPROSY

11.11a Classifying leprosy

As we have seen, leprosy is caused by *Mycobacterium leprae*, which is closely related to *Mycobacterium tuberculosis* and is also acid fast when stained by the Ziehl-Neelsen method. *Myco. leprae* is, however, not quite so acid fast as *Myco. tuberculosis*. Smears for leprosy are thus stained for a longer time with carbol fuchsin and decolorized with weaker acid. Because *Myco. leprae* causes disease of the skin and nerves and often the nose, it is most easily found in smears made from the skin or occasionally from the nose.

When *Myco. leprae* get into a patient a fight starts between the bacilli and his body. What may happen in this fight is shown in FIGURE 11-3. Many people fight the bacilli so well that they are never able to grow and multiply and cause disease. These are the healthy people

in Picture A, who are able to live with an infectious or open case of leprosy for many years and yet never get leprosy. Because they are so good at fighting leprosy they are said to have a high resistance to it.

A few people are unable to fight the bacilli well; so the bacilli win the fight and are able to multiply and cause severe disease. These people lose the fight against the leprosy bacilli because they have no resistance to leprosy. The severe kind of leprosy they get is called **lepromatous leprosy** (Picture D).

Between the many people with a high resistance to leprosy and the few people with a very low resistance to it there are others with some resistance, but not enough for them to win the fight completely. These people are only fairly good at fighting leprosy and get a mild kind of the disease called **tuberculoid leprosy** (Picture B) or a more serious kind called **borderline leprosy** (Picture C).

There are thus several kinds of leprosy which depend mostly on how much resistance a patient has to the bacilli. In each kind of leprosy the patient may have any of several different kinds of skin or nerve lesion (diseased places). Bacilli in a nerve can cause it to become thickened and damaged. The muscles which it supplies become weak and thin. The patient loses the feeling in the part of the body which it supplies. He may not be able to feel a piece of cotton wool when it touches him (light touch) or a pin prick (pain). He may also not be able to tell the difference between a test tube of hot water and a test tube of cold water when they touch his skin (the feeling of hot and cold). A part of the body without any feeling is said to be **anaesthetic**. We cannot say much more about the different kinds of leprosy lesion here, but you should know the kind of leprosy in which you are likely to find bacilli in the skin or nose. *The lower a patient's resistance the more likely you are to find bacilli.* Thus there are no bacilli to be found in the skin of patients with tuberculoid leprosy, but there are many millions in the skin of those with lepromatous leprosy.

The fight between man and *Myco. leprae* can be looked at likethis.

A. Resistance is so high that infection is never able to start—the patient remains well

The bacilli are unable to grow and multiply in the patient, so no disease is caused and no bacilli can be found in the skin by the ordinary methods.

B. Resistance high, but not so high as in A, so that slow infection results—tuberculoid leprosy (TT)

This kind of leprosy is usually mild, and it does not change into the more serious kind. The most common skin lesion is large, and has a raised edge. The skin of the lesion is paler than normal, thickened and anaesthetic. A lesion of this kind is called a **tuberculoid plaque**. Only one or at the most two nerves may be thickened. They thicken early on in the disease and on one side of the body only. There are no bacilli in the skin scrapings.

The different kinds of leprosy

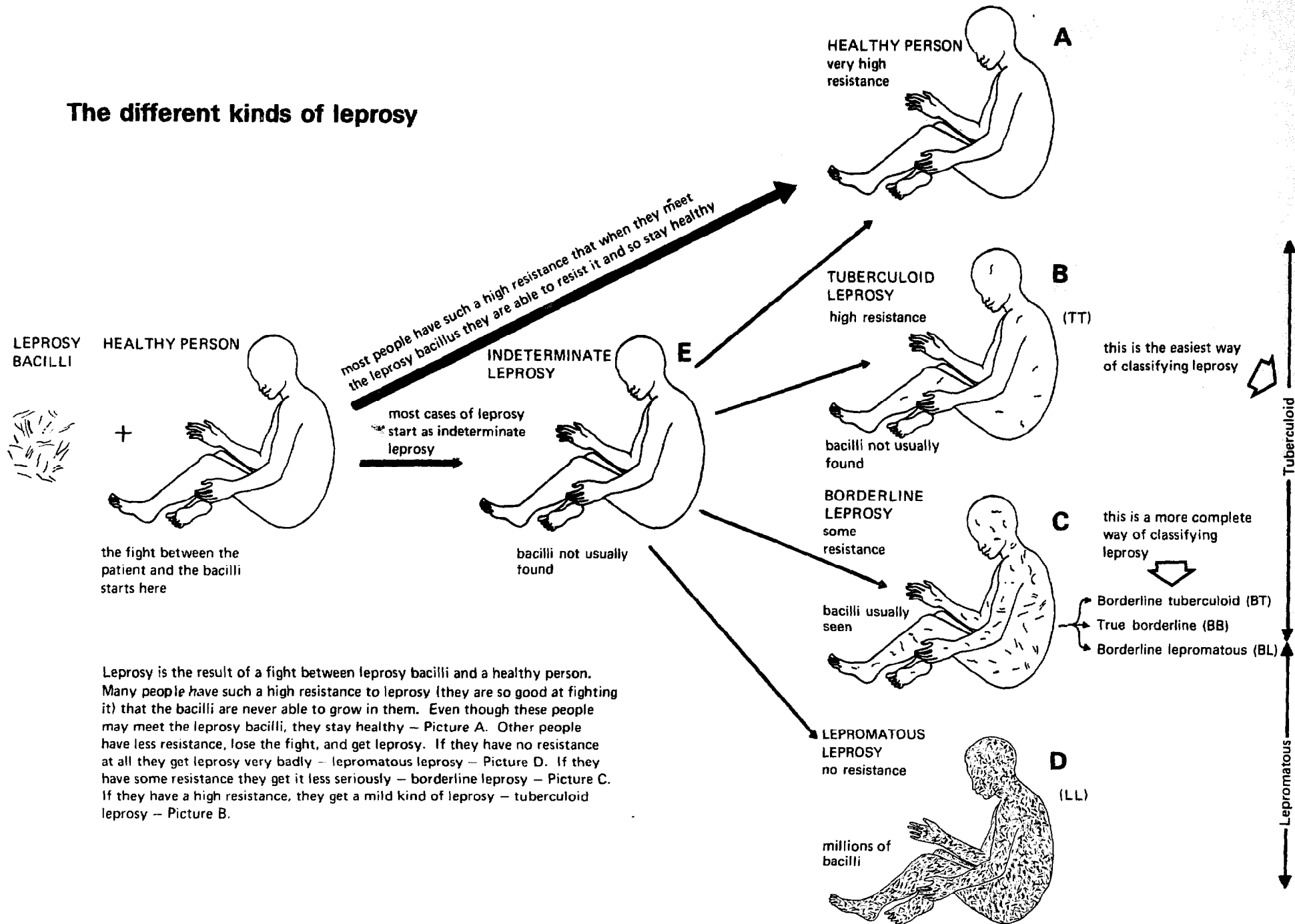

Leprosy is the result of a fight between leprosy bacilli and a healthy person. Many people have such a high resistance to leprosy (they are so good at fighting it) that the bacilli are never able to grow in them. Even though these people may meet the leprosy bacilli, they stay healthy – Picture A. Other people have less resistance, lose the fight, and get leprosy. If they have no resistance at all they get leprosy very badly – lepromatous leprosy – Picture D. If they have some resistance they get it less seriously – borderline leprosy – Picture C. If they have a high resistance, they get a mild kind of leprosy – tuberculoid leprosy – Picture B.

Fig. 11-3 The different kinds of leprosy

These patients usually have anaesthetic patches but no bacilli. They are not infectious, and the disease sometimes dies out by itself, but this may take a long time and leave much disability because some nerves are damaged.

C. A middle degree of resistance—borderline leprosy

Patients are often seen who are half-way between the tuberculoid and the lepromatous kind of the disease. These patients are said to have intermediate (middle) or borderline leprosy (also called dimorphous leprosy). This is a serious kind of the disease and may later change into the even more serious or lepromatous kind. This kind of leprosy is sometimes divided into three others, the middle one being the true borderline kind of leprosy—BB leprosy. Slightly less serious and more like tuberculoid leprosy is a kind called 'borderline tuberculoid' or BT leprosy. Slightly more serious and more like lepromatous leprosy is a kind called borderline lepromatous or BL leprosy. Bacilli can always be found in the skin of patients with BL leprosy. They can be found less often in BB leprosy and still less often in the milder BT leprosy. Any case of borderline leprosy may be infectious, especially BL leprosy.

D. Very little resistance—lepromatous leprosy (LL)

This is the most harmful kind of the disease; it remains serious and does not change into the other less serious kinds. Several nerves are usually involved equally on each side of the body, but only late in the disease, and there is generally not much anaesthesia until late on. Large numbers of bacilli may be seen in scrapings from the lesion, from the lobes of the ears or from the nose, or even from healthy looking skin. These patients are open or infectious and do not get better unless they are treated.

E. Indeterminate leprosy

When a leprosy patient is examined, it is usually possible to say that he has one of the above kinds of leprosy. However, there are a few patients, especially early on in the disease, for whom this is not possible. These patients have leprosy, but it is not the tuberculoid, nor the intermediate nor the lepromatous kind. They are therefore said to have **indeterminate leprosy** and are shown in Picture E in FIGURE 11-3. Indeterminate means undecided and is quite different from intermediate which means in the middle and which is the same as borderline leprosy. Many patients with indeterminate leprosy get better by themselves, some of them stay indeterminate, and others change into the tuberculoid, borderline or lepromatous kind of the disease. Most of these patients do not have bacilli in their skin and are not infectious.

F. Neural leprosy

A very few patients have leprosy of their nerves only, without any skin lesions, or any healed skin lesions.

Perhaps this way of dividing or classifying cases of leprosy looks too difficult. A simpler one is to divide all cases into indeterminate, lepromatous, and non-lepromatous kinds. In this way of classifying leprosy the borderline lepromatous (BL) leprosy is counted in with lepromatous leprosy, and all other borderline cases (BB and BT) are counted with the tuberculoid cases as being non-lepromatous. This easier way of classifying leprosy cases is shown on the right hand side of FIGURE 11-4.

The skin scraping in leprosy is useful for: (1) diagnosis; (2) finding if a case is infectious or not; (3) seeing if a case is active or inactive.

(1) Diagnosis

Leprosy is diagnosed by finding one or more of the following signs: (i) by finding skin lesions which are anaesthetic because the nerves to them have been destroyed by leprosy; (ii) by finding thickened and often tender nerves which have become diseased with leprosy; (iii) by finding bacilli in the skin of the more serious kinds of the disease. In tuberculoid leprosy anaesthetic patches will be found without bacilli in the skin. In lepromatous leprosy bacilli will be found in the skin, but there will usually be little or no anaesthesia. *A leprosy patient has usually either anaesthesia or bacilli, but not often both.*

(2) Infectiousness

Patients with many bacilli in their skin are likely to be infectious or open and thus dangerous to other people. Those with few or no bacilli are probably not infectious and are thus unlikely to spread the disease to other people.

(3) Activity

Skin scrapings also help us to know if a patient's leprosy is **active** or **inactive**. By active we mean that his leprosy is getting worse or progressing. By inactive we mean that his leprosy is healed. Leprosy is said to be active if any of the lesions are raised above the rest of the skin, if they are a red or coppery colour, or if they are increasing in size or number. The disease is active if an anaesthetic patch is getting larger, if the muscles supplied by a diseased nerve are getting weaker, or if a nerve is more tender than it should be when it is pressed. Leprosy is also active when there are bacilli or the remains of bacilli (acid-fast debris) in scrapings from the skin or nose. This is because, when the dead remains of bacilli are seen, there may be living bacilli somewhere else that are not seen. Leprosy is inactive when none of these things are present.

Leprosy patients should be treated with sulphones as long as their leprosy stays active. This is seldom less than 2 years in tuberculoid cases and is at least 4 in lepromatous patients. Tuberculoid patients should be treated for at least 18 months *after they have become*

inactive, and lepromatous patients for at least 5 years. Only when this long time of treatment is over can patients be 'released from control' and allowed to go away cured.

11.11b The skin scraping

The most important part of this method is the way in which the skin is scraped and smears made. The best instrument to use is a scalpel, which is a special kind of knife used by surgeons. It is most important to choose the right part of the skin from which to make the smears. You are most likely to find bacilli in *the edge of an active lesion*. As you have just read an active lesion is one which is spreading or raised or reddened, or in which the skin is thickened. By raised we mean that, as you move your finger over it, you can feel the edge of the lesion as being higher than the healthy skin. Also take a smear from the middle of the lesion, if it is flat (macular), or if it is raised equally all over, or if it is just a lump.

METHOD

MAKING A SKIN SCRAPING FOR LEPROSY. FIGURE 11-4

Take a clean slide without scratches. Choose the best side on which to make your smears. Write the patient's name in grease pencil on the other side where it will not be washed off by the stain.

1. Put several smears on a slide. There is room for about six. Start at one end with a smear from the edge of the lesion. If necessary take the next from the middle of the lesion (see above). Put next to it smears from the lobes of each ear. If you are going to do a nasal (nose) smear, do this next. Last of all, if there is room, take smears from the skin of the buttocks or thighs. If there are several lesions, start off with smears from two or three of these and leave out the smears from the buttocks. If there are no skin lesions, take smears from the lobes of the ears, then the thighs, the arms, the back, and the buttocks.

2. Take hold of some gauze with a pair of forceps. Dip it in spirit, and rub it firmly over the part of the body you are going to scrape.

3. Take a sharp clean scalpel and dip it in spirit.

4. Put the end of the scalpel into a flame for a second or two. This could be the flame of a Bunsen burner, a spirit lamp, or a match. Don't keep the scalpel in the flame for too long or it will get blunt—two or three seconds is quite long enough. Never let the scalpel get red hot.

5. Pick up the edge of the skin you are going to scrape in your fingers, and hold it firmly. This will help to stop it bleeding when you cut. *Don't let go until you have finished making your smear.*

6. Make a shallow cut into the edge of the skin about 5 mm long. This is as long as line A-B in this picture. Continue to pinch the skin together tightly, and only just cut into the top layer of the skin—you should just enter

what is called the 'papillary layer of the dermis'. There should be no bleeding while you are scraping, and only a very little when you have stopped.

7. *Turn the scalpel sideways.* Scrape the edges and bottom of the cut with the point of the scalpel. Start at one end of the cut, and scrape through to the other end. Then start at the beginning once more and scrape again.

8. You will now have a little red pulp (soft red substance) on the end of your scalpel. Try to take the same amount of pulp from each scraping you make, so that you are able to compare the number of bacilli in one scraping with those in another. Let go the skin and put a piece of dry cotton wool on the cut you have made.

9. Smear this red pulp in a little round area on your clean labelled slide.

10. Clean your scalpel in cotton wool and flame it as in steps 3 and 4 above. When your scalpel is clean and sterile again, make more smears from other parts of the body, cleaning and sterilizing it between each smear. Put the smears on the same slide in this order: lesion(s), ears, nose (if necessary), and lastly the buttocks or thighs.

If your smears are not already dry, let them dry and then fix them by passing the slide quickly through the flame.

If slides are not fixed at once, keep them in a box away from dust and insects. If they have to be sent to another laboratory, fix each slide and wrap it separately in a piece of paper before sending it off.

Stain your slide by the Ziehl-Neelsen method, but leave the carbol fuchsin on for 10 minutes with the hot method, and 30 minutes with the cold method. Decolorize with 1% acid-alcohol with both methods.

Search the slide for AAFB starting with the smears that came from the lesions. *Myc. leprae* looks like *Myc. tuberculosis*, except that it is more often beaded and may be found in groups or clumps (globi).

ALWAYS STERILIZE YOUR SCALPEL BETWEEN ONE PATIENT AND ANOTHER. IF YOU DON'T YOU MAY GIVE SOMEONE LEPROSY WHO HAS NOT ALREADY GOT IT.

11.11c Nasal smears

Bacilli can usually be found in the nose of patients with lepromatous leprosy. But bacilli can be found in the skin of these patients just as easily. A nasal smear may also be uncomfortable for the patient, but if it is done carefully it should not be painful. When AAFB from the nose are in globi we can be sure the patient has leprosy. But, when they are not in globi they may be the harmless mycobacteria described in Section 11.3. For these reasons nasal smears are not done as often as skin smears, and *you should not do them unless you are specially asked to.* The main reason for doing them is that bacilli may stay in the nose after they have gone from the skin. When a patient is relapsing (getting worse again after starting to get better) bacilli may also come back in the nose before they come back to the skin.

WHERE TO MAKE THE SMEAR

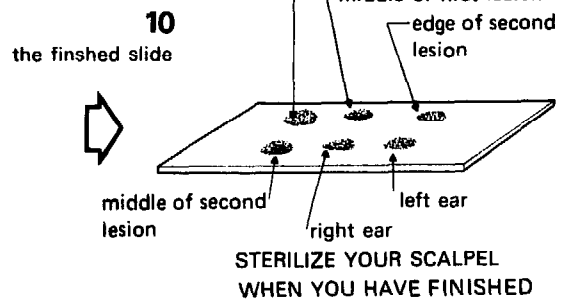
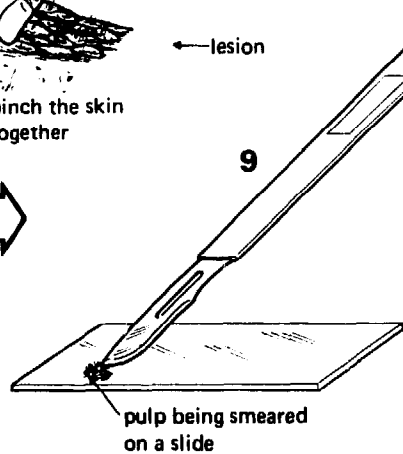
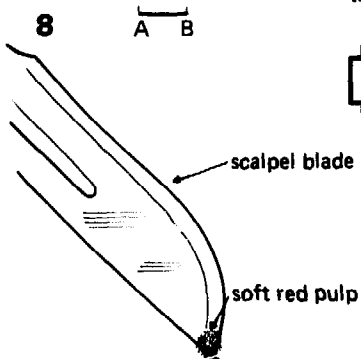
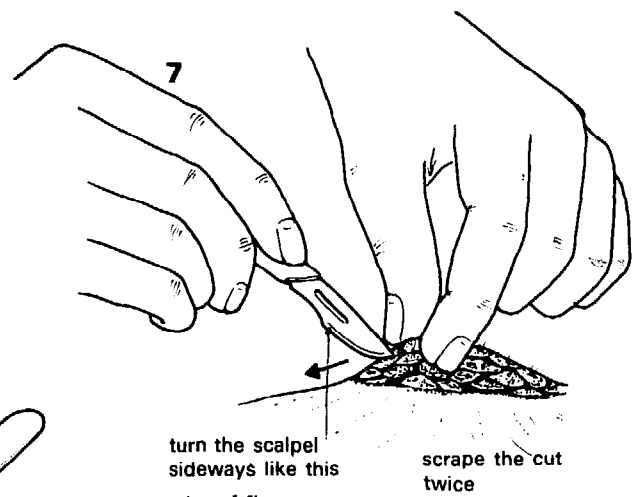
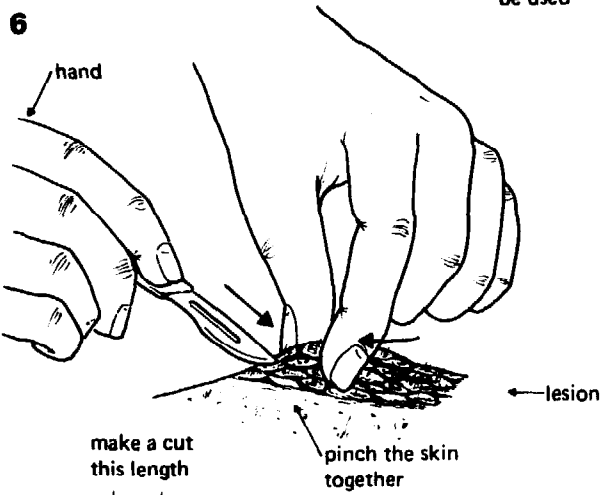
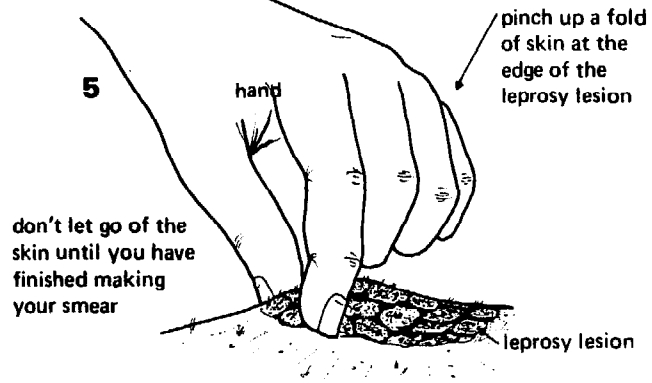
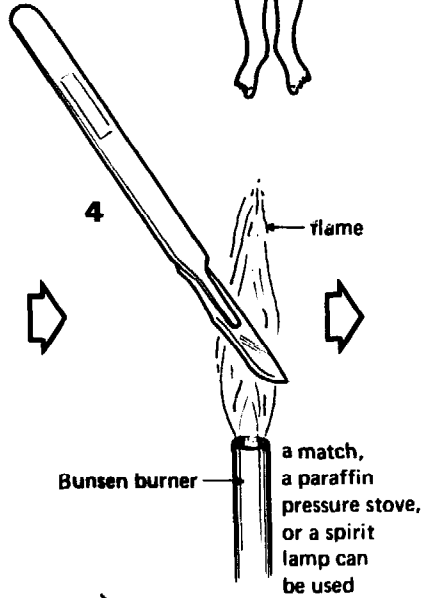
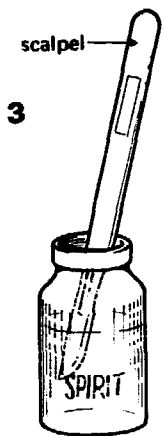
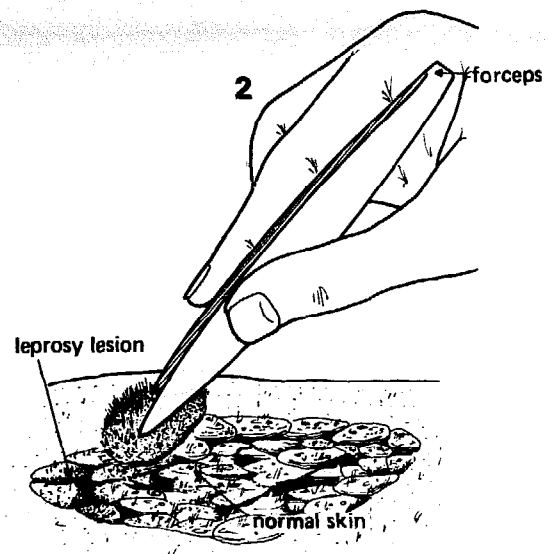
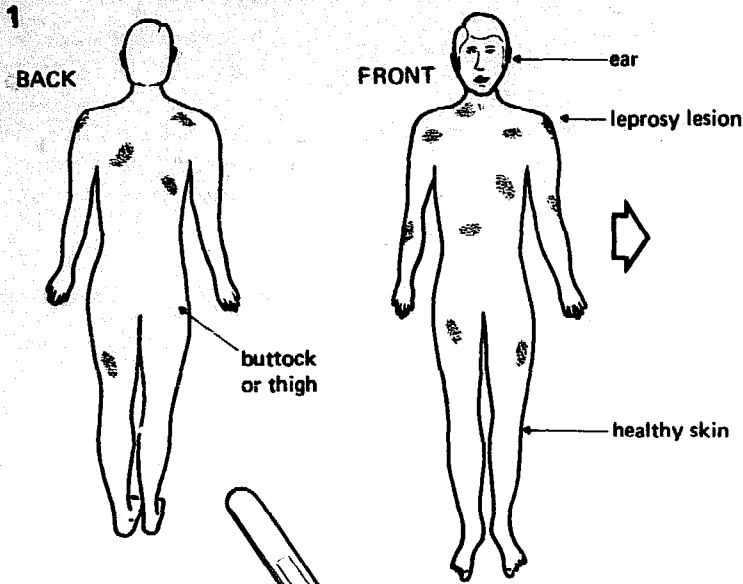

Fig. 11-4 A skin smear for leprosy

Nasal smears can be made in various ways. A wooden applicator stick round the end of which is a little cotton wool can be used. The best instrument is probably a *spud*. This is a small spade with which the nasal mucosa can be scraped. A useful *spud* can easily be made from a paper clip or a bicycle spoke.

METHOD

MAKING A NASAL SMEAR, FIGURE 11-5

Ask the patient to blow his nose to blow away any mucus. If he has no handkerchief, ask him to blow his nose in toilet paper or in his fingers.

1. Take a bicycle spoke or a strong paper clip. In this figure a paper clip is used.

2. Straighten out the paper clip.

3. Hit the end of the paper clip on a stone with a hammer until its end is flat.

4. The edge of the paper clip should be sharp, but not too sharp. This is now your *spud*.

5. You will want a special instrument called a nasal (nose) speculum to put into the patient's nose.

6. You will need a good light, so move the patient's head until light falls on his nasal septum. This usually means bending his head backwards.

7. Pinch the speculum together.

8. Put the end of the speculum into the patient's nose and leave it there. The speculum will open and its ends will hold his nose so that you can easily see inside.

9. Meanwhile flame your *spud* and leave it to cool.

10. Put the cool *spud* into the patient's nose and *gently scrape an area of the nasal septum*. The nasal septum is the middle part of the nose which divides one side from the other. When there are leprosy bacilli in the nose the mucosa is usually reddened and thickened, and there may be small yellow swellings called nodules. Try to dig out a small part of one of these nodules. They contain millions of bacilli. If there is an ulcer (open sore place) on the septum, scrape this.

Don't scrape the skin of the lower part of the inside of the nose. This part of the nose, where you can easily put your finger, is called the vestibule (entrance). You will not usually find mycobacteria here.

11. Scrape the mucosa once or twice until you have a little soft red pulp on the end of your *spud*. Don't scrape so hard that the mucosa bleeds more than a little. Bleeding spoils the chances of your finding bacilli.

12. Spread this soft red pulp in a small circular area on a slide. Nasal smears are usually put on the same slide as smears from the skin. Stain nasal smears for *Myc. leprae* in the same way as you would a skin smear.

11.11d Examining and reporting on smears for *Myc. leprae*

Search the smears you have made for bright red bacilli in the same way that you would search sputum smears for

Myc. tuberculosis (Section 11.1). Look at not less than 100 fields, unless the patient is lepromatous, when there will be millions of bacilli, and one field will be enough. You may find a few separate bacilli, or there may be many of them close together. Many bacilli close together inside a cell are called *globi* and are found in lepromatous leprosy. If you find a positive slide, keep it if possible so that it can be checked. After it has been checked, boil it in dichromate (see Section 3.12) or break it so that it cannot be used again. This will help to prevent false positive reports—see Section 11.2.

Leprosy smears can be reported in several ways. We shall explain two of them, and you must use whichever you are asked to.

WHO's method of reporting

Negative	No bacilli in 100 fields
One plus (+)	One or less than one bacillus in each field
Two plus (++)	Bacilli found in all fields
Three plus (+++)	Many bacilli found in all fields
Four plus (++++)	Many bacilli and many globi

Ridley's method of reporting

Negative	No bacilli in 100 fields
One plus (+)	1-10 bacilli on average in 100 fields
Two plus (++)	1-10 bacilli on average in 10 fields
Three plus (+++)	1-10 bacilli on average in one field
Four plus (++++)	10-100 bacilli on average in one field
Five plus (+++++)	100-1000 bacilli on average in one field
Six plus (++++++)	Many clumps or globi

As we have seen above, a patient's leprosy is still active if the debris or remains of bacilli can still be found in his skin or nose. If, therefore, in patients under treatment, you see acid-fast debris which looks like the remains of bacilli, report 'acid-fast debris present'. Make sure, however, that this is not just a deposit of carbol fuchsin on a badly made slide.

The bacteriological index

As well as reporting on each smear in one of the above ways, you may be asked to work out what is called the **bacteriological index**. It is a measure of the total number of live and dead bacilli in a patient. This is very easy and is only a way of averaging out the 'number of plusses' in a patient's smears. It is a useful way of showing how many bacilli a patient has. Examine the smears from each

part of the patient's body in one of the ways described above. Add up the number of plusses and divide by the number of smears you took. For example, you might get 2+ from the edge of the lesion, 3+ from the middle of the lesion, 4+ from the right ear, 2+ from the left ear, 1+ from the nose and none from the buttocks. This makes a total of 12 plusses from 6 smears. The bacteriological index is thus $12 \div 6 = 2$.

The morphological index

As we saw earlier on, a fight goes on inside a leprosy patient between his body and the bacilli. Bacilli which are growing and multiplying and so winning this fight stain as uniform dark red rods. By uniform we mean that a bacillus looks solid and stains in the same way all over. By dark red we mean that the bacilli are a dark red colour and are not pale. Bacilli which stain as uniform dark red rods are often called **solids**. But, if the body wins the fight and the bacilli start to be killed, they no longer stain in the same solid uniform way. As it dies, a rod-shaped leprosy bacillus starts to stain irregularly (in lumps) and then breaks into granules, as shown in Picture A, FIGURE 11-6. Dying bacilli may also stain a paler pink instead of a dark red. Pale or granular bacilli like this are often called **non-solids**. Only solid dark and uniformly staining bacilli are alive. Pale or irregularly stained granular non-solids are dead. The body takes a long time to get rid of dead leprosy bacilli. This is why non-solids and acid-fast debris can be found in skin smears long after treatment has started and the patient is getting better.

The number of solid rod-shaped live bacilli in every hundred of all kinds (alive and dead) is called the **morphological index**. It measures the percentage of live bacilli in a smear. The higher the morphological index (the nearer 100%), the more live bacilli there are, and the more infectious a patient is. A lower morphological index shows that there are fewer live bacilli and that treatment is making the patient better.

Even in the case of lepromatous leprosy not all the bacilli are alive, and even in an active untreated case the morphological index may only be 30% or 40%.

The morphological index is a good way of seeing how the fight between the patient and his bacilli is going. Like the bacteriological index, which is a measure of all bacilli in a smear, alive and dead, it tells us if the patient is winning or if the bacilli are winning. The morphological index is the better way of telling how the earlier stages of the fight are going. Let us say that a lepromatous patient starts treatment with sulphones. Most of his bacilli are killed in a few months; so they stain irregularly. The morphological index, which might have been 30% before treatment started, falls to 5% or even 0%. The body takes a long time to remove dead leprosy bacilli, so the bacteriological index, which was, say, 5 before treatment started, may only fall to 4. This is because the bacteriological index measures all bacilli, alive and dead. The morphological index, which falls so soon after suc-

cessful treatment has begun, is thus a more sensitive index of response to treatment than the bacteriological index.

Even though the sulphones can help the body to kill the bacilli and the morphological index falls to 5% or even 0%, the few that may remain hidden in the liver and the nerves can grow and multiply if the sulphones are stopped. This is why it is so important for a patient to go on taking sulphones for years after his skin smears are negative, so as to make quite sure that there are no live bacilli left in his body.

Leprosy bacilli may become resistant to the drugs used to treat the patient. Sulphones, which used to kill the bacilli, may no longer do so, and the bacilli are said to have become resistant. When this happens, the morphological index, which may have been 0% soon after the treatment started, rises again. The morphological index is thus a good way of telling if a patient has become resistant to his drugs. He must of course have been taking his drugs regularly, and this is why it is useful to be able to test his urine for sulphones as described in Section 8.10a.

METHOD

THE MORPHOLOGICAL INDEX, FIGURE 11-6

Choose a well-stained part of the film.

Find 100 separate organisms and count how many of them are solid, rod-shaped, and deeply and uniformly

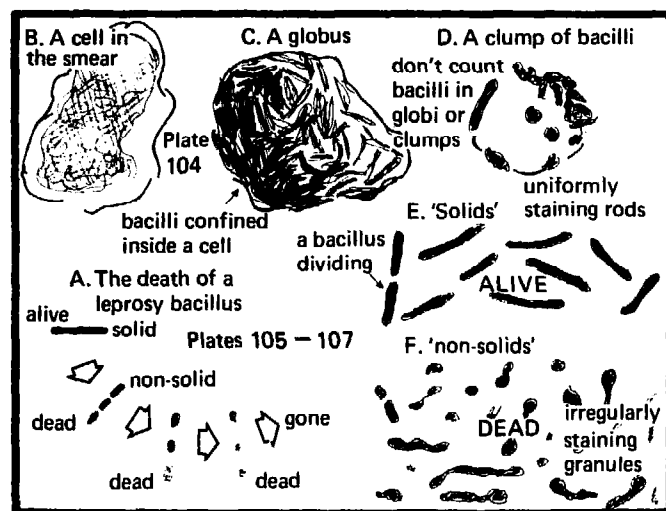

Fig. 11-6 The morphological index

stained like those in Picture E. These are the solids. Don't count any organisms in globi or clumps, like those in Pictures C and D. If an organism is pale or is very short and granular, it is a non-solid. If you find a longer than average solid bacillus with a short gap in the middle, it is probably about to divide into two. Count it as two solids. If you see a row of two or three granules together, which are the remains of one bacillus, call them one non-solid.

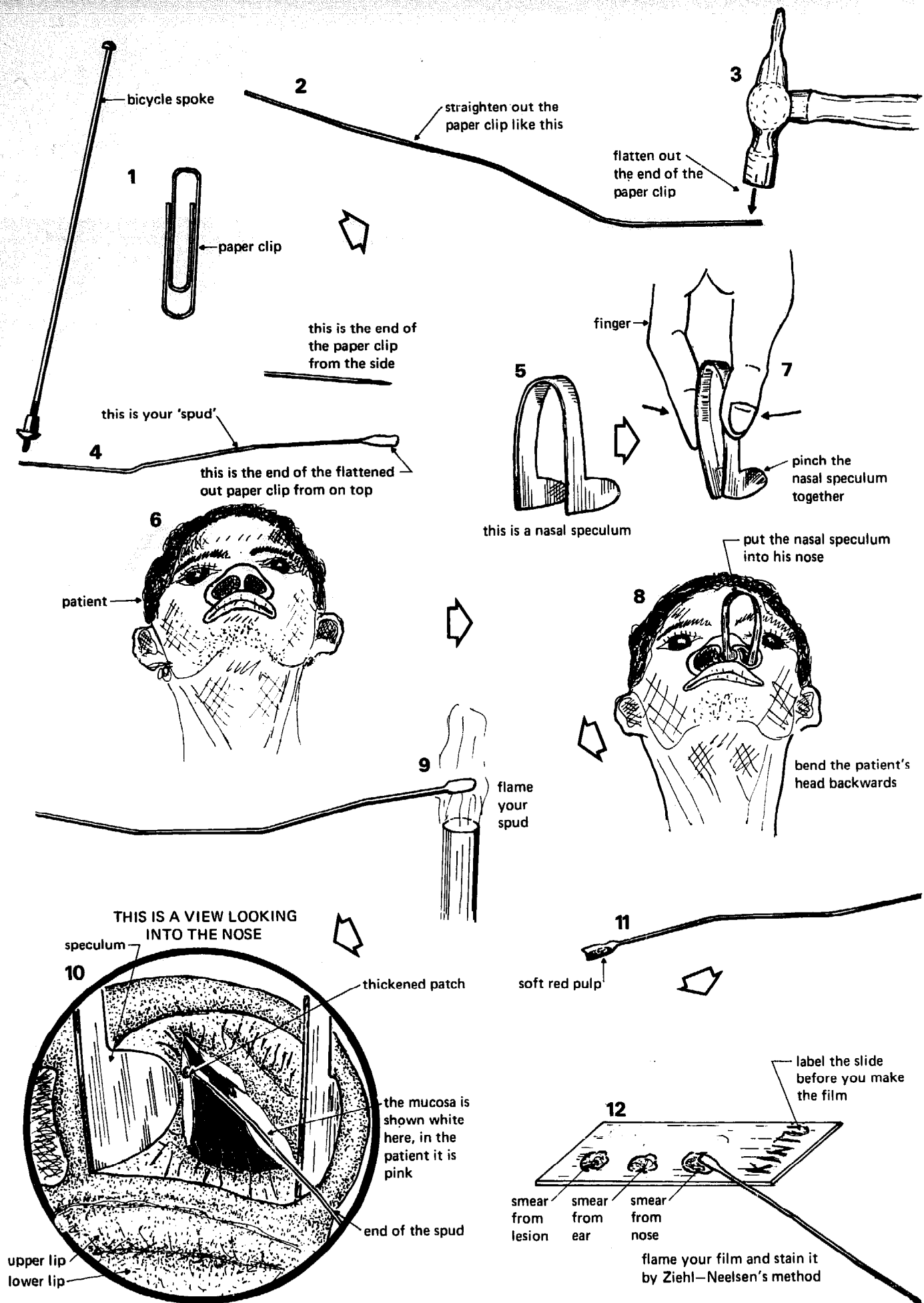

Fig. 11-5 A nasal smear for leprosy

METHODS FOR SOME OTHER DISEASES

11.12 Lymph node puncture for trypanosomes

The lymph nodes (lymph glands) are about the size and shape of a bean. There are some in the neck, some under the arm, and some in the groin. The groins are the folds between the abdomen or belly and the legs. There are many more lymph nodes deep inside the body. Lymph nodes filter lymph (fluid from the tissues) and are one of the places where lymphocytes come from.

When a patient is infected with a species of trypanosome called *Trypanosoma gambiense*, the lymph nodes at the back of his neck often become swollen (large). Trypanosomes can often be found in these swollen glands by puncturing them (making a hole in them) with a needle and sucking out some blood and lymph with a syringe. Moving trypanosomes can be seen, just as in blood (see Section 7.36) or CSF (see Section 9.14).

METHOD

PUNCTURING LYMPH NODES TO FIND TRYPANOSOMES

Carefully explain to the patient what you are going to do.

Fetch slides, coverslips, a sequestrene bottle, swabs, spirit, and a syringe with a sharp sterile needle.

Sit the patient down with his back to you. Feel for the biggest node at the back of his neck. Swab the skin over it with spirit.

Take the syringe in your right hand and pinch the node between your left finger and thumb.

Put the needle into it and try to suck out some fluid. Put the first drop of any fluid you get on to a slide. Put the rest of the blood into the bottle, if there is any. Put a coverslip on the slide.

Swab the skin again and put some adhesive plaster on the wound.

Look for *moving trypanosomes* all over the film, just as you would in blood (see Figure 6-14). If you can only get a very small drop of fluid, add a *small* drop of saline, or it will dry up.

If you cannot find trypanosomes on the slide, and you have enough blood in the bottle, spin it and look at the spun deposit.

When you try to suck fluid from the node you may think you are not getting any. But there will probably be a small drop in the needle. Blow this on to a slide and look at it. It may well be enough to let you find trypanosomes.

11.13 The rectal snip for *Schistosoma mansoni*

The trematode worm called *Schistosoma mansoni* lives in the veins of the large intestine (large gut). The female worm lays eggs in the veins which slowly push their way through to the inside surface of the gut. These ova are then passed out of the body in the stools where they can be found either in a saline smear (see Section 10.2) or by

the concentration test described in Section 10.3. This concentration test is probably the best way to find the ova of *S. mansoni*. But some people like to diagnose *S. mansoni* infections by looking at a small piece of rectal mucosa called a **rectal snip**. They put a special short, wide metal tube called a proctoscope (or a longer one called a sigmoidoscope) into the patient's anus (the bottom end of the large intestine). They look through this and take out a small piece of the mucosa of the large intestine with special forceps. This piece of mucosa is then squashed between two slides and looked at for the large lateral (side) spined ova of *S. mansoni*. Most of this method is for doctors.

METHOD

THE RECTAL SNIP FOR *S. MANSONI*—FOR DOCTORS ONLY

Pass a sigmoidoscope or a proctoscope. Look for a piece of mucosa that looks abnormal. Remove a small piece of the mucosa with a pair of forceps. If you cannot find a piece of abnormal looking mucosa, take a piece of normal mucosa. Don't take too large a piece or the gut will bleed too much. Put it on a slide. Add a drop of saline and put another slide on top of it. Squeeze the two slides together and look at the piece of mucosa through a low power objective. Look for schistosome ova. Either the ova of *S. haematobium*, or the ova of *S. mansoni* may be found, or possibly even both. These ova are shown in Figure 10-8.

11.14 The skin snip for *Onchocerca volvulus*

Onchocerca volvulus is a worm which lives in the skin and causes a disease called **onchocerciasis**. The worm makes lumps on the skin called onchocercal nodules, and it also makes patients blind. The female worm gives birth to many young worms called microfilariae. The microfilariae of most nematode worms which live inside the body tissue are found in the blood. These blood microfilariae are described in Section 7.37. The microfilariae of *O. volvulus* are different and are found in the skin. We can therefore diagnose onchocerciasis by cutting a very small piece of the patient's skin and looking for microfilariae in it with a microscope. If we watch we can see live microfilariae come out of the piece of skin and move about in a drop of saline under a coverslip. This is called doing a **skin snip** for onchocerciasis. Use a sharp scalpel and a sharp needle held in a loop-holder. If you do many skin snips keep a special loop-holder and needle for these alone. A sewing needle can be used, so can one of the needles that fit on to a syringe. But the best kind of needle to use is called a 'Hagedorn' needle and is used by surgeons for doing operations. Ask someone in the operating theatre of your hospital if they can give you a small Hagedorn needle. Put this into the end of a loop-holder; you may have to break the end of the needle to get it in. This needle is for lifting up the skin while you cut off a very small piece with a scalpel.

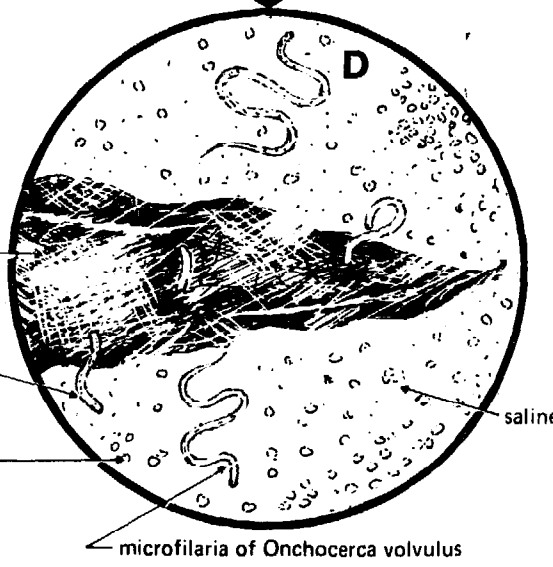
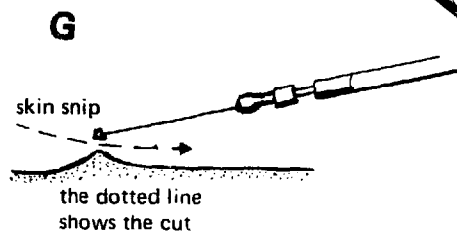
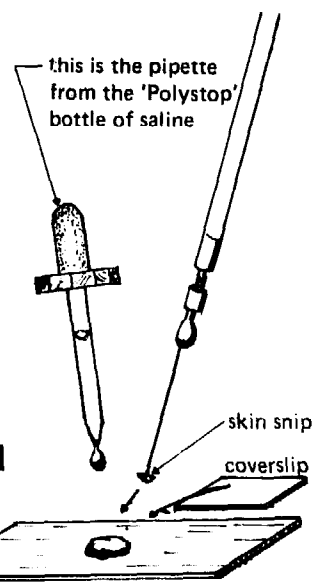
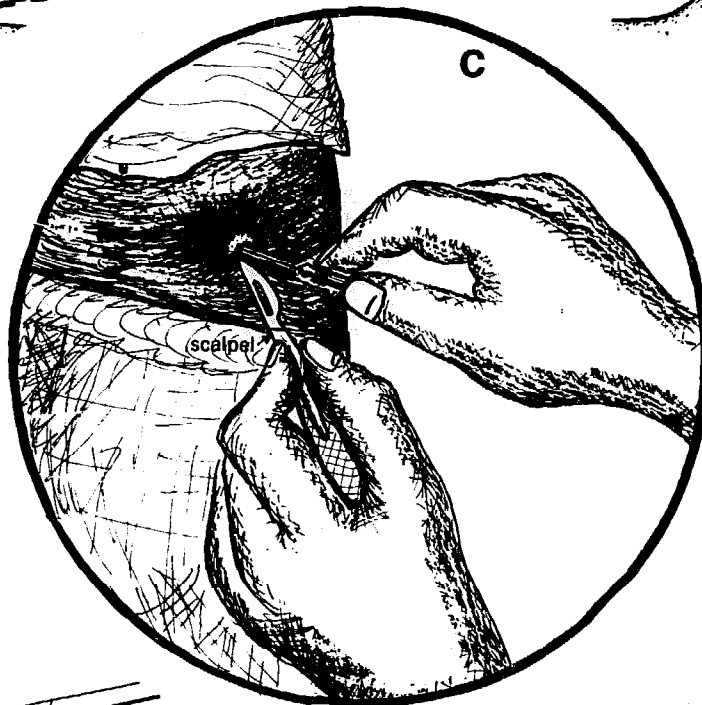
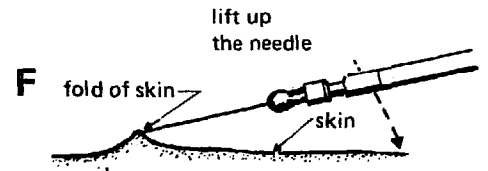
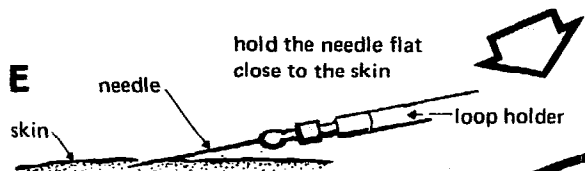
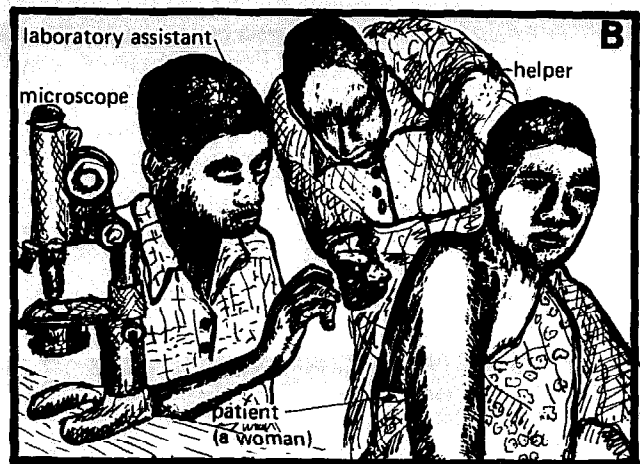
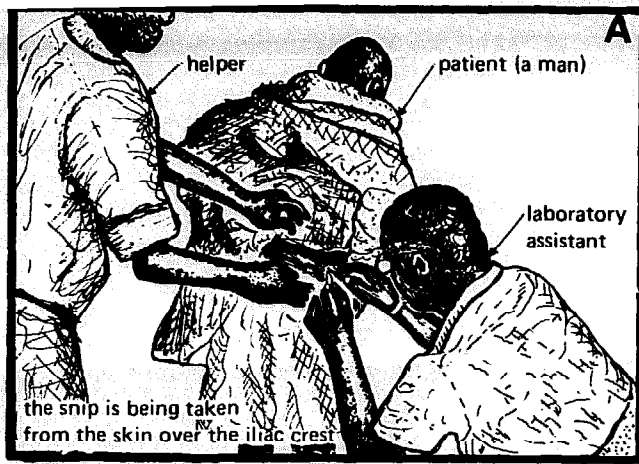

Fig. 11-7 The skin snip for onchocerciasis

Microfilariae are more likely to be found in skin snips taken from special parts of the body. In men we usually take skin snips from the skin over the iliac crest. The iliac crest is the top of the bone called the ilium which is part of the pelvis. Picture A, FIGURE 11-7, shows a skin snip being taken from the skin over the iliac crest of a man. The middle part of Picture A has been drawn much larger in Picture C. Here, the needle is holding up the skin and the scalpel is just going to cut off the skin snip.

In women it is usually easier to take a skin snip from the skin of the back of the shoulder. This is being done in Picture B.

If you only take a *small* piece of skin, there is no need to use a local anaesthetic. This is a drug which is injected into the place to be cut to stop the patient feeling pain.

METHOD

SKIN SNIPS FOR *ONCHOCERCA VOLVULUS*, FIGURE 11-7

If possible send the patient into the sun for half an hour and let the sun shine on the skin where the snip is to be taken. This will make it easier to find the microfilariae.

Swab the skin with spirit. Let the spirit dry.

Quickly flame the needle and let it get cool. Don't let it get red hot, or it will get blunt.

Push the needle into the skin where you want to take a snip. Hold it flat and only just push the point in. This is shown in Picture E.

Lift up the needle as shown in Picture F. This will raise a fold of skin.

Cut off the skin just under the needle with a sterile scalpel or a sterile razor blade. This is shown in Picture G. The dotted line shows where the scalpel has gone. The skin snip will stick to the needle.

Put the skin snip on a slide. Put a drop of saline on it. Cover it with a coverslip. Ring the coverslip with paraffin wax and vaseline as described in Section 7.23. This will stop the saline drying.

Look at the skin snip with your microscope. Use a low power objective. You will see small worms come out of the piece of skin and start moving about in the saline. These worms are the microfilariae of *O. volvulus* and have been drawn in Picture D. Some worms will come out of the snip very soon. If you don't see any worms at first, look again 20 minutes later. Don't call any specimen negative until you have looked at it after it has been taken for 20 minutes. Count the microfilariae and report the number you see.

11.15 Skin scrapings for fungi

When food such as bread is left in a damp warm place for a few days it usually becomes covered with many very short thin hairs. These may be white or coloured and are often green. They are the hairs or mycelia of

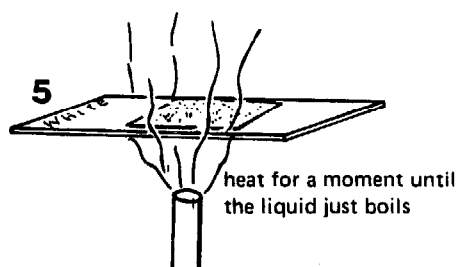
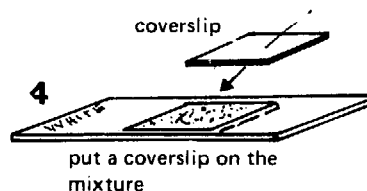
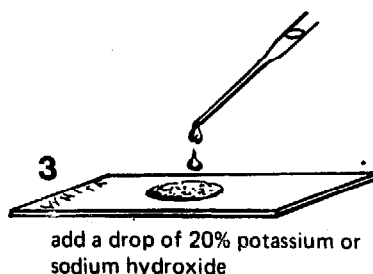
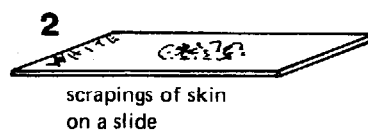
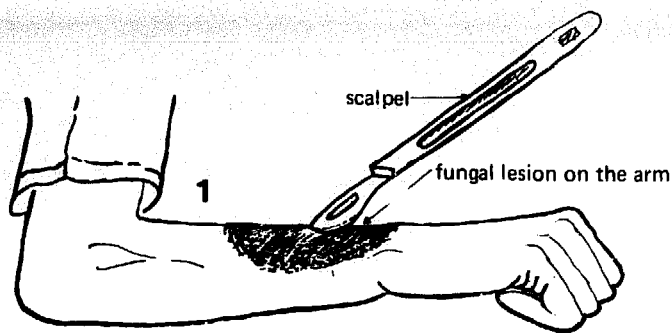

MICROSCOPIC VIEW

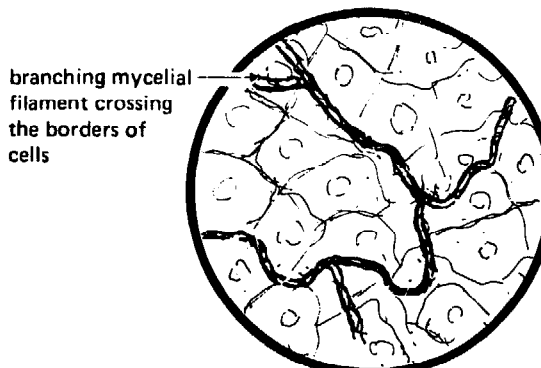

Fig. 11-8 Skin scrapings for fungi

plant-like organisms called moulds or fungi. If you look at a fungus (such as mouldy bread) with a microscope you will see that these fungal mycelia are long, thin, branching cells. Sometimes you will see groups of thicker, round cells joined on to them. These are the spores (seeds) of the fungus. Some fungi can grow as mycelial threads or as yeasts. Yeasts are large, short cells which grow by forming buds (unlike bacteria). Buds are daughter cells which grow from one end of the parent cell. Like bacteria most fungi are harmless and live in the soil. A few fungi grow and cause disease in man, especially in his skin, in his hair or in his nails. These fungi can often be seen when scrapings of skin, or nails, or pieces of hair are heated in a drop of strong sodium or potassium hydroxide and looked at with a microscope. As you remember from Section 1.6, potassium hydroxide is a very strong alkali. Strong hot alkali partly dissolves the skin or nail and makes the fungus easier to see. The method is easy, but it is sometimes difficult to be sure what is a fungus and what is not.

METHOD

SKIN OR NAIL SCRAPINGS FOR FUNGI, FIGURE 11-8

1. Take a scalpel. Pass it through a flame quickly to sterilize it. Gently scrape the skin lesion that you think may be caused by a fungus. You will be able to scrape off some small pieces off the top of the skin of the lesion. In Picture 1 there is a large fungal lesion on the arm. Don't cause any bleeding and don't hurt the patient. If the nail is diseased cut off a small piece. If you want to find fungus in hair, cut off a few short pieces of hair.

2. Put the skin scrapings, or the piece of nail, or the short pieces of diseased hair in the middle of a slide.

3. Add a drop of 20% sodium or potassium hydroxide

as made in Section 3.42b.

4. Place a coverslip on the drop of solution.

5. Gently heat the slide until the solution just boils.

Look at the scrapings with a high power objective and don't use too much light. Look for fungal mycelia or for yeasts. You may find it difficult to recognize these mycelia. Remember that mycelia always branch—that is, they divide into two as you follow them. They have two walls—they are not just lines. They also cross the border between one cell and another.

QUESTIONS

1. What is a counterstain? Why do we use counterstains? Give two examples of counterstains.

2. What are the advantages of the cold way of doing the Ziehl-Neelsen method?

3. What is meant by a false positive report? How would you prevent this when staining sputum films by the Ziehl-Neelsen method?

4. What diseases are caused by bacteria of the genus *Neisseria*? How would you diagnose them?

5. What is *Trichomonas vaginalis*; where and how might you expect to find it?

6. Name three specimens in which trypanosomes can be found. Describe how you would take and examine one of these specimens.

7. What organisms do you look for in a rectal snip? What other ways are there of looking for them? How would you examine a rectal snip?

8. If you thought a patient had onchocerciasis, how would you prove it?

9. What are the main kinds of leprosy? What are the differences between them?

10. What is the 'bacteriological index' and the 'morphological index'? Why are they used?

12 | Blood Transfusion

This chapter makes extensive use of material and drawings kindly supplied by Dr Jean Holland, formerly of the Uganda Blood Transfusion Service.

12.1 Blood groups and agglutination (FIGURE 12-1)

In the other chapters of this book you have read about the methods we use to find out what disease a patient has (to diagnose his disease). For example, you will have read about measuring the haemoglobin and looking for hookworm ova in the stools. This is important because, if you can find out why a patient is ill, he can be given the right treatment and often be cured. Blood transfusion is not done to diagnose a patient but to treat him. Blood transfusion means taking blood from a healthy person and giving it to a patient who has not got enough blood. The patient to whom the blood is given is called a **recipient** (recipient means receiver). The healthy person who gives blood is called a **blood donor** (donor means giver). A blood donor soon makes some more blood to replace (make up for) the blood he has given and a donor can safely give blood every 6 months.

Blood transfusion saves many lives, but it can be dangerous both to the donor and the recipient, unless it is very carefully done by someone who has been trained in blood transfusion work. This chapter explains the easier parts of blood transfusion, but the only way to really learn how to give a safe transfusion is to be trained in a good laboratory by someone who is experienced.

We cannot take blood from any donor and give to any recipient. This is because there are many different kinds of blood, even though every healthy person's blood looks the same. We call these different kinds of blood the **blood groups**.

Some blood groups can be mixed together and are said to be **compatible** but other blood groups cannot be mixed and are said to be **incompatible**. When a recipient needs to be given a blood transfusion, he *must* be given blood which will mix with his own blood. If a recipient is given the wrong kind of blood he may die. There are special methods for finding out the group to which blood belongs. We have first to find the recipient's blood group,

and then find some blood from the right kind of donor which will mix with his blood. There are many blood groups. We shall only describe the most important ones. There are the ABO blood groups and the Rhesus or Rh blood group.

There are four important kinds of ABO group: A, B, O, and AB. There are two important kinds of Rhesus group: Rhesus positive and Rhesus negative. Sometimes, instead of saying Rhesus positive, we call the blood D ('big D') positive.

A person with any kind of ABO group can be either Rhesus positive or Rhesus negative. People can therefore have these kinds of blood:

<i>ABO group</i>	<i>Rhesus group</i>	<i>Percentage of people of each blood group (Zambia)</i>
Group A	Rhesus positive	25.33
Group A	Rhesus negative	0.67
Group B	Rhesus positive	21.43
Group B	Rhesus negative	0.57
Group AB	Rhesus positive	1.95
Group AB	Rhesus negative	0.05
Group O	Rhesus positive	48.69
Group O	Rhesus negative	1.31

The blood groups are not all equally common. In the list above you will see the number of each blood group in every hundred (the percentage) that we find here in Zambia. In other parts of the world the percentage of people in each group will be slightly different. You will see that group O is the most common group, and that there are many more Rhesus positive people than there are Rhesus negative people.

A person's blood group is the same all his life. The blood groups are like the colour of a man's eyes or his skin: we are given them by our parents. Nobody ever changes his blood group.

You have read that blood contains red blood cells lying in a liquid called plasma. People of different blood groups have different red cells and different plasma. The red cells of each blood group are different because they have different 'places' of a special shape (called determinant groups). Group A red cells have A places. Group B red cells have B places. Group AB red cells have both A

and B places. Group O red cells have neither A nor B places.

The plasma of people with different blood groups is different because it contains special proteins called **antibodies**. These antibodies are long proteins with a 'hook' (called a valency site) at each end. The hooks on anti-A antibody hook on to A places on the red cells. The hooks on anti-B antibodies hook on to B places on red cells. There is no common anti-O antibody. If you look at a drop of blood through a microscope, you can see the red cells, but antibodies are so small that they cannot be seen.

Because each antibody has two hooks which can hook on to two red cells of the same group, antibodies can make red cells stick together in lumps or agglutinates. We can watch this **agglutination** or clumping on a slide or a tile as in FIGURE 12-1. Picture L shows a tube with anti-A serum in it. Picture M shows a tube containing some group A red cells. Picture N shows a drop of anti-A antibody and a drop of group A red cells being mixed on a tile. A minute or two after they have been mixed the cells will be seen to come together in lumps or agglutinates. These agglutinates are shown in the right hand side of the tile in Picture N. In the middle part of this figure is a diagram to help you learn what happens. Picture O is an antibody: it is anti-A. You will see that it is long and has the same kind of hooks (valency sites) at each end. Picture P is a group A red cell with special group A places (determinant groups) which fit the hooks on the anti-A antibody. The anti-A antibody is really very much smaller than the red cell and has been drawn much too big in these pictures. When anti-A antibody and group A red cells are mixed, they hold together to form an agglutinate, as shown in Picture Q. Pictures R and S show anti-B antibody and group B red cells. *Anti-A only agglutinates group A and group AB red cells. Anti-B only agglutinates group B and group AB red cells.* We say that these sera are specific for these blood groups.

Healthy people never have in their plasma any antibody against the special places on their own red cells, but they always have antibodies against the special places of the other ABO blood groups. This means that group A people who have red cells with special A places have anti-B antibody in their plasma. Group B people who have red cells with special B places have anti-A antibody in their plasma. Group O people have red cells without either of these special places; so they have both anti-A antibody and anti-B antibody in their plasma. Group AB people have both A and B special places on their red cells; so they can have neither anti-A nor anti-B antibodies in their plasma.

In this example the red cells are acting as **antigens**. You may have heard of antigens before. When bacteria enter the body, they act as antigens, and the body makes antibodies against them. These antibodies 'attack' (join on to) the bacteria and help the body to fight them. Most antibodies are only formed after an antigen has got into the body. Anti-A and anti-B antibodies are different. We are born with them.

12.2 Transfusion

In a blood transfusion a donor's red cells must never be allowed to agglutinate inside a patient. The donor's red cells must therefore be compatible with the patient's serum. If they are incompatible, they may agglutinate inside the patient who will have a **transfusion reaction**. He may shiver, have a fever, become jaundiced, and he may have pain in his back. His kidneys may stop working because they are blocked by agglutinated red cells. When a patient's kidneys stop working he passes no urine and is said to suffer from **anuria** (no urine). Because patients often die from transfusion reactions, we have to take great care to prevent agglutination of their blood.

Because group AB patients have no anti-A or anti-B antibodies in their serum, they can be given blood of any group. They are called **universal recipients** (receivers from everyone). Because group O red cells have no special A and B places on them, they can be given to anyone. Group O donors are therefore called **universal donors** (givers to everyone). Group A people must therefore be given group A or group O blood. Group B people must be given group B or group O blood. Group O people **MUST ONLY** be given group O blood. Group AB people can be given blood of any group. Even though we can give group O or universal blood, it is always better, if possible, to give blood of the right (homologous) group. This means giving only group A blood to group A patients, and only group B blood to group B patients, etc. But universal donor blood is often useful. Many hospitals always keep a bottle of group O blood ready in a special refrigerator. If a patient is bleeding to death rapidly, he can be given this group O universal donor blood without wasting time finding out what his own blood group is. Later he can be given blood of his own group. Always take a specimen of the recipient's blood into a dry tube before giving him universal donor blood in this way. It is often useful to be able to test the donor's blood before it has been mixed with universal donor blood.

12.3 Antisera

Antisera are used for grouping blood. Anti-A antibody is called anti-A antiserum or 'anti-A'. Anti-B antibody is called anti-B antiserum or 'anti-B'.

The anti-A antiserum we use for blood grouping comes from the serum of group B donors. Anti-B antiserum comes from the serum of group A donors. These donors are specially chosen so as to have strong antisera. Large laboratories choose their own special donors and make their own antisera, but small laboratories have to buy their antisera. Liquid antisera can be bought in small bottles which often have small pipettes in their stoppers. Anti-A is often coloured blue or green, and anti-B is often coloured yellow. Sometimes the sera are sold dry and are sealed (closed) into small glass tubes. These tubes must be opened and *water* added to them

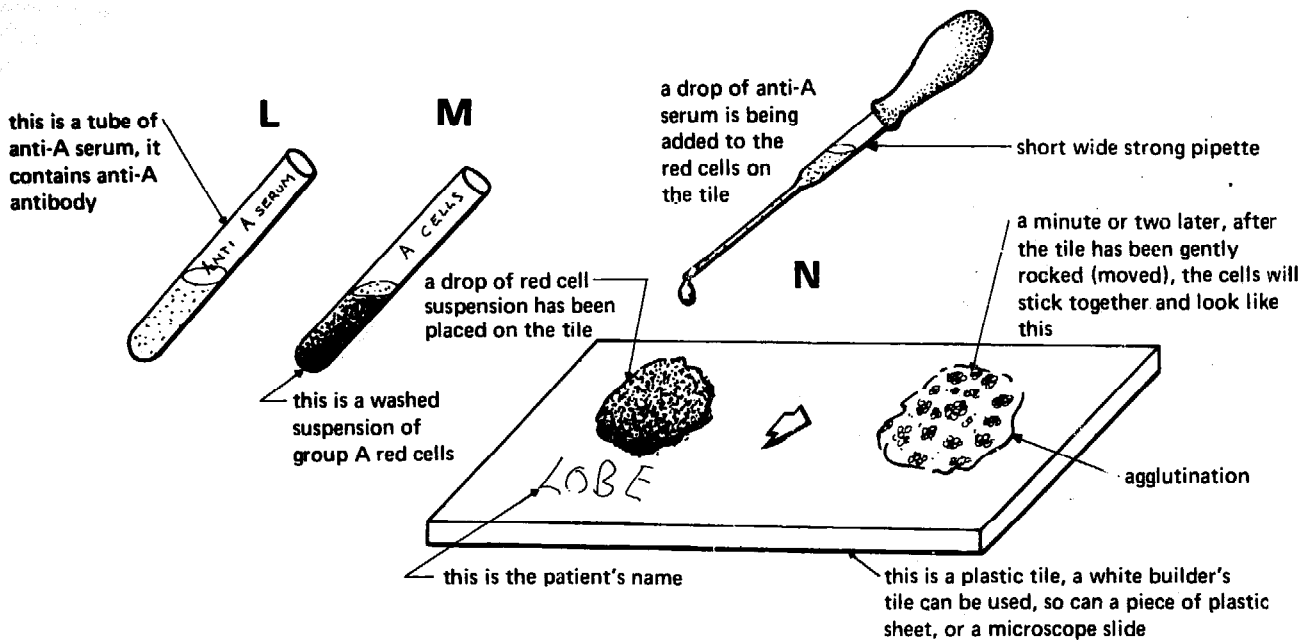

THIS IS A DIAGRAM OF WHAT HAPPENS

the hooks (valency sites) on an anti-B antibody and the special places (determinant groups) on the group B red cells are different from those on anti-A and group A red cells

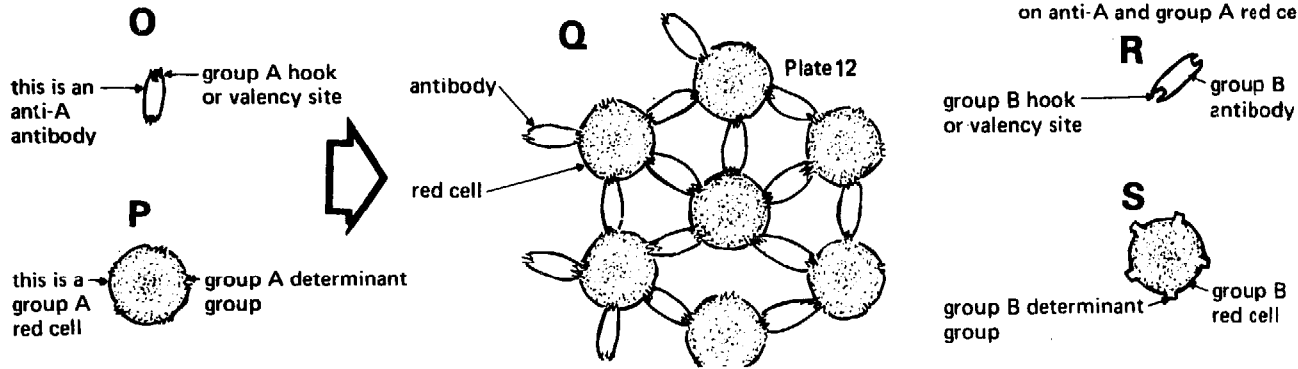

An Eldon card

this means that these cards are good enough for testing the Rhesus group of patients, but should not be used for donors : use liquid anti-D serum for rhesus testing donors

this is the control square : if you see agglutination here it means that the results in the other squares may be wrong : try the test again using a CONCENTRATED suspension of washed red cells on another card

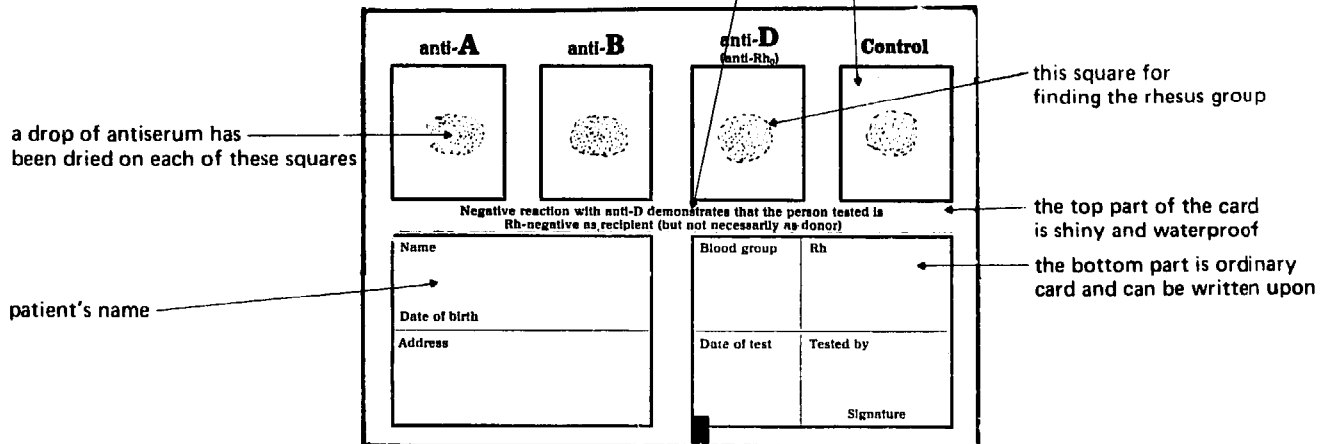

follow the instructions very carefully!!!

Fig. 12-1 Agglutination

(distilled water is the best, and you must *not* use saline). The water mixes with the powder in the tube and makes liquid antiserum ready to use. Read the instructions that come with these tubes carefully.

Most of the chemicals in the main list will keep good for ever. Whenever we want to use them we can be sure that they will work. But anti-A serum and anti-B serum are not like this. Antisera very easily go bad because micro-organisms grow in them. They may then stop working. **ALWAYS KEEP YOUR ANTISERA IN A REFRIGERATOR.** If you have a store of antisera that you are keeping for some time, keep it frozen solid in the coldest part of the refrigerator (the 'freezer'; see FIGURE 12-11). Keep the antisera that you are using every day in the main part of the refrigerator. It will stay liquid.

But if antisera so easily stop working, how do we make sure that the antisera we use are still working? We do this by using what are called **controls**. We test our anti-A with some red cells that we know are group A and some that we know are not group A. If we get good agglutination with group A cells, but not with O or B cells, we know our anti-A must be working. If our anti-A does not agglutinate A cells, we know it is not working. We test our anti-B in the same way with group B cells. Good laboratory workers do a control every time they group someone's blood.

But where can we find red blood cells that we can be quite sure are group A or group B? The best thing to do is to make sure that you know your own blood group and the blood groups of some of the other people working in the laboratory or the hospital, especially those people who are likely to stay in the hospital some time. Among them you will find some who are group A and some who are group B. Put a drop of blood from the ear of the person with the cells you want into a tube of saline. Centrifuge it to wash the cells, and re-suspend the deposit in just enough saline to make a good suspension for testing.

But how do we make sure that the people whose blood we are using really are group A or group B? If possible, send their blood to a big laboratory where it can be tested, and the answer can be sent back to you. If this is impossible, test the blood groups of the hospital staff with strong new antiserum. If you group several people and some come strongly 'A' and others strongly 'B', you can be sure the antisera are working well.

You can keep these A and B cells for doing controls in the refrigerator. It is best to keep them in bijou bottles of 'acid-citrate-dextrose' solution that is used to keep blood (see Section 12.9). But, unless they are sterile (see Section 1.20), these samples will not keep more than a day or two, even in the refrigerator. *Blood cells that are old and infected (see Section 1.15) may give the wrong blood group.* Where you can, therefore, always use fresh control A and B cells.

12.4 Washing red cells

You might think that the easiest way to group blood would be to put two separate drops of the patient's blood

straight on to a tile, and to add anti-A serum to one drop and anti-B serum to the other drop. We can do this, but it is a bad way to group blood because we sometimes get the wrong results. It is very important to 'wash' red cells before they are grouped. By washing red cells we mean washing away all the serum that came with the cells. This serum may cause the wrong results in blood grouping. Washing red cells is very easy. Add two or three drops of blood (not more) to a tube full of saline. We use saline, not water, because the cells would haemolyse in water. Then centrifuge the tube of blood and saline. There will then be some nearly clear supernatant saline and a small deposit of washed red cells. Take off all the supernatant with a pipette. The serum you want to remove is in this saline. Then add just enough clean saline to make the right strength of suspension for blood grouping. This suspension should be about 5% cells and 95% saline. Add about twenty times as much saline as red cells. It is not easy to measure, and the strength of the suspension is not important, *but don't make the suspension too weak.* You now have the 'washed cell suspension' which is used for blood grouping and cross-matching (see Section 12.6 for the meaning of 'cross-matching').

12.5 Blood grouping

It is quite easy to find out the group of someone's blood. All we need do is to mix on a tile one drop of our patient's red cells with anti-A antiserum and another drop of his red cells with anti-B antiserum. These are the things that may happen:

<i>Anti-A</i>	<i>Anti-B</i>	<i>The patient's blood group is:</i>
Agglutination	Nothing	Group A
Nothing	Agglutination	Group B
Agglutination	Agglutination	Group AB
Nothing	Nothing	Group O

If nothing happens when we mix our patient's blood with either anti-A or anti-B, his group is group O. If his blood agglutinates with both anti-A and anti-B, his group is group AB. If it agglutinates with anti-A, he is group A. If it agglutinates with anti-B, he is group B.

You will now be able to understand how to group a patient's blood. You will need a good strong Pasteur pipette, a cup of clean saline and a cup into which to put the waste saline. Read how to wash your Pasteur pipette in Section 3.9. It is also useful to have a wash bottle filled with saline (see Section 3.40). The cups for saline are shown in FIGURE 3-6 and in FIGURE 3-11.

The quickest and easiest way of grouping blood is to use a tile. The most accurate way is to use a tube.

METHODS

GROUPING BLOOD ON A TILE, FIGURE 12-2

1. Fill a Kahn tube or a centrifuge tube with saline. Label it with the patient's name. In Figure 12-2 the patient is called Phiri.

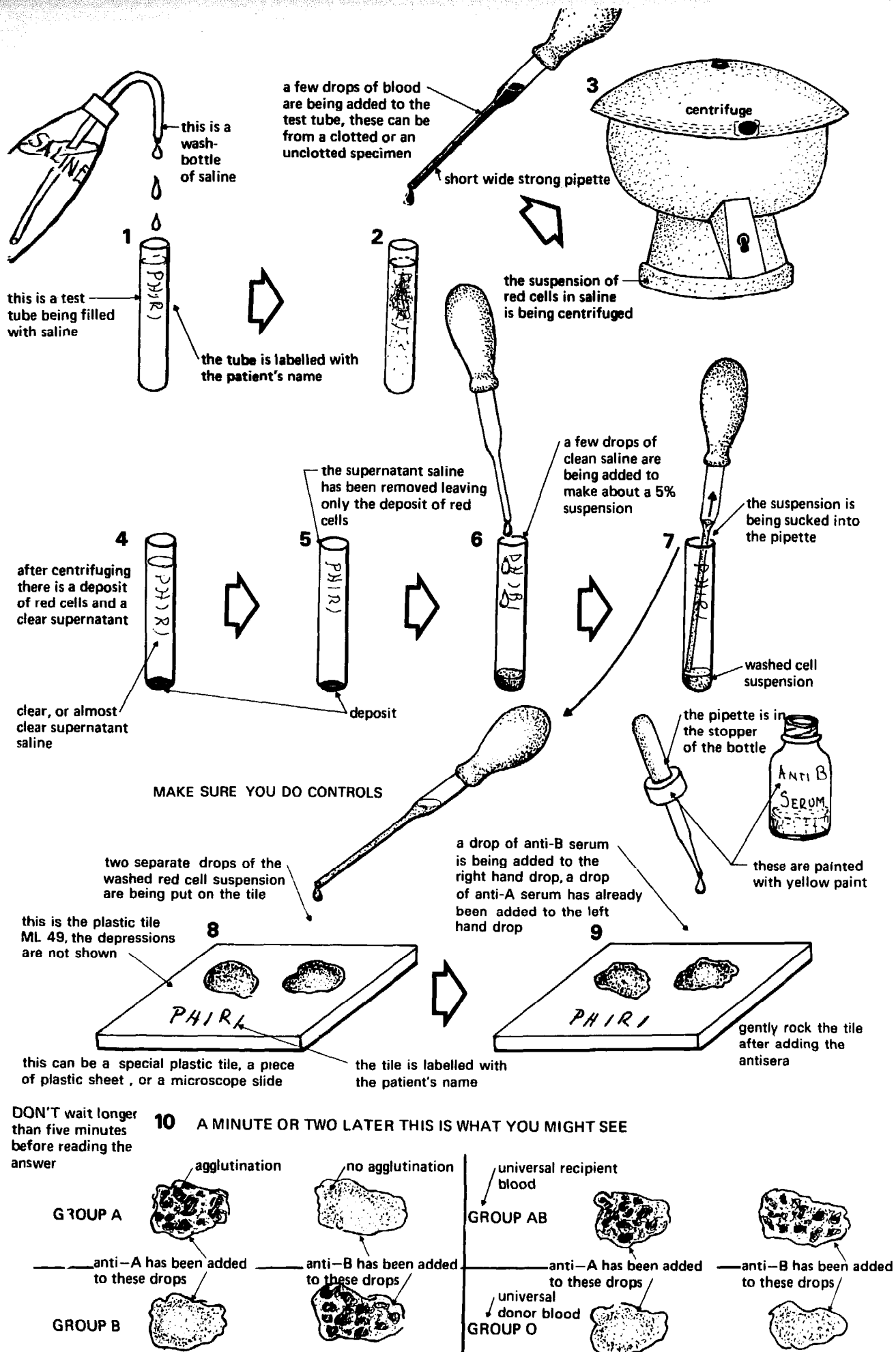

Fig. 12-2 Blood grouping

2. Add two or three drops of blood. This can be from the ear (see Section 4.7), from a sequestrenated specimen of blood, or from a clotted specimen. If you use a clotted blood specimen, break up the clot with your pipette and take some of the liquid blood from the bottom of the bottle. Try not to take up any clot into your pipette.

3. Centrifuge the suspension of blood and saline.

4. After centrifuging there will be a little deposit of cells at the bottom of the tube.

5. Take away the supernatant saline with a Pasteur pipette.

6. Add about twenty times as much saline as there are red cells. This will make a 5% solution. *Don't make the suspension too weak.* This is your 'washed cell suspension'.

7. Take up some of the red cell suspension into your pipette.

8. Put two separate drops of the suspension on different parts of a tile. If you have a plastic tile with depressions (holes) in it (ML 49) use this. You can also use a slide, as shown in Picture 18, Figure 12-3.

Using a clean pipette, put two separate drops of group A red cells below the drops of blood to be tested. Wash your pipette again, and put two separate drops of group B blood below the group A red cells. These are your *controls*. They have not been drawn in Figure 12.2.

9. Add one drop of anti-A to each of the three left-hand drops of cell suspension, and one drop of anti-B to each of the right-hand drops of suspension. If the sera are coloured, anti-A is blue or green and anti-B is yellow. Make sure you do not muddle up the pipettes and the bottles. In Picture 9, Figure 12-2, the cap of the anti-A bottle with the pipette in it and the label on the bottle are both painted with blue paint. The anti-B pipette and the anti-B bottle are labelled in yellow. This helps to stop them being mixed up.

10. Gently rock (move) the tile from side to side. If the blood is group O nothing will happen. If the blood is group A, B, or AB, it will agglutinate in the way shown in Picture 10. If the blood is going to agglutinate it will agglutinate soon—in about 2 minutes. *Don't let the blood dry up, and don't leave it longer than 5 minutes before reading the blood group.*

Always check that the group A red cells and the group B red cells give the right results. If they do not, you cannot tell the group of the patient.

ABO TUBE GROUPING

Prepare a washed 5% suspension of red cells as in steps 1 to 5 above. Add two drops of washed red cell suspension to each of two carefully labelled tubes. To one add two drops of anti-A. To the other add two drops of anti-B. Leave them on the bench for 2 hours. At the end of this time look for agglutination under the microscope.

REMEMBER WHAT YOU READ IN SECTION 12.3 ABOUT DOING CONTROLS. BEFORE YOU USE NEW BOTTLES OR TUBES OF SERA, MAKE QUITE SURE THEY WORK BY TESTING THEM WITH RED CELLS THAT YOU KNOW ARE GROUP A AND GROUP B.

12.6 Cross-matching or compatibility tests

As you read earlier on, if a patient is given the wrong blood, it may kill him. For example, if group A blood is given to a group B patient, he may die. It is thus very important that both the donor and the recipient be carefully blood-grouped. But even this is not enough, and so as to be quite sure that the blood we are going to give is safe, we do another test called a *cross-match* or a *compatibility test*. We cross-match the blood we are going to give to make sure it is compatible. We take a few drops of the patient's serum and mix it with some of the red cells we want to give him (some of the donor's red cells). We keep the mixture of cells and serum warm for about 2 hours and then we look at the mixture with a microscope. When we keep something warm in this way we say we *incubate* it. We incubate the donor's cells and the patient's serum. If after incubation the donor's cells still lie evenly in the patient's serum, then the blood is safe to give. We say the donor's cells are compatible with the patient—'the blood is compatible'. But, if after incubation there is agglutination, the blood is not safe to give the patient. Such blood is incompatible; and if we give it to the patient he may die. Cross-matching is therefore very important, and it must be done carefully.

There are several ways of cross-matching blood. The way we have just described uses the patient's serum and a suspension of the donor's cells in saline. It is therefore called the *saline cross-match*. A saline cross-match is useful, but an *albumen cross-match* is better. Good laboratories do both kinds of cross-match at the same time. In an albumen cross-match a drop of 30% bovine albumen is added to a saline cross-match after the test has been set up. Albumen is one of the plasma proteins. Bovine albumen is a thick liquid made from the plasma of a cow (bovine means from a cow). Sometimes it is bought as a powder which you dissolve in saline. If you are given bovine albumen as a dry powder, weigh one gram and dissolve it in 3 ml of saline. Keep bovine albumen in a small bottle with a pipette in it in the same way as you keep anti-A serum and anti-B serum. This is shown as Picture 9, FIGURE 12-3. Keep bovine albumen in a refrigerator. In the albumen cross-match the donor's red cells, the patient's serum and the bovine albumen are incubated and looked at under a microscope in exactly the same way as with the saline cross-match.

The albumen cross-match, the saline cross-match,

and blood grouping are all described in FIGURE 12-3. We shall describe the albumen cross-match first.

METHODS

THE ALBUMEN CROSS-MATCH, FIGURE 12-3

1. Take a few drops of blood out of the pilot bottle of the donor's blood that is to be cross-matched. You will read about the pilot bottle in Section 12.9.

2. Put these red cells into a tube full of saline. Spin (centrifuge) this tube of red cell suspension.

3. You will be left with a small deposit of washed red cells at the bottom of the tube.

4. Pipette off the supernatant saline to leave a deposit of nearly dry, washed red cells.

5. Add a few drops of *clean* saline to the cells at the bottom of the tube. As with the previous method, only add just enough saline to make a 5% suspension.

6. Put two drops of the washed 5% red cell suspension into a small test tube. Special small test tubes for this are in the main equipment list as ML 48b. We shall call these small test tubes 'cross-matching tubes'.

Add two drops of the patient's serum.

7. Mix by flicking (gently hitting) the bottom of the cross-matching tube with your forefinger. Put the tube in a water-bath at 37°C. There is a water-bath (ML 53) and a thermometer (ML 44) and a thermometer sheath (ML 45) in the equipment list especially for this. Use the metal test tube rack (ML 40) to hold the tube in. Leave the cross-matching tube in the water-bath for an hour and a half.

8. Let two drops of 30% bovine albumen (9) run down the side of the tube. *Don't mix*, but incubate for a further half hour (10).

After 2 hours' incubation take a clean, empty, thick Pasteur pipette, remove the cells from the bottom of the tube and lay them gently across a slide. Try not to mix them up too much. Look at them with a low power objective as shown in Picture 13.

THE SALINE CROSS-MATCH, FIGURE 12-3

Go as far as step 5 above.

Place two drops of washed cell suspension from the donor in the cross-matching tube. Add two drops of the patient's serum.

Mix, incubate for 2 hours and lay the deposit gently across a slide. Look at the deposit with a microscope.

What you may see is shown in Pictures 14, 15, and 16 in FIGURE 12-3. If the blood is compatible as in Picture 14 the cells will be lying separate from one another. *If the cells are sticking to one another (agglutinated), as in Picture 15, the blood is incompatible and must not be given to the patient.*

Sometimes the cells will be seen to be lying one on top of another like piles of coins in a way that is different from the sticking together anyhow of agglutination.

When cells lie together in this way, like piles of coins, they are said to form 'rouleaux'. (This word rouleaux is French for a pile of coins.) Rouleaux are shown in Picture 16 and in Picture F, FIGURE 7-11. Blood which forms rouleaux is safe to give to the patient. Blood cells form rouleaux because there are special proteins in the serum of the patient.

Rouleaux may also be seen because the patient has been given 'Dextran' or something like it. 'Dextran' is a thick clear liquid which is made in a factory. It is a kind of factory-made plasma. 'Dextran' is given to save the life of a patient who is bleeding. It is very useful instead of blood and is often given to patients while their blood is being grouped and cross-matched. If there is 'Dextran' in a patient's serum, it will cause rouleaux with all the blood that is cross-matched for him. A blood specimen for grouping and cross-matching must therefore be taken from a patient *before* he is given 'Dextran'. Taking a blood specimen for grouping and cross-matching is something for a doctor or medical assistant to remember. But a laboratory assistant should know about 'Dextran' and how it can cause rouleaux.

It is usually easy to tell rouleaux formation from agglutination, but sometimes it may be difficult. It is also possible to have both rouleaux formation and agglutination together. There is another test (the Coombs test) that can be done when this happens, but we will not say more about it here. *If you are not sure whether you are looking at agglutination or rouleaux, don't give the blood.*

The top part of FIGURE 12-3 shows blood being grouped on a slide. When you group blood on a slide it is useful to put a cross in the top left-hand corner of the slide. This cross or 'index mark' will help you to stop turning the slide round by mistake. If the slide is turned round by mistake, you may mix up the drops where you have put anti-A and anti-B and report a wrong group.

It is always wise to re-group (group again) the blood group of any bottles of stored blood as well as cross-matching it. This is especially important if blood has to be given in a hurry. You may well find a mistake in the ABO blood grouping more quickly with your grouping sera than by cross-matching. Re-grouping takes very little time and is well worth the extra trouble.

What should you do if the cross-match shows agglutination which means that the blood is incompatible for the patient? First, check the ABO group of the patient and the donor. This is the most likely cause of the trouble. Perhaps the recipient is group A, and the donor is really group B. If this is not the cause of the trouble and the ABO groups are right, try cross-matching the blood of some other donors. The blood of one or more of these may be compatible. When the trouble is not just a wrong ABO group (an ABO mis-match), it may be very difficult to find out why blood is incompatible. We cannot say more about it here. However, apart from ABO incompatibility, incompatibility is rare.

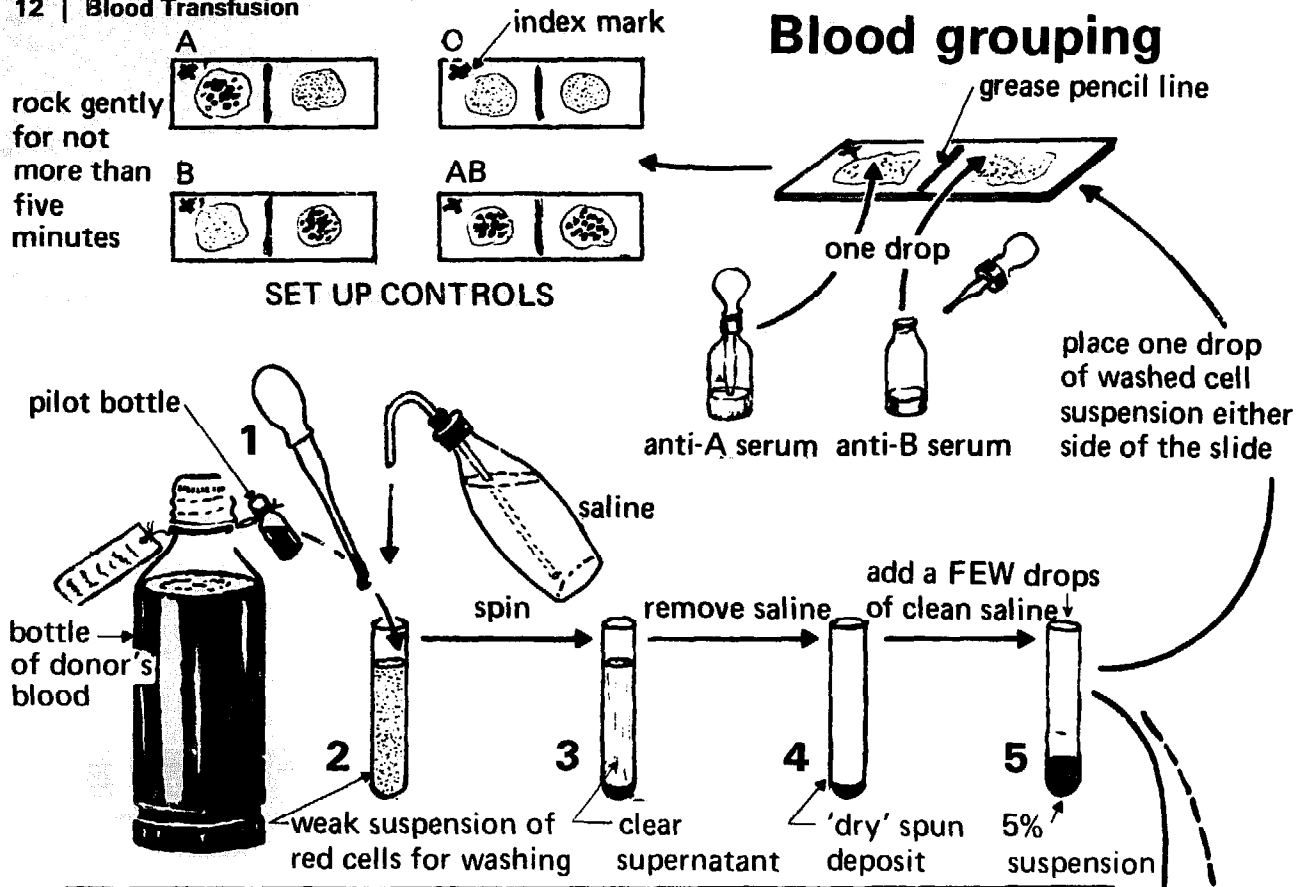

MICROSCOPIC APPEARANCES

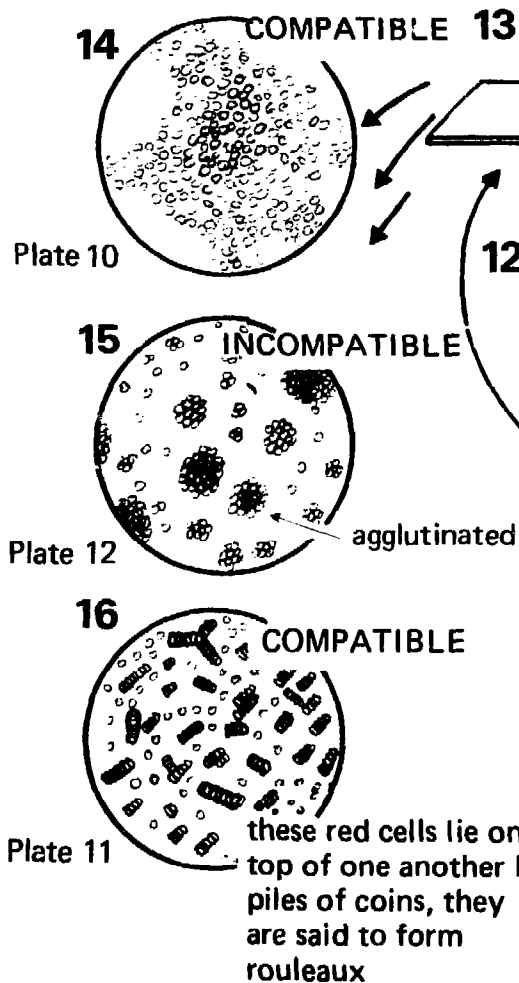

Cross-matching

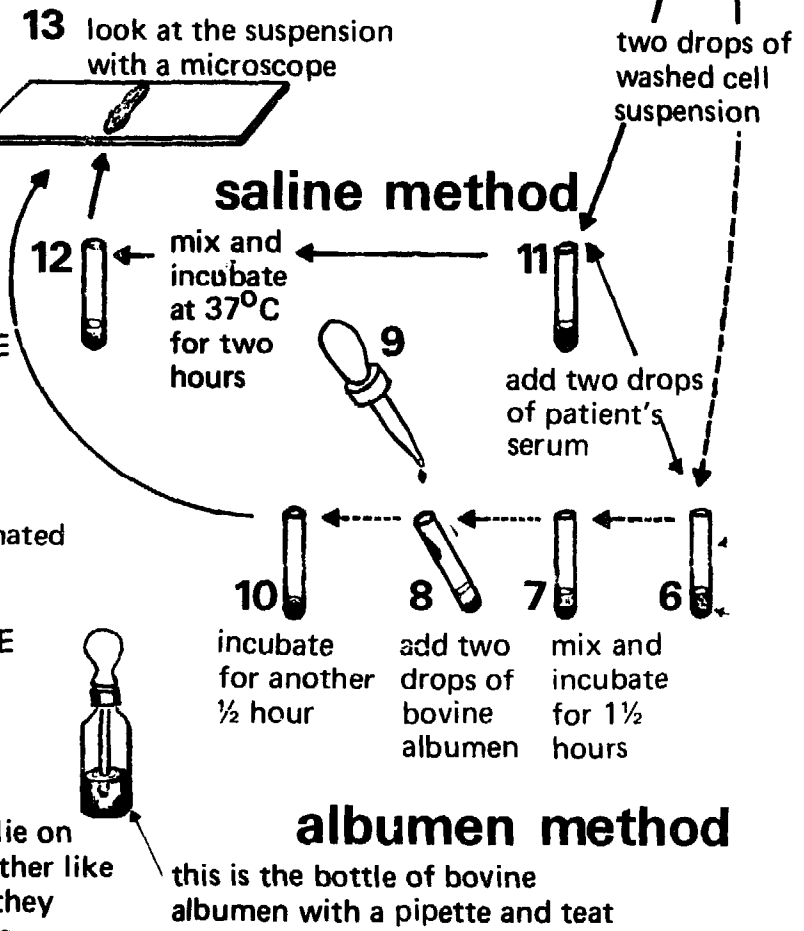

Fig. 12-3 Cross-matching

12.7 Rhesus grouping

ABO blood groups are much more important than Rhesus blood groups. Even so, large laboratories always give blood of the right Rhesus group. Rhesus negative patients should only be given Rhesus negative blood, and Rhesus positive patients are usually only given Rhesus positive blood. But Rhesus antisera for Rhesus grouping are sometimes hard to get and are expensive. Although it is possible to buy Rhesus antisera that work on a tile or a slide, most Rhesus antisera only work in a tube at 37°C (body temperature). If you are given Rhesus antisera that work on a slide, there will be instructions with the bottle. But you will probably be given what is called 'albumen antisera' or 'albumen anti-D'. 'D', as you will remember from Section 12.1, is another name for the most important Rhesus group. *Use albumen anti-D just as if you were doing an albumen cross-match. Use albumen anti-D instead of the patient's serum.* If, when you read the 'cross-match', there is no agglutination, the patient is Rhesus negative. If there is agglutination, the patient is Rhesus positive. It is even more important to do controls for Rhesus grouping than it is to do them for ABO grouping. For these controls you will need some red cells that you know are Rhesus positive and others that you know are Rhesus negative.

If you are only doing a few Rhesus groups, use Eldon Cards.

12.8 Eldon cards (FIGURE 12-1)

These are pieces of white cardboard with a smooth surface. They are printed with squares. On one square anti-A serum has been dried. On another square anti-B serum has been dried. Yet another is left plain. A drop of tap water is put in each square and a drop of blood is added. The mixture is then stirred with a special plastic stick. The blood agglutinates just as it does on a tile. Some cards have another square on which anti-D serum (Rhesus serum) has been dried. These cards can be used for Rhesus grouping.

Eldon cards are sold carefully wrapped in metal foil ('metal paper') and come with special instructions. *Follow these instructions very carefully. Always cross-match any blood before you give it by the albumen or saline method described in Section 12.6.* Don't try to cross-match on an Eldon card, even though the card says you can.

Eldon cards are usually used with plain blood—that is, with red cells that have not been 'washed'. When they are used like this, you may see agglutination in the control square which has no antiserum. This is due to heavy rouleaux formation in the blood being grouped. When this happens, wash the patient's cells free of his serum which is the cause of the rouleaux. Make them up in saline in a *strong* (45%) suspension, just like blood. Use this strong washed red cell suspension on the Eldon card. There should now be no agglutination in the control square—the control should be negative.

Because Eldon cards are sold with such good instructions nothing more will be said about them here. The address of the makers is given in Section 13.7 (ELD).

12.9 Equipment

So far we have only talked about blood groups and how to group and cross-match blood. You must now learn about the equipment that is used to take and store it. Many different kinds of equipment are used. We shall only describe one kind. It is the MRC blood transfusion equipment. MRC stands for the Medical Research Council of Great Britain who first made it. It can be used many times and is the cheapest kind of equipment. Some hospitals buy ready-made transfusion fluids in bottles called 'Vacolitres'. Other hospitals use fluids in plastic bags and take blood into plastic bags.

When a patient has not got enough blood, he may have to be given a litre or more of blood before he is well again. Blood from a donor is taken into a **blood-taking bottle** which holds about half a litre. If blood were taken into an empty bottle, it would soon clot. We cannot give clotted blood to a patient, so we put an anticoagulant into the bottle to stop it clotting. There are many anticoagulant solutions, but a common one is called 'acid citrate dextrose' or 'ACD' solution. Like sequestrene, citrate stops blood clotting. Dextrose, which is another name for glucose, is food for the blood while it is being stored in the refrigerator. There are 100 ml of ACD solution in the bottom of a blood-taking bottle. When 430 ml of blood have been added it is full.

The MRC blood-taking bottle is shown in FIGURE 12-4, together with the equipment that is used with it. On the right-hand side of this figure you will see a list of the equipment that is used with this bottle. Some of it is used to take blood from the donor into the bottle. This is the **taking set** and the **airway**. All the rest of the equipment is used to take blood from the bottle and put it into the recipient. This is the **giving set**.

The bottle, Figures 12-4 and 12-5

On the top of the bottle is a metal cap (1). You cannot see this cap in FIGURE 12-4 because it is under a plastic cover or 'Viscap' which is described in more detail in Section 12.13. The same bottle with the 'Viscap' removed and the taking set in position ready for blood-taking is shown in FIGURE 12-5. It has been put together carefully, so that it is still sterile.

The metal cap has holes in it through which needles can be pushed to put in and take out blood. The bottle is sealed (closed and micro-organisms kept out) by a rubber disc or circle (2) through which needles can be pushed. It is most important that nobody should open a bottle and let micro-organisms in before it is used. This is the purpose of the 'Viscap'.

The taking set and airway

These have been shown put together at the bottom of FIGURE 12-5. At the top of this figure you can see the pieces of the taking set and the airway taken apart. The taking set is made of two needles (15a) on the ends of a piece of rubber tube. One needle is put into the patient;

the guard tubes are pulled off to leave the sterile needles ready to use.

Blood bottles are often made so that there is little or no air inside them. When there is nothing in something, not even air, we say there is a vacuum. Blood bottles are therefore often made with a vacuum inside them. But it is difficult to make a perfect vacuum and not to leave any

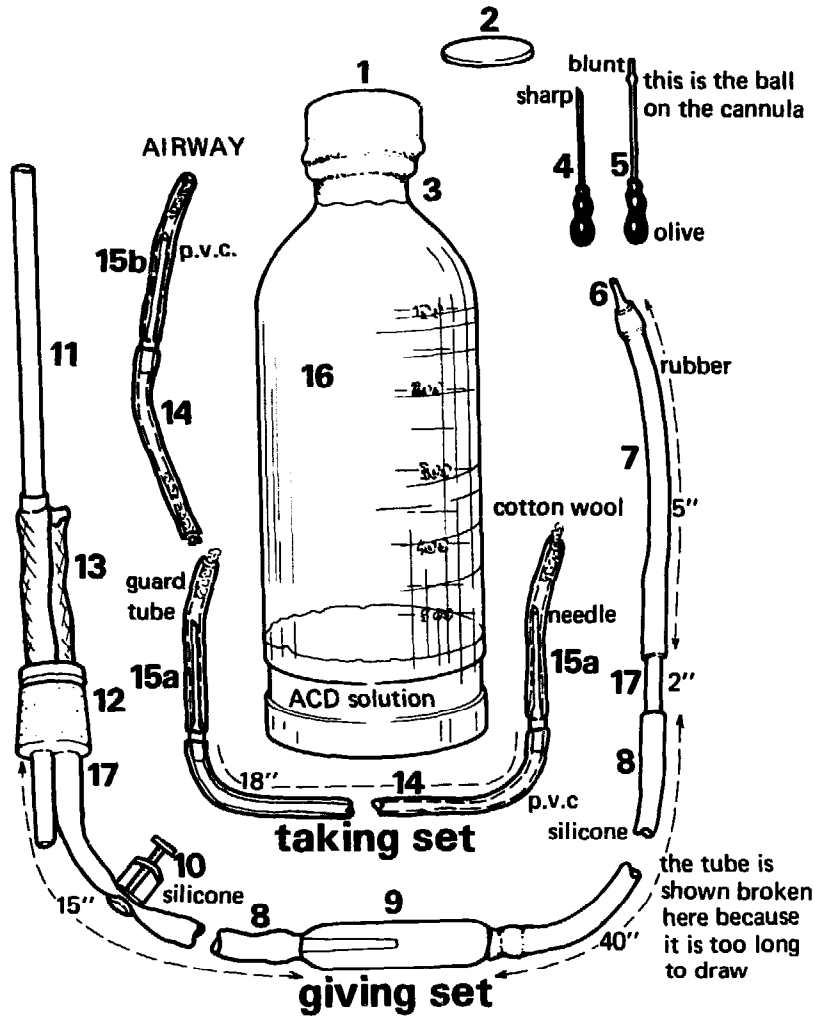

THIS IS THE LIST OF ALL THE EQUIPMENT

1. Cap, metal, screw thread with 14 mm hole for transfusion bottle.
2. Rubber disc, for metal screw cap.
3. Viscap, white opaque, size 6 cut down to 2 1/4" for use on transfusion bottle.
4. Needle transfusion, giving 1.5 x 35 mm. Olive tubing mount.
5. MRC pattern I.V. cannula 37.5 mm x 15 BWG.
6. Adaptor male metal olive tubing mount.
7. Tubing blood transfusion red rubber 3/16" bore x 1/16" wall.
8. Tubing, blood transfusion silicone 3/16" bore x 1/16" wall.
9. Drip counter, glass, MRC type.
10. Clamp, regulating MRC pattern.
11. Tube, glass 9 1/2" for MRC giving set.
12. Bung rubber with two holes MRC type.
13. Filter, gauze, metal MRC type.
14. Tubing, polyvinyl chloride 4 mm bore.
- 15a. Needle, blood taking, 1.9 x 40 mm.
- 15b. Needle, blood transfusion closure piercing 2.1 x 37 mm.
16. Transfusion bottle, 540 ml capacity, straight sided flint glass.
17. Tube, glass 2 1/2" for MRC type giving set.

the tin in which to keep this equipment, and the band to go round the bottle are not shown in this figure

all this equipment can be obtained from Messrs. Turner (TUR), see Section 13.7.

Fig. 12-4 MRC blood transfusion equipment

the other is put through the cap of the blood bottle. Only one needle on the taking set need be very sharp—the one which goes into the patient. Distinguish the sharp one by putting a piece of thread, wire, or a short length of bigger tubing round its adaptor. Because blood goes through the needles and the tube they must be sterile. The needles are therefore covered with short pieces of plastic tube or test tubes—these are the guard tubes. The ends of these guard tubes are plugged with cotton wool. The whole taking set is then autoclaved. Before the taking set is used

air in the bottle. If there is air in the bottle and we try to put blood into it, the air has to come out, or the blood will not go in. The air must therefore be allowed to come out as the bottle fills with blood. An airway is therefore used to let the air come out of the bottle. The airway is a needle with a short piece of tube on it. In the end of the short piece of tube is a piece of cotton wool. The cotton wool is to stop micro-organisms going down the tube into the bottle. The needle of the airway must be kept sterile like the needles of the taking set. It

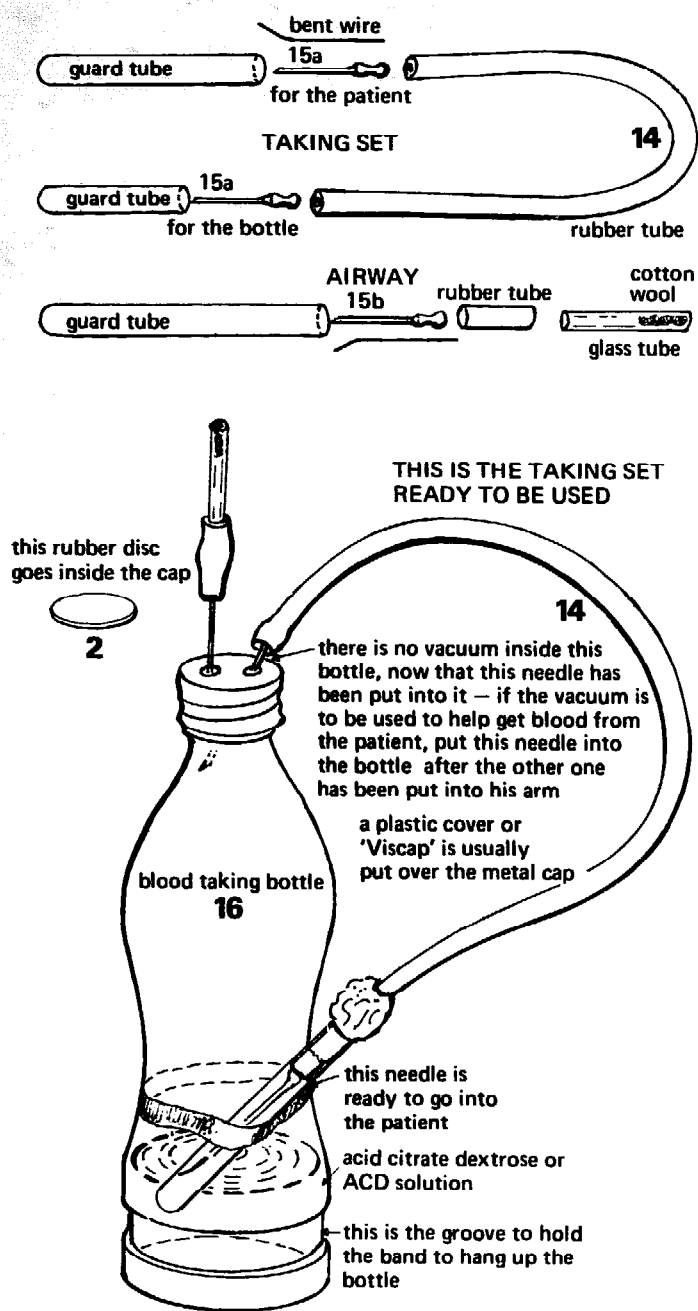

Fig. 12-5 The taking set

is therefore also kept covered with a guard tube until it is used.

The giving set

Blood is given to patients in the wards by doctors and medical assistants. Laboratory workers do not therefore use giving sets. But laboratory workers have to wash these sets after they have been used and make them ready for use again.

Giving sets work like this. When blood is to be given to a patient, the cap (1) is taken off the bottle and a cork (12) with two tubes (11, 17) on it is pushed into the bottle. To the shorter of these tubes some rubber tubing (8) is fixed, which goes to a needle (4). This needle is put

into a vein on the patient's arm. The bottle is turned upside down, and blood flows from the bottle through the tube and needle into the patient's vein. If blood is to come out of the bottle air must be allowed to go into it. The long tube (11) lets air go into the bottle. It is long so that the air can go above the blood in the bottle.

There are often small clots in the blood. A **wire gauze filter** (13) is therefore put over the end of the short tube (17) to stop blood clots going down this tube into the patient. Wire gauze is a kind of metal cloth. There is a screw clamp (tap) (10) to adjust how fast the blood should go into the patient. There is also a **drop counter** (9) to see how fast blood is flowing through the set. This has a wide tube with a short narrow tube inside it. Blood falls drop by drop from the narrow tube. By looking to see how fast the drops are going we can see how fast the blood is flowing from the bottle into the patient. Most of the giving set is made of **silicone tubing** which lasts a long time. Silicone tubing leaks (liquid comes out) after a needle is put into it; so there is a short piece of rubber tube at the end of the giving set. Doctors can inject drugs into the blood through this piece of rubber tube which does not leak. A short piece of glass tube (17) joins the silicone tubing to the rubber tubing.

A needle cannot be fixed straight into the end of a piece of rubber tubing; so a piece of metal called an adaptor (6) is used. One end of the adaptor fits into the rubber tubing and the other end fits into a special needle (4). *The adaptor must fit the needle.* The round end of the adaptor which fits the tubing is called the **olive**.

Record and Luer fittings

There are two kinds of adaptor and needle: one is called the **Luer fitting** (something which fits); the other smaller, older one is called the **Record fitting**. These are shown in Pictures R and S, FIGURE 12-6. In the same way there are Record and Luer syringes and Record and Luer needles for injections. A Record syringe or adaptor will not fit a Luer needle. A Luer syringe or adaptor will not fit a Record needle. Sensible people always buy Luer fittings whenever they buy new equipment. But there is still much Record equipment in many hospitals and clinics. *Whenever you pack a needle with a syringe or an adaptor be careful to make sure that they fit.* They must be either both Luer or both Record. You will see the words 'male' and 'female' with these fittings. The male fitting is the part which goes into the female fitting.

The 'cut-down'

You will have been wondering what a **cannula** is (Picture 5, FIGURE 12-4). The easiest way for a doctor or medical assistant to give a patient a blood transfusion is to put the special needle (4) straight into one of the patient's veins. But this needle is quite big, and some patients do not have veins that are big enough for the needle to be pushed into them. A cut must therefore be made in the patient's skin so that a vein can be found. When a vein is

found a little hole is made in it with a pair of scissors, and the end of a cannula is pushed in. The cannula has a blunt end so that it will not cut the vein. The cannula is tied in with a kind of string called *catgut* which dissolves in the body after a few weeks. There is a little round ball on the cannula, so that when it is tied into a vein it will not come out. You will see that both the needle and the cannula have large round handles so that they can be held more easily. Instead of a metal cannula, a cannula made of polythene is often used. These may be made from a piece of thin polythene tubing pushed on to the end of a needle.

Cutting the skin to put a cannula (or needle) into a vein is called doing a *cut-down*.

Preparing transfusion equipment

Two things have not been drawn in FIGURE 12-4. One is a metal band with a wire handle that fits round the bottom of the bottle so that it can hang up. The other is a tin to hold the giving set. These sets are wrapped in paper, and a tin is not opened until a giving set is wanted. *If a giving set is going to work it must be put together properly, exactly as in FIGURE 12-4, before it is autoclaved in a tin.*

Many taking sets can be autoclaved together in a large tin or drum, like the one shown on the table in Picture 12-10.

The useful thing about these MRC giving and taking sets is that they can be used many times. They are therefore cheap. But, if they are going to be used again safely, they must be washed very carefully. If sets are not well washed the patient who has the blood will get a bad fever and shiver: he will have a *rigor*. To prevent this, follow this method when you wash these sets.

METHODS

PREPARING MRC BLOOD TRANSFUSION EQUIPMENT

Try to prepare the equipment in a room where there is tap water and a good light. Blood transfusion equipment must always be washed in plenty of running water. If you have no distilled water, use ordinary water, preferably rainwater. The best way to run lots of water through transfusion equipment is to have a Luer adaptor specially fixed to a tap. If this is not possible, you will have to use a large syringe, which is not nearly as good.

CLEANING NEW TUBING

Clean new tubing just as carefully as tubing which has been used. (1) Soak tubing overnight in a sink full of water. Next day run plenty of tap water through the new tubing. (2) Put the new tubing in a large saucepan or metal bucket. Cover it with plenty of water and add four level dessertspoonfuls of sodium carbonate (about 25 g) for each litre of water. Sodium carbonate is also called washing soda, and it helps to clean the tubing. Move the

tubing about under the sodium carbonate solution until all the air has come out and it is full of solution. (3) Boil the tubing in the sodium carbonate solution for 15 minutes. (4) Take the tubing out of the solution and run plenty of water through it—all the sodium carbonate must be washed away. (5) Run some distilled water through the tubing and hang it up to dry. Make sure it gets really dry the same day or it may get dirty again before it is dry.

LOOKING AFTER USED TRANSFUSION SETS IN THE WARD

Ask the ward staff to run water through the sets *as soon as they have been taken from the patient*. This will wash most of the blood out from the inside of the tubing. Ask the ward staff to send the used sets back to the laboratory as soon as possible. If they do not do this, go and collect the giving sets from the wards yourself.

PREPARING THE GIVING SETS IN THE LABORATORY

Take the used sets to pieces *completely* and put the parts in a bowl of water. If you have many sets, it is best to have several bowls and to put each kind of part in a different bowl. Leave them to soak overnight.

Tubing. (1) Clean the outside of the tubing. If plaster is stuck to the tubing and will not come off, rub the tubing with cotton wool soaked in a little ether. Clean the inside of the tubing with water and let it stand in water for at least an hour. (2) Take a piece of wire about 100 cm long and bend over one end to make a small hook. Put a piece of gauze into this hook and pinch it tight with a pair of pliers. Put the other end of the wire into the tubing and pull the gauze through the tubing several times. This will remove clots of blood from the inside of the tubing. (3) Run plenty of water through the tubing. (4) Boil the tubing for 15 minutes in the way described above for new tubing. Use plain water and *not* sodium carbonate solution. (5) After boiling, run plenty of tap water through the tubing and then some distilled water. (6) Hang the tubing up to dry.

Drop counters and glass tubing. Soak these in a dilute solution of a detergent such as 'Teepol' (one teaspoonful of 'Teepol' to a bucket of water) or 'Pyroneg' which is safer and will not harm the blood so much if it is not completely washed away. Make sure that the tubes and droppers are filled with solution and that no bubbles of air remain inside them. Boil them for 10 minutes in the detergent. Then wash the droppers and tubing in plenty of water. Fill the droppers with water and shake them empty again. Do this many times. In this way you will wash away all the detergent from the droppers. Wash the glass tubing with a test tube brush under running water to remove all the detergent. Rinse the droppers and tubing with distilled water and then dry them. When this is done they should be bright and clean.

Rubber bungs. Soak the rubber bungs in detergent solution and boil for 10 minutes. Wash them under a tap using a test tube brush for the holes and a nail brush for the outside. Wash away all the detergent with plenty of tap water. Wash the bungs in distilled water and leave them to dry.

Wire gauze filters. Soak the filters in detergent solution and then wash them under a running tap. Scrub the outside with a nail brush and the inside with a test tube brush. Gently turn back the fold at the top so that any clots caught there can be washed away. Wash these filters very carefully or they will break and become useless. Wash away the detergent with plenty of water. Hold the filter up to the light to see that it is clean and not broken. Then wash it in distilled water and let it dry. If possible try to use these filters only once, as they are difficult to clean.

Needles. Leave the needles in detergent solution for some hours. Clean the inside of the hub (the wide part) with a piece of wire on the end of which you have wound a piece of cotton wool. Hold the needle under the tap and run a stream of water through it. If the needle is blocked push a thin piece of wire through it. Try not to scratch the inside of the needle or blood will clot as it goes through on its way to the patient. Wash the needles in distilled water. Boil them in distilled water. Rinse them in distilled water and then dry them. If the needles are blunt, sharpen them by the method described below.

WHENEVER YOU USE DETERGENT, MAKE SURE IT IS WASHED AWAY WITH PLENTY OF WATER AND NOT LEFT IN THE SETS.

Wash a cannula in the same way as you wash a needle. Wash and dry the regulating clamp.

You can put the sets together straight away, but if you leave the parts they must be kept away from the dust. Keep them in labelled boxes with a lid where cockroaches and other insects cannot get to them.

Put the sets together as shown in Figure 12-4. If the ends of the tubes fit loosely, cut these ends off where they have become too big. When you have put a set together, run some fresh distilled water through it and allow it to drain. Wrap the sets carefully, using either the special 'Cellophane' paper ('Cellophane' is clear, transparent paper) or brown paper. Take care that the tube is not kinked (bent sharply so that its inside is blocked). Pack each set in a tin with a needle and cannula. The doctor will use whichever he finds easiest. Make sure that you autoclave the sets within 1 hour after you have run distilled water through them. This is important because if you let the sets stand with distilled water inside the bacteria may grow, and even though the bacteria have been killed in the autoclave they may harm the patient.

Autoclave the sets at 15 lb. pressure for 15 minutes. Take the sets out of the autoclave and put a piece of 'Sellotape' around the edge of the lid and the tin. Mark

the tin 'Giving Set' and write the date they were sterilized on the lid.

PREPARING TAKING SETS

Prepare taking sets in the same way as the giving sets. Make sure that the airway is not blocked by the cotton wool filter being too tight.

Wrap up each set separately and take care that the tubing is not kinked. You can put up to four sets in the same tin or you can sterilize many sets in a drum. Put 'Sellotape' around the edge of the lid and the tin and write 'Taking Sets' on the top. Write the date of sterilization on the tin.

12.10 Sharpening needles (FIGURE 12-6)

Because needles have to go into patients they must be sharp. Needles are sharp when they are new, but they soon get blunt. The best way to sharpen blunt needles is to use a special machine which has a round stone that is turned by an electric motor (a special grindstone). But you can easily sharpen needles with an oilstone. An oilstone is a piece of smooth, hard stone which slowly shapes or sharpens metal that is rubbed on it. A drop of oil is used to carry away the little bits of metal that are rubbed off by the stone. Oilstones called 'Hand Arkansas' or 'Washita' are the best, but, whatever stone you use, it must be fine (smooth) and not coarse or rough. A new needle has a hollow concave bevel, as shown in Pictures A and B. If you look at the other side of the needle you will see that it has two small, flat faces or facets like those shown in Picture C. You will not be able to make a concave bevel with a flat oilstone, but you will be able to make a flat one which will work quite well.

METHOD

SHARPENING A NEEDLE, FIGURE 12-6

Put a drop of thin oil on your oilstone. Push the needle backwards and forwards along the stone as in Picture L. Keep the needle in the same position as you move it along the stone. Keep the bevel the same length as on a new needle. If, as in Picture M, you rock (tilt, tip, or alter the position of) the needle, the bevel will be round as in Picture F. *Make the bevel flat* as in Picture J.

When you have sharpened the needle a little you will see a thin edge of metal on the side of the bevel as in Picture H. This is the *burr*. Take off the burr by gently sharpening the needle on its outside as shown in Picture N. This will make the two facets as shown in Picture K.

When you get near to the shape you want, *sharpen the needle very gently indeed*. Always finish sharpening by giving one rub on the bevel followed by one on each of the facets. When the needles have been sharpened, soak them overnight in trichlorethylene which can be

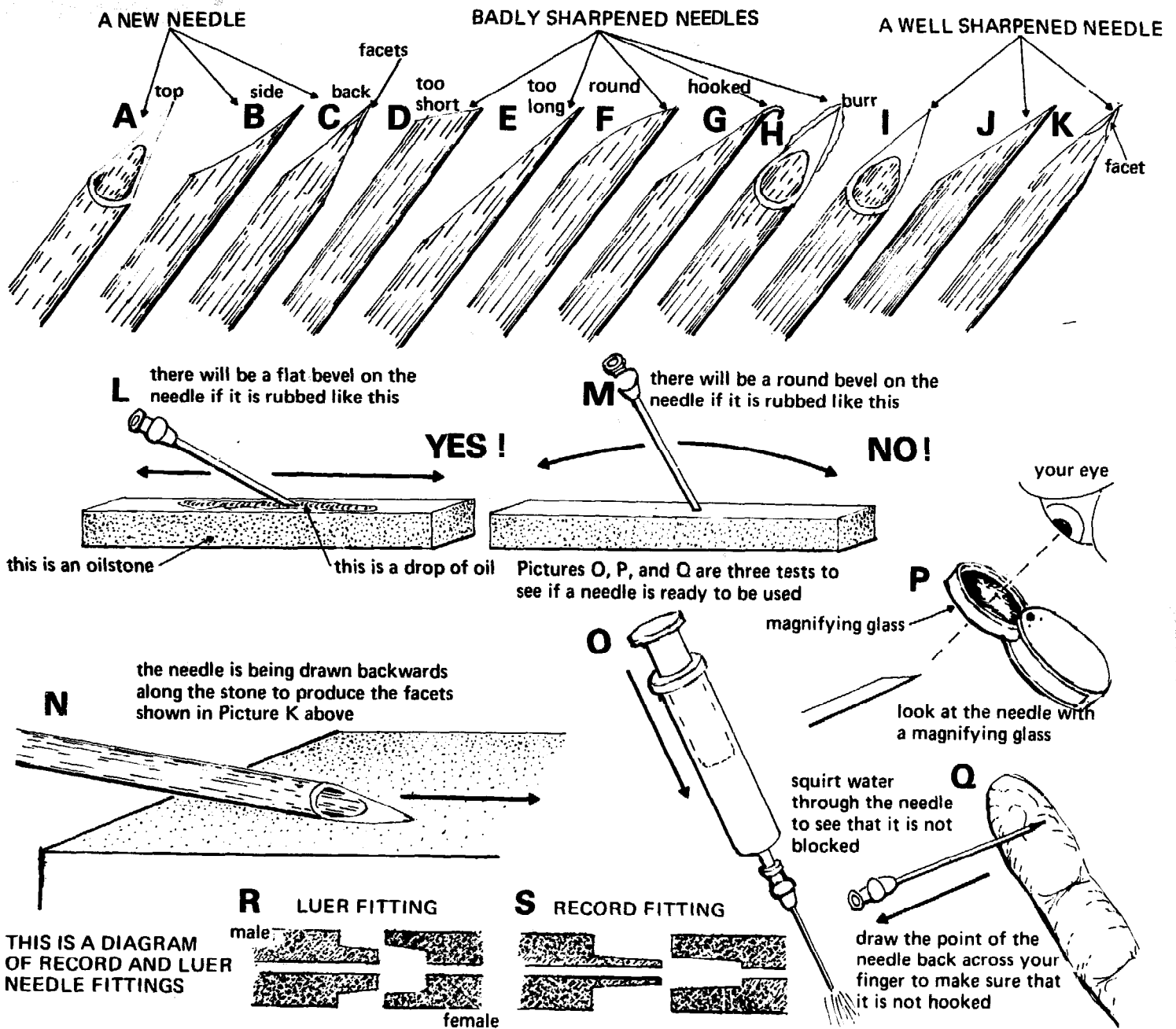

Fig. 12-6 Sharpening a needle

obtained from the theatre. This will remove the oil and any small particles that may have been left inside them during the sharpening. Drain them and polish them with a soft cloth.

Before you pack a needle inject some water through it with a syringe, as in Picture O. This will make sure that it is not blocked and that the hole inside it is empty.

If possible look at the needle under a magnifying glass so that you can see its shape better, as is shown in Picture P. A magnifying glass is a lens which is used for looking at small things.

Before you pack up a needle to be sterilized, rub the point across your fingers, as in Picture Q. This will tell you if it is hooked or not. Needles can be sharpened ten

times or more before they need be thrown away because they are too short.

The bevel must not be too short as in Picture D or too long as in Picture E. It must not be round as in Picture F or hooked as in Picture G. There must be no burr as in Picture H. A well-sharpened needle is shown in Pictures I, J, and K.

These instructions have been given so that you can sharpen the needles of blood transfusion equipment. But you can sharpen any needle in the same way. Make sure that all the needles in your hospital or health centre are sharp.

Once a needle has been put together with other equip-

ment and sterilized, it must not be touched. It must remain sterile so as not to contaminate the patient.

12.11 The pilot bottle

It is very important that no micro-organisms get into a bottle of blood. If they do they may grow and spoil the blood. If blood with micro-organisms in it is given to a patient he may die. The best way to stop micro-organisms getting into the blood is to follow this rule: **NEVER OPEN THE MAIN BOTTLE OF BLOOD UNTIL THE TIME COMES TO GIVE IT TO THE PATIENT.** Blood for grouping and cross-matching should be kept in a bijou bottle (ML 14a) containing about 1 ml of ACD anticoagulant solution. This bottle is called the **pilot bottle** and is tied to the main bottle with wire as shown in Picture 1, FIGURE 12-3. *The pilot bottle must never leave the main bottle until both bottles are finally washed up when the blood has been given to the patient. When you want some red blood cells for grouping and cross-matching, take them from the pilot bottle and NOT from the main bottle.* It does not matter if micro-organisms get into the pilot bottle as you open its cap to take out some red cells. But it will matter greatly if micro-organisms get into the main bottle.

A useful way to make pilot bottles is to open one of the main bottles and to pipette about 1 ml of the ACD solution inside it into several bijou bottles. (You will not be able to use the bottle you have opened: it will be contaminated.) Autoclave these bijou bottles with their caps on loosely. As soon as they come out of the autoclave or pressure cooker, screw their caps down tight. When sterilized like this, ACD solution in bijou bottles will keep for a very long time. Whenever you get blood bottles, tie pilot bottles on to all of them with wire. If you have no bijou bottles, use empty penicillin bottles instead.

12.12 Taking blood

You may be asked to take blood from a blood donor; so you must know how to do it. Two slightly different methods are described: one is for bottles with a vacuum, and one is for bottles without a vacuum. If blood bottles are made in the hospital, they will probably not contain a good vacuum.

METHOD

TAKING BLOOD, FIGURE 12-7

The donor must not suffer from giving his blood. Do not take blood from anyone who looks ill or who has recently been ill. If possible, measure his haemoglobin or his haematocrit to make sure he is not anaemic.

Several harmful micro-organisms can go from donor to recipient through blood transfusion. The most important of these are the viruses causing syringe jaundice which have been described in Section 4.8. This is difficult to prevent, but one way to reduce the risk is never

to take blood from anyone who has been jaundiced. Ask all donors if they have had jaundice, and if they have choose another donor. Malaria can also be spread by blood transfusion, but in many countries almost every donor will have had malaria, and they cannot be stopped from giving blood because of this.

Tie a label on to the bottle that is going to have the blood. Write the donor's name on it, also his blood group and the date. Write in also the date when the blood will expire—3 weeks later (see Section 12.14). If the patient has already been given a label, make sure it is the right one.

Ask the patient to lie down on a bed. Put a towel under the arm which is to be bled.

Put your hand round the donor's upper arm and hold it tight. Ask him to open and shut his hand. His veins will swell up. Put your hand tightly round the donor's wrist and push your hand up towards his elbow. This will push the blood in his veins up towards his elbow and make them swell. If there are no good veins in the first arm you look at, look at the other arm.

You will want something to put round the arm to make the veins swell up while you put the needle in. You can tie a piece of rubber tube around the arm as shown in Picture A, but it is better to use a sphygmomanometer (a blood pressure machine). If you use a sphygmomanometer, pump it up until it reads 50 or 60. The rubber cuff (arm band) of the sphygmomanometer should be tight enough to stop the blood getting out of the arm through the veins. But it must not be so tight that blood cannot come into the arm through the arteries. If the pressure in the cuff is right the veins of the arms will swell up.

The way in which you take the blood will depend upon whether or not there is a vacuum in the bottle.

IF THERE IS A VACUUM IN THE BOTTLE

Choose a large straight vein. It is better to choose one which does not move about too much under the skin. In the arm in Picture A most people would choose to put the needle in at the place marked 'X'. Because it is easier to draw a needle going into a straight vein, we have put the needle into the vein marked 'Y'.

Clean the place over the chosen vein with a swab soaked in 'Hibitane' (0.5% 'Hibitane' in 70% spirit). Rub the skin well for a minute; then, using a second swab soaked in 'Hibitane' solution, clean the skin over the vein from the middle outwards.

Take a guard tube from one of the needles of the taking set. If only one of the needles is sharp, make sure you use the sharp one. Hold the needle bevel upwards between your finger and thumb. Hold it by the adaptor and NEVER touch the point or shaft of the needle with your fingers. Hold it flat on the skin over the vein just below where you want to go into the vein. This is shown in Picture B. Push it through the skin. The vein may slide out of the way as you do so, as in Pictures C and D, but this does not matter. If the vein has slid out of the way,

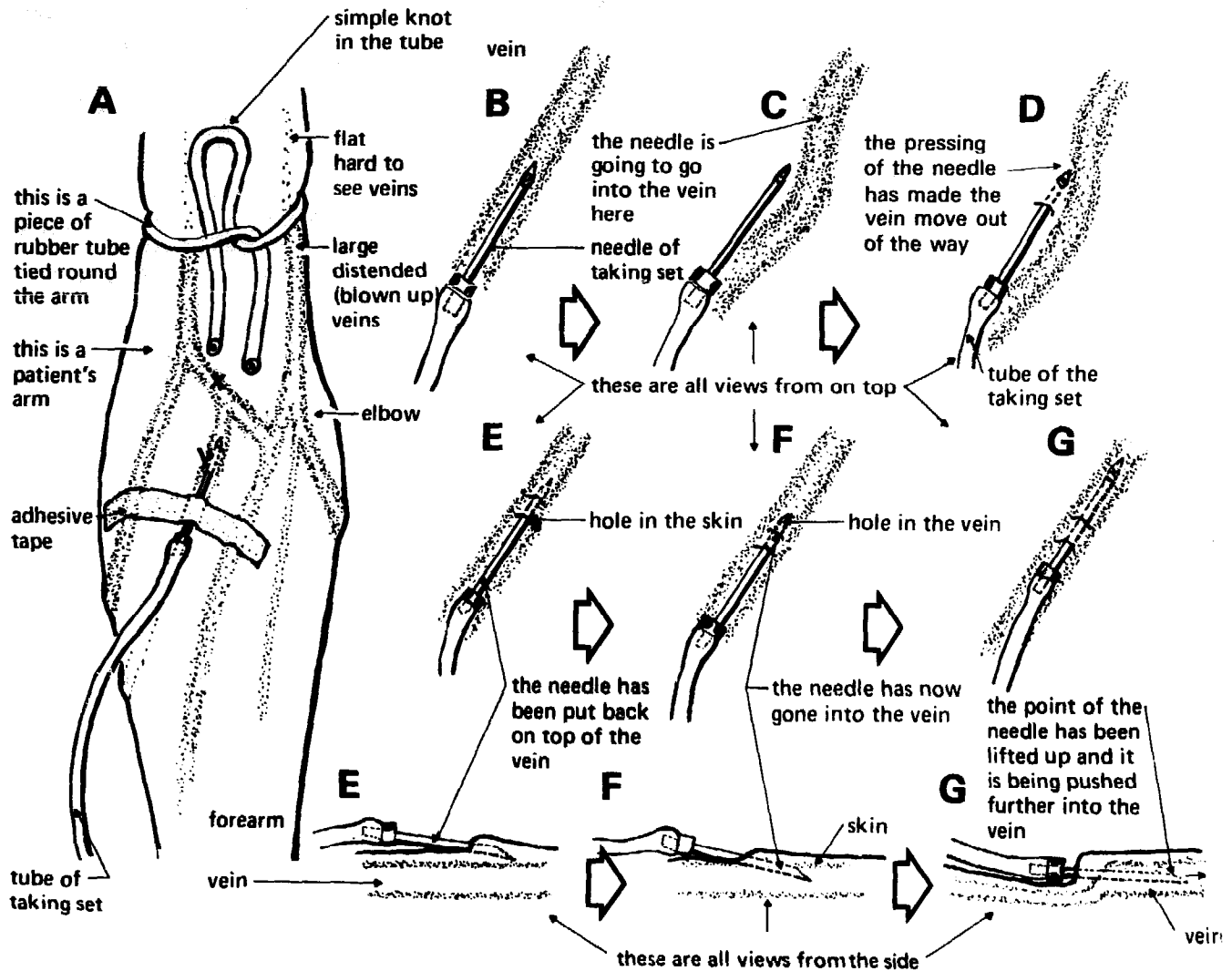

Fig. 12-7 Taking blood

put the needle back on top of the vein as in Picture E. Push the needle into the vein as in Picture F. As soon as the needle is in the vein, hold the point of the needle up a little, as in Picture G; otherwise the point of the needle will go through the vein, and the vein will bleed into the skin. With the point of the needle held up a little so that it does not touch the back wall of the vein, push the needle into the vein a bit more. While you are doing this blood will start to come down the tube.

As soon as blood is coming down the tube, push the other needle of the taking set into the bottle. Blood will then start to come down the tube very fast. Fix the needle in the patient's arm with a piece of adhesive tape (sticking plaster) as shown in Picture A. If the blood stops coming move the needle *gently* in the arm. Very often the blood stops because the vacuum has sucked the wall of the vein over the point of the needle. If you press down the point of the needle, blood will probably start coming again. If blood stops coming before the bottle is full, it may be because the vacuum is not good enough and there is air in the bottle. Put in an airway to let the air out as described below. Sometimes it helps to

make the blood flow if the patient opens and closes his hand tightly round something he is holding.

Gently mix the blood and the ACD solution as the bottle fills. This is very important because if you don't do this the blood may clot in the bottle.

IF THERE IS NO VACUUM IN THE BOTTLE

Pull the guard tube from the needle of the airway and push its needle into the bottle. Push one of the needles of the taking set (the blunter one) into the bottle, holding the bottle firmly while you do so.

Put the other needle of the taking set into the vein of the donor's arm, as has been described above. Don't let the needle of the airway touch the needle of the taking set inside the bottle; otherwise blood may go from one needle to the other and start coming out of the airway.

WHEN THE BOTTLE IS FULL, FIGURE 12-8

When the bottle is full to the bottom of the neck do these things:

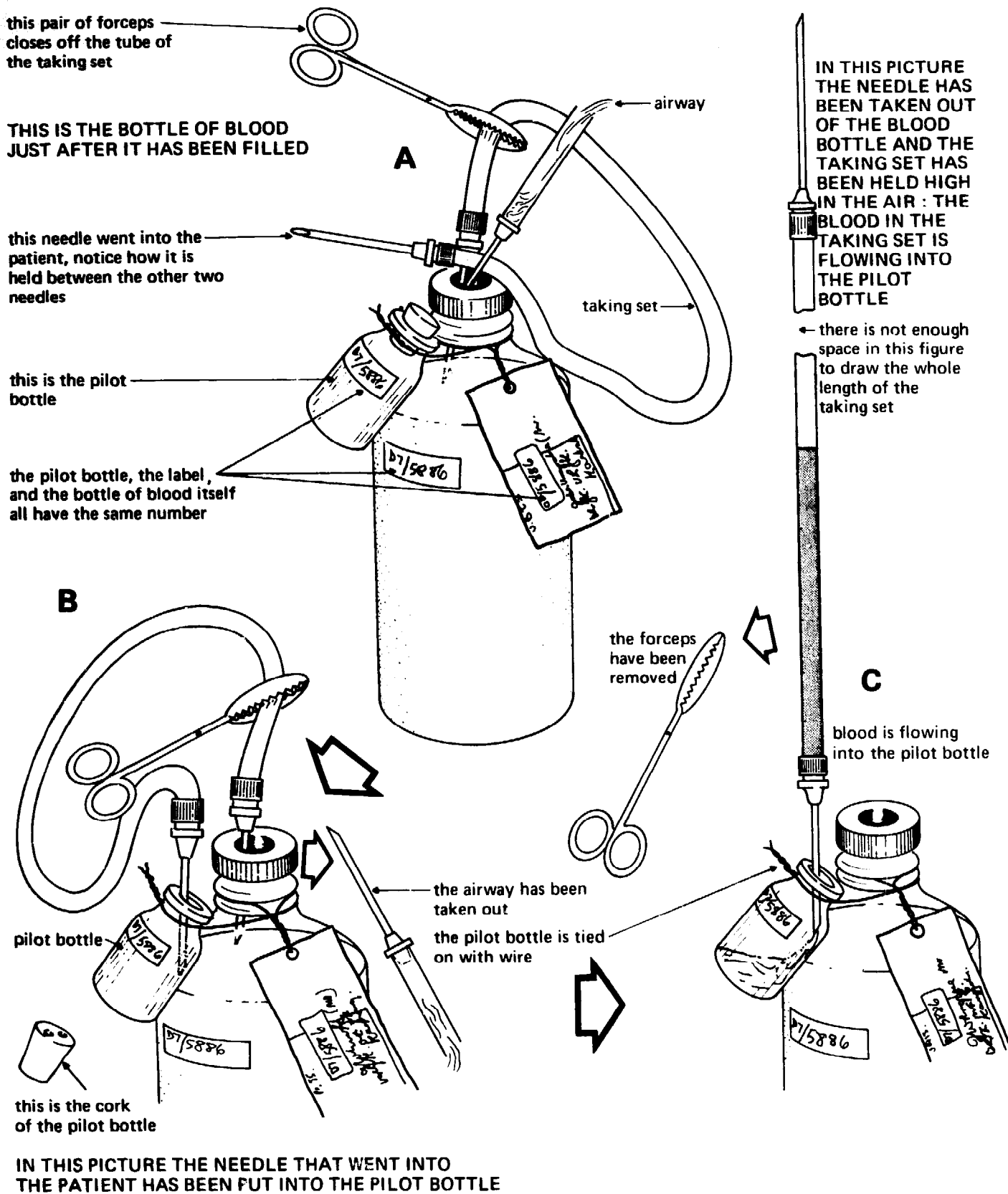

Fig. 12-8 What to do with a full bottle of blood

1. Put a pair of artery forceps on to the tube of the taking set. This will clamp (block or close) the tube of the taking set and stop blood flowing.

2. Let down the sphygmomanometer or take off the rubber tubing that has been tied round the donor's arm.

3. Put a piece of dry gauze over the needle and take it out of the donor's arm. Put this needle between the other two needles on the top of the bottle in the way shown in Picture A. Put a piece of adhesive tape across the dry gauze and ask the donor to put his thumb on it for 5 minutes. This stops the hole in his vein bleeding.

4. Take the airway out of the bottle. Put the needle which was in the patient's arm in the pilot bottle. This is shown in Picture B. Take the artery forceps off the tube of the taking set. Take the needle of the taking set out of the bottle and hold it up in the air. The pilot bottle will fill with the blood from the tube of the taking set. This is shown in Picture C.

Give the donor a cup of tea or a cold drink.

THINGS TO REMEMBER

Don't let the pressure in the cuff of a sphygmomanometer down or remove a rubber tube until you clamp the taking set. If you do, and the tube is not clamped, air may go up the tube from the bottle into the donor. This air may kill him.

Don't take the needle out of the donor's arm before you let down the blood pressure cuff. If you do, the patient may bleed into his arm. This may be painful and will cause a bruise.

Ask the patient to lie down for 15 minutes after he has given blood. If you want his bed for another patient, ask him to lie down somewhere else. Some donors faint when they give blood. Before a donor faints he may sigh, look worried, and sweat may be seen on his forehead and lips. If this happens when blood is being taken, stop taking blood, take away the pillow, and raise the foot of the bed. If the donor faints afterwards, sit him down with his head between his knees.

Blood donors can give blood once in 6 months. If they give blood more often than this they may become anaemic.

12.13 The Uganda Mobile Team (FIGURES 12-9 and 12-10)

The best way to get blood for a blood bank is for a mobile (moving) team from a hospital to visit places near by where there are many donors, such as secondary schools and offices. In this way a mobile team can bring back many pints of blood. If many donors are to be bled safely and quickly it is important that every member of the team knows what he has to do, and what equipment he must bring with him. This section describes the work of the mobile teams in Uganda, and you may find it useful to know what they do.

In the team there is a team leader who is usually a nurse, a doctor, or a medical assistant. There are also two

donor attendants, a driver, a clerk, and often a worker from the Red Cross. In Uganda donor attendants are trained for blood transfusion alone, but in most countries the laboratory assistant will have to do this work. The team described here is a large one and works from a blood transfusion centre. But a team can easily be smaller and work from a hospital. Sometimes there might only be a medical assistant or donor attendant and a driver.

Picture A shows how the team works. Donors are first seen by a donor attendant who measures their haemoglobin. They are then seen by a doctor or medical assistant, who makes sure they are well enough to give blood. The donors then go to a clerk who gives them a cardboard tie-on label like the one shown in Picture B. Each donor then takes his label and hands it to the second donor attendant who bleeds him. After this, he goes to see the Red Cross worker who gives him a cup of tea or a cold drink.

In Uganda the donor's haemoglobin is measured by a method which uses copper sulphate. This method is not described here, and you are advised to use the Lovibond method described in Section 7.1. Donors with haemoglobin of less than 12 g % should not be bled. If any anaemic donors are found they should be told to ask for treatment for their anaemia. Donors must also not be too small if they are going to give a full bottle of blood.

The label shown in Picture B is a piece of cardboard 5 cm × 10 cm which has been stamped with a rubber stamp and has a hole in one end. Through this hole a piece of string is threaded. The clerk fills in the details about the donor on the label and takes three sticky labels all with the same number on them. The number is the number of that particular pint of blood and is stamped on the sticky labels with the paging numerator described in Section 4.3. The numerator is set to stamp the same number three times and then moves on to the next number. One sticky label he fixes firmly to the cardboard on the tie-on label and the other two he only fixes loosely. One of the loose numbered sticky labels is stuck on to the pint of blood, and the other is stuck on to the pilot bottle. In this way it is certain that the tie-on label, the pilot bottle, and the bottle itself will all have the same number. These sticky labels are bought in rolls and are fixed to one another at their ends. Each label should be 1.5 cm × 5 cm.

Besides giving each donor a label for his bottle, the clerk does four other things. He checks the donor's **personal record card** and writes in the date of that day's donation. If the donor is a new one, the clerk makes out a new **donor registration card**. If the donor is an old one and is giving blood at the same place in which he has given it before, the clerk records the donation on the **blood bank record card**. The clerk keeps the blood bank record cards of the donors coming to each place together and brings these cards every time that place is revisited. For example, the cards for the National Theatre are kept together and brought to the National Theatre each time the team goes there. The clerk fills in a work sheet like that shown in Picture C. These are the records that large

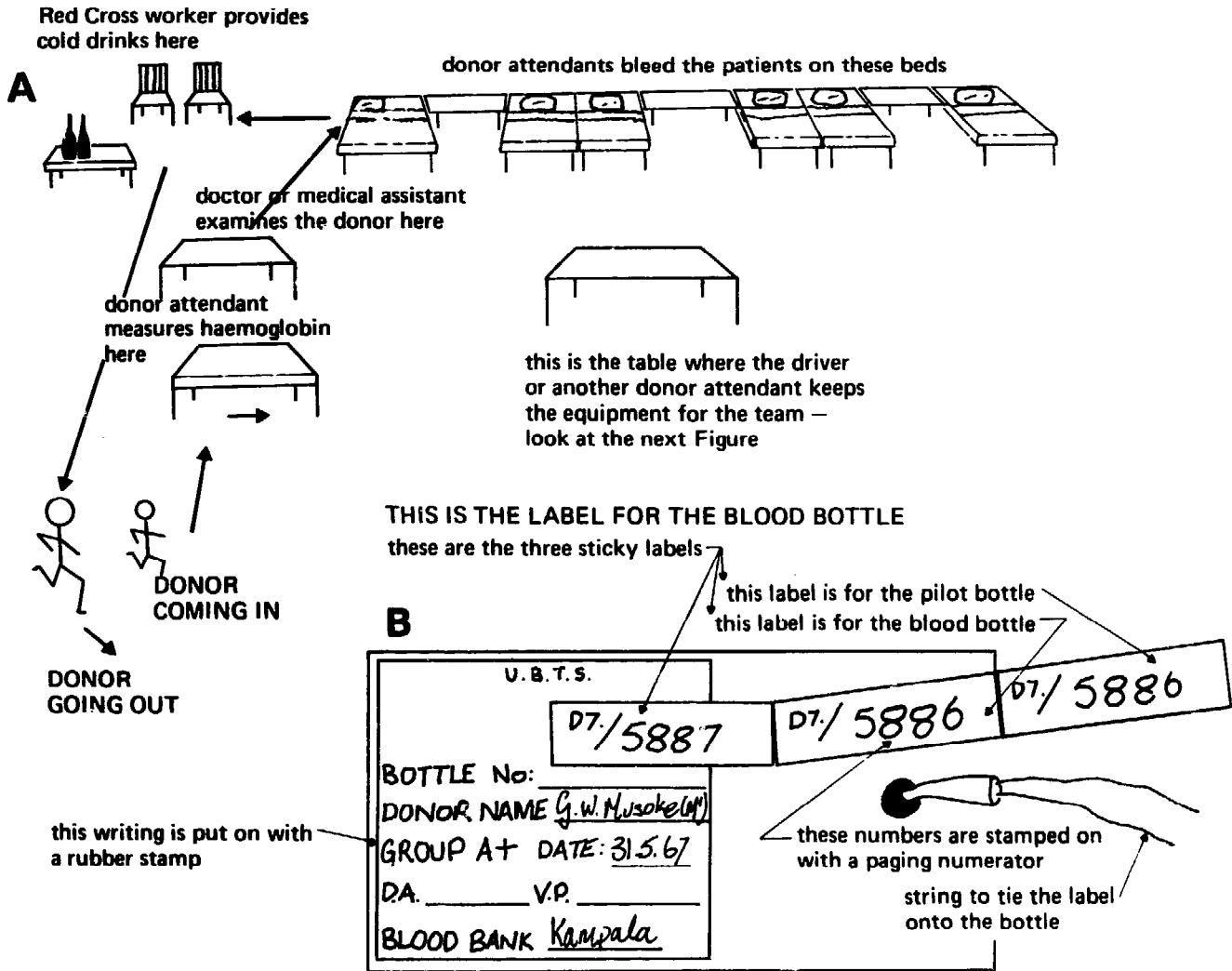

C THIS IS THE WORK SHEET— IT LISTS ALL THE BLOOD TAKEN

DATE: 31st May 1967 SHEET No: 1 SESSION National Theatre M.O. Dr. W. Okello ORIGINAL

Bottle No.	S. NO	NAME:	ADDRESS:	Amt.	A/RhD	Other	H.T.	Tribe	N.D	REMARKS:	LAB. USE	
											ABO	RhD
D7/5886	1	<i>G. W. Musoke</i>	<i>Banama Auction</i>		<i>A +</i>			<i>GANDA</i>	<i>4th</i>	<i>Lost badge.</i>	1	
	2										2	
	3										3	
	4										4	
	5											
	6											

the bottom of the worksheet has been cut off and is not shown in this picture

Fig. 12-9 The Uganda mobile blood transfusion team

blood banks use. A smaller blood bank might only need personal record cards for the donors and one kind of record card for the blood bank.

In Picture A, FIGURE 12-9, you will see the table on which the driver, who is also trained as a donor attendant, keeps all the blood transfusion equipment. This is shown more clearly in FIGURE 12-10. On the left of the table in this figure you will see the bottle of blood complete with its taking set. With the help of the donor attendant who took the blood, the driver will empty the blood from the taking set into the pilot bottle. HE WILL ALWAYS TAKE GREAT CARE TO PUT THE BLOOD FROM A PARTICULAR TAKING SET INTO THE PILOT BOTTLE BELONGING TO IT. This is very important because, if he makes a mistake, the pilot bottle and the main bottle might contain blood of different groups. In this way blood of the wrong group might be given.

The driver puts the used taking sets into the bucket you see under the table. He then puts 'Viscaps' on top of the bottles. He makes quite sure that the number on the tie-on label is the same as the number on the sticky label on the bottle of blood, and on the sticky label on the pilot bottle. Finally, he puts the full, capped, and labelled bottles into the wire crates you see under the table on the

left. Under the table on the right you will see another wire crate full of empty blood bottles waiting to be filled. You will see that these empty bottles also have 'Viscaps'. The driver is just about to take the 'Viscap' off an empty bottle using a paper knife. At the front of the table you will see empty bottles waiting to be filled; they have all had their 'Viscaps' removed, and on top of each of them there is a swab soaked in 'Hibitane' solution. The donor attendant taking the blood will come and fetch these bottles as he wants them.

12.14 Storing blood: the blood bank (FIGURE 12-11)

Blood taken into ACD anticoagulant solution will keep for 3 weeks in a refrigerator—not more. At the end of 3 weeks it must be thrown away. A store of blood in a refrigerator is called a **blood bank**.

There are two main kinds of refrigerator. One is the **absorption** type which makes no noise and does not have a motor. The other is the **compressor** type which can be heard running because it has an electric motor which drives its compressor.

The temperature inside a blood bank refrigerator must be very nearly the same all the time. It is not easy to make the absorption type of refrigerator keep the same

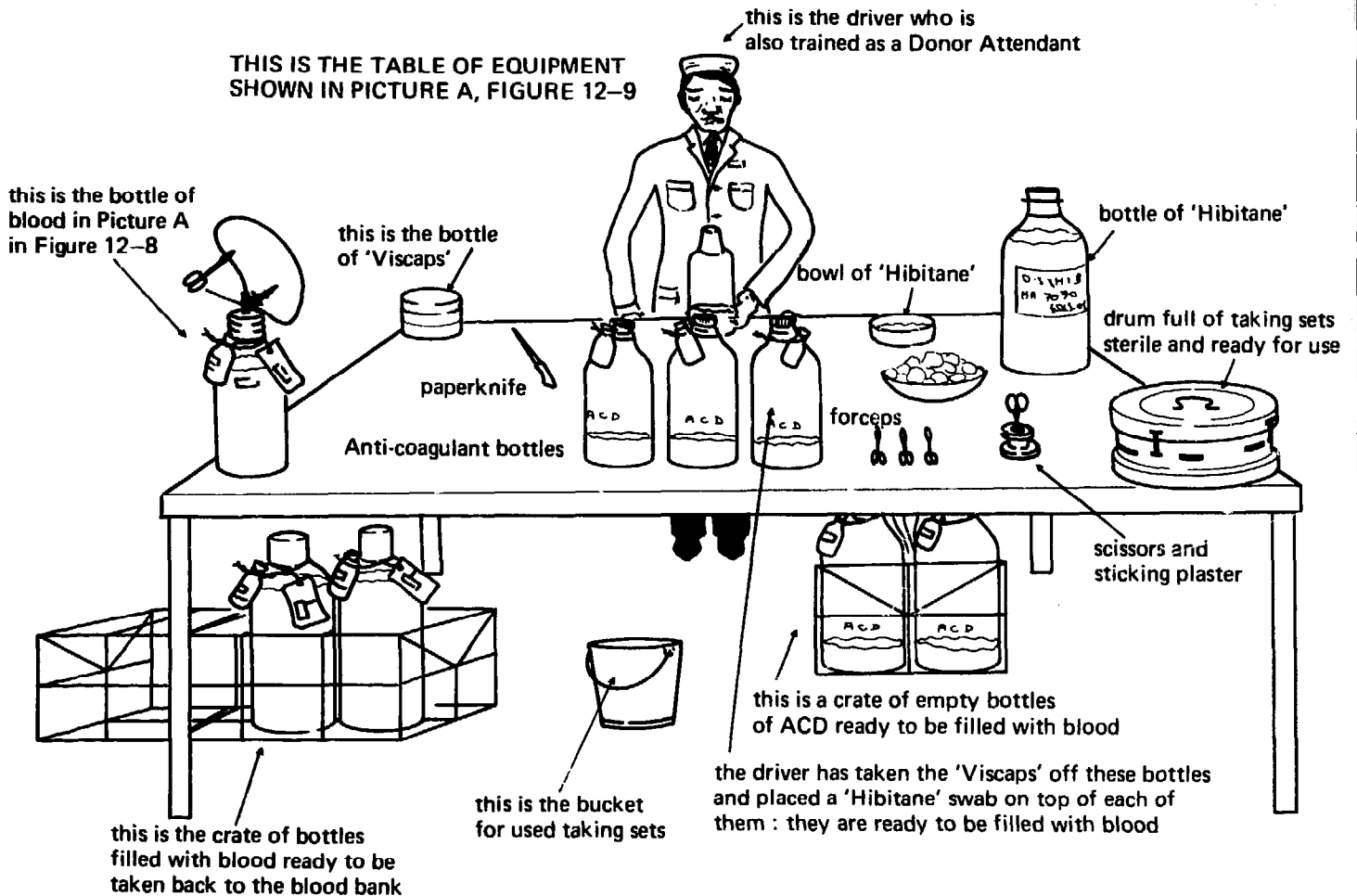

Fig. 12-10 Equipment for blood taking

temperature all the time, but the compressor type of refrigerator usually does this quite easily. You must, however, keep certain rules. For example, even an expensive refrigerator will not keep the same temperature if people are always opening the door or if they leave the door open for a long time.

A refrigerator must be kept at exactly the right temperature. The right temperature is between 4°C and 6°C. This is just a little above the temperature at which water freezes, which is 0°C. *If blood freezes the red cells will break open (lyse) and the blood will be very dangerous to the patient.* It may kill him. Blood which has been stored in a refrigerator which has got too warm may also be harmful. It is very important therefore to look after a blood bank refrigerator carefully and make sure that it always keeps blood at 4°C. You must defrost the refrigerator regularly. By defrosting we mean taking away the ice that always forms on the freezing part of the refrigerator after a few days. If this ice is not removed, the refrigerator will not keep blood at the right temperature.

METHOD

DEFROSTING A BLOOD BANK REFRIGERATOR

If your refrigerator works on paraffin take out the paraffin tank and put out the flame.

If your refrigerator works on electricity switch off the electricity and take the plug out of the socket.

Take everything out of the refrigerator. Blood must be kept cool; so put it into another refrigerator. If you have not got another refrigerator, or any special boxes into which to put blood to keep it cold, you must try to defrost your refrigerator when it is empty or nearly

empty. Put a bucket or tray underneath the freezing part of the refrigerator (the freezer) to catch the water which comes from the ice as it melts. Never try to take the ice away with a sharp instrument or tool. You may break the refrigerator, and it may be impossible to mend it. If you want to make the ice melt quickly, put a bowl of hot water in the refrigerator close to the ice. If you defrost the refrigerator regularly, there should never be so much ice that it is hard to remove. The refrigerator should never 'frost up'.

Leave the door open while the ice melts and falls into the bucket or tray.

Clean and dry the inside of the refrigerator.

If you have an electric refrigerator, plug it in and switch it on. If you have a paraffin refrigerator, fill up the tank with paraffin, clean the glass and trim the wick. By trimming we mean cutting the wick so that it is the same height all the way along. If the wick is the same height, it will burn with a flame without any smoke.

Put everything that you have taken out of the refrigerator into it again. Do not put anything back which is out of date or not wanted.

The best way to record the temperature of a blood bank is to use a special kind of recording thermometer which writes the temperature on a circular piece of paper. If you have not got a recording thermometer you can use a 'maximum and minimum' thermometer which records the highest and lowest temperature reached since the instrument was last set. If this is not available you can use an ordinary thermometer placed in a blood bottle filled with water. Look at the temperature of the water every day. Write it down on a piece of paper like that shown in Picture B, FIGURE 12-11. This has a tempera-

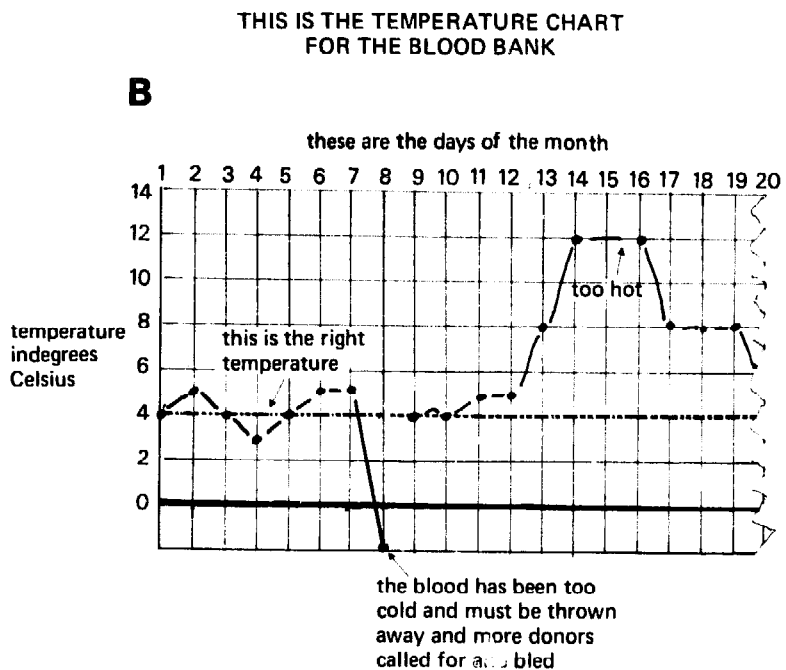
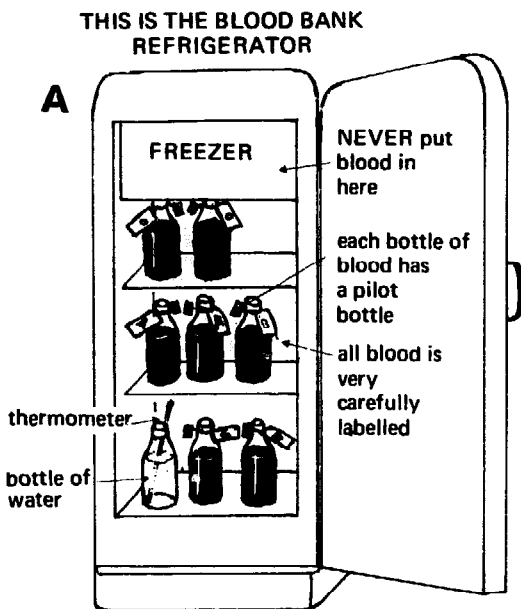

Fig. 12-11 The blood bank refrigerator

12 | Blood Transfusion

ture written down on the left-hand side and the days of the month along the top. You will see that the first 7 days the temperature was right, and it was 4°C. On the eighth day someone altered the adjustment on the refrigerator. The water turned into ice, the temperature went below 0°C, and all the blood in the blood bank had to be thrown away. New donors had to be called for and bled. On the 13th, 14th, and 15th the temperature was too hot. Blood does not keep well at this temperature; it could be used, but it would be better to throw the blood away and get more donors and bleed them.

12.15 Making blood transfusions safer

A blood transfusion may be dangerous and kill the patient because the blood is of the wrong group, because it was not stored well, or because the sets were not well washed and sterilized, or because they have become contaminated during storage. Blood may also be dangerous if the donor was diseased and especially if he has had jaundice. Blood transfusions will be safer if you remember these instructions carefully.

METHOD

MAKING BLOOD TRANSFUSIONS SAFER

Always label a specimen with both a patient's names or all his initials and if possible his hospital number as well. Never use a bed number because patients may change their beds!

Always label any blood you have cross-matched in the same way.

Check very carefully to see that the right blood is given to the right patient.

Don't forget to do control tests every time you group a donor or a recipient.

Keep your stock antisera in the freezer.

Always do a cross-match (compatibility test).

Keep an accurate record of everything you do in the blood bank, particularly the blood you issue.

Stop blood becoming contaminated by using sterile equipment and keeping it sterile. If a bottle is set up for taking blood and not used within half an hour, don't use it but set up a new one. If a needle is touched by mistake before being put into a bottle or into the patient's vein, don't use it but get a new set.

STORING BLOOD PROPERLY

Don't put blood in the freezer, and don't allow a bottle of blood to touch the freezer. It may haemolyse even if it touches the freezer. Blood must NEVER be allowed to freeze.

Always use pilot bottles and never open a bottle of blood until it is wanted.

Check the temperature of the blood bank daily, and record the temperature on a graph.

Don't use blood which has been out of the blood bank refrigerator for more than an hour.

Never store blood in a ward refrigerator.

Don't use a blood bank refrigerator to store food or specimens.

Make sure that one person, and one person only, is in charge of the blood bank refrigerator.

Don't use blood unless there is a clear line between the sedimented cells at the bottom of the bottle and the supernatant plasma on top. The plasma should be a pale yellow and free from any signs of haemolysis. Haemolysis is shown by a red colour which spreads upwards from the sedimented cells at the bottom of the bottle. There is often a white layer of fat on the top of the plasma; this does not matter, and the blood can safely be used.

NEVER GIVE BLOOD UNLESS YOU ARE SURE THAT IT IS SAFE.

QUESTIONS

1. Why do we wash red cells?
2. What is an Eldon card? Why are they so useful?
3. What is meant by rouleaux formation? Draw pictures to show the difference between rouleaux formation and agglutination.
4. What do we mean by 'cross-matching'? What may happen if it is not done?
5. What is 'Dextran' and why should we know about it?
6. Draw a picture of a blood-giving set and name its parts.
7. How would you sharpen a needle? Draw pictures of all the mistakes you should prevent when sharpening a needle.
8. What is a 'pilot bottle'? Why do we use them?
9. What are the most important things to be careful about when you store blood?
10. What blood groups do you know? Describe one way in which blood may be grouped.

13 | For Pathologists, Stores Officers, and Medical Administrators (Standard English)

'Oh yes, I used to test the urine until last year when my test tube broke.'

A medical assistant in charge of a rural health centre in a developing country.

13.1 A standard manual

This quotation well describes the laboratory services in many health centres, and those in district hospitals are frequently little better. There are several reasons why peripheral laboratory services should often be so bad. One of them is that there has hitherto been no suitable text from which staff could learn—a deficiency that this manual hopes to remedy. Another is that, although money is scarce, it is not usually so scarce that the necessary items of equipment costing only a few cents could not be supplied, if it was only more generally known what they were. The latter shortcoming this volume also hopes to remove and is the particular concern of this last chapter.

Both the manual and its equipment list have been prepared with the intention of saving the time and energy of those responsible for organizing pathological services in developing countries. Because the list and the text have been closely integrated with one another, two things follow. The first is that *all* the equipment listed here must be available and stocked by medical stores if the methods this manual describes are to be carried out. The second is that, if this equipment is to be issued, then staff must learn the methods *exactly* as they are described here. *Because of the close integration of text, methods, and equipment, it is advised most strongly that this manual, its methods, and its equipment be adopted as they stand, or with the fewest possible alterations.* This is particularly important where certain equipment has been extensively illustrated, the microscope, the balance, and the pressure cooker for example. Opinions are likely to differ on certain points, and to allow for these a number of different 'choices' or options have been included. These are discussed at the end of this chapter, and all are described in the text.

13.2 The scope of this manual

It might seem difficult to know what to include and what to leave out of a work of this kind. But in practice the choice has seldom been difficult. All methods for bacteriological culture have been excluded as requiring incubators and autoclaves, etc., which would at least double the cost of the laboratory. To describe them would have also added greatly to the length of the book. Agglutination reactions, such as those for typhoid and brucellosis have also been omitted on the grounds that they require reagents of limited shelf life, and do not yield important information with sufficient economy and frequency to warrant their being undertaken in peripheral laboratories. The exclusion of a reagin test for syphilis is more debatable. It is felt that too much reliance is often placed on this test in view of the known frequency of false positive reactions. No histological methods have been described because histology is usually only done by a few specialized auxiliaries in a central laboratory. Arrangements for the transport of specimens to a central laboratory have, however, been described in detail.

It might be argued, and with some reason, that the methods described here, and the outfit of laboratory equipment that go with them, are much too rudimentary. Perhaps they are, but the fact remains that there exist many hospitals and health centres where even the simple methods that this manual describes cannot be done. There are, for example, numerous district hospitals where the CSF cannot be examined, or the sugar or urea in the blood estimated. In few dispensaries or health centres can the haemoglobin be measured satisfactorily or the urine tested for protein. This manual has thus been written to help in raising the laboratory practice of these institutions to a certain useful *minimum* standard.

13.3 The equipment list

Most of the equipment in the main list is suitable for district hospitals and health centres. That suitable only for hospitals is marked 'Hospitals only'. A group of three capital letters inside brackets is a code for the firms supplying a particular item. The meaning of all these

codes is given in Section 13.7. After the code comes the firm's catalogue number. Thus (BTL) 215/1360/01 is Baird and Tatlock's code number for a polythene wash bottle (ML 8). A separate code number has been devised for all the items in the list. This starts with the letters ML (for Medical Laboratory). Thus ML 9 is a test tube brush. *It is strongly advised that, when a health service adopts this manual, medical stores adopt this ML code and insert it in their catalogues.* This will make it easier for a laboratory assistant up-country to order what he wants. Some of the items listed will already be in stores catalogues, usually spread through several sections. When these catalogues are reprinted it may be convenient to insert the ML numbers of these items after their existing code numbers, and to add new ML items to whichever section may be most suitable. For convenient reference the complete list of ML equipment and the sections in which it can be found might will be added as an appendix to such a catalogue.

In many cases alternative equipment to that specified would serve equally well, but, if different equipment is ordered, *it must agree closely with the specifications provided, if necessary amplified by the further details available in the catalogue of the maker quoted.* Apparatus for which there is no alternative supplier has been marked 'NO OTHER WILL DO'. Prices have been taken from 1971 catalogues and are given in USA dollars, converted at the rate of \$2.4 to £1 sterling (this being the exchange rate that was ruling at the time the list was made). They are mostly retail and sometimes include tax. Considerable reductions are therefore to be expected for bulk export orders. Equipment purchased through UNICEF will also be substantially cheaper than the prices quoted here.

13.4 Priorities in the creation of pathological services—build up the peripheral units first

The cost of the basic list of apparatus for a health centre adds up to about \$450, that for a hospital to about \$660. The basic chemicals for a health centre cost about \$60, those for a hospital about \$90. The equipment includes the cost of an Olympus microscope, and the chemicals are in a quantity appropriate to an initial stock. Recurrent equipment costs should be minimal and annual recurrent expenditure on chemicals is unlikely to exceed that of the initial stock.

It is instructive to compare these figures with the total capital costs of hospitals and health centres. We will assume for the purposes of argument, that, after certain of the more expensive options have been chosen and transport, etc., provided for, the cost of the laboratory equipment for a hospital will rise to \$750, and that for a health centre to \$500. We will also assume that a hospital has 100 beds and is built at the cost of \$8,400 a bed—a typical 1967 figure for East Africa. The cost of the laboratory equipment is seen to amount to about 0.07% of the capital cost of the whole hospital. Similarly, assuming that the capital cost of a health centre is

say, \$25,000, then the cost of the equipment and chemicals for its side room amounts to only about 2% of this. *Both these are such infinitesimally small proportions of the total sum that to skimp on the provision of elementary laboratory equipment must be considered totally false economy.*

It is instructive to compare the cost of the equipment listed here with that provided for other laboratories. One regional laboratory, which would be considered comparatively modest by the standards of industrial countries, was equipped in East Africa for the sum of \$25,000. This would have provided the equipment for no less than forty laboratories of the kind described here! It is contended that, in the present condition of the pathological services of developing countries, a given sum of money is likely to produce a greater return in human welfare if it is used to provide many simple laboratories rather than a few expensive ones. In effect the choices are these: either the blood electrolytes can be measured in one laboratory with a flame photometer (the regional laboratory above was provided with two, the other was spare), or the haemoglobin can be measured in fifteen health centres with the Lovibond disc: either one laboratory can be equipped with an autoclave to undertake bacteriology, or ten health centres can be equipped with the Olympus microscope to examine stools for hookworms and blood for sickling. The moral must be to provide cheap simple equipment first, and, except in teaching institutions, only to provide more expensive equipment after the need for the cheap equipment has been met.

The equipment listed here may be cheap, but it is wanted on such a wide scale that its aggregate cost will be substantial. All health centres, clinics, outpatient departments, and district hospitals need it, so do the ward side rooms of larger hospitals.

13.5a Some chemicals and equipment discussed

Several methods and the equipment needed for them require discussion.

The issue of chemicals to health centres and district hospitals

It is strongly urged that health centres be issued with chemicals and a balance and be expected to make up all their own reagents. This would ease supply difficulties, and to this end full and highly simplified directions for making every necessary reagent have been included in Chapter Three. District hospital laboratories should also be expected to make up their own reagents except for the few listed in Section 13.25.

The distribution of chemicals

Some medical stores may prefer to buy most chemicals in GPR grades in either barrels or drums and break them down into smaller lots for distribution. Other medical

stores may prefer to order chemicals in plastic bottles in the quantities suggested in Section 13.10.

Many chemicals can safely be scooped out of drums into polythene bags for sealing with a heat sealing machine—see FIGURE 4-3. A paper label can be put inside each bag to say what the chemical is. When first supplying a new laboratory these bags of chemicals should be accompanied by plastic bottles into which these chemicals can be put (such bottles have not been included in the equipment list). Chemicals are cheaper in bulk, and the cost of transport and the danger of breakage is reduced both on the journey to the medical stores and on the journey from it. Most chemicals are quite harmless and the only ones which may be difficult to distribute in this way are ferric chloride (hygroscopic), phenol (an oily, mildly corrosive liquid at tropical temperatures), and sodium hydroxide (corrosive and deliquescent). Immersion oil and the stains are required in such small quantities that they can well be bought in small units. Hydrochloric and sulphuric acid should be bought and issued in Winchester quarts ($2\frac{1}{2}$ litres). 'Teepol', formalin, spirit, and xylene should be bought in drums and dispensed into plastic bottles.

Containers

Four types of container are listed. It is suggested that a few glass universal containers and bijou bottles be issued for use inside the laboratory, and that *specimens be collected in plastic polypots and polytubes*. The polypot and lid listed at ML 14c is made of polypropylene. It only costs \$0.023 and can be boiled or autoclaved, washed, and reissued. They are thus much preferable to containers of waxed paper which cannot be autoclaved and reissued in this way, and which cost much the same. Polypots are comparatively watertight, and flat enough for a specimen to be looked at before a sample of it is taken for examination. They were specially developed as containers for pathological specimens by the Metal Box Company (MBO) and are highly recommended.

The Olympus microscope, Model K

This has been specified, because it is cheap and beautifully made, both optically and mechanically. It has been illustrated in many drawings, and great pains should be taken to supply it.

Some microscopes inevitably become unserviceable with time, so medical stores should keep a stock of serviceable microscopes that can be exchanged with those needing repair. Stocks of spare eyepieces and objectives should also be maintained.

Fuel supplies

The supply of suitable fuel for health centre laboratories is often difficult. In default of cylinders of gas or 'Labogaz' (Choice 17, Section 13.30) issue paraffin for a pressure stove and methylated spirit for a lamp.

Tablet and paper tests for the blood and urine

The classical methods have been described in preference to the more modern and convenient 'dip tests' because they are much cheaper. Sulphosalicylic acid for testing the urine for protein, for example, is a tenth the price of 'Albustix'. For the less commonly used tests the cost difference is less important, so 'Acetest' tablets have been included in the main list of chemicals, and the materials for Rothera's reagent included as Choice 14.

Equipment for blood transfusion

Detailed instructions have been given for the washing and preparation of the MRC blood transfusion equipment, which is still manufactured (TUR), although it is no longer used in the United Kingdom, having been replaced there by plastic disposable equipment. It can also be used for preparing intravenous salines and is believed to be the cheapest way of giving both blood and salines in the district hospitals of the developing countries.

Rubber stamps for laboratory reports

Suggestions for suitable rubber stamps for laboratory reports have been drawn in FIGURE 4-1. It is suggested that these be ordered on an appropriate scale and stocked by medical stores.

13.5b Upgrading peripheral laboratories

One of the aims of this text is to make the upgrading of peripheral laboratories easier, through the holding of refresher courses based upon it. Although he has never had the opportunity to try it, it is the writer's intention that groups of junior staff from outlying laboratories be called together for, say, a week, issued with a manual, given an intensive course on the methods it describes, and then sent back to their laboratories either with a complete outfit, or else with everything that their laboratory needs to bring it up to the level the manual describes. The course might well be held in a secondary school science laboratory, and the class could be taught with the equipment that they were later going to take back with them.

It is not enough that medical assistants, for example, be merely given a short course and then given an outfit to take back with them. *Provision must be made for the minimum shelving and benching shown in FIGURE 3-11*. A project for the upgrading of a series of laboratories or health centres must thus include the necessary funds for their conversion. This should preferably also include the fitting of a laboratory sink and tap, where this is required, such as that in Picture F, FIGURE 3-1 (WATER STANDARDS, two way, nozzle 23 cm from bench top, (BTL) 114/3250/02, (UNICEF) , one per laboratory). Such taps and a suitable sink for them should also be an indispensable part of any laboratory in a new health centre.

13.5c Teaching

The experimental edition of this manual has been extensively used for teaching. It has been found important that each student should own a copy and be *taught to use it*. It is thus essential that some of the teaching sessions should consist of issuing students with the equipment necessary for a particular method, and then requiring them to carry it out *from the book*. It is not easy to teach someone to teach himself from a book, particularly at the level of the readership intended for this one, but if an instructor can go even part of the way towards it, much of his work is done. The writer would, incidentally, be pleased to be told of even the smallest details in which its usefulness for this purpose could be improved.

It is hoped to prepare sets of multiple choice questions and teaching transparencies for use with this manual. These will be very inexpensive and are to be available from (TAL). The transparencies in particular may also be useful to the reader who merely wants to teach himself. Neither of these will be available before mid-1974.

Although primarily intended for the auxiliary, the methods described here are those with which every doctor and thus every medical student should be familiar. This means that teaching laboratories for clinical pathology should be equipped with the apparatus listed here, and the medical student given every opportunity to become proficient in the techniques described. Were the writer responsible for such a course, he would have the student permitted to take this text into an examination, so as to avoid the need to commit too much to memory. Ideally such an examination should be based on multiple specimens illustrating a hypothetical case and test the skill and speed with which a number of investigations can be done—*with the aid of the book*.

13.6 The supply of complete kits by UNICEF

The ideal way to buy equipment for a health centre or district hospital laboratory is in the form of a complete packaged kit containing all the necessary equipment and a copy of this text. As this goes to press it is hoped that UNICEF will be prepared to pack and distribute kits to the specifications given here. Readers wishing to obtain such kits should ask their governments to request UNICEF to pack and supply them to the government medical stores. If sufficient requests are received the kits may eventually become a standard UNICEF item.

At the time of writing a number of kits have already been supplied by Medical Assistance Programs Inc. (MAP) who may also be prepared to provide them.

13.7 The addresses of suppliers

Here is a list of the firms whose equipment is mentioned and the code letters, (AME) for example, that have been used to refer to them. For convenience the catalogue numbers of only one supplier of the common items of equipment have been given (Baird and Tatlock), but

alternative suppliers of many items may be found in the list below. If it was a stock item at the time of writing the UNICEF number of each item or its near equivalent has been included. If it was not available from UNICEF at the time of writing, or even its near equivalent, a space has been left for the subsequent insertion of a UNICEF number.

- (AME) Ames Ltd., Stoke Poges, Buckinghamshire, U.K.
- (BDH) BDH (International) Ltd., Poole, Dorset, U.K.
- (BIC) H. Bickerton Ltd., Mimram House, Tewin Water, Welwyn, Herts., U.K.
- (BTL) Baird and Tatlock (London) Ltd., Freshwater Road, Chadwell Heath, Essex, U.K.
- (CLA) Clay Adams Inc., 141 East 25th Street, New York, New York 10010, U.S.A.
- (EAS) Eastman Kodak Ltd., Rochester, New York, U.S.A.
- (EEL) Evans Electroselenium Ltd., 101 Leadenhall Street, London E.C.3, U.K.
- (ELD) Nordisk Insulin Laboratorium, Gentofte, Denmark.
- (EMI) James A. Jobling and Co. Ltd., E-Mil Works, Treforest Industrial Estate, Pontypridd, U.K.
- (GAL) Gallenkamp Ltd., Technico House, Christopher Street, London E.C.2, U.K.
- (G&G) Griffin and George Ltd., Ealing Road, Alperton, Wembley, Middx., U.K.
- (GAZ) A.D.G. Camping GAZ, 15 Rue Chateaubriand, Paris 8^e, France.
- (GRA) Grant Instruments Ltd., Barrington, Cambridge, U.K.
- (GTG) George T. Gurr Ltd., 136/144 New Kings Road, London S.W.6, U.K.
- (HAR) The Hartman Leddon Company, 60th Avenue, Philadelphia, PA 19143, U.S.A. The products of this company are retailed by The American Hospital Supply Corporation, International Division, 120 Raritan Centre Parkway, Edison, New Jersey, U.S.A.
- (HAW) Hawksley and Sons Ltd., Lancing, Sussex, U.K.
- (HOP) Hopkin and Williams Ltd., Freshwater Road, Chadwell Heath, Essex, U.K.
- (JOH) Johnsons of Hendon Ltd., 335 Hendon Way, London N.W.4.
- (KEE) C. Davis Keeler Ltd., 39 Wigmore Street, London W.1, U.K.
- (MAP) Medical Assistance Programs Inc., Box 50, 327 Gundersen, Illinois 6018, U.S.A.
- (MBO) The Metal Box Co. (Overseas), 37 Baker Street, London W.1, U.K.
- (MOS) Moseley Centrifuge Co., 119 Pentonville Road, London N.1, U.K.
- (MSE) Measuring and Scientific Equipment Ltd., 25-28 Buckingham Gate, London S.W.1, U.K.
- (OHA) Ohaus Scale Corporation, 29 Hanover Road, Fordham Park, New Jersey 07932, U.S.A.
- (OLY) Olympus Optical Co. Ltd., 43-2 Hatagaya 2-chome, Shibuya-ku, Tokyo, Japan.

- (ORT) Ortho Diagnostics, Raritan, New Jersey, U.S.A.
 (OXO) Oxoid Division, Oxo Ltd., Southwark Bridge Road, London S.E.1, U.K.
 (POV) Poviet Production N.V., Mauritskade 14, Amsterdam, Holland.
 (PRE) The Prestige Group Ltd., Prestige House, 14-18 Holborn, London E.C.1, U.K.
 (RAY) British Rayophane Overseas Ltd., Lancots Lane, St. Helens, Lancashire, U.K.
 (TAL) TALC (Teaching aids at low cost), Institute of Child Health, 30 Guildford Street, London W.C.1, U.K.
 (TIN) Tintometer Ltd., Waterloo Road, Salisbury, U.K.
 (TUR) R. B. Turner & Co. Ltd., Greenfields Road, Tindale Crescent, Bishop Auckland, Co. Durham, U.K.
 (XLO) X-lon Products Ltd., Glynn Street, London S.E.11, U.K.

13.8a General stores required

Certain general stores will be required. It is assumed that they will be available from the general issue to hospitals and health centres. They include syringes and needles, conical urine specimen glasses, cotton wool, surgical gauze, lysol, paraffin, and matches. These have not been included in any of the lists below, nor have the rubber stamps drawn in FIGURE 4-1. *These stamps should also become a medical stores item.*

13.8b Special equipment in the main list

This is the equipment illustrated and described in Chapter Two. In most developing countries it will almost all have to be ordered from overseas.

- ML1 BALANCE, Ohaus, triple beam with tare beam, sensitivity 0.1 g, capacity 610 g without attachment weights and capacity 2610 g with these weights, (OHA) Model 760, (UNICEF) 0910502, each \$49, one only.
 ML2 BALANCE SCOOP AND COUNTER-WEIGHT, for use with the above balance, polypropylene, (OHA) Model 703, (UNICEF) , each \$4.8, one only.
 ML3 BALANCE ATTACHMENT WEIGHTS, for use with the above balance; two 1 kg and one 500 g weights bring the capacity of the balance above up to 2610 g, (OHA) Model 707, (UNICEF) , set \$10.00, one set only.
 This balance and its attachments are sufficiently sensitive for all the reagents described in this book. It is robust and will also serve a number of other purposes in the health centre. *It is very highly recommended.*
 ML4 BLOOD SEDIMENTATION TUBE (Westergren sedimentation pipette), (BTL) 403/0302, (UNICEF) 0968000, each \$0.6, six.

Any standard Westergren sedimentation tube will do.

- ML 5 BOTTLES, dropping polythene, capacity 125 ml, (BTL) 215/0705, (UNICEF) 0919100 will serve, each \$0.17, thirty.

Most of the reagents used in this book are made up in these bottles. Bottles accurately to this specification must be supplied. The glass equivalent will not do.

- ML 6 BOTTLES, narrow mouth, polythene, liquid proof with cap and cone, capacity 1,000 ml, (BTL) 215/0480/04, (UNICEF) 0919310, each \$0.85, eight.

These are bottles for the larger volumes of reagents, and, although locally obtained glass bottles can be used instead, there will be occasions when suitable ones may not be easy to get.

- ML 7 BOTTLES, pipette, dropping, clear glass with PVC teat and 'Polystop' dustproof stopper, capacity 125 ml, (BTL) 215/0640/03, (UNICEF) , each \$0.95, five.

These are for Leishman's stain and buffer, and for saline and iodine solutions that are used one drop at a time. Bottles accurately to this specification *must* be supplied.

- ML 8 BOTTLES, wash, polythene, oval shape with polythene cap and tube, capacity 250 ml, (BTL) 215/1360/01, (UNICEF) 0921200, each \$0.53, eight.

Almost any polythene wash or 'squeeze' bottle will do.

BOTTLES, wide mouth, . . . six; these are described in more detail in the ordinary equipment as ML 62 (Section 13.9) and as often being obtainable locally. They are, however, important items, and if there is any doubt about their local availability, they *must* be supplied. UNICEF should supply the plastic equivalent (UNICEF) 0921300. They are used for Field's stain and are also for holding some dry reagents.

- ML 9 BRUSH, test tube, with winged head, overall length 24 cm, size of head 6 x 4 cm, (BTL) 216/0010, (UNICEF) 0923600, each \$0.05, five.

Any test tube brush of about this size will do.

- ML 10 BUNSEN BURNER, for use with bottled gas, 11 mm diam., (BTL) 218/0426/01, (UNICEF) , each \$1.6, one only.

The burner supplied must be suitable for use with bottled gas. It will only be necessary if it is decided to supply cylinders of bottled gas (ML 60) as well.

- ML 11 STAND, for six Westergren pipettes, (BTL) 403/0307, (UNICEF) 0968400, each \$2.4, one only.

This is the stand for the Westergren pipettes in ML 4.

ML 12 CENTRIFUGE, hand, four place, single speed, complete with buckets, (G&G) S 7-17-698, (UNICEF) 0926000, each \$15.2, one only.

This will not be needed if an electric centrifuge is supplied—see Section 13.17.

ML 13a COMPARATOR, 'Lovibond 1000', (TIN) DB410, (BTL) 307/1000, (UNICEF) 0931200, each \$12.6, one only. **NO OTHER WILL DO.**

This is the best routine instrument for measuring haemoglobin in clinics and health centres. It is best supplied with an adaptor to take round tubes, ML 13b (TIN) DB413, (UNICEF) \$0.82, one only. For the tubes themselves see under ML 48e.

ML 14 CONTAINERS, the following containers will be required:

(a) **BOTTLE**, media, McCartney, with aluminium screw cap and 3 mm rubber liner, capacity 5 or 7 ml, also known as a 'Bijou' or 'miniature' bottle, (BTL) 215/0050, (UNICEF) 0920980, each \$0.06, one hundred.

(b) **BOTTLE**, universal, with aluminium screw cap and rubber liner, wide mouth, 28 ml, (BTL) 215/0058, (UNICEF) 0921000, each \$0.08, one hundred.

(c) **'POLYPOT'**, standard black 56 ml (2 ounce), polypropylene tapered screw pot and lid for pathological specimens, height of pot 33 mm, diameter of lid 58 mm, (MBO) (UNICEF) 0932530 or 0932532 will serve, each \$0.023, order in multiples of 1000, five hundred.

(d) **'POLYTUBE'**, clear polystyrene with polythene push-in cap, 4 ml, 38 x 13 mm, (MBO) (UNICEF) each \$0.0075, order in multiples of 3,500, five hundred.

The more expensive glass bottles (a) and (b) are intended for use in the laboratory. The much cheaper 'polypot' (c) and 'polytube' (d) are for issue to the wards and patients. The polypropylene 'polypot' can be autoclaved and reissued. The 'polytube' can be reissued after washing. *All four types of container are necessary. Very large numbers of 'polypots' are likely to be needed.*

ML 15 COUNTING CHAMBER, improved Neubauer ruling, double cell, with pair of cover glasses, (BTL) 403/0040/03, (UNICEF) 0948200 will serve, each \$7.2, one.

A single cell counting chamber can be issued if necessary.

ML 16 COVER GLASSES, for double cell counting chamber, (BTL) 403/0050, (UNICEF) 0948300, pair \$0.95, five pairs.

These cover glasses are for the counting chamber ML 15.

ML 17 COVER GLASSES, microscope, 'cover-slips', square 22 x 22 mm, thickness No. 2, (BTL) 406/0147/33, (UNICEF) 0934001, box of 100 \$0.7, ten boxes.

These are the ordinary thin coverslips for microscope slides.

ML 18 CYLINDERS, measuring, plastic stoppered, 100 ml, graduated in 1 ml divisions, class B, (BTL) 241/1126/07, (UNICEF) 0937430, each \$2, two.

This item is used for making up the majority of stains and reagents.

ML 19 CYLINDERS, graduated, polypropylene, 1,000 ml, (BTL) 241/1150/06, (UNICEF) 0937410, each \$4.50, one.

One of these is for making reagents, another may be needed for dichromate cleaning fluid.

ML 20 DIAMOND, for writing on glass, (BTL) 240/0240, (UNICEF) 0968800 will serve, each \$2.80, one.

This can, if necessary, be dispensed with if glass writing pencils are supplied.

ML 21 DISCS LOVIBOND, for use with the Lovibond comparator listed above, (TIN) disc code number listed below, each \$12, one disc for each kind required. **NO OTHER WILL DO.**

TEST	(UNICEF) codes	(TIN) codes
(a) Oxyhaemoglobin		5/37x
(b) Sugar in blood		5/2A
(c) Sugar in blood		5/2B
(d) Urea in blood		5/9A
(e) Urea in blood		5/9B

The oxyhaemoglobin disc should be issued to all units. The blood sugar and blood urea methods each require two discs and will only be needed by hospitals. The disc 5/37x has been specially made with low values for use in developing countries. The disc 5/37 with higher values will not do so well.

ML 22 FILTER PAPER, Whatman No. 1, boxes of 100 circles:

(a) 5.5 cm diam. (BTL) 234/0290/02, (UNICEF) each \$0.38, five boxes.

(b) 11 cm diam. (BTL) 234/0290/05, (UNICEF) 0963000 will serve, each \$0.58, five boxes.

The small papers are for the solubility test for haemoglobin S (Section 7.26), etc., and the larger ones for filtering stains.

ML 23 FILTER PUMP, plastic, lightweight, with tap connection suitable for 12 mm bore vacuum tubing, (BTL) 235/0400, (UNICEF) 0968302, each \$3.40, one only.

This will only be useful if there is running

water and a suitable tap (see 13.5b and Picture F, FIGURE 3-1).

- ML 24 FORCEPS, blunt points, polypropylene, 13 cm long, (BTL) 406/0079, (UNICEF) 0721000 or 0722000 metal forceps will serve, each \$1.10, two.

These are mainly for holding slides while staining.

- ML 25 FUNNELS, polythene, flexible, (BTL) 237/0200/01, (UNICEF) 0945800, 63 mm diam., each \$0.19, five.

These are needed for several methods.

- ML 26 GAUZE, wire, tinned iron, asbestos centre, (BTL) 239/0100/02, (UNICEF) 0946500, each \$0.1, one. Hospitals only.

These go with the tripod.

- ML 28 HOLDER, for nichrome wire, with aluminium handle and screwed jaws, (BTL) 218/0858, (UNICEF) 0952000, each \$0.84, two.

This is a loop-holder—see FIGURE 3-7.

- ML 29 LENS TISSUE, Greens No. 105, sheets 30 × 20 cm, boxes of 100 sheets, (BTL) 246/1135, (UNICEF) 0964000 will serve, box \$1.35, one box.

Sheets of lens tissue have been chosen in preference to booklets as being cheaper. They are essential and are for cleaning microscope lenses.

- ML 30 (a) MICROSCOPE, monocular, (OLY) Olympus Model K, with 1.25NA Abbe condenser, mirror, plastic cover, oil bottle, blue glass filter and the following (OLY) equipment, (UNICEF) , complete about \$116 ex works, one only.
 (b) EYEPIECE, wide field 10×, (UNICEF) , each \$5.50, one only.
 (c) OBJECTIVE, 4× achromatic, (UNICEF) , each \$3.50, one only.
 (d) OBJECTIVE, 10×, achromatic, (UNICEF) , each \$4.40, one only.
 (e) OBJECTIVE, S-40×, spring loaded achromatic, (UNICEF) , each \$8.80, one only.
 (f) OBJECTIVE, S-100×, spring loaded achromatic, (UNICEF) , each \$16.50, one only.

Where electricity is available the following illuminator should be supplied:

- (g) ILLUMINATOR (OLY) LSK-2, (UNICEF) , price ?, one only.

For the above illuminator the following bulbs will be needed depending on the voltage of the area. Supply 6 spare bulbs of the kind appropriate. Medical stores should hold many spares. Only the bulbs supplied by Olympus fit this illuminator. There is no Philips equivalent. Some 12 volt bulbs should be stocked.

- (h) BULB, 110 volts, screw terminal, (UNICEF) 0960805.
 (i) BULB, 220 volts, screw terminal, (UNICEF) 0960905.
 (j) BULB, 12 volts, screw terminal, (UNICEF)
 (k) MECHANICAL STAGE, attachable, un-graduated KM, (UNICEF) , each \$11, one only.

This particular microscope, the Olympus model K, is highly recommended, partly because it is one of the best of its kind, but mainly because it is extensively illustrated in Chapter Six and will thus be easier for the reader of this book to understand. Unfortunately it has only been possible to illustrate one microscope. The microscope (UNICEF) 0960000 will serve but is not illustrated or described here. It is the Olympus model GB which includes a mechanical stage, so there is no need to order item (k) above. It does not, however, include an illuminator; so order either (OLY) LSK-4 which is (UNICEF) 0960800 for 110 volts or (UNICEF) 0960900 for 220 volts. Fortunately the same lamps, items (h) and (i) above fit both the LSK-2 illuminators for the model K and the LSK-4 illuminators for the model GB. The LSK-2 illuminator is illustrated in FIGURE 6-15a. The LSK-4 illuminator is the same except that it is fitted with a different kind of clip to attach it to the microscope.

Medical stores should keep a stock of spare objectives and eyepieces for this microscope. The replacement of a faulty objective or eyepiece may well make a previously unserviceable instrument usable again for comparatively little cost. The oil immersion objectives (×100) and the high power objective (×40) are those most likely to need replacing.

- ML 31 PENCILS, for writing on glass, (BTL) 252/0110/01, (UNICEF) 0965000, each \$0.13, twenty.

These are the standard grease pencils.

- ML 32 PIPETTE, calibrated at 0.02 ml, 0.05 ml, and 0.1 ml, (EMI) G.22171 (UNICEF) , each \$0.96, six.

This pipette is *essential* and has been specially designed for use with the methods described here.

- ML 33 MOUTHPIECE, to suit red and white cell pipettes, (BTL) 403/0048/11, (UNICEF) , ten \$1.3, two.

Used with ML 32.

- ML 34 TUBE, rubber, 20 cm long for use with glass mouthpiece, (BTL) 403/0048/12, (UNICEF) , ten \$0.86, two.

Used with ML 32.

- ML 35 PIPETTE**, type one, calibrated for delivery from zero mark at top to graduation mark, Class B.
- (a) 2 ml, (BTL) 241/2300/02, (UNICEF) 0966200, each \$0.84, five.
 - (b) 5 ml, (BTL) 241/2300/03, (UNICEF) 0966600, each \$0.84, five.
 - (c) 10 ml, (BTL) 241/2300/04, (UNICEF) 0967000, each \$0.84, five.
- Plastic pipettes can be supplied.
- ML 36 PROTEINOMETER STANDARDS SET**, (GAL) ME-450, (UNICEF) , each \$16, one only.
- Hospitals only. This is only used for measuring the CSF protein. Optional.
- ML 37 SLIDES**, microscope, 76 mm x 25 mm, 1.2-1.5 mm thick, (BTL) 406/0155/03, (UNICEF) 0969000, 100 \$1.50, five hundred.
- The cheapest slides will serve.
- ML 38 SPATULA**, Chattaway's, stainless steel, 18 cm, (BTL) 260/0170/02, (UNICEF) 0969800 will serve, each \$0.8, one only.
- ML 39 SPIRIT LAMP**, stout copper and fitted with wick, 120 ml, (BTL) 1966 Catalogue 218/1360, (UNICEF) 0955100, each \$4.2, one only.
- A glass spirit lamp will serve but is more breakable.
- ML 40 STAND FOR TEST TUBES**, anodized aluminium, to hold twenty test tubes 6 mm in diam., (BTL) 402/0606, (UNICEF) , each \$1.80, one only. Hospitals only.
- This stand goes in the water bath and is for blood grouping tubes. It can be improvised.
- ML 41 STAND FOR TEST TUBES**, three tiered to take two rows of tubes, rigid polythene, twelve holes 20 mm diam, (XLO) XT 3833, (UNICEF) 0978000 will serve, each \$0.9, two.
- Exact specifications are not important.
- ML 42 STAND**, tripod, triangular, malleable iron, (BTL) 261/1300, (UNICEF) 0985100, each \$0.90, one only. Hospitals only.
- Used with ML 26 for measuring the blood sugar.
- ML 43 TEATS**, rubber, red, (BTL) 257/0040/02, (UNICEF) 0923700, ten \$0.5 ten.
- These must fit the glass tubing ML 51.
- ML 44 THERMOMETER**, short type, general laboratory pattern, range 0°C to 50°C, in 1°C, about 15 cm long, (BTL) 268/0266/01, (UNICEF) , each \$1.4, one only. Hospitals only.
- This is a short thermometer for the water bath and fits the thermometer sheath below.
- ML 45 THERMOMETER SHEATH**, heavy brass with cut away front, for 15 cm thermometer, (BTL) 268/0287, (UNICEF) , each \$2.0, one only.
- This sheath protects the thermometer ML 44 above and for the water bath, ML 53.
- ML 46 TUBE**, polypropylene, conical, plain un-graduated, nominal capacity 15 ml, (BTL) 306/0182, (UNICEF) , each \$0.26, twenty.
- These can be replaced by the more fragile glass ones if necessary. See also ML 47.
- ML 47 TUBE**, graduated, conical with rim, polypropylene, 10 ml, (XLO) XT 5018, (UNICEF) , each \$0.4, five.
- Glass centrifuge tubes can be used, but these plastic ones last longer. The centrifuges listed here will take a 15 ml *plain* tube, but will not accept a 15 ml *graduated* tube which is slightly larger. No centrifuge tube supplied should be larger than 16 mm diam.
- ML 48 TUBES TEST**, to the following specifications:
- (a) Pyrex glass, medium wall, with rim, 125 x 16 mm, (BTL) 267/0045/04, (UNICEF) 0980000 will serve, ten \$1.0, one hundred.
- Almost any standard test tube will serve.
- (b) Soda glass, rimless, 50 x 6 mm, (BTL) 267/0035/02, (UNICEF) , 100 \$1.2, one hundred.
- These small test tubes are for cross-matching blood.
- (c) Kahn tubes, size 75 x 12 mm. rimless, (BTL) 403/0470, (UNICEF) 0979300, 100 , \$1.3, one hundred.
- Any Kahn tube will serve.
- (d) Lovibond cells, square section, glass moulded, calibrated at 10 ml, (TIN) DB 424, (UNICEF) , pair \$2.2, six.
- These cells are *square* in section and are for the 'Lovibond 1000', ML 13, which has square holes for square tubes. They are of moulded glass and are a quarter the price of fused glass cells (TIN) , (UNICEF) 0931204, which also fit the 'Lovibond 1000'.
- (e) Some laboratories may still be using the obsolete but still serviceable type of comparator using round test tubes. If this is so medical stores should stock these tubes. They are—Test tubes for Lovibond comparator. 13.5 mm diam., round, calibrated at 10 ml, (TIN) AF 217, (UNICEF) 0931245, each \$0.35. For convenience in ordering, these have been given the code ML 48e. These much cheaper round test tubes can be used with the Lovibond 1000 with the use of a moulded adaptor block, (TIN) DB 431, (UNICEF) , \$0.8. This is such a cheap addition to the Lovibond comparator that it has been included as ML 13b.
- ML 49 TILE**, spotting plate, white, rigid, PVC, 115 x 90 x 10 mm, with twelve depressions,

(BTL) 269/0050, (UNICEF) , each \$0.8, one only.

Used mainly for blood grouping and certain urine tests (see Section 8.9).

ML 50 TUBING, red rubber, bore 8 mm, wall thickness 3 mm, suitable for Bunsen burners, (BTL) 275/0231, (UNICEF) 0988000 will serve, metre \$0.9, two metres.

This is for the filter pump and Bunsen burner.

ML 51 TUBING, soda glass, one metre lengths, ext. diam. 6-7 mm, wall thickness 0.8-0.9 mm, (BTL) 275/0060/04, (UNICEF) 0987300, kilo \$1.5, two kilos.

For making Pasteur pipettes.

ML 52 WATCH GLASS, polypropylene, 80 mm diam., (XLO) XT1101, (UNICEF) , each \$0.48, two.

These watch glasses must be plastic and are for weighing chemicals. They can be dispensed with and pieces of paper used instead.

ML 53 WATER BATH, electrical, polypropylene lined, thermostatic, 30 x 12 x 9 cm inside, with flat lid, (GRA) JB 1, (UNICEF) , specify voltage, each \$45, one only. Hospitals only.

For blood grouping and cross matching.

ML 54 WICKS, for spirit lamp, (BTL) 1966 catalogue 218/1420, (UNICEF) x7, ten \$0.9, ten.

Spare for the spirit lamp ML 39.

ML 55 WIRE, nickel chrome, 22 SWG. (BTL) 277/0030/02, (UNICEF) 0989000 will serve, 60 g reel \$1.5, one metre.

Used with ML 28 for making wire loops.

13.9 Ordinary equipment in the main list

In some developing countries much of this equipment will be locally available. Some, the pressure cooker or the jar ML 62 for example, will probably have to be ordered abroad. If outfits are being made up for areas where this equipment is not readily obtainable locally, it is strongly advised that all or most of it be packed with the special equipment specified above. Much of it is *absolutely essential*.

ML 56 BRUSH, paint, small watercolour, (UNICEF) , each \$0.14, two.

For marking bottles and tubes.

ML 57 BUCKETS, each \$1.40, six. Two of them should be galvanized (UNICEF) 2170200 and four polythene (UNICEF) 2170000.

For washing equipment and disinfecting, etc.

ML 58 CUP, polythene, domestic. (UNICEF) , each \$0.28, four.

These are in lieu of beakers. If beakers are preferred supply 250-ml squat form plastic beakers as (BTL) , (UNICEF)

ML 60 CYLINDER OF BOTTLED GAS, one in use and one spare, each \$4, two. Reducing valve

and keys to fit the cylinder. It may be found more convenient to issue small tins of bottled gas which screw straight on to a gas burner. These tins of gas are expendable which removes the need to return and refill empty cylinders. If cylinders of bottled gas are not being provided, the Bunsen burner (ML 10), and the tubing red rubber (ML 50a), will not be needed either. Gas is useful but not essential, and the combination of a spirit lamp (ML 39) and a paraffin pressure stove (ML 71) can be used instead. Tins of bottled gas are listed in Section 13.30 as Choice 17.

ML 61 HAMMER (UNICEF) 4059220 or 4057000, each \$1, one only.

Useful for various purposes in the laboratory and health centre.

ML 62 JAR, with screw cap and wide mouth, 125 ml, each \$0.07, six.

If these jars are not available locally, their specification for order abroad are: BOTTLES, wide mouth, clear glass with plastic screw cap fitted with waxed disc, capacity 125 ml, (BTL) 215/0350/05. The screw caps for these jars are (BTL) 215/0352/05 and are also necessary. The plastic equivalent can be supplied instead, as (UNICEF) 0921300. These serve several important purposes.

ML 63 OILSTONE, small, fine, preferably Washita, or hard Arkansas, (UNICEF) 0559000 or 0559500, each \$0.6, one only.

For sharpening needles.

ML 64 PAINT, enamel, oil based, 120 ml jar, each \$0.44, one jar of red, yellow and black, (UNICEF) 2679000 will serve, but is large.

For marking tubes, bottles, etc.

ML 65 PAN, enamel, 2,000 ml, preferably with two handles, (UNICEF) 2036500 will serve, each \$1, one only.

For making carbol fuchsin.

ML 66 PEN, spirit marking, as 'Magic marker', (UNICEF) 1802808 will serve, each \$0.28, three.

A general purpose laboratory marker.

ML 67 PLASTICINE modelling clay, 250 g, (UNICEF) , \$0.3, one packet.

This is useful for a number of purposes; it makes a useful drying rack for slides.

ML 68 PLIERS, with wire cutters, 18 cm, (UNICEF) 4073500, each \$1, one only.

For making wire loops, etc.

ML 69 PRESSURE COOKER, Prestige 'Hi-Dome' pattern, (PRE), each \$11, one only.

This cooker is highly preferred because it is extensively illustrated. (UNICEF) 2039500 will serve. Stock spare gaskets, etc. FIGURE 1-5.

For sterilizing.

ML 70 SCISSORS, stout quality, 15 cm, (UNICEF) 2270500, each \$0.5, one only.

For cutting paper strips, etc.

ML 71 STOVE, 'Primus' paraffin (kerosene), pressure, complete with 'prickers', spirit bottle, etc., (UNICEF) 0170000, each \$5.60, one only.

For use with pressure cooker, or in lieu of Bunsen burner for making Pasteur pipettes.

13.10 Chemicals, etc.

General purpose reagents are satisfactory, and analytical grades are not required. The quantity specified is suggested as an initial order for a district hospital or health centre. In some countries regulations limit the use of orthotolidine on account of its carcinogenic properties. It is used for testing stools for occult blood, and there is no suitable alternative method. Precautions as to its use are described in the text.

SOLIDS

ML 73 ACID SULPHOSALICYLIC (also known as acid, salicylsulphonic), (UNICEF) 1090000, 500 g. \$4.50.

For urine and CSF protein.

ML 74 ACID TRICHLORACETIC, (UNICEF) , 100 g. \$1.0.

For Fouchet's test for urine bilirubin.

ML 75 BARIUM CHLORIDE, (UNICEF) 1011965, 500 g \$0.90.

For Fouchet's test for urine bilirubin.

ML 76 BARIUM PEROXIDE, (UNICEF) 1012001, 500 g \$0.95.

For stool occult blood test.

ML 77 CUPRIC (COPPER) SULPHATE, granular crystals, (UNICEF) 1017500, 500 g \$1.20.

For Benedict's test for urine sugar. UNICEF's 'Benedict's reagent ingredients kit', (UNICEF) 1012500 replaces this item and ML 87 and ML 90.

ML 78 FERRIC CHLORIDE HYDRATED, (UNICEF) 1019000, 500 g, \$0.85.

For Fouchet's test for urine bilirubin and testing the urine for PAS.

ML 79 IODINE CRYSTALS, (UNICEF) 1037500, 100 g \$3.0.

For Gram's method, and for examining stools for protozoa.

ML 80 O-TOLIDINE (*not* o-toluidine), (UNICEF) , 100 g \$3.85.

For stool occult blood test.

ML 81 PHENOL, detached crystals, (UNICEF) 1060000, 500 g \$1.10.

For Pandy's test for CSF protein.

ML 82 p-DIMETHYL-AMINO-BENZALDEHYDE (also known as 4-dimethylamino-benzaldehyde), (UNICEF) , 25 g \$1.85.

For Ehrlich's test for urine urobilinogen and test for urine sulphones.

ML 83 DIAMINO-ETHANE-TETRA-ACETIC ACID DIPOTASSIUM SALT (also known as

sequestric acid dipotassium salt, ethylene-diamine tetra acetic acid dipotassium salt, potassium EDTA or sequestrine), (UNICEF) , 100 g \$1.4.

Anticoagulant for blood samples.

ML 84 POTASSIUM FLUORIDE, (UNICEF) , 250 g \$1.2.

For blood sugar method.

ML 85a POTASSIUM IODIDE, (UNICEF) 1067500, 250 g \$2.10.

For Gram's stain, and iodine solution for stools for protozoa.

ML 85b POTASSIUM DIHYDROGEN PHOSPHATE (also known as potassium phosphate monobasic, anhydrous, KH_2PO_4), (UNICEF) 1068500, 500 g \$1.0.

For uses, see ML 85c.

ML 85c DI-POTASSIUM HYDROGEN PHOSPHATE (also known as potassium phosphate dibasic), anhydrous K_2HPO_4 , (UNICEF) , 500 g \$1.0.

Both these kinds of potassium phosphate (ML 85b and ML 85c) are used for making buffers for Leishman's stain, for the solubility test for haemoglobins A and S, and for gastric washings for AAFB.

ML 85d SAPONIN WHITE, (UNICEF) , 25 g \$0.7.

For solubility test for haemoglobins A and S.

ML 86 SODIUM ACETATE, (UNICEF) , 500 g \$0.92.

For urine urobilinogen.

ML 87 SODIUM CARBONATE ANHYDROUS, (UNICEF) 1074000, 1 kg \$1.09.

For Benedict's test for urine sugar, for haemoglobin diluting fluid, and for a modified Rothera's test.

ML 88 SODIUM CHLORIDE, (UNICEF) 1075005, 500 g, \$0.85.

For making saline for blood grouping, microscopy of stool, for formol saline, etc.

ML 90 TRI-SODIUM CITRATE, (UNICEF) 1076000, 1000g, \$2.90.

For Westergren ESR and Benedict's reagent for urine sugar.

ML 91 SODIUM HYDROXIDE PELLETS, (UNICEF) 1078000, 500 g \$0.85.

For skin scrapings for fungi, Nessler's solution for blood urea.

ML 93b SODIUM DITHIONITE (also known as sodium hydrosulphite), (UNICEF) , 500 g \$0.8.

For blood sickling test and solubility test for haemoglobins A and S.

LIQUIDS

ML 94a ACETIC ACID GLACIAL, (UNICEF) , 1 litre \$1.2.

For stool occult blood test, white cell diluting fluid, urine protein.

ML 94b ACETONE cheapest, (UNICEF) ,
2½ litres \$2.0.

For drying blood pipettes; can be dispensed with.

ML 94c HYDROCHLORIC ACID CONCENTRATED, (UNICEF) , 2½ litres \$1.2.

For acid alcohol for the hot method staining for AAFB.

ML 95 SULPHURIC ACID CONCENTRATED, (UNICEF) , 2½ litres \$1.2.

For the cold method of staining for AAFB (Section 3.35) and for making dichromate cleaning fluid. Can be dispensed with.

ML 96 OIL FOR IMMERSION LENSES, tropical grade (HAW) 994950, (UNICEF) 1037000, 250 ml \$3.0.

For microscopy—absolutely essential.

ML 97 FORMALDEHYDE SOLUTION 40%, (UNICEF) 1021000, 2½ litres \$1.9.

For making formol saline.

ML 98 'TEEPOL' (Shell Chemicals) or other liquid detergent, (UNICEF) , 100 ml \$0.1.

For cold method for staining for AAFB. Can be dispensed with.

ML 99 METHANOL (methyl alcohol) special quality for preparing Leishman's stain, (BDH) , (UNICEF) , 1 litre \$2.24.

For Leishman's stain for thin blood films. *Some of the cheaper grades of methanol may not be satisfactory.*

ML 100 SPIRIT RECTIFIED, (UNICEF) , 2½ litres \$0.7.

Cleaning the skin, cleaning slides, making carbol fuchsin for staining for AAFB, etc.

ML 101 XYLENE PURIFIED GPR, (UNICEF) , 1 litre \$0.97.

For cleaning microscope objectives—absolutely essential. Also called xylol.

STAINS

ML 102 BASIC FUCHSIN (UNICEF) 1023000, 200 g \$3.12.

For staining for AAFB, hot and cold methods, also counterstain for Gram's method.

ML 103 BRILLIANT CRESYL BLUE, (UNICEF) , 5 g \$0.13.

For staining blood cells for reticulocytes.

ML 104 CRYSTAL VIOLET, (UNICEF) 1016500, 25 g \$0.70.

For Gram's method. Some varieties of medicinal crystal violet may not be satisfactory.

ML 105 FIELDS STAIN A. (BDH), (UNICEF) , 25 g \$1.28.

ML 106 FIELDS STAIN B, (BDH), (UNICEF) , 25 g \$1.28.

For Field's thick film method for blood parasites, especially malaria.

ML 107 MALACHITE GREEN, (UNICEF) , 25 g \$0.7.

As a counterstain when staining for AAFB by the hot method. Can be dispensed with if methylene blue (ML 108) is available.

ML 108 METHYLENE BLUE, (UNICEF) 1054000, 25 g \$0.7.

For the cold method for staining for AAFB.

ML 109 UNIVERSAL INDICATOR TEST PAPER, pH 1 to 11, (UNICEF) 0932300, box of papers \$1.29.

For testing the pH of the stool in lactose intolerance, for testing the gastric juice for the presence of free acid.

ML 110 LITMUS PAPERS, (UNICEF) 0955204 red and 095206 blue, one package of each colour \$0.88.

For testing the pH of urine.

ML 111 'ACETEST' TABLETS, (AME), (UNICEF) , bottle of 100 tablets \$1.4.

For testing the urine of diabetics for acetone bodies. If these are not supplied, sodium nitroprusside and ammonium sulphate will have to be supplied in lieu, as described in Choice 14 (Section 13.27).

BIOLOGICALS

ML 112 ANTI-A SERUM FREEZE DRIED, (POV), (STA), (UNICEF) , 6 vials \$2.

ML 113 ANTI-B SERUM FREEZE DRIED, (POV), (STA), (UNICEF) , 6 vials \$2.

ML 114a 30% BOVINE ALBUMEN FREEZE DRIED, (POV), (STA), (UNICEF) , vial \$1.4.

These three items, ML 112, 113, 114a, are all used for blood grouping and will be needed by hospitals only.

ML 114b GLYCEROL UREASE SOLUTION, (HAR), (UNICEF) , 120-ml bottle \$3.60.

This is for the blood urea method and will only be needed if the Lovibond discs (ML 21 d and e) and Nessler's solution (Choice 12, Section 13.25) are also supplied. Hospitals only.

13.11 Prepared reagents

Nessler's solution, glycerol urease, Folin and Wu's alkaline copper solution, phosphomolybdic acid solution, 10% sodium tungstate, and two-thirds normal sulphuric acid should be prepared by central or regional laboratories, or by the medical stores, and issued to district hospitals. They are not required by health centres. Full

directions for the preparation of these reagents are given in Section 13.25.

CHOICES

13.12 Choices

The following is a list of choices or options which some services may decide to use. All these optional methods are described in the text. Section 13.32 contains a table to list the choices that it has been decided to use.

13.13 Choice 1. The MRC Grey wedge photometer

If this is to replace the Lovibond equipment in the main list (additional cost \$73), *delete* the following items:

- ML 13 COMPARATOR, Lovibond . . .
- ML 48 (d) Lovibond cells, square section . . .
- ML 21 DISCS LOVIBOND, all discs . . .
- ML 36 PROTEINOMETER STANDARDS SET . . .

Add the following items:

- ML 115 (a) PHOTOMETER, Medical Research Council, Grey wedge, in case complete, (KEE) H11302, (UNICEF) , each \$145, one only.
Medical stores should hold the following spares for this instrument. The types of bulb stocked should be related to the voltage of the electrical systems of the hospitals being supplied. **This instrument can be used without electricity.**
- (b) LAMP, 230 volts, (KEE) A2013, (UNICEF) .
- (c) LAMP, 110 volts, (KEE) A2023, (UNICEF) .
- (d) LAMP, 12 volts, (KEE) A2033, (UNICEF) .
- (e) CELL, glass for MRC Grey wedge photometer, (KEE) H11403, (UNICEF) , each \$3.50, three.

13.15 Choice 2. The EEL colorimeter

If this is to replace the Lovibond equipment in the main list (additional cost \$150), *delete* the following items:

- ML 13 COMPARATOR, Lovibond . . .
- ML 48 (d) Lovibond cells, square section . . .
- ML 21 DISCS LOVIBOND, all discs . . .

Add the following items:

- ML 117 (a) COLORIMETER, 'EEL', for 190-260 volt mains or battery operation, with instruction booklet, dust cover and two spare lamps, (EEL) 2 01, each \$168, one only. The UNICEF equivalent of this is (UNICEF) 0931000, costing \$222 but including a set of eight filters among which

are all those listed below as well as a set of 12 8 ml tubes and a spare photocell.

The following instrument is also available for operation on 110 v. mains and may have to be stocked in some areas.

- (b) COLORIMETER, 'EEL', with suitable transformer for operation on non-standard voltage ratings, with instruction booklet, etc., (EEL) 2 04, (UNICEF)

The following essential accessories and commonly required spares should be issued with every instrument of whatever type.

- (c) TEST TUBES, matched, 10 mm diam., 8 ml, (EEL) 02 99 011, (UNICEF) , \$2.4 ten,
FILTERS, Ilford for EEL colorimeter as follows, .
- (d) Ilford 625, (EEL) 989 01 023, (UNICEF) , each \$4.0, one only.
- (e) Ilford 608, (EEL) 989 01 017, (UNICEF) , each \$4.0, one only.
- (f) Ilford 622, (EEL) 989 01 020, (UNICEF) , each \$4.0, one only.
- (g) LAMP, spare for EEL colorimeter, (EEL) 001 44 005, (UNICEF) , each \$0.28, ten.
- (h) PHOTOCELL, (EEL) 001 54 001, (UNICEF) , each \$4.0, one only.
Spare meters should also be available with the local service agents or with the central laboratory or in the medical stores or, in certain instances, in the user's own laboratory. The quantity to be stocked will depend on the number of EEL colorimeters in use. The number suggested here are for the medical stores of a service where some dozens of EEL colorimeters are in use.
- (i) METER, replacement for EEL colorimeter, (EEL) 002 99 020, (UNICEF) , each \$32, two.

Some laboratories will find a trickle charger useful. It is suggested that this be ordered as required. When a battery model is issued a battery will be needed.

- (j) TRICKLE CHARGER, for EEL colorimeter, (EEL) 001 40 004, (UNICEF)
- (k) BATTERY, 2 volt for EEL colorimeter, (EEL) 001 40 001, (UNICEF)
The following standard is essential and must be supplied with every instrument. It is fragile and medical stores should keep some spares.
- (l) NEUTRAL GREY STANDARD sealed into an EEL tube for use with the EEL colorimeter, (EEL) 002 14 001, (UNICEF) , each \$4, one only.

This list does not limit the equipment made for this machine, but the additional sizes of test tube (medium and small) are not required for the methods described here nor are the wide range of Ilford filters that can be purchased for it.

13.16 Choice 3. Silica gel

In very humid climates it may be necessary to protect microscopes routinely from damp which allows moulds to grow on their lenses. The best way to do this at the health centre level appears to be to put the microscope into a stout polythene bag which can be closed with an airtight clip, and to stand it on a shallow metal dish filled with self-indicating silica gel, which can be regenerated by heating over a stove as required. See Section 6.18.

ML 118a SILICA GEL, self indicating, about 6 to 20 mesh, (HAW) 7554-5, (UNICEF) 1071800, 500 g \$1.1.

ML 118b THICK POLYTHENE BAG FOR MICROSCOPE, with closure, (OLY), (UNICEF) , each ?, two.

ML 118c SHALLOW METAL DISH to hold silica gel and support microscope, (OLY), (UNICEF) , each ?, one only.

It may be possible to improvise these locally, but they would be much better supplied.

13.17 Choice 4. Electric centrifuges

The basic list of equipment contains a hand centrifuge (ML 12) which is for units without electricity. If only a car battery is available, the Model X (10 volts) can be used. Where there is mains electricity an inexpensive plastic general purpose centrifuge, the 'MSE Minette' (\$80) can be used, or a more expensive general purpose one, the 'MSE Minor' (\$280). The latter has the advantage that it can be used with a special carrier head assembly, etc. (about \$70 in all), to measure the microhaematocrit. A very inexpensive instrument has recently become available which will do the microhaematocrit *only*. This is the Bickerton-Eaves machine which retails at about \$60. As will be seen from Section 7.2 the routine measuring of the haematocrit is often preferable to measuring the haemoglobin, and in units, such as antenatal clinics, where there are many of these investigations to be done, this instrument is likely to be invaluable. There is a 12 volt version that can be used with a car battery.

The (UNICEF) centrifuge 0925398 (110 volts, 50 cycles) will serve instead of the 'MSE Minor' centrifuge (ML 122a), but it does not have provision for microhaematocrit tubes.

Delete:

ML 12 CENTRIFUGE, hand ...

Add one of the following three centrifuges:

ML 120 CENTRIFUGE, electric, 'MSE MINETTE', complete with four place head and accessories

and 'on-off' toggle switch, *either* (MSE) 7604A (200-250 volts) *or* (MSE) 7604D (100-110 volts), (MSE), (UNICEF) , each \$50, one only.

ML 121 CENTRIFUGE, Electric, 'MODEL X', with four place head, buckets to take 4 x 15 ml tubes, etc., wired with separate windings for 12 volts DC and 220 volts AC, equipped with starting switch and rheostat, input 75 watts, (MOS), (UNICEF) , each \$95. one only.

ML 122 (a) CENTRIFUGE, electric, 'MSE Minor', basic outfit with four place 15 ml swing-out head, including metal buckets, rubber cushions and trunions, (MSE) ABIOOA, (UNICEF) , for 220 volts, or (MSE) ABIOOB, (UNICEF) , for 110 volts, each \$280, one only.

If the microhaematocrit is to be done with this centrifuge the following additional equipment will be required. The newer type of carrier head assembly, which became available as this book went to press, and which is listed below, does not require the plastic 'carrier segments' that were required by the older model which is shown in FIGURE 7-2. Medical stores should stock large numbers of heparinized microhaematocrit tubes, for these are expendable, a new tube being used for each test. Some extra trays of sealing compound should also be stocked, as these are also expendable in time.

(b) CARRIER HEAD ASSEMBLY for use with MSE Minor centrifuge, (MSE) 43119-104, (UNICEF) , each \$48, one only.

(c) MICROHAEMATOCRIT READER, (MSE) 41159-110, (UNICEF) , each \$14, one only.

(d) PVC SEALING STRIP for use with carrier head assembly for MSE Minor centrifuge, (MSE) 33811-112, (UNICEF) , each \$0.24 one only.

(e) MICROHAEMATOCRIT TUBE SEALING COMPOUND, (MSE) 42253, (UNICEF) , set of ten trays \$4, one set.

(f) HEPARINIZED MICROHAEMATOCRIT TUBES, (MSE) 59513, (UNICEF) 0926485, gross \$3, five gross.

If a separate instrument is required which will do the microhaematocrit alone for minimal capital cost, use the following:

ML 123 (a) MICROHAEMATOCRIT CENTRIFUGE, Bickerton-Eaves, (BIC), (UNICEF) , including two reader chart cards, gasket, sealing compound, 50 heparinized glass capillary tubes and a number identified stand, state voltage, 220/240 model \$60, 110/120-volt model \$65, 12-volt model \$65.

At least 500 additional capillary tubes will be needed when each instrument is supplied initially, and a large number should be stocked by medical stores.

ML 123 (b) MICROHAEMATOCRIT CAPILLARY TUBES, low cost, (BIC), (UNICEF) 0926485 will serve, gross \$1.0.

13.18 Choice 5. A Fuchs-Rosenthal counting chamber

If funds are available it is desirable to supply hospitals with a double Fuchs-Rosenthal chamber 0.2 mm deep (with double cover glasses to match) for examining the CSF. Instructions are, however, also given for using a Neubauer chamber 0.1 mm deep for the CSF.

ML 124 COUNTING CHAMBER, double cell Fuchs-Rosenthal ruling, (BTL) 403/0040/04, (UNICEF) , each \$9.4, one only.
For cover glasses for this chamber, see ML 16.

13.19 Choice 6. INH in the urine

If it is considered desirable to test the urine of tuberculous patients for INH, chloramine T and potassium cyanide will be wanted. *The chloramine T must be the brand made by Eastman Kodak (EAS).* The dangers of potassium cyanide are carefully described in the text.

ML 125 POTASSIUM CYANIDE CRYSTALS, (UNICEF) , 250 g, \$1.1.

ML 126 CHLORAMINE T must be (EAS), (UNICEF) , 100 g, \$0.5.

13.20 Choice 7. The cyanmethaemoglobin method

This is the most accurate method of measuring the haemoglobin using the EEL colorimeter. It has the considerable disadvantage in that the standards have to be kept in a refrigerator where they have a shelf life of about 6 months, and that a new ampoule has to be opened each day. It is because of these difficulties that less accurate but more convenient standards have been included as ML 117 (l) or (m) in Section 13.15.

If the cyanmethaemoglobin method is to be employed the following will be needed:

ML 127 (a) CYANMETHAEMOGLOBIN STANDARD, for photometric determinations of haemoglobin, (BDH) 23019, (UNICEF) , box of 25 x 10-ml ampoules, each box \$5, five boxes \$

These standards are probably best ordered direct by air when required and not stocked in a central store.

(b) DRABKIN'S REAGENT, conventional, stable dry reagent, (BDH) 22040, (UNICEF) , box of 24 tablets, each box \$5, two boxes \$

If these tablets are not supplied, potassium cyanide (see Choice 6 above) and potassium ferricyanide, (UNICEF) 1066975, 100 g should be supplied instead.

13.21 Choice 8. Sodium azide for preserving sera

If specimens of serum for serology have to travel a long way to a central laboratory for examination, it is useful to preserve them with sodium azide.

ML 128 SODIUM AZIDE, (UNICEF) 100 g \$1.18.

13.22 Choice 9. Ammonia for the oxyhaemoglobin method

Although it is standard practice to dilute a sample of blood in very dilute ammonia for the oxyhaemoglobin method, a dilute sodium carbonate solution is described here. Although it does not preserve the haemoglobin for as long as does ammonia, its use is advised here in health centres and district hospitals because ammonia is an unpleasant and hazardous substance to transport. If ammonia is to be used the following solution should be ordered. Very little will be needed.

ML 129 AMMONIA SOLUTION, 22%, SG 0.92, (HOP) 1402, (UNICEF) 1006000, 2½ litres \$1.1, 100 ml.

13.24 Choice 11. Dichromate cleaning fluid

There is no provision for making up dichromate cleaning fluid in the basic list of chemicals. If it is decided to use it the following reagent will be needed:

ML 131 POTASSIUM DICHROMATE, commercial, (UNICEF) 1066960, 500 g \$0.5.

13.25 Choice 12. Some additional equipment and chemicals will be required if certain reagents are not going to be prepared and issued by a central laboratory

It is strongly advised that the following six reagents be made and issued by a central or regional laboratory. These are: Nessler's solution, glycerol urea, Folin and Wu's alkaline copper, phosphomolybdic acid, 10% sodium tungstate and two-thirds normal sulphuric acid. The first two are for measuring the blood urea, and the last four are for measuring the blood sugar. Neither the blood sugar nor the blood urea are suggested on the list of techniques for health centres, so the following equipment will only be needed by hospitals which will not be supplied with the above six reagents.

ML 134 GLYCEROL, (UNICEF) 1024500, 500 ml \$1.12.

- ML 135 UREASE TABLETS for the determination of urea, (BDH), (UNICEF) , box of 6 tablets \$1.26, one box only.
- ML 136 MERCURIC IODIDE, (UNICEF) 1047505, 200 g \$4.0.
- ML 137 ACID, TARTARIC, (UNICEF) 1093600, 500 g \$1.12.
- ML 138 ACID, MOLYBDIC ANALAR, (UNICEF) , 200 g \$3.0.
- ML 139 ACID, ORTHOPHOSPHORIC 89% (SG 1.75), (UNICEF) , 1 litre \$2.1.
- ML 140 SODIUM TUNGSTATE ANHYDROUS, (UNICEF) , 100 g \$1.3.
- ML 141 ACID, SULPHURIC ANALAR, (UNICEF) , 500 ml \$0.78.
- ML 142 (a) FLASK, stoppered, one mark, Class B, 500 ml, (BTL) 241/1555/08, (UNICEF) 0939925, each \$1.2, two.
(b) FLASK, stoppered, one mark, Class B, 1000 ml, (BTL) 241/1555/09, (UNICEF) 0939930, each \$1.5, two.
- ML 143 BEAKER, low form, Pyrex glass with spout, 1000 ml, (BTL) 209/0310/10, (UNICEF) 0917000 will serve, each \$0.8, two.

Methods for making these reagents have not been included in the body of the text, so they are described below. Glycerol-urease can be purchased ready made (HAR) and is listed as ML 114b.

METHOD

MAKING GLYCEROL-UREASE SOLUTION

Take 5 g of jack beans or else the same quantity of jack bean meal or urease tablets. Powder the beans very finely in a pestle and mortar. Mix the meal or the powdered beans well with 100 ml of 70% glycerol in *distilled water*, stand overnight, centrifuge the suspension and store the supernatant in a refrigerator—it remains active for many months.

METHOD

MAKING NESSLER'S SOLUTION

(a) *Double iodide solution.* Dissolve 75 g of potassium iodide in 50 ml distilled water. Add 100 g of mercuric iodide, HgI_2 and wait till solution is complete. Then dilute to 500 ml with *distilled water* and filter. Dilute the filtrate to 1,000 ml.

(b) *10% sodium hydroxide.* Prepare a saturated solution of sodium hydroxide (about 55%) by adding an excess of NaOH to about 200 ml water and stopper securely. After two or three days decant the clear supernatant fluid, and dilute with distilled water to 10%. (Add 45 ml of water to each of 10 ml of supernatant fluid). Check the concentration by further diluting 10 ml to 25 ml, with distilled water, and titrating 10 ml of supposed 4% NaOH with N/1 acid. If the concentration

differs from the theoretical by more than + 5% (i.e. if in the titration 10 ml of sodium hydroxide requires more than 10.5 ml or less than 9.5 ml of N/1 acid) it must be adjusted.

(c) *To prepare Nessler's reagent from the above solutions.* Mix 350 ml of the 10% sodium hydroxide, 75 ml of the double iodide and 75 ml of distilled water. *Store the mixture in a dark bottle.* A precipitate may form in time—this is of no importance, but take care not to disturb it and use only the clear supernatant.

METHOD

PHOSPHOMOLYBDIC ACID SOLUTION

Dissolve 35 g of molybdic acid and 5 g of sodium tungstate in 200 ml of 10% NaOH plus 200 ml of water in a litre beaker. Boil vigorously for 20–40 minutes so as to remove as completely as possible the ammonia present in the molybdic acid—test this by smelling the steam from the beaker. Cool, and transfer to a 500-ml volumetric flask, washing it with sufficient water to make the volume 350 ml. Add 125 ml of 89% w/w phosphoric acid (S.G. 1.75) and make up to 500 ml.

METHOD

ALKALINE COPPER (FOLIN AND WU)

Dissolve 40 g of anhydrous sodium carbonate in about 400 ml of distilled water and transfer the solution to a 1,000-ml volumetric flask. Add 7.5 g of tartaric acid and wait until this has dissolved. Then transfer quantitatively to this flask 4.5 g of crystalline copper sulphate which has been dissolved in 100 ml of water. Mix and make up to 1,000 ml. A sediment forms in time, in which case decant the clear supernatant solution.

13.26 Choice 13. 'Dextrostix'

District hospital laboratories are likely to want to measure the blood sugar rather infrequently, but, when they do, it may be very important. Under these circumstances it is debatable whether Folin and Wu's method, which is longer and more complicated, but the reagents for which do not deteriorate on storage, is preferable to 'Dextrostix', which is much simpler, but which has a limited shelf life and may deteriorate rapidly if the lid is left off the bottle in a warm climate. It may perhaps be useful to have both methods available.

ML 144 'DEXTROSTIX TEST PAPERS', (AME), (UNICEF) , one bottle \$3.0.

13.27 Choice 14. Rothera's test

'Acetest' tablets (AME) have been included in the basic list. They are slightly more expensive than the classical Rothera test, but they are used so rarely for this additional expense to be minimal. If the standard Rothera test

is to be used, sodium nitroprusside and ammonium sulphate will be needed.

- ML 145 SODIUM NITROPRUSSIDE, (UNICEF) 1083000, 100 g \$1.68, 100 g.
- ML 146 AMMONIUM SULPHATE, (UNICEF) 1010000, 500 g \$0.28, 500 g.

13.28 Choice 15. 'Ictotest' tablets (AME)

These have not been included in the basic list because they are slightly more expensive than the reagents for Fouchet's test. If it is decided to use them the basic list must be altered as follows (ferric chloride is also required for the 'PAS' test):

Delete these:

- ML 74 ACID, TRICHLORACETIC, ...
- ML 75 BARIUM CHLORIDE, ...

Add this:

- ML 147 'ICTOTEST' TABLETS, (AME), (UNICEF) , one bottle \$2.0.

13.29 Choice 16. The 'Cellophane' thick smear

This method is described in Section 10.8b. *It is a very useful method, and the following materials should be supplied wherever possible.* As this goes to press negotiations are in progress with another supplier (BTL) to market cellulose film in rolls 22 mm wide in a form more convenient for both use and distribution than that shown below. Inquiries should thus be placed with this supplier before approaching the manufacturer (RAY).

- ML 148 (a) CELLULOSE FILM, wettable, 40-50 µm thick.

This is supplied by (RAY) as 'Rayophane regenerated transparent cellulose film', 55 µm reels on 76 mm core 152 mm wide. Any *wettable* cellulose film of the above thickness will serve. (UNICEF) , cost of 20 metres for distribution ? \$0.2.

- (b) GLYCEROL, (UNICEF) 1024500, 500 ml \$1.4, 500 ml.

13.30 Choice 17. 'Labogaz' (GAZ)

This is a Bunsen burner operating on butane in disposable canisters. A regular supply of canisters is required.

- ML 149 'LABOGAZ 200' BURNER, (GAZ), (UNICEF) , each \$2.0, one.
- ML 150 DISPOSABLE CANISTERS CONTAINING 200 g OF GAS, (GAZ), (UNICEF) , each \$0.3, ten.

13.31 Choice 18. This manual

Not the least important part of a laboratory are its manuals, and they are often lacking. It is suggested therefore

that this one be put on the medical stores list so that it is readily available. This may not be the usual place to put books but it may well be the best one.

- ML 151 'A MEDICAL LABORATORY FOR DEVELOPING COUNTRIES', by Maurice King, Oxford University Press, (UNICEF).

13.32 A table of choices

Senior pathologists may wish to record which choices they recommend for use in the service for which they are responsible. It is suggested that, if this manual is adopted for use in a medical service, the copies issued be marked in the table below, so that those using it shall know which choices it has been decided to use.

Choice	District Hospitals	Health Centres
Choice 1: The MRC Grey wedge photometer
Choice 2: The EEL colorimeter
Choice 3: Silica gel desiccant
Choice 4: An electric centrifuge (three alternatives listed)
Choice 5: A deep counting chamber
Choice 6: Urine INH
Choice 7: The cyanmethaemoglobin method
Choice 8: Sodium azide for preserving sera
Choice 9: Ammonia for the oxyhaemoglobin method
Choice 10: Buffer tablets for Leishman's stain
Choice 11: Dichromate cleaning fluid
Choice 12: Chemicals and equipment substituting for prepared reagents
Choice 13: 'Dextrostix'
Choice 14: Rothera's test
Choice 15: 'Ictotest' tablets
Choice 16: The 'Cellophane' thick smear
Choice 17: 'Labogaz'
Choice 18: This manual

13.33 References

Archer, H. E., and Robb, G. D. (1925) The determination of urea, *Quart. J. Med.*, **18**, 274.
 Bruce-Chwatt, L. J. (1970) De malariae morbo, *Lancet*, **ii**, 1943.
 Cook, G. C. (1967) Malabsorption, *Brit. med. J.*, **1**, 615.
 Dodu, S. A. (1967) Diabetes in the tropics, *Brit. med. J.*, **1**, 747.
 Eidus, L., and Hamilton, E. J. (1964) A new method for the determination of N-acetyl isoniazide in the urine of ambulatory patients, *Amer. Rev. resp. Dis.*, **89**, 587.

- Folin, O., and Wu, H. (1920) The determination of blood sugar, *J. biol. Chem.*, **41**, 367.
- Huntsman, R. G., Barclay, G. P. T., Canning, D. M., and Cawson, G. I. (1970) A rapid whole blood solubility test to differentiate the sickle cell trait from sickle cell anaemia, *J. clin. Path.*, **23**, 781.
- King, E. J. (1948) The determination of haemoglobin, *Lancet*, **ii**, 563.
- King, E. J. (1948) The determination of haemoglobin, *Lancet*, **ii**, 971.
- Lapeyssonnie, L., and Causse, C. (1960) Note sur une méthode de coloration rapide . . ., *Rev. Tuberc. (Paris)*, **24**, 1044.
- Ritchie, L. S. (1948) An ether sedimentation technique for routine stool examination, *Bull. U.S. Army med. Dep.*, **8**, 326.
- Sundeman, F. W., *et al.* (1935) Symposium on clinical haemoglobinometry, *Amer. J. clin. Path.*, **23**, 519.
- Wld Hlth Org. techn. Rep. Ser.* (1967) Control of ascariasis, **379**, 41.
- Wld Hlth Org. techn. Rep. Ser.* (1969) Amoebiasis, **421**, 34.

Epilogue

The opportunity of a spare page on which to insert an epilogue gives me the chance of leaving some final messages with the reader after proofs have been corrected, and before the book finally goes to press.

First, I hope that the careful specification of suppliers will not limit the use of this text. If you can find cheaper, better, or more easily obtainable equipment of the same specifications as those listed here, buy it. The catalogue numbers of individual firms have only been included in the hope of specifying equipment more exactly, and better sources of supply may be found than those suggested here.

New equipment is under development, and before bulk purchases are made, ask the Tintometer company (TIN) for details of their new haemoglobinometer which

promises to be better suited to health centre use than the 'Lovibond 1000' listed here.

The recent price reduction for plastic disposable blood transfusion equipment has made the rubber re-usable equipment suggested here much less competitive and it should probably now be considered obsolete.

Finally, before saying once more how much I look forward to improving a further edition—should this one sell out—I should like to thank the staff of Oxford University Press, particularly Mr. A. E. Gray, both for the care he has taken with this book, and for the kindness and forbearance with which he has borne the author's impatience.

July 1973

MAURICE KING

Vocabulary Index

A

AAFB. Acid and alcohol fast bacilli, 3.12, 9.18, 11.1

abnormal. If something is only found in sick people, we say it is abnormal, 1.3

ABO blood groups. The most important different kinds of blood, 12.1

ABO incompatibility. Blood which is not compatible for a patient because it is the wrong ABO group, 12.1

absorbed. Soaked up, held up, 5.12

accurate. Exact, 1.3

ACD solution. An anticoagulant solution used in blood transfusion, 12.9

acetic acid (ML 94a). A colourless liquid with a strong smell used to test stools for occult blood, 10.11, for testing the urine for protein, 8.3, and for making white cell diluting fluid, 3.45

'Acetest' tablets (ML 111). Used for testing the blood and urine for acetone, 2.4, 7.43, 8.7

acetone. A substance found in the blood and the urine of patients with severe diabetes, 7.43, 8.5, 8.7, 13.10

acid. See 1.6

acid alcohol. A reagent used in the Ziehl-Neelsen method, 3.16, 11.1

acute. An acute disease is a short-lasting severe disease, 1.3

adaptor. The part of a needle that fits on to a syringe, 9.5, 12.9

addresses of equipment suppliers. 13.7

adjust. To fix or alter something so that it works better, 1.3

adult. A fully grown organism, 1.3

'Afrigas'. A kind of bottled gas 3.4

agglutination. The sticking together of particles, such as red cells, by antibodies, 12.1

albumen. A plasma protein which is used in the albumen cross-match, 12.6

'Alcopar'. A drug used in treating hookworm infection. The same as 'Bephenium', 7.6

alkali. See 1.6

aluminium. A soft light metal

ammonia (ML 129). A dangerous liquid with a very strong smell, 1.10, 3.31, 7.1, 7.41

amoeba. A protozoon which moves with the help of 'feet' or pseudopodia, 1.9, 1.14, 10.7

amoebic dysentery. Dysentery due to *Entamoeba histolytica*, 10.7

amorphous. Without shape, 8.13

ampoule. A small bottle for drugs

anaemia. An anaemic patient has too little haemoglobin in his blood, 5.9, 7.5, 7.28

***Ancylostoma duodenale*.** One of the hookworms, 10.5

ancylostomiasis. A disease due to infection of the gut with the hookworm, 1.12, 7.6, 10.5

anhydrous. Dry, without water, 2.4

anisocytosis. Unequally sized red cells, 7.19

anti-A and anti-B serum (ML 112, ML 113). These are antisera used in blood grouping, 2.4, 12.3, 13.10

antibodies. Special proteins in the blood which can combine with a group of substances called antigens, 12.1

anticoagulant. A chemical, such as sequestrene, which stops blood clotting, 1.17

antigens. Substances which, when they get into the body, cause the body to make antibodies against them, 12.1

antiseptic. A chemical solution, such as iodine, for killing micro-organisms on the surface of the body, 1.19, 9.5

antisera. Sera containing antibodies, 12.3

anuria. A patient who makes no urine suffers from anuria, 12.2

anus. The hole through which stools leave the body, 10.4

aplastic. When the marrow stops making blood cells it is said to be aplastic, 7.27a

arachnoid mater. The net-like middle covering of the brain, 9.1

area. Part of something flat, such as part of a country or a town or a field, or the skin, or a blood film, etc.

arteries. Thick-walled blood vessels taking blood from the heart to the tissues, 4.7

asbestos. A special kind of wool which cannot be burnt. It is mined from the earth, 2.2, 11.1

***Ascaris lumbricoides*.** A long, thin, round, white worm which lives in the gut, 10.1, 10.5

-ase. Most enzymes end in -ase (lactase, urease)

aseptic. Without infection, 1.22

aseptic precautions. To do something using aseptic precautions is to do it while taking care that no micro-organisms get where they are not wanted, 1.22

aspirator jar. A big jar with a tap at the bottom, 3.3

atypical. Unusual, extraordinary, 1.3

autoclave. A machine for killing micro-organisms and making things sterile using steam at a high temperature and pressure, 1.20
azoospermia. No spermatozoa in the seminal fluid, 11.10

B

bacillary dysentery. Dysentery due to bacilli of the genus *Shigella*, 10.8
bacillus, bacilli. A rod-shaped bacterium, 1.14
Bacillus anthracis. A big Gram-positive bacillus which causes a disease called anthrax, 11.7
bacterial meningitis. Meningitis caused by bacteria, 9.16
bacteriology. The study of bacteria, 4.10
bacterium, bacteria. A small one-celled micro-organism in which there is no separate nucleus, 1.14
balance. A machine for weighing (ML 1), 5.1
barium chloride (ML 75). A white powder which is dissolved to make a 10% solution, used in Fouchet's test, 2.4, 3.17, 8.8, 13.10
barium peroxide (ML 76). A white powder used for the occult blood test, 2.4, 3.35, 10.10
barrel. The outer part of a syringe, FIGURE 4-3
basic fuchsin (ML 102). Deep purple crystals used to make carbol fuchsin stain, 3.23, 11.1, 13.10
basophil. Staining with basic stains. A basophil polymorph is an uncommon kind of polymorph with large blue granules in its cytoplasm, 7.14, Picture D, FIGURE 7-9
battery. A 'box' for storing electricity, 3.7
beaker. A laboratory cup, 3.11
beam. The main part of a balance which swings, 5.1
bench. A laboratory table, 3.1, 3.46
Benedict's reagent or solution. A reagent used for testing the urine for sugar, 3.18, 8.3
bephenium. A drug used for treating hookworm infection, 7.6
bevel. The sloping edge or end of something, 12.10
bijou bottle (ML 14a). A small specimen bottle with a screw cap, 2.2, 4.6
bile. A thick yellow-green fluid made by the liver and excreted into the intestine, 8.8
bilirubin. One of the pigments in the bile, 8.8
binocular. Two eyed. A microscope with two eyepieces, 6.8
biochemistry. The chemistry of living organisms, 4.10
blank. A 'blank' tube or cell is one filled with plain water only, 5.18
block. A square piece of something, 4.10
blood, methods for. Chapter Seven
blood grouping. Finding someone's blood group, 12.5
blood groups. The different kinds of blood, 12.1
blood sedimentation tube (ML 4). A tube used for measuring the ESR, 7.39
blood sugar. See 7.42, 8.6
blood transfusion. Taking blood from one person and giving it to someone else, Chapter Twelve
blood urea. See 7.41
'bloody tap'. Blood may get into the CSF during a diffi-

cult lumbar puncture. This is often called a 'bloody tap', 9.9
Borrelia duttoni. The organism causing relapsing fever, 7.35
bovine. From a cow, 12.6
bovine albumen (ML 114). One of the plasma proteins of a cow used in blood transfusions, 12.6, 13.10
box. A place on a form in which something is written, 3.11
brilliant cresyl blue (ML 103). Deep blue crystals used for staining reticulocytes, 2.4, 3.19, 7.23
Brownian movement. A kind of movement shown by any very small particle lying free in a liquid, 8.14
bruise. A coloured mark made by blood in the tissues, 12.12
buckets. The parts of a centrifuge which hold the centrifuge tubes, 1.5
buffer. A mixture of salts that helps to keep the pH of a solution the same, 1.7, 3.20, 3.21, 7.12
bulb. (i) A hollow glass ball. (ii) The glass from which electric light comes
bung. A rubber 'cork', 12.9
Bunsen burner (ML 10). A special stove or burner for burning gas, 2.2, 3.4
hurr. The thin edge of metal on a badly sharpened tool or needle, 12.10
buttocks. The parts of our bodies that we sit on, 11.11b

C

cannula. A blunt tube that is put into a patient's vein, 12.9
capillaries. Very small blood vessels joining arteries to veins, 4.7
capillary blood. Blood taken from capillaries, 4.7
carbol fuchsin. A stain made of phenol (carbolic acid) and fuchsin used for the Ziehl-Neelsen method. There is a 'hot' and a 'cold' type of stain, 3.22b, 3.23, 11.1. There is also dilute carbol fuchsin used with Gram's method, 3.24
case. A patient with a particular disease is said to be a case of that disease, 1.3
casts. Special things found in the urine, 8.13
catalogue. A book describing equipment, 2.1
catgut. A kind of surgical 'string' made from the guts of animals, 12.9
caustic. Burning, 1.6
cell. (i) The 'bricks' from which the bodies of large organisms are made, 1.9. (ii) A carefully made glass box used for holding coloured solutions, 5.11. (iii) The parts from which an electric battery is made, 3.7. (iv) A selenium cell is a piece of metal which makes electricity when light falls on it, 5.16
cell membrane. The outer 'coat' of a cell, 1.9
'Cellophane'. Thin transparent 'paper', 10.2b, 12.9
cent. A hundred or a hundredth part
centering screws. Part of a condenser, 6.4
Centigrade. A scale for measuring temperature in which water boils at 100, and freezes at 0. On the Centigrade scale the temperature of a normal human body is 37°C

Vocabulary Index

- central laboratory.** Sending specimens to a central laboratory, 4.10
- centrifuge (ML 12).** A machine for turning tubes of a suspension round very fast, 1.5, 2.5, 13.7
- centrifuge tube (ML 46 and 47).** Special tubes which fit into the buckets of a centrifuge, 1.5, 2.2, 5.7
- cerebral malaria.** Malaria of the brain, 7.32, 9.20
- cerebrospinal fluid.** The fluid that washes round the brain, Chapter Nine
- cestode.** A tapeworm is a cestode, 1.14
- chemical.** A chemical is a pure substance, 1.4, 13.10
- chip.** A small piece cut off something such as a glass chip, 4.7
- chloroquine.** A drug used to treat malaria, 7.34
- choices.** These are other chemicals and equipment you might use and which are not in the main lists, 2.5, 13.12, 13.13, etc.
- chromatin.** Coloured material inside the nucleus, 1.9, 10.7
- chromatin dot.** Part of a malarial trophozoite, 7.32
- chronic.** A chronic disease is a long-lasting disease, 1.3
- chuck.** The part of a loop holder into which the wire fits, 3.10
- clamp.** Something for holding things with, 12.9
- clear.** Easily seen through, 1.3
- click stop.** A catch which makes the objectives on the revolving nosepiece of a microscope stop exactly under the tube, 6.7
- 'Clinites' tablets.** Tablets for testing the stool or urine for sugar, 10.11
- Clonorchis sinensis.** See 10.6
- clot.** The soft red solid which forms when blood is allowed to stand, 1.17
- coarse.** Rough, thick, large
- coarse adjustment.** A knob which causes large movements of the tube or stage of a microscope, 6.9
- coaxial.** Two knobs or wheels are coaxial when they both move on the same rod or axle, 6.9
- coccus, cocci.** A round bacterium like a ball, 1.14
- cockroach.** A big insect that lives in houses
- collar.** Something which goes round something else, 3.4, 3.5
- coma.** A patient in coma seems to be asleep but cannot be woken up, 8.6
- comparator (ML 13).** An instrument for comparing things, 5.10
- compartment.** A space or room, 5.14
- compatible.** Donor blood is compatible for a patient if there is no agglutination when it is mixed and incubated with his serum; compatible blood is safe blood, 12.6
- concave.** Hollow, empty, 6.3, 12.10
- concentrated.** A concentrated solution is one in which there is a lot of something dissolved. A strong solution, 1.4
- concentration.** The concentration of a solution is the amount of something that is dissolved in it
- concentration method.** Methods which concentrate or gather together the parasites in a specimen, 7.38, 10.3
- condenser.** Part of a microscope containing several lenses which shines light on the thing we are looking at (the object), 6.2
- conical.** Shaped like a cone, FIGURE 1-2
- contacts.** (i) The contacts of a patient with an infectious disease include the person who infected him and the people whom he infected, 11.4a. (ii) Pieces of metal carrying electricity, 5.25
- container (ML 14).** A bottle or box for putting specimens in, 2.2, 4.6, 13.8b
- contaminate.** To contaminate something is to let micro-organisms (or anything else which might be harmful) get to it
- contract.** To get smaller
- contrast.** Specimens of poor contrast are those like unstained cells which can be difficult to see with a microscope, 6.15
- control valve.** A 'tap' on a pressure cooker which controls the pressure of steam inside it, 1.21
- controls.** Tests you do to see if a method is working, 1.24, 7.26, 12.3
- copper sulphate (ML 77).** Blue crystals used for making Benedict's reagent, 2.4, 3.18, 8.3, 8.6, 13.10
- cotton wool.** A kind of clean soft white cotton used in hospitals, 3.9, 13.8a
- counterstain.** A stain used to make cells or tissues a different colour from whatever is being stained by the main stain, 11.1
- counting chamber (ML 15).** A special piece of glass for counting cells, etc., 2.2, 2.5, 3.12, 7.29
- cover glass (ML 16).** A thick glass square that fits on top of a counting chamber, 2.2, 7.29, 13.8b
- coverslip (ML 17).** A very thin glass square that is put on top of a wet specimen on a slide, 2.2, 3.12, 6.7, 13.8b
- crenated.** Shrivelled up, 1.18, FIGURE 7-15, 7.25, 8.13
- crisis.** A time during an illness when the patient becomes very ill indeed, 7.27a
- cross infection.** An infection which goes from one patient to another in a hospital or health centre, 4.8
- cross-matching.** A way of telling if a donor's blood is safe to give to a patient, 12.6
- crystals.** Pieces of a solid which have the same simple shape, such as pieces of salt or sugar, 1.4
- crystal violet (ML 104).** Deep violet crystals used in Gram's method, 2.4, 3.25, 11.5, 13.10
- CSF.** Cerebrospinal fluid, 9.1
- CSF protein.** See 9.13
- 'cut down'.** When a needle is put into a patient's vein by doing a small surgical operation, this is called a 'cut down', 12.9
- cyanide.** Potassium cyanide is a very dangerous chemical, 8.9, 13.19
- cylinder.** (i) See measuring cylinder. (ii) A strong steel bottle containing gas under high pressure
- cyst.** The smaller 'sleeping' form of a protozoon, 1.14, 10.6, 10.9, 10.10
- cyte.** Words ending in 'cyte' mean some kind of cell

cytoplasm. The complicated watery mixture of things (especially proteins) inside cells, 1.9

D

dash board. The part of a car where the instruments are, 3.7

DDS. One of the sulphone drugs, 8.10

debris. Dirt, waste, rubbish, the remains of anything destroyed, 7.31

decimal. A way of writing fractions as tenths, hundredths, etc., 5.1

decimal point. The 'dot' in the middle of a decimal, 5.1

deficiency anaemia. An anaemia due to lack of the things that the body needs to make blood, 7.5, 7.6, 7.7, 7.8

defrosting. Removing the ice from the freezer of a refrigerator, 12.14

dehydrated. Lacking water, 8.6

deposit. The particles at the bottom of a liquid, 1.4

detergent. A very strong kind of soap, 1.3

'Dextran'. A thick fluid which is given to a patient before there is time to give him a blood transfusion, 12.6

diabetes, diabetic. A disease in which there is sugar in the urine, 7.42, 7.43, 8.5, 8.6

diagnosis. The name of the disease that a patient has. To diagnose a patient is to find what disease he has (Second Preface)

diagram. A simple drawing in which only the most important things are shown, 1.1

diamond pencil (ML 20). A pencil with a very hard stone called a diamond in it for writing on glass, 2.2, 13.8b

dichromate cleaning fluid. A solution of potassium dichromate and sulphuric acid used for cleaning very dirty glassware, 2.5, 3.12, 3.26, 13.24

differential white count. A count of the different kinds of white cells in the blood, 7.16, 7.22

dilute. A dilute solution is one in which there is a little of something dissolved, 1.4

Dipetalonema perstans. A filarial worm, 7.37

Dipyllobothrium latum. See 10.6

diplococci. Cocci which are seen in pairs, 11.6

disc. A circle of something, a plate is a disc, 5.10

discharge. An abnormal fluid, especially pus, coming from some part of the body, 1.3, 8.4, 11.6

disinfectant. A strong chemical solution such as lysol which is used for killing micro-organisms *outside* the body, 1.19, 3.12, 3.46

dissolve. When a solid seems to disappear in a liquid, like sugar in tea, it is said to dissolve, 1.3

distilled water. A specially pure kind of water, 3.15, 12.9

donor. A donor is someone who gives blood, 12.1

drill. A tool for making holes, 3.11

dropping bottle (ML 5). A special bottle for letting reagents fall out drop by drop, 2.2, 13.8b

duct. A tube, 8.13

dura mater. The tough outer covering of the brain, 9.1

dysentery. Bad diarrhoea with blood in the stools, 10.8

dysuria. Pain on passing urine, 8.4

E

Economics of laboratory services. See 13.4

EEL. A short way of writing EEL colorimeter, 5.16

EEL Colorimeter (ML 117). A machine for measuring coloured solutions, 2.5, 5.16 to 5.25, 7.41, 7.42, 13.15

EEL tube. A special tube which is only used with the EEL Colorimeter, 5.16, Picture C, FIGURE 5-8

Eldon cards. Special cards used for grouping blood, 12.8

electricity. See 3.6

elephantiasis. A disease in which parts of the body swell so that they look like the parts of an elephant, 7.37

Entamoeba coli. A harmless amoeba which lives in the gut, 10.7

Entamoeba histolytica. An amoeba which causes amoebic dysentery, 1.14, 10.7

Ehrlich's method and reagent. A test and reagent for urobilinogen, 8.8

Enterobius vermicularis. The thread worm, 10.4

enzymes. Special proteins that make the things cells need, 1.10

eosinophil. Staining with eosin. Eosin is an orange stain in Leishman's stain. An 'eosinophil' is a polymorph with large orange staining granules in its cytoplasm, 7.14. Picture J, FIGURE 7-9

eosinophilia. An abnormally high number of eosinophil polymorphs in the blood, 7.21

epithelial cell. A cell from the epithelium, 1.9, 8.11, 8.13

epithelium. The layer of cells covering the outside or inside of an organ or part of the body, 1.9

equipment. Special tools or machines (Second Preface)

equipment list. See 13.3, 13.8b

equipment for transfusion. See 12.9

eradicate. To drive out or stamp out, 7.33

erythrocyte. Another name for a red blood cell, 1.9

Escherichia coli. A bacterium which is a common cause of urinary infection, 8.13

ESR. Erythrocyte sedimentation rate or blood sedimentation rate, 7.39

ethanol or ethyl alcohol (ML 100). This is 'ordinary alcohol' or spirit, 2.4

evaporate. When a liquid goes into the air it is said to evaporate, 1.4

examination. Giving a patient a medical examination, means looking at him to see what is wrong with him (Second Preface)

expand. To get bigger

exudate. An abnormal fluid formed by a tissue, this is commonly pus, 1.3, 7.14

eyepiece. The part of an instrument which goes next to your eye and through which you look, 5.11, 6.1, 6.8

F

facet. A small face, or surface, 12.10

faeces. The waste from the bowel or gut, Chapter Ten

false positive report. A report which is sent out positive when it should be negative, 11.2

Fasciolopsis buski. See 10.6

fast. Able to hold on to a stain, 11.1

Vocabulary Index

- female*. A woman or belonging to a woman
- ferric chloride* (ML 78). Dark brown crystals used to make Fouchet's reagent, 2.4, 3.30, 8.8, 8.9
- field of view*. The view through the eyepiece of an instrument, 6.7
- Field's method, stains A and B* (ML 105, ML 106). A red and a blue powder used for staining thick blood films, 2.4, 3.28, 7.32
- filariac*. Nematode worms which live in the tissues, 7.37
- filariasis*. The disease caused by filariae, 7.37
- file*. (i) A tool for shaping something, 3.9. (ii) A box or drawer to put papers in, 4.1
- film*. Something spread very thinly. Here it means a specimen, such as blood, spread very thinly on a slide, 1.3
- filter*. (i) To remove the particles from a liquid by pouring it through something, usually a special paper, which will let the liquid go through and hold the particles back, 1.5. (ii) A piece of coloured glass which only lets light of certain colours go through, 5.12, 6.5
- filter paper* (ML 22). Circles of a special soft paper for filtering liquids, 2.2, 3.11, 13.8b
- filter pump* (ML 23). An instrument for sucking air which fits on to a tap and uses a stream of water to do the sucking, 2.2, 3.3, 13.8b
- filtrate*. The clear liquid which passes through a filter paper, 1.5
- fine*. Smooth, thin, small
- fine adjustment*. A knob which causes small movements of the tube or stage of a microscope, 6.9
- fine adjustment gauge*. Three lines on the side of a microscope to tell us how near the top or bottom of its run the fine adjustment is, 6.12
- fix, fixation, fixative*. To fix a tissue is to kill it and to keep it looking just as it did when it was alive, 4.10, 7.12, 11.1
- flagellate*. A protozoon which moves with the help of flagella, 10.10, FIGURE 10-13
- flagellum, flagella*. The hairs on a micro-organism which move and so move the organism, 1.14
- flame*. To flame something, such as a loop, a scalpel or a Pasteur pipette, is to kill the micro-organisms on it by putting it through a flame, 1.20, 3.10
- flask*. A thin glass bottle used in a laboratory, 4.10
- fluid*. In this book a fluid is used to mean the same thing as a liquid, 1.4
- focal length*. The distance of an object from the bottom lens of an objective, at which the object is clearly in focus, 6.7
- focus*. To focus an instrument is to adjust it so that you can see something through it clearly, 5.14, 6.7
- folic acid*. A substance in the food, lack or deficiency of which causes a special kind of anaemia, 7.7
- fontanelles*. The soft parts of an infant's skull, 9.3
- forceps* (ML 24). An instrument for holding things with, 2.2, 13.8b
- formaldehyde* or *formalin* (ML 97). This is a strong smelling liquid used to make formol saline for fixing tissues for histology, 2.4, 3.29, 4.10, 13.10
- formed*. Having some shape, 10.1
- formol ether concentration test*. A way of concentrating parasites in the stool, 10.3
- formol saline*. A solution of formalin and salt used for preserving or fixing tissues, 1.18, 4.10
- Fouchet's method and reagent*. A test for bilirubin in the urine, 3.30, 8.8
- free acid*. 'Strong acid', 11.9
- frequency*. Passing urine very often, 8.5
- Fuchs-Rosenthal counting chamber* (ML 124). A counting chamber 0.2 mm deep, 8.11, 9.9, 13.18
- fungi*. A group of organisms also known as moulds, 8.13, 11.15
- funnel* (ML 25). An instrument to stop liquids spilling when they are to be poured into something with a narrow mouth, 2.2, 13.8b

G

- gallipot*. A small pot or basin, 9.4
- galvanometer*. An instrument for measuring electricity, 5.16
- gametocyte*. A stage in the life of the malarial parasite, 7.33
- gas*. Air is a mixture of gases; a special kind of burnable gas is used in the Bunsen burner, 3.4
- gasket*. A rubber ring or washer, 1.21
- gastric*. Belonging to the stomach
- gastric juice*. The liquid that is made by the stomach to digest food, 11.9
- gastric washings*. A way of obtaining sputum from children for examination, 3.20, 3.21, 11.4a
- gauze*. (i) A thin cotton cloth used in hospitals. (ii) A cloth made of metal wires (ML 26), 12.9
- gel*. When a liquid goes nearly solid it is said to form a jelly or gel, 7.40
- genus*. The tribe to which an organism belongs, 1.13
- Giardia lamblia*. A flagellate which causes diarrhoea, 10.10
- giardiasis*. The disease caused by *Giardia*, 10.10
- giving set*. Equipment used to give blood, 12.9
- glass tube* (ML 51). 3.9
- glassware*. Equipment made of glass
- globulin*. One of the plasma proteins (two others are albumen and fibrinogen), 7.40
- globus, globi*. Many *Mycobacterium leprae* close together inside a cell are said to form a globus, 11.11d
- glucose*. The most important sugar in the body, 8.6
- glycosuria*. Sugar in the urine, 8.2
- gonococcus*. Another name for *Neisseria gonorrhoeae*, 11.6
- GPR*. General purpose reagent, 3.15
- graduated*. Divided in a way that can be used to measure things, 1.3, 5.7
- graduated pipette*. A pipette marked to hold known volumes of fluid, 5.7
- graduation marks*. The marks or lines used to graduate something, 1.3
- gram*. A small weight in the metric system, usually shortened and written 'g'

Gram's method. A way of staining bacteria, 11.5
granules. Small pieces of a solid, 1.4
graph. A special 'picture' for doing arithmetic, 5.21b
grease pencil (ML 31). A special pencil with a greasy lead that will write on glass, 2.2, 3.11, 13.8b
Grey wedge photometer (ML 115). A measuring instrument for coloured solutions, 2.5, 5.11, 9.13, 13.13
gross. Great, very large, very many, 'very positive', etc., 4.4
gut. This is the whole of the tube that joins the mouth to the anus. The intestines form part of it

H

haematocrit. The same as the packed cell volume, 7.2
haemocyto blast. The parent cell from which blood cells are formed, 7.17, Picture A, FIGURE 7-10
haemoglobin. The red substance inside red blood cells, 1.9, 5.9, 1.1, 7.7, 7.24, 8.13
haemoglobin diluting fluid. A fluid used for measuring the haemoglobin, 3.31, 7.1
haemoglobin solubility method. See 7.26
haemoglobinopathy. A disease caused by abnormal haemoglobin, 7.24, 7.25, 7.27
haemolyse, haemolysis. The breaking open and destruction of red blood cells, 1.18, 7.9
haemolytic anaemia. An anaemia due to destruction of blood inside the body, 7.9, 7.24, 7.32, 8.8
Haemophilus influenzae. One of the bacteria which cause meningitis, 9.16
Haldane scale. A way of measuring haemoglobin using a scale which runs from 0 to 100%, 5.13
head injury, CSF in. See 9.19
health centre laboratory. A general description, 3.46
helminth. A worm, 1.14
hepatitis. An inflammation of the liver, 4.8
Heterodera radiculicola. See 10.6
Heterophyes heterophyes. See 10.6
'Hibitane'. An antiseptic, 12.12, 12.13
histology. The study of tissues, 4.10
history. A medical history is the story of what has gone wrong with a patient (Second Preface)
holder (ML 28). A loop-holder, 3.10
hollow. Empty, with a hole inside, 1.3
holly leaf. A leaf with several sharp points; one of the shapes taken up by sickle cells, 7.25
hookworm. A small worm that lives in the small gut, 10.5
hookworm anaemia. Anaemia due to hookworm, 7.6
horizontal. Flat, 1.3
hyaline. Like glass, 8.13
hydrated. Containing water, 2.4
hydrochloric acid (ML 94c). A clear caustic liquid used for making acid alcohol and Ehrlich's reagent, 2.4, 3.16, 11.1
hygroscopic. A hygroscopic chemical takes water out of the air and becomes wet, 2.4
Hymenolepis nana. See 10.6
hyper-. More or too much
hyperglycaemia. Too much sugar in the blood, 8.6

hypertonic. Having a greater salt concentration than the cell cytoplasm, 1.18
hypo-. Less, too little
hypoglycaemia. Too little sugar in the blood, 8.6
hypotonic. Having a smaller salt concentration than the cell cytoplasm, 1.18

I

-iasis. This ending to a word means an infectious disease caused by a worm or a protozoan, 1.12, 7.38
Ilford. A firm who make filters, 5.18
immature. Young, not fully grown, 1.3
immersion oil (ML 96). A special oil used with the oil immersion objectives of microscopes, 2.4, 6.7, 6.14, 13.10
inaccurate. Not exact, rough, 1.3
incompatible blood. Blood is incompatible for a patient if agglutination takes place when it is mixed and incubated with his serum, 12.1
incubate. To incubate something is to keep it warm, 12.6
indicator. A chemical which changes colour when the pH changes, and in doing so tells us what the pH is, 1.7
infant. A young child, 1.3
infection, infected. We are said to be infected by a parasite when we have it living inside us. We suffer from an infection with that parasite, 1.12
infectious disease. Disease due to infection, 1.12
infinity. The largest possible number, 1.13
flammable. Very easily burnt, 1.4
INH. Isonicotinic acid hydrazide, a drug used to treat patients with tuberculosis, 2.5, 8.9, 13.19
insecticide. A chemical to kill insects
instrument. A special laboratory machine, 1.3, 2.1
insulin. A drug used in treating diabetes, 7.42, 8.6
interpupillary distance. The distance between the middle (the pupils) of a man's eyes, 6.8
intestine. The intestine is part of the tube through which food passes from the stomach to the anus. It is divided into two main parts, the small intestine and the large intestine
intracellular. Inside cells, 11.6
intramuscular needle. A needle for giving injections into the muscles, 9.5
iodine (ML 79). Small dark brown crystals used to make Lugol's iodine. Also used as an antiseptic, 2.4, 3.32, 13.10
iris diaphragm. Part of the condenser of a microscope which opens and closes to alter the light reaching the object, 6.3
iron. See 7.6
iso-. Equal, or the same
isotonic. Having the same salt concentration as the cell cytoplasm, 1.18

J

jaundice. The yellowing of a patient's tissues, 4.8, 8.8

Vocabulary Index

K

- Kahn tube** (ML 48c). A middle size of test tube, 2.2
Kernig's sign. One of the signs used to diagnose meningitis, 9.3
knurled. A knurled knob or ring is one which has a rough edge so that it can be easily turned and does not slip through your fingers, 5.14
kwashiorkor. A form of protein joule malnutrition (PJM), 8.4, 10.12

L

- labelling bottles, etc.** See 3.11
'Labogaz'. A kind of gas which is sold in small tins, 3.4, 13.30
laboratory. A medical laboratory is a room with special equipment (machines) for finding things out about patients (Second Preface)
lactase. An enzyme which digests the sugar called lactose, 10.12
lactose intolerance. The inability to digest and absorb lactose, 10.12
Leishman's buffer. A buffer made of phosphate salts used with Leishman's stain, 3.20, 7.12
Leishman's stain. A stain used for blood films, 1.7, 3.33, 7.12, 7.13
leishmaniasis. A disease caused by a protozoan parasite called *Leishmania donovani*, 7.40
lens. A piece of smooth curved glass for bending light. Spectacles have lenses, 5.11, 6.2
lens tissue (ML 29). Special soft paper for cleaning lenses, 2.2, 6.16, 13.8b
leprosy. A chronic disease due to infection with *Mycobacterium leprae*, 1.12, 11.1, 11.11
lesion. A diseased place in the body, 11.11
leucocyte. A white blood cell, 7.14
leucocytosis. An increased number of white cells in the blood, 7.21, 7.29
leucopenia. Too few white cells in the blood, 7.21
leukaemias, myeloid and lymphatic. A rare and serious blood disease in which there are too many white cells in the blood, 7.21
life cycle. The circle of stages through which an organism passes during its life, 7.32
liner. The black rubber circle inside the cap of a universal container or bijou bottle, 2.2
liquid. Something which flows and takes on the shape of the bottle or cup it is in, 1.4
Loa loa. A filarial worm, 7.37
local anaesthetic. A drug such as procaine which is injected into the tissues to stop the patient feeling pain in that area, 9.5, 12.12
loop. A loop is a ring or circle of wire or string. A wire loop is used as an easily sterilized spoon for small quantities of specimens, 3.5, 3.10, FIGURE 3-7
loop-holder (ML 28). A metal 'pencil' with a chuck at one end for holding wire, 2.2, 3.10, 13.8b
Lovibond cell (ML 48d). A special square tube which is only used with the Lovibond comparator, 2.2, 5.10, Picture C, FIGURE 5-5

- Lovibond comparator** (ML 13). A machine for comparing a test solution with coloured glass standards, 2.5, 5.10, 7.1, 7.41, 7.42, 13.8b
Lovibond discs (ML 21). Black plastic wheels with several coloured glass standards around their edges. There are discs for haemoglobin, blood sugar, and blood urea, 2.2, 5.10
Luer fitting. One of the sizes of fittings for syringes and needles, 12.9
Lugol's iodine. An iodine solution used for Gram's method and for staining protozoa in the stool, 3.32, 11.5, 10.2
lumbar puncture. Putting a needle into the lower part of the arachnoid space to obtain CSF, 9.1, 9.2, 9.4, 9.5
lymph. A thin fluid that comes out of the capillaries and is taken back to the blood through the lymph vessels, 7.37
lymph nodes. Bean shaped organs in the groins, and in many other parts of the body where lymph is filtered and in which lymphocytes are made, 11.12
lymph vessels or lymphatics. Small thin tubes which take a fluid called lymph back to the blood, 7.37
lymphocyte. A kind of white blood cell, 7.14, 7.16, Pictures A and C, FIGURE 7-9
lyse. To burst and break open. To dissolve, 1.18
lysol. A common disinfectant, 1.19, 2.3, 3.12, 13.8a

M

- macrocyte, macrocytic**. In a macrocytic blood film many of the red cells are larger than normal, 7.19
macrocytic anaemia. A type of anaemia in which abnormally large red cells are seen in the blood, 7.19
macrophage. A cell which is able to 'eat' bacteria and other small particles, 10.7
magnification. The number of times bigger an object is made to look, 6.7
magnifying power. The power of an objective or eyepiece to make an object look bigger, 6.7
malachite green (ML 107). A green stain used for counterstaining in the Ziehl-Neelsen method, 2.4, 3.34, 11.1
malaria. A disease caused by protozoan parasites of the genus *Plasmodium*, 7.5, 7.9, 7.32, 7.33, 8.8
male. Man or belonging to a man
Mansonella ozzardi. A filarial worm, 7.37
mantle. The cloth part of a paraffin pressure lamp that gets white hot, 6.11
manual. Need for standard manual, 13.1, 13.31
marrow. Red marrow is a tissue inside bones in which blood cells are formed, 7.17
mask. A surgeon's mask is a piece of loose cloth which goes over his nose and mouth. It catches any drops of fluid that may contain micro-organisms, 9.5
match. Something is said to match something else when it is equal to it in weight or colour, etc., 5.9
mature. Fully grown. Adult, 1.3
MCHC. The mean corpuscular haemoglobin concentration, 7.3, 7.19

measuring cylinder (ML 18 and 19). A tall glass jar for measuring liquids, 2.2, 5.7

meat fibres. Partly digested meat seen in the stools, 10.5

mechanical stage. A machine which moves a slide on the stage of a microscope, 6.10

megakaryocytes. Large cells in the marrow from which platelets are formed, 7.15

megaloblast. An abnormal type of immature red cell, 7.19

melaena stool. A stool which is black because it contains much partly digested blood, 10.11

membrane. A very thin covering, 1.3

meninges. The covering of the brain, 9.1

meningitis. Inflammation of the meninges of the brain, 9.1, 9.3, 9.16, 9.17, 9.18

meningococcus. Another name for *Neisseria meningitidis*, 1.23, 9.16

meniscus. The curved surface of a liquid, 5.7

menorrhagia. Very heavy monthly periods, 7.6

mercury. A heavy metal which is liquid at the temperature of a room, 2.2

merozoite. A stage in the growth of the malarial parasite, 2.32

Metagonimus yokogawai. See 10.6

metamyelocyte. An immature white blood cell, 7.17, Picture E, FIGURES 7-9 and 7-10

methanol or methyl alcohol (ML 99). This is a light, volatile, inflammable liquid used for making Leishman's stain, 2.4, 3.33, 7.12

methylene blue (ML 108). Deep blue crystals used as a counterstain in the Ziehl-Neelsen cold method, 2.4, 3.35, 11.1

methylene in acid alcohol. A solution used in the cold Ziehl-Neelsen method, 3.35, 11.1

metric system. The way of weighing and measuring using millilitres, grams, and centimetres, 5.1

mg A milligram or a thousandth part of a gram, 5.2

mg %. The number of milligrams of a substance that there are in 100 ml of a patient's plasma, 5.8

microcytic. In a microcytic blood film many of the red cells are too small; a microcyte is a small red cell, 7.6, 7.19

microfilariae. Larval (young) filarial worms, 7.37, 11.14

microhaematocrit. A way of measuring the haematocrit with a very small volume of blood, 7.2

micron. This is one thousandth of a millimetre or a millionth part of a metre, it is written ' μm ', 6.1

micro-organism. Very small organisms, 1.11

microscope (ML 30). An expensive machine for looking at things which are so small that they cannot be seen by the eye alone (Chapter 6)

millilitre. One thousandth part of a litre, written 'ml', 5.1, 5.7

mirror of a microscope. See 6.3

ml A millilitre or a thousandth part of a litre, 5.1, 5.7

mobile. Moving, 3.7, 8.14

Mohr's clip. A special instrument for clipping or closing a rubber tube, 3.3

monocular. One-eyed, a microscope with one eyepiece, 6.8

monocyte. A kind of white blood cell, 7.14, Picture B, FIGURE 7-9

motile. Able to move, 1.14, 8.14, 10.7

motility. Movement, 8.14, 10.7

mouthpiece (ML 33). A short piece of smooth glass tube attached to a rubber tube: used for filling pipettes by sucking through, 7.1, 13.8b

MRC blood transfusion equipment. Equipment designed by the Medical Research Council of Great Britain, 12.9

mucosa. The lining or inner surface of an organ like the gut or the bladder, 10.8

mucus. A sticky white substance made by some epithelial cells, 10.1

mycelia. The long hair-like branching cells of a mould or fungus, 8.13, 11.15

mycobacteria. The genus of bacteria causing tuberculosis and leprosy, 11.1

Mycobacterium leprae. The parasitic micro-organism causing leprosy, 1.12, 11.1, 11.11

Mycobacterium tuberculosis. The parasitic micro-organism causing tuberculosis, 1.12, 11.1

myeloblast. A kind of very young white cell which will grow to become a polymorph, 7.17, Picture B, FIGURE 7-10

myelocyte. An immature white cell, Picture D, FIGURE 7-10

N

nasal. From the nose, 11.11c

Necator americanus. One of the hookworms, 10.5

'*Needle and tube*'. A way of taking blood using only a large needle and a piece of rubber tube, 4.9

negative. Absent or not there, 1.3

Neisseria gonorrhoeae or the *gonococcus*. The cause of a venereal disease called gonorrhoea, 11.6

Neisseria meningitidis or the *meningococcus*. One of the bacteria which often cause meningitis, 9.16

nematode. A round worm, 1.14

nephritis. A kidney disease, 8.4

nephrotic syndrome. A kidney disease, 8.4

Neubauer counting chamber (ML 15). A special kind of counting chamber 0.1 mm deep, 7.29, 9.9, 13.8b

neutral. Neither acid nor alkaline, but between them both, 1.6

neutrophil polymorph. The common kind of polymorph containing many small purple granules. Neutrophil means neutral staining, 7.14, Picture G, FIGURES 7-9 and 7-10

nickel-chrome wire (ML 55). Special strong wire that does not get burnt in a flame, 3.10, 13.8b

nodule. A small lump, 11.11

nomogram. A special figure for doing arithmetic, 7.3

non-. Not

normal. If something is seen in healthy people, we say it is normal, 1.3

Vocabulary Index

normoblast. A young red cell with a nucleus, 7.14, Pictures I, J, K, FIGURE 7-10
normochromic. Normally coloured. A normochromic red cell is one which is normally filled with haemoglobin, 7.19
notch. A piece cut out of something, 5.2
notice-board. Instructions for the ward notice-board, 4.6
nozzle. The place on a syringe where the needle fits, 1.21
nuclear membrane. The 'coat' of the nucleus, 1.9.
nuclei. More than one nucleus
nucleoli. A 'hole' in the nucleus of some immature blood cells, 7.17
nucleus. A large 'ball' in the middle of a cell, 1.9
nut. Something which turns and fits on to a screw

O

object. The thing we look at with a microscope, 6.2
objective. The part of a microscope which 'looks at' the object and sends light up the tube to the eyepiece, 6.2, 6.7
oblique. Sloping. From one side
occlusive. Blocking, 7.27a
occult. Hidden
occult blood. Blood in the stool that can only be found by doing a special test, 10.11
occult blood reagent. A mixture of barium peroxide and ortho-tolidine used to test the stools for occult blood, 3.36, 10.11
oedema, oedematous. Fluid in the tissues causing them to swell, 8.4
Ohaus balance (ML 1). A laboratory balance, 5.1, 13.8b
oil immersion objective. An objective which can only look at an object through oil, 6.7
oilstone (ML 63). A special stone used for sharpening tools, 12.10, 13.9
Olympus microscope (ML 30). The name of a Japanese firm who make microscopes, 6.1, 13.8b
Onchocerca volvulus. A nematode worm which lives in the skin, 7.37, 11.14
onchocerciasis. The disease caused by the worm called *Onchocerca volvulus*, 11.14
opaque. Not easily seen through, 1.3
operculum. The 'door' or weak part in an ovum through which a larva can leave it, 10.6
organ. A part of the body, such as the brain, the heart, or the spleen, 1.9
organism. Any living thing, 1.11
ortho-tolidine (ML 80). A chemical used in testing the stools for occult blood, 2.4, 3.36, 10.11
-ose. Sugars end in 'ose', lactose and glucose for example, 8.3, 10.12
oval. Egg shaped
ovum, ova. An egg, or eggs, 1.12, 10.5, 10.6
oxyhaemoglobin. A kind of haemoglobin which is red because it has combined with (is joined to) oxygen from the air. Haemoglobin which is not combined with oxygen is purple and is called reduced haemoglobin, 7.1

P

packed cell volume, or PCV. The percentage volume occupied by the packed cells in a specimen of blood, 7.2
packed cells. The red cells at the bottom of a tube of blood which have been prevented from clotting and then centrifuged hard, 7.2
paging numerator. A page numberer or a machine for stamping numbers, 4.3, 12.13
Pandy's reagent and method. A saturated solution of phenol in water used as a simple test for an abnormal CSF protein, 3.37 (reagent), 9.10, 9.13 (method)
pans. The 'plates' for holding things on a balance, FIGURE 5-1
para-dimethyl-amino-benzaldehyde (ML 82). A yellow chemical used for making Ehrlich's reagent, 2.4, 3.27, 8.8
Paragonimus westermani. See 10.6, 11.4b
parasite. An organism which lives on or inside a larger organism, 1.12
parasitology. The study of parasites: often it only means the study of worms and protozoa, 4.10
parfocal. Objectives are said to be parfocal when they are mounted (held) in the nosepiece in such a way that an object in focus with one objective will be in focus with all the others, 6.7
particle. A very small piece of a solid, 1.4
'parts'. Measures, 5.8
PAS. Para-aminosalicylic acid, a drug used for treating patients with tuberculosis, 3.38, 8.9
PAS test strips. Strips of paper soaked in ferric chloride used to test the urine for PAS, 3.38, 8.9
Pasteur pipette. A special pipette made in the laboratory from glass tubing and used with a rubber teat, 3.9
PCV. See packed cell volume or haematocrit, 7.2
pellets. Small balls, 2.4
penis. A man's sex organ, 11.6
percentage or '%'. The number of something in every hundred of something else, 5.8
'Perspex'. A light, clear plastic like glass, 1.3, 7.2
pH. A way of measuring acidity and alkalinity, 1.7
pH of the stools. See 10.12
phenol (ML 81). A caustic, oily liquid when hot or crystals when cold: also called carbolic acid. Used for Pandy's reagent, 2.4, 3.37, 9.10, and carbol fuchsin 3.22b, 3.23
phosphates. See 2.4, 3.20
physiological saline. Isotonic saline, 1.18
pia mater. The soft inner covering of the brain, 9.1
pigment. A coloured substance, 7.32
pilot bottle. A small bottle of blood fixed to the main bottle of a donor's blood from which specimens for testing are taken, 12.11
pipette (ML 32, 35). A glass tube for holding or measuring volumes of liquid. See also Pasteur pipette and graduated pipette, 2.2, 5.7, 7.1, 13.8b
plane. Flat, 6.3
plasma. The liquid part of blood, 1.5, 1.17
plasmodium. The name of the genus (tribe) to which malaria parasites belong, 7.32, 7.33

- Plasmodium, falciparum, vivax, ovale, and malariae.* The four species of malaria parasite, FIGURE 7-29
- plastic.* This often means soft and easily bent. Used here it means a group of substances from which many useful things are made, 1.3
- plasticine* (ML 67). A kind of mud or clay which does not get dry, 2.3, 3.2, 3.11
- platelets.* Small pieces of cells found in the blood, 7.15, Picture H, FIGURE 7-9
- pliers* (ML 68). A tool for cutting and holding things, Picture 4, FIGURE 7-6
- plug.* A plug is something which can be pushed into a hole, 3.6
- plugged.* Blocked or filled up
- plunger.* The inside part of a syringe, FIGURE 4-3
- plus notation.* A special way of writing reports, 4.4
- pneumococcus.* Another name for *Streptococcus pneumoniae*, 9.16
- poikilocytosis.* Abnormally shaped red cells, 7.19
- pointer.* A hand which points to the graduations on the scale of a balance or galvanometer, 5.2, 5.16
- poise.* To poise something is to balance it, 5.2
- poising nut.* The nut on a balance which makes it swing evenly, FIGURE 5-1
- polychromasia.* Many polychromatic red cells in the blood, 7.19, 7.23
- polychromatic.* A polychromatic red cell is a young red cell stained with Leishman's stain. It looks purple, 7.19, 7.23, Picture D, FIGURE 7-11
- polymorph.* A polymorphonuclear leucocyte, 7.14
- polymorph leucocytosis.* An abnormally high number of polymorphs in the blood, 7.21
- 'Polypo'* (ML 14c). A special plastic container for sputum, stools, etc., 2.2, 3.12, 4.6
- polypropylene.* A special strong kind of plastic that can be autoclaved without spoiling, 1.3
- 'Polystop bottle'* (ML 7). A special bottle with a polythene stopper, a pipette, and a teat, 2.2, 7.11, 7.12, 13.8b
- polythene.* A common kind of plastic, 1.3
- 'Polytube'* (ML 14d). A special plastic container for blood, etc., 2.2, 3.12, 4.6
- positive.* Present, 1.3
- potassium cyanide* (ML 125). A very poisonous chemical used to test for INH in the urine, 5.7, 8.9, 13.19
- potassium fluoride* (ML 84). A white powder used to stop the cells of the blood or CSF breaking down (eating) sugar, 2.4, 4.6, 7.42, 9.15
- potassium iodide* (ML 85a). White crystals used in making Lugol's iodine, 2.4, 3.32
- powder.* Something made of small pieces of a solid: sugar or salt for example, 1.4
- precipitate.* Solid particles formed in a liquid, 1.4
- pregnant.* A woman is said to be pregnant when there is a child inside her
- preset focus lock.* A lock on the Olympus microscope which lets us focus on a second slide without having to use the coarse adjustment, 6.12
- pressure cooker* (ML 69). A small autoclave, 1.20, 1.21, 9.4
- pressure stove* (ML 71). A stove, such as a 'Primus' stove which uses paraffin or kerosine under pressure, 1.20, 3.9
- Primaquine.* A drug used in treating malaria, 7.33
- prism.* A glass block for bending light, 5.11, 6.2, 6.9
- proctoscope.* An instrument for looking through the anus at the last 10 cm of the gut, 11.13
- productive cough.* A cough in which sputum is produced, 11.4a
- 'Progressive directional crawl'.* The way *Entamoeba histolytica* moves, 10.7
- promyelocyte.* A young white cell which will grow to become a polymorph, 7.17, Picture C, FIGURE 7-10
- protein deficiency anaemia.* Anaemia due to lack of protein in the food, 2.8
- proteinometer* (ML 36). An instrument for measuring protein in the CSF, 2.2, 9.13
- proteins.* Complicated substances from which cells are made, 1.10, 7.8
- proteinuria.* Protein in the urine, 8.2, 8.3
- protozoon, protozoa.* A single celled micro-organism with a nucleus, 1.14, 10.7
- pseudopodium, pseudopodia.* The 'foot' of an amoeba, 1.14, 10.7
- pulp.* Soft tissue, 11.11
- puncture.* Putting an instrument into something, or making a hole in it, 9.2, 11.12
- pupils.* The dark middle parts of the eyes, 6.8
- purple.* A colour made by mixing red and blue
- purulent.* Like pus, 7.14, 8.1, 8.4, 8.11
- pus.* A thick, usually yellowish liquid made of millions of dying polymorphs. A pus cell is a polymorph, 7.14, 8.1, 8.4, 8.11
- pus cells in urine.* See 8.4, 8.11
- putrefy.* To rot or go bad, 1.15
- pyuria.* Pus in the urine, 8.4, 8.11

R

- rack.* Something for holding things, such as the test tube racks, ML 40 and 41, the slide rack, 3.11, or the staining rack, 3.2
- rainbow.* A curved line of colours seen when sun shines on rain, 5.12
- reagent.* The chemicals used in a 'Method'. Many reagents are solutions of chemicals in water, 3.15 to 3.45
- reagent, prepared centrally.* See 13.11, 13.25
- recipient.* A patient to whom blood is given, 12.1
- record.* Knowledge that is written down so that it is not lost, 4.1
- Record fitting.* One size of fittings for syringes and needles, 12.10
- rectal.* Belonging to the rectum which is the last part of the gut before the anus, 11.13
- red blood cell.* See 1.9, 7.19
- reducing valve.* A tap which lets the high pressure gas out of a cylinder slowly and at low pressure, Picture F, FIGURE 3-2, 3.4
- refrigerator.* A special box with a machine that keeps its inside cold, 12.3, 12.14

- Plasmodium, falciparum, vivax, ovale, and malariae.* The four species of malaria parasite, FIGURE 7-29
- plastic.* This often means soft and easily bent. Used here it means a group of substances from which many useful things are made, 1.3
- plasticine* (ML 67). A kind of mud or clay which does not get dry, 2.3, 3.2, 3.11
- platelets.* Small pieces of cells found in the blood, 7.15, Picture H, FIGURE 7-9
- pliers* (ML 68). A tool for cutting and holding things, Picture 4, FIGURE 7-6
- plug.* A plug is something which can be pushed into a hole, 3.6
- plugged.* Blocked or filled up
- plunger.* The inside part of a syringe, FIGURE 4-3
- plus notation.* A special way of writing reports, 4.4
- pneumococcus.* Another name for *Streptococcus pneumoniae*, 9.16
- poikilocytosis.* Abnormally shaped red cells, 7.19
- pointer.* A hand which points to the graduations on the scale of a balance or galvanometer, 5.2, 5.16
- poise.* To poise something is to balance it, 5.2
- poising nut.* The nut on a balance which makes it swing evenly, FIGURE 5-1
- polychromasia.* Many polychromatic red cells in the blood, 7.19, 7.23
- polychromatic.* A polychromatic red cell is a young red cell stained with Leishman's stain. It looks purple, 7.19, 7.23, Picture D, FIGURE 7-11
- polymorph.* A polymorphonuclear leucocyte, 7.14
- polymorph leucocytosis.* An abnormally high number of polymorphs in the blood, 7.21
- 'Polypot'* (ML 14c). A special plastic container for sputum, stools, etc., 2.2, 3.12, 4.6
- polypropylene.* A special strong kind of plastic that can be autoclaved without spoiling, 1.3
- 'Polystop bottle'* (ML 7). A special bottle with a polythene stopper, a pipette, and a teat, 2.2, 7.11, 7.12, 13.8b
- polythene.* A common kind of plastic, 1.3
- 'Polytube'* (ML 14d). A special plastic container for blood, etc., 2.2, 3.12, 4.6
- positive.* Present, 1.3
- potassium cyanide* (ML 125). A very poisonous chemical used to test for INH in the urine, 5.7, 8.9, 13.19
- potassium fluoride* (ML 84). A white powder used to stop the cells of the blood or CSF breaking down (eating) sugar, 2.4, 4.6, 7.42, 9.15
- potassium iodide* (ML 85a). White crystals used in making Lugol's iodine, 2.4, 3.32
- powder.* Something made of small pieces of a solid: sugar or salt for example, 1.4
- precipitate.* Solid particles formed in a liquid, 1.4
- pregnant.* A woman is said to be pregnant when there is a child inside her
- preset focus lock.* A lock on the Olympus microscope which lets us focus on a second slide without having to use the coarse adjustment, 6.12
- pressure cooker* (ML 69). A small autoclave, 1.20, 1.21, 9.4
- pressure stove* (ML 71). A stove, such as a 'Primus' stove which uses paraffin or kerosine under pressure, 1.20, 3.9
- Primaquine.* A drug used in treating malaria, 7.33
- prism.* A glass block for bending light, 5.11, 6.2, 6.9
- proctoscope.* An instrument for looking through the anus at the last 10 cm of the gut, 11.13
- productive cough.* A cough in which sputum is produced, 11.4a
- 'Progressive directional crawl'.* The way *Entamoeba histolytica* moves, 10.7
- promyelocyte.* A young white cell which will grow to become a polymorph, 7.17, Picture C, FIGURE 7-10
- protein deficiency anaemia.* Anaemia due to lack of protein in the food, 2.8
- proteinometer* (ML 36). An instrument for measuring protein in the CSF, 2.2, 9.13
- proteins.* Complicated substances from which cells are made, 1.10, 7.8
- proteinuria.* Protein in the urine, 8.2, 8.3
- protozoon, protozoa.* A single celled micro-organism with a nucleus, 1.14, 10.7
- pseudopodium, pseudopodia.* The 'foot' of an amoeba, 1.14, 10.7
- pulp.* Soft tissue, 11.11
- puncture.* Putting an instrument into something, or making a hole in it, 9.2, 11.12
- pupils.* The dark middle parts of the eyes, 6.8
- purple.* A colour made by mixing red and blue
- purulent.* Like pus, 7.14, 8.1, 8.4, 8.11
- pus.* A thick, usually yellowish liquid made of millions of dying polymorphs. A pus cell is a polymorph, 7.14, 8.1, 8.4, 8.11
- pus cells in urine.* See 8.4, 8.11
- putrefy.* To rot or go bad, 1.15
- pyuria.* Pus in the urine, 8.4, 8.11

R

- rack.* Something for holding things, such as the test tube racks, ML 40 and 41, the slide rack, 3.11, or the staining rack, 3.2
- rainbow.* A curved line of colours seen when sun shines on rain, 5.12
- reagent.* The chemicals used in a 'Method'. Many reagents are solutions of chemicals in water, 3.15 to 3.45
- reagent, prepared centrally.* See 13.11, 13.25
- recipient.* A patient to whom blood is given, 12.1
- record.* Knowledge that is written down so that it is not lost, 4.1
- Record fitting.* One size of fittings for syringes and needles, 12.10
- rectal.* Belonging to the rectum which is the last part of the gut before the anus, 11.13
- red blood cell.* See 1.9, 7.19
- reducing valve.* A tap which lets the high pressure gas out of a cylinder slowly and at low pressure, Picture F, FIGURE 3-2, 3.4
- refrigerator.* A special box with a machine that keeps its inside cold, 12.3, 12.14

Vocabulary Index

relapse. When a patient gets well for a time and then gets ill again he is said to relapse, 7.35

relapsing fever. An illness caused by *Borrelia duttoni*, 7.31, 7.35, Picture E, FIGURE 7-11

report. Something found out about a patient which is sent from the laboratory to the wards, 4.1

request slip. A small piece of paper sent to the laboratory asking for a method to be done on a patient, 4.1

reticulocyte. A young red cell stained with brilliant cresyl blue. It looks like a blue 'net', 7.17, 7.23, 7.28

reticulocytosis. Many reticulocytes in the blood, 7.17, 7.23, 7.28

retract. To get smaller, 1.17

revolving nosepiece. The part of a microscope which holds the objectives, 6.7

Rhesus group. One of the systems (kinds) of blood groups, 12.1, 12.7

rigor. When a patient has a rigor he feels very cold, he shakes all over and his temperature rises, 12.9

rod. Something long and thin like a pencil, 1.3

Rothera's reagent. A powder used for testing the urine for acetone: there are two kinds of Rothera's reagent, 3.39, 8.7

rouleaux. Red cells piled on top of one another like a pile of coins. 7.13, 12.6, Picture F, FIGURE 7-11

routine. The way in which things are done day by day, 3.13

ruled area. Some very small squares drawn on a counting chamber, 7.29

S

safety plug. Part of a pressure cooker which lets the steam out before the pressure inside the cooker gets too high and bursts it, 1.21

saline. A solution of salt in water, 1.4, 1.18, 3.40

saline stool smear. See 18.2a

salt. See 1.6

saturated. A saturated solution of a substance is one which will not dissolve any more of that substance, 1.4

saturated sodium acetate solution. A reagent used in Ehrlich's test for urobilinogen, 3.41, 8.8

scale. (i) A row of lines used to measure; a ruler has several scales, 5.2. (ii) The size something is drawn in a picture, 1.1

scalpel. A surgeon's knife, 1.20, 11.15

Schistosoma haematobium. A worm which lives in the veins of the bladder, 7.6, 8.13, 8.15, 10.3

Schistosoma mansoni. A worm which lives in the veins in the wall of the lower part of the gut, 7.2, 10.3

Schistosoma japonicum. See 10.6

schistosomiasis. Bilharziasis or infection with schistosome worms, 8.4, 8.15

schizont. A stage in the life cycle of the malarial parasite, 7.32, 7.33

Schuffner's dots. Dots seen in the red cells when they are infected by some species of malarial parasite, 7.34

scope. Words ending in scope are all instruments for looking at something, 6.1 (microscope), 11.13 (proctoscope)

scrapings. Small pieces that have been scraped or rubbed off something, 11.15

scum. A 'skin' on the top of a liquid, 7.12

seal. To seal something is to close or cork it, 7.23, 7.25, 10.1

segment. A part of something, 7.14, Picture G, FIGURE 7-10

selenium. A substance which makes electricity when light falls on it, 5.16, 5.25

'Sellotape swab'. A way of finding the ova of *Enterobius vermicularis*, 10.4

semen, seminal fluid. A man's seed, 11.10

sequestrene (ML 83). A chemical which stops blood clotting, 1.17, 2.4

serology. The study of sera, 4.10

serum, sera. The yellow liquid that comes out of blood when it clots, 1.17

shaft. A rod which turns, 1.5: the tube of a needle, 12.12

sheath. A covering which protects whatever is inside it, 2.3, 7.37

shelves. See 3.1, 3.46

shutters. Things which alter the amount of light getting through them, 5.16

sickle-cell, anaemia, crisis, disease, trait. See 7.24, 7.25, 7.26, 7.27

sigmoidoscope. An instrument for looking through the anus at the last 25 cm of the gut (the sigmoid colon), 11.13

signs. Something that is observed to be wrong with a patient, such as a pale tongue, a swelling, or a sore, 1.3

silicone tubing. A special kind of 'rubber' tubing made of a substance called silicone, 12.9

sink. A sink is a kind of basin with a tap, 3.2

siphon. A way of making water run upwards before it runs a longer way downwards, 3.3

skin scrapings for fungi. See 11.15

slide (ML 37). A piece of glass on which things are put when they are looked at with a microscope, 6.2

slide rack. Something for holding slides while they dry, 3.11

slip. A small piece of paper, 4.1

slit. A narrow space, 5.16

slot. A long hole, 6.16

smear. A specimen spread thinly on a slide, 7.11, 10.2, 11.11

snip. A small piece that has been cut off, 11.14

socket. The hole into which a plug fits, 3.7

sodium acetate (ML 86). White crystals used in Ehrlich's test, 2.4, 3.27, 8.8

sodium azide (ML 128). A very poisonous chemical used to preserve sera, 2.5, 4.10

sodium carbonate (ML 87). A white powder used in making Benedict's reagent, 2.14, 3.16, 8.3, and in testing the urine for acetone, 3.39, 8.7

sodium chloride (ML 88). 'Common salt', a white powder used for making saline, 1.4, 1.18

sodium citrate (ML 90). A white powder used in solution as an anticoagulant in the Westergren ESR, 2.4, 3.42a, 7.40

sodium dithionite (ML 93b). A chemical used to test the blood for sickling, 2.4, 7.25, 7.26

sodium hydroxide (ML 91). Hygroscopic white pellets which are dissolved to make a strong solution that is used for looking at skin scrapings for fungi, 11.15

solid. Something which does not flow and has its own shape, 1.4

solution. A liquid in which something is dissolved, 1.4

sparcs. Parts of your equipment you should keep to replace parts that break, 2.6, 5.22

spatula (ML 38). A chemist's spoon, 2.2

species. The name of a particular organism, 1.13

specimen. Part of something that is to be looked at. A specimen is part of a patient's stool, urine, blood, etc. (Second Preface), Chapter Four, 8.1

spectrum. The colours which make up white light; red, orange, yellow, green, blue, violet, 5.12

speculum. An instrument to help you to see something more easily, 11.11c

spermatozoa. The cells in the seminal fluid, 11.10

sperms. Short for spermatozoa, 11.10

sphygmomanometer. A machine for measuring the pressure of blood in the arteries, 12.12

spin. To turn round very fast, to centrifuge, 1.5

spirit (ML 100). A mixture, mostly ethyl alcohol. It is a fuel for the spirit lamp, a mild antiseptic, and is also used for making carbol fuchsin, 2.4, 3.22

spirit lamp (ML 39). A lamp for heating which burns spirit, 2.2

spreader. A special slide for spreading blood films, 7.11, 7.12

spring-loaded. A spring-loaded objective is one which springs back when it touches a slide, 6.7

spud. A very small spade, 11.11c

sputum. What a patient coughs or spits up, 11.1

sputum-negative. No AAFB present in the sputum, 11.1

sputum-positive. AAFB present in the sputum, 11.1

stage. The part of a microscope on which slides are put, 6.9

stain. A coloured chemical used to colour specimens before they are looked at with a microscope, 1.16, 3.15

staining rack for slides. See 3.2

stand (ML 40, 41, and 42). Something for holding or leaving things in. The same as a rack, 2.2

standard. Something whose weight, depth or colour or volume, etc., we are sure about, 5.9, 5.10, 5.11, 5.19

standard block. A piece of wood which comes with the Grey wedge and which contains a grey glass standard, 5.14

steatorrhea. Diarrhoea with much undigested fat in the stools, 10.10

sterile. Free from living micro-organisms, 1.20, 3.10

sterilize (sterilization). To kill all the micro-organisms in something, 1.20, 4.9

sterilizer. A machine for sterilizing, usually with boiling water, 1.20

stirring rod. A rod for stirring liquids, 3.9

stock. A stock of chemicals is the supply you keep, 2.6

stool. The waste from the bowel or gut, Chapter Ten

stool smear. See 10.2a, 10.2b

stopper. A cap or cork, 2.2

streaming. A kind of movement, 8.14

streptococcus. A coccus growing in chains like a string of beads, 9.16

Streptococcus pneumoniae. One of the bacteria which often cause meningitis, 9.16

streptomycin. A drug used for treating tuberculosis, 11.4

Strongyloides stercoralis. A worm living in the gut, 10.6

stud. A short rod

stylet. The wire that goes down inside a needle, 9.4

substance. Anything which is the same all through, 1.4

sugar in blood. See 7.42

sulphones. Drugs used in treating leprosy, 3.43a, 8.10

sulphosalicylic acid (ML 73). A white powder used for testing the urine and the CSF for protein, 2.4, 3.43b, 3.44, 8.3, 9.13

sulphuric acid (ML 95). A thick, clear, caustic, DANGEROUS liquid used for making dichromate cleaning fluid; dilute sulphuric acid is also used to measure the blood sugar, 2.4, 3.12, 3.26

supernatant fluid. The fluid on top of a deposit, 1.4

suppurative meningitis. Meningitis in which there is pus in the meninges, 9.16

suspension. Particles (such as blood cells) hanging in a liquid (such as plasma) form a suspension, 1.4

swab. A piece of gauze or cotton wool used for soaking up a fluid. To swab something is to soak up the fluid on it. To swab part of the body with antiseptic means to paint or cover it with antiseptic, 1.22

swollen. Large, fat, big

symptom. Something that the patient says is wrong with him, such as a pain, or feeling sick, 1.3

syringe. See 3.12, 4.9

syringe jaundice. A very bad kind of jaundice that can be given to a patient by giving him an injection with a dirty needle, 4.8

T

Taenia solium and *Taenia saginata*. Tapeworms, 10.1, 10.2, 10.5

taking blood. See 12.12

taking set. Equipment used to take blood, 12.9

tare. Something to balance the weight of the container in which it is being weighed, 5.2

target cell. A red blood cell with a thickening in the middle which is seen in some blood diseases, especially sickle-cell anaemia, 7.19, 7.27a

TCE. A shortened way of writing 'TetraChlorEthylene', 7.6

teat (ML 43). A little rubber bag which fits a Pasteur pipette, 2.2, 3.9

'Teepol' (ML 98). This thick pale yellow liquid is a commonly used detergent, 1.3, 2.4, 11.1

terminals. Screws on an instrument to take electricity to it or from it, 5.16

test solution. A solution whose depth of colour we want to measure, 5.9, 5.10

Vocabulary Index

- test tube* (ML 48). A short thick glass tube in which tests are done, 2.2, 13.8b
- tetrachlorethylene*. A drug used to treat hookworm infection, 7.6
- thermometer* (ML 44). An instrument for measuring temperature, 2.2, 12.6
- thick blood film*. See 7.31
- thick stool smear*. See 10.2b
- thin blood film*. See 7.11
- thrombocytopenia*. Too few platelets (thrombocytes) in the blood, 7.15
- tile* (ML 49). A flat square of plastic with holes in it, in which some tests are done, 2.2, 8.9
- time and motion study*. The study of the way of doing the most work with the least time and effort, 3.14
- tissue*. (i) The different parts from which the body is made, such as liver tissue, muscle tissue, skin tissue, etc., 1.9. (ii) Thin paper, such as lens tissue (ML 29), 6.16
- toxaemia of pregnancy*. A disease some mothers get when they are pregnant, 8.4
- trachea*. The tube which takes air down the neck to the lungs, 1.9
- transfusion*. Taking blood from one person and giving it to another person, 12.1
- transfusion reaction*. The illness a patient suffers from if he is given the wrong blood, 12.2
- transparent*. Clear, easily seen through, 1.3
- trematode*. A flatworm or fluke, 1.14
- trichloroacetic acid* (ML 74). Colourless crystals used to make Fouchet's reagent, 3.30
- Trichomonas hominis*. A harmless flagellate which lives in the gut, 10.10
- Trichomonas vaginalis*. A flagellate often found in the vagina, 8.13, 11.8
- Trichuris trichiura*. The whipworm, 10.1, 10.5
- triple*. In three parts.
- triple beam balance*. A balance with three beams (ML 1), 2.2, 5.1
- tripod* (ML 42). A stand with three legs, 2.2, 7.42
- trivet*. The shelf in a pressure cooker to hold things that are being sterilized, and thus keeps them out of the water, 1.21
- trophozoite*. The larger active form of a protozoon, 1.14
- trunion*. The parts of a centrifuge from which the buckets hang, 1.5
- Trypanosoma gambiense* and *rhodesiense*. Two flagellates, 7.36, 9.14, 11.12
- trypanosomiasis*. The disease caused by trypanosomes, 7.30, 9.14, 11.12
- tube of a microscope*. An empty tube at the bottom of which are the objectives and at the top of which is the eyepiece, 6.2, 6.8, 6.9
- tuberculosis*. A chronic disease, usually of the lungs, due to infection with *Mycobacterium tuberculosis*, 1.12, 11.1 to 11.4
- tuberculous meningitis*. Meningitis caused by *Mycobacterium tuberculosis*, 9.18
- tubing* (ML 50 and 51). Long pieces of tube that can be used for many purposes, 2.2, 3.4, 3.9
- turbid*. A fluid is turbid when it is cloudy or milky or if there are particles floating in it, 1.3, 9.10
- typical*. Usual, ordinary, 1.3

U

- umbilicus*. The 'hole' in the middle of the abdomen, 9.5
- undulating membrane*. Part of a trypanosome, 7.36
- universal*. Everyone, everything, everywhere
- universal container* (ML 14a). A specimen bottle with a screw cap, 2.2, 4.6, 13.8b
- universal donor*. A person of blood Group O whose blood can be given to anyone, 12.2
- universal indicator test paper* (ML 109). A paper coloured with a mixture of indicators which shows many colour changes and thus many different pH's, 1.8, 10.12
- universal recipient*. A person of blood group AB who can be given blood from anyone, 12.2
- uraemic*. Too much urea in the blood, 7.41
- urea*. A waste substance excreted in the urine, 7.41, 8.2
- urease*. An enzyme which breaks down urea, 1.10, 7.41
- urethra*. The tube taking urine from the bladder outside the body, 8.4
- urethral discharge*. A discharge from the urethra, 8.4, 11.6
- urine, clean specimen of*. See 8.1
- urinary tract*. The parts of the body where the urine is, the kidneys, ureters, bladder, and urethra, 8.1
- urobilinogen*. One of the bile pigments, 8.8
- uterus*. The womb, 7.7

V

- vacuum*. A space with nothing in it, not even air, 4.10, 12.9
- vagina*. A woman's birth passage, 8.4
- vein*. A thin-walled blood vessel taking blood from the tissues to the heart, 4.7
- venereal*. Spread through sex, 11.6
- venous blood*. Blood taken out of veins, 4.7
- vent*. A small hole to let something out, 1.21
- vertebrae*. The bones of the spine, 9.1
- vertebral column*. The spine or backbone, 9.1
- vertical*. Standing straight up, 1.3
- vessels*. Tubes
- vestibule*. The vestibule of the nose is its outer part which can be reached by a finger, 11.11
- virus*. The smallest and simplest kind of micro-organism, 1.14, 9.17
- virus meningitis*. Meningitis due to viruses, 9.17
- '*Viscap*'. A plastic cap put on bottles of blood, 12.9
- Vitamin B₁₂*. A vitamin used for treating some kinds of anaemia, 7.7, 7.19
- volatile*. A volatile liquid is one which evaporates very easily, 1.4, 2.4
- volt*. A way of measuring the strength of electricity. Most car batteries are 12 volts. Some mains electricity is 110 volts, some is 220 volts, 3.7

volume. The space that something takes up, occupies or fills, 5.7

W

wash bottle (ML 8). A special bottle which lets fluid come out of a tube when you tip or squeeze it, 2.2

washer. A common kind of washer is a rubber circle with a hole in it. Washers are often used to stop gases or liquid escaping. Metal washers are often used with nuts and bolts, 3.4, 5.22

washing equipment. See 3.12

watch glass, polypropylene (ML 52). This is a plastic dish or plate, on which chemicals are weighed, 2.2, 5.1

water in the laboratory. See 3.2, FIGURE 3-11

water-bath (ML 53). A bath of water kept warm all the time by electricity or gas, 12.6

wedge. Something which is thick at one end and thin at the other, 5.11

white blood cell. A leucocyte, 7.14

white cell count. The number of white cells in each cubic millimetre of blood, 7.22, 7.29

white cell diluting fluid. Fluid used for diluting blood to count the white cells, 3.45, 7.29, 9.9

wick (ML 54). The cloth in a lamp which is wet with oil or spirit, 2.2

wound. A cut in the body

Wuchereria bancrofti. A filarial worm, 7.37

Wuchereria malayi. A filarial worm, 7.37

X

xylol, xylene (ML 101). This is a volatile liquid used for cleaning the lenses of microscopes, 2.4, 6.16, Picture Z, FIGURE 6-20

Y

yeasts. Plant-like micro-organisms related to fungi, 8.13, 11.15

Z

zero. Nothing or '0', 1.3

Ziehl-Neelsen's method. A way of staining *Mycobacterium tuberculosis* and *Mycobacterium leprae*, 11.1

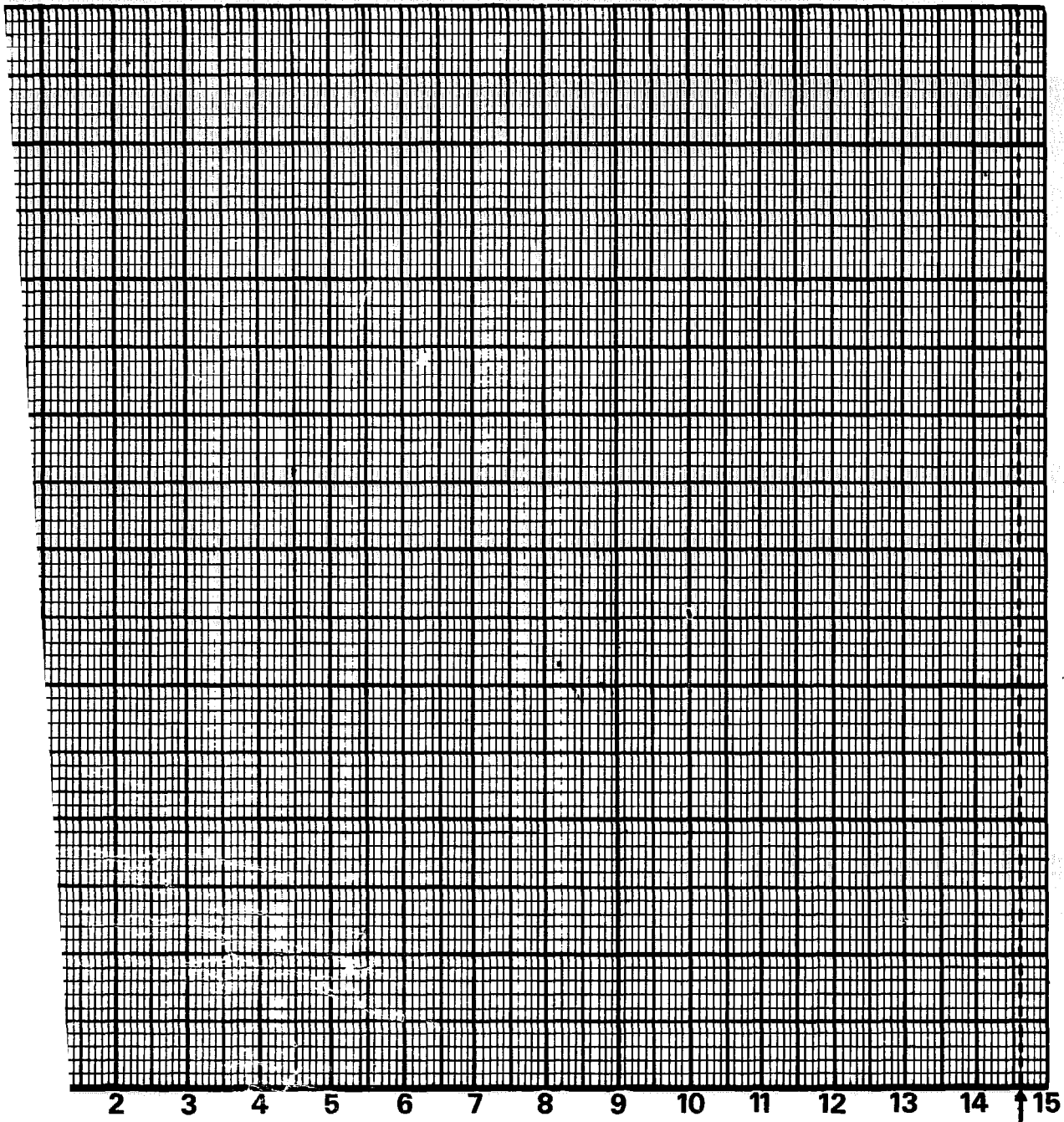

HAEMOGLOBIN - GRAMS PER 100 ML - 'GRAMS %'

14.6

and use
your own
graph

Neutral grey standard

Fig. 5-10 Making your own graph for the EEL

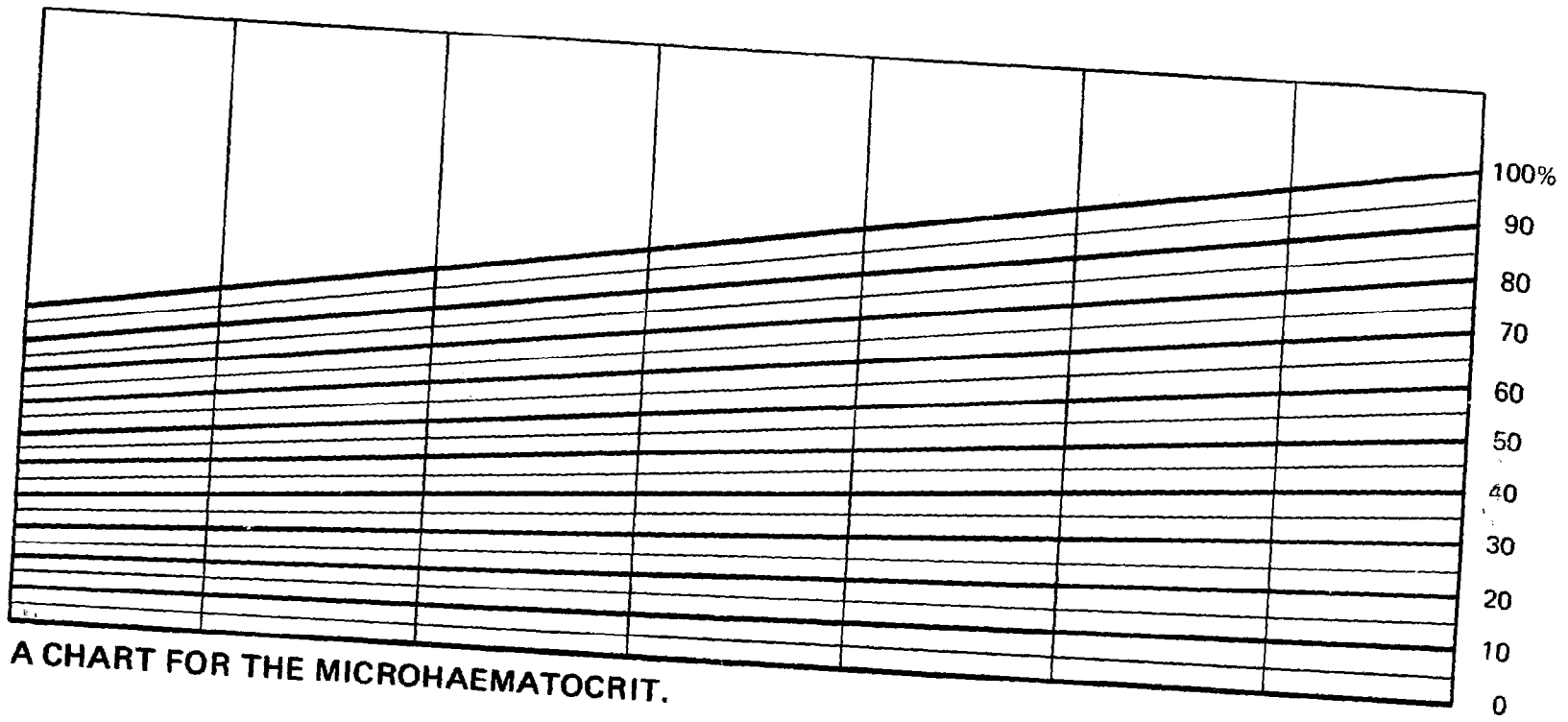

A CHART FOR THE MICROHAEMATOCRIT.

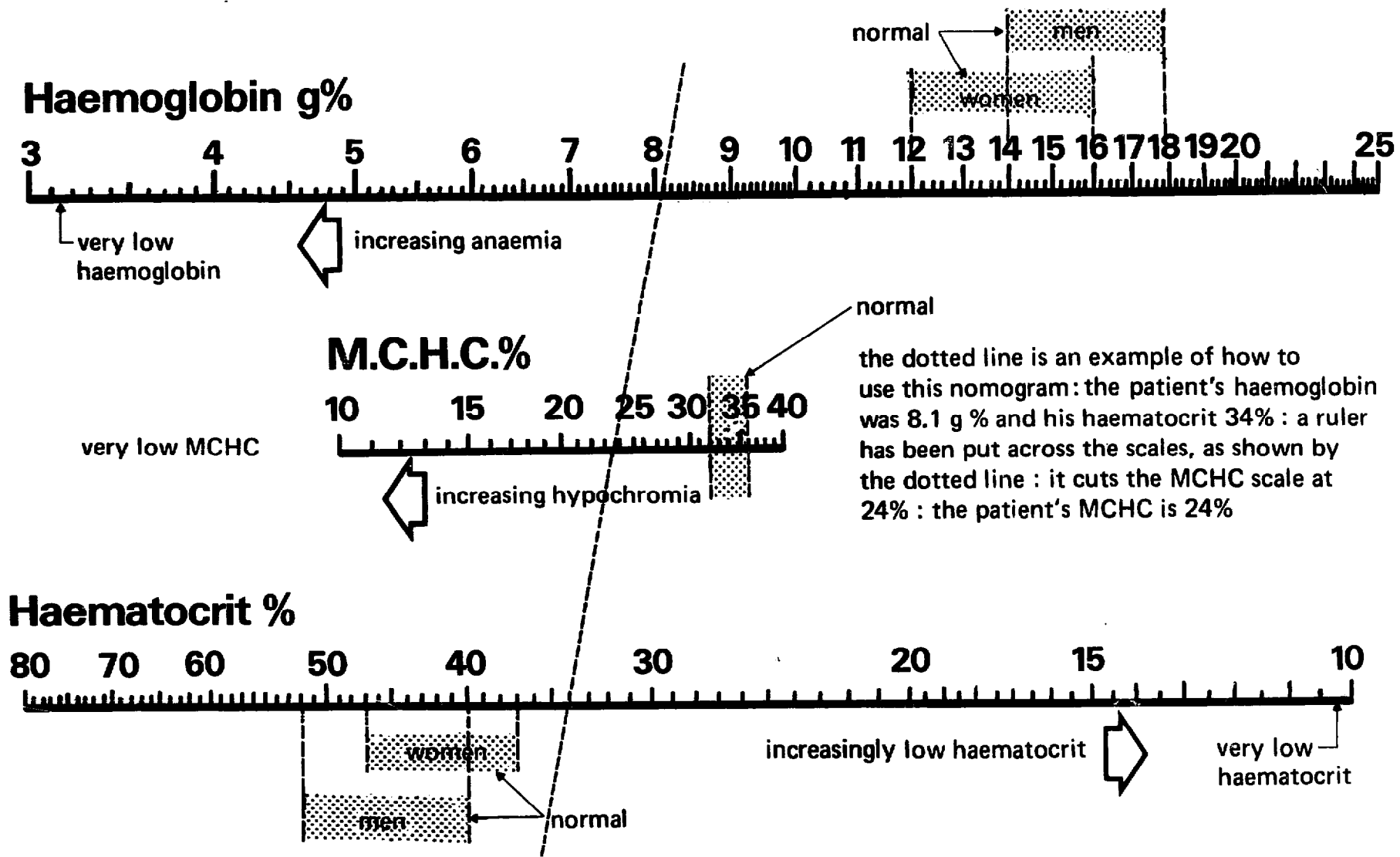

Fig. 7-4 A nomogram for the MCHC

Conversion scales for the Grey Wedge Photometer

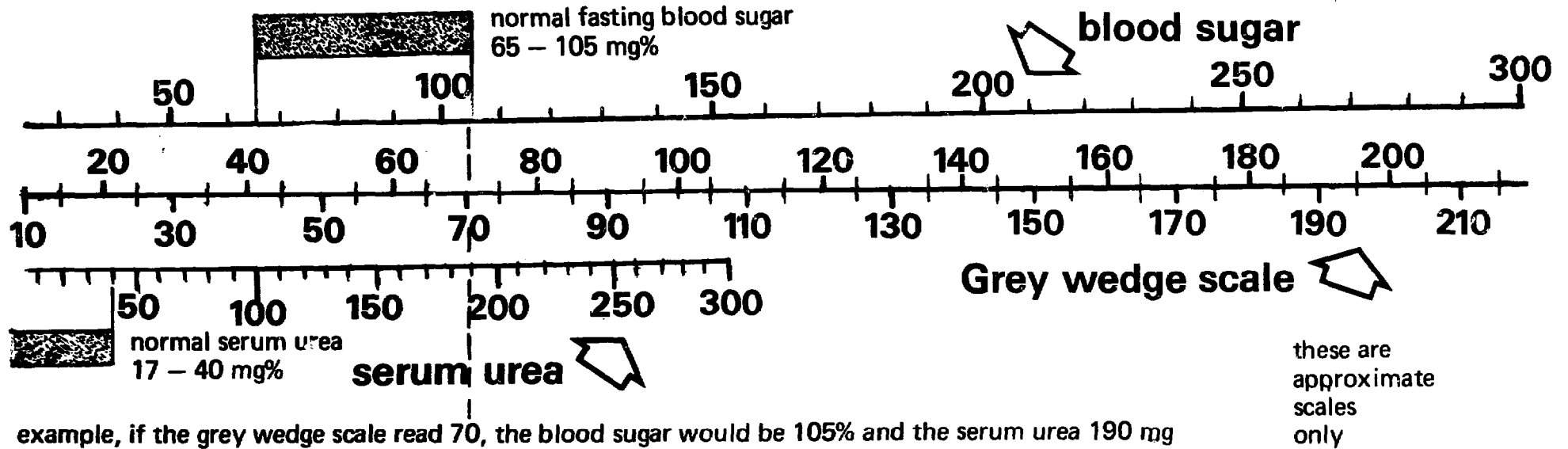

Fig. 7-35 The blood urea

EXPLAINING THE PLATES

The size of things. Many of the plates show things at different magnifications. For example, the red cells and the polymorph in Plate 1 are shown at a low magnification and look small. In Plate 2 they are at a higher magnification and look bigger. If you want to find out how large something really is, see if there is a red cell in the plate and compare it with this. A red cell is about $7.5 \mu\text{m}$ across (see Figure 6—3), so a polymorph which is a little larger might be perhaps 12 or $15 \mu\text{m}$ across. The microfilariae in Plates 51 to 55 are much larger and may be $100 \mu\text{m}$ long. Some of the plates have no red cells in them, and if you want to see the size of these things, look back to the black and white figures. These usually show a red cell with which you can compare what you see.

Stains. Most of the plates show things either unstained, or stained by the methods given in this book, such as Leishman's stain (Plates 1 to 9), Gram's stain (Plates 101 and 102), or Ziehl-Neelsen's stain (Plates 103 to 107). Some plates show things stained or preserved in other ways. Thus the malaria parasites in Plates 18 to 41 have been stained by Giemsa's method. This is like Leishman's method and is a good stain for blood parasites. *Borrelia duttoni* in Plate 43 is stained with methylene blue. The two microfilariae in Plate 53B have been stained black and grey with iron haematoxylin. This stains nuclear chromatin black and is a good stain for nuclei. The amoeba in Plate 87 is lying in a red solution of eosin. This does not stain the amoeba, but its redness lets the pale cytoplasm of the amoeba be seen more easily. Plates 70, 71, 74, and 75 show ova that have been preserved in a solution of Merthiolate, Iodine, and Formalin (MIF solution) which stains them slightly red.

All these plates were taken from specimens coming from man, and you might see any of them in your laboratory. Some of them show you what to avoid. Thus Plate 45 is a good Giemsa stained thick film, but in Plate 47 some haemoglobin has been left behind. The thick blood film in Plate 48 has been well stained by Field's method, but Plate 49 shows you the debris that you must avoid.

Many people have kindly helped with these plates. Especial thanks are due to Professor B. Bhagwandeem for kindly allowing the use of his department's photomicroscope, to Dr. M. Dowling for Plates 18 to 41, to Clay Adams Inc. for Plates 53A and 54, to Dr. Stanley Browne, O.B.E., for Plates 104, 105, and 106, to Miss Dawn Smith for Plate 107, and to Professor Leonard Bruce-Chwatt, O.B.E., for kindly commenting on the proofs of all of them.

This series of plates will doubtless be useful, but it is not ideal. The author will be delighted to hear from readers with colour transparencies that might be used in a second edition to improve the quality and completeness of the present series.

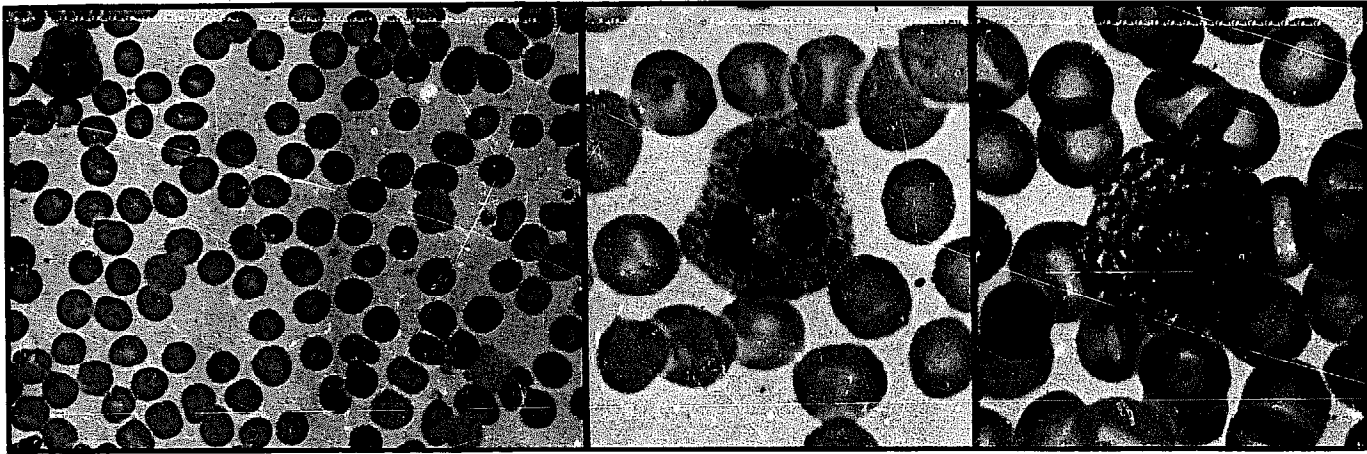

1. A normal blood film with a neutrophil polymorph at its top left corner. The red cells are nearly all the same size and shape and are well filled with haemoglobin. 2. The same neutrophil polymorph as in Plate 1. Its nucleus has

several segments and there are many very small purple granules in its cytoplasm. 3. An eosinophil polymorph with many larger pink granules in its cytoplasm. These sometimes stain slightly purple, as in this film.

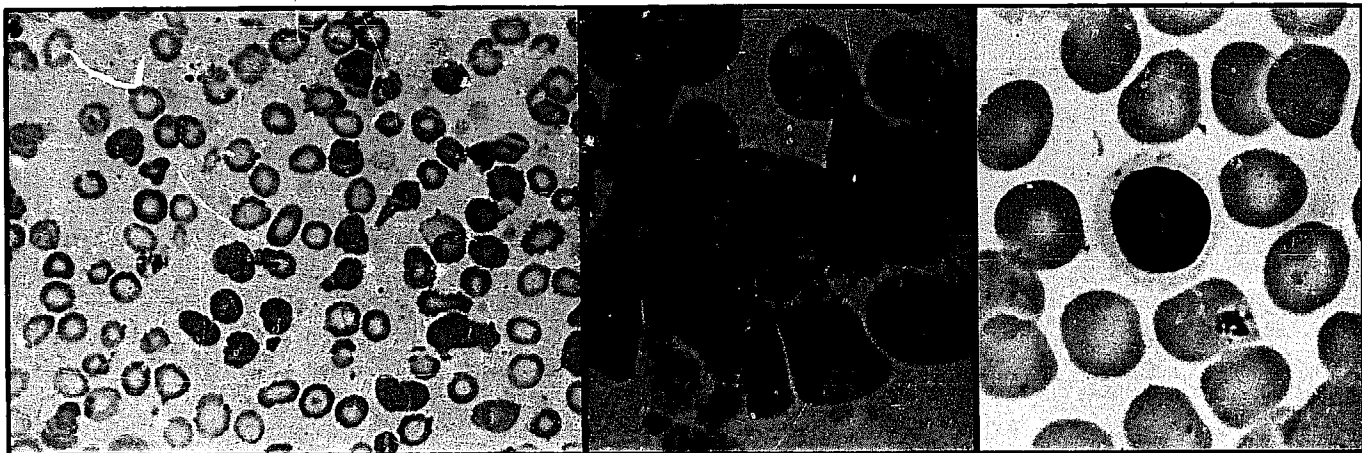

4. A hypochromic microcytic film from a very anaemic patient with a low MCHC. The cells differ greatly in size (anisocytosis) and shape (poikilocytosis) with many small cells (microcytes). They have a pale empty centre and are poorly filled with haemoglobin (hypochromic).

5. A basophil polymorph with a segmented nucleus and big dark blue granules. Part of a monocyte and some platelets are also shown. 6. A small lymphocyte with a round nucleus, clear pale blue cytoplasm and few granules.

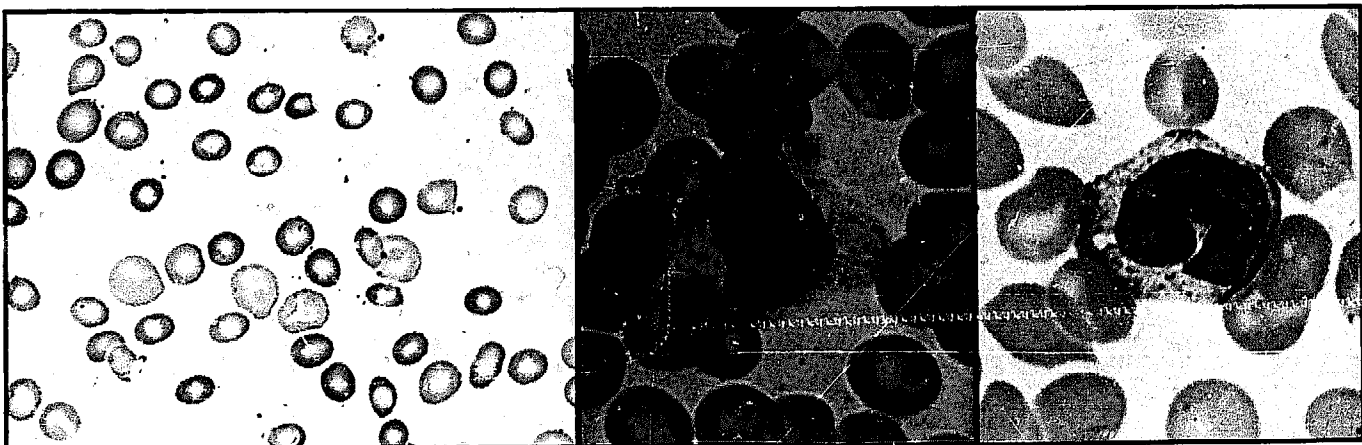

7. A normochromic macrocytic blood film. The cells are well filled with haemoglobin (normochromic), there is anisocytosis and many cells are larger than normal (macrocytes). 8. A large lymphocyte with a kidney-shaped nucleus and few purple granules in a clear pale

blue cytoplasm. 9. A monocyte with a kidney-shaped nucleus, more uneven nuclear chromatin than the lymphocytes, and some purple granules in a 'smoky' cytoplasm.

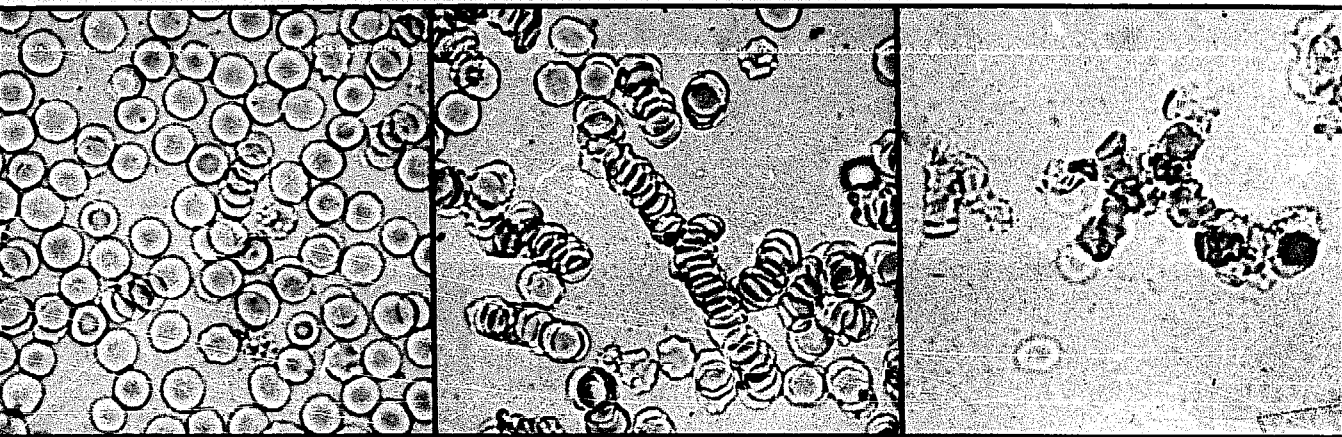

10

These are fresh unstained wet blood films from donor blood being cross-matched (see Pictures 14, 15, and 16, Figure 12—3). 10. The red cells have formed a few small rouleaux ('piles of coins')—the blood is compatible.

11

11. There are large rouleaux due to 'Dextran'—the blood is also compatible. 12. The cells have agglutinated in an ABO mismatch. Much larger agglutinates were seen in other parts of the film—the blood is incompatible. Some crenated cells, due to slow drying of the blood, are seen in 10 and 11.

12

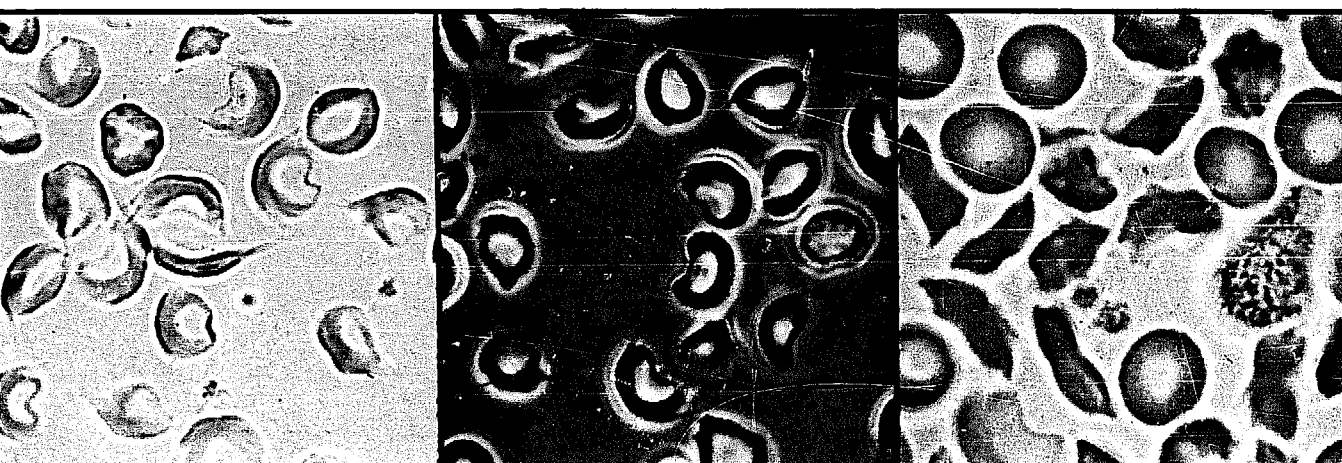

13

These are all wet films of sickle cells (Section 7. 24). 13. Several sickle cells with long sharp points or spikes can be seen. 14. These long spikes are seen much better when the same slide as 13 is looked at with a phase

14

contrast microscope. 15. This blood has also sickled, but most of the cells have more and shorter spikes. This is the 'holly leaf' kind of sickling. A white cell and two platelets are also seen.

15

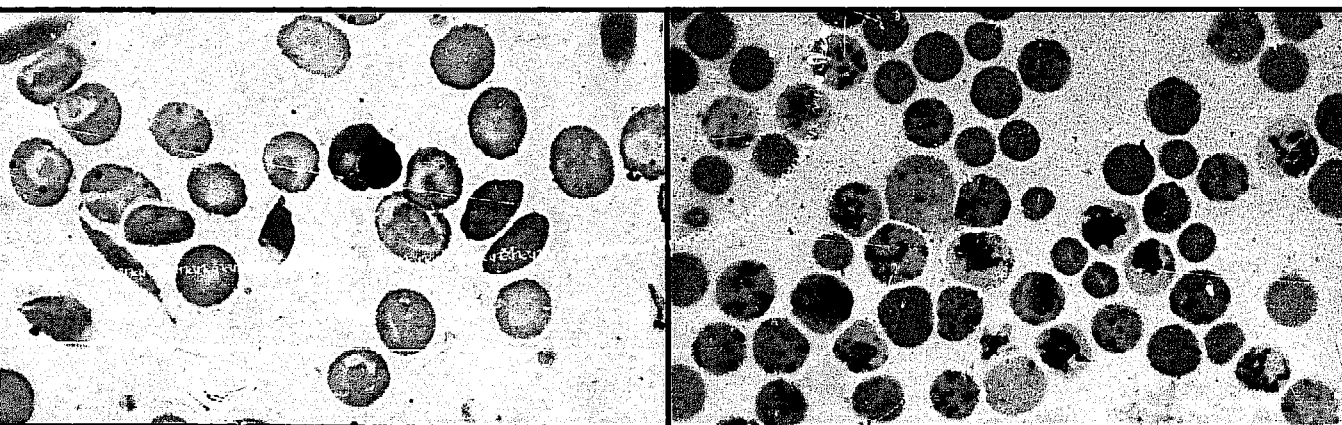

16

16. A Leishman stained thin blood film from a patient with sickle cell anaemia (haemoglobin SS). There is a late normoblast with a round dark nucleus, some slightly polychromatic (purplish staining) red cells, some target cells with a well stained centre around which is a paler

17

ring (see Picture D, Figure 7—II), and one long pointed sickle cell. 17. Reticulocytes from a cresyl blue stained dried blood film. This patient had a severe reticulocytosis with 30% reticulocytes (normal adult less than 2%).

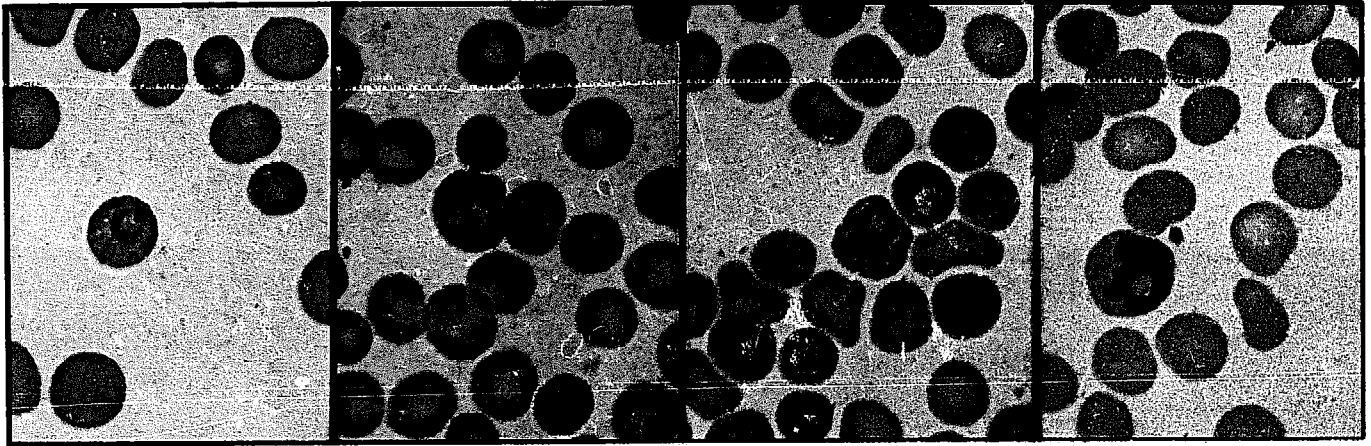

18
Plasmodium vivax. **18** and **19**. These are both young trophozoites. Fine red dots—Schuffner's dots—can be seen in the cytoplasm of all infected red cells. The infected cells in 19-25 are enlarged, and also perhaps

20 and **21**. These show developing trophozoites with irregular amoeboid cytoplasm. In **21** there is a clear pale vacuole in the trophozoite. Two granules of pigment can be seen in the cytoplasm of **20**.

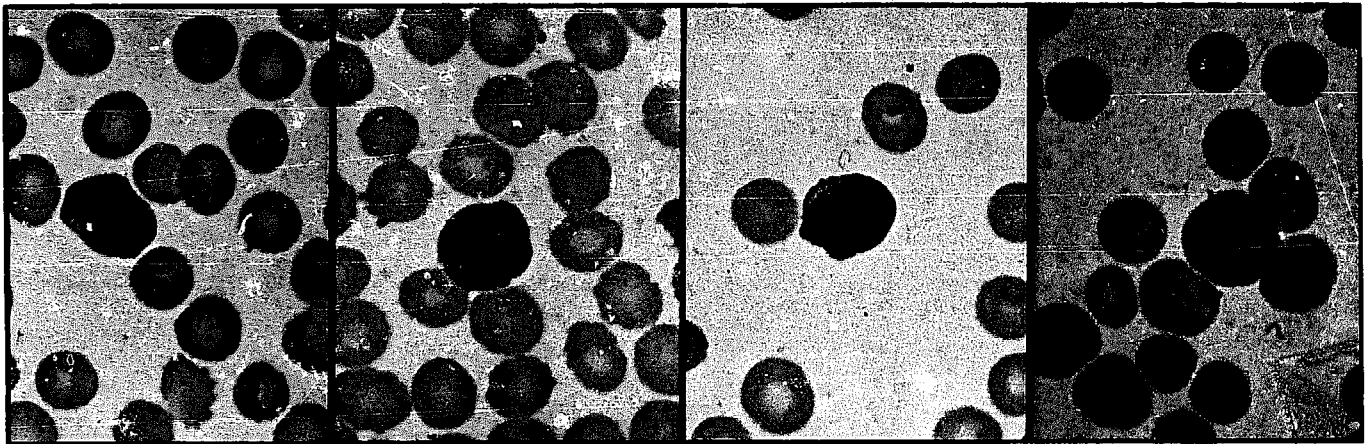

22
Plasmodium vivax. **22**. This is an early schizont, the chromatin has split into three pieces, Schuffner's dots are seen and there is a small clear vacuole. **23**. This is a late schizont which will soon break up into many merozoites. The nuclear chromatin has already divided into many

24 and **25**. **24**. A male gametocyte. The nuclear chromatin is mostly spread through the cell. **25**. A female gametocyte in which the chromatin is in one lump.

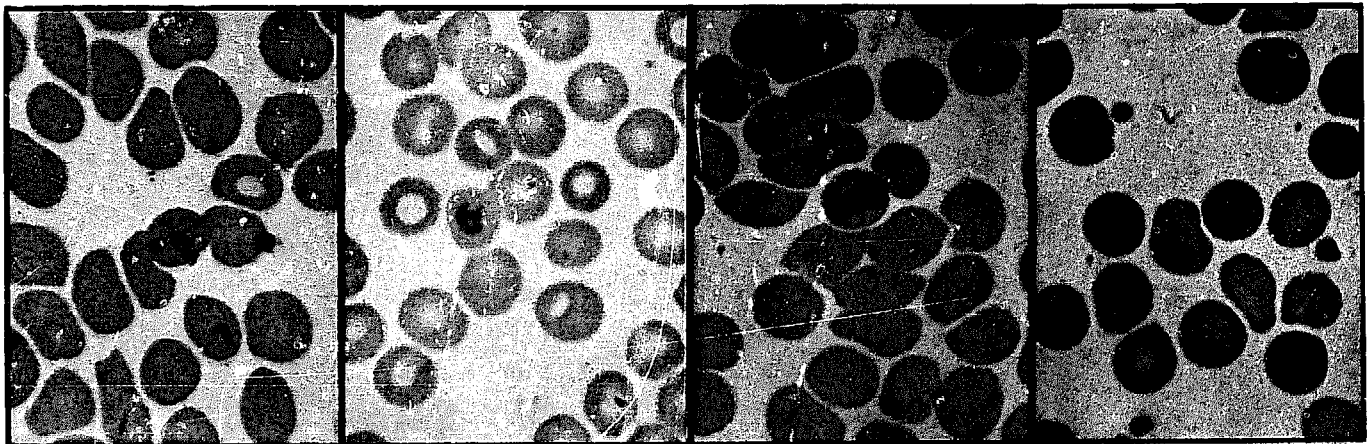

26
Plasmodium malariae. **26** and **27**. These are young trophozoites. **28** and **29**. These are older trophozoites. The infected red cells are not enlarged and there are no Schuffner's dots. There is some black pigment in the

28 and **29**. The cytoplasm of the trophozoites, especially **28** and **29**. The cytoplasm of *P. malariae* is often spread out in a band across the cell, as in **26** and **28**.

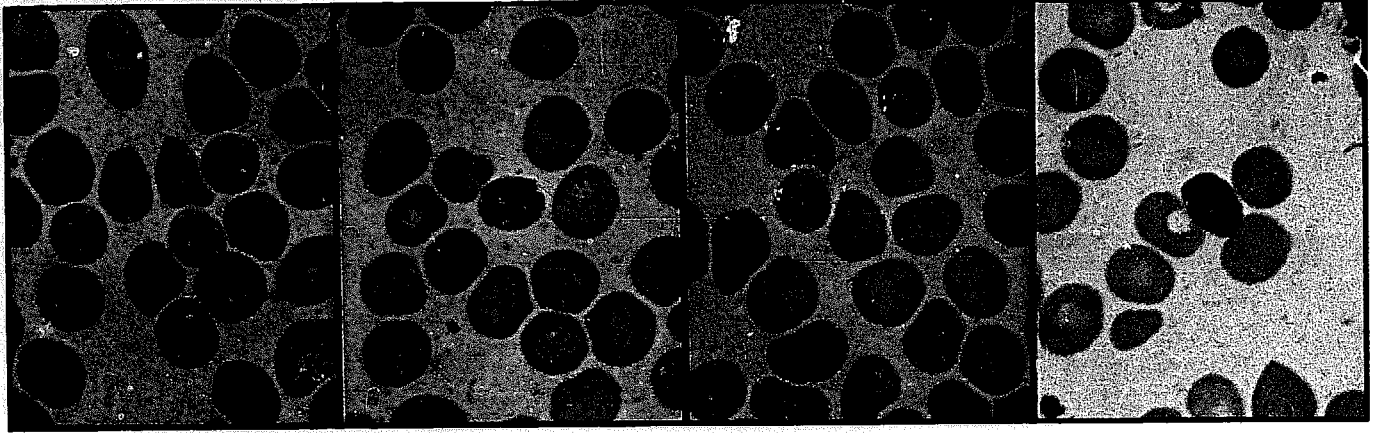

30

31

32

33

Plasmodium malariae. 30. The lowest parasite to the right is probably an early gametocyte, and the other two early schizonts. The infected cells are not enlarged. As usual with *P. malariae* there is much black pigment and the uninfected part of the cell looks normal. 31. A later

schizont with chromatin broken into pieces, also an early trophozoite with a large chromatin dot. 32. A male gametocyte. 33. A female gametocyte which is larger and its chromatin more together in one lump.

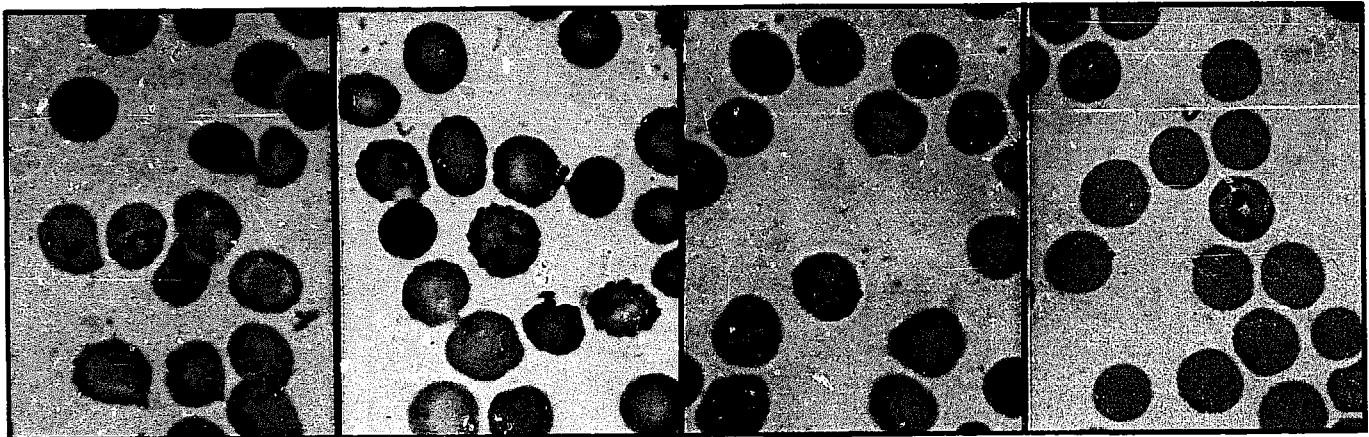

34

35

36

37

Plasmodium falciparum. 34 and 35. These show heavy infections with young trophozoites. Several cells have more than one parasite. Several parasites have a double chromatin dot. 36. Two trophozoites are stuck to the edge of a red cell. 37. An older trophozoite with red spots

in the cytoplasm of the red cell—Maurer's spots. These are larger and scarcer than Schuffner's dots, and are only seen in cells infected with the older trophozoites of *P. falciparum*.

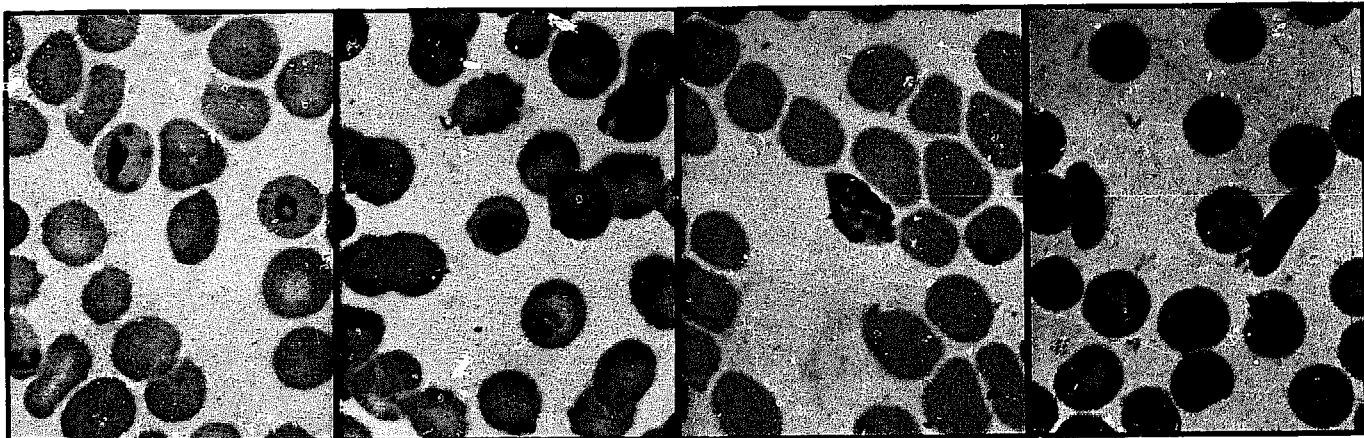

38

39

40

41

Plasmodium falciparum. 38. Three trophozoites, two of them showing Maurer's spots. 39. Several young trophozoites, including two in one cell, also an early schizont with chromatin in three parts. 40. A late schizont with chromatin in several parts and a large piece of pigment.

41. 'Crescents'—a female gametocyte (left) and a male gametocyte (right). In the female the chromatin is together in a lump and the cytoplasm bluish. In the male the chromatin is spread out and the cytoplasm purplish.

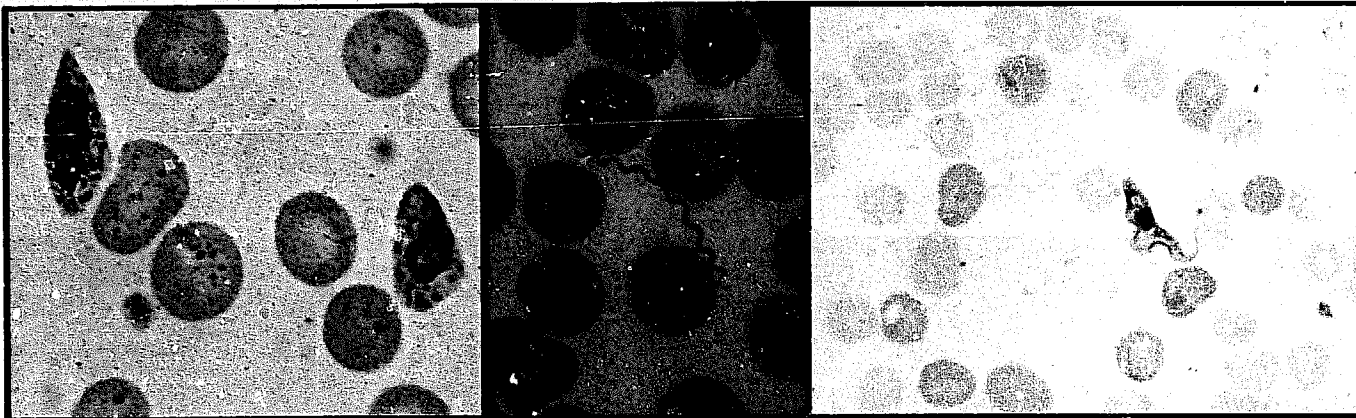

42

43

44

42. Two mature trophozoites of *Plasmodium ovale* stained by Leishman's method. The red cells are enlarged and usually have an irregular oval shape like those shown here. Schuffner's dots are easily seen. 43. *Borrelia duttoni* stained with methylene blue. This snake-like bacterium

is also seen in the thick film 46 below. 44. *Trypanosoma rhodesiense* or *T. gambiense*. These two trypanosomes look the same in a blood film. Several of the red cells are very polychromatic (purple staining).

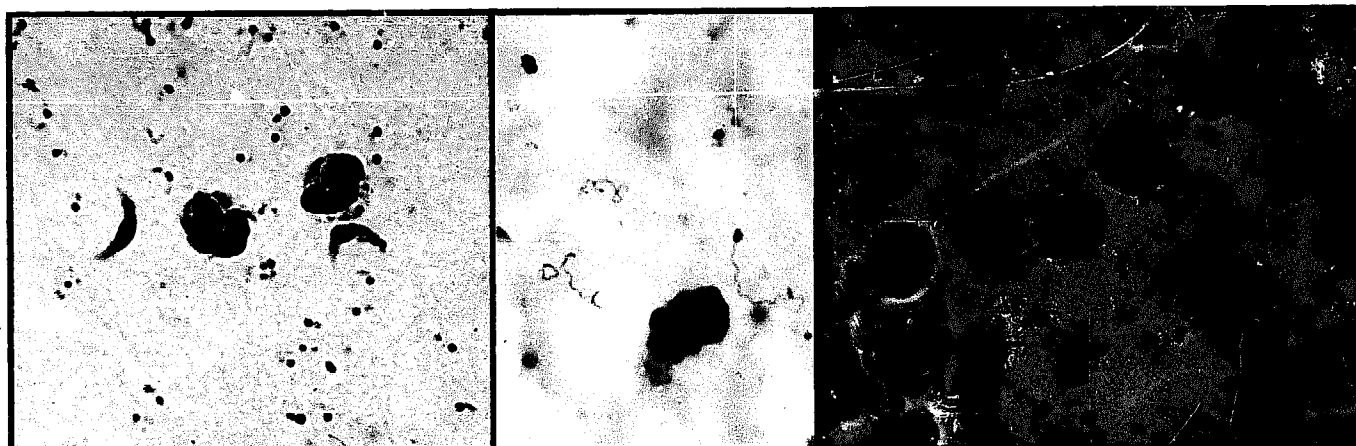

45

46

47

45. This is a Giemsa thick film showing two gametocytes of *P. falciparum* ('crescents'), many young trophozoites, probably also *P. falciparum*, and two polymorphs. 46. A thick film stained by Field's method showing *Borrelia duttoni*. 47. A Giemsa thick film showing a heavy

infection with many young malarial trophozoites, probably *P. falciparum*. All the haemoglobin should be washed out of a Giemsa thick film, and it should look like 45. Here too much remains and makes the film yellow-green.



48

49

50

48. Trypanosomes in a thick film stained by Field's method. The clear orange background of haemoglobin from the lysed cells lets the trypanosomes be seen very easily. 49. This is another Field's thick film and is not well stained. Try to get films like 48 and avoid the brown

debris shown here. You may have to search hard to find a parasite like that at the bottom of the plate—not all films are as easy as the next one. 50. A Field's thick film showing many young trophozoites—probably *P. falciparum*.

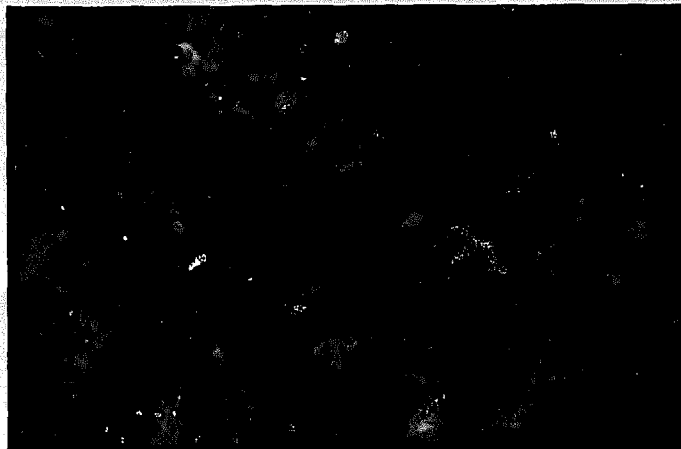

51

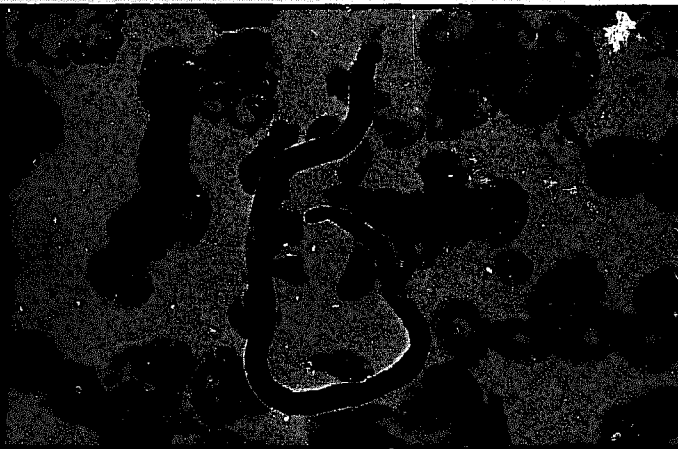

52

51 and 52. These are the same species of microfilaria. 51 is a Giemsa stained thick film with much dark purple background. 52 is a Leishman stained thin blood film. This microfilaria has no sheath and nuclei go right to the tip of its tail which is rounded in a small knob, as is usual

with this species. It is thus *Dipetalonema perstans*, which is also called *Acanthocheilonema perstans*. Something else is seen in this film. What is it? Answer underneath Plate 95.

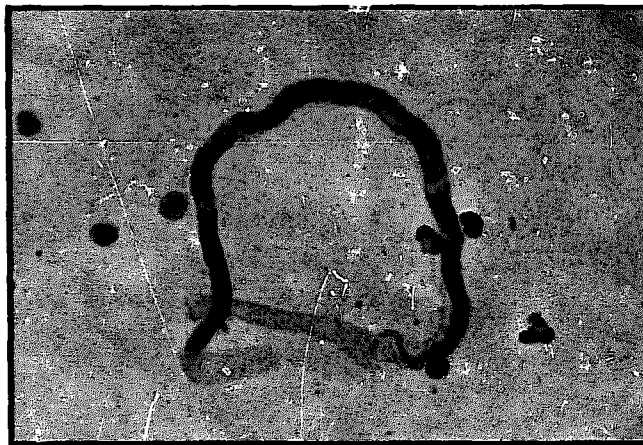

53A

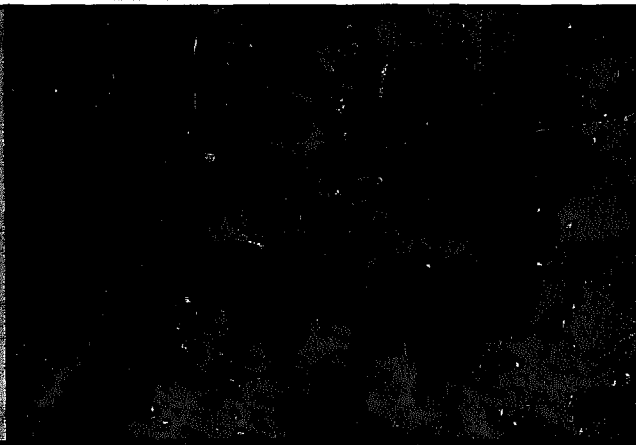

53B

53A. This is a Giemsa stained thick blood film. 53B. This is an iron haematoxylin stained film showing the tails of two microfilariae. The microfilariae in both plates are covered with sheaths and there are many nuclei right to

the tips of their tails. They are *Loa loa*—see Figure 7-31. It may not be easy to tell the species of a microfilaria. Look at several. Look for a sheath, and then at the nuclei at the tip of the tail.



54



55A



55B

54. This is a Giemsa thick film of *Brugia malayi* showing the sheath and two nuclei in the tail. 55A and 55B. These show a microfilaria and the tail of another from the same Giemsa film. Neither microfilaria has a sheath and their

nuclei stop well before the ends of their sharply pointed tails. They are both probably the microfilariae of *W. bancrofti* which have lost their sheaths.

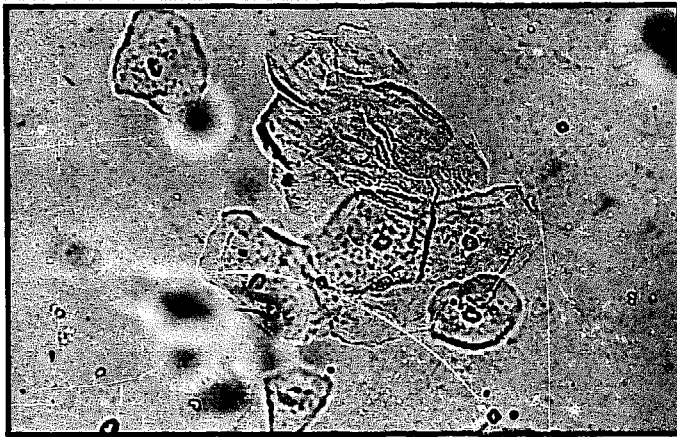

56

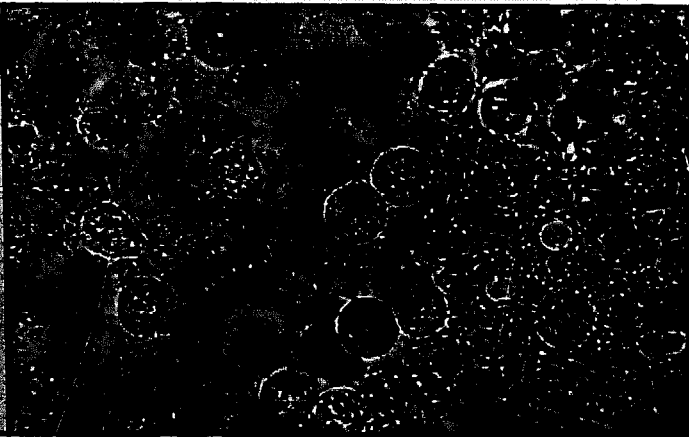

57

All the plates on this page are centrifuged urinary deposits. They are colourless specimens of poor contrast, so the iris diaphragm of the microscope was nearly closed to increase the contrast, and they were photographed in little light. 56. Some flattened epithelial cells, several of

them joined together. These are normal, and in women often come from the vagina. 57. Many very small bacteria, some round ball-like pus cells, and three red cells. All these things are abnormal.

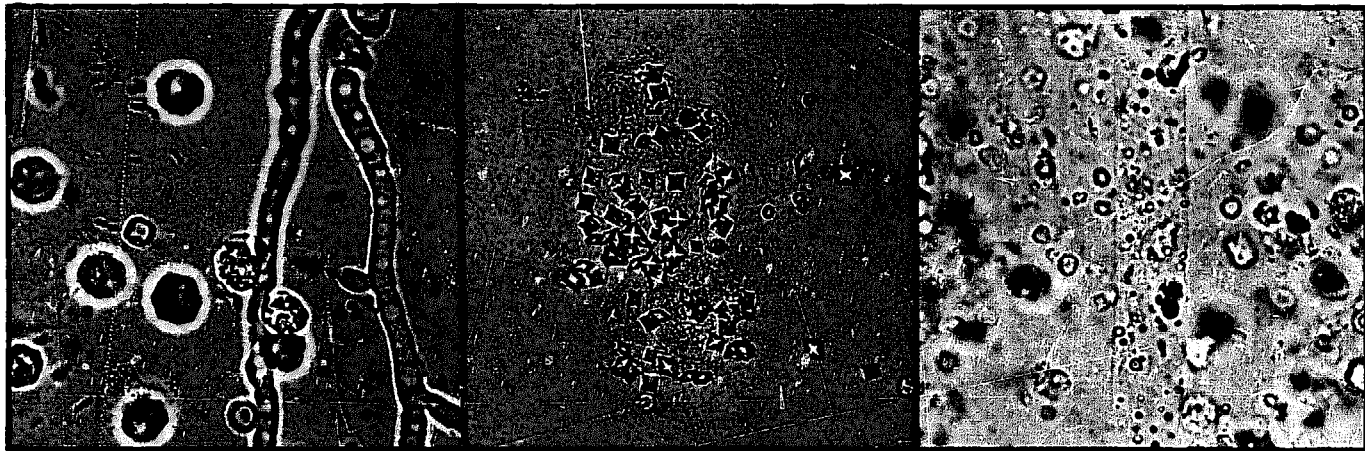

58

58. Two mycelia ('threads') of a mould or fungus, and some pus cells. The right hand mycelium branches near the bottom, and a short branch to the left is starting to grow half way up. A cell wall can be seen dividing two

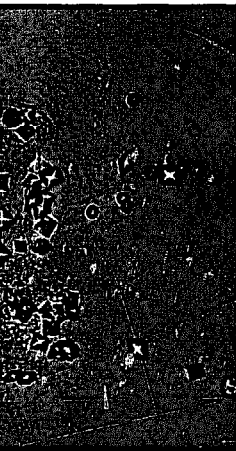

59

cells just below this branch. 59. Some 'envelope shaped' oxalate crystals. 60. A hyaline ('glass-like') cast can be seen going from the top to the bottom of the centre of the plate. It contains a few granules.

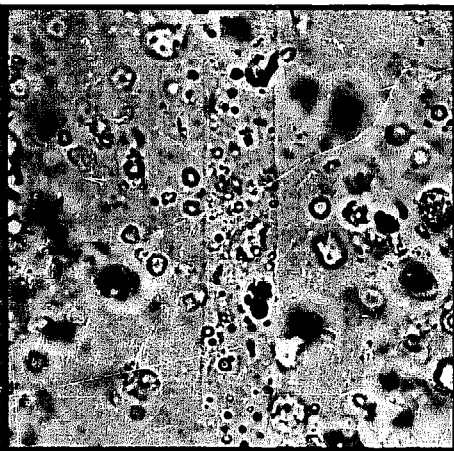

60

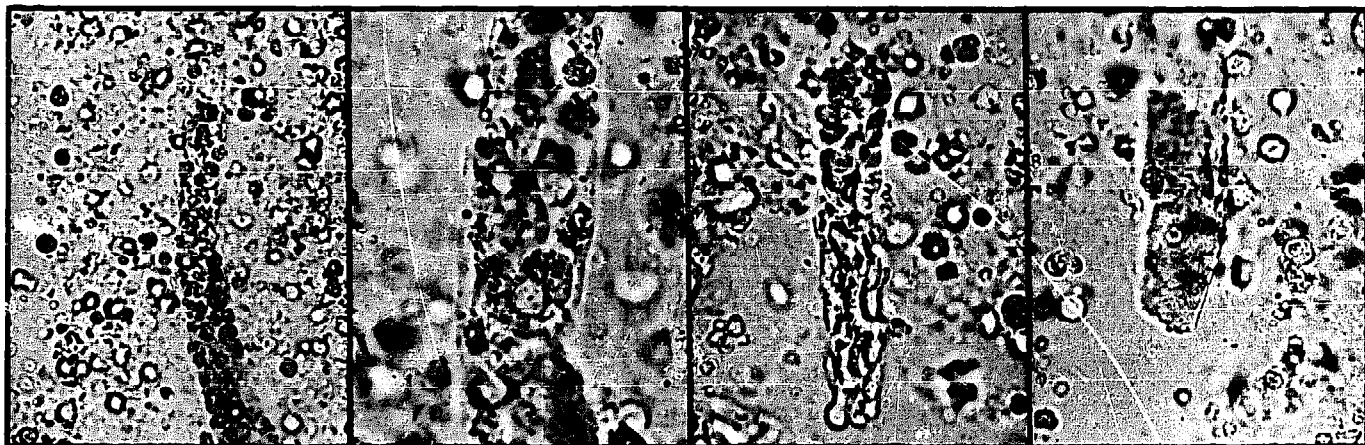

61

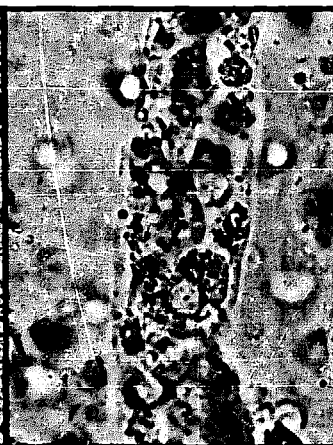

62

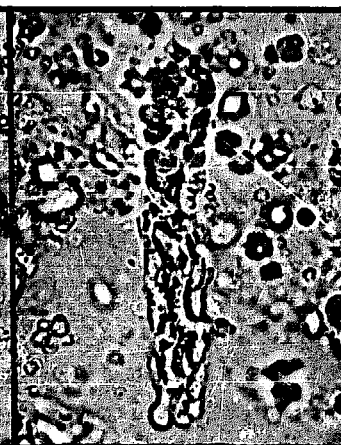

63



64

All the plates in this row show various kinds of cast. 61. A low power view of a cellular cast. 62. A high power view of the same cast as 61 showing the cells more clearly. 63. Another kind of cellular cast. 64. A small

granular cast. Many pus cells can also be seen in these plates. Another important kind of cast which is not shown is that made from red cells.

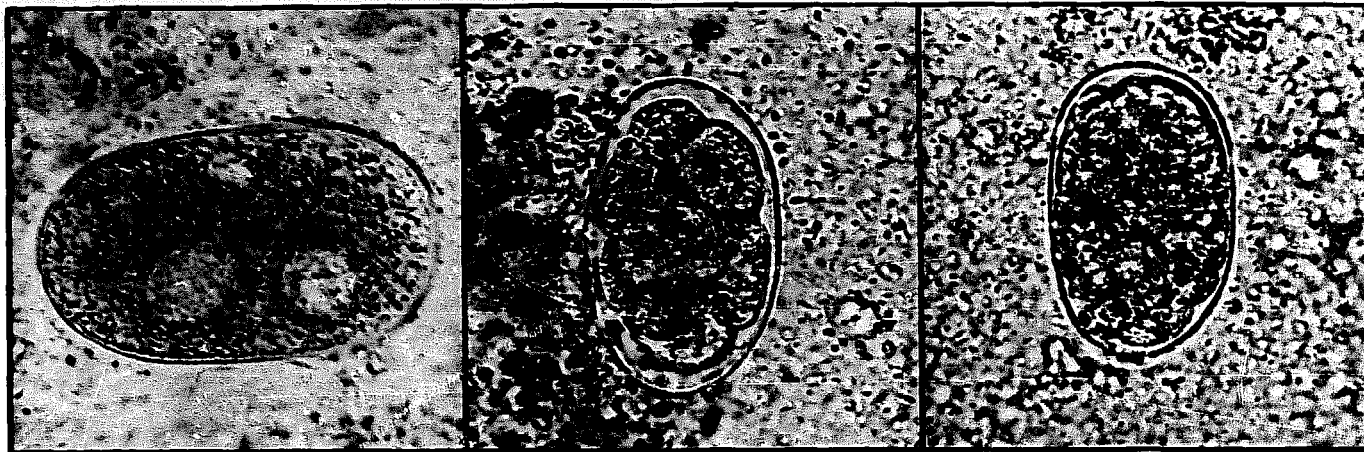

65

All the ova on this page are unstained, except for 70, 74, and 75, which have been stained red with merthiolate solution (MIF). 65-69 show stages in the life of the hookworm, *Ancylostoma duodenale* or *Necator americanus* which have ova that look the same. 65. There is still only

66

one cell, but its nucleus has already divided into three. 66. The hookworm ova is now in the morula ('ball') stage with about eight cells. 67. This is a later morula with too many cells to count.

67

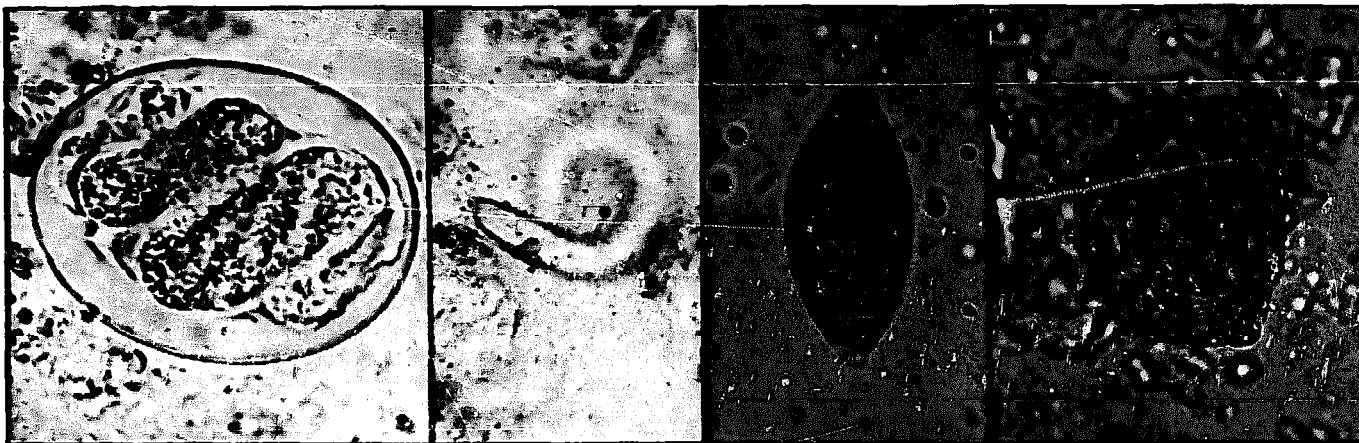

68

68. A hookworm embryo which is about to hatch and become a larva. 69. A newly hatched larva. This might be a hookworm, and it might be the larva of *Strongyloides*. It is not possible to tell the difference without looking more closely at its mouth and tail (Plate 82 and Figure

69

70

10-7). 70. The 'tea tray' ovum of the whipworm, *Trichuris trichiura*. All the rest of the ova on this page, 71-75, are different kinds of *Ascaris*. 71. The thick rough

71

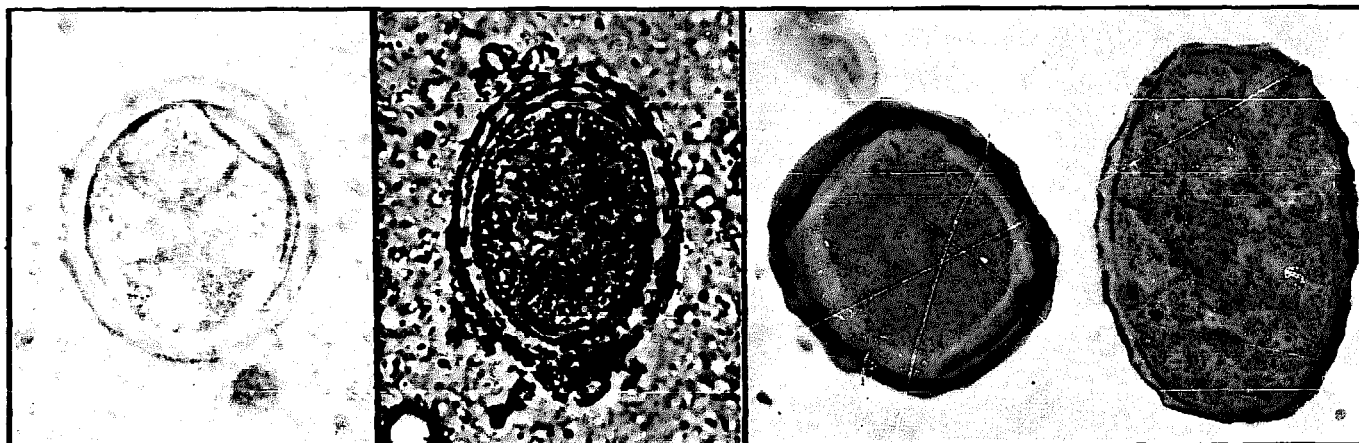

72

72. Most *Ascaris* ova have a thick rough outer wall or cortex like 71. Sometimes they lose part of this cortex and become 'decorticate' like this ovum which is in the four celled morula stage. 73. Another decorticate *Ascaris* ovum. 74. Another *Ascaris* ovum which is partly decorticate.

73

74

75. Most *Ascaris* ova are fertile and come from female worms that have mated with males. Some ova are infertile, like this one. Infertile *Ascaris* ova are larger, longer, and thinner walled with more granular cytoplasm than fertile ova.

75

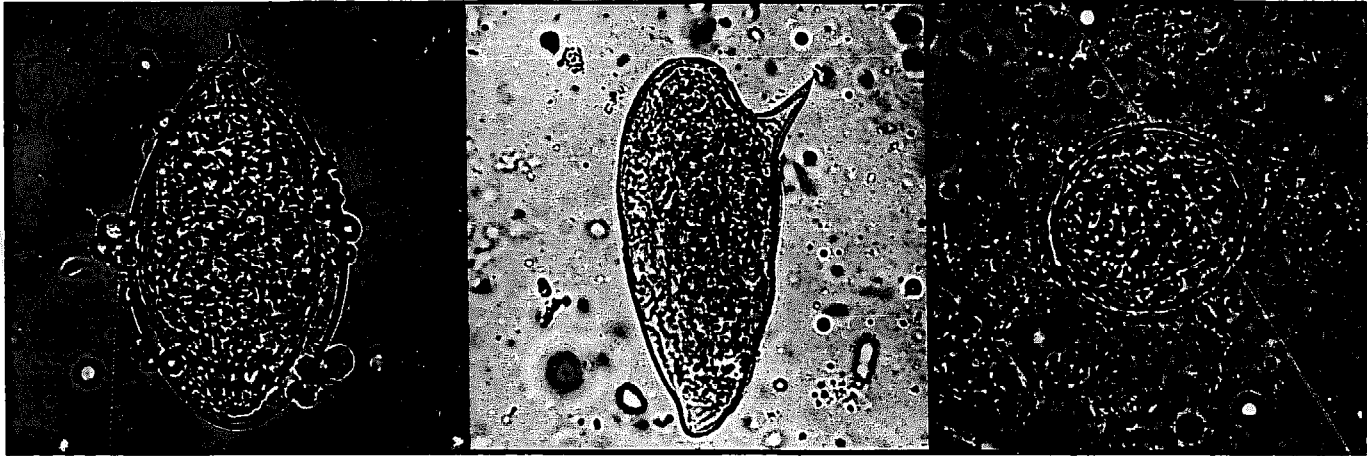

76

77

78

This row of plates show the three different kinds of Schistosome ova. **76.** This is *Schistosoma haematobium* with a terminal (end) spine. **77.** *Schistosoma mansoni* with a lateral (side) spine. **78.** *Schistosoma japonicum* is smaller and rounder than the others with a small spine

at one side which is hard to see, and is not shown on this plate. If the embryo (young worm) is alive inside a Schistosome ovum, small hairs or cilia can often be seen waving about on its surface.

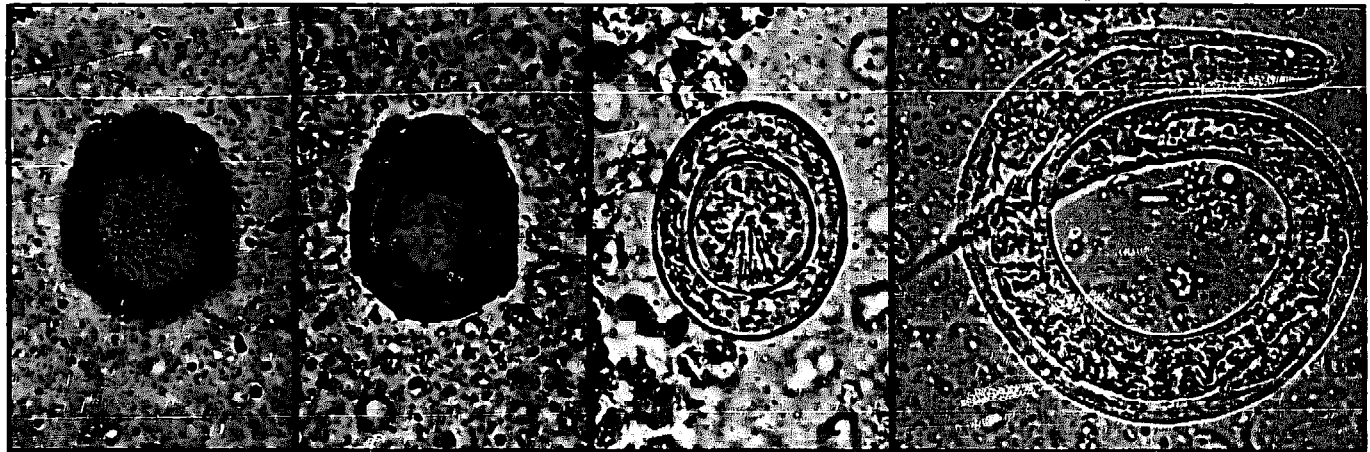

79

80

81

82

The ova of the tape worms *Taenia solium* and *Taenia saginata* look the same, so that the ovum in 79 and 80 might have come from either of these worms. **79.** A *Taenia* ovum looked at from on top showing the rough outer surface. **80.** The same ovum looked at through the middle. **81.** The

ovum of the dwarf (small) tapeworm, *Hymenolepis nana*. Three pairs of hooks can be seen inside 80 and 81. **82.** The larva of *Strongyloides stercoralis* showing its short mouth.



83

84

85

83. This is the ovum of *Fasciolopsis buski*. The operculum ('door') of this large ovum is not easy to see, but it is probably at the bottom of the plate. **84.** This may be any one of several much smaller ova, *Heterophyes heterophyes*, *Clonorchis sinensis*, or *Metagonimus yokogawai*,

which are not easy to tell from one another. **85.** This is a 'Sellotape' swab from the edge of the anus showing the ova of *Enterobius vermicularis*—see Figure 10—6. Notice how these ova are flattened on one side.

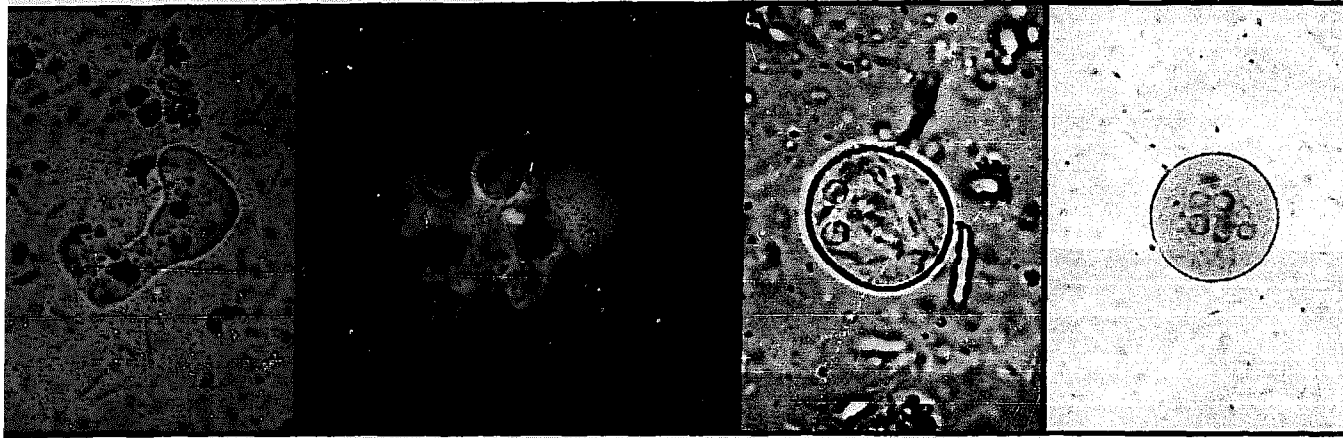

86. This is a low power view of *E. histolytica* showing pseudopodia ('feet') and ingested ('eaten') red cells. **87.** A high power view of *E. histolytica* in red eosin solution showing ingested red cells and a pseudopodium of clear ectoplasm. **88.** A cyst of *E. coli* in saline. **89.** A

cyst of *E. coli* in iodine. **88** shows the typical *E. coli* nucleus (see Figure 10—10), also some thin sharp chromidial bars. Two nuclei are shown in **88** and five in **89**, but more were seen above and below the plane (level) of the plate.



90. All the plates in the row show high power views of the cysts of *Giardia lamblia*. The cysts in **90** are stained with iodine, while the others are red MIF specimens. **90.** The curved bars are well shown. **91.** Two nuclei can be seen. **92.** This is the same cyst as **91**, but at a different level.

92. A curved bar is well seen. **93.** This shows the axostyle and the clear space inside the cyst wall (see Figure 10—13). If you cannot identify moving flagellates in the stool, look for these cysts.

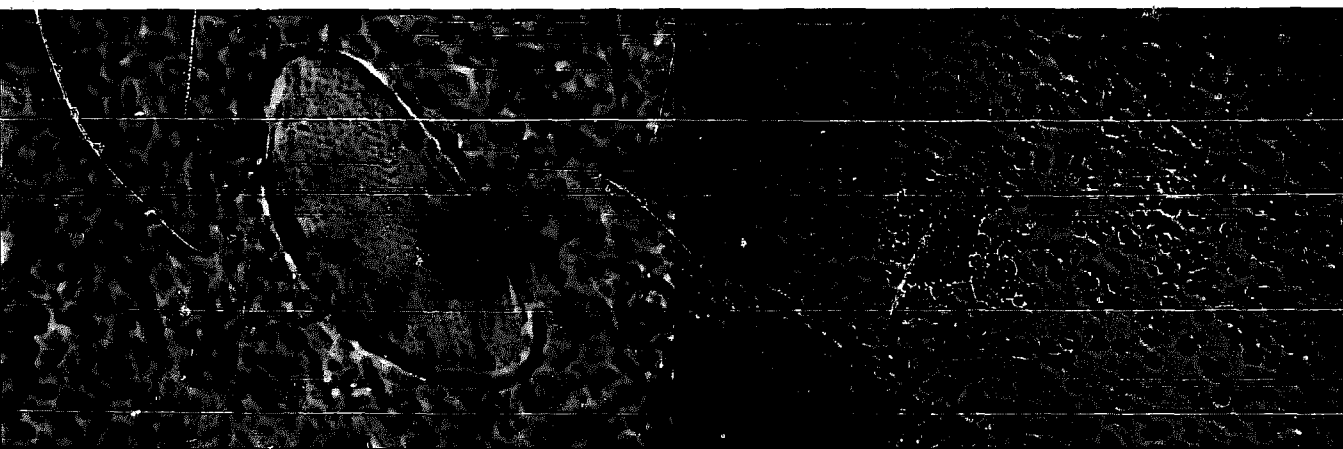

94. A meat fibre. Note its brown colour, its rounded shape from having been partly digested, and the cross striations (lines or stripes) going across it. **95.** A low power view of red cells and pus cells in the stool of a

patient with bacillary dysentery (see Picture A, Figure 10—12). (Answer to the question under Plate 52. There is a trypanosome at the top right hand corner of the plate.)

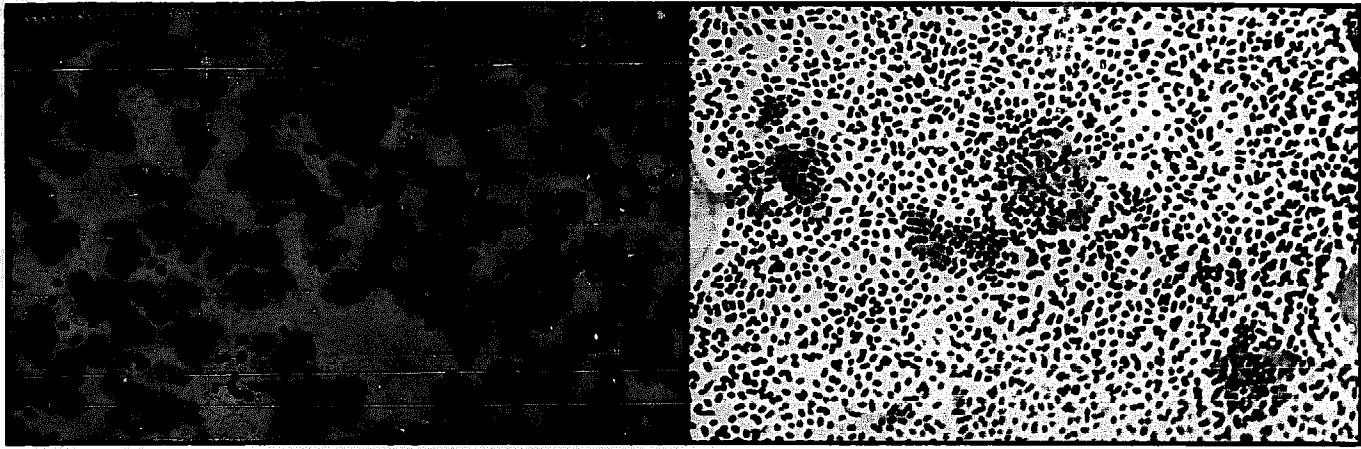

96

Both these plates show Gram stained CSF films from two patients with pneumococcal meningitis. 96. This is a high power view showing purple staining Gram-positive cocci—*Streptococcus pneumoniae* (pneumococci)—lying end to end (see Figure 9—6). The red staining

97

Gram-negative nuclei of polymorphs are also seen. 97. This shows a severe infection with many bacteria and few polymorphs. It is likely that the patient is being overcome by his infection.

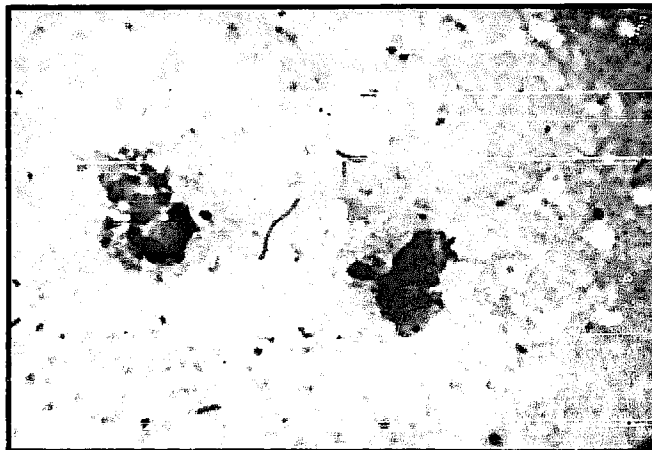

98

98. This is a Gram stained film of the CSF from a patient with *Haemophilus influenzae* meningitis. It shows two partly destroyed polymorphs and some red staining Gram-negative bacteria. These are pleomorphic (many

shaped) bacilli. Some are long and others are short like cocci. These are *Haemophilus influenzae*—see Figure 9—6, and Section 9. 16.

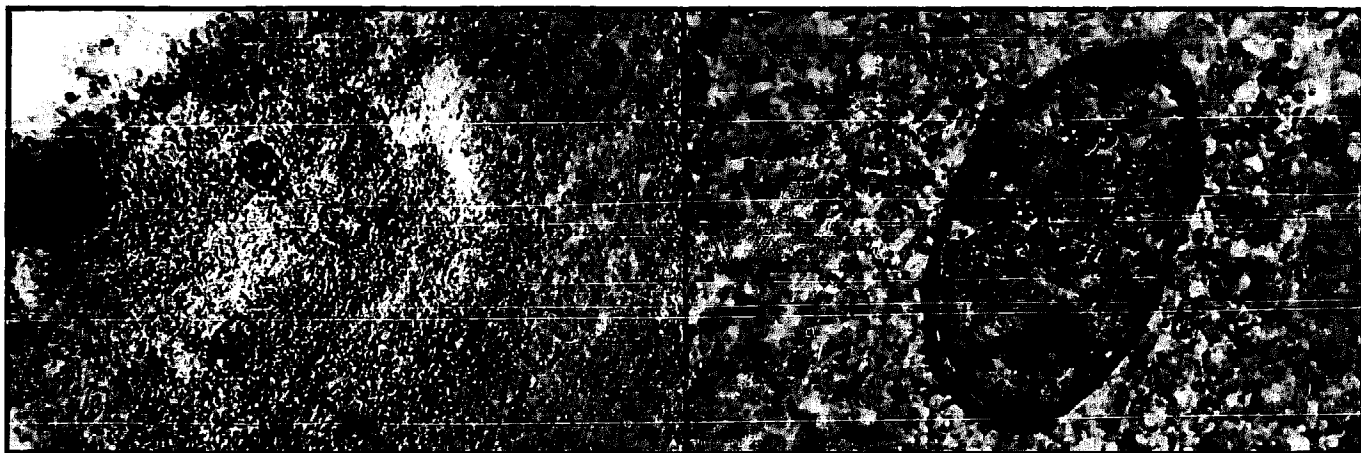

99

These are both wet films of the sputum showing ova of the trematode worm *Paragonimus westermani*. The adult worms are in the lungs and their ova have been coughed up in the sputum. 99. A low power view showing five

100

ova and many pus cells. 100. A high power view of one of the ova in 99. The operculum, ('door') is not well seen, but is probably at the top of the ovum in this plate—see Picture D, Figure 10—9.

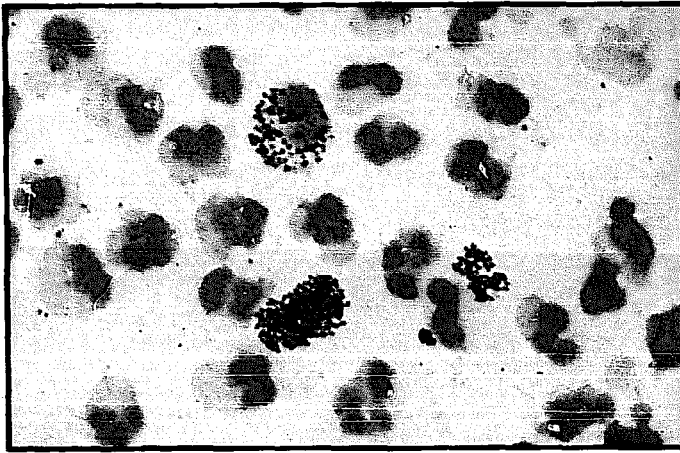

101

101. This shows red staining Gram-negative cocci lying inside some of the polymorphs in the pus from a urethral discharge. The patient has gonorrhoea, and these are *Neisseria gonorrhoeae*, or gonococci. A few cocci are seen outside the cells as diplococci (double cocci) lying

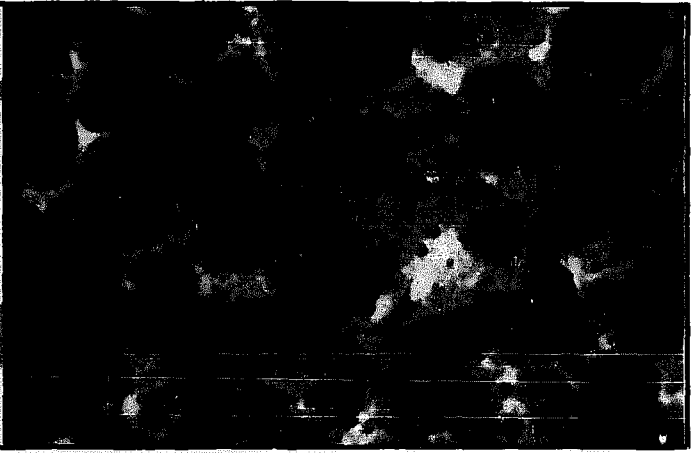

102

side by side. 102. This shows clumps (groups) of purple staining Gram-positive cocci in a film of pus taken from a septic (infected) wound. These are probably Staphylococci. Many red staining Gram-negative pus cells are also seen.

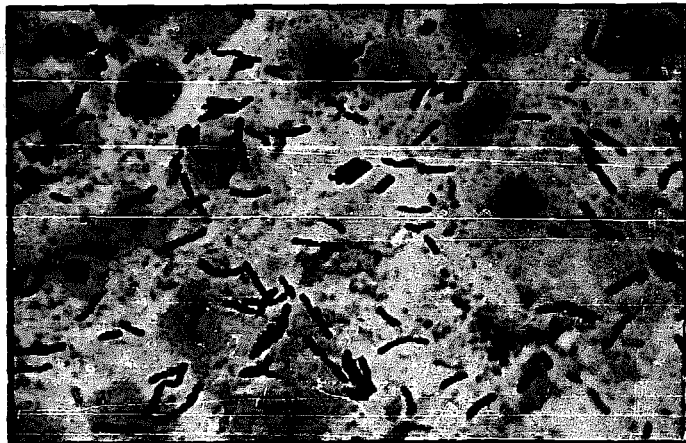

103

103. Sputum from a patient with tuberculosis stained by the Ziehl-Neelsen method to show red acid and alcohol fast bacilli ('AAFB')—*Mycobacterium tuberculosis*. The cells in the sputum have been stained green with malachite green—see Section 11. 1. 104. A Ziehl-Neelsen

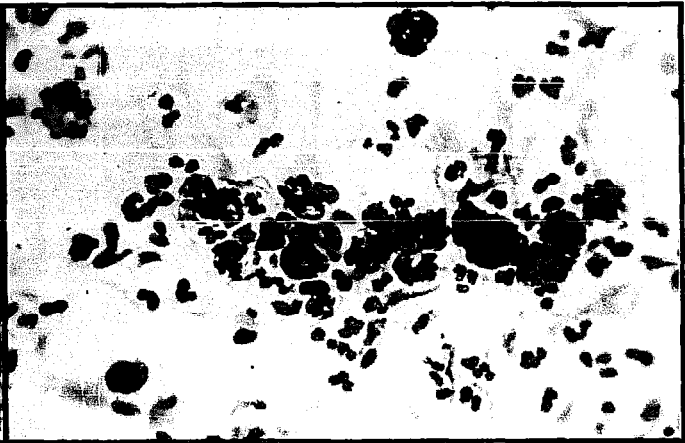

104

stained smear of a nasal scraping from a patient with lepromatous leprosy showing red staining AAFB—*Mycobacterium leprae*—in globi (groups inside the cell). This is a lower powered view than 104 and single bacilli are not seen so easily.

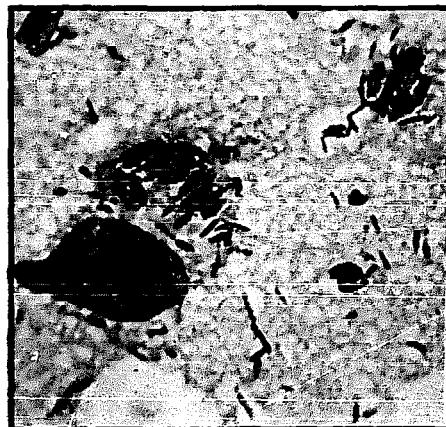

105

These are all Ziehl-Neelsen stained films from leprosy patients. 105. Most bacilli are solid, dark, uniformly staining red rods. They are 'solids' and the morphological index is high. 106. The patient has been treated and paler staining bacilli are breaking up into granules—they are



106

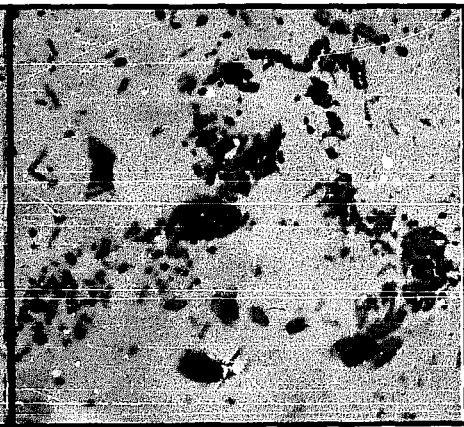

107

now mostly non-solids, and the morphological index is low. 107. After more treatment the bacilli have broken up further. There is now only acid fast debris and a few non-solids left.