

AT MICROFICHE
REFERENCE
LIBRARY

A project of Volunteers in Asia

The Backyard Mechanic (Volume 3)

Published by:

Superintendent of Documents
Consumer Information Center
P. O. Box 100
Pueblo, Colorado 81002
USA

Available from:

same as above

Reproduced by permission.

Reproduction of this microfiche document in any form is subject to the same restrictions as those of the original document.



★ THE ★
BACK-YARD
MECHANIC

Volume
Three

Reprinted from

DRIVER

THE TRAFFIC SAFETY MAGAZINE for THE MILITARY DRIVER

Table of Contents

Chap. 1.	The Electrical System, Part 1	2
Chap. 2.	Electrical System, Part 2	8
Chap. 3.	Fuses & Circuit Control Devices	16
Chap. 4.	Avoiding the Tuneup Rip-Off	23
Chap. 5.	Avoiding the Brakes Rip-Off	30
Chap. 6.	Automotive Body Work	38
Chap. 7.	Basic Dent Removal, Part 2	44
Chap. 8.	Automotive Painting	50
Chap. 9.	Automotive Painting, Part 2	56
Chap. 10.	Tuning for Mileage	63
Chap. 11.	Filters	70
Chap. 12.	Tubeless Tires	76
Chap. 13.	Lights	81
Chap. 14.	How to Make Your Car Last Forever	86
Chap. 15.	Case for the Log	92



DRIVER

THE
TRAFFIC SAFETY MAGAZINE
FOR THE
MILITARY DRIVER



An auto maintenance series designed to help the novice working at home, as well as to provide a few reminders for the experienced hobby-shop mechanic.

Prepared and written by

TSgt Ron Lathrop

with the

Air Force's DRIVER Magazine Staff,
AFISC /SEDD, Norton AFB, CA 92409

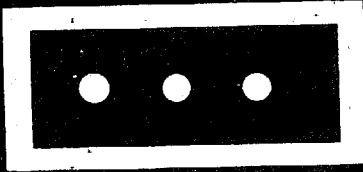

THE BATTERY CHARGING AND STARTING CIRCUITS

Rather than begin this article by introducing you to basic electricity, we're going to refer you to some material that will explain about all those ol' electrons and amps and volts, etc. That way, we can devote the space to theory and troubleshooting of your car's electrical system, and you can have plenty of time to absorb the fundamentals of electricity at your own speed.

If you're up on your amps and volts, skip this paragraph. If you're a novice at electricity or need a refresher, head out to your base library and read up on the following suggested texts:

Practical Electricity, by R. G. Middleton (Audel)

Electronics, by Robt. Irving (A. Knopf)

The Motor Car, by John Day (St. Martin's Press)

Any of these volumes will give you a thorough grounding (no pun intended) in electricity. Also, many Armed Forces career fields have excellent tests that you could perhaps borrow from a squadron, and the AF Extension Course Institute has some absolutely super courses that you can take.

What We'll Cover: There are seven basic circuits in an automobile (or truck, or motorcycle if you don't count the windshield wiper circuit). They are: the charging circuit, the starting circuit, the ignition circuit (covered in the February and March '77 issues of DRIVER), the horn circuit, the lighting circuit, the instrument circuit, and the electric windshield wiper and washer circuit.

In this issue, we'll cover the two most

complicated ones, the ones that in conjunction with the ignition create the most problems: the starting and charging circuits.

The Starting Circuit: As the name implies, this circuit consists of the bits and pieces necessary to start your car. It includes the starting switch (or solenoid), the ignition switch, the starter motor, the battery, connecting wires, and in most cases, the frame of the car.

The starting circuit is designed to carry high current (and as we all remember, current is what can really bite you) with a minimum loss of voltage. The battery supplies power to the starter motor, which must crank the engine. The ignition switch directs the current from

the battery through the starter solenoid and then to the starter. The starter must have a system that engages it with the engine flywheel and disengages it when the engine begins to run on its own.

The Charging Circuit: Components of the charging system include the battery, generator, voltage regulator, ammeter (or idiot light), wiring, and again, the frame of the car.

There is another component to this system and it has, for all practical purposes, replaced the generator. It is called an alternator, and its function is the same as that of a generator. It generates electricity to recharge the battery and run the other electrical circuits.

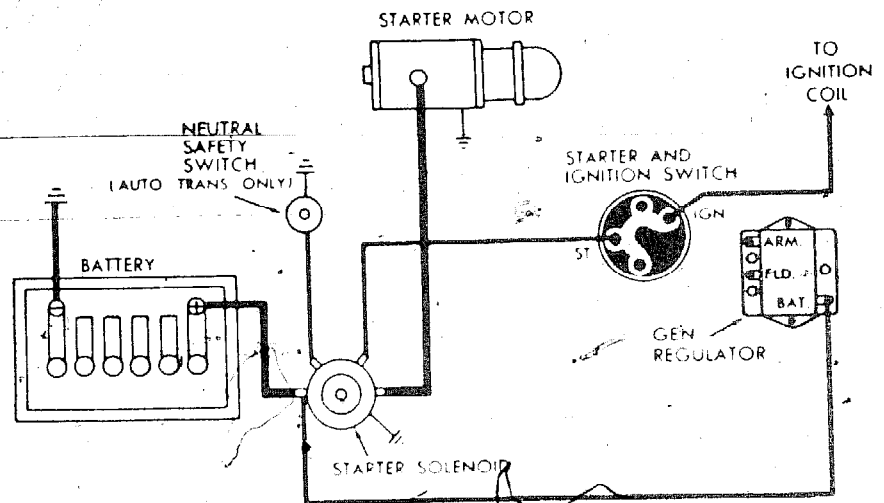

Typical starting circuit diagram shows which wires to check when shorting or bad connections are suspected.

BACK TO BASICS

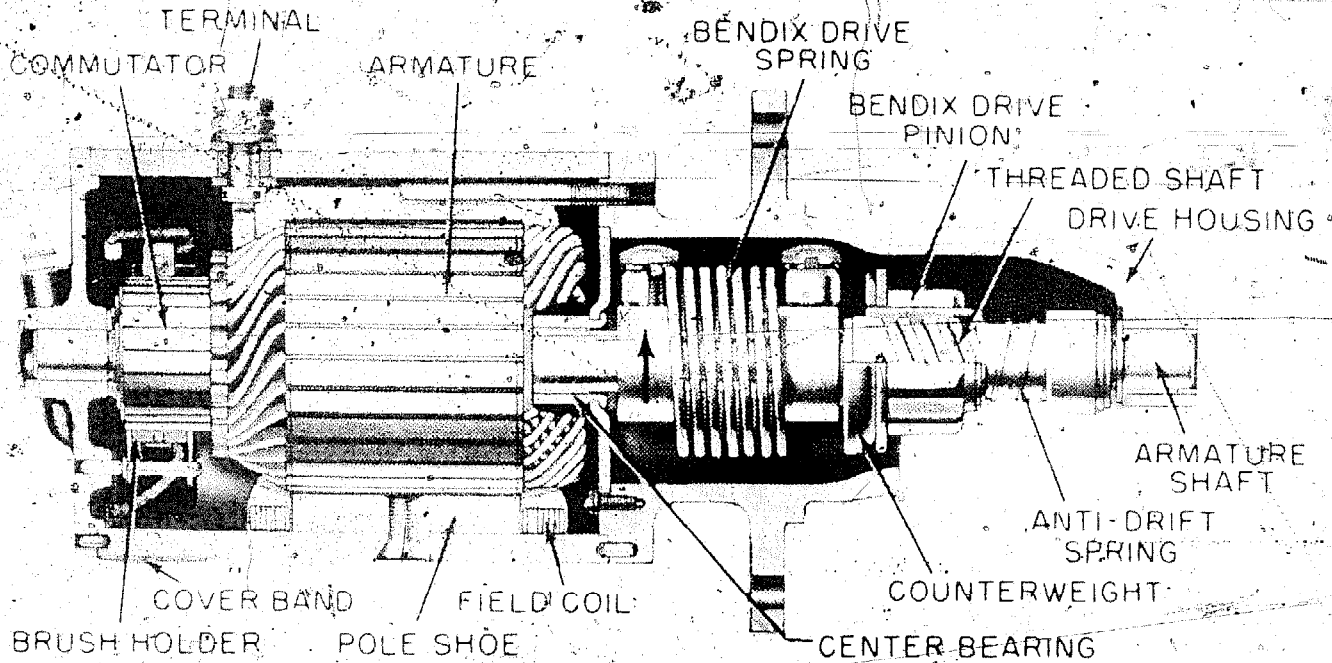

Specifics/Starting Systems: The starter itself is actually a small but very powerful DC motor. When you turn the ignition switch to the "start" position, a small current flows from the battery through the switch to the starter solenoid. The starter solenoid is actually a switch, too, but because it must carry high amperage to the starter, it is not a hand-actuated switch. The current from the ignition switch that flows to the solenoid (which can be located either on the inner fender well or integral with the starter itself) electro-mechanically actuates a plunger. This plunger actually operates the contact points of the solenoid which then contact each other and allow the high amperage from the battery to flow to the starter motor.

When the solenoid contacts are closed and current flows to the starter, the starter armature (the center portion of the motor) rotates. On one end of the armature shaft is a gear (called the pinion gear) which is automatically meshed with a gear on the outer edge of the engine flywheel. The motor turns the pinion gear which in turn drives the flywheel gear, causing the engine to turn over.

The ratio between the flywheel gear and the starter pinion gear is about 15:1, which means that once the engine starts the engine drives the starter armature 15 times as fast as the engine rotates. Even though a just-started engine ro-

tates at a moderate speed (about 750 revolutions per minute, or RPM), the corresponding starter armature speed would be in the neighborhood of 11,250 RPM, high enough to damage the arm-
continued

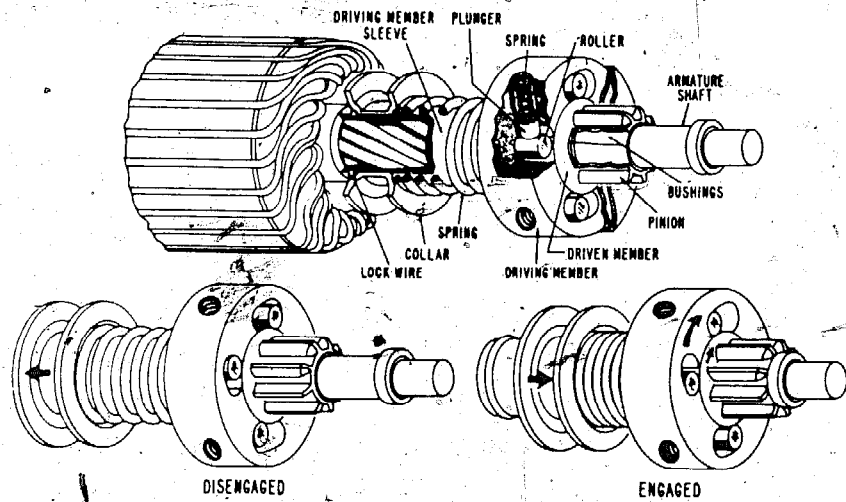

Overrunning clutch drive is used in place of Bendix drive in FoMoCo-type late model starters.

the backyard mechanic

continued

ature because of centrifugal force. So, we also need a method of disconnecting the starter pinion from the flywheel when the engine begins to run.

Bendix Drives: The Bendix drive, named after the man who invented it, is a system whereby the pinion is meshed and unmeshed with the flywheel by a method similar to threading a nut on a bolt. If you hold a bolt in one hand and spin a nut on it with the other, the nut will move up or down the bolt, depending on the direction of rotation.

The pinion gear represents a large nut which is mounted on the threaded armature shaft. Sudden rotation of the armature causes the pinion to move out from the starter armature end and mesh with the flywheel gear. As soon as the engine starts, it spins the pinion out of mesh because of the high speed at which the flywheel gear rotates the pinion. The pinion then spins back to the left, out of mesh.

Starter Troubleshooting: Starter problems usually lie in three areas: the battery, the starter itself, or the wiring and components in between. To quick-check the starter system, turn on the headlights. They should burn with normal brilliance. If they don't, the battery may be low . . . check it out with a battery hydrometer.

If the battery is in a charged condition and the lights burn brightly, one of three things should happen when you

operate the starter while someone checks the lights. The lights will: A, go out; B, dim considerably; or C, stay bright without any cranking action taking place.

If the lights go out as the ignition switch is moved to the "start" position, it is an indication that there is a poor connection between the battery and the starter motor. This poor connection can usually be traced to bad conditions at the battery cable/battery post connection. Remove the cable clamps from the terminals (ground lead first), check for corrosion and clean if necessary. Check the other ends of the battery cables where they go to the solenoid, starter, or ground (usually the engine block). Clean and retighten all connections.

If the lights dim considerably as the starter is operated and the starter turns slowly or not at all, or if a chattering or clicking noise is heard coming from the solenoid or starter, you probably have a low battery. Another possibility is that there is some mechanical condition in the engine or starter itself that is throwing an unusually heavy load on the battery with resultant dimming of the headlights.

Check the battery with a hydrometer. If it is fully or nearly charged, the trouble probably lies in either the engine or starter. In the engine, tight bearings or pistons, or cold, heavy oil may be sufficient to cause the problem. Low out-

side temperatures can cause the low battery indications, too, because a battery is much less efficient at low temperatures, and the engine is harder to crank. Those of you stationed at Williams AFB or Ft. Huachuca can probably disregard that last cause.

Inside the starter itself, a bent armature shaft, loose pole screws, or worn bearings may cause the armature to drag. Other internal problems may consist of thrown armature windings or commutator bars.

A further cause of slow cranking may be engine backfire resulting from the timing being advanced too far. To guard against failures internally in the starter, be sure you wait a few seconds after a false start to be sure the pinion has disengaged, and if backfire is causing the damage, re-time the engine.

If the lights stay bright and no cranking action results when the key is moved to the "start" position, it's a good indicator that there is an "open" in the circuit at some point. If the car is equipped with a solenoid switch, the solenoid control circuit can be jumped by placing a heavy (at least 10 gauge) wire across the solenoid main terminals. This should result in cranking action, but not a start (ignition key in "off" position).

If the starter does not operate with the solenoid jumped, chances are that it will have to be removed from the car for troubleshooting. One other thing to remember on a brightlight, no-crank situation is that the neutral/start switch mounted on the steering column (or shift linkage) may be bad. With the ignition key held in the start position, move the gear shift lever about the neutral quadrant. If you still have a no-crank, release the key and move the lever to the "park" position on automatic transmission-equipped cars and repeat the "hold-key-and-wiggle" trick.

Alternator/Generator System: We all know that our steel steeds function only with the generous assistance of electricity. Where does the electricity initially come from? The battery? Right. OK, how does the battery get recharged? The recharging current has to come

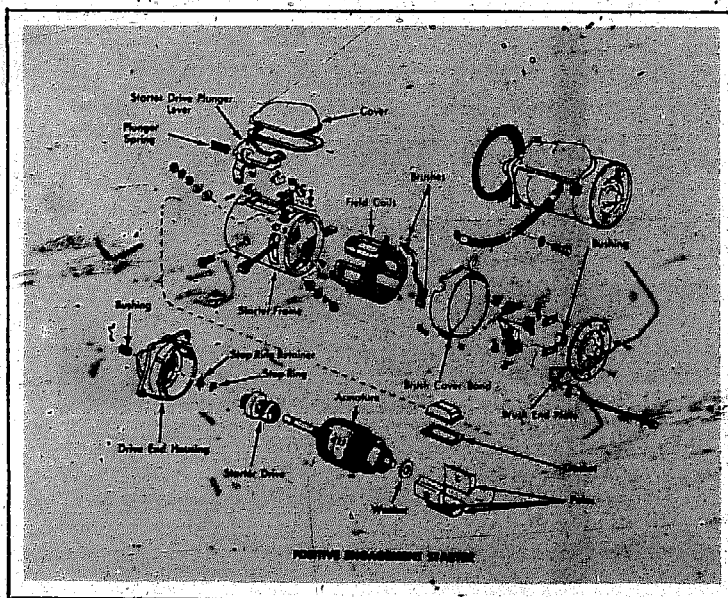

(left) Exploded view of typical starter. Internal problems may result from loose pole screws and/or overtight thru-bolts.

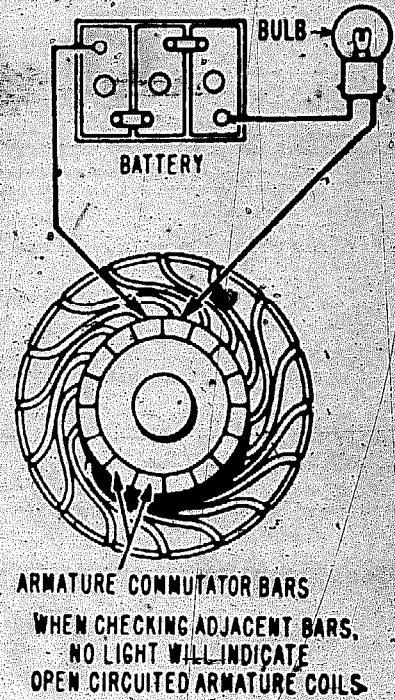
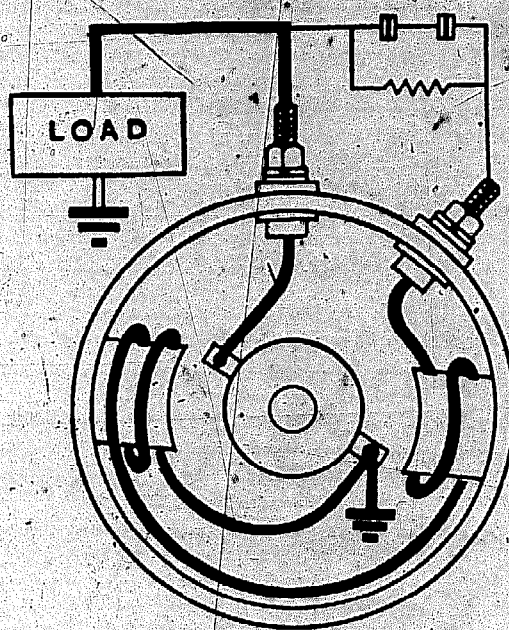
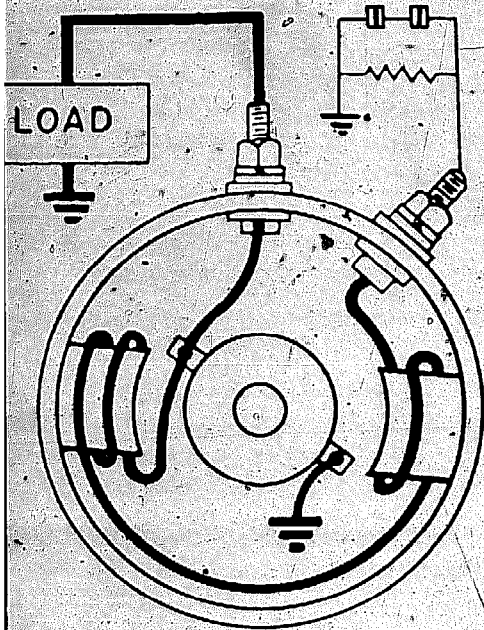

Wiring diagram of a generator having the field grounded externally through the voltage regulator. Easily identifiable because the grounded brush has only its own lead attached to it.

Generator with internally grounded field. Grounded brush has both its own lead and the field lead connected to it.

Generator armature test for open circuit. Same test can be used on starter armatures.

from somewhere ... so that's why cars (and most other wheeled and/or winged mechanical mules) have electrical generating systems. As we said in the beginning of the article, we won't go into basic electrical theory ... just take our word for it that a generator generates electricity (in the form of direct current) that is used to recharge the battery and run the various electrical systems in your car. If you want to know more about generator theory and construction, consult a Mitchell's or Motor Manual, or one of the other reference works we mentioned earlier.

In the early days of the automobile there were not too many electrical devices and the generator had (and needed) only a small capacity. As additional electrical equipment was introduced, it was necessary to increase the capacity of the generating system to cover the increased load. While the battery capacity of the 6-volt electrical system has increased only slightly to take care of the increased needs of starting motors and parking lights, the 6-volt generator output has increased from about 15 amperes (amps) to about 50. This is basically the limit of 6-volt automotive generators and was the point at which the 12-volt generator came into use.

Although the 12-volt generator is about the same size externally, it puts out about 25% more electricity and is

thus able to carry the entire electrical system load. This is possible because 12-volt generators can use finer wires to carry current and more powerful armature conductors and field coils can be used.

The generator is mounted on the front of the engine and is driven by a belt which may also drive the fan and water pump. It is about four inches in diameter and about nine inches long, and has a small turbine-like fan blade arrangement just behind its drive pulley. Again, the generator generates direct current (DC) for use in battery charging and electrical system operation. The output of the generator is directed to and through a device called the voltage regulator which takes the form of a small metal box mounted on the fender liner or firewall. The voltage regulator has at least three wires running to it and will have terminals marked FLD (field), ARM (armature), BATT (battery), or GEN (generator). It plays a large part in generator troubleshooting procedures, so locate it on your car and be familiar with the terminal names.

If your idiot light for the generator is on, or if your charge/discharge gauge indicates no charge, first make sure all connections on both the generator and regulator are clean and tight. Then, run the engine at fast-idle speed. If the generator still fails to show a charge, go on and read the next paragraph. If

a charge is now indicated, you had a poor connection in the circuit. Dirty or loose terminals and connections account for the majority of no-charge conditions concerning generators.

If the generator field is internally grounded (consult your owner's manual or one of the motor manuals) connect a jumper wire from the regulator terminal marked ARM (armature) to the FLD (field) terminal of the generator. If the generator field is externally grounded through the regulator, connect the jumper from the FLD terminal of the generator to the base of the regulator. What you have done is to take the regulator out of the circuit. Again run the engine and if the generator now shows a charge, you can assume the regulator is bad. (Your Motor or Mitchell Manual will have specific info, but generally, the foregoing procedure should *not* be used with double-contact voltage regulators.) With external-ground systems such as the Delco-Remy system, disconnect the generator FLD lead and ground it to the regulator base. With internal ground systems (Autolite, Bosch) disconnect the generator FLD lead and ground it against the ARM terminal of the regulator. If you don't do this little step, you'll probably burn up the lower set of contacts in your double-contact voltage regulator, which will,

continued

as they say, "render the regulator inoperative."

If you still don't have a charge indication, try shorting out the regulator's circuit breaker by running a jumper from the regulator ARM terminal to the regulator BATT terminal. Run the engine again. If you have a charge indication, the regulator is kaput. If you still have a no-charge, it's probably time to trip down to your friendly local generator rebuilder.

Changes AC to DC: The alternator, or AC generator, is really the neatest thing for cars since the pneumatic tire. Today's cars need a huge amount of electricity to run the power antenna and other important systems that are so necessary to the quality of driving today. To supply that power, we would have to use a DC generator about as big as the engine. Rather than use a huge generator, or drive it so fast its tongue hangs out, we use an AC generator to supply the car's thirst for electricity.

Unfortunately, your car can't use AC, or alternating current. So we have to have a way to convert the AC that the alternator provides. To do this, the alternator uses little "valves" called diodes. We call a diode a valve because that is its function. A diode will let DC pass ("valve" open) and not let AC ("valve" closed) get through. The actual function of the diode is to pass part of the AC in a steady stream, thereby creating the effect of DC.

In practice, an alternator uses six diodes, three "negative" diodes linked together in a circuit called a rectifier circuit, or just plain rectifier. This type of circuit arrangement provides a smooth constant flow of DC and the "one-way-valve" action of the diodes prevents current from the battery from discharging back through the alternator.

Newer alternators, called second-generation alternators, incorporate a built-in-voltage regulator that is basically unserviceable and unadjustable when compared to the old-style external voltage regulator. This type of alternator is trade-named Delcotron when manufactured by Delco-Remy, and Autolite, Motorola, Leece-Neville, and Chrysler all have similar products.

ALTERNATOR SERVICE RULES

- Be certain that the battery polarity of the system is known so that the battery is connected to the proper ground. Reversed battery polarity will damage rectifiers and regulators.
- Booster batteries used for jump starts

must be correctly connected to avoid alternator damage. Negative cable from booster battery to negative terminal on vehicle battery, positive cable from booster to positive terminal of vehicle battery.

- When a "fast charge" battery charger is used to charge a battery in an alternator-equipped vehicle, the vehicle battery cables should be disconnected, unless the charger has an "alternator protector" function. In that case, the cables don't need to be removed. Fast chargers should not be used to start an alternator-equipped car as rectifier damage may result.

- Unless the system includes a load relay or field (FLD) relay, grounding the alternator output terminal could damage the alternator and/or circuits. This is true even when the system is not in operation because no circuit breaker is used and the battery power is applied to the alternator output terminal at all times. The FLD or load relay acts as a circuit breaker in that it is controlled by the ignition switch.

- When adjusting the voltage regulator (on cars with adjustable, external voltage regulators), don't short the adjusting tool to the regulator base. The tool should be insulated by taping or installing a plastic sleeve.

- Before making any "on vehicle" tests of an alternator or regulator, the battery should be checked and the circuit inspected for faulty grounding and insulation.

- Check alternator drive belt tension to be sure the belt is tight enough to prevent slipping *while under load*. Correct tension, without the use of a tension gauge, is about 1/2-inch deflection over a one-foot span of unsupported belt.

- The ignition switch should be off and the battery ground cable disconnected before making any test connections.

- The vehicle battery must be fully charged or a fully-charged battery must be installed before any troubleshooting is done.

Testing of alternators usually requires both a voltmeter and an ammeter, jumper wires, and a thorough knowledge of the location of parts such as the carbon pile rheostat or the generator field control. Delco-Remy, Autolite, Chrysler, Motorola, and Prestolite systems all use different troubleshooting techniques so your best bet would be to gather up your tech data and head on off to the hobby shop.

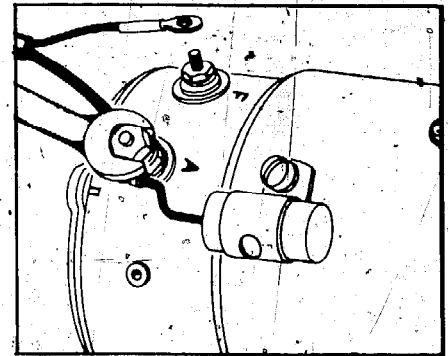

The condenser is always attached to the "A" or "ARM" terminal of the generator. If connected to the "F" or "FIELD" terminal it would make the voltage regulator go "toes-up" with a resultant overcharge condition in the battery and associated circuitry.

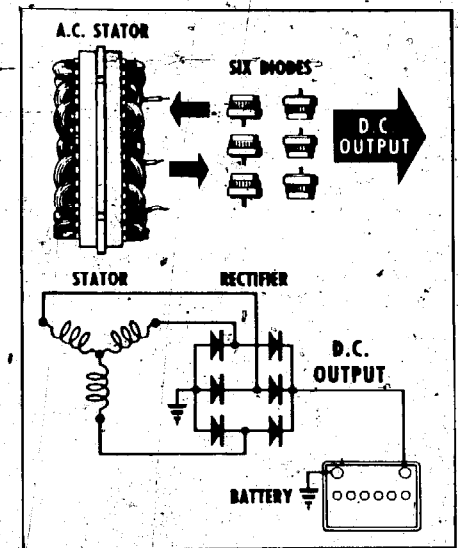

Alternator changes alternating current to direct current by use of diodes.

However, in deference to the fact that there are a lot of General Motors cars out there, and the fact that Delco-Remy external regulator systems are fairly easy to troubleshoot, we'll briefly go over the current output test series. Again, for other systems, or for Delco systems with internal regulator, consult your shop manual.

Delco Current Test

- Check and adjust belt tension.
- Disconnect ground cable from battery.
- Connect an accurate test ammeter between alternator terminal marked "BAT" and disconnected ground lead.
- Connect a tachometer from "DIST" terminal of coil to ground.

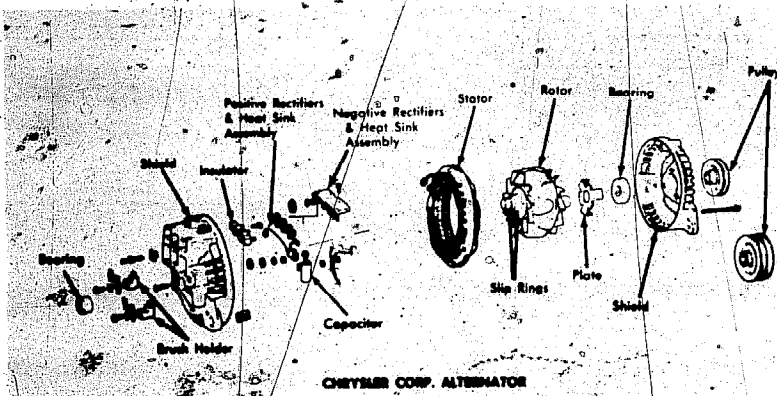

CHRYSLER CORP. ALTERNATOR

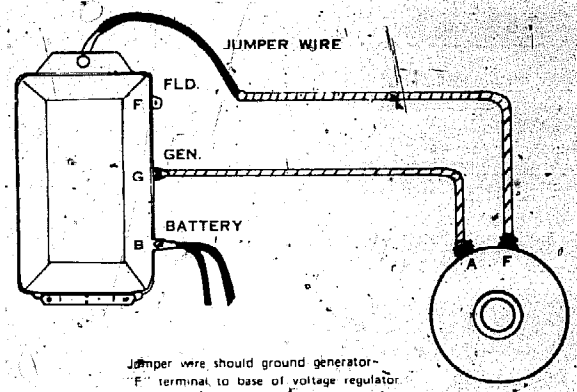

Jumper wire should ground generator- "F" terminal to base of voltage regulator.

Exploded view of Chrysler alternator shows location of heat sink screws. If these are loose, the diodes may overheat and go out to lunch.

External-ground systems should be jumped like this to take the regulator out of the circuit. Internal-ground systems should have the generator "FLD" lead grounded to the "ARM" terminal of the regulator.

- Reconnect battery ground cable and connect voltmeter across battery.
- Apply parking brake, chock wheels, and have your buddy start the engine.
- Turn on all electrical components and accessories.
- Adjust engine idle speed to factory specs (about 500 RPM in Drive).
- At idle, alternator output should be 5 amperes or more.

- Shift transmission to neutral and increase engine speed to 1500 RPM. Output should be 25 amperes or more.
- Shut off engine and turn off all accessories.
- If the output is low in either of these tests, try fooling the alternator into supplying full output. Unplug the "F" or "FLD" connection of the alternator and connect a jumper wire from the

- "F" terminal to the alternator's "BAT" or "B" terminal. Retest as shown before. If output is still low, the alternator is faulty. If the output is now OK, the trouble lies in the voltage regulator or wiring harness. Clean and check all connections.
- Remove "F" jumper, and reinstall "F" connector before you forget and move on to next month's chapter about the rest of your electrical system. ⚙️

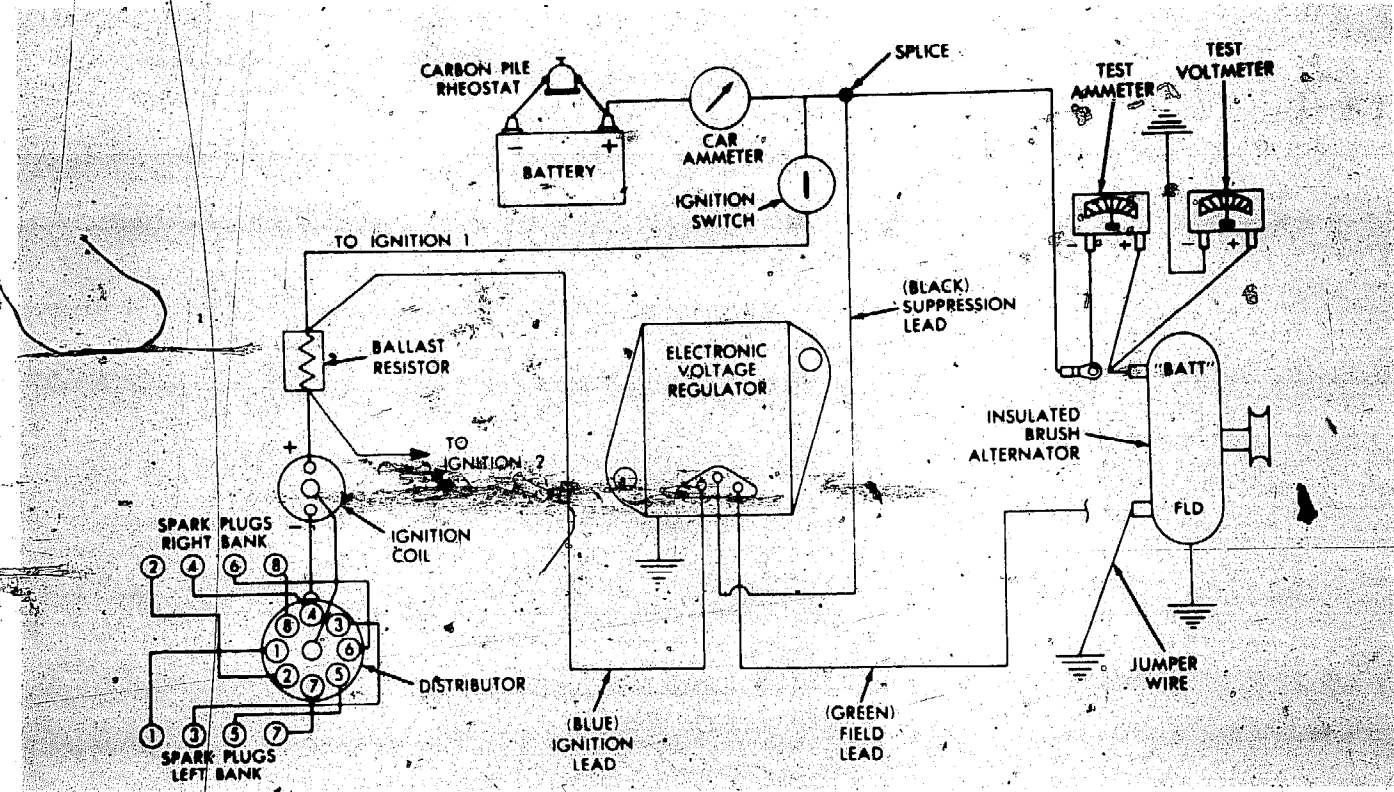

Schematic for current output test as mentioned in text.

BACK TO BASICS

THE BACKYARD MECHANIC

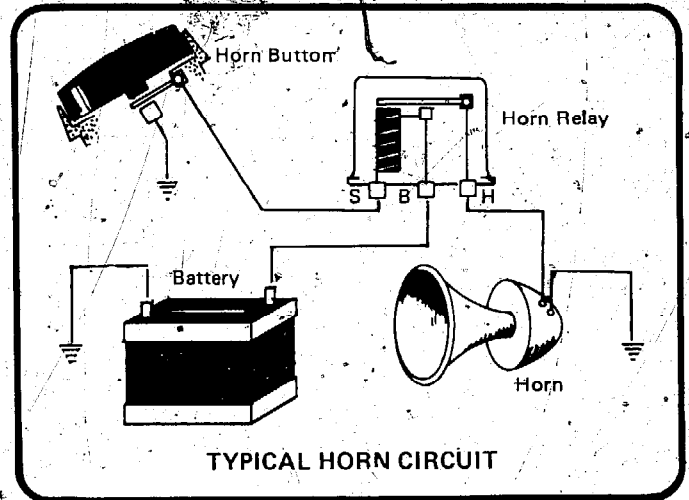
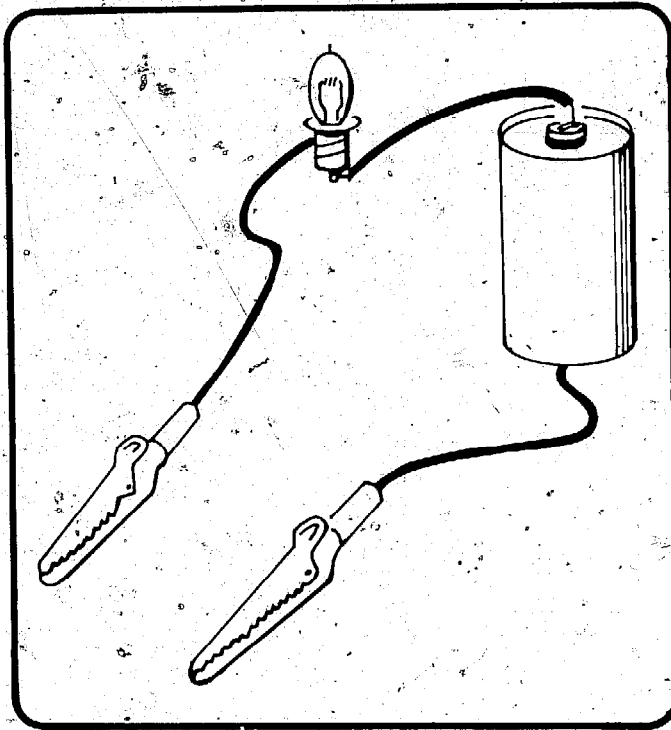

When horn button is depressed, electro-magnet inside relay pulls contact down to electrically connect horn with battery.

(left)

A homemade continuity checker can be useful in a lot of troubleshooting tests. By making the leads about two feet long, you can check continuity (broken wires, bad connections, etc.) in many circuits.

ELECTRICAL SYSTEM PART 2

HORNS, LIGHTS, INSTRUMENTS, AND WINDSHIELD WIPERS

As we mentioned in the October issue, this series presupposes you know a little about basic electricity. If you need some refreshing or you aren't that hot with electrons, check the October issue for a list of reference works that should be available at your base library.

In this issue we'll cover the operation of horns, lights, instruments and windshield wiper/washer systems. In the next installment, we'll give you troubleshooting procedures and diagnostic tool suggestions.

Wiring Basics: Those of you who have ever changed an electrical component, like a switch at home, have noticed that there are two wires (at least) running to every electrical component in your house. When you look

at a component in your car, you may be in for a shock (no pun intended) when you see only one wire leading to any given component. With the exception of the battery, most automobiles use the "single-wire" system to connect the bits and pieces.

Instead of two wires running to a turn signal bulb, for instance, one wire is connected from the battery to the bulb, and instead of another wire to carry current back to the battery, the frame of the car is used. From this little gem of information comes the statement that the MAJORITY of electrical problems in an automobile will stem from non-grounded or inadequately grounded components.

Another little item that has caused some confusion in the past is the terminology

associated with negative- or positive-ground systems and the resultant flow of current.

In cases where the positive post of the battery is grounded, all electrical components are connected to the negative side of the battery and current flows from the UNgrounded (live) post of the battery through the chassis of the car (the ground) which is connected to the positive battery post.

Where the negative post of the battery is grounded, the current flow is in the opposite direction . . . through the chassis, then through the electrical components, and back into the battery via the wires that connect the components themselves to the battery.

What all this means is that *current flow is always from negative to positive*

continued

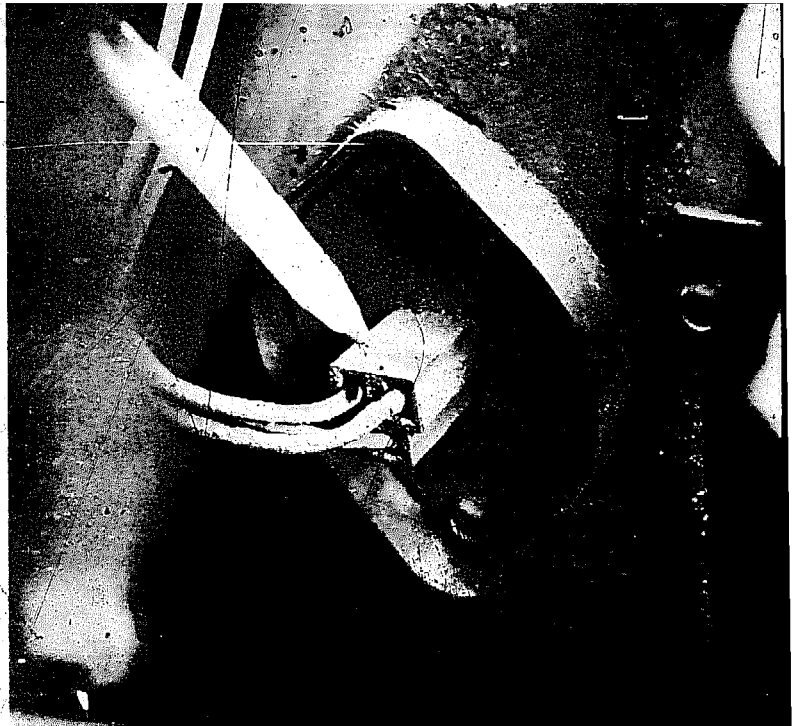
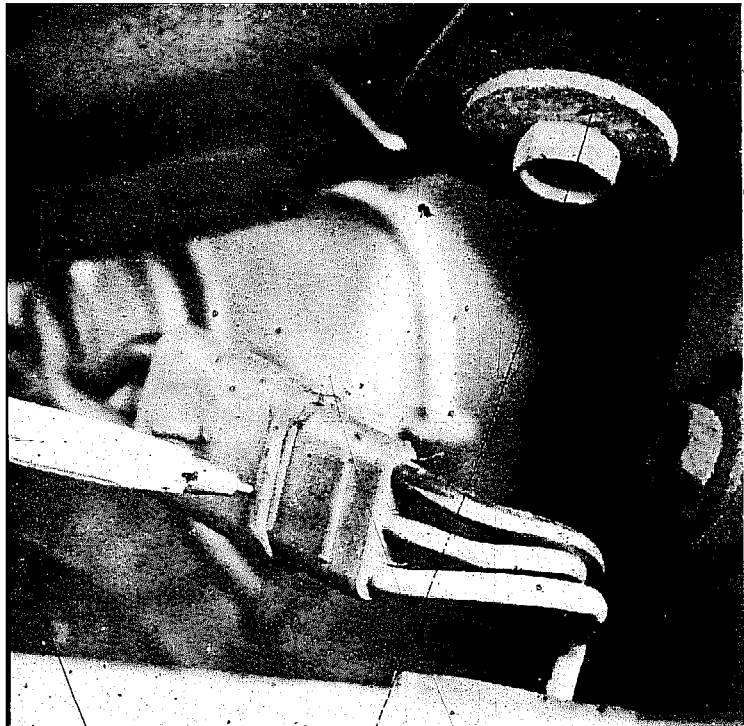

(left) This little goodie, known as a "multiple wire connector," is usually responsible for the majority of the open-circuit problems in a car. Connector halves MUST be clean internally, and seated positively together. Wire flexing, pull-checking, and engine vapors can cause the connector to malfunction. **(right)** Through-the-firewall connectors are usually located way down in the dark recesses of the engine compartment. They are subject to high temperatures, large amounts of oil and grease, and shearing forces generated when the body shifts on the chassis. They may also signal that a component is mounted on the firewall on the inside of the passenger compartment.

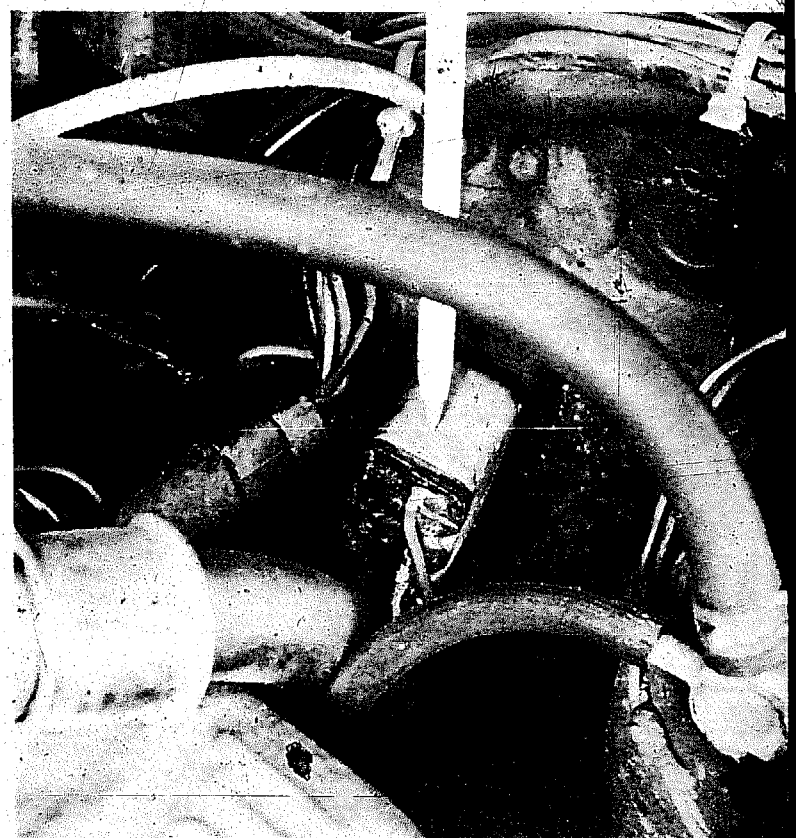
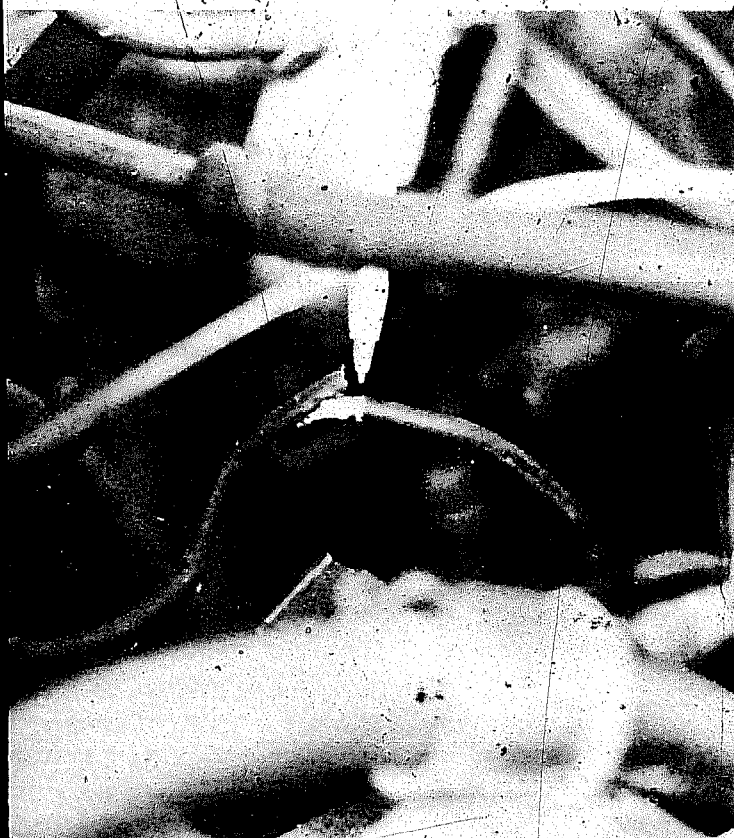

(left) And you want to know what causes short circuits? Bare wires like this are the prime contributors to the phenomenon known as the "smoke check." Insulation doesn't last forever, particularly in the engine compartment, and it can be chafed off where wires pass into the body or are bundled tightly together. **(right)** A little box with wires coming out of it usually mean some sort of coil-operated device, like a voltage regulator or a relay. It could be a horn relay, a windshield wiper relay, or any one of a dozen other components. Check your Mitchell's or Motor Manual to determine the function of the box in question. It could save you lots of troubleshooting time.

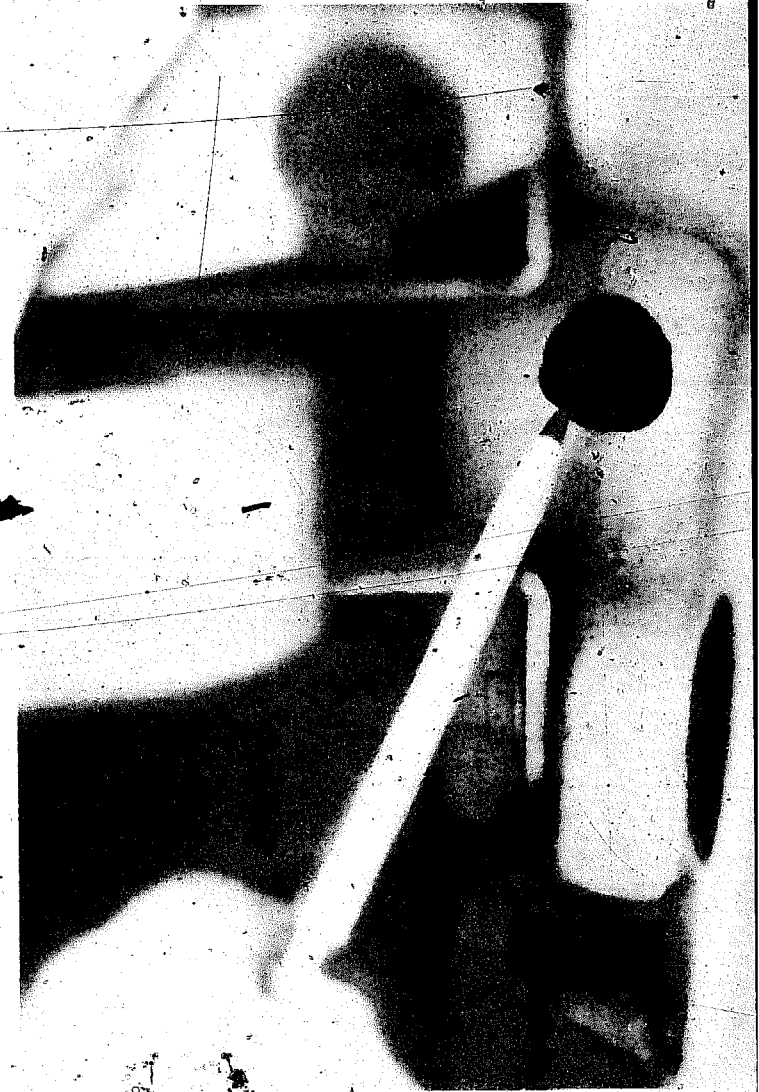
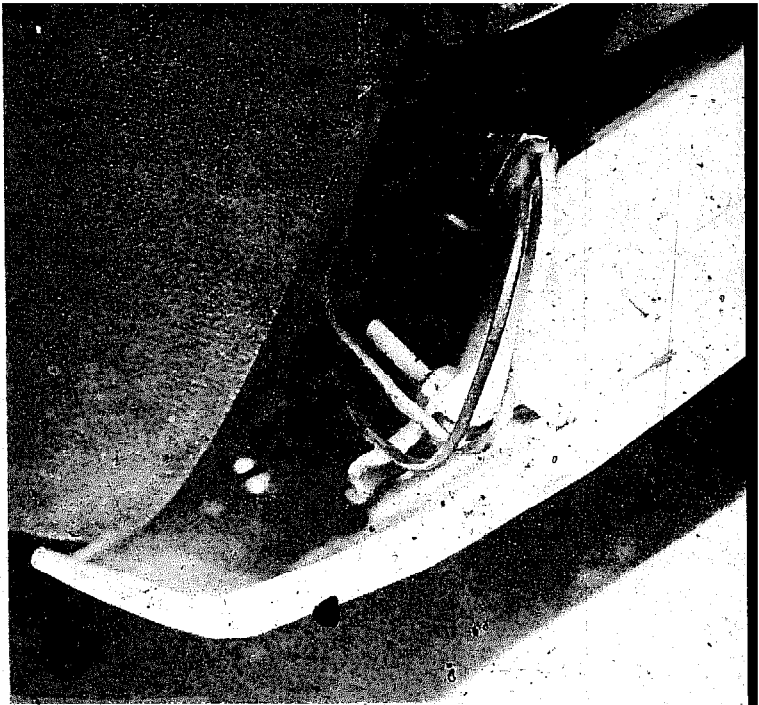
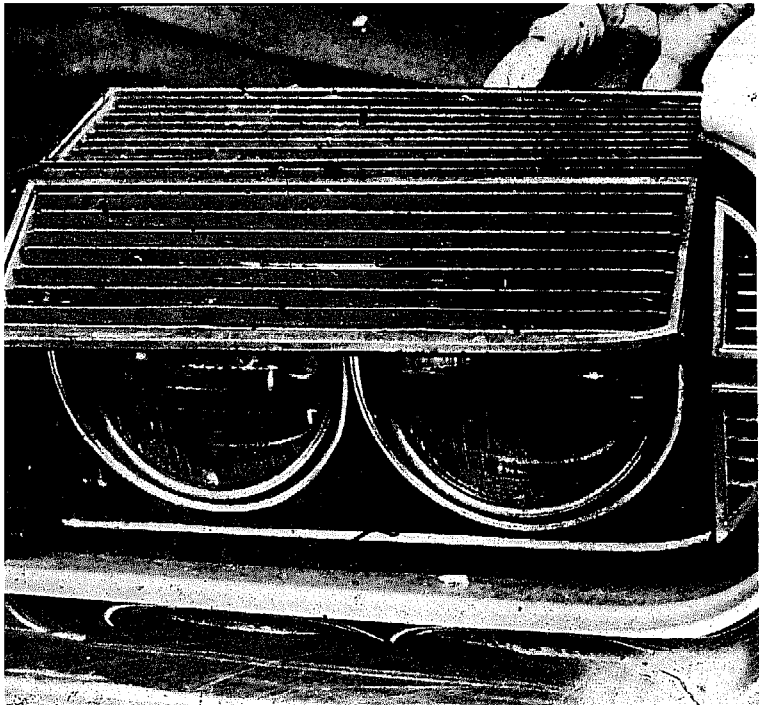

(left) Wires connecting the doors to the body get more flexing than any other set. They can also be pinched, stretched, and corroded more easily than most other wire sets. **(right)** Stuck door jamb switches can mean your interior light won't work. If fuse is good, suspect this switch. A glove box light switch that is stuck in the "on" position can drain your battery in a hurry and be a bear to find as well. If your battery mysteriously goes dead, suspect a stuck switch in the hood, trunk, or glove box light system.

the backyard mechanic

continued

(far left)

If you're not sure whether your headlight covers are electrically operated, or operated by engine vacuum, just turn the lights on with the engine off. Then turn the headlights off. If the cover stays open, your car uses vacuum to operate the covers. Electrically-operated systems will reclose the cover . . . vacuum systems won't. And while you're at it, why not clean the headlights? Concealed headlights sometimes don't get checked as often as they should.

(near left)

Remember that electrical wires aren't always confined to the body and engine . . . they can run in the doors, trunk, glove box, etc. If you have an elusive short in the lighting circuit, check the connectors and wiring inside the doors. This system gets a lot of moisture and can easily corrode or lose its insulation.

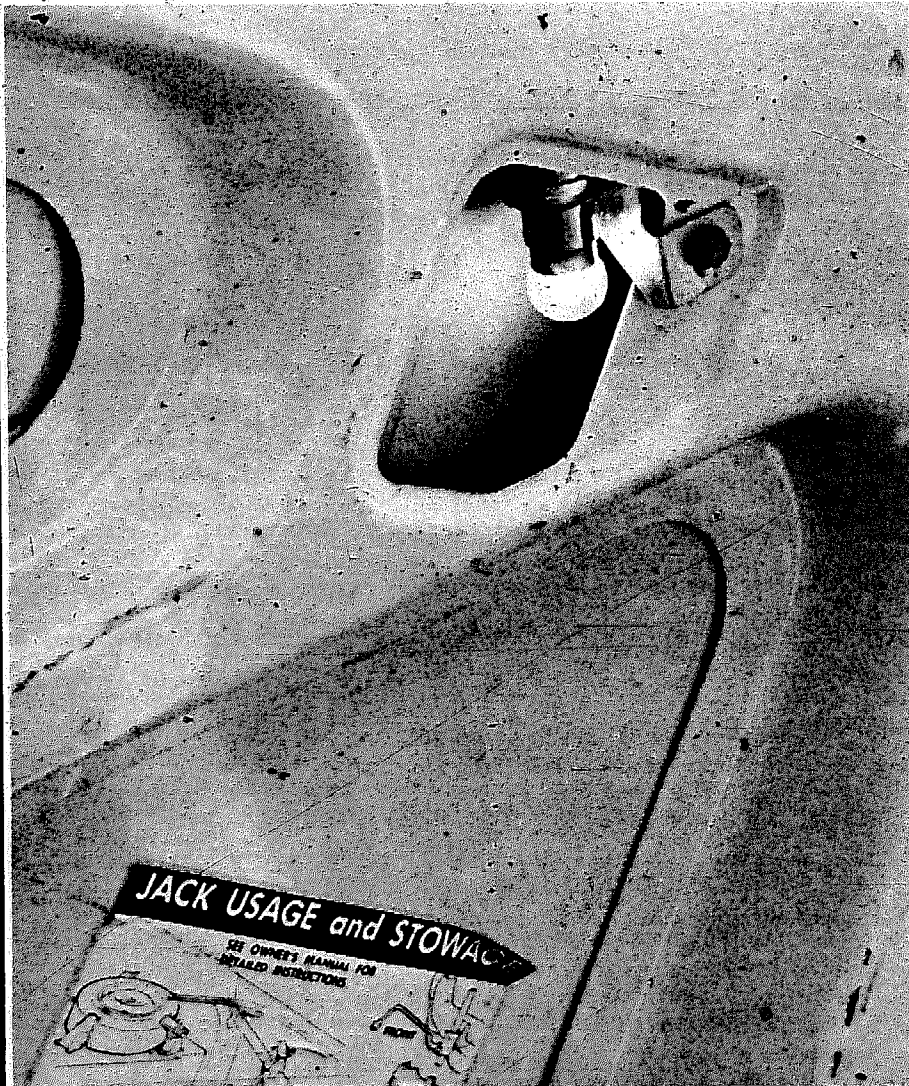

Trunk lights and underhood lights are usually operated by mercury switches. A mercury switch consists of a glass vial of mercury with an electrical contact in each end. When the switch is in the level position, mercury covers both contacts and allows current to flow. In the vertical position, the mercury only covers one contact and the switch is in the "off" position.

regardless of which terminal is used for the grounding terminal. What may confuse some people is that they associate the term negative (-) with ground when, in fact, the ground is whichever terminal is actually hooked to the chassis or engine block of the car.

The last thing to keep in mind is that in most instances, main automobile electrical circuits are parallel-wired, NOT series-wired. Main units are connected in parallel while switches that control these units are naturally wired in series with the components they control.

Types of Failures: The various components of the car's electrical system are usually grounded by electrically connecting one side of the unit to its housing. The housing is then attached mechanically to some metal portion of the car. The act of installing the unit to a power-supplying wire or line automatically completes the circuit, except that in actuality there is probably a switch or current-regulating device also located somewhere in the circuit to provide manual control of the device. An example would be the horn circuit where a switch connected to the horn ring on your steering wheel would actually control the operation of the horn. It would be a bit awkward to stop the car and electrically insert the horn into the power circuit, so we use switches or current-controlling devices to make driving a bit easier.

So, in essence, an electrical failure stems from the inability of the voltage to get from the power supply to the component. This inability to deliver voltage usually results from either a "short" or an "open."

The term "short" refers to a circuit that has been accidentally shortened. For instance, if the insulation on a wire should rot or chafe away and the wire come in contact with bare metal, the current would flow from the bare wire/bare metal connection back to the power source without reaching the component for which it is destined. This type of short circuit is also called a "ground" short.

"Open" is a term used to denote a circuit where the power supply wire

continued

has parted internally and voltage cannot flow. Connectors in the wiring system, and places where wiring comes in for lots of stretching or bending are the usual causes of open circuits.

If you determine that a fuse has blown, the cause will be a short circuit. Open circuits do not cause fuse blowing.

Horn Circuit: The horn circuit includes the battery, horn (or horns), horn relay, horn button, wiring, and chassis ground. When the horn button is depressed, battery power flows from the ready position at the horn button to the horn relay. The horn relay energizes and allows a heavier flow of current to go to the horn. The horn itself is usually made up of a coil, a moving plate, and a diaphragm.

Current energizes the coil which pulls on the moveable plate. When this movement is made a set of contacts inside the horn, and attached to the plate, disengage. This interrupts current flow to the coil and the plate returns to its deenergized position. This cycle of energize-deenergize is repeated many times per second and causes the diaphragm to move back and forth rapidly, much the same as a speaker cone does. The noise from this movement is directed out the cone of the horn. The tone of the horn can be adjusted by means of a screw located on the outside of the housing. This screw controls the tension of the diaphragm.

Current then flows from the horn coil to the car ground and then back to the battery. Horn problems usually are caused by: the horn button not making a connection, horn relay not operating, horn coil open (not shorted), or too much tension on the horn diaphragm.

Lighting Circuit: Lighting circuits are fairly straightforward. Power comes from the battery to a switch, then to the bulb socket, through a set of spring-loaded contacts, through the lamp filament, through another contact and then to the chassis ground.

All light circuits are fused because of the possibility of short circuits combined with the large amount of current

used in the lighting circuit. Problems with the lighting circuit usually consist of bad switches, corroded bulb sockets, or broken lamp filaments.

One of the trickier aspects of the lighting circuit is: what switch controls what lamp, and where is it located? Generally the following circuits are controlled by the listed switches which usually have the listed locations:

- head- and tail-lights . . . manually operated switch, usually labelled "lights" and located on the dash.

- brake lights . . . mechanically operated switch. Can be located either integral (though external) with the brake master cylinder, or inside the passenger compartment and mechanically attached to the brake pedal or linkage.

- dome light (interior light) . . . switch located in door jamb . . . can also be controlled by headlight switch.

- dash lights . . . controlled by turning headlight switch control knob.

- underhood, glove box, and trunk lights . . . usually controlled by mercury switches attached to hood, glove box door, or trunk. Switches sometimes located on trunk or hood lip and mechanically actuated.

- license plate light . . . controlled automatically by headlight switch.

Protective devices for the lighting circuit can be fuses, fusible links, thermal cutouts, or overload relays.

Light system troubleshooting is pretty simple. Corrosion of the attaching socket will normally be the problem, especially with head and tail lights, and burned filaments may account for the rest of the problems.

If you turn on the directional signals and they flash on one side but not the other, don't suspect the flasher . . . check the front and rear directional signal bulbs on the side that doesn't flash. Either the front or the rear bulb will be burned out.

Since tail light bulbs usually incorporate a dual-filament bulb when the

Taillight bulbs and wiring are accessible from the trunk in some cars, by removing the lens in others. Trunk-access systems are subject to corrosion from moisture and damage from being hit with the groceries as you put them in the trunk. Wiring and connectors are usually hidden behind cardboard or carpet, and can be hard to find.

tail light goes out the brake light will be inoperative also.

One dim headlight usually means that that particular headlight has a corroded terminal or that the air seal or front glass is cracked and is due to go out immediately if not sooner.

Interior light problems usually stem from sticking door jamb switches, and total instrument light failures can often be traced to a blown fuse caused by chafing wiring under the dash.

Motorcyclists would do well to consider that many companies manufacture "industrial" - or "farm" - rated bulbs that will replace motorcycle original equipment bulbs and last many times longer.

Windshield Wiper System: Windshield wiper systems aren't always electric . . . many are vacuum-operated, so if your wipers are out and you don't have a fuse marked "wipers," check under the hood for a loose or disconnected vacuum line.

Electrically-operated systems consist of a motor (or two), a switch, a fuse, and associated wiring.

Most systems use a single motor which operates both wipers through a system of mechanical linkage. The systems also may include a resistor attached to the wiper switch and used to control wiper speed.

Most wiper system electrical problems are usually confined to blown fuses caused by an overload condition in the motor. The motor gets overloaded when the mechanical linkage jams because of dirt, misalignment, etc. If one wiper moves but the other doesn't, the electrical portion is OK but the nonmoving arm is loose where it connects to the toothed drive drum.

continued

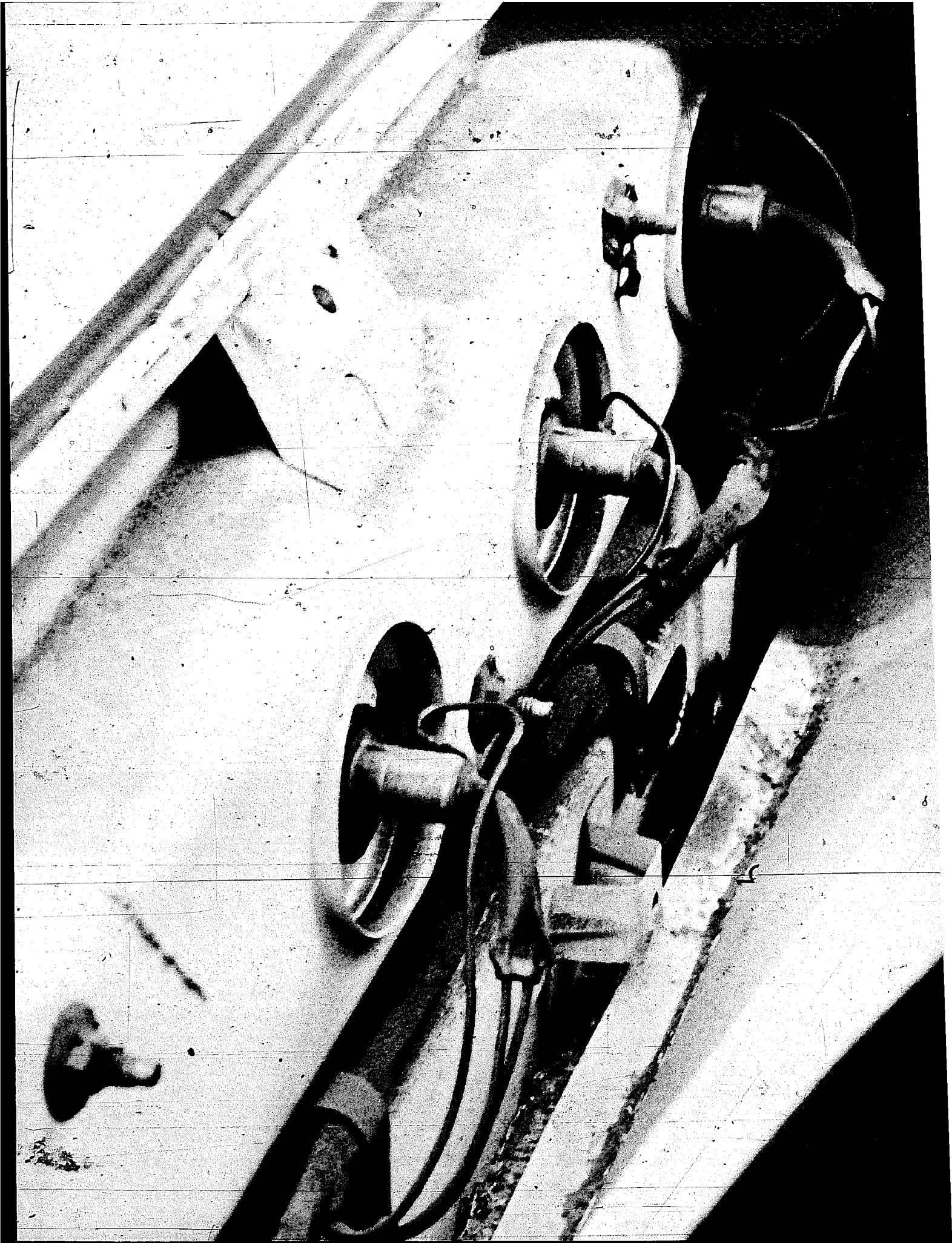

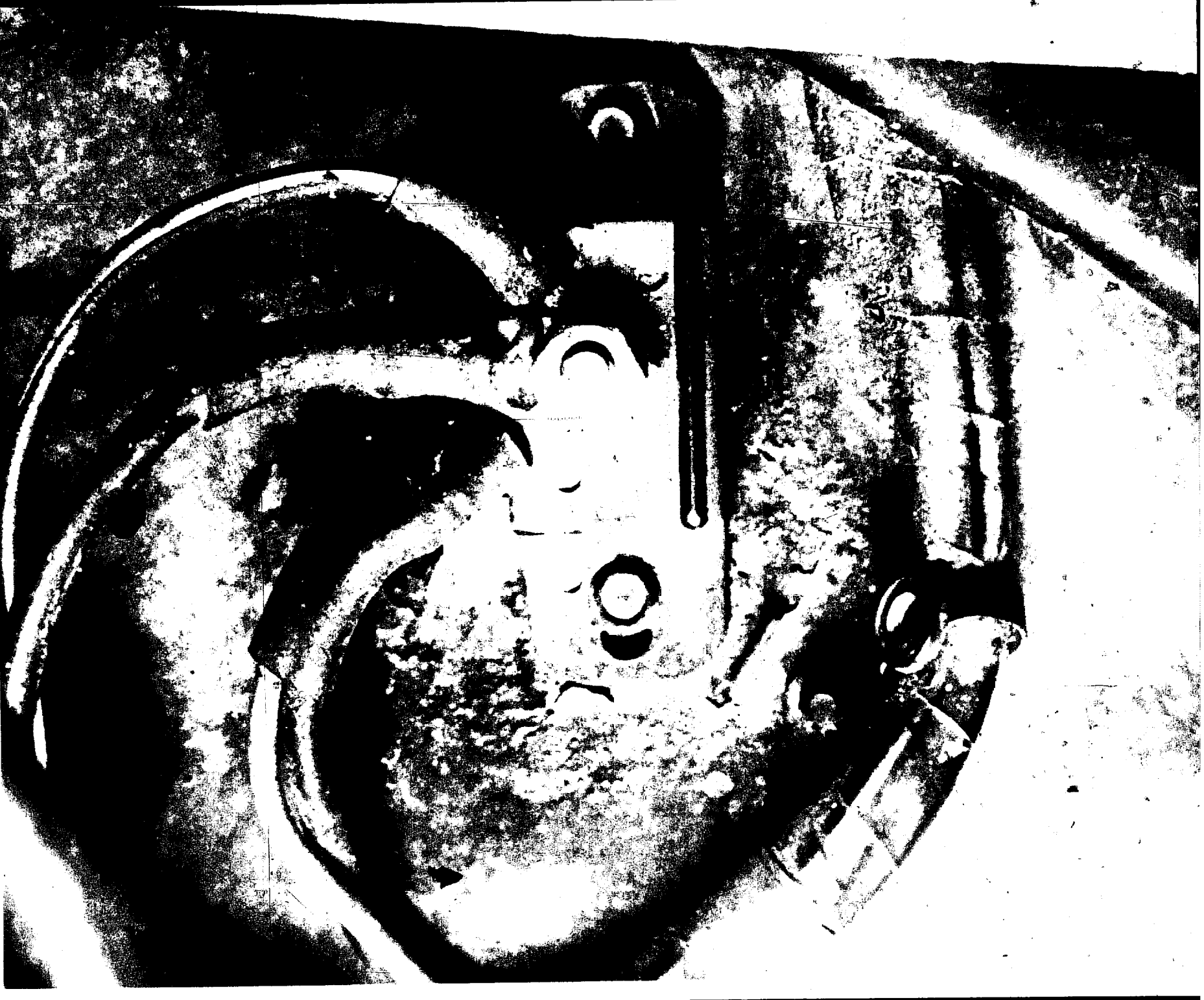

What do you think would happen if a piece of bare wire or a tool were to fall across this terminal when it's energized? It just smokes. Frank told me that before. And I cover terminals like this, but some electrical tape and do it yourself. An ounce of prevention is worth a pound of cure.

the backyard mechanic

continued

Windshield washer systems may be operated either by vacuum or pressure, and the pressure systems can be either manual or electric. Manual systems are powered by a foot pump in the passenger compartment while the electrical systems use a motor located either in or below the windshield washer fluid tank.

These motors can burn up because of a blocked fluid passage which causes them to run too fast and overheat, or because fluid level is too low. Keep fluid in the tank, and keep the lines to the nozzles clear, to insure washer operation.

Intermittent-operation wiper systems are usually controlled by a capacitor circuit. If the wipers operate continuously, there is an open in the capacitor circuit, and if they do not move at all there is a short. The capacitor and relays associated with the intermittent feature are contained in a small module near the wiper switch and must be replaced as a unit.

Instrument Circuit: The instrument or gauge circuit usually includes the generator light, oil pressure light, fuel gauge, and engine temperature gauge. Some cars may have gauges for each of the functions, as opposed to "idiot" lights.

Aftermarket oil pressure gauges are usually connected directly to the engine and do not use electricity, but factory oil-pressure-indicator systems are all electrically powered. In all systems using electricity, there is an oil pressure sending unit attached to the engine. This is connected to the gauge or light in the dash. Light systems use a simple switch in the sending unit. If oil pressure is good, the switch is in the open position and the light is not on. If pressure decreases, the switch is allowed to close and the light burns brightly. The same basic system is used for the engine overheat light except that the sending unit switch is actuated by heat instead of pressure.

Gauges use a variable resistor in the sending unit, and the gauge reflects the amount of current it gets from the sending unit, although the gauge is marked in pounds of oil pressure or degrees of temperature.

In the case of cars equipped with "idiot" lights, it is a good idea to occasionally turn the ignition key to "ON" without starting the engine. If the lights do not come on, chances are a bulb is burned out. . . . an ounce of prevention, etc..

Fuel gauges are controlled by a sending unit located inside the fuel tank and operate the same as mentioned above. In most cases, the fuel tank must be removed from the vehicle in

Next month: In next month's installment of Back to Basics, we'll cover basic troubleshooting procedures and show you an assortment of handy-dandy troubleshooting tools, aids, and tricks-of-the-trade.

order to replace the sending units, while the oil pressure and engine temp sending units can simply be unscrewed from the engine.

The "generator" light indicates the charge rate of the electrical system and takes the place of an ammeter. It is wired in between the battery and ignition switch and will therefore illuminate any time there is current flow from the battery. If the generator or alternator is working correctly there will be sufficient current generation to make the light go out.

A flickering "gen" or "alt" light at idle can mean a loose fan belt or intermittent voltage regulator, or it can mean that the engine idle is set too low. A continuous light indicates a charging failure caused by a bad alternator, generator, voltage regulator or battery, or it can mean the fan belt is broken. A short circuit is also a possibility, but usually the fuse associated with the circuit will blow and the generator light will go out.

An overheat light can mean a broken fan belt, loose radiator cap, low radiator-water level, or bad water pump.

An oil pressure light can indicate oil temperature too high, oil level too low, or clogged oil filter.

Accessories: Sequential turn signals like those used in Fords, Thunderbirds, and Mercury Cougars are controlled by a transistorized sequencer.

usually mounted in the trunk, on the driver's side. This unit must be replaced rather than repaired because it is sealed and opening it will destroy the circuit boards. If your front turn signal and the center rear turn signal light and flash, but the two outside rear signals do not, or if there is no sequencing, the sequencer is bad. If the front and rear signals light and stay lit, or if they do not operate, the flasher mounted under the dash is bad. If the turn signal fuse has blown, the signals will not operate.

Heated rear windows utilizing a wire grid as a heat source usually have three elements: a control (on-off) switch, a relay, and a fuse. These connect to the heating grid embedded in the rear window. Some systems also incorporate a timer. The timer permits current flow for a period of 5 to 7 minutes and then shuts off so as not to overheat the grid or the glass (in case the control switch is left on inadvertently). No heat at all from the grid can indicate a blown fuse, bad control switch, bad connection where the power lead connects to the grid, or a defective timer. Heat for only a short period usually means a defective timer, while continuous heat also indicates a defective timer.

Anti-theft systems built into the car (not aftermarket systems), when activated, will cause the headlights, taillights, and side marker lamps to flash, and the horn to sound. All this action happens about 90 times per minute and lasts for three to five minutes.

Arming the system will sensitize all the doors, the hood, trunk, and tailgate, forced entry of any of these components will cause the alarm to activate.

The system is armed by normal use of the key in either lock cylinder of the front doors. The alarm sensor is located under the instrument panel and above the glove box and you have to remove the glove box to get at it. To add insult to injury, the sensor is A. expensive, and B. non-repairable. Check for sticking door jamb, hood, trunk, and/or tailgate switches before you attempt to replace the sensor. ☺

Electrical system fusing and basic electrical problem guide



Don't overlook the obvious when you're troubleshooting. Corrosion of any wiring junction or connection is bad news, but if it's at the battery terminals it can cause problems in all other circuits.

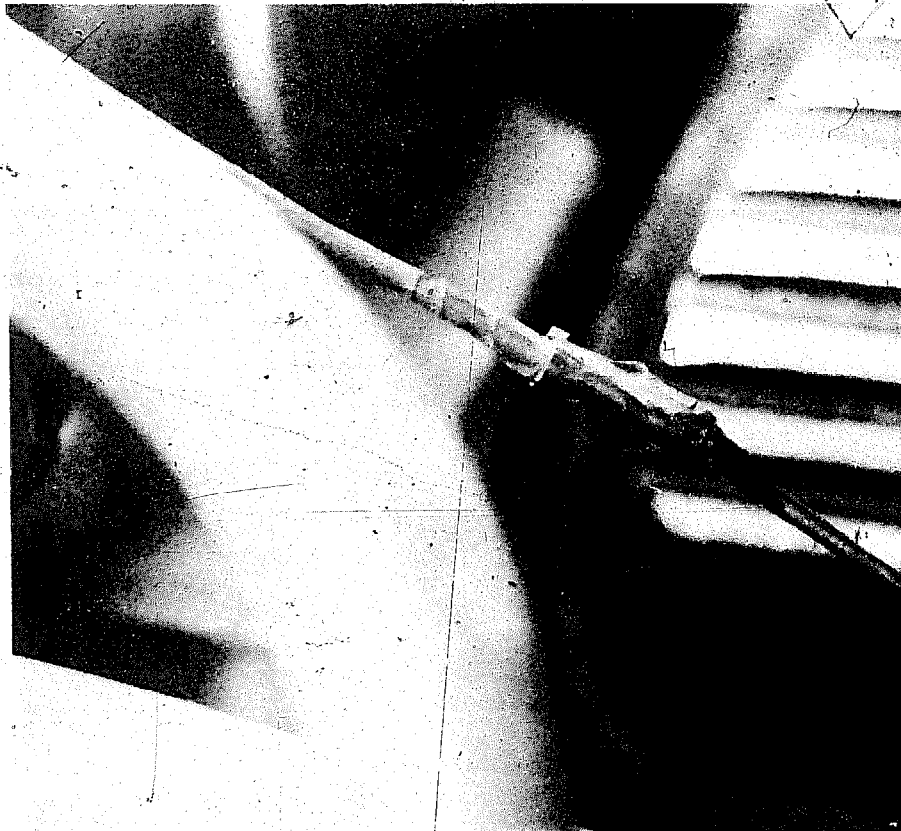

The text makes mention of fusible links. These links are nothing more than different-gauge wire inserted in the circuit wiring. If the fusible link blows, replace it with the same gauge wire and not an in-line fuse.

As we mentioned in the previous installment, the electrical system in your car is similar to that in your home. They both have a voltage source, wiring, mechanical connections, and some sort of circuit-protecting device.

The method most often used in both systems is the fuse, or fusible link. Circuit breakers are found in a few automotive electrical systems, but in many cases, they are not resettable like those in your house.

If you carry replacement fuses in your car and you know where the fuse box is located (courtesy of your handy owner's manual) the job of handling a blown fuse is relatively simple.

Correcting the trouble that caused the fuse to blow in the first place may not always be so easy, however.

The fuses used in an automotive electrical system are not the same type as those usually found in your house. They are small and cartridge shaped, and fit into clips or in-line holders. Finding which fuse is blown is usually

FUSES & circuit control DEVICES

easy. If the back-up lights go out, for instance, merely look for the appropriate label on the fuse block (or box). If the labels are not readable, or if the inop device is part of a larger circuit and not specifically listed on the block, visual appearance should give you a clue. If glass-cased fuses blow, they may take on a cloudy or blackened look inside the glass. Sometimes, the metal element inside the glass case will just separate and not leave any deposits on the glass. Look closely (after removing all rings, watches, etc.) at the fuse in question. If the glass is clear and you don't see any silver-colored wire, or if the glass is blackened, that's the one. Be careful though, because some fuses use extremely fine wire and unless you examine them very closely, they could appear to be blown.

Once you find the bad fuse, you must remove it from the holder. If it is the in-line type, you merely unscrew the two halves of the holder and remove the fuse. If it is in a fuse block, it will be held in by two metal clips. Don't attempt to remove this kind with a screw-

driver. The metal clips carry current, and the resultant shower of sparks can provide you with a degree of overstimulation that you don't really need. Another thing that may happen is that you could burn out all the wiring associated with the particular circuit and start a marvelous under-dash fire at the same time. Gently pry the fuse out of the holder with a popsicle stick or plastic rod, but don't use a metal prying device.

Better yet, give yourself a break and buy one of those inexpensive plastic fuse pullers from your friendly BX service station.

Once you have removed the blown fuse (or at least the one you suspect is bad) you must replace it with the correct type and size. We can't over-emphasize this point too much. Replacing fuses with ones of incorrect rating can lead to more trouble than you had when you started. A fuse of greater capacity than is needed may damage the unit it is supposed to protect.

As we mentioned in the previous installment, the single-wire system is

usually used in automobiles. With this system, a single wire delivers the current, and the metal chassis and body components bring it back to the battery. With the switch on a car lamp closed, the circuit to and from it is complete and the lamp will light. If a connection to the lamp loosens, or becomes corroded or begins to chafe, resistance is set up in the circuit, heating occurs, the lamp burns dimly, and if the wiring grounds the battery will discharge. Heavy discharge readings on an ammeter would warn of this, but if a warning light is used in place of the ammeter (as is the case with most cars) a very heavy short would be required to cause the warning lamp to glow.

If a simple circuit like this is protected with a fuse, however, any of the conditions mentioned above will cause the fuse to blow, and thus break the circuit.

To locate the cause of the blown fuse, always check wiring terminals for tightness first. Look for spots where a wire may be rubbing against metal.

continued

the backyard mechanic

continued

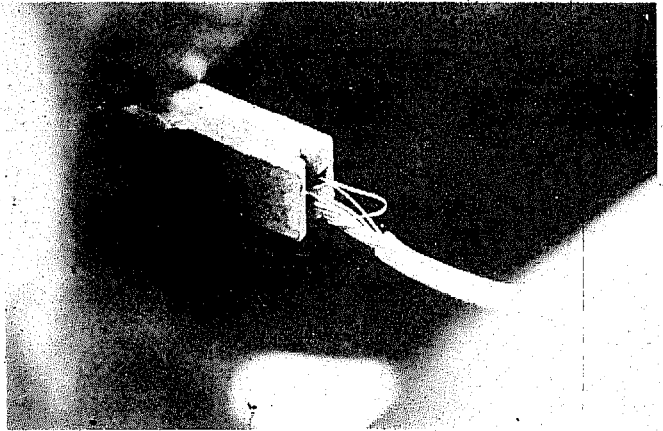

(left) The old "grind the battery cable on the fan belt" trick. If this doesn't get replaced or at least taped, starting circuit trouble is on the way. **(right)** There are a couple of problems here. One is the obvious hazard of bare wire close to metal components, and the other is that it's a great place for corrosion to get started.

For instance, if any of the light bulbs fail to work but the bulbs are known to be OK, then the problem can be traced to a blown fuse and replacement will restore the circuit. If the second fuse blows, the trouble lies somewhere else in the circuit.

A vibrating circuit breaker (like the one used in the headlight circuit) usually means a short which you must find

and correct. To do this, disconnect the switch wires one at a time until the vibration stops; this is the line in which you will find the trouble.

Except in very old cars and trucks, fuses have seldom been used for headlight circuit protection. On many older cars, lamp circuits are protected by a thermostatically-controlled limit relay or a bi-metal circuit breaker,

usually attached to the light switch. On most late model cars, all circuits except the headlights have been removed from the circuit breaker line and fitted with separate fuses.

The entire battery system on today's cars is protected by "fusible links." A fusible link is nothing more than a piece of wire that is spliced into a circuit in which the wiring is one or two standard thicknesses larger. For example, a piece of 14-gauge wire is spliced into a circuit composed of 10-gauge wire. This link is often covered by a plastic sheath of special shape, to aid in identification.

If the circuit is overloaded, the higher number (thinner) wire burns out and separates, just like a fuse element.

The location of these links varies according to the make of car. On late-model Chevrolets (except Corvette), there is a 16-gauge fusible link to protect all unfused wiring of 12-gauge or thicker. The link is located at or near the horn relay.

If a fusible link blows, the repair (after correcting the cause) is to splice in a new piece of wire of the appro-

continued

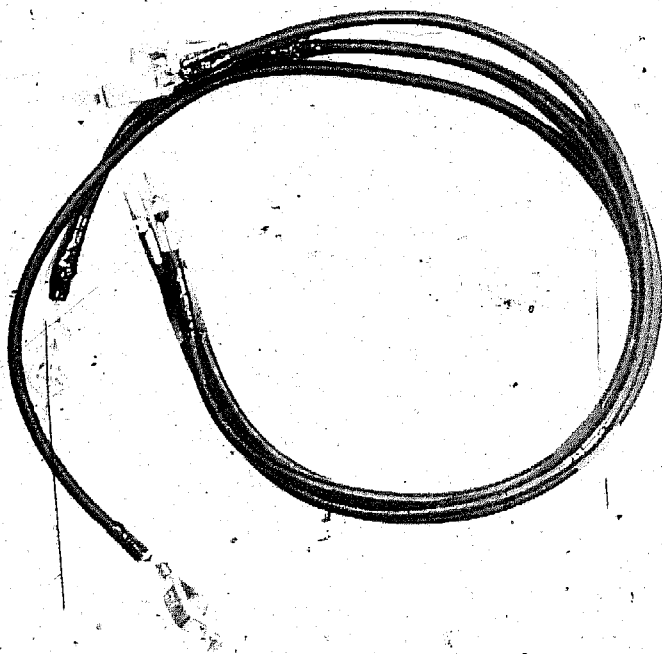

Your handy-dandy jumper cable kit. It's not for jump-starting dead batteries but for troubleshooting circuits. Remember that connection of a jumper in a live circuit will result in sparks. It's best to wire in the jumper and THEN apply power to the circuit.

(right)

A troubleshooter's best friend ... a voltmeter/continuity tester. A meter this expensive isn't needed by the average backyard mechanic and cheaper ones suitable for automotive troubleshooting (6- and 12-volt DC scale, ohms function, and AC volt scale) are available for less than \$10 from Sears, Radio Shack, etc.

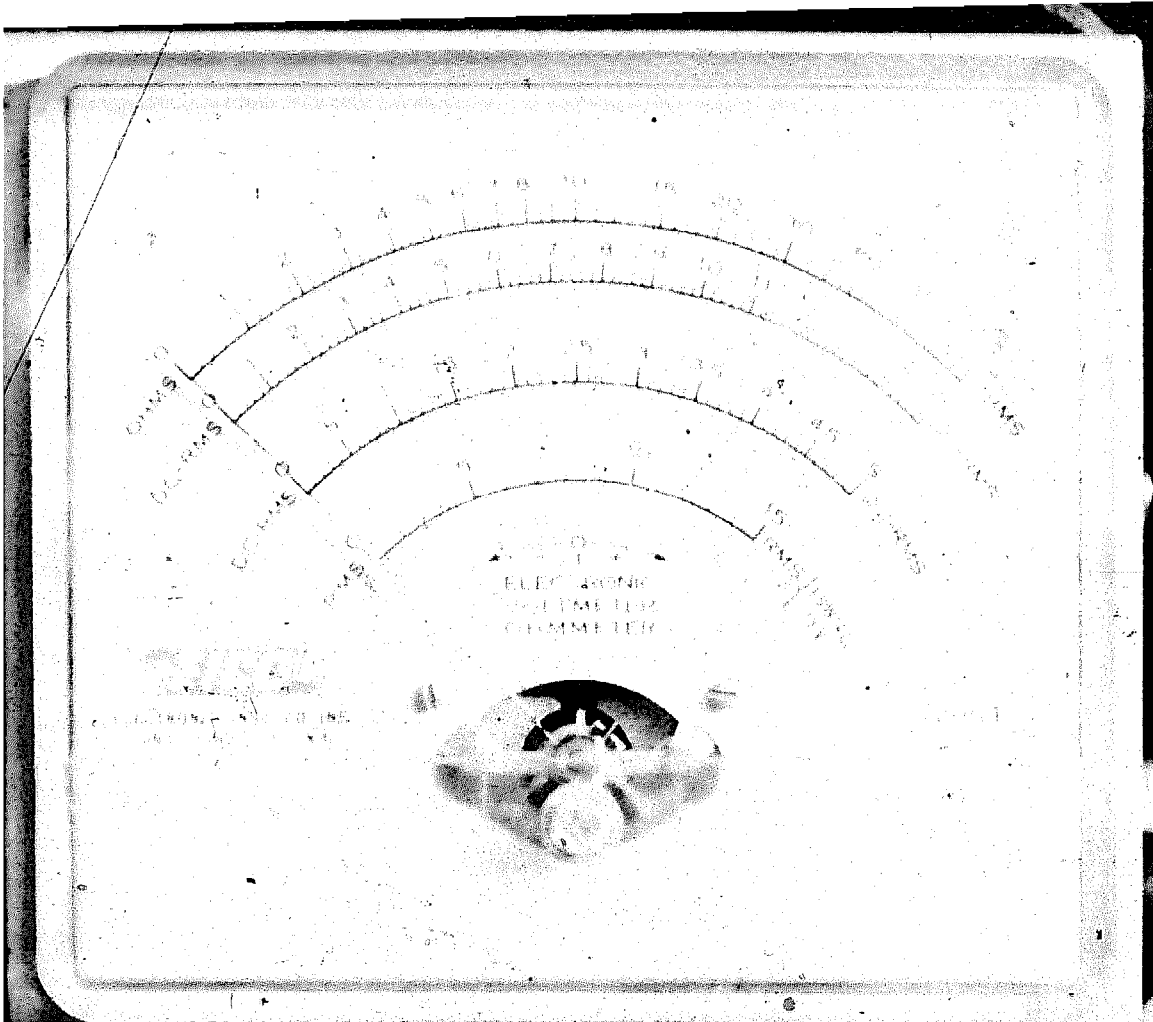

MODEL 232
PEAK TO PEAK
VTVM

EICO
REG. U.S. PAT. OFF.

ZERO (knob)

OHMS ADJ. (knob)

AC VOLTS (range selector)

-DC VOLTS (range selector)

+DC VOLTS (range selector)

OFF (range selector)

OHMS (range selector)

5V Rx10 (range selector)

15V Rx100 (range selector)

50V Rx1000 (range selector)

150V Rx10K (range selector)

500V Rx100K (range selector)

1500V Rx1M (range selector)

RANGE (knob)

FUNCTION (knob)

GND. (terminal)

ELECTRONIC INSTRUMENTS (text at bottom left)

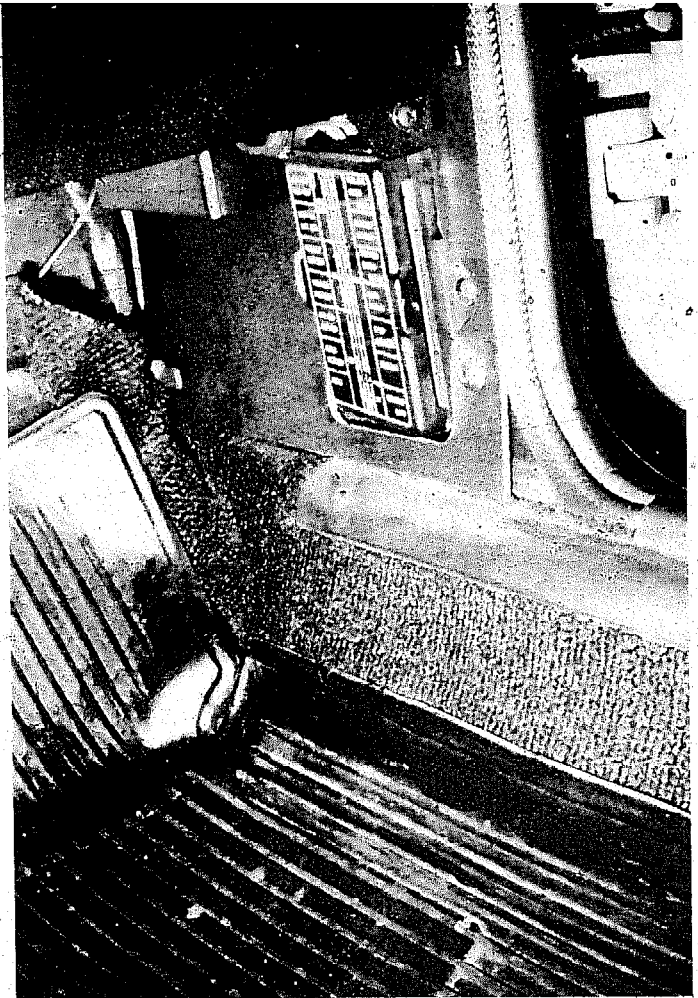
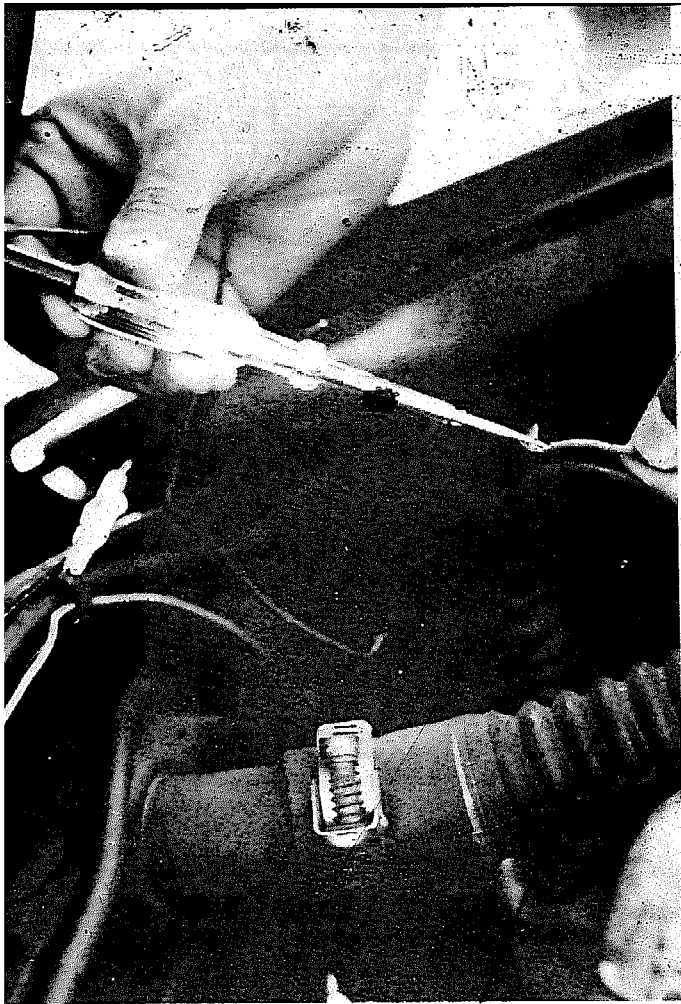

LIGHT (R) LUZ DER	HEAD LAMP	10 A	20 A	PARK. TAIL ESTAC TRASE
LIGHT (L) LUZ IZQ		10 A	10 A	
FLASHER LUZINTERM	IGN	10 A	10 A	CIGLIGHTER ENCEN DEDOR
FUELGAUGE CALIBRADOR		10 A	10 A	
AIR CON AIRE ACON	ACC	20 A	10 A	STOP LUZPARADA
WIPER LIMPIADOR		20 A	20 A	
RADIO		10 A	1 A	ST FLOORTEMP LAMP

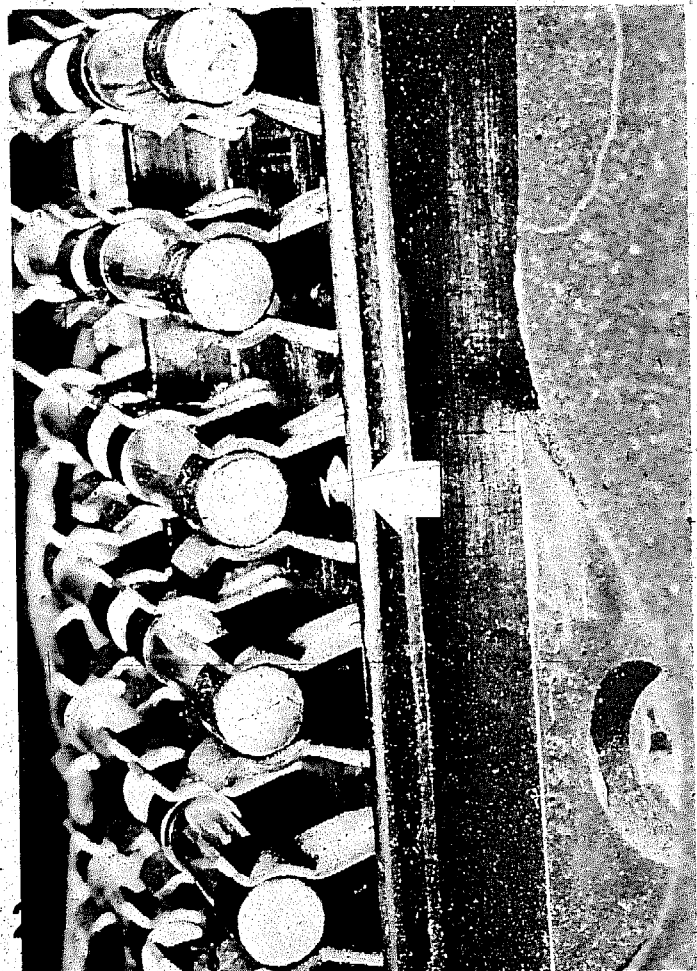

the backyard mechanic

continued

(far left)

Another handy but inexpensive tool to have is this voltage probe. It won't give voltage readings, but it does light up when voltage is present.

(near left)

Fuse box locations vary from car to car, but many times the box will be on the passenger side of the car near or under the dash. On most American cars, the directional signal flasher will be incorporated in the box by means of a plug-in socket.

appropriate gauge, solder or crimp-connect the terminals, and cover the splice with electrical tape or shrink tubing.

Remember that the circuits in cars are like those in your home . . . if you have too many lights or appliances on one circuit, a blown fuse will result.

The same thing is true in a car. Using a larger capacity fuse will prevent the fuse from blowing, but you're asking for trouble.

Although troubleshooting can take some sophisticated tools and techniques, some problems are not all that complicated. For instance, if a bulb fails to light, there are really only five possible causes: a bad bulb, a poor connection at the socket or bulb terminal, defective wiring, a defective switch, or a blown fuse.



If you use a little bit of logic, most troubleshooting will be as easy as diagnosing a bulb problem. Take your time, use common sense and safe procedures, and you'll be able to get all those electrons going to the right places in your car. Ⓢ

(far left)

Fuse boxes or fuse box covers are normally labeled as to each fuse's function. If the fuse box in your car isn't labeled, your owner's manual should have a diagram giving you the info about which fuse controls which circuit.

(near left)

This close-up shows a factory goof in a new Datsun . . . you may want to check your car for the same problem. Fuse box mounting screw (arrow) protrudes through block and almost makes contact with hot terminal. Even a little vibration could make the connection and quickly fry a circuit.

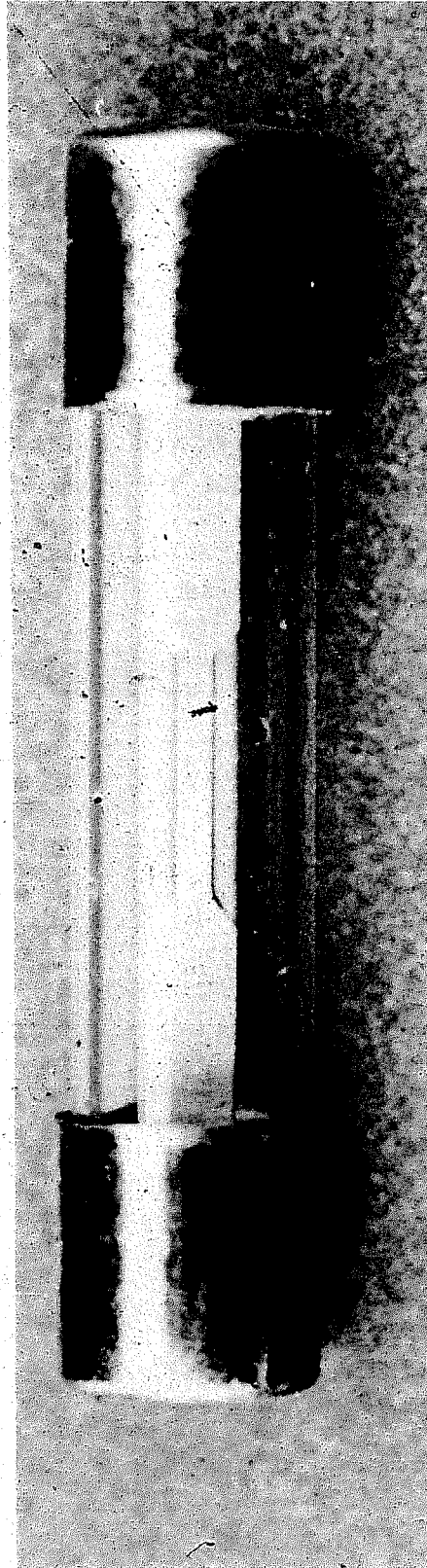

This is what a good fuse looks like. The metal element inside the glass case is not burned or melted.



A blown fuse will look like this. A brownish or bluish fog inside the glass case also means the fuse is bad.

continued

ELECTRICAL SYSTEM PROBLEM GUIDE

American Motors:

1975—Rough idle or stalling may be caused by induced resistance in the ignition harness. This build-up in resistance at terminals and connectors will cause a miss due to ignition interruption.

1974—Alternators should be equipped with two capacitors to protect against transient voltage which may damage transistors in the voltage regulator. Install an additional 0.5 mfd capacitor with the lead connected to the regulator terminal of the alternator and grounded to the alternator case.

1971-1975—The alternator indicator (idiot) light may glow dimly due to higher-than-normal resistance in the alternator field diode assembly. Replace the diode assembly.

A condition where all lights flicker at low engine RPM can be caused by a defective voltage regulator or alternator.

1974-1975—An inoperative seat belt interlock may be caused by a damaged interlock module due to jumper leads being connected to start relay in an attempt to energize starter motor solenoid.

Chrysler Corp.:

1970-76—Alternator "whine" heard at all levels of radio volume is caused by the electronic voltage regulator. To correct, install a capacitor; p/n 3501598 (info courtesy Chrysler Corp.).

1975—Inoperative instrument lights may be due to disconnected 6- or 12-way connectors feeding instrument cluster.

1975—Erratic horn operation may be caused by improper adjustment of the horn diaphragm tension screw that makes the horn draw very low current.

Ford Motor Company

1972—Thunderbird and Lincoln Mark IV models may have the ignition by-pass and ignition resistor wires installed into the wrong connectors, resulting in ignition points burning at low mileage.

1971—Models with 302" or 351"W engines have a distributor breaker cover made of metal, and a no-start condition may occur if the coil or condenser terminals contact the cover due to incorrect positioning.

1970-71—There may be a dieseling (run-on) problem on models equipped with throttle solenoid positioner and alternator indicator light. The positioner may be energized through the alternator indicator light, and this requires that a diode be installed in the light circuit.

1974—Engines with electronic ignition may have rough operation above idle due to crossed wires in the distributor-to-module engine harness.

1973—Low or no alternator output can be caused by electric choke wire shorting to the choke tube.

1973—Torino and Montego models may have a red-yellow wire from the seat belt buzzer coming in contact with a light green-red wire from the alternator warning light circuit. This can cause the alternator indicator light to stay on even though there is no alternator malfunction.

1970—There is the possibility of battery overcharge on models equipped with electro-mechanical voltage regulator. Another possibility is that the overcharge could have resulted from incorrectly-wired alternator-regulator connectors.

1976—Radio noise may exist on some early models due to an inadequate ground at the capacitor mounted on the ignition coil.

General Motors

Buick:

1970-75—If the alternator (idiot) light remains on with the ignition switch off, check for a shorted positive diode in the alternator's diode bridge. If the light remains on with the engine running, the wire to the alternator No. 1 terminal may be grounded.

1975—An incorrect fuel gauge reading can be caused by an intermittent open circuit in the dash-to-tank unit due to a loose contact at the dash's connector.

Chevrolet:

1970-75—No-start condition can be caused by loose or defective wiring between neutral-start switch and ignition switch, a burned fusible link in the starting circuit, or a poor terminal connection between energizer, horn relay, ignition switch, neutral-start switch, solenoid "S" terminal, or energizer ground cable.

1974-75—A no-start problem could be encountered because of an improperly installed battery ignition wire at the distributor cap (HEI system only).

1970-75—Slow cranking may be due to loose or defective wiring between energizer and engine block or solenoid "BAT" terminal.

1974—A battery that won't charge may be due to a wire omitted in the wiring harness that runs from the alternator connector to the bulkhead connector.

Pontiac:

1974-75—A no-start condition may be encountered in some models due to the pink battery ignition wire running to the distributor cap. The wire connector could have been installed with the harness terminal on the wrong side of the black distributor cap terminal.

1970—A short plunger in the glove box light switch may allow the switch to remain activated even though the glove box door is closed. This can result in the battery going dead for no apparent reason.

1972—When using the "battery post adapter" method of measuring alternator performance, you may obtain a low output reading. This is caused by the heater/AC motor running whenever the ignition key is in the "on" position.

(General Motors Products Diagnostics Reprinted courtesy of Mitchell Manuals Inc.)

The Backyard Mechanic

You can already feel the heart-burn coming. You're stock piling antacids in the top desk drawer. The old car is giving you very strong hints that it's ready for another tuneup. It's getting harder and harder to start. The buggy stalls no matter what you do. She's burning gasoline as if it were 25 cents a gallon! The acceleration is so poor, Boy Scouts ask if you need help getting across the intersection. (Or maybe you're the type who tunes up every 10,000 or so miles as routine?)

Any way you look at it, the engine needs a tuneup and you *know* the whole thing is going to take its toll on you.

Generally your mind is racing with one of two tuneup rip-off scams:

1) The mechanic will fix only enough to get your car back out the door with a property line guarantee: once you drive across the property line, he never wants to see you again. The problem being the car may not run long enough to get you out of his sight. If he does provide a guarantee, you end up taking the vehicle back every other week to get it "fixed right this time." Or until you're sick of talking to him with your teeth forced together, eyes shut and general body shakes. Then you give up and pay to have it done again, someplace else.

2) They say they can do it for \$50. However, once the car is in the shop and they've got it apart the bump-up starts. The sincere mechanic comes to you wiping his hands on one of those red rags, shaking his head saying something about, "Well, we found this

A GUIDE TO CONSUMER SURVIVAL

AVOIDING THE TUNEUP RIP-OFF



Spark plug wires can look perfectly OK clean or dirty, but may be electrically unusable. Remember, when pulling your own wires from the spark plugs, rotate them until they "pop" before pulling them loose. Jerking them away from the plugs can ruin the wires.

continued

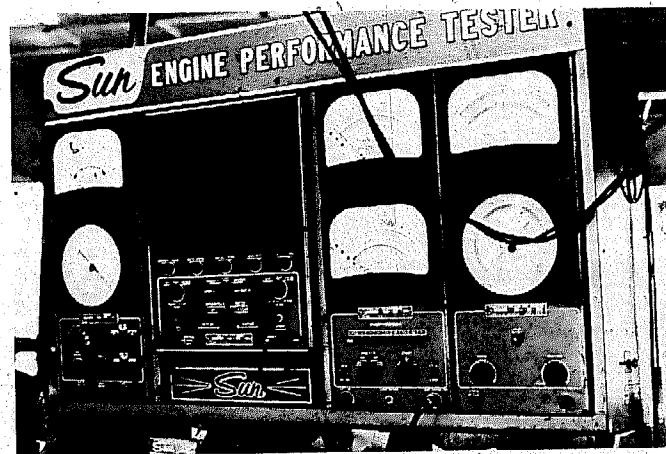
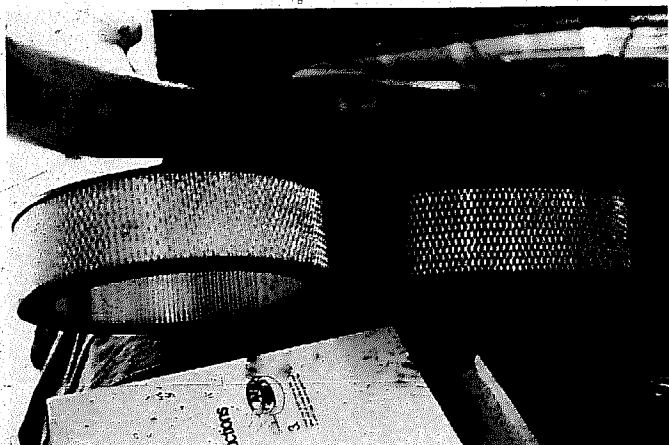

(left) **Air filters** are usually one item that you can readily check to see if you got what you paid for. No amount of air blasting is going to turn the used filter on the right white like the new one on the left. (right) **If the mechanic** you pick doesn't have a set of test instruments like this—boogie. He's not going to be able to do a proper tuneup.



HEY, MAN,
what's makin' my
wheels go:
**POKKAwhip!r
grindCLUNK?**

**POKKAwhip!r
grindCLUNK?**
Let's take a
(chuckle, chuckle)
LOOK-SEE...

(To the tune of
"It's Crying Time Again")
It's tuneup time again,
you're gainin bleed me,
I can see the dollar signs
in your eyes.
I can tell by the way
you hold my car key,
That it won't be long
before you bleed me dry.



the backyard mechanic

continued

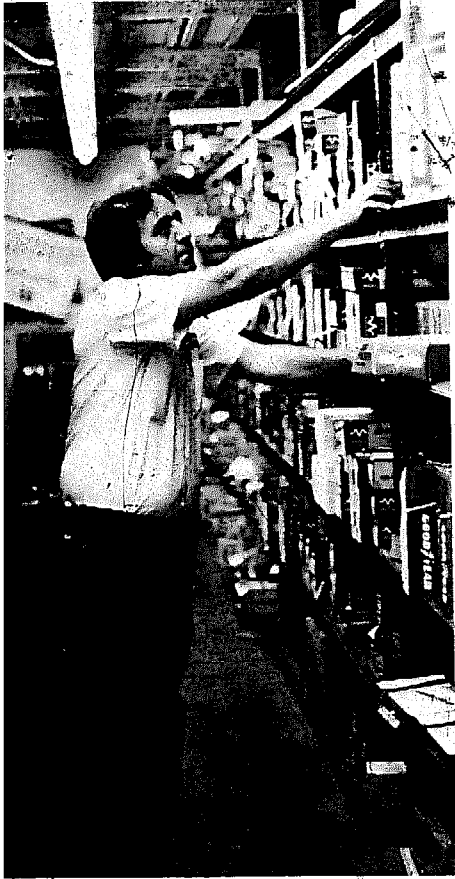

The parts man can be your ally. Shop for a reputable one just like you would for a mechanic.

wrong." And it doesn't seem like 10 minutes after he has your approval for \$25 more work that he's back with another "Well, we found . . ." and wanting another \$25. This goes on until they're bumped you into a \$100-plus minor tuneup or even the sky's-the-limit major tuneup.

But one thing is for sure when it's tune-up time: most of us *think* it's also rip-off time. It's as though tuneups were magic, but there are no magicians to perform the tricks.

It doesn't have to be that way. There are ways to insure that your vehicle gets the work it needs, and only the work it needs. At the same time, you can rest assured the tuneup lasts a reasonable length of time. This is true for not only the work you have done for you, but the work you do yourself.

Basically, there are two types of tuneups. There's the routine tuneup that should be done periodically. That is, a tuneup to solve a problem that has developed over a period of time. For

example, the car accelerates slower than it did before, the gas mileage isn't as high as it once was, the engine is harder to start, the car stalls, or maybe, it's been more than 10,000 miles since that last tuneup. These are all hints that it is tuneup time.

The other type of tuneup is really a repair. It's done to solve a problem that developed suddenly. For example, the engine starts missing, the car's running rough, or it won't start at all. These are problems that a tuneup might solve.

In either case, unless it is a real emergency don't settle for just one opinion. Get a second opinion. Most reputable shops will provide an opinion free. Some may even charge \$5 to \$10 for

putting the car on a scope to find exactly what's needed. Keep in mind that most manufacturer dealership service shops will charge \$17 to \$35 just to look at your chariot. So unless you're very sure the work is going to come under your new or used car warranty, you can get it for less.

Of course, the key is finding a reputable shop with a competent mechanic. A mechanic you can have confidence in.

Your question being, "If I'm new to the area, how do I find such a person?"

The answer is simple: Ask. Ask, "Where do you have your work done?" and "Are you pleased with the job?" Ask the people you work with. Ask the

continued

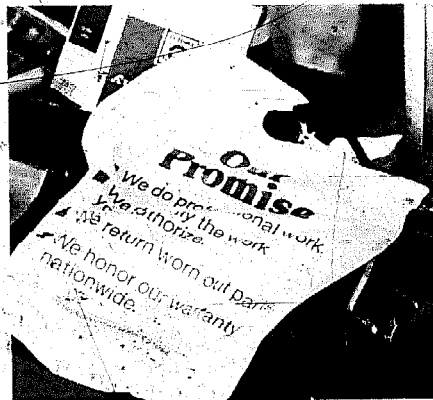

Even if you're not concerned about getting everything you paid for, always get your old parts. It is peace of mind.

(right, below)

There is a time when the new carburetor is more of a bargain than the rebuilding kit. Usually, the parts seller knows when that is, and isn't just bumping you up.

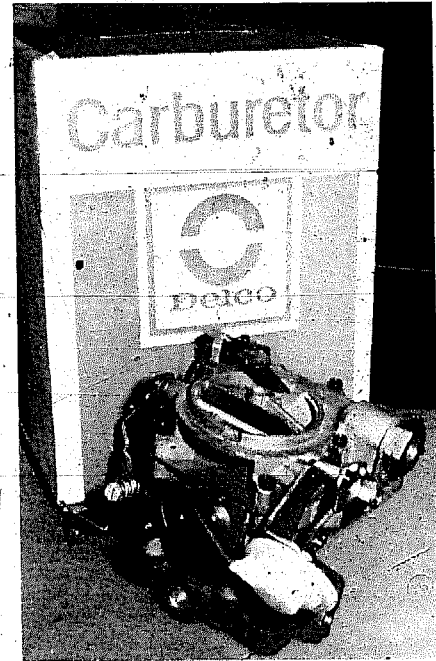

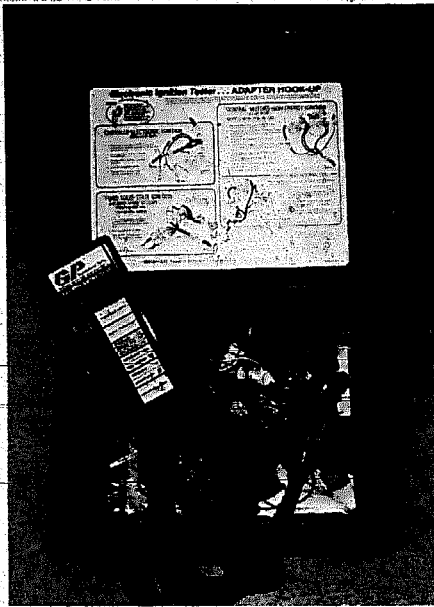

This piece of equipment checks out electronic systems with good or replace lights going one, two, three, four, five and six. You have to have one to properly check out the new systems. However, the \$200 price tag is too steep for most Backyard Mechanics.

auto hobby shop staff. Ask people using the auto hobby shop. Find out what different people have to say about where they get their work done and, especially, by whom. And get more than one opinion.

If you're really lost, go to a big organization. Any of the major service centers such as Goodyear, Firestone, B.F. Goodrich, Midas, Sears, Penney's, Ward's, etc. are good. These larger organizations give a little more. They are a little more understanding than the one-man organization just down the block. Besides you have a little more pull. You can always take your problem to upper management. Try that with the owner-operator-chief mechanic, grease monkey-gas-pumper-and-general go-for at the corner gas station.

Another plus to the big organization is their national operation. Generally they will honor the warranty at any store in the chain, even though it's on the opposite coast.

However, the independent mechanic can be just as good as the big organization, and in some cases a lot better. There can be many reasons why his business is not as large as the service center's. For one, he may not take credit cards, demanding cash instead. Perhaps he's already got all the business he wants. Or maybe he's a true professional and wants to be able to assure his customers of his personal touch on every job.

That's why it is important to find out what different people have to say

about the service they've received.

Other clues to a mechanic's competence include cleanliness of the establishment and working area.

Next, you might want to look for certification of the mechanic's abilities, whether it be a wall covered with "diplomas" or a sleeve-load of stripes to make any Army sergeant major jealous. This is a mechanic with experience and a source of reference. If he has gone to the trouble of passing courses, he's concerned about what he's doing—not just making a buck.

You also want to know if the proper equipment is available to handle your vehicle. If the tuneup technician doesn't have an infra-red, a scope and the proper tools, he's not going to be able to tune today's cars properly. Without this equipment, the mechanic can only guess about what's wrong. With the equipment and proper training in its use, he can pinpoint the problem.

If one thing goes wrong, it could indicate 100 other problems. Only an experienced mechanic can come to the right solution. And with today's complicated vehicles only an experienced mechanic with a scope can find the real problem.

For example, one of the plug wires has been burned by the exhaust manifold and the engine starts missing. It's missing so bad it sounds and feels as though it were about to self-destruct. Very few people think, "I've got a miss, and I can get out of it for \$2." Therefore, they have already prepared

themselves for the inexperienced, unscrupulous "operator" who says they need an entire set of wires, plugs, points, and may even toss in a carburetor overhaul to sweeten the price.

Whatever you do, don't walk into a shop and say, "I need all this; I need wires; I need this; and this; and this . . ." All you're doing is laying yourself open for the works.

Women may have been the real targets of the tuneup rip-off in the past because of their stereotyped lack of knowledge. However, with today's complicated vehicles almost anyone can be pulled into the trap. On the other hand, if you can assert yourself—let the mechanic know that you're no push over—then you're less likely to be taken. If you're too passive, take somebody with you who is more aggressive.

If you're concerned about paying for a part you didn't get, ask for your old parts back. Some firms make this a practice; you should make it a habit.

Probably the "grayest" area regarding paying for something you didn't get is the carburetor overhaul or installation of a rebuilt fuel/air mixer. This is because it is very, very difficult to tell the differences between a rebuilt or overhauled carburetor and one that has just been cleaned. This is why you must pick a mechanic you trust.

Did you need everything you paid for? Again, it's hard to say. Let's look at a distributor cap example and then you tell me.

The first mechanic did a complete \$100 tuneup, but only wiped off the cap. Two weeks later it arced across and the car stopped running. You never heard an owner cuss out one mechanic so much for not getting his problem fixed.

Another mechanic with a similar tuneup noted that the distributor cap didn't need replacing that very minute. But there was some carbon build-up and carbon tracks that he thought might cause a problem in the future. After finding too much resistance on the scope, he decided that the cap could cause a problem before the car came back for another tuneup—15,000 to 20,000 miles later.

Knowing that the customer would say, "I spent \$100 and have a problem within a month" if something went

the backyard mechanic

continued

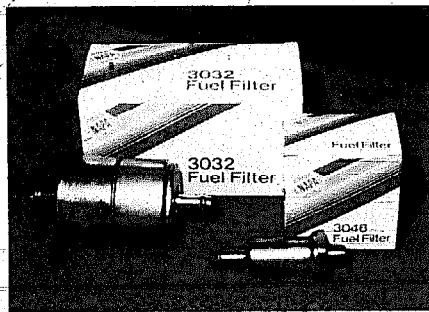

Fuel filters can be a very effective tuneup addition, especially if you just completed some carburetor work.

wrong, the second mechanic replaced the cap. He also rationalized, "People forget the price . . . as long as they get proper service."

The difference between the two jobs: \$6.

The bottom line for reputable mechanics: they depend on repeat business. Unless they're out in the desert somewhere—then they can depend on one-shot deals. Besides, good work compounds itself in word-of-mouth advertising. After all, that's how you discovered them.

Do it yourself: In the world of do it yourself, the parts counter person is going to be as important to your tuneup as the mechanic is when you take your

vehicle to the shop. And you should shop for a parts sales representative the same as you would a mechanic—ask around until you find a reputable one you can trust.

If you're wondering why you need a reputable parts seller when you're doing the work yourself, the answer is simple. He can steer you in the right direction as easily and as quickly as a bad mechanic can empty your pocket-book.

While it is possible for a parts seller to oversell you on what you need, your biggest worry should be that you might be undersold. Here's what happens:

You go in and say you're tuning up your '69 Dodge Dart. The dealer sells

continued



These cleaning chemicals can sometimes solve minor tuneup problems for a short period until there's time to do the job right. They should also be used to clean the carburetor and PCV periodically.

(right)

An electronic ignition module is an expensive item to replace. It becomes even more expensive if you don't read the directions and overheat the unit because you forgot to use the insulating material in the white tube.

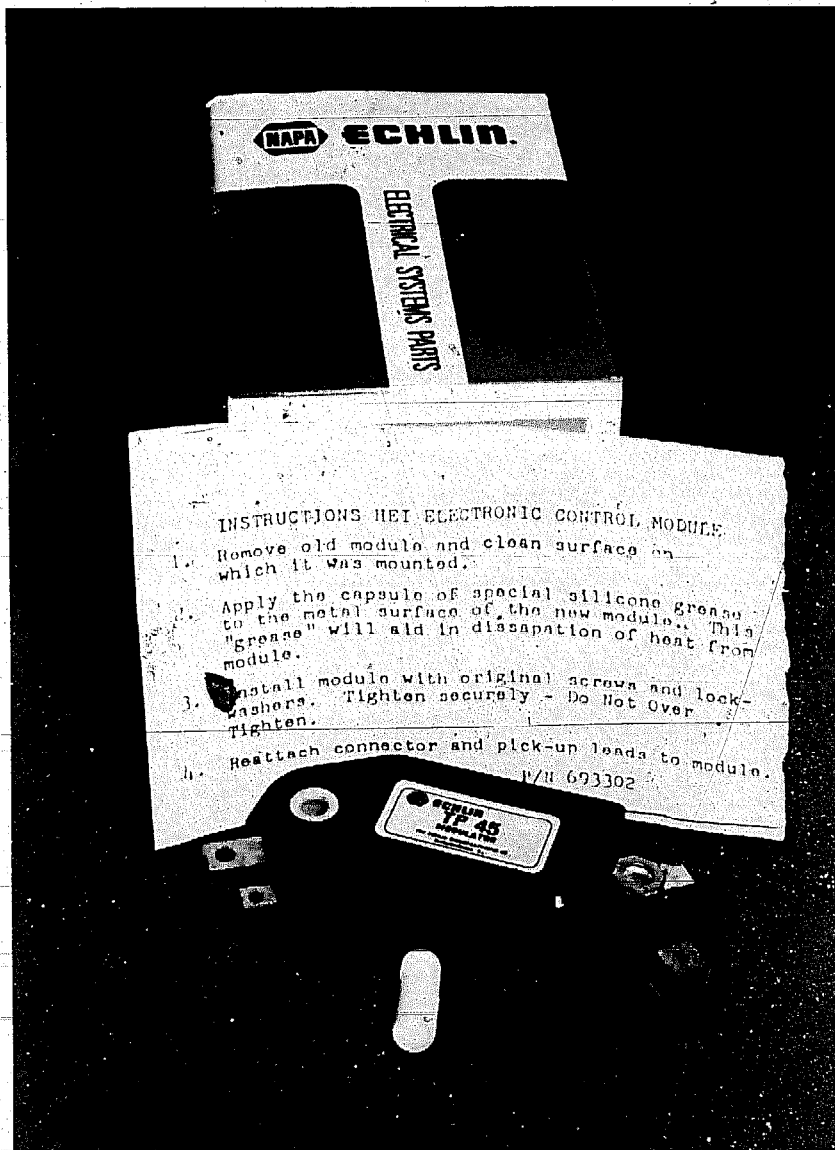

K-D TOOLS 2599

CARBURETOR & DISTRIBUTOR Adjusting Tool

Non-slip hooded screwdriver adapter easily reaches and adjusts carburetor mixture and idle where obstructions hamper access. The 1/4" hex bit is for Delco-Berry water-pump distributor adjustments. Constructed of "non-hink," flexible shaft and shock-resistant plastic handle.

K-D TOOLS

COMBINATION GAUGE SET

Thousands and Metric Equivalents etched on each blade.

4 SPARK PLUG GAP WIRE GAUGE

12 STRAIGHT BLADES

.010	.254
.012	.305
.015	.381
.016	.406
.017	.432
.018	.457
.019	.483
.020	.508
.022	.559
.024	.610
.025	.635
.028	.711

LOCK NUT

K-D TOOLS 166

SPARK PLUG GAP WIRE-GAUGE

With Electrode Adjusting Tools Thousands and Metric equivalents

Thickness	mm	Thickness	mm
.015	.381	.030	.762
.018	.457	.035	.889
.025	.635	.040	1.016

K-D TOOLS

you points, condenser, plugs, and asks if you need a rotor, cap and wires. If you stop and think about it, for the tuneup to work, everything has to be right. You may also need a pollution control valve, air filter, fuel filter, emission control filter . . . See what I mean?

What else can a good counter person provide? Troubleshooting assistance, that's what.

You've got a problem in your new electrical ignition system. Mr. Bad Guy sells you the whole control module for \$45. However, Your Friendly Fellow knows all you need is a rotor because he's been keeping up with the literature.

(left)
There aren't many special tools needed to do a basic-minor tuneup. Gauges for the points and plugs and a distributor tool will usually be enough in addition to the normal wrenches and screw drivers. But don't forget a spark plug socket saves a lot of broken plugs.

(below)
Wires, wires and more wires. Be sure to get the right set for your vehicle and motor.



the backyard mechanic

continued

Mr. Y.F. Fellow also listens to you when you come in. What he's looking for is to hear if you sound like you know what you're doing. If you don't, he's going to help you all he can—even to the point of sending you elsewhere.

You came in asking for a carburetor rebuild kit and he bumped you to a rebuilt carb or even a new one. Did he oversell you?

Probably not. Unless you're a real pro, rebuilding is not for you. And unless the parts seller is sure you know your problem is the carburetor, he may not be bumping you with the new model. You see, if he sells you a rebuilt, but there is another problem with the car, the car still won't run correctly. At that point you'll think it is the rebuilt carburetor he sold you. You'll take it off and return it. However, if it is a new carburetor, you'll realize there must be something else wrong and look further. Got the picture?

Also, the carburetor, whether you rebuilt it, the factory rebuilt it, or it's brand new, isn't going to work well unless you changed that old dirty fuel filter, too.

Are you beginning to get the full picture?

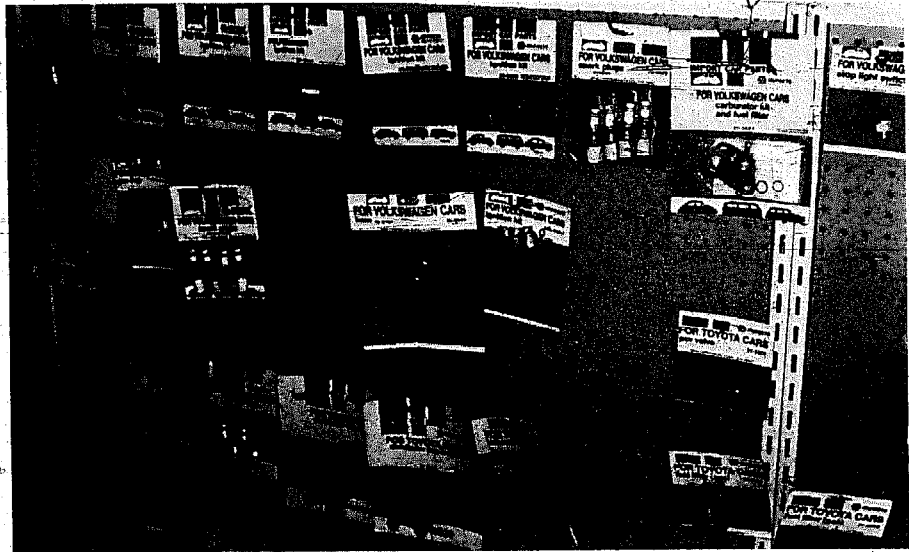

Tuneup kits and parts are usually available anywhere. However, beware of 99¢ spark plug specials—you'll get what you pay for—very little.

Now, if you are really into this Backyard Mechanic bit, your local parts store is going to help even more. More help because they also provide clinics on new systems. Clinics that are not only open to the public, but are also free. Even if there is a fee, it usually covers the cost of manuals handed out or equipment provided. For example, with an air conditioning clinic you usually get your own set of test equipment.

Parts sellers also have the latest information on the latest systems available, such as the new fit-in-your-palm electrical fuel pumps, or even the \$200 plug-in electronic ignition tester that gives you *good or replace* light signals one, two, three, four, five and six.

You should also expect your parts seller to provide you with all the specifications you need to do the tuneup at the time of the sale. If you forget the specs, he should be willing to read them to you over the phone.

And finally, don't be insulted when he gives you these last words of wisdom, "Read the instructions." Automotive technology changes so rapidly you never know when you're going to mess up doing something you've always done because it isn't done that way anymore. (D)

DRIVER wishes to thank Tom Miklosovic, Aron Durham and Frank Cardone of Goodyear Tire Co. and Joe Hallett of Action Auto Parts, San Bernardino, Calif., for their assistance in the preparation of this article.

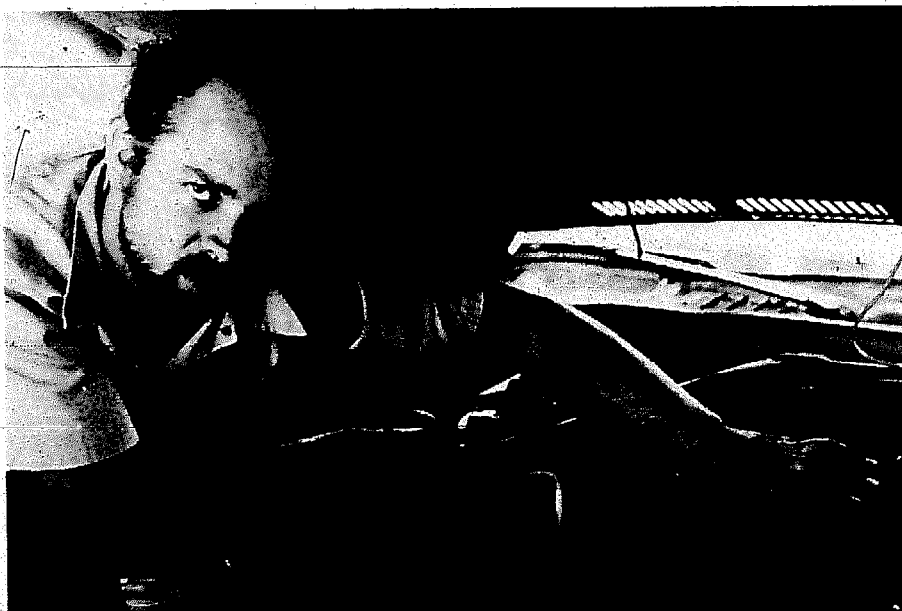

Is he a reputable mechanic you can trust? Ask around and find out what people have to say about him. It'll pay in the end.

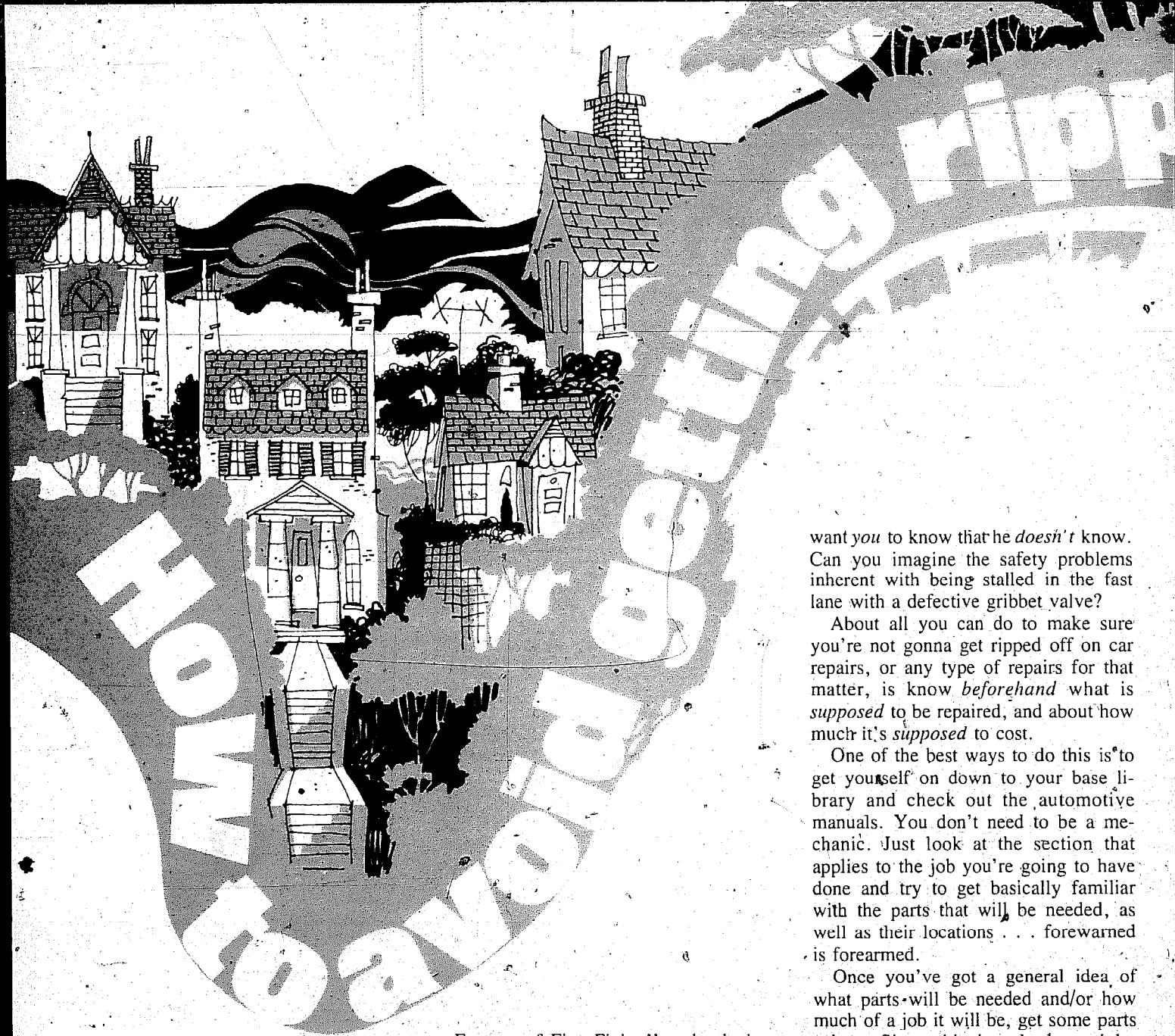

Beginning this month, we're changing the format of the Backyard Mechanic just a bit. Now don't worry, you'll still see the how-to-do-it features, the hints and tips, and all the tech stuff you're used to . . . but we've had a mountain of requests from our readers asking us to take a new tack and get into "consumerism."

To us, this means that many of you are running into repairs that you don't feel you're qualified to attempt. When this happens, you take your faithful steed downtown to "Friendly Fred's

Factory of Fine Fixing" and ask them to repair your broken "gribbett" valve or whatever. Friendly Fred fixes it all right . . . to the tune of \$150! Now \$150 is the going price for a valve job, but normally, a "gribbett" valve should only cost about \$60 to fix or replace.

So what do you do? You could go to the Better Business Bureau, but you should have done that to check Fred out *before* you took work to him. You *could* have your cousin Norvill do the work, but Norvill hasn't read an up-to-date maintenance manual in 17 years and he doesn't even *know* what a gribbett valve is. Of course, Norvill *would* do the work, even if he doesn't know what he's doing, 'cause *he* doesn't

want you to know that he *doesn't* know. Can you imagine the safety problems inherent with being stalled in the fast lane with a defective gribbett valve?

About all you can do to make sure you're not gonna get ripped off on car repairs, or any type of repairs for that matter, is know *beforehand* what is *supposed* to be repaired, and about how much it's *supposed* to cost.

One of the best ways to do this is to get yourself on down to your base library and check out the automotive manuals. You don't need to be a mechanic. Just look at the section that applies to the job you're going to have done and try to get basically familiar with the parts that will be needed, as well as their locations . . . forewarned is forearmed.

Once you've got a general idea of what parts will be needed and/or how much of a job it will be, get some parts prices. Since this is a brake article, let's compare some prices.

Parts cost for brake linings for four wheels, or linings for two wheels and disc pads for two wheels, should run between \$18 and \$25. Springs (if necessary) cost about \$4 per wheel, or \$12 for cars with four-wheel drum brakes. Wheel cylinder kits will cost about another \$12. So, the parts total alone, without adding in the cost of a can of wheel bearing grease, or for grease seals, or for any extra tools you may need, is about \$50.

That sounds expensive, until you read that the local brake repair shop is offering a "special." This special is "for one week only," or something

continued

The Backyard Mechanic

a guide

to

CONSUMER

SURVIVAL

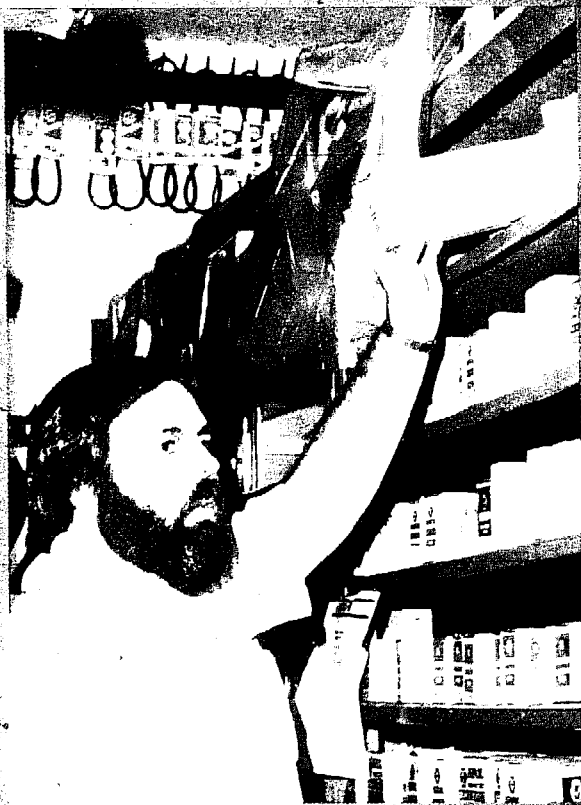

You can generally trust your parts-store man. He can advise you about the quality of the parts he sells and he knows that if you're unhappy, you know where to find him.

Them's the
(if you'll pardon the pun)
breaks,
pal.

Yuk
Yuk



the backyard mechanic

continued

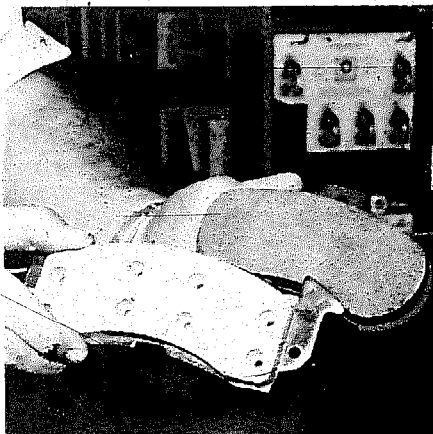

As a rule, riveted shoes or pads are better than bonded ones. See text for explanation.

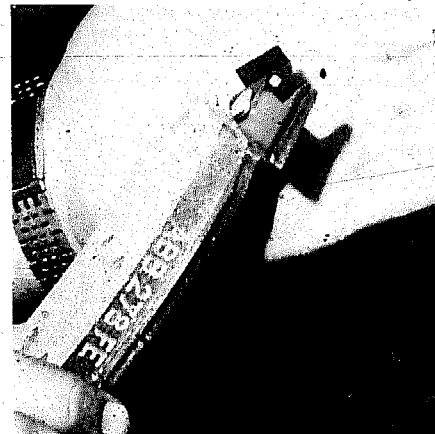
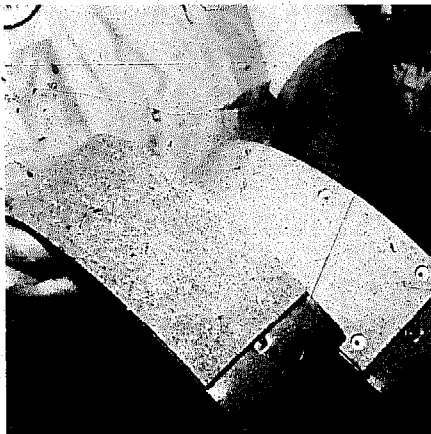

Newer disc pads come with this spring steel attachment that is supposed to rub against the rotor when the pad is worn down. The noise it produces will let you know you need brake work.

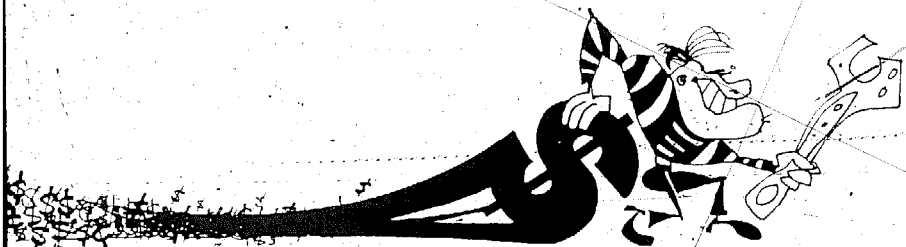

similar, and costs out at \$70 for parts, \$60 for labor, and gives a total of \$130!

Some of us feel that we can buy an awful lot of hand cleaner for that \$80 difference. But, some others may feel unqualified to take on a brake job, even with the assistance of the qualified people at the base auto hobby shop. Or perhaps we've let that brake job go till the last minute before our vacation and now we need brakes but don't have the time to do them. There are a lot of reasons for wanting someone else to do that brake job.

So what should you be aware of before you take your car down to Friendly Fred's brake shop? Well, like we said before, forewarned is forearmed. When you know approximately what the job will entail, and about how much it should cost, begin shopping around for a place to have the work done.

Probably the best way to pick a repair shop is word-of-mouth. Your friends can tell you about shops they've had problems with, or about those that gave great service. The Better Business Bureau can tell you if there have been an abnormal number of complaints

lodged against any one firm. The State Attorney General's office can often tell you if a firm has been sued or fined for bad business practices.

Some other items to consider are: will the shop give you a *written* estimate before the job begins, and will they call you if the job requires more parts or labor than the original estimate called for? Is the shop licensed by the state (if so required) to perform the type of repairs you want? Are they willing to give you your old parts back, or at least show them to you and explain why they were replaced? Do they want you to come back at about a 500-mile interval after repairs are performed, so they can check the work?

One other hint about picking out a repair shop. Stay away from "doomsayers." These guys will take a quick look at your car and say "geeze, . . . if you drive this one more mile, you're gonna kill yourself and your kids and two innocent bystanders." This type of hype is just plain bad news . . . make tracks out of there!

What should a brake job include? Well, at a minimum, we'd recommend the following:

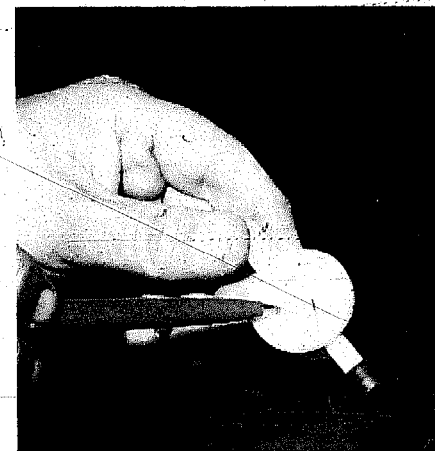

This white plastic check valve prevents vacuum loss in the power brake booster. It's cheap, so why not replace it at each brake job?

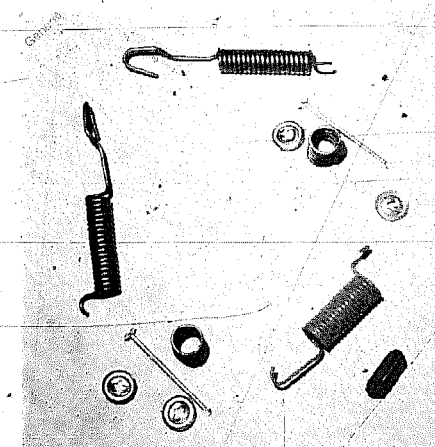

Return springs and hold-down hardware can be cleaned up, painted, and sold as new by a dishonest mechanic. Make sure that if you're billed for new ones, they come out of a package and not out of the guy's parts bin.

continued



TROUBLE SHOOTING

BRAKE INSPECTION & TESTING

Inspect brakes at frequent intervals for pedal reserve (clearance between pedal pad and toeboard with pedal firmly depressed, while brakes are cold). Increase pedal reserve by adjusting brake shoe to drum clearance. Brakes should be tested on dry, clean, reasonably smooth, level roadway (not with wheels jacked up). Test at different speeds both with light and heavy pressure. **CAUTION—Do not lock wheels and slide tires on roadway.**

CONDITIONS AFFECTING BRAKE PERFORMANCE

Following external conditions may affect brake performance and should be corrected before proceeding with trouble shooting of brake mechanism:

Tires—Should be same size on each side of vehicle with approximately same tread design and inflation.

Loading—Wheels should be equally loaded, as heavily loaded wheels require more braking power.

Suspension—Faulty shock absorbers, incorrect front end alignment, or loose wheel bearings may give impression brakes are too severe.

TROUBLE SHOOTING DRUM BRAKES

Low Pedal or Excessive Travel

Fluid low. Improper brake fluid. Air in system. Hoses expand under pressure. Wheel bearings or steering parts loose. Shoe and lining knock-back after violent cornering or rough road travel. Improper rear brake adjustment. Distorted shoes or linings. Master cylinder or power unit malfunction. Metering valve (for front brakes) not working. Piston and shoe assembly misaligned.

Pedal Applied; No Braking Action

Air in system. Leak past primary cup in master cylinder. Piston pushed back into bores. Hydraulic leak. Rear brakes out of adjustment.

One Wheel Drags

Front wheel bearings loose. Shoes adjusted too tight. Shoe return spring broken or weak. Piston stuck or cups distorted. Clogged line or hose. Drum out-of-round. Loose anchor pin. Distorted shoe. Defective lining.

Rear Brakes Drag

Improper adjustment. Parking brake cable frozen.

All Wheels Drag

Improper adjustment. Defective master cylinder. Improper adjustment of master cylinder push rod. Pedal linkage binding. Defective power unit. Defective proportioning valve.

Vehicle Pulls To One Side

Uneven tire treads. Worn front end parts. Incorrect front end alignment. Front wheel bearings loose. Loose steering. Loose backing plate or anchor pins. Loose or broken springs or "U" bolts. Improper lining. Improper adjustment. Defective drum. Loose or broken return spring. Defective wheel cylinder. Improper wheel cylinder size. Clogged or crimped line.

Brakes Squeak or Noisy

Improper lining. Lining loose on shoe. Foreign material on lining. Shoes scraping backing plate. Improper adjustment. Defective drum. Defective wheel cylinder. Weak or broken return springs. Loose anchor pin, wheel cylinder, or backing plate. Brake drum silencer spring missing (if equipped).

Brakes Fade (Fail to Hold)

Excessive heat build-up. Improper linings. Drums too thin. Lining soaked with fluid or oil. Improper fluid.

Pulsating Brake Pedal

Drums out-of-round. Loose brake drum. Worn or loose bearings. Bent rear axle.

Hard Pedal

Grease or fluid on lining. Improper brake lining or fluid. Improper adjustment. Pedal linkage binding. Faulty master cylinder. Glazed linings. Defective brake drums. Defective proportioning valve.

Brakes Chatter

Improper shoe adjustment. Loose backing plate. Foreign material on lining. Weak or broken return spring. Loose wheel bearings. Drum out-of-round. Distorted or misaligned shoes. Frozen strut rod bushings.

Snapping Noise In Front End

Grooved backing plate pad. Lack of lubrication on moving parts. Loose drums or backing plate. Loose or worn front end parts. Defective lining.

Power Brake Unit Does Not Boost

Test For Power Unit Operation—Stop engine and apply pedal pressure several times to remove all vacuum from system. Hold pressure on pedal and start engine. Pedal will move slightly forward when cylinder is operating.

Power Unit Does Not Operate—Vacuum check valve stuck closed. Vacuum pipe bent, broken or closed. Insufficient engine vacuum. Blocked air inlet. Air valve sticking in diaphragm. Faulty diaphragm. Faulty piston seal. Internal leaks.

continued

TROUBLE SHOOTING

continued



Problem: The engine will not start. The battery is fully charged and the starter motor is working properly. The fuel filter is clean and the fuel lines are clear. The spark plugs are new and the ignition timing is correct. The engine cranks but does not start.

Solution: Check the air filter. A dirty air filter can restrict the flow of air to the engine, preventing it from starting. Also, check the compression. Low compression can be caused by worn piston rings or a leaking valve. Finally, check the timing. If the timing is off, the engine will not start.

Problem: The engine is running but the car is vibrating. The vibration is most noticeable at idle and low speeds. The engine is otherwise running smoothly.

Solution: Check the engine mounts. Worn engine mounts can allow the engine to vibrate. Also, check the suspension. A loose or worn suspension component can cause vibration. Finally, check the tires. Uneven tire wear or a loose tire can also cause vibration.

Problem: The engine is running but the car is overheating. The temperature gauge is in the red and the radiator is hot. The engine is otherwise running smoothly.

Solution: Check the coolant level. A low coolant level can cause the engine to overheat. Also, check the radiator. A clogged radiator can restrict the flow of coolant. Finally, check the water pump. A faulty water pump can prevent the coolant from circulating.

Problem: The engine is running but the car is stalling. The engine stalls when the car is stopped or when the throttle is released. The engine is otherwise running smoothly.

Solution: Check the idle air control valve. A dirty or faulty idle air control valve can cause the engine to stall. Also, check the throttle body. A dirty throttle body can restrict the flow of air to the engine. Finally, check the fuel injectors. Dirty fuel injectors can cause the engine to stall.

Problem: The engine is running but the car is making a knocking sound. The knocking sound is most noticeable at idle and low speeds. The engine is otherwise running smoothly.

Solution: Check the oil level. A low oil level can cause the engine to knock. Also, check the oil quality. Old or dirty oil can cause the engine to knock. Finally, check the timing. If the timing is off, the engine can knock.

Problem: The engine is running but the car is making a clunking sound. The clunking sound is most noticeable when the car is stopped or when the throttle is released. The engine is otherwise running smoothly.

Solution: Check the timing chain. A loose or worn timing chain can cause a clunking sound. Also, check the timing belt. A loose or worn timing belt can cause a clunking sound. Finally, check the suspension. A loose or worn suspension component can cause a clunking sound.

Problem: The engine is running but the car is making a rattling sound. The rattling sound is most noticeable at idle and low speeds. The engine is otherwise running smoothly.

Solution: Check the timing belt. A loose or worn timing belt can cause a rattling sound. Also, check the timing chain. A loose or worn timing chain can cause a rattling sound. Finally, check the suspension. A loose or worn suspension component can cause a rattling sound.

Problem: The engine is running but the car is making a whining sound. The whining sound is most noticeable at idle and low speeds. The engine is otherwise running smoothly.

Solution: Check the timing belt. A loose or worn timing belt can cause a whining sound. Also, check the timing chain. A loose or worn timing chain can cause a whining sound. Finally, check the suspension. A loose or worn suspension component can cause a whining sound.



Drum brake overhaul:

- New brake linings all around
- New front grease seals
- Resurface (grind) all drums
- 4 new (or at least rebuilt) wheel cylinders
- Replacement of return springs and hold-down hardware
- Repack front wheel bearings
- Master cylinder inspection
- Bleed and flush hydraulic system
- Road test and final brake adjustment

For Disc/drum systems:

- New disc pads and new linings
- New disc hardware, new return springs and hardware
- Rotors resurfaced or replaced, drums turned (ground)
- Calipers overhauled or replaced, wheel cylinders too
- New front grease seals
- Repack front wheel bearings
- Master cylinder inspection
- Bleed and flush hydraulic system
- Road test and final brake adjustment

If a shop will do all of these things for you as a normal part of their brake overhaul routine, you've probably got a good shop. If the shop tells you that any of the steps aren't necessary, get it in gear and move on to another shop.

As in any form of business, there are dishonest-type bad persons out there just waiting to take advantage of you. This is particularly true if you're a woman alone. Unless you gals are experienced mechanics, you've got a better-than-average chance of being ripped off. Even though it may go against your grain, one of the best ways to prevent this is to take a man along when you make contact with the shop. Rightly or wrongly, a shop is less inclined to horse you around if there's a guy there with you. He doesn't need to know anything about brakes, or even cars, he's just there to look pretty and nod his head sagely. Window dressing, actually. Any body will do for this purpose.

There are a lot of ways to get ripped off on brake jobs. Read the following items, and be on the lookout for them.

If drums need to be reground, and most do, a bad guy will tell an unsuspecting customer that the drums were "out of limits," or worn past allowable

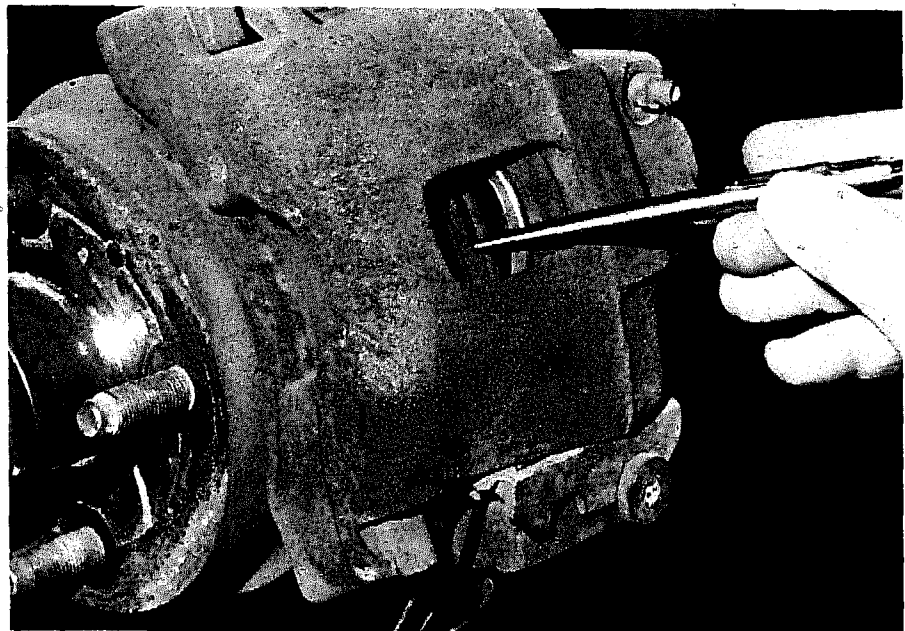
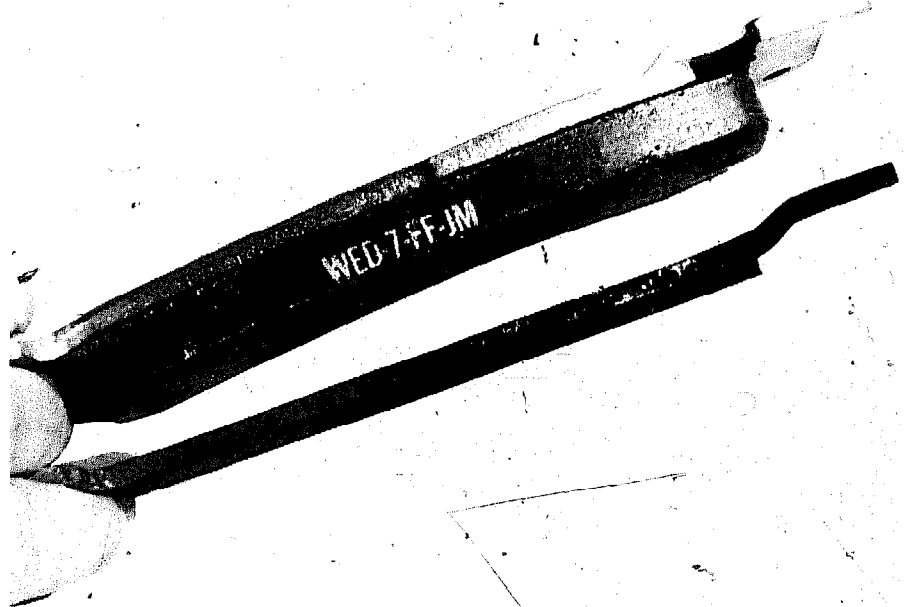

Thickness of old vs new pads. It doesn't happen very often, but a bad guy will tell you he installed new ones when actually he just left the old ones on. Check it out by removing a tire and looking through the caliper. It's easy to tell when new ones have been installed.

dimensions, and new ones were needed. He puts your old drums back on and charges you for new ones. An inspection after repairs are completed can avoid this scam. New drums will be painted on the outside, or at least be clean metal and not rusty.

A bad guy will just clean up wheel cylinders and charge you for new ones, or for a rebuild. He can also take re-

continued

the backyard mechanic

continued

turn springs he's kept around for this purpose, and show them to you and say, "The springs have lost their tension, so we hadda replace 'em."

In a related area, a funky shop will ask the customer if he or she would like the wheel bearings repacked and the tires rotated. Since most automotive tech people recommend these maintenance items, the customer says, "Yes." That's all well and good. But what a bad shop will do is charge you "flat-rate" for these items. The flat-rate manual lists the amount of time that a particular job should take. For instance, "repack front wheel bearings . . . 1.5 hours." Same for rotating tires. However, the rates and times in the flat-rate manual are based on the amount of time it takes to do a job from the start. Since the brake shop already has the bearings disassembled and the wheels off, it takes them about three minutes to do the jobs. Then, they charge you by the flat-rate manual. Boo, bad.

The bad shop will, while working on your brakes, squirt oil on the shocks, punch a hole in the muffler, or slice the tires with a knife. When you come to pick the car up, they'll tell you that the shocks are bad, the muffler's about gone, and you need two new tires. Hiss. Protect yourself against this ploy by knowing the condition of these parts *before* the car goes to the shop. Granted, these can be legit items of concern, but beware.

A shop can charge you for premium-quality linings or pads, and then put on cheap ones. You won't know about it till the el-cheapo items wear out in 10,000 miles. There isn't much you can do about this one. However, you'll probably be better off by specifying riveted, rather than bonded, brake shoes. With riveted shoes, or linings, the friction material is attached to the metal shoe with rivets, rather than bonded on with adhesive as in a bonded shoe. Riveted shoes generally are better quality shoes. And they provide you with a benefit in that when the shoe wears down, the rivet heads will be exposed and begin to scrape against the drum or rotor. This will make a noise that should tell you it's time to rebrake. Bonded shoes won't begin to make noise until the friction material

is all gone and the steel of the shoe contacts the drum. The steel shoe can really tear up a drum or rotor, while the soft brass rivets don't do nearly as much damage.

The bad guys will carry a small tube of brake fluid with them while making an inspection of the brakes. They'll pull a cap off of a wheel cylinder and spray the brake fluid inside. Then they'll show you the "leaking" wheel cylinder.

In the same vein, they'll squirt brake fluid up under the dash where there is a rod that connects the brake pedal to the master cylinder. Then they'll show you how the seals in the master cylinder are "leaking" and tell you what a good deal they'll make you on a master cylinder rebuild.

Other little things it would help you to know are:

- Be sure the mechanic checks the brake lines and hoses, particularly where the hose joins the metal fittings. Check for leaking, kinking, or cracking.

- Check the white plastic check-valve mounted on the master cylinder vacuum unit. This valve prevents air from getting into the vacuum booster diaphragm . . . air will cause a loss of vacuum and a loss of power-assist for the brakes. Scarey time!

- The master cylinder should be checked by running a finger down into the bottom of both front and rear portions of the fluid reservoir. Check for sludge or residue which could mean old fluid or deterioration of the brake lines. "Pulling" disc brakes can often result from this residue being pumped from the master cylinder to the caliper cylinder. The residue gets built-up on caliper cylinder walls and causes the piston to hang-up. This will cause the pads to be in constant contact with the rotor. This can cause pulling when the brakes are applied, and can also prematurely wear out the pad or cause hot spotting of the rotor due to the constant friction.

- Don't get sold by some sharpie salesman on "competition-rated" linings and pads. These competition linings and pads are tops for racing, but they are *bad news* for everyday use.

They are designed to function only when very hot . . . just the opposite of regular brake components. When they're "cold," as in normal driving, they take a *lot* of brake pedal pressure to operate. They're also noisy, useless when wet, cost a lot, and wear out more quickly than regular pads or linings. "Heavy-duty" or premium pads and linings . . . OK. Competition pads or linings . . . not unless you're gonna use the car for racing exclusively.

- If you're planning on doing a lot of out-of-the-area travel, consider getting the job done at one of the major service centers like Goodyear, Firestone, Midas, Sears, Penney's or Ward's. They are national stores and one store will generally honor the warranty of another store in the same chain, even though it's across the country.

- Remember that just because a lot of people get their work done at service centers instead of independent mechanics doesn't necessarily mean that the service store is so hot. Generally, it means that that store does work on credit or honors the company charge card. A small mechanic demands cash. Service centers can be a good deal, but so can the reputable independent mechanic.

- *Always* have the drums or discs "turned" or machined, even though you feel you just need linings or pads. The machining makes the friction surfaces seat much better against one another, thereby giving better braking performance. Machining also removes hot spots (hard areas on the drum or rotor) which cause shortened lining and pad life. Machining also eliminates warped or out-of-round conditions which can affect handling.

If you familiarize yourself with the job to be done, get a reputable shop to do the work, and know the condition of the car when it goes into the shop, the chances are excellent that you won't get ripped off. A little bit of time invested in reading this article and following the tips we've presented could be well worth your time and money. It can also help with your peace of mind. Remember, you can push a car without an engine, but you'll have a hard time getting it stopped without brakes! ⊕



(above)

If the mechanic tells you he resurfaced your rotors but they look shiny, like this, he's a bad person. Resurfaced rotors will have a satiny surface with tiny machining marks across the face of the rotor.

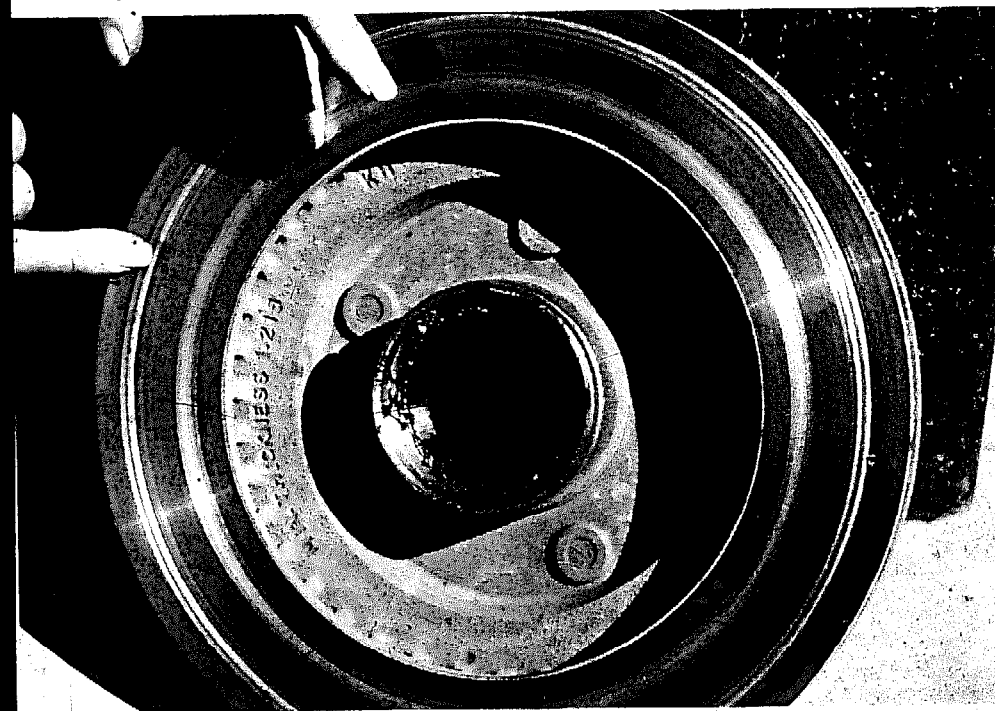

(left)

Going too long without replacing worn pads will destroy the brake rotor by grooving it beyond repairable limits. To machine away these grooves, too much metal would have to be removed, making the rotor too thin.

(below)

How can you tell how thin a rotor is allowed to be? Most rotors have factory minimums cast right into them. If a bad guy tells you he had to replace the rotors because they were too thin, make him show you the minimum dimensions and then have him measure the thickness in your presence. Forewarned is forearmed!

DRIVER wishes to thank Tom Miklosovic and Aron Durham of Goodyear Tire Co. and Joe Hallett of Action Auto Parts, San Bernardino, Calif., for their assistance in the preparation of this article.



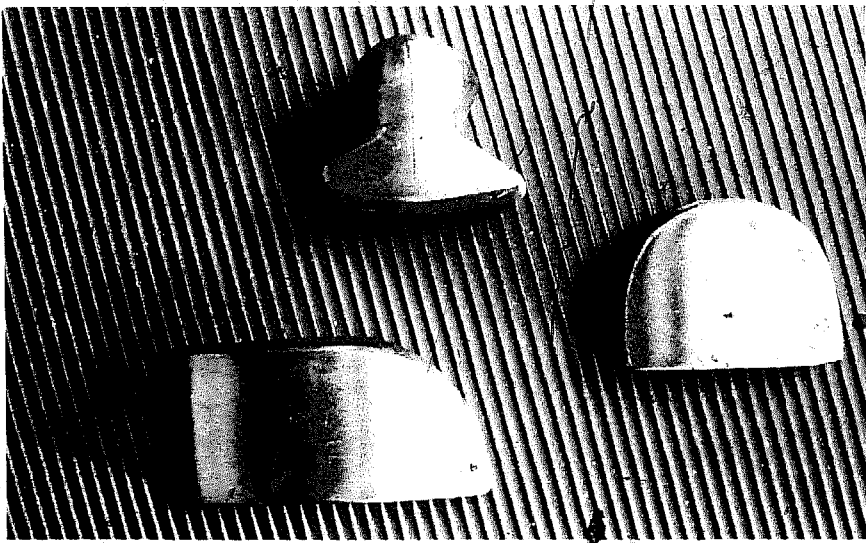

(above)
The dolly blocks (which are actually small anvils) shown here are: (top) general purpose, (lower left) toe dolly, (lower right) heel dolly. Also available are mushroom- and wedge-shaped dolly blocks.

(right)
The top object is a file holder, bottom two are sanding blocks that hold sandpaper and are used to uniformly sand large, flat surfaces.

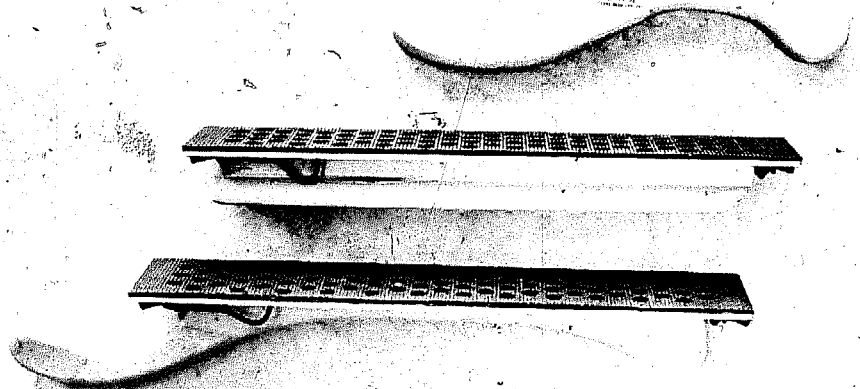

Scientists have discovered biorhythms quite recently compared to car owners. We have known about them for years! Biorhythms are a series of up-and-down cycles in your life and can be plotted well in advance. The scientific procedure can be a bit complicated though, and accuracy isn't 100% yet. However, we can tell exactly when a person will begin his or her biorhythm cycle just by knowing one simple fact . . . the time and day that person buys a new car.

It doesn't have to be a brand new Belchfire 8. It can be a three year-old Webby-Vickers 804 Economiser



THE BACKYARD MECHANIC

The backyard mechanic takes a few swings at automotive body work

Special. The fact of the matter remains . . . to the new owner, it is a new car, and woe be unto anyone who makes any nasty remarks about it.

To chart an individual's biorhythm, simply take the hour and date of delivery as the top end of the high cycle, add two hours, and that will be the bottom of the cycle.

How do we know this? Because it is guaranteed that about two hours after you take delivery of your new pride and joy, some turkey will put a dent in it. If you park it in the SAV-O-MART lot, three miles from the nearest car, someone will pull alongside and PING. Or you could park in your driveway and your dearly loved, but faintly senile, Aunt Alice will pull in with her old Buick . . . the one with the good body but tricky brakes.

In a flash, you've got a brand new car and a brand new dent. It never fails.

What can you do? Parking in a concrete garage is one answer, but that kinda defeats the reason you bought the car. You could stand guard over it, but as any Security Policeman can tell you, that 0200 to 0600 shift can be a real bear. One thing to do is accept the fact that your new car has a dent and won't get any more for a while. However, if you take a great deal of pride in your vehicle, the idea of a dent just doesn't sit too well. And of

course, sometimes we buy a predated car with the idea of "fixing it up," and selling it for a juicy profit. It all comes down to one thing . . . those dents, dings, and scratches have gotta go!

Beginning with this issue, the Backyard Mechanic will delve into the mysteries of automotive body repair and painting. We'll begin with tools and equipment, move on to actual repair techniques, and end up at painting. It isn't simple, but it isn't all that difficult either, if you have a minimum of manual dexterity and a lot of patience. Also, if you think this series won't be worth your while, swoop on over to your local auto-body repair

continued

need

bigger HAWKER?

continued

shop and check out his prices . . . it may change your mind about attempting body work yourself.

Basic tools: Unless you're the bionic man, your hands just will not work well for pounding out dents and creases in your steed's flank. Almost any type of body work outside of minor scratches will require a selection of hand tools designed for the job, and some dents and creases will require the use of power tools. Usually, a good selection of hand tools will cost from \$30 to \$200. That might seem like a lot until you remember the tools can be used over and over again, and \$200 is about what you'd pay for some minor repairs at a body shop.

Power tools are normally available at your base hobby shop, or can be rented from many tool-rental agencies.

After we cover what tools you'll probably need, we'll briefly go over the other materials used in most body work so that when you go to the auto parts place, you'll have a better idea of what is available for you to use in your particular situation.

Hammers: The tool most commonly used in automotive body work is the hammer, also called a dinging hammer. Used in conjunction with dolly blocks, hammers are the primary means of removing dents from sheet metal.

Take a look at the picture of the hammers. You'll notice that the face of the *dinging hammer* can be either round or square. The round-face hammer is used for general metal working in unconfined areas, while the square-face hammer is used where adjacent areas limit usefulness of the round hammer. Such an instance would be if you're working close to a fender welt, bead, or other ornamentation. You want as much of the hammer surface as possible to strike the work, and if you used a round-face hammer, the circumference of the face wouldn't allow you to work near an obstruction with full-face contact. Also notice that the face of the hammer may be slightly crowned.

The overall length of the head of a dinging hammer is usually between 4 and 6 inches. This variation in "reach" is needed because of, again,

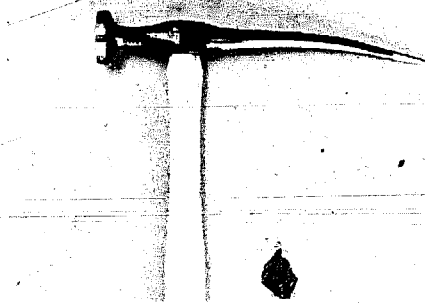

The combination or pick hammer, is probably the most-used tool in the body shop tool box.

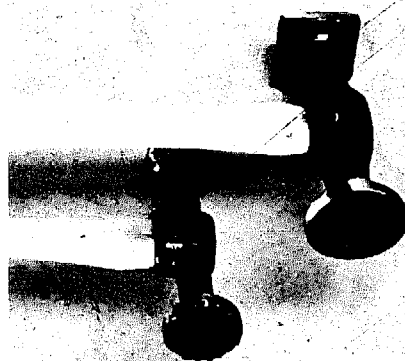

Notice the difference in the faces of these two dinging hammers. The one with the corrugated face is used for "shrinking" metal, while the smooth face is used for general-purpose work.

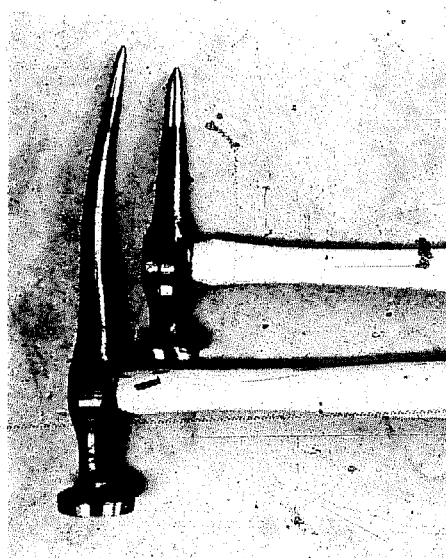

Dinging hammers come in different "reaches" or lengths so that if you have space limitations you can use the shorter, lighter one instead of fighting with the long one.

limited working space . . . under a fender, for instance.

The *combination hammer* will have both a dinging end and a pick-shaped end. It is used to remove small dents which would be difficult to remove with the dinging hammer and dolly block method. Combination hammers come in a variety of weights, point sharpnesses, and "reach."

Hammers resembling the dinging hammer, but having a corrugated face, are used for "shrinking" metal.

And of course, you'll always need a conventional mechanics' hammer (also called a ball peen) to strike cold chisels, since we all know that claw or carpenters' hammers are *never* used for anything except hitting nails.

Fiberglass handles for hammers are much less prone to shrinking and splitting, as opposed to wooden handles. Remember too that hammers are good for hitting *some* things, and not so good for hitting others . . . like, you don't use a hammer to hit the face of another hammer, concrete, caps from cap pistols, your buddy, welding tanks and fittings, or anything that will hit back. A hammer is *not* a pry bar, an auxiliary nut-loosening device, a wedge, or a generally accepted tune-up tool.

Dolly blocks: The term "dolly block" has been around a long time and stems from the word dolly, which is a device used when something is too heavy to be moved with human hands. Dolly blocks are used as small anvils because you can't use your hands to hold a metal surface steady when you're hammering against it.

Dolly blocks are held on one side of the metal while the other side gets whacked by the hammer. Dolly blocks come in many weights, sizes, and face curvatures so that the surface of the metal to be worked can be easily duplicated by using the correct dolly block.

Dolly blocks are *not* hammers, and we guarantee that if you use one as a hammer, when you strike the object to be struck, you will lose your grip, and the dolly block will fall from your hand directly onto your big toe. So, if you're gonna use a dolly block like a hammer, be sure you also use steel-toed safety

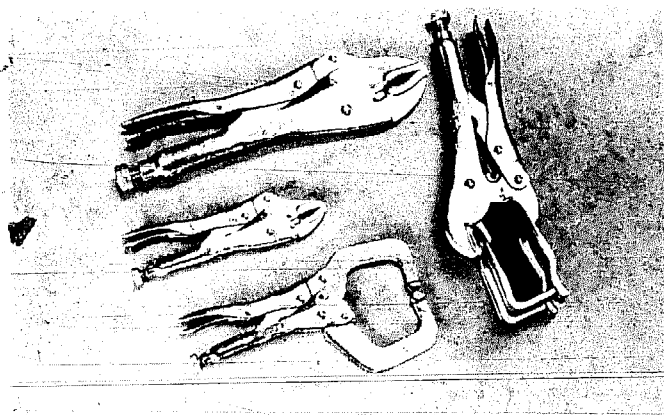

Vice-grip pliers are the bodyman's friend. They hold metal pieces together for alignment purposes and are used as mini-jigs to hold pieces prior to welding.

shoes. Now that we think about it, why not use safety shoes anyway? Then that turkey in the next stall in the auto hobby shop (who you always suspected wasn't wrapped too tight) can use tools incorrectly, slip, and *you* won't have to pay the price of *his* ignorance.

Spoons: The spoons we are referring to are not the ones which are what newborn rich kids have in their mouths... the spoons we speak of are multi-purpose tools. Of course, many people consider a screwdriver as a multi-purpose tool when actually its only function is to drive screws, but spoons are legit multi-purpose tools. They can be used as pry bars to pry metal back into its original position, or they can be used as dolly blocks when the area you want to straighten is beyond the reach of hand-held short dolly blocks. You can use a spoon as a dolly block, for instance, to back-up your hammering efforts on a door or deck lid where the clearances are too narrow to slide in a dolly block.

You can use a spoon to distribute the force of a hammer blow over a larger area. If you have a situation where there is a small crease in the metal and the paint surface isn't broken, you put the spoon against the ridge and then hit the spoon with the hammer. You can get rid of the ridge without marring the paint.

A spoon can also be used as a "slapper." Slap the dented metal with the spoon to remove the dent. Depending on the amount of enthusiasm with which you attack this last task, noise pollution can be a problem, so maybe a set of ear plugs would be in order.

Vise-grips: Vice-grip pliers have many uses around a body shop, the two primary uses being to hold pieces of metal together so that they can be

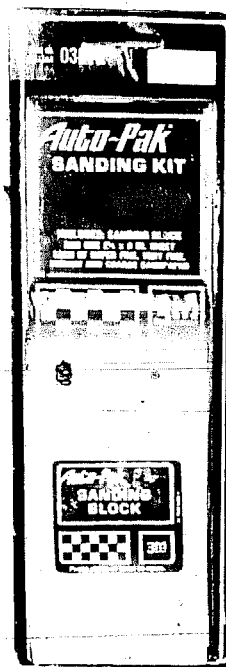

Some of the products and tools used for filling small dents and dings.

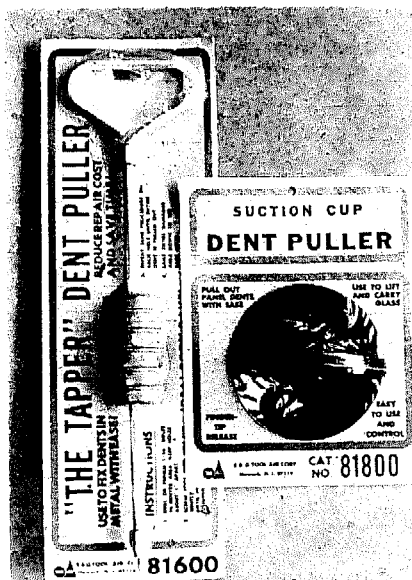

welded, and for holding the standard handleless stainless steel coffee cup which is always found at the better body shops, said cup being the junior-high school shop project of the shop owner who never learned the trick of attaching handles but who wouldn't want to part with the cup for sentimental reasons. Seriously, vice-grips are handy tools, but like most tools they require care. The threaded portion of the adjustment mechanism should be kept clean and well lubed, and the

continued

(left)
Dent pullers are used to remove both compound and simple dents. The suction cup puller doesn't leave any holes to fill, but the screw-end puller will work out even the biggest dents.

A spoon, or "slapper" (below) can be used as a dolly block for inaccessible areas, or as a dinging hammer. Make sure the grip is firmly installed before using this tool.

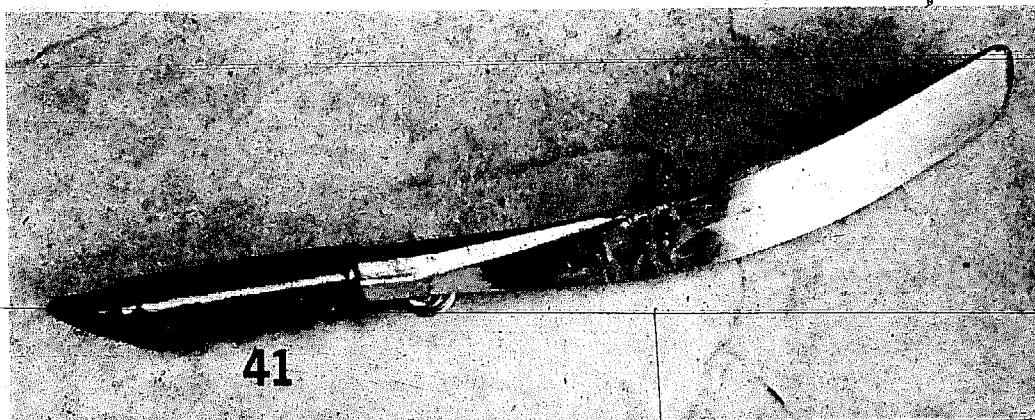

teeth in the jaws should be cleaned regularly with a wire brush.

File holder: Flexible files are used to shave off plastic filler material from surfaces that are curved. The file must be flexible to follow the contour of the curve, and the use of flexible file holders allows the file surface to be flexible while still providing an adequate surface so you can grip the tool with your hands.

Flexible files are also used to file metal surfaces after dinging work. High spots are cut down quickly, and the raspy file surface leaves marks on the flat metal which won't show in low spots, making them easier to find.

Hand tools: The tools we've described so far are considered basic tools for the body repair trade, but in addition to these tools you'll still need wrenches and other hand tools for disassembly of body components. Most major retail chains (Sears, Penney's,

Montgomery Ward) have basic hand tool kits on sale for about \$35. Since you'll need hand tools for almost any phase of automotive work, why not pick up a set the next time they're on sale? It's so much nicer to use the proper wrench on that stubborn nut, rather than skin your knuckles trying to get it off with a pair of borrowed pliers.

Power tools: Air- or electrically-operated tools that find continuous use in a body shop are grinders, orbital sanders, disc sanders, and files.

Having all of them at your disposal would be nice, but if your bucks are limited, rent an air file or a dual-action sander. The air-powered file is actually a powered sanding board. It covers large areas at one time and its length prevents ripples and waves in the metal which can foul up the final appearance of your paint job.

The dual-action sander is especially good for use on curved surfaces and

for "feathering" or tapering layers of paint around a damaged area.

Top quality powered tools can be bought for as little as \$50 from specialty mail-order houses, if you feel that you'll be needing them a lot more than a rental basis would justify.

Other stuff: The type of repairs you are going to make determine the kind of, and amount of, materials you'll need for the job. Some repairs will only require lacquer putty or spot putty. Others will be the filling of small dents and dings. These may require the use of body plastic, fiberglass mat, fiberglass cloth, auto body solder, or lead.

Your friendly local auto body parts and supply house can advise you in more detail than we can go into here. They can also tell you about sandpaper... whether you need "wet" or "dry," and inform you about what grits will be best for the job you want to do.

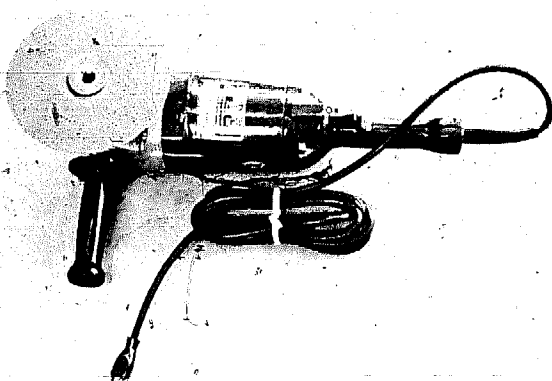

This professional-type grinder/buffer accepts different types of discs so that it can serve several purposes.

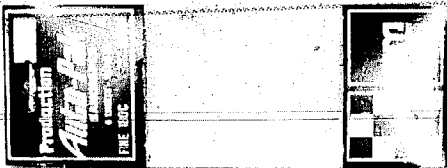

Fiberglass mat and fiberglass cloth have different purposes. Check with the salesman in the auto body supply shop to determine which is right for the job you want to do.

(left)

Small, flexible sanding blocks are good for gently curving areas on fenders or doors. You can make your own sanding block by wrapping sandpaper around a short length of old radiator hose.

At the body supply store, you'll also find the little tools that make any job go easier. This group of small tools would include squeegees (for applying body putty), putty knives, various masking tapes and papers, face and nose protection devices like air masks for the nose, and paint straining systems.

They also carry material that is necessary to many body repair jobs but that isn't found anywhere else. Stuff like door, window, and trunk weather stripping, seal adhesive, vinyl seat repair and coloring kits, headliner kits, pinstriping tape or paint, and engine and accessory paint.

Next: In our next installment, we'll cover simple dent and ding removal, and then we'll finish up with basic painting techniques and paint shop safety. Stay tuned . . . we'll show you how to turn that \$500 car into a thing of beauty.

An air-powered orbital sander can be rented for as little as \$8 a day and can save you much handwork.

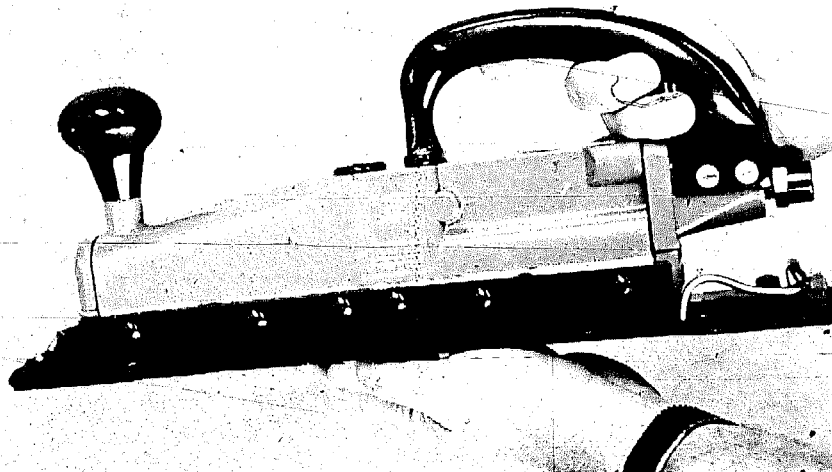

An air file is used for quickly and easily sanding large flat areas. It is quite expensive though, and unless you have to do the whole car, you might be better off getting **one of these dual-action, random-pattern orbital sanders.** They cost less, and with a five-inch pad, they can cover a lot of area almost as fast as the air file.

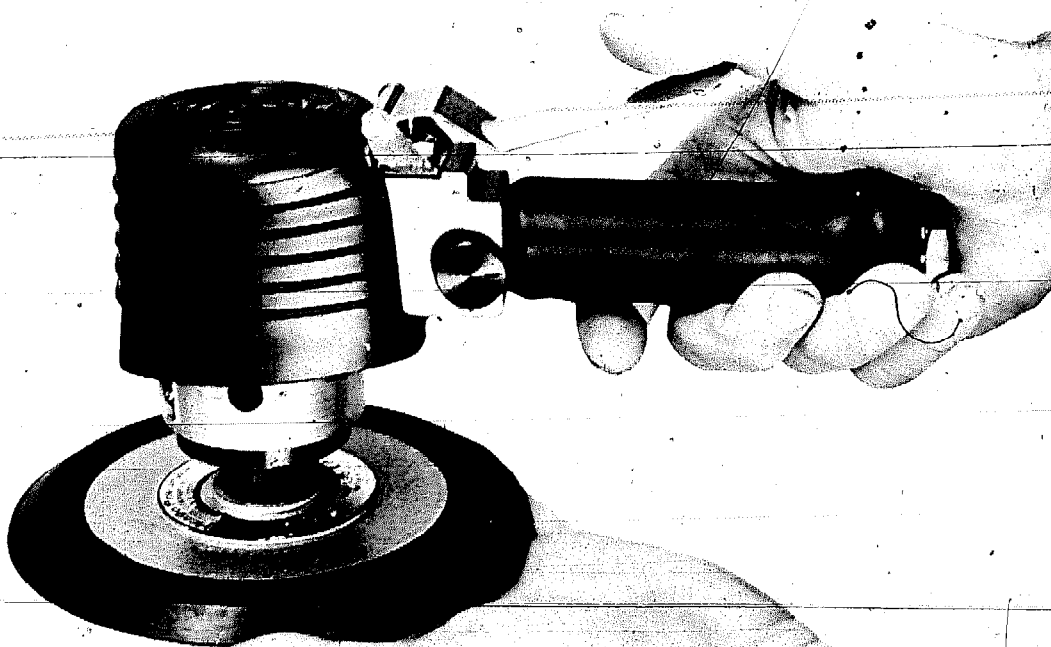

Try to get the parts you need before you begin the job. In almost every instance involving body work, you'll need spot putty, lots of good sandpaper, and masking tape.

DO YOU REALLY NEED A BIGGER HAMMER?

part 2
**basic DENT
removal**

So there you are in the parking lot, sadly surveying the job the Dent Phantom did on your car. You can just see yourself cruisin' down E street trying to look good, and everybody is pointing to your car and saying, "Ayyyyy, look at the dent in that car, man" . . . not exactly what you had in mind, is it? Right away you figure that dent has got to go.

But how to go about it? Well, you can take it to the body shop, but you figure that'll take up the best part of a C-note without leaving you change enough to hit the Burger Queen. You could get your best friend's second cousin to work on it, but then you remember that the last time you saw the guy he was trying to walk and chew gum simultaneously . . . and not doing very well.

That leaves you just one option. Get a hammer and dolly block, some plastic filler and sandpaper, and do it!

Think about the dent: The first thing to do after you've emotionally prepared yourself to unbend some metal is to look at the dent and see if you can visualize how it was formed. If you can see how it was formed, you can reverse the procedure to get the dent out. Sometimes what appears to be the biggest part of the dent is only the result of what happened as the dent was formed. When you remove the crease, for instance, that actually resulted from the main impact, the areas near that will magically pop out, too. If you carefully observe the damage first, you can avoid doing additional damage caused

by working on the wrong portion of the dent first.

Two basic techniques: There are two basic types of hammer and dolly block techniques. They are hammer-on-dolly and hammer-off-dolly. *Hammer-off-dolly* is usually the easiest to learn for beginners. The dolly block is positioned *next to* where the hammer will strike the work. The force of a hammer blow to the surface will cause the dolly to bounce or rebound back onto the rear surface of the work. What happens is that this trick will cause a low spot to be driven up with the dolly rebound, and a high spot to be driven down by the hammer force, all with a single hammer blow.

If you use the dolly block as an anvil, this is called *hammer-on-dolly* work, since you place the dolly directly *behind* the area you wish to attack. This hammer-on-dolly method should probably be used sparingly by beginners because it can cause the work (sheet metal) to stretch. Stretched metal will have to be shrunk with heat and beginners would be well-advised to avoid problems like this.

The actual technique of using a combination hammer isn't quite the same as swinging your dad's old carpenter hammer. The dinging hammer should be held close to the end of the handle, but with a fairly loose grip. It is swung with wrist action so that the hammer can lightly bounce off the work. Hard blows will only work-harden the metal or cause new dings by forcing the metal out of shape. So, the word is to use lots

continued

(near right)

Hammer-off-dolly technique used by most beginners. Hammer is placed adjacent to dolly. Hammer strokes lower high spots, rebounding dolly works on low portion.

(far right)

Hammer-on-dolly uses hammer in line with dolly block. Dolly forms anvil for flattening wrinkles, but metal may stretch with this method.

(near right)

After Hammering, spray a coat of primer and then sand lightly. High spots show shiny, lows contain primer.

(far right)

Pick hammer is used to ding down high spots.

(near right)

Rear view of fender shows proper pick hammer technique . . . use many little strokes, not several big ones.

(far right)

Get your squeegee ready by scraping off old plastic with knife. The smoother the squeegee edge, the smoother your filler will be.



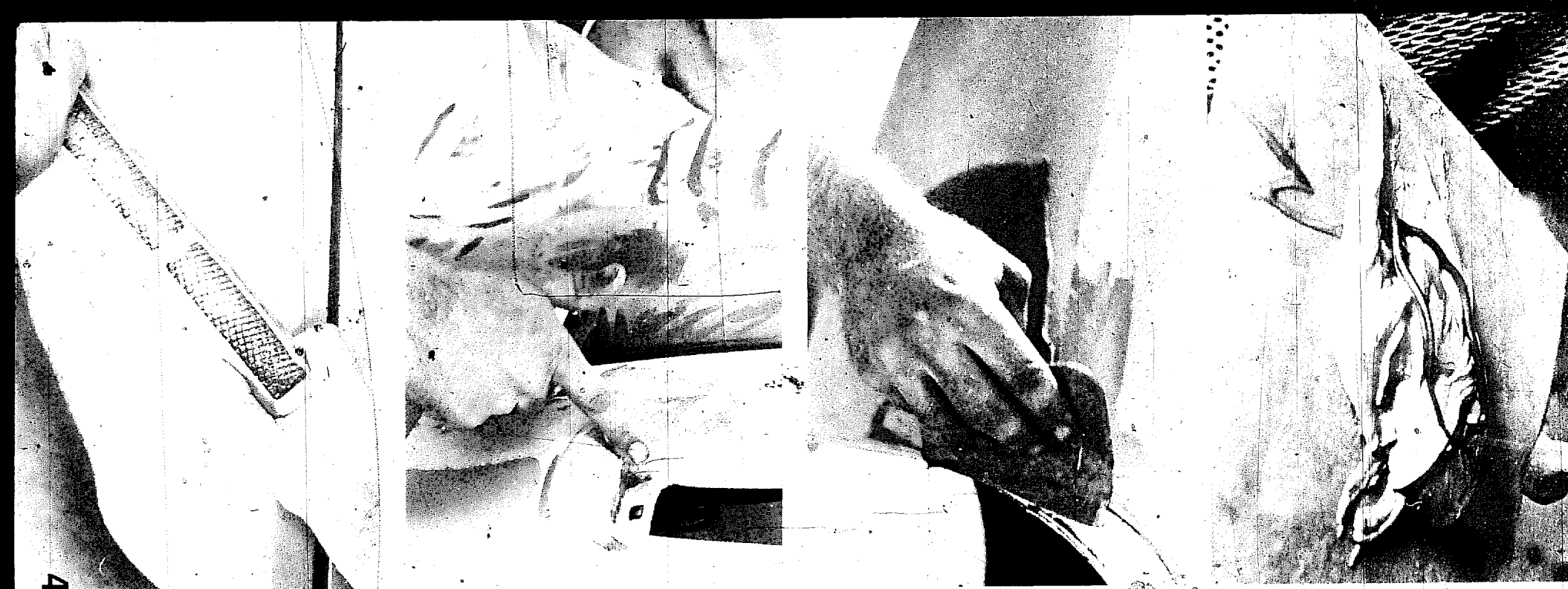

46



the backyard mechanic

continued

(far left)

Mix the plastic filler on a piece of clean cardboard or a piece of safety glass (with taped edges). Text tells correct color for good mixture.

(near left)

Make sure plastic filler is thoroughly mixed. If catalyst isn't fully mixed, portions of the filler will never harden.

(left)

Apply filler material using as few strokes as possible. One long stroke is better than several short ones.

(far left)

While filler is still soft, a finger is a good way to contour those complicated areas. This will save you a lot of time at the grinding/sanding stage.

(near left)

Hardened filler should follow contours of the area to be repaired.

(far left)

Use "cheese grater" at an angle to the work. This makes it cut faster and easier.

(near left)

Comparison of grated vs. sanded area.

of little, light blows rather than your best King Kong imitation.

The pen is mightier . . . After you've scoped out the way the dent was formed and the order of the blows necessary to remove it, spray on a bit of light-colored primer and take a felt-tip marker in your hot little hand. With the felt-tip, mark the high and low spots to be struck by using Xs and Os (or Qs and Ps . . . whatever trips your trigger). Draw arrows to indicate the edges of the dent and point them toward the center of the dent. This will give you a good picture of how to stagger your blows from one side to the other and from the top to the bottom of the dent. This will allow you to gradually reshape the metal without stretching it.

Make noise now: Attack the dent using the hammer-off-dolly technique, beginning with the hammer on the inside of the fender and the dolly on the outside. After the basic shape of the contour is worked out, swap the hammer and dolly positions, using the hammer on the outside surface. Work the dent out slowly, pausing often to check the contour with the palm of your hand. You'll be surprised at how accurate your palm can be. Your eyes will tell you that the surface is smooth, but your palm will tell you your eyes lie.

After the panel has taken its basic shape, lightly sand the area with a sanding block and medium sandpaper. Light sanding will reveal bare metal on high spots and leave paint in the low places. These lows can be brought up with the point of the combination hammer or filled with plastic filler if you don't trust your metal-working skills. You'll probably find that using the plastic will be easier for a beginner since it usually takes a great deal of experience to locate the low spot on the blind side of a fender and then strike it accurately.

Prepping for filler: All you macho dudes should like this part . . . the metal has to be *roughed-up* and all the paint removed preparatory to using plastic filler. The easiest way to do this is with a grinder or sander using open-coat discs pf around 16-grit. Open-coat

discs are preferred because they won't clog with paint or metal. It might also be a good idea to use a metal washing fluid (like Prepsall) to clean the surface of any grease or oil deposited by your greasy hands.

With the surface cleaned and ready, mix up a batch of filler according to the directions on the can. Remember, plastic filler will set-up (begin to harden) quickly, especially on hot days, so you have to work with a degree of rapidity (that's governmentese for "fast"). Most filler material consists of two parts, a base and a catalyst, or hardener. Mixed together thoroughly, the resulting material will usually be pinkish in color. If the color is too dark, that means the stuff will dry too quickly and crack. If it's too pale, that means the stuff won't harden at all . . . it'll just stay in a goop-like consistency that is thoroughly unpleasant to look at and work with.

Apply the filler with a large plastic (flexible) spreader. Put the plastic on smoothly and slowly, trying to apply no more than absolutely necessary. If you put too much on, it can sag before hardening, and it's just that much more to remove come sanding time. Also, try to apply the filler with the minimum number of strokes . . . the more you work with it, the more the chances of air bubbles in the finished material.

After applying the plastic, you can speed the drying process with a heat lamp, but this should be required only if the ambient temperature is pretty low. When the plastic attains the consistency of rubber, it's ready to be worked to a semi-final shape. Use a "cheese-grater" or Surform tool to shape the filler. Pull the grater in a diagonal manner to expose the greatest area of the file surface to the greatest amount of material. Go lightly here, because the grater will cut the plastic rapidly and you're gonna need some base material when you begin final sanding anyway. If a dark spot shows up, you'll know that it's a low spot and'll require more filler to level it up.

Shape-sanding: After you've established the semifinal shape with the

continued

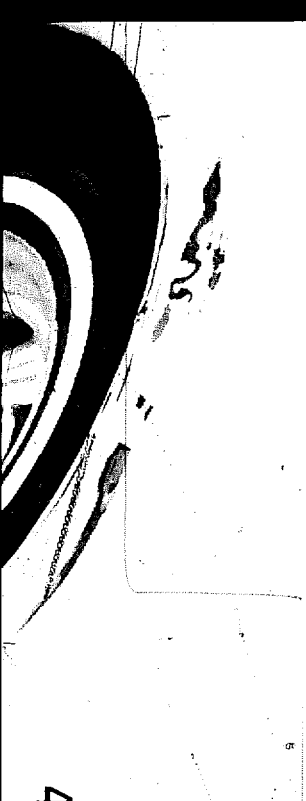
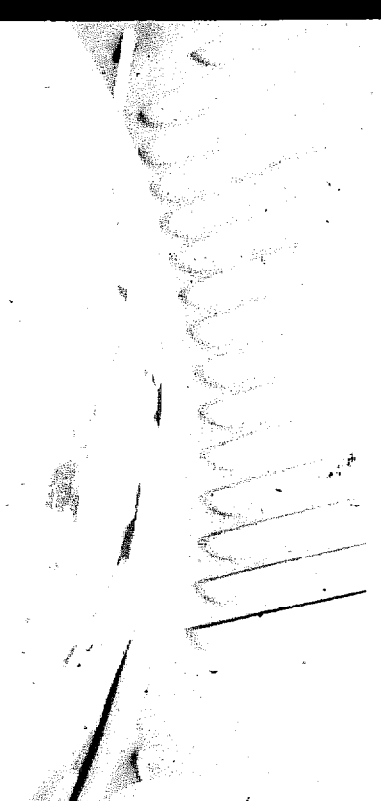
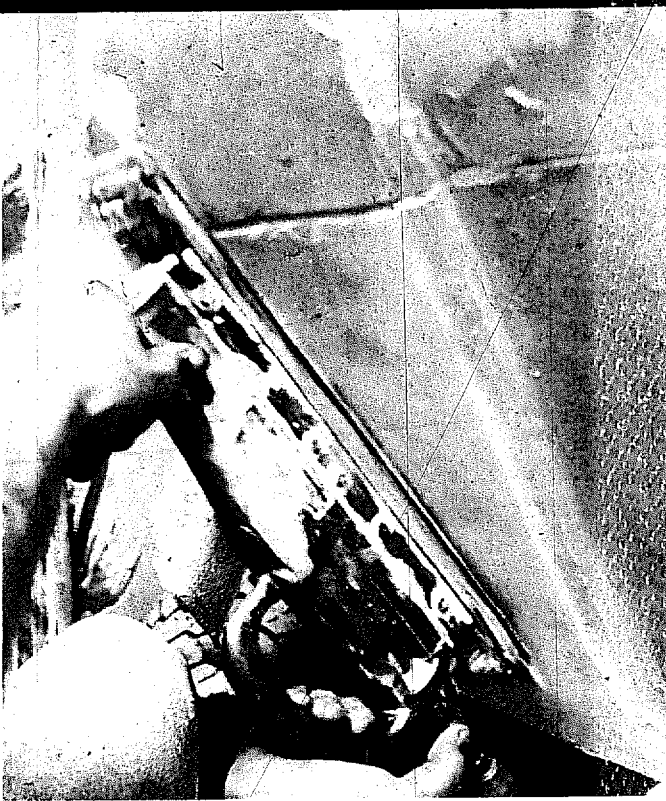

(far left)

Air file or sanding board is the most accurate way to sand large, uncurved areas. (Note our bodyman, Phil Knapp, uses a mask to keep dust out of his lungs.)

(near left)

The air file can also be used to contour areas by holding it at an angle to the work.

(far left)

Don't throw away that sandpaper when it's clogged. Try using a bristle or wire brush to clean it out first. It can save you some bucks in sandpaper costs.

(near left)

You'll find that your hand is one of the best ways to check an area for smoothness. Ripples show up well with this method.

(far left)

Shoot on a light coat of primer and then lightly hand-sand. Again, high and low spots will show as dark and light areas.

(near left)

Apply spot putty (also called lacquer putty) to the low spots. Use many strokes, as this will both force the filler into low spots and allow it to dry faster.

grater, get out the air file (or long sanding block). Sand the areas lightly, using as much of the face of the sander as possible for a smooth finish. After the first coat of filler has been sanded, you'll probably need to apply a second, extremely thin coat of filler. Apply, file, and sand this coat as before, then cover the area with a heavy coat of primer. Sand once again.

Now you'll probably find very minor imperfections, like pinholes or minute low spots. These can be filled or covered with spot putty (also called lacquer putty). Lightly spread the spot putty over the entire area, but instead of making only a few passes, make a lot of passes with a flexible squeegee. This will both help to fill pinholes and speed drying. If you have the time, though, it's still wise to let the spot putty dry at least overnight. Sand the spot putty

with very fine paper, preferably used wet to prevent the paper from clogging and putting in more scratches than you take out, and then final prime.

A one-hundred dollar dent can be worked out in about three hours by most amateurs, and if your calculator is charged up, that works out to a savings of about \$33 per hour. That, plus the fact that now people won't laugh at your dent, should put a smile on your face!

Next month, paint: In the next issue, we'll cover (no pun intended) the subject of painting your steed. A word of warning though . . . you might as well begin preparing yourself emotionally for this task. Painting requires many things, but mostly it requires *patience*. So, keep a tight rein on your emotions. We promise that the wait will be worth it! ☺

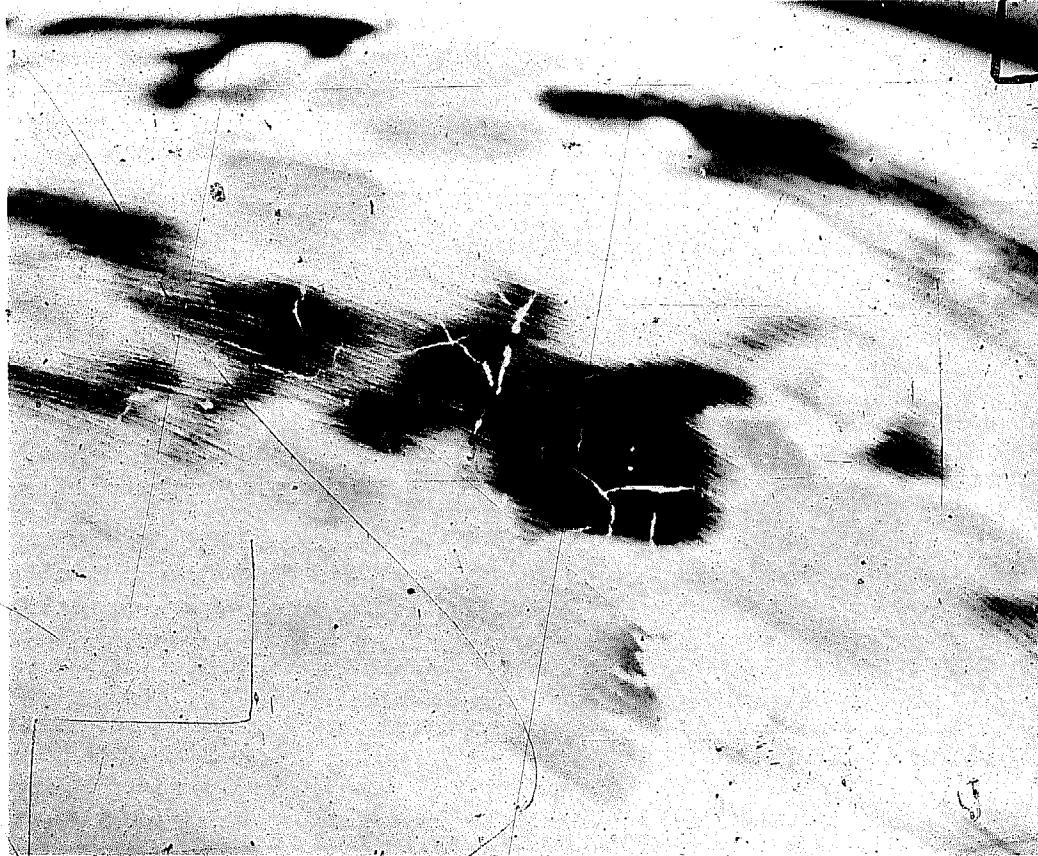

Prime again, sand lightly. If everything looks good, you're ready for paint. This picture also shows how spot putty can be used to fill cracks in old paint so you don't have to strip the whole panel down to metal.

DRIVER wishes to thank S&M Auto Body of San Bernardino, Calif., for their assistance with the photographs in this article.

Automotive
beauty
IS only
skin-deep

Let's face it . . . all the body work you've done on your faithful steed is of no avail if the paint job doesn't turn out right. All the hours of priming, sanding, filling, and grinding won't amount to a hill of beans if the finish looks like it was put on with a broom. So, herewith, let us offer a few helpful tips about paint, preparation, and equipment. We can't guarantee a perfect job your first time out, but if you use a little patience and good common sense, even a first-time automotive Rembrandt can turn out a paint job that will make the crowd go "OOOOHHHHHH." And next month, we'll cover masking and actual painting.

Paint: Paint (for automotive applications) is composed of two basic in-

gredients: One, the volatiles; and two, the film-forming material. The *volatile* is the part of the paint that evaporates, and the part that remains, the part that you actually see, is the *film-forming* material. A further breakdown will yield pigment and binders. The *binder* acts as a carrying device for the pigment and imparts body, toughness, and gloss to the film. *Pigment* is the coloring portion of the paint and serves to produce opacity (the quality of the paint which allows it to "hide" the material it covers) as well as providing protection for the binder.

Lacquer (both nitrocellulose and acrylic) dries by evaporation of the thinner or volatile material. They remain soluble (more or less) so that when they are recoated with the same type of

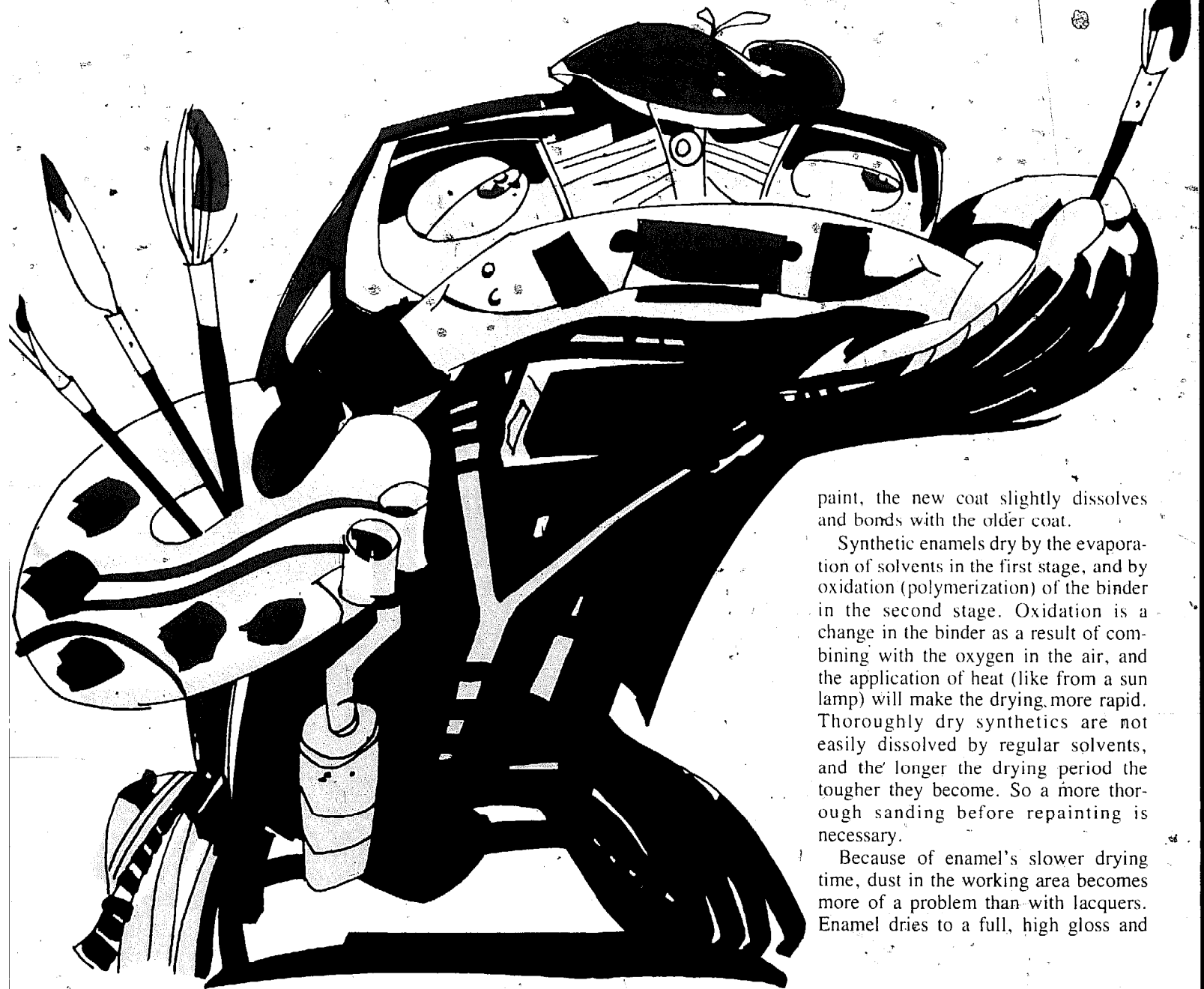

paint, the new coat slightly dissolves and bonds with the older coat.

Synthetic enamels dry by the evaporation of solvents in the first stage, and by oxidation (polymerization) of the binder in the second stage. Oxidation is a change in the binder as a result of combining with the oxygen in the air, and the application of heat (like from a sun lamp) will make the drying more rapid. Thoroughly dry synthetics are not easily dissolved by regular solvents, and the longer the drying period the tougher they become. So a more thorough sanding before repainting is necessary.

Because of enamel's slower drying time, dust in the working area becomes more of a problem than with lacquers. Enamel dries to a full, high gloss and

Automotive Painting

The basic parts of a modern spray gun should be familiar to you before you begin to work with it. Study the parts and definitions shown here, and next month we'll show you how to manipulate them so that your car gets a shiny coat of paint in the process.

(Illustrations courtesy of BINKS Mfg.)

Part A. The air nozzle (also called the air cap) is the most important part of the gun. The air nozzle directs air jets that atomize the paint and give the resulting particles velocity to reach the surface you're painting.

Part B. The fluid nozzle provides the means for controlling and metering delivery of paint to the air nozzle.

Part C. The needle assembly acts as a stop-start valve for material flow through the gun (in conjunction with the fluid nozzle).

Part D. The trigger activates and controls the air and paint movement to the nozzles.

doesn't require polishing, while lacquers need to be "rubbed out," or polished, to attain a full gloss. Another difference is that enamel is said to dry from the inside out, while lacquers dry from the outside in.

Since we advocate repainting with the same type of paint that is on your car now, you'll need to know what kind of finish it is. If the car has factory paint, just check the code letter for paint that is found in the VIN (vehicle identification number) located on the door or dash of your car. The letter, when refer-

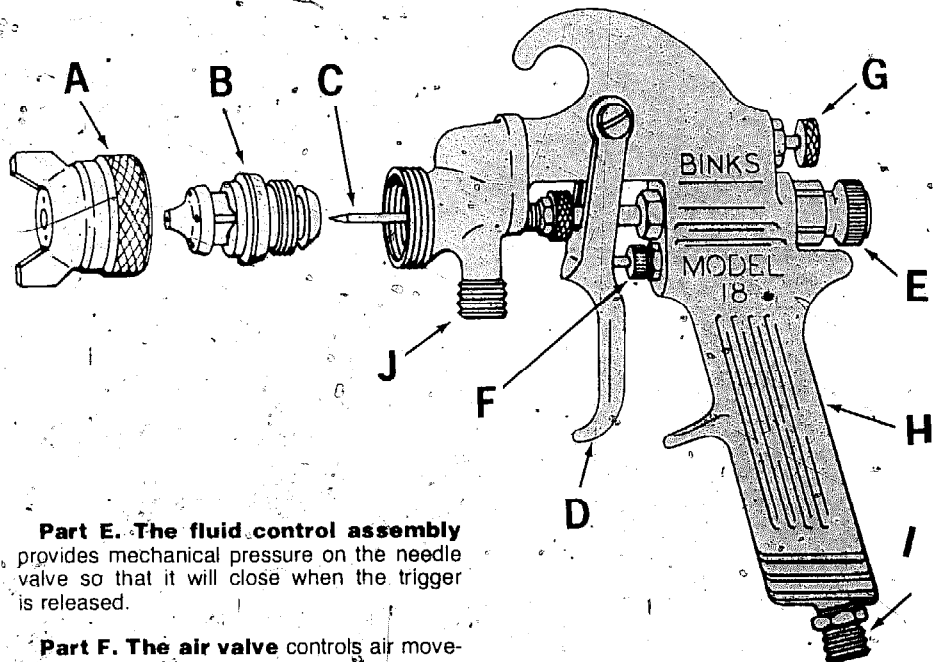

Part E. The fluid control assembly provides mechanical pressure on the needle valve so that it will close when the trigger is released.

Part F. The air valve controls air movement through the gun.

Part G. The side port control (or fan control) regulates the spray pattern width by controlling the air supply to the "horns" of the nozzle.

enced in a paint manual, will tell you what kind of finish was used, and what the factory name for the color is.

If the car has been repainted, rub a small area with lacquer thinner. If no color comes off on the rag, the finish is enamel. If some color shows on the

Part H. The spray gun body handle is thoughtfully provided so that all the parts may stay together and you may have a convenient method by which to hold the gun.

Part I. The air inlet is where the air hose is connected to the gun.

Part J. The fluid inlet is the connecting point for the paint supply (usually in the form of a quart-size canister).

continued

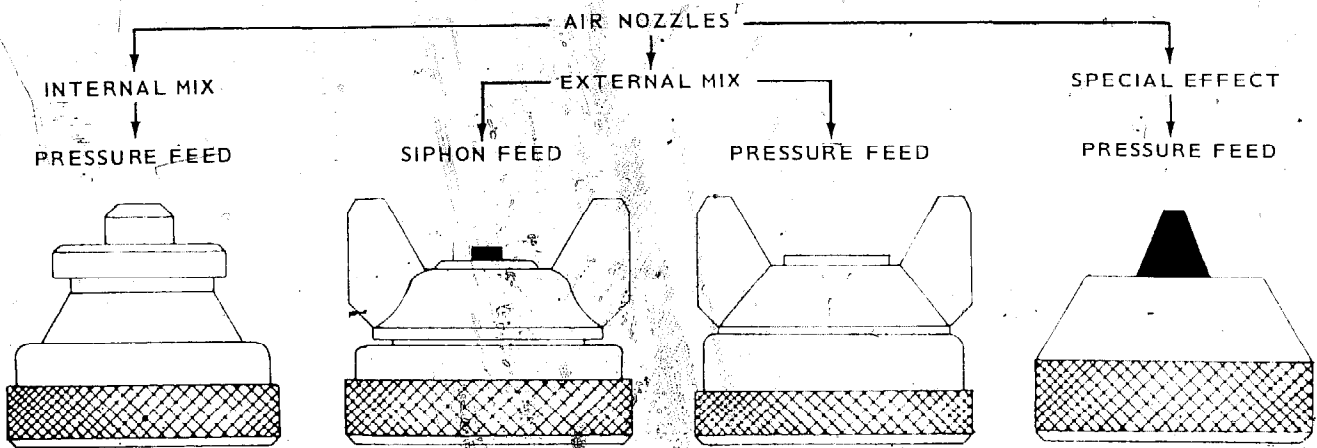

The external-mix air nozzles shown in the center are probably the type you will see most. Be sure you have the right type of nozzle for the system you're using.

SIDE-PORT CONTROL KNOB

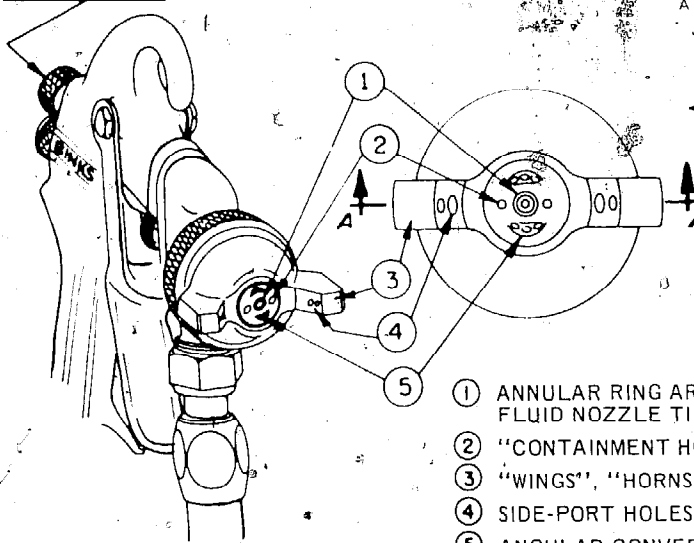

- ① ANNULAR RING AROUND THE FLUID NOZZLE TIP.
- ② "CONTAINMENT HOLES"
- ③ "WINGS", "HORNS" OR "EARS"
- ④ SIDE-PORT HOLES
- ⑤ ANGULAR CONVERGING HOLES

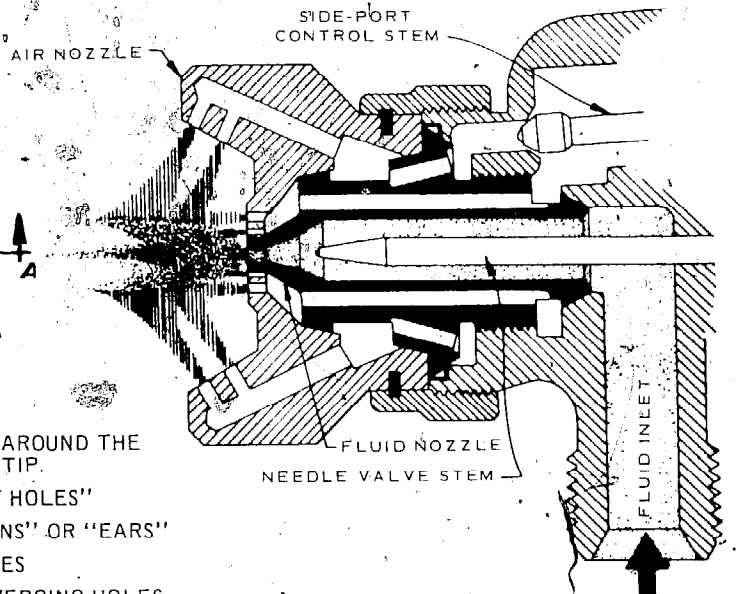

Air and Material Flow

External Mix Atomizing Holes

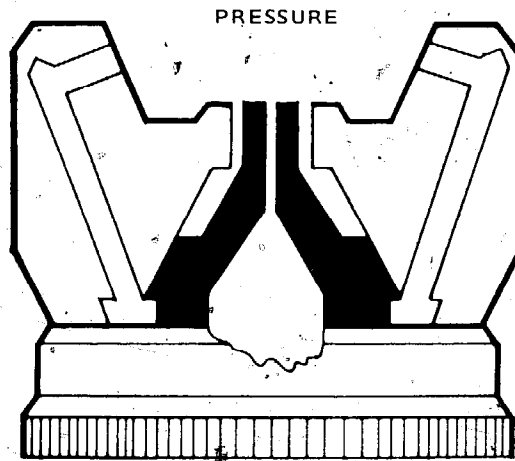
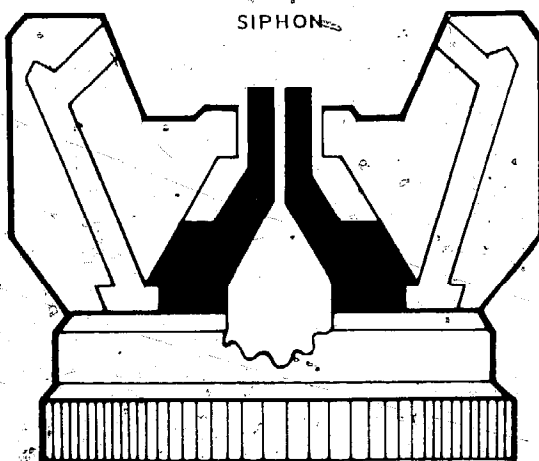

Siphon-feed nozzle is identified by the fluid nozzle which protrudes beyond the face of the air nozzle.

Pressure-feed external mix nozzle. Don't put a pressure-feed nozzle on a siphon-feed system.



continued

rag, you've got lacquer. To further identify the paint if you find it's lacquer, rub an area with silicone polish remover. Acrylic lacquer will come off with this method, while nitrocellulose will be unaffected.

Most cars today are finished in either synthetic enamel, acrylic enamel, or acrylic lacquer. Acrylic lacquer is recommended for use on all cars which were originally finished with lacquer. If acrylic lacquer is used over enamel, a sealer should be applied over the enamel, and you must do the entire panel since you can't spot-finish with this method.

If you elect to use acrylic lacquer over your old lacquer finish, sanding the surface (if it's in good condition) isn't really needed... just make sure the surface to be painted is clean.

If you're painting over enamel, the surface should be thoroughly sanded and cleaned if you're gonna use lacquer, and sealed if you're painting over enamel.

Whether you elect to use synthetic enamel, acrylic enamel, or acrylic or nitrocellulose lacquer, the decision mostly depends on what the old surface is VS your personal preference.

Some painters prefer nitrocellulose lacquer because it dries quickly and dust in the work area isn't much of a problem. Others go with enamel because, unlike lacquer, it doesn't involve the extra time- and labor-consuming step of polishing. Many painters we talked to recommend lacquer for beginners though, because mistakes (like runs or sags) can be easily corrected, but when enamel is on, you're stuck with it. The choice is yours.

Other Stuff: *Thinners* and *reducers* are solvents used to thin paints to the correct viscosity for spraying. Generally, thinners are used for lacquer and acrylic products while reducers are used for synthetic-based enamels. They are not usually interchangeable. Thinners are also sometimes formulated by manufacturers to provide specific thinning qualities for specific temperatures and levels of humidity.

Before you spray any primer, surfacer, sealer, or color coat, you've

got to be sure that all grease and/or wax has been removed from the surface. *Wax, polish, and grease removers* are used for this purpose, and they are extremely important since the adhesion of any paint film to a surface depends on how clean the surface is. "Clean" means not only physically clean, but chemically clean as well. The slightest film of rust, wax, oil, or moisture will prevent paint from adhering to a surface. The removers are solvent-type products and should be applied with clean rags and plenty of elbow grease. In case you were wondering... no, gasoline is *not* a grease remover. Not only is it dangerous to use, but it will cause the paint to crater or "fish eye" as it dries.

If your car has been polished with silicone-based cleaners, you'll need a remover specifically designed to obliterate any traces of those little "silly cones."

When automobile bodies have been stripped to bare metal, rust will creep up on the steel quicker than Tony Dorsett runs out a handoff from Roger Staubach. In order to prevent rust from forming, wipe the bare metal with a *metal-conditioning fluid*. This will not only prevent rust, but will chemically clean and etch the surface for better paint adhesion.

Another little goodie you'll definitely need before you lay on that paint is a *tack rag*. A tack rag is usually a piece of cheesecloth or soft cotton cloth that has been soaked in thin, non-drying varnish and then wrung out. If you're a nice person and keep it in its air-tight container, it'll remain sticky. Then, just before you apply any paint or primer to the surface, you wipe the surface with the tack rag. The tack rag will remove all the dust particles that have gathered on that nice clean surface... and then your paint job won't look like a relief map of the moon.

Spray guns: Why go to all the trouble of renting a spray gun and compressor, or going all the way out to the base hobby shop to use theirs, when for a few bucks, you can buy some spray cans of tangerine/puce metalflake lacquer and save yourself all that ex-

pense and grief? The answer is simple... cars that have been painted with a good spray gun in a controlled paint booth look like it. Cars painted in a backyard with 237 cans of spray paint look like it.

Now that we've convinced you to go the spray gun and paint booth (or at least enclosed garage) route, let's get into a bit about spray gun construction before we press on.

There are two basic types of paint spraying guns. One type has the gun and paint container as a single unit, the other has the gun separate from the paint supply. These two types can be further separated into bleeder and non-bleeder, external and internal mix, and pressure, gravity, or suction feed guns.

Guns designed without air valves are known as *bleeder* spray guns. Air flows through the gun at all times (preventing pressure build-up in the air line) and is used with small compressors with limited capacity. The trigger controls only the flow of paint in this type of spray gun.

A *nonbleeder* gun is equipped with an air valve which shuts off the air when the trigger is released. In this type of gun, the trigger controls both air flow and paint flow.

A gun that mixes and atomizes air and paint outside the air cap is called an *external-mix* gun, and is best suited for spraying fast-drying paints like lacquers.

An *internal-mix* gun mixes air and paint inside the air cap before the material is sprayed. This gun is commonly used for spraying slow-drying stuff like flat wall paint and automotive enamels.

Suction-feed identifies the type of gun where a stream of compressed air is used to create a vacuum so that paint is forced from an attached canister. The gun is usually limited to a one-quart capacity and is identified by the fluid regulating tip extending past the air cap. This type of gun is used mostly where there will be many color changes in the process of the job, or where relatively small areas have to be covered (like when you paint your car, maybe?).

continued

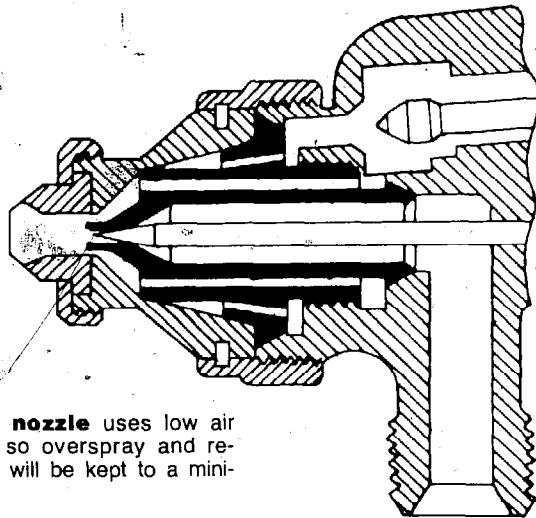

The internal-mix nozzle uses low air pressure and fluid, so overspray and rebounding or droplets will be kept to a minimum.

CARTRIDGE-TYPE RESPIRATORS

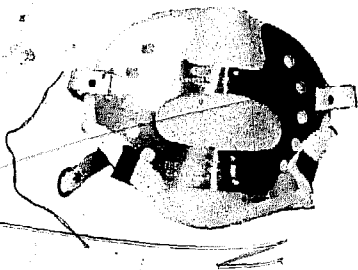

Face Pad Type

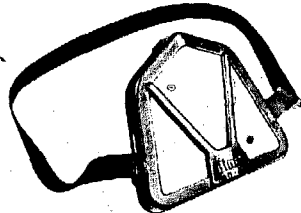

Double-Duty Pad Type



Filter Type

Wipe off the external surfaces with a solvent-soaked rag or, if necessary, use a soft bristly brush dampened with thinner. Remove the air cap and clean it in solvent. If the small holes remain clogged with paint, try soaking the cap in solvent for a while. If the holes remain clogged, ream them out with a match stick or a broom straw. Don't use anything metallic to ream out the holes (like a welding nozzle cleaning wire) because you can easily damage the holes by increasing their diameter.

A caution at this point . . . don't immerse your gun in solvent and then leave it overnight. This can allow sludge and crud to build up, and then, the next time you use the gun, all that junk will come out the first time you squeeze the trigger. This, in turn, will probably ruin the area you're trying to paint (not to mention ruining your smile and your day, too). Also, if the gun is left in the solvent too long, the solvent will function as advertised and eat off all the lubrication from the seals,

FILTER-TYPE RESPIRATORS

Cleaning the gun: Since you know now that you're going to use a spray gun instead of little spray cans to do the painting, you know too that the equipment will have to be cleaned. Let's get into spray gun care for a bit, and then we'll move on to paint shop safety.

Spray guns should be cleaned immediately after each use. If you don't accomplish this little step, you're gonna wind up with a spray gun that has dried paint in the nozzle and internal passages. If that happens, well . . . let's just say that if you've borrowed the gun, you're gonna spend 12 days trying to clean it, or you're gonna owe your buddy a new gun.

To clean a suction-feed gun and paint cup, first loosen the cup from the gun. While the paint pick-up tube is still in the cup, unscrew the air cap (air nozzle) two or three turns. Hold a folded, heavy cloth over the air cap and pull



Single Cartridge Type

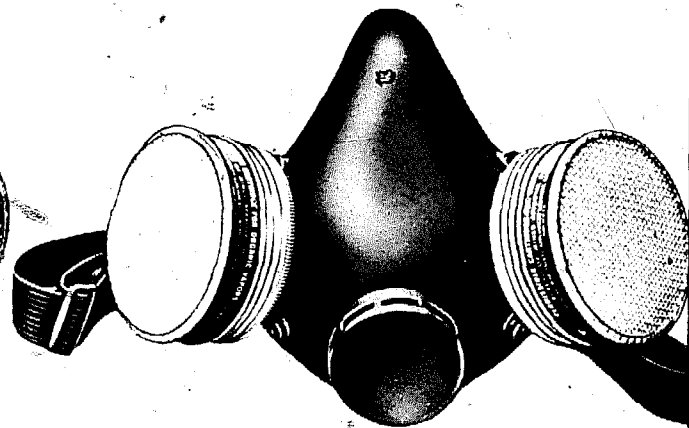

Double Cartridge Type

(Photos courtesy of BINKS Mfg. Co.)

the trigger. This will divert air into the fluid passageways and force any paint left in the passages back into the cup.

Then empty the cup and put in a small amount of solvent. Reinstall the cup and spray a bit of solvent to clean the internal passages. Remove, empty, and dry the cup.

packing, and sliding surfaces of the gun.

Paint shop safety: Basic shop rules apply to the paint shop as well as other shops. Rules like no horseplay, clean floors, sufficient ventilation, and proper illumination are all valid. But there is one particularly dangerous aspect to the paint shop . . . the danger of fire.

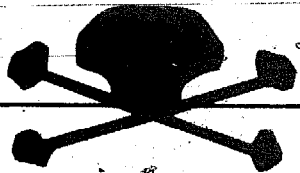

TOXIC EFFECTS FROM OVEREXPOSURE TO PAINT SOLVENTS

Solvent	Effect of Inhalation
Acetone	Irritating to mucous membranes; choking sensation
Alcohol, ethyl	Intoxication
Alcohol, isopropyl	Intoxication; headache
Benzene (beazol)	Injury to blood-forming organs, and to heart, liver; kidneys, etc.
Carbon Tetrachloride	Nausea, headache, vomiting; injury to liver (nephritis)
Cellosolve	Irritating to eyes, disagreeable odor
Cellosolve, methyl	Possibly affects blood-forming organs
Ethylene dichloride	Irritating to nose; retching; unconsciousness
Methylethyl ketone (MEK)	Irritating to nasal passages; choking sensation
Methylisobutyl ketone (MIBK)	Irritating to mucous membranes; choking sensation
Naphtha, V.M. + P.	Headache; vomiting; muscular twitching
Toluene (toluol)	Same as for benzene except little damage to blood-forming organs
Trichlorethylene	Similar to carbon tetrachloride; disturbed heart action
Turpentine	Irritating to nose and throat; headache; vomiting; stomach pains
Xylene (Xylol)	Same as for benzene except little damage to blood-forming organs

If you forget everything else, at least remember that paints and thinners are **HIGHLY FLAMMABLE**. That's a couple of polite words for saying that they burn like &@%\$!

Paints and thinners should *always* be kept in closed containers. This will lessen the danger of fire and save you money as well, because all that expensive stuff can't evaporate if it's kept in closed containers. Smoking and/or open flame should *never* be permitted.

There should be an ample number of fire extinguishers handy, and you should know their location like you know the back of your hand. And be sure you know how to use them correctly. Check them regularly to insure that they are properly serviced and charged.

Remember that you *can't use water* on oil, grease, gasoline, lacquer or thinner fires. You've gotta have a foam or dry chemical extinguisher. It might not be a bad idea to keep a bucket of fine sand handy, too.

Oily rags, tack rags, and paint rags and strainers should be kept in separate, lidded containers.

If you're repairing collision damage, keep in mind that the car's wiring might be damaged too, and that can lead to shorts and sparks. So why not disconnect the battery before you bring the car into the shop (or even before you work on it!).

Remember that paint and solvents contain material that can irritate your tender body. Gloves, long-sleeve shirts, long pants, and high-top shoes or boots are a good idea. Your lungs can be easily damaged too, so wear air filtration equipment at all times. You might even want to read the attached chart so you'll be familiar with the effects of inhaling some of the stuff found in paint shops.

NEXT MONTH

We told you this painting stuff was gonna take patience! If you can hang in there till next month, we'll show you how to mask off the shiny parts, how to mix and strain the paint, and how to apply that glossy stuff. Stay tuned.



WARRIORS

part 2

The two final steps . . . masking and painting

You've taken out all the dents and dings . . . you've finish-sanded until you thought your arm was going to fall off . . . you've metal-prepped and primed your trusty steed . . . and you're ready for that last step, the PAINT! Now, let's get that car masked and that paint sprayed on so we can see the results.

Masking: The Lone Ranger wore a mask to protect his identity. Your car needs a mask to protect it, too. Unfortunately, one of the biggest disadvantages to spray painting is overspray, that portion of the paint that doesn't go onto the surface you want it on. Overspray is no problem though, when you mask your vehicle the right way.

Areas that you don't want painted, such as chrome, glass, and different colored body panels, are protected by masking tape, masking paper, or a combination of the two.

Use Quality Products: Good quality masking paper will not permit paint to penetrate or seep through to the surface it protects. Masking paper is also capable of withstanding rough handling, and it contains a small amount of "stretch" which allows it to be fitted to slightly curved edges. Good paper will not scratch newly painted surfaces either. Newspaper *will not* meet any of these qualifications, so don't even *think* about using it!

Masking tape must adhere easily to both painted and unpainted surfaces, and equally important, it must be easily removed from surfaces without leaving a portion of its adhesive behind. Good tape will also remain on a surface even

continued

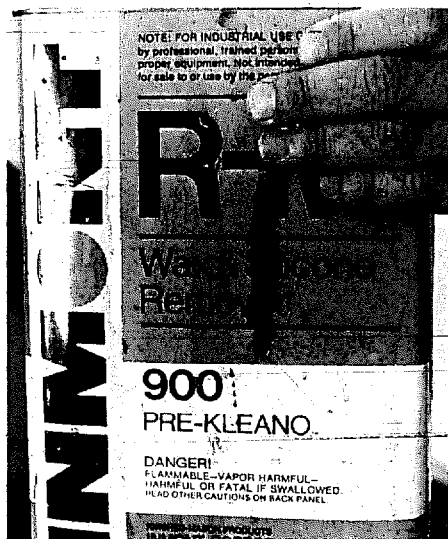

Part of the prep for any paint job is making sure that there is no wax or silicone residue left on any surface.

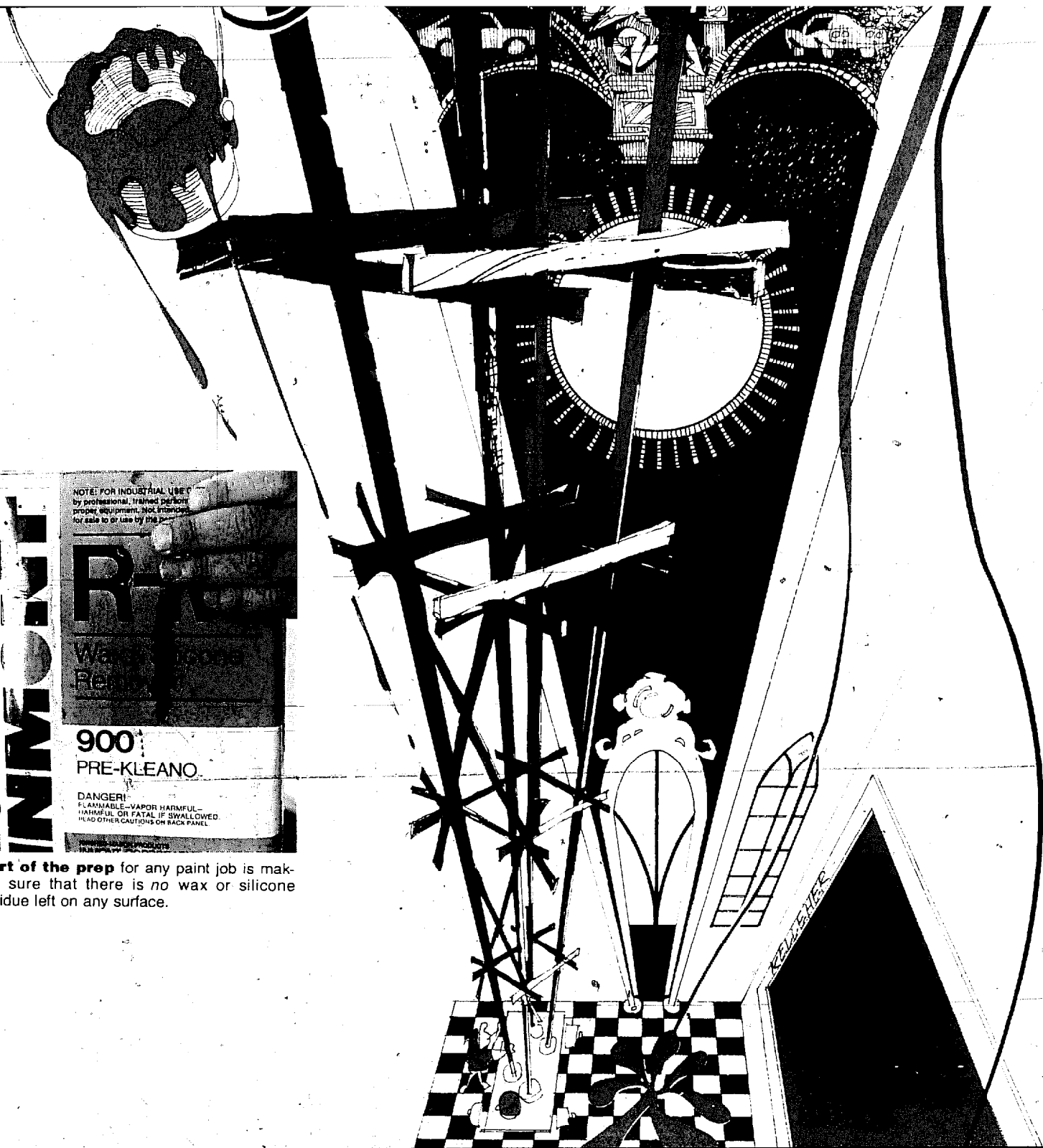

if it gets wet, like during wet-sanding operations.

If your base auto hobby shop has a paint shop, chances are it also has a dispenser for masking paper. This dispenser is nothing more than a stand which dispenses masking paper with tape already attached to one edge. As the paper is pulled from the roll, tape is automatically applied to one edge, with one-half of the width of the tape applied to the paper and the other half free. While not a must-have, this little goody makes a masking job go faster and easier, and lessens the chances for masking errors.

Masking rules: Masking tape, or tape/paper combinations, should only be applied to clean, dry surfaces which are free of silicone polish, rubber lubricants, dust, and grease.

Unless you're masking curved surfaces, the tape shouldn't be stretched. Just place it on the surface and press down gently, making sure that the edge of the tape, as well as the center, adheres to the panel. If the edges aren't sticking, paint can seep under the tape.

If you have a choice, tape shouldn't be applied or removed when temperatures are below 50 degrees F. Not a matter of choice is when tape should be removed . . . you've gotta wait 'til the paint is dry, not just tacky. And when you do remove it, pull it away from the surface at a 90-degree angle.

Also, tape should be stored in a cool, dry place, and shouldn't be left on a radiator or other hot surface.

Masking technique: Although the photographs will show you most of what to do, there are a few tricks that we'll briefly cover here.

■ **TRIM:** When you're doing trim, door handles, hood emblems, etc., you usually don't need paper, just tape. Select a tape which is wide enough to cover all or most of the part with a single pass. If more than one tape strip is required, don't forget to overlap the strips and seal them firmly to prevent paint seepage.

■ **WINDSHIELD:** You usually need two or three sheets of paper. Start with the

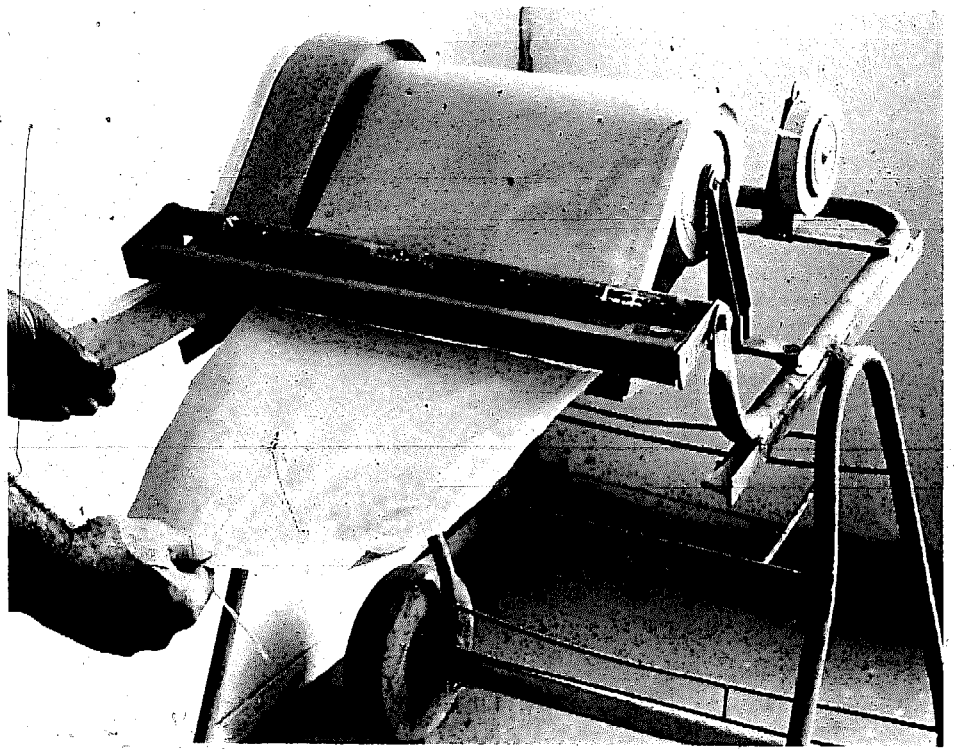

A taped-paper dispenser will make the masking job faster and easier.

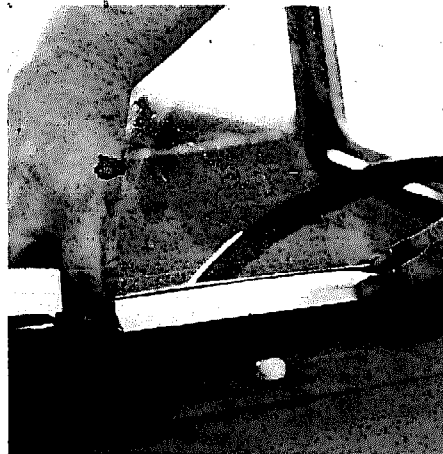

Masking tape should be applied firmly, but not so tight that it stretches.



lowest portion of the windshield and work up. The same goes for window glass too.

■ **BODY PANELS:** If you're just refinishing one panel, or if you're doing a two-tone job, you'll need to mask large areas. The trick is to select paper (or cut it) slightly wider than the panel to be covered. Attach tape to one edge, and apply the upper edge to the panel. Then crease the paper to the needed width and tape into position.



Before you mask glass, tape an outline (top) . . . then, tape the masking paper to the outline mask.

■ **UPHOLSTERY:** A professional paints the door jambs as well as the outside of the doors. But for this you need to mask off the upholstery. Use a narrow strip of masking paper about 10 feet long. Start at the outside lower corner and continue on around in a single operation. Follow the same route for the door frame, if necessary, and just to be sure, cover the seat, seat back, and carpet, too.

■ **HEADLIGHTS:** For headlights, use a piece of paper about six inches wide and long enough to reach about three-quarters of the circumference of the light. Place the tape along one edge of the paper so that one-half of the tape is exposed. Place the taped paper at some point on the lamp rim and run the paper on around. Then take a second piece of paper and use it to fill in the gap. If you've done it right, the result should be roughly cone-shaped. Twist and fold the cone against the lamp face. Then tape the fold flat against itself.

■ **WHEELS:** Listen up, all you little homemakers out there . . . to do wheels, you've got to make an apron. Seriously, masking circular surfaces is tricky, but if you use an apron mask you'll prevent the mask from buckling and/or wrinkling. Cut a length of masking paper about six inches wide and as long as

the wheel circumference. Then, make a pleat about 1/4-inch deep by crimping both edges. The pleat should be the full width of the apron. Press on, and pleat the whole piece at about four-inch intervals. Apply the mask to the wheel and fold the untaped edge so that it forms a cup shape out of the mask. When you spray, hold the gun opposite one side of the wheel and spray to the other side.

■ **ANTENNA:** Simple . . . just use a length of cardboard tube (like you find on coat hangers).

Spraying the paint: In the last installment, we covered spray guns. In case you missed it (or, like a bad person, used it to mask your windshield) we emphasized that a good spray gun, clean and in excellent working condition, is a must.

The guns used in auto body refinishing have two manual adjustments which must be correctly set to get a paint job that looks like a mirror instead of a soft candy bar. These two adjustments are the spreader adjustment valve (for side port control) and the fluid adjustment device.

The spreader valve controls the supply of air to the air horns on the air cap. If it's shut all the way off, the resulting

paint pattern would be round. As you gradually open this valve, air flows to the horns and changes the spray pattern to an oval. This allows you to select a pattern and a pattern width to suit the job. Remember how to get this oval pattern, as that's the one you'll be working with the most.

The fluid adjustment controls the amount of paint coming from the gun. When it's fully closed, no paint flows . . . fully open, just the opposite, paint everywhere. With this adjustment, you select a setting that will give a proper paint flow for the job you're doing.

Air pressure: The air pressure used to make the gun operate will vary with the thickness of the paint you're using and, to some degree, with the *type* of paint, whether lacquer, enamel or acrylic. Gun air pressure is adjusted by a regulator which should be part of your air supply system.

Up front, the correct air pressure is really a matter of experience, so use an old piece of cardboard and shoot a variety of pressures and pick the resultant pattern/pressure that suits the job you're doing. Remember though, the pattern can also be adjusted by the spreader valve. What you're looking for is a pattern that will cover a fairly large area at one time, yet not so wide as to be

continued



If you select masking paper of the proper width, you can mask surfaces with one sheet of paper.



When masking trim, cover ends or complex curves, and then do the rest with as few pieces of tape as possible.



continued

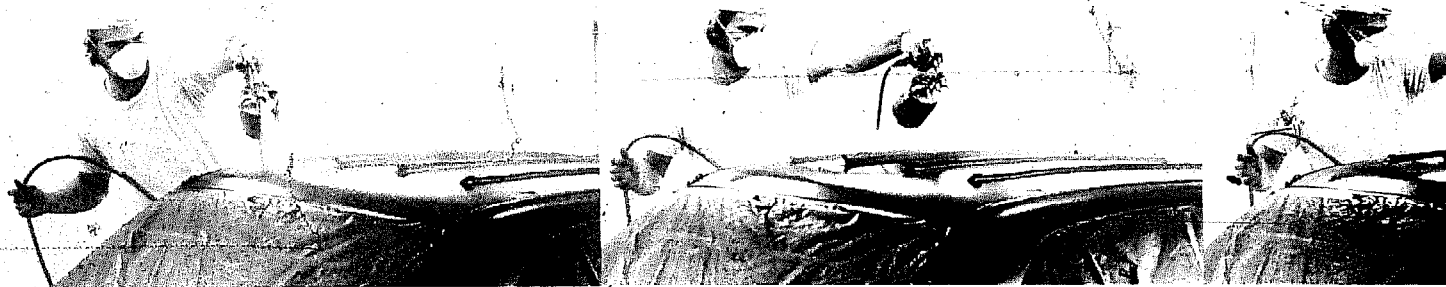

This sequence, shot with a motor-drive camera, shows how the gun should remain the same distance away from the surface during a paint pass. Always work parallel to the surface.

wider than the surface you want to paint.

Air pressure that is too low will result in under-atomized paint, which shows up as either a rough finish or its "orange peel." Too high an atomizing pressure will result in a "dry" spray and can also cause orange peel because the paint won't flow out. A good ballpark setting will be 50 pounds in a range of from 30 to 60 pounds. Remember, if your air pressure is limited for some reason, a pressure-feed system requires less air to function as opposed to a suction-feed set-up.

As you adjust the gun and the air pressure to get the pattern and the paint flow you want, check your practice sprays for signs of spitting. Spitting is caused by dried-out packing around the material needle valve, allowing air to get in fluid passageways. To cure it, just loosen the nut on the air valve and juice the packing with a little light oil. If spitting persists, check for dirt between the fluid nozzle seat and body, or for a loose fluid nozzle.

Distance: One of the most important things to get right is the distance from the surface to the gun. For synthetic enamels, try about eight inches, maybe as much as 10 inches. For lacquers, ballpark figures would be from six to eight inches.

If the gun is too close to the work surface, the paint will go on too "heavy" and could develop sags. If the gun is too far away, you'll get a dry, sandy finish. Once you find the right distance, hold the gun there for the entire length of the stroke. Imagine looking down on

yourself from a point on the ceiling. You shouldn't see a fan pattern . . . you should see the gun going in a straight line parallel to the work. If the gun is held at an angle (like at the end of a stroke when you don't work parallel to the surface) you'll get streaks, sags, and runs.

Always try for a wet coat. Use slow, steady strokes across the surface from one edge to the other. Also, overlap each stroke about 50%.

Stroke it! When you're doing a panel, begin the stroke past the panel. Then pull the trigger when the gun is opposite the start of the panel. Move the gun across the surface (remember, parallel to the surface) and release the trigger at the end of the panel. BUT, continue the stroke a few inches before reversing. This will assure full coverage without overspray.

Another little trick to consider is banding the panel. "Band-in" the ends of the panel with a vertical stroke, then spray the surface horizontally, triggering the gun at the beginning and end of each stroke. When the edges have been banded, the bad habit of whipping the gun is controlled since the banded surfaces act as a good signal to trigger and stop spray.

The stroke itself must be smooth and easy. Slow enough for the correct amount of paint to be deposited, but fast enough so as not to cause sags or run from too much paint. Again, overlap the strokes by about 50%.

When spraying a hood, trunk or other wide horizontal surface, always start at the side near you and work . . . the far side. This is particularly important to remember when working with lacquer. If you do it this way, any overspray will land on a dry surface. Overspray land-

ing on a wet surface will cause a sandy-looking paint cover. If a pressure gun isn't available, the suction gun can be tilted slightly to be as near to a right angle to the surface as possible.

Paint sequence: The painting sequence is important. First do the hidden areas, door jambs, hood edges, and inside the trunk lid. You can leave the doors open slightly to avoid sticking. Then go to the exterior in a sequence like this: passenger side roof, passenger door, passenger side rear fender, trunk, driver's side rear fender, driver's side roof, passenger side front fender, hood, driver's side front fender, and driver's side door. Most pros prefer to do the roof one-half at a time as they work around the car. Use a pressure of about 20 psi when doing the door jambs, then go back to the paint manufacturer's specs for the rest of the car. Again, don't work into dry or semi-dry areas . . . that'll cause air-streaks in the finished job.

Spraying temperature: All paints have a temperature at which they are happy. Go too much higher or lower and the finish will suffer. Too cold, and the paint will be thick and heavy . . . too light, the paint will be too thin. The ideal temp for most painting is around 70 degrees F. Painting materials and equipment should be stored at temps between 70 and 85 degrees F. The same holds true for the surface temperature of the car to be painted . . . you guys at Williams AFB or Ft. Lewis will have to use shade or heat lamps!

Techniques: Just before spraying the color coat, all the little nooks and crannies where dust and/or water can collect should be blown out with low-pressure air (don't forget your safety goggles). Then all surfaces should be carefully wiped with a tack rag.

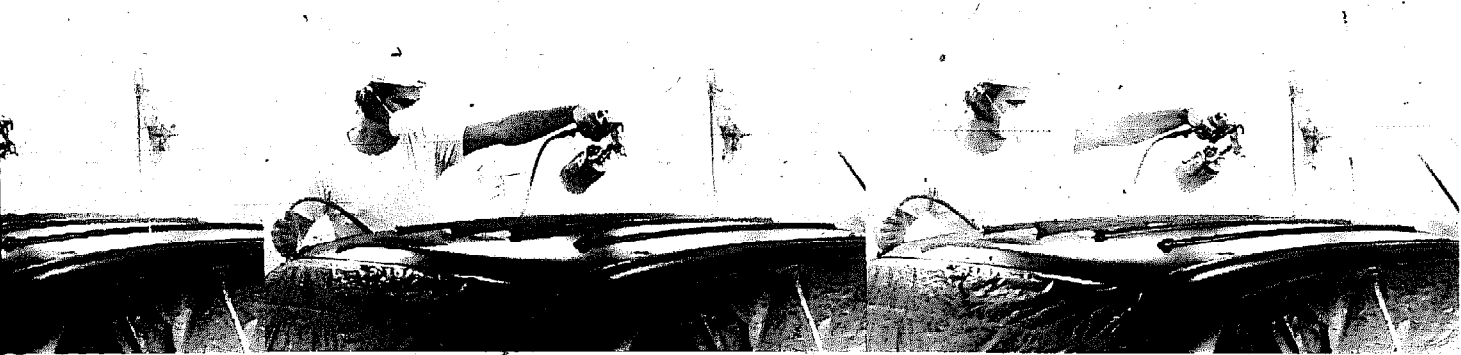

If the finish coat is nitrocellulose lacquer, the usual procedure is to spray three or four double coats thinned as per the maker's specs. Allow each coat to flash (shiny, external thinner to evaporate) before applying the next coats. Gun pressure will be about 40 psi, maybe 45 psi. Allow to dry overnight and then hand rub with polishing or buffing compound. Polish (dry buff) with a polisher using a lamb's wool hood on the disc. Allow 30 days for lacquer to harden before waxing.

If you're using acrylic lacquer or acrylic enamel, many paint makers recommend that after wiping with the tack rag, one or two coats of special sealer should be applied. When that has dried, three or four wet double-coats of acrylic enamel are put on. In hot weather, you may have to add a retarder to the paint to aid leveling and prevent blush (which is when the paint takes on a grey or white cast while drying). Allow each double coat to flash before applying the next coats. Most acrylics require at least four hours drying time, but overnight is best when you can swing it. You can wax acrylic after 60 days, and since it's so hard, polishing isn't normally required.

If you're working with enamel, the usual method (after the primer/surfacer has been applied) is to do the entire area with one medium coat of primer sealer. Blow out the nooks and crannies and wipe the whole thing with a tack rag. Spray the finish enamel, but be sure that the enamel is thoroughly stirred and mixed with the correct amount of reducer. Spray a medium first coat, allow to dry, and spray a full second coat.

Some paint makers say to spray one full panel at a time, applying two full

continued

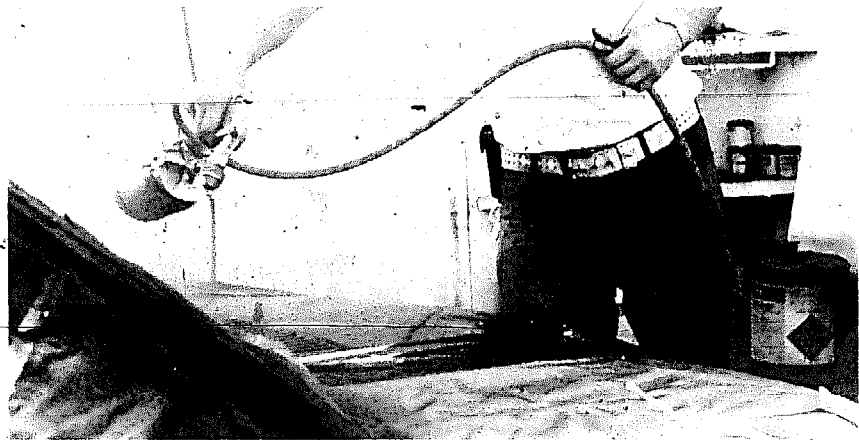

When working large, flat areas like a hood, start the stroke at the edge nearest you and work toward the far edge.

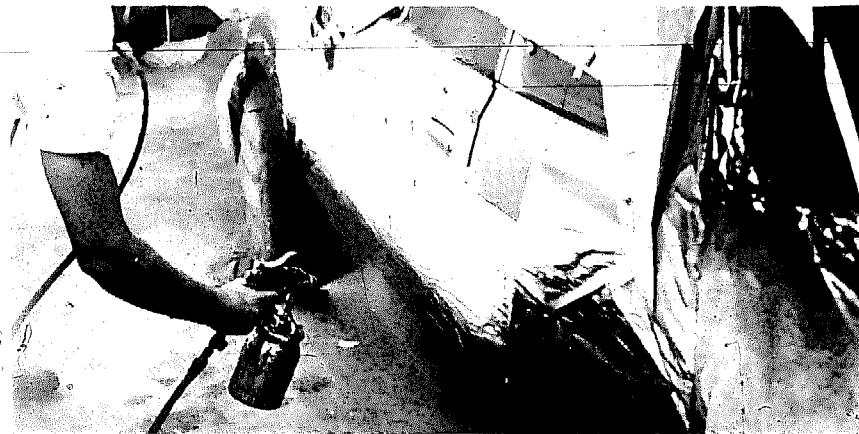

If you aren't going to paint the wheels, make up a cloth or plastic wheel cover and move it from wheel to wheel.



A surface like this is called a medium wet coat. Work carefully on vertical surfaces to avoid runs or sags.

the backyard mechanic

continued

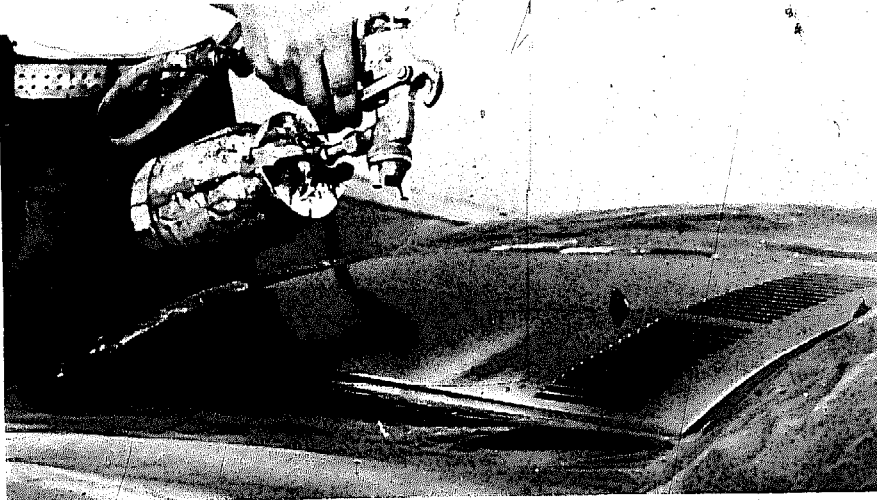

Look closely at the center of the photo . . . the lighter areas are where the paint is "flashing" or where the wet thinner is evaporating.

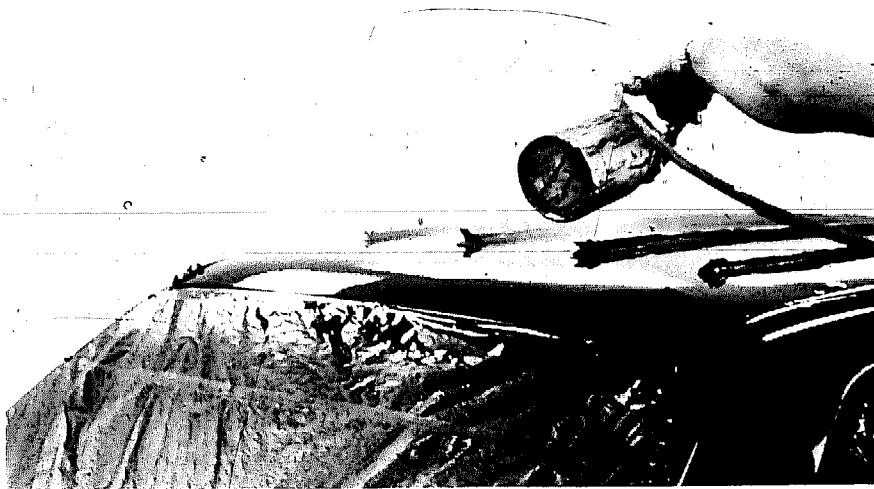

If you're working with enamel and your last wet coat looks like this . . . you're on your way to a great paint job!

wet coats to each panel, one coat immediately following the other. Metallic colors may require an additional coat, actually a mist coat.

Pressure for spraying enamel is around 65 psi when using a regular siphon gun. The mistake most amateurs make with enamel is putting too heavy a coat. A thick coat of enamel is no more durable than a normal coat, and is sometimes even less effective. Two correct coats of enamel will usually hide any color.

That's all folks: It took us three issues to tell you about auto body repairing and painting, but it'll only take you a couple of weeks of after-hours effort to get a superior paint job over good metal work. Remember, work slow and easy, keep things clean, and don't move on to the paint unless the surface is right. Experience is still the best teach-

er, but if you want a little more info before you plunge into getting that '55 Buick that your brother totalled back into shape, try reading Petersen's *Basic Bodywork and Painting*, or *Auto Restoration Tips & Techniques*, by the same publisher. They go into a lot more detail than we can here, and they're written at the enthusiast level and not for the pros.

If you pay attention to detail and have patience, your car will get a paint job that'll lend a whole new meaning to the phrase "SHINE IT ON"!!!

DRIVER wishes to thank S&M Auto Body of San Bernardino, Calif., for their assistance with the preparation of this article.

tuning for mileage

All the driving tips found earlier in this issue aren't going to do you as much good improving gasoline mileage as a tuneup.

But first, let's put to rest any rumors you've heard about super-trick ways of tuning a car to double the gas mileage: they ain't so. There just are no magic tricks or gadgets that will substantially increase fuel economy. The truth is, your car operates at its best when it is tuned properly to specifications. Thus the best way to maximize gas mileage and *performance* is to perform a thorough tuneup.

Now don't keep the *truth* to yourself. A recent study by Champion Spark Plug Company showed that about 42 percent of all the vehicles in the United States "show evidence of improper engine maintenance and are, therefore, wasting fuel." That 42 percent represents about 45 million vehicles wasting 3.2 billion gallons of gasoline annually!

The average tuneup produces an 11.7 percent improvement in fuel economy. There are vehicles that have seen 50 percent improvements as the result of such maintenance.

Let's put this into your gas tank and out of your pocketbook. During 1978, the average vehicle in this country traveled 11,824.46 miles, recorded 14.06 miles per gallon and thus used 841 gallons of gasoline. The 11.7 percent fuel economy improvement from a tuneup would have increased the mpg to 15.71* and cut the number of gallons to 752.9*. The 88.09 gallons* saved, at prices approaching \$1.50 per gallon represent a \$132.14* annual savings. Put that in your gas tank and drive on it!

*Figures stated are rounded; however, calculations were carried out eight decimal places. Therefore, using the figures displayed will not necessarily produce the exact answers shown.

Gasoline filters on GM vehicles are usually inside the carburetor. When removing the line note how the filter and spring insert in the filter housing so you can install the new filter correctly.

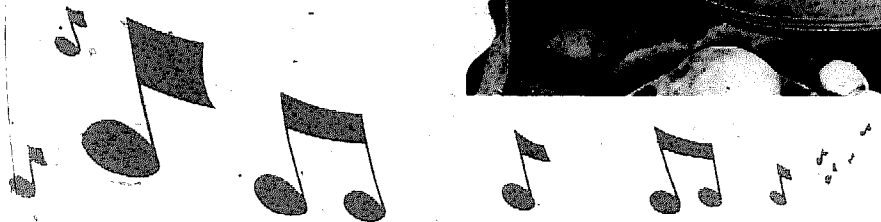

Of course, you don't gain anything by tuning an engine that doesn't need it. Signs that a tuneup is necessary include a drop in mpg, rough idling, hesitation, dieseling, hard starting, stalling, surging, pinging, misfire and lack of power.

If you're going to have somebody else tune your vehicle, check out the October 1979 DRIVER first. Even if you're going to do it yourself, give that issue's Backyard Mechanic a once-over. The bottom line of the October article is: find a reputable mechanic and/or parts store sales representative.

As the Backyard Mechanic is only a general guide to maintenance topics, a manual should be consulted when performing any maintenance. Procedures do vary from vehicle to vehicle. And as long as we're talking about the manual, read the section on tuneups completely before beginning. You'll not only get a good idea about what's involved, as well as what parts and tools will be required, but you also may find a very helpful hint buried in the fine print. Sometimes there's even a hint about step 7 in step 34.

Pre-tuneup: Pop the battery filler caps off and check the water level. If it is below the fill line or doesn't cover the tops of the plates in all the cells, bring the level up with distilled water. Tap water is for emergencies only.

Next remove the ground cable (the cable that runs to the vehicle's frame or engine—usually negative). Then remove the other cable. Wash a dirty battery case with a baking soda solution and rinse with clean water. Clean corroded terminals with steel wool or a special cleaning tool. Trace the positive battery cable to make sure all electrical connections are tight, especially at the starter. Now reconnect the cables—the ground cable last.

Take off the air cleaner and move the throttle back and forth a couple times. If raw fuel doesn't shoot into the carburetor, check the fuel system out before attempting a tuneup. Start a cold engine and make sure the automatic choke opens fully from closed. If the choke doesn't work smoothly, clean the linkage. When cleaning and lubricating the linkage doesn't improve choke operation it may be time for a complete servicing (see the vehicle's manual). Before servicing it might be a good idea to test switch and heater components of electrical choke units.

Now's a good time to spray a can of combustion chamber cleaner down the carburetor throat. It wouldn't hurt to completely clean the outside of this fuel-air mixer either.

Because it is very hard to tell when the gasoline filter is dirty, go ahead and replace it. Be very careful when

continued *

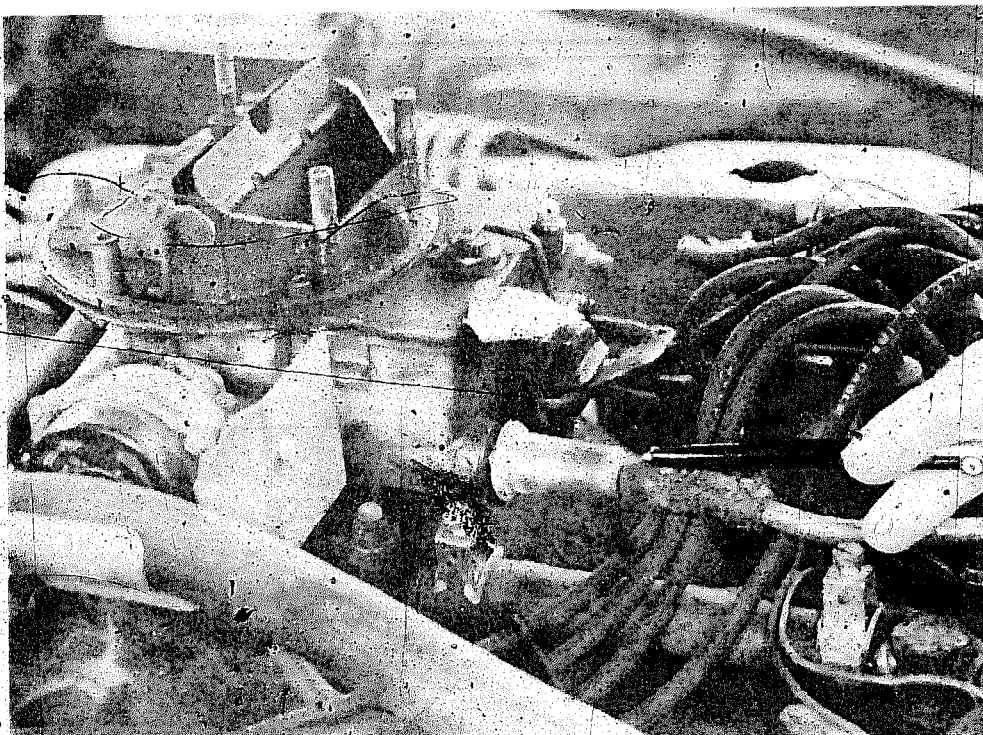

In-line gasoline filters clamp into the fuel line or, as on this Ford product, clamp to one end of the fuel line with the other end of the filter screwing into the carburetor.

removing the gas filter to have a rag under the connection to catch leaking gasoline.

Hold the air filter element up toward sunlight or a bright light bulb. If you can't see light coming through all the way around the filter, replace it. When replacing the air cleaner, make sure all the vacuum lines are also reconnected tightly.

Emission controls: Moving to the emission control system, there are a couple of ways to check the positive crankcase ventilation (PCV) valve. The simplest is to put a sheet of paper over the oil filler neck. If the paper is pulled in by suction, the system is operating. Another way to check PCV valve operation is to remove the valve from its seat and press your finger over its open end. Engine speed should drop at least 40 rpm. Even if the PCV valve is functioning correctly, tuneup time is as good as any for replacing it. Also replace the PCV filter inside the air cleaner housing.

To check the exhaust gas-recirculating (EGR) valve, you'll need a hand vacuum pump. Disconnect the hose to the EGR, attach the hand pump and pump up four inches of mercury. The engine should begin misfiring. If it doesn't, it's service time.

At every other tuneup it's a good idea to replace the filter in the fuel



PCV valves are usually located in the rocker-arm cover and should be replaced at every tuneup.



Almost hidden in the center of the picture is the heat riser. It should be doused regularly with solvent to keep it operating freely.

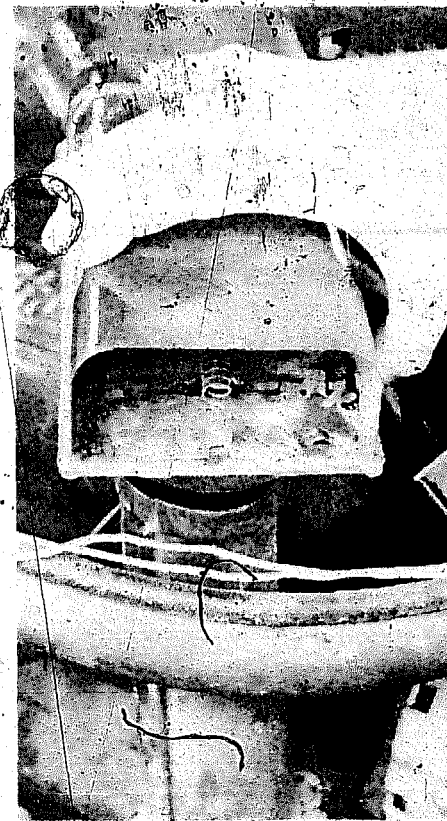

Thermostatically-controlled air cleaners need to be checked to ensure that the heat tube is properly connected at the air cleaner and manifold.

continued

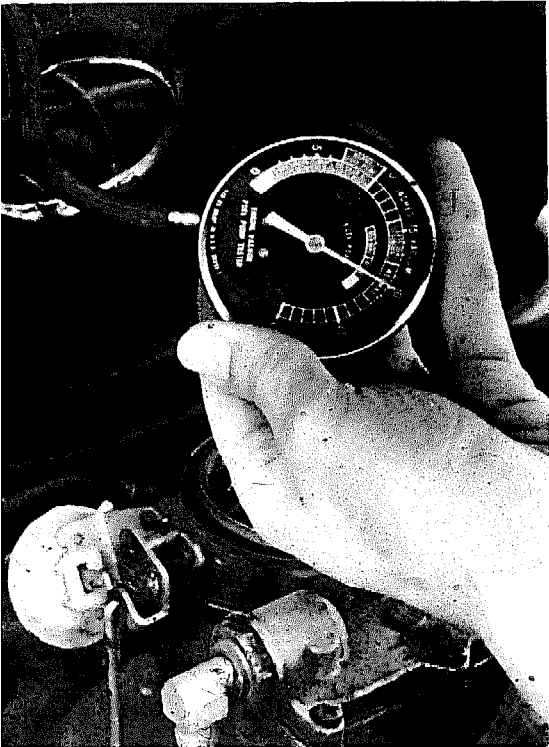

Vacuum is a good measure of an engine's performance. A steady vacuum gauge reading at idle is one of the signs of a healthy engine that can be successfully tuned.

evaporation system canister.

With the engine cold and turned off, locate the heat riser on the exhaust pipe or crossover pipe near the exhaust manifold. If you can turn the valve, give both ends a shot of solvent. If not, tap it lightly until it is free, then lubricate it.

Most car manufacturers since 1971 have a special thermostatically controlled air cleaner instead of the heat riser. A few cars have both. Start the cold engine and make sure this valve closes over the snorkel. It should reopen in about a minute. If it doesn't, it needs repair.

Can it be tuned? Before the actual tuneup can begin, you must establish that the engine can be tuned. An engine that's malfunctioning isn't going to be improved much with a tuneup. To establish engine condition you'll need a compression gauge and a vacuum gauge. You might also invest in a remote starter switch so that you can crank the engine from under the hood.

A sparkplug cable remover will allow you to reach cables in tight places such as below the exhaust manifold. Otherwise, grip the sparkplug cable boot with your hand, twist it back and forth until it pops loose, and then remove the cable. Be sure to mark each cable so that it can be reattached to the proper plug. One good way to do this is by wrapping marked tape around each cable. Another is to use marked clip-type clothespins.

Check the wires to make sure they aren't cracked and don't have damaged insulation. If they are in poor condition, replace them. The best way to install new wires is to buy a replacement kit designed for your vehicle's engine. The only trick is in replacing the wires one at a time so that the correct plug is connected to the correct part of the distributor cap.

With the cables removed and marked, take a straw and blow the dirt out of the sparkplug ports. These particles could drop into the combustion chamber

continued

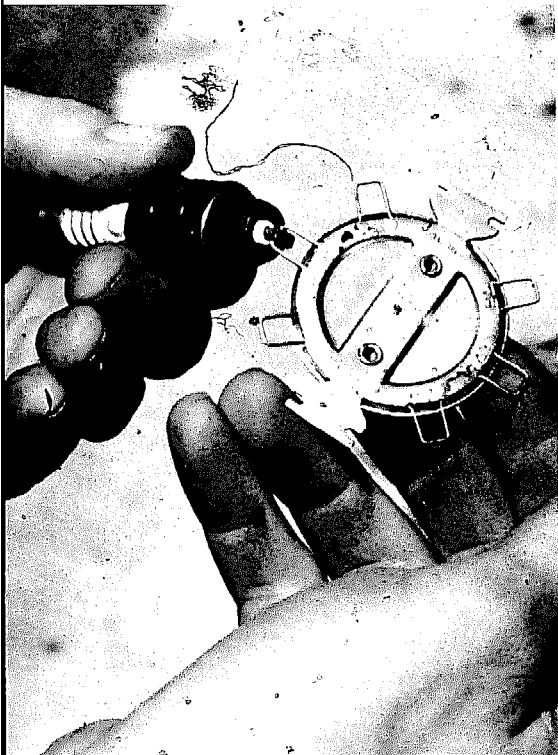

Sparkplugs should be gapped to specifications with a special wire gauge.



(left) **GM-type** distributor caps can be removed by turning the screws in the cap until the lock releases. (right) **Non-GM** distributor caps are held in place by external clips that can be popped off with a screwdriver.

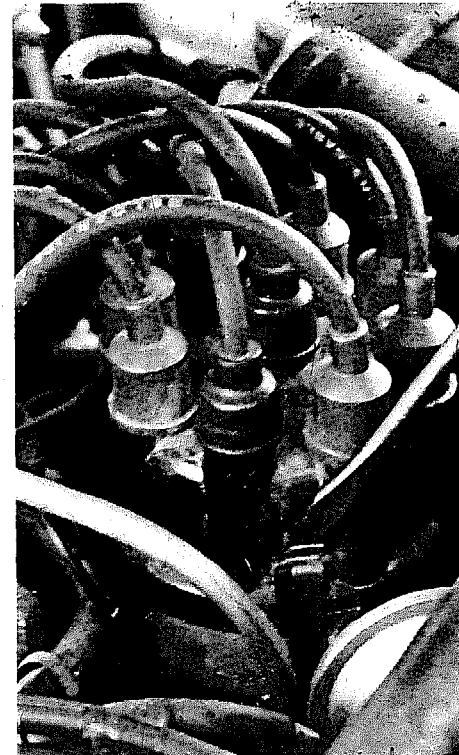

and cause serious internal damage. Carefully remove the plugs with a plug wrench or sparkplug socket and ratchet. Because the plugs may still be warm, leave them in the socket tool or handle them with a rag during inspection.

If the plugs have a crumbly chocolate-brown deposit, the engine is burning OK. But if the plugs are black and oily, either the plug is burning too cold or oil is leaking into the combustion chamber, fouling them. Oil fouling is common with older engines that have worn piston rings. In either case a hotter-burning plug should be used. On the other hand, a white powdery deposit means an engine is burning too hot and colder plugs are called for.

As you remove the plugs and examine them one at a time, you'll need to keep them in order. A cardboard box with holes punched into it and labeled to coincide with the plug's original position in the engine works well.

Push a compression gauge into the sparkplug depression and with the

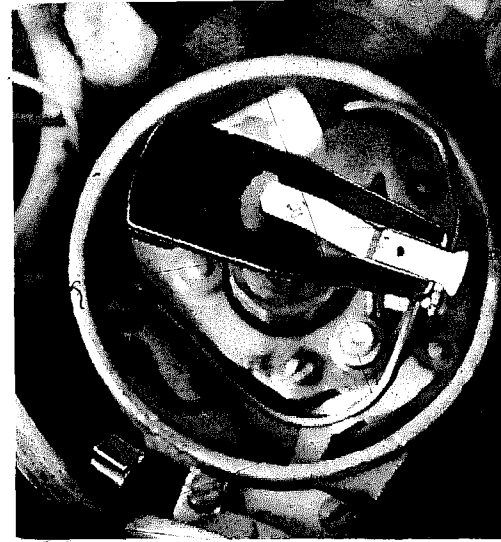
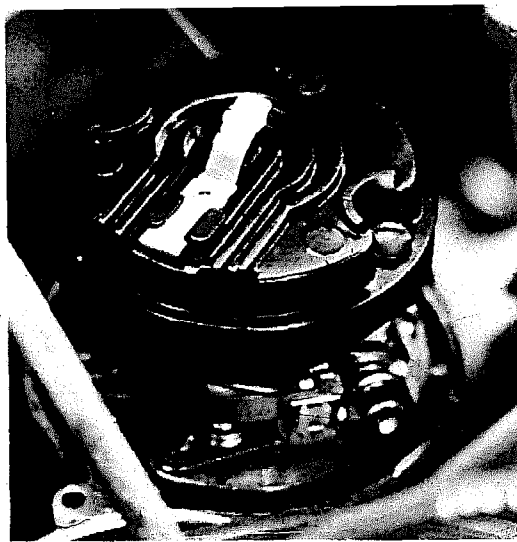

(left) **GM-type** rotor and distributor require slightly different service techniques than other distributors. (right) **Non-GM** distributor with rotor, points and condenser in place. Always note where the wires run from and connect to.

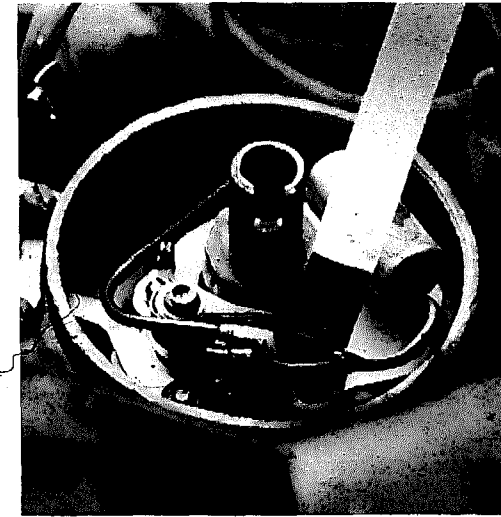
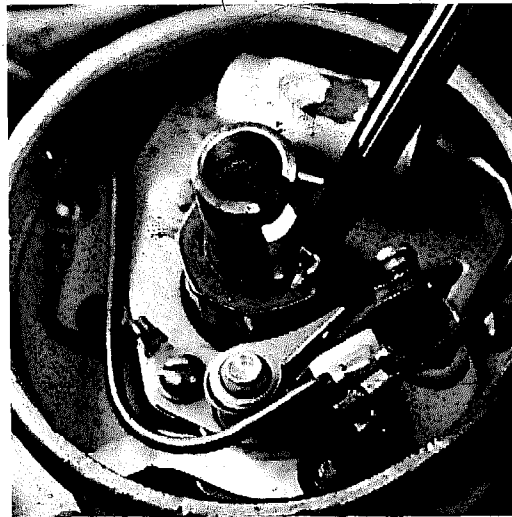

(left) **To adjust** the point gap, the rubbing block must be on a high lobe of the distributor cam. Some tuneup kits include a special ring that fits over the cam to hold the points open for gapping. (right) **With the points** held open by the cam, the gap can be adjusted to drag slightly on the specified feeler gauge. The adjustment slot is to the right of the feeler gauge and almost hidden by the wire from the condenser.

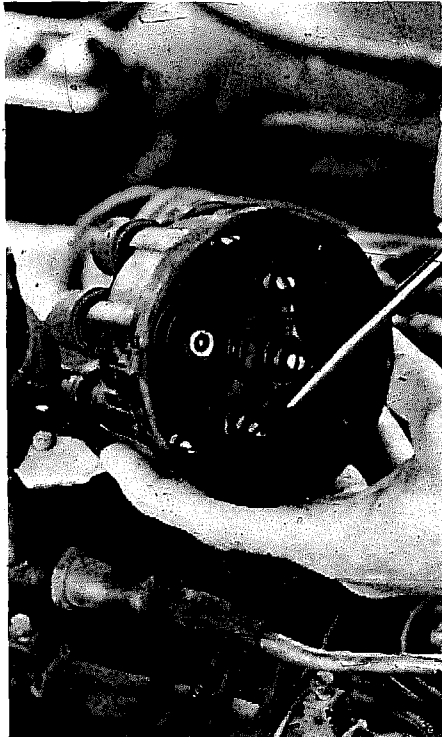

Light carbon deposits should be scraped off distributor cap contacts. If there is heavy carbon build-up or cracks in the cap, it should be replaced.

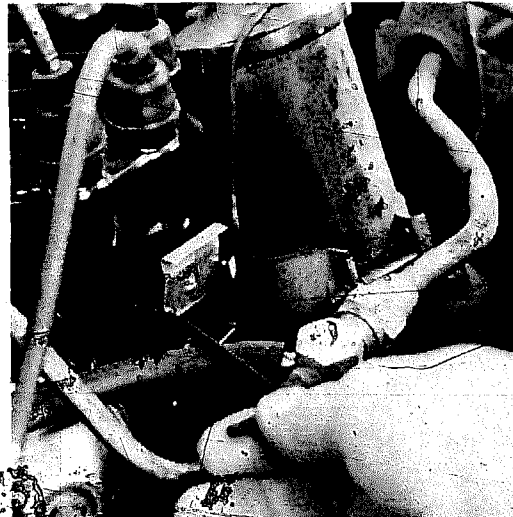

(left) **Dwell adjusting** access windows in the side of GM-type distributors allow points adjustments while the engine is running. If you don't have a dwell meter, turn the wrench to the right (clockwise) until the engine starts, to miss or dies. Then turn it back 1/2-turn to get the correct point gap. (right) **Before testing**, set the meter to either tach or dwell as well as selecting six or eight cylinder. For four-cylinder engines, double eight-cylinder readings.



the backyard mechanic

continued

throttle and choke valves wide open, crank the engine at least four revolutions. Make a note of the highest reading. Do the same thing with all the cylinders. Compare the lowest and highest cylinder readings. If there is more than a 25 percent difference, you have a problem with the valves, pistons or cylinders. If two low readings are side-by-side, there's a good chance of a blown head gasket. In any case, the tuneup should be put off until the repairs have been completed.

A vacuum gauge will help find even more problems than the compression check. For complete details about the vacuum gauge and its use, see the January 1980 DRIVER. Basically, you connect the vacuum gauge to a primary vacuum source on a warmed-up engine. Note the reading as the engine idles. The reading should be between 17 and 22 inches of mercury. However, some newer 4- and 6-cylinder models deliver acceptable performance at 15 inches. A slight flicker can be expected with high performance engines. There is also a drop of one inch for every 1,000 feet above sea level.

The good news comes with a steady reading at idle, while the needle drops toward zero and jumps past 20 when the throttle is opened and closed. Any other reading is bad news. Translations of these other readings into specific problems usually come with the gauge's instructions or see the January 1980 DRIVER.

The tuneup plug: An engine with a fresh set of sparkplugs gives the best fuel economy and performance. Therefore, if it is tuneup time it is time for a new set of plugs. In the long run the new set may be cheaper than cleaning the old ones. Always make doubly sure you're getting the correct plug for your engine. It is not unusual for the same size engine to use different plugs depending on manufactured year or horsepower rating. If you're changing heat ranges be especially careful—ask the parts counter person for assistance.

Although most plugs are pregapped at the factory, double-check each one to be sure it's to specifications. Install the sparkplugs finger tight. If they don't have gaskets, give them 1/16-

turn with the sparkplug wrench. Those plugs with gaskets get a 1/4-turn with the sparkplug wrench.

Getting to the point: After changing all the plugs you're ready to get into the distributor. Installing new ignition points and condenser are the only tricky

contacts with a wire brush or screwdriver.

Now remove the rotor. Check it over. If it is cracked, chipped, burned or corroded, replace it. But make sure the new rotor matches the old one in size, shape and design.

continued

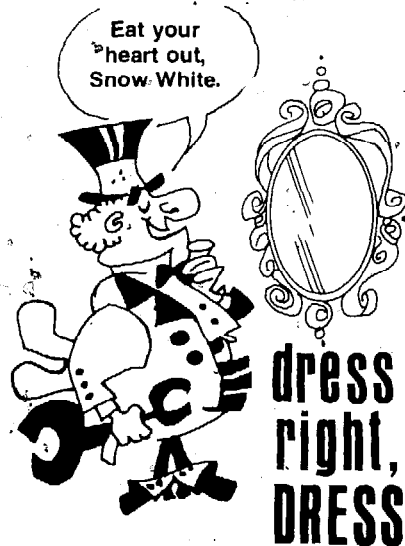

Dressing properly to work on your vehicle involves more of what NOT to wear than what to wear. When working on your car don't wear rings, watches, bracelets or any jewelry. Also don't wear neckties or loose clothing.

Wearing coveralls to protect your clothing and yourself from dirt and grease is a very good idea. Moreover, wearing safety-glasses is a must.

And you women backyard mechanics, tie up that long hair.

parts of a tuneup—but even this job is simple if you work carefully. (If you have an electronic-ignition system you won't have these items to replace.)

Whether your car has electronic or conventional (nonelectronic) ignition, you'll still have to remove the distributor cap and wipe it clean. Again, identify each cable so that it can be replaced on its correct terminal. Check the cap very carefully for cracks or excessive carbon deposits on the inside contacts. If either is found, a new cap is called for. If the cap is in good condition, gently scrape any carbon off the



■ Anytime you're working on a vehicle, read all the instructions available—the instructions in the manual on servicing the vehicle, the tool instructions, the instrument instructions, the first-aid instructions and the fire extinguisher instructions.

■ Set the parking brake. Put the transmission in neutral or the automatic in park.

■ If you're going to run the engine, make sure the area is well ventilated. If you can't ventilate the area, route the exhaust outside with a leak-proof hose. Carbon monoxide asphyxiation is to be avoided at all costs.

■ Keep hands, hair and test leads well away from the fan, fan belt, power steering belt, air conditioner belt, and any other moving parts.

■ Don't touch hot exhaust manifold, radiator, or high-voltage spark plug and coil terminals.

■ Never look down a carburetor while the engine is being cranked or running. Sudden backfires not only ruin good mustaches, beards and hairdos, the burns are painful.

continued

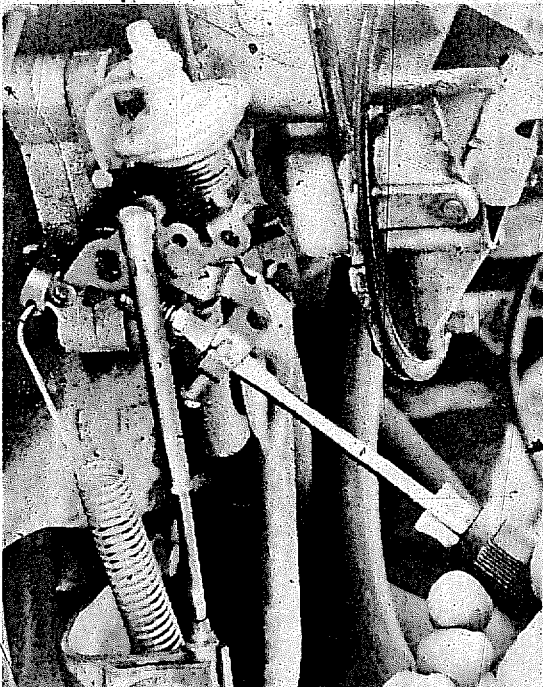

Hot idle speed is set at the solenoid or on the throttle linkage. Be sure to follow all the specifications and special procedures when setting the idle.

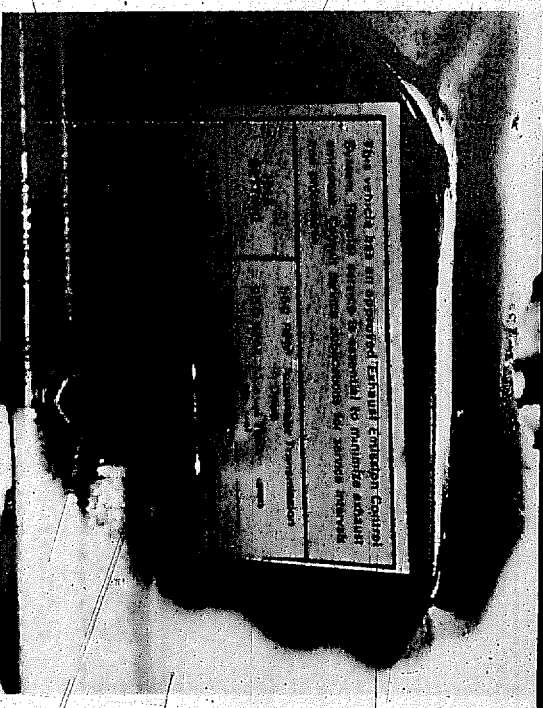

All cars made since 1971 have the vital specifications contained on an information plate in the engine compartment.

- Never use gasoline as a cleaning solvent.

- Keep a fire extinguisher rated for gasoline and electrical fires handy.

- Don't smoke or allow flame or spark to occur near carburetor, fuel line, fuel filter, fuel pump, spilled gasoline, cleaning solvents and other flammables. Be especially cautious of using anything electrical within 18 inches of the floor to avoid igniting gasoline vapors.

- Use the proper tool of the proper size for every job.

- Think about what might happen if your hand slips when working with a tight bolt or nut.

- Don't use worn tools.

- Don't cuss. Seriously, you may already have had one painful experience, but negative comments and thinking can distract you just enough to have another, more excruciating adventure!

At this stage if you have a conventional ignition, it's time to work on the breaker points. This is the time when you want to be especially careful not to drop any of the small hold-down screws. A magnetized screwdriver can be a big help.

On GM-type distributors, the points and condenser are held in place by set screws. Also notice that there are two wires that attach to the points. Generally the wires fit on a clip and can be pulled loose. However, some wires are held in place by a small nut—you'll need a small-ignition wrench to loosen

this nut. After removing the wire, carefully loosen the condenser and then the points by removing the hold-down screws. Now lift these parts off the plate.

Spray the plate with solvent and gently wipe it and the distributor clean. Apply a single drop of cam lubricant/lubricate the oil of the cam. Avoid over-lubricating.

Lock the new condenser on the plate with a screw in exactly the same place the old one was. Position the points on the plate with the guide hole over the guide post. Tighten down the screw and hook the wires back to the points. Since GM-type distributors are adjusted externally, put on the rotor and lock down the distributor cap.

The procedure for nearly all non-GM distributors differs when putting in the new points. Don't tighten the set screw all the way because adjustments have to be made. Tap the starter until the point rubbing block is on the peak of a cam lobe and the points are open. Insert a feeler gauge of the correct size (see your manual) between the points. Now adjust the gap until the gauge has a slight drag by moving a screwdriver blade in the special adjusting slots. Carefully tighten the set screw and double-check the gap.

Now connect the dwell meter according to its instructions and check for the correct reading. The manufacturer's dwell specification will be in degrees. On the GM-type distributors there is a small window in the cap. Slide this window up and turn the point-adjusting screw with a hex (Allen) wrench until you get the de-

sired reading on the dwell meter. Don't forget to close the window tightly when you're done.

Carburetor adjustments: One of the most important checks for fuel economy is the carburetor. Precise adjustment is necessary to get the best possible mileage from your vehicle. If your vehicle has fuel injection, don't tamper with it—it is best left to the experts. In almost the same self-service category as fuel injection are the carburetors on vehicles manufactured in 1975 and later. Strict exhaust-emission standards have made the carburetor one of the most complicated systems of an engine. It often requires expensive equipment such as an infrared exhaust analyzer, combustion analyzer and artificial enrichment with propane gas. Again, this is a job for the pros.

The pre-1975 models aren't so difficult. Warm the engine up, remove the air cleaner and connect a tachometer. Set the vehicle up according to the conditions outlined in the service manual on the vehicle emissions-control label. These conditions vary from manufacturer to manufacturer and can be very exotic. For example, some require the transmission to be in neutral, others in gear, some want the air conditioner on, others off, and still others specify lights on or off.

Check the tachometer to see if the idle rpm is according to the specifications. If not, locate the idle set screw at the throttle linkage or anti-dieseling solenoid and adjust it until the idle is at the right speed.

On pre-1974 engines you can also set the idle mixture as well as the idle

the backyard mechanic

continued

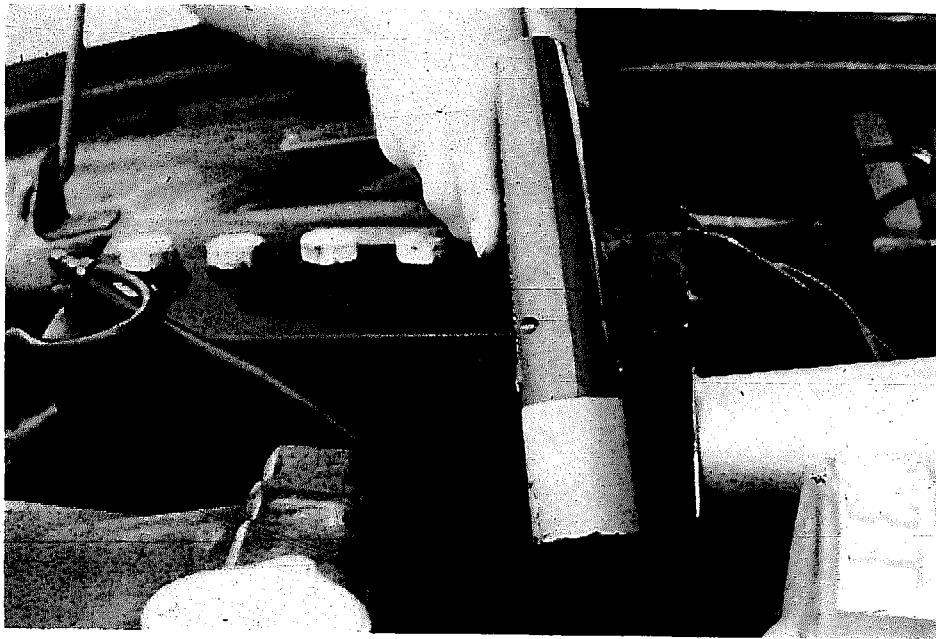

With the engine idling, aim the timing light at the marks, keeping it at about a 45-degree angle. Not aiming the light carefully is a major cause of timing error.

speed. Locate the mixture screw(s) one on single barrel carbs, two mixture screws on two-and four-barrel carbs. Turn the screw in until the idle roughens, then turn the screw out slowly until the highest possible tach reading is obtained. If there are two idle screws, repeat the procedure on the second screw. You may need to turn the idle speed down before adjusting the second screw since the engine may race when the first mixture is reset.

Never try to smooth out the idle by turning the speed up—a higher idle just wastes gasoline and contributes to dieseling. Finally, double check the idle speed with the air cleaner in place.

It's all in the timing: After setting the idle you're ready to make the final and most important adjustment—the ignition timing. With the tachometer and ignition timing light connected, locate the timing mark—you may have to clean the grease and grime off first. The mark is usually on the lower front pulley or on the vibration damper below the fan. Now carefully make a neat line with white chalk, white enamel paint or fingernail polish over the correct timing mark (given in your manual). This will help you see the mark while the engine is running.

Check the manual for information sticker to see if there are any special procedures for timing such as dis-

connecting the distributor vacuum advance line.

With the engine warm and idling at the correct speed, aim the light carefully at the timing marks. Not aiming the light properly is one of the primary causes of timing error—so be sure to keep the light at about a 45-degree angle and sight directly down the light.

The mark and timing pointer will align on each flash of the timing light if the timing is correct. If they don't line up, you will have to adjust the timing by rotating the distributor. To do this, you must loosen the clamp bolt that holds the distributor. Then slowly rotate the distributor until the timing mark and pointer align. Carefully lock down the clamp bolt and double check the setting.

The proof is in the MPG. Now re-check everything. Then after cleaning up your work area, buckle yourself into the vehicle and take a slow test drive. If everything seems to respond well, take the vehicle for a short highway drive. OK, you're all set. If you kept track of your miles per gallon before the tuneup, and you followed the tips from "Protecting^o Your Petrol Piggy Bank" earlier in this issue of DRIVER, you'll probably have a pleasant surprise the next time you compute mpg. It may even become More Pleasure Per Gallon. 

THE HOW AND WHY OF

filters

Servicing the various filters that your car uses is a rewarding job for two reasons: One, the actual job of servicing the filters (either cleaning or changing them) is really a simple job, and two, filter care is necessary to insure a normal service life for your car's mechanical components.

With the exception of the automatic transmission fluid filter and the power brake air filter, both of which do not appear on all cars, your car will always use three filters. They are the oil filter, the air filter, and the fuel filter.

Oil filter: Oil filters are necessary because one of the oil's primary functions is to clean internal engine surfaces. As the oil does its thing, the bits and pieces of junk removed from the engine have to go somewhere. Unless there is a filter in the system, these contaminants (both solid and chemical) stay in the oil and eventually go right back onto the surfaces inside the engine.

By using an oil filter, oil contaminants are trapped in the filter elements and do not go back into the engine. It's a good idea to change the oil filter each time you change the oil, because there isn't much sense in putting in four quarts of clean oil and leaving one dirty quart inside the filter. In less than five miles, the contaminated oil left in the unchanged filter will mix with the clean

oil and you've defeated the purpose of the oil change.

In order to change the oil filter, you'll need an oil filter wrench, some form of vehicle lift, and vehicle supports. You'll need the lift and the supports to get to the filter because it is usually located underneath the engine and you'll need space to wriggle underneath the car and get at it. The need for vehicle support (jack stands) should be evident. You'll also need a 5-or 6-quart container for the oil you'll be draining out.

Even though some filters are accessible from the top of the car, remember the filter is being replaced as part of the oil change. The engine oil drain plug is always located under the car, so like we said, you'll need to have the car up in the air.

After jacking or lifting the car up far enough for you to get underneath comfortably, and after you've put the weight of the car squarely on the jackstands, remove the oil drain plug which is located on the engine's oil pan. For good, thorough draining, the oil should be hot, and a 15-minute drive prior to draining should work fine. Be careful though . . . 15 minutes of driving will make all engine parts, including the oil pan and drain plug, very hot.

After the oil has stopped flowing from the drain hole, the oil filter can be removed. Simply slip the special oil filter wrench around the filter can-

nister (as shown in the accompanying pictures) and apply pressure counter-clockwise. Wrench safety rules dictate that you always pull a wrench, never push it. And remember, the filter, and the oil in it, will be very hot.

Lubricate the rubber gasket on the new filter with clean engine oil, and after oil has stopped draining from the filter mount on the engine block, install the new filter. Never tighten the new filter with the filter wrench . . . tighten it hand-tight only. If you tighten it with the wrench, you'll probably dent the outer layer of the filter and you will insure that after the filter has "set" onto the mount with engine heat, it'll be almost impossible to remove at the next oil change.

Reinstall the oil drain plug, refill with fresh oil, start the car and check for oil leaks, recheck oil level, and you're done. You can dispose of the old oil by simply taking it to a service station and pouring it in their drain-oil tank.

Some imported cars, and older GM products, have replaceable filter elements instead of actual cannisters or spin-on units. With this cartridge type, you must remove the cartridge container from the engine block, clean the container itself with safety solvent, and replace the cartridge. The long through-bolt that holds the container onto the engine will have one or more O-rings on it . . . check for tight fit and replace about every fourth oil

continued

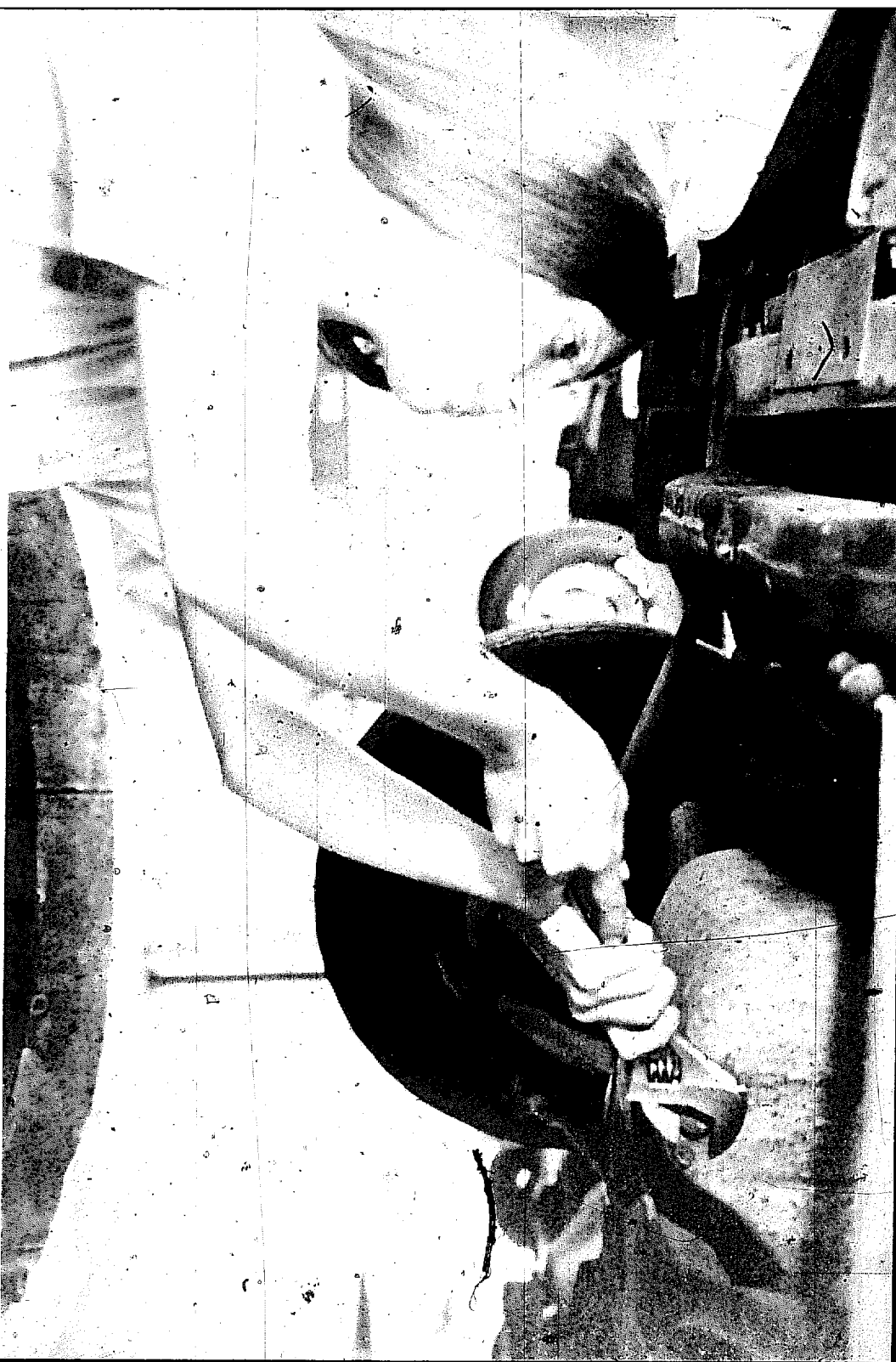

The oil drain plug in the engine oil pan is accessible only from beneath the car. Remember that wrenches should be pulled, not pushed. Saves the knuckles a lot of grief.

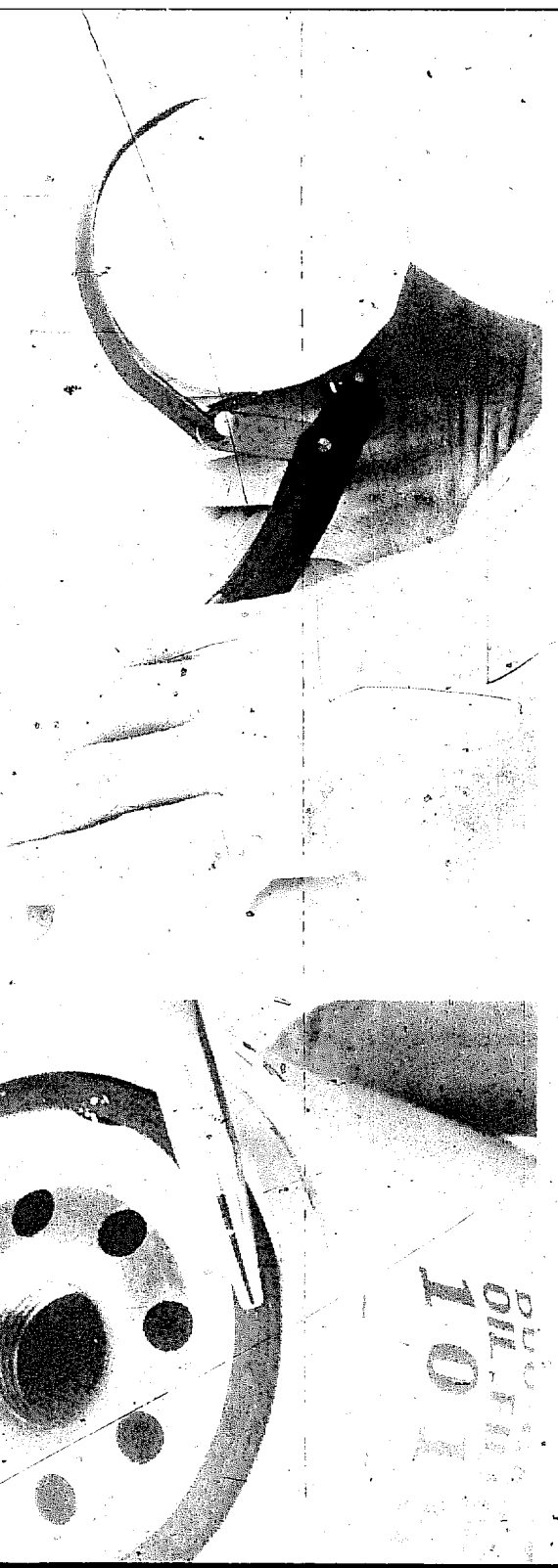

When removing the old oil filter, the oil-filter wrench fits on only one way. If the wrench won't tighten up, remove it and flip it over.

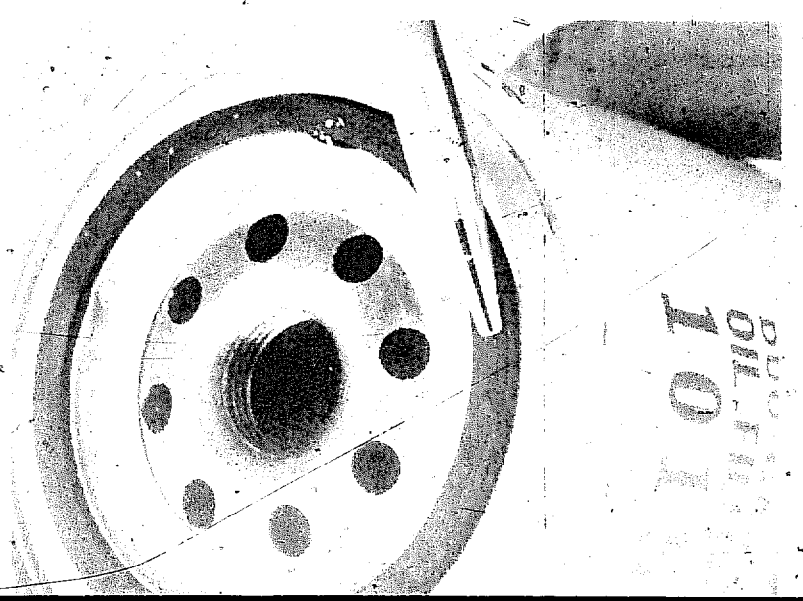

Spin-on type oil filters have rubber or neoprene O-rings to effect an oil-tight seal. Check the seal on the new filter for cuts or nicks before you install it.



After checking seat condition, pre-lube the seal with clean oil.



The new oil filter should be installed hand-tight only. If you put it on with a filter wrench, it'll take powers that you probably don't possess to get it off!

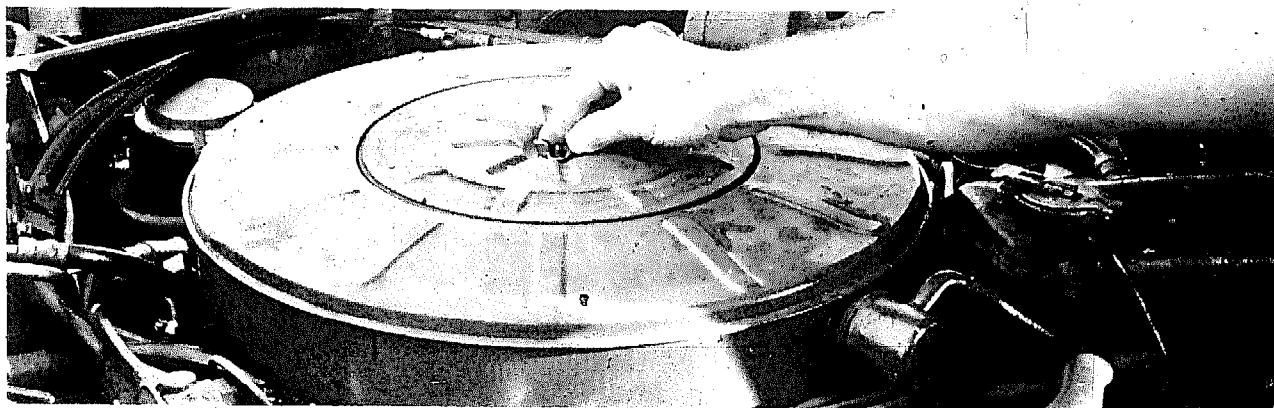

Underneath this huge metal cover lurks an air filter. Go ahead, remove the wing nut that holds the cover down.

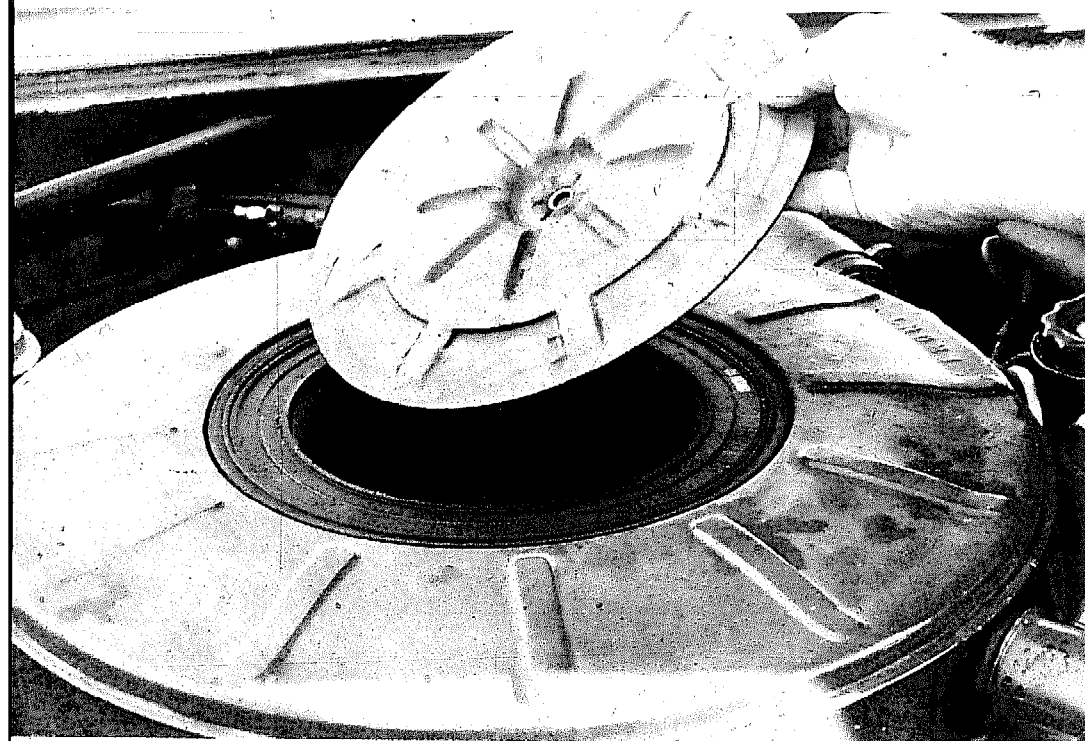

Remove the cover and VOILA! There you see the top of the air filter.

the backyard mechanic

continued

change. The container seats against a rubber seal inside the lip of the engine block mounting, and this seal should be replaced at every filter removal.

Air filter: This is really an easy one. On top of your engine you'll find a big piece that looks like a sewer cover (or a hubcap . . . smaller engines use smaller filters). In the center of this air filter housing there will be a wing nut (no jokes please) that holds the cover down. Just unscrew the wing nut, lift off the top of the filter housing, and remove the filter element. Install the new one after checking to see if it has any directions (like, "this side up" . . . some of them do) on it.

Some cars have three or four spring clips to hold the cover on, but that doesn't really make the job a lot more difficult, does it?

On a very few cars, the filter set-up can be a bit complicated. Cars equipped with fuel ejection or turbochargers can be like this, but your owner's manual will show you how to remove and replace the filter.

A small minority of cars are equipped with a cleanable foam air filter. Just gently remove the foam from its wire cage and soak it in safety solvent. Then, gently squeeze it, don't wring it out. Allow it to dry and then dunk it in clean engine oil. Again, gently squeeze out the excess oil, and refit it to the wire form.

After you lift off the filter cover, you may discover another, much smaller filter on the inside of the filter housing. This is to strain air going to a positive-crankcase-ventilation system. It slips in and out easily, and should be replaced at intervals specified in your owner's manual.

Gasoline filter: There are three types of fuel filters in use today: one is an element type mounted in or on the fuel pump; the second is a small plug of sintered bronze or pleated paper that fits into the carburetor fuel inlet boss, and the third is an in-line filter that mounts between the fuel pump and the carburetor.

The fuel pump type is replaced by simply unscrewing the cover (it may look like a mini oil filter), lifting out

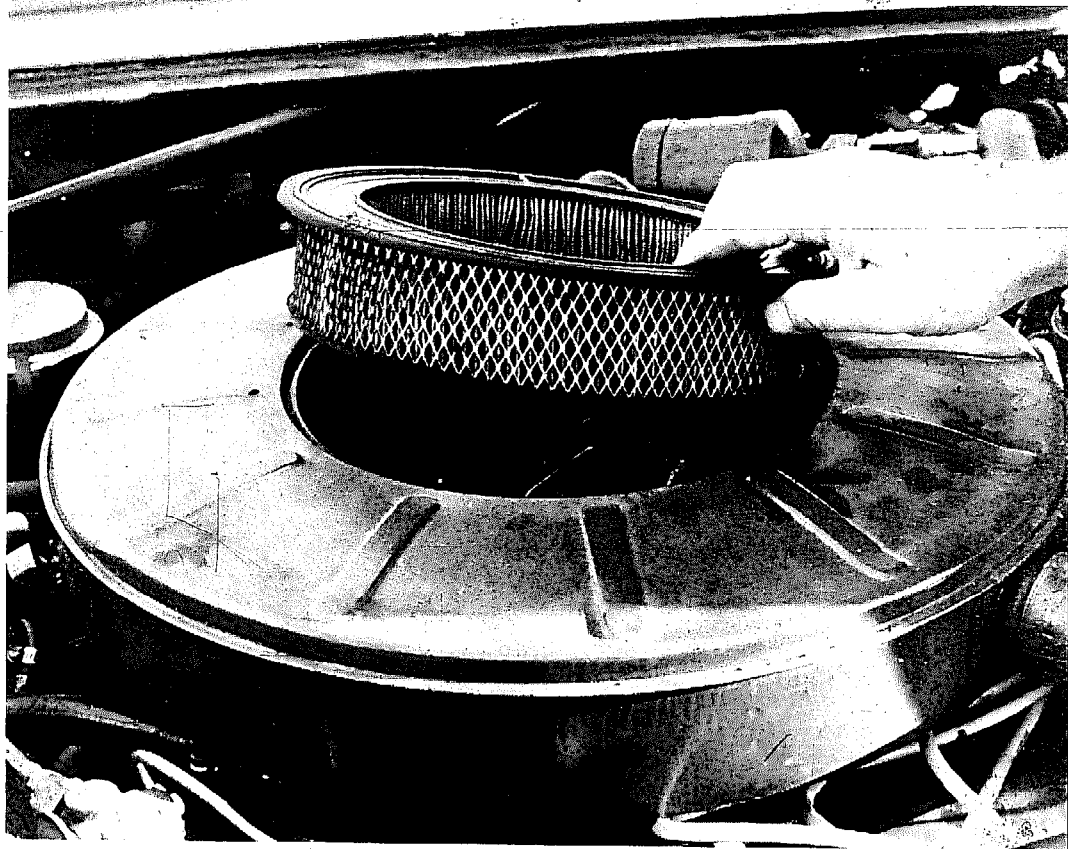

Just remove the old filter and slip in the new one. What could be easier?

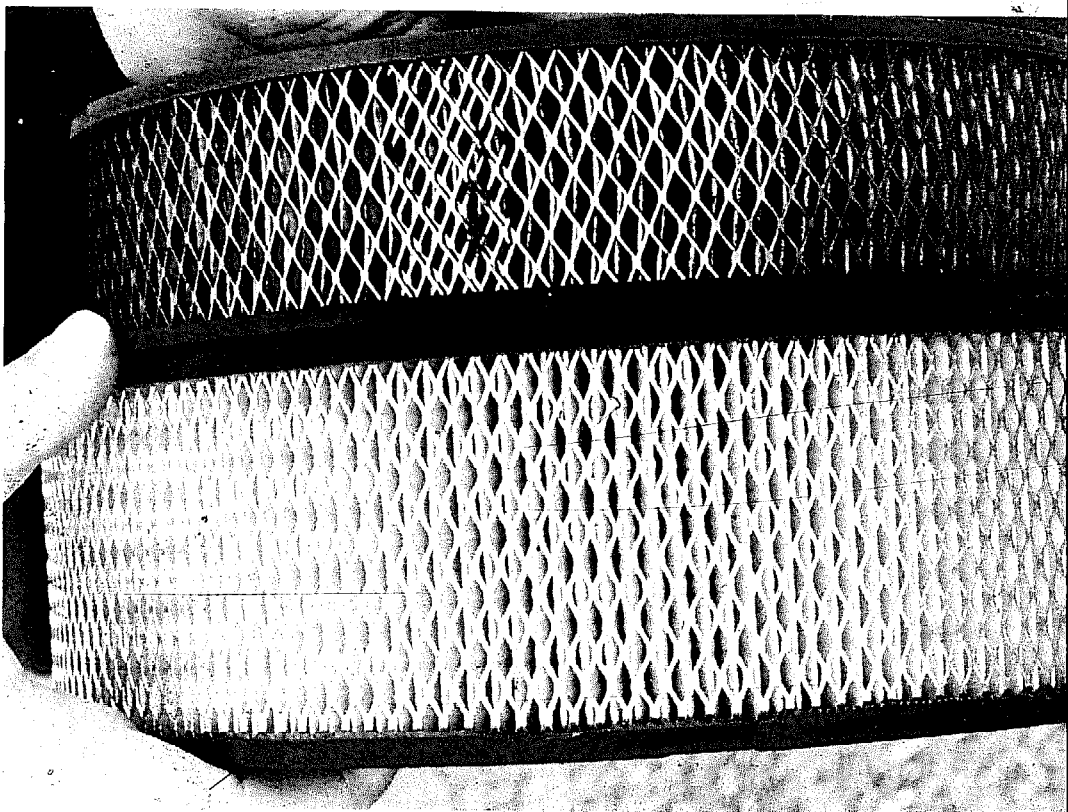

Can you tell the difference between the clean air filter and the dirty one? If you didn't have an air filter, all that yecch that the filter collected would be inside your engine, wearing things out!

continued

299
Emission
Control Filter



Small emission control filters fit inside the air cleaner housing. Not all cars have them, so check in your owner's manual to see if your car needs one, and how often it should be replaced if your car is so equipped.

3051

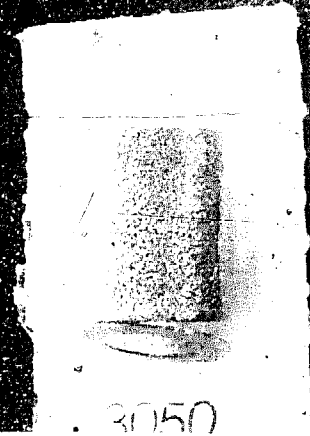

Sintered bronze and pleated paper are just two of the different materials used for in-the-carburetor fuel filters.



In-carb filters have little springs to position them. If you get fumble-fingered, the little spring will occasionally fall somewhere down inside the big engine, where it will be eaten by a gremlin . . . do not drop the spring.

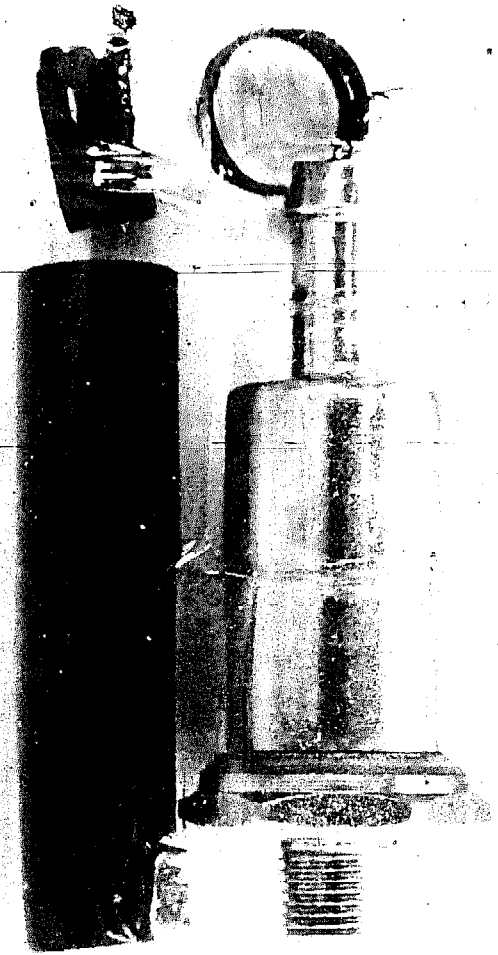

This type of fuel filter fits between the fuel-line and the carb. It can be overtightened very easily, and you'll wind up buying a new carb top or whole rebuilt carb if you strip the threads in the carb . . . be gentle, but firm.

the backyard mechanic

continued

the element, replacing it with a new one, and reinstalling the cover.

The type that fits inside the carburetor inlet boss (GM and late-model Ford products) requires undoing the fuel line fitting. Pull the fuel line out away from the carb (gently now, you don't want to bend the fuel line). Inside the carb housing you'll see the actual filter. Usually, there will also be a small easily-lost filter positioning spring . . . if you drop this spring, we guarantee you'll never find it again, so be prudent.

You can replace this type of filter, or you can discard it entirely in favor of an in-line type filter that is much harder to lose and that doesn't get clogged as often. This in-line type is now the most popular type of fuel filter since it's the easiest to install. It's also available in a kit that will include new fuel line fittings and extra, flexible fuel line.

The kit differs from the replacement-type filter in that the extra lengths of hose are included. The boxes for both contain four spring clamps.

To replace the filter on a car already equipped with an in-line filter, remove the clamps. The original-equipment clamps are pry-off things that you discard. Pull the hoses from the filter

necks and discard the filter.

Fit a spring clamp onto each hose. This can be done by spreading the tangs of the clamps with an ordinary pair of pliers, but it ain't easy! Instead, try filing a notch in the top of each plier jaw . . . the notch will hold the tangs with ease. If you're not too good with a file, run on down to your friendly auto parts place and ask for a pair of hose clamp pliers.

Then install the filter, making sure the arrow on the side of the filter points toward the carburetor. With the hoses firmly in place, spread the tangs of the clamps and move them to positions on the hoses that coincide with where the filter necks fit inside the hose.

The replacement type kit takes about 30 minutes to install and requires a tubing cutter.

Find a six-inch section of fairly straight fuel line between the fuel pump and the carburetor. Using the tubing cutter, chop out the section. (after, of course, cleverly measuring the length of the new filter). Fit a short length of flexible fuel line on the necks of the filter and secure them with the clamps.

Position the entire assembly into the gap in the fuel line and secure the whole shootin' match with the other two clamps.

Oh yeah, check for leaks. We'd rather not have you running around with gasoline leaking out onto that hot engine.

IF: If you can manage to change the oil, air, and fuel filters in your car, you may have the confidence to move on to bigger and better things, like the automatic transmission and power brake filters. However, we won't get into those two types of filters here because, with very few exceptions, these filters do not routinely need changing. They are replaced when the parent unit is rebuilt. They both require more time, labor, and tools than the average backyard mechanic has at his or her disposal.

But if you managed to get those filters changed and your car still runs, maybe that means that there are a few other little jobs that you can do. The more little jobs you do, the more confidence you have, and then the more jobs you'll do . . . it's a very pleasant, money-saving circle.

If you save money doing routine maintenance yourself, you'll have the money to get those major safety-related problems ironed out, things like tires and front-end repairs. And that, after all, is what "The Backyard Mechanic" is all about! 

True in-line type fuel filter mounts in the gas line, is easy to replace, and you can't strip threads in the carb housing. Its large size allows it to go longer periods between changes, too.

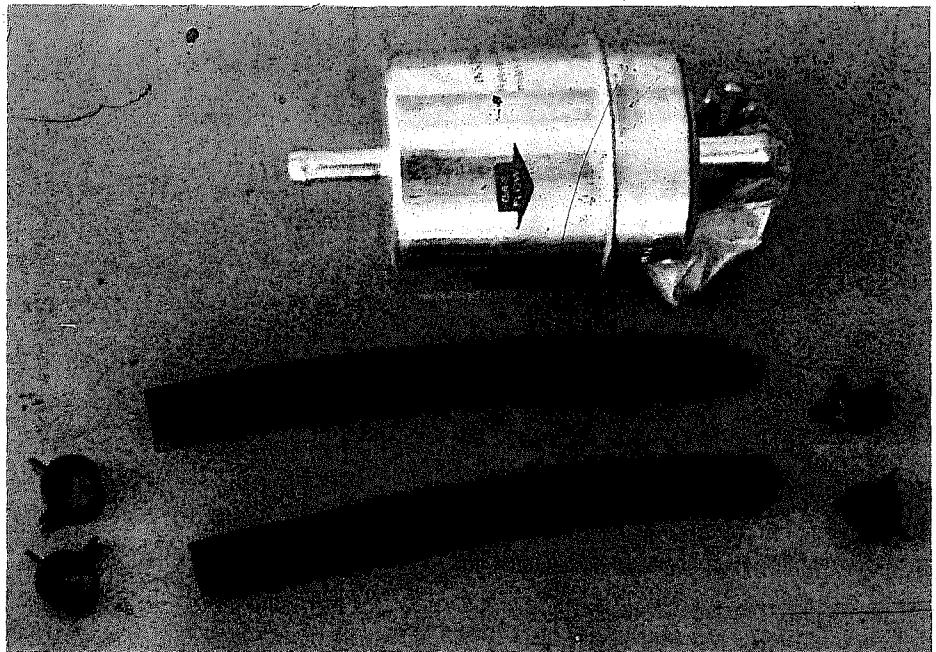

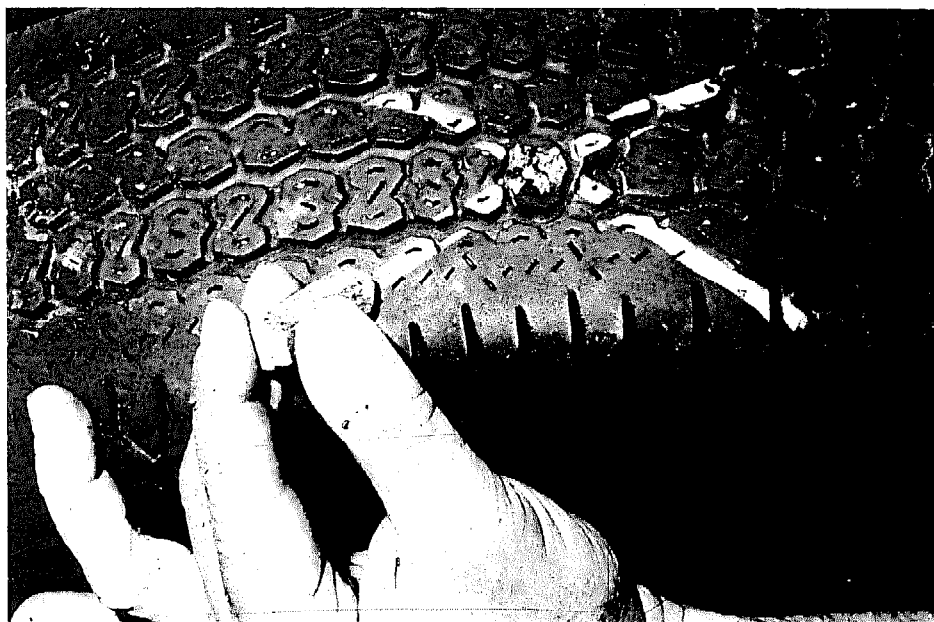

STEP 1: Inflate the tire to about 20 psi and use soap solution to locate puncture. Deflate the tire completely. Demount the tire carefully, using ample lubricant to prevent bead damage.



STEP 2: Locate and mark the damage. Remove the puncturing object and gently probe for evidence of separation and run-flat damage.

The routine usually goes like this: you pull into the gas station and tell the attendant, "I've had a flat tire and it's in the trunk . . . can you fix it?" The guy says, "Sure," pulls the tire out of the trunk and wheels it into the dark recesses of the garage. About 35 seconds later, he's back with the tire and says, "OK, that'll be \$4.50."

Of course, sometimes, they'll try to fool ya and say, "Sure, we can fix it, but you gotta leave it for two days!" It all comes down to the same thing . . . many stations just find the hole, use an air gun to put in a plug drenched with rubber cement, add some air, and give you back your "repaired" tire. It usually lasts until you're out of sight of the station. Sometimes, though, it'll hold up until you're on the freeway with the trunk loaded and all your relatives in the car . . . and a blowout at that point is not only irritating, it's dangerous.

We asked Firestone Tire Co. if there was really a correct and thorough way to patch tires so that they would be safe as well as sound. They told us "YES," and then gave us the step-by-step description of the best way to correctly seal a puncture in a bias, belted bias, or radial tubeless tire. They also gave us some safety-tips that can really help save your bacon.

So, if you get a flat, take this issue and get on down to the base hobby shop. If you're too far away from the hobby

After all, it's only flat
on the
bottom!

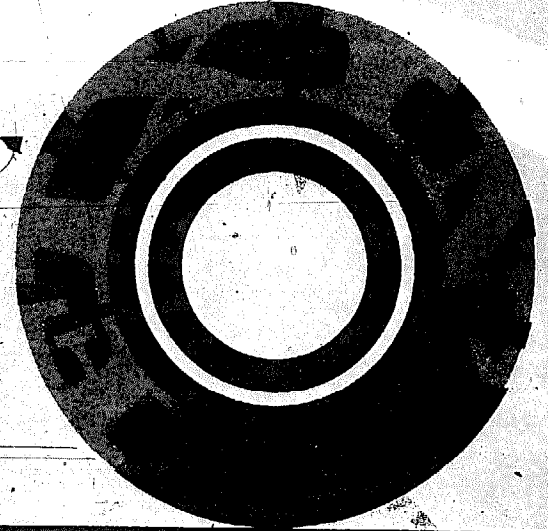
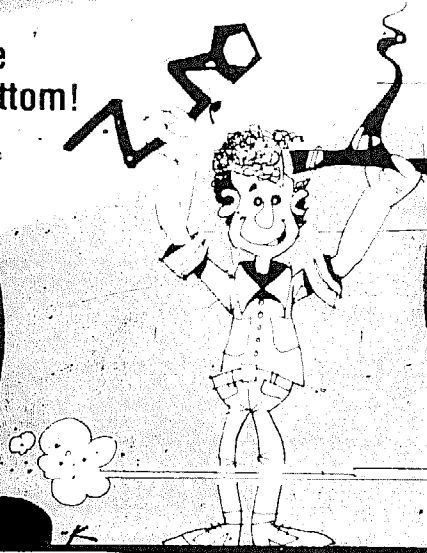
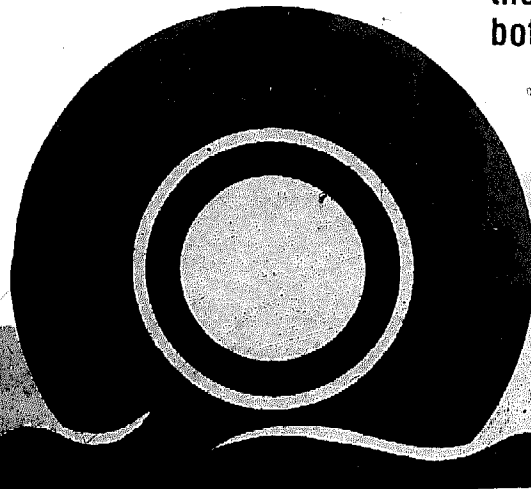

for Tubeless Tires

shop, take it to a reliable garage and tell 'em you want the tire patched *this* way, and this way *only*. After all, your safety, and the safety of your passengers, is too important to trust to a second-class tire repair job!

SAFETY TIPS

- *Never* repair *any* tire without internal inspection for evidence of damage caused by running the tire while flat.
- *Never* repair tires with run-flat damage, tread or ply separation, or defects.
- *Never* repair tires which have less than $\frac{1}{16}$ -inch tread depth remaining.
- *Never* repair damage greater than $\frac{1}{4}$ -inch in diameter.
- *Never* repair damage outside the repairable areas shown in the accompanying illustrations.

■ A SPECIAL WARNING NEVER INFLATE THE TIRE BEYOND 40 LBS PRESSURE!

If, when reassembling the repaired tire, the beads have not seated by the time pressure reaches 40 pounds, *deflate* the assembly, reposition the tire on the rim, relubricate, and reinflate. After seating the beads, adjust inflation to recommended pressure. Allowing the air pressure to build within the assembly in an attempt to seat the beads is *dangerous*. Inflation beyond 40 pounds pressure may break the head (or even the rim) with explosive force. Inspect

both sides of the tire to be sure the beads are evenly seated. If not, completely deflate the tire, unseat the beads, and repeat the entire mounting procedure. If a ring-type or other bead-seating device is used, follow the manufacturer's instructions to the letter. Again, *never exceed 40 pounds* inflation pressure.

■ Although the major tire companies say that a properly repaired tire is as good as new, we still remember when a repaired tire was relegated to use as a spare only. So if we were going to carry heavy loads, or drive on freeways a good portion of our time, we would place the repaired tire as the spare, just out of habit.

continued

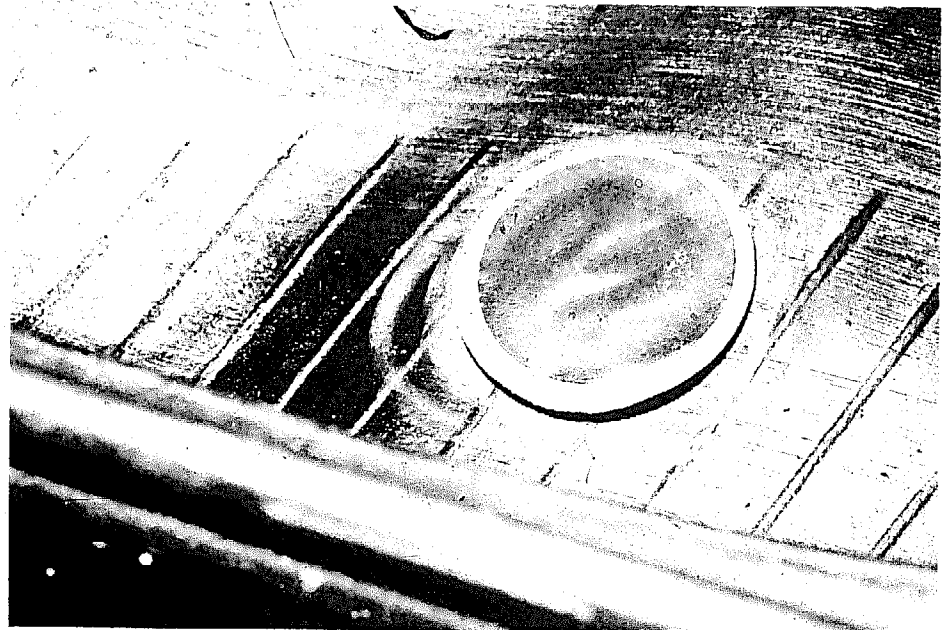

STEP 3: Spray liquid rubber buffer on the inner liner. Wet an area slightly larger than the patch you're going to use, and allow it to soak for 15 seconds. Remove dissolved material from inner liner with a scraper. Center the patch over the damage and draw a circle slightly larger than the patch.

the backyard mechanic

continued

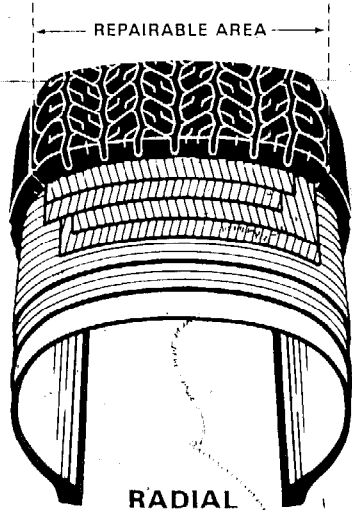
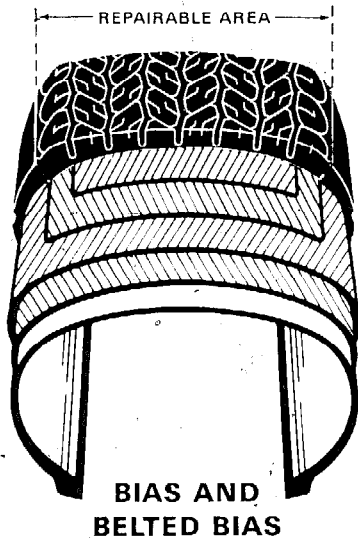
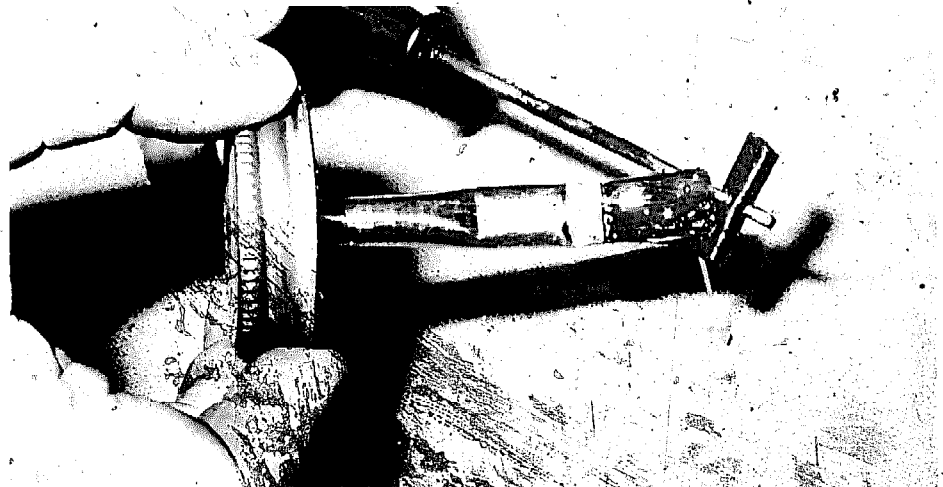

Fig. 1

NOTE: If the hole is too small for insertion of a plug, skip STEPS 7, 8 and 9. Use STEPS 10 and 11 instead.



STEP 4: Buff the area lightly or scrape it with a wire brush to remove molded pattern on innerliner, but don't buff through the innerliner. Vacuum to remove dirt and rubber dust.



STEP 7: Attach the plug to the probe. Apply cement to the plug and the tip of the probe. Don't touch the surface of the plug with your hand, since the oils on your hand won't allow the cement to adhere to the plug.

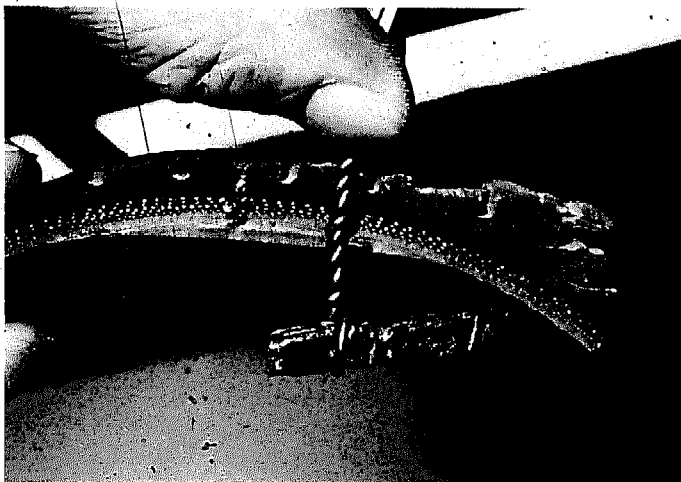

STEP 10: Insert closed end of the wire-inserting tool into the hole and pull it through to the halfway mark using pliers. Insert a plug through the "eye" of the tool about 1/4-inch. Apply cement to the plug and the "eye" of the tool (right). **STEP 11: Grasp the closed end** of the inserting tool with pliers and pull the tool and the plug into the hole, ending up with the plug end protruding slightly above the tread. Only one thickness of the plug should be required to fill the hole. Remove the inserting tool.

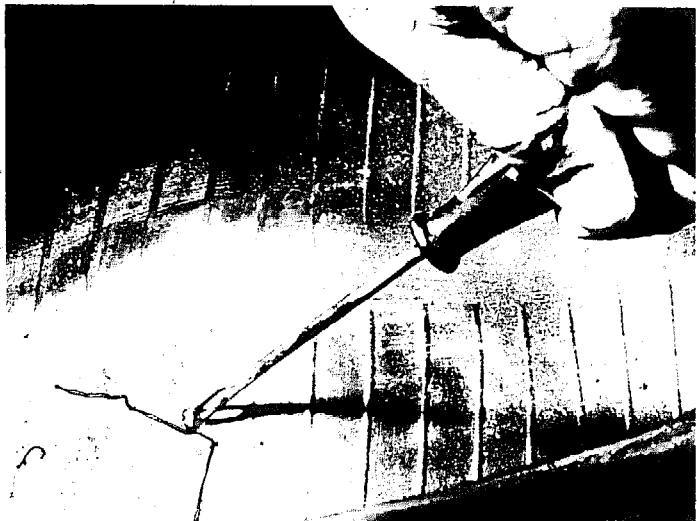
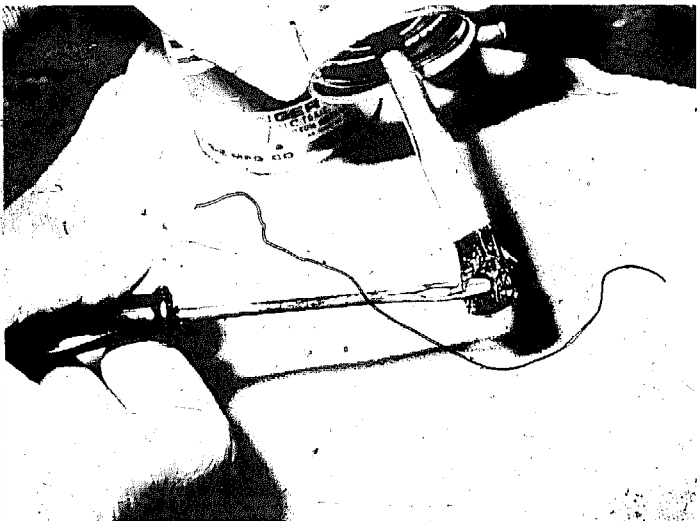

STEP 5: Apply cement to the probe inserter, but don't do it by dipping the probe in the can of cement because that'll contaminate the cement. Be sure the cement you're using is specifically designed for cold vulcanizing (right). **STEP 6: Insert the probe** into the damaged area and work it up and down to help remove junk from the hole. Then repeat steps 5 and 6 again. If the hole is too small to probe, then a plug isn't required. In this case, move on to STEP 13. (NOTE: If a steel-belted bias or radial construction tire has a puncture big enough to require a plug, but the hole is too small to insert both the probe and the plug without the wire cord tearing the plug, go to STEP 10.)

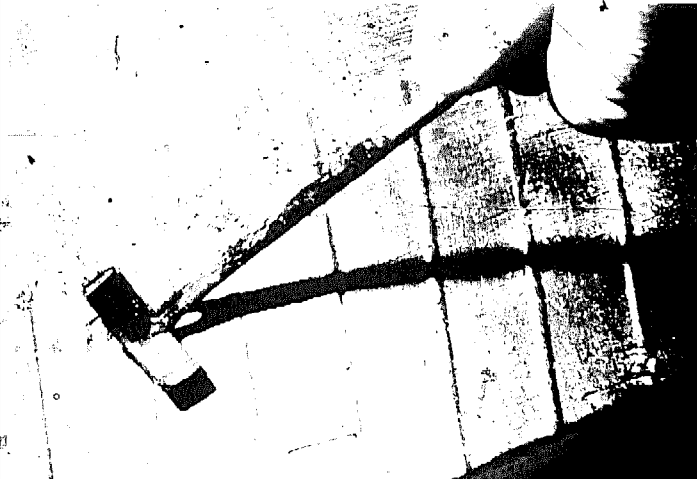

STEP 8: Insert the plug and probe into the hole. The plug must extend above both the tread and the innerliner surface. If the plug pops through, discard it and repeat STEPS 7 and 8 using two plugs on the probe (right). **STEP 9: Probe should extend** through the tread surface as shown. Remove probe slowly and go to STEP 12.

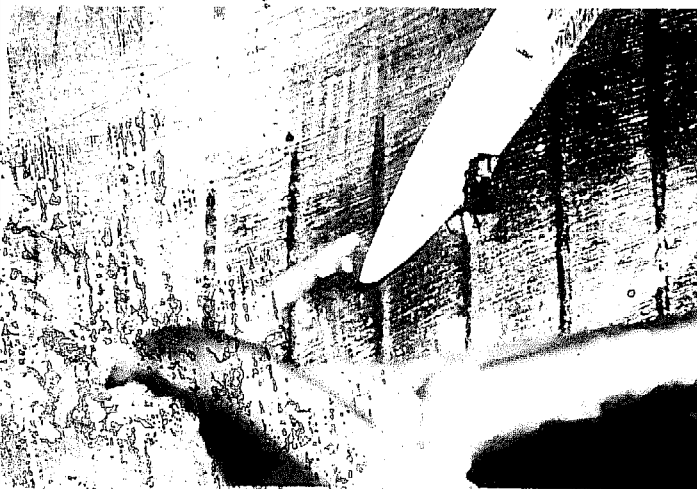

STEP 12: Trim the excess plug (on innerliner side) $\frac{1}{32}$ -inch above surface. Don't pull on the plug while cutting (right). **STEP 13: Using a clean brush**, apply cement to buffed area. Don't overlap onto unbuffed area. Allow cement to dry for 20 to 30 minutes.

Continued

the backyard mechanic

continued

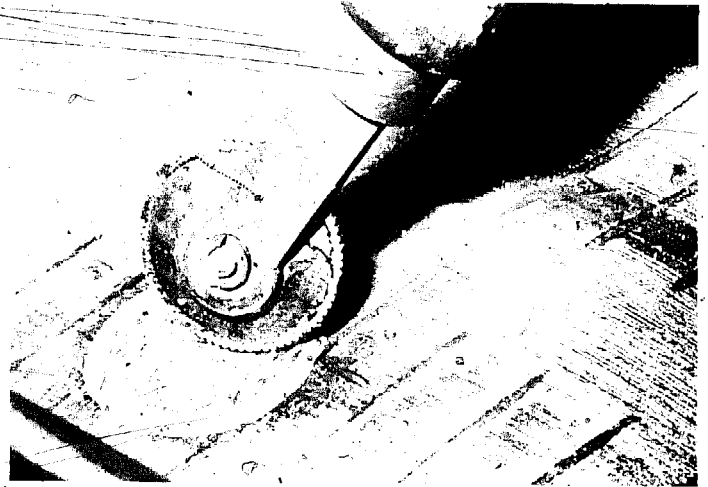
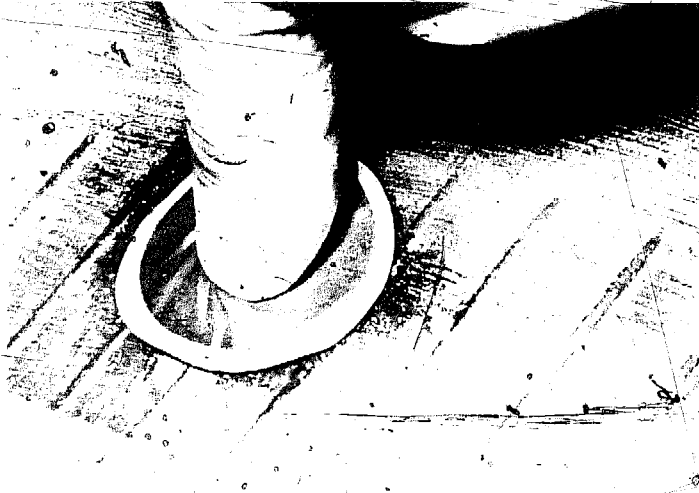

STEP 14: Remove patch backing, and center the patch on the hole using thumb pressure (right). **STEP 15: "Stitch" patch down**, working from the center to the edges. Then, remove the paper or plastic covering.

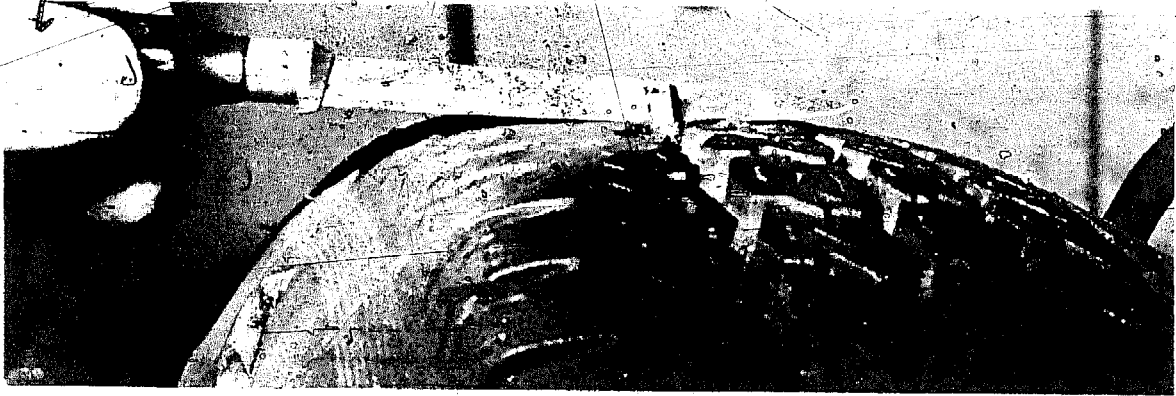

STEP 16: Trim the plug 1/4 to 1/2-inch above tread. Mount and inflate the tire and use the soap solution to make sure the leak is sealed. Bubbles will indicate air loss.



The Backyard Mechanic

Replacing automobile headlights is as simple as turning a screwdriver. Aiming them correctly is also relatively easy.

First of all there are some of you out there that can't be trusted to buy the correct lamp for your vehicle. However, everybody should pay close attention as I feel a quiz coming on.

Walk to the front of the car and take a good, long look at the lights. They'll either be round or rectangular. Remember which. Better yet, write it down on a slip of paper. Now count the number of headlights. There should be either two or four. If you get a number different than two or four you've counted something that isn't a headlight or your vehicle has an auxiliary lighting system. (A little hint here: Auxiliary lights are usually not built into the body of the car, while headlights normally are built in. There are exceptions to this, but the people that buy the cars that are the exceptions usually know it to begin with.)

With six you get a headache: If they are round and there are two of them, you'll need 7-inch replacement lamps. But if there are four round headlights, it is the 5 $\frac{3}{4}$ -inch model that will be required.

Should your vehicle have two rectangular lights, then you'll need 200mm replacements. Four rectangular lights call for 4x6-inch replacements.

With both round and "square" two-light systems, there is only one type of replacement bulb; however, the four-light models come in two types. One is a low/high light, while the other is a high beam only. How do you know which you need? Simple: the lights closest to the sides of the car (or top, on some) are the low/highs, while the inside or lower lights are high beam only.

Question: A vehicle has four round headlights. The left light, closest to the grille is burned out. What replacement lamp is required?

- A. 200mm "square"
- B. 7-inch round
- C. 5 $\frac{3}{4}$ -inch round low/high
- D. 5 $\frac{3}{4}$ -inch round high

Answer: D. The quad-light systems use the smaller bulbs with the low/high beams mounted as far to the sides of the vehicle as possible, and the high-beam-only lights mounted inside or below the others.

Out with the old, in with the new: Whether you're replacing a burned out bulb, installing brighter halogen seal-beams or European-style headlights, the steps to take out the old, put in the new are the same.

But before we get started, a few words about screws. Most automobiles are put together with Phillips head screws which allow machine assembly. The head can become clogged with sand and dirt making it difficult to get at. The more serious mechanics might consider replacing the Phillips head screws with slot head types.

Additionally, almost all the screws in the headlight assemblies are exposed to road splash and are frequently rusted. It is wise to spray them with rust-penetrating solvent before even thinking about turning them. Whatever you do, don't force them or you could ruin the mounting threads.

Those of you with concealed headlights are going to have to find a way of keeping the cover open while working on the lights. Most manuals will tell you how to accomplish this. If not, almost any mechanic or service manager can provide such information over the telephone. Sometimes it's easier to just remove the cover.

To get at the light itself, remove the headlight body molding. It is usually held in place by sheet metal screws. Once you've put the molding aside so that you don't step on it, remove the retaining ring screws and the retaining ring. Now all you have to do is carefully pull the headlight assembly out and unplug it from its wiring assembly.

Plug the replacement lamp into the assembly and carefully push the unit back into the adjusting ring where the other bulb was removed. There are glass tabs on the replacement bulb that help position the lamp when properly aligned in the adjusting ring slots. Put

the retaining ring over the bulb and install the attaching screws.

Another word of caution: Don't over-tighten the retaining ring screws when installing quartz lights. The lead crystal lens of these lights get hot when operating and the stress from over-tightening can easily lead to cracking from vibrations or even cold water splashes.

At this time you have to decide if the molding allows access to the adjusting screws when it is in place. If not leave it off until the headlights are aimed, otherwise put it back on. The same with the door or cover, if you removed it.

Ready, aim, light: As few backyard mechanics are going to lay out \$500 for a track-type aimer, headlight alignment will be limited to the portable aimer or casting shadows on a wall. Neighboring backyard mechanics with more than one car per family might pool their resources for a \$100 portable aimer. However, most of us will have to trek to the auto hobby shop to use one.

A versatile device, this system contains two aimers, with adapters for two- and four-lamp systems, rectangular headlights and floor slope measurement. *Floor slope measurement?* Yes, floor slope measurement. It's like this: if you aimed the lights while the car was on a hill, they would be properly aimed only for that hill. Therefore, you must either have the car level when actually aiming the lights or make adjustments for the slope. Which brings up another good point: Always have the tires properly inflated and at least half a tank of gas in the tank before attempting to aim the lights.

You start the aiming process by placing one of the aimers with floor slope measurement adapter beside the front wheel and the other beside the back wheel. On the same side of the vehicle, of course. Then level each adapter with the built-in bubble level and adjuster. Now look into one aimer turning the dial until the image from the other aimer is lined up. The dial

continued

the backyard mechanic

continued

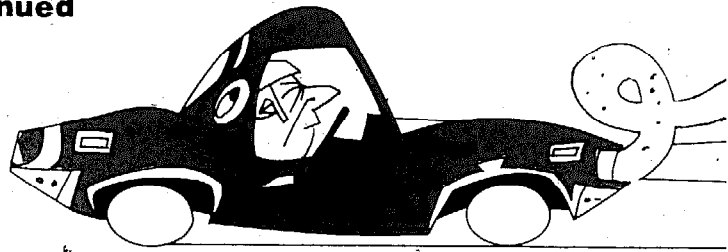

After insuring that the door will stay open, remove the headlight body molding to get at the lamp.

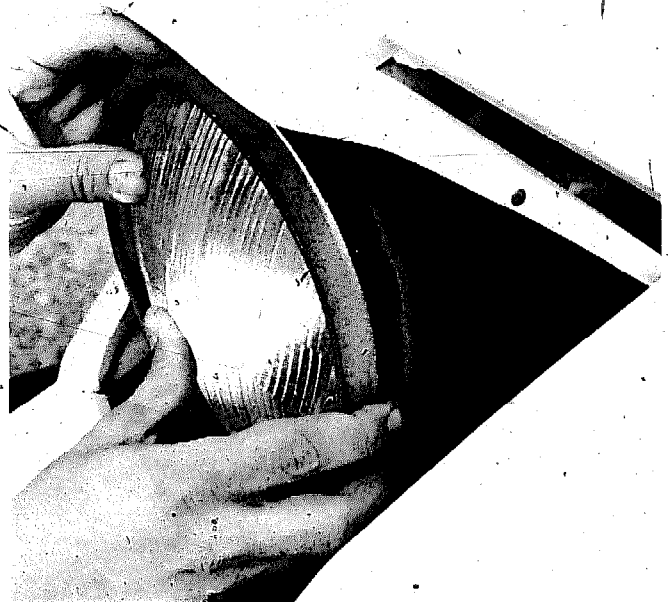

Having removed three screws, you can now remove the headlight retaining ring.

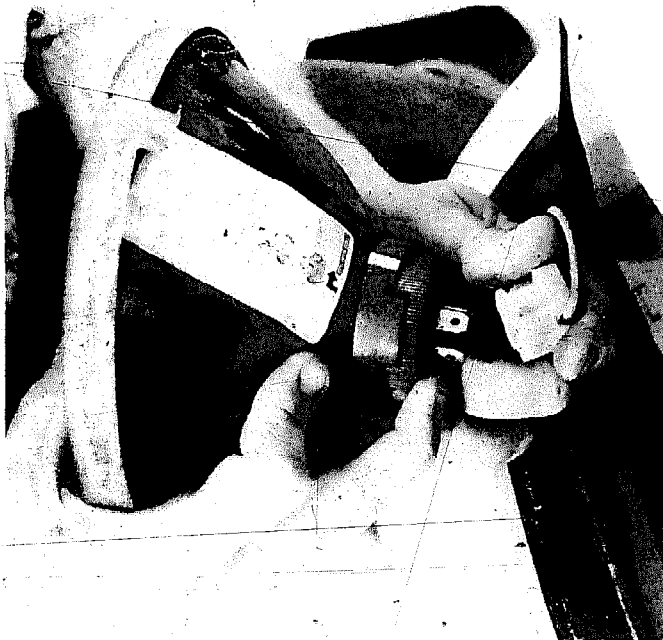

Pulling the lamp slowly from the housing, simply unplug it and plug in the replacement.

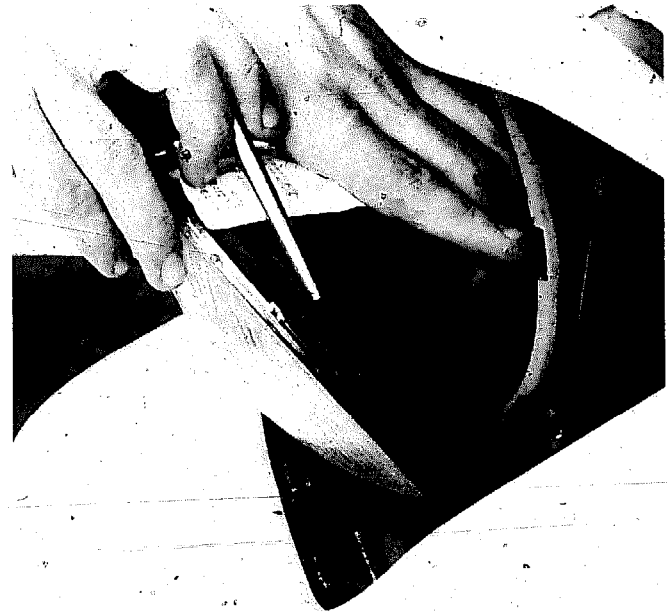

When pushing the bulb back into the housing be sure to align the tabs on the light with those on the housing.

HIGH BEAM AIM AT 25 FEET

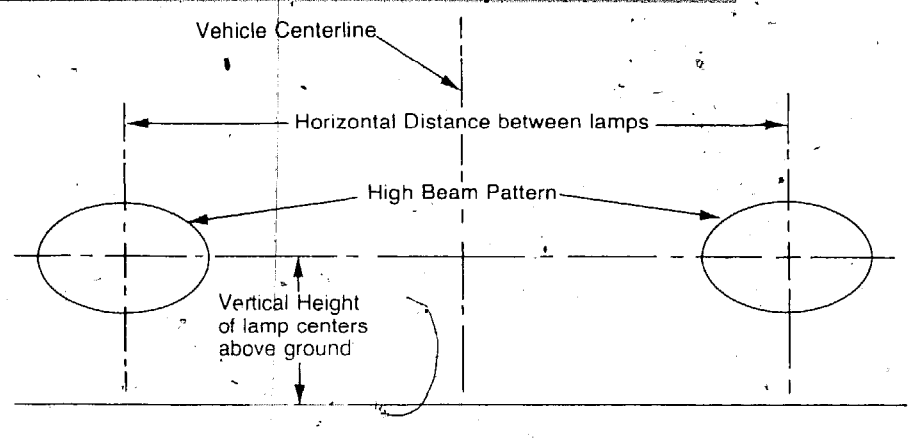

reading is the slope of the floor. This reading is then dialed into the aimer to automatically compensate for the floor slope during alignment.

The aimers can now be attached to the headlights via a special suction-cup arrangement. For vertical adjustment, turn the screws until the bubble is level. Horizontal adjustment is

aided by a set of mirrors and a split-image focusing arrangement. When properly aligned, the reflected image from the opposite-side aimer split by the mirrors will be lined up.

Zapping the garage door: Now there are ways of aiming headlights without all this fancy equipment – provided you have the time. First you'll

need a level area about 50 feet long and a "screen." This level area will have to be easy to get to and easy to find reference points on. This will allow you to duplicate the set-up in the future. The screen can be anything – the garage door, a wall or a piece of plywood a few inches wider and taller than the front of your vehicle.

Ideally, you would first take the car to a professional for aiming. Then you will position the vehicle on your level area, square with the screen and mark on the screen the center of the beam patterns. If you don't want to mark up your garage door, you might position plywood or cardboard in front of it as the screen. It is also a good idea to mark on the back of the screen the exact position of the car in reference to the screen to make future duplication easier.

You'll develop a marking system that best suits you. But if you are looking for a place to start, why not mark the center of the low beams with an

continued

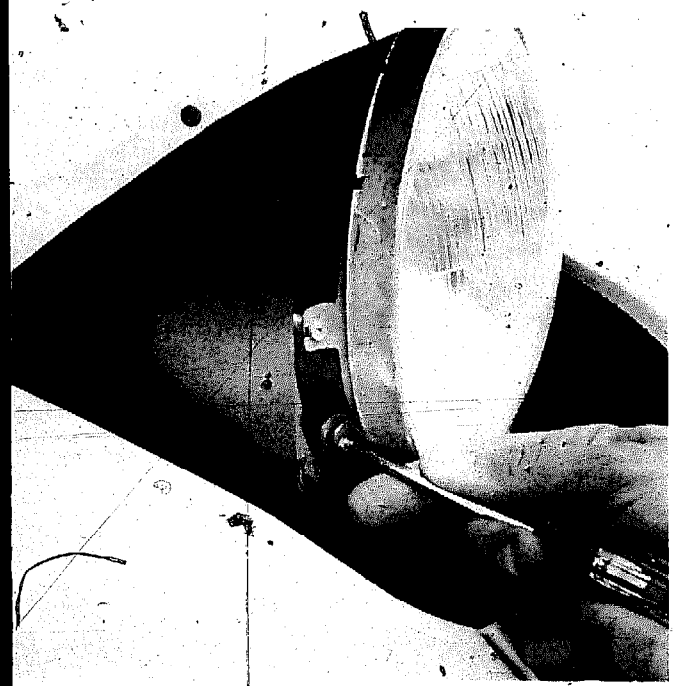

If you are installing European-style quartz lights be careful not to overtighten the retaining ring screws. The lead crystal lenses of these lights get hot and the stress from overtightened screws can easily crack them.



Raising or lowering the beam pattern is accomplished by turning the adjusting screw at the top of the assembly.

the backyard mechanic

continued

Now that you've purchased more light, how do you get it to shine on your subjects?

Horizontal alignment of the lights is accomplished via adjusting this screw on the side of the assembly.

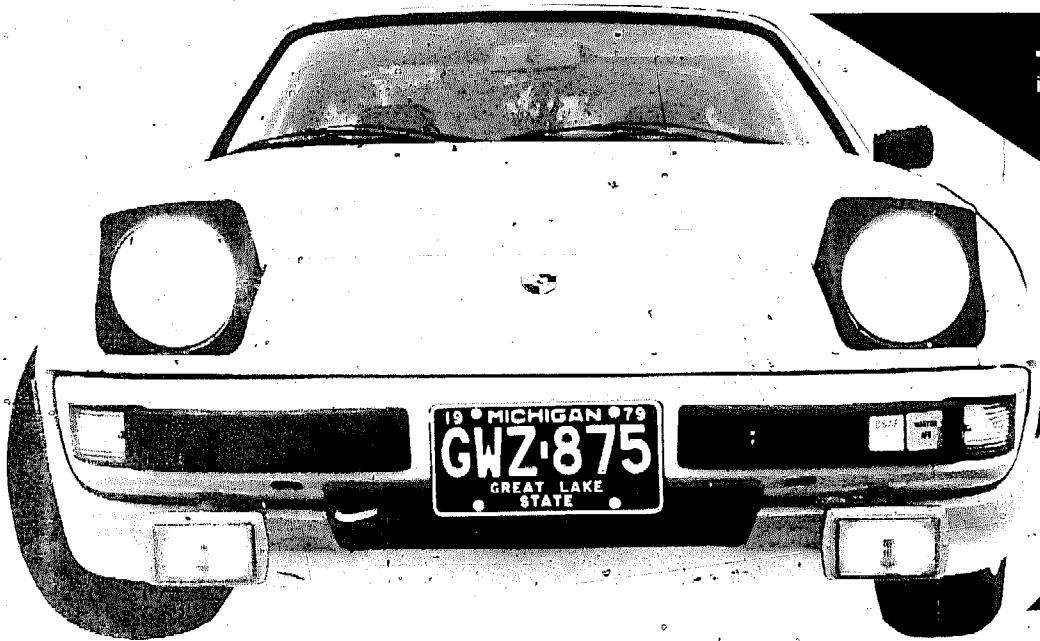
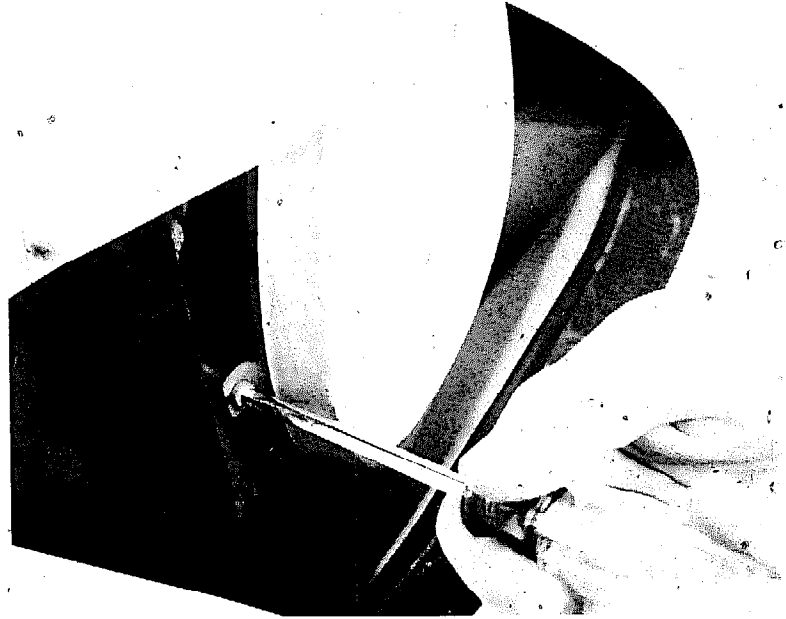

The vehicle almost looks happy with its lights all aglow.

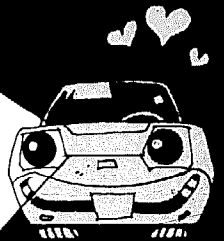

Aiming instructions for European-style lights and fog lights provide a light pattern with a distinct cutoff that is excellent in foul weather. The light almost seems to cut through rain, snow and fog without bouncing into the driver's eyes.



TYPICAL HEADLIGHT ASSEMBLY

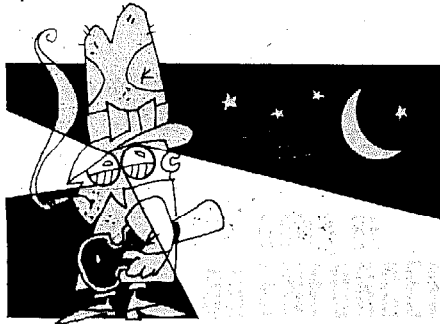
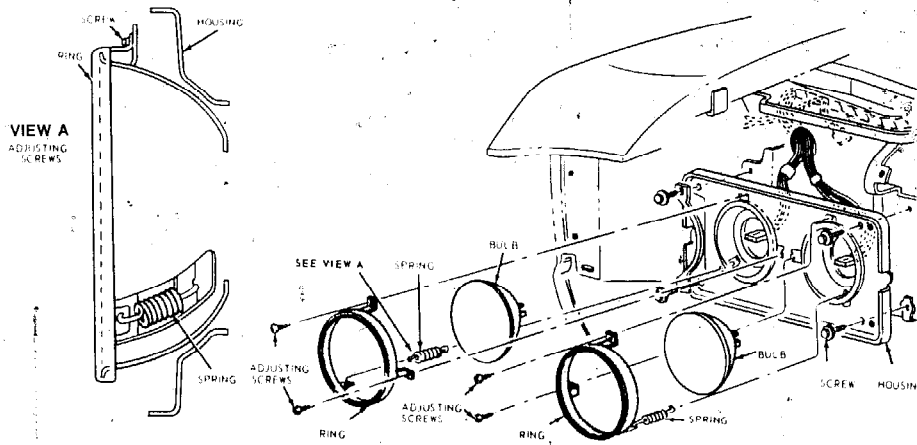

Properly aimed headlights and auxiliary lamps do NOT give you the right to become a "dim-or-I'll-blind-you" enforcer. It is far better when faced with another motorist who refuses to dim his high beams that you seek the shadows of the road's edge (as explained in the December 1979 DRIVER article "How Well Do You See After Dark?") than for both of you to be blinded.

As far as the laws go, most states require that driving lights be extinguished along with normal high beams within 500 feet of oncoming vehicles. Fines for not doing so are often higher than speeding penalties.

And a final plea for sanity: Never, never use high beams or driving lights as weapons against your fellow motorists, please.

what they are. Aim the H1 inner beams parallel to the ground and straight ahead.

Aiming auxiliary lights: The screen may also be used for aiming auxiliary lights such as driving and fog lamps. Again, the aiming stated here is for "ideal" use; check with local authori-

ties about the rules covering these units.

Driving lights used almost exclusively for long range should be aimed parallel to the ground and straight ahead. Driving lights used as cornering lamps should also be aimed parallel to the ground but 3 to 5 degrees left and right, respectively. That's from 15¾ to 24½ inches off center at 25 feet. An alternative is to criss-cross the lights 10 to 20 degrees: That works out to 52¾ to 109½ inches at 25 feet.

Fog lights are another story. First of all, most states with laws regarding fog lights require that the "light beam (measured a maximum of 25 feet in front of and to left of center of vehicle) not to be above a point 4 inches below the center of the fog light." If you can come up with a concrete aim from that, tell me. And that is also why we continue to advise checking with local authorities — and the guy that sold you the lamps isn't the kind of "authority" we have in mind — we mean legal authorities.

For the best maximum foul weather effectiveness, aim fog lights ½-degree down and 0-3 degrees left and right. That's above 2¾ inches below center and zero to 15¾ inches left and right at 25 feet. If, however, you're using your fog lights as cornering lamps aim them parallel and 5 to 10 degrees left and right. That translates to 26¼ to 52¾ inches left and right at 25 feet.

Again, all the aiming measurements given here are for ideal light use and not necessarily legal everywhere. Check with the local authorities.

And, yes, we will be covering installation of auxiliary lighting systems in the near future.

In conclusion, good aiming and better night visions. ☺

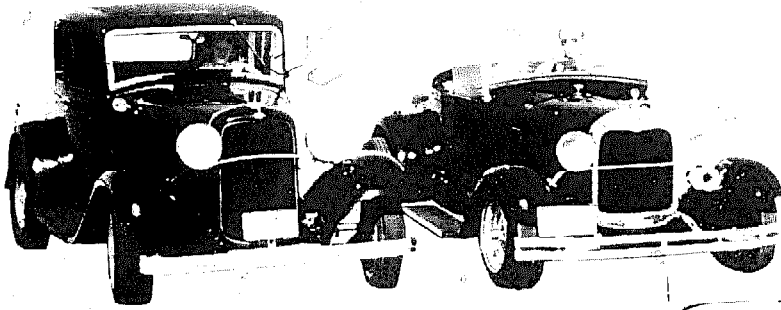

Cars can last forever with proper preventive maintenance programs. The newest car in this group was made more than 13 years ago.

how to

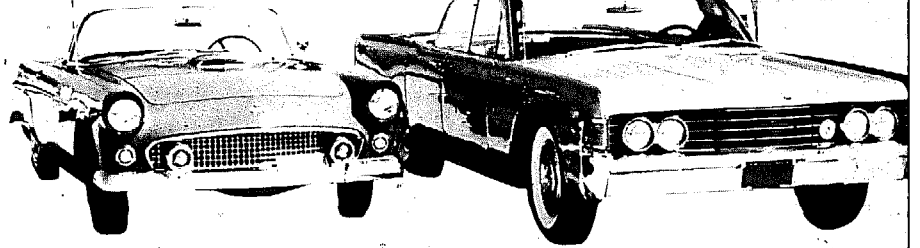

make your car

It's no secret the price of automobiles is skyrocketing. The last new car with a base price of less than \$4,000 disappeared from the American scene in April. Meanwhile, inflation keeps the price of used vehicles even with the original purchase price. Add to this tighter credit controls and many people are finding themselves out of the motor vehicle market.

Only a few people can afford new vehicles every two or three years. Most of us are looking at four, five or six years between trades. In fact the average age of a car on the road today has risen from 5½ to 6½ years old. Even then the costs are more than we can actually afford.

If only cars could last forever.

The truth is, they can last forever. Look around. You'll see backyard, shade tree and Saturday morning mechanics keeping 20- and 30-year-old vehicles running. There are also the classic car buffs. And museums discovered long ago that their treasures must be driven regularly because the vehicles deteriorate faster when not used.

So what's the secret to keeping cars looking and running like new for 10, 20, 30 or more years? Preventive maintenance. Preventive maintenance encompassing the entire vehicle; mechanical as well as appearance, both inside and out.

Preventive maintenance begins the instant the vehicle is delivered. If it is a used car, you gave it a complete stem to stern inspection before agreeing to purchase. You should do the same with a new vehicle. Visually check the entire finish for paint chips, thin spots,

overspray and even bare metal. Check the chrome for dents, scratches and coverage. Look over the interior for rips, stains or even missing trim. Examine under the hood and the underside for fluid leaks and sloppy workmanship.

Although most new vehicles pass a good quality control before leaving the factory, a lot of damage can happen during shipping. Are there signs of hastily-made repairs?

Everything should be noted by the sales representative and yourself along with an agreement on when and how the repairs are to be made before you take delivery of the vehicle. Get it in writing. This holds true for used vehicles, especially.

There are still plenty of things to do before leaving the dealer's lot. For example, make sure your vehicle has all the options on it that you ordered. Make sure they all work, too. Read the owner's manual and operate everything according to the instructions. It's not fun to run into a blinding rain shower and spend five minutes fumbling for the wiper switch only to find out they don't work.

Read and fully understand the warranty. And don't forget to ask about getting an extended warranty. It's really short-term insurance that can take you beyond the 12-month/12,000-mile manufacturer's limit until the vehicle is almost paid for. Kidding aside, the \$25 deductible maintenance

agreement is usually worth every penny in peace of mind.

Make sure all the paper work has been correctly completed before driving off the lot.

It should go without saying, but here goes anyway: Check the engine oil, transmission fluid, brake fluid radiator coolant, battery electrolyte and power steering fluid before driving the vehicle away. Check them again at the first gas stop. And don't forget to check the tire pressures. As a rule they are never correct. Use your own gauge, not just because the ones on the pump are never correct, but because your own gauge will give you the same constant pressure check.

You'll need at least two books in addition to those that came with your vehicle. One with words and pictures already on the pages, one without.

The pre-printed book is a shop manual or independently-published version. Even if you don't do your own maintenance, these manuals provide insight into the how's and why's of vehicle operation as well as maintenance. Besides they offer a great deal of trouble-shooting help in emergencies.

The blank-page book will become your vehicle's log. In it you will record gas, oil, parts and option purchases in addition to maintenance dates and mileages. These records will provide you with data about the mileage you're getting, when maintenance is due and

THE BACKYARD MECHANIC

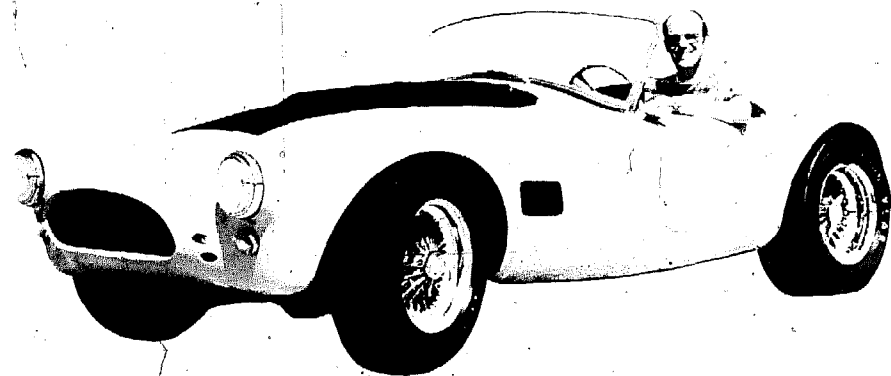

last FOREVER

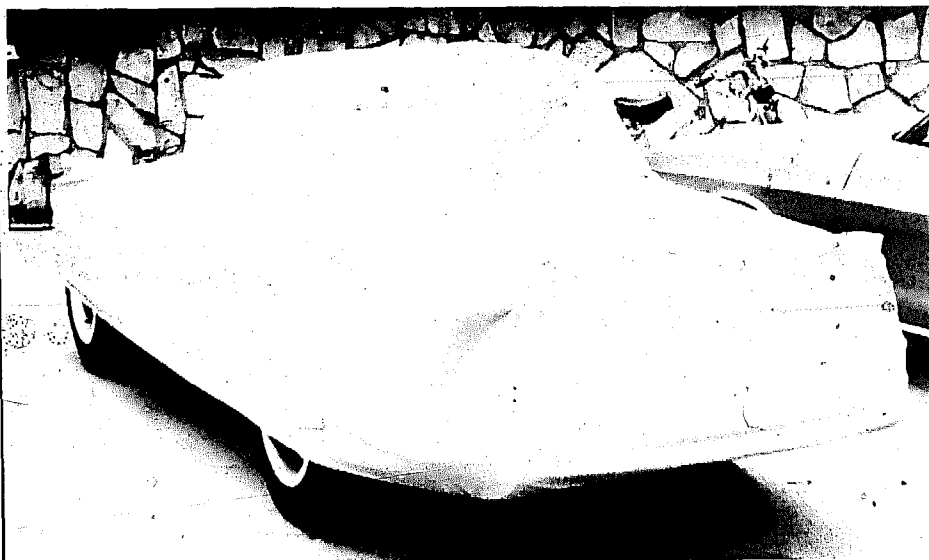

Car covers that are water repellant, not water proof, are best because they allow the finish to breathe.

other projections from past costs into future expenditures. This log should fit into the glovebox. Although you will develop your own way of recording entries, the article "A Case for the Log," in the March 1979 DRIVER will provide a good starting point. Since you're planning on keeping this vehicle forever, you may even record washings and waxings.

With a pre-owned vehicle, you are going to want to completely clean the engine, engine compartment, drive train and chassis before going too far. A spray-on water-soluble degreaser and running warm water should remove most of the dirt. A small wire brush can be used to remove rust from the exhaust manifold. Stubborn stains may require the use of lacquer thinner on a soft rag.

With the engine, its compartment, the drive train and chassis completely clean, check for leaks, oil stains, rust and signs of neglect. Repair these before attempting any further cleaning or appearance doctoring.

Small cans of spray paint available at all auto parts stores, including the large discount chains, make engine finishing easy. Make sure the paint used on exhaust manifolds, mufflers and exhaust pipes is rated for very high temperatures. Polish chrome or aluminum parts with paste cleaner. And coat all unpainted metal, rubber and plastic with silicone spray. Allow the silicone to dry and then buff with a soft cloth. Periodically respray these surfaces with silicone.

You will want to paint, polish and silicone new cars as well.

While rustproofing isn't pretty, it is necessary. If you have a new car's underchassis, engine compartment as well as the insides of doors and fenders sprayed within three months of purchase, it will usually be guaranteed against rust for three to five years. Because these self-healing goos stay soft forever, they make working under the vehicle messy. Therefore, be sure to get all your underside work done first.

Now to that beautiful exterior that everybody sees. Cover all exterior paint and chrome with a paint sealant. This silicone compound prevents air from oxidizing the paint. The base coat sealant must be put on before any wax has been applied. If the vehicle has already been waxed, the wax will have to be completely removed with a solvent. After the base sealant coat is applied, there is a conditioning coat that must be put on every six months. It's as easy as washing and waxing.

With older cars you'll want to remove dead paint with a polish, not rubbing compound. Abrasive rubbing compound can remove all the paint, leaving nothing but bare metal. Be especially careful around striping because even polish can remove these from the paint.

You'll also want to take care of all those nicks, clips and scratches before applying silicone. Be sure to completely clean the area to be touched up of all dirt and old wax or silicone. Use a small No. 1 or No. 2 artist brush, building the paint up in layers. If you get a lacquer paint you can wipe off any mistakes.

Alloy wheels should be cleaned with specially-made wheel cleaners, usually available from wheel makers. To protect wheel appearance, use heavy-duty wheel wax or two coats of silicone spray. Also spray both sides of the tires with silicone as well as silicone-spraying rubber bumpers.

At least once a month you'll want to wash the entire car with a mild soap and warm water. Always rinse the surface completely and dry with a turkish towel. Be sure to clean off road tar and other stains. The solvent that rustproofers gave you to clean up his

continued

continued

overspray works best. Touch up any new dings or scratches, finishing them over with sealant conditioner or bolster.

There are several good vinyl cleaners and conditioners on the market for vinyl roofs. Remember to silicone them when you're done.

Window glass is always cleaned with an ammonia glass cleaner and paper towels.

If you are using a wax, re wax every three months. The silicone conditioner is an every-six-months job.

Even if the vehicle is always garaged, get a car cover. The dust in the garage damages the finish. When the car is outside, sunlight, dust, dirt and pollution take their toll on the surface. The best car covers are water repellent, not water proof. Water-proof covers don't allow the car's finish to breathe. Moisture trapped under a cover can blister the paint.

The interior of the car is like the inside of a house; clean it from the top down. Vacuum the headliner or convertible top as well as the seats and carpet. Vinyl headliners, door panels, seats, dashboards and weatherstripping should be cleaned with non-abrasive vinyl cleaner on a soft cloth. Treat all cloth as "dry clean only."

Use a leather spray cleaner for leather. Then replenish lost lanolin with a "hide food." Always completely wipe off excess cleaners, conditioners and saddle soap, especially from cracks, because they can make



Preventive maintenance means more than checking items; it means replacing parts before they fail.

the hide too soft and it will pull apart. Flexible leather putty can be used to fix cracks and splits.

Clean doors and door jambs with household spray cleaners. Lacquer thinner works good here for removing grease.

Carpet can be cleaned with cornstarch, a brush and then vacuumed; or with home foam-style carpet cleaners. Grease stains can be removed with ketone or acetone. If you have a spot where the colors don't match, there are aerosol dyes that can be used. Can't find the correct color? Then use acrylic lacquer paint.

If you have real woodwork that has been varnished, clean it with glass cleaner. Household polishes may give a nice shine, but they turn yellow. Use lemon oil finish on unvarnished woodwork.

Interior bright metals such as chrome, aluminum, magnesium, brass and stainless steel are best cleaned with an ammonia glass cleaner. Paste metal cleaners tend to get on everything around the metal, making a real mess.

Now spray everything that isn't fabric (or glass) with silicone and buff. Everything from the dash to the weatherstripping. You may want to use a special leather protectant, but silicone will do the job there also. Wax the door jambs and ends. Use upholstery stain-proofing spray for fabrics.

Use coco or sisal floor mats to protect the carpet. While they don't keep dirt out as well as rubber or vinyl, they allow the carpet to breathe. As with the car cover, moisture won't be trapped under these type mats.

If you are any kind of a backyard mechanic at all, you'll get instruments

Get and keep the Lead Out

Engine survival is based on many factors not the least of which are what you put into it and what you demand out of it.

Even if your car will run on leaded gasoline, use unleaded if at all possible. Lead additive deposits build up on the spark plugs and other internal engine parts as well as in the oil, mufflers and exhaust pipes, cutting each part's life span.

After break-in, use a high detergent oil of the weight recommended by the manufacturer. These oils cling to cylinder walls and bearing surfaces, preventing start-up scoring.

The oil and filter must be changed regularly, whether the vehicle is driven

or not. Everyday use contaminates the oil with dirt and partially-burned hydrocarbon resins. Meanwhile, the oil in engines that aren't run regularly breaks down into a goeey sludge that has a high acid effect. And always change the filter with the oil. A dirty filter only contaminates the clean oil.

Perhaps the biggest determinant in engine life span is your driving habits.

Stop-and-go commuting to work or driving slowly to the corner store and back are among the worst as far as engine life is concerned. Perhaps the best exercise for your engine is 20 miles of continuous highway driving. This raises the oil temperature to a normal operating range, coats bearing surfaces with oil and lifts the entire block to an even temperature. Heating up the engine and auxiliary systems in this way burns off many of the corrosive deposits. These deposits came from water vapor built up in the system during all those short trips.

This 20-mile exercise will also bring to light problems that may have been overlooked in day-to-day commuting.

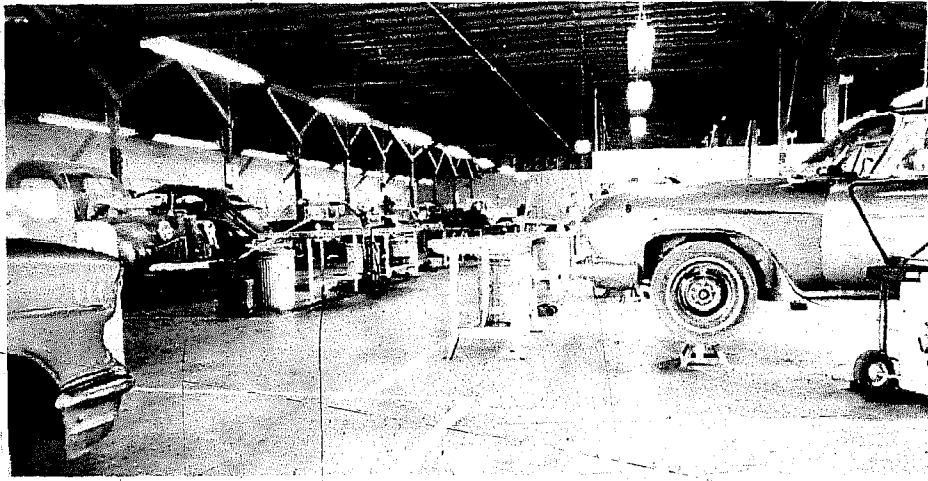

Auto hobby shops support the idea that cars can last forever. After all, none of the vehicles in this work area is a spring chicken.

to be backed up by the idiot—pardon me—warning lights. The minimum probably is an ammeter, water temperature and oil pressure gauges. For economical driving you'll probably also invest in a vacuum gauge (see January 1980 DRIVER).

Now is the time to plan your full preventive maintenance program. Not just the routines such as changing the oil every six months, but a full-scale plan. The plan should span as long as you intend to own the vehicle.

Where do you start? With the manual you bought. In fact, many independently published maintenance manuals already have such programs in them. Other good sources of information about what-to-do and when-to-replace are service managers and mechanics who work on your type vehicle. The 10-year maintenance plan on these pages reflects the average life

of conventional front-engine/rear-wheel-drive American-made vehicles.

The idea with these "lifetime" maintenance programs is to replace parts a few months before they fail. This not only brings you peace of mind, but such replacements are usually cheaper than service on items that failed while in use.

With many replacement items, it is far more economical to buy top quality units than their less-expensive equivalents. Take high-quality shock absorbers that last 100,000 miles instead of the 10,000-mile life span of original equipment shocks. Besides having to be replaced less often, the \$40 units provide a smoother ride and better handling than the \$10 ones. A top quality \$100 clutch will last three or more times longer than a \$50 unit.

The same is true when it comes to batteries. And the real bargain in keep-

ing a car "forever" comes with "lifetime" mufflers. We all know that no muffler will last a lifetime, but you'll get free replacements.

Carry this theme over into buying new units instead of rebuilt replacement items.

It is also better to do "system" replacements rather than unit repairs. When you buy a new battery, replace the cables, too. While replacing the brake linings, why not take care of the wheel bearings and wheel cylinders at the same time.

Remember, the idea is that it is cheaper to do the maintenance now than wait for the item to break. As with front-end alignments, the \$15 for labor is much less expensive than the cost of two or more \$100-apiece tires.

Now, stop and compare your car and the care it will be getting with Joe Average's buggy.

In just five years, Joe's chariot will be the color of a 1940 sofa, the chrome will resemble a cheap spoon that's been left in acid over the weekend and the interior—well, to put it mildly, the interior will be a royal mess. Joe will be viewing expensive repairs such as tires, brakes, battery, exhaust, catalytic converter, etc., as if he was on the business end of a sawed-off shotgun. Joe will gladly opt for a new \$10,000 car instead of \$1,000 to repair the old rattletrap.

Meanwhile, your wheels look like they just rolled off the showroom floor. You aren't faced with any repair bills that you haven't already taken care of or at least programmed into the budget. And, if you were lucky enough to buy the right car, your vehicle is increasing in value every year. To top all this, you can continue to drive your car for the next five years of more—for free.

Sure, at the end of 10 years the car might need a \$450 paint job (don't get the \$69 paint job because it looks like what it is—a cheap paint job) and a similar expenditure for chrome to make it look showroom fresh. But by then Joe will be on car number three and you'll still have that sharp pseudo-classic.

Remember, most cars are junk by age 12; but not those that got preventive maintenance and lots of tender loving care. (T)

continued

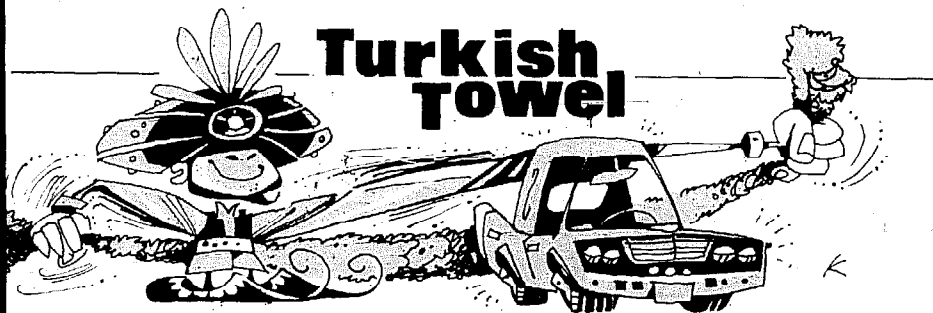

Whenever you are working on your vehicle's painted surfaces, use clean turkish towels only. Yes, last year's beach towel qualifies if it is clean, soft and has a deep nap. The deep nap lifts any particles away from the paint, preventing scratches. Use only one side, and get a clean towel when the one you're using is dirty. Always work in small areas, using steady, medium

pressure with long arm-length strokes in line with the vehicle. Never use a swirling motion.

Chamois should be used only on a surface that is completely free of any dirt or particles. If you just washed, rinsed and dried the car and want to wet it down again, then you can use a chamois. Otherwise you may scratch the surface.

The 10-year or 100,000-mile plan

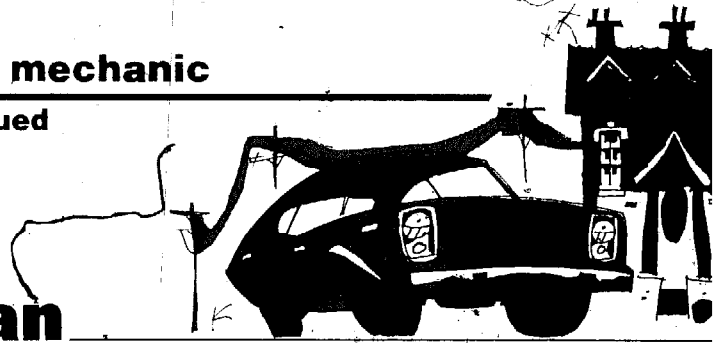

This maintenance guide reflects the average life span for a front engine/rear-wheel-drive American sedan. It is only a reference point from which you can develop your own lifetime preventive maintenance program.

WEEKLY Check:

- Engine oil level
- Tire air pressures
- All exterior lights
- Brake operation
- Emergency brake operation
- Horn

MONTHLY Check:

- Battery fluid level
- Windshield washer fluid level
- Coolant level
- Airconditioner belt
- Tire wear
- Brake fluid level
- Power steering fluid level
- Power steering belt
- Spare tire pressure

If you haven't been using the air conditioning, run it at full for at least five minutes.

SEMI-ANNUAL OR EVERY 7,500 MILES Check:

- All drive belts
- Starter connections
- Alternator connections
- Radiator hoses
- Clutch play
- Radiator cap pressure
- Manifold heat valve
- Air conditioning system for leaks
- Air conditioning refrigerant level
- Windshield wiper blades
- Windshield washer system

Replace:

- Engine oil
- Oil filter

Lubricate:

- Front suspension

Adjust:

- Timing

Rotate:

- Tires

Put a coat of conditioner or wax on the exterior of the vehicle as well as respray everything with silicone.

ANNUALLY OR EVERY 15,000 MILES Check:

- Entire brake system
- Tire tread depth
- Shock absorbers
- Engine mounts
- Steering linkage
- PCV Valve
- Sparkplug wires
- Rear axle fluid level

Replace:

- Sparkplugs, points and condenser (not on CDI systems)
- In-line fuel filter
- Windshield wiper blades
- Coolant, after flushing and back flushing radiator and block separately

Lubricate:

- Universal joints
- Shifting linkage
- Wiper linkage
- Hood release
- All body hinges

Adjust:

- Dwell
- Clutch pedal free travel

Clean:

- Air filter

EVERY TWO YEARS OR EVERY 30,000 MILES Check:

- Emission-control system

Replace:

- All drive belts
- Air filter
- Sparkplug wires
- Distributor cap and rotor (not on CDI units)
- Crankcase breather air filter
- Transmission lubricant and filter

Adjust:

- Automatic transmission
- Front suspension and steering
- Automatic choke

EVERY THREE YEARS OR EVERY 40,000 MILES Check:

- CDI for voltage output
- Wheel bearings; always repack and replace seals

Replace:

- Radiator cap
- All hoses
- PCV Valve
- Differential gear oil
- Original equipment shock absorbers

A car with a different schedule

Older cars need a lot more attention than newer models, besides not being able to go as far between routine maintenance such as oil changes and tune-ups. Here are a few hints to help you establish a maintenance schedule for these vehicles.

After an engine overhaul, change the

oil and filter at 500 miles, and then at 3,500-mile intervals or at least annually.

Think about fitting an electronic ignition to increase performance as well as part life.

While ball joints, control arm pivots and tie-rod ends should last 100,000 miles, the grease does get contaminated

with dirt and water. Install grease fittings in those vehicles with "lifetime" lubrication systems, and lubricate the front suspension every 7,500 miles with the highest quality molybdenum disulfate lithium grease. It wouldn't hurt to repack the wheel bearings then, either.

Replace manual transmission and differential gear oil every 30,000 miles. Because automatic transmission fluid has a harder life, replace it and the filter every 15,000 miles.



EVERY FOUR YEARS OR EVERY 50,000 MILES
Replace:

- Battery and cables
- Coil
- Brake linings, wheel cylinders and master cylinder
- Tires

EVERY FIVE YEARS OR EVERY 60,000 MILES
Replace:

- All light bulbs
- All fuses
- Complete exhaust system including catalytic converter
- Manual transmission clutch

EVERY SEVEN YEARS OR 70,000 MILES
Replace:

- Thermostat
- Water pump
- Fuel pump
- Universal joints

EVERY EIGHT YEARS OR EVERY 80,000 MILES
Replace:

- Wheel bearings
- Ball joints
- Tie-rod ends
- Steering idler arms



If this is your next purchase, we know you'll want it to last forever. With preventive maintenance and lots of tender loving care any vehicle can have a long life. By the way, this is the Ford concept car Fiesta GTK—a station-wagon design with room for a driver, four passengers and their luggage.

EVERY NINE YEARS OR EVERY 90,000 MILES
Replace:

- Carburetor complete with choke
- Starter and solenoid
- Alternator
- Voltage regulator
- Power brake booster
- Power steering pump

EVERY TEN YEARS OR EVERY 100,000 MILES

You've reached your goal. Even if smaller engines need a complete overhaul at this point, you should still have a car that looks and runs as good as new. It may even serve you for another 100,000 miles or more.

Let the Dealer do it



With most new cars, your first maintenance is due at 7,500 miles or six months. As the car is still under warranty, let the dealer do it, but check to make sure the mechanic actually did it.

Make sure:

- you got a new oil filter
- the drain oil plug is secure
- the crankcase is full
- the coolant level is correct
- the power steering fluid level is right

- the automatic transmission fluid is proper
- there's enough lubricant in the gearbox
- the rear axle has enough of the right weight lube

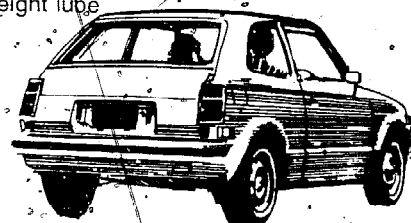

CASE for the LOG

How the maintenance of an auto log can save money, time and grief

by GEORGE F. HATVANY, Jr.

Have you ever wondered when was the last time you changed plugs and points, or the last time you charged the air-conditioning system, or had the shocks replaced, or rotated your tires? How about one of the best indicators of all for alerting you to the need for a tune-up . . . gas mileage, is it holding its own or slipping? All these questions and many more can be answered by keeping a log.

A small address book or note book can be used as a log. One can be purchased for 50 cents to a few dollars at any stationery store. I recommend keeping it in the glove compartment of the vehicle along with a good mechanical pencil with eraser.

The log should be broken down into two sections, a maintenance/replacement section and a gas mileage section.

The maintenance/replacement section is located in the front of the book and is annotated as to mileage and date plus a short description of maintenance performed and parts replaced. It progresses from the front of the log to the rear. A few example listings follow:

43,546—10 July 76—left rear tire repaired and all four tires rotated (Xed), repaired tire is now on right front.

44,723—15 Aug 76—fan belt replaced and car waxed

45,133—5 Sep 76—water pump replaced with a rebuilt unit

46,013—21 Sep 76—all four sets of brake shoes checked, look like they have another 20,000 miles on them, check again at 66,013 miles

Suppose the water pump is again replaced in another 10,000 miles. I recommend lining through the 45,133 mile water pump entry in such a manner as to leave it readable, example:

45,133—5 Sep 76—water pump replaced with a rebuilt unit

The lining through will alert you to the fact that water pump work was again done at some later date. Log the new water pump replacement, example:

55,300—17 Aug 77—replaced rebuilt water pump with another rebuilt unit, got 10,167 miles out of old unit.

If your vehicle starts to run rough, no sense in replacing the plugs and points and giving it a tuneup without first checking your log. Could be your log reveals you put new plugs and points in and did a tune up only 1,500 miles ago, so the problem could be a faulty fuel filter. Use your log as a trouble-shooting aid and anti-rip-off device. If you have your car worked on by someone other than yourself, you can tell the mechanic the plugs and points were new 1,500 miles ago. He may be a little less likely to charge you for a set of plugs and points and a tune-up when all you needed was a fuel filter.

The only periodic maintenance I don't recommend putting in the log book is the lube jobs and oil and oil filter changes. I think the time of your next lube job and oil filter change should be written on the face of your instrument cluster glass with a dark grease pencil, so it will always be in front of you as a constant reminder.

Should you change plugs just because you have 10,000 miles on them if they are performing well? The answer is no. But how do you know whether plugs and other parts need replacing? If the vehicle is obviously running improperly, then look for the problem. If the vehicle is running reasonably well, then a drop off in gas mileage as evidenced by the second part of your log,

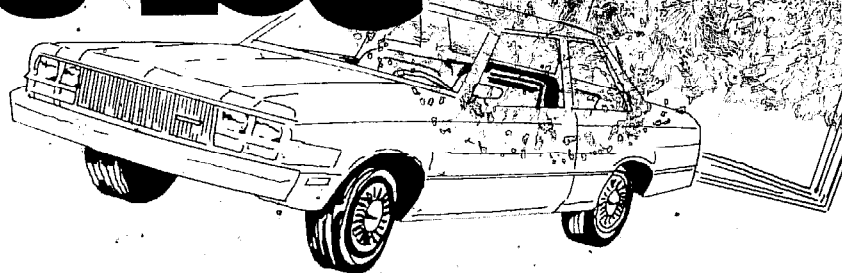

the gas mileage section, could tip you off as to when parts replacement and tuneup are required.

Every gallon of gas put through your vehicle should be kept track of starting at the back of the log and progressing toward the front. Gas mileage doesn't have to be computed every time the tank is filled but a running record must be kept so as to compute gas mileage at a later date. Sample gas mileage entry for my motorhome:

(1) 21 Nov 75 (4) 56,677.5
(2) 725.2 (5) 14.39
(3) 50.4

- (1) date tank filled
- (2) miles driven at time of fill up, subtract previous odometer reading from present one
- (3) amount of gas required to fill tank
- (4) current odometer reading
- (5) miles per gallon obtained, divide (3) into (2)

The trick is to arrive at the optimal gas mileage for your vehicle.

When a new or used vehicle is purchased I suggest it be tuned by an expert, you or a good mechanic. Once the vehicle's optimal miles per gallon is determined use it as a comparison guide. No sense in changing plugs and points and tuning up if your gas mileage hasn't decreased or the vehicle hasn't been running improperly. Also why take the carburetor apart at 60,000 miles if the car is running properly and the miles per gallon obtained are right up there with your optimal figure.

A well maintained log can save you time, money and a good deal of grief. Look at the log as an aid to maintenance, trouble shooting and arriving at a fair price paid for repairs or maintenance.