

AT MICROFICHE REFERENCE LIBRARY

A project of Volunteers in Asia

Manual for Building A Rammed Earth Wall

by: Lydia A. and David J. Miller

Published by:

Lydia A. and David J. Miller
2319 21st Avenue
Greeley, CO 80631 USA

Paper copies are \$ 5.00.

Available from:

Lydia A. and David J. Miller
2319 21st Avenue
Greeley, CO 80631 USA

Reproduced by permission of the authors.

Reproduction of this microfiche document in any form is subject to the same restrictions as those of the original document.

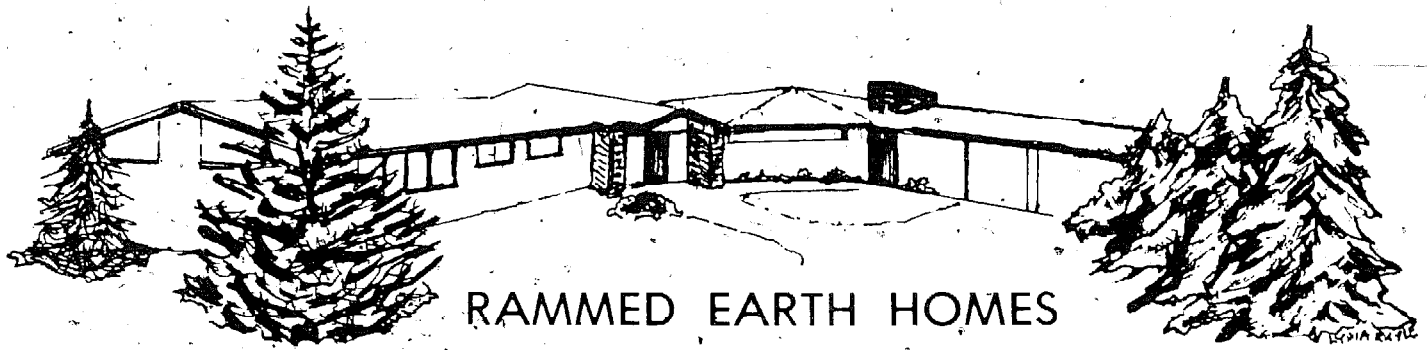

RAMMED EARTH HOMES

MANUAL

FOR BUILDING A RAMMED EARTH WALL



Copyright © 1980 by Lydia A. and David J. Miller

All rights reserved. No part of this publication may be reproduced or transmitted in any form or by any means, electronic or mechanical, including photocopy, recording, or any information storage and retrieval system without the written permission of the authors.

Published by

David J. and Lydia A. Miller
Post Office Box 1424
Greeley, Colorado 80632

We gratefully acknowledge the magazine, THE MOTHER EARTH NEWS, Number 61, 1980, for the pictures and story of our house built with rammed earth walls. We acknowledge the expertise of J. Palmer Boggs, Architect-Engineer-Designer, who designed the five houses we built with rammed earth walls during the years 1944-1951, in Greeley, Colorado.

TABLE OF CONTENTS

	PAGE
FORWARD.....	1
INTRODUCTION.....	2
HISTORY.....	3
RAMMED EARTH - Pise' de Terre.....	4
DESIGN.....	4
USING LOCAL MATERIALS.....	4
RAMMED EARTH NOT EASILY ACCEPTED.....	5
PSYCHOLOGICAL FACTORS.....	6
BUILDING CODES.....	7
SITE SELECTION.....	8
SOIL SAMPLE TESTS.....	8
SOIL TESTING.....	10
TESTING FOR MOISTURE CONTENT.....	11
STOCKPILING AND PREPARING THE SITE.....	12
MAKING A TEST BLOCK.....	13
STABILIZATION OF SOIL.....	13
THE TAMPING TOOL--RAMMERS.....	15
RAMMING PROCESS.....	16
FOUNDATION.....	17
THE FORMING PROCESS FOR RAMMED EARTH.....	20
BUILDING THE SIDE PANELS.....	20
ASSEMBLING OF FORM PANELS.....	22
LEAP FROGGING--MOVING PANELS UP AS WALL RISES.....	24
REFERENCES.....	26
APPENDICES.....	28

FORWARD

Living in earth houses is extremely comfortable. They are cool in the summer and warm in the winter. Prior to the days of air conditioning, adobe houses were preferred in the southwestern United States because of their well-known quality of balancing the heat of the day with the cool of the night; the thicker the rammed earth wall, the greater its regulating value.

Rammed earth houses have been the subject of numerous magazine articles, technical pamphlets by state and federal agencies, universities, books, handbooks, independent pamphlets and many unpublished manuscripts.

We wish you to know that we not only built rammed earth houses, but we have lived in a rammed earth house since the spring of 1945. The quality of living in a rammed earth house must be experienced to be believed.

Earth has proved to be one of the world's greatest building materials because it is:

- durable and historically the longest used by man
- universally available
- accessible to all who own or can buy a lot or building site
- a solar collector which stores heat. The heat is naturally transmitted to the inside of the home
- a natural barrier to cold winds and forces of nature including, tornadoes, earthquakes, insects, and rodents
- not rationed
- not monopolized by anyone

This manual presents the rammed earth building method as clearly as we can state it. It reflects our own experiences.

We do not cover the technical and engineering problems which may be encountered. These are best resolved by consulting professionals.

INTRODUCTION

The following is digested from "Wolfskill, et al". Texas A & M University. 21.

Probably, one of the first homes lived in by man after he came out of a cave was made of earth. To be sure, the earliest known kinds of earth construction were very crude by our standards today. Primitive man did little more than stick mud on poles woven closely together. But even with this, he found shelter that was better than anything else he had except his cave. He also had the advantage of being able to move around. He could live wherever he wanted.

Gradually, he learned that some kinds of mud made better houses than others. And some of the best ones lasted his whole lifetime.

Today there are many earth dwellings throughout the world that are centuries old. Man discovered that the earth homes that have lasted best were in areas where not much rain falls. However records show that earth homes lasted under the most extreme range of climatic conditions.

Today, with the advances made in the science of soil mechanics, what soils will do under many different conditions can be predicted and controlled. It is possible, even with little skill, today to build beautiful, inexpensive and durable homes using the oldest construction material known, the earth around us.

Strangely enough, it is the scientific road builders who have learned most about the way many kinds of soil will behave under a wide variety of conditions. These scientists know, for example, how to take soils that for centuries were considered useless for anything and, by combining them with materials called stabilizers, make them into mixtures that are excellent for earth construction.

As in most important discoveries, this new knowledge, from ancient methods, much of it learned since World War II, was found by work done in laboratories by highly trained technical men. It now remains to make these new techniques available to the people.

The United States of America has spent untold millions through its international agencies and the United Nations to teach undeveloped nations how to build homes of earth. At the same time the bulletins printed are either unpublished or their supply exhausted and available only by exhaustive search and by special duplication.

HISTORY

Earth is the world's most common building material. It is also one of the oldest; one of the most universal; one of the most comfortable, and one of the most used and abused. The late George Borg, of Strasburg, France, said most of the world's people live in earth homes.

Extensive experiments in the United States Universities of California at Davis, Michigan at Ann Arbor, Texas A. & M. at College Station, Oklahoma at Norman and South Dakota State College at Brookings, have reached the conclusion that rammed earth or adobe, properly built and planned, make high quality homes.

To these distinguished universities must be added the University of Kansas, Clemson College, The Universities of Saskatchewan and Iowa and Massachusetts Institute of Technology. for studies and theses demonstrating the feasibility of rammed earth.

The U. S. Department of the Army, Agriculture, Bureau of Standards, Housing and Urban Development through A.I.D., The Bureau of Public Roads, the governments of England, Germany, France, Israel, Australia, New Zealand, Belgium, Poland, and the U. S. S. R. have experimented with earth as a building material and recommend its use for housing.

The United Nations has sponsored programs for earth housing.

Outstanding constructions throughout the world are built of earth, including the great wall of China.

Sven Risom in his book, Nordiske Ler Jords Huse, documented fifty rammed earth houses actually built in Europe from 1295 to 1955. He includes photos of 60 homes of rammed earth or cob in Denmark, France and England.

Risom also gives a history or summary of earth houses from 2000 B. C. including Assyria, Mesopotamia, Palestine, Japan, Egypt, Greece, Italy, North Africa, Cameroon, Guldsten, Spain, Portugal, France, Morocco, Great Britain, Ireland, Wales, Austria, Hungary, Germany, Russia, North America and South America.

RAMMED EARTH (PISE' DE TERRE)

The following is quoted from Encyclopedia Britannica, 1968 edition, volume 18, pages 1148, 1149: 6.

"RAMMED EARTH (Pise' De Terre) is a building material resulting from the application of compaction of certain soils. Of the forms of earth building used by civilizations of varying technical development, rammed earth is the most durable. After World War II it was studied as an economic technique for underdeveloped regions. Its use is limited to soils with high sand and low clay contents, 70% 30% being a usual proportion, with the sand graded to various particle sizes. The mix, with about 10% water added, is compacted in molds by ironheaded rammers weighing 5 to 20 lb."

DESIGN

J. Palmer Boggs, Architect-Engineer who designed the Miller homes, was a devotee and a disciple of Frank Lloyd Wright. All the Miller houses are built without basements, are blended into the landscape or hillside, are without a single stair, step anywhere. All houses enjoy the natural look. All are solar orientated, with windows to the garden and sun and face away from the street.

Frank Lloyd Wright expresses accurately J. Palmer Boggs' ideas for the rammed earth houses for the Millers, quoting as follows from The Natural House, Horizon Press, 1954, "I began to see a building primarily not as a cave but as a broad shelter in the open, related to vista, vista without and vista within". 22.

Design and choice of building any structure depends entirely upon the person who wants to build with earth.

USING LOCAL MATERIALS

The use of local materials in an attempt to solve some of the problems of housing for people is of major importance, although cost is not the primary emphasis. The higher the ratio of "non-manufactured" local materials used in these attempts, the more easily the economies of any community or country will be able to support broadly based programs for better housing and more adequate community facilities.

Earth is nature's product. It requires no energy to produce.

Use of earth saves energy.

Rammed earth is labor intensive.

Rammed earth is massive and enduring.

Rammed earth is an accepted construction material.

Comfort and Quiet:¹ Rammed earth massive walls are excellent for passive solar buildings, contrary to common belief, and are extremely comfortable. This is surprising to many, and must be experienced to be believed. The comfort results from more balanced surroundings, particularly the radiant temperatures and humidity.

Earth structures are also very quiet due to mass, added insulation, and double glazing. This lack of noisy and irksome furnaces, compressors, fans, and ducts helps contribute to peace of mind.

RAMMED EARTH CONSTRUCTION NOT EASILY ACCEPTED

Acceptance of rammed earth is not simple nor easy. From 35 years experience, we have felt the unspoken skepticism and open criticism of engineers, builders and people generally. This general skepticism is aptly described by Anthony F. Merrill in his book, The Rammed-Earth House, Harper & Brothers, N.Y. 1947 as follows: 11.

"Introducing soil construction meets the opposition of many contractors, engineers, and tradesmen, who immediately reject anything new or unfamiliar. Some feel uncertain whether a new method of construction will give them the same profits and to others the customary method of construction seems much easier.

"Soil as a material for construction is not simple. Its application is not yet based on an exact knowledge of all its properties in spite of the fact that in many countries there are buildings of unstabilized soil, which have given service for hundreds of years. This indicates that satisfactory results can be obtained, provided that the soil used for construction is suitable for the purpose, that the work is carried out in a correct manner, and that suitable maintenance is assured."

Since the publishing of Merrill's book much has been learned and written. It is not possible in this manual to detail the progress made. Our objective is to pass on to you what we ourselves have learned so you can build the rammed earth walls of your dream home.

PSYCHOLOGICAL FACTORS

One reason for resistance to rammed earth is stated by Fitzmaurice, et al as follows: 7.

"In the inspections made by the author and members of his staff, adverse criticisms were frequently expressed by the occupants of stabilized soil houses. In very many cases these were obviously unjustified since the houses were entirely admirable and had no significant defects. It is evident that there is a considerable prejudice on the part of ill-informed persons, and this needs to be eradicated if stabilized soil is to take its proper place as one of the methods of solving the housing problem.

We have interrogated the people concerned on various occasions and we are forced to conclude that the prejudice is irrational. We suspect that in some cases it has been fostered by building contractors and people who are financially interested in competitive methods of construction. We think that this apparent prejudice is founded on the following:

- A. Earth walling is associated in the minds of the people with the squalid, dilapidated, unstabilized hovels which have been the normal form of housing in many parts of the world for generations past.
- B. It has been noted that as soon as a family attained a higher level of prosperity, they immediately had built for them a house of brickwork or stone masonry.
- C. Some of the earlier attempts at stabilization were not entirely satisfactory. Insufficient was known about the process; unsuitable soils were used; control was lax. This gave the opponents of the method plenty of material to work with and they were not slow to take advantage of it.

If stabilized soil is to take the place it merits as one of the methods of alleviating the world housing shortage it

is necessary to remove this prejudice from the minds of the public and the author can see only two ways of doing this. The first and foremost is to ensure that stabilized soil housing is first class. Get rid of cracked walls, peeling plasters and patches of eroding material only partially stabilized. It is the object of this manual to show how this can be done.

Having removed the technical objections, it remains to educate and inform the public that stabilized soil is, in fact, a durable material and that their houses will be in no way inferior to conventional houses. Emphasis must be placed on "stabilization", and the word "soil" can be kept in the background. Perhaps some of the psychological difficulties could be removed if a new term could be coined. In France the stabilized soil experiments after the war were described as "beton de terre". This translates as "earth concrete" which might be shortened to "earthcrete" or "soilcrete". Alcock refers to the psychological problem in his account of earth technique in West Africa."

Our comment on Fitzmaurice's statement is that stabilization per se does not answer the problem. The objective of the authors is to demonstrate that properly selected earth will build a fine home. We have done it. Earth homes must be presented on their intrinsic qualities. We agree that cement is needed in the soil cement placed on the reinforced concrete foundation beam.

BUILDING CODES

One Caution. In many areas, local regulations will influence what can be built, where it can be built, and how it can be built. Building and zoning codes, permits, licenses, and accepted practices vary widely from state to state and locality to locality. To avoid wasted or illegal effort, the owner, designer and builder, should know the restrictions and obligations during the planning and design period. This should always be done BEFORE settling on a definite site for construction.

Federal Housing Administration and Veterans Administration have refused to approve rammed earth throughout the years. The successful project at Mount Olivet near Gardendale, Alabama outside Birmingham in 1936 has been ignored. The authors visited these homes, viewed both interior and exterior. We found the owners happy, and found the houses in excellent condition in 1976.

Greeley, Colorado and Weld and Boulder Counties in Colorado have granted building code variances to permit rammed earth houses. The Miller houses, all built prior to the adoption of the Weld County, Colorado building codes enabled the granting of the variances. Savings and loan associations, insurance companies and commercial banks have all made loans on the Miller built homes on their sale and resale.

SITE SELECTION

The site for a rammed earth house should provide adequate drainage. Possible ground water or seepage problems will be discovered by soil testing, digging as deep as required and by asking former owners.

Solar access must be substantial if the structure is to include solar heating. The builder must be careful to choose a site not surrounded by natural obstructions, trees or high buildings that shut out the sun.

A standard city lot (50'x 100') is not an adequate site for solar orientation. House size and style selection is limited for such a lot. Neighboring lots may have large trees or structures that would shade your lot.

We were fortunate to acquire an acre of land through the inheritance of part of a farm owned by Lydia's parents. Our house in Colorado was designed and oriented to the southeast for optimum solar benefits. Latitude determines the solar positioning of a building.

Above all make the soil tests described in this manual to see that you have 70% sand and 30% clay and silt.

SOIL SAMPLE TESTS

Equipment and tools needed to make sample tests:

1. A dirt auger to drill holes in the ground is excellent. Post hole diggers are also good, especially if you do not plan to go very deep. You can extend the augur type digger by adding lengths of pipe.

2. Pick-axes, mattocks or a steel bar and a long handled shovel.

3. A supply of cans or plastic cartons large enough to hold a pound of a variety of soil samples.

The depth to which you are going to examine your soil will depend on how you are going to dig the soil for your house later. If you are going to dig by hand, you probably will not want to dig more than 3 to 5 feet deep. If your soil will be dug by machine, you will want to examine the soil as deep as the machine will dig, perhaps 8, 10 or more feet deep. Plan where the earth is to be gotten. Test the subsoil there.

First, dig out and toss aside the organic topsoil. In desert areas, there will be little or no topsoil as such. In wet, tropical areas, the top soil may be several feet thick. Once you are through the top soil, collect samples of subsoil from different places on your lot or building site.

Take the soil samples by auger or other method throughout the area from which the earth is to be taken. It is preferable to test each sample rather than to mix them together.

Test the sample soils separately in the same manner as for the stockpile of soil ready for construction.

Send one pound samples to your nearest Soil Testing Laboratory for technical analytical tests to verify your "home wash pan" test if you have any doubts. Professional help is always encouraged by us.

Mother Earth asked us to lead a work shop on rammed earth this coming summer, 1980. In preparation for the work shops, we visited Mother Earth's ECO Village to personally examine the site. We tested the soil by hand and shovel and the wash pan test in the motel room (roughly). We found the 70% sand aggregate and 30% silt and clay similar to our own tests in Greeley. We also built a test wall that is now weathering in ECO Village, Hendersonville, N.C.

We also brought samples from ECO Village to Colorado and had the samples tested at the Soil Testing Laboratory at Colorado State University at Fort Collins. The tests cost \$30 for each sample. The test verified our minimum 70% sand aggregate and gravel, 30% clay, which we had made by the wash pan test at ECO Village.

The Laboratory Scientist, Professor P.N. Soltanpour, asked for samples of the soils used by us in Greeley, for our rammed earth construction. He compared the Greeley soils with ECO Village soils.

Scientifically, the Greeley soils and the ECO Village soils are very different in composition. Professor Soltanpour states that both soils will make an excellent rammed earth wall.

SOIL TESTING

Soils can be tested in laboratories, but a home washpan test can accurately determine if the soil is suitable for ramming. If in doubt, ask for laboratory verification.

The washpan method of testing soils has proved to be an accurate measure for us. You may rely on it for testing the soil for your building project.

Mix the subsoil thoroughly. Fill three one-pound coffee cans of mixed soil from different places on the site and in the stockpile and put each into a separate flat pan. Mark these pans 1, 2, and 3. Dry the earth for about four hours in a household oven until thoroughly dry. Remove sample 1 from the oven; weigh it carefully and write down the weight. Put the soil in a pan at least six inches deep and five inches in diameter (a 2 lb. coffee can will do). Put the pan underneath the faucet in a sink and let a small stream of water run slowly into the pan. Stir the dried aggregate slowly. The object is to dissolve all clay and let it run over the lip of the pan. The muddy water along with all humus, bits of foreign matter and non-sand materials will flow out with the water over the lip. When the water is clear, pour the water carefully out of the pan. What is left is the sand residue,

Dry the sand residue in the oven. Weigh it and compute the residue weight against the original dry weight. Write down the findings for sample 1. Repeat the process for the remaining two samples.

Here is an example of what the data might be:

18 ounces sand residue
<hr/> 24 ounces dried aggregate = 75% sand

If the aggregate is 70-80% sand, it is optimum. If sand is 50%, it is poor to fair.

Average the percentages of the three samples. If the average of the three samples is 60-80%, you have optimum aggregate. If the average is 50%, it is poor to fair aggregate. In the latter situation, you can add river run gravel or a comparable material such as roadbase, to bring the sand content up to at least 60-70%. In our work, we brought the sand up to 75%.

TESTING FOR MOISTURE CONTENT

Excessive moisture prevents proper compaction and causes surface cracks on drying.

The proportion of moisture in the soil is important to rammed earth. The earth should feel damp when picked up by hand. Water determines the resistance of the soil to moisture, its plasticity and the ease with which it can be used for ramming.

Take a handful of the earth and squeeze it in your hand to form a ball. If the soil fails to make a firm ball, it is too dry; add water to the soil until it will bind. Drop the ball to a firm surface from shoulder height. If it shatters into small pieces, the moisture in it is satisfactory. If it is too wet it does not shatter. Repetition of the test gives you the "feel" of the correct moisture.

Once the moisture level is right (feels damp), cover the soil heap with a plastic sheet. Use the hand "feel" test several times daily to make certain the moisture percentage remains at a good level. Ten percent is the optimum moisture level.

The correct moisture level is one of the main factors in successful rammed earth construction. Too much water makes the soil sticky and hard to ram. Too little water limits the cohesion of the soil.

The aggregate should be kept dry from rain, yet kept moist. A heavy rain will moisten the soil too much and time will be wasted waiting for the soil to dry.

Anthony Merrill, in his book THE RAMMED-EARTH HOUSE,¹¹ recommends that the builder keep the stockpile moist. He suggests if the pile is not covered, the top of the pile should be wetted with a garden hose in the evening to give a good mix in the morning. Wet soil will have greater shrinkage and the walls will crack.

Surface cracks will not affect the durability of the wall and should be ignored. Dry soil will appear to ram solid but the particles of soil will not bind properly. With a little experience, the person tamping will learn to add a little moisture spray from a hose, a garden sprayer or a sawed off broom. Also, the builder quickly learns the "right feel" of the moisture and texture of the soils used.

STOCKPILING AND PREPARING THE SITE

It was our experience that it was more efficient to build the stockpile at the time the site was leveled for construction. We engaged an earth moving contractor who at one time used a bulldozer and at one time used a carry-all. The top soil was stockpiled for use for the lawn and garden. The subsoil was stockpiled. We had rocks up to several inches in diameter so it was necessary that the soil be screened. On the first house, we screened the soil by hand. The screen was made from a potato sorter with a 1" mesh. We used whatever went through the screen and stockpiled the rock for rockfill underneath the concrete floor. The screen was mounted at approximately a 60' angle on 2 x 6s. We actually used the screen for all of the houses except the Ruyle addition.

At the time we built the house in which we live, we had a Ferguson tractor. We borrowed a front lift loader and actually screened the soil by dumping the earth on the screen from the front lift loader. The rock that did not go through the screen rolled to the bottom and formed its own stockpile and the screened earth also formed a stockpile. We tested the moisture of the soil by hand test and if the soil was too dry we added water with a hose as the stockpile was built.

On the test walls that we built in 1979, we found that a roto-tiller did a better job in mixing the soil and helping get the dry earth mixed with the moist earth than did either a pugmill or concrete mixer. On the workshop in Billings, we had soil that was quite dry and was lumpy. We actually put together a makeshift screen out of a double thickness of chicken wire to screen out the lumps. The first day we had to break up what lumps were left with a shovel or by hand. The second day we had available a roto-tiller which did a very fine job.

On the workshop in Montana, the owner of the property wished to have a soil cement earth wall. We mixed the soil cement one day with a cement mixer but we found that the roto-tiller gave us a better mix than the old-fashioned concrete mixer run with an electric motor.

It is important to point out that the stockpile for the earth that goes into the wall, whether it is to include cement or not, should be mixed in advance to permit any moisture that is added to distribute itself evenly throughout the aggregate. Later on in this manual we will repeat the statement that if during actual ramming operations, the earth turns out to be too dry then water can be added with a sprinkling can, a bucket and a sawed off broom, a spray out of a hose or a garden sprayer filled with water. The latter is somewhat safer, since it gives a greater control of the amount of moisture applied.

If only a small amount of soil cement is to be used, it might be that this can be done by mixing it in the wheelbarrow and just turning the earth and the cement with a shovel. Our experience indicates that if you have the time to plan it, mixing with a roto-tiller is desirable.

MAKING A TEST BLOCK

Before beginning to ram the actual wall, the soil may be further tested by making a test block. A simple form can be made by nailing 2 x 6-inch lumber to make a block 6-in. x 8-in. x 16-in. The form must be bolted together, nails will not hold. Lay the form on a flat surface and tamp the soil into place. Remove the form and let the block dry. When dried, the block should not crumble or show excessive cracks. If the block test is satisfactory, the soil will surely be suitable and you may begin to build a wall.

STABILIZING THE SOIL

We have built two soil cement walls. Mixing of the properly selected aggregate is important. Mixture in one wall was simply by the shovel and screening method. One was mixed in part by a low speed pugmill, in part by a concrete mixer and in part by a rototiller. Observations indicated the plaster pugmill worked better than the concrete mixer even though it seemed to be less efficient from the point of the hand labor involved. A rototiller worked better than either the pugmill or the concrete mixer. Here again the time spent on the job depends upon the supervisor, the amount of hand labor available and the motivation of the worker. If the owner himself is the foreman, he will see to it that the work progresses.

The percentage of cement to be added depends upon the aggregate. The higher the sand content, the better the wall. Seventy per cent of sand, as determined by the wash pan test gives an aggregate that needs no soil cement except for foundation. High sand content plus good compaction produces a high quality wall. It is also true that whether compaction is with a backfill tamper operated by an air compressor, a low pressure 15 pounds per square inch electric tamper, or by hand, the quality of the wall depends upon high sand content and proper compaction.

The authors know that no stabilization is needed in rammed earth if the soil aggregate has a minimum 70% sand and 30% clay (Sticky when wet but hard when dry).

The advocates of stabilization, whether it is needed or not, have not, by adding cement, overcome the resistance to rammed earth as a building material.

Professor R.L. Patty in AGRICULTURAL ENGINEER, ^{14.} September 1942, Vol. 23, No. 9, states the following:

"At least 80 per cent of all soil types, as they will be found on farms over the United States, will be satisfactory for use in rammed earth walls. Two-thirds of these could be used just as they are dug up providing the outside surface of the wall is to be protected with stucco or plaster. The other one-third will need at least a small amount of sand added, although they are to be plastered. A recommended admixture of sand will make a high percentage of these walls good enough to stand indefinitely as bare wall.

"For farm building no admixtures other than sand are necessary. The sand will make a high quality soil and the wall may be left standing for a year or two. If it begins to roughen too much, it will just be right for stuccoing.

"Cinders can be substituted for sand as an admixture to a low quality soil. Cinders reduce shrinkage and cracking of the wall in the same way as sand, and reduce the strength in the same proportion. They can be used up to one measure of cinders to one of soil, if the wall is to be plastered."

THE TAMPING TOOL--RAMMERS

From looking at many drawings and from actual experience we recommend the weight of the handle and head to be between 8 and 15 pounds. The tampers are constructed of galvanized iron pipe for the handles and steel for the heads. The heads vary in size (see drawing). It is convenient to have varying head sizes, depending on the size of the structure, man-power and need. The three sizes shown in the drawing have proven satisfactory.

The weight of hand tampers is very important. The heavier the tamper, the faster the earth can be rammed. So use the heaviest tamper your workmen can handle all day long without tiring or overtiring. Short workmen cannot lift hand tampers weighing more than 15-18 pounds for very long without tiring. Experience has proven for the Millers that hand tampers weighing 8 to 15 pounds are a good average for most laborers.

It is generally assumed that the workers stand in the forms to do the ramming, though as a matter of fact many of them prefer to stand up on the edges of the form. In either case, the handle will have to be long enough to permit the worker to get the tamp down into the form and still be able to operate comfortably from whatever height he may be working, inside the form at earth level or from the top of the form.

The weight of the rammer will be somewhere around 8 to 15 pounds, depending upon whether the person using it is by nature a lifter-upper or a pusher-downer. If he is going to push down on the tamp he won't need as much weight as he will if he is just going to lift it up and let it fall with its own weight. Both systems work well, especially interchangeably.

Tamping will go faster if you do not need to tamp around the bolts. The form is designed so that the two bottom bolts will hold the form together for tamping. This is the only time that you need to tamp around the bolts. All other bolts and spacers are placed in the wall as the tamped earth is within one or two inches of the hole. When you get to the bottom of the next hole in the form, then stop and slip in the spacer and the tie bolt on uprights B and C attach the washer and tighten the nut. When the earth reaches within an inch or two of the top holes in Panels 3 and 4 you are ready for leap frogging, described later.

NOTE: Shown are three types of rammers that can be used. The recommended weight of handle and head should be between 8 and 15 pounds.

$\frac{3}{4}$ " galv. ϕ pipe used

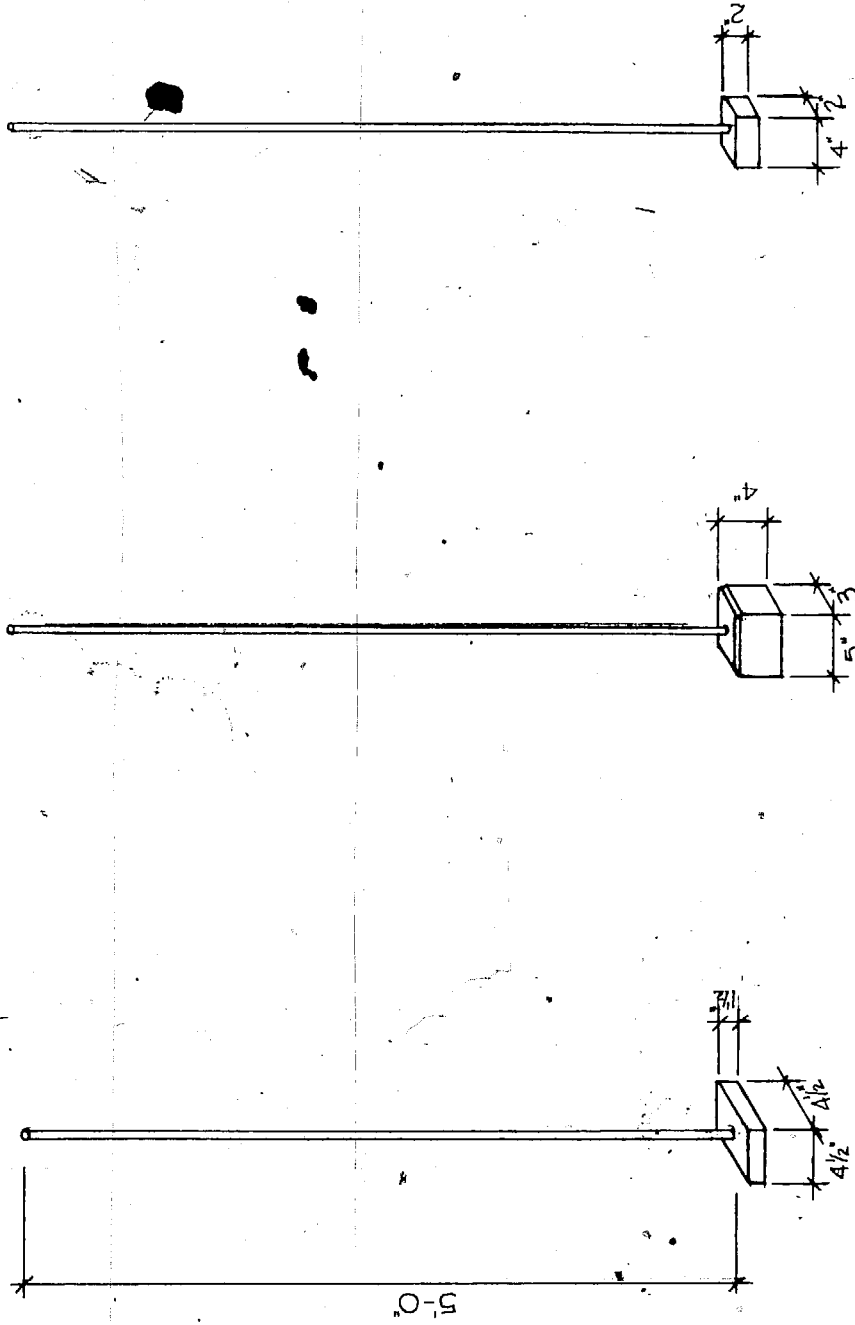

STEEL HEAD HAND RAMMERS

SCALE: $\frac{3}{4}$ " = 1'-0"

RAMMING PROCESS

The proper amount of loose soil to be put on in one layer or lift inside the rammed earth form is four inches. Layers which are placed too thick will be loose at the bottom and will cause problems. The man working in the form spreads the earth evenly.

The earth in the corners and sides of the form should be evenly tamped first, and then the rest of the surface evenly is tamped. A good rammed earth wall needs to be well tamped. Ramming should be done on each layer until the noise from the tamping tool changes from a dull thud to a clear, ringing sound.

The strokes of the rammer will press the earth in all directions and compact all of the earth in the form if tamped evenly. The worker should tamp from one end of the form to the other end. Then follow the same pattern about three times, or more, until the rammed earth rings.

Most rammed earth tampers are the hand type, but if you want to tamp the soil faster, two back fill tampers from an air compressor will speed up the job. This is expensive equipment.

One man using an air tamper can tamp the amount of soil in one-half to one-third the time that he could using a hand tamper. Many types of air tampers are available. Get a light one that does not weigh more than 25-30 pounds. It should be a long stroke machine of moderate feed that delivers sharp blows. A 4 x 6 inch tamping face can be used with this type of machine. Do not use a jack hammer. Be sure that the corners of the tampers are rounded. Grind off the corners $\frac{1}{4}$ to $\frac{1}{2}$ inch.

A constant air pressure of approximately 70 pounds per square inch is necessary. An air compressor with a free air delivery of 24 to 39 cubic feet per minute will operate one tamper. We used two back fill tampers from a 105 lb. air compressor run by a gasoline engine.

The tamping should be rapid, equable, and should not be in unison; that is, if more than one man is in the form, the men must not keep time striking the earth. Heavy blows must be avoided. Heavy strokes are apt to crumble the earth rather than compact it into a hard mass.

Be sure that no fresh or new loose earth is put into the form until the previous layer is well tamped. Layer after layer is placed into the form and tamped until the tamper hitting the earth rings. Check the moisture content often while you ram the wall.

When a delay occurs, as a break for lunch or over night, the layer must be moistened. You may use a sawed off broom and a bucket of water, a garden spray or a hose with a spray nozzle.

The moisture of the earth should be checked often while ramming, both in the stockpile and as it is put in the wall.

Any soft spots discovered should be rammed some more. Important places to check are directly against the form, in the corners and around the beveled strips of the endgates. We do not recommend the heaviest types, 16-18 and 20-30 pounds.

After the bottom form is filled to the bottom of the top hole, place the second panels by lifting form 3 on top of form 1 on one side and form 4 on top of form 2 on the other side. This forms the second lift.

Now put in the washers and spacers, slip in the tie bolt, and spin on the acme nuts on uprights. Before any earth is put into the second lift, the earth should be slightly moistened so that the fresh earth will adhere to the earth already tamped in the first lift of the form. Continue adding lifts and tamping the earth until the walls are raised to the desired height.

While building walls, provide openings at the proper locations for telephone cable, plugs, door and windows, anchors, electrical outlets and gas and water lines. Avoid the need cut out for an electrical conduit, box or a hole for a pipe after the earth wall is finished. You can cut a hole for conduit, boxes, or pipes so long as the earth is still "green" (not thoroughly dry). The drilling is difficult because (pise') rammed earth becomes almost as solid as concrete.

FOUNDATION

The foundation should be in two parts. The first should be a reinforced concrete beam. In a house without a basement it is recommended that the bottom of the trench excavated for the foundation you pour a concrete beam, which is to hold up the immense weight of the earth wall, be treated with asphaltum to harden the soil. It should be engineered by a

construction engineer to the proper width and depth, depending on the width and height of the wall. A vapor (moisture) barrier should be placed on top of the concrete beam. Plastic or tar are good vapor barriers. In our own homes the foundation was all concrete.

The second part of the foundation could be soil cement. The top of the soil cement part of the foundation should be built on the concrete beam up to a point 12 inches above the ground level. The top of the soil cement should again be sealed with a vapor barrier before the rammed earth wall is started. The vapor barrier will prevent capillary attraction of moisture into the bottom part of the rammed earth wall. The reason for the foundation extending 12 inches above the ground level is to prevent splashing or washing against the foundation, and to prevent moisture reaching the rammed earth wall. If the earth foundation were started at the ground level, the wall could be damaged as the rain from the roof drops on the lawn or the patio and splashes against the earth wall.

If the concrete beam is used in the virgin soil it should be $\frac{1}{2}$ again as wide as the thickness of the wall. The forms could then be placed directly upon the concrete beam after the moisture barrier is installed.

The following drawing is from J. Palmer Boggs² blueprint of the house in which we live. The three changes we recommend are a vapor barrier, 2 inches of insulation on the outside of the foundation down two feet below ground level and the foundation run 12 inches above ground level before ramming the earth.

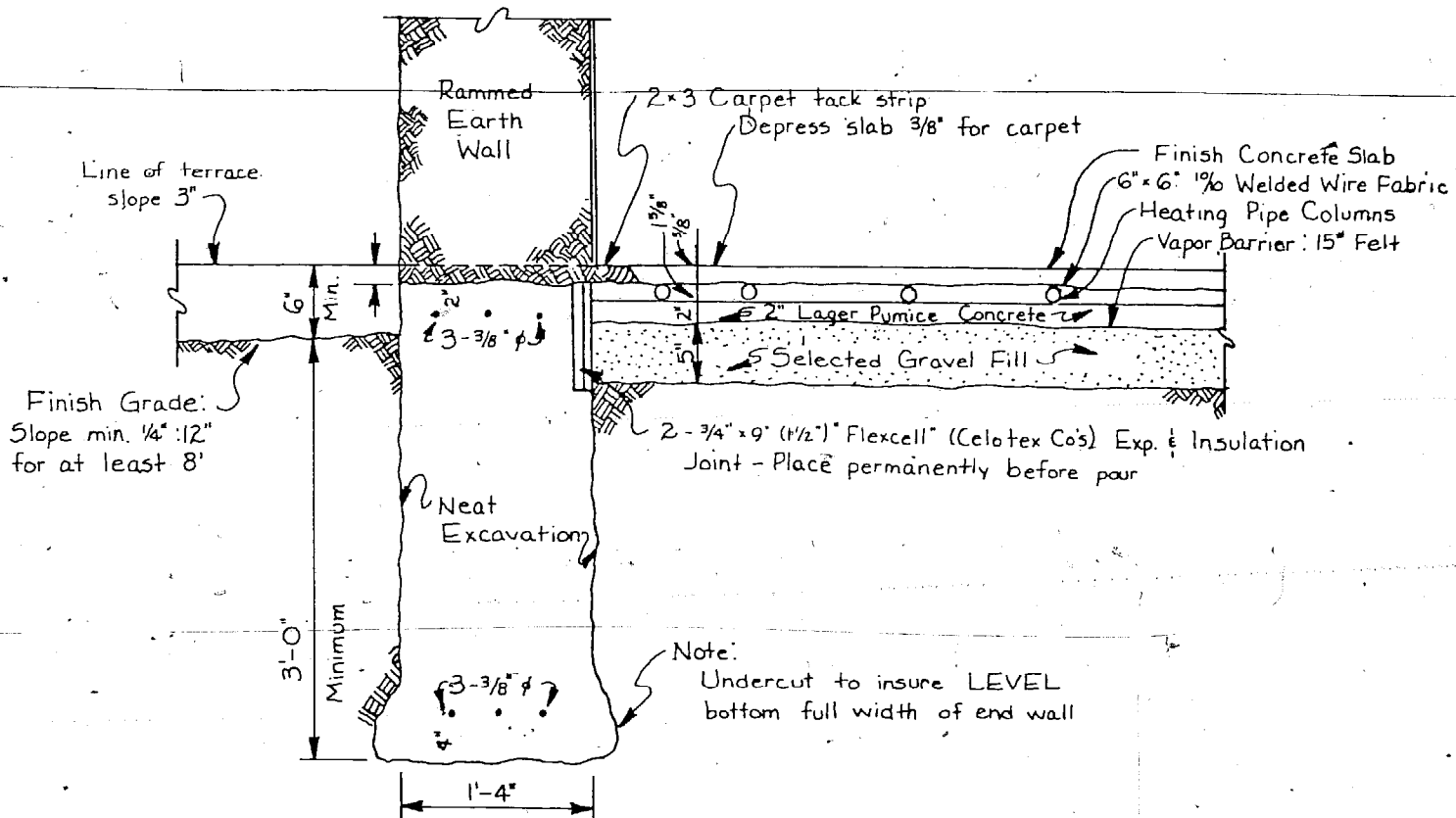

Typical Exterior Wall Foundation
Scale: 3/4" = 1'-0"

THE FORMING PROCESS FOR RAMMED EARTH

We have briefly traced the history of the experiments and studies conducted over the years on rammed earth forms and described the research done and results. We want to pass on to you our experience so that you may make your own choice as to which form you will build or rent. Concrete forms can be rented and used. We have used hand tampers and backfill tampers operated off of an air compressor and found either to be satisfactory.

The following are requirements for a successful form: It must be strong; it must not bend; it should be light enough for one person to lift, or not heavier than a man and his wife could lift. The form suggested is a minimum size form for multi-purpose use. We would rather have the form a bit too strong than too light. Whatever type of soil you use and whatever type of form you use, you will be surprised that almost anything will work with a little care, common sense and judgment.

The forms should be interchangeable, side for side and top to bottom, which means that you would have to cut a pattern or a jig to place the holes accurately. When drilling the holes the forms are to be laid with tempered masonite facing each other and 3/4" holes drilled through both forms at once. Number the outside of the facing pairs 1, 2 and 3, 4.

We developed a corner form 8' high that could also be used as side panels by drilling the holes on the same horizontal spacing as the panels. Placed opposite each other, the corner panels will serve as side panels. As a corner, it is used vertically. All panels are interchangeable, therefore, standardized.

Each of us has different abilities, each of us has available different supplies and materials. The purpose of the form is to hold the earth while you build the wall. If you intend to stucco it, then small bulges or even larger ones make no great difference. Neither do the joints nor rough spots. If your objective is to have a smooth wall that can be permitted to weather for a year or two while you decide what else you want to do with it, then you will need optimum appearance. Our form is designed to give you that.

An alternative plan is to have eight panels instead of four. This would be particularly helpful if a group were organized to help each other build all the earth walls consecutively on a mass production basis.

The Boggs forms though they were quite heavy had two great advantages. One was the wall height forming which protected the wall until the entire form was removed. The second was that the end gates were the height of the wall and assisted in the alignment both horizontally and vertically.

BUILDING THE SIDE PANELS

To make enough panels so that the bottom panel can be leap frogged (that is panel 1 put over panel 3 in order to fill lift 4) it takes two 4' x 8' x 3/4" plywood as well as two 1/2" x 4' x 8' tempered masonite. The lumber yard will ordinarily cut 4' x 8' in two for you to make four 2' x 8' panels. You will also need four quarts of contact glue to bond the tempered masonite onto the plywood. The plywood should be 3/4" AD five-ply with one side smooth. You will also need twelve 2" x 4" x 8's. Some prefer to use screws of the hardened variety. You may also use 8-penny nails driven through and clinched or 7-penny nails which could be driven through from the flat 2 x 4 side.

In building the forms, the contact glue should be placed on the rough side of the masonite and on the rough side of the 3/4" plywood and then bonded together. Contact glue bonds immediately upon contact so you need three pieces of scrap lumber at least 2' x 1" to lay on the 2' x 4' plywood so that you can place the tempered masonite in place above the plywood. It takes two persons; one to square each end. One person then pulls out the end scrap lumber to drop the tempered masonite on the plywood with the corners exactly true on one end. Pull the middle piece of scrap to let the masonite contact the plywood, and finally the opposite end is put onto the plywood by pulling the last scrap. Be careful to square the tempered masonite with the plywood before making contact.

Before nailing on the 2 x 4s to the plywood, and before you apply the glue to the rough side of the plywood, you need to mark the 2 x 4 with the spot where the 3/4" hole will be drilled.

Mark the true end and the top edge of each piece of plywood and each 2 x 4 with a red marking pencil. These will be the edges from which all measurements will be made.

Start with the piece of plywood that has the straightest edges, usually the mill cut edge. Lay it down flat; Mark the truest edge red. Do the same with all the 2 x 4 plywood panels. Place the one 2 x 4 on the top red marked edge of each of the two panels or of the four panels if you have room.

In assembling the first panel after we had drilled the 3/4" holes, we had a hard time putting in the 3/4" x 1 1/2" x 1/8" washers. They put us off 1/4" on the width of the wall. They got lost and we found it difficult to get them in place when we leap frogged form No. 1 over form No. 3.

We decided to drill a hole in the tempered masonite 1 1/2" wide and 1/8" deep before we drilled holes for the tie bolts. The drilling of 1/8" deep x 1 1/2" wide on masonite side is the space needed to glue the elusive 1/8" washer in assembling the form. We used quick dry contact adhesive for this.

We also drove three wide head nails on the edge of the washer.

One bolt needs four washers for the over all process. Two glued in place is very helpful, then only two washers remain loose for assembling. By standing panel No. 1 with the red edge up, we found it easy to mark the edge with a pencil to match the masonite side to the 2 x 4 side already marked. Then, with a pencil and square and the chalk line, we marked the center of the holes on the masonite side. We started each hole by drilling a 1/8" hole entirely through the panel. After we drilled the 1 1/2" x 1/8" inset for the washer, we also drilled the 2 x 4 side an inch deep with a 3/4" drill to avoid the splintering. Finally, we turned the panel over and drilled the 3/4" holes through panel No. 1 from the masonite side.

We built panels Number 2, 3 and 4 the same way.

Tie Bolts: The tie bolt is a 5/8" bolt made of cold rolled steel. It is 40 inches long with 10 inches of acme thread on each end. Acme nuts must be used with the bolts. The 40-inch length of the bolt adjusts to the spacings of a 12 inch, 14 inch, 16 inch or 18 inch wall.

The tensile strength of the 5/8" bolt is 35,000 pounds. The tie bolts and nuts were built at a machine shop (special order). The builder should ignore trade names when purchasing the acme bolt. The acme thread is a wide thread and holds the bolt more securely.

The acme thread is commonly called a "worm gear" thread. There are eight threads per inch. The acme thread is used in automobile steering gears.

Of course all thread bolts and nuts can be purchased in stores. These are not as durable as the acme cold rolled steel, but better than standard all thread bolts which have finer threads. These strip easily and need replacements. The acme threaded bolt is durable and will last for a longer period of time.

Endgates: To keep the earth from coming out of the forms at the ends, use a piece call an "endgate." Endgates also serve as spacer blocks at the ends of the forms so they should be as wide as the walls and a means of holding the wall plumb. In most cases endgates will be used right at the end of the forms, but they should be made so they will fit at any place inside the forms in case you have to ram short wall sections. Try to space endgates so they will be at least 8 inches from the nearest bolt. If you do not leave enough room, it will be difficult to ram the soil correctly.

Always nail a beveled piece of wood on the endgate so that it faces the inside wall. When the earth is rammed in the forms, the beveled piece will form a groove in the end of the wall. When the next section of wall is rammed, the groove will be filled with earth to form a solid joint that bonds the sections together.

ASSEMBLING OF FORM PANELS

Place vapor barrier over foundation before setting forms.

Vertical rows of bolts are referred to as A, B, C and D from right on the drawing page.

1. First step in assembly is to place panel 1 opposite panel 2 with masonite of both panels facing in. Slip tie bolt through top holes rows B and C without spacer to simply hold form together loosely.

2. Next, place the left endgate. One person holds endgate upright while the other slips on the three tie bolts-A. Repeat for the opposite endgate, Row D.

3. Place tie bolts in bottom holes rows A, B, C, and D without spacers.

4. Place the tie bolts, washers and spacers through the middle holes on rows B and C.

5. Place all uprights on rows A, B and C with washers and acme nuts and spin nuts to leave about one inch play. Pull out the top tie bolts rows B and C. They will only be in the way until the earth is rammed up to the third hole from the bottom.

6. One person plumb the endgate end wise (i.e. on the edge). If it is out of plumb, leaning right to the panel 1 side, drive a wedge under the end of panel 1. You may need to

pile up blocks on the ground level to get high enough to wedge the endgate level. If the endgate leans toward the panel 2 side, the wedge must be placed under the edge of panel 2. Then place level on panels. Use wedges on panel sides if needed to level and plumb.

7. Plumb the endgate on the outside plywood side. If it is not plumb, put wedges vertically against both ends of the tie bolts next to the 2 x 2s edge. If the endgate leans toward the opposite endgate, then one of the bolt holes is off plumb.

8. You must then pull out the nut, upright, washer and find which bolt hole is out of line. Get a rat-tail wood rasp and file out the hole until the endgate can be placed plumb.

9. Install, plumb and level the other endgate and panels in the same way.

10. It is most important to plumb and level panels accurately on the first assembling for a successful wall.

11. If you DO NOT do this, alignment cannot be corrected as with lumber or masonry. Rammed earth is massive, heavy and cannot be adjusted. You can only break it up, tear it down and start over.

ASSEMBLING PANELS 1 and 2.

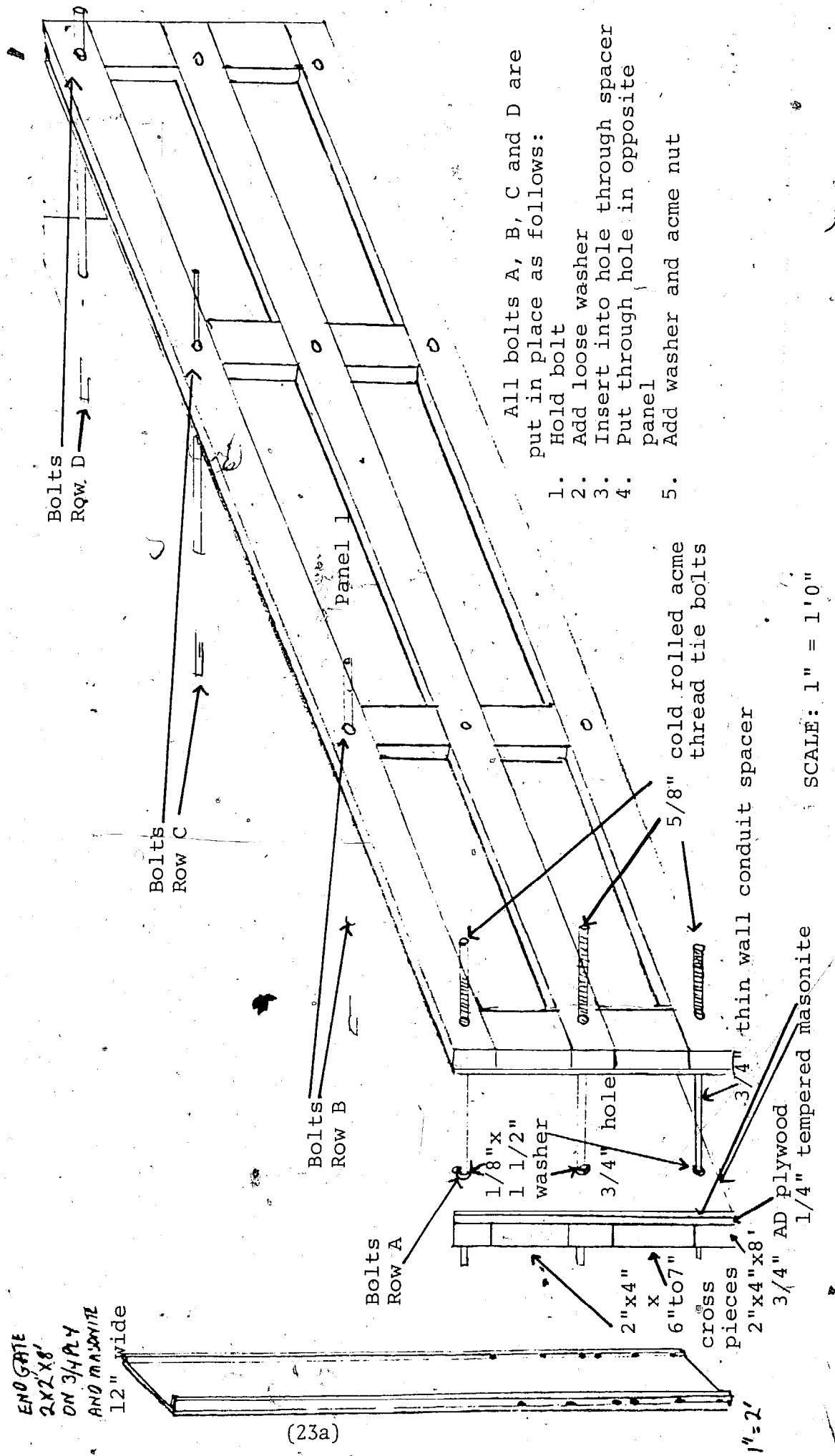

(23a)

1" = 2'

STANDARD SIDE PANEL

The standard side panel is built of 3/4" AD plywood 2x8 faced with 1/4" tempered masonite on inside. Masonite is glued to the rough side of the plywood with contact glue applied to the rough side of the plywood and the rough side of the masonite. Select the better edge of both the plywood and the masonite and mark it red. All measurements are from the red marked edge. Allow the contact glue to set 24 hours. Next glue on three 2x4x8s to the panel. Select the best 2x4x8 for the red edge. Apply resin wood glue to the poorer side of the 2x4.

Nail every 12" but avoid the places the holes are to be drilled. To accomplish this, lay all six 2x4s together on the rough side of the 3/4" panel square from red marked side.

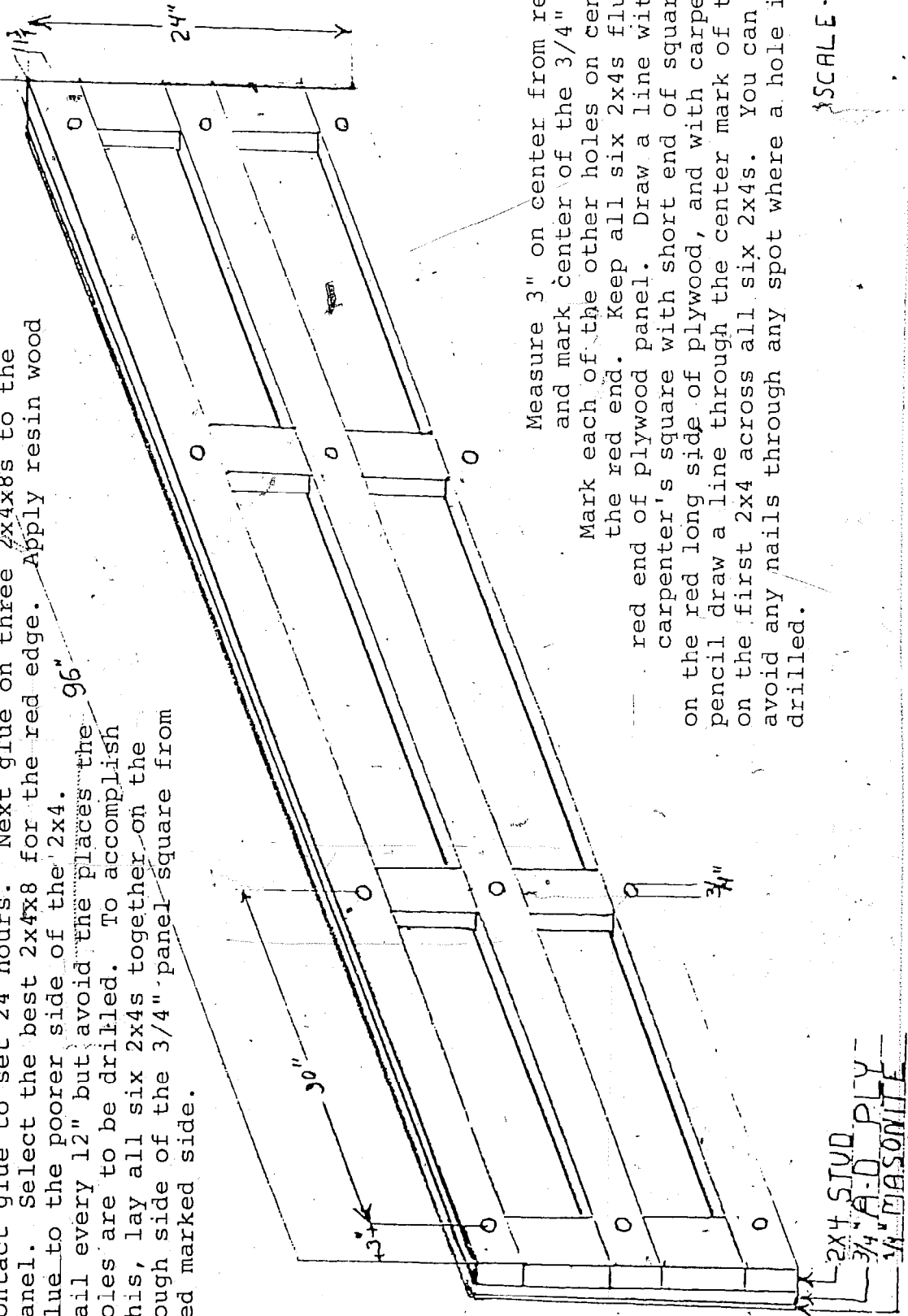

(23b)

Measure 3" on center from red end and mark center of the 3/4" hole. Mark each of the other holes on center from the red end. Keep all six 2x4s flush to red end of plywood panel. Draw a line with a carpenter's square with short end of square held on the red long side of plywood, and with carpenter's pencil draw a line through the center mark of the hole on the first 2x4 across all six 2x4s. You can then avoid any nails through any spot where a hole is to be drilled.

SCALE - 1"=1'

2x4 STUD
3/4" A-D PLY -
1/4" MASONITE

CORNER FORM PROPOSAL

We propose a wall height 8' --corner adaptable to a 12", 14", 16" or 18" wall. The drawing below is usable for lower walls or for building the corner in steps by moving the short form 2' heights. Only actual experience can tell which is the more efficient. The wall height/corner panel can be used as the standard wall panel. The holes are identical in horizontal spacing. With the yolk system, it needs no ties.

The width of the two corner panels is the width of the wall plus the thickness of the form, or 2 1/2 ". The outside corner is held together by a 1/4" x 2" steel strap long enough to reach first hole on the standard form section. The two corner panels on a 12" wall are 15 1/2" wide x 8' high.

The remaining computations (i.e. 14", 16", 18") have not been put on this sheet.

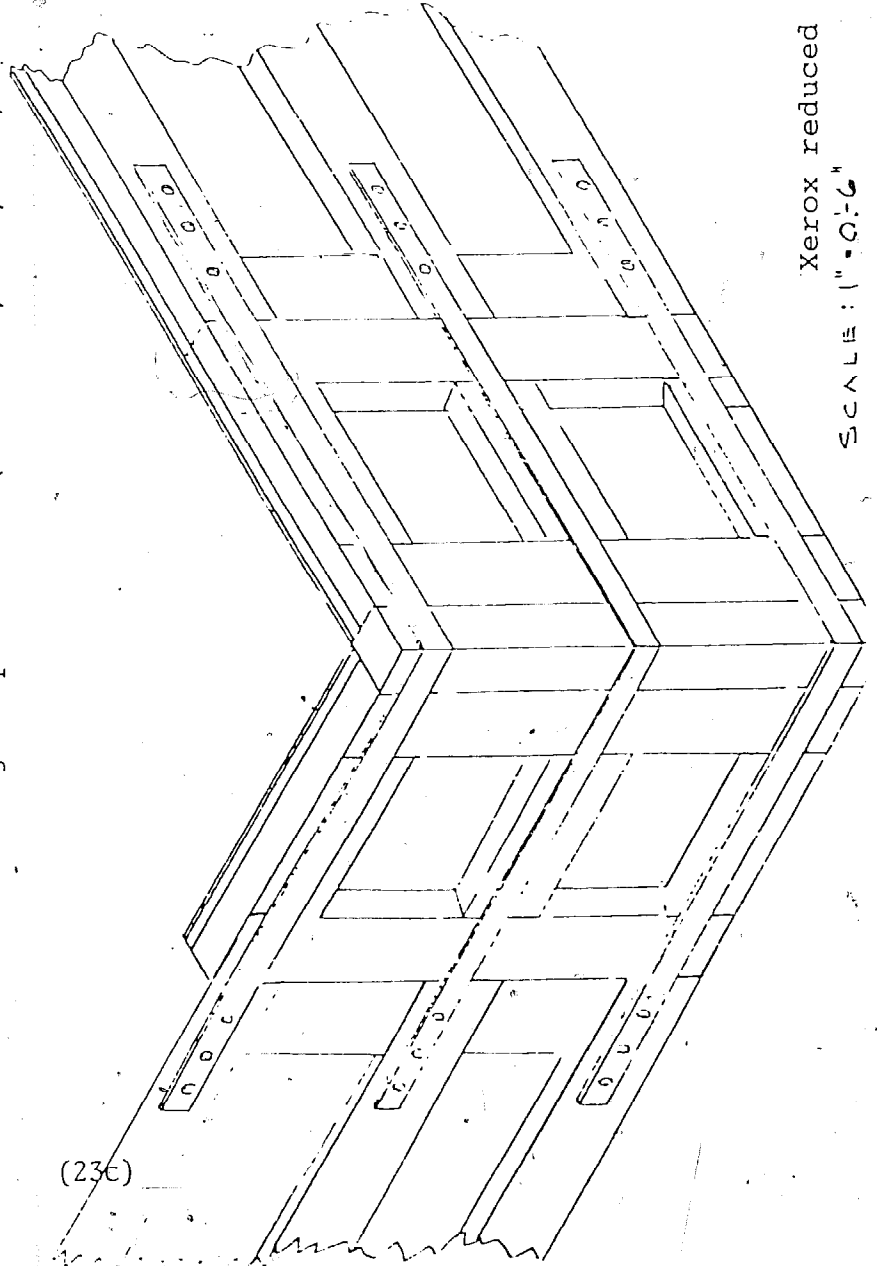

(236)

Xerox reduced
SCALE: 1" = 0.6'

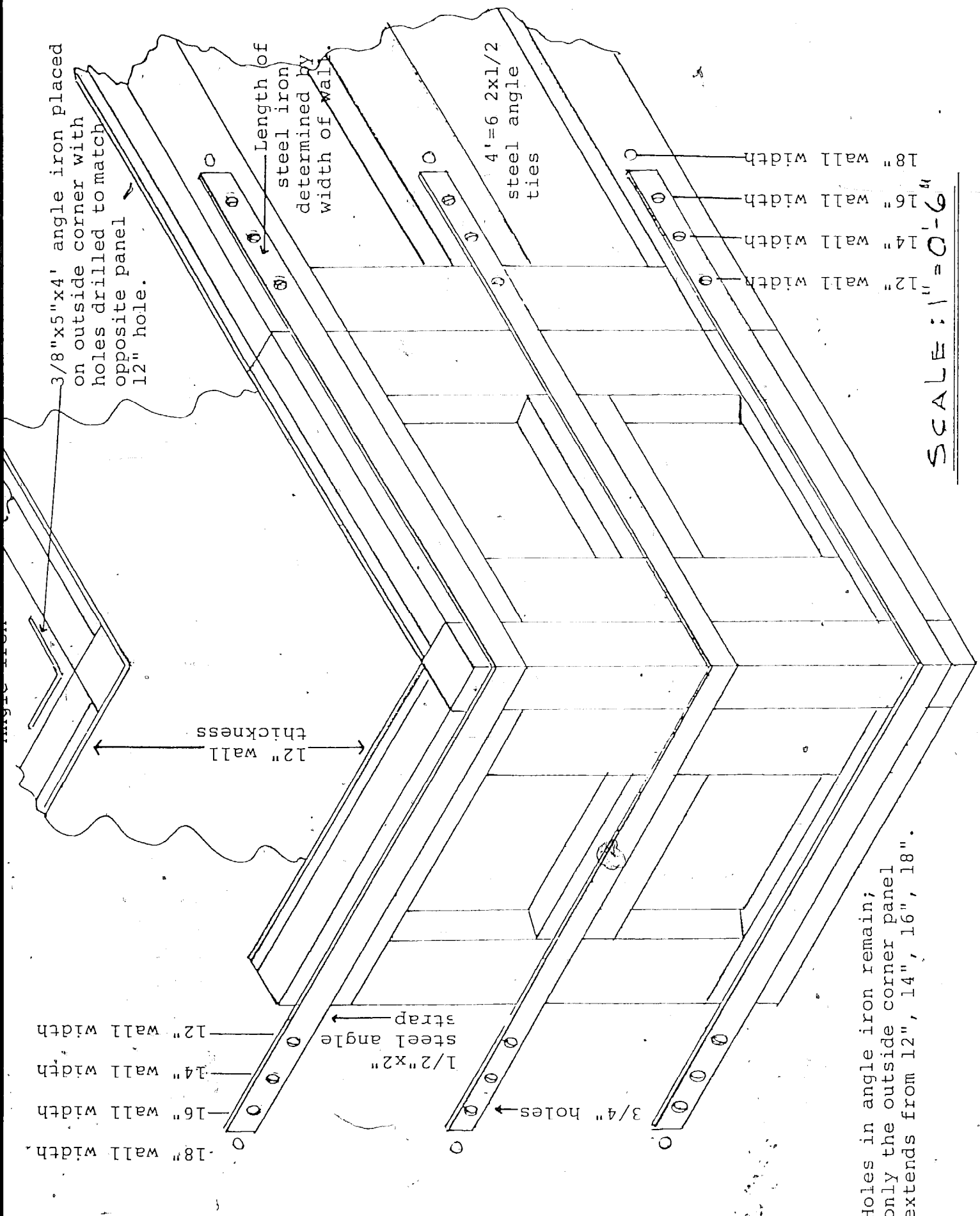

Holes in angle iron remain; only the outside corner panel extends from 12", 14", 16", 18".

5/8" Cold rolled steel - plain

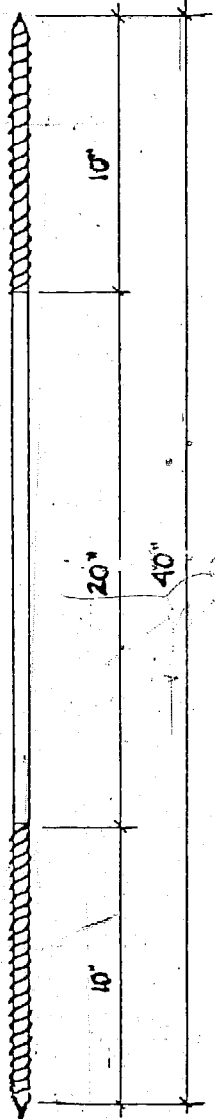

ACME BOLT
SCALE: 1/2" = 1'-0"

This is a short end gate with a 2x4 bevelled for a keyway. There should be a 2x2 on the back side.

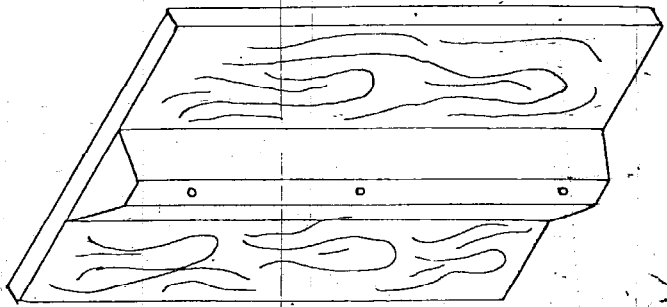

END-GATE

12" WALL STANDARD CORNER PANEL
(Not to scale)

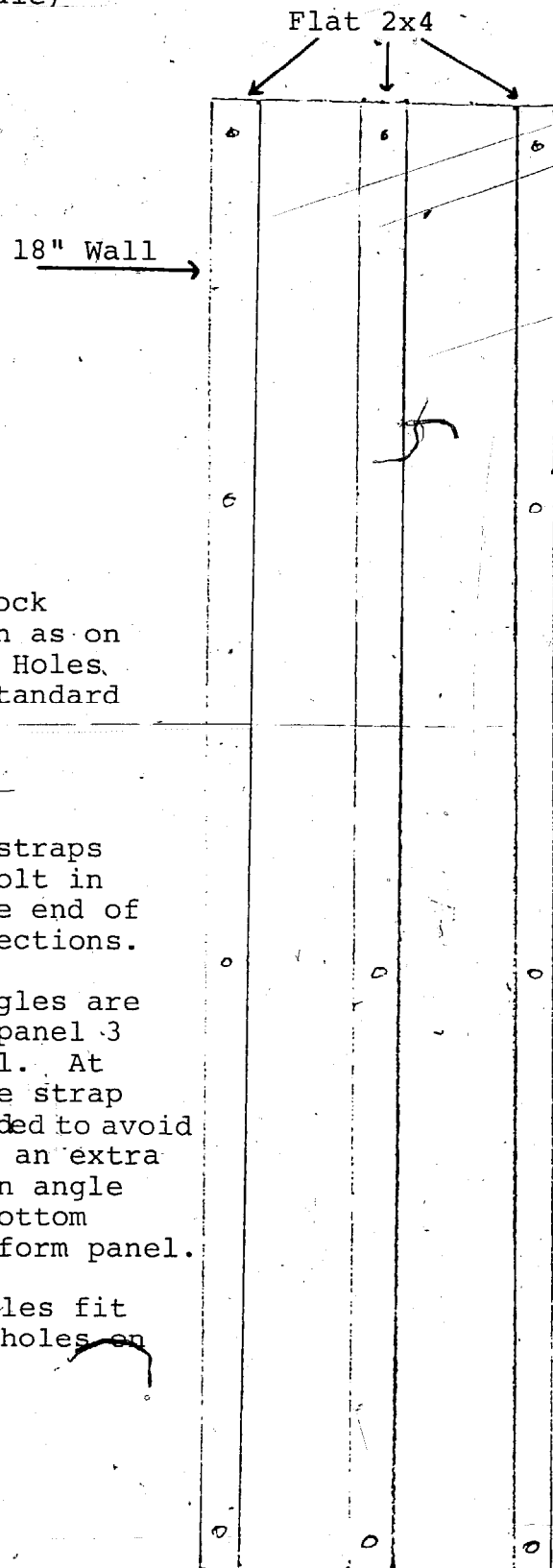
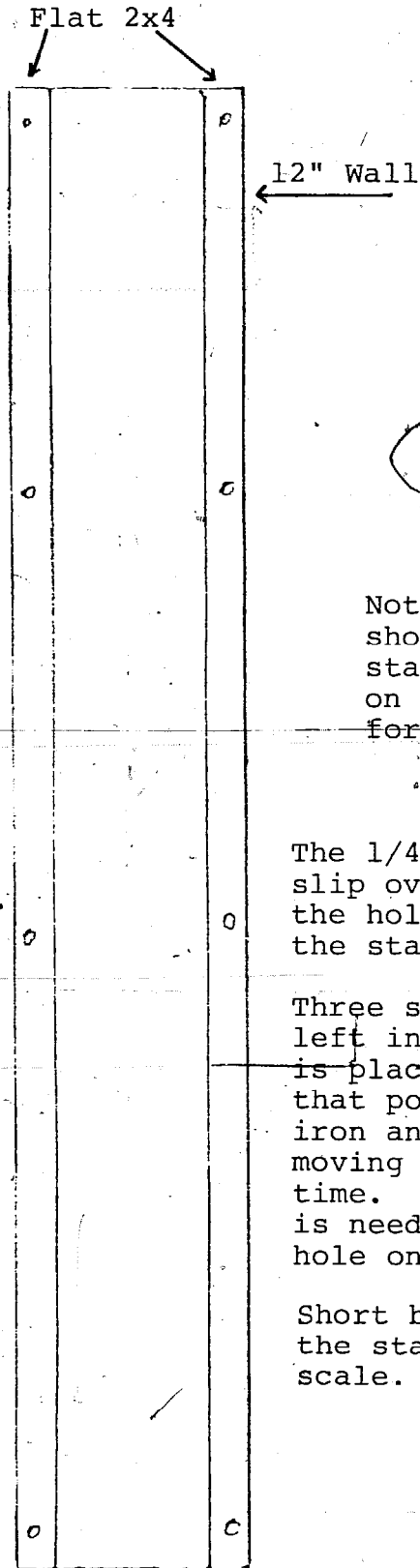

Note: Cross block
should be put in as on
standard form. Holes
on 2x4s as on standard
form.

The 1/4" x 2" iron straps
slip over the tie bolt in
the hole 3" from the end of
the standard form sections.

Three strap iron angles are
left in place when panel 3
is placed on panel 1. At
that point, two more strap
iron angles are needed to avoid
moving the uprights an extra
time. No strap iron angle
is needed for the bottom
hole on the second form panel.

Short blocks and holes fit
the standard panel holes on
scale.

15 1/2"

23"

ENDGATE CROSS BAR (YOKE)
(Not to scale)

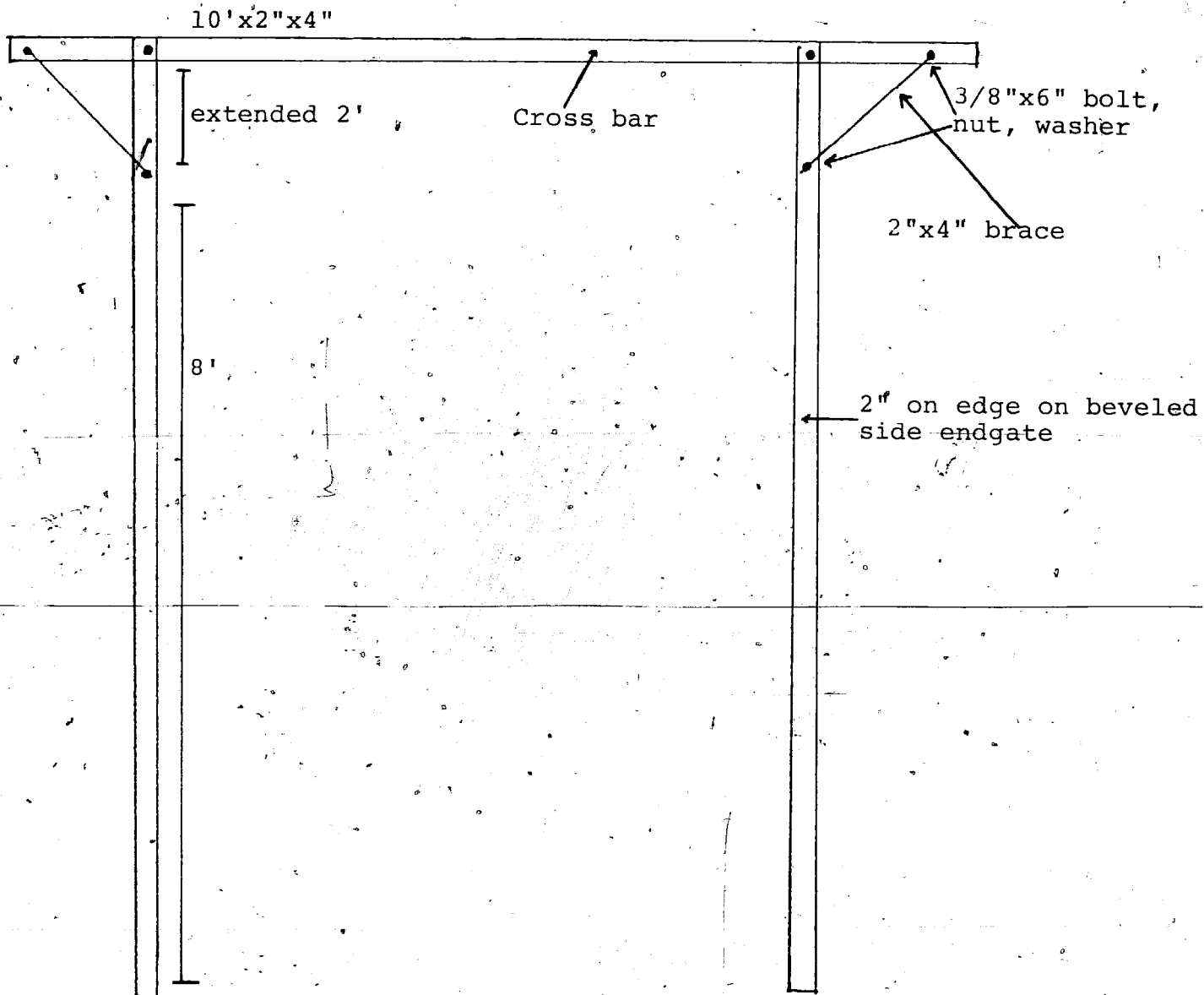

Yoke: The endgate has a beveled 2x4 to act as a keyway binder for the next section of the wall. This is extended two feet. A cross bar is placed in slots at the top of the extended 2x4 to serve as a positive alignment and as a beam to which an old-fashioned fence stretcher may be placed to lift the bottom form in leap frog fashion. The corners are braced with 2x4 with 3/8"x6" bolts, nuts and washers.

2x4
3/4" AD plywood masonite

1/4" tempered masonite

Endgate

bevelled 2x4 for keyway

This drawing shows the form with the earth rammed up to the top bolts on panel 3. Bolts in uprights B and C were not put in place until the earth had been rammed within an inch or two of the bolt holes.

End gate

inset washer

3/4" spreader

1/2" acme tie bolt

(23h)

Panel 3

Panel 1

Panel 4

Panel 2

Upright A

Upright B

Upright C

Upright D

SCALE: 1" = 1'-0"

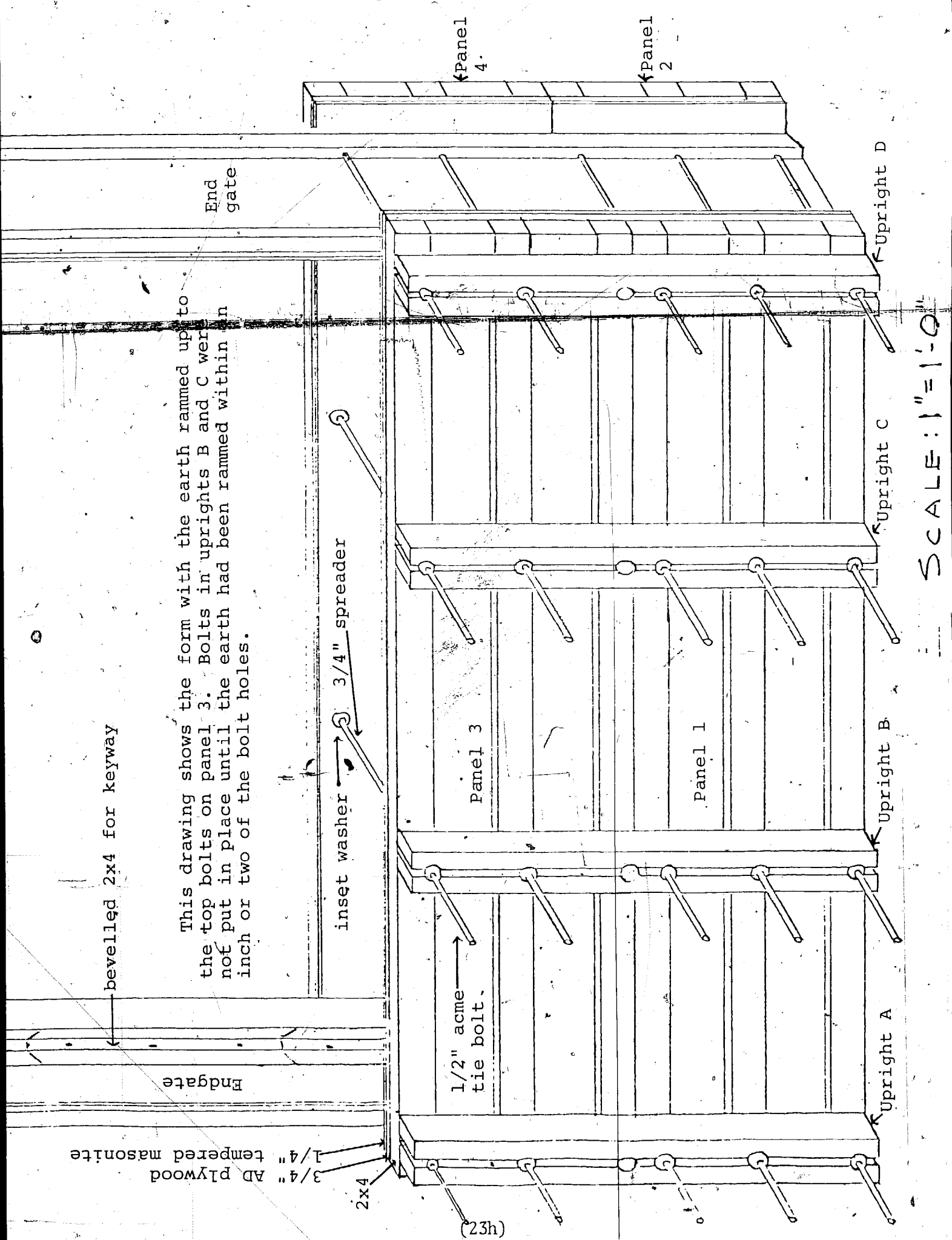

LEAP FROGGING-MOVING PANELS UP AS WALL RISES

Tamp earth between panels 1 and 2 within three inches of the top of the form, just under the tie bolts. Put panels 3 and 4 in place. Add bolts, washers, spacers and nuts. Leap frogging begins after panels 3 and 4 are filled with rammed earth to the bottom of the top holes. Release all of the nuts and washers. Remove the four uprights from both sides with the bolts to remain in place.

Carefully slide panel on the tie bolts away from the completed wall without twisting so the "green" wall will not spall at any point.

Carefully lift panel 1 and place it against the endgate on top of form 3. Each person has one end of form 1. Each person should have a 5/8" x 5" long bolt with a washer and nut in his pocket. Each slips a bolt through the side 2 x 2 on the endgate into the middle of the three end holes and spins on the nut. Panel 1 is now securely in place. Repeat the operation on the other side of the wall by removing the nuts, washers and the uprights and finally Form 2.

Each has a 5/8" x 5" bolt and washer in his pocket. Lift form 2 and place it carefully on form 4. Fasten form 2 by the 2 bolts through each end of the endgate through the middle hole on the end to hold form 4 in place.

You are now ready to install uprights B and C.

Slip uprights B and C over the bolts 5 and 6 on each of uprights B and C. Slip on the washer and spin on the nuts and spin them tight by hand. Repeat the same on the other side.

Next insert the tie bolts through the endgates. Do not insert the tie bolts and spacers on the top hole uprights B and C until the earth reaches the hole.

At this point, panels 1, 2, 3, 4 and endgates are holding the rammed earth wall. Remove panels 1 and 2 and you will see the first strip of rammed earth wall. Place uprights B and C onto bolts 5 and 6 on panels 3 and 4 (both sides). Place panels 1 and 2 on top of 3 and 4. In order to leap frog, you must now place the bottom of the upright to bolts in holes 4, 5 and 6. Loosely fasten the nuts and bolts. (Later to fasten tightly all nuts and bolts as when changing a car tire.) Add uprights A and D in same manner. Leap frogging is accomplished.

Hole 4 is the bottom hole for the leap frogging so uprights B and C are set first with panels 1 and 2 on top of panels 3 and 4 and bolted. The insertion of the nuts and washers will fit exactly as they did in the first setting of panels 1, 2, 3 and 4. (Uprights are now holding panels 3 and 4 tight with panels 1 and 2 above them. This is the leap frog position.)

You are moving only two feet of upright at a time. Panels 1 and 2 are now rammed; panels 3 and 4 are now rammed, but holding the forms; panels 1 and 2 are leap frogged on top of panels 3 and 4. Bolt together with the same process described earlier.

It is our experience that no concrete cap is needed on the wall. We recommend that you insert an eye bolt 12 inches long with a 12 inch piece of reinforcing rod through the eye of the bolt. The bolt should be set in the earth 8 inches or three lifts before tamping in the last 8 inches of earth. One bolt in the center of each 8 foot section is sufficient.

We have not provided the specifications and plans. That is beyond our abilities. We urge you to consult one of the many good books on house construction. As you know we ourselves retained an architect. He provided the plans and part of the supervision.

This manual is written to those who can help themselves. We challenge you to join those of us who have become rammed earth builders and believers.

REFERENCES

1. Bainbridge, David A., The First Passive Solar Catalog. Davis, Calif.: Passive Solar Institute, 1978. *
2. Boggs, J. Palmer, The Architectural Forum, 1946.
3. Commonwealth Experimental Building Station, NSB No. 13, Australia, Earth Wall Construction *
4. Cooperative Extension Service, Colorado State University, Fort Collins, Colorado. Soil Testing Laboratory.
5. Cytryn S., Soil Construction. Jerusalem: The Weizmann Science Press of Israel, 1957. *
6. Encyclopedia Britannica, 1968 edition, volume 18, pages 1148, 1149.
7. Fitzmaurice, Robert Manual on Stabilized Soil Construction For Housing. Technical Assistance Programme United Nations New York, 1958. *
8. Kern, Ken The Owner Built Home, Charles Scribner's Sons, New York, 1975. *
9. Lee, A.B. Houses of Earth. Washington, D.C.: A.B. Lee, 1937.
10. Long, J.D., Adobe Construction. California Experiment Station Bulletin 472.
11. Merrill, Anthony F., The Rammed Earth House. New York and London: Harper and Brothers Publishers, 1947.
12. Middleton, G.F., Earth-wall Construction. Canberra: Australian Government Publishing Service, Experimental Building Station Bulletin, No. 5, 1976.
13. Miller, Thomas A.H., Rammed Earth Buildings Built 1820-1854. U.S. Department of Agriculture, August, 1926.
14. Patty, R.L., Agricultural Engineer. Vol. 23, No. 9., Sept. 1942. Rammed Earth Walls for Farm Buildings S.D. Exp St. Bulletin 277.

15. Risom Sven Nordiske Ler Jords Huse Copenhagen, Rosenkilde OG Bagger
16. U.S. Department of Agriculture, Farm Security Administration, Experiments on Rammed Earth Construction. PSA Pub. 59.
17. U.S. Department of Commerce, Preservation of Historic Adobe Structures--A Status Report. National Bureau of Standards Note 934, February 1977. *
18. U.S. Department of Commerce, Structural, Heat-Transfer, and Water Permeability Properties of Five Earth Wall Constructions. National Bureau of Standards, Washington, D.C.: October 1, 1941. *
19. U.S. Department of Commerce, United States Bureau of Standards Bulletin BMS 78. *
20. Van Dresser, Peter. Homegrown Sundwellings. Sante Fe: The Lightning Press, 1977. *
21. Wolfskill, Lyle A., Dunlap, Wayne A., Galloway, Bob M., Handbook for Building Homes of Earth. Washington D.C.: Department of Housing and Urban Development. *
22. Wright, Frank Lloyd, The Natural House, Horizon Press 1954.

*-Available for purchase

APPENDICES

- A. Material and Price List, Greeley, Colorado, Feb. 1980. List includes enough materials for 4 standard panels, 2'x 8', 2 endgates, corner panels, brace, and other materials to complete one 8' high monolithic rammed earth wall section.
- B. Pictures, annotated, of the building of the standard form.
- C. Colorado State University Soil Testing Laboratory Analysis:
- 1 sample of earth from Greeley, Colorado from the Miller rammed earth house.
 - 2 samples of soils from ECO Village, Mother Earth, Hendersonville, NC.
 - Letter to Lydia A. Miller from Prof. P.N. Soltanpour, Soil Test Specialist, CSU.
- D. Architectural Forum, Dec. 1946 Rammed Earth, Miller's First House.
- E. Pise' Construction, NSB 18, Notes on the Science of Building, Australia (Available for purchase--address at end of article). Reprinted by permission.
- F. Earth-Wall Construction, NSB 13, Notes on the Science of Building, Australia (Available for purchase--address at end of article).

MATERIAL AND PRICE LIST

Quantity	Description	Unit Price	Total Price
---WOOD---			
24	2x4x8 Hem Fir	\$ 1.75	\$42.00
4	2x2x8 Hem Fir	1.12	4.48
3	2x4x10 Hem Fir	2.63	7.90
8	2x4x4 Hem Fir	.87	6.93
2	1x4x12 Pine	1.52	3.04
5	4x8 3/4" AD Plywood	21.00	103.20
5	4x8 1/2" Tempered Masonite	8.00	40.00
---BOLTS---WASHERS---SCREWS			
1	5/8x36 All Thread Course Bolt (For Example Only)	3.59	
6 box	No. 6 x 2" Flat Head	1.99	11.94
96	5/8 Flat 1 1/2" Washers (Double this amount needed for full form setting.)	.09	8.64
18	5/8 - 8 Acme Thread Cold Rolled Steel 10" each end of 40" long part	9.22	165.96
36	1" Hex 5/8 - 8 Acme Nut	5.25	189.00
---NAILS---			
2 lb.	16d Smooth Box	.59	1.18
2 lb.	8-Penny Box	.50	1.00
2 lb.	16-Penny Box	.50	1.00
2 lb.	6-Penny Box	.50	1.00
2 lb.	7-Penny Box	.50	1.00

Quantity	Description	Unit Price	Total Price
----------	-------------	------------	-------------

---CEMENT---GLUE---

2 qt.	Contact Cement	\$ 4.93	\$9.86
1 qt.	Pastewood Filler	3.95	
1 gal.	Contact Cement	13.95	
1 qt.	Resin Wood Glue	4.50	

---MISCELLANEOUS---

	Tools, Miscellaneous	11.20	
	Triangle	6.59	
	1" Wood Chisel	4.20	
	1/2" Wood Chisel	3.70	
	1/4" Wood Chisel	3.25	
	Chalk Line	.90	
2	Carpenter's Pencils	.50	1.00
2	Electric Drill Bits	1.49	2.98
	Sealer	.98	
36	3/4" Thin Wall Conduit at \$.33 per ft.	.33	11.88

---WORK EXPENSES---

	Greeley Planing Mill To Plane Endgates 2x4x10 Bevel		20.00
	David Atkinson Drawing and Form Construction		75.00
16 hr.	At \$3.50 per hr., Craig Hansen Building Forms		56.00
30 hr.	At \$3.10 per hr., Linda Cuplin Typing and Editing		93.00

856.99

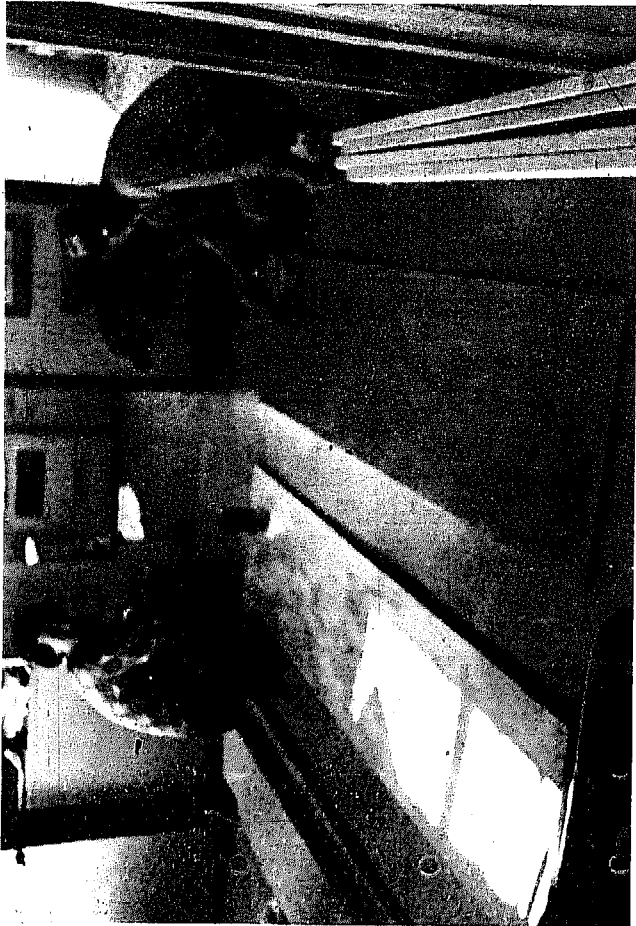

Contact glue applied to the rough sides of masonite and plywood panel 1. Bond accurately.

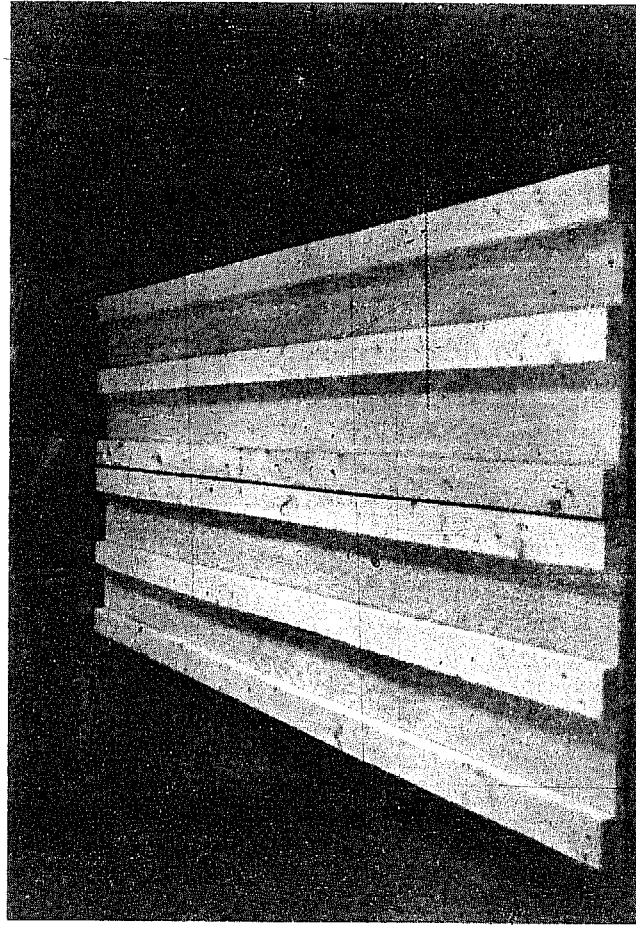

Two panels 2"x4"x8' with three 2x4s glued horizontally, two panels placed together as in actual form for wall.

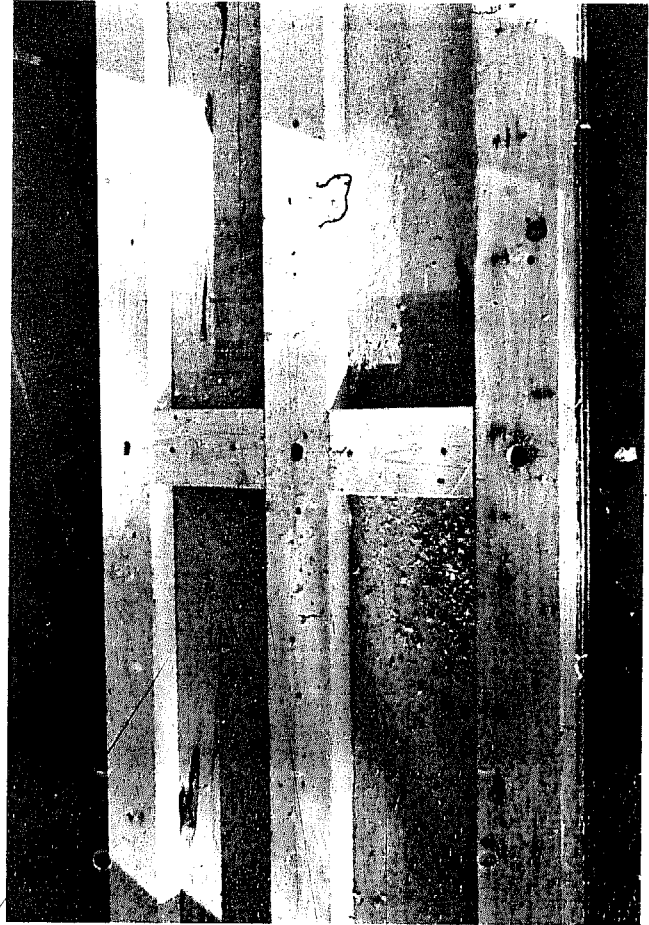

Add short blocks on end and on 30" centers.

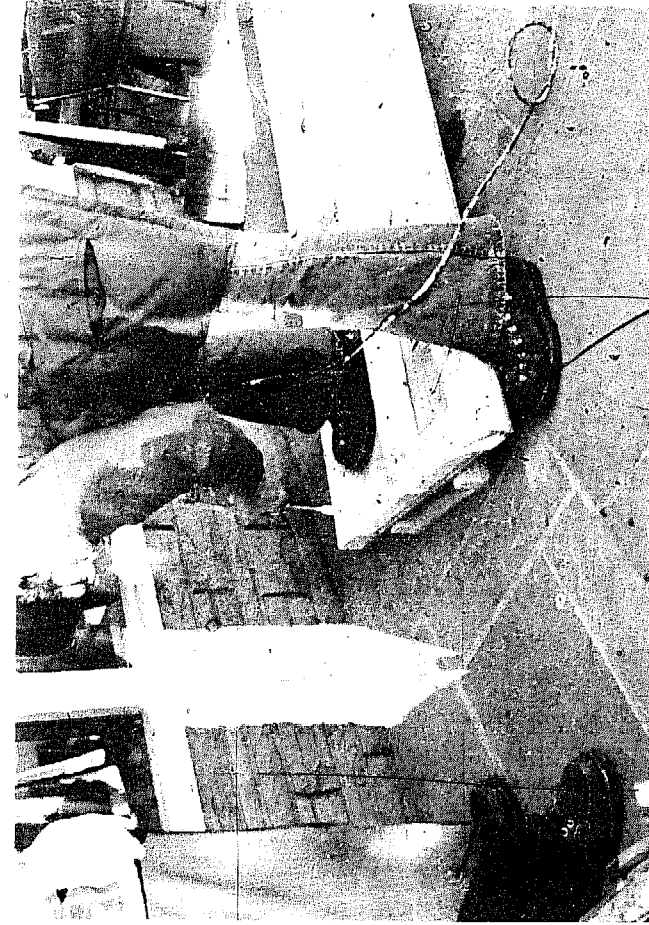

Drill 3/4" holes on centers and 1 1/2" from end.

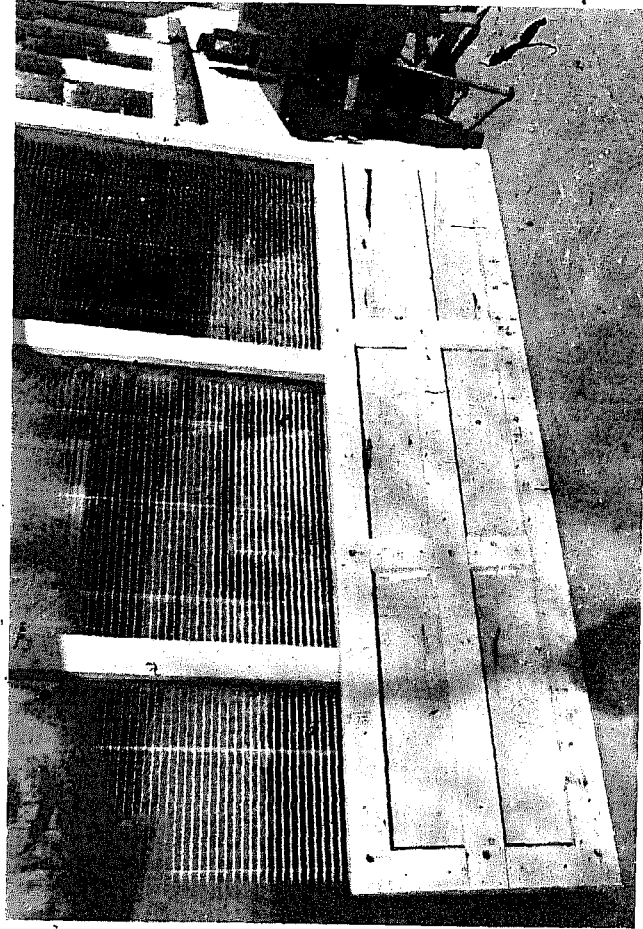

Completed detail with holes drilled, panel 1.

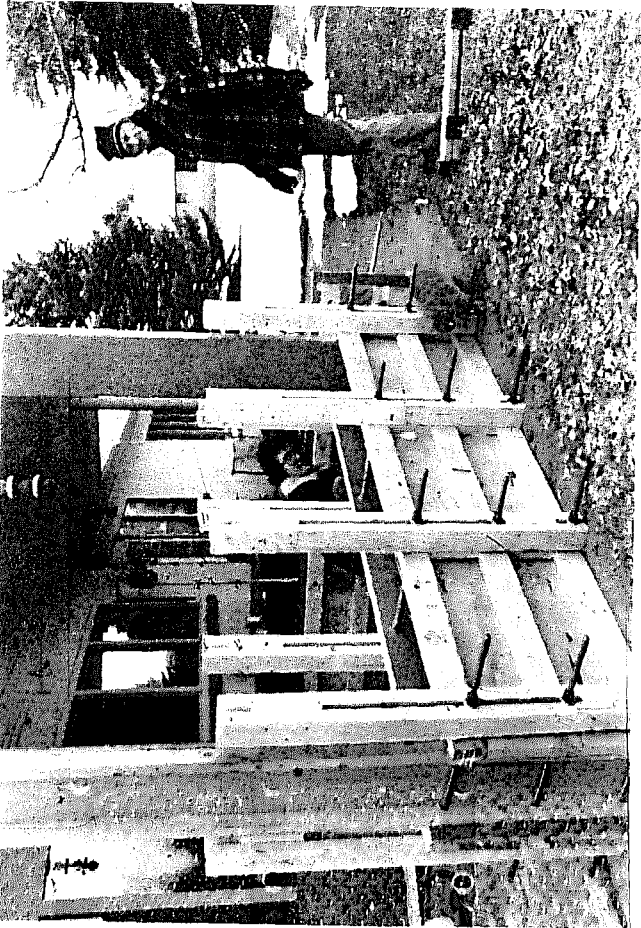

Endgates, panels 1 and 2 in place, bolts and uprights holding forms in place.



Completed detail with holes drilled, panel 1.

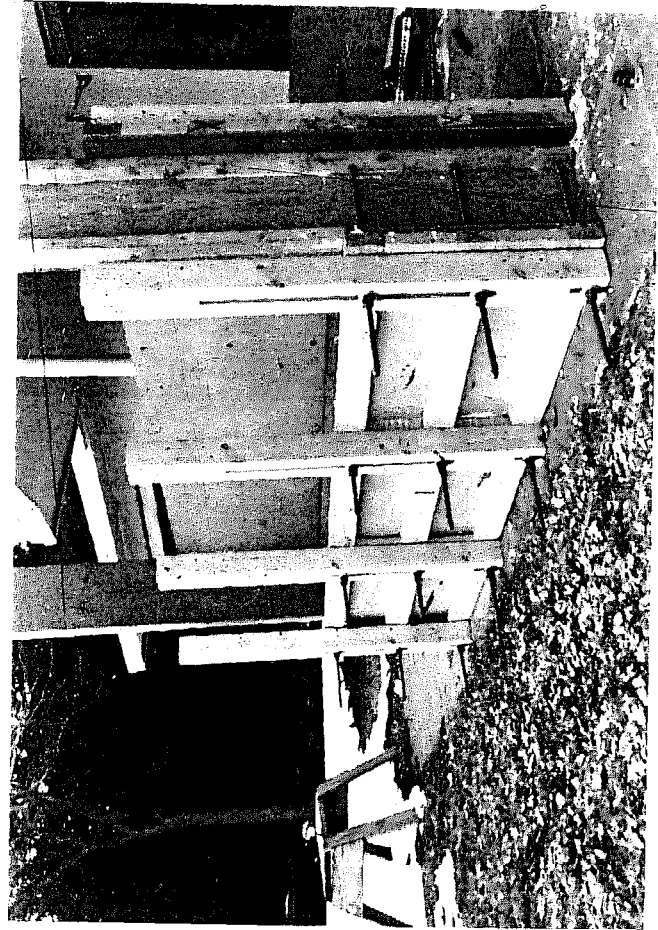

Panel 3 has been added on one side.

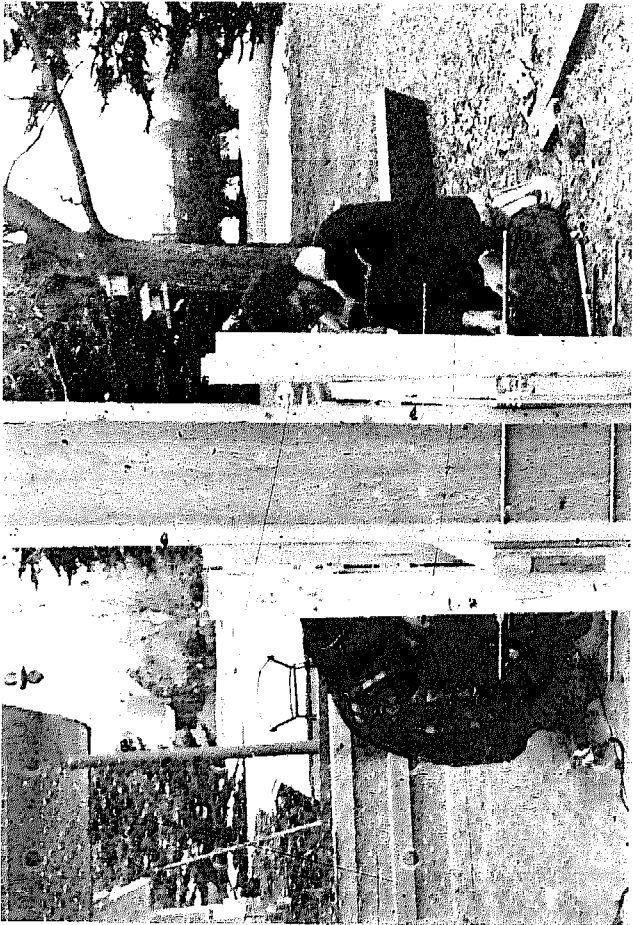

End view of assembly of form panels 1, 2 and 3.

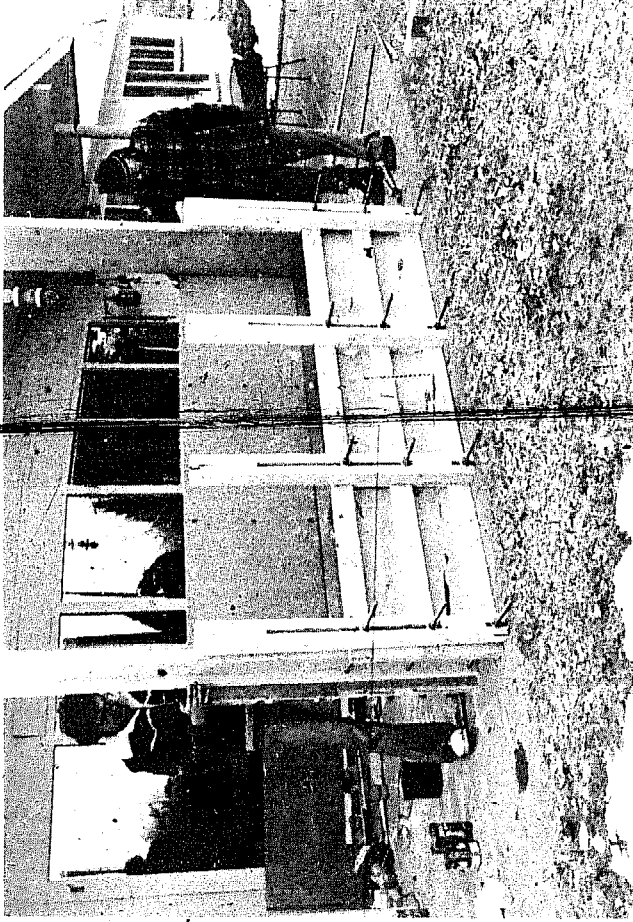

View of assembly of form panels 1, 2 and 3.

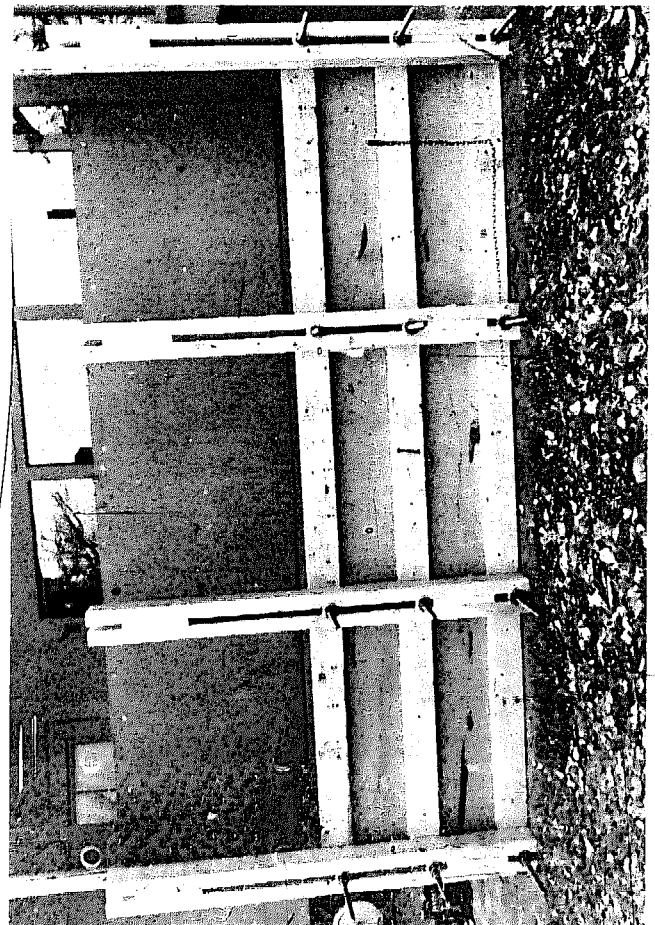

View of assembly of form panels 1, 2 and 3.

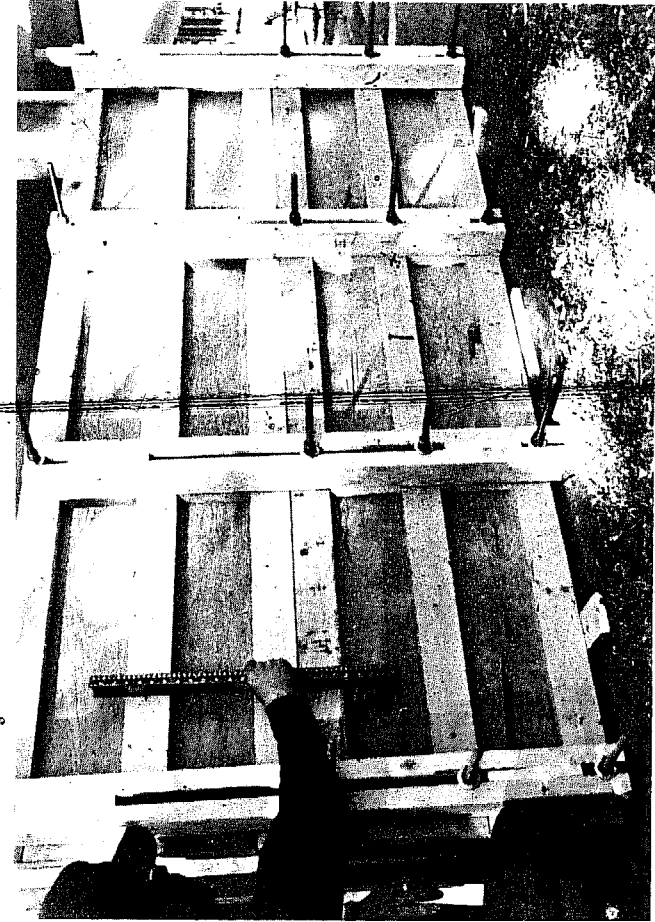

Leveling, plumbing...a MUST. Note blocks at base.



Close up view of process.

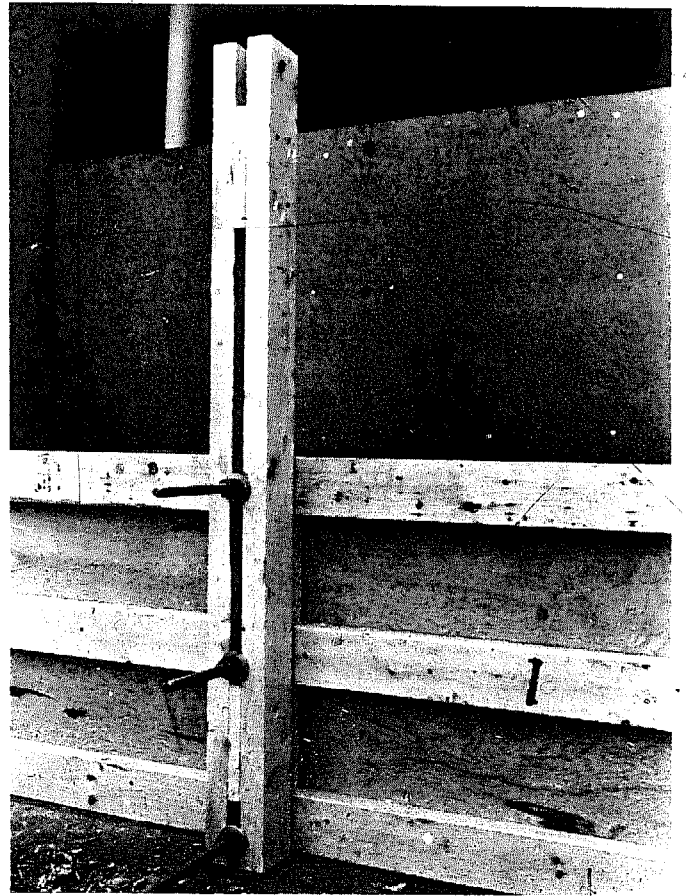

Close up view of panels 1, 2, 3.



Bolts without spacers fit on outside of endgate. Endgate is spacer.



Spacers and washers must be placed inside of the forms.

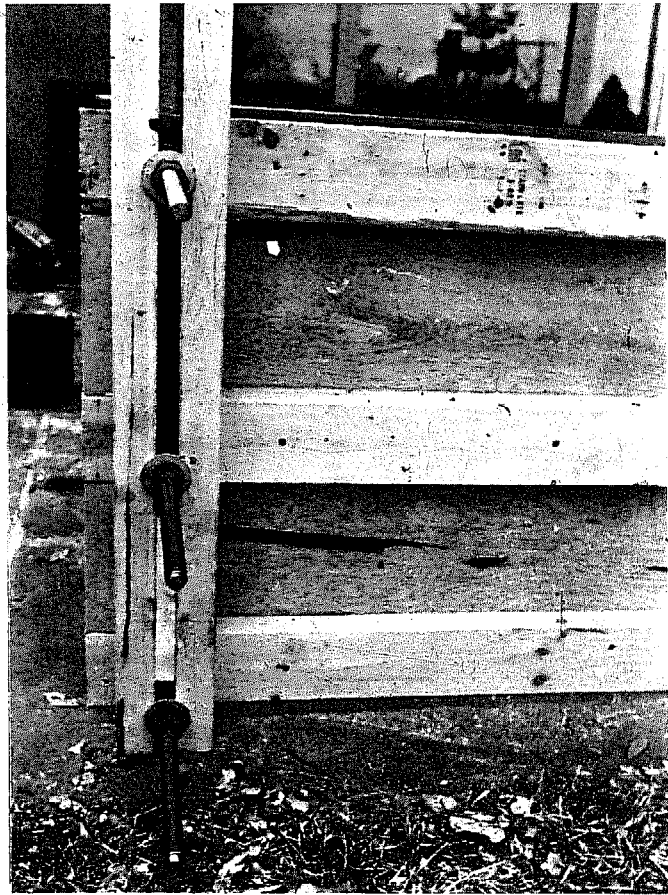

Close up side view of endgate in place.

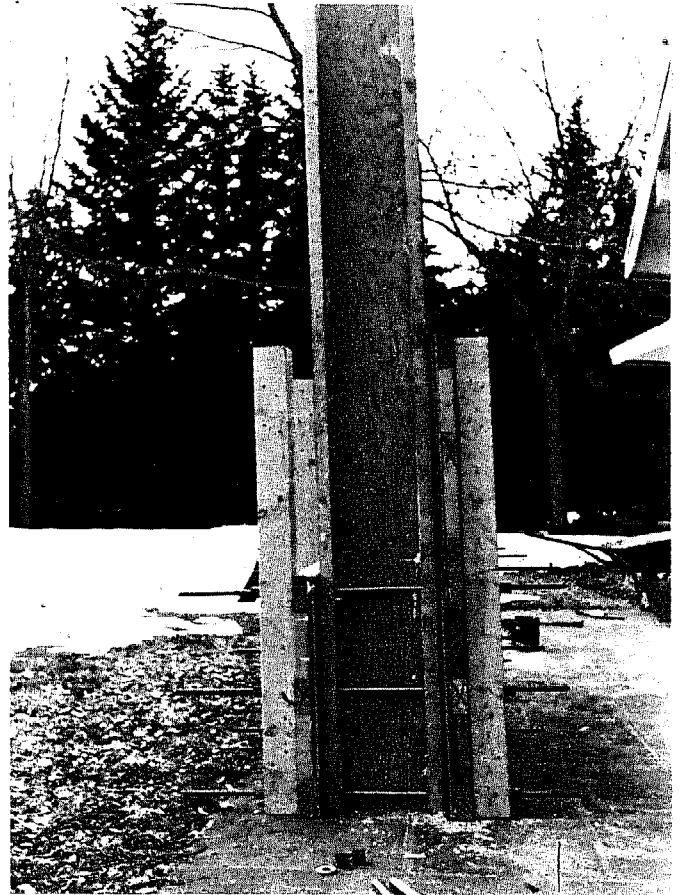

End view of endgate in place.



Beveled 2"x4"x10' nailed on center of inside of endgate; 12" wide for 12" wall.

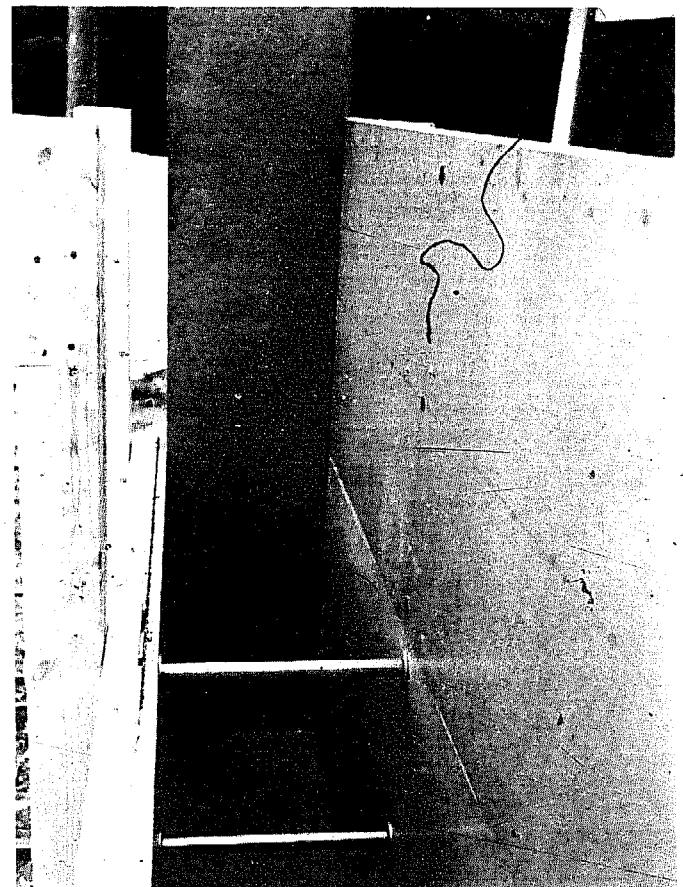

Endgate before the bevel, showing spacers.

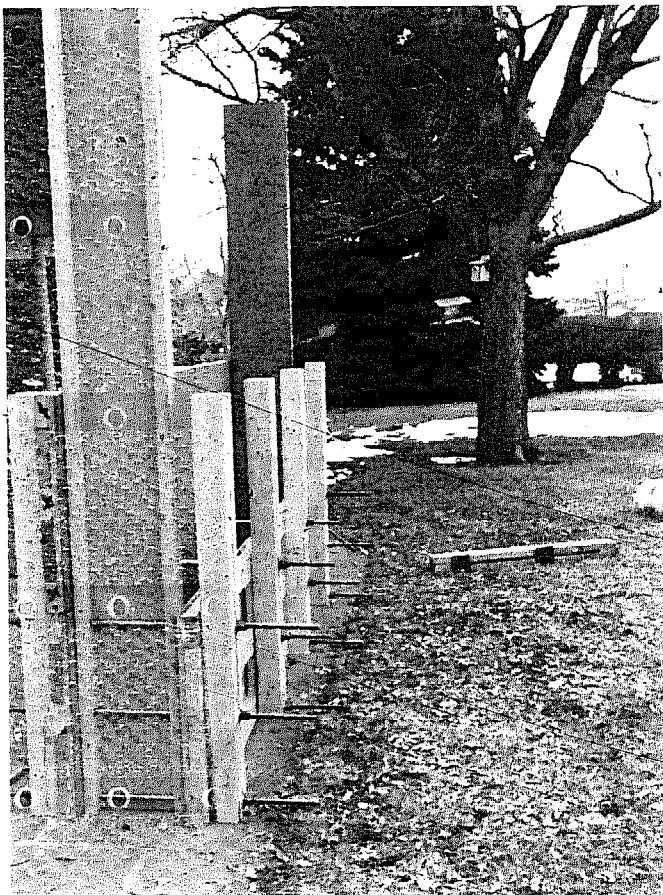

Both endgates in place. One end before bevel.

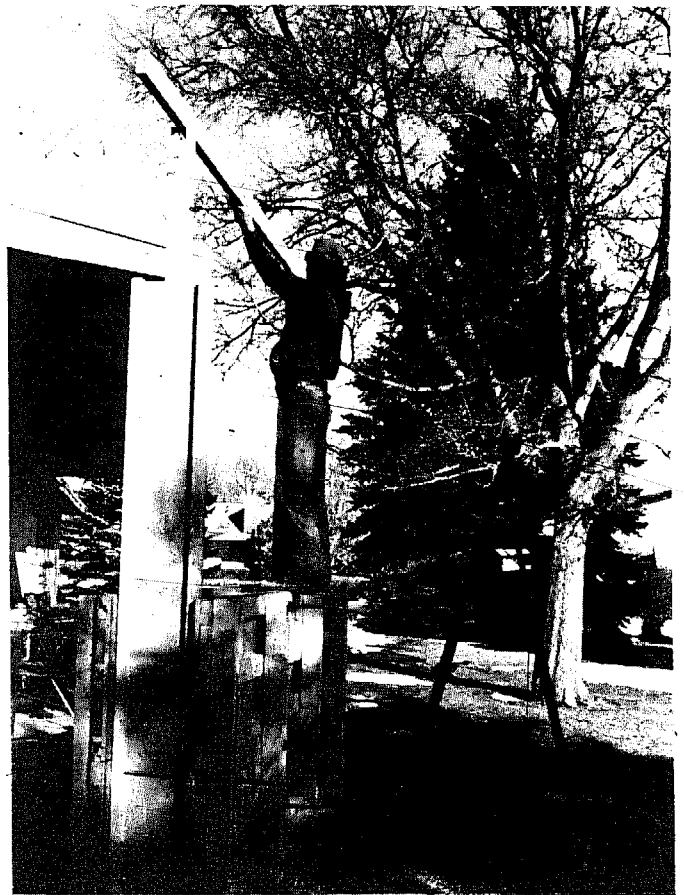

Putting 2"x4"x10' brace on top of 10" bevel, notched.

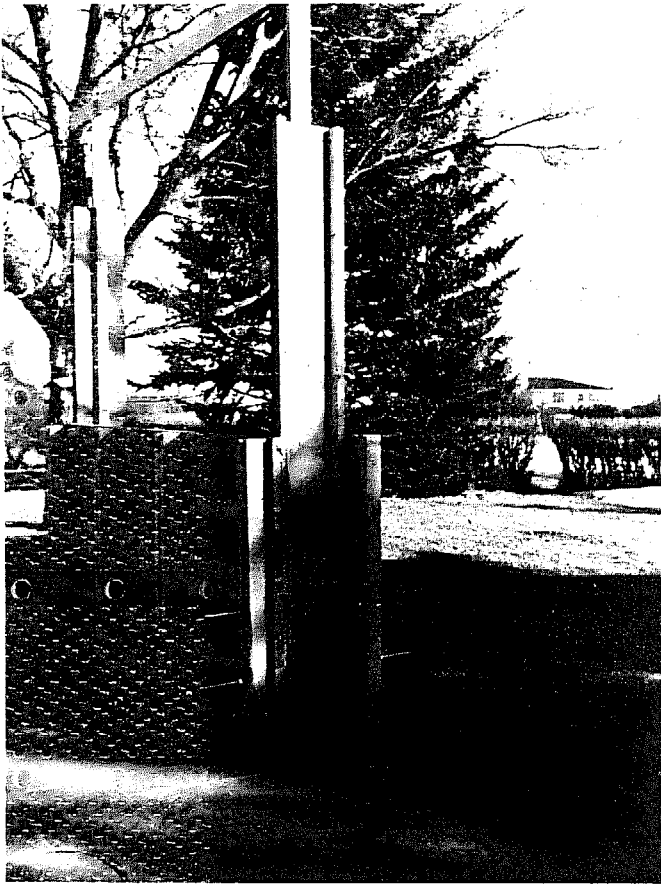

2"x4"x10' brace serves as balance yoke to hold form panels plumb.

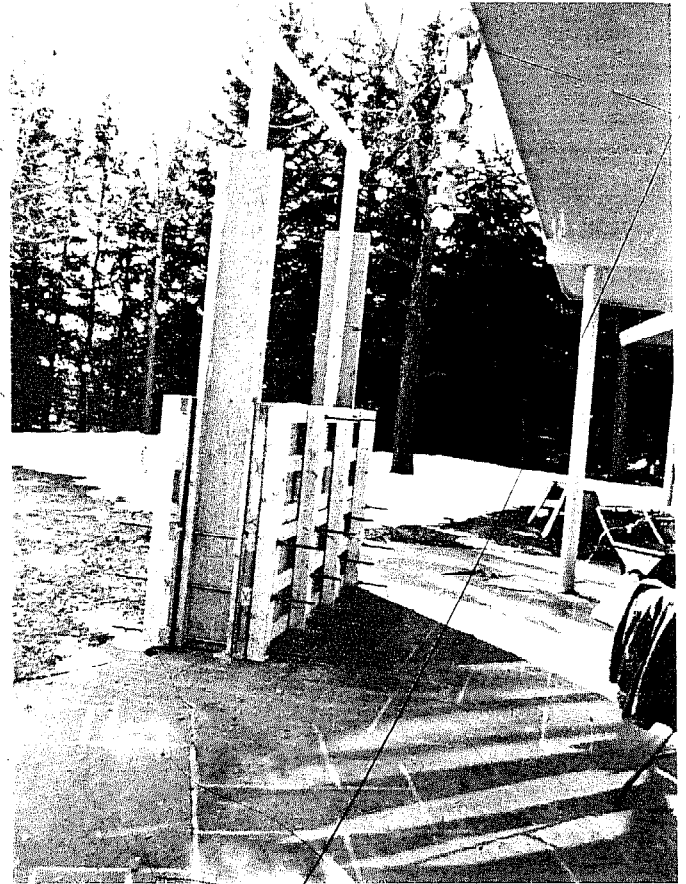

Completed setting of panels 1, 2, 3, 4, endgates and brace.

CSU SOIL TESTING LAB
 #6 OLD/VOC AD BLDG.
 FORT COLLINS, CO 80523

RESEARCH - SOIL ANALYSIS FORM

Please note: Your samples will be automatically discarded 30 days from the date on this report. If you wish to keep your samples or have question about any results; please notify us within this 30-day period.

Date Rec'd	Lab No.	Col. No.	Name		% Gravel	% S	% Si	% C	+ _{ext} %	Fraction			
1677	Earth from Miller home				10	76	17	7	5L				
1678	Hendersonville No. 1 coffee can				1	46	44	10	L				
1679	" " ECC village				0	38	51	11	SIL				
					Determined on < 2mm								
					m.e.l in the saturation extract								
1677				O.M.	Ca	Mg	Na	K	CO ₃	HCO ₃	SO ₄	NO ₃	
1678				1.2	65.0	6.0	4.7	0.7	0	2.8	2.6	33.6	25.9
1679				0.6	2.3	1.1	13.3	0.1	0	0.2	15.1	0.5	0.2
				0.7	0.6	0.2	1.2	0.1	0	0.2	0.6	0.7	0.4
				mmhos/cm saturation extract	- ppm in soil (soluble in the saturation extract)								
				Cond	Ca	Mg	Na	K	CO ₃	HCO ₃	SO ₄	NO ₃	
1677				5.1	27.4	2.0	26	8	0	46	25	147	99
1678				1.8	42.0	6	129	3	0	5	224	3	1
1679				0.2	40.1	5	11	1	0	5	8	5	2



Cooperative Extension Service

Colorado State University
Fort Collins, Colorado
80523

February 26, 1980

SOIL TEST

Mrs. Lydia A. Miller
Box 1424
Greeley, CO 80631

Dear Mrs. Miller:

Enclosed please find the analytical results on the soil samples you sent us. From the soil properties that we determined, it seems all three samples could be used for rammed earth construction. Clay and organic matter contents are low in all soils.

The insulation property (R value) of rammed earth is determined mainly by its degree of porosity, moisture content, and thickness. As the degree of compactness of rammed earth increases, its porosity decreases and its insulation property lowers. The higher the moisture content of rammed earth the lower its insulation value. Therefore, as rammed earth wall ages and loses its initial moisture, it becomes a better insulator. Obviously the thicker a rammed earth wall the higher its insulating value.

We do not determine insulation properties (R value) of rammed earth walls or any other objects. However, you may write to Solar Energy Research Institute (SERI) in Golden, Colorado and ask them about how you can have R value of rammed earth walls determined.

Sincerely,

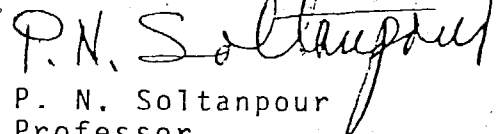
P. N. Soltanpour
Professor

PS/bn

DAVID J. MILLER
ATTORNEY AT LAW
804 7th ST. P. O. BOX 1424
GREELEY, COLORADO 80631

T. PALMER BOGGS
Engineer-Designer-
Consultant
No. 1 Texas Way
Payetteville, Arkansas
75201

PRODUCTS AND PRACTICE



RAMMED EARTH—One of man's oldest building materials—is used by a Denver engineer to build a modern house.

There is a perennial interest in rammed earth houses. Based partly on the idea that they ought to be dirt cheap and partly on simple amazement that any material as loose and friable as soil could ever be made to hold up a roof. In times of materials shortages, the idea of building a house out of ordinary dirt has an irresistible lure. As a matter of cold fact, rammed earth construction (or *terra pise*, as the Spanish called it) has many merits. When handled with care and intelligence—as in the new house of David Miller at Greeley, Colorado—rammed earth yields handsome, strong and durable walls. Rammed earth's low heat conductivity makes it good for both hot and cold climates. Although not as cheap as might at first appear, on well-managed jobs it may run as much as 20 per cent lower than conventional methods.

The limitations of rammed earth construction are, however, severe. First of all, it is necessary to use suitable soil—preferably 70 per cent sand and small gravel to 30 per cent clay—and it must be carefully sifted, mixed, dampened, tamped and cured. Because of the necessary form-work and scaffolding, it is seldom economic to build earth walls more than a story high. Beams are impracticable in *terra pise* (although current tests indicate the possibility of reinforced earth beams of surprising strength) and any columns must be very large in section. Earth walls must rest on concrete footings well above finished grade and must always be protected by projecting roof or coping. Such limitations as these automatically limit rammed earth to buildings which are simple in both plan and

elevation, with a minimum of tricky detailing.

The Colorado house follows the latest practices in rammed earth construction methods. Topsoil was removed by bulldozer and subsoil massed for convenient sifting and mixing. Forms were prefabricated. Moisture content was controlled (the mix must be just moist enough to ball in the hand), as was the curing process (like concrete, the strength of rammed earth increases with age). Even the intensity of the tamping stroke was important (a heavy stroke yields a wall five times as strong as a light one). Compressed air hammers, equipped with special tamping heads, were used to compact the soil. And, in forming the wall, care was taken to keep the wall rising uniformly along its entire length.

Recent advances in soil engineering, especially wartime experience in airport, highway and dam construction—indicate considerable possibilities in earth construction beyond those indicated in the Boggs house. For example, the strength of earth walls may be increased by as much as 80 per cent, according to one authority, by reinforcing with vegetable fibre. The addition of cement to the soil mixture also increases its strength, although it apparently reduces the thermal resistance of the rammed earth wall. (Asphalt emulsions also strengthen soil mixtures but cannot be used in rammed earth because the mix is too dry; however, emulsions have proved a very valuable addition to adobe bricks, which are mixed at a mud-like consistency.)

Many authorities feel that no exterior protection is necessary for *terra pise* and point



DESIGNER BOGGS plays a hose on a new earth wall to demonstrate its surprising resistance to weathering. Soil from the excavation (left above) was used to build the house at right.

to many structures which have endured for centuries without any surfacing. However, some finish is probably desirable, and several types are available. Cement stuccos are satisfactory but expensive because they require a reinforcing to achieve a permanent bond with the wall itself. Dagma plaster (a mud mix of three parts sand to one of clay) has been tested by South Dakota State College and found to make a handsome finish. However, dagma was not permanent unless (after a 10-day curing) it was sized and given two coats of lead oil paint. A very satisfactory alternative was found in the addition of asphalt emulsion to the dagma at the rate of 1/2 gal. per 100 lbs. of dry mix. This yielded a permanent finish with or without painting. According to the Department of Agriculture, the rammed earth wall may also be coated with sodium silicate or with paraffin dissolved in benzene. Or it may be painted with a formula of casein glue, trisodium phosphate, lime paste and formaldehyde—a mix which can be tinted any color desired.

PRODUCTS & PRACTICE

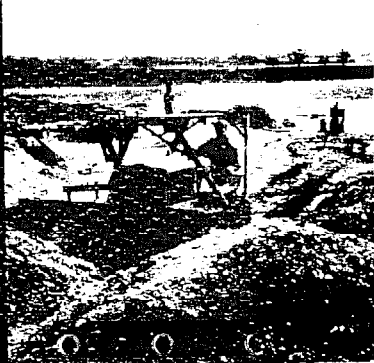

TOPSOIL REMOVED by bulldozer exposes subsoil suitable for rammed earth construction (7 parts sand to 3 parts clay and gravel).



SOIL IS SIFTED through coarse mesh to remove stones and debris. Aggregates can range from fine sand up to large gravel but finer particles must predominate.



MIX IS DAMPENED by hand. Unlike adobe, terra pise is barely moistened. Soils with high clay content are unsuitable due to high shrinkage and high erosion of clay.



FORMS ARE OILED before use to permit removal as soon as ramming is complete. Concrete footing is scored to assure good water- and frost-proof bond with the wall.

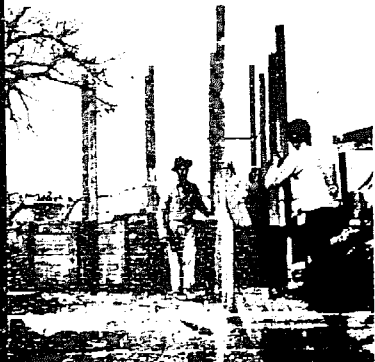

FORMS ARE HELD in alignment by vertical scaffolding tied by transverse rods. Holes left by removal of rods are plugged with dagga.

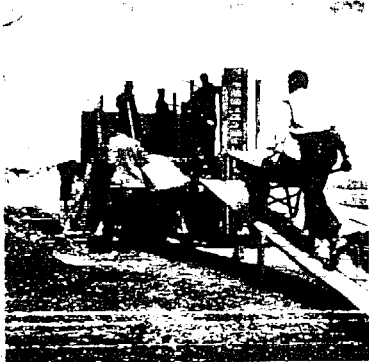

SOIL IS CARTED in wheelbarrows along ramps to point of ramming. This need for ramps and scaffolding sets practical limit of one story to use of rammed earth.



COMPRESSED AIR HAMMER with special head compacts soil. Each horizontal run, about 4 in. deep after tamping, is rammed in one continuous operation for each wall.



REMOVAL OF FORMS can take place immediately, though walls must cure before roof is framed. Initial set takes 10 days, but strength increases for several years.



EXTERIOR SURFACING on Miller house consists of dagga-cement plaster, brush-finished with water-proofing and finished with a cement base paint. Local failures in this finish led to tests of new formulae.



RAMMED EARTH HOUSE

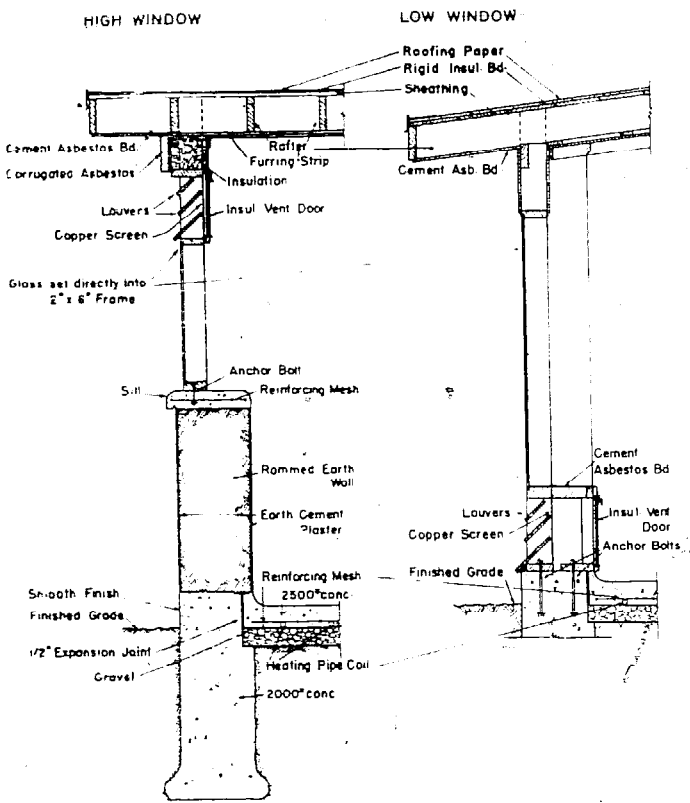

WALL SECTIONS



LIVING ROOM CORNER faces southeast and has floor-to-ceiling fenestration of simple design. There is no sash in conventional sense. Both the louvered ventilation panels and the glass itself are set directly in a dressed 2 x 6 in. frame. Where it abuts earth walls, this frame is bolted into a groove formed to receive it.



SINCE INTERIOR WALLS are exclusively formed by story-high cases of various sorts, the house has an unusual amount of storage space. Interior surfaces of earth walls are dagga plaster, waterproofed and then brushed with one coat of oil paint.

PLAN OF MILLER HOUSE. Like its elevation, reflects need for simplicity in successful rammed earth construction. Most glass areas and irregularities are concentrated along south side, permitting continuous earth walls along other three sides, with fenestration held to a bare minimum on north. Intermediate roof support is by wood posts and all interior partitions are replaced by built-in storage units of different types. Three-way division of bath is ideal for family of several children.

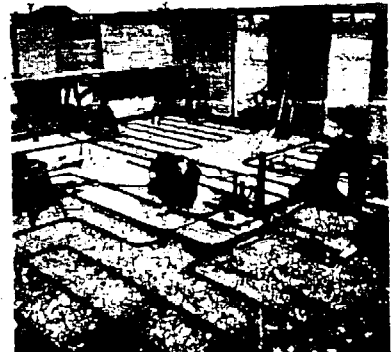
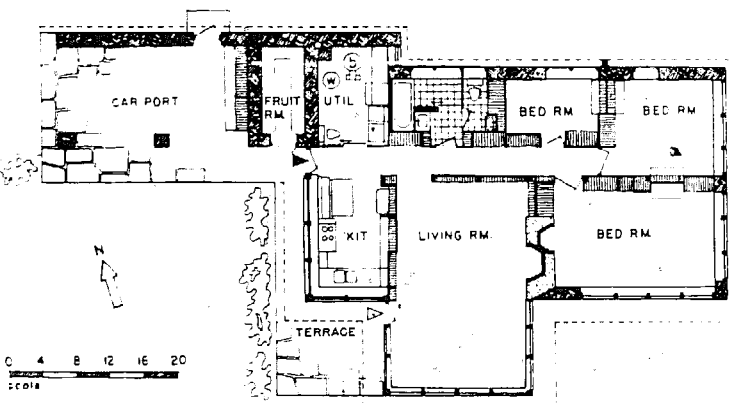

RADIANT FLOORS in the Miller house are similar to installation (shown above) in second of four completed houses. All slabs are topped with integrally-colored cement.

**EBS**Notes on the
Science of Building

Pisé Construction

The pisé or rammed-earth method of wall construction consists of ramming suitable moistened sandy loam between shutters. The dense, hard walls thus obtained are somewhat similar in appearance to walls of soft sandstone.

Designs for earth-wall buildings closely resemble those commonly used for other forms of construction. However, certain peculiarities of the material should be taken into consideration, particularly the low lateral strength of earth, a factor which dictates not only the minimum thicknesses of walls, but also the minimum widths of piers between openings for windows and doors.

The following notes briefly outline the methods of construction recommended as a result of investigation, ex-

periment, and test to eliminate the risk of failure and reduce the labour factor to a minimum. Careful site organisation is essential in order to achieve economical earth-wall structures. Since labour is the principal factor affecting costs, any building time that is non-productive owing to lack of foresight in planning the work, or to any other cause, will inevitably result in an excessive rise in the cost of the work. For greater detail, reference should be made to CEBS *Bulletin*, No. 5, 'Earth wall Construction'.

FOOTINGS

1.01. Footings. Footings for pisé walls should be the same as footings for solid brick walls of similar thickness on the same type of foundation.



Pisé house

INVERTED T-BEAM FOOTINGS

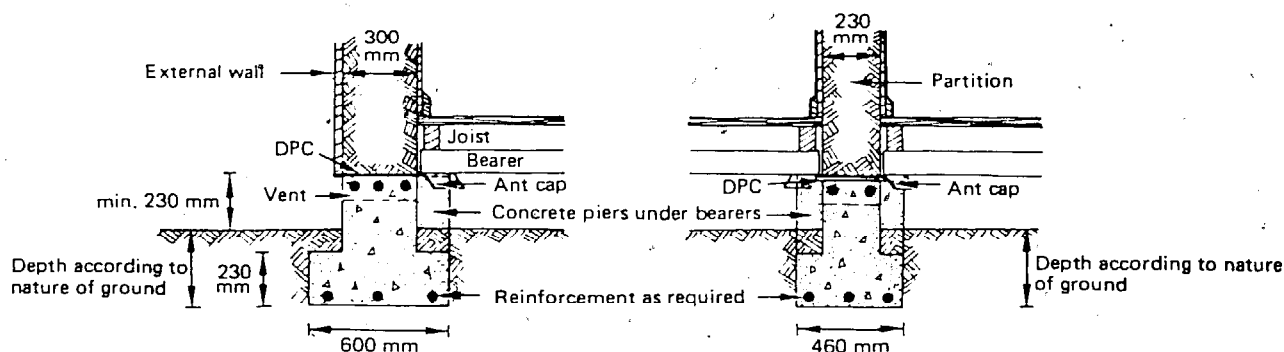

REINFORCED CONCRETE STRIP FOOTINGS

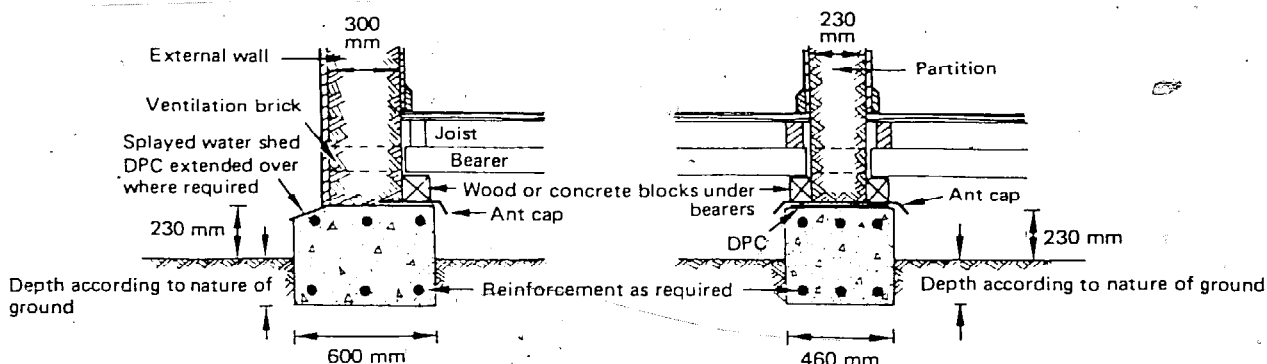

Types of footing for pisé walls

1.02. Protection of wall base. Because earth walls are very vulnerable at the ground line to damage by the eroding action of stormwater and back-splash, it is important that the bases of walls should be built of material that is in itself strongly water-resistant. This is best effected by using an inverted T-beam type of reinforced concrete footing, the stem of the T being continued to a minimum height of 230 mm above ground level. Alternatively, commencing from the footing, the base of the wall or the foundation wall may be built of brick, stone, or portland-cement-stabilised earth to the required height above ground level.

1.03. Damp-proof course. Damp-proofing should be provided, and placed at such a height as may be required by the design of the building. Usually a convenient position is immediately on top of the foundation wall. Most of the recognised types are suitable, but one of the more flexible types that will mould itself without fracture to the irregularities of its bed, is to be preferred.

1.04. Ant-proofing. Extensive enquiries indicate that termites (white ants) do not tunnel through earth walls, although they have been known to construct their galleries on the outer surfaces in search of suitable timber. If the bases of the walls are kept clear, the galleries can be seen and broken. Continuous strip shields should be fitted to the insides of the foundation and sleeper walls, laid directly on the damp-proof course. Free piers should be fitted with termite caps in the usual manner. (See also NSB No. 11; 'White Ants'.)

WALLS

2.01. Rammed-earth walls are built solid, with a minimum thickness of 300 mm for external walls of single-storey domestic buildings, and 230 mm for partition walls. The density and thickness of such walls make the use of a cavity unnecessary.

2.02. Walls are built *in situ*, in courses between 600 mm and 900 mm in height, and each course is constructed by progressively ramming sections about 2 m long at a time; it is unnecessary for any section to be cured before commencing the next. The newly rammed work is strong and self-supporting, and can be walked on; thus the sections can be regarded as large masonry units made and laid in the one operation.

FORMWORK

3.01. One of the advantages of earth-wall construction is the simplicity of the equipment needed for the work. The formwork and hand-rammer are comparatively inexpensive, and can be made by a carpenter.

3.02. A type of formwork has been designed at CEBS that can be moved in a horizontal direction without being dismantled. The sides of this type lap 150 mm over the base-wall, and are supported by two built-in rollers, one placed in a low position at one end of the form to ride on the base-wall or previous course, and one placed in a high position at the other end of the form to ride along

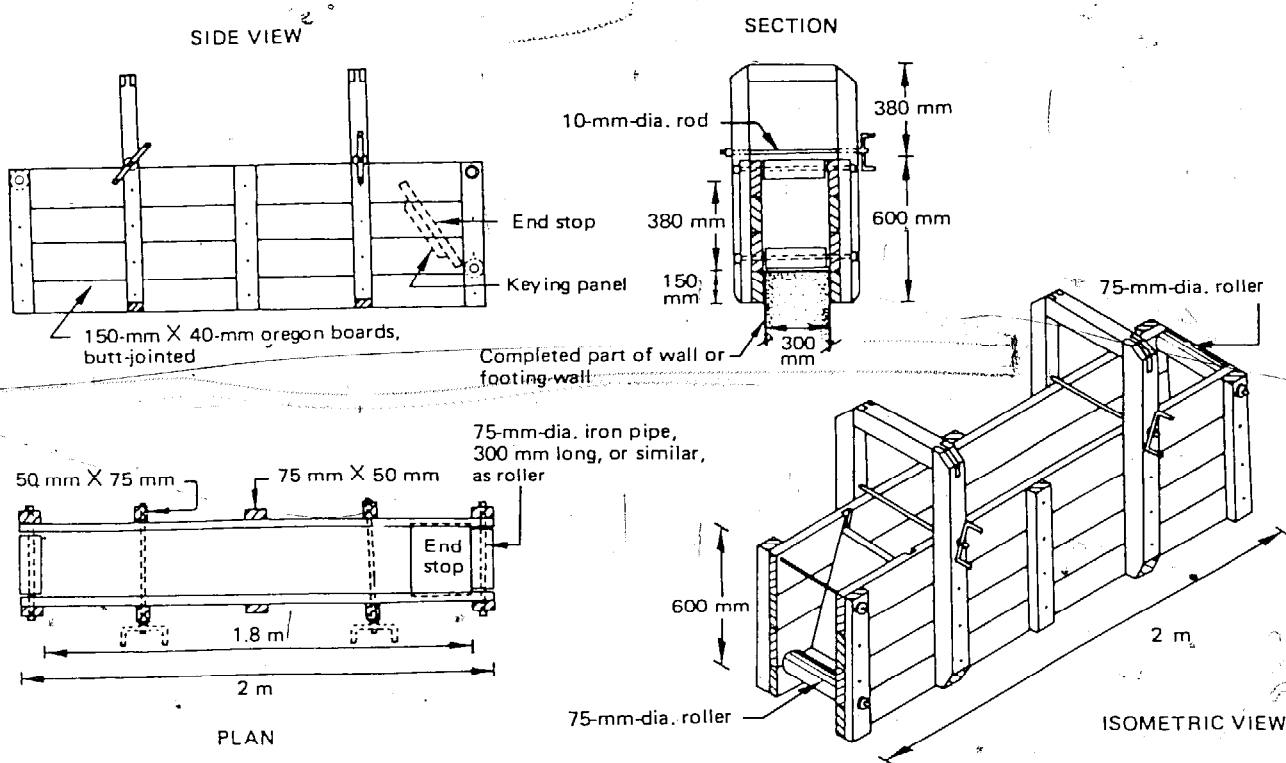

Details of crawler formwork

the newly completed section. When a section is rammed, the nuts are loosened on the tie-bolts to free the shutters from the wall surfaces, and the formwork is pushed along, supported by the rollers, until the high roller reaches the end of the section. Finally the formwork is plumbed with a level and the nuts are tightened. An L-shaped box is required for the corners; each wall-angle is rammed as one piece.

3.03. If the partitions are also to be of earth, a T-shaped box can be used for ramming the junctions with the exterior walls. But a considerable amount of manipulation is saved if the shell of the building is completed first, and the partition walls are built later and bonded or tied into the main walls.

3.04. To withstand the pressure of the rammed earth without bending, boards 40 mm thick are used for the sides of the formwork. The use of oregon or similar lightweight timber will facilitate handling.

RAMMING

4.01. Prepared moist earth is shovelled into the form to a depth of approximately 100 mm. This depth is important, as any more would result in incomplete compaction of the lower part of the layer due to the cushioning effect of the top stratum. The 100-mm layer is rammed until it is dense and hard, and then its depth should be approximately 60 mm. Ramming should be continued until the blows produce a ringing sound and no further impression can be made in the surface. It is best to ram along the sides of the form first, occasionally crossing over, and gradually moving towards the centre. Layers are successively rammed in this manner until the form is filled to the invert of the high roller. Before fresh earth is

thrown in, it is advisable to roughen and moisten the compacted surface of the previous ramming.

4.02. The rammer used for manual tamping should weigh from 8 to 9 kg; it may be of metal or wood, about 1.5 m in length overall, and should have a ramming face 100 mm to 150 mm square. Suitable wooden rammers that are easily made are illustrated. They are shod with wearing-plates of mild steel 6 mm or 7 mm thick, which are screwed through countersunk holes into the hardwood blocks.



Examples of hand-rammers



A mechanised ramming device showing guide rods to prevent rotation of hammer-head

4.03. Mechanical ramming by means of a tamper operated by compressed air has been developed. The time required by the use of this equipment is half that for manual ramming, and a considerable reduction in cost can be effected as a result of the elimination of the most laborious part of the work. A full description of a machine is given in *CEBS Bulletin*, No. 5.

4.04. The positions of wooden fixing plugs for skirtings, picture rails, architraves, door frames, window linings, fixtures, and fittings should be planned in advance, and these then placed in position as their locations are reached. A suggested type of plug with anchoring cross-piece is illustrated. Openings for doors and windows may be formed by stopping-off the formwork with shutters in the desired positions.

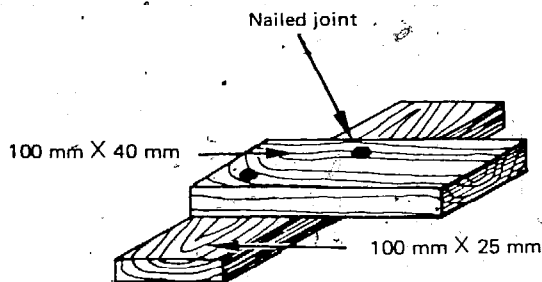

Typical wooden fixing plug with cross-piece for anchorage

TOPS OF WALLS

5.01. The tops of external walls require protection against damage by water. A bed of mortar laid before placing the wall plate will provide adequate protection.

5.02. Wall plates should be attached to the tops of the walls by means of some form of tie. Heavy wire or hoop-iron ties may be laid across the walls at about 300 mm from the top, with the ends left projecting each side sufficiently to pass up and over the plate to which they will be stapled. A better method is to bolt the plate to the wall, and this should be carried out as follows: with a brace and auger bit, holes are drilled in the top of the wall at 1-m centres, and 250-mm bolts are placed head down in them, with ends protruding 75 mm. The bolts are then grouted in, and mortar spread over the wall. The wall plates, with bolt holes drilled at 1-m centres, are later set in position and bolted down.

WALL FINISHES

6.01. Exterior surfaces. The external surface of earth walls should be protected against attrition by rain-water, and particularly against the scouring action caused by water trickling down the surfaces. Protection can be achieved:

- (a) by rendering,
- (b) by painting directly onto the earth surface, or
- (c) by the attachment of water-resistant sheeting, or facing, or veneer.

6.02. Portland-cement rendering is the treatment most commonly used. Adhesion of the rendering is a problem, however, and the characteristic shrinkage of the material increases the risk of failure. The render should therefore be well keyed to the wall by means of wire netting stapled on, or by one of several other suitable methods. Shrinkage is also responsible for cracking or crazing of the rendering, and, to reduce this tendency, rich mixes should be avoided. A mix of 1 part cement, 1 part lime, and 6 parts sand should be used.

6.03. Viscous materials, such as oil-based resinous compounds, bind well with the earth surfaces and have greater adhesive properties than water-mixed materials.

6.04. Two coats of standard-grade paint have been used successfully for exterior surface finishes, but it is important that a penetrating priming coat such as raw linseed oil should be applied first. The greatest disadvantages of this method of protection are the vulnerability of the thin skin to mechanical damage, and the necessity for re-painting every 3 to 4 years.

6.05. In addition to the paints discussed above, there are several others that will provide various degrees of protection; these include portland-cement washes, lime washes, cement-base paints, and resin-base paints.

6.06. The walls may be faced with more durable materials such as asbestos-cement flat sheeting nailed into position, flat field-stones on edge tied or keyed to the wall, tied brick veneer, or terra-cotta facing tiles.

6.07. Interior surfaces. Interior wall surfaces may be finished with a great range of materials. In general, any finish normally used in other forms of construction may equally well be applied to earth walls, and plaster, paint, kalsomine, board lining, fibrous-plaster sheet, and wood panelling are each satisfactory.

REFERENCES.

1. MIDDLETON, G.F. 'Earth Wall Construction'. *Bulletin*, No. 5. Commonwealth Experimental Building Station, Sydney, 1952.
2. 'Earth-wall Construction'. *Notes on the Science of Building*; No. 13. Commonwealth Experimental Building Station, Sydney, revised 1971.

NOTES ON THE SCIENCE OF BUILDING

Compiled by the Experimental Building Station (Department of Construction) and published by the Australian Government Publishing Service.

Copies may be obtained from:

Experimental Building Station,
P.O. Box 30, Chatswood, N.S.W. 2067

or by application to:

The Assistant Director (Sales & Distribution),
Australian Government Publishing Service,
P.O. Box 84, Canberra, A.C.T. 2600

© Commonwealth of Australia 1976

Recommended retail price 7 cents

DEPARTMENT
OF WORKS

NOTES ON THE SCIENCE OF BUILDING

13

COMMONWEALTH EXPERIMENTAL BUILDING STATION

Earth-wall Construction

INTRODUCTION

Earth-wall construction in Australia has a history dating from the earliest buildings of 'wattle and daub' and extending to two-storey contemporary dwellings and even to three-storey blocks of flats. There are earth-wall buildings here over 100 years old that can be expected to give many more years of service if adequate maintenance is continued. The strength of earth walls increases with their age. The heavyweight construction is conducive to comfortable thermal conditions indoors particularly in regions where the climate is predominantly hot and dry.

There has been some improvement in the methods, structural details, and equipment used in present-day earth-wall construction, so that a reliable result is ensured provided that good workmanship is employed and suitable earth material is used. This Note compares the methods of construction and discusses the choice of soil.

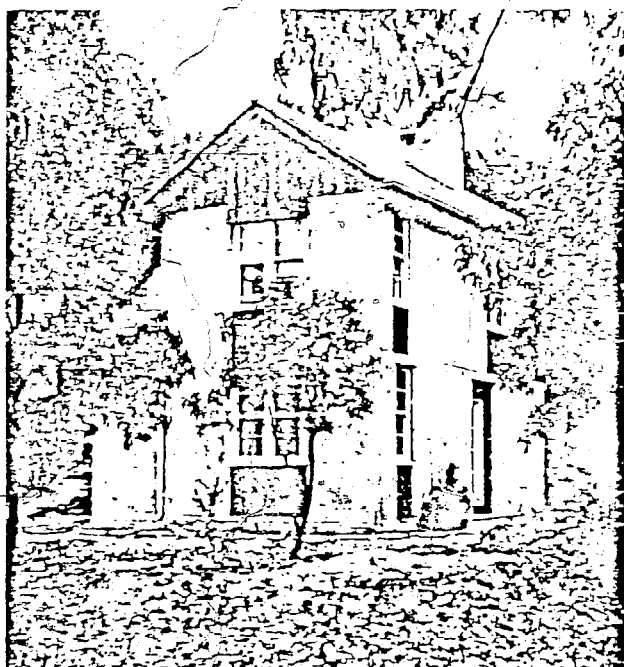

Pisé house

METHODS OF CONSTRUCTION

1.01. Of the ancient methods of earth-wall construction, wattle and daub, cob, and clay lump are obsolete and are mentioned only for general interest. But pisé and to a much lesser extent adobe are still being used in this country mainly in locations where conventional walling materials are in short supply or transport costs are high. The modern trend with these basic constructional systems is to use a stabilised-earth material instead of natural soil. A brief summary of the methods now in use is given in the accompanying table.

BRIEF SUMMARY OF METHODS

METHOD	PISE	ADOBE	STABILISED-EARTH BRICKS
Description	Earth rammed in forms	Earth puddled and moulded into blocks (straw binder)	Stabilised earth made into bricks
Soil type	Over 50% sand; remainder clay and silt	Over 50% clay and silt; remainder sand and granular material	Over 50% sand; remainder clay, silt and cement
Construction	In situ	Sun-dried precast blocks	Bricks, usually machine-made
Mpisture	7-10%	15-20%	Approx. 10%
Equipment	Formwork and rammer	Simple bottomless multi-unit mould	Brick-making plant
Stabilisation	Now usual (cement preferred)	Adobe (bitumen preferred)	Essential (cement preferred)

1.02. The marked difference in method between pisé and adobe construction arises from the clay and silt content, including the colloidal fraction that is required to bind the sand and granular particles together. Where

the clay content is less than 50 per cent it is necessary to use ramming in formwork (pisé) in order to obtain adequate binding; but there is not sufficient clay for its drying shrinkage to cause cracking problems. A clay content of more than 50 per cent is needed to bind adobe blocks; but cracking in the wall is limited because the blocks are left to complete their large drying shrinkage before being built into the wall.

1.03. Soil stabilisation. The addition of portland cement as a stabiliser to soil types that are suitable for pisé construction increases their water resistance and adds to their strength. This type of stabilised soil can also be used for the production of stabilised earth bricks.

1.04. Bitumen is most suitable for the stabilisation of soils for making adobe blocks. It increases their water resistance and durability but not their compressive strength.

1.05. Choice of method. The method of construction used depends mainly on the soil types available at the site, but is influenced by other factors that include local building by-laws, availability of labour, site conditions, and the facilities and equipment obtainable.

1.06. The labour time for pisé construction *in situ* compares favourably with that for the double handling entailed in the moulding and stacking operations of adobe block structures and in the subsequent building of blocks into the walls. The absence of cracking of pisé walls, owing to their high sand content, density, and low moisture content after ramming, contrasts strongly with the prolific surface cracking which is characteristic of adobe walls.

1.07. Adobe block construction is usually resorted to when soils of a high clay content only are available and it would be uneconomic to transport sand to the site. In certain circumstances it may be advantageous to mould the blocks under cover during winter, and stack them to dry out ready for building operations in summer.

1.08. The use of cement-stabilised earth bricks in Australia is believed to have been limited to large operations involving brick-making machinery or plant. The bricks have been laid in the same way as conventional burnt-clay bricks in areas where the latter were not produced in quantity.

SOILS FOR EARTH-WALL CONSTRUCTION

2.01. The approximate composition of the soil should be ascertained first, as the type of soil available determines the method of construction that can be adopted. The final choice should be made after analysis. Earth that is found to be of unsuitable proportions may sometimes be brought to the desirable condition by adding sand or clay, or by mixing together two types of soil.

2.02. Soil texture. The composition of a soil may be gauged roughly by visual examination and by feeling its texture. The texture is determined by the combination of gravel, sand, silt, and clay, including the colloidal fraction of the clay constituent. When the soil is dry and rubbed between the fingers, the sand particles are gritty to the touch, and the silt and fine particles adhere closely to the skin and have a silky feel when the sand particles are discarded.

2.03. Soil suitable for ramming (pisé) is reasonably stable in its natural state, and contains enough silt and clay to bind the sand together, but not enough to cause high shrinkage in drying. A soil having 65 to 70 per cent of sand meets these requirements best.

2.04. In the accompanying bar-graph, the average equivalent diameters of the particles of a common soil are shown according to the International System of soil-texture classification.

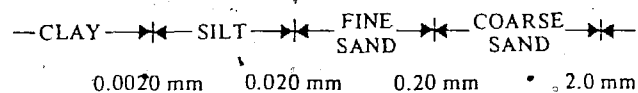

2.05. Common soils may be divided into these main textural groups:

SAND	UNSUITABLE	FRIABLE
SANDY LOAM LOAM	} SUITABLE FOR PISE	} SOFT
SILT LOAM CLAY LOAM		
CLAY	UNSUITABLE	} STICKY

2.06. Colour characteristics. Colour gives some indication of the constitution of the soil, but provides no more than a guide to its suitability. The main colours encountered are:

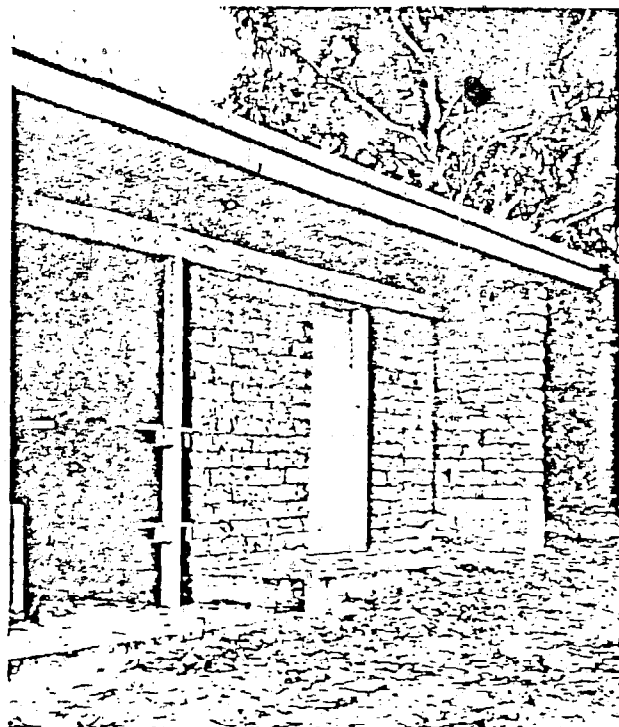

Experimental pavilion of unrendered adobe blocks 20 years after construction

- A: Black, and dark brown, indicating the presence of undesirable organic matter originating from the decay of plant or animal remains
- B: Red, and reddish-brown, indicating the presence of iron, possibly unhydrated iron oxide (haematite).
- C: Yellow, and yellowish-brown, indicating the presence of some iron, possibly hydrated iron oxide (limonite).
- D: Grey, greyish-blue, and yellow mottled, usually of high clay content indicating poor drainage.
- E: White.

2.07. Soils of colour A are unsuitable for earth wall construction, but soils of any other colour may generally be used.

2.08. Analysis. The following method of physical analysis is sufficiently accurate to enable a final selection of the soil to be made. A quantity of the selected earth is pulverised, placed in a shallow tray or dish, and heated in an oven to 105°C to extract moisture. A litre measure is filled with the dried earth; this exact quantity is put into a large shallow baking dish, and washed in repeated changes of water until all clay and silt have floated off and the water becomes clear. The residue is the sand, gravel, and granular mineral content. This residue is dried as before, and replaced in the measure. The amount removed during washing, in relation to the amount of dry residue, represents the proportion of clay and silt to the sand, gravel, and granular mineral present in the earth mixture.

2.09. Moisture. When the soil is prepared for ramming, the moisture content should be carefully regulated. If the earth is too wet, difficulty will be experienced in attaining good compaction, and the excess moisture will cause extensive surface cracks as the walls dry.

2.10. The moisture content of loose soil may be estimated by firmly pressing a handful between the two cupped hands to form a solid ball. (If the soil will not press into a ball without falling away, it is too dry.) The ball should then be held out at shoulder height, and dropped onto a smooth hard piece of ground. The shattering of the ball into its former loose state indicates consistency correct for ramming; if, however, the breakage is into a comparatively few pieces only, or into large pieces remaining unfragmented, the soil is too wet.

2.11. It will be found that with a soil of 65 to 70 per cent sand content by loose volume, the optimum moisture content is usually from 7 to 10 per cent by weight. The test should be repeated during the ramming operations to ensure uniformity of moisture content.

2.12. To obtain a workable plastic state, adobe soils (soils containing more than 50 per cent silt and clay) require a higher proportion of water than soils of high sand content. This is due to the fineness of the silt and clay particles, each of which must become surrounded by a film of water before even distribution can take place and the soil is of the proper consistency. The degree of plasticity will depend upon the fineness and quantity of these silt and clay particles; a soil containing approximately 60 per cent clay and 40 per cent sand

will usually absorb between 15 and 20 per cent of water by weight before becoming workable.

NOTES ON CONSTRUCTION

3.01. The main operations involved in the construction of a building such as a cottage, using the pisé and adobe systems are listed below. More detailed information appears in *Bulletin No. 5* which is listed in the references at the end of this Note.

3.02. Pisé construction. The construction of walls of rammed earth includes the following operations:

- (a) Gaining soil from the borrow-pit or the location of selected soil.
- (b) Preparing the soil (if necessary) by pulverising it to reduce any clods, and by removing any organic material, large stones, and other unwanted substances present in undesirable quantities.
- (c) Setting the formwork in position, and ramming loose soil in successive layers 100 mm deep until it is dense and hard. Each layer compacts to about 60 mm in depth.
- (d) Resetting the formwork, and repeating the ramming operations for each successive section of wall until an entire course is completed.
- (e) Repeating (c) and (d) for each successive course of 600 mm to 900 mm height until the walls are completed.
- (f) Stopping-off by inserting shutters across the interior of the formwork, to provide openings for doors and windows.
- (g) Providing wall-plugs and ties for fixing door and window frames, linings, skirtings, cupboards, and fittings generally.
- (h) Providing for the attachment of partitions, wall plates, and similar components.



Ramming a section of pisé wall by hand

3.03. **Adobe Construction.** Adobe-block walls are built in the same way as masonry walls. It is estimated that a team of three men can make about 300 blocks a day. For this purpose, a fairly large area of level ground is desirable, as it is necessary to leave the freshly moulded blocks unmoved for 2 to 3 days to harden sufficiently before handling. The blocks are then placed in stacks, and the moulding area cleared for another batch. A simple mould of the bottomless, multi-unit type is necessary for each team of two or three operatives. Immediately the mould has been filled, and the mud kneaded into the corners and pressed to remove air bubbles, the top is screeded and struck off, and the mould lifted and placed in position for the next filling.

3.04. The construction of walls of earth blocks (adobe) involves the following operations:

- (a) Preparation of a shallow pit of sufficient area to accommodate at least three days' supply of earth if continuous work is planned.
- (b) Preparation of soil by puddling in the pit and mixing in straw or other suitable binding material.
- (c) Moulding blocks in bottomless moulds, on level ground of sufficient area to accommodate 3 days' production (approximately 200 m² in area).
- (d) Stacking blocks on edge with spaces between their sides so that air can circulate and facilitate drying.
- (e) Building walls — bonding the blocks as in brickwork or masonry — and building-in lintels to openings, sills where required, brickwork or masonry fireplaces and chimneys, and all usual building components.
- (f) Providing wall-plugs and ties for fixing frames, linings, partitions, trim, wall plates, fixtures, and fittings.
- (g) Arrangements for cross-walls, floors, services, and roof.
- (h) Providing protective coating to all exterior wall surfaces, and providing exterior finishes and decoration.



Screeding-off adobe blocks in the mould

3.05. **Stabilised-earth bricks.** Cement-stabilised-earth bricks may be laid by tradesmen in walls using mortar in the same way as with burnt-clay bricks. The initial problem, of course, is to provide the mechanical mixing and brick-making plant that will ensure the production of strong bricks of consistent quality.

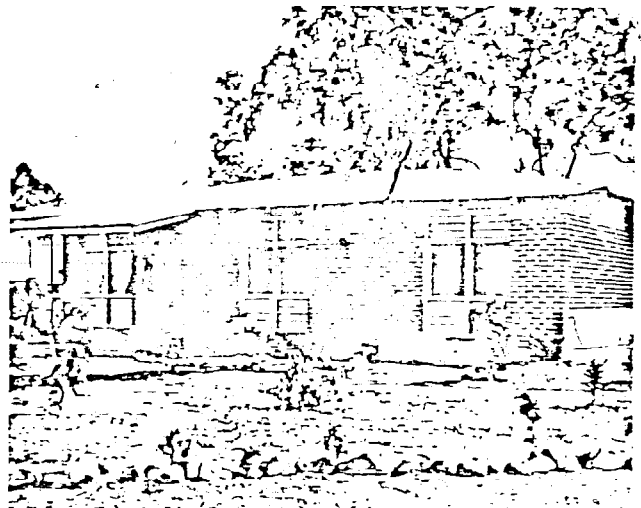

Dwelling constructed of cement-stabilised-earth bricks (Northern Territory Housing Commission)

CONCLUSION

4.01. It is reasonable to regard earth-wall construction as a proven method of building, but the labour content is high and its cost may not be justified unless spare time is utilised. Some people may use earth-wall construction because of the romantic appeal of earth as a building material and others see only that earth is there for the taking on their land. Any decision that is based on a broad economic assessment, however, must consider the availability and cost of alternative materials and of labour familiar with their use. Personal preference can then be exercised with some knowledge of the costs involved.

REFERENCES

1. MIDDLETON, G.F. 'Earth Wall Construction'. *Bulletin*, No. 5. Commonwealth Experimental Building Station, Sydney, 1952.
2. 'Pisé (Rammed-Earth) Construction'. *Notes on the Science of Building*, No. 18. Commonwealth Experimental Building Station, Sydney, 1964.

NOTES ON THE SCIENCE OF BUILDING

Notes on the Science of Building are produced and distributed by the COMMONWEALTH DEPARTMENT OF WORKS.

The Notes are prepared by the
COMMONWEALTH EXPERIMENTAL BUILDING STATION,
P.O. Box 30, Chatswood, 2067,
and are distributed by the Station and by the
COMMONWEALTH BUILDING DATA SERVICE,
P.O. Box 2807 AA, Melbourne, 3001.

