

AT MICROFICHE
REFERENCE
LIBRARY

A project of Volunteers in Asia

Elements of Solar Architecture for Tropical
Regions HWPSS SKAT Publication No. 10

by: Roland Stulz

Published by:
Swiss Center for Appropriate Technology
Varnbuelstrasse 14
CH-9000 St. Gall
Switzerland

Paper copies are \$ 5.00.

Available from:
Swiss Center for Appropriate Technology
Varnbuelstrasse 14
CH-9000 St. Gall
Switzerland

Reproduced by permission of the Swiss Center for
Appropriate Technology.

Reproduction of this microfiche document in any
form is subject to the same restrictions as those
of the original document.

ELEMENTS OF SOLAR ARCHITECTURE

FOR TROPICAL REGIONS

Roland Stulz

Publication No. 10
St. Gall 1980

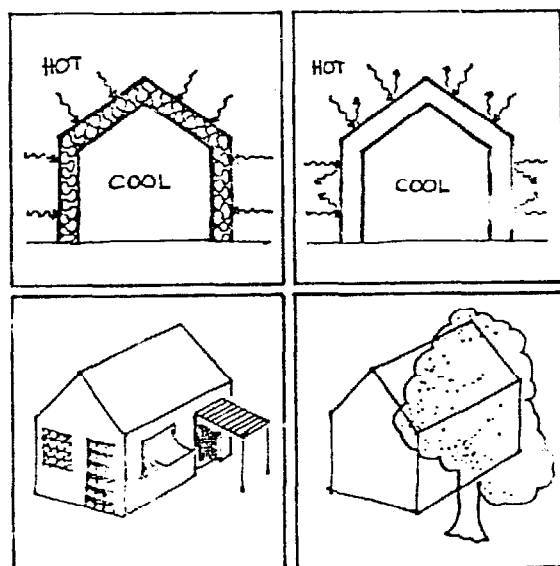

SKAT

Varnbuelstr. 14
CH-9000 St. Gallen
Tel. 071 / 23 34 81

SKAT
Schweizerische Kontaktstelle
für Angepasste Technik
am Institut für Lateinamerikaforschung
und Entwicklungszusammenarbeit
der Hochschule St. Gallen

SKAT
Swiss Center for
Appropriate Technology
at the Institute for Latin-American
Research and for Development
Cooperation, St. Gall University

SKAT
Centre Suisse pour la
Technologie Appropriée
à l'Institut Latino-Américain
et de Coopération au Développement,
Université de St-Gall

SKAT
Centro Suizo para
Tecnología Apropriada
en el Instituto Latinoamericano
y de Cooperación Técnica,
Universidad de Sankt-Gallen

ELEMENTS OF SOLAR ARCHITECTURE

Roland Stulz

Publication No. **10**
St. Gall 1980

- Author: Roland Stulz, Arch. ETH/Planner BSP, Zurich
- Published by: SKAT, Swiss Center for Appropriate Technology
at the Institute for Latin-American Research
and for Development Cooperation, St. Gall
University
- Comments,
enquiries: All questions and comments concerning this
publication and its contents are welcome at
SKAT. Please use the postcard-questionnaire
enclosed.
- Copyright: Material of this publication may be freely
quoted, translated or otherwise used.
Acknowledgement is requested.
- Price: SFr. 7.50, U.S.\$ 5.-

TABLE OF CONTENTS

0. INTRODUCTION
1. ORIENTATION OF THE BUILDINGS
2. ABSORPTION, INSULATION, HEAT STORAGE
3. SHADING, SOLAR RADIATION CONTROL
4. ROOF DESIGN
5. VENTILATION THROUGH WALL OPENINGS
6. AIR COOLING, HUMIDIFICATION
7. BIBLIOGRAPHY

0. INTRODUCTION

In tropical regions where hot climate predominates, man has made use of physical laws in building construction for ages to improve living conditions. Many traditional designs and materials have evolved in the course of time but have partly disappeared again with the advent of modern construction technology and industrial production of construction materials.

This publication aims at helping the layman to learn about some simple, inexpensive principles that may be applied in construction of new buildings and the improvement of existing houses. It may perhaps also serve the professional architect to recall those principles before starting off on a building activity. The brief booklet is by no means complete or exhaustive and concentrates on requirements for hot climate only. Neither solar heating aspects nor sophisticated technology for cooling or airconditioning are included but simple things only that can relatively easily be mastered such as:

- . orientation of building
- . making use of prevallent wind, crossventilation
- . reflecting, absorbing and insulating building materials for roofs and walls
- . using trees and obstructions to channel air flow and for shade
- . using the evaporation of water for cooling effects

The field of Solar Architectur is vast and there are many interesting approaches and technologies in the state of development that are beyond the scope of this publication. Persons interested in this field may make use of the enquiry service of SKAT. We shall deal with all specific questions within our capacity.

1. ORIENTATION AND POSITION OF THE BUILDINGS

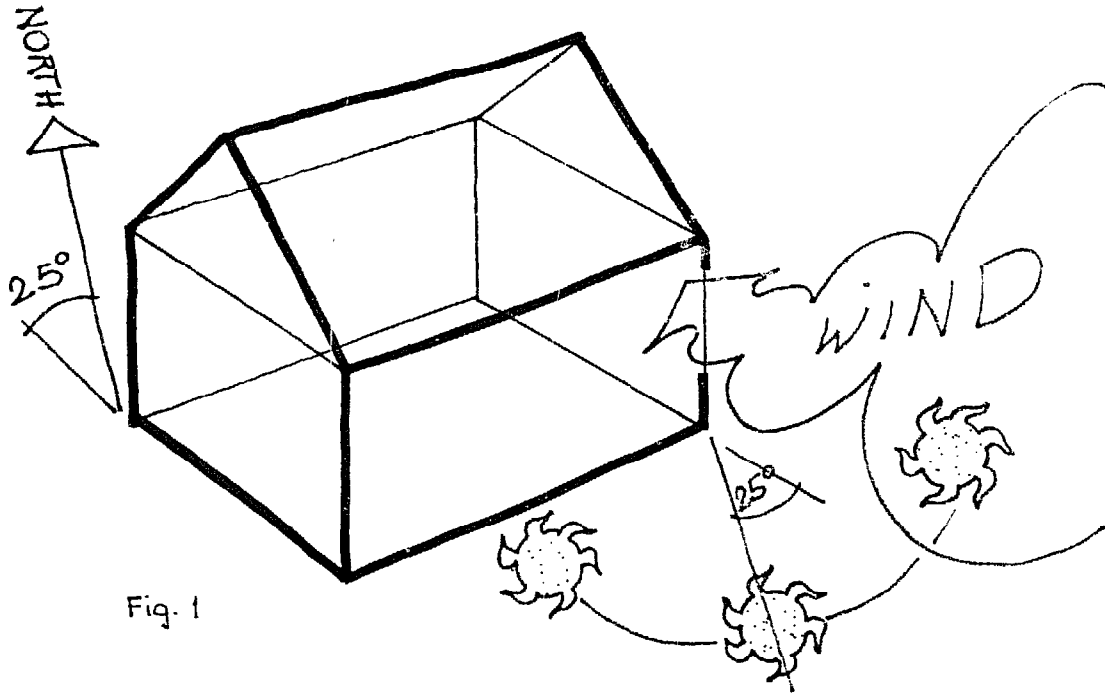

The appropriate orientation of the building in the landscape and in relation to sun and wind is the first main step in the planning process. The orientation and position of a building are most important for the room temperature and the interior climate of every building.

Orientation is mainly a design problem which doesn't create additional building costs, but provides better living comfort.

There are often constraints for an optimal selection of a building site and the orientation of the building due to adjacent buildings, roads and land properties.

1.1 SITE ORIENTATION CHART

In this chart (1) (see bibliography) we list the main aspects which have to be considered, when you make the selection of a building site:

	HOT HUMID REGIONS	HOT ARID REGIONS
OBJECTIVES	Maximize shade Maximize wind	Maximize shade late morning and all afternoon. Maximize humidity Maximize air movement in summer.
ADAPTATIONS: POSITION ON SLOPE	High for wind	Low for cool air flow
ORIENTATION ON SLOPE	South	East-Southeast for afternoon shade
RELATION TO WATER	Near any water	On lee side of water
PREFERRED WINDS	Sheltered from north	Exposed to pre- vailing winds
CLUSTERING	Open to wind	Along E-W axis, for shade and wind
BUILDING ORIENTATION	South, toward prevailing wind	South
TREE FORMS	High canopy trees. Use de- ciduous trees near building	Trees overhanging roof if possible

1.2 GENERAL RULES FOR HOT ARID REGIONS

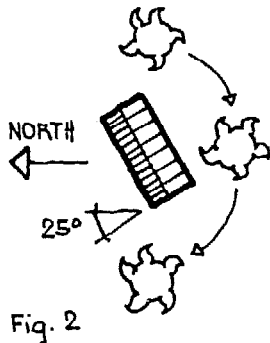

25° SOUTH ORIENTATION. Exterior wall openings should face south but should be shaded either by roof overhangs or by deciduous trees in order to limit excessive solar radiation into the dwelling. The size of the windows on the east and west sides should be minimized in order to reduce heat gains into the house in early mornings and late afternoons.

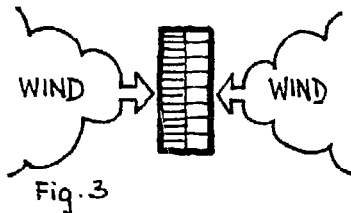

WIND ORIENTATION. Main walls and windows should be oriented toward the prevailing wind direction in order to allow max. cross ventilation of the rooms.

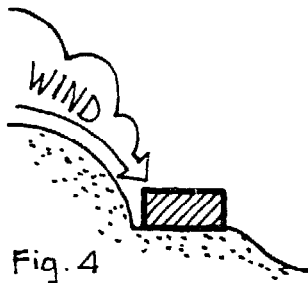

SLOPE ORIENTATION: Lower hillsides benefit from cooler natural air movement during early evening and warm air movement during early morning.

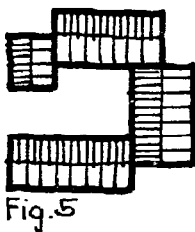

CLUSTERS. Multiple buildings are best arranged in clusters for heat absorption, shading opportunities and protection from east and west exposures.

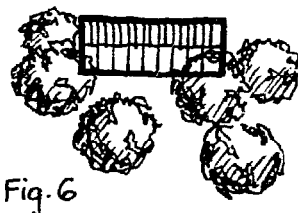

TREES. Natural shading by trees offers effective natural cooling.

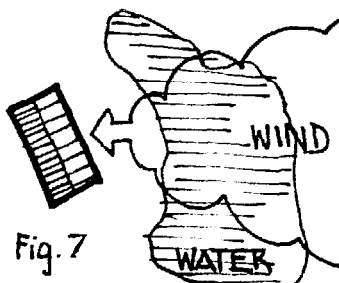

RELATION TO WATER. Indoor and outdoor activities should take maximum advantage of cooling breezes by increasing the local humidity level and lowering the temperature. This may be done by locating the dwelling on the leeward side of a lake or stream.

2. ABSORPTION, INSULATION, HEAT STORAGE

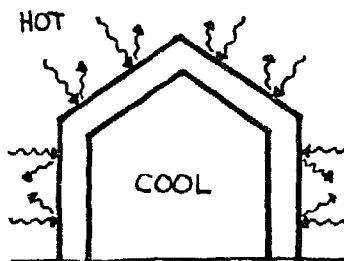

Fig. 8

ABSORPTION/REFLECTION. Heat and light radiation are either absorbed or reflected by building materials to a certain degree. In hot areas it is desirable to reflect the solar heat radiation during the day as much as possible. On principle this can be done by using bright outside wall or roof coatings. (See 2.1 table of solar radiation absorption).

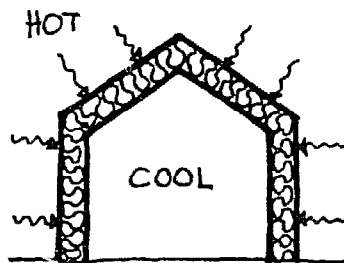

Fig. 9

INSULATION. The heat flow from outside into a room or vice versa can be reduced by insulating a wall or a roof. The insulation should be mounted at the "cold side" of the wall. Efficient insulation can on principle be obtained by porous materials, as e.g. wood, panels made of glassfibres or natural fibres (coco nut), polyurethane foam, bricks, porous concrete, etc. (See 2.2 table of heat insulation).

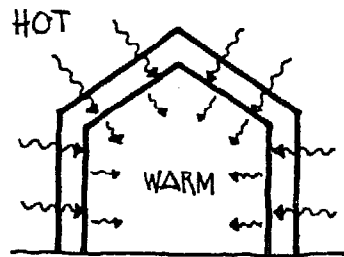

Fig. 10

HEAT STORAGE. Roof or wall materials store to a certain degree the heat of solar radiation or transmitted by warm air through walls and roofs. The stored heat radiates into the cool room air after a characteristic storage time. The heat storage capacity differs from one material to the other. It is high e.g. for rocks, water, concrete, etc. (See 2.3 table of heat storage capacities).

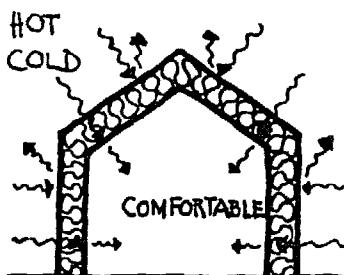

Fig. 11

ROOM CLIMATE. The comfortable room climate in a house is created by an optimum combination of air temperature, air humidity, air flow and surface temperature of walls, floor and ceiling. Therefore the ideal roof reflects and insulates well and the ideal walls reflect the solar radiation, they insulate the heat peaks during the day, they allow diffusion of humidity and they store a certain amount of heat which they can radiate into the room during the night (in hot arid regions). Wall openings allow a cooling air flow. (See 2.4 good examples).

2.1 TABLE OF SOLAR RADIATION ABSORPTION

ROOFS	white asbestos cement	50%
	copper sheeting	64%
	red roofing tile	70%
	galvanised iron, clean	77%
	bituminous felt	89%
	galvanised iron, dirty	89%
	asphalt	95%
	aluminium foil, unpolished	39%
	aluminium foil, polished	15%
WALLS	concrete	70%
	fire clay brick (red)	70%
PAINTS	white-wash	21%
	bright aluminium	30%
	yellow	48%
	dark aluminium	63%
	bright red	65%
	light green	73%
SURROUNDINGS	black	97%
	grass	80%
	sand, grey	82%
	rock	84%

Note: The lower the percentage of absorption, the better the reflection.

2.2 TABLE OF HEAT INSULATION VALUES

This list (2) gives a view over the insulation values of some main building materials.

Conductivity in W/mK (Watts (metre thickness, degree centigrade differential))

MATERIAL	Conductivity in W/mK
Adobe bricks	0.5
Burnt bricks	0.3 - 0.7
Cement mortar	1.5
Concrete	1.8
Earth (humid)	2.1
Stones, rocks (dense)	3.5
Sand (dry)	0.6
Asbestos-cement board	0.35
Plywood panel	0.14
Cork granulated	0.04
Wood (Dry)	0.1 - 0.2
Sawdust	0.06
Insulation panels (expanded poly- urethane)	0.03
Wood shredded, cemented in metal preformed stabs	0.12
Glass	0.8

Note: The lower the conductivity, the better the insulation effect. E.g. 10 cm of adobe bricks insulate as well as 36 cm of concrete, less than 1 cm of granulated cork or mineral fibre insulation board.

To obtain maximum insulation you can combine e.g. a brick or concrete wall with a natural fibre (coco nut) or expanded polyurethane insulation panel. Roofs can also be insulated directly under the roof panels or above the ceiling.

2.3 TABLE OF HEAT STORAGE CAPACITIES

The specific heat capacity indicates the amount of heat that is stored in a cubic foot of a certain material.

MATERIAL	SPEC. HEAT CAPACITY	
	(BTU/CUFT -°F)	(Wh/m ³ , K)
Adobe bricks	25.4	473.6
Burnt bricks	24	447.5
Cement mortar	19.2	358
Concrete	28	522.1
Sand	18	335.6
Stone, rocks	19	354.3
Limestone	22.4	417.7
Asbestos-cement board	28	522.1
Plywood or wood panels	9.9	184.6
Water	62.4	1163
Cast Iron	54	1006.9
Expanded polyurethane (insulating panel)	0.57	10.6

Note: The higher the heat capacity number the more heat is stored in the material. An insulating board e.g. has a very poor heat capacity whereas the poorly insulating concrete has a good heat capacity. Adobe is a very good material because it has quite good insulating and heat capacity qualities. That's the reason why an adobe building usually has a quite comfortable room climate in hot arid regions. In hot humid regions walls and roofs should have minimum heat capacities. Wood and insulating panels are appropriate for those regions.

2.4 GOOD EXAMPLES (HCT ARID. REGIONS)

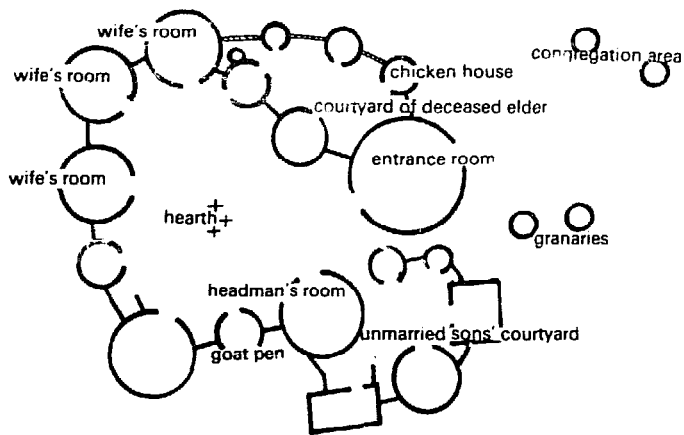
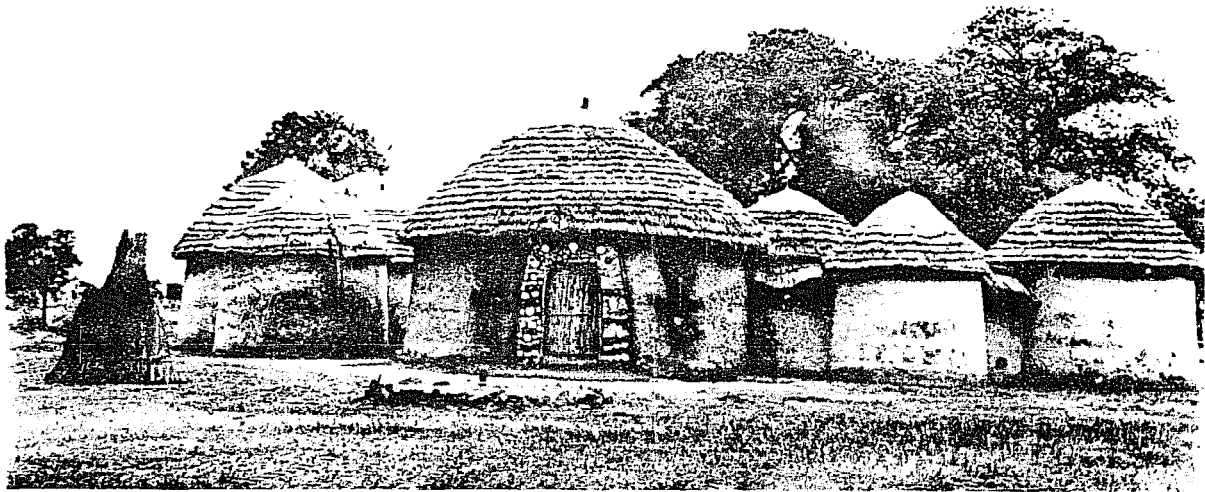

Fig. 12

Comfortable room climate
in small clustered adobe
rooms in northern Ghana...

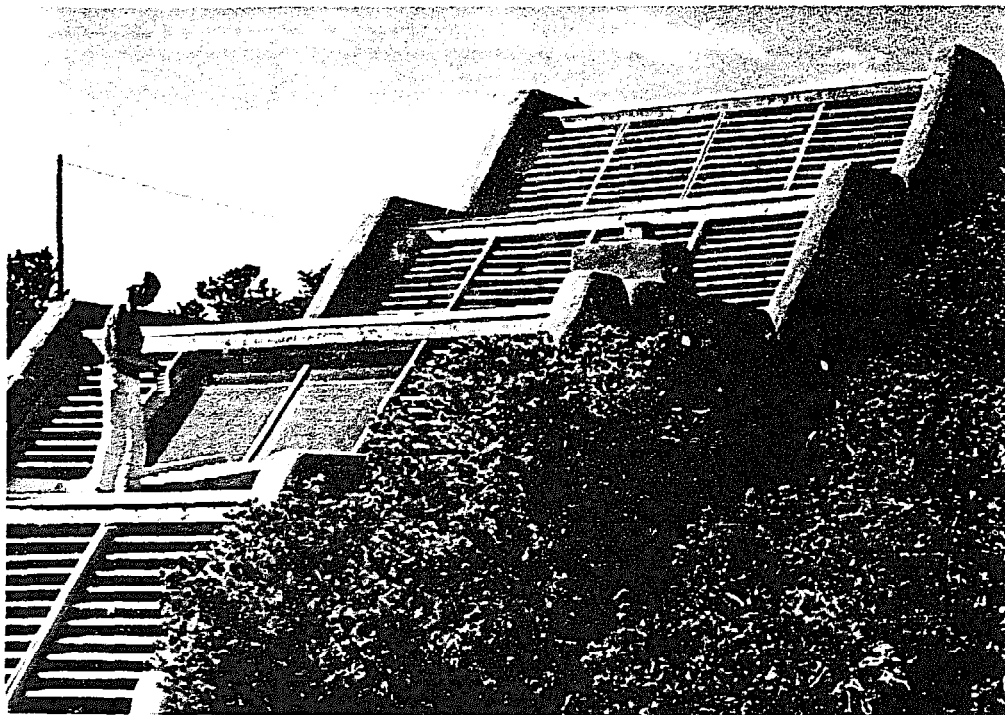

Fig. 13
...and modern solar architecture with
adobe bricks in the United States

2.4 GOOD EXAMPLES (HOT-HUMID REGIONS)

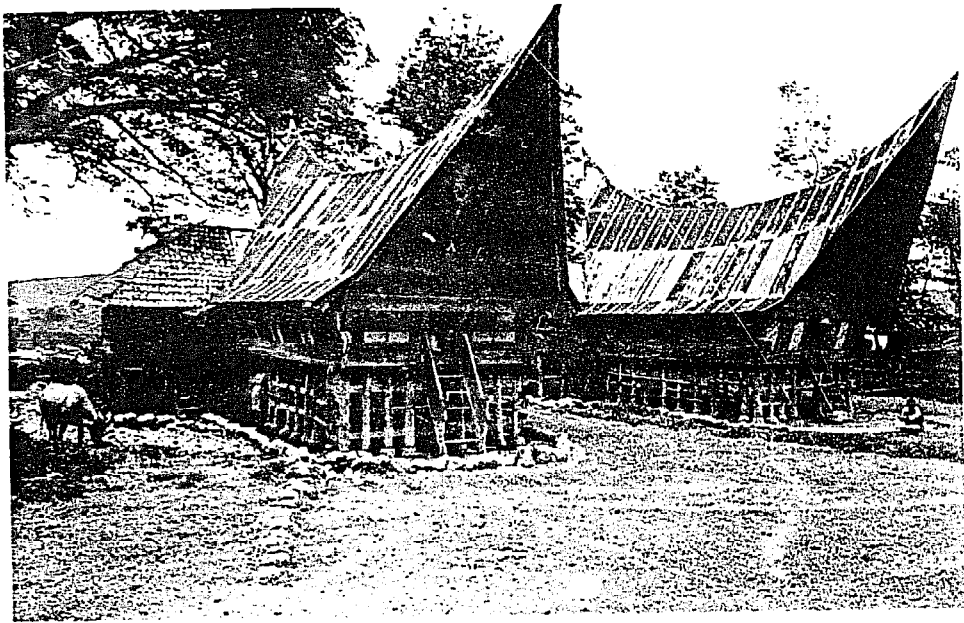

Fig. 14

These Batak-houses in Sumatra have transparent wood constructed walls with low heat capacity, good insulation and cross ventilation. The shading is provided by overhanging roofs...

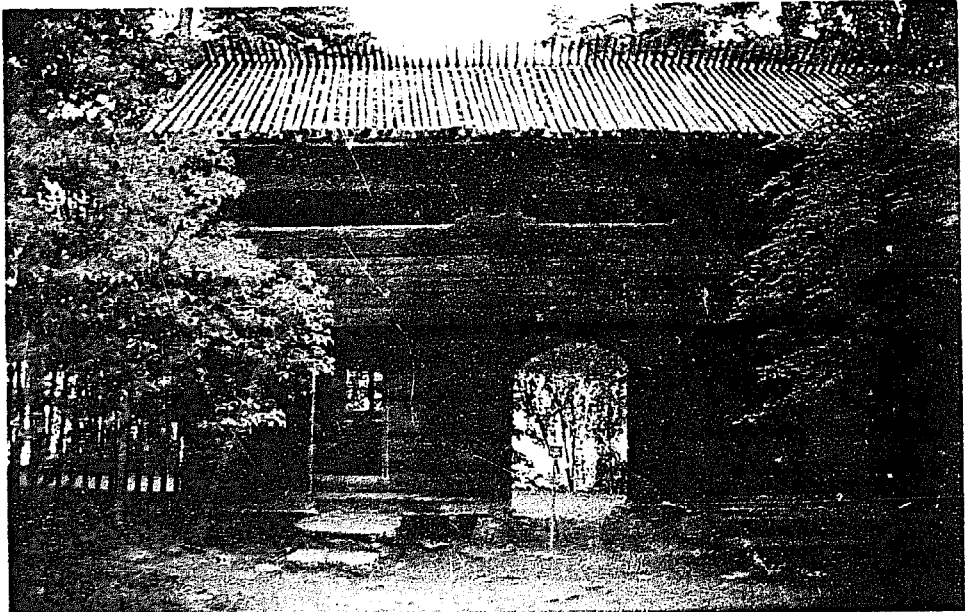

Fig. 15

...as well as balconies and trees

3. SHADING, SOLAR RADIATION CONTROL

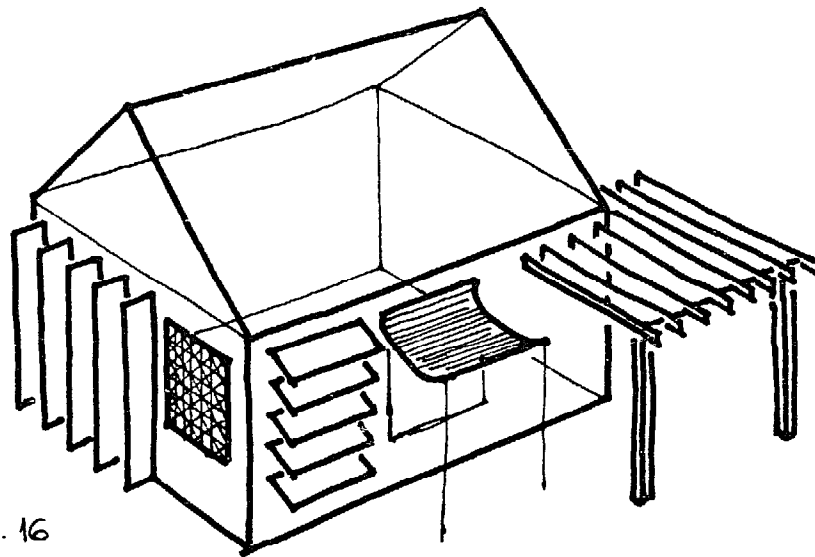

Fig. 16

Solar radiation control can be obtained with shadings like brisesoleils, 'louvres, pergolas, arabian mashrabias and all kinds of curtains made of wood, cement or bamboo. It can be used in any kind of building.

Solar radiation control is a simple and effective way to keep the radiation heat out of the rooms.

The shading can be produced with local materials and appropriate technologies.

Shading devices may in some cases interfere with optimal air flow for desired ventilation.

3.1 SHADING DEVICES

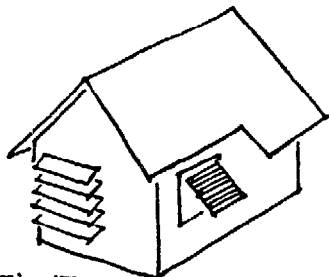

Fig. 17

HORIZONTAL SCREENING/ROOF OVERHANG.

This is very effective against overhead sun especially on north and south facades. It can be realized with a roof overhang or with fixed or moveable louvred windows made of glass, asbestos-cement, cement, wood, etc.

All horizontal screening must allow vertical air flow.

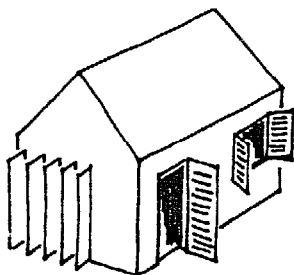

Fig. 18

VERTICAL SCREENING. Vertical screening elements are best against low sun, i.e. on west and east facades. Maximum efficiency can be obtained with moveable elements. A simple form of vertical screenings are also window shutters and doors.

These screenings can be made of wood, concrete fins, metal, etc.

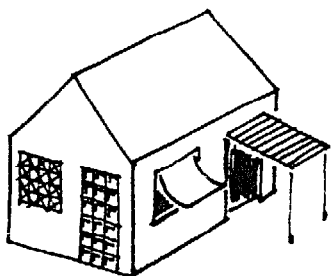

Fig. 19

MASHRABIAS, CURTAINS, SHUTTERS.

Arabian mashrabias are traditional wooden trellis-work which screens against sun as well as against glare.

It's made of wood or bamboo. Curtains of any flexible material (e.g. linen) can be fixed easily in any door or window and can be wetened to cool the air. Horizontal moveable shutters can be made of bamboo or natural fibre stripes. Screens of pre-formed cement or brick elements can also give good protection against solar radiation.

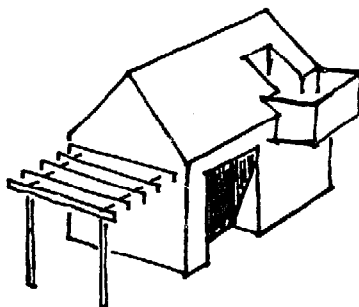

Fig. 20

PERGOLAS/BALCONIES/LOGGIAS. A pergola can be made of bamboo or wooden sticks. The horizontal screening can be grown in with creeping vegetation to give better shading. Balconies and loggias as architectural elements can be helpful to provide shading.

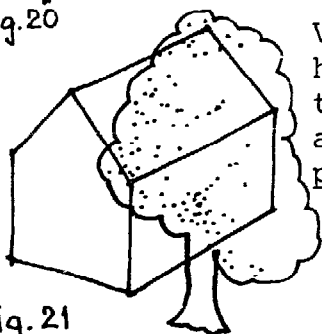

Fig. 21

VEGETATION. Shading with trees can be helpful as long as it doesn't stop the cross ventilation. Trees are also a source of insects and must therefore be planted in adequate distance of the building.

3.2 GOOD EXAMPLES OF SHADING

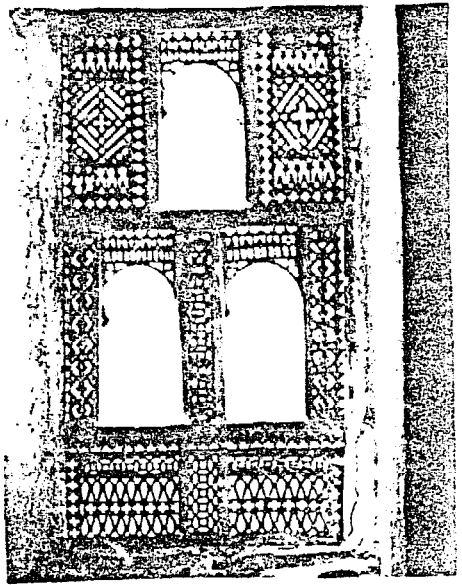
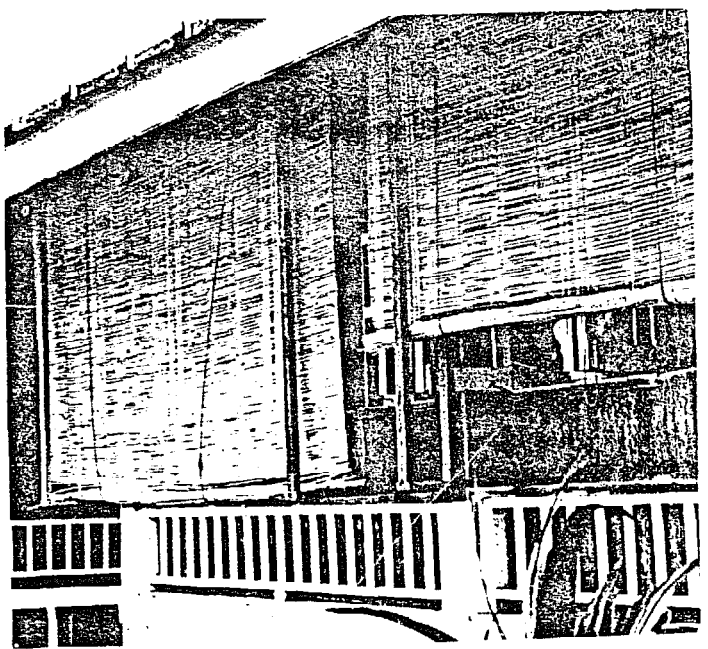

Fig. 22
Arabian mashrabia
(wooden trellis-work
instead of window)

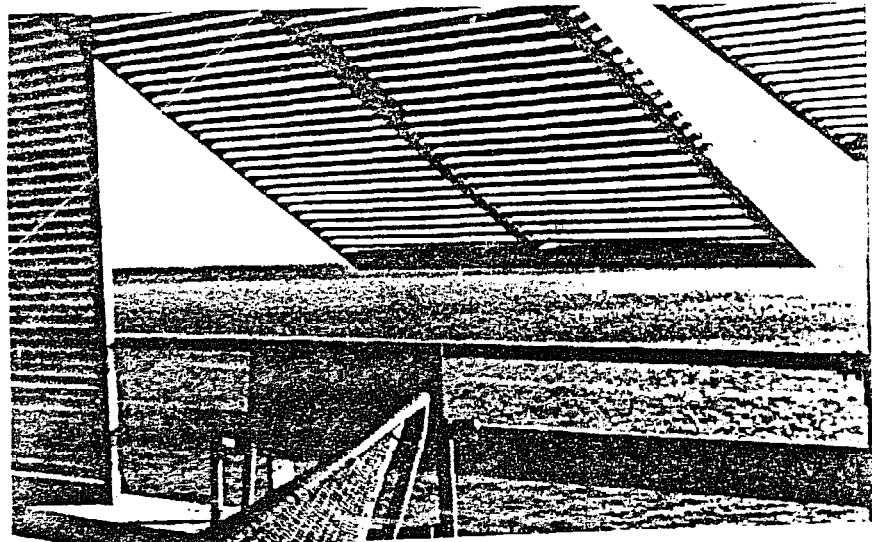

Fig. 23
Fig. 24
Movable horizontal
screening made of
reed, bamboo or wood

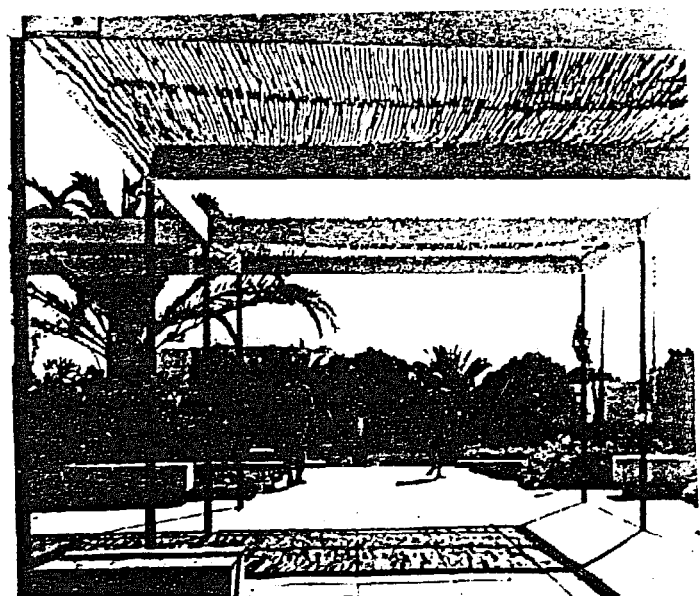

Fig. 25
Pergola with reed
covering

3.2 GOOD EXAMPLES OF SHADING

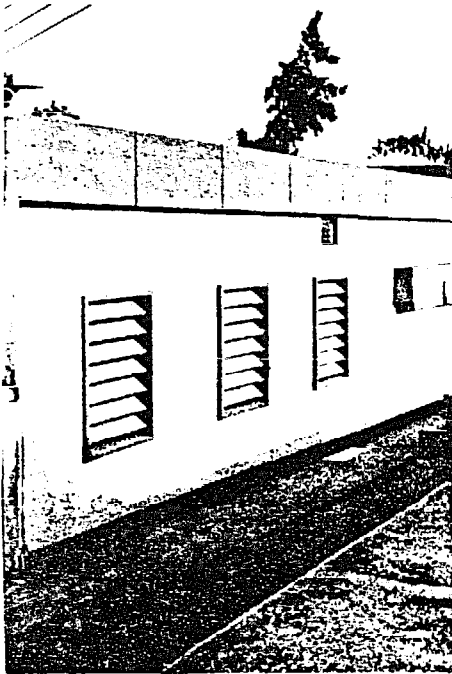

Fig. 26
Movable or fixed
window louvres

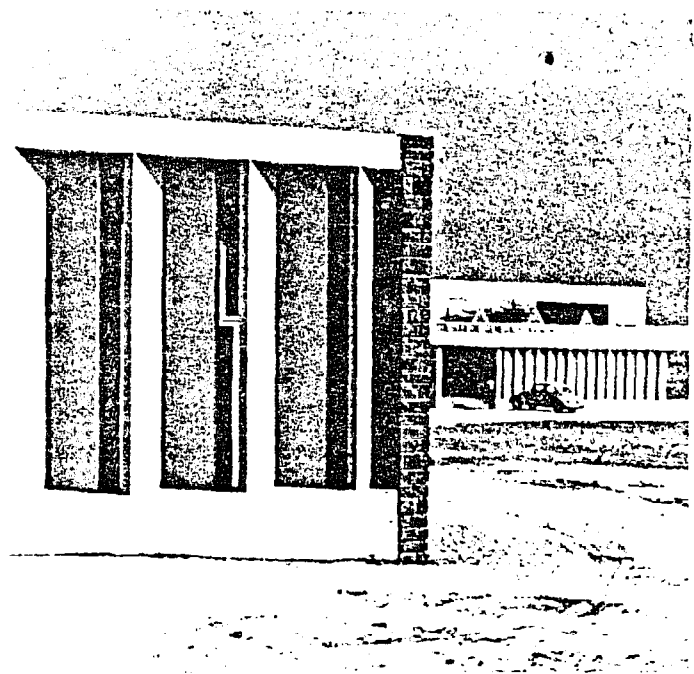

Fig. 27
Fixed vertical concrete
fins against morning
and evening sun

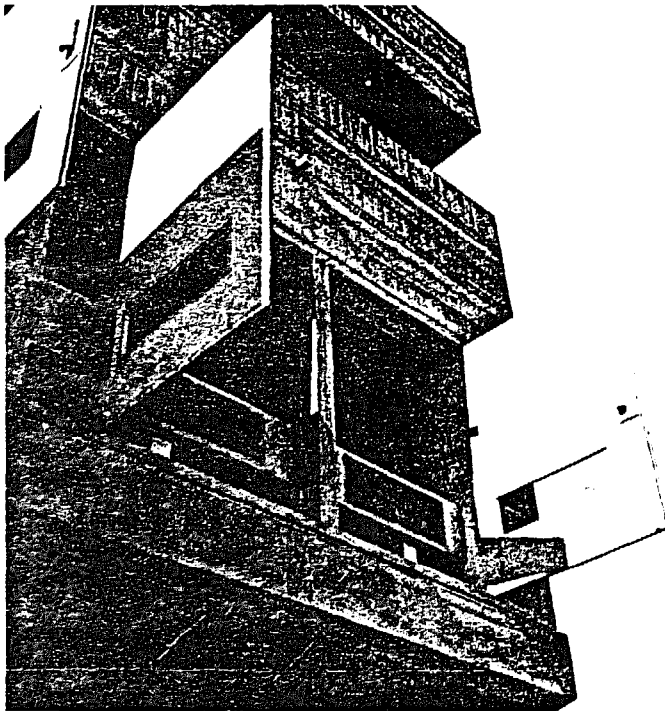

Fig. 28
Wooden shutters which can
be opened according to the
position of the sun

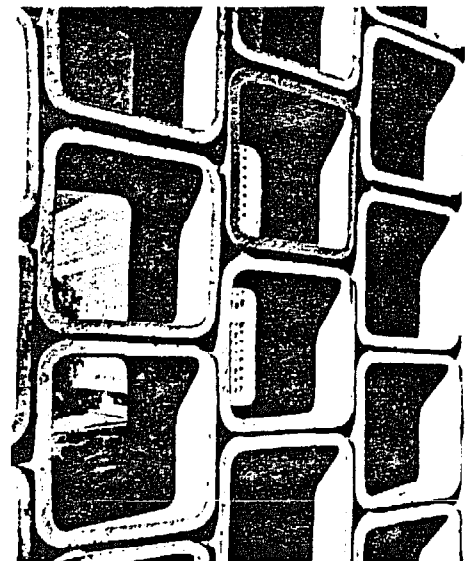

Fig. 29
Screen of preformed elements

3.2 GOOD EXAMPLES OF SHADING

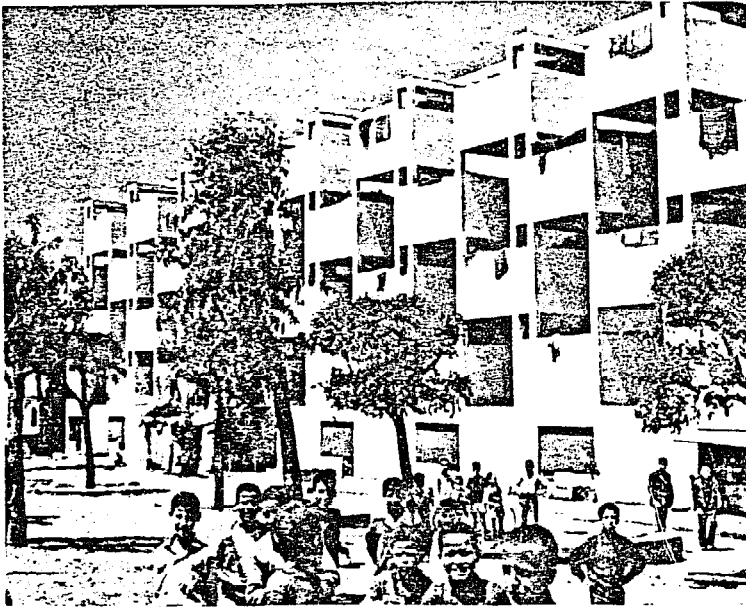

Fig. 30

Alternating balconies and loggias give good shading results

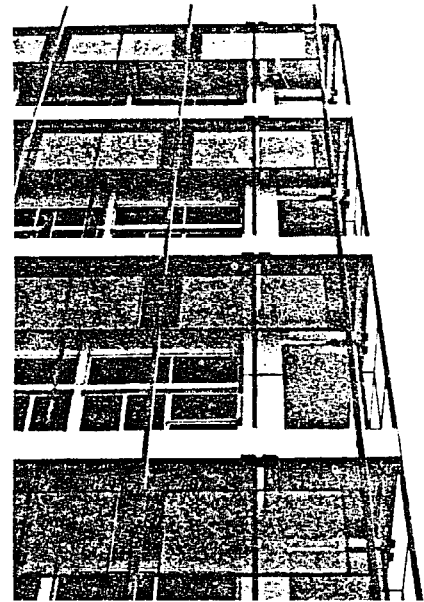

Fig. 31

Overhanging floor-slabs combined with heat-absorbant glass

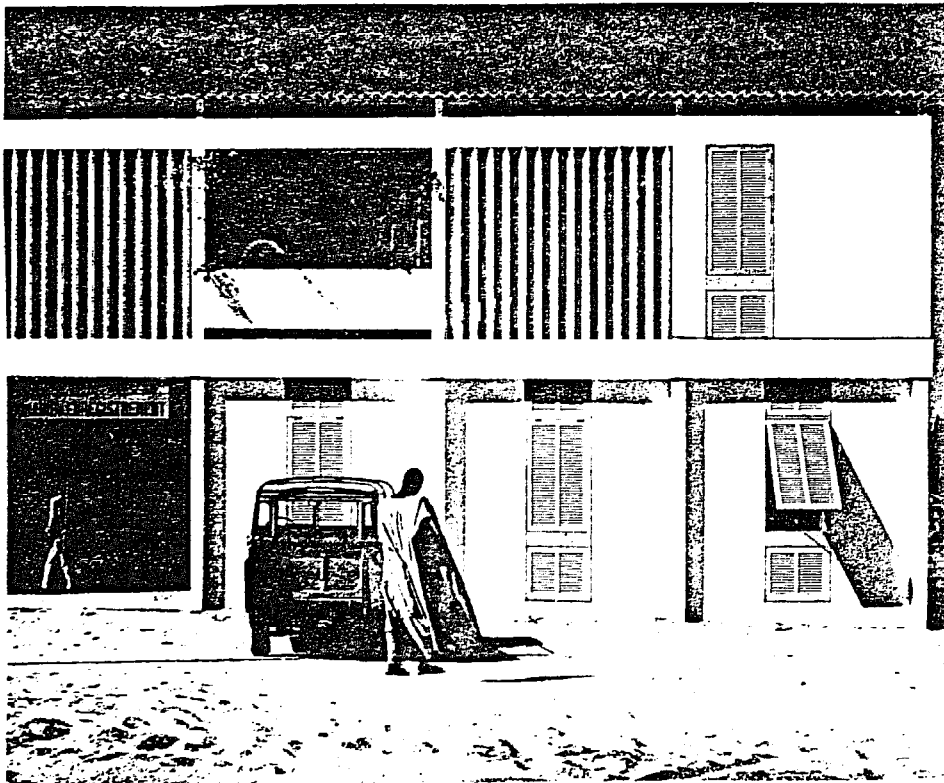

Fig. 32

Combination of loggia, vertical louvers and horizontal shutters

4. ROOF DESIGN

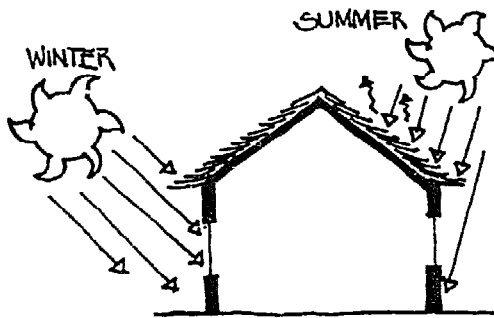

Fig. 33

ROOF OVERHANG. In some regions it is desirable to shade the sun off during summer and to use the solar radiation for room heating through windows during winter. This effect can be obtained with an appropriate roof overhang. Its dimension depends on the angle of the solar radiation. The roofing can be made of straw (good insulation)

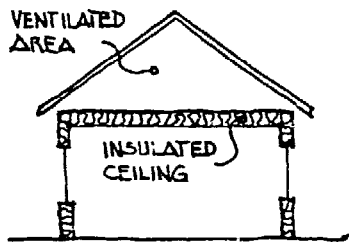

Fig. 34

VENTILATED ROOF. The roof covering should be made of a reflecting material (e.g. asbestos). The room under the roof has to be ventilated through wall openings to create a cool buffer zone between roof and ceiling. Best results for cool room are obtained with an insulated ceiling. Protect roof area against vermin, bats, etc.

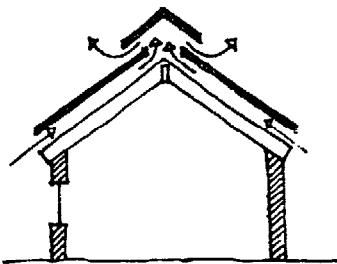

Fig. 35

ICEHOUSE ROOF. This double roof construction includes an outer roof of shingles and sheathing on wood nailers and an inner roof of roofing felt and sheathing on rafters (3). This construction has a good insulation effect.

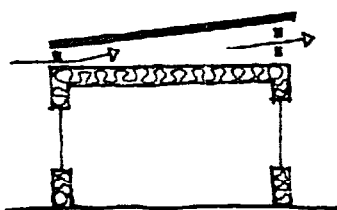

Fig. 36

FLAT ROOF. A flat roof should be covered with a ventilated roofing because it absorbs during summer the highest solar radiation rate due to the right angle between radiation and roof. Heavy rains can damage flat roofs relatively easily.

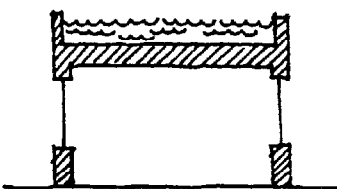

Fig. 37

ROOF POND. A roof pond creates a good room climate beneath due to heat reflection and absorption during the day and radiation of stored heat into the room during night. The roof pond may cause serious construction problems because the roof has to be 100% water proof and the structure has to resist to the heavy water load. A roof pond requires high standard technology.

5. VENTILATION THROUGH WALL OPENINGS

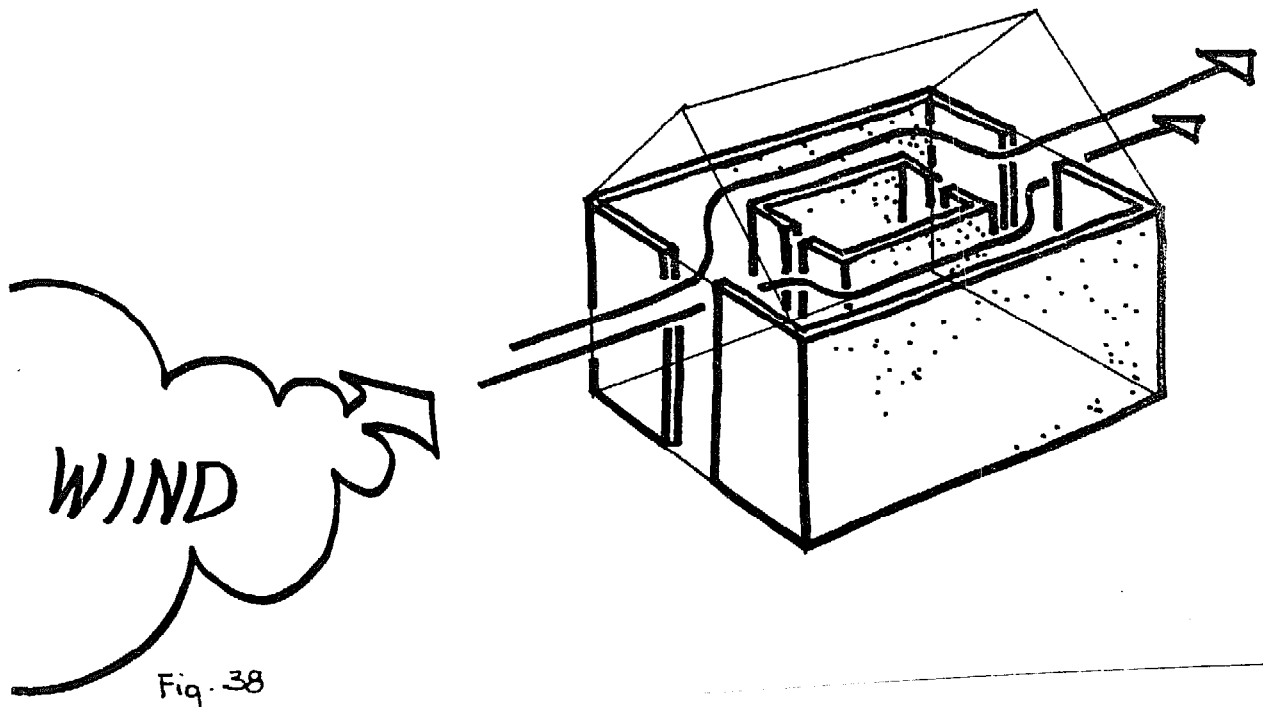

Fig. 38

The aim of planning wall openings is to obtain and control a cooling air-flow through the building. Some of the rules for planners and users are:

For hot arid regions

- Make large openings of roughly equal size so that inlets face the prevailing nighttime summer breezes and outlets are located on the side of the building directly opposite the inlets. This allows cross ventilation.
- Open the windows at night to ventilate the room and cool interior thermal mass.
- Close the building up during the daytime to keep the heat out.

For hot humid regions

- Make the outlet openings larger than the inlets. This creates high velocity of air flow which is necessary for effective cooling because hot-humid climates are characterized by high daytime and nighttime temperatures.
- Open the building up to the prevailing breezes during the day and the evening.

Openings in roofs

- Warm air rises and can get stacked under the roof. To prevent this stack effect, you can arrange outlets in the roof area.

5.1.1 DESIGN RULES FOR WALL OPENINGS

Air-flow in buildings are explained with examples using drawings from Robert H. Reed's "Design for Natural Ventilation in Hot Humid Weather". (4)

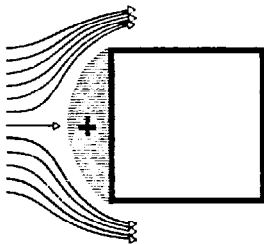

Fig. 39
Wind striking a building creates a region of high pressure on the windward side

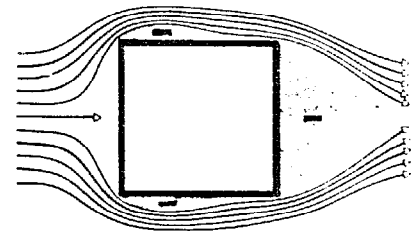

Fig. 40
The wind is deflected around the building creating low pressure zones along the sides and along the entire lee side

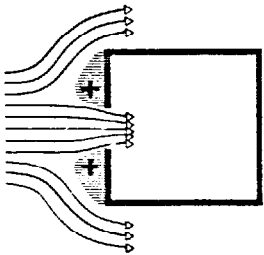

Fig. 41
Equal pressures on both sides of symmetrically located inlet

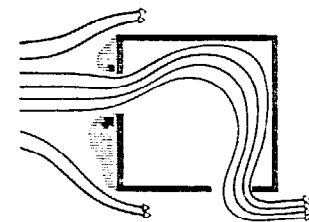

Fig. 42
The air-flow does not take the shortest route

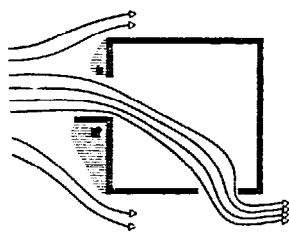

Fig. 43
Unequal pressures on both sides of inlet, air-flow deflected to a different route

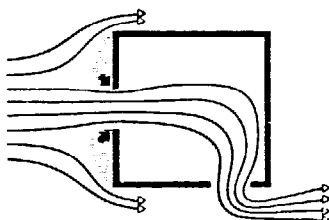
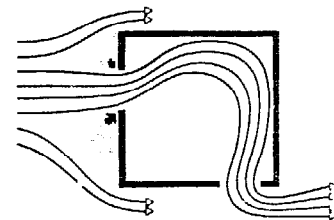
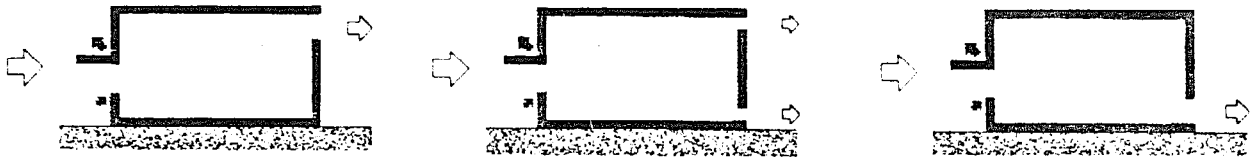

Fig. 44
Inlet altered by a wall on one side, an open door or shading device. The air flows diagonally through the room compelled by the pressure forces along the facade



5.1.2 DESIGN RULES FOR WALL OPENING



Location of outlet is not important. The air flow is determined only by pressures around the inlet as shown.

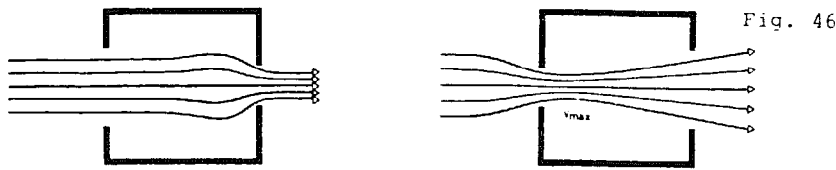

Fig. 46

The velocity of airflows is increased if the inlet is smaller than the outlet.

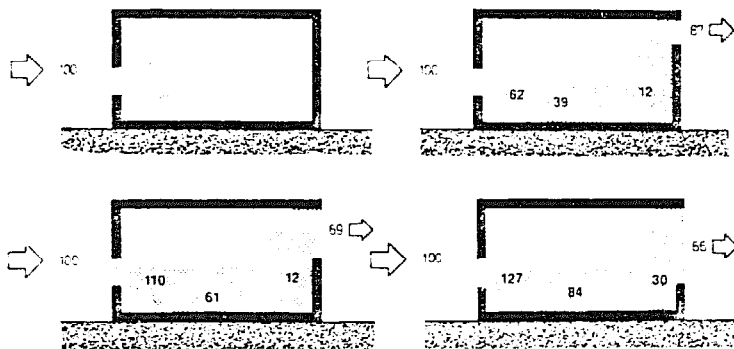

Fig. 47

The size of the outlet compared to the inlet is decisive. The air speed outside the building is taken as 100, the inside values are expressed as a percentage of this.

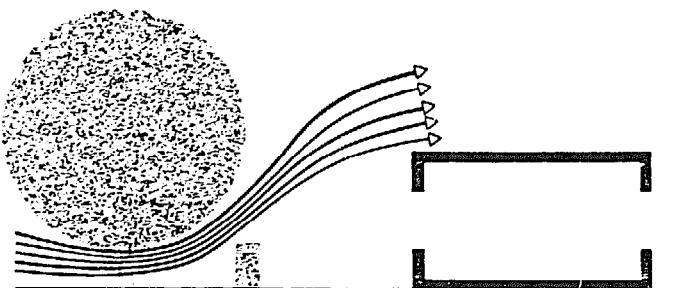
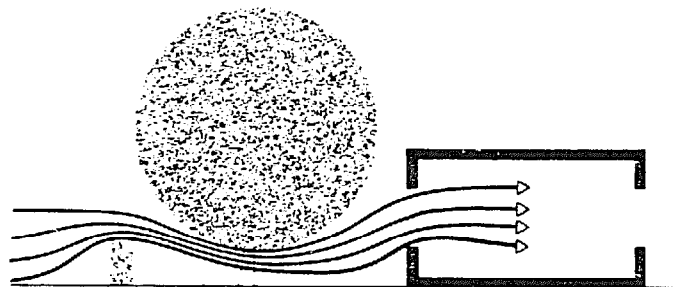

Fig. 48
49

Good cross ventilation requires that the wind approaches the building from the most favourable direction. Figs. 48 and 49 show that improvement can be made by landscaping or by taking suitable building measures. These changes too, are also based on the distribution of the pressure and suction on the facades and around the building.

6.1.1 AIR COOLING, HUMIDIFICATION

In hot arid regions the air can be cooled by humidifying it. Mainly in North Africa traditional methods of cross ventilation and air humidification show very good results (5).

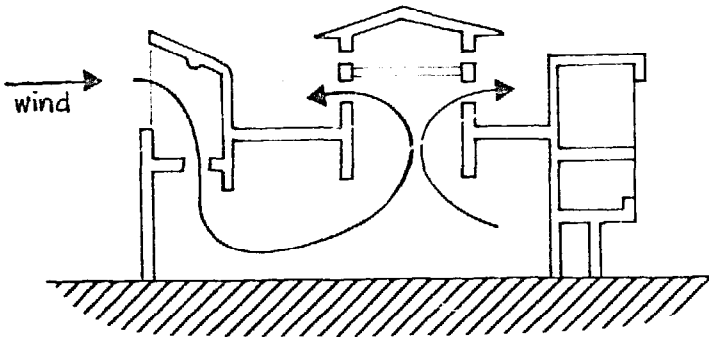

Fig. 50 A traditional system of cross ventilation through air captors on roofs or terraces

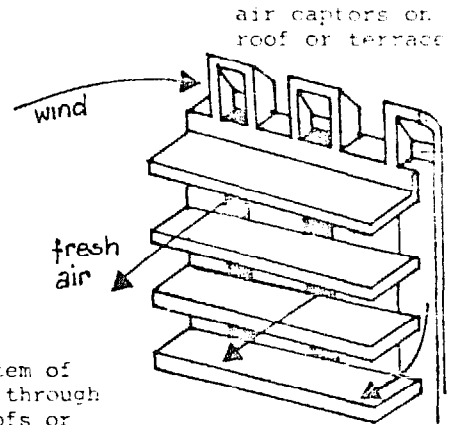

Fig. 51

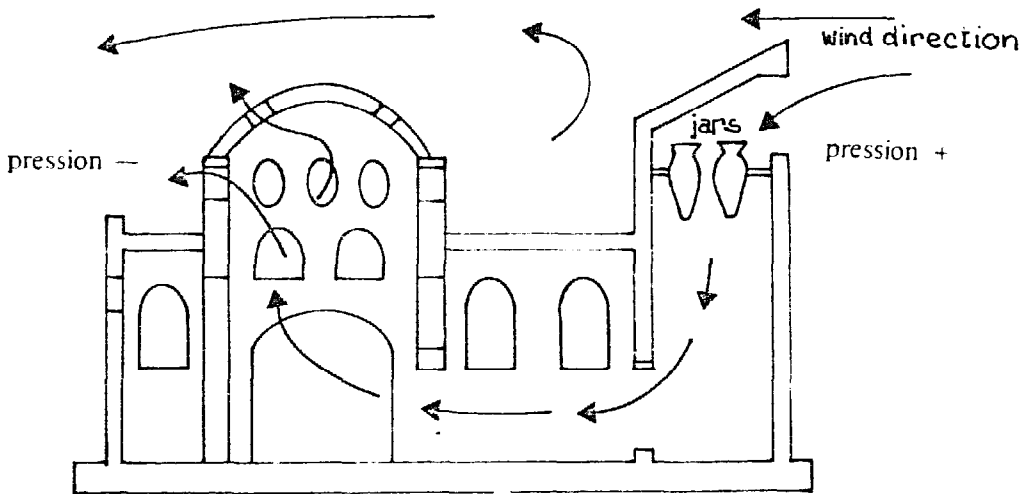

Fig. 52 By humidifying the air with water filled jars in the air inlets the effect of cooling can be improved

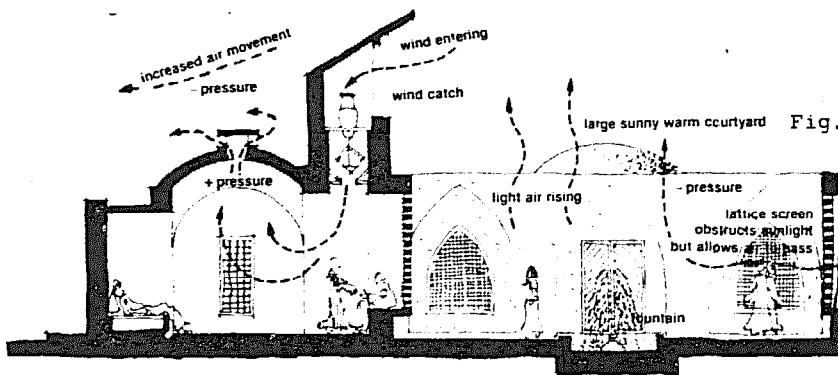

Fig. 53

6.1.2 AIR COOLING, HUMIDIFICATION

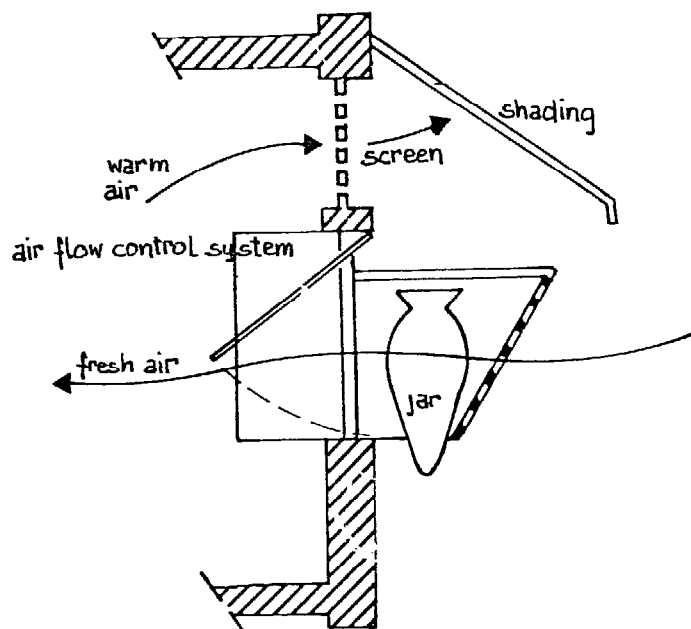

Fig. 54 An example, how the humidification jar can be realized in combination with a window

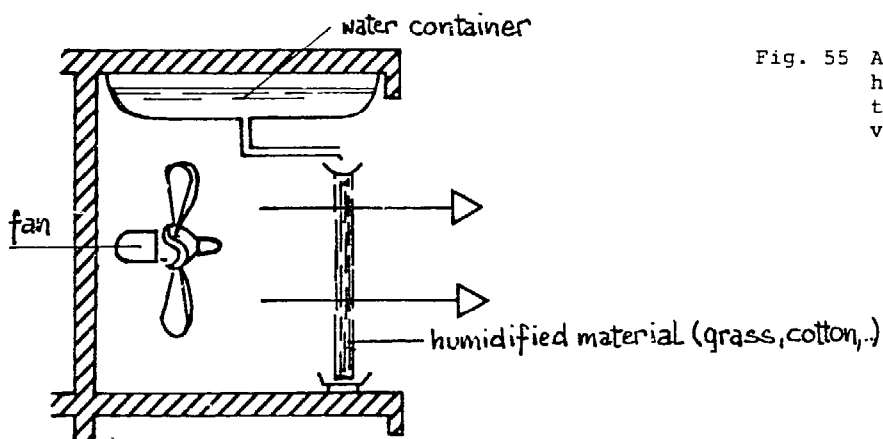

Fig. 55 Another technique to humidify the air with the help of mechanical ventilation

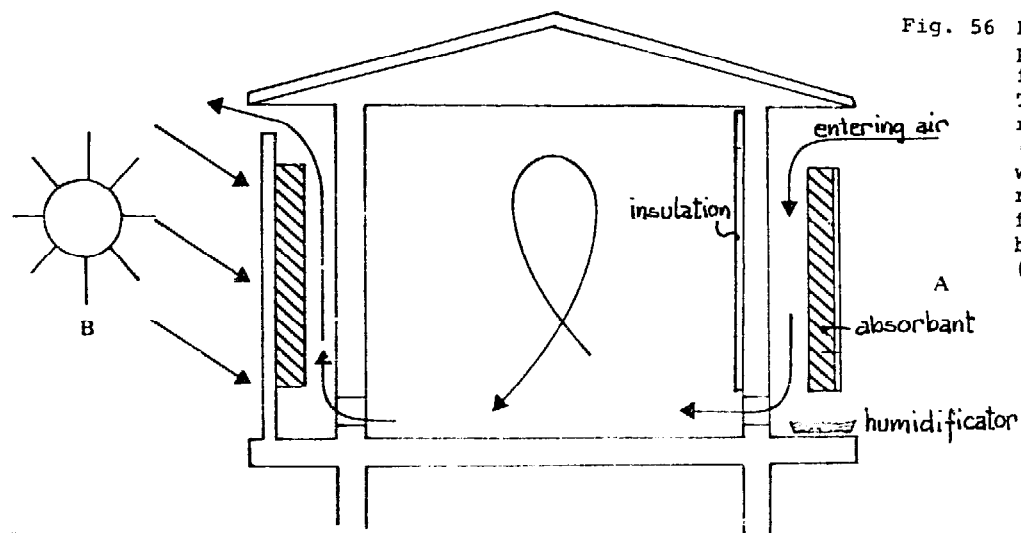

Fig. 56 Depending on the sun-position the air moves from A to B, resp. B to A. The air warmed up by solar radiation through the wall (side B) creates a wake which moves the air in the room. The warm air entering from side A is cooled down by evaporating water (humidificator)

7. BIBLIOGRAPHY AND TABLE OF PICTURES

Bibliography

- (1) Partially from "Solar Dwelling Design Concepts" by U.S. Dept. of Housing and Urban Development, May 1976 U.S. Government Printing Office, Washington, D.C. 20402.
- (2) From "The Passive Solar Energy Book" by E. Mazria Rodale Press, Emmaus, Pa., USA, 1979
- (3) See "The Passive Solar Energy Book"
- (4) From "Building in the Tropics" by G. Lippsmeier 1969 by Verlag Georg D.W. Callwey, München
- (5) From "Sahel et technologies alternatives" by CINAM (Republique française, Ministère de la coopération). Collection Technologies et Developpment No 3. August 1977

Table of Pictures

The pictures in this manual are made by the author or they are copied from:

- "African traditional architecture" (S. Denyer): Fig. 12 by Heinemann, London, 1978
- "Building in the tropics" (G. Lippsmeier): Fig. 22, 23, 24, 25, 26, 27, 28, 29, 30, 31, 32 See (4) above
- "Sahel et technologies alternatives: Fig. 50, 51, 52, 54, 55, 56 See (5) above
- "Mazingira" No. 12/1980: Fig. 53

SKAT Publications

1. Jean-Max Baumer: Schweizerische Kontaktstelle für Angepasste Technologie (SKAT), St. Gallen 1977, 39 Seiten
2. Jean-Max Baumer: Angepasste Technologien für Entwicklungsländer, Literaturstudie, St. Gallen 1977, 132 Seiten, vergriffen
3. Jean-Max Baumer: Angepasste Technologien für Entwicklungsländer, Bibliographie, St. Gallen 1977, 307 Seiten, vergriffen
4. Jürg Nipkow: Angepasste Technologien für Entwicklungsländer, Sonnenenergie-Geräte für Haushalte, St. Gallen 1977, 62 Seiten, Fr. 8.50
5. Sabine Huber: Probleme des Technologie-Transfers von Industrieländern in Entwicklungsländer, St. Gallen 1978, 43 Seiten, vergriffen
6. Gerhard Schwarz: Hemmnisse und Hindernisse bei der Verwirklichung des Konzepts der Angepassten Technologie in Entwicklungsländern, St. Gallen 1978, 53 Seiten, Fr. 14.--
7. Otto Langenegger: Einsatz von Bohrmaschinen für die Wasserbeschaffung in Aethiopien, St. Gallen 1979, 43 Seiten, Fr. 14.--
8. Helvetas: Manual for Rural Water Supply, St. Gall 1980, 175 pages, 10 scale drawings, Fr. 34.--
9. Felix Sigrist (editor): Desecador solar simple, St. Gall 1980, 25 pages, Fr. 7.--
10. Roland Stulz: Elements of Solar Architecture, St. Gall 1980, 24 pages, Fr. 9.--

Forthcoming:

- . Roland Stulz: Appropriate Building Materials
- . Ueli Meier: Harnessing Water Power on a Small Scale