

AT MICROFICHE
REFERENCE
LIBRARY

A project of Volunteers in Asia

Bread Box Water Heater Plans

Published by:

Zomeworks Corporation
P.O. Box 25805
Albuquerque, NM 87125 USA

Paper copies are \$ 3.00.

Available from:

Zomeworks Corporation
P.O. Box 25805
Albuquerque, NM 87125 USA

Reproduced by permission of the Zomeworks
Corporation.

Reproduction of this microfiche document in any
form is subject to the same restrictions as those
of the original document.

 BREAD  BOX
WATER HEATER PLANS - ZOMEWORKS

 BOX 712 ALBUQUERQUE, N.M. MARCH
75

INCLUDING PRINCIPLES,
DESIGN AND CONSTRUCTION
OF A SIMPLE AND EFFECTIVE
HOT WATER HEATER

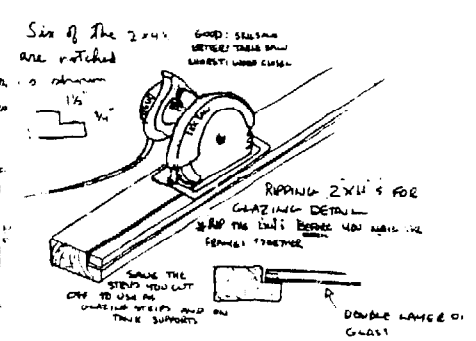
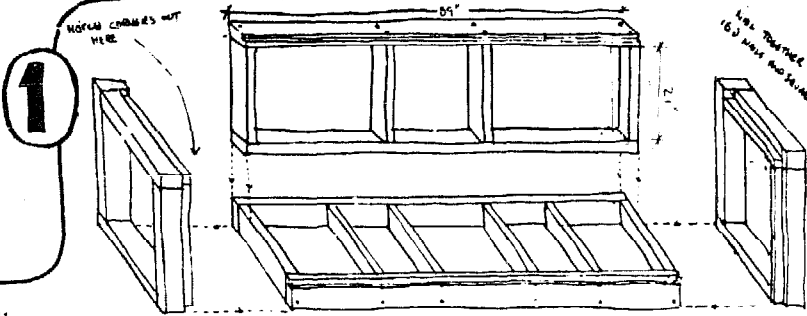

PARTS LIST almost complete

- WOOD**
 2ea 96" } top door
 2ea 28" }
 2ea 96" } bottom door
 2ea 21" }
 8ea 26" ends
 2ea 89" } bottom
 6ea 24 1/2" }
 2ea 89" } back
 4ea 21" }
 2 x 6" s TRIM SUPPORTS
 4ea 20"

- METAL**
 .024 aluminum or 24 gauge galvanized
 2ea 24" x 96" - bottom door
 2ea 31" x 96" - top door
 2ea 27 1/2" x 96" x 4"

- x 6 bottom
 2ea 27 5/8" x 27 5/8" x 2 1/2"
 end caps
 1ea 24" x 24" x 89"
 inside back x bottom
 2ea 24" x 24" inside ends

ask to choose & pick your own
 (ask to choose & pick your own)
 160 nails
 160 shank nails
 160 shank nails
 160 shank nails

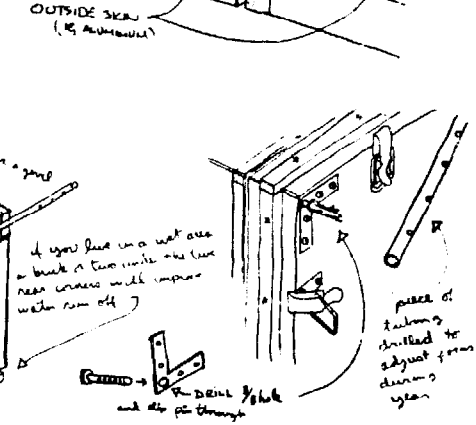
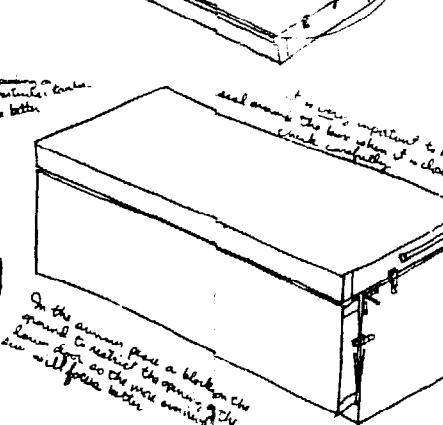
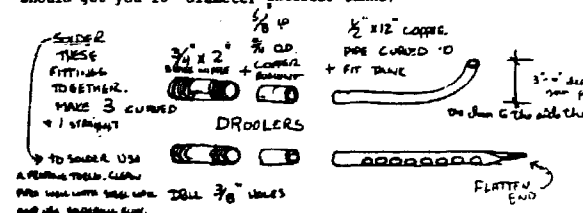
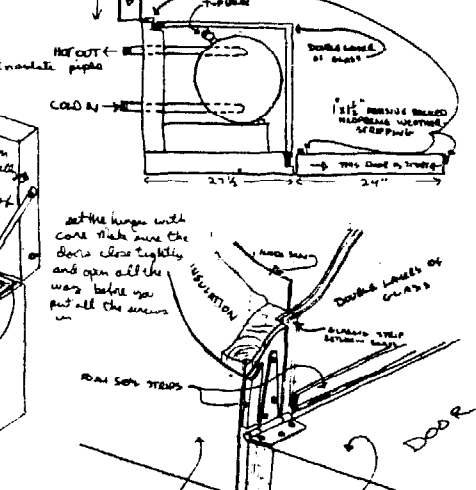
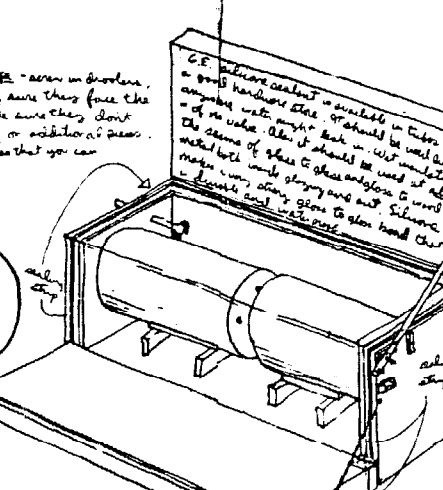
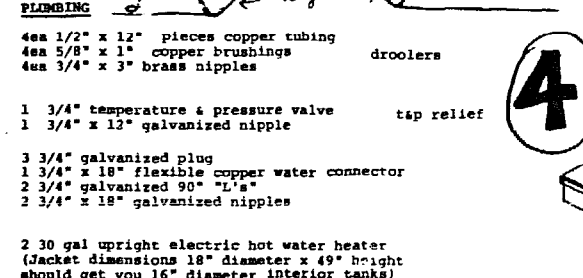
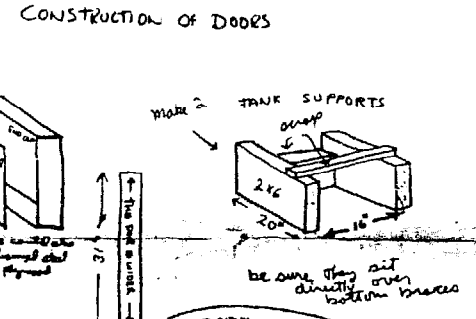
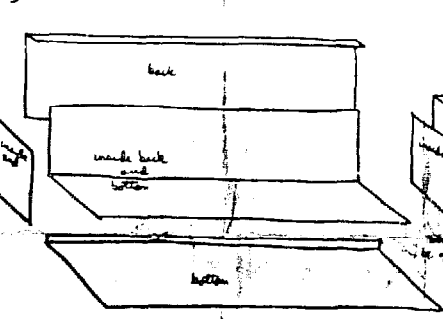
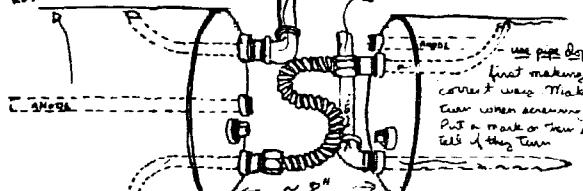
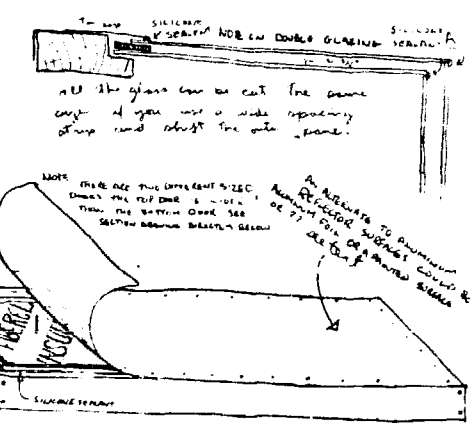
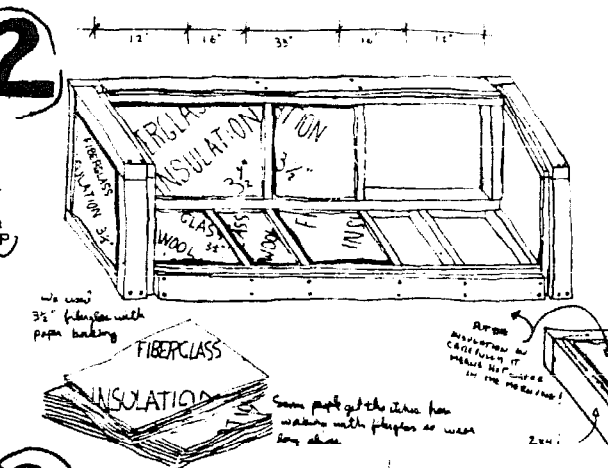

- PLUMBING**
 4ea 1/2" x 12" pieces copper tubing
 4ea 5/8" x 1" copper brushings
 4ea 3/4" x 3" brass nipples
 1 3/4" temperature & pressure valve
 1 3/4" x 12" galvanized nipple
 3 3/4" galvanized plug
 1 3/4" x 18" flexible copper water connector
 2 3/4" galvanized 90° "L"s
 2 3/4" x 18" galvanized nipples
 2 30 gal upright electric hot water heater (Jacket dimensions 18" diameter x 49" height should get you 16" diameter interior tanks)

- HARDWARE & MISC.**
 8 24" x 44" pieces strength glass (precut boxed glass is available in this size from large glass companies)
 34 1/2" x 1" adhesive backed neoprene weather strapping
 160 nails
 98 screws (or twist shank nails)
 4 latches
 3 1/2" x 5" "r" hinges
 1 3/8" x 2" pin w/ hairpin clip
 1 1/2" x 2 1/2" flat corner iron
 1 1/2" x 2 1/2" piece tubing for door support - aluminum or steel

It is very important to have a good seal around the door when it is closed. Check carefully.
 If you find in a wet area a leak a few inches and have near cracks will improve water run off.
 On the summer part a blackish grey stain from so the water coming. The sun will make water.

pieces of shingles drilled to adjust from summer to winter.

INTRODUCTION

Breadbox solar water heaters are simple and effective. One or more ordinary hot water tanks are strapped of insulation and painted flat black are placed in a glass-covered insulated box with insulated reflecting doors - the sun shines through the glass onto the tank and also bounces off the reflecting doors onto the tank. The doors are open during the day to receive the sun and then closed at night to conserve heat.

ABSTRACT OF PLANS

The plans describe the construction of a solar hot water heater using two 10 gallon electric hot water heater tanks with electric back up. They also discuss the principles of the design so that an interested person can vary the construction and know generally what to expect. The plans stress the relative importance of different aspects of the design - where you must be very careful and where you needn't be so careful.

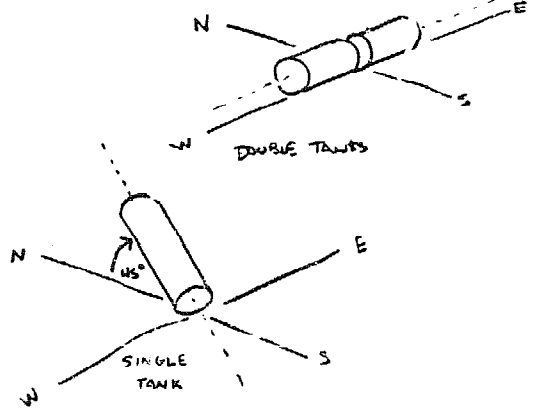

ORIENTATION OF BOX

The drawings show the box looking South with the long axis pointing East-West. This is usually the best orientation for a double tank heater. If you have only one tank, the best arrangement is to tilt the box at an angle and point it South - this eliminates the problem of the cold water mixing with hot (see section on stratification) - the North end of the tank will be high and the hot water will stratify there, while the cold water will rest at the low South end. The angle you tilt the box should be somewhat more than your latitude - 10° to 30° more.

This orientation makes it somewhat difficult for the reflectors to operate except near the middle of the day.

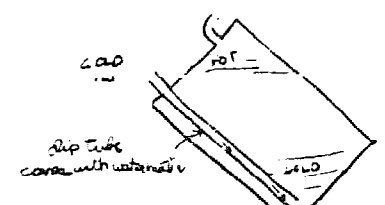
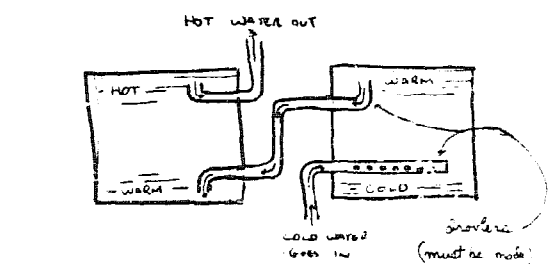

MIXING & STRATIFICATION

The efficiency of a box collector is somewhat hard to determine because it is hard to get all the heat out of the tanks. As you take off hot water, the cold water enters the first tank and mixes with the hot water - the doors act to slow it down in tanks with as little vertical depth for stratification as a sideways hot water tank. Multiple tanks reduce the problem. The water mixes in each tank before it moves to the next - this slows down the arrival of any cold water at the last tank.

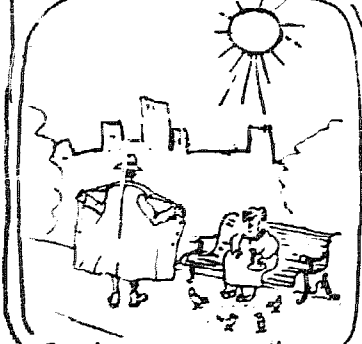

Open during the day to receive the sun

Tanks - use hot water tanks - they are glass lined and have a long life.

TESTING

For a week we drained 35 gallons of hot water from the heater every afternoon. On the afternoon of 13 February 1975 when we drained the heater, it started at 143°F. After 17 gallons, the temperature was 123°F and at 35 gallons, 107°F. It was a clear day - high temperature of 61°F and low of 26°F. The entering tap water was 61°F.

A vertical hot water tank has a very definite "heat cliff" as you extract the last hot water. A sideways tank slowly tapers off. Even though the total tank contents of a box heater may be 20 gallons, it is possible to extract at least 10 gallons of fairly warm water after a sunny day. The last 20 gallons of warm water is heat the first 60 gallons couldn't take with them because of mixing.

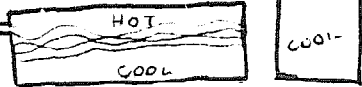

WHAT TO DO WITH ELECTRIC HEATING ELEMENTS

It's hard to get at the thermostat after the tank is glassed in. You can leave a door in the back and reach in to adjust the thermostat or you can set it once, seal it up and then either plug it in or unplug it depending on when you want back-up heat.

WHAT ABOUT FREEZING?

The large tank protects itself against freezing with its own bulk of warm water. Pipes leading to and from the tank must be protected as any other pipes.

If you are using the electric element as a back-up heater this will of course prevent the tank from freezing - the thermostat can be set low if this is all the use you want from the electricity. Heat tapes can be used on lines to and from the tanks.

One safeguard for lines that have the danger of freezing is to use High Molecular weight polyethylene or polybutylene. This material is so strong and resilient that it is able to go through repeated freezing and thawing cycles. It can also be used for hot water if the pressure is not extremely high. The pipe is made by Orangeburg Pipe, Celanese and Phillips Products.

In the case of power failure, another old standby method to prevent freeze-up is to let the faucet drip and keep water running through the pipes.

AUTOMATING THE DOORS

We attempted to automate the doors of breadbox heaters using from canisters as they are used in the skylid. It's not difficult to make a system to open and close the doors in response to the sun, but it is difficult to make something that can deal with wind, snow and ice and close tightly at night. Manually operated ropes and pulleys can be added to work the doors.

CHANGING SCALE

What happens if instead of a 16" diameter tank we use a 32" diameter tank - that is if we double all of the dimensions of the plan?

Such a heating system will work fine, but it will warm up and cool down more slowly. If we double all the dimensions the area exposed to the sun are 2²=4 times as great, but the quantity of water to heat is 2³=8 times as great. Consequently the water temperature would rise and fall at about 1/2 the rate of the smaller model.

AIR LEAKS

It is very important to close off any gaps in the glazing since a small draft around the tanks will rob them of much heat. The seal that the doors make is also very important. A 1/4" gap along the side of a door can render the door almost useless as insulation.

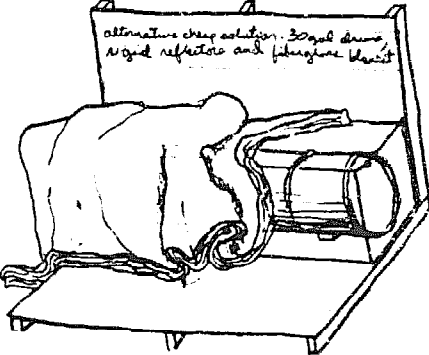

HOW TO USE SYSTEM

If you have two electric water heaters and you are considering replacing one with a solar water heater with electric backup, always install the solar water heater where the most water is used. It is always more efficient to heat a lot of water a little than to heat a little water a lot. Collectors always run more efficiently at low temperatures than at high temperatures.

REFLECTORS

The reflectors on the box heater serve to wrap the sun around the tank rather than focus the sun on the tank. A true focusing collector concentrates the intensity of the sun many times - the box heater with its flat reflectors never concentrates the sun more than about 1 1/2 times. The benefit of this relaxed concentration is that it works all year - even as the sun moves high in the summer and low in the winter.

The reflectors can be focused by looking from the direction of the sun and adjusting the doors until the image of the black tank appears. You can also place a hand mirror on the surface of the door, and move it until the spot of light appears on the tank.

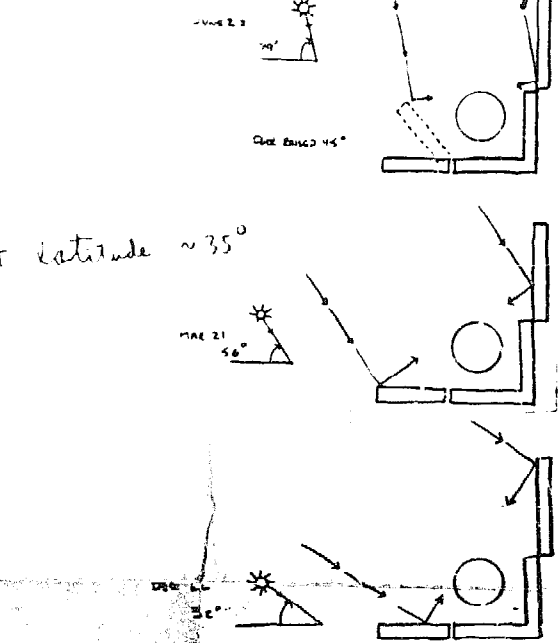

It is not necessary to use very shiny surfaces for the reflectors. The performance of fairly dull aluminum is almost as good as shiny aluminum and white paint also makes a good reflective surface for a box heater. The reason you are able to use dull aluminum or white paint is that the tank is so large and so close, the reflected beam can be scattered a good deal and still hit the target.

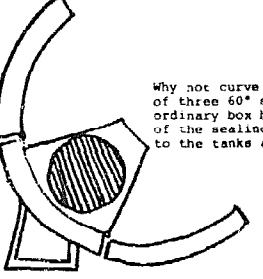

Why not curve the reflectors? We built one water heater of three 60" segments of a circle which we raced with an ordinary box heater. The curved reflectors burned parts of the sealing strip and failed to deliver as much heat to the tanks as the more pedestrian box.

The space between tanks and between the box and the tank ends is not wasted - sun ounces into the tank ends at all times except noon.

GLAZING

Even in fairly mild climates the box should have two glass covers. In extremely cold climates, three covers would make sense. The more glass covers, the more careless you can be about closing the doors promptly at night.

HEAT TRANSFER

The storage tank itself is exposed to the sun so the heat doesn't have far to go to reach the water. The sun striking the tank at the bottom and the sides sets up convection currents in the tank and tends to warm the water uniformly - the sun striking the tank along its top heats a relatively stationary layer of water stratified there - this water becomes especially hot during the summer when the sun is high - an hour or so after sundown this hot layer has given most of its heat by conduction to the cooler water below. The steel tank walls also help distribute heat.

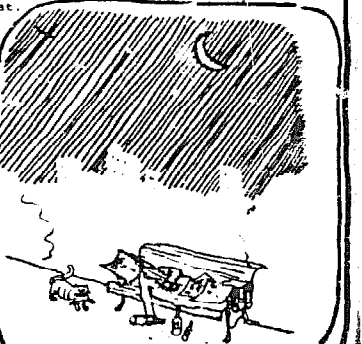

Close at night to conserve heat