

**AT** MICROFICHE  
REFERENCE  
LIBRARY  
A project of Volunteers in Asia

Small Hydropower for Asian Rural Development  
Proceedings of a Workshop on Small-Scale Hydropower  
Applications in Asian Rural Settings

Edited by: Colin R. Elliott

Published by: Renewable Energy Resources Information Center  
on the behalf of:  
National Rural Electric Cooperative Association  
1800 Massachusetts Ave., NW  
Washington, DC 20036

Available from: National Rural Electric Cooperative Association  
Renewable Energy Resources Information Center

Reproduced with permission.

Reproduction of this microfiche document in any form is subject to the same restrictions as those of the original document.

# **Small Hydropower for Asian Rural Development**

**Asian Institute of Technology  
Bangkok, Thailand**

**June 8-11, 1981**

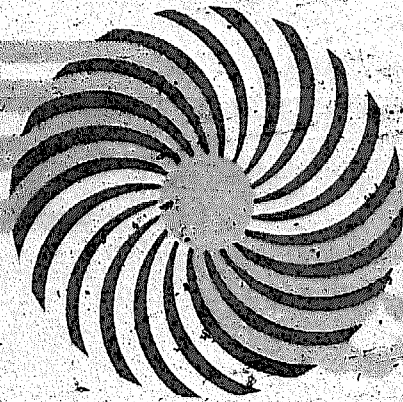

*Co-sponsored by:*

**Asian Institute of Technology  
National Economic and Social  
Development Board**

**National Rural Electric Cooperative Association**

*in cooperation with the*

**United States Agency for International  
Development**

Not to be reprinted without written authority

The Sponsoring Organisations are not responsible  
either for the statements made or for the opinions  
expressed in this volume.

Copyright © 1983, NRECA

**Published by the Renewable Energy Resources  
Information Center (RERIC) on behalf of the National  
Rural Electric Cooperative Association (NRECA)**

# **SMALL HYDROPOWER FOR ASIAN RURAL DEVELOPMENT**

---

**The Proceedings of a Workshop  
on Small-Scale Hydropower Technology  
Applications in Asian Rural Settings**

**held at**

**The Asian Institute of Technology  
Bangkok, Thailand  
June 8 – 12, 1981**

---

---

**EDITED BY :**

**Celin R. Elliott**

*Co-sponsored by :*

**The Asian Institute of Technology (AIT)  
The National Economic and Social Development Board (NESDB)  
and the National Rural Electric Cooperative Association (NRECA)  
in cooperation with the U.S. Agency for International Development (USAID)**

# Preface

---

*The spot fuel shortages and soaring energy prices of the 1970's signalled the beginning of a new economic reality worldwide. Now, as once abundant reserves of fossil fuels continue to diminish, the age of inexpensive energy to power the global economy has come to an end.*

*While spiralling energy costs have threatened living standards in many industrialized countries, their impact on energy-importing countries in the developing world is even more pronounced. Over the past decade, actual expenditures for imported oil by these countries have risen nearly tenfold. In developing countries, where foreign exchange and investment capital is frequently scarce, each barrel of imported oil represents a diversion of hard-won capital from critically-needed development programs. For many, the cost of imported energy may mark the fine line between economic survival and collapse.*

*The worldwide energy shortage has stimulated international interest in untapped non-depletable sources of energy. One such energy source is hydroelectric power generated by small powerplants. Small hydro plants can provide affordable, reliable electro-mechanical power to many areas of the world that are now without energy, particularly in isolated rural communities where the cost of transporting fuels and building transmission lines is high.*

*Small hydro technology has been well-developed for many years and, unlike conventional thermal energy technology, is not dependent on unreliable and costly sources of fuel. If properly conceived and developed, small hydro systems are not expensive to operate and maintain and can provide an efficient source of power for decades. Given today's uncertainties about global energy supplies, many developing nations, most prominently those in the Asian and South Pacific region, are turning to small hydropower as a significant component of their energy development programs.*

*This workshop, conducted under a centrally-funded cooperative agreement between the U.S. Agency for International Development (AID) and the National Rural Electric Cooperative Association (NRECA), and cosponsored by the Asian Institute of Technology and the National Economic and Social Development Board of Thailand, was one of a series of workshops designed to illuminate issues and problems associated with the development of small hydro schemes in developing countries. The workshops are one part of a larger effort, the Small Decentralized Hydropower (SDH) Program, whose objective is to enhance NRECA's technical capabilities in the field of small (1 MW or less) hydropower and to make this expertise available to developing countries. The SDH Program, in the course of its project activities, has assembled a team of specialists to provide in-country consulting services in areas such as plant siting, project design, economic and technical feasibility studies, environmental/social impact analysis, institutional development, and training. A wide variety of informational and instructional activities have been developed by the SDH team. This workshop, and others held in Latin America and Africa, provides an opportunity to share the results of this ongoing effort with individuals and organizations in developing countries active in the field of small hydro development.*

*Over one hundred participants attended the "Small Hydropower for Asian Rural Development" workshop, including delegates from fifteen countries in the Asian and South Pacific region: Australia, Burma, Bangladesh, Fiji, India, Indonesia, Malaysia, Nepal, Pakistan, Papua New Guinea, the People's Republic of China, Philippines, Solomon Islands, Sri Lanka, and Thailand. A complete list of participants appears at the back of this volume.*

*The workshop featured thirteen paper presentations on technical, economic, social, financial, and institutional issues which were followed by a series of small workshop discussion groups in the areas of resource assessment and site selection; technology: issues, design, manufacture, and operation; social impacts, community participation, and institutional issues; and economic feasibility and financial issues. Four special case-study presentations were made on mini-hydro activities in Indonesia, the Philippines, Malaysia, and the People's Republic of China. In addition to these, four slide presentations were made in place of a scheduled field trip, cancelled due to inclement*

weather, which do not appear in these proceedings. Finally, two panel discussions were held to examine contrasting views on centralized versus decentralized approaches to mini-hydropower development. The country profiles, which appear in Part I of this volume, were prepared by the delegations representing their respective countries.\*

The workshop was held at the Asian Institute of Technology, which was established in 1959 to meet the growing need for advanced engineering education in Asia. Supported by donations from numerous governments and international organizations, AIT has an enrollment of about 500 students from 35 nations. An international faculty of 65 offers postgraduate courses in nine academic divisions. AIT also maintains a strong continuing education program, of which this workshop was a part, to disseminate information throughout the region.

This workshop would not have been possible without the assistance of many people. Special thanks must go to: at the Asian Institute of Technology, Dr. Robert Banks, President; Dr. M. Nawaz Sharif, Vice President for Academic Affairs; Dr. Nicanor Austriaco, Director, Continuing Education Center; Dr. R.H.B. Exell, Associate Chairman, Energy Technology Division; Dr. Jacques Valls, Director, Library and Regional Documentation Center; and the students and support staff for their participation, planning, administrative management, and local arrangements; at the National Economic and Social Development Board of Thailand, Piromsakdi Laparojkit, Director, Energy Planning Sector; at the National Energy Administration of Thailand, Prepath Premanni, Deputy Secretary General; at the Provincial Electricity Authority, Dr. Chulapongs Chullakesa, Department Manager and Project Director, Office of Rural Electrification; at the Electricity Generating Authority of Thailand, Srid Aphaiphuminart, Director, Planning Department, for their invaluable assistance, cooperation, and advice; at the U.S. Agency for International Development in Bangkok, Donald D. Cohen, Director; Robert Queener, Assistant Director; Rod MacDonald, Chief Engineer, Office of Engineering, Science and Technology; and Mintara Silawatshananai, Engineer, Office of Engineering, Science and Technology; at the U.S. Agency for International Development in Washington, D.C., Alan Jacobs, Director, Energy Office, Science and Technology Directorate; Robert Ichord, Energy Advisor, Office of Technical Resources, Asia Bureau; Hassan Hassan, Chief Engineer, Asia Bureau; Jane Stanley, Environmental Office, Asia Bureau, for their long hours of planning, overall assistance, and direction; at the Small Decentralized Hydropower Program office of NRECA, Paul Clark, Training and Information Specialist; Jean Chin, Secretary; John Mashaw, management consultant at NRECA's Management Services Division, for their long hours of planning, management, and overall coordination; at the National Research Council of Thailand, Dr. Boon Indrambarya, for serving the plenary sessions as moderator; and last but not least, the workshop participants, particularly those who presented papers, served on panels, and the moderators and resource people for the workshops. Special recognition should be paid to Bob Yoder, Mark Henwood, Ibnu Subroto, Zenaida Santos, and Percy Favoreal, who presented valuable slide programs on Thursday of the workshop week at very short notice.

---

\*A summary of the program is given on p. 353

# Contents

	PAGE
<b>The Context of the Workshop</b> . . . . .	<b>1</b>
<i>by David R. Zoellner</i>	
<b>PART I Country Profiles</b>	
Bangladesh. . . . .	6
Burma. . . . .	9
Fiji. . . . .	12
India. . . . .	13
Indonesia. . . . .	17
Malaysia . . . . .	19
Nepal . . . . .	20
Pakistan. . . . .	28
Papua New Guinea. . . . .	30
People's Republic of China . . . . .	33
Philippines. . . . .	35
Sri Lanka. . . . .	38
Thailand . . . . .	40
<b>PART II Papers</b>	
<b>SECTION 1 Overview</b>	
Mini-Hydropower and the Asian Energy Problem. . . . .	46
<i>by S.N. Vinze</i>	
The Planning of Mini-Micro Hydropower Projects . . . . .	51
<i>by Mohar Singh Monga</i>	
Water Resources Planning for Mini-Hydropower: An Overview of Water Resources in Asia . . . . .	56
<i>by Suphat Vongvisessomjai</i>	
Energy Needs in Rural Development: The Case for Mini-Hydropower . . . . .	75
<i>by Chulapongs Chullakesa</i>	
<b>SECTION 2 Technology</b>	
Small Hydropower: Hydrological Methodology Without Streamflow Data . . . . .	80
<i>by Norman H. Crawford</i>	
Fundamentals of Hydraulic Turbine Design . . . . .	90
<i>by Roger E.A. Arndt</i>	
Site Location and Civil Works Design . . . . .	123
<i>by Allen R. Inversin</i>	
Electrical Aspects of Mini-Hydropower Systems . . . . .	140
<i>by Bard Jackson</i>	
Operation and Maintenance. . . . .	148
<i>by Gary Kitching</i>	
<b>SECTION 3 Economics and Evaluation</b>	
Considerations, Sources and Requirements to Finance Small-Scale Hydroelectric Systems. . . . .	154
<i>by Jorge R. Asin</i>	
Economic Feasibility of Small Hydroelectric Projects in Asian Development. . . . .	187
<i>by Mark Henwood</i>	
Productive End-Use of Mini-Hydropower for Rural Development . . . . .	196
<i>by Daniel Boyle</i>	
Evaluation Criteria for Small Decentralized Hydropower Programs . . . . .	208
<i>by Judith H. Magee</i>	

**SECTION 4 Case Studies**

China's Small Hydropower Development . . . . . <i>by Cheng Xuemin</i>	224
A Radical Approach to Rural Electrification for Developing Countries . . . . . <i>by Hoesni Nasaruddin and Rosli Alias</i>	229
Development of Small Hydropower Plants in the Philippines . . . . . <i>by Zenaida Santos</i>	237
Micro-Hydro Axial Flow Turbine for a Battery Charging System in Remote Areas . . . . . <i>by Djoko Susanto</i>	240

**PART III Panel Discussions**

The Local Approach to Development . . . . .	248
The Centralized Approach to Development . . . . .	258

**PART IV Workshop Summaries**

Resource Assessment and Site Selection . . . . .	270
Technology: Issues, Design, Manufacture, and Operation . . . . .	271
Social Impacts, Community Participation, and Institutional Issues . . . . .	273
Economic Feasibility and Financial Issues . . . . .	274

**PART V Additional Papers Contributed**

Frequency Controller in a Micro-Hydropower Plant . . . . . <i>by Harry Sosrohadisewoyo</i>	278
Decentralised Development and Management of Small Hydropower in Pakistan . . . . . <i>by M. Abdullah</i>	281
Centralised Development and Management of Small Hydropower in Pakistan . . . . . <i>by Mahammad Waseem Khan</i>	286
Socio-Economic Impact of Rural Electrification: Lesson from Central Java . . . . . <i>by Janice Brodman</i>	288
The Assessment and Role of Small Hydropower in Rural Development . . . . . <i>by Mangalam Srinivasan</i>	308
Micro-Hydropower Plants in Indonesia . . . . . <i>by Ibnu Subroto, Muchlison, Amiz Datunsolang, Sri Suwardo, Syahrul Arifin and Payaman Lubis</i>	314
List of Participants . . . . .	347
Program Summary . . . . .	353



# The context of the workshop

David R. Zoellner \*

**T**HIS workshop was designed to bring people together for a discussion of small decentralized hydropower (SDH) as a forum for an exchange of information, ideas, and opinions. For some, it was an introduction to the technology: what it looked like, what it could and could not do. For others, it was a chance to exchange solutions to problems, compare notes on experiences, and broaden the range of professional contacts. Out of the workshop would come a better understanding of the technology and its present state-of-the-art. There would also be an opportunity for each country delegation, with active programs, to summarize their progress and share their knowledge of mini-hydro development with the whole group.

Another objective of the workshop was to inform USAID Mission engineers of the capabilities of SDH technology and to further inform both Mission engineers and host-country representatives of the USAID centrally-funded program.

What has been learned? Foremost among the observations made during the workshop was the recognition that SDH provides an important ingredient to rural development. For the oil-importing developing countries, the rapidly-rising cost of conventional fuels is a serious constraint on their rural development programs. For example, Thailand now imports roughly 75% of its energy requirements. As Robert Queener pointed out at the outset, the huge import bill attached is felt hardest in the rural regions, since national economic resources must be mobilized to pay the bill. Renewable energy development, particularly in these remote rural regions, can help counter this growing economic strain on developing countries by replacing the need for costly imported fuels and by providing a foundation on which rural development can expand.

Small hydropower, among the various renewable energy options, is a leading technology in the race to refine and develop renewable energy sources in the developing world. As an already-developed technology, it is readily adapted to technologically primitive environments, is easy to operate and maintain, and,

like all renewable technologies, is not dependent on external sources of fuel. As the country profiles elsewhere in this volume reveal, the small hydro option has been fully embraced by countries in the Asian and South Pacific region, where experience in the development of SDH includes considerable activity in research, testing, and manufacture, as well as simple application.

Also learned was that SDH systems, while relatively straightforward and easy to construct, require careful coordination among the various parties to the development process and can be approached in different organizational contexts with vastly differing results. At one level, where national agencies are principally involved, there is a formidable problem of coordinating efforts. Typically, both a water resources agency and a power development agency are involved and charged with the responsibility of managing national resources to produce efficient and timely sources of energy. The challenge has frequently been to marshal these combined forces under a non-competitive, orchestrated approach to avoid costly delays and duplication of effort. At another level, it is clear that there is a second, although unconventional, approach to SDH development at the decentralized, or community/local, level. A number of examples of this approach were described. Generally an organization, often remotely connected to the national government, develops SDH systems characterized by local participation and management, simple, cost-effective design, with the impetus for the project coming from a specific need or end-use for the generated power. Although the role of SDH in energy planning is clear and easily defined for the centralized mode, its role is more difficult to define for the equally important, locally-planned and developed system.

Perhaps the most essential concern in discussions of SDH development centered around the twin issues of cost and financing. Without the latter, progress in this promising field will be restrained. A general lack of confidence was detected on the part of develop-

---

\* Assistant Administrator, International Programs Division, National Rural Electric Cooperative Association, and Manager of NRECA's Small Decentralized Hydropower Program.

ment banks, including the Asian Development Bank (ADB), in renewable energy technology. SDH is perceived as being new, largely untested, and applicable heretofore only on a comparatively small scale. The term "nuisance value" is often heard in the context of bank interest in such technologies, particularly when a few comparatively low-cost projects require as much bank administrative time and cost as single, large-scale projects. The banks, however, are clearly interested in SDH and have already made some loans in the region for this purpose to establish multi-project and integrated development programs. The ADB, for example, has made direct loans for SDH projects and indirect loans to national rural banks, which in turn make loans available to rural communities. Most frequently, however, the banks choose to fund centrally through national organizations rather than on a piecemeal basis for specific local projects. The ADB has employed this approach in making loans for SDH to Nepal, Malaysia, Burma, and the Philippines.

Strong interest was demonstrated for data reflecting the cost of equipment and other costs of installation. While it is generally misleading to compare cost data between projects in different countries, or even in different regions of the same country, because of variances in inflation rates, "market basket" values, imports, labor costs, materials, and institutional factors, it is evident that there is a wide variance in cost from US\$300 to over US\$3,000 per installed kW. There is a general dichotomy in cost between the centrally-developed and the decentralized systems. The latter tend to experience lower cost trends.

More difficult to assess are social costs — what they are and how they are quantified. No methodology has been developed to conduct an accurate feasibility study that includes such intangible costs as delays due to gradual social acceptance of the technology and other social dynamics that are often difficult to assess or predict. However, any resource or feasibility assessment for such a project must take into account human considerations and their impact on, and integration with, the projects.

In assessing the physical characteristics of an SDH project, the feasibility of the design, size, configuration of civil works, and equipment depend on such variables as flow, head, environmental characteristics, geologic formations, and climate, as well as the organizational approach to be used (centralized or decentralized). Stress was placed on the use of simple, standardized designs, and low-cost equipment.

Deliberations during the workshop identified a number of key areas in which problems in SDH development exist:

- sources of financing, particularly for non-conventional, decentralized projects;
- sources of information on the latest design and cost of equipment,
- identification and assessment of social phenomena in the development and application of SDH technology;
- power end-use considerations of what is required and what is appropriate;
- accumulation of vital data on physical characteristics for site assessment and development; and,
- a wide range of general problems in the developing world, including shortages of foreign exchange, technical expertise and skilled labor, and managerial know-how.

Above all, the need for institutional development to enhance the capability of organizations and individuals to come to grips with a host of technical and non-technical problems appears most critical.

### Recommendations

While recognizing that not all countries in this region have on-going SDH programs, the following recommendations are proposed.

1. *Institution-Building:* Emphasis should be placed on management in planning and implementing SDH programs. Efforts should be made to strengthen the ability of organizations to handle financing problems, end-use planning, resource assessment, design, construction, operation, and maintenance of SDH projects. Critical among these is the ability to recognize and respond to the social dynamics of SDH development, in predicting problems, and in integrating the local populations into the development process.

2. *Exchange of Information:* While this workshop was valuable, it afforded only a brief survey of many issues involved in planning and implementing SDH programs. Additional workshops, seminars, and information exchanges are needed on specialized topics such as equipment design, financing, and resource assessment. A vital part of this workshop, moreover, was the opportunity it provided to compare problems and solutions and to make new contacts — a unique value that should not be overlooked in considering future workshops.

3. *Financial Institutions:* The banks, both private and non-profit, need to be involved further in seminars such as this to gain knowledge of the state-of-the-art of SDH development and to afford them the opportunity to present information to managers and planners of SDH projects on requirements, risks,

and procedures to procure financing.

4. *Development:* The two methods of development (centralized and decentralized) and their different characteristics, advantages, and disadvantages must be recognized. Development agencies and financial institutions, in particular, should consider both as viable approaches.

5. *Methodologies:* More accurate and useful methodologies for planning SDH systems, predicting impacts, and assessing physical, economic, and human criteria must be developed. These topics include hydrology, social impacts, and power end-uses – areas where data in the developing world is scarce.

6. *New Ideas:* There is a continuing need to develop new and creative approaches to equipment design, civil works, financing, and integrated project

planning. Additional support is needed for research, testing, and demonstration of new concepts in SDH development, with particular attention to developing more cost-effective designs and implementation of schemes.

Embracing all of the foregoing recommendations is a final concern: the need to strengthen the coordination between many diverse groups, countries, and activities in small deventralised hydropower development. As stated in the Preface to this document, time is running out in the race to replace conventional thermal energy sources, especially for the oil-importing developing countries. A lesson clearly learned in this workshop above all others was that many faced with similar problems, can save much – time and money – by working together.

**T**HE delegations from the Asian and South Pacific nations represented at this workshop were requested to submit brief technical profiles of the history, conditions, and activities relating to small hydropower programs present in their respective countries. The following are edited versions of the country profiles that were submitted by members of the 13 delegations attending the workshop.

## **PART I**

### **COUNTRY PROFILES**

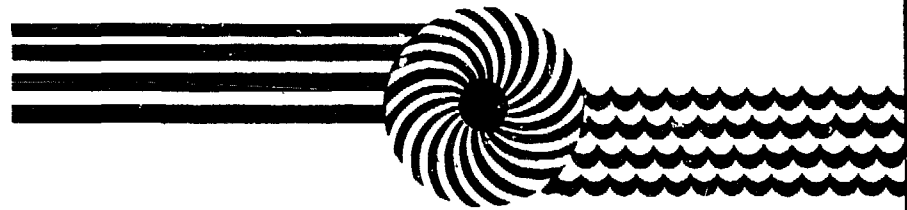

## BANGLADESH

**G**EOGRAPHICALLY, Bangladesh is an area of about 55,600 square miles or 143,953 square kilometers. It is a flat terrain formed in the deltaic basin of the mighty Ganges, the Brahmaputra, and the Meghna rivers with their innumerable distributaries and tributaries (Fig. 1). Only a small area in the north and southeast is undulated where hill ranges originate from India and Burma.

Formed from alluvial deposits of the large rivers, it is a flat plain for the most part. The topography declines within 400 km from an elevation of 85 m in the northwestern part to sea level in the southern parts – a slope of about 1 in 4,700.

Out of the total land area, 65% is used for cultivation, 15% holds forest area, and 10% is covered by a huge network of rivers, streams, and swamps.

The problem with the land is that it is too meagre for about 90 million human beings to meet their basic needs.

### Climate

The climate of Bangladesh is predominantly tropical monsoon which extends from June through September/October, during which 80% or more of the annual rainfall occurs. Storms sometimes occur which are of several days' duration and of low but steady intensity. The maximum temperature may reach 35° Celsius, with high humidity ranging from 80% to 98% during this period. The winter from November through May is dry, and during this period the lowest temperatures recorded are 4° to 5° Celsius, and the daily average is about 17° to 21° Celsius during December and January.

### Rainfall

The intensity of rainfall varies widely, ranging from about 50 inches in the central west part to 200 inches (508 cm) along the northeastern border. Rainfall in the territory of Bangladesh accounts for a runoff of about 100 million acre-ft of water.

### Surface Water and River System

The large rivers, namely the Ganges-Padma, the Brahmaputra-Jamuna, and the Meghna, which constitute the main surface drainage system of Bangladesh,

carry a tremendous amount of discharge but have a low gradient in the territory of Bangladesh before discharging into the Bay of Bengal. The average discharge of these rivers amounts to 1,170 million acre-ft, of which 450 million comes from outside the country.

There are a few rivers which originate completely inside the country and these are located mostly in the Chittagong and Chittagong Hill Tracts districts in the southeastern region.

A network of rivers crisscrosses the country. The river regimes are undefined, and overbank flow even during normal flood is a usual phenomenon. Besides the three large and a few more medium-sized rivers, there are many significant distributaries, tributaries, and streams in the country.

### Existing Electric System

In September, 1980, the country had a total peak demand of nearly 500 MW of electric power, with a total installed capacity of 838 MW. It has two isolated grids between the east and the west, separated by the Brahmaputra-Jamuna-Meghna river system. These grids will soon be integrated by the construction of a 10 mile long river crossing with a 230 kV transmission link. The highest transmission voltage in the country is 132 kV at present. Other voltage levels are 66 kV, 33 kV, 11 kV and 400 V.

Out of the total capacity, hydroelectric generation accounts for only 80 MW. There is no mini-hydro installation in the country at the moment.

### Hydroelectric Potential

Considering the average run-off and topography (an average elevation of 15 m above sea level), there is a theoretical potential for about  $52 \times 10^9$  kWh of hydroelectric power per annum in Bangladesh. However, only a fraction of it can be harnessed because of the flatness of the land. So far about 1.1% of this has been developed. Preliminary assessment is that another 2% is achievable at reasonable cost by conventional installations. Unfortunately no survey has yet been made to determine how much can be achieved through mini- or micro-hydro installations.

Surface water development programmes have been carried out since the early 1950's. The programme which has materialized so far includes, among

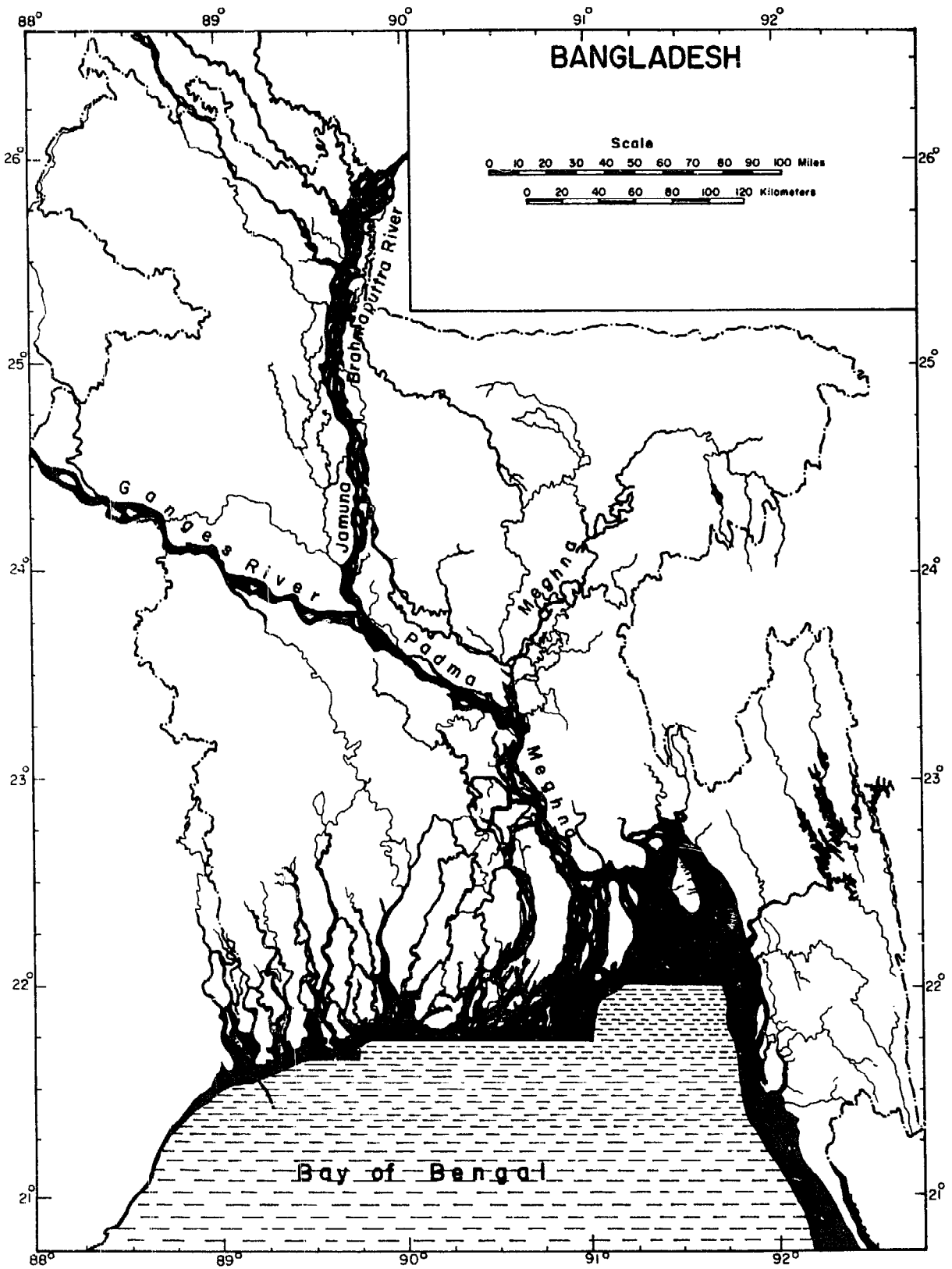

Fig. 1 The Ganges, Brahmaputra and Meghna rivers

some irrigation projects, a multi-purpose dam on the Karnafuli River in the southeastern part of the country.

### Potential from Small Rivers

A preliminary assessment of the Matamuhuri river in the Chittagong Hill Tracts, Lungla, Mahasing, Manu in Sylhet, Mahananda in Rajshahi, Mathabhanga in Kushtia and Nabaganga in Jessore indicate a potential of 552 million kWh of energy on the average flow of these rivers. There is ample opportunity for mini-hydropower development on these rivers as well as on other rivers in the country. However, unless these are taken up on the basis of comprehensive multi-purpose development, such as irrigation and power, optimum utilization of the potential would not be economically viable. In that case, an alternative small-scale mini-hydro approach can be employed. A feasibility study which is to be undertaken soon may indicate such possibilities.

### Conclusion

So far over 600 GWh have been exploited out of the hydropotential in Bangladesh, and another 480 GWh are in the process of development at the same site on the river Karnafuli. Another 7,000 GWh can be harnessed on the other rivers identified above.

It is estimated that the total exploitable potential could meet about 16% of the total demand for electrical energy by the turn of the century. Consequently Bangladesh must harness this renewable potential.

The simultaneous implementation of hydroelectric schemes with barrage construction is the only favourable way that low-head hydroelectric exploitation is possible at projects like the Brahmaputra and Ganges barrages at a reasonable cost.

In addition, mini- and micro-hydro possibilities exist on numerous rivers and streams which need identification. About 21 sites have so far been identified through a limited reconnaissance survey that was conducted recently.

Prefeasibility and detailed engineering studies need a standard of expertise that is not adequately available in the country. The large investment which is required for the implementation of these schemes is beyond the country's own resources.

Recommendations are therefore made as follows:

- feasibility studies for hydroelectricity should be made immediately for all the identified schemes, and priorities should be set for implementation;
- a comprehensive survey and prefeasibility study should be undertaken for identifying mini-hydro projects and for developing implementation strategies;
- international cooperation through bilateral arrangements for technical and financial assistance would be helpful and should be sought; and,
- UNIDO can assist in the process of technology transfer in the spirit of the Hangzhou-Manila Declaration on Mini-Hydro Generation (1980).

**B**URMA, a mountainous country endowed with plentiful rainfall, possesses abundant water resources. Over half the territory of the country is highland, dissecting the land by its north-south mountain ranges, which is a continuation of the Alpine-Himalaya belt. The geographic location is such that it enjoys the rain-bearing southwest monsoon wind resulting in heavy precipitation on the windward slopes, and less intensive rainfall on its leeward side. As a result, countless streams and rivulets with steep gradients generally traversing in an east-west direction are the tributaries of the country's main arteries, the Chindwin, Irrawaddy, Sittaung, and Salween rivers, which flow down towards the south and drain into the Bay of Bengal.

A favourable topography and an inexhaustible supply of water are suitable for waterpower developments, and preparing a comprehensive survey of the hydroelectric power resources of the country is contemplated. The potential is in the order of approximately 24,000 MW, of which only about 2% has been exploited. This potential consists of projects of sizeable magnitude, and a limited number of smaller scale, mini-waterpower developments. It may be mentioned that micro- or mini-hydropower projects are identified locally as power stations having an installed capacity of 1,000 kW or less.

### **Organization of the Electric Power Corporation**

The Electric Power Corporation (EPC), under the Ministry of Industry No. 2, is the sole agency for electrical power generation, transmission, and distribution in the country. As such, the EPC is responsible for surveying potential electric power sources and undertaking their development to meet the demands of growing industries and other requirements.

The functions of the EPC prescribed in accordance with its constitution are as follows:

- generation, transmission, and distribution of electric energy;
- submission of plans and implementation of approved plans;
- release of water for State organisations and for the public, and regulation of water in the navigation locks;
- testing, repair, and installation of electrical equipment;

- carrying out investigation and construction works for the purpose of electric power development; and,
- complying with the existing laws and procedures relating to generation, transmission, distribution, sale, and investigation work, and also with the regulations relating to safety measures.

### **The Electricity Supply System**

The electric supply system in Burma is divided into two parts: (a) the area of supply from the national grid, and, (b) the non-grid area.

*The Area of Supply from the National Grid:* In the area of supply from the national grid, the bulk of power comes from the Lawpita hydropower station, with an installed capacity of 168 MW. This power station feeds the Rangoon and Toungoo areas with 250 miles of 230 kV transmission line.

Two steam power stations, each with 30 MW installed capacity, run in parallel with the Lawpita hydropower station to feed the Rangoon load centre, and also act as a spinning reserve.

Lawpita power station also feeds the northern part of the country up to the Mandalay, Sagaing, Thazi, and Chauk load centres with 314 miles of 132 kV transmission line.

In addition, a gas turbine power station at Kyunchaung with an installed capacity of 54.3 MW is interconnected with the national grid system at the Chauk sub-station.

Another gas turbine power station at Myanaung, with an installed capacity of 49.2 MW, currently supplies the power requirements of Myanaung, the Kyankin cement mill, and the Prome area. A 66 kV transmission line is being constructed to feed three towns – Henzada, Bassein, and Myaungmya. Steps have already been taken to connect Myanaung and Rangoon with a 230 kV line, thus interconnecting this station with the national grid.

*The Non-Grid Area:* In areas remote from the existing power grid system, 6 to 1,000 kW diesel generating stations operate, mostly as isolated stations – but some relatively big stations operate as central stations to feed neighbouring towns and villages.



## Basic Principles for Development of Mini-Hydropower

Electrification of an area plays a vital role in the activity of the population in the area. It is the basic requirement for development of the community as well as for the advancement of the country. Since the world is facing a scarcity of fossil fuels, it is evident that means must be sought to conserve this form of energy to the greatest extent feasible. Though Burma possesses natural reserves of fossil and other fuels, the country favours limiting excessive use of these fuels and advocates substituting them with hydropower. Domestic needs have provoked the population in rural and remote areas to fell trees, resulting in rapid deforestation. This brings about not only loss of valuable timber but also impairment of the stability of mountain slopes, increasing sediment movement, causing a greater number of flood occurrences, and adverse changes in hydrologic regimes.

Hence, for nature conservation, to cater to domestic needs, and to promote small-scale cottage industries and other electro-mechanical workshops, a relatively cheap and uninterrupted supply of electricity is urgently needed, especially in remote parts of the country where accessibility is limited.

Since electrification of areas with concentrated activity – the urban and industrial areas – has to some extent already been carried out by means of power production plants of a suitable size and by interconnecting the grid system, the power supply system now needs to be extended to peripheral areas with sparser population and less concentrated activity, *i.e.* to rural areas.

The emphasis on electrification for small communities and rural areas runs parallel to that placed on the urban development plan, so that rural areas will not lag behind in relation to the development of the supply services in urban areas. Moreover, the people living in remote areas are eager to take an active role in the implementation of the power development plans – that is to say to play a practical role in bringing about the electrification process.

In response to the needs of the community and in line with the country's development plans, the EPC has formulated the following principles for developing relatively inexpensive mini-hydropower as

part of its rural electrification program:

- the site must be technically feasible;
- the area must be outside the periphery of the national grid power system,
- the area should be remote, and accessibility difficult; and,
- the community/area should be amongst the least developed in the country.

## Development Plan for Mini-Hydropower Resources

At present, the EPC has formulated a long-term, mini-hydropower development plan for the whole country. The main objectives of the plan are:

- to supplement the existing power supply with hydropower;
- to provide a more economical and reliable power supply and extend it to more rural areas – so as to stimulate economic activity and spread social welfare to a larger cross-section of the population;
- to substitute the use of petroleum products and natural gas with a renewable energy resource available in abundance locally for power generation; and,
- to conserve kerosene and petroleum products used for lighting and other purposes in rural areas and remote locations.

Under this plan, a few medium- and mini-hydropower projects are currently in various stages of construction, and several new projects are being proposed for investment decisions. At present, seven mini-hydropower plants are under construction. Out of these seven power plants, four are of the conventional run-of-the-river type, and the remaining three are of the bulb-type, or turbine generator sets to be installed at existing irrigation outlets. The installed capacity ranges from 60 kW to 4,000 kW, and will have a total installed capacity of 6,950 kW. Site surveys, investigations, design, and construction are being undertaken by the EPC, whereas turbines, generators, switch gears, and other electrical equipment will be purchased from abroad. The foreign currency portion of the total project cost is being financed by the Austrian Government.

The EPC has identified ten medium- and mini-



hydropower schemes for which financial assistance is being sought from the Asian Development Bank. Arrangements for the preparation of a feasibility study for the above schemes are expected to be made with the Bank's technical assistance.

It is the intention of the EPC to carry out implementation of the proposed mini-hydropower development projects with its own engineers. For the present, electrical and mechanical equipment will have to be imported. However, small water turbines are being manufactured locally as an experiment with a view to setting up a manufacturing plant for bigger production in the future.

### **Conclusion**

The world energy situation, as it has emerged since 1973 and subsequently in the developments in the last few years, gives clear indications of growing uncertainties regarding the availability of oil and gas, and their price in the international market. In this context, it would be prudent to conserve oil and gas and confine their use to sectors for which substitutes are not available.

It is evident that in most developed countries, during the 1900's, electrification has been characterized by a very large number of small water power stations which supply the bulk of power requirements. This being the case, Burma has set out to develop small (mini-) water power projects as an initial step to rural electrification. Concurrently, planning and implementation of medium- and large-scale hydro and thermal power projects to be amalgamated into the national grid power system are also under way. Unlike the heavy investments required for implementing large-scale hydro and thermal power projects, mini-hydropower developments need less investment. Such being the case, mini-hydropower developments become quite attractive for developing countries.

Mention should be made that the priority of projects selected, as outlined by the EPC's formulated principles (mentioned in the previous section), when combined with the welcoming attitude of the population in rural areas, whose social system is very different from that of the urban area population, the possibilities of voluntary labour and the availability of local resources when implementing the plans, are a positive asset to the successful development of the projects.

## FIJI

**T**HE government policy is to continue with the rural electrification programme so that essential services, growth centres, and employment can be made available in the rural section and consequently a check can be put on the rate of urban drift.

Also the government is interested in alternate forms of power generation so that it can reduce its fuel bill.

We have been using diesel generating sets (in the range 5, 10, 15, 20 kW) together with a micro-hydro 3 kW with a 60ft head in this scheme. A 250 kW, 400ft head mini-hydro scheme is expected to be installed late this year.

Also there are two hydro schemes (in Monasavu and Vatutu) of 20 MW each, which are expected to be operational within a 3 year period.

So far, there have been feasibility studies carried out on the use of micro- and mini-hydro schemes to be installed in about 20 locations. Work is expected to progress during the coming year.

Fiji is a group of islands consisting of two major islands with over 200 smaller ones. It is not possible to have a central scheme supplying power to the whole group, hence smaller units installed in different groups are a definite advantage.

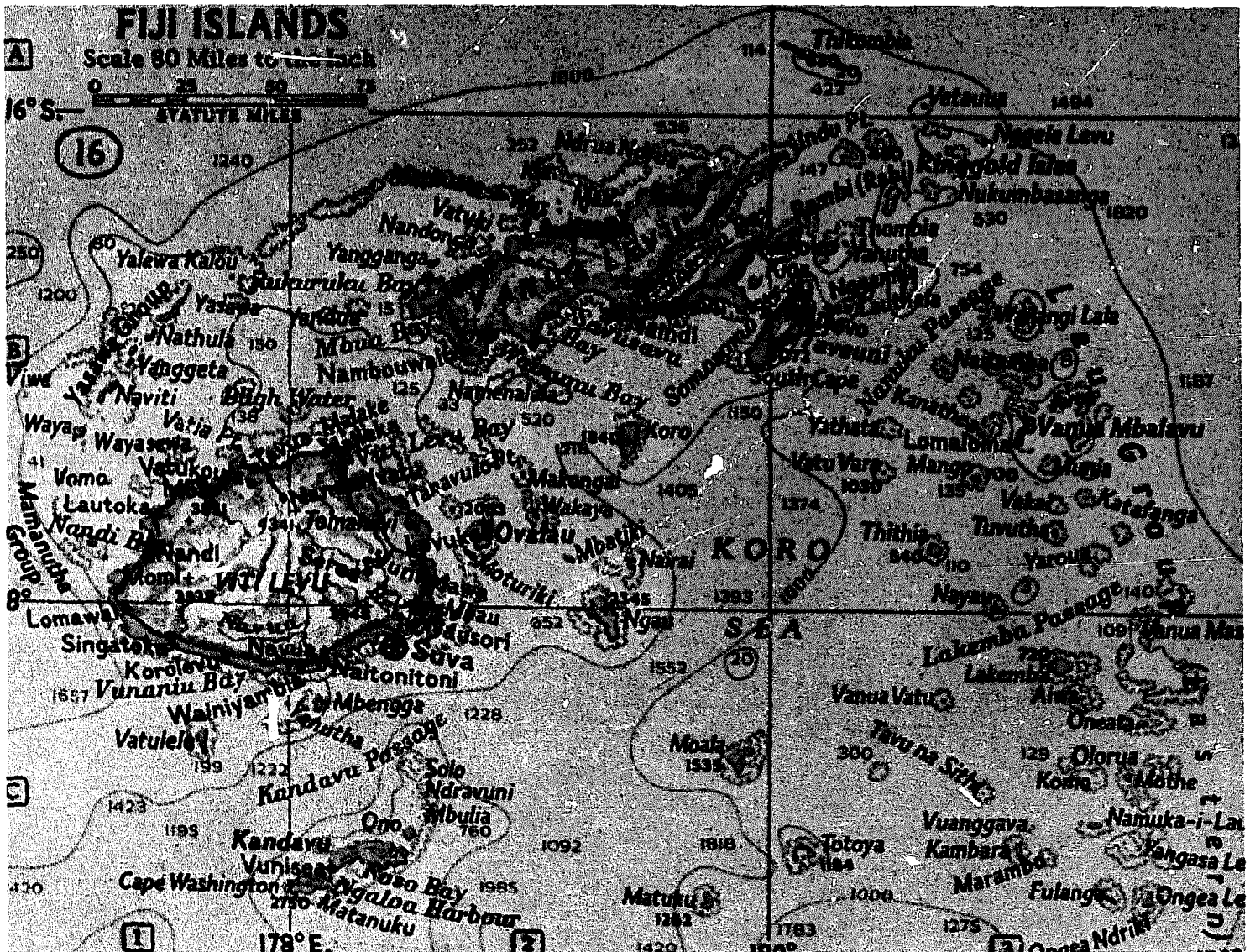

From National Geographic Atlas of the World, Revised Third Edition, Washington D.C., 1970.

# INDIA

## Presentation 1

**S**INCE independence in 1947, India has made rapid strides in the generation and utilisation of electric power. Until recently, attention was mainly concentrated on the development of major hydroelectric and thermal projects in order to meet the rising demand and to provide electricity at economic rates. Development of mini-hydro projects was limited mostly to the hilly regions of the country. The change in the energy spectrum and uncertainties about the availability of fossil fuels have created interest in the utilisation of mini-hydro. It is recognised that:

- this potential is an attractive pollution-free source of power; and,
- in a vast country like India, it can help to improve the quality of life and stimulate growth of rural industries and agriculture, particularly in remote or backward areas.

### Mini-Hydel Potential

The Central Electricity Authority of India is presently engaged in the task of re-assessing the hydro potential in the country, including micro/mini schemes. Although an accurate assessment of micro/mini potential would be premature at this stage, a study group has assessed a potential of 25 TWh from this source. This would give about 5,000 to 10,000 MW, depending on the load factor.

The low head installations, which form 50% of the total small/mini potential, are of particular significance. A number of such low-head power installations can be envisaged as being useful and cheaper by-products of medium- and small-scale irrigation, flood control and water supply schemes.

The potential of medium- and high-head sources is also quite substantial. These sources are generally located in the mountainous regions where the population density is low. In this case, the cost/benefit ratio may not be as good as for low-head installations. Such schemes will have to be developed as part of the development programme for the backward areas of the country.

### Mini-Hydel Stations in Operation

82 mini-hydro stations, up to a unit size of 5

MW, are in operation in India, with an installed capacity of 236.5 MW. This includes 68 mini-hydro power stations (up to a unit size of 2 MW) with an installed capacity of 49.5 MW.

### Mini-Hydel Stations Under Construction

37 mini-hydel stations are under construction. The details are as follows:

Unit Size	Installed Capacity	No. of Power Stations	No. of Units
Up to 2 MW	50.5 MW	30	81
2 MW - 5 MW	161 MW	7	15

### Mini-Hydel Activities

Realising the necessity of developing MHG sources, there is considerable activity in all connected spheres:

- the work of re-assessing mini potential is in progress. Hydraulic and other connected data are being collected for this purpose;
- a number of mini-hydel projects have been undertaken at dam sites which were constructed some time ago;
- about 340 sites for mini-hydel development have been identified;
- the technology for the manufacture of mini-hydel generating equipment and accessories are well established in the country. There are Indian firms which undertake the mini-hydel generating assignments from concept to commissioning. In fact, India has already exported mini-hydel generating equipment to Nepal, Afghanistan, Malayasia, and to other countries as well; and,
- every effort is being made to reduce the costs of mini-hydel schemes and to improve the cost/benefit ratio by simplifying civil works and standardising generating plants and equipment.

## Presentation 2

**I**NDIA is a vast country, with a land area of about  $3,280 \times 10^3 \text{ km}^2$  and a population of over 670 million. It is surrounded on three sides by sea, and in the northern part by mountains, called the Himalayan belt. There are other relatively lower hills in the central part of the country, as well as on the eastern and western side of the southern part of the country, called the eastern and western ghats. India has been richly endowed with natural resources.

India is a developing country, and basically its economy is centered on agriculture. In 1947, when the country gained its independence, the Government recognised the fact that to raise the standard of living in the country, all-round development would have to be carried out at a rapid pace. Maximum importance was given to two main fields (amongst others), namely irrigation and industrialisation. Very soon after independence, it was accepted that if any headway were to be made in the various aspects of the economy, particularly with regard to irrigation and industrialisation, electric power would have to be developed in order to achieve rapid growth in the economy.

### Electric Power Potential

Since independence in 1947, India has made rapid progress in generating and utilising electric power. This can be seen from the fact that as against a total installed capacity of 1,700 MW in 1947, the generation capacity of today is around 31,000 MW, comprising hydel, thermal and nuclear generation. During this period, attention was mainly concentrated on developing major hydroelectric and thermal projects in order to meet the rising demand and also to provide electric power at economic prices. At the same time the development of small hydro projects was taking place, though mainly in the hilly regions of the northern part of the country.

### Micro-Hydel Projects

*Present position with regard to mini/micro plants in India:* The development of a micro-hydel scheme in India dates back to 1897, when a micro-hydel project was carried out near Darjeeling. This was followed by a large number of schemes to provide

power supply to isolated villages, specifically in the hilly regions.

The need to provide electric power supply in the remote parts of the country, which cannot be supplied with electricity economically from the main transmission grid or from other sources (like diesel power, etc.), has led to a sense of urgency in developing micro-hydel schemes. Development has occurred mainly in the northern region of the country, as the Himalayan region affords considerable scope for micro-hydel projects. The streams in this region carry perennial discharges, assuring dependable availability of power throughout the year. They also descend rapidly, enabling concentration of high heads with a relatively short water conductor system.

In the course of exploiting micro-hydel potential, we have built up expertise in the design, engineering and construction aspects of micro-hydel schemes. We have also undertaken the manufacture of micro-hydel generating units of various types, covering a large range of heads.

With the expertise it has acquired, India has been able to give assistance in investigating and constructing mini- and micro-hydroelectric projects in other developing countries in Asia, notably in Bhutan, Afghanistan and Fiji.

### Preliminary Assessment Methodology

India recognised that the investigation procedures for small hydro installations could not be as elaborate as those for medium and large size plants, as the investigation costs should be comparable to the size of the proposed investment in the power plants. In view of this, a detailed topographic survey by aerial mapping, long-term gauging of hydrological data, and accurate measurement of flood discharges are not warranted for most of the proposed small installations. Instead we realistically assessed the streamflow characteristics by installing a stream gauging notch/weir and carrying out minimum flow gauging over a reasonable period before any investment decision was taken. Lean period discharges are considered more important than high flows, since the minimum discharge available for most of the year is usually selected as the designed discharge.

It was found that desk studies are not sufficient for assessing the potential for mini/micro power projects, as it was observed from on-site visits that in many cases even though the catchment area seemed big enough for a micro-hydel project from desk studies, the area was completely dry, or had very small flows, and even then over very short periods, (*i.e.* during the monsoon seasons); whereas in the adjacent areas quite dependable discharges were available throughout the year.

In many cases, the most accurate method of assessment, particularly in the hilly regions, is to make visits to these areas in the dry seasons and to collect information from the people living nearby. Also, flood flows could be approximately estimated with reference to the catchment area and the flood marks left by debris, as the powerhouse and other electrical installations have to be protected against flooding to avoid damage to the equipment or the necessity of closing down the power station.

### Site Selection and Hydraulic Designs

For the site selection for isolated mini- and micro-hydroelectric projects, the following factors are generally taken into consideration:

- nearness of the load centre, to avoid, as far as possible, high voltage lines and other costly step-up equipment;
- the potential load demand, present and future, which may include: (a) home lighting; (b) small-scale industries (like furniture, bakeries, saw-mills, flour/oil mills, *etc.*); (c) irrigation; (d) water supply (usually seldom required in the hilly regions, as this is provided by gravity flows); and,
- socio-economic aspects.

The salient features of small isolated hydroelectric schemes using medium and high heads usually consists of: the diversion structure and intake arrangements, the water conductor system, the desilting chamber, the forebay, the penstocks, the powerhouse, and the tailrace.

For most mini- or micro-hydel schemes, the drop-type weir is usually chosen. This consists of a reinforced concrete trough constructed just below the bed level of the stream, and has trashrack bars at the top to prevent ingress of stones and debris. The trough

has a longitudinal slope, so that the required discharge is drawn into the intake and silt is flushed out.

For the water conductor system, we have used either wooden flumes, galvanised iron sheet flumes, pre-cast concrete flumes, steel pipes, ordinary open flumes lined with stones, or concrete. The penstocks usually used are constructed from steel plates.

Depending on the head, discharge and capacity, various types of turbines, *i.e.* Kaplan/propellor type, Francis, turgo-impulse type, *etc.*; have been installed. For low heads, bulk type turbines have also been installed in a few cases.

### Operation and Maintenance

Because of the remoteness of most of these isolated mini- or micro-hydel stations, it is usually difficult to get trained personnel to run and maintain them. Consequently the trend is to design and manufacture units which are simple to run and maintain. Necessary action to select local young people and train them in daily operations is also being taken, so that highly trained technical people for maintenance purposes are only required for these stations periodically, and then only for short durations.

Currently the largest of the small hydel units which are manufactured locally have a capacity of 1,000 kW or so. Units of sizes ranging from 5 to 10 MW are also being manufactured indigenously along with larger units. Units of 1.5 to 2.5 MW capacity are also being manufactured in the country and are in the course of being installed. We have built up considerable expertise in the manufacture of high and medium head generating units. A large number of these units are presently in operation in India and abroad. We also have the necessary know-how to manufacture low-head turbines with small capacities.

### Economic Feasibility

The cost estimates of small hydel projects in India vary considerably from project to project, depending on the extent of civil works involved, whereas the cost of the electrical and mechanical equipment remains the same. For a particular size of installation, there can be a considerable difference in the civil works costs, depending on the length of the water conductor system and other factors. It is diffi-



cult to give a general figure, but the cost of the schemes recently constructed or under construction generally ranges from between Rs10,000 to Rs20,000 per kW, and occasionally the cost has been as high as Rs35,000 per kW.\*

One final point to make is that considerable work in India has been done to assess the hydroelectric potential for mini- and micro-hydel schemes, and the hydel potential for 3 MW and below up to 10 MW has already been done. As has already been pointed

out, to obtain a lower potential for installations below 3 MW, it is not possible to rely on desk studies, and consequently further work is under way to assess this potential also. Preliminary assessments show that it may be in the order of 25 TWh, which is equivalent to 5,000 to 10,000 MW, depending on the load factor.

India already supplies about 75% of the population with electric energy. By the end of the 6th Five Year Plan, this figure is likely to be considerably higher.

---

\* Rs9.6 = \$1.00 (December, 1982)

## INDONESIA

**T**HE geographical structure of Indonesia, consisting of many islands, is one of the factors affecting the development of the power system in the country. The level of electricity consumption is still among the lowest in the ASEAN region. Since the beginning of the first Five-Year Plan/REPELITA I (April 1, 1969), in line with the growth of the Indonesian economy, a rapid growth in the demand for electricity has occurred, doubling the demand over a five year period.

There are several options in meeting the demand for electricity, from building large capacity plants to small-scale isolated hydropower plants so as to develop all the available and potential hydropower resources. Due to its geography and the stage of development in the electric power sector, the planning in the electric power systems development is divided into two regions, namely Java and Outside Java.

The investment plan in the power generation sector up to the end of the 1980's has been formulated according to the following features:

- consistent development of hydropower resources; and,
- a shift from the use of fuel oil to coal for base energy generation.

### Hydropower Development

As a rough estimate, the undeveloped hydro potential in Indonesia amounts to about 31,000 MW, with a possible annual production of 155 TWh. So far, reconnaissance work and studies have been carried out to collect information and data relating to 748 river basins in 16 islands, and soon an overall hydro-potential study will be carried out with the assistance of the World Bank.

Until the end of REPELITA II (April, 1979), the total installed capacity of hydropower plants operated by the State Electric Power Company (PLN) was only 480 MW, with an annual energy production of 2 TWh. This amounts to 21% of the total installed capacity of PLN's power plants (about 2,280 MW). It follows that in the field of hydropower development much can be done and has to be done.

In view of the very extensive hydro resources in the country that still remain untapped, Indonesia is fortunate in being able to profit from the experience of other nations, and to have the opportunity of making integrated plans for the use of its rivers. This

should ensure that the country will fully employ the advantages of its terrain and climate and, most importantly, will avoid impairing future opportunities for full development and more extensive use of its hydro facilities.

In line with the world's growing concern with energy problems, every available hydropower resource nowadays, no matter how small it may be, will not be neglected without serious consideration. An example of the concern for the optimal use of the available and potential hydro resources in Indonesia is the development of the Citarum River in West Java. Although big hydropower plants have been built or are projected, such as the Jatiluhur Power Plant (150 MW), the Saguling power plant (with an ultimate capacity 1,400 MW) now under construction, the Cirata power plant (500 MW) under study, the hydro-potential of the majority of downstream currents (which is only about 6 MW) will not be disregarded. The Curug hydropower project supports this view.

Another mini-hydro project under construction is the power development of the Brantas River in East Java; at this Lodoyo afterbay it has been decided to put a 4.7 MW bulb-type generating unit as the last stage of the upstream hydropower development chain, so as to employ almost the entire available and potential hydropower resources. Two other mini-hydro plants now undergoing tests, both of them also connected to the electricity grid, are the Sempor power plant (1.1 MW) in Central Java and the Batang Agam power plant 3rd unit (3.5 MW) in West Sumatra.

### Micro-hydro Development

Various studies have been carried out concerning the financial viability of small-scale hydro plants, and as the cost of fossil-fuel-based electric generation is increasing, mini- and micro-hydro are becoming more attractive. Marginal economics have become irrelevant in the present oil situation.

Around the 1960's, the idea of micro-hydro came into the picture with the aim of speeding up the electrification of isolated rural areas, making use of small rivers and streams as well as irrigation canals. A micro-hydro project at that time was considered as an isolated and very small-scale hydropower plant with a unit capacity of up to only 100 kW. However, due to the world's concern to optimize and maximize the



development of renewable energy resources, the development of micro-hydro potential nowadays will be directed toward bigger units and interconnection to the grid, taking into account the development and stability of the system.

In Indonesia, the PLN is responsible for developing and implementing micro-hydro projects. As of 1968, however, only two micro-hydro pilot plants, with a capacity of 20 kW and 70 kW, had been constructed. During REPELITA I (1969/70-1973/74), some 12 micro-hydro plants, with capacities of between 16 and 200 kW, were built with a total capacity of 1,299 kW. During REPELITA II (1974/75-1978/79), 14 micro-hydro plants were completed, with capacities of up to 500 kW (a total capacity of 2,665 kW), and 8 micro-hydro plants are still under construction with a projected total capacity of 3,550 kW. In REPELITA III (1980/81-1984/85), another 14 micro-hydro plants are planned for larger units, among which 6 plants will have a unit capacity of 1,000 kW, and one will have a unit capacity of 2,000 kW (2 x 1,000 kW). Plants with unit capacities of, say, more than 2,000 kW should be considered as mini-hydro plants rather than micro-hydro plants.

Most of the turbines and panels were made locally, and all of these locally made turbines were designed by the PLN Hydropower Laboratory itself. For the most part they were made by two well-known workshops in the country. Small workshops were also entrusted to make turbine components. Due to the limited domestic market of micro-hydro turbines, the PLN is still obliged to play a role in the design and development of these turbines.

Some twenty turbine designs were made and tested by the PLN Hydropower Laboratory which can be further developed to a standardization or design experience for larger-scale models, starting with a scaled-up or scaled-down version. Most of them were of the Francis type, but there were also some Pelton and Kaplan types, with various specific speeds ( $n_s$ ).

Besides turbines with capacities of between 25 kW and 2 MW, preparations are being made to design turbines with capacities of up to 5 MW in consideration of the existing laboratory equipment and with the cooperation of some universities and workshops. Financial support is required to implement such a program.

The experience obtained in turbine design so far

is very important, not only for the development of micro- and mini-hydro for supplying electricity to some remote regions, but also for its role in the general context of developing the nation's renewable energy resources, utilising energy resources which are quite small. This effort is in line with the national energy policy of the Government to reduce fuel consumption for domestic use as well as for power generation.

Although a micro-hydro plant is small, the essential requirements are quite similar in constructing any type of hydro plant regardless of size: notably the collection of data, careful initial planning and accurate surveying — as well as the necessary capability and skill for the engineering and construction work.

The common problem which arises in developing micro-hydro power plants is the tendency for the budget provided to be on a "micro-scale" as well, and the limitations in supplying enough capable manpower, especially where skills are at a premium, with the result that these essential requirements cannot be fulfilled even at a minimum level. To overcome these limitations, the development of micro-hydro plants should not be undertaken as individual projects, but should be a part of the nation's hydroelectric power system development plan.

## Conclusion

A revival of interest in mini- and micro-hydro development, like the renovation efforts to conserve old dams and power stations, indicates a determination to tap every possible kW. This revival has taken place in many countries, including the U.S. (the world's biggest energy consumer), which has a big development program for mini-hydro.

In line with the policy of the Government to reduce fuel oil consumption for domestic use, and power generation, the development of micro- and mini-hydro is not only of significance in supplying electricity to remote regions. It also serves the concern to develop the nation's renewable resources in general.

The development of micro- and mini-hydro plants will be directed towards interconnection with the grid — if possible initiating parallel development with a small diesel generating plant supplying a mini-grid, thereby ensuring the optimum and maximum use of the existing hydro potential.

## MALAYSIA

**T**HE National Electricity Board of Malaysia (NEB) is currently in the process of implementing 22 mini-hydro projects which are scheduled to be completed by 1982. Moreover, the government has employed consultants to do a feasibility-cum-engineering design for 102 sites for the whole of Malaysia. The feasibility and design work is at present being carried out by consultants and is expected to be completed by the end of 1981 or the beginning of 1982. 82 of these sites together with the current 22 (totaling 104) will be in the 4th Malaysia Plan and will be implemented by the NEB. An implementing team has been appointed in the NEB, and this team is expected to carry out the mini-hydro programme. The team is at present under the direction of the Research & Development Department of the Board.

### Management

Due to the uniqueness of the programme as well as the implementation being carried out by a centralised agency, the management problems pertaining to policy, implementation and work associated with external government agencies and contractors will be obvious. The work of the team involves carrying out feasibility studies, design, and also the construction part of the programme, with the help of the local contractors. Machines are ordered from overseas, but some of these are likely to be made locally in the future. Due to the difficult problem of mobilizing such a central group in the large working area of Peninsular Malaysia, it was decided that some form of decentralisation of the mini-hydro team should take place on a temporary basis, whereby the secondary design team together with site supervisors are sent to the field to carry out the implementation. Each designer is expected to be able to carry out the implementation of at least four sites with the assistance of site supervisors assigned to particular sites.

The management of the mini-hydro team comes under the Project Manager who is assisted by Project Engineers. Technical assistants or Technician-Engineers are given the task of designing these schemes. The Project Manager is directly responsible to the General Manager of the Board, but at the same time liaises with the Mini-Hydro Coordinator of the Board who

provides the facilities required within the agency. The team itself is a complete unit having its own administrative staff together with vehicles and equipment suitable for surveying and other studies.

### Source of Financing the Equipment

In the initial 22 project stage, the financing for the projects is from the Central Government through the Economic Planning Unit of the country. Some external forms of finance may be expected by the Government for these projects in the form of support from the Asian Development Bank and the World Bank.

### Equipment

At the moment, the electro-mechanical equipment for the mini-hydro projects is being ordered from various manufacturers from all over the world. Machines are being imported from France, England, India, Japan, China, Australia, and other countries. This is because in the initial stage different technologies are being looked into, since the aim is to establish local industries capable of producing turbine generator units. As far as civil works are concerned, it is intended that everything is to be done by local contractors. The pipelines are available locally.

### End-Use Planning

An integrated scheme for mini-hydro is envisaged, and to this end the Board is currently working closely with the Drainage and Irrigation Department, The Water Works Department, The Forestry Department, and other agencies which may contribute to the maximum use of the electrical energy which is generated. The water from the tailrace of the mini-hydro scheme is to be used for irrigation purposes as well as for household use. The excess energy generated by the mini-hydro stations is expected to run small-scale industries, to pump water, and to process heat for agricultural purposes. Also there is a great possibility of using the heat for the production of alcohol from waste fruits and vegetables. The alcohol is expected to be stored as a fuel for use in the standby electric generator sets when necessary.

## NEPAL

**T**HE kingdom of Nepal lies on the southern slopes of the Himalayas and is bounded to the north by the Tibetan Region of the People's Republic of China and to the south, west and east by India. The area of Nepal is 140,700 sq km, extending 80 km from east to west and about 175 km from north to south. Nepal exhibits a wide range of terrain, with more than 80% of the country covered by hills and mountains and the remaining 20% by plains and lowlands. The total population of Nepal, according to a 1980 estimate, is about 14 million.

The water resources of the country are great. The total annual average runoff of Nepal has been estimated to be about 200,000 million cubic metres. Out of a total of some 25,000 MW power potential considered to be economically feasible for development, the total capacity installed or under construction amounts to only 128 MW, *i.e.* only 0.5% of the total. These facts clearly indicate the wide scope for developing hydropower energy by implementing large-scale or small-scale projects.

Administratively, the country is divided into five development regions, and these are in turn divided into 14 zones and 75 districts. The districts are again further subdivided into Panchayats. There are at present 23 Nagar Panchayats (Town Councils) and 2,911 Gram Panchayats (Village Councils). Under the commonly used nomenclature, the communities living in the Nagar and Gram are classed as urban and rural respectively.

The concept of five development regions was conceived with a view to achieve reduction in inter-regional disparity, balanced growth and regional integration, and to make the fruits of progress available to the majority of the population of the country. The strategy for regional development planning was introduced in 1970, *i.e.* the beginning of the 4th Five Year Plan, as the practice adopted till then by according priority to the investment programmes in the relatively more advanced parts of the country could not generate economic gains and benefits to the people equally. The regional approach has enabled implementation of balanced sectoral development programmes by integrating development activities at the regional level. All development efforts in Nepal necessarily involve rural development, as the number of urban centres are not many and the urban population is only about 6% of the total.

The national development programmes of the country are implemented under successive five year plans, the first of which was initiated in 1956. The current plan, which is the sixth, covers the period 1980-1985. The policy of His Majesty's Government regarding power development during the sixth plan is aimed at systematically undertaking development of small hydel projects in appropriate areas of the hill region by mobilizing local resources, even though the establishment of such infrastructures might not be normally feasible from strictly economic cost and benefit considerations.

The reliance on hydropower is an accepted factor for Nepal in view of the country's land-locked status and the limitation of other natural resources. Social and other non-economic factors should be given due consideration. In the long run it would definitely be the cheapest source of energy.

### Development of Small Hydel Projects

His Majesty's Government of Nepal (HMGN) established the "Small Hydel Development Board" (SHDB) under the Ministry of Water Resources (then the Ministry of Water and Power) in 1977. The SHDB is responsible for the planning, designing and construction of small hydel projects, which directly benefit the rural population and provide them with new opportunities for self-reliance.

Since its establishment, the SHDB has carried out surveys and investigations on 150 sites. There are 12 projects under construction. Three of these projects are scheduled to be completed in 1980-1981, three in 1981-1982, and six in 1982-1983. The detailed engineering design of 8 more projects is being carried out. A description of these projects is given in Annex 1.

Almost two-thirds of the total population of the country live in the hill areas, which are lagging behind in development activity on account of inadequate transportation facilities and scarcity of water and energy supplies. In the hills, firewood is the only source of energy for cooking and heating needs. The increased demand for firewood is resulting in the destruction of the forest cover in an alarming way, resulting in environmental degradation through soil erosion.

Moreover, the rural water supply situation in the

**Annex 1**  
**Description of the project**

Name	Installed Capacity kW	Total Cost US\$ x 1000	Remarks
1. Namche	4 x 125	2025	Under construction
2. Salleri	2 x 40	274	"
3. Phidim	2 x 130	494	"
4. Baglung	1 x 175	405	"
5. Doti	2 x 100	823	"
6. Jumla	2 x 130	874	"
7. Jomsom	2 x 130	890	"
8. Okhaldhunga	1 x 120	335	"
9. Khandbari	2 x 130	496	"
10. Ramechhap	1 x 60	262	"
11. Taplejung	1 x 100	308	"
12. Bhojpur	2 x 130	513	"
13. Ilam	3 x 100	4038	Under detail Engineering Design
14. Terathum	2 x 100	514	"
15. Dhunche	2 x 100	725	"
16. Bajhang	2 x 100	650	"
17. Tatopani	2 x 500	3101	"
18. Serpodaha	2 x 100	808	"
19. Churjhari	2 x 100	769	"
20. Bajura	2 x 100	552	"

The map overleaf indicates the locations of the projects.

hill areas is very critical. A long transmission main line in addition to the reservoir and break-pressure chambers make the cost of the project expensive. Small power plants would be most useful to pump water from nearby sources to desired localities.

Cottage industries, such as weaving, cold storage and canning etc., are expected to flourish with the development of small hydropower.

Kerosene is commonly used for lighting (and sometimes for cooking) in the hills. A family uses at least 1 litre of kerosene per month for lighting alone. The cost of kerosene is rising each year, and sometimes it is simply not available even if one is ready to pay a higher price.

Transistor radios are quite common among the people in the hills. These use imported dry cells to run. Electricity generated by small hydel will replace the dry cells as well as the kerosene.

Provision of electricity supply will not only save people from the laborious and hazardous task of

fetching timber wood over long distances (including severe climbs), but will also ultimately save them time which they can utilize for productive work. Furthermore, it will contribute to the preservation of forest resources.

The food problem has been particularly severe in the hills, and has contributed greatly to an increase in the incidence of tuberculosis as well as other malnutrition-related diseases. In the hills, there are many pockets of high level flat land called "Tars" located at about 50 to 150 metres from the river beds. If irrigation water could be provided by pumping, the Tars could make the hills self-sufficient in food production.

The benefits accruing from the development of small hydel projects can be summarised as follows:

- preservation of forest resources and maintenance of ecological balance;
- increased production of food grains;
- time saving associated with the collection of firewood;
- reduction of a laborious and hazardous task;
- promotion of cottage industries and handicrafts;
- establishment of cold storage facilities and canning industries;
- lift irrigation;
- provision of piped water supply;
- promotion of tourist industries;
- reduction in imports of kerosene oil, and diesel oil; and,
- relatively short implementation time and modest requirements for capital investment.

### Organization

There are seven agencies of HMGN principally responsible for the generation and provision of electrical utility services. With one exception, all of them are under the Ministry of Water Resources:

1. Electricity Department (ED);
2. Nepal Electricity Corporation (NEC);
3. Eastern Electricity Corporation (EEC);
4. Kulekhani Hydel Development Board (KHDB);
5. Marshyangdi Hydel Development Board (MHDB);
6. Small Hydel Development Board (SHDB); and,

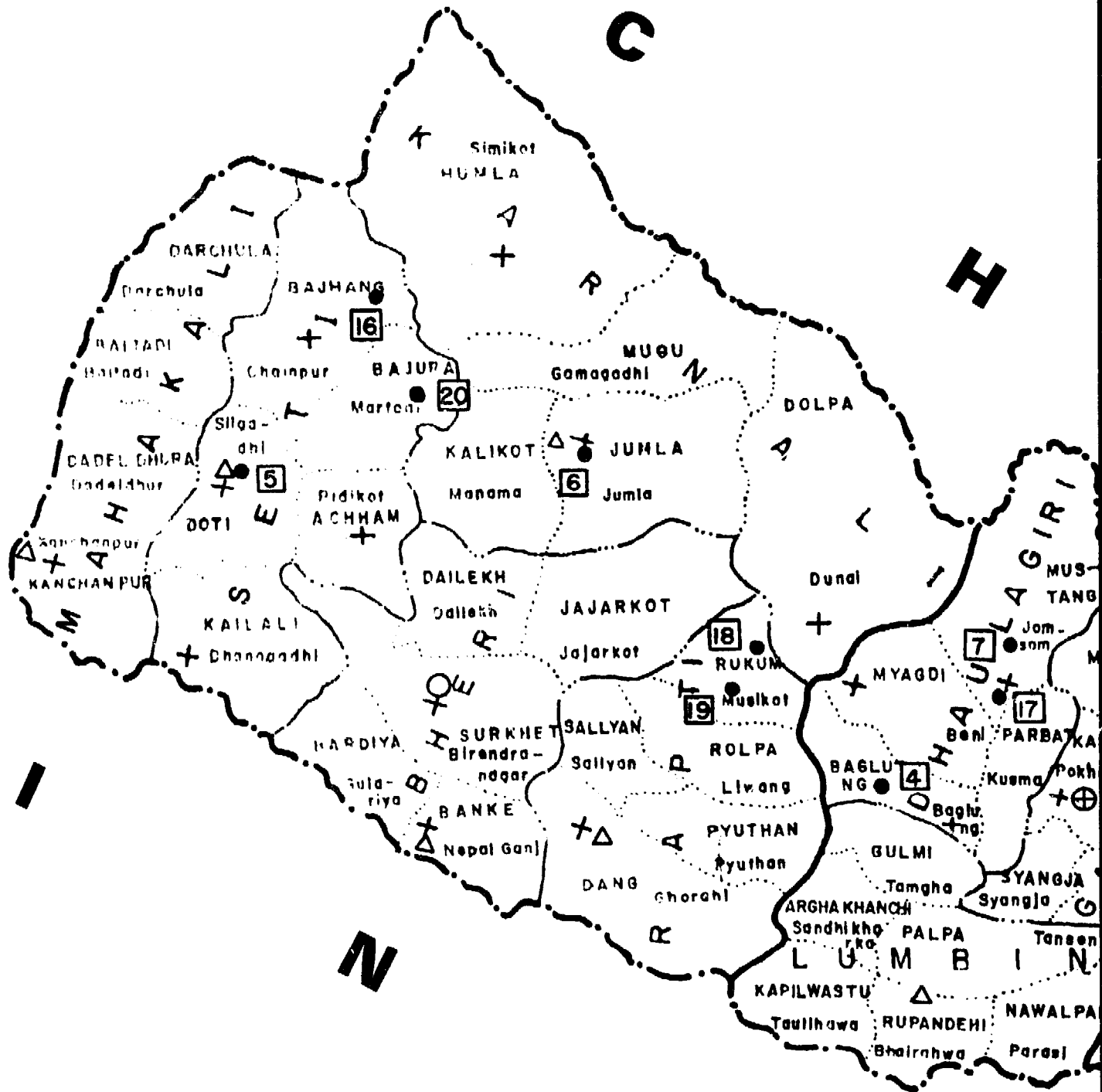

# MAP OF NEPAL

Scale 1" = 30 miles

# LOCATION OF SMALL HYDEL POWER PROJECT SITES

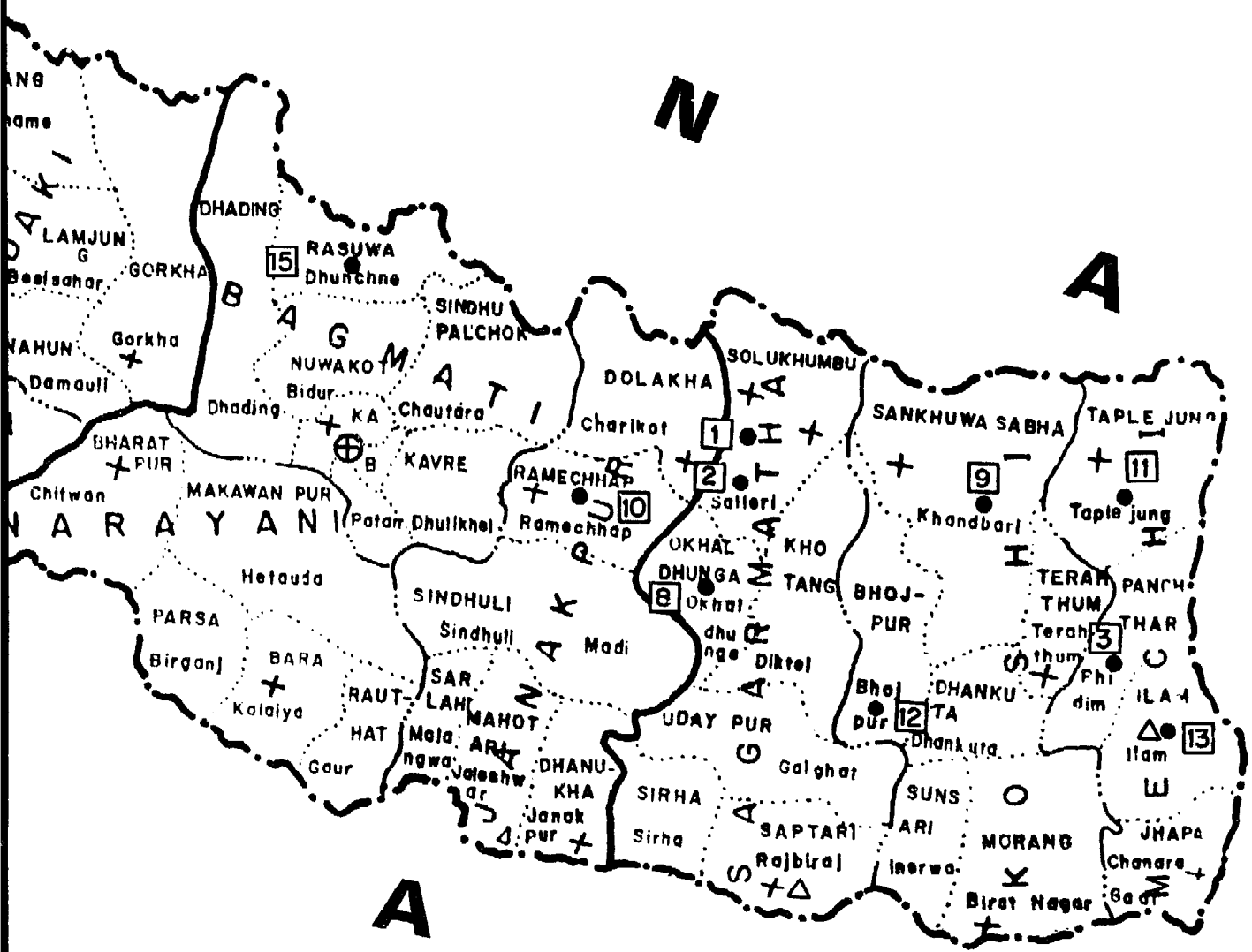

### 7. Butwal Power Company (BPC).

The Electricity Department is responsible for investigating, identifying and coordinating potential power development projects. The operation and maintenance of the projects in the Far Western Regions also falls within the jurisdiction of the ED.

The responsibility of operating and maintaining power projects in the Central and Western Development Regions lies with the NEC, which is an autonomous public sector enterprise. EEC operates and maintains electricity supply in the Eastern Development Region.

The Kulekhani and Marshyangdi Hydel Development Boards have been established to implement two specific medium sized projects, with a capacity of 60 MW and 50 MW respectively. These Boards operate outside the sphere of the ED and the NEC.

The Butwal Power Company has been set up in the private sector. It is responsible for operating and maintaining a project of 1.28 MW capacity constructed across a river in the Western Development Region.

The SHDB is responsible for the design and construction of small hydroelectric schemes for the supply of electricity to remote rural areas of Nepal.

### Organization of the SHDB

The Honourable Minister for the Ministry of Water Resources is the Chairman of the SHDB. The composition of the SHDB has been given in Annex 2. The Project-in-charge is the executive head of the Board. The organization chart of SHDB is outlined in Annex 3.

#### Annex 2 Composition of SHDB

1. Honourable Minister for the Ministry of Water Resources	Chairman
2. Honourable Assistant Minister, Ministry of Water Resources	Vice Chairman
3. Secretary, Ministry of Water Resources	Member
4. Executive Chairman, Nepal Electricity Corporation	Member
5. General Manager, Eastern Electricity Corporation	Member
6. Representative, Ministry of Finance	Member
7. Representative, National Planning Commission	Member
8. Chief Engineer, Electricity Department	Member
9. Project-in-charge, SHDB	Member

#### Annex 3 Organization chart of SHDB

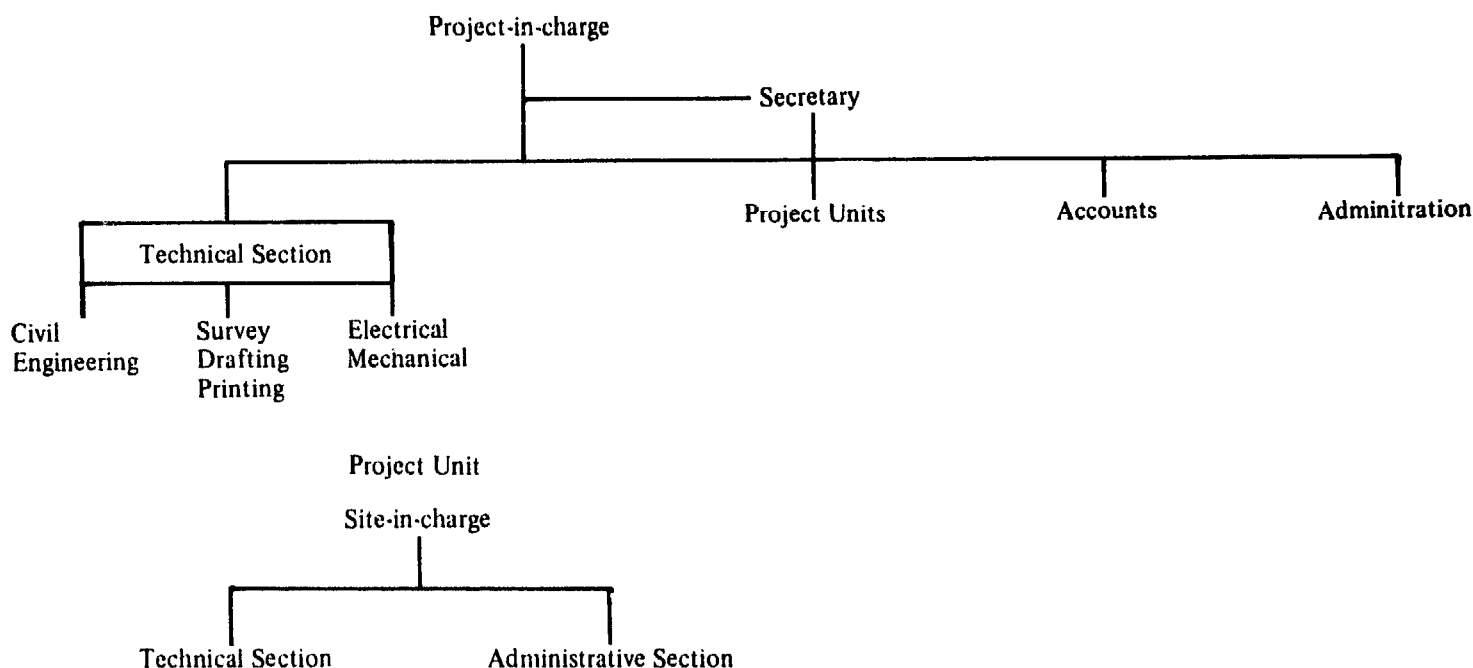

## Implementation of Projects

The first priority for the construction of projects goes to the district headquarters in the hills, which have no prospect of being supplied from either existing or convenient large hydroelectric schemes. The district headquarters are considered to be the centers for many aspects of economic and social activities. Projects may also be initiated at the request of political leaders.

The criterion of economic feasibility is not strictly applied, and priority is accorded to those projects which are simple and likely to generate more participation by the people.

When the need for a project has been established, a series of technical and managerial steps, such as reconnaissance surveys and preliminary reports, are undertaken. Initial approval of the project by the Ministry of Water Resources, detailed investigation, final engineering design and reports, and submission to the National Planning Commission (NPC) and the Ministry of Finance (MF) for inclusion in the following year's work plan are some other steps prior to undertaking project implementation. The annual plans are prepared based on the sector programme as reflected in the Five Year Plan. The fund allocation is made at the beginning of each financial year.

The construction works are carried out either departmentally or through contractors. A field office is established at each project site. The manpower needed to administer the project depends on the magnitude of the works involved and also on the method of execution. The duration of construction for smaller projects varies from 2 to 3 years.

## Problems

The major problems in the development of small hydel projects are listed below:

- shortage of technical manpower;
- shortage of funds (internal and external);
- procurement of equipment and construction materials not locally available;
- transportation of equipment and construction materials to the project sites, which are generally not easily accessible; and,
- lack of reliable local contractors.

As most of the construction materials and equip-

ment have to be imported, project costs tend to be high. The situation is further aggravated by the remoteness of the project sites and inherently difficult transportation conditions. Usually the materials and equipment have to be airlifted to the project sites.

There are also some extrinsic problems associated with small hydel project construction. Though the pattern of the load demand varies according to the supply area, location and region, the load factor in the proposed project area is quite low (20-25%), with the major load only for lighting purposes. In the case of most projects, the load in the day-time is almost negligible.

The higher unit price is another problem which discourages the use of power for other domestic purposes like cooking and heating.

## Steps Being Taken to Solve the Problems

In order to meet the shortage of technical manpower, local consultants are being hired to prepare project reports including detailed engineering designs.

The Nepal Engineering Institute (NEI) under Tribhuvan University is the only training institute where facilities are available for training graduate engineers and sub-professional categories of overseers. The graduate training course started only in July 1978, and 24 students are enrolled every year. Action is being taken by HMGN to expand the activities of the NEI to produce more engineers and overseers. Agencies like The United Nations Development Programme (UNDP) are being requested to include the training programme outside the country for funding from their country programme budget. Local companies are being encouraged to manufacture turbines, governors and penstock pipes. The use of high density polythene pipes as penstock pipes is being considered. The government is seriously considering the case for providing incentives to local manufacturers to enhance their applied technology. These steps are expected to reduce the cost of projects.

Efforts are being made to integrate small hydroelectric development with irrigation schemes and water supply systems so as to promote an effective load factor and improve the economic soundness of these decentralised projects.



## Design Aspects

While designing a small hydroelectric project, an attempt is made to make it simpler in both construction and later in operation and maintenance. A simple structure for diversion is built. The canals are unlined so far as soil conditions permit and wherever possible the existing irrigation canals are used with proper modifications. All controlling is done on the lower voltage side and use is made of simple combination fuses to protect against short circuit faults. Manual voltage regulators are used, and locally manufactured mechanical governors will eventually be installed.

## Financing of Projects

The small hydel programme is funded by the central government and the capital outlay made can be regarded as a non-recoverable grant to the concerned area. This programme has also received substantial external assistance both from multilateral and bilateral agencies in terms of grant aid or credit. The Asian Development Bank (ADB), the United Nations Capital Development Fund (UNCDF), the Organization of Petroleum Exporting Countries (OPEC), and the Swiss Association for Technical Assistance (SATA) are assisting the programme at present.

In the current 6th Five Year Plan, the programme consists of the installation of small hydropower schemes at 75 or more different places at a total cost of US\$10.0 million. It has been observed that Nepal will need external assistance for quite some time in the field of power supply in order to facilitate timely and proper execution of the projects. The possible future requirements for this sector can be summarised under the following general headings:

- grant-in-aid finance;
- loan finance;
- training (local and regional);
- material, supplies and equipment; and,
- technical cooperation.

## Operation and Maintenance of the Project

The operation and maintenance of completed projects will remain with the SHDB for a few years to come. Since proper operation and maintenance is essential to the success of the programme, the projects after completion cannot be left ignored and unattended. Thus local technicians are trained in operation and maintenance so that there will be less problems in recruiting staff. Workshop services are being made available in a suitably located place with a view to covering as many projects as possible.

## Selective Information about Projects

Some salient features of 5 of the 12 projects under construction are given in Annex 4 and Table 1.

### Annex 4 Salient features of some of the projects

1. Number of projects: 5
2. Total estimated cost: US\$1.9 million. (63% foreign exchange + 37% local currency)
3. Total rated capacity: 800 kW (ranging from 60 kW to 260 kW)
4. Inhabitants (1982): 33033  
Inhabitants served (1982): 7477 i.e. 22.6%  
Inhabitants (1996): 44117  
Inhabitants served (1996): 21596 i.e. 48.95%.
5. Specific consumption of energy per domestic consumer in 1982: 15-16 kWh per month.
7. Percentage of households served: 19-30% in 1982 and 30-70% in 1966
8. The annual load factor: 16.5-21.3% in 1982 and 29.8-34.4% in 1996
9. Cost break-down – Civil works: 27%, Electrical + mechanical works: 38%, Transmission: 18%, Engineering supervision: 17%
10. The average maximum selling price of energy to the consumers will not exceed US\$0.0625 per kWh; this price is considered affordable and optimal.
11. Economic features of the above-mentioned small hydro hydel projects are given in Table 1.

Table 1

Scheme	Installed Capacity kW	Total Cost	Cost per kW	Benefit/Cost Ratio		Internal Rate of Return %	Cost of Energy US\$ per kWh	
		US\$ 1000	US\$ 1000	6%*	10%*		6%*	10%*
Okhaldhunga	120	335.3	2.79	1.96	1.35	16	0.10	0.16
Khandbari	260	496.3	1.91	1.33	0.89	9	0.11	0.17
Ramechhap	60	262.2	4.37	1.13	0.83	7	0.17	0.25
Taplejung	100	308.3	3.08	1.37	1.03	11	0.16	0.18
Bhojpur	260	513.0	1.97	1.51	1.07	11	0.09	0.14

\* alternative discount rates

## PAKISTAN

**T**HE power potential of streams and rivers in the mountainous regions of Pakistan has been appreciated for a long time. Water wheels, utilizing the energy of flowing water, are used for grinding purposes. Many such installations are in operation in the mountainous regions, particularly in the North Western Province, Northern Areas, and Azad Kashmir.

In the mountainous regions, mini- and micro-hydel power stations can be built on small rivers and streams. In the plain, sites can often be located along irrigation canals.

### Mini- and Micro-Hydel Power Stations in the Mountainous Regions

The first small hydel power stations to be built in the Northern Areas of Pakistan were five power stations initiated in the 1960's by Pakistan's Water and Power Development Authority (WAPDA). Four of these, ranging in size from 50 kW to 400 kW, were completed in 1967; a fifth station (400 kW) was completed in 1973; and a sixth station (450 kW) was completed in 1975. During this period, the Northern Area Public Works Department (now the Northern Area Works Organization – NAWO) also installed four mini-hydel power stations, each with a 125 kW capacity. Before the construction of these power stations, electricity was generated at these locations by diesel generator sets, with fuel oil transported by air to the sites.

In 1973, a scheme was initiated by the Government of Pakistan to carry out investigations for more than 100 mini-hydel power stations in Pakistan. WAPDA was assigned to carry out the investigations.

In 1974, 100 standard turbo-generator sets, fifty of 50 kW each and fifty of 100 kW each were purchased by the Government of Frontier Province, Northern Areas, and Azad Kashmir. A separate department, Small Hydel Stations Project Directorate, at present under the Ministry of Water and Power, is in charge of construction of the power stations where these turbo-generator sets are being installed. Another government agency, the Kohistan Development Board, has also completed feasibility studies for utilization of some of these turbo-generator sets in the Kohistan area. Site selection, design, and construction of the mini-hydel power stations is carried out by the National Construction Company (NCC), a construction

company in the public sector. To date, about one dozen installations are under construction or completed.

The purchase of standard sets has posed the problem of finding sites to suit the sets. It would have been better if sites had been selected first and then each set ordered according to the particular site conditions.

The development of micro-hydel power stations with capacities of up to 50 kW is carried out under the supervision and guidance of the Appropriate Technology Development Organization (ATDO) of the Government of Pakistan. ATDO intends, where possible, to utilize local resources. An outstanding feature of the program is the participation of the local community, which undertakes the construction of the entire civil works.

The turbine is designed and fabricated locally; and the electric generator is, at present, purchased from the market. The University of Engineering and Technology at Lahore has undertaken the design and testing of locally fabricated generators. The plant is installed by ATDO with the assistance of the local people. One of the selection criteria for the site is that it should not be far from the village. The distribution system is laid out by the local people with the technical advice of ATDO. These stations not only generate electrical power, but many provide direct power for village industries, running a wide variety of machines. At present, about two dozen schemes, ranging in size up to 15 kW, are operational. Another dozen are under construction. The operation, maintenance, and management of the plant are the responsibility of the local community.

By utilizing simple technologies and local labor, these power stations are installed at a very low cost, ranging from US\$250-\$400/kW for plants ranging from 3 to 15 kW.

### Hydel Power Stations on Irrigation Canals

A large network of irrigation canals serve some areas far removed from the national power grid. Drops of up to 3 metres and beyond on these canals provide potential for power generation. In 1925, a private individual built a power station on a canal, near Renala Khurd in the province of Punjab, to produce electricity for his big farm. The total capacity



of the power station at present is 1,100 kW, made up of 5 units each of 220 kW. The national grid of Pakistan is now also supplying power to the areas around this mini-power station.

Though the potential exists for mini- and micro-hydel power stations along the canals, the several power stations which have been constructed are in

the 10-20 MW range.

One possible disadvantage of constructing power stations along the canals is that every year these canals are closed for 1½ months for repairs. The canals have to be closed during floods; during periods of short supplies, there are wide fluctuations both in the discharge and head.

## PAPUA NEW GUINEA

**T**HE annual increases (government or foreign oil suppliers) in imported fuel products used in electricity production makes the development and installation of hydropower in Papua New Guinea very attractive. Nearly all micro-hydro units presently in operation were imported at very expensive prices.

### Appropriate Technology Development Institute

To make the technology more compatible with the financial and technical capabilities of the people, the Appropriate Technology Development Institute (ATDI) has set up a small-scale industries program to:

- manufacture and help install Pelton turbines designed at the ATDI; and,
- fabricate and install a cross-flow turbine designed at the University of Technology in Lae.

In both cases, the cups and the blades are produced by casting and finally bolted and welded, respectively, to produce the finished runners. The basic reasons for going into local production are:

- the financial problems encountered in purchasing expensive units from overseas and the time lag involved in replacing spare parts; and,
- the necessity of producing a technology that is simple and easy to install.

It is intended, for example, that the same Pelton wheel diameter and the same cross-flow turbine diameter will serve high heads. At this stage, the ATDI will not manufacture units larger than 100 kW until the equipment fabricated to date is field tested. The ATDI is seeking technical information and advice on relatively cheap governing systems for their projects.

#### a. Romsis micro-hydro project

The decision to build this unit was made by the community. Initially, the community wanted to buy a diesel generator, but after further investigation into other possibilities, it was found that a hydropower unit was a better alternative.

This project is managed almost entirely by the people. They raise funds locally, write letters for funding from overseas donors, and organize the local labor force to work on different stages of the project; but they still require technical expertise to supervise the construction work. The University of Technology in

Lae and the North Solomons Provincial Government are presently providing this service.

During the eighteen months since the project started, one creek has been diverted to join another one to give sufficient flow rate, the headrace and dam have been built, and work in laying down the penstock has begun. The hardware going into this project is a Pelton turbine designed and built at the ATDI.

Financial support for the project came from the local community, the provincial government, and donating agencies such as the New Zealand High Commission of PNG, CUSO, and the Office of Village Development in Port Moresby.

While the power is primarily for lighting, one of the community planners for the project hopes to use some of the power to run a village chicken project or to dry cocoa during the rainy season. Fortunately for this project, the full-time manager lives in the village and there are some technical people in the community who could easily run the project if well trained.

#### b. Ogeramng micro-hydro project

The ATDI plans to install their first low-head turbine (cross-flow) on this site to produce 25 kW. All materials and technical manpower needed for the project must be flown to the site. This makes the project very expensive. Every kilogram flown in will cost about US\$0.25.

At this stage, the dam, headrace, and settling tank have been built. Work in laying the penstock should have started, but could be held up due to the start of the rainy season.

Technical management is presently provided by the Electrical Engineering Department at the University of Technology in Lae. The project is solely funded by the local provincial government at a cost of about US\$56,000. The provincial government's interest in this project is to replace the present fuel-consuming sawmill with a hydropower unit, and also provide lighting for the school.

The major problem in both of these projects is that there is no full-time technical expert on site. The Romsis project has technical personnel from the provincial government assigned to the project, but some serious civil works problems might be encountered at the Ogeramng site.

Just recently, the ATDI has been approached by at least four provincial governments to carry out feasi-

bility studies for them on hydropower generation. Although the ATDI expressed an interest, they still do not have the capacity in manpower and finance to help them. In the case of rural micro-hydro schemes, the ATDI has adopted a policy that the people first have to make the approach. The task of solving the social and local political problems is something that can only be solved by the community and should be left to the villagers. Local participation is vital if the project is going to be a viable community project.

### **Papua New Guinea Electricity Commission**

The Papua New Guinea Electricity Commission has embarked on developing a number of hydropower projects. The purpose of these projects is to:

- implement a government plan for rural development;
- reduce PNG's dependence on foreign oil for electricity generation;
- exploit the hydroelectric potential of PNG;
- accelerate the rate of development in certain areas; and,
- displace costly diesel generation, and provide power where no diesel generation existed.

However, these objectives were considered by the Asian Development Bank to be insufficient for the project to proceed. The Bank insisted that a market for them must be seen to exist and that they must be relatively inexpensive.

#### **a. Mini-hydro programmes**

The Electricity Commission is presently developing three mini-hydro schemes, with the fourth already completed. These schemes comprise a 200 kW power station at Sohun (New Ireland Province), a 400 kW power station at Ru Creek (West New Britain Province), a 200 kW power station at Tinutz (North Solomons Province), and a 500 kW power station at Lake Hargy (West New Britain Province).

The Sohun hydropower project was completed in late 1980 and is now in operation despite a leak in the weir foundation. The budget for this project was exceeded by about 100%, due mainly to underestimating concrete requirements (the actual cost was 250% more than estimated), underestimating the cost of inlet gates by a factor of more than 10, and basing the initial cost estimates on preliminary design.

As a result of these revelations, the other three projects were re-examined. With the exception of the Tinutz hydropower project, it was necessary to adjust upward the cost estimates of the other two schemes (the Ru Creek hydropower project cost increased by 100% over the original estimate).

#### **b. Funding of mini-hydropower projects**

Assistance for funding of the four mini-hydro projects was obtained from the ADB, which provided a loan to the PNG Government of US\$2.7 million. However, with the latest developments in the cost of these schemes, it has become necessary to request the ADB to review the other three projects with a view to injecting more funds into these projects.

#### **c. Development of mini-hydropower projects**

Construction of the four mini-hydro schemes has begun using the Commission's very limited skilled manpower resources and supervision and taking advantage of locally-available unskilled labor.

Since the Commission does not own earth-moving and construction equipment, it has to rely on the local Department of Works for such equipment as it becomes available. Delays in construction were expected, therefore, but not allowed for in costs since it may take up to several months for a bulldozer, or some other piece of equipment, to become available.

#### **d. Management of mini-hydropower stations**

From experience obtained on the first completed mini-hydro project, the Commission has found that the schemes are very costly since they do not ensure sufficient revenue generation for the Commission to be able to service its loans.

As a result, the Commission is in the process of proposing to the government that, among other things, the Commission should not be made to own and maintain these mini-hydropower stations unless the schemes return better than 10% internal rate of return against actual cash flows. However, the Commission will assist the government in operating and maintaining these power stations on a contractual basis should the government accept the proposal.

#### **e. Future development**

Responsibilities for rural electrification and development of mini-hydropower projects outside the



Commission's responsibilities have not yet been fully defined (the government has yet to consider and accept the proposal) in terms of financing and ownership of the schemes. However, despite these problems,

the Commission will maintain its role in taking the initiative to investigate mini-hydropower potential for the power systems it currently owns so as to displace costly diesel generation.

## PEOPLE'S REPUBLIC OF CHINA

**C**HINA has considerable hydropower potential. A nationwide survey, the third since 1949, has just been completed which focuses primarily on large hydropower projects.

Important theoretical hydropower potential in China amounts to 680,000 MW; total exploitable hydropower potential amounts to 370,000 MW. Exploitable hydropower potential has been subdivided in the survey into four categories, according to the investigation and engineering work for each site:

- sites with intensive geological investigations, including quadrants, and contemplated design studies with sufficient data to perform a feasibility study of the site;
- sites where only a limited amount of geological investigation, including quadrants, and design work has been completed, but where data is insufficient to perform a feasibility study;
- sites where only reconnaissance work has been contemplated and the concept of development has been suggested; and,
- sites where no field work has been done and only the potential has been assessed on maps.

Relatively speaking, by the end of 1980, the exploitable hydropower potential in the first two categories amounts to about one-third of the total exploitable hydropower potential in China.

There is no similar data on small hydro available now. It may be more difficult to assess the potential for small hydropower plants than to assess the potential for large ones.

In the past 32 years, China has built approximately 90,000 small hydropower projects of less than 500 kW each, with a total generating capacity of 4,000 MW.

In 1979, China had a record increment of 1,000,000 kW of new small hydro development in a single year. This increase is declining; China may develop an additional one half million kW this year.

Many small rivers in China were developed in stages, or in what is referred to in China as cascades or stairs. Current projects were carefully planned to utilize all, or nearly all, of the river's head. In such planning, the most important issue is to find an appropriate site. A large reservoir to attain a perfect access of the whole river flow may not be possible because

it is usually expensive. In many cases, a reservoir with an appropriate capacity will suffice. "Appropriate" means a reservoir large enough to provide a certain degree of flow regulation, but also small enough to be financially feasible.

Another important consideration is finding the proper balance of water uses in multi-purpose projects. It is usually difficult in China for a small hydro plant to have measureable flood control benefits because it always requires a large capacity to store the flood waters, usually too heavy a burden for a small hydro plant.

The most common use of small hydro is irrigation, always a high priority in China. Many small hydro plants were initiated as irrigation projects. The generation of hydropower is considered a means to derive some profit from the project, since the irrigation water rate is usually rather low, while the selling price of electricity is comparatively high.

The union between irrigation and power is not always a happy one. Conflicts in water uses are inevitable. In such cases, irrigation usually is the first priority for use of the water. River flows in the non-irrigation season may have to be stored for the use of the next irrigation season at the sacrifice of power generation. Therefore, the supply of power from a small hydropower station may be rationed during the dry season unless, of course, the small hydropower station is connected to a large power grid.

Comparison between an isolated hydro plant and an integrated small hydro plant shows that an isolated plant usually has a variation of river flow. Rural people must accept what the small hydro plant can provide and realise that the service may be intermittent and unreliable.

It is always the desire of rural people to integrate a small hydro station with the nearest power grid. Here again, integration is not always a happy marriage. When the integrated small hydro plant represents only a small portion of the total generation of the power grid, and when the grid is composed mainly of thermal power stations, there is no problem. But when a large number of small hydropower stations are integrated into the power grid, constituting a sizable portion of the main grid, the situation is complicated.

In many provinces in China, large hydro plants are principal generation stations in the power grid. The problem arises when the principal hydro plant in





the grid is also a run-of-the-river type. In the flood season, both the small, as well as the large, hydro plants possess a large amount of surplus river flow, while in the dry season both suffer from a severe shortage of river flow. Therefore, they cannot help each other.

Turning to the financial aspects of small hydro plants, it was common practice in China previously to subsidize construction of small hydropower stations through government loans. These covered equipment

costs and usually amounted to about one-third of the total construction costs.

Government loans, in the form of grants, were not repaid. However, a change is contemplated in this arrangement. Government loans will be changed into bank loans and will be repaid, but with very low interest rates of 3 or 4%. This change is needed for two reasons: cuts in government expenditures are needed and misuse of government grants must be prevented.

## PHILIPPINES

AS was true for many other developing countries during the 60's and 70's, Philippine electricity generating plants became addicted to cheap oil. The Government has established plans to reduce, if not eliminate, this dependence on oil for the generation of electricity. Primary emphasis is placed, in these plans, on the exploitation of domestic renewable energy sources.

The Philippines is a country of heavy rainfall and extensive steep mountains. The mountains are typically only a short distance from the sea. As a consequence, we have an abundance of short rapidly falling streams. The mini-hydro program is being developed to exploit the energy potential of this renewable resource.

Small hydro plants were installed in the Philippines in small numbers during the 1930's and again in the 1960's. However, no concerted effort was made to develop the enormous potential of the resources offered by our small streams. In part, no development occurred because large oil thermal power stations could supply very cheap electricity then, and in part because transmission costs from dozens of remotely located small sites were prohibitive.

In the 1970's the Philippines brought electric distribution systems to all its rural areas, virtually eliminating the transmission constraint. Oil thermal stations are no longer cheap sources of electricity. Thus, in 1979, a program was initiated to develop all economically competitive small hydropower sites, estimated to number several thousands, with an aggregate potential of 2,000 to 4,000 MW.

### The Mini-Hydro Program

The National Electrification Administration (NEA) has developed a nationwide system of locally owned and operated electric distribution cooperatives. These cooperatives, over 100 in number, provide decentralized management centers in all provinces. When one considers the administrative difficulty of planning and constructing hundreds or thousands of

small, scattered, remote power plants it only becomes feasible to execute, in a timely manner, such construction if dispersed administrative control is possible. With this consideration in mind, it was natural that the NEA and the rural electric cooperatives were assigned the task of executing the mini-hydro development program.

At the time this assignment was given to the NEA, no small hydro system had been constructed in the Philippines during the prior 15 years. There was only a rudimentary inventory of potential sites, almost no experience in data analysis, construction planning, etc., and few places in the world to turn to in order to gain experience.

Less than three years later we have put into operation five power plants, initiated construction on five more sites, placed equipment orders for about 20 plants and have completed 45 feasibility studies. Our inventory of potential is still far from complete; but data are being collected from over 50 teams in all islands.

In the early phase of this program, expatriate firms are supplying most electro-mechanical equipment as well as limited assistance with site selection, feasibility studies and engineering design. However in a large measure, except for equipment, the program is progressing using local capability. Within the next 2 to 3 years we will be manufacturing the majority of the required equipment.

We expect to have 20 to 25 power plants in commission by the end of next year with a capacity of 25-30 MW. By the end of 1987 there will be 250 or more power plants with an installed capacity of 300 MW. These plants will supply 30 to 35% of the electrical power needs of the rural areas outside Mindanao.<sup>1</sup>

### Program Data

Although some uncertainties exist, most of the facts, capability and financing required to reach the 1987 targets are in place.

<sup>1</sup> Currently large hydro sources are sufficiently cheap and plentiful in Mindanao, which deters any need to develop the small hydro resources there.

### Power plant development targets

Year	Site Investigation	Feasibility Study	Equipment Ordered	Plants Commissioned	MW Installed
1981	168 (416)	80 (45)	69 (20)	3 (3)	1 (.5)
1982	180	36	45	28	22
1983	192	26	25	35	43
1984	216	23	16	55	52
1985	240	16	25	23	53
1986	252	23	24	30	62
1987	264	—	—	30	67

The numbers in parenthesis beside the targets are the actual accomplishments as of May 1981.

### Financing availability as of May 1981 (MW of funding source)

Year	Local	UK	France	Norway	China	Germany	Japan	ADB	MW for which funding required
1981	0.7	0.3	—	—	—	—	—	—	—
1982	3	4	4	—	11	—	—	—	—
1983	7	5	5	5	15	2	—	4	—
1984	10	10	7	—	20	—	5	—	—
1985	15	—	—	—	30	—	—	—	8
1986	20	—	—	—	24	—	—	—	18
1987	30	—	—	—	—	—	—	—	37

### Local Manufacturing

Large power plants require a high degree of sophistication and generally cannot readily be manufactured in the Philippines. Small hydroelectric equipment ranges from the very basic to the only modestly complex. Such equipment can be, and is being manufactured in the Philippines.

Initially, the primary emphasis in the program is on the installation of imported equipment. Four factors determined this decision to use imported equipment:

- concessional financing available for imported equipment;
- the desire to test as wide a variety of technology as was feasible;

- the need for some technical assistance for program start-up; and,
- the time required to expand local manufacturing capacity.

While this first phase with imported equipment is on-going, the local manufacturing program is being nurtured. A 100 kW plant was commissioned in 1979, a 350 kW in 1980 and a 525 kW plant will be completed in September this year. In each case the turbines and most of the electrical equipment were manufactured in the country. We anticipate local manufacturing of 3 MW of equipment in 1982, 7 MW in 1983 increasing to 30 MW by 1987.

Our experience is that the local equipment is almost a third less expensive than that imported from developed countries and can be supplied in perhaps

half the time. We do not expect to encounter problems of reliability, although as yet we have very limited operational experience.

One constraint, until quite recently, has been that of financing. The requirement to pay cash to local firms has severely limited the NEA's ability to use local suppliers when foreign purchases could be financed at 5 to 7% interest and for 15 to 20 years. However, the Philippine Government has now established a facility which will make it possible to purchase local equipment on cash terms comparable to that of the imported equipment.

### **Some Unique Features of the Philippine Approach**

We are of course very proud of the progress we have made in less than three years. It is our judgment that a more conventional approach to the task of developing our mini-hydro potential might have added 2 to 4 years more to the development time required. I would like to briefly touch on some features which are unique to the Philippine program.

### **Simultaneous/Not Sequential Program Development**

In developing large power plants or any large project the sequence of events is typically: 1. idea, 2. pre-feasibility study, 3. review, 4. locate financing for feasibility study, 5. feasibility study, 6. review, 7. locate equipment financing, 8. order equipment, 9. manufacture equipment and contract for power plant construction, and so forth. Even this listing deletes several intermediate steps. The sequence can take several years and the repeated studies, especially involving foreign firms, can become very tedious and expensive.

In this program NEA has started with steps 1 and 7. Steps 2 and 8 have gone forward next. While the equipment is being manufactured, more detailed studies are carried out, designs are finalized and construction is initiated. Local firms provide the required technical inputs on a negotiated contract basis. Both time and money are saved. Given the small capacity of mini-hydro power stations it is critical that these analytic and engineering costs be minimized.

As a consequence, a new project has been formulated and the first power plants will be commissioned in less than three years. In less than a decade at least

250 power plants will be commissioned.

### **Local Administration**

We are developing hundreds of sites in the remotest parts of the nation. Communications are difficult in the Philippines even in many not-very-remote places. To try to administer from Manila, such a decentralized program in remote areas would be difficult if not impossible. Even if it could be successfully administered from Manila, it would be relatively expensive because of higher salaries and the requirements for high per diems.

The 100 plus rural electric cooperatives provide the management centers which administer much of the program. The co-ops collect site data, oversee A & E firms and construction contractors. Eventually, they will do a significant share of the construction work. They will own and operate the power plants.

Without this decentralization, the program would be slower by two years or more and costs of construction and operation would be significantly greater.

### **Grid Connection**

A major limit on achieving low cost operations for rural small hydro plants is the difficulty of achieving high utilization rates for isolated units. The Philippines has developed island-wide, interlinked rural electric distribution grids. With these grids, and by tying the small hydro plants to the grid, it is possible to generate power at the maximum rate possible given the available water. Thus, utilization factors approach 52 to 55% rather than the 20 to 25% which might be expected from isolated units. Generation costs are consequently halved.

### **Domestic Engineering and Manufacturing**

The last factor is straightforward. Expatriate consultants have been used to a minimum extent. This has significantly reduced planning and development costs. Local manufacturing will reduce equipment costs.

We believe this use of local capability is worth what may be the greater risks of errors. We estimate that generation costs are probably reduced by 15% because of the minimum expatriate work involved.

## SRI LANKA

**S**RI Lanka is an island of 24 districts, with a land area of 25,332 square miles situated off the southern tip of India. Around the coast is a plain which is fairly broad in the northern region. The central part of the country is mountainous with the highest elevation being 8,282 ft. above sea level. The rivers radiate from this central hill country. The country receives rainfall from two monsoons, the southwest and northeast, and because of the central hills only one part of the country receives rain from each of these monsoons.

### History of Electric Power in the Country

The sole authority for electricity supply in our country is the Ceylon Electricity Board (CEB). Although in the initial stages the electric power plants were steam driven or diesel powered, after the 1950's the country moved into large-scale (by the country's standards) hydro generation, with a limited thermal support. The position prior to 1977 was a hydro installed capacity of approximately 325 MW and a thermal capacity of about 60 MW. During this period 85% of the country's energy was met by hydro, and during some years of good rainfall 100% of the energy

was met by hydro. The annual energy requirement was in the region of 1,133 million units with a peak demand of 240 MW.

### Abandoning of Earlier Small Hydro Plants

With the commencement of the main hydro schemes referred to above and with the grid lines and sub-transmission lines being constructed right throughout the country, attractive incentives were offered during that period for customers to take bulk supplies off the transmission lines. Many mini-hydro schemes which were in operation in the central hill regions serving the tea factories were neglected and closed down due to this. A survey carried out by the Estates Development Authority recently, although not complete, reveals the information given in Table 1. It shows that a large number of plants were out of commission in 1979, the year the survey was carried out.

### Present Energy Crisis

From our country's point of view the energy crisis has to be viewed from two angles:

1. whatever thermal power is generated is tied

**Table 1**  
Simple Survey on Mini Hydro Plant Installed in factories

Region	Number of replies received	Number of Factories originally having Mini Hydro Plant	Total kW of such plant	Number Presently estimated in Operation
1. Nuwara Eliya	22	19	970	13
2. Awissawella	5	4	141	1
3. Matara	5	1	48	1
4. Matale	5	5	113	3
5. Kegalle	6	6	155	3
6. Balangoda	5	5	213	2
7. Haputale	4	22	52	1
8. Nawalapitiya	25	17	691	5
9. Hatton	30	19	670	3
10. Badulla	31	7	337	3

Note:

1. These figures based on a study conducted in 1979 with data called for up to 1977.
2. Certain factories had a larger horse-power turbine with only a very small generator, as most of the power was directly taken on to a main shaft for driving machinery by belts. In this cases the total kW has been estimated from the horse-power ratings.

- up with the high cost of imported oil; and,
2. after 1977, with the liberalization of imports and the opening up of new industrial concerns, an unprecedented demand for energy is now being faced. Compared to the figures given earlier, the 1980 energy demand was 1,668 million units with a power cut. Power cuts have had to be resorted to in order to bring down the large draw-offs from reservoirs to meet the high energy requirements. The maximum peak recorded during this period was 368.5 MW with power cuts. Incidentally, the maximum peak recorded so far during 1981 (this year) is 380.3 MW with power cuts, and there was about 5.3 million units consumption per day before power cuts were introduced.

million units per year at 50% load factor.

With the energy crisis, further sites for mini-hydro plants were investigated by an energy sub-committee during 1979. This committee made a study for the identification, assessment and development of such schemes. Seventy waterfall sites, 21 mini-dam sites, 30 sites in existing irrigation reservoirs and 31 proposed reservoir sites have been identified. The total potential from all these sites was about 95 MW of power and 395 million units. The estimated cost in implementing these schemes varied from 2 to 15 million Rupees for a 0.5 to 1 MW plant.\*

The CEB is also at present putting up a demonstration plant to revive interest in this field. This plant is of 16 kW capacity with a head of 50 to 60 metres. The CEB, with foreign participation, is also pursuing another scheme in the hilly country for a plant with a capacity of 3 to 4 MW with a head of 80 to 110 meters.

### Sources of Alternate Energy

Although the other alternate sources of energy like windpower, solar cells, biogas and solar cooking are being tried out, these are, however, in the early stages of development in our country. The most promising "alternative source of energy" would be a revival of the very large number of small hydro plants in the estates in the central hill regions. Although this would not be able, in some cases, to meet both the entire load of the factories and also, during the night, the domestic load of the staff quarters, it could undoubtedly contribute in limiting the draw-off of energy from the national grid.

### Mini-Hydro Potential

From Table 1 it can be seen that from the limited results of the survey conducted there could be about 3½ MW available with an estimated energy of 15.0

### Conclusion

This country is fortunate in having "ready-made" sites which can be revived and could thereby give an appreciable contribution of power and energy. Unfortunately most of the old equipment at these sites (*i.e.* at rubber and tea factories) need heavy repairs, and also in some places some of the equipment has been sold as scrap. What is required is a special unit with adequate funding to go into these places and carry out the necessary repairs so as to put these sites back into operation. Out of these, 32 mini-hydro plants (totaling to about 1 MW) have been identified which could be reconditioned. Just as attention is presently being focused on other alternative sources of energy, what is now urgently required is similar attention in order to revive these old mini-hydro schemes.

\* Rs15.36 = \$1.00 (December, 1982)

## THAILAND

**P**OWER development has been vital for economic progress in the past decade in Thailand. In this field Thailand has developed many power plants, most of them being gas turbine and thermal plants which use fuel oil as the source for producing electricity. There are about 17 oil fuel plants located in various parts of Thailand. The role of crude oil in the energy sector amounts to 83% of imported crude oil. The Thai Government intends to reduce the share of crude oil to 76% in 1986 and to keep this figure as the maximum level.

The seriousness of the situation of dependence on oil has long been realised since the energy crisis in 1973. Efforts are being made to encourage the development of the natural resources available within the country. Hydropower development is being considered, and is an obvious choice to reduce oil consumption. Many large-scale hydropower projects have been constructed in the past decade. Because of the limitations of the potential dam sites, most large-scale projects have already been developed. Small-scale projects are now being considered for construction.

The development of small-scale hydropower projects has been under way in the country since 1969. Most of them are in the northern part of Thailand, where the topographic conditions and riverflow are available and suitable for hydropower development. Twelve projects are operating. The biggest among these is one with an 800 kW capacity. The small-scale hydropower plants in the country can be classified into two categories. Those with a capacity of between 1 kW – 100 kW are known as micro-hydro plants and those with between 100 kW – 6,000 kW capacity are known as mini-hydro plants.

### Plan for Development

The National Energy Administration (NEA), a governmental department, is responsible for all aspects of energy planning, energy administration and development. The NEA has submitted an energy master-plan to the Thai Government, which will be incorporated in the Fifth 5-year National Economic and Social Development Plan. Small-scale hydropower projects are emphasized in connection with development for rural communities in remote areas. There is an urgency to move development into the rural areas which have no electricity supplies. Presently only

36% of the total number of households have access to electricity.

The Fifth National Economic and Social Development Plan has now been approved by the Government, and the NEA is the department that takes responsibility for the development of national energy resources. The development of small-scale hydropower projects is given high priority and it is anticipated that the projects developed would help save 94 million litres of oil annually.

The fifth 5-year plan covers the years 1982 to 1986. The NEA has identified the most promising small-scale hydropower projects for the 5th plan, totalling 50 projects ranging in size from between 50 kW – 6,000 kW. After completion of the 50 proposed projects, electricity can be provided for about 40,000 households in rural areas. The total power capacity will be about 59,900 kW and the annual energy supply about 225 GWh.

In selecting a project for study in the initial stage, the following criteria have been used:

- the project should be situated in an area which is at a distance from the existing distribution system. This will serve people in the rural areas. It will also help to prevent the introduction of another diesel generating plant which it is trying to replace;
- the project should be located in an area where it can easily be connected with the existing distribution system. This will ensure the sale of the total energy generated as it would be fed into the system. This will also help reduce the consumption of oil.
- the project should be located in an area where the existing supply is through diesel generating plants. This will help replace old and inefficient diesel generating plants and help reduce oil consumption;
- the project should be situated in an area where there are promising uses for it, such as the use of electric pumps for irrigation and local industries; and,
- the project should be connected with one which already exists as an irrigation project. The possibilities of installing turbines and generators in these projects are being considered.

Small-scale projects of this nature usually have



some pondage capabilities. This pond would also provide fish to the villagers.

### **Constraints**

There are many constraints in developing small hydropower projects. One of these is the cost of the project, and many projects studied are not economically feasible. The rural areas do not have a high demand for power in the initial stages. Time would be required before the demand increases to the average level. In general, small projects do not have the same economic advantage as medium- and large-scale projects, so often have to be dropped on the grounds that they are too expensive. The unit construction cost of small-scale projects is very high ranging from US\$1,500-\$6,300/kW. The high cost is due to the construction of civil works — since, for example, the access road to the dam site, and also the waterways, are likely to be rather long. Another constraint is obtaining reliable information on the project, especially on the amount of riverflow. There is no adequate hydrological information on the interesting projects. Many projects under study have no records at all. In order to make the projects more attractive and more economically sound, solutions have to be found to reduce the costs as far as possible, and especially to find a solution to reduce the costs of the waterway, the access road and the transmission line. The NEA is currently investigating and doing some research to

find the best and cheapest method of carrying out the construction of waterways. Assistance could also be sought from foreign countries for such works, and the project could be financed with soft loans to reduce the costs.

### **Conclusion**

It can be concluded that the trend in the development of small-scale hydropower projects in Thailand will increase in the next decade, even if the cost of development is comparatively high. This would be because the need for rural development would outweigh the economics of small hydropower projects. Standardization of power plant equipment will contribute to lowering the costs of machinery. The application of appropriate local technology will help make the projects more attractive. The fifth 5 year economic and social plan calls for provision of electricity for rural people in remote areas. The benefits gained by the construction of 50 small-scale hydropower projects will promote and improve the standard of living in the rural communities. Electricity will be provided for lighting, pumping water for irrigation purposes, driving motors for domestic industries, and providing electricity for medical purposes (such as refrigeration for medicines and electricity for dental devices). It is anticipated that this development will lead to bigger programmes in the sixth plan.



**M**OST of the papers presented at the workshop have been arranged in the four sections which follow. The first section, deals with general aspects of small hydropower development, outlining its potential and the factors involved in exploiting it. In the second section, the specific concern is the actual technology involved; and in the third section, economic considerations form the central focus. The fourth section is devoted to situational applications of the technology, with reference to specific countries. Each section is preceded by a separate introduction. Where biographical notes on the authors were provided, they are presented at the end of the texts concerned.

## **PART II**

### **PAPERS**

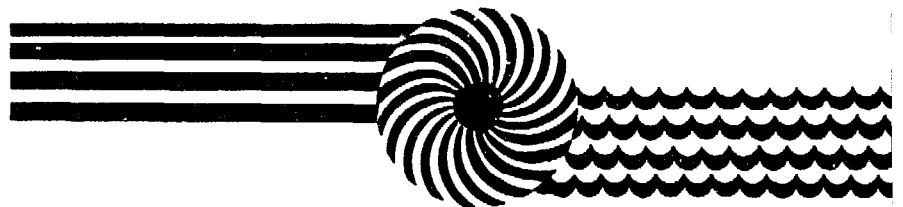

## ***PART II : SECTION 1***

### **Overview**

---

*The papers presented in this section provide an overview of mini-hydropower development in the Asian context. S.N. Vinze, of the Asian Development Bank, the keynote speaker, presents an overview of energy supply problems facing developing countries in Asia; Mohar Singh Monga, of the National Energy Administration of Thailand, looks at issues involved in the planning of mini-hydro programs; Suphat Vonguissessomnai, of the Division of Water Resources in Asia at AIT, presents an overview of water resources in Asia, their characteristics, and the problems associated with them; and Vibulya Kuhirun presents a paper prepared by Chulapongs Chulakesa, of the Provincial Electricity Authority of Thailand, which focuses on the benefits derived from mini-hydropower, energy cost-savings, and the self-sufficiency aspects which make hydro-power an attractive option. Following Mr. Singh's paper is a record of a discussion which followed his presentation.*

## Mini-Hydropower and the Asian Energy Problem

S.N. Vinze\*

---

**ABSTRACT :** The energy problem looms large in the challenges for Asian developing countries in the coming years. Developmental efforts require the increasing availability of energy in a world of shrinking availability of fossil fuels - particularly of oil, which became the main source of commercial energy in the 1960's. The high cost of oil is significantly affecting the economies and developmental efforts of the Asian developing countries. New strategies and policies are therefore being formed and efforts like the Regional Energy Survey of the Asian Development Bank will assist. The development of indigenous, renewable resources is an essential component of any new strategy — and hydropower, with its well-understood technology, will observe development wherever feasible. Mini-hydropower, though a minor energy source, qualifies as an important component of integrated rural development and should find a definite place in developmental policies. The current awareness of this is encouraging.

---

### Introduction

**T**HE Asian energy problem, like Asia itself, is large and variegated. With the increases in oil prices since 1973, the regime of low-priced energy has come to an end. The sudden and large increases in oil prices have brought into focus the larger and more real energy crisis caused by worldwide depletion of fossil fuels: first oil, and later others. The stir caused by this has also brought to notice the second energy crisis (faced mainly by the developing countries, and particularly the poorer of these) mainly as a result of the depletion of the traditional fuels — such as firewood. Rapid deforestation, the increasing diversion of fuel wood and charcoal to urban areas and the pressure of population growth is causing the ecosystem, which supported village life, to break down. For the developing world these two crises are closely linked because, in the modernization process, the shift from non-commercial fuels to oil has been the key to emergence from subsistence to modern means of production. The skyrocketing of petroleum prices has caused a re-

surgence in the demand for energy from biomass, thus leading to even more rapid depletion of forest reserves. Asia, representing almost half of humanity, and an even larger proportion of the developing world, has been hit hard by the energy crisis — more so, because parts of Asia are some of the fastest growing regions of the world, and the energy demand is growing very rapidly. The worst sufferers are the large rural populations, whose supplies of scarce and costly fuels get curtailed, and development of alternative sources of energy, particularly electricity, gets postponed.

For the present deliberations, I believe it would be appropriate to limit our horizon to the 27 developing member countries (DMC's) of the Asian Development Bank. These countries extend from Afghanistan to Korea on the mainland and include the island nations of Southeast Asia and the Pacific. Mainland China is not a member. India is a member but has not been borrowing from the Bank. As such, the Bank's statistics do not usually cover these two countries.

---

\*Mr. S.N. Vinze is the Manager of the Power Division/East in the Asian Development Bank.

## Changing Trends of Energy Use

During the 1960's the region experienced a rapid increase in commercial energy consumption of 10.7% a year, with the average annual rate rising from 9.7% in 1960-65 to 11.7% in 1965-70. India, which is not included in these figures, experienced a growth in commercial energy consumption of about 6.9% during this period. In contrast, there was a marked decline in the rate of growth of commercial energy consumption in the 1970's. For the region, the average growth rate during 1970-78 fell to about 5.7%. Except for the Republic of China (Taiwan), Indonesia and Burma, growth rates for all countries declined in the 1970's. It is noteworthy that the consumption growth rate in Indonesia, the major oil producing country in the region, increased from a meager 4.3% a year in the 1960's to 13.8% a year during 1970-78. From 1960 to 1978, commercial energy consumption grew at a faster rate than gross domestic product (GDP) in all the countries of the region, except in Burma and Sri Lanka. This resulted in marked increases in the commercial energy/GDP ratios, reflecting a confluence of several forces. Most of the countries underwent structural changes in their economies during the period, such as greater industrialization, which required more inputs of commercial energy. Urbanization was also a force, since it was accompanied by increased demand for commercial (in contrast to non-commercial) fuels.

## Changing Pattern of Energy Sources

Partly because of low-priced oil in the 1960's and its price changes later, there were marked changes in the mix of primary energy sources in commercial energy consumption in the region. These changes included:

- a continued increase in the share of petroleum, from 58% in 1960 to 75% in 1978, for all countries in the region except India (43.4% in 1960 to 48% in 1978). Consumption grew at an annual rate of 13.1% in the 1960s, compared with 6.3% during 1970-78;
- the degree of dependence on petroleum as a commercial energy source among petroleum importing countries exceeded 90% for 10 countries and was between 60-90% for another 8;
- a marked decline in the share of coal in most of the countries;
- a rapid increase of natural gas consumption (higher than for any other energy source) in countries having natural gas resources

(e.g. Bangladesh, Pakistan, Indonesia); and,

- the virtually static share of hydropower at around 2% of total commercial consumption in the region from 1960 to 1978. In only five countries – Afghanistan, Laos, Nepal, Pakistan and Sri Lanka – does hydropower represent more than 5% of commercial energy consumption.

The phenomenon of cheap oil, discouraging development of renewable resources such as, hydropower, has been worldwide. In fact, in the more advanced countries like France, Germany, Norway and the United States, a number of isolated and small hydropower plants actually discontinued operation in the period between 1945 and 1975.

## Impact on the National Economies

The energy importing DMCs' balance-of-payments deficit on current account – reflecting the rising bill of petroleum imports and the effect of inflation on prices of industrial imports – increased from \$4.2 billion in 1970 to \$18.6 billion in 1979, during which period the cost of petroleum imports in the total import bill of DMC's more than doubled, from 7.5% to over 15%. The shortfall was financed by substantial inflows of external financing or was accompanied by a deceleration of investment activities (via reduced developmental imports).

The long-term prospect of increasing scarcity continues to exert upward pressure on petroleum prices. This, in turn, places a greater burden on the non-oil exporting DMC's – as seen in these figures: In 1973, imported petroleum costs to DMC's amounted to about \$2 billion, accounting for only 8% of their total export earnings. In 1980, however, this figure rose to \$32.1 billion (23.4%), and by 1990 it is expected to increase to \$83 billion (35%).

## The Energy Sector and the Role of the Bank

The Bank and the developing countries of Asia have long recognized the key role that energy plays in social and economic development. For this reason the Bank has given special support to the priority given by governments in Asia to the construction of hydroelectric power plants, gas wells and pipelines, coal mining, geothermal power units, rural energy, and other projects aimed at increasing the DMCs' indigenous energy supply. This special support includes assistance in formulating policies and programs which are conducive to efficient use and conservation of energy, such as rehabilitation and extension of trans-

mission and distribution systems.

Traditionally, electric power has dominated Bank operations in the energy field, accounting for over 90% of energy sector lending.

In late 1979 the Bank expanded its activities in the following areas:

- increasing assistance for the development of indigenous sources of electric power, *i.e.* geothermal, coal, lignite, natural gas, and hydroelectric (including mini-hydro). In particular, the Bank considers financing rural mini-hydro<sup>1</sup> projects with short gestation periods for providing local electricity supply to villages, small industries and agro-businesses;
- financing projects that use non-traditional renewable energy sources such as biogas and gasohol;
- increasing assistance for the preparation of energy master plans;
- technical assistance for energy demand management, conservation and pricing policies; and,
- assessing the implications of the economic development plans with regard to their impact on energy availability and utilization.

### Evolving New Strategies

Last year the Bank also undertook a Regional Energy Survey (RES) which focused on such issues as the availability of and demand for specific energy resources, the implications of increasing energy costs for economic growth, investment needs and institutional and policy matters.

This information is needed to assess the magnitude of efforts to be mounted, and to formulate the policies and the strategy of the Bank. It will also be of value in determining an appropriate division of labor between the Bank, other aid agencies and commercial enterprises, in order to obtain the advantages of specialization and avoid duplication of effort between them, in the best interests of the developing countries of Asia and the Pacific.

At the Eleventh World Energy Conference in Munich last September, a round table discussion was

held on the International Financial Implications of Energy Problems. The discussion brought out the massive investments required in the area of energy in the coming years in both developed and developing countries – the latter confirmed by the Bank's RES. The message for the developing countries is a grim one: With rising energy needs, increasing investment costs (due to inflation), larger balance-of-payments deficits and growing reservations on the credit-worthiness of the DMCs, they would have to rely mainly on themselves in coping with their energy problem. Some outside help could be expected – channeled mainly through the World Bank and regional development banks like the ADB. The resources of these Banks will of course need to be very considerably strengthened for the purpose. Besides finances, institutional reforms and manpower development will also be required in DMC's.

### The Case for Mini-Hydropower

Where does mini-hydropower or, for that matter, hydropower as such, figure in this overview of the Asian energy problem? What is its relevance? What are the prospects? What priorities does it enjoy, or should it correctly enjoy? How can the prospects be actually realized? The following fact stands out in the renewed worldwide search for energy resources. Hydropower is the one renewable energy resource with which mankind has been familiar the longest and for which well developed and highly efficient energy conversion technology<sup>2</sup> is available. Harmful environmental impact of hydropower is generally minimal except for land submergence under reservoirs, and in the case of mini-hydropower, nil. Most importantly, it is hydropower that is most suitable for developing countries to harness on the basis of self-reliance and self-help. India, for example, has been getting 40% of its electrical energy from hydropower. The larger proportion of the investments are in the form of civil works, which are generally within the capabilities of the developing countries.<sup>3</sup> Even the plant and equipment required are relatively simple and, in the case of mini-hydropower, capable of being manufactured in the developing countries. Many DMC's are making significant progress in this direction.

<sup>1</sup> "Mini" connotes different magnitudes in different countries. For the present purpose "mini" refers to unit sizes of up to 1,000 kW.

<sup>2</sup> The conversion efficiency from the natural resource to electricity is 85-90% for hydropower compared to 20-35% for thermal resources (fossil fuels, nuclear, geothermal).

<sup>3</sup> Only the small island countries in the Pacific Ocean would be the exceptions.

These include Nepal, Thailand and the Philippines. Better equipped countries like India and Korea are already self-sufficient.

Mini-hydropower, where feasible, provides an attractive means of achieving rural electrification. A large proportion of the poor in the developing countries live in the rural areas. Rural electrification, therefore, means much more than what various, purely financial or economic ratios may indicate. Electrification brings with it a sense of modernization, a better quality of life, and most importantly, a means of employment and economic activity all year round. However, rural electrification is costly and the cost of the traditional paths, *viz.* extension of the national grid or the setting up of isolated diesel-electric plants, are increasingly costly. In the 1950's and 1960's, diesel sets provided an economical means of opening up and electrifying new areas, but increasing oil prices and higher transportation costs for carrying the oil to remote areas has made this means of electrification prohibitive. This has resulted in mini-hydropower coming back into its own for the following main reasons: (1) it gives, hopefully, cheaper electricity; (2) not requiring any imported energy, it is independent and also, therefore, more secure.<sup>4</sup> (3) it conserves resources, particularly kerosene and diesel oil required for lighting and for powering the irrigation pumps and agro-industries; and (4) it injects technology into the rural areas.

### Retrospect and Prospects

The main reason why hydropower and, much more so mini-hydropower with all its advantages, is not seen to be playing a larger role in energy programs is that hydropower is available only at certain specific sites, often very inconveniently located. The requirement of additional investment on access roads, the long time required for adequate investigations and construction of large civil works (in the case of large hydro developments), and high investment costs, have served as deterrents – particularly during the past decades in the era of cheap oil.

The Bank's Regional Energy Survey shows that by 1978-79, approximately 23% of the total electric generating capacity in its DMC's consisted of hydropower. The total identified hydropower potential is

substantial, amounting to some 165 GW, but the developed potential is only 6.4 GW (this excludes India, which has hydropower installation of over 12 GW). In a number of countries, particularly in Afghanistan, Indonesia, Nepal, Malaysia, Papua New Guinea and the Philippines, the potential may actually be much higher as the existing surveys are rather incomplete. The older surveys also need to be updated in most countries as, with increasing fuel prices, more and more hydropower potential comes within practical possibilities every year. The mini-hydropower potential is small compared to the total hydropower potential. In Norway,<sup>5</sup> for example, where water power has been intensively and extensively developed (99.8% electricity comes from hydropower), 156 stations are mini-hydro (out of a total of 587) but they contribute only 0.2 TWh in the total annual generation of 86.8 TWh. In India, the mini-hydro installed capacity amounts to only 80 MW in the total hydropower installed capacity of over 12,000 MW.

Mini-hydropower developments come in two forms. One develops modest flows of mountain streams to generate electric power for electrifying remote areas. The other develops power from relatively large steady flows of irrigation canals or water supply schemes by concentrating and using the head available in the water conveyance system. This provides cheap additional energy supply to existing power systems, thus saving fuels.

### Techno-Economic Requirements

The technical requirements for mini-hydropower development are three-fold. First, suitable sites; second, robust and simple electro-mechanical equipment, easy to transport and repair, and possibly capable of being manufactured within the country; third, a simple and cheap water diversion and conveyance system which can deal with local problems (such as silt load in the water, floods, irrigation requirements, use of the stream for timber floating, etc.), and utilize mainly local materials and be capable of being maintained by the local people. The hydraulic works are usually the major item of cost and cause problems in unfamiliar areas. However, such works have been constructed and maintained for centuries for running the water mills on the Himalayan moun-

<sup>4</sup> Some small island countries in the Pacific fear that they would have to go without electricity if the oil tanker does not keep its schedule, and therefore insist on developing hydropower.

<sup>5</sup> Data presented at Eleventh World Energy Conference.

tain streams in India and Nepal by local people. These techniques have been improved upon and, in the late 1950's, a number of standard designs were developed and tried out by the Indian Central Designs Office. Availability of new materials like plastic pipes have made further improvements possible.

In the planning scenario, it is important not to adopt mini-hydro as a creed. Each installation or series of installations, must be justified as the least-cost solution for that area and the future extensions of the power transmission grids must be taken into account. Load promotion activities must be initiated early to achieve early full utilization of the generating capacity by building up the peak load and maximizing the load factor. In fact, integrated rural development with mini-hydro as one of the components is perhaps the best approach. Advance arrangements for the training of operation and maintenance personnel is essential for a successful and reliable operation, thereby building up consumer confidence.

### Current Experience

The developing countries of Asia are aware of the possibilities of mini-hydropower development and some have already gained considerable experience. India has some 153 generating units (totalling about 80 MW of capacity) now in operation in 61 mini-hydro stations, and a further 59 units are under construction in 23 more stations. India also presents some unique experience in canal drop hydro stations. On the Ganga canal, for example, 8 power stations built between 1920 and 1955 are in operation, their 26 units ranging in size from 0.2 to 6.8 MW. Nepal, Afghanistan, Pakistan have also initiated mini-hydro developments for several years. Under the changed circumstances of the energy crisis, Nepal, Malaysia, the Philippines, Western Samoa, Burma and Papua New Guinea have initiated country-wide surveys for identifying sites and planning development.

Four Bank-financed mini-hydro installations are nearing completion in Papua New Guinea. These range in capacity from 200 to 800 kW using 14 to 30 m of head. Each has about 16 km of 22kV transmission line and will supply rural industrial loads. The Bank has approved this year the financing of a mini-hydro-

power project in Nepal under which 8 isolated systems with installed capacities ranging from 200 kW to 1,000 kW will be developed. One of these will also result in the development of irrigation facilities. A central maintenance workshop and training of plant operators and linemen is also provided. One feature of the project is that it provides for transportation of the electro-mechanical equipment by helicopters to the otherwise inaccessible sites. Another is that the planning complements the future expansion of the national grid.

The Bank is also taking an active interest in current mini-hydropower developments in many other countries, notably Malaysia, the Philippines, Burma, Laos, and Western Samoa.

### Conclusion

Summing up, the Asian energy problem is a major factor impeding the economic progress and development efforts of developing countries in the 1980's. Although outside help will be forthcoming, the countries will mainly have to rely on self-help. In this context, mini-hydropower would present an attractive solution wherever suitable sites can be located. Mini-hydropower development may not appear to improve the energy situation significantly; however, its real contribution would be far greater than the numbers would suggest. It would help open up inaccessible remote areas, provide security of electric supply, and most importantly, inject technology and inspire self-confidence which will be valuable in other developmental activities. Considerable awareness of this has already been generated and institutions like the Bank are already oriented to assist in this developmental effort.

The developing countries and the financing agencies assisting them stand to benefit considerably by conferences like this where all the various aspects of prospective mini-hydro developments are considered. Some very useful information and cross-fertilization of ideas resulted from the seminar-workshops organized by the United Nations Industrial Development Organization (UNIDO) in Kathmandu, Peking and Manila in the last two years. I trust that the current seminar-workshop will make a further significant contribution in this international effort.

S.N. Vinze has been active in power engineering for 34 years. He developed and made trial installations of standard designs for water diversion and water conveyance structures for mini-hydro plants during 1957-1960. From 1969 to 1970 he served as a member of the power economy committee of the Indian Power Sector. Since 1978 he has been responsible for ADB Management of the Loan and Technical Assistance Program in the Power Sector, Loan Administration, formulation and guidance of institutional/sectoral development plans for the power sector in 23 borrowing countries.

# The Planning of Mini-Micro Hydropower Projects in Thailand

Mohar Singh Monga\*

**ABSTRACT :** This paper examines the present state of hydropower facilities in Thailand, and the country's total potential and development plans. An outline of technological considerations in the planning process is provided, together with a discussion of the economic aspects involved and the availability of funding sources for small hydropower development.†

## Introduction

**T**HAILAND, like other developing countries, has faced severe economic strains since the oil crisis in 1973. To meet with the ever-increasing demand for energy, it is looking into the development of all possible resources to help reduce the consumption of oil, which presently is the main source of energy. Investigations are being carried out for the development of biomass, wind, solar, geothermal, hydropower and other indigenous resources, should they prove economically viable.

Hydropower facilities are proving to be a more competitive source of energy, especially those of medium and large size capacities. Rural development is also being accelerated, and providing an adequate energy supply to these areas is gaining a prominent place in development plans. One way of meeting the rural development goal is through mini- and micro-hydropower resources. An estimate of the hydro potential of the country by Prapath Premmani, based on a 1:250,000 scale map covering an area of 68,760 km<sup>2</sup>, gave a figure of 1,066 MW. The areas investigated were divided into six zones where the flow varied from 2.05 litre/sec/km<sup>2</sup> to 10.55 litre/sec/km<sup>2</sup>.

An inventory on hydropower potential for me-

dium and large projects totalling 136 projects prepared in 1978 showed that there is a possibility of developing at least 24,576.9 MW of hydropower, which would yield an annual energy production of 106,710.5 x 10<sup>6</sup> kWh. The figures given include the potential on international rivers.

The estimated potential of one big river basin in the northern part of the country showed that there are 100 sites which can be developed as mini-hydro plants, giving a total capacity of 113 MW and capable of generating 432 x 10<sup>6</sup> kWh of energy.

As no clear definition exists with regard to the terminology of micro, mini, medium or large hydropower projects, these terms are here defined as:

Type of Plant	Capacity (in kW)
Micro	0 – 100
Mini	100 – 6,000
Medium	6,000 – 20,000
Large	> 20,000

The medium and large projects are usually all interconnected to the main systems, which serve almost all the provinces of the country. There are a number of districts not connected to the system which are served by diesel generating plants, and there are

\* Chief, Investigations Planning Division National Energy Administration Thailand. The views expressed in this paper are personal, and do not necessarily concur with those of the National Energy Administration.

† Editor's abstract.



also rural areas where no electricity is supplied. To supply electricity to rural areas needs the extension of the existing distribution networks into the areas concerned, which is a fairly expensive operation and one which is not likely to be an attractive solution. The other method would be to install more diesel generating units, which have a low investment cost when compared to other sources. But the rise in fuel costs has made the operation of diesel plants more expensive and less attractive. It is in these areas that mini- and micro-hydro schemes are now playing an important role.

There are presently about 276 diesel generating plants throughout the country with about 90 MW capacity. These plants consume about 33 million litres of oil a year. Many of them operate for only a few hours a day, and since a large number of them are rather old, the reliability of supply cannot be guaranteed. Mini- and micro-hydro projects currently under way envisage the replacement of diesel plants in areas where the development of mini and micro plants proves feasible.

Development of each mini-hydropower project takes considerable time. If the development of a whole basin is planned, it may require more than a decade before the work is completed. A basin in the north of Thailand which has 10 projects can be considered as an example. Assuming that the funds available, or which could be obtained from foreign sources, are sufficient for 5 projects to be developed per year, and each project takes 3 years to complete, it would take 23 years to develop the whole basin. This example shows the magnitude of the task involved in the development of mini and micro resources.

### Planning of Mini- and Micro-Hydropower Projects

The main structural features of medium and large hydropower projects are similar to those of dams, intake structures and powerhouses. The powerhouse normally would be at the toe of the dam. As is the case with similar projects of this sort, mini- and micro-hydro plants have a small weir, a headrace structure, a penstock and a powerhouse. The capacity of a project depends on the available head and the flow. For medium- and large-scale projects, the dam is usually high, making available the desired head, and the flow is regulated from the storage reservoir.

A mini or micro project usually consists of weirs a few meters high, providing no adequate head for the project. It also provides no adequate storage which could be regulated. As catchments are relatively

small, the flows are also relatively restricted. Should the powerhouse be located next to the weir, the project would never be feasible. The only way to make the project attractive is to provide a waterway which would carry the water to a certain extent, assuring a certain head before discharging into a penstock and then to a powerhouse. Obviously, the waterway, which will be referred to as the headrace, would normally be long and would be an item which would account for a major share of the costs of the project. The other components that take a fair share of the costs of the project are the transmission lines, power plants, and road construction to the site.

### Costs of project

Obviously, one main criterion in selecting a project for implementation is the cost of the project. If studies reveal that at a certain cost the project is both financially and economically viable, then the chances that the project will be implemented are very high. Normally, small projects do not have the same economic advantage as medium- or large-scale projects, and often have to be rejected on the grounds that they are too expensive.

The output of a mini or micro project in the form of energy is small and the revenue, especially for a micro-hydro power project, may be so small that it is not even possible to support the staff who are manning the powerhouse. It is imperative that costs should be minimized in every way possible.

Investigation costs should be kept as low as possible. The costs on sub-surface geological investigations, elaborate mapping of areas, and excellent camping facilities should be kept to what is absolutely essential. Elaborate designs and refined feasibility studies may be unnecessary. It is worth remembering that even a hundred thousand dollars saved on the costs could change the picture of the project.

As regards construction, as mentioned earlier, the headrace is usually long, and the costs play a major role. If the headrace is a concrete pipe, transportation costs to the site would be extremely high; consequently it is more practical and much cheaper if the pipes are cast *in situ*. It is well worth trying to reduce the costs which might be involved in this part of the project by utilizing local material and simple techniques. The road need not be very good or even asphalted. Transmission line costs should also be reduced, possibly by using local materials. If concrete poles have to be used, they again may perhaps be cast at the site location. Present technology allows moulds for prestressed concrete poles to be carried into site areas at reasonable costs.

It has been found that at a tariff of US\$0.0625, a 50 kW micro plant would produce a net positive income in the 24th year – at a plant factor of 30%, a unit cost of US\$2,000 per kW, and a discount rate of 12%. The project life is taken to be 30 years. A project with a 600 kW site and 50 years life would produce a net income in the 46th year with the same unit costs and conditions.

In an initial study of 25 mini projects, the project with the lowest unit cost was found to be a project with a capacity of 6,000 kW at US\$1,500 per kW, and the project with the highest cost was found to be a project with a capacity of 400 kW at US\$6,300 per kW.

A study of 5 micro-hydropower projects shows that the costs vary from US\$1,970-\$4,400 per kW.

### Selection of projects

In the initial stages, the following criteria have been used in selecting a project for study:

- the project should be located in an area where it could easily be connected with the existing distribution system. This alleviates doubts as to the possibility of the sale of energy, as the whole energy supply can be fed into the system. It also helps reduce the consumption of oil and contributes to the reliability of the system;
- the project should be situated in an area which is at a distance from the existing distribution system. The project can then serve people in rural areas and accelerate the rural electrification programme of the country.
- the project should lie in an area where the existing supply is obtained by means of diesel generating plants. This will help to replace the diesel plants, provide a continuous supply of electrical energy, and help reduce the consumption of oil;
- the project should be located in areas where there are promising uses, such as the use of electric pumps for irrigation and use in local industries. A project of this nature would have some pondage capabilities. The pond would also provide fish to the villagers, possibly as a source of extra income; and,
- turbines and generators should be installed at existing irrigation projects. These should tie in with the national grid.

### Development Plan

In developing mini- and micro-hydropower

projects, development plans for the mini-hydro projects and micro-hydro projects should be made separately.

### Mini-hydro projects

As can be seen from the figures mentioned earlier, there are already more than 100 projects for development. Assuming that each project takes 3 years to complete, and that each year after the third year 5 projects could be completed, it would take more than 3 decades to complete them all. This is only part of the potential development. The total would take a much longer time.

To be realistic, it is understood that the National Energy Administration (NEA), which is an agency of the government authorized to plan and develop mini- and micro-hydropower resources, has laid out plans for inclusion in the fifth National Economic Development Plan during 1982-1986 to develop 25 mini-hydro power projects. In the sixth plan it is anticipated that the same number would be developed. Revisions might be made to put these projects in line with any changes in national policy and existing conditions.

### Mini-hydro projects

Micro-hydro projects cannot be designed and constructed in the same manner as mini-hydro projects. The latter are usually isolated and serve very small areas. If the investment costs are high, such facilities could not be constructed. Furthermore, the energy demand would also be low. Nevertheless, as a matter of general policy, developments must be made in such rural areas. Such developments will help to stop the influx of job seekers into the city. Projects for small isolated rural areas have to be planned so that they can be completed within one dry season. The design and construction have to be very simple: local labour and materials need to be used, and construction of all structures has to be carried out locally. Locally manufactured turbine generators, transformers, etc. must be used to reduce the high costs. The NEA, in the long term development plan for the country, has proposed developing 5 micro-hydro projects per year in addition to the mini-hydropower projects.

As it appears that the operation of this type of project would not provide revenue sufficient to support the manning of skilled persons at the powerhouse in the early stages, a few projects are planned as pilot projects which would invite participation by the villagers. The project might be operated on a co-operative basis. Details are being worked out, but until they are finalised it will remain uncertain how these projects are to be operated.

### Existing mini- and micro-hydro projects

There are at present 11 mini- and micro-hydro projects which are either in operation, nearing completion, or under construction. The details are given in Table 1.

### Source of Funds

Since Thailand is a developing country, funds are required for numerous development projects. It is doubtful if budget allocations can be made available to develop all the possible hydro resources. Budget allocations could be made available for one or two projects at a time, and it might be necessary to seek funds from foreign sources. Technical assistance or grants could be obtained from various countries. Again, allocations would only be applicable to a very limited number of projects. In order to develop the projects as planned, foreign loans would have to be sought. The cost of each particular project is not so great, in the sense that loans for individual projects may be obtained through interested loaning agencies. Moreover, a number of projects could be combined into a package which would be attractive to loaning agencies.

As the interest in developing these resources have increased universally, a number of industrialised countries have indicated their willingness to provide grants for feasibility studies, and for financing design, engineering and supervision services, as well as developing off-shore products. A number of proposals are being made from different countries, but each has to be examined carefully with regard to the terms offered, and the degree of flexibility and competitiveness they allow.

USAID has made offers for the development of 10 micro projects and two mini projects in the form of loans and grants combined. A few countries have also made offers to provide engineering services, detailed design information, and components from abroad.

### Conclusion

It can be anticipated that the trend of development in mini- and micro-hydropower projects will increase at a rapid pace in the next decade. Research and development to standardise power plant equipment will contribute to lowering the costs of machinery, and the application of appropriate local technologies will help make the projects more attractive.

### Reference:

1. PREMMANI, PRAPATH, *Development of Mini-micro Hydroplants in Thailand*, Paper submitted to the Workshop on Mini/Micro Hydro Plants, Kathmandu, Nepal, September (1979).

### Discussion

*Questioner from the Audience:* As Mr. Singh mentioned, the common problem faced in developing mini-hydro is limited financing, particularly during the investigation period. Our experience has shown that problems arose afterwards, during the construction period, when we experienced surprises, such as landslides, that caused delays. As a result, people became irritated and political problems arose. To overcome this, according to our experience, the development of mini-hydro should be taken up, not as an individual project, but rather as part of the mis-

Table 1  
Existing and Under Construction Mini-Micro Hydropower Projects in Thailand

Project	Location	Capacity (kW)	Head (M)	Status	Turbine type	Origin of Turbine
Mae Hong Son	Mae Hong Son	800	40	Operating	Francis	Imported
Ban Yang	Chiangmai	112	67	Operating	2 x 50 kW Cross Flow	Imported
Ang Kang	Chiangmai	10	30	Operating	12 kW Francis	Local
Doi Pui	Chiangmai	5	17	Operating	Cross Flow	Local
Na Don	Nakhon Si Thammaraj	15		Operating	Pelton	Imported
Mae Chon	Chiangmai	5	17	Under Rehabilitation	Cross Flow	Local
Mae Kum Luang	Chiangmai	3000	116	Near Completion	Francis	Imported
Huai Nam Dang	Chiangmai	100	70	Operating	Cross Flow	Local
Huai Mae Phong	Phayao	900	400	Under Construction	Pelton	Imported
Mae Sa	Chiangmai	1.5	10	Under Construction	Cross Flow	Local
St. Paul Youth Centre	Chumporn	15	8	Operating	Cross Flow	Local

sion's electric power system development planning program, and as part of the development of the hydro potential resources of the entire country. With this broader approach, a cross-subsidy is possible since overheads can be broadened in a large project to cover personnel, equipment, and so on. I would like to know what Mr. Singh's experience has been in this regard.

*Mr. Singh:* Thank you very much for your interesting point. Usually the cost is already subsidized by the government in one way or the other. The construction work for our mini-hydro projects is not usually carried out by consultants. Much of the work is done by the staff of the National Energy Administration, so these costs are not shown as a cost of the project. In one way or another, they are being subsidized.

*Dr. Roger Arndt, U.S.:* I had a question for Mr. Singh on the slide showing the relative cost of turbines manufactured locally and those which are imported. There was a significant difference in the cost and also a significant difference in the efficiency. I am curious to know whether the best of both worlds couldn't be achieved by some sort of licensing agreement with foreign manufacturers so that the designs could be utilized and manufactured locally, thereby keeping the cost down, but raising the efficiency.

*Mr. Singh:* We have looked into the question of a licensing agreement; but during the past eight years, only three or four micro-hydro projects have been constructed. If this rate continues, we think the time is not right for a licensing agreement arrangement since it would not be economically attractive to the manufacturers.

*Mr. S.T.S. Mahmood, Bangladesh:* I have a supplementary question to my predecessor's question. If I am right, you quoted 20,000 Baht per kilowatt.\* Was that the cost of electro-mechanical equipment only?

*Mr. Singh:* Yes, that was the cost of the electro-mechanical equipment only, consisting of turbines, generators, governors, and the switchboard.

*Mr. Mahmood:* In addition, you said top priority was given to an area which has access to transmission lines. To my mind, since we are talking about rural energy, this should have been the second priority. Would you kindly elaborate on this?

*Mr. Singh:* I may have misled you on this. The whole purpose is to serve rural areas. We consider those areas that are near the existing distribution network, but where the distribution network has not

yet reached, as first priority. We build up those areas so that the existing system can be expanded, which makes the project look more attractive, in our view.

*Dr. A.N. S. Kulasinghe, Sri Lanka:* I was also interested in the disparity in efficiency and cost between the locally-manufactured machinery and the imported equipment. As far as the cost is concerned, I am not at all surprised because that is our own experience, but I was a little surprised about the difference in efficiency, that the locally-manufactured one was 60%, whereas the imported one was 80%. It really would depend on the type of turbine you are trying to manufacture. I would like to know what these turbines were?

*Mr. Singh:* What I was referring to are cross-flow turbines.

*Dr. Kulasinghe:* That makes it even worse then. Our own experience is that we can make highly efficient cross-flow turbines at relatively low cost, so there must be some problem with your units.

*Mr. Singh:* As I said, the projects that have been developed are very few indeed, so the manufacturing of these turbines is only at a very early stage. Manufacturing three or four turbines doesn't allow much experience to increase efficiency — but of course we are trying to improve on the performance of our turbines.

*Mr. Mahmood:* One more question on the cost issue. Have you tried any low-head, large-flow turbines in your planning?

*Mr. Singh:* Actually when I say cross-flow turbines, I am including Pelton turbines. As you are aware, the catchments are relatively small, so the flow usually is very low, about 300 litres per second per plant. For big irrigation canals, which have huge flows, such as three cubic meters per second, we are still trying to import some of the turbines for installation in these canals. But we have no projects with very large flow with low heads.

*Mr. Waseem Khan, Pakistan:* Mr. Monga said that micro-hydro civil works can be completed in one year. What do you base this time period on — that is, what is the starting point and the completion point in calculating one year?

*Mr. Singh:* I didn't say we finished in one year. I said we *tried* to finish one in one year, in one dry season. (laughter) The time period begins as we go into the field and start constructing the weir, usually in November or December. We try to finish between May or June, before the rain comes, so that the construction is not handicapped.

\*22.2 baht = US\$1 (December, 1982)

# Water Resources Planning for Mini-Hydropower: An Overview of Water Resources in Asia

By Suphat Vongvisessomjai\*

**ABSTRACT :** Seasonal variations of meteorological and hydrological conditions result in floods and droughts which require the planning of water resources in order to store the flood water for use during the drought period. The planning of water resources depends upon types and sizes of projects, the factors involved *etc.* Emphasis will be placed on presenting an overview of water resources in Asia by providing meteorological, hydrological and economic data, as well as various mini-hydropower projects in the region. It can be seen from these data that there is an abundant potential for hydropower generation.

## Introduction

**S**EASONAL variations of meteorological and hydrological conditions result in floods and droughts which require the planning of water resources in order to store the flood water for use during droughts for power generation, *etc.* Planning is necessary to make life better and the essence of planning is not to find the best, but the best possible. Efforts must be made to utilise the huge water resources in Asia (Table 1). The present abundant water resources would certainly be insufficient to satisfy all future needs. With the fast rising oil price, all possible hydropower potential should be identified, because projects uneconomic in the past might be economic at present or in the future.

The planning of water resources depends upon the types and sizes of projects and the other factors involved. Emphasis will be placed on presenting an overview of water resources in Asia or the data required for the planning of these resources.

## Water Resources Planning

Planning is sophisticated work; it involves not only such complexities as technical know-how and economic knowledge but it also depends upon a combination of realistic data, criteria, and a high degree of

skill and experience. The following important factors should be included in water resources planning:

1. technical;
2. economic;
3. environmental;
4. social; and,
5. political.

Water Resources Projects can be classified as follows:

1. hydropower;
2. irrigation;
3. flood control;
4. domestic and industrial water supplies;
5. navigation; and,
6. salinity control.

A system that theoretically has an infinite number of components that can be combined in an infinite number of ways would be unmanageable. It is a judicious choice, for which no methodology can be laid down, that brings the problem down to manageable, though still formidable, proportions.

## Data Required

The data required for water resources planning are meteorological, hydrological, and economic, *e.g.* the demands for power, *etc.* The characteristics of these data for water resources planning in Asia will be presented.

\*Chairman, Division of Water Resources Engineering, Asian Institute of Technology, Bangkok.

Table 1  
Asia-Basic Data of Major International Rivers in the ECAFE<sup>1</sup> Region  
(Sources: UN Water Resources Series No. 29, 1966 or Ref. 1)

River	Riparian countries (A)	Total Length km	Total Drainage area sq km	Precipitation and Runoff <sup>a</sup> (B)			Discharge <sup>b</sup> (B)					Silt flow <sup>c</sup> (B) (by weight; 1m <sup>3</sup> = 1.65 tons)				
				Mean annual rainfall mm	Mean annual runoff mm	Runoff Coefficient %	Max m <sup>3</sup> /sec	Min m <sup>3</sup> /sec	Average m <sup>3</sup> /sec	Specific flood discharge m <sup>3</sup> /sec/sq km	Average unit discharge m <sup>3</sup> /sec/sq km	Max content %	Min content %	Average content %	Average annual silt runoff 1,000 tons	Average annual silt runoff per unit area ton/sq km
Mekong	China, Burma, Laos, Thailand, Cambodia, Viet-Nam	4,350	795,000	1,380	722	52.4	67,000	1,250	14,800	0.014	0.0229	0.31	—	0.06	170,000	435
Red	China, Viet-Nam	1,200	120,000	1,500	1,090	72.7	35,000	700	3,900	0.31	0.0345	0.70	0.01	0.106	130,000	1,080
Brahmaputra	China, India, Bangladesh	2,580	580,000	2,125	1,177	55.4	72,460	2,680	19,200	0.149	0.0372	0.30	—	0.12	735,000	1,370
Meghna	India, Bangladesh	950	80,200	3,500	1,715	49.0	13,100	—	3,515	0.203	0.0543	—	—	—	—	—
Ganges	India, Bangladesh	2,200	977,500	1,250	367	29.4	61,200	1,170	11,610	0.0628	0.0119	0.30	—	0.13	480,000	492
Kosi	Nepal, India	730	86,900	1,790	643	36.0	23,000	150	1,770	0.265	0.0204	5.0	—	0.286	160,000	1,840
Gandak	Nepal, India	425	45,800	—	1,375	—	23,000	200	2,000	0.434	0.0386	—	—	0.312	196,000	4,275
Gogra	Nepal, India	1,020	132,000	960	525	54.7	14,809	320	2,200	0.112	0.0167	—	—	—	—	—
Indus	China, India, Pakistan	2,900	970,000	612	460	75.0	31,200	490	6,770	0.078	0.022	—	—	0.33	680,000	2,230
Sutlej	China, India, Pakistan	1,450	86,000	480	280	58.4	13,900	78	532	0.23	0.009	—	—	—	—	—
Kabul	Afghanistan, Pakistan	480	77,850	450	317	70.5	6,700	118	680	0.10	0.101	1.52	almost nil	0.505	20,400	805
Helmand	Afghanistan, Iran	1,050	370,000	250	32.4	13.0	17,000	—	286	0.061	0.0012	—	—	—	—	—

NOTE: (A) Those countries having within their boundaries a significant portion of the drainage of the stream under consideration.

(B) The location or portion of the drainage area commanded by the gaging stations for precipitation and runoff, discharge and silt flow given under (a), (b) and (c) for the respective rivers are shown below. Figure within brackets indicates the drainage area above the station in sq km.

Mekong	(a) Rainfall—whole basin; Runoff—Kratie(646,000). (b) Kratie(646,000). (c) For max. silt content—Vientiane(299,000); for average silt content and annual silt runoff—Mukdahan(391,000).	Kosi	(a) Whole river basin. (b) Chatra(86,900) (c) Chatra (86,900).
Red	(a) Whole river basin (b) Max. and average at Vietri(113,000), min. at Hanoi (c) Max. min. and av.—at Hanoi; silt runoff—whole basin.	Gandak	(a) Whole river basin (b) Outfall
Brahmaputra	(a) Whole river basin (b) Max. and Min—Pandu(424,309); Av. Bahadurabad(536,600) (c) Bahadurabad(536,600)	Gogra	(a) Whole river basin (b) Outfall
Meghna	(a) Rainfall—whole basin; Runoff—Bhairab Bazar(64,700) (b) Bhairab Bazar(64,700)	Indus	(a) Hills catchment (b) Max.—Sukkur, Min.—Kalabagh(305,000), av.—Sukkur; specific discharge and average unit discharge—Attock. (c) Hills catchment—Kulabagh(305,000)
Ganges	(a) Rainfall—whole basin; Runoff—Hardinge Bridge (b) Hardinge Bridge(976,200). (c) Hardinge Bridge(976,200).	Sutlej	(a) Rupar(60,500) (b) Rupar(60,500)
		Kabul	(a) Whole river basin (b) Warsak(67,500) (c) Sarobi(25,350)
		Helmand	(a) Whole river basin (b) Qal eh Bist(278,000)

— Information not available.

<sup>1</sup> ECAFE—Economic Commission for Asia and the Far East (United Nations).

Table 1 (Continued)

<b>Total drainage area</b>	795,000 sq km	307,000 sq mi	<b>Average annual discharge</b>		
Drainage area of the lower basin in Laos, Cambodia, Thailand and Viet-Nam	609,000 sq km	236,000 sq mi	at Chiang Saen (1961-63)	2,770 m <sup>3</sup> /sec	97,700 cfs
Drainage area at Chiang Saen (near Burma border)	189,000 sq km	73,000 sq mi	at Vientiane (1923-44 and 1948-63)	4,575 m <sup>3</sup> /sec	161,500 cfs
Drainage area at Vientiane	299,000 sq km	115,500 sq mi	at Kratie (1933-44, 1946-53 and 1960-63)	14,800 m <sup>3</sup> /sec	522,000 cfs
Drainage area at Kratie (547 km from the sea)	646,000 sq km	250,000 sq mi	<b>Minimum discharge</b>		
			at Chiang Saen	570 m <sup>3</sup> /sec	20,100 cfs
			at Vientiane	701 m <sup>3</sup> /sec	24,800 cfs
			at Kratie	1,250 m <sup>3</sup> /sec	44,100 cfs
<b>Length of main river</b>	4,350 km	2,700 mi	<b>Specific flood discharge at Kratie</b>	0.104 m <sup>3</sup> /sec/sq km	9.50 cfs/sq mi
from source to Chiang Saen (upper basin)	1,955 km	1,215 mi	<b>Average unit discharge at Kratie</b>	0.0229 m <sup>3</sup> /sec/sq km	2.10 cfs/sq mi
from Chiang Saen to the sea (lower basin)	2,395 km	1,485 mi	<b>Maximum annual runoff at Kratie (1939)</b>	567 billion m <sup>3</sup>	460 million acre ft
<b>Slope of river</b>			<b>Average annual runoff</b>		
from source to China border	1:400		at Chiang Saen (1961-63)	87.3 billion m <sup>3</sup>	70.7 million acre ft
from China border to Vientiane	1:2,900		at Vientiane (1923-44 and 1948-63)	150 billion m <sup>3</sup>	121.5 million acre ft
from Vientiane to river mouth	1:16,000		at Kratie (1933-44, 1946-53 and 1960-63)	467 billion m <sup>3</sup>	378 million acre ft
<b>Average annual precipitation over river basin</b>	1,380 mm	54.5 in	<b>Mean annual runoff expressed in depth at Kratie</b>	722 mm	28.4 in
			<b>Minimum annual runoff at Kratie (1936)</b>	39 billion m <sup>3</sup>	317 million acre ft
<b>Maximum flood discharge</b>			<b>Maximum silt content at Vientiane</b>	3,076 ppm	or 0.31 %
at Chiang Saen	11,900 m <sup>3</sup> /sec	420,000 cfs	<b>Average silt content at Mukdahan (1962)</b>	597 ppm	or 0.06 %
at Vientiane	20,800 m <sup>3</sup> /sec	735,000 cfs	<b>Average annual silt runoff at Mukdahan (1963)</b>	170 million metric tons	
at Kratie	67,000 m <sup>3</sup> /sec	2,360,000 cfs	<b>Average annual silt runoff per unit area at Mukdahan (1963)</b>	435 m tons/sq km	1,100 long tons / sq mi

### Meteorological conditions

Most countries in Asia are under the influence of a tropical monsoon climate characterised by two major seasons. The southwest monsoon from mid-May through September, during which hot, moist, equatorial air masses traverse these countries, brings moderate to heavy rains and winds from the southwest and west. The northeast monsoon, from November

to mid-March, brings a reversal of these conditions, with dry air movement and little or no rainfall. Besides the tropical monsoon, Asian countries suffer from two sources of tropical cyclones; one in the Pacific and Far-East, and the other in the Indian Ocean or the Bay of Bengal. Table 2 shows data of the monthly mean temperature and precipitation at some stations in Southeast Asia. Humidity and evaporation data are also important for water resources planning.

**Table 2**  
(Ref. 2) – Monthly Mean Temperature and Mean Precipitation at Some Stations in Southeast Asia

Station	N E		Jan.	Feb.	Mar.	Apr.	May.	June	July	Aug.	Sept.	Oct.	Nov.	Dec.	Mean and Total	Period
Saigon (Vietnam)	10°47'	temp.	25.8	26.3	27.8	28.8	28.2	27.4	27.1	27.1	26.7	26.5	26.1	25.7	27.0	51-60 (10)
	106°42'	rain.	6	13	12	65	196	285	242	277	292	259	122	37	1808	51-60 (10)
Hanoi (Vietnam)	21°30'	temp.	15.6	17.2	19.4	23.5	27.3	28.9	28.5	28.5	27.1	24.4	21.4	18.2	23.3	
	105°52'	rain.	18	29	39	79	193	234	322	333	248	116	44	18	1673	
Phnom Penh (Cambodia)	11°33'	temp.	26.1	27.5	28.9	29.4	28.8	28.1	27.6	27.7	27.3	27.2	26.4	25.4	27.6	31-60 (30)
	104°51'	rain.	9	8	28	73	146	129	129	147	231	250	134	36	1320	31-60 (30)
Savannakhet (Laos)	16°33'	temp.	21.3	24.1	27.2	28.9	28.3	27.9	27.3	27.1	26.6	25.3	26.7	21.1	25.9	51-60 (10)
	104°45'	rain.	6	18	22	93	171	247	239	324	278	59	3	0	1406	51-60 (10)
Vientiane (Laos)	17°57'	temp.	21.5	23.8	26.7	28.8	28.4	28.1	27.7	27.4	27.1	26.4	24.4	21.4	25.9	51-60 (10)
	102°34'	rain.	51	14	25	78	209	260	259	354	399	50	14	1	1714	51-60 (10)
Bangkok (Thailand)	13°44'	temp.	26.1	27.6	29.2	30.3	29.8	28.9	28.4	28.2	27.9	27.6	26.7	25.5	28.0	51-60 (10)
	100°30'	rain.	9	29	34	89	166	171	178	191	306	255	57	7	1492	31-60 (30)
Chiangmai (Thailand)	18°47'	temp.	21.3	23.1	23.4	29.0	28.8	27.9	27.4	27.0	26.8	26.2	24.4	21.5	25.6	51-60 (10)
	98°59'	rain.	7	12	15	49	144	146	188	231	289	126	39	10	1254	31-60 (10)
Nakhon-Ratchasima (Thailand)	14°58'	temp.	23.4	26.5	28.6	30.0	29.5	28.7	28.2	27.9	27.4	26.2	24.3	22.5	27.0	51-60 (10)
	102°07'	rain.	7	33	45	83	157	111	132	139	244	171	37	3	1162	31-60 (30)
Rangoon (Burma)	16°46'	temp.	24.3	25.2	27.2	29.8	29.5	27.8	27.6	27.1	26.8	26.3	27.7	25.0	27.3	51-60 (10)
	96°10'	rain.	8	5	6	17	260	524	492	574	398	208	34	3	2530	51-60 (10)
Mandalay (Burma)	21°59'	temp.	20.2	23.0	27.5	31.8	30.9	29.6	29.5	28.6	28.8	28.1	25.1	22.2	27.1	51-60 (10)
	96°06'	rain.	3	0	16	14	151	110	77	99	127	152	25	2	776	51-60 (10)
Kuala Trengganu (Malaysia)	5°20'	temp.	26.7	27.4	27.7	28.7	27.9	27.4	27.1	27.4	27.0	27.0	27.0	26.7	27.2	24-36
	103°08'	rain.	292	163	160	155	135	109	117	147	191	279	610	554	2912	24-41 (15)
Labuan (Malaysia)	5°17'	temp.	27.2	27.5	28.0	28.0	27.8	28.1	27.8	27.5	27.5	27.5	27.2	27.2	27.5	16-54 (21)
	115°16'	rain.	112	117	150	297	345	351	318	297	417	465	419	285	3573	16-54 (14)
Singapore	1°18'	temp.	26.1	26.7	27.2	27.6	27.8	27.4	27.3	27.3	27.3	27.2	26.7	26.3	27.1	51-60 (10)
	103°50'	rain.	285	164	154	160	101	127	183	230	102	184	236	306	2282	51-60 (10)
Jakarta (Indonesia)	6°11'	temp.	25.9	25.9	26.3	26.4	26.9	26.6	26.5	26.7	27.0	27.0	26.7	26.2	26.6	11-40
	106°50'	rain.	300	300	211	147	114	97	64	43	66	112	142	203	1799	64-45 (28)
Balikpapan (Indonesia)	S 1°17'	temp.	26.1	26.4	26.4	26.1	26.4	26.1	25.6	26.1	26.1	26.4	26.1	26.1	26.1	(6)
	116°51'	rain.	201	175	231	208	231	193	180	163	140	132	168	206	2228	(43)
Manila (Philippine)	14°31'	temp.	25.4	26.1	27.2	28.9	29.4	28.5	27.9	27.4	27.4	27.2	26.4	25.4	27.3	51-60 (10)
	121°00'	rain.	18	7	6	24	110	236	253	480	271	201	129	56	1791	51-60 (10)
Chittagong (E. Pakistan)	22°21'	temp.	19.9	23.6	25.6	27.7	28.3	27.8	27.5	27.6	27.8	27.3	24.1	20.7	25.7	31-60 (30)
	91°50'	rain.	10	23	58	116	285	507	642	572	344	228	56	17	2658	31-60 (30)



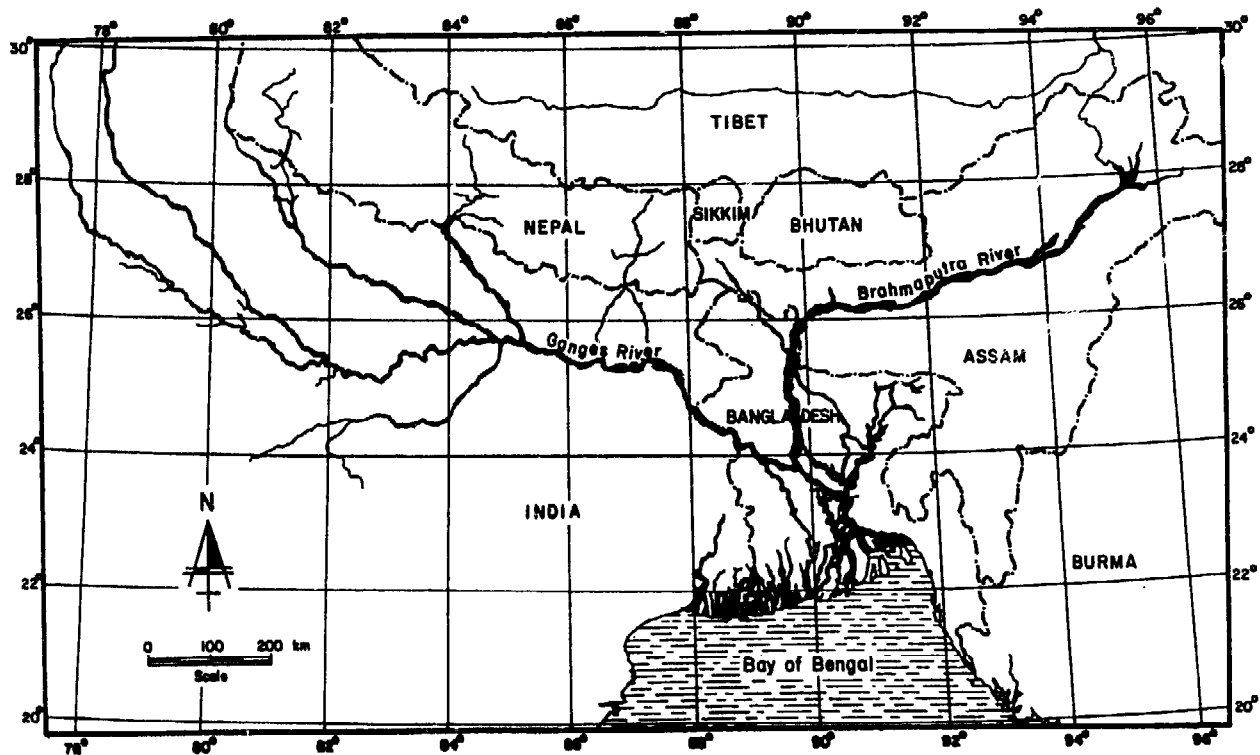

Fig. 1 The Ganges, the Brahmaputra and the Meghna Rivers

### Hydrological conditions

Typical river systems in Asia, the Ganges and Brahmaputra, the Mekong, and the Chao Phraya River of Thailand are shown in Figs. 1-3. Other important rivers in the region are listed in Table 1.

### Electricity generation growth

The electricity supply industries in Asian countries have a history of expansion at a rate of about 10% per year. Examples of installed generating capacity of hydroelectricity in 1971, 1974 and 1976 are listed in Tables 3, 4 and 5 respectively. Figs. 4 and 5 show the curves of generation of all types of electricity from 1966-1974 and from 1970-1976 respectively, for various developing countries for the medium range of production of electricity. The installation schedule of electric power plants in Thailand is shown in Fig. 6.

### Mini-Hydropower

Hydropower is a clean, abundant, and ever-renewable source of power. Its greatest advantage is its environmental acceptability. Hydroelectric projects are capital intensive, and hence are very sensitive to the financing terms for the capital investment required to construct them. However, the annual costs of operation of such a project are low, being only 10 to 15% of

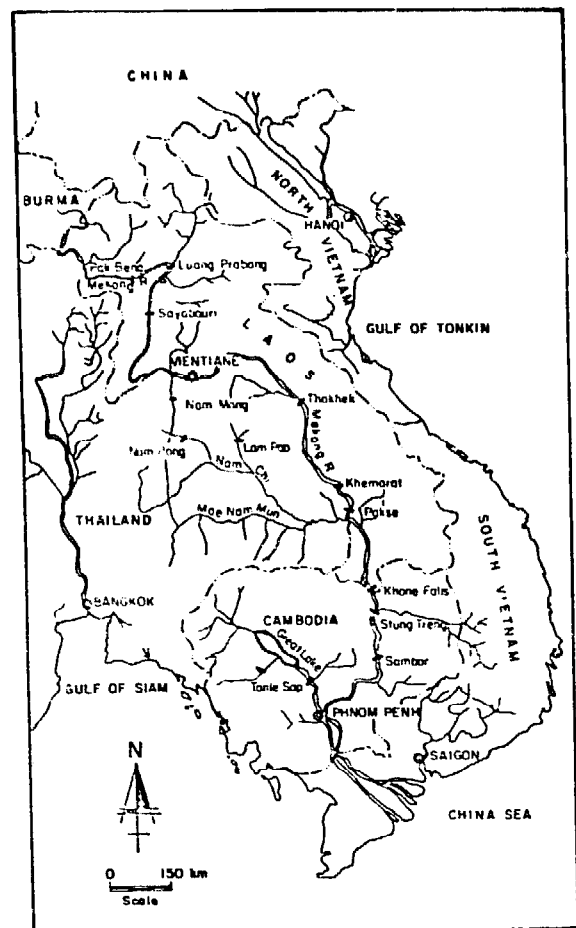

Fig. 2 The Mekong River

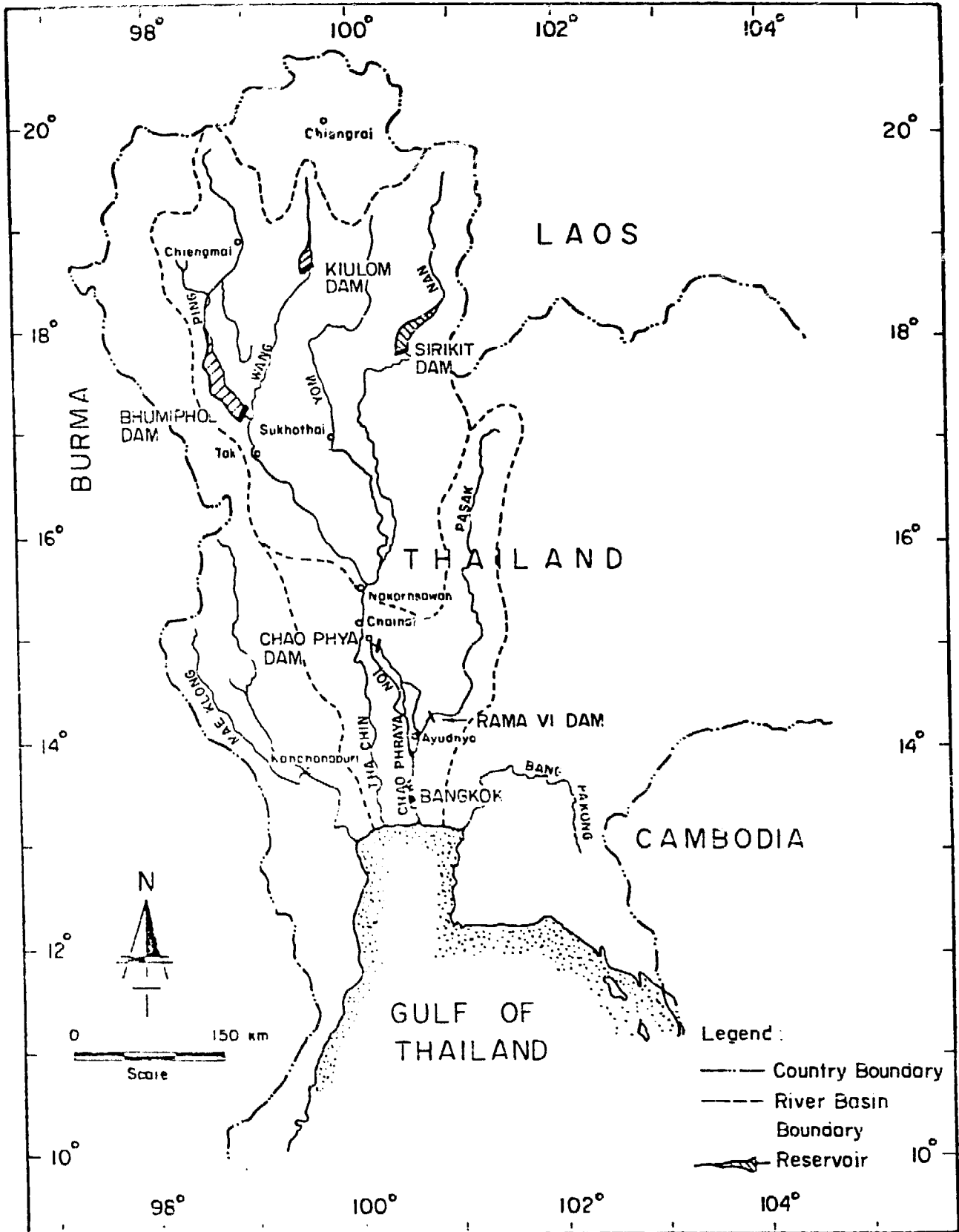

Fig. 3 The Chao Phraya River and Its Tributaries

**Table 3**  
**Asia-Hydroelectric and Thermal Power Generating Capacity and Production, 1968**  
 (Source: (U.S. Federal Power Commission, 1971 or Ref. 1)

Country	Installed capacity (MW.) <sup>1</sup>			Energy production (GWh.) <sup>2</sup>			Population (1,000)	Kwh. per capita
	Hydro	Thermal	Total	Hydro	Thermal	Total		
Afghanistan	241	34	275	298	24	322	16,113	20
Burma	103	157	260	341	199	540	26,389	20
Cambodia	0	57	57	0	122	122	6,557	19
Ceylon	113	104	217	472	199	671	11,964	56
China (Mainland)	4,200	11,700	15,900	13,000	29,000	42,000	730,000	58
China-Taiwan	721	1,341	2,062	3,864	6,172	10,036	13,466	745
Hong Kong	0	1,054	1,054	0	3,718	3,718	3,925	947
India	5,910	8,404	14,314	20,117	26,776	46,893	523,893	90
Indonesia	283	382	665	941	742	1,683	112,825	15
Iran	309	1,642	1,951	848	3,988	4,836	27,081	179
Iraq	0	651	651	0	1,542	1,542	9,030	171
Israel	0	1,020	1,020	0	5,244	5,244	2,745	1,910
Japan	17,841	35,346	53,187	73,928	190,717	264,645	101,080	2,618
Jordan	0	60	60	0	150	150	2,103	71
Korea (North)	2,210	515	2,725	10,800	3,000	13,800	13,000	1,062
Korea (South)	327	1,126	1,453	927	5,147	6,074	30,470	199
Laos	0	13	13	0	32	32	2,825	11
Lebanon	198	176	374	756	260	1,016	2,580	394
Macau	0	18	18	0	46	46	260	177
Malaysia <sup>3</sup>	195	507	702	796	2,163	2,959	10,305	287
Mongolia	0	185	185	0	342	342	1,210	283
Nepal	14	24	38	40	15	55	10,652	5
Pakistan	913	1,102	2,015	3,100	3,205	6,305	123,405	51
Philippines	547	1,819	1,736	1,703	5,020	6,723	35,883	187
Saudi Arabia <sup>4</sup>	0	904	904	0	3,058	3,058	7,840	390
Singapore	0	464	464	0	1,549	1,549	1,988	779
Southern Yemen	0	83	83	0	172	172	1,195	144
Syria	16	200	216	44	700	744	5,701	131
Thailand	381	516	897	1,390	1,566	2,956	33,693	88
Turkey	733	1,240	1,973	3,172	3,657	6,829	33,539	204
USSR <sup>5</sup>								
Vietnam (North)	5	182	187	10	460	470	20,700	23
Vietnam (South)	164	274	438	15	753	768	17,414	44
<b>Total 1968</b>	<b>35,424</b>	<b>70,645</b>	<b>106,069</b>	<b>136,562</b>	<b>299,738</b>	<b>436,300</b>	<b>1,939,435</b>	<b>225</b>

<sup>1</sup> MW.—Megawatts—Thousand Kilowatts.

<sup>2</sup> GWh.—Gigawatt-hours—Million Kilowatt-hours.

<sup>3</sup> Includes Malaya, Sabah, Sarawak.

<sup>4</sup> Includes Saudi Arabia, Bahrain, Kuwait.

<sup>5</sup> Included in USSR—Europe.

**Table 4 (Ref. 5)**  
**Installation Generating Capacity of Public Electric Utilities and Self-Generating Industries, by Ownership and Type of Prime Mover, 1973 and 1974 (in Megawatts)**

Country and year (1)	Public electric utilities			Self-generating industries (5)	Total (6)	
	Publicly-owned (2)	Privately-owned (3)	Total (4)			
ESCAP region <sup>a</sup>	1973	27,029.7	14,937.6	41,967.3	1,078.5	43,045.8
	1974	28,648.3	15,848.6	44,496.9	1,076.5	45,573.4
Afghanistan	1973	216.0	19.6	235.6	—	235.6
	1974	216.0	19.6	235.6	—	235.6
Australia	1973	5,034.9	—	5,034.9	—	5,034.9
	1974	5,534.9	—	5,534.9	—	5,534.9
Bangladesh	1973	80.0	—	80.0	—	80.0
	1974	80.0	—	80.0	—	80.0
India	1973	6,688.0	277.0	6,965.0	3.0	6,968.0
	1974	7,249.0	280.0	7,529.0	3.0	7,532.0
Indonesia	1973	404.0	—	404.0	—	404.0
	1974	404.0	—	404.0	—	404.0
Iran	1973	804.0	—	804.0	—	804.0
	1974	804.0	—	804.0	—	804.0
Japan	1973	7,121.0	14,398.0	21,519.0	1,070.0	22,589.0
	1974	7,172.0	15,306.0	22,478.0	1,068.0	23,546.0
Malaysia: West	1973	266.2	27.0	293.2	—	293.2
	1974	266.2	27.0	293.2	—	293.2
Nepal	1973	35.9	—	35.9	—	35.9
	1974	36.4	—	36.4	—	36.4
New Zealand	1973	3,590.6	—	3,590.6	...	3,590.6
	1974	3,591.7	—	3,591.7	...	3,591.7
Pakistan <sup>b</sup>	1973	867.0	—	867.0	—	867.0
	1974	867.0	—	867.0	—	867.0
Papua New Guinea	1973	37.8	—	37.8	5.5	43.3
	1974	49.8	—	49.8	5.5	55.3
Philippines	1973	591.0	16.0	607.0	—	607.0
	1974	590.0	16.0	606.0	—	606.0
Republic of Korea	1973	421.1	200.0	621.1	—	621.1
	1974	421.1	200.0	621.1	—	621.1
Republic of South Viet-Nam	1973	163.9	...	163.9	—	163.9
	1974 <sup>b</sup>	163.9	...	163.9	—	163.9
Sri Lanka	1973	191.0	—	191.0	—	191.0
	1974	291.0	—	291.0	—	291.0
Thailand	1973	516.0	—	516.0	—	516.0
	1974	910.0	—	910.0	—	910.0
Western Samoa	1973	1.3	—	1.3	—	1.3
	1974	1.3	—	1.3	—	1.3

<sup>a</sup> No data available for Bhutan, Burma, Cambodia, China, Gilbert Islands, Laos, Trust Territory of the Pacific Islands or Tuvalu.

During the period reviewed above, there were no hydroelectric generating stations in Brunei, Cook Islands Fiji, Hong Kong, East Malaysia, Mongolia, Nauru, Singapore, Solomon Islands or Tonga.

<sup>b</sup> Preliminary figures not confirmed, or latest figures not available.

**Table 5 (Ref. 6)**  
**Installed Generating Capacity of Public Electric Utilities and Self-Generating Industries, by Ownership and Type of Prime Mover, 1975 and 1976 (in MW)**

**A. Hydro (generators driven by water-wheels)**

Country or area and year	Public electric utilities			Self-generating industries	Total	
	Publicly owned	Privately owned	Total			
(1)	(2)	(3)	(4)	(5)	(6)	
ESCAP region <sup>a</sup>	1975	29,642.6	16,916.1	46,558.7	1,070.0	47,628.7
	1976	29,825.9	17,975.1	47,801.0	1,053.0	48,854.0
Afghanistan <sup>b</sup>	1975	216.0	19.6	235.6	—	235.6
	1976	216.0	19.6	235.6	—	235.6
Australia	1975	5,534.9	—	5,534.9	—	5,534.9
	1976	5,534.9	—	5,534.9	—	5,534.9
Bangladesh <sup>b</sup>	1975	80.0	—	80.0	—	80.0
	1976	80.0	—	80.0	—	80.0
India	1975	8,183.0	281.0	8,464.0	3.0	8,467.0
	1976 <sup>p</sup>	8,183.0	281.0	8,464.0	3.0	8,467.0
Indonesia	1975	403.5	...	403.5	...	403.5
	1976	445.6	...	445.6	...	445.6
Iran	1975	804.0	—	804.0	—	804.0
	1976	804.0	—	804.0	—	804.0
Japan	1975	7,215.0	16,571.0	23,786.0	1,067.0	24,853.0
	1976	7,275.0	17,630.0	24,905.0	1,050.0	25,955.0
Malaysia:						
Peninsular Malaysia	1975	266.2	27.0	293.2	...	293.2
	1976	265.4	27.0	292.4	...	292.4
Nepal	1975	35.8	0.5	36.3	—	36.3
	1976	35.8	0.5	36.3	—	36.3
New Zealand	1975	3,624.9	—	3,624.9	—	3,624.9
	1976	3,616.9	—	3,616.9	—	3,616.9
Pakistan <sup>b</sup>	1975	867.0	—	867.0	—	867.0
	1976	867.0	—	867.0	—	867.0
Philippines	1975	589.0	17.0	606.0	—	606.0
	1976	589.0	17.0	606.0	—	606.0
Republic of Korea	1975	621.0	—	621.0	—	621.0
	1976	711.0	—	711.0	—	711.0
Samoa	1975	1.3	—	1.3	—	1.3
	1976	1.3	—	1.3	—	1.3
Sri Lanka <sup>b</sup>	1975	291.0	—	291.0	—	291.0
	1976	291.0	—	291.0	—	291.0
Thailand	1975	910.0	—	910.0	—	910.0
	1976	910.0	—	910.0	—	910.0

<sup>a</sup> No data available for Bhutan, Brunei, Burma, China, Cook Islands, Democratic Kampuchea, Lao People's Democratic Republic, Maldives, Papua New Guinea, Tonga, Trust Territory of the Pacific Islands or Viet Nam. There are no hydroelectric generating stations in Fiji,

Gilbert Islands, Hong Kong, Mongolia, Nauru, Sabah, Sarawak, Singapore, Solomon Islands or Tuvalu.

<sup>b</sup> Preliminary figures not confirmed, or latest figures not available.

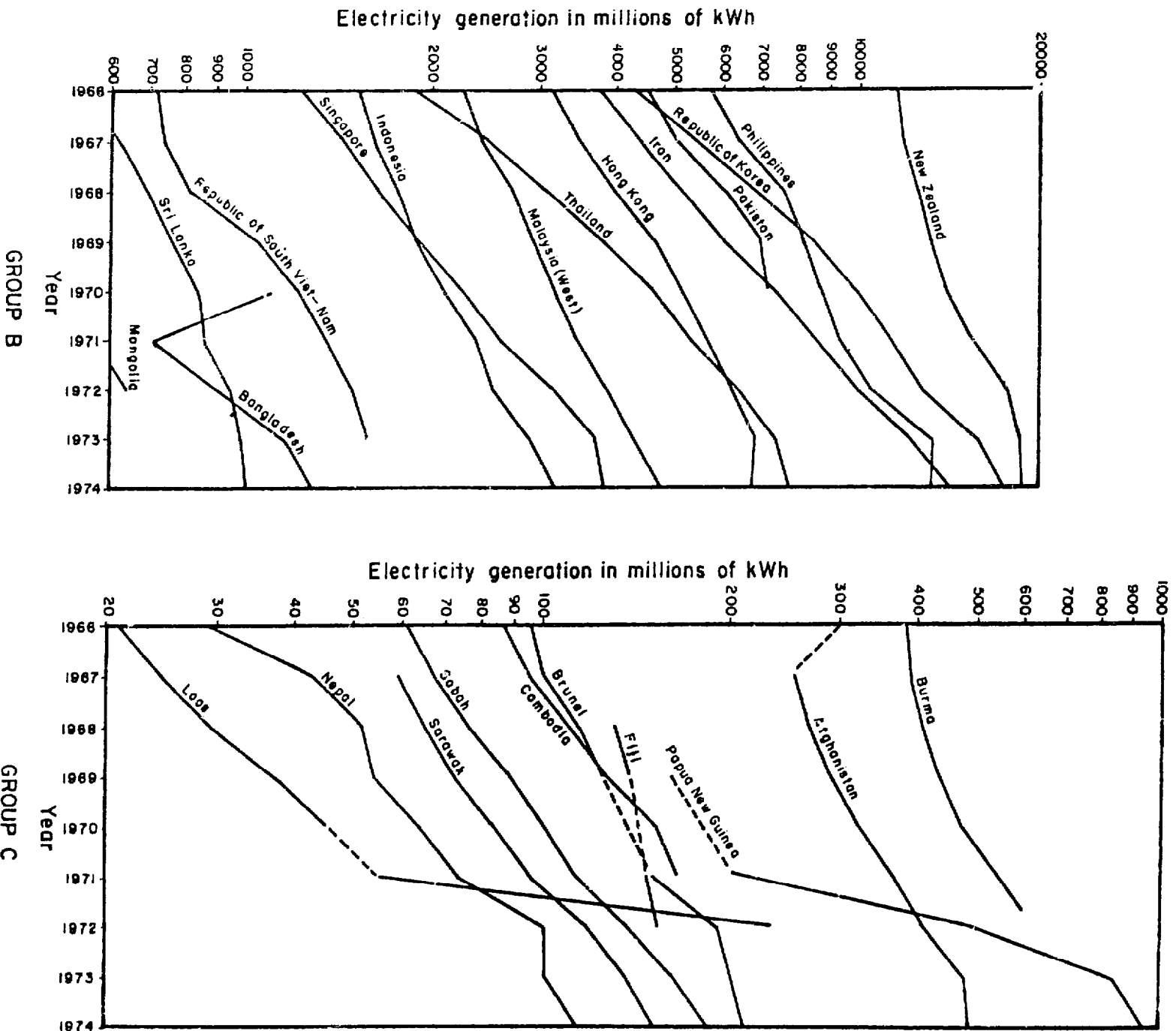

Fig. 4 Rates of Growth of Electricity Generation in 1974  
 Group B - 1,001-20,000 million kWh  
 Group C - 101-1,000 million kWh (Ref. 5)

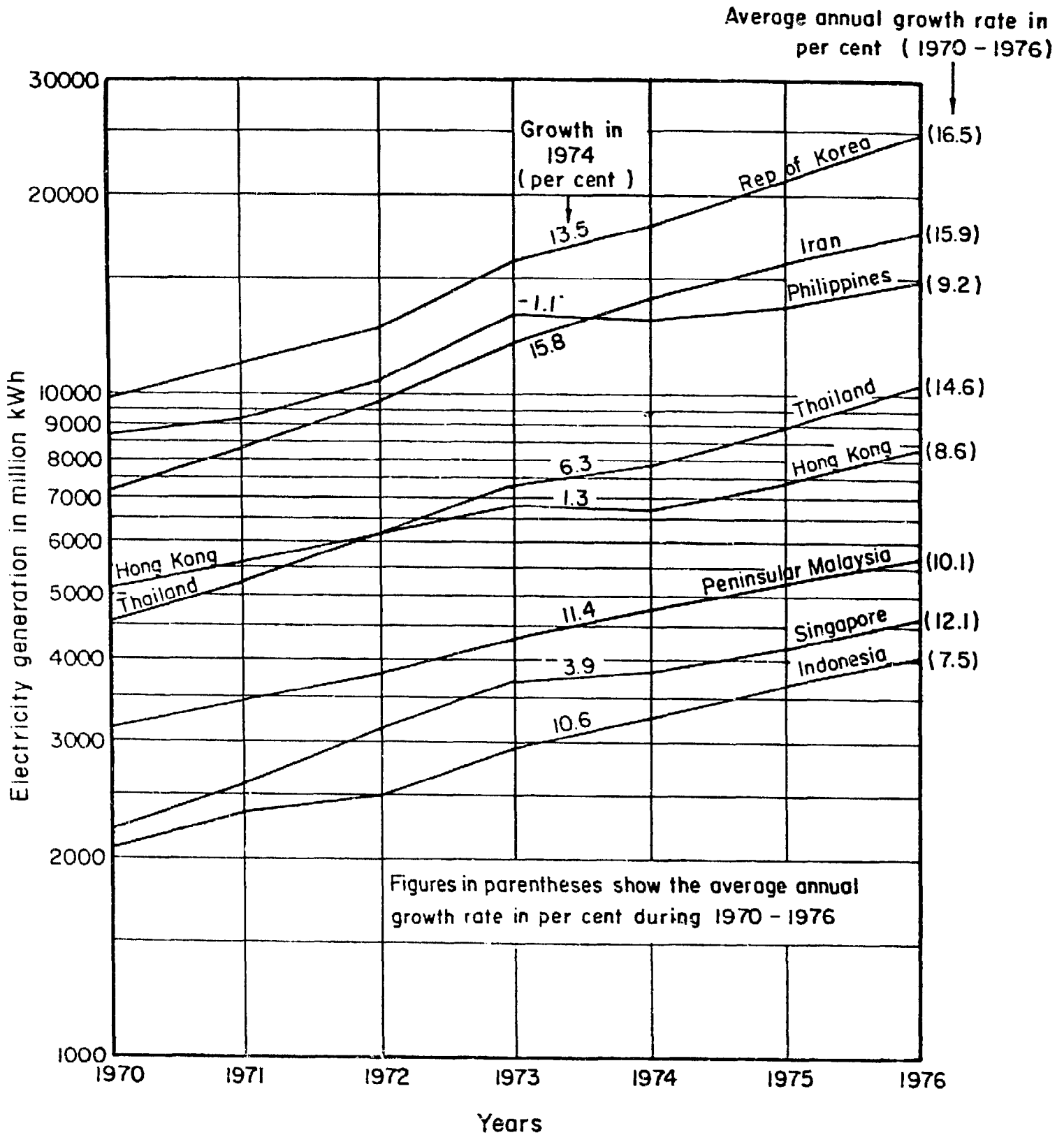

Fig. 5 Electricity Generation Growth of Eight Selected Developing Countries of the Region with Medium Range of Electricity Production. 1970 - 1976 (Ref. 6)

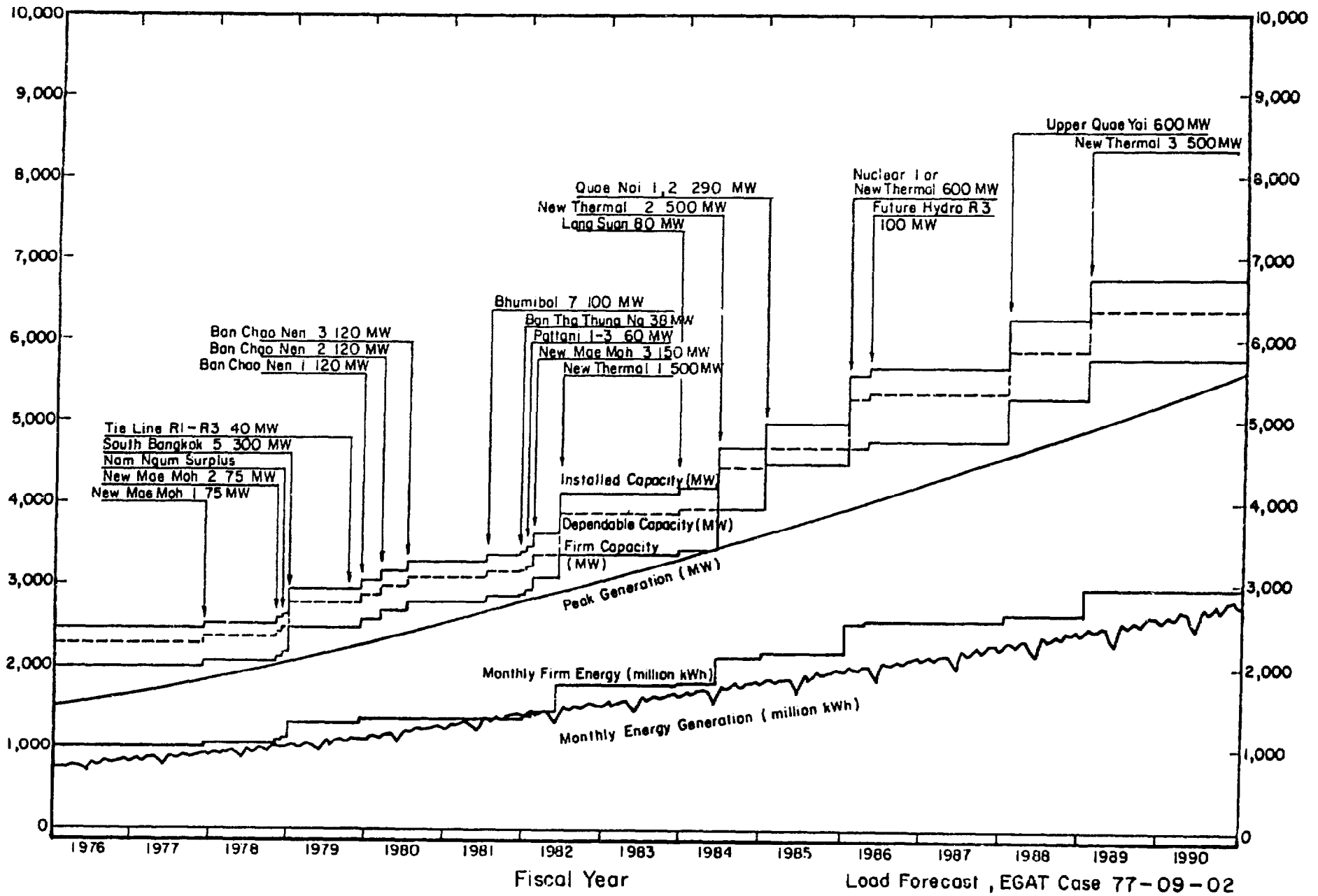

Fig. 6 Installation Schedule of Electric Power Plant in Thailand (EGAT)



the total cost. The information presented in the previous section, Tables 3-5 and Figs. 4-5, shows that there is general acceptance of hydropower plants with a larger capacity than mini-hydropower. Some examples of mini-hydropower projects in Asia will be presented below.

**The People's Democratic Republic of Laos**

The Mekong Secretariat in 1980 identified and

**Indonesia**

Woodward (1975) made a study of micro-hydro-

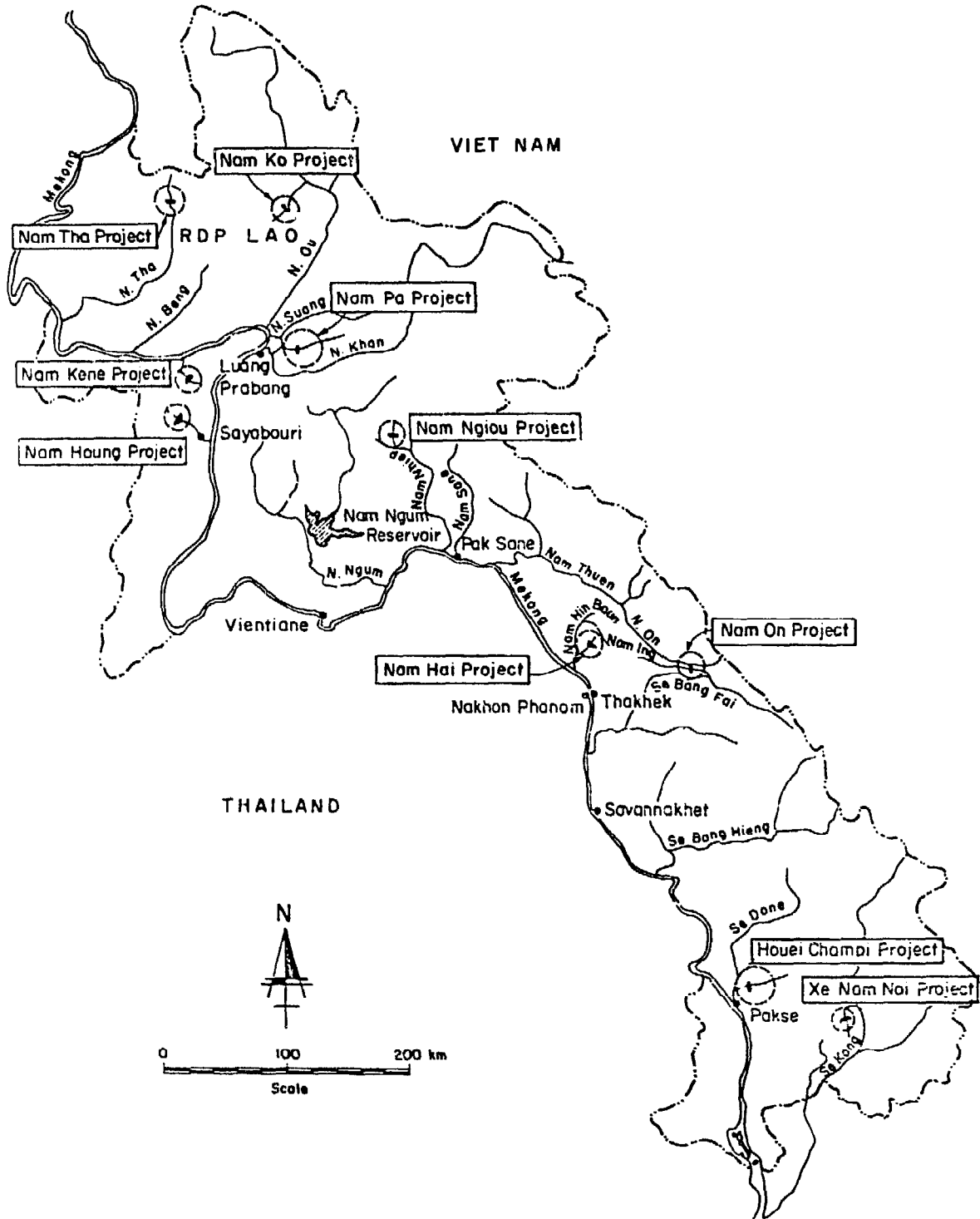

Fig. 7 Location Map of 10 Small Water Resources Projects in the Lao PDR (Ref. 4)

**Table 6**  
**Summary of Salient Project Features**

Characteristics	Nam Tha Project	Nam Ko Project	Nam Kene Project	Nam Pa Project	Nam Ngiou Project	Nam Hai Project
1. Purpose	I	P	P	I, P	P	P, I
2. Catchment area (km <sup>2</sup> )	530	710	385	700	310	24
3. Reservoir						
HWL (m above MSL)	616	665	530	360	1,040	1,090
LWL (m above MSL)	600	665	530	345	1,040	1,080
Gross storage (10 <sup>6</sup> m <sup>3</sup> )	44	negl.	negl.	350	negl.	30
Net storage (10 <sup>6</sup> m <sup>3</sup> )	20	nil	nil	93	nil	20
Reservoir area at HWL (km <sup>2</sup> )	32	negl.	negl.	12.7	negl.	2.2
4. Dam						
Crest length (m)	200	100	100	350	100	100
Height above river bed (m)	25	5	5	50	5	30
5. Estimated flow						
Average flow (m <sup>3</sup> /sec)	9.3	32	6.0	19	15.8	1.4
Average flow through (m <sup>3</sup> /sec)	3.0 <sup>a</sup>	2.3	1.3	11	1.2	1.4
6. Power features						
Intake channel (m)	n.a.	10,000	13,000	n.a.	4,000	n.a.
Pressure tunnel (m)	n.a.	n.a.	n.a.	n.a.	n.a.	1,100
Pumping plant:						
– Dynamic head (m)	n.a.	n.a.	n.a.	n.a.	n.a.	n.a.
– Pipe line (m)	n.a.	n.a.	n.a.	n.a.	n.a.	n.a.
Penstock length (m)	n.a.	300	300	70	290	2,200
Tailwater elevation (m MSL)	n.a.	485	400	310	900	200
Rated head (m)	n.a.	178	128	38.7	139	850
Firm capacity (kW)	n.a.	2,700	1,100	3,500	1,080	8,000
Installed capacity (kW)	n.a.	6,700	2,700	5,800	2,700	16,000
Firm energy (GWh/year)	n.a.	22.0	9.2	22	8.5	70.0
Average energy (GWh/year)	n.a.	29.4	12.0	29	11.4	81.2
Load centre	n.a.	Nam Tha	Sayabouri	Luang Prabang	Xieng Khouang	Thakhek
Transmission length (km)	n.a.	80	70	18	2	80
7. Potential irrigation area (ha)	2,500	n.a.	n.a.	negl.	n.a.	1,500

<sup>a</sup> Regulated minimum flow for irrigation.

Notes: P = power; I = irrigation; negl. = negligible, n.a. = not available.

electric power plant development and rural electrification in Indonesia. Tables 7 and 8 list his proposed development scheme for phases I and II respectively.

#### Thailand

Large-scale electric power generation is done by the Electricity Generating Authority of Thailand, EGAT, which was formed in May 1969. Mini-hydropower is the responsibility of the National Energy Administration, NEA. NEA has been recently planning 25 mini-hydropower projects in Thailand which are summarised in Table 9.

Srisaichua (1980) studied the small-scale hydropower potential of two sites in the north and another site in the northeast of Thailand. The objectives were

to evaluate the feasibility of the projects for customers in isolated villages. The results obtained from the study indicated that small hydropower projects, when compared with diesel power plants, were economically feasible.

#### Summary

A review of meteorological and hydrological data of water resources in Asia indicates that hydropower generation has the potential to meet part of the electricity generation growth of the region. Planning of water resources is essential in order to redistribute or store flood water for power generation, dry season irrigation, and various other uses.

Table 6 (Continued)

Characteristics	Nam On Project	Houei Champi Project			Sa Nam Noi Project
		H. Champi weir	H. Bang Lieng weir	Total	
1. Purpose	P, I			P, I	P
2. Catchment area (km <sup>2</sup> )	335	46	4	50	240
3. Reservoir					
HWL (m above MSL)	540	950	850		760
LWL (m above MSL)	540	950	850		760
Gross storage (10 <sup>6</sup> m <sup>3</sup> )	negl.	negl.	negl.		negl.
Net storage (10 <sup>6</sup> m <sup>3</sup> )	nil	nil	nil		nil
Reservoir area at HWL (km <sup>2</sup> )	negl.	negl.	negl.		negl.
4. Dam					
Crest length (m)	100	120	70		100
Height above river bed (m)	10	10	10		5
5. Estimated flow					
Average flow (m <sup>3</sup> /sec)	16.0	2.3	0.2	2.5	10.6
Average flow through turbines (m <sup>3</sup> /sec)	0.83	0.12	0.01	0.13	0.7
6. Power features					
Intake channel (m)	n.a.	2,000	n.a.	2,000	4,500
Pressure tunnel	n.a.	n.a.	n.a.		n.a.
Pumping plant:					
– Dynamic head (m)	120	n.a.	n.a.		n.a.
– Pipe line (m)	1,000	n.a.	n.a.		n.a.
Penstock length (m)	1,400			1,000	1,000
Tailwater elevation (in MSL)	170			400	260
Rated head (m)	468			435	490
Firm capacity (kW)	3,200			540	2,250
Installed capacity (kW)	5,300			900	5,600
Firm energy (GWh/year)	10			4.5	17.5
Average energy (GWh/year)	25			5.8	23.4
Load centre	Pakse			Paksong	Attapeu
Transmission length (km)	100			15	40
7. Potential irrigation area (ha)	700			100	n.a.

Notes: P = power, I = irrigation; negl. = negligible; n.a. = not available

## Indonesia -- Micro-Hydro Development Scheme -- Phase I

Table 7 (Ref. 7)

## TECHNICAL SCHEDULE

		1	2	3	4	5	6
Station		Balapusuh	Madjalengka	Sungai Paar	Bengkajang	Lampung	Belah Batu
Norminal Runner Size	inches	13½	13½	13½	13½	16½	16½
Output	b.h.p.	95	149	179	134	116	114
Gross Head	metres	12	15	18	13	9	10
Est. Net Head	metres	11.6	14.35	17.35	12.5	8.55	9.45
Flow	Litres/sec	750	950	940	1010	1150	1050
Turbine Speed	r.p.m.	603	625	740	628	424	446
Runaway Speed	r.p.m.	1100	1210	1330	1130	763	803
Speed rise with 100% load rejection		21%	30.5%	30.5%	32%	27%	29%
Pressure rise above Gross Head with 100% load rejection		38%	51%	49%	54%	37.5%	34%
Casing Assembly Pressure tested to ft. head		100	100	100	100	100	100
Max. height from Min. Tail Water level to Power House floor level metres		2.5	2.5	2.5	2.5	2.5	2.5
<b>General electrical data</b>							
Generator voltage	220/127 volts		50 cycles				
Generator speed	1500 r.p.m.						
Step-up transformer	220/6000 v		50 cycles				
Step-down transformers	600/220 v		50 cycles				

## SMALL HYDROPOWER FOR ASIAN RURAL DEVELOPMENT

Table 8 (Ref. 7)  
Indonesia – Micro-Hydro Development Scheme May, 1971

No.	Village	Province	Generator		Transformer			
			Rating (KVA)	No.	Step-up		Step-Down	
					Rating	No.	Rating	No.
1	Bolang	West Java	225	1	200	1	200	1
2	Tjibening	West Java	250	1	250	1	250	1
3	Tjiampea	West Java	100	1	75	1	75	1
4	Tjiamis	West Java	100	1	100	1	100	1
5	Dawuhan Kulon	Central Java	125	1	125	1	125	1
6	Dumiaju	Central Java	75	1	75	1	75	1
7	Bekdjo	Central Java	50	1	50	1	50	1
8	Bobot Sari	Central Java	150	1	150	1	150	1
9	Tjurug	Central Java	250	1	250	1	250	1
10	Karang Asem	Central Java	35	1	35	1	35	1
11	Karang Pandam	Central Java	35	1	35	1	35	1
12	Tapen	Central Java	100	1	100	1	100	1
13	Sleman	D.I.I. Jogjakarta	250	1	250	1	250	1
14	Bandjar Arup	D.I.J. Jogjakarta	100	1	100	1	100	1
15	Sewahan	East Java	100	1	100	1	100	1
16	Tanggul	East Java	100	1	100	1	100	1
17	Balong	East Java	100	1	100	1	100	1
18	Bondowoso	East Java	250	1	250	1	250	1
19	Banjuwangi	East Java	75	1	75	1	75	1
20	Tanah Djawa	East Sumatra	125	1	125	1	125	1
21	Sarulla	East Sumatra	150	1	150	1	150	1
22	Nunthe	East Sumatra	75	1	75	1	75	1
23	Pakkat	East Sumatra	75	1	75	1	75	1
24	Takengun	East Sumatra	100	1	100	1	100	1
25	Lawang Agung Lama	South Sumatra	125	1	125	1	125	1
26	Lubuk Buntak	South Sumatra	250	1	250	1	250	1
27	Muara Dua	South Sumatra	20	1	20	1	20	1
28	Kerintji	Djambi	100	1	100	1	100	1

**Table 9**  
**NEA 25 Mini-Hydropower Projects in Thailand**

PROJECT NO	LOCATION (PROVINCE)	SALIENT FEATURES OF 25 SMALL HYDRO PROJECTS						REMARKS
		CATCHMENT AREA (KM )	AVERAGE FLOW (CMS)	EFFECTIVE HEAD (M)	INSTALLED CAP (KW)	ANNUAL ENERGY (GWH)	CONSTRUCTION COST (MB)	
1	PHANG NGA	45.6	2.05	66.5	1,040	4.37	54.62	<u>1/</u> Reservoir-Type Projects <u>2/</u> The Project are under Feasibility Studies
2	SURAT THANI	27.2	1.10	209	2,700	11.12	111.69	
3	CHIENG MAI	86	1.72	86	1,500	6.22	61.10	
4	CHIENG MAI	129	2.58	247	6,000	27.95	178.53	
5	CHIENG MAI	163.4	4.90	100	2,800	11.02	88.97	
6	RANONG	65	2.54	114	500	4.15	40.33	
7 <u>1/</u>	CHIENG RAI	394	5.60	48	5,600	16.16	306.96	
8	CHIENG MAI	95.3	1.90	171	3,000	11.28	101.17	
9	CHIENG MAI	77	1.08	114	400	2.70	27.66	
10	KANCHANABURI	150	3.00	172	1,000	11.02	55.39	
11 <u>1/</u>	CHIYAPHUM	337	1.80	217	6,000	26.30	367.90	
12	NAN	117	2.34	185	2,000	6.70	112.92	
13	CHIENG MAI	550	5.50	53	1,500	6.00	69.96	
14	CHIENG MAI	26.2	0.78	81	300	1.44	20.00	
15	SURAT THANI	10	0.40	170	200	1.05	17.12	
16	CHIENG MAI	72	1.80	310	800	4.40	61.14	
17	SATUN	4.35	18.70	9.50	400	3.01	41.02	
18	UTTARADIT	225	3.80	45	200	1.55	29.39	
19 <u>2/</u>	MAE HONG SON	111	2.87	250	2,000	8.20	82.93	
20 <u>2/</u>	CHIENG MAI	85	1.70	52	400	2.46	30.81	
21 <u>2/</u>	CHIENG MAI	75	1.87	38	1,120	5.00	117.00	
22 <u>2/</u>	MAE HONG SON	198	5.36	31	400	2.58	50.53	
23 <u>2/</u>	CHIENG RAI	30	0.75	237	2,000	9.05	74.84	
24 <u>2/</u>	CHIENG MAI	120.8	-	66.5	2,100	6.10	79.29	
25 <u>1/2/</u>	CHIENG MAI	61	1.77	85	6,000	17.30	269.29	

**References:**

1. FRITS VAN DER LEEDEN, *Water Resources of the World, Selected Statistics*, Printed by Water Information Center, Inc., Port Washington, New York (1975).
2. *Proc. Symposium on Water Resource Utilisation in Southeast Asia*, Series III, Kyoto University (1966).
3. Mekong Secretariat, *Planning and the Mekong Project*, Committee for Coordination of Investigation of the Lower Mekong Basin (1973).
4. Mekong Secretariat, *Preliminary Study of 10 Small Water Resources Projects in the Laos PDR*, Interim Committee for Coordination of Investigation of the Lower Mekong Basin (1980).
5. ESCAP, *Electric Power in Asia and the Pacific 1973 and 1974* (1976).
6. ESCAP, *Electric Power in Asia and the Pacific 1975 and 1976* (1978).
7. WOODWARD, J.L., *Micro-Hydro Electric Power Plant Development and Rural Electrification in Indonesia*, Department of Electrical Eng., The Papua New Guinea Univ. of Technology, Papua New Guinea (1975).
8. Electricity Generating Authority of Thailand, *This is EGAT* (1973).

**Suphat Vongvisessomjai**, an Associate Professor and Chairman of the Water Resources Engineering Division at AIT, completed his doctoral work in Coastal Engineering at AIT in 1972, and subsequently worked at the Institute as an Assistant Professor.

Born in 1942, Dr. Suphat has served as principal investigator for eight coastal projects sponsored by various agencies in Thailand and abroad. He serves as a committee member of various government agencies in Thailand.

## Energy Needs in Rural Development: The Case for Mini-Hydropower

Chulapongs Chullakesa\*

**ABSTRACT :** This paper will view the role of mini-hydro power in serving the energy needs of rural regions from the perspective of the current efforts of the Provincial Electricity Authority to provide electrification to 95% of all villages in Thailand by 1990. Most of the villages will be connected to the national grid, except the very remote villages which will be served by other means. It is thought that mini-hydropower offers the best means to serve this purpose. PEA has initiated its mini-hydro program with two pilot facilities, which will be examined in the paper.

### Introduction

**R**URAL electrification is recognized as a main component of the basic infrastructure for rural development, together with water and road components. It is a means whereby the rural populace can increase their agricultural and agro-industrial production which will, in turn, result in inducing village prosperity by increasing the people's incomes and raising their standard of living. At the same time, it would simultaneously improve the basic rural social development by strengthening their communities' social and political stability – including child and adult education, public health care, the reduction of migration to cities, and last but not least, the improvement of the quality of life.

This is in general accordance with the national development policy of most countries in the world, which always emphasize rural infrastructure development and the distribution of higher incomes to the underprivileged rural poor.

The rural *economic* sectors which can be supported or developed by means of electricity under the rural electrification program are, for example, agricultural and domestic pumping, village rice-mills and agriculturally-related industries (wood-working shops, vehicle and farm-equipment repair shops, vegetable and fruit processing shops, food and commercial shops,

*etc*).

The rural *social* sectors which can be supported or developed by means of electricity under the rural electrification program are, for example, residential street lighting and public lighting, radio-television education for children and adults, health and medical facilities, the water-supply system and domestic appliances (irons, fans, refrigerators, cookers, radios, televisions, *etc*).

Most developed countries have completed their rural electrification programs, in the process bringing prosperity, stability and advancement to their nations. These are countries in North America, Europe and Australia, and some parts of Asia and Africa (for example, Japan, Taiwan, Israel and South Africa). On the other hand, many underdeveloped countries, mostly in Africa, have no such electrification program as yet. Perhaps a few more decades will be necessary for them to start up this nationwide electrification development.

Presently many developing countries, mostly in Asia and Latin America (and some in Africa), are putting increasing resources into rural electrification, and the resources which these countries allocate to this development increase as their per capita incomes rise. Countries like China, India and Brazil have gone quite far, and will soon reach the target of total electrification. Countries like the Philippines, Thailand,

\*Department Manager, Office of Rural Electrification, Provincial Electricity Authority, Ministry of Interior, Government of Thailand.



Egypt and Chile have gone almost half-way, and will probably reach the target within the next 10 years.

In general, there is scope for some degree of rural electrification in most developing countries, though the type and extent of electrification will depend on the level of overall rural development. Estimates indicate that the following percentages of the rural populace may be served by electricity in the next 10 years (1981-1990):

- |                            |             |
|----------------------------|-------------|
| - Latin American countries | - about 33% |
| - Asian countries          | - about 25% |
| - African countries        | - about 10% |

Normally a rural electrification project is based on 3 steps of investigation. First there is a reconnaissance study which recommends whether the project should be undertaken or not, depending on the readiness of a national government to take on the program and the capacity of the rural people to use electric power productively. Second is the master plan, or "prefeasibility study", which outlines the overall parameters of the program - for example, the areas of priority, the financial commitment involved, and the time-frame for the long-term program. Third is the package of subsequent short-term projects on a time-slice basis - for example, annual or phase sub-programs to fit in with national development plans. Thailand, like many other developing countries, has worked out a rural electrification program on this basis.

For some time rural communities or villages have relied mainly for electricity on "conventional" extensions from grid systems which are supplied from large power plants using either hydro, thermal, or, in some developing countries nuclear energy. Although this technology is standard, there has also been the popular alternative of using diesel autogeneration (based on a least-cost calculation) in the past. In other words, Small Diesel Generation (SDG) has been the only dominant option for the network in past decades. Thailand is one example of a country which is in this category. A few years ago, the number of small diesel plants (50-6,000 kW) had risen to almost 500 (as compared to 120 presently), operated by a state enterprise, the Provincial Electricity Authority (PEA) of Thailand. In other developing countries as well, there have generally been no other options or alternatives for electric supply to rural areas other than network and diesel sources.

The sharp rise in world petroleum prices during recent years has greatly increased the production cost of electricity by conventional oil-fired power plants (thermal, diesel and gas-turbine). In particular, it is no longer feasible for oil-importing developing countries to utilise SDG. Consequently many developed and developing countries which are critically affected by imported oil prices have devised their energy programs to accommodate the new approaches of "non-conventional" energy sources instead of using "conventional" energy from oil. These renewable energies for small electricity generation, in order of priority, are:

1. mini-hydro generation (MHG);
2. the solar cell system (SCS);
3. the windmill system (WMS); and,
4. the biomass system (BMS).

Thailand, has already articulated its renewable energy policy with regard to these options in the forthcoming fifth National Plan of Social and Economic Development (1982-1986). The PEA, NEA (National Energy Administration) and EGAT (Electricity Generating Authority of Thailand) have been assigned by the Government of Thailand to be the primary agencies responsible for development, and for the realization of alternative local energy sources for electricity production.

The PEA of Thailand has set up an MHG sub-program which is integrated with the Accelerated Rural Electrification (ARE) program (as shown in Table 1). The MHG program will, over a period of 14 years, cover about 500 potential stations of 1 MW and below at a total investment cost of about US\$500 million. The PEA's MHG program is intended to be a simple system, using a standardized design, and runoff type systems suitable for operation in remote areas. The PEA policy of MHG development is to install an alternative source of supply to the ARE Program, instead of simply expanding from the grid system, and to replace presently operating SDG wherever this is proved to be feasible from a least-cost calculation estimate.

The PEA's MHG program is intended as a joint venture with the various government departments involved, i.e., Irrigation, Forestry, Agriculture, Environment, NEA, EGAT, etc., so that the project can be comprehensively organised and produce the maximum benefits, both tangible and intangible, for the rural people and the nation as a whole.

**Table 1**  
**Investment Program for**  
**Accelerated Rural Electrification (ARE) Project – National Program (18 Years) (1977-1994)**  
**Mini-Hydro Generation (MHG) Project – National Program (14 Years) (1981-1994)**

Estimated Investment (Million Baht)					
Subprogram	Time Slide	Number of Villages	Total Project	Foreign Component	Local Component
ARE Project – First Stage	1977-82	5,200	2,195.0	941.0	1,254.0
ARE Project – Second Stage	1981-85	8,000	5,525.5	2,138.6	3,386.0
		(+MHG)			
ARE Project – Third Stage	1984-88	3,700	5,130.0	2,250.0	2,880.0
		(+MHG)			
ARE Project – Fourth Stage	1987-91	(MHG)	6,070.0	2,700.0	3,370.0
ARE Project – Fifth Stage	1990-94	(MHG)	1,340.0	596.0	744.0
<b>Total Program</b>	<b>18 Years</b>	<b>16,900</b>	<b>20,260.5</b>	<b>8,625.6</b>	<b>11,634.0</b>
		<b>(+MHG)</b>	<b>(M\$990.0)</b>	<b>(M\$421.5)</b>	<b>(M\$568.0)</b>

- Remarks:
1. Total ARE Villages in Stage 1, 2, 3 = 16,900 villages
  2. Total MHG Stations in Stage 2, 3, 4, 5 = 500 stations
  3. Total Investment For ARE Villages = 10,275.5 Million Baht (502.1M\$)
  4. Total Investment For MHG Stations = 9,985.0 Million Baht (487.9M\$)
  5. ARE = Accelerated Rural Electrification Project
  6. MHG = Mini Hydro Generation Project
  7. Use Exchange Rate of US\$1.00 = 20.465 Baht.

## ***PART II : SECTION 2***

# **Technology**

---

*In this section, five experts focus on the technical aspects of converting falling water into reliable sources of energy. Norman Crawford, of Hydrocomp, Inc., presents a methodology for assessing hydrologic characteristics at a remote site where data is not available; Roger Arndt, of the University of Minnesota, discusses aspects of hydraulic equipment and turbine design; Allen Inversin, of NRECA, looks at civil works' designs that have been developed for a number of small-scale projects in various parts of Asia; Bard Jackson, of NRECA, discusses electrical aspects of small hydro plants; and Gary Kitching, of Small Hydro Electric Systems and Equipment, discusses maintenance and operation issues. Question-and-answer discussion sessions follow the papers by Norman Crawford and Roger Arndt.*

# Small Hydropower : Hydrological Methodology Without Streamflow Data

Norman H. Crawford\*

---

**ABSTRACT :** Small decentralized hydropower stations are located on small streams that rarely have streamflow records. A designer must estimate streamflow data to determine the power potential of the site and to estimate the reliability of the power source. These estimates require "flow duration" data at the site, the percent of time a given flow is equalled or exceeded. The peak flow at a site may be needed to design diversion dams or spillways, and locate equipment above the highest water level expected during a flood. A simple calculation technique that gives monthly streamflows based on monthly rainfall and lake evaporation is presented. An example application of this technique is given. A calculation technique for peak flows is presented. These techniques are designed to use the sparse meteorologic and watershed data that are available on small watersheds. The calculations can be done using graphs and tabular sheets. The hydrologic techniques recommended for small hydropower sites will give results of moderate accuracy, based on a minimum of field information.

---

## Introduction

**H**YDROPOWER sites on small watersheds are seldom gauged. Streamflow records are not available. To design a small hydropower project, two types of hydrologic data are required. Flow duration data are needed to select the hydraulic capacity of the plant and to give the reliability of the power. Reliability is most important at small hydro sites that are not connected to a national power grid.

Flow duration data or a flow duration curve are based on five or more years of measured or calculated streamflow data.

The section titled *Calculation of a Flow Duration Curve on an Ungauged Stream* gives calculation methods, assumptions, and an example. The section titled *Calculation of a Peak Discharge on an Ungauged Stream* gives methods, assumptions, and data requirements. The section titled *Conclusions and Accuracy of Methods* discusses the expected accuracy of the techniques given in this paper, and compares the

techniques to more comprehensive hydrologic analysis methods.

## Calculation of a Flow Duration Curve on an Ungauged Stream

The continuous flow in a stream results from the hydrologic cycle (Figure 1). When continuous monthly or daily flows are arranged in order of magnitude, a flow duration curve (Figure 2) can be plotted. The reliability of power production can be calculated from a flow duration curve. For example, if a 20 meter head were available, the flow duration curve in Figure 2 shows that a 127 kW power source could be developed at 85% reliability, assuming an 85% overall efficiency for the project. Streamflow results from precipitation. Flow moving from the land surface during and immediately following precipitation, creates flood hydrographs and peak flows. Water that is absorbed

---

\*Hydrocomp, Inc., 201 San Antonio Circle, Suite 280, Mountain View, California 94040, U.S.A.

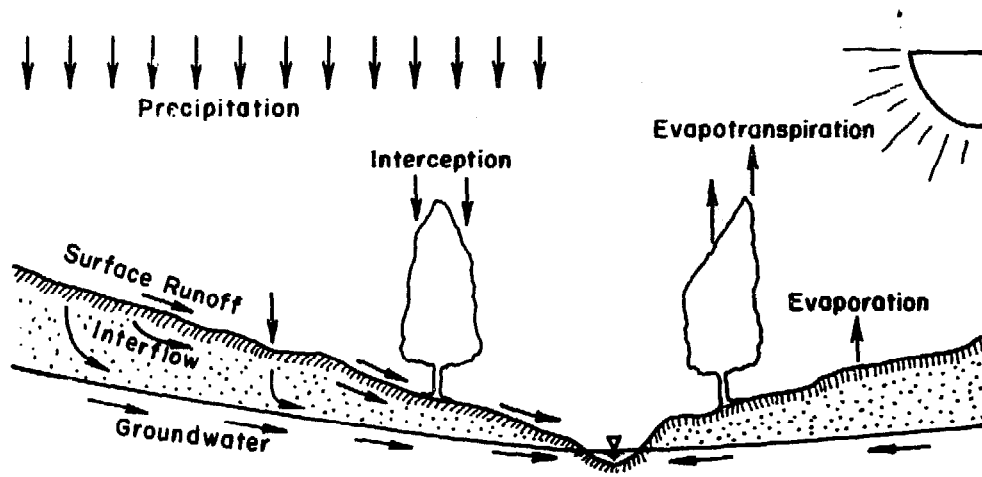

Fig. 1 The hydrologic cycle

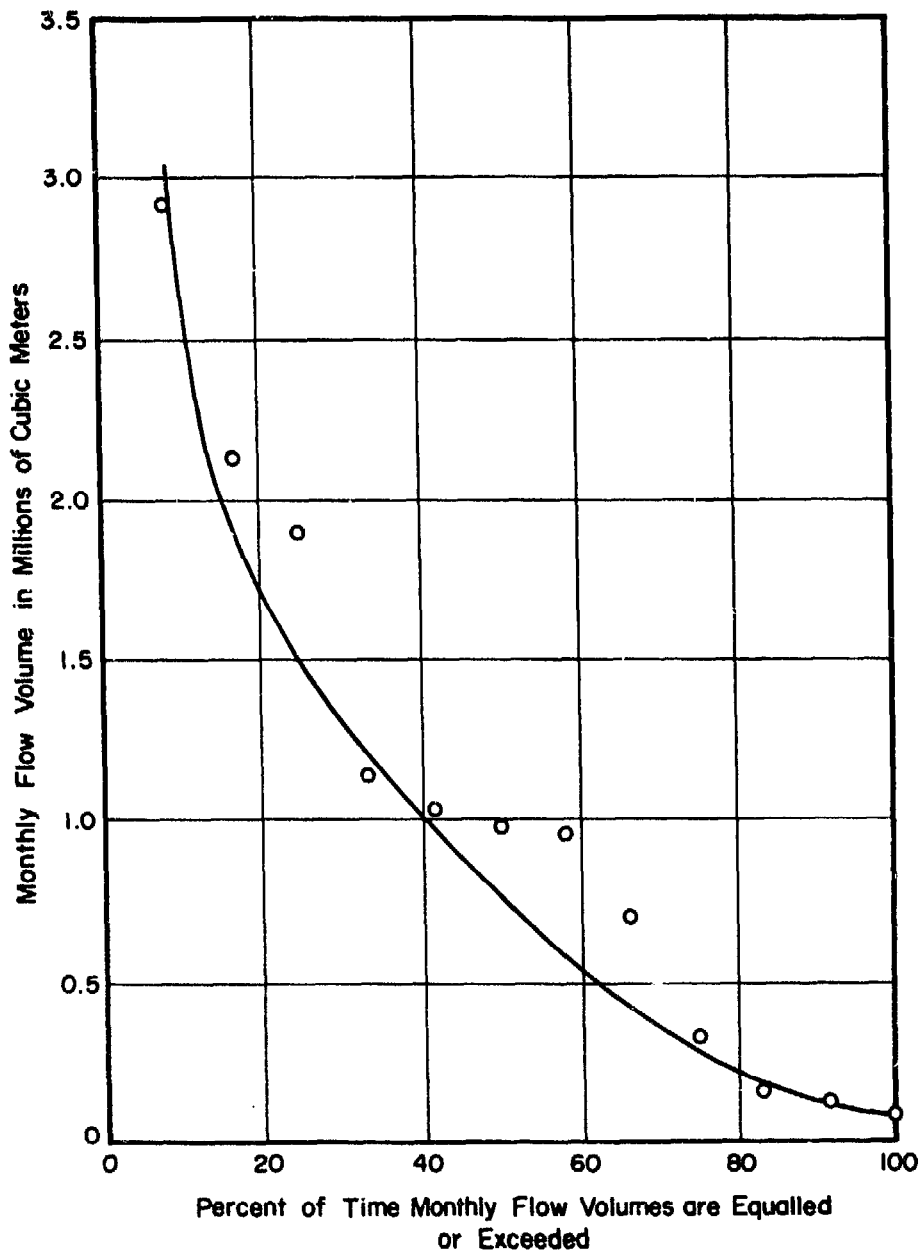

Fig. 2 Flow duration curve for monthly flow volumes

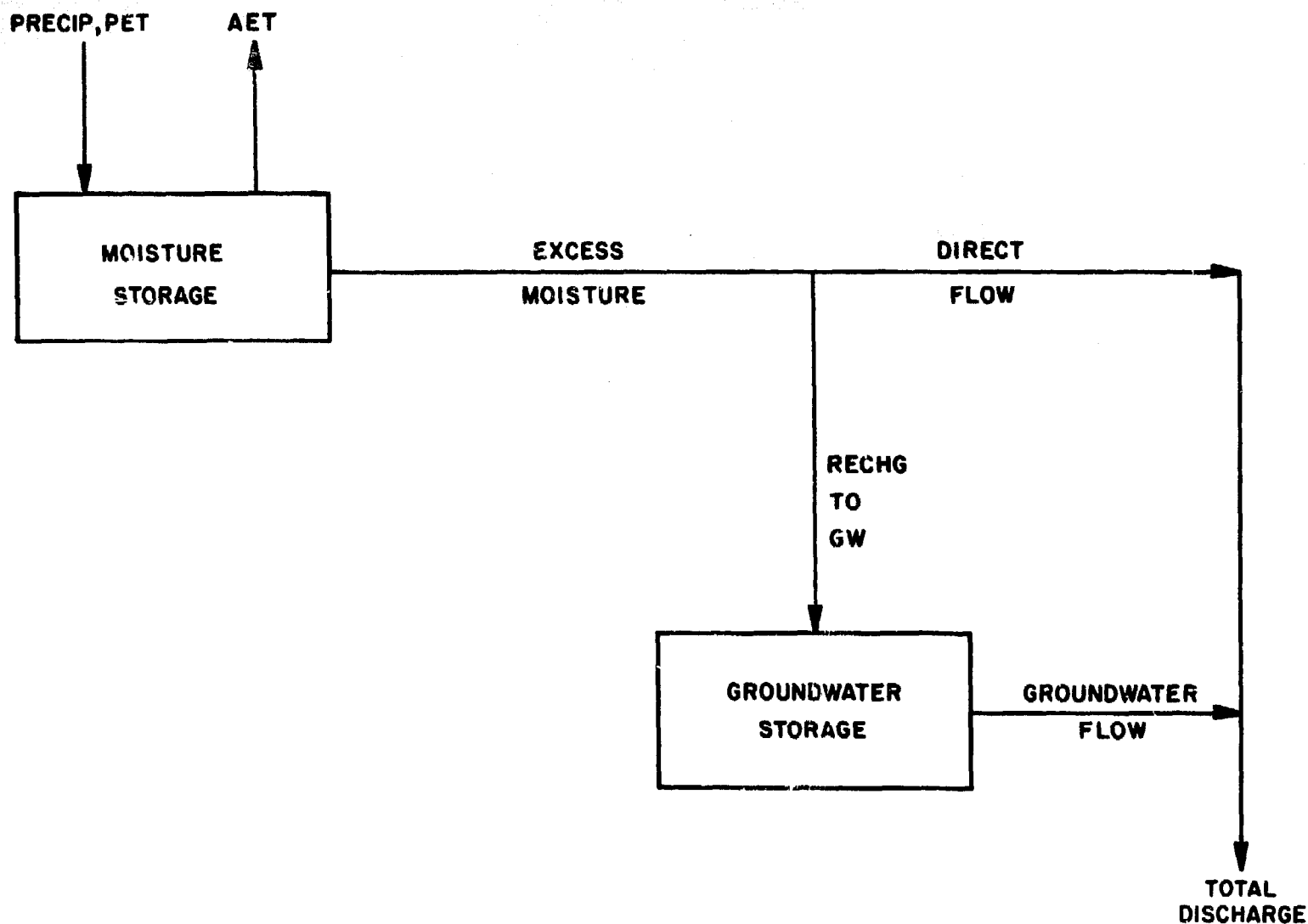

Fig. 3 A sketch of monthly runoff calculations from rainfall and potential evapotranspiration data.

by the soil during rainstorms, moves as subsurface flow into stream channels and provides continuous flows. Flow duration curves are based on continuous streamflow data. On ungauged streams where streamflow measurements are not available, precipitation and potential evapotranspiration records can be used to calculate continuous flows. The calculations mimic key hydrologic processes; infiltration of water into the soil profile, surface runoff, and flow along subsurface flow paths into the stream.

The calculation method uses monthly precipitation and potential evapotranspiration data to calculate monthly streamflow. When continuous flows for flow duration curves are calculated on a monthly interval, the channel routing process can be neglected.

A sketch of the calculations is shown in Figure 3. When the calculated monthly streamflows are found, they are used like observed flows to calculate the flow duration curve for a site.

Calculations of monthly flows from meteorologic data are based on the water balance in the watershed. The water balance equation is:

$$\text{Precipitation} - \text{Actual Evapotranspiration} + \text{Storage Change} = \text{Runoff}$$

The water balance equation applies to the watershed over any time interval, where precipitation, actual evapotranspiration and runoff are the volumes of water entering and leaving the watershed in the time

interval. The storage change is the change in soil moisture and groundwater storage in the time interval, calculated as the initial storages less the final storages. Water is held in storage in the soil, in groundwater aquifers, and in lakes and snowpacks. All water flows into or out of the watershed are assumed to be included in the runoff.

The following steps are used to calculate monthly runoff and a flow duration curve from meteorologic data:

1. assemble five or more years of concurrent rainfall and potential evapotranspiration data;
2. estimate the watershed characteristics of the basin;
3. calculate, using a tabular form, the monthly streamflows for five or more years based on these rainfall and potential evapotranspiration data; and,
4. calculate the flow duration curve using the calculated monthly streamflows.

#### Rainfall and Potential Evapotranspiration Data

Streamflow calculations require monthly rainfall on the watershed, and monthly potential evapotranspiration data. Rainfall data that is observed in or near the watershed must be found. Rainfalls often increase with elevation, and gauges are usually placed in villages along river valleys. Meteorologic and agricultural services prepare maps of mean annual rainfall. These maps can be used to adjust gauged rainfall, and to estimate rainfall on the watershed.

Potential evapotranspiration is the amount of water that would evaporate from the watershed if water supply is ample. The actual water loss, called the actual evapotranspiration, is less than or equal to the potential evapotranspiration. The potential evapotranspiration may be estimated and published by a national meteorologic services office.

The potential evapotranspiration is quite uniform from year to year. A mean monthly distribution of potential evapotranspiration will be sufficient for purposes of calculating monthly runoff.

#### Estimating Watershed Characteristics

The tabular calculations of monthly flows that will be described use three coefficients to represent watershed characteristics. They are:

NOMINAL = an index to the soil moisture storage capacity in the watershed;  
 PSUB = the percentage of runoff that moves

out of the watershed on subsurface paths; and,

GWF = the rate of discharge from the groundwater storage to the stream.

These watershed characteristics can be estimated for ungauged streams using the following guidelines:

NOMINAL =  $100 + C$  (mean annual precipitation) where  $C$  is 0.2 in a watershed with year-round rainfall, and 0.2 in watersheds with seasonal rainfall. NOMINAL is millimeters. The value of NOMINAL can be reduced by up to 25% in watersheds with limited vegetation and thin soil cover.

PSUB = 0.5 in a typical watershed, increasing to 0.9 in watersheds known to have highly permeable aquifers, and decreasing to 0.3 in watersheds with thin soils and limited aquifers.

GWF = 0.5 in a typical watershed, increasing to 0.8 in watersheds that have little sustained flow, and decreasing to 0.2 in watersheds known to have reliable sustained flows.

#### Calculations of Monthly Runoff

Calculations of monthly runoff are made using a tabular sheet, Table 1. A step by step procedure for computing data in this table follows.

##### Initial Steps:

Select the values of the coefficients representing watershed characteristics and enter them in the column headings: NOMINAL above column 5, PSUB above column 13, and GWF above column 16.

Initial or starting conditions are needed for the soil moisture storage (column 4) and the ground water storage (column 14). If rainfall is seasonal and the tabular calculation begins in the dry season the initial storages will be low.

Enter the initial soil moisture in column 4, and the initial groundwater storage in column 14. Then proceed as follows for each column.

COLUMN	COMMENT
(1)	Enter the Month and Year of the data.
(2)	Enter precipitation (PRECIP) on the watershed for the month (gauge rainfall must be adjusted to represent watershed rainfall).
(3)	Enter potential evapotranspiration (PET) on the watershed.

**Table 1**  
**NRECA Flow Duration Model**

(1)	(2)	(3)	(4)	(5)	(6)	(7)	(8)	(9)	(10)	(11)	(12)	(13)	(14)	(15)	(16)	(17)	(18)
DATE	PRECIP	PET	MOISTR STORAGE	STOR RATIO	PRECIP /PET	AET/ PET	AET	WATER BALANCE	EXCESS MOIST RATIO	EXCESS MOIST	DELTA STORAGE	RECHG TO GW	BEGIN STOR GW	END STOR GW	GW FLOW	DIRECT FLOW	TOTAL DISC
(mo/yr)	(mm)	(mm)	(mm)	NONIMAL = 410			(mm)	(mm)		(mm)	(mm)	(mm)	(mm)	(mm)	(mm)	(mm)	(mm)
1/80	356.3	21.7	500.0	1.22	16.42	1.00	21.7	334.6	.70	234.2	101.9	141.9	25.0	166.9	106.8	90.7	197.6
2/80	196.4	38.4	601.9	1.47	5.12	1.00	38.4	158.1	.86	135.7	22.4	82.8	60.1	142.9	91.4	52.9	144.4
3/80	145.6	79.1	624.3	1.52	1.84	1.00	79.1	66.5	.89	58.9	7.6	35.9	51.4	87.4	55.9	23.0	78.9
4/80	59.8	118.3	631.9	1.54	.51	.89	104.9	-45.1	.00	.0	-45.1	.0	31.5	31.5	20.1	.0	20.1
5/80	26.9	155.4	586.7	1.43	.17	.76	118.8	-92.0	.00	.0	-92.0	.0	11.3	11.3	7.2	.0	7.2
6/80	11.6	171.5	494.8	1.21	.07	.63	108.1	-96.5	.00	.0	-96.5	.0	4.1	4.1	2.6	.0	2.6
7/80	19.9	191.6	398.3	.97	.10	.54	103.3	-83.4	.00	.0	-83.4	.0	1.5	1.5	.9	.0	.9
8/80	33.7	154.7	314.9	.77	.22	.52	80.2	-46.5	.00	.0	-46.5	.0	.5	.5	.3	.0	.3
9/80	17.2	137.9	268.5	.65	.12	.41	56.7	-39.5	.00	.0	-39.5	.0	.2	.2	.1	.0	.1
10/80	299.6	88.9	228.9	.56	3.37	1.00	88.9	210.7	.16	32.8	177.9	20.0	.1	20.1	12.9	12.8	25.7
11/80	275.8	41.7	406.8	.99	6.61	1.00	41.7	234.1	.49	115.2	118.9	70.3	7.2	77.5	49.6	44.9	94.5
12/80	350.0	29.8	525.7	1.28	11.74	1.00	29.8	320.2	.74	237.7	82.5	145.0	27.9	172.9	110.6	92.7	203.3

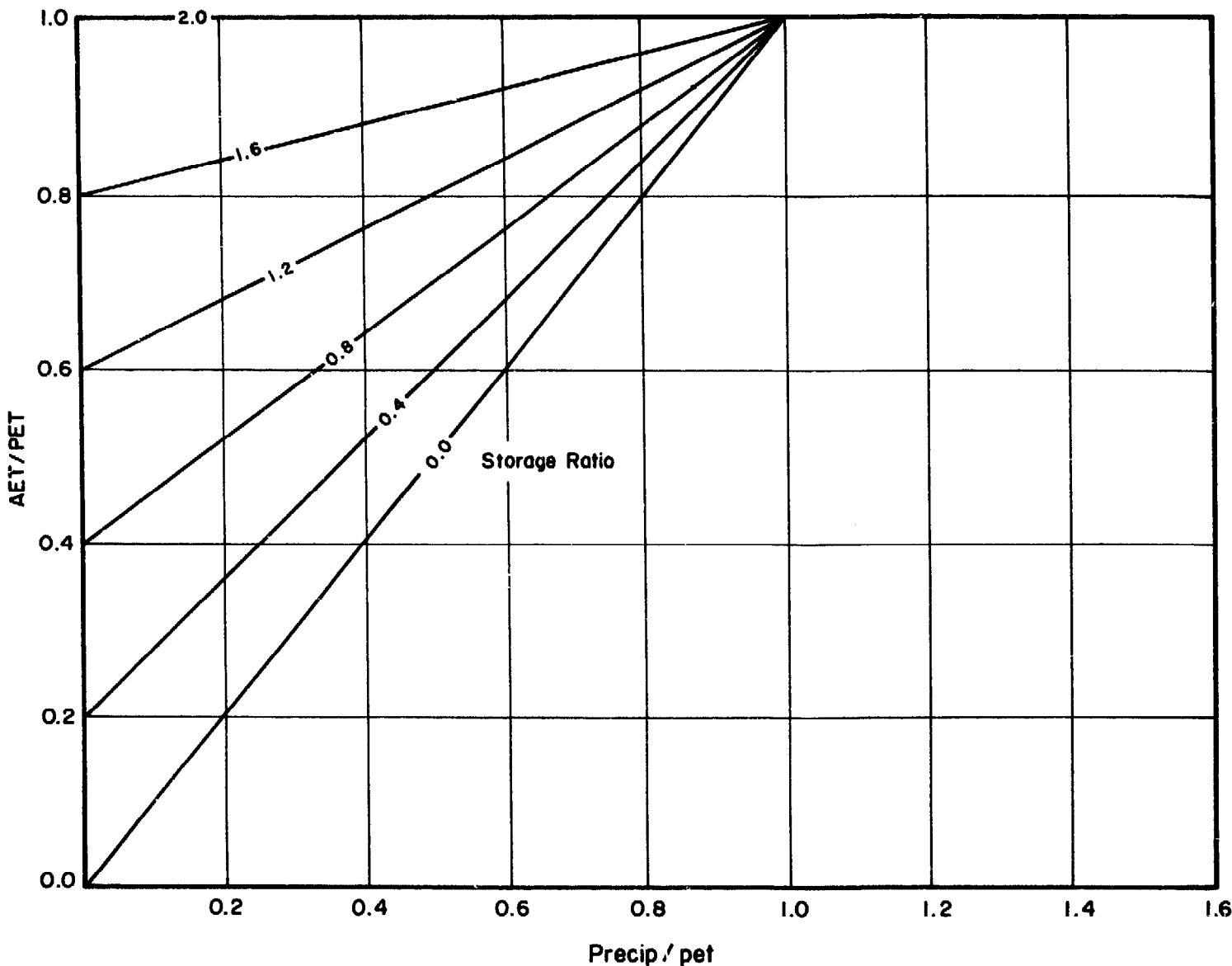

Fig. 4 AET/PET ratio



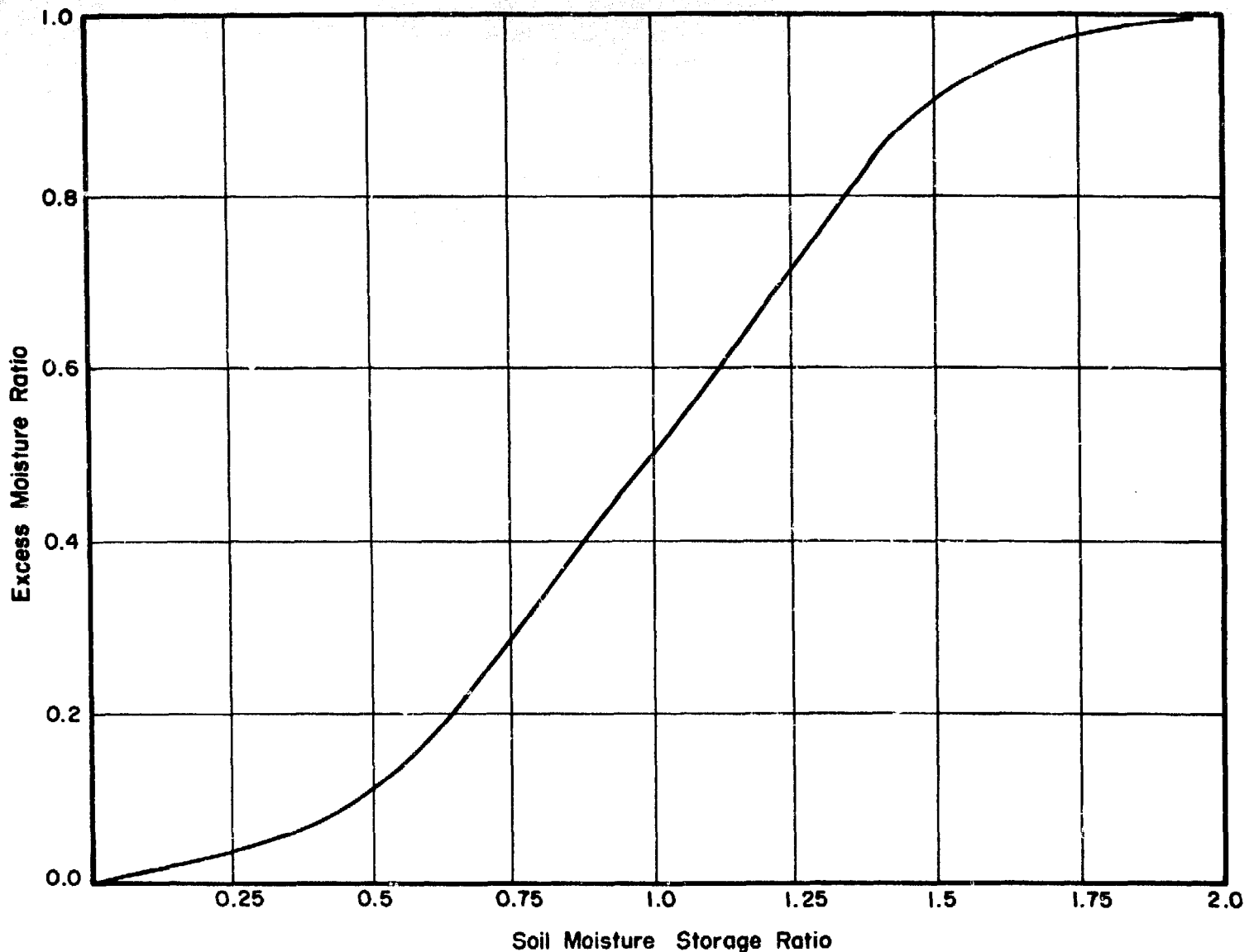

Fig. 5 Soil moisture storage ratio

- (4) MOISTR STORAGE was entered previously as an initial condition or from the prior month calculation.
- (5) Calculate the soil storage ratio (STOR RATIO) the value in column (4) divided by NOMINAL.
- (6) Calculate the ratio PRECIP/PET, column (2) divided by column (3). Enter the result in column (6).
- (7) Enter Figure 4 with PRECIP/PET and the STOR RATIO (column (5)), and find the value of the ratio of actual to potential evapotranspiration, AET/PET. Enter the value of AET/PET in column (7).
- (8) Calculate AET as PET multiplied by the AET/PET ratio, column (3) times column (7), and enter AET in column (8).
- (9) Calculate the WATER BALANCE for the month where WATER BALANCE = PRECIP - AET, column (2) less column (8). Enter the result in column (9).
- (10) If the WATER BALANCE is positive, enter Figure 5 with the STOR RATIO (column (5)), and find the excess moisture ratio (EXCESS MOIST RATIO). If the WATER BALANCE in column (9) is negative, the EXCESS MOIST RATIO is zero. Enter the EXCESS MOIST RATIO in column (10).
- (11) Calculate the excess moisture (EXCESS MOIST) where EXCESS MOIST is the EXCESS MOIST RATIO times the

- WATER BALANCE, column (10) times column (9). Enter the result in column (11).
- (12) Calculate the change in soil storage (DELTA STORAGE) where DELTA STORAGE is WATER BALANCE minus EXCESS MOIST, column (9) minus column (11). Enter the result in column (12).
- (13) Calculate the recharge to groundwater storage (RECHG TO GW) as PSUB times EXCESS MOIST, PSUB times column (11). Enter the result in column (13).
- (14) BEGIN STOR GW was entered previously as an initial condition or from the prior month calculation.
- (15) Calculate the end of month groundwater storage (END STOR GW) by adding the RECHG TO GW in column (13) to the BEGIN STOR GW in column (14). Enter the result in column (15).
- (16) Calculate the groundwater discharge to the stream (GW FLOW) where GW FLOW is GWF times END STOR GW or GWF times column (15). Enter the result in column (16).
- (17) Calculate the direct runoff to the stream (DIRECT FLOW), where DIRECT FLOW is EXCESS MOIST less RECHG TO GW, column (11) minus column (13) Enter the result in column (17).
- (18) Calculate the streamflow as the DIRECT FLOW plus GW FLOW, column (17) plus column (16). Enter the result in column (18). This result is in millimeters and can be converted to cubic meters for the month by multiplying by the watershed area in square kilometers times 1,000.

Reset initial conditions for the next month:

The BEGIN STOR GW for the next month is END STOR GW less GW FLOW, column (15) minus column (16). Enter this result in column (14) for the next month.

The beginning MOISTR STORAGE for the next month is the current MOISTR STORAGE plus DELTA STORAGE, column (4) plus column (12). Enter this result in column (4) for the next month.

The tabulation steps are repeated until all of the month of precipitation and potential evapotranspiration have been considered. An example of a completed table for monthly flows is given as Table 1.

### Calculation of a Peak Discharge on an Ungauged Stream

This section describes how to calculate the peak flood flow at a possible hydroelectric site, using the available data on the watershed, and the tables and figures that follow. Field data needed are a contour map of the watershed, and regional data on rainfall intensity versus time of rain for a 50 to 100 year storm. The steps involved in calculating the peak discharge are:

1. using channel and watershed characteristics, determine the flow time for the water to move through the watershed. This will be the time of rain for the design storm.
2. from regional meteorological data, determine rain intensity for the design storm.
3. determine watershed losses, excess rain, and peak discharge.

### Calculating the Time of Rainfall

In order to compute the time of rainfall the data needed are:

- $L$  = channel length in kilometers;  
 $ER$  = change in elevation between the highest point in the watershed and the site, in meters; and,  
 $AREA$  = watershed area, upstream of the site in square kilometers.

Calculate the Duration of Rainfall in hours ( $TR$ ), as

$$TR = 0.95 * (L^3 / ER)^{.385}$$

where  $L$  is in kilometers,  $ER$  is in meters, and  $TR$  is in hours.

### Estimating Rain Intensity

Given the Duration of Rainfall, use data on Duration of Rainfall versus Rain Intensity to find the rainfall intensity on the watershed. The relationship between Duration of Rainfall and Rainfall Intensity can be displayed graphically, as shown in Figure 6.

### Estimating Excess Rain and Determining Peak Flow

Rainfall will be lost during the storm due to infiltration. Table 2 describes various soil types and gives a loss rate for each. Losses are greater in watersheds with heavy vegetation. A correction factor for vegetation density can be selected that is multiplied by the loss rate for the watershed soils to give the total loss rate for the watershed,  $LR$ .

Once the rate of rainfall loss has been determined, Excess Rain can be calculated by subtracting the

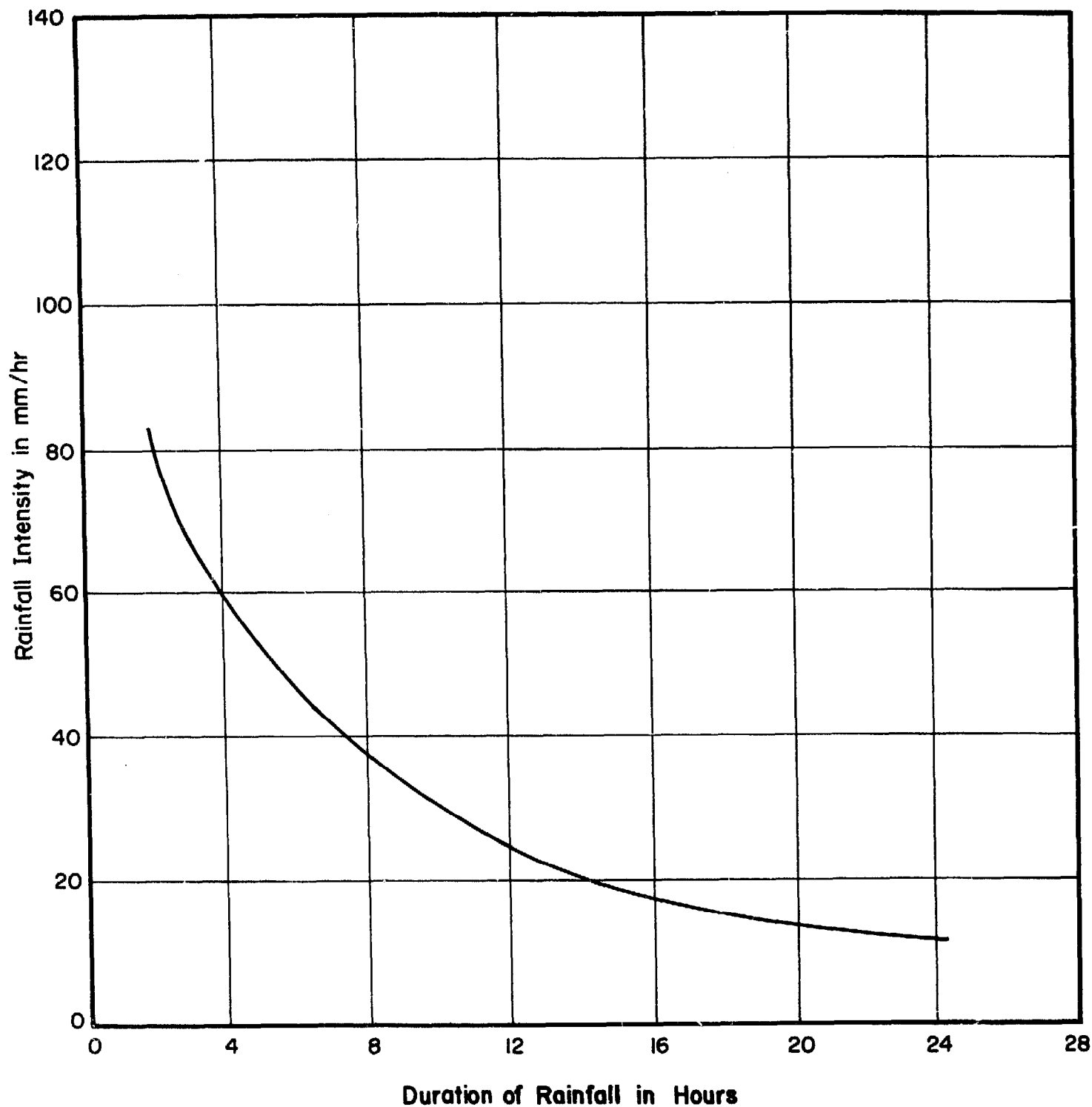

Fig. 6 An example of rainfall intensity vs. duration of rainfall for 50 year return period.

losses from the Rainfall Intensity,  $RI$ . The total excess rainfall rate is then

$$XR = RI - LR$$

where  $XR$ ,  $RI$  and  $LR$  are all in units of mm/h.

The final step is to determine the peak discharge

at the site:

$$\text{Peak Flow (cms)} = 0.28 * XR * \text{watershed area (km}^2\text{)}$$

Where  $XR$  is excess rain in mm/h and peak flow is in  $\text{m}^3/\text{sec}$ . An example of a peak flow calculation for Dry Creek in California follows:

**Table 2**  
**Watershed Loss Rates and Correction Factor**  
**for Predominant Vegetation**

Predominant Soil Type	Loss Rate (mm/hr)
Impervious Rock	1
Tight Clay	1
Clay and Silt	3
Silt and Sand	5
Sand and Gravel	10

Predominant Vegetation	Correction to Loss Rate (multiply by)
Sparse – little vegetation, bare soil, scrub brush	0.5
Moderate – grassland, cropland, mixed forest	1.0
Heavy – dense forest, tropical forest	2.0

Example: A watershed with clay silt soils and dense forest cover would have a loss rate of 3.0 mm/hr and a correction factor of 2.0 so its total loss rate would be  $3.0 \times 2.0 = 6.0$  mm/hr.

#### Dry Creek Watershed Near Cloverdale, California

$$\begin{aligned}
 L &= 28 \text{ km} \\
 ER &= 620 \text{ m} \\
 AREA &= 230 \text{ km}^2 \\
 TR &= 0.95 * (L^3/ER)^{.385} \\
 &= 3.75 \text{ h}
 \end{aligned}$$

From rainfall intensity/duration data,  $RI = 65$  mm/h. Using Table 2, soil type is silty clay, vegetation is mixed to heavy forest:

$$\begin{aligned}
 LR &= 3 * 1.5 = 4.5 \text{ mm/h} \\
 XR &= RI - LR = 60.5 \text{ mm/h} \\
 \text{Peak Flow} &= 0.28 * (XR) * (AREA) \\
 &= 3,900 \text{ cms}
 \end{aligned}$$

#### Conclusions and Accuracy of Methods

Included in this paper are hydrologic methods to:

- calculate monthly streamflow using monthly precipitation and potential evapotranspiration data, and watershed characteristics that represent soil moisture storage, subsurface flow volume, and the persistence of subsurface flows.

- calculate expected peak flows from a watershed using rainfall intensity-duration data, the length of a design storm rainfall based on channel characteristics, and estimates of watershed infiltration or loss rates.

These methods can be expected to operate with moderate accuracy. They use a minimum of field data, and they are appropriate for the design of small hydropower installations, with installed capacities of one megawatt or less.

#### Sources of Uncertainty in Flow Duration and Peak Flow Estimates

All hydrologic estimating techniques are uncertain. The uncertainty may come from bias in the basic meteorologic data used in the calculations, insufficient basic data and insufficient information on watershed characteristics, or inadequate representation of actual hydrologic processes in the calculation technique.

The sources of uncertainty in estimates of monthly streamflow and flow duration curves, in order of importance, are as follows:

1. bias in monthly precipitation or potential evapotranspiration data: if mean annual precipitation amounts are over-estimated by ten percent, calculated streamflows will be too high by more than ten percent;
2. short meteorologic records (less than 5 years);
3. unknown watershed characteristics and bias in the NOMINAL, PSUB and GWF factors that represent these characteristics; and,
4. simplified hydrologic processes for monthly runoff calculations (Figure 3).

The sources of uncertainty in estimates of peak flows, in order of importance, are as follows:

1. the rainfall intensity-duration data may be inaccurate: if rainfall intensity is low by 20% the calculated peak will be low by 20%;
2. the calculated "duration of rainfall" based on the overall channel characteristics may be in error. Errors are likely if there are marshes or lakes along the channel; and,
3. the watershed loss rates may be incorrect.

#### Reducing the Uncertainties

Uncertainty can be reduced by checking and verifying the meteorologic data used in the calculations, and by doing more investigation of regional watershed characteristics and flow characteristics at the proposed hydro site.

All hydrologic calculations should be checked for reasonableness against any information that can be obtained in the field. People living near a stream often recall high floods, and may be able to describe typical seasonal streamflows. The calculation of monthly flows could be adjusted if field data indicate, for

example, that the persistence of subsurface flows is greater than assumed. If field data indicate that historic peak flows are much less than the calculated peak flow, the rainfall intensity data for the watershed could be reviewed, and a field trip could be made to see if there are lakes or marshes along the stream channel above the site.

If a record of streamflow on a nearby stream is available, and monthly flow calculations are done for this gauged stream, values of the watershed characteristics (NOMINAL, PSOB and GWF) that best match recorded and calculated monthly flows can be found. These watershed characteristics can be transferred to the ungauged stream where the hydro site is located, with appropriate adjustments for any soils and vegetation differences. This approach to using the flow records on nearby gauged streams is recommended because the meteorologic records for the ungauged stream are most critical for the flow duration curve and peak flow estimates. Thus, the calculations on the ungauged stream are based on the meteorologic data for the ungauged stream, and regional soil storage and groundwater flow characteristics derived from nearby streams.

Use of comprehensive hydrologic analysis methods, like simulation modeling of the hydrologic process, could further reduce uncertainties. These methods include more precise techniques for calculating soil moisture and streamflow. They are appropriate for the design of large power and irrigation projects and they use detailed field data. They are not recommended for the hydrologic design of small hydropower projects (1 MW or less) because the field data collection and the time required for analysis would be impractical.

The calculations described in this paper could be completed within a few days for a prospective small hydropower site. They provide moderate accuracy based on minimum field data, and will be useful for making the needed hydrologic estimates.

## Discussion

*Mr. C.M.L. Kridakorn, Thailand:* I would like to ask Mr. Crawford a question dealing with the excess runoff from rainfall. Do you have any simpler method, by using runoff coefficients, to assess rainfall runoff?

*Mr. Crawford:* In calculating monthly flow, I had considered using a runoff coefficient, but you need to make the runoff coefficient a function of the soil moisture, which is different in different months, depending on the soil moisture that is present. For calculating monthly flows, you have to have that kind of scheme. I don't think it would be possible just to use one value for the excess moisture all the time.

*Mr. Waseem Khan, Pakistan:* Mr. Crawford, you said that the discharge calculations depend mainly on the precipitation rates, which are very uncertain and variable. To what degree, in percentage terms, do you think your calculations are correct?

*Mr. Crawford:* You mean the peak flow? (Mr. Khan: Yes.) I would say perhaps plus or minus 50%.

*Mr. Bard Jackson, U.S.:* Norman, I believe that, in calculating your peak flow, you mentioned using a one-in-fifty-year-flood criterion. Is that what you would recommend? In areas where you don't have 50 years of data, how do you evaluate what your one-in-fifty is?

*Mr. Crawford:* That's similar to the previous question. I believe I show that a major uncertainty in estimating peak is the uncertainty of the rainfall. It is quite common in estimating peaks to use rainfall intensity duration. This basic data is made up, for example, for drainage design and for highway crossing design and for all sorts of small works where you have to have an estimate of peak flow. Rainfall intensity frequency duration plots are compiled from all the information in a region. You may not have 50 years of recorded rainfall at any one point, but you might have five years from one place, ten years somewhere else, and so on. You use all the data in the region to come up with a rainfall intensity frequency for the region as a whole. If your data for rainfall intensity frequency is poor, then it is a source of error in estimating the peak.

As to the frequency of the flood that you might use, your approach should depend on the extent of the damage that is likely. For example, perhaps your powerhouse will be flooded out once in 50 years, but it won't necessarily be washed away, which requires rebuilding it. The standard practice in engineering, if there isn't a likelihood of too much damage, is to use somewhat in the range of a 50-100 year return period of damage, which is roughly the largest flood that people would remember in the region.

## Fundamentals of Hydraulic Turbine Design

Roger E.A. Arndt\*

---

**ABSTRACT :** The paper traces the development of the hydroturbine from the crude water wheels of the 1770's. The principles of energy transfer from liquid to rotating components is reviewed to provide an understanding for the various design criteria used for turbines of different application (e.g. high-head, low-head). This discussion is followed by a review of the principles of similitude to provide the engineer with a sufficient background to understand the application of various turbine designs to a given situation. The background material provides a sufficient framework for the review of existing designs available for the development of mini-hydropower systems. The paper concludes with a review of the state-of-the-art, and a critique of necessary developments to improve the economic advantages of hydropower in the near future.

---

### Introduction

**W**ATER turbines produce approximately one-fourth of the world's electric power. The St. Anthony Falls, just outside my office window, serves as a constant reminder of the role that hydropower has played, not only in the development of Minneapolis (Kane, 1966), but in the development of our civilization as we know it today. It is expected that hydropower will continue to have a place in our energy picture and will have an increasingly important impact on the growth of the less developed parts of our world.

Since we are currently in transition from a relatively stagnant period of design and development to an anticipated renaissance of small turbine development, this paper is structured in such a way that the basics of turbine performance as well as a summary of turbine characteristics which affect the operation of a hydropower site are provided. Cook-book procedures for turbine selection are avoided. Instead, a firm grounding in the basic principles of turbine hydrodynamics is given, which should provide the reader with the necessary tools to not only select a turbine from the current offerings but also to have the ability

to evaluate new turbine types which may appear in the future.

The water turbine has a rich and varied history (Rouse and Ince, 1963; Smith, 1980) and has been developed as a result of a natural evolutionary process from the water wheel. Originally used for direct drive of machinery, the use of the water turbine for the generation of electricity is a comparatively recent activity. Much of its development occurred in France, which unlike England, did not have the cheap and plentiful sources of coal which sparked the industrial revolution in the eighteenth century. Nineteenth century France found itself with its most abundant energy resource being water. To this day *houille blanche* (literally white coal) is the French term for water power.

In 1826 the Société d'Encouragement pour l'Industrie Nationale offered a prize of 6,000 FF to anyone who "would succeed in applying on a large scale, in a satisfactory manner, in mills and factories, the hydraulic turbines or wheels with curved blades of Bédidor" (Smith, 1980). Bédidor was an eighteenth century hydraulic and military engineer who, in the period 1737-1753, authored a monumental four volume work, "Architecture Hydraulique," a descriptive com-

---

\*St. Anthony Falls Hydraulic Laboratory, University of Minnesota, Minneapolis, Minnesota 55414

pilation of hydraulic engineering information of every sort. The water wheels described by Bélidor departed from convention by having a vertical axis of rotation and being enclosed in a long cylindrical chamber approximately one meter in diameter. Large quantities of water were supplied from a tapered sluice at a tangent to the chamber. The water entered with considerable rotational velocity. This pre-swirl combined with the weight of water above the wheel was the driving force. The original tub wheel had an efficiency of only 15% to 20%.

Water turbine development proceeded on several fronts during the period 1750 to 1850. The classical horizontal axis water wheel was improved by such engineers as John Smeaton of England (1724-92), who incidentally used in this endeavor the first avowed model experiments and also played an important role in windmill development, and the French engineer J.V. Poncelet (1788-1867). This resulted in water wheels having efficiencies in the range of 60% to 70%. At the same time, reaction turbines (somewhat akin to the modern lawn sprinkler) were being considered by several workers. The great Swiss mathematician, Leonhard Euler (1707-83), investigated the theory of operation of these devices. A practical application of concept was introduced in France in 1807 by Manoury de Ectot (1777-1822). His machines were, in effect, radial outward-flow machines. The theoretical analyses of Burdin (1790-1893), a French professor of mining engineering who introduced the word "turbine" in engineering terminology, contributed much to our understanding of the principles of turbine operation and underscored the principal requirements for high efficiency. A student of Burdin, Benoit Fourneyron (1802-1867), was responsible for putting his teacher's theory to practical use. His work led to the development of high speed, outward-flow turbines with efficiencies of the order of 80%. The early work of Fourneyron resulted in several practical applications and the winning of the coveted 6,000 franc prize in 1833. After nearly a century of development, Bélidor's tub wheel had been officially improved.

Fourneyron spent the remaining years of his life developing some 100 turbines in France and Europe. Some turbines even found their way to the U.S., the first in about 1843. The Fourneyron centrifugal turbines were designed for a wide range of conditions, with heads as high as 114 meters and speeds as high as 2300 r.p.m. Very low-head turbines were also designed and built.

As successful as the Fourneyron turbines were, they lacked flexibility and were only efficient over a narrow range of operating conditions. This problem

was addressed by Hoyd and Boyden (1804-79). Their work evolved into the concept of an inward flow motor due to James B. Francis (1815-92). The modern Francis turbine is the result of this line of development. At the same time, European engineers addressed the idea of axial flow machines, which today are represented by "propeller" turbines of both fixed pitch and the Kaplan type.

Just as the vertical axis tub wheels of Bélidor evolved into modern reaction turbines of the Francis and Kaplan type, development of the classical, horizontal-axis water wheel reached its peak with the introduction of the impulse turbine. The seeds of development were sown by Poncelet in 1826 with his description of the criteria for an efficient water wheel. These ideas were cultivated by a group of California engineers in the late 19th century, one of whom was Lester A. Pelton (1829-1908), whose name is given to the Pelton Wheel, which consists of a jet or jets of water impinging on an array of specially shaped buckets closely spaced around the periphery of a wheel. Thus, it can be said that the relatively high speed reaction turbines trace their roots to the vertical axis tub wheels of Bélidor, whereas the Pelton wheel can be considered as a direct development of the more familiar horizontal axis water wheel. Turbine configurations as we know them today are generally in the form as originally developed. For example, the overwhelming majority of Pelton wheels have horizontal axes. Vertical axis Pelton wheels are a relatively recent development. In over 250 years of development many ideas were tried, some were rejected and others were retained and incorporated in the design of the hydraulic turbine as we know it today. The development has resulted in highly efficient devices, with efficiencies as high as 95% in the large sizes. In terms of design concept, these fall into roughly three categories, reaction turbines of the Francis and propeller design and impulse wheels of the Pelton type. The rest of this paper is devoted to a review of the principles of operation, the classification and selection of turbines for given operating conditions, and a review of performance characteristics and operational limitations. Most of the development efforts to date have been placed on large turbines, with small turbine technology consisting chiefly of scaling down larger turbines. The validity of this concept is reviewed, and areas where improvements can be made are addressed.

## Principles of Operation

### Euler's Equation

The torque on the runner of a turbine can be

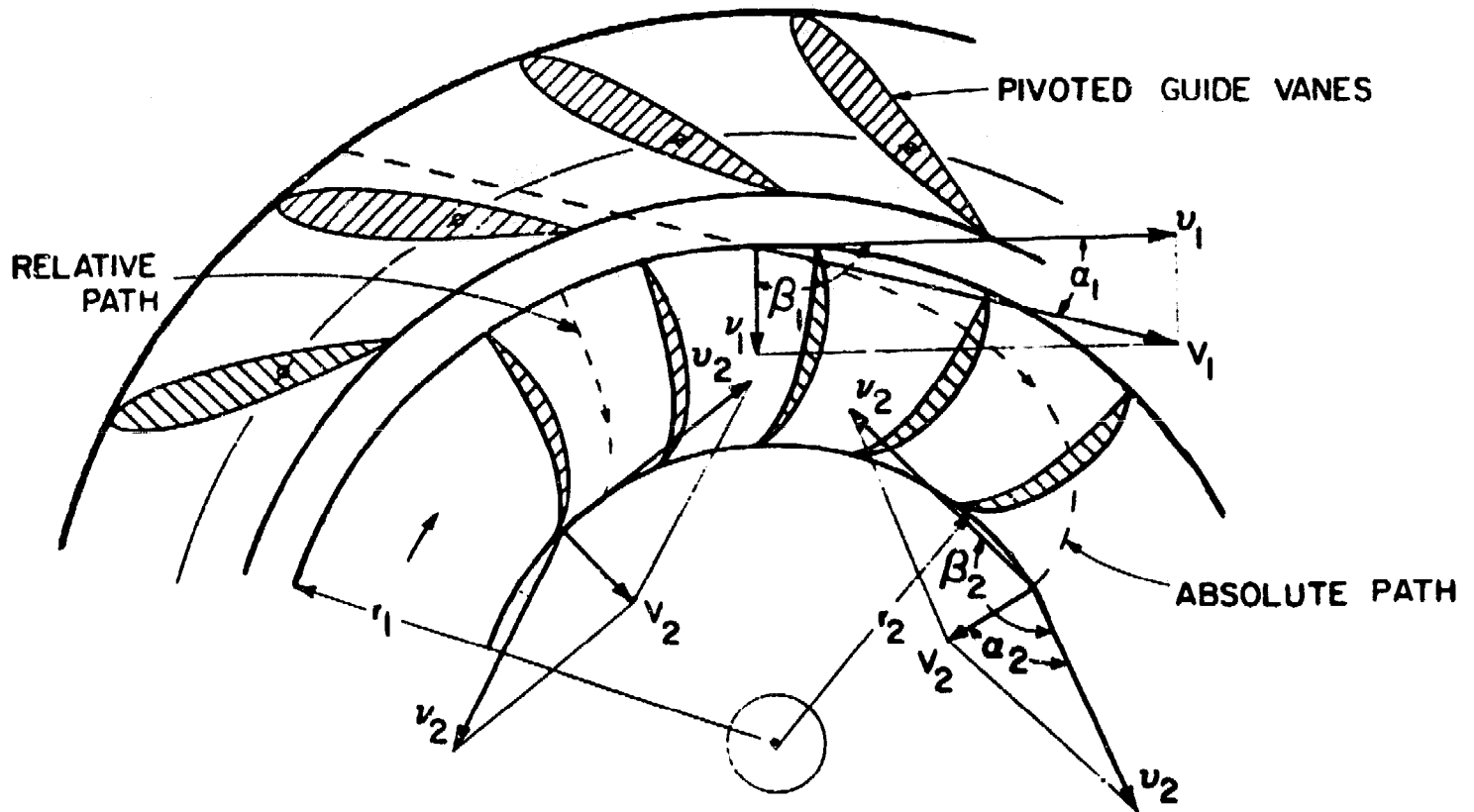

Fig. 1 Definition sketch for radial flow turbine runner. Adapted from Daugherty and Francini (1977).

found through conservation of radial momentum. In other words, the torque on a runner is the difference between the rate of angular momentum entering the runner and that existing. Referring to Fig. 1, this can be written as:

$$T = \rho Q (r_1 V_1 \cos \alpha_1 - r_2 V_2 \cos \alpha_2) \quad (1)$$

wherein  $\rho$  is the fluid density and  $Q$  is the volumetric rate of flow.

Since the power produced is proportional to the product of mass flow rate and head, we can write the following:

$$T\omega = \rho g Q H_u \quad (2)$$

$$\omega r_1 = u_1 \quad (3)$$

$$\omega r_2 = u_2 \quad (4)$$

$$\text{Thus } H_u = (u_1 V_1 \cos \alpha_1 - u_2 V_2 \cos \alpha_2) / g \quad (5)$$

where  $H_u$  is the head utilized by the runner in the production of power. We must be careful to keep in mind that  $V_1, V_2$  are absolute quantities, whereas  $u_1$  and  $u_2$  are the peripheral speeds at entrance and exit respectively. In a fixed frame of reference the abso-

lute velocity  $V$  is related to the vector sum of the relative velocity  $v$  and the velocity of a body moving with velocity  $u$ .

In vector notation:

$$V = u + v \quad (6)$$

We will define the angles of  $\alpha$  and  $\beta$  as respectively the angles made by the absolute and relative velocities of a fluid with the linear velocity  $u$  of some body. This is illustrated in the diagram below.

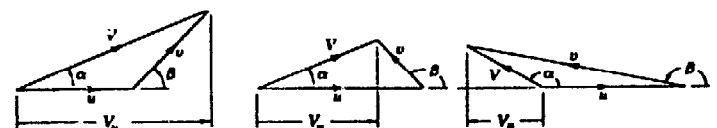

Fig. 2 Typical velocity triangles.

It is obvious from inspection of the figures that

$$V \sin \alpha = v \sin \beta \quad (7)$$

$$V \cos \alpha = u + v \cos \beta \quad (8)$$

The energy equation written between two points is given by



$$\frac{P_1}{\gamma} + z_1 + \frac{V_1^2}{2g} - \frac{P_2}{\gamma} + z_2 + \frac{V_2^2}{2g} \quad (9)$$

$$= H_L + (u_1 V_1 \cos \alpha_1 - u_2 V_2 \cos \alpha_2)/g$$

wherein  $H_L$  represents frictional losses and the last term on the right hand side of the equation represents the head absorbed by the turbine. It follows from Eqs. (7) and (8) that

$$V^2 = v^2 + u^2 + 2vu \cos \beta \quad (10)$$

$$uV \cos \alpha = u(u + v \cos \beta) \quad (11)$$

combining Eqs. (9), (10), and (11) results in the so-called energy equation in a rotating frame of reference.

$$\frac{P_1}{\gamma} + z_1 + \frac{V_1^2 - u_1^2}{2g} - \frac{P_2}{\gamma} + z_2 + \frac{V_2^2 - u_2^2}{2g} = H_L \quad (12)$$

Note that if there is no flow,  $v_1 = v_2 = 0$  and the equation reduces to that for a vortex. If there is no rotation, the equation reduces to the familiar form of the energy equation.

### Turbine Efficiency and Losses

#### Definitions

The hydraulic efficiency of a turbine is defined by

$$\eta_h = H_u/H$$

where  $H_u$  is the head utilized by the runner and  $H$  is the net head on the turbine, defined as the difference between the total head at the entrance to the turbine proper (entrance to the spiral casing and the total head at the tailrace). The definition of net head is illustrated in Fig. 3. The hydraulic efficiency expresses the effectiveness of the transfer to the runner of the available power in the fluid that flows through it. Also illustrated in Fig. 3 is the definition of gross head; the difference between headwater and tailwater elevations.

#### Similarity Considerations

##### Similitude Theory

The grouping of parameters brought about by dimensional or inspectional analysis permits the writing of any physical relationship in terms of fewer dimensionless qualities ( $\pi$  numbers) representing ratios of significant forces for the problem. This provides a method to extrapolate model test data to prototype situations by equating corresponding dimensionless numbers. As applied to hydraulic machinery, simi-

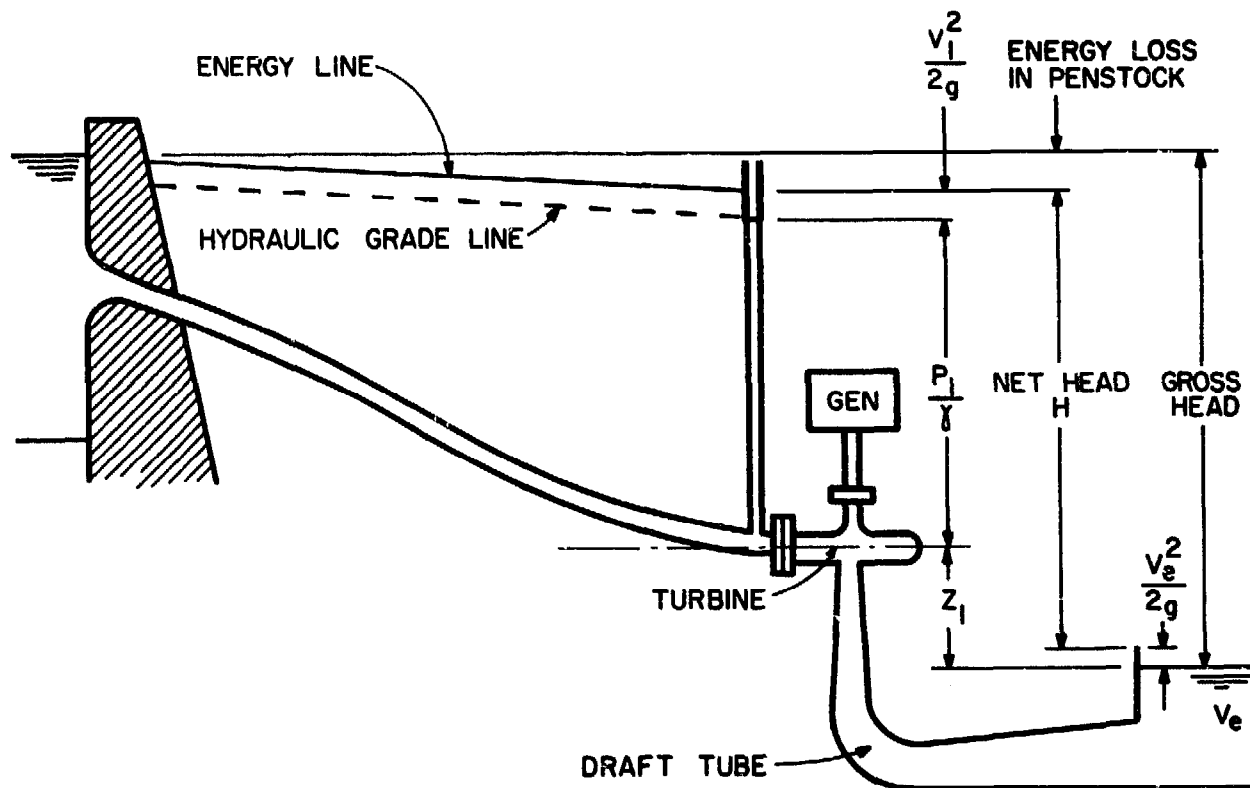

Fig. 3 Definition sketch for net head.

$$\frac{P_1}{\gamma} + z_1 + \frac{V_1^2}{2g} - \frac{P_2}{\gamma} + z_2 + \frac{V_2^2}{2g} \quad (9)$$

$$= H_L + (u_1 V_1 \cos \alpha_1 - u_2 V_2 \cos \alpha_2)/g$$

wherein  $H_L$  represents frictional losses and the last term on the right hand side of the equation represents the head absorbed by the turbine. It follows from Eqs. (7) and (8) that

$$V^2 = v^2 + u^2 + 2vu \cos \beta \quad (10)$$

$$uV \cos \alpha = u(u + v \cos \beta) \quad (11)$$

combining Eqs. (9), (10), and (11) results in the so-called energy equation in a rotating frame of reference.

$$\frac{P_1}{\gamma} + z_1 + \frac{V_1^2 - u_1^2}{2g} - \frac{P_2}{\gamma} + z_2 + \frac{V_2^2 - u_2^2}{2g} = H_L \quad (12)$$

Note that if there is no flow,  $v_1 = v_2 = 0$  and the equation reduces to that for a vortex. If there is no rotation, the equation reduces to the familiar form of the energy equation.

### Turbine Efficiency and Losses

#### Definitions

The hydraulic efficiency of a turbine is defined by

$$\eta_h = H_u/H$$

where  $H_u$  is the head utilized by the runner and  $H$  is the net head on the turbine, defined as the difference between the total head at the entrance to the turbine proper (entrance to the spiral casing and the total head at the tailrace). The definition of net head is illustrated in Fig. 3. The hydraulic efficiency expresses the effectiveness of the transfer to the runner of the available power in the fluid that flows through it. Also illustrated in Fig. 3 is the definition of gross head; the difference between headwater and tailwater elevations.

### Similarity Considerations

#### Similitude Theory

The grouping of parameters brought about by dimensional or inspectional analysis permits the writing of any physical relationship in terms of fewer dimensionless qualities ( $\pi$  numbers) representing ratios of significant forces for the problem. This provides a method to extrapolate model test data to prototype situations by equating corresponding dimensionless numbers. As applied to hydraulic machinery, simila-

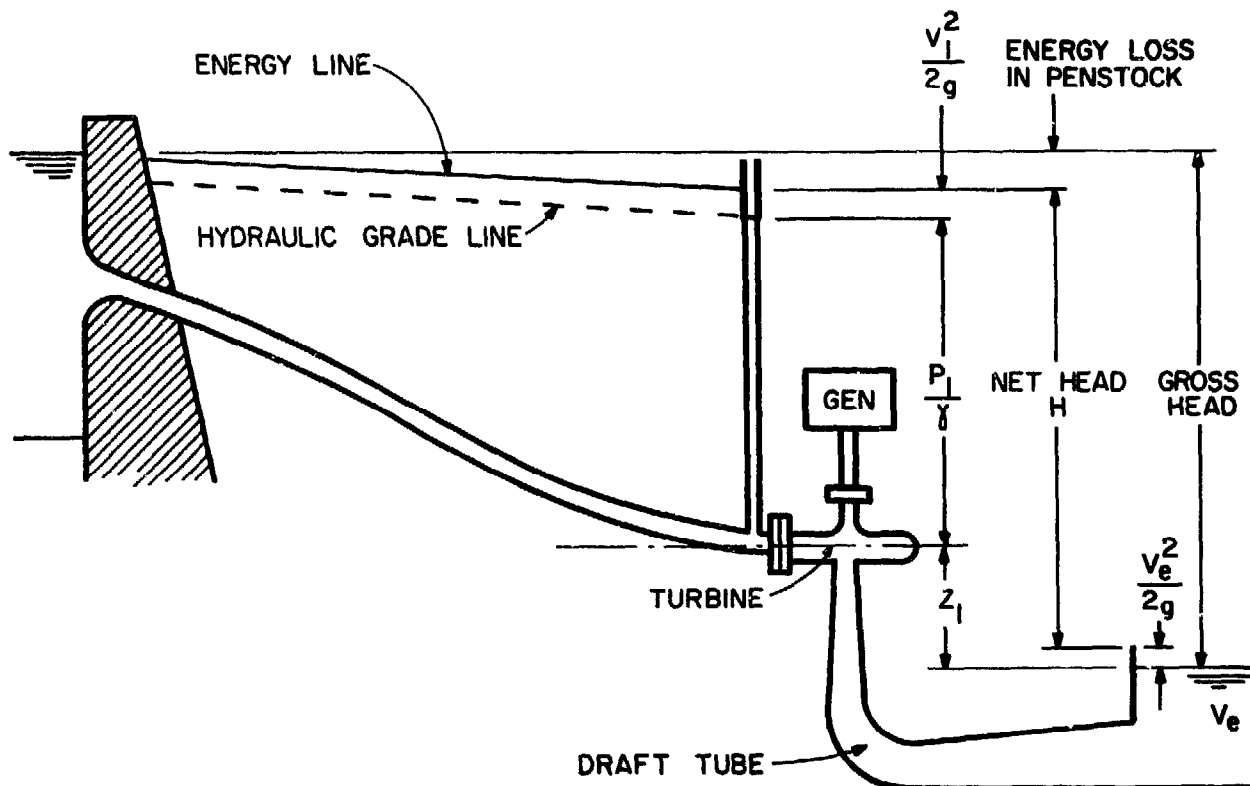

Fig. 3 Definition sketch for net head.

rity considerations provide, furthermore, an answer to the following important question: Given test data on the performance characteristics of a certain type of machine under certain operating conditions, what can be said about the performance characteristics of the same machine, or of a geometrically similar machine, under different operating conditions? Similarity considerations provide in addition a means of cataloguing machine types and thus aid in the selection of the type suitable for a particular set of conditions.

The problem of similarity of flow conditions can be summarized as follows: Under what conditions will geometrically similar flow patterns with proportional velocities and accelerations occur around or within geometrically similar bodies? Obviously the forces acting on corresponding fluid masses must be proportionally related, as are the kinematic quantities, so as to insure that the fluid will follow geometrically similar paths. An answer to this question can be obtained by examining the fundamental laws of motion and identifying the relevant forces. While these laws cannot yet be used to predict theoretically the flow conditions in a machine with unknown performance characteristics, the information they provide on forces and boundary conditions enables the determination of an answer to the similitude problem.

Similarity of the velocity diagrams at the entrance to the runner is a necessary requirement. Referring to Fig. 1, assuming equal angles  $\alpha$  in model and prototype, the ratio  $V_1/u_1$  must be held constant. If  $V_n$  denotes the radial component of the velocity (normal to the flow passages), we have

$$Q_e = f_b \pi \frac{B}{D} V_n D^2 \quad (14)$$

where  $f_b$  represents the fraction of free space in the inlet passages of the runner ( $f_b \sim 0.95$ ) and  $B$  is the width of the passages. With

$$V_n = V_1 \sin \alpha_1 = V_{R_1} \sin \beta_1 \quad (15)$$

Eq. (14) becomes

$$Q_e = (f_b \pi \frac{B}{D} \sin \alpha_1) V_1 D^2$$

Since 
$$u = \Omega r = \frac{\pi n}{60} D \quad (16)$$

we have

$$\frac{V_1}{u_1} = \frac{1}{(f_b \pi \frac{B}{D} \sin \alpha_1)}$$

$$\frac{Q_e}{u_1 D^2} = \frac{1}{(f_b \pi \frac{B}{D} \sin \alpha_1)} \frac{60 Q_e}{\pi n D^3} \quad (17)$$

Constancy of the ratio  $Q_e/nD^3$  or  $Q_e/\Omega D^3$  is then a necessary condition for similarity.

If we now make the assumption that viscous forces are small relative to inertia forces and thus can be neglected in first approximation, and that furthermore the fluid does not change its physical properties as it passes through the machine (which excludes compressibility effects and cavitation, to be dealt with later), the only other forces that appear in the fundamental equations of motion are the pressure forces. Their ratio to inertia forces is proportional to  $\Delta p/\rho V^2$  or, if the head  $H_u$  utilized by the runner is introduced, to  $g H_u/V^2$ . Under the assumptions made, the condition

$$Q_e/\Omega D^3 = \text{constant} \quad (18)$$

is sufficient for similarity. The condition

$$g H_u/V^2 = \text{constant or } g H_u/\Omega^2 D^2 = \text{constant} \quad (19)$$

follows from the basic laws and permits calculation of the head  $H_u$  for similar operating conditions. The equality of the ratio  $g H_u/V^2$  for model and prototype also follows from inspection of Euler's equation (5) under the assumption of negligible viscous effects.

Velocity coefficients  $\phi$ ,  $C_1$ , and  $C_2$  are customarily introduced as

$$u_1 = \phi \sqrt{2gH}, V_1 = C_1 \sqrt{2gH}, V_2 = C_2 \sqrt{2gH} \quad (20)$$

In terms of these coefficients, the hydraulic efficiency  $\eta_h$  defined by Eq. (13) can be written with the use of Eq. (5) as

$$\begin{aligned} \eta_h &= \frac{u_1 V_1 \cos \alpha_1 - u_2 V_2 \cos \alpha_2}{gH} \quad (21) \\ &= 2\phi \left( C_1 \cos \alpha_1 - \frac{D_2}{D_1} C_2 \cos \alpha_2 \right) \end{aligned}$$

If the viscous losses embodied in  $\eta_h$  can be assumed to occur under hydro-dynamically rough conditions, in the sense that the losses are independent of Reynolds number,  $Re$ , and depend only on geometric ratios and relative roughness ( $Re$  must be high enough for the losses to be purely turbulence-controlled), then  $\eta_h$  must be the same in model and prototype, provided that the relative roughnesses are the same and the geometry is faithfully reproduced. Under these conditions Eq. (19) becomes

$$gH/\Omega^2 D^2 = \text{constant} \quad (22)$$

Analogous considerations can be made about the volumetric efficiency  $\eta_v$ . Here Reynolds number effects may be more significant due to the smallness of the leakage-flow passages. But if one can assume Re independence, and under strict geometric similarity (including surface roughness and running clearances),  $\eta_v$  must be the same in model and prototype and Eq. (19) becomes

$$Q/\Omega D^3 = \text{constant} \quad (23)$$

Equations (22) and (23) permit calculation of the net head  $H$  and total flow rate  $Q$  for similar operating conditions.

### Scale Effects

The foregoing assumptions are reasonably accurate for turbines of fairly large dimensions operating under non-cavitating conditions. In particular, relative roughnesses and running clearance ratios are the same if similarity considerations are applied to the same machine. For large differences in the size of two geometrically similar machines, such as between model and prototype, roughnesses and clearances cannot be geometrically scaled due to fabrication limitations. Certain formulas have been developed to correlate model and prototype data, all of them containing a strong dose of empiricism. The Moody step-up equation (Moody and Zowski, 1969)

$$(1 - \eta_1)/(1 - \eta_2) = (D_2/D_1)^n \quad (24)$$

has been found to give satisfactory results for turbine flows. The basic assumption in Moody's derivation is Reynolds number independence (hydrodynamically rough flow) and the same degree of surface finish in model and prototype. The derivation is based on assuming losses of the form given by the Durey-Weisbach equation with  $f = A(k/D)^n$ , where  $A$  is constant. Since  $k$  is assumed to be the same for model and prototype, it disappears from the final result. The empirical exponent  $n$  is based on turbine test results:  $n \sim 1/5$  according to Moody, but it may become appreciably smaller if the formula is used with models with very smooth walls and close running clearances. It should be emphasized that Moody's formula has been developed solely with regard to the effect of relative roughness. No consideration is given to changes in the relative size of the running clearances, which obviously affect  $\eta_v$ , nor are mechanical losses explicitly taken into account (although these factors certainly

affect the empirical  $n$  values). The formula is nevertheless used to correlate overall efficiencies.

The power,  $P$ , developed by the turbine is given by

$$P = \eta \gamma Q H = \eta_m \eta_v \eta_h \gamma Q H \quad (25)$$

Thus, even if  $\eta_n$  and  $\eta_v$  are the same in model and prototype,  $\eta_m$  would be different generally due to differences in disk friction losses and in the losses in bearings and stuffing boxes. Obviously, if the mechanical losses are small, changes in  $\eta_m$  would also be small, and could be subsumed in the empirically determined values of the coefficients and/or exponents in the available step-up formulas. Camerer's formula (Camerer, 1924; Nechleba, 1957), as does Moody's Eq. (24), takes into account solely surface roughness effects. A formula of Ackeret's (Muhlemann, 1948), a second formula of Moody (Nechleba, 1957; Muhlemann, 1948), and a formula due to Hutton (1954) all incorporate Reynolds number effects and the net head ratio thus appears explicitly in them, in addition to the size ratio of model and prototype. All of them are based on derivations that ignore volumetric losses and mechanical losses, although the selection of the empirical coefficients is based on actual turbine test data.

It may be noted here that Euler's (5), or the basic relationships of Eqs. (9) and (12) as applied to reaction turbines, imply simplifications which require in actual calculations the use of experimentally determined coefficients. Thus, for example, fluid particles in different streamlines generally have different velocities and, furthermore, their radial distances to the axis of rotation at entry to or exit from the runner are also different, because the entrance or exit edges of the vanes are not always parallel to the turbine axis. Despite these problems, the theory is useful in many ways: it shows the nature of the performance curves of a given machine, it permits identification of each separate factor affecting the performance, and it shows how changes in design should be made to alter the characteristics of a machine as obtained from experimental testing. It also sheds light on the nature of the similarity laws and possible scale effects.

Similar considerations can be made regarding the theory of impulse (Pelton) wheels (to be dealt with later) which is based on a simplified version of Eq. (2). Essentially, the same results are obtained regarding similarity relationships. For Pelton wheels, however, the efficiency is nearly independent of size and Eq. (24) or similar equations do not apply. As the size of a Pelton wheel increases, there is a deterioration in the smoothness of the jet before it strikes the buckets,

which nullifies any benefits from reduced friction losses. Furthermore, there are no leakage losses to make a difference.

The similarity results in these sections can be used, with due regard to the approximations involved, to predict the performance of a machine under operating conditions different from those of available experimental data, and the performance of geometrically similar machines if performance characteristics are available for one of them. Some examples of application are given later.

### Specific Speed

Similar flow conditions are ensured by the constancy of the ratio  $Q/\Omega D^3$ , which implies constancy of the ratio  $gH/\Omega^2 D^2$ . In other words,

$$gH/\Omega^2 D^2 = f(Q/\Omega D^3) \quad (26)$$

This relationship can also be written in terms of a third dimensionless number which does not involve the representative dimension  $D$  of the machine, and which can replace either of the two arguments in Eq. (26). Such a number can be obtained by appropriate multiplication of powers of the dimensionless numbers in Eq. (26):

$$N_s Q = (Q/\Omega D^3)^{1/2} (\Omega^2 D^2/gH)^{3/4} = \Omega Q^{1/2}/(gH)^{3/4} \quad (27)$$

This dimensionless number is called the specific speed. For hydraulic turbines, however, the definition of the specific speed is based on the power  $P$  delivered by the turbine as a variable, instead of the flow rate  $Q$ . The corresponding dimensionless number of  $P$  is  $P/\rho\Omega^3 D^5$ , which is a function of  $gH/\Omega^2 D^2$ . Eliminating  $D$  between these two numbers one gets

$$N_s = \Omega (P/\rho)^{1/2}/(gH)^{5/4} \quad (28)$$

The two specific speeds are related by

$$N_s = \sqrt{\eta} N_{sQ} \quad (29)$$

which is obtained making use of Eq. (25). If we choose  $N_s$  as the independent variable in these relationships, then all other dimensionless combinations can be expressed as functions of  $N_s$ . These include also the dimensionless torque,  $T/\rho\Omega^2 D^5$ , and the efficiencies, under the assumption of negligible scale of effects.

The specific speed describes a specific combination of operating conditions that ensures similar flows in geometrically similar machines. It has thus attached to it a specific value of the efficiency  $\eta$  (assumed

approximately constant for similar flow conditions regardless of size). It is then customary to label each series of geometrically similar turbines by the value of  $N_s$  which gives maximum  $\eta$  for the series. Unless otherwise stated, this is the  $N_s$  value referred to when the terminology specific speed is used. The value of  $N_s$  thus defined permits the classification of turbines according to efficiency. Each geometric design has a range of  $N_s$  values where it can be used with only one value corresponding to peak efficiency. In subsequent sections this idea will be used to classify turbine designs.

The  $N_s$  as defined is dimensionless. It is common in practice to drop  $g$  and  $\rho$  from the definition and define  $n_s$  as

$$n_s = n\sqrt{P}/H^{5/4} \quad (30)$$

with  $n$  in r.p.m. In English units, the units of  $P$  are horsepower, and the units of  $H$  are feet. In metric units, the unit of  $P$  is either the metric horse-power or the kilowatt, and the unit of  $H$  is the meter. The relationships of these three definitions of  $n_s$  to the dimensionless  $N_s$  are:

$$n_s = 43.5 N_s \quad (\text{English units})$$

$$n_s = 193.1 N_s \quad (\text{Metric units using metric horsepower})$$

$$n_s = 166 N_s \quad (\text{Metric units using kW for power}) \quad (31)$$

### Cavitation

#### Introduction

Cavitation can be defined as the formation of the vapor phase in a liquid flow when the hydrodynamic pressure falls below the vapor pressure of the liquid. It is distinguished from boiling, which is due to the vapor pressure being raised above the hydrodynamic pressure by heating. In its initial stages, cavitation is in the form of individual bubbles which are carried out of the minimum pressure region by the flow and collapse in regions of higher pressure. Calculations, as well as sophisticated laboratory experimentation, indicate that collapsing bubbles create very high impulsive pressures. This results in substantial noise (a cavitating turbine sounds like gravel is passing through it). More important, the repetitive application of the shock loading due to bubble collapse at liquid-solid boundaries results in pitting of the material. As the process continues, cracks form between the pits and solid material is spilled out from the surface. The mechanical effects of cavitation are enhanced by the high temperatures created by collapsing bubbles and the presence of

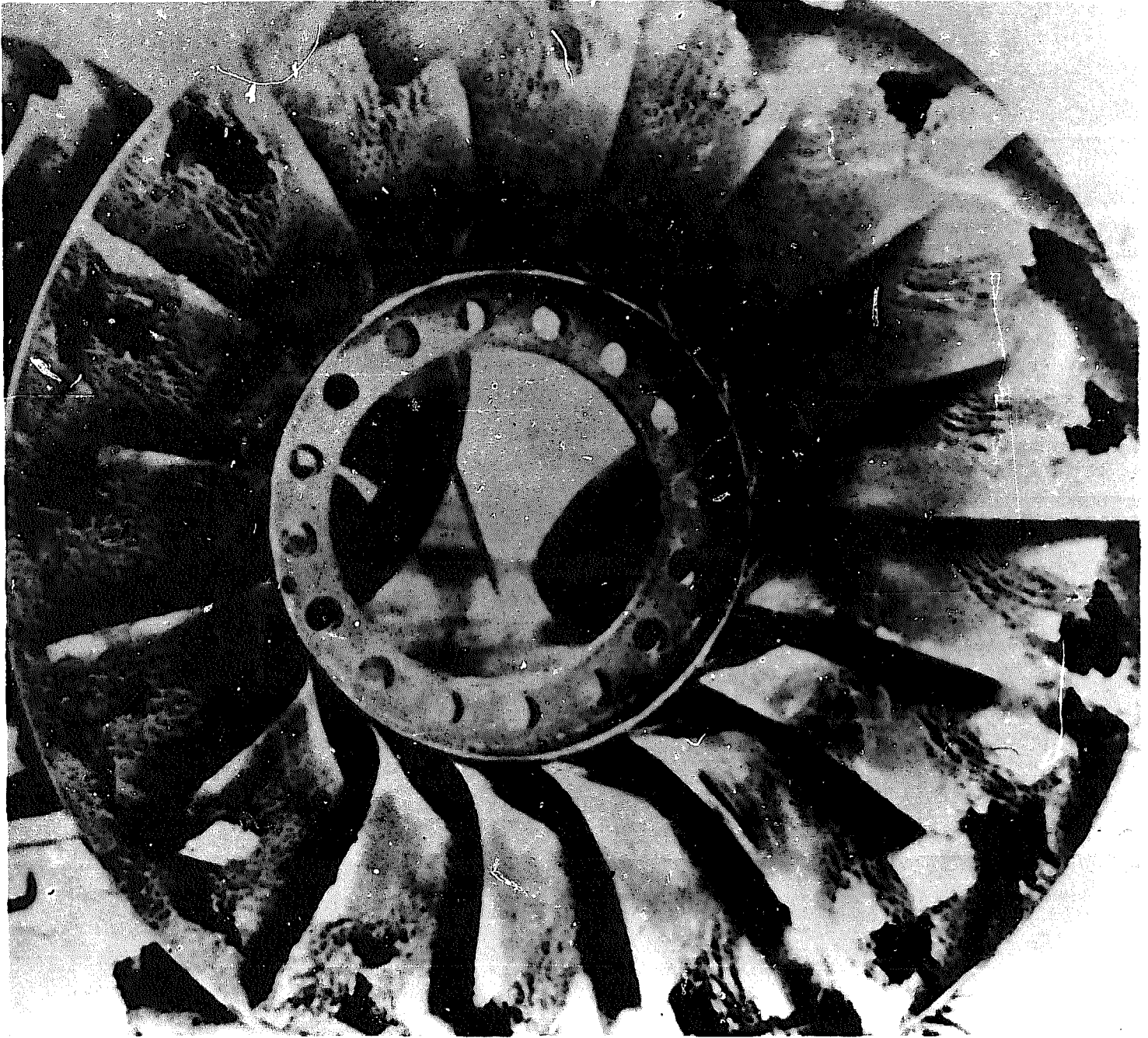

Fig. 4 Cavitation erosion on a turbine runner.

oxygen rich gases which come out of solution. The details of the erosion process are complex, but the results are of practical significance. Many components of a turbine are susceptible to extensive damage as illustrated in Fig. 4. In more developed forms of cavitation, large vapor filled cavities remain attached to the boundary. Each cavity or pocket is formed by the liquid flow detaching from the rigid boundary of an immersed body or flow passage. The maximum length of a fixed cavity depends on the pressure field. Termination may occur by reattachment of the liquid stream

at a downstream position on the solid surface or the cavity may extend well beyond the body. The latter case is known as supercavitation. Under these circumstances, the pressure distribution on the boundary can be substantially altered. If developed cavitation occurs on the runner or wicket gates of the turbine, the performance is changed. Cyclical growth and collapse of the cavities can also occur, producing vibration. Thus cavitation can degrade performance and produce vibration, as well as reducing the operational lifetime of the machine through erosion.

*The Cavitation Index*

The fundamental parameter in the description of cavitation is the cavitation index

$$\sigma = (P_o - P_v) / \frac{1}{2} \rho V_o^2 \quad (32)$$

The state of cavitation is assumed to be a unique function of  $\sigma$  for geometrically similar bodies. If  $\sigma$  is greater than a critical value, say  $\sigma_c$ , there is no cavitation and the various hydrodynamic parameters are independent of  $\sigma$ . When  $\sigma$  is less than  $\sigma_c$ , various hydrodynamic parameters such as the lift and drag of various components and the power and efficiency of a turbine are functions of  $\sigma$ . Noise, vibration, and erosion also scale with  $\sigma$ . It should be emphasized that the value of  $\sigma$  where there is a measurable change in performance is not the value of  $\sigma$  where cavitation can first be determined visually or acoustically. The critical  $\sigma_c$  can be thought of as a performance boundary such that:

- $\sigma > \sigma_c$  no cavitation effects
- $\sigma < \sigma_c$  cavitation effects: performance degradation, noise and vibration

The precise value of  $\sigma_c$  defined by inception is normal-

ly only determined in the laboratory. It should not be confused with more pragmatic definitions such as the value of the cavitation index at a measurable change in hydraulic performance expressed by power, capacity or efficiency, or at a measurable change in vibration level.

When the value of  $\sigma$  is less than  $\sigma_c$ , fixed or attached cavities can form on the suction side of a lifting surface. The minimum pressure is the vapor pressure, independent of upstream velocity and pressure; hence

$$C_{p_m} = -\sigma \quad \sigma < \sigma_c \quad (33)$$

where  $C_{p_m}$  is the minimum pressure coefficient defined by

$$C_{p_m} \equiv (P_{p_m} - p_o) / \frac{1}{2} \rho V_o^2$$

Assuming the pressure distribution on the pressure side to be uninfluenced by cavitation on the suction side, it is easily seen that the lift coefficient,  $C_L$ , should be proportional to  $C_{p_m}$ . This is shown in Fig. 5. At each value of the angle of attack,  $\alpha$ , there is a value of  $\sigma$  above which  $C_L$  is independent of this parameter. At

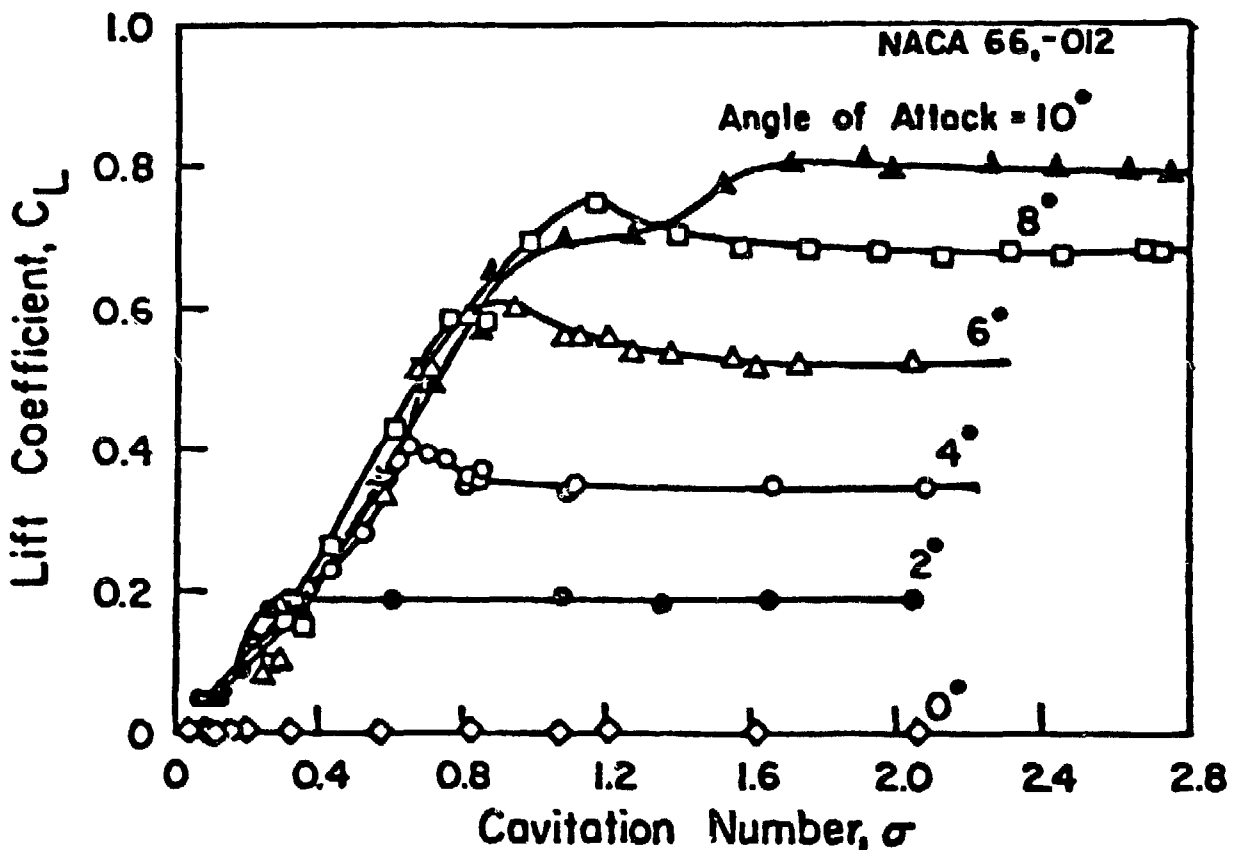

Fig. 5 Variation in lift coefficient with cavitation number. (Kermeen, 1956)

lower values of  $\sigma$ ,  $C_L$  decreases with decreasing  $\sigma$ . Note that as angle of attack increases,  $C_L$  increases and "cavitation stall" occurs at increasingly higher values of  $\sigma$ . In a turbo-machine the picture is qualitatively the same. As previously mentioned, the angle of attack is proportional to flow coefficient at a fixed wicket gate setting. Obviously the flow is more complicated, but the analogy between a hydrofoil and the blade section of a propeller turbine can be seen.

The introductory material on cavitation was based on simple geometric shapes and an easily defined cavitation parameter. The flow in a turbine is obviously more complex and less easily quantified. There still is, however, a definite need to define operating conditions with respect to cavitation. For example, it is sometimes necessary to specify under what conditions the degree of cavitation will be the same for the same machine operating under different heads and speeds, or for two machines of similar design but different heads and speeds, or for two machines of similar design but different size, e.g. a model and a prototype. The accepted parameter for this purpose is the Thoma sigma,  $\sigma_T$ . This is defined as

$$\sigma_T = H_{sv}/H \quad (34)$$

where  $H_{sv}$  is the net positive suction head. Referring to Fig. 3, this is defined as

$$H_{sv} = H_a - z_1 - H_v + (V_e^2/2g) + H_Q \quad (35)$$

where  $H_a$  is the atmospheric pressure head,  $z_1$  is the

elevation of the critical location for cavitation above the tailwater elevation,  $V_e$  the average velocity in the tailrace, and  $H_Q$  the head loss in the draft tube. If we neglect the draft tube losses and the exit velocity head, Thoma's sigma is

$$\sigma_T = (H_a - H_v - z)/H \quad (36)$$

Each type of turbine will cavitate at a given value of  $\sigma_T$ . Clearly cavitation can only be avoided if the installation is such that  $\sigma_T$  is greater than this critical value. The value of  $\sigma_T$  for a given installation is known as the plant sigma. For a given turbine operating under a given head, the only variable is the turbine setting,  $z$ . The critical value of Thoma's sigma,  $\sigma_{TC}$ , controls the allowable setting above tailwater:

$$z_{allow} = H_a - H_v - \sigma_{TC}H \quad (37)$$

It must be borne in mind that  $H_a$  varies with elevation. As a rule of thumb,  $H_a$  decreases from the sea level value of 10.3 meters by 1.1 meter for every 1,000 m above sea level. Thus a turbine sited at Leadville, Colorado or Quito, Ecuador, for example, would have an allowable turbine setting that is three meters less than that at sea level. In fact,  $z_{allow}$  could easily be negative, implying a required turbine setting below the tailwater elevation.

The determination of  $\sigma_{TC}$  is usually done by a model test. A schematic of the correlation between performance breakdown and  $\sigma_T$  is shown in Fig. 6. This figure is based on information presented by Dee-

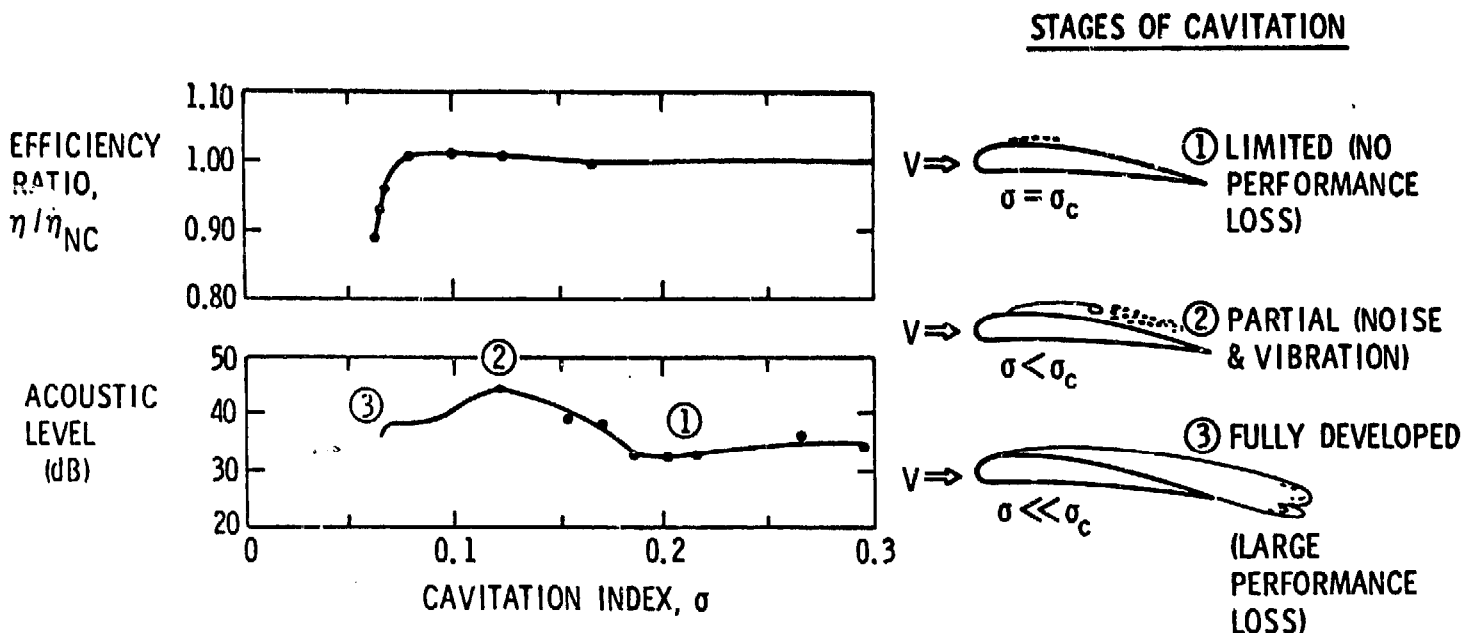

Fig. 6 Schematic of the correlation between performance break down, noise, and erosion with cavitation index.



prose et al (1974). Note the similarity in the trend of performance with  $\sigma_T$  and the correlation of lift coefficient at fixed  $\sigma$  with  $\sigma$  as shown in Fig. 5. As has already been emphasized, a measureable drop in efficiency occurs at value of  $\sigma_T$  that is well below the value corresponding to the detection of cavitation inception acoustically. Note also that maximum noise and presumably maximum erosion rate occur at a value of  $\sigma_T$  intermediate between the value at inception and that at performance breakdown. A slight rise in efficiency is often also noted at intermediate values of  $\sigma_T$ .

#### Suction Specific Speed

The critical value of  $\sigma$  is a function of the type of turbine involved, i.e. the specific speed of the machine. A cavitation scaling parameter often used in pump application is the suction specific speed

$$S = \Omega \sqrt{Q} / (gH_{sv})^{3/4} \quad (38)$$

The suction specific speed is a natural consequence of considering dynamic similarity in the low pressure re-

gion of a turbomachine. The dynamic relations are

$$gH_{sv} D_e^4 / Q^2 = \text{const}, \quad gH_{sv} / \Omega^2 D_e^2 = \text{const} \quad (39)$$

where  $D_e$  is the eye or throat diameter. These relations hold when the kinematic condition for similarity of flow in the low pressure region of the machine is satisfied:

$$Q / \Omega D_e^3 = \text{const} \quad (40)$$

Elimination of  $D_e$  in Eq. (39) yields the suction specific speed. Using Eq. (26) for the power developed by a turbine, the relationship between  $\sigma_T$ ,  $N_s$ , and  $S$  is given by

$$\sigma_T = (1/\eta^{2/3}) (N_s/S)^{4/3} \quad (41)$$

If  $S$  can be assumed to be constant, then Eq. (41) produces a relationship between  $\sigma_T$  and  $N_s$ . Allowable values of  $S$  do vary, but an acceptable conservative value in non-dimensional units is 3. A comparison between Eq. (41), assuming  $2 \leq S < 4$  and actual turbine experience, is shown in Fig. 7. An efficiency of

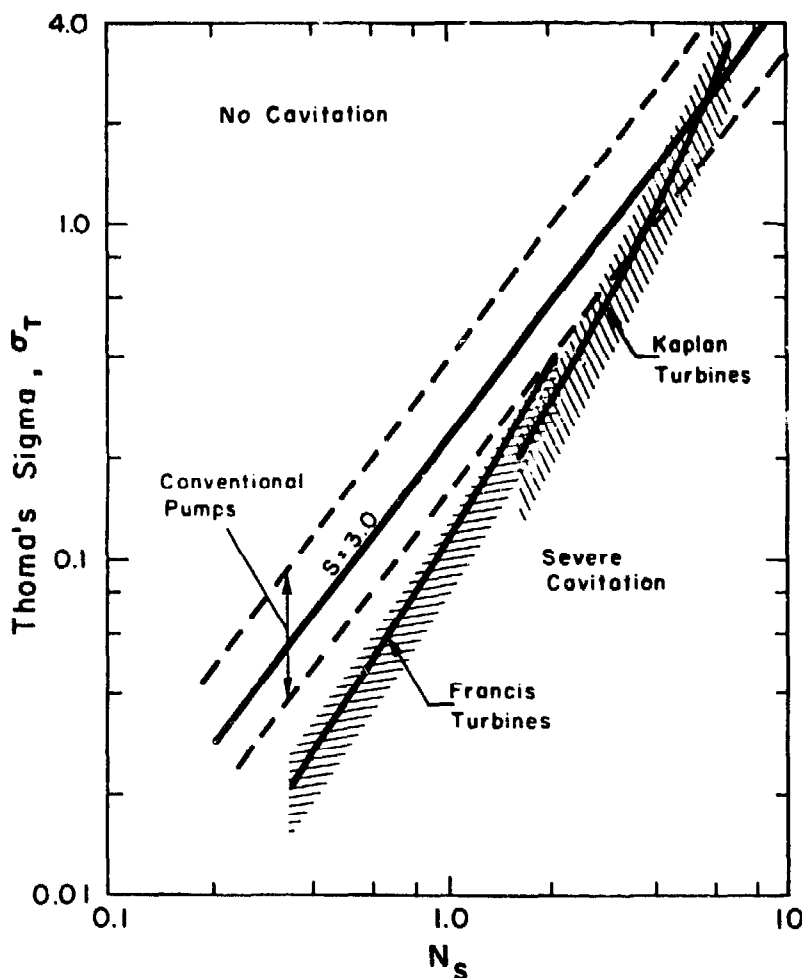

Fig. 7 Allowable Thoma's sigma as a function of specific speed. (Adapted from Moody and Zowski, 1969).

0.9 is assumed. The allowable  $S$  for turbines appear to be higher than for an equivalent pump. Note also that the trend of limiting  $\sigma_T$  for turbines has a steeper slope than the constant  $S$  lines. This could imply that different specific speed designs are not equally close to the optimum with regard to cavitation or that the factor  $S$  cannot be considered a constant. It should be kept in mind that since the flow direction for a pump and a turbine are in opposite directions, only the inception point should be similar. Under developed cavitating conditions, the flow situation could be quite different, with cavity closure occurring on the runner in the case of a pump, whereas it would occur downstream of the runner in the case of the equivalent turbine.

Figure 7 is a useful chart for estimating the turbine setting for various types of turbines in conjunction with Eq. (37). This is a useful procedure for preliminary design and comparison between different types of turbines for the same installation. However, the manufacturer's recommendation should be followed in the final design.

## Turbine Technology

### Overall Description of a Hydropower Installation

The hydraulic components of a hydropower installation consist of an intake, penstock, guide vanes or distributor, turbine, and draft tube. The intake is designed to withdraw flow from the forebay as efficiently as possible, with no or minimal vorticity. Trash racks are commonly provided to prevent ingestion of debris into the turbine. Intakes usually require some type of shape transition to match the passageway to the turbine and also incorporate a gate or some other means of stopping the flow in case of an emergency or turbine maintenance. Some types of turbines are set in an open flume; others are attached to a closed conduit penstock. In all cases, efforts should be made to provide uniformity of the flow, as this uniformity has an effect on the efficiency of the turbine. For low head installations, the diameter of a closed penstock must be quite large to accommodate the large discharges necessary for a given power output. Its size is a compromise between head loss and cost. The selection of the actual penstock configuration is dependent on the location of the powerhouse with respect to the dam.

For some types of reaction turbines, the water is introduced to the turbine through casings or flumes which vary widely in design. The particular type of casing is dependent on the turbine size and head. For small heads and power output, open flumes are com-

monly employed. Steel spiral casings are used for higher heads, and the casing is designed so that the tangential velocity is essentially constant at consecutive sections around the circumference. This requirement necessitates a changing cross-sectional area of the casing. Some examples of intakes and casings are shown in Fig. 8 where dimensions are given in terms of the runner diameter. As the inflow has an effect on the turbine efficiency, the design of the special casing is carried out by the turbine manufacturer.

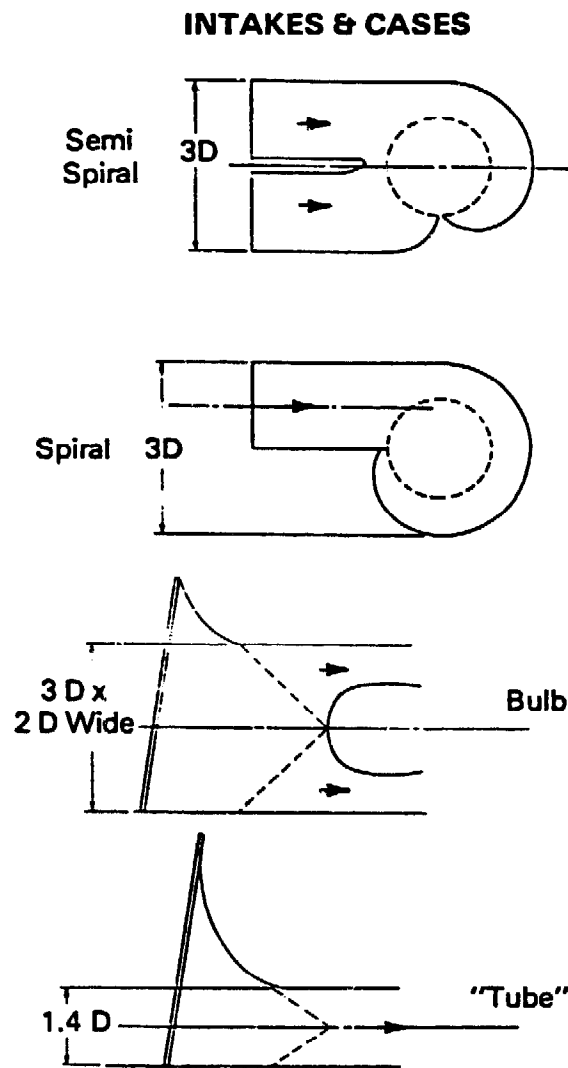

Fig. 8 Typical intake and case dimensions. (Mayo, 1979)

Discharge control for some types of reaction turbines is provided by means of adjustable guide vanes or wicket gates around the outer edge of the turbine runner. The vanes are tied together with linkages and their positioning is regulated by a governor. The adjustable vanes are shown schematically in Fig. 1. The flow area can be readily varied from zero to a maximum by rotation of the vanes. In addition, the velocity diagrams at the entrance and exit are a function of the

guide vane position and therefore the efficiency of the turbine also changes. Wicket gates can also be used to shut off the flow to the turbine in emergency situations. Various types of valves are installed upstream of the turbine for this purpose for turbines without wicket gates.

One purpose of the draft tube is to reduce the kinetic energy of the water exiting the turbine runner. Within limits a well-designed draft tube will permit installation of the turbine above the tailwater elevation without losing any head. Different designs of a draft tube are common, ranging from a straight conical diffuser to configurations with bends and bifurcations. Some typical shapes and relative dimensions are shown in Fig. 9, where the dimensions again are given in terms of the runner diameter.

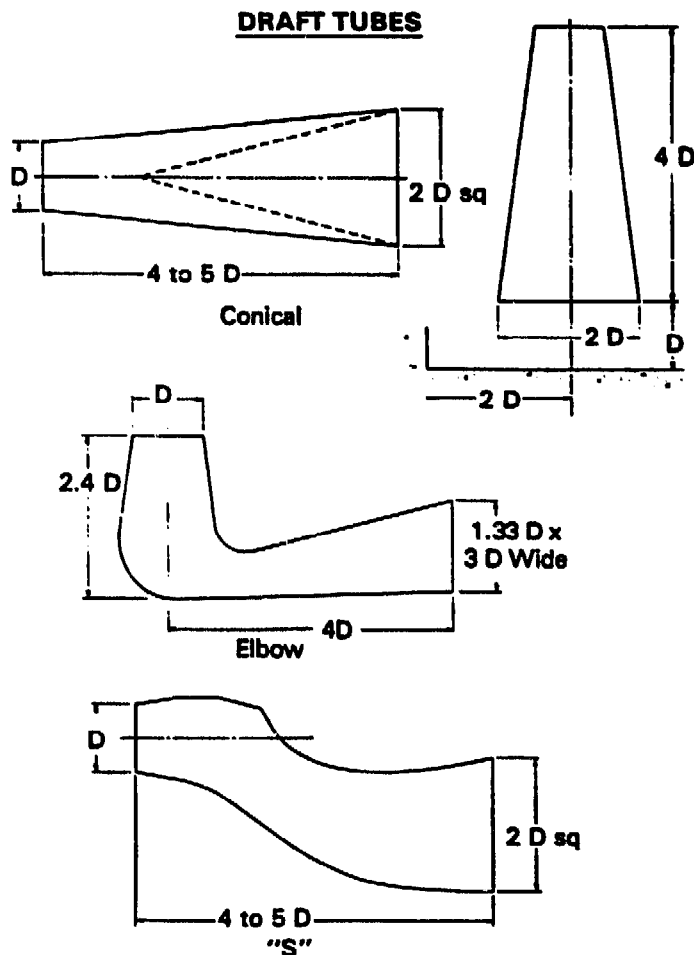

Fig. 9 Typical draft tube dimensions (Mayo, 1979)

The simplest form of draft tube is the straight conical diffuser. Efficiency of energy conversion is dependent on the angle of the diverging walls. Small divergence angles require long diffusers to achieve the area necessary to reduce the exit velocity. Long diffu-

sers increase construction costs, and therefore the angle in some cases may be increased up to about 15 degrees from the typical optimum value of about 7 degrees. In addition to the increased loss through a large angle diffuser, flow separation can lead to unstable flow. Flow instability is to be avoided, as it has an adverse effect on turbine performance.

For some types of turbine installations, such as a vertical axis turbine, the flow must be turned through a 90 degree angle after leaving the turbine. This is accomplished by adding an elbow between the turbine and draft tube, which has an influence on the draft tube performance, and requires careful design.

Experimental data on diffusers are available in the literature. However, the flow leaving the turbine runner can have a swirl component of velocity which has an effect on the draft tube efficiency. The magnitude of the swirl is dependent on the type of turbine and operating conditions. Excessive swirl can result in surging in the draft tube, as well as load fluctuations and pressure fluctuations that can cause mechanical vibrations of severe magnitude. However, a small swirl component has been found to be beneficial.

A draft tube design adequate for one type of runner may not be satisfactory for another. Therefore, the draft tube is considered an essential part of the turbine, and its design is carried out by the turbine manufacturer.

An example of some typical losses and their sources are shown in Fig. 10 for a Kaplan turbine. For small discharges, major losses occur in the runner and distributor. This is typical for a turbine operating at off-design conditions, and is associated with the shock losses in the runner. As the discharge increases, the runner and distributor losses decrease to relatively small values. The draft tube losses increase, but the largest increase is in the losses at the draft tube exit. It becomes obvious that efforts should be made to reduce this loss, which can be accomplished by enlarging the draft tube exit area. However, as such enlargement increases the construction cost, compromises must again be made.

### Turbine Classification and Description

There are two basic types of turbines, denoted as impulse and reaction. In an impulse turbine the available head is converted to kinetic energy before entering the runner, the power available being extracted from the flow at atmospheric pressure. In a reaction turbine the runner is completely submerged and both the pressure and the velocity decrease from inlet to outlet. The velocity head at the inlet to the

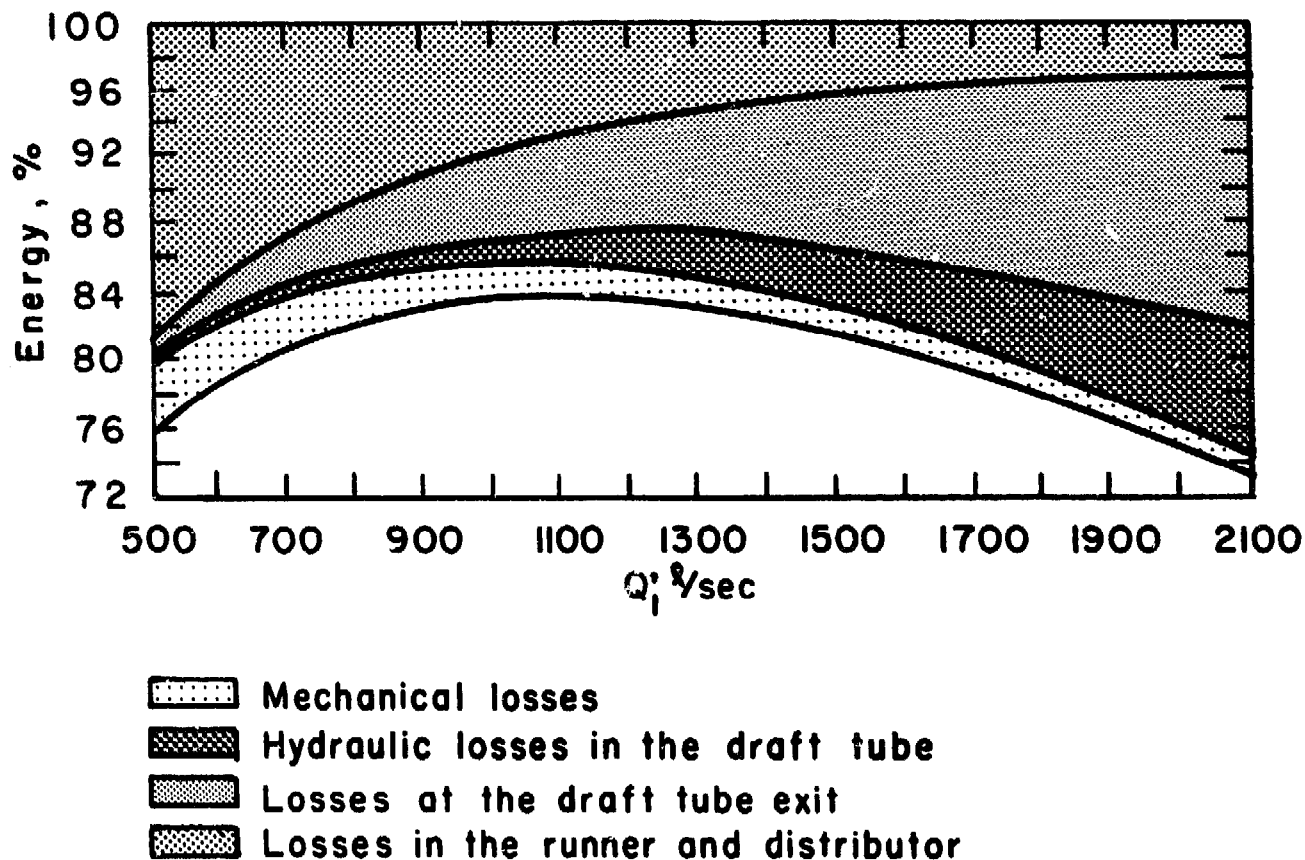

Fig. 10 Energy balance for a medium speed Kaplan turbine model as a function of unit discharge for a 1 m diameter and 1 m head. (Kovalev, 1965).

turbine runner is typically less than 50% of the total head available. In either machine the torque is equal to the rate of change of angular momentum through the machine as expressed by the Euler equation.

#### Impulse Turbines

Modern impulse units are generally of the Pelton type and are restricted to relatively high head applications (Fig. 11). One or more jets of water impinge

on a wheel containing many curved buckets. The jet stream is directed inwardly, sideways, and outwardly thereby producing a force on the bucket which in turn results in a torque on the shaft. All of the available head is converted to kinetic energy at the nozzle. Any kinetic energy leaving the runner is "lost". It is essential that the buckets are designed in such a manner that exit velocities are a minimum. No draft tube is used since the runner operates under essentially atmos-

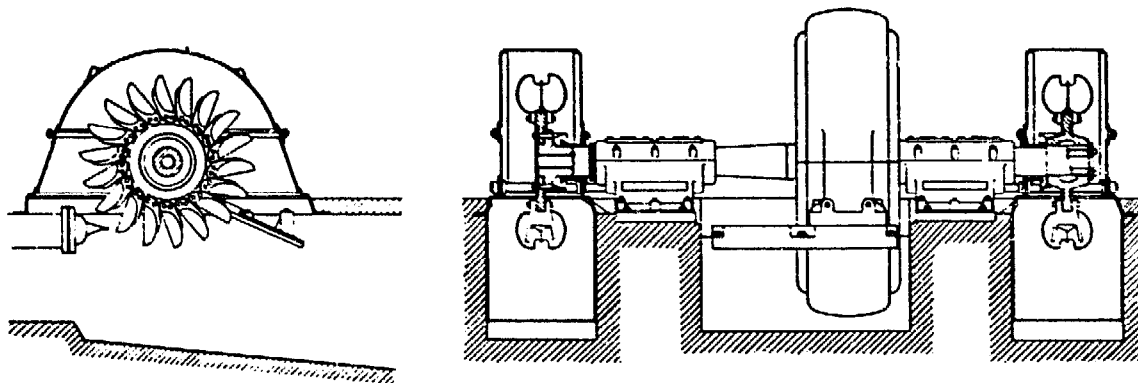

Fig. 11 Double-overhung impulse wheel. (Daily, 1950)

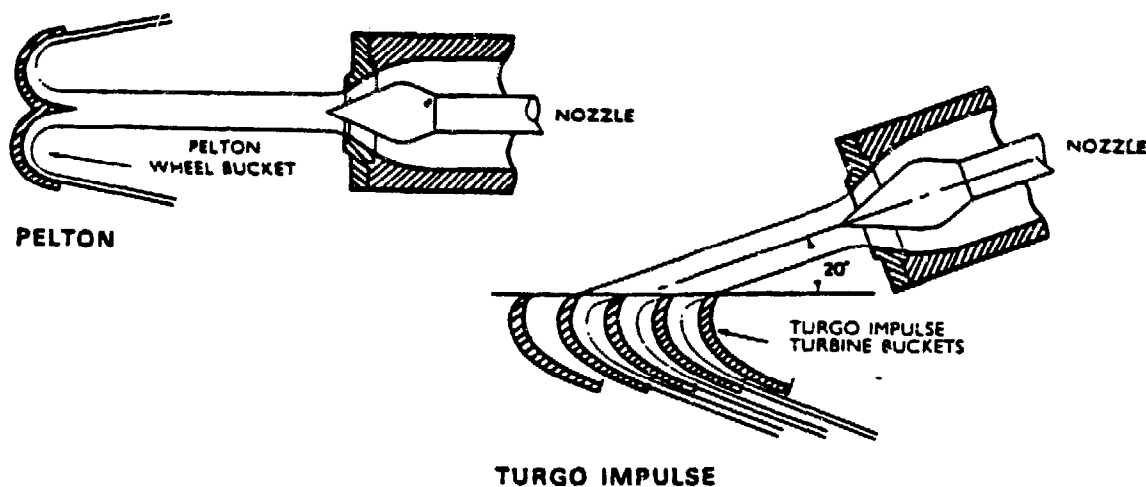

Fig. 12 Turgo and Pelton wheels contrasted. The jet on the turgo strikes three buckets continuously, whereas on the Pelton it strikes only one. A similar speed increasing effect can be had on the Pelton by adding another jet or two.

spheric pressure and the head represented by the elevation of the unit above tailwater cannot be utilized.\* Since this is a high head device, the loss in available head is relatively unimportant. As will be shown later, the Pelton wheel is a low specific speed device. Specific speed can be increased by the addition of extra nozzles, the specific speed increasing by the square root of

the number of nozzles. Specific speed can also be increased by a change in the manner of inflow and outflow. As shown in Fig. 12, a Turgo turbine can handle relatively larger quantities of flow at a given speed and runner diameter by passing the jet obliquely through the runner in a manner similar to a steam turbine. The jet impinges on several buckets continuously, whereas only a single bucket per jet is effective at any instant in a Pelton wheel.

The Banki-Mitchell turbine illustrated in Fig. 13 is a variation on this theme. The flow passes through the blade row twice, first at the upper portion of the wheel and again at the lower portion. The flow exits the blade in the opposite direction from the first pass and hence this configuration tends to be self-cleaning since debris impinging on the periphery of the runner at the top dead center is removed by the flow on the second pass at essentially bottom dead center.

Most Pelton wheels are mounted on a horizontal axis, although newer vertical axis units have been developed. Because of physical constraints on orderly outflow from the unit, the maximum number of nozzles is generally limited to six or less. Whilst the power of a reaction turbine is controlled by the wicket gates, the power of the Pelton wheel is controlled by varying the nozzle discharge by means of an automatically adjusted needle, as illustrated in Fig. 14. Jet deflectors, Fig. 14a, or auxiliary nozzles arranged as in Fig. 14b are provided for emergency unloading of the wheel. Additional power can be obtained by connecting two wheels to a single generator or by using

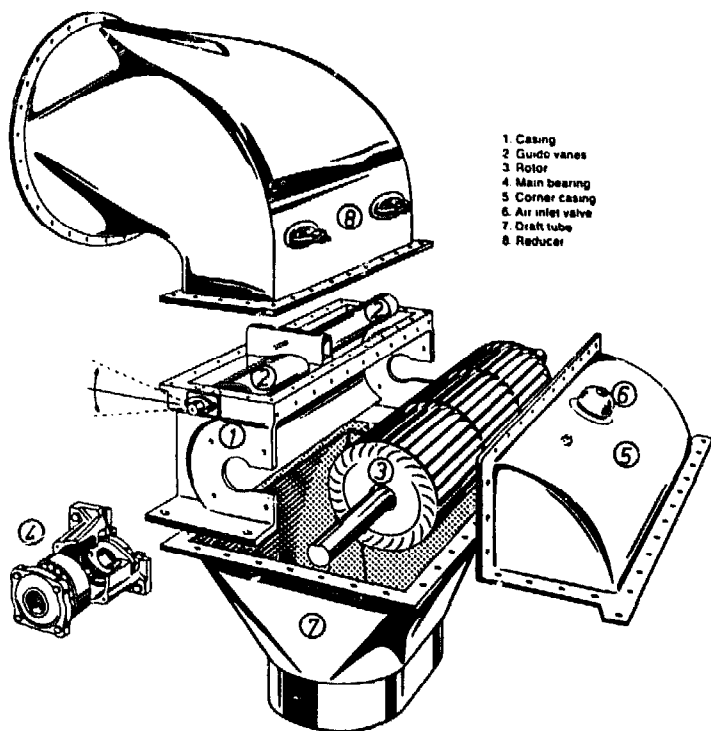

Fig. 13 Ossberger cross flow turbine.

\*In principle, a draft tube could be used, which requires the runner to operate in air under reduced pressure. Attempts at operating an impulse turbine with a draft tube have not met with much success.

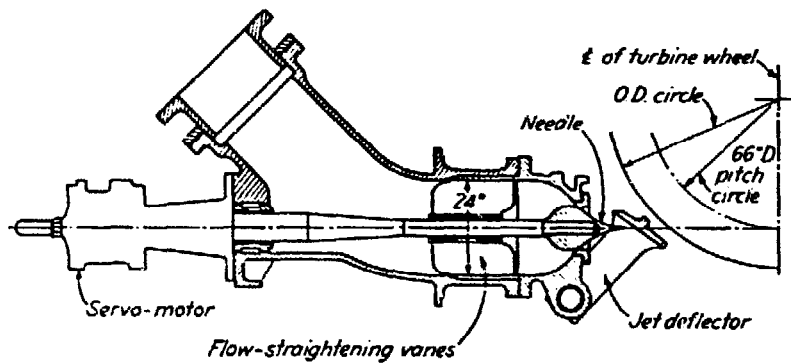

Fig. 14a. Pelton 45° elbow-type needle nozzle with jet deflector. (Daily, 1950)

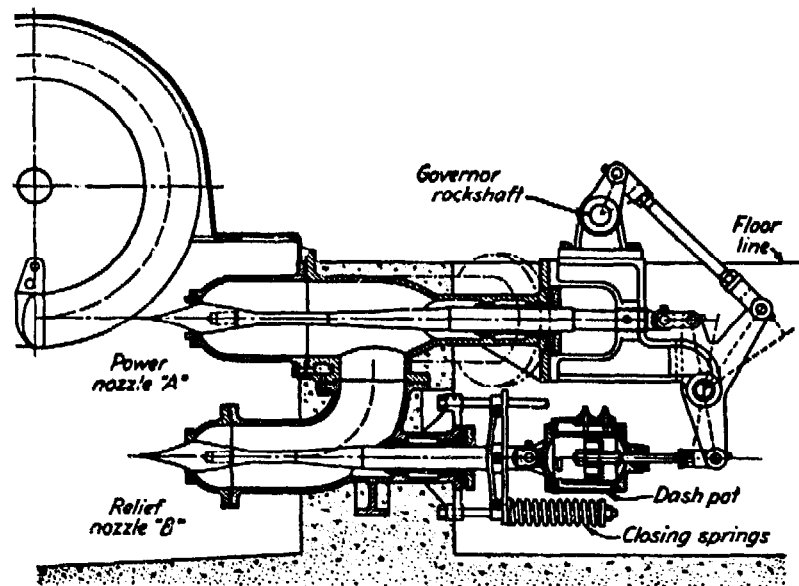

Fig. 14b. Pelton nozzle with auxiliary relief nozzle. (Daily, 1950)

multiple nozzles. Since the needle valve can throttle the flow while maintaining essentially constant jet velocity, the relative velocities at entrance and exit remain unchanged, producing nearly constant efficiency over a wide range of power output. This is a desirable feature of Pelton and Turgo wheels. Throttling of the Banki-Mitchell turbine is accomplished differently, as illustrated in Fig. 13. An adjustable guide vane is used which functions in a manner similar to the wicket gates in a reaction turbine. If operating conditions require, the guide vanes can be divided into two separately controlled sections. For most installations, the lengths of the two guide vane sections are in the ratio 1:2, allowing for utilization of 1/3, 2/3, or the entire runner, depending on the flow conditions. This combination provides a relatively flat efficiency curve over the power range 15% to 100%.

### Reaction Turbines

Reaction turbines are classified according to the variation in flow direction through the runner. In radial and mixed flow runners, the flow exits at a radius different (in modern designs the inlet flow is always inward) than the radius at the inlet. If the flow enters the runner with only radial and tangential components, it is a radial flow machine. The flow enters a mixed flow runner with both radial and axial components. Francis turbines are of the radial or mixed flow type, depending on the design specific speed. Two Francis turbines are illustrated in Fig. 15. The radial flow runner (Fig. 15a) is a low specific speed design, whereas the mixed flow runner (Fig. 15b) achieves peak efficiency at considerably higher specific speed.

Axial flow propeller turbines are generally either

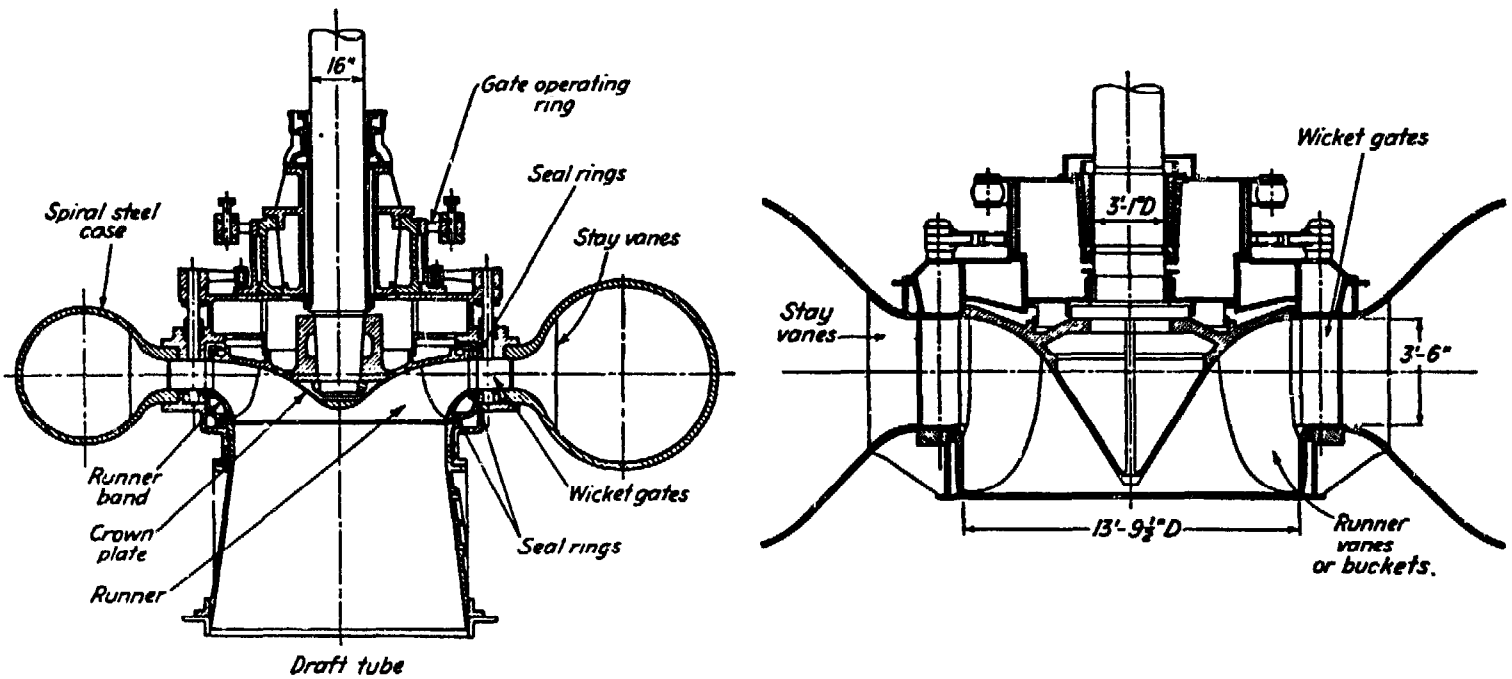

Fig. 15 Two examples of Francis turbine. (Daily, 1950)

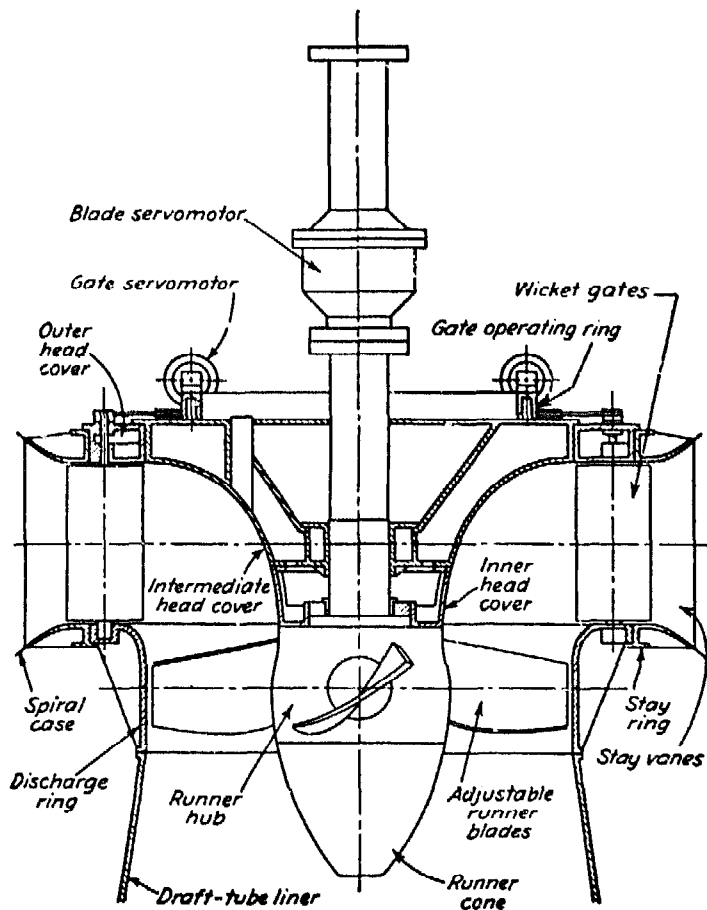

Fig. 16 Smith-Kaplan axial-flow turbine with adjustable-pitch runner blades,  $N_s = 3.4$  (Daily, 1950)

of the fixed blade or Kaplan (adjustable blade) variety. The "classical" propeller turbine, illustrated in Fig. 16, is a vertical axis machine with a scroll case and a radial wicket gate configuration that is very similar to the flow inlet for a Francis turbine. The flow enters radially inward and makes a right angle turn before entering the runner in an axial direction. The Kaplan turbine has both adjustable runner blades as well as adjustable wicket gates. The control system is designed in such a manner that the variation in blade angle is coupled with the wicket gate setting in a manner which achieves best overall efficiency over a wide range of flow rate. The classical design does not take full advantage of the geometric properties of an axial flow runner. The flow enters the scroll case in a horizontal direction, issues radially inward from the guide case where it forms a vortex and discharges into the draft tube in a vertical direction with very little whirl component remaining. The flow must then again be turned through  $90^\circ$  to discharge into the tailwater in a horizontal direction. From a design point-of-view, this is less than desirable for many reasons. The flow field entering the runner is highly complex and it is difficult to design the proper pitch distribution from hub to tip for minimal shock losses. There are additional losses in the elbow and the tortuous flow path required from inlet to outlet requires additional civil works.

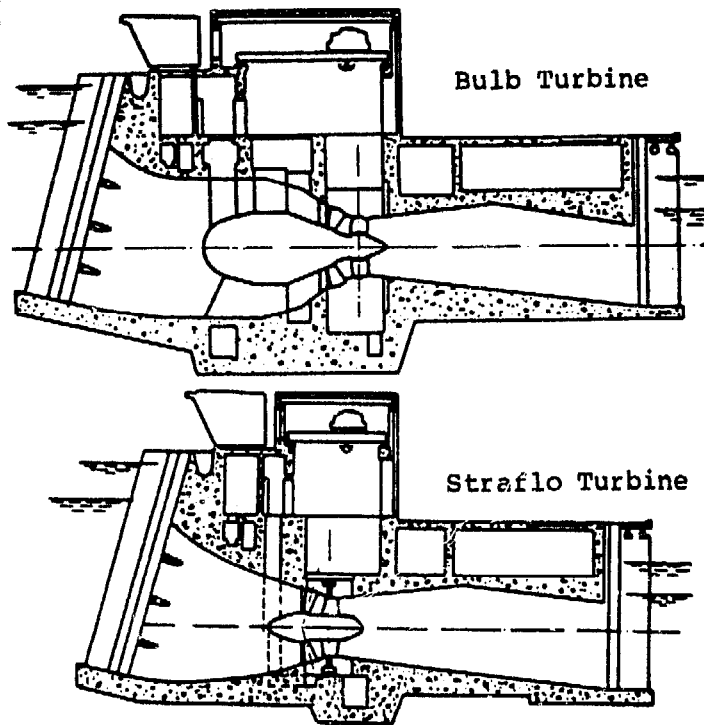

Fig. 17a. Comparison of structures required for Straflo vs bulb turbine with same output and head.

More modern designs take full advantage of the axial flow runner; these include the tube, bulb, and Straflo types illustrated in Fig. 17. The flow enters and exits the turbine with minor changes in direction. A wide variation in civil works design is also permissible. The tube type can be fixed propeller, semi-Kaplan, or fully adjustable. An externally mounted generator is driven by a shaft which passes through the flow passage either upstream or downstream of the runner. The bulb turbine was originally designed as a high output, low head unit. In large units, the generator is housed within the bulb and is driven by a variable pitch propeller at the trailing end of the bulb. Smaller units are available in which an externally mounted generator is driven by a right angle drive which is housed within the bulb (Fig. 18). Because of the simplicity of installation, the various modern axial flow machines are of considerable interest for low head applications.

In addition to the radial flow and mixed flow Francis and axial flow propeller units, there is the Deriaz turbine which is a mixed-flow propeller unit of the Kaplan type. This turbine was originally developed for pumped storage applications, but shows great promise for applications in the medium head range. The turbine consists of a series of controllable pitch blades mounted on a conical hub. The turbine can have either a conventional scroll case and

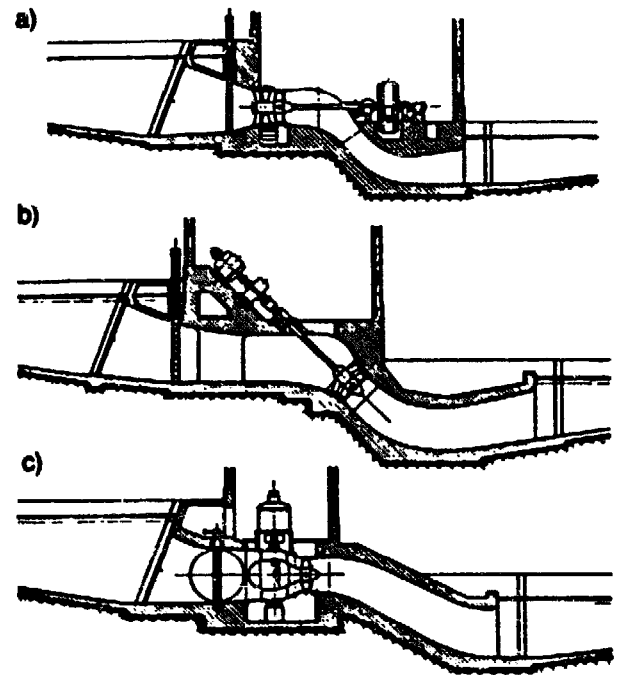

Fig. 17b. Various tube turbine arrangements.

gate apparatus or a more specialized flap system for controlling the inlet flow. This unit provides the same flat efficiency curve over a wide range of power as the standard Kaplan propeller units but, because of the

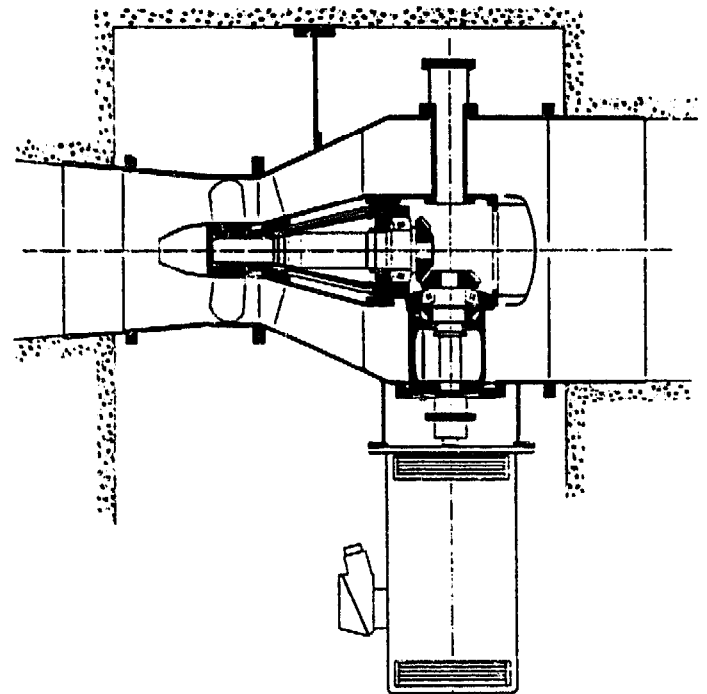

Fig. 18 Right-angle drive bulb turbine.



mixed flow design, is applicable to higher head applications. However, at the present time (1981) there do not appear to be any units available to a small size (less than 1 MW capacity).

### Performance Characteristics

#### Comparative Performance of Impulse and Reaction Turbines

The two basic types of turbines tend to operate at peak efficiency over different ranges of specific speed. This is due to geometric and operational differences. In order to give the reader a perspective of the operational characteristics of each type, a brief discussion of operational principles is presented below. This is followed by a summary of the performance of commercially available equipment in subsequent sections.

#### Impulse Wheels

Typical types of impulse wheels are illustrated in Figs. 11 to 13. For a given pipeline there is a unique jet diameter that will deliver maximum power to a jet. Denoting the jet diameter by  $d_j$  the power is given by

$$P_j = \gamma Q V_j^2 / 2g = \gamma (\pi/8g) d_j^2 V_j^3 \quad (42)$$

Let  $\Delta h$  denote the difference between the reservoir surface elevation and the nozzle elevation. Neglecting losses at the entrance to the pipe and in the nozzle, Eq. (12) yields

$$\frac{V_j^2}{2g} + f \frac{L}{d_p} \frac{V_p^2}{2g} = \Delta h \quad (43)$$

where  $V_j$  is the jet velocity,  $V_p$  is the velocity in the pipe, and  $d_p$  and  $L$  denote, respectively, the pipe diameter and length. As the size of the nozzle opening is increased, the flow rate  $Q$  gets larger while the jet velocity  $V_j$  gets smaller, since the losses in the pipeline increase with  $Q$ . Using  $V_p = V_j (d_j/d_p)^2$  and Eq. (43), it can be shown that maximum power is obtained when

$$\Delta h = 3f \frac{L}{d_p} \frac{V_p^2}{2g} \quad (44)$$

$$H = V_j^2 / 2g = (2/3) \Delta h \quad (45)$$

$$\text{and } d_j = (d_p^5 / 2fL)^{1/4} \quad (46)$$

Thus, for a given penstock geometry and  $\Delta h$ , the

maximum power available to the turbine can be calculated. From Eqs. (25) and (45), it should be noted that the maximum possible plant efficiency is 2/3 for this case. It follows from this argument that the net head to be used for turbine selection lies between  $\Delta h$  and  $2/3 \Delta h$ . For a given  $Q$  and  $\Delta h$ , and value of  $d_j$  can be calculated for the two head extremes. The minimum penstock diameter can be determined from Eq. (46) with a fixed  $f$  and  $L$  using the latter  $d_j$ . However, to increase the plant efficiency, the penstock diameter should be slightly larger than the minimum diameter. Computations of the plant efficiency should be made for several diameters. The final selection of  $d_p$  and  $d_j$  will depend on the available turbines and on an economic analysis of the installation.

Of the head available at the nozzle inlet, a small portion is lost to friction in the nozzle and to friction on the buckets. The rest is available to drive the wheel. The actual utilization of this head depends on the velocity head of the flow leaving the turbine and the setting above tailwater. Optimum conditions corresponding to maximum utilization of the head available dictate that the flow leave at essentially zero velocity. Under ideal conditions, this occurs when the peripheral speed of the wheel is one-half the jet velocity. In practice, optimum power occurs at a speed coefficient,  $\phi = u_1 / \sqrt{2gH}$  somewhat less than 0.5. In fact, it can be shown that best efficiency will occur when  $\phi = \frac{1}{2} C_v \cos \alpha_1$ , where  $C_v$  is the velocity coefficient for the nozzle

$$C_v = V_j / \sqrt{2gH} \quad (47)$$

and  $\alpha_1$  represents the effective angle between the jet velocity and the peripheral velocity of the runner entrance to the bucket. Since maximum efficiency occurs at fixed speed for fixed  $H$ ,  $V_j$  must remain constant under varying flow conditions. Thus the flow rate,  $Q$ , is regulated with an adjustable nozzle. There is some variation in  $C_v$  and  $\alpha_1$  with regulation, and maximum efficiency occurs at slightly lower values of  $\phi$  under partial power settings. Present nozzle technology is such that the discharge can be regulated over a wide range at high efficiency.

A given head and penstock configuration establishes the optimum jet velocity and diameter. The size of the wheel determines the speed of the machine. For a wheel of diameter  $D$ , the speed in radians per second is

$$\Omega = 2u_1 / D = (2\phi/D) \sqrt{2gH} \quad (48)$$

Using Eq. (25) for the power  $P$  and the equation

$$Q = V_j \pi d_j^2/4 = C_v \sqrt{2gH} \pi d_j^2/4 \quad (49)$$

for the flow rate  $Q$ , one obtains for the specific speed of the machine the relationship

$$N_s = 2^{1/4} \sqrt{2\pi\eta} C_v \phi d_j/D \quad (50)$$

or approximately

$$N_s = 1.3 d_j/D \quad (51)$$

Practical values of  $d_j/D$  for Pelton wheels to ensure good efficiency are in the range 0.04 to 0.1, corresponding to  $N_s$  values in the range 0.05 to 0.13 (10 to 25 in metric units using the metric horsepower). In Turgo turbines the relative wheel diameter can be half that of a Pelton wheel resulting in specific speeds approximately twice that of the conventional design. Higher specific speeds are possible with multiple nozzle designs. The increase is proportional to the square root of the number of nozzles. Crossflow turbines can operate at even higher specific speed ( $N_s = 0.6$ ) because the length of the runner can be much larger than the diameter, which permits large values of flow through a relatively small diameter runner. This is possibly one of the reasons why the crossflow turbine has seen application over such a wide range of head and power (Fig. 24). However, in considering an impulse unit, one must remember that efficiency is based on net head and the net head for an impulse unit is generally less than the net head for a reaction turbine at the same gross head because of the lack of a draft tube.

#### Reaction Turbines

The main difference between impulse wheels and reaction turbines is the fact that a pressure drop takes place in the rotating passages of the reaction turbine. This implies that the entire flow passage from the turbine inlet to the discharge at the tailwater must be completely filled. A major factor in the overall design of modern reaction turbines is the draft tube. This was not always the case. In earlier days, when low speed, large diameter Francis turbines were installed under low heads, the lack of a draft tube or very short conical tube resulted in a nominal velocity head loss from the runner. This was not particularly critical for installations which are underdeveloped based on today's standards since water was spilled over the dam much of the year. However, since today it is desirable to reduce the overall equipment and civil construction costs by using high specific speed propeller runners, the draft tube is extremely critical from both a flow

stability and an efficiency viewpoint. Since the runner diameter is relatively small, a substantial percentage of the total energy is in the form of kinetic energy leaving the runner. To recover this efficiently, considerable emphasis should be placed on the draft tube design.

The practical specific speed range for reaction turbines is much broader than for impulse wheels. This is due to the wider range of variables which control the basic operation of the turbine. As an illustration of the design and operation of reaction turbines for constant speed, refer again to Fig. 1. The pivoted guide vanes allow for control of the magnitude and direction of  $\vec{V}_1$ , i.e.  $V_1$  and  $\alpha_1$ . The relationship between blade angle, inlet velocity, and peripheral speed for shock free entry can be obtained from Eqs. (7) and (8) as

$$\cos \beta_1 = \frac{V_1 \cos \alpha_1 - u_1}{V_1 \sin \alpha_1} \quad (52)$$

Without the ability to vary the blade angle, it is obvious that shock free entry cannot be completely satisfied at partial flow. This is the distinction between the power efficiency of fixed propeller and Francis types at partial loads and the fully adjustable Kaplan design.

Referring to Eq. (21), optimum hydraulic efficiency would occur when  $\alpha_2$  is equal to  $90^\circ$ . However, overall efficiency of the turbine is dependent on the optimum performance of the draft tube which occurs with a little whirl in the flow. Thus, best overall efficiency occurs with  $\alpha_2 \cong 85^\circ$  for low specific speed Francis turbines to  $\alpha_2 \cong 75^\circ$  for high specific speed turbines. The hydraulic efficiency (Eq. 21) is approximately

$$\eta_h = 2 \phi C_1 \cos \alpha_1 \quad (53)$$

With  $\alpha_1$  in the range of  $10^\circ$  to  $25^\circ$  and  $C_1 \cong 0.6$ , the speed coefficient,  $\phi$ , is approximately 0.8 compared with a little less than 0.5 for an impulse turbine. Note also that  $C_1 \cong 0.6$  implies that only 40% of the available head is converted to velocity head at the turbine inlet compared with 100% for the impulse wheel.

The determination of optimum specific speed in a reaction turbine is more complex since there are more variables. For a radial flow machine (refer to Fig. 1), a relatively simple expression can be derived. Combining Eqs. (14), (15), (20), (25), and (48), the expression for specific speed, Eq. (28), is

$$N_s = 2^{5/4} (2 \pi \eta_f C_1 \sin \alpha_1 B/D)^{1/2} \phi \quad (54)$$

or approximately

$$N_s = 5.5 (C_1 \sin \alpha_1 B/D)^{1/2} \phi \quad (55)$$

Using standardized design charts for Francis turbines (Fig. 17),  $N_s$  is normally found to be in the range 0.3 to 2.5 (58 to 480 in metric units using metric horsepower).

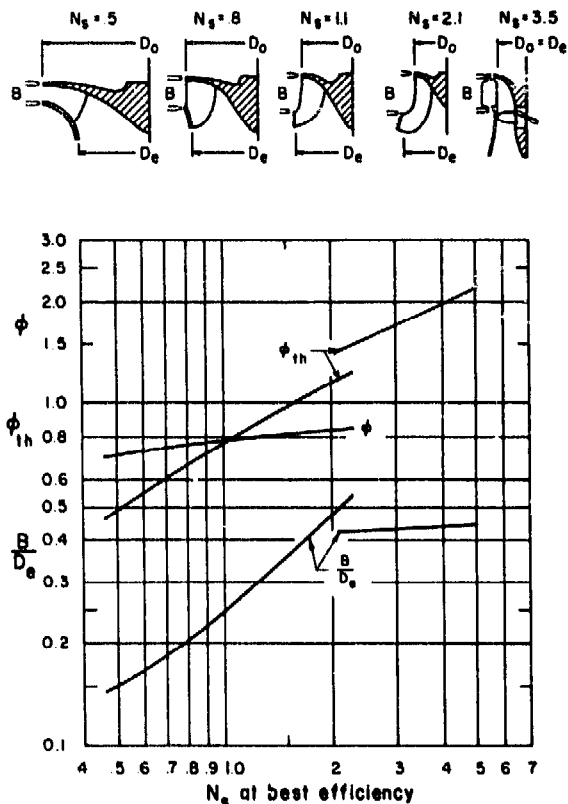

Fig. 19 Empirical design constants for reaction turbines. (Daily 1950)

*Performance Comparison*

The physical characteristics of various runner configurations are summarized in Fig. 20. It is obvious that the configuration changes with speed and head. This can be expressed in terms of peak efficiency versus specific speed, as illustrated in Fig. 21. As already discussed, impulse turbines are efficient over a relatively narrow range of specific speed, whereas Francis and propeller turbines have a wider useful range. Variable geometry is an important consideration when a turbine is required to operate over a wide range of load. Pelton wheels and Turgo wheels tend to

operate efficiently over a wide range of power loading because the needle valve is capable of metering flow at a constant discharge velocity. Thus the relative velocities through the runner remain fixed in magnitude and direction which allows for maximum runner efficiency independent of flow rate. A comparison of efficiency variation with load as a function of the level of sophistication of a tube turbine is illustrated in Fig. 22. Fixed gates and blade settings result in peak efficiency at 100% load and the efficiency drops off rapidly with changes in load. On the other hand, a Kaplan type tube turbine can maintain efficiency over a relatively broad range of conditions. Also illustrated in the same diagram is the variation of efficiency for an impulse wheel. Although its peak efficiency is less than the high speed tube turbine, the impulse unit is able to maintain a relatively high efficiency over a wide range of conditions. Both Francis and Deriaz units are designed to operate at medium specific speed. Like the Kaplan type, the Deriaz unit maintains its high efficiency over a wide range of load, but has not been used in small applications. The decision of whether to select a simple configuration with a relatively "peaky" efficiency curve or to go to the additional expense of installing a more complex machine with a broad efficiency curve will depend on the expected operation of the plant. If the head and flow are relatively constant, then the less expensive choice is justified. On the other hand, many run-of-the-river plants may be more economical with the installation of Kaplan or Deriaz units.

Because various types of turbines tend to operate best over different specific speed ranges, the head and power available at a given site dictate what options are practical. This is illustrated in Fig. 23, where the various types of turbines that would be useful at various combinations of head and desired power output are plotted over a range of head and power from 2 to 400 m and 10 kW to 20,000 kW. The figure is constructed with the following assumptions: speed in the range 600 - 3,600 r.p.m.,\* direct drive, and specific speed in the range of optimum efficiency for a given design. At constant  $n$  and  $n_s$ , the head is related to the power by

$$H \sim (n/n_s)^{4/5} P^{2/5} \quad (56)$$

Thus the upper limit represents maximum r.p.m. (if

\*The speed range is based on the assumption of 60 Hz current and a maximum of 12 poles in the generator. (Number of poles equals 7200/n.)

**IMPULSE RUNNERS**

Pelton, Doble  
(Tangential)

Low Speed



Nozzle  Bucket

High Speed



Turgo  
(Diagonal)

Nozzle  Buckets



Michell, Banki  
(Crossflow)



High Head - Low Volume  
Low RPM For Given Head  
Head Measured To Nozzle or Centerline  
Do Not Recover "Suction" Head

**REACTION RUNNERS**

Francis

High Head



Medium Head



Low Head



Propeller

Darriez

Adjustable  
Blades

Mixed Flow

Fixed  
Blades

Axial Flow

Medium  
Head



Low  
Head



Kaplan = Coordinated Blades & Gates

Low Head - High Volume  
Higher RPM For Given Head  
Output Limited By Cavitation

Fig. 20 Physical characteristics of various turbine runners compared. (Mayo, 1979)

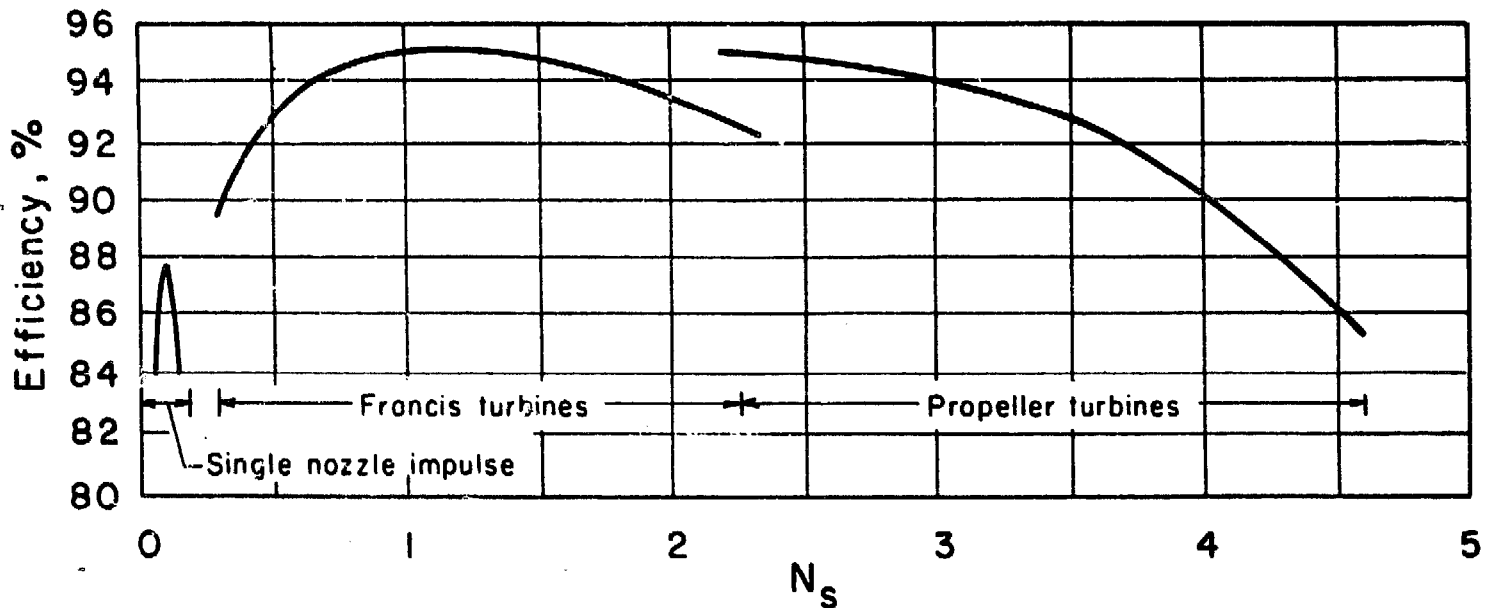

Fig. 21 Efficiency of various types of turbines as a function of specific speed.

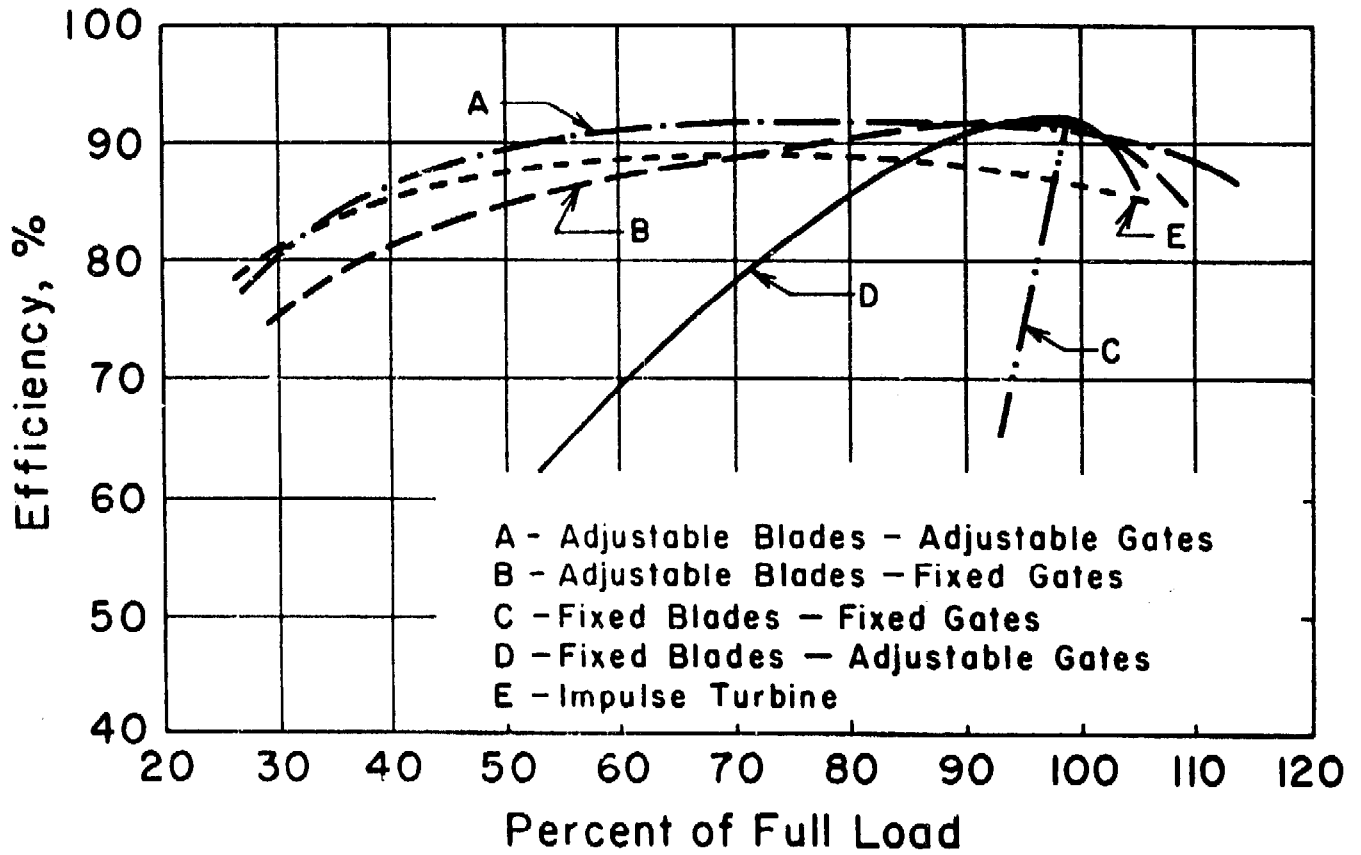

Fig. 22 Turbine efficiency as a function of load. Comparison between an impulse turbine and various configurations of the high speed propeller unit.

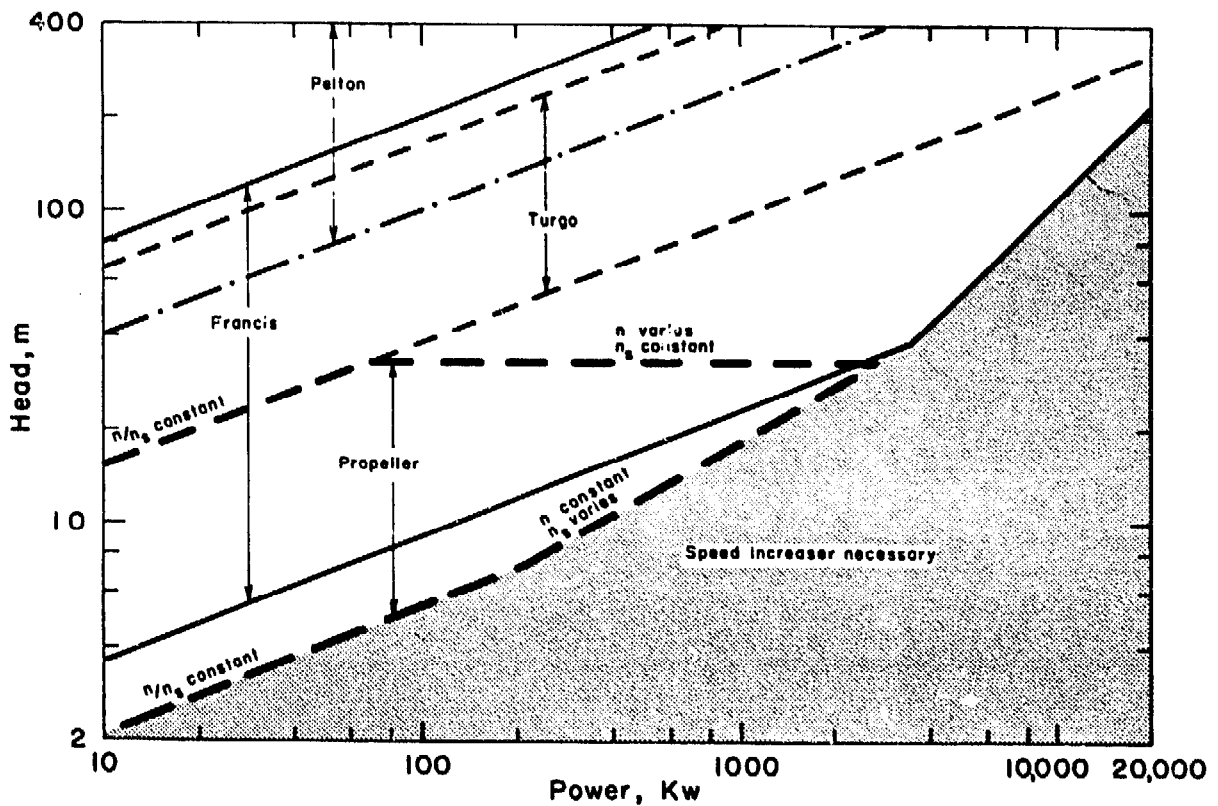

Fig. 23 Range of application of various types of turbines.

possible without cavitation) and minimum  $n_s$ . The lower boundary is determined from the lowest r.p.m. and maximum  $n_s$  without cavitation. Cavitation limits are based on a net positive draft head of one atmosphere. For example, the lower curve for the propeller turbine is determined with  $n$  of 600 r.p.m. and  $n_s$  of 764 ( $N_s = 4.6$ ). Since the critical cavitation number is a function of  $n_s$  (Fig. 7), and the plant sigma is a function of draft head and net head (Eq. 36), a point is reached where the two sigmas are equal. This occurs at the break in the lower curve. If it is desired to maintain the same speed at higher heads,  $n_s$  must decrease to avoid cavitation. Thus,  $n_s$  decreases along the lower curve to the right of the breakpoint.

#### Survey of Commercially Available Equipment

The recent interest in small-scale hydropower has stimulated the turbine manufacturers to produce turbines suitable for this application. Larger units have been scaled down to match the lower head and power requirements. As cost of equipment has a significant

impact on the economic feasibility of a small-scale installation, a major thrust has been made to develop standardized units to reduce cost. Many of these standardized units are supplied complete with the generator and auxiliary equipment. The larger and well established equipment manufacturers are adding such equipment as a line item, and the number of smaller manufacturers is rapidly increasing in response to the anticipated demand. The small companies are in general developing equipment for the lower power outputs in the range of less than 200 kW.

A summary graph based on commercially available equipment as a function of head and power output is shown in Fig. 24 to indicate the coverage as it currently exists. This graph should be compared with Fig. 23. This summary should be used only as a guide to available turbines, as different units are rapidly being offered by the various manufacturers. It can readily be seen that several types of turbines are available for a given head and power output. The crossflow turbine covers a wide range of conditions.

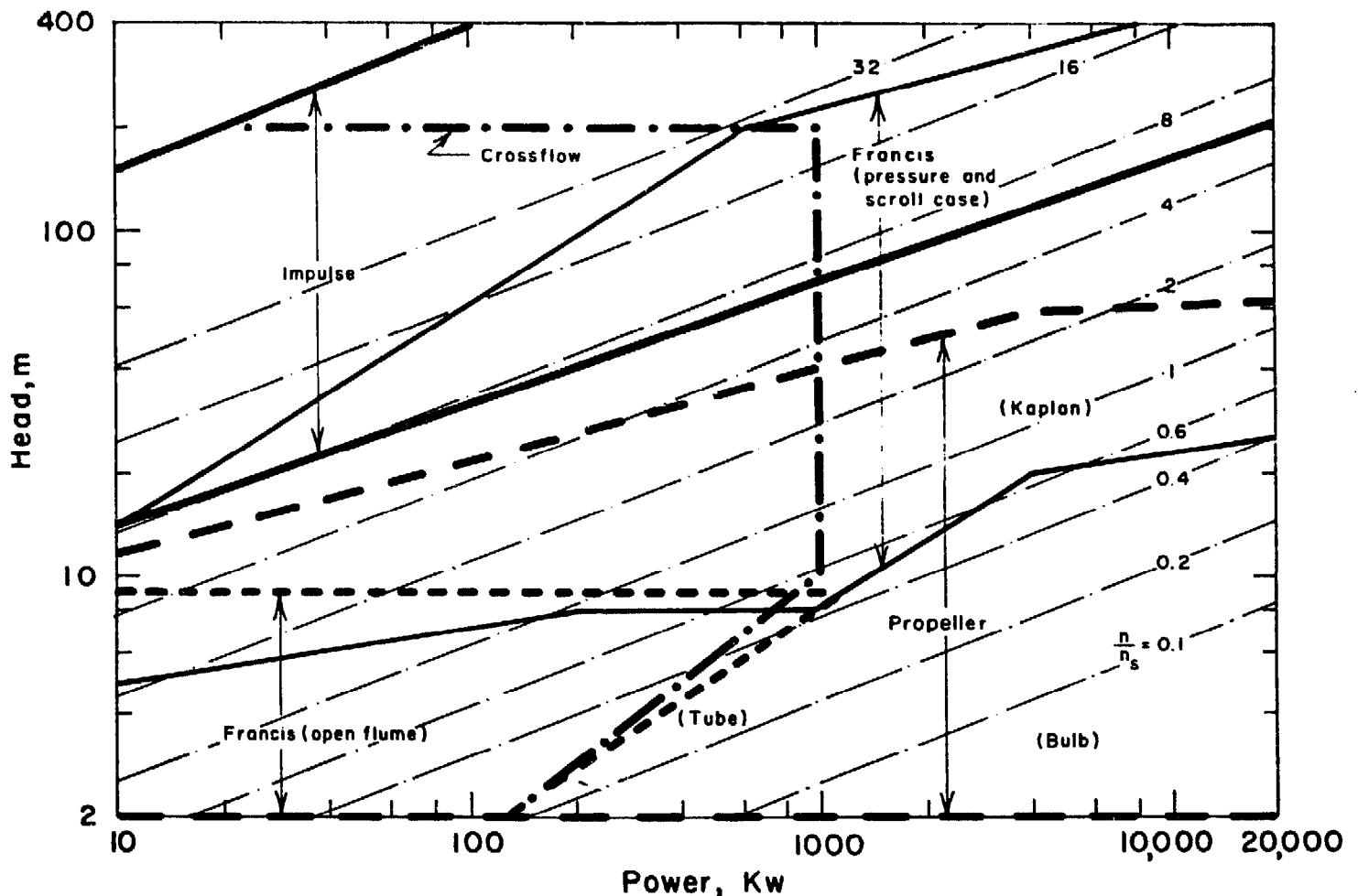

Fig. 24 Summary chart of commercially available turbines.

The propeller turbine classification includes the vertical Kaplan, bulb, and tube turbine units. The Kaplan turbine is commonly used for the higher heads and power output, and the bulb for essentially the same output at lower heads. The tube turbine range includes the lower heads and power outputs. Standardized tube turbines are available in this range, and may be economically attractive for the mini-hydro projects and also in the upgrading or rehabilitation of old hydropower stations.

For the micro-hydropower sites, which are low-head and have power outputs of less than 100 kW, some standardized propeller turbines are also available. These small units have been developed specifically for this application, and attempts have been made to simplify the machine and thus lower initial equipment costs. The simplification may result in reduction of efficiency of the unit, and this should be considered in the assessment of economic feasibility.

Accurate performance data are usually not available for smaller turbines. In fact, model tests are often not performed for turbines smaller than about 5 -- 10 MW. As an example, consider a 500 r.p.m., 15 MW turbine operating at its design point with an efficiency of 92% under a 100 m head. The same design could be scaled down to 500 kW at 1,200 r.p.m. and 50 m head. Since the specific speed is constant, the size, speed, and head will vary according to

$$H_1/H_2 = n_1^2 D_1^2/n_2^2 D_2^2 \quad (57)$$

Thus  $D_1/D_2 = 3.39$ . The change in efficiency could be estimated by using the Moody formula (Eq. 24) in reverse (a Moody step-down equation, if you will). This yields  $\eta_2 = 89.9\%$ . Scaling down to even smaller sizes would bring about even more dramatic reductions in efficiency. This is true only for reaction turbines in which leakage and frictional losses are disproportionately higher in the smaller sizes.

#### *Present Trends in Turbine Development*

As previously mentioned, attention is being directed toward the development of standardized turbines to cover a wide range of applications. Some turbine manufacturers are exploring the possibility of using pumps operated as turbines. It is expected that continued efforts will be made in this area. For many remote and relatively inaccessible sites, lightweight turbines of small size would be attractive. The use of plastics, etc. for various elements could perhaps reduce cost through mass production techniques as well as weight for the smaller units. These elements may

require more maintenance, but the lower cost of the parts may offset the increased maintenance cost.

### **Hydraulic Structures and Operational Considerations**

#### **Integration of Turbine with Inlet and Outlet Works**

From the discussion under *Turbine Technology* (p. 101 ff.), it is apparent that several types of turbines may be appropriate for given flow conditions. It is therefore necessary to make a decision as to which particular unit is most economical. In addition to the cost of the turbine and generator, the cost of the associated civil works must be considered, as this cost can represent a large portion of the total cost of a small-scale hydropower installation. Some types of turbines require larger civil works than others. Several alternate preliminary layouts should be evaluated, each of which may have different inlet and draft tube requirements. The necessity of this evaluation has become increasingly evident with the recent interest in retrofitting existing sites for power production. The original turbines either may not exist or may not be capable of repair, or it may be desirable to replace the unit with a modern turbine of different capacity. The condition and the extent of the existing civil works may influence the type of turbine to be finally selected. For example, if an open flume Francis turbine was originally installed but is no longer useable, it may prove to be more economical to install a new turbine of the same type of a different design with roughly the same overall dimensions as the original equipment if the rest of the structure is still in good condition. In other cases, it may be most cost effective to abandon the existing structure and select a different type of turbine. It is therefore necessary to analyze each site on an individual basis. In so doing considerable cost savings may be realized.

#### **Cavitation or Turbine Setting**

Another factor that must be considered prior to equipment selection is the elevation of the turbine with respect to tailwater elevations. As previously discussed, hydraulic turbines are subject to pitting due to cavitation. For a given head, a smaller, lower cost, high speed runner must be set lower (i.e., closer to tailwater or even below tailwater) than a larger, higher cost, low speed turbine runner. Also, atmospheric pressure or plant elevation above sea level is a factor as are tailwater elevation variations and operating requirements. This is a complex subject which can only be accurately resolved by model tests. Every run-

ner design will have different cavitation characteristics, therefore, the anticipated turbine location or setting with respect to tailwater elevations is an important consideration in turbine selection.

Cavitation is not normally a problem with impulse wheels. However, by the very nature of their operation, cavitation is an important factor in reaction turbine installations. The susceptibility for cavitation to occur is a function of the installation and the turbine design. As already discussed, this can be expressed conveniently in terms of Thoma's sigma. The critical value of  $\sigma_T$  is a function of specific speed, as illustrated in Fig. 7. As the specific speed increases, the critical value of  $\sigma_T$  increases dramatically. For minimization of cavitation problems, the plant  $\sigma_T$  must be in excess of the critical  $\sigma_T$  denoted on the chart. This can have important implications for turbine settings and the amount of excavation necessary. The criteria for establishing the turbine setting have already been discussed in Section 2.4. As an example, consider a 500 kW machine operating at 500 r.p.m. under a head of 10 meters. The specific speed is 3.8. This will be an axial flow turbine having a critical  $\sigma_T$  of about 0.9. At sea level the maximum turbine setting would be

$$z_{B_m} = 10 - 0.09 - (0.9 \times 10) = 1 \text{ meter}$$

If the same turbine was installed at Leadville, Colorado, elevation  $\sim 3000$  m, the maximum turbine setting would be

$$z_B = 6.7 - 0.09 - (0.9 \times 10) = -2.3 \text{ meters}$$

Considerable excavation would be necessary. Thus, cavitation can be an important consideration.

### Speed Regulation

The speed regulation of a turbine is an important and complicated problem. The magnitude of the problem varies with size, type of machine and installation, type of electrical load, and whether or not the plant is tied into an electrical grid. It should also be kept in mind that runaway or no load speed can be higher than the design speed by factors as high as 2.5. This is an important design consideration for all rotating parts, including the generator.

It is beyond the scope of this section to discuss the question of speed regulation in detail. However, some mention of this should be made since much of the technology is derived from large units. The cost of standard governors is thus disproportionately high in the smaller sizes. Regulation of speed is normally accomplished through flow control. Adequate control

requires sufficient rotational inertia of the rotating parts. When load is rejected, power is absorbed, accelerating the flywheel and when load is applied, some additional power is available from deceleration of the flywheel. Response time of the governor must be carefully selected since rapid closing time can lead to excessive pressures in the penstock.

A Francis turbine is controlled by opening and closing the guide vanes which vary the flow of water according to the load. A powerful governor is required to overcome the hydraulic and frictional forces and to maintain the guide vanes in fixed position under steady load. On the other hand, impulse turbines are more easily controlled. This is due to the fact that the jet can be deflected or an auxiliary jet can bypass flow from the power producing jet without changing the flow rate in the penstock. This permits long delay times for adjusting the flow rate to the new power conditions. The spear or needle valve controlling the flow rate can close quite slowly, say 30 to 60 seconds, thereby minimizing any pressure rise in the penstock.

Several types of governors are available which vary with the work capacity desired and/or the degree of sophistication of control. These vary from pure mechanical to mechanical-hydraulic and electro-hydraulic. Electro-hydraulic units are sophisticated pieces of equipment and would not be suitable for remote regions. The precision of governing necessarily will depend on whether the electrical generator is synchronous or asynchronous (induction type). There are advantages to the induction type of generator. It is less complex and therefore cheaper and typically has slightly higher efficiency. Its frequency is controlled by the frequency of the grid it is feeding into, thereby eliminating the need of an expensive conventional governor. It cannot operate independently but can only feed into a network and does so with a lagging power factor which may or may not be a disadvantage, depending on the nature of the load. Long transmission lines, for example, have a high capacitance and in this case the lagging power factor may be an advantage.

Some general features of the overall regulation problem can be demonstrated by examination of the basic equation for a rotating system

$$J \frac{d\Omega}{dt} = T_t - T_L \quad (58)$$

where  $J$  = moment of inertia of rotating components  
 $\Omega$  = angular velocity  
 $T_t$  = torque of turbine  
 $T_L$  = torque due to load

Three cases may be considered in which  $T_t$  is equal to,



less than, or greater than  $T_L$ .

For the first case, the operation is steady. The other two cases imply unsteady operation, since  $d\Omega/dt$  is not constant, and usually a governor is provided so that the turbine output matches the generator load.

Speed regulation is a function of the flywheel effect of the rotating components and the inertia of the water column of the system. The starting up time of the rotating system (Bureau of Reclamation, 1966) is given by

$$T_s = J\Omega^2/P = Jn_o^2/6818 \text{ HP}_r \quad (59)$$

where  $J$  = flywheel effect of generator and turbine, kg m sec<sup>2</sup>

$n_o$  = normal turbine speed, r.p.m.

$\text{HP}_r$ , rated metric horsepower

The starting up time of the water column is given by

$$T_p = \Sigma LV/gh_r \quad (60)$$

where  $L$  = length of water column

$V$  = velocity in each component of the water column

$h_r$  = rated head

For good speed regulation it is desired to keep  $T_s/T_p \leq 8$ . Lower values can also be used, although special precautions are necessary in the control equipment. It can readily be seen that higher ratios of  $T_s/T_p$  can be obtained by increasing  $J$  or decreasing  $T_p$ . Increasing  $J$  implies a larger generator, which also results in higher costs. The startup time of the water column can be reduced by reducing the length of the flow system, lower velocities, or addition of surge tanks, which essentially reduce the effective length of the conduit. A detailed analysis should be made for each installation, as for a given length, head, and discharge, the flow area must be increased to reduce  $T_p$  which leads to associated higher construction costs.

A method for determining the speed rise as a result of load rejection is incorporated in Fig. 25 for several specific speed machines. The abscissa is the ratio of  $T_G/T_S$ , where  $T_G$  is the full closing time of the governor

$$T_G = 0.25 + T_C \quad (61)$$

and  $T_C$  is the rated governor time in seconds, which generally varies from 3 to 5 seconds. With the ratio determined, the percent speed rise  $S_R$  for no water hammer and a given specific speed can be found in

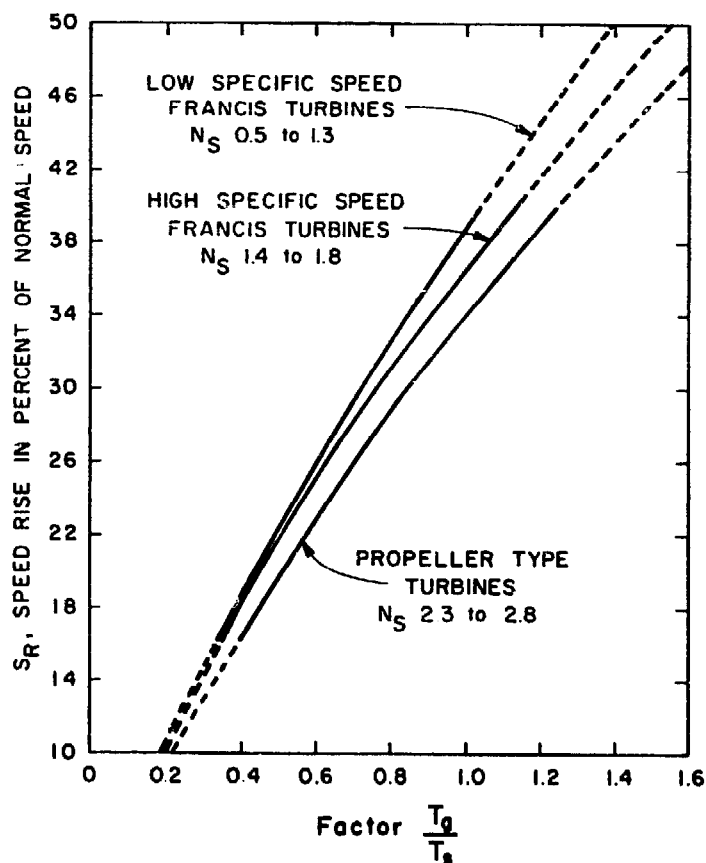

Fig. 25 Speed rise for full gate load rejected with no water hammer. (Bureau of Reclamation, 1966)

Fig. 25. This value should be modified to include the startup time of the pipeline, or

$$S_R = S_R (1 + T_p/T_c) \quad (62)$$

It is desired to keep the speed rise for full load rejection to less than 45%, although in some cases higher percentages can be permitted if regulating ability is sacrificed. If the speed rise is excessive, consideration should be given to providing surge tanks. Further discussion is beyond the scope of this section, and the reader is referred to the previously mentioned reference for more detail.

### Emergency and Abnormal Conditions

Emergency conditions can arise if the system experiences a sudden drop in load and the guide vanes remain open as a result of failure in the regulating system. The speed will rise rapidly until a maximum is reached, which is called the runaway speed. The runaway speed is dependent on the type of turbine, distributor opening, head, and in the case of a Kaplan turbine, the runner blade angle.

Based on field tests, an equation (Bureau of Re-

clamation, 1966) has been developed for use in predicting the runaway speed,  $n_r$ , for various types of turbines. This formulation is

$$n_r/n_d = K_n (H_{max}/H_d)^{1/2} \quad (63)$$

where  $K_n = 0.28 N_s + 1.45$   
 and  $n_d =$  design speed, r.p.m.  
 $N_s =$  specific speed  
 $H_{max} =$  maximum head  
 $H_d =$  design head

Thus, the ratio of runaway to normal speed is higher for propeller turbines than for Francis turbines and may attain values up to about 2.6. This factor must be considered in the design of the turbine and generating equipment as the increase in centrifugal force can be substantial.

As previously mentioned, for an adjustable blade runner the runaway speed is a function of the blade angle. If the blade angles are increased from their optimum value, the runaway speed is decreased. At the larger blade angles, the shock losses are higher and equilibrium conditions are reached at lower speeds. However, an increase in blade angle can also result in serious vibration, which can cause damage to the tur-

bine unit.

If the blade angle is decreased, the velocity vectors are changed so that the losses are reduced, and the runaway speed is increased. In fact, the theoretical runaway speed with a closed blade runner approaches infinity. This is not actually realized, however, due to frictional windage losses in the generator.

**Future Needs**

**Economics**

Figure 26 contains cost information developed during a preliminary analysis of small, low-head hydropower potential in the State of Minnesota. Twenty four existing dams were considered, most which had produced power in the past. Flow duration curves were established from data available from the geological survey. Estimates of yearly energy production were based on the flow duration curves and net head, assuming the plant would be operating at full capacity at a flow rate equal to the 25% exceedance level. The total cost of refurbishing was based on guidelines established by the U.S. Bureau of Reclamation and include new turbines, generators and switchyard equipment, miscellaneous power plant equipment, transmission lines over level terrain, and/or new refurbished civil

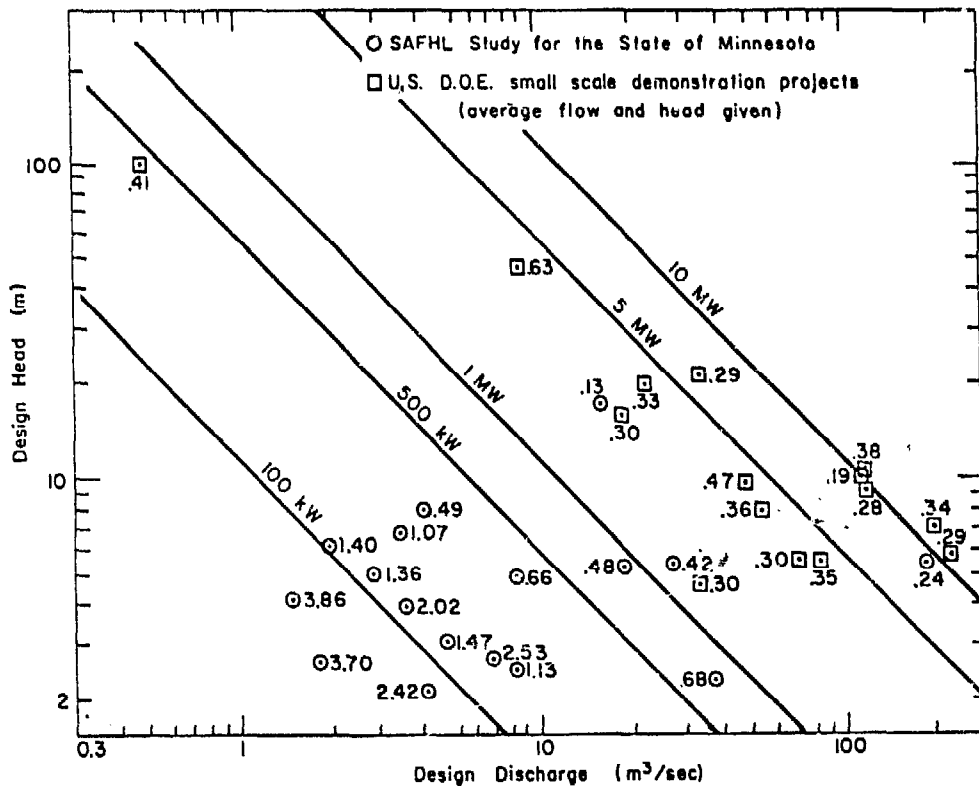

Fig. 26 Relative cost of hydropower plant installment at existing dam sites vs design hydraulic head and design turbine discharge (\$ (1980)/kWh produced annually).

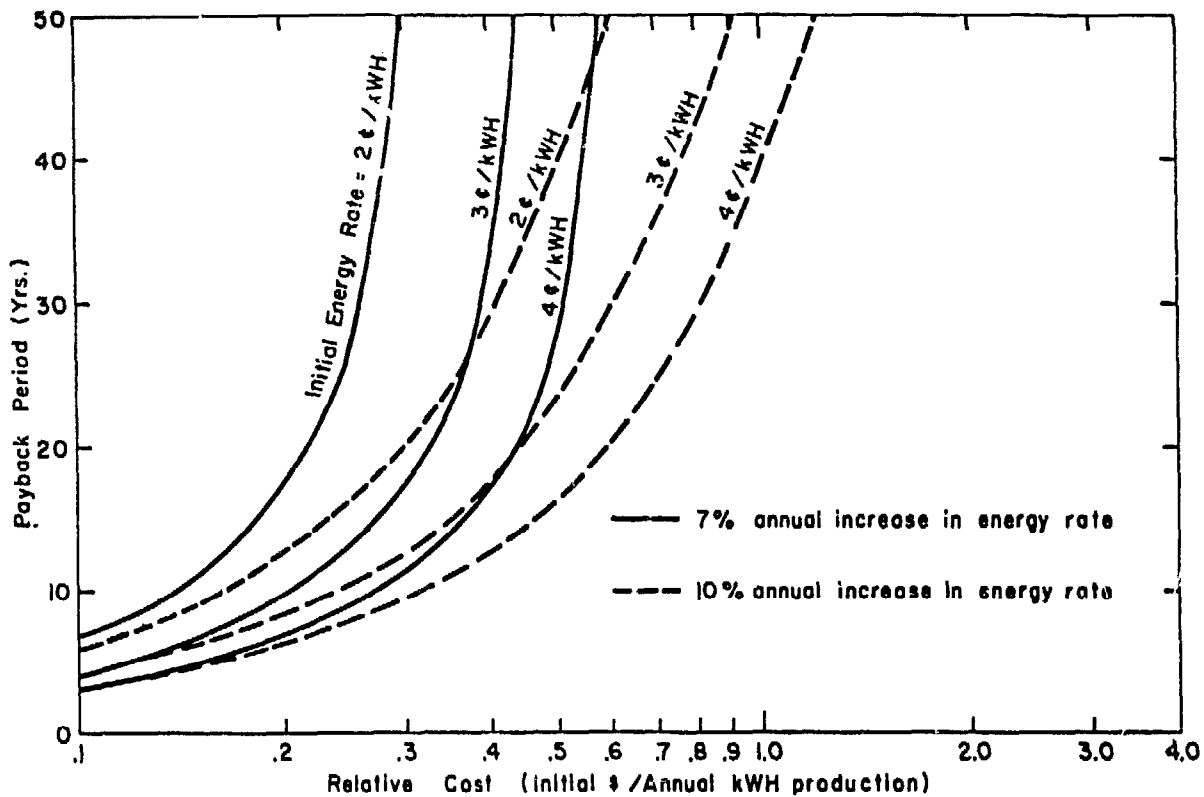

Fig. 27 Payback period vs relative cost of hydropower facility at three initial energy rates. 7% interest assumed.

works. As an indication of the relative cost, the total cost of the project is divided by the total kW hour production for one year. Fig. 27 provides information on the pay-back period as a function of relative cost. Since the proposed developments are publicly owned, a 7% interest rate is assumed. The pay-back period has been computed for energy valued at three different rates and two inflation rates. For example, assuming a 20 year pay-back period with a 10% inflation rate and energy at 3 ¢ per kW hour, relative costs greater than \$0.45 are not feasible. Inspection of Fig. 26 shows that a dramatic increase in relative costs for installations with a capacity less than 200 kW. This is reflective of the fact that much of the large turbine technology is simply not viable in the smaller sizes. Improvements must be made in both the costs of the equipment and the civil works. This can include, for example, new technology in power regulation, new techniques in production such as injected molded plastic parts etc. Reduction in civil works could be achieved through the use of pre-cast modular components, reduction in size of draft tube, turbines with more resistance to cavitation allowing higher settings etc.

#### Non-Conventional Uses of Hydropower

In many parts of the world, electrical grids are non-existent. Power development will depend on the

establishment of a base load. Since load diversion is an attractive regulation technique, consideration should be given to the development of localized absorption of the energy produced. This could include, but not be limited to electrolytic manufacture of fertilizer (Anonymous, 1978; Treharne et al) and electrolytic production of hydrogen (Nuttall). If attractive and safe methods for producing and storing hydrogen can be developed, the use of fuel cells becomes an attractive method of energy storage where large impoundments of water are not feasible or uneconomic. Hagen (1976) shows that methanol can be produced electrolytically in regions having a source of limestone. The cost of production could be as small as \$0.14/l. Consideration of these possibilities in the economic analysis could substantially change the cost benefit ratio at remote sites.

#### Summary

It has been shown that the head utilized by a turbine runner to produce power can be derived from a suitable form of Euler's equation of motion. The head utilized, and consequently the power developed, is dependent on the velocity vectors of the inlet and exit flow of the runner. The velocity vectors are determined by the operational conditions and the turbine

design. Overall efficiency of the turbine is the product of the hydraulic, volumetric, and mechanical efficiencies. Each of these are dependent on various energy losses in the turbine unit, and the origin of these losses has been briefly discussed.

Similarity considerations permit the formulation of dimensionless numbers. These numbers are useful in the extrapolation of test data taken with a model turbine to full-scale conditions and therefore predict performance. One of the most significant dimensionless numbers is the specific speed, which consists of a combination of operating conditions that ensures similar flows in geometrically similar machines. Each type of machine has a value of specific speed that gives maximum efficiency, and it is therefore convenient to classify the various turbine designs by the specific speed at best efficiency.

Cavitation must be avoided in turbines, as it results in loss of performance and can cause erosion damage to the runner and possibly other parts of the structure. Each particular turbine type has its own cavitation limits which are determined from model tests. High specific speed turbines are more susceptible to cavitation than low specific speed units. The setting of the turbine with respect to the tailwater elevation must be carefully considered to ensure cavitation-free operation, and is based on the manufacturer's recommendations.

Turbines can be classified in two broad groups, impulse and reaction turbines. An impulse turbine is driven by a high velocity jet impinging on buckets around the periphery of the wheel, whereas the reaction turbine requires that the flow passages be completely filled. Reaction turbines can be subdivided further into radial, mixed, or axial flow types. The radial and mixed flow types have fixed runner blades, except for the Deriaz turbine, and the axial flow machine many have either fixed or adjustable blades. In addition to differences in blade geometry, each type of reaction turbine has different requirements for a draft tube. The draft tube is considered part of the turbine, and its energy losses are charged to the turbine performance. Some draft tube configurations may require a large amount of excavation to achieve the desired turbine setting.

The overall efficiency of an impulse turbine is quite constant over a broad range of operating conditions, which is achieved by throttling of the flow at the nozzle. Fixed-blade reaction turbines have a more peaky efficiency curve, whereas the efficiency curve for an adjustable blade unit is relatively flat. The latter unit is particularly suited for installations subject to a

wide variation in flow conditions. However, an economic analysis must be made to justify the higher cost of the fully adjustable turbine.

A wide variety of turbines is becoming commercially available for application to small-scale hydropower sites. Standardized units are offered by manufacturers in a range of sizes to reduce equipment costs. With increased demand for lower cost units to make marginal sites feasible, it is expected that further developments in standardization will be made. The manufacturers should be contacted for their recommendations.

Several operational conditions are also significant. Most turbines are designed to operate at a constant rotational speed which is controlled by a governor. Some general guidelines are given concerning speed regulation. With a sudden loss in electrical load, the turbine will reach a runaway speed that is considerably greater than the normal speed. The turbine and generator must be designed to tolerate the additional centrifugal forces. Provisions should also be made for emergency shutdown of the flow to the turbine, either by wicket gates or appropriate valves.

A review of small turbine technology indicates that most of our knowledge is based on the design and operation of large machines. The laws of similarity indicate that current designs are adequate for the needs of small facilities (defined as 3 m to 300 m head and power in the range 10 kW to 1,000 kW). The only exception to this appears to be at ultra low head in the 500 kW to 1,000 kW range. However, it does appear that current manufacturing techniques are not amenable to the smaller sizes where relative costs on a per kW basis rise sharply. New regulation technology and the use of plastics etc. could sharply reduce the relative cost in the smaller sizes. Smaller turbines are not usually tested, and reliable information on efficiency is generally not available. Impulse wheels are less sensitive to reductions in efficiency as size decreases. However, Francis and Kaplan units are more susceptible to reductions in efficiency in the smaller sizes where leakage and mechanical losses are relatively larger.

### Acknowledgments

Preparation of this paper was supported in part by grants from the St. Anthony Falls Hydraulic Laboratory Seed Research Fund and the Minnesota Energy Agency. The author appreciates the help of Dr. Paul Cooper of Ingersoll-Rand Corporation who was kind enough to supply preliminary data on the utility of existing pumps as hydroturbines.

Much of the material contained here is based on

an abridged version of Chapter 5 "Hydraulic Turbines" in *Small Hydropower Systems Design*, Mc Graw-Hill, 1982, by R.E.A. Arndt, C. Farrell, and J. Wetzel (edited by J. Fritz).

## References

ANONYMOUS (1978), *A Mini-Nitrogen Fertilizer Plant Based on Hydroelectric Power*, Int'l. Fertilizer Development Center (IFDC), Muscle Shoals, Ala, Project Proposal Phase 1, June.

BUREAU OF RECLAMATION (1966), *Selecting Hydraulic Reaction Turbines*, Engineering Monograph No. 20.

CAMERER, R. (1924), *Vorlesungen uber Wasserkraft - Maschinen*, Verlag von W. Engelmann, Leipzig.

DAILY, J.W. (1950), *Hydraulic Machinery*, *Engineering Hydraulics*, (ed. by H. Rouse), John Wiley & Sons.

DAUGHERY, R.L. & FRANZINI, J.B. (1977), *Fluid Mechanics With Engineering Applications*, 7th Ed., McGraw-Hill Co.

DEPROSE, W.M., KING, N.W., McNULTY, P.J., & PEARSALL, I.S. (1974), *Cavitation Noise, Flow Noise, and Erosion*, In *Cavitation*, pp. 373-381, Inst. Mech. Eng., Herriot-Watt University, Edinburgh.

HAGEN, D.L. (1976), *Methanol: Its Synthesis, Use as a Fuel, Economics and Hazards*, M.S. Thesis, University of Minnesota, December.

HUTTON, S.P. (1954), *Component Losses in Kaplan Turbines and the Prediction of Efficiency from Model*

*Tests*, *Proc. Inst. Mech. Engrs.*, Vol. 168, 743.

KANE, L.M. (1966), *The Waterfall That Built a City*, Minnesota Historical Society.

KERMEEN, R.W. (1976), *Water Tunnel Tests of NACA 66, - 012 Hydrofoil in Non-Cavitating and Cavitating Flows*, Calif. Inst. Technol. Hydrodyn. Laboratory Report, Rep. 47-7, 12 pp.

MAYO, HOWARD H., Jr. (1979), *Low-head Hydroelectric Unit Fundamentals*, 1979 *Engineering Foundation Conference, Hydropower: A National Resource*, Dept. of the Army Institute for Water Resources, Corps of Engineers, March 11-16.

MOODY, L.F. & ZOWSKI, T. (1969), *Hydraulic Machinery*, *Handbook of Applied Hydraulics*, (ed. by C.V. Davis), McGraw-Hill.

MUHLEMANN, E. (1948), *Zur Aufwertung des Wirkungsgrades*, *Schweizerische Bauzeitung*, p. 331.

NECHLEBA, M. (1957), *Hydraulic Turbines - Their Design and Equipment*, Artia-Prague, Czechoslovakia.

NUTTAL, L. J., *Conceptual Design of Large Scale Water Electrolysis Plant Using Solid Polymer Electrolytic Technology*, General Electric Company.

ROUSE, H. & Ince, S. (1963), *History of Hydraulics*, Dover Publications, Inc.

SMITH, N. (1980). *The Origins of the Water Turbine*, *Scientific American*, Vol. 242, No. 1, January.

TREHARNE, R.W., MOLES, D.R., BRUCE, M.R.M., & McKIBBEN, C.K., *Non-Conventional Manufacture of Chemical Fertilizers: Small-Scale Fertilizer Production Technology*, Technical Paper.

Roger Arndt was educated at the City College of New York where he received a Bachelor of Civil Engineering degree in 1960. He did graduate work at the Massachusetts Institute of Technology where he received a SM in 1962 and a PhD. in 1967. All of his educational background has been in civil engineering with an emphasis in hydrodynamics. He is presently Director of the St. Anthony Falls Hydraulic Laboratory and holds the rank of Professor of Hydromechanics at the University of Minnesota. He is also Chairman and Director of graduate studies in the Fluid Mechanics program. He is a member of the graduate faculty in the departments of Civil and Mineral Engineering at the Pennsylvania State University, a senior research engineer at the Lockheed California Company, and a research engineer at Alleghany Ballistics Laboratory.

Professor Arndt's current research activities are in the areas of cavitation, turbo machinery, and aeroacoustics. He is the author of approximately 50 papers and chapters in various books. Most of his publications are in the areas of cavitation, hydraulic turbines, and aerodynamics noise. His honors include the George Taylor Teaching Award, AIAA Outstanding Faculty Advisor Award, the Lorenz G. Straub Award, listing in Who's Who, and the first Theodore Ranov Distinguished Lecture Award. He is consultant to many companies and government agencies. Professor Arndt has taught and developed a broad variety of courses including Perfect Fluid Turbines, Aerodynamically Induced Noise, Viscous Flow, Turbulent Flow, Pumps and Turbines, Potential Flow Analysis, Experimental Methods, Aerospace Structures, Special Projects, Experimental Methods, etc. He has been involved in several continuing education programs in the areas of cavitation, aerodynamics of helicopter and viscous aircraft, dynamic flow measurement techniques, introduction to engineering for exceptional freshman, and development of small hydropower systems.

Professor Arndt has been active in developing hydropower in the State of Minnesota. He has cooperated extensively with state authorities as well as making several presentations of the development of hydropower for local T.V. programs. He initiated a program of developing a hydropower museum and is currently on the hydropower museum committee responsible for reviewing the progress of a team of consultants currently working on this project.

## Discussion

*Mr. Sularso, Indonesia:* I would like Dr. Arndt to comment on the relative economies of the propeller-type and the cross-flow turbines for low-head applications.

*Dr. Arndt:* That's a very difficult question to answer for a couple of reasons. There is obviously an overlap, in certain cases, where the cross-flow and the propeller-type would fit the same applications. Typically, when you talk about economy, you've got to talk about a couple of things. Generally speaking, the cross-flow turbine will not have the same efficiency as a well-designed propeller-type, but you can debate how much the efficiencies are really worth. I haven't seen enough information to know how the actual costs of the machines would compare. There are many home-built cross-flow types, as you are well aware. So, I'm a little perplexed as to how to answer that question. I would think, however, that given an equal size between the two units, there wouldn't be much cost difference between them. But, to the best of my knowledge, the propeller-type turbine would be more efficient than the cross-flow type. Although it is very popular, because it is easy to fabricate, there are very few hard facts available on the precise efficiencies of these cross-flow types.

*Dr. M. Abdullah, Pakistan:* I would like to ask Dr. Arndt to give me some idea of the efficiency of the cross-flow turbine, particularly regarding the inlet angle, which is set in certain configurations from about 10-15 degrees to 40-50 degrees, without affecting the efficiency. I wonder if you have some experience in this matter?

*Dr. Arndt:* I have very little experience with the cross-flow turbine. One of the best papers I have seen on the cross-flow turbine was published in 1949 as part of an Oregon State University experiment, in which they investigated in detail how the design parameters influence the efficiency. All the efficiency studies I have seen indicate that it tends to be fairly low — in the range of 60-70%. Many higher efficiencies are quoted, but I have not seen any documented proof of those efficiencies. On this basis, it is very hard to make a good comparison with other turbine types.

*Dr. Abdullah:* My second question is about the market potential which you mentioned in your presentation. You mentioned a sum of \$6.5 billion. Does this represent only the U.S. domestic market or does it include exports as well?

*Dr. Arndt:* No, that was just the central portion of the U.S., which is where I am from. I just mentioned that market to give a general idea. The \$6.5 billion

figure was based on the market value of power in that region, which is the annual power that can be produced by developing the additional available resources, multiplied by the retail worth of the power. That figure doesn't include the really major power-producing areas of the U.S., such as the northwest, where a substantial amount of power has already been developed.

*Dr. Abdullah:* My last question is, what is the potential of small-scale hydro in the U.S., particularly since the U.S. is already industrialized and widely electrified? Is there any additional potential for mini- or micro-hydro development?

*Dr. Arndt:* Yes and no. What is considered to be mini-hydro in the U.S. would be considered macro-hydro in other parts of the world. But if you define mini-hydro between 300 kW and one MW, then there is much real potential and there are many interesting reasons why that potential is there. Some of it is real, but other potential exists because of certain laws that were passed to encourage the development of mini-hydro in the U.S. Those of you who are aware of tax rates in the U.S. know that they are very high. A law was passed to permit an additional investment tax credit by investing in a hydropower site. Under this new law, the total investment tax credit is 21% of the total investment, which amounts to a strong incentive for the development of hydropower. Another incentive is the way the state and Federal regulatory agencies now operate, whereby utilities are required to buy back the power from the small developer. Both of these recent developments have produced what could be called a "gold rush" for developing sites.

Right now, there is a backlog at the Federal Energy Regulatory Commission of 700 applications for sites, whereas two years ago there were almost no applications. This gives you an idea of how quickly things are developing. The increased cost of oil affected the U.S., as it has all parts of the world, and people have become much more interested in doing this kind of thing. In my home state of Minnesota, we have an installed capacity of somewhere around 6,600 MW and we import much more power than that. Calculations indicate that, if we developed all the hydro potential, we could produce about 10,000 MW of power, or the equivalent of one nuclear power plant. If it is worded that way to the state legislature, it has a tremendous amount of political impact and encourages development to a high degree. Hydropower is just like motherhood in the U.S. and, for that reason, people are very interested in developing it. It is renewable, non-polluting, and, since we have a tre-

mendous number of sites which are already substantially developed, there is minimal environmental impact. There is no reason not to use that potential and it is now being developed.

*Dr. A.N.S. Kulsinghe, Sri Lanka:* Since the question of efficiency has been raised, I would like to add a little from my experience. We found that the cross-flow, or Banki, turbine lost efficiency due to the presence of a shaft in the center which got in the way of the cross-jet from one side to the other. Logically, we just removed it and put in stub shafts on the run-

ner and a set of guide vanes to receive the water and direct it to the other side at the correct angle. I believe we got an efficiency increase of 10%. This is an inexpensive way of doing it and improves the performance of the turbine.

*Dr. Arndt:* You did not say what the 10% was in addition to.

*Dr. Kulasinghe:* Generally, our model tests were around 70%; therefore, the efficiency increased to about 80%.

## Site Location and Civil Works Design

Allen R. Inversin\*

---

**ABSTRACT :** Small hydropower presents numerous advantages over the diesel alternative for power generation. But because of the approaches to the implementation of small hydropower schemes which have been adopted in the past, the impression that small hydropower is a high-cost alternative and a source of recurring maintenance problems is generally held. Before small hydropower can be more widely accepted as a viable and cost-effective alternative, this impression must be countered. The proper selection of a location for the proposed small hydropower scheme and the appropriate design of its civil works are important aspects if this form of power generation is to have a significant role.

Based on actual field experiences in the developing countries, this paper briefly discusses factors which must be considered in selecting a site as well as the function and design of the major civil components of small hydro schemes. These are presented in the light of reducing both the costs associated with materials and engineering expertise and the maintenance problems associated with the civil works.

---

### Introduction

**A**S a step towards greater self-reliance in power generation, small hydropower is gaining in appeal in many countries around the world. Though, like all technologies, small hydropower is not necessarily appropriate under all circumstances, a vast potential yet remains virtually untapped.

But in order for small hydropower to become a serious contender as an economically viable technology, well thought out and sometimes innovative designs are required. Attempting to design small hydro-power schemes by simply reducing designs of large hydroelectric projects in scale is technically possible; but unfortunately costs are not scaled down accordingly. Consequently, small hydro schemes must be designed on their own merits. This requires an understanding of those factors which influence the selection of a viable site. It requires an awareness of particular operational problems which may prove to be

potentially disruptive and have to be addressed at the design stage. And finally, once a site has been selected, it requires an openness to the use of alternative materials and other than conventional designs, a return to basic principles and new solutions found in the light of new constraints.

NRECA is planning a detailed micro-hydro handbook to deal with these and numerous other aspects in the implementation of micro-hydro schemes. This paper can only provide an introduction to this area. It highlights some of the factors involved in site selection. It describes the functions of the various components of the civil works for small hydropower schemes as well as examples of operational problems encountered in the field, and presents some options for design and alternative materials.

This paper describes some of the *technical* aspects of small hydropower schemes which must be considered in designing practical and economically viable schemes. It must be kept in mind that this is, of

---

\*Micro-Hydro Engineer, NRECA, Washington.



course, only *one* aspect. Other critical aspects, including social, managerial, institutional, and financial aspects, will be discussed elsewhere during this workshop.

### Site Location

The selection of an appropriate site for the installation of small hydropower schemes requires the consideration of several factors. Some factors are obvious. The site must, for example, be accessible so as to facilitate construction, operation, and maintenance of the installation. Also, the powerhouse must be situated at a reasonable distance from the consumers. But other factors, described below, involve an understanding of the technical requirements for the operation of a hydropower scheme.

#### Effect of power requirements on site location

In designing a scheme to generate the power ( $P$ ) required by a particular community, a flow of water ( $Q$ ) must fall through a height ( $H$ ). Though there is a relationship between  $Q$  and  $H$  and the power required, the head necessary for the generation of a

specific power can fall anywhere in a wide continuum, from a very low head to a very high head.

$$P = 7Qh$$

where  $P$  = power (kilowatts)  
 $Q$  = water flow ( $\text{m}^3/\text{sec}$ )  
 $H$  = net head (m)

The relationship does not specify one unique head to generate the desired power. The relationship does, however, provide guidelines for the choice of these parameters and the final determination of head and flow must be based on a careful review of the topology of the area in the light of this relationship.

A low-head installation requires a larger flow of water. This implies larger turbines and the necessity of tapping a large river. With the large and intense rainfall in many parts of the tropics, tapping large rivers can lead to major problems with the intake structure. The intake must be able to handle a river whose depth may vary widely and which often transports large quantities of debris – tree trunks, boulders, gravel, and sediment.



WONODADI, INDONESIA Low-head, 210 kW installation at a drop on an irrigation canal.

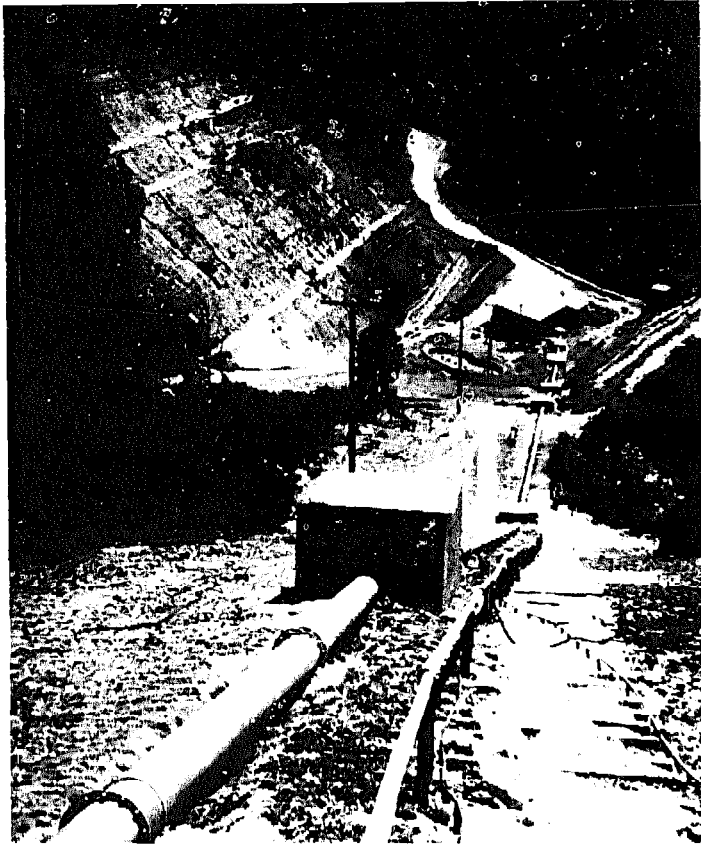

NAM DANG, THAILAND High-head, 100 kW installation.

A high-head site, on the other hand, would require lower flows to produce the same desired power and has a number of advantages. The lower flow implies the need for a turbine smaller in physical size (and cost). It also means that a smaller source of water need be tapped, simplifying the design of the civil works at the intake.

But with high-head sites, the source of water is often not above the powerhouse but at some distance. Though this water can still be conveyed in a pipe all the way to the powerhouse, a much longer and larger diameter (and costlier) pipe would be necessary. Usually the most cost-effective method of bringing this water to a point more nearly above the powerhouse is with an open channel. Though it will generally be less expensive to substitute head for flow in the power equation, one possible disadvantage of high-head sites might therefore be in the construction and operational problems associated with the additional civil works.

#### Effect of water requirements on site location

Depending on the hydrological conditions prevalent in the area, the scheme might either be a run-of-the-river type or require storage capacity.

A scheme incorporating the storage of water

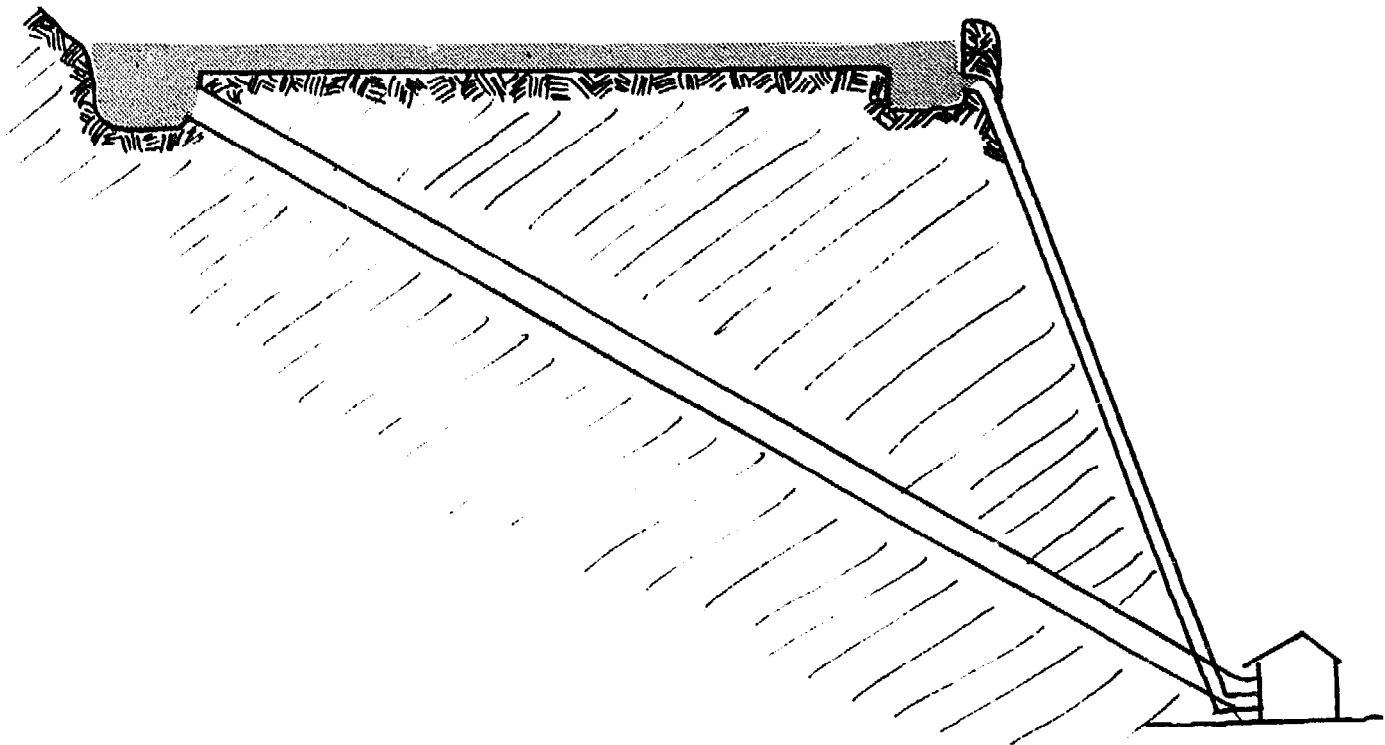

Design options: Long large diameter penstock vs. shorter, smaller diameter penstock with headrace.

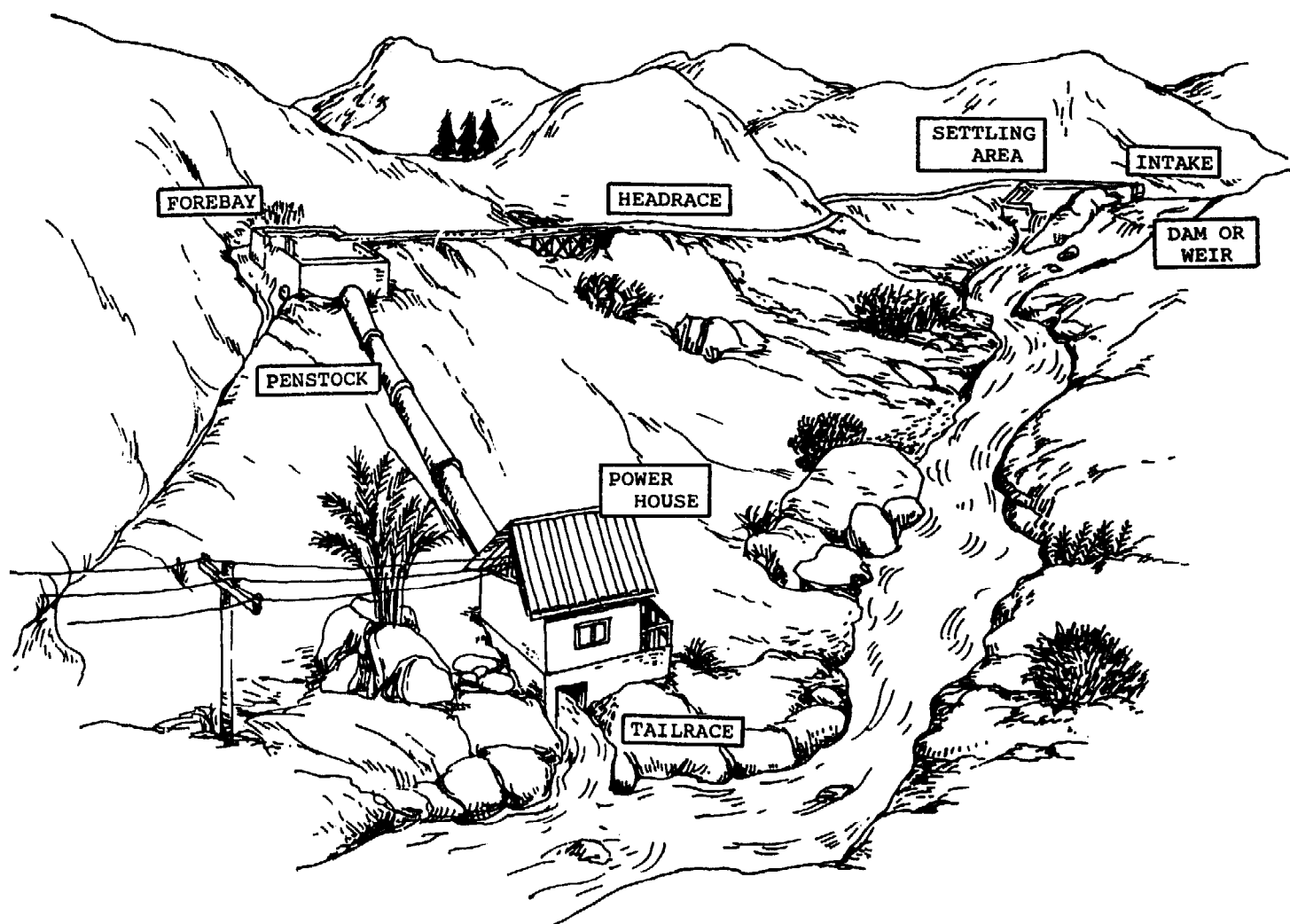

Components of a hydroelectric scheme.

may be required either in regions of pronounced dry periods, during which time the flow of the river is not adequate to supply the power requirements, or on streams where the flow is more than adequate during one portion of the day but insufficient during another portion due to increased power requirements during that time. Storage schemes require the construction of a dam, and a dam requires careful design and site location. Even then, dams are susceptible to quickly silting up, washing away during times of unusual floods, or they can lead to environmental problems (adversely affecting fish, water quality, etc.) or creating conditions conducive to the propagation of disease-carrying organisms. In addition to the complexities in the design and construction of dams, storage areas can rapidly be completely filled in with stones, sand, and silt, so as to render their use for storage ineffective anyway.

Where the river flow is more than sufficient to meet the power requirements year-round, a run-of-the-river scheme can be constructed. This simply

implies the diversion of a portion of the flow in the river through the intake to the hydro scheme. No dam is usually necessary, though a permanent weir can be built across the river bed to prevent the gradual lowering of the river bed in the vicinity of the intake through erosion over the years. In areas where no noticeable lowering of the bed is apparent, a weir may be built simply to ensure that the water is diverted toward the intake during periods of low flow.

If one were to make a general rule, it would be fair to state that to minimize cost and potential operational problems, higher-head, run-of-the-river schemes are favoured. But the trade-offs involved in selecting one kind of scheme over the other are country and site specific and require that options for each area be considered on their own merits.

### Civil Works Design

Once a site has been tentatively identified, the design for the civil works necessary to convey the

water from the river to the turbine is not unique. Because the civil works components to be included are well known, it is easy to fail to realize that a variety of design options exist. And the final choice among these options effects the potential maintenance problems with the scheme and ensuing frustrations, the costs associated with materials and labor used in the construction of the scheme, and the labor required in the regular maintenance of the civil works.

Either of two approaches to the construction of small hydropower schemes have generally been pursued to date. The first approach is undertaken by engineers who use conventional designs which have served their purpose in major hydroelectric projects. Using these designs, but scaling them down to small hydro dimensions, often results in high costs which are necessary to cover materials and expertise. The second approach is undertaken by those with little field experience with hydro schemes and not aware of the possible problems which can be encountered. Though this approach might result in lower costs, it

also generally results in more operational problems. Unfortunately both of these approaches reinforce a generally held impression that small hydropower is a high-cost alternative and a source of recurring maintenance problems. This impression can only be countered by a carefully thought out approach.

The sketch opposite illustrates how all the basic civil works components fit into a small hydropower scheme. Depending on the topology at the site or on the type of scheme envisioned, one or more of these components might not be necessary and could be omitted.

1. *Dam or Weir* – a structure placed across a stream; the former is generally for the storage of water and/or for increasing usable head on low-head sites, whereas the latter is often placed on the river bed immediately downstream of the intake to prevent the gradual lowering of the bed by erosion in the vicinity of the intake and/or used to divert available water towards the intake in times of low stream flow.

Dams for small hydropower schemes might be



YAIBOS, PAPUA NEW GUINEA (90 kW) A weir constructed of concrete layered over stone-filled wire baskets. A temporary stone diversion wall directs the dry-season river flow to the intake off to the left.

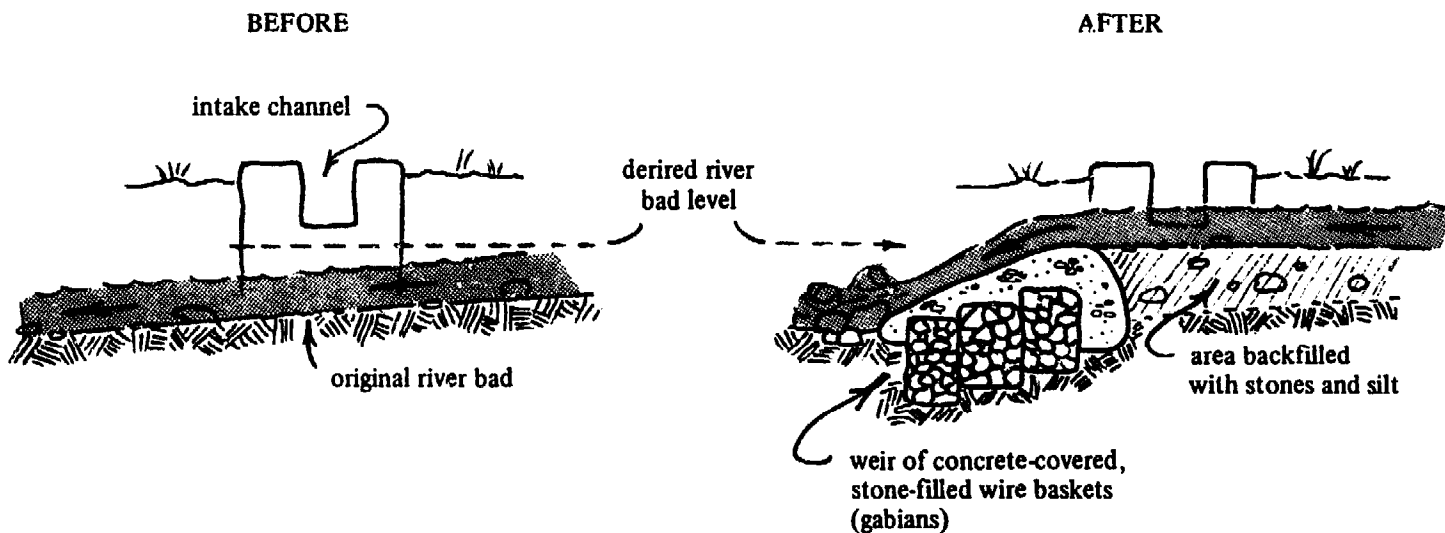

SECTIONAL VIEW ACROSS RIVER

A design option for a weir.

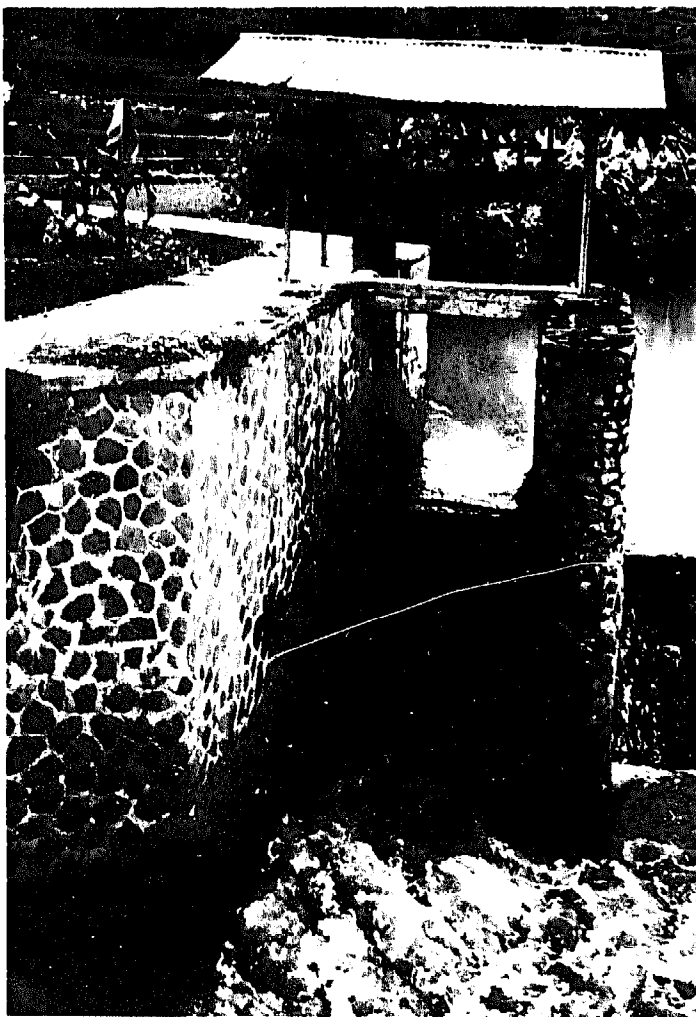

TALAGA KULON, INDONESIA Intake structure

constructed of either earth and rocks, timber, masonry, and/or concrete. But as mentioned previously, unless the necessary expertise for proper site selection, dam design, and construction is available, they should if possible be avoided. Even if properly constructed, they may add to the cost of the scheme or add to future problems.

Weirs, on the other hand, are comparatively trouble-free. Where the river flow is such that the erosion and gradual lowering of the river bed is a real possibility, a low wood, masonry, or concrete structure might be keyed into the bed so that its crest coincides with the desired level of the river bed. If the weir is not constructed on a rock foundation, erosion at the toe of the weir might threaten to undermine it. The energy of the water flowing over the weir must therefore be dissipated, possibly by forming a deep, stilling pond, just downstream of the weir or by placing a bed of sufficiently large stones there. If the river bed is wide and the dry season flow is low, it might be desirable to *slightly* slope the crest of the weir toward the intake so as to divert the low flow in that direction.

When a stream flow is low, a temporary weir or low fence of stones, branches, etc. can be easily built across the river to channel the water towards the inlet. The principal advantage of a temporary weir of local materials is that, at times of heavy rains, it can be washed away, permitting the flood waters to continue straight down the river, without damaging the intake and/or flooding the headrace. It can be easily rebuilt

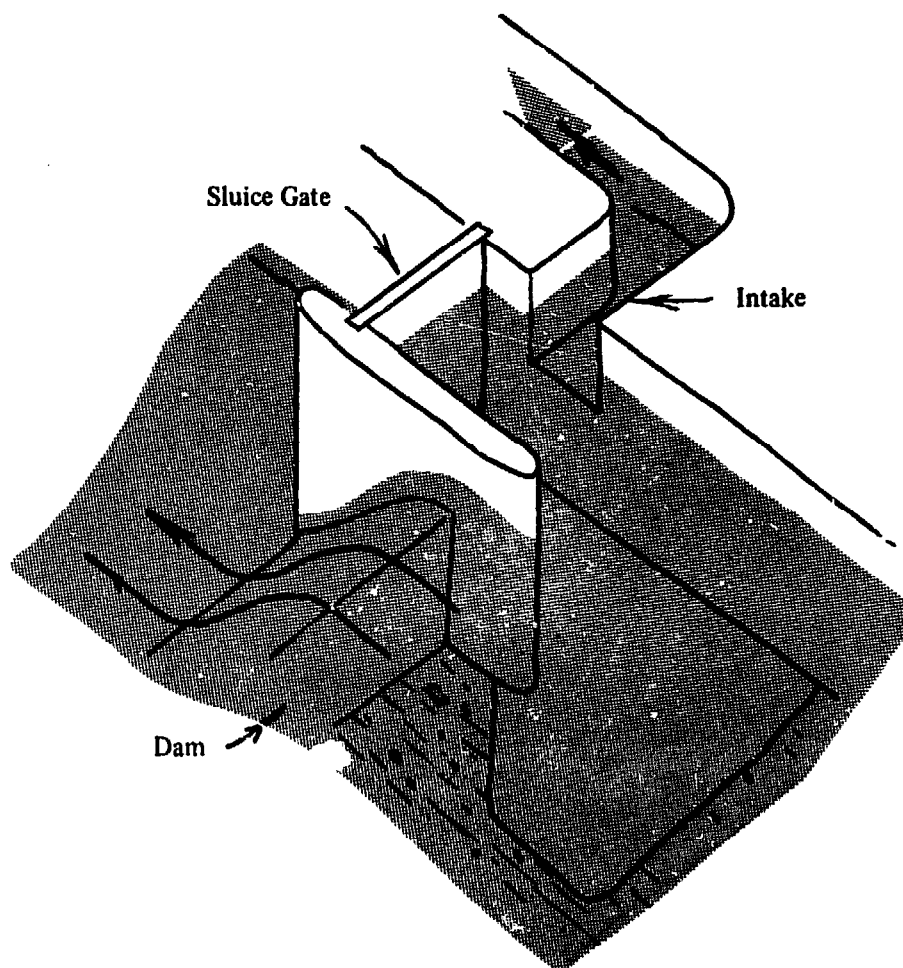

A design option for an intake

when necessary.

2. *Intake* – to take in water from the stream or reservoir and permit a controlled flow of water into the headrace while minimizing the intake of heavy bed-load and floating debris.

The principal maintenance task associated with civil works is often the removal of sediment and debris carried by the incoming water. It is therefore essential that the civil works design adopted removes as much silt, bed-load, and debris from the water as possible as it enters the intake. One of the principal causes of problems in the operation of small hydropower schemes is found in a poorly designed intake, and that is the reason why this topic is covered here in greater detail.

In selecting a place for the intake along a river, it must be kept in mind that there is a natural tendency of the river to deposit sediment on the inside of the bends along the river. Consequently, in order to minimize maintenance problems, this position for the intake should generally be avoided.

When taking in water from a stream whose level may increase markedly during rainy periods, it is desirable to locate the intake behind or under large, permanently placed boulders or rock outcrops. These then serve to limit the water that can enter the intake and to deflect flood flows and river-borne debris away.

Once a location for the intake along a river has been found, a not uncommon design in small hydro schemes is orienting the intake virtually upstream. This generally has grave consequences in times of heavy rains when not only the bed-load and river-borne debris but the entire river itself may be funneled into the intake. To avoid this problem, intakes are often oriented as close to perpendicular to the direction of the river flow as possible at the site.

The intake can be constructed of a wide range of materials. On the one hand, it can simply be an earth channel normal to the river. This should generally be faced with stones (“rip-rap”) to prevent erosion during times of high flows.



SOPAS, PAPUA NEW GUINEA Intake trashrack facing slightly downstream toward the crest of the weir in order to avoid rainy season floods.

On the other hand, when a dam is constructed across a stream, a modification of the design illustrated is often employed. Behind dams, silt and bed load are retained and a gate is provided in the dam structure just downstream of the intake so that this area can be flushed out periodically. This area should be paved with concrete or rock to prevent erosion occurring when the area is flushed. The level of the bottom of the intake channel should be raised above the river bed so that the heavier bed-load is prevented from being washed directly in.

As part of the intake structure, provision is generally made for a gate to cut off flow into the scheme when maintenance or repair work has to be undertaken.

A trashrack to keep out floating debris and larger stones is also often included. Generally it is fabricated of vertical steel bars set in a frame and set across the intake channel, inclined slightly in the direction of the water flow. Debris which has accumulated in front of

the trashrack must be removed periodically to ensure proper operation of the scheme. Depending on the location, this can be a task requiring continual attention during periods of heavy rains.

To minimize just these maintenance problems, a self-cleaning design was developed at a 90 kW scheme in Papua New Guinea and seems appropriate where flows in excess of those required by the turbine are available. It automatically removes all but the sand, which is removed in a settling area just downstream of the intake. This trashrack is in the form of a sheet of iron, perforated with 10 mm holes which lays just below the crest on the downstream side of a small dam. Some of the water overspilling the dam filters through the sheet into the intake channel and the excess water carries the debris and bed-load over the sheet and on down the river. The sheet is reinforced with lengths of pipe oriented vertically down, and welded to the top of the sheet. This also serves to protect the sheet from damage by large boulders



BUNDI, PAPUA NEW GUINEA (70 kW) A self-cleaning trashrack designed locally. Water flowing through the trashrack can be seen (at lower right) dropping into the headrace channel.



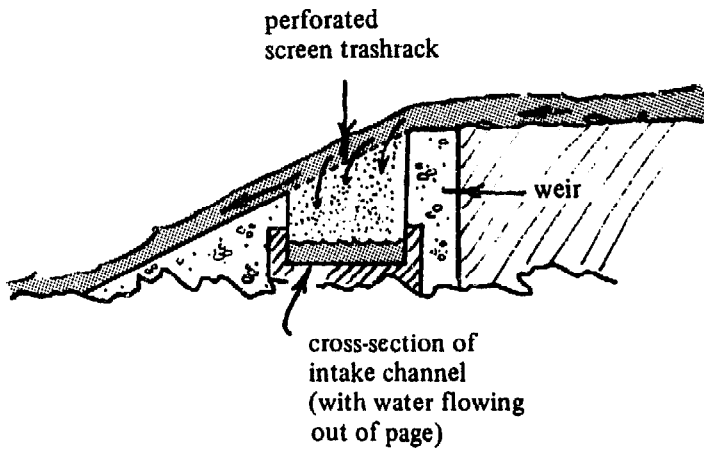

Cross-sectional view of a trashrack used at Bundi, PNG.

which are carried by the river.

Spillways are also often incorporated in the wall of the intake channel. This permits excess water that might enter the intake and damage other components of the scheme to overspill back towards the river

without eroding the area immediately around the intake structure.

3. *Settling Area* – that portion of the civil works where the denser material carried by the water, especially sand and silt, is removed. These areas are optimally used in pairs, one at the entrance to the headrace to prevent settling in the headrace, and one before the penstock inlet, usually as part of the forebay, to protect the turbine.

If properly designed, settling areas can be periodically cleaned out with the minimum of effort, by operating a sluice gate and letting the water carry out the sediment. However, the realities seem to indicate that not much thought is generally given to their design, and consequently cleaning out the settling areas becomes a labor intensive operation – man and shovels.

Depending on the quality of the water and its speed along the headrace, settling could occur along its entire length if no settling area precedes it.

It is advisable to include a settling area at the end of the headrace, usually as part of the forebay. During

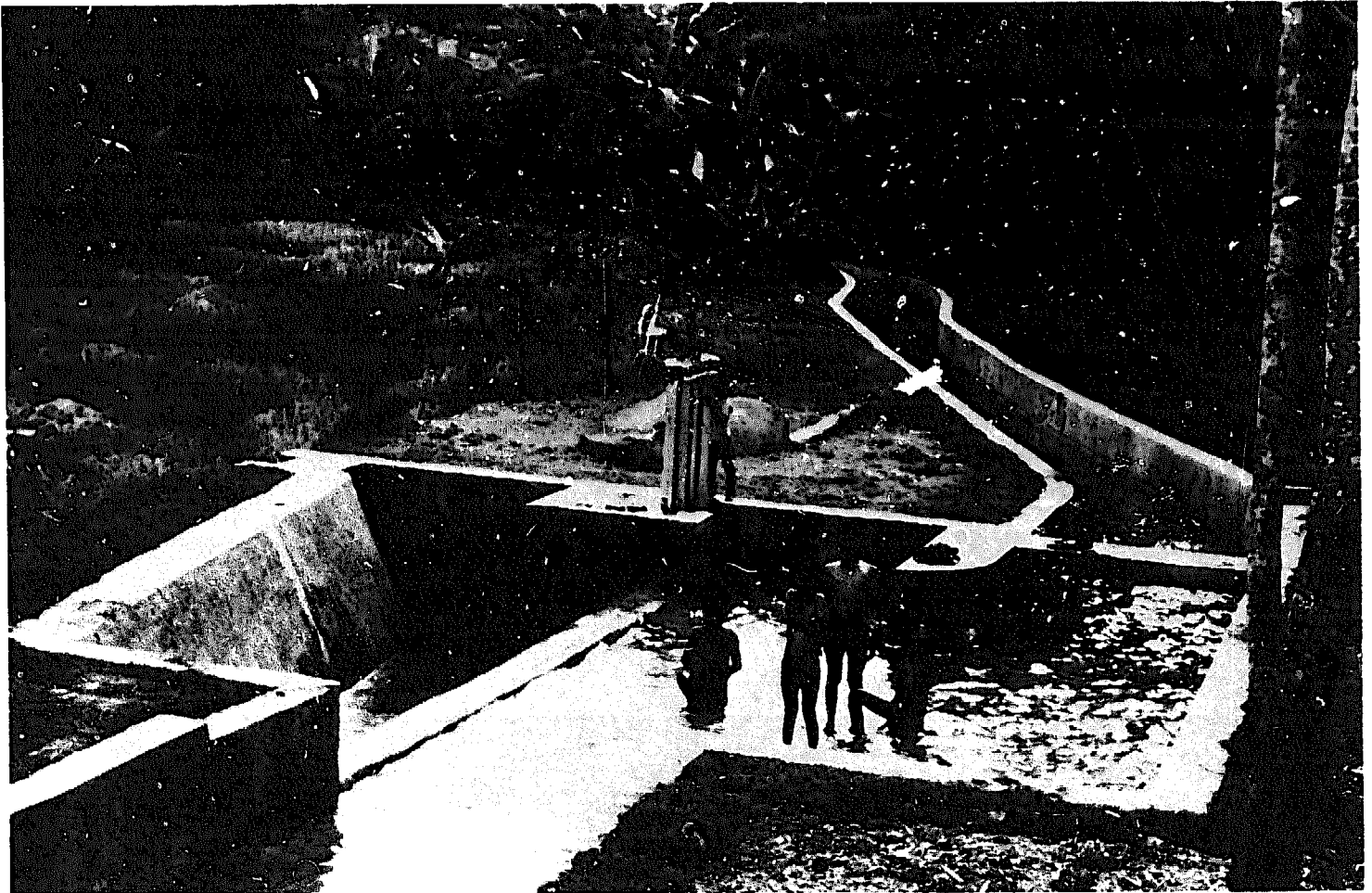

TALAGA KULON, INDONESIA (260 kW) Settling area with spillway for overflow on a canal, used for both irrigation and the generation of electricity.



KUDJIP, PAPUA NEW GUINEA (90 kW) Intake to the penstock seen at lower left. With no provision made for a forebay for settling, landslides from the slope at the right resulted in excessive wear of the turbine.

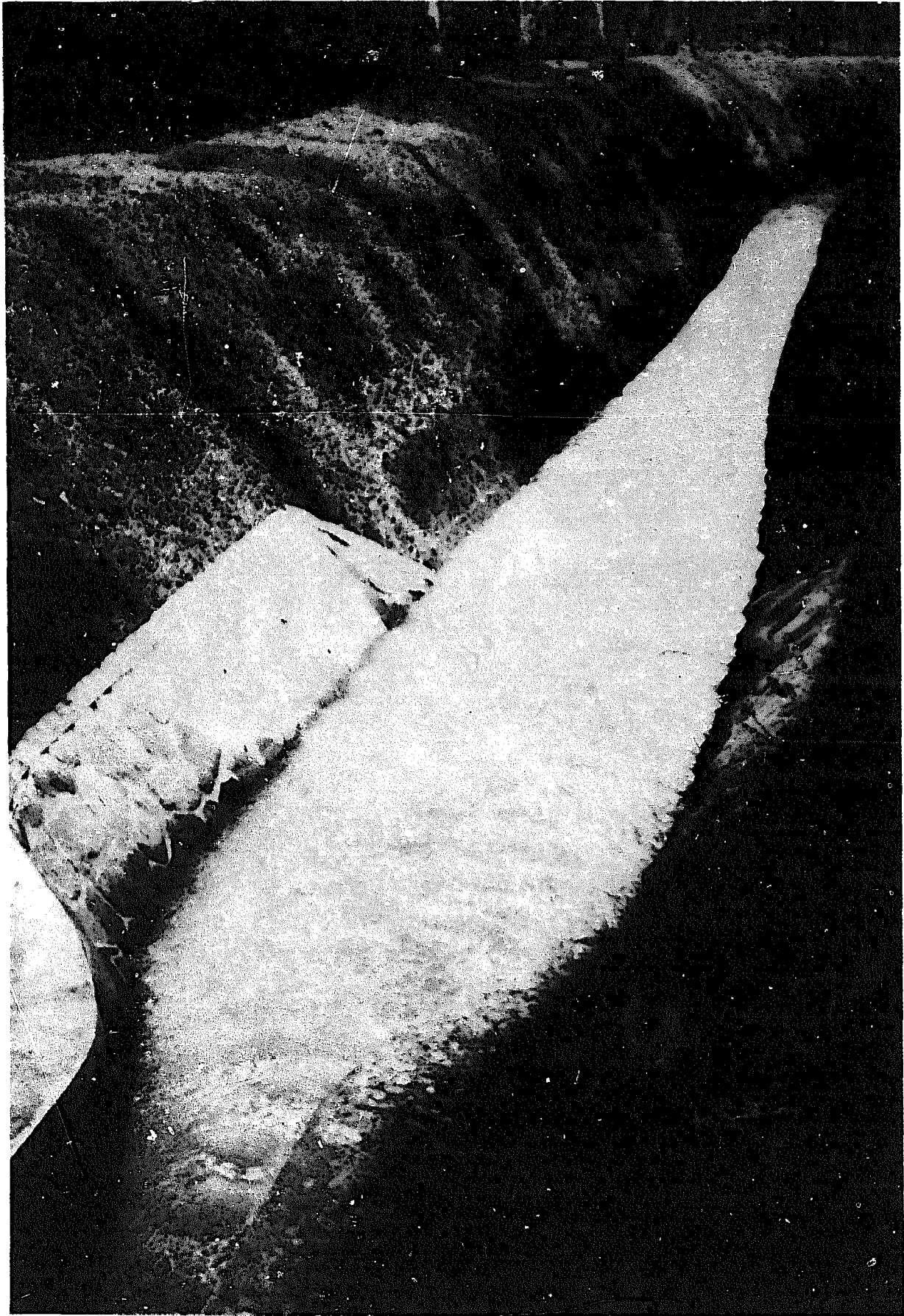

An unlined earth irrigation canal in Indonesia with masonry used only at points of potential erosion.

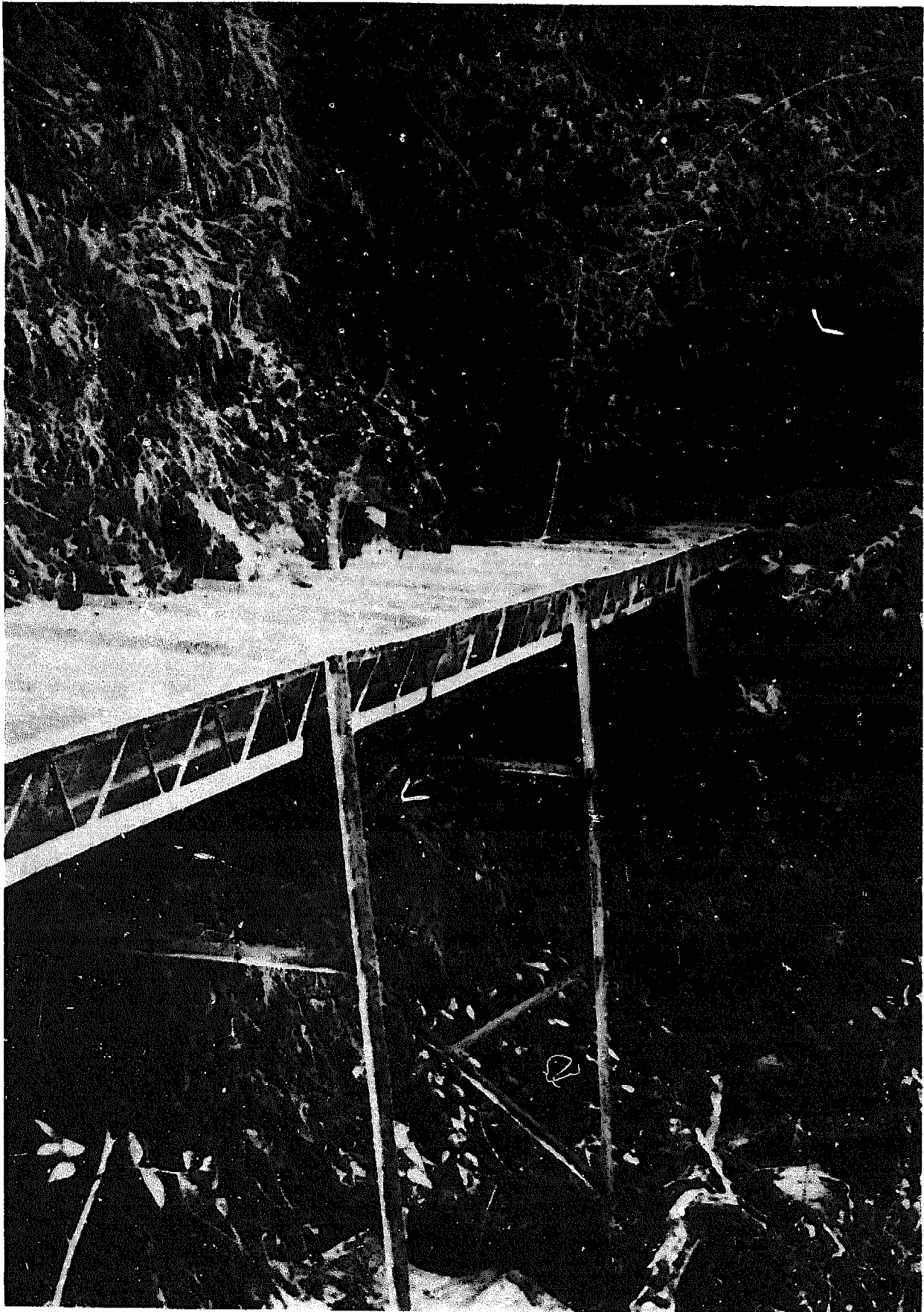

RUGLI, PAPUA NEW GUINEA (25 kW) A galvanized iron sheet trough serving as a flume to convey head-race water around a rock face.

the rains, it is possible that runoff from the hillside uphill of the headrace can be swept into the canal and this would have to be removed from the water before it enters the penstock.

4. *Headrace* — a canal conveying water, often over relatively long distances, from the intake to the forebay, at minimum cost and head loss. Included as part of the headrace may be flumes (suspended or supported canals across a gully, etc.), siphones (for going under roads, gulleys, etc. or across dips in the land), drops (for dissipating energy when a sudden fall along the headrace is unavoidable), and spillways (to safely convey excess water entering the headrace away from the civil works).

Soil conditions and geological formations along the alignment of the headrace must be stable in order to ensure that frequent landslides will not damage the canal. If conditions permit, a ditch can be constructed between the headrace and the uphill slope to contain the runoff. However, appropriate structures must then be constructed to carry this runoff water over or under the headrace. Alternatively, a portion of the headrace may go underground in partially full pipes. If slides are a possibility, spillways should be incorporated at appropriate intervals along the headrace to prevent water from overspilling and undermining it should it become blocked. When the soil is pervious, the canal should be lined, and concrete is often used for this purpose.

The headrace can be made of a wide variety of materials. These range from an earth headrace to those made of concrete, with some segments sometimes made of steel or wood. The headrace across small dips in the land should be carried in flumes and not built over filled-in soil. Otherwise there is the possibility of the headrace settling, which might well impair its operation.

The headrace usually has as shallow a slope as economically possible so as to maximize the head remaining between the forebay and the turbine. Cross-sectional dimensions necessary for it to carry the required flow is straightforwardly determined from any hydraulics handbook. There is a trade-off between slope and cross-sectional area in that as the slope becomes smaller (increasing the remaining head and potential power of the system), the speed of the water decreases and a greater cross-sectional area (at a higher cost) is necessary. Also, if the speed becomes too small, any sediment still carried by the water entering the headrace would tend to settle in that canal. On the other hand, if the headrace is too steep, the speed of the water is increased to the point that it can erode an earthen headrace.

5. *Forebay* — a final settling area, with trash-rack, just before the water enters the penstock, possibly with a gate for shutting water to the penstock and a spillway for safely removing any excess water entering; it must have at least excess storage capacity to make up for the sudden small increases in demand of the turbine during the time that the flow in the headrace is returning to equilibrium.

Generally, forebays are constructed of concrete and should be constructed no larger than necessary, especially if cost is a factor. If, by proper design of the civil works, one is *ensured* that the water entering the forebay remains of sufficiently high quality, and if storing water behind a dam is of no interest, then virtually no forebay is necessary. The flow through the intake can be adjusted to provide the maximum flow that could be required by the turbine, and during times when less power is used excess water would overflow the forebay spillway. It is also possible to construct a forebay in earth, as a sort of pond. However, depending on soil conditions, periodical filling and emptying of the forebay and other disturbances occurring therein can gradually erode the side of the forebay.

Since any forebay will act as a settling area, appropriate gates should be incorporated so that it can be completely drained when desired.

6. *Penstock* — a pipe used to convey the water with minimum friction losses from the forebay, under pressure, to the turbine.

Penstock pipes are conventionally made of steel, but these are generally expensive and, for remote schemes, can be heavy and difficult to transport. In Nepal, penstock pipe is locally fabricated in 2 m lengths, and two such lengths can be carried by one man.

A range of alternative materials can be used in the construction of penstock pipe; asbestos-cement, prestressed concrete, PVC and polyethylene, fiber-glass-reinforced polyester, and wood. Each has its advantages and disadvantages, some generally valid while others are country-specific.

7. *Powerhouse* — a shelter to house the turbo-generating and associated control and electrical equipment. A firm foundation for the turbine and generator is essential.

The powerhouse may be anything from a small structure, to cover only the turbo-generating equipment, to a structure which might include a workshop, office, and storage area. Assuming appropriate standards are maintained, the powerhouse can be constructed of a variety of materials, from bush materials to concrete and steel.

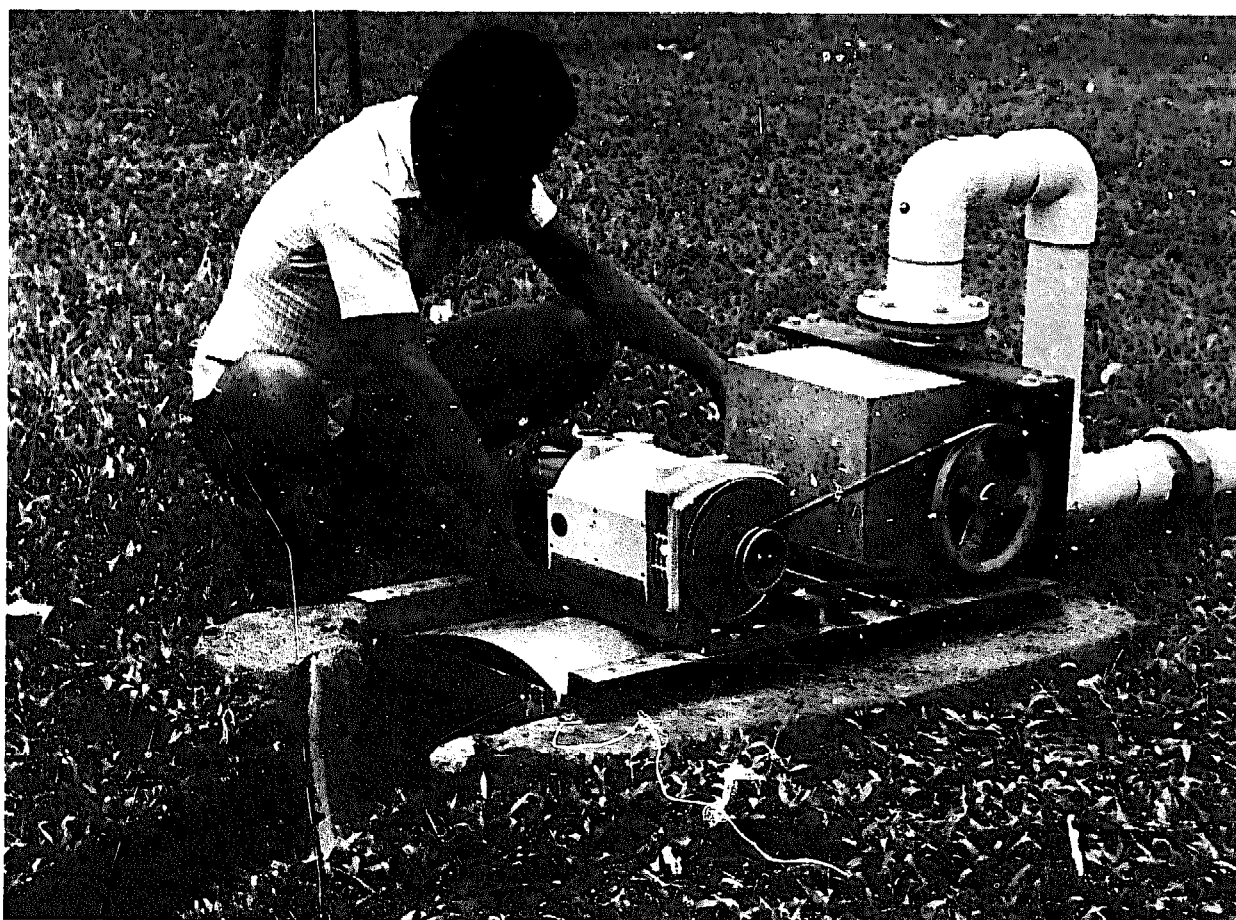
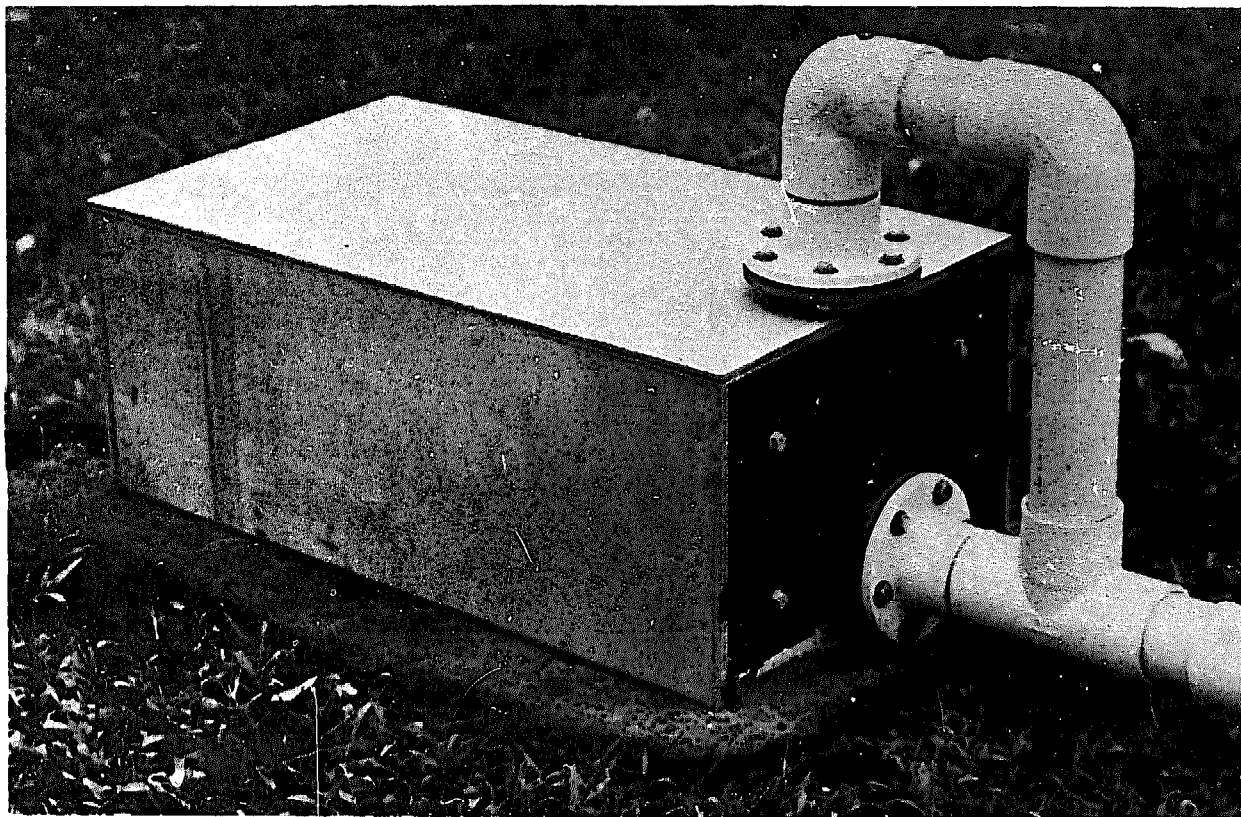

A 5 kW Pelton prototype designed at the Appropriate Technology Development Institute (Lae, PNG) for local fabrication and quick, trouble-free installation. A box can be used to protect the equipment from the elements.

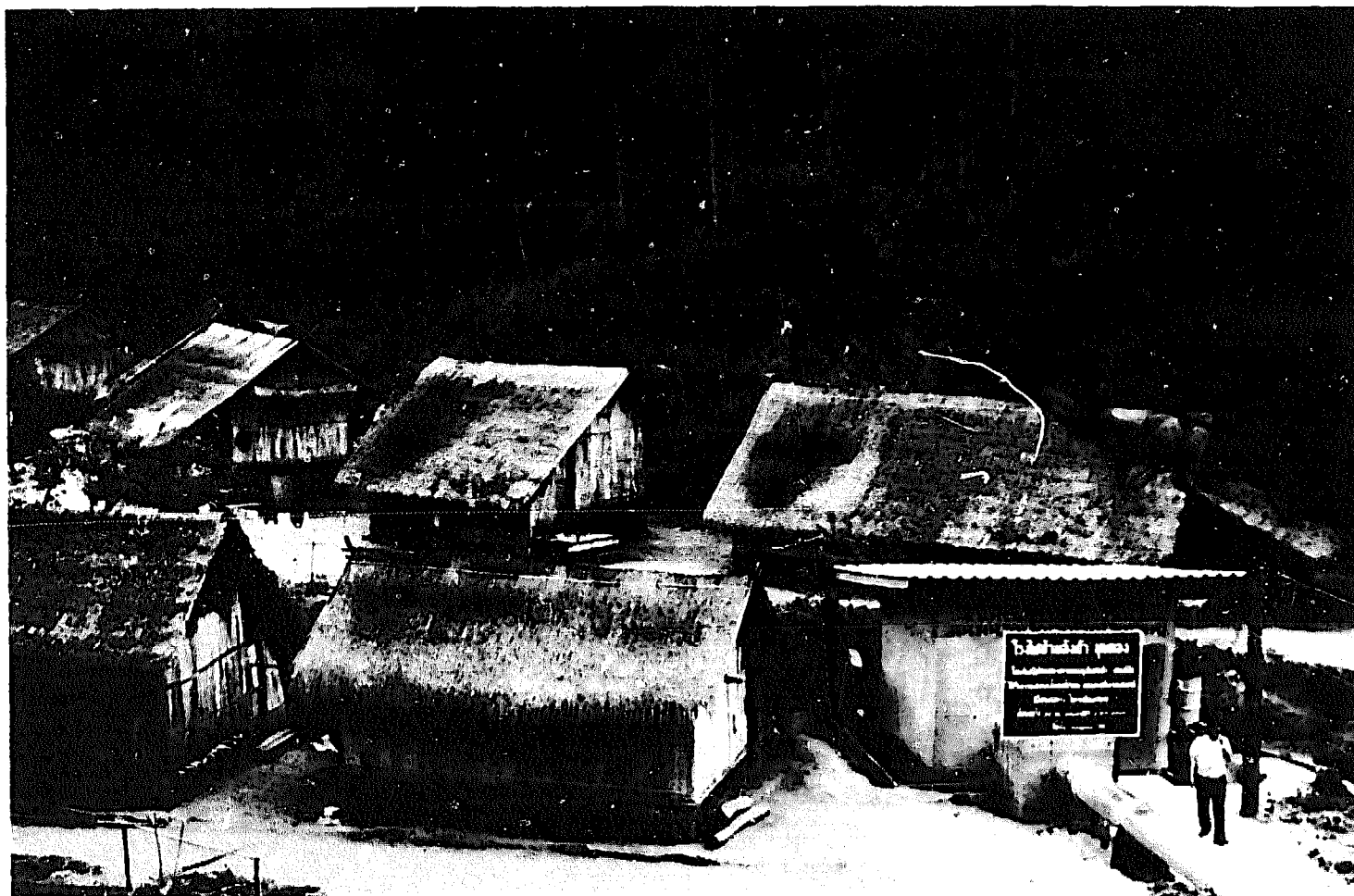

KHUN KHONG, THAILAND (12 kW) concrete power house and village houses wired for lights.

8. *Tailrace* – a canal used to convey the spent water from the turbine back into the river.

This canal should be offset from the main river into which it is returning in order to prevent stones and gravel from being washed up by the river into the tailrace during periods of heavy rains. This debris might adversely affect the operation of a turbine, especially one which relies on a draft tube.

### Conclusion

In summary, it must be emphasized that small hydropower must be seen in a proper perspective. In numerous areas, there may well be no real potential – and then either grid distribution from a larger hydroelectric scheme or diesel generation might be the only alternatives. But where a potential exists, small hydropower possesses real advantages over diesel generation. Not only is it a well-tried, conventional technology, but unlike diesel, it avoids a reliance on increasingly costly fuel, and the difficulties in obtaining and then transporting this fuel to possibly remote areas. Recurring costs can be kept low and the life of the turbo-

generating hardware is long. And the hardware is less troublesome to run and maintain.

On the other hand, two common arguments against the use of small hydropower have been the high costs associated with the turbines and civil works and the complexities of implementing and managing small schemes patterned after models used for large hydro schemes. However, the high cost of turbines is largely being countered by local fabrication of turbines and other related equipment. This is being done in Nepal, Thailand, Indonesia, India, Pakistan, Papua New Guinea, as well as other nations, and this topic should be further explored in the ensuing panel discussions and workshop sessions at this conference. Secondly, costs and management problems associated with the civil works can be reduced by proper site selection, appropriate designs, and local commitment to providing labor, materials, and overall management.

So it is reasonable to conclude that, properly undertaken, small hydropower may well be an alternative with even greater potential than it has been credited with to date.

**Allen R. Inversin** after ten years overseas, recently returned to the United States to join NRECA's Small Decentralized Hydropower Program as a Micro-Hydro Engineer. In addition to keeping abreast of small hydro developments primarily in the developing countries, he prepares appropriate documentation to address the needs encountered in implementing small hydropower projects. Allen Inversin studied six years at the Massachusetts Institute of Technology where he received the Bachelor's, Master's, and Engineer's Degrees in aeronautical and astronautical engineering. Upon graduation, he served for six years in Laos with International Voluntary Services in science and mathematics education at the National Teacher Training College near Vientiane, both teaching and preparing an extensive sourcebook on the use of local materials in the teaching of the secondary school sciences. Continuing with IVS, he spent the last four years with the Appropriate Technology Development Unit on the campus of the Papua New Guinea University of Technology in Lae. Two major undertakings there were the coordination and design of a village micro-hydro and water supply scheme in a remote mountain area and the development of a Pelton prototype design suitable for local manufacture.



## Electrical Aspects of Mini-Hydroelectric Systems

Bard Jackson\*

---

**ABSTRACT :** The electrical system of a small hydro installation covers the transfer of the mechanical power out of the turbine to the electrical power uses of the consumers. Each aspect of the electrical design must fit into the system goal for reliable, low cost energy.

The mechanical energy from the turbine is converted to electrical power by the generator. The electricity is usually alternating current (AC) as a design frequency of 50 or 60 hertz. Where an existing distribution system can regulate the speed, a simple induction generator can be used. Otherwise, a synchronous machine must be used which requires a governing device to regulate the speed. The generator must be protected from abnormal operating conditions such as ground faults and lightning surges, and selected to meet the demands of the future electric consumers.

The electricity produced at the generator voltage is transformed to the grid voltage and distributed to the consumers. The transformer and electric power lines must be sized to mesh with the generator characteristics, and each segment adequately protected. The quality, reliability, and cost of electric service at the end of the lines are the parameters that consumers use when choosing to invest in electric power equipment. The decision to purchase motors, pumps, light bulbs, etc. will determine if the project is to be successful.

---

### Introduction

**W**HEN planning a small decentralized system, one must use a "systems" approach. That is, the electrical portion of the design must be planned with the same reliability index, cost constraints, etc. as the mechanical and civil aspects of the system.

The electrical portion of the system covers the energy flow from the turbine shaft to the consumer's end-uses. The design standards, equipment selection and protection used on this portion of the system will be the major component of the cost, quality, and reliability of a consumer's service.

This paper divides the electrical portion into four sections; generators, control systems, protection, and the distribution system.

It does not cover such topics as load determination, load growth forecasting, cost estimates, etc. that

affect the electrical design, since these topics are discussed in other papers.

The energy from the turbine is converted into electrical energy by the generator. The quality of the generator output is determined by the accuracy of the governing and control devices. The electricity produced at the generator voltage is transformed to the grid voltage and then distributed to the consumers. The protection of each component in this system has an effect on the reliability of the electric service.

When a consumer pays for electrical service he is interested in the energy cost, quality and reliability of his service. The goal when planning the system is to provide him with reliable power at the lowest possible cost. Only when the consumer chooses to purchase electric motors, pumps and such devices of his own accord can the project be considered successful.

---

\*Principal Engineer, NRECA, Washington.

## Generators

The electric generator converts the mechanical energy of the turbine into electrical energy. The two major components of the generator are the rotor and the stator. The rotor is the rotating assembly to which the mechanical torque of the turbine shaft is applied. By magnetizing or "exciting" the rotor, a voltage can be induced in the stationary component, the stator. The speed of the generator is determined by the turbine selection, except when connected through a speed increaser.

If the effective head of the turbine is high enough, the generator is directly coupled. At lower heads the generator is connected through a geared speed increaser or a V-belt drive.

Generators with capacities of 1,000 kW and below are generally purchased as a package with the turbine. A variety of competitive designs are available using reaction or impulse-type turbines.

In general, turbine and generator costs per installed kW decrease as the capacity of the unit increases. The higher the generator voltage, the smaller the cost per kW and size of the generator. Also, the lower the head, the higher is the cost per installed kW due to lower synchronous speed turbines. Savings can also be made in generator costs by horizontal settings, thus eliminating the need for thrust bearings.

For mini size generators, the cost of 3 phase units is approximately the same as 1 phase units.

*Generator efficiencies:* The efficiency of an electrical generator is defined as the ratio of output power to input power. There are five major losses associated with an electrical generator; the fixed friction and core loss and the variable field copper loss, armature copper loss and stray loss. Typical values for efficiency range from 85 to 98%. This efficiency value is representative throughout the loading range of a particular machine; i.e., the efficiency at  $\frac{1}{4}$  load or at  $\frac{3}{4}$  load.

The value of the power loss due to inefficiencies should be considered when specifying the generator.

### Classification of generators

The choice of an AC generator, synchronous or induction, is a function of application. Selection should be based on a case by case analysis.

*Synchronous:* The synchronous generator is the most common generator in mini-hydro systems. The excitation of the generator is achieved by impressing a direct current (DC) source across the rotor field coils and creating a magnetic field which induces a voltage potential in the stator coils. The rotor rotates

at synchronous speed. Present day designs employ a static excitation device which converts an alternating current (AC) source to a DC source via solid state circuitry. The static system has replaced the shaft-driven DC excitation generator and costs comparatively less, has a quicker response time and accommodates discharge of the field energy without a field discharge resistor upon a sudden disconnection of the unit from the system. However, for small generators a brushless shaft driver exciter may still be used in lieu of a static excitation system. The brushless exciter is an AC generator with rectifiers on the main shaft to produce DC current for the field.

The exciter-regulator controls generator reactive power output, power factor and voltage levels. The equipment is used in conjunction with the synchronizing equipment in the starting sequences of placing the generator on-line. Once the exciter-regulator brings the machine voltage up to system voltage and the synchronizing equipment matches frequency and phase with the system, the generator may be connected to a power grid. Small machines are frequently started and brought up to nearly synchronous speed without excitation. Then the breaker is closed and excitation is applied to pull the generator into phase and synchronous speed. This procedure eliminates the cost of the synchronizing equipment.

Synchronous generators are required for:

- isolated operation;
- high capacity installations;
- power factor improvement; and,
- end of the line installations.

*Induction:* The major difference between an induction and a synchronous generator is that the induction generator obtains its excitation from the power grid.

An induction generator has a fixed power factor which can be a disadvantage because other generators in the system will be required to provide the reactive power. Synchronous generators can vary their power factor and contribute reactive power into the system.

In evaluating whether or not an induction generator or a synchronous generator should be used, it is important to establish not only the effect upon the system of absorbing excitation, but its cost. Some locations may not be suitable for supplying the reactive power, such as a remote location or one near the end of a distribution line. In general, the power factor and the efficiency of induction generators are higher for high-speed than for low-speed machines. A rule of thumb guide, which may be conservative for induction generators, is that they should be used in applications below 600 HP and above 600 r.p.m.

A distinctive property of the induction generator is its simplicity, which accounts for its lower cost. The rotor is a simple squirrel-caged un-insulated winding like an induction motor. The stator can be of standard induction motor-type design. Connecting it to a bus or system requires no synchronizing equipment. The machine may be brought up to its synchronous speed and the breaker closed, connecting the machine to the system.

In summary, induction generators may be used for:

- operation in conjunction with a large system;
- low capacity and high generator speeds; and,
- applications not requiring power factor correction.

*DC Power:* Another option is to generate direct current and either use it "as-is" or convert it to AC through the use of an inverter. A DC-to-AC system has several advantages, especially in very small systems (less than 5 kW). The excess power generated by a DC system can easily be stored in batteries, thereby extending the system's peak capacity. DC generators are not speed-sensitive and no governor is needed. Thus, a small DC system may cost less and serve a peak load better than a comparable AC system. Over 10 kW, AC systems are generally preferred.

*Selection:* When selecting a generator, make sure that it:

- handles your load without unnecessary apparatus for staggered load switching;
- keeps the voltage up during all expected power factor loads, thereby reducing the need for high efficiency motors and/or oversize transmission cables;
- generates the electric power efficiently during all load conditions; and,
- has the proper insulation for your climate and use.

## Control Systems

The regulation of the frequency and voltage of alternating current electricity permits the use of this energy with the maximum efficiency. That is, electrical motors work best at their design voltage and frequency. Controlled frequency and voltage of the energy provides protection of the user's equipment against failures arising from insulation breakdown, overspeed, or overheating and burnout.

## Governors

The system frequency is regulated by the turbine's governor. The governor senses the system opera-

ting conditions, compares this to the desired conditions, and adjusts system controls accordingly.

Governors can either regulate the input flow to the turbine or the output load on the generator, and they can either sense the system load or the generator speed.

*Flow Regulating Governors:* Most governors sense generator speed and regulate the flow to the turbine runner. In broad classifications, speed controllers can be categorized as:

- all electric;
- all mechanical;
- electro-mechanical;
- electro-hydraulic;
- mechano-hydraulic; or,
- electro-mechano-hydraulic.

In the last four classifications, the prefix term refers to the type of speed sensing and the suffix term refers to the type of actuation or servo motor. There are nine parameters for evaluating the governor needs of small and micro hydro installations:

- cost;
- output work;
- speed control;
- stability;
- droop;
- maintainability;
- cold start;
- local manufacturing capability; and,
- load sense control.

An essential feature in a governor is to insure that all of the rotating parts are designed to stand prolonged runaway under maximum head conditions with the gates wide open.

*Load Regulating Versus Flow Regulating:* The constant load system is a simpler type of governing. The regulator keeps the sum of the system demand load and the load dissipated into ballast resistors constant. This constant generator load, with a constant turbine head, will give a constant shaft speed. The advantages associated with this type of control are: electronic current sensing and load switching is very quick; the magnitude of frequency changes in the rotating equipment is very small; there are fewer moving parts and thus a reduced probability for mechanical malfunctioning; and, instantaneous inductive load such as motor starting are reduced because of the availability of excess power in the ballast. They are generally less expensive than flow regulating governors for single phase generators.

The disadvantages associated with constant load regulation are keyed upon resource utilization. Capacity based on a high percentage availability of stream

flow wastes the flow with lower availability. The constant load system has no droop capability or part-gate regulating capability. Without droop, the synchronizing of two or more small turbines will not be possible. Load sharing modules are available for electric speed governors and may be adapted to constant load controllers.

*Switchgear:* For single unit small hydroelectric installations, the switchgear will consist of the generator circuit breaker, bus, a disconnect switch, a line circuit breaker and metering equipment.

Breakers are classified by type, voltage class, continuous rated current and interrupting capacity. In packaged small turbine-generator units the generator circuit breakers are usually provided by the manufacturers.

Packaged units usually include indicating meters to provide information on voltage levels, current levels, watts, and frequency. We recommend adding watt-hour meters to this standard package so that one can evaluate the total energy output of an installation.

## Protection

When planning a protection scheme, one usually starts by dividing the electrical system into zones of protection. Protection devices are then specified to "see" all faults or other abnormal conditions in its zone. Zones should overlap to provide back-up protection in case the primary protection device fails to operate.

The level of protection you plan for an electrical installation is a function of the investment being protected. Even though the basic problems associated with protecting large generators also applies to small generators, it is not cost effective to require the same degree of sophistication.

Generators are rarely damaged when they are provided with reasonable protection. Yet failures do occur and with very serious consequences.

Obviously, one has to protect against faults and lightning. If the generator voltage gets too high, it indicates that the voltage regulator may not be functioning correctly and the unit should be shut down before the insulation is damaged. The over-voltage relay is also back-up protection for overspeed.

*Induction Generator:* A general rule-of-thumb guide concerning protecting induction generators is to use the same protection as you would for the same size induction motor.

An induction machine draws an in-rush current of about 7 to 10 times its rated current. Consequently, the overcurrent protection must be set very high for

starting. Instantaneous overcurrent relays should be set above the minimum in-rush current, and thermal (time delayed) overcurrent settings should be at least 120% of the rated output current.

One characteristic of an induction generator is that the output will decay within a few cycles after the machine has been short circuited. For a three-phase machine, this means a fault on one or two phases will cause the machine to operate in an unbalanced way. Single-phasing of three-phase induction generators by the operation of single-phase protective devices that are commonly used on rural distribution systems can damage an induction generator. Hence, single-phasing protection should be used on systems with single-phase protection devices.

*Synchronous Generators:* The protection of a small synchronous generator is similar to induction generator protection, but there are some significant differences:

- possible synchronizing surges will be smaller than induction machine in-rush currents. The maximum current output will only occur as a result of a fault in the system,
- the synchronous generator can supply a continuous fault current. Unlike the small induction generator, the synchronous generator fault current must be interrupted by an overload or undervoltage device; and,
- finer three pole operation are preferred to achieve better synchronizing control.

*Larger Generators:* For generators over 100 kW, the following additional types of protection should be considered:

- faults in windings – (differential relays);
- overheating of windings or bearings;
- failure or loss of field for synchronous machines;
- motoring of generator (requires from 0.2 to 2.0% of rated kW depending upon the type of turbine);
- single-phase or unbalanced current operation;
- out-of-step relays for interconnected synchronous units; and,
- synchronizing check relays.

## Distribution

The AC electric power from a mini-hydroelectric facility is usually transformed to a higher distribution (primary) voltage, transferred to system loads over the distribution lines, then transformed down to the service (secondary) voltage where it is used by

consumers. The cost for distribution facilities will be a major part of the hydroelectric project, unless a distribution system presently exists with some other power source. Distribution costs can account for about 50% of the capital cost required to serve rural consumers. Hence, a good understanding of the distribution system as part of a mini- or micro-hydro-power project is essential for a sound feasibility study.

### Technical Planning

A well-designed distribution system minimizes the initial capital cost, the annual energy losses, the operating cost, and the future capital cost when building for system growth. The planner is initially faced with several different combinations of design voltages, line conductor sizes, and system configurations which all could perform adequately. In addition, the planner must consider factors such as reliability, safety, and land use impacts which are not easily quantified. Mathematical expressions can be used to determine the most economical choice; but the number of factors is so high that the expressions become complicated, difficult and unsatisfactory. Therefore, NRECA offers the following general guides for approaching a distribution system plan.

### Interconnection with an Existing Distribution System

Interconnecting a small hydroelectric generator to an existing distribution system must be done with regard to the safety, electrical protection, and service quality of the existing system.

Many existing distribution lines are protected by reclosers which respond to faults by briefly de-energizing the line, and then reclosing to restore service in the likely event that the fault was temporary. This operation may be repeated up to three times before the recloser "locks out" leaving the line de-energized. If a hydro unit feeds directly into a line protected by a recloser, the alternate disconnecting and reconnecting may result in damage to the generator because of excess current or abrupt torque changes. Whenever a recloser is used near a small generator, the effects of the recloser operation on the generator should be investigated.

When interconnecting with a small isolated distribution system that may have an existing small generating unit, the operating characteristics of the new and existing units must be examined to ensure that the units can be operated in parallel. Speed-droop characteristics must be coordinated to ensure

that one generator will not "motorize" the other. Inertia constants should be similar.

When a small hydro unit is interconnected with an existing system, and in the event of a fault in the existing system, the hydro unit will supply a portion of the fault current. Hence, the protective devices must be recalculated and set to account for the additional fault current. Before workers can go out to repair the faulted line, it must be ensured that the generating unit cannot feed back into the faulted line, thus endangering the public and line crews. Generally, we recommend that the hydro unit be de-energized and kept out of service until a faulted line is repaired or safely isolated from the system.

### Voltage Selection

Generally, a higher voltage has greater construction costs and gives less reliable service. A lower design voltage has greater energy losses and requires a larger conductor size to distribute the same quantity of power. As these factors tend to balance each other, the most important consideration in voltage selection is a national standard. A standard national distribution voltage will offer the following advantages:

- standardized designs,
- less spare parts inventory;
- isolated systems will be easier to interconnect into a national grid in the future;
- neighboring systems can share spare parts, mobile transformers, etc; and,
- markets will develop for possible local manufacturing of hardware.

We encourage the development of national distribution voltage standards where they do not presently exist.

### Conductor Size Selection

Various charts and graphs for determining the optimum conductor size for given voltage levels, future loads, conductor lengths, and desired voltage regulation are given in distribution handbooks. However, to reduce a multiplicity of conductor sizes, warehouse items, and overall operation and maintenance procedures, the following guidelines are recommended:

- for main three-phase feeders, use a conductor with plenty of excess capacity, such as a 1/0 ACSR. Main feeders affect all consumers, and therefore, a cost slightly in excess of the most economical wire is justified;
- for all taps, use one conductor size, such as a 4 ACSR for both the primary and neutral

conductors. This will simplify warehousing operations, and maintenance procedures;

- for secondary lines, match a 1/0 ACSR and a 4 ACSR with the distribution transformer capacity; and,
- use a standard insulated conductor for service drops.

By minimizing the number of sizes of the conductors, one also minimizes the number of sizes of connectors, splices, and maintenance activities.

### Pole Structure Selection

Where timber products suitable for manufacture of wood poles are available, a full pressure treated wood pole may be produced for 50% less than other equivalent concrete support structures. Although spun, pre-stressed concrete poles can be produced to any desired specification, an average concrete pole of comparable size is twice the weight of a wood pole with one-third less tensile strength. In urban electrification, where poles are spaced at intervals of less than fifty meters, strength requirements are of little concern and the economics of wood vs. concrete are not so pronounced. However, in rural electrification, with spans of 150 to 200 meters, tensile strength is a major consideration, and the total cost per kilometer of wood pole line, when compared with concrete, is substantially reduced.

Breakage in transportation over country roads is minimal for wood poles but becomes a measurable factor with concrete poles. Wood pole attachments are simple, which simplifies field framing. The attachments for concrete poles are more expensive and have reduced insulation levels. A wood pole can be handled more easily in the field with simple equipment and requires no special foundations.

Long-lasting wood poles can be produced locally in many areas at appreciable savings, thereby contributing to the advance of rural electrification and the development of new small businesses.

### System Configuration

We recommend the single-phase, three-phase, multi-grounded neutral system configuration, which has economic and technical advantages over ungrounded distribution systems. A single-phase tap can serve loads from the three-phase primary at the beginning of electrification. As load growth takes place, a cross-arm can be added to the single-phase pole, and the line converted to V-phase or three-phase service.

### Route Selection

The following criteria should be considered in selecting routes for distribution lines:

- the existence of all-weather roads for main three-phase feeders;
- the existence of at least seasonal roads for single-phase taps; and,
- consumer density.

In the first pass of electrification through a rural area, high consumer densities will yield maximum returns from initial investments, which is always a desirable approach. Next, one should solicit potential consumers in or near existing facilities in the following order:

- those who may be connected directly from existing secondary facilities,
- those who may be connected through the extension of existing secondary facilities;
- those who may be served from existing lines with the addition of a transformer and secondary facilities, and,
- extensions of primary lines of no more than two spans.

Systems maps should be developed indicating consumers, single-phase, and three-phase distribution lines.

### Meters

Customer meters add to the overall cost of the project and some rural systems have operated without them. In such cases, each system consumer pays a standard monthly rate regardless of the amount of energy used. Eventually, a few large consumers may use most of the system energy and, in effect, be subsidized by the other consumers. To prevent this inequity, we recommend that consumer meters be installed on larger loads.

### REA Standards

The United States Rural Electrification Administration (REA) has printed numerous specifications, standards, and instructions for the planning, designing, constructing, and operating of rural electric power systems. Over a third of the electric distribution lines in the U.S. were built to these specifications. All of these specifications and standards are available for a small fee from the Superintendent of Documents, U.S. Government Printing Office, Washington, D.C. 20402.

Rural areas require a high standard of construc-

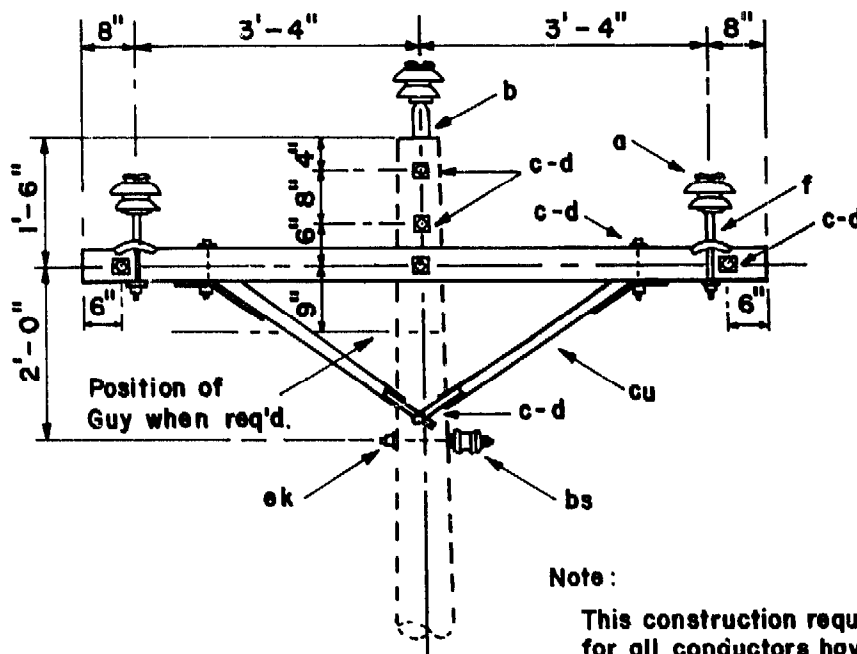
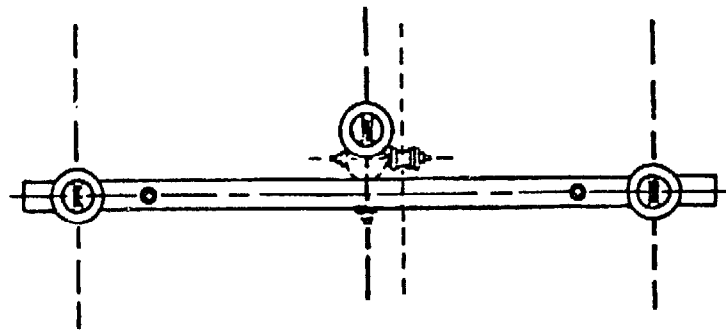

Note:

This construction required for all conductors having a breaking strength of more than 4500 pounds

ITEM NO.	MATERIAL	ITEM NO.	MATERIAL
a	3 Insulator, pin type	f	2 Pin, crossarm, clamp type
b	1 Pin, pole top, 20"	g	1 Crossarm, 3 3/4" x 4 3/4" x 8'-0"
c	2 Bolt, machine, 1/2" x req'd length	bs	1 Bolt, single upset, insulated
c	6 Bolt, machine, 5/8" x req'd length	cu	1 Brace, wood, 60" span
d	2 Washer, round, 1 3/8" dia.	ek	Locknuts
d	10 Washer, square, 2 1/4"		

14.4 / 24.9 KV.  
3-PHASE CROSSARM CONSTRUCTION - 0° TO 2° ANGLE  
(LARGE CONDUCTORS)

Jan. 1, 1963

VC I-2

tion to minimize future operations and maintenance costs. The further the consumer is from a service headquarters, the higher the standard of construction required. The NRECA strongly recommends the use of REA standards as a minimum requirement.

### Cost Estimates

We recommend that all distribution construction be planned, bid, constructed, and paid for on the basis of assembly units. An assembly unit is a collection of materials to serve a specified function. For example, the materials required for a three-phase cross-arm support is unit assembly VC-1. An illustration of the VC-1 unit is shown in Figure 1, which is taken from REA Form 803: *Specifications and Drawing for 14.4/24.9 KV Line Construction*.

All of the materials required for distribution line construction are included in their appropriate unit assemblies. The number of assemblies required per kilometer of distribution line can be calculated and used for estimating the cost per kilometer of line.

Table 1

Cost per consumer served from 3 phase distribution system;  
500 consumers, 5000/6000 population located 10 kilometers  
from 3 phase grid

10 KM	Feeder 14.4/24.9 KV	@ 3,253.84 = 32,538.40
1 KM	Feeder 14.4/24.9 KV used for distribution	@ 4,492.49 = 4,492.49
1/2 KM	Tap 14.4/24.9 KV	@ 4,643.83 = 2,321.92
1/2 KM	Tap 14.4 KV	@ 3,083.93 = 1,541.97
3 KM	3 W Secondary	@ 3,577.38 = 10,732.14
1 KM	3 W Secondary	@ 3,313.38 = 3,313.38
2 KM	3 W Secondary	@ 728.60 = 1,457.20
13	25 KVA Transformers CSP - 14.4 KV	@ 361.13 = 4,694.69
200	6 Services	@ 15.85 = 3,170.00
300	6 Services	@ 12.91 = 3,873.00
500	Class 100 Meters	@ 26.96 = 13,480.00
200	Interior House Wiring Installations	@ 31.45 = 6,290.00
	Total	= \$87,869.19
		= \$176/Consumers

27.78 Consumers/Kilometer

Other base cost estimates are included in Table 1, which shows the total cost estimate of serving a typical 14.4/249 kV system with a three-phase main feeder and serving 500 consumers. The costs are from a 1972 study in Nicaragua and are not representative of today's cost.

### Comments on Rural Electrification

Although the NRECA could possibly be prejudiced about the overall urgency of expanding electrical service, we do recognize that rural electrification is a marginal program if measured only in direct monetary return; it requires a long-term investment of resources and competes with other worthwhile infrastructure development. Since it is a program which requires grassroots support and often experiences a time lag between established goals and accomplishments, rural electrification should be viewed as a basic ingredient, or as one part of a total development program.

### References

1. *Electrical Transmission and Distribution Reference Book*, Westinghouse Electric Corporation, 1950.
2. *Applied Protective Relaying*, Westinghouse Electric Corporation, 1975.
3. CARTMILL, CHARLES, *Small Hydro Control and Operation*, University of Idaho, 1980.
4. INIQUEZ, ROBERTO, *Hydroelectric Generation, Small Hydroelectric Powerplants*, August 1980.
5. HOSKING, EVERETT, *Governor Selection for SDH Installations in Thailand*, Draft Report, NRECA, 1981.
6. JACKSON, BARD, *Distribution Considerations for Mini/Micro Hydro Projects, Small Hydroelectric Power plants*, August 1980.
7. ZASTROW, ORVILLE, *Study of Problems Associated with Interconnection of Wind Generators with Rural Electric Distribution Line*, prepared for NRECA, March 1981.
8. *Draft Interim Recommendations for Interconnecting Small Power Producers*, REA, 1980.

**Bard Jackson** is the Principal Engineer for NRECA's Small Decentralized Hydropower Program. Mr. Jackson received his B.S. in Electrical Engineering from the University of California at Long Beach in 1969 and his MSEE from the Georgia Institute of Technology in 1975. His area of specialized study was in electric power system planning.

Mr. Jackson has over 10 years of power plant operating and planning experience. He served in the U.S. Navy for four years where he supervised the operations of nuclear and oil-fired power plants. He worked for the U.S. Rural Electrification Administration for several years where he assisted U.S. cooperatives with power planning activities such as load forecasting, optimal generation expansion, plant siting, and construction management. In June, 1980, he joined NRECA's Small Decentralized Hydropower Program. Mr. Jackson is a licensed Professional Engineer in Washington, D.C.



## Operation and Maintenance

Gary Kitching\*

---

**ABSTRACT :** Small hydroelectric plants can be very easy to operate and almost maintenance-free, provided the proper turbine design is chosen to do the job. The wrong selection of equipment can cause problems in both phases of their management. The turbine must be of simple and durable design. This will make maintenance much easier and less costly, as most of the work can be performed using very little skilled labor. The maintenance of properly designed power plants with a generating capacity of up to 100 kW can be handled by no more than two people and without the use of delicate instruments.

---

### Introduction

**T**HE installation, operation, and maintenance of a small hydroelectric system is of primary concern. If the hydroelectric plant is to maintain its operation throughout its designed life-span, it is necessary to do everything properly at the beginning. The average lifetime for a hydroelectric plant is about sixty years – although there are many hydro plants around that are close to one hundred years old that are still functioning due to careful planning and maintenance.

The pipeline is of great importance to the performance of a small hydroelectric system. If the pipeline does not receive adequate attention, it will effect the entire system. Should it be sized inaccurately, it could hamper the operation; or if it is not properly installed the entire system could cease to operate.

The careful selection of both the turbine and generator is essential. The turbine should be compatible with the generation needs of the area. If the turbine is much too large, it is just a waste of money and will not be cost effective. If the turbine is too small, there will be a problem holding the electrical load.

The following discussion is concerned with details regarding the pipeline, turbine, and generator.

### The Pipeline

The intake of a pipeline should be made to serve several functions. It should divert the water to a settling area where suspended solids may settle out of the water. The intake should also be able to hold enough water to keep the pipeline full enough so that no air is drawn down the line, and the intake should be made with a good trashrack to stop any rocks or large sticks from entering the pipeline. This could have a very bad effect on the turbine. The settling pond or box is also very important for keeping sand out of the turbine.

Small Hydroelectric Systems has a turbine running in Randel, Washington, which is very near to Mt. St. Helens. When the volcano blew, it dumped almost a foot of ash in the area of the turbine. The owner of the hydro plant had a large settling box which caught most of the ash that was in the water, and as a result the turbine never stopped running. Due to the owner's careful planning, no damage was incurred.

The pipeline should also have a revert pipe near the intake, and anywhere the pipeline goes down and then up again, to remove any air that can get trapped in the pipeline. An air bubble can be a problem because it can sit in one spot in the pipeline and will actually break down the effective head in the line, cutting down

---

\*Small Hydroelectric Systems and Equipment, Acme, Washington.

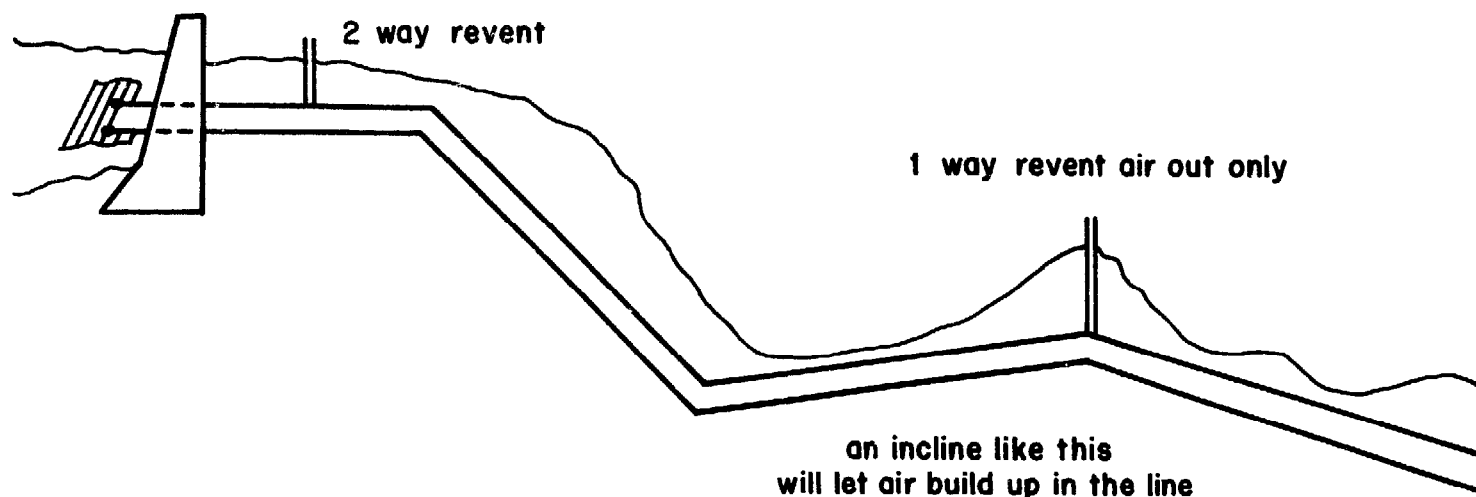

drastically the turbine's power output. This is not usually a problem on pipelines that are short and fall straight down a hill, but can be a problem on pipelines of around a mile in length. This problem could be eliminated if the line was properly revented, as the diagram below illustrates. There are other reasons for reventing a pipeline. An important one is that the pipeline at the intake may get plugged or closed off. A revent is all that is needed to prevent the pipeline from collapse, which can be a real danger with plastic pipe.

The pipeline should be installed in such a manner as to avoid any rework of the pipeline in the future. It should be installed away from the stream so that it will not be damaged by floods. It should also be buried with at least two feet of dirt on top of the pipe. When the pipeline is being installed, care should be taken in handling it, especially if the pipe is plastic. The pipe should be packed with sand — if possible so that no rocks can rub or work against the pipe, which could cause a leak in the future.

One thing that is overlooked quite often is the flushing of the pipeline after the pipeline is finished. Before the turbine is connected, the line should be totally flushed out to remove all debris from the line so that there is nothing left in the line that could do damage to the turbine runner. In some cases, after the turbine has been started, a rock or piece of wood comes down the line, plugs the nozzle, and blows up the pipeline. The pipeline, in this circumstance, would not have blown up if it had been flushed.

The maintenance of a pipeline should be very minimal. The important thing to consider in the maintenance of the pipeline is the intake. One must ensure that as little silt as possible goes down the line.

### The Turbine

The operation and maintenance of the turbine will be shown in five parts, beginning with the bearings. This will explain what to look for when selecting the type of bearings for the turbine and the type of maintenance needed. The next topic will be the shafts, showing the need for heavy shafts. The third topic will be the wheel or runner and how to select the best one. The fourth topic will relate to the maintenance of the turbine. The last topic to be discussed will be the maintenance of the overall plant.

There are several types of bearings that can be used on a turbine. These are heavy-duty tapered bearings, spherical bearings, regular ball bearings, and sleeve-oil bearings. The first type of bearings to consider using are heavy-duty tapered bearings; these are probably the best to use with small hydroelectric plants because of their high thrust-carrying ability, and their radial load capability. These are also the safest bearings to use. The outside of the roller is very hard but the center of the roller is soft, which will not allow the roller to shatter. These bearings work exceptionally well for turbines that are left unattended for long periods of time.

Other bearings to consider are spherical roller bearings. They also have a high radial and thrust-carrying capability, but not as high as heavy-duty tapered bearings. These bearings are often used when a shaft is misaligned, and are suitable provided that the bearings are properly sized.

Regular ball bearings can be the most problematic because of the small contact area of the ball in the cone. These bearings have very little thrust-carrying

capability and can shatter very easily because the balls are hardened all the way through. These bearings are not practical when a turbine is to be left unattended for a long time.

Lastly, one might consider using sleeve-oil bearings. These are probably the most efficient bearings to use. One hindrance is that the bearings use an oil pump which must be watched consistently. If neglected, the bearings could lose their oil and destroy the entire system.

Another factor to consider when selecting a bearing is the type of seal that is required. The seals to avoid are rubber seals. These can be blown off with a high pressure grease gun which will totally destroy any sealing capability of the bearing. The best type of seal to use on a bearing is one with a labyrinth seal. Bearings with this type of seal will not be blown out because they allow excess grease to weep out of the bearing. This type of seal will also have a longer life-span than other seals.

The shaft is another very important part of the turbine. It can create some of the biggest problems for the turbine operator. If the shaft becomes bent, it can destroy the bearings and possibly the runner. The best protection against bending is to be very generous with shaft sizes. It is the shaft size, not the type of metal used, that determines bending moment.

One other area to look at when selecting the shafting is how well it fits the bearings. If a shaft is several thousandths of an inch undersize when the set is screwed on the bearings it could run eccentrically and cause vibrations. With shafting that is ground and polished, the fit is a push fit, so that the shaft cannot move to either side of the bearings. This will keep the shaft concentric.

The wheel, which is also referred to as the runner, requires very careful selection. There are several types of runner available. There are impulse, Turgo, Francis, propeller and cross-flow runners. The impulse runner (Pelton type) is about the easiest to operate because the turbine housing is not pressurized. Also, the only type of seal needed on the shaft is a seal against splash. The construction of an impulse wheel is very important. This increases both its lifetime and its safety. The best runner is a one-piece casting of either stainless steel or manganese bronze. Cast iron should not be used as it is very brittle and could fracture with explosive force.

The Turgo runner is similar to the impulse runner except that the jet of water striking the Turgo wheel hits the wheel at an angle which creates a very complicated bearing arrangement.

The Francis runner is usually used on medium

and high heads with large flows of water. This runner suffers from cavitation because the entire runner is covered with water all the time. This turbine is also under pressure inside the housing. Therefore the water seal is more of a problem.

The propeller turbine operates very well with low head and high flows. Unfortunately these turbines also suffer from cavitation eventually. If the proper stainless steel is used in the runner it will greatly increase the turbine's life span. In most cases the propeller runner will require less maintenance than the Francis runner.

The cross-flow turbine will also suffer from some cavitation, and care should be taken in the selection of the turbine so that it will suit the site. This type of turbine can work well if used properly, as it is best used with low heads.

The maintenance of different types of turbines can be as different as the turbines themselves. The impulse and Turgo both need very little maintenance after they are in operation. About the only tasks that are necessary are greasing the bearings and operating the valves once a month. With other types of turbines such as the propeller, Francis and cross-flow, it is important to check with the manufacturers. They will know the exact maintenance required to maintain the turbine's efficiency.

The impulse type of turbine will require a lot less maintenance than any other type of turbine because it is designed so that the runner is operated in a large chamber with a generous amount of room surrounding it. If the bearings should work themselves loose, the runner will not strike anything. With the propeller, Francis and cross-flow type of turbines the runners have a very close tolerance between the runner and the turbine housing. In some cases this spacing can be as small as just a few thousandths of an inch. If something were to happen to the bearings or the shaft, the turbine could be destroyed very quickly.

## The Generator

The generator will be explained in five parts: the types of generators that are available, the different speeds of generators that can be used, the need to get the most efficient generator available, voltage regulations and uses, and the maintenance of generators.

There are several types of generators on the market today. The recently built generators have a brushless design and Class F insulation. They have the ability to start 1 HP/kW output. The newer types of generators are usually built with twelve wires so that the generator can be wired for a wide range of

voltage. The older style of generators have either slip rings and brushes that can and will wear out in a short period of time. They are also larger compared to the newer models of generators.

The speed of the generator is dependent on the number of poles in the generator. As a two-pole generator would run at 3,600 r.p.m. for sixty hertz, a four-pole would run at 1,800 r.p.m. and a six-pole would run at 1,200 r.p.m. The most commonly used generators are the four-pole or 1,800 r.p.m. type. These are extremely efficient and fairly low in cost for their power output. The two-pole or 3,600 r.p.m. type of generator is usually built very cheaply and is only designed for part-time operations, with the exception of the very large generators that handle 500 kW or more.

There is an increasing interest in the generator industry to build a small, efficient 3,600 r.p.m. generator to give the general public a better selection. At the present time we do not know of any continuous 3,600 r.p.m. generators on the market.

The efficiency of the generator is very important for two reasons. First, if a generator is inefficient you are losing power. Also, the lost power is being turned into heat in the generator. This problem could destroy the generator, especially in a warm climate. Small generators should have an efficiency level of about 80%-85%. Generators of above 40 kW should have an efficiency level of around 90%-95%.

The generator can be regulated by either internal transformer regulation, which can handle the voltage within 5% without any external regulation, or by external electronic regulation, which can maintain the voltage to within 1%. This is very good for the operation of delicate instruments, whereas the internally regulated generator is very good for motor starting.

The maintenance of the generator should entail very little except normal greasing. The bearings in the generator are usually good for several years but the manufacturer of the generator should be consulted for any special maintenance that may be required.

### **The Turbine-Generator**

The turbine-generator combination can use three

types of drives. They include belt drives, gearboxes and direct drives. The need for overspeed protection will be explained.

In most cases the belt drive is the best selection to make because it is easily maintained and requires little knowledge to set it up. Gear drives can be very expensive and create enormous problems due to their complexity in construction. Gear drives should only be used when there is no other choice. When the drive is over 200 HP, a direct drive is not possible.

In some cases it is best to choose a direct drive where possible if the turbine speed can be matched with the speed of the generator. Also, the wheel size may have to be altered to match the speed of the generator. This is worthwhile in turbine sets of over 125 kW, due to the fact that belt drive in that power range is not really feasible.

Overspeed is one of the biggest dangers to the operation of the generator, since most generators can only withstand about 25% overspeed, and runaway on a turbine is 100% of operating speed. Runaway can be avoided by simply having a deflector to deflect the water away from the runner. This can only be done on impulse turbines such as the ones built by Small Hydroelectric systems and Gordon and Gilks. With turbines such as the propeller and Francis types, it is very difficult to control overspeed, since the water cannot be diverted away from the runner. Consequently, to control overspeed can be very expensive, as a water bypass needs to be used to control overspeed on these types of turbines.

### **Conclusion**

In conclusion, of the several types of turbines for use in remote areas, the impulse type turbine requires the least amount of maintenance. The impulse type of turbine is about the easiest type of turbine to operate due to its very simple design.

When a person is looking for a turbine, he should take a very close look at the bearing arrangement for ease of maintenance. Access to the runner and the nozzles is also very important. If all these points are taken into consideration, one should have little problem in getting the best turbine for the site.

**Gary Kitching** has worked for about five years with the design and construction of small hydroelectric equipment. His company manufactures small turbine equipment and has recently participated with General Electric in a test using his turbine runners.

## ***PART II : SECTION 3***

# **Economics & Evaluation**

*The papers in this section deal with the non-technical aspects of mini-hydropower development and their evaluation: economics, financial considerations, institutional issues, and social implications. Jorge Asin, of International Economics Group, Inc., discusses financial issues in the context of economic returns and requirements; Mark Henwood, of Henwood Associates, looks at ways to assess economic costs and benefits in judging the economic feasibility of different types of mini-hydro projects; Daniel Boyle, of NRECA, discusses various options for productive end-uses of rural energy sources; and Judith Magee, of AMARU IV Cooperative, Inc., discusses criteria that should be considered in evaluating mini-hydro projects before and after implementation. The papers by Jorge Asin and Mark Henwood are followed by question-and-answer discussion sections.*

## Considerations, Sources and Requirements to Finance Small-Scale Hydroelectric Systems

Jorge R. Asin\*

---

**ABSTRACT :** This paper focuses on two issues. The first of these deals with the institutional arrangements necessary to bridge the gap between production and demand of small hydroelectric systems for use in rural areas of developing countries. Emphasis is placed on financial arrangements among institutions and the derived economic benefits that result from using small-scale hydro. The second issue deals with sources of financing from public, private and specialized development sectors of nations which support the development of small-scale hydro as central tools to improve living conditions in rural areas of developing countries.

The essence of the paper is conceptual and not technical. It is geared to assist in the development of criteria and policy rather than in calculating project engineering and economics. As such, this paper identifies institutions and resources. It does not attempt to conduct estimates of costs and benefits.

---

### SUMMARY:

*The objective of this paper is the identification of processes to finance the development and use of small hydro-electric systems in LDC's in order to improve the living conditions of rural populations.*

*This summary briefly describes conclusions and comments presented throughout the paper.*

*Political, social and economic criteria for LDC's in general lose all validity when data and comments are disaggregated, i.e., when a country or a region is analyzed by itself. This paper provides a matrix of suggested key indicators which constitute initial information to study a country or groups of countries from political, social, and economic perspectives (pp. 160 ff.)*

*Financial conditions in LDC's have deteriorated as a whole in recent years. This concept excludes events in oil exporting countries whose economic conditions are rather favourable, and in most cases have the financial means to import or manufacture capital goods.*

- 1. Financial needs for non-oil exporting LDC's require very special consideration. Deterioration of economic conditions as mentioned above have worsened their ability to finance technology. However, the same countries need technology with urgency. What becomes important is to establish formulas by means of which their use of small hydroelectric power will constitute assets for their development.*
- 2. Securing loans to finance small-scale hydro-electric systems must result not only from traditional credit-worthiness identification of borrowers, but also from impact analyses. It is necessary to establish whether use of small-scale hydro will result in economic production, increased productivity, and/or provision of services essential to the well-being of the population.*

---

\*Rural Development Systems Division, International Economics Group, Inc., Washington D.C.

3. *With reference to possible manufacture of small-scale hydroelectric systems in LDC's, a most viable way should be the use of joint ventures, where know-how is imported and manufacture occurs in an LDC with ownership participation of citizen(s) of the host-country. Financing and insurance for this kind of operation is available.*
4. *A survey of various private development and public financing organizations shows adequate levels of monetary resources earmarked for capital purchases of energy components in development projects. The survey showed that while financing is available, the formulation of energy projects is not always adequate. The same survey shows that some financing for small-scale hydro is disguised under integrated, regional, and agricultural projects.*
5. *Identification of hydraulic resources for small-scale hydroelectric systems should be studied in conjunction with beneficiary population characteristics, and local institutions. Various host country and international development institutions respond to borrowers according to specific parameters. Practice of this kind of funding is seldom found in rural areas of LDC's. Establishment of guidelines and institutional linkages is of utmost importance in many cases.*
6. *Detailed studies of technical characteristics are requirements in most cases for the acquisition of small-scale hydroelectric systems. These studies should include cost/benefit analysis, benefit distribution, impact study, direct and indirect benefits, etc.*

*Financial sources in LDC's have not been traditionally abundant. LDC's have borrowed significantly from international markets throughout past years. Their indebtedness often represents much danger to political and economic stability. Financing must consequently be geared to promoting their development by assisting in the structuring of capital formation schemes. Small-scale hydroelectric systems can become assets from this perspective if processes are devised to reduce unit and construction costs, including studies, and if the end result is the use of electricity to foster economic production.*

*Clearly, the terms financing and economic development are not synonymous. Each one represents a specific function whose common denominator is its being part and parcel of the general economic process.*

*To further clarify this difference, it is necessary to state that the primary function of finance is to obtain funds. Economic development, on the other hand, is a less concrete term. It refers to a political, social, and economic direction, where, in most cases, it is assumed that increases in economic production capacity will bring about better living conditions.*

*Thus, the existence of financial institutions and mechanisms provides funding to acquire technology which, in turn, should promote production and thus economic development.*

*Clearly defined criteria for funding small hydroelectric projects in LDC's do not exist. Several institutions are attempting to write down parameters to respond to needs in this area. However, it often occurs that not establishing defined criteria provides more flexibility to determine funding. Strict regulation as to credit for a project not complying with all requirements could result in it being declined. This could occur even if all other factors are sound and the project as a whole makes sense. As a consequence, some funding organizations expressed views indicating their preference to operate without established criteria. Still, as traditionally occurs, there exist procedures and overall conditions that must be met to secure financing, i.e., a project requires specific studies and the responsible party must be credit-worthy.*

*Alternatives for financing result not only from the availability of more than one lender. Financing must be the result of optimizing the mix of (1) resources, (2) end-user and the clear definition of the project, and (3) a study of all potential institutions serving that kind of client.*

*Preparation or assistance in the preparation of the financing package (including studies and supply and demand identification) should be the work of specialized groups (see Exhibit 1). A specialized group should be responsible for planning funding from above, by programs or projects, and maintaining awareness as to the availability of least-costly money for the implementation of work in the area of small-scale hydro.*

## EXHIBIT 1

PRIVATE  
PUBLIC  
DEVELOPMENT

## BANKING COMMUNITY

## Specialized SSH GROUP

- o Studies
- o Funding
- o Project Implementation

METHODOLOGICAL FLOW  
DESCRIBED IN APPENDIX A

## END-USERS

Rural Populations

Cooperatives

Rural Businesses

National Utility Companies with responsibility for rural electrification.

## Recommendations

1. *To carry out work to communicate with institutions specializing in rural development in LDC's (host-country and international organizations).*
2. *Improve the level of knowledge of the impact of small-scale hydropower for rural development.*
3. *Study rural organizations in LDC's and pay specific attention to practical needs and responsibility with regard to exogenous technology.*
4. *Study grass roots' interest and potential to partially finance, manage and maintain small-scale hydroelectric systems.*
5. *Disseminate information as to the advantages of using small-scale hydro. Use adequate communication means (e.g., 'people who understand and care for the success of development believe in and know small-scale hydro technology'), and establish forward linkages among the demand for electricity, the rural institutions that can pay attention to studying problems, and finally, funding institutions. A support mechanism to help projects be carried out should be maintained.*
6. *Once the above-mentioned items have been clearly understood, it will be necessary to plan and establish least-cost strategies to meet objectives. An important consideration is the determination of organizations and the structures of end-users. It is at this level, indeed, where the political decision to accept or reject technology will in an ultimate sense be determined. Participation at this level will determine the need to use technology, to approve financing (which ideally should be co-financing with local funds participation) and to support operations throughout time.*
7. *The establishment of support organization(s) for this type of purpose is essential. This kind of organization, disregarding who supports it, should not see the supply side of technology alone. It should be equally dedicated to promote the welfare of the target population.*



## Introduction

**T**HE effectiveness of using small hydroelectric systems *vis-à-vis* conventional technologies (mainly petroleum dependent) has become widely accepted among international energy experts.<sup>1</sup> Simultaneously, the need to further develop energy sources in rural settings, especially in marginal areas in less developed countries (LDC's) and the need to reduce energy generation costs in many places that depend on diesel and other hydrocarbon fired systems, has revealed significant potential gain through the development and activation of small hydroelectric plants.<sup>2</sup>

There is also wide consensus among members of the international development community about the relevance of hydro-electricity as indicated by the quotation that follows: "Forestry products and hydroelectric power, among [the other] renewable major energy sources, are most suited to produce [other] non-liquid forms of energy."<sup>3</sup> The text from which this quotation is extracted emphasizes the importance of bioconversion and hydroelectricity as the most promising technologies for development.

Small-scale hydroelectric technology is rapidly gaining momentum in development schemes in LDC's, yet its active propagation could be held back by various structural factors which can be summarized as follows:

1. lack of structural flow of communication between potential rural end-users of hydroelectric energy and funding mechanisms (including technical support);
2. lack of organizational initiative at the rural population level to promote appropriate development tools and management of hydroelectricity and other services; and,
3. lack of knowledge on the part of development institutions about the impact resulting not only from the access of rural populations to energy technologies, but also from the possible participation of the same populations in the process of energy production and distribution. Participation can occur in the form of end-user associations, subscription to the energy scheme, and/or work activity on any of the different levels of energy production and distribution.

The organizational and structural weaknesses mentioned above constitute the basis of the difficulty in absorbing exogenous technology. It is management and know-how capability that establishes the links between rural areas and the more active centres of economic activity. Nevertheless, apart from the organizational problem, there remain an additional

set of constraints that make adoption of technology in rural areas of LDC's still more difficult, *i.e.*, securing financing itself becomes a major problem.

Financing on the local-rural level must face several difficulties, among which the following areas are major elements to consider:

1. weakness of financial institutions on the rural level;
2. increasing costs of exogenous technology;
3. increasing interest rates for financing; and,
4. foreign exchange difficulties in terms of quantity and costs.

This last set of constraints, except for the first one, constitutes the much-debated issue of "LDC's historical deterioration of terms of trade," where it is assumed (not precisely demonstrated) that there is a decrease in the LDC's import/export ratio throughout time.<sup>4</sup> That decrease would mean that LDC's pay more for imports than they used to. Thus, a central consideration in adopting technology ought to be the allocation of least-cost technology and the effects on production that new technology would bring about.

Therefore a major issue becomes the allocation of the best means to acquire adequate technology.

This paper will look into the domestic (LDC) and international markets to finance small hydroelectric technology for use in rural areas of LDC's.

In order to facilitate the understanding of this process, a general model to identify the key participants needed to promote the use of small-scale hydroelectric systems is described in Exhibit 2 (p. 158).

However, in identifying the role of participating institutions and their relationship with one another, major elements of disaggregation become clear, *i.e.*, funding cannot be looked at from only one perspective. It must be considered from at least two possible angles: one that deals with specific characteristics of the demand side (including energy organizations) and the consumer (end-user) himself; and, the other, from the supply side. Finally, between production and consumption there is a need to establish the role of intermediary agents, including technology promotion, through impact studies and funding/financing availability.

Hardware also requires consideration from the point of view of LDC importation or manufacture. Specific considerations for this type of decision are suggested throughout this paper. For instance, pages pp. 168, 172 deal with joint venture, which is the system most adequate for an LDC to import technological knowhow and produce hardware locally.

Above all, the objective of this paper is to identify key institutions that are interested in promot-

**EXHIBIT 2**

**Institutional relationships required to promote the use of small hydroelectric systems**

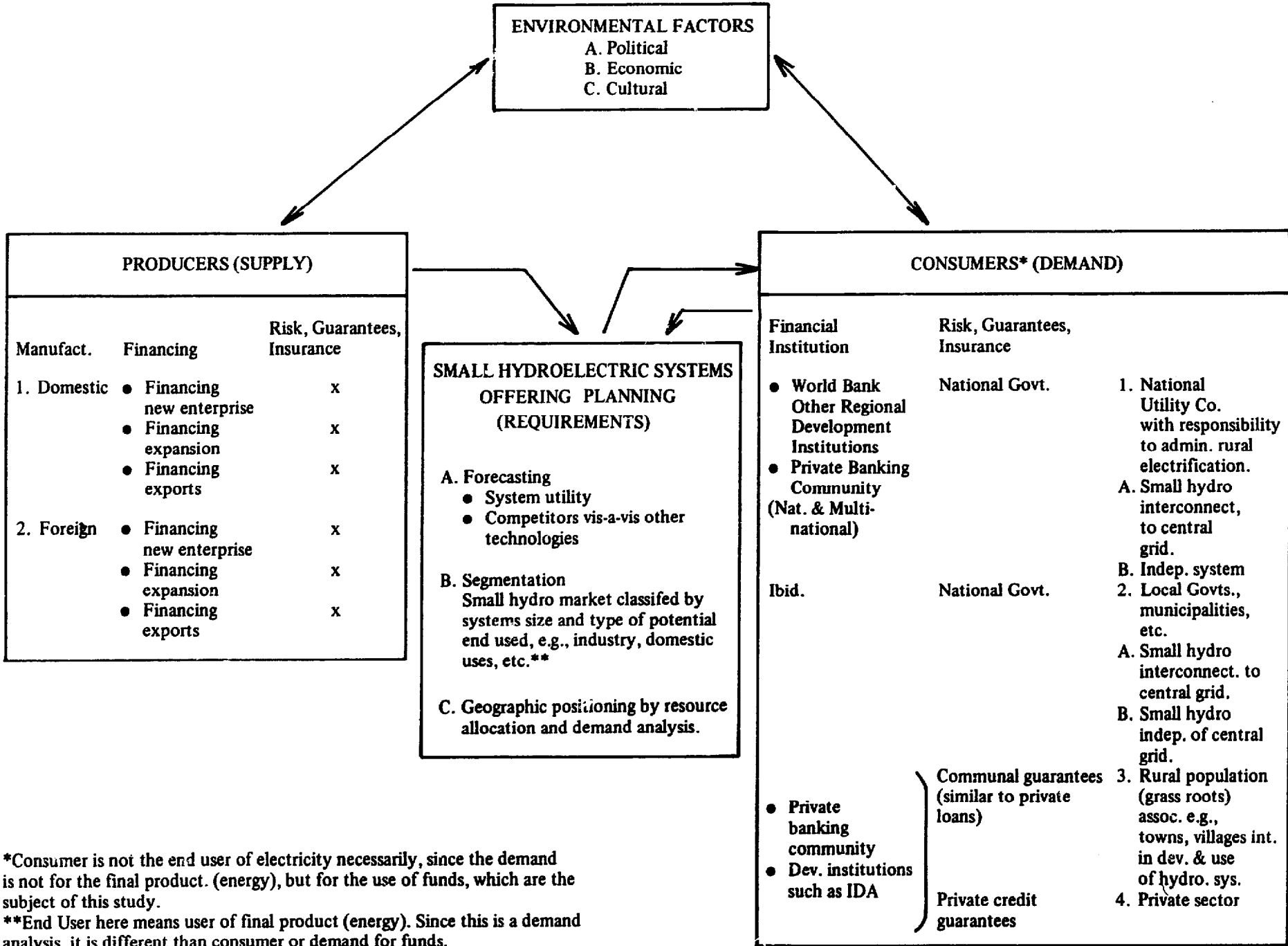

\*Consumer is not the end user of electricity necessarily, since the demand is not for the final product. (energy), but for the use of funds, which are the subject of this study.

\*\*End User here means user of final product (energy). Since this is a demand analysis, it is different than consumer or demand for funds.

ing the use of small hydro and to establish the requirements that would make this technology financeable in terms of direct purchases or manufacture.

The paper also suggests the need that presently exists to understand the impact resulting from adopting small hydro systems on a wider scale, i.e. in a manner that would attempt to bring electricity to large numbers of populated, industrial, dynamic centers of LDC's. These questions will undoubtedly remain in existence for some time to come:

- Will this technology become a liability or will its impact result in overall gain (i.e., production, better health and other services)?
- Will rural populations contract obligations that will only drain their limited monetary resources? Or, on the contrary, will the impact result in increased production and economic surplus that will pay back the financial obligation and still derive a surplus to improve conditions?

Thus, questions answered with regard to financing small hydro should be geared not only to understanding requirements to allocate capital resources, but also to understanding cost/benefit, distribution of benefits among participating institutions, and conditions of dependence resulting from the adoption of technology. Answers to the above questions should not only provide an idea about the economic benefits resulting from this kind of effort. It should also help maintain political and social stability under which orderly development is reasonably more likely to occur.

As a consequence of findings that occurred through the preparation of this paper, many changes took place. Major modifications of the concepts that underlie the preparation of this work and understanding of this subject are explained below.

The identification of institutions required for financing small-scale hydro evolved from understanding the feasibility of implementing projects using this technology and the need to expand their use through adequate methods tending to simplify operations and reduce costs. The search for financial mechanisms suggested many changes within the terms of reference of this study. The original terms of reference (see Appendix B) emphasized studying financing as a topic detachable from the institutional context of system productivity, end-users organization, systems packaging, promotion, and requirements for effectively using the proposed system. But the new and expanded scope of work utilized an approach that required the study of institutions on *all levels* of participation, from the existing to the potential supply and demand sides of the socio-economic spectrum, in order to later

formulate possible financing mechanisms.

A comprehensive model to conceptualize and analyze the institutions necessary to carry out technology transfer work was developed in order to detect interaction among various small hydro supply and demand institutions. This model helped to realistically identify producer (supply) and consumer (demand) characteristics and to understand more fully the marketing package which, in this case, stressed financing. Thus, this study deals comprehensively with financing institutions in the public, private and international development sectors and with the most appropriate financial mechanisms and requirements to promote the use of this kind of technology.

In order to facilitate the understanding of the institutions involved, their inter-relationships, and their limitations, the diagram shown on the opposite page (Exhibit 2) was designed. This diagram outlines major institutions, which serve as supply, demand and technology-offering mechanisms, and their changing levels of interaction as required to activate the process of technology transfer.

Exhibit 2 lists major types of institutions required for the process of making small hydroelectric systems available in rural areas of LDC's. This diagram includes all the institutions contemplated in the original scope of work, but they are now organized in a more logical fashion as the result of expanding the scope of work.

The focus of the new approach to studying financial requirements for this technology results from the clear understanding that the general primary task is to conduct a market-offering analysis of small-scale hydro systems where financing is a basic factor. The previous outline avoided the use of the term *marketing* since this word does not always sound befitting in the development field. However, it was found to be a realistic and proper term since it describes what appears to be the correct path for bringing hydroelectricity and derived economic benefits to rural areas of the Third World. Furthermore, commercialization of small-scale hydroelectric systems as well as other technologies, products and services should be a prime objective of development schemes provided that there is a good distribution of benefits among all participants.

The report accompanying this study will carefully explain the institutional relationships outlined in Exhibit 2 and help identify specific organizations that respond to needs in various levels of activity connected with the development and use of small hydroelectric systems.

Finally, Appendix C provides a list of development and other related, pertinent organizations, e.g., World Bank, Inter-American Development Bank, Asian

Development Bank, A.I.D., and various private organizations. They have been selected according to their level of dedication to fostering the use of renewable energy technologies, and identifying small hydro whenever possible. The list will include names, policies and criteria of key organizations responsible for financing/funding projects which include or specialize in the use of small hydro. A condensed list of requirements for securing funding for such projects is also included (pages 167-168).

### **Political, Social and Economic Conditions in LDC's (The Human Environment)**

This study presents an overall approach to financing small hydro in LDC's. However, any generalization regarding political, social, and economic conditions in LDC's as a whole can only have scant validity. It is important that each nation and even each micro-region where development for small hydro activities takes place be analyzed case-by-case. For the purpose of providing some basic parameters that would indicate favorable or unfavorable conditions to consider developing a project, a list of the main political, social and economic indicators is provided below. This list makes up minimum data to start considering the development of such a project, one that includes or is essentially small hydro system(s) in this case.

#### **Political**

- Elected Government
- De Facto* Government
  - Civilian
  - Military
- Date of Last Presidential Change
- Political Economy
- Centrally Planned System
- Free Market System

#### **Social/Cultural (Incidence of other relevant non-political or economic factors)**

- Population Growth (percent rates)
- Demographic Patterns (urban/ rural)
- Religion as Nation-Building Factor
- Educational Levels
- Ethnic Distribution
- Language

#### **Economics**

- GNP (in US\$)
- Sectoral Distribution Among Population Segments
- Growth Rates
- Main Production
- Petroleum Exporting

### **Sectoral Relationship of Economic Growth to Hydropower Supply and Demand.**

A country's analysis in economic, political, social and natural environmental factors should provide material to consider not only the use but also the manufacture of small hydroelectric systems.

### **Economic and Financial Conditions in Non-Oil Exporting LDC's**

In general, economic conditions in non-oil exporting LDC's have deteriorated in recent years (Exhibits 3 and 4). The World Bank official view on this matter is expressed as follows:

The non-oil exporting countries find themselves in the uncomfortable position of having to cope with three kinds of external shock at the same time: first, the increase in the price of oil, which has a direct effect through the higher import bill for oil and an indirect effect through the cost of imports of industrial goods whose prices may increase faster as a result of higher energy costs; second, the implementation of stabilization policies in industrialized countries, resulting in a sharp rise in nominal and real interest rates in world financial markets; and, third, the slowdown of economic activity in the industrial countries – in part owing also to the implementation of stabilization policies – which in turn leads to a reduction in the demand for imports from the developing countries.<sup>7</sup>

The international relationship in areas of finance and economic development is of the utmost importance for LDC's. The relationship of imports and exports is the essence of the process. Yet, as mentioned above and as shown in Exhibit 5 that relationship has been acutely affected by new developments in the general economic conditions in LDC's. Exhibit 5 shows current accounts of the Balance of Payments. This exhibit provides precise information as to conditions both in industrialized and non-oil exporting LDC's. Although neither group is strong with regard to current balances, it is the LDC's that have a worse relative (percentage) condition of deteriorating balances in the 1973-1980 period.

With a decrease in their rate of growth (5.6% in the 70's, 4.3% in 1979),<sup>8</sup> the LDC's ability to acquire more technology has again deteriorated. These conditions for LDC populations at large and for industry in particular have become more stringent and consequently more prone to failure.

**EXHIBIT 3**  
**Non-Oil Developing Countries:**  
**External Debt and Debt Service, 1973-80<sup>1</sup>**  
(In per cent)

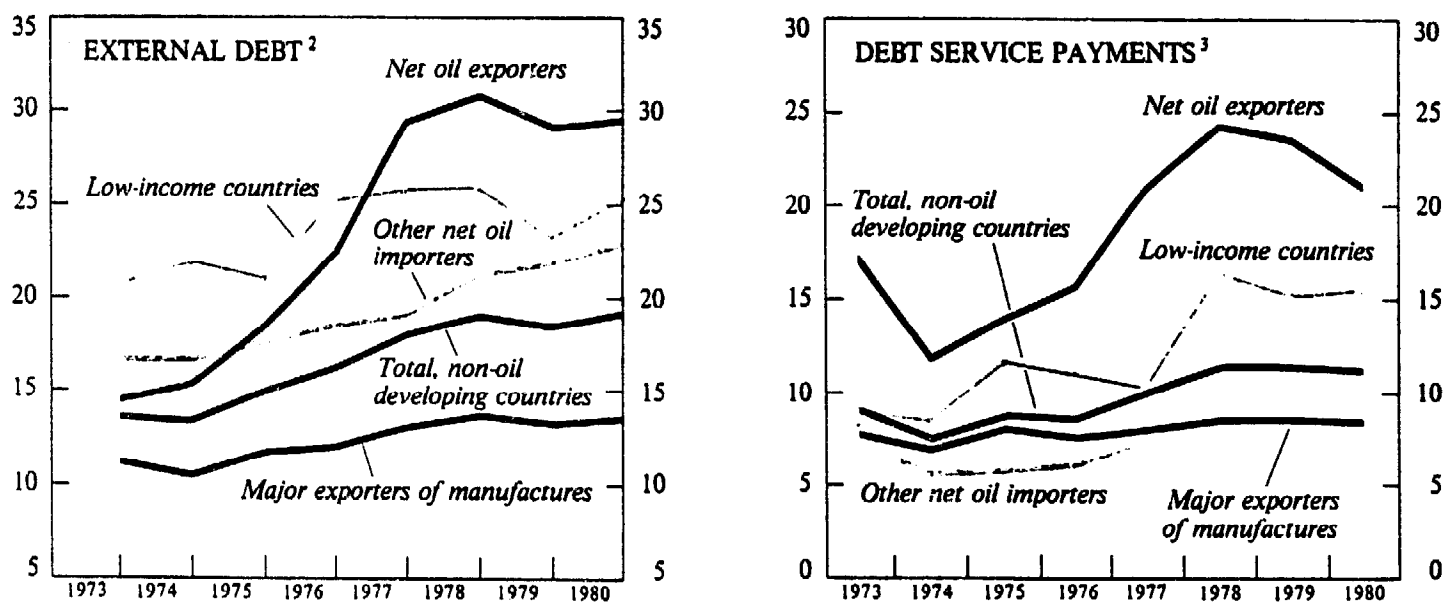

<sup>1</sup>The debt and debt service ratios plotted in this chart relate only to external public, or publicly guaranteed, debt with an original or extended maturity of more than one year.

<sup>2</sup>Ratio of external debt to gross domestic product.

<sup>3</sup>Ratio of annual debt service payments to annual exports of goods and services.

**EXHIBIT 4**

External Debt

**Non-Oil Developing Countries: External Debt,<sup>1</sup> Relative to Exports and to GDP, 1973-80<sup>2</sup>**

(In per cent)

	1973	1974	1975	1976	1977	1978	1979	1980
<b>Ratio of external debt to exports of goods and services<sup>2</sup></b>								
All non-oil developing countries	69.8	63.8	76.2	78.4	81.8	86.3	80.1	74.0
Net oil exporters	85.7	74.8	107.6	117.7	136.1	142.0	118.9	96.8
Net oil importers	67.3	61.7	70.3	71.0	72.0	76.2	72.4	68.8
Major exporters of manufactures	60.9	55.4	61.9	60.8	60.8	62.7	57.2	53.1
Low-income countries	136.3	139.3	173.6	188.7	186.0	203.4	201.9	196.7
Other net oil importers	61.0	54.5	62.8	64.4	68.2	76.6	78.2	76.4
<b>Ratio of external debt to GDP<sup>2</sup></b>								
All non-oil developing countries	13.7	13.4	15.0	16.3	18.1	19.2	18.5	19.3
Net oil exporters	14.6	15.3	18.4	22.4	29.6	30.8	29.2	29.8
Net oil importers	13.5	13.1	14.2	15.1	16.0	17.0	16.5	17.3
Major exporters of manufactures	11.2	10.4	11.7	12.0	13.1	13.7	13.2	13.6
Low-income countries	20.8	21.9	21.1	25.3	25.8	25.9	23.2	25.2
Other net oil importers	16.8	16.8	17.7	18.6	19.1	21.4	22.0	23.1

Sources: World Bank Debtor Reporting System, IMF Data Fund, and Fund staff estimates and projections.

<sup>1</sup>Public and publicly guaranteed long-term external debt. (Does not include private debt that is not guaranteed by the government of the borrowing country).

<sup>2</sup>Ratio of year-end debt to exports or GDP for year indicated.

## Amount and Relative Magnitude of Outstanding Debt

In nominal terms, the outstanding public and publicly guaranteed medium-term and long-term external debt of non-oil developing countries at the end of 1979 – close to \$250 billion – was well over three times the total at the end of 1973. In real terms also, the end-1979 debt appears to have been relatively high. The ratio of that debt to 1979 exports of goods and services by the non-oil developing countries (taken as a rough scale factor reflecting both real growth in world trade and inflation of world trade prices) was about 80 per cent, compared with 70 per cent for 1973. As a proportion of the estimated aggregate GDP of the non-oil developing countries, the same year-end debt totals amounted to 18½ per cent in 1979 and less than 14 per cent in 1973.

EXHIBIT 5  
Summary of payments balances on current account, 1973-80<sup>1</sup>  
(in billions of U.S. dollars)

	1973	1974	1975	1976	1977	1978	1979	1980
Industrial countries	18.1	-13.2	16.2	-2.1	-5.1	30.8	-10.6	-51½
Canada	—	-1.6	-4.6	-3.9	-4.0	-4.6	-4.4	-6
United States	8.8	7.2	21.3	7.8	-11.3	-10.3	3.2	½
Japan	0.1	-4.5	-0.4	3.9	11.1	16.8	-7.9	-16
France	0.1	-4.7	1.0	-5.1	-2.1	5.2	4.0	-2
Germany, Fed. Rep. of	7.1	12.6	7.1	7.3	8.4	13.2	0.4	-8
Italy	-0.9	-6.8	0.7	-1.6	4.2	9.2	6.4	1
United Kingdom	-1.2	-7.0	-2.8	-0.7	1.6	4.6	-0.9	3
Other countries	4.1	-8.4	-6.1	-9.9	-12.9	-3.3	-11.4	-20½
Developing countries								
Oil exporting countries	6.6	67.8	35.0	40.0	31.7	5.0	68.4	115
Non-oil developing countries	-11.3	-36.9	-45.8	-32.1	-28.0	-36.2	-54.9	-68
By area								
Africa	-2.0	-4.8	-9.1	-8.1	-5.8	-6.7	-5.0	-4½
Asia	-2.5	-9.8	-8.7	-2.5	-1.5	-5.9	-13.8	-21
Europe	0.3	-4.4	-4.8	-4.2	-7.4	-5.2	-9.3	-11
Middle East	-2.4	-4.6	-6.8	-5.4	-4.6	-5.7	-8.1	-10
Western Hemisphere	-4.7	-13.3	-16.5	-11.9	-8.7	-12.7	-18.6	-21½
By analytical group								
Net oil exporters	-2.6	-5.1	-9.8	-7.6	-6.4	-7.1	-8.2	-6
Net oil importers	-8.7	-31.8	-36.0	-24.5	-21.6	-21.6	-29.1	-62
Major exporters of manufactures	-4.0	-19.8	-19.5	-11.2	-5.6	-8.5	-20.7	-28
Low-income countries	-3.4	-6.6	-7.0	-5.3	-4.9	-7.3	-9.1	-11
Other net oil importers	-1.3	-5.4	-9.5	-8.0	-11.1	-13.3	-16.9	-23
Total <sup>2</sup>	13.4	17.7	5.4	5.8	-1.4	-0.4	2.9	-4

<sup>1</sup> Goods, services, and private transfers. The figures for 1980 have been rounded to the nearest \$0.5 billion.

<sup>2</sup> Reflects errors, omissions, and asymmetries in reported balance of payments statistics, plus balances of listed groups with other countries (mainly the U.S.S.R., other nonmember countries of Eastern Europe, and the People's Republic of China).

Source: World Bank, *World Economic Outlook*, Washington, D.C., May, 1980.

The possibilities for financing technology transfer and hardware importation must be looked at with increasing hesitation by both financial organizations and LDC technology users. The risks for both have worsened due to prevailing economic conditions. Payback failures by technology buyers would undoub-

tedly result in corresponding losses for financing organizations. Thus, current schedules of credit guarantees and the processes of industrial venture analysis have become more rigorous and strict.

While economic conditions deteriorate and financial risks increase, strong pressures including demand-

pull inflation resulting from increases in population and higher levels of need for goods and services force upward the need to invest in order to better supply and promote development in LDC's. It is the author's opinion that the term financing of technology, *vis-à-vis* the simpler term borrowing, implies that credit received will be used for acquiring capital goods whose use will not only result in repayment of the obligation but in equity building. That is what is desired from financing the acquisition of technology, and this process is different than simpler consumption borrowing. However, the resources for investment are not always available. Specific characteristics related to these conditions will be identified below.

### Financial Needs

As stated before, the main concern of this paper is to establish the financing processes that are required to develop small hydroelectric systems for use in rural areas of LDC's. Less developed nations, in most cases, have gone through much neglect of their rural areas in recent decades. Typical of this situation (and also probably a cause of it) was the implementation of the Singer-Prebisch thesis. This action-thesis, developed to foster the dynamics of industrialization in the Third World, and more specifically in Latin America, concentrated its objective on urban centers, drastically neglecting the rural setting. Its authors were soon to lament their shortsightedness. Their plan for development created serious imbalances between urban<sup>9</sup> and rural settings causing not only deterioration in the production of foodstuffs, fostering rural unemployment and consequently rural-urban migration, but also precluding the development and maintenance of adequate rural institutions. Thus, financial mechanisms for credit, savings, and investment in rural areas were too often short-lived or became almost completely atrophied.

Yet, in recent years, new formulations and efforts have begun to pay increasing attention to this problem. Financing mechanisms in Third World rural areas, especially for agricultural purposes, are becoming a less neglected activity. This new level of attention by credit and other financial institutions is acknowledged, for instance, by Leonard F. Miller in his book, *Agricultural Credit and Finance in Africa*. Similarly, past lack of means to create and/or improve appropriate technology for rural activities seems to be presently superseded by a renewed emphasis on the development or reinforcement of rural institutions. Financial institutions capable of supporting the development of small hydroelectric technology in rural areas are scarce at best.

Thus, it is clear that essential to the financing of hydroelectric systems or other technologies is the understanding of supply and demand conditions for the given technology and the social, political, and economic framework through which the process, where financing is the "mobilizer," flows.

Financing should be the "mobilizer," not only in the sense that it starts technology transfer action (small hydroelectric systems in this case), but from the point of view of promoting production and/or increasing production throughout the economic complex or for specific endeavors, *e.g.*, putting a factory into operation, upgrading grain processing in an agricultural unit, *etc.* As such, loans for technology should not be guaranteed as a result of political commitments or for the purpose of promoting sales of technology alone. Financing ought to be based on the educated estimate of returns on potential production resulting from improving production conditions as a consequence of the use of adequate technology.

Thus, financing technology should not be a process tending to create additional liability for the consumer; it should be a process to help develop production and build equity which will offset the liability resulting from securing financing.

New financial mechanisms and schemes must tend to improve production conditions, as mentioned above. The processes that tend to either sell technology irresponsibly or to distribute money for political reasons and without planning economic results should be done away with. Scarce financial resources in rural areas of LDC's require careful management in order to avoid further deterioration of already disadvantaged conditions.

Clearly, the function of capital financing is to actively contribute to the creation or expansion of production whose returns (return of capital normally known as interests) partially would amortize the loan used for its adoption, leaving the surplus to improve social welfare, thus generating *development*.

Previous paragraphs focused on major issues which can be summarized as follows:

- financing in LDC's should not be a process solely designed to make technology available for target populations. It should be a process directed at improving economic conditions in order to generate production to amortize loans (financing) and simultaneously create an economic surplus that can be assessed as synonymous with development itself;
- financing of energy systems should not be accepted as a final package of products/ser-

vices, but as an intermediate product/service whose final purpose is to promote production of economic goods and services; and,

- financial mechanisms should also consider technology which, in addition to energy, is needed to complete the production cycle of goods and services, *e.g.*, a financial scheme could include the development of a small hydroelectric system and also the equipment and technology to foster production such as agricultural products, processing, canning, transportation, *etc.*, in rural areas.

The implementation of financing schemes of that type, again requires careful planning of production processes and should not be left to totally random possibilities. It is often believed that infrastructural development such as rural electrification establishes its own forward linkages to industrial initiative and development. What is suggested here is that incentives for these forward linkages be planned and pushed forward at the time hydroelectric systems are accepted for use, thus accelerating the pace of the development process. Availability of adequate finance mechanisms will have that objective, provided there is also promotion of production know-how.

### Loan Security

Exhibit 1 identified key players in the process for carrying small hydroelectric systems from the supply to the demand side. Exhibit 6 shows the role of linking together supply and demand required by technology transfer packages along with the financial processes. The preparation of a technology transfer packages (including financing) is often, although not exclusively, the work of intermediary agencies such as development divisions of various ministries, bi-lateral and multilateral organizations, *e.g.*, U.N. agencies, World Bank, A.I.D., Asian Development Bank, Organization of American States, *etc.*, or a combination of them, and/or the private sector and its financing institutions.

Thus, intermediaries between supply and demand (supply and demand of small-scale hydro systems in this case) are organizations heavily concerned and most frequently participating in the financing process.

This kind of "offering package", as it is called in market analysis, is normally the result of work performed by a significant institution such as the ones mentioned above. Project packages are carried out by these institutions in consort with LDC governments' agencies. Examples of this situation can be seen in work presently performed to that end by the World Bank in

Ghana. Also, IDB is preparing a package to fund several hydroelectric plants simultaneously in Panama. However, it is also possible to consider that private farmers, industrialists, and private groups or individuals could directly determine the need to use small hydroelectric systems or other technologies. Clearly, loan securities and requirements to secure loans to acquire technology have to vary according to the type of borrower. Consequently, in considering financing, and above all, in trying to understand the requirements demanded by funding institutions, the demand market must be segmented according to criteria that would include:

1. borrower type – individual, rural association, cooperative, private firm, *etc.*, proposed use of technology (giving emphasis to the difference between production/productivity promoting efforts and consumer uses such as domestic uses); and,
2. existing funding organizations and their authorized area of activity. Institutions, whether private, public and/or development ones, are also segments and operate under guidelines that stipulate who their clientele is and who it is not.

Again, going back to the framework of reference presented in Exhibit 2, it is possible to list in order the institutions of supply and demand and their linkage through finance organizations that tend to respond to needs identified by development specialists.

Appendix C provides a general view on the areas of activity of various international development organizations. This appendix will provide general guidelines from which to determine in a generic way who qualifies to apply for financing and therefore who is a potential client for a given organization. Qualifying to apply for financing to a specific organization does not imply qualifying for the actual loan, which is a different process. This second process is the specific establishment of credit-worthiness resulting from individual case analysis, *i.e.*, the actual credit applicant must demonstrate ability to pay back the loan (financing) for a technological package.

Along with the classification of the borrower and the corresponding institution that would respond to particular needs, remains the issue of establishing criteria for securing a loan to finance small-scale hydroelectric systems. A generalization of these criteria according to borrower classification and the corresponding type of institution that would respond to particular needs is presented below.



**A List of Requirements Needed to Apply for Funding**1. *For New Ventures*

The potential client must comply with the following requirements:

- Fill out a credit application form (provided by the financing organization).
- Provide a certified copy of the new company organizational chart, including copies of all legal documents, names and information on members of the board of directors.
- Companies (or individual) registration documentation, including registration copies on affiliated companies, if any exist.
- Personal balance sheets and *curriculum vitae* of venture owners and top management. Also other banking and commercial reference documents.
- Balance statement as of the new company's accounts, signed by a certified public accountant.
- Financial statements of other business ventures the partners are connected with.
- Capability statement approved by the Office of Foreign Investors if the venture includes technology transfer from overseas.
- Solvency documents from proper authorities.

2. *For a Specific Project*

- A copy of project registration with the corresponding government agency.
- A copy of project registration with the Ministry of Development/Industry.
- A copy form filled out for registration with the Ministry of Development/Industry.
- Project study (engineering and economics).
- A copy of the prefeasibility study.
- If a plant is involved, a copy of the lay-out and blue-prints of the plant.
- Copies of the studies, such as soil studies.
- A work proposal, with all details.
- A permit from corresponding authorities to work on all parts of the project.
- A statement of purpose from the Chief Project Engineer.
- Invoices (or cost estimates) of equipment prices.
- A proposal of civil, mechanical and other engineering work.
- A proposal for fixed and variable costs.
- A proposal on equipment and other transportation expenses.

- A time schedule of activities, by specific tasks.
- A time schedule for disbursement.

3. *Loan Guarantees*

- The title of ownership of physical guarantees offered.
- The legal documentation of real estate collateral.
- A certified statement of indebtedness.
- Certified evaluation documents of the collateral offered. If the collateral consists of machinery or equipment, the following details must be specified: brand name, serial number, date of purchase and price, depreciation, present worth, life cycle expectancy, etc. .
- Evaluation certificates must come from competent certified experts. These experts should be registered with corresponding agencies. It will be further required that the following information on the evaluation also be submitted: business registration and any existing modification to its charter, Certificate of the Board of Directors, other pertinent information.
- Also, documentation on the evaluation institution in the areas of financial statements.
- Commercial and bank references on evaluation.
- Certificate of tax compliance.
- Insurance policies.

4. *For Established Organizations*

Besides the requirement specified for new ventures, this category should add:

- a) From the potential client:
  - Financial statements, copies signed by C.P.A., and a statement of accounts prepared 60 days before submitting the loan application.
  - Sales accounts for the past three months.
  - Sales prices for manufactured products.
  - Insurance policy copy.
  - Tax liability compliance certificate.
  - IRS solvency certificate.
  - Other specific documents are required depending on each case.
- b) From the International Development Community (e.g. Asian Development Bank loan applications): The Bank has no special application form for loans or guarantees. Prospective borrowers address preliminary inquiries to the Bank. On the basis of

EXHIBIT 6

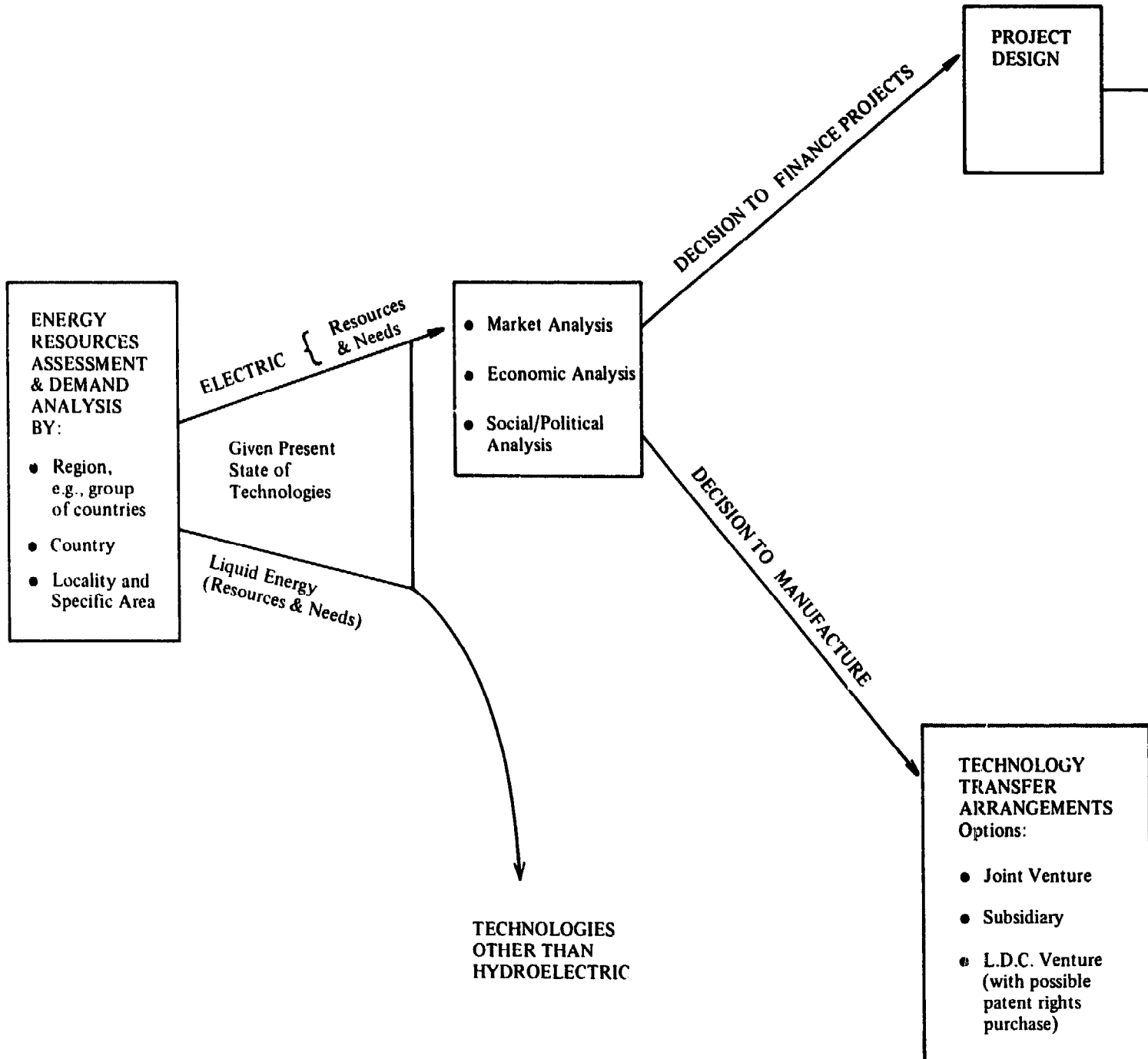

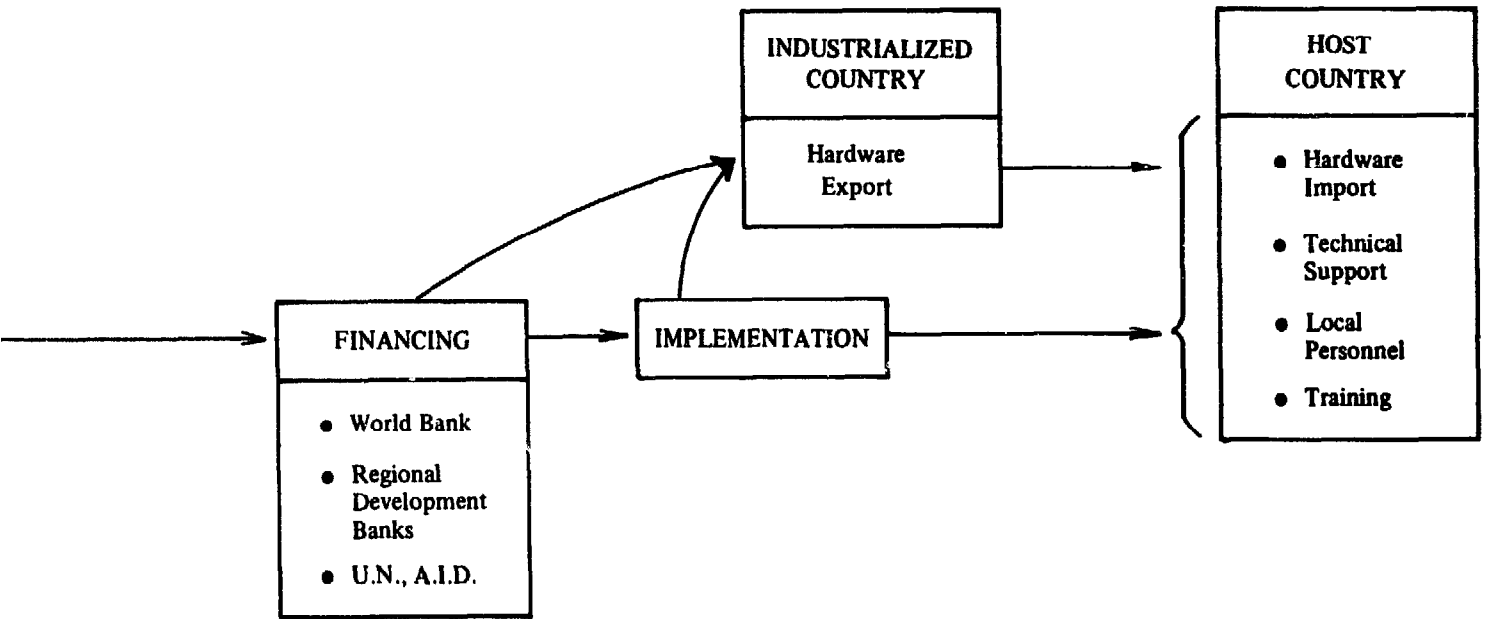

---

Supply and Demand Links

---

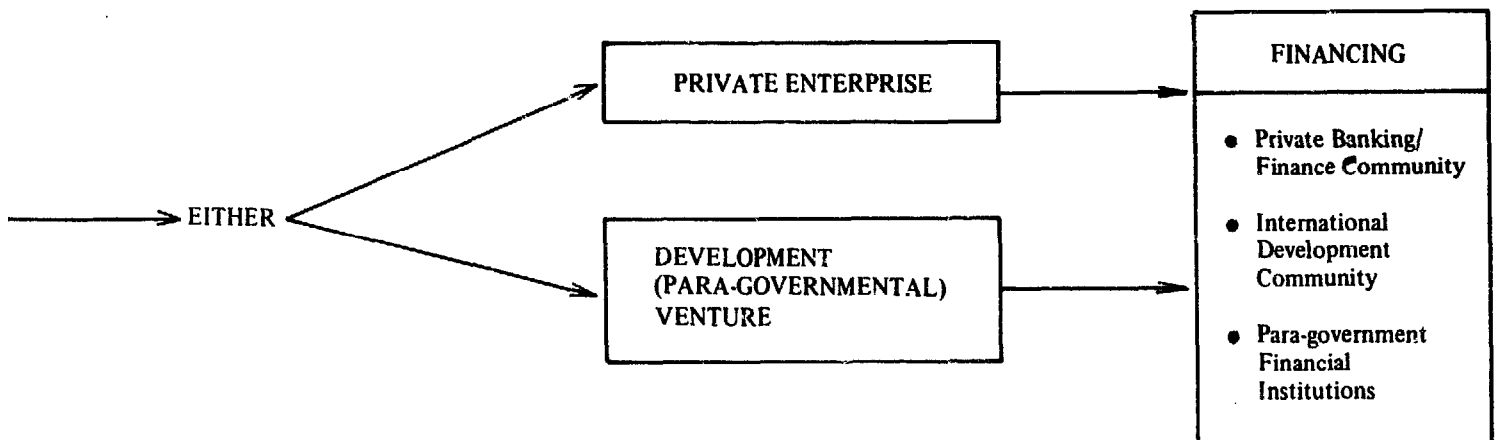

these inquiries, the Bank decides what additional information is required. Since only projects of high national priority and having governmental support will be considered by the Bank, applications are normally submitted through the governments concerned.

In processing an application for a loan or guarantee, the Bank deals only with the applicant or authorized representative, not with intermediaries.<sup>10</sup>

### Joint Ventures

The term joint venture is most commonly used in reference to agreements reached by entrepreneurs from more than one country to provide a product or service in places where technology or technological know-how will be transferred. This kind of arrangement results from the desire of a local entrepreneur to use his knowledge of local conditions to advantageously adopt modern technology or products from abroad that could find local demand. The advantage for the foreign entrepreneur results from having a partner in a joint venture who is experienced and knowledgeable of the local market and can therefore provide significant inputs to operate internationally.

Underlying all this is the fact that in recent times, LDC's national policies determined that foreign direct investment be restricted, *i.e.*, that foreign organizations not be entitled to complete ownership of the factors of production in business ventures. Recent policies require local participation with approximately 50% ownership by host country citizens.

Thus, joint ventures are often the best way to circumvent barriers of entry to a specific market. These ventures most commonly will consist of the development of natural resources and/or build-up of manufacturing capability. To that end, legal matters, capital investment, and operational obligations are required to include detailed specificity in draft and project designs. The guest and the host parties must draw up careful contractual terms as to the corresponding responsibilities. The process of joint venture formation, of course, before any action, requires identification of appropriate counterparts, who, having researched the potential market, decide to go ahead with the venture.

Host country activities for this type of arrangement include, besides market research and the decision to proceed, a series of complex and often costly steps that must be planned, designed and implemented. These steps are:

- Production
- Wholesale Distribution
- Retail Distribution

(Additionally, in many cases, including small

hydro systems, maintenance and support systems would be required).<sup>11</sup>

This three-part process, resulting from the establishment of joint venture, must always be the sequence, not the preface, to a market analysis process as outlined in connection with Exhibit 1 of this paper.

Usually joint ventures occur with the participation of individuals or organizations whose business activities have already acquired adequate levels of maturity in the past. As such, these organizations have established credit and can resort to various sources for financing. Most frequently, this type of private enterprise will use private banking financing, and only in exceptional cases will have to rely on co-financing where a development agency and a private bank share risks for a venture, or, lastly, approach a development institution alone.

Joint ventures are becoming a most acceptable arrangement for operating business internationally. These arrangements do not have the advantage of absolute venture control that direct investment offers, nor are they risk free in terms of capital investment loans, as is the case for local licensing. However, they offer an intermediate agreement and a potentially better distribution of revenues on the international scale. Unlike other forms of international venture arrangements (such as the aforementioned direct investment on licensing), joint ventures require sharing responsibilities, contributing with complementary inputs, and distributing profit as required by the arrangement (normally 51% local and 49% foreign).

Without this kind of international agreement, comfortable conditions under which to operate in many nations of the world do not seem to exist.

An example of this condition prevails in Brazil.<sup>12</sup> Brazil has developed in recent years successful policies to increase its production level and retail ownership under the control of its citizens. With that purpose in mind, Brazil stipulates the following requirements:

1. that 51% of the ownership of any business organization be the property of its citizens; and,
2. the importation of products identical or similar to those manufactured in the nation is not allowed. This second business requirement is controlled through legislation known as the Law of Similar.

Neither law precludes the development of international business ventures. Nor do they hamper the transfer of technology. Their objective is to achieve better income distribution on the international level.

### Available Financing

Although, as mentioned earlier in this paper, rural

institutions have not evolved as effectively as would ideally be the case, it does not mean there is a complete vacuum of financial and other mechanisms in many areas outside rural centers. As a matter of fact, several development organizations have geared their work efforts in the past decade to mobilizing resources to promote development in the field of agriculture and agribusiness in LDC's.<sup>13</sup>

Consequently, some institutions and forms of rural organizations exist in the countryside of many LDC's (see p. 176: *National, Regional and International Finance Organizations*). These organizations under appropriate guidance could effectively use monetary schemes to finance the installation of hydroelectric systems. However, these systems, as mentioned before, could only be acceptable provided that their use results in amortization of capital and equity building.

A preliminary survey of the money market for these kinds of technology has shown adequate resources. The public, private, and international development communities have given indications, and in many cases provided documentation, as to the availability of funds for the development of energy alternatives, and small hydro in particular.

A survey conducted throughout international development organizations in the Washington, D.C. area and also in various foreign countries revealed the existence of the above-mentioned funding capability.

#### Access to Project Financing (General Practice)

Three main sets of principal players have been identified for the process of financing small-scale hydroelectric technologies, *i.e.*, users of technology (demand), suppliers of technology, and intermediate agents that bridge the gap between supply and demand. Of these three sets, only two are essential in some cases (supply and demand), *i.e.*, if the user knows what he wants, knows where to get it and has the independent financial capacity. This latter case can occur with regard to the purchase of small hydroelectric units.

However, in most cases there is need for financing by a third type of organization, *i.e.*, organisations which, without representing directly the supplier of equipment or the purchaser, are capable of providing financial resources. Thus, various types of banks, government agencies, *etc.* serve this purpose.

Furthermore, if the idea is to promote the use of small hydroelectric systems, due to their utility as tools of development and their potential as substitutes for other, more costly, technologies, then this third set

of players increases in importance. In this case, promoters of the system are required to develop simpler, easier to handle, less costly technological packages. These packages will constitute incentives for potential beneficiaries to use this technology. For this purpose, it is necessary to segment demand by "borrower" characteristics and link each type to the corresponding type of financing institution(s). The main idea throughout this process is to establish a centralized promoting structure that could clearly understand the shortest, most direct way to finance the development and long-run operation, including maintenance, of small-scale hydro.

By a centralized structure is meant an institution that could specialize in the development of small hydroelectric systems on national or regional (more than one country) levels. Of course, many organizations such as national governments, development institutions, banks, *etc.* partially meet the objective here suggested. However, their role is not a complete one for reasons which include lack of specialization in some cases; lack of authority to promote projects, in other cases; present lack of expertise in this field, *etc.*

Probably, small-scale hydroelectric systems can be any of the above under different circumstances. What remains an important issue is the early identification of the system's purpose, and the establishment of linkages for production. LDC's, due to financial and other scarcities, cannot afford to invest capital (borrowed or other) and let it remain idle for long.

In conclusion, access to project funding is determined by the road available for the user (borrower) to communicate with appropriate funding organizations, and then with the compliance of financial requirements specific to a given organization.

Examples provided above in the section *Loan Security* (pp. 164, 171) include specifications. Adequate studies of the project potential and positive credit background are in essence the general premises under which credit for financing small hydroelectric systems is possible.

Additional specifications as to the technical requirements necessary to secure financing are presented in Appendix C. Considering potential users' (individuals or groups) actions required to secure financing, it is necessary to understand the advantages that could result for technical, and simultaneously, promotional work performed by an agency specializing in these tasks. These advantages are as follows:

- advantages resulting from economies of scale to study hydroelectric resources by con-

sidering regions and groups of potential sites instead of individual cases;

- distribution of studies and information to potential end-users, *e.g.*, electric companies, village populations, rural entrepreneurs, *etc.* This could be a valuable incentive to promote development; and,
- the availability of support services in the form of manufacturers' information, training, technical evaluation, maintenance, *etc.*

### Technical Requirements to Manage Financing of Small-Scale Hydro

This section expands technically areas covered in the previous section. Its objective is to specify and describe work activities, sequentially arranged, that would help organize the process of project planning in order to request financing. This section includes a methodological approach to considering engineering and economic areas of analysis needed in order to have a financial institution provide funds to carry out a project.

This section does not help determine the kind of institution that could respond to a specific case, which is what borrower classification would do. Borrower classification and corresponding funding institutions will be found in Appendix C. Appendix D will deal with the methodology or steps required for potential borrowers to select appropriate funding institutions.

#### Identification of Need

##### *Categories of Need*

Financial needs associated with the development and effective utilization of hydroelectric resources in less developed countries may be segregated to facilitate the identification of sources for funds and the evaluation of financial risks. Needs are segregated for the purposes of this report in accordance with phases of the project. The project may be the development and operation of the small hydroelectric power generating station, a related manufacturing enterprise, or a related commercial venture. Phases and functions performed within these phases are as indicated below.

(a) *Phase 1, Identification and Appraisal of Opportunity.* Opportunity for development of hydraulic resources or for activation of a related enterprise may become evident as a result of increasing demand for power or power-generating equipment, increasing fuel cost for thermoelectric power generation, high cost of imported equipment, or other causes. The opportunity may be first recognized by a government analyst,

a landowner, a representative of a local interest group, an entrepreneur, a foreign investor or any other interested individual.

Specialized engineering and economic skills are required for effective appraisal of potential. Market analyses and studies of demand trends are essential. For hydroelectric site development, hydrologic and geologic investigations are also required. It is common practice for these functions to be performed by agencies of government at the national level, or by consulting service organizations.

(b) *Phase 2, Conceptualization, Planning and Design.* Analyses, conducted early in Phase 2, will determine the technical and economic feasibility of the project. These analyses will include detailed definition of demand trends, conceptual designs for site development, construction, installation, organization, operation, maintenance, repair, sales, distribution and business expansion.

Detailed designs will be prepared for grading, construction and equipment installation. Implementation schedules, cost estimates and plans for product distribution and recovery of costs will be prepared.

Capability to perform Phase 2 tasks exists in the private sector and among agencies of government at the national level in most developing countries. Investors or the LDC government are appropriate sources for Phase 2 funds.

Where capability to perform Phase 2 tasks does not exist within a developing country, expertise may be borrowed from an appropriate source within the region.

(c) *Phase 3, Activation.* When it has been determined, on the basis of Phase 2 effort, that activation is warranted and desired, attention may be directed to acquire material and equipment and to proceed with construction, installation, checkout and initial operation.

If the project is government-sponsored, funding for Phase 3 may be arranged by the government. If the project is private, cooperative or joint venture, a portion of the Phase 3 funding requirement may be invested, and the remainder may be obtained from local, national or regional lenders (this is discussed in other sections of this paper).

(d) *Phase 4, Sustained Operation.* Functions included in Phase 4 are marketing, management, training operation, product distribution, maintenance, repair, community service and growth. Several organizations may cooperate to perform these tasks, or an institution may specialize in carrying out this function. Funds for Phase 4 will include those acquired from sale of products or services. They may also include

investment funds and subsidies. Such subsidy may be provided by government or by local community interest groups. Ideally, there should be mixed funds, partly community savings and partly financing sources.

#### *Distribution of Financial Need*

It is helpful to view individual elements of cost with respect to the total cost to be incurred during the life of the project. A comprehensive analysis of costs will include those for personnel, material, equipment and support services of all categories. Estimates of personnel costs will include specification of skill levels and sources as well as rates and total monetary values.

Distribution of total cost among project phases differs for various types of enterprise. A reasonable first assumption will normally approximate the distribution below.

Identification and Appraisal of Opportunity	5%
Conceptualization, Planning and Design	10%
Activation	20%
Sustained Operation (ten years)	65%
Total	100%

Effort applied in Phases 1 and 2 should verify technical and economic feasibility. This effort will also influence the costs to be incurred later in Phases 3 and 4. Total project costs and financial risk will be minimized by thorough and professional conduct of Phases 1 and 2.

#### *Magnitude of Finance Need*

Total capital required for activation and operation of an enterprise associated with the development and utilization of hydraulic resources for small-scale projects in developing countries varies widely. US\$200,000 FY 1981 is sufficient to design, activate and initiate operation of a small hydroelectric power station. An investment of several millions may be required to activate a manufacturing facility to meet a regional need for high-value components of small hydroelectric power stations.<sup>14</sup>

#### **Loan Security**

An appreciation of the nature of the total environment which surrounds a small venture in a developing country is required for sound appraisal of financial risk. It is helpful, also, to place in proper perspective the motives and aims of all who may influence the activation or operation of the venture. The actions of these participants will generally influence risk and

provisions for loan security.

#### *Participants*

Many individuals act directly to influence the success or failure of an enterprise in a developing country. For effective appraisal of financial risk, each of these individuals must be identified, their motives must be determined, and the effects of their participation must be evaluated in advance.

A generalized view of the environment surrounding a new venture is presented in Figure 1. All the interest groups shown are likely to be directly involved. Cooperative arrangements among principal interest groups are common. The intent is to multiply or augment influence as required to achieve specific individual objectives. Financial risk must be appraised and loans must be secured on the basis of a thorough understanding of interest, motives, objectives, the balance of influence, and the probability of financial success. It must be recognized, also, that many participants subjugate financial considerations to moral, political or personal objectives.

The depth of the fiscal environment is also shown in Figure 1. Investment funds are available, and loans can be arranged at any level shown. Suppliers can offer lenient terms for payment. Investors and government agencies can guarantee loans. A sound financial plan can be prepared for almost any venture by thorough appraisal of the desires and intentions of all participants. The basic business plan can also be adjusted to compensate for risk and to maximize probability of success.

#### *Instruments*

Loan guarantees are effective instruments for loan security. Each venture will have unique circumstances, and specific individuals, agencies and institutions must be identified for the particular purpose of providing appropriate and effective guarantees. (See Appendix C).

#### **Joint Venture**

Joint venture is recognized as an effective approach for reduction of the probability of failure. The foreign (U.S. or other) participant in the joint venture can supply technical, marketing and management skills, and investment funds. The domestic (LDC) community can provide the entrepreneurs, materials, labor and (possibly) investment funds. Effective consolidation of the joint interests will reduce financial risk, enhance credit worthiness, support favorable loan decisions, and provide a sound foundation for suc-

cessful business operation.

### Objectives

Motivation for joint venture may reflect any one of a number of personal or organizational objectives. It is misleading to assume that such motivation is only for financial profit. As an initial step in the development of any joint venture, it is essential that all beneficiaries be identified in advance individually, or by category, and that motives and objectives of all be clearly defined. Objectives will only be achieved if they are identified, defined clearly and accepted as objectives to be achieved by the venture.

### Phasing, Participation and Allocation of Responsibility

The process of development and operation of an enterprise is, as mentioned previously, phased. For the purposes of this report, four phases have been defined. These phases are:

1. identification and appraisal of opportunity;

2. conceptualization, planning and design;
3. activation; and,
4. sustained operation.

Organization requirements differ for each of these phases and also for various types of enterprises. The following comments are particularly pertinent to the specific case of activation and operation of a joint venture in a less developed country.

(a) *Phase 1, Identification and Appraisal of Opportunity.* Any one of a number of individuals or organizations may identify and appraise opportunity for joint venture. Principal candidates are:

1. the local entrepreneur;
2. the local cooperative;
3. the local investor;
4. the agency of the domestic (LDC) government;
5. the foreign (U.S. or other) manufacturer; and,
6. the foreign (U.S. or other) investor.

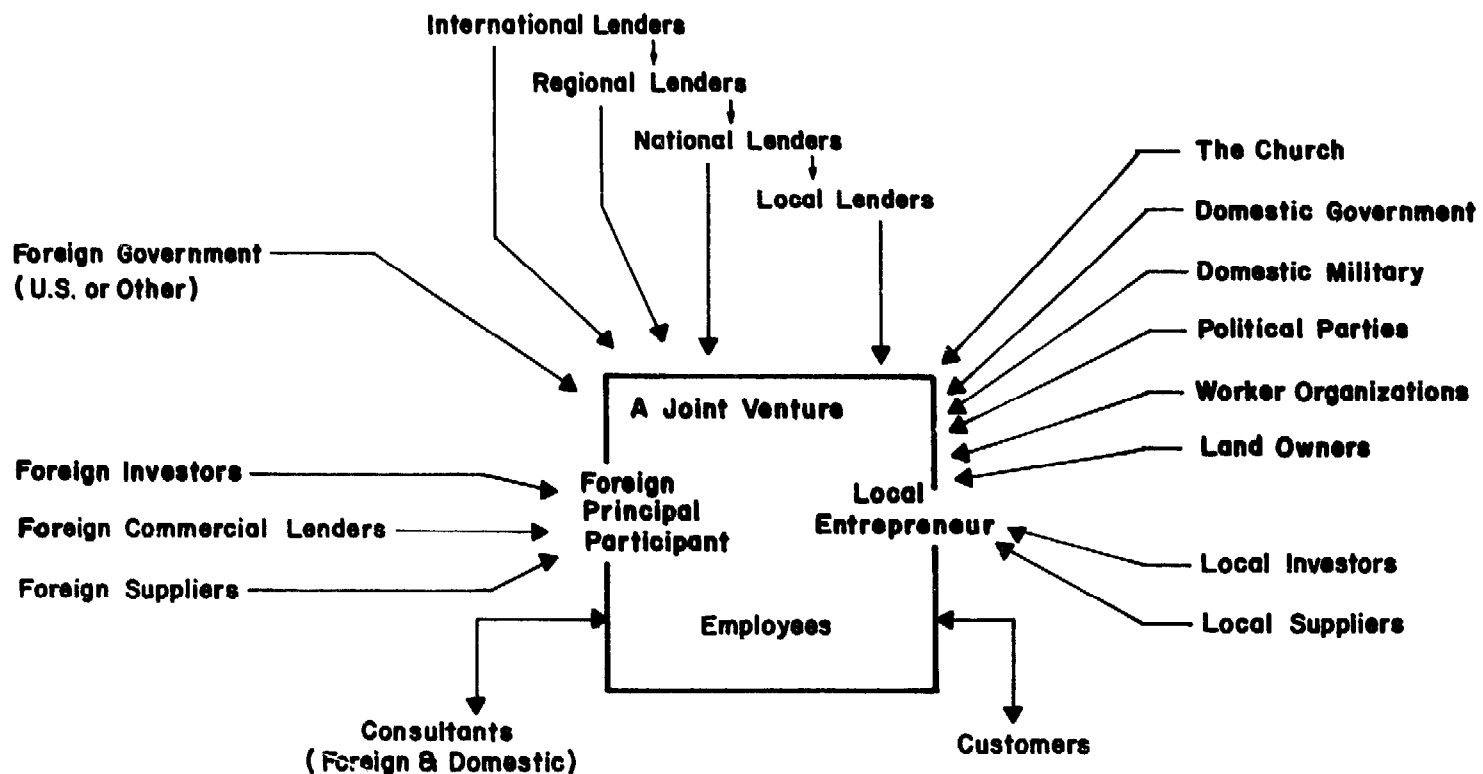

Fig. 1 The Environment



It is reasonable to assume that funds required for the Phase 1 effort will be provided by the interested individual or agency. They may elect to arrange for consulting and support services.

(b) *Phase 2, Conceptualization, Planning and Design.* The decision to proceed with the Phase 2 effort may be made by any one of the interested individuals or groups identified under Phase 1 above.

A committee form of organization is suggested to accomplish Phase 2 objectives. Direct participation by the following should be encouraged:

- the local entrepreneur;
- the leader of the local worker group;
- the local representative of the domestic (LDC) government;
- the local lender;
- the representative of the foreign participant in the joint venture;
- the representative of the foreign (U.S. or other) government; and,
- the local representative of the church (if appropriate).

These participants together command all the resources required to establish the joint venture. They may desire to retain services of specialized consultants to perform specific analyses and detailed design tasks.

If the interests of participants conflict seriously, this will become evident in the course of deliberations. If such conflicts do emerge, and if they cannot be resolved, the venture should be recognized to be of high risk. Further effort may not be justified.

(c) *Phase 3, Activation.* Phase 3 activities include: site preparation, acquisition of material and equipment, construction, installation and checkout, and demonstration of successful operation. This work must be closely coordinated. Extensive resources and high skill levels are required. Tasks are dissimilar in many respects to those to be performed in Phase 4 (Sustained Operation).

An experienced foreign (U.S. or other) contractor may be supplied with plans, specifications and designs prepared in the course of Phase 2, and this contractor may be assigned full responsibility for performance of all Phase 3 tasks in accordance with these guidelines. This approach is suggested. Funding for Phase 3 can be arranged as indicated previously.

(d) *Phase 4, Sustained Operation.* Phase 4 functions include: marketing, management, acquisition of materials and support services, training, supervision, quality assurance, maintenance and repair, community service, and fiscal records and financial control.

Responsibility and authority for achieving Phase 4 objectives must rest with the principals of the joint venture. They will normally maintain direct communication with respective investors and lenders to maintain effective financial control.

Close contact with sympathetic representatives of local worker groups, government, and the church will enhance the probability of success.

#### **Elements of Technical Analysis Required for Financing (Engineering and Economic Considerations)**

Identification of possible uses of small-scale hydro in LDC's will require studies, calculations and decisions on many levels and with respect to various aspects of this technology.

Criteria for making decisions will result from different perspectives of interest and knowledge. Preparation of homogeneous, simplified packages of operation will tend to reduce costs, activate progress, and motivate potential uses.

Institutionalization of standard engineering and economic procedures to expedite this process will help all participants maximize efficient use of their resources.

It is also necessary to classify criteria for funding into two groups: one that relates to efficiency in the standard engineering and business sense, emphasizing maximum output of electric power of optimum quality at lowest cost; the other classification consists of a comprehensive assessment of the impact on the environment, both physical and human environment, in terms of production, productivity, disruption of socio-cultural patterns, and other factors.

Both the enterprise and the societal outlook are not mutually exclusive; on the contrary, efficient energy production by power organizations must include concern for public well-being.

Technical considerations that will determine the engineering and economic viability of a project are listed below. They are the basis for securing funding for specific projects.

#### *Costs Concepts*

- Future costs
- Direct and indirect costs
- Opportunity costs
- Sunk costs
- Social costs
- Managerial costs

#### *Revenues Concepts*

- Demand analysis

- Load forecast
- Direct sales
- Marginal tariffs
- Net sales
- Other related revenues

#### *Evaluation of Alternatives*

- Comparison of annual costs
- Capital expenditures
- Hydraulic engineering costs
- Civil engineering costs
- Electromechanical costs
- Architectural costs
- Operating and maintenance costs (O&M)
- Interest and the time value of financial resources
- Capital recovery factor
- Total annual costs
- Economic life of the project

#### *Present-Worth Comparison*

- Comparing the PW of future costs
- Valuation of future income by discontinuing
- PW of future benefits
- Net present worth

#### *Determination of the Rate of Return*

- Rate of return on investment
- Calculating the internal rate of return
- Benefit-cost analysis
- Cost-savings analysis
- Sensitivity analysis

#### *Sources for Project Funds*

- Internal sources
- External sources
- Debt financing
- Optimum external financing

#### *Capital Planning and Budgeting*

- Rate of return criterion
- Minimum rate of return
- Cost of capital
- Working capital
- N.P.W. as a criterion

#### *Economic Analysis*

- Short-run cost functions
- Fixed and variable costs
- Linear programming for minimum cost (maximum profit)
- Marginal costs and marginal revenues
- Changes in the demand schedule
- Fixed tariff structure

- Break-even analysis
- Long-run cost variations

The elements of analysis described above apply to most cases (projects) for small hydro development in LDC's. The analyses and evaluations to reach decisions based on these elements can be very simple or very sophisticated, depending on the size of the project and the quality of the engineering design.

For most engineering and institutional decision-making, monetary income and costs will promote convenient measures for summarizing the potential future performance of alternative courses of action. However, costs as determined by the usual accounting systems, which are designed to measure past events, are not always suitable for decision-making purposes.

When all the significant effects of an investment plant can be estimated in monetary terms, a tangible analysis of the worth of the proposal can be made. Annual cost comparisons, present worth calculations and rate of return determinations will promote a measure of economic viability applicable to all investment projects.

#### **Elements for Financial Analysis**

Funds for future small-scale hydroelectric plants will often be derived from both internal and external sources. In the case of the LDC's, internal sources are chiefly government funds, inter-institutional financing, public utility allocations and others, such as those derived from depreciation recoveries, retained earnings and sale of fixed assets. External sources of funds are principally obtained through the sale of bonds, stock, public financing from government agencies and international financing from other financial intermediaries and development agencies.

Although short-term loans from banks are not usually considered sources of funds for capital investment, they may in some cases provide the way for long-term funds.

To consider an optimum plan for external financing, small-scale hydroelectric projects require consideration of the technical intricacies of the implementing agency's capital needs. The most desirable methods and timing of financing will depend on country-specific factors and existing legislation.

Under the financial scope, the goal will be to provide the required funds in such a way that the total cost of the financial resources from all sources will be as low as possible and at the same time keep the debt-capital ratio low enough that the project's financial stability will not be threatened in periods of adverse conditions. Nevertheless, in most LDC's, the current

tariff structure imposes a certain degree of subsidy to the power purchaser, and thus it becomes more difficult to make accurate financial estimating.

All small-scale hydroelectric project planning should include a continuing review of the prospective cash position several years in the future. The cash position forecast must include the following: forecasting sales and budgeted or estimated costs (to this are added depreciation changes and subtracted capital), investment expenditures, increases in working capital requirements, etc. When this review indicates that additional cash will be needed by the project, decisions concerning the amount, nature and timing of external financing must be made, or certain projected investments will have to be eliminated.

### Sources of Funds in LDC's

Project funding in just about any LDC is available from both domestic and international sources. Taxes and other government (LDC) revenues are cycled through the national banking system to other government or quasi-governmental financing institutions. Some of these institutions specialize in technology, others in industrial development, and some also work with rural and agricultural activities. Most of these organizations are potentially capable of funding small hydro projects.

Similarly, the private financing community through domestic or multi-national banking organizations can respond to this kind of need. Finally, development institutions (World Bank, IDB, Asian Development Bank, Development branches of the European Economic Community, AID, and others) can, under various circumstances, respond effectively to needs in this area.

Exhibit 6, on pages 166-167, provides a conceptual structure of the large world financial community. It goes from the national government level and its relationship to major world institutions such as the International Monetary Fund and large multi-national banks to lower levels of banking and financing institutions.

Capital resources do filter through the existing structure to less developed areas including rural areas of LDC's. An example of capital resources and credit availability in rural areas is given by the following statistical information:

Although the financial structure on both the domestic and international level weakens as it approaches rural areas, there are still some active participants trying to promote the expansion of these financial systems.

Among the main active rural systems that deal

### Institutional lending for agriculture in selected countries<sup>16</sup>

Country	Loans Outstanding	New Loans US\$ Million	Debt Per Capita of Rural Pop. US\$ Million	Year of Observation
Ghana	19.0	6.0	4.0	1971
Bangladesh	130.0	4.3	1.0	1972-73
Thailand	73.0	42.0	20.0	1970
Brazil	—	1,500.0	40.0	1969
Mexico	1,671.0	—	84.0	1971
Paraguay	33.0	—	22.0	1968
Venezuela	448.0	—	179.0	1968

Source: World Bank, Agricultural Credit, May, 1975, p. 19.

with some financing in rural areas, the following ones are most significant:

- Government credit unions
- Cooperatives
- Branches of commercial banks
- Branches of governmental financial systems
- Grass roots associations
- Agro-industrial financial resources
- Surplus individual income resulting from earnings (savings)
- Local money leaders

Institutions listed above respond to needs in development efforts and either individually or through co-financing can fund projects. However, the linkage between rural end-user and financial institutions in many cases requires a specialist or an agency exogenous to the immediate area to activate the venture and establish the linkages.

### Private Institutions

The main organizations with established networks of operation in rural areas are agricultural extensions, various types of cooperative systems, and a few other mechanisms. Other funds available from organizations mentioned in *Sources of Funding in LDC's* (above), cannot be smoothly filtered to the grass roots level unless special systems are developed for this purpose.

Private institutions whose objective is profit generation will have the most stringent rules and regulations for granting financing. The "borrower's" qualifications and venture will have to meet rigorous standards of financial soundness. Thus, private banks and other private financial institutions will only support this type of effort when the borrower clearly qualifies from a purely financial point of view.

It is most likely that the development of small hydro through private financial institutions will only occur in the following cases:

1. the borrower is a private entrepreneur operating in a rural setting. His credit and project design must be economically viable;
2. new ventures where key personnel (ownership and management) have already established credit-worthiness;
3. co-financing to develop a larger project where, most likely, the national government will be the guarantor; and,
4. well-established cooperatives who decide to provide electricity to members of their system and resort to their own funds as partial payment for the project.

### Public Institutions

Public institutions, in a way which is not dissimilar to that of development institutions, provide financing for activities that are deemed useful for larger segments of society and which tend to have a good measure of success. Unlike private institutions, public organizations do not always adhere to rigid economic criteria and efficient payback. Frequently, the objective of public funding is geared not only to direct venture results, but to indirect socio-economic consequences. Thus, it often occurs that project funding, besides using economic criteria, is determined by the analysis of impact on a region. In this way, pure economic analysis does not lose intrinsic importance, but becomes less than the exclusive criteria for funding.

Basic requirements for possible funding of small-scale hydroelectric projects by different types of institutions was presented in *Loan Security* (pp. 164, 172). That section dealt with a combination of requirements and guarantees to secure financing of technology. The next section presents a list of major financial institutions by region (Asia, Africa, Latin America, and the Middle East) that can respond to needs to fund development and use of small-scale hydroelectric projects.

### National, Regional and International Financial Institutions

This section provides a list of major financial institutions dealing with development in rural areas of Asia, Africa, Latin America, and the Middle East.

#### Agricultural/financial and other rural institutions

##### Africa

(Ethiopia) – Chilalo Agricultural Development Unit

(Ghana) – Agricultural Development Bank  
 (Kenya) – Guaranteed Minimum Return (program)  
 (Kenya) – Agricultural Finance Corporation  
 (Morocco) – Societe de Credit Agricole et de Prevoyance  
 (Morocco) – Caisse Nationale de Credit Agricole  
 (Morocco) – Caisse Locale de Credit Agricole  
 (Nigeria) – West Region Finance Corporation  
 (Nigeria) – Fund for Agricultural and Industrial Development  
 (Sudan) – Agricultural Bank of Sudan  
 (Tunisia) – Banque Nationale de Tunisie  
 (Uganda) – Cooperative Credit System

##### Asia

(Afghanistan) – Agricultural Development Bank of Afghanistan  
 (Bangladesh) – Agricultural Development Bank of Bangladesh  
 (Bangladesh) – Agricultural Development Bank  
 (Bangladesh) – Bangladesh Krishi Bank  
 (Bangladesh) – Cooperative Credit System  
 Bangladesh) – Kotwali Thana Central Cooperative (association)  
 (India) – Primary Cooperative Credit Societies  
 (India) – Primary Land Development Bank  
 (Indonesia) – Acronym for “Bimbingan Missal” meaning “Mass Guidance”  
 (Iran) – Agricultural Cooperative Bank of Iran  
 (Iran) – Agricultural Development Fund of Iran  
 (Jordan) – Agricultural Credit Corporation  
 (Lebanon) – Lebanese Credit Bank for Agricultural and Industrial Development  
 (Thailand) – Bank for Agriculture and Agricultural Cooperatives  
 (Turkey) – Supervised Credit Program  
 (Republic of Korea) – National Agricultural Cooperative Federation  
 (Turkey) – Turkish Republican Agricultural Bank

### Policies and Loan Criteria for Project Financing in LDC's

Policies with regard to the three identified sets of participants in the development and use of small scale hydroelectric systems must be considered, *i.e.*, policies and loan criteria with regard to supply, demand and intermediary institutions require analysis. Supply must be looked at under three possible circumstances – export/import, domestic manufacture/supply in LDC's, and joint venture. Most industrialized countries that manufacture small-scale hydro will be willing to export. There are for this purpose private banking facilities such as export financing and insurance systems; also, in riskier cases, financing and insurance is possible through agencies such as the Import/Export Bank (Eximbank).

Similarly, in the case of joint ventures that require U.S. capital investment for manufacture overseas, the Overseas Private Investment Corporation (OPIC) insure overseas risks of U.S. funds overseas.

Although present U.S. policies with regard to investment are channeling more resources toward domestic activities, it is most likely that there will

remain considerable levels of private funding and banking credit for joint ventures and (whenever possible) direct investments overseas.

LDC private and public institutions will have to see the potential use of small-scale hydro in terms of their resources, cost/benefit (on the domestic and international level), and finally in terms of its general impact. Economic criteria may not be the only way of determining small-scale hydro; however, it will remain a central issue that requires investigation in terms of direct and indirect effects.

LDC policies in general will tend to develop industry and small-scale hydro will not be an exception. Whenever possible, manufacturing facilities for these systems will be developed and will most likely have the support, guarantee, and assistance from national government agencies and financial agencies of regional integration schemes. Financial intermediaries will normally be willing to do business with suppliers and manufacturers of small-scale hydro. Their role will be most significant in hardware export or manufacture. However, financing requirements are very different for those two cases.

LDC import financing for small units will require arrangements with corresponding banks and normally insurance. Private banks are normally ready to respond to this type of need. If the risks are somewhat above their parameters, agencies such as (Eximbank can both finance and insure merchandise. Long-term financing is more difficult. It often requires co-financing. Co-financing is an arrangement with the participation of more than one lender taking the risks. Provided the borrower(s) financial strength and reputation are adequate, private banks can grant unsecured loans. This type of financing can occur within the private business community.

Secured loans are those where the borrower's credit-worthiness is not on par with requirements of the banking (financing) institution. Financing in this case would have to be secured; this often requires possession of or title to real estate or other valuable items.

Finally, guarantees provided by national or regional governments on financing administered by development, rather than private, enterprises are not uncommon. Financing in this kind of situation can result from the identification of a project by a government agency or a local institution with political influence. International finance organizations, either development ones such as the world Bank, IDB, African Development Bank, *etc.* can be approached with this project. It is then for the government to act as intermediary and guarantor for financing.

### Development Priorities

Limited capital resources throughout LDC's make it difficult to aggressively undertake private and/or development enterprises.

Generally speaking, production of foodstuffs and energy are on a higher order of priority in most countries. Forecasts on food shortages have alarmed nations in recent years; and, shortages in supply and significant increases in the price of petroleum have motivated nations to find substitutes for petroleum-fired systems.

Still, despite serious needs in those areas, non-oil exporting LDC's have limited budgets (including international credit). Most LDC's seem to be considering small hydro systems to generate electricity under the following circumstances:

- when cost/benefit analysis shows that retrofit of hydrocarbon-fired systems by small hydro is effective;
- when abundance of water resources and demand forecast for a given area coincide with development plans of a central government;
- when rural populations are motivated by hydroelectric energy specialists as to the benefits of implementing projects;
- when central electric utility companies show interest in small-scale hydro and undertake the tasks of developing expertise in the use of this technology; and,
- when private enterprises see the benefit and possible business expansion through the production of their own electricity.

### Recommendations

Previous work experience has shown that using electric systems for forward linkages is, by itself, only seldom successful for the establishment of new industrial activity in rural areas of LDC's. Additional to the difficulty in producing desired economic impacts, the establishment of electric energy infrastructure is a costly process. Consequently, electricity projects should further insure success at the productive end, *i.e.*, availability of electric power should help improve the level of economic output and raise total and net revenues for impacted areas.

Electric energy systems often fail as an incentive to mobilize local resources because they are not normally connected with support mechanisms geared to implant industrial dynamics in the areas where they are introduced. Thus, much of the purpose of developing electric energy is wasted, *i.e.*, actual development is not induced in sufficient dimension by the mere

availability of electricity in rural areas.

The case here established is even more significant when the considerations and analysis pertain not to extension of the central electric grid to rural areas where costs are marginal costs for the central electric company and average price of electric units (kWh) can remain relatively low, but to isolated independent systems where total costs must be observed as direct and exclusive components of an independent project. In this type of situation, the electric system must be looked at not only in terms of engineering possibilities and costs per kilowatt installed, but also, and not less significantly, in terms of the recipient population's socio-economic mix and their potential for making productive use of this energy by increasing local economic output, augmenting local revenue through industrial processing and consequently gaining from "value added." Finally, in an overall manner, the existing mix of production factors must be reconsidered and linked to the appropriate technology. This study requires:

- study of existing economic production;
- determination of which agro and other rural industries are likely to benefit from the use of electricity;
- microeconomic and benefit/cost analysis of potentially successful industries;
- design of production and distribution rearrangement model to use economies of scale; and,
- determination of rural institutions and private enterprises apt to interrelate electric energy to productive uses.

The introduction of energy as well as other technologies to any given environment constitutes a modification of the status quo. This modification can result in changes in a combination of demographic, psychological, economic, social, potential, and other factors, depending on the specific case. The impact of this modification varies according to the qualities and quantity of production capability of the technology as well as the socio-economic characteristics of the target population(s).

The potential range of effects resulting from combining technology and development is extremely wide and the objective of development schemes must be to optimize that relationship, thus maximizing benefits

for target populations and minimizing risk on investment for funding institutions.

Electric energy technologies, unlike other technologies, are normally designed to serve populations with a variety of needs. It is the exception when this technology is designed and built for use of a particular and unique objective. Normally an electric plant aims at serving a gamut of activities, *i.e.*, industry, commerce, health, education, etc. However, these uses do not all automatically occur.

Experience shows that it is the exception in developing nations when a forward linkage actually occurs, *i.e.*, electricity infrastructure is not by itself a motivating factor for people to react by mobilizing factors of production and developing schemes to improve the level of material output.\* The end result of the introduction of electricity most often is illumination of streets and households and upgrading of public services, with little or no increase in production or productivity levels among the recipient population.

Clearly, the use of energy technologies for development does not always produce expected results. The frequency of this occurrence results from the treatment of technology not as a component of a balanced development scheme, but rather as an independent factor where its use is assumed to automatically generate attitudes conducive to improving conditions and stimulate production. Extensive observation of conditions after electric energy services have been made available indicate that little, if any, successful forward linkages really occur in rural areas of LDC's.

Electric energy systems are already expensive and their prices and costs of operation will continue to increase, making it more difficult for central government organizations to afford them. Thus, it is realistic to assume that further development of electric energy projects in rural areas will have to include an analysis from below, *i.e.*, an analysis where major consideration is given to the beneficiary population, which, in some cases, will be required to co-fund or be partially responsible for the development of this kind of electricity system. Typical of this situation will be those cases where industrial uses are clearly identified and the implementation of a production increase scheme requires the use of energy.

---

\*Material output means production of products and processing of basic material resources into final products. Production is not meant except for very particular cases, as an increase in services, which often constitute sources of disguised un-employment and transfers of money, but normally do not provide the means for real, direct economic growth in a macro-economic sense.

## APPENDIX A

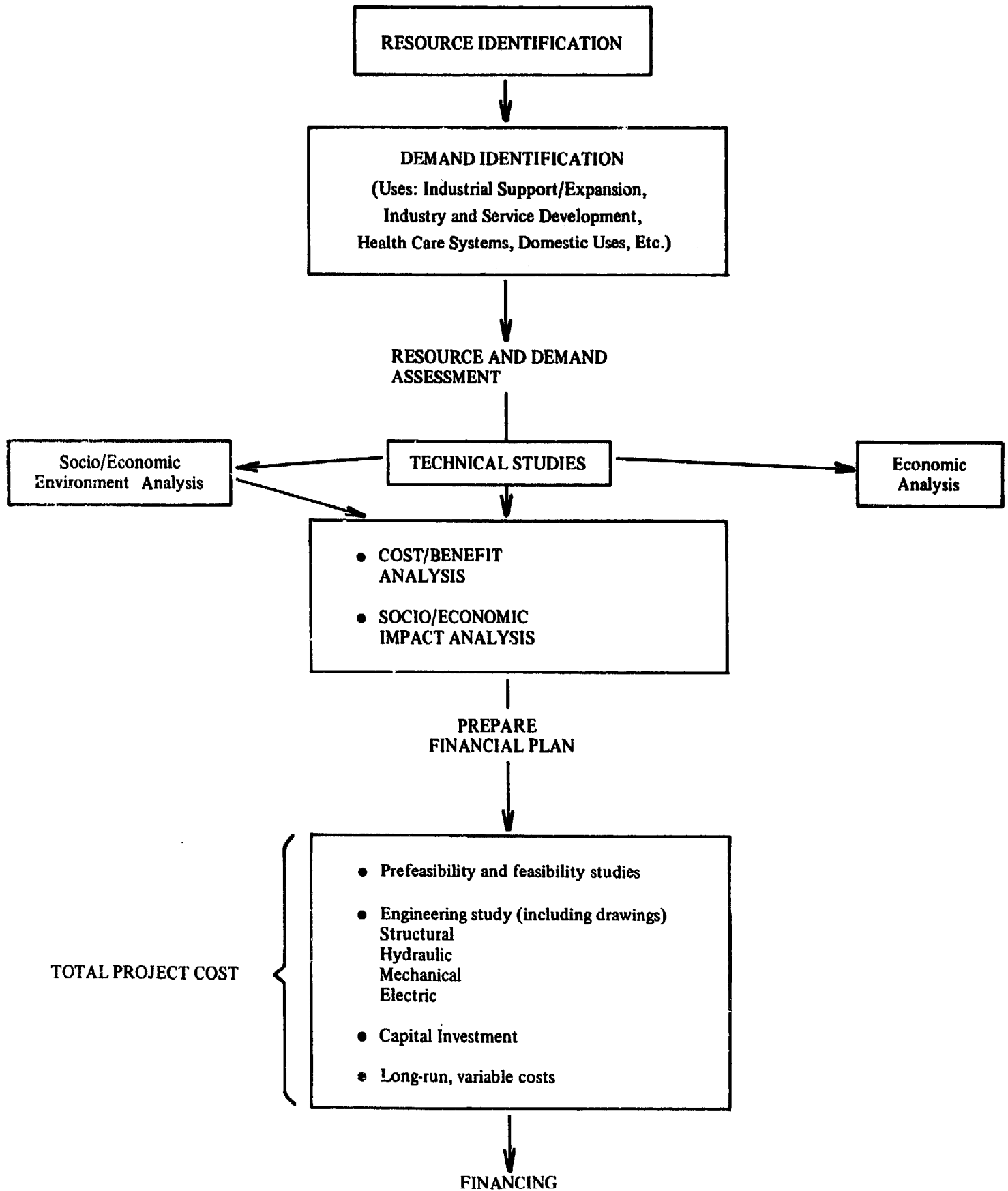

APPENDIX B

FINANCING  
BORROWER/FINANCE  
INSTITUTION COORDINATION

Borrower Qualifications  
By Type:

- Individual
- Firm
- Cooperative
- Central Energy Company

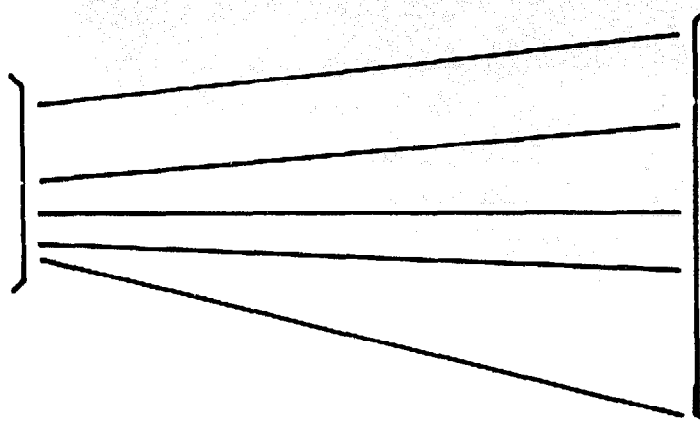

Financial Institution

Domestic Institution:

- Private Bank
- Other Private Fin. Institution (Private)
- Cooperatives
- Other Institutions
- Govt. Finance Sys. (Agri. Bank, Ind. Development) (Public)

- International Institutions
- Private & development

SELECTION

FUND AVAILABILITY DETERMINATION

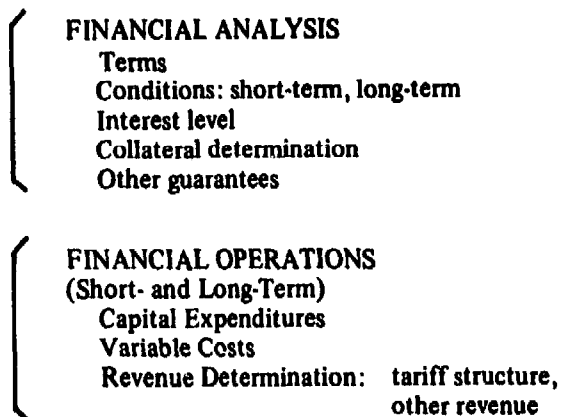

PREPARE DETAILED PLANS

PREPARE FLOW CHARTS

DETERMINE PROJECT PROFIT/LOSS

PROJECT FINANCING

APPROVE  
or  
DISAPPROVE

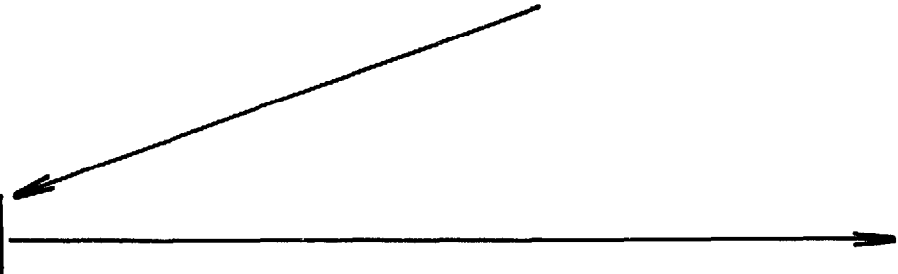



## APPENDIX C

**Financial Sources available to LDC's ("A")**

- IMF
- The World Bank family comprising: IBRD, IDA, and IFC
- Regional development banks, such as: Asian Development Bank, Inter-American Development Bank, European Development Banks.
- Governments and their agencies in developed countries: development agencies, such as USAID; banking and financial institutions geared to financing through bilateral agreements, such as KfW in West Germany; and, export credit agencies, such as: Eximbank in the U.S., Hermes in West Germany, Cofas in France, and ECGD in the UK.

Please note that numbers 1, 2 (excluding IFC), 3, 4a and 4b lend exclusively to governments and/or public sector institutions, whether they are owned by central or state governments.

**Sources available to National Governments**

National governments can obtain loans and credit from the institutions listed under 2, 3, and 4 of section "A", with the guarantee of their central government. Acquisition of direct loans from foreign sources is possible only under 4c.

**Sources available to Corporations**

Public, para-public and private development corporations generally borrow from IBRD and regional development banks with their governments' guarantees. They also borrow directly, or with a government guarantee, from the international money of these development finance companies is IFC, which participates in equity requirements of the project and provides long-term financing to the project.

**Institutions eligible for borrowing**

The institutions eligible for borrowing from the lending agencies described under "A" are:

- national governments, generally through their Ministry of Finance;
- public sector commercial companies covering agriculture, industry, the energy sector, and transportation;
- public sector non-commercial institutions such as education, health, infra-structure, rural development, etc;
- private sector commercial companies; and,
- development finance companies whether public, para-public, or private.

The above institutions are not all eligible for borrowing from all the lending agencies described under "A". This brief study has been limited to describing IMF, IBRD, IDA, and IFC's criteria for lending.

**International Monetary Fund (IMF)**

The main function of the IMF is lending financial assistance to member countries who have a balance of payments problem. The financial assistance discussion is usually conducted between the IMF and its member country's treasury, central bank, stabilization fund, or other similar fiscal agencies, and entails an economic and financial program that is designed to overcome the difficulty. The IMF's financial supervisory regulatory function relates to the balance of payments.

The fundamental and distinctive characteristics of the IMF's financial assistance is its doctrine of conditionality which includes:

- the member's preparedness to pursue policies set by the Fund, designed to overcome that country's balance of payments problems. The objective of the program is a balance of payments position that can be sustained over a medium term, such as five to eight years ahead. The conditionality of the Fund helps a member to achieve adjustment with the financial, technical, and moral support of the Fund;
- the policies must be consistent with the purpose of the Fund;
- the policies must be designed to overcome the members balance of payments problems within a moderate (temporary) period; and,
- the policies must be such as to increase the member's monetary resources, so that it will be able to repurchase its currency from the Fund in accordance with the principle that use of the Fund's resources must be temporary so that they can revolve for the benefit of all members.

Uniform treatment in applying conditionality is regulated to a certain degree by a body of principles and practices developed by the IMF. However, these articles do not define or regulate the kind or degree of conditionality that the Fund should apply.

**International Bank for Reconstruction and Development (IBRD) and International Development Association (IDA)**

The IBRD and IDA generally operate within the framework of a developed lending program which determines the amount for specific countries for the

forthcoming five years. Each project within the lending program is evaluated by IBRD/IDA, and if found economically feasible, the amount and conditions for the loan are then proposed to the respective Board of Directors for approval.

The main purpose of IBRD loans is to provide its member countries with additional funds, in order to augment investment and production in those countries. These countries are generally credit-worthy countries which are unable to obtain financing with reasonable terms from market resources. The IDA, on the other hand, has a slightly different objective, which is to aid low-income member countries that do not quite meet the terms for IBRD loans. However, IDA funds available to low income countries are rather limited and are generally granted to governments for specific needs.

The general criteria determining a country's eligibility for IBRD/IDA lending are:

A. The country's per capita income: At present, the upper limit for IDA loans is \$550 at 1976 prices. However, during the past few years, the majority of countries which have received IDA resources have had a per capita income of \$280 at 1976 prices. Although there is no ceiling limit for Bank loans, virtually all countries borrowing from the Bank have a per capita income below \$2,000. This is due to the belief that when a country's per capita income exceeds this level, its access to private capital at reasonable terms will improve, and thus its needs for IBRD loans will diminish. It should also be noted that the per capita income guidelines are generally revised from time to time, depending on the state of the world economy and the monetary fluctuations;

B. Country size: The size of the country (as reflected by its GNP, trade and population) is another factor affecting the World Bank's lending. The larger a country's population, economy and trade, the more capacity it has for effectively absorbing loans and credits towards improving its productivity.

C. Economic and social performance: The level of lending to a country is generally graduated and depends on that country's ability to use capital effectively and efficiently. Countries which have a record of poor performance could be denied loans, unless they are willing to take measures which would improve their performance and increase their absorptive capacity. However, it should be noted that in evaluating a country's performance, a distinction is made between controllable and uncontrollable factors determining a country's economic performance.

Finally, due to the increasing interest in a more fair distribution of income in developing countries,

the World Bank has been increasingly channelling its funds to projects and programs which directly benefit the lower income groups.

D. A country's need for external capital and the extent to which it can be obtained from non-bank sources at reasonable terms. Economic performance, trade, production and the availability of suitable projects for investment are all important factors in determining a country's need for external capital. In addition to the above factors, the level of a bank loan is also determined by the project investment opportunities and the balance between foreign exchange and local currency requirement of the project. Furthermore, the World Bank may also offer a member country further assistance, by coordinating assistance from other countries, or by co-financing a project with other lenders. In the latter case, co-financing may be in the form of joint-financing or parallel financing.

E. Absorptive capacity: The absorptive capacity of a country's economy is important, especially in view of its direct relationship to the availability of suitable projects in need of foreign financing.

F. Credit-worthiness: The final criteria in obtaining a loan is for the borrower to satisfy IBRD that it has sufficient prospects in meeting its debt service obligations promptly and in full, and that it will not default in its obligations to other lenders. The IBRD's appraisal of a country's credit worthiness is determined by the following:

- the outlook of its balance of payments development over the medium and long term;
- the level of existing and projected foreign debts, the country's potential for foreign exchange earnings, degrees of vulnerability to foreign exchange fluctuation in its earnings, and its import requirements; and,
- willingness to repay its debts, as indicated by the country's previous records in meeting its obligations, repeated rescheduling of external debts, or frequent delays in payment, warrants a country's approach to new lendings.

Very poor countries with lower negative national savings generally are not regarded as credit-worthy for IBRD loans. Most LDC's fall into this category and are usually aided by IDA.

In short, before lending to a country, the Bank tries to satisfy itself that the country in question is both capable and willing to meet its debt service obligations through the life of the loan. If a country is credit-worthy, the World Bank lends through its IBRD funds rather than its IDA funds. However, it is worth mentioning that, although IDA funds are lent to coun-

tries which are not considered sufficiently credit-worthy, they must nevertheless meet IDA criteria and present evidence that their lack of credit-worthiness is not due to poor performance.

Finally, there is another category of countries known as the "blend countries" which are those who are recognized as credit-worthy for a limited amount of borrowing from IBRD and who meet IDA lending criteria. In such cases a blend of lending may be achieved through the IBRD and IDA jointly financing the same project or by separate IBRD and IDA operations in the same country.

### **International Finance Corporation (IFC)**

The IFC is an affiliate to the World Bank and was established to promote growth in the private sector and to assist productive projects contributing to the economic development of its developing members.

The main objective of the IFC is to provide and bring together financing, technical assistance, and management needs and to develop productive investment opportunities in its member countries, regardless of whether they be private, mixed, or government enterprises. In addition, the IFC, as an international institution, may help facilitate the process by which investors and governments can arrive at mutually satisfactory agreements. The IFC is one of the few international organizations which can make both equity and loan investments.

In April, 1978, the IFC Board approved a five year program setting new operational priorities and objectives, which are as follows:

- broadening country coverage with emphasis on the least developed regions;
- setting country program objectives responsive to the development priorities and circumstances of its member countries;
- using IFC abilities as an intermediary in international investment flows; and,
- increasing non-project related policy assistance aimed at improving the environment for private enterprise and enhancing its contribution to economic and social development.

However, before entering into any agreement, the IFC must be satisfied that certain criteria exist. These criteria can be listed as:

A. The project is economically feasible, potentially profitable, and to the benefit of the host country.

B. IFC always co-finances the projects. This is in line with its policy of encouraging private sector development in conjunction with local interests. Since

IFC seeks to mobilize capital from other sources, it expects its own contributions to be less than 50% of the total investment. IFC's investment for its own account usually ranges between \$1-20 million; however, when financing is in the form of equity, IFC normally will not provide more than 25% of the share capital venture. It is worth mentioning that the IFC will not finance any project for which it believes there is sufficient private capital at reasonable terms available.

C. In investing in a project, the IFC will always seek the approval of the host country.

D. The IFC will only invest when appropriate arrangements for repatriation of its investment and earnings exist. The corporation does not require nor accept government guarantee for repayment.

E. The IFC loans are based on commercial terms, but are flexible with regard to the type or manner of financing. The IFC normally lends at fixed rates for periods ranging between seven to twelve years. A mortization is usually payable semi-annually or quarterly after the expiration of an agreed-upon grace period. A commitment fee at the rate of 1% per year is payable on the undisbursed portion of a loan. Interest rates vary according to circumstances of particular transactions. Most IFC investments consist of a share subscription or a long term loan (or both) or a long term loan with an equity feature.

F. IFC financing may be used for any legitimate business purpose related to the project. Thus, there are no limitations on how the loan is spent. The only requirement is that it has to be spent in one of the World Bank member countries or in Switzerland.

G. As a general rule, the IFC does not participate in the management of the firm; however, it does maintain an active surveillance over its investments and requires annual financial statements audited by independent public accountants.

H. The IFC is constantly revolving its funds by selling portions of its investment portfolio to other investors.

## **APPENDIX D**

### **METHODOLOGY FOR COMPLIANCE WITH ENGINEERING AND ECONOMIC CRITERIA FOR FINANCING**

Traditionally, small hydro systems were analyzed one by one, and, therefore, approval or declination of financing was also considered on a case-by-case basis.

With the idea of reducing costs, both in the area of management and analysis, a macro-regional or small-

scale hydro group approach is considered.

The process should go as follows

Financing manufacture, mainly through joint ventures as described in pp. 168-169, and 172-173 requires additional steps. Some of these steps are major tasks. They include detailed market analysis where not only project demand forecast is required, but above all, demand for specific technology requires careful consideration. Also essential in market analysis is demand segmentation, geographic position, competition, and

price determination. That kind of possibility should begin with accurate typological assessment of resources (considering potential system size, demand load, and various other characteristics), and finally establishing the entrepreneurship and dynamics in this field.

*Editor's Note: The references relating to the superscript numbers in this paper could not be obtained from the author.*

**Jorge R. Asin** presently manages the Rural Development Systems Division of International Economics Group, Inc., Washington, D.C. This division of I.E.G. specializes in providing consulting services to international development organizations where energy and other technologies constitute a meaningful component for the improvement of living conditions in developing countries.

Before joining I.E.G., Mr. Asin was associated with private organizations and worked as manager and senior associate in projects with the United States Agency for International Development, The Organization of American States, the U.S. Department of Energy, NASA, the United States Department of Labor, and other institutions. His next assignment in Latin America and Europe is sponsored by a division of the United Nations and the Inter-American Development Bank.

Mr. Asin has also worked with the Inter-American Press Association in areas connected with freedom of the press and international transfer of newspaper technology to Latin America.

He holds an M.A. and has worked toward a PhD at Georgetown University, Washington, D.C., specializing in the economics and social development of developing countries. He currently teaches Microeconomics and Marketing at the Benjamin Franklin University in Washington, D.C.

## Discussion

*Questioner from the Audience:* I have a question for Mr. Asin regarding the social acceptance of the technology, which I think is the main issue. In my opinion, the introduction of this new technology might be a liability if it is not socially acceptable. In the rural sectors of Asia, for example, people are very sensitive to traditional values. What do you think about this?

*Mr. Asin:* I agree with you. I think that social acceptance is, of course, a very important issue here. We have seen situations in which some technologies have not been accepted and were rejected socially. I don't think that is going to be the case with small hydroelectric systems. Electricity is a basic requirement for development, but we have to accept the fact that not everybody is familiar with it and with the benefits it provides. There has to be a process of education of world populations to demonstrate what electricity can do. In some cases, acceptability may not take place immediately. Perhaps you can comment on some case in which you think that this type of technology has not been accepted.

*Questioner from the Audience:* I am not referring

to this new technology. In Nepal, we have plans to introduce new heat ovens using cement to improve efficiency. These have not been accepted so easily. I'm referring to such cases.

*Mr. Asin:* Let me relate a case which is rather similar. I don't have documentation on this case, but heard about it through people working in North Africa, where solar cookers were introduced several years ago. The reaction of the population at large was not to use the solar cookers at all because cooking is done in the evening and, has not only the practical function of producing food, but is a social event as well. Solar cookers have to be used during the day, at noon, and having to cook at noon was just not accepted. They wanted to cook at night so that they could have the social function, in addition to the practical side of cooking. I don't think that will be the case in terms of having electric power.

*Mr. Hoesni Nasaruddin, Malaysia:* Mr. Asin, you commented that the main purpose of isolated microhydro is to maximize the use of electrical energy for productive purposes. From examples we have seen of rural electrification in Asian countries, the amount of electrical energy that goes to the home doesn't seem to tie up with production. I feel that whatever produc-

tion comes from the rural sector should be in terms of agricultural output, rather than utilization of electrical energy to introduce new forms of small industry. I would have thought the use of electrical energy would be for lighting, educational television, if it exists, or for radios aimed at encouraging increased agricultural output in rural sectors.

*Mr. Asin:* You have touched on two important areas. For instance, you can help educate through television, which I think would be desirable for the population at large, but there still must be something more economically concrete than that. Once you get into the financing of a project, you have to pay back on that project. If educational television can succeed in producing an economic effect, it will be a contribution. The electric infrastructure has to have an economic payback in the form of increased production. Having electricity and television in the home does not develop the means to pay back for the technology adopted. It is necessary to go further into the development of hydroelectric schemes to assure that there is a mechanism for fostering systems of production, or for fostering demand, which in turn will mean that the production of electricity itself must be increased.

*Dr. A.N.S. Kulasinghe, Sri Lanka:* I think we are talking about two levels of infrastructure. The lecturer probably thought of small hydro schemes at a different level. When he said a megawatt was small, I think he was speaking out of context. In most of our countries, especially in the rural areas, mini-hydro goes up to about one megawatt. The end-use of electricity is also different. A micro-hydro plant cannot support much industry except for something like agriculturally-based industries such as grinding and hulling rice. Generally, most of these mini- and micro-hydro plants supply little more than lighting for communities. In certain other areas, small industries can be supported. So, when you consider the viability of a small-hydro project like this, it is not possible to consider only industrial production as a form of pay-back; the social implications of lighting in rural homes must also be considered.

Another valuable aspect in certain areas is the replacement of imported oil for lighting. In Sri Lanka, this is important because, in most of the rural areas where the grid has not penetrated, kerosene oil is used for lighting. This is a tremendous drain on foreign exchange resources in the country. Production of electricity through mini- and micro-hydro plants has an immediate economic effect which can be quantified quite easily. I think this difference would have to be appreciated in testing the viability of a small hydro project. If you consider only the industrial return,

most will not be viable; but if you consider the socio-economic values attached to these small schemes, they will be viable without any industry-based end-uses. However, sponsoring small industries, which are practicable within those limits, would be very desirable.

*Mr. Asin:* The difference in context probably comes from the fact that I am generally thinking about economic development and see energy as a very necessary and meaningful component. As said in my presentation, it is almost an additional factor of production.

Electricity requires a substantial capital investment. LDC's do not have an abundance of resources. Therefore, how do they best use available resources, whether from private sources or from banking institutions? My point is that this type of technology, as well as any other technology, should be used primarily with the intention to increase production.

*Dr. Nguyen Duc Lien, Thailand:* I would like to add a comment to Mr. Kulasinghe's point. It depends on how we define micro-hydro. For example, the Thai in the opening session classified mini-hydro as up to six MW. To maximize the resources available, you must first look at the general demand characteristics of the area, whether they are for basic domestic consumption, social activities, or other needs. Social problems must be dealt with first. Then, you can look further at small-scale industrial activities such as saw mills, rice mills, mining, and so on. It depends on the particular situation. For example, is there a great deal of timber that can be processed? Are there mining activities underway? The demand in the different sectors must be surveyed to decide whether to develop a larger installation to meet these other demands.

I agree with the speaker that using greater power production for productive uses can help solve the financing problem. It is hard to finance a project that doesn't have an irrigation component or an industrial component. It also depends on the political situation. Perhaps you can get a grant from the government to develop the area. In general, as far as the economic and financing problems are concerned, we have to look to the government for the most part, whether it's for pumping irrigation, flood control, or for other sectors. You have to look at everything at once; otherwise, you are not going to maximize all the available resources.

*Mr. Asin:* I think you really completed the comment. As you said, it is necessary to look at the demand in terms of the best potential for the utilization of energy in the various sectors of the economy.

*Ms. Kaye Bowman, Australia:* I would like to float an idea about the difference between social and

productive uses. It seems to me that one feature worth considering quite carefully is that, in rural areas in a non-market situation, there is much overlap in the way economic, or productive, end-uses occur. They are more integrated into the whole social system. So, if a project is to pay for itself in monetary terms, productive end-uses must enter the picture. However, the main unit of value in rural areas is more likely to be time than money – the more time they have, the more productive they can be in producing food for their own use, which does not go through the market econo-

my at all. I just wanted to separate those two issues. In an urban context, the money economy is very important, but in a rural context, it's a bit different.

*Mr. Asin:* Yes, I think that's a very interesting point which can be demonstrated. I am not disregarding the tremendous utility of having more hours during the day for different functions, but the end result of electrification is not enough. The social side is important, but that by itself will not pay back the costs of the technology nor will it result in economic development.

# Economic Feasibility of Small Hydroelectric Projects in Asian Development

Mark Henwood\*

---

**ABSTRACT :** This paper discusses small hydroelectric development in the context of competing energy sources which are capable of delivering electrical energy. While hydroelectric generation has many attractive characteristics, such as proven, relatively simple technology, and a stable cost pattern over time, the objective in a rural development program is not to utilize hydropower *per se*, but rather to formulate productive and ultimately self-supporting development.

The paper considers the two basic types of hydro developments, the isolated system and the interconnected project. The fundamental differences in these two types of projects are discussed. The paper also considers the proper treatment of oil displacement in economic analysis.

The role of economic analysis as a useful analytical technique is discussed. Analysis is generally used to address two basic questions in rural electrification: (1) what is the lowest cost method of supplying electricity? and, (2) what is the lowest cost method economically justified?

In the process of examining how these questions are approached, the primary key to a successful isolated hydroelectric development is apparent. This is obtaining a high project load factor by carefully and realistically planning the productive uses to which electric energy can be put.

The paper concludes with some observations regarding development strategies for making practical use of a country's hydroelectric resources.

---

## Introduction

A primary reason for the renewed interest in small hydropower is the fundamental change in world energy use and economics signalled by the past eight years of rapidly escalating oil prices. In all sectors of energy consumption, from national governments and multinational corporations, to the smallest of enterprises, great emphasis is being placed on indigenous energy resources with stable cost patterns over time. The primary thrust is to obtain energy without the

relentless escalation expected in imported petroleum-based fuels, and to escape the consequential severe balance-of-payments problems. Renewable resources are frequently looked to as an energy source not subject to continual cost escalation, and by definition renewable resources are almost always domestic.

Of the renewable energy sources, falling water, or hydropower, is certainly one of the most promising technologies that is immediately available. Hydro-power projects do not suffer from continuous cost escalation and, in general, many projects are quite

---

\* Henwood Associates, Inc., Sacramento, California U.S.A.

economical when compared to alternatives. Regarding Asia, the technical requirements of hydroelectric projects are well suited to the local capabilities. Hydro projects use long-established technology and hydroelectric sites are available in many parts of Asia.

From an economic standpoint, it is important to view small hydroelectric projects as a means to an end: the delivery of electric energy for a variety of useful purposes. As such, small hydroelectric projects compete with other methods of supplying electricity.

In the case of expanding generation capacity of a large utility grid, hydropower is usually compared on the basis of life-cycle cost with thermal generation sources, such as petroleum, natural gas, coal, or nuclear central stations. Recently however, geothermal and biomass powered generation have become generation sources of competitive significance. Because the least cost expansion plan is highly specific to a country's resource availability of hydro and other sources, hydropower may not always be the economic choice for new generation.

In rural electrification fewer electric supply options are available and hydropower takes on a much greater role. Generally, the planner of a rural electrification program has the choice of extending the utility grid system, installation of isolated diesel generators, or construction of isolated small hydroelectric plants. In grid extensions, transmission line construction costs are of paramount importance in the short term. However, it should not be overlooked that grid extensions do not eliminate the ultimate need to establish generation resources to supply the new load. Diesel generation is a practical means of rural electrification with relatively low capital cost, but suffering from high cost fuel with a large potential for future cost escalation and supply problems. Hydropower, where water resources are available of suitable hydrological characteristics and location, is generally high capital cost but has very low future cost escalation potential.

The rural electrification planner should view these three methods as tools to achieve the goal of electrification. As is discussed later in this paper, these three methods of delivering electricity may all be parts of electrifying an area in a staged and coordinated fashion.

### **Two Basic Types of Hydro Development (from a Demand Perspective)**

From an engineering standpoint hydroelectric projects are generally classified according to hydrologic considerations, such as the presence of storage or pondage, or as run-of-the river projects. However,

from the point of view of economic analysis, a different distinction is appropriate based on the load characteristics the project will serve. The two basic project types from this viewpoint are interconnected projects and isolated projects.

When a hydroelectric project is interconnected with a grid its operation pattern is governed by the economics of the various generating sources in the grid. In general, a procedure called economic dispatch is employed which results in using generation sources with the lowest incremental cost first and progressively adding more expensive incremental cost sources as load increases. Since hydropower has essentially zero incremental cost, utility systems normally use all available hydroelectric power. Consequently, the economics of an interconnected project are based on (1) project construction cost and (2) the productive capability of the project based on its hydrology.

The isolated hydroelectric project serves the demand placed on it by the area of distribution. Experience has shown that rural demand does not generally allow a hydroelectric unit to produce up to its production capability more than a few hours a day. Consequently, the economics of an isolated project are primarily controlled by (1) its cost and (2) the rural demand pattern.

This difference in the demand characteristics of the isolated and interconnected project can have an enormous impact on the project's economics. By way of illustration, consider a hydro project whose hydrology is such as to allow the project to have an annual plant factor of 75%. If the project is interconnected it would operate at its capability and would achieve the 75% plant factor. This same project if run as an isolated system would only serve local demand. Experience in many parts of the world shows that a typical plant factor in this situation would be around 25%, or one third of the interconnected output. This translates into a unit cost for electricity from the same project being three times higher when isolated *vis-a-vis* interconnected.

The implications for planning isolated systems are very clear. While the impact of careful planning on capital costs might be as much as 20% or 30% change in costing, the impact of careful planning on the demand side can realistically result in a 100% reduction in unit costs. It cannot be stressed too much that load planning is the key to truly productive and economic isolated hydroelectric projects.

### **Economics of Oil Displacement**

In Asia and Oceania much of current electric



generation is from petroleum sources, either isolated diesel units or thermal plants in a grid. For small hydro projects that can displace oil (or other exportable petroleum products), either current or prospective oil use, project benefits are, at minimum, the value of oil displaced. The proper value to use is the international oil price and it is entirely appropriate to consider escalation in this value so long as inflation is treated in a consistent fashion on the cost and benefit side. There is a consensus that *in the long run* oil will escalate at a rate somewhat greater than general inflation. Frequently 2% is used.

Sometimes the fact that displacing oil results in a national benefit equal to world oil prices is obscured by internal policies of providing oil at subsidized rates. This is more typical in net oil exporters who, without an apparent drain on the treasury, can price oil internally below the world market. Even so, displacing oil consumption internally results in more exports at world prices. The national benefit is clear even though the internal cash flows will no doubt be different.

### The Role of Economic Analysis

Two basic questions economic analysis attempts to answer when trying to deliver kilowatt-hours are:

1. what is the lowest cost method?; and,
2. is the lowest cost method economically attractive?

The first question is reasonably amenable to solution by standard techniques. The second question is frequently harder to answer, particularly for isolated projects, because of the dual problems of estimating usage and establishing the value of usage.

### Life Cycle Cost Analysis

There are many ways of analyzing economic problems but all methods share the common usage of present value concepts. Regarding the question of lowest cost alternatives one reasonably simple method of analysis is presented below. Equation (1) is utilized to calculate the total life cycle cost of a generating source, *accounting for changing production* as time passes. This is necessary to account for the typical build-up of local demand or for prospective interconnection with a grid.

Life Cycle Cost =

$$TLCC = CC + \sum_{t=1}^L \frac{(OM_t + VC_t \times P_t)}{(1+r)^t} \quad \text{Eq. (1)}$$

where:  $TLCC$  = total life cycle cost (\$),  
 $L$  = useful life of project (years)  
 $CC$  = completed capital cost (\$),  
 $OM_t$  = annual operation and maintenance cost in year  $t$  (\$),  
 $VC_t$  = variable per unit production cost, primarily fuel, in unit  $t$  (\$/kWh)  
 $P_t$  = production in year  $t$  (kWh)  
 $r$  = the discount rate

In estimating the quantities used in life-cycle calculations the effects of escalation and inflation must be accounted for. Associated with future costs is a real escalation rate, an apparent escalation rate and a discount rate. The *real escalation rate* is the annual rate of increase in a cost and is independent of, and in addition to, inflation. Real escalation results from a resource depletion, increased demand with limited supply, etc. The *apparent escalation rate* is the total annual rate of increase in a cost. Included in the apparent escalation rate are the effects of inflation and real escalation. The apparent escalation rate is described by the following equation:

$$(1+e) = (1+e_r) \times (1+i) \quad \text{Eq. (2)}$$

where:  $e$  = the apparent escalation rate  
 $e_r$  = the real escalation rate  
 $i$  = the inflation rate

The *discount rate* is the annual rate used to take into account the opportunity cost of capital. This is frequently the weighted cost of capital for private enterprise analysis. This rate and the effects of inflation are used when moving dollar amounts either forward or backward through time to a single point in time for comparison.

In general:

$$(1+r) = (1+x) \times (1+i)$$

where:  $r$  = discount rate (opportunity cost of capital in the presence of inflation)  
 $x$  = opportunity cost of capital in the absence of inflation  
 $i$  = inflation rate

An assumption of 10% opportunity cost of capital in the environment of a 6% inflation implies a 3.8% ( $1.10/1.06 = 1.038$ ) cost of capital in the absence of inflation.

It is recommended that inflation be considered in long-range planning studies for probably a more ac

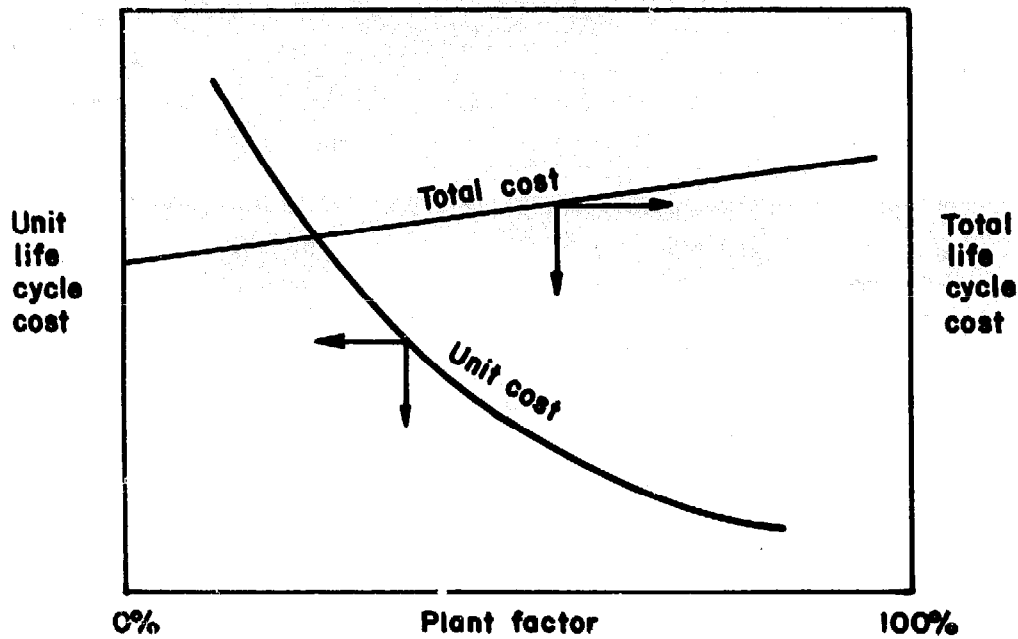

Fig. 1 Presentation of total and unit life cycle cost analysis results

curate portrayal of future conditions. However, if a study is made where inflation is neglected in future costs, inflation must also be neglected in the discount rate.

If it is desired to calculate life cycle cost on a per unit basis, this can be accomplished as follows:

$$ULCC = \frac{TLCC}{\sum_{t=1}^L P_t / (1+r)^t} \quad \text{Eq. (3)}$$

where: *ULCC* = per unit life cycle cost, (\$/kWh) other quantities as in Eq. (1).

It may also be desirable to represent life cycle costs as a function of plant factor. If the plant factor is assumed constant over the life of the project, this would simply require calculating the life cycle costs for various plant factors and plotting them *versus* plant factors. Figure 1 illustrates how results of this type of calculation would be portrayed.

If the analysis were used to examine whether a diesel unit or a hydro unit should be installed, the results might be portrayed as in Figure 2.

Even if the annual plant factor is not constant, the results of constant plant factor calculations can be used. This is possible by calculating the "levelized" plant factor which, for economic comparison, is directly comparable to the constant plant factor calculations. This is performed as follows:

$$LPF = CRF \times \sum_{t=1}^L \frac{APF_t}{(1+r)^t} \quad \text{Eq. (4)}$$

where: *LPF* = levelized plant factor %  
*CRF* = capital recovery factor for *L* years and *r* discount rate  
*APF<sub>t</sub>* = annual plant factor in year *t*  
*r* = discount rate

Example:

Data assumptions:

Discount rate	10%
Useful life	20 yrs.
Plant factor	
years 1-5	20% (isolated)
years 6-20	80% (interconnected)

Letting *PWF* = present worth of an annuity, Equation (4) can be calculated for the data in a slightly different fashion as:

$$\begin{aligned} LPF &= CRF_{20} * [20 * PWF_5 + (PWF_{20} - PWF_5)] \\ &= .117 * [20 * 3.79 + 80 (8.51 - 3.79)] \\ &= 53\% \end{aligned}$$

As the results of the example show, a project which operates at a 20% plant factor for 5 years during isolated operation, and at 80% plant factor for 15 years after interconnection, has the economic characteristics of a plant operating at a constant 53% plant factor. Referring to Figure 2, accounting for future

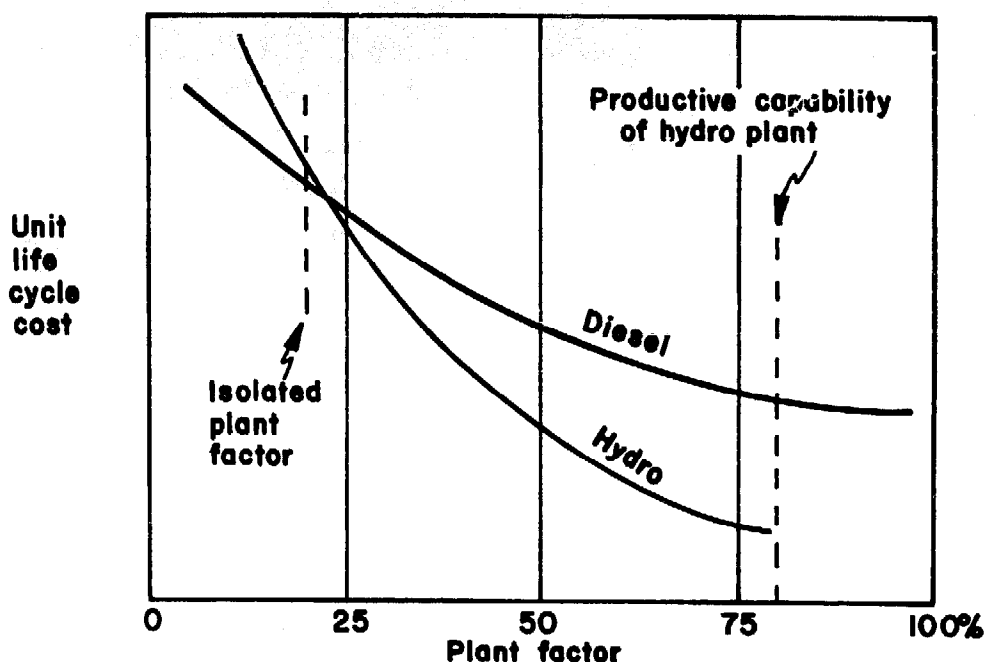

Fig. 2 Illustrative results of a diesel versus hydro analysis

interconnection would change the decision in the least cost option of an initially isolated project.

### Benefit Cost Analysis

Equations (1) through (4) are one analytical procedure for exploring which of several alternatives are the lowest cost. To establish whether the lowest cost method is economically attractive, benefit cost analysis is usually employed. In benefit cost analysis, the present value of project benefits are compared to the present value of project costs as the ratio in the following equation:

$$BC \text{ ratio} = \frac{\sum_{t=1}^L B_t / (1+r)^t}{CC + \sum_{t=1}^L C_t / (1+r)^t} \quad \text{Eq. (5)}$$

where:

- $B_t$  = benefits in year  $t$
- $CC$  = capital cost
- $C_t$  = costs in year  $t$
- $L$  = useful life
- $r$  = discount rate

If the ratio is greater than 1, the benefits exceed costs, and the development is judged economically viable. It should be noted, however, that financial liquidity and risk questions are not addressed directly by the type of analysis and may render a project infeasible even though it appears economic.

The relative simplicity of life cycle and benefit cost calculation should not disguise the true difficulty in obtaining meaningful results. The most difficult part of any economic analysis is the accurate estimating of all the parameters. In particular, the economic benefits of power usage are the most difficult value to establish, followed by determining the amount of usage of power in isolated situations.

### Project Benefits

The economic benefits of constructing a small hydroelectric project can stem from numerous sources and encompass both direct monetary benefits and non-monetary benefits. Examples of the types of benefits include many areas, some of which are discussed below.

Projects which *reduce costs* have cost reduction as a clear benefit. The cost being reduced can be an existing cost, such as kerosene for lighting and cooking, or a contemplated cost such as the fuel usage in a planned irrigation pump powered by a diesel engine. These types of benefits are sometimes referred to in demand studies as existing or diverted demands, the value of which can be counted as project benefits.

Projects which *produce revenue* have the funds generated by power sales as benefits. When an established utility system is expanding and projects are being added to meet load growth, project benefits can be established under existing rate schedules. Note that in many cases, this problem is treated as one of simply choosing the cheapest method of meeting load growth

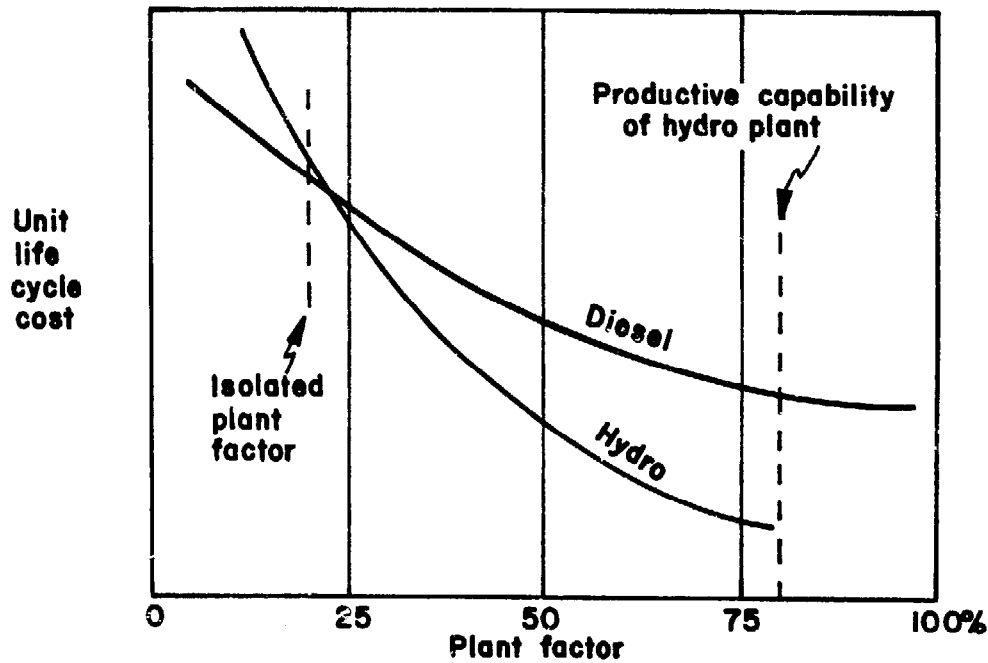

Fig. 2 Illustrative results of a diesel versus hydro analysis

interconnection would change the decision in the least cost option of an initially isolated project.

### Benefit Cost Analysis

Equations (1) through (4) are one analytical procedure for exploring which of several alternatives are the lowest cost. To establish whether the lowest cost method is economically attractive, benefit cost analysis is usually employed. In benefit cost analysis, the present value of project benefits are compared to the present value of project costs as the ratio in the following equation:

$$BC \text{ ratio} = \frac{\sum_{t=1}^L B_t / (1+r)^t}{CC + \sum_{t=1}^L C_t / (1+r)^t} \quad \text{Eq. (5)}$$

where:

- $B_t$  = benefits in year  $t$
- $CC$  = capital cost
- $C_t$  = costs in year  $t$
- $L$  = useful life
- $r$  = discount rate

If the ratio is greater than 1, the benefits exceed costs, and the development is judged economically viable. It should be noted, however, that financial liquidity and risk questions are not addressed directly by the type of analysis and may render a project infeasible even though it appears economic.

The relative simplicity of life cycle and benefit cost calculation should not disguise the true difficulty in obtaining meaningful results. The most difficult part of any economic analysis is the accurate estimating of all the parameters. In particular, the economic benefits of power usage are the most difficult value to establish, followed by determining the amount of usage of power in isolated situations.

### Project Benefits

The economic benefits of constructing a small hydroelectric project can stem from numerous sources and encompass both direct monetary benefits and non-monetary benefits. Examples of the types of benefits include many areas, some of which are discussed below.

Projects which *reduce costs* have cost reduction as a clear benefit. The cost being reduced can be an existing cost, such as kerosene for lighting and cooking, or a contemplated cost such as the fuel usage in a planned irrigation pump powered by a diesel engine. These types of benefits are sometimes referred to in demand studies as existing or diverted demands, the value of which can be counted as project benefits.

Projects which *produce revenue* have the funds generated by power sales as benefits. When an established utility system is expanding and projects are being added to meet load growth, project benefits can be established under existing rate schedules. Note that in many cases, this problem is treated as one of simply choosing the cheapest method of meeting load growth

without explicitly considering a project's economic desirability.

The problem of estimating project benefits for a decentralized small hydro project meeting a new load is considerably more complicated. Frequently, the benefits of introducing a new electricity supply is approached based on the willingness of purchasers to pay for the power. The willingness to pay may be estimated on the alternate costs of accomplishing the function electricity will perform, the increased productivity from introducing electric machinery, or the increases in the quality of life due to lighting, refrigerated food storage, etc. Typically, these types of benefit estimates are the subject of specific studies. These studies explore satisfying existing but unserved demands, diverting demand from other energy sources, and generating new demands.

Benefits can also result in an *indirect fashion*. For example, if a hydro project allows the replacement of wood as a cooking fuel, direct benefits are the cost of obtaining wood. In the case of some Asian countries, very significant indirect benefits might accrue by reducing the depletion of commercial forests and by reducing erosion resulting from indiscriminate cutting (which also affects agricultural yields).

A pattern of project benefits over time is needed for the project economic analysis. The estimate may be a simple initial value with a constant escalation or it may reflect a growing stream of benefits due to increased usage of a project's output as the load increases. If inflation is explicitly included in the analysis, care must be taken to account for the monetary value in the year in which the benefits are stated.

In terms of making the best economic decisions, benefit estimating is as important as cost estimating. Consequently, sufficient effort should be spent on benefit estimating so the *accuracy* of benefit and cost estimates is comparable. Doing so will also result in a good understanding of the value of the project's output and will ultimately result in the formulation of better projects.

### Development Strategy

Because of the basic difference in economics of interconnected versus isolated projects, it may be desirable to structure small hydroelectric programs in two parts. One program would concentrate on constructing projects for immediate interconnection to a grid. If the projects have reasonably high plant factors (in excess of 50%) and oil displacement in the grid is possible, the program should be both financially and economically sound. Such a program should be able to at-

tract financing from conventional international sources and can be operated as a self-supporting development.

The other program would be centered around infrastructure types of developments in isolation from the national grid. For these projects every effort should be made to formulate projects which are as close to self-liquidating as possible. The primary method of doing so would be to establish projects where residential loads, typically morning and evening, are complemented by some type of commercial day-time load.

Along with isolated project planning there should be close coordination with transmission system planning. The purpose of coordination would be to establish where and when grid extensions could take place in areas with potential for multiple isolated developments. Effective coordination could allow multiple interconnections which would result in reducing per unit costs of interconnection as well as providing the grid with some very low cost energy.

As a final observation, in some instances it may be desirable to use diesel generation on a temporary pilot basis prior to construction of a hydro resource. This might allow planners to prove up sufficient load in an area to justify the hydro project. It might also be a low capital cost method of providing needed energy while awaiting grid extensions, more favourable financial climates, or the results of multi-year hydrological studies of hydro development. Also, it is technically quite feasible to operate these same diesel units interconnected with an isolated project to serve peak demands. Consequently, the unit's value would not necessarily be lost after displacement by a hydro plant.

### References

- Asian Development Bank, *Annual Report*, 1980.
- Electric Power Research Institute, *Technical Assessment Guide*, (PS-1201-SR), Palo Alto, California, 1979.
- Electroperu, *El Programa de Pequeños y Medianos Centrales Hidro electricas en El Peru*, April, 1979
- National Rural Electric Cooperative Association (USA), *Small Hydroelectric Powerplants, an Information Exchange on Problems, Methodologies, and Development*, Conference Proceedings from Quito, Ecuador, August 19-21, 1980.
- Rural Electrification, A World Bank Paper*, World Bank, 1975.
- TURVEY, A. and D. ANDERSON, *Electricity Economics, Essays and Case Studies*, World Bank, 1977.
- U.S. Army Corps of Engineers, *Feasibility Studies for Small-Scale Hydropower Additions, A Guide Manual*, July 1979.

**Mark Henwood** has been involved in energy-related areas since 1971. Specifically relating to hydroelectric development, he was formerly employed by Development and Resources Corporation, an international consulting engineering firm, as an associate engineer. His responsibilities included hydroelectric project operations studies as well as project economic and financial analysis. Mr. Henwood also gained substantial experience while employed as Director of Energy Projects for Auslam and Associates, Inc., an economic consulting company. In this capacity Mr. Henwood directed the technical activities of numerous projects concerning the evaluation of energy resources. Many of these projects involved computerized techniques for evaluating hydroelectric developments in large interconnected electric systems.

His firm, Henwood Associates, provides consulting services to the hydroelectric industry and is the owner, developer, and constructor of four small hydroelectric projects in California. Two projects are scheduled to be in service in 1981. The first project is the reactivation of a 300 kW plant which was the sole source of power for a lumber town. Mr. Henwood's responsibilities have included the contractual, marketing, and financial aspects of corporate developments, as well as primary responsibility for consulting services. In this capacity, Mr. Henwood has gained wide experience in all aspects of hydroelectric development. He holds Bachelor of Science and Master of Science degrees in electrical engineering from the University of California, Davis, and is a member of the International Association of Energy Economics, and the Institute of Electrical and Electronics Engineers, Power Systems Group.

## Discussion

*Questioner from the Audience:* Mr. Henwood, you talked about productivity. What do you mean by productivity and how do you measure it if the product is software?

*Mr. Henwood:* When I refer to the productive capability of a plant, I mean the ability of the hydro plant to produce energy based on the amount of available water in a year compared to what it theoretically would be able to produce. When the hydro project is integrated with an electric grid, the plant is allowed to produce all the energy that the available water enables it to, and consequently the effective unit cost of that production is substantially lower, typically, than it is in isolation.

*Mr. Nurul Huda, Bangladesh:* In comparing diesel and hydro plant life cycles, what are the life periods you considered in drawing this conclusion? I was confused by your graphs, if I understood them correctly, which showed that the hydro unit has a shorter life than the diesel. Yet, generally, we know that the life of a diesel plant is comparatively short unless you replace the whole system. Could you explain this further?

*Mr. Henwood:* The graph, showing the plant factors that the two different kinds of generation sources might experience versus the unit cost, was intended to compare the actual useful lives of the two units. I think you are correct that a diesel plant cannot be expected to function for as many years as a hydro plant. However, the diesel plant, if need be, can be run 24 hours each day, whereas the hydro plant may not be able to function all day, or at its full capacity for that time, simply because the water is not always available.

The graph had more to do with water availability than the useful life of the two projects.

*Dr. Roger Arndt, U.S.:* My question is for both Mr. Asin and Mr. Henwood. It was made very clear that the plant factor has to be very high for a small electric plant to be economical, but it seems to me that, in planning rural electrification of a small area, it almost has to be a two-step process, since the market for the electricity doesn't even exist when you go in to do this. I think you almost need a "planned obsolescence" in the sense that you would first go in with a very small plant and get people used to electricity, and then have a long-range plan that allows you to expand the size of the plant. It is different from what you would do in the U.S., where typically you would optimize the total productivity of a given site initially. In this region, we are talking about a completely different type of planning process.

*Mr. Henwood:* You bring up an excellent point. I think it was typical, even in the U.S., to plan a very large hydro project in this fashion. I know of a number of instances in the northwestern U.S. where the hydro resources were very large, compared to the amount of demand present, and the pattern of development was to establish the civil works suitable for the ultimate development of the project, and yet only install one mini-hydro turbine. The point, of course, is to keep down your capital investment at first and only apply capital to the project as the demand increases.

As an interesting strategy, it might be possible to use the small diesel generators in such a fashion, as you suggest, to see what the social acceptance is — to find out whether there will be demand for more than just lighting. Then, based upon the experience of

the diesel generators, you could simultaneously be collecting hydrologic data to establish the viability of the hydro site. As a second stage, you could replace that diesel generator with the hydro plant, and of course, that diesel generator would still be suitable for relocation to another site for a similar type of use.

*Mr. S.T.S. Mahmood, Bangladesh:* In this question of financial feasibility, look at it this way: here is a river site created by God who probably never did any physical feasibility study (laughter). We are going to utilize this for the benefit of mankind, and yet here we are thinking of feasibility studies, and so on. It appears to me that the whole mini-hydro concept is a social welfare project where everybody can join in the costs and benefits, particularly in the LDC's. They must depend on industrialized countries in their endeavor to raise the standard of living from a very low level to a subsistence level. I feel that financial organizations should come up with soft-term loans, such as an interest-free loan or perhaps a grant. Mr. Asin, can we expect such cooperation?

*Mr. Asin:* Frankly, I don't think I have a very clear answer to that. There are all kinds of financing mechanisms; some of the financing is through very soft loans, of course. The sense of participation of communities is very important; even if the contribution for projects is small, it can have a tremendous psychological impact on those populations. I saw a case in Latin America in which the project was organized by a combination of international development organizations together with the government of one of the Latin American nations. They went into a rural setting, where electricity had never existed before, and suggested that the local population's contribution be in the form of labor input, with less emphasis, if any, on a cash contribution. The population took it very positively and the systems were installed with local labor, reducing the cost of the systems tremendously. Rural populations will not be able to come up in all cases with a large amount of money, but labor itself, obviously, can be very meaningful.

At a different level of development, where there is not necessarily a subsistence economy, but rather a poor rural population with some kind of surplus production, the contribution can be both through labor and in cash. That obviously will provide an even greater level of participation and interest and people will feel as if they are part of the project and are not just having a new technology imposed on them. That level of participation is meaningful and is one of the key elements of development.

*Mr. Lukis Romaso, Papua New Guinea:* I'd like

to comment on the technical aspect of making hydro plants reliable as a follow-up to Mark Henwood's comment that a hydro plant can only run if it has enough water. My concern is with the two major hydro projects we developed in Papua New Guinea using consultants at considerable expense to study water flows and to recommend what type of equipment should be installed. These studies are not only expensive, but are critical to the success of the project. If you over-design a project based on faulty data, you take the risk of creating too high an expectancy for power capacity that can't be achieved. In the case of these two hydro schemes, we just aren't getting the flows we expected to get. Sometimes it makes me feel that the cost of having these studies done by someone else wasn't worth it and that I was capable of doing just as well myself.

*Mr. Henwood:* Avoiding that kind of mistake is really the key issue in providing adequate hydrologic investigations, particularly in terms of the use to which the power will be put. I have heard a number of comments here about using hydropower for agricultural milling purposes. We might find circumstances where a certain project was installed to mill grain, grind flour, and to dry crops. Some of these uses may be very critical within a certain time period and, if they are not accomplished in a timely fashion, there might be a tremendous loss in crop value. In those circumstances, the value of the hydrologic investigation, and the necessity for high accuracy, is greater than it is in other circumstances, such as where you are simply providing lighting. If the lights don't function very well for several months, it wouldn't create the same problem as not being able to dry crops at the required time. It's a mistake that is difficult to avoid.

*Ms. Judith Magee, U.S.:* I certainly strongly agree that it is very important to try to maximize productive uses of electricity. However, I would argue, even though it's the conventional way of doing things, against using a cost/benefit analysis to assess whether or not to proceed with an electrification program or whether to use hydropower or diesel. We don't have adequate tools to measure the benefits of health clinics and schools. I suspect that many rural electrification projects have indirect economic benefits. For example, if children are studying longer, you may not get immediate economic benefits. However, in the long run, we have an investment in human capital which should have an indirect economic impact. That might also be true of people watching television, or of a community working together and developing certain skills in management training. All are investments in

human capital. I think economists probably realize that they are almost impossible to measure in an adequate way.

I also would suggest that you might be able to develop other uses for rural electrification besides the economic uses. You can use those kinds of programs to lead to other kinds of programs, but their outcomes also are impossible to measure. When you are looking at feasibility, you want to consider not only economics, but also to think very carefully about what kinds of indirect and non-economic benefits there would be.

*Mr. Asin:* That's right. My idea, basically, is how to create institutionalized systems of incentives so that productive uses of electricity can go forward. We have the infrastructure in the form of the electric system. The challenge is to create such incentives so that those productive uses will take effect.

*Mr. Henwood:* I, unfortunately, agree with you that cost/benefit analysis is not always a very satisfactory way of measuring the relative merits of projects. Yet we live in an environment where we have constraints on what we can accomplish. Those constraints in the hydro area will ultimately boil down to the fact that there is greater demand for concessionary financing than there is concessionary financing available. In this atmosphere, there is an absolute need for some method of determining the relative merits of projects so that the financing that is available is used most effectively. The problem to which you alluded, of non-monetary benefits, is an age-old problem that economists face. Many, many methods have been developed which attempt to place monetary values on those indirect benefits to help choose the best project. Economic analysis needs to be looked at in that light. However, I absolutely agree that, when we are considering rural development, those benefits are properly included in the assessments. The problem is that it is still very difficult to place the proper value on those other indirect benefits.

*Mr. Norman Crawford, U.S.:* I have a comment on the previous question about the consultant's estimates of the hydrology. It is prudent not to put a consultancy firm in a position where the hydrologic estimates that it makes determine whether or not a project goes ahead if that same consultancy firm is expecting to get several million dollars in design fees

if the project goes ahead, and nothing if it does not. Human nature being what it is, it is better to have an independent agency of some sort determine the feasibility of a project.

*Mr. Ibnuoe Soedjono, Indonesia:* Many participants have mentioned the social considerations of rural electrification. In this connection, I would like to say that social benefits actually do strengthen a project's viability when the cost/benefit ratio falls marginally below unity. In underprivileged areas, governments may consciously want to provide assistance through an electricity subsidy or a grant in aid. It is necessary to realize that real and effective social benefits are closely intertwined with economic development, which is why I would like to distinguish between financial and economic considerations. Financial criteria are based on commercial considerations of profit and loss, but economic considerations are based on the principle of cost/benefit analysis and can logically be expanded to include intangible social benefits. If we are trying to develop electrification in rural areas, we have to focus on economic considerations and not get tied up with financial considerations.

*Dr. M. Abdullah, Pakistan:* Rural areas are being electrified also by methods other than small hydro. I'm sure that bankers and financiers are aware of benefits achieved by electrifying rural areas by extending the grids. Have they achieved economic returns? If so, then it would be worthwhile looking at the benefits of small hydro installations in the rural areas. Several speakers have already said that social cost/benefits are more important than economic cost/benefits. I would like to know from the financiers and bankers what has been the experience gained by extending loans for rural electrification by the conventional method.

*Mr. Asin:* Neither of us is a banker, so I don't think that it is really possible to answer that question completely. I think that an important issue will be the attempt to make evaluations to determine social benefits. The next paper, if I am not mistaken, deals precisely with the methodology for conducting social evaluations of small hydro projects.\*

*Mr. Henwood:* This afternoon both Mr. Asin and I will conduct workshops with representatives from the Asian Development Bank to discuss such issues.† I think it will be most interesting.

\*See Judith H. Magee, "Evaluation Criteria for Small Decentralized Hydropower Programs," pp. 273-274.

†See 'Workshop Summaries', notably pp. 209-222.



# Productive End-Use of Mini-Hydropower for Rural Development

Daniel Boyle\*

**ABSTRACT :** The integration of mini-hydro schemes into development efforts aimed at improving the overall productivity of an area is a topic which requires an in-depth consideration of several broad issues. The author's discussion focuses on some of the special opportunities and limitations which mini-hydro schemes present in terms of productive end-uses and applications.

The battery charging system is the best way to utilize very small-scale hydropower potential as electric power, because by this method a small capacity of electric power can be distributed widely to the villagers. As a prime mover to convert hydropower into mechanical power we have chosen a simple axial flow turbine or propeller tube turbine in view of the fact that their efficiency and r.p.m. are high.

## Introduction

**T**HE end-use of hydro-energy can be classified into two broad categories:

1. directly coupled end-use. In this case there is a specific planned end-use of the energy, either mechanical or electrical, for a single farm, mill or other installations; and,
2. local, regional or central grid electrification.

The approach to provision of power for a specific end-use (productive or otherwise), such as in the first category, is straightforward and based on engineering principles. Rural electrification is a subset of the second category of hydro-energy applications. The productive end-uses of electricity for rural development are vast. Although the array of productive uses appropriate to a specific site are finite, planning for and promoting those uses will require special effort.

Improving productivity either at the macro- or micro-level implies optimization of resource allocation at that level. Optimization of available mini-hydro-energy resources in rural areas in the context of integrated rural development is a multi-dimensional topic. The actual characteristics of each of these dimensions

will depend on the particular hydro site, but in general, the relevant issues include:

*Technical Aspects:* kWh available, mechanical vs. electrical power, extent of grid and/or grid interconnection, reliability, load factor, peak demands, etc.

*Socio-Cultural Aspects:* Amenability of the population to the adoption of technological innovation, "appropriateness," local taboos, etc.

*Economic Aspects:* Level of other infrastructure developments, resources of area and their potential for development, macro-economic goals, price of power supply, demand for power, load growth, alternative fuels, social costs and benefits, availability of financing capital/labour intensive development strategies, related equipment costs, market access, etc.

*Practical Aspects:* Access to related equipment such as pumps, compressors, pipes, valves, lighting fixtures, electrical equipment, etc.; local availability of skilled labor for installation and maintenance, etc.

*Institutional Aspects:* Scheme management (centralized vs. decentralized), member relations and power use programs, existence of other extension services and agencies to promote improvements in agricultural productivity, etc.

\*Mini-hydropower development specialist SDH/NRECA

The site specificity of these issues precludes a coherent discussion of their relevance in the context of this workshop. They are mentioned only to alert the participants to their importance. Still, in devising plans for the productive end-use of mini hydropower, we have to begin somewhere. I would like my presentation to be viewed as a proposal to open a discussion on the *potential* role of mini-hydro schemes as an energy source in productive activities\*

Specifically, this session will deal with the potential role of mini-hydropower in productive activities by discussing: 1) some general features of small-scale hydropower as an energy supply source, and 2) some selected characteristics of rural demands for energy. These remarks will be followed by some ideas for power use fact sheets which might be useful in developing power use programs in conjunction with community awareness and agricultural extension services.

### The Potential Role of Mini-Hydropower in Productive Activities

A logical starting point in planning for the productive end-use of mini-hydropower is to look at the relationship between energy demands in rural areas and mini-hydro as the power supply.

### Some Salient Supply Characteristics

Mini hydro schemes can generate power for isolated use, for regional grid connection or connection to a central grid. In the isolated case, power can be purely mechanical shaft power to drive connected machines; or alternatively, the turbine can drive a generator to produce electricity. A third option is to combine the two in a hybrid mechanical/electrical scheme. Other hybrid systems could include a mini-hydropower supply in tandem with a back-up or alternative energy source (diesel, solar, wind, etc.). Whenever the system produces electricity, the need for a generator and associated transmission and distribution of power is evident.

Storage methods (dams, reservoirs, etc.) can provide options of timed end-use, such as seasonal use of hydropower. In Colombia, I helped a coffee farmer measure available flow and head of a small water source on his land to determine if he could install an

inexpensive Pelton to provide power for lighting appliances and TV for his workers' quarters. The scheme would have involved the daily loading of a large tank which would have been emptied at night. Unfortunately, the available water would have restricted expected loads to a mere 1½ hours of daily operation. Nonetheless, the example shows how a single supply characteristic can affect productive end-use.

In terms of voltage regulation, the scale of the system (*i.e.* kW output and degree of interconnection) will largely determine the potential array of end-uses. Motor loads have starting requirements of up to 7 times running current, and the system must be of sufficient capacity to meet this instantaneous demand. Thus smaller size isolated systems will not be capable of starting several large motors simultaneously. On grid systems, severe instability can result if a single motor has a rating with respect to other loads of a third or more of the system capacity.<sup>1</sup> In both cases, reliability of power is crucial to productive end-use.

### End-Use Energy Demands

Demand for energy is a derived demand. That is, the need for energy in any economic activity is linked to the demand for the economic good or service in question. Energy as an input to production can be direct (*i.e.* energy used to power a machine or process that produces a product for sale), or indirect (*i.e.* those uses where energy provides a greater efficiency of operation, longer hours or improved conditions for an enterprise).<sup>2</sup>

End-use of energy falls into three major categories:

*Work:* Mechanical work means movement of a force through a distance. Motion can be linear (*e.g.*, the lifting of water), or rotational (turbine or motor shaft). Thus, work energy is a form that accomplishes such productive tasks as: milling, cutting, compressing fluids, pumping water, ventilation, conveyor operations, grinding, polishing, lathing, etc.

*Heat:* Heat energy is used for numerous productive purposes. Water heating, space heating, drying, stream production, ironing, cooking and brooding are examples.

*Light:* Technically, light is a result of electromagnetic energy, but it is still an end-use of energy. Light-

\*The term "productive activities" requires definition. In the context of this paper it means economic or social activities which lead to improvement in living standards, either directly or indirectly, with special attention being given to those economic activities which lead to income generation.

ing finds productive applications on the farm (egg production, improved working conditions, *etc.*), in industry (longer work day, higher quality output), commercial and/or institutional establishments (night sales, advertising), and in the home.

Water power at the point of entry to the turbine is kinetic and/or pressure energy. That energy is used to rotate a shaft which in turn drives either a generator to produce electricity or is coupled directly to some machine. Some systems are hybrid, that is, they can produce both mechanical and electrical power. I have extracted a number of tales from various publications which provide data on electrical power consumption characteristics in rural industry and on the farm. Similar data would be required for the specific region where sites are being developed in order to facilitate matching supply to demand and in judging the appropriateness of certain end-uses and output levels under given power supply limitations.

Mechanical power production from mini-hydro is limited to provision of heat and work, since lighting requires electricity, kerosene or candles. Where the work or heat energy that is required is close to the power source (*i.e.* can be done at the site), direct mechanical power utilization is the most cost-effective means of tapping the stream, because expensive generators, transformers, transmission towers, cables, substations and hook-ups are necessary. Prime examples of this type of power use were prevalent in the past century in the U.S. and other parts of the world.

Today, such sites can be seen in Nepal where power is tapped from irrigation canals for communal rice milling, payment for the milling being in cash or kind.<sup>3</sup> Whereas work energy can be tapped directly from the turbine shaft, heat generation by mechanical means has to be produced by friction in one way or another. An ingenious method of heating air for spice and other food driers was also developed in Nepal.<sup>4</sup>

### Representative Power Use Fact Sheets

The potential productive end-uses of mechanical and electrical energy, where they are for urban or rural areas, are vast. Generalizations about benefits, costs and effects on productivity for any given application of energy can only be viewed as representative of historical findings. To pinpoint specific applications for a given area requires knowledge of both the

resources of the area and the present and projected demand for goods and services. The mini-hydro planner for a given area wants to know several things with respect to productive end-use. These include, but are not limited to:

- the array of existing and potential productive end uses of energy for the area;
- the power requirements for those uses, including growth estimates;
- how much power is available;
- how the hydropower scheme best meets local power needs;
- whether or not hydropower is socially acceptable;
- what public attitudes toward change and mechanization are;
- the local availability of skilled labor; and,
- general trends in the local economy.

The end-user of energy has a different perspective. He wants to know how to best apply the available energy to his activity.

The fact sheets presented here represent an initial attempt at developing some readily accessible information for power planners and end-users on the potential implications of discussion. They can be embellished with photographs and slides, and adapted for audiovisuals. The number of fact sheets could be expanded indefinitely. They could be made either more general or more specific. Information could be added or deleted to improve their quality and relevance. In the final analysis, they could be useful for lending to institutions and host country agencies dealing with small hydropower, or used by project implementers for community educational and/or promotional campaigns.

Conceivably, the fact sheet format could be used to inventory end-uses, listing their salient features. The inventory could be used as a checklist for selecting appropriate uses for a given scheme by matching the features of any use to the development goals of the area (keeping the supply limitations in mind).

Their use warrants a word of caution. They are not for design purposes. They are expected to serve as tools to be used in conjunction with power use programs.\* Consequently, to be effective they would have to be adapted for in-country use and fortified with a list of in-country references for design purposes.

\*For example, the Rural Electrification Board of Bangladesh has implemented a power use program as a member service to promote efficient power utilization.<sup>5</sup>

## Mechanical VS. Electrical System Comparisons

CHARACTERISTIC	MECHANICAL	ELECTRICAL
Work:	Shaft connected devices – direct with coupling, gears, belts, chains, clutches or through fly-wheel.	On line electric motors, single or three-phase, depending on power output, transmission and distribution scheme, solenoids.
Heat:	Friction – either viscous dissipation in fluids or mechanical scraping contact.	$I^2R$ term electric resistance heating. Inductive furnaces, hysteresis.
Motion:	Rotational – shaft. Linear – through some type of belt system, linkage, or other device.	Rotational – motor shaft. Linear – solenoid arrangement or mechanical connections listed at left.
Transmission:	Losses prohibit long distance transmission of mechanical power.	Power (kW) = voltage x current (I) Losses = (Current) <sup>2</sup> x resistance. Therefore, for a given kW output, losses are minimized by higher transmission voltage, depending on the distance. Voltage determines complexity and size of towers, insulators, etc. Current determines cable size.
Distribution:	Single shaft through building – individual machines connected by belts, linkages, gears, etc.	Low voltage, service entrance and circuit design per requirements.
Losses:	Bearing and connector (i.e., gear train, belts, etc.).	(Current) <sup>2</sup> x resistance of circuit.
Efficiencies:	Properly designed bearings, couplings, belts, gears, etc., should have efficiencies above 90%.	Generators and transformers have efficiencies often above 98%. Transmission losses can run up to 15% when long distances are involved. Distribution losses usually need to be held to 2-3%.

## Base Load and Load Leveling Ideas

*Electrical*

- Battery Charging
- Water Supply System
- Pumped Storage
- Irrigation
- Drainage
- Milling
- Electronic load control for heat production

- Fertilizer Production
- Heat Generation for: drying purposes, water heating, steam production, greenhouses, absorption refrigeration, water sterilization, several agricultural processes.

*Mechanical*

- Pumped Storage
- Water Supply System

- Irrigation
- Spin drying
- Milling
- Heat generation for: drying purposes, water heating, sterilizing water, agricultural processes.

Depending on the power output of the system, the above ideas could be implemented on a one-by-one basis or in combination, at an individual or communal level.

### **Irrigation<sup>6</sup>**

#### *Potential Benefits for Agricultural Production*

Significant increases in crop production and quality.

Drought disaster protection.

Allows for crop diversity and planting of cash crops in land otherwise too arid.

Potential for multiple cropping.

#### *Major Cost Elements*

Highly dependent on:

- type of system;
- method of distributing water;
- well depth;
- available rainfall;
- location, quality and amount of water;
- type of crops;
- soil type and topography;
- type of crops;
- soil type and topography; and,
- wind characteristics.

#### *Load Considerations*

Highly seasonal.

Intermittent daily load.

Inductive with low power factor.

High torque, slow speed starts implying high inrush currents.

#### *Technical Considerations*

General methods of applying water to fields:

- surface or furrow;
- flooding;
- rotary sprinkler,
- oscillating overhead pipe;
- drip; and,
- perforated pipe.

Area of cultivation.

Type of crops.

Water source and suitability.

Soil type and characteristics.

Topography.

Distance from water source.

Rainfall, hydrological data.

Wind characteristics with surface applications.

Availability of technical assistance.

#### *Appropriate Setting*

Access to and existence of markets for increased produce.

Lack of rainfall for 2-3 week lengths during important growth periods.

Drought or dry spells prevalent.

Quality of water source available.

Topography and soil type permitting.

Revenue increases justify costs.

#### **Pressurized Water Systems<sup>7</sup>**

##### *Potential productive applications and benefits*

#### *General*

Greatly enhances comfort and convenience.

Vastly improves sanitary and health conditions.

Time spent carrying and/or pumping water available for other uses.

#### *Agriculture*

Major contribution to productive capacity of farm. Ease of washing down and providing water for livestock.

Significant gains in dairy, livestock, crop, poultry and egg production.

Garden products quality and output increase by 50-100%.

#### *Industry*

Water for critical processes available automatically, in measured quantities.

Cleaner equipment and surroundings.

Healthier, more sanitary environment for workers.

Better appearance of products, packaging and factory.

#### *Commerce*

Improves range and quality of goods and services offered by hotels, restaurants, stores, etc.

#### **Major Cost Elements**

#### *Initial*

Well preparation, pump, motor, wiring, conduit, piping, valves, motor and flow control devices, installation.

*Recurring*

Electricity consumption and occasional maintenance.

*Load Considerations***Daily Water Requirements (Gals/Day)**

Adults (all purposes)	35
Cattle	15
Hogs	4
Sheep	2
Horses and Mules	12
Chickens (per 100)	3

Water pump motors and a highly inductive load with high inrush currents.

Water supply layout.

Intermittent load.

*Technical Considerations in System Planning*

Potability of water supply.

Type and depth of well.

Type and efficiency of pump.

Current and future water needs.

Distance from water source.

Pipe supports.

Thermal expansion problems, etc . . .

*Appropriate Settings for Installations*

Adequate and potable water supply.

Gravity system not feasible.

Water at reasonable depth for drilling.

*Related Equipment and Expertise for Design*

Pumps (type selected per conditions).

Motor and motor control.

Availability of spare parts.

Local availability of electrical/mechanical trades.

Agricultural engineer and/or hydrologist for farm systems.

Mechanical/electrical engineer for larger-scale systems (communities, industries, etc. . .)

**Mechanical Heat Generation<sup>8</sup>  
(Prototype design)****Potential productive applications***General*

Heated air to 110°C with accompanied forced convection.

*Agricultural Processing***Drying:**

Spices                      Vegetables and fruits                      Yarn

**Maize****Rice****Tea and Tobacco****Butterfat****Paper****Coffee**

Parboiling of rice and other goods.

Concentrate production.

Distillation processes.

Cheese making.

Warm water for cleaning purposes.

Fruit processing into jellies, marmalades, etc . . .

*Industry and Commerce*

Low temperature heat (110°C) for large variety of end-uses.

*Major Cost Elements*

Nepal prototype heat generator with 25 kW drive (Jan. 1981) = US\$800.

*Technical Considerations*

Volume of air requirements.

Temperature for process.

Power supply.

*Appropriate Setting*

Developed for isolated villages with severe deforestation problems (implying high alternative fuel costs) and extensive need for local agricultural processing.

For more information:

"The Heat Generator" by Reinhold Metzler

Butwal Engineering Works Pvt. Ltd. (BEW)

c/o United Mission to Nepal

P.O. Box 126

Kathmandu, Nepal

**Fertilizer Production by Water Works<sup>9</sup>  
(Under Development)***Potential Benefits*

May be used effectively during slack periods as base load and load leveling technique.

Requires only readily available components and low level technology.

Eliminates need for natural gas or other fossil fuel.

Economically feasible means of producing high quality fertilizer.

Fertilizer produced near the areas where used, thereby eliminating need for transportation and distribution (generally large components of fertilizer costs).

Waste heat from process available for crop drying, space and water heating, etc.

*Power Consumption and Output*

Field testing of unit rated as 3 kW (1,000 volts, 3 amperes). Output is sufficient to fertilize 5-20 hectares, depending on amount of fertilizer per hectare.

Developer: R.W. Treharne

Further Information: R.W. Treharne, C.K. McKibben, D.R. Moles, D. Torell:

"Fertilizer Production by Water Power."

University of Nevada Field Day Program (1980)

### Electric Motors<sup>10</sup>

Electric motors are a highly efficient, versatile means of performing mechanical work. They are unparalleled in their ability to do the many backbreaking tasks on the farm. One kilowatt-hour from an electric motor can do what requires 10 hours of a man's time. They provide the driving force for milkers, separators, grinders, shop tools, fans, compressors and a host of other devices.

There are various types of electric motors and their selection depends essentially on their end-use. Farm machines usually incorporate one of four types: the split-phase, the capacitor, the repulsion-induction and the universal.

Maintenance is minimal but crucial to longevity and efficiency of operation. They should be clean and dry and lubricated according to the manufacturer's

recommendations. Proper selection for use, overload protection, wire sizing and guaranteed voltage levels are all essential to a motor's performance.

### Conclusion

From the Amaru IV Cooperative report:

"The particular suitability of small hydro to a productive use strategy is its flexible size: a hydro-generating unit can be installed to meet exactly and only the needs of a particular productive use. A small hydro program designed to facilitate the distribution to and use by existing rural industries would encounter fewer difficulties than attempts to introduce new productive uses or accomplish multi-purpose village electrification. There is a strong precedent. The major financial questions would be repayment of credits, not collection of routine billings. Maintenance would be less likely to arise as a problem because a rural industry or better-capitalized farm is likely to have among its employees individuals with mechanical ability and tools."<sup>11</sup>

Productive end-use of the power has to be planned in conjunction with scheme development in order

Type	Relative Cost	Size Range	Starting Characteristics	Applications
Split Phase	Lowest	Up to 1/3 HP	Light loads 5 - 7 x FLC	Ventilating fans Small grinders Bottle washers Some shop tools
Capacitor	Intermediate	Full range	Medium loads 3 - 4 x FLC	Almost all farm equipment except heaviest loads
Repulsion-Induction	Highest	1/4 - 10 HP	Heaviest loads 3 x FLC	Deep well pumps Air compressors Conveyors Feed grinders Ensilage cutters
Universal	Integral to or built into the appliance or device	Fractional horsepower	High starting torque and very high in-rush current, no inherent speed regulation.	Full range of appliances such as: vacuum cleaners, sewing machines, food mixers, and electric drills.

Motor selection is determined by horsepower requirements, starting load, speed and voltage.

Source of Information: *Farm Electrical Equipment Handbook*, 10, Edison Electric Institute.

to optimize the potential economic benefits. Such planning should take the following into consideration:

- the socio-cultural context of adopting the end-use;
- resource development needs and goals of the local population and their implicit power requirements;
- technical aspects of the system and their implications on the potential end-uses;
- existing and future economic activities of the area and their suitability for mechanization, both from a technical and social standpoint; and,
- concurrent educational programs for community development to include illustrated discussions of: safety considerations, productive applications of power, energy consumption and costs, etc.

## APPENDIX

### Electrical Power

Tables 1 and 2 provide an overview of electrical power use in three regions of India (Madras, U.P., W. Bengal) as of 1963. They were extracted from a report to USAID prepared by the General Electric Co. and the Massachusetts Institute of Technology.<sup>12</sup> Although they refer to the specific areas where the study was performed, the load characteristics and consumption figures should approximate those in other parts of the world. As such, the reader might gain insight into the general consumption patterns his system might acquire, depending on the array of economic activities to be served.

**Table 1**  
**Technical Characteristics of Agricultural Processing Machinery**

Process or Operation	Equipment	Motor Rating (hp)	Output (lb/h)	Power Consumption (kWh/100 lb)
Oil pressing & extraction	Hydraulic Press			
	Large	22	1,500	1.3
	Medium	16	1,000	1.5
	Small	8	130	4.5
	Screw Expeller			
	Large	20	2,000	1.0
	Medium	15	1,000	1.5
	Small	5	100	5.0
	Rice hulling	Disc Sheller (German)	25	2,400
	Japanese rubber Roller sheller	3	300	2.0-2.5
	Cereal milling	Large	20	800
	Small	5	180	2.0-3.0
	Cotton ginning	Large	20	
	Small	5	78	2.75-3.2
	Fodder chopping	Rotary cutter	2-10	
Sugarcane processing	Crusher	3-15		.50-3.0
	Refining pan			



Table 2  
Estimates of Annual Power Consumption in Agricultural Processing

Sample	Processing Operation	Connected Load (hp)	Peak Aggregate Demand (kW)	Annual Hrs. of Operation (h)	Annual Power Consumption (kWh)
Madras	Rice hulling & husking	3		800	2,400
	Cereal milling	5		7,000	35,000
	Oil pressing & groundnut shelling	5		2,200	11,000
	Cotton ginning	10		800	8,000
	Fodder chopping	3		100	300
	TOTAL	26	19		56,700
U.P	Rice hulling & husking	3		560	1,680
	Cereal milling	5		4,350	21,750
	Sugarcane crushing	6		5,050	25,250
	Cotton ginning	10		60	600
	Fodder chopping	3		145	435
TOTAL	27	20		49,725	
W. Bengal	Rice hulling & husking	3		2,625	7,875
	Cereal milling	5		380	1,900
	Oil pressing	5			275
	Fodder chopping	3		92	
TOTAL	16	12		11,348	

Exhibits A and B, from the United Nations publication, *Rural Electrification*,<sup>13</sup> (Appendices 3 and 4), lend further insight into general load characteristics in rural settings. Appendix 3 provides data on electricity use in the tea industry in India and Appendix 4 is a Swiss example of an entirely electrified farm and its corresponding load characteristics.

#### Power Requirements of a Tea Factory

Type of Machine	Total Power Required (hp)
Withering fans . . . . .	14 (a pair)
Rollers . . . . .	40 (a bank of five)
Roll breakers . . . . .	2
Tea driers. . . . .	7
Cutters, sifters, packers and exhaust fans	5 to 7

#### Growth of tea industry load in Madras State

Year	Connected Load (kW)
1933-1934 . . . . .	950
1938-1939 . . . . .	3,561
1943-1944 . . . . .	3,868
1948-1949 . . . . .	4,749
1949-1950 . . . . .	5,205

\*"Rural Electrification in Madras State (India)" (Proceedings of the World Power Conference, 1951).

#### Exhibit A Electricity in the Tea Industry in India\*

Several tea factories in South India use electricity for the processing of tea leaves. Electricity is used for withering, rolling and drying the tea leaf. The average handling capacity of a factory in South India is 8,000 lb of wet leaf in 24 hours and the average connected load per factory is 110 kW.

## Exhibit B The Entirely Electrified Farm†

The research farm of the Central Swiss Power Co. (CKW) at Rothenburg near Lucerne, may serve as an example of a fully electrified farm.

### 1. Power

There are two classes of electric apparatus, those with a built-in motor and those used only temporarily which are driven by a motor on wheels or a portable motor.

#### (a) Devices with built-in motor

	(kW)
Threshing mill . . . . .	15.00
Lift for goods . . . . .	2.06
Milk-cooler . . . . .	1.47
Drying machine . . . . .	0.99
Milker . . . . .	0.74
Stable ventilator . . . . .	0.60
Cream-separator . . . . .	0.37
Cleaning apparatus for animals . . . . .	0.24
Laundry centrifuge . . . . .	0.20
Refrigerator . . . . .	0.12
Total . . . . .	21.79

#### (b) By means of a 4 kW motor on wheels and 2 portable motors (each for 2.2 kW), the following operations can be carried out:

Threshing	
Mincing of fodder	
Rough grinding of corn	
Manure-pumping	
Manure-stirring	
Milling	Total 8.20 kW
Potato-sorting	
Water-pumping	
Turnip-topping	
Grinding	
Hay-baling	
Fruit-pressing	

† Ringwald, F.: "Electricity in Farming and Gardening" (Proceedings of the World Power Conference, New Delhi, 1951).

Consequently the fully electrified farm is equipped with over 13 built-in and rolling and portable motors with a total output of approximately 30 kW.

### 2. Light

Devices for general lighting and those for specific purposes are summarized as follows:

	(W)	
Dwelling house . . . . .	990	
Farm building . . . . .	1,340	
Poultry pen . . . . .	200	
Pigsty . . . . .	480	
Barn . . . . .		
General lighting . . . . .	2,895	
Stable lighting . . . . .	280	
Total . . . . .	6,185	(6.2 kW)

### 3. Heat

The numerous heating apparatuses are sub-divided as follows:

	(W)	
Dwelling house		
Kitchen water heater . . . . .	600	
Bath water heater . . . . .	1,200	
Kitchen range . . . . .	12,900	
Space heating . . . . .	2,000	16.7 kW
Farm building		
Washing machine . . . . .	7,500	
Bottle sterilizing apparatus . . . . .	3,000	
Drying machine . . . . .	1,250	
Various additional heating apparatus . . . . .	1,500	13.25 kW
Poultry pen		
Heating of perches . . . . .	720	
Drink water heating . . . . .	50	
Space heater . . . . .	1,000	1.77 kW
Pigsty		
Pig food stove . . . . .	4,500	
Water heater . . . . .	300	
Radiator . . . . .	250	5.05 kW
Barn and stable		
Stable water heater . . . . .	300	
Space heating of calves' stable . . . . .	1,200	
Water heater for cattle drinking water . . . . .	1,200	2.7 kW
Total . . . . .		39.47 kW

Thus the fully electrified farm of 23 hectares contains the following installations:

	(kW)
Power . . . . .	30.0
Light . . . . .	6.2
Heat . . . . .	39.5
Total . . . . .	75.7

### Annual consumption of power

	Power (kWh)	Light (kWh)	Heat (kWh)	Total (kWh)
Refrigerator . . . . .	1,000			
Milk-cooler . . . . .	700			
Washing centrifuge . . . . .	10			
Machine for cleaning cattle . . . . .	70			
Milking machine . . . . .	630			
Stable ventilator . . . . .	240			

## Annual consumption of power (Cont.)

	Power (kWh)	Light (kWh)	Heat (kWh)	Total (kWh)
Dehydrator, mechanical part . . . . .	200			
Lift for goods . . . . .	30			
Cream-separator . . . . .	100			
Threshing mill . . . . .	1,500			
Dwelling house . . . . .		850		
Farm building . . . . .		375		
Pigsty . . . . .		185		
Barn general lighting . . . . .		420		
Stable lighting . . . . .		1,000		
Poultry pen, lighting to increase breeding . . . . .		100		
Kitchen range . . . . .			3,800	
Washing machine . . . . .			2,300	
Dehydrator (heat) . . . . .			650	
Food stoves (2) . . . . .			4,000	
Drinking water tank for animals (6 winter months) . . . . .			3,200	
Stable water-heater . . . . .			2,650	
Kitchen water-heater . . . . .			5,000	
Sterilizing apparatus . . . . .			4,000	
Heating for perches . . . . .			1,020	
Heating for drinking water (during 5 to 6 winter months) . . . . .			70	
Space heating . . . . .			940	
Total . . . . .	4,480	2,930	27,630	35,040
% . . . . .	14	8	78	
per ha . . . . .	195	129	1,210	1,534

Annual costs based on an average price of Rp8.284 per kWh: Swiss Fr 2,901.71 (Swiss franc = 100 rappen or centimes)

Table 3\*

Ranges of typical power requirements for several rural industries in Colombia<sup>14</sup>

Type of Agro-Industry	Range of Power Requirements (kW)
Saw mill	30-60
Carpentry shop	3-15
Sugar mill	10-20
Grain mill	3-20
Loom	0.5- 6
Coffee processing	5-30
Quarry	6-30
Ice factory	6-60
Preparation of fish	5-10
Cold storage plant	6-60
Roofing tile plant	2-12
Pumping station	2-100

\*Source: Vibilidad De Las Microcentrales Hidroelectrical En Colombia. C. CH. LG. LTDA. Ingenieros Contratistas Fundacion Mariano Ospina Perez Bogota, Colombia October, 1979.

## References

1. General Electric Company, *Small-Scale Power Supplies for Rural Communities in Developing Countries*, U.S.A.I.D. Report No. TA/OST-AN-63-3-1, March 1963.
2. AMARU IV Cooperative, *Guide to Evaluation Framework for Small Hydro Units in the Field and Lessons from the Literature*, p 155, Draft product developed under AMARU IV/NRECA contract, April 1981.
3. YODER, et al. *The United Mission to Nepal's Involvement in Small-Scale Water Power Development for Milling*, Draft, Cornell University, January 1980.
4. METZLER, REINHOLD, *The Heatgenerator*, Butwall Engineering Works Pvt. Ltd., United Mission to Nepal, January 1981.
5. Rural Elec. Board of Bangladesh, *Member Service and Power Use Instructions*, PBS Instruc-

- tion 300-2.
6. American Association for Vocational Instructional Materials, *Planning for an Irrigation System*, AAVIM, Second Edition, 1980.
  7. JONES, DANIEL E., *Farm Water Systems*, Unpublished paper from the AID sponsored Inter-American Training Program on Rural Electrification.
  8. METZLER, REINHOLD. op cit.
  9. TREHARNE, et al., *Fertilizer Production by Water Power*, University of Nevada Field Day Program (1980).
  10. Edison Electric Institute, *Farm Electrical Equipment Handbook*. Edison Elec. Inst., 1950.
  11. AMARU IV Cooperative. op cit. p. 48.
  12. General Electric Co., *Analysis of Demand for Electric Power in Rural Communities*, USAID contract AID REPAS-1, March, 1963.
  13. United Nations, *Rural Electrification*, 1952.
  14. C.CH.LG. Ltd., *Viabilidad de Las Micro Centrales en Colombia*, Fundation Mariano Ospina Perez, p. 24, Bogota, 1979.

**Daniel Boyle.** After a three month contract to investigate the productive end-uses of hydropower for remote areas of developing countries and to devise audio visual descriptions of their role in development, the author was made a staff member of the Small Decentralized Hydropower Program of the National Rural Electric Cooperative Association (NRECA). In the position of Mini-Hydro Development Specialist, he is responsible for site evaluation work and country wide assessments of mini-hydro potential in addition to continuing his activities in the area of productive end-uses.

Before joining NRECA, Mr. Boyle was a Peace Corps Volunteer in Colombia where he helped design and build an appropriate technology center, developed prototype solar food driers and investigated energy needs in the Colombian countryside. In addition, while in Colombia, he did consultant work for small businesses ranging from sugar mill manufacturers to food processing plants.

After graduation from the University of Delaware where Mr. Boyle majored in a combined mechanical engineering and business administration curriculum, he worked as a field engineer for the Square D. Company. There, he performed duties related to the marketing of major electrical equipment in conjunction with construction projects in Philadelphia, Pa. In that position, he received training in all types of electrical distribution and control equipment.

## Evaluation Criteria for Small Decentralized Hydropower Programs

Judith H. Magee\*

**ABSTRACT :** Evaluation of small decentralized hydropower (SDH) systems should occur at two critical junctures: a pre-project evaluation of the site of user community to determine their suitability for an SDH system, and an evaluation of the system after it is in place and functioning. A pre-project evaluation is essential for SDH programs; in addition to providing necessary information about the probable success of the project, it can also provide valuable baseline data for a post-project evaluation. A "community application form" to screen for significant technical, social and economic factors is recommended. The post-project evaluation should occur early enough to allow for necessary modifications while the project is still under supervision. An on-site evaluation consisting of interviews, examination of records and observation is recommended, to take place one year after the SDH system is in place. An early post-project evaluation can also be useful in providing relevant data for future SDH projects.

Evaluation criteria for SDH systems at both the pre-project and post-project stage should be closely linked to the specific purposes and goals of the SDH program. While this appears self-evident, measures to be utilized in evaluating site suitability or project success will vary widely among the many possible purposes of the SDH programs. Evaluation of productive uses will entail different criteria than measurement of social benefits; the same is true for least cost, direct motive, community ownership, and other possible purposes. For multi-purpose electrification, a variety of evaluation criteria will be needed. With a clear understanding of exactly what the project is designed to accomplish, evaluation instruments can be designed that are simple, inexpensive and highly informative.

### Introduction

**T**HE AMARU IV Cooperative, a Washington-based consulting firm, was contracted by the National Rural Electric Cooperative Association (NRECA) to set up evaluation criteria for its Small Decentralized Hydropower (SDH) Program. Specifically, AMARU was to: —

“ . . . develop a set of criteria from which a methodology could be developed that would evaluate the effectiveness of small-scale (up to

1,000 kW) decentralized hydropower systems in developing countries and which would also predict the suitability of a community (or any other user) for this energy resource.”

To fulfill these objective, the AMARU team researched the literature on small hydro, developed a series of case studies of specific small hydro systems, interviewed persons involved in hydro programs, and analyzed some evaluation systems currently in use.

The thrust of the research was on *social, cultural and economic criteria* that could be used in conjunc-

\*Associate, AMARU IV Cooperative, Inc., Washington, D.C.

tion with technical criteria in evaluating *multi-purpose village electrification* systems. SDH units installed at specialized institutions (businesses, hospitals, etc.) and systems with direct motive applications (without electricity) will require different evaluation criteria, although certain major requirements of SDH systems, such as installation/construction, maintenance and management, will pertain to all sites and user communities.\*

From its research, the AMARU team made the following recommendations:

1. Adequate evaluation criteria can only be developed where the purposes and objectives of the SDH system (*i.e.*, what is to be accomplished) are clearly defined and understood. This is especially critical at the pre-project stage, as goals and objectives will influence the scale and form of the SDH system. For both pre-project and post-project evaluations, program goals and objectives will dictate the kinds of baseline and end-of-project data to be collected.
2. Evaluation of SDH systems is recommended at two stages: a) a pre-project evaluation of the site and user community using a self-administered community application form; and b) an on site post-project evaluation after the system has been in operation one year.

The AMARU team also drafted preliminary outlines for the community application form and post-project evaluations. These documents need to be tested in the field and further refined.

## Evaluation Criteria for SDH Projects

### Defining goals and objectives

SDH programs can have any number of goals and objectives, some highly specific and others more generalized. Specific goals include such purposes as replacement of existing diesel generators, use of SDH systems to improve village water supply, or the electrification of a processing plant. More generalized objectives include improvement in the quality of life and economic development. Many SDH projects, like traditional rural electrification programs, will be multi-purpose; *i.e.*, they will serve a number of different institutions and groups, such as businesses, households, irrigation systems and public services. For these

systems, program goals could cover a variety of economic and social objectives, such as business expansion and job creation, improved health conditions, increased agricultural output, decreased outmigration from rural areas, access to communications, and so forth.

In evaluating SDH programs, both at the pre-project and post-project stages, goals and objectives must be clearly defined and understood so that appropriate evaluation criteria can be drawn up to evaluate potential user communities and to measure program accomplishments. It does not matter what the project objectives are, as evaluation criteria can be created to deal with any single objective or a multitude of objectives; nor does it matter if objectives are specific or general. What makes evaluation difficult is the lack of understanding of what the project is designed to accomplish.

Let us take the hypothetical case of an SDH project that would provide electricity to a sawmill for lighting and equipment. Such a project is actually being planned in Latin America. If the program objective was simply the provision of the electricity, then the only criteria used to evaluate the project would be whether electricity was or was not provided and whether the system was reliable (technical evaluation). If, however, the SDH system was installed as a least-cost option, then the SDH unit would need to be compared to other energy systems that could be used. Relative costs for equipment, installation (including civil works and labor costs), fuel (including transportation costs), maintenance and repair (including salary costs), spare parts and back-up system (if necessary) would need to be assessed. Cost calculations should cover the life of the system(s) to take into account differing capital and operating costs and life-spans (*i.e.*, how soon the unit would have to be replaced). Any constraints — lack of skilled labor, transportation difficulties, fuel availability, *etc.* — that would limit the options that were available would, of course, have to be considered.

If the SDH project had as its purpose the expansion of the sawmill through use of electricity, then criteria could be established to compare the output of the plants before and after electrification. Such criteria as production levels, plant size, profits and employment levels could be used. If a purpose of the project was to better working conditions for emplo-

---

\*The term "user communities" can be defined as those individuals, groups, villages/municipalities or institutions that will use the SDH system.

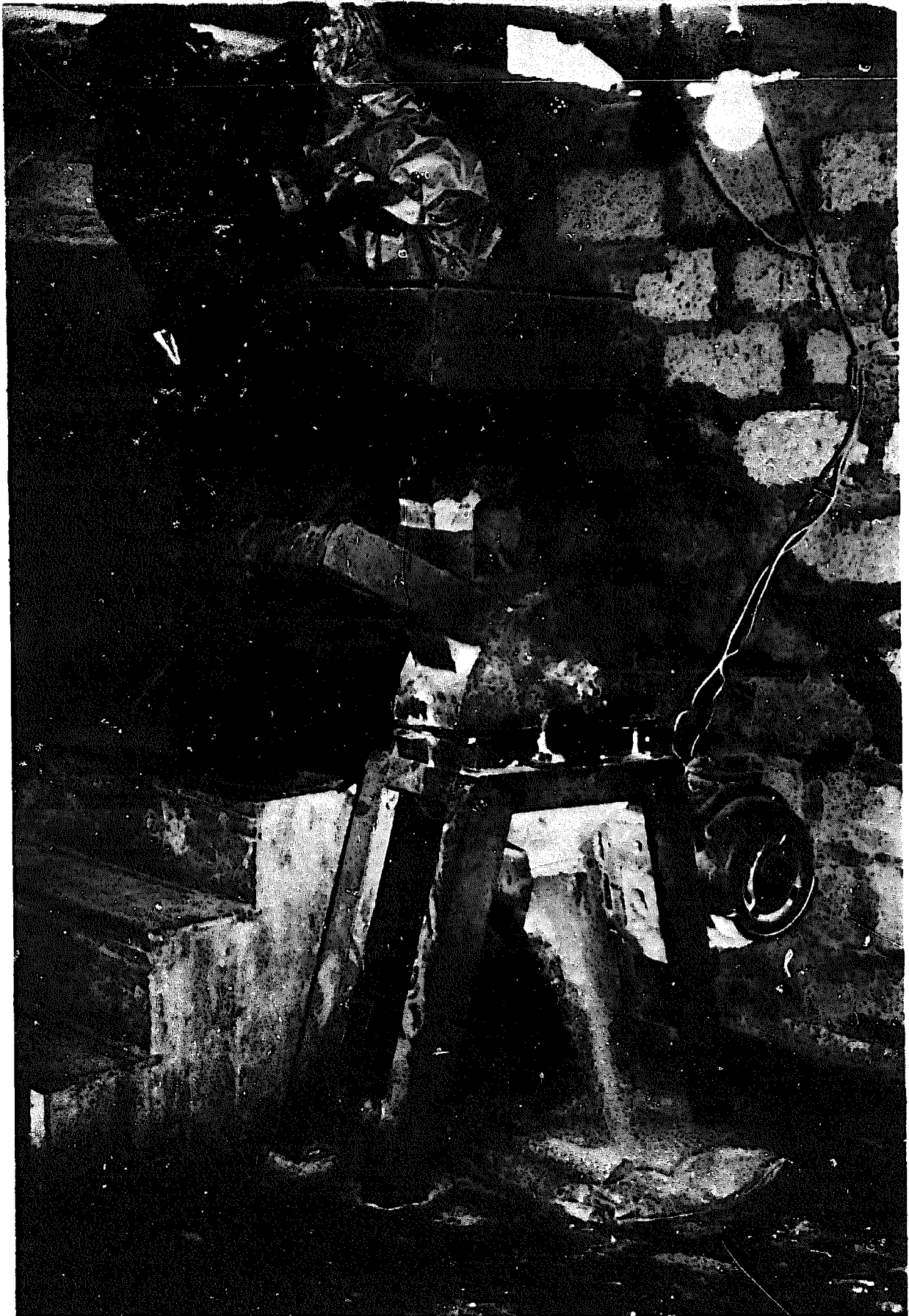

Milling – Nicaragua.

yees, then criteria such as wages, hours, productivity, lighting and substitution of electric tools for hand tools would be important. Safety factors and displacement of workers by machines would also be significant.

If electrification of the sawmill had as its goal the economic development of the village or region, then criteria such as increased employment, increased profits to be spent locally and the development of other attendant industries (such as a furniture-making factory) would be important. And finally, if the goals of the SDH project encompassed all of these objectives, then all of these criteria could be used.

Multi-purpose village electrification will require a number of social and economic criteria, many of which are discussed below. Criteria to measure the impact of electrification on such areas as agriculture, employment, business, health, education, public services, communications and other areas affected by electricity can be established, and should be included as part of the pre-project and post-project evaluations.

### Some possible purposes

While there are many possible purposes of SDH systems, there are a number of major objectives that are frequently mentioned in the literature and planning documents on small hydro. These include electrifications of rural areas (non-grid or possibly mini-grid), nationwide electrification via small hydro installations (grid), least-cost energy option, direct motive applications, productive uses and social benefits. A number of these purposes can be combined (e.g., productive uses and remote areas), but each will require different evaluation criteria. In many instances, specific user communities are targeted as recipients of SDH installations. Most frequently, the poor are cited as possible beneficiaries, either through social benefits or productive uses.

In addition to these major purposes, personnel involved in small hydro programs frequently make certain assumptions about SDH projects which could also qualify as objectives, or "sub-objectives." One assumption involves community participation. Many hydro programs call for local management of the system (and possibly local ownership), local maintenance and local labor (paid or volunteered) to build the system. Another assumption involves costs. In some hydro programs, capital costs are to be borne either totally or partially by the local community. In most hydro programs, even in instances where the system is donated to the local community, there is the assumption that the system will not be subsidized and that the

community will be able to cover operating costs.

All of these objectives and assumptions necessitate different evaluation criteria for both site selection and post-project evaluation. While it is not possible to offer a detailed description of evaluation criteria for each objective or sub-objective in a brief paper, some points can be mentioned. Electrification of remote areas is basically a geographical objective which does not necessarily entail any other purposes. Pre-project evaluation criteria would involve selection of sites that will not be reached by grid extensions; if there is the expectation that the hydro unit might be hooked up to the grid at some future date, then synchronization becomes important. Electrification of remote areas might entail local management and maintenance due to travel difficulties, but this is not an absolute.

Nationwide electrification through small hydro systems is the only major purpose that does not require installation of hydro units at a particular site, such as a village or mill. Rather, sites would be selected for their hydro potential rather than their proximity to populated areas. A nationwide program entails centralized management, although maintenance of particular units could be local (but under national supervision).

To achieve the purpose of productive uses of electricity, the hydro unit will need to be sited at a center of production, such as a mill or factory. A hydro unit could also be sited at a village to provide electricity for cottage industries and/or commercial enterprises.

If the purpose of the SDH program is to benefit the poor, then criteria used to fulfill this objective need to be identified. If a decision is made that the poor will benefit most from productive use of electricity, then SDH systems might be located in economically depressed areas or in areas which have a high concentration of poor people. If the SDH unit is sited at a production center, then program officials will need to ascertain whether poor people will benefit through employment at the site. If the SDH unit is used for irrigation or direct motive applications to benefit poor farmers, then program officials would need to know if poor farmers will actually be beneficiaries. Finally, if the poor are to be aided through increased social benefits, such as household electricity, then program officials must be certain that poor households will be able to afford electricity and appliances. For this objective and other objectives involving the poor, subsidization may be necessary. In that case, program objectives calling for local solvency of SDH systems may have to be subordinated.

Community involvement is an integral part of



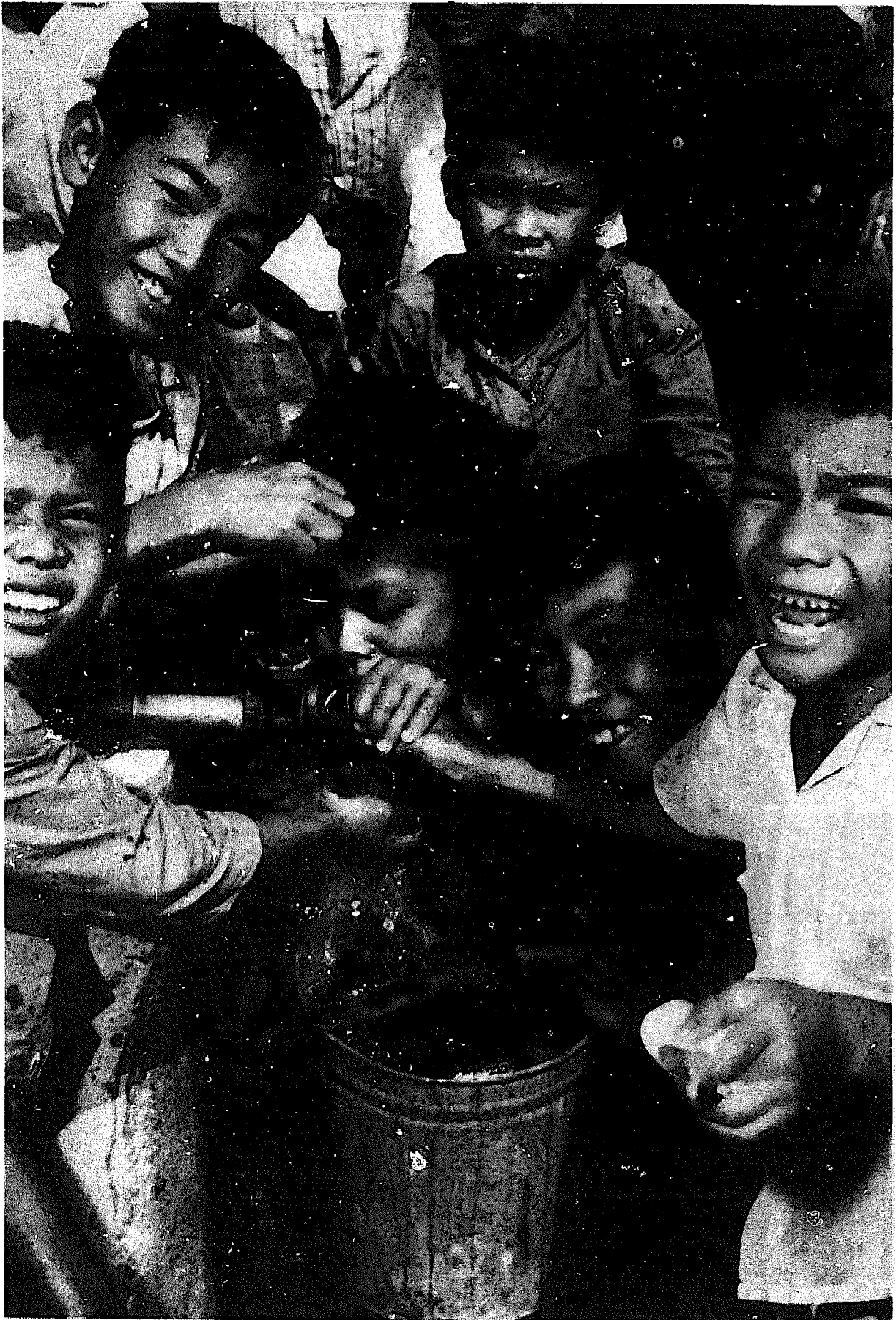

Pressurized water system – Vietnam.

many hydro projects. Some programs, such as NRECA's SDH program, see decentralized local control as a prime objective. If local involvement is desired or expected, then the willingness and ability of communities to build, manage and maintain the system become criteria for site selection. If a community has had experience in building public works or operating machinery, it might be a better choice for the SDH system than a community with no such experience. If the community is expected to cover operating costs, then communities with the greatest demand for electricity might be favored.

The discussion could go on indefinitely, but the major point is that SDH program officials must clearly define the purposes of their project and the various aspects of the project that must be considered (beneficiaries, installation/construction costs, *etc.*). Then each objective and aspect of the project will need criteria established so that potential user communities can be more effectively evaluated.

### Measuring outputs

Measurement of project impacts or outputs will also be dependent on clearly established objectives, and program officials should know what project outputs they expect before the SDH system is installed. For projects with highly specific goals, such as the electrification of the sawmill noted above, evaluation criteria are fairly straightforward and obvious. For projects with a combination of objectives, such as a locally managed direct motive application benefiting poor people in remote areas, each aspect of the project can be segregated and measured by evaluation criteria that are relevant to that particular purpose.

For SDH projects with more generalized goals and objectives, such as improvement in quality of life, criteria need to be formulated relative to the way in which the nation, social group and/or sponsoring agency view this concept. Unfortunately, many evaluators are put off by these generalized objectives because they feel such goals are vague and unmeasurable. Statements that refer to life improvement or enhancement are generalized, it is true, but they are neither vague nor unmeasurable. While each society will have its own ideas of what constitutes a "good" life, there are a number of social features that all would agree are beneficial. Most individuals, whatever their nationality, would define improved health care, better nutrition, education, cultural enrichment and adequate food production as positive social benefits, however they may prioritize them as needs for their own society. Add to these commonly-perceived benefits

the unique aspirations of the local society, and a useful and measurable definition of life quality can be developed. With a clear definition of this concept, evaluation criteria can be drawn up fairly quickly and easily. In the section on Post-Project Evaluation, there is a detailed list of the most commonly used social indicators of life quality.

When the SDH system is part of a larger program, such as economic development, measurement of the impact of the SDH system itself, apart from other aspects of the program, requires careful thought and planning. It is frequently stated in the literature that electrification itself does not "cause" anything to happen and that it must be part of a larger program (economic development, health and sanitation, education, *etc.*) before any impacts will be noticeable. While it is always difficult to prove or disprove such sweeping oversimplifications of the issues, we believe it is still possible to isolate direct impacts of electrification within a larger program.

As an example, take the case of an electrified health clinic in a village where health care has improved. How can you assess the role of the electricity itself in this process, apart from the clinic? If the clinic was originally non-electrified, a comparison could be made of the "before and after" operations through interviews (with patients and clinic staff) and through examination of records. Such phenomena as lighting (for treatment and operations), hours of operation, and electrical equipment (X-ray machines) should be examined. In addition, other areas where electricity relates to health, such as potable water, can be investigated. If the clinic was always electrified, a comparison could be made with a similar, non-electrified clinic in another village. Obviously, in both these cases, other variables such as quality of staff and funding must be taken into account in making comparisons, but it is still possible to analyze whether electrification has or has not made a difference.

Similar evaluations could be made for education. While electricity in and of itself is not going to teach anyone to read, it could facilitate this process for children in school and at home and it could be the impetus for adults to learn (night classes) and to allow both children and adults to learn new skills (shop welding). The effects on education of electrified appliances such as TVs could also be evaluated.

## Project Evaluation

### Pre-project evaluation

Evaluations of potential sites and user commu-

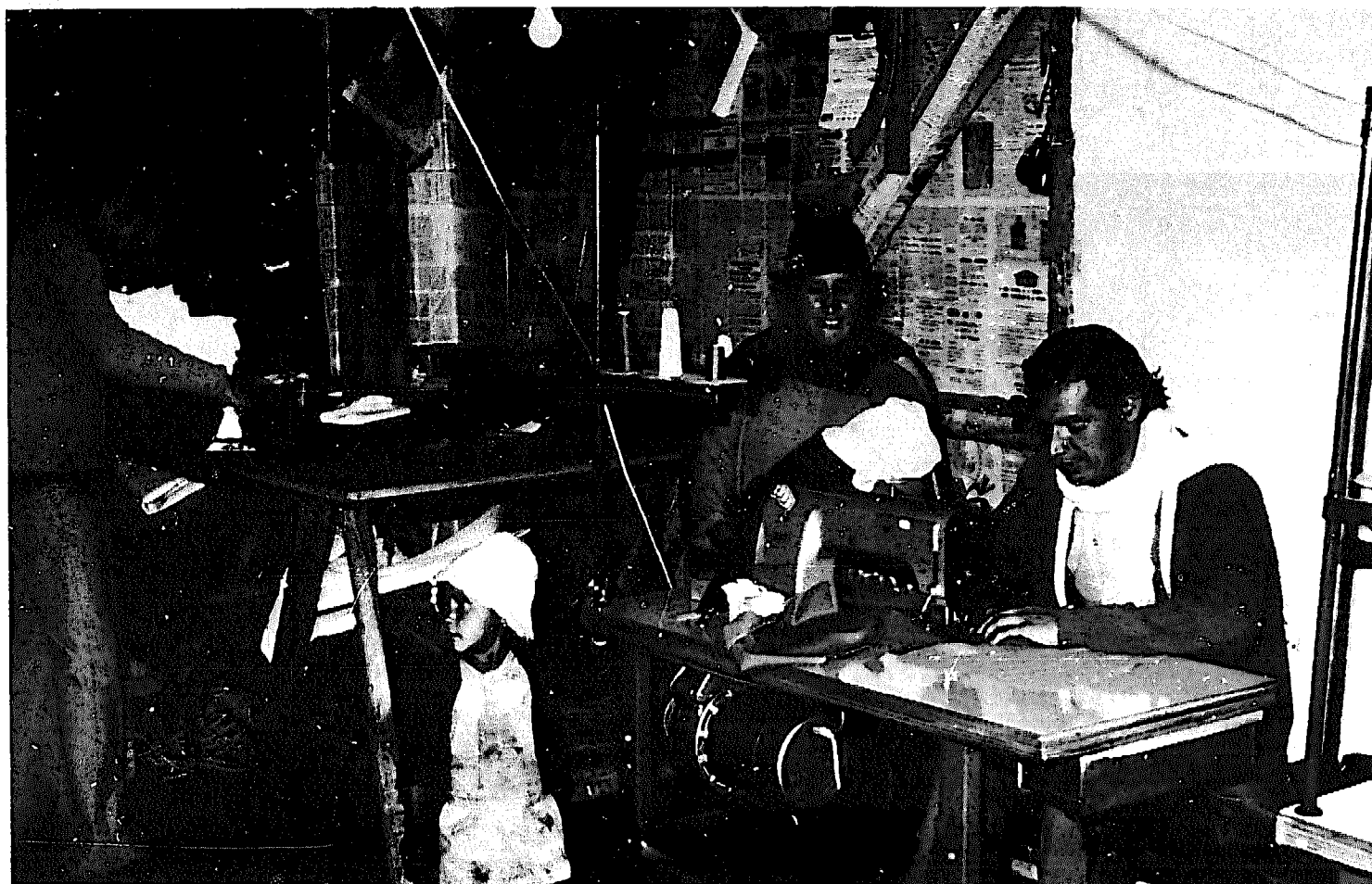

Small-scale industry – Ecuador.

nities to determine their suitability for small hydro systems is important for at least three reasons. First, careful evaluation and site selection can go a long way toward ensuring the success of the project. Secondly, in most national or international small hydro programs, there will be more potential sites than funds to cover installation of SDH systems, and choices will have to be made among the sites that are available. Informed choices can be made by a good evaluation procedure. Finally, a good pre-project evaluation can serve as valuable baseline data for a later post-project evaluation.

Technical evaluation of hydro sites has long been standard practice, ranging from fairly informal procedures consisting of a few measurements and calculations to elaborate, detailed feasibility studies. Many manufacturers of small hydro equipment use standardized questionnaires that are sent out to prospective customers. Since most of these manufacturers do a mail-order business exclusively, without site visits, they must rely on the technical data submitted by their customers. From this data, a manufacturer

selects the equipment that best matches the needs of the customer and sends it out. From a technical standpoint, pre-project evaluation criteria appear to be well-established.

Evaluation of user communities is a more recent phenomenon. In the vast majority of cases of existing small hydro systems, the users have themselves initiated the purchase and installation of the unit. Hundreds of SDH systems are being used successfully by businesses and private voluntary agencies around the world. A smaller number of SDH systems have been installed by villages and municipalities on their own initiative. In China, where thousands of small hydro units have been installed in the past ten years, there has been an interesting mix of local initiative and government support. Hydro units are planned, installed and paid for by local communes, with the government providing technical assistance and low-cost loans.

In instances where small hydro units have been installed and maintained on local initiative, evaluation of the user community has not been a significant issue, since the users have demonstrated their desire and need



Meat cutting – Nicaragua.

for the SDH unit by virtue of their willingness to install and pay for the system. More recently, however, small hydro programs have been initiated by governments and by bilateral and multilateral funding agencies, and SDH units have been “bestowed” on local communities with or without their active support. In many instances, while there has been technical evaluation of the hydro sites, there has been no corresponding evaluation of the user community to determine its suitability for a hydro unit. Assumptions have been made by outside agencies that the community wants, needs and will use the system, and that the system will be used for the purposes planned by the donating agency.

In contrast to units that have been locally initiated, systems that have been bestowed on communities have a mixed record of success. While some have been enthusiastically received, many others have experienced severe problems, and a number have been discontinued. In some cases, user communities have been unable to manage or maintain the systems, necessitating outside personnel to perform these functions,

often with increased costs and delays. In other cases, communities have been unable to use the electricity supplied by the SDH system through inability to pay the cost of hook-ups, service charges and electric appliances, including light bulbs. In a number of cases, there was an expectation of industrial and/or commercial demand for electricity, but this was not realized because these establishments did not exist, where not developed, and could not or would not use the electricity supplied by the SDH system.

To avoid these kinds of problems, a pre-project evaluation of the user community is strongly recommended. This evaluation could take many forms, but a useful tool might be a “community application form” that would screen potential applicants for those characteristics necessary for the successful operation of an SDH system. The criteria to be used in evaluating user communities will naturally depend on the specific purposes of the SDH project (as discussed below), and the community application form should reflect the goals and objectives of the SDH program. However, there are certain requirements common to

all SDH systems, whatever their purposes and whatever type of user community. These include installation and construction of the system, management, maintenance and repair.

In designing the community application form, the Amaru team drew on the experiences of local groups that have built and operated their own hydro systems. The application form reflects the kinds of issues these user communities had to deal with in building, maintaining and using their SDH units. It is recommended that the application form be *self-administered* by the user community. The act of preparing the questionnaire itself can be a means by which the user community develops or enhances the management and planning skills that will be needed to successfully operate a small hydro unit.

A broad outline of the community application form is contained in Appendix I. This outline refers primarily to village-level, multi-purpose electrification; application forms for specialized institutions or single-purpose electrification projects can be tailored to elicit data specific to the site and user community.

The technical information section consists of site, stream and system characteristics. As noted above, manufacturers of hydro equipment have developed useful questionnaires to elicit this kind of information, and these instruments could be used as a guide in formulating this section of the application form.

The problem-solving section contains a number of hypothetical questions covering construction, costs, management, repair/maintenance and uses of the electricity. This is by no means a comprehensive list – additional questions should be formulated relative to local conditions and practices. The questions noted here deal with problem areas that have been common to bestow systems. By confronting these issues at the outset, the user community will be in a much better position to deal with the system once it is installed.

The area survey involves a census of the community or area to be served by the SDH system. There are a number of good survey instruments currently in use in various rural electrification programs. In the Philippines, pre-electrification surveys are standard practice, and the National Electrification Administration has developed some very useful material that could serve as a guide in developing surveys for SDH programs.

If the applicant is a community or municipality, data should be gathered on settlement patterns, households, business and commercial establishments, public facilities and social services, communications linkages, transportation, occupations and agriculture. Information on current use of electricity (diesel generators, grid extensions, *etc.*) should also be obtained. Other

useful data includes information on irrigation systems and water supply, traditional organized groups (*e.g.*, cooperatives, religious associations, *etc.*), and present energy use (for cooking, illumination, heating, *etc.*). If the user community is a specialized institution, data should be gathered on planned uses of electricity for such purposes as water pumping, lighting, equipment, *etc.*

The area survey is important for two reasons. First, it enables the user community to more accurately predict the demand for electricity from the SDH system. Secondly, it provides baseline data for later evaluations. The survey should include items that the evaluators wish to measure both before and after electrification. For example, if it is anticipated that the hydro unit will enable second crops through improved irrigation, then baseline data should be gathered on current crops, yields and prices.

It will be obvious to the reader that many user communities will need assistance in preparing this kind of application form. Technical evaluations will need to be made or supervised by qualified personnel, and the user community may not be able to answer the problem-solving questions and conduct a survey without outside assistance and training. The point of the community application procedure is not to make it unduly difficult for a community to receive an SDH system, and it would be unfortunate if communities were excluded because they could not handle the paperwork involved in an application process. The point of the entire procedure is that it forces the potential user community to deal with the system itself – to plan for its use and to resolve those problems that will inevitably occur in its operation. Deserving user communities should be provided with assistance in preparing their applications, either by SDH program personnel or designated volunteers, such as university students.

Finally, it is recommended that the community application form be updated by the user community one year after installation of the SDH system and used as part of the post-project evaluation. The same kinds of information and questions will be asked, but phrased in the past tense. For example, instead of asking "How will you assess fees?" the question will be "How are you presently assessing fees?"

#### Post-project evaluation

A post-project evaluation of the SDH system can provide program officials with valuable data. It can assess whether program goals and objectives are being met and can point out problem areas that need to be corrected. Since many SDH installations will be pilot

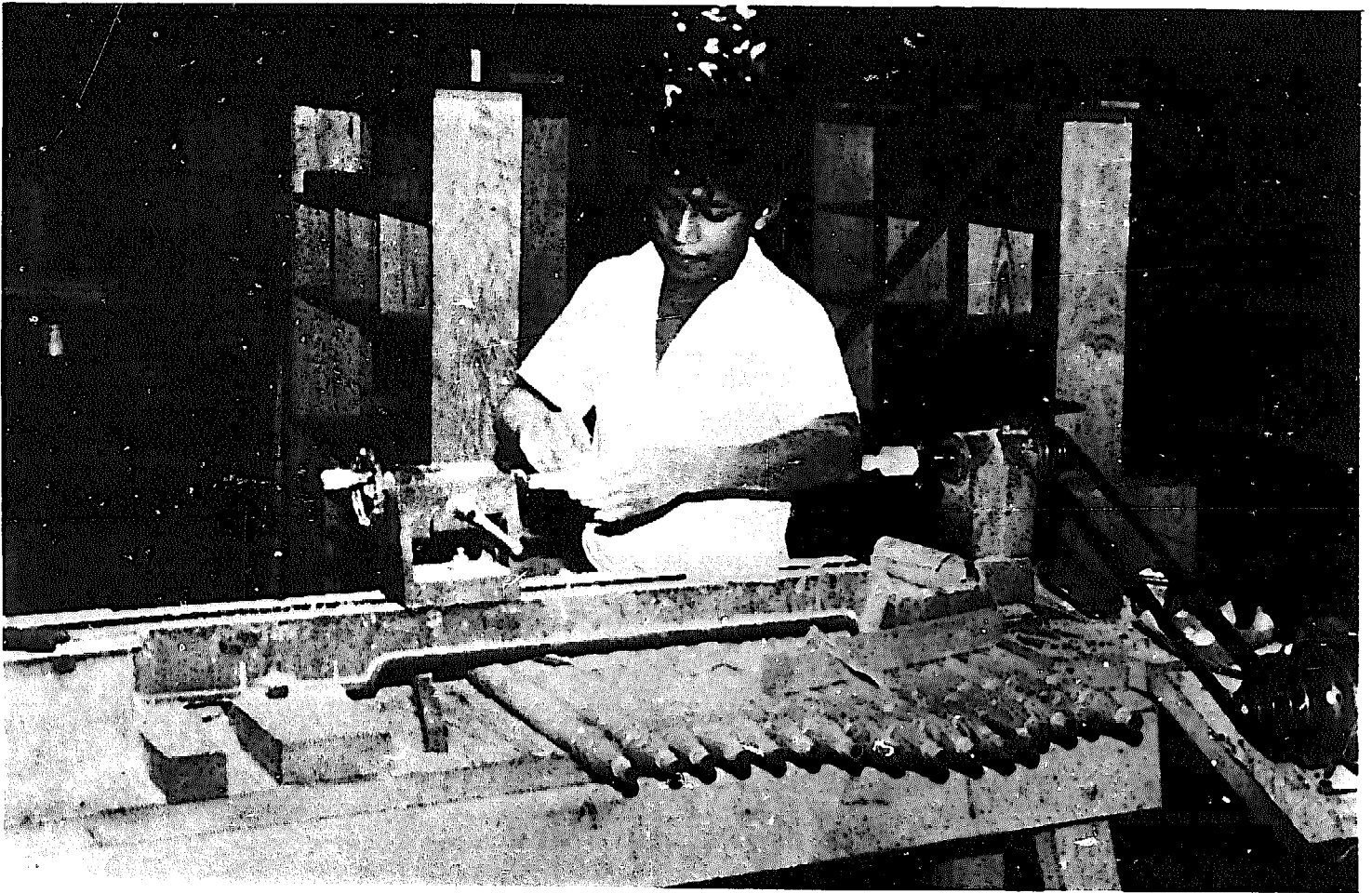

Woodworking lathe – Nicaragua.

projects, careful evaluation of these units can be helpful in the planning and installation of future SDH systems.

It is recommended that an on-site evaluation of the SDH system be undertaken one year after installation. Obviously, a year is not a very long period of time in which to gauge the impact of electricity on a community. While there are usually some immediate effects, the full impact of electricity will not be obvious for a number of years. The reason for recommending a post-project evaluation after one year is that most SDH projects will still be under the supervision of the sponsoring agency, and an early evaluation can allow needed modifications while agency personnel are still available. Further evaluations can be undertaken at later periods, and it is recommended that follow-up studies be conducted at intervals for a number of years.

Prior to visiting the site, the evaluator should examine the community application forms – both the initial application and the updated form. By comparing the two forms, important factors can be singled

out for investigation at the site. For example, if the number of households or businesses has increased (or decreased) since electrification, this could be investigated at the site to determine if electrification influenced this phenomenon.

The post-project evaluation should consist of three parts: observational data, examination of records, and interviews; if possible, photographs should also be taken. The evaluator should be able to perform a fairly comprehensive investigation in two days. The evaluation procedure used in this discussion is designed for use in a village-level multi-purpose electrification system. Evaluation formats for specialized institutions or single-purpose electrification can be designed from this generalized format by selecting out, and possibly expanding, those aspects of the evaluation which apply to the specific site. Items to be investigated will, of course, vary among cultural groups and world areas. For example, the use of such appliances as rice cookers and fans will be restricted to certain geographical and cultural areas.

The hydro plant and associated civil works should

be examined in the company of the local technician, and system characteristics and technological problems should be discussed. Records should be examined, if possible, to determine costs for hook-up and service, how fees are assessed (meters, minimum monthly rates, current limiters, *etc.*), how much electricity is used and by whom, peak loads and other information. The distribution lines should be traced throughout the community and the evaluator should note which businesses, public buildings and households are hooked up. If there are differences in household hook-up by location, house type (construction materials) or any other criteria, these differences should be noted.

Domestic uses of electricity should be observed in at least two households, and it is recommended that the evaluator seek accommodation in a "typical" electrified household. Uses of household lighting should be observed – for convenience, studying, entertaining, and productive use (such as sewing or embroidery). Any changes in household routine since electrification should also be investigated. For example, if women or other household members are doing chores in the evening now instead of during day-light hours, this should be noted. The use of appliances, if any, should also be observed and should include both owned and shared appliances. If people charge others to use their appliances (such as TV watching) this should be noted under productive uses. The substitution of electricity for wood, kerosene, batteries, candles, *etc.* should be investigated and questions should be asked about the relative costs of these fuels. If there is enough information on appliances, the data should be ranked according to which appliances are the most popular. If there are appliances for sale in the community or surrounding area, the evaluator should note which appliances are available.

Electricity use in public buildings and outside public areas should be investigated. Street lighting and/or special lighting for downtown or market areas should be observed. Use of electricity for lighting and equipment in public buildings such as churches, post offices, or government offices should be noted. Public officials and community residents should be asked about the effects of electrification on public activities, such as night-time use of public facilities and playgrounds, increased economic or social activity, public safety, and public water supply.

The use of electricity in commercial establishments should also be observed. If new electrical equipment or appliances, such as refrigerators, cooking devices, jukeboxes or TVs have been purchased, this should be noted. Owners and patrons should be asked about the effects of electrification on commercial

activities, such as hours of operation, new services that are available and increased sales or profits. If new commercial establishments have been opened as a result of electrification, this should be noted.

Electricity use in businesses should be investigated by the evaluator. If there are only a few businesses in the community, they could all be included in the evaluation. If there are a large number, selections could be made by categories, *i.e.* manufacturing, processing, *etc.* If possible, business records should be examined with respect to profits and employment levels. Interviews should be held with the owner or foreman and at least one employee. Areas of interest include lighting (for convenience and fine detail work), reliability of electricity (is there any back-up system), employment levels (include both new hiring and displacement of workers by electricity), increased profits or expansion, and use of electrical equipment (including safety factors). Any new businesses since electrification should be noted. The evaluator should not forget to include in-home businesses such as grocery stores, auto repair shops and cottage industries.

Farmers should be interviewed with regard to electrified irrigation systems or direct motive applications, and the effects of electrification on crop yields and growing season. If electricity has enabled night-time farming or processing, this should also be noted.

If there is a health clinic or hospital, the evaluator should investigate use of electricity by this agency. Health officials and patients should be asked about lighting, hours of operation and equipment (particularly new equipment). If there are any changes in public health since electrification, such as incidence of gastro-intestinal disease and birth rates, this could be noted. If possible, medical records should be examined. Health officials should also be asked about the local water supply. If there is no health clinic in the community, but there are rural health workers who visit the area, these individuals should be contacted.

School officials and pupils should be asked about use of electricity in the school. Topics to be investigated include classroom lighting, study habits, night classes and/or use of school buildings at night, and the use of electrical equipment such as loudspeakers or shop tools. If possible, school records should be examined for any changes in attendance, performance and enrollment.

After the evaluator finishes his/her investigation of the selected topics mentioned above, he/she should hold a series of short interviews with members of the community at large with regard to the effects of elec-



Irrigation project – Bangladesh.

tricity on their lives. (In some cases, the village will designate individuals to be interviewed.) The evaluator should make sure that representatives from all sex, age, economic and social groups are included. Questions should be open-ended and interviewees should be encouraged to talk as much as possible. All questions should have a “before and after” component to compare activities before and after electrification. Suggested questions include: What do people do in the evenings? Where do they get together? What are people using electricity for? How much do you pay for electricity? Do you feel it is too expensive (or not)? Why don't you have electricity in your house (non-electrified)? How reliable is the electricity and what happens if the power goes off (back-up) How has your life changed since electricity came to the village?

One technique for eliciting information from respondents relative to the impact of electricity on their lives is the “daily round.” In this method, the evaluator asks the interviewees to tell what they do from morning to bedtime. The daily round should be collected for two days – a typical work day and a special

day (holiday, feast day, market day, *etc.*). The interviewee should ask what changes, if any, have occurred in his/her normal activities since electrification.

### Conclusion

In this brief paper, certain aspects of evaluation of SDH programs have been discussed, and examples given of evaluation criteria for village-level multi-purpose electrification. Evaluation criteria, like goals and objectives, can be virtually endless, and program officials will need to expand these evaluation formats to investigate other areas of interest. Certain important areas, such as communications and cultural enrichment, were not discussed. These outputs and others should be investigated. By clarifying goals and objectives, and by clearly defining the requirements of each SDH project (beneficiaries, community participation, non-subsidization, *etc.*), program officials will be better equipped to make decisions regarding site selection and to select the kinds of evaluation criteria that will be needed to measure program accomplishments.



**Appendix I**  
**Elements of Community Application Form**  
**(Pre-Project Evaluation)**

- I. Information on the User Community — name, type of organization, legal status, *etc.*
- II. Technical Information — site, stream and system characteristics. (Can be modelled on manufacturers' questionnaires.)
- III. Problem Solving — This will vary with uses and purposes of electricity and the terms under which the SDH system is installed. Questions should reflect the problems the user community will need to deal with for successful operation of the SDH system. Some examples:
  - a. Uses of electricity — How will you use the electricity? Who will use it?
  - b. Construction — Who will build the system (both installation and public works)? What materials will be needed? Are materials locally available? If not, where will you get them? How much will they cost?
  - c. Labor — Will local labor be used to build the system? Will workers volunteer their labor or will they be paid? How will you pay them? What skills do local workers have that would be helpful in construction of the hydro system?
  - d. Payment — How will you pay for the system (include capital costs and operating costs)? Will electricity be sold? If so, how will you assess rates? How will you collect payment?
  - e. Management — Who will manage the system? How will it be managed (organizational form)? Will the manager(s) be paid?
  - f. Maintenance — Who will repair and maintain the system? What will you do if the system breaks down? Where will you get assistance if the unit cannot be repaired locally? Where will you get spare parts? What maintenance will be needed?
  - g. Previous experience with public works or machinery — Has your group ever built a major civil works or public building? (Examples include roads, irrigation systems, schools, *etc.*) Describe how you built it.
- IV. Area Survey
  - a. Present uses of electricity, if any.
  - b. Hours of daylight and seasonal variations.
  - c. Settlement patterns — Include a map or diagram of the village, noting households, businesses, public areas and other institutions, such as schools, clinics, post office, *etc.* Show distances from the hydro site.
  - d. Households — Construction materials (describe different types). Composition of household — average number of people, relationship, average number of children. Indicate what households wish electricity, and planned uses (*e.g.*, lighting, appliances, cottage industries, *etc.*).
  - e. Businesses — For each, indicate type, present use of electricity (*i.e.*, diesel generators, *etc.*), number of employees, planned uses of electricity. Indicate whether the business will use community electricity from the hydro unit or will continue to use its own generator (or will keep its generator as back-up).
  - f. Commercial establishments — For each indicate type, present use of electricity, number of employees, planned use of electricity.
  - g. Farms — Include both large agrarian enterprises and small farms. Present use of electricity, if any. Crops, livestock, processing, mechanizations. Include seasonal variations in agrarian production, problems (disease, drought, *etc.*), market prices, transportation to markets. For large agrarian enterprises, describe the labor force (migrant, tenant farmers, *etc.*). Describe households for the labor force (as in d. above).
  - h. Irrigation and water supply — Describe the present irrigation system and indicate possible uses of electricity. Describe the village water supply, including both public and private wells, pumps, *etc.*
  - i. Public areas — Markets, downtown areas, recreational centers and others. Indicate planned uses of electricity, such as street lighting.
  - j. Institutions — Schools, religious institutions, health clinic/hospital, government offices, *etc.* Indicate planned uses of electricity.
  - k. Communications — Radio stations, others, if any. Indicate planned uses of electricity.
  - l. Linkages — Roads, trails, railroads, docks or ports, and others.
  - m. Transportation — Cars, taxis, trucks, bicycles, *etc.*
  - n. Occupational data — Indicate major occupations present in the village and the number employed in each area. Indicate seasonal changes, if any, and employment outside the village (commuters).

- o. Population – Indicate the total number of people in the village, including breakdowns by sex and age.
- p. Traditional groups – Indicate if there are any organized groups such as cooperatives, religious associations, age sets, village council, and others.
- q. Present energy use – Indicate what fuels are used for lighting, cooking, heating and cooling (if applicable), and the cost of each type.

**Judith H. Magee** is an applied anthropologist who lives in the Washington, D.C. area. Dr. Magee received a B.A. from the George Washington University in Washington, D.C. in 1965, and a PhD from the University of Colorado in 1977. Her specialized areas of study within anthropology concerned economic development and technology transfer programs in developing countries. Since 1977, Dr. Magee has been working in the field of appropriate technology. She worked for the National Center for Appropriate Technology in Butte, Montana from 1977-79. Since 1980, Dr. Magee has worked as a consultant in Washington, D.C. on various appropriate technology projects. She is a current associate of the AMARU IV Cooperative, a Washington-based consulting group, and worked with AMARU on its research contract with NRECA to set up evaluation criteria for the SDH program. Dr. Magee's publications in appropriate technology include *Down to Business: An Analysis of Small-scale Enterprise and Appropriate Technology* (1979), and *The Co-op Bank and Appropriate Technology* (1980).

## ***PART II : SECTION 4***

# **Case Studies**

---

*In place of a field trip which was cancelled due to road conditions, four of the delegates present at the workshop gave papers which discuss aspects of their countries' mini-hydro projects. Cheng Xuemin, of the People's Republic of China, discusses various criteria which are used in selecting mini-hydro projects in the PRC; Hoesni Nasaruddin discusses a new system of rural energy distribution in Malaysia using an electrical current limiter and a battery charger; Zenaida Santos, of the Philippines, discusses the progress of that country's program to install 250 mini-hydro plants by 1987; and Djoko Susanto of Indonesia discusses his country's plans to develop very small hydropower sources for both electrical and mechanical applications. Mrs. Santos' presentation is based on the text given in Part I, Country Profiles. The papers by Cheng Xuemin, Hoesni Nasaruddin and Zenaida Santos are followed by question and answer sections.*

## China's Small Hydropower Development

Cheng Xuemin\*

### Topography and Climate

CHINA has a vast territory of 9,600,000 square kilometres. There is a large variety of topographical features in the whole country. Generally speaking, the eastern part of China is low and flat, while the western part is elevated and mountainous. In between them, there are hilly countries spread over the central, southern, eastern, and northeastern provinces. The highest plateau of China is the Qinghai-Tibetan Plateau, with an average elevation of over 4,000 metres above sea level, and an area of around 2,000,000 square kilometres. Many important rivers in China, including the Yangtze River, the Yellow River, the Yalutzangpo River, the Lancan River and the Nu River, originate from this plateau.

The climate in China is generally mild. Most of the precipitation comes in the form of rainfall, which is carried inland from the moonsons (typhoons) formed in the summer months in the southwestern Pacific Ocean. Precipitation is most plentiful in the coastal provinces of eastern China. An annual rainfall of 3,000 mm has been recorded in Taiwan Province. From east to west, or from the coast to inland, the precipitation decreases gradually. The Tarim Basin in the Xinjiang Autonomous Region has an annual precipitation of only 50 mm. The total surface runoff of all the rivers in China is about 2,600 cubic kilometres annually.

### Hydro Potential

A national survey of hydropower potential was carried out in 1977-80. The survey aimed at exploitable potential as well as theoretical resources.

The results of the survey indicate:

- the total theoretical hydropower potential is 676,050 MW;
- the total exploitable hydro potential is 378,530 MW, corresponding to an annual generation of 1,923,304 GWh; and,

- the total exploitable hydro potential consists of 1,706 hydropower sites, with individual capacities of over 10 MW each.

The regional distribution of hydro potential in China is shown in Table 1.

Table 1  
Hydropower potential in China (according to regions)

Region	Theoretical potential		Exploitable potential	
	1,000 MW	1,000 MW	1,000 GWh	%
North	12.30	6.92	23.225	1.2
Northeast	12.12	11.99	38.391	2.0
East	30.05	17.90	68.794	3.6
Central South	64.08	67.43	297.365	15.5
Southwest	473.31	232.34	1,305.036	67.8
Northwest	84.18	41.94	190.493	9.9
Total	676.05	378.53	1,923.304	100.0

It can be observed from Table 1 that:

- two-thirds of the total hydro potential is concentrated in China's southwest;
- the potential in northern China, northeastern and eastern China represents only a small percentage of the total, but the absolute values still represent a significant amount; and,
- in the central southern region, the exploitable potential is somewhat larger than the theoretical potential. This is due to the fact that the huge Three Gorges Project on the Yangtze River is situated in Hupei Province of the central southern region, while a part of the potential utilized by this project belongs theoretically to Sichuan Province of the southwestern region.

There are as yet no similar statistics on small hydropower potential available. As a general concept, small hydro potential is most abundant in southern China, where ample precipitation and the rolling topo-

\*Chief Engineer, BOAF, Ministry of Power, Beijing, People's Republic of China.

graphy give good opportunity to small hydro development. Northern China is more or less arid, and water is more precious. It is only in some particular localities that small hydropower can be exploited on a sizable scale.

### Hydropower Development

Up to the end of 1980, the total installed capacity of hydropower in China was 20,320 MW. This can be broken down according to plant size as follows.

**Table 2**  
China's hydropower installations (1980)

Size	No. of stations	Installed capacity MW	Electricity generated GWh
Over 250 MW	18	8,080	29,400
250-12 MW	95	5,560	16,700
12-0.5 MW	1,707	3,230	7,800
0.5 MW & less	90,000	3,450	4,300
Total		20,320	58,200

The last two categories in Table 2 are grouped as small hydro stations, while stations with a capacity of less than 500 kW are termed rural hydropower stations.

Provinces in southern and southwestern China occupy a leading role in the development of small hydropower, due to favourable hydrological and topographical conditions. Guangdong, Sichuan, Hunan, Guangxi, Fukien and Zhejiang are provinces which have small hydropower stations in operation with a capacity of more than 500 MW. Up to now, over 70% of the countries in China have built their own small hydro stations, and about 50% of China's rural population is served with electricity from small hydro stations in conjunction with regional power grids.

The increase of small hydropower stations in China has been substantial in recent years. About 1,000 MW of new capacity was commissioned in 1979, 500 MW in 1980, and about 260 MW in the first half of 1981.

In the early stages of small hydropower development, stations with very small capacities, say less than 10 kW, were built. They are now giving way to larger stations. Statistics show that the average plant size of small hydro was 32 kW in 1970, and increased to 70 kW in 1979. The new small hydro plants commissioned in 1981 have an average plant size of 250 kW. The

increase in plant size usually results in a decrease in the construction cost per kW installed.

### Basic Experiences

#### Planning

One of the basic experiences accumulated in the development of small hydropower stations in China has been that there is a need for proper planning. An overall planning scheme is always desirable. Not only for the individual site, but also for the entire riverlet, or small stream. Many small rivers in China were developed in a series of projects, or in cascades. A chain of stations were carefully planned to utilize all or nearly all the head of the river. In such planning, the most important issue is to find an appropriate reservoir site, preferably on the upstream reaches. It is not suggested that a large reservoir be found to attain a perfect regulation of the river flow, since a large reservoir is always very expensive. In many cases, people should be satisfied with a reservoir of appropriate capacity. That means a reservoir which is large enough to give a certain degree of flow regulation, but is also small enough to be within the financial reach of the sponsor of the project.

Another important issue in the planning of small hydropower development in China is a proper balance of water uses amongst different water users in a multi-purpose development. It is very seldom in China for a small hydro plant to have mentionable flood control benefits, because the storage capacity required to handle the flood water is always very large, and will turn out to be a burden too heavy to be carried by a small hydro plant.

The most common partner of a small hydro project is irrigation. As may be the same as in many other countries, irrigation in China always has a very high priority in rural development. As a matter of fact, many small hydropower plants were initiated as irrigation projects. This was the original purpose. The generation of electricity is sometimes considered as a well cherished incidental benefit. The power revenue, which is usually high due to the high retail price of electricity, will repay the construction cost of the project in a very short period, and afterwards it will become an attractive source of income to the community concerned.

But the union between irrigation and power is not always a happy one. Conflicts in water uses are inevitable. If there is insufficient water supply, irrigation usually has the prior claim to use the water. River flows in the non-irrigation season may have to be stored for the next irrigation season, at the sacrifice

of power generation. In this case, the supply of electricity may have to be suspended – unless, of course, another source of electricity supply can be obtained.

Insufficient hydrological data is always a major difficulty to be overcome in the planning of small hydropower stations. Many provincial authorities in China have compiled charts and tables of hydrological characteristics for small watersheds in their respective provinces, based on interpolation and extrapolation of observed data in the region. The average annual yield of a watershed as well as the seasonal variations can be roughly estimated from these charts and tables. It is also a general practice in China to set up a water gauge at the project site while the project is under consideration. A few months of such gauge records can be used to correlate with gauge records of some other gauge stations in the vicinity with longer durations. This is an easy approach and gives near approximations when used with good judgement.

The annual utilization hours of small hydropower in China averages 1,800-2,000 h/yr. Stations with capacities of less than 500 kW have an average utilization of 1,300 h/yr, and those with capacities of between 500 kW and 12,000 kW have an average utilization of 2,600 h/yr. Efforts are being made to raise the utilization hours of small hydro in order to make more efficient use of the plant and to improve the overall economy of small hydropower development.

#### Use of local material and labour force

Earth, rock, timber, brick, sand, gravel and lime are the most popular local materials used in small hydro power constructions in China. Dams made of earth and stone can be traced many years back in Chinese history. They are now being built in great numbers and with improved skill and technology.

The earth dams currently built are mostly of the conventional rolled-filled type, with a clay core wall. The selection of a suitable impervious material for the core wall is a critical issue. Compaction of the fill material is usually done by tractors, and a good quality control should be assured. Ample provision for flood spillways is essential for successful operation in the event of excess flooding.

Stone masonry dams are popular in areas where quarried stone is available in sufficient quantities at low cost. In Sichuan Province, for example, where good quality sand stone is available in abundance, stone masonry dams of different designs were built in large numbers. The highest stone masonry dam in service has a height of 97.5 metres and is of the arch-dam type. Masonry dams are advantageous in flood

handling. A spillway can usually be arranged on the top of the dam with little risk of flood damage.

Both earth dams and masonry dams are labour-intensive structures. The entire common labour-force and the skilled labourforce can be recruited locally. The construction schedule can be arranged to avoid the seasons of maximum agricultural activities.

Powerhouse structures are usually made of timber and brick, or occasionally of reinforced concrete, with foundations made of stone masonry or concrete.

Precast reinforced concrete pipes have been used in China for penstocks of small hydropower stations in order to save steel and make the best use of the local material. Precast reinforced concrete penstocks have been successfully used in a small hydro station in Gaungdong Province with a diameter of 1.3 metres and a head of 168 metres.

Operational personnel are trained locally, or are sent to a nearby existing small hydro station for training and practice.

#### Small hydropower machinery

The manufacturing of small hydropower machinery has grown up rapidly and has spread widely over the country. More than one hundred state-run factories, with a total production capacity of one million kilowatts of small hydro power machinery per year, have been established since 1949.

The products have been standardized and unified into a series of models and types which have become universally adopted by all the manufacturing factories in China. There are now 26 models of hydraulic turbine runners with 83 varieties available, suitable for heads from 2.5 to 400 metres.

One bulb-type generating set with a capacity of 500 kW using a head of 4 metres has been installed in Zhejiang Province, and another set of 10,000 kW capacity using a head of 6 metres is in the research and development stage.

**Table 3**  
Hydraulic turbines produced in China

Types	Units of less than 500 kW		Units of 500-10,000 kW	
	No. of runner models	No. of varieties	No. of runner models	No. of varieties
Axial flow	2	10	4	11
Tubular			3	4
Francis	3	12	10	32
Impulse	3	10	1	4
Total	8	32	18	51

Micro generating sets have been built with capacities from 0.5 to 75 kW, for heads from 2.5 to 40 metres. They are produced in complete sets with all the necessary auxiliaries, are easy to transport, erect and operate, and are most suitable for remote and inaccessible sites.

Small hydropower generators are mostly of the synchronous type. Asynchronous generators are rarely used due to a shortage of reactive power in rural grids.

Speed governors used for small hydraulic turbines have been built for five types of operation, *i.e.*, manual, electric, electric-hydraulic, electronic-electric, and electronic-hydraulic.

In several cases, regulating valves for hydraulic turbines have been used to replace the conventional surge chamber, resulting in a great saving in the construction cost. For instance, a small hydro station in Hunan Province has three turbines of 1,600 kW each, with a head of 88 metres and a pressure conduit of 1,957 metres in length. It was originally proposed to build a surge chamber with a diameter of 7 metres and a height of 45 metres costing 400,000 Yuan (Renminbi). Instead, three regulating valves were installed costing only 40,000 Yuan (RMB). The station has been operating successfully.

#### Use of electricity in rural areas

In 1980, 37.4 TWh of electricity was consumed in rural areas in China. This represents 14.9% of the national total electricity consumption. Compared with 1949, when only 20 GWh of electricity was consumed in rural areas, an increase of 1,870 times this amount has been achieved in the past three decades. The per capita consumption of electricity in China's rural community is, however, still very low, amounting to only 46.8 kWh/capita/year. About 50% of the rural population were served with electricity in 1980, and one third of the electricity consumed in rural areas was supplied by small hydropower stations.

Electric lighting is usually the first benefit of electrification. It brings about a drastic change in the daily life of the peasants. It is universally needed and produces effects far beyond the economic benefits. Daily activities can be extended for several hours which would otherwise be wasted. Rural cultural life is greatly enhanced due to the introduction of electric lighting. The amount of electricity used for lighting represented only 15% of the total consumption in rural areas in 1980, and this amount is certainly outweighed by its importance.

The processing of agricultural products comes next in importance to lighting. Electric mills save a

great deal of time and labour at little cost, and are admired by every household in the rural community. The processing of oil seeds, cotton wool, sugar cane, tobacco and many other items meet the local demand and avoid a lot of back-and-forth transportation. Some of the processing operations are of a seasonal nature, and might be arranged to suit the seasonal variations of small hydro generation.

Small industries have been booming in electrified rural areas. They include small chemical fertilizer plants, small agricultural machinery factories, small coal mines, brick and tile factories, small textile factories and even small iron and steel works, according to the resources available locally. The development of small factories in rural areas has been promoted so as to provide a supplement to large industries. They certainly fulfill this purpose, but sometimes at higher production costs. In this case, the government has to subsidise and advise the small factories how to improve their management and reduce their production costs.

Electricity used in providing irrigation and drainage pumping consumes 44% of the total electricity for rural uses. A large number of pumping stations were built with capacities of up to tens of megawatts. The large pumping stations usually use electric motors while the small pumps are driven by diesel engines. There is a tendency to shift from diesel engines to electric motors as a result of government restrictions on using fuel oil. Some of the pumping irrigation stations have to pump water to a height of 400 to 500 metres. In such cases, a lower electricity tariff has to be specially designed to reduce the burden of electricity bills for the peasants.

#### Cost data

The construction cost of small hydropower stations varies widely due to different physical conditions. Generally speaking, a minimum construction cost of 600 to 800 Yuan RMB per kW can be expected under very favorable conditions. The maximum value would be about 2,000 Yuan RMB per kW. About 1,000 to 1,400 Yuan RMB per kW typifies average conditions. Civil engineering work accounts for 40% to 60% of the total construction cost, while the remaining 30% to 50% goes to the electrical and mechanical sectors. The sales cost of electricity in rural areas is about 5 to 6 fens RMB per kWh.

Despite the splendid contribution made by achievements with small hydro stations to rural development in China, there remains much room for improvement. Efforts are being exerted to promote new small hydro stations, as well to improve the management of existing stations, aiming at a still

higher degree of electrification in China's rural community.

### Discussion

*Questioner from the Audience:* I wonder if Mr. Cheng could describe how the community is organized to maintain the hydro plants?

*Mr. Cheng:* For the most part, the small hydro plants in China are run by the common people. It is not very difficult to operate a small hydro plant, as you know. There are always some technicians in the community, but the work is always accomplished by common people.

*Questioner from the Audience:* You calculated that there are 686,000 MW of total hydropower potential in China. How much of that has been developed?

*Mr. Cheng:* About 20,000 MW.

*Questioner from the Audience:* I understand that you do not always use conventional materials in constructing your sites, not even concrete. What do you generally use?

*Mr. Cheng:* Many were made of wood. These turbines are very small ones, maybe a few kilowatts. They were built in the 1950's and are rather popular, but now most of them have been replaced by metal ones.

*Questioner from the Audience:* Which metals? Stainless steel?

*Mr. Cheng:* Yes, we use quite a lot of stainless steel, particularly for larger turbines, but not the small turbines. We also use cast steel or what we call manga-

nese steel, or chromium steel.

*Question from the Audience:* How much of the developed potential is in small hydros?

*Mr. Cheng:* We have about 4,000 MW in small plants, the remaining 16,000 MW in larger ones — larger than 500 kW.

*Questioner from the Audience:* Why did you change from government loans to bank loans? What is the difference?

*Mr. Cheng:* Well, it is quite different. They don't have to repay a government loan. But they do have to repay a bank loan, with interest as well. The interest is very low, only 3 or 4%. The government doesn't need to use the bank loan requirements.

*Questioner from the Audience:* I have one brief question, Mr. Cheng. I understand that there are plans for a training and development centre in China for mini hydro that is being developed in cooperation with the United Nations. I wonder if you might comment on that?

*Mr. Cheng:* Yes, there is such a training center, and I think it will start operating in the next three months.

*Questioner from the Audience:* I have heard people say that mini-hydro in China may be seen as a transitional phenomenon, rather than something contributing to a large extent to the future development of China. What is your opinion on that?

*Mr. Cheng:* This is an on-going program, and I think mini-hydro projects are going to stay. Although we have many hydropower stations of various sizes, about 50% of the people don't have any power yet. We still have to provide power for the other 50% of the population.



## A Radical Approach to Rural Electrification for Developing Countries:

Hoesni Nasaruddin and Rosli Alias\*

---

**ABSTRACT :** A technique of rural distribution, with rural electrification being redefined, is discussed in the light of rural development relating to small power sources. The system, employing a current limiter, a battery charger and a battery limits the demand of the consumer from the point of view of the source. The consumer's supply of electricity is taken in terms of energy rather than electrical power. The advantages of the system are presented in detail and its significance for the rural electrification programme in relation to micro-hydro stations, small diesel stations, and excessively long lines extended from the grid is elaborated.

---

### Introduction

**I**N developing countries, utility administrators definitely face problems in the implementation of rural electrification programmes, especially in extending electrification to very remote areas. There are even areas not far from the local grids which do not receive an electric supply. This is because the technical standards and the philosophy of rural supply adhered to by utility administrators are a stumbling block to the potential rural consumer. For electricity to be introduced to rural areas in a more dynamic and economical manner, a radical approach to rural electrification is required. The approach presented here requires a redefinition of rural electrification in its basic aspects. The acceptance of this then depends greatly on the attitude of implementors, social scientists and politicians to the new concept. In this area one also has to define the limits of electrical energy that *can* be supplied to the rural consumer, rather than the limits of electrical power that *could* be made available to him. Growth in the use of electricity may be limited, but the socio-economic impact that will prevail has got to be taken into account.

### Present Concepts

One of the present methods of rural electrification, as seen in many countries, is simply to extend lines from local grids. Systems of transmission may vary, depending upon the ingenuity of the implementor. Technical constraints to the supply utilities are high due to system losses, voltage variations, loading conditions, cable capacitances, and other factors. In cases where the area is isolated, supply may be given through diesel, small thermo-dendro or mini-hydro stations; but these again are limited in capacity due to the standards that have been adhered to. Innovative methods are thus abandoned and supply cannot be given unless total rehabilitation of the distribution systems takes place. This results in very expensive rural electrification programmes.

There is little advantage in terms of time and money in the existing methods of supply. The following assessments are true when seen in a proper perspective:

- in terms of cost benefit, a rural electrification programme is usually a loss programme;
- in terms of operation, the small load does not

---

\*National Electricity Board, Kuala Lumpur, Malaysia.

justify the revenue collection procedures service and the maintenance of systems; and,

- it is normal that the rate of growth in energy consumption in rural areas will be higher than expected for the initial period of supply. This will increase system rehabilitation cost unless controlled growth is allowed for.

The normal technique of supplying the consumer also creates problems in areas where diesel stations, mini-hydro and small thermo-dendro stations are the sources of supply. Uncertainty arises in estimating the required capacity for rural power stations, especially when it is known that load factors are low. The time spent by these stations operating at low utilisation rates is expensive.

### Redefinition

In adopting an approach to supplying rural consumers, one has to look into the requirements and the needs of the consumers in terms of their utilisation of electrical energy. In many instances, the consumption of electrical energy is rather low, and it is normal that the maximum demand per consumer in rural electricity supply systems in developing countries will be in the order of 200 W or less. The growth of the system in rural areas is perhaps 10% per annum in the first few years, after which the growth of the whole system stagnates. Further growth of the system takes a longer period because of constraints on the financial ability of the rural consumer. This being the case, a philosophy should be adopted whereby the demand for electricity is limited and a new form of supply system is put into operation. Hence it is necessary to redefine rural electrification. The definition ought to be as follows: *rural electrification in developing countries is a means of supplying electricity whereby the rural consumer is supplied in terms of quantities of electrical energy rather than in terms of electrical power.*

With this definition, limitations arise; but the supply utility concerned will reap definite advantages, and the growth of rural electrification in countries adopting such a definition, and also adopting a new system of supply, will definitely increase.

### Birth of a System

In this system of rural supply, called the 'limited

charger system', the following equipment is provided for each household consumer:

- a current limiter of approximately 60 to 100 W;
- a battery charger capable of maintaining RMS voltage for a variation of 50% input.<sup>1</sup> This battery charger charges a battery. The consumer can demand as much as 200 W for a 60 W limiter connected in the system;<sup>2</sup>
- DC wiring for an equivalent of 8 x 20 W load. The voltage of the system is 12 V;
- lighting is by means of fluorescent lamps with individual invertors (lamps will have a long life span as heater elements are not used);
- TV and other accessories for household requirements are to be of direct current types; and,
- batteries of the system are normally automobile batteries each of 105 A/h or greater. The battery size depends upon household requirements.

The circuit diagram of the supply system to the rural consumer is shown below.

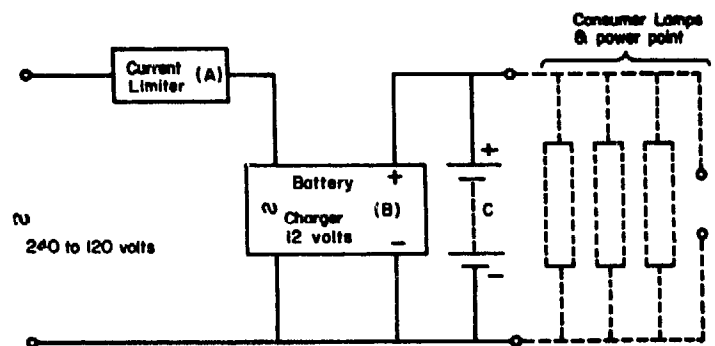

Fig. 1 Limited charger system

The system to be employed is analogous to the concept of the present system of water supply where the water tank provides excess demand requirements for the day. Thus, the 'limited charger system' consists of a current limiter (A) which is first connected to a battery charger (B) of 60-100 W. The 12 V charger charges a battery (C) which becomes the reservoir for electrical energy. This idea was developed to meet the need to store electrical energy in mini-hydro schemes, to minimize its costs and to reduce plant capacity. The system can also be used for consumers in:

<sup>1</sup> Refer to Appendix 'C'

<sup>2</sup> Refer to Appendix 'A'

- rural diesel stations;
- wind energy systems; and,
- solar energy systems.

After further analysis, it was found that this 'limited charge system' would be of considerable use for rural areas supplied from local grids.

### Application to Rural Systems Extended from Local Grids

When a 'limited charger system' is provided to the rural consumer (where the main supply comes from a local grid) the following observations can be made:

- the household is fed constantly at say, 60 W. This is the maximum value and it is governed by the current limiter. Available energy on demand is 200 V.
- it can be seen that the battery is charged most of the time during the 24-hour period and the grid supplies the consumer. During the operation of the system, a larger energy output is available from both the battery and the charger; and,
- the current limiter has the function of preventing overloading of the mains. The system load factor is almost unity.

The concept of use of this system is shown in the diagram below.

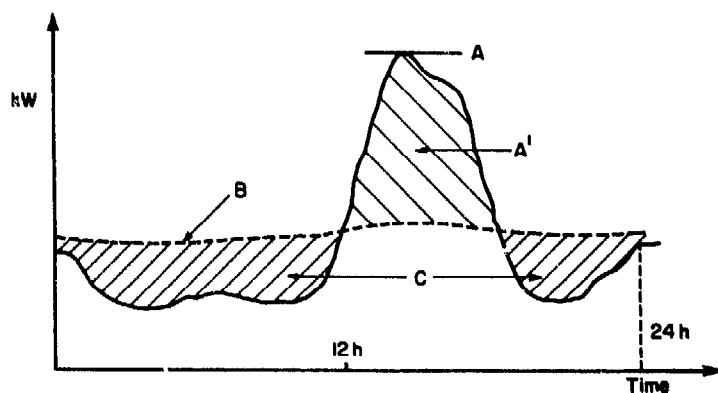

Fig. 2 Demand diagram

In a normal system, the maximum demand is as indicated at level A. In the case of the 'limited charger system', where the battery compensates for the extra requirements of electrical energy, the new demand for the system would be at level B. The area

shaded A<sup>1</sup> indicates that the extra energy required is actually retrieved from areas C, where energy storage has taken place. The capacity of the battery determines the level of demand of the new system.

### Advantages of a 'Limited Charger System'<sup>3</sup>

Since the charger converts alternating current to direct current, it is obvious that this system is independent of frequency. With each household taking approximately 60 W through the limiter, the number of consumers for such a system can be rather large. As an example, a 100 kW source of supply can cater for approximately 500 consumers in the conventional manner, but in this new system the number of consumers that can benefit from the system ranges from 1,000 to 1,800 consumers. It should be noted that the charger is specific in its duty, seeing that it can be made to maintain RMS voltage for a variation of 50% input. The extension of long low voltage distribution lines becomes possible i.e. many times that present length at full load. This also means that the high voltage system (say 11 kV) can be extended to an isolated village where the secondary winding of the low voltage transformer registers a new operational minimum of 50% of, say, 240 V (i.e. 120 V).

Single-phase and long distribution lines in the system become possible since load balancing is easier and is not a problem. In the longer 'limited charger system' the sizing of wires can be more economical as voltage drops of 50% can be allowed for. One can see that although the limited current is used, the energy capacity per consumer is increased with the number of batteries. Any over-loading on the supply system will cut off the battery-charger from the mains.

For the operational point of view, the feeding end from the grid sees the load factor of the rural scheme as approaching unity. The 'limited charger system' is independent of frequency. The diversity of the system is minimised and the power factor will be greatly improved. Voltage fluctuations, which are a major problem in normal and off-line rural systems, will be limited. In other words, the voltage difference between day and night due to any Ferranti effect will be controlled by the system. All this means that from the point of view of operation, the energy fed to the consumer is under control. This also means that there can be optimum usage of energy and better stability of supply. The stability of supply can be seen from

<sup>3</sup>Refer to Appendix B.

the fact that faults occurring on the feeder lines will not prevent the use of the batteries as standby supply units. From the implementors point of view, the 'limited charger system' of distribution can be cheap, and there will be a reduction in the wastage of electrical energy. House wiring is at low voltage, and is therefore a safety aspect of the system.

The 'limited charger system' can be changed to a normal system when there is adequate demand. The system can be retained even after voltage levels have been raised to normal. This system then becomes a standard system which supplies lighting, TV, radio etc., whilst the direct 240 V AC system provides for larger machinery, refrigerators, irons and other high energy-consuming electrical appliances.

An added advantage of such a system is that optimum use can be made of diesel stations and other generating stations of limited capacities. In the case of diesel stations which run for 12 hours only, the introduction of this system can extend the time electricity is available to the consumer to 24 hours, although the battery is charged within the 12 hour period.

The 'limited charger system' plays a major role when used with micro-hydro stations where the energy output of the micro-hydro stations can be stored in batteries at the consumer end. This cuts down the need for water storage demands and also the need for extensive governing of turbine speeds. The consumers form a constant load to the generating system, thereby cutting excessive speed variations. A properly balanced system may even eliminate the use of governors in micro-hydro schemes. It should be noted that the system is independent of frequency and voltage.

### **Economics of the System**

The cost of the system is relatively low. The single-phase long-distance wiring can be economical and the operational costs can be minimal. The spending of money at a later date to improve the system will show better cost benefit. An evaluation of the 'limited charger system', together with that of a normal system, is shown in Appendix A.

The economics of the system do not merely concern the cost but also the social benefits offered. It should be taken into account that the system will provide electrical amenities to a community which would otherwise be without any, due to technical and development constraints in the area.

In most cases of rural electrification, the load demand is mainly for domestic purposes and lighting, and therefore any rural electrification project can be proved to be financially uneconomic. Seeing it from

the point of view of system development, the capital cost incurred to supply this rural demand is not feasible, especially when the load factor for the requirements is low.

The normal alternative is to supply the demand through a 12-hour diesel electric generating system. Even this system is limited in its long-distance distribution capability.

The aim of the 'limited charge system' is to provide the minimum electrical amenities, such as lighting, television and radio, as well as to control the load in the area served. The normal grid system can be extended once the system has established a better load demand.

### **Distribution Design**

The proposed system will extend the distribution distance considerably. Also the consumer end would not be subjected to low voltage since the 'limited charge system' will ensure a good voltage level. Thus a single-phase line will extend much further than the normal system. This is more appropriate for rural electrification since consumer distribution is scattered. The cost incurred in developing the distribution system will serve as a basis for rehabilitation to the normal system in the future. Hence it will help to reduce the capital cost in future system improvement.

The extension of the distribution system also reduces the number of distribution sub-stations since voltage regulation is not rigid. In all probability, the demand for more low-voltage line boosters will increase. They can be located in accordance with an appropriate location of sub-stations for future system improvement.

A single-phase 11 kV system can also be applied as a means of transmission in this system. Hence the cost will be much lower than for a three-phase system. Of course, limitation of distribution is governed by the ingenuity of the design engineer.

### **Consumer Connection**

The individual consumer has to bear the responsibility of taking care of the batteries. This responsibility will give them a better understanding of electrical supply facilities. They have to maintain the battery to achieve good supply, and hence instructions of keeping a battery in good condition have to be provided.

There is no metering involved, and consequently no man-hours will be spent by the supply authority in reading meters for billing purposes. Billing can

be done on a fixed rate basis.

## Conclusion

The advantages of the 'limited charger system' are obvious. However, to establish such a system for rural electrification an appropriate definition of rural electrification needs to be accepted. The attitude of the implementors, social scientists and politicians towards the system is of great importance. The impact of such a rural electrification system will be outstanding if the limitation is acceptable to the rural consumer and to the electricity supply authority. With such a system, a greater number of rural consumers, can have the benefit of electrical energy, and this means a faster development programme for rural electrification. It is also obvious that the programme of system improvement can be controlled. In terms of operational effectiveness, the advantages of the 'limited charger system' far outweigh those of existing systems. In the context of rural electrification for developing countries, one can see that this system would bring benefit to the rural people. The system in no way limits the use of electrical energy, and in time it restrains the rural consumer from being wasteful and creating an unnecessary burden on his finances. For a utility, the system is financially viable, as the cost of distribution, the stability of supply, the control of the system and the revenue collection procedures are greatly reduced, seeing that the system encourages a fixed monthly payment for the use of electrical energy.

## APPENDIX A

### Evaluation of the Limited Charger System

In calculating the individual consumer's consumption, the utilisation time is important. Utilisation time is the duration the consumer uses the load. This load is referred to as connected load demand. The relationship between the connected load demand and utilisation time can be shown as:

$$\text{Connected load demand} = \frac{\text{energy available per day}}{\text{utilisation time}}$$

The proposed system is presented below:

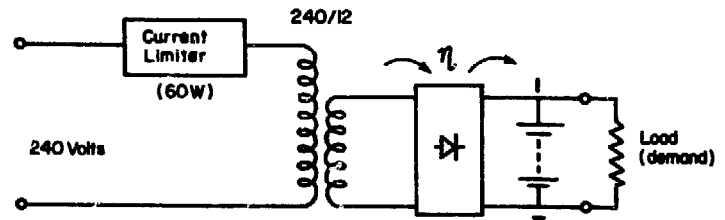

$$\begin{aligned} \text{Energy available/annum} \\ &= \frac{\text{rated size of current limiter} \times 24 \times 365 \times \eta^*}{100} \end{aligned}$$

$$\begin{aligned} \text{Connected load demand/day} \\ &= \frac{\text{rated size current limiter} \times 24 \times \eta}{\text{utilisation time} \times 100} \\ &= \frac{24 \times \text{rated current limiter} \times \eta}{\text{utilisation time} \times 100} \end{aligned}$$

The range of utilisation time is between 0 – 24 h. In general the maximum demand of the consumer never reaches utilisation of more than 6 h per day.

$$\begin{aligned} \text{Hence connected load demand} \\ &= \frac{24 \times \text{rated size of current limiter} \times \eta}{6 \times 100} \\ &= \frac{4 \times \text{rated size of current limiter} \times \eta}{100} \end{aligned}$$

The relationship of the current limiter's connected load with consumption can be drawn graphically as below:

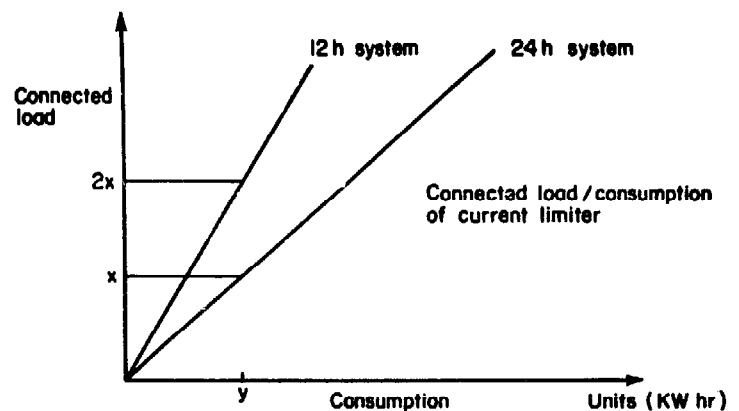

for  $y$  units the size of the consumption current limiter for a 24 h system is half that of 12 h system.

\* Assuming that the battery is able only to absorb  $\eta$  % of the electrical energy input due to inefficiencies etc.

Also the relationship of the connected load demand against utilisation time can be taken as:

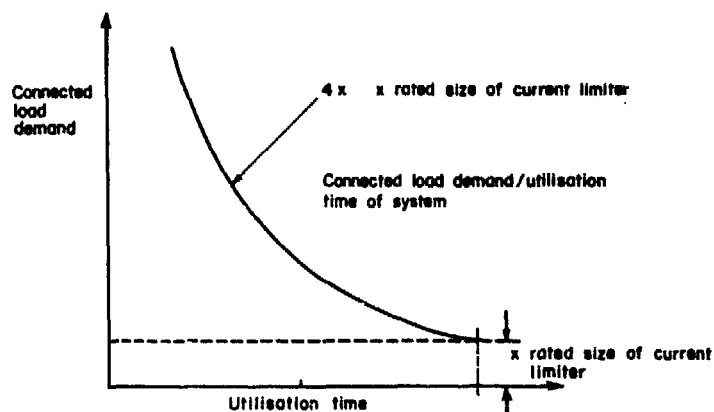

The minimum value of connected load demand is at the rated limiter current value.

The definition of utilisation time as against load factor is taken because the system under consideration limits the consumer consumption to a fixed amount of energy per month.

Similarly we can visualise the connected load demand as the maximum demand of the consumer connected for any particular utilisation time. However, in the context of maximum demand, as seen from the source of supply for this system, it is limited to the rated value of the current limiter. Hence, for a consumption of 30 kWh/month, limiter rating is about 41 W or a current equivalent of 0.167 A for a 24 h system.

Electrical energy consumption per month = 30 units  
Consumption per day = 1 unit, i.e. 100 watt-hr.

Hence for a 240 V, 24 h supply system, the current limiter is rated as:

$$\begin{aligned} \text{Size of limiter} &= \frac{\text{watt-hour}}{24 \text{ h}} \\ \text{say} &= \frac{1,000}{24} \\ &= 41.7 \text{ W (say 50 W due to efficiency of charging)} \end{aligned}$$

Hence the supply authority sees the consumers consumption as 50 W only.

The rated voltage is at 240 V. However, the system supply voltage can be very much lower as descri-

bed earlier.

*Examples of economic evaluation*

The following are the assumptions taken in the economic comparisons between the limit charger system and the normal supply system for power distribution in rural electrification:

(a) Assumptions

For the limited charger system:

- (1) Diversity factor = 1
- (2) Load factor = 0.8
- (3) Individual consumption = 30 units per month
- (4) Capital cost per consumer = 300 M Ringgit
- (5) The distribution cost per consumer = 1,500 M Ringgit
- (6) Fixed rate tariff per consumer = 7.50 M Ringgit
- (7) Cost of battery (12V, 105AH) = 150 M Ringgit
- (8) Incremental cost of battery = 5%

(b) Assumptions

The normal grid system:

- (1) The diversity factor = 0.6
- (2) Load factor = 0.15
- (3) Tariff rate = 0.25 per unit
- (4) Capital cost including contribution per consumer = \$1,800 M Ringgit

(c) Common data

- (1) Capacity of the source = 25 kW per firm output
- (2) Life span of output = 15 years
- (3) Reliability factor = 0.9

The rate of interest varies from 1% to 51% and the benefit to cost ratio, comparing the ability of the source to supply a different number of consumers, is as shown in the diagram below:

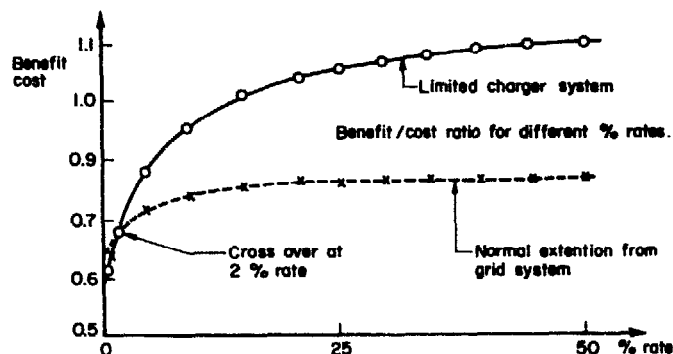

From the above graph, an imaginary system indicates that a small source (25 kW firm) is able to supply

a large number of consumers who would be able to benefit more than they would from the normal system of supply. The benefit to cost ratio of the system intersects at as low as 2%, but for real cases the merits and de-merits of both systems can only be seen from the social benefit that arises in reality. This social benefit cannot be quantified. If the benefits are quantified, the advantages of the limited charger system in rural electrification will outweigh the normal system of supply.

## APPENDIX B

### List of Advantages of a Limited Charger System

- The system is independent of source frequency.
- It can supply a large number of consumers.
- There is no problem of voltage drop.
- It is possible to have long lines.
- It can have single phase lines.
- It saves in the size of distribution wire.
- There is a sufficient supply available to consumers
- The load factor of the system is almost unity.
- The voltage fluctuation in the system as seen from the source is small.
- There is control in energy usage and the system can grow.
- The supply is stable and a standby system forms automatically.
- House wiring is cheap.
- It is a low voltage system (12V), which is safe and available at a low cost.
- It is a good means of introducing electricity to rural consumers.
- The system can be retained after rehabilitation of the system takes place.
- Its source-limited capacity and storage ability are optimised.
- The system is applicable to micro-hydro, diesel or grid systems.
- The capacity of the source is small compared to normal distribution system requirements.
- There is a fixed tariff and no meter reading is required.
- It creates an energy saving attitude.

## APPENDIX C

### Battery Charger Types

Two types of battery chargers can be designed for the 'limited charger system'. Each type of design is

dependent upon requirements, the type of source of supply, the reliability needed etc. The simplest of the two designs consists of a circuit as shown below:

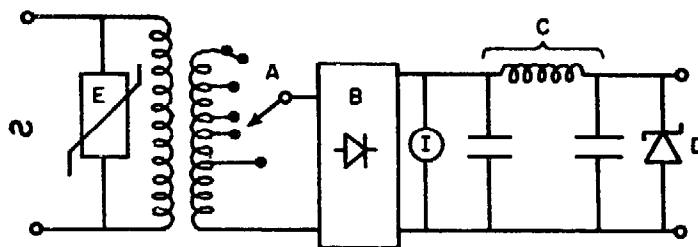

The above is a simple system where a transformer with tapped secondary winding A is connected to a rectifying unit B followed by an RC filter C. D is a zener diode for surge protection at the output of the charger. E at the primary winding of the transformer is a metal oxide varistor for lightning surge protection. I is a voltage indicator made up of combinations of light emitting diodes and zener diodes which will indicate voltage levels for proper operation of the charger. A simple charger can be made by omitting C and I.

The above charger is connected to the mains in series with the current limiter and its output is connected to the battery. In its charging operation, the switch at A is moved to a suitable tap position where indicator I indicates the most suitable tap position. Slight adjustments may be made by the consumer for his system requirements depending upon the voltage level of the mains. Once this has been set, there is no necessity for frequent future adjustment.

In the second type of design the battery charger is capable of automatic voltage regulation by maintaining an RMS output for a 50% mains voltage variation. This system is more complicated and utilises thyristor controlled circuitry for its operation. The basic circuit of the system is as shown below:

As in the first type, the circuit consists of the normal charger system, but thyristors are incorporated

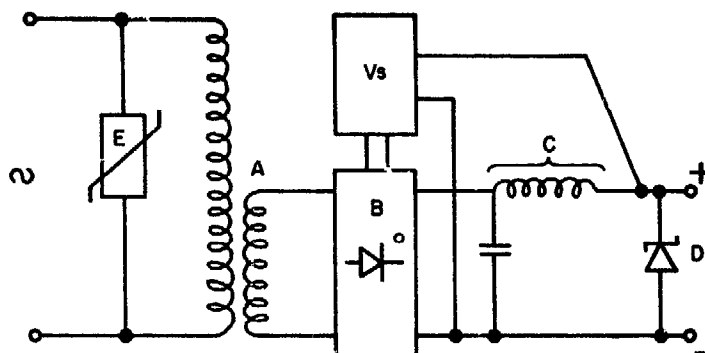

in the bridge rectifier unit.  $V_c$  is a circuit which ensures the charging voltage of the charger and maintains this output for a 50% variation in the mains input voltage.

### Discussion

*Questioner from the Audience:* Can Mr. Nasaruddin tell us about the economics of his system?

*Mr. Nasarruddin:* We are still completing the analysis, but we have found that it is very economical. If, for instance, in one case you have 100 kW, you can supply more than 1,500 people; whereas in the other case, you probably could only supply 500 people. That is a big difference.

As a means of extending electrical energy to rural areas, we found that the costs of putting up the plant, and the subsequent operating costs are low. I could not give you the exact rate of return because it is still being worked on. But from the most recent results, it would seem to be somewhat more economical than the normal system. Remember that you don't have to have a three-phase system; you only use a single-phase system.

Please bear in mind that this system is a redefinition of the concept of rural electrification. If you want to talk of rural electrification as just a normal system, just an extension of your 230-volt grid system, that is different, and more costly.

*Questioner from the Audience:* What part of the system are you responsible for, and what must the rural consumer provide?

*Mr. Nasarruddin:* We provide the battery, but the rest of the electrical system, the charger and everything, comes from us. We also pay for the wiring, which is very simple. It is just normal low-safety wire because of the low voltage, 12 volts. It is just like your automobile system. It is very safe.

*Questioner from the Audience:* We have tried the system already on a small scale, but the problem is the battery. What kind of battery do you recommend? Is it a sulfuric acid battery, nickel cadmium, or something else?

The second question is, can you absorb all the energy described in A and B? It shows that all the energy cannot be absorbed.

*Mr. Nasarruddin:* Now, as to the first question: in our country we use a sulfuric acid battery system. Some of our power stations have had it for over 50 years or longer.

Now, as far as the demand is concerned, this is only an approximate curve. Of course, batteries don't charge suddenly and then maintain a charge; the charge drops down. For one battery, yes, it won't

absorb it all. But if you have 500 or 600 batteries going at once, some going off and some going on, it's different. You can always add any number of batteries you want because the only limit is that you are getting a fixed wattage of 20 watts, 24 hours a day. Suppose something is wrong with your turbine and you have to take it off for a day; you are allowed to do that because, in this system, we calculate for a supply for three days. We can last with no supply for three days. It should go down only to the 30% discharge level of the battery.

*Questioner from the Audience:* How did you explain this system to the people in small villages? How did you convey your approach, or educate people in maintaining the batteries and so on?

*Mr. Nasarruddin:* In our country, people have been using batteries for a long time. They put the batteries in their bicycles, go about 10 or 20 miles away, get it charged and then bring it home and run their television, or their lighting with it. So, the problem is one of convenience, not maintenance.

*Questioner from the Audience:* Is this true country-wide?

*Mr. Nasarruddin:* Yes. In most rural areas, before the coming of the transistor radio, we had a lot of radios and batteries in every village. In the mosque where they pray, they have a battery system for the loudspeaker, and things like that.

*Questioner from the Audience:* How is it financed?

*Mr. Nasarruddin:* We finance the cost of wiring the house, in which the consumer pays back a certain amount, exclusive of his tariff, payable within five or ten years. The battery comes to about \$100 to \$150 in Malaysian dollars. The wiring system should not cost any more than \$50 or so. The cost of the charger is about US\$20.00. Now, with the other system, where you provide the normal 230 volt facility, it costs around \$300 to \$500 just for the lighting system. There is another cost factor to keep in mind – conservation. Since the capacity of the battery system is limited, you can prevent waste. In the case of the diesel station, they keep their lamps turned on for hours on end, and you waste the fuel. With this system, they know that a battery will drain down if they aren't careful, since then they have no lights for the next few days. It is really very efficient. Imagine: for 10 kW, I can supply more than 150 consumers with as good a system as can be supplied from the grid.

*Questioner from the Audience:* What is the capacity of the charger?

*Mr. Nasarruddin:* The capacity of the charger is limited to 60 watts. Anything bigger would be useless because of the limits I just discussed.



## Development of Small Hydropower Plants in the Philippines

Zenaida Santos\*

### Introduction

**A**S was true for many other developing countries during the 1960's and '70's, electricity generating plants in the Philippines became addicted to cheap oil. The government proposes, if not to eliminate, at least to reduce dependence on oil for the generation of electricity. Primary emphasis in these plans is placed on exploiting domestic, renewable energy sources.

The Philippines has heavy annual rainfall and extensive steep mountains. The mountains, typically only a short distance from the sea, supply an abundance of short, rapidly-falling streams. The many hydropower programs under development exploit the energy potential of this renewable resource.

Small plants were established in the Philippines in small numbers during the 1930's and again during the 1960's. However, there was never a concentrated effort by the government to develop the enormous resources offered by small streams. This resource was not tapped because large oil/thermal power stations supplied very cheap electricity and because transmission costs for thousands of remote small sites were prohibitive.

By the 1960's, the Philippines had electric distribution systems in all rural areas, virtually eliminating transmission constraints. But oil/thermal power stations were no longer cheaper sources of energy. In 1979, a program was initiated to develop all economically-competitive, small hydropower sites, with an estimated aggregate potential of about 2,000 to 4,000 MW.

The National Electrification Administration (NEA) developed a nationwide system of locally-owned and operated electric distribution cooperatives which were assigned the task of executing the mini-hydro development program. The more than 100 cooperatives provide a centralized management center in each province which is necessary because of the administrative difficulty of planning and constructing hundreds of small remote power plants.

When this assignment was given to NEA, no small hydro system had been constructed in the Philippines during the previous 15 years. There was almost no experience in data-gathering or construction planning.

However, within three years, five power plants were operating, five more were under construction, equipment orders for 20 plants had been placed, and about 50 feasibility studies were completed. The inventory of potential sites is far from complete, but data is being collected in areas throughout the Philippines where electric cooperatives are operating.

In the early stages of the program, foreign firms supplied electro-mechanical equipment and provided limited assistance for site selection, feasibility studies, and engineering design. However, in large measure, except for equipment, the program is progressing using local capabilities. Within the next two to three years, most of the equipment required will be manufactured in the Philippines.

By the end of 1982, 20 or 25 power plants will be operating with a capacity of about 20-25 MW. By the end of 1987, there will be about 250 or more plants with an installed capacity of 300 MW. These power plants will supply about 30 - 35% of the electrical power needs of the rural areas in the Philippines except on the Island of Mindanao where a large hydro project provides power at much cheaper rates.

Although some uncertainties exist, most of the capability and financing required to meet these targets are in place. Half the program is funded from foreign sources, which is used to buy equipment.

Large power plants require a high degree of sophistication and generally are not readily manufactured in the Philippines. However, equipment for small hydro plants can be, and is being, manufactured in the Philippines.

Initially, the equipment used is primarily imported because of four factors: (1) the concession of financing available for imported equipment; (2) the desire to test as wide a variety of technology as feasible; (3) the need, initially, for technical assistance for

---

\*Executive Director, Mini-Hydro Development Office, National Electrification Administration, Manila, The Philippines.

program start-up; and, (4) the time required to expand local manufacturing capability.

The local manufacturing program is being organized during the initial phase which emphasizes the installation of imported equipment. At this stage, a 100 kW plant and a 350 kW plant have been commissioned. Another with a 525 kW capacity is being installed. The turbines for these plants were locally-manufactured as was part of the electrical equipment.

The Philippines anticipates manufacturing equipment locally for a 3 MW plant in 1982 and for a 7 MW plant in 1983. This pace will increase depending on how quickly local manufacturers can respond. Experience shows that the local equipment is almost one third less expensive than imported equipment.

Problems of reliability are not expected. The Philippines has a technology transfer agreement with the People's Republic of China, which has installed most of the locally-manufactured units.

From the beginning, financing for manufacturing equipment locally has been a problem. Buying equipment from local manufacturers required paying cash, which would be very difficult to explain to electric cooperatives which get their equipment from very low-cost concessional loans. However, a recent ruling by the Central Bank of the Government of the Philippines has set up a procedure which will make it possible to purchase local equipment on cost terms competitive with imported equipment.

The Philippines is very proud of the progress made to date. However, had a conventional approach been taken in developing small hydro, it may have taken years to accomplish everything. Typically, the sequence of events in developing large projects includes: (1) working on the idea; (2) locating financing for the feasibility study; (3) conducting the feasibility study; (4) reviewing the feasibility study; (5) locating financing for equipment; (6) ordering or manufacturing equipment; and (7) constructing the project. This sequence may take several years and is quite expensive.

Instead, the NEA program started first with the idea, then looked for financing for equipment, and then proceeded with the other steps of the conventional approach. While equipment is manufactured, detailed studies are carried out, designs are completed, and construction is initiated. Local firms provide required technical input on a negotiated contract basis, which is negotiated through NEA on behalf of the electric cooperative. Both time and money are saved.

As a result, a new project was formulated in less than three years and three power plants are now in operation. The NEA anticipates meeting its goal of

putting up 250 plants by about 1987.

Hundreds of sites in the remotest parts of the nation are under development and communications are sometimes difficult. It would be difficult, if not impossible, to try to administer a decentralized program in these remote areas from Manila. Even if it could be successfully administered from Manila, it would be more costly because of paying higher salaries in Manila and paying per diem to supervisors of projects in the provinces.

As mentioned above, electric cooperatives provide the management centers for administering the program. The cooperatives oversee firms hired and the construction contractors. Without this decentralization, the program would be slower by two or more years and the cost of construction would be much greater.

A major problem in achieving low-cost operations for rural small hydro plants is the difficulty of achieving high utilization rates for isolated units. The Philippines has developed an island-wide electric distribution system. Now, by tying the small hydro plants to the existing grids, it is possible to generate power at the maximum rate possible, given the available water.

Domestic engineering and manufacturing will reduce the overall costs of small hydropower systems in the Philippines. Local manufacturing also will eventually reduce equipment costs.

## Discussion

*Questioner from the Audience:* Mrs. Santos, you said you are trying to manufacture most of the equipment in your country. Does that include the governor system?

*Mrs. Santos:* So far, the only manufacturer which has joined the program is Atlantic Gulf, and they feel that it will take some time before they will be able to manufacture the governor. As of now, they are importing it from the People's Republic of China, with which they have a licensing agreement.

*Questioner from the Audience:* Who finances these purchases?

*Mrs. Santos:* The government has directed the Governor of our Central Bank, the Ministry of Energy, and the Administrator of the National Electrification Administration to come up with a scheme, through our private or our government banks, to enable the electric cooperatives to purchase locally-manufactured equipment. The interest they will charge us will be about 10%, with 20 years to pay.

*Questioner from the Audience:* Charged to the NEA?

*Mrs. Santos:* To the user. NEA will have to gua-

rantee the loan to the electric facilities and we will do this, not only through the government bank, but also through the private banks in the local areas. For a while, that was our constraint. Here we were encouraging the local manufacturers, but we could not buy what they were going to manufacture because we had to pay cash.

*Questioner from the Audience:* Was it difficult to involve local banks in the Philippines and get them interested in the program?

*Mrs. Santos:* No, they are interested in the program. Actually, when we were working on this scheme, they were participating in the discussions to see how they could get involved.

*Questioner from the Audience:* Is private capital fairly easy to get in the Philippines for developing rural industry and productive use programs?

*Mrs. Santos:* I guess one reason why they have no apprehension is because, as of now, energy is the number one priority in the country. It used to be food and agriculture, but this year it is energy, so that helps us very much.

*Questioner from the Audience:* Mrs. Santos, this is about the cooperative system. We find considerable

difficulty in collecting revenues in the village. Sometimes only 25 to 30% pay. What is your experience in organizing cooperatives? Does that help to increase the rate of collections?

*Mrs. Santos:* There are areas where we don't have 100% collections, but there are also areas where we don't even have meters, where we don't have bill collectors. The members themselves, knowing that they are a part owner of the electric cooperative, voluntarily pay their own bills. Once in a while, you run into some people who will not pay right away, but they pay eventually.

*Questioner from the Audience:* Couldn't you have a system whereby, if the people didn't pay up, you would cut off their supply?

*Mrs. Santos:* Yes, we can cut the power off. That usually works, and then we just reconnect it right away. When people don't pay the co-op, everybody suffers because the co-ops, in turn, have to pay their bills to our national power corporation. Otherwise there are penalty charges. If they pay on time, they are given a 3% discount. So the manager has to make sure he pays his bill on time also, because he himself might be disconnected. Then everybody in the co-op suffers.

## Micro-Hydro Axial Flow Turbine for a Battery Charging System in Remote Areas

Djoko Susanto\*

---

**ABSTRACT :** In remote villages there is a great deal of very small-scale hydropower potential which has not been utilized, and this unexploited water energy is ironically wasted. On the other hand, as a result of the development program in Indonesia, people in the villages have had the opportunity to know and use some electrical appliances such as radios, televisions and cassette players, although the electric power distribution has not reached their villages.

The battery charging system is the best way to utilize very small-scale hydropower potential as electric power, because by this method a small capacity of electric power can be distributed widely to the villagers. As a prime mover to convert hydropower into mechanical power we have chosen a simple axial flow turbine or propeller tube turbine in view of the fact that their efficiency and r.p.m. are high.

---

### Introduction

**H**YDROPOWER potential in Indonesia is estimated at about 31,000 MW or 155 million MWh per annum. The present rate of utilization is less than 2% of the total potential. Undoubtedly hydropower is a significant energy alternative in Indonesia, and with its large unexploited potential it has a bright future for development, especially in connection with the fuel conservation program. The development is either in the form of large, medium- or small-scale plants.

Part of the hydropower potential which has been utilized is from large- and medium-scale plants. In addition, there is still a great deal of hydro potential for small-scale hydropower (less than 25kW) in the remote villages. This small-scale hydropower potential can actually be utilized for rural electrification, because for the next 5-10 years the electric distribution from the State Electricity Corporation (PLN) will not reach most rural areas. In order to utilize the small

capacity hydropower potential for electricity we can use the battery system, or direct current electricity. The introduction of electricity by this method will enable us to reduce the amount of kerosene presently consumed for lighting purposes in rural villages.

To develop most of the small-scale hydropower potential available in the villages involves the construction of low-head, small-capacity plants, which are not normally considered for power generation. To utilize this energy source we use an axial flow or propeller tube turbine. The advantages of this turbine are its specific speed and its relatively high efficiency. As a prototype we designed a turbine for use with a head of 2 m, with a maximum capacity of around 0.150 m<sup>3</sup>/sec.

### Battery Charging System

In the case of village electricity it should be emphasized that we do not intend to provide a full-

---

\*Staff of Energy Research Laboratory, Directorate of Technology Development, Agency for Development and Application of Technology, Republic of Indonesia.

scale electrical system to replace or to be in competition with regular power line electricity, but rather to provide a simple low-cost battery system which will replace petromax or kerosene lamps, and give small villages the advantages of communication (radio/TV) in the interim period of 5-10 years until the more formal electrical system can reach them. It is hoped that villages will become independent of kerosene.

From a survey, we found that there were some families which owned electrical appliances such as television, radios and cassette players. To operate these appliances they used wet cell batteries (used for motorcycles and automobiles), and there were small shops which recharged the batteries for an average of US\$0.5. Each battery requires recharging approximately every 10 days.

Although battery-powered neon lights are available and widely used in cities, virtually no use is made of them in the villages. All lighting requirements are

met by petromax or kerosene lamps. The battery system can supply the electrical appliances and also provides light that replaces petromax and kerosene lamps.

The advantages of the battery charging system can be appreciated from the following description of the principle of operation of the system. Each house is limited to a maximum consumption of approximately 250 Wh during an 8-hour period from an automobile type battery. This power is used to operate a maximum of 4 direct current neon lights and a TV/radio. So by using a 2,500 W generator we can recharge 80 batteries (houses) in 16 hours. In order to recharge these 80 batteries, every 20 houses (batteries) requires one battery charger, so we need at least 4 battery chargers. The generator will recharge each group of 20 batteries for 4 hours and after that it will be switched to the next battery charger for 4 hours and so on until all 80 batteries are fully charged.

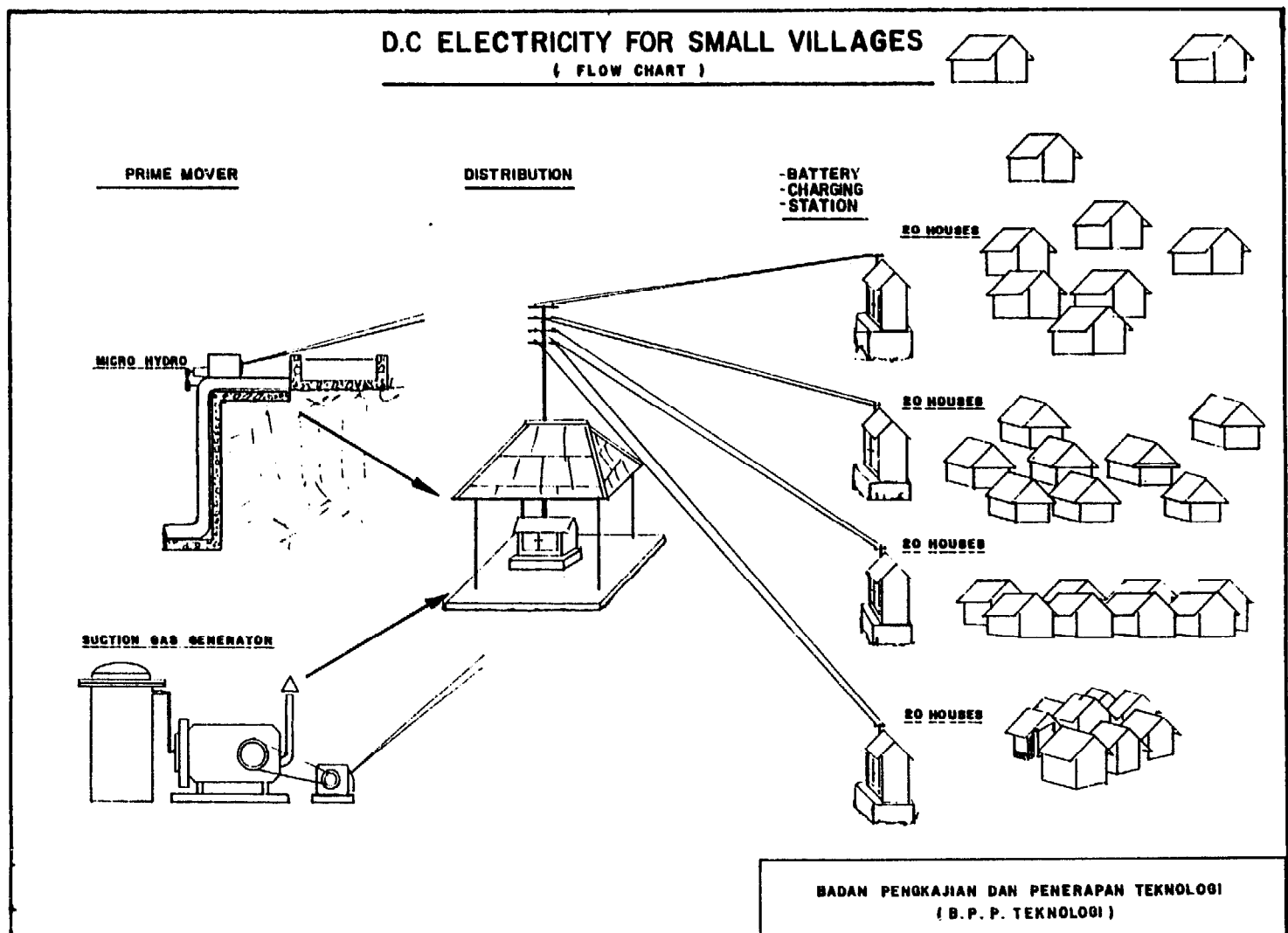

Fig. 1

(Fig. 1)

All 80 batteries in the village can now use the available 250 Wh capacity for the next 8 hours. This amounts to a total of 20,000 Wh daily from only one 2,500 W generator. Equivalent service for 80 houses using lines carrying AC voltage would require a generator of at least 8,000 W.

### Governing System

Our system is designed to use a standard AC generator, which is available in the local market. The generator is a 230 V single-phase alternator which incorporates an automatic voltage regulator. The transmission lines are therefore AC until they reach the battery chargers (transformers) which are located at each house group. Because our end load is a solid state transformer and the generator incorporates voltage regulation we do not require a full-time governor system for precision r.p.m. control.

In case there should be sudden full-load dumping (overspeed) we have incorporated a switching circuit which will transfer the system to a dummy resistor which will absorb the load and prevent overspeed damage.

### Turbine Selection and Design

The small-scale hydropower sources that are available in the remote villages are low head and small capacity. Such potential is not normally considered for power generation. There are several alternatives that can be chosen to utilize this potential as electric power, *i.e.* water-wheels, Banki turbines and propeller turbines. Although a water-wheel is easy to manufacture, its efficiency is very low, its dimensions are large, and its life span cannot be guaranteed. The manufacture of Banki turbines (cross flow turbines) is relatively easy, but this turbine is designed as an impulse turbine for a high head, so if it is operated with a low head its efficiency decreases. Our practical experience has been that the construction of these turbines was over-simplified, which caused some problems concerned with the durability of their bearings and blades.

Finally, there is the possibility of choosing propeller turbines (reaction turbines) which give the best performance if operated with a low head. The propeller turbine, which is also called "an axial flow turbine" or "propeller tube turbine," has a horizontal shaft. The manufacture of this turbine is relatively difficult but the efficiency is high, particularly if operated at a constant load in their nominal values.

The axial flow turbine is one type of reaction turbine. In this turbine water flows in an axial direction, and due to the different pressure between the inlet and outlet of the runner, a lift force that turns the runner is produced.

In order to develop the country's hydropower potential utilizing low-head plants with a small capacity, we have designed an axial flow turbine that will be operated for a head of 2 metres with a maximum capacity of 0.150 m<sup>3</sup>/sec (Fig. 2). This turbine has four runner blades, and we hope that the resulting rotational speed will be 1,000 r.p.m. The design details are as follows:

- the diameter of the rotor is 0.2 m and its specific speed is 236;
- from a hydraulic efficiency assumption of 0.86, the maximum power that might be generated is 2,660 W, or 2.66 kW;
- to prevent cavitation, the allowable highest head difference between the runner and tail-race is 7.3 m;
- to get the best lift force, the profile of the runner blade is designed according to the standard Go - 428;
- the maximum strength that might be applied to the runner blade is 429.2 N/cm<sup>2</sup>, so it is safe to use cast iron material with an ultimate strength of 11,760 N/cm<sup>2</sup> and a hardness of 137, because the maximum strength that might be required does not exceed the allowable maximum strength, namely 2,205 N/cm<sup>2</sup>;
- although the efficiency of the runner blade is high enough (about 0.96), if the turbine does not use a guide blade or a guide vane, the turbine efficiency becomes low. The design has seven guide blades and the adopted profile is Go - 443, or a symmetrical shape profile;
- by using the same material, the guide blade is also safe enough, because the maximum strength that might appear is only 386.7 N/cm<sup>2</sup>; and,
- this turbine has two kinds of bearing. The outer bearing is an angular contact ball bearing serial type FAG-7206. We take this bearing because, from the calculation, ideally it has a life span of 81,118, or 9 years. The inner bearing is a sliding bearing and the designed operating temperature is 49 °C.

### Manufacturing

The main components, such as the runner and the guide blades are made of cast iron (GG-12) with the following composition: carbon (3.5%), phosphor

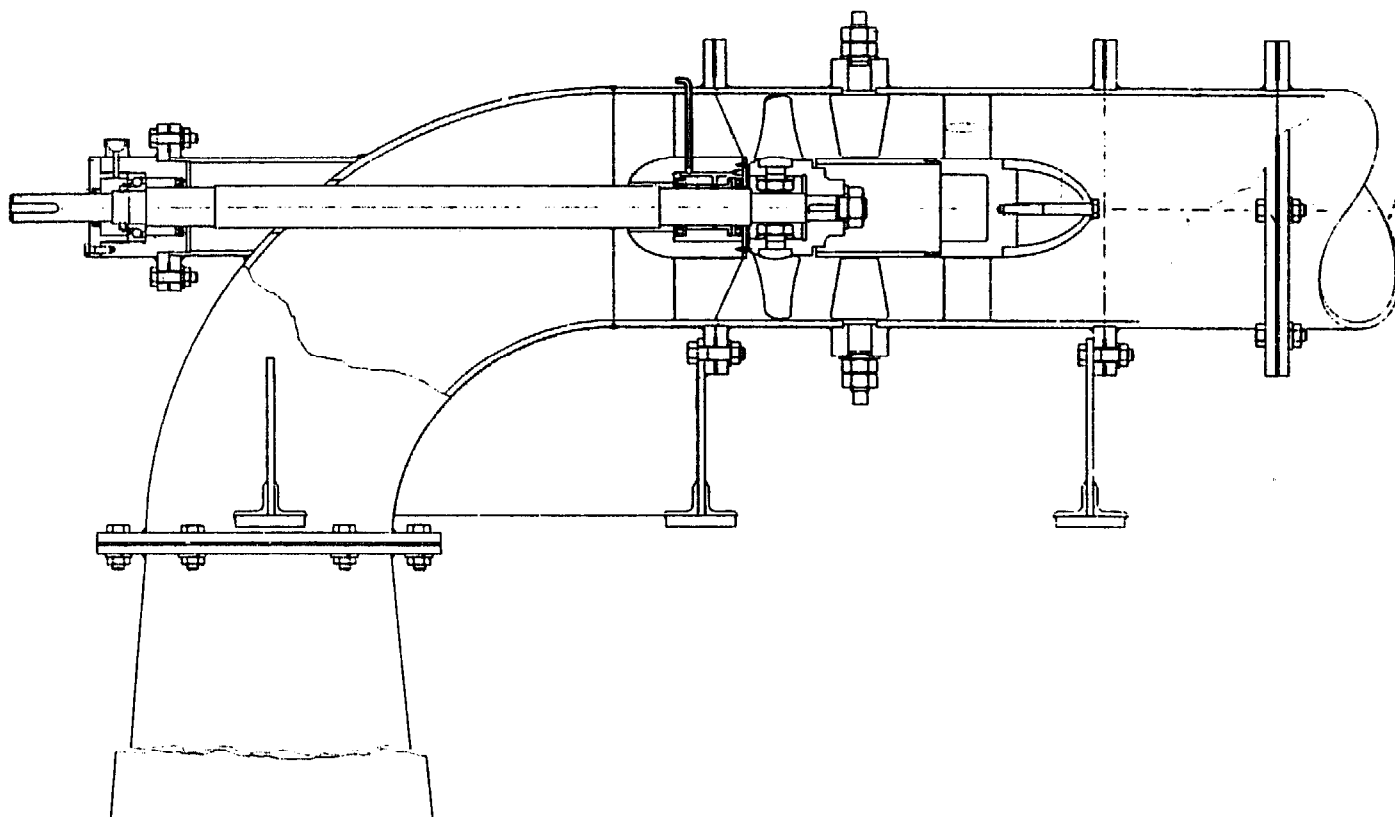

Fig. 2. Axial flow turbine

(0.15%), silicon (2.25%), manganese (0.5-1.2%), sulphur (maximum 0.05%) and ferro. The turbine shaft is made of special steel (St. 50), 38 mm in diameter.

The sliding bearing is made of bronze. The other components, which are not very important, are made of standard steel (St. 37), in the form of solid, plate or pipe steel.

There are several steps in the manufacturing process of runner and guide blades *i.e.* pattern making, mold making, foundry and finishing.

The pattern is made of balsa sheets and the dimension is equal to the designed dimension plus the clearance with regard to the following considerations:

- reduction of the casting metal with the temperature decreases;
- further finishing; and,
- the allowable minimum thickness of the mold.

The mold is made of silica-sand and mixed or stirred thoroughly with 4% of sodium silica as a

binding agent. By blowing  $\text{CO}_2$  gas into the mixture, the mold will harden in a short time. To liquify the cast iron, we use an induction furnace. The advantages of this furnace are that it is easy to control its temperature and its composition, there is only a small loss of metal, and there is a stirring action on the liquid metal.

The raw material that we use is "pig iron". The reason for the choice of this material is that it is rather cheap and its casting ability is good.

### Testing

Testing of this turbine has not yet been carried out, but it is being installed in the test facility. The purpose of the testing is to find the performance and the characteristic curves, *i.e.* the constant head, the constant speed and the constant efficiency curves.

Our test program will start in the first week of July and continue for approximately two months. Once testing of the turbine has been completed,

an additional period of four months is scheduled for a complete system test in an actual small village site.

### References

1. NOTODIHARDJO, MARDJONO, *Hydro power development in Indonesia*, Jakarta, November 1979.
2. WIDODO, S., *Rencana dan Pembuatan Turbin Air Aksial*, Department Mesin ITB, 1980.
3. PETERMANN, H. & FLEIDERER, *Stromungsmaschinen*, Springer Verlag, 4th ed., Berlin, Heidelberg, New York, 1972.
4. NECHLEBA, MIROSLAV, *Hydraulic turbines*, Artia Prague, Czechoslovakia, 1957.
5. SULARSO, & KIYOKATSU SUGA, *Dasar Perencanaan & Pemilihan Elemen Mesin*, PT Pradnya Paramita, Jakarta, 1979.
6. NIEMANN, G., *Machine Element, Design & Calculation in Mechanical Engineering*, Volume I, English Edition, Springer Verlag, Berlin, Heidelberg, New York, 1978.



**I**N defining an appropriate approach to the development of small hydro systems, it is readily apparent that a distinct dichotomy between locally-conceived and managed systems and those under a more centralized, national approach exists, reflecting contrasts in the design, construction, financing, management, and, importantly, cost. While not unique to this technology, the local/centralized dichotomy as seen in the context of mini-hydro development is the particular interest since, unlike many other renewable energy technologies, mini-hydropower is one which has been developed on a relatively large scale in numerous isolated regions of Asia. This dichotomy brings into sharp focus various methods program managers can employ to improve the planning and management of mini-hydro schemes, and reduce construction and maintenance costs.

Two panels on this subject were held, one dealing with the local approach to development, and one with the centralized approach. Moderator Dr. David Zoellner examined various aspects of the approach to development with panelists representing both perspectives in these discussions, including topics such as the impetus for development, the sources of financing, the management structure, survey, design, and construction techniques, and the socio-economic implications of each type of system. The panels are reproduced here in full to give the reader a complete picture of the discussions as they took place.

## **PART III**

### **PANEL DISCUSSIONS**

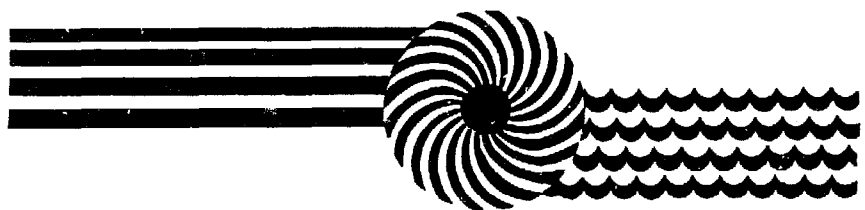

## Panels

### Panel 1 : Local Technology and Management

*Moderator (David Zoellner):* This morning we have scheduled a panel discussion for this time on local development. I would like to introduce the panelists:

- **M. Abdullah**, Chairman of the Department of Electric Engineering, University of Peshawar;
- **Percival Favoreal**, General Manager of Camarines Sur IV Electric Cooperative, the Philippines;
- **Harry Sosrohadisewoyo**, with the Laboratory of Electrical Conversion, Institute of Technology, Bandung, Indonesia;
- **Robert Yoder**, who is presently in graduate studies at Cornell University, New York; and,
- **Lukis Romaso**, Operating Manager for the Appropriate Technology Development Institute, University of Technology, Papua New Guinea.

During the last year, one of the results of our activity has been that we have realized that there is a clear dichotomy in the style of development carried out in small-scale hydropower development. I don't think this dichotomy is unique, but it is certainly apparent in our work. The dichotomy is one of development at the local level or a more centrally-planned style of development.

The localized style of development is harder to describe than the centrally-planned one, but generally is a more labor-intensive style, perhaps using volunteer labor. It is more closely associated with local fabrication techniques and designs. The technical assistance comes from diffused sources and the money is generally local from various and assorted sources.

Since all of these gentlemen on the panel have extensive experience, I hope I will be able to extract some of their experiences in responding to these topic areas. The five topic areas are (1) the impetus for development; where did development come from; how did it get started?; (2) what is your approach to development; what is your philosophy; what is your practice?; (3) what about the sources of finance; where did the money come from?; (4) the system of maintenance and operation; how do you keep the system going?; and, maybe most importantly, (5) end-use

planning; how do you go about matching the power that you are producing to the use?

Let's begin with the impetus for development. What was the impetus for development from your experience; where did it come from; what was the purpose? Was it spontaneous; was it a result of demand; was it organized or unorganized? What are the social, political, and economic settings against which your local development experiences have taken place, and what is the proper role of government in all of this? Mr. Sosrohadisewoyo?

*Mr. Sosrohadisewoyo:* There are several modes in Indonesia. In one mode, the impetus came from the power company, not the PLN, but the POJ. The power company believed that, although they generated much power, the villagers who live near the power station could not afford to buy or to have electricity. Based upon this idea, this company constructed a small hydropower station by using a secondary irrigation channel.

*Moderator:* Okay. Mr. Yoder, how did things get started for you in Nepal?

*Mr. Yoder:* When I speak of my experience in Nepal, I have to qualify that. I am not speaking for the whole country, but rather in terms of my very specific experience in working to establish a one MW hydropower station and, later, in developing small-scale hydropower for milling grain.

The one MW plant was established in the early 1960's when electric power was needed to run the machines in a workshop in one of the larger towns outside the capital city. Hydropower, if it could be developed, was the obvious solution. The impetus to develop this one MW scheme came directly from the needs in the workshop.

In searching the nearby region for a suitable site, the rivers were found unsuitable for hydropower development compared to the higher altitudes, but a power source was needed nonetheless.

It was a staged project. The first stage was to provide power for the workshops. Later, it was discovered it was possible to tunnel to overcome some of the

difficulties in the area prone to landslides. Therefore, it was possible to expand and supply power to the surrounding area.

*Moderator:* At that time, what was the political setting in Nepal, the social acceptability of what you were doing? Were you fighting against any resistance? Was there apathy, strong local support, or what?

*Mr. Yoder:* No, there was certainly no resistance. There was a lot of skepticism from the local community, however. I remember meeting with people from the community in the mid-1960's where there were serious questions about whether this particular river could be tamed and power extracted. In fact, when the first stage came on line, there was excess power available for distribution to the town. It was not until several street lights were put up, and people actually saw that light was available, that the first request came for connection. But closely following the first request came a multitude of requests and, thus, it almost required policing to put some order into the following connections.

*Moderator:* Mr. Romaso, what was the impetus for your local activities?

*Mr. Romaso:* In Papua New Guinea, people switched to hydropower to replace diesel and gas generators which are very popular. As far as capital costs are concerned, the diesels are very cheap. Even before the price of fuel went up, mission stations and villages in outlying areas in central Papua New Guinea still found it really expensive to get fuel for generating purposes.

There is very little spontaneity in building hydro-power schemes of any size since the land tenure system in Papua New Guinea is very different from other countries. There is no such thing as free land and there is very little government land. Most land is locally-owned and, therefore, any development in hydro-power has to be negotiated in terms of ownership, on a shared basis.

*Moderator:* Okay. Mr. Favoreal, how did you get started?

*Mr. Favoreal:* In the Philippines, the mini-hydro program is just one part of the total electrification program. Projects on the local level are implemented through electric cooperatives. In the Philippines, the mini-hydro program was initiated to replace oil imports from the Middle East.

Generally speaking, the NEA is just now starting its mini-hydro program. In 1979, we were operating a diesel plant serving the northeast coastal towns, villages, and municipalities, and were spending roughly \$2,000 to \$3,000/month on operating costs

for the system which served 1,000 households. We then began to think of harnessing the mini-hydro potential in that area, designing our own equipment, and constructing the civil works. Of course, we have the full backing of the NEA which is responsible for the electrification program in the Philippines. The NEA now has a very big program.

*Moderator:* Thank you, Mr. Favoreal. Dr. Abdullah?

*Dr. Abdullah:* In Pakistan, the need for small hydroelectric plants evolved from the necessity to provide electricity to rural areas. Pakistan has about 45,000 villages of which about 10,000 have been electrified. Electrification is generally provided through an extension of the national grid, which results in very high costs, particularly in hilly areas which need long-distance transmission lines — a distribution network. Since the density of the load is fairly low, it has been very expensive.

Just to give you an idea, the average cost of electrifying a village under this system is about 500,000 rupees. One dollar is about ten rupees, so you can make the conversion. The Government of Pakistan considered the small hydroelectric system as one viable electrification option. They drew up a scheme to build 100 small hydro plants in 1973 or 1974 and hoped it would be less expensive and more competitive compared to the present system.

About ten plants were installed using conventional technology and methods. The work was given, therefore, on a turnkey basis, to local contractors and ultimately proved to be very expensive. The average cost was about 50,000 to 60,000 rupees per kilowatt or about \$5,000 to \$6,000 per kilowatt. Again, this is very expensive in terms of the benefits of rural electrification.

About 95% of the electricity is used for domestic purposes. The communities have a very low level of industrial development, so it is not economically justifiable to invest heavily in electrification on this basis.

In the mid-1970's, there was a general awareness of the shortage of fuel and a growing appreciation of alternative energy sources. We in the University realized that water technology, in the form of water mills, had been in use in certain parts of Pakistan for a very, very long time. The local people diverted water to develop irrigation systems and used the water flow to run mills for grinding purposes.

On our visit to certain villages, we found that a small electric generator could be installed in the existing system. Since then we have been quite active, and believe that the needs of rural people should be met in

an appropriate manner. By appropriate we mean the costs should be low, the technology should be acceptable, and the people should be able to operate and maintain the installations.

*Moderator:* Okay. The next topic is your approach to development. How do you deal with labor, design, equipment, expertise, feasibility requirements, the influence of local costs of material and labor? What is your objective? Is development haphazard or planned; do you have a specific philosophy developed over time, or are you developing your approach as you go along? Dr. Abdullah?

*Dr. Abdullah:* Since we have experience with small hydroelectric projects initiated earlier and found that the cost was too high, our approach has been to rely on local technology and local resources. We feel that even if we install these plants at a high technical level, it will be very difficult to maintain and operate them. It will be quite expensive and we will not be able to meet all the demands from the local people.

So, our approach to this development is to rely heavily on the local talent, resources, and manpower with very little guidance and supervision from a higher level. With that approach, we developed a very simple system, from the waterways to the power plant, to the distribution system, and to the end-use components. We feel that, if all these components are basically simple, then this approach will be acceptable and can be successfully implemented.

Our experience over the last five years has been very encouraging. Not only has the demand been very heavy, but we have been monitoring the projects and we find that they are fairly successful.

*Moderator:* What is your source of expertise? Where do you get the specialists you need for the work you are doing?

*Dr. Abdullah:* For the development of the turbine, the expertise came from the University. Since the turbine is fairly simple, it is being fabricated in a local workshop. Other required expertise is available in the villages, including carpenters, masons, wiremen, and other technicians; but central control of the technology is with the University.

*Moderator:* Thank you. Mr. Favoreal, how did you deal with the labor, construction, and design of the equipment? How did you put together the sources of expertise? Was it organized or unorganized?

*Mr. Favoreal:* Our electric cooperative relies on expertise at the local level. However, for the overall implementation of the nationwide electrification and the mini-hydro programs, NEA has created a Mini-Hydro Development Office to implement the program

on a large scale with goals and targets for each year. The NEA Development Office offers contracts with A & E consultants on the local level to oversee design and implementation of the schemes. In my particular electric cooperative, we started by actually coming up with the design ourselves. It is really a learning process. Generally speaking, we believe that for any developing country to survive, the needed materials and expertise must be available on a local level. Of course, we also have to depend on the experience of the other developed countries.

*Moderator:* How did you manufacture equipment for your hydro station?

*Mr. Favoreal:* For the first 100 kW, we used a propeller-type turbine that has a specific speed of 160. We manufactured it locally in a small machine shop by hand. We also used automotive bearings made at the local level. However, in the NEA's nationwide program, we also have the expertise of having industries in the area, like AG&P and Philips, which manufacture hydroelectric equipment locally.

*Moderator:* What is your approach to development of equipment, expertise, and feasibility considerations, Mr. Romaso?

*Mr. Romaso:* One of our policies at the moment is to make sure, even before we start moving into the area of implementation, that we go back to the people who requested the hydro project and ask them first to solve their land problems, the social problems that may be associated with the project, and any political problems. These issues we feel are most important and very vital, even before a project goes ahead. These could be major problems if not solved when the project begins. The technical expertise is there or can be obtained one way or another. Solving the social and political problems in the village must be left to the people who run, or will run, these projects.

It provides an opportunity to negotiate labor costs and gives the people a feeling that they own the project. Oftentimes, people feel that, if we come up with a project and give it to them, it is not their project, it is a gift. But if they feel that they own the project, you can work out the terms of financing the project. Where cash income is very limited, as in most rural areas of Papua New Guinea, the project can be negotiated in terms of labor. So your labor costs for the project are minimal because labor is provided by the villagers.

So far most of the micro-hydro plants are run with Ossbergers. However, they are expensive. We have found that availability of spare parts is a problem and, therefore, have started to manufacture some belts and

wheels.

We have also built one prototype of a cross-flow turbine, but it hasn't been tested yet. Incidentally, we would appreciate any information regarding availability and prices of hardware manufactured by countries or firms represented at this workshop.

*Moderator:* Do you develop your technology locally from other designs, buy other people's equipment, or both?

*Mr. Romáso:* If it is easier for us to manufacture it, we will do so. We are now setting up a small-scale industrial center which will enable us to manufacture and will consider manufacturing under a license arrangement or on agreed terms.

*Moderator:* Mr. Yoder?

*Mr. Yoder:* The one MW scheme I mentioned before was a staged project that involved over two kilometers of tunneling. The first stage took about the first 500 meters of that tunnel and produced 50 kW which was used in drilling the rest of the tunnel. The initial intake was a temporary structure with water diverted in the traditional manner of putting sticks and stones in the river. As the final powerhouse was established, the first turbine was operated through a temporary outlet. In the third stage of the project, the tail-race tunnel was dug, and the draft tube put in. In the final stage, the intake area was stabilized by putting an eight-meter high dam across the river.

The whole project was very labor intensive, rather than capital intensive. We used equipment from a powerhouse in Norway that was put out of operation because it was incorporated into a larger scheme. The equipment was old, but very robust.

*Moderator:* Was the labor voluntary or —

*Mr. Yoder:* No, the labor was all hired and mostly seasonal. People came out of the hills looking for employment during the winter season. Usually, 100 to 200 people were employed on the project at a time.

*Moderator:* Were they skilled? Was there any training involved?

*Mr. Yoder:* The training was on-the-job training and was probably the most important aspect of the project. Over the 12 years it took to construct the project, there were close to 3,000 people working at one time or another, for either one week, or in some cases, up to twelve years. Some had skills and some were trainable. An important corps of people was built up who now have been transferred to a permanent company that is installing hydro schemes in Nepal.

This was extremely important in the operation and maintenance of the project. The National Electricity Corporation has taken over the operation of

the plant. About fifteen people who were involved in the construction are employed by the NEA to operate and maintain the plant.

*Moderator:* That is very interesting. Mr. Sosrohadisewoyo?

*Mr. Sosrohadisewoyo:* Our university is the oldest technical university in Bandung and has three missions: education, research, and social service. Each mission has its own director. We set up the Micro-hydroelectric Team to serve the public need. Generally, the impetus comes from the government which turns to the Institute.

The team consists of several disciplines: mechanical, electrical, civil, and hydro engineering. When a request comes to the team, we identify our jobs and then go on to the software, design, specifications, and tender documents, if needed.

So far, we rely on local production for our equipment. The first turbine we made was made from an old car wheel which cost 50¢ to 1\$ on the junk market. The buckets were made from an old pipe with a certain diameter and cut into pieces to make a Pelton turbine. We made it in 1976 and tested it and, I believe, it is still working. The next piece of hardware we focused on was the cross-flow turbine. Mr. Sularso is producing the design and the manufacturing is done by our local manufacturers but, with many failures. One of the rotors broke after three weeks of operation; one broke after three months; and another after six months or so. We keep modifying it.

*Moderator:* Was it a materials problem or a design problem?

*Mr. Sosrohadisewoyo:* Experts said it was a manufacturing weakness that the rotors were not welded properly. This is something that NRECA can assist us with since our experience is limited.

The next test was with a propeller turbine which we developed in our laboratory, but it doesn't do what it was designed to do. We need to modify the design and have asked a private company to help us.

We tried several types of generators: the conventional synchronous generator, an induction machine with the condenser banking, and a modified DC machine series-wound. We have many old DC machines that were used by tea plantations, but they are no longer used because of modernization at the plantations. You can buy them for about \$100 for a 15 kW machine.

The automatic frequency controller we built on our own with the electronic load controller mentioned in the workshop this afternoon. It is a three-phase controller. The first attempt was for a digital load controller, the next modification was for an analog/

digital load controller; and the latest modification is what I call the hybrid load controller which is a combination between the digital and the analog.

Most of the components are imported, but some are made like resistors and condensers. But the ICs, such as the LM-7402, are still imported. The assembling process for these imported components is appropriate technology because it doesn't need any high degree of skill. The assembling process is done with very simple tools such as a soldering iron.

*Mr. Romaso:* I think that you can buy the most efficient equipment anywhere in the world, but I would generally assess a project in terms of the specific conditions and its purpose. For example, if I were to build a hydropower plant in the central rural area of Papua New Guinea, it would merely be for lighting purposes. The question of efficiency and the quality of your turbine should be related to its purpose. Costs are a major factor in micro-hydro development, but they should be considered in the specific context of what degree of technological sophistication is required.

*Moderator:* Do you find that costs vary quite a bit on the local level or —

*Mr. Romaso:* Yes.

*Moderator:* Raw materials and labor?

*Mr. Romaso:* Yes. In one of the examples Allen Inversin showed yesterday, they have been using a DC-3 generator from the last World War, and it just broke down about three months ago. (laughter) Now they have to improve that and are willing to buy a new generator. There the purpose is purely for lighting and that is all they need. The level of technology and the cost of that technology should reflect the modest purpose of the scheme.

*Moderator:* Dr. Abdullah, I believe you have a question.

*Dr. Abdullah:* Yes I have a question for our friend from Papua New Guinea. It appears that we in Pakistan and my friends in Papua New Guinea have certain common approaches to development. You mentioned in your address that ownership is given to the local people. Can you clarify whether it is a local individual or whether it is given to a local community or a common society?

*Mr. Romaso:* In most cases, it is community-owned. So far, the only ones that could be called privately-owned are the hydro plants run by the mission stations. Anything purely local is community-owned. Again, the problems of land ownership and social implications come in and, therefore, it is much healthier for people to say, "We work together; we own the plant together; we share the cost of labor, material,

maintenance, and so forth." But for anything private, even hydroplants owned by the mission, there are certain labor costs which are minimal or which are free.

*Moderator:* The next topic is the source of finance. Where does the money come from, whether from public or private sources? What are the requirements for finance? Do the requirements and the source of finance have an influence on the design or outcome of the program? Dr. Abdullah?

*Dr. Abdullah:* When we started this work, the financing was through the Appropriate Technology Development Organization (ATDO). This organization primarily develops, adapts, and disseminates the technology. So, initially the machinery part and the technical parts were financed by the ATDO which is a federal government agency.

At the same time, the local material was the responsibility of the local community. So, we started putting up these plants on a cost-sharing basis. Later on, when the technology was fairly well accepted, we started phasing out the government input and approached the local government and the local cooperative societies to share in certain components of the system.

At the present, the cost is shared by three agencies: the ATDO provides technical services; the local, or provincial, government shares the cost of generators and, to a certain extent, the cost of distribution; and the local populace is responsible for the entire civil works, including the powerhouse building and the distribution. Our experience shows that, if the financing is entirely from government agencies, we will not be able to achieve the success we want. So, we believe there will be less reliance on financing from central agencies and an increasing contribution from the local people.

*Moderator:* Is there any repayment involved, or is this a grant?

*Dr. Abdullah:* No, there is no repayment involved. Neither the government, the ATDO, nor the University collects any taxes or revenue. Once the plant is built and is operational, it is given to the local people. It is then their responsibility to maintain and operate it and meet the financial requirements.

*Moderator:* Mr. Favoreal?

*Mr. Favoreal:* In the Philippines, the loans come from the government, which in turn gets a loan from a foreign lending institution such as the Asian Development Bank, or the World Bank. The loans from NEA are made to the electric cooperatives to finance particular mini-hydro projects.

The feasibility studies are undertaken by the Mini-Hydro Development Office to assess the economic and financial viability of the project. The terms and conditions vary from site to site.

In my particular case, the loan for a 275 kW, locally-manufactured mini-hydro plant was 5.5 million pesos. Divide that by 7 or 8 to get the dollar equivalent. This is payable in 10 to 20 years with the first payment due one year after the plant begins. The feasibility study for the project includes the investment costs of the project. The electric cooperative repays NEA in the form of semi-annual amortizations.

*Moderator:* Mr. Romaso?

*Mr. Romaso:* Financing comes in several forms. Hydropower is financed by the government including consultant costs, hardware, and maintenance. The government gets money from the ADB, among other sources, and has to pay interest on some of its loans for hydro plants, but in other hydro projects, I am not certain.

As far as our rural micro-hydro plants are concerned, we normally require free labor and a 10% cash contribution from the village against the cost of the hardware. The rest is obtained either from the provincial government or from the central government.

Other groups, like the mission churches, finance the construction costs purely by contributions from kind people from other countries who have missions within parts of New Guinea. Maintenance costs are supposed to be paid from money collected in the form of user fees.

*Moderator:* Thank you. Mr. Yoder?

*Mr. Yoder:* The one MW power plant was organized from the beginning as a private limited company with the workshops owning about two-thirds of the shares, and the government, through both the electricity department and through the Nepal Industrial Development Corporation, the other one-third shares. Capital came partially from grants from Norway and partly from loans from the Nepal Industrial Development Corporation. Some additional capital was contributed by the Government of Nepal. The last stage of the project, when 450 kW were being produced already, was almost entirely financed from revenue earned through the sale of power.

Possibly more interesting, is the financing of small 25 kW sites developed for mechanical power for milling grain. The approach used was not to scale down large power schemes, but instead to start over and build up from the bottom to make things very simple and as cheap as possible.

These projects usually involve three milling processes at one installation: oil pressing; flour grinding;

and rice hulling. The owner takes out a loan from the Agriculture Development Bank in Nepal to finance the capital investment for the machinery which he repays in installments. There are over 60 of these installations in the country now, constructed by a variety of workshops, and, when I checked just last week, none has defaulted on its loan.

*Moderator:* Thank you. Mr. Sosrohadisewoyo?

*Mr. Sosrohadisewoyo:* As far as the capital costs are concerned, out of 20 micro-hydro projects that I know of, only one is financed by a private company, a tea plantation. The rest are financed by the government.

This money goes through several pockets: The Directory General of Cooperatives; the local government; and the power company. About 5% is financed by the private power company.

*Moderator:* I would like the panel to address the topic of end-use planning, which is matching the power that has been generated to the use. How do you go about doing that? Is that something which has evolved? Is the power mechanical, electrical, or a mix? How do you determine what the growth potential is of a given region, or is that important? Is the purpose simply to enhance the quality of life or to help agricultural processes without any broader emphasis on economic growth in general? Mr. Sosrohadisewoyo?

*Mr. Sosrohadisewoyo:* We are of the opinion that the mechanical power can always be derived from the electrical power. The advantage of having electrical power output is that you can transmit the power anywhere else around the village. If you transfer it to mechanical power, then you have to use the power at that place. So we think that electrical power is more flexible and can be used for mechanical purposes, or simply for heat and light. We, therefore, decided to convert all the energy to hydroelectric power and then distribute it.

*Moderator:* How do you determine how that energy is used?

*Mr. Sosrohadisewoyo:* We started with the study, and if there was industrial potential, we decided to have electrical energy and frequency control. If there was only lighting potential, the frequency controller was not important and it reduced the costs to leave it out of the scheme.

*Moderator:* Mr. Yoder?

*Mr. Yoder:* I think the situation in Nepal is not unique to Asia, but it may be unique in India or Sri Lanka. About 95% of the population lives in isolated rural areas where distances are measured, not in miles but in hours or days of walking from the nearest road or transport facility, and where the majority

of the energy is used for cooking. We began to ask questions about the direction in which hydropower development was going, whether the large plant, central grid type of micro-hydro in the range of 1-5 MW, or, in more recent years, hydro in the 50-200 kW range. We started looking at load centers in the country and discovered that milling grain is probably the largest use of commercial energy. In many cases, diesel fuel was being carried into the hills to operate single-cylinder diesel engines to run mills. In considering basic energy requirements for cooking, we began to ask whether hydropower could be used to meet cooking needs. Obviously, this is difficult to do.

The next step was to see whether it was possible to develop power on a very small scale to meet the milling needs using direct mechanical power. We discovered that this energy could be converted to small-scale electrification in the 10-50 kW range that could be used for cooking needs.

The milling project has been very successful. An additional use that has just been developed is direct mechanical conversion to heat, using air friction to produce heat for drying crops. There are several prototypes of this system operating now in Nepal which have wide applicability.

As for the question of using electricity for cooking, I have spent several years now looking at an energy storage cooking device which technically has very good potential, but socially I see limitations in it. In order to operate it cheaply and to conserve the greatest degree of energy, you need to cover both the cooking chamber and the pot. Traditionally, Nepalis like to stir the food and see when it reaches the boiling point which is not possible with this device. As soon as you take the lid off, it stops boiling. You need to have a watch to time the cooking period, but most of these people don't have watches. If you do time it, you can cook very efficiently with it.

One serious problem in small-scale hydroelectric development in rural areas, where firewood is becoming scarce and prices of wood are going up, is that the demand for cheap, efficient electrical cooking systems will quickly outstrip the energy supply available from 100-200 kW installations, which only permit 100-200 people to cook at one time. This results in a very, very sharp peak load, but, during the rest of the day, there will be very little load.

*Moderator:* Thank you, Mr. Yoder. Mr. Romaso?

*Mr. Romaso:* Power is used for lighting purposes in rural areas of Papua New Guinea and for running clinics. Just before I left, we received a request for two micro-hydro plants to run a clinic for night deliveries. During the day they shut it off.

That limited end-use makes our controllers cheap and simple. With those that I worked with or have been associated with directly, we only have dump loads on the tailrace and a hotwater system for the kids in the schools which, by the way, improved health care in the area considerably. Suddenly, there was less scabies because kids were taking hot showers in the morning, at lunch hours, and before they went home.

Papua New Guinea produces quite a lot of coffee and requests have now come in for micro-hydro or mini-hydro plants in the highlands region to run coffee mills. So, very soon we will be engaged in direct mechanical coupling.

*Mr. Favoreal:* In the Philippines, the electric cooperative operates more like a utility company. In my co-op, we have nine towns and we are now serving eight municipalities and around 50 villages. We have a distribution line system of about 170 kilometers.

Power is used for irrigation, rice mills, ice plants, and small industrial loads. Mini-hydro is just one part of the overall operation of the utility cooperative. The corporation charges for distribution and generation, which forms one department in the entire set-up. Mini-hydro is tied into the national grid through the cooperative distribution line. The national grid, which is owned by the National Power Corporation, provides the power generation and transmission. Our electric cooperative distributes this in the form of voltages up to 13.2 kV, which forms the co-op grid.

Our mini-hydropower is tied into the lines, so end-use, or market potential, is not a problem. This is one of the criteria for mini-hydro development in the Philippines. If it is grid-connected, especially for the run-of-the-river type, the cost is very low and the project is considered viable. Otherwise, it would not be viable since the mini-hydro plant would operate at roughly only 50-60% of capacity.

*Moderator:* Okay. Dr. Abdullah?

*Dr. Abdullah:* As I mentioned earlier, our initial approach was to electrify the villages. The load is mainly domestic, but we soon found that there was potential small-scale industry as well. We established some processing units in the villages, mainly in the form of rice milling, flour grinding, woodworking, and such activities. All of these units are housed in the powerhouse building and the motive power of the plant is utilized to run these units.

We have about 22 plants in operation. Of these, I would say about half have small-scale cottage industries in the powerhouse building. In addition, we have used electrical energy in two plants to run a motor for operating a wheat thresher. We feel that in our system



the cost of the electric motor is comparable to the cost of the device it is running.

The powerhouse is located very close to the town or village, about a kilometer away. Transmitting the electrical power one kilometer is no problem. But we encourage such units to be run on motive power rather than using the electrical energy and have been quite successful. We have a lot of demand. We also advise the local community on the type of processing units available in the market and I think we are doing fairly well.

*Moderator:* Thank you, Dr. Abdullah. If members of the audience have any questions, we will be happy to entertain them.

*Questioner from the Audience:* I am Mangalam Srinivasan and I direct the Technology Policy Unit at The American University in Washington. My work is mostly in energy technology assessment in developing countries.

Bob Yoder mentioned that in Nepal much of the energy goes for cooking, which is true in all developing countries, particularly in Southeast Asia. What concerns me about that statement was that the introduction of the use of electricity for cooking is really not nearly as important as the other uses to which electricity should be put such as street lighting and refrigeration, which have health and sanitation benefits in development and community systems.

About 50-75% goes for cooking. Nepalese cooking, which I happen to know a little bit about, doesn't lend itself to electric cooking and, therefore, I was wondering if it isn't a serious misconsideration in energy distribution, particularly when we have no street light community systems, to target the energy use for cooking.

I find in India, when villages are electrified, people get maximum utilization out of street lights. The children gather there and put on skits and it is used for studying as well. This is very interesting to me because often, when we talk about electricity for cooking, we are coming from somewhere else, not from the rural areas. When we say hot water faucets, we are also coming from somewhere else. I wonder if you have any comment on that.

*Mr. Yoder:* Yes, I think you have a very good point. The primary reason for looking at alternative energy sources for cooking in Nepal is that, as the population has increased in the last two decades, the forests have decreased proportionately. There are areas of Nepal, for example around central Nepal, where firewood is now carried from one day's walk away where the hills are completely bare. Alternatives are

desperately needed.

There is no question in my mind that firewood is the most efficient way of storing energy for cooking. It is by far the best solution. But, until firewood plantations are initiated and reforestation can take place, alternatives are needed. In fact, I suggest that electricity for cooking is not a solution except in certain isolated instances, such as an urban center, where firewood is now very expensive.

Street lighting is probably one of the first uses that is developed when electrification takes place. It is of benefit to the whole community, not only to the few individuals who have the means for making an electrical connection and having lights in their houses. You have a very good point.

*Moderator:* I believe there was another question in the back.

*Questioner from the Audience:* I am Janice Brodman from Harvard University. One thing I am really interested in that relates to a study project I did in Indonesia is that there seems to be tremendous potential for electricity use substituting for diesel motors, but there are problems because of a lack of information and a lack of capital to buy new electric motors.

How do you get the information, for example in Nepal and Papua New Guinea, to coffee millers and rice millers that electric motors are a viable substitute? How do you get, or how do you deal with the problem of financing? Are people having problems getting capital?

*Moderator:* Mr. Romaso, would you like to take a shot at that?

*Mr. Romaso:* The people who own coffee plantations in the highlands of Papua New Guinea buy a car every year. They are fairly rich and can afford power generation for milling coffee.

*Moderator:* Does that also mean they have access to communication sources?

*Mr. Romaso:* Yes. Papua New Guinea is an urban center and fairly well developed. It can buy anything from anywhere in the world. It has access to equipment from Australia, Japan, and America and can get it quickly.

*Moderator:* Mr. Yoder, would you like to speak to that?

*Mr. Yoder:* I would like to correct one statement you made. In Nepal, to my knowledge, no water turbine has been installed on a very small scale in the rural areas using an electric motor for milling. It is all direct mechanical coupling to milling machines. However, in the one MW case that I was involved in, there are

some 20 mills operating with electric motors.

Disseminating this information is a very important step. Mr. Karki, who represents one of the workshops in Nepal and is in the audience here, can talk about that. Their workshop, in the early 1960's, installed roughly six or eight water turbines to operate mills, which were left alone to operate for about ten years. It is very interesting to look at a demographic map of the area where the mills have been installed now. The highest concentration of population is definitely within a certain radius around where those early mills were installed. People in their travels passed by these mills, saw them operating, and saw them as useful.

In the next important phase, the Agriculture Development Bank of Nepal took a very active part in promoting this. Through the Bank's branch and sub-branch offices throughout the country, information was distributed, people were taken to mills, and the operation was explained.

Financing is a serious problem. It takes roughly \$5,000 to \$6,000 to establish a mill and there are not many people in Nepal with that kind of capital. Roughly 50-80% of the capital can be raised through a loan which is fairly easily repaid, since it is very lucrative to run a milling operation.

However, the other 20-30% represents more than many people have available. We followed the traditional pattern of ownership initially, along with the other workshops that are involved, simply because we needed the opportunity to develop the process: the water turbine, the installation teams, the whole works. It takes time and some experience to come up with a good product.

At this point, efforts are under way to look at alternative ownership patterns. The cooperatives are fine if they work and if you can get them established. However, it requires considerable effort and considerable time, up to five years, to get a cooperative established that is viable.

*Mr. Romaso:* Excuse me, is the ownership pattern based on some traditional pattern?

*Mr. Yoder:* Yes, the traditional pattern for owning diesel mills in Nepal is through private enterprise.

*Moderator:* Thank you. Yes, the next question, please.

*Questioner from the Audience:* I am Nguyen Duc Lien from the Mekong Committee. The problem varies from country to country, in terms of your first question directed to the panel, regarding the initiation of the project. In my own experience in dealing with some ten projects, the initiative comes from two direc-

tions.

In one mode, the planner goes out to identify the projects; in the second, he gets requests from the communities, provinces, and villages. This second mode is important, since a planner doesn't have a chance to spend much time in the field.

On the second point of end-use, I would like to say that the uses of electricity produced by small-scale hydropower depend on the situation. If funding for the project is based purely on costs and benefits, it is very difficult to get a loan to finance the project, even if the project has irrigation or industrial components. If the project is set up for only domestic uses, or where it is locally used, then it is even more difficult, unless it has been given a very high priority based on political or social conditions. In that case, you simply have to build it regardless of the costs and benefits. But in terms of the financial concerns, I found it very, very difficult if industrial components were excluded from the project.

*Moderator:* Thank you very much. Is there anyone on the panel who would like to add anything to those comments?

*Dr. Abdullah:* I fully agree with the speaker that initiative has to come from both the planners and the local community. Our experience is that the local people are shy and are reluctant to come to the people in the planning section or to people at a high level; it is also difficult for the planners to approach people. Our experience has been that the local leaders in the towns who are concerned should go to the rural areas and assess their needs and requirements. They should also establish a very close relationship with the rural people. You can't simply tell the people to invest \$1,000 or \$2,000 unless they are assured of their benefits.

*Moderator:* Any other questions from the floor?

*Questioner from the Audience:* S.T.S. Mahmood from Bangladesh. I have a minor question of all the panelists regarding the specific costs of the plants. Dr. Abdullah has already indicated a sum of something like 50,000 rupees per kilowatt. It may be even more. When a plant is integrated with the national grid, like Mr. Favoreal's cooperative in the Philippines, it is very simple to charge the consumers uniformly. But when we are talking about an isolated area, like Papua New Guinea, I wonder what the electricity charge is in a local area. Is it based on a national tariff, or are the charges higher than the national tariff? Are the tariffs subsidized?

*Mr. Romaso:* In the last micro-hydro plant we built, the cost per kilowatt was 1,000 Kina local cur-

rency, which is about US\$715 (one Kina is about US\$1.40).

As I said earlier, rates are not at all based on the national tariff. We have tried to provide some guidance, but the ultimate decision regarding tariffs is in the hands of the people. Maybe Kaye Bowman, who lived with the people there, could give some idea of what the tariff charges are.

*Ms. Bowman:* In villages where electricity schemes are owned and operated by the people themselves, the choice of tariff structure has been left up to them. Quite often, it has also included the option of paying no tariff, which is what happened in the three schemes that have been in operation for several years. This leads to problems in maintaining the plant. They do not have good answers to this problem at the moment, except perhaps to find small grants from their local governments.

In the particular scheme that I have taken much interest in, the tariff is based on what they felt they could afford to pay, which is a weekly unit rate. It is not associated with actual units of electricity a user may use, but is merely a flat rate to cover weekly usage. They are running into problems with communal uses such as street lighting and I have yet to return there to find out what they are doing about that. But, in that case, they are interested in paying for their full use of electricity so that they can maintain the plant.

I would like to get back to an important point that Janice Brodman made regarding information exchange. I think, in the cases of these other three villages, they are not fully aware of the extent of the maintenance costs that might occur, which makes it very difficult for them to appreciate the importance of setting tariffs so that they will have income to keep the plant in operation.

*Moderator:* Thank you. I think Dr. Abdullah has a comment.

*Dr. Abdullah:* I would just like to clarify something. In the villages where we have installed plants, we are not governed by the national tariff structure. We leave it to the community to decide the basis for collection of revenue. Generally, it is not based on the number of units consumed since there are no electric energy meters installed at the houses. The rate is a flat rate and is based mainly on the number of bulbs which a household uses.

Just to give you a rough idea, it costs three or four rupees per bulb per month, which amounts to about 20 rupees per household per month, or \$2.00 per month. This covers the cost of maintenance of the plant only.

*Moderator:* Thank you, Dr. Abdullah. Mr. Favoreal?

*Mr. Favoreal:* In the Filipino experience, the two mini-hydro plants that NEA has supervised cost from \$800 to \$2,000 per kilowatt. With the 7-9% interest rate, payable in 12 years, the rate, including amortization and maintenance costs, is roughly 6¢ per kilowatt hour for a grid-connected system. A grid-connected unit will carry a 60-70% load factor. The load factor for a decentralized, or an isolated mini-hydro plant will be roughly 10-20% and, therefore, the cost of generation will be comparatively very high or roughly 12¢ per kilowatt hour.

*Moderator:* Thank you. Would you introduce yourself, please?

*Questioner from the Audience:* Hoesni Nasaruddin from Malaysia. In looking back at what the panel said, there seem to be general uses of the electricity supplied to an isolated area. That is, normally consumers use electricity for lighting or to run a radio or television, but rarely use it for an electric iron or cooker.

Looking at it from this point of view, I would like to ask the panel whether, in the case of mini- or micro-hydro, you would attempt to redefine rural electrification in terms of the amount of energy supplied to the consumer. In a normal rural electrification system, perhaps in Pakistan or elsewhere, you supply a certain amount of demand. If the house owner puts up lights and has a television, he would probably use 200 watts for his household, but only at that particular time. On the other hand, you could simply supply the consumer for 24 hours each day with 60 watts. Can you redefine it in terms of energy supplied? Mr. Romaso?

*Mr. Romaso:* In Papua New Guinea, we are very, very careful to identify and solve the social problems that are connected with hydropower, and with electricity in general, in rural areas.

Electricity has much greater psychological, social, and political impacts on rural areas of Papua New Guinea, so we are very careful not to create too much of a shock in the lives of the people. To start with, we don't have television in Papua New Guinea. People rarely use big amplifier radios and things like that in rural areas. Again, it can be viewed as an additional problem that you introduce into the lives of people. That is why I say we are really very aware of the social impacts of hydroelectrification. The amount of power we supply to people is very limited. You only get a light bulb or two in a house, and there are not hot plates for instance. If there is a hot water system, it is a central or community system.

*Moderator:* Dr Abdullah?

*Dr. Abdullah:* I think we should take into account that the present system of rural electrification has very low consumer saturation of about 15% according to studies put out by different agencies. This means that, even though you have the capacity and the resources to extend the lines, the consumers are just not able to purchase the electricity and, therefore, the present conventional system of electrification is very expensive.

On the other hand, we don't conduct what is called a market survey for each household to determine that 200 watts are needed for lighting and, 100 watts are needed for fans, and so on because of our limitations. Instead, we go the other way around and have not faced any difficulties. The consumer saturation is very, very high. In the areas where we have established these plants, 90% of the people have connections, depending on their capacity and on the cost they can bear. Some people cannot even afford \$10 for the domestic wiring and connections, so we don't force them. Instead, we say, "If you can afford and can manage with one or two bulbs, instead of living in the dark and using a candle or burning wood or charcoal, go ahead." We find that this system is very well accepted and is very suitable.

*Moderator:* Mr. Yoder?

*Mr. Yoder:* This question allows me to get into my pet subject and that is –

*Moderator:* One minute only. (laughter)

*Mr. Yoder:* – for an isolated system of small capacity, the traditional methods of electrification just aren't economically feasible. The meter itself, if metering is the method undertaken, is usually more capital-intensive than most consumers can afford. By allowing unlimited access, you have extremely high peak demands and very low utilization for most of the time. For a small hydro plant, particularly run-of-the-river types, which most plants are, this is extremely unfortunate since it reduces the load factor down to probably less than the 15% that was quoted.

Therefore, the suggestion of reorienting it by setting a tariff, not on the basis of per kilowatt or units of energy used but, rather, on installed capacity or even going a step further, and using a load-limiting device to sell the capacity based on whatever the consumer decides he needs, tends to utilize the power 100% of the time. This levels out the load in a much more satisfactory manner for small-scale generation. Unfortunately, except for instances in Norway where this was the traditional method many years ago before a grid network connected isolated power plants, I have not seen examples of this in recent years.

## Panel 2 : Centralized Development and Management

*Moderator (Dr. Zoellner):* This is the second of two panels we have scheduled to examine the dichotomy between local and more centralized approaches to planning and managing small hydro schemes. Before we proceed, I would like to introduce the panelists:

- Waseem Khan, Chief Engineer, Mangla Dam, Water and Power Development Authority, Pakistan;
- Ibnu Subroto, Civil Engineering, State Electricity Corporation, Indonesia;
- Zenaida Santos, Executive Director, Mini-Hydro Development Office, National Electrification Administration, Philippines;
- Hoesni Nasaruddin, Project Manager, Mini-Hydro-power, National Electricity Board, Malaysia; and,
- Martin Solo, Electrical System Planning Engineer, Papua New Guinea Electricity Commission.

This panel will cover the same topic areas as discussed in the local panel, but from a centralized perspective. We will briefly cover the topics of (1) impetus of development, (2) the approach to development, (3) sources of finance, (4) the system of maintenance and operation, and (5) end-use planning. I'd like to start with Waseem Khan and ask what were the reasons for creating this centralized approach; what were the interests for development; what was the setting in which Pakistan developed its program?

*Mr. Khan:* The program should suit the needs of the country and the situation. The context of Pakistan may not be exactly the same as in the other countries since their programs would be tailored to their own conditions. In developing countries, the scarce resources are financing, skills, and know-how. The best use of them is achieved by pooling them and using them in a coordinated manner. That's exactly why we have created an organization, the Water and Power Development Authority, to survey possible sites, make the feasibility reports, rank the studies, and fix the priorities. That's essential because we have to have a well-organized, long-term 20-year plan, as well as a short-term, five-year plan.

*Moderator:* With all due respect, those are the sorts of issues we will discuss later on. I'm mainly interested in the setting in which your program was developed and I believe we have that. Thank you very much. Ibnu Subroto, I'm interested in the origins of your program. How did it get started? What were the considerations behind developing small hydro programs, or rural electrification programs with potential for developing small hydro? What made you think now

was the time; what was it that brought it about? Was it the price of oil or was it more complicated than that?

*Mr. Subroto:* Indonesia is a country of many, many islands, big and small. In Indonesia, therefore, transportation difficulties are very great, especially in the outer reaches of Java. About twelve years ago, we started a micro-hydro program to provide rural people with supplies of electricity because we considered transporting diesel to be excessively difficult. Moreover, the skilled labor to maintain diesel systems is also a problem. Of course before the war, there were some micro-hydro plants in Indonesia, most of which were for plantations, not communities. We began with a small program of about six units in 1978-1979 which were developed by the local villagers.

*Moderator:* Indonesia is an oil-producing country, is it not?

*Mr. Subroto:* Yes.

*Moderator:* Does Indonesia export any oil?

*Mr. Subroto:* Yes, but not as much then as now. I don't know why at that time micro-hydro was not considered feasible, since the operation and maintenance of these plants is relatively simple.

*Moderator:* Thank you. Mrs. Santos?

*Mrs. Santos:* I think I should begin by giving a background on the rural electrification programs in the Philippines. It will help the audience, or at least those who were not sitting with us in the last workshop, to understand the way the Philippines is approaching mini-hydro. There are two agencies that are charged with electrification: the National Power Corporation which is in charge of large hydro schemes and transmission; and the National Electrification Administration, to which I belong, which is in charge of distribution in rural areas and which is now in charge of developing the mini-hydro program.

The cost of generating power is high in the Philippines because 80% of it is generated from oil. In terms of mini-hydro, only a few plants were built from the 1930's to the 1960's because it was cheaper to generate from thermal sources. There was no concentrated effort by the government to develop a mini-hydro program. But in 1979, when costs began going up, the government began developing a mini-hydro program. At present we have a 300 MW program which we plan to install between now and 1987. This should provide about 35% of the needs of the rural cooperatives. I mentioned the word cooperative because we are implementing our mini-hydro program through our cooperatives. In the Philippines, I would say we have a well-organized plan on how to implement the mini-hydro program.

*Moderator:* Would you say that the impetus for developing a mini-hydro program was basically an economic one and a function of the price of oil?

*Mrs. Santos:* Yes, because we felt that we could not bring power to the rural areas if we just relied on our grid of which 80%, as I mentioned, is generated from oil. We know that mini-hydropower will not reduce that percentage as far as the rural areas are concerned, but at least we should be able to stabilize it. As we bring on new units, we hope to reduce our dependency on oil. It will take years, but as I said, by 1987 about 35% should be generated from this 300 MW.

*Moderator:* Thank you. Mr. Nasaruddin?

*Mr. Nasaruddin:* I think mini-hydro in Malaysia is similar to that of the Philippines. We have quite a number of mini-hydro plants because the country, as you know, has a number of tin mines which have their own mini-hydro plants. In addition, quite a number of small municipalities, in the early 1900's, developed mini-hydro plants in the range of 5 kW to 800 kW. But then, because fuel was cheap at that time, the move was toward thermal stations, not hydropower.

As a result, now we are 85% dependent on thermal and 15% on hydro. But the impetus toward mini-hydro was not so much due to fuel, but was due more to the objective of rural electrification. Mini-hydro capacity in Malaysia ranges only between 50 kW and 500 kW which, as you know, is not a practical economic range. We found that if we were to supply a rural area with extensions from the grid, there is a limitation of distance due to the high cost of transmission and we could never recover the cost of an isolated scheme. But by having a mini-hydro plant somewhere as part of a rural grid, which would later be connected to the main grid, we found that we could recover the cost of the plant and even transmission costs. As a result, the existence of the mini-hydro station itself pays back whatever we spent on earlier rural electrification efforts.

As a result, we went with an extensive program which started last year. The National Electricity Board started thinking about doing 22 trial projects itself, because we wanted to know what kind of mini-hydro we should get involved with. At the same time the government, being enthusiastic for the idea, called in three consultants to be involved in the feasibility studies and the engineering design for the 102 sites the plan is now scheduled to implement. The consultants were called in because we do not have the manpower to complete the studies in one year as the plan calls for.

*Moderator:* But your impetus for development

was basically to provide rural electrification in terms of beginning the program?

*Mr. Nasaruddin:* Yes.

*Moderator:* I will get back to your approach to development in just a moment. I'd like to give Mr. Solo an opportunity to answer the question first.

*Mr. Solo:* Our programs are a result of the government's plan for rural development. The PNG Electricity Commission, the only executing agency for the government with respect to electricity, took on the task of carrying out the rural electrification program for the villages. We started off by looking at four mini-hydro schemes. At the time, we knew that the schemes would be of general benefit to the economy by displacing diesel fuel. Diesel generation is a very costly means of energy generation. We do not have oil and, therefore, have to import all our oil.

*Moderator:* Would you say that the principal reason you looked to renewable energy resources was because you're importing oil?

*Mr. Solo:* From the Commission's point of view, our task is to displace diesel generation fuel because of the high cost of having to use fuel in generation. At the same time, we have 20,000 MW of hydropower potential, which is considerable. It is obvious to us that we should pursue developing renewable resources with the overall aim of reducing the cost of generation.

*Moderator:* Thank you very much. I'd like to move on to the second topic. Several of the panelists have already begun to describe their approach to development. How do you deal with labor? How do you approach designing and manufacturing equipment? What's your source of expertise? Do you develop it internally, import it, or is it a combination of the two? What are the feasibility criteria that you deal with? What's the influence of local costs, if any, in the centrally-planned approach? I'd like to ask each of the panelists to think about those and perhaps other topics in their approach to development, and would ask each to be as specific and brief in their response as possible. Mr. Solo?

*Mr. Solo:* Of four mini-hydro schemes that we are presently constructing, we have completed one. The feasibility studies and preliminary design were done by our very limited staff. Before it is actually funded, the Asian Development Bank has to come in and assess the mini-hydro schemes themselves and report before they grant the funds for these projects.

Because the Commission does not have many skilled people, we have had to utilize the very few that we have only up to a certain stage, after which the skilled person has had to be transferred to another project. We have had to rely on local labor, the unskil-

led workforce at low cost, to do menial tasks.

We do not manufacture equipment, especially electro-mechanical equipment. It is imported from overseas. The one mini-hydro scheme that we have completed used an Ossberger unit from Germany. Concrete and other materials are also imported.

*Moderator:* Are there any particular costs that influence your development? For example, are there costs in Papua New Guinea that vary regionally, or are the costs of materials, labor, and so on, the same in Port Moresby as in other parts of the country?

*Mr. Solo:* It varies from region to region, but a major factor is the land itself on which the project is sited, which in the end may be responsible for either the completion or non-completion of the project. It can also be a very expensive factor. Purely for traditional reasons, we have had to delay some projects merely because the owners do not want to give up their rights to the land. If at first they do give up their rights to the land, we have to be very cautious because later on they may come back and demand twice or three times as much as what we originally gave to purchase the property. This is a major problem in some of our projects.

*Moderator:* Thank you, Mr. Nasaruddin?

*Mr. Nasaruddin:* The problem we're facing now with hydro projects in Malaysia is actually labor. It's not so much that we can't get labor, but people are reluctant to go into the jungle to build the weirs, pipelines, and so forth.

*Moderator:* Malaysian labor?

*Mr. Nasaruddin:* Yes, the local Malaysian labor. It's very high-cost, especially now, in Southeast Asia.

*Moderator:* It is cheaper to import labor?

*Mr. Nasaruddin:* I would think it would be because we found that in some of our schemes, especially in the oil palm states, much labor comes from neighboring countries.

In the program that we're going to carry out, we are doing the feasibility studies and the design work ourselves for the first 22 projects. We hope to learn from these initial schemes how the overall plan should be carried out.

The turbines we will use come from all over the world. We've imported ten so far, from France, England, India, China, Australia, and America, to study the type of turbines and the technology that is available. We feel that we eventually must learn how to build them ourselves. The main criteria in selecting the machines is utilizing technology from the 1950's rather than the latest and feel this era of technology is more appropriate for our own local manufacture. We are now looking into making turbines ourselves

and are developing our own expertise. Although we have consultants coming to assist us, they are mainly coming to do the feasibility studies and the design. We believe it is important to create our own expertise because we feel that the program in Malaysia could be carried out perhaps for the next 20 years since the potential is large.

*Moderator:* Thank you. Mrs. Santos?

*Mrs. Santos:* The approach in the Philippines is unique. Usually you would approach this problem as follows: first, you have the idea and how to go about it. Then you've got the prefeasibility study. You review your prefeasibility study. Then you locate financing for your equipment. You order your equipment. Then the equipment is manufactured. Then you go into construction. That's about seven or eight steps. Instead, we went to step one and worked on the idea on how to approach the program and went right on to step seven, which is locating financing for the equipment. Once we had financing and equipment, we went back. We prepared our prefeasibility study and then the feasibility study. Based on this, we ordered equipment. While the equipment had been ordered and was being manufactured, we went into detailed engineering design and went on to construction.

By the time the equipment is to be delivered in Manila, the power plant should be ready to receive the equipment. We made a little short cut, but I think it's the way we have to do it in order to come up with a big program like 300 MW.

*Mr. Khan:* Mrs. Santos, you said you ordered the material before and the detailed engineering was done afterwards. Am I correct?

*Mrs. Santos:* Yes.

*Mr. Khan:* I think the detailed engineering should be done first and the materials should be ordered afterwards.

*Mrs. Santos:* We were ordering the equipment based on the outline engineering that was being prepared by our own local consultants. Once you have that, then you have the specifications for your equipment. Then the detailed engineering, the very detailed design of the dam, the penstock, and the power line can come in as the equipment is manufactured. It depends on where your equipment is coming from. Equipment from the People's Republic of China will reach us in about 10 to 20 months. The British units will come to us in about 14 months. Of course the locally-manufactured equipment should be available in about six month's time. We want to make use of the full time in manufacturing doing the very detailed design work.

*Moderator:* Otherwise it causes increased delays

in the entire program. You're trying to optimize the amount of time that you have which, I think, was your reason for changing the order. What was your source of expertise for this work? I'm curious about your feasibility criteria.

*Mrs. Santos:* At the very start, the country was lucky to be able to get concessional loans. We have a British loan for about \$33 million, which would be good for about 20 MW. The British loan carries with it technical assistance from the British Government. They look after their own loan.

We had a grant from Norway, and I think Thailand also has a grant from Norway, to do feasibility studies. For their project, they did that, but we have been using our own local consultants.

*Moderator:* How do you work out the feasibility criteria?

*Mrs. Santos:* One criterion was the proximity to the rural electrification power grid which we started in the early 1970's. We have a distribution system in practically all the rural areas. Another, of course, is proximity to existing power load. There are areas in the Philippines where you have much potential, but there is no load.

*Moderator:* Did you have the flexibility to choose your own feasibility criteria or were these imposed on you by the sources of the funds, or was it some sort of compromise?

*Mrs. Santos:* No. We had our own. All we did was order the material. We used our loan just for the equipment. The civil works, of course, were done locally. We'll be using our own contractors during the construction period. I guess I don't have the same problem as Mr. Solo. We have a big construction group and there are many Filipinos in that sector. I don't think we will have a problem.

As far as equipment is concerned, we're having to import equipment because of the concessional loans and to give our local manufacturers time to get started. We do have manufacturing capability and feel that half of the 300 MW could be supplied by local manufacturers. They have their own licensing agreements.

*Moderator:* Thank you. Mr. Subroto?

*Mr. Subroto:* Your program of 300 MW is for about 300 sites, roughly speaking?

*Mrs. Santos:* Roughly, if you consider one megawatt per site.

*Mr. Subroto:* So, there would be 300 sites. Do you have enough data for so many sites?

*Mrs. Santos:* Yes.

*Mr. Subroto:* The correct data for 300 sites is a tall order.

*Mrs. Santos:* We have an inventory of 4,500 potential mini-hydro sites. We feel that the capacity should be about 2,000 to 4,000 MW. So, the 300 MW we have in the program is really a very small fraction of the whole potential.

I understand your point. It's 300 and how do we go about doing that? Again, because of the system that we have in the Philippines, where we do our rural electrification through the electric cooperatives, this will not be a problem for us. It's the rural electric cooperatives that are gathering the data for the sites. We train them in how to do the site selection and the scheme development. So, the data would be coming from the electric cooperatives themselves. Based on this, we go through a process of economic site assessment. If a site is too difficult to do, or would be too expensive, we defer it. We're working through the electric cooperatives to select the sites for us.

*Mr. Subroto:* How do you manage all this?

*Mrs. Santos:* It is my office, the National Electrification Administration, that is going to do all this. I agree with you, I'll have to come up with a very, very big engineering staff, which will be difficult because everybody is new in this field. But we have local consultants who are doing feasibility studies for us and who are going out to the sites to help the electrical cooperatives do the reconnaissance surveys. We have negotiated contracts, on behalf of the electric cooperatives, to do these things for us. We only started the program last year and, as of now, we have finished about 50 feasibility studies. We're supposed to submit four to the Asian Development Bank for funding. So, it's being done through the local consulting firms in cooperation with the electric cooperatives. It's the only way to do it.

*Moderator:* Thank you, Mrs. Santos. If I might move on to Ibnu Subroto for just a moment, I'd like to ask him a question. Given your approach to development, how do you plan to develop your own capability for manufacturing or for equipment development? What are some of your ideas? You have some testing and demonstration capabilities and there is some manufacturing capability already in Indonesia. In your anticipated program of development, how do you plan to get into manufacturing, or are you interested in manufacturing in Indonesia eventually?

*Mr. Subroto:* I have mentioned, that, since 1972 or 1973, we have begun to design our own turbines. At the moment, the capacity of our micro-hydro technology is only to 100 kW. Since we feel that there is a long-term future for micro-hydro in Indonesia, the units will be built on a mass scale. And, as I said, we are beginning to design our own turbines.

*Moderator:* What are some of the problems you might expect to find in manufacturing your own equipment? Do you anticipate funding problems to manufacture on a large scale? Do you anticipate problems developing adequate foundry facilities or other kinds of technical, design, or expertise problems?

*Mr. Subroto:* At this time, we are beginning with studies, calculations, and so on. We make the detailed design and then give it to the manufacturer, but we are just learning how to build turbines. We have many people working to improve the turbine performance and we are studying what is being learned from this experience. We have permanent contacts with two manufacturers who understand what our intention is. So, after maybe two or three years of study and communication with the manufacturer, I think we will be able to solve the problem.

*Moderator:* Thank you. Waseem Khan, you have described a bit of your approach to development. In Pakistan, is there strong interest in developing your own source of expertise?

*Mr. Khan:* Yes, Dr. Zoellner. Actually, in small hydro we have experience covering a period of nearly 30 years. It's really interesting to see how we developed this program. Originally we required technical assistance for everything; even the smallest installations were designed by outside help. But now we have gained sufficient experience and we have our own designing and planning capability, which includes micro-hydro. Sometimes, for specialized jobs, or if the work load is too great, we engage our Filipino consultants to do certain studies for us. But the expertise and knowledge is entirely local and is gradually developing and improving all the time.

*Moderator:* What do you envision is the proper role of government in Pakistan in the development of mini-hydro?

*Mr. Khan:* I haven't described my organization entirely. The Water and Power Authority, an autonomous body, has been charged with overall development of the country. The government only provides funds and leaves it to the Authority to do its own planning, to fix its own priorities, and to determine what is required of it. The role of the government ends with the provision of funds. They don't get into the details, although sometimes they provide guidelines; for example, they say this year we are interested in providing electrification to 2,000 villages instead of 1,500.

*Moderator:* Thank you. I'd like to give the audience a chance to ask some questions of the panel, but I would like to move on to one other topic first. Then there might be some questions from the floor



on the topics that we have covered, or perhaps others, such as maintenance and operation, end-uses, or whatever the audience would like to ask of the panelists.

I'd like to raise the topic of finance. As you consider sources of funds for your problems, what do you think is important? Are you concerned about your ability to repay? Are you concerned about private or public sources of finance? How do you view the influence of the source of financing on the outcome of your problem? Mr. Khan?

*Mr. Khan:* The funds are provided to the Authority by different sources. One is the government in the form of loans. Another form of financing we receive is loans that the Authority obtains from financial institutions. A third form is the floating of bonds; a fourth is foreign loans, such as from the Asian Development Bank and the World Bank; and a fifth is the sale of power, which is a sizeable amount.

In arranging financing, we do experience difficulty with offshore currencies when the big financial institutions come in, such as the Asian Development Bank.

*Moderator:* What kind of difficulties?

*Mr. Khan:* We can't earn enough offshore currencies to finance all our programs.

*Moderator:* Thank you. Mr. Subroto?

*Mr. Subroto:* As for Indonesia, all financing is from the government, through the state-owned electric corporation. For some projects, we have received funding from other countries, such as the United Kingdom and France. Part of our program is financed fully by the government and part from these loans. For example, the loan from the United Kingdom can be used only for the generating equipment. We do the studies, and so on, by ourselves. As for the loan from France, the feasibility study is included.

*Moderator:* Is there any interest in Indonesia from the commercial banks in funding energy projects? Is there any private capital in Indonesia, or in other countries, for investment in energy projects that you are aware of?

*Mr. Subroto:* Do you mean from other financing sources?

*Moderator:* Yes.

*Mr. Subroto:* In Indonesia, there may be other groups involved in other projects outside our program, such as cooperatives, universities, or local governments, but we don't arrange the funding for these projects.

I did mention our activities in the area of turbine manufacturing. Since our program is not on a large scale, we have the time to study this aspect of our development. We are making a 100 kW turbine, a 1.3

MW Pelton turbine, and a Francis turbine under 1 MW. These turbines haven't been built yet, but we hope that their performance will be good.

*Moderator:* Thank you. Mrs. Santos?

*Mrs. Santos:* In our 300 MW program, for about half of that, or 150 MW, we already have received concessional loans. Let me describe these loans. From the British Government, which will be funding about 20 MW, we have a combination of a government loan and a buyer's credit. The government portion is 2% interest for 25 years. Others here should probably try getting that type of deal. The buyer's credit is 7.5%.

The Chinese supply agreement that we have for 100 MW, which is the biggest, is only 7.5% with fourteen years to pay. With the French loan we have, the government portion is 3.5% with 25 years to pay. The buyer's credit is 7.5%. The German loan, which is a small loan, will cost us only 3% interest with 30 years to pay. The Norwegians will be providing a grant of about \$5 million for a 5 MW plant. We're still negotiating with the Japanese for a program of about 19 sites, which they will be funding at about 3.25% with about 25-30 years to pay. The ADB will be coming in to fund four projects. We have not discussed how much they are going to charge in interest on the program. Of course, the World Bank will probably be doing an appraisal of our project next year. With the ADB and the World Bank, we can go into international bidding, in which our own local groups can participate.

For the other half, which should be coming from our own manufacturers, the government will be giving a concessional loan, or some sort of a discount facility, which can be used to buy locally-manufactured equipment and which will make our manufacturers more competitive with foreign equipment suppliers. So, we have the full support of the government for local manufacturing. Through the local A & E firms, we are funding the civil works ourselves.

*Moderator:* Thank you, Mrs. Santos. Mr. Nasaruddin?

*Mr. Nasaruddin:* As far as finance goes, the first 22 projects we are developing will be financed by the government since it's part of the rural electrification program and will cost about \$20 million. Half of the next 82 projects are in the process of being assessed by the World Bank. The whole program should come to about \$100 million, but that includes the rural distribution and transmission costs, as well as the mini-hydro plants.

As far as local manufacture is concerned, as you know, Malaysia has been a tin-mining country, and many of the local foundries have been making

spiral casing for pumps. They have also been making Pelton wheels for private companies. In the manufacturing sector, the various manufacturing elements, the people who build the electrical panels and the other electrical components, have not come together yet. The people who build the turbines exist. It's now up to us to put them together to come up with a complete system.

*Moderator:* Thank you. Mr. Solo, what about financing in Papua New Guinea?

*Mr. Solo:* We don't have much money in Papua New Guinea, so we rely heavily on foreign assistance. Four mini-hydro projects that we are presently constructing are being financed by the Asian Development Bank. I would like to tell the ADB representative that we will need more money for those projects. (laughter) We are finding that we are over-committed and that we have exhausted all our funds. Some of our projects have already exceeded 100% of the estimated cost.

The arrangement for funding these projects was based on special criteria since we do not have manufacturing facilities for electro-mechanical equipment in Papua New Guinea. The source of funding is 100% foreign, through the ADB, and all materials are imported on the basis of foreign cost. The only contribution we make is the actual labor for constructing the mini-hydro sites. We cannot expect to get any assistance from the financial community in Papua New Guinea. I doubt that they have the money to lend us, but also our Act doesn't provide for loans to be made to us from the country's commercial banks. There are some other projects that are funded from foreign sources such as the Overseas Economic Cooperation Fund of Japan.

The ADB sets criteria for funding the four projects we are working on, one of which is that they would like to see revenue generated from those mini-hydro schemes. They impose a 10% internal rate of return on those projects.

*Moderator:* Thank you very much. Before I turn the panel over to the floor for questions and discussion topics, I'd like to ask Shiba Sharma Natha of Nepal to step to the nearest microphone and talk a little bit about the program in Nepal in terms of the approach to development, finance, equipment, and so on.

*Mr. Khan:* Dr. Zoellner, may I say a few words first?

*Moderator:* Certainly.

*Mr. Khan:* The Philippines program is very ambitious and I wish them every success. But we have passed through a similar stage where we wanted to

develop our small hydro potential in a hurry. We built about 80 small hydro stations in the 1950's, totalling an installed capacity of 80-90 MW. But after operating these sites for the last 15 or 20 years, we have discovered that the hydrology data was not collected properly and soils were not investigated properly because all of it was done in a hurry. Now we are facing trouble. Foundations are giving us trouble. Sometimes there is not enough water because the data we collected was not adequate. So, this is a word of caution. I don't want to alarm them, and I wish them every success, but these things which are supposed to last for a long time should be done carefully.

*Moderator:* Thank you, Mr. Khan. I'm sure your suggestion is well taken.

*Mrs. Santos:* Let me say that when I tell you that we are doing it in a hurry, I mean we took a short-cut. But when we go into the technical data, we're doing the projects the way they should be done. That's why we're not even doing it ourselves. We hired local expertise who have had experience in this field. We have large hydro schemes that were designed by our own Filipino designers, dams that are being funded by the ADB and the World Bank. So, as far as the technical side is concerned, we have to make sure they're taken care of, otherwise we would not be able to pay all these loans that we have incurred. All of that is being taken into consideration. It would be very difficult to pass on four projects to ADB if we don't go through all this. We have manufactured one and it's working. Mr. Nasaruddin saw it; Mr. Vinze saw it; and Mr. Mahmood saw it. I invite others to come to the Philippines and look at it. Now, there may have been mistakes, but we learned from them.

*Moderator:* Excuse me, but I'm going to have to ask Mr. Sharma to discuss the experience in Nepal and we can come back to this later.

*Mr. Sharma:* The mini-hydro program in Nepal is backing up the rural electrification program as a whole. The low level of energy consumption per capita in Nepal is creating many problems. Compared to other countries of similar status in the region, consumption of energy in Nepal is very low. With this in mind, His Majesty's Government of Nepal has initiated this program which we hope will help us reduce use of fuelwood for energy. Such use is depleting forest cover in our country at an alarming rate and we want to stop it. We hope that the establishment of this mini-hydro program in the remote rural areas will change the life-style of the local people.

The impetus for development of our mini-hydro program began with scattered efforts to build some projects. Of course, some of them are still functioning.

In order to organize the effort in a better way, the government has established a Small Hydel Development Board responsible for designing and constructing projects. During the Sixth Hydel Plan, which runs from 1981 to 1985, the government is constructing 20 hydel projects at a cost of \$22.2 million.

As far as the financing of these projects is concerned, as I said, they are part of the rural electrification program and are being funded by the central government. Of course, there are many multilateral and bilateral agencies which have come forward to assist us. The ADB is funding eight projects. The United Nations Capital Development Fund, OPEC, the Swiss Association of Technical Assistance, the Government of Austria, and the Government of Yugoslavia are assisting us in implementing projects in Nepal.

In the approach to development, the greatest importance is attached to areas which are not likely to be connected to the national grid. Also, district headquarters, which are semi-urban areas where many economic and social activities are centered, have been given priority by the government for development.

I should say a few things about the problems we are facing. The first problem is a shortage of manpower. Of course, a shortage of funds also exists. Also, due to the difficult transportation situation in rural areas, the transportation cost of the electro-mechanical equipment is quite high.

We also give great importance to public participation. People come forward to help the government in any manner they can. They help us in collecting the locally-available material such as gravel and sand and they also help in carrying the materials and equipment to the project sites.

*Moderator:* Thank you very much, Mr. Sharma. What I'd like to do now is to open the discussion to the audience, and with Dr. Boon's permission, limit this to ten minutes, if that's acceptable. Dr. Kulasinghe?

*Dr. Kulasinghe:* My question deals with the conditions attached to the loans, mainly in the Philippines. Many loans appear to have been presented by a number of organizations. But it's usually the practice of the authority or the country giving the loan to put certain conditions on the procurement of services and materials. This limits the usefulness of the loans sometimes, since you are tied to certain conditions, which tend to raise costs. I'd like to know from the representative of the Philippines what these conditions are and whether they have any limiting factors on the execution of the project.

*Mrs. Santos:* You're right. If I have a British loan,

I get British equipment; if it's a French loan, then I get French equipment; and, if I get a Chinese loan, then I get Chinese equipment. But we're only using the loan for equipment. For the rest, we are the funding source. Everybody offers loans with strings attached. That's why I would want to go through the ADB and the IBRD, because then everybody gets a chance to compete.

*Moderator:* Thank you, Mrs. Santos. The gentlemen in the next to last row, you had your hand up? Excuse me, before you begin, I'd like to include Mr. Sharma in the group of which you can address questions.

*Questioner from the Audience:* I've got a question for him too. First, I'd like to ask a question of the entire panel regarding organization. I couldn't get a clear idea about the system of organization used to develop mini-hydro potential; whether the countries concerned were progressing well and are taking a positive step toward development of mini-hydro. Have these countries organized a separate management concern for mini-hydro development?

Question number two is for Mrs. Santos about the selection of 4,500 sites. How did you do it? How much time was required to perform this site selection and what details were taken up in the prefeasibility of 4,500 sites?

For all the panelists, I couldn't get an idea about the specific per kilowatt costs of various mini-hydro projects that have been constructed.

Mr. Sharma mentioned 20 projects. My question to him is: what is the total megawatt capacity of the 20 projects?

*Moderator:* Can we start with Mr. Sharma, please?

*Mr. Sharma:* As I mentioned before, 20 projects are being constructed at the cost of about \$22 million. These projects range from 60 kW to about 500 kW. The total installed capacity is about 5.2 MW in all 20 projects.

*Moderator:* Thank you, Mrs. Santos?

*Mrs. Santos:* The data for the 4,500 sites is really very preliminary. The selections were based on data that we gathered from the other agencies involved in water like the National Irrigation Administration, the National Power Corporation, and the National Water Resources Council. But, on our own, we have looked at about 1,000 sites already. As to the specific details, there really isn't enough time here to get into it. Why don't we sit down later on and we will show you a typical case that we have done?

*Moderator:* Could you restate your first and third questions very briefly?

*Questioner from the Audience:* What are the spe-

cific costs of the plants up to a range of about 100 kW, then 100-200 kW, as well.

*Moderator:* All right, thank you. Mr. Solo?

*Mr. Solo:* Our experience is from the 200 kW scheme which we have just recently commissioned. The cost is about US\$4,000 per kilowatt.

*Moderator:* Mr. Nasaruddin?

*Mr. Nasaruddin:* We can't give you a general price because each country has its own problems depending, of course, upon how long your access road has to be. We have one case of a 250 kW plant that cost about US\$2,000. Another, which was 500 kW, came to about US\$1,750, but that one is located in difficult terrain. We have another that's about 100 kW that cost almost US\$3,000, and another about 60 kW, that's coming to almost US\$4,000. As your kilowatt goes down, the price goes up.

*Moderator:* Mr. Santos?

*Mrs. Santos:* In my case, I think we'll have to break it up into the cost of the equipment and the cost of the civil works because I get equipment from different sources. As far as civil works are concerned, I would say we're coming out at about \$1,000 per kilowatt. From our latest data on the British equipment, we're running at about US\$900-\$1,000; on French equipment, it's roughly the same. For the local manufacturers, it's about \$600 per kilowatt.

*Mr. Nasaruddin:* Permit me to make a point here. In our experience the larger the machine, the cheaper it is per kilowatt, and as it gets smaller, the price goes up. Then, of course, it depends upon whether it is a low-head turbine, which is very expensive, or a smaller high-head machine, which is very cheap.

*Questioner from the Audience:* In the case of the Philippines, US\$33 million was loaned from the U.K. Is that correct?

*Mrs. Santos:* Yes.

*Questioner from the Audience:* And that's for 20 MW capacity?

*Mrs. Santos:* Well, roughly.

*Questioner from the Audience:* So that was \$1,700 per kilowatt.

*Mrs. Santos:* As Mr. Nasaruddin said, it will depend on the particular site. The one we're building in one of our provinces, which has three units of 910 kW, is coming out to be an average of about \$1,000 per kilowatt.

*Questioner from the Audience:* The arithmetic is not quite clear. US\$1,700 per kilowatt is the average price that you are paying on U.K. contracts, right?

*Mrs. Santos:* Yes.

*Questioner from the Audience:* So, when you

install it, it's going to be, on the average, more than US\$1,700.

*Mr. Nasaruddin:* I don't think that is necessarily so. If you are buying a 1 MW unit, which probably will come to maybe US\$500 per kilowatt and your civil works may be another US\$500, it's US\$1,000 for that particular site. You cannot go on such a general basis, because then it will be very expensive.

*Mrs. Santos:* On my Chinese units, we used our first purchase order for 11 MW. The units varied from about US\$300-\$340 per kilowatt depending on the model. If you divide US\$30 million by 100 MW, I come up with US\$300. But Percy Favoreal should talk about the home made units. Percy, how much did it cost you overall installed?

*Mr. Favoreal:* US\$700.

*Mrs. Santos:* US\$700, equipment and civil works, for the 100 kW that we installed in Percy Favoreal's co-op.

*Questioner from the Audience:* Is the cost reduced if large quantities are ordered?

*Mrs. Santos:* Yes. Even the local manufacturers are supposed to bring down their cost per unit if they manufacture more units for us. We expect that, as more local manufacturers join the program, the lower the cost will go. Moreover, we want to go into standardized sizes which would also lower the cost of the equipment.

*Questioner from the Audience:* Has there been any specific organization created for the development of mini-hydro in any country? In the Philippines, for instance?

*Mrs. Santos:* Yes. The National Electrification Administration has a presidential decree, which amended the charter of the corporation, to develop the mini-hydro program. Our definition of mini-hydro is 5,000 kW and below.

*Questioner from the Audience:* Has NEA created any other, say, directorate or some special office to—

*Mrs. Santos:* We have created within NEA the Mini-Hydro Development Office, which I'm heading as of now, to develop the mini-hydro project.

*Questioner from the Audience:* Let me direct a question to the delegate from the Philippines again. I was quite interested when you said you had the rural electric cooperative set up to distribute the sale of energy to the people in rural areas. Now, I assume that these cooperatives are running at a loss, because initially the project could not pay off itself. How are these financed? Are they financed by the government? And how do they pay off their loans? Can you throw some light on this?

*Mrs. Santos:* The loan is extended to the National Electrification Administration, which we pass on to the electric cooperatives. Our computations show they'll make money and they'll be able to pay back the loan.

*Moderator:* Thank you. Mr. Nasuaddin?

*Mr. Nasaruddin:* I was interested in the comment by the delegate from Pakistan, who mentioned that he had problems with his small-hydro program. We heard, through an associate at the Intermediate Development Technology Group in the United Kingdom, that there was another country which had a large number of micro- or mini-hydro projects, about 1,000 units. We learned that it was a failure for some reason. I feel that, if that is the case, we ought to try to find out what the reasons were for such a failure in the long run. If I am going to construct 500 or 600 projects and there is a good chance that it is going to fail, I would want to know why it might fail. If I can get some information from this particular country, or even from Pakistan itself, at least we can be sure we don't make the same mistakes.

*Mr. Khan:* When I said we should not hurry up, I meant that we should not do it in haste. Two areas are troubling us: insufficient hydrological data and insufficient geological data. In the beginning when we commissioned it, the program was running fine. Everybody was saying, "You have done a fine job producing power." But after a while, the soil structures started giving in because they were not investigated properly. There were problems with the foundations and the buildings started tilting. Some of the foundations of the generators had uneven settlement. Some of the canal stations didn't have as much water as the sets were designed for and we couldn't get the power we wanted. These are the only two major problems. There were no electrical problems with the plant. If you can be careful about it, I think you have every reason to succeed.

I'd like to thank our panelists and Mr. Sharma for their participation this morning. And if there are any other questions, I'm sure that they would be glad to meet with you during the coffee break. Dr. Boon, thank you.

**F**OUR series of workshop discussions were held to afford participants an opportunity to examine in greater detail various issues raised during the plenary sessions of the workshop. The subjects of the workshops and the moderators for each were:

1. Resource Assessment and Site Selection: **Mo-har Singh Monga**, Thailand; **Hoseni Nasaruddin**, Malaysia;
2. Technology: Issues, Design, Operation and Manufacture: **A.N.S. Kulasinghe**, Sri Lanka; **Allen Inversin**, United States;
3. Economic Feasibility and Financial Issues: **Jorge Asin**, United States; **Mark Henwood**, United States; and,
4. Social Impacts, Community Participation and Institutional Issues: **Kaye Bowman**, Australia; **Hiran Dias**, Sri Lanka.

In addition to the workshop moderators, special thanks should go to those who served as resource experts in these discussions: **Mike Del Rosario**, **Percy Favoreal**, and **Frank Denton**, Philippines; **Marsal Alimin**, **Ibnu Subroto**, and **Harry Sosrohadisewoyo**, Indonesia; **Roger Arndt**, **Janice Brodman**, **Mangalam Srinivasan**, **Judith Magee**, **Norm Crawford**, and **Gary Kitching**, United States; **Muhammed Ghazi Haji Hassan**, Malaysia; **M. Abdullah**, Pakistan; **P.K. Behl** and **S.N. Vinze**, India; and **Lukis Romaso** and **Martin Solo**, Papua New Guinea.

The following are brief summaries of the discussions which took place.

## **PART IV**

### **WORKSHOP SUMMARIES**

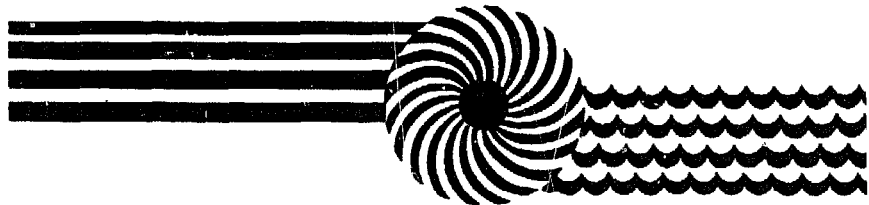

## Workshops

### Resources Assessment and Site Selection

The process of resource assessment for the selection of sites is inseparable from the broader economic, financial, social, institutional, and political concerns involved in the decision to develop mini-hydro generation sources.

Resource assessment should be based on overall water use potential, not simply hydroelectric potential, and should be closely linked with a location's development objectives. Questions dealing with load potential (both present and future), social needs and benefits, labor availability, access, financial and rate structure considerations, as well as simple hydrologic and natural resource assessments must be answered before decisions can be made to maximize the benefits of a small hydro project. Sites selected purely on the basis of generation potential, and which are not developed under a broader criteria base, may not result in maximization of overall developmental benefits to a country or region, and may represent the misuse of the scarcest resource of all, financing.

Prior to performing resource assessments of mini-hydro potential, the underlying objectives of the program must be explicitly identified. For, depending on the nature of the project, the procedure for assessing and selecting sites will differ. Three possible program objectives are: (1) substitution of hydro generation for oil fuel generation; (2) general rural electrification; and (3) providing impetus for economic growth in isolated regions. In the first and third cases, economic and cost criteria are likely to be more significant. In the second case, political, social, and demographic criteria, such as the effect of a project to reduce migration of rural people to urban areas, are likely to be given more weight. However, in any case where a mini-hydro project is being considered, the criteria most likely to affect the selection procedure are those dealing with cost.

In assessing resource potential for site selection based on physical characteristics, criteria should include:

- sufficient rainfall;
- sufficient flow;

- sufficient head;
- boulder and rock formation;
- suitable topography;
- suitable location for powerhouse placement;
- access to roads; and,
- access to end-users.

Another criterion suggested by Frank Denton of the Philippines was a penstock length-to-head ratio which should be no greater than 5 to be deemed practical.

A delegate from Nepal pointed out that, in topographical terms, favourable hydropower characteristics tend to be found in mountainous regions where populations are sparse, and hence load potential is low. Hoesni Nasaruddin of Malaysia made the additional point that such sites, and sites surrounded by dense jungle, tend to raise project costs due to difficult access. These sites, nevertheless, may favour the hydro option since grid extension in such cases is prohibitively high, and since fuel-based generating facilities are costly to run due to transportation problems. Mr. Nassruddin also suggested the possibility that rural populations might be relocated so as to give them access to a generating source, once established in a remote area.

Non-physical criteria should include:

- present and future potential load;
- productive end-use potential;
- social benefit potential;
- suitable demography and demographic characteristics;
- multi-sector integration potential; and,
- proximity to the grid.

It was generally agreed that multi-sector uses of existing water resources should be given priority in assessing and selecting projects. This should be particularly relevant in utilizing existing water resource development civil works structures, which represent the greatest cost component of small hydro projects. However, it was pointed out that typical multi-sector projects, which include irrigation components, are likely to have low-head hydropower characteristics,

which tend to increase the cost of turbine equipment.

The question of data collection was discussed with no conclusions. It was generally recognized that adequate flow data was critically important to the success of a project, both for economic and environmental reasons. Mark Henwood pointed out that if flow expectations are too optimistic, a danger exists of over-developing a site, hence making it uneconomic. Underestimating peak flow could cause serious damage to equipment and to the watershed areas in cases where containment structures are inadequately designed.

The dilemma arises, both in terms of physical resource assessment and socio-economic assessment, between the need for extensive preliminary investigations and the problem that this can add inordinately to the cost of a project. A judgment, therefore, must be made on how much risk is acceptable in deciding how much effort should be expended in gathering data, depending on the underlying objective of the project. Simple rural electrification projects may not require as great an effort as projects which are designed to provide a more reliable source of power, such as for industrial or commercial end-uses. It was pointed out, however, that such projects, for which financing is particularly difficult to find, the need for adequate prior investigations may be all the more important.

### **Technology :**

#### **Issues, Design, Manufacture, and Operation**

The workshop discussions centered mainly on problems relating to selection, design, and manufacture of turbines and associated equipment as well as on problems relating to civil engineering works.

The selection of suitable types of turbines based on ease of design and manufacture, economics, and convenience in operation were discussed. The suitability of turbines under various conditions of head and flow was also considered. The following types of turbines were selected as most appropriate for the following conditions:

- propeller-type turbines for conditions of low head and high discharge; and,
- Pelton and Turgo impulse turbines for high-head conditions.

These are suitable for the full range of conditions in micro- and mini-hydro plants. However, the cross-flow turbine is eminently suitable especially for an overlapping range between the types of turbines mentioned above, in view of its popularity and simplicity.

The Francis turbine presents certain difficulties

of design and manufacture which make it unsuitable for local manufacturers in most developing countries except where experienced manufacturers are available. The cost of a Francis turbine is also generally higher than that of the others mentioned.

Standardization, to help reduce costs, for a range of turbines would be helpful, especially to many developing countries where the non-availability of resources for design and development of turbines makes it necessary for such information to be made available if adequate progress is to be made in this field. One or more organizations, with the requisite experience and resources, should prepare standard designs for a suitable range of turbines for use by all parties. This requires a preliminary study of the conditions and requirements in the various countries concerned. Funding for this work should be provided by an agency such as USAID.

The governor, used for speed control of the turbines, is an expensive piece of equipment which can form a substantial part of the cost of installation. One possible solution to this cost problem is the use of induction generators connected to the grid wherever this is practicable. This is the cheapest solution since it eliminates the necessity for the governor. Wherever these conditions do not apply, it is necessary to use a speed control device which can be produced at low cost.

For small Pelton and Turgo turbines, a simple mechanical device in the form of a deflector can be used. However, for larger impulse turbines and for reaction turbines, like the propeller turbine, a speed control device with servo-motor operation is necessary, except where load control is affected.

The load controller, which keeps the load on the machine constant by diverting a part of the power to ballast with variation in consumer load, is suitable up to about 50 kVA. This energy diverted to ballast can be used to manufacture calcium nitrate fertilizer or dry food products, or can be stored in batteries.

Further possibilities in the selection of non-conventional, locally-available material for the manufacture of turbines and the use of an entirely new type of turbine which extracts energy from flowing water were also discussed.

The use of fiber-reinforced concrete in constructing the casing of a turbine, in place of cast iron or fabricated steel, can reduce costs, and is suitable in developing countries where labor costs are low. In Sri Lanka, where the use of concrete in machine construction has been practiced for some years, costs have been considerably reduced.

The stream turbine, a vertical axis turbine using



aerofoil blades which dip vertically into the flowing water, is a simple device. Waterflow causes the blades to rotate about the vertical axis, rotating the shaft which can be used to drive a pump, generator, or other device. It operates on the same principle as a vertical axis windmill with efficiencies in the order of 45% (approximately 80% of Bentz coefficient). A very low-cost device, the stream turbine can extract energy from flowing water as in irrigation canals.

Penstock design and construction are a large part of the cost of a mini- or micro-hydro project. Wood-stove pipes and steel-lined concrete pipes may be suitable and less costly alternatives to the present uses of steel or PVC pipes.

The headworks (intake and diversion weir) should be designed as simply as possible. A grating across the river bed is especially successful where no dam is required. Where a dam or weir is required, rollcrete (lean dry concrete compacted by vibrating rollers) is a good alternative to traditional material.

Induction generators are the most economical where practicable. Even where a grid connection is not available, they can be used with capacitor banks, but require speed regulation because of the absence of the controlling effect of the grid.

Where synchronous generators are required, a permanent magnet machine with ironless rotors should be considered. Recent work indicates that they can be made in developing countries at low cost and can operate at low speed without large increases in cost.

As power is introduced and the population begins to rely on it, a reliable supply with a minimum of interruption of blackouts and brownouts is needed. One method of minimizing down-time (time needed to repair non-functioning equipment) is to keep a spare runner at the generating site. A damaged runner can be removed and sent out for repairs while the second runner continues to supply power.

Foreign companies often seem interested only in selling complete turbo-generating units. It may be desirable to import only those components which are difficult to fabricate in a country (e.g. the runner and bearings).

Possible solutions to runner deterioration, due to the presence of silt and sand in the water and/or cavitation include:

- fabricating or casting the runner of stainless steel or, less expensive and possibly more appropriate, of mild or cast steel with worn areas repaired with an overlay of stainless steel;
- use of rubber or epoxy linings; and,
- better design of forebay and/or other settling areas in the civil works.

On several occasions during the workshop, participants noted that, as the design power output of small hydropower schemes decreases, the installed cost/kW increases. Frank Denton's analysis of initial studies of a number of potential sites in the Philippines indicated that above approximately 300 kW, installed costs/kW (total cost of civil works and equipment) tend to be relatively constant; below 200 kW, costs/kW tend to increase very rapidly (see graph). While studying sites in Minnesota, Dr. Roger Arndt encountered a similar trend with system costs/kW increasing rapidly for outputs below several hundred kW. These high costs should be expected when conventional designs, equipment, and methods of management for large schemes are used to implement small hydropower schemes.

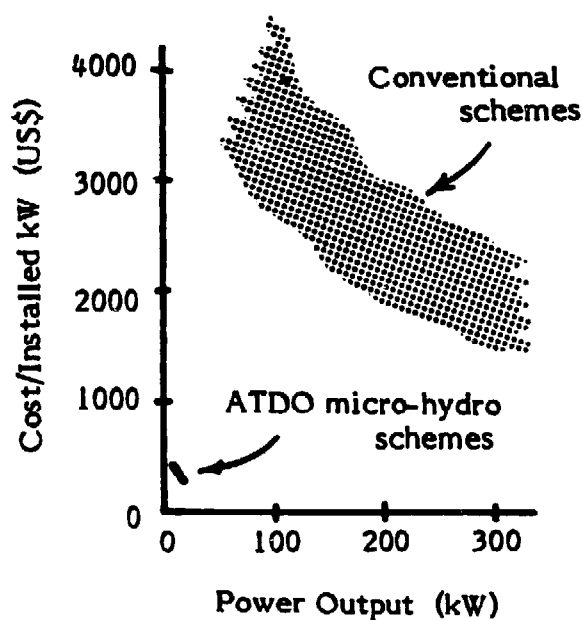

System costs/kW in relation to output, based on studies of potential sites in the Philippines.

Consequently, there was marked interest in the workshop discussion groups in learning how to reduce relatively high costs/kW for small hydropower plants by: (1) reducing technical complexity of turbo-generating and control equipment design to facilitate local manufacture and reduce equipment costs; and (2) reducing cost of designs for civil works' components.

Dr. M. Abdullah of the University of Peshawar in Pakistan described his approach to implementing small hydropower schemes in the micro (1-100 kW) range. Costs for those rural schemes average US\$300/installed kW, much below the figures generally quoted. This large reduction in costs is attributable to:

- simple design of the turbo-generating and

control equipment (locally-fabricated cross-flow turbine; design of systems so that governors were unnecessary);

- use of local materials and low-cost techniques for most civil works components;
- reliance on local expertise, available both at the university and village levels, for designing and implementing the scheme;
- use of local labor for the construction of civil works and installation of equipment; and,
- use of villagers in operation and maintenance for the scheme.

Just as the more conventional approaches studied by Dr. Denton and Dr. Arndt indicate that small hydropower is economically more appropriate above several hundred kW, Dr. Abdullah's approach seems especially appropriate in the power range below approximately 100 kW. In this range, communities served by the hydropower units are small and relatively close knit. This social cohesion substitutes for government regulation. As the unit size increases above this range, the increasing size of the community, in terms of the number of people and the geographical areas, implies a greater social diversification. This approach to implementing and managing small hydropower schemes may be more prone to technical, operational, and managerial difficulties.

The two methods of implementation complemented each other. Because of the scope and nature of its small hydropower projects the modified, more conventional approach the Philippines used seems appropriate above several hundred kW. The approach used in projects under Dr. Abdullah's direction seem appropriate at the lower end of the power range (below 100 kW) where emphasis is on serving remote rural villages outside the grid.

Even small plants with outputs as low as 10-20 kW should not be viewed as useless since they can be economically profitable in addition to providing social benefits. As Bob Yoder pointed out, plants with 5-10 kW output are, in economic terms, successfully replacing diesel plants in remote areas of Nepal for processing rice, flour, and seed oil through direct mechanical coupling.

### **Social Impacts, Community Participation and Institutional Issues**

Small decentralized hydropower schemes are aimed particularly at communities isolated from an existing centralized grid supply of electricity. Participants in the workshop recognized that such communities are likely to be without the economic means to

pay the full cost of a project. In addition, many members of these communities have only limited knowledge and skills with which to manage and make use of an electricity supply. However, these constraints were not considered sufficient to conclude that SDH projects have only limited application, but rather that a more comprehensive, systematic approach must be taken in planning SDH projects.

It is important to involve the community in the project from the outset during the planning stage, whether initiative for a project comes from the community itself or from a governmental agency. If the community is involved, construction costs can be reduced if it supplies labor and materials. Another important, but more intangible, aspect of this community involvement stems from the socio-psychological impacts which can help promote a sense of optimism within the community. These indirect, intangible benefits, such as the ability for children to study at night and promoting community activities at community centers, are as important as direct benefits. This is especially important since, when the initiative for a project comes from the community, it usually comes from well-to-do groups who benefit most. In such cases, those members of the community least likely to benefit from the project because of lack of economic resources are more reluctant to participate in the project, particularly if it entails sacrifices. Making credit available on easy terms so that the potential productive uses for electricity in an area can be actualized will help alleviate this problem.

There was some debate among workshop participants over how much emphasis should be placed on social benefits and their costs and economic benefits and their costs. Generally, the participants agreed that these factors should be weighed equally.

Financial support services, therefore, are very important in developing an SDH project. It may be necessary to build in a subsidy to enable the poor to get connections.

The community must participate in the maintenance and operation of the plant. Because of the isolation factor, communication difficulties can be a problem in having an outside technician come in to repair the plant. Therefore, technical as well as managerial skills should be included as a training component of an SDH project during the implementation phase.

The national agency involved must provide the major technical input in developing a hydro site. The relationship between the local people and the national agency requires an institutional arrangement. Coopera-

tives have successfully served as the vehicle for this institutional arrangement in many developing countries. One of the features of these cooperatives is that they are based on traditional social structures and are, therefore, more likely to facilitate successful introduction of the scheme into an isolated community.

Participants in the workshop considered the effect which the introduction of electricity may have on a community's activity pattern. Evidence suggests that women should particularly be considered in developing projects because they are most likely to be affected in this regard. Looking at the traditional pattern of energy use in a village, women perform most of the energy-related tasks such as milling flour or rice and weaving. Although mechanization eliminates drudgery, it also eliminates jobs.

Very few reliable studies have been conducted to determine what happens after electricity is introduced into a village. There are still many untested assumptions about the actual benefits and costs of SDH projects. More comprehensive assessments of the changes that occur when electricity is introduced into isolated villages must be made.

To enhance the benefits obtained from rural electrification, programs using electricity effectively should be introduced with the technology. People need information, credit on easy terms, and similar services to utilize the new source of power.

### **Economic Feasibility and Financial Issues**

The Economic Feasibility and Financial Issues workshop was divided into two sections. The first part dealt with the banking institutions. Later, several delegations presented case analyses of their countries. Participants looked at several elements that they felt were of importance and considered how to establish economically viable projects including benefits, monetary and non-monetary, and how these benefits affect the lending institutions in their approach to providing money for projects.

Mr. Burrell, of the Asian Development Bank (ADB), commented on the ADB's policies. He believes that the ADB is very enthusiastic about the possibility of lending money for alternative sources of energy. However, one of the conflicts facing the ADB is that it must move a large amount of money each year, with a budget of about \$1.6 billion, but does not have sufficient staff to handle small projects. Therefore, the hydro projects with which it deals directly have to be rather substantial, with the minimum funding in the facility of \$1 million.

Another alternative, in the case of central electric

systems, is that the ADB can look directly at sites. It can consider funding a family of sites — several sites that together require a relatively large amount of money.

A third alternative is lending the money to national development institutions such as agricultural banks or industrial development banks in the country. Funds can be made available as a bulk loan which the domestic banks then disburse according to smaller requests for funding.

Mr. Vinze, also of the ADB, pointed out that the banks are partners in development and can be helpful, as well, in dealing with problems related to local currency and foreign exchange. Mark Henwood agreed that it is very important to start thinking that banks can contribute to development and noted that if, in some cases, a bank cannot respond immediately to a request for funding, it does not necessarily indicate that it does not want to fund a project, but rather that its operating procedures may not allow for it. If the ADB cannot respond to this kind of request, there are other financing mechanisms to which countries can resort.

The ADB demands, of course, that a project be economically viable. One very important element to consider is the ranking of projects. Banks require that the least-cost sequence of project selection for rural electrification, or for any type of project, be a criterion. Therefore, development banks determine the viability of a project according to the technology that costs the least for a particular purpose. Another criterion is that the rate of return must be very close to the financial cost.

Mr. Burrell pointed out that a project proposal must be prepared in a certain way; it must state clearly the purposes of the project; and, it must analyze the project, demonstrating that it has the potential for self-liquidation, that the money can be repaid, and that the project has the means to become solvent.

Mr. Burrell accepted, however, that there may be exceptions and that there are cases in which the monetary element cannot be the sole determinant, but that a project's social benefits must also be considered. However, it is difficult to calculate these social returns. The ADB had developed a formula to calculate them, but it was not very successful and has been abandoned.

Dr. Zoellner was interested in what institutional risks, such as lack of historical data or adequate flow data, the ADB was willing to assume, and generally what kind of analysis is required to approve a loan. It was felt that, generally, very precise historical data is essential.

Mr. Nasaruddin wanted to know the criteria to

finance mini-hydro projects that would be connected to the grid. Mr. Vinze indicated that it is not possible to give a general answer. The ADB must look at each project case by case and look at its total costs as well as its economic viability and social benefits.

The second part of the workshop dealt with case reviews. Frank Denton presented a general perspective of the Philippines case. The system in the Philippines is very mature compared with most other nations in the area since the electrification program started long ago. The Philippines has depended mainly on oil-fired generating units, but a process of substitution of these units is underway. Although hydroelectric sites are being developed as fast as possible, the Philippines still depends on oil for electric generation for 80% of its present capacity.

Financing is not difficult since here it is a case of technological substitution; while the institutions are very well established and operate economically, the replacement of hydro for diesel adds even further economic advantages. Equally important in the process

of financing hydro systems in the Philippines is the organization of end-users in the form of cooperatives. This consumer organization system has been successful throughout the years.

The Philippines electric organization does not find systems smaller than 600 kW economical. They will only consider a system with a capacity above that level. The position of the Philippines regarding the economics of units smaller than 600 kW brought interesting challenges from the representatives of Pakistan, Mr. Abdullah and Mr. Khan.

Pakistan and several other nations in Southeast Asia find that the use of indigenous resources can reduce their costs of manufacturing small units to very low levels. Pakistan has several small systems (15 kW) that have operated without problems for up to five years. The cost of these systems is \$300/kW. The importance of demonstrations, the favorable economics of manufacturing, and installing very small units is great, since funding for this type of project will undoubtedly depend on its being the least-cost technology.

**I**N addition to those papers presented at the workshop, several participants contributed papers on various topics in small hydropower development, which appears in this section. Many of these papers were prepared by resource people for the workshop discussion groups and the panels.

**PART V**  
**ADDITIONAL PAPERS**  
**CONTRIBUTED**

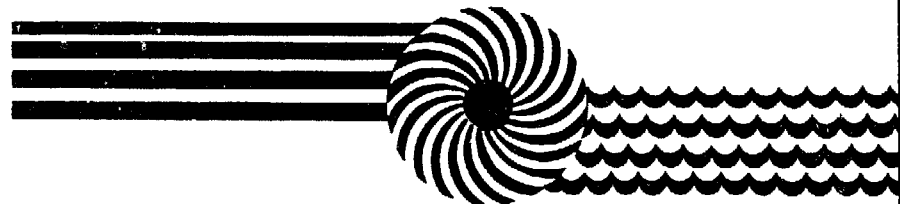

# Frequency Controller in a Micro-Hydropower Plant

Harry Sosrohadisewoyo \*

## Introduction

**I**N micro-hydropower stations with solitary operation, the frequency of the AC voltage is kept constant by a frequency controller, the object of which is to ensure the balance between the hydraulic power input and the electrical power output. Therefore, two general solutions are possible:

- to tune the hydraulic power input to the electrical power output; or,
- to tune the electrical power output to the hydraulic power input.

The first solution is the conventional solution which implies a water-flow regulator using a valve or a diverter. Such a system has been applied for years. The second solution implies dissipation of energy in a certain ballast load, and it will be discussed in more detail, since it will be the focus of this presentation.

The ballast load should be adjustable to compensate the variation of consumers' load, tuned to the hydraulic power input. This adjustment is done automatically by means of an electronic controller.

Energy dissipation in a ballast load seems like a waste of power which would not occur with a water-flow regulator. However, except in a relatively unusual case where the supply of water is limited (for example if the turbine is fed from a reservoir), a water-flow regulator causes waste of power by shedding water, whereas a ballast load can be usefully employed.

It is also important to note that an electronic load controller is not less appropriate for use in a developing country than a necessarily complicated mechanical governor, whose manufacturing process will require high precision engineering facilities.

Most of the components needed should be imported, but the assembling of an electronic load controller of this sort requires very limited facilities. Furthermore, the assembling of such an electronic load controller can be carried out in low volumes, and does not require high-level skills.

The advantages of such a controller applied in a

micro-hydropower plant as compared to the conventional mechanical governor are:

- it is cheap in price: in Bandung, Indonesia, the production cost of such a controller is about Rp.30,000 or about US\$500 for a 30 kVA power plant, whereas the cost of a mechanical governor of the same size, after import taxes, is about Rp.5,500,000 – or about US\$9,000;
- it requires no maintenance, since there are no moving parts;
- it gives the possibility of using surplus power in the ballast load for various purposes, such as fish drying, absorption refrigeration, and other industrial processes;
- it improves the load factor, and hence improves the economics of the whole system, since there are possibilities of using surplus power in the ballast load; and,
- it opens the possibility of using a simple turbine, since no provision is needed for varying the water flow by means of valves or gates.

All the above mentioned advantages lead to the possibility of using secondary irrigation channels for micro-hydropower plants, since there is a challenge in Indonesia to do this.

## Digital Electronic Load Controller

Digital switching was the first idea on how to realize the electronic load controller. In this case, the

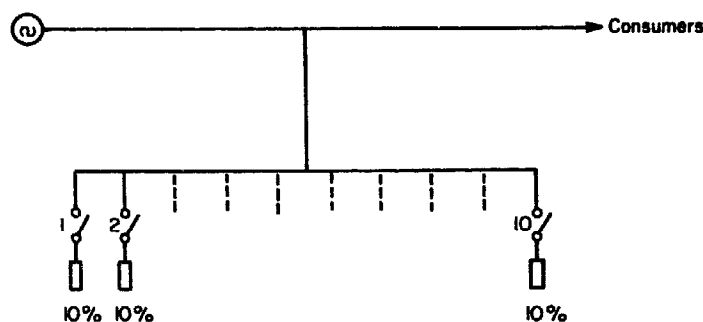

\*Institute of Technology Bandung Bandung, West Java.

ballast load is divided linearly into, say, 10 groups. This means that every time the ballast load is switched in, the load of the generator is increased by 10%, or every time the ballast load is switched off, the load of the generator is reduced by 10%.

The basic operation principles are as follows:

1. At no load, that is to say if all the consumers switch their load off, all the energy is dissipated in the ballast load. This can be formulated as:

consumer: 0%  
ballast: 100%

2. If the consumers start to switch their load on, then the generator starts to get overloaded. If the consumers' load reaches 10%, the first switch is opened, then the overload ceases. In this situation, the new condition will be:

consumer: 10%  
ballast: 90%

This process continues until the following condition is reached:

consumer: 100%  
ballast: 0%

3. If at this point the consumers start to switch their load off, the generator starts to be underloaded, until the consumers' load drops to 90%, and the first ballast switch is closed. The condition can then be described as:

consumer: 90%  
ballast: 10%

The process continues until the first condition is reached, *i.e.*:

consumer: 0%  
ballast: 100%

From the above description, it is obvious that:

- there is an overload when the consumers' load increases. This is not a serious problem since most of the generator manufacturers allow overloading up to 10% continuously. If this is not desirable, then the initial setting should be reduced to, say, 90% of the rated load;
- there is a change in frequency when the load changes. To suppress the frequency deviation, more division on the ballast load is needed. The limit will be the optimization of cost versus the frequency deviation impact; and,
- switching torques are very dominant, especially on low ballast load division.

## Analog Electronic Load Controller

In a system utilizing a digital electronic load controller, the frequency changes with the change of load. An improvement has been made to overcome this problem.

In the new system, the switching is not operated digitally, but by an analog controller. It is possible to devise such a system by applying silicon controlled rectifiers (SCR), the firing of which is executed by pulses, instead of digital switches. By controlling the timing of the pulses, the firing of the SCR can be controlled. If the pulse timing can be controlled from  $0^\circ$  to  $180^\circ$  continuously, the firing of the SCR can be controlled from  $0^\circ$  to  $180^\circ$  continuously as well. It means that the current flow to the ballast load can be controlled, or in other words the load can be tuned.

The current flowing through the SCR can be illustrated as follows:

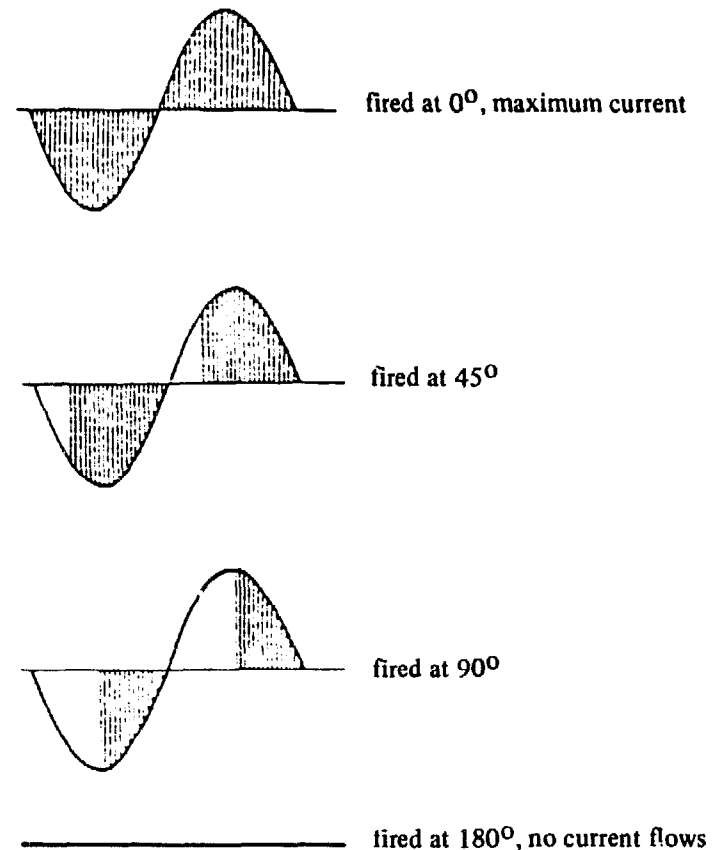

The disadvantage of this system is that it creates "radio interference" due to the cutting of the current waves. It is therefore not recommended for use in certain areas.

### Hybrid Electronic Load Controller

To eliminate radio interference, the switching method should be changed. This is a compromise between the digital and the analog controller, and could be called a "hybrid electronic load controller".

SCR components are still used in this system, but the current control is done by counting the amount of current wave flowing through the SCR. It can be illustrated as follows:

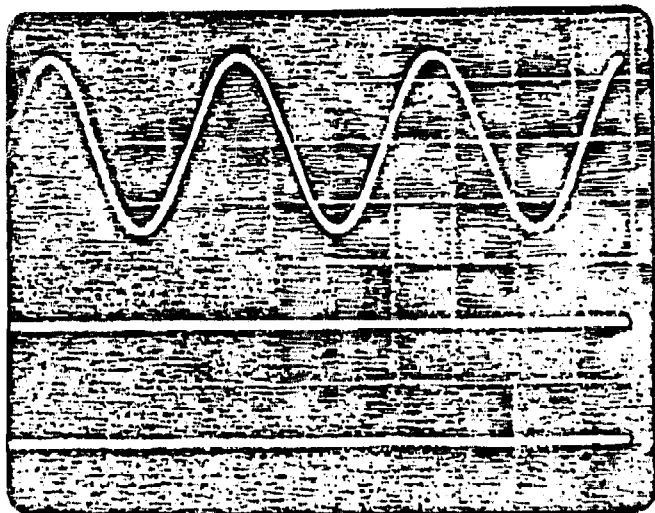

Consumer 100% Ballast 0%

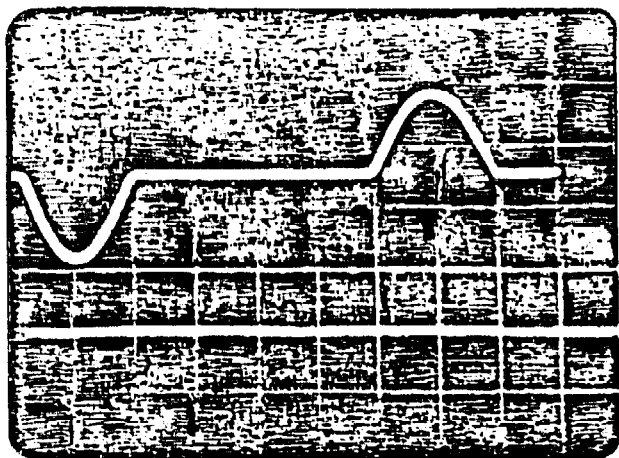

Ballast 25%

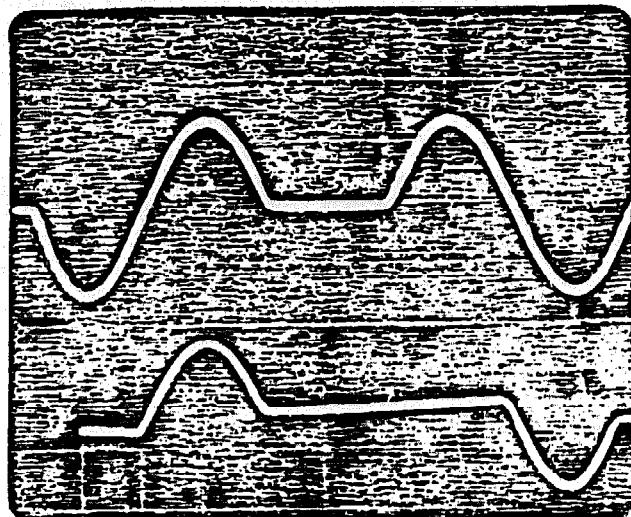

Ballast 50%

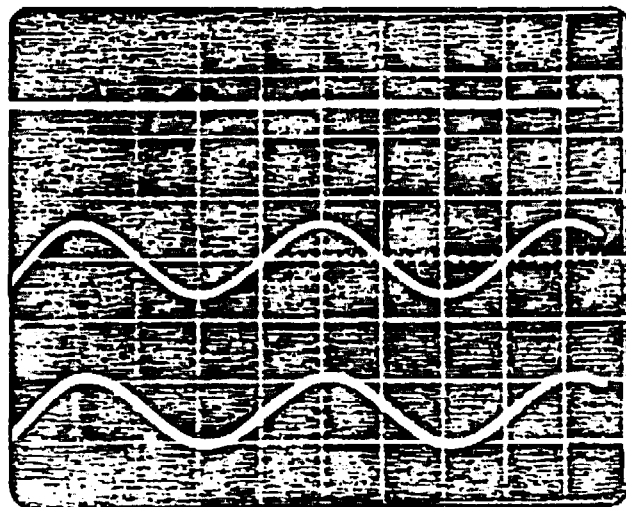

Consumer 0%  
Ballast 100%

This equipment is being developed in the Laboratory of Electric Energy Conversion in the Institute of Technology Bandung, Indonesia, and will be applied directly in the Ciberes Micro-Hydro Power Plant, West Java, Indonesia.



## Decentralized Development and Management of Small Hydropower in Pakistan

M. Abdullah\*

### Introduction

**I**N Pakistan, the Federal Government, through the Water and Power Development Authority (WAPDA) is responsible for electricity generation, transmission and distribution. In spite of an extensive network of national grids, the benefits of electricity are enjoyed only by a limited portion of the population. Out of 43,000 villages, nearly 10,000 have so far been electrified. The annual development plan of WAPDA envisages rural electrification, at the rate of about 1,000 villages each year.

Since more than two-thirds of the total population live in villages, it is highly desirable to accelerate the rate of rural electrification. The present system of electrification, by extending the transmission and distribution lines from central power plants, is quite expensive for rural areas, because of the low load density and the long distances involved. The average cost of electrifying a village under the present system is nearly Rs500,000.† There is therefore a strong need to look for a suitable option for electrifying rural areas, expeditiously and at lower cost.

### Mini-Hydro Electric Plants

In order to supplement the existing elective facilities in rural areas and to meet electricity needs at a low cost, the Appropriate Technology Development Organisation (ATDO) in the Ministry of Science & Technology, Government of Pakistan, initiated a program for the development of mini-hydroelectric systems utilizing locally available resources of technology, men and material.

At present, 22 mini-hydro generating (MHG) plants are in operation, with capacities ranging from 5 to 12 kW. Twelve plants with capacities in the range of 5 to 50 kW are under construction. Each installation is designed to match the conditions at the site. The availability of water ranges from 2 cu ft/sec to

15 cu ft/sec, and the head is in the range of 15 ft to 100 ft. These plants are installed in the hilly areas where natural water streams flow almost perennially, and fall can be created easily.

In order to meet the objectives of the program, the free-stream radial flow Banki turbine has been adapted, and is fabricated by local mechanics at a cost which can be afforded by communities in the rural areas. The intake structure, power channel, and the powerhouse are made by local people using locally available material, e.g. stone and wood. The penstock is either a wooden channel or an iron pipe.

Typically a 10 kW plant costs Rs29,000 (US\$-2,900) as detailed below:

● Civil works	Rs 8,000
● Turbine	Rs 2,000
● Generator	Rs15,000
● Technical Services	Rs 4,000
Total	Rs29,000 per kW installed.

The cost of a distribution system depends upon the area to be served. The average cost for a plant of 10 kW is Rs8,000.

### Source of Equipment

The main equipment and components used in the MHG systems are a penstock, a turbine, and a generator. The penstock, in the case of low-head installations, is made from wood, which is easily available in these areas. In the case of higher heads, iron pipes are used for the penstock. These pipes have to be brought from the main cities, and therefore pose problems of transportation – particularly for installations at remote sites. The turbine is fabricated in a local workshop in a town.

The portable, imported electric generators are purchased from the local market. Generators are purchased and stocked in sufficient number so that they can be installed as and when required. The ATDO

\*Department of Electrical Engineering, NWFP University of Engineering & Technology, Peshawar, and Consultant to ATDO, Government of Pakistan.

† Rs 10 = US\$ 1.00 (December, 1982)

have evolved generators independently, which are about 70% locally fabricated, and these are undergoing field trials. Some reduction in cost is anticipated by using these generators.

In addition to the main components mentioned above, auxiliary items such as measuring instruments, switches, protective devices and others are also used in the plants. All these items are available on the local market, except the measuring instruments which are obtained as imported items. Distribution materials, e.g. copper wire, insulators and poles, are also available locally. Wooden poles are invariably used; these are made locally in the village.

### Financing

In the initial stages of the MHG program, the ATDO financed all the machinery and components required for the plants. This was considered necessary to establish and demonstrate the viability of the projects. Once the motivational momentum has been achieved and the technology accepted by the local people and other agencies, the ATDO tapers off its financial subsidy. Presently, the schemes are implemented on a cost sharing basis. The cost of the turbine and generator unit is shared between the ATDO and provincial governments through their agencies or cooperative societies. The local community/local entrepreneurs meet the cost of the penstock, the distribution wire and the expenses on civil works. The cost of providing technical services is borne by the ATDO. It is hoped that in the future a greater share of the cost will be borne by provincial governments and local entrepreneurs, and the ATDO will for the most part provide only technical guidance.

Because of power availability during the daytime, efforts were made by the ATDO to encourage the establishment of cottage-level industrial units, e.g. wood cutting, rice husking, etc. This activity is now beginning to gather momentum, and so far about 12 such units have been established, contributing to employment opportunities, economic betterment and an improved level of skill acquisition.

A number of banks in Pakistan have introduced schemes for advancing loans to farmers for agro-based rural development programs. It has been proposed that loans should be made available to rural cooperative societies where cottage industries will be established on the MHG plants. The income from the industrial units will pay off the loan.

### Local Fabrication

Small-scale decentralized hydropower systems are

particularly suited to local manufacturing and fabrication. From ancient times, people living in hilly areas have used natural water resources for irrigation and motive power. The same technology, with some modification, is used in today's mini-hydro systems.

A hydroelectric system can be divided into four components: water supply, powerhouse, turbine generator unit and distribution system. The fabrication of each of these components needs capital, raw materials, technology and labor.

With regard to the water supply system and the powerhouse, traditional technology based on local raw materials has been successfully used in our MHG systems. The installations are all run-of-stream applications, and such a water supply system is not in itself an item requiring fabrication or equipment. However, availability of labor becomes a major consideration in water supply systems, particularly when machinery is neither available nor suitable in most cases. Labor is available in most areas, and the local people have been employed to carry out the civil works. Capital requirements are also low as locally available raw materials, e.g. stone, aggregate, sand and timber, are used. Reinforcing steel and cement are used on a limited scale only. Masons and carpenters are mostly available in the villages.

The capital cost and the technology needed for the turbine depends upon the selection of the prime mover. We have selected the Banki turbine for our installations.

A very simple process has been adapted for the fabrication of the turbine rotor. End plates of the required diameter are cut from ¼ inch thick mild steel plate. Rotor blades of appropriate curvature are either obtained from pipes with a suitable diameter, or by bending 1/8 inch thick flat mild steel plate of a suitable width. The end plates are marked to indicate the position of the blades. Both ends of the rotor blades are then welded electrically on the end plates. Thus a squirrel cage shaped rotor is obtained.

For each installation, a turbine rotor of designed dimensions is fabricated to match the quantity of water and head available. The rotor has a through-shaft, supported by three ball bearings. The driving pulley, usually of the V-type variety, is mounted on the shaft. The nozzle of the turbine is made from steel sheet. Standardization of turbine dimensions is not considered necessary.

The technology for fabricating the turbine is simple, and a village-level technician is capable of making wheels of this sort; practice in sheet metal work and electric welding are the only skills necessary. The technology does not demand any sophisticated processes

or precision workmanship. A skilled technician can make a turbine within a couple of days. Our own practice is to have the turbines made by a technician in a local workshop. The fabrication of these turbines in a large workshop is neither necessary nor desirable. In view of the overhead charges and higher wages in such workshops, the cost of these turbines would be much higher than the price under the present system. The demand for these turbines is also limited, so mass production is not required.

As regards the manufacture of electric generators, it is intended to invite industrial firms to develop and fabricate these machines based on the prototype units already made by the ATDO. There are a number of industries in Pakistan that have the necessary facilities for making rotating machines. Most of these industries make electric motors of different types and various capacities, and the same facilities can be used for making generators. Measuring instruments, such as voltmeters and ammeters, are not made locally and therefore they will continue to be imported for the time being.

The distribution system involves laying electric wires on wooden poles and domestic wiring and fittings. The laying of distribution lines is usually done by local labor. However, for wiring and fittings a trained wireman/electrician is needed, and a person with the necessary training is not readily available in every village. He is usually hired from a town on daily wages. No sophisticated technology is needed for the distribution systems; the work is done manually. The distribution poles are made by a local carpenter. Distribution wires, domestic wiring material and fittings are all brought from a nearby town.

### **Management & Operation of the Plants**

The success of any decentralized scheme depends primarily on the involvement and participation of the local community. In order to obtain local participation, the community must be assured that the scheme is entirely for their well-being and benefit, and that the government is simply doing its best to lend a helping hand — and is not concerned to exercise control over the project. The local community should feel that they are responsible for the jobs which they are capable of doing.

The success of MHG systems in Pakistan owes a great deal to the ATDO policy of maximising local involvement and participation. Representatives of the local community are involved in most stages of the work. From the initial identification of the site for the installation of the plant, local people are associated

with the staff of the ATDO. In fact, sites are now being located, and demand initiated, by local people, after which further work is carried out.

From the start, all the stages of the civil works, the creation of the plant, the distribution system and the domestic wiring requirements are explained to the local community. The distribution of responsibilities among the local community, the ATDO and the provincial government is also explained to the villagers. The project is approved only after they agree to work in accordance with these conditions and share the responsibilities.

During the course of their work, the ATDO provides them with technical guidance and supervision. The installation of the turbine and generator is carried out jointly by the staff of the ATDO and local people. The plant is run by the ATDO staff for a few days, during which period a local technician learns the various phases of operation of the plant. Once the plant is running successfully, the project is handed over to the local community. Thereafter the community is responsible for the management, operation and maintenance of the plant.

The community chooses a person from amongst themselves to be responsible for the operation and maintenance of the plant, and decides the allocation of electricity connections amongst the residents of the village. All those who contribute labor or cash are given connections. Depending upon the magnitude of power generated by the plant, each household is allowed a certain amount of the connected load.

In order to meet the running cost of the plant and provide for incidental expenses, community representatives decide on the rate of charges to be collected from the users. Usually a fixed rate per light point is collected; only a couple of installations have energy meters on the premises of consumers. Government agencies do not collect any revenue or taxes from these installations.

The local people are managing the systems very well indeed. They themselves solve the local issues resulting from the distribution and use of electricity. Minor technical problems are also attended to by the community, and the local people would only need to approach the ATDO if any major problems should arise. Whenever required, the local people volunteer their services and carry out the requisite work quickly without waiting for any external help. There is a strong link between the local community and the ATDO, whose staff make occasional visits to the plant and share experiences. However, no major problem or breakdown has been reported during the last two years.

## End-Use Planning

The MHG systems are primarily planned and implemented with the objective of supplying electricity to domestic consumers and providing power to cottage industries. Plants are designed and operated to provide electricity at the normal supply voltage.

The areas to be served are surveyed and the nature and magnitude of the load is estimated so that the output of the plant can be utilized for both the social and economical development of the community. Electricity requirements for private residences and community premises are assessed. The agricultural products of the locality are estimated with a view to indentifying the processes which could be mechanized. Existing productive activities, whether operated by animal power, manpower, or diesel engine power, are taken into consideration. All the aspects of replacing such units with power from the MHG system are discussed with the community. The availability of suitable local skill, resources, and marketing conditions are also considered while deciding on the industrial uses of the plant.

The ATDO also provides the necessary guidance to the local community on opportunities for productive uses of the plant. Information on the availability of industrial and/or processing units of suitable capacity and their cost is also provided to the villages by the ATDO.

The lighting load is mainly due to filament lamps; however the use of flourescent lamps is encouraged wherever people can afford their initial cost. Most of these MHG systems are operating in regions which have a cold climate, and the use of fans is therefore limited. Some well-to-do villagers have also installed television receivers in their homes. The public buildings in the villages, *e.g.* dispensaries, religious places, schools and important points on the streets have also been lighted.

In addition to supplying electricity for lighting purposes, a number of MHG plants supply power to cottage industries and agricultural processes. In most cases, the industrial units, *e.g.* flour milling, rice husking, cotton ginning, saw milling, wood-working lathes and grinding wheels, are housed at the plant. The motive power of the water turbine drives a line-shaft, which in turn is coupled to the industrial units through suitable pulley-belt drives. These units are run during the day-time, when the electric generator is either uncoupled or run on a light load. During the night-time, when there is no industrial load, the electric generator feeds supply to the consumers. The period for which the generator is operated during the night is

decided by the local people themselves; usually it varies from 6-8 hours every night, after dusk.

The electricity generated at the plants is also used for industrial purposes at some of the locations. Electrically driven wheat threshes and corn shellers have been operated in the field. The units are mobile, as a long length of electric cable is connected to the motor. The thresher or sheller unit is moved to a convenient location in the field and electricity is tapped from the nearby distribution pole. At one installation electric welding is also carried out.

These industrial units are a great help to the local people. Most of the locations at which MHG systems are installed are far from any town, and access to them is difficult. People from adjacent villages carry the agricultural products to the plants and get them processed. This also provides employment to a few people at such installations.

At one location it is proposed to build a 10 kW plant which, during the day-time, will drive an electrical motor pump set which will lift water to an elevation of 60 ft for irrigation purposes.

So far, 22 units with a total capacity of about 150 kW have been installed. A survey of some MHG plants was carried out in October 1980. The 13 plants surveyed have a total capacity of 87.5 kW, have lighted 553 houses, and serve a population of about 5,000 people. Small-scale industrial activity has also been initiated at 4 sites. Brief statistics on the surveyed plants are given in Appendix A.

The introduction of this appropriate technology in the remote areas is bringing a socio-cultural reformation. The following are some of the aspects of this reformation:

- a sense of pride;
- increased awareness of the need for development;
- a sense of participation in the development process through self-help and minimum reliance on the government;
- increased hours for students to study;
- easy movement at night because of street lighting (*e.g.* from house to mosque and back);
- smokeless lighting, resulting in a good effect on respiration;
- improved forestation;
- introduction of small-scale industrial activity; and,
- more employment opportunities and increased income.

**Appendix A**  
**Brief Statistics on some of the micro hydel plants**  
**installed in the Swat area**  
**(Survey conducted in October 1980)**

Name of Site	Capacity (kW)	Houses Electrified	Persons Benefitting	Street Lights	Industrial Activity Initiated	Employment Generated
1. Lilowni (1)	12.5	60	450	7	(i) Wheat grinder (ii) Rice machine (iii) Oil expeller (iv) Cotton winnowing machine (v) Saw machine (vi) Wooden lathe (vii) Spice grinding machine (viii) Grinder	7
2. Lilowni (2)	3	12	87	4	—	—
3. Lilowni (3)	3.5	11	87		—	—
4. Lilowni (4)	5	70	680	5	—	—
5. Bande China	3.5	13	100	6	—	—
6. Barkana	10	40	410	8	(i) Cotton winnowing machine (ii) Wheat thresher (iii) Maize thresher	5
7. Alpuri	10	190	1,760	31	—	1
8. Shalpin	5	3	20	4	—	—
9. Miandum	5	10	60	5	—	1
10. Barkalay	5	35	275	8	—	1
11. Ganor	5	22	180	5	—	—
12. Shang	10	44	300	15	(i) Two wheat grinders (ii) Saw machine (iii) Cotton winnowing machine	6
13. Margai	10	43	410	20	(i) Two wheat grinders (ii) Rice machine, (iii) Saw machine (iv) Wooden lathe (v) Cotton winnowing machine (vi) Grinder	7
<b>Total:</b>	<b>87.5</b>	<b>553</b>	<b>4,819</b>	<b>118</b>		<b>28</b>

# Centralised Development & Management of Small Hydropower in Pakistan

Muhammad Waseem Khan

## Introduction

**A**T present, development of all hydropower including mini-hydro schemes, is centralised and is being undertaken by the Water and Power Development Authority (WAPDA). Although the development of small hydropower was initiated as early as 1924 when a 0.11 MW station at Renala was commissioned in the private sector, it remained at the provincial level until 1958. During this period, a 1.9 MW station at Malakand, a 2.0 MW station at Dargai, a 0.12 MW station at Kurram Garhi in NWF Province, and a 22 MW station at Rasul in the Province of Punjab were installed.

Pakistan is fortunate in having a big hydel potential. In the northern hilly areas, there are sites where hundreds of small mini-hydro schemes can be developed. In the plains, Pakistan possesses a large network of canals where small hydro stations can be developed.

## Centralised Development

In developing countries, which are short of adequate financial and technical resources, the most economical method is to pool all the available resources for unified and coordinated development. With this aim in view the government created WAPDA in 1958, with responsibilities which include the investigation, planning and execution of schemes in:

- the general transmission and distribution of power;
- irrigation, water supply and drainage;
- control of water logging and salinity;
- flood control; and,
- inland navigation.

In developing countries, these services are sometimes given with regard purely to social considerations in terms of the limited resources in the area, and without considering whether there will be adequate finan-

cial returns. It therefore becomes more essential that available know-how and financial resources are used fully and most economically, at the same time keeping overall development strategies in mind. Moreover, in developing countries specialised skills like the collection and analysis of hydrological data, making a topographic survey, geological mapping, sub-surface investigations etc, which are required for planning hydro schemes, are only available through a central organization. These tasks are therefore being undertaken by WAPDA, whose centralised functions have proved the desirability and benefit of such an arrangement in order to achieve an accelerated pace of development.

WAPDA has planned and executed a number of mini-hydro schemes since 1960 viz: Shadiwal 1.2 MW, Chichoki 1.3 MW, and Nandipur 1.3 MW. All these stations are on irrigation canals, with heads ranging from 5 to 7 meters. They are interconnected with local grids to maximise the utility of water during high and low periods of discharge in different seasons.

The northern hilly areas of Pakistan, though not easily accessible, are abundant in water resources. A large number of small villages are situated in these regions, which due to their remoteness are devoid of basic amenities. The government and WAPDA have therefore planned a large number of mini stations to provide at least power for lighting. Projects which have already been planned and executed are functioning in Chitral, Gilgit, Skardu etc. The stations vary in size from 50 kW to 1,000 kW.

A scheme for providing hydropower to 100 remote villages in the northern hilly areas is also under way. The units have been standardised either as 50 kW or 100 kW plants. Ten have already been installed, and work on the rest is in hand.

These schemes are generally planned so as to be economically feasible; but for certain areas the projects are undertaken as a matter of social obligation, like other services. The financing for such development is made up of:

---

\*Chief Engineer, Mangla Dam Water & Power Development Authority, Mangla.

- grants made to WAPDA by federal and provincial governments;
- loans obtained by WAPDA from federal and provincial governments;
- sale proceeds from bonds;
- loans obtained by WAPDA;
- foreign aid and loans; and,
- sale of power.

### Management

Centralized management of mini-hydro plants has not been resorted to for many good reasons:

- remoteness, difficult access and lack of communication prevents a centralized agency like WAPDA from exercising effective control over management;
- overheads, by virtue of the distance involved, may make centralized management less economical;
- centralized management by WAPDA may cause a disproportionate erosion of WAPDA's resources and a diversion from bigger and more economically beneficial functions; and,
- it is important to cultivate a sense of participation in the local administration.

The management of small hydro plants is therefore decentralized to a very large extent. Regional Heads are provided with annual funds and allocate them to the stations according to their needs. The staff for maintenance and operation is recruited and trained locally and looked after by Circle Heads, who are in charge of sub-divisions immediately below the regional level. These sub-divisions are further divided into the lower tiers, to make the management, operation and maintenance as decentralised as possible. The Circle also arranges procurement of spares for the plant, for which separate funds are made available according to the demand.

Although manufacture of mini-hydro sets has recently been started in Pakistan, all the old plants used imported sets. Spare parts are manufactured in the country as far as possible and repairs are undertaken locally, but some special components are still imported. Extensive overhauls, such as refurbishing runners and bearings, shafts, motors and protective gear, for which specialised knowledge and facilities are required, cannot be economically made available in remote mini stations.

A system of regional support and pooling of staff has therefore been evolved. For example, for major repairs to mini stations in Chitral, the northern areas, Malakand, Dargai and Kurram Garhi, overhauling is undertaken at the nearby and centrally located station at Warsak (240 MW). For the small canal stations of Rasul, Nandipur, Chichoki and Shadiwal, support is given from the nearby Mangla station (800 MW). The help is in the form of workshop facilities, special tools, material and testing equipment. Most important of all, the specialised personnel available at these large stations provide advice as and when necessary. Some of the periodical jobs, like testing of protective gear, is done by deputising personnel from large stations to these mini-hydros, once a year.

This system has proved most effective and economical and has assured availability of specialised knowledge and skills at the time of need. Thus the management, operation and maintenance of mini-hydros, though decentralised, is supported from central stations as well.

The main question is still that of economics. Is it prudent or possible for the nations of the Third World, with limited financial resources, to continue to undertake development that is not economical and initially meant only as a social uplift for their people? The answer is yes; because a social uplift is a step towards helping people make economic progress. However, it is imperative to think of ways and means to make the development of mini-hydro installations more economical. This can be done by attracting active participation of the local population in the development and management of the installations on a cooperative basis. The local population should be expected to contribute towards providing the labour, which is available in plenty in the rural areas of countries like Pakistan. In return, the local population can share direct as well as indirect benefits.

The other step is to make such development as multi-purpose as possible, and to include afforestation, irrigation, food production, fisheries development, etc. Only then will mini-hydro development become economically more attractive and the burden on the State will be reduced. This will obviously also result in expeditious development of more and more sites, spreading the benefits of the modern age far and wide into the mountains and bringing a socio-economic revolution in the lives of the people, thus creating prosperity not only for them but for the country as a whole.

# Socio-Economic Impact of Rural Electrification: Lesson from Central Java\*

Janice Brodman\*\*

## Introduction

**T**HE goals of rural electrification (RE) are significantly different from those of conventional electrification programs. For the latter, the primary objective is to produce satisfactory electricity service at rates appropriate to general public demand and the generation of a profit for the electricity provider. In contrast, the goal of an RE development program is to provide electricity to a "special public," thereby foregoing profit for an extended period. In recent years a second major goal has been adopted for RE projects: stimulation of certain kinds of electricity uses, generally referred to as "productive uses," i.e., the use of electricity to increase production, sales and income in rural areas.

The differing goals of the two types of electrification programs have important implications for the design and implementation of RE programs. While engineering and economics expertise are as crucial to the design phase of RE as they are to conventional electrification projects, RE projects also require social science expertise. Because RE seeks to stimulate behavioral changes, successful program implementation requires not only the ability to provide satisfactory electricity service, but also responsiveness to special public needs, and the ability to provide complementary inputs.<sup>1</sup>

## Factors in Successful RE

Four major factors are decisive in determining the probability of success of an RE program: 1) the definition of program goals and the degree of unity on

those goals, 2) program responsiveness, 3) program resources, and 4) the village socio-economic context.

*Goals:* The number and clarity of project goals, and the extent of change from the status quo envisioned by those goals, are important conditions determining the likelihood of project success. Other conditions being equal, where goals are fewer in number, more explicitly stated, and more limited in their attempt to change the status quo, they are more likely to be accomplished.<sup>2</sup> For example, RE programs with the simultaneous goals of increasing productivity and raising education will be more difficult to implement successfully than programs concerned primarily with one or the other. Programs focusing on increasing productive use of electricity by small businesses or small farmers will be more problematic than those attempting to substitute electricity for kerosene lighting. This is not to suggest that an RE program should not aim at a broad range of effects or at substantial changes in the status quo. It is only to say that the number and kinds of goal priorities must be weighed against available project resources. Whatever the goals adopted, they should be clear to all involved in project implementation.

Another crucial element is unity among major actors regarding goals. Where there is conflict, the strategies of some actors are likely to directly or indirectly undermine attainment of the goals in question. Achieving a consensus on goals may require compromise and accommodation. Care must be taken to ensure that compromise does not ultimately sacrifice goals.

*Program Responsiveness:* There are two components of responsiveness: input and output. In order to be responsive, a program must be able to gather

---

\*This paper takes the form of an introductory analysis. Because the field work on which the case study is based has only recently been completed, data calculations have thus far been limited to some very simple percentage relationships. Considerably more comprehensive analysis of the data is in progress. Particular attention is being paid to examination of precise quantitative changes in production, employment, profit and income across different socio-economic populations.

\*\*Development Administration, Harvard University, Cambridge, Massachusetts.

<sup>1</sup> The concept of two types of development projects, one a general public demand based service, one a service to a special public appears in "Administering to the Poor (Or, If We Can't Help Rich Dictators, What Can We Do For The Poor?)" by John D. Montgomery. *Public Administration Review* (September/October 1980).

<sup>2</sup> Goal characteristics which make development projects more or less "problematic" are presented by Peter S. Cleaves, "Implementation Among Scarcity and Apathy: Political Power and Policy design," in Merilee S. Grindle, ed., *Politics and Policy Implementation In the Third World*. Princeton, N.J.: Princeton University Press, 1980.



information in a timely manner and utilize that information to design effective and appropriate measures.

Gathering information from the field is far from easy. In some areas the political context may be less than conducive to responsiveness. For example, the governing regime may discourage the kind of interactive relationships between program personnel and public which are important to obtaining accurate field information. The bureaucratic context often deters responsiveness. The system of incentives and constraints within which bureaucrats work tends to encourage them to "look upward" rather than downward, *i.e.*, to be more responsive to upper level administrators than to the public. Bureaucratic orientation and roles tend to reinforce standard routines rather than accommodation to changing public needs. "Cognitive distance" between bureaucrats and the public, particularly rural populations served by RE, is often great.<sup>3</sup> Thus, to be responsive, RE programs require an organization, a structure of rewards, and personnel training/experience quite different from those of ordinary electrification and other government programs.

The "output" component of responsiveness is the program content. This includes the "technical" content, *e.g.*, tariff schedules, single- vs. three-phase systems, load capacity, use of meters, *etc.* It also includes the administrative design and the content of complementary inputs, *e.g.*, information dissemination.

*Resources.* The financial and human resources available to the program will be important in determining what can be accomplished. Allocation of resources to RE should be made in view of program goals. The sizeable capital investment for installation and maintenance of the electricity system will not

be enough. Special training for program administrators may be required. Resources for complementary inputs will often be necessary.

*Village Context:* The socio-economic, physical infrastructure, and energy-use conditions in villages where the RE program is implemented will strongly affect the achievement of project goals. Certain economic conditions, *e.g.*, levels of income and costs of alternative fuels, will be fairly obvious contextual elements to be considered. Social and political conditions, while more subtle and difficult to assess, will be equally important in determining project outcomes. Highly developed rural areas may adopt and utilize electricity in ways concordant with certain project goals with little or no additional input from the RE program. Other villages may require substantial assistance. Thus, it is important to carefully consider the village context in order to design the project appropriately and to anticipate the kinds of complementary inputs which may be necessary.

### Interrelationships Between Factors

The relationships between these factors are represented in the diagram below. Note that there are feedback relationships. Project responsiveness will require on-going accumulation of information about project outcomes. Information regarding project outcomes may also lead to changes in the definition of project goals.

Consideration of the interrelationship between the four factors should be an integral part of program design. The process of goal information should consider village conditions and the likely level of program resources. Resources should be allocated commensurate with goals, requirements to achieve responsiveness

Diagram 1: Process of RE project development

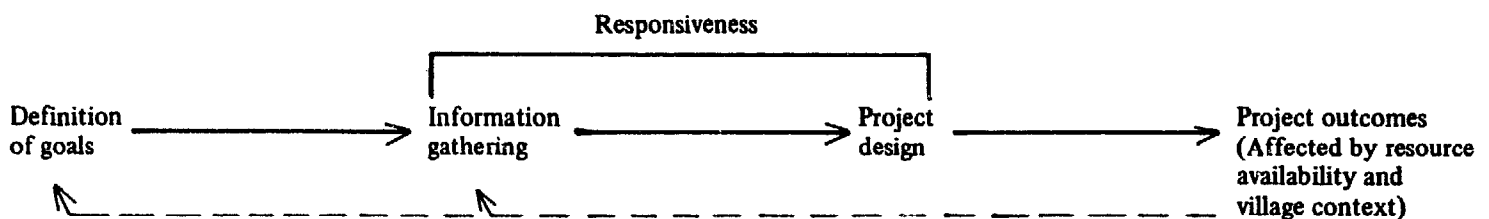

<sup>3</sup> Characteristics of bureaucracies which tend to limit responsiveness are discussed in John D. Montgomery, "Administering to the Poor." Dr. Montgomery suggests cognitive distance can be reduced by changing bureaucratic incentive systems. He recommends increasing interaction between target populations and program administrators through the use of small scale projects, new standards of performance for local officials who must deal closely with the public, and project-trained para-professionals.

**Table 1**  
**Factors determining RE program probability of success**

Success More Difficult To Achieve	Success Easier to Achieve
<b>Goals</b> <ul style="list-style-type: none"> <li>– Envision extensive changes from the status quo</li> <li>– Several in number</li> <li>– Ambiguous (<i>e.g.</i>, “raise living standards”)</li> </ul>	<b>Goals</b> <ul style="list-style-type: none"> <li>– Envision limited changes from the status quo</li> <li>– Few in number</li> <li>– Explicit (<i>e.g.</i>, increase productive uses of small farms)</li> </ul>
<b>Responsiveness</b> <ul style="list-style-type: none"> <li>– Ineffective/limited mechanisms for gathering field information</li> <li>– Program design unresponsive to information on field conditions</li> </ul>	<b>Responsiveness</b> <ul style="list-style-type: none"> <li>– Effective mechanisms for gathering accurate, timely field information</li> <li>– Program design responsive to information on field conditions</li> </ul>
<b>Resources</b> <ul style="list-style-type: none"> <li>– Limited resources</li> </ul>	<b>Resources</b> <ul style="list-style-type: none"> <li>– High level of resources</li> </ul>
<b>Village Context</b> <ul style="list-style-type: none"> <li>– Underdeveloped village</li> </ul>	<b>Village Context</b> <ul style="list-style-type: none"> <li>– Highly developed village</li> </ul>

and village conditions. Responsiveness mechanisms should be designed in view of the kinds and level of complexity of goals, project resources, and village conditions.

In Table 1, characteristics associated with greater difficulty of implementation are listed on the left; those associated with lesser difficulty of implementation on the right. Program designers may be able to improve the probability of program success by “balancing” these factors. If, for example, the level of resources available is very limited, it would be worthwhile to consider limiting the number and complexity of goals, designing a very responsive system which can target resources effectively, and choosing villages which are relatively well-developed.

### **The Indonesian RE Program: A Case Study**

Indonesia is currently experimenting with several different types of RE projects. The one studied by the author is a “model RE project,” part of a large central-grid RE program run by the State Electric Company (PLN). The experience gained from that program can be instructive for all types of RE.

The “model RE project,” a United States

Agency for International Development/Government of Indonesia effort, made electricity available at subsidized rates in eight villages in District Klaten, Central Java.<sup>4</sup> Electricity was made available throughout three villages; five villages were electrified in only small sections.

The District Klaten is a rice-intensive area with a dynamic household industry sector and a strong small-scale village industry sector. While the district is comparatively prosperous, income disparity is also relatively great. Situated between two major cities, each about 60 km away, the district capital is a relatively developed rural town. It has a large paved road to both cities. The villages receiving electricity are all within 10 km of the district capital. Two of the “totally electrified” villages have one boundary along the main road. The third lies on a paved artery of that road. In sum, although still decidedly rural, the RE villages are more developed economically and socially than most Indonesian villages, and have good access to the markets of rather advanced rural towns. There is also access to other external markets, or, more commonly, access to traders who are channels to external markets. This access offers outlets for increased village production.

<sup>4</sup> This model project was the first phase of a plan to bring electricity to 98 villages in Central Java.

The survey on which this case study is based was conducted October 1980 – February 1981, one and a half years after the “model RE” villages received electricity.<sup>5</sup> The study is, therefore, an examination of the short-term effects of RE in those villages. The survey areas included only villages and parts of villages in which electricity was made available.<sup>6</sup> 334 households (15% of all households in the survey area) were interviewed. These included 117 non-electrified households (“non-adopters”) and 217 electrified households (“adopters”).<sup>7</sup> Of the households included in the sample, 92 (28% of the total household sample) had a home industry.<sup>8</sup> 123 businesses (representing 94% of all businesses) were interviewed.<sup>9</sup> All those businesses had electricity.

### Outcomes of the Model RE Program

Two major articulated goals of the project were to obtain a high hook-up rate and to develop productive uses of electricity.<sup>10</sup> While both those goals were clearly stated in project proposal and feasibility studies, the project design was not devised to encourage productive uses of electricity. Rather, the project was designed for widespread household coverage. It was a single-phase, low-load system offered at a low tariff/installation rate with long-term loans available for installation costs.<sup>11</sup> In design at least, it was actually, in the words of one PLN officer, a “household lighting project.”

The RE rates were attractive. 78% of the total population of households in areas where the RE program was available installed electricity. In addition, of the survey’s 117 non-adopters, 20% reported reasons other than electricity cost for not taking electricity (*e.g.*, they were out of the village when the sign-up list was circulated; they are in the process of improving their house and will install electricity when improvements are complete). It is also intriguing to note that 26% of the non-adopters (*i.e.*, of the sample of officially unelectrified households) actually have electricity. Village values and ties induced some households to allow other, poorer households to hook into their system and pay a small part of the monthly bill.

88% of the businesses in the survey area also installed electricity through the RE program. An additional 6% of the businesses had installed electricity before the RE program began. Thus, 94% of all businesses in the survey area were electrified.<sup>12</sup> The goal of widespread household and business electrification was, then, achieved in the model RE area. Table 2 presents household and business rates of installation.

Installation of electricity was, however, only one of the project goals, and in many ways the simplest one to implement. Electricity had to be *used*, for education, for production, for village activities, in order for it to provide benefits. Yet the Klaten project was limited to electricity installation. It had

<sup>5</sup> The survey was sponsored and funded by the Ministry of Finance, Government of Indonesia, and Harvard University, USA.

<sup>6</sup> See Appendix A for a discussion of data generation methodology, Table A: Samples as Proportions of Total Sampled Populations, and Table B: Distribution of Home Industries in Electrified and Non-electrified Households.

<sup>7</sup> The 117 non-adopters represented 24% of all non-electrified households in the survey area. The 217 adopters represented 12.5% of all electrified households in the survey area.

<sup>8</sup> It is extremely difficult to draw a clear line between “businesses” and “home industries.” Many “businesses” do not have a business permit, yet employ people outside the household; or are (relatively) large restaurants and clearly not “home industries,” but are run only by family members. Some “household industries” are run in the home on a very informal basis, yet occasionally employ several people from outside the home. Scale can change significantly from the wet (generally slower) season to the dry (more active) season in terms of workforce and productivity. For this report, “businesses” were those operations identified as businesses by the village Lurah and Carik. Households were income-generating operations run in the home which were “picked up” in the household survey. There may be recategorization of certain home industries in future reports.

<sup>9</sup> Unless otherwise modified, the term “businesses” will be used to include all types of businesses: industrial, manufacturing, and service-providing operations, restaurants, stores, and tea shops. For the distinction between home industries and businesses, see note 8.

<sup>10</sup> “Proposal and Recommendations: Indonesia – RE I,” and “Proposal and Recommendations for the Review of the Development Loan Committee,” Department of State, Agency for International Development, Washington, D.C., September 1977. Also discussions with officials from PLN. Some program problems were related to formulation of goals. However, discussion of those difficulties is beyond the scope of this paper.

<sup>11</sup> 1,250 W load capacity is relatively high for a home. However, it is low for a business operation.

<sup>12</sup> Businesses which installed electricity through the USAID/GOI RE program of subsidized rates are considered to have “RE” electricity. Businesses which installed electricity before the RE program began, and at the considerably higher “regular” rate, are here considered to have “non-RE” electricity.

**Table 2**  
**Household and business rates of electricity installation**

Type of Population	Total Population	Installed Electricity		Did not Install Electricity
		Installed "RE" Electricity*	Installed "Non-RE" Electricity*	
Total Population of Households	100% (2225)	78% (1741)	—	22% (484) <sup>†</sup>
Total Population of Businesses	100% (131)	88% (115)	6% (8)	6% (8)
Total = 94% (123)				

\*Businesses which installed electricity under the USAID/GOI RE program of subsidized rates are considered to have "RE" electricity. Businesses which installed electricity before the USAID/GOI RE program began are considered to have "Non-RE" electricity.

<sup>†</sup>26% (126) of this group of officially non-electrified households actually had electricity in their homes.

no mechanisms to encourage beneficial uses of electricity. Although electricity *was* used to create a variety of benefits in the model RE villages, those benefits were primarily due to characteristics of the villages rather than to the RE program. Of course, the benefits which did occur should not be discounted. However, as the discussion of "economic outcomes," below, shows, the unresponsive nature of the project limited the progress toward a priority goal: development of productive uses of electricity.

### Indirect Economic Outcomes

Three benefits with indirect economic implications were widely reported by survey respondents. Because the survey was concerned primarily with productive uses of electricity, no attempt was made to measure these perceived benefits. However, if villager perceptions of these changes are accurate, the immediate benefits should produce positive longer-term economic consequences.<sup>13</sup>

71% of adopters with school children reported

that electricity had caused an increase in their children's study time.<sup>14</sup> As there was no effort on the part of the RE program, village teachers, nor other government officials, to encourage electricity use for increased study time, this result appears to have been an outcome of villagers' own concern for education. If respondents' perceptions are correct, this increased investment in human capital should eventually yield economic rewards.

The second widely-reported benefit was increased "safety" at night.<sup>15</sup> More than 80% of both adopters and of non-adopters said that electricity had made the village safer. An even greater percentage of the business respondents said electricity had made the village safer. The greater safety was due to lighting of village paths, an outcome of the village headmen's (*Lurah's*) efforts. Each adopter was urged to put a lightbulb on the path outside the home. Most complied. While the *Lurachs* had hoped to get some assistance for street lighting from PLN, none had been forthcoming. Nevertheless, the system of private contribution for street lighting appears to have been effective. Also, if respondent

<sup>13</sup> Appendix B presents the survey questions on which this discussion of indirect economic benefits is based.

<sup>14</sup> We also talked with three school teachers about changes they had observed in their classes. Their impressions concurred with survey responses that there has been a distinct improvement in students' studying due to the use of electric lighting.

<sup>15</sup> The size of that response was surprising to this author since I thought of villages as being rather safe places. In chatting with respondents I asked if there really had been a problem with theft before electrification. I was assured emphatically that this had been a problem, but it was now virtually eliminated. There are no supporting data available since apparently most thefts were small and were not reported to the *Lurah* or police. I could not help but wonder to what extent the feeling of safety also reflected fear of ghosts and spirits, now dispelled by lighted streets. In any case, villagers certainly feel more secure.

**Table 3**  
**Perceptions of indirect economic benefits of electrification<sup>1</sup>**

Type of population	Total population	Kind of benefit perceived:		
		Village is safer	Village is more active at night	Increased study time by school-children in the home
Adopters	100% (217)	83% (181)	72% (156)	
Non-adopters	100% (117)	81% (95)	71% (83)	—
Adopters with Schoolchildren	100% (167)	—	—	71% (119)
Total Business Sample	100% (123)	90% (111)	23% (28)	—
Sample of Commercial Business (i.e., <i>warungs</i> , restaurants, stores)	100% (38)	—	34% (19)	—

<sup>1</sup> Appendix B presents survey questions on which this table is based.

perceptions are accurate, the reduction in economic and social cost of petty theft will provide indirect economic benefits.

Another consequence of street lighting was increased night-time activity, both formal and informal. More than 70% of both adopters and of non-adopters suggested electricity had benefited the village by stimulating more night-time activity. A far smaller percentage (23%), or all businesses, perceived that benefit. However, of stores and tea-shops (*warungs*), which might be expected to directly benefit from increased

night-time activity, 34% suggested that electricity had benefited the village by stimulating more night-time activity. Table 3 presents summary statistics of respondents' perceptions of benefits.<sup>16</sup> Although village night-time activity was not directly measured by the survey, change in business work hours were measured. 21% of commercial businesses (i.e., stores, restaurants, *warungs*) reported that electricity had enabled them to increase their incomes because they are now open at night, or because there is more customer activity at night (See Table 4).<sup>17</sup>

**Table 4**  
**Increased income among commercial businesses due to increased night-time activity**

“Has use of electricity developed your business?”  
 (If answered “yes”) “How has electricity developed this business?”  
 “Have the profits of your business gone up with that use of electricity?”

Type of population	Total population	Reported increased income with electricity use, due to longer work hours at night or more customer activity at night	Did not report that electricity use at night increased income
Commercial businesses	100% (38)	21% (8)	78% (30)

<sup>16</sup> Appendix B presents the survey questions on which this discussion of benefits is based.

<sup>17</sup> Further discussion of the ways electricity use affected incomes of commercial and other businesses appears below.

Thus, a variety of benefits with indirect or long-term economic consequences were widely perceived: increased safety, increased night-time activity, and among adopters, increased children's study time. Two of these benefits were a function of the high hook-up rate, due to low tariff and installation charges; all were a consequence of the villagers' own initiative. They indicate the kinds of benefits which can accrue to RE in certain rural settings without inputs other than an attractive tariff schedule.

### Direct Economic Outcomes

As discussed above, development of productive uses is at least formally designated as a major project goal. For the Klaten project, however, if the villagers were to use electricity "productively," they had to

find ways to do so using a single-phase, low-load system designed primarily for household lighting and small appliances. Furthermore, they had to do so without any assistance from the RE (or any other development) project. As the data presented below indicate, the dynamic economic character of the Klaten area facilitated the development of some productive uses; however, the project design and lack of complementary inputs mitigated against development of a substantial portion of potential productive uses.

As Table 5 shows, 11% of household adopters reported using electricity to increase their incomes. As indicated by Table 6, most of these households raised their incomes by using electricity in their home industries. As is also clear from that table, a relatively high proportion of adopters with home industries reported using electricity to increase their incomes.

**Table 5**  
Use of electricity to increase income among adopters

"Has your income increased with the use of electricity?"

Type of population	Total population	Reported that income increased with the use of electricity	Reported that income had not increased with the use of electricity
Adopters	100% (217)	11% (24)	89% (193)

**Table 6**  
Rates of electricity use in home industries to increase income

"Has your income increased with the use of electricity?"  
(If answer "yes") "How did electricity increase your income?"

Type of population	Total population	Use electricity in home industry to increase income	Use electricity in ways other than in home industry to increase income	Do not use electricity to increase income
Adopters	100% (217)	9% (19)	2% (5)	89% (193)
Adopters with a home industry	100% (62)	31% (19)	—	69% (43)
Adopters who use electricity to home industry	100% (24)	79% (19)	21% (5)	
Total households with a home industry	100% (92)	21% (19)	—	79% (73)

**Table 7**  
**Kinds of electricity use in home industries to increase income**

“Has your income increased with the use of electricity?”  
 (If answer “yes”) “How has electricity increased your income?”

Type of population	Total population	Kind of electricity use in home industry to increase income:		
		To work longer hours, faster	To use electrical equipment	Use electricity in other ways in the home industry
Adopters who increased income with electricity use in a home industry	100% (19)	53% (10)	26% (5)	21% (4)

Those who used electricity in home industries to raise income did so primarily by increasing work hours and using electrical equipment (see Table 7).<sup>18</sup> Those home industries which used electrical equipment used small appliances: freezers, sewing machines, a plastic welder.

Thus, during the year and a half of electrification, income generation effects had begun among adopter households. However, direct effects were clearly felt by a fairly small proportion (11%) of adopters. Most of those who raised their incomes with electricity use did so by using small electrical appliances in their home industries or by increasing their hours of work in their industries.<sup>19</sup>

The major evidence of productive uses effects would be expected to appear among businesses. And

indeed it is in the business sector that productive uses most widely appear. It is also in this sector that a failure of responsiveness of RE program design and implementation becomes evident.

33% of all business respondents reported that electricity use had “developed” their businesses. This group included businesses using electrical equipment, businesses using electric lighting to increase work hours, and businesses using electricity in other ways. In those businesses which now work longer hours due to electric lighting, employee wages have increased.<sup>20</sup>

However, not all business respondents who reported that electricity “developed” their businesses also reported increased profits accompanying that development. 27% of the business respondents reported that their profits had increased with the use of

<sup>18</sup> An additional 77% of the adopters with home industries reported using electric lights in their home industries, but said that use did not change their work hours because formerly they used oil lamps during those same hours.

<sup>19</sup> Developing accurate data on villager incomes is a notoriously difficult task. Villagers are very reluctant to divulge accurate information regarding incomes. Furthermore, there are many income-generating activities that are not considered to be “home industries” by participants. Field impressions indicate that for this survey, the data understated to some degree the income effect of electrification. For example, some respondents’ use of electricity to increase income were not reported by respondents at the time of the survey, but emerged in informal talks with villagers. On the other hand, care had to be exercised to ensure that villagers reporting use of electric lights to increase home industry work hours actually increased work hours rather than merely substituting electric for kerosene lighting. In sum, village surveys of RE require very careful design, including “cross-check” questions, sensitivity to villager perspectives, and patience.

<sup>20</sup> Almost all paid employees received increased wages for the longer hours worked due to electricity use. Some workers, particularly those who are relatives of the business owner, and who “manage” the business, do not receive extra compensation for overtime.

**Table 8**  
**Development of businesses due to electricity use**

"Has use of electricity developed your business?"  
 (If answered "yes") "Have the profits of your business gone up with that use of electricity?"

Type of population	Total population	Reported that business "developed" due to electricity use	Reported that profits increased with electricity-caused development	Reported that profits did not increase with electricity-caused development
Total sample of businesses	100% (123)	33% (40)	27% (33)	6% (7)
Business respondents reporting electricity use developed the businesses	100% (40)	100% (40)*	83% (33)†	17% (7)**

\*83% (33) of this group were businesses which had installed "RE" electricity (see Note 11 for definition of "RE" vs. "Non-RE" electricity). 17% (7) of this group were businesses which had "Non-RE" electricity.

†79% (26) of this group were businesses with "RE" electricity. 21% (7) were businesses with "Non-RE" electricity.

\*\*100% (7) of this group were businesses with "RE" electricity. None were businesses with "Non-RE" electricity.

electricity. Those who said their businesses had developed but had not realized increased profits were primarily respondents with marketing problems or who were experiencing difficulty in their use of electricity. An additional three business respondents used electrical equipment but felt it had not "developed" their businesses.<sup>21</sup> Tables 8 and 9 present summary data on business respondents reporting electricity "developed" their businesses.

The use of electricity by home industries and by businesses, particularly the use of electric lights to increase work hours, had made an impression on villagers. Asked whether electricity had changed employ-

ment opportunities or income in their village (apart from the effects on the respondent's own home industry or business), 43% of all household respondents and 50% of the business respondents said that they thought employment opportunities or income had increased in their village due to electrification. As examples of that increase, most respondents mentioned increased work hours in home industries and businesses. Some mentioned that new businesses had opened, such as ice-makers and battery-chargers.<sup>22</sup> No respondent perceived a decrease in employment opportunities or income due to electrification. This latter perception was supported by business respondents, none of whom

<sup>21</sup> These three businesses included: two businesses which used a T.V. which employees could watch while working, and one businessman, a metal furniture maker, who used an electric welder, but said he used it rarely. The two foregoing businesses with T.V.'s were the only businesses in which T.V.'s were reported being used.

<sup>22</sup> 50% of the electrified household sample perceived an increase in employment opportunities or income in their village due to electrification; however, only 30% of non-adopters perceived such a change. One important factor contributing to this difference in perception appears to be differences in socio-economic status. Survey data relating to differential effects of electrification are still in the process of being analyzed. However, field observations indicate that a larger proportion of non-adopters than adopters are poor and rather cut off from village economic activity. For them, and the sector of the village they represent and in which they operate, there has been little economic change.



**Table 9**  
**Kinds of electricity use to develop business\*\***

“Has use of electricity developed your business?”  
(If answered “yes”) “How has electricity developed this business?”

Type of population	Total population	Reported ways of using electricity to develop the business:				
		Increased production with electrical equipment* <sup>1</sup>	Improved quality or made new goods with electrical equipment* <sup>1</sup>	Increased workhours with electric lights*	Electricity attracts more customers*	Used electricity in other ways to develop the business*
Total sample of businesses	100% (123)	6% (7)	7% (9)	12% (15)	7% (9)	7% (8)
Business respondents reporting electricity use developed the businesses	100% (40)	18% (7)	23% (9)	38% (15)	23% (9)	20% (8)

\*Sum to more than 100% because some businesses reported more than one way electricity use developed the business

<sup>1</sup>Total businesses using electrical equipment = 19. 16 reported that the use of electrical equipment “developed” their businesses. Three reported that the use of electrical equipment had not “developed” their businesses.

\*\*Stratification by “RE” and “Non-RE” Electrified Business is presented in Appendix C

**Table 10**  
**Perceptions of changes in village employment opportunities or income due to electrification**

“In your opinion, has electricity coming to this village changed employment opportunities or income in this village?” (If answered “increased”) “Give examples.”

Type of population	Total population	Respondent answering:			
		Employment opportunities increased	Employment opportunities decreased	No change	Don't know
Total household sample	100% (334)	43% (143)	0	53% (176)	4% (15)
Total business sample	100% (123)	50% (61)	0	45% (55)	5% (6)

reported a decrease in the workforce with the use of electricity.<sup>23</sup> Table 10 presents summary data on perceptions of employment changes in the villages due to electrification.

### Obstacles to Development of Productive Uses

Many Klaten businesses took advantage of their access to markets, and the attractive RE tariff rates, to use the new technology, electricity, to increase their production and sales. However, closer examination of the use of electricity by businesses reveals that development of potential productive uses was limited by program unresponsiveness. It must be reiterated here that this examination of the Klaten project was conducted after only one and a half years of electrification. However, as the discussion below illustrates, the negative consequences of the conditions discussed below are likely to persist unless improvements are made in the program's responsiveness.

Two important conditions hindered development of productive uses of electricity. The first concerned tariff rates. As mentioned above, the RE system installed a single-phase system of 1,250 W. In Indonesia, most electric motors larger than 5 HP require three-phase electricity (those larger than 5 HP which can be used with single-phase are considerably more expensive). The charge of installing three-phase in a business which currently has the RE system is more than Rp. one million, a sum far beyond the resources of any village business.<sup>24</sup> Tariff rates for a three-phase system are also very high. In fact, the rates for a village business, as a "small business," are higher than those charged to a large business. For a general service utility program this makes sense; for an RE "productive uses development" program it does not. Likewise, installation of a single-phase system, with greater load capacity than the RE system provides, puts a village business in another category of high tariff rates.

The second inhibiting condition was an absence of complementary inputs. Had the tariff structure been more responsive to village business conditions,

we might expect to see eventual progress toward development of productive uses. Indeed, as we have seen, some productive uses did develop where villagers could use the single-phase low-load system "productively." Lack of complementary inputs, however, slowed the response time to the new technology considerably.

The adoption of electrical machinery by businesses reflects these conditions. Of the 123 businesses surveyed in the RE villages, 31% are retail stores or restaurants/tea shops ("commercial"); 69% are service providers or production industries ("production").<sup>25</sup> Although the former group may use electricity to some extent, e.g., for refrigerators, we would not expect them to make much use of electrical equipment. That expectation is supported by the data: only three commercial businesses used electrical equipment. It is to the latter group that we look for development of productive uses, and creation of a major part of the electric load. And, indeed, it is within that group that we find the greatest exploitation of electricity for productive uses. 16 of the production businesses do use electrical equipment or tools for production. Examining this use more closely, we find that all of the electrical tools and machinery used are small hand tools, small appliances, or sewing machines. However, an additional 19 of the production businesses use diesel motors. Table 11 presents figures on the use of electrical equipment and diesel motors by businesses.

During the past year and a half there has been no conversion by businesses from diesel motors to electric motors. Of course, businesses are not likely to buy a new motor until their currently owned motor is no longer economically profitable. What is of crucial importance here is the fact that businesses which have bought rotary motor power during the past one and a half years have bought diesel motors. Also, as discussed below, many business respondents who consider buying motors consider only diesel motors. Examination of the reasons for continued use of diesel motors indicates that development of this very substantial portion of undeveloped potential produc-

<sup>23</sup> All businesses which now use electrical equipment increased or maintained their workforce. The social relationships between business owners and workers are complex and are being further analyzed. However, it can be said that the vast majority of business owners in these villages do not consider adding machinery to reduce labor costs, but rather to increase production and, in fact, increase labor use.

<sup>24</sup> Based on information received in interviews with officials in PLN. Solo, the branch headquarters for the area including District Klaten. No business person knew of the option to use single-to-three phase converters.

<sup>25</sup> The types of service-providers in the village are: tailor, sawmills, rice mills, battery rechargers, radio repair, car repair, bicycle repair. Types of industries are: makers of furniture, *kerupuk*, tofu, clothes, building materials, ice, bread, pottery, woven bamboo mats, nets, printed materials, plastic bags, pastries; also milk producers and tobacco curers.

**Table 11**  
**Businesses use of electrical equipment and diesel motors**

“Is a refrigerator used by this business?”  
 “Is a T.V. used by this business?”  
 “Is electricity used in the production process? Do not include lighting.”  
 (If answer “yes”) “What kind of equipment is used?”  
 “Is any fuel besides electricity used for equipment here? Do not include lighting.”  
 (If answered “yes”) “What kind of fuel is used?”  
 “What equipment is used with that fuel?”

Type of population	Total population	Respondents reporting using electrical equipment	Respondents reporting using diesel motors
Total sample of businesses	100% (123)	15% (19)	15% (19)
Total sample of production businesses*	100% (85)	19% (16)	22% (19)
Total sample of commercial businesses†	100% (38)	8% (3)	0

\*Production businesses are 69% of the total business sample.

†Commercial businesses are 31% of the total business sample.

tive use of electricity will require fundamental changes in the RE program.<sup>26</sup>

There are three important reasons why businesses continue to adopt diesel motors. The first is cost. All diesel motors which were being used in the businesses were 6 HP or more. As mentioned earlier, that size motor requires three-phase electricity, and PLN's charge for installation of three-phase renders it an infeasible option for village businesses. In fact, one village business continues to use a 125 kVA electricity generator. Another businessman is waiting to use a new piece of machinery until his newly-purchased diesel motor arrives. Business people like these refrain from substituting electricity for diesel power because

installation costs are too expensive. The tariff is also disadvantageous, both for businesses requiring three-phase and those requiring more than 1,250 W in single-phase. This is particularly true in the context of subsidized rates for petroleum fuels and considering the higher cost of electric motors of equivalent horsepower. 21% of business respondents who felt that there was electrical equipment which could be used advantageously in their business reported that they did not use that equipment because “electricity is too expensive.” (See Table 12.)

The second reason is lack of information. Business people had received no information on comparative costs, maintenance requirements, *etc.* for electric as

<sup>26</sup> This discussion obviously assumes that development of productive uses of electricity by businesses, including substitution of diesel power by electrical power, is socially profitable. It is beyond the scope of this paper to assess the validity of this assumption. The objective of this study is to determine how RE projects which have been approved by governments and funding agencies can best attain their stated goals. For the purposes of this paper, it must be assumed that those governments and agencies have carried out their responsibility in conducting feasibility and cost/benefit studies, and that the goals have been demonstrated to be socially profitable.

**Table 12**  
**Business respondents reporting**  
**"there is electrical equipment which could be used to advantage but is not yet used"**

"Is there a way electricity could be used to advantage in this business, but is not yet used?"  
 (If answered "yes") "What is that use? State the electrical equipment"  
 "Why don't you use electricity in that way?"

Type of population	Total population	Respondent reported "appropriate" equipment is 5 horsepower or less	Respondent reported "appropriate" equipment is more than 5 horsepower	Reported reasons for not using "appropriate" equipment:			
				Lack of money/capital	Insufficient demand	Electricity too expensive	Other reasons
Business respondents reporting that there was electrical equipment which could be used to advantage in the business, but was not yet used*	100% (52)	69% (36) <sup>†</sup>	29% (15) <sup>†</sup>	42% (22)	27% (14)	21% (11)	10% (5)

\*This group is 42% of the total business sample, 100% (123).

<sup>†</sup>One business did not state type of equipment.

compared with diesel motors.<sup>27</sup> Nor was there an outlet to which business people could go for more information on electricity use. While they might be able to obtain some information from businesses in the city which sell electric motors, they are wary of the objectivity of such information sources. Furthermore, they have not, as yet, any reason to go to such lengths for information on electric motors. Many are completely uninformed, or misinformed (*e.g.*, those who think electric engines come only in small sizes because they have only seen those sizes, or those who believe that electric motors are not as "strong" as diesel and that they would have to buy a much larger

horsepower electric motor for equivalent power). Diesel motors are generally the only rotary power village business people have ever seen (other than for small appliances), and the only kind of motor with which they have any experience.

The "information gap" extends to the amount of power available to the business. For administrative reasons, PLN bills show the installed load capacity to be 450 W. Actually, all RE consumers have 1,250 W available. Almost every respondent believed he/she was limited to 450 W, and behaved accordingly. One businessman had *three* meter systems installed in his business because he felt he needed 1,300 W. He is hav-

<sup>27</sup> Likewise, no business person knew of the option to use a single-to-three phase converter. This absence of information was true as of February 1981. There is a "productive uses consultant" recently stationed in Klaten by USAID. Presumably he will include an information component in his program to assist development of productive uses. However, resources, jurisdictional, and "contacts" limitations may prevent that consultant from developing the administrative mechanisms which would be necessary to ameliorate the problems of program unresponsiveness, at least in the near future.

ing difficulty now because his electricity bills are high and he must continue to use his diesel motor which is larger than 5 HP.

The billing system is a mystery to almost all respondents. They do not understand how much of their bill reflects use, and how much installation. Consequently, they do not know the marginal costs incurred for using higher wattage lightbulbs or small electrical equipment.

Several business respondents said they would not use electric motors because of past experience with electricity. Their comments reflect another example of misinformation. Although the RE system (220 V) has, thus far, a very good reputation, the "town" system (110 V) apparently often experiences power failures. Some business owners conceptualize the 220 system as a kind of "machine" which, although running well now, will begin to "break down like the town system."<sup>28</sup> This perception dissuades them from considering the use of an electric motor even though their diesel motors break down frequently.<sup>29</sup>

The third reason for non-adoption of electric motors is lack of capital. For many businesses, lack of capital was a major obstacle to their use of electrical equipment. 42% of all business respondents said that there was electrical equipment which could be used advantageously in their business, but which they did not yet utilize. For 29% of those respondents, "appropriate machinery" was an electric motor larger than 5 HP.<sup>30</sup> For 69%, "appropriate machinery" was a small electric tool or appliance. The reasons given by those respondents for not using electrical equipment which they perceived as advantageous reflects the issues discussed above. 42% said that they lacked the money/capital to buy the equipment; 27% felt that demand

did not justify their investing in the equipment; 21% said electricity costs were too high; 10% gave other reasons.<sup>31</sup> Table 12 presents summary data on businesses reporting that there is electrical equipment which could be used to advantage, but is as yet unutilized.<sup>32</sup>

Of course, the response "lack of capital," given as the reason for not buying electrical equipment, does not necessarily mean that if loans were made available businesses would use them for electrical equipment. That response must be considered within the context of the overall village business situation. 50% of all business respondents reported that lack of capital is the most important obstacle to increasing their sales and production. They perceive themselves to need more capital for a variety of inputs. Thus, it is important to scrutinize the relationship between "lack of capital" and potential electrical equipment use very carefully. For the Klaten survey, the attempt was to approach this relationship from another angle. Businesses were asked how the government could best help them. 56% replied "with capital/loans." 67% of those respondents were production businesses; 33% were commercial businesses (see Table 13). The production business respondents who reported wanting help with capital were asked how they would use the capital if loans were forthcoming. 22% said they would use capital to buy electrical equipment or tools. 17% said that they would buy diesel motors. 50% said they would use the loans for purposes other than machinery or tools, e.g., materials, stock. In sum, as shown in Table 14, 12% of all production businesses appear to be interested in increasing their use of electrical equipment if loans were made available to them. However, another 9% of production businesses still appear likely to purchase diesel rather than electric

<sup>28</sup> Actually, of course, the problem with 110 V was related to overloaded power supplies, a situation which has been remedied with the additional capacity provided by a new power station.

<sup>29</sup> Businesses with diesel motors reported frequent machinery breakdowns, averaging 1-2 times a month for at least an hour.

<sup>30</sup> Some respondents specified electric saws as the type of machinery which was appropriate for their business but not yet utilized. It is possible that saws of less than 5 HP would be adequate for these businesses. It is also possible that if a feasibility study showed electric saws a worthwhile investment, an effective way of providing that capacity would be to develop a cooperative effort among several furniture makers to purchase and maintain one electric saw.

<sup>31</sup> These data indicate another obstacle to electricity use: limited markets. However, it is far more complicated and difficult to help develop village business marketing than to lower electricity costs, provide information and provide loans. In the view of this author, marketing assistance is beyond the capability of LDC RE programs in most cases; certainly in the case of the Klaten program. It is important for RE to focus on the areas appropriate to its resources.

<sup>32</sup> It is extremely important that assistance be rendered in a knowledgeable manner. Some businesses may think certain equipment would be advantageous, when, in fact, it would not. A comprehensive approach to helping businesses use electricity profitably is required. Such an approach would consider the business's overall situation, and whether inputs are necessary *before* electrical equipment can be used profitably, as well as the inputs required to obtain electrical equipment. Thus, marketing assistance may be necessary before loans for equipment are considered. Ideally, the RE program can either provide the necessary assistance or direct the business to another source of assistance.

**Table 13**  
**Business respondents wanting government help with loans**

“How can the Indonesian government best help this business?”

Type of population	Total population	Production businesses**	Commercial businesses†
Business respondents reporting government can best help with loans/capital*	100% (69)	67% (46)	33% (23)

\*This group represents 56% of the total business sample, 100% = 123.

\*\*Service providers, manufacturing, and other industrial businesses.

†Stores, restaurants, *warungs*

motor power.

Thus, a significant portion of potential productive uses goes undeveloped: use by business owners who are using or plan to use diesel fuel for rotary power, and business owners who feel that electrical equipment would improve their business, but are prevented from buying the equipment due to lack of capital or are deterred by the cost of electricity. This

situation reflects lack of responsiveness to business conditions in the RE program design and implementation. Most importantly, it indicates how lack of responsiveness can actually build obstacles to achievement of project goals into the program design. The Klaten experience also indicates some of the difficulties involved when the national RE program is conducted by a utility company. Because the goal orienta-

**Table 14**  
**Projected use of capital by business respondents wanting government assistance with loans**

“If loans at long-term, low rates were made available by the government to this business, how would those loans be used?”

Type of population	Total population	Responses on ways loans would be used:			
		Would use loan for electrical equipment	Would use loan for diesel equipment	Would use loan for other purposes	No answer/don't know
Total sample of production businesses	100% (85)	12% (10)	9% (8)	33% (28)	6% (5)
Production businesses wanting help with loans/capital	100% (46)	22% (10)	17% (8)	50% (28)	11% (5)

tion, expertise, and standard operating procedure of a public utility are so different from those required for a successful RE project, it is extremely difficult for such an agency to successfully "take on" a national RE program. There has been some tacit acceptance of this fact in the creation in many countries of a special RE agency, separate from the public utilities.

### Conclusion

The Klaten RE project provided a variety of direct and indirect economic benefits. Those benefits which occurred were, however, primarily a consequence of village socio-economic conditions rather than an outcome of project design and administration. In fact, project design obstructed progress toward one major project goal, development of productive uses. Absence of complementary inputs further inhibited the development of productive uses.

The way in which program design affected the development of other beneficial uses has not been examined here. However, program unresponsiveness, particularly the absence of complementary inputs, can be expected to have limited other beneficial uses of electricity as well.

For RE to be successful, articulation of goals is not enough. Accurate field information must be gathered and used in the project design stage. Mechanisms to provide complementary inputs should be an integral part of the project design. Those inputs must be appropriate to the village socio-economic conditions and responsive to villager needs. Interaction between program personnel and villagers is necessary to provide timely information regarding changing needs. Without responsiveness, an RE project becomes a hit-or-miss proposition dependent for generation of benefits on the independent and spontaneous responses of the villagers in the area in which it is implemented.

### Lessons for Small Hydropower Systems

The Klaten experience has lessons for small village hydro systems. Like any other system, village hydro systems require clear goals, responsiveness to the target population, and adequate resources for carrying out project activities. However, the major weakness of the Klaten central grid RE program, lack of responsiveness, may be precisely the area of greatest strength for village hydro systems. The village system is likely to be quite sensitive to villager needs. It can be an important connecting link between the population and local bureaucratic agencies concerned with electricity use and development of rural employment

and income.

On the other hand, the difficulties for village hydro systems may appear in other areas of implementation. One potential problem area for village systems derives precisely from its responsiveness: the possibility of being "captured" by local elites. A village system tends to be more susceptible to this problem than does a centrally-run program because it is more sensitive to village input, conflicts, *et c.* Therefore, it is important for village systems to define goals very clearly, including which populations are to be served toward what end. It may be necessary for some higher level government agency to oversee the activities of the village RE system to ensure adherence to program goals.

The second area of potential difficulty relates to resources, particularly for complementary inputs. The village system is unlikely to have access to many resources beyond those necessary to install and run the system, and disseminate information. The source of complementary inputs like loans will probably have to be other agencies. However, the village system may be able to play a "directive" role, indicating what kinds of complementary inputs are needed and how they should be distributed. Again, there is a problem of the potential "capture" of resources by the local elite. Indeed, the problem is most likely to occur at this stage. Electrification can be designed as an "area-coverage" system which, with reasonable tariff rates, can serve the village widely. Complementary inputs, however, are likely to be limited and distributive. Thus competition is more likely to develop over such inputs than over electricity itself. Where there is such competition, there is always a threat that local elites will appropriate the resources for themselves.

However, with a carefully designed program, adequate resources, and some "overseeing" by higher level agencies, the village hydro system has an excellent chance of developing a responsive system which will serve rural areas well.

### Appendix A

Data for this study was generated in four surveys: (1) a village survey; (2) interviews with the National Electrical Company (PLN); (3) interviews with village leaders; (4) interviews with government officials (including bank officials) at district and sub-district levels. Discussions were also held with USAID officers. Participant observation of the villages was conducted for four months. Extensive examination was made of secondary sources.

The village survey was by far the largest and most

intricate methodologically. It was conducted in the areas of the eight villages which had electricity available. The "village survey" was, in fact, a series of surveys of households, home industries, and businesses. A random sample of the population of electrified households and of the population of non-electrified households and a census of businesses was conducted. 25% (121) of all (484) non-electrified households,\*\* 12.5% (217) of all (1,740) electrified households in the Survey Area\* were interviewed. 92 home industries (all home industries in the sample of households) were interviewed; 62 had electricity, 30 did not. 100% (131) of the businesses in the Survey Area were interviewed; 123 had electricity, 8 did not. A subsection of home industries and businesses were surveyed two to three times.

The methodology of the village survey was designed to identify, through a series of very careful interviews, the economic, social and energy use effects of electrification both independently and in conjunction with other inputs. The data developed for comparative analysis are both cross-sectional (electrified and non-electrified households; electrified and non-electrified home industries; businesses using electrical machinery and those using alternative machinery), and based on respondent recall. Respondent recall was utilized in order to obtain information on actual changes due to electricity use in productivity, income, energy use, and community activity. Memory data is always fraught with uncertainty. Thus, checks of various kinds were made on all memory-recall data in order to develop dependable data. For example, one to two checks were made on all productivity and income data

generated in the business survey. Thus, in the first survey, business people were asked whether, *due to electricity use*, work hours in their business had changed. If they replied in the affirmative they were asked what form the change took and how many hours were added or subtracted, on average, each day for how many days per month. Two months later we re-visited those businesses which reported work hour changes and asked what hours (from what hour to what hour) they had ordinarily worked before electrification and what hours they kept after electrification. The responses from the first survey questions and the second were later compared. The results were extremely consistent.† (The fact that respondents were recalling repetitive actions that took place only 1½ years before no doubt contributed to consistency.) A third interview was conducted one month later, again including all businesses which reported work hour changes due to electricity use. Where there had been inconsistencies in the first two interviews, I talked further with respondents to develop a clear idea of what changes had actually taken place (the results of that third interview illuminated certain aspects of businesses for which hours vary greatly during rainy and dry seasons). All businesses interviewed in the third survey were asked precisely which workers had had changes in work hours, the number of hours/month change for each worker, and consequent changes in wages. We also talked with workers regarding the changes.

This kind of thoroughness was maintained throughout the surveys in order to ascertain accurately changes *due to electrification*.

---

\*The Survey Area included all the areas of the villages where the "model RE" program made electricity available.

\*\*Four of these households could not be interviewed; thus, the total sample was 117 non-electrified households.

†This statement is based on my field observations. Reliability coefficients will be developed in the final report. For home industries, the responses showed greater fluctuation and required more participant observation and discussion with respondents.



**Table A**  
**Samples as proportions of total sampled populations**

Type of population	Total population	Survey sample size
Total population of electrified households	100% (1741)	12.5% (217)
Total population of non-electrified households	100% (484)	24% (117)*
Total population of electrified businesses	100% (123)	100% (123) Commercial = 31% (38) Production = 69% (85)
Total population of non-electrified businesses	100% (5)	100% (5)**

\*Of the 121 non-electrified households designated for the sample, 4 could not be interviewed

\*\*These businesses were interviewed; however, data was not presented in this paper

**Table B**  
**Distribution of home industries in electrified and non-electrified households**

Type of population	Total population	Households with a home industry	Households without a home industry
Total sample of electrified households	100% (217)	29% (62)	71% (155)
Total sample of non-electrified households	100% (117)	26% (30)	74% (87)
Total sample of households	100% (334)	28% (92)	72% (242)

**Appendix B**  
**Table C**  
**Perception of change in schoolchildren's study time**

"If there are schoolchildren in this home, has electricity caused a change in their study time?"

Type of population	Total population	Adopters with schoolchildren replying:*			
		Study time increased	Study time decreased	Study more in afternoon less at night	No change
Total sample sample of adopters with schoolchildren in the home	100% (167)	71% (119)	0	0	29% (48)

\*Adopters replying "no schoolchildren in the home" = 46  
Adopters not replying regarding schoolchildren in the home = 4

**Table D**  
**Perception of benefits from electricity**

To respondents who replied "yes" to the question: "Has electrification of this village brought benefits (other than changes in employment opportunities) to this village?" the following question was asked: "What benefit?"

Type of population	Total population	Respondents naming the following benefits:			
		Village is safer	Village is more pleasant, like a town, more attractive	Village is more active at night	Other
Total sample of households	100% (334)	83% (276)	32% (106)	72% (239)	13% (44)
Adopters	100% (217)	83% (181)	36% (78)	72% (156)	12% (25)
Non-adopters	100% (117)	81% (95)	24% (28)	71% (83)	16% (19)
Businesses	100% (123)	90% (111)	31% (38)	23% (28)	7% (9)

**Appendix C**  
**Table E**  
**Kinds of electricity use to develop business, by businesses**  
**with "RE" electricity and "non-RE" electricity**

Type of population	Total population	"RE" businesses	"Non-RE" businesses
Total sample of businesses reporting business developed due to electricity use	100% (40)	83% (33)	18% (7)
Total sample reporting development due to use of electrical equipment	100% (16)	75% (12)	25% (4)
Total sample reporting development due to increased work hours	100% (15)	87% (13)	13% (2)
Total sample reporting electricity attracts more customers	100% (9)	56% (5)	44% (4)
Total sample reporting development due to other kinds of use	100% (8)	100% (8)	0

# The Assessment and Role of Small Hydropower in Rural Development

Mangalam Srinivasan\*

## Introduction

**T**HE use of hydraulic energy to accomplish tasks in agriculture and crafts is an ancient practice that has been used successfully for thousands of years. This was accomplished by turning a wheel by means of falling water. The advantages of developing hydroelectric resources in general, and small hydro plants in particular, are well-known: we are dealing here with a resource that is continuously renewable, non-polluting, efficient, and distributed rather widely across the globe; we also know that the technology is mature, reliable, offers a flexible operation agenda and involves no fuel costs.

Rural areas of most developing countries have been bypassed by most conventional power development schemes. In those instances where power did come to the villages, it has been mostly for use in agriculture, especially to operate pump sets. The domestic sector, which uses a considerable amount of the total energy used in these countries, is not a beneficiary to most electrification schemes. In recent years there has been an accelerated interest in small hydro development, especially in view of the Chinese experiments which are prolific and impressive, consisting mostly of units of 500 kW or less. Given the immense potentiality that characterizes the rivers and streams in terms of small hydropower<sup>1</sup> the prospects for accelerated social and economic development of the developing nations are sanguine. The problems, therefore, seem to center around the proper assessments of the potential impacts, the methods of analysis and operation, and the formula used for distributing the benefits due to electricity among the

various sectors of the rural population, including rural women.

## The Power Sector and Rural Electrification

Less than 15% of the total rural population of 700 million are beneficiaries of any kind of rural electrification scheme in Asia.<sup>2</sup> The percentage figure varies from region to region, country to country and, within countries, from one state to another. Although governments in developing countries seem, on paper, to recognize the importance of bringing electricity to villages,<sup>3</sup> in actuality, government planners offer many reasons why the plans have not been implemented. Some of the most important reasons given range from low demand for power in the rural areas to great dispersion of peoples in the countryside making it impossible to set up transmission distribution systems, the high costs of production and distribution and the costs of subsidies and of capital.

Electricity is a convenient energy source, universally preferred for domestic lighting. The advent of electricity in a village is usually celebrated with much fanfare by the people of the area. The introduction of electricity to farms means better irrigation systems, and the lighting of streets and homes usually means that the village is economically viable. Not only energy consumption in general, but also increasing electricity consumption itself, exhibits a high degree of correlation to increasing incomes.<sup>4</sup>

Electricity production in Western industrialized countries is generally related to the demand generated for this particular form of energy, although in most developing countries, the lack of electricity production

\* Technical Policy & Assistance Council Center for International Technical Co-operation American University, Washington, D.C.

<sup>1</sup> T. Gilsig, Director, Hydro-Quebec, Montreal, Canada, gives the following estimate: "... the total annual energy of water flowing in the rivers of the world is very approximately, 290 million terajoules. For a variety of physical, technical, economical, and economic reasons, about 35 million terajoules are considered to be ultimately exploitable; this corresponds to 2.2 million MW at 50 capacity factor. Approximately 18% of this ultimate capacity has been developed."

<sup>2</sup> International Bank for Reconstruction and Development, 1975.

<sup>3</sup> The Third, Fourth and Fifth Five Year Plans, Planning Commission, New Delhi, Government of India Press.

<sup>4</sup> H.E. Guyol, *The World Electric Power Industry*, University of California, Berkely Press, 1969. Alan Strout, *The Future of Nuclear Power in the Developing Countries*, Cambridge: MIT, 1977.

is the major reason for the low demand for electricity. Assuming that demand is responsible for production is to ignore natural endowments (in the case of hydro-power, exploitable water resources; in the case of thermal power, available coal resources; and in the case of nuclear power, the availability of uranium) – and also to ignore the policy variables and the political priorities. There are other factors such as investment feasibilities, environmental considerations and foreign supply constraints which may also hamper the production procedures. There are also many ideological problems, such as the national grid versus small hydro-electric power sources, centralized distribution versus local supplies, which plague the national power debates. Many arguments have been advanced as to why centralized electrical supply should not be preferred for rural energy planning and why indigenous and small-scale energy production should be advocated.

The cost of electrification is of course high, especially in the initial years; there are problems of high investment capital requirements during the construction phase, and the low-load factor – all of which contribute to the time of the project and the money costs. The time involved in building the network of transmissions is yet another factor. As regards short-term and long-term costs, it has been pointed out in a World Bank study on "Rural Electrification,"<sup>5</sup> that in the long term electricity supplied from a large grid is less expensive from the point of view of the consumers due to economies of scale. Several studies have shown that the loss of electricity in transmission contributes considerably to the cost of electricity to the consumers. The percentage of such loss has been variously estimated depending on the agency investigating the matter. It ranges from 20% to 50%, and the prevention of such losses has been the subject of study and discussion for some time now. For example, the Rural Electrification Corporation in India has been involved in setting up proper maintenance procedures and better planning to combat energy losses in transmission.<sup>6</sup> Again, these reasons provide us with even stronger grounds for looking more closely at small hydro development.

### Equity Constraints

The whole debate on the cost of rural electrica-

tion is an excellent base from which to study the question of equity in energy planning in the context of urban and rural sectors in developing countries. Rural electrification offers important benefits; many of them are not directly quantifiable in economic terms in the immediate present and future but are vital for the existence of a strong democratic state. Electricity has many uses apart from increasing production in the fields by means of its use in irrigation, *etc.* More importantly, it has to be viewed as an essential item for the progress of life in the villages. The benefits due to safety, sanitation, education and viable rural industry are easily connected to a dependable energy source. Lighting the villages by means of electricity is long overdue and has been neglected because of the differential perspectives in viewing urban and rural needs. At the philosophical level, rural electrification has not been considered as an item which would enhance the modernizing image of the country. In addition, cost calculations are made which show that rural electrification will be an unnecessary and added burden to the country's financial resources. Perhaps if these concepts are changed, ways will be found to improve the situation, and the importance of this source of energy for the villages will be realized. An equitable policy approach to this matter is not only an ethical prerogative, but has also been shown to be an essential condition for the progress of the country as a whole.<sup>7</sup>

Electrified villages hold a bigger promise for multi-sectoral development undertaken by the government in rural areas. A 1977 mimeographed paper on rural industries points out that electrified villages and small towns attract a considerable number of industries.<sup>8</sup> Food processing, crafts and other village oriented industries can function more efficiently and effectively with the use of electricity than they do at the present time using only manual methods.

### Assessment of Benefits

There are very definite benefits to be derived from rural electrification which are separate from those derived from the use of any other source of energy. Some of the most important ones are:

#### In the domestic sector:

- For better lighting, heating and cooking needs.

<sup>5</sup> International Bank for Reconstruction and Development, "Rural Electrification," October 1975.

<sup>6</sup> Annual Reports: Rural Electrification Corporation. Government of India, New Delhi.

<sup>7</sup> Village electrification is an added incentive to keep the rural population from fleeing the countryside. The productive benefits due to electricity are already discussed.

<sup>8</sup> Small Industries Institute, Prospects for Modernizing Rural Artisans Trades and Decentralized Small Industries. Hyderabad, 1977.

- For use in home industries. In rural areas, economic activities are maximized from the households where all the members, including children, participate in a given income producing activity. Weaving, crafts and other activities are generally undertaken from the home base. When electricity comes to rural areas, especially to people's homes, presumably it can be used in cottage industries, both to reduce drudge labour and to increase productivity.
- In increased communication and education type activities. Radio and television can be effectively used to impart necessary knowledge of weather conditions, agricultural information, family planning, *etc.*

#### In the rural communities:

- Electricity can be used in schools for education by means of radio and television and by the use of necessary laboratory appliances.
- For lighting in dark, monsoon days and for extra-curricular activities such as theatre, community meetings at night and for adult education.
- In rural clinics for refrigeration of medical supplies, for use of sterilizers, *etc.*

#### In the agricultural sector:

- In irrigating the land by means of pump-sets, tube wells, *etc.*
- For drying the harvest, for processing, grinding, and packaging.

Radios are the only electrical appliances which have made an inroad into the rural areas of the developing world so far. Even the electric iron is a relative rarity. Rural industries mostly run on muscle power. Smithy, carpentry, weaving, pottery, tanning of leather, *etc.* usually involve the use either of human power or animal power. In limited areas, small craftsmen have successfully used electric power to produce more and better items. Because of the effective way in which time is organized, owing to the availability of electricity at designated times every day, craftsmen have been able to produce more in less time, which partly explains the increase in income that they have derived. A large part of the non-industrial uses of energy is in the home. These uses consist of cooking, heating and lighting.

At the disaggregate level, energy uses can be

analyzed as follows:

- industrial uses – smelting, melting, boiling, *etc.*;
- transportational – to move goods and people;
- explorational – finding minerals, water, *etc.*;
- household – cooking, lighting, water heating;
- agricultural – ploughing, seeding, harvesting, milling, packaging;
- constructional – dwelling, grinding, lifting, raising, *etc.*; and
- chemicals – medicine, fertilizers.

Regional characteristics, cultural and religious norms, and resources, often determine energy uses. Accordingly problem dimensions in energy analysis will reflect different sets of needs, and solutions for each region and for each community within these regions; hence the need for disaggregated and demand-based analysis in rural energy planning.

#### Rural Electrification and Public Policy

According to the Overseas Development Council,<sup>9</sup> in 1977 the percentages of village and rural population served by electricity were: Latin America, 23%, North Africa and the Middle East, 15%; Asia, 16%; and Africa, 40%. Given the present rate of expansion of about 1% per year, only 1 in 4 rural inhabitants will live in areas with electricity by the year 2000 and unless incomes increase, for the majority it will still not be affordable at that time. Rural electrification is caught up in various ideologies as to its feasibility and desirability, because of its connections to centralized grids, external dependencies and costs. In addition, the notion that villagers in general, and women in particular, should only be connected to small and basic technologies, crafts, and minimum facilities, persists among policy analysts whose differential outlooks, one for the urban section and the other for the rural section, one for men and the other for women, are being fanned by international experts who have decided to promote the two levels of living in the name of concern for the environment and concern over basic needs of the villages in the developing world. In all of these debates, what the rural people and women themselves want has been overlooked. Those villagers who have had an opportunity to evaluate the benefits of electricity are very impressed with this source of energy.

<sup>9</sup> James W. Howe et al., "South-North Co-operation of Energy for Development." A discussion for the Cairo Energy Workshop on Energy Future for Developing Countries, November 1980.

At the present time, the data on rural electrification are not separated either in terms of the users of electricity or in the context of activities which utilize electric power. Oftentimes, if one transmission line has gone to a village, it is entered into the statistical year book under the title "Number of Electrified Villages". For instance, in India, in the densely populated state of Uttar Pradesh with 1,130,000 villages, electricity is to be found only in 20,000 villages.<sup>10</sup> In many of these villages, village electrification simply means that the farm lands are being irrigated by tube wells. It does not tell us anything about household electrification or other uses of electricity. There is now mounting evidence that villagers in general, and women in particular, want electric energy in their villages. It brings hope to their villages and to their own lives. Village women look at electricity as security that their village will continue to survive. It has also been found that electrified villages often attract educated city people and doctors. So long as village electric supplies are connected to the central grid and the controls are extra-territorial we will continue to hear arguments against rural electrification on the basis of high investment costs.

Of the various energy consuming sectors in developing countries, rural areas are particular candidates for unilateral government policies which involve little or no local participation. The sectors of rural areas which are to be beneficiaries of rural electrification are predetermined by policy. In the case of locally situated small hydro plants such situations may be avoided by determining the purposes and priorities of the projects by means of requirement analyses prior to the inception of the projects.

### **Small Hydro Projects and Energy Needs of Rural Women**

The level and scale of technology coupled with its locational aspects offer small hydro projects the opportunity to be of particular use to some of the sectors which have been overlooked by conventional power development in developing countries.

International energy statistics have so far been merely concerned with commercial sources of energy, and as such under-report the extent of energy consumption in developing countries, where non-commercial and traditional sources of energy make up the ma-

ior portion of the total energy use. Such under-reporting directly reflects on the non-inclusion of the rural areas of developing countries, which are large users of traditional and non-commercial sources of energy in the domestic and agricultural sectors; and it has led to ignoring the animate energy (of which 40 to 80% is being contributed by women) expended in the rural areas. Consequently, the role of women in the development and use of energy, especially in terms of the time spent in collecting, sorting and preparing the fuel material, as well as their own physical labour contribution in the fields, at home and in crafts has suffered gross under-estimation.

The oil crisis has led developing countries to reassess their energy strategies and turn their attention toward renewable energy sources, especially for the rural areas. The sudden interest in traditional and non-conventional sources of energy has spurred research and development activities, and in some cases sources of energy technologies have been introduced in haste without regard to the users, their needs and cultural preferences, and almost entirely without their participation. Even when training has been given and skills have been imparted with respect to the new sources of energy and technologies, women have been totally left out of such processes, except in very rare cases.

According to the UN, 26.4% of the female population are in the workforce, and 70% of the female population live and work in the rural areas of developing countries.<sup>11</sup> In many of these countries, women are also the mainstay of their rural economies. Rural women's work extends to every aspect of life in the rural areas — whether it be in food and agricultural production, food processing and marketing or in road and building construction. Such work is in addition to their regular chores as mothers, wives, and as householders serving large and extended families. In providing these primary needs, women expend considerable energy. For example, in Kenyan villages, women fetch and carry all the water needed for cooking and drinking in households.

### **Important Benefits to the Nation Through Small Hydropower Development**

Rural women have traditionally looked to fuel wood, forest products and forest floor debris for extra

<sup>10</sup> Uttar Pradesh Ministry of Power, 1978.

<sup>11</sup> The International Labor Organization, 1975.

income. It is a common sight in many parts of the developing world to see women walking miles with small bundles of brushwood to market towns to cash in on their hours of labor in collecting wood, twigs and other forest products. But with the increasing monetarization of wood, this source of income for women and their families is being taken over by middlemen and by urban industries. Wood is being sold for profit to urban consumers by men in the rural areas at the expense of domestic needs. The implications in terms of depleted forest resources are well known, not only to government planners and international experts, but to the local people who live closer to these resources. Many traditional cultures venerate their natural resources and consider land and forests as sacred and as legacies to be passed on from generation to generation. They use what is absolutely necessary for their survival, and now even this has become a strain on resources.

In many areas of the world, rural women spend considerable time collecting fuel wood and with constantly receding forests walk many miles to find this most vital resource. Improved stoves may alleviate some of the drudgery involved in collecting fuel by burning it more efficiently and therefore reducing fuel consumption. This economy also saves storage space for fuel. Such factors directly concern the health of women and children and the overall welfare of the family; and reduced consumption of fuel wood saves space, which is at a premium for the rural poor. In many parts of the world, especially in the tropical forests and rain-forests, although firewood collection is highly hazardous, women still have to collect wood and often are required to pay a toll to get into the forest land.

Hoskins presents the epitome of the subject of "women in forestry in developing countries" in these most convincing words:<sup>12</sup>

Women are more apt to be illiterate, the least served by extension services, especially in non-homemaker subjects, may have the least flexibility in time use, have the least mobility, the least financial resources, and may be invisible as to their needs. These facts make it imperative to include a fine tuning in examining the issues in the light of their potential participation. What specific problems do women have in gaining and retaining access to land or use of tree products?

What specific time, financial, or other constraints may have to be overcome to free women to participate? What types of assurances can women have to receive benefits they value from projects?

Household energy makes up a large part of the overall energy use in the developing countries. Women are the substantial users of household energy and as such they are in a position to investigate any opportunity that may exist for fuel conservation and labor-saving through improved or new sources of energy or through the utilization of better technologies. Brown and Smith offer the following assessment of the rural energy scene as it affects women.<sup>13</sup>

In Bangladesh, for example, a recent study found out that over 90% of the hours required for water carrying, fuelwood collection, cooking and the connected activities for paddy parboiling, husking and drying were spent by women. It is changes in just these activities, however, that would seem to offer the highest marginal return through substitution of alternative technologies powered by traditional fuels. In contrast, farm mechanization, chemical fertilizers, pesticides and transport – traditional male concerns – are not likely to be easily powered by alternative means of using traditional fuels. Intermediate are those changes affecting small-scale industrial and commercial activities which are likely to concern both men (machine shops) and women (textile factories). This sexual differentiation may be quite important in understanding the barriers to expanded uses of traditional fuels as well as the structural characteristics of the switch to commercial fuels. To the extent that men make the investment decisions, energy system changes may have a lower priority than they might appear to warrant in the eyes of an outsider concerned with overall technical or labor efficiency.

Rural people in general, and women in particular, adopt to technologies better if they are structurally simple, local in substance, use familiar methods and are of manageable size. Against these criteria small hydro projects have the opportunity to offer maximum benefits.

### Implications for Policy

At the present time the policies, decisions,

<sup>12</sup> Marilyn W. Hoskins. "Women in Forestry." USAID, 1979.

<sup>13</sup> Harrison B. Brown and Kirk R. Smith. "Energy for the People of Asia and the Pacific," published in *Annual Review of Energy*, Vol. 5, 1980.



designs, operation and maintenance of small hydro projects are all in the hands of men, notwithstanding the local nature of their projects. The policy to integrate national energy plan targets with local energy objectives, and with the economic and social development of the country as a whole. This will involve examining each rural energy context by –

- Resources: human and material  
 Means: by which the resources are being developed and utilized  
 Effect: of the various developments on human and environmental ecology with special reference to women.

There are specific inadequacies concerning the data, survey, conventions and indices used to assess rural energy use and development. Insufficient and inconsistent data have distorted both the nature and dimensions of the problem as well as the solutions extended.

### **Methodological Steps Needed to Fully Integrate Rural Issues in Small Hydropower Development Projects**

A complete review and examination of the existing arguments and assumptions governing rural energy uses, sources, technologies and strategies are required. An empirical analysis of demand and supply aspects of these energy applications and their societal impacts as they concern the rural citizens and their life styles, needs to be undertaken. Economic and social analysis of the effects of energy technologies in the rural areas and their viability in relation to the rural family structure, and whether the fuel substitutions are compatible to the type and quantity of cooking and heating activities undertaken by women, need to be studied more thoroughly. An inventory of the type of energy

sources, technologies and applications which have been introduced in the last few years in selected rural areas and how they have impacted on men and women, await further investigation.

Based on the above considerations, policy should establish procedures for:

- how to assess the kind of data required and how to obtain them;
- how to resolve the problems and overcome the obstacles which occur in development projects, so as to utilise more effectively the existing and new energy sources and thereby enhance the quality of life for the inhabitants;
- what actions might be necessary to enlist the participation of women in rural energy decisions, to attract public and private funds to the rural areas to be used for energy resources development, and to improve their technologies for better and more efficient use by women;
- developing infrastructures which might make the contribution and participation of rural people in the energy field economically and socially viable;
- what training and skills need to be imparted to the rural people so that they could make a more effective contribution toward the development of energy systems and technologies for their areas, and could afford greater creative participation in all energy decisions which concern them; and,
- corrective measures which may be needed to alter the existing conditions, arising from inherently discriminatory attitudes toward rural areas, in an attempt to bring about equitable distribution of the benefits resulting from new energy developments.

## Micro-Hydropower Plants in Indonesia

Ibnu Subroto, Muchlison, Amir Datunsolang, Sri Suwardo, Syahrul Arifin, and Payaman Lubis\*

### SUMMARY:

**Site Selection:** *The success of the construction of a micro-hydropower plant is highly dependent on the accuracy of the preliminary study. The first stage in the series of studies involved in the design for constructing a micro-hydropower plant is the site selection study. Thus the site selection study is the first key to the success or failure of the construction of a micro-hydropower plant.*

*In the site selection study for micro-hydropower plants in Indonesia, the general characteristics of Indonesian micro-hydropower plants are always considered. These are:*

- *small capacity, while investment costs are relatively high;*
- *isolated locations; and,*
- *difficult field conditions.*

*The criteria used in selection are:*

- *the capacity which can be provided;*
- *the technical aspects of construction;*
- *the connections between the site and the load centre; and,*
- *the facilities available.*

*The study involves both the technical field, such as hydrology, topography and geology, and the socio-economic field. The implementation of this study is divided into two parts, i.e.*

- *desk study: collecting the processing data; and,*
- *field study: to get to know field conditions.*

*Although in practice there are often difficulties because of limited funds, and the time and workforce available, these should not be made an excuse for not carrying out an accurate study.*

**Hydrology:** *Micro-hydropower plants are usually of the run-of-the-river type, and this is also true of micro-hydropower plants in Indonesia.*

*Since the investment costs are relatively large and a considerable workforce and time are needed for the design and implementation of construction, the maximum amount of useable energy must be taken from the river discharge. In view of this, the hydrological study must be emphasized in order to find out the characteristics and seasonal pattern, and the river discharge in the dry season, together with the characteristics of the river basin in connection with groundwater flow. This is because only a small river basin is involved, and the data required for design is minimal or even totally unavailable. This situation will not change much in the future, and consequently this study and research will become even more important, since it will also involve irrigation and the conservation of the environment.*

*Since there is a great lack of hydrological data for design, the river discharge should be continuously noted up to the last stages of the detailed design, and even in making the technical specifications. Apart from this, it should also be borne in mind that over-design in the civil engineering works with regard to river discharge will only have a small effect on investment costs compared with the losses which might otherwise be incurred.*

**Geology and Geotechnics:** *Local geological conditions are one of the main factors to be considered in selecting a site and establishing the feasibility of a micro-hydropower plant project, since they will have a great influence on the investment costs.*

\*Energy Research Laboratory, Directorate of Technology Development, Agency for Development and Application of Technology, Republic of Indonesia.

Thus in the study stage of a micro-hydropower plant, it is very important to carry out a geological investigation, which is then continued as a geotechnical investigation to determine the mechanical and physical characteristics of the soil. These investigations are carried out in three stages, i.e. the desk study stage, the exploratory stage and the feasibility study stage.

From a complete study, we can obtain a picture of the degree of difficulty involved in project construction. However, this investigation is carried out at different levels in accordance with requirements and in view of the projected capacity of the micro-hydropower plant.

Micro-hydropower plants in Indonesia can be divided into three categories, i.e. large, medium and small. From the geological point of view, these three kinds of micro-hydropower plants have the following characteristics:

- geological conditions are one of the main factors considered in selecting a site for a large micro-hydropower plant;
- geological conditions are not the main factor in the selection of a site for a medium micro-hydropower plant; and since a geological study is not always essential, the study may concentrate more on geotechnical and soil mechanics aspects; and,
- geotechnical conditions have only a very small effect on a small micro-hydropower plant, so the study is carried out using only field observation.

On the basis of the above characteristics, there are certain limits to geological and geotechnic investigations depending on the type of micro-hydropower plant to be constructed. Because of the numerous obstacles encountered, the activities involved in the investigation frequently cannot be carried out as they should be.

**Generating Equipment:** The utilization of hydropower potential using local skills in Indonesia was begun with micro-hydropower plants. The organized construction of micro-hydropower plants in Indonesia was only begun in 1968; up to the end of Pelita III (the third five-year development plan) it is planned to have completed 26,385 kW: 47 units with a capacity per unit of 20-4,000 kW, with 70% of the plants having a locally manufactured turbine unit.

Along with the physical construction of micro-hydropower plants, knowledge of the science and technology of generating equipment has also developed, including: selection of the type of turbine, generator, protection and control system; the standardization of turbine design; manufacture in the factory; quality control; testing and development at the Hydropower Laboratory at Capayung; installation; on-site testing; operation and maintenance, etc.

In the development of turbines for micro-hydropower plants in Indonesia priority is given to the Francis type, followed by the Pelton and propeller types.

It is hoped that this embryonic experience will be a stimulus for future development. The targets to be reached require an increase in the number and quality of specialist staff, an increase in research activity, an improvement in the capability of local industry in the manufacture of hydraulic turbines, and the use of these locally made hydraulic turbines. These targets should be realised in short-term and long-term programmes in a unified way.

**Economic Analysis:** Considering the current price of oil, hydropower plants are clearly more economical than thermal power plants, particularly if it is borne in mind that oil fuel will become more and more scarce and expensive in the future. Because of the varying geological conditions, morphology/topography, hydrology, the distance to the load centre, and economic factors for each site, the unit cost of electric power, both per kW and per kWh, will also vary, as will the Benefit/Cost Ratio (BCR) as well. The purpose of an economic analysis is to find out to what extent a hydropower plant is economic as compared to a thermal plant. From the economic analysis, it is clear that the larger the monthly river discharge utilized, i.e. with the aid of a reserve thermal plant, the more economical the hydropower plant will be.

The reserve thermal power plant itself, since it only operates for about 3 months of the year and at evening peak load time, will have a longer service life than the hydropower plant. In view of the increase in demand, this thermal power plant must always be provided.

## Site Selection

Site selection is defined as a study and investigation carried out in a particular river basin in order to select one or several locations where the available hydropower can be used to generate electric power.

The study here is limited to the pre-reconnaissance stage, and does not include the detailed reconnaissance study, although occasionally in the case of potential sources of large capacity, this pre-reconnaissance study may be carried out more than once.

Micro-hydropower plants in Indonesia have specific characteristics, which include the following:

- because their capacity is low, the investment cost per kW is relatively high compared to the investment for a large-scale hydropower station;
- the micro-hydropower plants in Indonesia are generally located in isolated areas, far from large cities; and,
- they are usually in mountainous areas with difficult terrain, so their construction is generally difficult.

These characteristics are the basis for the idea that there should be a careful study and investigation in order to select a good site before further and more detailed investigations are carried out.

### Selection Criteria

The criteria usually used for selecting a site for a micro-hydropower plant in Indonesia are as follows:

#### Capacity

The generation capacity depends on the discharge and the head which is available. An attempt should be made to ensure that the capacity provided for corresponds with future needs and that the available energy is optimally utilized from the technical and economic point of view.

#### Technical aspects of construction

The structures required for a micro-hydropower plant are not essentially different from the structures for a large-scale hydropower station, the only difference being the smaller scale. Although the construction of these structures can be made as simple as possible, the isolation of the site usually makes carrying out the construction work relatively difficult. In selecting a site, these structures should be planned in such a way that constructing them does not involve heavy work and is in accordance with the local level of technological skill.

## Relationship of the site with the load centre

The site of the micro-hydropower plant should be as close as possible to the load centre. Thus, high transmission costs can be reduced and high power losses can also be prevented. The standard use for determining the maximum length of a transmission line is 5 km for each 100 kW.

### Facilities

The facilities which should be considered in selecting a site are:

- the site should be near the existing main roads;
- there should be good communications between the site and nearby large towns and cities;
- there should be a quarry near the project site, which can be used for construction; and,
- there should be adequate manpower available for construction.

These four criteria should be considered in combination, since in practice it is very difficult to find a site which meets all four criteria well. Using these four criteria as a guide, the site selection study can be carried out.

### Study Activities

The studies carried out in selecting a site for a micro-hydropower plant are of two kinds, a *desk study* and a *field study*. The purpose of the desk study is to collect, study and process the technical and non-technical data obtained, both before and after the field study. The purpose of the field study is to provide visual confirmation of the data obtained concerning a potential source of hydropower and to carry out a general study of field conditions, obtaining additional data to be processed in the desk study.

The extent to which each level of activity is carried out depends on:

- the kind of potential source (river, lake, waterfall, irrigation channel, etc.);
- the capacity which will be provided; and,
- local field conditions.

#### Desk study

The presence of a potential source of water power in an area can be determined from the published literature, on the basis of investigations, or from information received from local government bodies.

The potential source may be a river, waterfall, lake or irrigation channels. The size of the potential which can be utilized to generate electric power de-

depends on the area of the river basin and the topographical conditions. These factors will determine what head can be obtained.

In one river basin, there may be several sites for a micro-hydropower plant, each one having a different discharge and head. By studying the size of the head and discharge, it is possible to estimate the capacity which could be obtained. The formula usually used is

$$P = 7.5 * Q * H \text{ kW.}$$

where:  $Q$  = flow in  $\text{m}^3/\text{sec}$ .

$H$  = head in metres.

Of these various sites, several alternative sites should be selected which appear capable of providing an electric power capacity which would accord with needs.

In order to obtain a description of the topography of the river basin, a topographical map is required. The larger the scale of this map, the easier it will be to study it. The scale of Indonesian topographical maps at present varies according to the region. Topographical maps with a scale of 1:50,000 are available for Java, Sumatra and Irian, while for certain regions of Java maps with a scale of 1:25,000 are already available. For other regions, such as Kalimantan, Sulawesi, Nusa Tenggara and Maluku, there are only maps with a scale of 1:100,000.

With the aid of these topographical maps, the following points, among others, need to be studied:

- the location of each alternative site and its distance from villages which are prospective consumers;
- the possibility that there are other sites which would be more suitable;
- the area of the drainage basin for each location;
- an estimate of the construction which would be required and the lengths of channels, tunnels and penstock, together with the location of the power station; and,
- the condition of the terrain around the site, and any public constructions near it, such as highways, railways, bridges, *etc.*

Rough estimates of the discharge which can be utilized for each location may be made if the area of the river basin is known and hydrological data (such as the rainfall, evaporation, *etc.*) is available for the surrounding area. The value of the head may be estimated from the contour interval. An effort is also made to obtain geological and socio-economic data.

Geological data may be in the form of geological maps of the surrounding area, reports of the results of geological investigations, and notes concerning geolo-

gical events. Socio-economic data are usually sought directly in the field.

From previous experience, we have found that the data obtained is often incomplete. This is particularly true of micro-hydropower plants of small capacity, the site of which cannot be seen on topographical maps, and consequently analysis is difficult. In this case, an attempt is made to obtain clearer information by sending a form containing a list of questions to the local government bodies (see Exhibit A) which, it is hoped, will be able to assist in providing the required information. The list of questions put forward is usually sufficiently complete, since it includes almost all aspects of the selection criteria.

#### EXHIBIT A

##### Micro-hydro power plant technical specifications: pre-data questionnaire.

1. *Location*
  - Village : .....
  - Kecamatan : .....
  - Kabupaten : .....
  - Province : .....
  - PLN. Region : .....
2. *Source of water*
  - 2.1 *River*
    - Name : .....
    - Discharge : .....
    - Source of data : .....
    - Method of measurement : .....
    - Discharge at the beginning of rainy season : .....
    - Discharge during rainy season : .....
    - Discharge at end of rainy season : .....
    - Discharge during dry season : .....
    - Colour of water : .....
    - Condition of river bed : .....
    - Width of river : .....
    - Length of conducting required : .....
  - 2.2 *Irrigation channel*
    - Name : .....
    - Discharge : .....
    - Source of data : .....
    - Method of measurement : .....
    - Discharge at the beginning of rainy season : .....
    - Discharge during rainy season : .....
    - Discharge at end of rainy season : .....
    - Discharge during dry season : .....
    - Colour of water : .....
    - Condition of irrigation channel bed : .....
    - Width of irrigation channel : .....
    - Entry channels required : .....
3. *Head* : ..... metres

4. *Distance from power source to load centre* : . . . . . km
5. *Consumers*
  - Length of roads in consumer area : . . . . . km
  - Number of permanent houses : . . . . . km
  - Number of semi temporary houses : . . . . .
  - Number of heads of families : . . . . .
  - Number of inhabitants : . . . . .
  - Industry : . . . . .
6. *Facilities*
  - 6.1 *Transport of equipment to site (is there already a road; will a road have to be made?)* : . . . . .
  - 6.2 *Classification of land around the site (wet rice farming, plantation of forest)* : . . . . .
  - 6.3 *Materials available near the site* : . . . . .

All the data selected for each location is then studied carefully. By this means, it is possible to make a rough evaluation of which site has the highest economic value. However, this conclusion is still provisional, since conditions in the field also remain to be considered.

For this reason, a field study at each alternative site is a very necessary operation in order to obtain more complete data for further consideration. On the other hand, if the data obtained from the desk study indicates that there is no good alternative site, further study is not needed.

#### Field study

The main purpose of the field study is to provide visual confirmation of the existence of hydropower potential as indicated by the information received. Most investigations of hydropower potential in Indonesia were carried out thirty or forty years ago. Subsequent changes in the life style of the community, affecting the people's environment, make it very probable that the data obtained does not correspond to present-day conditions. Other purposes of the field study are to examine conditions in the field and to seek additional data in accordance with requirements.

The field study will include both technical fields, such as hydrology, topography and geology, and non-technical fields, such as sociology and economics. Field study activity at this stage is still confined to general aspects, and does not deal with detailed problems. The results of the study will be considered in selecting a number of really good sites, the study of which can

be continued into the reconnaissance stage.

Hydrological studies in the field involve the study of the characteristics of the flow, the environment in the drainage area, and patterns of land and water usage, among other factors, in order to ensure the continuity of a discharge which can be utilized. To give a rough reference for the discharge, measurements are carried out at the same time at several places. Occasionally, as a preparation for the reconnaissance study, a water level gauge is installed, the reading being noted by local inhabitants. If required, a rainfall measuring station is also installed. So as not to obtain a false impression of the amount of the discharge, this hydrological study is best carried out in the dry season, because fluctuation of discharge during the dry and wet seasons is very considerable.

It is a great advantage if there are already rainfall measuring stations in the river basins concerned, from which data can be obtained for the last 10-20 years. Analysis of this data can be used to determine the discharge which can be utilized. Interviews with local inhabitants about the condition of the river in the dry season and when it is in flood can also provide material for consideration in planning.

In the case of micro-hydropower plants of small capacity, many of the river basins cannot be studied from topographical maps. Furthermore, there may be no satisfactory data concerning rainfall, so that estimating the discharge is largely based on the results of simultaneous measurements carried out in several places at various times.

The main purpose of the topographical study is to check the size of the head which can be utilized. This measurement can be made by using an altimeter. By studying the topographical conditions, it is possible to estimate what civil constructions will be required for each alternative site, together with the layout of each construction. All the problems which might be faced in connection with local topographical conditions are also studied. Taking photographs will facilitate the recollection of field conditions in processing the data later.

The geological study at this stage is a study of the surface geology, in order to ensure that the selected site and the sites for the buildings are not in the area of a fault or crack, and are stable so that there is no danger of a landslide. If considered necessary, test pits may be dug in order to study the conditions of the soil, in view of the fact that it may later be used as base soil for the foundation of buildings.

In the socio-economic study carried out in the villages which are potential consumers, the following points, among others, are studied:

- the desire of the community for electric power;
- the reaction of the community to the possibility that a micro-hydropower plant will be built, particularly in view of the fact that there may have to be compulsory purchase of land owned by local inhabitants;
- general economic conditions;
- the number of inhabitants and the number of houses/buildings;
- the current position with regard to electrification; and,
- communication facilities with surrounding areas or with the nearest large towns.

This socio-economic data is usually obtained by contacting local government bodies and by interviewing the inhabitants.

Using the selection criteria as a guide, all the data obtained both from the field study and from the previous study is carefully processed. From the results of this processing, it is possible to conclude which of the various alternative sites selected are most economic. Reconnaissance studies will be carried out at these sites later, and in this further study the feasibility can be determined by more detailed calculations. Only after the reconnaissance study will one site be definitely selected to be developed as a micro-hydropower plant.

It is often the case that the results of processing the data indicate only one good site, or even that there is no other alternative, and in the event it is possible to proceed directly to the feasibility study stage. In certain cases, such as that of a small micro-hydropower plant, the data obtained may be considered already sufficient, so that the next stage is a study for detailed planning needs.

The precision of the site selection depends on the completeness of the data which can be obtained. The more complete the data obtained, the more precisely the site selection can be carried out, and further studies will be facilitated. In practice there are often difficulties, including the limited workforce, time and money available, so that there are often errors in selecting a suitable site. Unfortunately, these errors are only realized when construction work is already in progress, or even when construction has been completed.

### Hydrology

In order to estimate the capacity and the energy which can be provided by a hydropower plant, it is first necessary to know the characteristics of the flow

of the river. Thus the first study to be carried out before constructing a hydropower plant is the hydrological study.

The first step in a hydrological study is the desk study, comprising a study of the literature and the collection of data. This data includes meteorological data, which can be obtained from the Meteorological and Geophysical Institute (Badan Pusant Meteologi dan Geofisika), Jakarta. This data gives the location of the station of observation, the rainfall, wind, solar radiation, humidity and elevation.

Apart from this facility, monthly and annual isohyet maps have been drawn up, the accuracy and reliability of which still require further study. In general, the data obtained is very incomplete because of the small number of stations and the short and interrupted period of observation.

It is often possible to obtain additional data from the Agriculture Service, the Estate Service, the Forestry Service and the local government. Other data includes land use and land cover, *i.e.* whether the land is used for rice fields, for irrigation, for settlements, or whether it is critical land, the kind of forest which covers it, *etc.*

A topographical map is needed in order to know the form of the river and its tributaries, and the cross-section and the slope of the river. For catchment areas where there is irrigated wet rice farming (or where this is planned), the bodies subordinate to the Directorate General of Water Resources Development have often already measured and recorded the discharge of the river.

In order to obtain a picture of the characteristics of the runoff coefficient and the base flow of the river, it is necessary to know the type of rock in the catchment area concerned. This data can be obtained from the Geological Survey of Indonesia (Direktorat Geologi), Bandung. At present, 748 river basins or catchment areas in Indonesia are known (see Table 1, p. 321). However, it is not known how many of the total number have a potential which could be used for mini micro-hydropower plants (20 kW), for micro-hydropower plants (20-5,000 kW), medium-scale hydropower plants (5-30 MW) and large hydropower plants (over 30 MW).

Using the data already obtained as a basis, the next step is to get to know conditions in the field, *i.e.* the reconnaissance survey. This stage involves the study of conditions in the river basin, including land use and land cover, the kind of rock and the groundwater in the catchment area, in connection with the factors of base flow of the river and of infiltration, noting how well the topographical map corresponds to

actual field conditions, the existence and use of any hydraulic construction works, *etc.* It is also necessary to visit the rainfall measurement stations in order to observe the condition of the equipment and the recording system.

Where there is a possibility of the site being near a catchment area within which there is already hydraulic construction work, observation and investigation of the kind mentioned above should also be carried out for the catchment area in order to obtain comparative data.

The installation of a water level gauge is necessary in order to obtain river discharge data for several months, particularly in the dry season. For micro-hydropower plants with a fairly large capacity (*e.g.* over 500 kW), this river discharge data should be collected over a longer period. The recording period depends on the other data obtained. It is often possible to obtain meteorological and hydrological data for a site from a local organization, such as the Agriculture Department, the Estates or Forests Services, or the local government. This data is very useful in forming a description of the river discharge which will be utilized.

The flood discharge is also studied and investigated from conditions in the field and information from local inhabitants. Further analysis and processing of the literature and field data obtained is then carried out.

In order to estimate hydrological values and coefficients, several assumptions are required which are obtained from experience and study. The analysis and processing of the data mentioned above will give an estimate of rainfall, evaporation, runoff coefficient, base flow, flood discharge and other factors. It is then possible to estimate the minimum discharge, the mean minimum discharge, the maximum discharge, the mean maximum discharge, the 365-day, 275-day, 240-day and 200-day discharge, the flood discharge, and the 25-year and 50-year flood discharges.

For micro-hydropower plants of small capacity (for example, below 200 kW), it is usually possible to proceed directly from the results of the reconnaissance survey to the feasibility study stage, according to other technical conditions. The results of the calculations mentioned above still only give a general picture of the discharge of the river, which can be combined with surveys in other fields to give the capacity and potential of the selected site. This will then determine whether or not surveys and studies in other fields are to be continued; for the larger the capacity and potential, the more detailed the study and survey should be. Micro-hydropower plants in Indonesia are

mainly run-of-the-river plants, several sites having a lake as a natural reservoir. For this reason, it is necessary to know as much as possible about the characteristics of the discharge, particularly during the dry season, and so the hydrological study will concentrate on the base flow.

The factors which influence the base flow are the topographical conditions, land use and land cover, the structure and characteristics of the soil layer, infiltration characteristics from the top layer, and the groundwater in the catchment area.

Meteorological data for the construction of a micro-hydropower plant of a fairly large capacity (*e.g.* over 2 MW) is usually only available from at most one rainfall measuring station, and consists only of incomplete observed data. For a micro-hydropower plant of smaller capacity, which only receives rainfall from one small catchment area, there is generally no meteorological station available. In view of this, meteorological data available for catchment areas situated upstream, downstream, alongside or nearby must be studied and utilized as well as possible. Appropriate statistical methods must be selected for this purpose.

In view of the difficulties mentioned above, the gathering of river discharge data carried out in the course of the reconnaissance survey should be continued, even up to the time of preparing the detailed design. This will give the most reliable data concerning the discharge.

For a small-capacity micro-hydropower plant, receiving water from a catchment area of no great expanse, *i.e.* approximately 100-200 km<sup>2</sup>, it is impossible, and indeed unnecessary, to make a very precise calculation of the flood discharge. This is because floods can be countered by raising the walls and the sides of the dam a little, giving the dam a height of 1-2 m. For a micro-hydropower plant of large capacity, the flood discharge can be calculated, for example by the Iwai method, with a return period of 25-50 years.

#### **Obstacles encountered and further plans**

As shown above, the hydrological study for the planning of a micro-hydropower plant requires satisfactory meteorological and hydrological data. However, the data available is minimal or even non-existent. The planning of a micro-hydropower plant also demands coordination with planning for irrigation.

In practice, many rivers which have potential sites for a micro-hydropower plant have not yet been considered for irrigation by the organizations concerned. Since Indonesia is an archipelago and the system for collecting data and for planning is not yet well coor-



minated, the surveying and planning will require a large workforce and a long period of time.

The workforce in the field of hydrology at present generally deals with hydrological problems affecting agriculture, for which there is satisfactory data. In view of the characteristics of micro-hydropower plants, which are usually isolated and use a run-of-the-river plant system, there will probably be differences in analysis and calculation of the hydrological data. Because of this, study and investigation is needed, together with discussions and seminars.

Considering that the construction of micro-hydropower plants will continue for the next several decades, and that hydrological data represents the upstream point of a chain of activities in the construction of a micro-hydropower plant, the collection of hydrological data must be carried out in places where a micro-hydropower plant will be built. On the other hand, the selection of a site for a micro-hydropower plant requires activities which are just as difficult.

#### Hydrological study of micro-hydropower plant sites in Indonesia

Sites for micro-hydropower plants in Indonesia are in relatively small river basins. The area of the river basins is on average from 20 km<sup>2</sup> to 300 km<sup>2</sup>. This area is planimetrically measured from topographical maps, which are obtainable from the Army Topographical Service (Jawatan Topografi Angkatan Darat) and from Bakosurtanal, Jakarta. The scale of the topographical maps obtained from these two bodies is on average from 1:40,000 to 1:200,000. Maps of land use and land cover can be obtained from the local government or from the Directorate of Land Use, Jakarta. From these maps it is possible to analyze the vegetation conditions and the type of land use in the river basin. General geological maps and aerial photographs are also needed, if these are available, in order to help in the analysis of flow patterns and the characteristics of the surface soil structure.

Once the position and area of the river basin is known from these maps, it is possible to look for a rainfall measuring station in an area directly affecting the river basin, and which is plotted on the topographical map. However, in practice rainfall measuring stations are scarce, or even non-existent, in river basins where there are micro-hydropower plant sites. In general, they are from 2 km to 20 km outside the river basin.

Obtaining complete rainfall and climatological data is also often made difficult by the fact that the stations are not maintained and installed in an effective network or distribution system. The data includes

that collected by the Meteorological and Geophysical Institute. Up to now, the density of rainfall stations for a given river basin has not been formulated for Indonesia.

According to Varshney in his book "Engineering Hydrology," the number of measuring instruments required is as follows:

0	–	75 km <sup>2</sup>	–	1 measuring instrument.
75	–	150 km <sup>2</sup>	–	2 measuring instruments.
150	–	300 km <sup>2</sup>	–	3 measuring instruments.
300	–	550 km <sup>2</sup>	–	4 measuring instruments.
550	–	800 km <sup>2</sup>	–	5 measuring instruments.
800	–	1,200 km <sup>2</sup>	–	6 measuring instruments.

However, in view of the topographical conditions and latitude and longitude of Indonesia, these criteria are still insufficient in practice. Therefore, in addition to the data available, it is necessary to collect literature in the form of books, research reports, and any other suggestions which can help in the analytical approach used. Only after all this data is complete are calculations made and the data analyzed. The first stage is an investigation of the geographical conditions (*i.e.* the form and conditions of the topography, vegetation cover, geomorphology, flow patterns, and latitude and longitude data), which can be carried out in the field after a desk study.

This investigation gives data for determining the value of the runoff coefficient and is carried out if there is no data available from the installation of a water height gauge in a particular river basin. The climatic conditions in the river basin are then investigated to find out whether it is homogeneous with the area around it, forming one region. This may be done in the field or by using rainfall data and the latitude and longitude data. This has been done at a micro-hydropower plant site in Central Sulawesi. The rainfall data available were as follows: a rainfall measuring station located downstream on the Hanga-Hanga river, 2.5 km from the dam of Hanga-Hanga micro-hydropower plant, recorded an annual rainfall of 1,050 mm. The Pagimana rainfall station, upstream on the Hanga-Hanga, about 15 km from the Hanga-Hanga watershed, recorded an annual rainfall of 1,200 mm. A rainfall station located about 25 km to the east had an annual rainfall of more than 2,500 mm; and to the west/south-west on average more than 3,000 mm/annum. Thus an investigation is needed to determine and analyze the rainfall.

Apart from this, it is necessary to calculate the correlation between rainfall measuring stations and climatological stations located within and outside the

river basin, in order to determine which rainfall or climatological station is the most suitable for the purposes of the calculation. The limits used are as follows:

$r = 1$	= dependent
$r = 0.6-1$	= good correlation
$r = 0-0.6$	= low correlation
$r = 0$	= no correlation

The magnitude of the runoff coefficient is then calculated. This is very important in determining the size of the runoff, or flow of the river. The magnitude of the runoff coefficient is influenced by soil humidity, the area and form of the river basin, the length of the period of rain, the slope of the river basin, the direction of the wind in the river basin, evapo-transpiration, infiltration and percolation of the soil.

Thus the runoff coefficient can be calculated if the discharge data and the data mentioned above is complete. However, if this data is not available, then the only data which can be taken into account is data from the literature, of which two examples are presented in the following Tables:

**Table 1**  
River runoff coefficients\*

Mountain areas with steep slopes	0.75 - 0.90
Hilly country	0.70 - 0.80
Undulating country with shrub cover	0.50 - 0.75
Cultivated flat land	0.45 - 0.60
Irrigated wet rice fields	0.70 - 0.80
Rivers in mountain areas	0.75 - 0.85
Small rivers in flat areas	0.45 - 0.75

\*Based on hydraulic formulae and published by the Civil Engineering Society, Tapan.

**Table 2**  
Values of the runoff coefficient\*

	Slope	Sandy loam	Silt loam clay	Clay
Forest slope	0-5 %	0.10	0.30	0.40
	5-10%	0.25	0.35	0.50
	10-30%	0.30	0.50	0.60
Glassland/ shrubs slope	0-5 %	0.10	0.30	0.40
	5-10%	0.15	0.35	0.55
	10-30%	0.20	0.40	0.60
Agricultu- ral land slope	0-5 %	0.30	0.50	0.60
	5-10%	0.40	0.60	0.70
	10-30%	0.50	0.70	0.80

\*Published in "Hidrologi Untuk Bangunan Air" by Ir. Imam Subarkah, Bandung.

After assessing the runoff coefficient, the average monthly rainfall, the minimum rainfall and the planned-for rainfall need to be calculated. Many methods can be used for these rainfall calculations, but the method generally used in Indonesia is the regional analysis method.

When the rainfall which will be utilized has been corrected and analyzed, the discharge flow is calculated. There are several methods available for calculating the discharge flow, but the Rational methods are normally used.

The result should be checked by installing an automatic water level recording gauge at each site. The data obtained is always evaluated for comparison. The result is analyzed again in detail in order to find the efficiency of river flow, the minimum discharge, the average monthly discharge, the 365-day, 275-day, 245-day and 185-day average discharges, and the 2-year, 5-year, 10-year, 25-year, 50-year and 100-year flood discharges.

Once these values are obtained, suggestions can be made concerning the utilization of various alternative flow discharges for the planned power plant. In practice, on the basis of data concerning discharge from observation and from information at the site, the characteristics of micro-hydropower plants are as follows:

*Kepala Curup Micro-Hydropower Plant (Sumatra).*

Name of river	: Elang
Area of river basin	: 48 km <sup>2</sup>
Smallest calculated discharge*	: 1.5 m <sup>3</sup> /sec
Calculated 100 year flood discharge:	220 m <sup>3</sup> /sec
Smallest discharge from gauge	: 1.7 m <sup>3</sup> /sec
Land use/land-cover in river basin	: primary forest, tea plantations.

Average annual rainfall : 3,300 mm

*Hanga-Hanga Micro-Hydropower Plant (Central Sulawesi).*

Name of river	: Hanga-Hanga
Area of river basin	: 42 km <sup>2</sup>
Smallest calculated discharge	: 0.66 m <sup>3</sup> /sec
Calculated 100-year flood discharge:	10.5 m <sup>3</sup> /dtk
Smallest discharge from gauge	: 0.9 m <sup>3</sup> /sec
Land use/land cover in river basin	: forest and dry fields
Average annual rainfall	: 1,000 mm.

*Maja Micro-Hydropower Plant (West Java).*

Name of river	: Cilongkrang
Area of river basin	: 21 km <sup>2</sup>
Smallest calculated discharge	: 0.6 m <sup>3</sup> /sec
Calculated 100-year flood discharge:	110 m <sup>3</sup> /sec

Smallest discharge from gauge	: 0.65 m <sup>3</sup> /sec
Land use/land cover in river basin	: dry fields and wet rice fields
Average annual rainfall	: 3,600 mm

\*Smallest discharge means the smallest flow discharge encountered each year.

### Hydrological Investigations

The construction of a hydropower project requires a substantial investment. In view of this, every kWh which can be generated from a river must be optimally utilized. For a hydropower project which uses the run-of-the-river plant system (usually micro-hydropower plants) where a reservoir is not needed, hydrological problems require detailed consideration.

Complex and sophisticated hydrological theories, including parameters and components, are intended to give information concerning the characteristics of flood discharge. As is known, there are four systems, each system including several methods. These systems are: empirical models, black box models, simulation or process models, and combined models.

Methods used include: the unit hydrograph model, non-linear routing models, regression analysis, the constrained linear systems (CLS) model, the tank model, simulation or process models, the streamflow synthesis and reservoir regulation (SSARR) model, which is used by the Direktorat Penelitian Masalah Air (Directorate of Water Research) of the Department of General Works, the Stanford watershed model, the Baughton model, the Sacramento model, combined models, and others. These systems and methods require complete hydrological data. The following may be given as examples:

#### *Bakaru Hydropower Station, South Sulawesi*

- |  |                     |
|--|---------------------|
| (a) Number of rainfall measuring and meteorological stations | : 8                 |
| (b) Period of observation                                    | : from 1921 to 1975 |
| (c) River discharge data                                     | : 16 years          |
| (d) Flood discharge data                                     | : 26 years          |

#### *Saguling Hydropower Station, West Java*

- |   |                     |
|---|---------------------|
| (a) Number of rainfall measuring stations | : 89                |
| (b) Period of observation                 | : from 1918 to 1970 |
| (c) River discharge data                  | : 50 years          |
| (d) Flood discharge data                  | : 50 years          |

The possibility of applying the hydrological theories mentioned above should be studied in order to

obtain information on base-flow characteristics in the dry season.

For the construction of a micro-hydropower plant (capacity 25 kW-5 MW), like the construction of a hydropower station, a knowledge of the characteristics of the discharge of the river is essential, and forms the basis for the planning of the project as a whole. In practice, the meteorological data available for planning a micro-hydropower plant is still insufficient, due to an insufficient period of measurements taken at or near the planned site. The construction of a micro-hydropower plant cannot await the records from measuring instruments which are being installed, or will be installed, since the time period involved before construction could start would be too long.

By knowing the characteristics of the discharge of a given river, and by using assumptions or hypotheses which are in accordance with field conditions, it is hoped that the discharge of the river can be optimally used for a micro-hydropower plant.

Basically, the planning of a micro-hydropower plant requires values for the discharge for various periods: Q 65; Q 300; Q 270; Q 240; Q 240 + days. A knowledge of the characteristics of each of these values for the discharge is required, comprising:

- average value;
- minimum value;
- probability of occurrence; and,

**Table 3**  
Known river basins in Indonesia

No.	Island	Number of river basins	Area of river basins (km <sup>2</sup> )	Potential river basins (km <sup>2</sup> )	Potential (MW)
1.	Sumatra	214	410,187.6	239,000	3,082
2.	Nias	11	4,164	3,450	—
3.	Java	111	116,788.5	67,900	3,225.175
4.	Madura	17	4,547.1	2,960	—
5.	Bali	38	5,121.1	3,880	39.5
6.	Lombok	12	4,318.9	2,580	—
7.	Sumbawa	41	14,296.6	8,270	—
8.	Sumba	12	11,198.6	6,270	27.4
9.	Flores	24	14,261.4	8,710	8.6
10.	Timor	12	13,841.1	8,420	28.5
11.	Kalimantan	50	537,436.0	111,821.6	3,047
12.	Sulawesi	128	163,774.7	90,600	2,408.6
13.	Halmahera	8	19,020.3	9,950	—
14.	Baru	6	9,124.7	6,640	—
15.	Seram	13	17,449.6	10,540	—
16.	Irian Jaya	51	284,802.9	144,800	6,680.81
	Total	748	1,630,315.1	725,891.6	18,717.585

- period of occurrence.

A knowledge of the characteristics of river discharge, in conjunction with information on other electric power generation systems, will make it clear that many factors influence and determine the characteristics of the discharge of a river, for example:

1. Geohydrology: soil stratification, structure, characteristics of the soil and other factors (influencing and determining the base flow).
2. Infiltration: land use, structure of the topsoil, condition of the river basin, rainfall intensity, etc.
3. Meteorology: rainfall, evaporation, wind, solar radiation.
4. Land use and land cover: type of forest, wet rice fields, critical land, settlements etc.

It is considered necessary to investigate each of the factors which have an influence.

## Geology and Geotechnics

### Study and investigations for micro-hydropower plants in Indonesia

Geological and geotechnical data are needed in planning a micro-hydropower station in order to:

- determine whether the site selected for the planned project can be regarded as safe and economic from the geological and geotechnical point of view; and,
- determine the most suitable type of foundation and its measurements.

Apart from these two main objectives, there are also other aims: to determine the quality of sand and stone to be used as construction materials and to determine the water tightness of the reservoir basin. However, since the micro-hydropower plants already constructed in Indonesia are for the most part classified as light constructions, with no precise specifications concerning the quality of construction materials, and are of the run-of-the-river type, these two objectives do not apply.

In order to study geological and geotechnical conditions, investigations must be carried out upstream, around the intake dam or proposed reservoir site, along the route of the waterways, and downstream from the powerhouse site (*i.e.* the tailrace). This area of investigation is limited by the extent to which local geological characteristics influence the constructions which will be built there. Apart from this investigation, a study involving the analysis of all data collected is also needed in order to draw a conclusion concerning the two aspects mentioned above.

This study and investigation activity should be carried out in three stages.:

*Desk Study:* This involves seeking and collecting any indications available so as to obtain a general picture of local geological conditions from existing data. The data which can be collected include geological maps, research reports, publications, topographical maps and even oral reports. All the data collected form base data for further investigation.

From the geological map, we can obtain a picture of the surface geological conditions: the types of rock found and their distribution, the origin of these rocks and how they were formed, whether or not there are faults, and even tectonic lines. Apart from this, the literature and oral reports may give an indication of past tectonic activity, its destructive power, and what damage was caused.

Another factor to be considered concerns landslides — where they occurred and what damage was caused. The main points to be considered concerning erosion are whether the river can alter its channel, and the extent to which the river bed has been scoured. The topographical map gives an idea of the local morphology. A connection can then be sought between the form of the area and the kind of rock forming it: whether gently sloping areas are composed of alluvial deposits or not, or whether volcanic areas are composed of tuff or other rocks. Thus as much data as possible should be listed and become the basis for investigations in the field in the next stage.

However, not all the data obtained is reliable. Testing is required using certain methods before the data can be fitted to the actual field conditions. The testing methods used are:

1. comparing the data obtained with similar data, and attempting to obtain logical data; and,
2. comparing topographical data with geological data, and seeking a logical relationship between the two.

*Reconnaissance survey:* This involves a field observation and the analysis of all the data obtained since the initial stage, in order to obtain a more detailed picture of local geological and geotechnical conditions. This observation is a check on the information collected by close range study of the surface conditions in an investigation area. From this, the geological features encountered, *i.e.* the kinds of rocks and their distribution, are re-mapped.

In order to obtain information about conditions below the surface, test trenches or test tunnels are dug, and if necessary soil samples are taken for testing in the laboratory.

From the test trenches or tunnels, it is possible to find the thickness of the surface layer, so that the

depth of the foundations of the construction can be estimated. The results of laboratory tests can give a picture of the physical and mechanical properties of the rocks found in the bottom layer.

When enough data has been collected, it is analyzed in order to find the influence of local geological and geotechnical conditions on the buildings which will be constructed there. This analysis must include the type, structure and characteristics of the rock, and clearly indicate the kind of rock, the depth of consolidated soil which can support a building, its bearing capacity, the permeability and extent of weathering of the rock, the stability of any slopes found, and all the physical and mechanical characteristics which can be obtained for each prospective construction site. An analysis must also be carried out of tectonic activity so as to determine whether any faults found are active or not.

On the basis of this analysis we can determine:

- the most suitable site for the project and the most suitable locations for construction works (dam and intake, headrace, surge tank, penstock pipes, power station, tailrace etc); and,
- the most economical type of foundation and the appropriate dimensions for it.

At this stage, an accurate picture has been obtained of the surface geology, while only a rough impression has been obtained of the sub-surface layers. Thus further investigations are needed, i.e. exploration work. Since by this stage a safe site for the project and locations for the facilities buildings (dam, waterway, powerhouse) have been established, the locations for exploration work, such as the bore and penetrometer point, can be fixed.

*Feasibility Study:* This involves exploration work, laboratory tests of the soil samples, and analysis of all the results of the investigation, in order to find the degree of feasibility of a micro-hydropower plant from the geological and geotechnical point of view. Finally the results of the analysis become the basis for the design of a sub-structure.

At this stage, all the information concerning geological and geotechnical conditions, as explained for the reconnaissance stage, will be made more complete and its reliability tested, particularly for information about sub-surface conditions, since these were either rather difficult to estimate at the previous stage or may not have been investigated.

In order to obtain more complete information about the surface geology, as explained for the reconnaissance stage, there should be further field investigations and analysis concerning the topography and the

connection between this and the kind of rock forming it, the area of the valley or the height of the hills or mountains around it, the pattern of land use, the mechanism of landslips encountered, the direction of these landslips, the rock composition of each layer found, the erosion, etc.

Apart from the relationship between topography and geology, geological phenomena should be investigated, including rapids or waterfalls: whether there is rapid erosion of the river bed, whether there are cracks, whether there are active faults, whether there is water seepage from the hill-side (if present), etc. The causes of these phenomena and their influence on the buildings in the area should then be investigated. On the basis of the above analysis, a conclusion can be drawn concerning the stability of the site observed and the location of the micro-hydropower plant construction works.

In addition, the type and dimensions of foundation can be determined. Investigation of the sub-surface layer is carried out by boring, and if still necessary the digging of test pits, trenches or test tunnels if the rock is not too deep. All this is required in order to discover the layering, composition and classification of rocks, and the characteristics of the soil.

After the above results have been obtained, permeability tests are carried out at prospective dam sites and along the route of the headrace, and the bearing capacity is tested with a standard penetration test (SPT) or a penetrometer (Dutch cone), particularly at prospective sites for dams/intakes, penstock pipes and the power station. Undisturbed soil samples are also taken at certain depths in each bore hole, and are tested in the laboratory so that the physical and mechanical properties of the soil are ascertained. These two properties are important data for sub-structure design.

However, even when construction is already under way, changes in design are sometimes needed, which demand additional or new data. Thus the exploration work is a continuing process.

The table below gives a summary of activities which have to be carried out in a geological and geotechnical investigation for micro-hydropower plants in Indonesia (see Table 4).

### **The Limitations on Studies and Investigations for Micro-Hydropower Plants in Indonesia**

All the study and investigation activity, in the three stages discussed above, is intended to give a general picture needed to achieve a complete, safe, and economical design from the geological and geotechni-

**Table 4**  
**Geological & geotechnical investigation activities**

Investigation activity	Type of test	Classification of test	Method of testing	Foundation material			
				Rock	Soil	Sand/Grovel	
Core drilling	(a) Permeability	1. Field testing	– logeon test	*			
			– examination of bore hole (if soil water level high).	o	*	o	
			– test well method		o	*	
		2. Laboratory testing	tests with:				
			– undisturbed sample (constant head)			o	*
			– disturbed sample				o
	(b) Bearing capacity	1. Field testing	– standard penetration test		*	*	
			2. Laboratory testing	– direct shear test		*	*
			– triaxial test		*	*	
			– consolidation test		*	*	
	(c) Characteristics of soil/rocks	– physical  – mechanical	Laboratory testing	– water content	o	*	*
				– grading		*	*
– specific gravity					*	*	
– Atterberg limit					*	*	
– compaction					*	*	
– standard direct shearing					o	o	
– standard permeability						*	
– consolidation						*	
Test pits and tunnel test	Soil classification			*	*	*	

**Key:**

o: carried out if necessary

\*: must be carried out.

cal point of view. Activities of this kind are mainly needed for micro-hydropower plants of smaller capacity. Only activities which correspond to the essential data need be carried out.

It is known that the capacity of a power plant, in this case a hydropower plant, can also determine the type of construction. In order to indicate the limits in the construction of micro-hydropower plants, Indonesian plants may be divided into three kinds:

1. small micro-hydropower plants: capacity about 25 kW-150 kW;
2. medium micro-hydropower plants: capacity about 250 kW-1 MW; and,

3. large micro-hydropower plants: capacity about 1 MW-5 MW.

Basically, these three types have the following characteristics:

Small micro-hydropower plants require relatively light, simple constructions. The influence of geological characteristics is very slight or almost non-existent, so the condition of the soil and rocks is always regarded as adequate. In general, topographical conditions are good; and they have a small catchment area, so the discharge is small.

In medium micro-hydropower plants, the construction works required are not too heavy. The local geotechnical conditions need to be taken into account,



The geotechnical investigation carried out for the dam and intake of the Hanga-Hanga micro-hydropower plant consisted only of test pits

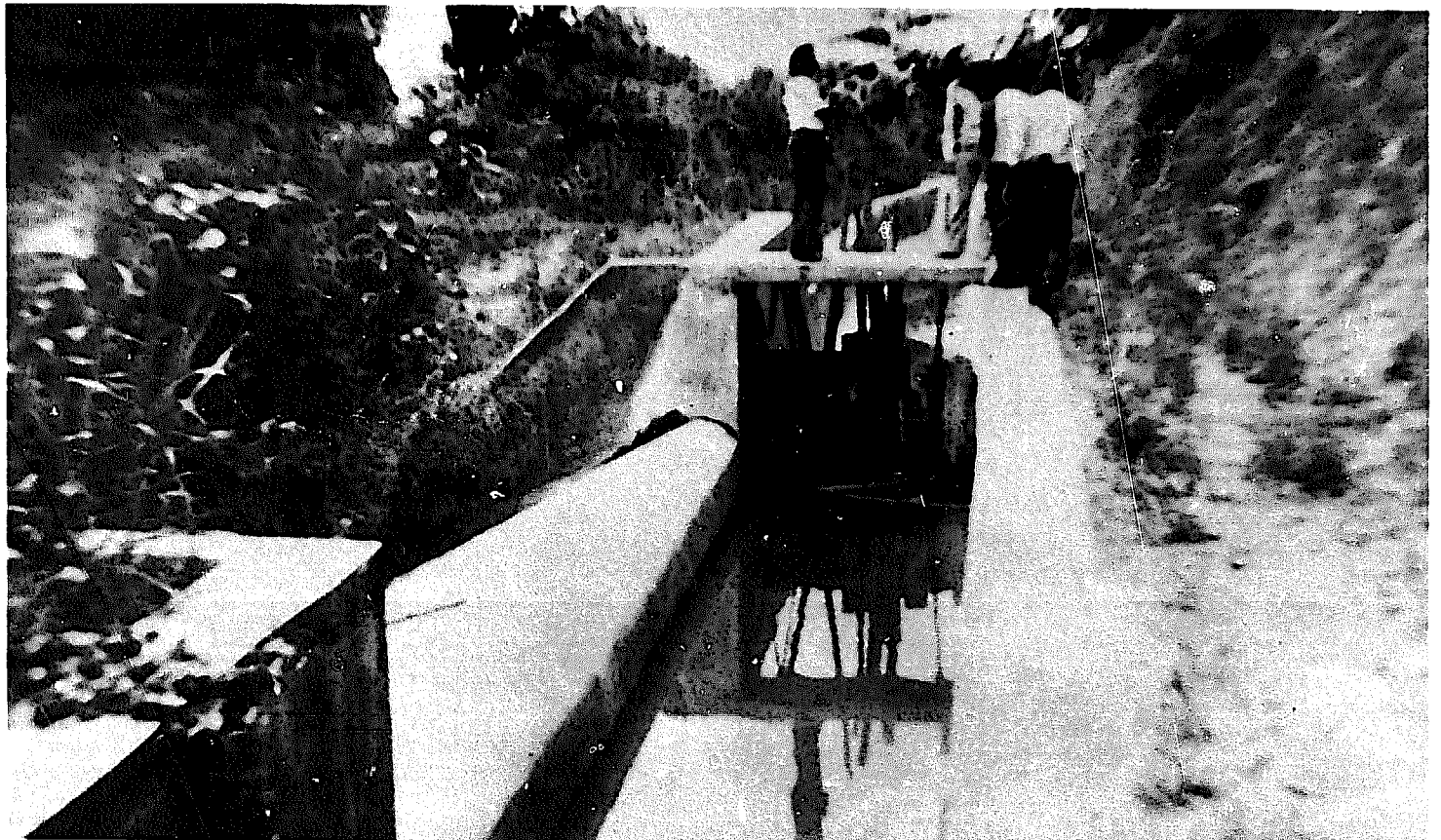

Intake channel and tailrace of the Hanga-Hanga micro-hydropower plant, with satisfactory slope stability. Investigation of the soil was by means of test pits.

**Table 5**  
**Study and investigations for micro-hydropower plants in Indonesia.**

Stage	Class of micro-hydropower plant		
	Small	Medium	Large
Desk study	Study using geological maps not required; sub-surface investigations started directly <i>i.e.</i> penetrometer tests at prospective construction sites. In general, desk study not needed.	Desk study carried out to determine type of rock in investigation area, erosion, landslopes around planned site. For micro-hydropower plants with a capacity of 500 kW-1WM, the desk study must be more detailed.	Desk study must be carried out with as much data as possible.
Reconnaissance survey, (R.S.)	R.S. not necessary. Field observation to study local soil conditions (marshy, firm, rocky <i>etc.</i> ).	Should be carried out so that rough estimates can be made of measurements and type of sub-structure construction. This is necessary since the economic aspect of the construction plant is already given more importance. The physical and mechanical properties of the sub-soil receive top priority.	Must be carried out.
Feasibility study.	Feasibility study not necessary.	Should be carried out, but from the geological and geotechnical points of view can be limited in accordance with the problems mentioned for the R.S.	Must be carried out in full.

while local geological conditions only form secondary data. The site selected is one where topographical conditions are *good* or *moderate*. Thus topographical conditions are always taken into consideration in determining the site, so that sites where the conditions are difficult have to be abandoned. They have a fairly extensive catchment area, so that there is a moderate discharge.

Large micro-hydropower plants require relatively heavy construction works, so the construction of the foundation may be expensive. Geological and geotechnical conditions will be a major factor in site selection; but difficult topographical conditions are not always a consideration in selecting a site. For example, if necessary (depending on the topography), tunnels for water flow may be justified although they require larger funds. They have a large catchment area, so that the river discharge is also large.

On the basis of this classification, the level of study and investigation required can be categorised as shown in Table 5. However, the characteristics of one type of micro-hydropower plant are not always the same; there may be variations depending on topographical, hydrological and geological conditions.

An example is the Angkup micro-hydropower plant, which has a capacity of 375 kW ("medium type"). In spite of this, on the basis of topographical, geological and hydrological conditions, this plant should be classified as "large".

The local geology shows an extensive distribution of hard rocks near the surface, so the plant must be sited above these rocks. Because of this geology, the topography is such that the slopes at the site and around it (such as the line of the penstock pipes, the site of the powerhouse, *etc.*) are steep. Thus initially excavation must be carried out with explosives, particularly for the route of the penstock pipes and on the site of the powerhouse. Topographical conditions at the site of the powerhouse are difficult since it is on a steep river bank, so the foundation base is at a depth of 4 m below the river water level. This micro-hydropower plant has an extensive river basin, so for the discharge available the capacity provided would be classified as "large". However, because the type of turbine installed is one that does not use the discharge to the fullest extent, the capacity is in fact classified as "medium".

A different situation is found at Muara Labuh



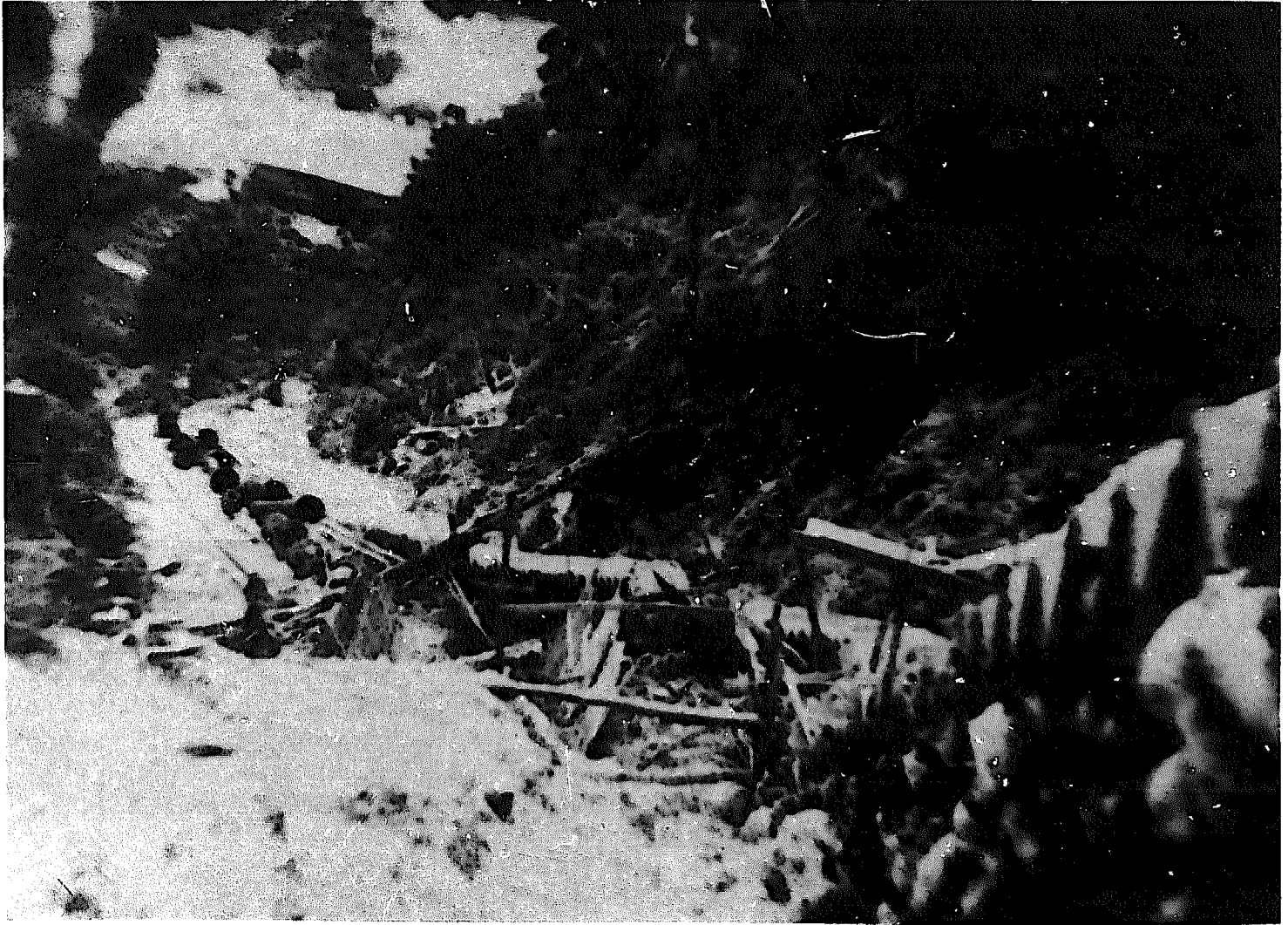

Route of penstock pipes for the Hanga-Hanga plant with work in progress. The conditions, limestone rocks and a relatively steep inclination, make a heavy construction necessary. Soil investigation was by test pits.

micro-hydropower plant. This plant has a capacity of 400 kW ("medium" type). For several reasons, local geological conditions are treated as for a "light" type of plant, i.e. there is only a superficial observation in the field, without sub-surface investigations. Furthermore, the observation is only made for the purpose of studying the local topography. As it happens, conditions correspond to those for a medium micro-hydro plant; for example, difficulties were encountered along the route of the penstock pipes, where some of the rock was in the form of boulders, so excavation work was made difficult. However, the mechanical properties of the soil layer did not greatly differ from the original estimate.

#### **Applications of Geological and Geotechnical Studies for Micro-Hydropower Plants in Indonesia**

Implementation of the geological and geotechni-

cal studies described are very difficult because of the many obstacles encountered.

Obstacles frequently encountered are:

- the shortage of experienced personnel, particularly in the field of geology and geotechnics;
- the short time available between the planning stage and the construction stage; and,
- difficult topographical conditions, so that carrying out field investigations, particularly exploration work, is very expensive.

Experienced personnel are a guarantee that an investigation will be carried out in a satisfactory manner. It is common knowledge that field and laboratory investigations of geological and geotechnical conditions can be costly. Thus the investigation must be accurate to the greatest extent possible for the sake of reliability and cost effectiveness.

On the basis of these considerations, no investigation of soil conditions by boring and laboratory investigations is carried out for small micro-hydropower plants, or even occasionally for medium micro-hydropower plants – for example the Bajawa, Pontak, Maura Labuh and Talangkrasak plants. Data for sub-structure planning is based on assumptions drawn from surface investigations and observations.

The limits for funds required for surveying, study and design have usually already been fixed, *i.e.* about 5%-10% of the costs of the project. It will be appreciated that the investigation which can be carried out with such funds is limited, particularly for small and medium micro-hydropower plants.

Examples of plants where the investigation procedure was reduced to a minimum are the Bajawa micro-hydropower plant (150 kW) and the Pontak micro-hydropower plant (60 kW). In planning, the soil was assumed to have normal characteristics, an assumption which is often made in planning foundations for houses. This assumption was made without even seeing the sub-surface layers of soil, let alone classifying them.

The same was true for the Muara Labuh micro-hydropower plant (400 kW). No geological or geotechnical investigations were ever carried out. On the basis of an estimate of the type of soil supporting the foundations, it was assumed that the soil had a normal bearing capacity. This assumption was strengthened by the fact that there were micro-hydropower plant buildings of almost the same weight near this site. These buildings dated back to the period of Dutch rule.

The case of the Talangkrasak micro-hydropower plant (250 kW) was somewhat different. Geological and geotechnical investigations were only carried out when construction was already under way. When the design was drawn up, the calculations concerning sub-surface constructions (foundations) were based on estimated data, as in the other cases above. Measurements with a penetrometer carried out later at the location of the powerhouse, penstocks and weir were intended to re-investigate the assumptions concerning soil conditions which were made in designing the schemes.

Geological and geotechnical investigations basically require a lengthy period of time if reliable results are to be obtained. The fact that these investigations were not carried out during the design period of the Pakis Baru micro-hydropower plant (150 kW) was an example of the consequences of the lack of time available before construction had to start. The government felt it necessary to press for the project to be

implemented as quickly as possible. In view of this policy, and the technical consideration that the constructions were relatively light, the soil was assumed to have normal characteristics, as is assumed in the design of houses.

For almost all small or medium micro-hydropower plants constructed on difficult terrain, the topographical conditions were one reason for not carrying out a field investigation. Getting bore or penetrometer apparatus to the site would be very expensive in relation to the funds available.

The easiest way to carry out exploration work is to dig test pits or test tunnels. These two operations are intended to find the depth of consolidated soil for foundations, or to test the bearing capacity of the soil layer where the foundation base will be placed.

Samples of both disturbed and undisturbed soil can be taken from these holes if the characteristics of the soil genuinely need to be ascertained. This was the case at the Hanga-Hanga micro-hydropower plant (1,000 kW). The required exploration work, using a penetrometer and boring, was not carried out because of the difficult terrain, which made it impossible to get the equipment to the site. The only work possible was the digging of a test pit to a depth of 4 m. From the results of this test pit, the depth of the foundation base for the construction works could be determined, and by classifying the soil type, the mechanical and physical properties could be estimated.

Since a micro-hydropower plant with a capacity of 1 MW-5 MW requires relatively heavy construction works, all the data required for the sub-structure design and stability analysis should be obtained, insofar as this is possible. Lack of this data will increase the risk factor, particularly the risk of damage from geological activity, since the influence of local geological characteristics on the heavy construction will be greater.

Thus for large micro-hydropower plants, such as those at Banding Agung (2 x 4 MW), Kepala Curup (1 x 1 MW) and Poigar (2 x 1 MW), the investigation should be as complete as possible (as shown in the summary of activities in Table 4), from the desk study and reconnaissance survey stages to the feasibility study stage. In short the study and investigation activities for these large micro-hydropower plants are not influenced by the obstacles mentioned above.

#### Suggestions

The micro-hydropower plants constructed in Indonesia up to the present have various capacities and are classified as small and medium. As explained, there is no complete data from geological and geotech-

nical investigations available for most of these plants. However, the number of micro-hydropower plants suffering damage as a result of soil conditions is still small compared with the number of plants in existence. Damage has only occurred at four micro-hydropower plants, including the three sites taken as examples below:

*Tonjong micro-hydropower plant:*

- slippage of headrace channel banks;
- subsidence of powerhouse caused by land settlement and,
- sedimentation of intake caused by erosion/landslips downstream near the weir.

*Tenga micro-hydropower plant:*

- slippage of headrace channel banks. Here there was a danger of the channel being cut since it ran along steep slopes.

*Bajawa micro-hydropower plant:*

- because of the topographical conditions, part of the headrace channel had to run along unlined artificial tunnels.

Leakage of water through the cracks of rocks is a problem; the extent of leakage is not known. The small amount of damage indicates that the assumptions used for sub-structure design concerning local geological and geotechnical conditions can still be relied upon for small micro-hydropower plants. However, these indications cannot be fully relied upon, so further proof is still needed. Thus, in future, for small, medium and large micro-hydropower plants, the quality of study and investigation must be improved, particularly in the field of geology and geotechnics.

For this purpose, efforts should be guided by the following:

- geological and geotechnical investigations should be carried out in accordance with requirements in order to obtain a better and more reliable design and improved safety with regard to the influences of soil and rock characteristics;
- when faced with technical or other obstacles, at least minimal investigations should be carried out, even though using simple methods. In this way, the assumptions used are always based on the true soil conditions, even though only an approximation, so that the risk of damage is reduced;
- additional experienced personnel are needed so that study and investigation in this field can be carried out as well as possible and

satisfactory results can be obtained. The skills of existing personnel should be upgraded, and discussions and other similar efforts should be more frequent; and,

- it is hoped that Indonesian contractors, particularly contractors in the field of civil engineering for micro-hydropower plants, will involve personnel who have a good knowledge of geotechnics and geology. This is necessary so that the contractor can be sensitive to any inappropriateness in the design with regard to the actual conditions (where there have been no investigations). If so, the work can be stopped immediately and a way out sought so that prospective damage can be prevented or at least reduced.

## Generating Equipment

### Civil engineering aspects

In Indonesia, there are various "forms" of potential micro-hydropower plants, from low head (large Q) for use in lowland areas and agricultural areas, up to high head, for use in mountain areas. Priority in the utilization of this potential is given to projects which are the most economical and feasible, and which lend themselves to technical implementation in the near future.

In lowland areas, there are indeed more prospective consumers; but the civil engineering works will be expensive, since a large Q requires a large dam. Furthermore, these conditions demand generating equipment which is technically complex and expensive. However, this potential is economically viable if combined with an irrigation programme.

In mountainous regions, where there is medium- and high-head potential, consumers are usually scarce compared with areas of low-head potential. However, both the civil construction work and the manufacture of the generating equipment (particularly the turbine) are cheap and simple.

In Indonesia, priority is given to the construction of micro-hydropower plants in areas where there is medium- or high-head potential but where consumers are relatively numerous.

### Kind and type of turbine used

In accordance with conditions and civil engineering data, micro-hydro powerplants in Indonesia frequently use a Francis spiral case, horizontal shaft turbine. At some sites, other kinds of turbine are used, such as: Pelton, Kaplan, Francis, open flume, tu-

bular (propeller) etc.

Data concerning micro-hydropower plant sites in Indonesia and the type of turbine used can be seen in Appendices I-VI.

The use of the Francis turbine is considered to have many advantages:

- a fairly extensive range, from 10 m heads to 150 m heads of which Indonesia has an abundance;
- simple and reliable construction; and,
- a satisfactory efficiency curve.

In order to meet the need for micro-hydropower plant turbines with varying data ( $H$  and  $Q$ ) in large numbers, quickly, easily and economically, turbine designs have been standardized to a certain degree. Standardized turbines for micro-hydropower plants in Indonesia are at present limited to standard  $n_s$ , i.e. several turbines have been made as prototypes having various  $n_s$  values (see Appendix I).

From these prototypes, it is clear that turbines can be made by enlarging or reducing their measurements in accordance with requirements. For a site with a known  $H$  and  $Q$ , the turbine used is selected from a standard  $n_s$  (specimen turbine) in such a way that for a given value of  $H$ , a size is obtained which can use the field  $Q$  to the best possible advantage.

Selection is based on the following equations:

$$\frac{N}{N_1} = S^2 \left( \frac{H}{H_1} \right)^{3/2}$$

where  $N$  = power at  $H$   
 $N_1$  = power at  $H_1$

$$\frac{Q}{Q_1} = S^2 \left( \frac{H}{H_1} \right)^{1/2}$$

where  $Q$  = discharge at  $H$ .  
 $Q_1$  = discharge at  $H_1$ .

$$\frac{n}{n_1} = \frac{1}{S} \left( \frac{H}{H_1} \right)^{1/2}$$

where  $n$  = optimum r.p.m. at  $H$   
 $n_1$  = optimum r.p.m. at  $H_1$

Compared with the fully standardized system, the above system has several advantages:

- it is better able to make use of the field data than the fully standardized turbine;
- for a need which is not yet large it does not disturb the construction schedule; and,

- although based on standard  $n_s$ , if calculations show that the turbine required is close to an existing size (design plant), the existing turbine can be used, thus the standardization of  $n_s$  is developed to become a full standard ( $n_s$  and size).

### Generator, transmission and electrical equipment

As is known, the r.p.m. of a generator has a value which depends on the number of poles, in accordance with correlation.

$$n_{gen} = \frac{60f}{p}$$

where  $f$  = frequency;  
 $p$  = pole number

As a consequence of turbine standardisation, the r.p.m. of the turbine selected is usually not the same as the r.p.m. of the generator. There are two alternative methods of overcoming this difference in r.p.m. The first is to use a gear box or belt and pulley for transmission so that the still operates at its optimum r.p.m. The second method is to select a generator which has an r.p.m. as close as possible to that of the turbine, and to connect it directly. Thus the turbine will be forced to have the same r.p.m. as the generator, which is not its optimum r.p.m. This choice is only economical if the reduction in power as a result of the divergence from optimum r.p.m. is less than the price of the gear box, or of the design cost if one is tailor made.

The choice between these two alternatives is a financial problem. For a micro-hydropower plant of small capacity (500 kW), a gearbox or belt-drive is usually chosen. A cheap generator, or one which is common on the market, is selected. Usually, this generator runs at 1,000 r.p.m., 380 V, 3 phase A.C.

For greater economy, generators may be ordered in bulk for several sites with varying turbine r.p.m. values, and only then is a gearbox or pulley sought to match the r.p.m. For a micro-hydropower plant of large capacity (1-2 MW), a generator which has a speed as close to that of the turbine is selected and it is directly coupled. A gearbox to handle this power would be too expensive.

It should be borne in mind that the r.p.m. of the turbine and of the generator should be as close to each other as possible when selecting the kind and size of turbine, so that apart from utilizing the field discharge to the best advantage, it should also have an r.p.m. as close as possible to that of a standard generator. Control panels, transformers, protective relays etc.

are ordered on the basis of technical specifications previously established.

### Safety and Control

In general, micro-hydropower plants in Indonesia are still isolated. For a small capacity plant of 25 kW, control is usually manual. For a larger plant, particularly those already interconnected, control is automatic, using a governor. The function of the governor is to maintain a constant r.p.m. (frequency) with changing load.

There are two basic types of governor. The first type controls the guide vanes to regulate the volume of water entering the turbine, so that there is a balance between output and input. The second type uses the "brake" system, the brake functioning to absorb the surplus output of the turbine and the network load with fixed guide vanes.

For a plant where field conditions result in a relatively long penstock compared with the head, the "surge" or water hammer must be taken into consideration. The water hammer can be controlled and regulated by the following methods, among others:

- larger or thicker penstock;
- surge tank;
- valve;
- slowing down/altering governor shutting;
- increasing the moment of inertia of the generator/flywheel; or,
- setting up an interconnection system.

The choice of one from these alternatives involves financial considerations.

### Acquisition of Electro-mechanical equipment

Electrical equipment such as generators, control panels, protective relays, transformers, *etc.* are standard and are manufactured by mass production methods; thus this kind of equipment can easily be acquired by ordering it from the factory. The same is true of governors, which are standard and can be manufactured by mass production methods. Governors are usually ordered from factories abroad, but recently plans have been made to produce simple governors designed in Indonesia.

The case is different for turbines, which are designed to suit field conditions, including head, discharge and fluctuation, load characteristics, *etc.* Thus a turbine must basically be of "tailor made" design. Standardisation is possible for small units, but the standardisation must be over a wide range so as to suit all kinds of field conditions, and there is no guarantee that there will be sufficient use of each of the standard turbines. Therefore, hydraulic turbines are usually not

manufactured by mass production, but to order. Because turbines are made to order, Indonesian production is able to compete with foreign production. From experience, the acquisition of turbines from local sources has the following advantages:

*Speed:* The acquisition of turbines from abroad not only requires the same processes as for the acquisition of turbines from local sources (drawing up of contract, manufacture *etc.*), but also other processes involving various organisations, such as: money transfer, port customs, transportation *etc.* If, for example, the data should be insufficient or incorrect, a longer period is required for correspondence.

*Cheaper Price:* The price of locally manufactured turbines is on average between 1/3 and 1/4 of the price of a foreign turbine. For comparison, an example is given of the tender for the manufacture of a Pelton turbine  $n_p = 28$ ,  $D = 910$  mm for the Hanga-Hanga micro-hydropower plant in Sulawesi in 1977. Tenders were made by both local and foreign factories.

Table 6  
Local vs foreign turbines

No.	Tendering Company	Price (Rp)	Factory	Delivery Period.
1.	PT. Andikas Jaya	154.590.000 90.000.000	Voit-Germany United Eng - Singapore	11 months 11 months
2.	PT. Gaya Ika	41.000.000	Gaya Ika - local	9 months
3.	PT. Barata M&E	34.000.000	Barata-local	11 months
4.	PT. Boma Bisma Indra.	37.640.000	BBI - local	4 months

*Transfer of knowledge/technology:* It will be realized that the acquisition of turbines from abroad will not provide as much experience or knowledge as when the turbines are manufactured locally. All the problems, experiences (discoveries) are capital for future development which cannot be measured in financial terms. Also from the point of view of providing work opportunities, the local acquisition of turbines is more advantageous.

*Quality:* The quality of locally produced turbines is not much different from that of foreign turbines, with regard to both efficiency and performance.

### Local Hydraulic Turbines

#### Design

The main problem in the acquisition of local tur-

bines is the problem of design. At present, local manufacturers are unable to deal with the design problem. Attempts have been made to obtain licences from foreign companies, but without success. Up to now, the designing of turbines in Indonesia has been carried out by the Hydropower Laboratory/Electric Power Research Centre/PLN (State Electricity Corporation).

Stage 1 of the designing of a hydraulic turbine is the "hydraulic design," which includes: determining the shape and curve of the runner, draft tube, stay blades, guide vanes, *etc.* The most important and most difficult part of the hydraulic design is the runner, particularly for a Francis turbine. The design process for a runner is difficult and requires experience, precision, perseverance, estimations, *etc.* It should also be realized that the runner is the part which plays the largest role in determining the efficiency or the output of the hydraulic turbine.

In order to meet the needs of micro-hydropower plants with various values of  $H$  and  $Q$ , a standard runner and a standard turbine should be constructed (see Appendix 1). From this standard turbine, turbines can be made by increasing or decreasing the measurements, up to certain limits, in accordance with needs. The increasing or decreasing of the size from the standard turbine mainly involves problems of construction design. Thus, up to a certain capacity and dimensions, various changes in construction need to be looked at, bearing in mind the following factors:

- strength;
- manufacture;
- installation; and,
- maintenance.

For example, for a turbine with a small capacity and small dimensions, the use of ordinary bearings is sufficient and is considered more practical. However for a larger capacity and larger dimensions, considering the life time, maintenance *etc.*, the use of sliding bearings should be considered. Also, changes in the shaft with regard to the runners, regulating parts, sealing, *etc.* should be envisaged. Figs. 1 and 2 show the ratio of construction for the Francis Turbine Horizontal Shaft for NS 150, with sides of 20" and 33".

### Manufacture

Most of the turbines designed by the Hydropower Laboratory are manufactured by local factories. Several factories in Indonesia are able to manufacture complete hydraulic turbines of good quality – for example: PT Barata M & E, Surabaya; PT. Boma Bisma Indra, Surabaya; PT. Dwika, Tegal. Small workshops are invaluable in the manufacture of hydraulic tur-

bine components such as gear wheels, clutch or other small parts, both those demanding precision work and those not demanding precision work.

At this time, PT. Barata is considered the main and most capable manufacturer of hydraulic turbines in Indonesia, both from the point of view of facilities and of the skills of their workforce. The facilities owned by PT. Barata M & E used in the manufacture of hydraulic turbines include the following casting facilities:

- one coupola furnace for cast iron with a capacity of 6 tons/charge;
- two induction furnaces with a capacity of 2 tons; and,
- one Acc furnace for cast iron with a capacity of 6 tons/charge, the composition being controlled by computer (Gresik Branch).

### Factory inspection

Problems in the field involving installation, operation and maintenance very much depend on the result or quality of factory manufacture, and therefore quality control is very important. Usually, quality control is carried out through cooperation between the Quality Control Department of the factory and members of the PLN staff; but most factories are still very dependent on guidance, supervision and directions from the PLN staff in matters which the factory itself should be able to carry out.

Quality control involves the following matters, among others:

*Checking turbine parts:* Turbine parts such as runners, casings, shaft *etc.* each have to be investigated for factors such as casting quality (to see, for example, whether they are porous or not) dimensions, profiles, quality of work, *etc.* For some parts, because of their shape, checking must be carried out when the model is made – for example: profile/shape or runner curve, casing *etc.* – since if this is done after the parts have been manufactured there will be difficulties and the work will be less thorough.

*Checking turbine unit assembly:* For this the parts of the turbine must be assembled, both in part and as a whole (one unit) for investigation of the fitting, clearances, shaft throw, static balancing, *etc.* Each item has certain limits which must be met if difficulties or failures in the field are to be avoided. The main examples are:

- runner clearances which are too large will cause loss of discharge, so efficiency/power will be less than expected; while too small a clearance, should there be the smallest lack of precision in installation, will cause friction in

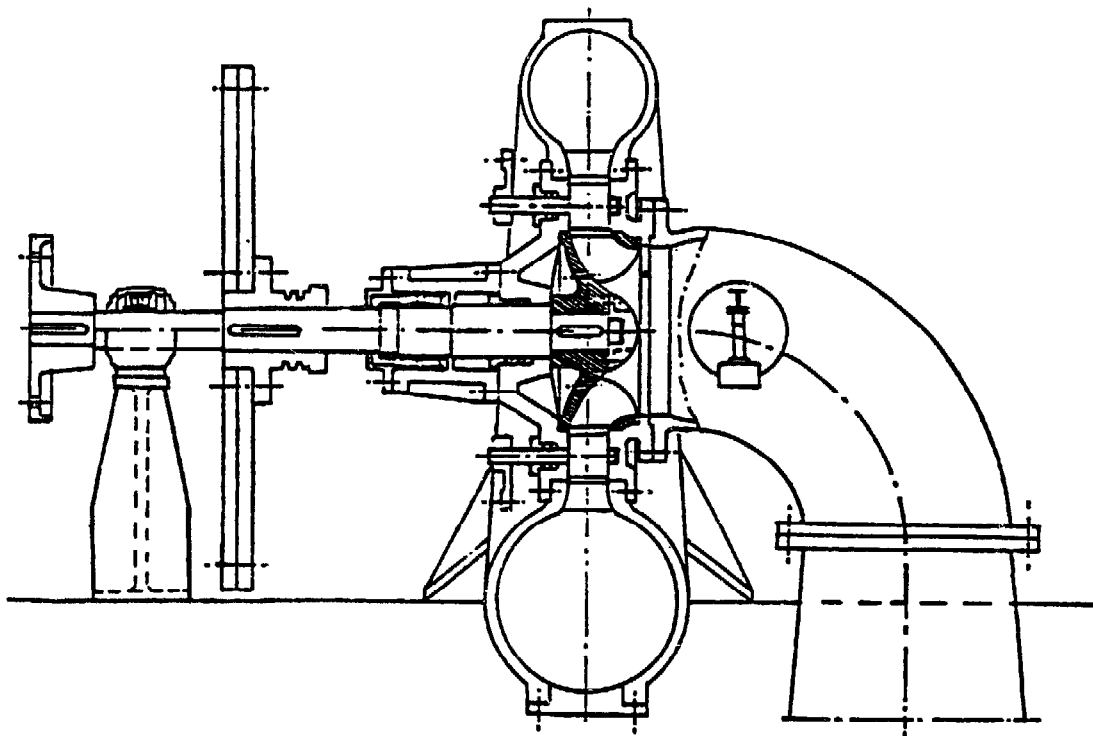

Fig. 1 Francis turbine horizontal shaft;  $N_s$  150; size 20"

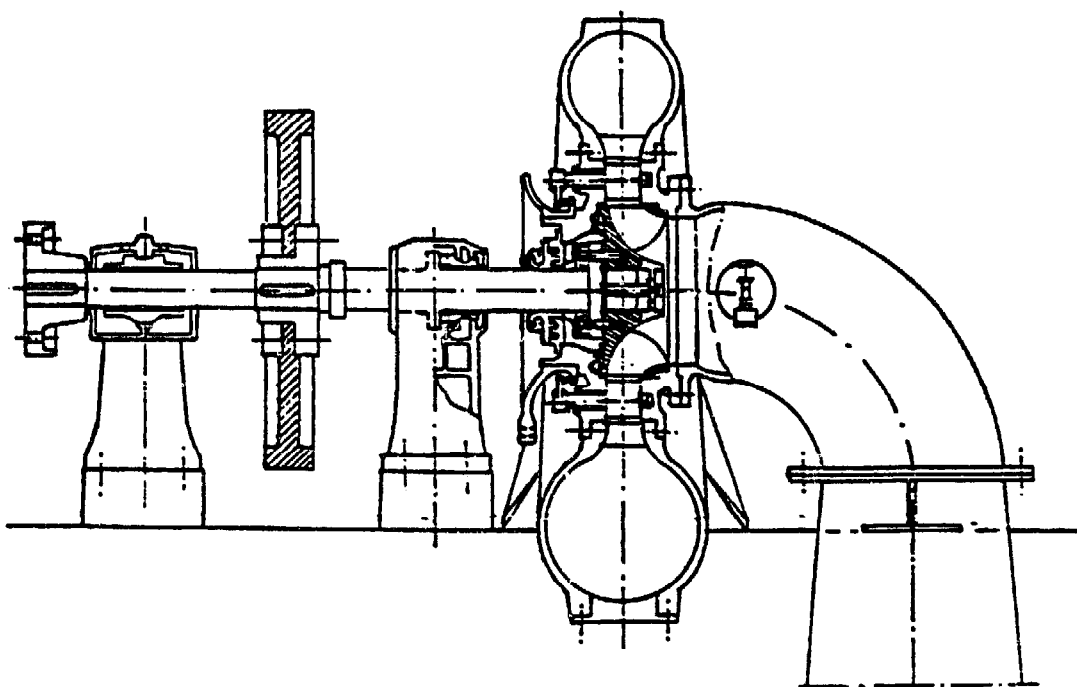

Fig. 2 Francis turbine horizontal shaft;  $N_s$  150; size 33"

the housing and will have a fairly pronounced effect in raising the temperature of the bearings; and,

- fittings, such as the fitting of the clutch with regard to its shaft, must be firm; but it must be possible to release it with certain equipment such as a tracker. This condition can be achieved with a shaft which is only a few microns (depending on the diameter of the shaft) larger than its clutch. This requires special attention from the manufacturer and the quality control department.

*Checking of turbine assembly with other units:*

To avoid lack of equipment or errors arising in the complete assembly of the turbine unit with the gear box, generator, valve, adaptor, governor, *etc.*, the complete assembly should be tried while still in the factory. Unexpected difficulties often appear in this process – for example:

- faults in control linkage;
- the pendulum pulley or governor pump do not match the turbine pulley; and,
- one part does not match another part (*e.g.* flange adaptor/valve with flange casing, *etc.*).

*Running and balancing tests:* In order to obtain advance knowledge of the problems which might arise during field operation, particularly those concerning bearing temperature and vibration, these tests are essential, particularly for large capacity turbines or turbines with high r.p.m.

After the turbine, gear box and generator have been assembled, centering is carried out as in the field. (see following section). The turbine is rotated gradually (with a DC electric motor) up to normal r.p.m., and the bearing temperature and vibration observed. The cause of any deviations is sought, in order to find a solution. If in the course of this investigation there is excessive vibration because the static balancing process was not complete, dynamic balancing must be carried out. The equipment used is a "Vibration Analyzer Dynamic Balancer Mechanalysis Model 350".

Some of the main problems encountered in the local manufacture of turbines are as follows:

- drawings may not be complete, requiring repeated communication (matters forgotten during the design process);
- some factories still require guidance and close supervision;
- the manufacture of important turbine parts with high quality material has not yet begun (for example the manufacture of a thin runner which is proof against cavitation, corrosion *etc.*);

- inability to manufacture certain required shapes of turbine parts (for example a shaft which is in the form of a flange in certain parts, and forging work); and,
- quality control equipment has not yet been developed.

### Installation

Erection work has its own problems and its own art. Several kinds of activity must be carried out before the real erection work can proceed. These activities are carried out by members of the PLN staff.

The transportation of the generating equipment from the factory or from Jakarta to the site is the responsibility of the contractor, but the generating equipment is not transported to the powerhouse, only to the nearest point accessible to the vehicle transporting the generating equipment.

The transportation of the generating equipment to the powerhouse has its own problems, which demand expertise and a certain art. The generating equipment includes several heavy parts, notably a heavy turbine casing (up to 3 tons), a heavy generator (up to 2 tons), and a heavy fly wheel (up to 15 tons). Also, the terrain to be crossed is difficult, over steep hills and valleys with a height of up to 150 m. The equipment used is very simple, *e.g.* ropes, tackle, *etc.*

Placing the generating equipment on the foundation involves moving the generating equipment above the foundation and placing the equipment in the correct position (for example, the casing must be upright and level with the penstock). In order to reduce investment costs, a micro-hydropower plant is usually only equipped with a fixed crane. Thus the moving and positioning of the equipment must be carried out with the aid of levers, beams, tackle, *etc.*, and the crane is only used when the equipment is below it.

Before accurate centering is carried out, the pre-centering stage must be gone through first. This involves arranging the turbine parts in their "correct" positions without considering the relations with other parts (for example, clearances). This stage includes: testing the casing with a spirit level; adjusting the position of the draft tube, bends, *etc.*; installation of standard bearings, shaft, runner and levelling of the shaft; and, adjustment of the positions of the gear box, generator *etc.*, using the clutch centering as a guide.

Once pre-centering has been completed, the true centering should be carried out. At this stage, the correlation between one part and the other parts should be considered. The operations in centering include the following:

- the shaft must be level;



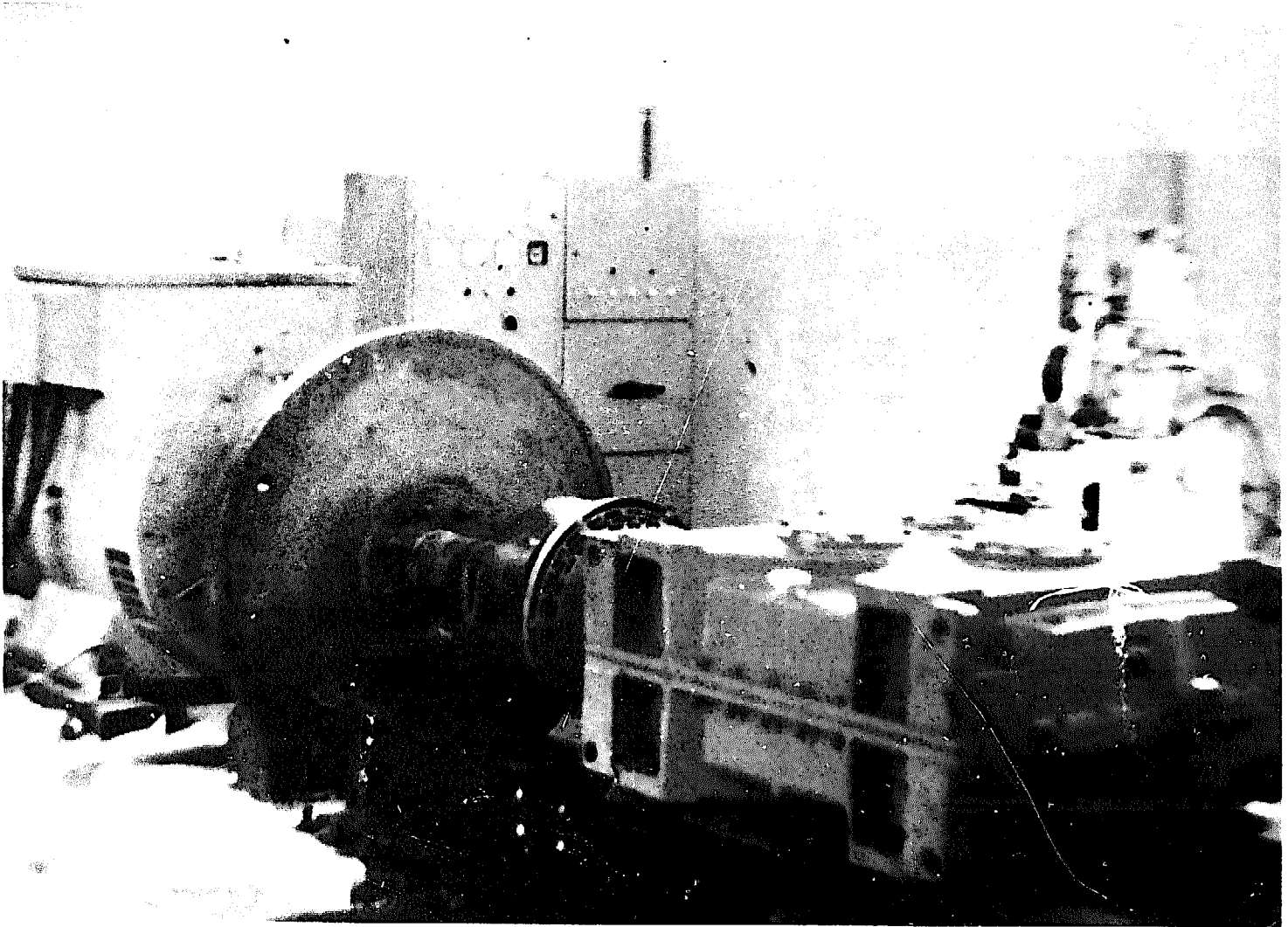

The generator unit, gear-box, governor and panel of the Talangkrasak micro-hydropower plant, Yogyakarta.

- the position of the casing must correspond to the position of the shaft – being upright, level and central with regard to the shaft. This is because, on the basis of experience, the levelling of the casing cannot always be relied upon, or does not guarantee that the shaft is level.

Indicators that the casing is already upright and straight with regard to the shaft are as follows:

- the clearance between the shaft and the casing bushing must be even;
- the clearance between runner and casing, both axial and radial, must be even; and,
- the bearing clearance, both axial and radial, must be even.

For the manufacture of a good turbine, all the data must support each other. For example, levelling in conjunction with a casing which is upright and cen-

tral with regard to the shaft will give a level casing, and provide even clearances between bushings and axis, runner and casing, etc. If these conditions do not correspond, the cause of the fault must be determined so that it can be dealt with.

Final checking is required to make certain that the results of centering are satisfactory. If centering is complete and there are no other faults (for example, lack of precision in factory inspection), the rotating parts will be easy to rotate by hand. Thus apart from centering data, the ease or difficulty of rotating the rotating parts is an indication of centering.

It should be noted that this procedure is specifically for a horizontal micro-hydropower plant turbine. For vertical constructions, there will be a few differences (both in procedure and in indications). One should appreciate also that shaft throw, for example, is an important indication of centering.

### Operation and maintenance

In operating a micro-hydropower plant, even operators in the villages do not find difficulties, particularly if it is already equipped with a governor. However, for a micro-hydropower plant which is manually controlled, discipline and alertness on the part of the operator is essential.

Maintenance is still felt to be insufficient in several places. The operator often does not react to symptoms of turbine breakdown, and may exhibit, for example, a lack of reaction to a rise in bearing temperature, noise, vibration, *etc.* A lack of response to a rise in bearing temperature is frequent; and consequently when, because of some minor factor, the temperature of the bearings rises, the turbine is only stopped after damage is total. In order to prevent this, it is planned to equip micro-hydropower plants with thermal relays.

### Testing

In support of research and development of micro turbines in Indonesia, testing is carried out at the Hydropower Laboratory, Cipayung – Bogor.

Unlike a closed circuit laboratory, where a model of the turbine has to be made for testing, the prototype itself can be tested at the Hydropower Laboratory. This is possible because the construction/installations of the Cipayung laboratory are a model of a micro-hydropower plant, with one reservoir and several stations below, with various heads (graduated), from a head of 4.9 metres to a head of 42.5 metres.

The head at each station can be varied to a limited extent using a valve. Thus a test at the Cipayung Hydropower Laboratory is a prototype test, with a head different from the design head.

The turbine discharge output, optimum r.p.m. and other expected values (as a reference) can be obtained from the equation given on page 317.

For testing micro turbines, the Cipayung Laboratory has several advantages:

- there is no need to make a model, so the work does not have to be carried out twice, as would be the case if a model were used;
- an error factor for similarity between the model and the prototype should not exist;
- there is no need for as high a degree of accuracy as with the model system;
- turbine performance, *i.e.* vibrations, heating, bearings, noise *etc.*, can be directly observed; and,
- the prototype test at the Cipayung Hydro-

power Laboratory can be used as a model for larger dimensions or capacities. It is estimated that it can represent a capacity of up to 5 MW.

*Testing equipment:* The Cipayung Hydropower Laboratory has equipment which includes the following:

- power measuring apparatus: dynamometer, prony brake, generator with water resistance, *etc.*;
- discharge measuring apparatus: venturi meter rectangular weir;
- r.p.m. measuring apparatus: stroboscope, tachometer;
- head measuring apparatus: manometer, vacuummeter; and,
- other apparatus: ascelograph, vibrometer, flexiglass, *etc.*

*Tests:* The tests carried out in the Laboratory are as follows:

- turbine efficiency tests;
- turbine cavitation tests;
- index tests; and,
- reliability tests.

*Types of Turbine Tested:* Turbine types with  $n_s$ : 311, 200, 150 (Francis turbine) and  $n_s$ : 28 (Pelton Turbine) have been tested, and the results were as expected. The efficiency (overall) varied from 75-80%. Other types, with  $n_s$ : 700 (Kaplan) and  $n_s$ : 28 (Pelton) have not yet given the expected results and are still being investigated.

### Economic Analysis

The investment required for a micro-hydropower plant is much larger than for a thermal power plant, varying from 3 to 5 times as much. Unit cost varies from US\$1,500-\$2,500 per kW (taking into account only the cost of generation, and not including transmission and distribution). The investment cost per unit for the plant as mentioned above is greatly influenced by technical conditions, where there are several variables. In view of this, an economic analysis is required to determine whether the planned scheme will be profitable. This economic analysis can be presented as a basis for consideration to government leaders who decide national policy.

In view of the large investment needed for construction, the increasing price and short supply of oil fuel, the increasing demand for energy, and the fact

that hydropower is a renewable resource, the energy which can be generated should be used to the best advantage.

Micro-hydropower plants in Indonesia are generally of the run-of-the-river plant type, and so there is no reservoir or daily storage pond. River discharge is generally variable, and therefore during the dry season, for 2-3 months, the discharge will decrease, and thus the output of the micro-hydropower plant will also decrease. This decrease in the discharge, as compared to the planned discharge, which would allow optimal utilization, is about 25%. In order to overcome this decrease in discharge – apart from paying attention to the daily load curve – the provision of a diesel plant is required. With an average daily load of 60% of peak load, this diesel plant will operate for 15% of the time each year, so that the service life of the diesel plant in theory is about 100 years (the service life with normal operation is 15 years). From this it can be seen that the investment for a diesel plant is relatively very small.

**Criteria for Economic Analysis**

In evaluating a planned project from the economic point of view, a number of criteria can be used, including:

- net present worth value (NPV);
- internal rate of return (IRR); and,
- net benefit cost ratio (BCR)

**“Benefit” and “Cost”**

In order to determine the meaning of “Benefit” and “Cost” for a planned micro-hydropower plant, the function of the planned plant must be known first. If the planned facility is for a new source of power (where no electric power was available previously), the

benefit and cost are the benefit and cost of the project itself. However, if the planned facility is a response to the increasing load on a power system (small-scale in relation to demand), then “Benefit” is the annual cost (“Cost”) of a standard plant in the power system of the area concerned, and is as follows:

Fixed Cost = Capital Cost + Operation Maintenance  
 The general formula for Capital Cost is:

$$\text{Capital Cost} = \frac{i(1+i)^n}{(1+i)^n - 1} (1 - L) + iL$$

where, *i* = interest rate  
*n* = service life  
*L* = residual value.

The calculation of capital cost, operation and maintenance costs involves the full cost of construction (plant, transmission, and substations). Operation and maintenance costs also include:

- salaries of personnel;
- overhaul costs;
- administrative costs;
- taxes; and,
- other costs.

The standard plant is taken as a diesel plant, since this is commonly used.

The annual cost factor for several interest rates and for various kinds of plant can be seen in Table 7.

The variable cost is the annual fuel cost, which can be calculated from the formula:

Annual fuel cost =  $C_{kWh} \times 8760 \times \alpha \times P$   
 and  $C_{kWh} = 860 \times f/\eta$   
 where:  $C_{kWh}$  = Cost of fuel (mills/kWh)  
*P* = Available capacity (kW)

**Table 7  
 Annual Cost Factor**

	Service Life (Years)	Capital Cost			O & M Cost (%)	Total		
		i = 6%	i = 9%	i = 12%		i = 6%	i = 9%	i = 12%
Hydro Power Plant	40	6.60	9.30	11.10	1.5	8.10	10.8	13.60
Diesel Power Plant	15	9.90	12.10	14.40	4.0	13.9	16.10	18.40
Gas Turbine Power Plant	12	11.3	13.50	15.70	2.0	13.3	15.50	17.70
Oil-fired Steam Power Plant	20	8.50	10.80	13.30	3.0	11.50	13.80	16.30
Transmission & Substation	25	7.60	10.10	12.70	1.5	9.10	11.60	14.20

Note: *i* = interest rate.  
 Residual Value = *L* = 10%.

- $\alpha$  = Annual utilization factor  
 $f$  = Cost of fuel per K cal (US\$/10<sup>3</sup> K cal)  
 $\eta$  = Annual average operating efficiency  
 860 = Conversion factor.

“Cost” is the annual cost of the plant itself, so that in the economic analysis for the plant it can be calculated to what extent the cost of fuel and standard plant generating facilities can be reduced. In determining the capacity of the standard generating unit, the capacities of the other units in the system should be taken into account, in order to attain the most economical method of operation and maintenance.

#### Influencing factors

Factors which can influence the economic analysis should be evaluated, calculated and analyzed, as follows:

#### Service Life

- the service life of a micro-hydropower plant is on the average 35-45 years;
- the service life of a diesel power plant (DPP) is taken as 15 years; and,
- the service life of transmission and substations is 40 years.

In Table 8, the service life of various plants and retirement plant values are given.

*The period of construction* (construction timetable) and financing expenditure schedule are used to calculate the interest on capital at the time of construction.

*Interest rates:* The interest rates usually used are 6%, 9% or 12%, depending on the source of finance.

*Residual value:* taken as 10% of the investment.

*Cost of operation and maintenance:* The costs of operation and maintenance are taken as follows –

Microhydropower plant: 1.5% of investment.

Standard plant (DPP): 4% of investment.

Fuel costs: Rp. 98.39 (cost in 1980). See Table 9.

**Table 8**  
Service Life

Power Source	Economic Analysis	Plant Retirement
Hydro Power Plant	40	–
Diesel Power Plant	15	20
Gas Turbine Power Plant	12	15
Thermal Power Plant	20	25 – 30

**Table 9**  
Fuel Cost

Item	Unit	Diesel	Gas	Steam	
				Oil	Coal
Fuel		HSD	HSD	HO	Coal
Calorific Value	kcal/l kcal/kg	9,600	9,600	10,000	6,000
Efficiency (Design)	%	35	20	30/33	30/33
Fuel Price	US\$/kl US\$/ton	157	157	137.26	27.50
Fuel Cost:					
Generating End.	mills/kWh	40.98	71.78	39.75/36.16	13.40/12.19
Plant Service	%	3	3	5	8
Sending End.	mills/kWh	42.25	74.00	41.84/38.06	14.57/13.25

Utilization factor: 97%.

Design efficiency: 35%.

Losses: transmission and substation = 6 %.  
plant service (DPP) = 6 %.

*Operational time:* A micro-hydropower plant is assumed to be able to operate all year round, in view of the fact that only two weeks are required for overhaul/inspection for each 40,000 operating hours. A diesel plant (DPP) requires two weeks for overhaul in the first year and one month in the following years (inspecting capacity 10%).

*Load forecast and growth rate of demand:* 10%-15%.

*Daily load curve:*

Average load: (55%-65%) of peak load.

Minimum load: (30%-45%) of peak load.

*Interim replacement:*

- Civil construction: 0.35% of civil construction costs;
- Electro-mechanical: 0.5% of electromechanical costs;
- Transmission and substation: 0.35% of transmission and substation costs.

### Calculation of Construction Costs

*Construction costs:* mini-hydropower construction costs comprise the plant construction costs and the transmission and substation construction costs, including.

- a. Preparatory work:
  1. access road (temporary);
  2. temporary facilities; and,
  3. temporary electric power facilities.
- b. Civil construction work:
  1. intake and water channel construction; and,
  2. power station.
- c. Electro-mechanical work.
- d. Land compensation.
- e. Technical services.
- f. Administrative costs.
- g. Unexpected expenses during construction (for civil engineering work).
- h. Construction period interest (power plant).
- i. Transmission and substation work
- j. Construction period interest transmission and substation).

The sub-total of (a) to (h) is the plant construction cost, while the sub-total of (i) and (j) is the construction cost of transmission and substation.

### Analysis of Type of Work

- a. *Preparatory work:*
  - making an access road for transport during

construction;

- supply of electric power to operate construction and lighting equipment; and,
- temporary facilities, comprising communications facilities, lifting equipment, store, office, workshop and housing facilities.

#### b. *Civil construction work:*

The civil construction work for a micro-hydro plant includes:

- intake constructions: dam, cleaning sluice, and intake sluice;
- water channels: intake channel (open/closed), overflow construction, sand collection construction, daily storage pond, drainage channel, penstock pipes, surge tank and outflow channel.
- power station: including turbine, generator and governor foundations (commenced from design work).

#### c. *Electro-mechanical work:*

Electromechanical work begins with the manufacture, setting in the factory, transport to site and installing of electromechanical equipment including: turbine, generator (and accessories), transformer, switchgear and other equipment.

#### d. *Land compensation:*

Compensation for land both for the planned construction site and for other construction facilities.

#### e. *Technical services:*

Technical services involve field investigation, drawing up of a detailed design, drawing up tender documents, tender expenses (up to the evaluation stage), and supervision.

#### f. *Administrative costs:*

Administrative costs include all the costs of administration during construction, usually 5% of the total cost (a) to (d).

#### g. *Unexpected expenses:*

Unexpected expenses are estimated at 5-15% of the total cost (a) to (d).

#### h. *Interest rate:*

The interest rate is taken to be either 6%, 9% or 12%.

### Benefit and Cost Analysis

#### *Capital expenditure*

Capital expenditure is calculated as follows:

— Cost of construction of plant

## Analysis of Benefits and Costs

No.	Item	Unit	Cost	Notes
1.	Sending end			
1.1.	Maximum power	kWh		- Annual energy
1.2.	Maximum power	kWh		- Utility factor 97%
1.3.	Average power	kW		
1.4.	Available energy	kWh		
2.	Recipient			
2.1.	Average power	kW		- Loss factor 6%
2.2.	Available energy	kWh		- Loss factor 6%
3.	Capital expenditure			
3.1.	Plant	10 <sup>3</sup> Rp.		
3.3.	Transmission & substation	10 <sup>3</sup> Rp.		
4.	Annual expenditure			
4.1.	Plant	10 <sup>3</sup> Rp.		- Rp/kW.
4.2.	Transmission & substation		10 <sup>3</sup> Rp.	
4.3.	Total	30 <sup>3</sup> Rp.		
5.	Annual benefit			
5.1.	Power (kW)	10 <sup>3</sup> Rp.		- Rp/kW.
5.2.	Energy (kWh)	10 <sup>3</sup> Rp.		- Rp/kW.
5.3.	Total	10 <sup>3</sup> Rp.		- Rp/kW.

- Cost of technical services and administration
- Unexpected expenses

## Sub total

- Interest during construction

## A. Total cost of plant

- Unexpected expenses

## Sub Total

- Interest during construction

## B. Total cost of transmission &amp; substations

Cost of construction of plant = (A + B)

## Cost of Power

- Transmitting costs =

cost of plant construction x annual expenditure factor  
energy potential x utility factor.

- Cost of power for recipient =  
(Cost of plant construction x annual expenditure factor x construction costs of transmis-

sion and substation x annual expenditure factor for transmission and substation)/  
(Potential energy x Utility factor x (1 -  
Transmission & substations loss factor).

- Cost of power from standard plant (DPP) =  
(Cost of construction x Fixed annual expenditure + Total annual energy x Fixed expenditure factor)/

[Total annual energy x (1 - plant service)].

## Future Development

Efforts to master the science and technology of the mechanical equipment of hydropower plants which have been pioneered up to now need to be continuously increased. The hydropower plants in Indonesia have up to the present been, for the most part, the result of imported technology, both hardware and software.

The development of science, technology and expertise will not be complete if it is only carried out on paper. Thus it must be accompanied by laboratory research and application in the field. Particularly in the case of machinery, a good final product can only

be achieved through a repeated process: study and research – design – manufacture – testing – evaluation and further research modifications. In view of this, it is vital to draw up a list of software and a clear picture of both the software and the hardware.

It is estimated that in the next 5 years, a programme will be set up which will stimulate the development of the science and technology of hydropower plants in Indonesia, so as to achieve the following goals:

1. a local machine industry able to manufacture hydropower generating equipment of various kinds and of various capacities up to 1 MW per unit, of international quality;
2. a service industry in Indonesia able to design and to supervise the manufacture and installation of hydropower generating equipment/systems of various types and of capacities up to several tens of MW;
3. research and development activity in Indonesia by research institutions, institutions of higher education and industry, to be unified, directed, and carried out by staff able to absorb the latest technology from abroad and apply it in Indonesia.

In view of the scope and the goals to be achieved, a short-term and a long-term programme should be set up. Furthermore, an environment and a climate which make possible the achievement of the goals should be created.

The short-term programme, over a period of 2 years, could consist of the following activities:

1. the formation of a "core team" with the task of drawing up a programme, assembling potential experts from various institutions and monitoring the programme. The core team would consist of the Electric Power Research Centre, the Institute of Technology, Bandung (ITB), and PT. Barata, being respectively a research institution, an institution of higher education, and a manufacturer;

2. applying the latest developments in science and technology to support design and manufacturing. For example, there should be a project to draw up a design procedure and its computerisation for a hydraulic turbine;
3. standardization of mini and micro turbines. Up to the present, the micro-hydropower plants set up in an organized and directed manner by the PLN have had capacities of 25 kW or more. In Indonesian villages, there is a great deal of potential for micro-hydropower plants from irrigation channels, with a capacity of less than 25 kW. This potential could be utilized by the village communities themselves both in terms of capital and of carrying out the work, only requiring direction/information/guidance from the government. Guidance is particularly vital in the field of generating equipment. Suitable kinds of turbine include the Banki, water wheel, propeller, etc;
3. the formation of an information and documentation network open to the public, or at least to the members of the group; and,
5. arranging scientific/technical seminars in order to disseminate the results of work carried out and to produce new ideas which could be developed.

The long-term programme (5-10 years) should include the following:

1. estimating the future development of hydropower generation in Indonesia, as part of the national energy policy;
2. estimating the role of industry and research in Indonesia in the manufacture of local hydropower generating equipment;
3. estimating the need for professional and sub professional staff; and,
4. programmes to develop science and technology and human resources, for all groups expected to participate in this field.

**APPENDIX I**  
**Standardization of Turbines by**  
**Water Power Laboratory – Power Research**

No.	Turbine			Head (m)	P (Hp)		Q (l/sec)		n (r.p.m.)		Number of Turbines	Manufacture (Factory/Place)
	Type	N <sub>s</sub>	Runner Diameter		Min.	Max.	Min.	Max.	Min.	Max.		
1.	Francis	311	6"	1,22 – 21,3	0,67	49,3	59	247	444	1.840	1	Pt. B.B.I – Surabaya
2.	Francis	311	7½"	1,22 – 21,3	1,10	81	93	387	353	1.480	1	Pt. B.B.I – Surabaya
3.	Francis	311	11"	1,22 – 21,3	2,49	182	199	831	277	1.152	1	Pt. Barata – Surabaya
4.	Francis	311	13½"	1,22 – 21,3	3,88	284	299	1.255	196	823	6	Pt. Barata – Surabaya
5.	Francis	311	16½"	1,22 – 21,3	5,90	1.130	447	1.870	160	675	2	Pt. Barata – Surabaya
6.	Francis	311	21"	1,22 – 21,3	9,70	700	726	3.010	126	525	2	Pt. Barata – Surabaya
7.	Francis	311	27"	1,22 – 21,3	15,52	1.160	1.135	5.000	98	410	–	–
8.	Francis	311	36"	1,22 – 21,3	27,20	1.465	2.040	7.980	74	274	1	Pt. Barata – Surabaya
9.	Francis	250	12,8"	1,52 – 30,5	2,80	256	179,2	800	293	1.308	–	In Process
10.	Francis	200	22"	3,05 – 61	16	1.383	473	2.118	222	991	2	Pt. Barata – Surabaya
11.	Francis	150	6"	3,05 – 22,8	0,68	14,1	23	63	660	1.810	1	Pt. B.B.I – Surabaya
12.	Francis	150	12,6"	4,57 – 107	3,3	243	260	1.087	244	1.015	3	Pt. B.B.I – Surabaya
13.	Francis	150	20"	9,15 – 107	43	1.716	444	1.519	470	1.605	1	Pt. Dwika – Tegal
14.	Francis	100	21"	3,35 – 107	222	1.835	619	1.250	588	1.190	–	Planned
15.	Pelton	26	396 mm	140		175		135		1.000	1	Pt. Barata – Surabaya
16.	Pelton	22	422 mm	125		81		115		1.000	1	Pt. Teha – Bandung
17.	Pelton	28	910 mm	160	1.480	1.920	900	1.200		545	1	Pt. B.B.I – Surabaya
18.	Kaplan	700	654 mm	5			81	2.000		500	2	Pt. Barata – Bandung
19.	Francis	150	30"	3,05 – 107	18,9	2.940	576	3,110	132	783	–	–
20.	Francis	150	33"	3,05 – 107	22,7	4.767	697	3.763	160	947	–	–

Jakarta, January – 1980.  
Hydro Power Laboratory.

**APPENDIX II**  
**PLN Micro Hydro Power Projects**  
**Installed before 1969 (Pelita I)**

No.	Site	Province	Installed Capacity (kW)	Generating Equipment					Completed	Remarks	
				Turbine		Governor	Generator	Control Panel			
				Type	Manufacture I/L						
1.	Cijedil	West Java	2 x 122	Francis Hor	J.M. Voith	I	J.M. Voith	Siemens	–	1923	Near Puncak
			2 x 154	Francis Hor	J.M. Voith	I		–	–	1931	
2.	Kluncing	East Java	1 x 52	Francis Hor	Escher Vyss	I		AEG	–	1927	Near Banyuwang
3.	Tarutung	North Sumatra	2 x 60	Francis Hor	Smeelder	I		Siemens	–	1925	
4.	Wonosobo	Central Java	1 x 124	Francis Hor	Escher Wyss	I		AEG	–	1943	
5.	Banjar Negara	Central Java	1 x 256	Francis Hor	J.M. Voith	I		BBC	–	1949	
6.	Cibinong	West Java	1 x 20	Francis Ver	Stork	I		–	–	1962	
7.	Ubrug	West Java	2 x 100	Francis Hor	Escher Wyss	I	AEG	Siemens	–	1924	Aux Unit
8.	Lamajan	West Java	2 x 96	Pelton Hor	Stork	J	Charnilles	Smits SI	–	1925	Aux Unit
9.	Kracak	West Java	2 x 60	Pelton Hor	Escher Wyss	I	AEG	Smits SI	–	1927	Aux Unit
10.	Mendalan	West Java	1 x 120	Pelton Hor	Stork	I	Heemaff	Oerlikon/Schorch	–	1955	Aux Unit
11.	Sungai Penuh	Jambi	1 x 70	Francis Hor	Escher Wyss	I	Heemaff	Oerlikon	–	1957	



**APPENDIX III**  
**List of Micro Hydro Power Projects is Completed during 1st Pelita (1969/1974)**

No.	Site	Province	Instale Capacity (kW)	H (m)	Q (l/sec)	Completed	Generating Equipment					Cost in US\$ 10 <sup>3</sup> (For Generating)	Cost/kW US\$ 10 <sup>3</sup> (For Generating)	Stage	
							Turbine			Governor	Generator				Control Panel
							Type	Manufacture	I/L						
1.	Balapusuh	Central Java	16	6	400	1969	-								
2.	Karang Asem I	Bali	30	27	170	1969	Francis	Gilbert Gilkes	I	Gilkes	MC. Parlane				
3.	Talaga	West Java	200	27	600	1970	Francis	-	L	-	-				
4.	Kota Agung	Lampung	60	12	720	1972	Francis	TISCO	L	-	-	37.768	0.544		
5.	Maron	East Java	80	9.5	1200	1972	Francis	Gilbert Gilkes	I	Gilkes	-	59.936	0.736		
6.	Karang Asem II	Bali	80	14	800	1973	-	-	-	-	-	45.232	0.560		
7.	Ngarogoso	Central Java	60	30	300	1973	Francis	TISCO	L	-	Unelec	26.672	0.432		
8.	Sungai Puar	West Sumatra	75	115	100	1974	Pelton	Gaya Ika	L	-	Unelec	51.280	0.672		
9.	Rutteng	NTT	120	16	1070	1974	Francis	Gilbert Gilkes	I	Gilkes	MC. Parlane	78.512	0.656		
10.	Takalala	South Sulawesi	98	8	900	1974	Francis	Gilbert Gilkes	I	Gilkes	MC. Parlane				
11.	Munte	North Sumatra	80	9	1100	1976	Francis	Gilbert Gilkes	I	Gilkes	MC. Parlane	73.792	0.912		
			899												

Note: I = Import  
L = Local  
US\$1 = Rp 625  
Pelita: Five Year Development Program.

**APPENDIX IV**  
**The Micro Hydro Power Projects**  
**Installed During 2nd Pelita (1974/1979)**

No.	Site	Province	Instale Capacity (kW)	H (m)	Q (l/sec)	Completed	Generating Equipment					Cost in US\$ 10 <sup>3</sup> (For Generating)	Cost/kW US\$ 10 <sup>3</sup> (For Generating)	Stage	
							Turbine			Governor	Generator				Control Panel
							Type	Manufacture	I/L						
1.	Sewito	South Sulawesi	540	6.5	12000	1976	Kaplan	Spojene Branake	I	J.M. Voith	Smith SI	-	-		
2.	Sidourip	Bengkulu	100	13.7	1040	1976	Francis	Gilbert Gilkes	I	Gilbert Gilkes	-	125.824	1.248		
3.	Tanggung	East Java	60	4.5	1900	1976	Kaplan	TISCO	L	-	-	25.920	0.432		
4.	Tonjong	Central Java	200	18.7	1200	1977	Francis	PLN-Barata	L	Jyoty	Siemens	97.312	0.608		
5.	Kota Anau	West Sumatra	160	23	1000	1978	Francis	PLN-Barata	L	Jyoty	Hitzinger	115.696	1.115		
6.	Pakis Baru	East Java	100	130	110	1978	Polton	PLN-Barata	L	Jyoty	Jyoty	115.696	1.115		
7.	Narmada	NTB	100	15	950	1978	Francis	PLN-Barata	L	Jyoty	Jyoty	129.712	1.296		
8.	Wamena	Irian Jaya	120	4	2500	1977	Francis	Gilbert TISCO	I	Gilbert Gilkes	Dursley Mawdsley	-	-		
9.	Pontak	North Sulawesi	60	5	1700	1979	Opeen Flume	TISCO	L	-	Unelec	28.560	0.640		
10.	Tenga	North Sulawesi	180	24	1070	1979	Francis	PLN-Barata	L	Jyoty	Hitzinger	-	-		
11.	Hejagong	Central Java	575	16.30	4050	1979	Bulb Unit	CGEE Alsthom	I	Neyrpic	Unclec	1480.560	2.576		
12.	Wonodadi	Central Java	210	3.8	7200	1979	Bulb Unit	CGEE Alsthom	I	Neyrpic	Unclec	918.528	4.368		
13.	Haruyan	South Kalimantan	185	5	5000	1979	Bulb Unit	CGEE Alsthom	I	Neyrpic	Unclec	799.472	4.640		

Note: I = Import  
L = Lokal  
Pelita: Five year Development Program

**APPENDIX V**  
**The Micro Hydropower Projects**  
**Completing began 2nd Pelita (1974/1979)**

No.	Site	Province	Instale Capacity (kW)	H (m)	Q (l/sec)	Completed	Generating Equipment				Cost in US\$ 10 <sup>3</sup> (For Generating)	Cost/kW US\$ 10 <sup>3</sup> (For Generating)	Stage		
							Turbine			Governor				Generator	Control Panel
							Type	Manufacture	I/L						
1.	Lempur	Jambi	90	26	500		Francis	PLN-Barata	L	Jyoty	Jyoty	Icosa			
2.	Bajawa	NTT	100	42	550		Francis	PLN-Barata	L	Jyoty	Hitzinger	Icosa			
3.	Talang Krasak	Central Java	320	6.9	5560		Francis	PLN-Barata	L	Jyoty	Hitzinger	Icosa			
4.	Sawidago	Central Sulawesi	100	13.6	1100		Francis	PLN-Barata	L	Jyoty	Jyoty	Icosa			
5.	Muara Labuh	West Sumatra	400	30	1900		Francis	PLN-Barata	L	Jyoty	Jyoty	-			
6.	Kepala Curup	Bengkulu	1000	63	2250		Francis	PLN-Barata	L	Jyoty	Van Kick	SEG			
7.	Hanga-Hanga	Central Sulawesi	1400	160	1250		Felton	Andikas Jaya	L	Wood Ward	Van Kick	SEG			
8.	Angkup I-II	Aceh	756	-	-		Bulb Unit	CGEE Alstom	I	Neyrpic	Uneloc	CGEE Alstom			
			3550												

Note: I = Import  
L = Local

**APPENDIX VI**  
**The Micro Hydropower Projects Pelita Plan III (1979/1984)**

No.	Site	Province	Instale Capacity (kW)	H (m)	Q (l/sec)	Completed	Generating Equipment				Cost in US\$ 10 <sup>3</sup> (For Generating)	Cost/kW US\$ 10 <sup>3</sup> (For Generating)	Stage		
							Turbine			Governor				Generator	Control Panel
							Type	Manufacture	I/L						
1.	Banding Agung	South Sumatra	2 x 2000	75	7200	1983								F.S.	
2.	Waelega	NTT	2 x 750	210	1020	1983								R.S.	
3.	Talaga II	West Java	200	-	-	1982								D.D.	
4.	Poigar	North Sulawesi	2 x 1000	75	3600	1983								F.S.	
5.	Wamena II	Irian Jaya	120	4.95	3500	1983								D.	
6.	Tirtomoyo	Central Java	2 x 1000	450	640	1983								R.S.	
7.	Sunur	South Sumatra	-	-	-	-								-	
8.	Tombolo	South Sulawesi	750	-	-	1983								F.S.	
9.	Tuweley	Central Sulawesi	2 x 1000	110	2500	1983								D.C.	
10.	Lubuk Gadang	West Sumatra	2 x 750	110	2000	1983								D.C.	
11.	Soluma	Bengkulu	2 x 300	-	-	1983								D.	
12.	Kepala Curup II	Bengkulu	2 x 1000	100	1000	1983								-	
13.	Bedegung	South Sumatra	1000	80	1750	1983								-	
14.	Bahorok	North Sumatra	1000	-	-	1983								-	
			18.670												

Note: I = Import  
L = Lokal  
1 US\$ = Rp. 625.-  
Pelita: Five year Development Program.

## List of Participants

### AUSTRALIA

Kaye Bowman  
Australian National University  
Canberra

### BANGLADESH

S.T.S. Mahmood  
Director of Planning  
Power Development Board  
Dhaka

M.D.N. Huda  
Chief Engineer  
Barrage Design  
Water Development Board  
Dhaka

Dennis Zvinakis  
USAID/Dhaka

Ed Gaither  
NRECA/Dhaka

M.H. Khan  
Project Planning  
Power Development Board  
Dhaka

### BURMA

U Win Kyaw  
Assistant Executive Engineer  
Power Development Department  
Electric Power Corp.  
Rangoon

U Khin Maung Tint  
Assistant Executive Engineer  
Power Development Department  
Electric Power Corp.  
Rangoon

### FIJI

Vinod Kumar  
Electrical Engineer  
Ian MacAllan & Co  
Suva

Manmohan Narayan  
Principal Mechanical Engineer  
Public Works Department  
Government of Fiji  
Walu Bay  
Suva

### INDIA

H.S. Dubey  
Chairman  
Himachal Pradesh State Electricity Board  
Simla

A.H. Raina  
Chief Engineer, Generation  
National Hydroelectric Power Corporation  
New Delhi

P.K. Behl  
Hydro Designs Directorate  
Central Electric Authority  
New Delhi

### INDONESIA

Anton Soedjarwo  
Director  
Yayasan Dian Desa  
Yogyakarta, Central Java

Robert Davis  
USAID/Jakarta

Ir. Muchlison  
Chief, Mechanical Dept.  
Hydro-Power Laboratory  
Power Research Institute  
Jakarta Selatan

**Ir. Ibnu Soedjono**  
 Director  
 Research and Development  
 Department of Trade and Cooperatives  
 Jakarta

**Ir. Sularso**  
 Dept. of Mechanical Engineering  
 Bandung Institute of Technology  
 Bandung, West Java

**Ir. Djoko Susanto**  
 DC Electricity for Small Villages Project Office  
 Agency for Development and Application of  
 Technology (BPPT)  
 Jakarta Pusat

**Marsal Alimin**  
 DC Electricity for Small Villages Project  
 Department of Technology (BPP Technology)  
 Jakarta Pusat

**Peter McNeil**  
 NRECA/Jakarta

**Ibnu Subroto**  
 Chief of Micro-hydro  
 Power Research Institute  
 Jakarta Selatan

**Ir. Harry Sosrohadisewoyo**  
 Dept. of Electrical Engineering  
 Laboratory of Electrical Conversion  
 Institute of Technology Bandung  
 Bandung, West Java

**Professor Ir. Suryono**  
 Perusahaan Umum  
 Listrik Negara  
 Jakarta Selatan

#### **MALAYSIA**

**Muhammed Ghazi Bin Haji Hassan**  
 Senior Planning Engineer  
 Rural Electrification  
 National Electricity Board  
 Kuala Lumpur

**Hoesni Nasaruddin**  
 Senior Research Engineer  
 National Electricity Board  
 Kuala Lumpur

#### **NEPAL**

**Umesh Devkota**  
 Engineer  
 Small Hydro Development Board  
 Kathmandu

**Shiba Natha Sharma**  
 Executive Director  
 Water and Energy Commission  
 Kathmandu

**Rewat Bahadur Karki**  
 Production Engineer  
 Balaju Yantra Shala (P) Ltd.  
 Kathmandu

**Ganesh Bahadur Shrestha**  
 Engineer  
 Mini-Hydro Development Board  
 Kathmandu

#### **PAKISTAN**

**Mohammed Abdullah**  
 Chairman, Dept. of Electrical Engineering  
 NEFP University of Peshawar  
 Peshawar

**Waseem Khan**  
 Chief Engineer, Mangaler Dam  
 Water and Power Development Authority  
 Lahore

#### **PAPUA NEW GUINEA**

**Lukis Romaso**  
 Operating Manager  
 Appropriate Technology Development Institute  
 PNG University of Technology  
 Lae

**Martin Solo**  
 Electricity Commission of Papua New Guinea  
 Port Moresby

#### **PEOPLE'S REPUBLIC OF CHINA**

**Cheng Xuemin**  
 Chief Engineer  
 Bureau of Foreign Affairs  
 Ministry of Electricity Power  
 Beijing

**PHILIPPINES**

A.D. Burrell  
Officer-in-Charge  
Power Division West  
Asian Development Bank  
Manila

Juan Michael V. Del Rosario  
Vice President  
Atlantic, Gulf & Pacific, Co.  
Manila

Frank Denton  
Consultant  
National Electrification Administration  
Manila

Zenaida Santos  
Executive Director  
Mini-hydro Project Office  
National Electrification Administration  
Manila

Percival Favoreal  
General Manager  
Casureco IV  
Manila

S.N. Vinze  
Manager,  
Power Division East  
Asian Development Bank  
Manila

Profirio N. Zablan, Jr.  
Assistant Vice-President  
Philippine Electric Corporation  
Manila

**SOLOMON ISLANDS**

Martin Sam  
Senior Engineer  
Electricity Authority  
Honiara

**SRI LANKA**

M.A.R.V. Fernando  
Principal Research Engineer  
National Energy Research and Development  
Center  
Colombo

Leroy Purifoy  
USAID/Sri Lanka

A.N.S. Kulasinghe  
Director  
National Energy Research and Development  
Center  
Colombo

M.A.Q. Saleem  
Electricity Board  
Colombo

**THAILAND**

Preecha Kuwinpant  
Professor  
Political Science Department  
Chulalongkorn University  
Bangkok

Chanaphun M.L. Kridakorn  
Chief, Construction Planning and Control  
Division  
Hydroelectric Construction Department  
Electricity Generating Authority of Thailand  
Bangkok

Taweesak Mahasandana  
Assistant Director  
Hydroelectric Construction Department  
Electricity Generating Authority of Thailand  
Bangkok

Sumonchart Suvarnapradip  
Engineer Class I  
Power Plant Engineering Division  
Energy Technology Division  
Electricity Generating Authority of Thailand  
Bangkok

Kanchit Chaemsaitong  
System Planner  
Committee for Coordination of Investigations  
of the Lower Mekong Basin  
ESCAP  
Bangkok

Pachern Sridurongkatum  
Executive Agent  
Committee for Coordination of Investigation  
of the Lower Mekong Basin  
ESCAP  
Bangkok

Adul Chairoon  
Civil Engineer  
Water Resources Branch  
Investigation and Planning Division  
National Energy Administration  
Bangkok

Chalermchai Ratnarak  
Assistant Chief, Projects Division  
Planning Department  
Electricity Generating Authority of Thailand  
Bangkok

Sompol Thieravarut  
Engineer Class III  
Water Resources Planning and Development  
Division  
Planning Department  
Electricity Generating Authority of Thailand  
Bangkok

Nguyen Duc Lien  
Planning Engineer  
Committee for Coordination of Investigations  
of the Lower Mekong Basin  
ESCAP  
Bangkok

Piromsakdi Laparojkit  
Director  
Energy Planning Sector  
National Economic and Social Development  
Board  
Bangkok

Sornsing Chooppawa  
Senior Civil Engineer  
Micro Hydropower Construction Project  
Construction Branch  
Technical Division  
National Energy Administration  
Bangkok

Niyom Maprachong  
Senior Planning Engineer  
Water Resources Branch  
Investigation and Planning Division  
National Energy Administration  
Bangkok

Wichit Wetchaphan  
Planning Engineer  
Water Resources Branch

Investigation and Planning Division  
National Energy Administration  
Bangkok

James Ogata  
Engineer  
Peace Corps of America  
Bangkok

Viradej Limcharoenviriyakul  
First-Grade Engineer and Field Engineer  
Office of Rural Electrification  
Provincial Electricity Authority  
Bangkok

Sangan Tungdajahirun  
Third-Grade Engineer and Project Engineer  
Office of Rural Electrification  
Provincial Electricity Authority  
Bangkok

Pichart Watnaprateep  
Technical Forest Officer  
Watershed Management Division  
Royal Forestry Department  
Bangkok

Mohar Singh Monga  
Chief  
Investigations and Planning Division  
National Energy Administration  
Bangkok

Boon Indrambarya  
Advisor  
National Research Center  
Bangkok

Vibulya Kuhirun  
Deputy Director Office of Rural Electrification  
Provincial Electricity Authority  
Bangkok

Phasook Longsomboon  
Second-Grade Engineer and Liaison Engineer  
Office of Rural Electrification  
Provincial Electricity Authority  
Bangkok

Adulya Krailassiri  
Technical Forest Officer  
Watershed Management Division  
Royal Forestry Department  
Bangkok

Robert S. Queener  
Assistant Director  
USAID/Thailand  
Bangkok

Eduardo Abores  
Graduate Student  
Asian Institute of Technology  
Bangkok

Nicanor Austriaco  
Director,  
Continuing Education Center  
Asian Institute of Technology  
Bangkok

Hiran Dias  
Associate Chairman  
Division of Human Settlements Development  
Asian Institute of Technology  
Bangkok

M.Z. Haque  
Graduate Student  
Asian Institute of Technology  
Bangkok

Shyam K. Manandhar  
Graduate Student  
Asian Institute of Technology  
Bangkok

Bruce J. Odell  
Director  
Office of Program and Project Development  
USAID/Thailand  
Bangkok

Mintara Silawatshanani  
Engineer  
Office of Engineering & Science of Technology  
USAID/Thailand  
Bangkok

Mofazzel Ahmed  
Graduate Student  
Asian Institute of Technology  
Bangkok

Felipe Butlig  
Graduate Student  
Asian Institute of Technology  
Bangkok

R.H.B. Exell  
Associate Chairman  
Energy Technology Division  
Asian Institute of Technology  
Bangkok

Charles Gunaratnam Jeevaraj  
Graduate Student  
Asian Institute of Technology  
Bangkok

W.S.R. de Mel  
Graduate Student  
Asian Institute of Technology  
Bangkok

Bhuiyan Abdur Rahman  
Graduate Student  
Asian Institute of Technology  
Bangkok

Suphat Vongvisessomjai  
Chairman  
Division of Water Resources Engineering  
Asian Institute of Technology  
Bangkok

M. Nawaz Sharif  
Vice President for Academic Affairs  
Asian Institute of Technology  
Bangkok

Vanchai Jaisin  
Engineer  
USAID/Bangkok

Huynh Ngoc Phien  
Assistant Professor  
Asian Institute of Technology  
Bangkok

Jacques Valls  
Director  
Library & Regional Documentation Center  
Asian Institute of Technology  
Bangkok

Robert R. Morton  
Senior Engineer  
World Bank  
Bangkok

**UNITED STATES**

**Roger Arndt**  
 Director  
 St. Anthony Falls Hydraulic Laboratory  
 University of Minnesota  
 Minneapolis, Minnesota

**Daniel Boyle**  
 Mini-hydropower Development Specialist  
 SDH/NRECA

**Jean Chin**  
 Secretary  
 SDH/NRECA

**Norman Crawford**  
 President  
 Hydrocomp  
 Palo Alto, California

**Bard Jackson**  
 Principal Engineer  
 SDH/NRECA

**Jorge Asin**  
 Vice President  
 Rural Development Systems  
 International Economics Group, Inc.  
 Washington, D.C.

**Janice Brodman**  
 Graduate Student  
 Harvard University  
 Cambridge, Massachusetts

**Paul Clark**  
 Info. and Training Specialist  
 SDH/NRECA

**Mark Henwood**  
 Vice President  
 Henwood Associates  
 Sacramento, California

**Allen Inversin**  
 Micro-Hydro Engineer  
 SDH/NRECA

**Gary Kitching**  
 Manager  
 Small Hydro Electric  
 Systems and Equipment  
 Acme, Washington

**Judith Magee**  
 Associate  
 AMARU IV Cooperative, Inc.  
 Washington, D.C.

**Doug Miller**  
 Hydro-Turbine Division  
 Allis-Chalmers  
 York, Pennsylvania

**Bob Yoder**  
 Graduate Student  
 Cornell University  
 Ithaca, N.Y.

**John Mashaw**  
 Energy Management Consultant  
 SDH/NRECA

**Boris Ponomaryov**  
 Senior Technical Officer  
 Division of Natural Resources & Energy  
 United Nations, New York

**Mangalam Srinivasan**  
 Director  
 Technology Policy and Assistance Council  
 CITC  
 American University  
 Washington, D.C.

**David Zoellner**  
 Program Manager  
 SDH/NRECA



## Program Summary for Asian Rural Development

### MONDAY, JUNE 8 -

Morning: First General Session

**Welcoming Remarks:** Robert S. Queener (Assistant Director, U.S. Agency for International Development, Thailand); M. Nawaz Sharif (Vice-President for Academic Affairs, Asian Institute of Technology); Piromsakdi Laparoikit (Director, Energy Planning Sector, National Economic and Social Development Board of Thailand); Donald D. Cohen (Director, U.S. Agency for International Development, Thailand); and, David R. Zoellner (Assistant Administrator, International Programs Division, National Rural Electric Cooperative Association).

S.N. Vinze, (Manager, Power Division, East Asian Development Bank) *Mini-Hydropower and the Asian Energy Problem*; Mohar Singh Monga (Chief, Investigations and Planning Division, National Energy Administration, Thailand) - *Planning for Mini-Hydropower Development*; Suphat Vongvisessomjai (Chairman, Division of Water Resources Engineering, Asian Institute of Technology) - *Water Resource Planning for Mini-Hydropower*.

Afternoon (General Session, continued): Norman Crawford (President, Hydrocomp, Inc.) - *Hydrologic Methodology Without Stream Flow Data*; Roger Arndt (Director, St. Anthony Falls Hydraulic Laboratory, University of Minnesota) - *Mini-Hydropower Turbine Design*; Allen Inversin (Micro-Hydro Engineer, Small Decentralized Hydropower Program, National Rural Electric Cooperative Association) - *Site Location and Civil Works Design*.

Evening: Get Acquainted Reception (AIT Center).

### TUESDAY, JUNE 9

Morning: Second General Session

**Panel: Local Technology and Management.** (Countries represented - Pakistan, Philippines, Indonesia, Nepal, Papua New Guinea); *Electrical Design* (Bard Jackson, Small Decentralized Hydropower Program, NRECA); *Operation and Maintenance of Mini-Hydro Equipment* (Gary Kitching, Shop Manager, Small Hydroelectric Systems and Equipment).

Afternoon: **Workshops - Resource Assessment and Site Selection; Technology; Issues, Design, Manufacture and Operation.**

Evening: Reception and Banquet.

### WEDNESDAY, JUNE 10

Morning: Third General Session

*Financial Issues and Strategies for Mini-Hydropower* (Jorge Asin, Vice President, Rural Development Systems, International Economics Group, Inc.); *Economics of Mini-Hydropower Development* (Mark Henwood, Vice President, Henwood Associates); *Planning for Productive End-Uses of Mini-Hydropower* (Dan Boyle, Mini-Hydropower Development Specialist, Small Decentralized Hydropower Program, NRECA); *Evaluation Criteria for Mini-Hydropower Systems* (Judith Magee, Associate, AMARU IV Cooperative Inc.).

Afternoon: **Workshops - I: Social Impacts, Community Participation and Institutional Issues; II: Economic Feasibility and Financial Issues.**

### THURSDAY, JUNE 11

Morning: Fourth General Session.

**Panel: Centralized Development and Management.** (Countries represented - Pakistan, Malaysia; Papua New Guinea, Indonesia, Philippines); *Energy Needs in Rural Development: The Case for Mini-Hydropower* (Vibulya Kuhirun, Deputy Director, Office of Rural Electrification, Provincial Electricity Authority, Thailand).

Afternoon: **Workshop Summaries - Resource Assessment and Site Selection; Technology: Issues, Design, Manufacture and Operation; Social Impacts, Community Participation and Institutional Issues; Economic Feasibility and Financial Issues.**

### FRIDAY, JUNE 12

Morning: Fifth General Session

**Case Studies:** *China's Small Hydropower Development* (Chieng Xuemin, Bureau of Foreign Affairs, Ministry of Electricity Power, Beijing); *A Radical Approach to Rural Electrification for Developing Countries* (Hoesni Nasaruddin, National Electricity Board, Kuala Lumpur); *Development of Small Hydropower Plants in the Philippines* (Zenaida Santos, Mini-Hydro Project Office, National Electrification Administration, Manila); *Micro-Hydro Axial Flow Turbine Battery Charging System in Remote Areas* (Djoko Susanto, Project Office; Agency for Development and Application of Technology - BPPT - Jakarta Pusat).

Afternoon: Workshop Conclusion and Summary; Workshop Adjournment; Closing Reception.

\* \* \* \* \*