

AT MICROFICHE
REFERENCE
LIBRARY

A project of Volunteers in Asia

Microhydropower Handbook, Volume 1

by EG&G Idaho for the U.S. Dept. of Energy

Published by:

National Technical Information Service (NTIS)
5285 Port Royal Road
Springfield, Virginia 22161
USA

Available from:

same as above

Reproduced by permission.

Reproduction of this microfiche document in any form is subject to the same restrictions as those of the original document.

MICROHYDROPOWER HANDBOOK - VOLUME I

EG&G Idaho, Incorporated
Idaho Falls, ID

Jan 83

U.S. DEPARTMENT OF COMMERCE
National Technical Information Service

NTIS[®]

MICROHYDROPOWER HANDBOOK
Volume 1

J. D. McKinney, EG&G Idaho
Prof. C. C. Warnick, University of Idaho
B. Bradley, Bradley Engineering
J. Dodds, EG&G Idaho
T. B. McLaughlin, EG&G Idaho
C. L. Miller, EG&G Idaho
G. L. Sommers, EG&G Idaho
B. N. Rinehart, EG&G Idaho

Published January 1983

EG&G Idaho, Inc.
Idaho Falls, Idaho 83415

Prepared for the
U.S. Department of Energy
Idaho Operations Office
under DOE Contract No. DE-AC07-76ID01570

REPRODUCED BY
NATIONAL TECHNICAL
INFORMATION SERVICE
U.S. DEPARTMENT OF COMMERCE
SPRINGFIELD, VA. 22161

Published by the
Technical Information Center
U.S. Department of Energy

DISCLAIMER

"This book was prepared as an account of work sponsored by an agency of the United States Government. Neither the United States Government nor any agency thereof, nor any of their employees, makes any warranty, express or implied, or assumes any legal liability or responsibility for the accuracy, completeness, or usefulness of any information, apparatus, product, or process disclosed, or represents that its use would not infringe privately owned rights. Reference herein to any specific commercial product, process, or service by trade name, trademark, manufacturer, or otherwise, does not necessarily constitute or imply its endorsement, recommendation, or favoring by the United States Government or any agency thereof. The views and opinions of authors expressed herein do not necessarily state or reflect those of the United States Government or any agency thereof."

This report has been printed directly from copy supplied by the originating organization. Although the copy supplied may not in part or whole meet the standards for acceptable reproducible copy, it has been used for reproduction to expedite distribution and availability of the information being reported.

Available from the National Technical Information Service, U. S. Department of Commerce, Springfield, Virginia 22161.

Codes are used for pricing all publications. The code is determined by the number of pages in the publication. Information pertaining to the pricing codes can be found in the current issues of the following publications, which are generally available in most libraries: *Energy Research Abstracts, (ERA)*; *Government Reports Announcements and Index (GRA and I)*; *Scientific and Technical Abstract Reports (STAR)*; and publication, NTIS-PF-360 available from (NTIS) at the above address.

NOTICE

THIS DOCUMENT HAS BEEN REPRODUCED FROM THE BEST COPY FURNISHED US BY THE SPONSORING AGENCY. ALTHOUGH IT IS RECOGNIZED THAT CERTAIN PORTIONS ARE ILLEGIBLE, IT IS BEING RELEASED IN THE INTEREST OF MAKING AVAILABLE AS MUCH INFORMATION AS POSSIBLE.

1. a

ACKNOWLEDGMENTS

The authors would like to thank the following people and organizations for their contribution to this handbook:

A. Batra, C. Grube, and E. Jewell of Centrac Associates, Inc.;

G. L. Smith of Appropriate Technology; and

J. Volkman of Intermountain Energy Systems
for supplying draft material for the handbook.

J. T. Parker, EG&G Idaho, technical writer; and

S. C. Hall, EG&G Idaho, illustrator.

Meinikheim Machines, Banks, Idaho; and

GSA International Corporation, Katonah, New York
for reviewing the handbook in draft form.

K. Grover of GSA International Corporation

who supplied much practical design information, and whose
experience in the hydropower field is reflected throughout the
handbook.

CONTENTS

1.	INTRODUCTION	1-1
1.1	Purpose	1-3
1.2	Cost of Development	1-5
1.3	Category of Developer	1-5
1.4	Organization of the Handbook	1-6
1.5	Event Sequence	1-7
1.5.1	List of Events	1-7
1.6	Event Schedule	1-15
2.	WHAT IS HYDROPOWER?	2-1
2.1	History and Typical Microhydropower Systems	2-2
2.2	Head	2-4
2.3	Flow	2-6
2.4	Kilowatt	2-8
2.5	Power Equation	2-11
2.6	Microhydropower Sources	2-14
2.6.1	Natural Sources (Run-of-the-Stream)	2-14
2.6.2	Manmade Source	2-20
2.7	Typical Example Sites	2-24
2.7.1	Manmade Source	2-24
2.7.2	Run-of-the-Stream Source	2-26
3.	POWER POTENTIAL	3-1
3.1	Power Required	3-1
3.1.1	Typical Household Loads	3-1
3.1.2	Metering	3-5
3.2	Inspection of Potential Hydropower Development	3-8
3.2.1	Manmade Sites	3-8
3.2.2	Run-of-the-Stream Sites	3-10

3.3	Determining Available Flow	3-12
3.3.1	Flow Duration Curve	3-12
3.3.2	Existing Stream Flow Records	3-15
3.3.3	Stream Flow Correlation	3-21
	3.3.3.1 Flow measurement	3-22
	3.3.3.1.1 Container method	3-24
	3.3.3.1.2 Weir method	3-26
	3.3.3.1.3 Float method	3-34
	3.3.3.2 Flow computations	3-41
	3.3.3.3 Exceedance value flow duration curve	3-42
3.4	Head and Distance Measurements	3-48
3.4.1	Head Measurements	3-48
	3.4.1.1 Pressure method for measuring pool-to-pool head at run-of-the-stream site	3-48
	3.4.1.2 Level survey to measure head at run-of-the-stream sites, canal drops, and industrial discharge sites	3-51
	3.4.1.3 Survey methods for manmade dams with low head	3-55
	3.4.2 Distance Measurement for Run-of-the-Stream Site	3-56
3.5	Determining Design Capacity, Head, and Flow for Category 1 Developers	3-56
3.5.1	Power Requirements and Minimum Flow Known; Calculate Head	3-58
3.5.2	Head Fixed and Flow Known; Calculate Design Capacity	3-59
3.5.3	Head and Power Requirements Known; Calculate Minimum Flow and Percentage Exceedance	3-60
3.5.4	Head and Flow Vary; Calculate Design Capacity	3-61
	3.5.4.1 Seasonal head fluctuation	3-62
	3.5.4.2 Erratic head fluctuation	3-62
3.6	Determining Design Capacity, Head, and Flow for Category 2 Developers	3-62
3.6.1	Head Fixed and Flow Known; Calculate Design Capacity	3-64
3.6.2	Variable Head and Known Flow; Calculate Design Capacity	3-65
3.7	Determining Annual Energy	3-66

4.	DESIGN, EQUIPMENT, AND SAFETY REQUIREMENTS	4-1
4.1	Turbines	4.1-1
4.1.1	Impulse Turbines	4.1-1
4.1.1.1	Pelton wheel turbine	4.1-3
4.1.1.2	Crossflow turbine	4.1-4
4.1.1.3	Turgo impulse turbine	4.1-5
4.1.2	Reaction Turbines	4.1-7
4.1.2.1	Francis turbines	4.1-8
4.1.2.2	Propeller turbines	4.1-9
4.1.3	Pumps Used as Turbines	4.1-10
4.1.4	Turbine Application	4.1-14
4.1.5	Regulating Turbine Speed	4.1-17
4.1.6	Turbine Setting	4.1-18
4.1.7	Draft Tube	4.1-19
4.2	Contact Turbine-Generator Manufacturers and Suppliers	4.2-1
	Microhydropower Turbine-Generator Information Request	4.2-4
4.3	Go/No-Go Decision and Design Criteria Selection	4.3-1
4.3.1	Go/No-Go Decision	4.3-1
4.3.2	Design Criteria	4.3-7
	Design Specification	4.3-8
4.4	Intake System	4.4-1
4.4.1	Water Quality	4.4-2
4.4.2	Run-of-the-Stream Sources and Canal Drops	4.4-4
4.4.2.1	Stream diversion works	4.4-5
4.4.2.2	Intake and power canal	4.4-8
4.4.2.3	Settling basin	4.4-14
4.4.2.4	Forebay	4.4-18
4.4.2.5	Trashrack	4.4-22
4.4.2.5.1	Trashrack design area	4.4-28
4.4.2.5.2	Length of trashrack wetted area	4.4-29
4.4.2.5.3	Nominal width	4.4-30
4.4.2.5.4	Width of the trashrack	4.4-31
4.4.2.5.5	Bundle size	4.4-33
4.4.2.5.6	Trashrack supports	4.4-35
4.4.2.5.7	Width of trashrack support structure	4.4-35
4.4.2.5.8	Length of trashrack support structure	4.4-36

4.4.2.6	Penstock intake	4.4-37
4.4.2.7	Additional hardware	4.4-41
	4.4.2.7.1 Skimmers	4.4-41
	4.4.2.7.2 Stop log weir check	4.4-42
4.4.2.8	Alternative layouts	4.4-42
4.4.3	Existing Dam Intakes	4.4-42
	4.4.3.1 Open flumes	4.4-47
	4.4.3.2 Siphon penstock	4.4-47
4.4.4	Design Layout	4.4-48
4.5	Penstock and Valves	4.5-1
4.5.1	Locating the Penstock	4.5-1
4.5.2	Design Layout	4.5-3
4.5.3	Material Selection	4.5-3
4.5.4	Penstock Sizing	4.5-6
	4.5.4.1 Selecting pipe diameter	4.5-6
	4.5.4.2 Selecting pipe material	4.5-11
	4.5.4.3 Calculating penstock system head loss	4.5-16
4.5.5	Valves	4.5-20
	4.5.5.1 Penstock intake	4.5-20
	4.5.5.2 Penstock upward slope	4.5-20
	4.5.5.3 Turbine isolation valve	4.5-21
	4.5.5.4 Turbine bypass "Y"	4.5-26
	4.5.5.6 Turbine flow control valve	4.5-27
4.5.6	Siphon Penstock	4.5-28
4.5.7	Additional Design Considerations	4.5-30
	4.5.7.1 Hydrostatic thrust	4.5-30
	4.5.7.2 Thermal expansion and contraction	4.5-30
	4.5.7.3 Pipe spans and support	4.5-35
	4.5.7.4 Ultraviolet degradation	4.5-36
	4.5.7.5 Penstock anchoring	4.5-37
	4.5.7.6 Freezing	4.5-37
4.5.8	Design layout	4.5-37
4.6	Powerhouse	4.6-1
4.6.1	Physical Features of the Powerhouse	4.6-1
4.6.2	Powerhouse Size and Dimensions	4.6-4
4.6.3	Minimum Powerhouse Standards	4.6-5
4.6.4	Location and Mounting of the Equipment	4.6-5
4.6.5	Powerhouse Costs	4.6-7
4.6.6	Design Layout	4.6-8

4.7	Tailrace	4.7-1
4.7.1	Size of the Tailrace	4.7-1
4.7.2	Tailrace Intake	4.7-1
4.7.3	Design Considerations	4.7-3
4.7.4	Design Layout	4.7-3
4.8	Generators and Electrical	4.8-1
4.8.1	Electrical Safety Considerations	4.8-1
4.8.2	Generator Selection	4.8-3
4.8.3	Sizing the Generator and Electrical Distribution System	4.8-6
4.8.4	Metering	4.8-10
4.8.5	Generator Speed Selection	4.8-11
4.8.6	Cost of Generators	4.8-12
4.8.7	Electrical Equipment Sizing	4.8-12
4.8.8	Sizing the Electrical Distribution System	4.8-15
4.8.9	Overcurrent Protection	4.8-19
4.8.10	Step-Up Transformer	4.8-19
4.8.11	Grounding	4.8-20
4.8.12	Governors and Load Control Systems	4.8-22
	4.8.12.1 Governors	4.8-22
	4.8.12.2 Load controllers	4.8-23
4.8.13	Utility Tie-ins	4.8-26
4.9	Drive Systems and Speed Increasers	4.9-1
4.9.1	Direct Connection Drives	4.9-2
4.9.2	Speed Changing Drives	4.9-3
	4.9.2.1 Chain drives	4.9-3
	4.9.2.2 Belt drives	4.9-5
	4.9.2.3 Gear Drives	4.9-16
5.	DESIGN PACKAGE, CONSTRUCTION, AND INSTALLATION	5-1
5.1	Design Package	5-1
5.1.1	Final Drawings	5-2
5.1.2	Data Sheets, Specifications, and Bid Packages	5-2
5.1.3	Material Takeoff Sheets	5-3
5.1.4	Detailed Cost Estimate	5-4
5.1.5	Construction Schedule	5-6
5.2	Construction and Installation	5-7
5.2.1	General	5-7
5.2.2	Civil Works	5-9
	5.2.2.1 Excavation and backfill	5-9
	5.2.2.2 Concrete	5-11

	5.2.2.2.1	Placement	5-12
	5.2.2.2.2	Compaction	5-14
	5.2.2.2.3	Curing	5-14
	5.2.2.2.4	Watertightness	5-24
	5.2.2.2.5	Air entrainment	5-19
	5.2.2.3	Concrete forms	5-19
	5.2.2.4	Concrete reinforcing steel	5-20
	5.2.2.5	Anchor bolts	5-23
	5.2.2.6	Penstock	5-26
5.2.3	Mechanical Equipment		5-26
	5.2.3.1	Equipment installation	5-27
	5.2.3.1.1	Positioning and setting equipment	5-27
	5.2.3.1.2	Aligning and adjusting equipment	5-28
	5.2.3.1.3	Bolting	5-30
	5.2.3.2	Flushing and testing water passages	5-30
	5.2.3.3	Lubrication	5-31
	5.2.3.4	Equipment checkout	5-32
5.2.4	Electrical		5-33
6.	STARTUP, OPERATION, AND MAINTENANCE		6-1
6.1	Initial System Startup		6-1
	6.1.1	Synchronous Generator Startup	6-1
	6.1.2	Connecting Synchronous Generators to Utility Powerlines	6-3
	6.1.3	Induction Generator Startup	6-7
	6.1.4	System Troubleshooting	6-8
6.2	Startup		6-9
6.3	Maintenance		6-10
	6.3.1	Manuals	6-11
	6.3.2	Waterways	6-11
	6.3.3	Mechanical	6-12
	6.3.4	Electrical	6-13
		Power plant equipment maintenance check list	6-13
6.4	Safety		6-16
6.5	Spare Parts		6-16

7.	ECONOMIC CONSIDERATIONS	7-1
7.1	Category 1 Developer	7-1
7.2	Category 2 Developer	7-4
8.	LEGAL, INSTITUTIONAL, AND ENVIRONMENTAL CONSIDERATIONS	8-1
8.1	Environmental Considerations	8-2
8.1.1	Environmental Considerations During Construction	8-3
8.1.1.1	Water quality	8-4
8.1.1.2	Diversion of stream flow	8-4
8.1.1.3	Sediment control and dredging	8-4
8.1.1.4	Wildlife and migratory fish	8-5
8.1.1.5	Historical significance and aesthetics ...	8-5
8.1.2	Environmental Considerations During Operation	8-5
8.1.2.1	Effects of water level fluctuations	8-6
8.1.2.2	Instream flow requirements	8-6
8.1.2.3	Water quality changes	8-7
8.1.2.4	Effects on migratory fish	8-8
8.2	State and Local Requirements for Development	8-9
8.2.1	Water Rights	8-14
8.2.2	Public Utility Commission Permits	8-15
8.2.3	Use of State Lands	8-16
8.2.4	Dam Safety and Other Safety Requirements	8-16
8.2.5	State Environmental Considerations	8-17
8.2.6	Historical and Archeological Considerations	8-19
8.2.7	Transportation Permits	8-19
8.2.8	Local Planning, Zoning, and Building Permits	8-20
8.3	Federal Requirements	8-20
8.3.1	Federal Energy Regulatory Commission Regulations ...	8-20
8.3.1.1	No jurisdiction	8-22
8.3.1.2	Notice of exemption for existing dams ...	8-24
8.3.1.3	Conduit exemption	8-26
8.3.1.4	Case-by-Case Exemption	8-27
8.3.1.5	License	8-28
8.3.2	Corps of Engineers and EPA Permits	8-29
8.3.3	Other Federal Laws and Federal Land-Use Permits ...	8-33
8.4	Marketing	8-34
8.4.1	Sales Contract	8-35

8.4.2	PURPA	8-36
8.4.2.1	Qualifying facility	8-37
8.4.2.2	Avoided cost	8-38
8.4.2.3	Sales Opportunity	8-39
8.5	Example Sites	8-41
8.5.1	Run-of-the-Stream Site	8-41
8.5.2	Manmade Site in New Hampshire	8-47
8.6	Bibliography	8-53
APPENDIX A--TECHNICAL SUPPORT		A-i
A-1	Development of The Power Equation	A1-1
A-2	Estimating Minimum Stream Flow	A2-1
A-3	Rainfall Runoff Correlation	A3-1
A-4	Stream Flow Projections Where a Gage Correlation Does Not Exist	A4-1
A-5	Economic Analysis	A5-1
A-6	Electrical Theory	A6-1
A-7	Turbine Setting and Specific Speed	A7-1
APPENDIX B--EXAMPLE PROJECTS		B-i
B-1	Run-of-the-Stream Project	B1-1
B-2	Manmade Site	B2-1
APPENDIX C--DISCUSSION OF FEDERAL LAWS AND FEDERAL LAND-USE PERMITS ...		C-i
APPENDIX D--ADDRESSES OF FEDERAL OFFICES		D-i
APPENDIX E--ADDRESSES OF STATE AGENCIES		E-i
APPENDIX F--MANUFACTURERS AND SUPPLIERS OF EQUIPMENT FOR HYDROPOWER INSTALLATIONS SMALLER THAN 100 kW		F-i
APPENDIX G--GLOSSARY, ABBREVIATIONS, AND CONVERSION TABLE		G-i
APPENDIX H--LIST OF ENERGY LAW INSTITUTE STATE REPORTS		H-i
APPENDIX I--FORMS		I-i

FIGURES

1-1	Comparison of water wheel and water-driven turbine	1-1
1-2	Simple tools and aids	1-2
1-3	Types of scale	1-3

1-4	Event sequence	1-8
2-1	Head illustrated	2-5
2-2	Cubic foot illustrated	2-7
2-3	Cubic foot per minute illustrated	2-7
2-4	Kilowatt illustrated	2-9
2-5	Effect of doubling either head or flow	2-15
2-6	Stream without a dam	2-16
2-7	Waterfall	2-16
2-8	Dam	2-17
2-9	Canal drop	2-17
2-10	Run-of-the-stream development	2-18
2-11	Run-of-the-stream development	2-18
2-12	Installation at an old mill site	2-21
2-13	Siphon penstock at an existing dam	2-22
2-14	Installation at a canal	2-23
2-15	Installation using wastewater discharge	2-25
3-1	Daily electrical load chart	3-4
3-2	Sample of completed daily electrical load chart	3-5
3-3	Electrical meter, showing readings taken 30 days apart	3-6
3-4	Flow duration curve	3-14
3-5	Flow measurement table	3-24
3-6	Measuring flow by the container method	3-25
3-7	Weir details	3-27
3-8	Tongue-and-groove lumber dam, with weir	3-28
3-9	Log crib dams	3-29
3-10	Priming plank	3-31
3-11	Relationship of weir and measuring post	3-32
3-12	Float method for estimating flow	3-35

3-13	Form used for exceedance value flow duration curve	3-43
3-14	Flow duration curve for exceedance values in Table 3-3 (site flow scale missing)	3-44
3-15	Flow duration curve with completed site flow scale	3-47
3-16	Pressure gage measurement of head for run-of-the-stream sites	3-50
3-17	Types of level	3-52
3-18	Level survey method of head measurement	3-54
3-19	Method for daily head measurements at dam site	3-55
4.1-1	Impulse turbine (pelton wheel)	4.1-2
4.1-2	Reaction turbine	4.2-3
4.1-3	Crossflow turbine	4.2-5
4.1-4	Turgo impulse turbine	4.2-6
4.1-5	Francis reaction turbine	4.2-7
4.1-6	Vertical shaft pump used as a turbine, with 90-degree gear box	4.1-14
4.4-1	Typical diversion works	4.4-6
4.4-2	Gabion weir	4.4-7
4.4-3	Estimating design flow for Category 1 and Category 2	4.4-11
4.4-4	Canal cross-sectional area	4.4-12
4.4-5	Canal spillway	4.4-13
4.4-6	Sketch of canal cross-sectional area	4.4-15
4.4-7	Diagram of settling basin	4.4-16
4.4-8	Flow control gates	4.4-17
4.4-9	Sketch of settling basin	4.4-18
4.4-10	Diagram of forebay	4.4-19
4.4-11	Penstock intake structure cross-section	4.4-20
4.4-12	Vertical slide-in trashracks	4.4-21
4.4-13	Vertical slide-in trashracks	4.4-22

4.4-14	Barrel-type trashrack	4.4-26
4.4-15	Typical trashrack bundle	4.4-26
4.4-16	Trashrack dimension diagram	4.4-27
4.4-17	Penstock intake structure, showing typical trashrack supports, cleanout pipe, and wing walls	4.4-36
4.4-18	Sketch of forebay and penstock intake	4.4-40
4.4-19	Forebay and penstock intake	4.4-41
4.4-20	Typical skimmer layout	4.4-43
4.4-21	Stop log weir check configurations	4.4-44
4.4-22	Alternative layout for intake system	4.4-45
4.4-23	Alternative layout for intake system	4.4-46
4.5-1	Sketch of proposed penstock routing	4.5-4
4.5-2	Pipe diameter selection graph	4.5-7
4.5-3	Pipe diameter selection graph	4.5-8
4.5-4	Pipe diameter selection example	4.5-10
4.5-5	Butterfly valve body and disk	4.5-21
4.5-6	Butterfly valves	4.5-22
4.5-7	Ball valve, gate valve, and globe valve	4.5-23
4.5-8	System to prevent surge pressure	4.5-25
4.5-9	Arrangement showing turbine bypass "Y" and purge valve	4.5-25
4.5-10	Purge valve in operation	4.5-27
4.5-11	Types of turbine flow control valve	4.5-29
4.5-12	Typical thrust block	4.5-33
4.5-13	Typical concrete support saddle for above-ground piping	4.5-36
4.6-1	Powerhouse installation with long tailrace	4.6-2
4.6-2	Wooden powerhouse	4.6-3
4.6-3	Metal powerhouse	4.6-3
4.6-4	Typical powerhouse	4.6-5

4.7-1	Tailrace intake structure	4.7-2
4.8-1	Limits of cost vs kW for 1800-rpm synchronous generators	4.8-13
4.8-2	Cost vs kW for induction generators	4.8-14
4.8-3	One-line diagram of typical power system for a Category 1 developer	4.8-15
4.9-1	Types of rigid coupling	4.9-4
4.9-2	Belt drive terms illustrated	4.9-7
4.9-3	Conventional belt selection chart	4.9-8
4.9-4	Arc of contact	4.9-11
5-1	Cost estimate form for microhydropower project	5-5
5-2	Consistency of concrete in dry, narrow forms	5-13
5-3	Placing concrete on slope, and control of separation	5-15
5-4	Placing concrete in forms	5-16
5-5	Placing concrete in top of narrow form	5-17
5-6	Placing slab concrete	5-17
5-7	Compaction with vibrators, and treatment of rock pocket	5-18
5-8	Reinforcing bar grades	5-22
5-9	Reinforcing bar embedment standards	5-24
5-10	Methods for tying reinforcing bar intersections	5-25
8-1	Sample flow diagram of procedure for dealing with state regulations (New Hampshire)	8-13
8-2	Flow diagram of possible options for FERC licensing	8-23
8-3	Application process for an exemption from licensing requirements	8-27
8-4	FERC preliminary permit process	8-30
8-5	Flow diagram of U.S. Army Corps of Engineers permit procedures	8-32
8-6	Flow diagram of licensing process for a microhydropower project in the state of Washington	8-33

8-7	Flow diagram of licensing process for a microhydropower project in the state of New Hampshire	8-48
-----	-----------------------------------------------------------------------------------------------------	------

TABLES

1-1	Typical time range for microhydropower development events ...	1-15
3-1	Typical household appliance loads	3-2
3-2	Gaging sites in Hillsborough Co., NH and Stevens Co., WA	3-17
3-3	Station Number 12408500--duration table of daily values for year ending September 30	3-23
3-4	Flow per inch of weir width	3-33
3-5	Plant factor based on site characteristics	3-68
4.5-1	Piping alternatives	4.5-12
4.5-2	Friction loss correction factor	4.5-17
4.5-3	Sizing of air valves	4.5-20
4.5-4	Area of bearing for concrete thrust blocks	4.5-32
4.5-5	Soil condition multipliers	4.5-34
4.6-1	Powerhouse costs	4.6-7
4.9-1	Sheave dimensions	4.9-7
4.9-2	Correction factors for loss in arc of contact in degrees	4.9-11
5-1	ASTM standard reinforcing bars	5-21
5-2	Torque values for low-strength bolts	5-30
7-1	Costs for Year One	7-2
7-2	Costs in Year Fifteen	7-3
8-1	State responses to microhydropower survey	8-10
8-2	Possible state permits required for development of a microhydropower project	8-11
8-3	Possible local permits	8-21
8-4	List of pertinent federal laws	8-33
8-5	Local permits that might be necessary in the state of Washington	8-45

1. INTRODUCTION

For centuries, energy from falling water has been converted by man to perform useful work. At the turn of the century, this country was dotted with thousands of picturesque water wheels being turned by the weight or velocity of falling water. The turning water wheels converted the energy of the falling water into mechanical energy, or shaft horsepower. Usually, the water wheel turned a shaft that was connected to some work process such as a gristmill. Today's modern turbines, although they look much different than the old water wheels, represent refinements of similar technology--a more efficient way of converting the energy of falling water to mechanical energy, resulting in faster shaft rotation (see Figure 1-1). If the shaft from a turbine is connected to an electric generator, the two pieces of equipment become known as a hydroturbine-generator unit or a hydroelectric-generator. In general, it can be said that the modern turbine rotates much faster than a water wheel. The faster speed is an advantage in hydroturbine-generator units.

The size of hydroturbine-generator units can vary from a very small turbine connected to a car alternator to a large unit like those in Grand Coulee Dam on the Columbia River. Microhydropower plants are the smallest of the turbine-generator units, producing 100 kilowatts (kW) or less of power [134.1 horsepower (hp) or less]. This handbook only considers units in this size range that convert the mechanical shaft energy of a turbine into electric energy from a generator.

There are many types and makes of turbines. This handbook discusses those turbines that would most likely be connected to small generators producing less than 100 kW of electric power. Water wheels are not addressed in this handbook.

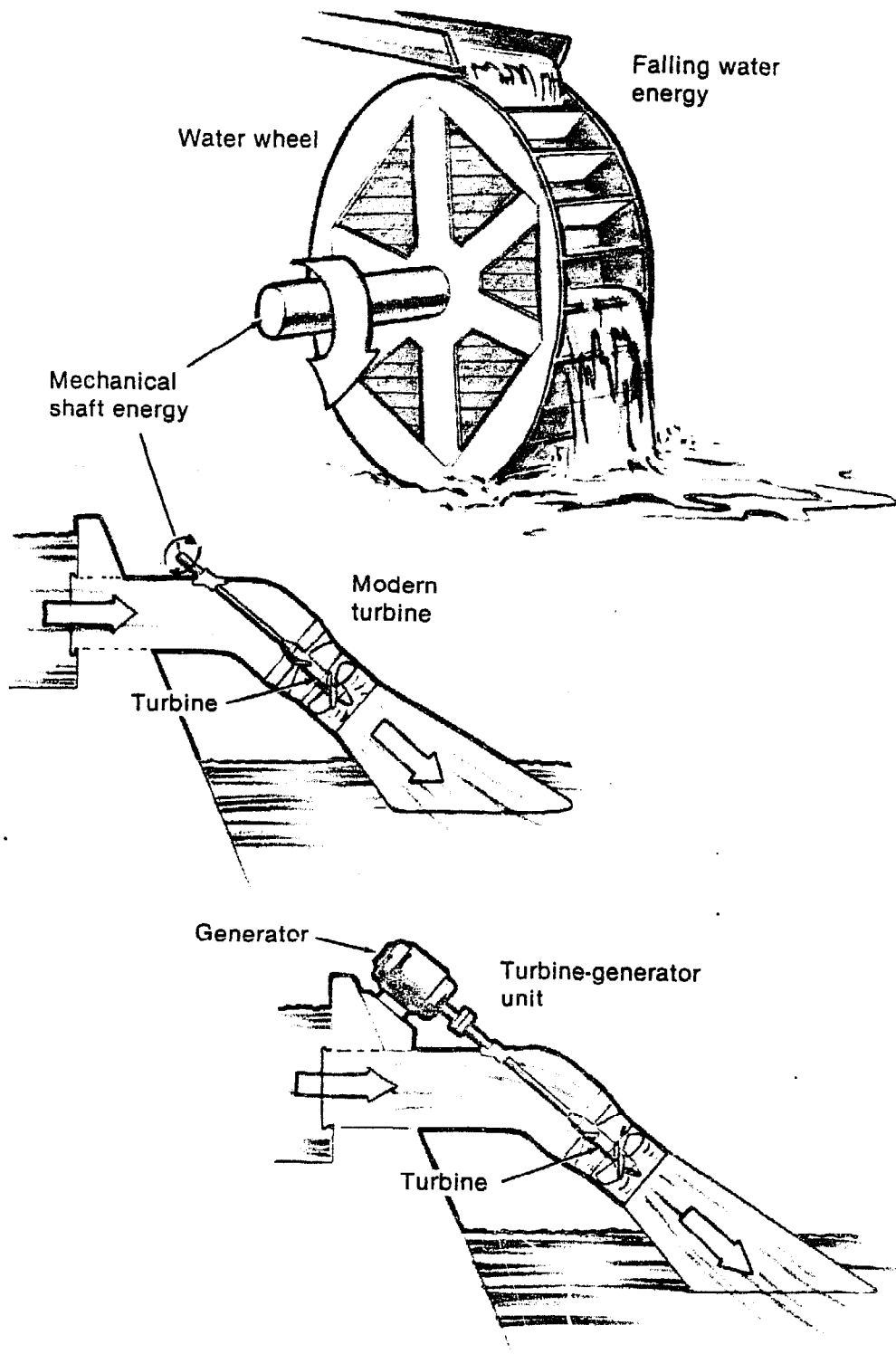

INEL 2 2305

Figure 1-1. Comparison of water wheel and water-driven turbine.

1.1 Purpose

The purpose of this handbook is to provide a mechanically proficient lay person with sufficient information to evaluate microhydropower site potential, lay out a site, select and install equipment, and finally, operate and maintain the completed system. The actual construction details of the site are not included; rather, pointers are given as to what help he should expect from a construction contractor, and general guidelines on construction details are provided. In addition, information about obtaining financing and permits is provided. To help offset the cost, the person performing the work, referred to as the "developer," is encouraged to do as much of the work as possible. However, developers with major areas of uncertainty should consider professional assistance.

The handbook has been written with the aim of keeping the format simple and straightforward. The reader is encouraged not be intimidated by what may be unfamiliar or appear too technical. The handbook assumes that the reader has little working knowledge of hydropower or the engineering concepts behind the use of hydropower. The reader is encouraged to take the time to read and understand each section of the handbook, especially the mathematics, tables, charts, and graphs. A thorough understanding of the information presented in the handbook will greatly enhance the chances for a successful development--one that produces the energy expected and saves the developer money and time in the long run. Keep reading and studying the contents of this handbook; don't give up!!! The mathematical procedures presented in this handbook are limited to multiplication, division, and square roots. More sophisticated procedures may yield greater accuracy, but for the purposes intended, the procedures presented should be sufficient.

Figures 1-2 and 1-3 show simple tools and aids you can use in making and recording calculations, making sketches, and doing similar work that will be needed during the site development process. A pocket calculator can be of great benefit in performing many of the calculations. You will also need a ruler or scale, a triangle, and graph paper or quadrille paper. Graph paper with 10 divisions to the inch and a scale with the same

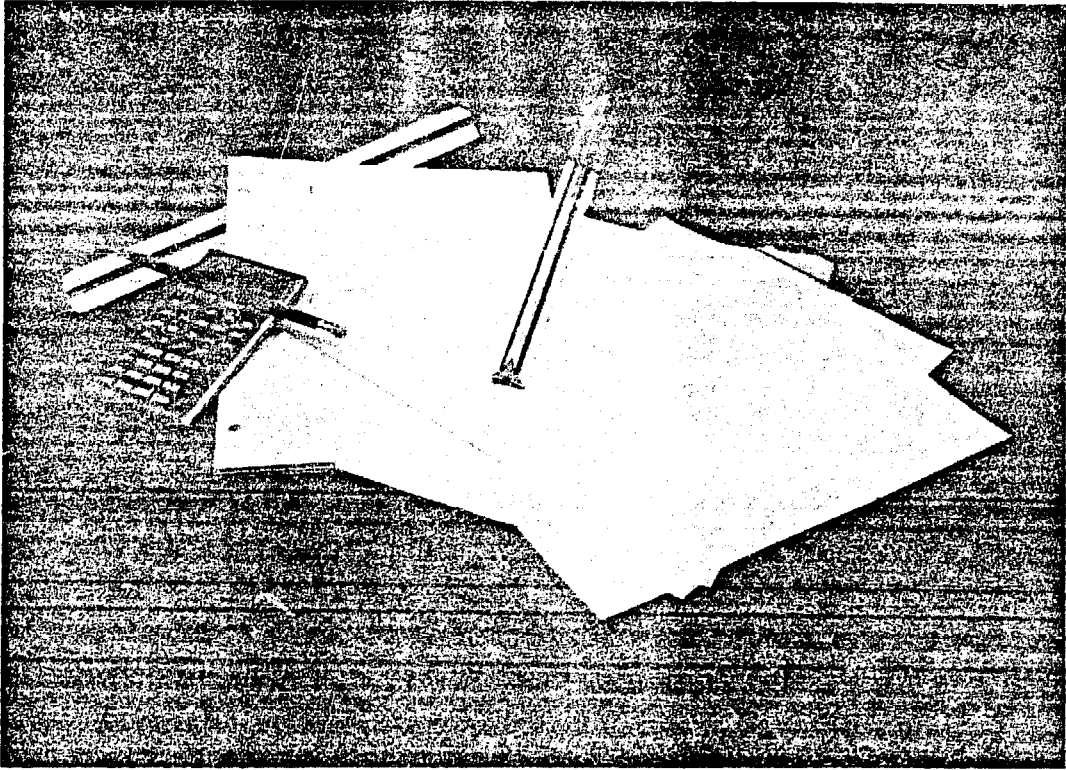

Figure 1-2. Simple tools and aids.

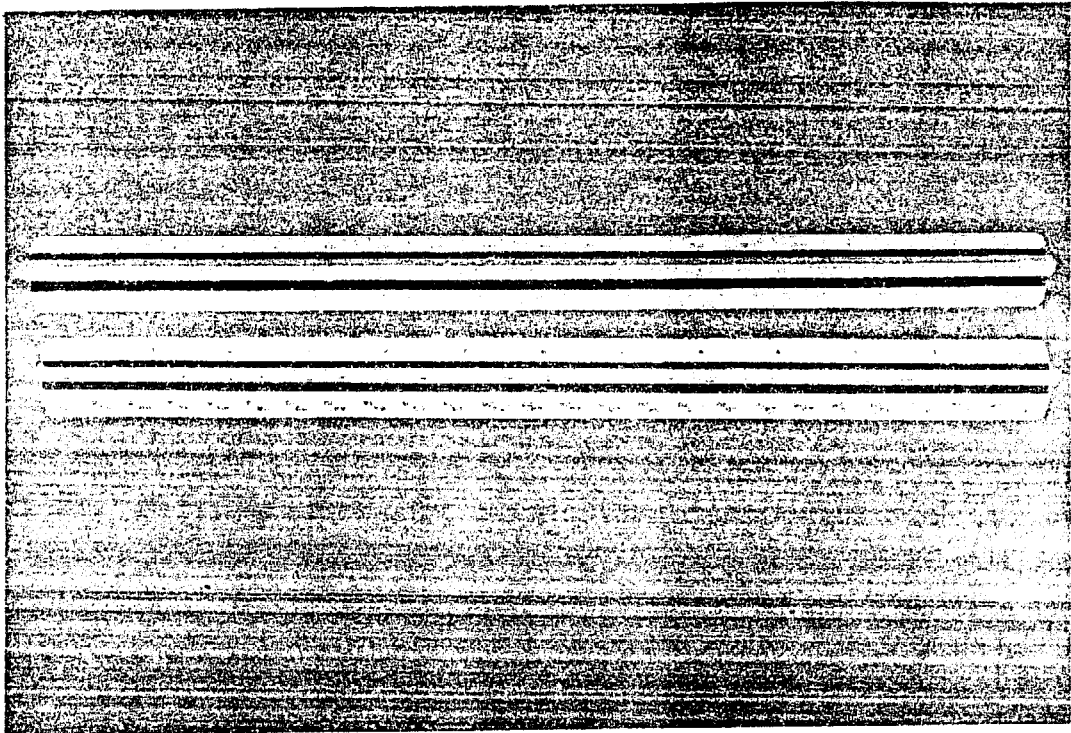

Figure 1-3. Types of scale.

divisions can be very helpful. All of these items are easily obtainable at a stationery or office supply store.

1.2 Cost of Development

At the time of this writing, 1982, the typical development cost may range from \$1,000 to \$4,000 per installed kW. A typical single-family home will require a peak power demand of 5 kW. (If electricity is used for heating, the demand may reach 12 to 20 kW.) This means that a developer who wants to install a unit for personal use may have to invest from \$5,000 to \$20,000.

The installation cost can vary greatly, depending on the work required to prepare the site and on the physical dimensions of the turbine-generator unit to be used. The handbook demonstrates how to estimate installation cost and how to balance design tradeoffs, cost, and projected energy production.

1.3 Category of Developer

The majority of people interested in microhydropower are motivated by a desire to be energy independent. The remainder of those interested desire to produce as much energy as possible as a source of revenue and will generally install larger units than those in the first category. This handbook addresses both categories of interest.

You are encouraged to determine which of the two categories applies to you. It will make a difference in how you design your microhydropower system. If you are unsure which category you should be in, you should evaluate the site as a Category 2 developer and make a final decision later as to which category you build to.

Category 1. The primary motivation is to supply electricity where a utility source is not available, or to develop a separate source of electrical energy and thus become energy independent. The developer in this category is more interested in generating only what energy is

needed and in having that energy available for as much of the year as possible. The developer is not interested in recovering the maximum energy available from the stream. As a result, the system will be designed for the minimum stream flow of the year. The Category 1 developer will generally have a smaller investment than the Category 2 developer.

Category 2. The primary motivation is to produce the maximum energy available from the stream for the dollar invested. The developer may or may not plan to use the energy generated. The operating capacity will generally be greater than 50 kW. The design flow will usually be 70 to 75% of the maximum annual stream flow.

1.4 Organization of the Handbook

The handbook is intended to aid the individual who has a small site that does not justify the expense of professional engineering services. The handbook is divided into eight sections, including the Introduction. You are encouraged to peruse the handbook and obtain a general knowledge of its content before starting actual development. Sections 2 through 8 represent the major steps that any site development must go through. With the exception of Sections 7 and 8, which cover financial and institutional requirements, the sections are presented in the order that must be followed in development. The actual development steps given in Sections 2 through 6 should be completed in the sequence presented to the maximum extent possible. Sections 7 and 8 should be read and followed from the beginning of development through actual operation. Subsection 1.5 below describes the actual steps in more detail.

Several appendices are provided. They contain technical data and conversion tables, descriptions of the development of two example sites, a discussion of applicable federal laws, lists of federal and state agencies, a list of equipment manufacturers, and a glossary of terms.

1.5 Event Sequence

To help in using this handbook, an event sequence--a logical sequence of major steps to be followed in developing a microhydropower plant--is presented below, with a brief narrative describing each event or step. Each event is also cross-referenced to the appropriate section in the handbook. A developer who follows this sequence should encounter minimal delays in the development process and should gain the most from this handbook.

In reading through the event descriptions for the first time, you may encounter terms that are confusing and statements that, without more background, have little meaning to you. Don't worry about the details of the events at this time. The sequence is set up for continual reference as you work through the handbook. As you proceed, the terms and statements should become clear. Keep this subsection marked for quick reference, and as you finish each step refer back to be sure you pursue the next most important step.

Not all events listed below must be done one at a time. There are some steps that can be performed simultaneously. Figure 1-4 is a graphical representation of the events. The figure will be explained in more detail after the narrative description.

1.5.1 List of Events

1. Lightly Review the Handbook. Skim through the handbook. Become familiar with its organization and with the major subjects covered in each section. As you are reviewing, study the figures and diagrams in particular. Refer to the glossary (Appendix G) for meanings to unfamiliar terms. Don't worry if you don't understand some of the sections. They should become clear as you work with them.
2. Read Sections 1 and 2 and Subsection 8.1. The most important items in Section 1 are the event sequence and the determination

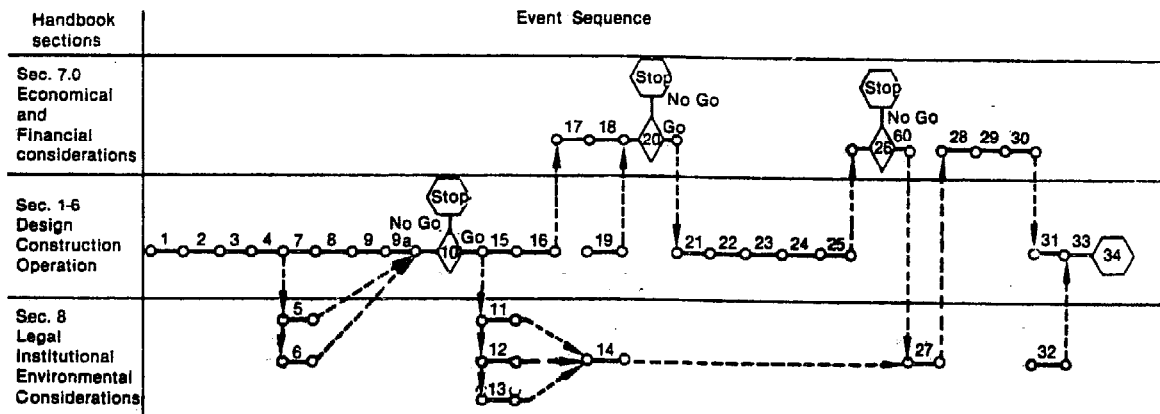

INEL 2 2700

- | | |
|---------------------------------------------------------------------------------------------------------------------------------------------------------------------------------------------------------------------------------------------------------------------------------------------------------------------------------------------------------------------------------------------------------------------------------------------------------------------------------------------------------------------------------------------------------------------------------------------------------------------------------------------------------------------------------------------------------------------------------------------------------------------------------------------------------------------------------------------------------------------------------------------------------------------------------------------------------------------------------------------------------------------------------------------------------------------------------------------------------------------------------------------------------------------------------------------------------------------------------------------------------------------------------------------------------------------------------------------------------------------------------------------------------------------------------------------------------------------------------------------------------------------------------------------------|------------------------------------------------------------------------------------------------------------------------------------------------------------------------------------------------------------------------------------------------------------------------------------------------------------------------------------------------------------------------------------------------------------------------------------------------------------------------------------------------------------------------------------------------------------------------------------------------------------------------------------------------------------------------------------------------------------------------------------------------------------------------------------------------------------------------------------------------------------------------------------------------------------------------------------------------------------------------------------------------------------------------------------------------------------------------------------------------------------------------------------------------------------------------------------------------------------------------------------------------------------------------------------------------------------------------------------------------------------------------------------------------------------------------------------------------------------------------------------------|
| <p>All categories</p> <ol style="list-style-type: none"> 1. Lightly review the Handbook 2. Read Sections 1 and 2 and Subsection 8.1 3. Determine power requirements (Subsection 3.1) 4. Make site inspection (Subsection 3.2) 5. Make initial contact with state and local agencies (Subsection 8.2) 6. Make initial contact for Federal land-use Permit (Subsection 8.3.3 and Appendix C) 7. Determine available flow (Subsection 3.3) <p>Category 1 with an existing dam, canal drop, or industrial waste discharge site</p> <ol style="list-style-type: none"> 8. Measure head and distance (Subsection 3.4) 9. Determine design capacity (Subsection 3.5) <p>Category 1 with a run-of-the-stream site</p> <ol style="list-style-type: none"> 8. Determine design head (Subsection 3.5) 9. Measure head and distance (Subsection 3.4) <p>Category 2 with an existing dam, canal drop or industrial waste discharge site</p> <ol style="list-style-type: none"> 8. Measure head and distance (Subsection 3.4) 9. Determine plant capacity (Subsection 3.6) 9.a Determine annual energy production (Subsection 3.7) <p>Category 2 with a run-of-the stream site</p> <ol style="list-style-type: none"> 8. Determine plant capacity (Subsection 3.6) 9. Measure head and distance (Subsection 3.4) 9.a Determine annual energy production (Subsection 3.7) | <p>All categories</p> <ol style="list-style-type: none"> 10. Go-No Go 11. Determine federal requirements (Subsection 8.3) 12. Obtain state and local permits (Subsection 8.2) 13. Obtain federal land use Permit (Subsection 8.3.3) 14. File for FERC license Subsection 8.3) 15. Read section on turbines (Subsection 4.1) 16. Contact manufactures and suppliers (Subsection 4.2) 17. Determine market potential (Subsection 8.4 and Section 7.0) 18. Determine financing options (Subsection 7.0) 19. Make preliminary cost estimate (Subsection 4.3.1) 20. Go-No Go (Subsection 4.3.1) 21. Select the design criteria (Subsection 4.3.2) 22. Design the system (Subsections 4.4 through 4.8) 23. Assemble the design package (Subsection 5.1) 24. Negotiate an equipment package (Subsection 5.3) 25. Make a project cost estimate (Subsection 5.2) 26. Go-No Go (Subsection 5.2) 27. Obtain FERC license (Subsection 8.3) 28. Finalize the marketing contract (Subsection 8.4) 29. Develop financial package (Subsection 5.0) 30. Obtain financing (Subsection 7.0) 31. Finalize design (Subsection 5.4) 32. Obtain local building permit (Subsection 8.2) 33. Construct the system (Subsection 5.0) 34. Operate the system (Subsection 6.0) |
|---------------------------------------------------------------------------------------------------------------------------------------------------------------------------------------------------------------------------------------------------------------------------------------------------------------------------------------------------------------------------------------------------------------------------------------------------------------------------------------------------------------------------------------------------------------------------------------------------------------------------------------------------------------------------------------------------------------------------------------------------------------------------------------------------------------------------------------------------------------------------------------------------------------------------------------------------------------------------------------------------------------------------------------------------------------------------------------------------------------------------------------------------------------------------------------------------------------------------------------------------------------------------------------------------------------------------------------------------------------------------------------------------------------------------------------------------------------------------------------------------------------------------------------------------|------------------------------------------------------------------------------------------------------------------------------------------------------------------------------------------------------------------------------------------------------------------------------------------------------------------------------------------------------------------------------------------------------------------------------------------------------------------------------------------------------------------------------------------------------------------------------------------------------------------------------------------------------------------------------------------------------------------------------------------------------------------------------------------------------------------------------------------------------------------------------------------------------------------------------------------------------------------------------------------------------------------------------------------------------------------------------------------------------------------------------------------------------------------------------------------------------------------------------------------------------------------------------------------------------------------------------------------------------------------------------------------------------------------------------------------------------------------------------------------|

INEL 2 3214

Figure 1-4. Event sequence.

of your development category. Section 2 begins the actual work of the handbook by defining such terms as head, flow, and kilowatt. The power equation is presented in Subsection 2.5. This equation is the basis for all hydropower development. Subsection 2.6 describes the types of microhydropower source. The type of source you have (Run-of-the-Stream, Existing Dam, Canal Drop, or Industrial Waste Discharges) establishes how you design your system. Subsection 2.7 identifies the characteristics of the two example sites used in the handbook. Subsection 8.1 describes some of the environmental considerations you may have to address.

3. Determine Your Power Requirements (Subsection 3.1). In Subsection 3.1 you will determine how much power you should have to meet your needs. This number is important as a base for comparison with the power-generating potential of the your source. Category 1 developers will use the required power as their first design point and base the rest of their system design on it.
4. Make Site Inspection (Subsection 3.2). Subsection 3.2 leads you through a detailed inspection of your site. You are given a list of things to consider in your inspection. After the inspection, you should establish a preliminary layout for your site.
5. Make Initial Contact with State and Local Agencies (Subsection 8.2). At this time, it is important to establish the initial contact with the state agencies. Subsection 8.2, State and Local Requirements for Development, tells how to proceed and identifies what should be discussed in these contacts.
6. Make Initial Contact for Federal Land-Use Permits (Subsection 8.3.3 and Appendix C). If any part of your site will involve the use of federal lands, you should contact the appropriate agency at this time to determine the land-use requirements. Subsection 8.3.3 and Appendix C tell what steps to take.

7. Determine Available Flow (Subsection 3.3). Subsection 3.3 presents various methods for measuring stream flow. If you are a Category 2 developer, you will be given additional instructions on how to develop a flow duration curve. The curve is important in selecting the right equipment and determining how much energy can be generated in a year.

Note: How you proceed through the next two events depends on which category of developer you are and what type source you are developing.

Category 1 with an Existing Dam, Canal Drop, or Industrial Waste Discharge Site

8. Measure Head and Distance (Subsection 3.4). Subsection 3.4 describes various survey methods useful in measuring head and discusses the measurement of intake to powerhouse distances.
9. Determine Design Capacity (Subsection 3.5). Subsection 3.5 has several parts to choose from. You should follow Subsection 3.5.2 to calculate the design power capacity of the site. This number can then be compared with your power requirements, which were determined in Step 3. If the calculated power is less than the requirements, the site will not produce all the power you need. If the calculated power is more than your requirements, then you may be able to sell the excess power to a utility, or you can reduce the design flow to meet only your needs.

Category 1 with a Run-of-the-Stream Site

8. Determine Design Head (Subsection 3.5). Run-of-the-Stream developers have the option of determining how much head they wish to develop. Section 3.5.1 shows you how to determine the amount of head required to meet your needs.
9. Measure Head and Distance (Subsection 3.4). Subsection 3.4 describes various survey methods.

Category 2 with an Existing Dam, Canal Drop, or Industrial Waste Discharge Site

8. Measure Head and Distance (Subsection 3.4). Subsection 3.4 describes various survey methods useful in measuring head and discusses the measurement of intake to powerhouse distances..
9. Determine Plant Capacity (Subsection 3.6). Subsection 3.6 explains plant capacity and gives a rule-of-thumb method for analyzing plant capacity.
- 9a. Determine Annual Energy Production (Subsection 3.7). Subsection 3.7 discusses annual energy production and explains plant factor.

Category 2 with a Run-of-the-Stream Site

8. Determine Plant Capacity (Subsection 3.6). Run-of-the-stream developers will evaluate plant capacity for a range of heads.
9. Measure Head and Distance (Subsection 3.4). A survey should be conducted to determine if the head ranges are reasonable.
- 9a. Determine Annual Energy Production (Subsection 3.7). Subsection 3.7 discusses annual energy production and explains plant factor.

Note: All categories of developers proceed from here.

10. Go/No-Go. This is a logical place to address the first Go/No-Go decision, which is a decision whether or not to proceed with the development. This event does not refer to any particular section in the handbook. Instead, it is a simple comparison of the power required (determined in Step 3) and the power that can be produced (calculated in Step 8 or 9). If the power required is less than or equal to the calculated power, your decision can be "go" and

you should proceed to the next event. If the power required is considerably more than the calculated power, then you might consider a "no-go" decision and find some other means of generating power.

11. Determine Federal Requirements (Subsection 8.3). Read Subsection 8.3 and determine which exemption category you think your site fits into. It is a good idea to write or call the FERC to verify the procedure you think appropriate.
12. Obtain State and Local Permits (Subsection 8.2). In accordance with your initial contacts and Section 8.2, obtain all the state and local permits needed to accompany your FERC license request. (The term "License" in this handbook also implies exemption).
13. Obtain Federal Land-Use Permits (Subsection 8.3.3). If you are going to use federal lands in any way, you must have a permit from the agency with jurisdiction over the land before the FERC will grant a license. In Step 6 you determined what requirements would be imposed on you. To obtain a permit, you must be prepared to show how you will comply with the requirements.
14. File for FERC License (Subsection 8.3). In accordance with Subsection 8.3, file with the FERC for the appropriate exemption.
15. Read Section on Turbines (Subsection 4.1). Subsection 4.1 describes the various types of turbine available to microhydro-power developers. Read the section and determine which type or types best fit your site.
16. Contact Manufacturers and Suppliers (Subsection 4.2). Subsection 4.2 presents a form to fill out and send to the turbine manufacturers and suppliers. The manufacturer or supplier completes the form or supplies the requested information in some other way, and then returns the information to you. With this information in hand, you will now be able to determine the preliminary site economics and establish the design criteria.

17. Determine Market Potential (Subsection 8.4). If you are a Category 2 developer or a Category 1 developer who might sell excess power, read Section 8.4 "Marketing" and then contact local utilities to determine their interests.
18. Determine Financing Options (Section 7.0). Section 7.0 discusses several financing options. Review the section to determine which options might be available to you.
19. Make Preliminary Cost Estimate (Subsection 4.3.1). After the forms are returned from the manufacturers and suppliers, you can make a preliminary cost estimate for the project. This first rough-cut estimate of the project cost should be considered preliminary, but it should indicate the financial magnitude of the project.
20. Go/No-Go (Subsection 4.3.1). The first Go/No-Go decision (Step 10) was based on the power potential of the site. This decision is based on the economic potential of the site. If you consider the development worth the investment, proceed. If not, drop it.
21. Select the Design Criteria (Subsection 4.3.2). If your decision is "go," it is time to select the best turbine-generator and establish the design criteria that will be used for the design work in the remainder of Section 4.0.
22. Design the System (Subsections 4.4 through 4.9). Follow the procedure in Subsections 4.4 through 4.9 to design the system.
23. Assemble the Design Package (Subsection 5.1). In Subsection 5.1, you will assemble the designs of Section 4.0 into a design package and check to make sure that the system will fit together (that is, verify dimensions, lengths, flows, velocity, etc.). Correct any deficiencies to make sure that you are aware of all costs which can be identified.

24. Negotiate An Equipment Package (Subsection 5.1.2). Contact the manufacturer(s) and supplier(s) identified in Step 21 and negotiate or receive bids for the equipment package.
25. Make a Project Cost Estimate (Subsection 5.1.4). From the information in Section 4.0 and Subsection 5.1.4, make a detailed project cost estimate for the complete project.
26. Go/No-Go (Subsection 5.1.5). Like the previous Go/No-Go decision, this decision is based on the economics of the system.
27. Obtain FERC License (Subsection 8.3). Most lending institutions will require an FERC license before they will loan money for a hydropower project. Federal law requires a license before construction begins. In Step 14, you filed for a license. You will have to have a license before proceeding much further.
28. Finalize the Marketing Contract (Subsection 8.4). If you plan to sell power, it is time to negotiate a firm price for the power and obtain a legal contract.
29. Develop Financial Package (Section 7.0 and Appendix A-5). Develop a financial package to present to the lending institutions.
30. Obtain Financing (Section 7.0). Obtain the financial resource required to construct the project.
31. Finalize Design (Subsection 5.1). If the purchased equipment requires changes in any of the design criteria, correct the design to account for the changes. If it does not, use the design from Step 23 for construction of the project.
32. Obtain Local Building Permits (Subsection 8.2). Obtain county and/or city permits before starting construction.

33. Construct the System (Section 5.2). Procure equipment, construct the system, and install all components.
34. Operate the System (Section 6.0). Section 6.0 describes some of the things that should be considered during the first startup of the system. This section also tells you how to bring the system on line.

Each of the 34 events are shown in Figure 1-4 as an activity line. The event is referenced to the activity line by placing the event number above the line. The figure shows which events can be performed simultaneously. The figure shows event sequence only; it does not represent a time frame for doing the work.

1.6 Event Schedule

Table 1-1 shows the typical range of time that might be required to complete each event shown in the logical sequence of events (Figure 1-4).

TABLE 1-1. TYPICAL TIME RANGE FOR MICROHYDROPOWER DEVELOPMENT EVENTS

<u>Events</u>	<u>Typical Time Range^a</u> <u>(months)</u>	
	<u>Low</u>	<u>High</u>
<u>All Categories</u>		
1. Lightly review the handbook	--	--
2. Read Sections 1 and 2 and Subsection 8.1	--	--
3. Determine your power requirements	1/4	1
4. Make site inspection	1/4	1/2
5. Make initial contact with state and local agencies	1	2
6. Make initial contact for Federal land-use permits	1/2	2

TABLE 1-1. (continued)

Events	Typical Time Range ^a (months)	
	Low	High
<u>All Categories</u>		
7. Determine available flow	1/4	12
<u>Category 1 with an Existing Dam, Canal Drop, or Industrial Waste Discharge Site</u>		
8. Measure head and distance	1/4	1
9. Determine design capacity	1/4	1/2
<u>Category 1 with a Run-of-the-Stream Site</u>		
8. Determine design head	1/4	1/2
9. Measure head and distance	1/4	1
<u>Category 2 with an Existing Dam, Canal Drop, or Industrial Waste Discharge Site</u>		
8. Measure head and distance	1/4	1
9. Determine plant capacity	1/4	1/2
9a. Determine annual energy production	1/4	1/2
<u>Category 2 with a Run-of-the-Stream Site</u>		
8. Determine plant capacity	1/4	1/2
9. Measure head and distance	1/4	1
9a. Determine annual energy production	1/4	1/2
10. Go/No-Go	--	--
11. Determine federal requirements	1/4	1/2
12. Obtain state and local permits	2	6
13. Obtain Federal land-use permits	2	6
14. File for FERC license	1/2	1
15. Read section on turbines	--	--

TABLE 1-1. (continued)

Events	Typical Time Range ^a (months)	
	Low	High
<u>All Categories</u>		
16. Contact manufacturer and suppliers	1	3
17. Determine market potential	1	3
18. Determine financing options	1	3
19. Make preliminary cost estimate	1/4	1/2
20. Go/No-Go	--	--
21. Select the design criteria	1/4	1/2
22. Design the system	3	6
23. Assemble the design package	1	2
24. Negotiate an equipment package	1	3
25. Make a project cost estimate	1	2
26. Go/No-Go	--	--
27. Obtain FERC license	1	6
28. Finalize the marketing contract	1	3
29. Develop financial package	1	3
30. Obtain financing	3	6
31. Finalize design	1/4	2
32. Obtain local building permits	1/4	1/4
33. Construct the system	3	12
34. Operate the system	--	--

a. The reader is cautioned not to add up the columns of months to obtain total elapsed time, since many of the events are simultaneous.

2. WHAT IS HYDROPOWER?

Hydropower is the power derived from the natural movement or flow of masses of water. Most commonly, this power is harnessed by taking advantage of the fall of water from one level to another, thus exploiting the effect of gravity. The energy of the falling water is converted to mechanical energy by the use of a turbine. Microhydropower turbines come in many shapes and sizes--from waterwheels, to pumps used as turbines (where water is forced through the pump in the opposite direction), to squirrel cage turbines, called crossflow turbines. Once the turbine is used to convert water energy to mechanical energy, the mechanical energy in turn can be used to perform work or converted to some other form of energy, such as electrical energy (called hydroelectric energy). The energy-producing potential at any given hydropower site depends on the energy of the water, which in turn depends on the distance the water falls, called the head, and on the amount of water flowing.

The actual amount of mechanical or hydroelectric energy produced at such a site also depends on the efficiency at which the turbine or turbine-generator unit can convert the water energy to the other forms of energy. Sites with modern microhydroelectric units will have efficiencies ranging from 40 to 75%. In other words, 40 to 75% of the energy-producing potential is actually converted into useful energy.

This section of the handbook discusses the recent history of waterpower, definitions of head and flow, the definition of kilowatt, the power equation (a more detailed development of the power equation is given in Appendix A-1), types of microhydropower source, and two example sites. (The example sites are discussed in the remaining sections of the handbook and are presented as complete examples in Appendix B.) A reader who is familiar with these subjects may want to skim over this section.

2.1 History and Typical Microhydropower Systems

The use of hydropower as a source of mechanical energy dates back more than 2,000 years to the earliest waterwheels. Such wheels in one form or another were the primary source of power for many centuries. French engineers started making improvements in waterwheels in the mid 18th century and continued to lead the field until the mid 19th century. A French military engineer, Claude Burdin (1790-1873), first used the term "water turbine" from the Latin turbo: that which spins. (Although water wheels fit this definition, they are not now classed as turbines by most of those working in the hydropower field.) The first commercially successful new breed of hydraulic turbine was a radial-outflow type. The water entered at the center of the turbine and flowed outward through the turbine runners (blades). The turbine was developed by a student of Burdin, Benoit Fournegron (1802-1867). In 1836, a patent was awarded to Samuel B. Howd of Geneva, New York for a radial "inflow" turbine. The idea was perfected by James B. Francis and Uriah A. Boyden at Lowell, Massachusetts in 1847. In its developed form, the radial inflow hydraulic turbine, now known as the Francis turbine, gave excellent efficiencies and was highly regarded.^a

Another class of turbine used the concept of a vertical wheel driven by a jet of water applied at one point in its circumference. The approach led ultimately to the Pelton wheel, which uses a jet or jets of water impinging on an array of specially shaped buckets closely spaced around the rim of a wheel. The Pelton wheel was developed at the end of the 19th century by a group of California engineers, among them Lester A. Pelton (1829-1908).^b

Waterwheels and modern turbines are often differentiated by stating that modern turbines are smaller, run at higher speeds, will work submerged,

a. The Design and Performance Analysis of Radial-Inflow Turbines, Volume 1, Northern Research and Engineering Corporation, Cambridge, Massachusetts.

b. "The Origins of the Water Turbine," Norman Smith, Scientific American, January 1980, Vol. 242.

can use a wide range of heads of water, and, finally, are more powerful or more efficient.^a Waterwheels, on the other hand, produce shaft mechanical power with slow rotational speed and high torque. The rotation speed might range from 6 to 20 revolutions per minute (rpm). Where water wheels were used in industry, power was transmitted by pulleys and belts to perform work such as milling and grinding or operating saws, lathes, drill presses, and pumps. These operations needed the higher torque and only modest rpm.

It is worth noting that water wheels offer high torque and thus are capable of driving heavy, slow-turning mechanical equipment. If that is the type of power you need, you should look at the possibility of using a waterwheel. They will operate even with large variations in the water flow rate, and they require minimal maintenance and repair. In addition, trash racks and screens are usually not required, since most waterwheels can operate with dirt, stones, and leaves entrained in the water.

Electric generators, however, require rotation speeds ranging from 720 to 3,600 rpm. Generators operating at higher speeds are smaller and cost less than those operating at lower speeds. For this reason, the modern turbine is favored for the generation of electricity.

The generation of electric power from flowing water has been a source of energy in the United States for a century. The first electricity from hydropower was produced in 1882 by a 12.5-kilowatt (kW) plant in Appleton, Wisconsin. Since then, the number of hydroelectric power generating facilities in the U.S. has grown to more than 1,300, and total capacity now surpasses 76,000 megawatts (MW).

Early hydroelectric power plants were small, and the power they produced went to nearby users. But by the early 1900s, design and engineering advances had opened the way for larger facilities and greater transmission distances. Improvements in dam construction equipment and techniques made much larger dams possible, while the use of alternating current (a-c)

a. "The Origins of the Water Turbine," Norman Smith, Scientific America, January 1980, Vol. 242.

generators, transformers, and the development of suspension-type insulators led to long-distance, high-voltage power transmission systems.

By the 1920s, emphasis had shifted to the development of large hydroelectric power projects, and as time went by, smaller developments--those under 25 MW--were more and more ignored. During the 1950s and 1960s, a combination of economic factors--the need to replace worn out turbine-generator equipment and the availability of inexpensive fossil fuel--made it appear that a number of smaller hydropower facilities built early in the century had outlived their usefulness, and many of these were shut down and disposed of by their owners. Recently, however, the rapidly rising costs of fossil fuels and the high cost of meeting environmental standards for new thermal power plants have prompted a new look at hydropower's role in the national energy picture. And because almost all of the economically feasible and environmentally acceptable sites for large hydropower projects have already been developed, this new look at hydropower is focusing on smaller installations.

2.2 Head

Hydropower has been defined as energy available from falling water--water that is changing elevation. If the change in elevation is measured, the measured distance is called "head." Head is usually measured in feet. For example, if a stream is impounded by a small dam and the upstream pool behind the dam is 20 feet higher than the stream below the dam, the head of water at the dam is 20 feet (see Figure 2-1). Likewise, if a road crosses a stream where the elevation of the water is 6,020 feet above sea level, and at some distance downstream the road crosses the stream again where the elevation of the water is 6,000 feet, the available head between the two crossings is 20 feet.

Thus, head is vertical change in elevation measured in feet. Feet of head is a convenient way of expressing the theoretical energy available for any given amount of water. The mathematical symbol used for head is "h." Subsection 3.4 of the handbook discusses how to measure head.

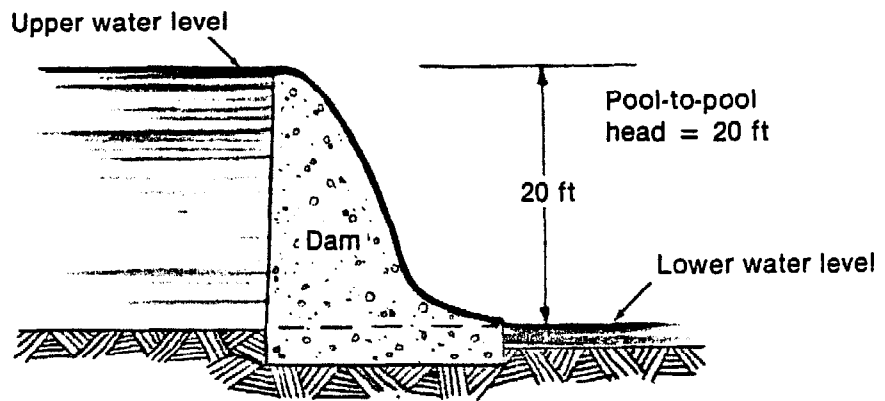
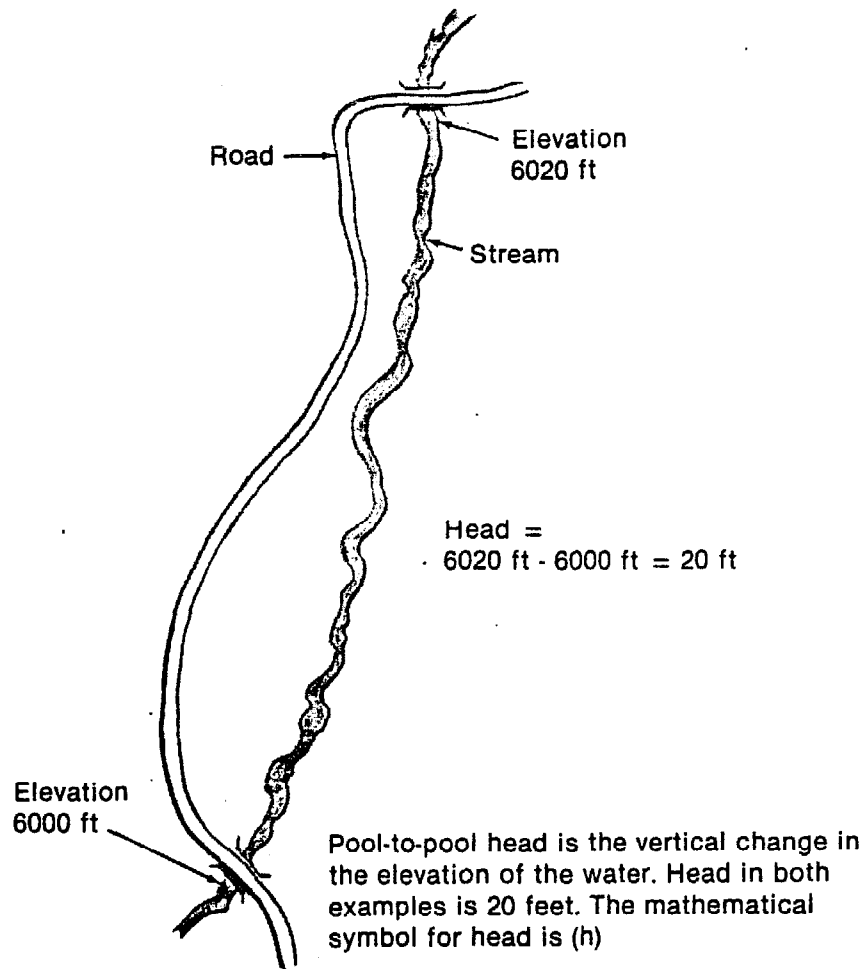

INEL 2 2359

Figure 2-1. Head illustrated.

NOTE: You should be aware that two terms are used for head, and that you must know the difference between these terms when dealing with turbine manufacturers so that you will convey the proper information for turbine selection. The head given above, 20 feet, is termed the pool-to-pool head (sometimes referred to as the gross head). This is the total hydraulic head available to perform work. The turbine manufacturer sizes his turbine for net effective head (net head). Net head is the pool-to-pool head less hydraulic losses from friction, entrance losses, trashrack losses, etc. Calculation of these losses is discussed in Subsection 4.5. It is important that you make it clear to the manufacturer or engineer which head you are referring to in your discussions or correspondence.

2.3 Flow

To compute theoretical power from a hydropower site, the head and the volume of water flowing in the stream must be known. The gallon is a standard unit for volume. The cubic foot is another unit of volume that may not be as familiar. The cubic foot is the standard unit of volume in hydropower. One cubic foot of water contains 7.481 gallons (see Figure 2-2).

$$1 \text{ cubic foot (ft}^3\text{) of water} = 7.481 \text{ gallons (gal)}$$

Flow is the volume of water passing a point in a given amount of time. For example, if a pipe has water running into a 1 ft³ container and it takes 1 minute to fill the container, the "flow" of the water out of the pipe is 1 cubic foot per minute (see Figure 2-3). The time period for measured flow can either be a minute or a second. In microhydropower, you may encounter both units, depending on the literature you read. It is important to remember that since a minute is 60 times longer than a second, flow per minute is 60 times larger than the same flow per second.

In this handbook, flow is expressed in cubic feet per second. The mathematical symbol for flow is "Q".

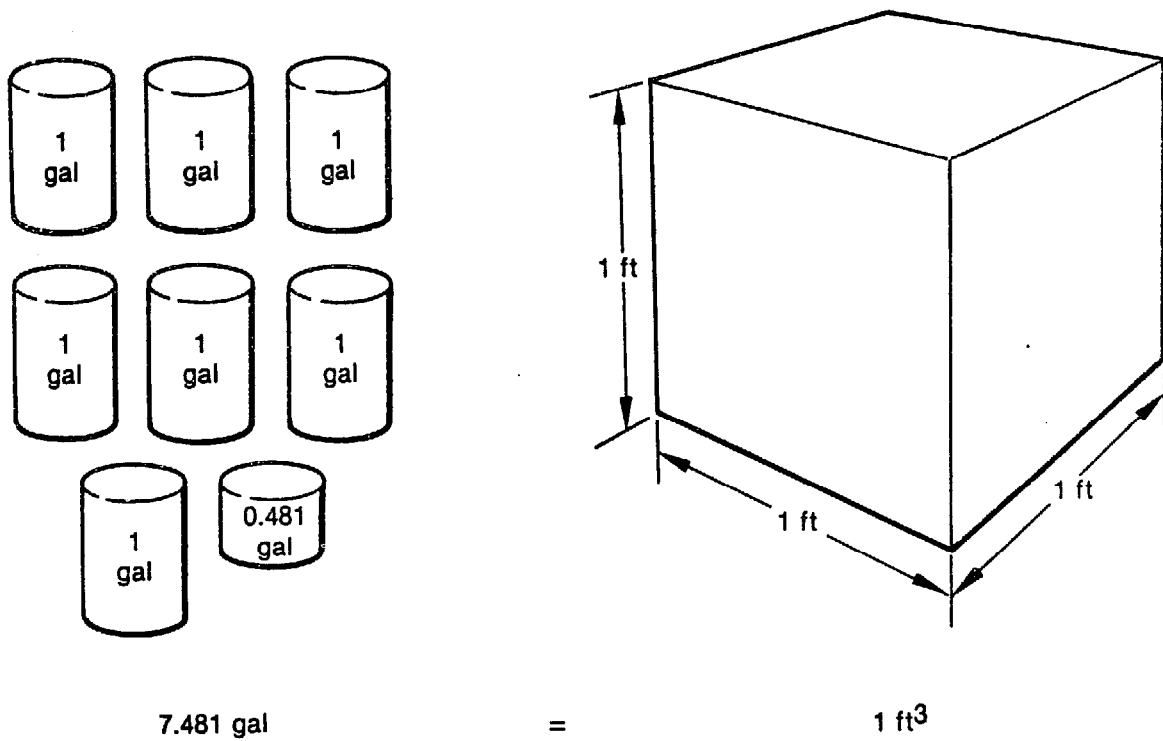

INEL 2 1252

Figure 2-2. Cubic foot illustrated.

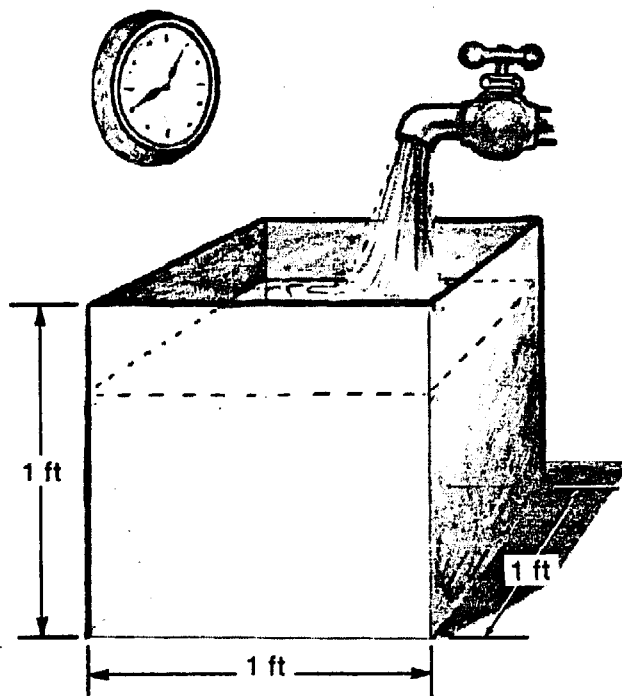

The mathematical symbol for flow is (Q). Flow is the volume of water (V) flowing over a given amount of time (t)

$$Q = \frac{V}{t}$$

The container volume is equal to one cubic foot. Assume it takes one minute to fill the container; then the flow is 1 cubic foot per minute (cfm)

$$Q = \frac{1 \text{ cubic foot}}{1 \text{ minute}} = 1 \text{ cfm}$$

INEL 2 2318

Figure 2-3. Cubic foot per minute illustrated.

$$Q = \frac{V}{t} \quad (2-1)$$

where

Q = flow in cubic feet per second (cfs)

V = volume of water in cubic feet (ft³)

t = time of measurement in seconds (sec).

Assuming that the volume of water is 1 cubic foot and the time of measurement is 1 second, the flow, Q, would equal 1 cubic foot per second, expressed as 1 cfs. Subsection 3.3 of the handbook discusses how to measure flow in cfs.

2.4 Kilowatt

The basic unit of electrical power used is the kilowatt, abbreviated as kW. A kilowatt is equal to 1,000 watts (W). For example, ten 100-watt light bulbs burning at the same time would require one kilowatt. If the lights were to burn for one hour, the amount of energy used would be one kilowatt-hour, abbreviated as kWh (see Figure 2-4). The kilowatt-hour is the standard measurement of energy from which most domestic electric bills are computed.

The term "microhydropower" is applied to any hydroelectric plant that generates 100 kW or less. One thousand (1,000) 100-W light bulbs burning at one time would require 100 kW:

$$1,000 \text{ light bulbs} \times 100 \text{ W} = 100,000 \text{ W}$$

$$100,000 \text{ W} \div 1,000 = 100 \text{ kW.}$$

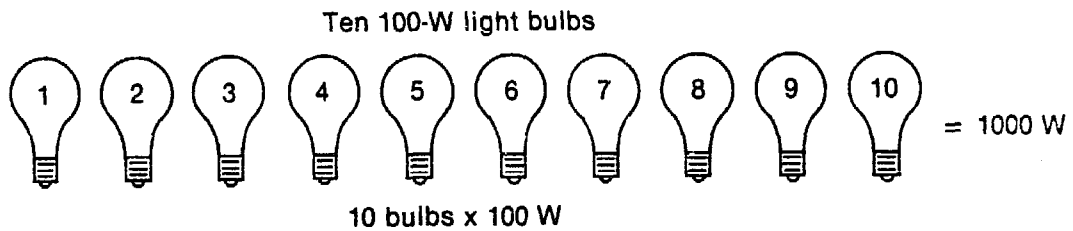

1 kW is defined as 1000 W

If the ten bulbs were lighted for 1 hr,
the energy used by the bulbs would
be 1000 W x 1 hr, or 1 kW x 1 hr,
expressed as 1 kWh

INEL 2 1255

Figure 2-4. Kilowatt illustrated.

If the lights were to remain on for one hour, the amount of energy used would equal 100 kWh:

$$100 \text{ kW} \times 1 \text{ hr} = 100 \text{ kWh.}$$

If the energy costs 50 mill's (5¢) for each kWh, then 1,000 lights burning for one hour would cost \$5.00:

$$1,000 \text{ lights} \times 100 \text{ W} \times 1 \text{ hr} = 100 \text{ kW} \times 1 \text{ hr} = 100 \text{ kWh}$$

$$100 \text{ kWh} \times \$0.05 \text{ per kWh} = \$5.00.$$

Each additional hour the lights remained on would cost another \$5.00. The average household (not including electric heat) consumes about 1,000 kWh per month.^a Assuming the same cost of 5¢ per kWh, the monthly electric bill would be approximately \$50.00.

a. The Publication, Electrical World Directory of Electric Utilities, 1979-1980, 88th Edition, McGraw-Hill Publishing Co., which gives average residential consumption for most utilities in the United States, shows that this average varies widely depending on the utility and location. The value chosen for presentation here (1,000 kWh/month) is approximately midrange.

In actual practice, a typical home has a peak demand of about 5 kW. This means that at some time during a typical month there will be a period during which the household will be consuming power at a rate of 5 kW. A large group of homes taken together would have an average peak demand of about 2.5 kW per home, and an average demand of 1.4 kW. The average peak demand per home is reduced for a group of homes because not all appliances are in use at the same time, and the more homes, the more the peak is spread out. This would indicate that a stand-alone 100-kW plant could actually supply the energy needs of 35 to 40 homes, assuming that the annual production is 50% of the theoretical maximum from the 100-kW plant. (The reason for the 50% assumption is explained later in the handbook.) If a 100-kW hydropower plant is used in place of diesel power units, the plant would displace diesel fuel at the rate of 22 gallons per hour (gph), or about 100,000 gallons per year (gpy).

If you develop a microhydropower plant that produces more energy than you consume, you may be able to sell the excess power to the local utility. For example, if an average of 25 kW is available for utility buyback 40% of the time during a year and the utility agrees to pay you 50 mills per kWh, you would receive \$4,380 per year in revenue from the utility:

$$24 \text{ hr/day} \times 365 \text{ days/yr} \times 0.40 \text{ (time available is 40\%)} = 3,504 \text{ hr/yr}$$

$$3,504 \text{ hr/yr} \times 25 \text{ kW} = 87,600 \text{ kWh/yr}$$

$$87,600 \text{ kWh/yr} \times \$0.05 = \$4,380 \text{ annual revenue.}$$

The cost of installing a microhydropower plant typically ranges from \$1,000 to \$4,000 per kW of installed capacity. A 30-kW plant might cost anywhere from \$30,000 to \$120,000. It is the intent of this handbook to help keep installation costs to a minimum.

2.5 Power Equation

If you plan to develop a microhydropower site, you must become familiar with the basic power equation:

$$P = \frac{Q \times h \times e}{11.81} \quad (2-2)$$

where

P = power in kW

Q = flow in cfs

h = head in feet (pool-to-pool or net effective head, depending on the efficiency factor selected)

e = efficiency (to be explained)

11.81 = conversion constant for power in kW divided by the density of water.

A more detailed development of the power equation is provided in Appendix A-1. Equation (2-2) is the standard equation that is used throughout the remainder of the handbook to calculate power in kW.

Any power-producing system produces less power than is theoretically available. The efficiency factor, e, of any given system is the actual power produced divided by the theoretical power available, expressed as a percentage:

$$e = \frac{P}{P_{th}} \times 100 \quad (2-3)$$

where

e = efficiency of the system in percent

P = actual power produced

P_{th} = theoretical power available

100 = conversion to percent.

For a microhydropower system, the efficiency may range from 40% to 75%. The efficiency depends on site conditions, the equipment used, and the actual installation method.

The mechanical shaft efficiency of the turbine and associated equipment depends on the following:

- Flow variation effects on the turbine
- Head variation effects on the turbine
- Flow restriction or disturbances at the intake structure
- Friction losses in the penstock, valves, and other associated equipment (penstock is pipe that conveys water to the turbine)
- Turbine losses due to friction and design inefficiencies
- Configuration of draft tube (pipe that carries water away from turbine).

If the efficiency is to include the generator output, the following equipment-related losses also reduce the overall efficiency value:

- Speed increaser losses due to friction and design inefficiency
- Generator losses due to friction and design inefficiency.

The actual efficiency of a particular installation cannot be determined until the site is operational and the head and flow are known for any given power output. Section 4 discusses in more detail how to estimate friction losses and other variables that affect the overall efficiency. For the remainder of the discussion in this section and Section 3, the assumed value for efficiency is 60%. For individual developments, 60% can be used for first-cut calculations of power output, but this value should be refined (up or down) as more is learned about the particular site. The 60%-efficiency figure can be used with the pool-to-pool head since it contains the efficiency losses for head that one would expect to find at a typical site. The 60% efficiency can be used with the pool-to-pool head as it contains the efficiency losses for head which one would expect to find at a typical site.

If the efficiency is assumed to be 60%, then from Equation (2-2)

$$P = \frac{0.60}{11.81} \times Q \times h$$

$$P = 0.051 \times Q \times h$$

The equation solves for the power produced (P), which is dependent on the value of the two variables, flow (Q) and head (h). If we assume that the flow is 10 cfs and the head is 10 feet, the equation solves for power as follows:

$$P = 0.051 \times 10 \times 10$$

$$= 0.051 \times 100$$

$$= 5.1 \text{ kW}$$

Now, notice what happens if the flow doubles to 20 cfs:

$$\begin{aligned} P &= 0.051 \times Q \times h \\ &= 0.051 \times 20 \times 10 \\ &= 10.2 \text{ kW} . \end{aligned}$$

In other words, doubling the flow doubled the power. Next, see what happens if the flow returns to 10 cfs and the head is doubled to 20 feet:

$$\begin{aligned} P &= 0.051 \times Q \times h \\ &= 0.051 \times 10 \times 20 \\ &= 10.2 \text{ kW} . \end{aligned}$$

The same power is produced by doubling either the head or the flow. The point is that head and flow have an equal effect on the power equation. Figure 2-5 shows this relationship. Another difference to note in the figure is that the higher head option uses smaller equipment.

2.6 Microhydropower Sources

A microhydropower system can be developed from either a natural source or a manmade structure. Natural sources include a stream without a dam (Figure 2-6), a waterfall (Figure 2-7), a spring branch, or even a natural lake. Manmade sources include any structure used to increase head or provide a source of water other than a natural source. Examples of manmade sources are dams (Figure 2-8), canal drops (Figure 2-9), and industrial or domestic wastewater discharge.

2.6.1 Natural Sources (Run-of-the-Stream)

A microhydropower system developed on a natural stream is referred to as "run-of-the-stream." Figures 2-10 and 2-11 show two such systems with

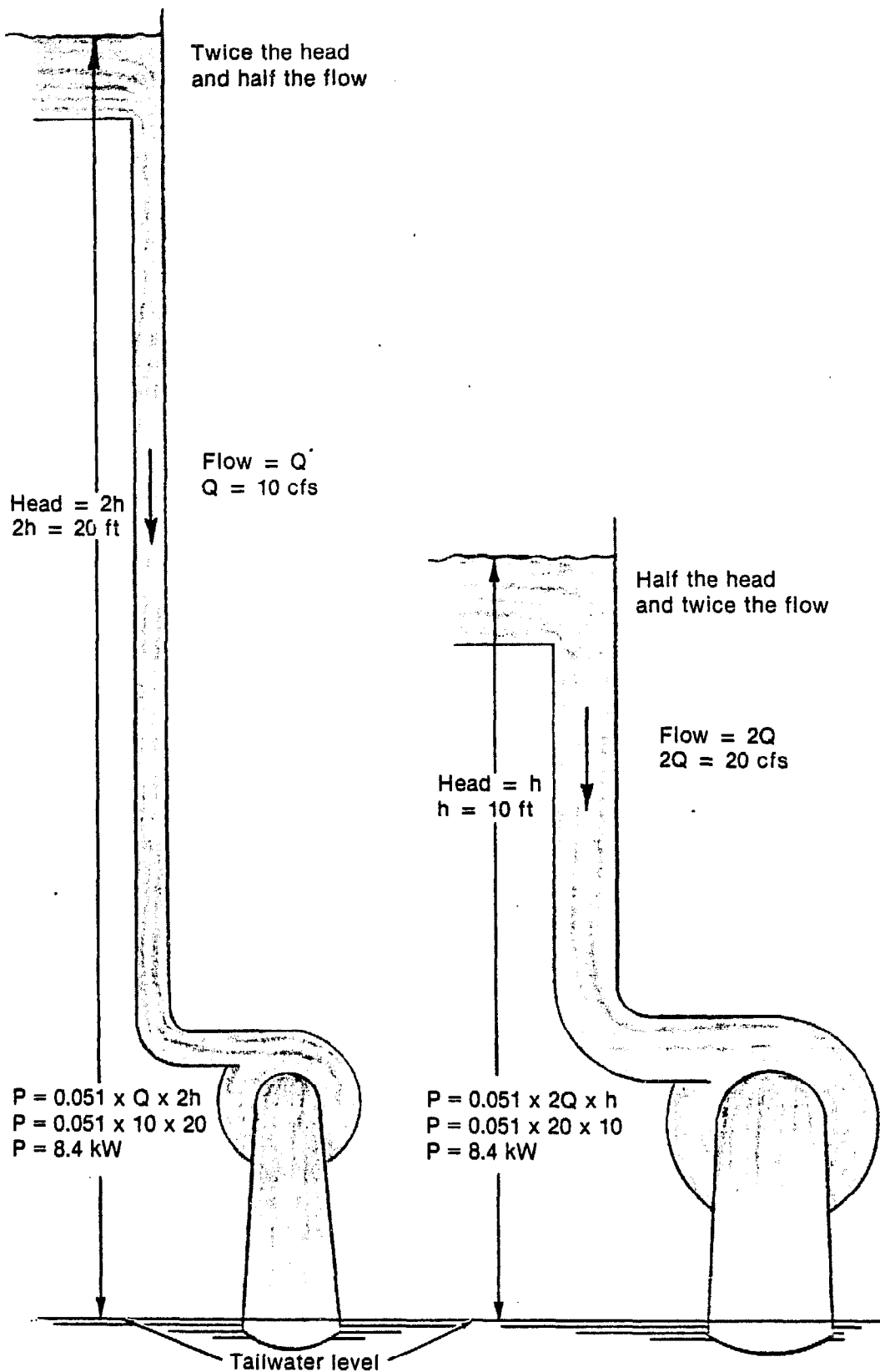

INEL 2 2320

Figure 2-5. Effect of doubling either head or flow.

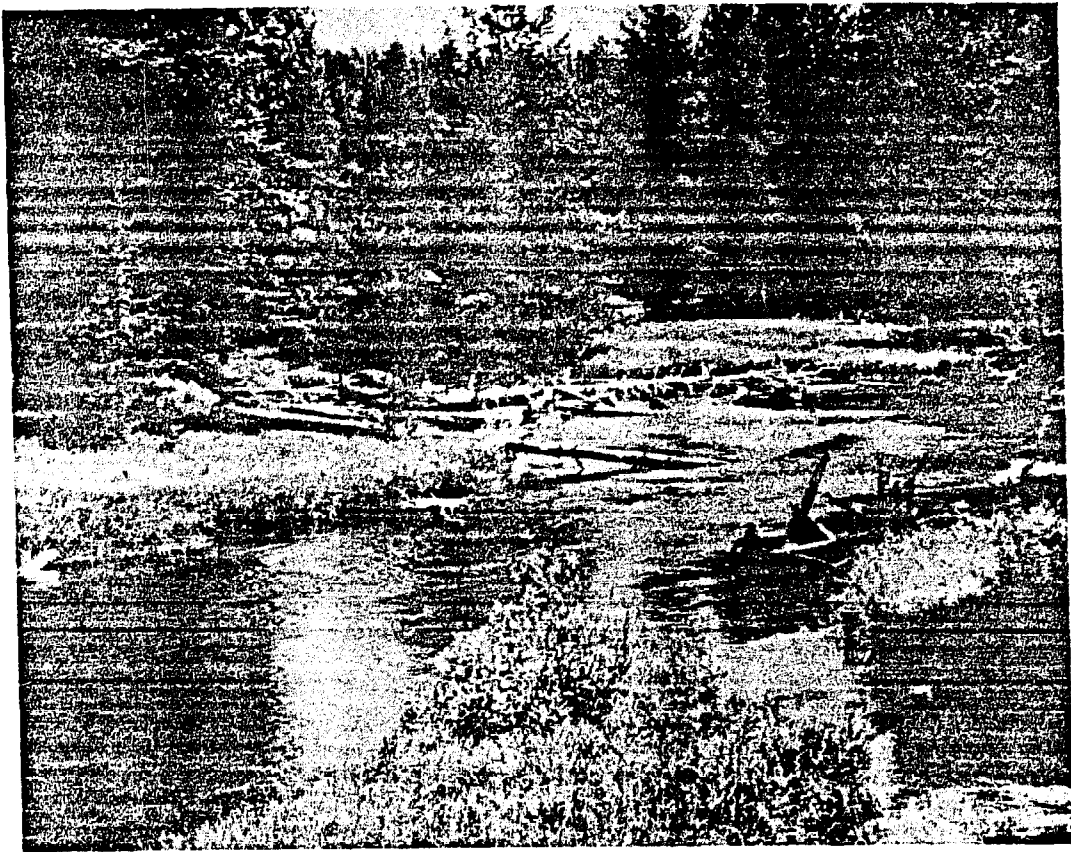

Figure 2-6. Stream without a dam.

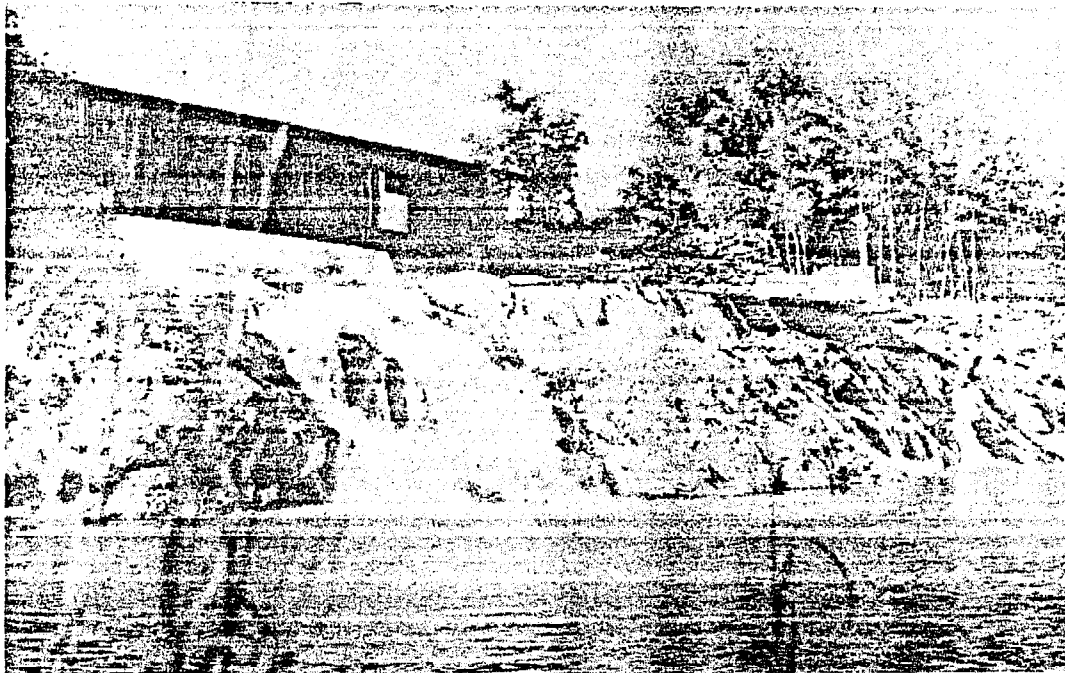

Figure 2-7. Waterfall.

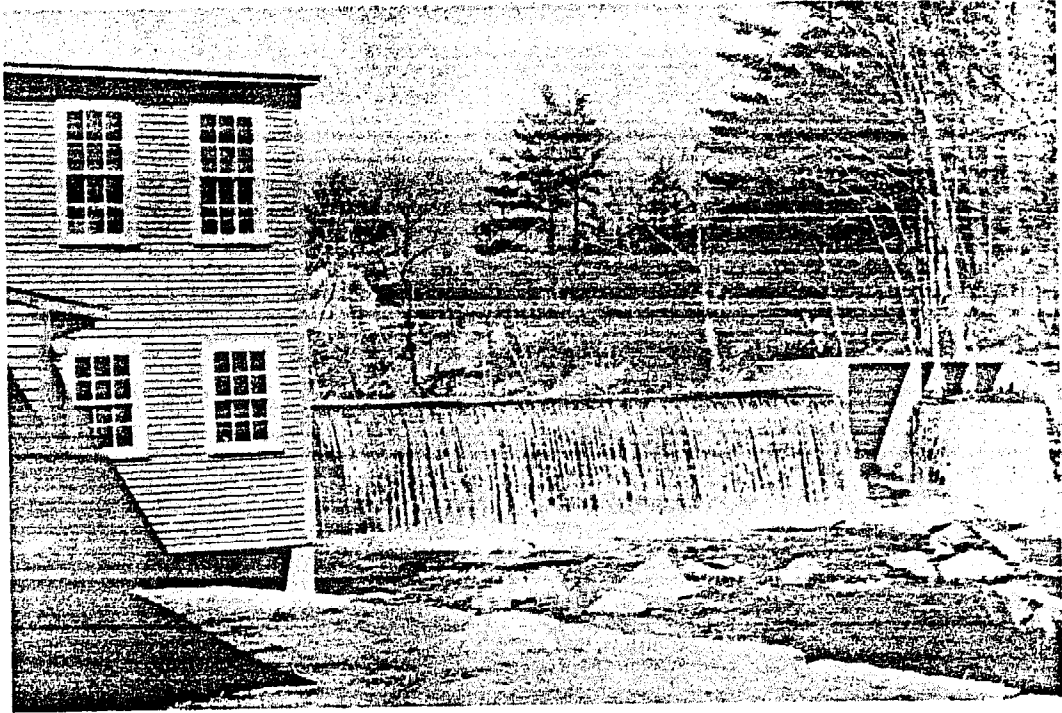

Figure 2-8. Dam.

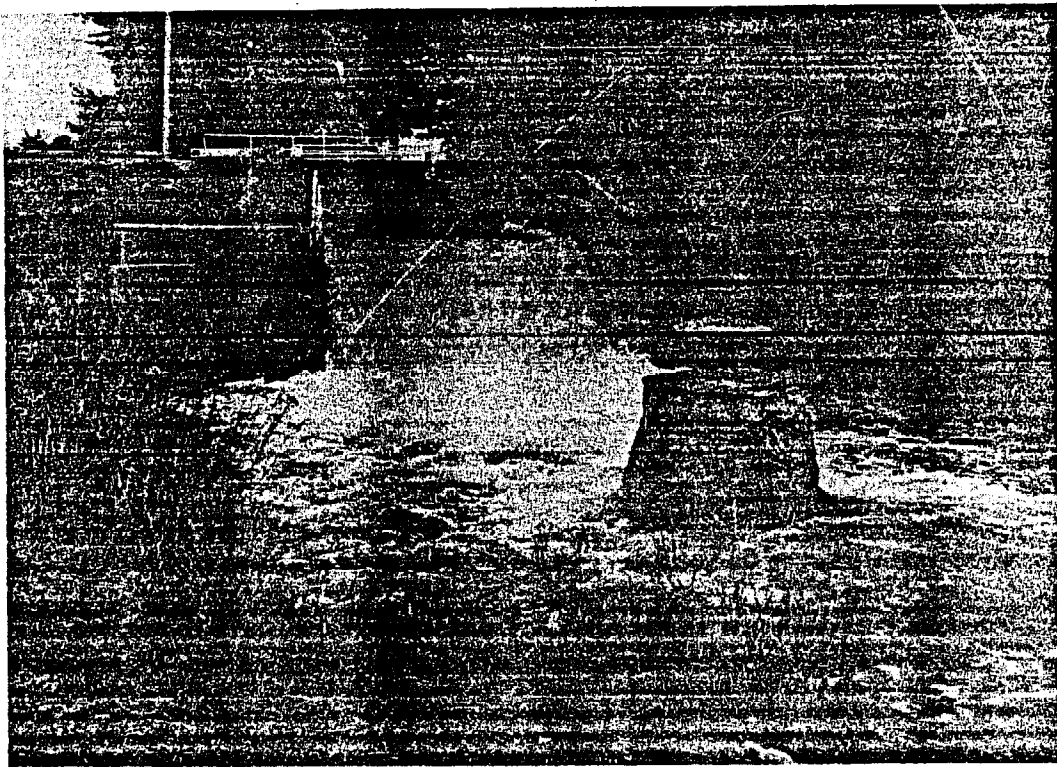
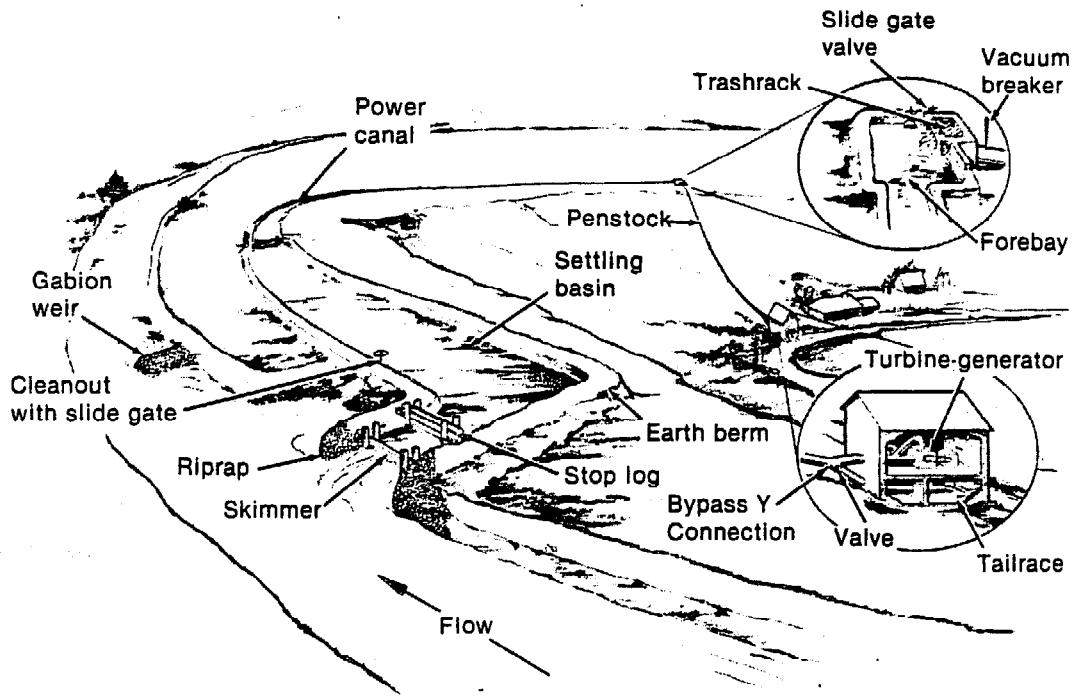
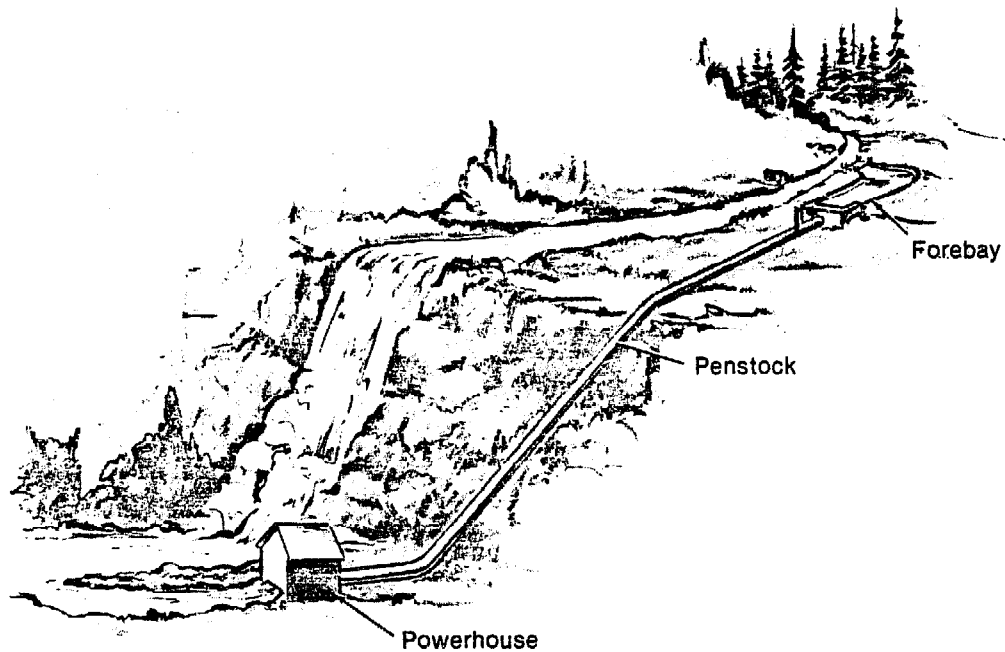

Figure 2-9. Canal drop.



INEL 2 1275

Figure 2-10. Run-of-the-stream development.



INEL 2 2322

Figure 2-11. Run-of-the-stream development.

appropriate nomenclature. In a run-of-the-stream development, an intake structure diverts water from a stream to a penstock. The structure consists of:

- Stream Diversion Works--The diversion works divert water from the stream into the intake system.
- Settling Basin--The settling basin is located near the diversion works and is used to settle out suspended material before the water enters the power canal.
- Power Canal--The power canal carries water from the diversion works and settling basin to the forebay. A canal is useful where the water can be carried at approximately the same elevation to a point from which the penstock can be made as steep, straight, and short as possible.
- Forebay--The forebay is a settling basin designed to settle out suspended material before the water enters the penstock. Some type of forebay is required in all run-of-the-stream developments.
- Penstock Intake Structure--The penstock intake structure provides the transition from the forebay to the penstock. It also provides the framework for the trashracks and intake gates.

The penstock carries the water from the forebay to the turbine. Ideally, the penstock should be as steep, straight, and short as possible. The powerhouse contains the turbine-generator, controls, and associated equipment, and the tailrace returns the water to the stream.

The design head can be adjusted depending on the available flow and power requirements (Subsection 3.4.1). Therefore, the location of the intake structure is a function of how much head is needed. At natural sources that capitalize on the change in elevation of a waterfall, the head

is set by the elevation of the waterfall, and the design procedures should be the same as for manmade sources where the head is established by the characteristics of the site.

Natural sources may have aesthetic value, which should be considered. For example, if all the water flow from a waterfall or a stream is to be used for power production, the waterfall or a portion of the stream will be dried up. If only a portion of the flow is used, aesthetic and other environmental effects are minimized.

Natural sources are subject to annual stream variation. For Category 2 developers, power generating potential will vary with the flow.

2.6.2 Manmade Sources

Existing manmade sources can generally be modified to install a microhydropower system without much of an environmental impact. The construction of a dam for the sole purpose of developing microhydropower systems is generally economically prohibitive. However, if a dam is being built for other purposes, a microhydropower system may be a logical and economical addition to the project. Small dams typically have a relatively small change in elevation (head), 35 feet or less. With a small head, the flow has to be larger to produce a given amount of power, and larger flow means bigger turbines--and thus more expense than for installations operating with a larger head to produce the same amount of power. Figure 2-12 shows a possible installation at an old mill site. Figure 2-13 shows a siphon penstock that could be used on an existing dam at which there is no way to draw the water out of the reservoir.

In certain parts of the country, manmade structures such as canal drops provide excellent opportunities for hydropower production. Flow can be seasonal, but it is generally constant during the months of operation. For canals where the flow is seasonal, care should be taken to ensure that enough energy can be produced annually to justify the expense. Figure 2-14 shows such an installation.

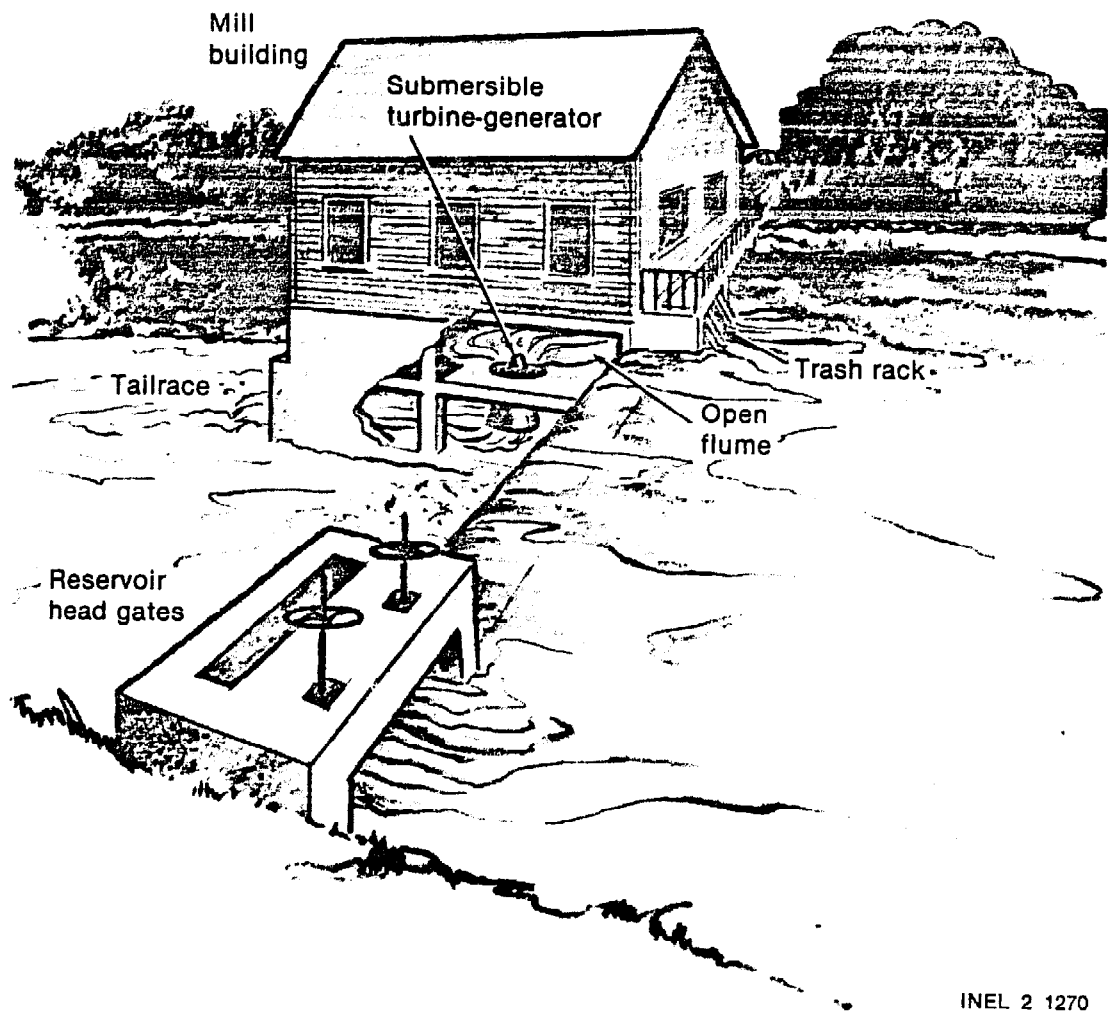
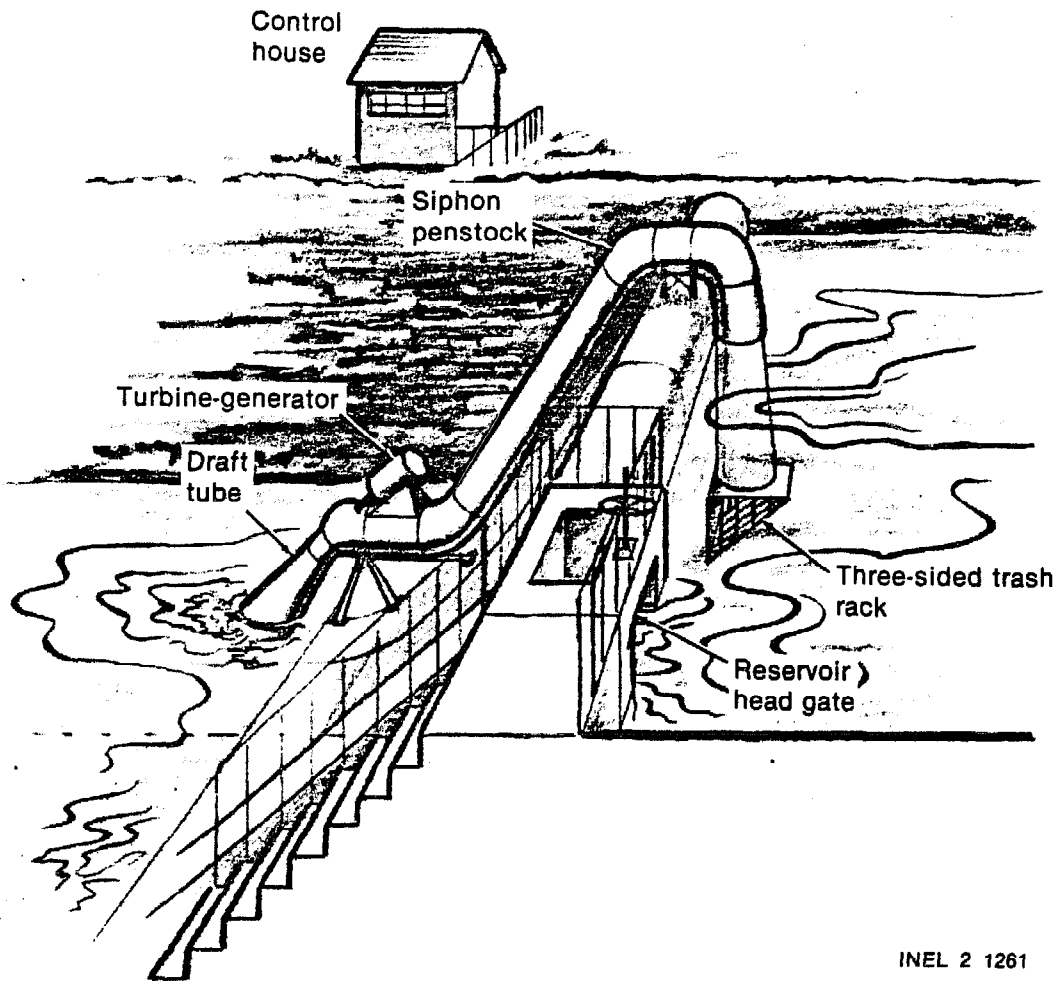
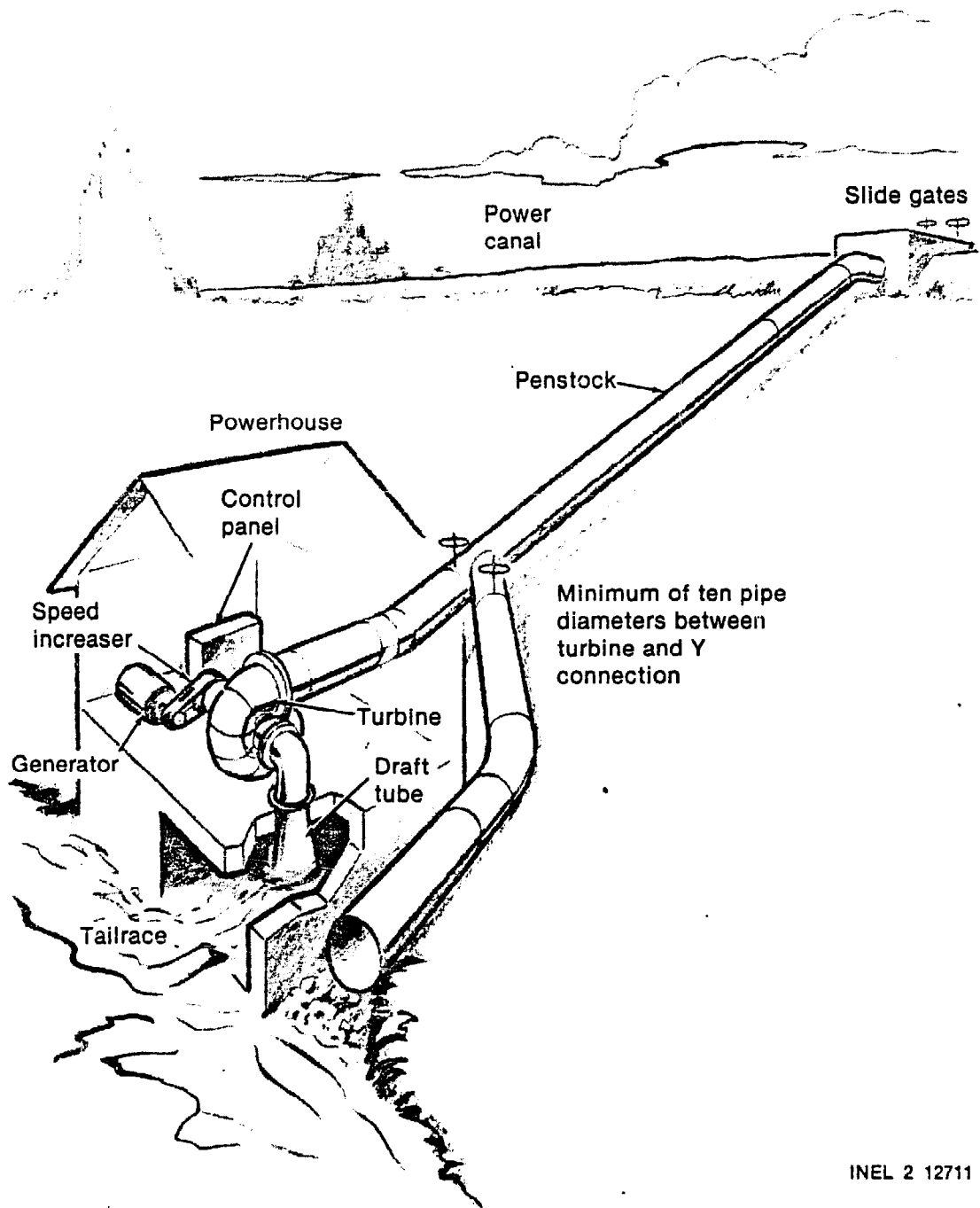

Figure 2-12. Installation at an old mill site.



INEL 2 1261

Figure 2-13. Siphon penstock at an existing dam.



INEL 2 12711

Figure 2-14. Installation at a canal.

Wastewater discharge from industrial or domestic treatment plants may have sufficient head and flow to be useful for hydropower. Those associated with such institutions may want to develop such a source. Private developers may be able to develop such a source, but the first hurdle is obtaining permission. Sources of this nature usually offer a steady flow, which helps to optimize turbine selection and minimize equipment cost. Figure 2-15 shows such an installation.

2.7 Typical Example Sites

Two site examples are presented in Appendix B. One involves developing an existing dam, and the other makes use of a natural, run-of-the-stream source. The specifications for these examples are given below. The developer is encouraged to determine which example most closely represents the site to be developed and to follow the details of the example as a guide for proceeding through the handbook.

2.7.1 Manmade Source

An existing dam is located on a small stream in the rolling hills of New Hampshire. The developer's site includes an old, retired gristmill. The mill and dam produce a 12-1/2-foot drop in the stream elevation. Upstream from the dam, the pool has filled in with gravel and silt, leaving it only 3 feet deep. The elevation of the pool is fairly constant, with the crest of the dam acting as the spillway. In a 20-foot wide gorge below the dam, the depth of the stream's normal flow varies from 26 inches in April to 8 inches in late August. Occasional spring rains will raise the stream to 3-1/2 feet. Twice in the last fifteen years the stream has flooded above the 5-foot gorge and inundated a lower pasture. During those floods, the stream was approximately 40 feet and 60 feet wide, respectively, and the depth of water in the pasture averaged 3 inches and 8 inches

The developer's residence and 75-head dairy operation are located near the old mill. The residence includes a washer, dryer, refrigerator, freezer, electric stove, hot water heater, and electric heat. The electric

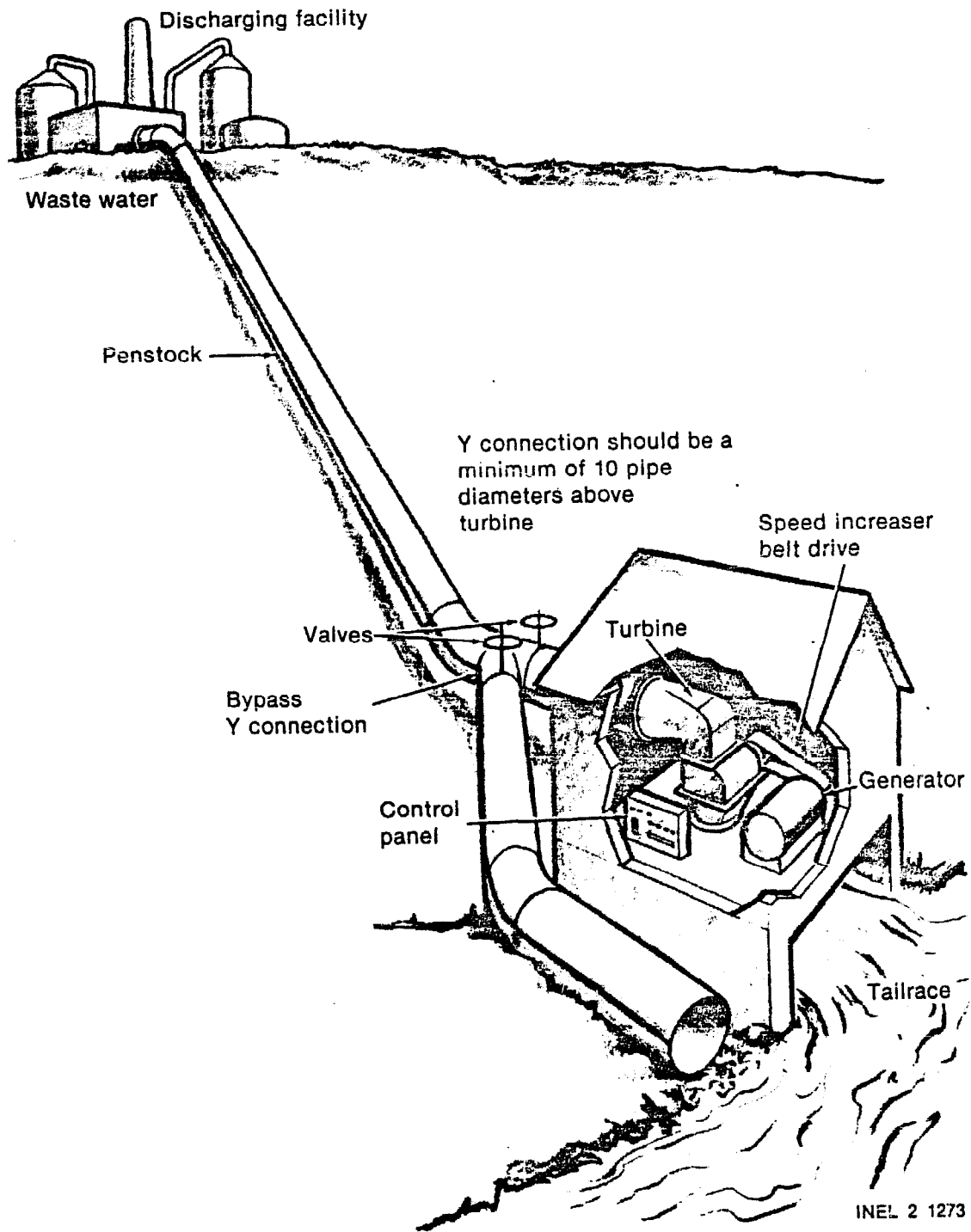

Figure 2-15. Installation using wastewater discharge.

utility's distribution line for the valley is within 300 yards of the mill. The developer hopes to supply his electrical needs and sell any excess power to the utility.

2.7.2 Run-of-the-Stream Source

The run-of-the-stream site is located in mountainous terrain in Washington. The average annual temperature range is from a high of 98°F to a low of -35°F. The stream flows from a narrow canyon that opens onto a high mountain meadow. The developer's property ends at the entrance to the canyon, which is the beginning of U.S. Forest Service property. A Forest Service road provides access to the canyon and is used for logging operations. The road crosses the stream and parallels it for approximately 1/4 mile before ascending into the canyon. According to a U.S. Geological Survey (USGS) contour map, the canyon floor rises approximately 440 feet in a mile.

The stream is fed by snow melt and small springs and contains small native fish. The size of the stream varies annually from 7 feet wide and 12 inches deep to 4 feet wide and 5 to 6 inches deep. Eight months out of the year the stream is usually at least 5 feet wide and 10 inches deep. At the location favorable for a powerhouse, high water markings are observed approximately 3 feet above the natural stream bed. At that height, the width of the stream would approach 25 feet.

Irrigation water rights are held by ranchers below the developer's site. Nonconsumptive water rights will have to be obtained by the developer.

The developer's primary objective is to provide power for two family dwellings that are currently satisfactorily supplied power from a 14-kW diesel generator. The dwellings each have electric water heaters, refrigerators, freezers, and use an electric resistance heater as a backup for wood heat. The dwellings commonly share a washer and dryer and are supplied with water by a 3/4 hp, submersible well pump typically energized 10% of

the time. The developer also has a small shop with a table saw, drill press, grinding wheel, and other small tools that are used an average of 3 hours a day.

3. POWER POTENTIAL

This section shows you how to determine the amount of power you need and how to calculate the amount of power that potentially can be produced from your site. The needed power is referred to as required capacity, and the calculated power is referred to as design capacity. The design capacity is a function of head and flow and gives a quick indication of whether enough power can be produced to meet the developer's needs.

Before proceeding, you should have determined whether you are a Category 1 or Category 2 developer (Subsection 1.3) and if your hydropower source is manmade or run-of-the-stream (Subsection 2.6).

3.1 Power Required

In Section 2.0, you have become generally familiar with how electrical power can be produced from available water resources. Your next step is to determine how much power is needed for all of the electrical loads, such as lights, appliances, heaters, motors, etc., to be served by your development. The quantity of power that can be produced from a resource is the system capacity, measured in kilowatts. The quantity of power needed for all of the electrical loads to be served by your development is the required capacity, also measured in kilowatts. The system capacity must be equal to or greater than the required capacity, or system load. This subsection will familiarize you with fundamental power requirements such as typical household loads, metering, and nameplate data.

3.1.1 Typical Household Loads

To determine household power load, individual items should be checked to determine their rated power demand. The power demand can be found on the nameplate generally attached to the appliance or item of equipment. Where nameplates cannot be found, the values given in Table 3-1 can be used to estimate the power needed.

TABLE 3-1. TYPICAL HOUSEHOLD APPLIANCE LOADS

Appliance	Power (W)	Average Hours of Use/Month	Total Energy Consumption (kWh/month)
Air conditioner	800 to 1600	150	120 to 240
Blender	600	6	2
Car block heater	850	300	300
Clock	2	720	1
Clothes dryer	4600	19	87
Coffee maker	600 to 900	12	7 to 11
Electric blanket	200	80	16
Fan (kitchen)	250	30	8
Freezer	350	240	84
(chest, 15 ft ³)			
Furnace fan	300	200	60
Hair dryer (hand-held)	1200	5	6
Hi-fi (tube type)	115	120	14
Hi-fi (solid state)	30	120	4
Iron	1100	12	13
Bathroom exhaust fan	70	30	2
Light (60 watt)	60	120	7
Light (100 watt)	100	90	9
Light (fluorescent, 4-ft)	48	240	12
Mixer	124	8	1
Radio (tube type)	80	120	10
Range	8800	10	100
Refrigerator (standard 14 ft ³)	300	200	60
Refrigerator (frost free 14 ft ³)	360	500	180
Sewing machine	100	10	1
Toaster	1150	4	5
TV (black and white)	255	120	31
TV (color)	350	120	42
Washing machine	700	12	8
Water heater (40 gal)	4500	87	392
Vacuum cleaner	750	10	8
Electric heater		winter use	
1 kW	1000	150	150
1.5 kW	1500	150	225
2 kW	2000	150	300

TABLE 3-1. (continued)

Appliance	Power (W)	Average Hours of Use/Month	Total Energy Consumption (kWh/month)
Furnace-electric			
10 kW	10000	150	1500
15 kW	15000	150	2250
20 kW	20000	150	3000
Shop Equipment			
Water Pump (1/2 hp)	460	44	20
Shop Drill (1/4 in. 1/6 hp)	160 to 250	2	0.3 to 0.5
Skill Saw (1 hp)	1000	6	6
Table Saw (1 hp)	1000	4	4
Lathe (1/2 hp)	460	2	1

Electrical appliances are rated in watts (or kilowatts), and electrical motors are usually rated in horsepower. During the tabulation of the household power demand, if motors are listed, the horsepower rating must be converted to kilowatts. Theoretically, to convert horsepower to kilowatts, the horsepower rating is multiplied by 0.746 (1 hp = 0.746 kW). However, to allow for the inefficiencies of electric motors and for other factors, you should use a factor of 1 hp = 1 kW when estimating the power demand for any motors on the household load list. Also, the starting current of a motor is typically six times the operating current. In other words, a 1 hp motor may require 6 kW to get started. This causes a momentary peak demand that you must account for when determining your system load.

The household appliance requirements listed in Table 3-1 are typical. The watts listed are approximate, and the average use per month will vary with climate, home insulation, and the user's personal habits. The first column lists the power each appliance requires when being used. The next column estimates typical monthly use of the appliances. The third column lists the energy consumption for the month and is simply the product of the first two columns divided by 1000 to convert to kilowatts [(power in watts ÷ 1000) x hours per month = kilowatt-hours per month].

Appliances or equipment	Watts	Hourly load schedule (Noon)																							
		1	2	3	4	5	6	7	8	9	10	11	12	1	2	3	4	5	6	7	8	9	10	11	12
Washer	700																								
Dryer	4600																								
Refrigerator	360	-	-	-	-	-	-	-	-	-	-	-	-	-	-	-	-	-	-	-	-	-	-	-	-
Freezer	560	-	-	-	-	-	-	-	-	-	-	-	-	-	-	-	-	-	-	-	-	-	-	-	-
Stove (50% utilization)	4000																								
Hot water Heater	4500																								
Electric heat (50% on at a time)	4500	-	-	-	-	-	-	-	-	-	-	-	-	-	-	-	-	-	-	-	-	-	-	-	-
Lights - daytime	200																								
- nighttime	600																								
Radio	50																								
Vacuum cleaner	750																								
Television	350																								
Milking machines	5000																								
Lights	1000																								
Milk heater	3000																								
Total hourly load in kW (W ÷ 1000)																									
		0.71	1.85	0.36	5.21	0.76	20.2	18.7	17.2	8.71	8.84	12.9	17.6	5.91	12.24	8.64	1.66	8.11	9.71	12.86	12.09	5.71	3.71	7.06	17.86

INEL 22411

Figure 3-2. Sample of completed daily electrical load chart.

3.1.2 Metering

If a developer is connected to an electrical utility system, he can measure his daily, weekly, and monthly consumption by reading the electric meter. The electric utility measures the use of electrical power with meters. In general, each home will have one meter to measure all power consumption. Several types and styles of meters are used. One common type is shown in Figure 3-3. The figure shows two readings taken 30 days apart. The number of kilowatt-hours (kWh) used during the 30-day period is 1,660 (16,250 - 14,590, read from the small circular dials near the top of the meter). The average power used during the month is determined as follows:

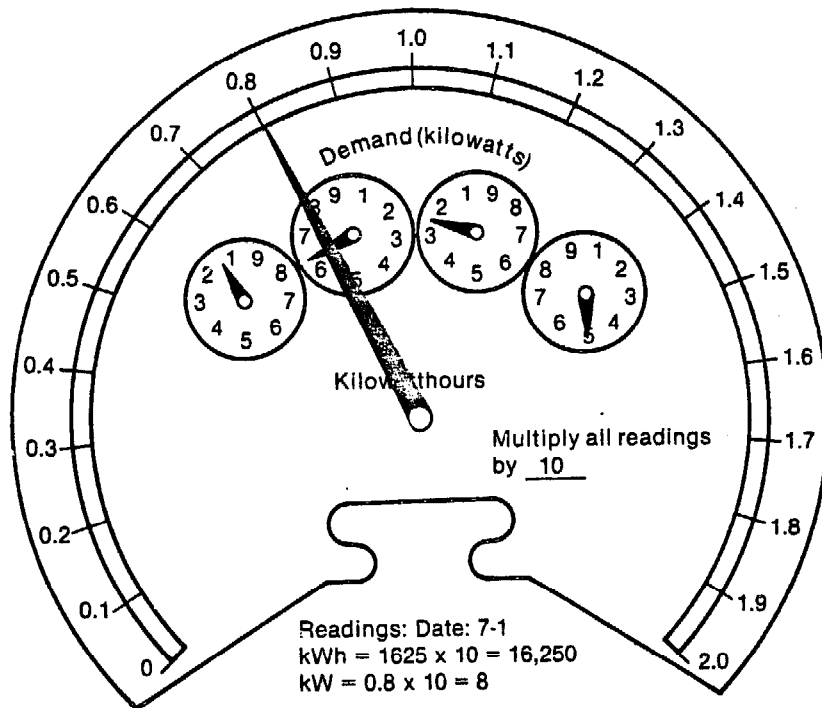
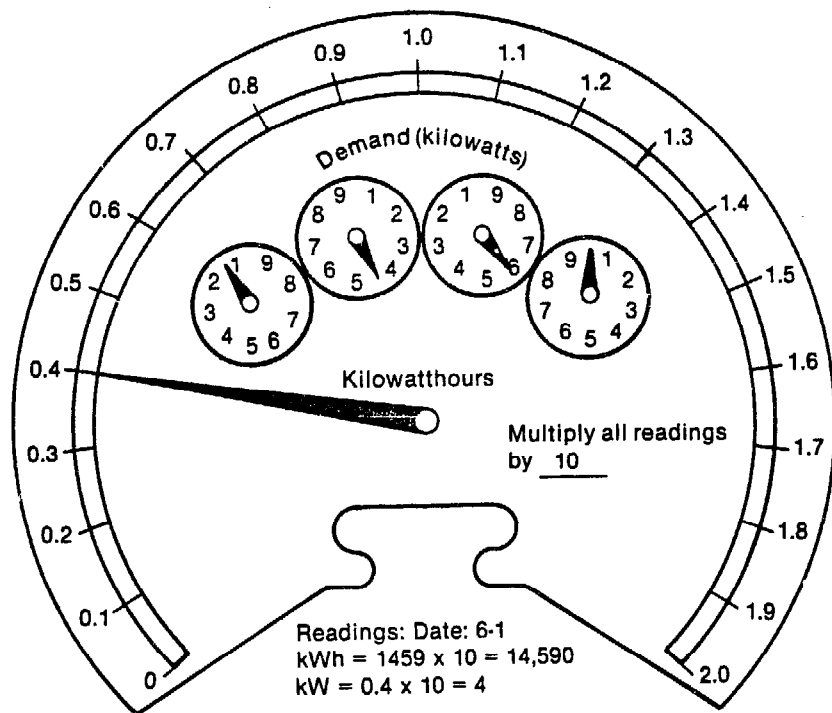

INEL 2 2299

Figure 3-3. Electric meter, showing readings taken 30 days apart.

$$P_m = \frac{E_m}{24 \times D_A} \quad (3-1)$$

where

P_m = average power for the month in kW

E_m = total energy used for the month in kWh

24 = number hours in a day

D_A = number of days in the month or measurement period.

From Figure 3-3:

$$P_m = \frac{1660}{24 \times 30}$$

$$P_m = 2.3 \text{ kW}$$

This is the average demand for the month. It does not represent the peak demand. The meter shown in Figure 3-3 also has a demand meter which can be read directly. For example, at the beginning of the month, the large pointer is at 0.4, indicating that the maximum demand was 4 kW (0.4 x 10). At the end of the month, the meter shows that at some time during the month the demand reached 8 kW. The meter will always read the maximum demand until it is reset by the utility.

The demand meter is used frequently by the utility as an important indicator. It measures kilowatts and indicates the maximum value of kilowatts required during a given time interval, usually 15 minutes. The utility usually reads and resets the demand meter for monthly billings.

If your electric meter does not measure demand, you can determine your maximum demand by reading the meter hourly. This method is not as accurate as using a demand meter, but it is good enough for estimating purposes. If electric motors are used, add the starting demand to the hourly reading.

Another method of determining maximum demand is to measure electrical use with a recording ammeter. This is a device that can plot amperage used versus time. If you use a recording ammeter, you should monitor each current-carrying conductor on equal time. This will allow an accurate measurement of the maximum current since each current-carrying conductor is not loaded equally. The power use in watts can then be determined from Equation (A6-5) for single-phase power or from Equation (A6-7) for three-phase power (see Appendix A-6).

$$P = E \times I \text{ (single-phase)} \quad (\text{A6-5})$$

$$P = 1.73 \times E \times I \text{ (three-phase)} \quad (\text{A6-7})$$

3.2 Inspection of Potential Hydropower Development

Next, you should conduct a site inspection. Although most will be familiar with site details, an inspection done with a few key points in mind may bring to light important issues previously overlooked. You should review the following outline and make notes on important issues. Also, before making the site inspection, review Subsection 2.6, Microhydropower Sources. Identify the type of source that most closely resembles the source for your site. Study the appropriate figure(s) and become familiar with the major components of your microhydropower system. Then, with these items in mind, conduct the inspection. After making the inspection, sketch the preliminary layout on a sheet of graph paper.

3.2.1 Manmade Sites

While the construction of a new dam for the sole purpose of developing a microhydropower site is not generally practical economically, there are literally thousands of existing dams, built for a variety of purposes, that may be attractive to the developer. The water level is often strictly

controlled, so that a hydropower project at the site could use only the net inflow into the reservoir. These factors and their effect on your project should be determined early on. Some dams may be usable for only part of the year, which would also seriously affecting a project's economics.

The reservoir of many older dams will be partially filled with silt. Any impoundment with silting behind the dam will obviously have less reservoir capacity. The silt level may be a key factor in the dam's structural stability. Equilibrium of the dam, water, and silt may have been changing over the years. To remove the silt might upset the balance and cause a dam failure. Removing the silt also presents environmental problems because dredging will increase the silt load of the stream, and if the silt is removed and trucked away, disposal may present a further problem. Silt removal can be an expensive way to increase reserve capacity.

When reviewing the use of an existing dam, the following items should be considered:

- Dam structure
 - What is the state of repair?
 - How much work and material will be required to make the structure functional?
 - Does the dam have a spillway, and is it adequate?
 - How can the water be directed to the turbine?
 - Is the powerhouse part of the existing structure? If so, how much work is needed to repair it?
 - Can the height of the structure be increased easily? If so, what will be the effect upstream?

- Reservoir pool
 - What is the depth of the pool at the structure?
 - How much annual variation occurs in the pool? Will the variations change if you install a turbine that discharges water at a uniform rate?
 - How much debris is carried by the water, both on the surface and suspended in the water? Will the debris clog an intake trashrack easily?
- Construction features
 - Is the site easily reached for construction?
 - Will you have to divert the water? If so, what will be involved?
 - Are there any hazards near the construction site (overhanging power lines, etc.)?

3.2.2 Run-of-the-Stream Sites

The following items should be considered when evaluating a run-of-the-stream site.

- Identify one or two powerhouse locations (most powerhouses are located near the stream that supplies them with water).
 - How far will the power be transmitted?
 - Can you identify a high water mark?
 - Can a vehicle get to the site?

- Would there be any advantage to locating the powerhouse near the place where the power will be used?
 - How much shorter would the transmission distance be?
 - Could the penstock be shorter?
 - Could a tailrace be constructed easily to carry the water away from the powerhouse?

- Investigate potential penstock routing (the ideal penstock routing would be as short as possible, as straight as possible, and as steep as possible while still delivering the required flow and head).
 - Will the water rights, soil permeability, etc. allow the use of a power canal to shorten the penstock?
 - If the canal is a possibility, look uphill from the powerhouse location, identify the steepest slope to which a power canal can be run, and find several appropriate points on that slope for such a canal.
 - If a power canal cannot be built, locate the penstock intake near the stream.
 - Walk uphill from the powerhouse, identifying several areas that could be used for a forebay.
 - From these locations, what is the straightest or the shortest routing for the penstock?

- Walking along the proposed penstock routing, determine if there are logical areas where a forebay and penstock intake structure can be built.

- Can equipment be driven to the site (backhoe, cement mixer, or ready-mix truck, etc.)?
 - How deep can the forebay be?
 - If a power canal is used, can the canal be run level from the stream to the forebay?
 - If the canal is more than 1/2 mile long, can a settling basin be built near the stream?
- Consider placement of diversion works.
 - Can the diversion works be set at right angles to the stream?
 - Can a backhoe be used in the area?
 - Who owns the property?

3.3 Determining Available Flow

Available flow is the flow that can be used in a microhydropower system to generate electricity. The flow available to generate electricity varies as the stream flow varies. In the spring, most streams are at their highest level, and more flow is available to generate electricity; in late summer, on the other hand, most streams are at their lowest level, and less flow is available to generate electricity. Category 1 developers, who require power at a constant level year round, should design their systems for the minimum available flow of late summer. They do not need the additional power that could be produced in the spring because of the larger flow available. Category 2 developers, however, who are interested in producing the most energy for the dollar invested, will use the larger flow available in the spring.

3.3.1 Flow Duration Curve

To determine available flow, engineers use statistical methods to project future stream activity from past stream flow records. The most common

of such a hydrologic study is a flow duration curve. The curve is plotted on standard graph paper and shows the stream's average flow pattern. Available flow can be determined from this flow pattern. Figure 3-4 is an example of a flow duration curve. The scale on the left side of the graph measures flow in cfs, and the scale at the bottom of the graph measures the percentage of exceedance. For example, the value of flow shown on the curve above the 50% exceedance mark is 50 cfs, which means that, for this example, flow will equal or exceed 50 cfs 50% of the time during an average flow year. In curves of this type, the exceedance values at the bottom of the graph are always the same, while the flow scale on the left side of the graph is determined by the range of the flow pattern.

Since Category 1 developers are interested in the low-flow period of the year, the flatter portion near the bottom of the curve is of particular interest to them. Category 2 developers are normally interested in flows between 20 to 35% exceedance. The most economical design flow for Category 2 developers is usually in the range of 25% exceedance. The design flow is the available flow selected for use in sizing the microhydropower system.

Category 1 developers, who are interested only in the low-flow pattern of the stream, may be able to establish a value for available flow without developing a flow duration curve. To accomplish this, you should be completely familiar with the stream, especially with what it looks like during low-flow periods. Developers who feel sufficiently familiar with their streams can turn to Appendix A-2, "Estimating Minimum Stream Flow." Once again, this method is recommended only for those who have lived with a stream for a number of years and can accurately estimate the average annual low-flow mark on the stream bank.

The remaining Category 1 developers and all Category 2 developers should develop a flow duration curve. Developing such a curve may not be easy for the developer, and the first step may be to seek some assistance. One possibility is the U. S. Department of Agriculture, Soil Conservation Service (SCS). The assistance will vary from state to state depending on other priorities and personnel availability. You are encouraged to visit

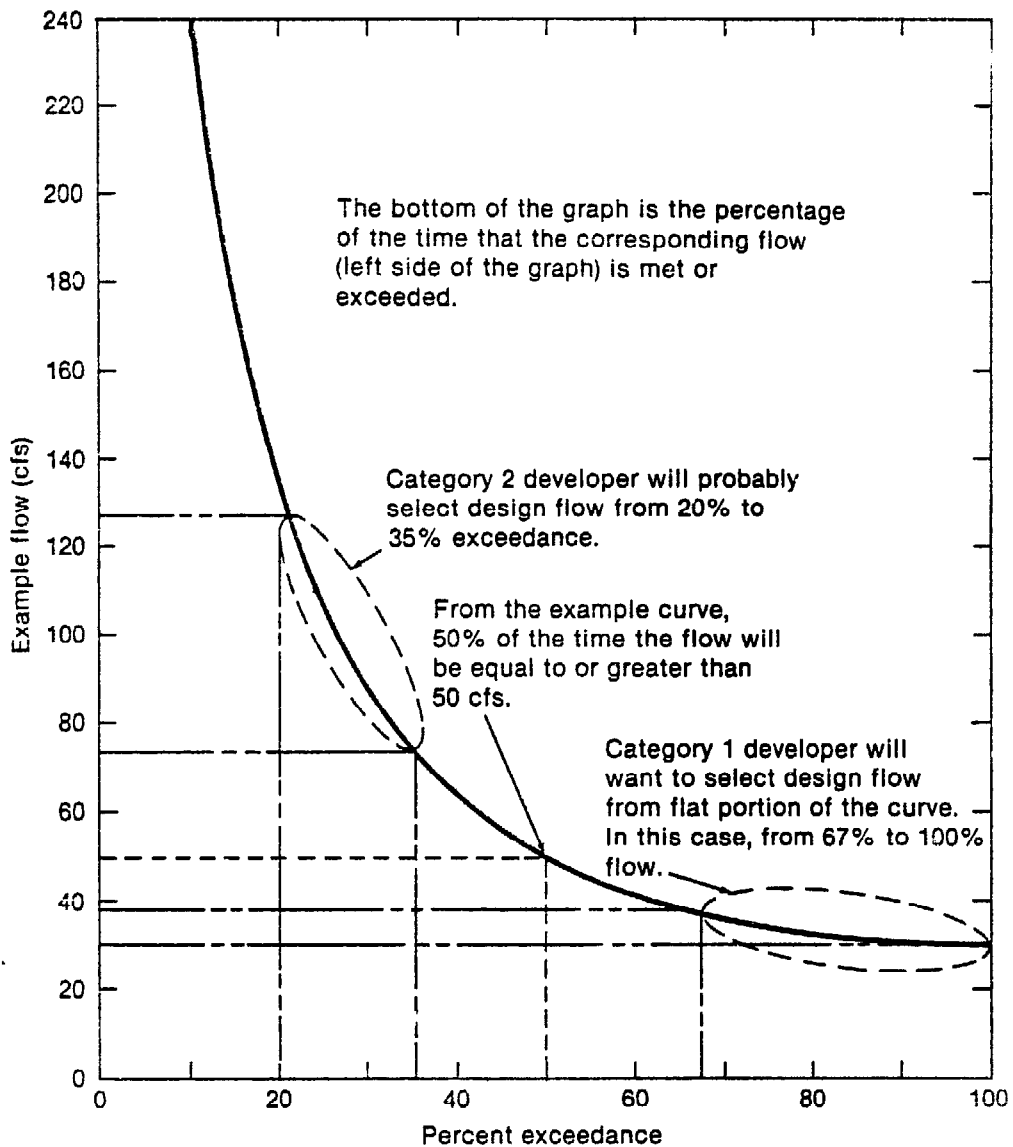

INEL ? 1256

Figure 3-4. Flow duration curve.

the local county office of the SCS to determine what assistance might be available. They may perform the hydrologic study and even provide technical assistance with design and construction of intake or impoundment structures. Keep in mind which portion of the flow duration curve you are interested in. This will help the SCS determine how much assistance they might be able to offer.

3.3.2 Existing Stream Flow Records

If you are not able to obtain assistance and have to develop the flow duration curve yourself, you will have to collect additional information. First, you should gather information about the existing stream flow records in the area of the site. The initial step is to contact the U.S. Geological Survey (USGS). To locate the nearest USGS office, look in the white pages under U.S. Department of the Interior, Geological Survey, Water Resources Division, or write the appropriate regional office:

Northeastern Region

USGS
National Center, Mail Stop #433
12201 Sunrise Valley Dr.
Reston, VA 22092

Central Region

USGS
Field Center Location
Mail Stop #406, Box #25046
Denver Federal Center
Lakewood, CO 80225

Southeastern Region

USGS
Richard B. Russell Federal Bldg.
75 Spring St., S.W., Suite 772
Atlanta, GA 30303

Western Region

USGS
Field Center Location
345 Middlefield Road
Mail Stop #66
Menlo Park, CA 94025

Present the USGS with the following information:

- Section number, township, range, county, and state of the proposed site.
- The name of the stream on which the site will be located, and a reference to some easily identified landmark. Give the distance and direction from the landmark to the site.
- The name of any streams that feed into your stream above the proposed site.
- The name of the stream that your stream drains into, and the distance from the proposed site.

When you contact the USGS, request a "NAWDEX" for the county in which the site is located and the surrounding counties, and the "duration table from A9-69 program" for the gage that will most closely correlate to the flow at your site. Important: The gage must be active (currently operating) and have daily flow readings year round. There may be a minimum charge for the printouts. The NAWDEX, or National Water Data Exchange, is a listing of all federal and state and some private stream gages placed in the counties in question. Table 3-2 is a reduced copy of a NAWDEX printout for Hillsborough County, New Hampshire and for Stevens County, Washington. The NAWDEX printout lists the following:

- The agency that placed the gage
- The station number
- The station name and location
- When the gage started and stopped recording
- Whether the data is interrupted (rather than continuous)
 - y = yes
 - n = no
- The measurement (complete flow)
 - 1 = daily year round
 - 2 = daily seasonal
 - 3 = monthly year round
 - 4 = monthly seasonal
 - E = activity eliminated

TABLE 3-2. GAGING SITES IN HILLSBOROUGH CO, NH AND STEVENS CO, WA

Organization Code	Organization Station Number	Station Name and Location	SW Begin Year	SW End Year	Interrupted Record	Complete Flow	SW Active Status
USCE	EM03	Nubanusit Brook Below Edward MacDowell Dam					
USCE	E04	Piscataquog River					
USCE	E05	Piscataquog River Below Everett Dam					
USCE		Edward MacDowell Dam NH	1950			1	Y
USCE		Contoocook R AB Hopkinton LK HL3					
USEPA	PMN004	RCN 1					
USEPA	1-CNT	Connecticut River					
USEPA	1-MER	Merrimack River					
USEPA	3-6-NSH	Nashua River					
USEPA	330201	Powder Mill Pond					
USEPA	330202	Powder Mill Pond					
USEPA	330203	Powder Mill Pond					
USEPA	330501	Glenn Lake					
USEPA	330502	Glenn Lake					
USEPA	330601	Kelly Falls Pong					
USEPA	8-MER	Merrimack P. at Bedford, H. H.					
USGS	01081900	Town Line Brook Tributary near Peterborough,	1971	1979			N
USGS	01082000	Contoocook River at Peterborough, NH	1938	1979	Y	E	N
USGS	01082500	Edward MacDowell Reservoir at W. Peterborough	1950				Y
USGS	01083000	Nubanusit Brook Near Peterborough, NH	1920		Y	3	N
USGS	01083500	Contoocook River Near Elmwood, NH	1917	1924		E	N
USGS	01084000	North Branch Contoocook River Near Anthim, N	1924	1970		E	N
USGS	01084500	Beards Brook Near Hillsboro, NH	1945	1976	N	E	N
USGS	01090480	Rays Brook at Manchester, NH	1972	1979	Y		N

TABLE 3-2. (Continued)

Organization Code	Organization Station Number	Station Name and Location	SW Begin Year	SW End Year	Interrupted Record	Complete Flow	SW Active Status
USGS	01090500	Merrimack River at Manchester, NH	1924	1950		E	N
USCS	01090700	Everett Lake Near East Weare, NH	1962				Y
USGS	01090800	Piscataquog River BL Everett Dam, NR E Weare	1963		N	1	Y
USGS	01091000	S Branch Piscataquog River Near Gufftown, N	1940	1940	N	E	N
USGS	01091500	Piscataquog River Near Gufftown, NH	1936	1978	Y	E	N
USGS	01091950	Bowman Brook Tributary Near Bedfore, NH	1967	1969			N
USGS	01092000	Merrimack R Nr Goffs Falls, Below Manchester	1936		N	1	Y
USGS	01093500	Messabesic Lake Near Manchester, NH	1941				Y
USGS	01093610	Merrimack River Tributary Near Merrimack, NH	1967	1967			N
USGS	01093800	Stony Brook Tributary Near Temple, NH	1963		N	1	Y
USGS	01093900	Tucker Brook Near Wilton, NH	1964	1973	Y		N
USGS	01093910	Tucker Brook Near Milford, NH	1964	1972	Y		N
USCS	01094000	Souhegan River at Merrimack, NH	1909	1909	Y	E	N
USGS	01094006	McQuade Brook Near Bedford, NH	1911	1979			N
USGS	01094008	Babousic Brook at Merrimack, NH	1910	1910			N
USGS	01094010	Maticook Brook Near South Merrimack, NH	1964	1972	Y		N
USGS	01094020	Maticook Brook Near Merrimack, NH	1964	1973	Y		N
USGS	01094040	Chase Brook Near Hudson Center, NH	1964	1972	Y		N
USGS	01094050	Chase Brook Near Litchfield, NH	1964	1972	Y		N
USGS	01094160	Pennichuck Brook Near Nashua, NH	1967	1969			N
USGS	01096502	Nissitissit Brook Near Hollis, NH	1971	1973			N
USCS	01096506	Nashua River Near Hollis, NH	1973	1963			N
USGS	01096507	Nashua River at Nashua, NH	1978				Y
USGS	01096508	Merrimack River at Nashua, NH	1974				Y
USGS	01096510	Merrimack River Tributary at Hudson Center,	1934	1972	Y		N
USGS	01096520	Old Maids Brook Near Nashua, NH	1964	1972	Y		N
USCS	01096530	Musquash Brook Tributary Near Hudson, NH	1964	1972	Y		N
USNWS	2-5702-N	Nashua NH On Merrimack R	1939		Y		Y
USNWS	44386000NEEDED	MacDowell Dam NH	1979		N		Y
USNWS	44389000NEEDED	Amoskeag Dam NH	1978		N		Y
USNWS	44390000NEEDED	Baboosic BK at Merrimack NH	1981		N		Y
USNWS	44391000NEEDED	Merrimack R at Nashua NH	1979		N		Y
USBPA	12409000	Colville R at Kettle Falls WA	1970				Y
USEPA	540112	WPSS Northport Washington					
USEPA	543182	Columbia R, at Northport WA					
USFS	21001212	East Fork Cedar Creek					
USFS	21014206	Pierre Creek					
USFS	21014304	Pierre Lake					
USFS	21016201	Cottonwood Creek					
USFS	21016204	North Fork Chewelah Creek					
USFS	21017106	Lake Gillette Swim Area					
USFS	621001111	Silver Creek					
USFS	621001209	Meadow Creek					
USFS	621001210	Smackout Creek					
USFS	621001212	East Fork Cedar Creek					

TABLE 3-2. (Continued)

Organization Code	Organization Station Number	Station Name and Location	SW Begin Year	SW End Year	Interrupted Record	Complete Flow	SW Active Status
USFS	621016105	Addy Creek					
USFS	621016201	Cottonwood Creek					
USFS	621016202	Sixmile Creek					
USFS	621016203	South Fork Chewelah Creek					
USFS	621016204	North Fork Chewelah Creek					
USFS	621017102	Lake Thomas Campground					
USFS	621017103	Gillette Recreation Area					
USFS	621017104	Lake Thomas					
USFS	621017106	Lake Gillette					
USFS	621017206	Deer Creek					
USFS	621017207	South Fork Mill Creek					
USFS	621017208	Middle Fork Mill Creek					
USFS	621017213	North Mill Creek					
USGS	12399500	Columbia River at International Boundary	1893		Y	1	Y
USGS	12399510	Columbia R Auxil at Interna Bndry, Wash.	1942				Y
USGS	12399600	Deep Creek Near Northport, Wash.	1972	1976	N	4	N
USGS	12399000PLANNED	FY76 Change Operation OWDC32842 To	1976			1	Y
USGS	12399800	Deep C NR Northport WA	1972			1	Y
USGS	12400000	Sheep Creek NR Velvet Wash	1929	1932	Y	2	N
USGS	12400500	Sheep Creek Near Northport, Wash.	1929	1948	Y	2	N
USGS	12400520	Columbia River at Northport, Wash.					
USGS	12404860	Pierre Lake Near Orient					
USGS	12406000	Deer Lake Near Loon Lake, Wash.	1952	1978	N		1
USGS	12406500	Look LK NR Loon Lake Wash	1950		N		Y
USGS	12407000	Sheep Cr at Loon Lake Wash	1950	1959	Y	2	N
USGS	12407500	Sheep Creek at Springdale, Wash.	1952	1972	N	2	N
USGS	12407520	Deer Creek Near Valley, Wash.	1959		N	2	Y
USGS	12407530	Jumpoff Joe Lake Near Valley, Wash.	1961	1975	Y		N
USGS	12407550	Waitis Lake Near Valley, Wash.	1961	1975	Y		N
USGS	12407600	Thmason Creek Near Chewelah, Wash.	1953	1973			N
USGS	12407680	Colville R at Chewelah, Wash					
USGS	12407680PLANNED	Colville R at Chewelah, Wah					
USGS	12407700	Chewelah Creek at Chewelah, Wash.	1956	1974	N	2	N
USGS	12408000	Colville River at Blue Creek, Wash.	1921		Y	1	Y
USGS	12408195	Leo Lake Near Tiger					
USGS	12408200	Patchen (Bighorn) C Nr Tiger, Wash.	1953	1973			N
USGS	12408205	Heritage Lake Near Tiger					
USGS	12408210	Thomas Lake Near Tiger	1961	1966			N
USGS	12408214	Gillette Lake Near Tiger					
USGS	12408216	Sherry Lake Near Tiger					
USGS	12408300	Little Pend Oreille River Near Colville, was	1946	1976	N	4	N
USGS	12408300PLANNED	FY76 Change Operation OWDC01562 to	1976			1	Y
USGS	12408400	Narcisse Creek Near Colville, Wash.	1953	1973			N
USGS	12408410	Little Pend Oreille R at Arden, Wash					
USGS	12408420	Haller C Nr Arden Wash	1959		Y	2	Y

TABLE 3-2. (Continued)

Organization Code	Organization Station Number	Station Name and Location	SW Begin Year	SW End Year	Interrupted Record	Complete Flow	SW Active Status
USGS	12408440	White Mud LK Nr Colville WA	1961	1966			N
USGS	12408500	Mill Creek Near Colville, Wash.	1939		N	1	Y
USGS	12408700	Mill Cr at Mouth NR Colville Wash	1959	1965	N	2	N
USGS	12409000	Colville River at Kettle Falls, Wash.	1921		N	1	Y
USGS	12410600	South Fork Harvey Creek NR Cedonia, Wash.	1953	1973			N
USGS	12410650	North Fork Harvey Creek NR Cedonia, Wash.	1953	1973			N
USGS	12429800	Mud Creek Near Deet Park, Wash.	1953	1973			N
USGS	12433100	Chamokane Creek Near Springdale, Wash.	1973	1978	Y	E	N
USGS	12433200	Chamokane CR Below Falls Near Long Lake, was	1970	1968	N	1	N
USGS	41058000NEEDED	Grouse C WA	1979		N	1	Y
USGS	41059000NEEDED	Narcisse Creek WA	1980		N	1	Y
USGS	41060000NEEDED	Magge C NR Daisy WA	1980		N	1	Y
USGS	41061000NEEDED	Hunters C NR Hunter WA	1980		N	1	Y
USGS	470121117062501						
WA001	54A070	Spokane River at Long Lake					
WA001	54A089	Spokane R 2 M Below Ninemile Dam					
WA001	54A120	Spokane R at Riverside State PK					
WA001	54A130	Spokane R at Fort Wright Bridge					
WA001	59A070	Colville River at Kettle Falls					
WA001	59A110	Colville River at Blue Creek					
WA001	59A130	Colville River at Chewelah					
WA001	60A070	Kettle River Near Barstow					
WA001	61A070	Columbia R at Northport					
WA013		Little Falls Power Station	1910			1	Y

- The current status of the gage
 - y = active
 - n = not active.

Remember that the gage selected must be active (Status Category y) and must have a daily year round flow record (Measurement Category 1).

When you receive the NAWDEX, look for the gage closest to your site on your stream that has a daily reading and is currently operating. If the gage belongs to an agency other than USGS, contact that agency, reference the gage number, and inquire if they have "developed a flow duration curve or calculated exceedance values from their data." If they have, request a copy of the information, and have it available for future reference in Subsections 3.3.3.3 and 3.5.

The second item requested from the USGS is an A9-69 printout. The A9-69 program is a statistical analysis of the daily flow data. Your request must specifically ask for the "Duration Analysis." None of the other information available from A9-69 is needed for the handbook method of flow projections. Table 3-3 is an example of a duration table. The item of interest is the last column in the table, "Value Exceeded 'P' Percent of Time." These values will be used in Subsection 3.3.3.3 to develop a flow duration curve from the exceedance values.

3.3.3 Stream Flow Correlation

The next step is to correlate stream flow at the selected site to the flow reading at an existing gage. Two methods of doing this are used. The first, called "Flow Measurement Correlation," involves measuring flow at the proposed site, correlating the measured flow to flow data from a nearby gage, creating a flow duration curve from the gage data, and then modifying the flow scale of the curve to adjust to the flow measured at the proposed site. This method is discussed in this subsection.

The second method, called "Rainfall Runoff Correlation," which should require less time, involves using a map that shows geographic points where equal amounts of precipitation occur (called an isohyetgraph), determining the drainage basin area and the runoff coefficient, creating a flow duration curve from the known gage data, and correlating this to the calculated average runoff or stream flow at the site. This method is discussed in Appendix A-3.

3.3.3.1 Flow Measurement. Most developers do not have flow data for their site. In fact, many have only a rough estimate of the present flow. Therefore, since the flow at the proposed site must be measured for the flow measurement correlation, the next step is to make this measurement. The measured flow can then be compared with the nearest gaging station that has exceedance data available and from which current daily flow readings can be received.

Flow should be measured accurately as close as possible to the proposed intake structure location. For existing dams, the flow can be measured just downstream or over the spillway. Collect four or more days of record, representing different flows. To get different flows, the days should not be consecutive. Disregard days with similar flows and unusually high-flow days that are a direct result of a local heavy storm in the drainage area of the site or of the gage with which the site is being compared. For each day in which measurements are taken, make a minimum of six measurements during the 24-hour period to ensure that average flow for the day is found. Calculate the average as follows:

$$Q_{\text{avg}} = \frac{Q_1 + Q_2 + Q_3 + Q_4 + Q_5 + Q_6}{6} \quad (3-2)$$

where

Q_{avg} = average of measurements made

Q_1 to Q_6 = individual flow measurements

6 = number of flow measurements.

TABLE 3-3. STATION NUMBER 12408500--DURATION TABLE OF DAILY VALUES FOR YEAR ENDING SEPTEMBER 30

Discharge-(CFS)

Mean

Mill Creek Near Colville, Wash.

Class	Value	Total	Accum	Perct	Class	Value	Total	Accum	Perct	Class	Value	Total	Accum	Perct
0	0.0	0	12784	100.0	12	21.0	630	5842	45.7	24	130.0	266	1239	9.6
1	4.0	9	12784	100.0	13	24.0	552	5212	40.8	25	150.0	175	973	7.6
2	4.7	43	12775	99.9	14	28.0	435	4600	36.5	26	170.0	231	798	6.2
3	5.4	105	12732	99.6	15	33.0	367	4225	33.0	27	200.0	163	567	4.4
4	6.3	265	12627	98.8	16	38.0	421	3858	30.2	28	230.0	141	404	3.1
5	7.3	345	12362	96.7	17	45.0	348	3497	26.9	29	270.0	109	263	2.0
6	8.5	692	12017	94.0	18	52.0	320	3089	24.2	30	320.0	76	154	1.2
7	9.9	421	11325	88.6	19	60.0	355	2769	21.7	31	370.0	86	78	.6
8	11.0	1349	10904	85.3	20	70.0	335	2414	18.9	32	430.0	21	32	.2
9	13.0	1938	955	74.7	21	81.0	273	2079	16.3	33	500.0	10	11	
10	16.0	830	7617	59.6	22	95.0	244	1806	14.1	34	580.0	1	1	
11	18.0	945	6787	53.1	23	110.0	323	1562	12.2					

VALUE EXCEEDED 'P' PERCENT OF TIME

V95	=	8.1
V90	=	9.5
V75	=	13.0
V70	=	14.0
V50	=	19.0
V25	=	50.0
V10	=	130.0

The method is simple. Discharge all the water through a pipe or similar device into a known volume, and record the time required to fill the container (Figure 3-6). From the volume and time, flow can be converted to cfs.

EXAMPLE: Assume that the 55-gallon drum shown in Figure 3-6 is filled in 1 minute and 14 seconds. Calculate the flow.

From conversion tables:

7.481 gallons (gal) = 1 cubic foot (ft³)

1 minute (min) = 60 seconds (sec)

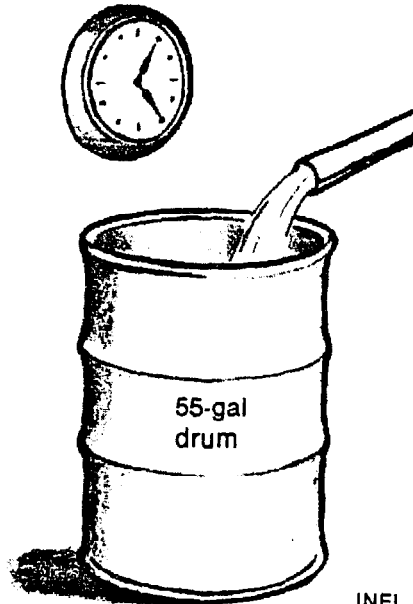

INEL 2 1268

Figure 3-6. Measuring flow by the container method.

Volume in ft³:

$$55 \text{ gal} \times \frac{1 \text{ ft}^3}{7.481 \text{ gal}} = 7.35 \text{ ft}^3 \text{ in the barrel .}$$

Time in seconds:

$$1 \text{ min} \times \frac{60 \text{ sec}}{\text{min}} + 14 \text{ sec} = 74 \text{ sec} .$$

From Equation (2-3):

$$\text{Flow} = \frac{\text{Volume}}{\text{Time}}$$

$$Q = \frac{V}{t} = \frac{7.35 \text{ ft}^3}{74 \text{ sec}} = 0.10 \text{ cfs} .$$

(NOTE: This flow would require a very large head to produce any significant power.)

Record this flow on the daily flow table (Figure 3-5).

3.3.3.1.2 Weir Method--A weir is a rectangular notch in a dam or similar structure forming a spillway that functions as a water meter. Once installed, a simple depth measurement can be accurately converted into flow. The method is practical for smaller streams where a temporary dam can be constructed. It can also be used on smaller existing dams where the water is continuously discharged over the spillway. The weir can be an integral part of a temporary dam constructed of tongue-and-groove lumber, or it can be a removable gate type made of metal plate. The downstream face of the weir must be beveled at least 45 degrees, and the bottom must be level when installed. The sides should also be beveled and should be at right angles (90 degrees) to the bottom. If the weir is constructed of wood, leave a 1/8-inch lip on the upstream face to prevent the wood from chipping (Figure 3-7).

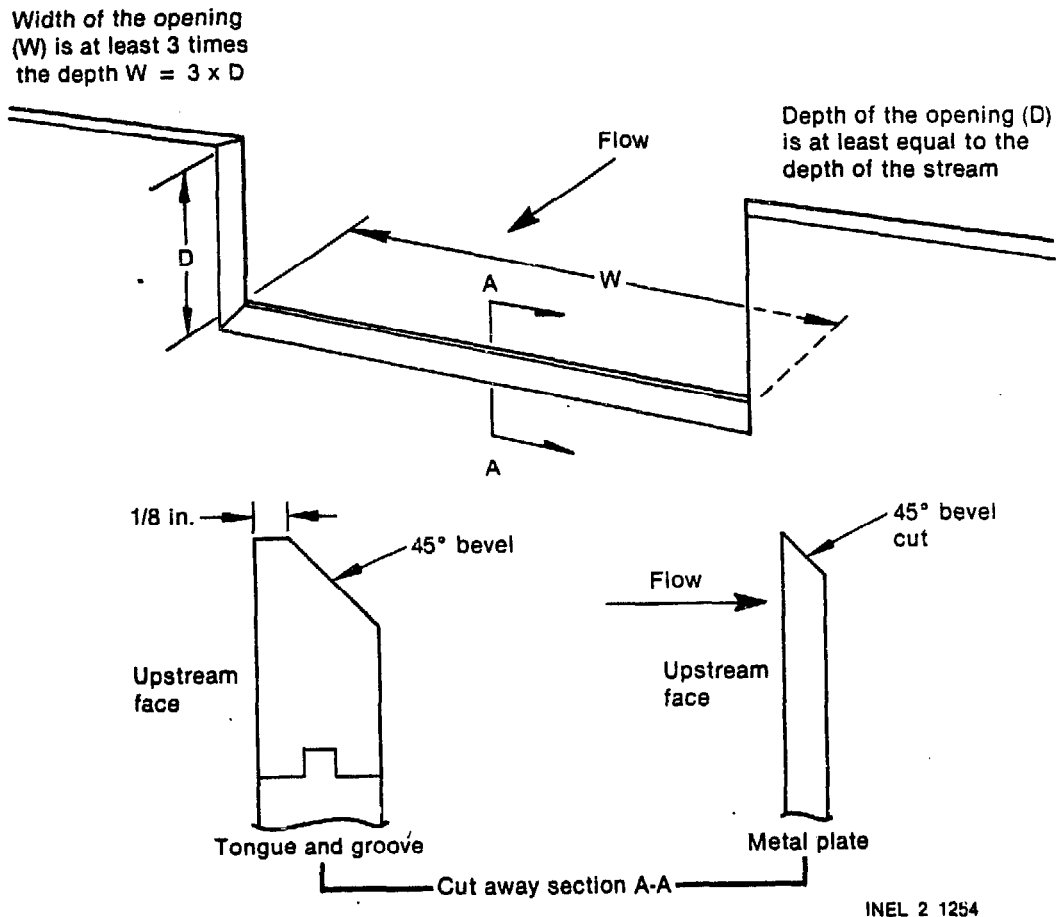

Figure 3-7. Weir details.

The type of temporary dam depends on the size of the stream and the required height of the dam. Suggestions for two dams are offered below: tongue-and-groove lumber for very small streams (Figure 3-8), and log crib for small streams (Figure 3-9).

Before building a dam, determine the size of the weir. To do this, select a convenient location along the stream to construct the dam. At that location, measure the deepest point in the natural stream bed. If the

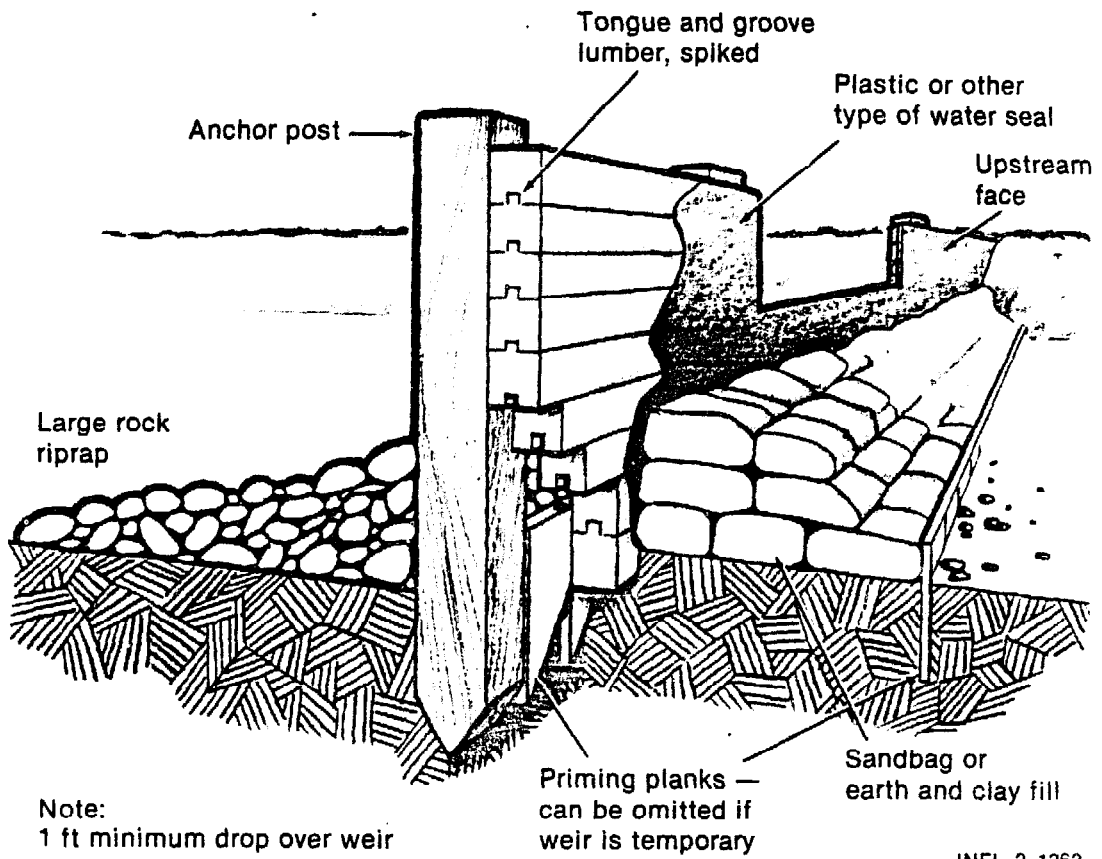
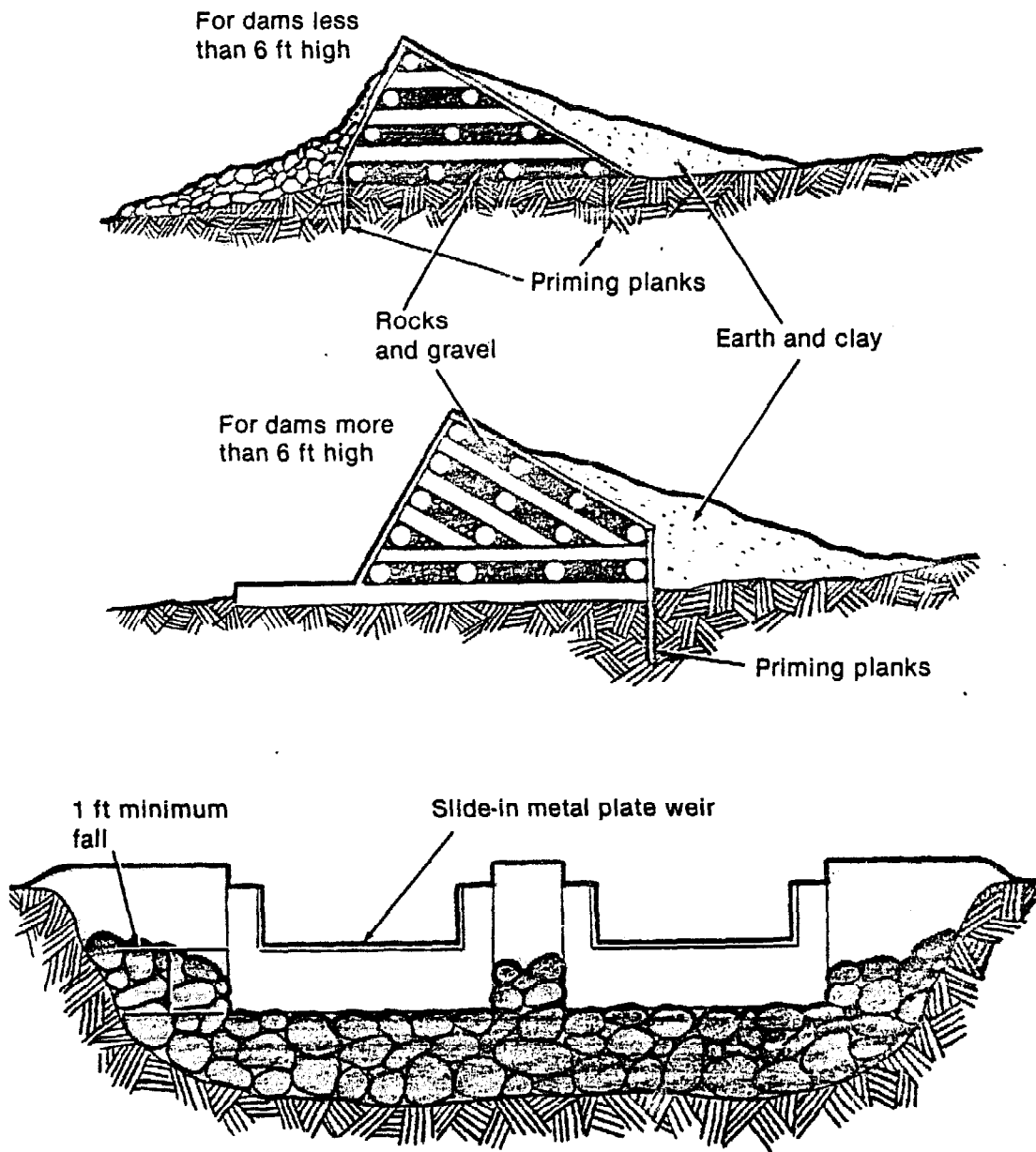

Figure 3-8. Tongue-and-groove lumber dam, with weir.



If more than one weir is used,
the bottom of each weir must be at the
same elevation.

INEL 2 1263

Figure 3-9. Log crib dams.

stream is unusually low at the time of measurement, estimate the additional depth for average flow. The depth of the weir notch should be at least equal to the depth of the stream. The width of the notch should be at least three times the depth (Figure 3-7).

The tongue-and-groove dam and weir is constructed of lumber spiked together. If possible, divert the stream around construction areas. Dig a trench across the stream perpendicular to the flow. This trench must be smooth enough so that the bottom piece of lumber can be leveled. Clay or earth can be used for leveling. Drive the downstream priming planks (see Figure 3-8) 2 to 3 feet deep into the stream bed to limit seepage under the dam. Priming planks are wooden boards, preferably tongue-and-groove, with one end cut to a point on one edge (Figure 3-10). They are driven into the soil so that the long pointed side is placed next to the previously driven plank. Then as each successive plank is driven, it is forced snug against the preceding board.^a If the weir is a temporary installation, both upstream and downstream priming planks can be omitted.

Drive the timber anchor post into the stream bed until solid resistance prevents further driving. Shim between the post and the tongue-and-groove lumber while building the dam to maintain a vertical plumb on the dam.

After the lumber is in place and the weir notch is smooth, drive the upstream priming planks and waterproof the upstream face of the dam. Next, place sandbags or earth fill against the front face. Avoid placing the fill too close to the weir opening. Water turbulence upstream from the weir face will affect the measurement accuracy. Finally, at least 5 feet upstream from the weir, drive a post into the stream bed so that the top of the post is level with the bottom face of the weir. Use a carpenter's level to assure that the top of the post and the bottom face of the weir are level. NOTE: The post should be located so that it can be easily reached from the bank (Figure 3-11).

a. Robin Saunders, Harnessing the Power of Water, Energy Primer, Portola Institute.

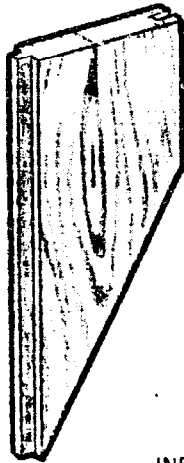

INEL 2 1267

Figure 3-10. Priming plank.

For crib dams, use several logs stacked together like a corncrib--hence the term "crib dam." A crib dam consists of green logs or heavier timbers stacked perpendicular to each other, spaced about 2 or 3 feet apart. Spike these together where they cross, and fill the spaces in between with rocks and gravel. Cover the upstream side, especially the base, with earth or clay to seal the edges. The priming planks should be driven 2 to 3 feet deep into the soil.

Protect the downstream face of the dam from erosion or undercutting wherever water will spill over. This is most important during times of heavy flow! The spillways can be made of concrete, lumber, or simply a pile of rocks large enough to withstand the continual flow. Crib dams can be built with the lower cross-timbers extended out to form a series of small water cascades downstream. Each cross-timber step should be at least as wide as it is tall.^a Finally, as with the tongue-and-groove dam, drive a post into the stream bed at least 5 feet above the weir, and make the top of the post level with the bottom of the weir (Figure 3-11).

a. Robin Saunders, Harnessing the Power of Water, Energy Primer, Portola Institute.

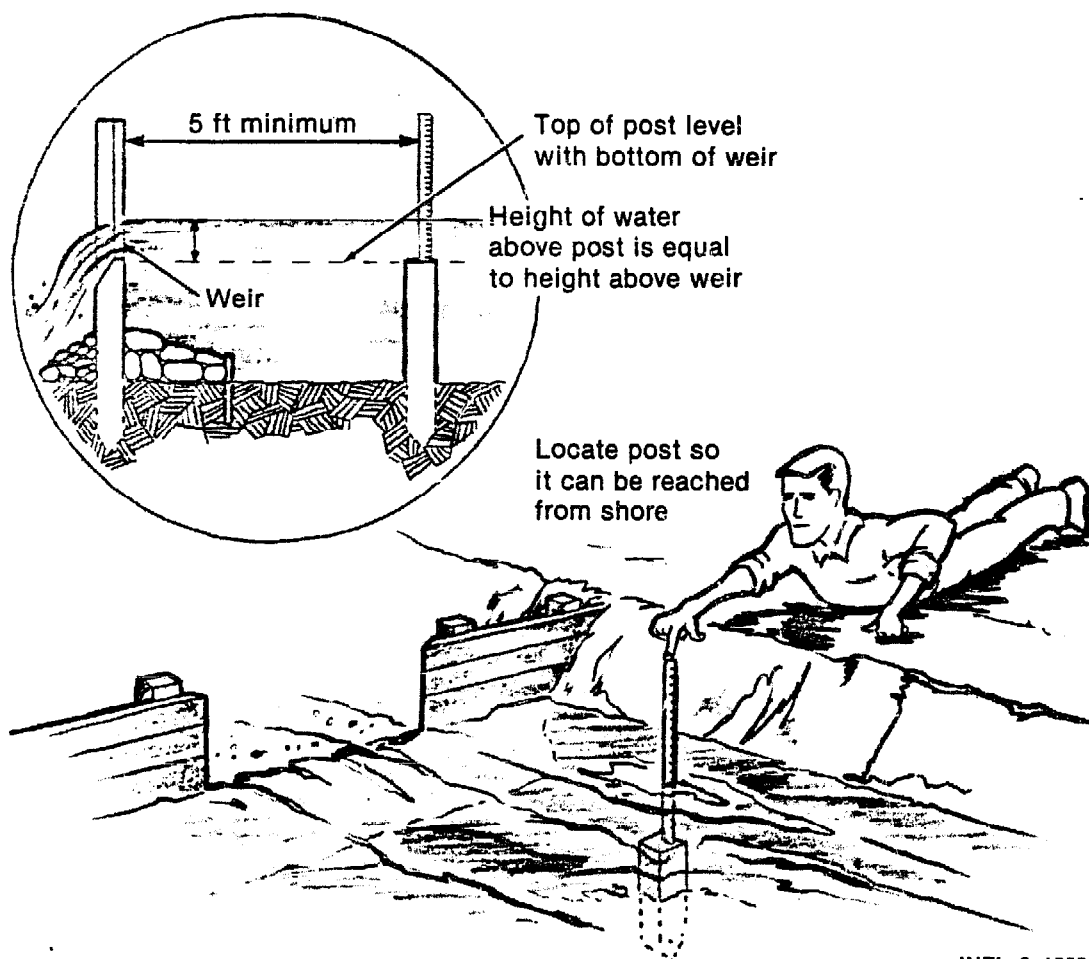

Figure 3-11. Relationship of weir and measuring post.

To measure the water depth above the weir, simply place a yard stick on the post and read the depth to the nearest 1/8 inch. The flow for measured depth is read directly from Table 3-4. This table lists flow for each inch of weir width. To convert to total flow, multiply by the width of the weir(s) in inches. Enter the resulting value in your flow table (Figure 3-5).

EXAMPLE: Assume that the weir is 3 feet wide and that the depth is measured at 4-3/8 inches.

TABLE 3-4. FLOW PER INCH OF WEIR WIDTH (cfs)

Inches	0	1/8	1/4	3/8	1/2	5/8	3/4	7/8
0	0	0.003	0.008	0.0015	0.0024	0.0033	0.0044	0.0055
1	0.0067	0.0080	0.0094	0.0108	0.0123	0.0139	0.0155	0.0172
2	0.0190	0.0208	0.0226	0.0245	0.0265	0.0285	0.0306	0.0327
3	0.0348	0.0370	0.0393	0.0415	0.0439	0.0462	0.0487	0.0511
4	0.0536	0.0561	0.0587	0.0613	0.0640	0.0666	0.0694	0.0721
5	0.0749	0.0777	0.0806	0.0835	0.0864	0.0894	0.0924	0.0954
6	0.0985	0.1016	0.1047	0.1078	0.1110	0.1142	0.1175	0.1208
7	0.1241	0.1274	0.1308	0.1342	0.1376	0.1411	0.1446	0.1481
8	0.1516	0.1552	0.1588	0.1624	0.1660	0.1697	0.1734	0.1771
9	0.1809	0.1847	0.1885	0.1923	0.1962	0.2001	0.2040	0.2079
10	0.2119	0.2159	0.2199	0.2239	0.2280	0.2320	0.2361	0.2403
11	0.2444	0.2486	0.2528	0.2570	0.2613	0.2656	0.2699	0.2742
12	0.2785	0.2829	0.2873	0.2917	0.2961	0.3006	0.3050	0.3095
13	0.3140	0.3186	0.3231	0.3277	0.3323	0.3370	0.3416	0.3463
14	0.3510	0.3557	0.3604	0.3652	0.3699	0.3747	0.3795	0.3844
15	0.3892	0.3941	0.3990	0.4039	0.4089	0.4138	0.4188	0.4238
16	0.4288	0.4338	0.4389	0.4440	0.4491	0.4547	0.4593	0.4645
17	0.4696	0.4748	0.4800	0.4852	0.4905	0.4958	0.5010	0.5063
18	0.5117	0.5170	0.5224	0.5277	0.5331	0.5385	0.5440	0.5494
19	0.5549	0.5604	0.5659	0.5714	0.5769	0.5825	0.5881	0.5937
20	0.5993	0.6049	0.6105	0.6162	0.6219	0.6276	0.6333	0.6390
21	0.6448	0.6505	0.6563	0.6621	0.6679	0.6738	0.6796	0.6855
22	0.6914	0.6973	0.7032	0.7091	0.7151	0.7210	0.7270	0.7330
23	0.7390	0.7451	0.7511	0.7572	0.7633	0.7694	0.7755	0.7816
24	0.7878	0.7939	0.8001	0.8063	0.8125	0.8187	0.8250	0.8312
25	0.8375	0.8438	0.8501	0.8564	0.8628	0.8691	0.8755	0.8819
26	0.8882	0.8947	0.9011	0.9075	0.9140	0.9205	0.9270	0.9335
27	0.9400	0.9465	0.9531	0.9596	0.9662	0.9728	0.9792	0.9860
28	0.9927	0.9993	1.006	1.013	1.019	1.026	1.033	1.040
29	1.046	1.053	1.060	1.067	1.074	1.080	1.087	1.094
30	1.101	1.108	1.115	1.122	1.129	1.136	1.142	1.149
31	1.156	1.163	1.170	1.178	1.184	1.192	1.199	1.206
32	1.213	1.220	1.227	1.234	1.241	1.248	1.256	1.263
33	1.270	1.277	1.285	1.292	1.299	1.306	1.314	1.321
34	1.328	1.336	1.343	1.356	1.358	1.365	1.372	1.378
35	1.387	1.395	1.402	1.410	1.417	1.425	1.432	1.440

From Table 3-4, the flow per inch of weir width is found to be 0.0613 cfs. Since the weir is 36 inches wide, the total flow is therefore:

$$36 \times 0.0613 = 2.21 \text{ cfs .}$$

3.3.3.1.3 Float Method--The float method is recommended for larger streams where a temporary dam is not practical. The method is not as accurate as the previous two, but for large amounts of water, precise measurements are not as critical.

Equation (2-1) expressed flow as volume divided by time:

$$Q = \frac{V}{t}$$

The float method uses another definition for flow: Flow is equal to the area of a cross-section of the flowing water multiplied by the velocity of the flowing water--that is, the speed with which that cross-sectional area is moving (Figure 3-12). This subsection discusses how to determine area and velocity for this calculation.

$$Q = A \times v \tag{3-3}$$

where

Q = flow in cfs

A = area in square feet (ft²)

v = velocity in feet per second (fps)

NOTE: Both Equation (2-1) and Equation (3-3) express flow in cfs.

To use the float method, you must determine two quantities:

- The average cross-sectional area of the stream
- The velocity at which the stream is moving.

To determine the average area, choose a length of stream at least 30 feet long (the longer the better) that is fairly straight, with sides approximately parallel. The stream should have a relatively smooth and unobstructed bottom. If there are large rocks in the bed or if the stream flow is irregular, you will have to apply an appropriate correction factor to the velocity.

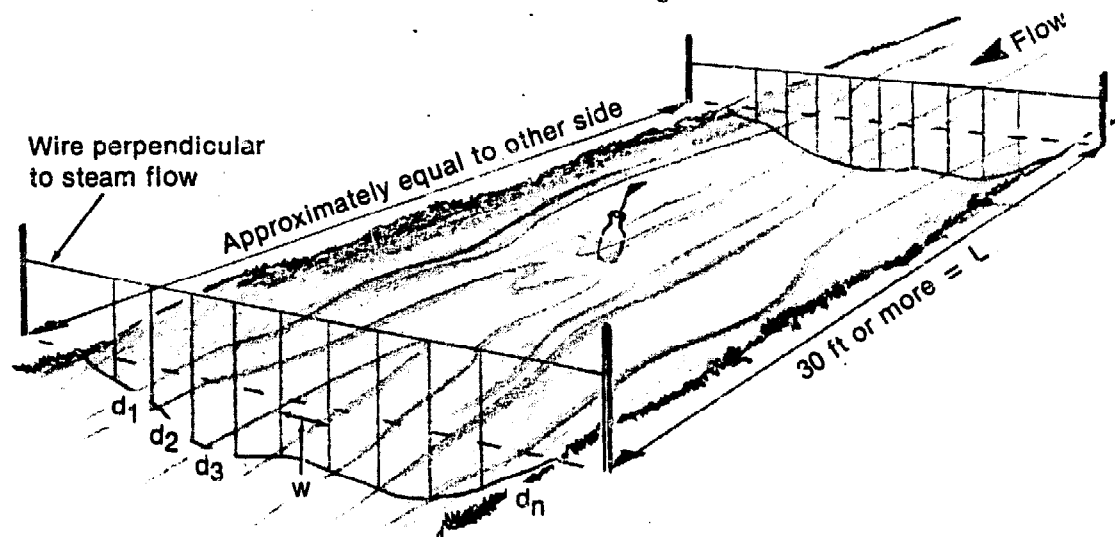

INEL 2 1264

Figure 3-12. Float method for estimating flow.

To start, stake out a point at each end of the chosen length of stream and drive a post on each side of the bank at these points. Connect a wire or rope between the posts crossing the stream (Figure 3-12). Use a carpenter's line level to level the taut wire. Measure the width of the stream at each crossing. Divide the width into convenient equal segments (1 to 2 feet each). Cross the stream, tying a marker (string or ribbon) on the

wire or rope to mark each equal segment. With a yard stick, measuring rod, or similar device, measure the depth of water at each marker. (It is usually easier to measure the distance from the stream bottom to the wire and then subtract the distance from the wire to the top of the stream.) Add up all the readings and multiply by the segment width.

$$D = (d_1 + d_2 + d_3 + \dots d_n) \quad (3-4)$$

where

D = sum of the depths measured.

d = measured depth of the stream at each marker in inches

n = number of markers

EXAMPLE: Assume that the stream is 20 feet wide and that wires have been stretched across the stream in two places 45 feet apart. Find the sum of the depths measured.

First, divide each wire across the stream into 2-foot segments. Since 2 divides into 20 feet 10 times, use 9 markers to identify the segments, marking the first segment 2 feet from the shore and continuing across in 2-foot intervals. The last segment marker should be 2 feet from the opposite bank. Next, measure the depth of the stream at each marker, and add up all the depths measured.

$$D = d_1 + d_2 + d_3 + \dots d_9 = 168 \text{ in.}$$

Now, determine the cross-sectional area of the stream. To do this, multiply the sum of the depths measured (D) by the width of the individual segments (W) and divide by 144 to convert from square inches to square feet.

$$A = \frac{W \times D}{144} \quad (3-5)$$

where

A = cross-sectional area in ft^2

W = width of individual segments in inches

D = sum of the depths measured in inches

144 = the number of square inches (in^2) in a ft^2

EXAMPLE:

$$A = 24 \text{ in.} \times \frac{168 \text{ in.}}{144}$$

$$A = 28 \text{ ft}^2$$

Repeat the process at the other crossing, add the two areas together, and divide by two to obtain an average cross-sectional area for the selected length of stream.

$$A = \frac{A_1 + A_2}{2} \tag{3-6}$$

where

A = average cross-sectional area in ft^2

A_1 = cross-sectional area at the first crossing in ft^2

A_2 = cross-sectional area at the second crossing in ft^2

2 = number of areas added together

EXAMPLE: From the example above, $A_1 = 28 \text{ ft}^2$; assume that
 $A_2 = 34.5 \text{ ft}^2$

$$A = \frac{28 \text{ ft}^2 + 34.5 \text{ ft}^2}{2}$$

$$A = 31.2 \text{ ft}^2$$

Next you must determine the velocity of the stream flow. Make a float of light wood, or use a bottle that is weighted to ride like a piece of wood (Figure 3-10). A small flag can be put on the float so that its progress can be followed easily. Now set the float adrift upstream from the first wire. Time its progress down the stream with a stopwatch, beginning just when the float passes the first wire and stopping just as it passes the second wire. Repeat the measurement at least six times at various locations across the stream to obtain an average time. Perform this measurement on a calm day since wind will cause errors in your measurements.

$$T = \frac{t_1 + t_2 + t_3 + \dots + t_n}{n} \quad (3-7)$$

where

T = average time in seconds

t = recorded time for each drift in seconds

n = number of drifts

Since the water does not flow as fast on the bottom as it does on the surface, you must apply a correction factor (c) to the average time. For a straight stream with a smooth bottom, use 0.8. For a stream with large rocks on the bottom, use 0.6.

$$T_c = \frac{T}{c}$$

(3-8)

where

T_c = corrected time in seconds

T = uncorrected average time in seconds

c = correction factor (no units)

EXAMPLE: Assume that the two wire crossings are 45 feet apart and that the bottom is smooth and uniform. Find the stream velocity by timing six drifts.

Measured drift times:

$$t_1 = 23, t_2 = 26, t_3 = 22, t_4 = 25, t_5 = 23, \text{ and } t_6 = 25.$$

From Equation (3-7):

$$T = \frac{23 + 26 + 22 + 25 + 23 + 25}{6}$$

$$T = \frac{144}{6}$$

$$T = 24 \text{ sec}$$

Assume that $c = 0.8$ (for smooth bottom). From Equation (3-8):

$$T_c = \frac{24}{0.8}$$

$$T_c = 30 \text{ sec}$$

Velocity is distance divided by time:

$$v = \frac{L}{T_c} \quad (3-9)$$

where

v = velocity in fps

L = distance between wires in feet

T_c = corrected time in seconds

From Equation (3-9) (continuing the example):

$$v = \frac{45 \text{ ft}}{30 \text{ sec}}$$

$$v = 1.5 \text{ fps} .$$

Both quantities needed to compute flow are now known and can be substituted into Equation (3-3), $Q = A \times v$.

EXAMPLE: $A = 31.2 \text{ ft}^2$ and $v = 1.5 \text{ fps}$; find Q .

$$Q = A \times v$$

$$Q = 31.2 \text{ ft}^2 \times 1.5 \text{ fps}$$

$$Q = 46.8 \text{ cfs} .$$

The float method is easier to set up than the weir method, but it is more difficult to make daily readings. Each time the depth of the stream changes, you must determine a new area and velocity. If the stream is used by others, it is not advisable to leave the wires or ropes across the stream. They should be taken down after each reading.

One suggestion that might simplify repeat measurements is to place a yardstick on a post and drive the post into the stream bed so that the yardstick can be read. Each time the measurements are made and the flow determined, record the depth on the yardstick. Then every time that depth appears on the yardstick, the flow is the same as previously determined, and since different flows are needed for correlation, another day should be selected to make further measurements.

In summary, select the best measurement method for the stream, locate the measurement station near the proposed location for the intake structure, and begin taking measurements.

3.3.3.2 Flow Computations. You should now have several days of flow measurement recorded. The next step is to determine from the gage previously identified as closest to your site the flow readings for the days on which your flow measurements were made. Record the gage readings in the appropriate column (Q_2) of the flow table (Figure 3-5), and compute the correlation by dividing the gage reading into the measured flow.

$$c = \frac{Q_1}{Q_2} \quad (3-10)$$

where

c = correlation number

Q_1 = measured daily flow in cfs

Q_2 = gage daily flow in cfs

If a good flow pattern relation exists between the site and the gage, the correlation value will be approximately the same for each day of measurement.

EXAMPLE: Assume that four measurements were made at the site and the flow was computed. Also assume that the gage readings have been received and recorded.

Computed Flow, Q_1 (cfs)	Gauge Flow, Q_2 (cfs)	Correlation Q_1/Q_2
26.7	50.3	0.53
30.3	59.6	0.51
33.7	68.9	0.49
31.2	65.3	0.48

The variation in the correlation ranges from 0.53 to 0.48, or 0.05 variation. Since the variation is small, the correlation is good.

If the variation becomes greater than 0.15, the correlation between the site and the gage may not be sufficient to use the gage exceedance value to project stream flow at the site. A developer who cannot obtain a good correlation should use the procedure given in Appendix A-4, "Stream Flow Projections Where a Gage Correlation Does Not Exist."

3.3.3.3 Exceedance Value Flow Duration Curve. An example of a flow duration curve was presented in Figure 3-4. The curve was plotted from exceedance values obtained from the A9-69 printout (Table 3-3). The printout lists flow values for seven exceedance percentages (95, 90, 75, 70, 50, 25, and 10%). The 95% flow value means that that flow will be met or exceeded 95% of the time. The 70% flow will be met or exceeded 70% of the time, etc. If other than USGS exceedance values are used, the seven exceedance percentages may be different, but they can be used to develop a flow duration curve as easily as the USGS values.

The next step is to construct the flow duration curve. Figure 3-13 shows a reduced copy of standard 8-1/2 x 11 inch graph paper with 20 grid markings per inch. Paper with 10 divisions per inch could just as easily

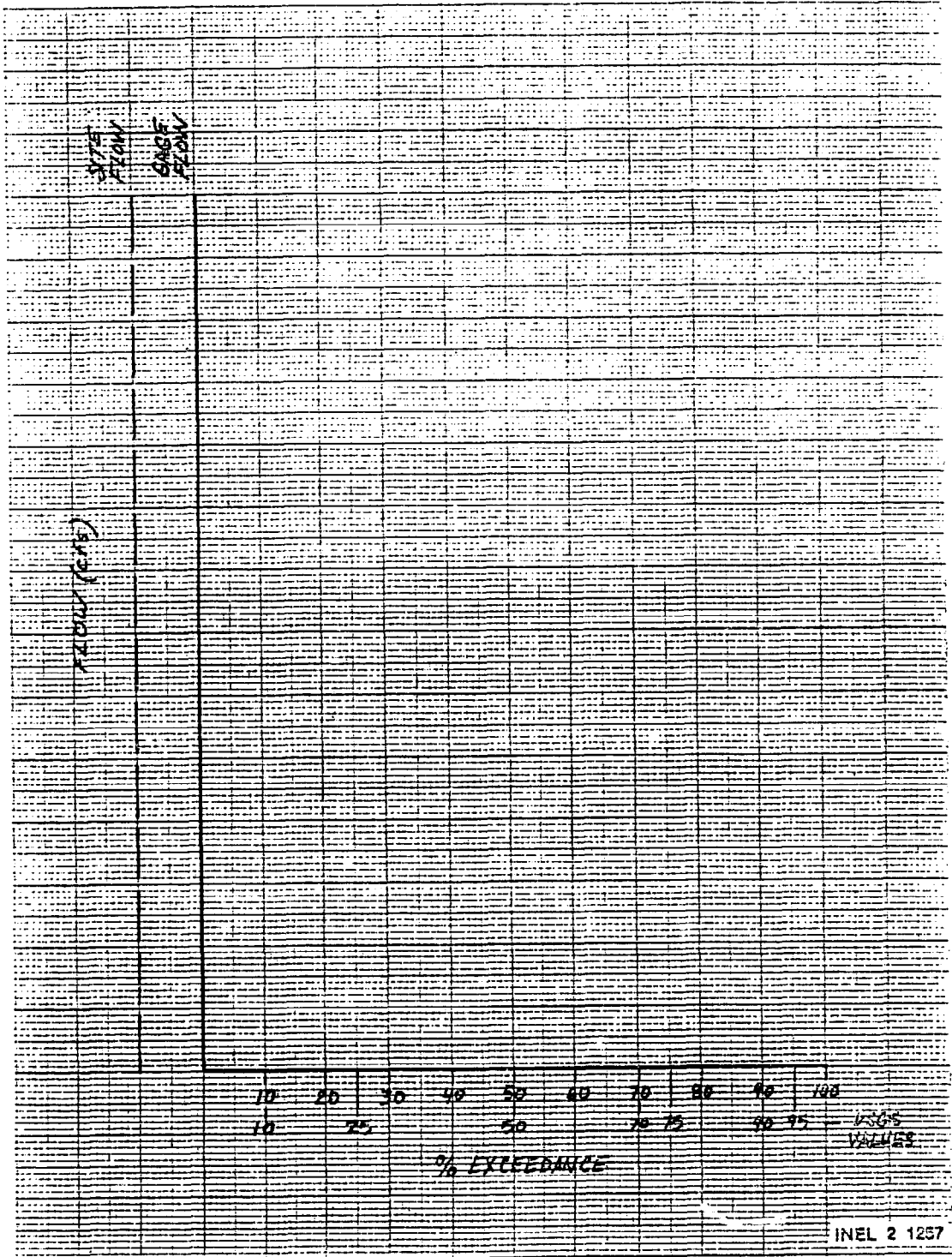

Figure 3-13. Form used for exceedance valve flow duration curve.

be used. The paper can be obtained at most office supply stores. Two coordinates are shown on the figure. The vertical coordinate is for the flow scales, and the horizontal is for the exceedance percentage. The seven USGS exceedance values are indicated below the horizontal axis.

The vertical axis is not scaled because the two scales that will be shown depend on the amount of flow to be plotted. The easiest method to determine the vertical scales is as follows. First, make the axis 6 to 8 inches long and divide it into convenient increments. For example, assume that the USGS 10% exceedance flow is 390 cfs. Make the axis 8 inches long, and find the next larger number above 390 into which 8 will divide evenly. Eight will divide into 400 fifty times. Therefore, make the increments 50 cfs per inch. Figure 3-14 is a flow duration curve for the exceedance values given in Table 3-3. Since in this example the 10% exceedance flow is 130 cfs, the vertical axis was made 7 inches long and a 20 cfs per inch increment was selected. Look at Table 3-3 for 95% exceedance; the flow is 8.1 cfs. To plot the first point, place one straightedge on the graph so that it passes vertically through the 95% mark, and another so that it passes horizontally through the 8.1 cfs flow level; mark the point where the two straightedges cross. You can use a draftsman's right triangle for this purpose. Repeat this procedure until the other six points are plotted. Connect the points together to form a curve. A drafting tool called a french curve will aid in drawing a smooth curve, but its use is not necessary. You can probably obtain satisfactory results by connecting each point with a straight line. The flow duration curve for the gage exceedance is now plotted.

Next, the scale for the site flow needs to be developed. Refer back to the previous subsection in which the correlation values were computed [last column of the flow table (Figure 3-5)]. Find the average correlation value by adding the numbers together and dividing by the number of readings.

$$C = \frac{c_1 + c_2 + c_3 + \dots + c_n}{n} \quad (3-11)$$

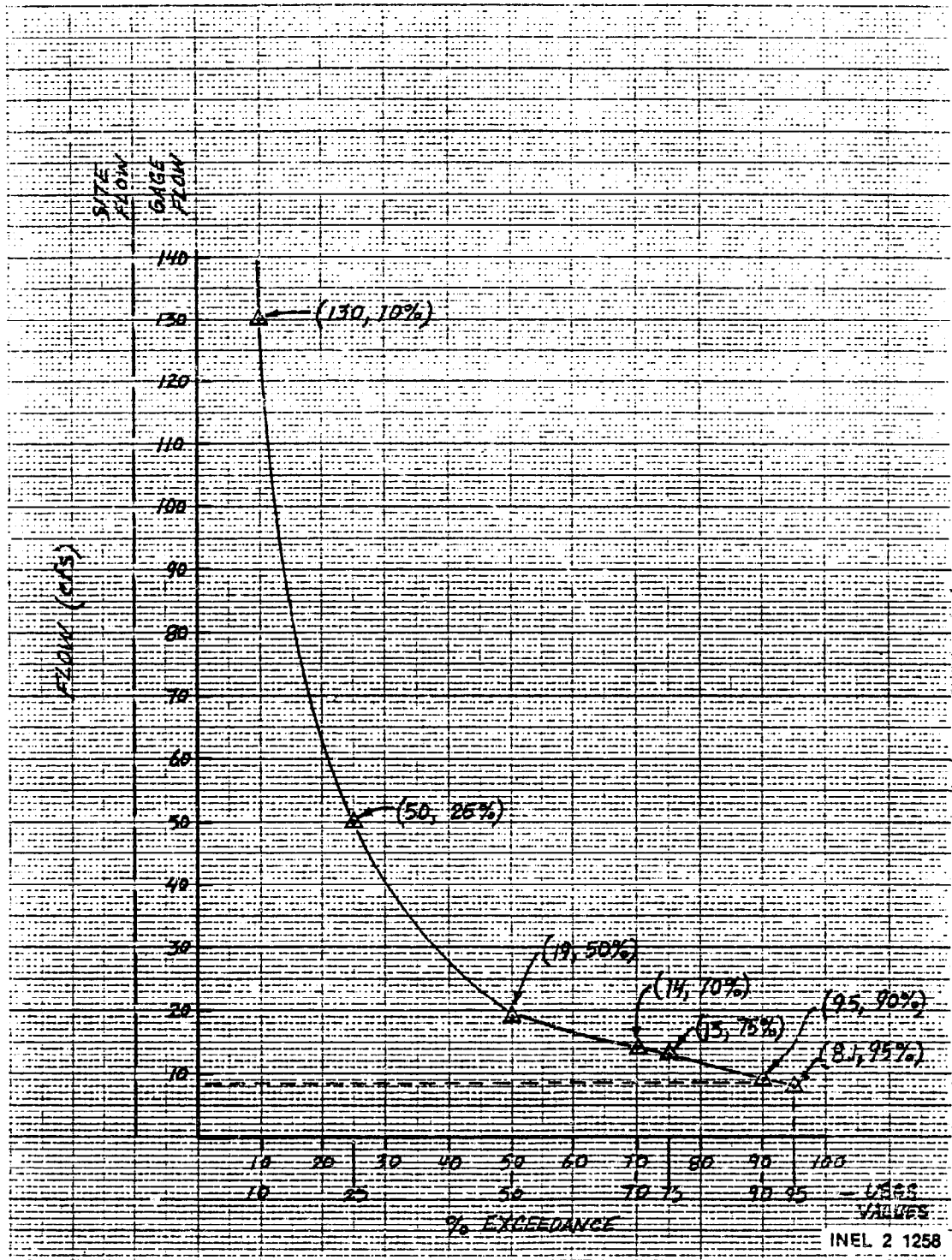

Figure 3-14. Flow duration curve for exceedance values in Table 3-3 (site flow scale missing).

where

C = average correlation

c = daily correlation value

n = total number of correlations

For the Mill Creek example (Table 3-3, Figure 3-14), assume the following correlation values: $c_1 = 0.70$, $c_2 = 0.65$, $c_3 = 0.72$, and $c_4 = 0.74$.

From Equation (3-11):

$$C = \frac{0.70 + 0.65 + 0.72 + 0.74}{4} = \frac{2.81}{4}$$

$$C = 0.70$$

To find the site flow scale, multiply the gage scale by C. Thus, 10 cfs gage \times 0.70 = 7 cfs site, 20 cfs gage \times 0.70 = 14 cfs site, etc. Figure 3-15 shows the flow duration curve with the completed site flow scale. From the site flow scale, the minimum stream flow is around 5.7 cfs, and the 25% exceedance is 35.1 cfs.

Take another set of flow measurements a month or two after the first and check for correlation again. If the average correlation value is close to the first value, then the correlation is good and the curve (Figure 3-15) can be used for design. If the average correlation is not reasonably close (more than 0.15 difference), refer to Appendix A-4, "Stream Flow Projections Where a Gage Correlation Does Not Exist."

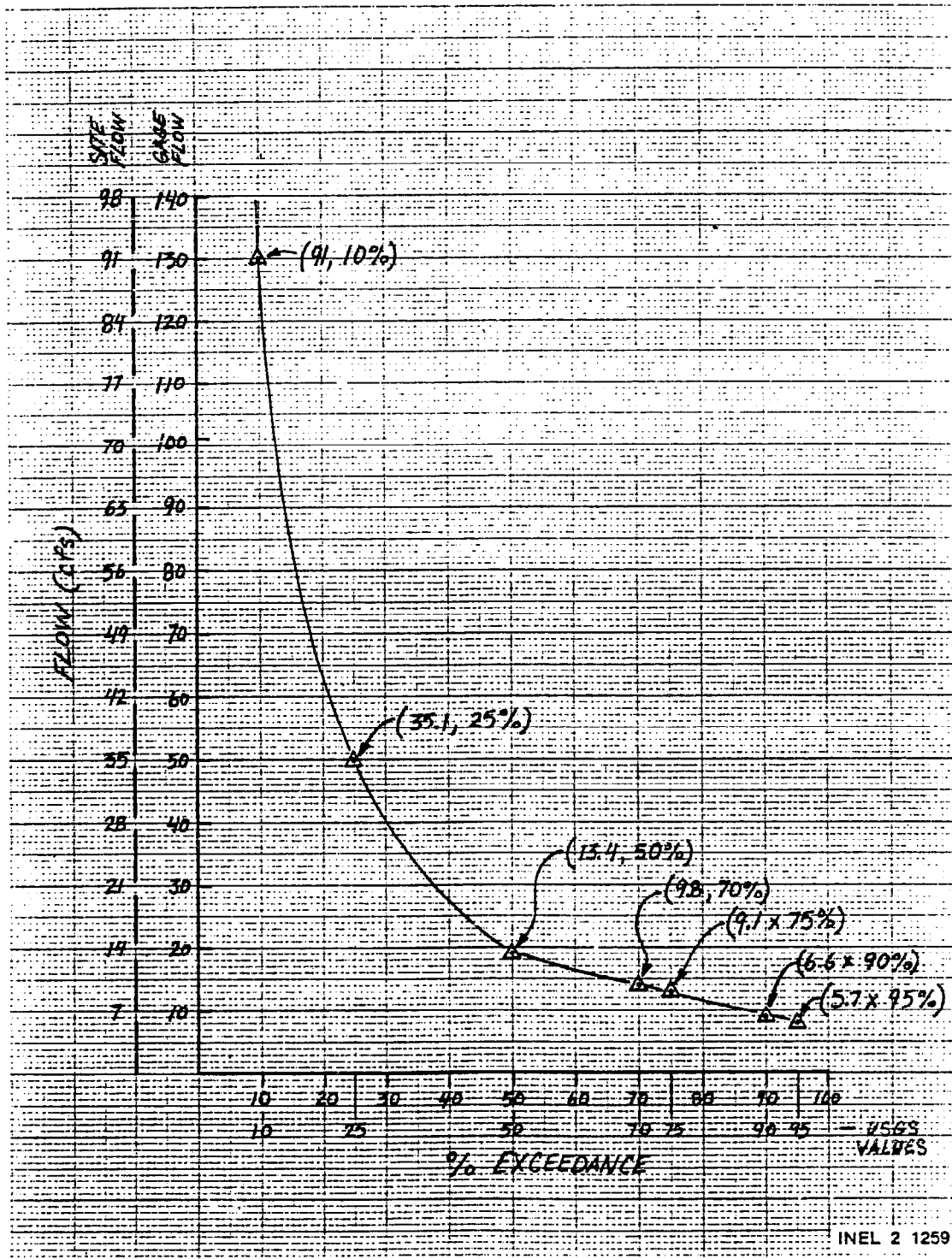

Figure 3-15. Flow duration curve with completed site flow scale.

3.4 Head and Distance Measurements

Before physically measuring head and distance, run-of-the-stream developers should proceed to Subsection 3.5.1, "Power Requirements and Minimum Flow Known; Calculate Head" to determine how much head is needed. After the head calculation, return to this section for the measurements.

Pool-to-pool head is the change in elevation measured in feet of vertical fall. If a power canal is used, the pool-to-pool head is only the change in vertical elevation from the water surface at the penstock intake to the tailwater surface elevation at the turbine. The change in elevation for the power canal does not count, since the canal is not under pressure. Head and flow are the two quantities used to compute power (Equation 2-2).

Some developers may want to hire a professional surveyor, who will use a survey level, rod, and steel chain, or even more sophisticated equipment, to measure head and distance. For the developer who wishes to do the work himself, this subsection gives suggestions on surveying.

If you have followed the instructions in Subsection 3.2, you have already made a preliminary site inspection, and run-of-the-stream developers have selected a penstock routing. You should also have determined the amount of head you require, or the amount available from the site. You are now ready to measure head and distance, starting from the proposed powerhouse location. After measuring pool-to-pool head and distance, make a sketch of the site showing the route and the distance.

3.4.1 Head Measurements

If the proposed powerhouse and penstock intake are near the stream, you can use the pressure method described immediately below to measure head. If they are not, you will have to use other survey methods.

3.4.1.1 Pressure Method for Measuring Pool-to-Pool Head at Run-of-the-Stream Sites. Head is measured in feet and represents pressure resulting from the weight of the water.

Weight of water = 62.4 pounds per cubic foot (lb/ft³)

1 square foot = 144 square inches

Therefore:

$$\frac{62.4 \text{ lb/ft}^3}{144 \text{ in}^2/\text{ft}^2} = 0.433 \text{ psi/ft of head}$$

1 foot of head = 0.433 pounds per square inch (psi)

The pressure method uses this relationship to measure head. A pressure gage, which can be purchased for \$10 to \$20, is connected to the bottom end of a pipe or hose, and the static pressure in the pipe or hose is read on the gage. Static pressure means that the water is not flowing in the hose at the time of measurement.

This unique adaptation of the pressure-head principle is perhaps the simplest method for measuring head in a stream that changes elevation fairly rapidly. The only equipment required is a hose and a pressure gage. The gage should range from 0 to 10 psi if the head measurement will not exceed 20 feet for any single measurement. The gage should be accurate to at least the nearest 1/4 psi (0.1 psi accuracy preferred).

Starting with the lower end of the hose at the proposed powerhouse tailrace location and working upstream toward the proposed intake location, place the hose along or in the stream, submerge and anchor the upstream end of the hose, and allow water to flow through the hose until all air is removed and the water flows freely (Figure 3-16). Connect the pressure gage to the lower end of the hose and record the pressure. The upstream end of the hose should not be pointed directly into the stream flow but should be at a 90-degree or greater angle to the flow. If it is pointed directly into the flow, the pressure gage, because of the velocity of the water, will give a reading slightly higher than the static pressure. While

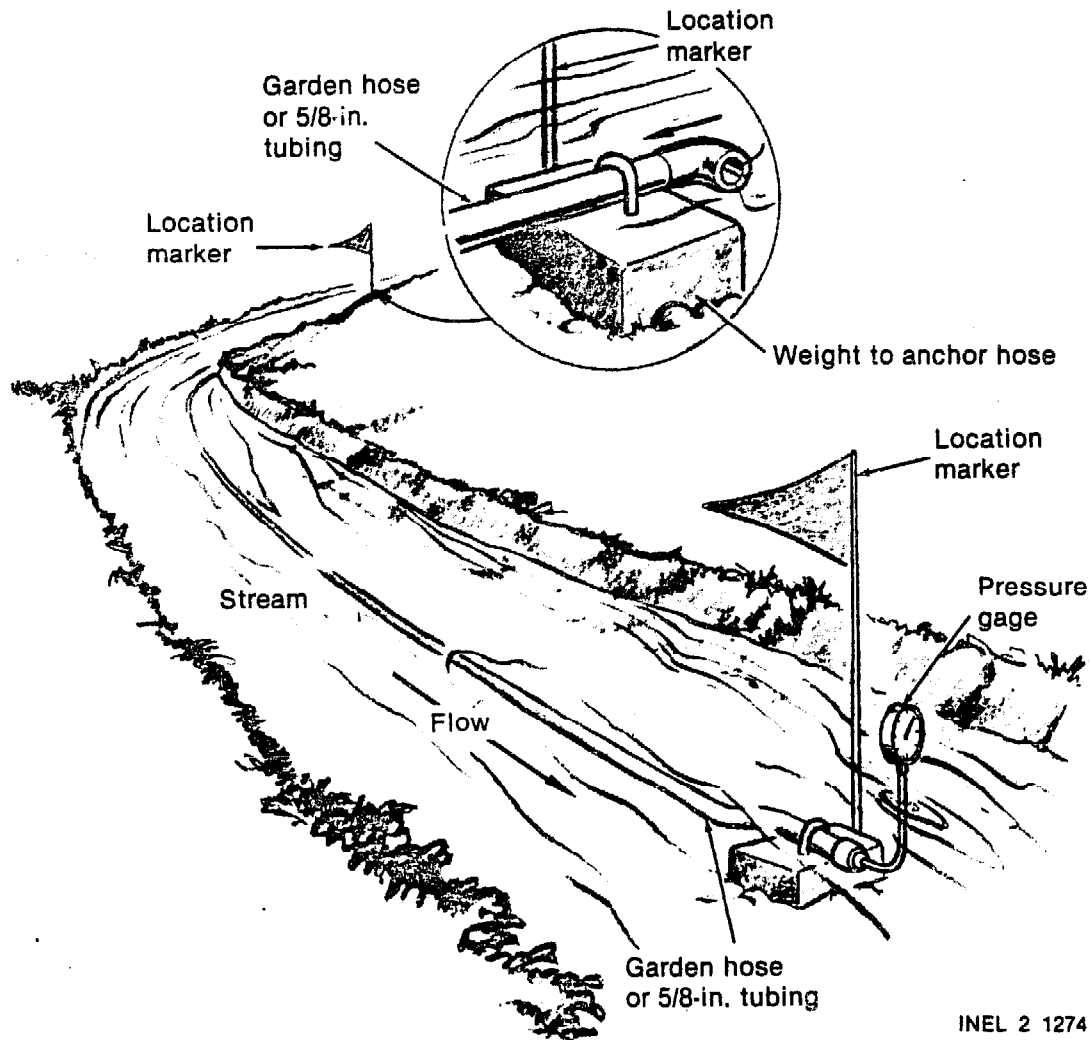

INEL 2 1274

Figure 3-16. Pressure gage measurement of head for run-of-the-stream sites.

this error will not be great for a single reading, the cumulative effect of a large number of readings taken at the site will be an erroneous head measurement. Mark the location of the upper end of the hose so that the lower end can be placed there for the next reading. Continue the process until the length of stream in question is measured. Note: When making the last reading, coil the excess hose somewhere upstream from the gage; it won't affect the reading as long as all the air is removed. After taking the readings, add all the pressures and divide by 0.433.

$$h = \frac{P_1 + P_2 + P_3 \dots P_n}{0.433}$$

(3-12)

where

h = pool-to-pool head in feet

P = individual pressure measurement

n = number of measurements

0.433 = pressure per foot of head in psi

EXAMPLE: Assume that four readings were taken-- $P_1 = 5.6$ psi, $P_2 = 4.8$ psi, $P_3 = 6.1$ psi, and $P_4 = 5.9$ psi. Find the head.

$$h = \frac{5.6 + 4.8 + 6.1 + 5.9}{0.433} = \frac{22.4 \text{ psi}}{0.433}$$

$$h = 52 \text{ ft}$$

NOTE: The hose(s) should be at least 100 feet or longer so that pressure readings are greater than 1 or 2 psi. Also, the fewer the readings, the smaller the error.

Compare the measured head with the required head, and adjust the location of the proposed intake point as needed to obtain 5 to 10% greater pool-to-pool head to allow for system losses.

3.4.1.2 Level Survey to Measure Head at Run-of-the-Stream Sites, Canal Drops, and Industrial Discharge Sites. If a power canal is going to be used, a level survey method will have to be used to measure the change in elevation from the powerhouse to the penstock intake. Although the level surveying procedure is independent of the equipment used to make the survey, the various types of equipment will be discussed first, and then the procedure.

The best equipment for making such a survey is a survey level (Figure 3-17) and rod designed specifically for surveying. With a few minutes of instruction, you can easily set up and level the level. A construction rental business should have such equipment available. Other possible sources of equipment are building contractors or the state highway department.

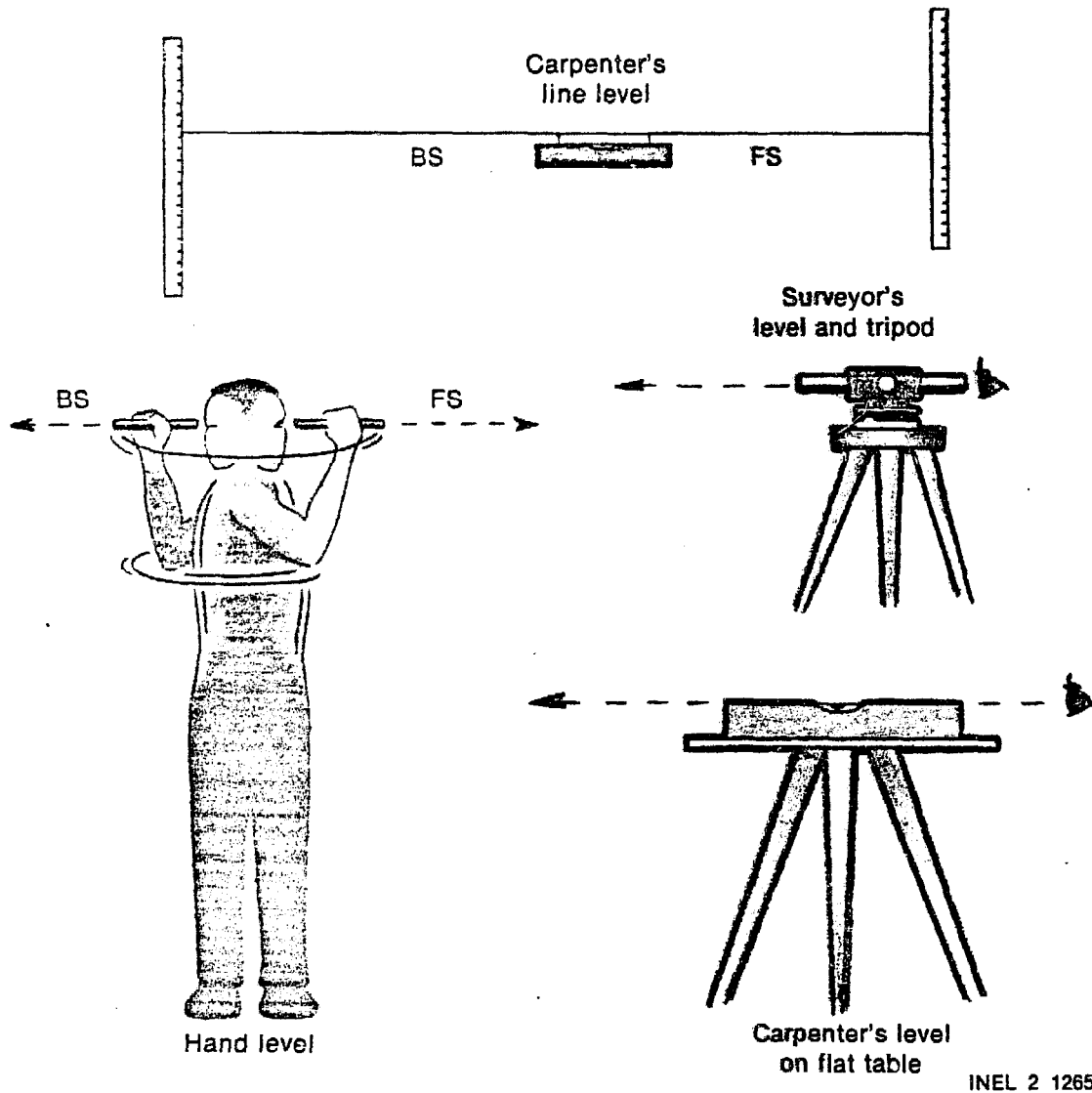

Figure 3-17. Types of level.

The surveyor's hand level is the next-best alternative. The hand level works on the same principle as the survey level, except that the person holding the level becomes the tripod. The person holding the level should stand facing at a right angle to the survey line (Figure 3-17) and should look over one shoulder to the back sight (BS) and the other shoulder to the front sight (FS) without moving the feet when shifting from one sight to the other.

A third type of level is a carpenter's level placed on a table or similar device. To take a reading, sight across the top of the level (Figure 3-17).

The rod is a straight, rectangular pole on which a measurement scale is placed. A regular survey rod is divided into feet and hundredths of a foot. A tape measure or three yard sticks placed on a 10-foot 2 x 4 or 2 x 2 will work. The person holding the rod can assist the reading of the rod by using a pointer that moves up and down the scale until the correct number is pointed to. To make sure that the rod is held vertically, hold the rod facing the level and slowly rock the rod back and forth toward the level until the minimum measurement is read.

The locations for the powerhouse and the penstock intake structure were preliminarily determined in Subsection 3.2. Use the same locations for the initial level survey. Place the measuring rod on a rock or similar solid object at the waterline at the powerhouse location. Place the level in the line of sight between the rod and the intake location. Level the level and read the height off the rod (Figure 3-18). The first reading to be taken is the height of the level above the stream. Record the reading and note it as BS (back sight). The person with the rod now proceeds uphill past the level and places the rod on a solid rock (or something similar) called the turning point. The rod should be faced downhill toward the level. The person with the level sights uphill toward the rod. Make sure that the level is still level before reading the rod. After checking, read

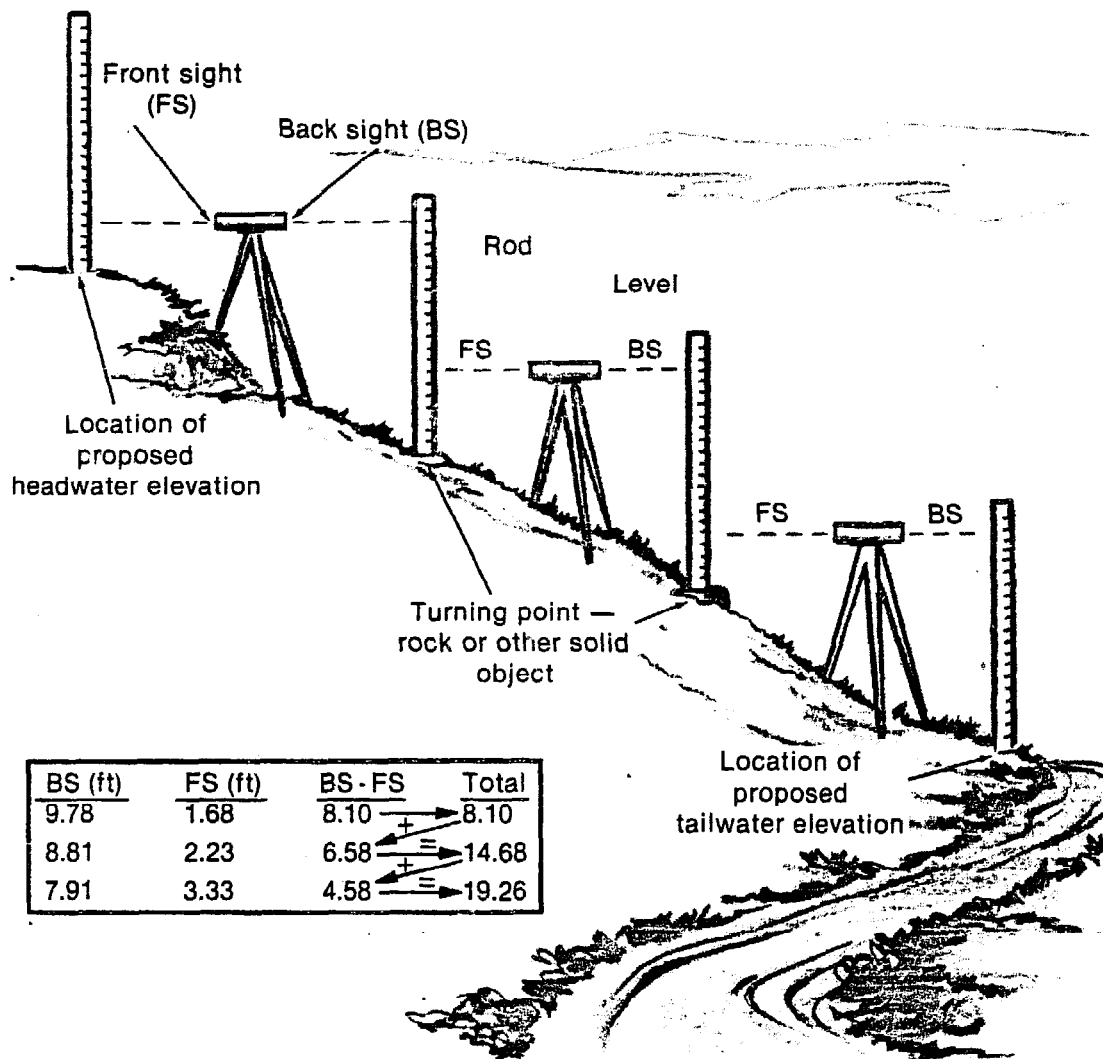

INEL 2 1266

Figure 3-18. Level survey method of head measurement.

the height on the rod and record the reading as FS (front sight). Subtract the FS reading from the BS reading and record the difference. Now, move the level uphill past the rod and along the path previously chosen. After the level is set up and leveled again, sight downhill toward the rod, which has been turned around to face the level. Read the height and record the reading as a BS. Continue in this manner, alternately moving the rod and level up the hill. After each FS measurement, subtract the FS measurement from the preceding BS measurement and add the results to the previously recorded differences. For run-of-the-stream sites, continue measuring elevation until the required head is reached.

3.4.1.3 Survey Methods for Manmade Dams with Low Head. Dam sites may have the problem of a fluctuating head. A method should be developed to measure head when measuring flow. You can use the pressure method described in Subsection 3.4.1.1 if a pipe penetrates the dam and a blind flange with a gage can be placed on the pipe. Otherwise, use the level survey method described in Subsection 3.4.1.2 to establish an initial head. Figure 3-19 shows a method for daily head measurements.

How to use the data being gathered depends on the fluctuation pattern. If the head fluctuation is seasonal, the average flow and head will have to be computed for the season instead of annually. In such situations, low flow usually corresponds to low head. Head at high flow should also be considered, since high flow may increase the tailwater elevation, thus reducing the head. You should pay particular attention to the low- and high-flow seasons to determine how much power (if any) can be produced during those periods.

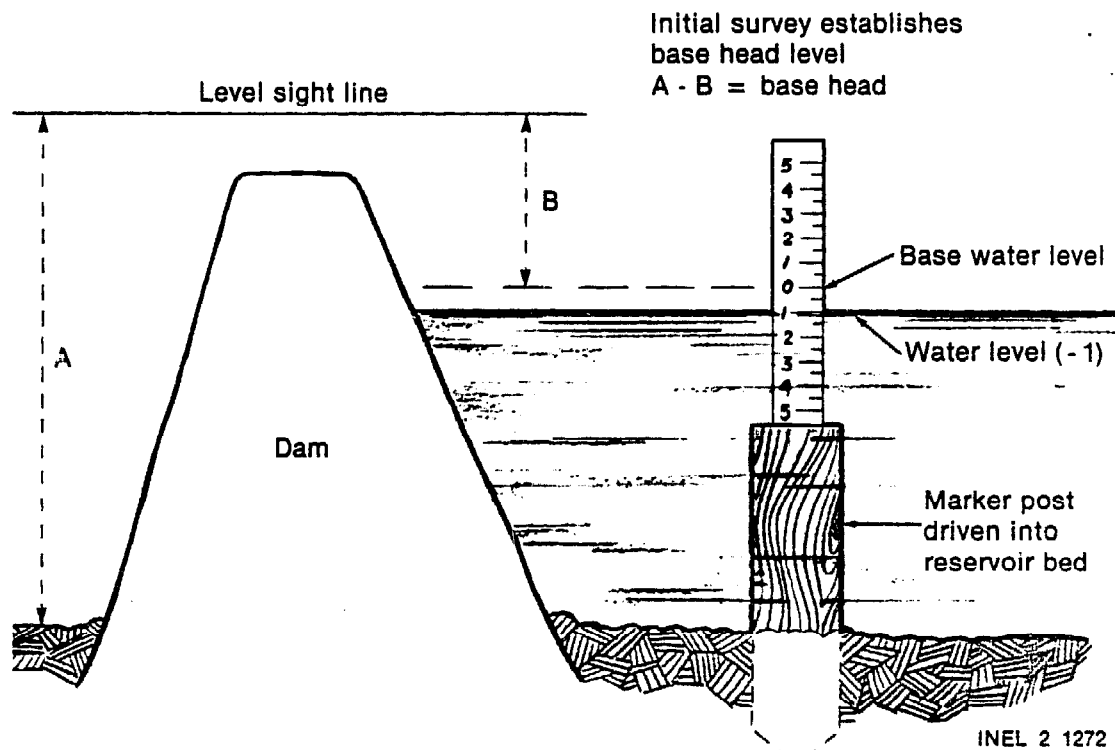

Figure 3-19. Method for daily head measurements at dam site.

If the head fluctuation is erratic, which is typical of small impoundment structures, you can use the average head for the rough first cut at calculating power. Once you have selected a flow for the preliminary design, you should estimate the effect of that flow on the reservoir drawdown. If your turbine uses less flow than is normally discharged, the effect is minimal. However, if the turbine uses more than the normal flow, the drawdown will be faster, and if the turbine's flow requirement is high enough, it may have to cycle on and off to prevent total drawdown.

3.4.2 Distance Measurement for Run-of-the-Stream Site

For run-of-the-stream sites, the distance from the intake structure to the powerhouse must be known to determine the length and size of the penstock and estimate the cost. As mentioned in Subsection 3.2, it is a good idea initially to lay out the system on a USGS contour map. Once the locations for the intake power canal, penstock intake, and powerhouse are proposed, select the shortest unobstructed distance between these locations. Remove brush and similar material, stake the proposed locations, and measure the distance along the line staked. A 100-foot steel tape is preferred so that the tape can be pulled tight (5 to 10 pound pull) for each measurement. Start at one location and measure to the other, recording each measurement. A common mistake in distance measurement is forgetting to record a measurement. One way to keep this from happening is to have both persons record each measurement and to make sure that the correct number is recorded before moving to make the next measurement. The total distance between the points is the sum of all the measurements.

3.5 Determining Design Capacity, Head, and Flow for Category 1 Developers

The information in this subsection is for Category 1 developers, those who want to be energy independent. The hydropower system will only be designed to supply the power needs of the developer. Category 2 developers

are referred to Subsection 3.6, "Determining Design Capacity, Head, and Flow for Category 2 Developers."

If you are a run-of-the-stream developer, you should already have determined your power requirements and the minimum stream flow and, for manmade sources, measured the available pool-to-pool head. In this subsection, you will use the power requirements and minimum stream flow to determine the design head for your project.

The basic power equation [Equation (2-2)] will be used for all calculations.

$$P = \frac{Q \times h \times e}{11.81} \quad (2-2)$$

where

P = power in kW

Q = flow in cfs

h = head in feet

e = efficiency (assumed to be 60%)

11.81 = constant of conversion

To calculate design head, the equation is rewritten to solve for head. If the value of e is 60%, the design head calculated will be the pool-to-pool head of your site since this value of e includes penstock losses.

$$h = \frac{11.81 \times P}{Q \times e} \quad (3-13)$$

To calculate flow if head and power are known, the equation is rewritten to solve for flow:

$$Q = \frac{11.81 \times P}{h \times e} \quad (3-14)$$

The flow value used for the first series of calculations should be the minimum flow. On most flow duration curves, the 95% exceedance site flow can be used for the minimum flow value. Be sure to use site flow, not gage flow. If the minimum flow will not produce the power required, or if it requires too large a head to produce the required power, you can estimate the relative economic benefit of the system from other sections of this book and determine from that whether or not to proceed with the development. There are four different calculations to use, depending on what is known and what needs to be computed.

- o Power requirements and minimum flow are known; calculate head.
- o Head and flow are known; calculate design capacity.
- o Head and power requirements are known; calculate minimum flow.
- o Head and flow vary; calculate design capacity.

Select the appropriate calculation, and follow the procedure given below.

3.5.1 Power Requirements and Minimum Flow Known; Calculate Head

From Equation (3-13), compute head. Use the previously determined values for power requirement (P) and minimum flow (Q). Determine if the calculated head is reasonable from the standpoint of physical installation and length of penstock (Subsection 3.2). If the head is reasonable, go to Subsection 3.4 to measure head and stake out the intake system. Then use the flow and head as design points, and proceed to Section 4 to select equipment.

If the calculated head is too large for the site, go to Subsection 3.4 and measure the maximum reasonable head. After the maximum head is determined, go to Subsection 3.5.3 and calculate flow for the site with a fixed head and a known power requirement.

3.5.2 Head Fixed and Flow Known; Calculate Design Capacity

In Subsection 3.1, you determined how much power was required to meet your needs. When head and flow are used to compute power, the power is called design capacity. Equation (2-2) is used to compute design capacity for a given head and flow.

$$P = \frac{Q \times h \times e}{11.81}$$

Compare the rated capacity with the power required. If the rated capacity is greater than the required power, you can use Equation (3-14) to compute a lower design flow, using the power required as the design capacity.

$$Q = \frac{11.81 \times P}{h \times e}$$

The power value used in Equation (3-14) should be the power required for your development. The head is still fixed. The design points are now defined for power, head, and flow. Proceed to Section 4.0 to select equipment.

If the calculated design capacity is less than the estimated power required, then the site will not produce all the energy needed year round. Use the power required as the value for the design capacity, P, and go to Subsection 3.5.3 to compute minimum flow requirements and determine what percentage of the year the required power will be available.

3.5.3 Head and Power Requirements are Known; Calculate Minimum Flow and Percentage Exceedance

Use Equation (3-14) to compute minimum flow.

$$Q = \frac{11.81 \times P}{h \times e}$$

Once flow is determined, refer back to the flow duration curve and locate the flow value on the vertical axis for site flow. If you used the method in Appendix A-2 to estimate minimum stream flow, you should return to Subsection 3.3 to create a flow duration curve.

When you have located the flow value on the vertical axis of the flow duration curve, draw a horizontal line to the right to intersect the curve. Where the line intersects the curve, draw a vertical line down to the percentage exceedance scale (horizontal axis). Read the percentage exceedance value where the vertical line intersects the axis. The percentage exceedance means that the system has the potential to supply the required power that percentage of the year.

EXAMPLE: Assume that the maximum practical head at the site is 30 feet and that the required power is 12 kW. Use Figure 3-15 as the flow duration curve. Find the minimum flow and the percentage exceedance.

Using Equation (3-14):

$$Q = \frac{11.81 \times P}{h \times e}$$

$$Q = \frac{11.81 \times 12}{30 \times (0.60)}$$

$$Q = 7.9 \text{ cfs}$$

Assume that a minimum stream flow requirement of 3 cfs has been established by the state to sustain fish habitat. Therefore, the minimum design flow in the stream would be:

$$7.9 \text{ cfs} + 3.0 \text{ cfs} = 10.9 \text{ cfs}$$

Round to 11 cfs.

On the flow duration curve, Figure 3-15, estimate the location of 11 cfs on the site flow scale, draw a horizontal line to intersect the curve, and then draw a vertical line to intersect the flow exceedance scale. The vertical line should be at 60% on the flow exceedance scale. Thus, the required power will be produced 60% of the year.

Turbines will continue to generate some power at flow ranges as low as 35% to 55% of the design flow. The amount of power for the percentage of design flow depends on the turbine-generator unit. Units will always work most efficiently at design flow and capacity. Developers in this situation should consult with various manufacturers to determine how much power can be produced in the lower flow ranges.

3.5.4 Head and Flow Vary; Calculate Design Capacity

For sites where both head and flow vary, determining the size of the turbine and the average power potential becomes the most difficult. You should construct a flow duration curve if you have not already done so.

Head fluctuation can be either seasonal, corresponding to average flow, or erratic, controlled by sources other than average flow.

If head becomes too small (less than 5 to 10 feet, depending on the turbine type), no power can be generated. Any period of time with less than minimum head cannot be considered for power generation.

3.5.4.1 Seasonal Head Fluctuation. With seasonal head fluctuation, the head should be related to flow. From the flow duration curve, mark off average head for seasonal flows. Follow the procedure in Subsection 3.5.2 to calculate design capacity for each season. You will have to measure head and flow several times each season to ensure that the relationship between head and flow is known. Using the head and flow relationships, determine the point where the design capacity most closely equals the power required. At that point, determine what portion of the year power production can be expected (Subsection 3.5.3).

If the design capacity is more than the power required, even at low head and flow, go to Subsection 3.5.3 to calculate design flow, and then proceed to Section 4.0 to select equipment.

3.5.4.2 Erratic Head Fluctuation. Erratic head fluctuation can have a number of causes, including a reservoir that is too small, discharge that is too large for the size of the reservoir, or control of the flow by other interests such as irrigation, etc.

The procedure for calculating rated power depends on how much the head fluctuates and how often. The first step is to calculate design power for the smallest head and lowest flow. If the design capacity is near the power required, use the head and flow as preliminary design points and proceed to Section 4.0. If the design capacity is considerably less than the power required, continue to increase the value for head and flow as they increase for the site until the design capacity equals the required power. At that point, determine how much of the year power would be available and decide if the project is worth while.

3.6 Determining Design Capacity, Head, and Flow for Category 2 Developers

The information in this subsection is for Category 2 developers, those who want to develop the maximum energy available from the site at the least investment.

In an effort to produce the maximum energy at the minimum cost, there are several effects that need to be pointed out. Normally, a larger hydroelectric plant produces a greater amount of energy, but, a larger plant costs more to construct and operate. Conversely, a small plant costs less to construct and operate, but it also produces less energy. Based on this, the best method of optimizing the project economics is to compare energy production costs in terms of a value per kilowatt hour (kWh). As an example, assuming all other economics are the same, two plants can be compared as follows:

- 1st Plant. A 50 kW plant that produces 263,000 kWh of energy per year at 60% plant factor (see Subsection 3.7) at an annual cost of \$10,000 per year (including principal, interest, and operating and maintenance costs, as discussed in Section 7).

$$\text{Costs per kWh} = \frac{10,000}{263,000} = \$0.038 \quad .$$

- 2nd Plant. A 60 kW plant that produces 315,000 kWh of energy per year at 60% plant factor (see Subsection 3.7) at an annual cost of \$15,000 per year (including principal, interest, and operating and maintenance costs, as discussed in Section 7).

$$\text{Costs per kWh} = \frac{15,000}{315,000} = \$0.0476 \quad .$$

If you can sell your power for \$0.055 per kWh, the 1st plant will return $263,000 \times (0.055 - 0.038) = \4471 per year, and the 2nd plant will return $315,000 \times (0.055 - 0.0476) = \2331 per year. In this example, the smaller site represents the best investment for the developer since the profit margin is higher.

One method of determining the design capacity to produce the maximum amount of energy requires the use of a flow duration curve. It is recommended that the Category 2 developer rely on the turbine-generator manufacturer for the detailed energy production analysis and the costs for the economics.

The Category 2 developer can make a preliminary evaluation of the best design capacity and economics using the following "rule-of-thumb" method. The flow (Q) in the design capacity equation should be based either on flow at 25% exceedance on the flow duration curve or on the average annual flow, unless there are periods of zero flow. In that case, use the average during flow periods.

3.6.1 Head Fixed and Flow Known; Calculate Design Capacity

For many Category 2 developers, the head at the site will be fixed and cannot be altered because an existing dam is used. Given this fixed head and a known flow, the design capacity can be determined using Equation 2.2 as the basic equation and solving for P_d .

$$P_d = \frac{Q \times h \times e}{11.81}$$

where

P_d = design capacity in kW

Q = flow in cfs. Use the average annual flow or flow at 25% exceedance, whichever is greater

h = head in ft

e = efficiency (assumed to be 60%)

11.81 = constant of conversion

This preliminary design capacity should be used as a guide, since the type of turbine and the site characteristics will also affect the design capacity and economics. At this point, the turbine-generator manufacturer should be contacted as outlined in Subsection 4.2

3.6.2 Variable Head and Known Flow; Calculate Design Capacity

If the head at a potential microhydropower site is not fixed, and the objective is to produce the maximum amount of energy possible, then the head should be set as high as possible. The head ranges can be determined during the site inspection as discussed in Subsection 3.2. However, there are several items to consider when determining the best location for the intake structure, which is the point from which head is measured.

Items to consider when maximizing head for a Category 2 development:

- Generally, as the head increases, the cost of the turbine-generator equipment decreases.
- To gain additional head, additional penstock is required, which increases costs because of increased length and extra design requirements for pressure and safety.
- Site access and terrain may restrict additional head.
- Head affects the type of turbine that can be used. See Subsection 4.1.
- Additional head may provide an installed capacity of greater than 100 kW, which may change the licensing requirements. See Section 8.

The Category 2 developer should select several heads on the basis of the site inspection and the considerations in this section and develop a range of heads for additional review.

Once the head ranges have been determined, then the design capacity can be determined from Equation (2-2). Calculate the design capacity for each head.

$$P_d = \frac{Q \times h \times e}{11.81}$$

where

P_d = design capacity in kW

Q = flow in cfs. Use the average flow or flow at 25%
exceedance, whichever is greater

h = head in ft

e = efficiency (assumed to be 60%)

11.81 = constant of conversion

This preliminary design capacity should be used as a guide to contact the turbine-generator manufacturers, as described in Subsection 4.2

3.7 Determining Annual Energy

The energy potential is represented by the installed capacity operating for a period of time. This energy term is given in kilowatt-hours (kWh). If a power plant could operate continuously, the amount of energy produced in a year's time would be as follows:

$$\text{Design capacity} = \text{kW} \times 8760 \times 24 \text{ hr/day} \times 365 \text{ days/yr.}$$

However, due to normal fluctuations in stream flow, high- and low-flow limitations on the turbine, and maintenance and down time, the plant will not operate at 100% capacity continuously. Therefore, a plant factor, which is the ratio of the average annual power production to the installed capacity of the plant must be introduced to estimate the average annual energy.

$$P_F = \frac{P_a}{P_d} \times 100 \quad (3-15)$$

where

- P_F = plant factor, as a percentage
- P_a = average annual power production in kW
- P_d = design capacity in kW.

For example, in the Northeast, a plant factor of 50% to 60% has been found acceptable for small plants, while in the Northwest, a plant factor of 30% to 40% may be more practical. A plant factor of 50% is a good average to use for preliminary calculations. The estimated annual energy can be determined as follows:

$$E_A = P_F \times P_d \times 8760 \quad (\text{Eq. 3-16})$$

where

- E_A = annual energy in kWh
- P_F = plant factor expressed as a decimal
- P_d = plant design capacity in kWh
- 8760 = hours per year (24 hr/day x 365 days/yr)

Depending on the category of developer and the site characteristics, larger and smaller plant factors can be used in the annual energy calculation. Table 3-5 can be used to refine the plant factor.

TABLE 3-5. PLANT FACTOR BASED ON SITE CHARACTERISTICS

<u>Site Characteristics</u>	<u>Type of Developer</u>	
	<u>Category 1</u>	<u>Category 2</u>
Constant head and flow		
Does not vary more than 5%	0.9	0.9
Constant head and variable flow		
Varies less than 30%	0.8	0.8
Varies between 30 and 50%	0.6	0.6
Varies more than 50%	a	0.4
Variable head and flow		
Varies less than 30%	0.5	0.5
Varies between 30 and 50%	0.3	0.3

a. The Category 1 developer sizes the installed capacity to match the lowest flow, and therefore the flow should not vary more than 50%.

In order to use this table, you must be able to calculate head and flow variation. These variations can be calculated as follows:

$$\delta Q = \left(1 - \frac{Q_1}{Q_d}\right) \times 100 \quad (3-17)$$

where

δQ = flow variation, expressed as a percent

Q_1 = flow during low-flow period, in cfs

Q_d = design flow used for the installed capacity, in cfs

NOTE: Perform calculations in () first.

$$\delta h = \left(1 - \frac{h_1}{Q_h}\right) \times 100 \quad (3-18)$$

where

δh = head variation, expressed as a percent

h_1 = head at the lowest point, in feet

h_d = design head used for the installed capacity, in feet

NOTE: Perform calculations in () first.

EXAMPLE: Assuming a design flow of 10 cfs with a low flow of 8 cfs, and a design head of 100 feet with a low head of 96 feet, determine the plant factor.

$$\begin{aligned} \delta Q &= \left(1 - \frac{8}{10}\right) \times 100 \\ &= (1 - 0.8) \times 100 \\ &= 0.2 \times 100 \\ &= 20\% \end{aligned}$$

$$\begin{aligned} \delta h &= \left(1 - \frac{96}{100}\right) \times 100 \\ &= (1 - 0.96) \times 100 \\ &= 0.04 \times 100 \\ &= 4\% \end{aligned}$$

$P_F = 0.8$, based on constant head and variable flow of less than 30%, from Table 3-5.

4. DESIGN, EQUIPMENT, AND SAFETY REQUIREMENTS

In this section, the following subjects are addressed.

- General discussion on turbines
- Contacting turbine generator manufacturers and suppliers
- Making a go/no-go decision and establishing design criteria
- Designing an intake system
- Designing penstock and valves
- Designing a powerhouse
- Designing a tailrace
- Selecting a generator and designing electrical equipment
- Designing a drive system and speed increasers.

The developer who has followed the instructions in the previous sections has accomplished the following:

- Has identified with the appropriate developer category.
 - Desires to be energy independent producing power for personal needs.
 - Desires to produce the most power for the dollar invested.
- Has identified the type of source.
 - Run-of-the-stream
 - Manmade.

- Has selected preliminary design head, or knows the head variation.
- Has measured flow and has selected a preliminary design flow.
- Has determined the power requirements.
- Has preliminary selection for location of intake structure and power house.
- Has measured length of penstock and transmission lines based on preliminary locations.

With this information, the next step is to contact various manufacturers and request additional information. A general discussion on turbines is provided next to aid in selecting the manufacturer whose turbines have the best potential of meeting the site criteria.

4.1 Turbines

This subsection presents a general discussion on the types of turbines, their areas of use, methods of regulating turbine speed, and design of draft tubes.

Hydraulic turbines are classified as impulse turbines or reaction turbines according to the process by which the water head and flow are converted to mechanical power. In impulse turbines, the head is converted to velocity in a stationary nozzle directed toward the turbine wheel, called a runner (Figure 4.1-1). The water jet from the nozzle is directed against curved buckets on the runner, which deflect the jet and reduce its velocity. The force resulting from this deflection is applied to the turbine runner, creating the turbine torque and power.

In reaction turbines, part of the available head may be converted to velocity within stationary parts of the casing, and the remainder or all of the head is converted to velocity within the turbine runner (Figure 4.1-2). The forces resulting from the velocity change act on the turbine runner, creating torque and power. In most cases, the impulse and reaction turbines in use today are the descendants of designs named after their inventors. Several of the more common types of hydraulic turbines and their areas of application are described below. Impulse turbines are used for higher head sites, usually with more than 60 feet of head. Reaction turbines are more appropriate for lower head sites.

4.1.1 Impulse Turbines

Impulse turbines are most suited for sites with relatively high head and low flow. This is because the high head and corresponding high water velocity concentrates the available water power into a small flow area. The concentrated power is most efficiently converted by directing one or more water jets against buckets on the runner. The runner deflects the jet and reduces its velocity. The best efficiency in impulse turbines, occurs when the speed of the runner is about 1/2 that of the water jet as it leaves the nozzle.

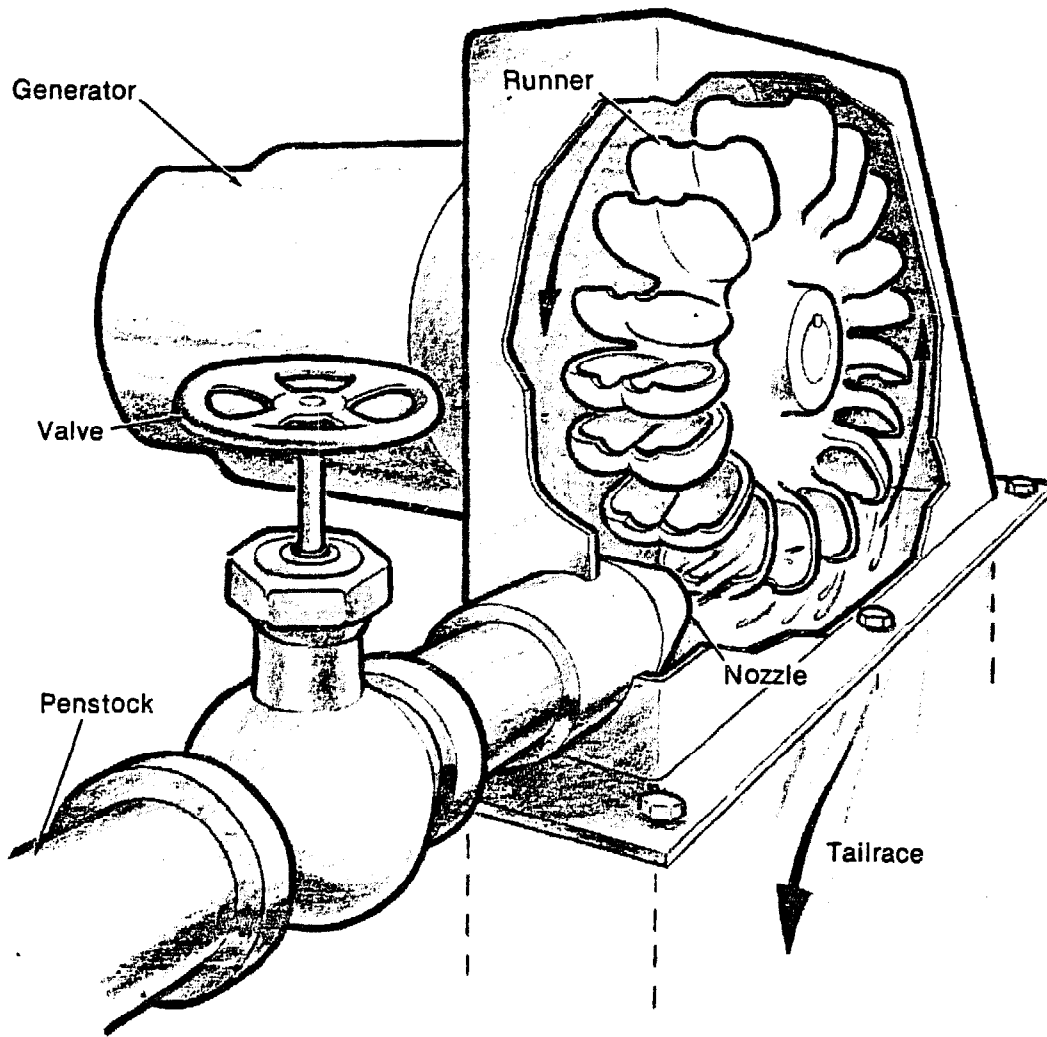

INEL 2 2331

Figure 4.1-1. Impulse turbine (Pelton Wheel)

An advantage of impulse turbines over the reaction turbines is that since the head is converted to velocity in the stationary nozzles, there is no pressure drop across the runner. Consequently, no close-clearance seals are needed between the runner and the turbine housing. This makes the impulse turbines simpler to manufacture and maintain, and more tolerant of less-than-clean water conditions.

Impulse turbines are manufactured in three basic types: Pelton Wheel Turgo, and Crossflow. Each type is discussed below.

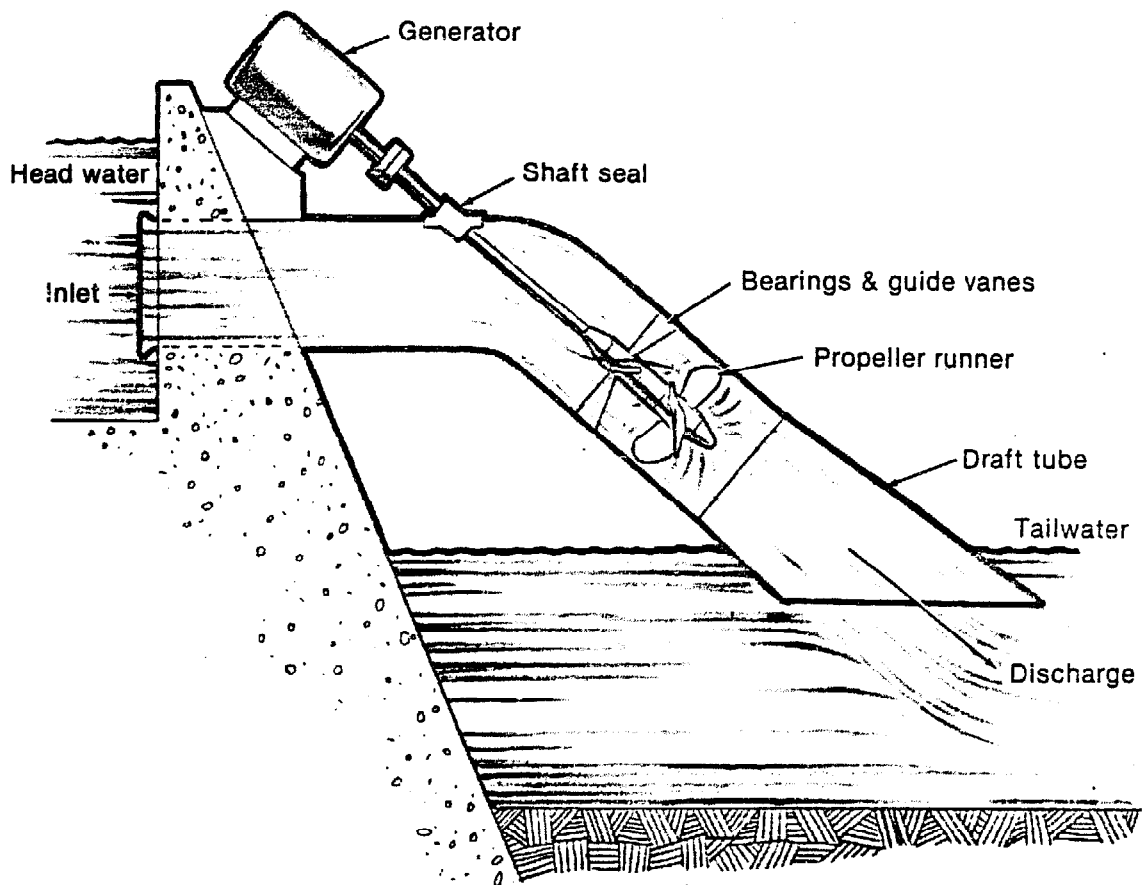

INEL 2 2328

Figure 4.1-2. Reaction Turbine

4.1.1.1 Pelton Wheel Turbine. The best known impulse-type turbine is called the Pelton Wheel turbine, named after one of its inventors. This turbine, shown in Figure 4.1-1, has buckets on the runner that split the flow from the nozzle into two streams that are discharged from the sides of the runner. After the flow is diverted and split, the water drains from the turbine casing at a low velocity. An inherent limitation on the flow rate that a Pelton Wheel can handle is the size of water jet that can be efficiently diverted by the runner buckets. Several jets can be employed around the periphery of the runner to increase power. Under optimum conditions, a Pelton turbine can achieve up to 90% efficiency, due to the simple flow path through this type of turbine.

Application Guidelines--Pelton Turbines:

- Head: 75 feet of head and up
- Flow: Varies, but lowest of all turbines relative to head
- Cost: \$300 to \$500/kW on suitable site. Cost per unit of output will decline as head increases. Peltons are uneconomic at low heads because limited water handling restricts output.

4.1.1.2 Crossflow Turbine. The crossflow (sometimes referred to as Banki) impulse turbine was invented to accommodate larger water flows and lower heads than the Pelton Wheel turbine. The crossflow turbine, shown in Figure 4.1-3, uses an elongated, rectangular-section nozzle directed against curved vanes on a cylindrically shaped runner. The water jet is slowed down in two stages, encountering the runner vanes twice as it passes through the horizontal runner. The elongated design of the runner and inlet nozzle increases the turbine flow capacity, which permits accommodation to lower heads. However, the more complex flow path through the crossflow turbine results in a lower efficiency, about 65%.

Application Guidelines--Cross-flow Turbines:

- Head: 25 to 200 feet
- Flow: Can be built to accommodate a wide range of flow as needed
- Cost: \$500 to \$1,200/kW. Price varies with flow requirements, control systems used, and level of quality.

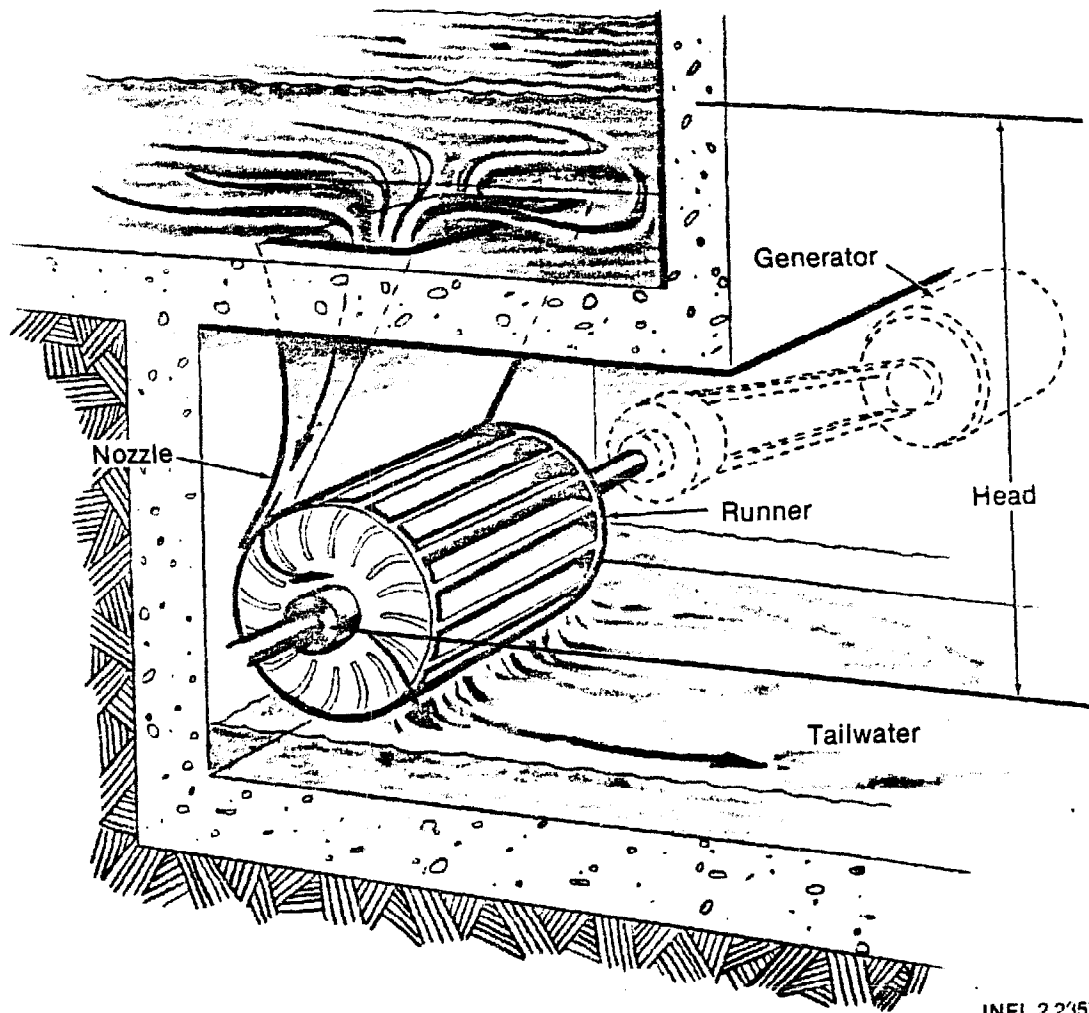

INEL 2 2357

Figure 4.1-3. Crossflow turbine

4.1.1.3 Turgo Impulse Turbine. The Turgo impulse turbine, shown in Figure 4.1-4, is an impulse turbine that can accommodate more water flow than a Pelton turbine. More and larger nozzles can be placed around the circumference of the runner due to the flow orientation away from the nozzles. An additional advantage of the Turgo turbine is that for the same head and runner diameter, the speed is about twice that of the Pelton turbine. The Turgo can achieve efficiencies of 92%, and maintains high efficiencies with flows as low as 25% of design.

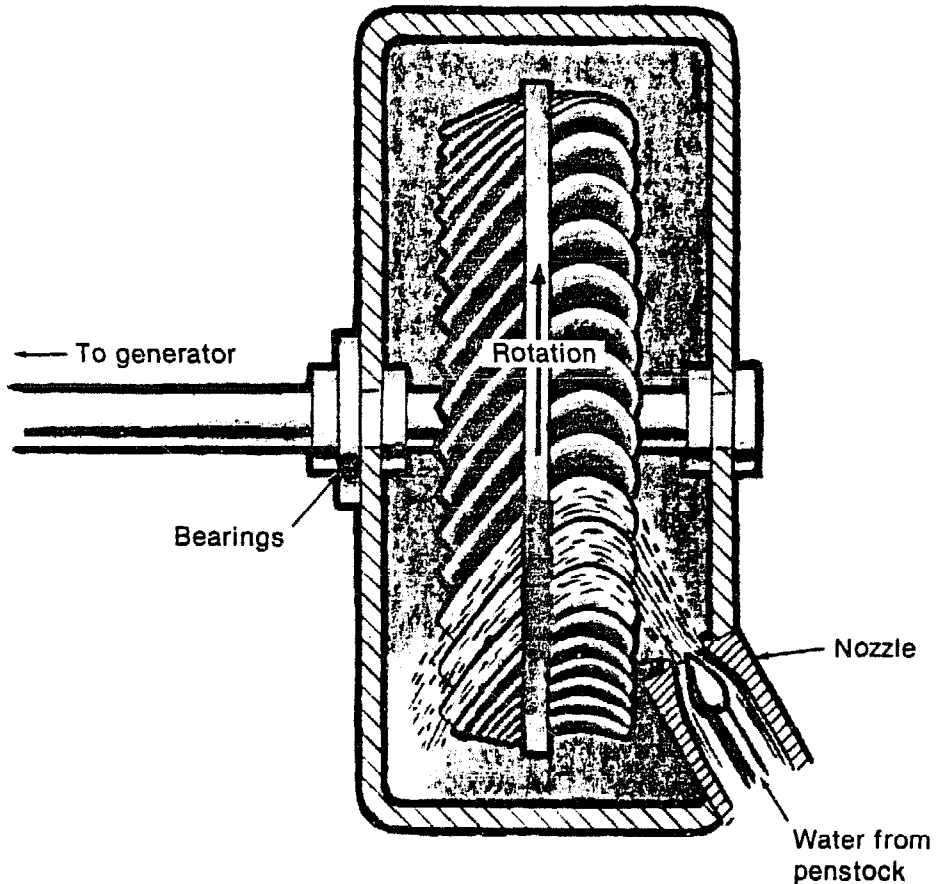

INEL 2 2351

Figure 4.1-4. Turgo impulse turbine

Application Guidelines--Turgo Turbines:

- Head: Comparable to Pelton--75 feet and up
- Flow: For the same size runner, the Turgo will handle three times more volume than the Pelton. Also, for equal size flow, runner can be smaller and speed will be slightly more than twice that of the Pelton runner.
- Cost: \$500 to \$700/kW. As with the Pelton, economics of the turbine improve with increased head.

4.1.2 Reaction Turbines

Turbines in which part or all of the head is converted to velocity within the runner are referred to as reaction turbines. The Francis turbine shown in Figure 4.1-5, named after its developer, is a reaction turbine. Propeller-type turbines are also reaction turbines that develop torque and power by imparting a whirl velocity to the water. A typical example is shown in Figure 4.1-2. Reaction turbines are more suitable than impulse turbines for lower head, higher flow applications, although there is considerable overlap in practical applications. In terms of mechanical design, an important feature of reaction turbines is that to maintain good efficiency, a close running clearance seal must be maintained between the runner and the casing. This is because reaction turbines operate with the

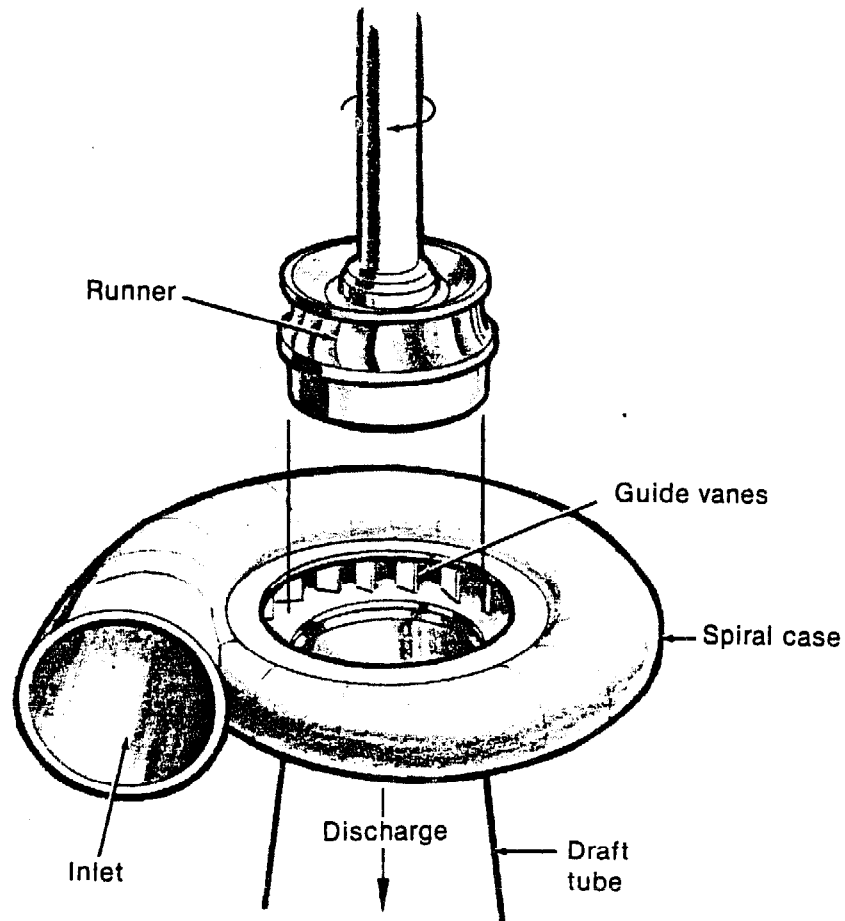

INEL 2 2356

Figure 4.1-5. Francis reaction turbine

head applied across the runner, and leakage past the runner is lost power. For this reason, the performance and efficiency of reaction turbines is more likely to be degraded by entrained sand and silt in the water causing seal wear than is that of an impulse-type turbine. However, for low head applications, reaction turbines offer smaller turbine diameters and higher rotational speed than traditional impulse turbines. This advantage of a smaller runner for a given flow is offset by the fact that more flow is needed because of the lower head.

4.1.2.1 Francis Turbines. This design was first developed in the late 19th century. The Francis turbine has seen wide acceptance and is used in a full range of head and flow characteristics. Being a reaction turbine, the Francis uses both pressure and velocity to operate. Water is introduced radially--perpendicular to the shaft--at the entrance of the runner and turns 90 degrees within the runner to discharge axially--parallel to the shaft (Figure 4.1-5).

The flow is generally controlled by wicket gates. There are usually 12 to 24 wicket gates, and they are connected, by links to a gate ring to move in a coordinated fashion. The gates control flow and, alter the angle of that flow into the runner. The water in most modern Francis units is distributed to the gates and turbine via the spiral case. Note that the cross-section of the spiral case decreases as it moves around the runner because of the smaller volume of water. Not all spiral cases are shaped like this. It was common in earlier days to place the Francis turbine in the bottom of an open flume or box (Figure 2-12).

Francis turbines can be placed either horizontally or vertically and can be used on heads of 6 to 1,000 feet. Francis turbines can provide very good efficiency down to a flow of 50% of the design flow. For reasons relating to specialized design, and thus cost, Francis units have not been widely used in microhydropower installations in recent years.

Application Guidelines--Francis Turbines:

Head: 6 to 1000 feet

Flow: Design to suit--high volume with medium speed

Cost: \$500 to \$1,500/kW.

4.1.2.2 Propeller Turbines. There is a wide variety of turbine designs that have in common the use of a propeller-shaped runner. Only a few are applicable to microhydropower projects. Propeller turbines are reaction turbines, and most are axial flow, meaning that the water flow path is parallel to the turbine shaft. The runner resembles a boat propeller, although the two are in fact quite different. A boat propeller does not run inside a pressure casing, but a turbine runner does. Some people have successfully modified boat propellers for use as runner. The modifications usually consist of cutting off the curved end of the blade. Efficiency in the 50% range is not uncommon.

As with the Francis runners, this reaction turbine is full of water from the start of the penstock to the end of the draft tube. The runner rotates and power is extracted by the blade displacing water as the column of water moves through the turbine. Units designed for higher heads will have more blades while those used on lower heads, will have fewer blades. Blades on low head units will be set at a greater angle from the flow direction, while blades on high head designs will be set at a reduced angle.

Some propeller designs make use of preswirl vanes set upstream from the runner (Figure 4.1-2). The vanes give a tangential component to the column of water that increases the efficiency of the runner.

Fixed-blade propeller designs offer very good efficiency and high specific speed over a fairly narrow range of flow. Generally, as flow drops off, efficiency falls rapidly. The solution is to make the turbine adjustable in some way. Some designs adjust the angle of the guide vanes, some the blade angle of the runner, and some both. This adjustability is

reflected in price increases. There are several types of turbines in the microhydropower range that use a simple fixed pitch propeller type runner. Fixed pitch units perform well at the design conditions, but suffer at other flow points. They are thus suitable for sites that offer constant flow conditions. Also, fixed pitch units often cost considerably less than the adjustable units.

Application Guidelines--Axial Flow (Propeller) Turbines:

Head: 6 to 100 feet

Flow: Design to suit--high volume with high speed

Cost: \$500 to \$1,500/kW. Low head will cost more but civil works are often less expensive.

4.1.3 Pumps Used as Turbines

When the flow in a centrifugal pump is reversed by applying head to the discharge nozzle, the pump becomes a hydraulic turbine. Pumps are usually manufactured in larger quantities and may offer a significant cost advantage over a hydraulic turbine. The potential advantage of using a pump as a turbine should be carefully evaluated by comparing cost, operating efficiency, and the value of the electric power produced with the same values for a traditional hydraulic turbine under the same head and flow conditions.

When a pump is used as a turbine, to operate at the rated pump speed, the operating head and flow rate must be increased over the rated head and flow rate for normal pumping operation. A common error in selecting a pump for use as a turbine is to use the turbine design conditions in choosing a pump from a catalog. Because pump catalog performance curves describe pump duty, not turbine duty, the result is an oversized unit that fails to work properly.

Since turbine performance curves for pumps are rarely available, you must use manufacturer's correction factors that relate turbine performance with pump performance at the best efficiency points. For pumps with specific speeds up to about 3500, these factors vary from 1.1 to 2.5 for head and flow and from 0.90 to 0.99 for efficiency (for a discussion of specific speed, see Appendix A-7). At this point, you should know your site's head and flow from worked performed in Section 3. These values are the turbine performance characteristics and must be converted to pump characteristics in order to properly select a pump. This is done as follows:

$$Q_p = \frac{Q_t}{C_Q}$$

$$H_p = \frac{H_t}{C_h}$$

$$e_t = e_p \times C_E$$

where

- Q_p = capacity of the pump in gpm
- Q_t = capacity of the turbine in gpm (site flow)
- C_Q = capacity correction factor
- H_p = head of the pump in feet
- H_t = net effective head of the turbine in feet (site net effective head)
- C_h = head correction factor
- e_t = turbine efficiency at best efficiency point

- e_p = pump efficiency at best efficiency point
 C_E = efficiency correction factor.

Note that the head used for the turbine (site head) is the net effective head and not the pool-to-pool head (see Subsection 2.2). You will have to size your penstock (see Subsection 4.5) and do preliminary design work on your intake structure (see Subsection 4.4) before you can calculate the net effective head.

Once you have determined Q_p and H_p , you can review manufacturer's pump curves and select a pump that has these characteristics at best efficiency and operates at the desired speed.

In most cases, pump manufacturers treat correction factors as proprietary data. When these factors are not available, you will have to contact the pump manufacturer and supply head, capacity, and speed data so that he can select the proper pump.

Stepanoff^a gives a method for approximating the transformation of pump characteristics to turbine characteristics. His analysis assumes that the efficiency as a turbine is approximately equal to that obtained when operating in the pumping mode. The correction factors are:

$$C_Q = \frac{1}{e_p}$$

$$C_h = \frac{1}{e_p^2}$$

$$e_p = e_t$$

a. A. J. Stepanoff, Centrifugal and Axial Flow Pumps, 2nd Edition, John Wiley and Sons, Inc., New York, 1957.

This method provides a very rough approximation. It is known from tests that different pumps operating as turbines have operated at higher and lower efficiencies than the best efficiency of the pumping mode. It appears that the wide variations in pump geometry affect some performance characteristics while leaving others relatively unaffected. The end result is that relationships between pump performance and turbine performance of pumps are difficult to correlate in generalized formulas. You should contact the manufacturer if you are serious about using a pump as a turbine.

Since pumps are not specifically designed for reversed flow or for coupling with generators, consideration must be given to determining if the pump and generator bearings can support the reversed loads. This is particularly important in the case of vertical shaft pumps, which normally transfer their shaft weight and hydraulic thrust load to a thrust bearing in the drive motor. In this case, the generator must be designed for vertical mounting and have a thrust bearing capable of supporting the thrust loads. The pump manufacturer or a consulting engineer must be contacted to estimate vertical pump shaft loads when a pump is operated as a turbine.

Another possibility is to use a vertical shaft pump with a 90-degree gear box (Figure 4.1-6). The photo is of a 50-kW plant using a spring flow of 7.1 cfs and 140 feet of head. The plant was originally built to power the equipment in a gravel pit without an intertie to the local utility. Total plant costs were approximately \$40,000. It is capable of producing power valued at more than \$1,000 per month. The right-angle gear case is the type normally used in a well-pump installation. The generator was obtained used from a Caterpillar motor-generator plant.

The range of flowrate over which a pump can provide efficient turbine performance at constant speed will usually be more limited than that of a hydraulic turbine. This is because pumps have no provision for a regulating or diversion valve in their discharge (inlet for turbine operation) flow passage. Hydraulic turbines, on the other hand, have flow regulating wicket gates designed to restrict the flow. Obviously, it would be very difficult and expensive to modify a pump casing to install a

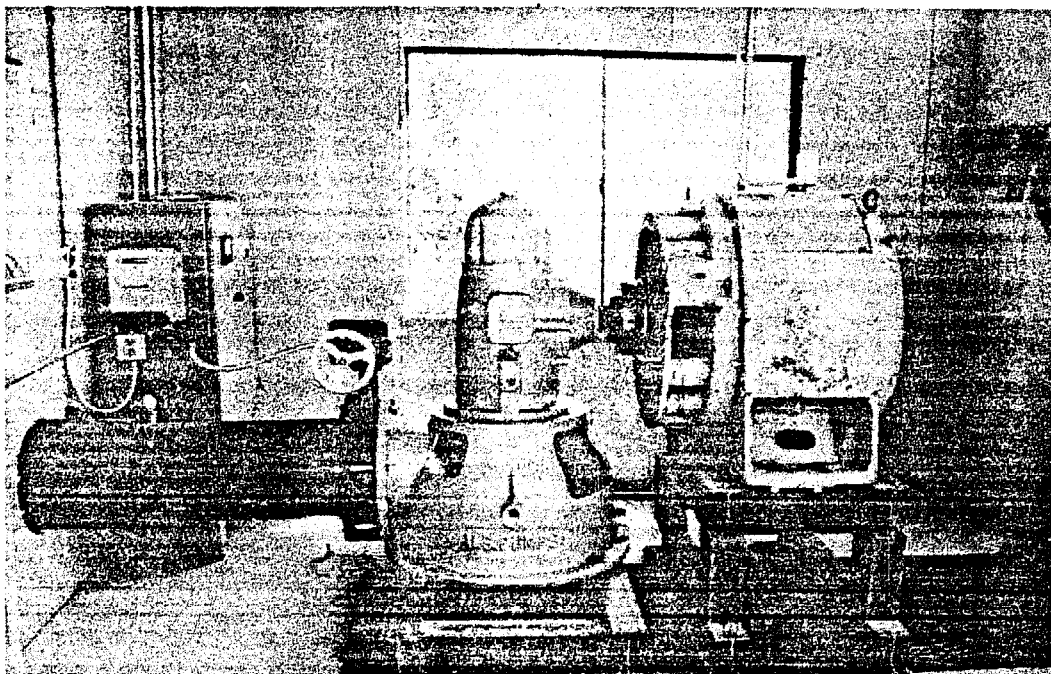

Figure 4.1-6. Vertical shaft pump used as a turbine, with 90-degree gear box.

regulating valve. A throttling valve installed upstream from the pump would not serve the same purpose, because the velocity produced at the valve would be dissipated in the piping and be unavailable for producing power in the pump (turbine). Using a pump as a hydraulic turbine should be restricted to situations where the flow is constant.

4.1.4 Turbine Application

The best way of obtaining the most efficient and reliable turbine, generator, controls, and auxiliary equipment is to obtain a preengineered package from a competent, experienced supply firm (see Subsection 4.2). The supply firm, given the site data and user requirements, should have the engineering capability and practical experience to select and assemble compatible equipment. Since a given supplier generally does not have knowledge of or access to all the suitable turbines that may be available, obtain proposals and quotations from several suppliers. Provide each supplier with the same site data and power requirements. The considerations

involved in selecting a turbine for a given site are outlined below. This information is provided as a guide in turbine selection, and must not be considered a substitute for the detailed engineering needed to support a high-quality hydropower installation.

Particular combinations of site head and flow dictate the type of turbine that will efficiently produce power. For conditions where different types of turbines overlap, the selection process should be based on a comparison of equipment costs and performance quotations from competing manufacturers of several suitable turbines. In general, the turbine offering the highest shaft speed for the given head and flow should result in the lowest equipment cost.

If the head and flow allow the use of either impulse or reaction type turbines, the selection should be based on an evaluation of the following factors:

- If the water is sand or silt laden, an impulse turbine should be favored to avoid performance loss due to wear in the reaction turbine seals.
- If the turbine must be located some height above the tailwater level, a reaction turbine with a draft tube at the outlet should be favored to make use of the maximum head available (see Subsection 4.1.7).
- If the head and flow rate can be maintained relatively constant (which should be the case for most Category 1 developers), using a pump with reverse flow as a turbine should be considered since the initial cost and availability may be advantageous.
- A turbine that turns fast enough for direct coupling to the generator shaft should result in a more compact installation and less long-term maintenance than one coupled through drive belts or a transmission.

If the head and flow conditions indicate that a Pelton-type impulse turbine is most suitable, the tradeoffs between turbine size, speed, cost, and efficiency can be observed by comparing manufacturers' quotations for the turbine unit, drive system (direct coupling, V-belts, gear box, etc.), and generator. If the available water flow varies significantly over the period of time that power is needed, the use of a spear type regulating valve (see Subsection 4.5.5.5) built into the turbine nozzle should be evaluated in terms of cost and efficiency gains. Valving the flow to several nozzles may provide adequate flow and power control.

If the flow rate is at the upper end of the impulse turbine range, the crossflow (Banki) or Turgo-type impulse turbines should be evaluated. They offer higher speed than the Pelton Wheel, handle more flow, and do not require the close running seals needed by the Francis turbine and other reaction-type turbines. The crossflow turbine will be of particular interest to the individual who is capable of designing and building a turbine rather than purchasing a manufactured unit. The runner blades on a crossflow turbine have only cylindrical curvature and can be fabricated from sectors cut from common steel pipe. C. A. Mockmore and F. Merryfield^a present the hydraulic theory needed to correctly design a crossflow turbine.

If the site conditions of relatively low head and high flow rate are suitable only for a reaction-type turbine, the choice is between the Francis turbine or a propeller-type turbine. Both of these types are available with movable gates to maintain good performance over a range of flow rates. As mentioned before, the Francis turbine uses movable inlet flow wicket gates, while the propeller turbine may use variable pitch runners or gates to adjust to changing flow conditions. The cost of controlled position runners and gates in these turbines is generally too high to make them feasible for microhydropower installations. Fixed geometry versions of the Francis and propeller types offer good performance over a limited range of flowrates.

a. C. A. Mockmore and F. Merryfield, "The Banki Water Turbine," Oregon State College, Bulletin Series No. 25, February 1949.

4.1.5 Regulating Turbine Speed

With only a few exceptions, the electric power generated by a hydropower installation must be regulated to a frequency of 60 cycles per second (Hz) to be useful in powering motors and appliances. Notable exceptions would be using a turbine for producing mechanical power to drive equipment directly, and electric generation for the purpose of space or water heating, or absorption refrigeration.

Maintaining constant electric power frequency and voltage requires that the turbine be operated at constant speed. In commercial hydropower installations, turbine speed control is performed by a governor that senses generator frequency and positions the turbine nozzle spear valve, wicket gates, or runner blade angle to maintain 60-Hz power. These methods of speed control are designed to maintain a high turbine efficiency over a wide range of flows and corresponding power output. The cost of conventional governor mechanisms may well be prohibitive for microhydropower installations.

It is possible to operate a microhydropower installation interconnected to a power utility without benefit of a speed governor. Such installations are manually brought on line, and once set, they will supply to the utility the amount of power that corresponds to the hydro energy supplied to the turbine. Speed control of such an installation is inherently maintained, for normal operating limits, by the natural characteristics of the system after it is connected to the power utility. The operation can continue indefinitely, provided that variations in water flow and head stay within reasonable limits. In effect, the power utility is providing speed control for this mode of operation.

If the power plant is to be operated without a connection to a power utility, as in a Category I installation, then some form of speed regulation is probably a necessity.

A less costly method of speed regulation for small turbines and pumps used as turbines is to use an electronic load control device. Electronic

load control allows stand-alone generation of regulated 60-Hz power. These devices sense the power frequency and adjust a variable fraction of the electric load to maintain the turbine-generator speed constant at 60 Hz. The range of power output that is varied to maintain constant turbine speed depends on the amount of water power that is available, and the variations in electric load demanded from the unit. These factors must be defined and analyzed by a supplier of electronic regulation units to determine if this method is feasible and economic for your installation. The power dissipated by the controller to maintain constant speed can be put to use for space or water heating, absorption type refrigeration, or rejected as heat by resistors placed in the turbine water flow stream.

These methods are explained in more detail in Subsection 4.8.

The conventional speed regulator discussed at the beginning of this subsection is a mechanical governor that controls inlet water flow to the turbine. A relatively recent development is the use of electronic speed sensors and microprocessors to control inlet water flow. This type of speed regulation should be more economical than the conventional governor system but may be difficult to purchase from conventional equipment suppliers. Some microhydropower developers have been very successful using innovative methods of speed control.

4.1.6 Turbine Setting

The setting of a reaction turbine in relation to the minimum tailwater elevation can have a significant impact on the life of the turbine. Improper turbine setting can lead to the phenomenon known as cavitation, which results in pitting of the runner. In reaction turbines, reduced pressures occur in the hydraulic passages as the fluid is accelerated to high velocities, and vapor bubbles form in the flowing stream. When these bubbles are then carried into a region of higher pressure, they can collapse rapidly. If this collapse occurs adjacent to the runner surface, it results in the removal of a small amount of the metal, and this process, if allowed to continue, accelerates with time. Thus, the cavitation that causes this type of damage to a turbine is to be avoided.

Excessive cavitation damage can be avoided by setting the horizontal centerline of the turbine's runner a specified distance above or below the tailwater elevation. The correct distance should be supplied by the turbine manufacturer and should be closely adhered to. From an equipment standpoint, a deep setting is better because it provides sufficient pressure at the runner discharge to allow the use of smaller, higher speed turbines, and therefore lower cost units, without excessive cavitation. The civil costs will be greater with the deeper setting because of additional excavation and more powerhouse work. A balance should be maintained between the civil costs and the equipment costs as determined by the turbine setting. For a further discussion on turbine setting, see Appendix A-7.

The setting of impulse turbines in relation to the tailwater elevation is not critical for prevention of cavitation. Impulse turbines are generally located as close as possible to the tailwater elevation to use as much of the available head as is possible, but they must run free of any tailwater interference.

4.1.7 Draft Tube

This section discusses draft tubes for reaction turbines. If you have an impulse turbine, the contents of this section are not important to you. Reaction turbines (Francis, propeller, and pumps-as-turbines) operate with the flow path completely filled with water. This allows the turbine to be mounted above the tailwater, and still use the full available head by means of a draft tube. A draft tube is a conical pipe, straight or curved depending on the turbine installation, that maintains a column of water between the turbine outlet and the downstream water level. Water leaves the turbine runner at a relatively high velocity, constituting a substantial portion of the total energy available. To recover this energy efficiently, the velocity must be reduced gradually and friction losses minimized. If the velocity is not reduced, the water will spill out the end of the turbine outlet into the tailwater, and the energy contained in the flowing water will be dissipated as turbulence in the tailrace.

The draft tube outlet must remain below the water surface at all water levels to prevent air from entering the tube and displacing the water column. It is the velocity of the water in the draft tube that acts, when reduced, as a suction head on the turbine runner. This suction head can be enhanced by converting part of the flow velocity to pressure within the draft tube. This requires a tube of expanding flow area, with the diameter at the tube outlet about two times the diameter at the inlet, where it attaches to the turbine. The angle between the opposite walls of the expanding draft tube should be between 7 and 20 degrees to give optimum pressure recovery. The design of the draft tube for a commercially manufactured turbine should be approved by the manufacturer.

The majority of microhydropower sites will use straight conical draft tubes, (see Figures 4.1-2 and 4.6-4). For preliminary layout purposes, the draft tube outlet diameter should be twice the turbine runner diameter and the length of the tube should be four times the runner diameter. The bottom of a vertical conical draft tube should not be closer than one runner diameter to the bottom of the tailrace. The tailrace width for a vertical conical draft tube should be four turbine runner diameters, but can be only two diameters wide for a horizontal draft tube.

There are other draft tube designs that use curved sections to reduce the amount of excavation required. These are elbow or "S" shaped and should be designed by the turbine manufacturer on the basis of his model tests.

4.2 Contact Turbine-Generator Manufacturers and Suppliers

Microhydropower developers will want to select a standard turbine and not undergo the expense of having a turbine specifically designed to meet the site characteristics. To select a standard turbine-generator unit that will generate the most energy for the dollar, you should contact various suppliers and request them to recommend the unit that they feel best fits your site. Use the form that follows to provide the information the manufacturer will need. Provide as much information as possible to aid the manufacturers and suppliers in determining which unit to recommend. Pictures and drawings should be included if available. Identical information should be supplied to all manufacturers and suppliers so that you can evaluate the responses fairly. A listing of manufacturers and suppliers is included as Appendix F, and additional forms can be found in Appendix I.

To aid your understanding of the form, a narrative description referring to the major headings of the form is provided below.

I. REASON FOR DEVELOPMENT

By choosing the most appropriate category, you are telling the manufacturer or supplier why you desire to produce power. If you state that you want to be able to generate power independent of the utility, you will be able to generate power when the utility service is interrupted or even if disconnected from the utility. This tells the manufacturer or supplier that he must supply a more expensive synchronous generator, along with speed regulating equipment. (Generators are discussed in Subsection 4.8). If you state that you don't mind being dependent on the utility, then the recommended generator will probably be an induction generator, which will use a less expensive motor starter for switchgear.

II. TYPE OF SOURCE AND AMOUNT OF HEAD

Choose the category that best describes your type of source (Subsection 2.6), and give the available head (Subsection 3.4). If you are a run-of-the-stream developer and you have a fixed head, list that head. If you are not sure you have selected the best head, list the ranges of head available so that the manufacturer or supplier can select the head that best fits his equipment.

If the site is an existing dam which has a fluctuating head (Subsection 3.5.4), describe the characteristics of the fluctuation. In the additional comments, include an explanation of how the head fluctuation corresponds to flow variations.

III. AMOUNT OF FLOW

If you have developed a flow duration curve, be sure and include a copy of the curve. This will help the manufacturer or supplier to optimize his turbine selection. If you have estimated flow on the basis of an average monthly flow value, then include that information. If you have a source, such as a canal, that flows only during part of the year, be sure and include that information.

IV. PERSONAL POWER NEEDS

List the results you obtained from Subsection 3.1.

V. ADDITIONAL INFORMATION

Include any additional information that might aid the manufacturer or supplier to evaluate your site requirements. Call the utility to learn how far the nearest substation is from your site. This distance will determine whether or not an induction generator can be used.

If you are developing an existing site with a turbine already installed and you would like to consider using it again, write the original turbine manufacturer to obtain information. In addition to the site data included above, send the following information, if available:

Name of the site

Name of the original turbine purchaser

Date the turbine was purchased

Contract number

Name plate data

Drawing numbers of the turbine.

After receiving the responses back from the manufacturer or supplier, proceed to the next section to make a preliminary cost estimate, decide whether or not to proceed, and establish design criteria.

MICROHYDROPOWER TURBINE GENERATOR
INFORMATION REQUEST

(DATE)

GENTLEMEN:

I am interested in installing a microhydropower system. The following site specifications are supplied for your evaluation. Please review the specifications and answer any appropriate questions concerning your equipment.

My Name: _____

Address: _____

Phone No. () _____

Project Name: _____

I. REASON FOR DEVELOPMENT

(Check One)

- 1. I am interested in supplying my own electrical needs. I do not plan to intertie with a utility. Therefore, I will require a synchronous generator.
- 2. I am interested in supplying my own electrical needs. When my needs are less than the energy produced, I would consider selling to a utility. However, I want to be able to generate power independent of a utility. I therefore require a synchronous generator and speed control equipment.
- 3. I am interested in supplying my own electrical needs. I want to be able to sell excess power to a utility. An induction generator is acceptable since I do not care to generate power independent of the utility.
- 4. I am interested in generating as much power as possible for the dollar invested. However, I want a synchronous generator so that I can generate power if the utility service is interrupted.
- 5. I am interested in generating as much electrical power as possible for the dollar invested. I am not interested in generating independent of the utility.

II. TYPE OF SOURCE AND AMOUNT OF HEAD

(Check One)

- 1. The site is a run-of-the-stream site and can have a pool-to-pool head from _____ to _____ feet.
- 2. The site is an existing dam and has a constant/variable pool-to-pool head of _____ to _____ feet.
- 3. The site is a canal drop/industrial waste discharge and has a pool-to-pool head of _____ feet.

III. AMOUNT OF FLOW

(Check One)

- 1. The flow values are based on the attached flow duration curve.
- 2. The flow value is based on a minimum stream flow of _____ cfs. This is because my objective is to supply my energy needs as much of the year as I can.
- 3. The flow is available _____ months out of the year and is fairly constant at _____ cfs.
- 4. The flow values are based on monthly averages in cfs:

Jan. _____	May _____	Sept. _____
Feb. _____	Jun. _____	Oct. _____
Mar. _____	Jul. _____	Nov. _____
Apr. _____	Aug. _____	Dec. _____

- 5. Other: See V-9, Additional Information.

IV. PERSONAL POWER NEEDS

A copy of the daily load use table is attached. The daily peak load is estimated to be _____ kW. Major electrical equipment is listed below.

_____	_____
_____	_____
_____	_____
_____	_____
_____	_____
_____	_____

The voltage I need is _____, and is single/three phase.

V. ADDITIONAL INFORMATION

1. Site location and stream name _____

2. Name of local utility _____
Distance to nearest substation is _____ miles.
3. The quality of the water is usually clear/murky/silt laden/muddy.
4. Site elevation is _____ feet.
5. Annual average temperature variation is from _____
to _____ °F.
6. A sketch of the site is/is not included.
7. Existing structures or equipment that should be used, if
possible, include _____

8. The proposed diameter and length of the penstock are (leave blank
if not known): _____ inches in diameter, _____ feet in
length.
9. Additional information to be considered _____

The information returned to you by the manufacturer will assist you in developing your site and preparing a final design specification (Subsection 4.3.2) or bid package (Subsection 5.1.2). The following narrative is provided to aid in understanding the information returned by the manufacturer or supplier:

I. GENERAL COMMENTS

This section allows the manufacturer to state exactly what scope of information is included in the package. It also allows him to specifically exclude equipment, make recommendations, or qualify any of the information he has included.

II. RECOMMENDED EQUIPMENT SUPPLIED BY COMPANY

This section provides a listing of the equipment, type, and manufacturer included on the form.

III. EQUIPMENT SPECIFICATION

This section provides the detailed information on each item of equipment to be furnished. The manufacturer will have made some assumptions and performed calculations in order to supply this information. You should study it carefully since you will have to use it in your design. The power production of the turbine-generator will be based on a net effective head (see Section 2.2) that the manufacturer has calculated from information you have given him or he has assumed. Your final design should confirm that your site can provide this head. The rating of the generator may be higher than the power needed by you. In this case, the manufacturer has probably selected a standard generator. Since generators come in specific sizes, he will pick one which is the nearest to your needs but higher.

The turbine setting (reaction turbines only), size of powerhouse, and weight of the unit are other items you will need to know in the design of your site. The annual energy production calculated by the manufacturer may differ from your calculations, but it will be a more accurate number, particularly if you have provided him with a flow duration curve and the seasonal head variation.

IV. COST OF EQUIPMENT RECOMMENDED

The cost provided by the manufacturer will be for the equipment listed in Section II of this form. Unless a bid is attached, you should use this price only for cost estimating purposes. Before ordering the equipment, ask the manufacturer for a firm bid.

V. ADDITIONAL INFORMATION

This section is to allow the manufacturer to offer recommendations or other services. It also provides the delivery time for the items listed on the form. This information is needed when preparing the construction schedule (see Subsection 5.1.5).

(TO BE COMPLETED BY MANUFACTURER/SUPPLIER)

Name of Company _____
Address _____

Phone No. () _____ Date _____

I. GENERAL COMMENTS _____

II. RECOMMENDED EQUIPMENT SUPPLIED BY COMPANY

1. Turbine Inlet Gate or Valve

Manufacturer _____
Type _____
Model No. _____

2. Turbine

Manufacturer _____
Type _____
Model No. _____

3. Generator

Manufacturer _____
Type _____
Model No. _____

4. Is load diverter/governor included? Yes/No.

Yes: Type _____
Model No. _____
No: Type recommended _____
Model No. _____

5. Additional items supplied with package, e.g. transformer, protection devices, auxiliary equipment. Provide manufacturer, dimensions, operating characteristics

III. EQUIPMENT SPECIFICATION

For a net effective head at the turbine of _____ feet and a flow of _____ cfs, the generator will provide an output of _____ kW (assumed power factor of _____). This will result in a computed efficiency of _____%. Based on the information provided, the annual energy production is calculated to be _____ kWh.

1. Turbine:

_____ rpm at recommended head and flow.
Diameter of runner _____ and type _____.

2. Generator:

Operating rpm _____.
Overspeed allowance _____%
Voltage _____ single/three phase.
Rating _____ single/three phase.
Power factor _____

3. Speed increaser

Type _____
Ratio _____
Rated input horsepower _____
Service factor _____

4. Draft tube, if used:

Length _____
Elevation from turbine runner centerline to tailwater at lowest water level _____
Outlet area _____
Inlet diameter _____

5. Is unit assembled on equipment frame? Yes/No

Yes: Dimensions of frame _____

6. Recommended powerhouse minimum dimensions:

Length _____ ft
Width _____ ft
Height _____ ft.

7. Weight of assembled unit _____ lb
Shipping weight _____ lb
Wetted weight _____ lb
Recommended mass of equipment pad _____ lb.

8. Is shutoff valve or gate provided ahead of turbine? Yes/No

No: Recommended size _____
Type _____
Manufacturer _____.

9. Recommended spare turbine-generator parts

10. Expected operating life with normal maintenance and operating conditions: _____ yrs.

11. Turbine warranty provisions included? Yes/No

12. Is cooling water required for the generator, speed increaser, and/or lubrication system? Yes/No

Yes: Flow _____ at _____ temperature, _____ system
Flow _____ at _____ temperature, _____ system
Flow _____ at _____ temperature, _____ system

13. Recommended powerhouse ventilation _____ cfm.

14. With the information provided, the minimum output for the unit would be _____ kW at _____ head and _____ cfs flow. The maximum output for the unit would be _____ kW at _____ head and _____ cfs flow.

15. Diameter of turbine inlet _____ in. and outlet _____ in. or outlet dimensions _____ in. by _____ in.

16. Lightning protection is/is not provided.

IV. COST OF EQUIPMENT RECOMMENDED

(Choose Appropriate Answer(s))

1. The cost estimate is/is not based on a complete unit cost.
2. The cost delivered to the site is _____.
Bid is/is not attached.
3. On the basis of information provided, the cost of the equipment recommended should approach _____ delivered to the site.
(This is not a bid.)
4. The cost estimates are good until _____.

V. ADDITIONAL INFORMATION

1. Recommended material and equipment not furnished by company.

Penstock: Size _____ Material _____
Valves _____
Electrical equipment _____
Additional items _____

2. Delivery time for packages _____

3. Recommended design considerations _____

4. Additional services provided by Company (i.e., financing, complete design, installations, etc.).

5. Specific Comments _____

6. Please provide a list of three or four developers with addresses who have installed and operated your units.

_____	_____
_____	_____
_____	_____
_____	_____

4.3 Go/No-Go Decision and Design Criteria Selection

Before proceeding, this is a logical place to make the second go/no go decision. If the decision is to proceed with the project, then the design criteria should be selected.

4.3.1 Go/No-Go Decision

This decision will be based on economics; therefore, you need to make a preliminary cost estimate. Evaluate the responses received from the manufacturer inquiries. The evaluation should be based on dollars for kW of installed capacity and dollars per kWh of energy production.

Category 1 developers who don't want to sell to a utility should look at the dollar for kW capacity. Remember, the higher the head the less expensive the turbine generator unit, but the more expensive the penstock. A later paragraph will tell you how to adjust for civil cost. Category 2 developers and those Category 1 developers who plan to sell to the utility should compare cost to the energy production (kWh), since the financial return is based on kWh sold to the utility. A unit that costs less per kW capacity may produce a lot less energy (kWh) and thus may not be as good a buy. Therefore, compare all responses in accordance with the procedure presented below to select the best economic alternative.

Before proceeding, look at the manufacturer's information sheets. Be sure that you are evaluating equivalent items. In other words, if one manufacturer or supplier is supplying a complete unit including governor or load controller, etc., and the other is supplying a turbine or a generator, the two costs cannot be compared without adding the additional cost to the second machine.

For a preliminary cost estimate, a rule of thumb is that the civil cost (i.e., structures, earthwork, penstock, transmission line, etc.) should be less than or equal to the machinery cost. Therefore, to make a rough estimate of construction cost, take the equipment cost and multiply by 2. If you are using an existing flume with very little civil work, the

estimate can be reduced. However, if the site will require an extra long penstock (1000 feet or more), or a lot of earth work, or anything else out of the ordinary, the civil cost estimate should be increased. After adding the machinery and civil cost together, round to the nearest \$1,000 for a construction cost estimate.

The following items should be added to the construction cost estimate: 10% for administration cost (legal fee, taxes, permits, etc.), and 25% contingency to cover any uncertainty that may not be known or considered in the estimate. These should be added as follows:

- Take the estimated construction cost and multiply by 10%. Add the results to the construction cost.

EXAMPLE: Assume a 15-kW site with estimated construction cost of \$31,000.

$$\$31,000 \times 0.10 \text{ (10\%)} = \$3,100$$

Adjusted cost estimate = $\$31,000 + 3,100 = \$34,000$ (rounded to nearest \$1,000).

- Take the adjusted cost estimate and multiply by 25%. Add the results to the adjusted cost estimate to determine the total preliminary cost (C_p).

EXAMPLE: Adjusted cost \$34,000

$$\$34,000 \times 0.25 \text{ (25\%)} = \$8,500$$

Total preliminary cost estimate = $\$34,000 + \$8,500 = C_p$
= \$42,000 (rounded to nearest \$1,000).

The total preliminary cost estimate is now determined. Next, divide the estimated cost by the kW capacity of the site.

EXAMPLE: \$42,000 preliminary cost estimate and 15 kW capacity

$$\frac{\$42,000}{15 \text{ kW}} = \$2,800 \text{ per kW.}$$

The cost of a microhydropower installation will probably range between \$1,000 and \$4,000 dollars per kW installed capacity. Your estimate should be in that range.

CAUTION: This is a very rough estimate. It should only be used to decide if you are willing to invest that magnitude of dollars. The final estimate may vary up or down by 25% or more. The rest of this handbook will help you find ways to reduce the cost.

Category 2 developers will want to evaluate how much revenue can be recovered from the investment. To do that, take the annual energy (kWh) value, from the manufacturers returned form (III. EQUIPMENT SPECIFICATIONS), and multiply annual energy by 30 years.

$$E_T = E_A \times 30 \quad (4.3-1)$$

where

E_T = total estimated energy over 30 years in kWh

E_A = manufacturer's estimated annual energy generation in kWh

30 = 30-year economic life of the site.

EXAMPLE: Assume that the 15-kW generator will produce 65,700 kWh annually. Find the total estimated energy over a 30-year period.

From Equation (4.3-1):

$$E_T = E_A \times 30$$

$$E_T = 65,700 \times 30$$

$$E_T = 1,971,000 \text{ kWh.}$$

Now, if you have not already done so, contact the utility to determine how much they are willing to pay for your power. They will quote a rate in mills per kWh. A mill is one tenth of a cent, 30 mills is 3 cents. So if the utility quotes 35 mills per kWh, they are actually quoting 3.5 cents per kWh. To determine your economics, take the total estimate energy production (E_T) times the mill rating.

$$R_T = E_T \times M_R \tag{4.3-2}$$

where

R_T = total estimated return in dollars

E_T = total estimated energy production in kWh

M_R = mill rating, in dollars per kWh.

EXAMPLE: The total estimate energy was computed to be $E_T = 1,971,000$ kWh. Assume that the utility mill rating is 35 mill per kWh, and find the total estimated return.

$$35 \text{ mills} = 3.5 \text{ cents} = \$0.035.$$

From Equation (4.3-2):

$$R_T = E_T \times M_R$$

$$R_T = 1,971,000 \times 0.035$$

$$R_T = \$68,985$$

$$R_T = \$69,000 \text{ (rounded to nearest } \$1,000\text{)}.$$

It costs money to use money. If you had \$42,000, you could invest that money and earn at least three times that much in 30 years. Likewise, if you have to borrow \$42,000, it would cost you at least 3 times that much to use the money for 30 years. Therefore, the return on your investment (total estimated return = R_T) should be at least 3 times the total estimated cost (C_p).

$$R_T = 3 \times C_p \text{ (or more)} \quad (4.3-3)$$

where

R_T = return on investment

C_p = total estimated cost.

In the example, R_T should be at least 3 times larger than \$42,000, or \$126,000. Since $R_T = \$69,000$, which is considerably less than \$126,000, the preliminary economics are not favorable for the site.

Assume that the estimate of the total cost is high by 30%. Would the site be economical then?

$$\$42,000 \times (100\% - 30\% = 70\%)$$

$$\$42,000 \times 0.70 = \$29,000$$

$$\text{New } C_p = \$29,000.$$

From Equation (4.3-3), $R_T = 3 \times C_p$ (or more), and $3 \times \$29,000 = \$87,000$. Since \$87,000 is still larger than \$69,000, the site is probably not an economical investment. Unless something can be done to reduce cost or increase return, the site should be considered a no-go.

Another way for Category 2 developers to take a quick look at economics is to determine what mill rate (M_R) will be required to break even

(Investment = Return). To do this, take the total estimated cost (C_p), multiply by 3, and divide by the total estimated energy.

$$M_R^1 = \frac{1000 \times 3 \times C_p}{E_T} \quad (4.3-4)$$

where

M_R^1 = required mill rate to break even

1000 = constant number to convert dollars to mills

3 = adjust total cost estimate

C_p = total cost estimate in \$

E_T = total energy generated in kWh.

EXAMPLE: Assume that the total estimated cost was $C_p = \$29,000$ and that the total energy generated was 1,971,000 kWh, and find the mill rate required to break even.

From Equation 4.3-4:

$$\begin{aligned} M_R^1 &= \frac{1000 \times 3 \times C_p}{E_T} \\ &= \frac{1000 \times 3 \times \$29,000}{1,971,000} \end{aligned}$$

= 44 mills per kWh, or 4.4 cents per kWh to break even.

In other words, a contract with a utility would have to be negotiated for more than 44 mills per kWh.

CAUTION: The approaches presented in this subsection (4.3.1) are very crude. They should only be used for the roughest estimation of economic feasibility. If the economics look halfway reasonable, it is advisable to proceed to a detailed design and cost estimate.

4.3.2 Design Criteria Selection

If Subsection 4.3.1 has indicated that the project is worth pursuing and that the investment capital is in a range that you can handle, now is a good time to review the financial section (Section 7.0) and formulate a plan to pursue financing for the project. Also, the turbine selection should have been narrowed down to two or three manufacturers or suppliers. Before selecting the turbine-generator, contact the developers listed at the end of the Turbine-Generator Information Request form to see how their equipment is performing and if they have encountered any unusual problems. Get as much information as you can on the equipment. In particular, does the unit produce the power (kW) it is supposed to, and is the unit reliable? After gathering all the information you can, select the turbine-generator unit on which you will base your final design criteria.

Design Specification

1. Net effective head of _____ feet, or pool-to-pool head range from _____ to _____.
2. The design flow is _____ cfs.
3. Turbine:
 - a. Manufacturer _____
 - b. Supplier _____

 - c. Type _____
 - d. Model No. _____
 - e. Shaft speed at design head and flow _____ rpm
 - f. Diameter of turbine inlet _____ inches
 - g. Diameter or dimension of outlet _____ inches
 - h. Setting of turbine at throat _____ feet above minimum tailwater level.
4. Speed increaser type _____
ratio _____
input power _____
5. Generator:
 - a. Manufacturer _____
 - b. Supplier _____

 - c. Type _____
 - d. Model No. _____
 - e. Operating speed _____
 - f. Voltage _____ phase _____
6. Wetted weight of equipment _____ pounds
7. Dimensions of equipment frame _____ feet
8. Load diverter/governor:
 - a. Manufacturer _____
 - b. Supplier _____

 - c. Type _____
 - d. Model No. _____

4.4 Intake System

The function of the intake system is to direct water into the penstock or the turbine inlet. The intake system must also prevent trash or other foreign material from damaging the turbine. This section discusses water quality and the major components of an intake system. The majority of the writeup is directed toward run-of-the-stream developers. Those with canal drops will be interested only in certain aspects of the run-of-the-stream material. Existing dams are addressed in Subsection 4.4.3. If you are using waste-discharge water, this subsection will probably not be appropriate since you are more than likely connecting to an existing discharge pipe.

The design of the intake system components depends on the amount of water the system must handle. That amount of water is the previously determined flow design criteria. Equation (3-3) showed that the amount of water is equal to the cross-sectional area of the stream times the velocity at which the stream is moving:

$$Q = A \times v \quad (3-3)$$

where

Q = design flow in cfs (from Design Criteria in Subsection 4.3)

A = cross-sectional area in ft²

v = velocity in fps.

In this section, you will determine the size of your intake system components. The size is nothing more than the cross-sectional area, A. Equation (3-3) can be rewritten to solve for A:

$$A = \frac{Q}{v} \quad (4.4-1)$$

Equation (4.4-1) will be used to design (size) the intake system.

Engineers use more sophisticated procedures for relating velocity to area for an open channel, but these procedures are beyond the scope of this handbook. Conservative approaches will be used to calculate the needed areas.

Working from the sketch made in Section 3, your next step is to determine what intake system components are needed and to size those components. The components required will depend on the source and quality of the water (how much silt the water carries).

4.4.1 Water Quality

Hydraulic turbines generally are designed for clean water, and they operate best when only clean water is run through them. Potentially damaging materials range in size from gravel and large sticks down to fine silt and sand. Very large items will cause immediate damage when contacting the spinning turbine runner, while the damage caused by silt and sand will usually occur over longer periods of time. Silt and sand suspended in water can wear away the internal surfaces of the turbine, resulting in declining turbine efficiency.

Very large material, such as pieces of wood or gravel, can be removed effectively with trashracks that do not allow material of a particular size or larger to pass. The clear spacing in the rack is largely determined by the maximum object size that will pass through the turbine without causing damage.

The removal of silt and sand requires a different approach, since a screen fine enough to filter sand would often be clogged and would thus be impractical. In general terms, the amount of material that can be suspended in water relates to velocity of water and size of particles.

Very fast water such as that present in a river at flood stage can keep large amounts of material in suspension. Because the microhydropower plant intake cannot filter the silt from the water, the system must be designed to sufficiently reduce the velocity of the water to allow the suspended material to settle out. This process involves the use of a forebay for a run-of-the-stream sources and a reservoir for a manmade source.

A generating system fed by clear springs usually will not require an extensive intake system. A simple forebay and penstock intake with trash-rack may be adequate. For a stream that drains cultivated land and has a high silt load, a larger forebay or a reservoir would be essential.

If you are uncertain about the water quality, take a clear bottle or canning jar, fill it with water from the stream, and let it stand to see what settles out. Noticeable settlement indicates that a forebay is advisable.

The ultimate test of an intake system is to remain functional after a large flood. A system that will stand the test of time and still deliver the design flow is designed well.

The design and the components of an intake system are as varied as the physical conditions of the site and the imagination of the developer. The material presented here should be used as a guideline. It represents the benefit of knowledge and experience gained by a number of engineers and manufacturers.

Further discussion on intake systems is divided into two types of sources:

- Run-of-the-stream sources and canal drops
- Manmade sources such as existing dams and industrial waste discharges, where appropriate.

4.4.2 Run-of-the-Stream Sources and Canal Drops

Run-of-the-stream and canal drop developers must take water from a flowing stream or canal and introduce the water into a penstock. The intake system needed to do this may include the following components (see Figure 2-10, Subsection 2.6).

- Stream-Diversion Works--Diverts the water from the stream into the intake system.
- Settling Basin--Located near the diversion works, and used to settle suspended material before the water enters the power canal. The basin is recommended when the power canal is 1/2 mile or longer.
- Power Canal--The power canal and intake canal carries water from the diversion works to the settling basin or the forebay.
- Forebay--A settling basin designed to settle out suspended material before the water enters the penstock.
- Penstock Intake Structure--Provides the transition from the forebay to the penstock. The structure also provides the framework for the trashrack.
- Additional Hardware--e.g., skimmers, trashracks, stop logs, and intake gates or valves. These are essential elements of an intake system.

The intake system described in this subsection includes all the components. Some layouts may be able to do without some of the components. These alternatives will be discussed.

After reading all the material on intake structures, it will be time to finalize the design, check the design against the natural terrain, and finally make a cost estimate. Before proceeding, review the sketch of the

intake system made in Section 3. Are any changes to the preliminary design contemplated? If so, make a list of the things you are considering. After you are satisfied with the preliminary layout, proceed with this subsection.

4.4.2.1 Stream Diversion Works. The ideally designed diversion works will direct the design flow out of the stream while allowing the stream-carried debris to float on down the stream. The works must also function equally well in low flow and high flow. Where severe freezing occurs, the intake must be deep enough to prevent ice from restricting flow.

One form of diversion works or penstock intake is a dam across the stream. A dam or a check may perform well on a canal, but can be a real source of trouble on a stream. Unless properly engineered, a dam can easily wash out, taking the penstock with it. There is also increased liability to the developer if the dam washes out and causes water damage downstream.

Experience has shown that a diversion works set at 90 degrees in relation to the stream attracts the least amount of debris and is better able to withstand the force and erosion effects of flood waters (see Figure 4.4-1). Two modifications are made to the stream itself, Gabion weirs and deepening the channel at the intake. These and other features of the works are discussed below.

- Gabion Weir--Two weirs should be placed in the stream on the same side of the stream as the intake canal. To steer debris away from the intake, an upstream weir should be placed 50 to 100 feet above the diversion. This weir should extend across approximately 1/3 of the stream width. The upstream weir should be angled downstream approximately 20 to 30 degrees. The second weir should be downstream from the diversion at a distance approximately two to three times the intake canal width. The downstream weir should be perpendicular to the stream bank, extending across 1/2 the width of the stream. This weir facilitates the diversion of water. The weirs are simply piles of large rocks held together in bundles with chicken wire or something similar.

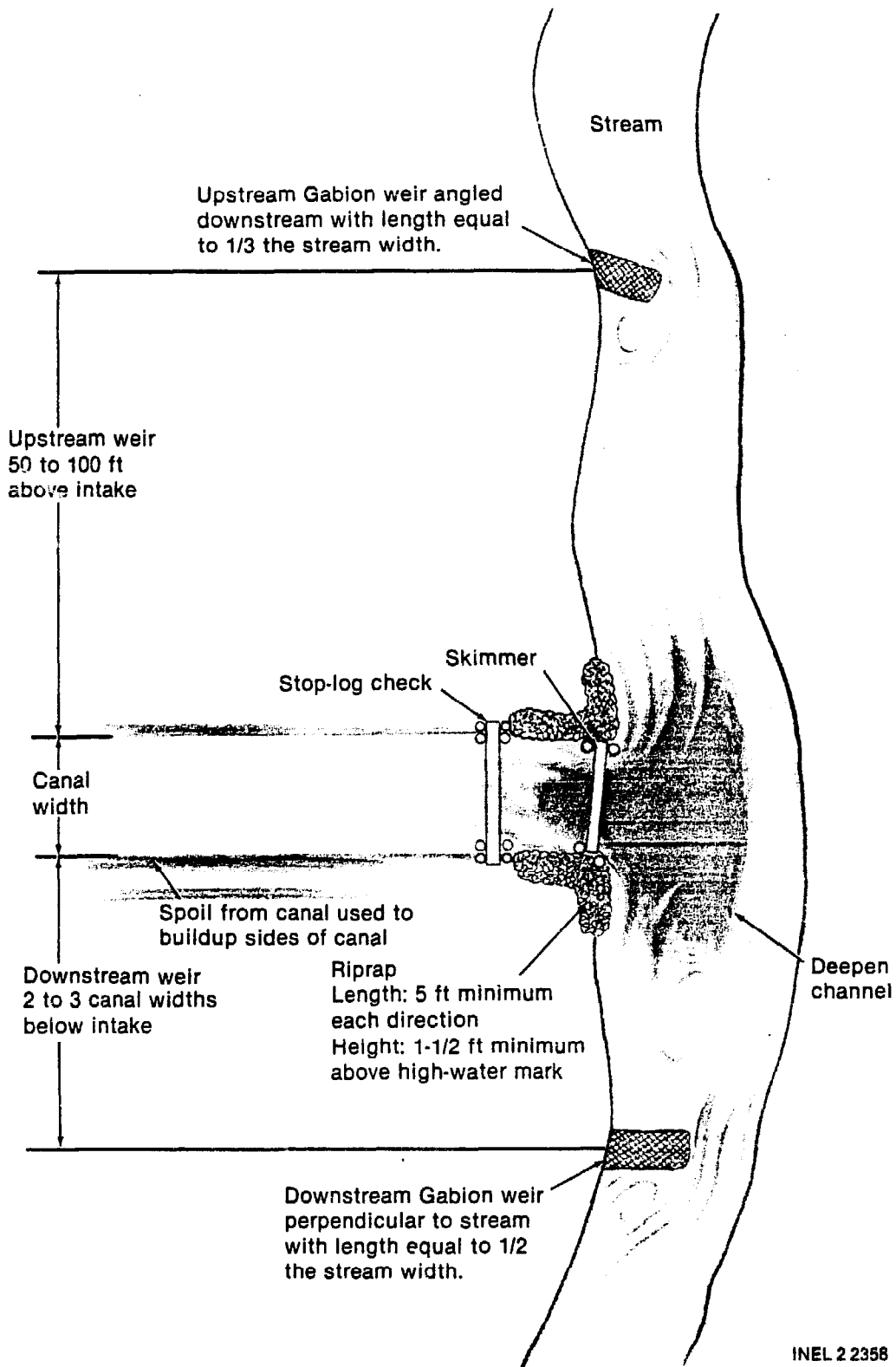
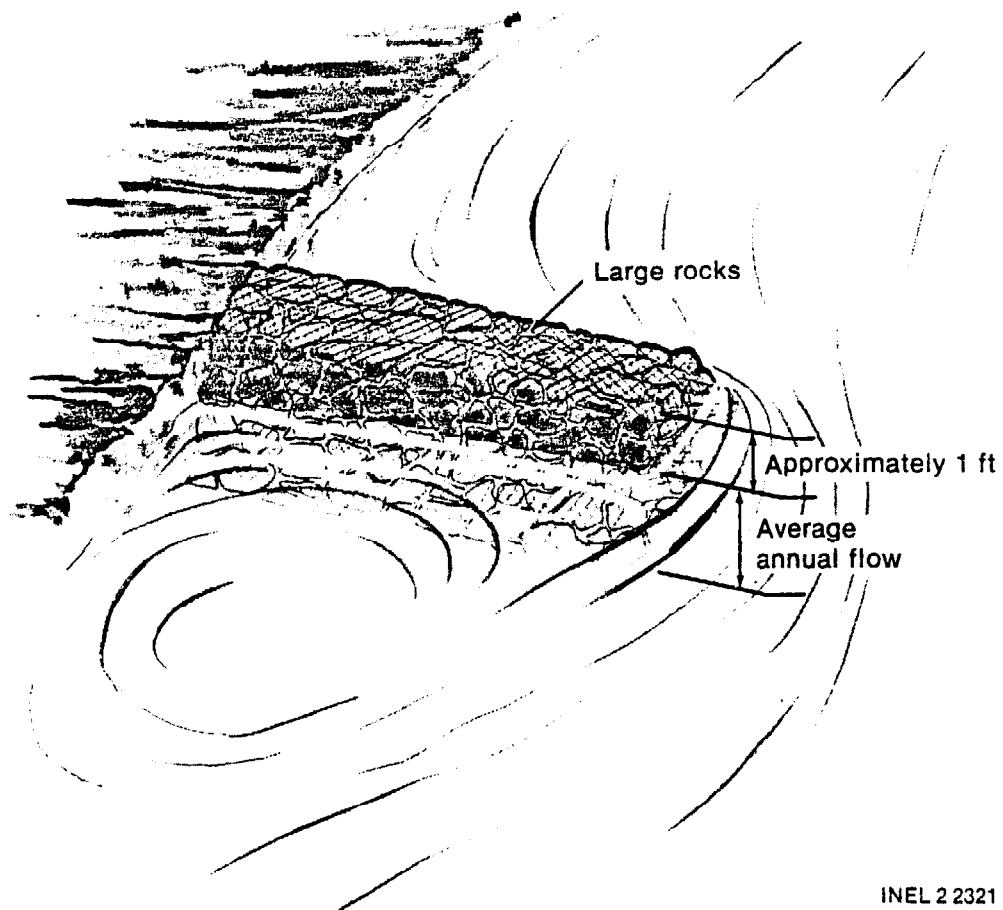

Figure 4.4-1. Typical diversion works.

The bundles are stacked on top of one another in pyramid fashion. The structures should be sized so that high water flows over the top of the weirs (see Figure 4.4-2).

- Deepening the Channel--The advantage of deepening the channel at the diversion is that the deeper pool reduces the velocity of the stream, limiting the amount of debris attracted to the intake. The deeper pool also reduces the effect of freezing. Ideally the dredging can be accomplished by a backhoe from the bank, and the deepened part can be cleaned out every few years.



INEL 2 2321

Figure 4.4-2. Gabion weir.

- Skimmer--At the entrance of the intake canal, a skimmer should be placed and angled slightly downstream. See Subsection 4.4.2.6.1 for design and installation considerations.
- Riprap--Riprap consists of large rocks placed along the bank to control erosion. If the material is available, the riprap should be constructed with 8-inch-diameter or larger rock. It is recommended that the riprap be placed at least 5 feet in each direction from the corner of the diversion (see Figure 4.4-1). Since the purpose of the riprap is to protect the intake structure from routine erosion and floods, it should be piled at least 1 foot higher than the high-water marks in the area.
- Berm--The berm consists of material dug from the canal, settling basin, and forebay. The berm should be the same height as the riprap.

4.4.2.2 Intake and Power Canal. The intake canal transports water from the stream to the settling basin or the forebay. The power canal is designed exactly like the intake canal and transports water from the settling basin to the forebay. These canals must be designed large enough to carry the design flow needed by the turbine. The recommended velocity in the canals is 2 fps: When the velocity and the design flow are known, Equation (4.4-1) can be used to calculate the cross-sectional area of the canals, provided that the recommended slope is maintained in the canal.

$$A = \frac{Q}{v} \quad (4.4-1)$$

Since the recommended velocity is 2 fps, the equation can be rewritten for canals:

$$A_c = \frac{Q}{2} \quad (4.4-2)$$

where

A_c = area of canal in ft^2

Q = design flow in cfs

2 = design velocity in canal in fps.

EXAMPLE: Assume that the design flow is 7.5 cfs; use Equation (4.4-2) to find the area of the canal.

$$A_c = \frac{Q}{2}$$

$$A_c = \frac{7.5}{2}$$

$$A_c = 3.75 \text{ ft}^2.$$

Since the area of a canal is a product of width and height, two factors should be taken into account:

- The flow must be attracted into the canal even during low stream flow for Category 1, the intake at low stream flow must attract the design flow for Category 2, the intake must not attract the portion of stream flow that is required by the state to keep the stream alive (state-imposed minimum stream flow).
- The deeper the canal, the smaller the freezing problem-- particularly if the flow in the canal must stop for some reason during cold weather.

These two considerations dictate that the bottom of the canal should be at least as deep as that of the natural stream. The exception to this rule would be if the diversion works were located at a naturally occurring

deep pool in the stream (an ideal situation). In this case, the canal bottom should be well below the low-flow mark of the stream. For most cases, the canal bottom should be set at or below the natural stream bottom.

The actual flow of water into the canal is controlled by the demand of the turbine. A stop log wier check, described in Subsection 4.4.2.6.3, is also used to control flow and water level in the canal.

The dimensions of the canal can be determined with the following steps.

- Estimate the depth of the design flow for the natural stream in inches (see Figure 4.4-3): For Category 1, estimate the depth of the minimum annual low flow. For Category 2, estimate the depth of the design flow
- Use the estimated depth, along with the previously determined canal area, in Equation (4.4-3) to determine the canal width.

$$W_c = 12 \times \frac{A_c}{d} \quad (4.4-3)$$

where

W_c = width of canal in feet

A_c = area of canal in ft^2 , from Equation in (4.4-2)

d = estimated depth of design flow in inches

12 = number of inches per foot.

EXAMPLE: Using the previous example, $A_c = 3.75 \text{ ft}^2$, assume that the design flow depth is 15 inches; use Equation (4.4-3) to find the canal width.

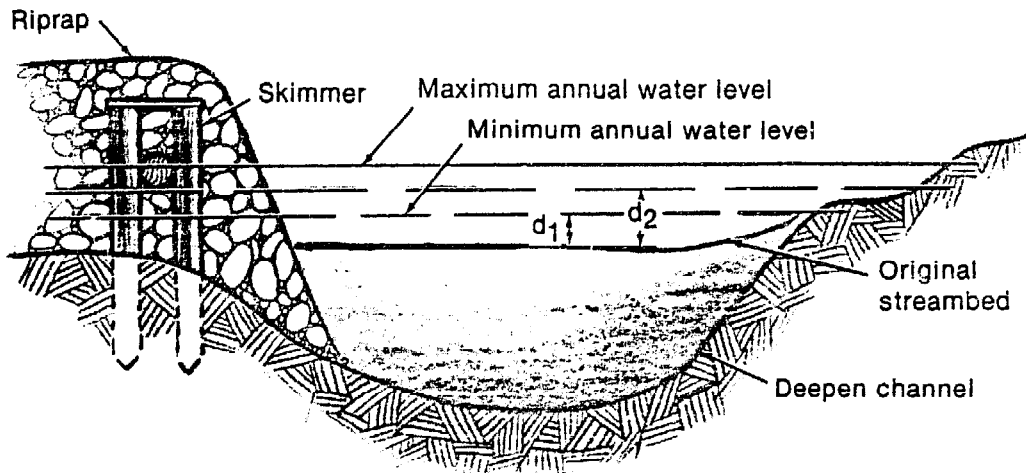

d_1 = Depth at which the estimated low-flow value occurs for the Category 1 developer

INEL 2 2317

d_2 = Depth at which the estimated design-flow value occurs for the Category 2 developer

Figure 4.4-3. Estimating design flow for Category 1 and Category 2.

$$W_c = 12 \times \frac{A_c}{d}$$

$$W_c = 12 \times \frac{3.75}{15}$$

$$W_c = 3.0 \text{ ft.}$$

An actual canal will probably not have rectangular sides like the crosshatched area in the Figure 4.4-4. Therefore, the calculated width should be the bottom width of the canal. The sides of the canal should be cut back (angled out) so that the soil will stand freely without sluffing into the canal. The angle at which the side stands freely is called the "angle of repose." The additional area of the canal outside the rectangular crosshatch will compensate for the friction losses in the canal.

- d_c = Depth of canal
- d_1 = Depth at which the estimated low-flow value occurs for the Category 1 developer
- d_2 = Depth at which the estimated design-flow value occurs for the Category 2 developer

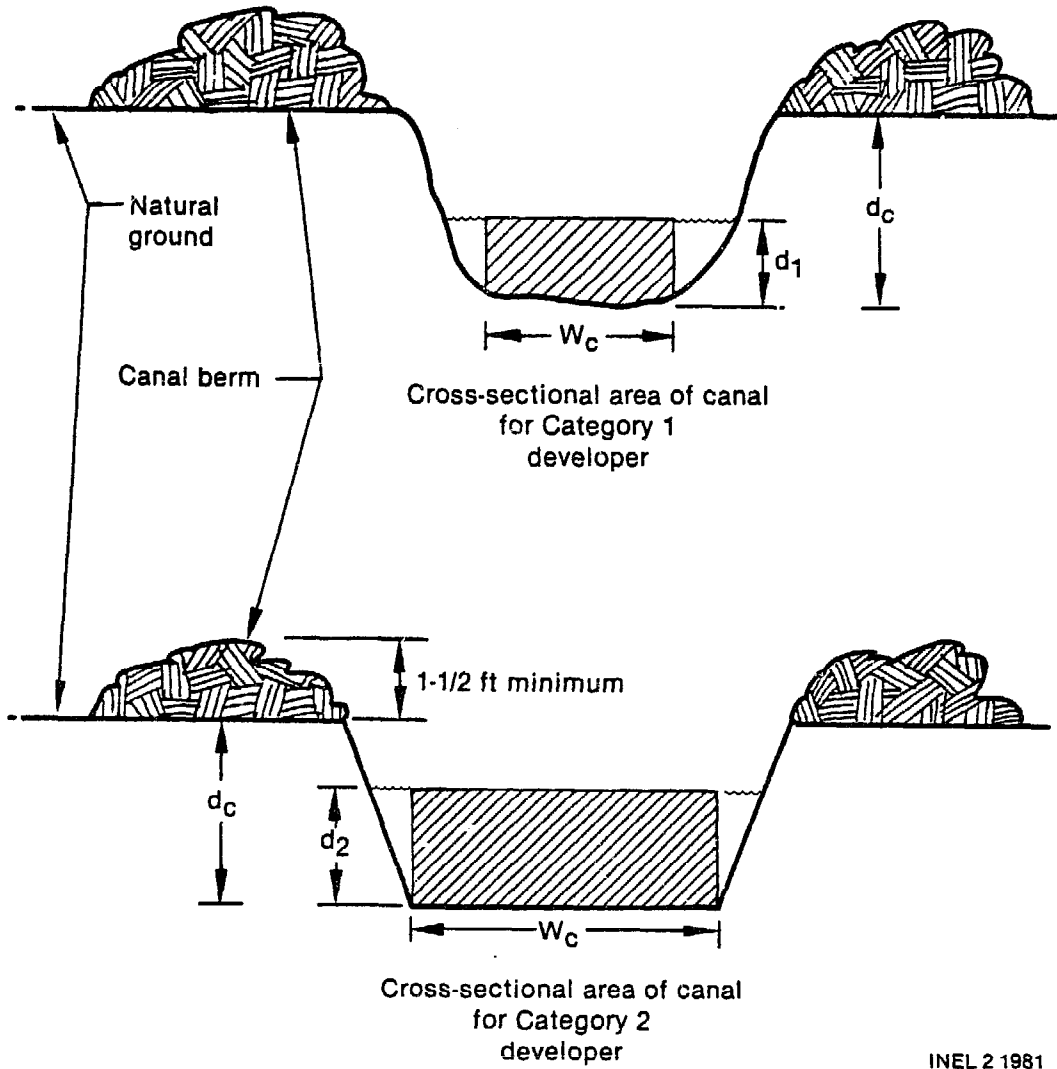

INEL 2 1981

Figure 4.4-4. Canal cross-sectional area.

Short canals can remain fairly level. Longer canals will require a slight downward slope. Check with your local Soil Conservation Service to determine the required slope. Setting the grade is critical and should not be attempted without the aid of some type of leveling instrument (see Subsection 3.4).

CAUTION: If the power canal is long, snow melt or a heavy rainstorm may put more water in the canal than the turbine can handle. This situation could result in flooding the intake system. To reduce the effects of such a flood, the canal should be equipped with an overflow spillway (see Figure 4.4-5).

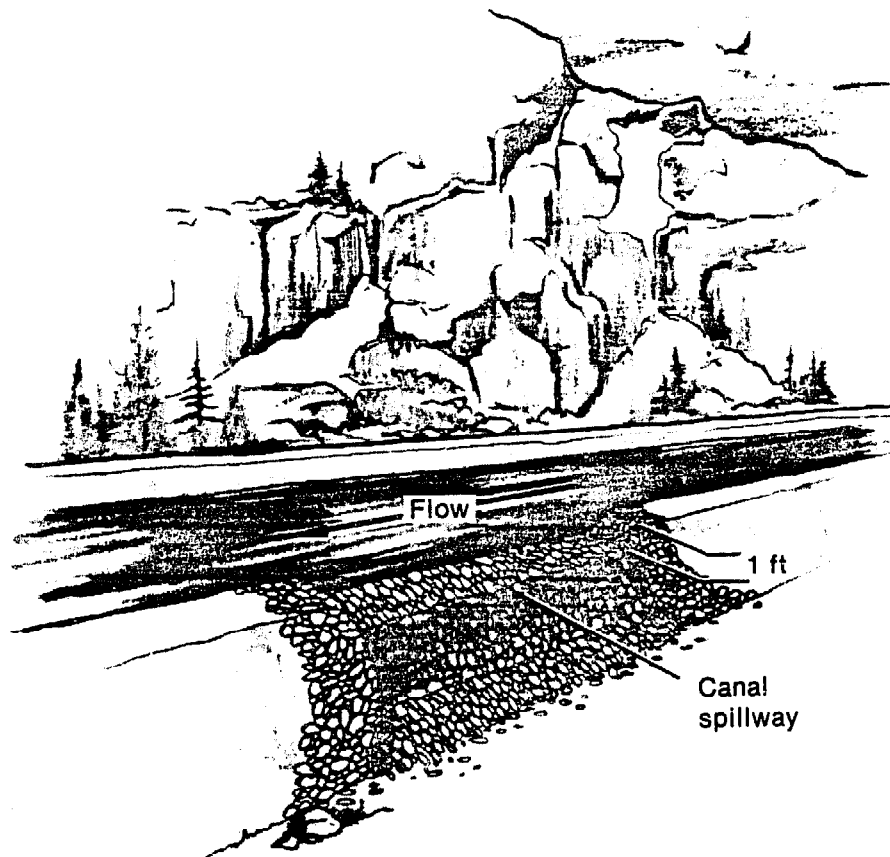

INEL 2 2325

Figure 4.4-5. Canal spillway.

Also, it is very important that the top of the berm for the canal and forebay be kept at the same elevation as the top of the diversion structure, because if the penstock were closed, the water in the canal would seek the same elevation throughout the intake system (canal, forebay, etc). If the berm in the forebay were lower than the overall water level, the forebay would be flooded. If the canal is so long that it is not practical to keep the berm at the same elevation, a series of stop logs should be used to section off the canal.

After sizing the canal, make a sketch of the cross-sectional area of the canal. Note the width (W_c) and the total depth (d_c). The total depth is the distance from natural ground to the bottom of the canal. Figure 4.4-6 is a sketch of the example canal.

4.4.2.3 Settling Basin. A settling basin is recommended for sites where the power canal will be 1/2 mile or longer. The purpose of the basin is to prevent sediment buildup in the power canal. The basin slows the water down and allows the settlement of the larger material (fine sands, etc.) to occur in the basin. Periodically, the basin is flushed out through a cleanout pipe.

A good rule of thumb is to make the basin four times wider than the power canal, 2 to 3 feet deeper, if possible, and at least 90 feet long (see Figure 4.4-7). If this rule is followed and the power canal is designed for 2 fps, then the settling basin velocity will be less than 0.5 fps.

Thus,

$$W_s = 4 \times W_c \quad (4.4-4)$$

where

W_s = width of settling basin in feet

W_c = width of canal in feet, from Equation (4.4-3).

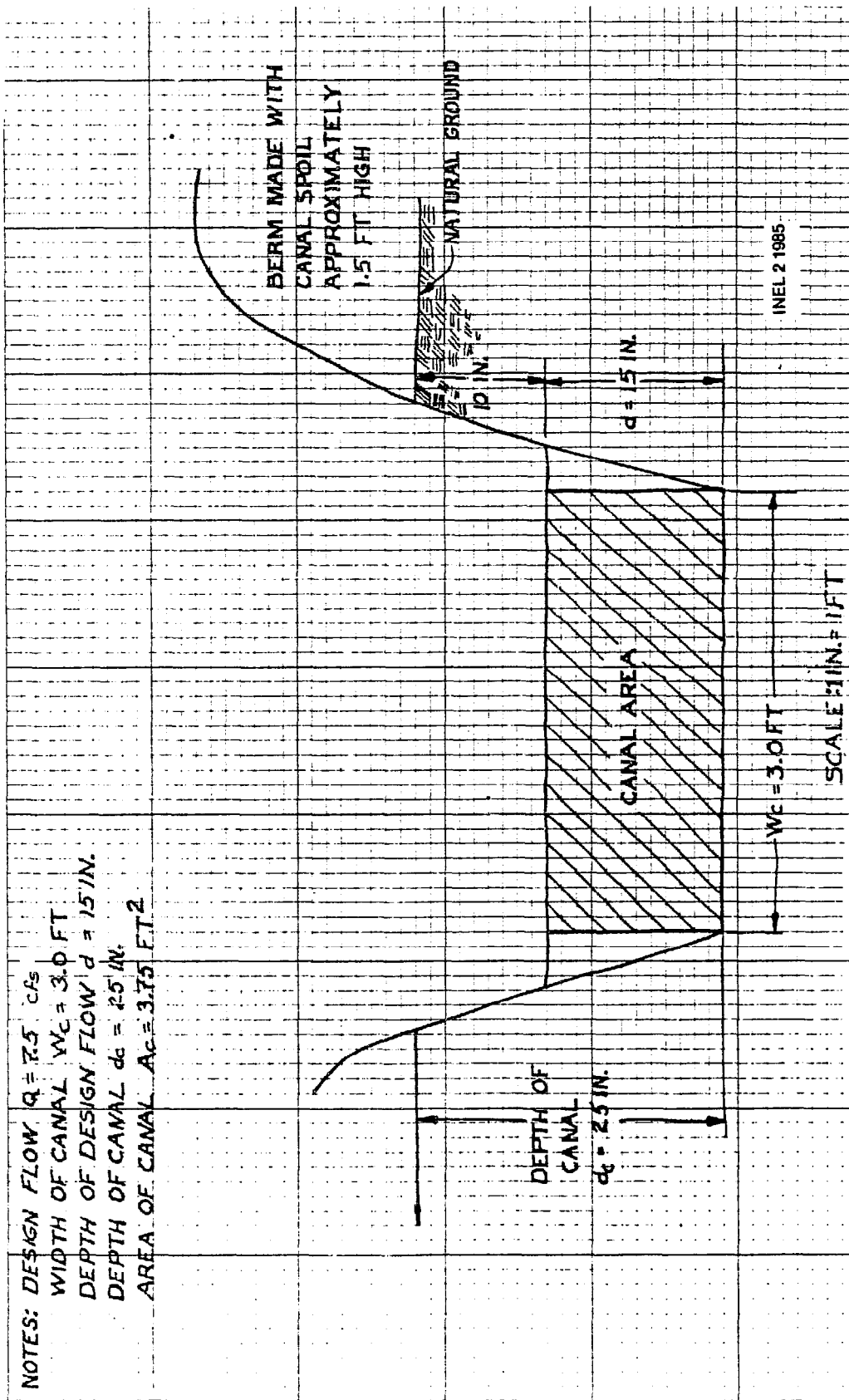
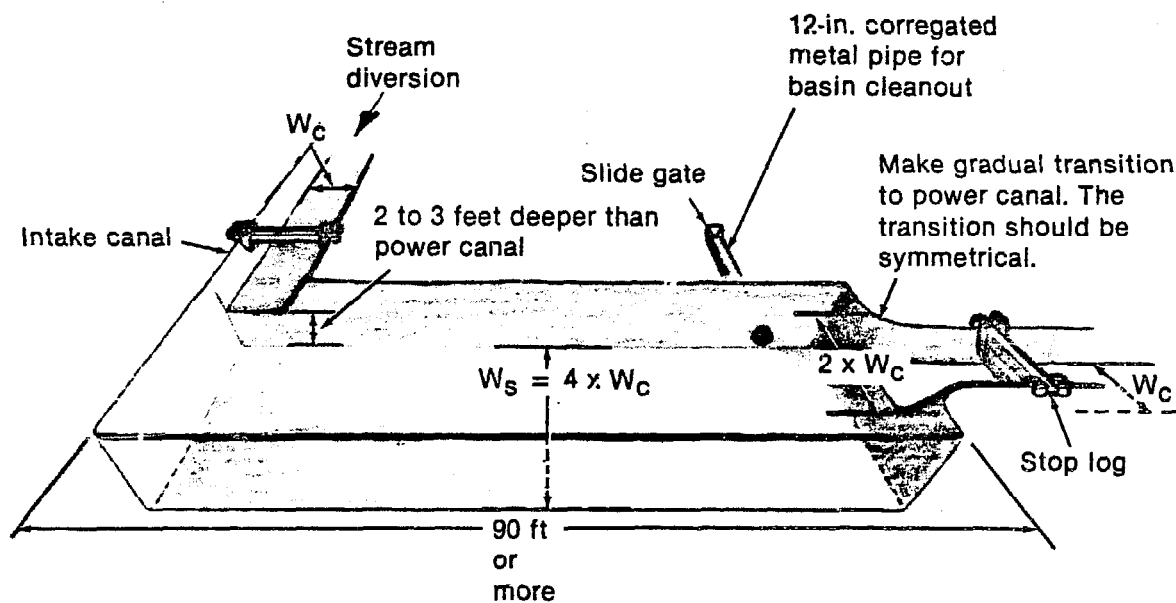

Figure 4.4-6. Sketch of canal cross-sectional area.



Note:

The settling basin should be near the diversion structure.

The settling basin is four times wider than the power canal

W_c = Width of power canal

INEL 2 2362

Figure 4.4-7. Diagram of settling basin.

The key to keeping the basin functioning is to maintain the slow velocity and large volume in the basin. To accomplish this, the basin should be equipped with a cleanout pipe. The pipe should be at least a 12-inch, corrugated metal pipe that drains from the bottom of the basin. To control flow in the pipe, some type of valve is required. A slide gate, as shown in Figure 4.4-8, is possibly the simplest. Some developers actually have the gate partially open to allow for continuous cleanout.

EXAMPLE: From the canal example, the width of the canal (W_c) = 3 feet. Use Equation (4.4-4) to find the dimensions of the basin.

Connection to corrugated
metal pipe

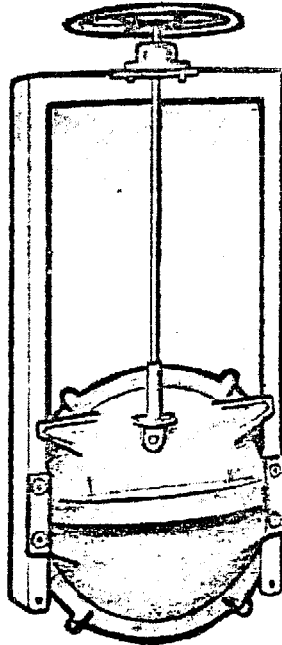

Slide gate

Canal slide gates

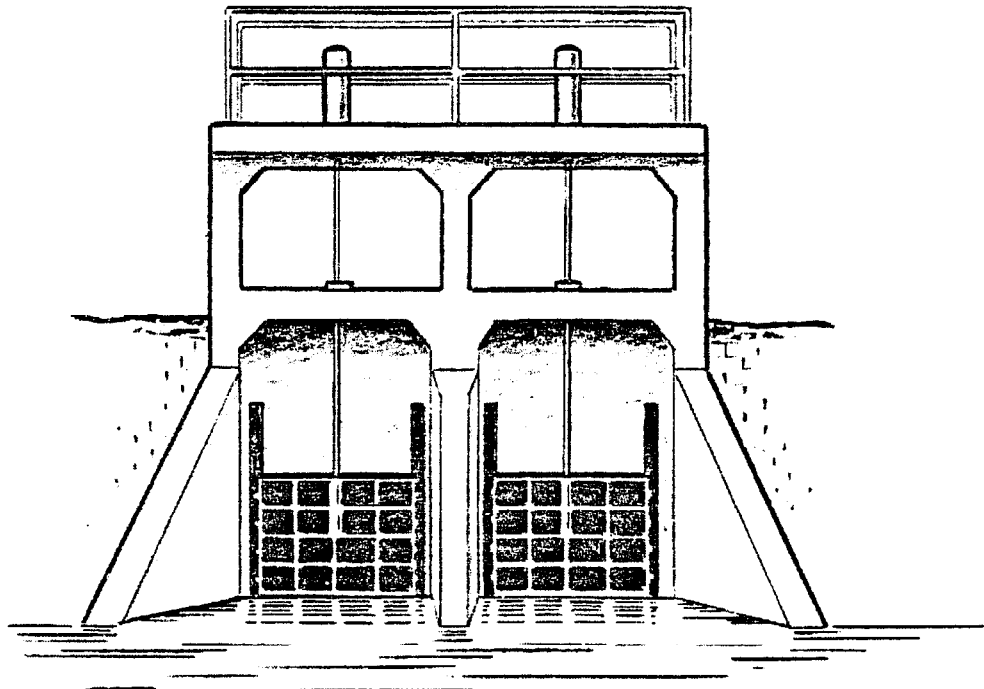

INEL 2 2319

Figure 4.4-8. Flow control gates.

$$W_s = 4 \times W_c$$

$$W_s = 4 \times 3$$

$$W_s = 12 \text{ ft}$$

Thus, the basin should be 12 feet wide and 90 feet long.

After determining the basin dimensions, make a sketch of the basin. Figure 4.4-9 is a sketch of the example.

4.4.2.4 Forebay. Some type of forebay is required for all run-of-the-stream sites. The forebay is a settling basin to protect the turbine from suspended debris. The recommended velocity in the forebay is 0.25 fps; therefore, the cross-sectional area of the forebay should be eight times larger than that of the power canal (the velocity in the canal, 2 fps, is eight times larger). It is advisable to maintain a depth-to-width ratio of 1-to-1 (the depth should be equal to the width), as shown in Figure 4.4-10. This is not always possible in areas where rock, shale, boulders, or other obstructions limit the depth of excavation. In such cases, try to keep the area at least eight times larger than the canal.

Since the area of the forebay is eight times larger than the canal, Equation (4.4-5) can be written:

$$A_f = 8 \times A_c \tag{4.4-5}$$

where

$$A_f = \text{area of forebay in ft}^2$$

$$A_c = \text{area of canal in ft}^2, \text{ from Equation (4.4-2).}$$

EXAMPLE: In the previous example, the area of the canal was computed to be $A_c = 3.75 \text{ ft}^2$. Using Equation (4.4-5), determine the dimensions of the forebay.

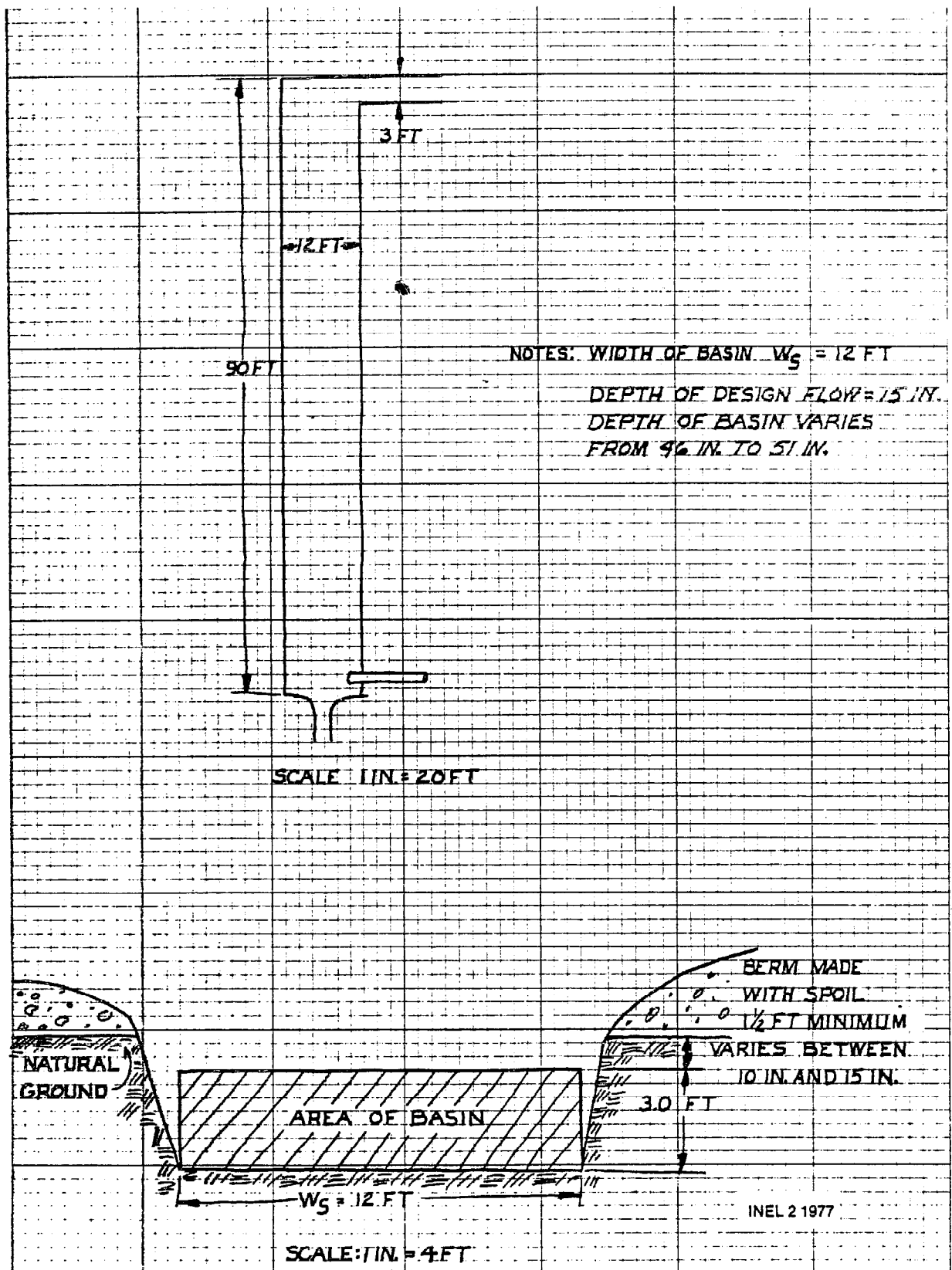

Figure 4.4-9. Sketch of settling basin.

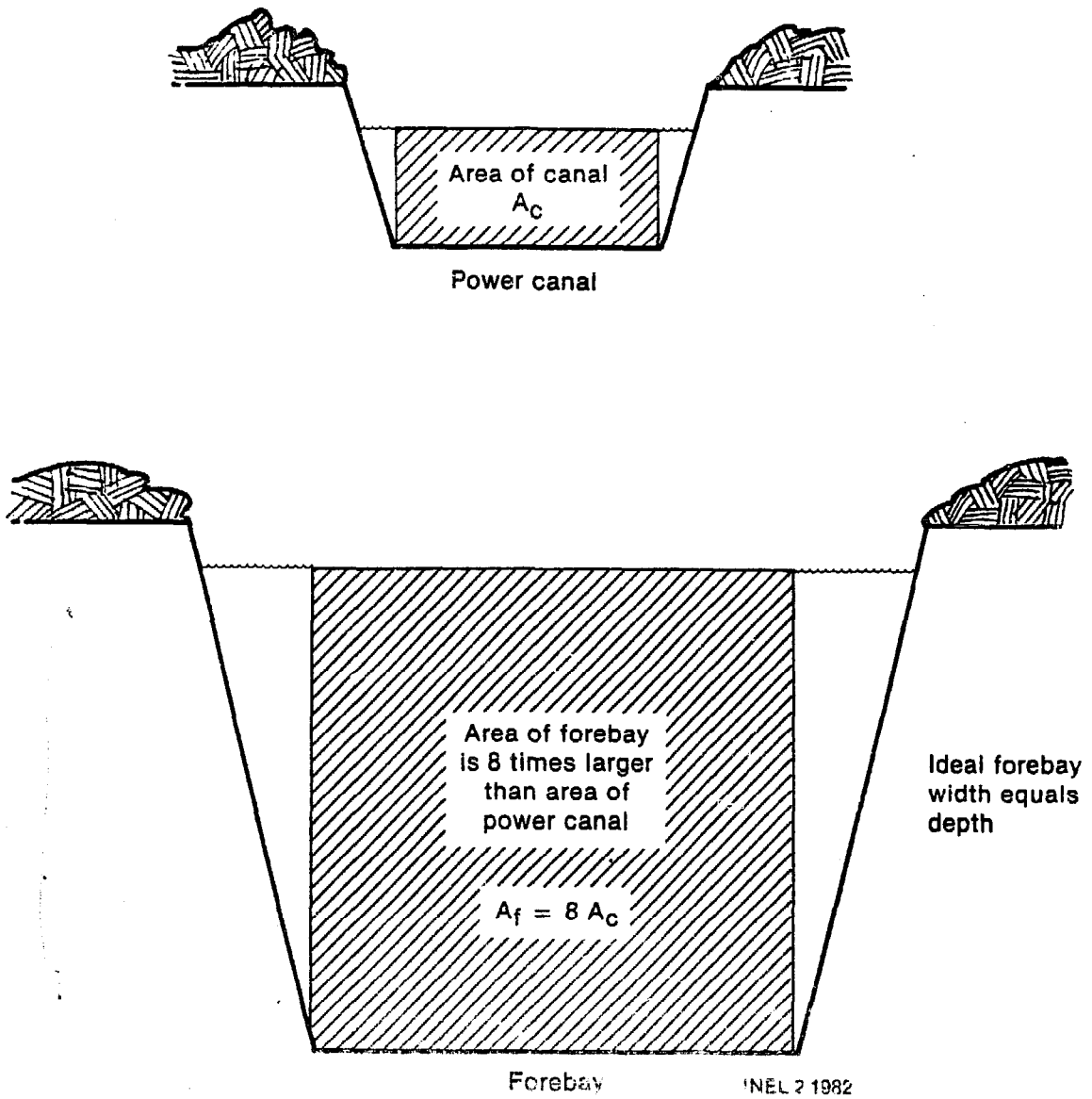

Figure 4.4-10. Diagram of forebay.

$$A_f = 8 \times A_c$$

$$A_f = 8 \times 3.75$$

$$A_f = 30 \text{ ft}^2$$

NOTE: Since the ideal situation is to have the depth equal to the width, and since area is the product of width times the depth, take the square root of A_f . If your calculator

does not have a square root ($\sqrt{\quad}$) function, find the square (product of a number multiplied by itself) that is closest to but larger than A_f . For example, $5 \times 5 = 25$ and $6 \times 6 = 36$; therefore use 6×6 . Never use a width less than the canal width.

Assume in this example that you have a square root function on the calculator. The square root of 30 is 5.48. Therefore, the ideal forebay dimensions would be 5.5 feet by 5.5 feet.

Now assume that in the area where the forebay is to be placed the maximum available depth is only 4 feet; find the new forebay dimensions. Since area equals width times depth and depth is known, divide area by depth to get width:

$$W_f = \frac{A_f}{d_f} \quad (4.4-6)$$

where

W_f = width of forebay in ft

A_f = area of forebay in ft^2 , from Equation (4.4-6)

d_f = depth of forebay in ft.

Therefore,

$$W_f = \frac{30}{4}$$

$$W_f = 7.5 \text{ ft}$$

The forebay should be oriented with respect to the penstock so that the penstock can be kept as straight as possible. In most cases where a power canal is used, the penstock takeoff will be placed at a 90 degree angle to the canal on the downhill side of the forebay.

The length of the forebay should be at least 45 feet to allow sufficient time for the fine sand, etc. to settle. If it is impractical to make the forebay 45 feet long, make the length as long as practical, and widen the forebay, if possible. The wider area will reduce the velocity and increase the settling time.

The forebay should also be equipped with a method for clean-out. The simplest method is to install 12-inch corrugated pipe through the downhill berm. The pipe should be placed on the bottom of the forebay. A slide gate should be placed on the pipe to control flow.

A skimmer should be placed in the forebay ahead of the trashrack. The skimmer should be angled to force the trash to the side of the forebay. The skimmer is discussed in Subsection 4.4.2.7, Additional Hardware.

4.4.2.5 Trashrack--Although the trashrack is actually part of the additional hardware, it is discussed separately at this point because the trashrack must be sized before the penstock intake structure on which it is mounted can be sized.

A trashrack is an essential element of any hydropower project. Microhydropower units in particular must be protected from trash carried by the water. The rack must strain unwanted material from the water and yet have enough openings to allow the design flow to pass through without significant loss of head. The rack must also be strong enough to withstand water pressure forced against it if the rack becomes completely clogged with trash. A trashrack mounted on the penstock intake structure is shown in Figure 4.4-11.

The design for microhydropower trashracks varies widely. In evaluating any design or your own creation, two key points should be kept in mind.

- The open, clear area of the rack must be large enough to allow the design flow to pass smoothly.

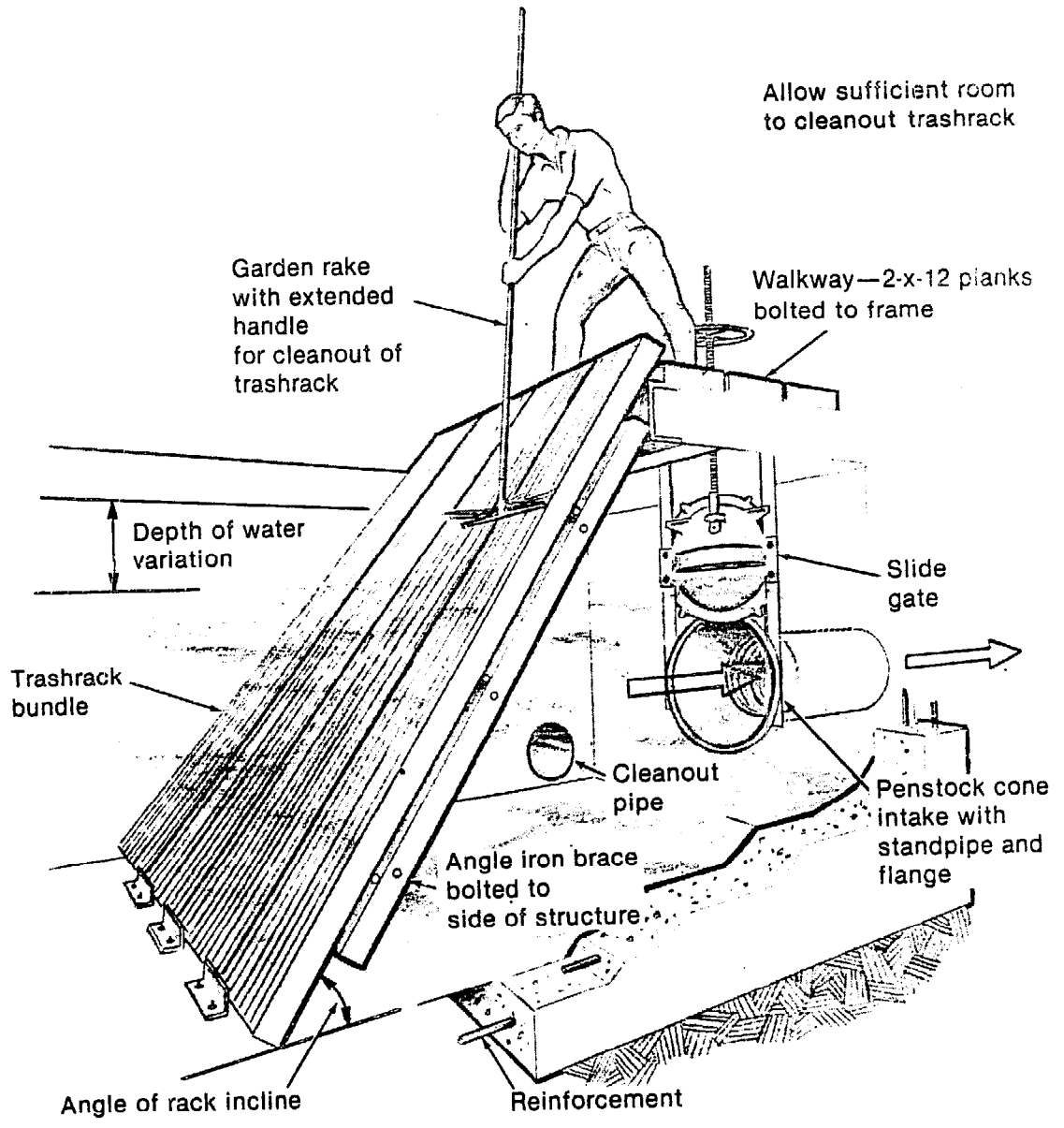

INEL 2 2323

Figure 4.4-11. Penstock intake structure cross-section.

- The rack must be designed for easy, periodical cleaning without interfering with the operation of the turbine.

Figure 4.4-12 and 4.4-13 are photos of two vertical slide-in racks, set one behind the other. Figure 4.4-14 is a photo of a barrel-type trash-rack connected directly to the penstock intake.

The simplest trashrack is made of bundles that can be easily handled by one person. A typical bundle can be fabricated from 2- to 3-inch flat stock bars (strap metal), shown in Figure 4.4-15. Most racks should be made with bars 1/4-inch wide (very small ones can be made with 1/8-inch bars). The bars can be fabricated into bundles typically 12 inches wide with the bars placed vertical to the flow (see Figure 4.4-11). The length can vary according to the site criteria (usually less than 10 feet for ease of handling). The clear space between the bars is the area that must be designed to pass the design flow without causing significant head loss. For microhydropower projects, the spacing can range from 1/2 inch to 1 inch (see Figure 4.4-15). The smaller spacing is recommended for smaller turbine units. Racks fabricated into bundles in this fashion can be removed individually for repair, maintenance, etc. Keep a spare!^a

Because the design area is the clear area between the bars, sizing the trashrack is not as simple as finding the area of the power canal or the forebay. The area of the bars must be added to the design area to obtain the dimensions of the wetted area of the rack, the area submerged during normal design flow (see Figure 4.4-1b). And since the rack is set at 45 or 60 degrees, the area is based on that incline angle. The steps involved are discussed in the paragraphs that follow.

a. K. M. Grover, "Site Selection and Turbine Sizing," (presented at Quito, Ecuador, August 1980), GSA International Corporation, Katoosh, G.M. 10536.



Figure 4.4-12. Vertical, slide-in trashracks.

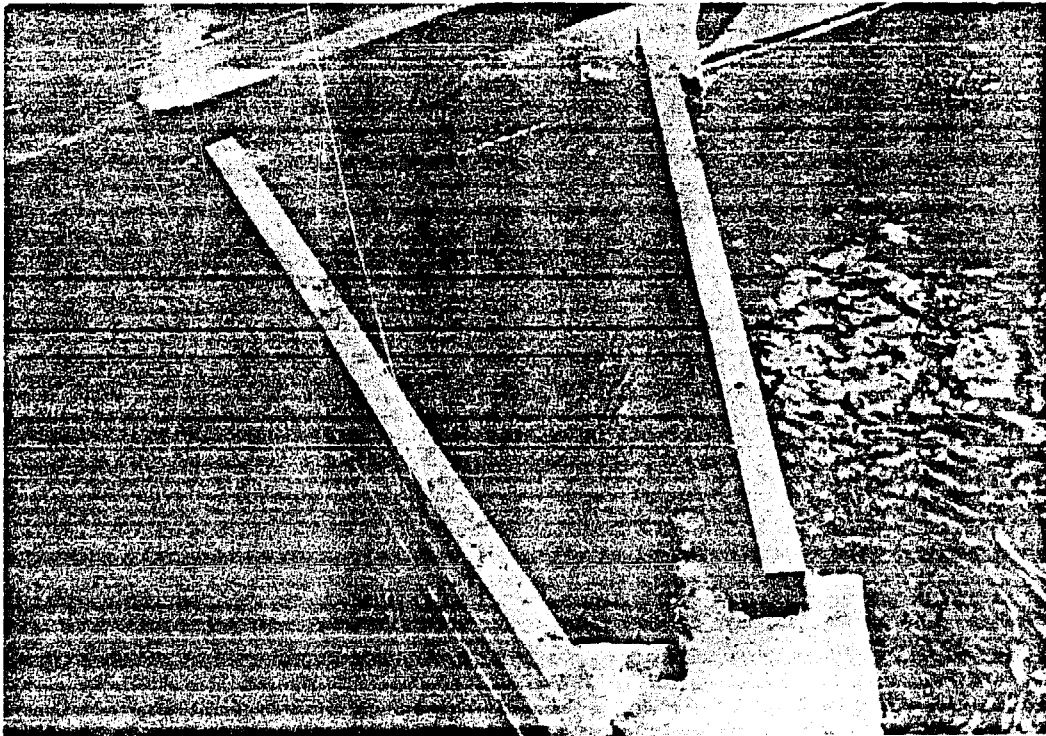

Figure 4.4-13. Vertical, slide-in trashracks.

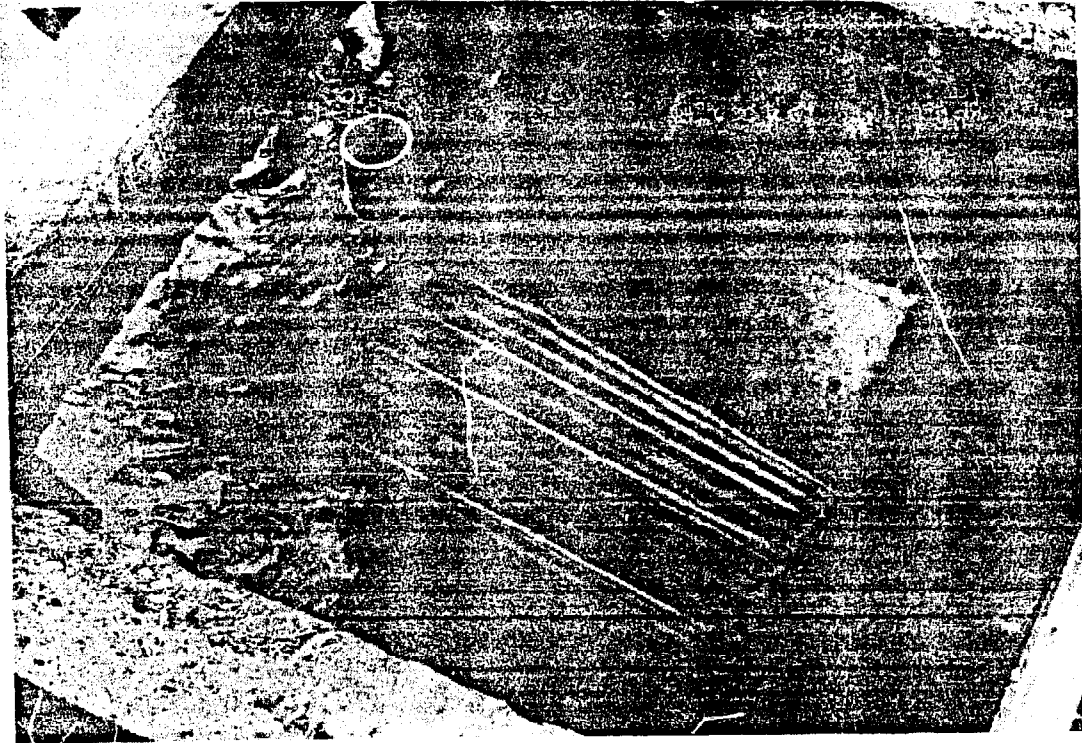

Figure 4.4-14. Barrel-type trashrack.

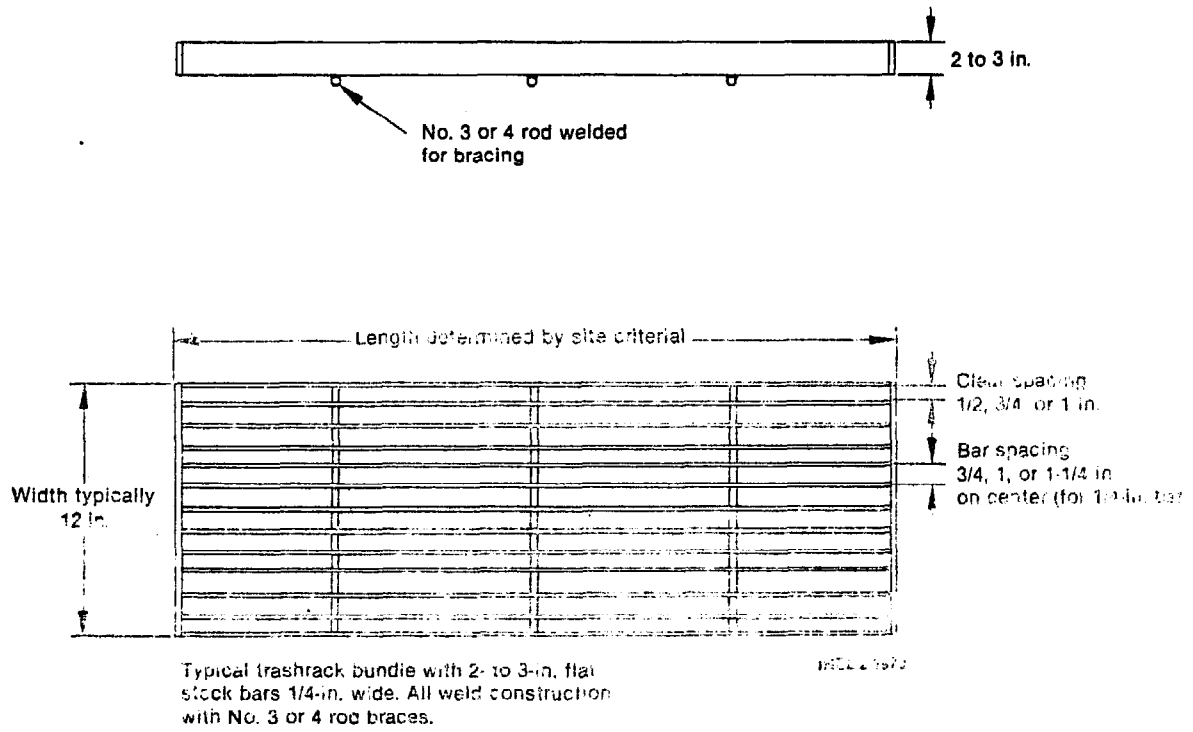
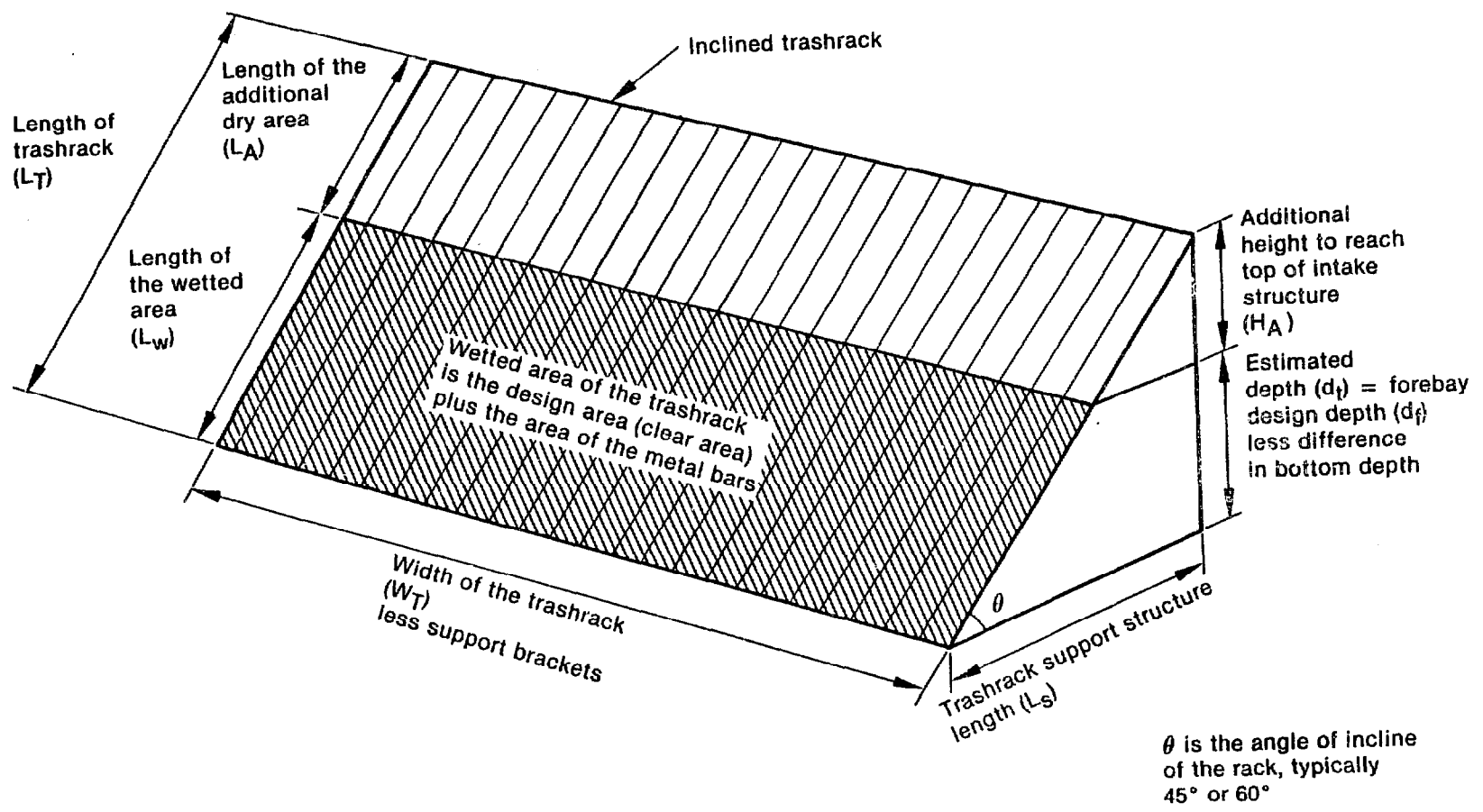

Figure 4.4-15. Typical trashrack bundle

4.4-27



INEL 2 1983

Figure 4.4-16. Trashrack dimension diagram.

4.4.2.5.1 Trashrack Design Area--The design area is the clear, open area in the rack through which the water passes. The design velocity for a trashrack is 0.5 fps. Therefore, Equation (4.4-1), $A = \frac{Q}{V}$, can be rewritten for $V = 0.5$ fps:

$$A_{DT} = \frac{Q}{0.5} \quad (4.4-7)$$

where

A_{DT} = design area of trashrack in ft^2

Q = design flow in cfs

0.5 = velocity through rack in fps.

EXAMPLE: As in the previous example, the design flow is 7.5 cfs. Find the design area of the trashrack.

$$A_{DT} = \frac{Q}{0.5}$$

$$A_{DT} = \frac{7.5}{0.5}$$

$$A_{DT} = 15 \text{ ft}^2$$

NOTE: Since 0.5 fps is four times smaller than the velocity of the power canal (2 fps), the design area for the rack is four times the area of the canal ($A_{DT} = 15 \text{ ft}^2$ and $A_c = 3.75 \text{ ft}^2$).

4.4.2.5.2 Length of Trashrack Wetted Area--The length of the wetted area is the length of the rack set in the incline (see Figure 4.4-16). To calculate the length, the depth of the water on the rack must be estimated. The water depth is equal to the depth of water in the forebay less any difference in elevation between the forebay bottom and the intake structure bottom. In most cases, the two bottom elevations will be the same; then the previously determined forebay depth (d_f) can be used directly.

$$L_w = \frac{d_t}{\sin \theta} \quad (4.4-8)$$

where

L_w = length of the wetted area of the trashrack in feet

d_t = depth of water in the intake structure equal to d_f (from Subsection 4.4.2.4) less the difference in elevation between the bottom of the forebay and the intake structure

$\sin \theta$ = trigonometric function of the angle of incline of the trashrack, usually 45 or 60 degrees.

Since the recommended angle of incline is either 45 or 60 degrees, and since $\sin \theta$ for these angles is 0.707 and 0.866, respectively, Equation (4.4-8) can be rewritten as follows:

$$L_w = \frac{d_t}{0.707}, \text{ for 45-degree incline} \quad (4.4-8a)$$

$$L_w = \frac{d_t}{0.866}, \text{ for 60-degree incline} \quad (4.4-8D)$$

EXAMPLE: From the previous example, the depth of the forebay is 4 feet. Find the length of wetted trashrack for 45- and 60-degree angles.

From Equation (4.4-8a) for a 45-degree incline:

$$L_w = \frac{4}{0.707}$$

$$L_w = 5.6 \text{ ft .}$$

From Equation (4.4-8b) for 60 degree incline:

$$L_w = \frac{4}{0.866}$$

$$L_w = 4.6 \text{ ft .}$$

4.4.2.5.3 Nominal Width--The nominal width is the width of the design area (clear area). It does not consider the width of the metal bars. The following equation is used to compute the nominal width:

$$W_N = \frac{A_{DT}}{L_w} \quad (4.4-9)$$

where

W_N = nominal width of the wetted area in ft

A_{DT} = design area in ft^2 , from Equation (4.4-7)

L_w = length of the wetted area in ft, from Equation (4.4-8)

EXAMPLE: Assume from the above that $L_w = 4.6$ ft and that

$A_{DT} = 15 \text{ ft}^2$. Find W_N .

$$W_N = \frac{15}{4.6}$$

$$W_N = 3.75 \text{ ft.}$$

The nominal width must now be corrected to account for the width of the bars.

4.4.2.5.4 Width of the Trashrack--To find the width of the trashrack, the area of the metal bars in the rack must be added to the design area. This is difficult to determine since the total width is not known; therefore, the number of bars is not known. The only thing that is known is the area of the openings between the bars (design area). It was previously recommended that all racks be made with 1/4-inch bars (except for very small units, which can be made of 1/8-inch bars). For racks made with 1/4-inch bars, the following ratios can be used to compute the trashrack width:

- For 1/2-inch clearance between bars, the ratio is 3 inches of rack width for every 2 inches of opening: $r = 1.50$.

- For 3/4-inch clearance between bars, the ratio is 2 inches of rack width for every 1-1/2 inches of opening: $r = 1.33$.
- For 1-inch clearance between bars, the ratio is 5 inches of rack width for every 4 inches of opening: $r = 1.25$.

For very small racks, when 1/8-inch bars are used, only a 1/2-inch opening between bars should be allowed.

- The ratio is 5 inches of rack width for every 4 inches of opening: $r = 1.25$.

Now the width of the trashrack can be computed using the correct ratio:

$$W_T = r \times W_N \quad (4.4-10)$$

where

W_T = width of the trashrack in ft

r = ratio of total width to clear area width

W_N = nominal width in ft, from Equation in (4.4-9).

EXAMPLE: From the previous example, $W_N = 3.75$. Assume that the rack is constructed of 1/4-inch-wide bars with 3/4-inch openings. Find the width of the trashrack.

$$W_T = r \times W_N$$

$$W_T = 1.33 \times 3.75$$

$$W_T = 5 \text{ ft.}$$

4.4.2.5.5 Bundle Size--To size the rack bundles, you must use the wetted dimensions of the trashrack. (L_w = length of wetted area, and W_T = width of trashrack, as shown in Figure 4.4-16).

- Width of Bundle--Divide the trashrack width (W_T) into convenient widths, each approximately 12 inches wide. This sets the width of the bundle and the number of bundles. (Remember, it is advisable to have an extra bundle.)
- Length of Bundle--The length is the sum of the wetted length plus the extra length required to bring the rack to the top of the intake structure. Figure 4.4-11 shows the rack extended to the walkway so that debris can be easily raked onto the walkway.

To determine bundle length, go back to the forebay section (Subsection 4.4.2.4) and determine how high the top of the berm is above the design flow level. Add 6 inches to 1 foot to that distance so that the intake structure is above the berm. This distance is the additional height required for the bundle to reach the top of the intake structure (see Figure 4.4-16). The distance will have to be divided by the $\sin \theta$ of the angle, as was the case for L_w [Equation (4.4-8)]:

$$L_A = \frac{H_A}{\sin \theta} \quad (4.4-11)$$

where

L_A = additional length in feet

H_A = additional height in feet

$\sin \theta$ = trigonometric function of the angle of incline of the trashrack, usually 45 or 60 degrees.

As with Equation (4.4-8), the equation can be rewritten for 45- and 60-degree inclines:

$$L_A = \frac{H_A}{0.707}, \text{ for 45 degrees} \quad (4.4-11a)$$

$$L_A = \frac{H_A}{0.866}, \text{ for 60 degrees.} \quad (4.4-11b)$$

EXAMPLE: Determine the length and width of trashrack bundles from the previous examples, where $W_T = 5$ feet, and $L_W = 4.6$ feet for a 60-degree angle of incline. The forebay berm is 2.5 feet above the design flow level.

Width of Bundle: 5 feet total; therefore make six bundles, each one foot wide (one extra bundle).

Length of Bundle: The design intake structure is 6 inches above the forebay berm; therefore, $H_A = 2.5 \text{ ft} + 0.5 \text{ ft (6 in.)} = 3 \text{ ft}$.

From Equation (4.4-11b) for a 60-degree incline:

$$L_A = \frac{H_A}{0.866}$$

$$L_A = \frac{3}{0.866}$$

$$L_A = 3.5 \text{ ft}$$

Thus,

$$L_T = L_W + L_A \quad (4.4-12)$$

where

L_T = total length of bundle in feet

L_W = wetted length of bundle in feet, from
Equation (4.4-8)

L_A = additional length of bundle in feet, from
Equation (4.4-11)

$$L_T = 4.6 + 3.5 \text{ ft} = 8.1 \text{ ft.}$$

Add a few extra inches so that the rack will be above the walkway, say to a total of 8.5 feet. Make the rack bundle 1 foot wide and 8 feet 6 inches long.

4.4.2.5.6 Trashrack Supports--Figure 4.4-17 shows some typical supports for the rack bundles. Each bundle can easily slide into its frame. The frame should be spaced with inside dimensions at least 1 inch wider than the bundle. This will help to ensure that the bundle does not bind in the frame.

The frame is constructed with 2- to 3-inch angle iron as shown in the figure. All connections are welded except where they are bolted to the intake structure.

4.4.2.5.7 Width of Trashrack Support Structure--The sum of the bundle widths plus the additional width required for support frames equals the width of the trashrack support structure.

EXAMPLE: From previous examples, $W_t = 5$ feet; five bundles require six frames. Allow 2-1/2 inches additional width per bundle.

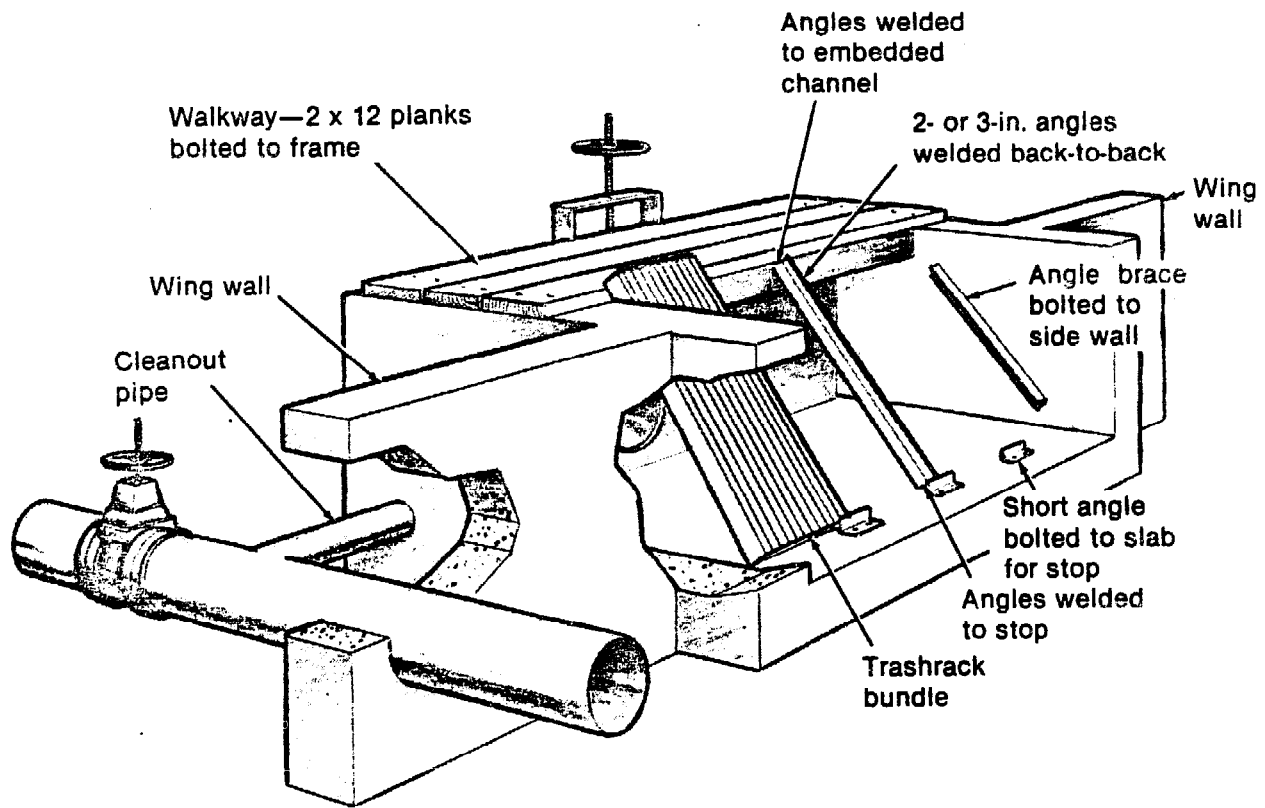

INEL 2 2329

Figure 4.4-17. Penstock intake structure, showing typical trashrack supports, cleanout pipe, and wing walls.

Therefore, $6 \times 2.5 = 15$. Add an additional 15 inches to the width of the bundles. Thus, total width = 6 feet 3 inches.

4.4.2.5.8 Length of the Trashrack Support Structure--The length of the trashrack support structure L_s , in Figure 4.4-16, can be found by multiplying the total length of the trashrack by the cosine of θ .

$$L_s = \cos \theta \times L_T \quad (4.4-13)$$

where

L_s = length of intake structure required for trashrack in feet

L_T = total length of trashrack in feet

$\cos \theta$ = trigonometric function of the angle of incline of the trashrack, usually 45 or 60 degrees.

Rewrite Equation (4.4-13) for 45- and 60-degree angles of incline:

$$L_s = 0.707 \times L_T, \text{ for 45 degrees} \quad (4.4-13a)$$

$$L_s = 0.5 \times L_T, \text{ for 60 degrees.} \quad (4.4-13b)$$

EXAMPLE: Assume that $L_T = 8.1$ feet and that the angle of incline is 60 degrees. Find L_s from Equation (4.4-13b).

$$L_s = 0.500 \times 8.1$$

$$L_s = 4 \text{ ft.}$$

4.4.2.6 Penstock Intake. The penstock intake provides a transition from the forebay to the penstock. The structure provides the following functions:

- Anchors the penstock
- Provides a framework for the trashrack and gates
- Diverts the water into the penstock.

The intake design will vary with each site. The size of the structure is dictated by the size of the trashrack; therefore, the trashrack dimensions must be determined as outlined in Subsection 4.4.2.5 before proceeding with the penstock intake.

The penstock intake structure generally will be constructed of concrete and should have steel reinforcement. If the structure is to be a large one, engineering services should be considered for design of the reinforcement. Figure 4.4-11 shows an example of a cross section of an intake structure. Points that should be considered in the design of a structure are:

- Bracing for the trashrack should be poured into, or attached to, the structural concrete.
- A walkway should be permanently attached above the rack to allow for cleaning of debris from the rack without interference of other equipment.
- A cleanout pipe is advisable.
- The penstock connection must be solidly mounted to the structure.
- Although not essential, a conical penstock intake provides a smoother water flow than does the butt end of a pipe and, consequently, loses less energy.
- The penstock intake should be far enough from the bottom of the structure to prevent the penstock from picking up debris off the bottom.
- The top of the penstock intake should be 1-1/2 pipe diameters below the low-water elevation. In areas where surface ice is a problem, the intake should be below the normal ice level.

CAUTION: The area at the top of the intake structure between the trashrack support and the structure's backwall should be sealed off at all times. The 2 x 12 wooden plank walkway shown in Figure 4.4-11 should be bolted down to prevent small animals or people from accidentally falling into the water behind the trashrack and getting sucked into the penstock.

After the trashrack is sized, determine the dimensions of the intake structure. The width of the intake structure is the same as that of the trashrack support structure, which was determined in Subsection 4.4.2.5.7. The length of the intake structure is equal the length of the trashrack support [L_s , from Equation (4.4-13) in Subsection 4.4.2.5.8] plus the additional length required to allow an adequate trashrack cleanout area (see Figure 4.4-11). Usually 3 or 4 feet is sufficient for a working area.

EXAMPLE: From the examples in the trashrack section, the total width is 6 feet 3 inches; the length for rack supports is 4 feet. Find the dimensions of the penstock intake. Add 3 extra feet for cleanout to the length, for a total length of 7 feet; the width remains 6 feet, 3 inches.

The penstock intake should be constructed of reinforced concrete. Where the concrete will be poured in more than one step, use commercially available water stops in the concrete. Water stops are long strips usually made of rubber 8 to 12 inches wide. Half of the width is placed in the first pour and the other half is cast into the next pour. Lumberyards should have this material or something similar.

Water will tend to seep between the concrete and the earth fill around the structure. If the seepage is large enough, the earth fill will be washed away from the structure. To prevent this, increase the length of the seepage path by adding wing walls (see Figure 4.4-17). The length of the wall depends on the depth of the forebay. A rule of thumb would be to make the wall as long as the forebay is deep.

Make a sketch of the forebay and penstock intake for your site. Figure 4.4-18 is a sketch of the sample site, and Figure 4.4-19 is an artist's drawing of the same figure.

NOTE: For smaller intakes, the cleanout walkway can be located behind the back wall, as shown in Figure 4.4-19. (This feature is also shown in Figure 4.4-22.)

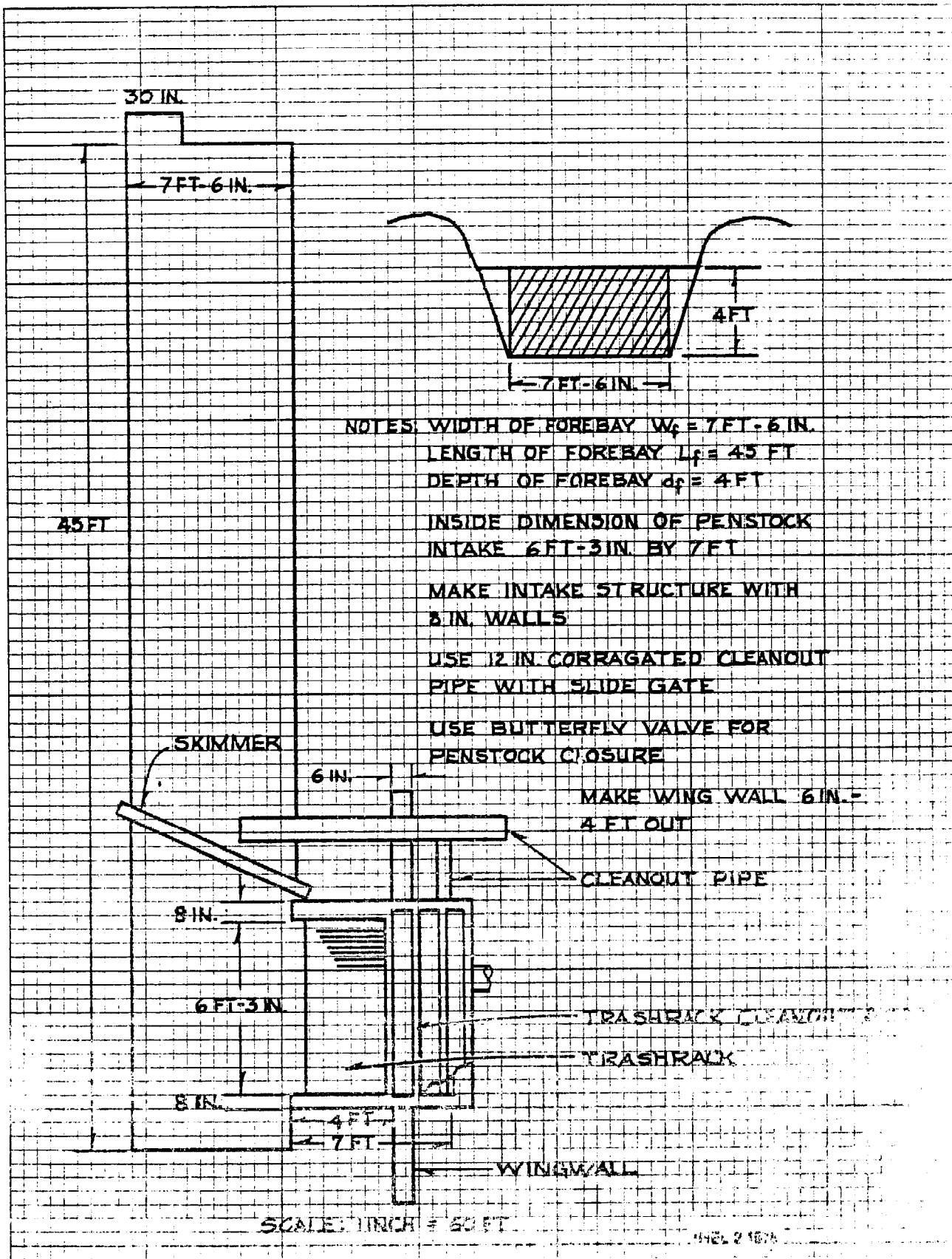

Figure 4.4-18. Sketch of forebay and penstock intake

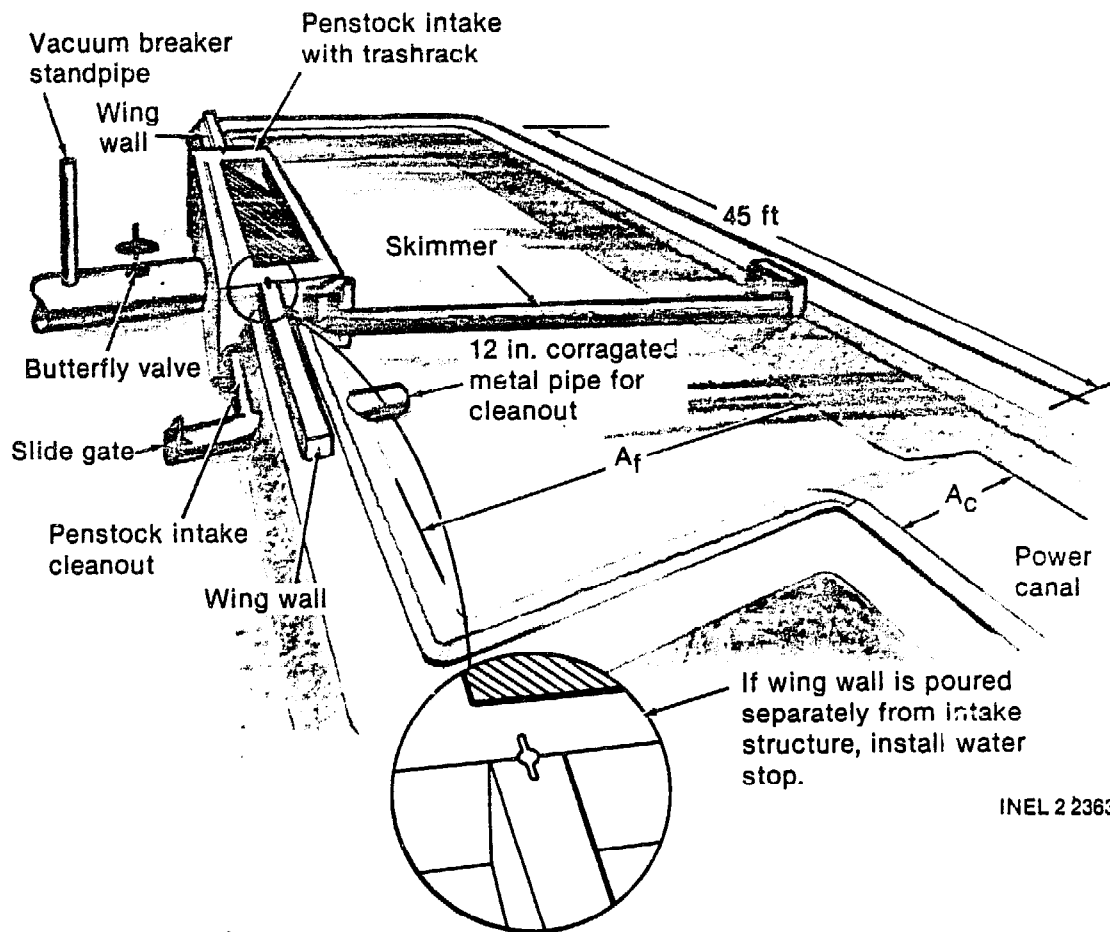

Figure 4.4-19. Forebay and penstock intake.

4.4.2.7 Additional Hardware. The following additional hardware items will be a part of most installations.

4.4.2.7.1 Skimmers--A skimmer is a floating log or something similar that skims trash floating on the surface, preventing further passage. At the diversion works, it prevents stream trash from entering the intake canal. In the forebay, it prolongs the timespan between trashrack cleanouts by diverting debris floating on the surface.

The skimmer should be set at angle to the stream flow. By angling the skimmer, the trash is forced to the downstream side and can easily be removed. Figure 4.4-20 shows a typical skimmer layout. The skimmer floats between two anchor posts on each side of the canal. Some authorities recommend that the skimmer be anchored down to prevent trash from working under it.

4.4.2.7.2 Stop Log Weir Check--In the canals at some location close to the entrances, a stop log weir check should be constructed. The check must be constructed properly so that the logs can be easily inserted in the case of an emergency. Two concepts for a stop log check are shown in Figure 4.4-21. One is made of logs and the other of poured concrete. Either method will serve the purpose equally well. The logs are stacked in the check so that they are readily available for use by pulling the pin. A canvas or a sheet of plastic placed in the canal upstream from the logs will settle against the logs and form a seal to stop any remaining seepage.

As a weir check, the water level in the canal downstream of the check can be controlled by raising or lowering the logs to restrict the canal opening.

4.4.2.8 Alternative Layouts. It is not always physically possible to construct an intake system as previously described. Whatever the configuration, the intake must take water from the stream and introduce it into the penstock. Figures 4.4-22 and 4.4-23 show two alternative intakes for a run-of-the-stream project in a narrow canyon.

4.4.3 Existing Dam Intakes

A suitable intake at an existing dam might be an open flume similar to that shown in Figure 2-12, where the water enters the flume through a trashrack, flows into the turbine, and exits through the tailrace. Another method is a penstock penetrating the dam; a third possibility is an open mill-race (small wood or concrete-lined canal) that diverts the water to a water wheel or turbine intake.

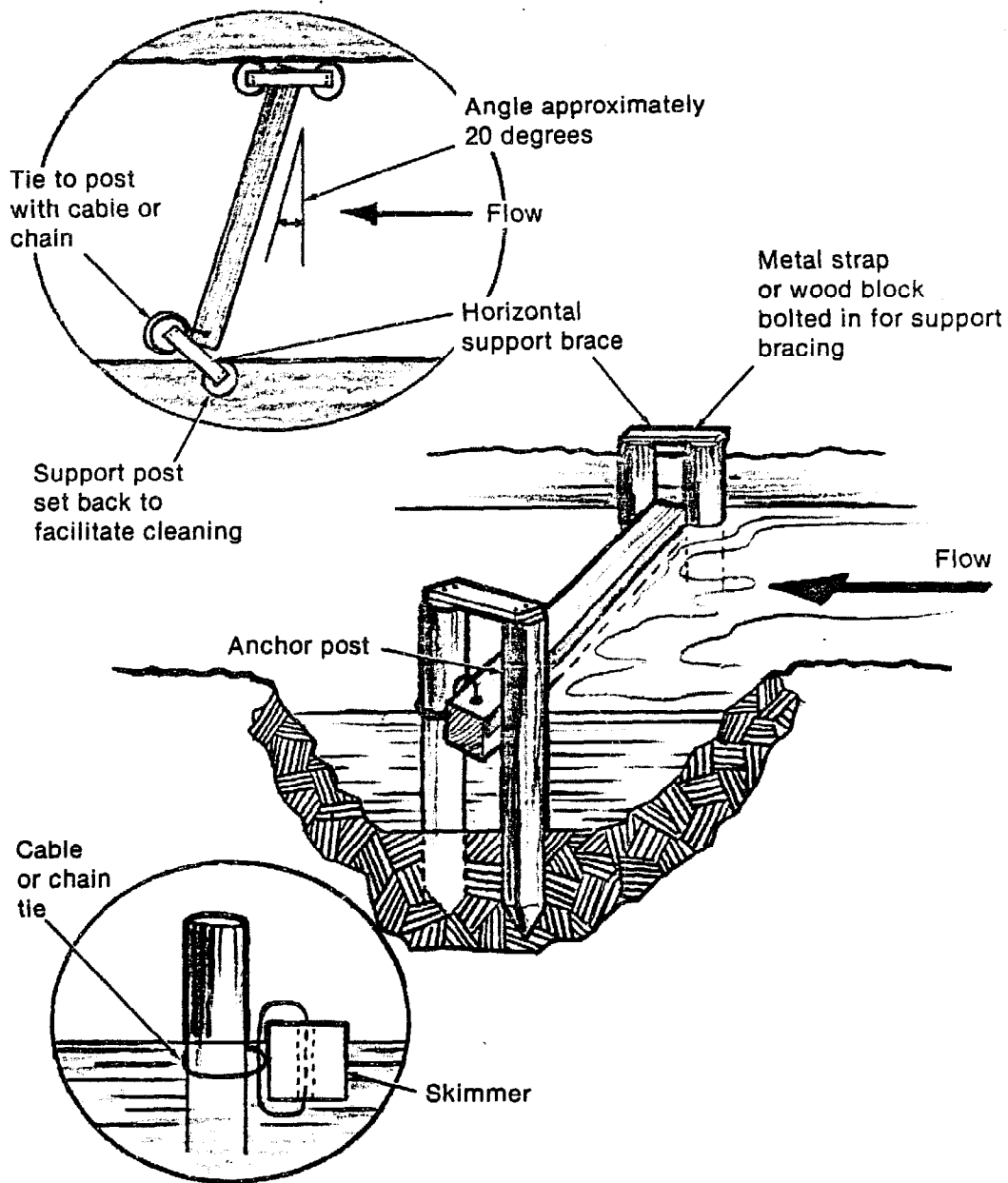

INEL 2 2365

Figure 4.4-20. Typical skimmer layout.

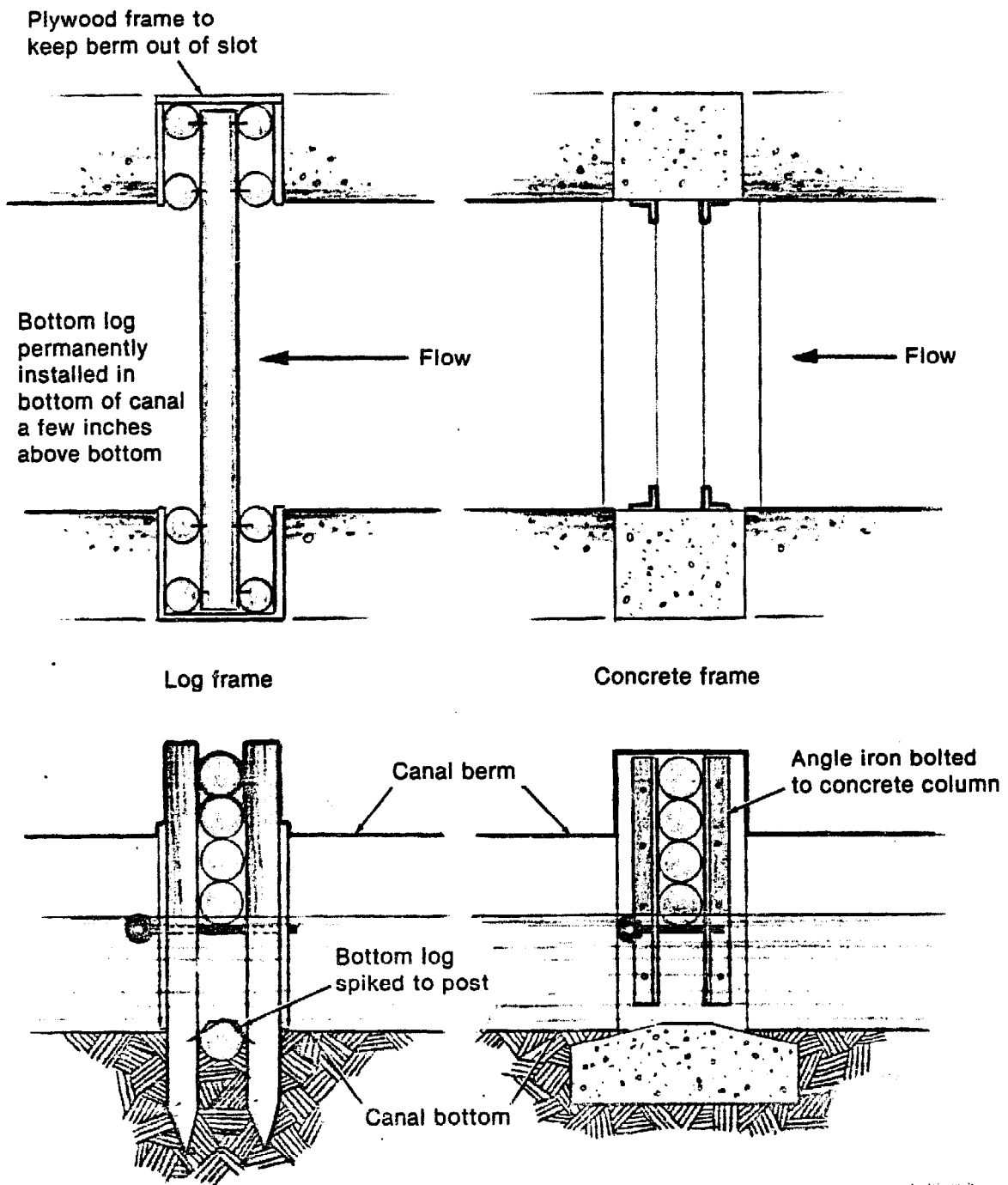

INCL 725.1

Figure 4.4-21. Stop log weir check configurations.

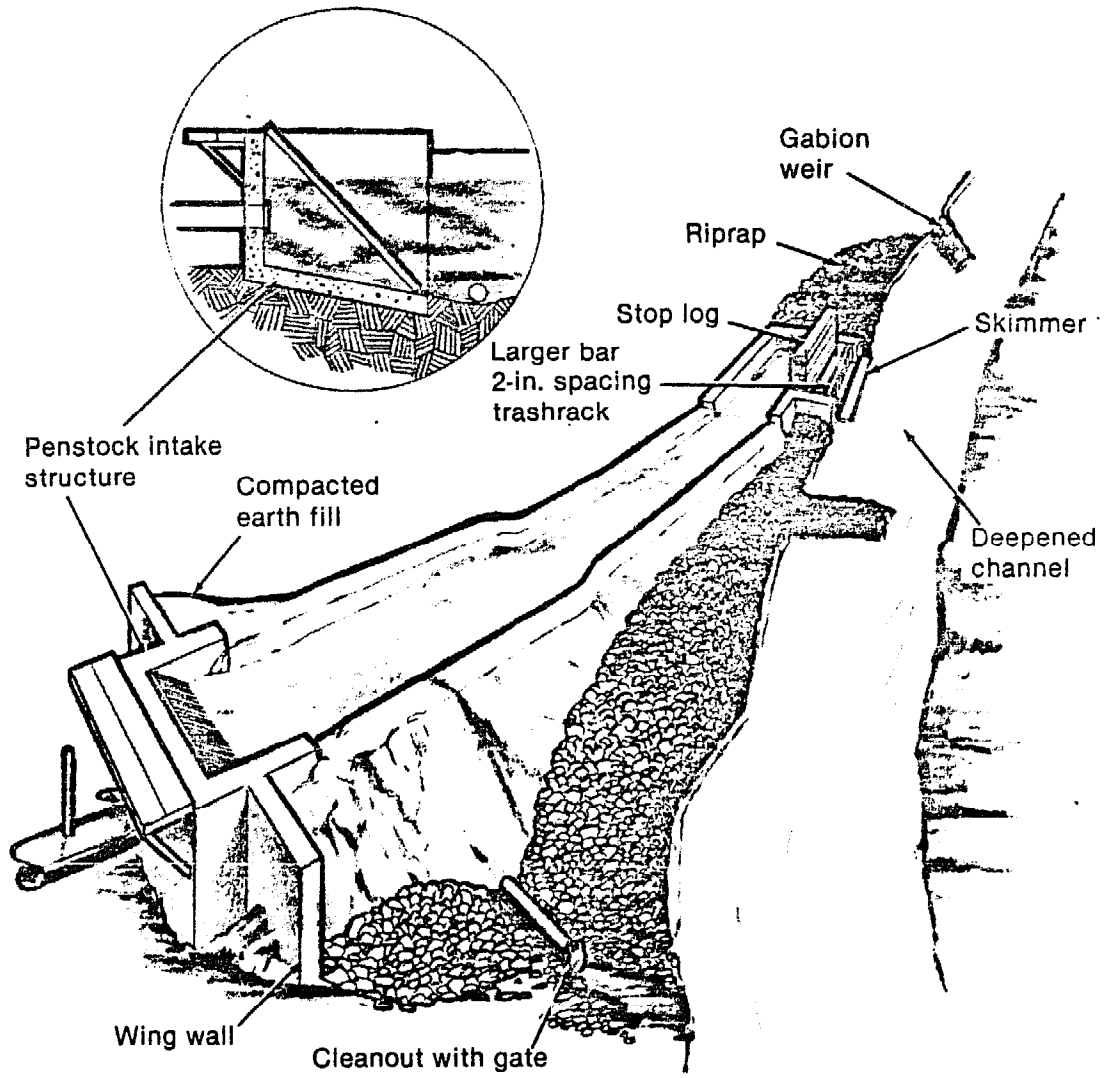

INEL 2 2360

Figure 4.4-22. Alternative layout for intake system.

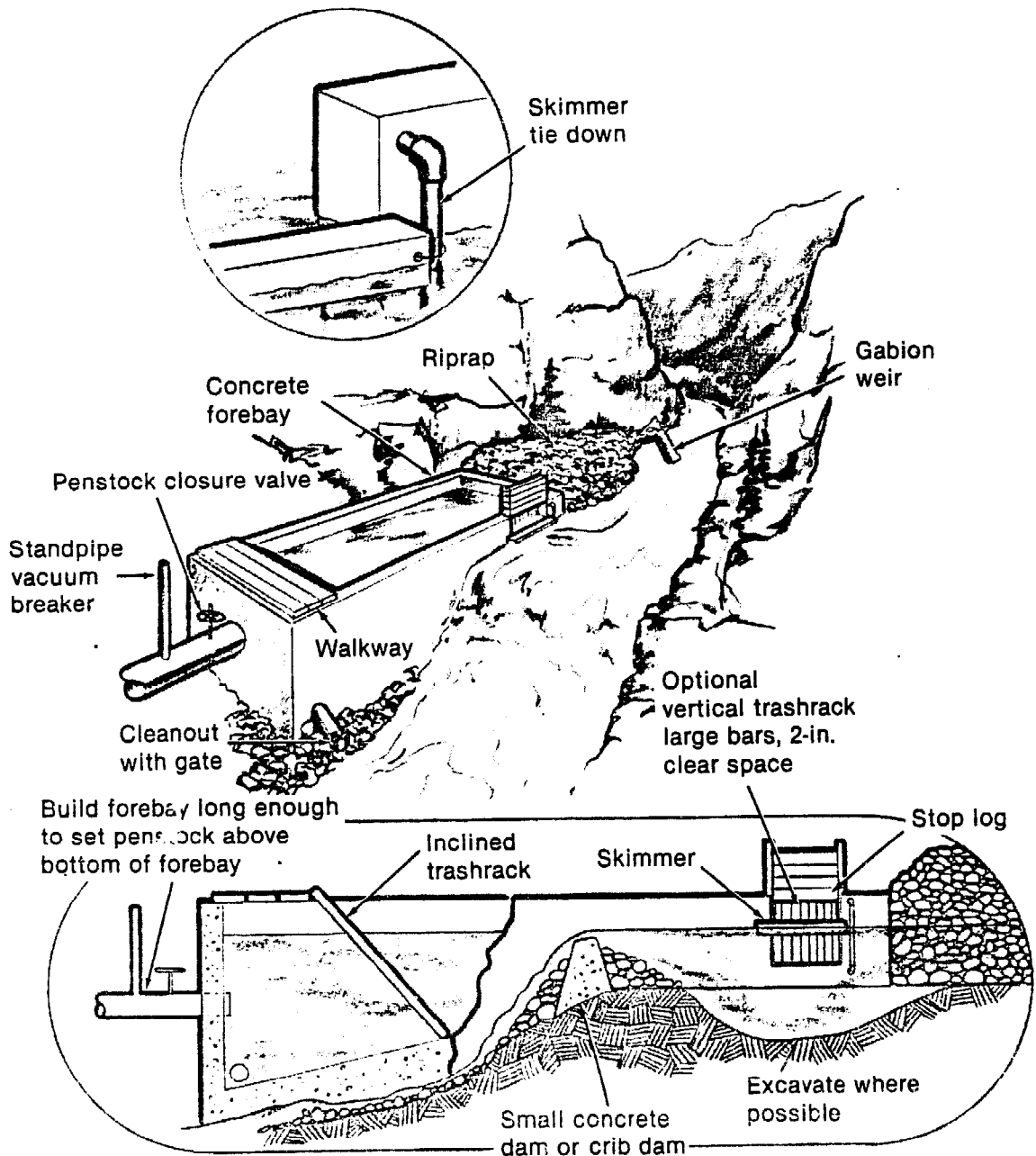

INEL 20361

Figure 4.4-23. Alternative layout for intake system.

If the dam does not have one of the above features, some method will have to be devised to channel the water over, around, or through the dam to a form that can be used for power production. A siphon penstock is a possibility for moving water over the dam. To move it through the dam, the dam may have to be modified. Any modification to the structure of an

existing dam should not be attempted without the direction of a professional engineer who has had experience in such modifications. Channeling the water around the dam would require a power canal that would take water out of the stream far enough above the dam so that the canal and penstock intake is above the dam crest. This type of system would use the run-of-the stream intake discussed in the preceding section.

4.4.3.1 Open Flumes. A dam with an open flume that dumps into a tailrace can have a turbine set between the two. There would be no penstock, but the system should include a trashrack (Subsection 4.4.2.5) and a stop log (Subsection 4.4.2.7).

4.4.3.2 Siphon Penstock. A siphon hydropower project works just like any other siphon. The penstock is run over the top of the dam, routed down the back of the dam, and connected to the turbine just above the tail water elevation. Siphons have a limit on how high they will lift water. If the lift is much more than 10 feet, a professional engineer should be consulted.

The siphon penstock should be located to one side of the dam to minimize exposure to floods. The siphon elbow (the bend that goes over the lip of the dam) may freeze in very cold climates because the pressure is lower at that point, and the freezing point will be slightly higher than normal. Most freezing problems can be solved by insulating the elbow.

The intake should be equipped with a trashrack similar to that in Figure 2-13. To compute the area of the rack, follow the procedures given in Subsection 4.4.2.6. If the first design for the rack results in a rack that is too large, the velocity can be increased to as high as 2 fps.

4.4.4 Design Layout

After you have decided on the type of intake, make a sketch or sketches of the system. As much as possible, make the sketches to scale and identify dimensions, materials, quantities, and anything else needed to ensure that all important points and cost factors have been considered.

If earth work is involved and you plan to hire the work done, the cost is generally based on an hourly rate or on the amount of material (earth) moved. The hourly rate and estimated number of hours will have to be obtained from a local contractor. If the cost is per yard, you should estimate the yards involved to verify the contractor figures.

$$1 \text{ yd}^3 = 27 \text{ ft}^3$$

To compute the volume in yards of material, first figure the volume in cubic feet, and then divide by 27:

$$V = \frac{L \times W \times d}{27} \quad (4.4-14)$$

where

- V = volume in cubic yards
- L = length in feet
- W = width in feet
- d = depth of the excavation in feet
- 27 = number of cubic feet per cubic yard.

The volume of the material in a truck is 20 to 30% larger than the material volume was in the ground. The contractor will usually price the volume on the basis of what is in the truck. Therefore, if you buy material, multiply the computed volume from Equation (4.4-14) by 1.3 to estimate cost.

If concrete work is involved, the total number of cubic yards should also be computed. Small amounts of concrete can be prepared from ready-mix bags; for large amounts, consider either a portable concrete mixer or ordering direct from a ready-mix company.

Estimate the materials and cost, including labor cost. These figures will be added to the other costs determined in Section 5 to arrive at a total project cost estimate.

4.5 Penstock and Valves

The penstock is a pipe that carries water from the intake to the turbine. Most microhydropower systems will include some type of penstock. Depending on the site characteristics, the penstock length may range from a few feet for manmade structures to several hundred feet for some run-of-the-stream sites. The exception is the manmade structure with an open flume (Figure 2-12). This type of site has no penstock. Developers with an open flume leading to the turbine can proceed to the next section. This section discusses location, design, and installation of the penstock and its associated valves.

If you have received a penstock recommendation from the turbine manufacturer, you should contact suppliers to obtain pipe specification and pricing information. If you plan to follow the turbine manufacturer's recommendation, you should review the contents of this section before ordering the pipe in order to facilitate making a design layout of the penstock and to make sure that you have considered all materials and costs.

4.5.1 Locating the Penstock

Run-of-the-stream developers determined a preliminary routing for the penstock in Section 3.4. Manmade sources generally do not allow much latitude in penstock routing. The developer using an existing dam has the option of a siphon penstock (Figure 2-13) or a power canal routed around the dam (see Subsection 4.4.3). Any modification to an existing dam is beyond the scope of this handbook.

In general, the optimum penstock is as short, straight, and steep as practical and has a continuous downward gradient. A power canal can be constructed to divert the water to give the best penstock alignment, (see Subsection 4.4.2). These characteristics will minimize construction costs and friction loss.

The following are some of the major factors that must be considered in selecting a penstock route:

- Accessibility. The route should be accessible to personnel and equipment required for pipe installation, inspection, and maintenance. In those areas where equipment access is difficult or impossible, installation and maintenance must be performed manually.
- Soil Conditions. Soils along the pipeline should be examined to identify rock outcroppings, soft or unstable soils, or other characteristics that would interfere with penstock installation or damage the penstock.
- Natural or Man-Made Obstructions. These include trees, roadways, buildings, stream crossings, and other features that require special care.
- Gradient. The penstock is best routed to take advantage of the natural downward gradient. If the line cannot be located so as to have a constant downward gradient, an air relief valve or equivalent device is required at every local high point, and a drain valve is required at every local low point.
- Above- or Below-Ground Installation. A buried penstock has certain advantages over an above-ground installation. Anchoring and supporting the pipe are simplified, ultraviolet radiation effects on PVC pipe are eliminated, and the effects of weather (thermal expansion, freezing) are reduced. In addition, physical damage to the pipe from falling rocks and trees or other sources is also prevented. On the other hand, an above-ground pipe will have a lower construction cost, may allow for more direct routing (fewer bends), and is readily accessible for inspection or repair. Another alternative is to have a combination of above- and below-ground installation.

4.5.2 Design Layout

To work with the penstock section, you will find a sketch of the proposed penstock routing helpful. In Subsection 3.4, the routing was surveyed. Take the information from that survey and on a sheet of graph paper sketch out the routing. Figure 4.5-1 is an example of such a sketch. You are encouraged to make a similar sketch of your site as well as an elevation view to confirm grades and elevations.

The sketch is helpful in identifying the number of elbows needed, in determining where the penstock will be above or below ground, and in locating anchors and thrust blocks (Subsection 4.5.5), etc. The sketch will also be helpful in the rest of this section for such items as estimating the cost of outside help, additional equipment, total material requirements, etc.

4.5.3 Material Selection

The turbine manufacturer may have recommended a certain material for the penstock. You may want to consider other material that might be less expensive. The most common penstock materials include:

- PVC (polyvinyl chloride)
- Steel
- Polyethylene
- FRE (fiber reinforced epoxy)
- Transite (asbestos cement).

For each of these materials, you must consider a number of factors:

- Cost
- Availability

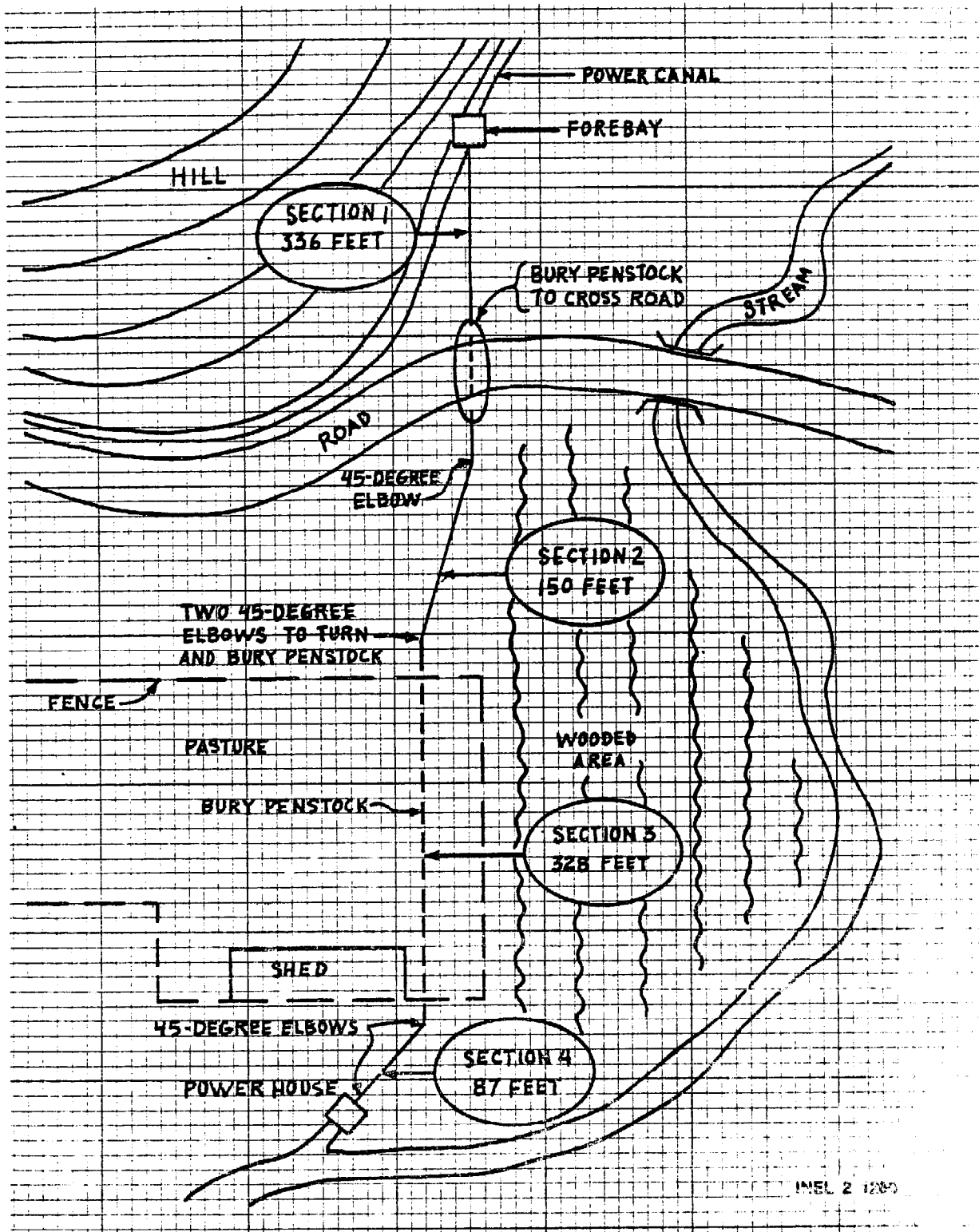

Figure 4.5-1. Sketch of proposed penstock routing

- Physical properties (friction, strength, chemistry)
- Joining methods and installation limitations.

These factors are greatly influenced by a number of local and special conditions that are beyond the scope of this handbook. Certain observations, however, are in order.

Material costs vary with season, general economy, raw material surpluses or shortages, location, and other factors.

In some cases, used pipe materials may be locally available. Their use can reduce material costs, provided that the pipe is in satisfactory condition. You should attempt to establish the history of the pipe (length of service, material carried, maximum pressures) as well as to evaluate the uniformity of dimensions and wall thicknesses. Visual inspection of the stockpiled pipe is also recommended.

Material availability relates to manufacturing, marketing, and local economic demand. Certain materials are available only in specific size ranges. The head and flow conditions encountered will dictate the physical properties required in the material to be used and will thus influence the cost.

Each material alternative is governed by specific joining and installation requirements. Joining methods that require special skills or equipment will tend to increase construction costs. In addition, certain materials are not recommended for above-ground installation. In most instances, and especially for above-ground installations, some form of restrained joint will be required. Restrained joints include welding, concreting, or flanging of pipe to prevent joint pullout when the penstock is pressurized.

4.5.4 Penstock Sizing

A satisfactory penstock diameter depends on three factors:

- Energy (head) losses due to friction between the water flowing in the pipe and the inside pipe wall
- Pressure limitations of the pipe as a function of wall thickness
- Cost of the pipe and installation.

For a given flow rate, as the pipe diameter decreases the velocity of the water must increase, and the corresponding energy loss increases. This occurs because friction is a function of velocity. As velocity increases, friction increases. On the other hand, a larger pipe diameter would mean a decrease in velocity and a corresponding decrease in friction (head loss). The cost of the pipe however, increases drastically with the increase in size. The procedure presented here will help you balance energy loss with pipe size, material, and wall thickness. A velocity of 4 fps is recommended for the initial penstock design. Once the proper pipe size is selected, the material and installation cost can be evaluated to select the best buy.

The energy losses associated with friction can be expressed directly as feet of head loss.

EXAMPLE: Assume that a site has a measured head of 112 feet and that the developer calculates the energy loss in the penstock system as 8.6 feet. The actual head available to produce energy is not 112 feet but 103.4 feet ($112 - 8.6$).

Friction losses in the penstock system represent energy that is not available for power generation.

4.5.4.1 Selecting Pipe Diameter. The first requirement for sizing a penstock is to select the proper pipe diameter, using the design flow from Subsection 4.3. Figures 4.5-2 and 4.5-3 are graphs to help in making this

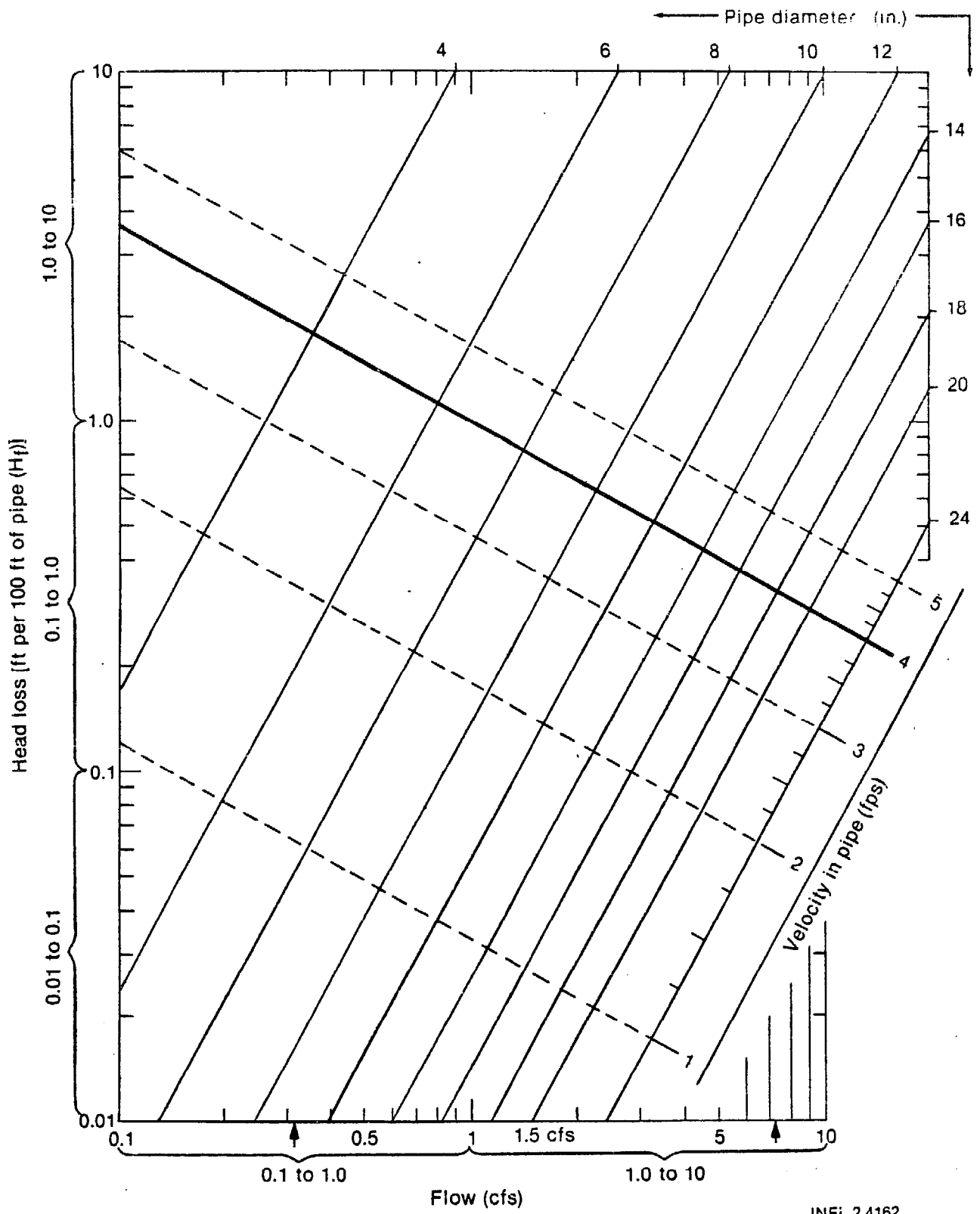

INEL 2 4162

Figure 4.5-2. Pipe diameter selection graph.

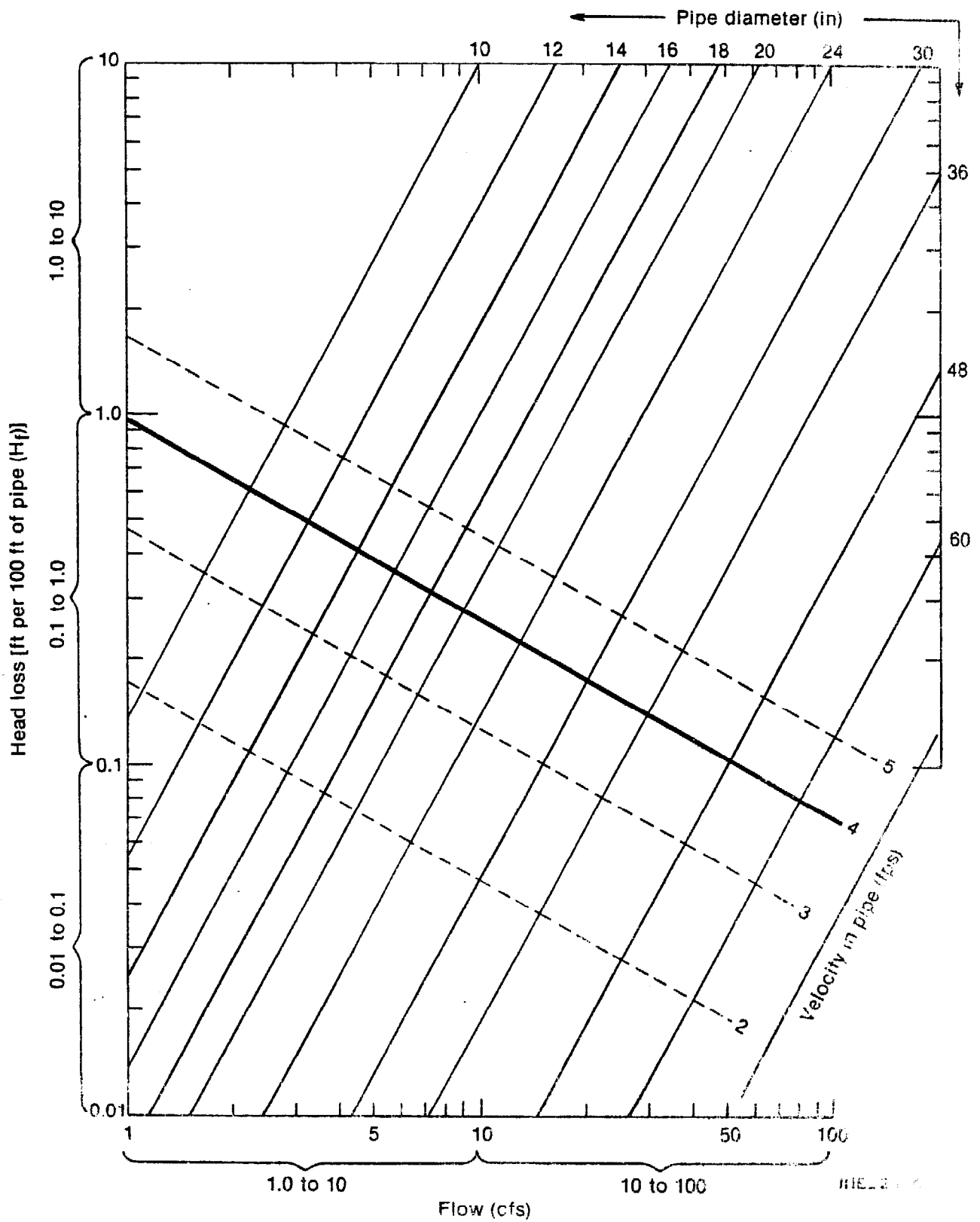

Figure 4.5-3. Pipe diameter selection graph.

selection. A range of flow values is shown at the bottom of each graph. If the design flow is between 0.1 cfs to 10.0 cfs, use the first graph, and if it is from 10.1 cfs to 100 cfs, use the second graph. Consult the manufacturer if the design flow is more than 100 cfs.

1. On the appropriate graph, find your design flow.

NOTE: The graph is on log paper. The range of flow values is marked with brackets (i.e., 0.1 cfs to 1.0 cfs). As examples, flow readings of 0.32 cfs and 7.2 cfs are shown with small arrows at the bottom of the graph on Figure 4.5-2.

2. Draw a vertical line up from the design flow value to the recommended velocity line (the 4 fps line running diagonally line from the upper left corner to right center). The intersect point with 4 fps will be bracketed by two pipe diameter lines (diagonal lines running from the upper right to the lower left). Either of the bracketing penstock sizes can be used, but it is recommended that the larger size be selected to keep velocity (and head loss) low. Lower velocity will also result in less water hammer. A penstock head loss of 5 to 10% of the pool-to-pool head can be a reasonable design starting point.

The actual velocity of water in the penstock will be the point at which the vertical line representing flow intersects the selected pipe size line and will probably be slightly lower than 4 fps if the larger pipe size is chosen.

EXAMPLE: Referring to Figure 4.5-4, assume a design flow of 4 cfs. From 4 cfs (Point 1), draw a vertical line up to the 4 fps line (Point 2). Select the larger of the pipes--in this case, the 14-inch diameter pipe (Point 3). At Point 3, the velocity of 4 cfs in the 14-inch pipe can be estimated as 3.7 fps (Point 3 is approximately 0.7 of the way between 3 fps and 4 fps).

3. From the pipe size intersect (Point 3), draw a horizontal line to the left side of the graph. The numbers on the left side of the graph represent the head loss per 100 feet of pipe length.

EXAMPLE: From Point 3, draw a line to the left side of the graph (Point 4). At Point 4, read the head loss factor as 0.34 ft per 100 feet of pipe. The actual loss depends on pipe material.

4. Record the penstock diameter and actual velocity (Point 3 in the example) and the friction loss factor (Point 4).

4.5.4.2 Selecting Pipe Material. It is now time to consider various pipe material alternatives so that the actual friction losses can be calculated. Virtually any of the materials previously discussed can be used, but experience indicates that two materials, PVC and steel, stand out as the most likely choices for the greatest number of installations. As previously stated, local and site specific factors can influence material options and must be considered.

The selection of pipe material and pipe wall thickness depends on the pressure that the pipe will experience. There are two types of pressure to be considered:

- Static pressure, which is the pressure at the bottom of the pipe when the pipe is filled and the water is not flowing.
- Pressure waves, which are caused when the amount of water flowing is suddenly changed, as by opening or closing a valve.

Static pressure depends on the head in the penstock. Pressure waves depend on how fast the flow changes in the penstock.

To aid in determining the design pressure rating of the penstock and selecting the suitable pipe material, Table 4.5-1 lists the wall thickness (t_w), pressure rating (P_R), and surge allowance factor (S_A) for several sizes of commonly available pipe materials.

TABLE 4.5-1. PIPING ALTERNATIVES

Pipe size Pipe material ↓	4 in.			6 in.			8 in.			10 in.			12 in.			14 in.			16 in.			18 in.			20 in.			24 in. ^a											
	t _w	P _R	S _A	t _w	P _R	S _A	t _w	P _R	S _A	t _w	P _R	S _A	t _w	P _R	S _A	t _w	P _R	S _A	t _w	P _R	S _A	t _w	P _R	S _A	t _w	P _R	S _A	t _w	P _R	S _A									
Steel	0.24	1400	57	0.28	1200	56	0.25	800	54	0.25	640	52	0.25	540	51	0.25	490	50	0.25	430	49	0.25	380	48	0.25	340	47	0.25	280	45									
							0.32	1100	56	0.37	1030	55	1.38	890	54	0.38	810	54	0.38	710	52	0.38	630	52	0.38	570	51	0.38	470										
													0.41	1000	55	0.44	970	55	0.50	990	55	0.50	880	54	0.50	790	53	0.50	660					0.50	660				
																									0.59	950	54	0.69	940	54									
PVC (polyvinyl chloride)	0.11	100	12	0.16	100	12	0.21	100	12	0.26	100	12	0.31	100	12																								
	0.17	160	15	0.25	160	15	0.33	160	15	0.41	160	15	0.49	160	15	← PVC pressure pipe not available →																							
	0.26	250	18	0.39	250	18	0.51	250	18	0.63	250	18	0.75	250	18																								
PE (polyethylene)	0.265	100	9	0.39	100	9	0.51	100	9	0.63	100	9	0.75	100	9	0.82	100	9	0.94	100	9	1.06	100	9	1.12	100	9	1.41	100	9									
	0.41	160	11	0.60	160	11	0.78	160	11	0.98	160	11	1.16	160	11	1.27	160	11	1.46	160	11	1.64	160	11	1.81	160	11												
	0.62	250	13	0.91	250	13	1.18	250	13	1.47	250	13	1.75	250	13	1.92	250	13																					
A-C (transite— asbestos cement)	0.32	100	41	0.46	100	41	0.56	100	40	0.62	100	39	0.72	100	38	0.74	100	38	0.83	100	37	0.95	100	37	1.06	100	37	1.24	100										
	0.41	150	44	0.53	150	43	0.63	150	41	0.83	150	42	0.96	150	41	1.11	150	41	1.23	150	41	1.47	150	42	1.64	150	42	1.98	150										
	0.41	200	44	0.66	200	45	0.81	200	45	1.02	200	45	1.18	200	44	1.38	200	44	1.57	200	44	2.09	200	45	1.98	200	45	2.81	200	45									
FRP (fiber reinforced epoxy)	0.07	225	17	1.11	250	16	0.14	225	16	0.18	225	15	0.21	225	15	0.26	225	15	0.29	225	15																		

a. Above 24 inches, see manufacturer

The procedure for determining penstock pressure rating (design pressure rating) is as follows:

1. Using the total design head determined earlier in Subsection 4.3, establish the static head on the penstock. From the relationship developed in Subsection 3.4.1 (1 foot of head = 0.433 psi), the static pressure can be determined by using Equation (4.5-1).

$$S = 0.433 \times h \quad (4.5-1)$$

where

S = static pressure in psi

0.433 = converts feet to psi

h = Design head in feet.

EXAMPLE: Assume that the head in Figure 4.5-1 is 325 feet. Use Equation (4.5-1) to find the static pressure in the penstock at the turbine.

$$S = 0.433 \times h$$

$$S = 0.433 \times 325$$

$$S = 141 \text{ psi.}$$

2. Using the penstock diameter previously established, select from Table 4.5-1 one (or more) potential pipe materials and select the t_w , P_R , and S_A factors for these materials.

NOTE: Select these factors for a pressure rating value (P_R) greater than the static pressure determined in Step 1 above. If the head is large, the pressure value should be significantly larger than the static pressure.

EXAMPLE: Assume a 14-inch pipe and static pressure of 141 psi. Select pipe materials from Table 4.5-1.

Steel: All have a P_R greater than 141 psi.

PVC: Not available.

PE: The P_R is above 141 psi for both 1.27 and 1.92 t_w , but only the 1.92, with a P_R of 250 psi, is significantly above 141 psi.

AC: The P_R is significantly above 141 psi only for the 1.38 t_w , with a P_R of 200 psi.

FRP: The 0.26 t_w has a $P_R = 225$ psi.

Therefore, consider the following pipe material and thickness:

Steel: $t_w = 0.25$, $P_R = 490$, $S_A = 50$

PE: $t_w = 1.92$, $P_R = 250$, $S_A = 13$

AC: $t_w = 1.38$, $P_R = 200$, $S_A = 44$

FRP: $t_w = 0.26$, $P_R = 225$, $S_A = 15$

3. For each pipe material selected, use Equation (4.5-2) to determine the penstock design pressure (P_d).

$$P_d = S + (S_A \times v) \quad (4.5-2)$$

where

P_d = penstock design pressure in psi

- S = static pressure in psi, from Equation (4.5-1)
- S_A = surge allowance factor from Table 4.5-1
- v = velocity of the water in the pipe in fps, from Figure 4.5-2 or 4.5-3.

NOTE: To use Equation (4.5-2), multiply S_A and v before adding to S.

EXAMPLE: From the previous example, S = 141 psi, and from Figure 4.5-4, v = 3.7; use Equation (4.5-2) to find the design pressure for the pipes to be considered.

$$P_d = S + (S_A \times v)$$

Steel: $P_d = 141 + (50 \times 3.7)$
 $= 141 + 185$
 $P_d = 326$ psi

PE: $P_d = 141 + (13 \times 3.7)$
 $P_d = 189$ psi

AC: $P_d = 141 + (44 \times 3.7)$
 $P_d = 303$ psi

FRP: $P_d = 141 + (15 \times 3.7)$
 $P_d = 196$ psi

4. The design pressure rating, P_R , must be greater than the P_d value for the material and wall thickness selected. If it is not, recalculate the design pressure using the next thicker wall, or select another material.

EXAMPLE: From Steps 2 and 3 above, the following is known:

Steel: $P_R = 490$ psi, $P_d = 326$ psi

PE: $P_R = 250$ psi, $P_d = 189$ psi

AC: $P_R = 200$ psi, $P_d = 303$ psi

FRP: $P_R = 225$ psi, $P_d = 196$ psi

Since the P_R is larger than the P_d for steel, PE, and FRP, these materials can be used. AC, with a P_R smaller than the P_d , cannot be used in this example.

For pipe materials and wall thicknesses not included in Table 4.5-1, you should contact the pipe supplier for the necessary information. The data from the supplier will probably list wall thickness as (t), design pressure as (P), and allowable surge pressure as (W).

4.5.4.3 Calculating Penstock System Head Loss. The next step is to calculate the total penstock head loss. The total losses are a function of both turbulence and friction.

Turbulence is caused by the intake structure and by bends and obstructions in the pipe. Turbulence factors can best be considered by adding equivalent pipe length to the overall length of the penstock to get the adjusted length (L_a). This can be done by the following steps:

- Multiply the number of 90 degree bends by 30 feet
- Multiply the number of 45 degree bends by 15 feet
- Add 15 feet for the entrance at the intake

- Add 100 feet for the turbine isolation valve
- Sum all the additions and add to the total penstock length.

EXAMPLE: From Figure 4.5-1:

0 each 90 degree bends
 5 each 45 degree bends
 5 x 15 = 75 feet
 Intake structure--15 feet
 1 turbine isolation valve--100 feet
 Total additions = 190 feet

The pipe length shown in Figure 4.5-1 is $336 + 150 + 328 + 87 = 901$ feet; $901 + 190 = 1,091$ feet. Adjusted length (L_a) = 1,091 feet

Friction losses are a function of pipe size, length, and material. The friction effect is accounted for with the pipe material correction factors shown in Table 4.5-2.

TABLE 4.5-2. FRICTION LOSS CORRECTION FACTOR (f_c)

<u>Pipe Material</u>	<u>Factor (f_c)</u>
Steel	1.16
PVC	0.77
PE	0.77
AC	0.87
FRP	0.77

To obtain the head loss due to turbulence and friction, multiply the adjusted penstock length (L_a) determined above by the material correction factor from Table 4.5-2. Multiply this number by the H_f factor previously determined from Figure 4.5-2 or -3 and divide the result by 100. This final number is the energy loss, in feet of head, for the flow, penstock length, and material selected. Use Equation (4.5-4) to determine total head loss.

$$h_1 = \frac{f_c \times L_a \times H_f}{100} \quad (4.5.4)$$

where

h_1 = head loss in feet

f_c = f_c friction loss correction factor from Table 4.5-2

L_a = adjusted length of penstock in feet

H_f = head loss factor from Figure 4.5-2 or 4.5-3.

EXAMPLE: From the previous examples:

$L_a = 1091$ feet

$H_f = 0.34$ (Figure 4.5-4)

From Table 4.5-2:

Steel: $f_c = 1.16$

PE: $f_c = 0.77$

FRP: $f_c = 0.77$

For steel pipe

$$h_1 = \frac{1.16 \times 1091 \times 0.34}{100}$$

$h_1 = 6.2$ feet

For PE and FRP

$$h_f = \frac{1.77 \times 1091 \times 0.34}{100}$$

$$h_f = 2.9 \text{ feet}$$

This loss must be subtracted from the site's available head. Since it is a friction loss, it will not be available to produce power.

EXAMPLE: If the pool-to-pool head at the developers site is 42 feet, the net effective head for the site is $42 - 2.9 = 39.1$ feet.

You must recognize that a number of pipe diameter and material combinations exist for transporting the desired flow from intake to turbine. The optimum pipe diameter tends to be a site-specific decision, and several alternative configurations should be evaluated. The following general suggestions may help with this evaluation.

- Penstock diameter (and cost) can be reduced until the maximum recommended velocity of 5 fps is reached. This will increase friction losses.
- Penstock friction (energy) loss can be reduced by increasing the diameter and therefore decreasing velocity. Offsetting costs may be realized if the reduced velocity reduces the pipe pressure class.
- Penstock friction loss can also be reduced by selecting alternative pipe materials having a lower loss coefficient.

The Category 2 developer may want to compare energy loss and pipe costs to arrive at an optimum pipe diameter.

NOTE: Higher friction in the pipe reduces the potential of freezing in the penstock. See Subsection 4.5.7.

4.5.5 Valves

During the life of the generating facility, it will periodically be necessary to stop flow to the turbine for maintenance and repair or to dewater the penstock for repair. Also, reaction turbines use valves to control flow and to prevent overspeed. For this reason, suitable valves or gates at either end of the penstock should be incorporated into the development plans.

Various types of valves can be used. For gates in canals or on corrugated metal pipe, slide gates are ideal (Figure 4.4-8). Butterfly valves work well at either end of the penstock. Figure 4.5-5 is a photograph of a butterfly valve body and disc, and Figures 4.5-6 and 4.5-7 present drawings of butterfly, gate, ball, and globe valves.

4.5.5.1 Penstock Intake. As discussed in the Intake subsection (4.4), a slide gate or butterfly valve can be incorporated into the structure at the intake of the penstock. The penstock inlet downstream from the valve must be open to the atmosphere to prevent the formation of a vacuum during penstock dewatering. This can also be a part of the inlet design, or an air admission valve can be added. This could consist of an open vent stand-pipe with the top elevation higher than the water surface at the forebay (Figure 4.4-13).

4.5.5.2 Penstock Upward Slope. At any point on the penstock where a high point exists, (that is, where the pipe has an upward slope) an air release valve should be installed. Similarly, a drain must be installed at any low point. Use Table 4.5-3 for approximate sizing of the air valves.

TABLE 4.5-3. SIZING OF AIR VALVES

<u>Valve Diameter (inches)</u>	<u>Maximum Penstock Flow (cfs)</u>
1	Up to 4
2	Up to 8
3	Up to 15

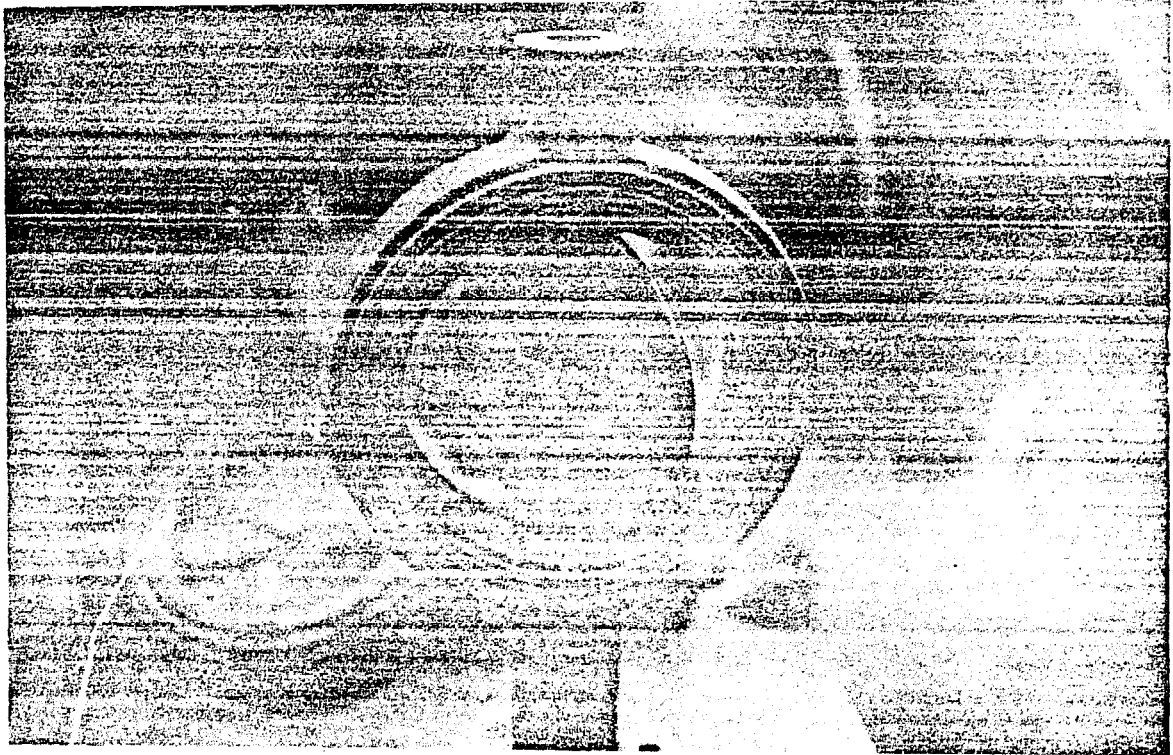
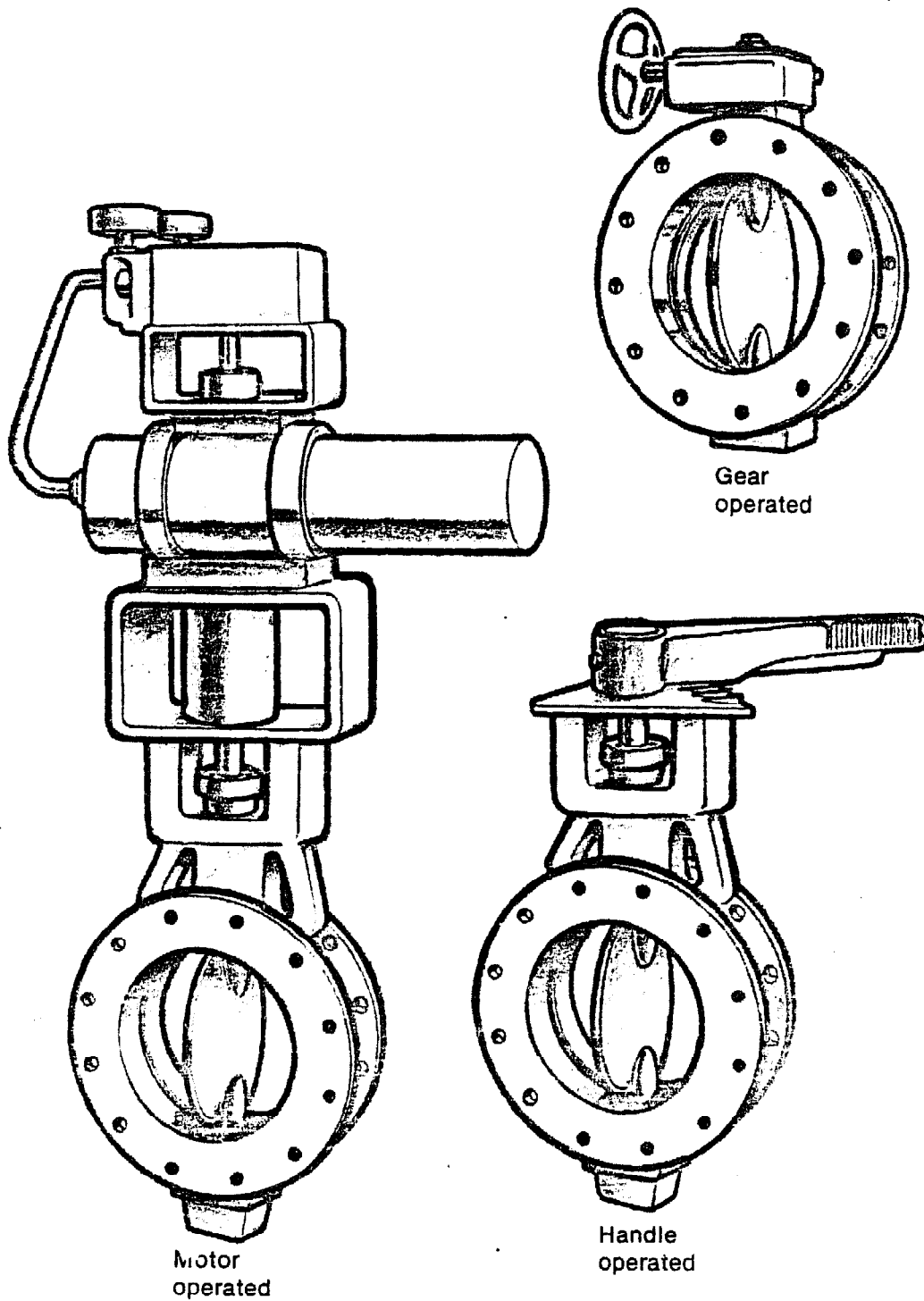

Figure 4.5-5. Butterfly valve body and disk.

4.5.5.3 Turbine Isolation Valve. At the lower end of the penstock, an isolation valve is required for stopping flow to the turbine. The turbine isolation valve should be connected (flanged) to the turbine to permit disconnecting the turbine from the penstock. The valve could be any one of a number of gate valves, globe valves, ball valves, or butterfly valves. However, the head loss is greater in a globe valve. The least expensive of these options are the butterfly and gate valves. The valve should be the same size as the penstock and have a pressure rating above the design pressure previously determined for the penstock.

The butterfly valve is the most common in microhydropower use. A significant characteristic of the butterfly valve is its relatively quick rate of closure. Some reaction turbines use the isolation valve to prevent turbine overspeed. To accomplish this, they take advantage of the quick



INEL 2 2327

Figure 4.5-6. Butterfly valves.

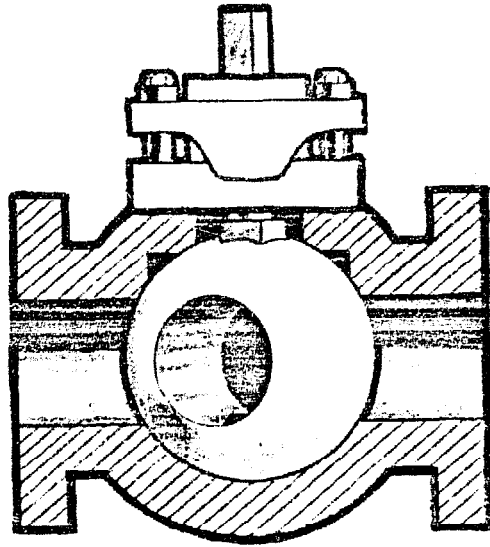

Ball valve

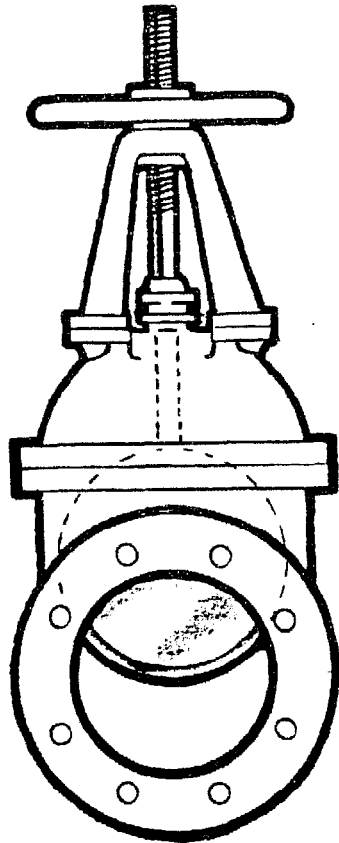

Gate valve

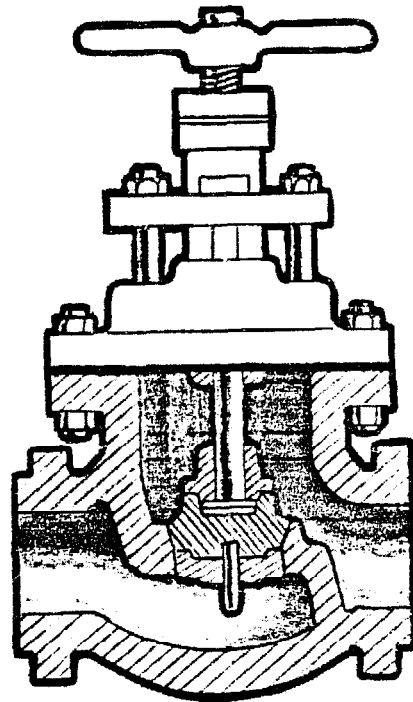

Globe valve

INEL 2 2326

Figure 4.5-7. Ball valve, gate valve, and globe valve.

closing characteristics of the butterfly valve. When this is done, some other means must be designed into the penstock to eliminate surge pressure on the penstock. If no method is provided to eliminate surge, care must be taken to close the valve slowly. Providing a geared, motor-operated valve with backup power supply and with slow closure rate will reduce the potential for creating excessive surge pressures.

Surge pressure can create havoc with a penstock. It can cause a pipe to jump and send a wave of pipe movement up the length of the penstock. If the pressure is high enough, the penstock will rupture and cause other damage or even injury.

CAUTION: The water will actually force a butterfly valve closed after it is halfway closed; therefore, be very careful if you plan to use a handle type actuator (Figure 4.5-6). The handle has flown out of the hand of more than one unsuspecting operator. And, of course, a valve that is slammed shut will create surge pressure.

Many clever and innovative systems can be worked out to prevent surge pressure. Figure 4.5-8 is a drawing of such a system. An extension arm is welded on to the handle of the valve. In the open position, the handle is suspended by a solenoid hook or pin from the power house ceiling. A weight is attached to the handle to pull the handle down when the solenoid is released. The falling weight causes the handle to close the valve until the water pressure begins to assist in the closure. At that point, the shock absorber takes over and prevents the valve from slamming shut. Another approach is to prevent the surge pressure by opening other valves at the same time as the isolation valve is closed. Solenoid-operated valves that fail open can be used in place of the purge valve shown in Figure 4.5-9. When the generator loses its load and stops generating energy, the solenoid valve opens as the isolation valve closes. The solenoid valve should be at least half the size of the penstock.

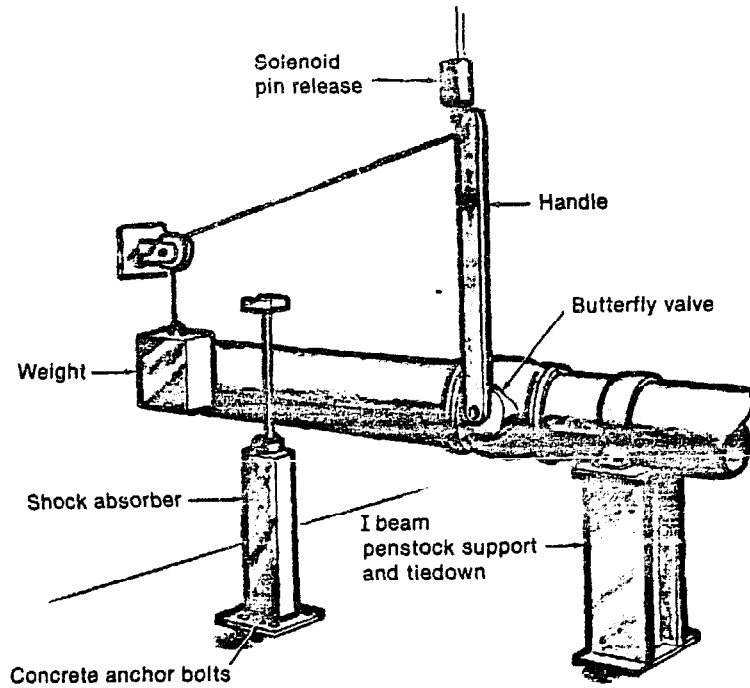

INEL 2 2353

Figure 4.5-8. System to prevent surge pressure.

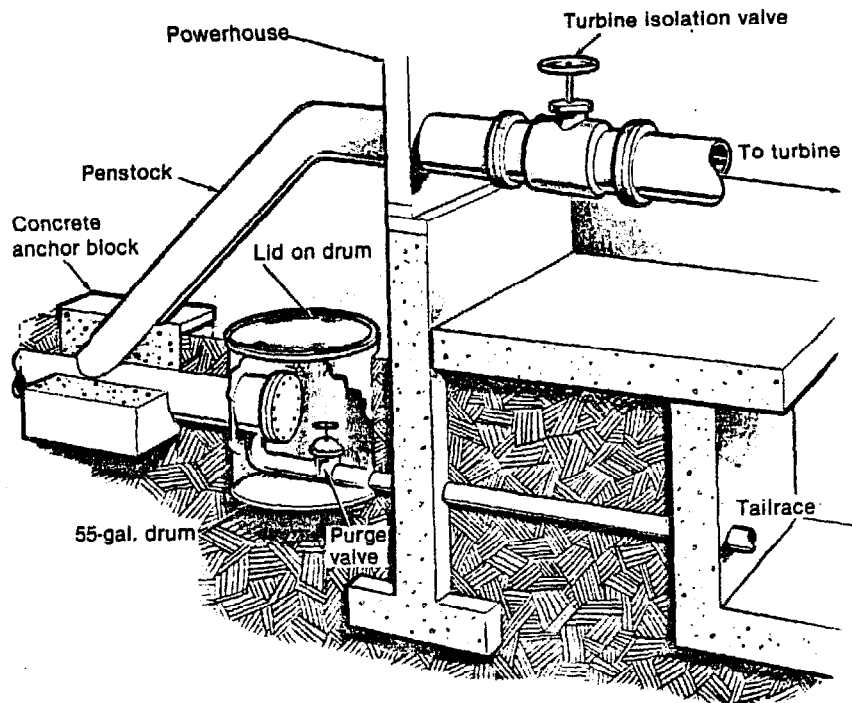

INEL 2 1370

Figure 4.5-9. Arrangement showing turbine bypass "Y" and purge valve.

Another possibility with low head is a standpipe at the lower end of the penstock. The pipe can either be opened to the atmosphere or sealed with air in the pipe under pressure. The air in the pipe will act as a shock absorber for the surge pressure. If the pipe is sealed, provision should be made to check the water level in the pipe, since the air pocket may have to be replaced periodically. The air will be absorbed into the water over long periods of time. Also, standpipes have a tendency to freeze in the cold months because the water is stagnant. If a standpipe is used, heaters and insulation should be added to keep the water from freezing.

4.5.5.4 Turbine Bypass "Y". Figure 4.5-9 shows two additional recommendations for penstocks. To reduce the possibility of getting foreign material into the turbine, it is advisable to make a "Y" connection off the main penstock and have the turbine branch of the penstock above the bypass. To keep the turbulence of the "Y" out of the turbine, place the "Y" at least 10 pipe diameters above the turbine, e.g., place a 14-inch pipe 140 inches above the turbine.

The second recommendation for the "Y" is a purge valve. This would consist of a 4- to 6-inch valve on a tee near the lower end of the bypass. In the case of the figure, the purge valve and the blind flange on the penstock are housed in a partially buried 55-gallon drum cut to fit. The drum with lid acts as a manhole and can help prevent freezing of the valve. This valve is piped to discharge into the tailwater and serves several functions. Among these are:

- A "blowoff" cleanout for silt or sand that has been carried down the penstock.
- A bypass valve to maintain flow in the penstock if the turbine is shut down (for example, to prevent freezing).

CAUTION: The water in the penstock is under pressure. The purge valve and discharge pipe must be anchored. In addition, the discharge pipe should be directed into the tailrace. If a reaction turbine is used,

the discharge should be into the tailrace pool of water below the draft tube. The water in the pool will help to dissipate part of the energy. You can never be too careful when dealing with a pressurized penstock. Remember, there is more potential energy in a penstock than the electrical energy that the generator generates, and both can be very dangerous when not handled correctly.

Figure 4.5-10 is a photograph of a purge valve in operation.

4.5.5.5 Turbine Flow Control Valve. Control of flow to the turbine is usually a feature of the turbine package. If the rate of flow to the turbine is to be controlled (to control speed and generator output), this is typically accomplished by means of wicket gates on a Francis turbine, needle or spear valves on Pelton and Turgo turbines, and control gates on a

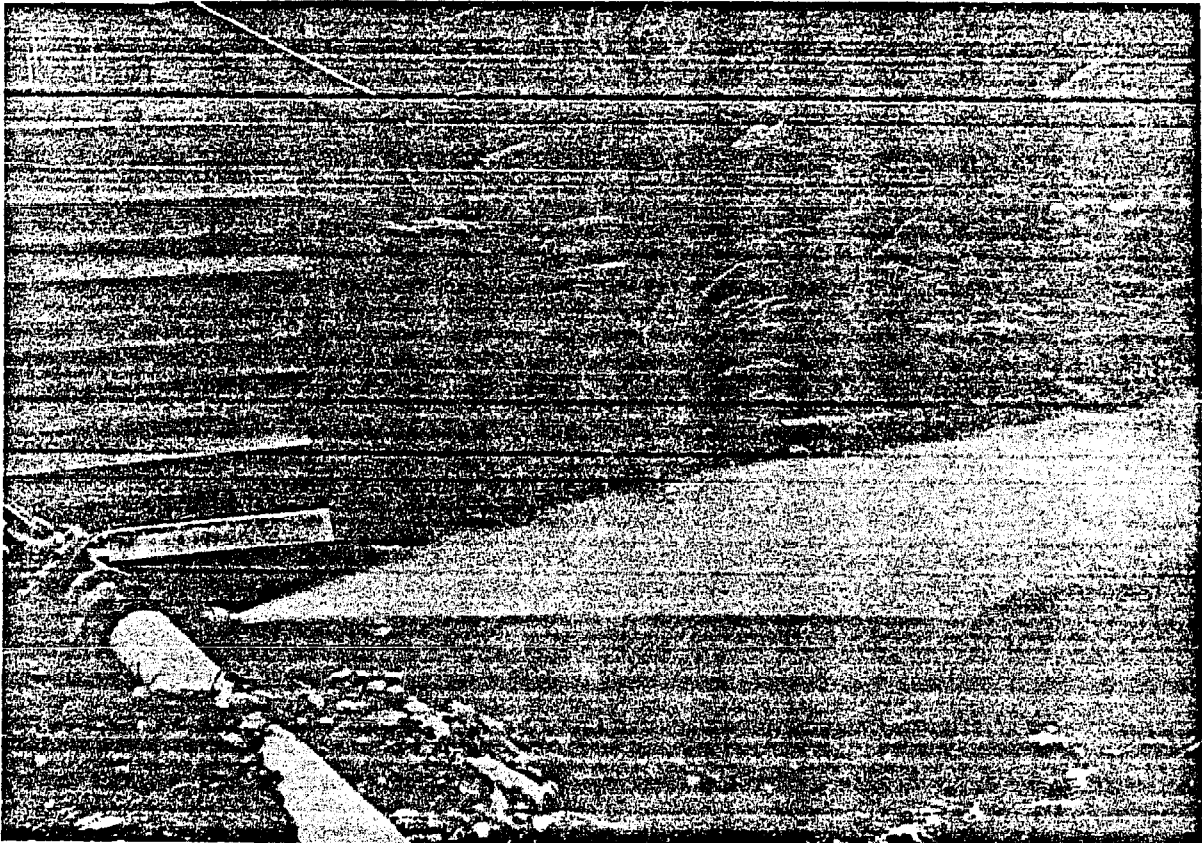

Figure 4.5-10. Purge valve in operation.

cross-flow turbine (see Figure 4.5-11). These valves and their associated governors are integral parts of the turbine unit and are provided by the turbine manufacturer.

Other turbines such as pumps used as turbines do not lend themselves to flow control. The best alternative is a load diverter where a constant flow is applied to the pump and the diverter controls the turbine speed (see Subsection 4.8).

4.5.6 Siphon Penstock

The siphon penstock is a good option where the lift is small and no other method is easily available to transfer the water to the turbine. If you plan to use a siphon penstock (see Figure 2-13), the hydraulic considerations already discussed (velocity and friction head losses) apply. Additional considerations include a means of starting the siphon. In order to start a siphon, the penstock must be completely full of water when the lower downstream valve is opened. For small diameter penstocks, a foot valve on the suction end can be used. For larger diameter penstocks, some form of automatic priming device must be used. A partial vacuum is drawn on the high point of the penstock until the pipe is filled with water. Once the penstock is filled, the water will start flowing to initiate the siphon action.

The maximum theoretical height to which a siphon can raise water at sea level is 34 feet. As a rule of thumb, the maximum practical lift a developer should design to is 20 feet at sea level. This lift could be even less at high elevations or when using siphons with high friction losses. At an elevation of 5000 feet, for instance, the maximum theoretical lift is 28 feet instead of 34 feet. With friction losses, the practical lift will be less than 20 feet. If you feel that a siphon penstock is the best choice for your site and you are not familiar with fluid flow calculation techniques, you should seek professional help for the design.

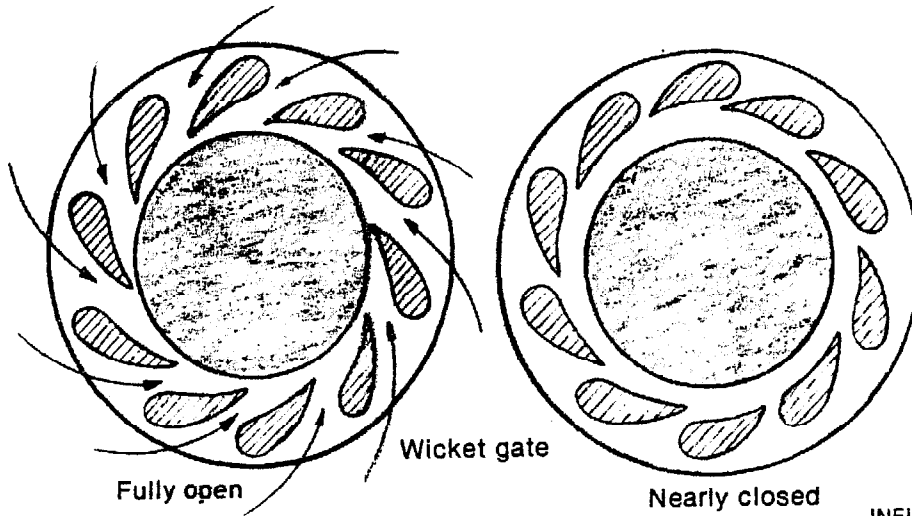
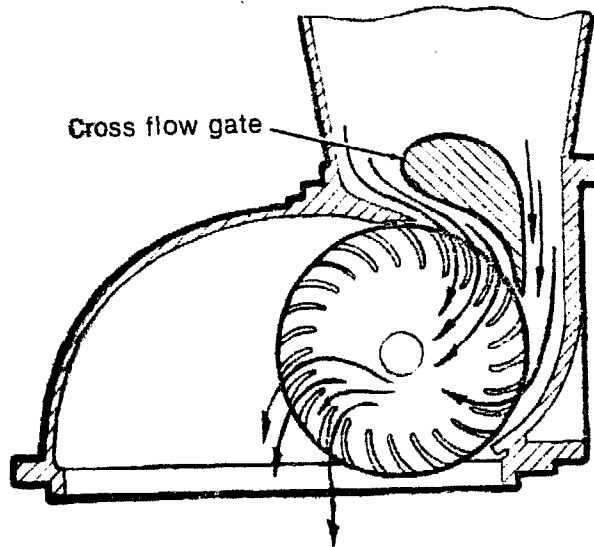
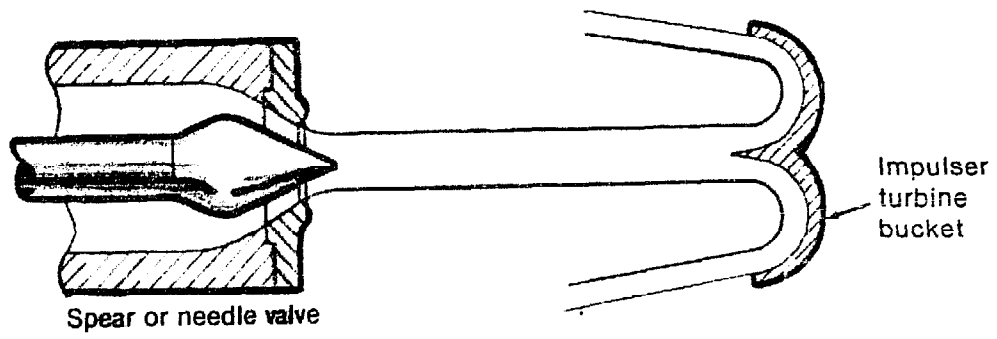

INEL 2 2354

Figure 4.5-11. Types of turbine flow control valve.

In climates where the temperature occasionally drops below zero, the exposed portion of the penstock should be protected from freezing. The pressure at the top of the penstock is less than the atmospheric pressure and thus raises the freezing temperature of the water. A coat of spray-on insulation should suffice.

A rule of thumb in siphon penstock design is to keep the lift to a minimum. In other words, go no higher than absolutely necessary to clear the obstacle you wish to cross. This keeps the low (negative) pressure in the penstock to a minimum. If the lift is much over 2 or 3 feet and the penstock is large, some type of pipe stiffening is advisable. The stiffening can be ribs welded along the length of the pipe. They will help prevent the penstock from collapsing under the negative pressure.

In selecting a location for the penstock, try to locate it so that flood waters will have the least amount of effect on the penstock. If possible, design some type of protection around the pipe.

Some siphon penstocks have the upstream pipe flared out in a cone shape to reduce entrance head losses and the formation of vortices, which cause unstable turbine operation.

4.5.7 Additional Design Considerations

In addition to the specific design considerations--keeping the penstock as straight and short as possible; maintaining a continual downward grade; and using the proper pipe diameter, wall thickness, and material--other items such as thrust or pressure that tends to separate the pipe, thermal expansion, pipe span, pipe support, ultraviolet degradation, and freezing must be considered. Whether the penstock is above or below ground makes a difference on how these secondary considerations are handled.

4.5.7.1 Hydrostatic Thrust. From a safety standpoint, the most significant aspect of penstock design is the restraint of the pipe. Hydrostatic thrust will cause a penstock to move (crawl) and can even separate

joints. The thrust is the reaction of a pressurized penstock to changes in flow direction or to outlet nozzles. For example, a garden hose with water flowing through a nozzle will move about freely if not held. Likewise, a 6-inch, 90-degree elbow with a 200-foot head will be subject to a force of nearly 3,500 pounds that tends to pull the elbow away from the connecting pipes. The following formula defines this thrust load for pipe bends.

$$T = 1.57 \times S \times D_p^2 \times \sin \frac{\theta}{2} \quad (4.5-5)$$

where

T = thrust in pounds

S = static pressure in psi, from Equation (4.5-1).

D_p^2 = pipe diameter squared (multiplied by itself), in inches squared

$\sin \frac{\theta}{2}$ = trigonometric function, where θ is the angular change in direction; for a 45-degree bend, $\sin \frac{\theta}{2} = 0.38$, and for a 90-degree bend, $\sin \frac{\theta}{2} = 0.71$.

EXAMPLE: Assume a 6-inch pipe diameter, a 200-foot head, and a 90-degree bend. Find the thrust at the bend.

First, use Equation (4.5-1) to convert head to static pressure.

$$S = 0.433 \times h$$

$$S = 0.433 \times 200$$

$$S = 86.6 \text{ psi}$$

Now, From Equation (4.5-5)

$$T = 1.57 \times S \times D_p^2 \times \sin \frac{\theta}{2}$$

For a 90-degree bend, $\sin \frac{\theta}{2} = 0.71$. Therefore,

$$T = 1.57 \times 86.6 \times 6 \times 6 \times 0.71$$

$$T = 3475 \text{ lbs.}$$

To resist this thrust, you will either have to use restrained joints (glued PVC or welded steel) or push on or unrestrained joints with thrust blocks. Above-ground penstocks must always use restrained joints. Buried, unrestrained joints must include thrust blocks. A thrust block is a poured-in-place concrete mass bearing on the side of the trench to prevent movement of the pipe. Figure 4.5-12 shows a typical thrust block.

To design a thrust block, you must determine the area (A_t) that pushes against the undisturbed side of the trench. In Figure 4.5-12, it is the height (h_t) times the width (W_t). Table 4.5-4 provides a basis for finding the area required for the thrust block.

TABLE 4.5-4. AREA OF BEARING FOR CONCRETE THRUST BLOCKS

Pipe Size (inches)	45-degree Bend (area in ft ²)	90-degree Bend (area in ft ²)	Tee, Plug, and Cap (area in ft ²)
4	2	2	2
6	3	5	4
8	3	8	6
10	5	13	9
12	7	18	13
14	10	25	18
16	18	32	23

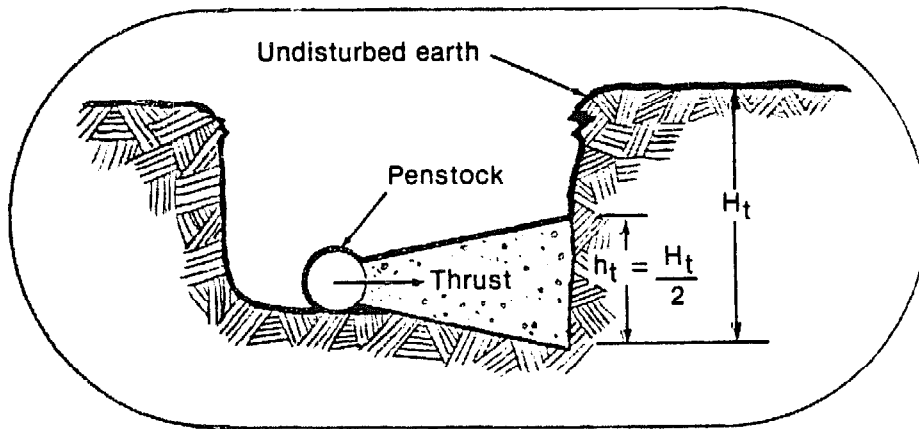
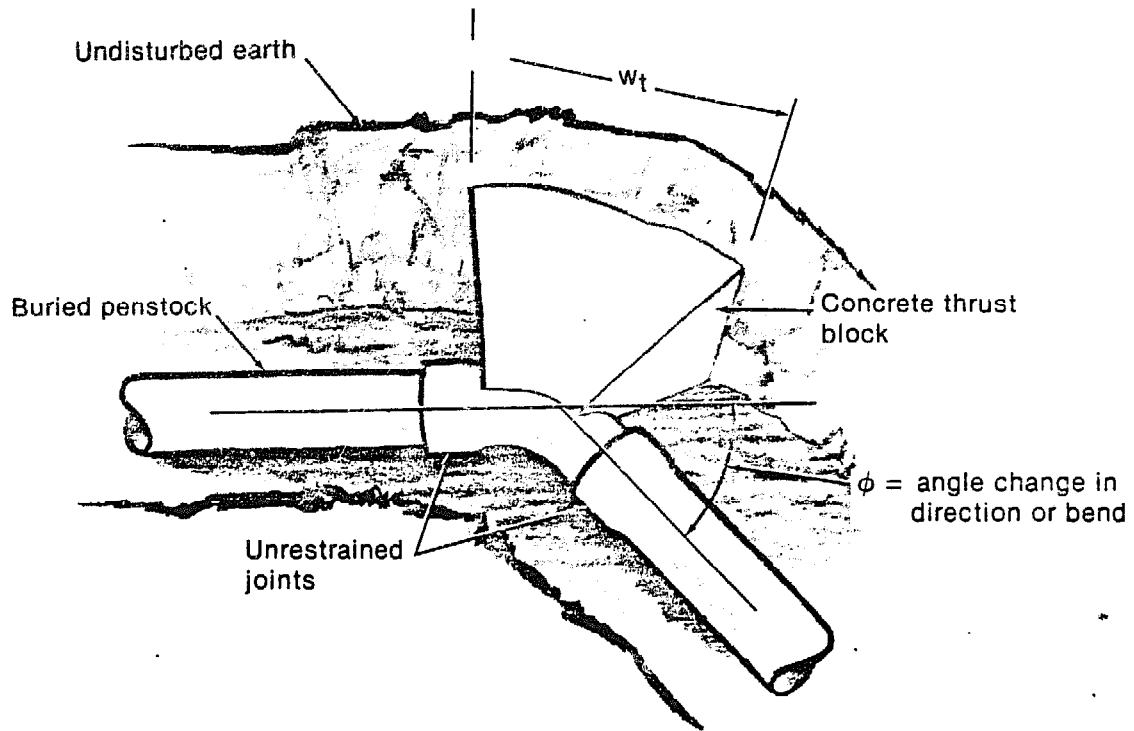

INEL 2 2316

Figure 4.5-12. Typical thrust block.

To allow for soil condition, the areas given in Table 4.5-4 should be multiplied by the appropriate factor from Table 4.5-5.

EXAMPLE: Assume a 6-inch pipe with a 90-degree bend. Find the bearing area (A_t) of the thrust block when buried in sand and gravel.

From Table 4.5-4, the area is 5 ft².

From Table 4.5-5, the multiplier is 1.33.

Therefore, $A_t = 1.33 \times 5$

$$A_t = 6.65 \text{ ft}^2 .$$

Now that the area is known and the height is set by half the depth of the trench, the width (W_t) can be computed.

$$W_t = \frac{A_t}{h_t} \tag{4.5-6}$$

TABLE 4.5-5. SOIL CONDITION MULTIPLIERS

Soft clay	4
Sand	2
Sand and gravel	1.33
Shale	0.4

where

W_t = width of the thrust block in feet

A_t = area of the thrust block in ft^2

h_t = height of the thrust block, equal to half the depth of the trench in feet

EXAMPLE: Assume that the trench is 4-feet deep; find the width of the thrust block if the area is 6.65 ft^2

$$h_t = \frac{4}{2} = 2 \text{ feet.}$$

From Equation (4.5-6)

$$W_t = \frac{6.65}{2}$$

$$W_t = 3.33 \text{ feet, or 3 feet 4 inches (12 x 0.33 = 4 inches)}$$

4.5.7.2 Thermal Expansion and Contraction. The penstock will most likely be continuously full of water at a relatively constant temperature. Temperature changes that occur due to a drained pipe or extreme climatic conditions will cause expansion or contraction of the pipe. PVC pipe will expand (contract) at the rate of 0.36 inches per 100 linear feet for every 10°F temperature change. For steel, the expansion coefficient is 0.08 inches per 100 linear feet per 10°F . This means that a 1000-foot PVC penstock will increase in length by about 4 inches for a temperature change of 10°F . In some cases, deflection at elbows will accommodate this change. If larger temperature changes are anticipated, care should be taken in the routing and anchoring of pipes. (Consult the pipe supplier for assistance in this case.)

4.5.7.3 Pipe Spans and Support. The maximum unsupported span for a PVC pipe is from 6.5 feet for a 6-inch diameter pipe to 8 feet for a 12-inch diameter pipe. For steel pipe, the maximum span should be limited to about 15 feet for the smaller diameters and 25 feet for anything over a 14-inch pipe. The pipe should be allowed to expand and contract longitudinally (due to temperature changes) at the supports without abrading or cutting the pipe material. Figure 4.5-13 shows a typical concrete support saddle for above ground piping. If the pipe is layed on the ground, assure that the soil under the pipe is free of rock and debris and that the soil is firmly packed to support the pipe. The sides of the pipe should be bermed to keep surface water from eroding the soil underneath.

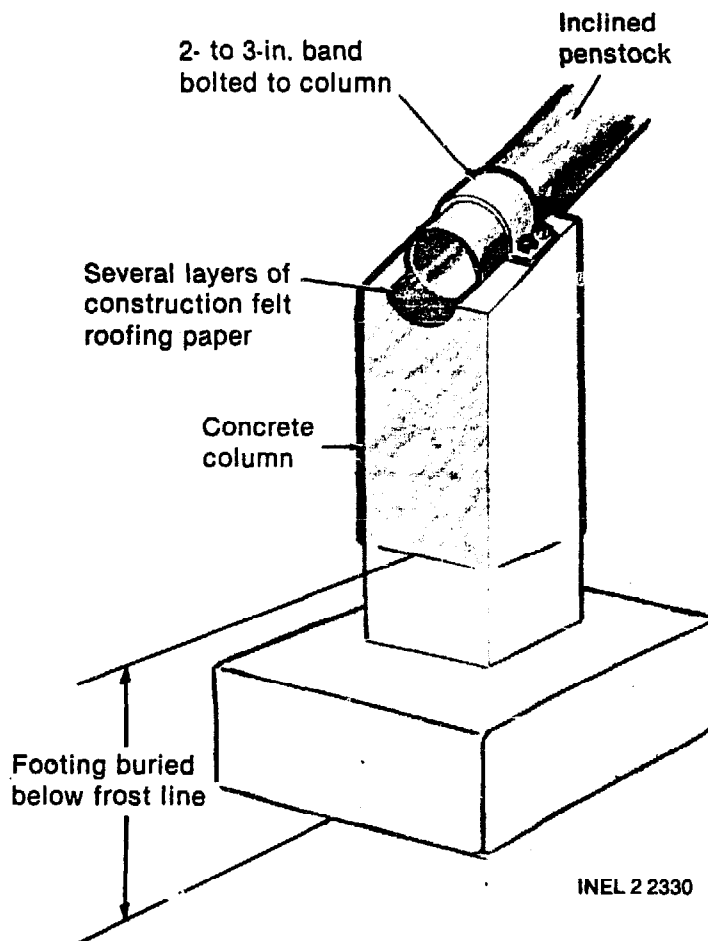

Figure 4.5-13. Typical concrete support saddle for above-ground piping.

4.5.7.4 Ultraviolet Degradation. PVC is susceptible to damage by sunlight, and above-ground use of PVC pipe in areas exposed to direct sunlight is typically not recommended unless the pipe is painted or otherwise covered. Below ground, PVC is good for 10 to 15 years.

4.5.7.5 Penstock Anchoring. If the penstock is more than 100 feet in length, it should be anchored. To anchor a penstock, a mass of concrete can be poured around the pipe. Before pouring the cement, coat the pipe with a material similar to tar and wrap with several layers of felt roofing paper. A rule of thumb is a yard of concrete for each 12 inches of pipe diameter; therefore, a 12-inch pipe would have a 3 ft x 3 ft x 3 ft block of concrete for an anchor.

The primary location for the anchor is just before the penstock enters the powerhouse (Figure 4.5-9). The anchor restricts movement of the penstock at the powerhouse, avoiding the possibility of the penstock separating from the turbine and eliminating loads on the turbine casing. The installation of the anchor is an important additional safety factor to prevent penstock failure because of movement of the penstock.

For long runs of above-ground pipes on steep slopes, intermediate anchors should be provided to reduce pipe stresses from the weight of the pipe and water. The anchor block should be firmly attached to the slope so that its weight will not add to that already on the pipe.

4.5.7.6 Freezing. A hydropower system does not produce energy. Rather, it transfers energy from one form to another. If water flows down a stream from Point A to Point B, the water has dissipated the same amount of energy that you can recover in a turbine.

In a free stream, energy is dissipated in the form of heat. Heat is generated by the friction of water within itself and with the stream bed. Likewise, if the water is piped from A to B, the friction between the water and the pipe will generate a certain amount of heat. The less the friction, the less the heat generation, and conversely, the more the friction, the more the heat. An old steel pipe with riveted sides has a lot of friction

and will very seldom have a freezing problem. PVC, on the other hand, has a very low friction factor, and ice will usually build up in the pipe in freezing temperatures. If your site is in the mountains or in the northern half of the U.S. and you plan to use PVC, you should consider burying the penstock to reduce or eliminate the freezing problem.

If for some reason flow in the penstock must be stopped in the winter, drain the penstock or use the purge valve to keep some water flowing.

4.5.8 Design Layout

After you have decided on the type and length of penstock, make a sketch or sketches of the system. If earthwork or concrete is involved, calculate the volume as in Subsection 4.4.4. Be sure to include all valves and other associated equipment required to make the system functional.

4.6 Powerhouse

It should be noted that not all hydropower plants will require a powerhouse. Projects using a "bulb" turbine will have the turbine-generator package located directly in the water. In these cases, space should be provided only for the location of the electrical switchgear. Other turbine units may be designed for outdoor installation of the generator and switch gear.

The purpose of a powerhouse is to house the turbine-generator set and electrical components. The powerhouse protects the equipment from the elements, limits access for safety and security, and provides space to maintain and service the mechanical and electrical equipment. The powerhouse should be constructed to fit the equipment. Consequently, the equipment should be selected before the powerhouse is planned. Some powerhouse details will be supplied by the turbine-generator manufacturer.

The location of the powerhouse depends on the local site conditions. A Category 1 developer who has sufficient head and flow may decide to locate the powerhouse next to the load source and thus reduce the transmission distance. Since the powerhouse is generally located adjacent to the stream it should be located above the high water mark of the stream or flooding will result during spring runoff. If the high water mark results in the house being too far above the stream (so that the vertical distance from the house to the stream is not available as head to an impulse turbine), then the house can be set lower and a long tailrace used so that the elevation of the floodwater at the tailrace exit is lower than the powerhouse, as shown in Figure 4.6-1. Or, you can use a reaction turbine with a draft tube installed as discussed in Section 4.1.6, which will allow the turbine to be set higher and still use the head.

The physical orientation of the powerhouse should be set to keep the penstock straight. A straight penstock is much more important than a perpendicular powerhouse parallel to the stream. Notice the location of the powerhouse in the sketch in Figure 4.6-1.

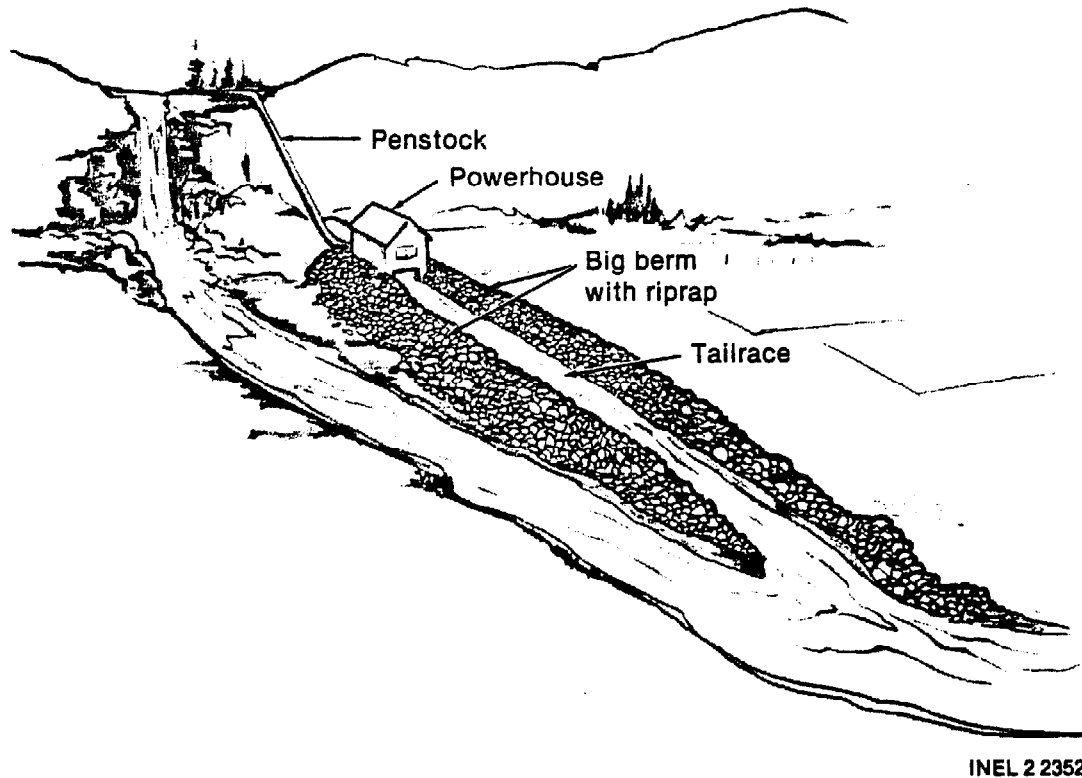

Figure 4.6-1. Powerhouse installation with long tailrace.

4.6.1 Physical Features of the Powerhouse

The powerhouse must be designed to accommodate the equipment and provide adequate room for personnel to work on it. Detailed powerhouse requirements can only be obtained from the equipment manufacturer. Powerhouses can be constructed of wood (Figure 4.6-2), metal (Figure 4.6-3), or masonry depending on the availability and cost of material. In all cases, the footings, foundation, floor slab, and equipment pad should be constructed of concrete.

The powerhouse should include an opening or access for the penstock to connect to the equipment and an opening for the water to exit the powerhouse in the tailrace. Other accesses or openings may be:

- A door large enough to handle the largest single item. The dimensions of the various components can be obtained from the manufacturer. The door should have a lock to control access.

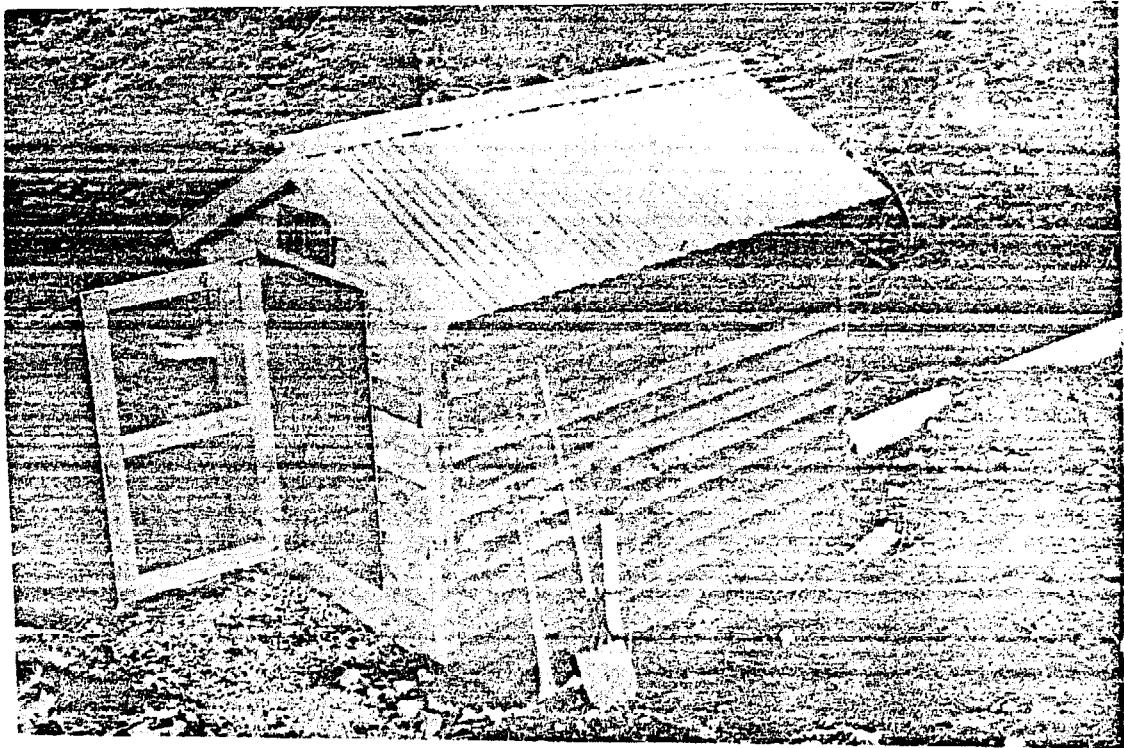

Figure 4.6-2. Wooden powerhouse.

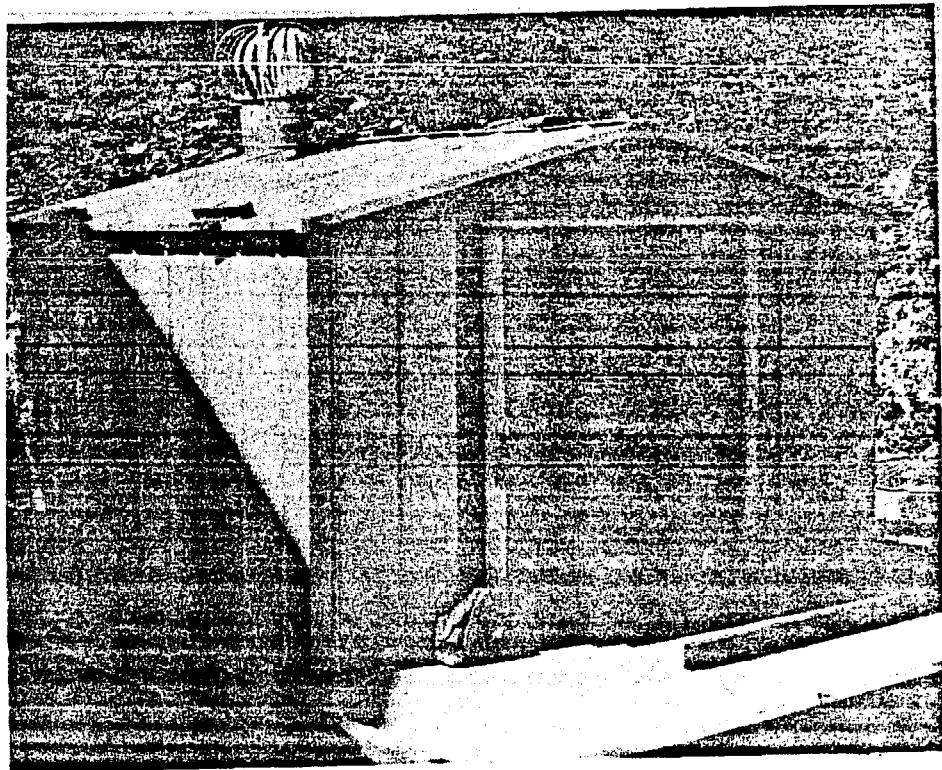

Figure 4.6-3. Metal powerhouse.

- Windows, louvers, and roof vents to provide good cross-ventilation for temperature control and removal of dampness. Since most generators are designed to operate in a temperature range of 20 to 100°F, the number and size of ventilation openings should be adjusted to the climate.
- Conduits for electrical wires to allow the connections between the control equipment in the powerhouse and the distribution lines outside the powerhouse.
- Floor drains to allow water from leaks, condensate, or repair and maintenance activities to drain from the building.
- Small pipe openings for piping or tubing since some generators may be water cooled.

The powerhouse should include other features such as lighting and electricity. Thought should be given to how equipment can be installed and removed. It may be worth while to incorporate a beam into the powerhouse structure for this purpose. A temporary "A" frame structure or oversized doors to allow a forklift to enter could accommodate equipment placement without a beam. Figure 4.6-4 illustrates some of the typical features of the powerhouse. The illustration shows a turbine with a draft tube. If the turbine is an impulse turbine, the draft tube will not be included. The draft tube must discharge below the water level. The tailrace can be equipped with a weir to provide a pool of water for discharge of the the draft tube. The weir can be a simple metal plate slipped into an angle iron frame bolted to the precast concrete tailrace wall (Figure 3.9). See Subsection 4.7 for the design and size of the tailrace.

4.6.2 Powerhouse Size and Dimensions

The powerhouse should be sized for sufficient and safe clearance around the turbine and generator equipment. Once the size of the turbine-generator set is known, it is recommended that the minimum

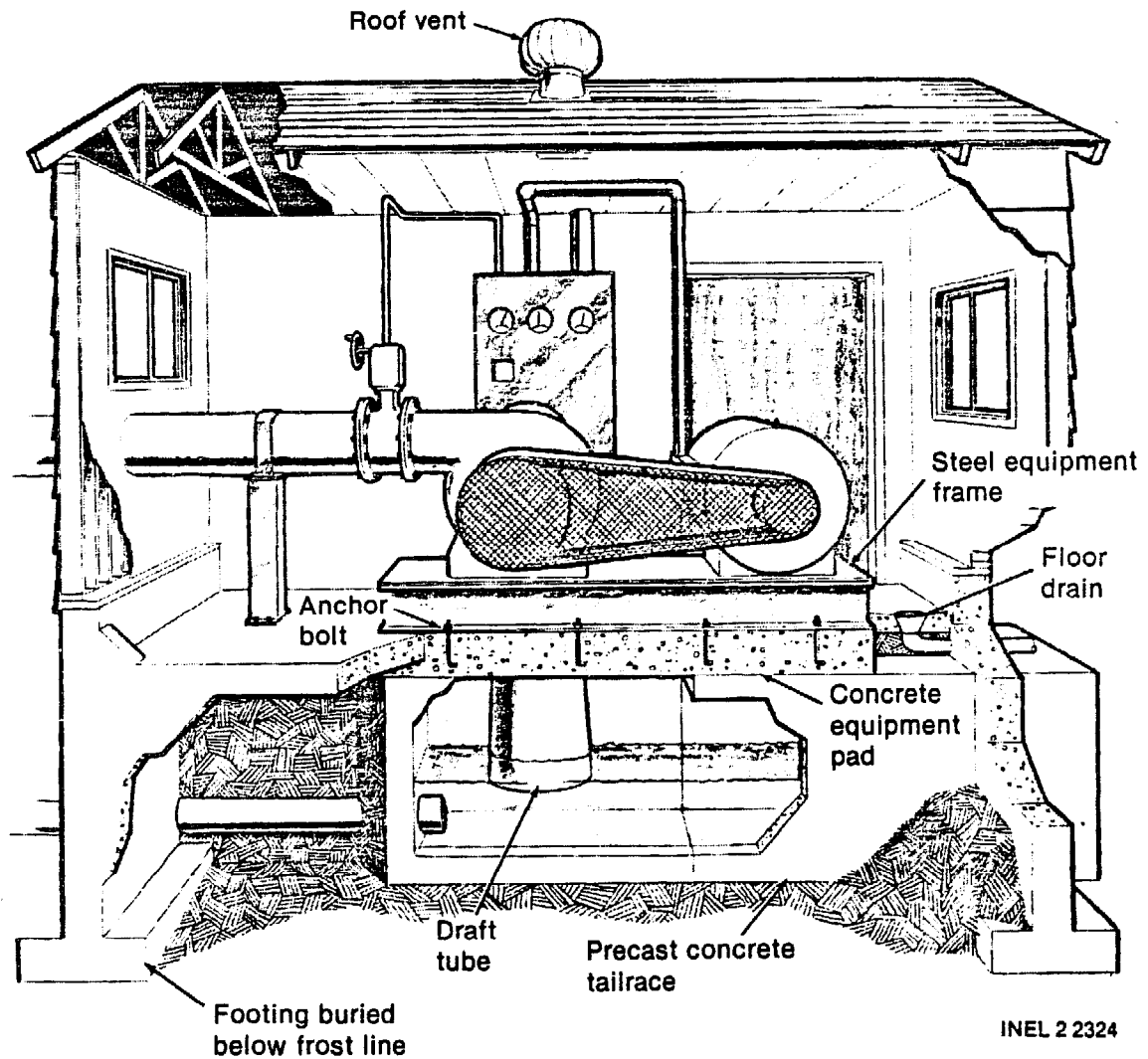

Figure 4.6-4. Typical powerhouse.

powerhouse width be at least two times the equipment width and the length be at least three times the equipment length. Additional considerations would be storage space for spare parts and space for repairs and maintenance. The inside height should be sufficient to allow movement while standing.

4.6.3 Minimum Powerhouse Standards

The powerhouse should be a weathertight enclosure with a strong roof structure to handle snow and rain. The building should be locked to discourage theft and vandalism. The concrete used in the construction

should have a strength of at least 3000 psi. If ready-mix concrete is ordered, specify the maximum strength. The floor level should be at least 1 foot above the highest maximum water level of the tailrace.

4.6.4 Location and Mounting of the Equipment

A concrete pad is necessary to mount the turbine-generator equipment or the metal equipment frame. Equipment mounting specifications, details, and requirements must be obtained from the equipment manufacturer to plan for the construction of the mounting pad. The pad serves as a base for mounting the equipment and as a mass (dead weight) to dampen the vibration created by rotating machinery. The weight of the concrete pad should be at least two times the weight of the equipment plus the weight of the water in the turbine. Once the weight of the equipment and water has been determined, the size of the pad can be determined since concrete weighs approximately 110 pounds per cubic foot. To support any equipment, the concrete pad should be at least six inches thick. To support heavy equipment (more than 2000 pounds) the thickness of the pad should be increased.

EXAMPLE: Assume that the weight of equipment plus water is 1000 pounds

$$\text{Weight of concrete} = 2 \times 1000 = 2000 \text{ pounds}$$

$$\text{Amount of concrete} = 2000 \text{ lb} \div 110 \text{ lb/ft}^3 = 18 \text{ ft}^3$$

$$\text{Size of 6-inch-thick pad} = 18 \text{ ft}^3 \div 0.5 \text{ ft} = 36 \text{ ft}^2$$

The 36-square-foot, 6-inch-thick pad should be made to match the length and width of the equipment. For example, if the length and width of the equipment is basically square, then the pad should be square, or in this case 6 x 6 feet.

Normally, the equipment pad should be placed on compacted soil or rock and poured separately from the floor pad. Expansion joints should be placed between the equipment pad and floor pad. This will minimize the

transfer of vibration into the floor pad and building. It will be necessary to use reinforced steel bars in the equipment pad to maintain the integrity of the concrete. The reinforcing should be at least Number 4, located 12 inches on center each way. To aid the grounding of the generator, the reinforcement should be welded together and a lead brought out for a ground attachment.

The turbine package will be bolted directly to the equipment pad with bolts. These bolts can be cast into the pad as it is poured or welded to an angle iron cast into the concrete. The arrangement and spacing of the bolts must match the holes drilled in the equipment frame see Subsection 5.3.2.

Electrical panels are generally mounted on the wall, high enough from the floor so that flooding will not cause serious damage.

4.6.5 Powerhouse Costs

The average material costs per square foot of building space for a typical powerhouse as discussed in this section are shown in Table 4.6-1.

TABLE 4.6-1. POWERHOUSE COSTS

Item	Costs per Square Foot of Building ^a ($\$$)
<u>Concrete</u> --Includes footings, foundation, equipment pad, floor, and tailrace under powerhouse	5.00
<u>Building Structure</u> --Based on wood frame with metal exterior includes walls and roof	5.00
<u>Miscellaneous</u> --Includes door, windows, vents, and electrical equipment	<u>2.00</u>
TOTAL MATERIAL COSTS PER SQUARE FOOT OF BUILDING	12.00

a. 1982 dollars.

A 10- x 12-foot building would contain 120 square feet of building space. The average material costs for this powerhouse would be $120 \times \$12$ per square foot = \$1440.

If the powerhouse is constructed by a building contractor, the average cost per square foot of building will be twice the material costs. In this example, $120 \times \$24$ per square foot = \$2880. Costs may vary depending on the site location and availability of local material and labor.

These costs are for the powerhouse structure and do not include costs for the penstock, turbine-generator, control equipment, and any tailrace beyond the powerhouse. These costs are covered in the appropriate sections.

4.6.6 Design Layout

Once the size of the powerhouse is determined, sketch the layout of the powerhouse on a sheet of graph paper.

4.7 Tailrace

A tailrace is a canal or conduit that carries water from the powerhouse to the next desired location (usually back into the stream).

4.7.1 Size of the Tailrace

The tailrace should be large enough to carry the design flow. The velocity in the tailrace can be 2 fps. In parts of the country where fish migration is a consideration, the velocity at the tailrace exit should be reduced to less than 0.5 fps. Migrating fish will be attracted into the tailrace if the velocity is too high.

For sizing the tailrace for 2 fps, refer to section on power canals, Subsection 4.4.2.2. The power canal and tailrace will have the same cross-sectional area. Note that the slope for the tailrace must also be equal or greater than that of the power canal. If the reduced velocity is needed at the stream entrance, make the end of the tailrace four times wider. If the same depth is maintained, the velocity will be reduced to 0.5 fps.

4.7.2 Tailrace Intake

Generally, the tailrace will start below the powerhouse and is an integral part of the powerhouse design. The width and depth is set by the area for 2 fps. As in Figure 4.6-4, the powerhouse footings and the tailrace intake are usually constructed from concrete. The concrete can either be precast or poured in place. Since the equipment pad is usually directly on top of the tailrace, the concrete must be structurally sound. If you pour the cement yourself, be sure and use a sufficient number of reinforcing bars. If you are not sure how to do that, then a precast concrete box culvert purchased from a manufacturer is strongly recommended.

Figure 4.7-1 shows two types of precast concrete box culverts connected together. The open top is the "U" shape type, and the closed top is the box type. In the culvert, both ends are open; therefore, an end

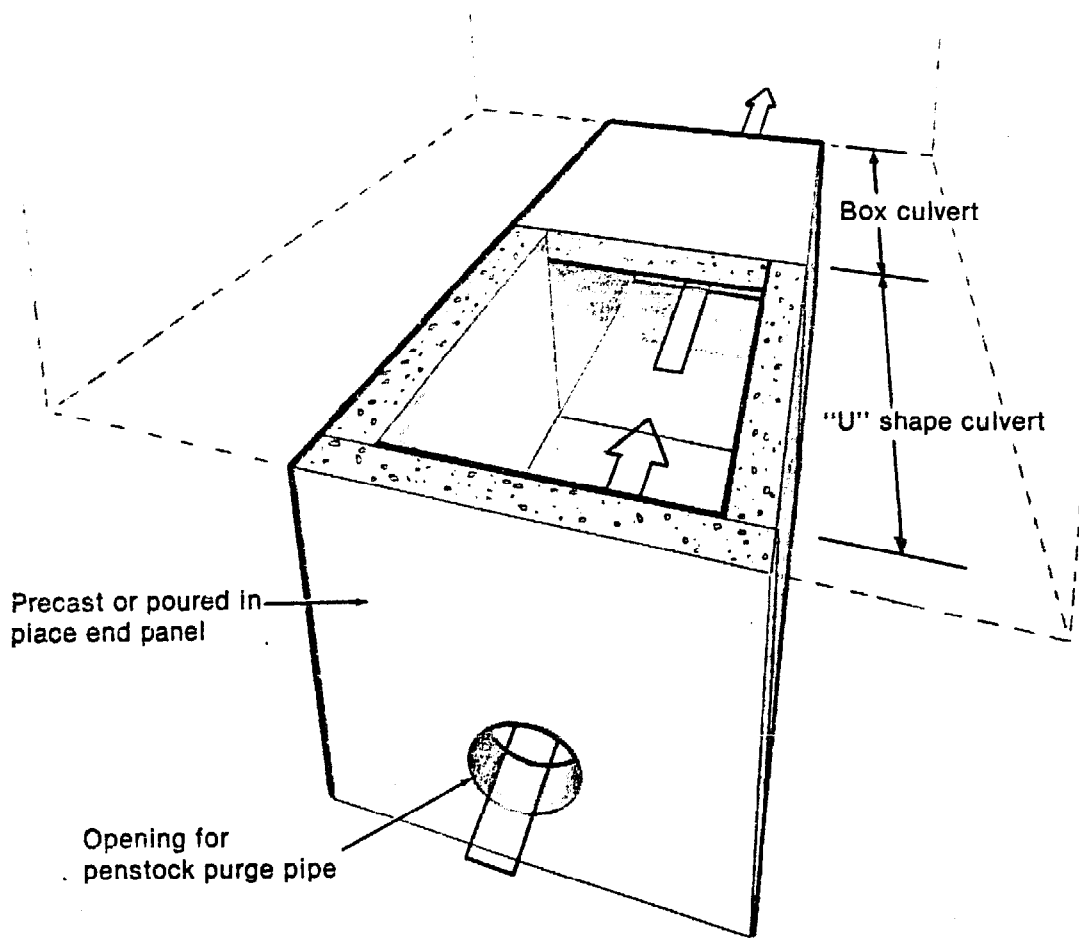

INEL 2 2314

Figure 4.7-1. Tailrace intake structure.

panel will either have to be poured in place or precast with the culvert. In either case, an opening for the purge pipe should be cast into the panel. If you decide to pour your own intake, the physical arrangement can be similar to that shown in Figure 4.7-1 or can resemble just the "U" shape.

As mentioned in Section 4.6.1, if a draft tube is used, a pool of water must be maintained in the intake. The pool should also be drainable and cleanable. A metal weir can be installed near the end of the tailrace intake. The weir is held in place by angle iron bolted to the side of the tailrace. The height of the weir should be less than half the height of the tailrace. This will ensure that the weir can be inserted and removed.

Also, when the purge valve is opened, there will be a high-pressure stream of water exhausted into the tailrace pool. The weir mounting must be strong enough to withstand that force.

4.7.3 Design Considerations

The area and size of the tailrace was determined by the design flow and the velocity. Figure 4.6-1 showed a powerhouse set lower than the high-water mark of the stream. A long tailrace is used to lower the elevation of the tailrace exit to a point where flood water cannot back up the tailrace and flood the powerhouse. In this case, a berm and rip rap will have to be constructed to protect the powerhouse and the tailrace from flood waters. The berm should be at least 3 feet above the high water mark. The higher the berm, the less the possibility of washing out the powerhouse and all the equipment.

An additional advantage to a long tailrace is that the flood waters will not raise the water level on the reaction turbine draft tube. If the tailwater rises on a draft tube, the effective head is reduced and less power is produced.

If the excavation involves a large volume of soil, a backhoe will be necessary. The cost of equipment rental and operating time must be estimated. Survey the potential location for the tailrace for rock outcrops and other obstacles that will increase the cost of construction. If these obstacles are too severe, an alternative location for the powerhouse should be considered.

4.7.4 Design Layout

If the tailrace is a significant activity, sketch the tailrace on a sheet of graph paper and estimate the material to be excavated. The cost of the excavation can be determined in the same way as the cost of the intake structure (Subsection 4.4.3.)

4.8 Generators and Electrical

A generator is an electromechanical device that converts mechanical energy, "torque," into electrical energy. This is accomplished by driving a coil through magnetic lines of force and so that the coil interacts with those lines of force to produce a voltage at the coil terminals.

The electrical distribution system for a microhydropower installation is selected for transmitting the power developed in the generator to the point of use.

This section is written with the assumption that the developer has some background in electricity and the terminology of electrical construction and generator operation. Electrical and generator terminology and the theory of a generator are discussed in Appendix A-6, which contains the following.

- A description of synchronous and induction generators and their associated equipment
- Standard voltage characteristics
- Connection diagrams for a 12-lead generator to match standard voltage characteristics
- Standard nameplates and an explanation of terms
- Standard generator insulation ratings and enclosures.

You may want to study Appendix A-6 on electrical theory and standard generators before studying this subsection of the handbook.

4.8.1 Electrical Safety Considerations

The National Electrical Code (NEC) should govern the installation of any electrical equipment from the terminals of the generator to the point

of consumption. The NEC is a legal document and is enforced by local electrical inspectors. However, the NEC is also a document based on common sense and on electrical installation practices that have been found to be safe and to minimize the risk involved in the use of electricity. You should comply with all requirements of the NEC. A copy of the regulation can be obtained from bookstores or from equipment suppliers.

CAUTION: If you have questions on electrical requirements or the connection of any piece of electrical equipment, you should get help from a licensed and qualified industrial electrician. Electricians have various areas of expertise; therefore, make sure the one you hire is qualified to work with generators and protection equipment. An electrician not qualified to handle a power system can be as much of a hazard as a nonelectrical person making the installation.

You should obtain wiring and connection diagrams of all equipment. Study these connection diagrams before installing equipment to make sure that you understand how the system is wired and how each wire and piece of equipment relates to the system. These diagrams will be helpful for final checkout and for future trouble shooting.

You should always get an electrical permit and have your electrical system inspected. The electrical inspector will verify that the electrical installation meets the intent of the NEC and can operate in a safe manner. The electrical inspector will probably not verify that the controls and wiring are connected to the proper terminals, but he will verify that the system is grounded properly and that the system has been wired according to recognized electrical practices.

The utility should be responsible for all connections to its power lines. Never attempt to make any connections to a utility system. Notify the utility, and they will have a line electrician available to make the intertie.

The following are some very basic NEC considerations that should be included in all microhydropower installations:

- Ground all systems. This will require voltage selections that will contain a neutral conductor, such as 120/240 volt, single phase, three-wire; 120/208 volt, three-phase wye four wire, or 277/480 volt, three-phase, four wire.
- Install properly sized and rated equipment and wire on all systems. Do not skimp.
- Install overcurrent and short circuit protection on all circuits including the generator, the distribution system, and the branch circuits connected to the electrical system. Do not bypass this equipment. It is installed for the purpose of protection. Use that protection. The cost is minimal when compared to the cost of replacing burned out equipment.

The Category 2 developer who ties into a utility will require equipment that is rated for the voltage of that utility. This will generally be a level of 7200 to 12470 volts, but could be higher. All transformers and protective equipment must be rated for the voltage level used by the utility.

Equipment ratings and wire sizes are basically dependent on the number of amperes that the equipment has to carry. These ratings should always be watched to verify that the equipment is matched to the system. For example, if a generator circuit breaker is too small, it will trip when it is not supposed to; however, if it has too high a rating, the equipment may burn up before the breaker trips. Therefore, always install properly rated equipment.

4.8.2 Generator Selection

There are many different types of generators that can produce power. These include synchronous generators, induction motors used as generators, direct current (dc) generators, and many hybrid generator systems. The standard generators in use on microhydropower projects are the synchronous generator and the induction motor used as a generator.

The synchronous generator is primarily used on stand-alone installations such as those for the Category 1 developer. This generator supplies its own excitation current through either a rectifier system or an external dc generator or battery system. The generator can also be used with utility system interties. This requires synchronizing equipment to determine when the unit can be safely connected to the power line. The equipment is generally a system of lights or an indicating dial to indicate when the generator voltage is in phase with the voltage of the utility.

The induction generator is actually an induction motor used as a generator. It is capable of operating as a generator only when connected to an outside electrical power system. The generator output voltage does not appear at the output terminals until after the generator is connected to the outside power system. Thus, there is no way to synchronize an induction generator with an outside power system as is done with a synchronous generator. To function as a generator, an induction motor must be driven about 1 to 5% faster than synchronous speed, or 2 to 6% faster than the speed it would have when functioning as a motor. The amount of output power that is generated by an induction generator is approximately proportional to the excess speed above synchronous speed. This excess speed is called slippage.

There are two ways to place an induction generator in operation. One method is to bring the machine up to speed by starting it as a motor, then overdrive the unit with the turbine to generate electricity. A second method is to bring the induction machine up to speed with the turbine and then close the main breaker to interconnect the generator with the line. The second method of starting an induction generator has been found to reduce the transients that are noted on a power line when an induction machine is connected to the line. The generator must be connected to the powerline before the turbine overspeeds the unit; otherwise damage to the machinery may occur.

An induction generator requires from the powerline a magnetization current that is out of phase with the normal power. This need for magnetization current is a requirement of the unit operating either as a

motor or as a generator. This characteristic of induction motors and generator places an abnormal demand on the power supply line that may be objectionable to the power company. Power companies sometimes require the installation of power factor correcting equipment to compensate for the magnetization current. The magnitude of this problem depends on the capacity of the connecting power line and the size of the induction generator. If the induction generator is started as a motor, the surge of magnetization power at the initial starting instant is approximately five times normal. This may impose a limitation on the method used for startup.

This problem is similar to that encountered in starting any large motor, with the key factor being the size and capacity of the supply line. All power companies are very familiar with the problem and can best judge and predict the extent and solution to the problem.

Another cost for an induction generator is for equipment to correct the power factor. The sum of the additional cost is comparable to the cost of synchronizing equipment and should be considered as tradeoff items when evaluating the use synchronous versus induction machines in the selection of a generator.

A Category 1 developer will probably install a synchronous generator. If the developer buys new equipment, he will want to specify a self-exciting, self-regulated generator. Other forms of excitation are available; however, the self-exciting, self-regulated machine has performed well in "stand alone" microhydropower installations.

The Category 2 developer will have to consider various items before determining which generator to use:

- Technical ability of personnel operating the plant and whether they can start and parallel a synchronous generator with a utility line.
- The length of power line to the first distribution substation. Will the power line be capable of providing the magnetizing current for an induction generator?

- The cost of power factor corrective capacitors versus synchronizing equipment. This should include capital costs and maintenance costs.

4.8.3 Sizing the Generator and Electrical Distribution System

You will have to determine the voltage, phasing, and power output of the generator. The Category 1 developer will probably desire a generator connected to supply 120/240 volts, three-wire, single phase.

The power output of this generator will have to be totally consumed by the equipment located at the site. Therefore, the developer should closely consider the equipment that is connected to the generator and how it can be connected to use the power generated. This can be done with a load control system that controls the loads connected at any time and provides a load sink for any excess load.

The Category 1 developer will have to determine whether to size the generator to handle just the loads connected at the present time, or to provide some excess capacity and a load sink. The developer will then have to make sure that the water source can supply the power required.

The reason for consuming all of the power is that the generator must maintain a constant speed or rpm to maintain a constant frequency. If the load is allowed to vary at random, the speed of the generator will vary, and the frequency will fluctuate. Fluctuating frequency will destroy small motors and solid state equipment.

A single-phase generator can be a generator that is single phase, or a multiphase generator connected as single phase. You can also use one phase of a three-phase generator. This would only produce about 1/3 the power capability of the generator; however, this can be done without seriously harming the generator.

The Category 2 developer will want to investigate the utility's power line and the type of generator and electrical system needed to connect to that line. If the power line is single-phase and you want to use some of

the generator output, you will probably generate power at 120/240 volts single-phase. If the power line is three-phase and you desire to use some of the output, you will probably want to generate power at 120/208 volts three-phase, four wire. You can then connect to the generator and "dump" the excess power to the utility. If the power line is three-phase and you desire to sell all of the power developed to the utility, you will probably want to generate power at 277/480 volts, three-phase, four wire.

The Category 2 developer will have to supply step-up transformers and protection equipment to connect to the utility's power lines. Since the Category 2 developer desires to receive maximum return on his investment, the generator power output will be sized for the maximum economical power that the water source can provide.

With the voltage selection, number of phases, and kilowatts of power production known, you can determine the size and ratings of the electrical equipment to be used in the system.

You will also want to consider the following items in generator selection:

- Bearings. Generators usually have a single bearing for a horizontally mounted unit and a two-bearing system for a vertically mounted machine. If the system is a packaged turbine-generator, the supplier will provide the proper bearing to match his system.
- Generator insulation. The generator insulation level should be rated for continuous loading. An insulation level of 105°C will generally be acceptable.
- Generator enclosure. The generator enclosure needs to be determined. A drip-proof enclosure will generally be acceptable.
- Special features. Special features desired on the generator will have to be determined. These items could include a generator winding heater to keep moisture out of the generator

during times when generator is not operating, and a generator rating that can handle motor starting overloads or special power factor ratings on efficiency voltage, etc.

If you are building your own turbine, you may desire to purchase the generator only. This generator could be new or used. A new generator would be purchased in a fashion similar to that of the packaged turbine-generator. Therefore, the equipment supplier would need some of the information supplied in the information request form contained in Subsection 4.2, as well as the desired operating speed.

If you plan to purchase a used generator, you should have it inspected and tested by a competent motor repair shop.

Some items to look at in used machines are:

- Inspect the motor to see if there are points of heavy wear or overheating in the commutator and brushes, the windings (as far as can be seen), and the bearings. Check the cleanliness of the motor to determine its previous maintenance. See Figures A6-15, -17, and -19 in Appendix A-6 for location of these items.
- Check the ratings of the used generator and compare them to the following electrical characteristics needed for the system:
 - Kilowatt or horsepower. A horsepower motor needs 1 kilowatt of power, but will only generate less than 0.7 kilowatt.
 - Voltage
 - Phase
 - Amperage ratings at various operating voltages
 - Frequency
 - Service factor

If the generator is old, it should be rated for continuous or motor duty. A generator rated for standby duty may not hold up under continuous operation at full load.

When you have found a generator or induction motor that is properly priced and appears to be suitable for your application, you should have a motor repair shop or other qualified personnel test the machine. This inspection should include:

- Test the insulation of the generator wiring with a megohmmeter.
- Check the pressure and position of generator brushes; clean and replace as required.
- Clean the machine thoroughly, blowing out dirt from windings; wipe the commutator and brushes.
- Check the shaft for end play.
- Check the air gap.
- Examine the connections of the commutator and armature coils.
- Check rectifiers on self-excited synchronous generators to see that they are not burned out.

If the used generator requires reworking, you should get a price quote on the amount of work. Compare this price and the cost of the used generator against a new machine.

There are some units for sale that have been installed and operated for many years. If you find an old turbine and generator suited for your flow and head requirements, you may consider purchase of that system. The unit may not be as efficient as a modern unit, but the cost may be acceptable. You should have the generator checked out as described above. In addition, you will have to examine the turbine, or have it checked, as follows:

- Check all movable bearing surfaces for wear and pitting.
- Check all turbine runners for pitting, rust, and wear to make sure that the turbine is in good shape or can be rebuilt.
- Check the shaft for wear. Can it be rebuilt?

Again check all associated costs and verify that they are reasonable in comparison with the cost of a new unit.

4.8.4 Metering

The generator system should have three metering devices to determine ac voltage output, ac amperes output, and output frequency for a synchronous generator or rpm for an induction generator. A kWh meter may also be required.

The voltage can be measured directly at the generator output terminals. Select a voltmeter with the proper range for the voltage of the system. An ammeter will measure the current flow. However, because ammeters have a maximum current rating of 5 amps, a current transformer is used with the ammeter connected to the secondary of the transformer.

CAUTION: The current transformer should never be removed from the system without a shorting wire or bar installed between the terminals of the transformer.

In stand-alone systems, a frequency meter will be required to verify that the frequency is within the parameters required by the system. For installation of induction generators, an indication of rpm is needed to determine slip.

The Category 1 developer does not require a kWh meter. However, you may want a meter to determine energy use in your system. The Category 2 developer will require at least a kWh meter to determine how much power is sold to the utility. Other metering requirements may be set by the utility. These are discussed in Subsection 4.8.13.

4.8.5 Generator Speed Selection

The synchronous speed of a generator is determined from Equation (A6-14)

$$\text{rpm} = \frac{f \times 120}{p} \quad (\text{A6-14})$$

where

rpm = synchronous speed

f = frequency in Hertz (cycles per second)

p = number of stator poles.

As can be seen from the equation, the frequency and poles interact to determine the speed of a generator.

Standard speeds of regularly manufactured generators are 3600, 1800, 1200, and 600 rpm. However, because of overspeed considerations, most generators for microhydropower applications are specified in the 900 to 1800 rpm range.

The overspeed of a generator is the speed that the generator will attain when it becomes unloaded and the turbine still has full flow and head available. Turbines and generators can reach speeds two to three times greater than normal operating speeds. This is especially critical in a high-head installation.

Therefore, most generators should be selected in the lower speed of range of 1800, 1200, or 900 rpm so that the machine can withstand a speed of two or three times normal speed for short periods. The control system should always contain some method of shutting down the turbine and generator in response to overspeed.

Subsection 4.5 describes methods of shutting down the water flow under overspeed conditions. It describes ways to minimize the impact of small overspeeds due to varying loads on a generator by the use of governors and load controllers.

4.8.6 Cost of Generators

The costs of both synchronous and induction generators are related to the size of the equipment. The costs of both generators are based on standard production models of the equipment. For this reason, the "standard" synchronous generator is an 1800-rpm generator that is manufactured for the gas- or diesel-fueled emergency or standby generator market.

Figure 4.8-1 is a graph showing the limits of cost versus kilowatt for 1800-rpm synchronous generators, and Figure 4.8-2 is a graph of cost versus kilowatt for induction generators. These costs are in 1982 dollars.

4.8.7 Electrical Equipment Sizing

The Category 1 developer will want to analyze all electrical loads to determine which ones will be used at what times. You should tabulate the electrical loads on the basis of use not only during the day but also at night.

The standard household has many electrical appliances that are used during the day. However, these loads are not all used at the same time. Table 3.1 in Subsection 3.1 gives standard loads used in a residence and gives kWh of use per month for each piece of equipment.

It is evident from a study of this table that heating loads have the greatest power use. Careful study of the table will indicate methods for programming a daily use pattern to keep the generators fully loaded.

The electrical loading required for the Category 1 developer example (Appendix B) has been developed to show how a power system will have to be

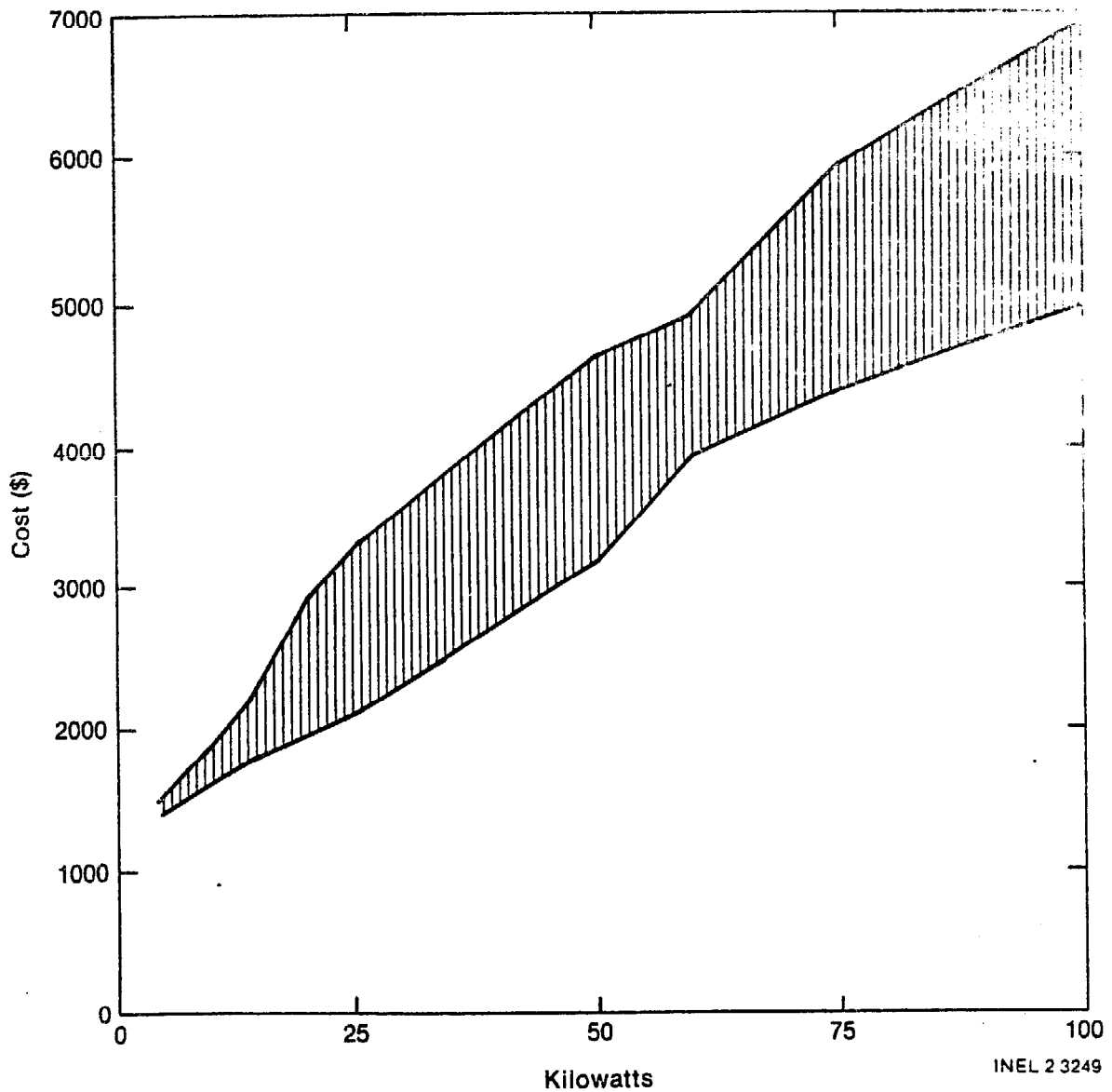

Figure 4.8-1. Limits of cost vs kW for 1800-rpm synchronous generators.

analyzed. The example loading is developed in detail to show how electrical loads relate to a site potential and the equipment that will be selected.

The analysis for a Category 2 developer is very simple. You determine what you can generate, what you can use, and "dump" the remaining power to the utility. If your power consumption exceeds the power available from the generator, then you can supplement by drawing power from the utility.

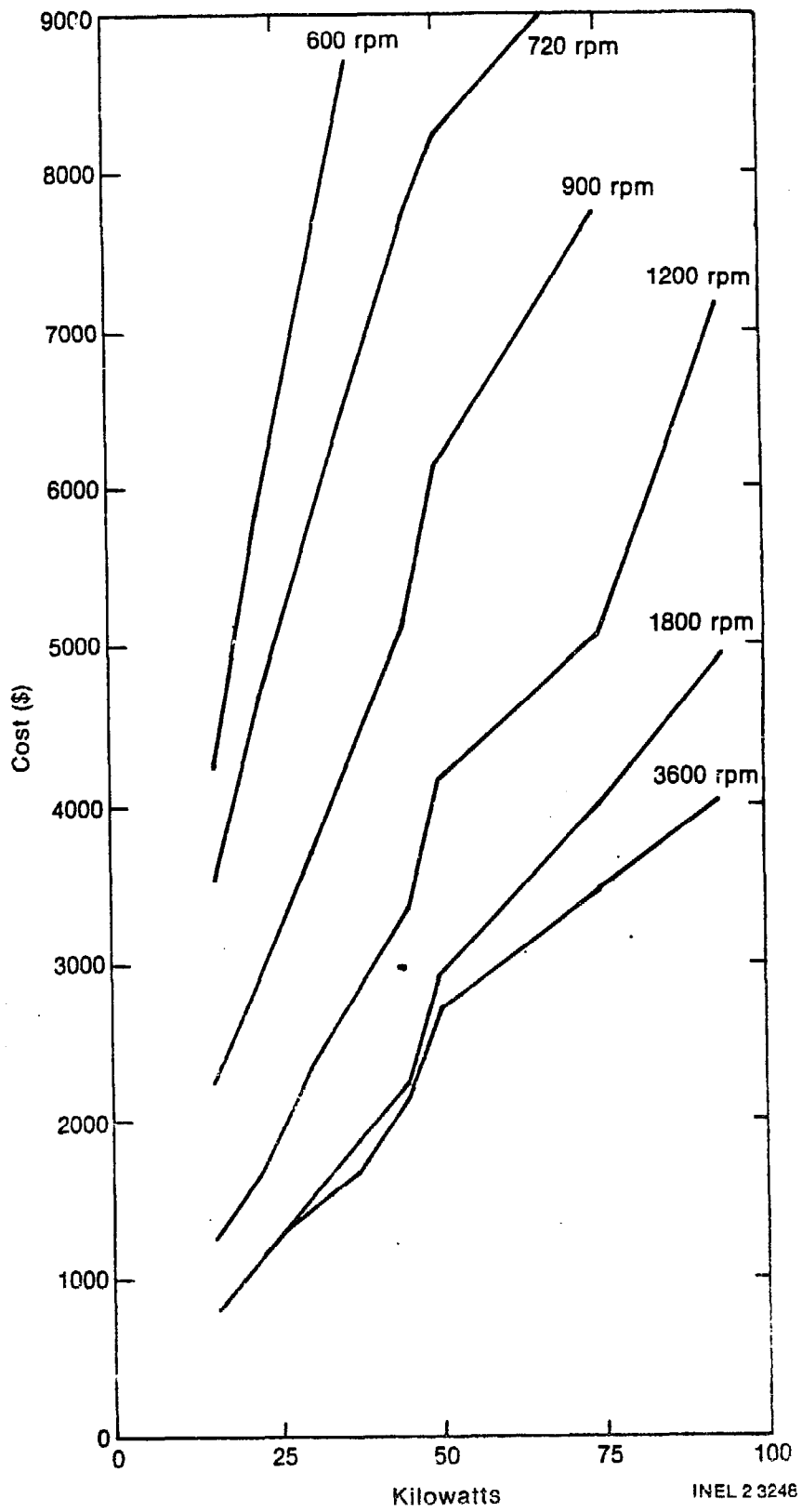

Figure 4.8-2. Cost vs kW for induction generators.

The load analysis for a third situation is even simpler. This is where a Category 2 developer desires to sell all of the power produced to a utility. This system requires little load analysis. The generator will be sized to produce maximum power on the basis of flow, head, and investment capital.

4.8.8 Sizing the Electrical Distribution System

After you have selected a generator and the ratings of that generator you are ready to design the transmission and distribution system for the electrical energy produced. This is the wiring system that distributes the electrical energy from the generator location to the point of use. It will consist of wiring, overcurrent protective devices, such as circuit breakers or fuses, panelboards, load control systems, and in the case of the Category 2 developer, transformers and high-voltage protection devices.

Figure 4.8-3 is a one-line diagram showing the various components of a typical power system for a Category 1 developer. The generator will have a set of wires from its load terminals to the generator overcurrent device (see Subsection 4.8.9).

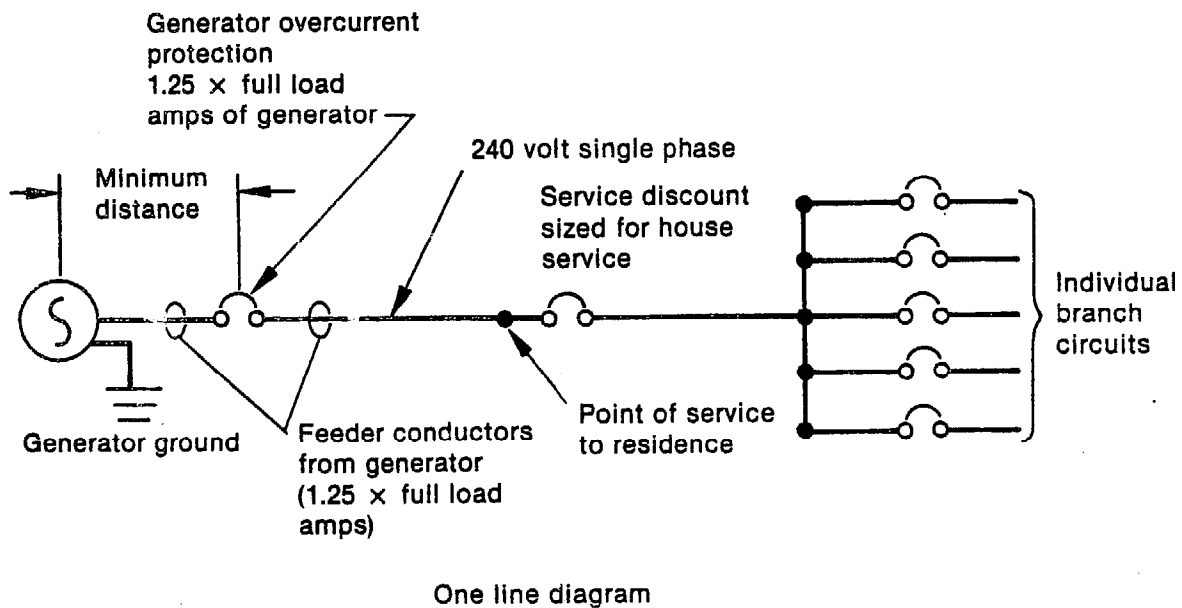

INEL 2 3250

Figure 4.8-3. One-line diagram of typical power system for a Category 1 developer.

The main panel can be located at the house. The electrical wiring from the generator overcurrent device to the house can be installed overhead or it can be directly buried in earth or pulled in buried conduit. The length of this feeder wire has a bearing on the wire size of the wire required for this feeder. The effect of the feeder length is known as the voltage drop of the feeder.

The size of the residence's electrical service equipment is set by the NEC. The residence's service entrance wiring and panels must be sized according to its connected load and then derated as allowed by the NEC. There could be a circumstance where the house service wiring and service disconnect may be considerably larger than the feeder that supplies the house from the generator. A load control system will control this maximum load, but the service will still require the minimum size dictated by the NEC. All electrical overcurrent protective equipment and wire is sized on the current carrying capacity of the equipment. The equipment and wire also have a voltage rating that states that the equipment will safely operate at a given voltage.

Wire ampacity is sized for a single-phase unit from the equation

$$I = \frac{1000 \times P}{E} \quad (4.8-1)$$

where

I = amperes

P = power in kW

E = voltage

1000 = kW to watts conversion function.

Using the example of the 15.5-kW, 120/240-volt, single-phase generator for the rural site, we find the minimum ampacity of the conductor to be

$$I = \frac{1000 \times 15.5}{240}, \text{ or}$$

$$I = 64.6 \text{ amperes.}$$

The NEC requires that the conductor be rated for 125% of its continuous full-load current. Since the generator must operate fully loaded to maintain frequency and speed requirements, the wiring and overcurrent devices can be considered to carry continuous loads. Therefore:

$$I_m = 1.25 \times I \quad (4.8-2)$$

where

$$I_m = \text{minimum wire ampacity}$$

$$1.25 = 125\%$$

$$I = \text{amperes, from Equation (4.8-1)}$$

Thus, for the example

$$I_m = 1.25 \times 64.6$$

$$I_m = 80.7 \text{ amps minimum wire ampacity}$$

This is the minimum ampacity of the wire. You should use wire with a higher ampacity than minimum for your installation. Table 3.10-16 in the NEC Handbook can be used to select the proper size wire with insulation that is heat and water resistant (Type THW).

CAUTION: All conductors must have mechanical protection such as conduit or direct burial cables, or be suspended at least 18 feet above ground.

Voltage drop is also a consideration if the load is located a long distance from the generator location. Voltage drop can be calculated as follows:

$$E_D = \frac{I \times R \times l}{1000} \quad (4.8-3)$$

where

E_D = voltage drop

I = amperes

R = resistance of wire in ohms per 1000 feet (see NEC Handbook, Table 8)

l = length of wire in feet

Voltage drop should be limited to a maximum of 5% of the voltage. To figure the percentage of voltage drop, take the calculated voltage drop [E_D from Equation (4.8-3)] and divide by the line voltage (E).

$$\% \text{ drop} = \frac{E_D}{E} \times 100 \quad (4.8-4)$$

where

% drop = percentage of voltage drop

E_D = calculated voltage drop in volts

E = line voltage (e.g. 120, 208, 240, 480)

If I (amperes) is constant and the length of the line is fixed, then the only other variable is R (the resistance of the power line). The resistance decreases as wire size increases. Voltage drop will not be

problem in most microhydropower installations, because the current is limited to the current produced by a 100-kW generator. The distance to the load or point of power consumption will be short, generally less than 500 feet.

4.8.9 Overcurrent Protection

The amperage rating of overcurrent protection devices can be selected in the same fashion as the minimum ampacity for wire. From Equation (4.8-2):

$$I_m = 1.25 \times I$$

The ampacity of overcurrent protective devices has to be selected from standard ratings. The NEC will allow the use of the next higher rated device. (For the example of 80.7 amps, a 90-amp breaker can be used.)

The overcurrent device for the generator should be located as close to the terminals of the generator as practical. This device can be mounted right on the generator and can be specified to be supplied with the generator by the manufacturer.

4.8.10 Step-Up Transformer

When connecting to the utility, the Category 2 developer will need a step-up transformer that will interface between the generator voltage and the distribution voltage of the utility. This transformer will have to have a kilovoltampere (kVA) rating that is equal to or greater than the kVA rating of the generator. This transformer should have a low-voltage overcurrent device located near the transformer and must have a high-voltage fuse and lightning arrester located on the high-voltage side of the transformer. Again, the high- and low-voltage overcurrent protective devices should be rated at 125% of the full-load, high-side, and low-side currents of the transformer.

CAUTION: The utility's high voltage is dangerous. The utility will make the final connections.

The utility may require additional protective relays. These are discussed in Subsection 4.8.13. The sizing of these devices is critical to the operation of the system. That equipment can be determined cooperatively by the developer, the utility, the electrician, and the supplier when the equipment is needed.

4.8.11 Grounding

Grounding of the power system is very important. If you plan to produce power at 120/240 volts, single-phase; 120/208 volts, three-phase, four wire wye; or 277/480 volts, three-phase, four wire wye; then a very definite ground reference point for the electrical system neutral needs to be established.

If you wish to establish voltage at 240 volts, three-wire, three-phase, delta; or 480 volts, three-wire, three-phase, delta; then an additional ground needs to be established for equipment grounding. Delta generation systems are not recommended for personnel safety and equipment protection reasons.

The NEC requires that a buried metal water pipe with direct contact in earth for a length of 10 feet or more be used as the main grounding electrode. This ground point has to be supplemented with one or more additional ground points. It would be desirable to plan at least 15 feet of buried metal water pipe at the generator location. Other methods of establishing a system ground are discussed in Article 250 of the NEC Handbook.

It has been found to be good practice to weld all of the rebar in the equipment pad as part of the ground system. This rebar should be at least 20 feet in total length and at least 1/2 inch (No. 4) in size. If these requirements are met, the rebar can be connected to the generator as the ground system.

Additional ground points that have to be bonded to the metal water pipe are the metal frame of a building, if available, and a ground ring encircling the building consisting of at least 20 feet of bare copper wire not smaller than No. 2 AWG.

Additional ground points to supplement the generator grounding electrodes are other metal underground structures and pipes, rod and pipe electrodes, and plate electrodes 2 feet square.

To summarize, the generator ground should consist of the following:

1. All grounds bonded or connected together at one point, preferably in the overcurrent device enclosure.
2. At least 10 feet of buried water pipe, such as metal penstock, waterline, etc.
3. A ground connection extending from the rebar of the equipment pad. All the rebar in the pad should be welded together.
4. A No. 2 AWG copper ground wire encircling the generator building. This ground wire can be put in the ground when the footings are dug.
5. A ground wire to the metal frame of the building if the building is metal.
6. Additional buried structures or pipes, rods, etc.

Ground Systems 1 through 5 are required, if available at the generator site. Ground System 6 can be used if available.

You should install the best ground system that you can implement to maximize the safety of the system.

4.8.12 Governors and Load Control Systems

In order to maintain the generator at a constant 60 hertz (Hz) frequency, it is necessary to maintain the generator shaft at a constant rotational speed. In a stand-alone system, the rotational speed of the microhydropower generator can vary as loads are added to or subtracted from the electrical system. When Equation (A6-14) is rewritten to solve for frequency (f), it can be seen that frequency varies directly with rpm since the number of poles are fixed in any specific generator.

$$f = \frac{120 \times \text{rpm}}{p} \quad (\text{A6-14})$$

where

- f = frequency in Hz
- rpm = revolutions per minute
- p = number of poles.

Therefore, it is desirable to either control the speed of a hydropower generator by throttling the water to the turbine, or control the load of the power system so that the load always remains constant. Speed control is achieved with an electromechanical governor that controls the flow of water entering the turbine. A load control system maintains a constant load on a generator by using electric relays, or electronic switches, or a combination of both to continuously correct the load to the required level.

4.8.12.1 Governors. There are many small plants that use governors for speed control. The governor usually consists of a vertical shaft that has counter opposed flyweights suspended from the top of the vertical shaft. As the speed of the shaft increases or decreases, the flyweights move up or down the shaft, respectively. This movement is amplified,

usually hydraulically, so that small variations in speed can be sensed and a proper control signal transmitted to the valves or deflectors that control the water pressure.

The industry standard governor is a Woodward type UG, hydraulic turbine control. The same governor that is used on large hydroelectric plants is the one that is used on microhydropower plants. This governor is capable of an output of 8 foot pounds of torque. This output is adequate to power some methods of speed control such as operation of deflectors to deflect the water emitted from the nozzles of a small Pelton wheel. If a means of conserving water is desired for a plant operating from reservoir storage, the governor signal must be amplified again to be able to close a valve to adjust flow. The second stage of amplification is usually accomplished by a larger hydraulic pump that actuates a ram to move the valve actuator. This actuator must respond quickly enough to maintain adequate frequency control, but the flow of water cannot be changed so rapidly that damage to the penstock occurs. Governors are able to provide speed control for a microhydropower installation in the range of 85% of full load speed to 110% full load speed.

4.8.12.2 Load Controllers. Many small hydro plants are using electrical and electronic control schemes. Frequency can be measured electronically and compared against a set point. If the frequency measured is low, i.e., the system is overloaded, then a low-priority load can be deenergized. This method is referred to as Electrical Relaying. Loads can be added or dropped in discrete units. Obviously, the type of load that can be started and stopped often must be one that will not create a hazard, an inconvenience, or a premature equipment failure by being automatically switched in and out. The best loads for intermittent switching are electric heating loads. Motors will overheat and can fail if started and stopped too often.

The development of solid-state electronics has provided many devices that switch much faster and are as reliable as the older electromechanical relays. Some of the solid-state switching devices are used only for electronic logic and signalling, while others are able to handle power

loads directly. The silicon controlled rectifier (SCR) or triac is commonly used to switch power loads.

Electronic switches or triacs are capable of controlling the electrical waveform to produce a frequency of 60 hertz but with a diminished amount of power. A load can, therefore, be varied continuously over the range from zero voltage to full load voltage.

An electronic load control system can sense changes in the generator output and can adjust the load by switching electric relays and by controlling electronic switches that can continuously vary their connected load to match the generator output.

Consider the load system that was plotted in the run-of-the-stream example problem (Appendix B).

The system has loadings that must be capable of continual operation and cannot be controlled, such as:

- Refrigerator
- Freezer
- Well pump
- Kitchen equipment
- Kitchen range
- Lighting
- TV and stereo
- Shop equipment.

The loads that can be controlled by the load control system are:

- Water heaters
- Electric dryers
- Electric heat during the winter
- Electric heat loads in other areas, which can be added to keep the generator fully loaded.

With the operation scenario given in the example in Appendix 4, the power system will have a base load that varies between 2.2 and 12.6 kW. This leaves the remainder of the generator output for other controlled loads. Electrical water heaters can be installed and set up to be used to control load, operating whenever the generator loading allows.

In addition, the owner of this system needs a heat load operated through an electronic switch that will allow the load to be continuously varied as the other loads vary. For example, 6 kW of baseboard heater could be installed in the greenhouse to provide this load. The other loads, such as the water heaters or house baseboard heaters, can be switched on a priority basis by relays as the loading of the generator allows.

EXAMPLE: At 4 p.m. one day, the generator has a base load of 7.4 kW that is a combination of kitchen loads, shop loads, lighting loads, and the well pump. Since the generator is operating at full capacity, this leaves 6.6 kW of loads to be controlled. A frequency monitor notes the need for additional loads and sends a signal to the load control panel to start controlling the loads.

The first priority load is switched on--6 kW of greenhouse heat. There are still 0.6 kW of generated power that need to be consumed. The second priority load, a water heater, comes on. This load is 4.5 kW. Therefore, the first priority load is reduced by use of the triac switch to 2.1 kW. Thus, there are 2.1 kW of load in the greenhouse heaters that are now being controlled by the triac. As the base load increases, this varied load will be reduced to zero. Then the loads on priority control will be switched off.

By controlling the loads in this fashion, the system controls the load on the generator and keeps the frequency constant. The load control system is suited for stand-alone power system because it allows the generation system to operate at peak efficiency.

4.8.13 Utility Tie-Ins

There are several reasons for connecting to a utility grid.

- Generation of revenue. If the generation of revenue is a primary concern, the developer will want to tie into a utility to maximize the return on investment.
- Load sink. For Category 1 developers able to consume the majority of the power generated by the site, the utility may provide a load sink by taking the excess energy and keeping the system fully loaded.
- Power Backup. The utility can act as a backup power source for the Category 1 developer whose system is down for repairs, or when the water source is too low for power production.
- Reduction in equipment costs. Connection to an outside system alleviates the need for expensive speed-regulating equipment.

Utilities have many different requirements for connection to their power lines. These can range from as little as a lockable disconnect switch at the point of tie-in to the utility system, to a total control system that involves power metering, telemetering, and protective relaying.

The utility will require that protective equipment be installed for the following reasons:

- Safety. There are times when the power line will be down for maintenance or repairs, or due to accidents, and the generator will have to be taken off the power line. This will require both automatic and manual disconnects.
- Protection of the generation equipment. There are instances where the generator should be taken off the power line to minimize the potential for damage.

- Utility safety. The utility will also require protection for their system and equipment.

The protection equipment that must be installed on a microhydro-power site for utility intertie depends on the requirements of the utility. You will have to provide overcurrent and short-circuit protection for the output of the generator. Some utilities may require little more than a lockable disconnect switch on the line side of the generator overcurrent protective equipment. Another protective system may be a high-voltage switch controlled by an undervoltage relay. This equipment would be owned by the developer. There are many other inexpensive potential protective schemes.

The most sophisticated and expensive protective system currently being proposed by utilities requires over- and undercurrent protection, over- and undervoltage protection, differential phase protection, and reverse power protection. If the generator is a synchronous machine, the utility will also require a synchronizing device to connect the generator to the system.

The protective equipment listed above will probably have to be industrial grade. This equipment and the associated voltmeters, ammeters, kilowatt meters, switches, and protective equipment become expensive when mounted in a cabinet and installed at the site.

Some utilities may require notification each time the generator is connected online. Notification can be made either by a telephone call or by telemetering equipment installed to monitor the generator's activity. This notification is for the safety of personnel working on the line.

CAUTION: The protection and disconnect system may appear expensive to the developer. However, the intent of this protection is to protect life and property. Work with the utility for this goal.

The utility will require you to install, maintain, test, and calibrate metering equipment to measure the flow of power into the utility's grid. This metering will be by a kWh meter that measures power "out" from the

generator. The utility may also require a power "in" meter to measure both demand and kWh used by the microhydropower system.

The utility may also require that you install metering to measure reactive power, or kilovar hours. This would normally be when you are using a large induction motor as a generator.

You will also have other equipment on the system that will have to intertie with a utility. This will include step-up transformers, protective equipment, and a high-voltage power line. Most utilities will quote you a price for installing this equipment; others will insist on installing the equipment so that it is installed according to their standard practices.

You will have to maintain the high-voltage line and step-up transformer. A utility may do this for you but they will charge a maintenance fee.

CAUTION: Make sure that the people working on the high-voltage line are qualified and capable of performing this work.

You may elect to have the power company install and maintain the protective equipment, step up transformer, and power line. The power company would be paid for all of their installation work at the time the equipment is installed. A separate maintenance contract would then be written between you and the utility specifying that you pay the utility a monthly percentage of the construction cost for maintenance.

Another arrangement could be for you to contract with private firms for all equipment installation and then set up a maintenance agreement with the utility specifying a flat rate for maintenance and repairs.

There are many other requirements that a power utility may impose upon the microhydropower developer. These requirements may cost money and would have to be included in all financial analyses of the system.

Following are additional requirements that you need to consider carefully for their legal implications.

- Power factor correction. Power factor corrective capacitors may be required to correct the line power factor to 85% or even 95% when an induction motor is used as the generator. These capacitors could be mounted at the generator site or could be furnished to the utility to be mounted on another segment of the power line remote from the generator location.

CAUTION: When capacitors are used with induction motors, the motor may continue to generate power even when the utility power is interrupted. This could be a potential hazard to utility personnel and should be discussed with them if they require the use of a capacitor.

- Liability insurance. This insurance could be required to indemnify the utility or developer from loss, damage, expense, and liability to persons who could be injured by the developer's or utility's construction, ownership, operation, or maintenance or by failure of any owner to maintain the system. Insurance limits of \$1,000,000 or more could be required.
- Easements. The developer will require easements and right-of-ways to the utility for any interconnection equipment and will therefore need a surveyor to write up the easement.
- Shutdown impacts. The contract may also address what happens when the utility or developer has problems that cause the loss of power generation capabilities by the developer or the utility. This item needs to be addressed to minimize the impact of the shutdown.

The microhydropower developer should remember that the utility is in business to distribute and sell power. The utility desires to generate its own power or to buy power in bulk. The role of the microhydropower

developer as power producer is somewhat minimal to a utility. Therefore, the microhydropower developer will need to maintain a good rapport with the utility and should be willing to work with their requirements.

4.9 Drive Systems and Speed Increaseers

The drive system is used to mechanically connect the turbine shaft to the generator shaft. This connection may take one of several forms depending on turbine speed and preference of the designer. Where the turbine speed matches that of the generator, the shafts of each are directly connected using a coupling. When the turbine rotates either slower or faster than the generator, a speed increaser or reducer must be installed in the system. This may take the form of a gear drive, belt drive, or chain drive.

Most generators will be selected in the 900 to 1800 rpm range for microhydropower applications. Once the turbine has been selected and its rotational speed determined, the ratio of generator speed to turbine speed can be calculated.

$$R = \frac{G_{\text{rpm}}}{T_{\text{rpm}}} \quad (4.9-1)$$

where

R = Speed Ratio

G_{rpm} = Generator speed in rpm

T_{rpm} = Turbine speed in rpm.

EXAMPLE: Assume that the turbine operates at 600 rpm and an 1800-rpm generator is being used; find the ratio.

$$R = \frac{1800}{600}$$

$$R = 3$$

Therefore, the drive system selected must be capable of converting every revolution of the turbine into three revolutions of the generator.

The power that a drive must transmit is an important consideration when selecting and designing a drive system. In Subsection 2.5, the basic power equation was given. An efficiency of 60% was recommended for use in calculating your system's power. This power should not be used to size your drive system, since some of the losses included in the 60% will not be present between the turbine and the drive. The most accurate method of determining the power developed by the turbine is to use the basic power equation but to substitute the turbine efficiency provided by the manufacturer for "e" and the site's net effective head (see Subsection 2.2) for "h". If neither of these values are known, an assumed efficiency of 100% and the pool-to-pool head can be used. This will be conservative and oversize your drive but can be used in preliminary calculations.

4.9.1 Direct Connection Drives

When the turbine speed matches the generator speed, direct connection offers advantages over speed increasing or reducing devices. Direct connection avoids the efficiency losses associated with speed changing devices, maintenance is minimal, and the system is more compact. The major disadvantage of a direct drive is the possible damage that could occur should either the generator or turbine suddenly "lock up" from a lightning strike or debris entering the turbine. The damage to the still rotating component and shafts could be extensive in this case. Even with this disadvantage, however, direct drive is a highly desirable feature.

The connection of the generator shaft to the turbine shaft can be done with either rigid or flexible couplings. Rigid couplings provide a fixed union between the shafts, requiring that the shafts have good initial alignment and stable support bearings. Misalignment can cause worn or failed bearings, fatigued shafts, broken coupling bolts, or worn bores in the coupling flanges. The three principal types of rigid couplings are compression, ribbed, and flange-face. These are illustrated in Figure 4.9-1.

Compression couplings attach to the shafts by the compressive force generated when tapered sleeves are wedged inward as the two halves of the coupling are drawn together by tightening bolts. This coupling is suitable for light to moderate torque loads. A ribbed coupling employs a long key set in keyways in both shafts and the coupling housing to lock the shafts together. A flange-face coupling uses keys to lock the individual flanges to each shaft and the flanges are then bolted together. Both of the latter two couplings are capable of sustaining high torque loads. These couplings are not particularly suitable for axial loads (loads along the shaft axis). Such loads result from hydraulic thrust of the turbine or from the weight of the rotating components on vertical turbines. If such loads exist, a flange that is an integral part of the shaft should be used.

In cases where misalignment between the shafts can be expected, a flexible coupling should be employed. These couplings are common and are referred to as chain, slider, gear, and flexible member couplings. These couplings may be particularly unsuitable for axial loads. When using these couplings, contact the coupling manufacturer for specific data on load (torque and thrust), deflection, and speed capabilities.

4.9.2 Speed Changing Drives

For the majority of microhydropower sites, some sort of speed increaser drive will be required because of insufficient head or flow to operate the turbine at generator speed. These drives will increase the cost of the installation but are necessary in order to provide synchronous speed for ac generator operation. It is possible that the turbine could rotate faster than the generator in special cases. A speed reducer type of drive would be needed in this case, and the same information is applicable as with speed increasers.

4.9.2.1 Chain Drives. Chain drives have many applications and have the advantage of high efficiency, no slippage, and relatively high load capacity and life. Like couplings, they lock the generator and turbine shafts together, which can cause damage if one component stops suddenly, as

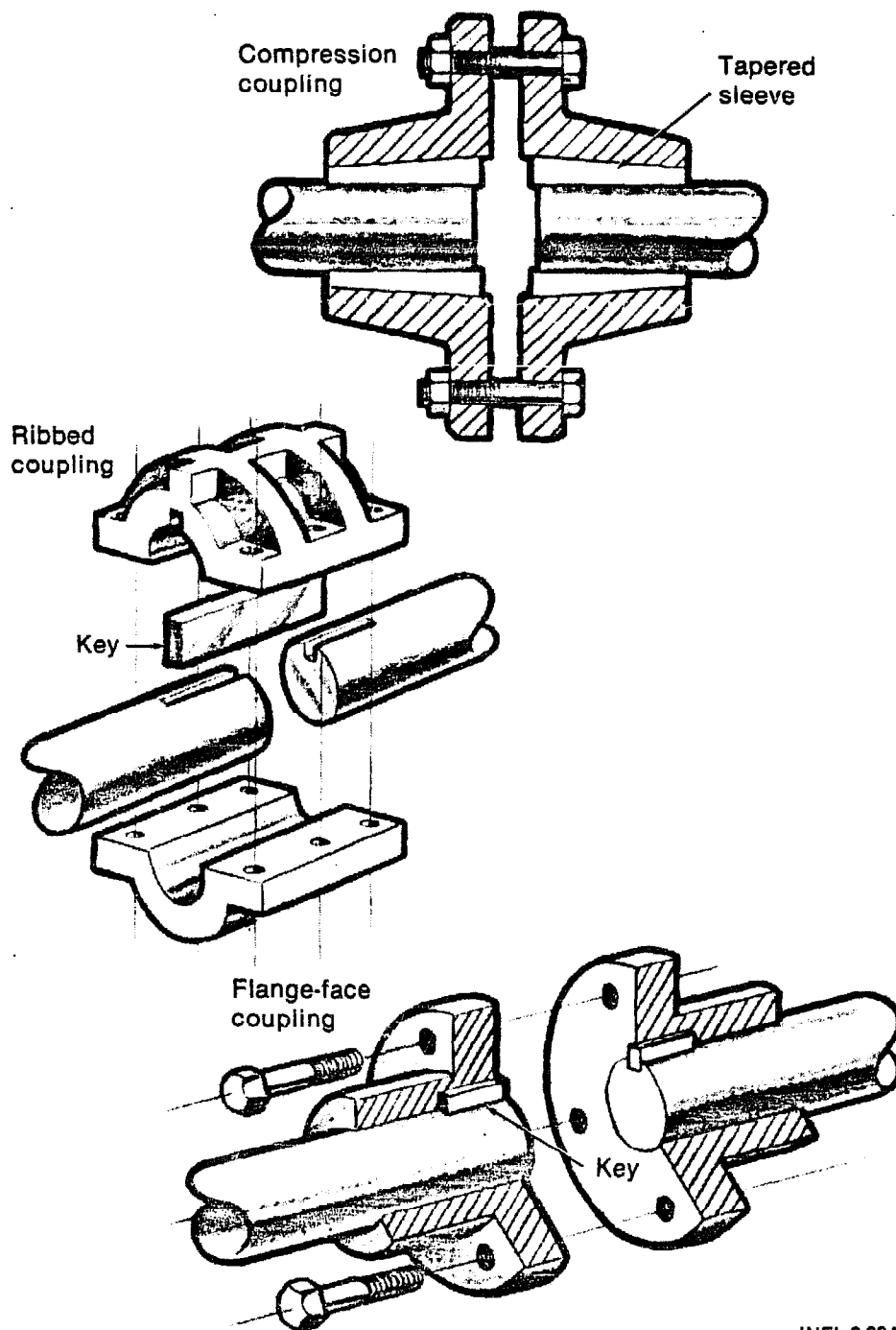

INEL 2 2347

Figure 4.9-1. Types of rigid coupling.

previously discussed. Manufacturers catalogs are the best source of information on procedures for selecting and specifying chain drives. Input information required includes: transmitted power, speeds of driving and driven shafts, space limitations, center distances, and operating conditions. If you determine that a chain drive is the type of system you

wish to install, you should contact a manufacturer for further information. Normally, belts are preferred to chains for microhydropower applications because they are less costly to install and maintenance is minimal.

4.9.2.2 Belt Drives. Belt drives provide the lowest cost means of transmitting power from one shaft to another. They operate smoothly and quietly and can absorb appreciable shock. Slippage of the belt and its sheave can occur if the shaft of either the generator or turbine locks up, providing an added measure of protection to the equipment. The basic power transmission belt is the V-belt. It provides the best combination of tractive force, operating speed, and service life. Flat belts were the first belt used for industrial power transmission and still find applications today. To prevent slippage of flat belts during operation, however, the belt must operate under high tension. Such high tensile loads require heavier shafts and bearings, as well as a heavier mounting framework for the drive. Synchronous belts have evenly spaced teeth on the bottom surface that mesh with grooves on the pulley to produce a positive, no-slip driving effect similar to a chain drive. While these belts can be used for microhydropower applications, there does not appear to be any advantage over using a V-belt, and they are more expensive. V-belts are considered the best selection for belt drive arrangements.

To facilitate interchangeability and insure uniformity, V-belt manufacturers have developed industry standards for various types of V-belt drives. Three major areas of application--industrial, agricultural, and automotive--are covered by the standards. Only the industrial type of belts are of concern for microhydropower use.

Industrial V-belts are made in standard cross-sections and are referred to as conventional, narrow, and light duty. Conventional belts are available in A, B, C, D, and E cross-sections; narrow belts are made in 3V, 5V, and 8V cross-sections; and light duty belts come in 2L, 3L, 4L, and 5L cross-sections. Belts are designated by a symbol for the cross-section accompanied by the length designation. The length designation is in inches except for narrow belts where it is in tenths of an inch. For conventional

belts, a B90 belt has a B cross-section and is 90 inches long. For a narrow belt, 5V1400 indicates a 5V cross-section and a 140-inch length. Belts carrying the same designation and power rating are interchangeable.

The selection of belts should be done with the help of a manufacturer or his catalog. There are several terms that the developer must be familiar with in order to properly design a belt drive. The wheel on which the belt operates is referred to as the sheave or pulley. As the belt bends around the sheave, the outer belt surface is stretched while the inner surface is compressed. In the middle of the belt is a neutral axis that does not change circumferential length. This line that does not change length is called the pitch line, and it forms a pitch circle with a pitch diameter on the sheave. The sheaves are selected and sized by their pitch diameter in the catalogs. The distance between sheaves is called the center distance. Figure 4.9-2 illustrates belt drive terms.

The sheave diameter and belt cross-section are selected in a preliminary manner from charts and tables in a manufacturers catalog. Selection is always based on the smaller diameter sheave, which revolves at the highest rate. The chart shown in Figure 4.9-3 is for the preliminary selection of conventional cross-section belts. Similar charts exist for narrow and light-duty belts.

Once the type of belt has been selected, the smaller sheave diameter can be selected from a table. Table 4.9-1 is typical of the tables found in catalogs. It gives minimum recommended pitch diameter for the smallest sheave. To use a smaller sheave than recommended would fatigue the belt, reducing its operating life. The pitch diameter of the larger sheave is found by multiplying the speed ratio and smaller diameter sheave together. This large sheave diameter is compared to standard sheaves available in catalogs, and the sheave with the nearest diameter is selected.

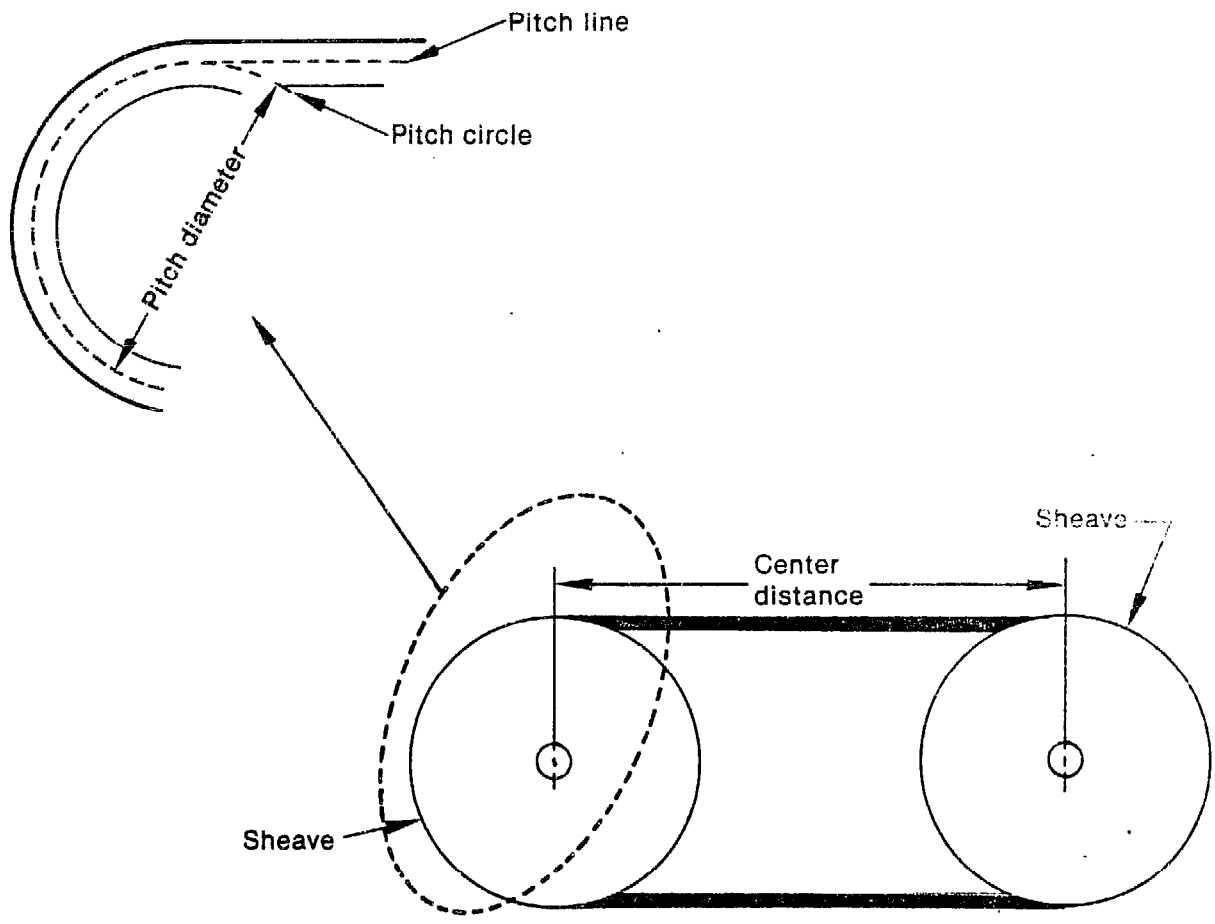

INEL 2 2278

Figure 4.9-2. Belt drive terms illustrated.

TABLE 4.9-1. SHEAVE DIMENSIONS

Belt Section	Belt Size (in.)	Minimum Recommended Pitch Diameter (in.)
A	1/2 x 11/32	3.0
B	21/32 x 7/16	5.4
C	7/8 x 17/32	9.0
D	1-1/4 x 3/4	13.0
E	1-1/2 x 1	21.6

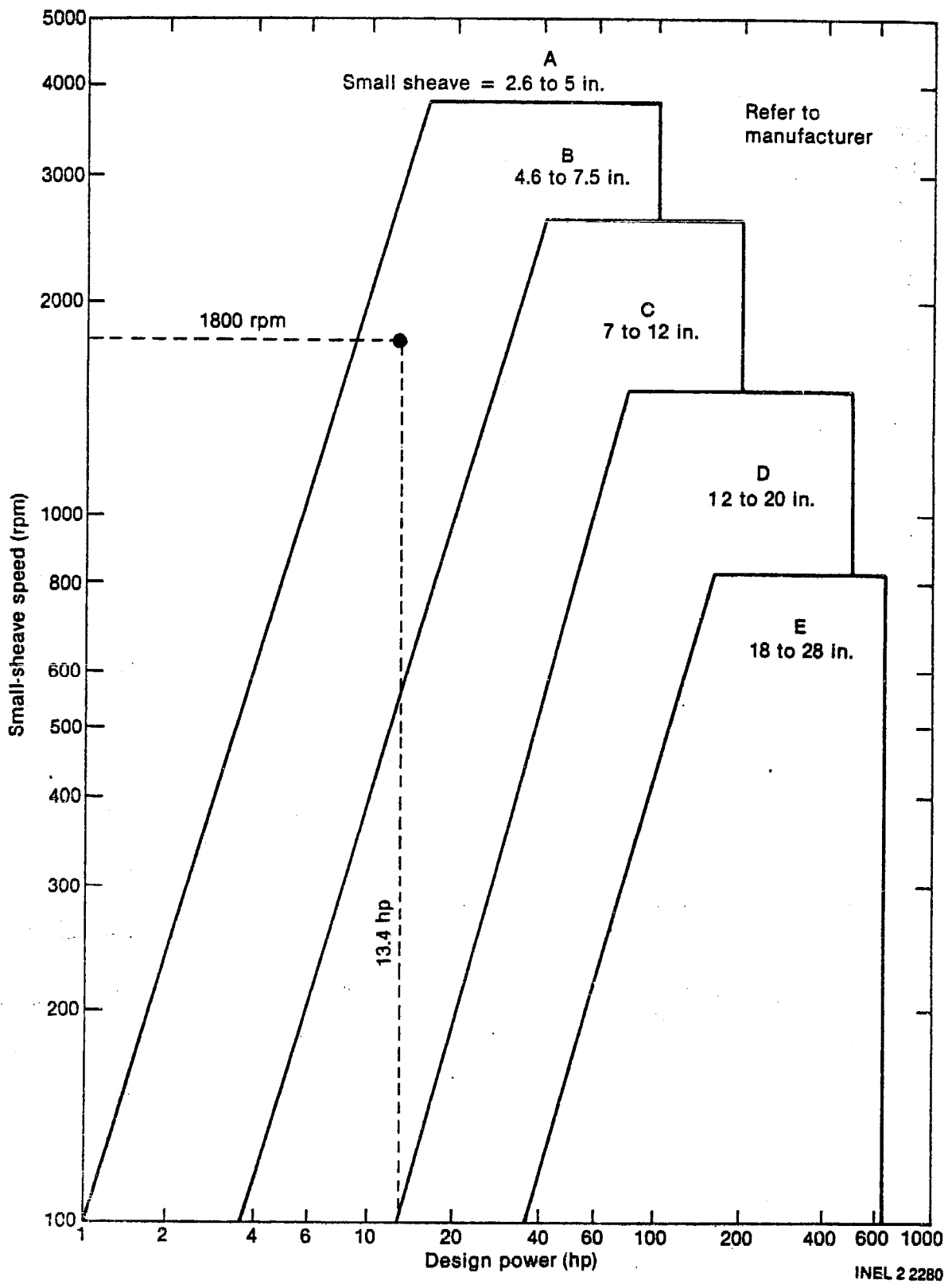

INEL 2 2280

Figure 4.9-3. Conventional belt selection chart.

You can now calculate the power that the belts must transmit. The power of the turbine is used as the starting point. This power rating must be modified to account for starting loads, peak loads, intermittent service conditions, and any other operating factors that may affect the rating of the drive. These various conditions are incorporated in a service factor. The turbine power rating is multiplied by this service factor to give the design power of the belt drive. For hydroelectric turbines, a service factor of 1.4 or 1.5 should be adequate. Therefore, if your hydroelectric turbine is calculated to produce 10 kW and a belt system is to be selected as the drive, the belts should be designed for 14 to 15 kW.

Calculate an approximate center distance unless the distance is already fixed by the system design. A rule of thumb is that the center distance should be 1 to 1-1/2 times the larger sheave diameter. Centers should not exceed 2-1/2 to 3 times the sum of both sheave diameters. Once the approximate center distance is calculated, you can calculate the initial belt length with the following equation:

$$L = 2C + 1.57 (D + d) + \frac{(D - d)^2}{4C} \quad (4.9-2)$$

where

- C = center distance in inches
- D = pitch diameter of the large sheave in inches
- d = pitch diameter of the small sheave in inches
- L = pitch length of the belt in inches.

Compare the belt length to the manufacturer's standard belt lengths, and select a belt closest to the calculated belt length. Then recalculate the true center distance using the following equations:

$$K = \frac{L - 1.57 (D + d)}{2} \quad (4.9-3)$$

$$C = K - \frac{(D - d)^2}{8K} \quad (4.9-4)$$

where

- C = center distance in inches
- L = pitch length of the belt in inches
- D = pitch diameter of the large sheave, in inches
- d = pitch diameter of the small sheave, in inches
- K = a factor.

The remaining calculation is called the arc-length correction factor. Horsepower ratings given in catalogs are for belts having a 180-degree arc of contact. For drives other than these, a correction factor must be applied. This factor can be found in catalog tables once you have calculated the arc of contact.. Use the following equation to calculate the arc of contact:

$$\alpha = \frac{(D - d) \times 57}{C} \quad (4.9-5)$$

where

- α = arc of contact in degrees
- D = pitch diameter of the large sheave in inches
- d = pitch diameter of the small sheave in inches
- C = center distance in inches.

Typical correction factors are shown in Table 4.9-2, and an illustration of the arc of contact is presented in Figure 4.9-4. This correction factor is multiplied by the basic power rating of the V-belt to obtain the true belt power rating.

TABLE 4.9-2. CORRECTION FACTORS FOR LOSS IN ARC OF CONTACT IN DEGREES

<u>Loss in Arc of Contact (degrees)</u>	<u>Correction Factor</u>	<u>Loss in Arc of Contact (degrees)</u>	<u>Correction Factor</u>
0	1.00	50	0.86
5	0.99	55	0.84
10	0.98	60	0.83
15	0.96	65	0.81
20	0.95	70	0.79
25	0.93	75	0.76
30	0.92	80	0.74
35	0.90	85	0.71
40	0.89	90	0.69
45	0.87		

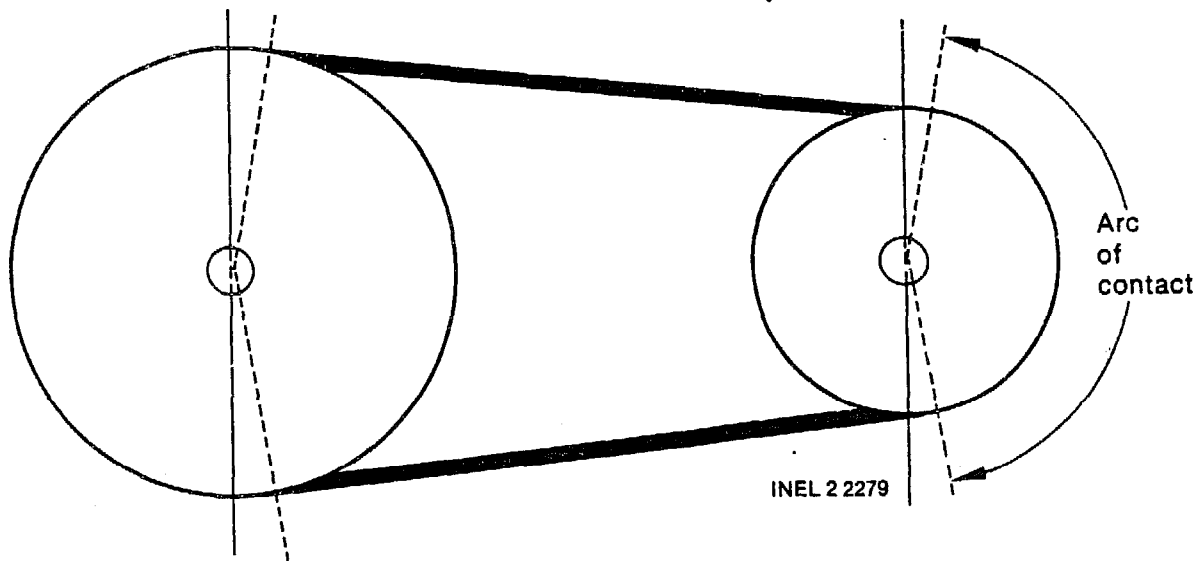

Figure 4.9-4. Arc of contact.

Other correction factors are also used by manufacturers and will be found in their catalogs. Corrections are used for long belt lengths and for high speed ratios. Once you have determined the true belt power rating, find the number of belts needed by dividing the calculated power rating of the drive system by the power rating of the belts:

$$B = \frac{R_D}{R_B} \quad (4.9-6)$$

where

B = number of belts

R_D = power rating of drive system (turbine power x service factor)

R_B = true belt power rating.

EXAMPLE: Assume that the turbine operates at 600 rpm and the generator at 1800 rpm. The turbine power has been calculated at 10 kW or 13.4 horsepower (10 kW x 1.34 hp/kW). Select the belts using the following steps:

Step 1. Select Belt Type

From Figure 4.9-3 at 13.4 hp and 1800 rpm, the belt type is "B".

Step 2. Power Rating of the Drive System

1.5 is the selected service factor. Therefore,
13.4 hp x 1.5 = 20.1 hp

Step 3. Select Sheave Diameters

From Table 4.9-1, the minimum pitch diameter (d) of the small sheave is 5.4 inches. Calculate the larger sheave pitch diameter (D) by multiplying the speed ratio (R) by the small sheave diameter.

$$D = R \times d \quad (4.9-7)$$

where

D = pitch diameter of large sheave in inches

R = speed ratio, from Equation 4.9-1

d = pitch diameter of small sheave in inches.

R was found to be 3 in a previous example. Therefore:

$$D = 3 \times 5.4$$

$$D = 16.2 \text{ inches}$$

Check this diameter against manufacturers standard sheave diameters from catalogs; assume that the nearest sheave diameter is found to be 16.0 inches.

Step 4. Determine Belt Length and Actual Center Distance

Using the rule of thumb that the center distance (C) should be 1-1/2 the large sheave diameter (D):

$$C = 1.5 \times 16.0$$

$$C = 24 \text{ inches}$$

The belt length is calculated using Equation 4.9-2:

$$L = (2 \times 24.0) + [1.57 \times (16.0 + 5.4)] + \frac{(16.0 - 5.4)^2}{4 \times (24.0)}$$

$$L = 48 + 33.6 + 1.17$$

$$L = 82.77 \text{ inches}$$

Checking a manufacturer's catalog reveals that a B81 belt has a pitch length of 82.8 inches. This is so close to the calculated length that the center distance will not change significantly. It is recalculated here as an example using Equations 4.9-3 and 4.9-4:

$$K = \frac{82.8 - [1.57 \times (16 + 5.4)]}{2} = 24.6$$

$$K = 24.6$$

$$C = 24.6 - \frac{(16 - 5.4)^2}{8 \times (24.6)}$$

$$C = 24.03$$

Step 5. Find the Horsepower Rating per Belt

The horsepower rating per belt is found in each manufacturer's catalog for his specific belts. Assume that the manufacturer's catalog allows 6.3 hp per belt after considering correction factors for a speed ratio of 3 and a long belt. Find the arc length correction factor, using Equation 4.9-5:

$$\alpha = \frac{(16 - 5.4) \times 57}{24}$$

$$\alpha = 25.18 \text{ degrees}$$

From Table 4.9-2, the factor is 0.93 for 25 degrees

$$\text{hp} = 6.3 \times 0.93$$

$$\text{hp} = 5.86 \text{ per belt}$$

Step 6. Determine Number of Belts

From Equation 4.9-6:

$$\frac{20.1 \text{ hp (power rating from Step 2)}}{5.86 \text{ hp (per belt hp from Step 5)}} = 3.43 \text{ belts}$$

Use 4 belts.

The drive selected then has the following specifications:

4 belts, Size B81

Turbine sheave--4 grooves, 16-inch pitch diameter

Generator sheave--4 grooves, 5.4-inch pitch diameter

It is important to select your belt drive system in accordance with recommended practices. Belt drives optimized for compactness using the latest technology usually have the longest service life. Both overbelting and underbelting produce sizable energy losses. For example, the loss in energy approximately doubles from 3% to 6% when a belt drive is operated at only one-half the rated load capacity. In general, the energy loss due to factors such as belt flexure remain constant even though the belt operating load is decreased by half the rated capacity. Energy losses increase when belt loads exceed their capacity due to belt creep and distortion. This occurs when the belts are underdesigned.

Poor belt maintenance can be another cause of significant energy losses. Low belt tension can cause losses of as much as 10%, and misalignment, worn sheaves, and debris in the grooves all contribute to efficiency loss and reduced belt life. Belt tensioning is an important consideration, and the manufacturer's catalog should be reviewed or the representative contacted to obtain data on correct tensioning of belts. Belt drives should always be designed with center distance adjustment since belts will stretch during use and require periodic adjustments.

4.9.2.3 Gear Drives. Gear drives provide the strongest and longest service of the mechanical drive trains considered when speed increasing or decreasing is required. They are also the most expensive drive systems. If you feel that a gear drive is needed to couple the turbine and generator, you should contact a manufacturer of such drives to assure proper installation.

The most common gears used for the transmission of power between parallel shafts are spur gears, helical gears, and herring bone gears. Spur gear teeth are straight and parallel to the shaft axis. They have no end thrust loads, and are economical to manufacture and easy to maintain. Helical gears have teeth that form a helix. They have greater load carrying capacity, and operate more smoothly and quietly than spur gears of equivalent size. Helical gears are more expensive to manufacture and, because of their design, they produce end-thrust that in turn requires end-thrust bearings. Herring bone gears are double-helical gears that eliminate the end thrust loads of single helical gears. These gears are primarily used for the transmission of heavier loads, which would not be present in microhydropower units. Their expense is probably not warranted for small microhydropower installations.

If the turbine and generator must be mounted at right angles to one another, several gear combinations can be used. The simplest and most inexpensive are bevel gears, which have straight teeth and would perform satisfactorily for microhydropower installations. More expensive gears, which are quieter and can sustain higher loads, are spiral bevel gears and

crossed helical gears. Gear drives are also available for situations where shafts are not parallel or perpendicular but are skewed at an angle between zero and 90 degrees.

The design of gear drives is a complicated procedure and best left to the manufacturers of those drives. The calculations for gear tooth, bearing, and shaft loadings, as well as the selection of seals and lubrication are major tasks beyond the scope of this book. When discussing a gear drive with the manufacturer, be sure to have available the power to be transmitted, speed ratio, space limitations if any, the arrangement of the turbine and generator, and any thrust loads that the turbine may introduce into the drive.

5. DESIGN PACKAGE, CONSTRUCTION, AND INSTALLATION

In this section you will assemble the design package (including the final cost estimate and a construction schedule), order equipment and material, and construct and assemble the system.

5.1 Design Package

At this point in the project, you should have a clear idea of how the project will look and what it will do. Events 1 through 22 in the event schedule given in Section 1 should be completed or in progress. All design information should now be put into a single design package so that you can readily refer to any design aspect of the job or track costs and progress during construction. This design package will also help identify problems during initial system startup and during later operation and maintenance of the project. As you obtain equipment manuals and other information during construction, add these to the design package.

The design package should consist of final construction drawings, specifications or data sheets for major components, material takeoff sheets, bid packages, cost estimate, and final schedule. Depending on your particular site, you may not need some of these items in the design package. The purpose of the design package is to ensure the following:

- All site considerations and constraints have been identified
- All equipment has been identified and selected
- The size and operating specifications for the equipment and material are compatible
- All construction material has been identified
- All outside labor has been identified
- All known problem areas have been identified and solved

- The budget and schedule are reasonable and realistic.

5.1.1 Final Drawings

Collect and review all sketches drawn in Section 4. Correct any deficiencies in the design. Provide clear sketches to identify the work to be done by a contractor or someone else. The drawings need not be professionally done, but they should be drawn to scale and show enough detail so that contractors and inspection officials will clearly understand the project. Copies of the drawings will be needed, and therefore the drawing size and material should be compatible with the copying method. Drawings on letter size graph paper can be photocopied, but larger drawings can only be reproduced using a blueprint or similar process.

The recommended drawings include one sketch showing the entire system and several smaller ones showing details of specific components. An elevation cross section should be drawn that includes the elevation of the intake, powerhouse, and tailrace; it should also include the gradient or slope of the penstock. The final drawings should contain enough detail so that an accurate materials list can be generated. Forgotten or insufficient materials can cause serious delays during construction.

The agencies responsible for issuing the permits you must obtain will be more receptive when you present complete plans and working drawings. Furthermore, you will save time during the permit process by having good drawings so that specific questions can be answered quickly.

5.1.2 Data Sheets, Specifications, and Bid Packages

The major data sheets you should have at this point are the Turbine-Generator Information Request in Subsection 4.2 and the Design Specification in Subsection 4.3. If data have changed since the basic concept was presented to the manufacturers, resubmit the new data--for example, new site characteristics--to ensure that the turbine-generator will function properly at your site. The data sheet submitted by the turbine manufacturer should also be in the design package.

For large turbines and other large equipment, you may want to write a formal bid specification. This can be a performance specification or a procurement specification. The former specifies performance characteristics, the latter specifies equipment. In most microhydropower applications, formal specifications will not be necessary, but you should still prepare data sheets that describe the performance requirements of major equipment to be purchased. This allows you and the manufacturer to agree on equipment performance and costs.

For items such as pipe, valves, wiring, and concrete, you can call or visit several suppliers to obtain quotes for the items without bothering to use data sheets. This is an acceptable method, but a written quote with a description of any ordered items prevents unwelcome surprises when the items are delivered. Although this paperwork may seem unnecessary, it takes little time and provides a record of the purchase agreement.

Poor timing in the ordering and delivery of material and equipment can delay construction. For example, it may take from 6 months to a year to obtain a turbine-generator, and therefore delivery times should be known and ordering complete before construction begins. Always request that suppliers state delivery times when discussing material procurement.

5.1.3 Material Takeoff Sheets

To estimate cost and order material accurately, a material list must be prepared. Carefully review each drawing and sketch to determine exactly what material must be procured. (This further points to the need for accurate drawings and sketches.) List each item to be procured on a "material takeoff sheet." This sheet should contain a description of the item, the quantity, and the name of the supplier, if known. An inaccurate list can waste time and money: the cost and time to deliver a couple of forgotten lengths of pipe or an additional 4 cubic yards of concrete to a project in a remote area can be substantial. You should therefore recheck the material takeoff list to ensure that all needed items are ordered. Order spares if an accurate count cannot be made, or if some items could be lost or damaged. Most suppliers will allow you to return undamaged extras that are not needed.

While estimating the material needed for the project, include construction material such as concrete forms, scaffolding, and earth moving equipment; include these on your material takeoff sheets.

5.1.4 Detailed Cost Estimate

A detailed cost estimate includes the material cost, the estimated labor cost to install or construct an item, and any equipment rental required. The material takeoff sheets should be used as starting points for preparation of the cost estimate.

The three most common materials on the sheets will be concrete, wood for concrete forms and for the powerhouse, and pipe for the penstock. The length of penstock should be known by this time. If concrete is purchased commercially, keep in mind that it is sold by the cubic yard and that 1 cubic yard equals 27 cubic feet. From the working drawings, determine the volume of concrete in cubic yards for the entire project. For example, a forebay wall that is 5 feet tall, 8 feet long, and 6 inches thick would have a total volume of 16 cubic feet ($4 \times 8 \times 0.5 = 16$), or about 0.60 cubic yards ($16 \div 27 = 0.60$).

Figure 5-1 is a suggested form to help determine the project cost. For a given item, the form lists the description, material quantity and units, material cost per unit, unit labor hours to install material, total labor hours, labor rate, labor cost, material cost, and total cost. All material, labor, rentals, and equipment should be included in the cost estimate. Copies of the form can be found in Appendix I.

For the total estimated cost, sum the above estimated costs, add 10% for administration (permits, etc.), and then 15% of that sum for contingency.

EXAMPLE: Assume that the summed estimated cost is \$10,630; find the total estimated cost.

For administration cost, $\$10,630 \times 0.10$ (10%) = \$1,063.

The sum is then $\$10,630 + \$1,063 = \$11,693$.

For contingency, $\$11,693 \times 0.15 (15\%) = \$1,754$.

Thus, the total estimated cost is $\$11,693 + \$1,754 = \$13,447$.

Now, make the final go/no-go decision. Like the previous decisions, this one should be based on economics. Category 1 developers can compare the total project cost to the benefit gained from the project. Category 2 developers should do a more detailed analysis using the procedure outlined in Subsection 4.3.1. If the decision is to proceed, refer back to Section 1.5 to make sure that Events 27 through 32 are completed before starting construction.

5.1.5 Construction Schedule

Prepare a construction schedule to determine when work on the project must be done, or when it can be done. In developing the schedule, be sure to consider the following:

- Weather--In cold climates, winter can present a serious obstacle. Snow and cold can make the job unpleasant and may affect the quality of the work. Concrete in particular is difficult to work with in freezing temperatures, and concrete work should be scheduled for the best weather possible.
- Streamflow--Work on streams is easier if done in the dry season, which, for most of North America, is in late summer and early fall. Check the stream flow data to determine the dry time.
- Use of Machinery--If you rent small construction equipment such as a backhoe or grader, identify and schedule the tasks for which it will be used before the unit arrives so that you can get maximum output for least cost.
- Availability of Contractors--As the schedule is developed, make sure that the contractors will be available at the time allocated for the task. Make sure that the contractors understand clearly what is expected of them. Use the working drawings to help in this process.

- Availability of Material--To meet a construction schedule, it is important that the material be on the site when needed. Although more common items can usually be obtained as stock items from local building material suppliers, specialty items such as penstocks, valves, and turbine-generator sets must be ordered; delivery times can be critical.

Several people can work on different parts of the system at the same time. For example, one may be digging the penstock trench while another is stringing the transmission line. If only one person is building the system construction time will obviously be correspondingly longer. Keep in mind that projects of this kind will almost always take longer than anticipated, especially the first time. When scheduling work, take care that unexpected delays don't push critical parts of the project into the winter months. Concrete work should be done when above-freezing temperatures are assured for one week following the pour. Otherwise, the fresh concrete will have to be protected.

A construction schedule is a working document. Even the effort to generate one will be helpful. Most of the needed information is developed for the drawings and cost estimates. To develop the schedule, you will need a list of tasks, their sequence and duration, and who will do them (if more than one person is on the project). A time line summarizing this information can then be generated.

5.2 Construction and Installation

5.2.1 General

Preparations for the construction of the microhydropower project should be carefully planned to assure that construction delays are minimized. The material takeoff sheets and schedule (see Subsection 5.1) should ensure that the construction materials and equipment will be available when needed. There are other problems that can delay or stop construction if you do not consider them. Review any special requirements of your site. The following items should be considered for all sites:

- Heavy Items--Plan to have appropriate lifting equipment available to offload heavy items (e.g., turbine-generator, transformer) and set them in place.
- Access--Provide sufficient access to bring construction equipment onto the site. This may require improving existing roads or building new ones.
- Utilities--The utilities needed for construction (e.g., power, water, compressed air) should be identified early so that you can arrange to have them available when construction starts.

For somewhat remote development sites, the most versatile piece of equipment for lifting and excavating is probably a backhoe. A backhoe can usually be rented locally, or the backhoe work can be contracted for at reasonable hourly rates.

Although ready-mix concrete is usually less costly, limited site accessibility may require that concrete be mixed at the site. For example, if loaded concrete trucks cannot pass over light-duty bridges or culverts, a small, gas-powered concrete mixer can be rented for onsite mixing.

If an overhead powerline is required, it must be installed by an experienced powerline contractor. The equipment and experience required for setting the poles and for installing wire, crossarms, insulators, and pole-mounted transformers are not normally available except through such a contractor. Direct burial of cable for an underground powerline is a different matter; only rented trenching equipment is needed.

Temporary diversion structures required to divert water flow away from construction sites can cause temporary impoundment problems or soil erosion. If a temporary coffer dam of some size is required and water flows are significant, the help of a consulting engineer will ensure a sound structure; worker safety and the integrity of the construction in progress is of primary concern.

5.2.2 Civil Works

The civil works include excavation, placement of the penstock, construction of the powerhouse, laying of concrete, and the building of canals and diversion structures. Depending on your experience and available time, you may want to do some of this work yourself. If you are not experienced in this area, you should hire a contractor to do the work. Failure of civil works through inexperience can be catastrophic to the project. For instance, if insufficient compaction of soil in the trench allowed the penstock to sag and rupture, the resulting flooding could damage the powerhouse.

It is not the intent of this section to enable an inexperienced person to do the work himself; the intent is to provide guidelines and terminology so that you can understand what a contractor is doing and why. References are included so that you can study particular aspects of the job and perhaps do portions of the work yourself.

5.2.2.1 Excavation and Backfill. The burial of the penstock, construction of the powerhouse, and placement of footings require experience with soil and rock excavation and backfill. The excavation and backfill provide a solid base for support of the structure under consideration.

Soil can be excavated by hand or with specialized machinery. For safety, trenches or other excavations more than 5 feet deep should have sides backsloped at approximately 45 degrees to prevent cave-ins on workers. Explosives are used to excavate rock: the rock is drilled, the charges placed, the explosive fired, and the debris cleared away. An experienced contractor should do this work.

The contractor may wish to sample the soil or test the area to be excavated. Although specific soil tests can provide valuable information and save money, you can avoid unnecessary costs by verifying what data and tests are needed. For example, most microhydropower structures will be small; heavy soil loading is not anticipated. The contractor may only need tests to determine the amount of rock in the excavation area or the suitability

of the soil as backfill material. Question any aspect of the construction job that you are not familiar with. Most contractors will gladly explain the benefits of testing or of a specific method of working.

Consolidation of soil is a principal cause of structure settlement. Consolidation results when a load on the soil causes the ground water to flow out of the soil. In saturated sands and gravel, which are very porous, consolidation occurs quickly because the water can move freely through the voids. In fine-grained cohesive soil such as clay, the capillary size of the pore spaces between the soil grains prevents water from flowing freely and slows consolidation. Under a load, however, the water will gradually be forced out, allowing the soil particles to crowd together. This reduces the volume of the bed, allowing the structure resting on the soil to settle.

The contractor's experience should help prevent excessive or uneven settlement that can damage the structure. He may suggest increasing the bearing area of a structure's footings, placing a more porous bed of material under the structure to drain the water and spread the bearing load, installing pile foundations, or providing a drainage system to remove the water and keep the soil dry. Soil tests can determine if a settlement problem will exist. Keep in mind that the microhydropower structures should not produce large loads and that proper design of footings will spread the load over a large area and minimize settlement.

Backfill of trenches and areas around structures is important. Proper backfilling supports underground structures and the penstock. When backfill is placed, it should be tamped at regular intervals to ensure that it is compacted. The backfill material should be low in organic content (leaves, branches, etc.) and should not contain large quantities of rocks.

The moisture content of the backfill should also be controlled. Too much or too little moisture can cause the fill material to settle. If settling produces a depression along the penstock or a footing, runoff could erode the remainder of the soil and leave the structure unsupported. Moisture content of the backfill material should be controlled near its optimum

level, at which a given soil can be compacted to its maximum density by means of standard compaction methods. This optimum level can be determined by soil analysis or can be judged by experience.

Excavation for footings should be deep enough so that the footing base is below the frost line. If soil freezes, ice crystal formation causes swelling and upheaval of the soil mass. Settlement from thawing can then damage concrete structures extensively.

The detailed information in References a through d will help you if you plan to lay underground pipe or compact soil yourself.

5.2.2.2 Concrete. Concrete is a mixture of sand, gravel, crushed rock, or other aggregate held together by a hardened paste of cement and water. When properly proportioned and mixed, the raw mixture can be cast into a predetermined size and shape. The proportioning and mixing can significantly impact the workability and texture of the concrete. Excessive aggregate and minimum sand give a textured rather than a smooth surface. Oversanding the mixture gives a putty-like appearance. Neither mixture produces good concrete.

Workability can be visualized as a composite of texture and slump. The term slump is used in concrete specifications. Slump is determined by filling a frustum of a cone with a concrete mixture, removing the cone, and measuring the subsidence of the mass below its original height. The amount of subsidence is the slump value. Concrete mixes that have low slump values

a. Handbook of Culvert and Drainage Practice, Armco Drainage and Metal Products, Middleton, Ohio.

b. Handbook of Steel Drainage and Highway Construction Products, American Iron and Steel Institute, New York, NY.

c. Handbook of Soil Compactionology, Bros/Tema Division, American Hoist & Derrick Co., St. Paul, MN.

d. Soil Compaction and Equipment for Confined Spaces, Wacker Corp., Milwaukee WI.

are stiff and hard to work into tight spaces. For thin walls or areas congested with reinforcing steel, a concrete with a high slump is desirable since it will flow into all areas with minimum tamping or vibration. The wetter the concrete mix, the higher its slump value and the lower its ultimate strength.

You should determine what application the concrete is intended for and then decide on whether you need it wet, dry, or medium. For most micro-hydropower work, a minimum slump of 3 inches and maximum of 6 inches should be adequate. This is a medium mixture and should cure in 28 days with a compressive strength of 3000 pounds or more per square inch. Figure 5-2 illustrates the use of slump to achieve correct consistency in deep, narrow forms.

Water used for mixing cement should be clean and free of organics and excessive minerals. Generally, any potable water is suitable for use. Sewage, industrial waste, and corrosive salt waters should be avoided.

Detailed information on the use of concrete can be found in References a, b, and c.

5.2.2.2.1 Placement--Concrete is placed in structures using either chutes or wheelbarrows. Chutes should have a slope of one vertical to two horizontal so that the concrete mixture flows freely. Flatter slopes encourage the use of additional water, leading to segregation in the mixture

a. Joseph J. Waddell, Concrete Construction Handbook, McGraw-Hill, New York, NY.

b. Concrete Manual, U.S. Department of Interior, Bureau of Reclamation, Washington, D.C.

c. Design and Control of Concrete Mixtures, Portland Cement Association, Skokie, ILL.

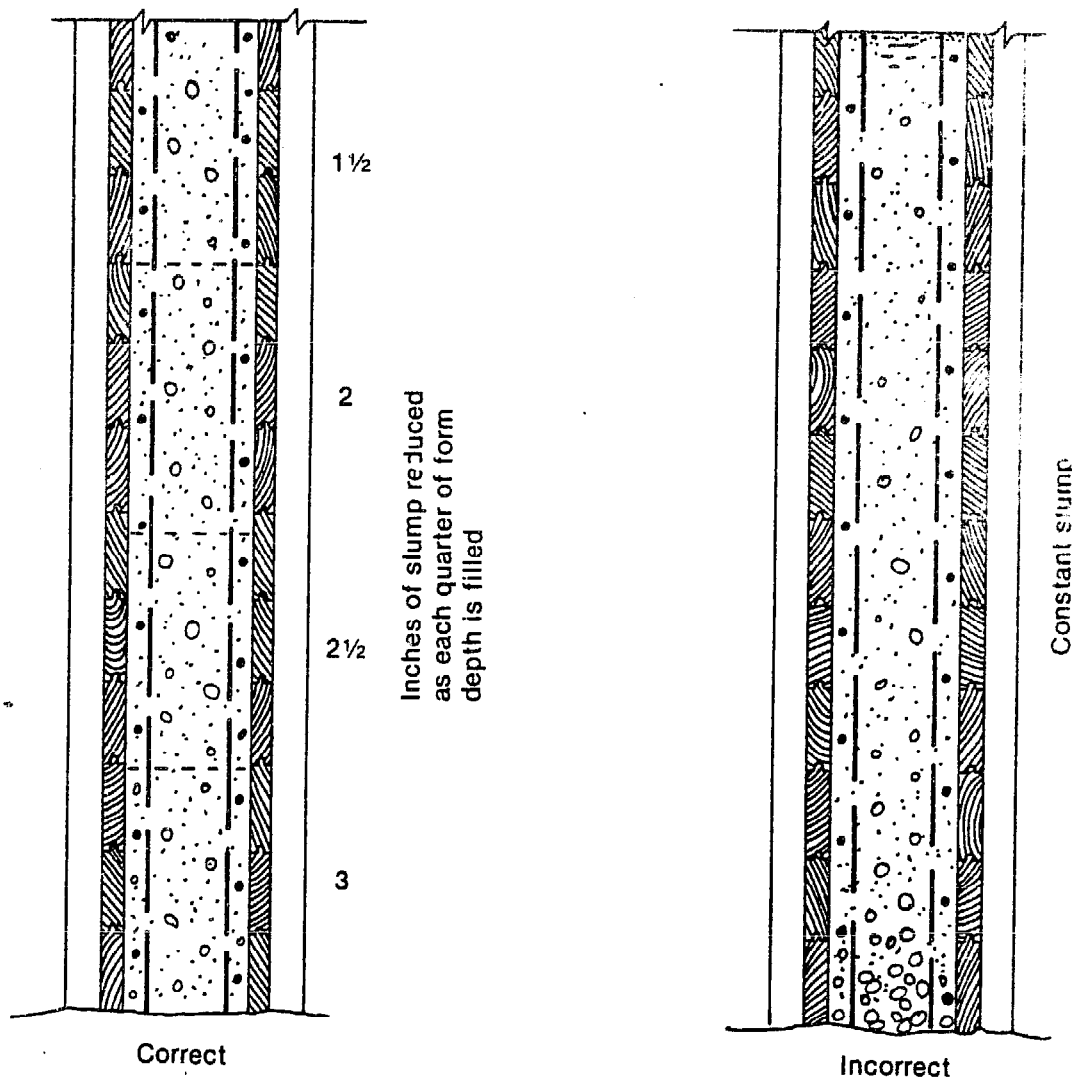

Correct

To use wetter concrete at bottom of deep narrow form. Use drier concrete as more accessible lifts near top are reached. Water gain tends to equalize quality of concrete. Settlement and shrinkage are minimum.

Incorrect

To use same slump at top as required at bottom. High slump at top results in excessive water gain with resultant discoloration and loss of quality and durability in the upper layer.

INEL 2 2667

Figure 5-2. Consistency of concrete in dry, narrow forms.

and low strength. The method of placement is also important in preventing segregation. Figures 5-3 through 5-6 provide some examples of placement methods. These examples were taken from Reference a.

NOTE: If you are pouring the equipment pad during construction of the powerhouse, time spent to ensure a level and smooth surface will simplify the installation of equipment.

5.2.2.2.2 Compaction--Concrete is compacted by manual spading, walking in, tamping, or vibrating. Vibrators can be applied to the concrete or to the outside of the form. When placing concrete on a previous pour that is not yet rigid, compaction is important to ensure mixing and bonding at the interface. Compaction works the concrete into the corners of the forms and into areas of dense reinforcing bar placement. Figure 5-7 shows the use of vibrators to compact concrete. The figure also shows removal of a rock pocket to allow better compaction and ensure consolidation of the pour.

5.2.2.2.3 Curing--Curing of concrete ensures proper hydration so that it develops the needed strength and hardness. Concrete should be kept moist for a period of at least 7 to 14 days. Sprayed-on membrane curing compounds can be used to retain moisture, or canvas, straw, earth, or burlap can be placed over the concrete and dampened periodically.

5.2.2.2.4 Watertightness--Concrete can be made practically impervious to water by proper proportioning, mixing, and placing. Patented compounds are on the market for producing watertight concrete, but good results can be obtained by increasing the percentage of cement in the mix. The mixture should contain more fine material and an additional portion of cement. Six bags of cement per cubic yard of concrete will give an acceptable mixture.

a. Concrete Manual, U.S. Department of Interior, Bureau of Reclamation, Washington, D.C.

Placing concrete on a sloping surface

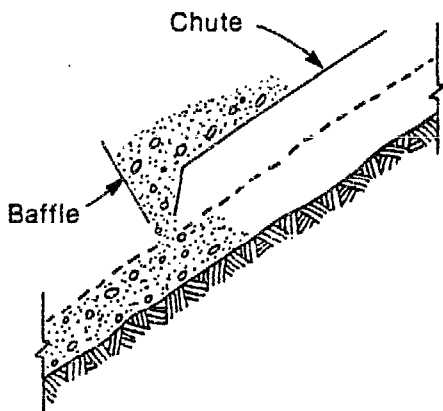

Correct

Place baffle and drop at end of chute so that separation is avoided and concrete remains on slope.

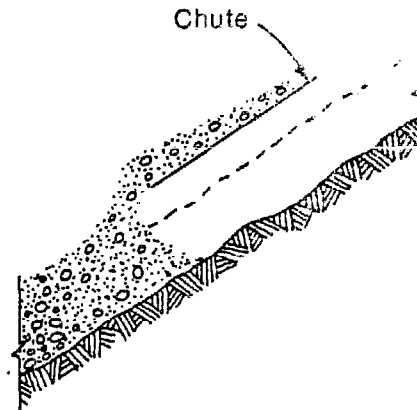

Incorrect

To discharge concrete from a free end chute on a slope to be paved. Rock is separated and goes to bottom of slope. Velocity tends to carry concrete down slope.

Control of separation at the end of concrete chutes

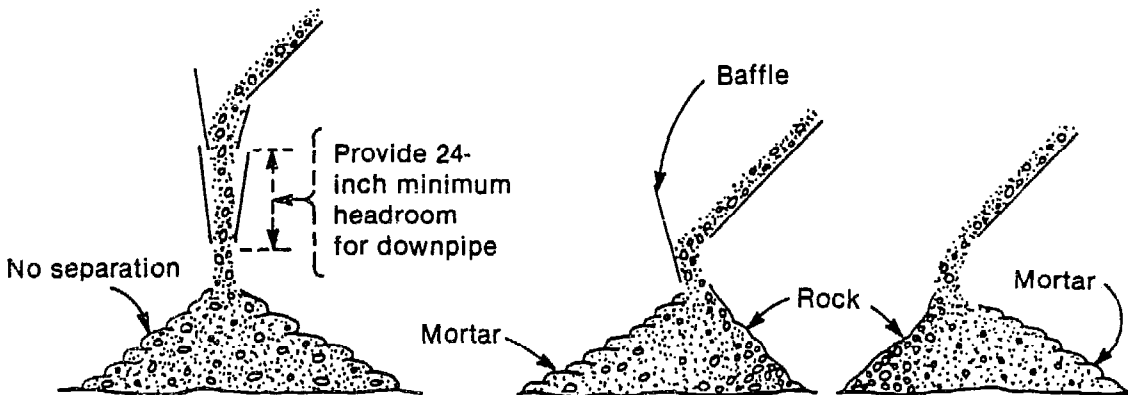

Correct

The above arrangement prevents separation, no matter how short the chute, whether concrete is being discharged into hoppers, buckets, cars, trucks, or forms.

Incorrect

Improper control or lack of control at end of any concrete chute, no matter how short. Usually, a baffle merely changes direction of separation.

INEL 2 2673

Figure 5-3. Placing concrete on slope, and control of separation.

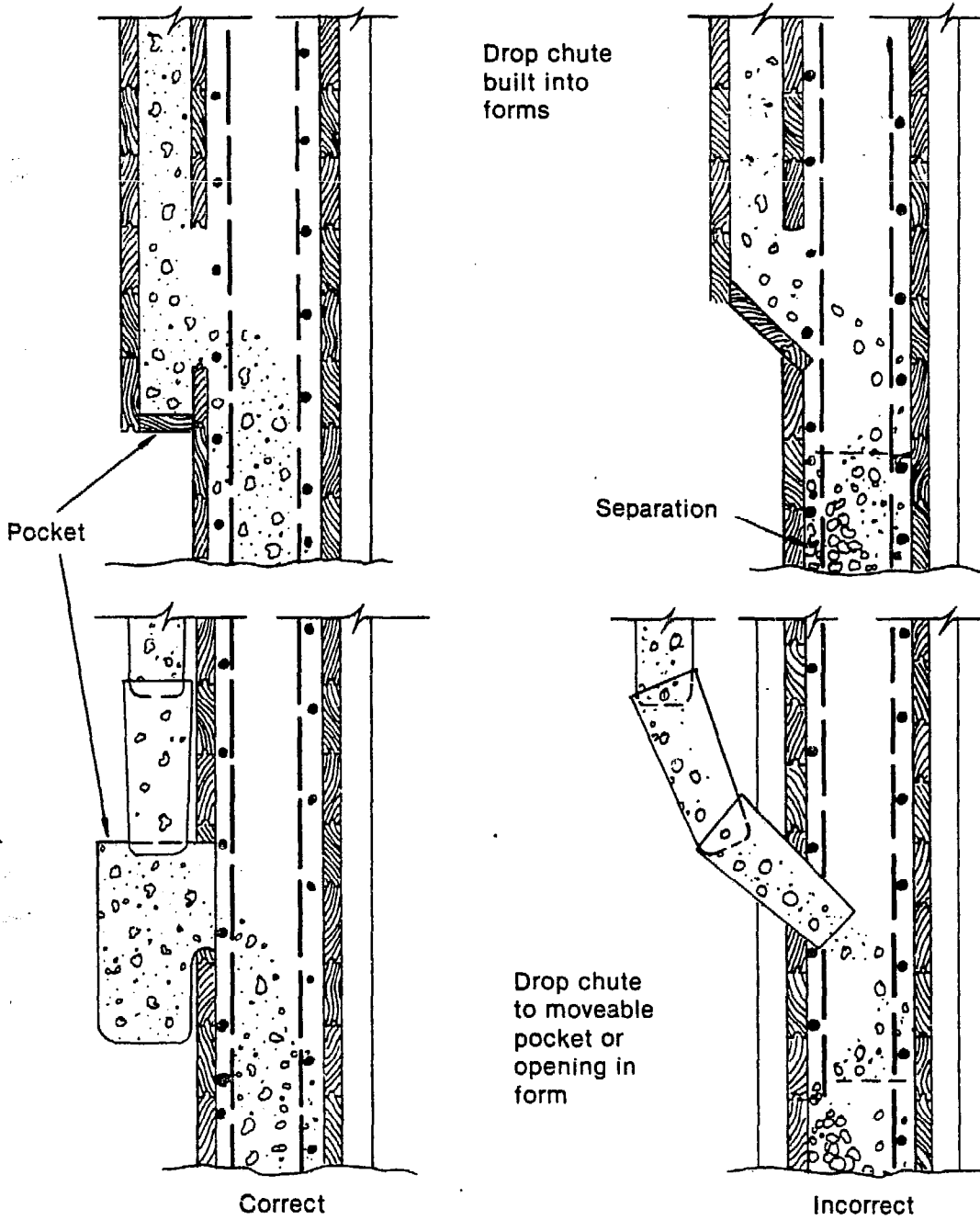

Drop chute
built into
forms

Separation

Pocket

Drop chute
to moveable
pocket or
opening in
form

Correct

Incorrect

Drop concrete vertically into outside pocket under each form opening so as to let concrete stop and flow easily over into form without separation.

To permit high velocity stream of concrete to enter forms on an angle from the vertical invariably results in separation.

INEL 2 2668

Figure 5-4. Placing concrete in forms.

Placing concrete in top of narrow form

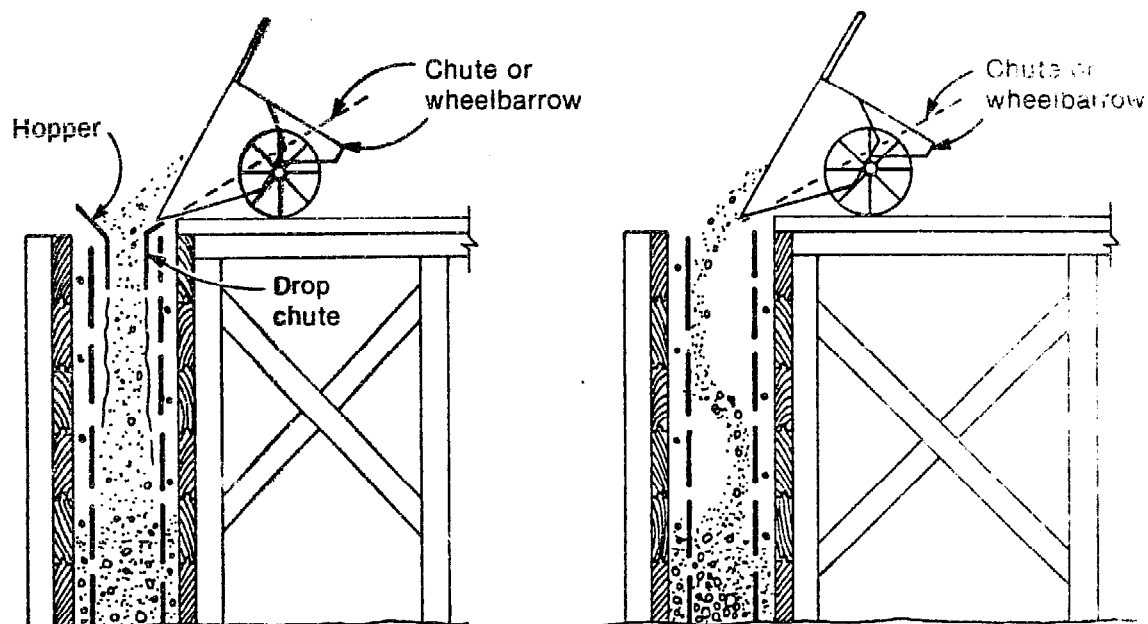

Correct

Discharge concrete into light hopper feeding into light flexible drop chute. Separation is avoided. Forms and steel are clean until concrete covers them.

Incorrect

To permit concrete to strike against form and ricochet on bars and form faces causing separation and honeycomb at the bottom.

INEL 2 2671

Figure 5-5. Placing concrete in top of narrow form.

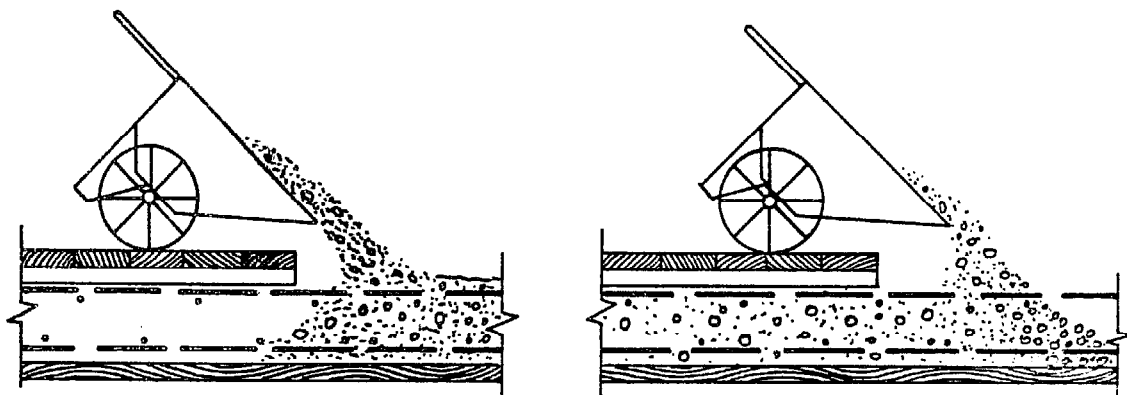

Correct

To dump concrete into face of concrete in place.

Incorrect

To dump concrete away from concrete in place.

INEL 2 2670

Figure 5-6. Placing slab concrete.

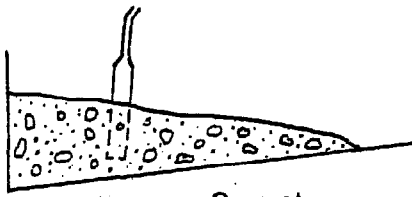

Correct

Start placing at bottom of slope so that compaction is increased by weight of newly added concrete as vibration consolidates.

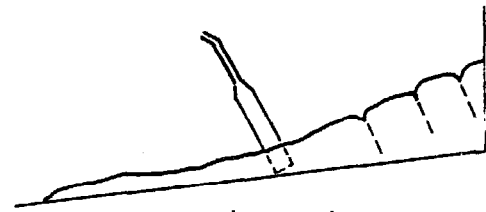

Incorrect

To begin placing at top of slope. Upper concrete tends to pull apart, especially when vibrated below.

When concrete must be placed in a sloping lift

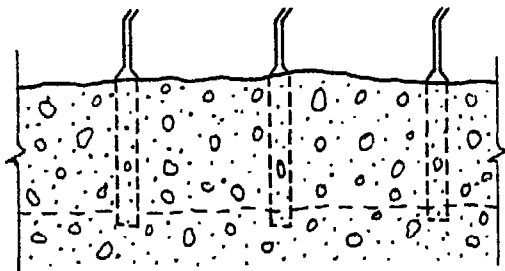

Correct

Vertical penetration of vibrator a few inches into previous lift (which should not yet be rigid) at systematic regular intervals.

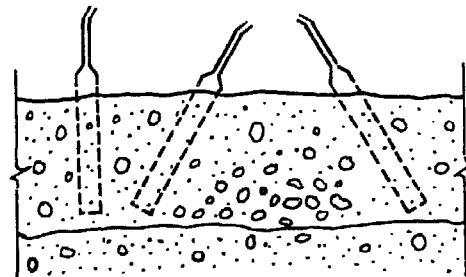

Incorrect

Random penetration of the vibrator at all angles and spacings without sufficient depth to assure monolithic combination of the two layers.

Systematic vibration of each new lift

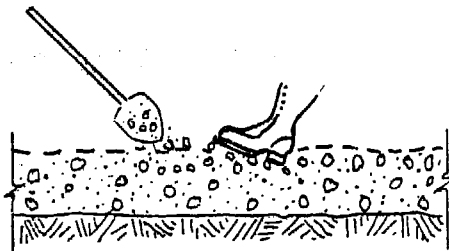

Correct

Shovel rocks from rock pocket onto a softer, amply sanded area and tramp or vibrate.

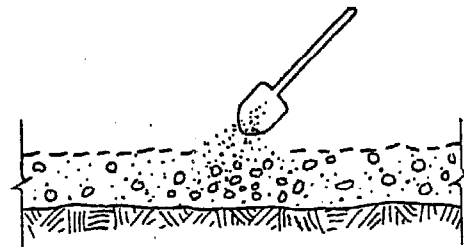

Incorrect

Attempting to correct rock pocket by shoveling mortar and soft concrete on it.

Treatment of rock pocket when placing concrete

INEL 2 2669

Figure 5-7. Compaction with vibrators, and treatment of rock pocket.

New concrete can be bonded to old by wetting the old surface, plastering it with neat cement (a mixture of cement and water), and pouring the new concrete before the neat cement has set. Where two surfaces adjoin and one will be poured and allowed to harden before pouring the second, rubber water stops designed to waterproof joints should be installed in the first pour.

5.2.2.2.5 Air Entrainment--The entrainment of air using resins or other air-bubble-forming compounds gives the concrete somewhat greater plasticity and freedom from segregation, and increases its durability against freezing and thawing. Although the added resins and the resulting air voids reduce the strength of the material, the greater workability of the air-entrained mixture allows a reduction of water content and a higher ratio of coarse aggregate to fine, thus compensating for any loss in strength.

5.2.2.3 Concrete Forms. Concrete to be placed for slabs, walls, or columns must be supported in forms. The purpose of the forms is to contain the concrete until it has the strength to stand by itself and to prevent leakage that will cause the concrete to honeycomb. It is important that the forms have sufficient strength and rigidity to prevent bulging or sagging, which will permanently damage the structure. The pressure on the forms is equivalent to that of a liquid with the same density as concrete. The forms should be left in place 7 days for vertical walls and 28 days for a support structure.

The forms should be checked for line and grade when they are placed. The interior surface of the forms must be smooth and tight at joints to give a clean finish to the concrete. All dirt, shavings, and other debris should be removed from the forms. Wood forms should be drenched for 1/2 hour or more before placement of concrete, since swelling of dry forms in contact with wet concrete may distort the form. Forms that are reused should be thoroughly cleaned and oiled. A light oil should be used, and any excess should be wiped off to prevent staining the concrete surface.

Stability is an important consideration in construction of forms. If there is any movement of the forms as the concrete is poured, all work should be stopped and the problem corrected. Some common deficiencies resulting in form failure are:

- Inadequate cross-bracing of the shores
- Inadequate horizontal bracing and poor splicing
- Failure to regulate the rate of concrete placement
- Poor regulation of the horizontal balance of form filling
- Unstable soil under the mud sills
- No provision for lateral pressure
- Inadequate bracing for wind pressure
- Vibration from adjacent moving loads
- Nearby embankment slippage.

If vibrators are to be applied to the outside of the form, it is essential that the forms be sturdy enough to prevent misalignment or other damage from this added stress.

5.2.2.4 Concrete Reinforcing Steel. Reinforced concrete is a combination of steel and concrete fabricated into a structural member. Concrete is weak in tension, and steel bars embedded within the concrete provide the needed tensile strength. The concrete protects the steel against corrosion and fire damage. The concrete adheres to the surface of the bars, and lugs on the bars also anchor them in the concrete. This gripping action, referred to as a bond, keeps the bars from slipping through the concrete so that the concrete and bars act as a single unit.

Reinforcing steel is available as single bar lengths or wire mesh. In light gages, wire mesh is available in rolls and is common for building construction. Large sheets of heavier gages are used for highly loaded slabs. The wire mesh is furnished in square or rectangular patterns welded at each intersection. A 4-inch-square mesh will greatly enhance a slab's durability and resistance to cracking. If lighter gages are used, the concrete will tend to push the wire to the bottom of the form. A hook tool should then be used to pull it back up into the concrete after the concrete has been tamped and before troweling the surface. The wire should be pulled up about 1 inch from the bottom of the form.

Single bar reinforcing steel is used for walls, columns, and the equipment pad. Reinforcing bars come in many sizes and several grades. Table 5-1 gives the available sizes of bars, and Figure 5-8 shows the various grades with identification marks. The grades refer to the different strength properties of the materials from which they are fabricated. For microhydropower applications, any of the grades should be acceptable.

TABLE 5-1. ASTM STANDARD REINFORCING BARS

<u>Designation</u>	<u>(in²)</u>	<u>(lb/ft)</u>	<u>Diameter</u>
#3	0.11	0.376	0.375
#4	0.20	0.668	0.500
#5	0.31	1.043	0.625
#6	0.44	1.502	0.750
#7	0.60	2.044	0.875
#8	0.79	2.670	1.000
#9	1.00	3.400	1.128
#10	1.27	4.303	1.270
#11	1.56	5.313	1.410
#14	2.25	7.650	1.693
#18	4.00	13.600	2.257

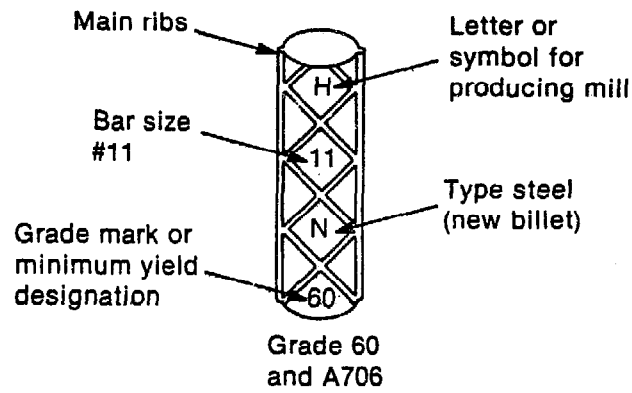
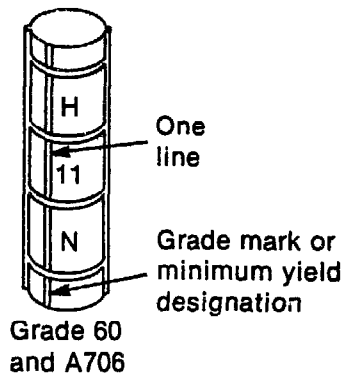
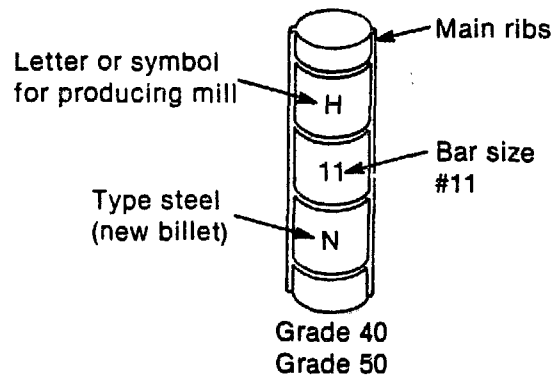

INEL 2 2675

Figure 5-8. Reinforcing bar grades.

The proper embedment of the bars in the concrete is important to the strength of a reinforced concrete member. The minimum standards shown in Figure 5-9 can be used when the embedment has not been specified on drawing. The exact positioning of the bars in relation to one another is generally not as critical as the embedment as long as the number of bars called for used. The amount of steel bar used should be determined by a technical person if the structure is to be heavily loaded and unsupported over a long distance. If you are not familiar with the placing of reinforcing bar in concrete, seek help in determining the bar size and placement. If the equipment pad is to be placed on the ground, No. 4 rebar on 1-foot centers should provide an adequate mounting pad.

Once the bars have been placed, they should be securely held in position by wiring or welding the bar intersections to avoid displacement during pouring. This wiring or welding of the bars only provides stability; it adds nothing to the strength of the structure. The number of intersections that must be tied or welded is a matter of judgement, but it should be sufficient to secure every intersection around the periphery and every third or fourth intersection in the interior. Methods for tying bar intersections are shown in Figure 5-10. If the bars are welded at the intersections rather than tied, the slab and bar can serve as an electrical ground through a lead from the bar to the generator ground system.

Additional information on the placement of reinforcing bar can be found in Reference a.

5.2.2.5 Anchor Bolts. Anchor bolts to mount major equipment should be positioned before pouring the concrete for the equipment pad or powerhouse floor. If anchor bolts have not been set into the concrete, you may have to chip out the concrete to install and grout the bolts in place. For mounting small equipment, the concrete can be drilled to install concrete anchors.

a. Manual of Standard Practice for Placing Reinforcing Bars, Concrete Reinforcing Steel Institute, Chicago, IL.

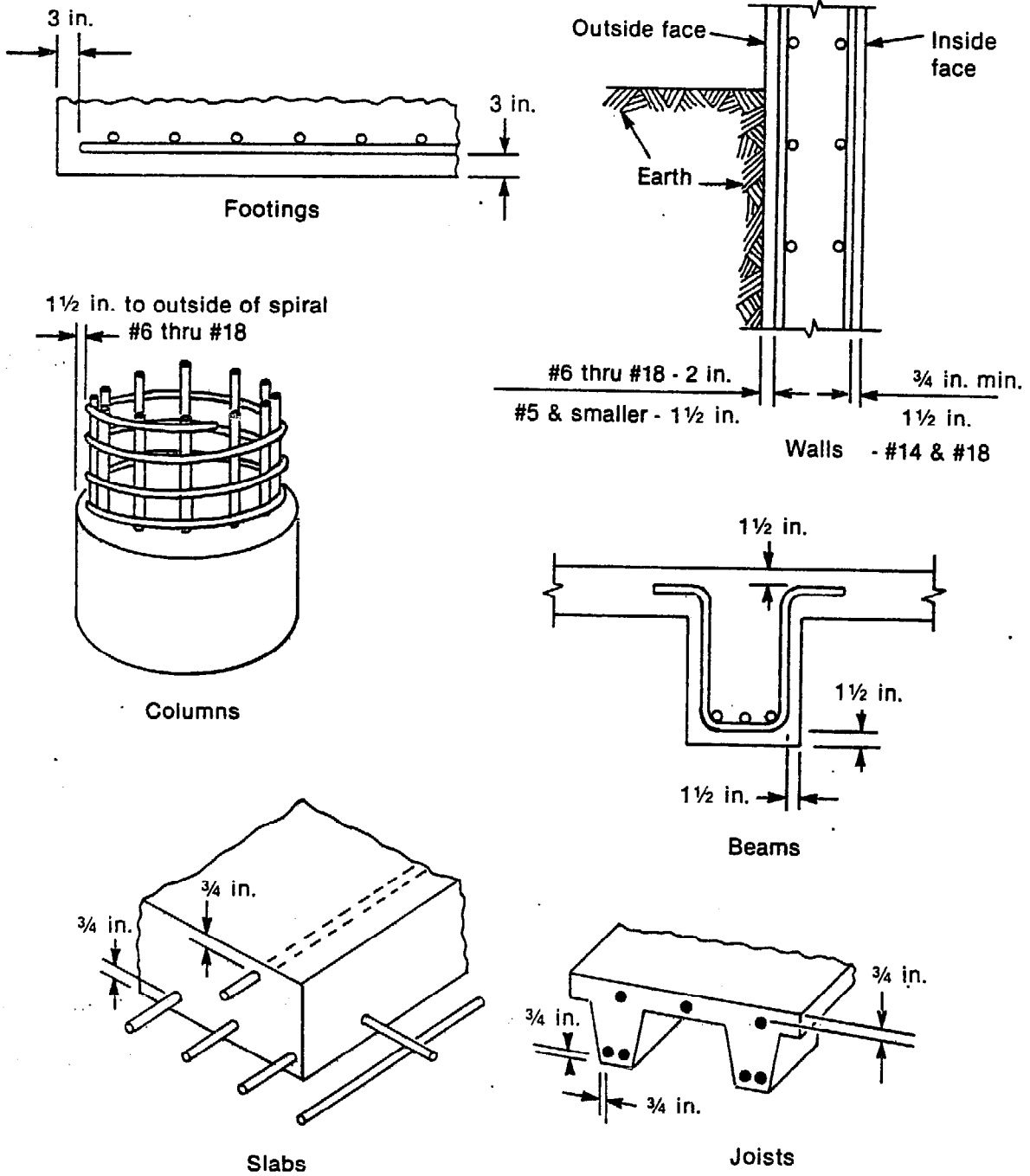

INEL 2 2672

Figure 5-9. Reinforcing bar embedment standards.

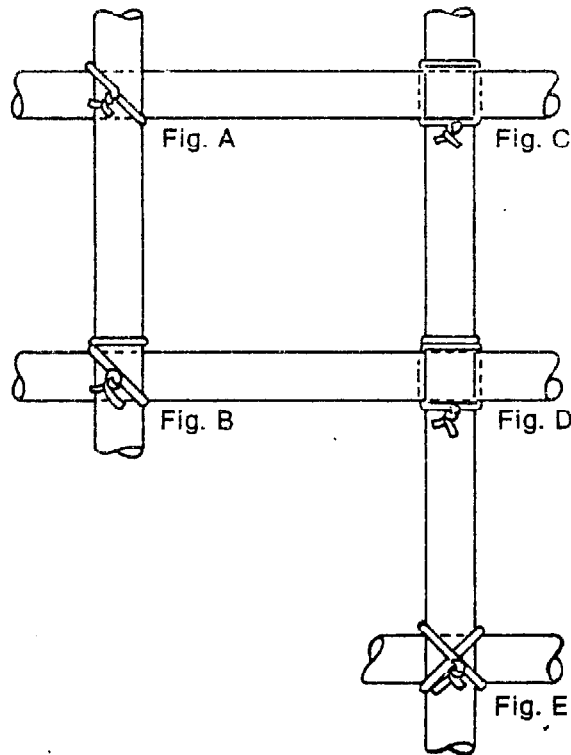

INEL 2 2676

Figure 5-10. Methods for tying reinforcing bar intersections.

The anchor-bolt size should be recommended by the equipment manufacturer. If the equipment must be leveled, leave an additional 1/2- to 1-inch length of bolt above the floor over the length needed for the equipment base, nut, and washer to allow for shimming and grouting (see Subsection 5.3).

A solid connection of the turbine-generator to the equipment pad is essential. The mounting bolts poured into the pad must line up precisely with the corresponding holes in the turbine frame. To ensure this alignment and proper bolt depth, some turbine manufacturers supply a steel template and mounting bolts. (A steel template can also be fabricated, if necessary, once the exact spacing, depth, and bolt size is known.) Each bolt is inserted in the corresponding hole in the template and held securely with a nut. The steel template assembly is then cast into the equipment pad.

A less costly plywood template can also be used. A plywood template is usually not cast into the slab, but used only to aid in placing the mounting bolts. For plywood templates, two nuts, one above and one below the template, are adjusted to hold the bolt at the proper depth.

If anchor bolts are poured into the concrete and protrude from the floor, you will have to lift the equipment and place it on the bolts. Therefore, heavy lifting equipment or other lifting provisions, should be available in your powerhouse. If concrete anchors are used, the equipment can be rolled or skidded into place and the bolts then installed and tightened.

5.2.2.6 Penstock. To ensure tight joints, penstocks are typically laid from the lowest elevation up. The pipe should be well supported even in the bottom of the trench. Rocks should not be in contact with the pipe; where rocks are a problem, the trench should be lined with sand or fine dirt before placing the pipe. Straw can also be used to provide a bedding for PVC or other plastic pipe. If steel pipe is used, a protective coating to prevent corrosion should be specified, and the pipe should not be bedded in cinders.

The route of the pipe, whether it is above or below ground, should be graded so that a channel for surface runoff is not formed. If the installation is aboveground, remove nearby trees that could fall and large rocks that could roll on the pipe. Do not backfill the penstock until it is pressure checked for leaks (see Subsection 5.3). When all leaks have been corrected, 6- to 7-inch layers of loose material should be placed and lightly tamped until the pipe is covered by at least 6 inches of fill material. The remainder of the trench can then be filled all at once and the site graded.

5.2.3 Mechanical Equipment

Most mechanical equipment will be installed and checked out after the civil work is completed. The mechanical equipment work includes setting, leveling, and aligning major equipment such as the turbine-generator;

flushing and cleaning water passages; adjusting equipment for operation and lubricating newly installed equipment. In addition to the usual wrenches, screwdrivers, and pliers needed for working on mechanical equipment, a hand-held tachometer, pressure gage, carpenter's level, square, hydraulic jacks, come-alongs, chain hoists, dial indicator, caliper, feeler gages, straight edge, and torque wrench could be required. Plan to have needed tools available.

5.2.3.1 Equipment Installation.

5.2.3.1.1 Positioning and Setting Equipment--The major equipment to be installed in the powerhouse is the turbine-generator set. In many cases, this will be furnished assembled on a frame; lifting and positioning of this item over the equipment pad can become a major obstacle if not carefully planned. If the powerhouse has been designed with sufficiently large doors, the entire unit can be lifted by a forklift and set into position. If this is not feasible, and the powerhouse overhead does not have a beam capable of supporting the weight of the unit, a steel "A" frame can be constructed over the pad for lifting and positioning. If anchor bolts are not protruding from the floor, the equipment can be pushed into position on rollers made of pipe (3/4- to 1-1/2-inch diameter). Hydraulic jacks can then be used to remove the rollers and lower the equipment into position.

If the turbine-generator set is furnished assembled on a frame, the entire assembly must be leveled after it is positioned on the pad. If you have poured the pad during construction of the powerhouse, the extra time spent to ensure a level and smooth equipment pad will be time well spent, and the frame need only be set on the pad and bolted down. However, if the pad is not level, perhaps because an existing building is being used, the unit may have to be leveled and grouted in place. The frame should be leveled with hydraulic jacks and metal shims placed between the floor and frame for support. A nonshrinking grout cement, mixed according to the manufacturer's directions, should then be forced under the frame to fill the area on which the frame will rest. After the grout has dried, the nuts can be placed on the anchor bolts and tightened to hold the unit in place.

5.2.3.1.2 Aligning and Adjusting Equipment--If the turbine, generator, and drive system are purchased as separate units, you must attach them to a frame. Separate components are lighter to handle during installation, but some times a shaft alignment is needed. If a belt drive system is used, the shafts of the turbine and generator will be parallel, and the alignment is not as critical as with direct drive or gear drive systems. For a belt-drive system, check the shaft alignment before bolting the generator and turbine to the frame. Accurately measure the distance between the shafts at the motor end; adjust to the same shaft distance at the outer end by moving one of the components. A large caliper can also be used to measure the distance. To check vertical alignment, place a level along each shaft, and shim the front or back of the components to raise or lower the ends of the shafts as required. Securely tighten the component that will not be moved to prepare for tensioning the belt.

The sheaves should then be placed on the shafts. Check the shafts and keyways first to ensure that they are smooth and free of burrs. Wipe the shaft, key, and sheave bore with light oil. Do not drive the sheaves on the shaft; they should slip on freely. If the sheaves or keys do not slip on freely, remove and check the size or correct the problem. Once both sheaves are in place, tighten one and then place a straight edge across its face, above the shaft. Slide the other pulley on its shaft until the sides of its face evenly touch the straight edge; tighten it in this position. The sheaves should now be aligned.

A properly designed belt system can be tightened by moving one of its components, which will have elongated mounting bolt holes. When mounting the belt(s) do not force it (them) over the sheaves; adjust the component position to allow the belt(s) to slip on easily. Then tension the belts to the manufacturer's recommendations and tighten the component mounting bolts, making sure to maintain alignment as described above.

If the motor and generator are directly connected to one another or to a gear box through couplings, the shafts of the components must be accurately aligned within the manufacturer's tolerances to prevent excessive wear on the shafts and bearings. If the couplings are flanges that are an

integral part of the shafts, the components can be brought together so that their flange faces touch and then a feeler gage inserted between the flanges at their periphery. Move each component and shim as necessary until the flanges are flush with each other. Rotate the flanges several times and check separation to ensure that the shafts are not at an angle to one another. To determine if the shafts are in line with one another, a dial indicator can be attached firmly to the outer diameter (rim) of one flange with hose clamps (a bracket bolted to one flange with the dial indicator attached is the most accurate method), and the pointer of the indicator on the outside diameter of the other flange. Rotate both flanges together through 360 degrees to locate the point of minimum reading. Move or shim one unit to bring this point to zero on the dial indicator. Repeat this operation until the shafts are in alignment, then tighten all mounting bolts and insert and tighten the coupling bolts.

If the coupling is not integral with the shaft but slides on the shaft (such as the flange face coupling shown in Figure 4.9-1), the angular alignment can be done more accurately with a dial indicator than with a feeler gage. Separate the couplings enough so that the pointer of the dial indicator, attached as discussed above, can touch the face of the coupling flange. One coupling is rotated through 360 degrees to locate the minimum reading position. The units are moved to bring this reading to zero, and the measurement is repeated. This procedure can be used with any of the couplings where some separation between flanges is possible.

A reverse indicator method of alignment can be used when the couplings are ribbed or otherwise unsuitable for the above alignment methods. Attach a dial indicator firmly to the outside diameter of one shaft with hose clamps, and place the pointer on the outside diameter of the other shaft. Rotate the shafts in unison and determine the minimum reading. Move the units to bring this reading to zero, and then repeat the procedure. Once the first shaft is aligned in this way, remove the dial indicator, attach it to the opposite shaft, and repeat the procedure to align both shafts. Recheck the alignment by repeating the entire procedure.

5.2.3.1.3 Bolting--All bolts should be torqued to their required loads. This procedure is important not only for bolts used for mountings and couplings, but for those used for valves and flanges that prevent leakage of water to the turbine. Bolts in circular patterns should be tightened alternately from one side of the pattern to the other. Bolts in a straight line pattern should be tightened from the center of the line outward, alternating from one side of the center to the other. First, tighten all bolts to 75% of the recommended torque; then repeat the procedure, using the alternating technique to bring all bolts to 100% of the recommended torque.

Torques for equipment bolts are normally supplied by the manufacturer. If torque values are not provided for low-strength bolts, use the values given in Table 5-2; for high strength bolts such as ASTM-A-325, ASTM-A-193 B7, or ASTM-A-409, increase these values by a factor of 2 to 3.

5.2.3.2 Flushing and Testing Water Passages. Before turning water into the system and before the penstock trench is backfilled, it is imperative that the entire system from intake to tailrace be checked. This includes checking the gates and valves to ensure that they operate smoothly

TABLE 5-2. TORQUE VALUES FOR LOW-STRENGTH BOLTS

<u>Bolt Diameter (in.)</u>	<u>Torque (ft-lb)</u>
1/4	2
3/8	10
7/16	18
1/2	28
9/16	40
5/8	55
3/4	100
7/8	160
1	250
1 1/8	340
1 1/4	490
1 1/2	850

without binding. Walk the canal and intake structure and remove all debris. If everything is in order physically, the next step is to flush the canals and intake structure.

Flushing clears the system of all loose material that could be washed into the penstock and then into the turbine. This flushing will loosen and remove the small particles and leave the larger, more stable rock. This process is known as "armoring" and is an important preoperational step.

To flush the intake canal, close the slide gate or valve so that loose material cannot enter the penstock. Flush the water and loose material through the intake structure cleanout pipe. Be sure that the water path below the outlet is riprapped to prevent erosion of the soil. Flush the system for several hours, or as long as necessary to get it clean. This flushing operation also provides a good opportunity to check that your stop log frame or canal intake gates can regulate flow properly and stop flow quickly.

When the intake is clean, flush the penstock. Open the penstock purge valve and close the turbine isolation valve. Slowly open the inlet slide gate or valve to the penstock intake. Water should flow into the penstock and bypass the turbine. Whatever is in the pipe should go out the purge valve. After flushing for several hours, slowly close the purge valve. After the valve is closed, check the penstock for leaks. If no leaks are present, drain the penstock and backfill where needed. After backfilling, open the purge valve and then the headgate. Slowly close and open the purge valve and check for signs of movement in the penstock. Increase the anchorage and support of any section that is questionable.

5.2.3.3 Lubrication. Before operation, the turbine-generator and other equipment should be lubricated according to the manufacturer's requirements supplied with the units. Gear boxes should be filled with oil; bearings and shafts should be greased to ensure smooth operation.

5.2.3.4 Equipment Checkout. The turbine-generator must be checked out before it is energized. Auxiliary turbine-generator systems, such as cooling or lubrication systems, should be checked out first to ensure that they function in accordance with the manufacturer's instructions.

The turbine-generator can now be checked for rotation and vibration. With the penstock purge valve open and the valve to the turbine closed, the penstock headgate can be opened slowly. Allow water to fill the penstock until it flows freely through the penstock purge valve, and then slowly shut the purge valve. Check to be sure that the generator is not connected electrically to the system, and then partially open the turbine inlet valve. Because the generator is unloaded, the inlet valve should not be fully opened under any circumstances or the turbine will quickly reach runaway speed.

Once the equipment is rotating near design speed, a check for vibration and shaft speeds can be made. A hand-held tachometer is useful to determine speed. Accessable shafts and bearings should be checked for quietness of operation. A screwdriver or metal rod firmly pressed against the bearing housing will indicate rumbling or uneven operation that may be due to dirt. A whistling sound is attributable to improper lubrication or insufficient internal clearance. Unusual noises should be investigated immediately.

The temperature rise caused by bearing operation may make the bearing housing too hot to touch. Bearings can operate to temperatures of 200°F and greater without failure. If you suspect that the temperature is too hot, consult the bearing manufacturer. Operating temperatures can be predicted from the operating parameters of your site.

Make a manual check of the emergency shutdown system at this time to ensure that it operates reliably.

Once all checks have been made, the system can be shut down: slowly shut the turbine inlet valve, and then slowly open the penstock purge valve and close the intake headgate.

5.2.4 Electrical

CAUTION: Electricity is Hazardous. As stated in Subsection 4.8.1, a qualified electrician should help install the electrical system.

Before the electrical system is energized for the first time, it should be inspected by an electrical inspector. In many localities, this inspection will be a state or county requirement.

The electrical system can be constructed concurrently with other portions of the microhydropower system. The final connections to the generator, however, cannot be made until the generator is permanently installed.

Some rules for the electrical installations are:

- All conductors must be mechanically protected, or else routed at such a height that they are not a hazard. Mechanical protection can be conduit, metal raceway, or burial in the earth. Minimum heights for overhead lines should be as specified by the National Electric Code (NEC).
- All conduits, boxes, equipment enclosures, and other electrical equipment must be securely supported and anchored. Standard installation procedures are to support all boxes and enclosures independently. Conduits should be anchored every 8 feet on center and within 3 feet of every bend or enclosure and as specified by NEC.
- All wire splices must be properly made and properly insulated as defined by NEC.
- All wiring connections to equipment must be made up tight.

CAUTION: Do not energize the system until all protective equipment for that specified portion is installed.

- The electrical installation consists of connecting the generator to the load through the overcurrent protective devices. These pieces of equipment will be interconnected by the system wiring and made ready for service.
- If the power system has a load control system, this system must be set up, connected, and made ready for operation.
- If the power system interconnects to a utility system, the step-up transformer and its protection equipment must be installed and made ready for service. This work will usually be done by the utility company and the cost billed to the developer. Even if the utility does not perform this installation, close coordination with them is required.

CAUTION: Do not connect to the utility's power line.

- When the generator has been permanently set and aligned, the electrical system can be connected to the generator. The coils of the generator will have to be interconnected to provide the required voltage in accordance with the supplier's recommendations. After the generator has been connected to provide the voltage desired, it can then be interconnected to the rest of the system.
- All system connections must be verified before the system is energized for the first time. This should be done on a point-to-point basis. Any wiring diagrams that have been produced will be helpful in this final checkout.
- Final connection to a utility line must be made by the utility. The utility should be contacted and asked to proceed with any work they have to perform. All disconnects must be left open at this time.

6. STARTUP, OPERATION, AND MAINTENANCE

Once the completed microhydropower system has been checked out, startup, equipment calibration, and steady-state operation are the next items of concern. After the system has been placed in steady-state operation, a good maintenance system must be implemented to ensure that the equipment will give trouble-free operation.

6.1 Initial System Startup

Starting up the completed system for calibration and then steady-state operation requires the following test instruments:

- Fuse tester
- Hand-held tachometer
- Volt-ohm-ammeter
- Clamp-on ammeter
- Pressure gage with an air purge valve.

6.1.1 Synchronous Generator Startup

If the no-load test run of Section 5 checks out as expected, then startup and operation of the generator with a small amount of connected electrical load can begin. The generator should not initially be started fully loaded; it should be started with about 10% load and then incremental loads added if smooth operation continues. Resistance loads that produce heat will work best because they are steady and can be easily controlled in small increments. If a load controller is being used in the system, you should analyze it to determine what resistance can be used. If motor loads exist, they should be disconnected during the low output testing of the generator since sufficient power may not exist to operate them at their design

condition. This can be done by throwing the breaker in the panel. If you are using a governor, review the manufacturer's data to determine at what minimum load it will operate, and start there.

Slowly open the turbine isolation valve a small amount to generate the 10% load. The generator is loaded, and the system should run at its design speed. The amperage meter should reflect the power being generated, and both frequency and voltage should be right on specification.

Two or three frequency cycles either side of 60 Hz is acceptable, but any more than that will require adjustment of the governor. A 10% system load will depend on the size of the system. For a 10-kW plant, 10% will be 1 kW, or 1000 watts (about the load rating of one small baseboard heating unit or a hand-held hair dryer). Larger plants will require correspondingly greater converted loads to get to the 10% load level. Many homes powered by microhydropower plants use electric heat, and these systems can be operated so that the loads are connected in increments for testing purposes.

Once the system is operating well at the 10% load level, the load can be increased. The power output will increase, but the frequency should stay right at 60 Hz. There may be a momentary blip in frequency when the additional load comes on, but that should last only a second or two until the governor system compensates.

The frequency is a function of generator speed, and the governor or electronic load controller will control either the power supplied by the turbine or the electrical load on the generator so that generator speed and frequency are maintained. Both hydraulic and electronic systems may require some adjustment before they operate properly.

Specific operating instructions for governors should come from the operation manuals for those units. Each has its own sequence for making adjustments and fine tuning the system. Once the right set points are found, mark the panel faces so they can be reset if moved.

Let the unit run at part load for 1/2 hour or more. Monitor temperatures of the generator and bearings for abnormal heat buildup. Listen for any vibration that is more than a common type hum, and be aware of any abnormal smells that could indicate excessive heat buildup or electrical insulation problems.

Increase the electrical load on the generator gradually. The frequency meter should remain at 60 ± 1 Hz, indicating that the governor is operating properly. Heat and vibration levels should not change. As the load on the generator changes, the speed of the turbine and generator should remain the same. You can check this function by varying the load. The frequency meter will show any problems by varying more than 1 Hz from the 60-Hz reading.

When you have the system operating at full output, note the way it sounds and feels. Later, any change in those characteristics may indicate that something is wrong. An intuitive sense of when it is running well will be very helpful. It may be helpful in developing that sense to sit and watch the unit run for several hours.

When one or more of the various protective devices such as governors or load controllers (see Subsection 4.8.12) are included, they should be activated to be certain that they work properly. Be certain that all operators understand the operation of these devices and know how to reset them if necessary.

The tachometer can be used to verify generator or turbine speed if problems are encountered with speed control and frequency output. The electrical instruments should be used to help adjust over current relays, emergency shut down relays and circuit protective devices included in the electrical control system.

6.1.2 Connecting Synchronous Generators to Utility Powerlines.

The utility's representatives should be present during initial startup and synchronization of the generator to the powerline. Synchronous generators are connected to active utility powerlines only after the generator has been brought up to the frequency and voltage of the powerline.

Making a smooth connection to the powerline requires that certain prerequisite conditions be met. The output voltage of the generator must be the same as the powerline, the speed of the generator must correspond to the frequency of the powerline, and the generator voltage must be in phase with the powerline. In actual practice, there is some tolerance in these conditions. A slightly higher generator voltage when connecting to the powerline does not cause any serious problem. At the instant the connection is made, the two voltages are forced to be the same. Minor differences in voltage are neutralized by the internal impedance of the generator, which will seek a phase angle with respect to the powerline that brings the voltages together.

Some minor difference in generator speed with respect to the powerline is tolerable at the instant the connection is made, but immediately following closure, the generator speed becomes locked to that of the powerline. Any appreciable difference in speed at the instant of closure will result in a corresponding mechanical and electrical jolt to the system.

When the individual cycles of the powerline are exactly in step with those of the generator, then the generator and the powerline are said to be "in phase." It is only when the generator and powerline are in phase that the generator can be smoothly connected to the powerline. This is roughly equivalent to engaging two rotating mechanical gears. It is not sufficient that the gears be rotating at the same speed to make a smooth engagement. It is also necessary that the gear teeth be properly aligned at the instant of engagement. If the generator and powerline are out of phase, the generator is operated either faster or slower than the powerline until the two systems are in phase. In actual practice, the speed of the generator is adjusted until it is as near the frequency of the powerline as possible. The speed of the generator, however, rarely remains precisely the same as the powerline for more than a few seconds at one time. With this slight difference in speed, the two systems will slowly wander into and out of phase. It is necessary to observe the phase relationship and close the connection to the powerline only at the instant when the two systems are in phase.

The typical power plant has voltmeters to compare voltages of the two systems and a synchroscope to determine the relative speed of the two systems. A synchroscope is a round dial with a single pointer. The pointer rotates at a speed which is the difference between the frequency of the powerline and the generator. The pointer comes to a halt when the generator is operating at the speed of the powerline; and the pointer points up when the systems are in phase. In a typical plant, the pointer on the synchroscope will not come to a complete halt until the generator is connected to the powerline. After the connection is closed, the pointer will remain fixed pointing upward. Counterclockwise rotation of the pointer indicates that the generator is rotating more slowly than the powerline frequency, and clockwise rotation indicates that the generator is rotating faster than the powerline frequency. It is generally accepted that closure to the powerline is best made with the pointer moving slowly clockwise and with the needle slightly past the straight up position. This, however, is somewhat dependent on the characteristics of the plant.

If the voltage, speed, and phase are correct, the generator is said to be synchronized with the powerline, and connection to the powerline can be made with no noticeable mechanical or electrical reaction. A mismatch of voltage, speed, or phase when connection to the powerline is made will cause a mechanical reaction and an electrical surge in the connecting lines. The severity of the reaction will depend on the degree of mismatch. Closure of the connection when the generator is 180 degrees out of phase is the worst case situation. Such an event may result in an electrical surge that is worse than short circuit and could do considerable damage to the generator. A properly designed system will have protective equipment that should prevent damage from such an event by disconnecting the generator from the line.

Use of a synchroscope is one of several ways that can be used to synchronize the generator with the powerline. There is a very unsophisticated method that uses lamps connected between the powerline and generator to indicate phase and frequency and in a crude way voltage also. The lamps blink on and off at a rate that corresponds to the difference between the speed of the generator and the frequency of the powerline. When the lamps stop blinking, the generator speed is matched to the powerline. Depending

on the connection, the lamps will be full bright or totally dark when phase and voltage are correct. Similarly, voltmeters can be connected so as to react with the same pattern as the lamps. Combinations of lamps and voltmeters can also be used. A problem with this method is that both lamps and voltmeters have reaction patterns that lag behind the true voltage being indicated. However, such systems have been used very successfully.

Some equipment suppliers are supplying microhydropower developers with solid-state equipment that senses when conditions are correct for closing the connection to the powerline and automatically closes the switch. In these installations, the operator adjusts speed and voltage. When conditions are correct, the system automatically makes the connection without the need for a synchroscope.

With the generator connected to the powerline, load can be added by increasing water flow to the turbine. As load is increased, it may be necessary to add excitation current if the generator has an external exciter, but most small plants begin operation with an excess of exciter current, which permits a wide range in generator load without need for adjusting the exciter current. Self-excited generators are usually self adjusting. If the exciter current is run too low, the power factor of the generator will be low and the generator may pull out of synchronism.

For this type of installation there is little need for automatic speed regulating equipment unless there are periods when the plant is to run stand-alone.

Before three-phase generators are connected to a powerline, it is customary to check the phase rotation of the generator. It is possible to make an error in the wire connections so that phase rotation is opposite that of the powerline. Checking the phase rotation is usually done with a special meter with leads that clip onto the three output leads of the generator. The generator should come with sufficient wiring information to be able to make the connections without error. However, it is a good idea to check the phase rotation from the actual output voltages of the generator because

an error could cause damage to the generator. If a synchroscope is used on the plant, incorrect phase rotation would be shown by the fact that it would not function.

6.1.3 Induction Generator Startup

The startup of an induction generator differs somewhat from a synchronous generator. An induction generator is always connected to a utility powerline, and so a utility representative should be present for initial startup. The induction generator should be energized momentarily to check for correct rotation acting as a motor. Any reverse current relays will have to be switched out of the control circuitry. If rotation is incorrect, then a reconnection of the wires at the generator will correct the problem. Once the generator has been wired to rotate correctly acting as a motor, then it can be energized again to run as a motor.

While the generator is running as a motor, make calibration checks to determine what the incoming power characteristics are on all phases. Look for an imbalance in voltage between phases. A difference of ± 5 to $\pm 8\%$ is probably not abnormal, but more than 10% could indicate a problem on the utility line.

Check the shutdown circuitry to ensure that it functions properly for over- and undervoltage tripout, over- and underfrequency shutdown, reverse current trip, etc.

After the shutdown circuitry has been checked and the relays have been properly adjusted, the generator can then be energized again as a motor. Once the unit is running smoothly, open the turbine inlet valve slowly while monitoring the system ammeter. Remember, reverse current relays will be switched out of the control circuit at this time. As additional water is allowed to flow through the turbine, the ammeter will slowly decrease until the synchronous speed of the generator is reached (no motor slip exists). Once the synchronous speed is exceeded, the generator begins to function not as a motor but as a generator, and the ammeter now reads output instead of input. The turbine inlet valve can be set for maximum generator output, and

the reverse current relays can be switched back into the control circuit. The generator is now on-line, and the synchronization of the power output from the generator is being controlled by the utility's system. With the water running, check the shutdown controls again to ensure their proper function.

6.1.4 System Troubleshooting

If your plant is not producing the power output for which you have designed it, there are a few checks you can make before contacting the turbine manufacturer. These data may help in understanding the problem. A pressure gage can be placed on a tap immediately upstream from the turbine. This device can give the pressure at the turbine from which you can determine your head. Check the pressure with the turbine isolation valve both closed and full open while the turbine is fully loaded.

Use one of the methods discussed in Section 3 to check the flow in your system while the turbine is running fully loaded. This can be done in the intake structure or canal. The stop log structure could be used to fabricate a weir. With head and flow information available, you can discuss the turbine problems with the manufacturer. The manufacturer will also need to know the size of your penstock where the pressure measurement was taken in order to calculate the velocity head at this point. If you are using a reaction turbine with draft tube, the elevation from the pressure tap to the tailwater level must be measured.

If the flow in your system is lower than predicted, check the trashrack, intake structure, and waterways for obstructions. Review all of your calculations to ensure that you have not made a mistake. Observe your system in operation. Ensure that the draft tube, if used, is always submerged to prevent air from entering.

Compare the output of the generator with the calculated power from the head and flow. Dividing the generator output by the calculated power will give the efficiency of your system. Compare this with the predicted efficiency. If it is low, check the drive to ensure that it is functioning

properly, i.e. that the belts are not slipping. If all appears to be working, have an electrician check the generator operation.

6.2 Startup

Normal operation of the system should be relatively trouble free. Things that can cause shutdown include an interruption of water flow, overheating of bearings, unloading the generator, overloading the generator, a power surge due to lightning, and--if your system is connected to a utility--a power outage on their line or utility power being out of specification for individual relay settings.

Startup procedures in a step-by-step sequence should be written down and posted at the generator. If a shutdown has been caused by a loss of water, or by bearing or drive problems, the startup procedure after the water flow has been restored and problems corrected should be the same as for initial startup. If an electrical problem has caused a shutdown, then after investigation to determine the cause and corrective action as required, the startup procedure should include bringing the generator up to speed and resetting appropriate tripout relays.

Continue to monitor the equipment for excessive temperatures or vibrations. The powerhouse should be kept clean, and clear access around equipment and controls should be maintained. Electrical hazard warning signs should be posted where appropriate, and electrical control boxes should be kept locked or interlocks provided for foolproof tampering. The powerhouse should be kept locked and a security fence provided.

An operational log is another useful tool to keep records on power outputs, water flows, etc. This information can be useful in future planning for plant upgrade, future power sales, and in plotting the cost of operating the overall plant.

If your system uses an induction generator, there are two methods for starting it. The first is the method discussed in the checkout procedure

where the generator is operated as a motor until it reaches synchronous speed and then is overdriven by the turbine to generate power. This method will cost money for the power to operate the generator as a motor.

The other method is to bring the generator up to synchronous speed with the turbine. The generator is connected to the utility line and overdriven by the turbine to start generating electric power. The speed of the generator should be not greater than but very near to synchronous speed when connected to the powerline. Since it is being started in the no-load condition, you must be cautious in opening the turbine inlet valve to prevent the unit from reaching runaway speed.

If your microhydropower installation is remote from your residence, you should have instruments to remotely monitor the status of the plant. These instruments may take the form of a single alarm that tells when the plant has tripped off line. This is particularly true if it is tied into a utility powerline so that loss of power would not be noticed at your residence. The alarm would tell you when the system needs attention. Other more detailed instrumentation could be installed to allow you to monitor specific operating characteristics of the plant, such as volts, amperes, power, head, etc. Cables can be buried or attached to the power poles to transmit this information to your residence.

6.3 Maintenance

Maintenance of a microhydropower plant is not complicated, but a constant effort should be maintained to ensure a trouble free plant. With periodic maintenance, properly built systems should run for years without major overhaul. Problems that arise because of mechanical failure, such as burned out bearings or runner damage, should be repaired promptly to avoid more serious damage. Hydropower plants are installed in areas where conditions are not ideal. Dust, dirt, and moisture are abundant, making good housekeeping and regular maintenance a necessity.

A maintenance log is a good way to spot continuing problems that may necessitate some system redesign, or to verify maintenance on items covered

by warranty. You should maintain such a log for your own information and as a notice of when maintenance is due.

6.3.1 Manuals

Maintenance manuals should be obtained for all major equipment purchased. If you have bought used equipment, write the manufacturer for a manual. Follow all directions in the manuals in servicing the equipment. If manuals are not available, the general information given in the following sections provides guidance for maintaining equipment.

6.3.2 Waterways

Inspect the canals, penstocks, settling basins, intake structure, and tailrace at least four times a year for signs of erosion, movement, or leakage. Drain and inspect the underwater portions of the system at least once a year. Concrete repairs can be made with an epoxy cement to cover exposed reinforcing bar and seal damaged areas. Inspect the trashrack, gates, and stop logs for damage, and repair if necessary. Clean debris from the waterways and repair erosion of the earthen portions of the structures, or add riprap.

Depending on your particular site, flush the settling basins and forebay as appropriate. Observe the quantity of settlement in these structures to determine how often this must be done. If there are large quantities of settlement, you may want to crack open the valve(s) on the system's flush line(s) to allow a slow continuous purge of these structures.

Another maintenance task that depends on the characteristics of the stream on which your site is located is trashrack cleaning. This may be a daily chore in spring when the stream is high and carrying a lot of debris, in summer when moss is floating on the water, in fall when leaves from trees fill the stream, or in the winter when ice builds up on the trashrack. The cleaning of the trashrack is an area that must be attended to as often as necessary to prevent loss of power generation. A trash rake should be kept in the powerhouse to clean the rack.

6.3.3 Mechanical

Inspect your turbine once a year when you drain the system to inspect the waterways, or follow the maintenance schedule in your manual. Inspect the metal blades or buckets for signs of erosion. If the erosion is heavy on these items, you may want to remove and repair them by welding. If erosion appears heavy every year, it could be a sign of problems in the design of your system such as improper turbine setting. This is an area where help should be requested from the turbine manufacture. Check the surfaces of the spiral case, needle valve, draft tube, and wicket gates for damage, and repair as necessary.

If the turbine has unusual vibration, check the bearing and shaft clearances, the turbine blades or buckets, and the water passages. Turbine vibration is an indication of serious problems and should be corrected immediately.

Lubricate shafts and bearings at regular intervals. Manufacturers will specify a lubrication period generally based on hours and type of service. If there are no guidelines for greasing of equipment, you should probably lubricate the bearings every 1200 to 2000 hours of operation. Wipe off any grease that has leaked from around the seals onto the outer bearing surfaces. Dirt will collect in these areas if this is not done.

Gear boxes, hydraulic governors, and other equipment containing a reservoir of lubrication or working fluid should be checked every 3 months and refilled if necessary. Use only the fluids recommended by the manufacturer. Remove and clean filters for these systems yearly unless otherwise directed.

Check valve packings and flange joints for leakage. If leakage noticed is not critical, replace the packing or gasket during your annual shutdown of the water system. If leakage is excessive, shut the system down right away and replace the packing or gasket. Test all manual and motor-operated valves monthly to ensure proper operation.

Inspect the belt drive system every 6 months or when the unit is shut down. Check the tension in the belts to ensure that they meet manufacturers' recommendations. Belts tend to loosen with operation and should be tightened periodically. Loosen the unit that is designed to take up the slack and tighten the belts, making sure to maintain alignment. If you are in doubt about the alignment, refer to Section 5 for aligning procedures.

Check the belts for cracks, tears, or worn areas. If you decide to replace a belt because of a problem, replace all the belts on the drive at the same time. Loosen the drive to remove and replace the belts. Do not force the belts over the sheaves. Again, ensure that alignment is maintained.

Clean the sheaves and belts periodically of dust, oil, and rust, which reduce belt life and efficiency.

Review and check other mechanical equipment such as ventilation fans, doors, or hoists, and oil and service as needed. Check and tighten bolts and nuts on moving parts such as the sheaves on the belt drive, couplings, shafts, etc. Anchor and mounting bolts and nuts should also be checked periodically.

6.3.4 Electrical

A systematic and periodic inspection of the generator is also necessary. Most generators are located in areas where dirt can accumulate and lower the insulation resistance. Some type of dust are highly abrasive and can damage seals and bearings. Hence, it is desirable to clean generators periodically. For severe conditions, weekly inspection and partial cleaning may be needed. Most machines require a complete cleaning about once a year.

At the annual inspection and cleaning, air-clean the generator using moderate-pressure, compressed air (about 25 to 30 psi). On most ac generators, this requires removing some of the protective covers.

On large machines, take generator insulation resistance readings periodically with a megohmmeter. As long as the readings are consistent, the condition of the insulation can be considered good. Low readings indicate increased current leakage to ground or to other conductors, perhaps caused by deteriorated insulation, moisture, dirty or corroded terminals, etc.

Inspection and servicing should be systematic. Frequency of inspection and degree of thoroughness may vary and must be determined by the owner. This will be governed by the importance of the produced power, the nature of the service, and the environment. An inspection schedule must therefore be elastic and adapted to the needs of each system. The following checklist, covering both synchronous and induction generators, is based on average conditions insofar as dust and dirt are concerned. If your generator manufacturer has not provided such a checklist, use this one as a guide.

POWER PLANT EQUIPMENT MAINTENANCE CHECK LIST

Daily

- Check air inlets and exhaust screens for blockage or accumulated dust.
- Check the voltmeter to see that the generator is running at a steady voltage.
- Check the frequency meter to see that the frequency is correct and stable.
- Check for any unusual noise, vibrations, or temperature changes in the bearings or casings on the turbine, generator, and any gear boxes.

Weekly

- Check oil level in bearings and gear boxes as appropriate.
- Examine switches, fuses, and other controls.

Monthly

- Lubricate ball and roller bearings as recommended by the manufacturer.
- Check for any leaking seals on all bearing housings.

Biannually

- Clean the generator thoroughly, blowing out dirt from windings, and wipe commutator and brushes as appropriate.
- Check the brushes (if used), and renew any that are more than half worn.
- Drain, wash out, and replace oil in the sleeve bearings (or service as recommended by the manufacturer).
- Inspect and tighten any loose electrical connections on the generator and control section components.
- Examine the drive system critically for smoothness of running, absence of vibration, and worn gears, couplings, or belts.
- Check anchor bolts, end-shield bolts, pulleys, couplings, gear and journal setscrews, and keys for tightness.
- Observe that all covers, belts, and gear guards are in good order, in place, and securely fastened.

Annually

- Clean out and replace the grease in ball- or roller-bearing housings (or service as recommended by the manufacturer).

- Test generator insulation with a megohmmeter.
- Check clearance between the shaft and journal boxes of sleeve-bearing units to prevent operation with worn bearings.
- Clean out undercut slots in the generator commutator if required.
- Examine connections of the commutator and armature coils.
- Inspect the armature bands.

6.4 Safety

Post warning signs to explain the correct operation of valves, electrical switches, and test equipment. Provide a fuse puller for replacing fuses, electrical interlocks, and keyed safety bypasses. Keep the equipment pad clean and free of water. Protect electrical equipment from water. Keep a fire extinguisher rated for electrical fires in the powerhouse. Provide guards on all moving equipment such as belts and shafts. Provide guard rails around the intake and cleanout areas if falling into them would be hazardous.

Provide security fences around the powerhouse and transformer pad as well as the intake structure. Locks to prevent unauthorized operation of bypass valves and the headgate are also good safety precautions.

Provide an emergency shutdown switch at the generator to shut the turbine and electrical system down. This switch should be used only in emergency situations and should be labeled as such.

6.5 Spare Parts

The powerhouse should be stocked with spare parts for the power plant. Many sites will be located in remote areas where the availability of parts

is limited. Review the manufacturers literature to determine what spare parts are recommended. Additional item that should be kept are:

- Fuses
- One set of belts
- Valve packing
- Gasket material
- Bearings
- Lubricants
- Valve trim (seats, plug, disk, etc.)
- One section of trashrack
- Generator brushes.

7. ECONOMIC AND FINANCIAL CONSIDERATIONS

Economic and financial considerations are an important aspect of evaluating the potential use of microhydropower. Accordingly, the following section details some economic and financial concerns. The section is divided by developer categories. The Category 1 developer is discussed first, and the Category 2 developer is discussed second. For a detailed discussion on how to prepare an economic analysis, see Appendix A-5.

7.1 Category 1 Developer

Category 1 developers are unique because their primary motive for operation is to supply energy for their own needs. The market for this energy is identified and quantified. This situation may occur in remote areas not presently served by electrical utilities or where present electrical needs are served with small fossil-fueled generators.

To perform an economic analysis, you must first estimate your current power consumption and identify its cost. Assume, for example, that you have identified your needs at about 64,000 kWh per year, i.e. you need a 15 kW unit. You have three options: purchase the required electricity from a utility, generate your own power with a gasoline-fired generator, or install your own microhydropower unit.

Electricity purchased from the utility currently costs \$3200 per year at 50 mills per kWh, or 5¢ per kWh. This dollar amount assumes extra charges for peaking, transmission hook-up, etc. This cost is highly geographically dependent.

The gasoline-fired generator has a capital installed cost of \$5000 and will require \$4,670 per year to purchase gasoline for operation. One gallon of gasoline will generate 13.7 kWh. Therefore, 64,000 divided by 13.7 equals 4670 gallons per year; at \$1.00 per gallon, the cost is \$4,670.

The microhydropower unit (15 kW) will cost \$22,500 if \$1,500 per kW is used as an estimate. Operating costs can be estimated at 1% per year of capital costs, or \$225.

Annualizing the costs of the installed equipment over a 15-year life cycle results in \$1500 per year for the microhydropower unit and \$333 per year for the gasoline-fired generator. The following table shows these costs for Year 1.

TABLE 7-1. COSTS FOR YEAR ONE

	<u>Utility</u>	<u>Gasoline-Fired Generator</u>	<u>Microhydropower</u>
Annualized Cost	-0-	333	1500
Operating Costs in Year 1	3200	4670	225
Total Costs	3200	5003	1725

Clearly, the microhydropower unit holds an economic advantage. Because gasoline prices and electricity prices fluctuate with inflation, the cost per year will not remain constant over the 15-year life cycle. Hence, an escalation factor must be used to determine the annual costs at the end of the 15 years. Using 6% per year escalation on all costs subject to inflation, i.e., operating costs, the following cost table can be prepared with the escalation formula:

$$F_V = P_V (1 + r)^n$$

Where

F_V = Future value

P_V = Present value

r = Escalation percent; 6% = 0.06

n = Number of years.

TABLE 7-2. COSTS IN YEAR FIFTEEN

	<u>Utility</u>	<u>Gasoline-Fired Generator</u>	<u>Microhydropower</u>
Annualized Cost	-0-	\$ 333	\$ 1500
Operating Costs in Year 15	7,669	11,192	539
Total Costs	7,669	11,525	1,839

Again, the microhydropower unit holds the economic advantage.

Financing alternatives for the Category 1 developer may be limited, but some suggestions are presented. The first and most widely accepted suggestion is the power company. Public or private utilities may find it beneficial to finance 50% or less of the project, depending on how costly it would be to install service to the area. Bank financing should also be pursued. A second mortgage on the property or a loan secured by other collateral may be obtainable through your commercial bank. In some cases, a line-of-credit extended for farm operations could be used to finance the microhydropower development. Another alternative is the equipment manufacturer. They may have some financing arrangements available; however, this may be very costly in interest charges. Finally, the Small Business Administration (SBA) should be contacted if a business is involved. More elaborate financing mechanisms such as limited partnerships set up for tax shelters may be too complicated and costly for the very small developer.

The requirements necessary before going to any lender would be a capital cost estimation, revenue estimation, and operating cost estimation.

These estimates along with a financial statement of the developer will help initiate discussions about financing. The preparation of these estimations is presented in Appendix A-5.

7.2 Category 2 Developer

The critical factor for Category 2 developers is to contact the utility company serving the area and work out a contract for the purchase of the power. This market element is essential to the successful completion of the project. Because of recent legislation, the utility company, either public or private, may be willing to negotiate a contract. The utility may also be helpful in obtaining permits, obtaining financing, and obtaining engineering advice.

In determining the economics of the potential site, a complete analysis of capital equipment costs is a prerequisite. Also, the potential revenues and operating costs must be identified and estimated with the help of the utility district. Alternative methods of securing the power should be evaluated. The mechanics of preparing a cash flow analysis, benefit-cost analysis, simple payback, and a sensitivity analysis are detailed in Appendix A-5.

Financing options may be limited. The utility company will know the potential financing options acceptable in a particular area.

Basically, the two kinds of financing available are debt and equity. Debt financing places a contractual obligation on the developer to repay the loan in accordance with the loan terms. Equity financing is the amount of collateral, cash, or services the developer uses as his down payment. This debt-equity arrangement is similar to a home mortgage where the down payment is the original equity and the debt is the amount borrowed. Because hydropower tends to be capital-intensive, the debt fraction is generally quite high. "Capital-intensive" means that the original cost of equipment and installation are much higher than the operational costs.

Bank financing may be available for Category 2 developers. However, previous experience indicates that the key to arranging the financing is the contractual agreement between the utility company and the developer. Commercial banks typically offer construction loans on a short-term basis, with the long-term financing available when the project is complete. Although this appears to be two separate loans, they are generally negotiated at one time, i.e., prior to construction.

Another possible source of financing is the Small Business Administration (SBA). This is usually an excellent source of financing for any small business. And, this source should definitely be pursued if the developer appears financially "thin." This means that the financial statement of the developer does not meet the minimum requirements of the lending institution. This minimum requirement is usually that income, less expenses, allows for 1-1/4 times the payment of principal and interest.

You may want to investigate a limited partnership. Limited partnerships can be formed with the aid of an attorney. They generally are structured as a tax shelter in an effort to pass along tax advantages from the developer to other persons who want the tax savings. The developer becomes the general partner and usually contributes a 10% equity share. The limited partners contribute the other 90% of the equity. This is a fairly complex source of financing and requires legal counsel.

Microhydropower presents some risk in development. It is important before securing financing to understand the risk-return tradeoff.

In general, an institution expects higher returns for accepting greater risks. For example, oil companies risk millions of dollars to drill a well that may never produce. But if they strike oil, their returns are extremely high. Lending institutions such as commercial banks are risk-averse. As risk increases, they charge higher interest rates. At some point the risk becomes so great that they will not even participate in the loan. If you intend to use any debt financing, you must convince the lending institution

that your project presents an acceptable risk. The more risk that you can remove from the lending institution, the lower the interest rate you will pay.

The greatest risk for a microhydropower development is the sale of the power. That is why it is essential to work out a contractual agreement with the utility company. Another risk is that the project may not operate at its designed capacity. Professional engineering services will lower this risk. Another risk is that the expected revenue will be less than anticipated. This could happen for several reasons. The water flow could be below normal, the equipment may require more shutdown time than anticipated, or the rate paid by the power purchaser may fall below forecast. The contractual agreement with the power company will lessen this risk.

The risk level assigned to your microhydropower development by a lending institution will be primarily a function of that institution's perception of your capacity to repay the loan. The institution's previous experience with you and collateral other than the hydropower site are important considerations. To obtain a loan, you must present the bank with a sound business plan as well as a sound technical plan. If you prepare these plans without professional assistance, you must be prepared to demonstrate to the bank that you are qualified to prepare them.

The business plan should contain the necessary permits and licenses. All construction costs should be identified. Wherever possible, provide vendor quotations and contracts. This lessens the risk of underestimating the project's total cost. The business plan should also contain realistic projections of the project's revenues and operating costs over a period at least as long as the proposed term of the loan. This projection must show that the project can afford the loan payments. However, as a minimum you should be able to demonstrate that the annual revenues less the annual operating costs exceed the debt service (i.e., interest and principal loan payment) by at least 25% during the entire life of the loan. This is called a 125% debt service coverage.

The most uncertain projection in the business plan is likely to be the project's annual revenues. As previously mentioned, the marketing arrangement is closely related to the financing alternatives available. You can significantly reduce the bank's risk by presenting a power purchase contract. Most banks will not consider the loan without such a contract. The degree of security a bank assigns to a power purchase contract will depend on the reliability of the purchaser and the terms of the contract. The most secure arrangement for the bank would be a "Hell-or-high-water" contract with a major utility. Under such a contract, the utility would agree to make annual payments to you whether or not your microhydropower site operates as designed. In negotiating this contract, risk is transferred from you and the bank to the utility. In return for accepting this risk, the rate offered by the utility will be lowered. This type of contract represents the greatest security to the bank and the smallest return to you. At the other extreme, you and the utility could negotiate a contract for the utility to purchase power at the negotiated rate. Because this rate can be volatile, such a contract presents a greater risk to the bank. To compensate for increased risk, the bank may lend a lesser amount for a shorter period of time at higher interest rates than if you had negotiated a "Hell-or-high-water" contract.

The revenues projected in a business plan can be lower than the revenues that you actually expect to receive. For example, you may expect your revenues to escalate by 8% per year as the price of energy increases with inflation. You may consider this an acceptable risk and base your expected return on it. However, a lending institution would find such a risk unacceptable if their debt service depended upon it. An acceptable risk to a bank might be on the order of "current rates will not decrease over the term of the loan." When you and the lender have different perceptions about the project's future, the lender's perception will dominate the loan negotiations. It is for this reason that it is best to have a long-term power purchase contract.

8. LEGAL, INSTITUTIONAL, AND ENVIRONMENTAL CONSIDERATIONS

This section focuses on the many local, state, and Federal laws that apply to microhydropower development, the regulations that are involved, and the problems that must be addressed in getting the certifications, permits, and licenses or exemptions necessary to proceed with construction of a microhydropower project. The fact that microhydropower developments are very small and may cause very little impact does not, in most cases, exempt the developer from complying with these laws and regulations. Fortunately, there is an ongoing effort at all levels of government to simplify the licensing procedures for microhydropower developments.

The process of obtaining the necessary permits and licenses or exemptions for any hydropower project should always be started at the beginning of the project. A systematic approach to licensing^a will greatly reduce the time required and minimize the pitfalls encountered. This systematic approach should begin with the initial agency contacts. The key agencies in the licensing process should be alerted early to the proposed project and asked for information on the prerequisites for their specific permits, certifications, licenses, etc. The developer must deal with three levels of government: local, state, and Federal. Normally, all three levels must be fully satisfied before construction can begin. At the local level, the developer must comply with county, township, or municipal planning and zoning regulations. Especially where urban development has surrounded an existing dam, it is important to make sure that a generating facility is acceptable under applicable codes. A building permit and possibly other local permits are needed to build or refurbish a microhydropower development. Normally, cognizant state agencies and the Federal Energy Regulatory Commission require compliance with local laws before issuing their respective licenses.

a. As used here, the term "licensing" includes all permits, licenses, certifications, letters, and exemptions necessary for a project.

At the state level, at least a water right permit, a water quality certification, and a general environmental certification are necessary. A variety of other state permits may be required, depending on the specific site.

The Federal Energy Regulatory Commission (FERC) is the agency responsible for licensing at the Federal level. Where a microhydropower project does not involve Federal land, a navigable stream, or an upstream Federal water project, submitting copies of the state permits and certifications along with the appropriate FERC exemption or license form is generally adequate. Where Federal lands, a navigable stream, or an upstream Federal water project are involved, additional permits are needed from the appropriate Federal agencies. In a few cases involving private onsite energy use and a private water source, an FERC license will not be necessary. However, this special case should always be cleared with the FERC to avoid any later problems.

Because requirements vary widely from site to site and from state to state, it is not possible to present a generally applicable step-by-step procedure for obtaining all the necessary certifications, permits, and licenses or exemptions. Therefore, this section discusses considerations that affect the licensing process and the various requirements encountered at the various levels of government, and then presents a general discussion of procedures for licensing the two example sites used in this handbook.

8.1 Environmental Considerations

Environmental considerations affecting microhydropower development and operation are very site specific. The general guidelines outlined in this subsection are intended to acquaint the developer with most of the issues that should be addressed. In most areas, local, state, and Federal agencies can be helpful in identifying potential ecological concerns. Following is a partial list of such agencies:

- Federal Fish and Wildlife Service

- State Fish and Game Department
- Federal Environmental Protection Agency
- State Department of Environmental Resources
- State Health Department
- National Historical Society
- Army Corp of Engineers
- Soil Conservation Service
- County and university extension services.

Generally, a developer can expect better cooperation from the appropriate agencies if initial contact is made early in the planning stages of a project. These early contacts can provide the developer with valuable information on stream characteristics and on previously overlooked adverse environmental impacts that could block the project.

Environmental considerations development are different during the construction and operation phases of a microhydropower project, although some overlapping does occur. Therefore, the two phases are considered separately.

8.1.1 Environmental Considerations During Construction

Environmental concerns during microhydropower project construction fall into five broad categories:

- Water quality
- Diversion of stream flow

- Sediment control and dredging
- Wildlife and migratory fish
- Historical significance and aesthetics.

8.1.1.1 Water Quality. Water quality concerns during microhydropower project construction usually involve turbidity (see Subsection 8.1.1.3) and changes in nutrient loading, temperature, and dissolved oxygen values. Regulations and standards governing these parameters vary considerably depending on the type of watershed and its uses. Contact a local office of the U.S. Environmental Protection Agency (EPA), the state agency concerned with water quality, or an appropriate local agency or county extension service to determine what regulations are applicable to the proposed development.

8.1.1.2 Diversion of Stream Flow. During construction, you may have to divert part or all of the flow in a stream. If such action is necessary, there are usually several options that you can employ (i.e., construction during low flow periods or winter months, temporary dikes, etc.) to minimize any adverse environmental effects. State and local agencies and county extension services can usually help in outlining these options.

8.1.1.3 Sediment Control and Dredging. Dredging operations and sediment control during construction are an important problem that must be addressed. Before starting construction, consider what actions are necessary to control erosion and minimize sediment transport from all disturbed areas (e.g., access roads, equipment site, transmission lines, etc.). The Soil Conservation Service, as well as other agencies, can be very helpful in outlining plans with the developer.

Dredging of existing channels or impoundments can result in increased nutrient loading and decreases in dissolved oxygen in the water. Materials that have settled to the bottom of a stream are often subject to a reducing environment caused by a lack of oxygen. This condition can result in a buildup of toxic elements that may cause adverse environmental effects if

the settled material is put back into suspension. If these conditions are present, you may require special permits to dispose of the dredge material.

8.1.1.4 Wildlife and Migratory Fish. During the planning stage of any microhydropower project, contact the appropriate fish and wildlife agencies to ensure that the proposed project will not affect any threatened or endangered species. If migratory fish species occupy the watershed, schedule construction of the project to minimize any conflicts. State and Federal agencies can help in protecting sensitive areas and providing suggestions for restoring areas that have been disturbed.

8.1.1.5 Historical Significance and Aesthetics. During the project planning stage, contact the appropriate state agency and check the National Register of Historic Places to ensure that the proposed project will not affect any protected historical or archeological site. At the same time, bring any adverse impact on the aesthetics of the project area, including proposed transmission lines, to the attention of the appropriate agencies or planning commission.

8.1.2 Environmental Considerations During Operation

Environmental concerns during microhydropower project operation fall into four broad categories:

- Effects of water level fluctuations
- Instream flow requirements
- Water quality changes
- Effects on migratory fish.

Some of the concerns addressed for the construction phase may need to be considered again for the operating phase. Most of the following concerns need to be addressed on a site-specific basis.

8.1.2.1 Effects of Water Level Fluctuations. Effects of water level fluctuations are usually associated with man-made sources (e.g., impoundments) since run-of-the-river operations, by definition, do not normally have significant adverse impacts. Potential impacts include:^a

- Reduction in riparian habitat, vegetation, wetlands, and avian nests
- Inundation of small tributaries
- Decreased stability of stream banks
- Decrease or loss of quality aquatic habitat and spawning areas
- Altered sedimentation patterns
- Stranding of fish and benthic invertebrates
- Disruption of fish migration
- Alteration of food chains
- Changes in algal communities.

8.1.2.2 Instream Flow Requirements. The instream flow requirement may be the most significant issue associated with microhydropower development. This term refers to the amount of water flow needed in a natural stream or channel to sustain the instream values, or uses of the water in the stream, at an acceptable level.^b It identifies the flow

a. S. G. Hildebrand, L. B. Gross, Hydroelectric Operation at the River Basin Level: Research Needs to Include Ecological Issues in Basin-Level Hydropower Planning, EPRI WS-80-155, June 1981.

b. J. M. Loar, M. J. Sale, Analysis of Environmental Issues Related to Small-Scale Hydroelectric Development V. Instream Flow Needs for Fishery Resources, ORNL/TM-7861, October 1981.

regime that will sustain all uses of water within the channel while maintaining aesthetics and water quality. Water uses include support of fish and wildlife populations, recreation, hydropower generation, navigation, and ecosystem maintenance, which in turn includes freshwater inflow to estuaries, riparian vegetation, and floodplain wetlands.^{a,b}

You can obtain the minimum flow requirements that must be met for rivers and streams in many areas of the country from the Fish and Wildlife Service and from state Fish and Game agencies. These requirements will differ depending on changes in the flow regime patterns. For the microhydropower developer, localized changes are the major concern, since in many of the projects water will be diverted through a flume or penstock to a generator at a lower elevation before being returned to the original stream channel. Projects on the effluent end of liquid waste disposal operations must maintain sufficient flow to ensure that the waste stream is adequately diluted and that none of the water quality discharge standards for the watershed are exceeded (e.g., dissolved oxygen, temperature, etc.).

Finally, because water used to maintain instream flow is usually not available for power production, the potential energy that can be produced by a microhydropower project may be less than expected. This is a major concern since your microhydropower system may be faced with a mismatch between energy demand and stream flow requirements.

8.1.2.3 Water Quality Changes. Water quality concerns that may be an issue to the microhydropower developer include:

a. K. Bayha, "Instream Flow Methodologies for Regional and National Assessment," Instream Flow Information Paper No. 7, FWS/OBS-78/61, Cooperative Instream Flow Service Group, U.S. Fish and Wildlife Service, Fort Collins, Colorado; unpublished report, 156 pp, 1978.

b. P. S. Wassenberg, S. Olive, J. L. Demott, C. B. Stalnaker, "Elements in Negotiating Stream Flows Associated with Federal Projects," Instream Flow Information Paper No. 9, FWS/OBS-79/03, Fort Collins, Colorado, 41 pp, 1979.

- Changes in nutrient transport and cycling
- Altered temperature regimes
- Altered dissolved oxygen regimes
- Altered material cycles, including trace elements, heavy metals, and organics.

The most subtle changes to consider are possible secondary impacts on biological components of impoundments and tailwaters.

8.1.2.4 Effects on Migratory Fish. The issue of fish migration is perhaps the most obvious ecological concern in most hydropower developments. An improperly designed microhydropower project can block the downstream migration of juveniles or the upstream migration of returning adults. Contact local fish and game personnel early in the planning stage to determine if migrating fish are a concern and what type of structure should be designed into the project to avoid any adverse impacts.

Fish migrating upstream are generally blocked by obstructions greater than 18 inches in height. The extent of blockage varies with flow and species and size of migratory adult. Bypass systems for adults can be engineered since the swimming abilities of most migratory species are fairly well understood.

The downstream movement of juveniles presents a more significant problem for microhydropower developments. Turbine intakes must be screened and regularly cleaned to minimize adverse impact. Another way of minimizing the mortality of migrating juveniles would be to shut down for the period of downstream migration. Most downstream migrating species leave smaller tributaries during a 2- to 4-week period. Shutdown during this time could eliminate problems with downstream migrating species. If your project is designed to take all or a significant proportion of the flow of a stream in which there are migrating species, you will probably have to consider the shutdown option.

8.2 State and Local Requirements for Development

Because state and local laws vary widely, it is difficult to define the specific state and local requirements that must be met in developing a microhydropower plant. Many states have energy offices to assist in energy development and energy conservation programs. Several have developed useful guidelines and handbooks similar to this one to aid the energy developer. Contact your state energy office or its equivalent to determine if such a document exists. State energy offices are listed in Appendix E-8.

Table 8-1 lists the responses of the various states to a microhydropower survey, showing whether certain requirements are in effect and indicating whether a single agency exists to help the developer meet the many state requirements. Table 8-2 lists the state permits that might be required by a state--in this case, the State of Washington--for a conventional hydropower project development. Figure 8-1 is a flow diagram showing a sample procedure for dealing with state regulations--in this case, the state of New Hampshire. These two examples can serve as guides to microhydropower developers.

The Department of Energy has funded studies of the legal, energy incentive, and institutional problems encountered in many states with small-scale hydropower development. Appendix H lists the titles of publications for states studied for the Department of Energy by the Energy Law Institute of the Franklin Pierce Law Center, Concord, New Hampshire.

The rest of this subsection briefly discusses the more general requirements of

- Water rights
- Public Utility Commission permits
- Use of state lands

TABLE 8-1. STATE RESPONSES TO MICROHYDROPOWER SURVEY

Name of State	Survey Questions						Name of State	Survey Questions					
	Q-1	Q-2	Q-3	Q-4	Q-5	Q-6		Q-1	Q-2	Q-3	Q-4	Q-5	Q-6
Alabama	QNR	QNR	QNR	QNR	QNR	QNR	Montana		C		C	X	
Alaska	X	A		C	X		Nebraska	X	C				
Arizona	QNR	QNR	QNR	QNR	QNR	QNR	Nevada	X	C	X	C		X
Arkansas		R					New Hampshire	X	R			X	
California		C		X	X		New Jersey		R		Y		X
Colorado		A					New Mexico	A					
Connecticut	X	R		C	X		New York	QNR	QNR	QNR	QNR	QNR	QNR
Delaware	X	R	X	X		X	North Carolina	X	R		C	X	X
Florida		C		C			North Dakota		A				
Georgia	X	C					Ohio		R		C		
Hawaii		A		C			Oklahoma		C				
Idaho		A					Oregon	X	A	X		X	
Illinois	X	R		C			Pennsylvania	X	R				
Indiana	X	R		C	X	X	Rhode Island	X	R		C	X	
Iowa	X	O		C			South Carolina		R		C		
Kansas	X	R		C	X		South Dakota	X	C		C		X
Kentucky	X	R	X				Tennessee		R		C		
Louisiana		O		X			Texas	QNR	QNR	QNR	QNR	QNR	QNR
Maine	X	R			X		Utah	QNR	QNR	QNR	QNR	QNR	QNR
Maryland		C					Vermont	X	R		X	X	X
Massachusetts	X	R	X	X	X		Virginia		R	X	C		
Michigan	X	R		C			Washington	X	A		X	X	
Minnesota	X	R		C			West Virginia	QNR	QNR	QNR	QNR	QNR	QNR
Mississippi		A		C			Wisconsin		R		C		
Missouri		R					Wyoming	QNR	QNR	QNR	QNR	QNR	QNR

Q-1. "X" indicates states with a central clearinghouse to handle applications for microhydropower developments.

Q-2. "R" indicates states that follow the riparian doctrine in water rights regulations, "A" indicates states that follow the appropriation doctrine, "C" indicates states that follow combination of the two, and "O" indicates states that follow other water rights doctrines.

Q-3. "X" indicates states having exemptions for microhydropower developments (under 100 kW).

Q-4. "X" indicates states that require an environmental impact statement for small hydropower developments, and "C" indicates states where the need for an environmental impact statement is determined on a case-by-case basis.

Q-5. "X" indicates states that provide tax or marketing incentives other than those imposed by PURPA (P.L. 950619), the Federal legislation that requires utilities to buy power from small hydropower producers.

Q-6. "X" indicates states that have a separate state agency for handling hydropower development permits and state certification.

QNR. "QNR" means Questionnaire Not Returned.

TABLE 8-2 POSSIBLE STATE PERMITS REQUIRED FOR DEVELOPMENT OF A HYDROELECTRIC PROJECT

Permit	Agency	Comments	Fees	Approximate Time
State Environmental Policy Act compliance	WDOE and/or lead agency		None	3 weeks 3 years
Permit to appropriate public waters (water right)*	WDOE	Required for any use of water for hydropower generation. An existing right may be changed to hydropower use upon approval by WDOE.	Examination fees: \$10 minimum, or for each cfs appropriated: 1-500 - \$2/cfs. 500-2000--50¢/cfs. 2000 + -20¢/cfs. Other fees also apply. Contact any WDOE office or see RCW 90.03.470.	2+ months
Reservoir permit & dam safety approval*	WDOE	For any man-made reservoir with a volume of 10 acre-feet or 10 feet in depth.	\$10 or cost, whichever is greater	2+ months
Water quality certification*	WDOE	Required before an FERC license is issued.	None	2 months 1 year
Temporary modification of water quality criteria	WDOE	Required for any activity that will result in temporary violation of state water quality standards (Chapter 173-201 WAC).	None	2 months
Flood control zone permit*	WDOE	Required if project is located in designated flood control zone.	None	1 month
NPDES and/or state waste discharge permit*	WDOE	Needed if pollutants will be discharged into surface or ground waters.	None	2 months
Sewage and industrial waste treatment approval*	WDOE	May be required if project includes sewage treatment or disposal system.	none	2 months
Annual power production license fee	WDOE	Assessed at the beginning of every year. Based on theoretical water power. 50 hp exemption.	0-50 hp--exempt 500-1000--10¢/hp 1000-10,000--2¢/hp 10,000+---1¢/hp	----
Hydraulic project approval*	Fisheries and Game	Required for any construction affecting surface waters or stream bed.	None	2 months
Public water supply approval*	Social & Health Services	If public drinking water supply is needed or altered.	None	3 months

TABLE 8-2 (Continued)

Permit	Agency	Comments	Fees	Approximate Time
Archeological approval	OAHP	Contact prior to surveys required by FERC.	No set standards	2 months
Forest practices application/notification*	DNR	For construction on forested, nonfederal land.	None	5-30 days
Surface mining permit*	DNR	Operations disturbing 2 acres or 10,000 tons or greater of surface material on nonfederal land.	\$25	2-3 months
Burning permit*	DNR	To burn wood and debris.	None	1 week
Dumping permit*	DNR	Dumping 750 cubic yards of land-clearing debris on nonfederal land.	None	1 week
Lease of state lands	DNR	Facilities, transmission lines on state lands.	Fair market value	4 months
Right of way or road use	DNR	For easements to cross state lands.		2+ months
Application to purchase valuable material	DNR	Covers excavation and use of any stone, rock, sand, gravel, or silt from state lands.	Fair market value	2+ months
Permit to temporarily remove or destroy survey monument	DNR	Removal or destruction of any section corner or other land boundary mark or monument.	None	2 weeks
Permit to operate overheight vehicles on state highways	DOT	Road conditions are sensitive to damage from overweight vehicles.	None	1 day
New source construction approval*	Local Air Pollution Control Authority	For dust control during use of construction machines such as concrete batch plants and asphalt plants.	Based on amount of pollutants emitted	1-2 months

NOTE: Most projects will not require all of the permits listed. Small projects are likely to require only a few of these permits.

* Included in the Washington Environmental Coordination Protection Act
 WDOE- Washington Department of Ecology OAHP- Office of Archeological and Historical Preservation
 DNR - Department of Natural Resources DOT - Department of Transportation

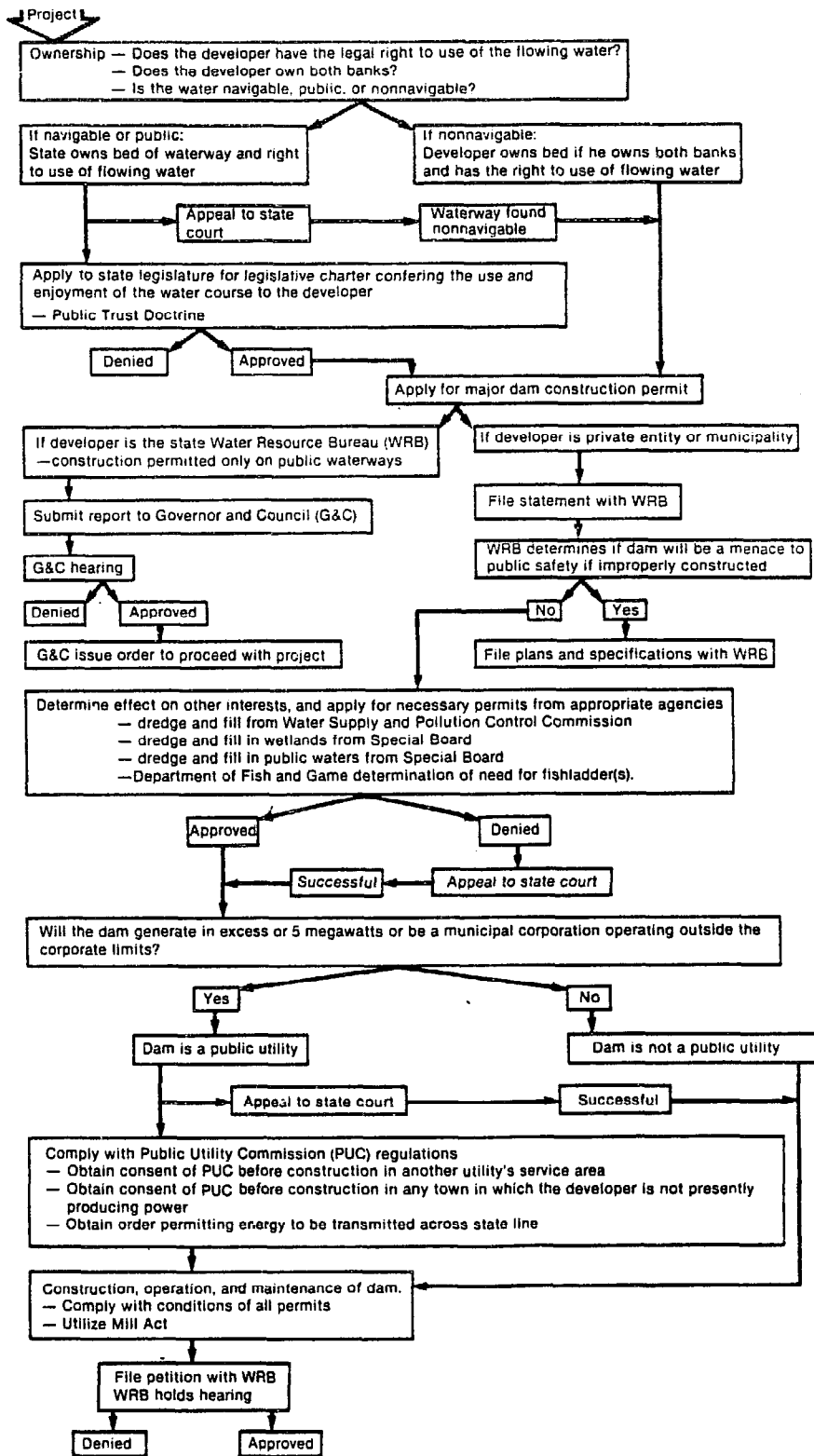

INEL 2 2689

Figure 8-1. Sample flow diagram of procedure for dealing with state regulations (New Hampshire).

- Dam safety and other safety requirements
- State environmental considerations
- Historical and archeological considerations
- Transportation permits
- Local planning, zoning, and building permits.

8.2.1 Water Rights

Securing a water right is one of the most important state requirements to be met in a microhydropower development. Obtaining an appropriate water right is a requirement for FERC licensing. Contact the water agency in your state to determine what the requirements are and to start the process of obtaining the water rights. State water agencies are listed in Appendix E-1. In some states, the water rights agency is separate from the water resource department.

Different doctrines prevail in different states for administering water rights. Basically, all waters are the property of the state, and the user is given permission or acquires a right to use the water for some beneficial use. In the eastern states, the "riparian rights" doctrine prevails, specifying that a land owner adjacent to a stream has a right to use the water in the stream in a reasonable manner as long as that riparian owner does not inflict substantial injury to other riparian landowners upstream or downstream. Thus, if your development is in a state where the riparian rights doctrine prevails, you must have ownership along a stream to qualify for a water right. Generally, you must have title to both banks of the stream. Throughout the country, development of hydropower has traditionally been considered a reasonable use of water, even when a diversion from the natural channel is required. Some states require a formal application for the riparian water right while others do not.

In the western states, a different water rights doctrine, the "prior appropriation" doctrine, prevails. In states where this doctrine applies, a person, company, or government entity may acquire a water right without owning the land. Simply stated, the first person to appropriate water and apply it to a beneficial use has first right to use the water from that source. Subsequent appropriators may take water but only after the first appropriator's use has been satisfied. Usually, this system operates on a permit basis, and the date of application for a water right permit constitutes the priority date. In some states that have not had a mandatory permit system, constitutional provisions have been interpreted to mean that if the beneficial use has been exercised, a water right has been secured. Most states have now converted to a mandatory permit system to administer water use.

Under the prior appropriation doctrine, you should file for a water right permit as soon as possible; if there is competition for the development of a particular site or section of a stream, the earliest water rights application has the prior claim.

Some states have a dual procedure for acquiring water rights in which elements of both the riparian rights doctrine and the prior appropriation doctrine apply.

8.2.2 Public Utility Commission Permits

Two types of permits may be issued by the Public Utility Commission (PUC) or its equivalent in each state. One is a certificate that authorizes construction of an electrical power plant or an electrical transmission line. This certificate verifies the need for the facility, provides for administrative reporting of energy production, and covers possible fees charged for licensing the production of electrical energy in the state. The license authorizing construction of the hydropower facility may also be handled by another state agency.

The second type of permit involves confirming the "qualifying facility" status for avoided cost under the Federal PURPA act, which is discussed in Section 8.4, Marketing.

Contact your State PUC or its equivalent to obtain the necessary permits. State PUCs are listed in Appendix E-2.

8.2.3 Use of State Lands

You may need to acquire or use land administered by the state for your construction site, water conveyance system (penstock or canal), transmission line, or access roads, or as a source of construction materials. The beds of navigable streams in most states are owned by the state. Different states have different policies for leasing or for outright sale of the state lands involved. Customarily, the development site requires full ownership of the land, while rights-of-way for access, transmission lines, water conveyance systems, and material sources such as rock require only leases or use permits. Contact the appropriate state agency to determine what steps you will have to take and to start the process. State agencies responsible for administration of state-owned land and land laws are listed in Appendix E-3.

Most states have land withdrawn or set aside for parks, natural areas, scenic areas, wild or recreational river segments, wildlife refuges, mineral sites, and hydropower sites. You should make certain that your site does not impinge on any of the withdrawn or reserved areas, since development of a microhydropower site in these areas will be difficult or impossible. A variety of state agencies administer portions of the state lands, but a state Department of Lands, or Land Commission, or Department of Natural Resources usually has maps of state lands and the withdrawn areas and sites, as well as personnel familiar with these areas.

8.2.4 Dam Safety and Other Safety Requirements

The responsibility for administering dam safety programs to reduce the risk of dam failure has been delegated to the states by the Federal government. FERC regulations require that a hydropower developer obtain appropriate permits from an authorized agency. Normally, you will need a dam safety permit if your dam or impounding structure is greater than a specified height in feet or if your reservoir capacity is greater than a specified volume in acre feet. The dam height and water volume

requirements vary from state to state. Many dams or impoundments used in microhydropower projects are exempt from this permit requirement because of their small size. Contact the state Department of Water Resources or the equivalent agency in your state (listed in Appendix E-1) to find out if you need a permit and to start the permitting process if necessary.

A related safety requirement is that of flood plain protection, which requires that appropriate restraints be made to protect structures in a flood plain. This is mandated by Federal legislation, A Unified National Program for Flood Plain Management, P.L. 90-448. The administration of this program is handled at the Federal level by the Federal Emergency Management Agency. Some states have old mill acts that provide rules and regulations governing the control of flooding that could result from mill impoundments. At present, most states have flood plain zoning and local flood control districts that prescribe the standards of construction that must be met in the flood plain. To obtain advice and get necessary permit information, contact the local planning and zoning commission, the State Department of Water Resources (listed in Appendix E-1), or a district office of the U.S. Army Corps of Engineers (listed in Appendix D-1) or the Federal Emergency Management Agency. Each of these entities will have some jurisdictional concern.

Another often obscure safety requirement that must be met is a permit for the use of explosive materials during construction. This is normally regulated by the Public Safety Division of a State Department of Labor.

8.2.5 State Environmental Considerations

Environmental considerations involve three principal areas of concern:

- Water quality and pollution control
- Fish and wildlife
- General environmental impact.

Some states have enacted environmental coordination legislation that covers all three together. However, Federal legislation has generally separated the water quality aspects. The actual monitoring and administering of the water quality standards on navigable streams has been delegated to the states. In rare cases where a state's programs did not meet the mandates of Federal law, the EPA has administered elements of the water quality and pollution control regulatory program.

Your microhydropower development will require a state certification that water quality standards will be maintained. In most cases, you can obtain a permit to allow a temporary violation of the water quality standards during construction. To start this process, contact the state agency concerned with water quality, which may be a Department of Pollution Control, Department of Ecology, or Department of Health and Welfare. State agencies responsible for water quality and pollution control are listed in Appendix E-4.

Much of the water quality control involves fish and wildlife considerations; a number of states have separately administered Fish and Wildlife Departments that exercise control over the fish and wildlife and the habitat associated with each. Although permits are not normally needed, state laws usually require that developments minimize and mitigate effects on fish and wildlife. In some cases, the Fish and Wildlife Agency has classified streams and designated in general what activities are permitted along streams and in land areas where fish and wildlife can be affected. You can obtain maps of these streams from your State Fish and Wildlife Agency. Appendix E-5 lists the various state Fish and Wildlife agencies.

You should contact the Fish and Wildlife agency in your state to determine if there will be opposition to your microhydropower development. A primary environmental consideration will be the minimum flow required to maintain aquatic life in the stream. Diversions for microhydropower development that reduce stream flow to below this minimum will not be permitted. This problem was discussed briefly in Subsection 8.1, Environmental Considerations.

A third, somewhat overlapping concern is that of general environmental impact. This state requirement arises from individual state environmental protection acts that are much like the National Environmental Policy Act, P.L. 91-190. In a number of states, this act is designated the State Environmental Protection Act, abbreviated SEPA. The environmental concerns mandated extend beyond fish and wildlife to cover the impacts of many types of developments--including microhydropower--on land forms, plant life, and human activity. Normally, microhydropower developments are small enough that general environmental impacts are negligible. State agencies that administer SEPA programs are Departments of Ecology and Departments of Environmental Protection. Appendix E-6 lists the state agencies concerned with environmental protection.

8.2.6 Historical and Archeological Considerations

In most states, historical and archeological sites are protected by law. A state certification of compliance with the law is required under the National Historic Preservation Act, P.L. 89-665, for FERC licensing. Each state has an agency or council that maintains a list of protected sites. Appendix E-7 lists the state agencies concerned with archeological and historic preservation. Contact the appropriate agency in your state to determine if your development impacts such a reserve or dedicated area, and to obtain any necessary letter of compliance.

8.2.7 Transportation Permits

You may need permission to connect an access road from your microhydropower development to an existing highway. Contact the state Highway Department for that purpose.

A minor but important permit you may require during development of your project is one for transporting oversize or overweight equipment over a state highway. In most microhydropower developments, a need for this permit is unlikely.

8.2.8 Local Planning, Zoning, and Building Permits

Local governments require certain permits for any type of construction development with an investment value greater than some specified minimum. Often this requirement is mandated under a state law requiring that a comprehensive plan be developed for communities and counties. Such plans are usually administered at the county or city government level. A planning and zoning commission receives an application and makes a recommendation concerning it to the administrative officials of the community or county, who in turn issue the necessary permit or the required certificate of compliance. Table 8-3, from the State of Colorado Small-Scale Hydro Office, is an example of possible local permit requirements. You should contact local agencies to determine what the requirements are in your area and to start the process of obtaining necessary permits.

8.3 Federal Requirements

8.3.1 Federal Energy Regulatory Commission Regulations

The major Federal agency concerned with hydroelectric development in general and microhydropower development in particular is the Federal Energy Regulatory Commission (FERC). This agency issues preliminary permits, licenses, and license exemptions for hydroelectric developments. The FERC has jurisdiction where non-Federal hydroelectric projects affect navigable waters, occupy Federal lands, use water stored behind government dams, or affect interstate commerce. This includes almost all developable sites.

For microhydropower developments, one of five conditions may apply:

- The FERC may rule that it has no jurisdictional responsibility.
- The FERC may permit a categorical exemption from licensing under FERC Order No. 202.

TABLE 8-3. POSSIBLE LOCAL PERMITS

Action Required	Agency	Reason
Zoning conditional use permit/Special use permit	Planning Department/Zoning Department	Required if hydropower is not a use permitted under present zoning.
Drainage of surface water permit	Department of Public Works	If surface water is to be drained. May be required for other permits.
Building permit	Building Department	For construction of powerhouse and other structures.
Temporary road closure Permit	Department of Roads or Department of Public Works	Needed for any construction that would close a road to traffic.
Other road permits of temporary nature	Department of Roads or Department of Public Works	To operate overweight vehicles, etc.
Utility permits	Department of Public Works	Needed for transmission lines; interconnection.
Plumbing permit	Building Department or Plumbing Department	Approval of any plumbing plans.
Temporary sewage holding tank permit	Sanitation Department or Department of Health	For sewage facilities installed as part of project on permanent basis.
Grading permit	Department of Roads or Department of Public Works	For all excavation or filling activities except as noted in Uniform Building Code.
Floodplain permit	City/County/Planning Department/Zoning Department/Building Department	For any development in a regulated floodplain that would potentially affect flood flows or flood elevations.

Data derived by Colorado Small-Scale Hydro Office in consultation with state agency officials.

- The FERC may permit a "conduit" exemption under FERC Order No. 76.
- The FERC may permit a case-by-case exemption under FERC Order No. 106.
- The FERC may rule that a formal license application is necessary.

You should first review the material in this subsection to determine which of the above conditions applies. If you are still uncertain as to which condition applies after reviewing this information, write a letter requesting an opinion on whether the FERC will assert jurisdiction and which condition will apply. The letter should give the stream location; the type of diversion; the design head, flow, and capacity, including, if available, a flow duration curve for the site; and the land ownership involved. Contact the FERC at:

Federal Energy Regulatory Commission
 Office of Electric Power Regulation
 825 North Capitol Street, N.E.
 Washington, D.C.

Figure 8-2 is a flow diagram showing possible FERC licensing options and a list of the FERC regulations that apply. The paragraphs that follow discuss, in order of increasing effort and time requirement, developer actions necessary to obtain FERC licensing.

8.3.1.1 No Jurisdiction. The area of no FERC jurisdiction is quite rare. All of the following conditions would have to apply:

- The development should be in a water conveyance system such as a pipeline or canal that is privately owned.
- Control of the water should be entirely independent of a free flowing stream or connected lake system.

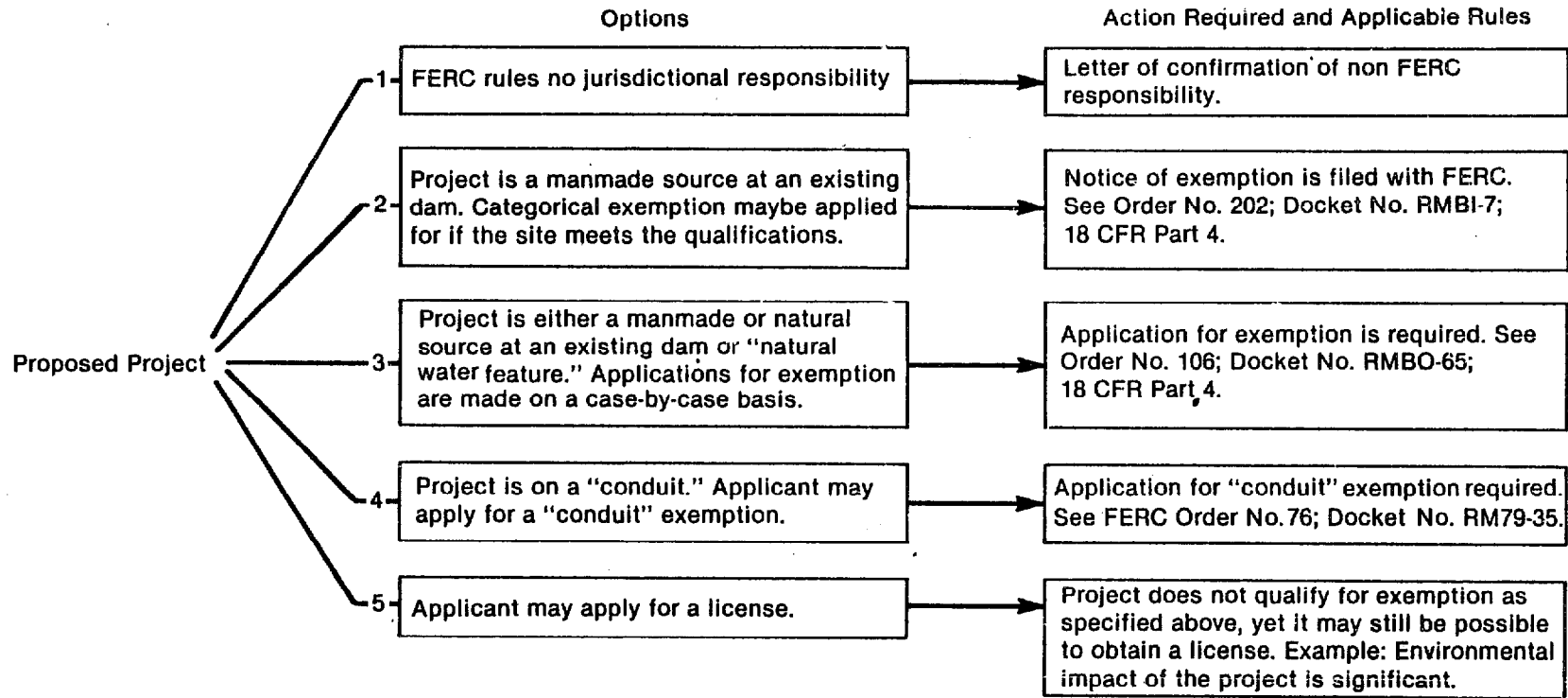

INEL 2 2684

Figure 8-2. Flow diagram of possible options for FERC licensing.

- The power produced should not be connected to a commercial transmission system.

If you believe that your development may qualify, write to the FERC requesting a "no jurisdiction" ruling.

8.3.1.2 Notice of Exemption for Existing Dams. If your microhydropower project involves an existing dam, the simplest action you can take is to obtain FERC approval through a "notice of exemption" from licensing,^a which only takes 30 days from the time of filing with the FERC. Figure 8-3 is a flow diagram of the application process for the exemption.

The requirements for approval under this categorical exemption are quite stringent. To qualify, your proposed microhydropower development must meet the following conditions:

- The proposed development cannot be larger than 100 kW (it is assumed throughout this handbook that you are planning a microhydropower development of 100 kW or less)
- The project must use the water power potential of a manmade source at an existing dam for generating electrical power.
- Either the existing dam must be at a site where there is no significant existing population of migratory fish, or it must not obstruct the passage of fish upstream or downstream.
- The development must not divert water from the waterway for more than 300 feet from the toe of the dam to the point of discharge back to the waterway.

a. See FERC Order No. 202, Docket No. RM81-7 dealing with 18 CFR Part 4. This can be found in the Federal Register, Vol. 47, No. 20, January 29, 1982, pp 4232-4246.

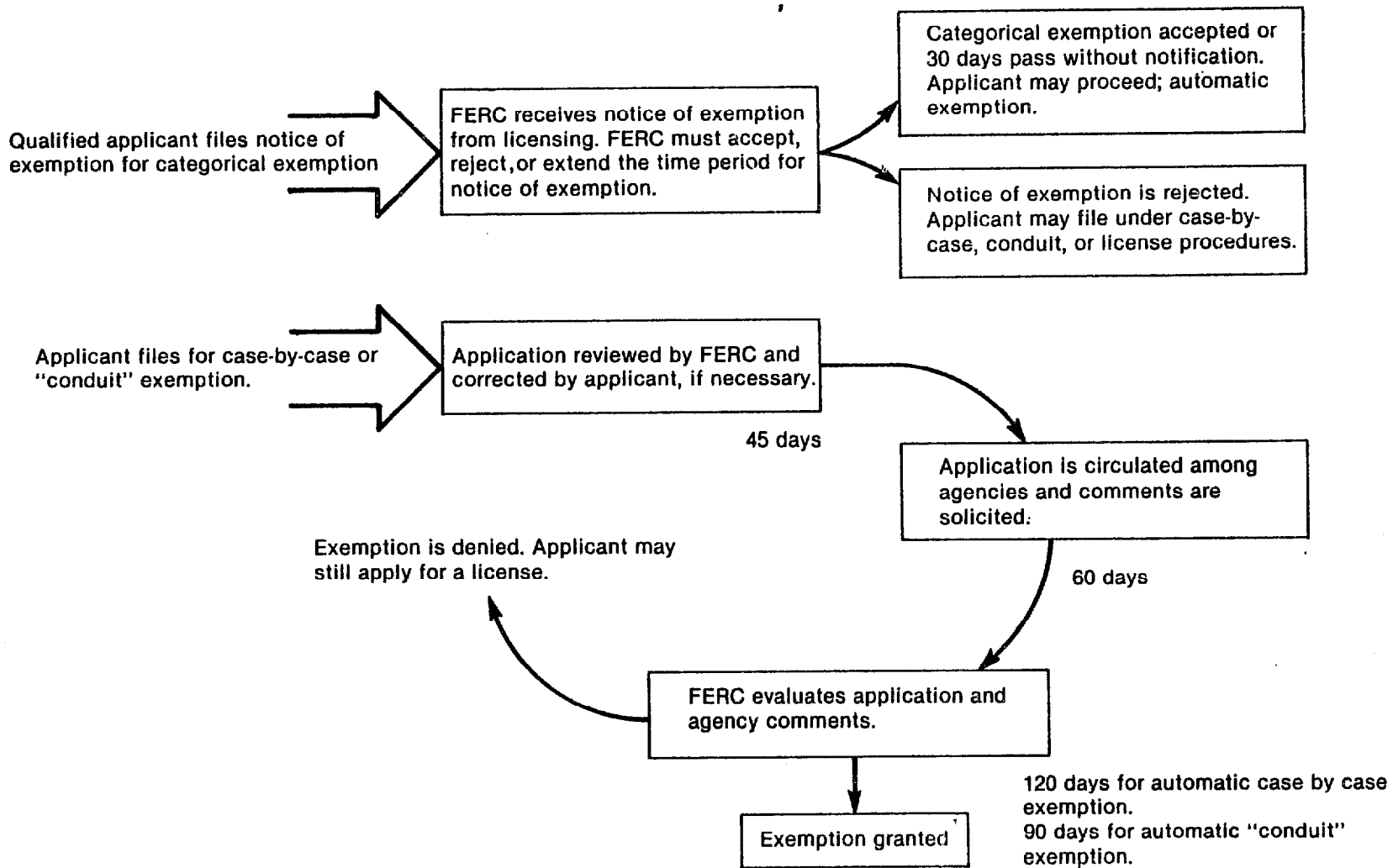

INEL 2 2683

Figure 8-3. Application process for an exemption from licensing requirements.

- Construction or operation of the development must not adversely affect any threatened or endangered species or critical habitat listed in the regulations of the U.S. Fish and Wildlife Service of Department of the Interior and the National Marine Fisheries Service of the Department of Commerce.

If only Federal lands are needed to develop and operate the proposed microhydropower project, any developer may file a notice of exemption from licensing if the site meets the above criteria. If non-Federal lands are required to develop and operate the project, the developer must have all the real property interests in the necessary non-Federal lands in order to file a notice of exemption.

In filing a notice of exemption with the FERC, you should include copies of letters from the U.S. Fish and Wildlife Service or a similar state agency and the state historical agency. The notice of exemption from licensing is automatically approved if no followup from the FERC is received within 30 days of the filing.

Although this action completes the licensing procedure with the FERC, it does not eliminate the need for you to meet all state and local requirements or to obtain approval to use any Federal lands that may be involved.

8.3.1.3 Conduit Exemption. If your microhydropower project does not qualify for the notice of exemption but does use a manmade canal or conduit, then your next option is to request a conduit exemption.^a The conduit exemption is simpler than a case-by-case exemption (the next category) because of its location on a manmade conveyance system. If your site meets the following qualifying criteria, your application for exemption will be granted within 90 days of filing with the FERC:

a. The conduit exemption is explained in FERC Order No. 76, Docket No. Rm 79-35, which can be found in the Federal Register, Vol 45, No. 83, April 28, 1980, pp 28,085-28,092.

- The site must be entirely on non-Federal land.
- The principal purpose of the conveyance system must be other than the generation of electrical power, i.e., water supply for irrigation, domestic use, industrial use, etc.
- No dam can be involved that would not have been built even without the hydropower generation.

Your application for exemption will be circulated by the FERC to appropriate Federal agencies for 45 days. If these agencies return no comments within that period, their acceptance of the application is assumed. The FERC then has another 45 days to act on the application. If the FERC takes no action within 90 days of the initial filing, the application for exemption from licensing under Part I of the Federal Power Act is automatically granted. If all necessary local and state requirements have been met, you can now proceed.

8.3.1.4 Case-by-Case Exemption. If your microhydropower project does not qualify for the notice of exemption and is not using a man-made canal or conduit, then your next option is to request a case-by-case exemption.^a The case-by-case exemption process is similar to that for conduit exemptions, but it is broader in coverage and takes 120 days for automatic approval. The case-by-case exemption covers existing dams and natural water features--that is, elevation features in streams that lend themselves to diversions for water power generation without the need for a dam or impoundment--on all lands.

For this case, if your project uses an existing dam, it must have been built prior to April 20, 1977; furthermore, the impoundment cannot be altered through reconstruction of an unsafe dam. The operation of the project must be acceptable to the U.S. Fish and Wildlife Service, or the

a. The case-by-case exemption is explained in FERC order No. 106, Docket No. RM80-65, which can be found in the Federal Register, Vol 45, No. 224, November 18, 1980, pp 76,115-76,165.

National Marine Fisheries Service, or a similar state agency where appropriate.

If the project site is totally on Federal land, any developer may apply for an exemption. If non-Federal land is involved, the developer must have all the necessary non-Federal real property interests on order to apply.

As mentioned above, your exemption is automatically granted in 120 days if the FERC has not acted. Once again, this does not exempt you from applicable local, state, and Federal regulations not covered by Part I of the Federal Power Act. However, obtaining this exemption is a major step, and it often satisfies other requirements.

8.3.1.5 License. If your microhydropower project cannot be exempted under one of the above options, then your remaining course is to pursue a license, generally a minor license. Normally, this procedure will be too expensive for Category 1 developers to justify. If this route must be followed, it would be wise for a Category 2 developer to build a project large enough to cover the costs involved in the rather lengthy licensing process. Also, you will probably require the assistance of an architectural engineering firm with experience in hydropower to complete the licensing process.

There are three actions normally taken by the FERC:

- Issuing an exemption from licensing (already discussed in the previous paragraphs)
- Issuing a preliminary permit for a hydropower development
- Renewing or issuing a license for a hydropower development.

The purpose of obtaining a preliminary permit is to secure priority for your license where there is competition for development of a site. This protects your claim to the site while you collect the necessary data

and make feasibility studies in preparation for submitting the formal license application. You do not have to have a preliminary permit, but obtaining one may be a very important step in protecting your claim to a particular site. Figure 8-4 is a flow chart of the FERC preliminary permit process. The contents of an application for a preliminary permit are specified in Section 4.81 of Chapter 1, Federal Energy Regulatory Commission, Title 18, Conservation of Power and Water Resources, Code of Federal Regulations (CFR).

The license application is the final and most complex step in the FERC licensing process. If you cannot obtain an exemption from licensing as described above, you should be able to use the FERC's short-form license application for your microhydropower development. The short-form license applies to minor projects. The requirements for the short-form license application are specified in Section 4.60 of Chapter 1, CFR 18.

FERC licensing regulations give municipalities and quasi-government agencies a preference under competitive licensing action. You should consider the advantage or disadvantage of this preference to a developer when applying for a license. Under the new rule-making orders of the FERC, however, this advantage for municipalities and quasi-governmental developers ceases to exist when exemptions are applied for. Thus, as an individual microhydropower developer, you are better off securing an exemption of one form or other rather than going through the complex licensing process.

8.3.2 Corps of Engineers and EPA Permits

The U.S. Army Corps of Engineers (COE) through three important Federal Acts--Section 10 of the Rivers and Harbor of 1899; Section 404 of P.L. 92-500, the Federal Water Pollution Control Act; and Section 103 of P.L. 92-532--has responsibility for permits authorizing structures and materials movement in navigable streams of the United States. This is often referred to as the navigation servitude requirement through which the Corps of Engineers protects the navigability of the waters of the nation. This authority covers the placement of fill necessary for the construction

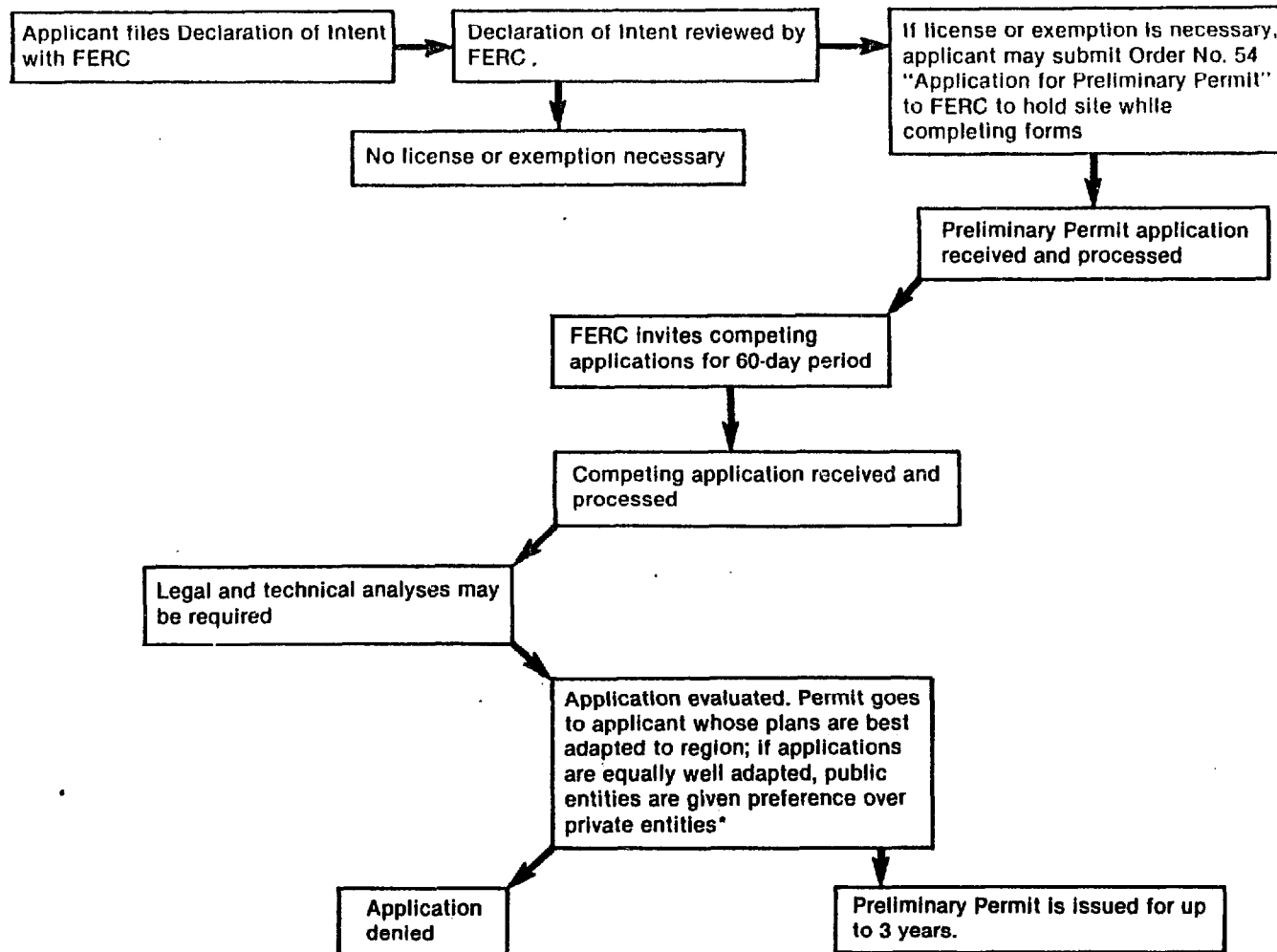

*Recent practice seems to indicate that the permit goes to the earliest applicant because limited information on the best adopted plan is not available.

INEL 2 2682

Figure 8-4. FERC preliminary permit process.

of any structure; the building of any structure or impoundment requiring rock, sand, dirt, or other materials; the building of dams or dikes; fill for structures such as intake and outfall pipes associated with power plants; and any dredging. Figure 8-5 is a flow diagram of the procedure to be followed in securing a COE permit, known as the 404 permit. Contact the COE to determine how your project is affected and to obtain copies of the form (Form 4345) you must use to apply for the 404 permit. COE offices are listed in Appendix D-1.

You may have to provide several inputs under EPA-administered programs. The most important of these, required under Section 402 of P.L. 92-500 (33 U.S.C. 1341), is frequently referred to as the 402 permit or, more specifically, the National Pollution Discharge Elimination System (NPDES) permit. This section of the act covers the discharge of any pollutant into a navigable stream from any point source. It requires that you determine whether your microhydropower development will discharge any pollutants. If your project in any way diminishes the quality of the water by adding sediments, decreasing the oxygen content, or increasing the temperature, it can be considered as discharging pollutants. Another question is whether a microhydropower development constitutes a point source. The courts have tended to rule that a dam does constitute a point source of pollution.

While Federal responsibility for this program lies with the EPA, the actual administration and field checking are generally delegated to an appropriate state agency. To apply for a 402 permit or a waiver showing compliance with the Federal water quality standards, obtain EPA Form 7550-8 from the state agency responsible for assuring compliance with these standards. This form can also be obtained from the nearest regional office of the EPA. The state agencies responsible for water quality and pollution control are listed in Appendix E-4, and EPA offices are listed in Appendix D-2.

The EPA may also require inputs under Section 404 of P.L. 92-500. The 404 and the 402 permitting processes have many overlapping provisions, and the question arises: If a 404 permit is granted, does it exempt a

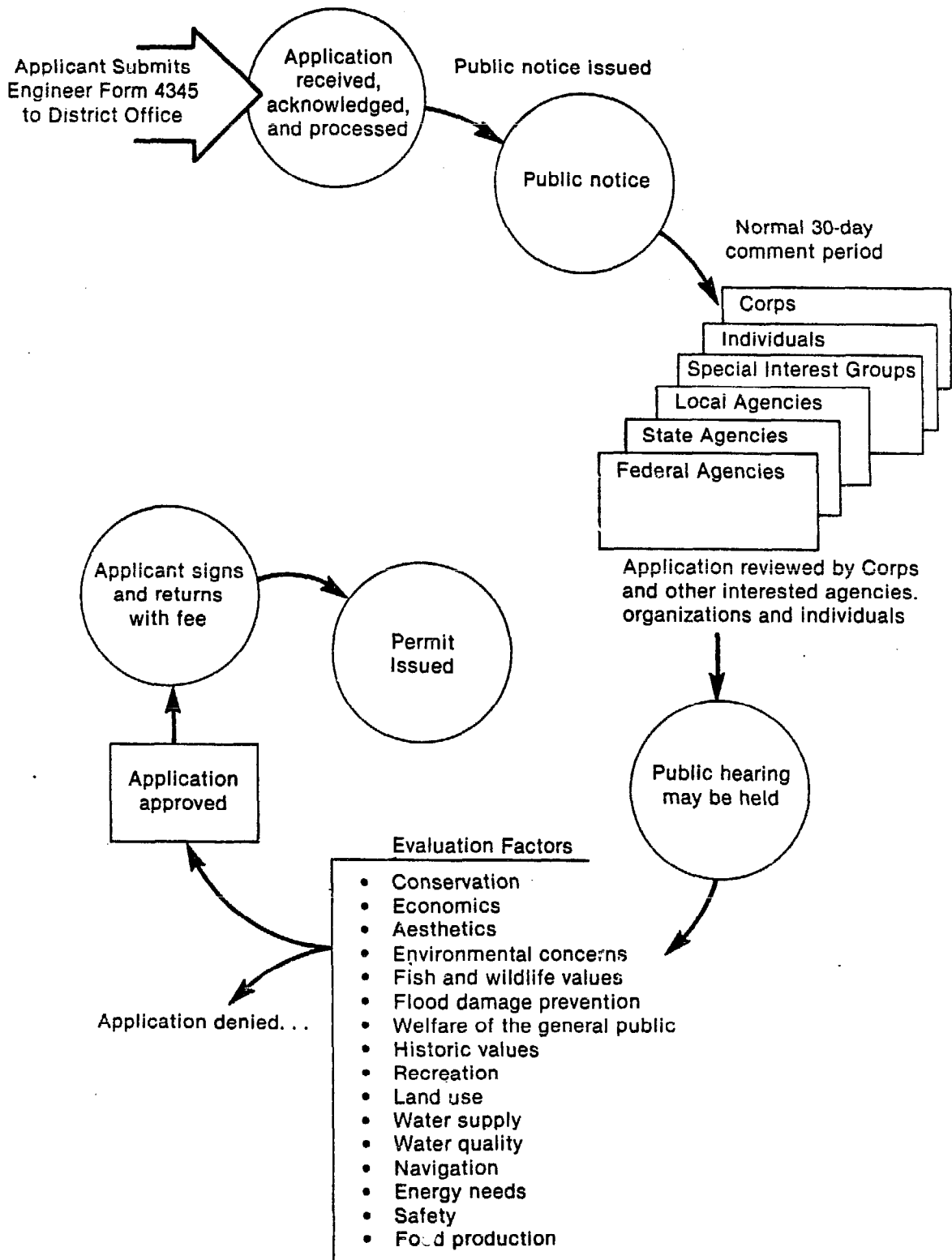

INEL 2 2681

Figure 8-5. Flow diagram of U.S. Army Corps of Engineers permit procedures.

developer from obtaining a 402 permit? There seems to be confusion in the courts on this issue. While two references^{a,b} appear to support the contention that obtaining a 404 permit does exempt the developer from obtaining a 402 permit, it would be prudent to check with the EPA.

8.3.3 Other Federal Laws and Federal Land-Use Permits

Even though the permit processes described above cover the most frequently needed Federal permits, there are other Federal laws you may need to consider, depending on specific characteristics of your site. The most important of these laws are listed in Table 8-4, and a brief discussion of their significance to microhydropower development is presented in Appendix C. Also in Appendix C is a discussion of Federal land-use permits such as for the use of Forest Service land. You should determine at an early stage whether any of these are applicable and, if so, take the appropriate steps to obtain any necessary permits, approvals, etc.

TABLE 8-4. LIST OF PERTINENT FEDERAL LAWS

-
1. National Environment Policy Act (January 1, 1970), 91st Congress
(P.L. 91-190)
42 U.S.C. 4321F.
 2. Fish and Wildlife Coordination Act (August 12, 1958), 85th Congress
(P.L. 85-624)
16 U.S.C. 661-64; 1008
 3. Endangered Species Act (December 28, 1973), 93rd Congress
(P.L. 93-205)
16 U.S.C. 1531-41F.
 4. National Historic Preservation Act (October 15, 1966), 89th Congress
(P.L. 89-665)
16 U.S.C. 460a-t

a. W. H. Rogers, Environmental Law, West Publishing Co., 1977, p. 399.

b. Environmental Law Institute, Air and Water Pollution Control Law, 1980, p. 485.

TABLE 8-4. (continued)

-
5. Federal Water Pollution Control Act (October 18, 1972), 92nd Congress (P.L. 92-500)
33 U.S.C. 1251-1265F.
 6. Water Quality Improvement Act (April 3, 1970), 91st Congress (P.L. 91-224)
33 U.S.C. 466 + more
 7. Clean Water Act Amendments of 1977 (December 27, 1977), 95th Congress (P.L. 95-217)
33 U.S.C. 1251
 8. Wild and Scenic River Act (October 2, 1968), 90th Congress (P.L. 90-542)
16 U.S.C. 1271-87
 9. National Wilderness Preservation Act (September 3, 1964), 88th Congress (P.L. 88-577)
 10. Coastal Zone Management Act (October 26, 1972), 92nd Congress (P.L. 92-583)
16 U.S.C. 1451-1464
 11. Federal Land Policy and Management Act of 1976 (October 21, 1976), 94th Congress (P.L. 94-579)
43 U.S.C. 1701, 02F
 12. Federal Power Act (June 10, 1920; Aug. 26, 1935; May 28, 1948, etc.).
See also Federal Water Power Act
 13. Public Utility Regulatory Policy Act of 1978 (November 9, 1978), 95th Congress (P.L. 95-617)
16 U.S.C. 2601-2633F
 14. National Trails System Act (October 2, 1968), 90th Congress
 15. Pacific Northwest Power Planning and Conservation Act (December 5, 1980), 96th Congress (P.L. 96-501)
16 U.S.C. 837-839
-

8.4 Marketing

All Category 2 developers and some Category 1 developers who plan to sell their excess power will be required to enter into a sales contract with a utility. The contract can be negotiated directly with the utility, or the developer may decide to pursue a contract based on the Public

Utility Regulatory Policy Act (PURPA) rates, which may or may not be set by the State PUC. Generally, only Category 2 developers will want to pursue the PURPA rate and then only if they are producing significant power.

The first part of this subsection discusses a general sales contract. The second part explains PURPA and what is required to qualify.

8.4.1 Sales Contract

If you are a microhydropower developer who plans to sell power, you will be required to enter into a written contract for the sale of produced energy to the power distributing utility. This is a negotiated agreement. If you are able to finance the project without other securities as collateral, you will generally need a contract that runs until the conclusion of debt service payments in order to obtain the necessary financing. The following are representative contracts:

- One with constant cash flow, in which the purchasing utility pays a set annual fee independent of the power produced, with an escalation clause, if desired
- One written to recover all the facility costs plus some profit for the developer
- One written to require the purchasing utility to pay a floating price based on its cost of purchasing power elsewhere.

In general, the first case will be less risky for the developer and thus will usually involve a lower price for the electricity produced. The second case puts more risk on the developer since it does not cover the risk of zero output. The third case gives the developer the least protection but would likely result in a higher unit price for the electricity sold. Variations of these forms of contracts will prevail, depending on the desires of the contracting parties. It is customary for these sales contracts to be on file with the State PUC because the information is necessary for the commission to set utility rates.

Normally, you will be required to pay for all costs of interconnection with the purchasing utility's system. You will also be expected to purchase insurance covering liabilities arising from the operation of your microhydropower development and its interconnection with the purchasing utility's system. The contract will normally specify the phase, current frequency, voltage, and delivery location of the delivered energy, and will require appropriate facilities for its connection to the purchasing utility's system. The terms of the agreement will also define the sales price or prices, termination procedures, and provisions for reasonable inspection and for interruption of the electricity. Many purchasing utilities have developed a standard agreement form for units in the microhydropower range of 100 kW or less.

You should contact the individual purchasing utility or utilities early in the planning process to obtain needed information and to develop the necessary harmonious working relations. Where more than one purchasing utility is available, there may be a significant difference in the avoided cost permitted by the PUC. Hence, you should inquire with more than one utility if possible. You should also contact the State PUC for information on the various options that are available in the negotiation of the sales contract.

8.4.2 PURPA

The U.S. Congress in 1978 enacted the Public Utility Regulatory Policy Act (PURPA), P.L. 95-617 (16 U.S.C. 2701), to help preserve nonrenewable energy resources and to give incentives for development of renewable resources that are not being used to their optimum potential. This includes existing dams and remaining stream sites that are readily adaptable to power generation but are presently undeveloped. The construction of small-scale hydropower plants at such stream sites could lessen the nation's dependence on foreign oil and help alleviate inflation by countering the Country's balance of payment deficits. The full text of PURPA can be found in the Federal Register, Volume 45, No. 56, dated March 20, 1980.

Provisions of the act encourage municipalities, electric cooperatives, industrial development agencies, private entities, and nonprofit organizations to undertake small-scale hydropower developments at qualified sites. This is done by requiring electrical utilities to purchase the power produced by these small power plants at the utility's avoided cost (see Subsection 8.4.2.2). The act eliminated several problems for developers: (a) the reluctance of electric utilities to purchase the power produced because of the lack of in-house control and the perceived unreliability of the production, (b) the charging of discriminatory rates for backup power by some electrical utilities, and (c) being considered an electric utility and thus becoming subject to extensive state and Federal regulations.

8.4.2.1 Qualifying Facility. Significant among PURPA requirements is the definition of a "qualifying facility." Your facility can qualify for avoided-cost payments from electrical utilities under PURPA as specified above under the following conditions:

- The power development and all other facilities at the same site that use the same energy source must not exceed a generating capacity of 80 MW. Facilities are considered as located at the same site if they are within one mile of each other and, for hydropower facilities, if they use water from the same impoundment for power generation.
- More than 50% of the facility's total energy input must come from the use of biomass, waste, renewable resources, or a combination of these.
- The small hydropower facility may not be owned by a person or company primarily engaged in the generation or sale of electric power. A cogeneration or small production facility will be considered as owned by a person or company primarily engaged in the generation of electric power if more than 50% of the equity interest in the facility is held by an electric utility or utilities, or by a public utility holding company or companies or any combination thereof.

8.4.2.2 Avoided Cost. The provisions of PURPA, P.L. 95-617, are designed to provide incentives for developing renewable energy resources, including hydropower. A number of states have also passed state public utility regulatory acts to further encourage development of renewable resources, including hydropower. If the purchasing utility can reduce its costs or avoid purchasing energy from another utility by purchasing electric energy from a qualifying facility (as defined above), the rate for the purchase is to be based on those energy costs that the utility can avoid, which are called the avoided costs. This implies that the purchasing facility can defer or delay the construction of a new generating plant, or decrease the purchase of power from another utility because of the power purchased from the small hydropower development.

Factors influencing the price you will receive for power you sell under PURPA include:

- The availability of capacity or energy² at a qualifying facility during daily and seasonal peak energy demand periods
- The reliability of the capacity or energy supply
- The duration of the period during which the qualifying facility can contractually guarantee a given capacity or supply of energy to the utility
- Coordination between the scheduled outages of the qualifying facility and of the utility
- The backup capability of the qualifying facility in the event of a utility system emergency
- The lead time associated with the addition of the qualifying facility

a. The difference between the energy and capacity of a hydropower plant is important in understanding the avoided-cost rate. These terms are defined in the Glossary (Appendix G).

- Costs or savings that can result from differential line losses in transmitting and delivering the energy
- Alternative nonrenewable energy fuel costs.

PURPA also requires that the purchasing utility offer to purchase the total output of energy or capacity or any portion of either that the qualifying facility wishes to offer. The avoided-cost rate that must be paid to a qualifying facility

- Shall be just and reasonable and in the public interest
- Shall not discriminate against the qualifying power producer.

The ultimate responsibility for defining the avoided cost has been assigned to the State PUC or its equivalent in each state. The PUCs in turn have required the purchasing utilities to present their supporting information for defining the avoided costs. The burden of proof falls on the purchasing utility when it establishes an avoided-cost rate for the purchase of power. The rate must be based on accurate data and systematic costing principles.

You must contact both the purchasing utility and the State PUC when making arrangements for an avoided-cost sale contract under PURPA. State PUCs are listed in Appendix E-2. Knowing how to contract with a purchasing utility is important to the early planning of any microhydropower project from which you plan to sell power. A detailed treatment of this topic for the state of Washington is covered in Marketing Manual, Volume II, Developing Hydropower in Washington State, published by the Washington State Energy Office and the Department of Energy.

8.4.2.3 Sales Opportunity. The PURPA act specifies that purchasing utilities must purchase the output from qualifying facilities. To take advantage of this sales opportunity, you must first know that your proposed microhydropower development is a qualifying facility, as discussed in Subsection 8.4.2.1, above. Purchasing utilities can include investor-owned

utilities, municipal electrical utilities, electric cooperatives, public utility districts, state agencies, federal agencies, or any person who sells electricity. Federal electric energy marketing entities like the Tennessee Valley Authority and the Bonneville Power Administration can also be purchasing utilities. Federal power marketing entities are listed in Appendix D-7.

A purchasing utility cannot have more than a 50% equity interest in a microhydropower development if the development is to be classified as a qualifying facility and claim the avoided cost price structure mandated by PURPA. This means that no public utility holding company or person owning a portion of the purchasing utility can claim the avoided-cost provisions of PURPA if they also have an equity interest greater than 50% in the qualifying facility.

The state can furnish listings of purchasing utilities. This information is normally available from the State PUC (listed in Appendix E-2) or from the Office of Energy (listed in Appendix E-8) in each state.

Section 292.303 (f) of PURPA indicates that there are situations in which a purchasing utility is not obligated to purchase energy from the qualifying facility of a microhydropower developer:

- A purchasing utility is not obligated to purchase from a qualifying facility during periods when such purchases would result in a net increase in operating expenses for the electric utility
- A purchasing utility can discontinue purchase from a qualifying facility during an emergency if the purchase of energy will contribute to the emergency.

The state PUC or energy regulatory agency has the authority to verify whether these exemptions from purchase can be allowed. As mentioned earlier, State PUCs or the equivalent agencies are listed in Appendix E-2.

8.5 Example Sites

This section presents step-by-step procedures for obtaining the necessary certifications, permits, and licenses or exemptions for the two example sites used in this handbook:

- A run-of-the-stream site in Washington State
- A manmade site in New Hampshire.

8.5.1 Run-of-the-Stream Site

The run-of-the-stream site is located in mountainous terrain in Washington. This site has been described previously in Subsection 2.7. The owner is a Category 1 developer whose primary objective is to provide power for two family dwellings that are currently satisfactorily supplied power from a 12-kW diesel generator.

For this example, it is assumed that title to the generating site belongs to the developer. It is also assumed that during the reconnaissance study, the developer contacted

- The Federal Energy Regulatory Commission (the Federal agency responsible for licensing essentially all non-Federal hydropower projects)
- The Washington Department of Ecology (WDOE) (an environmental checklist was obtained, filled out, and returned)
- The Washington Department of Fish
- The Washington Office of Archeological and Historical Preservation
- The Washington State Energy Office (WSEO), and
- The U.S. Forest Service.

to determine whether there are any major hindrances to development. Major hindrances to development would include the presence of a threatened or endangered species in the site area, an anadromous fish run in the stream, a historic site at the diversion dam or power plant site, a scenic designation for the site, or major agency opposition for some reason. Each agency contacted was asked for advice, the prerequisites for its permit(s), and the time involved between application and issuance.

Figure 8-6 shows a flow diagram of the licensing process for microhydropower projects in Washington. The State of Washington has published an excellent guide book for the licensing process, Developing Hydropower in Washington State: A Guide to Permits, Licenses, and Incentives, which can be obtained from either the WDOE or the WSED. The developer in Washington should obtain this guide book early in the reconnaissance process and follow it throughout.

As soon as the reconnaissance study indicates an environmentally and economically favorable site, the developer should submit to the FERC a notice of intent to file for an exemption or preliminary permit. Although a notice of intent is not necessary, it is generally a good investment, since it secures the site against all competition that might be considering the same site. A notice of intent to file for exemption only requires an acknowledgment, whereas it generally takes about 6 months to obtain a preliminary permit from the FERC. The applicant should specifically ask for any recent additions or changes in the application process. A number of ways to simplify the process for small-scale hydropower developments, especially microhydropower, are currently under study by the FERC.

Every hydropower project must have a water right. Filing for a water right permit should be one of the developer's first steps, in order to establish his claim. Since the WDOE issues Washington water right permits, there should be no technical problems in obtaining the permit if the developer has already established contact with the WDOE as previously suggested.

Initiating Contacts made with:

1. Federal Energy Regulatory Commission
2. Washington Department of Ecology
3. Washington Department of Fish
4. Washington office of Archeological and Historical Preservation
5. Washington Energy Office

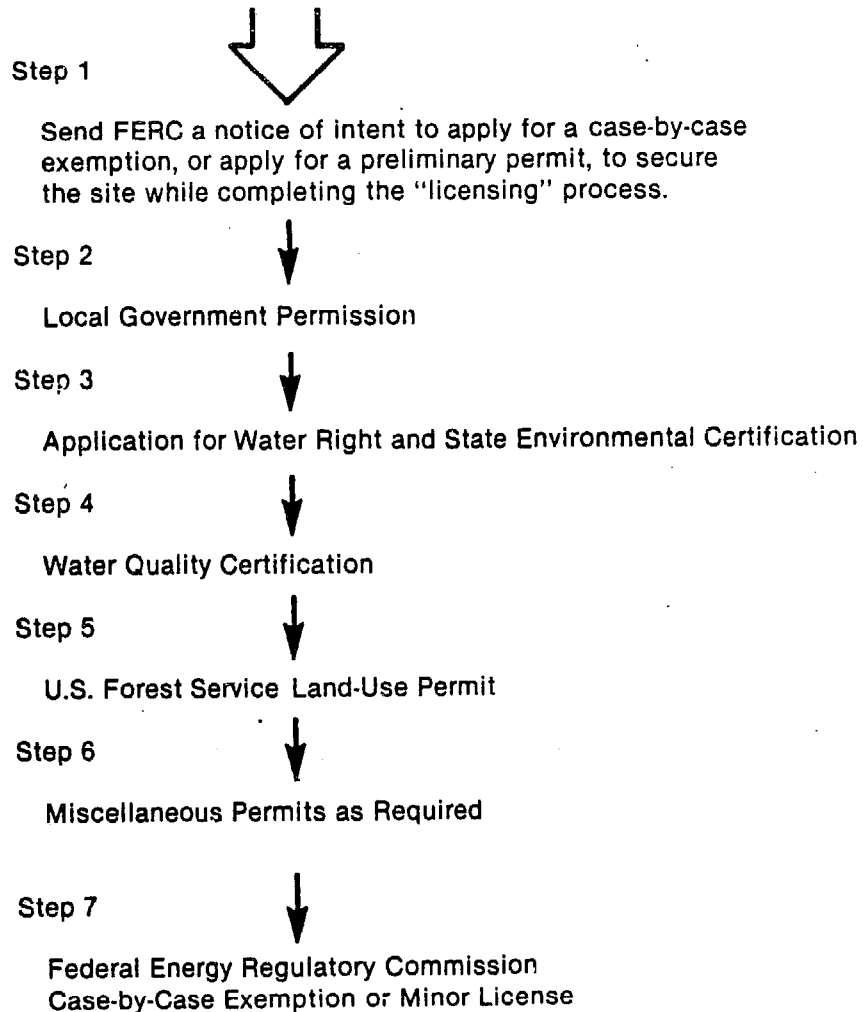

INEL 2 2680

Figure 8-6. Flow diagram of licensing process for a microhydropower project in the state of Washington.

Insofar as possible, the developer should accomplish the steps described in the following paragraphs simultaneously.

The microhydropower project must comply with local planning and zoning ordinances. In this case, the agency for the developer to work with is probably the county planning and zoning commission or the public works department. The developer may have to obtain a building permit or a letter certifying that the proposed project is in compliance with local ordinances. The building process itself should be discussed with these local officials since a variety of specialty permits may be needed, depending on the actual construction process. Page 13 of the Washington guide book, reproduced here as Table 8-5, lists local permits commonly required in the State of Washington.

The project will also need environmental certification under SEPA, the Washington State Environmental Policy Act. The WDOE is the administrator of this program. This step should be straightforward if the environmental checklist was filled out and turned in to the WDOE during the reconnaissance study. The expected result at this point is a negative declaration, meaning that no significant environmental impact is expected as a result of the project. This expectation is based on the incorporation of suggestions received during initial contact with the agency about minimizing the potential environmental impact of the project. Had a major obstacle arisen during the initial contacts, it would probably have required an environmental impact statement, or at least a hearing, either of which would seriously jeopardize the economics of a microhydropower project.

If the environmental certification does not include historical and archeological considerations, then the developer should contact the appropriate agency and obtain a letter certifying that the site is in compliance with the related state code. In the State of Washington, this is the Office of Archeology and Historic Preservation. FERC Order No. 202 does not require a historical and archeological certification on categorical exemptions for microhydropower projects, but the other exemption and licensing options do.

Water quality certification is also required under Federal law (Federal Water Pollution Control Act, P.L. 92-500; Water Quality

TABLE 8-5. LOCAL PERMITS THAT MIGHT BE NECESSARY IN THE STATE OF WASHINGTON.

LOCAL PERMITS			
The local (city and county) permits that are necessary for a hydro project will vary from county to county		in number, type, application, location, and cost. The following table shows the most common permits.	
<u>Name</u>	<u>From</u>	<u>Reason</u>	<u>Approximate Time</u>
Shoreline substantial development permit	County Planning Department	Required if any part of project is within 200 ft of an applicable shoreline. ^a	4 months
Zoning conditional use permit	County Planning Department	Required if project is not in conformance with zoning for county master plan.	3 months
Surface water drainage plan approval	County Department of Public Works	Drainage plan must be approved before several other permits can be issued.	1 month
Commercial building permit	County Building and Plumbing Department	Applies to construction of powerhouse.	2 weeks
Temporary road closure permit	County Department of Public Works	Needed for any construction that would completely close a road to traffic.	1 week
Utility permits	County Department of Public Works	Needed for transmission lines and utility intertie.	2 weeks
Sewage holding tank variance	County Department of Health	For sewage facilities installed as part of the project on a permanent basis.	2 months
Grading permit	County Department of Public Works	For all excavation or filling activities, except as noted in the Uniform Building Code.	1 month
Plumbing permit	County Building and Plumbing Department	Must approve plumbing plans.	1 day
Interlocal agreement for construction on county roads	County Department of Public Works	Short-term agreement applies to upgrading and performing maintenance work on county roads used by overweight construction equipment	1 month review 3 months agreement
Permit to operate overweight vehicles on city or county roads	City/County Department of Public Works	Required only where road conditions are sensitive to damage by overweight vehicles.	1 day

^aShorelines on segments of streams upstream from a point where the mean annual flow is 20 cfs or less and shorelines on lakes less than 20 acres in size are not designated as applicable shorelines.

INEL 2 2665

Improvement Act, P.L. 91-224; and Clean Water Act Amendments of 1977, P.L. 95-217). The WDOE is the state agency responsible for this certification. For the described project, there should be no significant problems, although the developer may have to install the diversion structure and bury the penstock piping in accordance with agreed specifications. In this particular example, the developer may have to obtain the USFS land use permit described below before the water quality permit can be issued. The key to minimizing problems at this stage lies in clarifying the priority of applications during the initial contacts with the various cognizant agencies.

A U.S. Forest Service permit to use government land for the diversion structure, penstock, and access roads will be necessary. The developer should obtain the necessary forms during the reconnaissance study so that they can be filled out as the required information becomes available.

A variety of other permits could be necessary, depending on the final project plan and on local and state regulations. Insofar as possible, these should be determined in advance during the reconnaissance study. (See pp 13, 17, and 18 of the Washington handbook for other local and state permits which might be necessary).

Since the FERC is required by Federal law to ensure compliance with appropriate local, state, and Federal laws before issuing a license or exemption, The FERC short-form license or exemption is generally the last permit the developer obtains before starting construction. In the case of the categorical exemption for microhydropower under FERC Order No. 202, however, this is not true. The categorical exemption can be granted before other Federal, state, and local requirements are complied with. In any case, the developer should obtain the specific forms required at the time of initial contact during the reconnaissance study. Much of the information required by the FERC is identical to that required by the state. Therefore, certifications or permits from the various state agencies are generally acceptable to the FERC and will greatly expedite obtaining this final license.

Once again, the importance of establishing early and ongoing communication with the permitting agencies to assure orderly compliance with their requirements cannot be emphasized too strongly.

8.5.2 Manmade Site in New Hampshire

The manmade site is located at an existing dam on a small stream in the rolling hills of New Hampshire. The site includes an old, retired gristmill. The electric utility's distribution line passes within 300 yards of the mill. This site has been described previously in Subsection 2.7. The owner is a Category 2 developer whose primary objective is to supply his own electrical needs and sell any excess power to the utility.

As with the previous example, it is assumed that the developer has approached the licensing process systematically by establishing early contact with key local, state, and federal agencies. These include

- The Federal Energy Regulatory Commission
- The New Hampshire Water Resource Board
- The New Hampshire Water Supply and Pollution Control Commission
- The New Hampshire Department of Fish and Game
- The New Hampshire Department of Resources and Economics
- The responsible local government entity.

Figure 8-7 shows a flow diagram of the licensing process for a microhydropower project in New Hampshire. Also see Figure 8-1, which shows a detailed flow diagram of the State of New Hampshire requirements for hydropower projects of all sizes.

Initial Contact with local, state and Federal agencies

1. FERC
2. N.H. Water Resource Board
3. N.H. Water Supply and Pollution Control Commission
4. N.H. Department of Fish and Game
5. N.H. Responsible local government entity

Step 1



Submit a letter of intent to file a notice of exemption, or file for preliminary permit with intent to file for exemption

Step 2



Legal title to dam site

NOTE: As many as possible of these steps should be performed simultaneously.

Step 3



Water right

Step 4



Dam safety permit

Step 5



Water quality certification

Step 6



Dredge permit

Step 7



Historic site certification

Step 8



Fish and game certification

Step 9



Planning and zoning certification or building permit

Step 10



FERC exemption

INEL 2 2679

Figure 8-7. Flow diagram of licensing process for a microhydropower project in the state of New Hampshire.

No two water development sites are exactly the same. The exact number of permits, certificates, and licenses or exemptions required will vary with the site characteristics and the mix of private lands, public lands, public waters, and navigable and nonnavigable waters involved. The exact step-by-step sequence for licensing this New Hampshire site cannot be specified without additional site-specific information and the output of interactions with the various local, state, and Federal agencies. The best procedure is for the developer to establish agency contacts early, ask for the necessary licensing forms and any written instructions that might be available, and then systematically complete the paperwork for local, state, and Federal licensing.

When making the initial agency contacts, the developer should take or send a land ownership map of the site, a drawing of the proposed project, and some pictures of the dam, gristmill, pond area, and stream. These will help the agency personnel in outlining requirements for licensing the development.

At the state level, the developer must obtain at least a water right permit, a dam safety permit, and a water quality permit or certification under Section 401 of P.L. 92-500. The state agency responsible for these is the New Hampshire Water Resource Board. The Water Resource Board must also consider effects on scenic and recreational values, fish and wildlife, downstream flows, and public uses where appropriate. The developer should secure all applicable forms at the initial contact.

During the initial contact, the developer should also ask the Water Resources Board about the historical classification of the old gristmill and dam. If the Water Resources Board cannot immediately answer this question, the developer should call or visit the Department of Resources and Economic Development (see Appendix E-9), which is in charge of historic preservation, to determine whether the proposed development is affected in any way.

During initial contact with the Fish and Game Department, the developer should clarify the status of the impacted land area and the

stream. Since the stream has a considerable flow, it may be important to anadromous fisheries, or it may be classified as public trust or even as navigable. Any of these could present additional requirements leading to time delays and additional costs. The developer should also ask whether the development might affect any threatened or endangered species in the vicinity of the dam site. The presence of such species could greatly complicate the development of the site.

If the project calls for dredging, the developer will need a permit from the Water Supply and Pollution Control Commission (see Appendix E-4). The correct form should be obtained during initial contact with the agency and filled out in a timely fashion.

Next, assuming that the initial inquiries do not uncover any insurmountable difficulties, the developer should procure a legal determination of ownership of the affected lands and the riparian right to the water. Legal ownership of both sides of the stream at the dam site is critical. The pondage area could be acquired by eminent domain if necessary, provided the developer has legal title to the dam site.

As soon as the site ownership is determined, the developer should submit to the FERC a notice of intent to file for an exemption or preliminary permit. Although a notice of intent is not necessary, it is generally a good investment, since, with one exception, it reserves the site against competitive licensing applications. The developer should have obtained the necessary forms during the first contact with FERC and should have gathered the required information during the reconnaissance study.

The next step is a study to ascertain as closely as possible the technical, economical, environmental, and institutional feasibility of the project. The larger the project, the more likely it is that a professional engineer or consulting firm should be handling this step. An engineer will need to certify the safety of the dam in this particular project.

Since this project is less than 5 MW, it is exempt from New Hampshire Public Utility Commission regulations, but the PUC avoided-cost rulings

could be a major input to the economic analysis and overall project feasibility. Therefore, the developer should seek out the New Hampshire PUC (see Appendix E-2) to get this information.

If the stream is considered navigable, the developer will have to obtain a permit under Section 10 of the Rivers and Harbors Act of 1899 from the COE, which is responsible for protecting navigable streams. If dredging is involved, a permit under Section 404 of P.L. 92-500 will probably be required from the COE as well as from the state. Considerable review is involved in these permits since The U.S. Environmental Protection Agency, the U.S. Fish and Wildlife Service, and various state agencies all comment on them.

At the same time the state and Federal permits are being secured, the developer should be working with local governmental entities to establish compliance with the necessary planning and zoning regulations and obtain a building permit. Land ownership certification and a dam safety permit may be prerequisites for a building permit. The key to minimizing problems at this stage lies in clarifying the priority of applications during the initial contacts with the various cognizant agencies.

All of the necessary forms for licensing should be filled out as part of the feasibility study so that, with a favorable feasibility report, licensing can be completed shortly thereafter. The time from the initial contacts to the licensed project may be more than a year. The larger the project, the longer this process will take.

Since the FERC is required by Federal law to ensure compliance with appropriate local, state, and Federal laws before issuing a license or exemption, The FERC short-form license or exemption is generally the last permit the developer obtains before starting construction. In the case of the categorical exemption for microhydropower under FERC Order No. 202, however, this is not true. The categorical exemption can be granted before other Federal, state, and local requirements are complied with. In any case, the developer should obtain the specific forms required at the time of initial contact during the reconnaissance study. Much of the

information required by the FERC is identical to that required by the state. Therefore, certifications or permits from the various state agencies are generally acceptable to the FERC and will greatly expedite obtaining this final license.

Once again, the importance of establishing early and ongoing communication with the permitting agencies to assure orderly compliance with their requirements cannot be emphasized too strongly.

The FERC is currently streamlining its licensing process for microhydropower projects. The developer should seek the latest rulings from the FERC during the initial contact so as to comply with the correct regulations and minimize the paperwork involved. The

Governor's Council on Energy
2 1/2 Beacon Street
Concord, NH 03301
(603) 271-2711

should also be contacted for the latest New Hampshire information on legal requirements and also other information on incentives, sales contracts, marketing, and technical information helps.

Finally, when the project is licensed for construction, the developer must secure annual permits and plan for annual costs. These should also be considered in the reconnaissance and feasibility study stages because of how they influence the overall project economics.

8.6 Bibliography

Alward, R., Eisenbart, S., Volkman, J., and Haumberger, H., Microhydropower Reviewing an Old Concept, National Center for Appropriate Technology, Butte, Montana, 1979.

Colorado Office of Energy Conservation, et al., "Water Over the Dam, A Small Scale Hydro."

Klingeman, P. C. and Wheeler, G., Microhydropower: Oregon Development Guide, Extension Circular 1096, Oregon State University Extension Service, January, 1982.

McGuigan, D., Harnessing Water Power for Home Energy, Garden Way Publishing Co., Charlotte, Vermont, 1978, 101 pp.

Office of Federal Register, Code of Federal Regulation, Conservation of Power and Water Resources, Title 18, Parts 1-149, Current year, U.S. Government Printing Office, Washington, D. C.

State of Alaska, Division of Energy and Power Development, "Hydroelectric Commercialization Kit," September 1981.