

# **AT** MICROFICHE REFERENCE LIBRARY

A project of Volunteers in Asia

Rotor Design for Horizontal Axis Windmills

by: W.A.M. Jansen and P.T. Smulders

Published by:

Steering Committee for Wind Energy in  
Developing Countries

P.O. Box 85  
3800 AB Amersfoort  
The Netherlands

Paper copies are \$ 4.00; single free copies are available to research institutions in developing countries.

Available from:

Steering Committee for Wind Energy in  
Developing Countries

P.O. Box 85  
3800 AB Amersfoort  
The Netherlands

Reproduced by permission of the Steering Committee for Wind Energy in Developing Countries.

Reproduction of this microfiche document in any form is subject to the same restrictions as those of the original document.

# rotor design for horizontal axis windmills

by W.A.M. Jansen and P.T. Smulders

May 1977



STEERING COMMITTEE FOR WINDENERGY IN DEVELOPING COUNTRIES  
(Stuurgroep Windenergie Ontwikkelingslanden)

P.O. BOX 85 / AMERSFOORT / THE NETHERLANDS

This publication was realised under the auspices of the Steering Committee for Windenergy in Developing Countries, S.W.D.  
The S.W.D. is financed by the Netherlands' Ministry for Development Cooperation and is staffed by

the State University Groningen,  
the Eindhoven Technical University,  
the Netherlands Organization for Applied Scientific Research, and  
DHV Consulting Engineers, Amersfoort,

and collaborates with other interested parties.

The S.W.D. tries to help governments, institutes and private parties in the Third World, with their efforts to use windenergy and in general to promote the interest for windenergy in Third World countries.

ROTOR DESIGN FOR  
HORIZONTAL AXIS WINDMILLS

by

W.A.M.Jansen\*)  
and  
P.T.Smuiders\*)

MAY 1977

Publication SWD 77-1

This publication is released under the auspices of the Steering Committee for Wind Energy in Developing Countries, S.W.D. The S.W.D. is financed by the Netherlands' Ministry for Development Cooperation and is staffed by

the State University Groningen,

the Eindhoven University of Technology,

the Netherlands Organization of Applied Scientific

Research T.N.O. and

DHV Consulting Engineers, Amersfoort.

The S.W.D. tries to help governments, institutes and private parties in the Third World with their efforts to use wind energy and in general to promote the interest for wind energy in Third World Countries.

- \*) Wind Energy Group, Laboratory of Fluid Dynamics and Heat Transfer, Department of Physics, Eindhoven University of Technology, Eindhoven, The Netherlands.

Contents	page number
INTRODUCTION.	2
LIST OF SYMBOLS.	3
UNITS OF MEASURE.	4
1 WIND ENERGY - WIND POWER.	5
2. HORIZONTAL-AXIS WINDMILL ROTOR.	6
2.0 <u>Airfoils.</u>	7
2.1 <u>Torque and power characteristics.</u>	11
2.2 <u>Dimensionless coefficients.</u>	14
2.3 <u>Basic form of windmill characteristics.</u>	16
2.4. <u>Maximum power coefficient.</u>	17
2.4.0 Betz coefficient.	18
2.4.1 Effect of wake rotation on maximum power coefficient.	19
2.4.2 Effect of $C_d/C_1$ - ratio on maximum power coefficient.	20
2.4.3 Effect of number of blades on maximum power coefficient.	21
3. DESIGN OF A WINDMILL ROTOR.	22
3.0 <u>Calculation of blade chords and blade angles.</u>	22
3.1 <u>Deviations from the calculated chords and angles.</u>	27
4. EFFECT OF THE REYNOLDS NUMBER.	30
4.0 <u>Dependance of airfoil characteristics on Re-number.</u>	30
4.1 <u>Calculations of the Re-number for the blades of a windmill rotor.</u>	32

#### Appendix

I Literature	34
II $C_1$ - $\alpha$ and $C_1$ - $C_d$ characteristics, NACA 4412.....24	36
III Collection of maximum attainable power coefficients, for different numbers of blades and $C_d/C_1$ -ratios, as function of the design tip-speed ratio $\lambda_o$	42
IV Note on the theoretical assumptions on which the design method is based	50
V $\phi = f(\lambda_r)$	52

## INTRODUCTION.

This publication was written for those persons who are interested in the application of wind energy and who want to know how to design the blade shape of a windmill rotor. We have received many requests on this issue from parties inside and outside the Netherlands. In writing this booklet we were uncertain as to the level at which it should be written.

So some might find it too easy, others too difficult.

We would like to emphasize that the design procedure, as given in one of the chapters, is very simple. It is important however that a number of basic ideas and concepts are well understood, before an attempt is made to design a rotor. Therefore quite a lot of attention is given to explaining lift, drag, rotor characteristics etc. So we ask the reader to be tolerant and patient. Those who are not familiar with the basic concepts we urge to go on and not to be afraid of the first formulas and graphs presented here.

Although a good rotor can be designed with the procedure as presented here, a few things should be noted. In the selection of a rotor type, in terms of design speed and radius, the load characteristics and wind availability must be taken into account. We have seen various good rotors coupled to wrong types of loads or to too high loads. Although it is possible to change the number of revolutions per minute with a transmission, this will not solve the problems that may arise when the selected design figures are basically incorrect. A second remark is that rotors can be very dangerous. No strength calculations are given in this book, but remember that the centrifugal forces can make a rotor explode if it is not strong enough. Touching a rotor during operation will lead to serious injury. The availability of certain materials and technologies can be taken into account in the earliest stages of the design. We therefore hope that, with this book, the reader will be able to design a rotor that can be manufactured with the means and technologies as are locally available.

$a_n$	constant	
A	area	$m^2$
B	number of blades	-
c	chord	m
$C_d$	drag coefficient	-
$C_l$	lift coefficient	-
$C_p$	power coefficient	-
$C_Q$	torque coefficient	-
d	diameter	m
D	drag	N
E	energy	J
$E_v$	energy per volume	$Jm^{-3}$
f	plate bending of arched steel plate	m
L	lift	N
m	mass	kg
n	number of revolutions per second	$s^{-1}$
P	power	W
Q	torque	Nm
R	rotor radius	m
r	local radius	m
Re	Reynolds number	-
$Re_n$	Re for $B = C_l = r = V_\infty = 1$	-
u	tangential blade speed at radius r	$ms^{-1}$
V	velocity, speed	$ms^{-1}$
$V_\infty$	undisturbed windspeed	$ms^{-1}$
W	relative velocity to rotor blade	$ms^{-1}$
$\alpha$	angle of attack	-
$\alpha_c$	design value for angle of attack	-
$\beta$	blade angle, blade setting	-
$\eta_B$	factor for blade number effect on $C_p$	-
$\lambda$	tip-speed ratio	-
$\lambda_o$	design value for tip-speed ratio	-
$\lambda_r$	local speed ratio at radius r	-
$\nu$	kinematic viscosity	$m^2 s^{-1}$
$\rho$	density	$kgm^{-3}$
$\phi_v$	volume flow	$m^3 s^{-1}$
$\phi$	angle between plane of rotation and relative flow velocity at the rotor blades	-
$\Omega$	rotor angular velocity	$s^{-1}$

## UNITS OF MEASURE.

The units used in this publication belong to, or are based on the so-called Syst eme International d'Unit es (SI).

Those who are not familiar with these units or who have data given in units of other systems (for example windspeed in mph), we here give a short list with the conversion factors for the units that are most relevant for the design of windmill rotors.

length	1 m	= 3.28 ft
area	1 m <sup>2</sup>	= 10.76 ft <sup>2</sup>
volume	1 m <sup>3</sup>	= 35.31 ft <sup>3</sup> = 264.2 gallons
speed	1 ms <sup>-1</sup>	= 2.237 mph
	1 knot	= 0.5144 ms <sup>-1</sup> = 1.15 mph
mass	1 kg	= 2.205 lb
force	1 N	= 0.225 lbf = 0.102 kgf
torque	1 Nm	= 0.738 ft lbf
energy	1 J	= 0.239 calories = 0.2777 * 10 <sup>-6</sup> kWh = 1 Nm
power	1 W	= 1 watt = 1 Js <sup>-1</sup> = 0.738 ft lbf s <sup>-1</sup> = 1 Nms <sup>-1</sup>
	1 hp	= 0.7457 kW
	1 pk	= 0.7355 kW



## 1. WIND ENERGY - WIND POWER.

Wind is air in motion. The air has mass, but its density is low. When mass is moving with velocity  $V$  it has kinetic energy expressed by:

$$E = \frac{1}{2}mV^2 \quad [J] \quad (1-1)$$

If the density of the flowing air is  $\rho$ , then the kinetic energy per volume of air, that has a velocity  $V_{\infty}$ , is:

$$E_v = \frac{1}{2}\rho V_{\infty}^2 \quad [Jm^{-3}] \quad (1-2)$$

If we consider an area  $A$  perpendicular to the wind direction (see fig. 1.1), then it may be seen that per second a volume  $V_{\infty} A$  flows through this area.  $V_{\infty}$  is the undisturbed wind velocity.

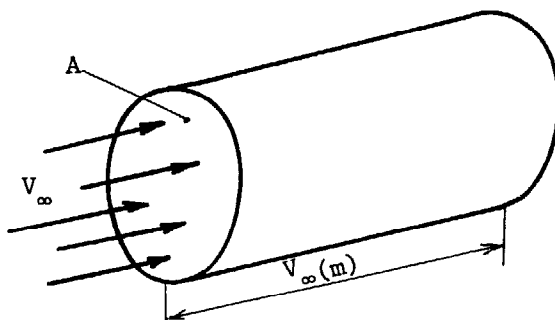

fig. 1.1 Area  $A$  and volume flow per second  $V_{\infty} A$ .

So the flow per second through  $A$  is:

$$\phi_v = V_{\infty} A \quad [m^3 s^{-1}] \quad (1-3)$$

The power that flows with the air, through area  $A$ , is the kinetic energy of the air that flows per second through  $A$ .

Power = Energy per second.

Power = Energy per volume \* Volume per second.

Equations (1-2) and (1-3) combined give:

$$P_{\text{air}} = \frac{1}{2} \rho V_{\infty}^2 * V_{\infty} A \quad [\text{Js}^{-1} = \text{watt}]$$

$$\boxed{P_{\text{air}} = \frac{1}{2} \rho V_{\infty}^3 A} \quad [\text{W}] \quad (1-4)$$

This is the power available in the wind; as will be seen, only a part of this power can actually be extracted by a windmill.

The above derived relation for the power in the wind (1-4) shows clearly that:

- the power is proportional to the density  $\rho$ .  
This factor can not be influenced and varies slightly with the height and temperature (For 15°C at sea level  $\rho = 1.225 \text{ kgm}^{-3}$ ).
- in case of horizontal axis windmills the power is proportional to the area  $A = \pi R^2$  (area swept by the blades) and thus to  $R^2$ . Radius R is chosen in the design.
- the power varies with the cube of the undisturbed windvelocity  $V_{\infty}$ . Note that the power increases eightfold if the windspeed doubles.

## 2. HORIZONTAL AXIS WINDMILL ROTOR.

To extract the power from the wind, several devices have been used and are still in use throughout the world. Examples of such devices are sailboats and windmills.

This book deals only with the design of rotors for horizontal axis windmills, which are rotors with the axis of rotation in line with the wind velocity. The rotor rotates because forces are acting on the blades. These forces are acting on the blades because the blade changes the air velocity. The next paragraph deals with the relations between the velocity at the rotor blade and the forces acting on the blade.

## 2.0 Airfoils.

The rotor of a windmill consists of one or more blades attached to a hub. The cross sections of these blades can have several forms, as illustrated in fig. 2.1 and we call these cross sections airfoils.

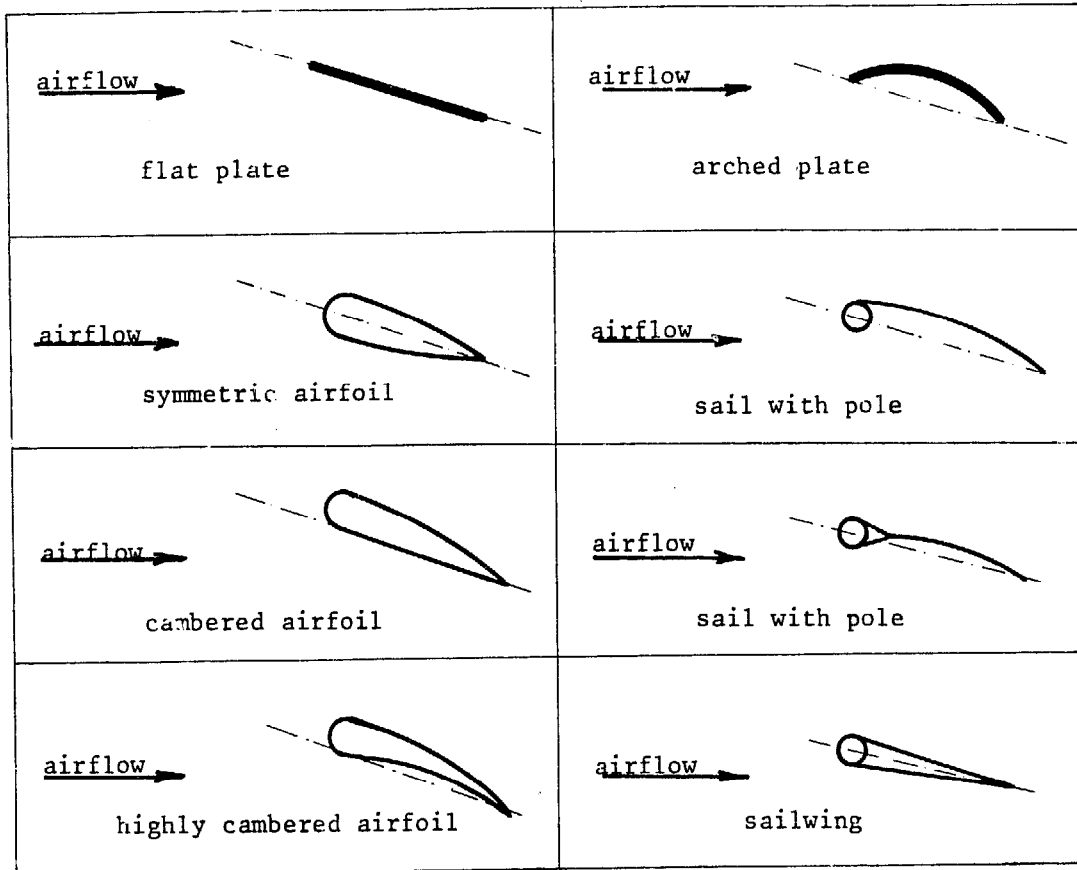

fig. 2.1 Types of airfoils.

An airfoil is a surface over which air flows. This flow results in two forces: LIFT and DRAG. Lift is the force measured perpendicular to the airflow - not to the airfoil! Drag is measured parallel to the flow. See fig. 2.2.

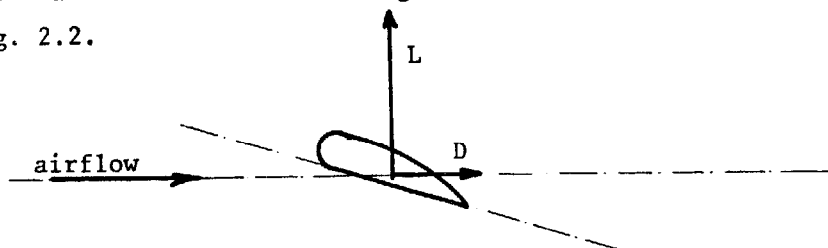

fig. 2.2 Lift and drag.

All airfoils require some angle with the airflow in order to produce lift. The more lift required, the larger the angle.

The chord line (fig. 2.3) connects the leading edge and the trailing edge of the airfoil.\* The angle required for lift is called angle of attack  $\alpha$ . The angle of attack is measured between the chord line and the direction of the airflow. See fig. 2.3.

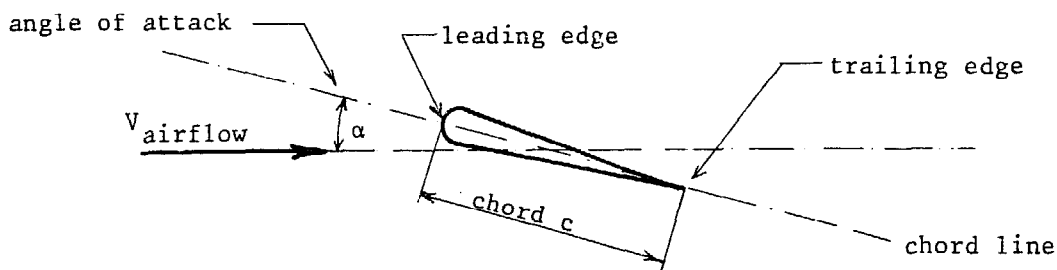

fig. 2.3. Chord line and angle of attack.

We want to describe the performance of an airfoil independent of size and airflow velocity. Therefore we divide lift  $L$  and drag  $D$  by  $\frac{1}{2}\rho V^2 A$  where

$$\begin{aligned} \rho &= \text{air density} && [\text{kgm}^{-3}] \\ V &= \text{flow velocity} && [\text{ms}^{-1}] \\ A &= \text{blade area (= chord * blade length)} && [\text{m}^2] \end{aligned}$$

The results of these divisions we call lift coefficient  $C_l$  and drag coefficient  $C_d$

$$C_l = \frac{L}{\frac{1}{2}\rho V^2 A} \quad [-] \quad (2-1)$$

$$C_d = \frac{D}{\frac{1}{2}\rho V^2 A} \quad [-] \quad (2-2)$$

As stated before, the amount of lift and drag that is produced, depends on the angle of attack. This dependence is a given characteristic of an airfoil and is always presented in  $C_l$ - $\alpha$  and  $C_l$ - $C_d$  graphs. See fig 2.4.

\* For some airfoils the chord line is defined otherwise.

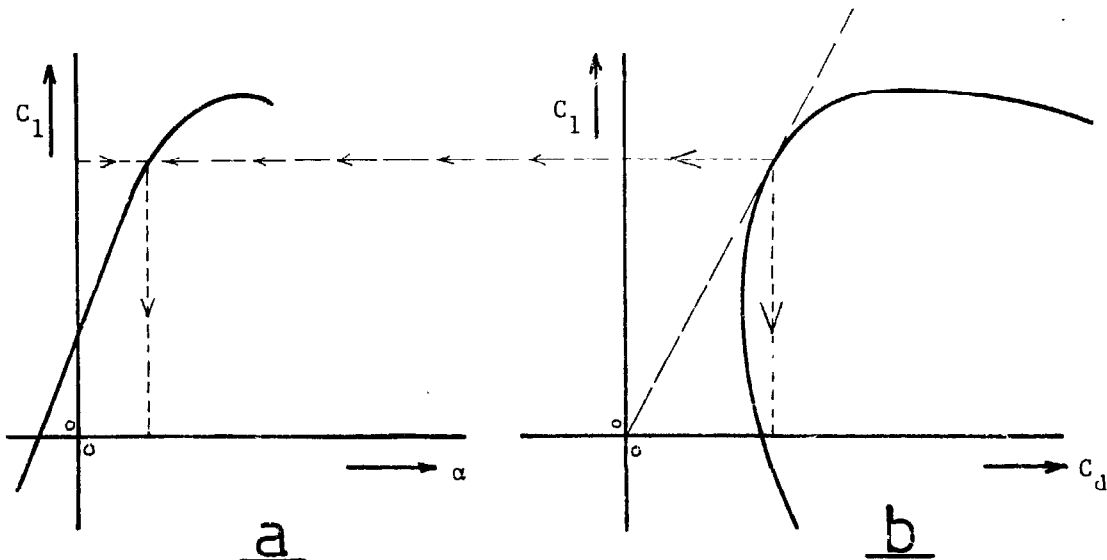

fig 2.4. Lift and drag characteristics.

In Appendix II  $C_l$ - $\alpha$  and  $C_l$ - $C_d$  characteristics of a series of NACA airfoils is presented as an example. For the design of a windmill it is important to find from such graphs the  $C_l$  and  $\alpha$  values that correspond with a minimum  $C_d/C_l$ -ratio<sup>\*</sup>). This is done in the following way:

In the  $C_l/C_d$  graph a tangent is drawn through  $C_d=C_l=0$ . See fig 2.4.b.

From the point where the tangent touches the curve, we find  $C_d$  and  $C_l$ . From fig. 2.4.a we find the corresponding angle of attack  $\alpha$ .

The  $C_l$  and  $\alpha$  values that are found in this way we call  $C_l$ -design and  $\alpha$ -design and the division of  $C_d$  by  $C_l$  is the minimum  $C_d/C_l$ -ratio:  $(C_d/C_l)_{\min}$ .

Table 2.1 on p. 10 gives these design values for several airfoils.

Note that it is not important for the behaviour of the airfoil whether it is standing still in an airflow with velocity  $W$  or that it is moving with velocity  $W$  in air that is at rest; what matters is the relative velocity that is "seen" by the airfoil. See fig. 2.5.

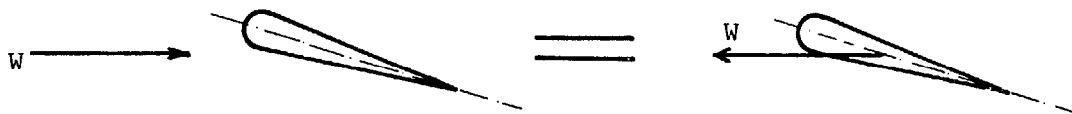

fig 2.5 Relative velocity.

A blade element of a windmill rotor "sees" a relative velocity that results from the wind velocity in combination with the velocity with which the blade element moves itself. See fig 2.6.

\* ) We will see on p. 11 that a maximum power is obtained when the drag to lift ratio is as small as possible.

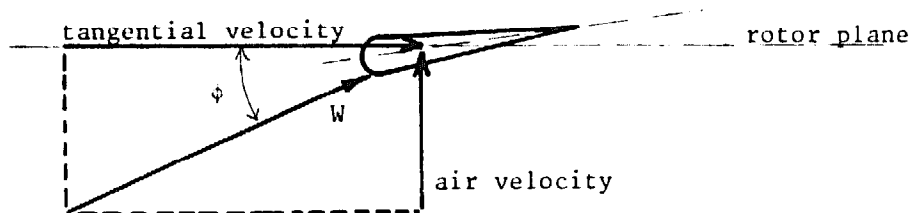
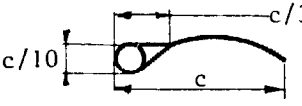



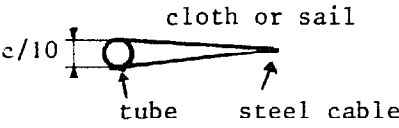
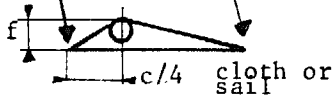

Fig.2.6 Relative velocity on rotor blade

$\phi$  is the angle between the relative velocity  $W$  and the rotor plane.

TABLE 2.1

airfoil name	geometrical description	$(C_d/C_{lmin})$	$\alpha^\circ$	$C_l$
sail and pole		0.1	5	0.8
flat steel plate		0.1	4	0.4
arched steel plate	 $f/c=0.07$ $f/c=0.1$	0.02 0.02	4 3	0.9 1.25
arched steel plate with tube on concave side	 $d < 0.1c$ $f/c=0.07$ $f/c=0.1$	0.05 0.05	5 4	0.9 1.1
arched steel plate with tube on convex side	 $f/c=0.1$	0.2	14	1.25
sail wing	 cloth or sail tube steel cable	0.05	2	1.0
sail trouser	 $f/c=0.1$ $d_{tube} \approx 0.6f$ cloth or sail	0.1	4	1.0
NACA 4412	see appendix II	0.01	4	0.8
NACA 23015	see Lit(1) in appendix I	0.01	4	0.8

## 2.1 Torque and power characteristics.

The components in the plane of rotation of the lift forces result in a force working in tangential direction at some distance from the rotor center. This force is diminished by the component of the drag in tangential direction. The result of these two components is a propelling force in tangential direction at some distance from the rotor center.

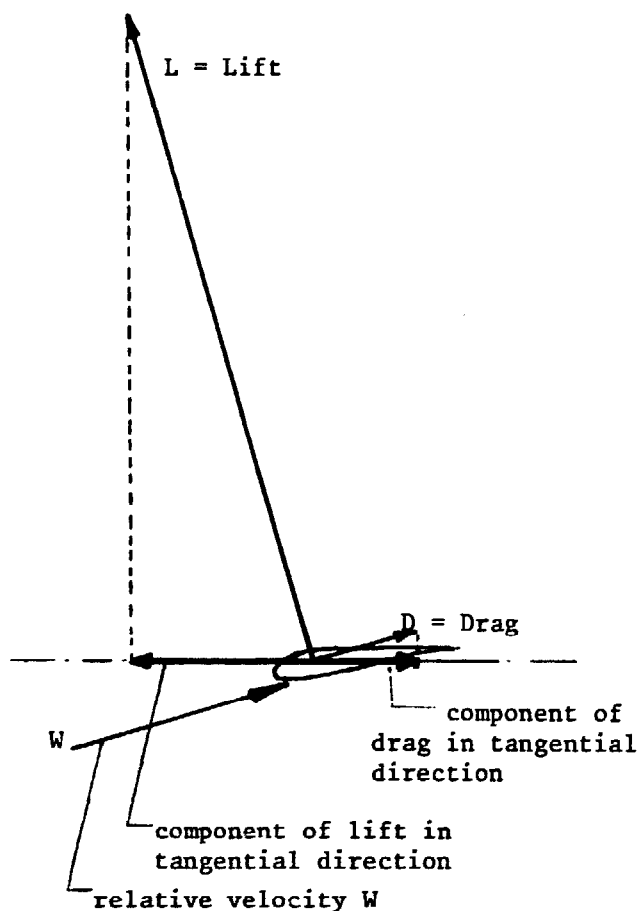

The product of this propelling force and its corresponding distance to the rotor center is the contribution of the blade element under consideration to the torque  $Q$  of the rotor. The rotor rotates at an angular speed  $\Omega$  ( $= 2\pi \times$  number of revolutions per second).

$$\Omega = 2\pi n \quad [\text{rad sec}^{-1}] \quad (2-3)$$

The power that such a rotor extracts from the wind is transformed into mechanical power. This power is equal to the product of the torque and the angular speed.

$$Q = \text{torque} \quad [\text{Nm}]$$

$$\Omega = \text{angular speed} \quad [\text{rad s}^{-1}]$$

$$\text{power } P = Q * \Omega \quad [\text{W}] \quad (2-4)$$

A windmill of given dimensions transforms kinetic energy from the wind into a certain amount of power. Equation (2-4) clearly shows that a windmill for a high torque load (for example a piston pump) will have a low angular speed; a high speed design will only produce a small amount of torque (for example for a centrifugal pump or an electricity generator).

We call a graph, that shows the dependance of the windmill torque on the angular speed, a windmill torque characteristic. Fig.2.7.a shows torque characteristics of two different windmills designed for the same power but for different angular speeds. The windmill torque characteristic depends on wind speed  $V_{\infty}$ , so we have many curves in one characteristic.

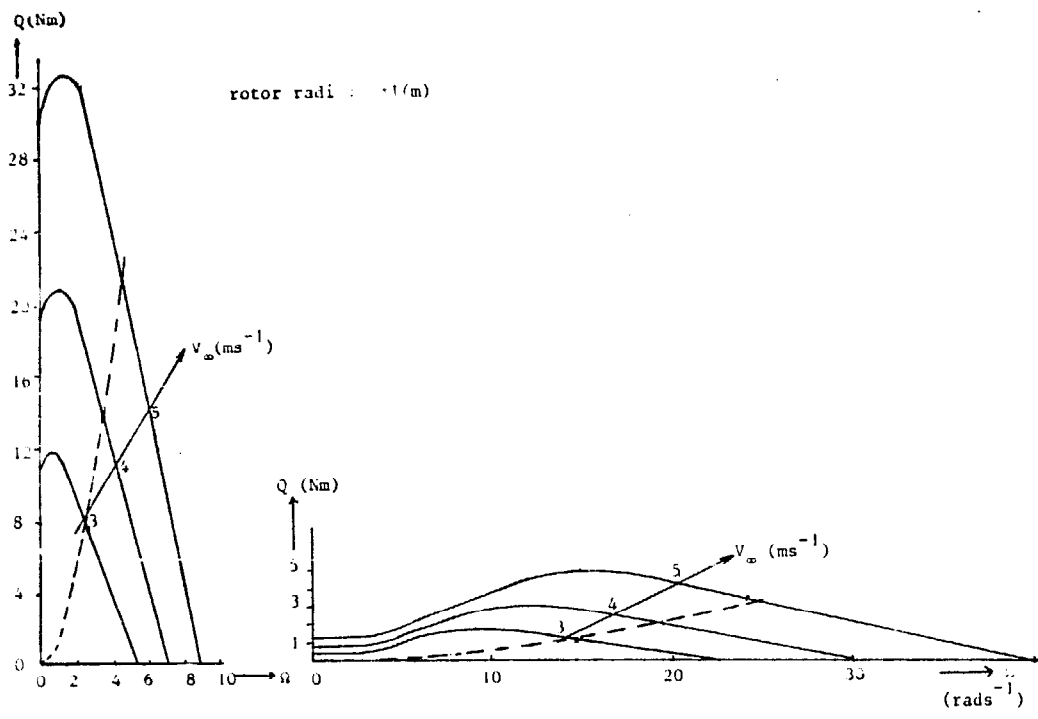

fig. 2.7.a. low speed windmill

high speed windmill

torque characteristic

torque characteristic

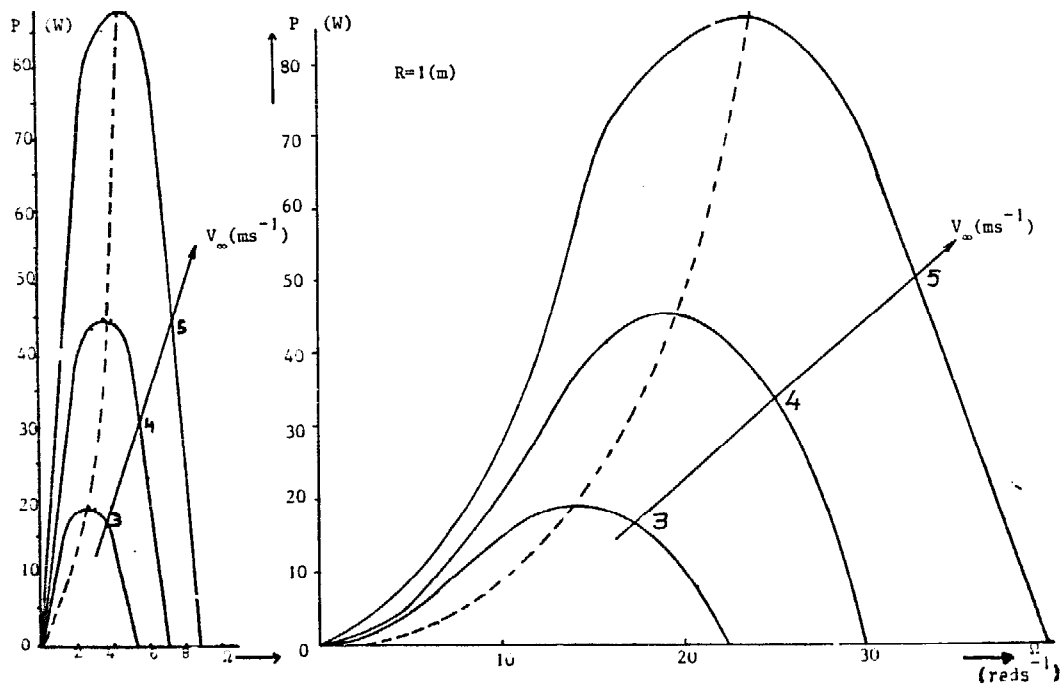

fig. 2.7.b. low speed windmill

high speed windmill

power characteristic

power characteristic

With relation (2-4) it is very simple to derive from the torque characteristics the corresponding power characteristics. See fig. 2.7.b, where the power-angular speed curves, belonging to windmills of fig. 2.7.a, are shown.



- Note: 1) The power of the two windmills is the same, but is delivered at different angular speeds  $\Omega$ .
- 2) The maximum power is delivered at a higher angular speed than the maximum torque.
- 3) The maximums of the power curves in fig. 2.7.b. vary with the cube of the angular speed  $\Omega$ :

$$P_{\max} \sim \Omega^3 \quad (2-5a)$$

while the corresponding torque values vary with the square of the angular speed  $\Omega$ :

$$Q_{(\text{at } P = P_{\max})} \sim \Omega^2 \quad (2-5b)$$

- 4) The starting torque, i.e. the torque at zero revolutions per second, is considerably lower for high speed than for low speed windmills.

Before selecting the speed of the rotor to be designed, the designer must compare the torque characteristic of the load with the torque characteristic of the rotor.

For a proper match of a load to a windmill rotor it is important that both load and windmill operate at angular speeds where their efficiencies are maximum. The angular speed at which the rotor has its maximum efficiency is not always equal to the angular speed at which the load has its maximum efficiency. In that case we need a transmission. It is in most cases not difficult to determine the transmission factor needed for the optimum angular speeds of both load and rotor, but remember that a transmission also changes the torque. In practice this means that the transmission factor cannot be chosen on the basis of angular speeds only.

## 2.2 Dimensionless coefficients.

In order to be able to compare the properties and characteristics of different windmill designs under different wind conditions we write the mechanical power as the power in the air multiplied by a factor  $C_p$

$$P_{\text{mech}} = C_p * P_{\text{air}} \quad (2-6a)$$

$C_p$  is called power coefficient and is a measure for the success we have in extracting power from the wind. With relation (1-4) we may write

$$C_p = \frac{P_{\text{mech}}}{\frac{1}{2} \rho V_{\infty}^3 \pi R^2} \quad (2-6b)$$

For the same reasons we divide the speed  $u$  of the rotor at radius  $r$  by the windspeed. See fig. 2.8

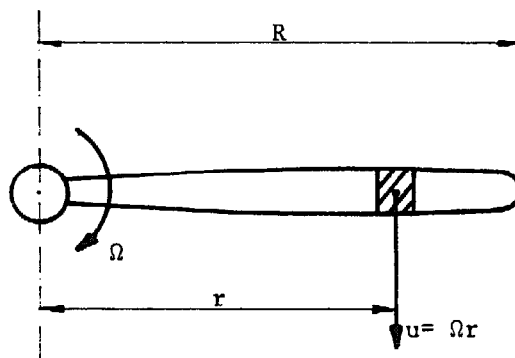

fig. 2.8 Definition of speed ratio.

The result  $\left(\frac{u}{V_{\infty}}\right)$  we call local speed ratio and is noted

$$\lambda_r = \frac{u}{V_{\infty}} = \frac{\Omega r}{V_{\infty}} \quad (2-7)$$

The speed ratio of the element of the rotor blade at radius  $R$  we call tip-speed ratio:

$$\lambda = \frac{\Omega R}{V_{\infty}} \quad (2-8)$$

Note: Later it will be shown that a windmill has one value of  $\lambda$  at which the power coefficient is maximum. This  $\lambda$  is often called 'the tip-speed ratio of a windmill' or 'the speed ratio of a windmill'.

There is of course a direct relation between  $\lambda$  and  $\lambda_r$ . Relations (2-7) and (2-8) together give

$$\lambda_r = \frac{r}{R} * \lambda \quad (2-9)$$

From relation (2-4) we know that

$$Q = \frac{P}{\Omega} \quad (2-10)$$

With this relation we define a dimensionless torque coefficient in the following way:

$$P = C_p \frac{1}{2} \rho V_\infty^3 \pi R^2 \quad (2-6b)$$

$$\Omega = \frac{\lambda V_\infty}{k} \quad (2-8)$$

$$Q = \frac{P}{\Omega} \quad (2-10)$$

$$\longrightarrow \frac{C_p}{\lambda} = \frac{Q}{\frac{1}{2} \rho V_\infty^2 \pi R^3}$$

We define:

$$C_Q = \frac{Q}{\frac{1}{2} \rho V_\infty^2 \pi R^3} \quad (2-11)$$

Note that in this way relation (2-4) is still valid but now in dimensionless form:

$$C_p = C_Q * \lambda \quad (2-12)$$

### 2.3 Basic form of a windmill characteristic.

The power coefficient  $C_p$  in equation (2-6) is not an efficiency but may be interpreted as a measure of the success that a windmill has in transforming wind energy into mechanical energy. For one specific windmill  $C_p$  varies with the tip-speed ratio of the windmill. In dimensionless form this is shown in a so-called  $C_p - \lambda$  characteristic based on formulas (2-6) and (2-8).

See fig. 2.9 where one curve now represents all the curves for different  $V_\infty$  of fig. 2.7.b.

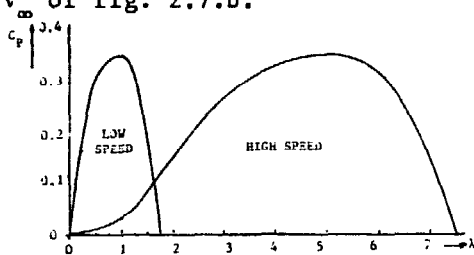

fig 2.9  $C_p - \lambda$  characteristic.

This characteristic is independent of air density  $\rho$ , windspeed  $V_\infty$  and radius  $R$ .

Using relation (2-12) we may derive from fig 2.9 a dimensionless form of the torque-speed characteristic of the windmill:  $C_Q - \lambda$  curve; see fig 2.10. Also here one curve represents all curves of fig 2.7.a.

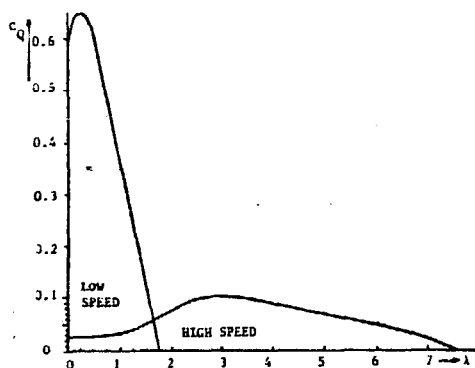

fig 2.10  $C_Q - \lambda$  characteristic.

Note that the power is zero if  $\lambda = 0$  but that the torque is not. See relations (2-4) and (2-12).

#### 2.4. Maximum power coefficient.

The power coefficient  $C_p$  as defined with relation (2-6) describes how much power we get from the wind with a windmill. The power in the wind is given by relation (1-4). We are of course very interested in how much wind power we can transform into mechanical power with a windmill. In other words, we want to know what the highest power coefficient  $C_p$  is for a given windmill that is designed for a certain tip-speed ratio. Betz was the first one to show that the theoretically maximum attainable power coefficient is 0.593. This result will be clarified in the next paragraph. Three other effects cause a further reduction of the maximum power coefficient. How to find the maximum power coefficient that takes these effects into account will be explained in the next four paragraphs:

2.4.0 Betz coefficient

2.4.1 Effect of wake rotation on maximum power coefficient

2.4.2 Effect of  $C_d/C_1$ -ratio on maximum power coefficient

2.4.3 Effect of number of blades on maximum power coefficient

#### 2.4.0 Betz coefficient

It is not possible to transform all the wind energy that flows through cross sectional area A (fig 1.1) into mechanical energy. If we could transform all the energy in the air this would mean that we could extract all kinetic energy from the air; the air velocity behind the rotor would then be zero and no more air would flow through the rotor. The process of extracting kinetic energy from the wind will stop and no more power will be transformed. If on the other hand the air velocity behind the rotor is equal to the wind velocity, no kinetic energy has been extracted and also in this case no power will be transformed. In this way it may be understood that, if the flow velocity behind the rotor is either zero or equal to the wind velocity  $V_{\infty}$ , in both cases the mechanical power is zero. Between these values there is an optimum value of the wind velocity behind the rotor.

Betz found this value to be  $\frac{1}{3} V_{\infty}$  and calculated the maximum power coefficient (Betz coefficient).

$$C_{P_{\max}} = \frac{16}{27} = 0.593 \quad (2-13).$$

This value is however only valid for a theoretical design for a high tip-speed ratio, with an infinite number of blades and a blade drag equal to zero. The effect of deviations from these three assumptions will be shown one by one in the next three paragraphs.

#### 2.4.1 Effect of wake rotation on maximum power coefficient.

The Betz coefficient suggests that, independent of the design tip-speed ratio  $\lambda_0$ , we may expect a maximum power coefficient  $C_P$  of 0.593. Relation (2-13) is however only valid for high tip-speed ratios and for low tip-speed ratios considerable deviations exist. This can be explained in the following way:

The power is: torque \* angular speed. The torque is produced by forces acting on the blades in tangential direction, multiplied by their corresponding distances to the rotor center. These forces are the result of velocity changes of the air in tangential direction (action = reaction; force = mass \* velocity change per unit of time). The direction of the velocity change in the air is opposed to the direction of the forces acting on the blades. Since the air has no tangential velocity before passing the rotor, the velocity change means that behind the rotor the wake rotates in a direction opposite to that of the rotor. This wake rotation means a loss of energy because the rotating air contains kinetic energy (see relation 1-1). Since a certain amount of power is to be transformed, we know from relation (2-4) that a low tip-speed ratio (= low angular speed  $\Omega$ ), means that the torque  $Q$  must be high. High torque means large tangential velocities in the wake; the consequence is a loss of energy and a lower power; the more so if the design tip-speed ratio is lower. The result is shown in fig. 2.11. The graph presented in fig. 2.11 shows the collection of maximum obtainable power coefficients of ideal windmills i.e. windmills with an infinite number of blades without drag.

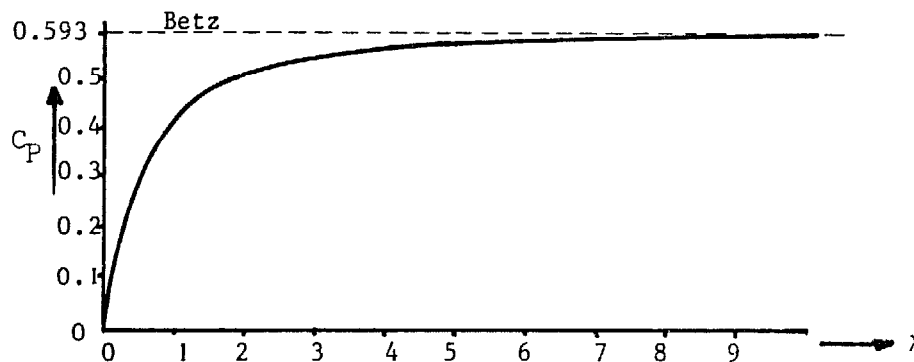

fig. 2.11 Collection of maximum power coefficients of ideal windmills.

### 2.4.2 Effect of $C_d/C_l$ -ratio on maximum power coefficient.

The factor  $C_d$ , as defined in par. 2.0, is a measure for the resistance of the blades against moving through the air. The  $C_d/C_l$ -ratio determines the losses due to this resistance. These losses are calculated and included in the collection of maximum power coefficients of fig. 2.11. The results are shown in fig. 2.12.

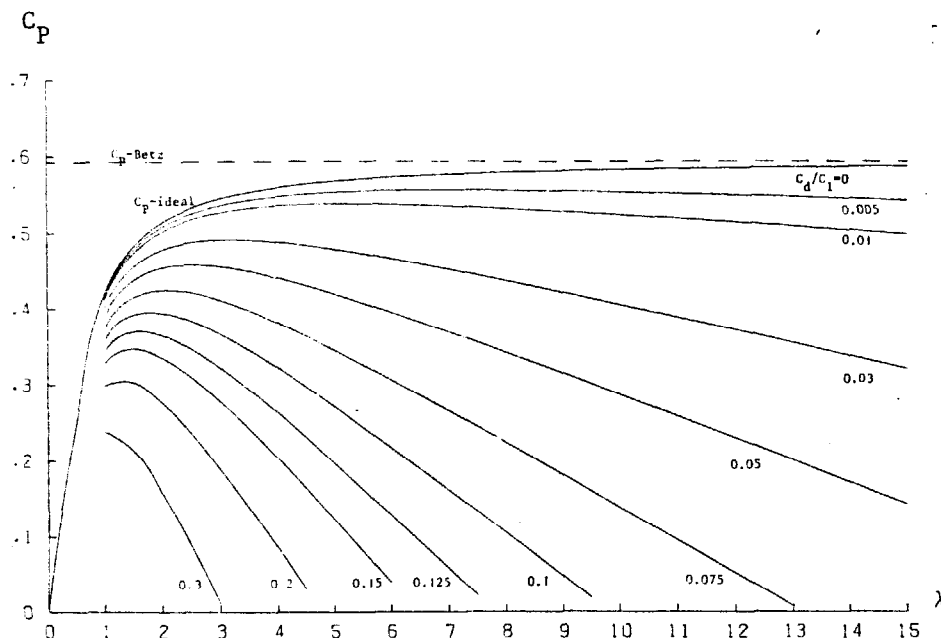

fig. 2.12 Effect of  $C_d/C_l$ -ratio on  $C_p$ -max for a rotor with an infinite number of blades.

Fig. 2.12 shows that a rotor, designed for a tip-speed ratio  $\lambda = 2.5$  with airfoils having, for example, a minimum  $C_d/C_l$ -ratio of 0.05, will have a maximum power coefficient  $C_p = 0.46$ . If the rotor is designed for  $\lambda = 10$ , at the same  $C_d/C_l$  value, the  $C_p$  value at  $\lambda = 10$  will have a maximum of 0.3.

Note that from fig. 2.12 it is clear that it is useless to design a rotor for  $\lambda = 10$  with airfoils that have  $(C_d/C_l)_{\min} = 0.1$ .



### 2.4.3 Effect of number of blades on maximum power coefficient.

The number of blades also affects the maximum power coefficient. This is caused by the so-called "tip-losses" that occur at the tips of the blades. These losses depend on the number of blades and the tip-speed ratio. The losses have been calculated and as example are included in the collection of maximum power coefficients for  $(C_d/C_1)_{\min} = 0.03$  of fig. 2.12. The results are shown in fig. 2.13.

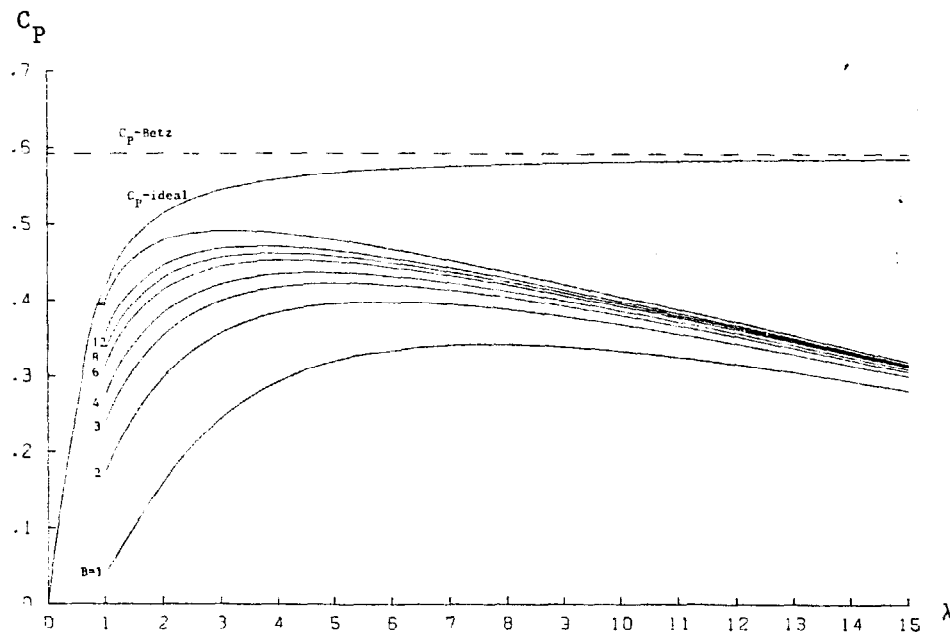

fig. 2.13 Influence of number of blades  $B$  on  $C_{p-\max}$  for  $C_d/C_1 = 0.03$ .

In appendix III graphs like fig. 2.13 are shown giving the maximum expected power coefficient for  $\lambda$ -design between 1 and 15.

The first group of graphs shows  $C_{p-\max}$  for constant number of blades  $B$  while the  $C_d/C_1$ -ratio is varied. The second group gives  $C_{p-\max}$  for constant  $C_d/C_1$ -ratio while  $B$  is varied.

Conclusion: If design figures for tip-speed ratio  $\lambda$ , number of blades  $B$  and  $C_d/C_1$ -ratio have been chosen, the expected power coefficient  $C_p$  may be read from the graphs in appendix III.

### 3 DESIGN OF A WINDMILL ROTOR.

#### 3.0 Calculation of blade chords and blade setting.

In chapter 2 it was shown that the selection of the number of blades  $B$  affects the power coefficient. Although  $B$  has no influence on the tip-speed ratio of a certain windmill, for the lower design tip-speed ratios, in general, a higher number of blades is chosen (see table 3.1). This is done because the influence of  $B$  on  $C_p$  is larger at lower tip-speed ratios. A second reason is that choice of a high number of blades  $B$  for a high design tip-speed ratio will lead to very small and thin blades which results in manufacturing problems and a negative influence on the lift and drag properties of the blades (this problem will be dealt with in chapter 4).

$\lambda_o$	$B$
1	6-20
2	4-12
3	3-6
4	2-4
5-8	2-3
8-15	1-2

table 3.1 Selection of number of blades.

A second important factor that affects the power coefficient is the drag. Drag affects the expected power coefficient via the  $C_d/C_l$ -ratio. This will influence the size and, even more, the speed ratio of the design.

In paragraph 2.0 a list is shown with several airfoil types and their corresponding minimum  $C_d/C_l$ -ratios (table 2.1 on p. 10). Promising airfoils in this table have a minimum  $C_d/C_l$ -ratio between 0.1 and 0.01.

A large  $C_d/C_l$ -ratio restricts the design tip-speed ratio. At lower tip-speed ratios the use of more blades compensates the power loss due to drag. See Appendix III. In this collection of maximum power coefficients it is seen that for a range of design speeds  $1 \leq \lambda_0 \leq 10$  the maximum theoretically attainable power coefficients lie between  $0.35 \leq C_{P_{max}} \leq 0.5$ .

Due to deviations, however, of the ideal geometry and hub losses for example, these maximums will lie between 0.3 and 0.4. This result shows that the choice of the design tip-speed ratio hardly effects the power output. Two other factors, however, limit the choice of the design tip-speed ratio. One is the character of the load. If it is a piston pump, scoop wheel or some other slow running load, that in most cases will require a high starting torque, the design speed of the rotor will usually be chosen low; this allows the designer to use simple airfoils like sails or steelplates. If the load is running fast like a generator or a centrifugal pump, then a high design speed will be selected and airfoils with a low  $C_d/C_l$ -ratio will be preferred. The second factor is that the locally available technologies will often restrict the possibilities of manufacturing blades with airfoils having low  $C_d/C_l$ -ratios. But even in the case of a high speed design, simple airfoils like arched steel plates, can give very good results.

We will pass over in silence the problems related to starting torque and optimum angular frequency of the load. Now we can design a windmill rotor for a given windspeed  $V_\infty$  and a power demand  $P$ . Selecting in table 2.1 an airfoil in terms of a minimum expected  $C_d/C_l$ -ratio, we can choose a design tip-speed ratio  $\lambda_0$  with the help of appendix III. With table 3.1 a number of blades  $B$  is chosen and, returning to appendix III we can find the maximum power coefficient  $C_{P_{max}}$  that may be expected.

*example: design rotor with 7% arched steelplates.*

Table 2.1 -  $(C_d/C_l)_{min} = 0.02$

Appendix III Page 48 -  $1 < \lambda_0 < 8$ ; we choose  $\lambda_0 = 4$ .

Table 3.1 -  $B = 4$

Appendix III Page 43 -  $C_{P_{max}} = 0.48$

With relation (2-6) we can now calculate the desired radius  $R$  of the rotor.  
For conservative design we take  $C_p = 0.8 * C_{p_{max}}$ .

$$R = \sqrt{\frac{2P}{\pi \rho V_{\infty}^3 C_p}} \quad (2-6)$$

*example: the rotor to be designed must deliver 1100 Watts of mechanical power ( $P = 1100$  Watt) in a wind with  $V_{\infty} = 8$  [ $ms^{-1}$ ].*

$$R = \sqrt{\frac{2 * 1100}{\pi * 1.225 * 8^3 * 0.8 * 0.48}} = 1.7 \text{ [m]}$$

Design of the blades.

We need the following data:

rotor radius	$R$	[m]
number of blades	$B$	[-]
design tip-speed ratio	$\lambda_{(t)}$	[-]
airfoil data:		
design lift coefficient	$C_{l_0}$	[-]
corresponding angle of attack	$\alpha_0$	[-]

Airfoil data may be found in table 2.1, Appendix II and literature (1), (5), (6) and (12).

Once these data are known, it is now very simple to calculate the blade geometry; i.e. the chord  $c$  of the blade and the blade angle  $\beta$ , the angle between the chord and the plane of rotation, fig. 3.1.

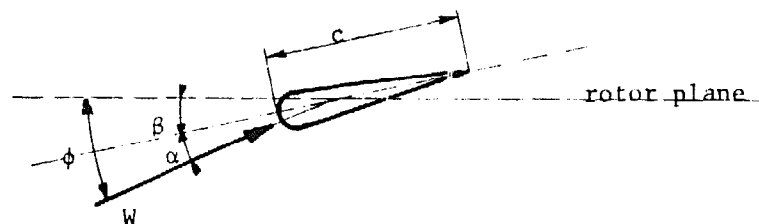

fig. 3.1 Blade setting  $\beta$ .

Only three simple formulas are needed and one graph

$$\lambda_r = \lambda_o \times r/R \quad (2.9)$$

$$c = \frac{8\pi r}{BC_1} (1 - \cos \phi) \quad (3.1)$$

$$\beta = \phi - \alpha \quad (3.2)$$

and graph  $\lambda_r - \phi$  (appendix V)

The underlying theory is too complicated to be explained here (see appendix IV and the literature references appendix I). The reader who is primarily interested in the design of the rotor, can do without this theory.

Now the design procedure is as follows:

Divide the blade with radius R in a number of parts of equal length. In this way we find cross sections of the blade. Each cross section has a distance r to the rotor center and has a local speed ratio  $\lambda_r$ , according to (2.9).

In appendix V we can find the corresponding angle  $\phi$  (see fig. 3.1) for each cross-section.  $\phi$  is the angle of the relative air velocity W that meets the blade section at radius r. We now calculate the chord with relation (3.1). (For ease,  $(1 - \cos \phi)$  has been added in the graph of appendix V). The blade angle at the corresponding radius is found with (3.2).

*example: We continue our design of a rotor with*

$$R = 1.7 \quad [m]$$

$$B = 4$$

$$\lambda_o = 4$$

*airfoil = 7% arched steel plate*

*table 2.1 gives for this airfoil:*

$$C_{l_o} = 0.9 \quad (\text{i.e. the value for minimum } C_d/C_l)$$

$$\alpha_o = 4^\circ \quad (\text{i.e. the corresponding angle of attack}).$$

*With equations (2-9), and (3-1), (3-2) we can now compute the values of the following table:*

Table 3.2

cross section number	$r(m)$	$\lambda_r$	$\phi^\circ$	$\alpha_o^\circ$	$\beta^\circ$	$c(m)$
1	0.2125	0.5	42.3	4	38.3	0.386
2	0.4250	1	30.0	4	26.0	0.398
3	0.6375	1.5	22.5	4	18.5	0.399
4	0.8500	2	17.7	4	13.7	0.281
5	1.0625	2.5	14.5	4	10.5	0.236
6	1.2750	3	12.3	4	8.3	0.204
7	1.4875	3.5	10.6	4	6.6	0.177
8	1.7000	4	9.4	4	5.4	0.159

The result is the blade chord  $c$  and the blade setting  $\beta$  at various stations along the blades. Plotting the chords (fig 3.2) gives the blade form and plotting  $\beta$  shows the desired twist of the blade.

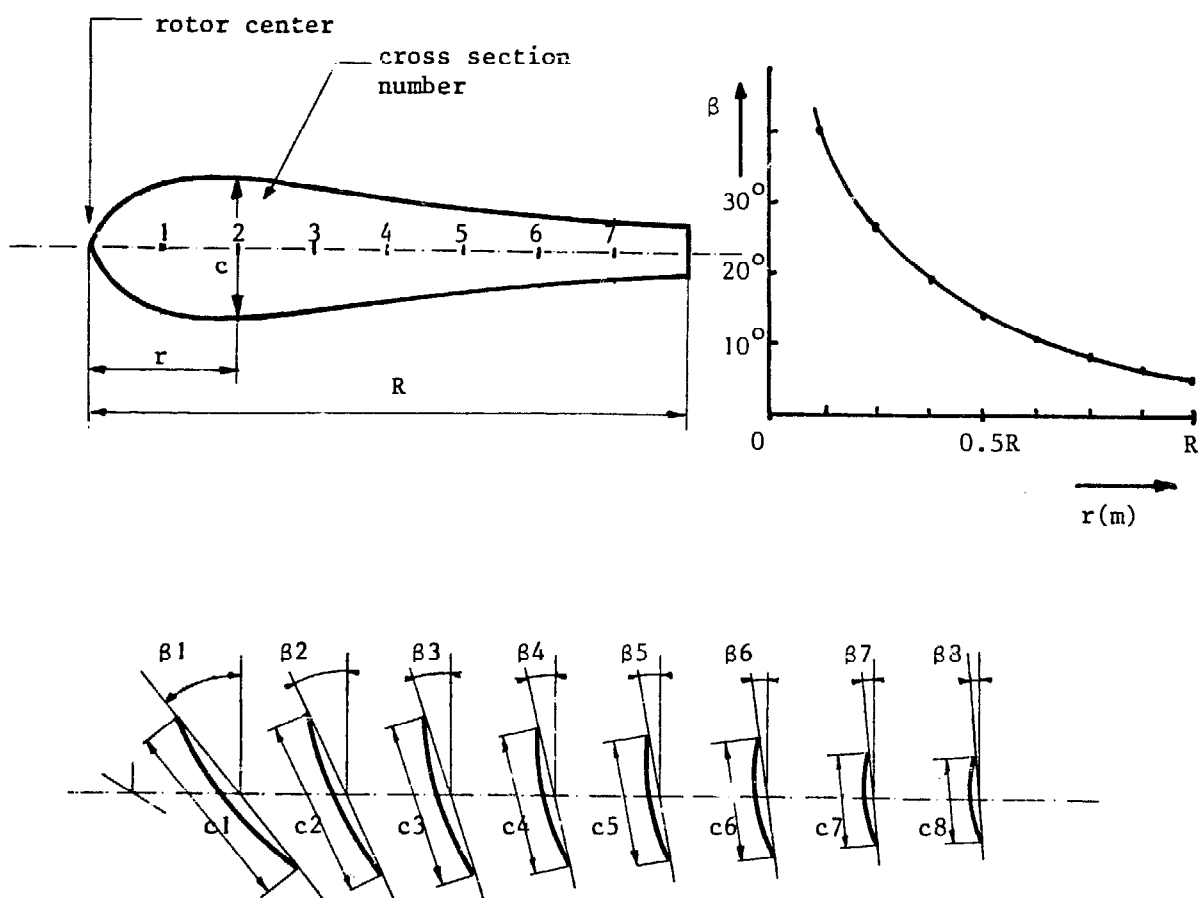

Fig. 3.2 Blade form, twist and cross sections of the blade.

### 3.1 Deviations from the calculated chords and blade setting.

In the last paragraph we showed how to calculate the ideal blade form. The chords as well as the blade angles as calculated in par. 3.0 vary in a non-linear manner along the blade. Such blades are usually difficult to manufacture and lead to an uneconomic use of materials. In order to reduce these problems it is possible to linearize the chords and the blade angles. This results in a small loss of power. If the linearization is done in a sensible way the loss is only a few percent.

In considering such linearizations it must be realized that about 75% of the power that is extracted by the rotor from the wind, is extracted by the outer half of the blades. This is because the blade swept area varies with the square of the radius; also the efficiency of the blades is less at small radii, where the speed ratio  $\lambda_r$  is small. On the other hand, at the tip of the blade the efficiency is low, due the so-called tip losses discussed in par. 2.4.3.

For the reasons mentioned above, it is advised to linearize the chords  $c$  and the blade angles  $\beta$  between  $r = 0.5R$  and  $r = 0.9R$ .

*example: we linearize the blade chords  $c$  and angles  $\beta$  as calculated in table 3.2 of par. 3.0.*

*The nearest value of  $r$  to  $0.5 R$  in table 3.2 is  $r = 0.85 (= 0.5 R)$ .*

*The nearest value of  $r$  to  $0.9 R$  in table 3.2 is  $r = 1.4875 (= 0.875 R)$ .*

*In table 3.2 for these values of  $r$  the following values of  $c$  and  $\beta$  were calculated:*

$r$ [m]	$c$ [m]	$\beta^\circ$
0.85	0.281	13.7
1.4875	0.159	6.6 <sup>o</sup>

We can now linearize the chords and blade angles by writing  $c$  and  $\beta$  in the following way:

$$c = a_1 r + a_2$$

$$\beta = a_3 r + a_4$$

With the values of  $c$  and  $\beta$  at  $r = 0.85$  and  $r = 1.4875$ , the constants  $a_1$ ,  $a_2$ ,  $a_3$  and  $a_4$  are found.

$$c = -0.191 r + 0.444$$

$$\beta = -11.14 r + 23.17$$

Suppose we have a hub for the rotor and the hub has a radius  $r = 0.17$  [m] then we can calculate the chords and blade angles at the foot and at the tip of the blade:

$$c_{foot} = -0.191 * 0.17 + 0.444 = 0.412 \text{ [m]}$$

$$c_{tip} = -0.191 * 1.7 + 0.444 = 0.119 \text{ [m]}$$

$$\beta_{foot} = -11.14 * 0.17 + 23.17 = 21.3^\circ$$

$$\beta_{tip} = -11.14 * 1.7 + 23.17 = 4.3^\circ$$

The result of the linearizations is shown in fig. 3.3 where blade form and twist in the blade are shown and compared with the blade form of fig. 3.2.

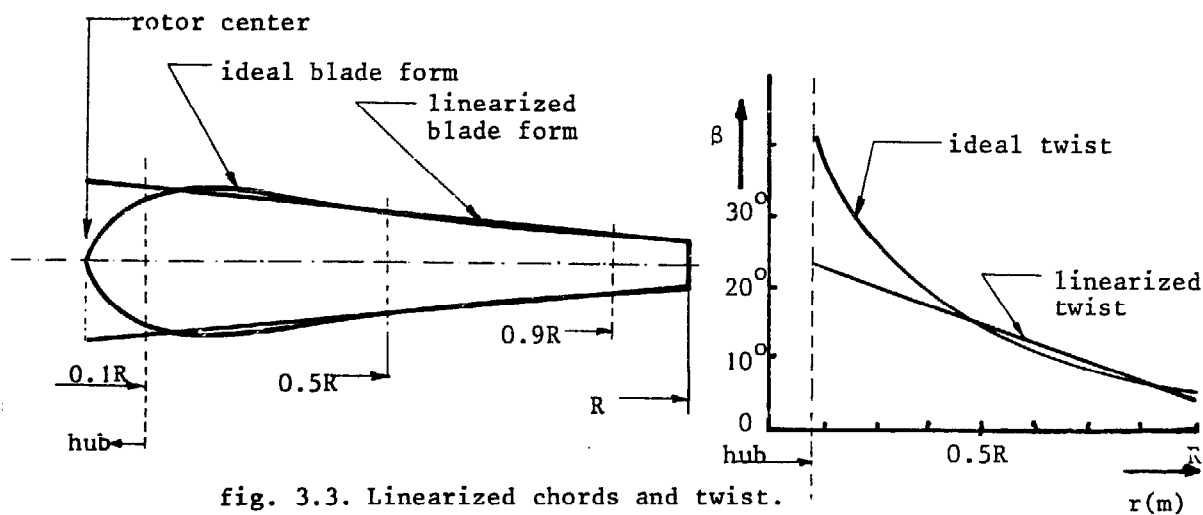

fig. 3.3. Linearized chords and twist.



As may be seen from fig. 3.3 the changes in chords and blade angles are very small at the outer half of the blades. At the inner half the chords also remain almost unchanged. A rather large change is found in the blade angles for  $r < 0.5 R$ . For reasons as stated on the first page of this chapter, this will not lead to any significant power loss but may have a considerable effect on the torque that is produced at low angular speeds. In general the starting torque will be less and in cases where the starting capacities of the windmill are very important, this effect should not be forgotten. An example of a load that demands a high starting torque is the single stroke piston pump. For this load, the size of the windmill is often determined by the demanded starting torque.

## 4. EFFECT OF THE REYNOLDS-NUMBER.

4.0 Dependence of airfoil characteristics on the Re-number.

The airfoil characteristics depend on the so-called Reynolds-number ( $Re$ ) of the flow around the airfoil. For an airfoil  $Re$  is defined as  $Re = \frac{W \cdot c}{\nu}$ , where  $W$  is the relative velocity to the airfoil,  $c$  is the chord and  $\nu$  is the kinematic viscosity (in our case that of air).

All airfoils have a critical  $Re$ -number. If the  $Re$ -number of the flow around the airfoil is less than this  $Re_{critical}$  then the  $C_l$ -value is lower and the  $C_d$ -value is higher; above this  $Re_{critical}$  the performance is considerably better. See for example fig. 4.1 where the effect of the  $Re$ -number on  $(C_d/C_l)_{min}$  is shown.

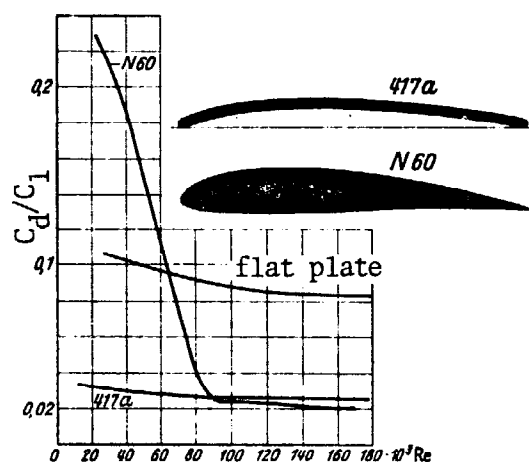

fig. 4.1. Effect of  $Re$ -number on  $(C_d/C_l)_{min}$ -ratio for three different airfoils.

In general the critical  $Re$ -number for airfoils with a sharp nose will be  $10^4$  while for the more conventional airfoils like NACA the critical  $Re$ -number is about  $10^5$ ; some of the very modern airfoil types have a critical  $Re$ -number of about  $10^6$ .

Fig. 4.2 shows the inverse value of the  $C_d/C_l$ -ratio of various airfoils as  $f(Re)$ .

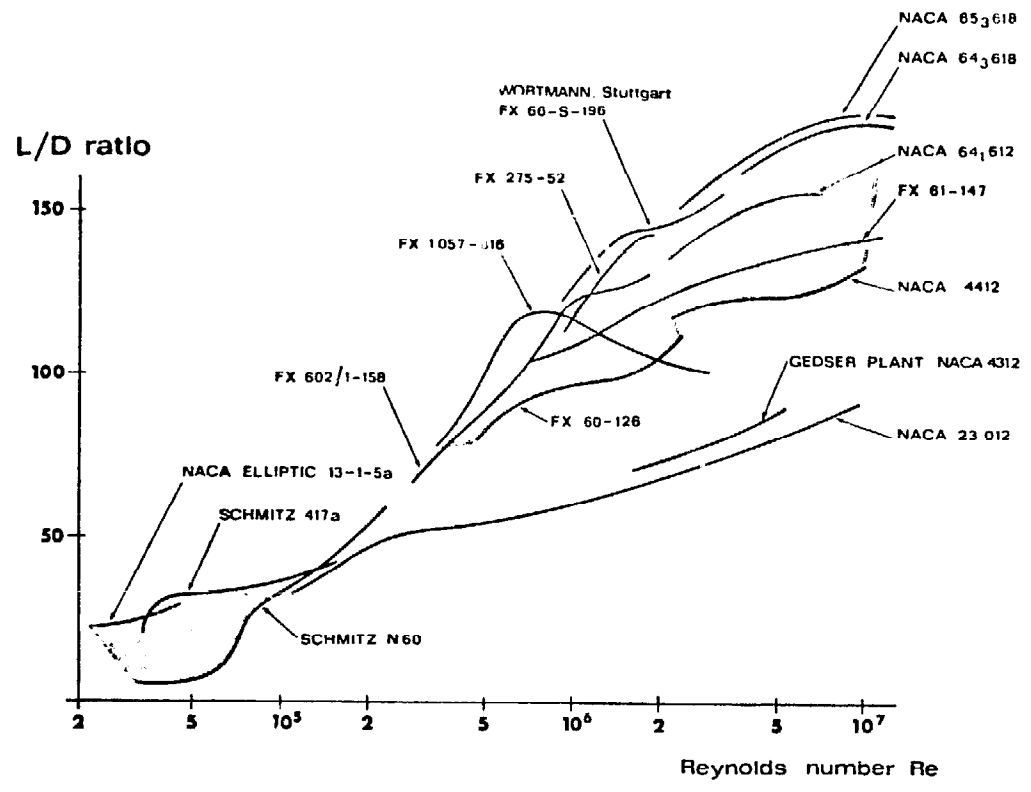

fig. 4.2. Inverse value of minimum  $C_d/C_l$ -ratio as function of the Re-number for several airfoils. From lit(5).

#### 4.1 Calculation of the Re-number for the blades of a windmill rotor.

For the condition that the rotor runs at  $\lambda = \lambda_{\text{optimum}}$  the Re-number of the flow around the airfoil can be determined with fig.4.3 in the following way:

- if B = number of blades
- r = radius = distance to rotor center of blade element under consideration
- $\lambda_r$  = speed ratio of blade element under consideration
- $C_l$  = design lift coefficient of blade element under consideration
- $V_\infty$  = undisturbed windspeed

the Re-number is:

$$Re = \frac{V_\infty * r}{B * C_l} * Re_N$$

$Re_N$  may be read from the graph presented in fig. 4.3 (valid for air: kinematic viscosity  $\nu = 15 * 10^{-6} \text{ [m}^2 \text{ s}^{-1} \text{ ]}$ )

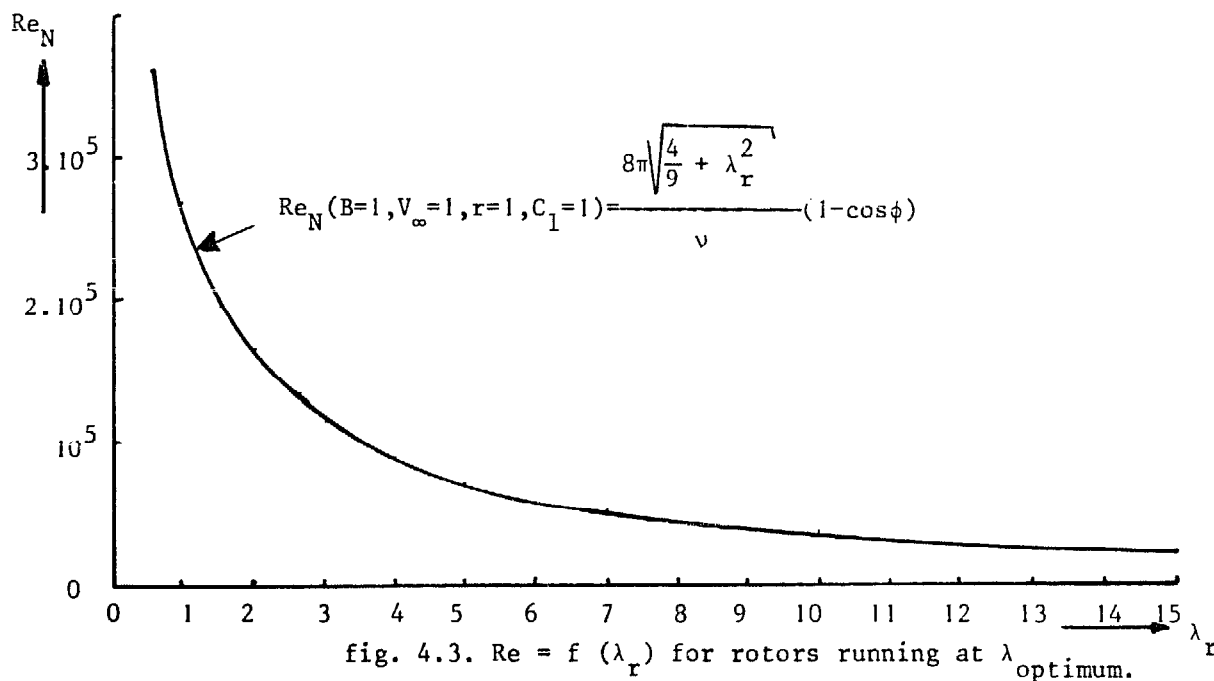

fig. 4.3.  $Re = f(\lambda_r)$  for rotors running at  $\lambda_{\text{optimum}}$ .

example: we will check the Re-number for the rotor as designed in chapter 3.

airfoil: 7% arched steel plate

radius :  $R = 1.7$  [m]

tip-speed ratio:  $\lambda_0 = 4$

$C_l$ -design = 0.9

Number of blades  $B = 4$ .

1) at the tip  $\lambda_r = \lambda_0 = 4$ .  
 $r = R = 1.7$  [m]

fig 4.3 -  $Re_N = 9 \cdot 10^4$

$$Re_{r=R} = Re_N \cdot \frac{R \cdot V_\infty}{B \cdot C_l} = \frac{9 \cdot 10^4 \cdot 1.7}{4 \cdot 0.9} V_\infty$$

$$Re_{r=R} = 4.25 \cdot 10^4 V_\infty$$

2) at  $r = 0.5 R$   $\lambda_r = 2$ ;  $r = 0.85$

$$Re_{r=0.5R} = \frac{17 \cdot 10^4 \cdot 0.85}{4 \cdot 0.9} V_\infty = 4 \cdot 10^4 V_\infty$$

3) at  $r = 0.2 R$   $\lambda_r = 0.8$   $r = 0.34$

$$Re_{r=0.2R} = \frac{28 \cdot 10^4 \cdot 0.34}{4 \cdot 0.9} = 2.6 \cdot 10^4 V_\infty$$

Conclusion: for the whole blade, the Re-number is, even for very low windspeeds, higher than the critical Re-number for steel plates ( $= 10^4$ ).

Thus the assumed minimum  $C_d/C_l$ -ratio is correct.

## APPENDIX I.

## LITERATURE.

- ( 1 ) Abbot I.H., van Doenhoeff A.E.  
Theory of Wing sections, including airfoil data  
Dover Publications, Inc., New York, 1959.
- ( 2 ) Beurskens J., Houet M., Varst P. v.d.  
Wind Energy (in Dutch), diktaat no. 3323, Eindhoven University of  
Technology, Eindhoven, the Netherlands.(English edition to be published in 1977)
- ( 3 ) Durand W.F.  
Aerodynamic Theory, Volume IV, Dover Publications, Inc., 1965.
- ( 4 ) Golding E.W.  
The Generation of Electricity by Wind Power  
E. and F.N. Spon Ltd., 11 New Fetter Lane, London EC4P 4EE, first published  
1955, reprinted with additional material 1976.
- ( 5 ) Hütter U.  
Considerations on the optimum design of wind energy systems (in German),  
Report wind energy seminar, Kernforschungsanlage Jülich, Germany, September  
1974.
- ( 6 ) Jansen W.A.M.  
a) Literature survey horizontal axis fast running wind turbines for  
Developing Countries.  
b) Horizontal axis fast running wind turbines for developing countries  
Steering Committee for Wind energy in Developing Countries, P.O.Box 85,  
Amersfoort, the Netherlands, June 1976.
- ( 7 ) Kraemer K.  
Airfoil sections in the critical Reynolds range (in German),  
Göttingen, Forschung auf dem Gebiete des Ingenieurwesens, volume 27,  
Düsseldorf 1961, no. 2.
- ( 8 ) Schmitz F.W.  
Aerodynamics of flying models, measurements at airfoil sections I, (in  
German), Luftfahrt und Schule, Reihe IV, volume I, 1942.

- ( 9) Schmitz F.W.  
Aerodynamics of small Re-numbers (in German),  
Jahrbuch der W.G.L., 1953.
- (10) Wilson R.E., Lissaman P.B.S.  
Applied Aerodynamics of wind power machines.  
Oregon State University, U.S.A., May 1974.
- (11) Wilson R.E., Lissaman P.B.S., Walker S.N.  
Aerodynamic performance of wind turbines.  
Oregon State University, U.S.A., June 1976.
- (12) Park J.  
Symplified Wind Power Systems for Experimenters.  
Helion Sylmar, California, U.S.A., 1975.
- (13) Riegels F.W.  
Aerodynamische Profile (Windkanal-messergebnisse, theoretische unterlagen)  
R. Oldenbourg, München 1958.  
English translation:  
Aerofoil sections (wind tunnel test results, theoretical backgrounds)  
Butterworth, London 1961.

**NACA 4412**

(Stations and ordinates given in per cent of airfoil chord)

Upper surface		Lower surface	
Station	Ordnate	Station	Ordnate
0	0	0	0
1.25	2.44	1.25	-1.43
2.5	3.39	2.5	-1.95
5.0	4.73	5.0	-2.49
7.5	5.76	7.5	-2.74
10	6.59	10	-2.86
15	7.89	15	-2.88
20	8.80	20	-2.74
25	9.41	25	-2.50
30	9.76	30	-2.26
40	9.80	40	-1.80
50	9.19	50	-1.40
60	8.14	60	-1.00
70	6.69	70	-0.65
80	4.89	80	-0.39
90	2.71	90	-0.22
95	1.47	95	-0.16
100	(0.13)	100	(-0.13)
100	.....	100	0

L.E. radius: 1.58  
Slope of radius through L.E.: 0.20

**NACA 4415**

(Stations and ordinates given in per cent of airfoil chord)

Upper surface		Lower surface	
Station	Ordnate	Station	Ordnate
0	.....	0	0
1.25	3.07	1.25	-1.79
2.5	4.17	2.5	-2.48
5.0	5.74	5.0	-3.27
7.5	6.91	7.5	-3.71
10	7.84	10	-3.98
15	9.27	15	-4.11
20	10.25	20	-4.15
25	10.92	25	-3.98
30	11.25	30	-3.75
40	11.25	40	-3.25
50	10.53	50	-2.72
60	9.30	60	-2.11
70	7.63	70	-1.55
80	5.55	80	-1.03
90	3.08	90	-0.57
95	1.67	95	-0.36
100	(0.16)	100	(-0.16)
100	.....	100	0

L.E. radius: 2.48  
Slope of radius through L.E.: 0.20

**NACA 4418**

(Stations and ordinates given in per cent of airfoil chord)

Upper surface		Lower surface	
Station	Ordnate	Station	Ordnate
0	.....	0	0
1.25	3.76	1.25	-2.11
2.5	5.00	2.5	-2.99
5.0	6.75	5.0	-4.06
7.5	8.06	7.5	-4.67
10	9.11	10	-5.06
15	10.06	15	-5.49
20	11.72	20	-5.56
25	12.10	25	-5.49
30	12.76	30	-5.26
40	12.70	40	-4.70
50	11.85	50	-4.02
60	10.44	60	-3.24
70	8.55	70	-2.45
80	6.22	80	-1.67
90	3.46	90	-0.93
95	1.89	95	-0.55
100	(0.19)	100	(-0.19)
100	.....	100	0

L.E. radius: 3.56  
Slope of radius through L.E.: 0.20

**NACA 4421**

(Stations and ordinates given in per cent of airfoil chord)

Upper surface		Lower surface	
Station	Ordnate	Station	Ordnate
0	.....	0	0
1.25	4.45	1.25	-2.42
2.5	5.04	2.5	-3.48
5.0	7.82	5.0	-4.78
7.5	9.24	7.5	-5.62
10	10.35	10	-6.15
15	12.04	15	-6.75
20	13.17	20	-6.98
25	13.88	25	-6.92
30	14.27	30	-6.76
40	14.16	40	-6.16
50	13.18	50	-5.34
60	11.60	60	-4.40
70	9.50	70	-3.35
80	6.91	80	-2.31
90	3.85	90	-1.27
95	2.11	95	-0.74
100	(0.22)	100	(-0.22)
100	.....	100	0

L.E. radius: 4.85  
Slope of radius through L.E.: 0.20

**NACA 4424**

(Stations and ordinates given in per cent of airfoil chord)

Upper surface		Lower surface	
Station	Ordnate	Station	Ordnate
0	0	0	0
0.530	3.964	1.970	-3.472
1.536	5.624	3.464	-4.656
3.775	7.942	6.225	-6.066
6.153	9.651	8.847	-6.931
8.611	11.012	11.389	-7.512
13.674	13.045	16.326	-8.169
18.858	14.416	21.142	-8.416
24.111	15.287	25.889	-8.411
29.401	15.738	30.599	-8.238
40.000	15.606	40.000	-7.606
50.235	14.474	49.765	-6.698
60.405	12.674	59.595	-5.562
70.487	10.312	69.513	-4.312
80.464	7.447	79.536	-3.003
90.320	4.099	89.680	-1.655
95.196	2.240	94.804	-0.964
100.000	.....	100.000	0

L.E. radius: 6.33  
Slope of radius through L.E.: 0.20

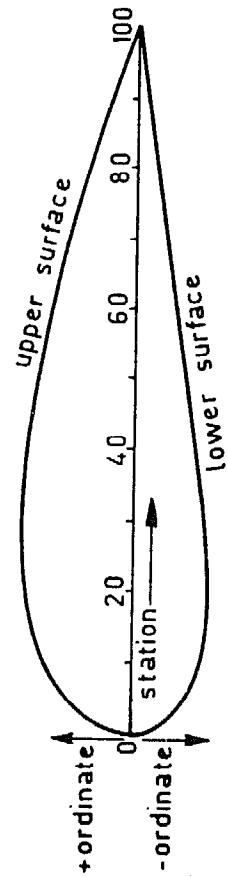



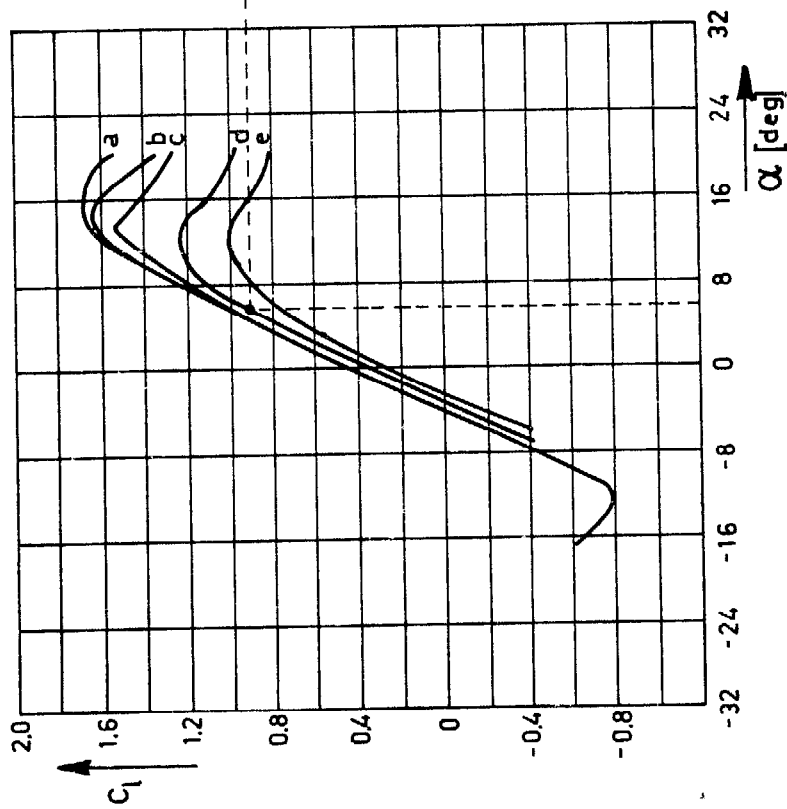
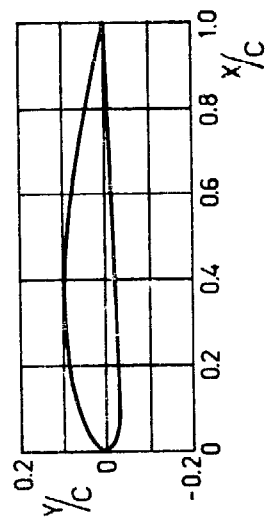
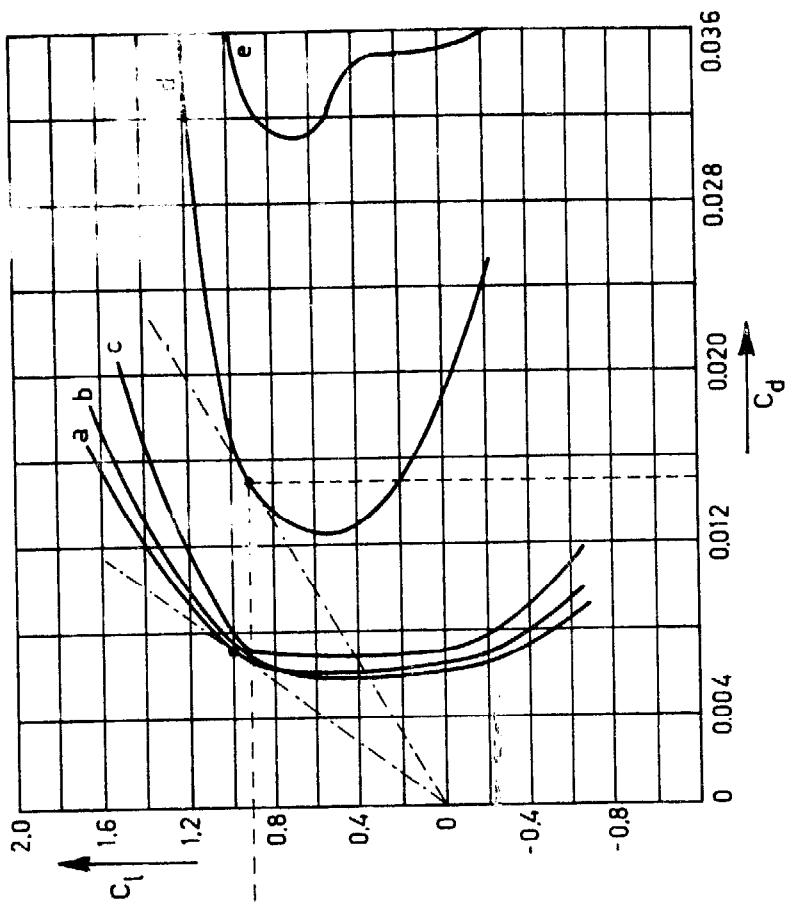

- a.  $Re = 9.0 \cdot 10^6$
- b.  $Re = 6.0 \cdot 10^6$
- c.  $Re = 3.0 \cdot 10^6$
- d.  $Re = 1.64 \cdot 10^5$
- e.  $Re = 4.21 \cdot 10^4$

NACA 4412

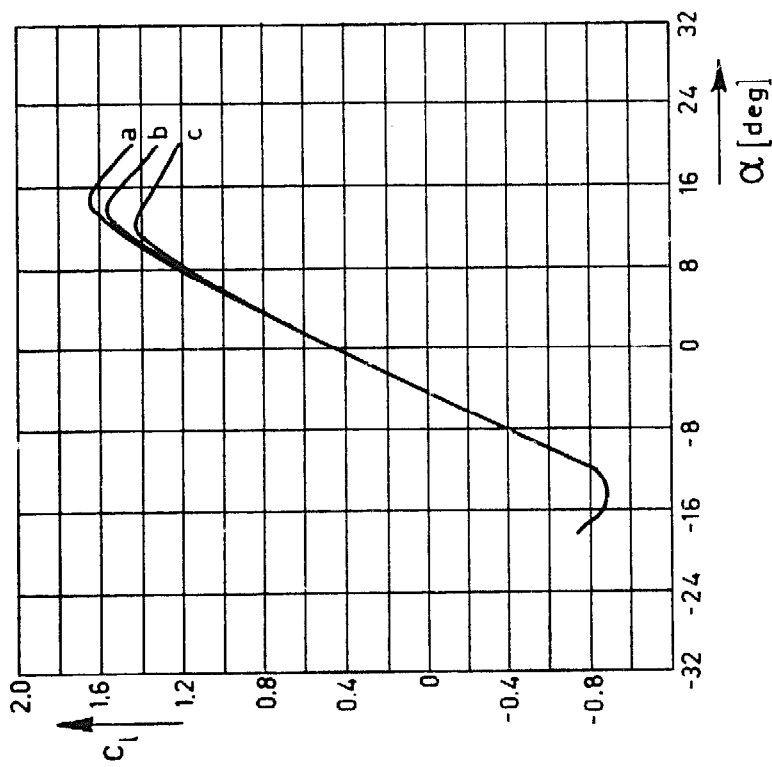
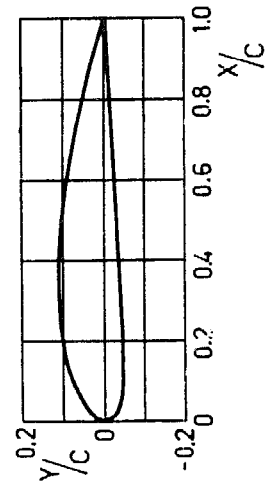
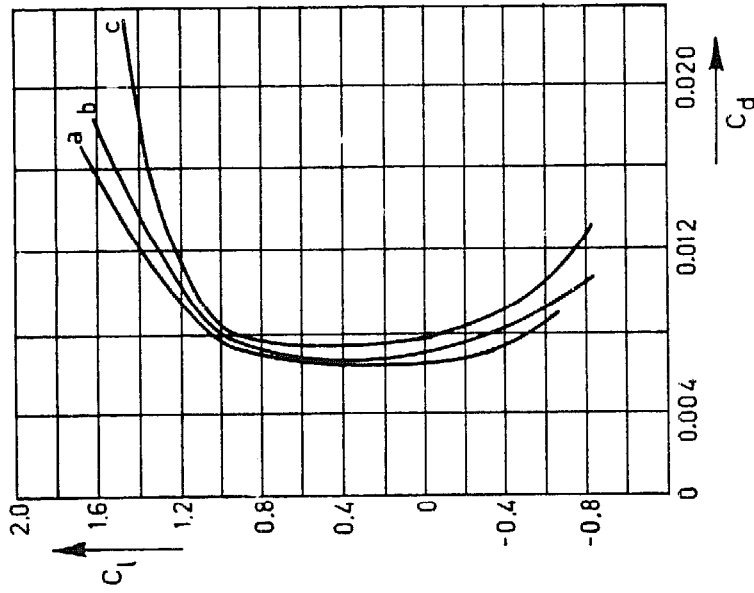

- a.  $Re = 9 \cdot 10^6$
- b.  $Re = 6 \cdot 10^6$
- c.  $Re = 3 \cdot 10^6$

NACA 4415

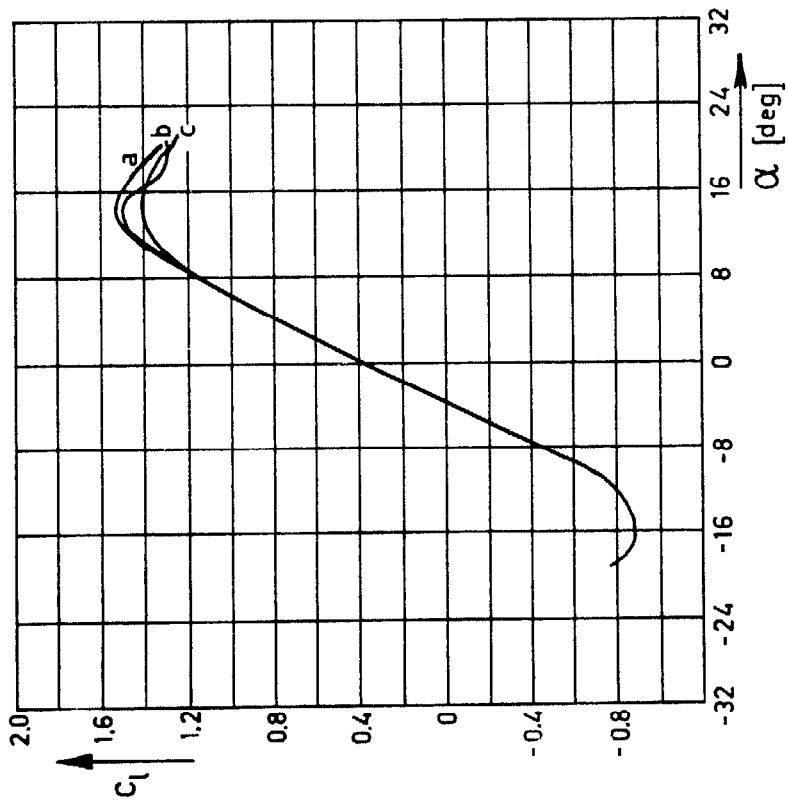
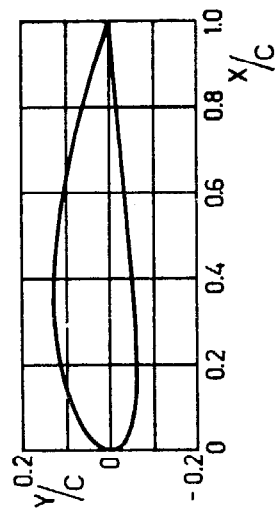
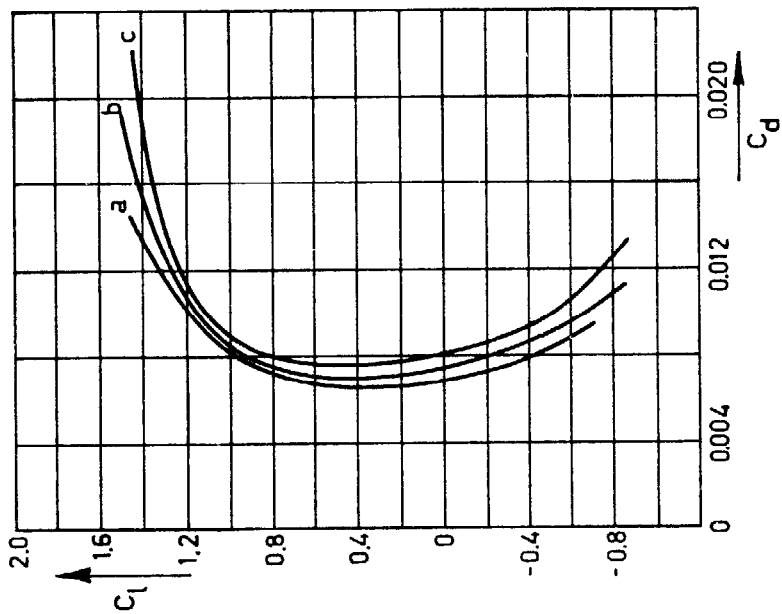

- a.  $Re = 9 \cdot 10^6$
- b.  $Re = 6 \cdot 10^6$
- c.  $Re = 3 \cdot 10^6$

NACA 4418

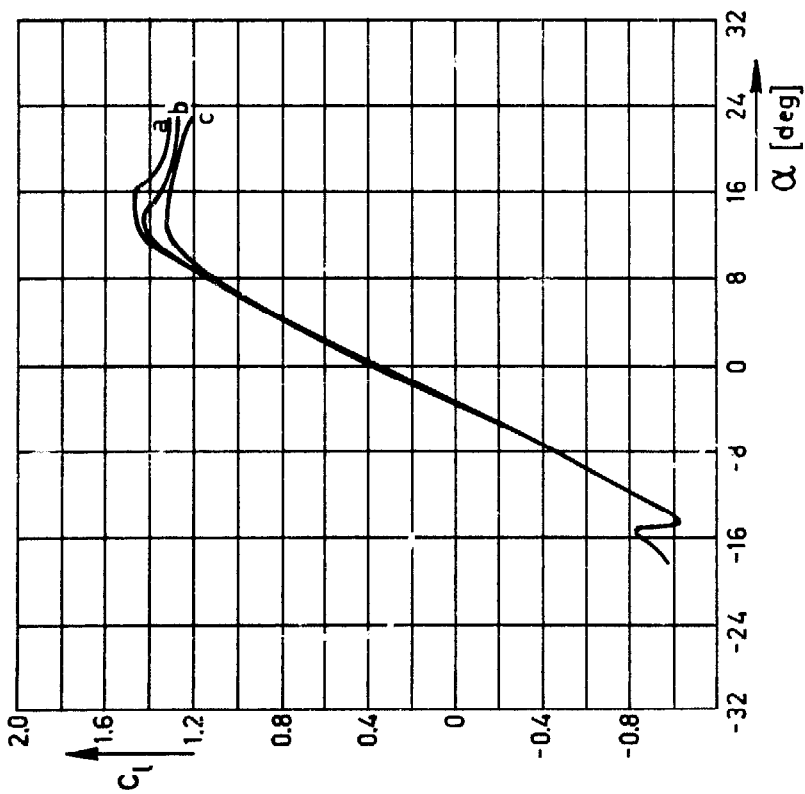
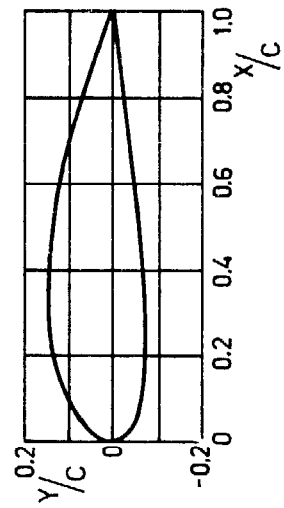
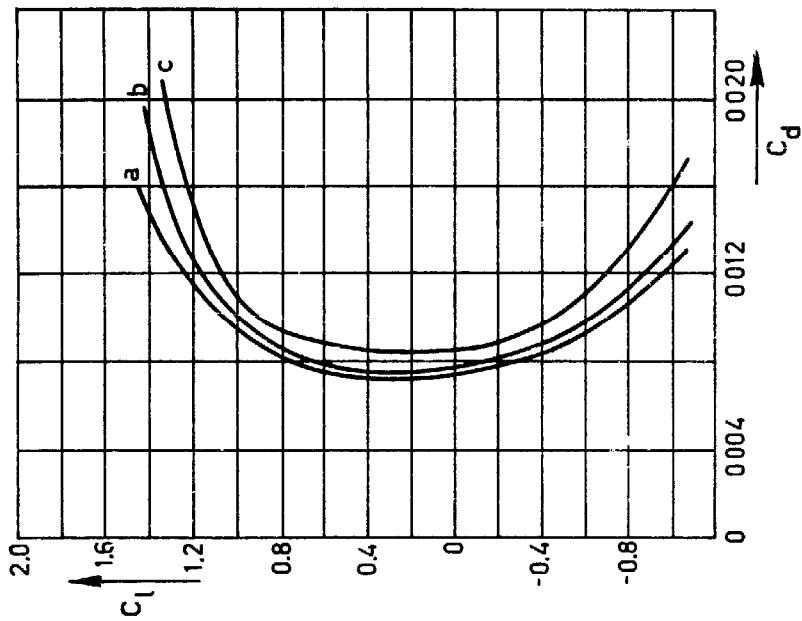

- a.  $Re = 9 \cdot 10^6$
- b.  $Re = 6 \cdot 10^6$
- c.  $Re = 3 \cdot 10^6$

NACA 4421

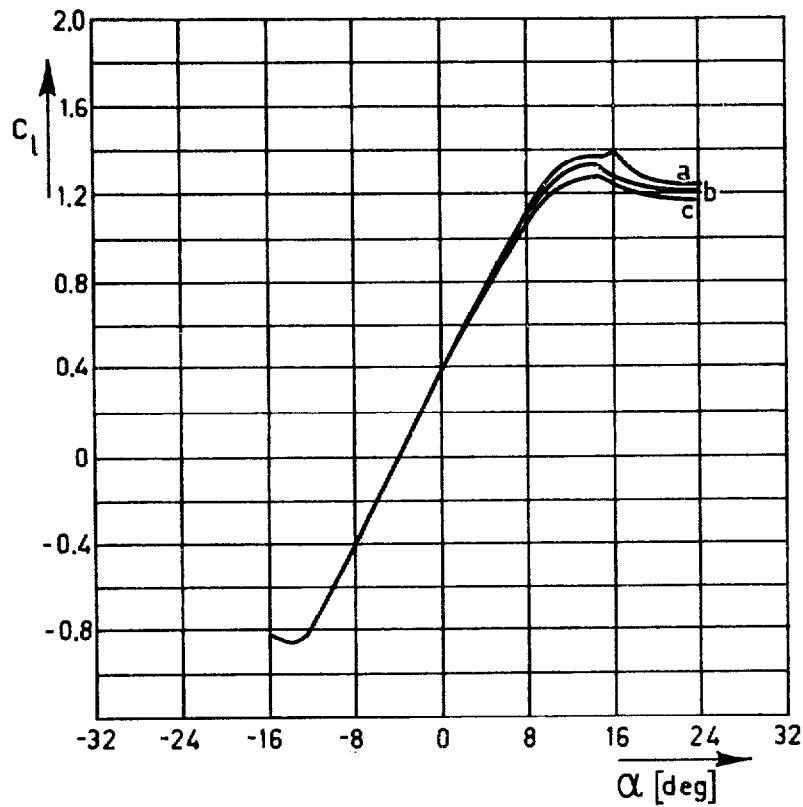

- a.  $Re = 9 \cdot 10^6$
- b.  $Re = 6 \cdot 10^6$
- c.  $Re = 3 \cdot 10^6$

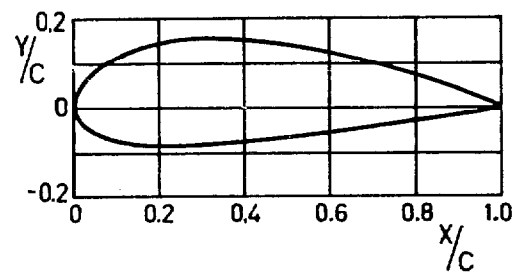
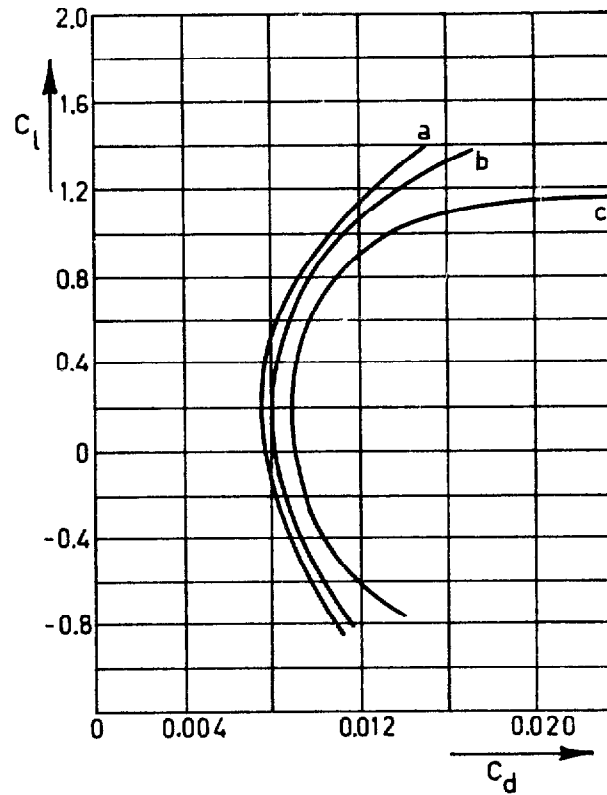

NACA 4424

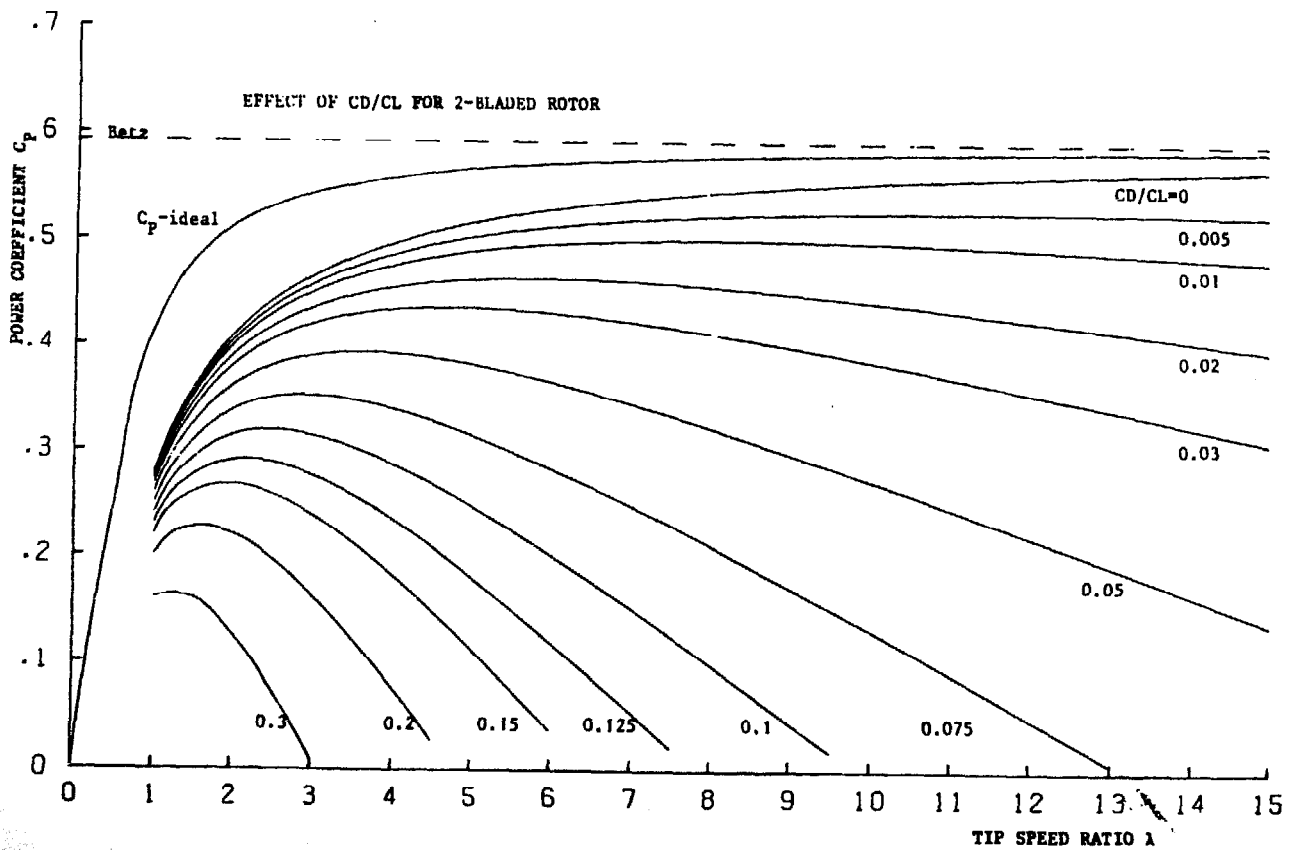
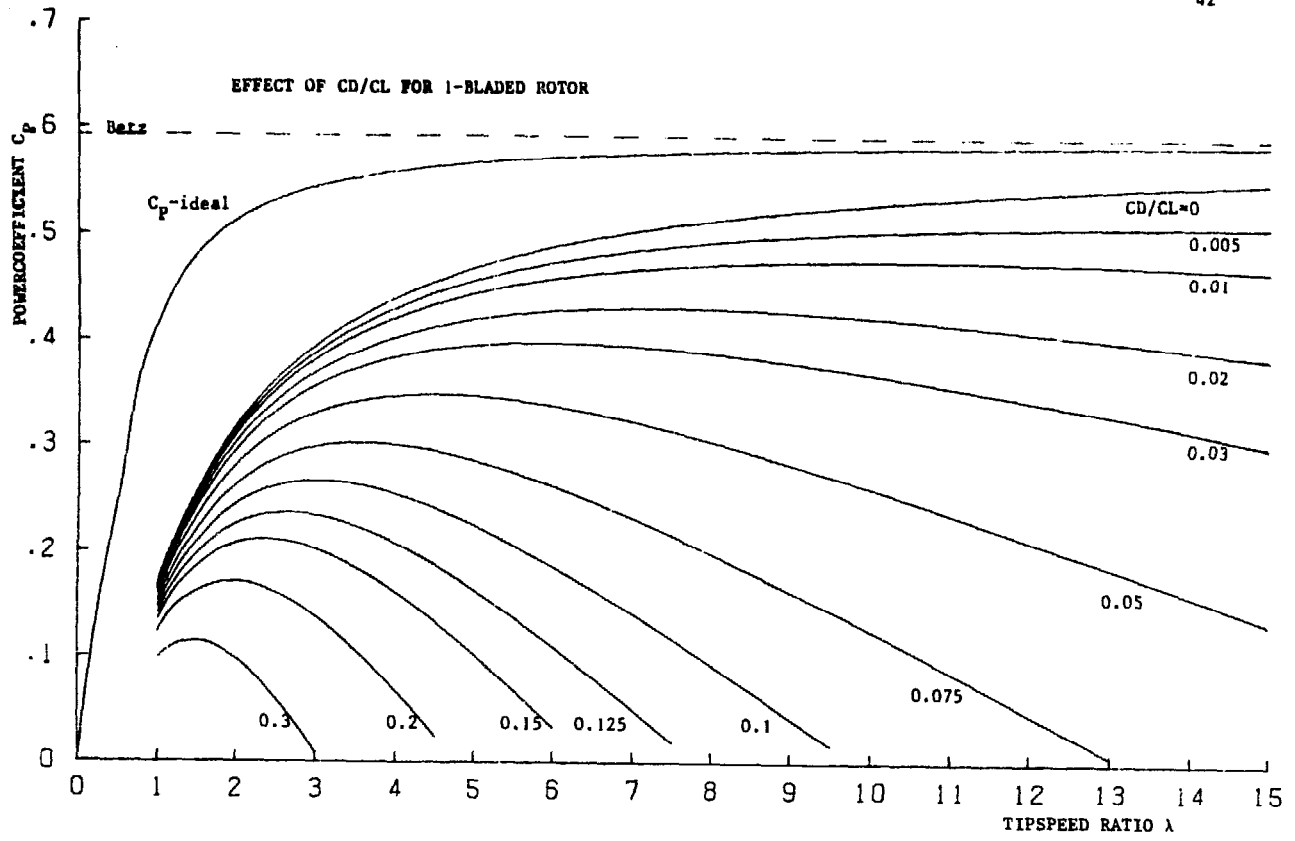

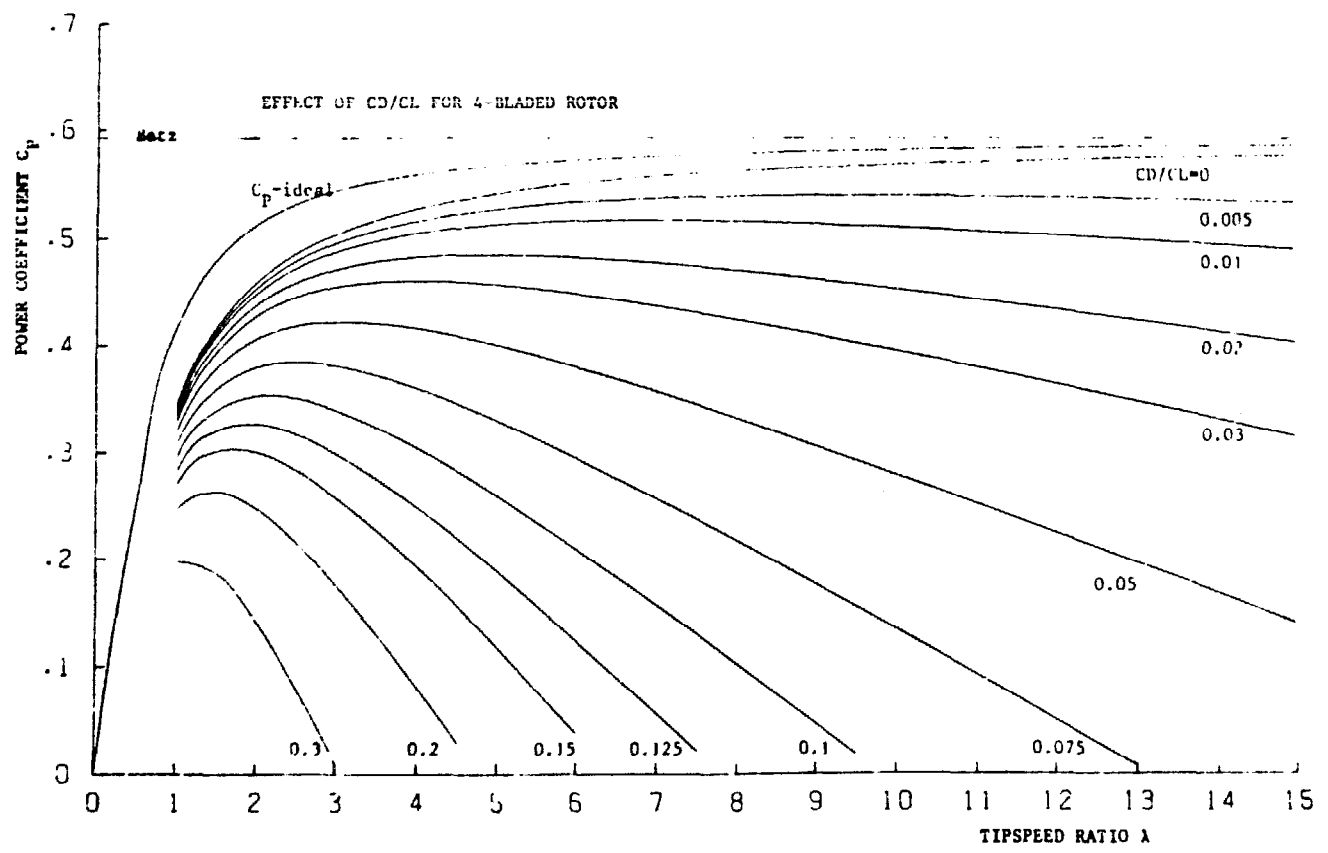
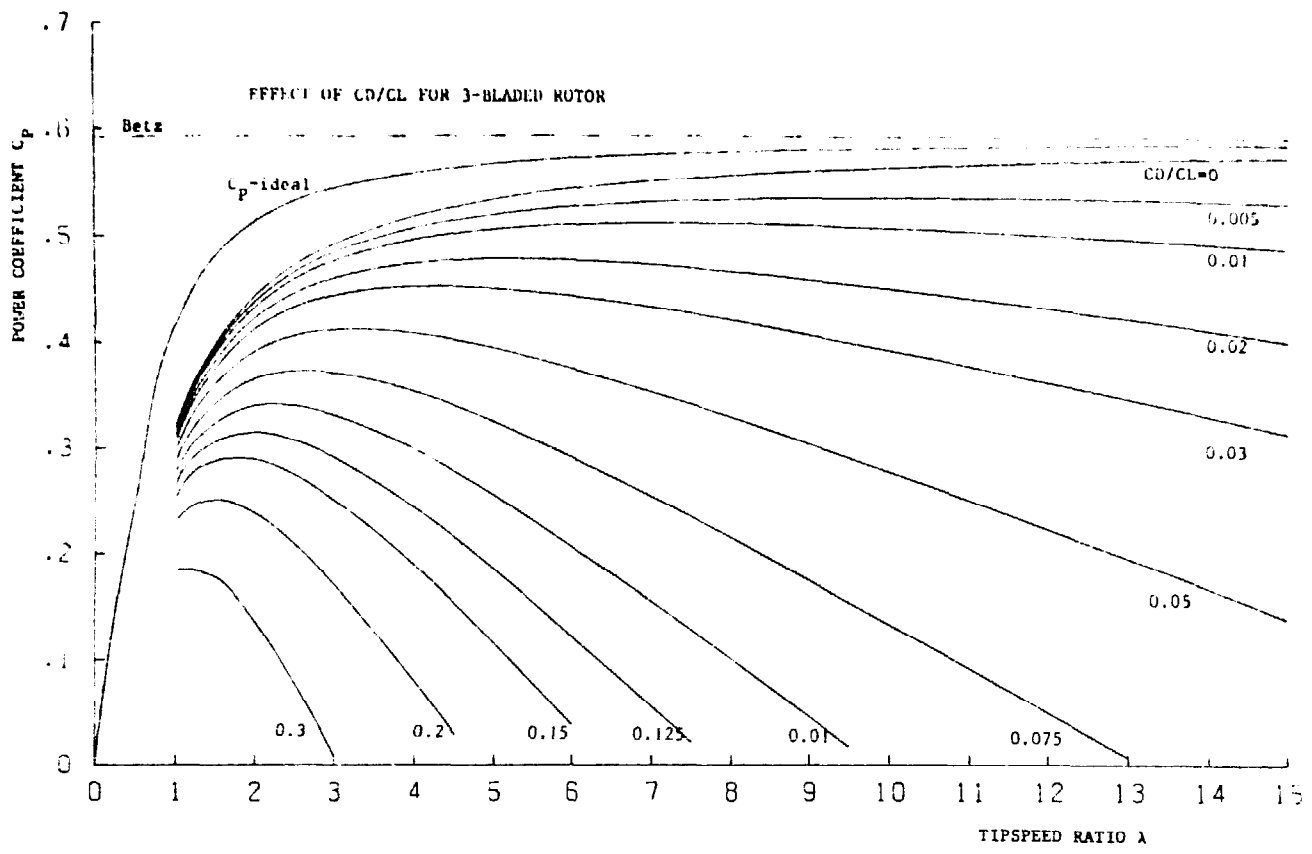

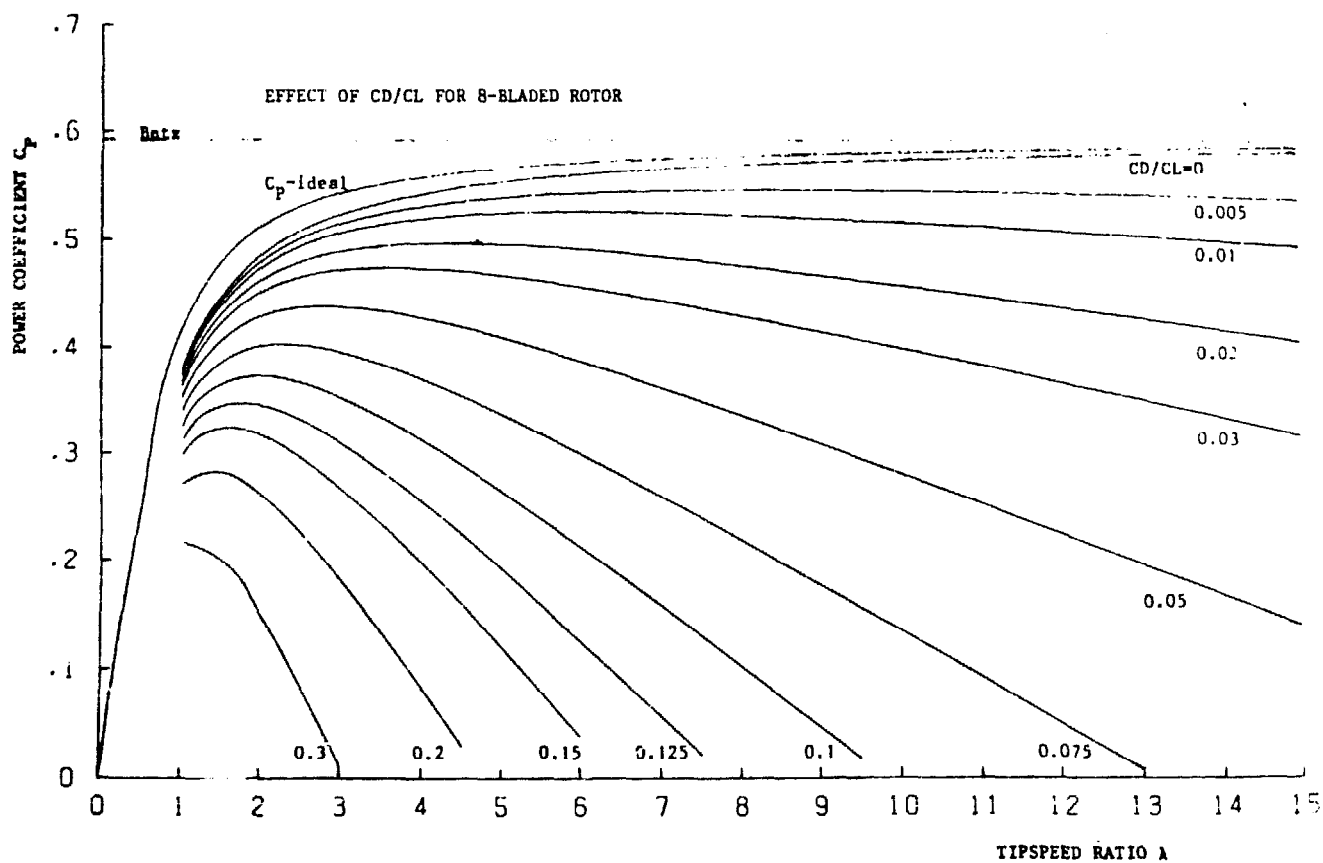
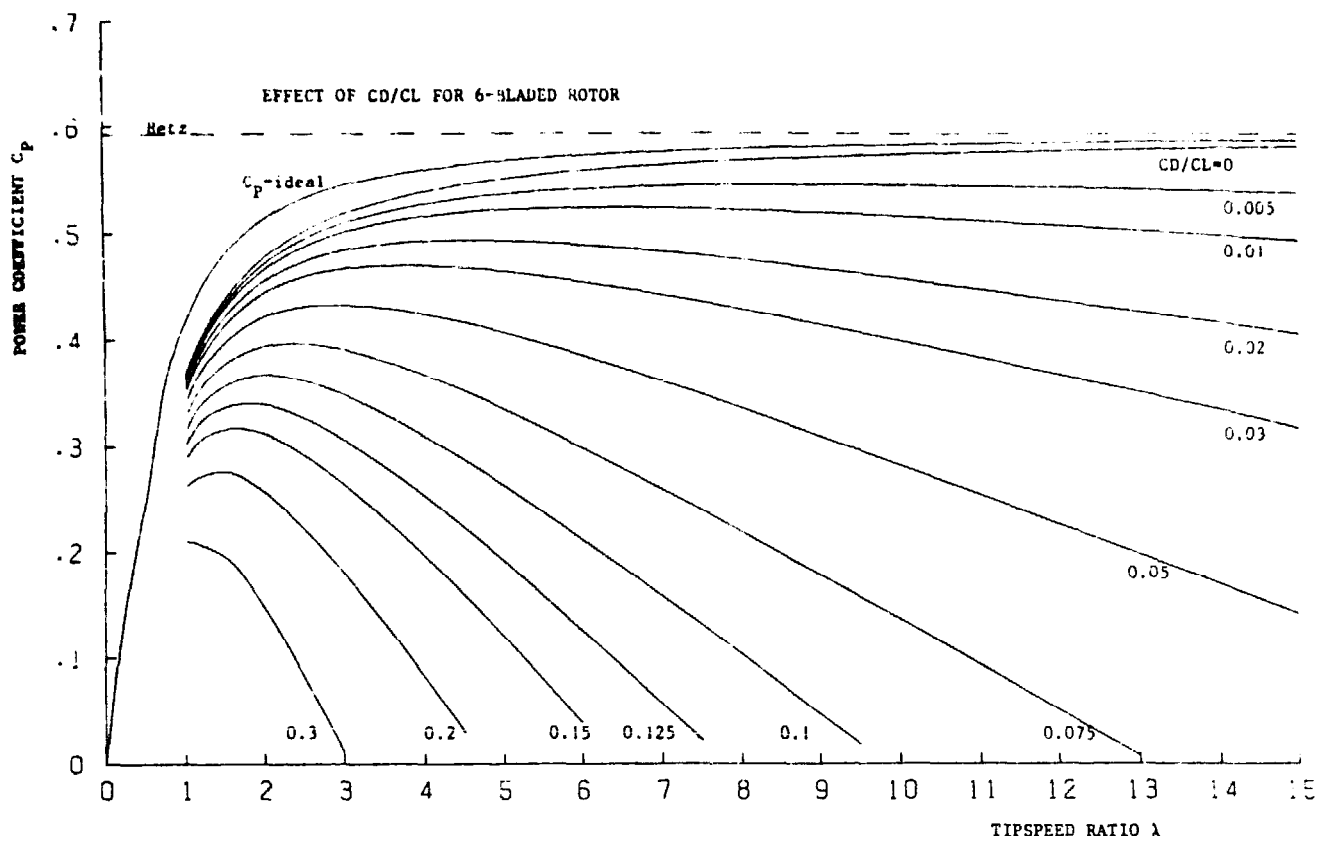



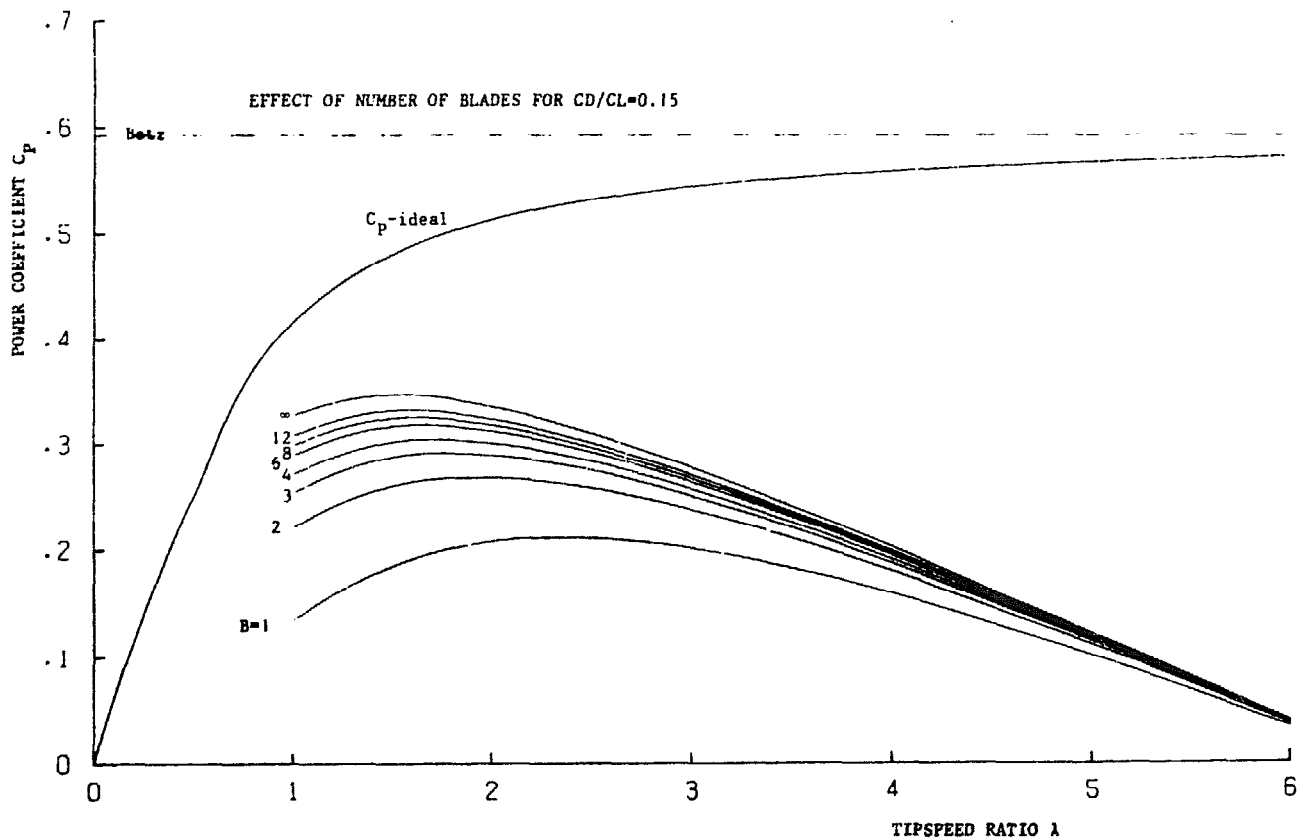
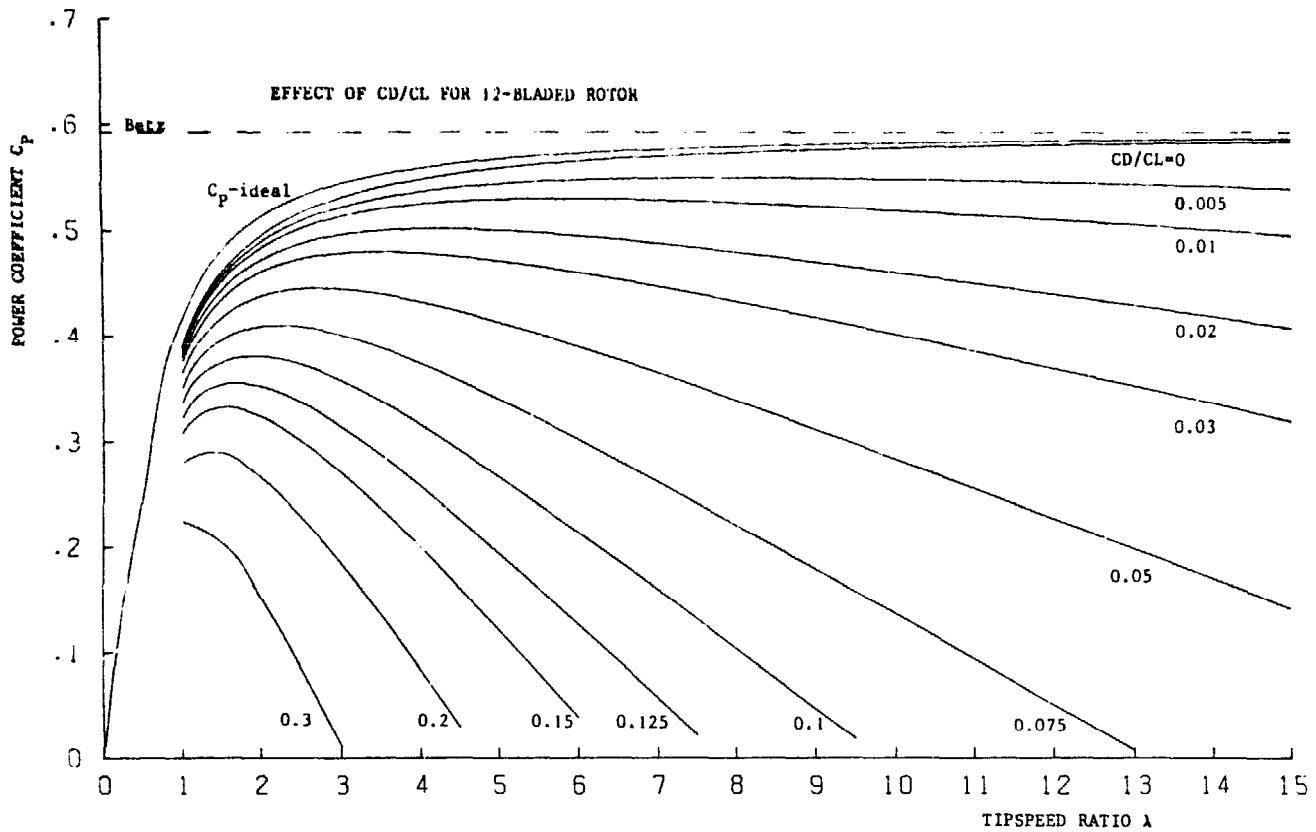

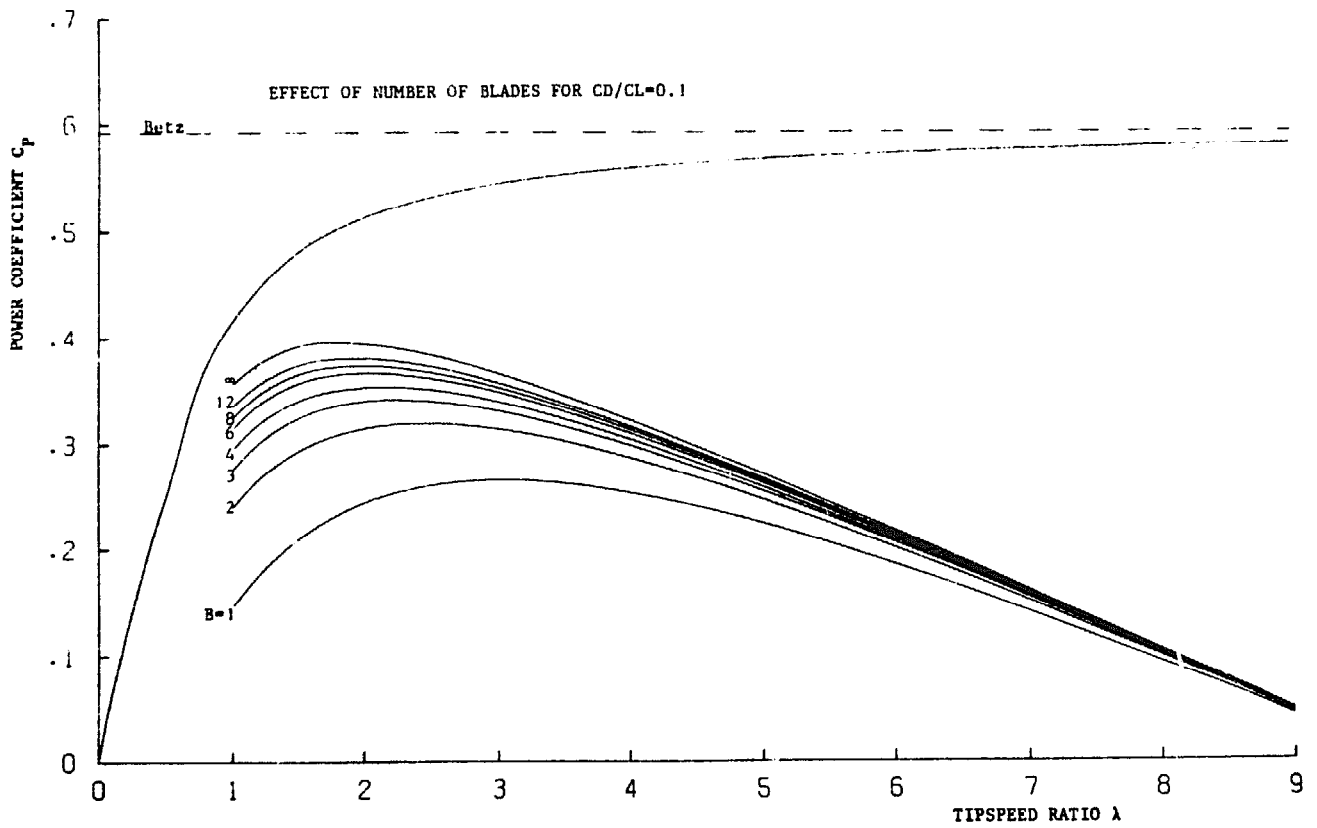
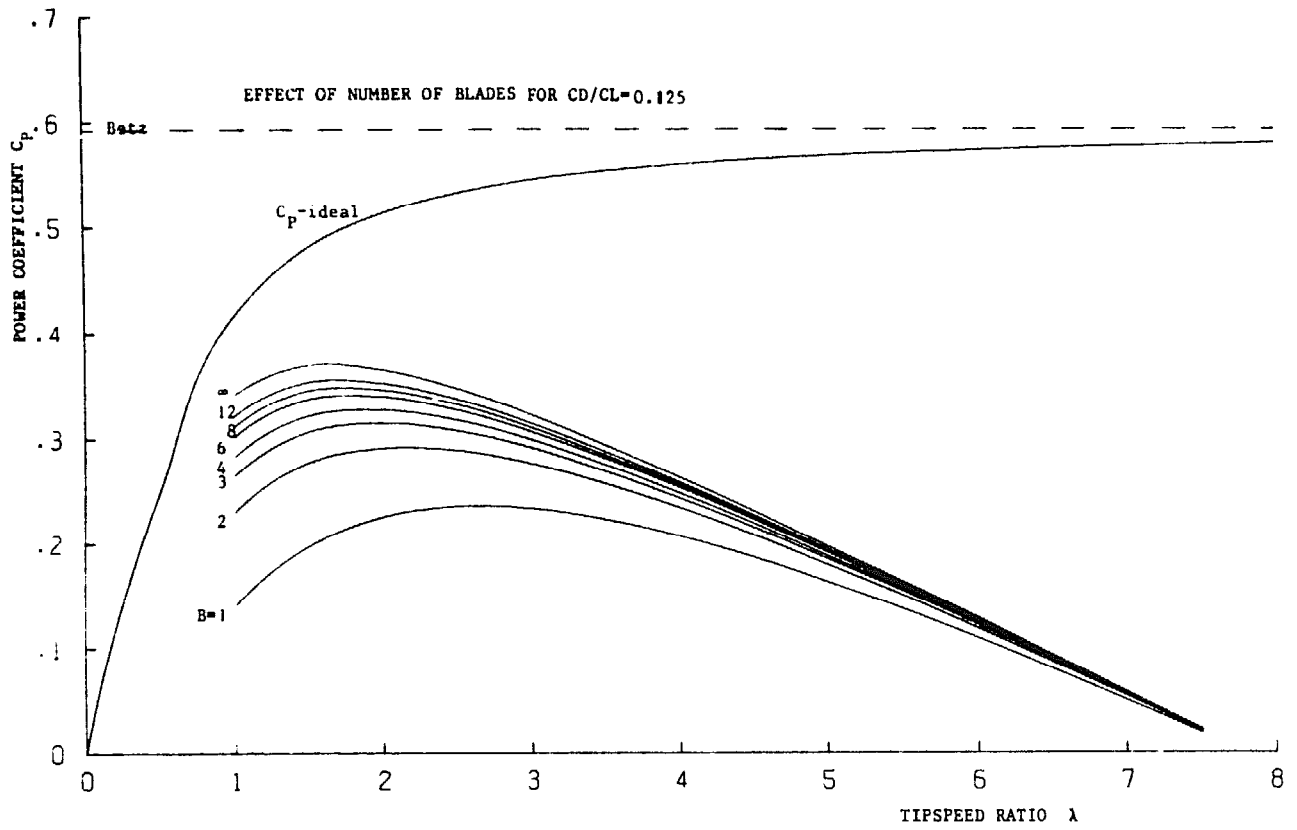

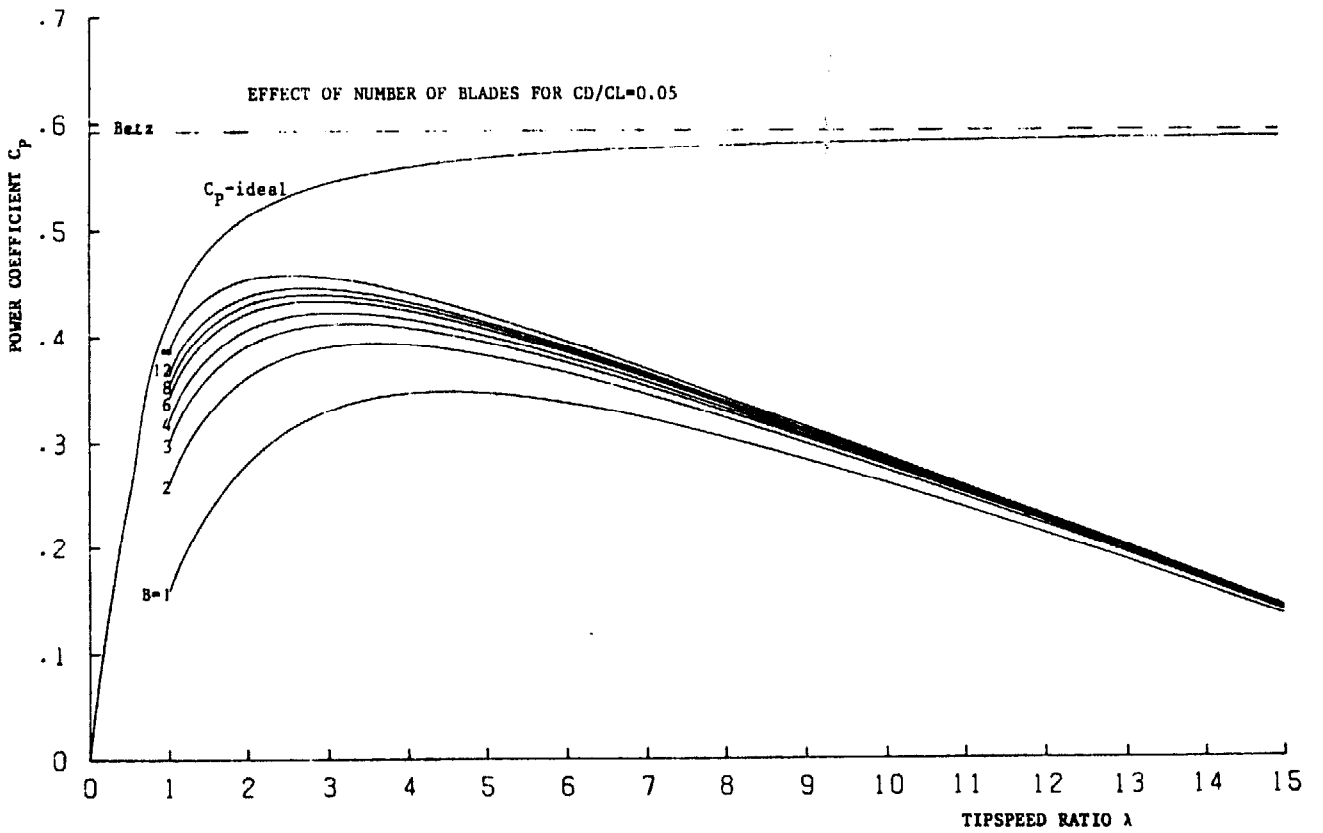
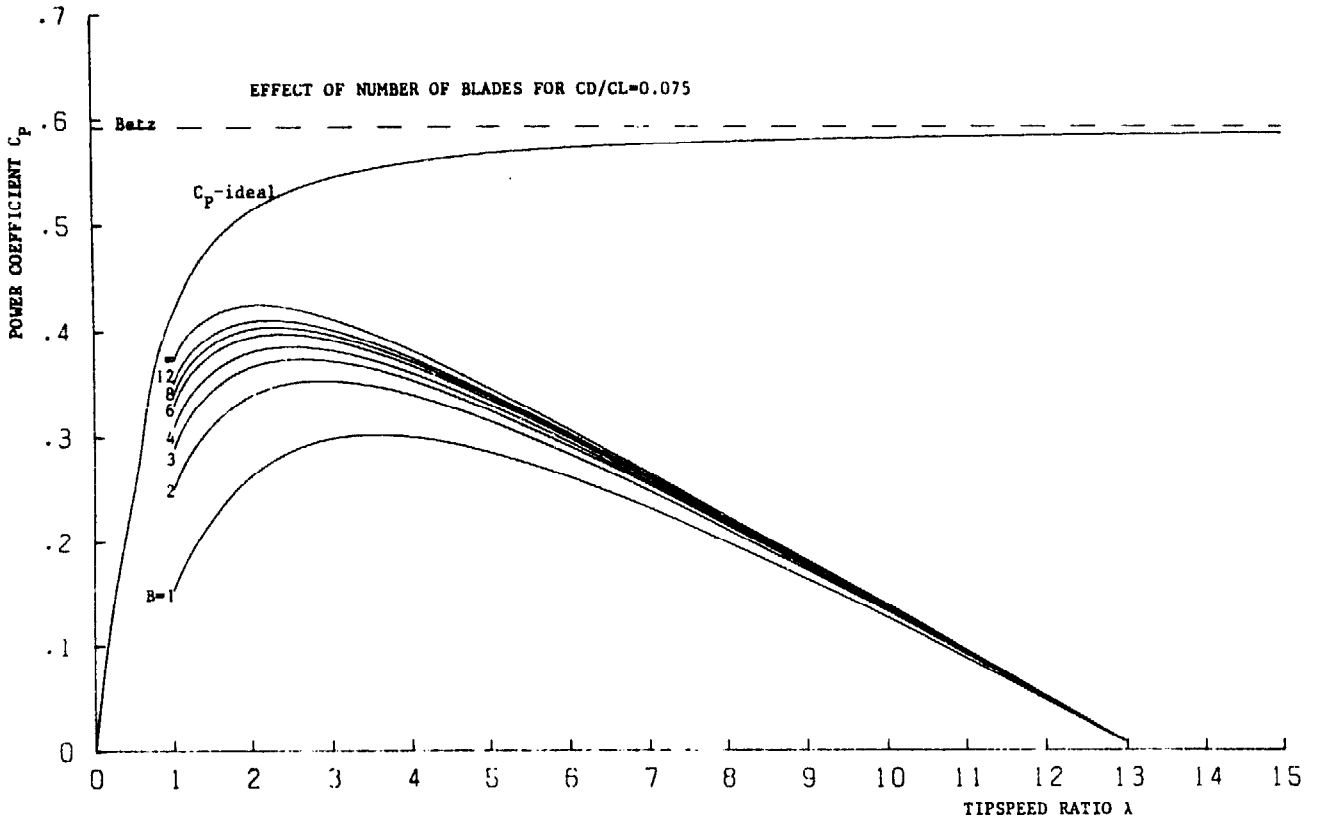

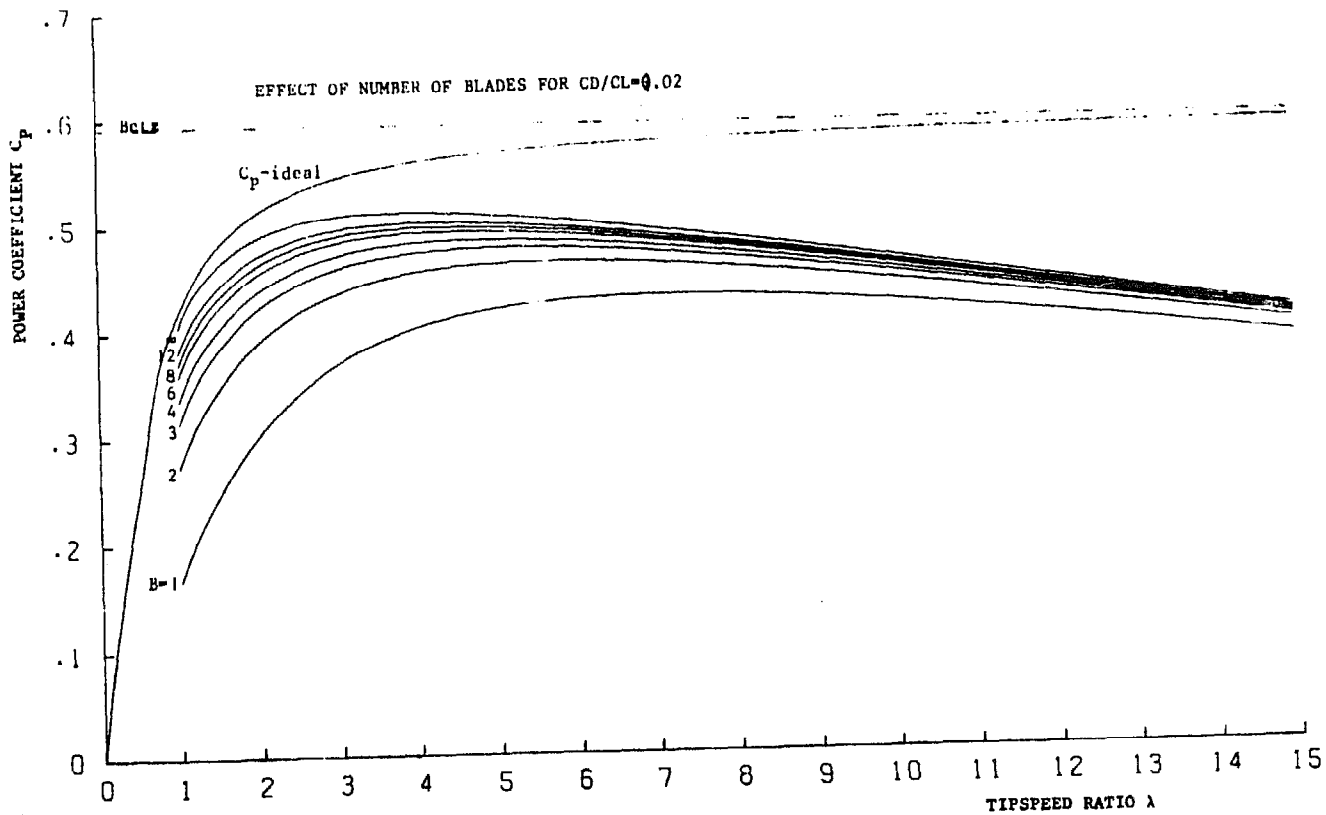
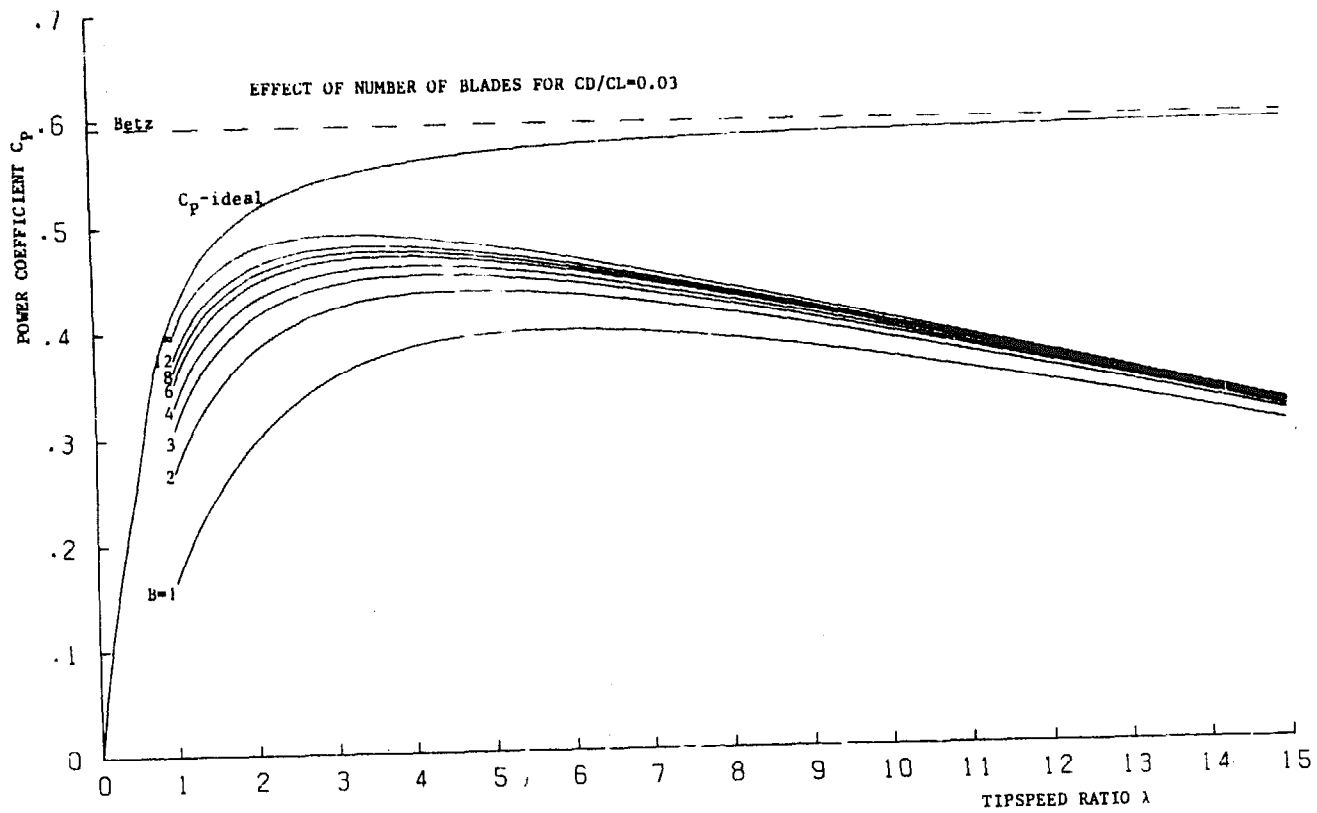

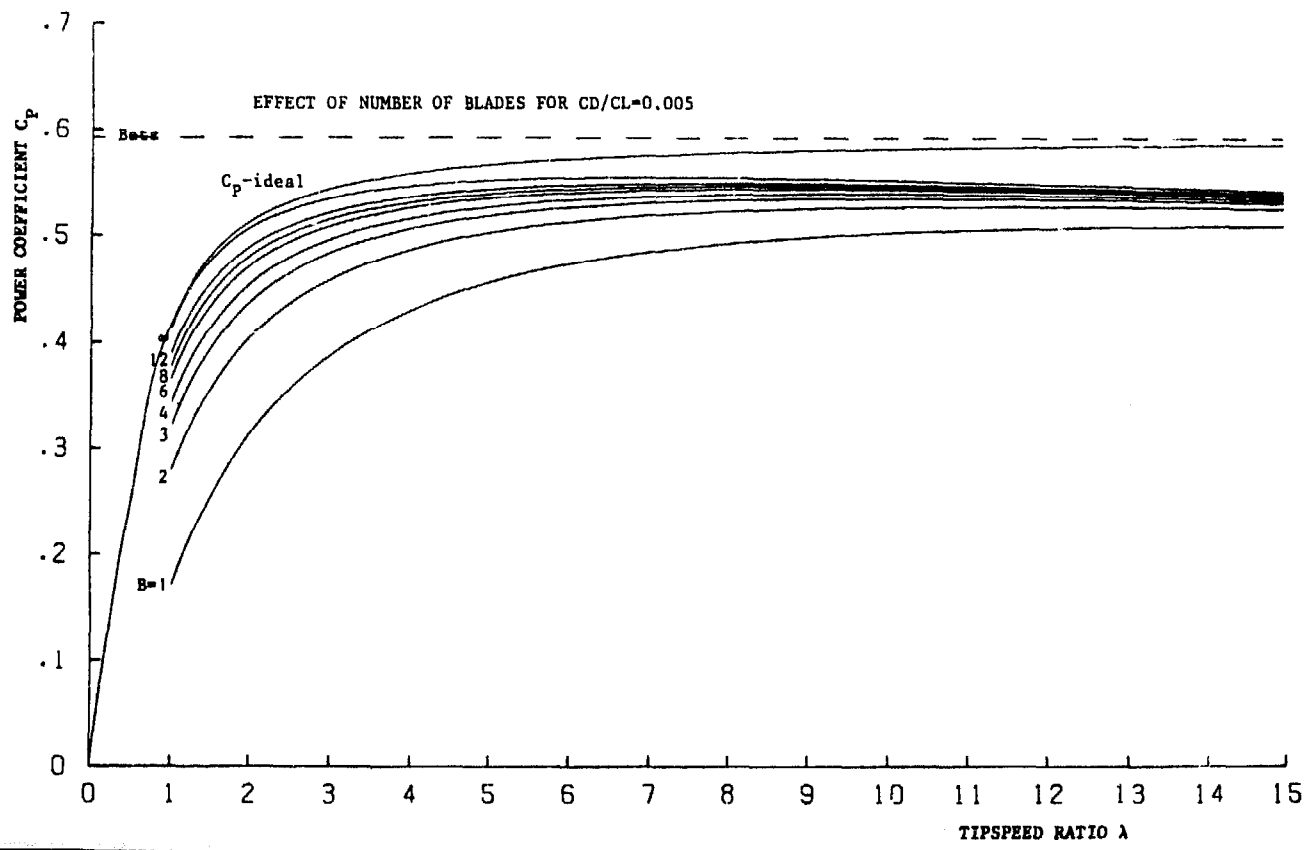
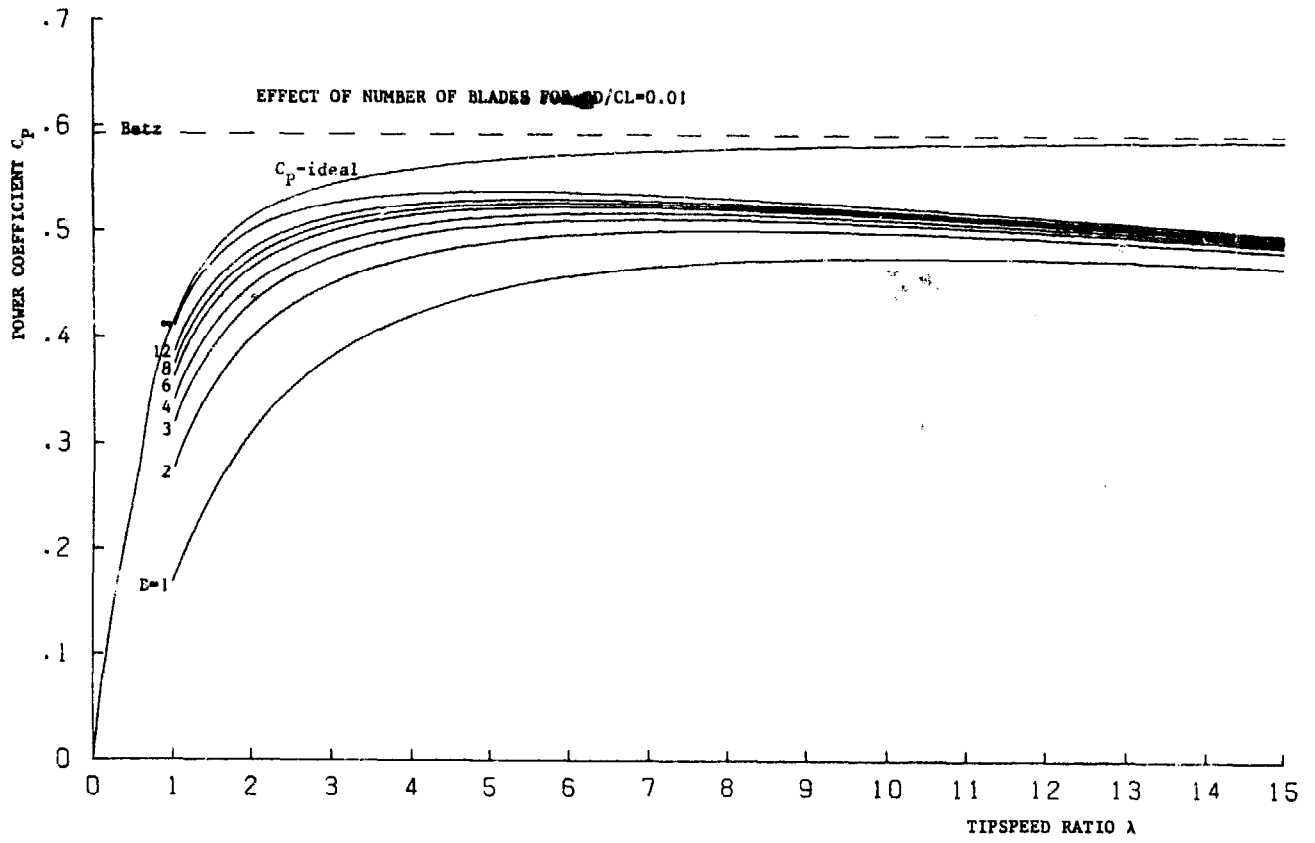

Note on the theoretical assumptions on which the design method is based.

The design procedure presented in this publication is based on general momentum theory and blade element theory as can be found in for example lit (2-3-6-10). This simple design procedure ignores tip effects as mentioned in paragraph 2.4.3. In the collection of maximum power coefficients given in Appendix III, however, the tip losses are included.

As described in paragraph 2.4.0 - 2.4.3, the attainable power coefficient can be described with the following effects:

- 1) Betz coefficient  $C_{P_{\text{Betz}}} = \frac{16}{27}$
- 2) wake rotation
- 3) blade drag
- 4) tip losses due to finite number of blades

Effects 1) and 2) can be described with the following approximation (error  $\leq 0.5$  percent for  $\lambda \geq 1$ ):

$$C_{P_{\text{ideal}}} = \frac{16}{27} = e^{-0.35\lambda^{-1.29}}$$

with  $\lambda = \lambda_{\text{optimum}}$ .

Effect 3) can be described by reducing  $C_{P_{\text{ideal}}}$  with an approximation for power loss due to drag (max error = 2 percent for  $\lambda = 1$ ; error  $\leq 0.1$  percent for  $\lambda > 2.5$ )

$$C_{P_{\text{drag}}} = \frac{16}{27} \frac{C_d}{C_l} \lambda$$

with  $\lambda = \lambda_{\text{optimum}}$  and  $\frac{C_d}{C_l}$  is  $\frac{C_d}{C_l}$  at  $C_{l_{\text{design}}}$

$C_{P_{\max}}$  including drag is:

$$C_{P_{\max}} = C_{P_{\text{ideal}}} - C_{P_{\text{drag}}} = \frac{16}{27} \left( e^{-0.35\lambda^{-1.29}} - \frac{C_d}{C_l} \lambda \right)$$

Effect 4) can be included by multiplying  $C_{P_{\max}}$  with factor  $\eta_B$ :

$$\eta_B = \left( 1 - \frac{1.386}{B} \sin \frac{\phi}{2} \right)^2$$

$B$  = number of blades;  $\phi$  is found in Appendix V with  $\lambda_r = \lambda_{\text{tip}}$

Thus  $C_{P_{\max}}$  is:

$$C_{P_{\max}} = \eta_B (C_{P_{\text{ideal}}} - C_{P_{\text{drag}}})$$

$$C_{P_{\max}} = \left( 1 - \frac{1.386}{B} \sin \frac{\phi}{2} \right)^2 \frac{16}{27} \left( e^{-0.35\lambda^{-1.29}} - \frac{C_d}{C_l} \lambda \right).$$

## APPENDIX V

$$\lambda_r = \frac{\sin\phi(2\cos\phi-1)}{(1-\cos\phi)(2\cos\phi+1)}$$

$\lambda_r$	$\phi$	$(1-\cos\phi)$
10.00	3.807	0,00220
9.75	3.904	0,00232
9.50	4.006	0,00244
9.25	4.113	0,00258
9.00	4.227	0,00272
8.75	4.347	0,00288
8.50	4.473	0,00305
8.25	4.607	0,00323
8.00	4.750	0,00343
7.75	4.902	0,00368
7.50	5.063	0,00390
7.25	5.236	0,00417
7.00	5.420	0,00447
6.75	5.618	0,00480
6.50	5.831	0,00517
6.25	6.060	0,00559
6.00	6.308	0,00605
5.75	6.577	0,00658
5.50	6.870	0,00718
5.25	7.190	0,00786
5.00	7.540	0,00865
4.75	7.926	0,00955
4.50	8.353	0,01061
4.25	8.827	0,01184
4.00	9.357	0,01336
3.75	9.954	0,01505
3.50	10.630	0,01716
3.25	11.402	0,01774
3.00	12.290	0,02292
2.75	13.322	0,02691
2.50	14.534	0,03200
2.25	15.975	0,03862
2.00	17.710	0,04739
1.75	19.830	0,05930
1.50	22.460	0,07585
1.25	25.773	0,09948
1.00	30.000	0,13397
0.75	35.420	0,18507
0.50	42.290	0,26025
0.25	50.642	0,36584
0.00	60.000	0,5

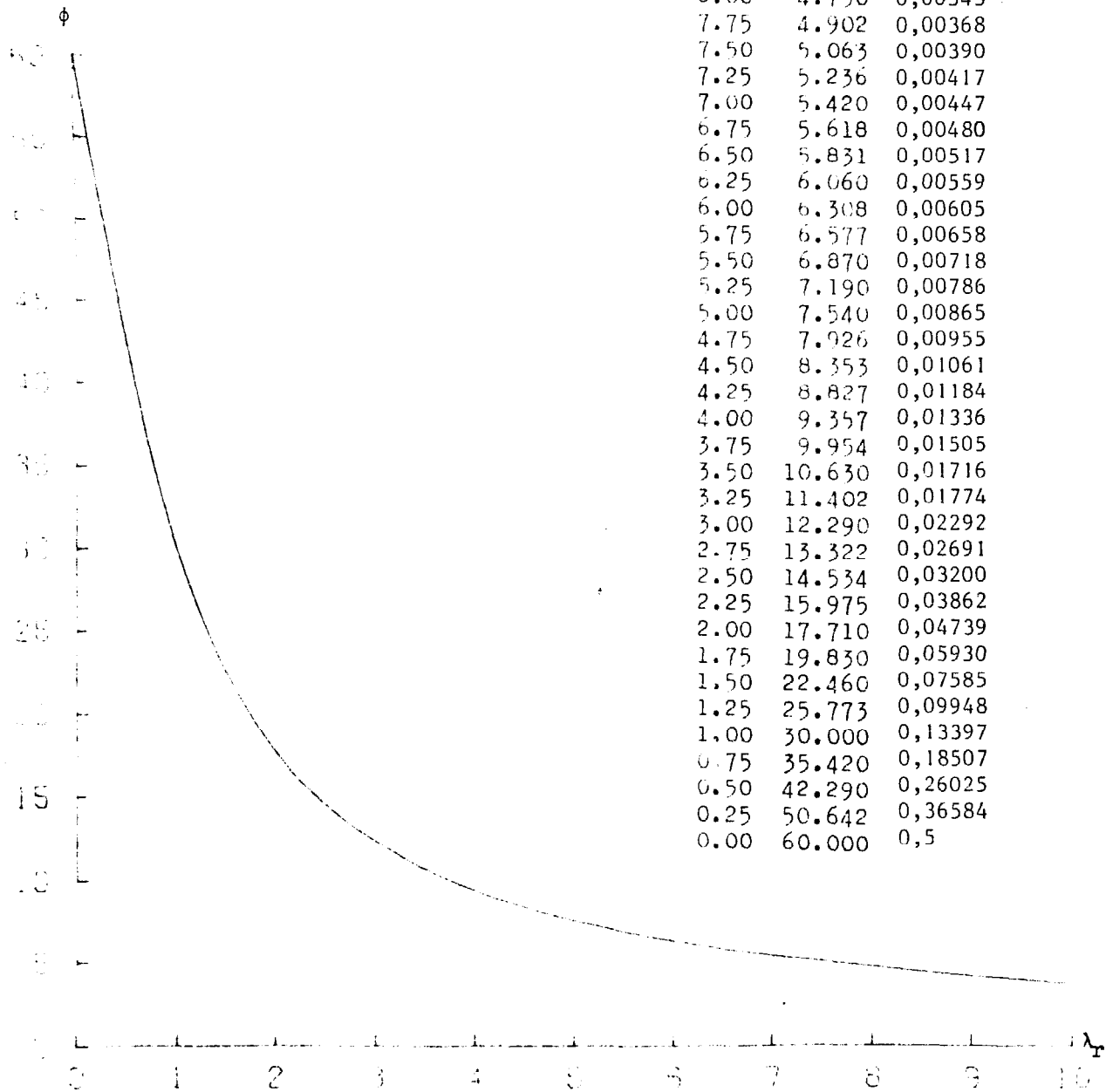

Angle  $\phi$  between relative velocity and plane of the rotor versus the speed ratio of an element at radius  $r$  for a windmill with a flow equal to the flow of an ideal windmill.



## SWD PUBLICATIONS

Serial number		Price (incl. mail)	
		US \$	Dfl
SWD 76-1	Wind-energy utilization in Sri Lanka; potentialities and constraints. By A. Dennis Fernando and P.T. Smulders, 18 p., May 1976	2,-	7,50
SWD 76-2	Literature survey; horizontal axis fast running wind-turbines for developing countries. By W.A.M. Jansen, 43 p., March 1976	3,-	7,50
SWD 76-3	Horizontal axis fast running wind-turbines for developing countries. By W.A.M. Jansen, 91 p., June 1976	7,-	17,50
SWD 77-1	Rotor design for horizontal axis windmills. By W.A.M. Jansen and P.T. Smulders, 52 p., May 1977	4,-	10,-
SWD 77-2	Model for cost comparison of windmills with engine pumps. By L. Marchesini, 25 p., (available January 1978)	3,-	7,50
SWD 77-3	Static and dynamic loadings on the tower of a windmill. By E.C. Klaver, 39 p., August 1977	4,-	10,-
SWD 77-4	Construction manual for a cretan windmill. By N. van de Ven, 59 p., October 1977	5,-	12,50
SWD 77-5	Performance characteristics of some sail- and steel-bladed windrotors. By Th. A.H. Dekker, 60 pag., December 1977	5,-	12,50

Research institutes in third world countries may ask for one copy free of charge, writing directly to:

SWD,  
c/o DHV Consulting Engineers,  
P.O. Box 85,  
Amersfoort, The Netherlands.

SWD publications can only be ordered by sending money to:

Bank Mees en Hope, acc. 25.00.72.009  
P.O. Box 293,  
Amsterdam, The Netherlands

and stating:

- a) serial number of publication wanted,
- b) on money transfer: file 3.00.34.04,
- c) self addressed address in printing letters.