

# **AT** MICROFICHE REFERENCE LIBRARY

A project of Volunteers in Asia

Lorena Stoves: A Manual for Designing, Building  
and Testing Low-Cost Wood-Conserving Cookstoves

by: Ianto Evans and Michael Boutette

Published by:

Volunteers in Asia  
Appropriate Technology Project  
P.O. Box 4543  
Stanford, CA 94305 USA

Paper copies are \$ 5.00.

Available from:

Volunteers in Asia  
Appropriate Technology Project  
P.O. Box 4543  
Stanford, CA 94305 USA

Reproduced by permission of the Aprovecho  
Institute.

Reproduction of this microfiche document in any  
form is subject to the same restrictions as those  
of the original document.

# lorena stoves

designing, building and  
testing wood-conserving  
cookstoves



By Ianto Evans  
and Michael Boulette

A Holmwood Asia Publication

**Lorena stoves are low-cost, fuel-saving cookstoves, made of sand and clay. This book:**

- **discusses the design of efficient, locally appropriate Lorena stoves, with examples from Guatemala, Indonesia, Senegal and the United States**
- **shows how to find and test soils, how to make lorena mix, and how to build stove blocks and carve them out**
- **presents a variety of ways to evaluate fuel savings and efficiency of new and traditional stoves, at the village level**

**Illustrated with 150 line drawings and photographs**

**\$4.00**

# **lorena stoves**

**a manual for designing, building and  
testing low-cost wood-conserving cookstoves**

**By Ianto Evans and Michael Boutette  
Aprovecho Institute**

**Edited by Kent Keller and Ken Darrow  
Appropriate Technology Project**

**July 1981**

**A Publication of  
The Appropriate Technology Project of Volunteers in Asia**



The Appropriate Technology Project of Volunteers in Asia is supported in part by the following organizations:

Church World Service  
Catholic Relief Service  
Presiding Bishop's Fund for World Relief (Episcopal Church)  
United Methodist Committee on Relief  
Maryknoll Fathers  
United Church Board for World Ministries  
United Presbyterian Church  
CODEL (Coordination in Development)

Cover graphic by Michael Boutette  
Drawings by Michael Boutette and Ianto Evans  
Photos by Jim Kalin and Don Flickinger

Thanks to Margaret Thomas for her help in reviewing and typing, and to David Cappert, Elizabeth Gerns, Karen Kennedy, Mark Nelson, and Pat Sitton for helping review the final version.

Thanks also to Estacion-Experimental ICADA-Choqui in Quezaltenango, Guatemala, sponsors of the initial development and dissemination work on Lorena stoves.

Many people contributed to the appendix on evaluating fuel savings and testing. Part 2, "Stove Tests at the Village Level", could not have been written without the generous sharing of experiences by Bill Stewart and Don Flickinger. Stephen Joseph's work on efficiency testing was influential. Mary Pat O'Connell, Linda Shaw, Bill Bower, and Robert Young provided helpful review and comment.

Special thanks to Elida Escobar, a Guatemalan friend, who asked if a stove could be built for her and thereby started the whole project.

Copyright © 1981  
by Ianto Evans, Michael Boutette, and Volunteers in Asia Inc.  
All rights reserved.

First Printing ("Lorena Owner-Built Stoves"), January 1979, 2000 copies  
Second Printing ("Lorena Owner-Built Stoves"), October 1979, 3000 copies  
First Printing, Revised Edition ("Lorena Stoves"), July 1981, 3500 copies

ISBN 0-917704-14-2

Addresses:

Estacion Experimental/ICADA-CHOQUI  
Apartado 159  
Quezaltenango, Guatemala

Aprovecho Institute  
442 Monroe Street  
Eugene, Oregon 97402, USA  
Appropriate Technology Project  
Volunteers in Asia  
Box 4543  
Stanford, California 94305, USA

Additional copies of this manual can be obtained for \$4.00 plus \$1.00 postage from Appropriate Technology Project, Volunteers in Asia, P.O. Box 4543, Stanford, California 94305, USA. Discounts for bulk orders.

## Introductory Note

Firewood scarcity, until recently ignored by most energy analysts and economists and even by most foresters, has with astonishing rapidity become a major concern of development aid agencies and many Third World governments. In Jakarta, in New Delhi, in Ouagadougou, and in Washington, D.C., planners are poring over lists of fast-growing tree species, considering alternatives to wood for cooking, and examining the organizational prerequisites of successful village forestry. Many Third World forestry departments are realizing that they must transcend their historical police-like roles as mere guardians of forest reserves and instead carry forestry beyond the forests into the farms and villages of the countryside.

Even as these belated efforts to restore depleted wood supplies are pursued, however, an equally important part of the solution—the more efficient use of wood—remains comparatively neglected. The wide dissemination of cheap, thermally efficient stoves—of which the Lorena mud stove is one of the best examples—can reduce the economic and ecological burdens of firewood scarcity more quickly than any other measure. Offering a potential bridge to a sustainable energy future for the poorest third of humanity, wood-conserving stoves rank alongside village woodlots and biogas plants as critical elements of appropriate Third World energy strategies. Suitable designs are available and their economics, even for the desperately poor, are favorable. The task is now to spread them about as quickly as possible.

—Erik Eckholm  
November 1978

## Foreword

Almost 20 years ago the United Nations Food and Agriculture Organization issued a report comparing the fuel use of common Indonesian cooking stoves with that of several improved models. These comparisons showed great fuel savings with the improved stoves. Similar claims of dramatic efficiency gains in improved Indian "chulah" stoves date back 25 years or more. And in the last few years, variations of the Guatemalan "Lorena" stove have seemed to offer substantial fuel savings.

Yet for two decades, better stoves have met with a curious lack of interest by the scientific community and development program planners. This is remarkable, for it appears to be the glamor-less improved stove—rather than petroleum products, biogas plants, or solar devices—that holds the key to expanded energy supplies for the rural majority of the planet's people for the rest of the century. Well-informed observers estimate that roughly 80% of the energy consumed in rural areas of the Third World is in the form of wood and agricultural residues burned in cooking. A similar 80% of wood cut appears to end up under cooking pots.

Why has there been such neglect of improved stoves? One reason is that planners and development officers who have been interested in rural development and rural energy supplies have not known how advantageous better stoves could be. The figures are impressive. Data from several sources indicate that improved stoves can save one-half of the wood normally used in open fires, if the stoves are designed to fit local cooking practices and are built and operated properly. This is an enormous, very significant savings. It means that in many areas where forest depletion is occurring at a great rate, improved stoves could theoretically reverse the tide, putting natural growth back ahead of the cutting rate. The pressure on newly-planted village woodlots can be reduced, making it more likely that trees will grow to full size before being cut. In human terms, it means that for millions of people the time-consuming, back-breaking task of finding and carrying firewood long distances can be eased.

What will be required to achieve the potential gains offered by improved cooking stoves? 1.) Most importantly, such stoves must be very low in cost if they are to be affordable to the poor majority. This implies the use of local labor and materials, and low or no transport costs. Among Lorena stoves, the smallest design is quite heavy, weighing more than a hundred pounds. It has to be built on the spot where it will be used. This

means that there can be no central production and distribution of Lorena stoves.\* 2.) Secondly, many people must learn to build such stoves. In Guatemala, Senegal, and Mexico professional stove makers now build stoves to order in kitchens. A consequence of successful Lorena stove promotion may be a small resurgence in rural craftsmanship—those skills so long beleaguered and eroded by industrial production.

Indeed, for this reason and others the Lorena stove belongs in that unique class of tools that the late E.F. Schumacher smiled upon. It is sophisticated in concept, yet relatively easy to build and affordable by all. Needing no capital except common hand tools and no transportation networks except the footpath, the making of Lorena stoves creates jobs and protects the environment at once. Non-violent, it reduces the crushing burden of huge loads of firewood carried on the backs of millions of villagers over great distances, and slows the environmental destruction that follows this desperate search for fuel. And it uniquely challenges the creative expression of the maker, to best suit local cooking practices, to shape unusual and delightful forms, and to carve ornate exteriors. The Lorena stove is more a concept and a material than a particular stove design. This quality allows widely varying cultural adaptations, and it may just capture the imagination of the majority not yet geared to industrial uniformity.

The essential role played by local people in the evolution of the Guatemalan Lorena stove is a lesson to all of us. Rural Guatemalans showed great patience with the foolishness of outsiders, quietly and politely indicating the impracticality of prototypes at different stages in the stove's evolution, and joining in the design process. The basic stove design that emerged from this process seems popular because it takes into account the needs and desires of the people of highland Guatemala.

The very important task of promoting the widespread use of efficient stoves will have to include great attention to local adaptation, a process in which user participation is crucial. Based on user recommendations, Lorena stoves being built in Java have evolved rapidly and radically away from the large Guatemalan designs, towards small two-burner designs. In many countries stove builders have found that the promotion of "fixed" designs over more than a relatively small geographical area is very difficult, as fuels, foods, and cooking patterns differ. Another factor that is neglected in conventional stove diffusion efforts is the tendency for trainees to continually alter the designs. Both of these factors point to the need for careful attention to the teaching of both theory of efficient stove design and simple testing techniques that reveal the effects of design changes on fuel efficiency. Without these elements in training courses, any stove design

---

\*Stove designers in Sri Lanka are investigating the use of pottery "liners" which contain all the most important firebox and tunnel dimensions for a small stove. Lorena mix is packed around the outside as insulation. If these liners prove practical in use, a single potter could "manufacture" hundreds of them at low cost.

taught becomes a fixed, sterile technology that cannot be adapted to fit new circumstances, doomed to suffer declining fuel efficiency as the distance increases from the original stove testing center.

The question of the extent to which stove training should include information on theory and testing is related to the larger issue of who "does science" and for what purposes. The development of efficient cookstoves has not been dependent on a scientific breakthrough, but simply some careful study based upon known scientific principles. Much still remains to be learned, for the problem has yet to be thoroughly investigated. Yet the world's applied science and technology skills remain in the hands of a few, and are directed towards problems unrelated to those facing the bulk of humanity. If these skills had been directed towards the real needs of most of the world's poor people, the human and environmental wastage caused by inefficient cooking fires would never have reached its present tragic level. Today, with development officers and aid agencies scrambling to combat the fuelwood crisis, the "rescue" attempt is dwarfed by the problem.

This scientific neglect itself comes as the structure of educational systems, information flow, and agenda-setting for research topics all work against the development of basic relevant scientific and technical skills among the poor of the developing countries. Denied scientific skills and without a voice in the charting of human affairs, people are hindered in any attempts to improve their technology, and offered a choice of industrial products that poorly match their needs and financial resources—and destroy the existing crafts skills. Until this strangling net has been broken and the people finally included and supported in the process of solving their own problems, the needless tragedy of human suffering and environmental destruction will reappear time after time, always dwarfing the belated solutions.

We have seen how people's participation was essential to the initial development of the Lorena stove in Guatemala. We know that people's participation in adapting improved stoves to fit their own cultural preferences and needs will be crucial in other places, as it has been in Java. And we must expect that people's participation in the identification and solution of their problems, whether technological or political in nature, is an essential, critical step in transforming rural development from a process of "fighting fires" to one of real renewal and growing vitality.

—Ken Darrow  
June 1981

## Table of Contents

Introductory Note by Erik Eckholm .....	3
Foreword .....	4
The Other Energy Crisis: Firewood .....	9
Preface .....	12
How to Use This Book .....	13
Who Is This Book For? .....	14
Building Improved Stoves .....	15
Improved Stoves and Efficiency .....	16
Design .....	19
What to find out before designing stoves .....	20
Design modifications .....	27
Stove examples .....	28
A case of design modification in Java .....	35
Construction and Use .....	39
How to build a Lorena stove .....	40
Soil tests .....	41
Lorena mix .....	45
Stove Bases .....	50
Building the block .....	52
Carving the stove .....	58
Dampers .....	64
Chimneys .....	66
Finishing the stove .....	69
Cooking .....	70
Maintenance and safety: cleaning the chimney .....	72
Useful ideas for "tuning" a stove .....	73
Troubleshooting .....	74
Possible modifications for heating indoor areas .....	76
Topics for further research .....	78
A brief history of the Lorena stove .....	79
Appendix: evaluating fuel savings and testing at the village level .....	83
Estimating fuel savings .....	85



## The Other Energy Crisis: Firewood

Dwindling reserves of petroleum and artful tampering with its distribution are the stuff of which headlines are made. Yet for more than a third of the world's people, the real energy crisis is a daily scramble to find the wood they need to cook dinner. Their search for wood, once a simple chore and now, as forests recede, a day's labor in some places, has been strangely neglected by diplomats, economists, and the media. But the firewood crisis will be making news—one way or another—for the rest of the century.

While chemists devise ever more sophisticated uses for wood, including cellophane and rayon, at least half of all the timber cut in the world still fulfills its original role for humans—as fuel for cooking and, in colder mountain regions, a source of warmth. Nine-tenths of the people in most poor countries today depend on firewood as their chief source of fuel. And all too often, the growth in human population is outpacing the growth of new trees—not surprising when the average user burns as much as a ton of firewood a year. The results are soaring wood prices, a growing drain on incomes and physical energies in order to satisfy basic fuel needs, a costly diversion of animal manures to cooking food rather than producing it, and an ecologically disastrous spread of treeless landscapes.

The firewood crisis is probably most acute today in the countries of the densely populated Indian subcontinent, and in the semi-arid stretches of central Africa fringing the Sahara Desert, though it plagues many other regions as well. In Latin America, for example, the scarcity of wood and charcoal is a problem throughout most of the Andean region, Central America, and the Caribbean...

The costs of firewood and charcoal are climbing throughout most of Asia, Africa, and Latin America. Those who can, pay the price, and thus must forego consumption of other essential goods. Wood is simply accepted as one of the major expenses of living. In Niamey, Niger, deep in the drought-plagued Sahel in West Africa, the average manual laborer's family now spends nearly one-fourth of its income on firewood. In Ouagadougou, Upper Volta, the portion is 20-30 percent. Those who can't pay so much may send their children, or hike themselves, out into the surrounding countryside to forage—if enough trees are within a reasonable walking distance. Otherwise, they may scrounge about the town for twigs, garbage, or anything burnable...

Trees are becoming scarce in the most unlikely places. In some of the most remote villages in the world, deep in the once heavily forested Himalayan foothills of Nepal, journeying out to gather firewood and fodder is now an **entire day's** task. Just one generation ago the same expedition required no more than an hour or two...

The increasing time required to gather firewood in many mountain villages of Nepal is leading to what the kingdom's agricultural officials fear most of all.

For, once procuring wood takes too long to be worth the trouble, some farmers start to use cow dung, which was formerly applied with great care to the fields, as cooking fuel. As this departure from tradition spreads, the fertility of the hills, already declining due to soil erosion, will fall sharply. In the more inaccessible spots there is no economic possibility whatsoever of replacing the manure with chemical fertilizers...

The accelerating degradation of woodlands throughout Africa, Asia, and Latin America, caused in part by fuel gathering, lies at the heart of what will likely be the most profound ecological challenge of the late twentieth century. On a global basis, an ecological threat to human well-being far more insidious and intractable than the industrial pollution of our air and water—which has preempted thinking on environmental quality—is the undermining of the productivity of the land itself through soil erosion, increasingly severe flooding, creeping deserts, and declining soil fertility. All these problems are accentuated by deforestation, which is spreading as lands are cleared for agriculture and as rising populations continue their search for firewood. Rainwater falling on tree-covered land tends to soak into the ground rather than rush off; erosion and flooding are thus reduced, and more water seeps into valuable underground pools and spring sources...

And so the circle starts to close in Nepal, a circle long completed in parts of India. As wood scarcity forces farmers to burn more dung for fuel, and to apply less to their fields, falling food output will necessitate the clearing of ever larger, ever steeper tracts of forest—intensifying the erosion and landslide hazards.

—from **Worldwatch Paper No. 1**  
**“The Other Energy Crisis: Firewood”**  
by Erik Eckholm

**Lorena Stoves**

## PREFACE

This book has been revised considerably since it first appeared (with the title **Lorena Owner-Built Stoves**) in 1979. Since that time, improved stoves have attracted a great deal of attention. Lorena stoves are now in use in about a dozen countries around the world. At the Aprovecho Institute we are learning more and more about Lorena design, and we have included as much of this information as possible in this new edition. More space has been given to describing stove designs developed in Africa and tropical Asia, in order to give the reader an idea of the range of design possibilities. Major changes have been made in the sections dealing with soil analysis and mixing. Also included is a description of the dry mix method now in general use in Guatemala and West Africa. We have made corrections where necessary and tried to make the book easier to use.

The appendix on testing is new. We have made this addition in the belief that anyone building or promoting stoves should be able to evaluate the fuel performance of both traditional and new alternatives.

To help with information exchange, Aprovecho Institute is publishing periodic reports dealing with a wide range of low-cost stoves. If you are interested in being on the mailing list, please write to us at the address in the front of this book. We would also appreciate receiving information from other people working with improved stoves. Your experiences and suggestions would be of great help.

## HOW TO USE THIS BOOK

This book shows how to design, build, and test a Lorena stove that will be fuel-efficient and reflect local conditions and needs.

It is important that you read the **entire** book several times before starting your first stove. There will probably be no actual examples of Lorena stoves in your area, and you may feel that you have little skill, but if you carefully follow the instructions you should be able to build a working Lorena stove. Keep in mind that Lorena is highly adaptable and can be modified to meet a wide range of situations. The variations are limitless.

Don't be discouraged if your first stove looks imperfect or does not work very well. Your second stove will be much better. When we first began experimenting with the stoves, we built six before we got one we were happy about. The first four cracked horribly (not enough sand) and the fifth (badly designed) burnt food in one pot and wouldn't even boil water in the second. We now have a lot of experience with Lorena stoves and this book will allow you to profit from (rather than repeat) our mistakes. You should be able to make a good stove by the second attempt.

Once the stove is built it is important to compare its performance to that of traditional methods. (In some cases "improved" stoves have turned out to be less efficient than traditional cooking practices.) The appendix on testing gives guidelines and procedures for comparing the fuel savings and efficiency of different cooking methods.

When you have finished, please read this book again. If parts of the book are not clear, please let us know. You may be able to help us improve the book.

We want very much to know about designs, innovations, and improvements that you develop. At the Aprovecho Institute we have limited testing facilities. We need information from people in other areas who are adapting Lorena stoves to fit their own circumstances. (Some suggestions for further experimentation can be found on page 78.) Let us know how useful the stoves are in your area, and how easy or difficult this book is for you to use in learning or teaching Lorena stove construction.

Apart from construction, you must learn how to cook on this stove, how to use it at maximum efficiency, and how to maintain it. The principles of cooking on this stove may be quite different from any other stove you will have used, so it will take time to work out the best possible way to use it.

### WHO IS THIS BOOK FOR?

Knowledge of Lorena stoves was initially spread through workshops conducted by Estacion Experimental CHOQUI in Guatemala and by Aprovecho Institute in the United States. Over 1000 people were trained from many different countries. Other organizations, notably CEMAT in Guatemala, have taught large numbers of people to build Lorena stoves. But many interested people are not able to come to workshops. Early articles about the stoves appeared in *Appropriate Technology Journal* (August 1977) and *Undercurrents* (#23, August 1977), and led to requests for information from over 70 countries. A brief pamphlet (in Spanish and English) was sent to many inquirers. We were pleased to hear that some people, using only the incomplete pamphlet instructions, had been able to build Lorena stoves that worked well. We felt encouraged to develop a book that would thoroughly cover theory and practice of Lorena stove construction, even though a skill of this kind is clearly learned more easily from personal instruction.

This book is intended for use by a wide variety of people. We especially hope it will be used by agricultural promoters and community development workers, who are willing to learn and then teach other people how to build Lorena stoves.

The book should be of particular interest to people working to halt the spreading firewood shortage/deforestation crisis of the Third World. One of the major causes\* of this crisis is the use of inefficient methods of burning wood for cooking. (Some reports indicate that 80% of the wood cut in the Third World is used for cooking.) If inefficient methods of burning this wood were replaced by efficient low-cost stoves, a dramatic reversal of the process of deforestation could be achieved. Experience with the Lorena stove in many places indicates that it can save up to ½ of the firewood burned in commonly used cooking systems. Promotion of fuel-efficient stoves should logically be added to reforestation and village woodlot programs.

In countries such as the United States, efficient but expensive metal stoves are increasingly being used for home heating. Here, the Lorena stove may provide an alternative that can be owner-built, without special tools, at almost no cost. The use of Lorena stoves for indoor heating is being investigated (see pages 76-77).

---

\* Other causes include population growth and unequal land distribution that forces the poor onto marginal hillsides for wood-cutting and cultivation.



## BUILDING IMPROVED STOVES

What is an improved stove? It is a tool that offers a better way of cooking for a particular area and group of people. It must be very low in cost, to be affordable to the rural poor majority in developing countries. It must use no more fuel than traditional stoves or open fires, and in most places it should use much less. People must be able to use it to cook the foods available to them, in the manner to which they are accustomed. An improved stove should fit in with (or improve) the environment of the cooking area. Its construction should rely on locally available materials, and skills that local people already have or can easily learn.

Lorena (sand and clay) stoves of many kinds have met these criteria. Lorena, in fact, should not be thought of as one specific stove design, but rather as a method of building a great variety of stoves to suit a variety of local conditions. Here are some of the advantages of this sand-clay construction approach:

- 1) It can be used to make stoves of almost any shape, size, and function, to use all sizes and types of pots, and to fit any cooking habits.
- 2) It can be used to make stoves to burn almost any fuel.
- 3) Such stoves can be built wherever there is sand available and clay in the soil.
- 4) The materials cost very little.
- 5) The method of construction requires only skills that are present anywhere that adobe, brick, mud or concrete are presently used.
- 6) The approach requires only construction tools that are found in even the poorest household.
- 7) The stoves require labor but little capital in construction.
- 8) When fitted with a chimney, such stoves can remove smoke from the kitchen.
- 9) Such stoves can heat water with waste heat that normally escapes with the smoke from the fire.

Other advantages include:

- 10) Stoves made of this material can be designed to help heat the home in cold regions.
- 11) Sand-clay stoves can be broken apart and the material can be reused to build a new stove.

Stoves made of sand and clay may be completely inappropriate for some people. Nomadic people, for example, who need a stove that is light and transportable, cannot use thick-walled sand-clay stoves. In this situation, a small metal or ceramic stove may be more suitable. **In many areas, a modification of an existing stove could bring significant improvement.**<sup>1</sup> Many of the ideas contained in this book could be used to modify traditional stoves.

## IMPROVED STOVES AND EFFICIENCY

A cooking stove contains the heat of the fire, controls the flow of air to the fuel as it burns, and directs energy from the fire to the cooking pot. "Efficiency" is a description of how well a stove performs this task. An improved stove has a greater efficiency because more of the energy of the burning fuel is made available for cooking. Here are some of the reasons why Lorena stoves can give improved efficiencies:

- 1) The thick sand-clay material keeps the firebox walls very hot, which improves the combustion of firebox gases.
- 2) The tight fit of the pots in the potholes reduces air leaks, helps prevent heat loss, and increases control over burning rate.
- 3) The firebox is designed for control of combustion processes and shaped to direct maximum heat to the pot.
- 4) A chimney and set of dampers can be used to control the air flow through the stove, for more complete burning of fuel, and to hold residual heat in the stove body.
- 5) Potholes are designed to allow the pots to sit low into the stove to capture as much heat as possible, and to avoid losing heat from the sides of the pots.
- 6) In areas where more than one pot is used, multiple cooking potholes can be incorporated to allow simultaneous cooking with heat from one fire; heat not used by the first pot can be used by the second pot, and so on.
- 7) Baffles underneath each pothole create turbulence in the flow of hot gases, so that heat is transferred more effectively to the pots; offset tunnels also contribute to this effect.
- 8) The flexibility of Lorena as a material allows stoves to be designed for maximum efficiency in many differing situations. For example:
  - a) In areas where long, slow cooking is done, the body of a large Lorena stove stores much of the heat, which can then be used for extending cooking time of slow-cooking foods or for baking, after the fire has died out. This heat will also gently heat the outer surface of the stove. In Guatemala little children cuddle up to the stove on cold mornings.
  - b) In areas where cooking is done quickly, small Lorena stoves heat up to efficient operating temperature in a short time because they have less firebox wall and tunnel surface area.
- 9) Water containers, if used, absorb some of the heat that would otherwise escape up the chimney, reducing the need for additional fuel to heat water.

**Despite all these advantages, no one should assume that a new stove design is more efficient than a traditional design, even an open fire.** Stove builders and promoters who have made this assumption often find out later that traditional cooking methods are more efficient and effective than expected. Furthermore, traditional stoves often have certain design features which would improve the efficiency of new stoves. Efficiency tests, wood consumption tests, and other simple tests can help to identify these features and indicate what kinds of new modifications might improve performance of both traditional and experimental new stoves.

---

1. For more information on these topics, see **Helping People in Poor Countries Develop Fuel-Saving Cookstoves** (page 143).

**Design**

## WHAT TO FIND OUT BEFORE DESIGNING STOVES

It is essential that the people who are expected to use the new stoves be involved in the design process. Discuss the design with them at every step. Their desires and ideas should be reflected in the stove. The design should fit the needs of the cook while being as fuel-conserving as possible.

Before designing stoves with local people, there are some basic questions you should seek answers to:\*

- What local stoves already exist? Can they be modified? Do the people have ideas which could be used?
- What sizes and types of fuel are used? Does this vary seasonally? Do people have choices or preferences in fuel?
- Everyday pots: how big are they, how many are used at one time, and are they used with lids?
- How many meals are normally cooked per day? How long are different foods cooked, in what sequence? Does this vary seasonally? Are there different foods for special occasions? If so, how often? How much heat is needed for different methods such as simmering vs. frying?
- How do people build cooking fires? Where do they build them?
- How high would they prefer a stove to be?
- Is there a need for hot water?
- What purposes other than cooking does the fire have?

As you think about designing a Lorena stove, use the principles outlined here as a basis from which new ideas may be generated. The flexibility of the lorena material allows you to build many variations of these basic designs. Here are some guidelines to follow during the design process:

1. A Lorena stove's physical strength depends on its thick-walled construction. Be aware of the minimum distances shown in the figures and table on this page and the facing page.

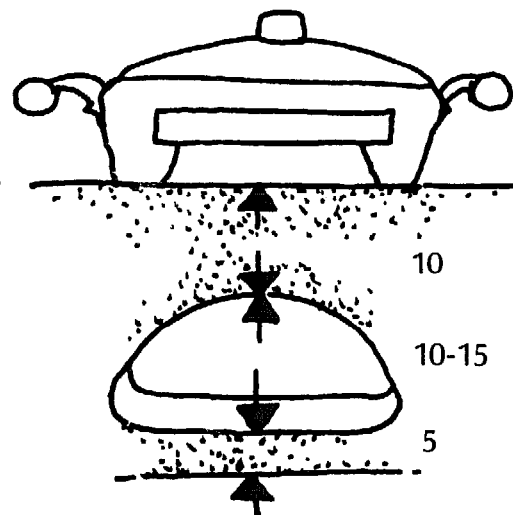

\* For more information and ideas on answering questions like these, we recommend **TransCultural Study Guide** (see page 144) and **Helping People in Poor Countries Develop Fuel-Saving Cookstoves** (see page 143).

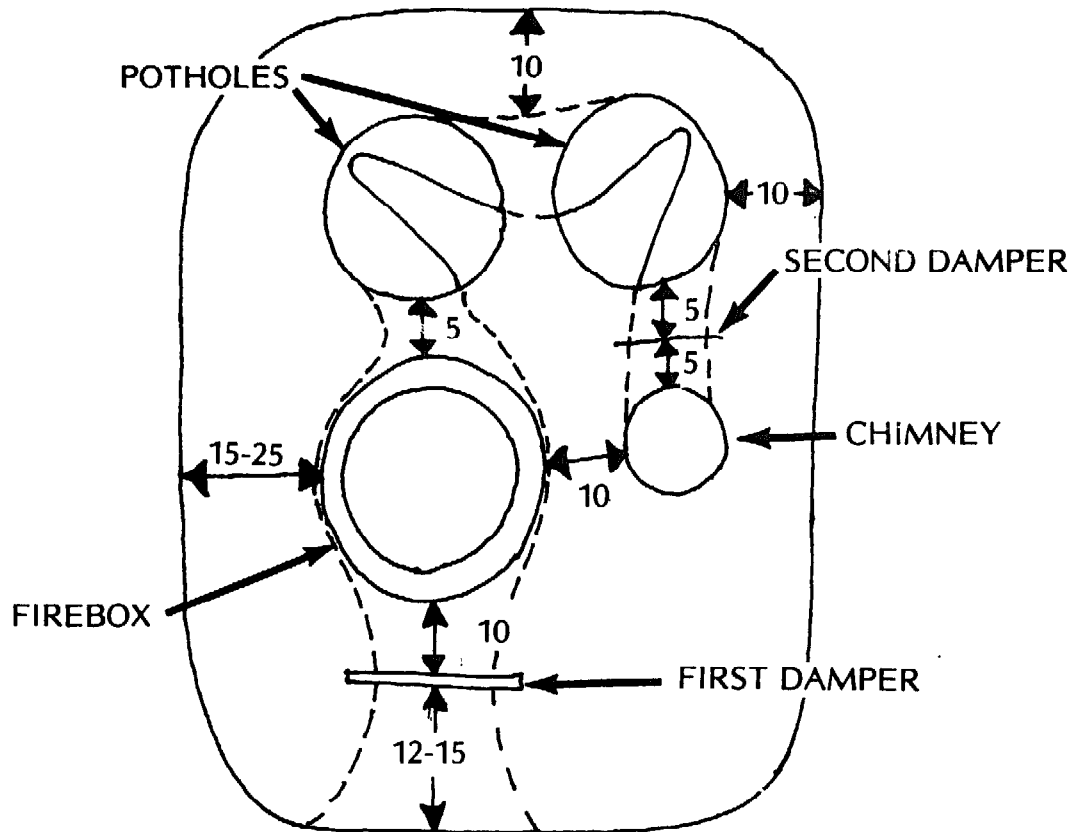

**Recommended Distance Between:**

- Mouth of firebox and first damper . . . . . 15 cm is best, 12 cm minimum
- First damper and pothole over firebox . . . 10 cm
- Firebox and outside edge of stove . . . . . 15 to 25 cm
- Two potholes . . . . . 5 cm minimum
- Tunnel and outside edge of stove . . . . . 10 cm minimum
- Pothole and outside edge of stove . . . . . 10 cm minimum
- Chimney and firebox . . . . . 10 cm minimum
- Second damper and pothole . . . . . 5 cm
- Second damper and chimney . . . . . 5 cm
- Top of firebox entrance and top of stove . . . 10 cm minimum
- Bottom and top of firebox entrance . . . . . 10 to 15 cm, depending on whether dampers are used and height of chimney
- Bottom of firebox entrance and base . . . . . 5 cm minimum, unless base is not flammable.

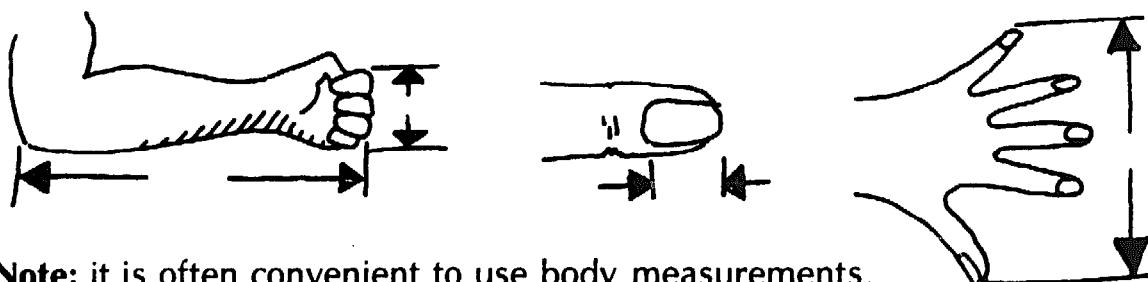

**Note:** it is often convenient to use body measurements. This saves the trouble of searching for rulers.



2. The dimensions of the firebox are very important. The distance between the bottom of the first pot and the bottom of the firebox should be between 12 and 22 cm. A distance of less than 12 cm does not allow good combustion.

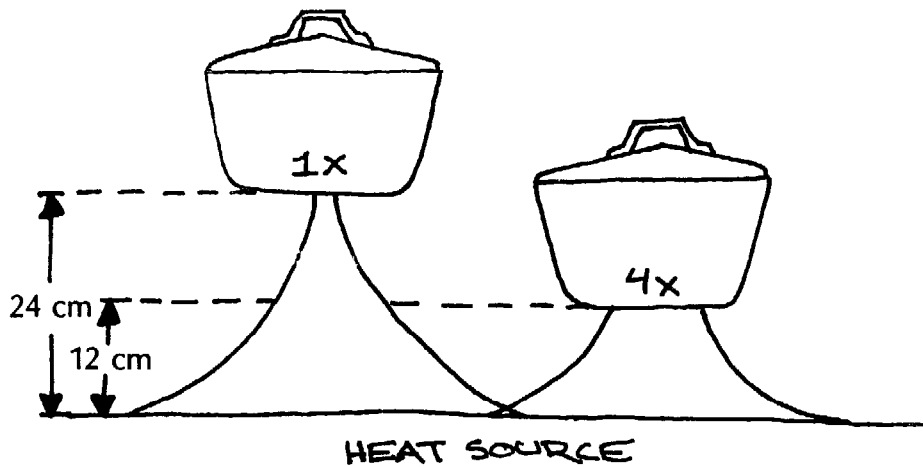

4 TIMES AS MUCH RADIANT HEAT REACHES THE POT  
CLOSER TO THE HEAT SOURCE

Several considerations affect the choice of firebox height:

- Low fireboxes (12-15cm) are more important where cooking time is longer (soups, grains, etc.). The short distance ensures that the coals are close to the pot for good radiant heat transfer. (By doubling the distance you would lose 75% of the radiant heat from the coals.) Stoves with medium or high draft need low fireboxes because flames and hot gases tend to be drawn away from the first pot by the draft.
- Higher fireboxes (up to 22cm) seem to work best where cooking is quick. The large firebox makes starting the fire easy, and cooking is done by flame contact and convection rather than radiation from coals. High fireboxes work best in stoves with low draft, as high draft would draw the flame and gases away from the pot before substantial heat could be transferred.
- The firebox should not be wider or much longer than the first pot. This keeps the fire directly under the pot.

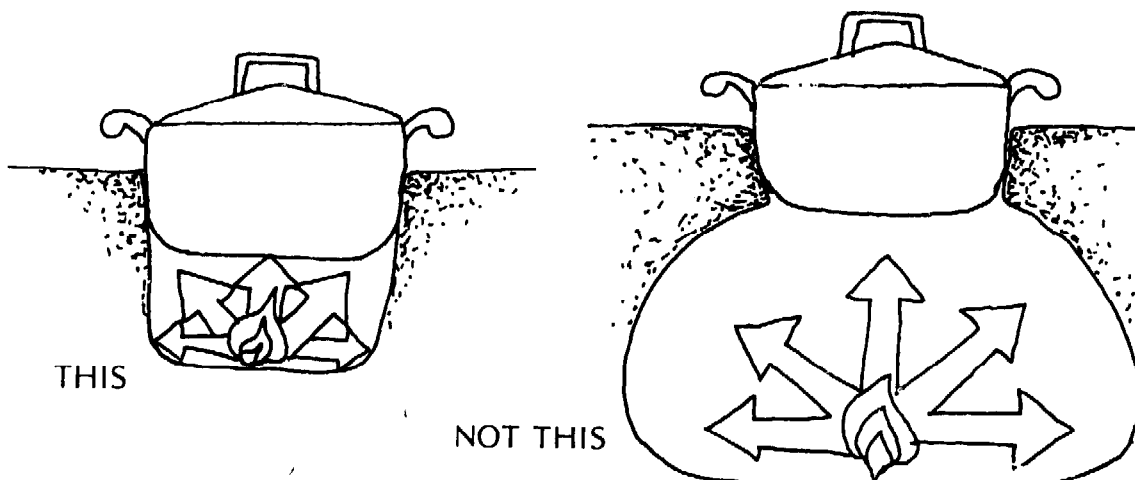

These guidelines could mean that the size of wood used in a particular area will not fit all the way into the firebox; wood may have to be cut or split to be used. This point should be discussed with the people who will use the stove, as the time or the tools may not always be available.

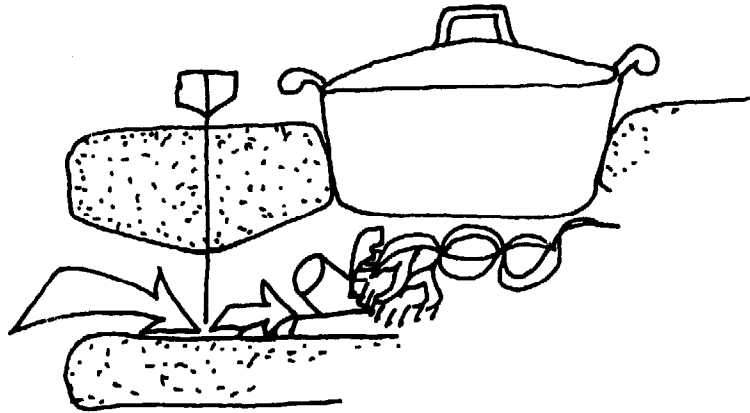

DAMPER DIRECTS  
AIR TO COALS

3. Dampers can improve the efficiency of most stoves. The first damper, in front of the firebox, controls the amount of air reaching the fire. When it is almost closed, it directs the air to the coals where it is best utilized. (Air entering the firebox without a damper may cool the flames or the bottom of the first pot.) The second damper, at the very end of the tunnel system, is used to prevent heat from escaping up the chimney during slow cooking, to seal up the stove for overnight heat retention, and to reduce overall draft through the stove. Dampers are most important in stoves with tall chimneys and high draft, where some control over the flow of air is essential.

In certain situations, however, dampers may present problems.

- Metal to make dampers may be expensive or hard to come by.
- Metal dampers may corrode.
- Damper slots may wear out to the point of making dampers ineffective, or weakening the stove.
- There may be problems with incorrect use.

Dampers are useful tools, but they are not applicable in every situation. If the draft of the stove is low, metal is hard to get, or people do not easily understand the proper use of dampers, it may be better not to use them.

4. A chimney should be used where smoke in the cooking area is a problem or when high draft is required. High draft is needed to burn certain fuels and to draw air through a large stove (having more than 2 potholes). On smaller stoves, the last pothole is where the smoke escapes.

5. The pot needing the most heat should be placed above the firebox.

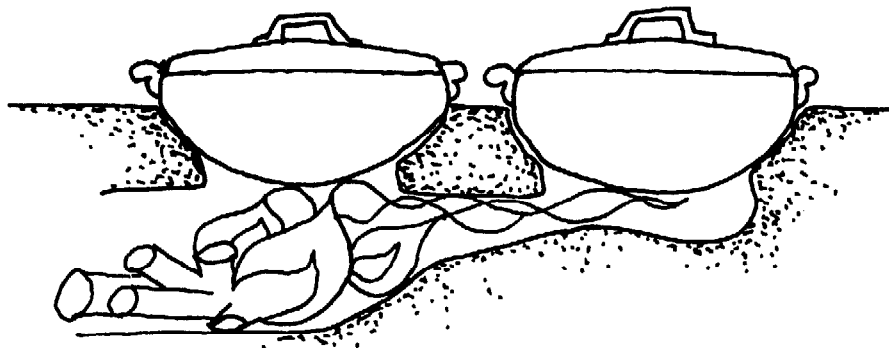

SECOND POTHOLE  
CLOSE TO FIREBOX

6. If you are designing a stove that has a second or third pothole, these should be as close to the firebox as possible. This allows a greater quantity of heat to be transferred directly to the pots rather than into the stove body.

7. The tunnel out of the firebox should exit at the rear, not from the side. This allows for even burning of the wood while providing the pots with good exposure to the hot gases.

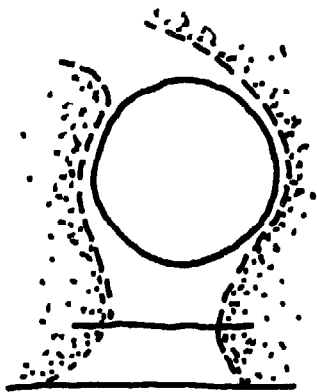

THIS

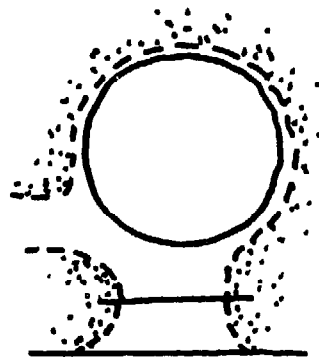

NOT THIS

8. In stoves with third or fourth potholes for warming food or heating water, potholes should be located at bends in tunnels. This creates turbulence which increases the transfer of heat from hot gases to the pots.

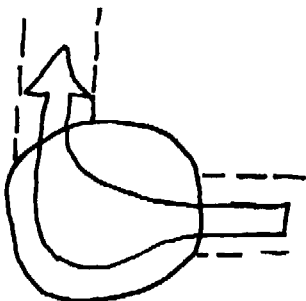

THIS

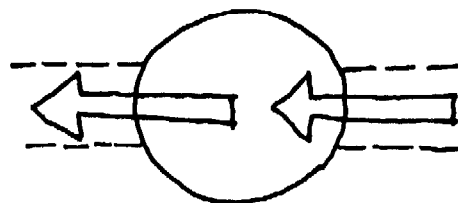

NOT THIS

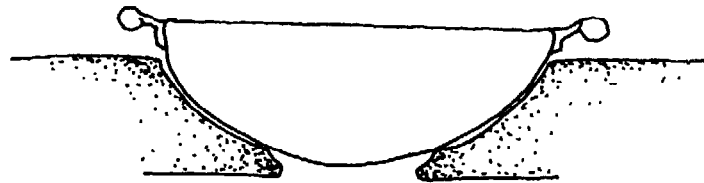

A POTHOLE  
WHICH FITS  
A VARIETY  
OF POTS

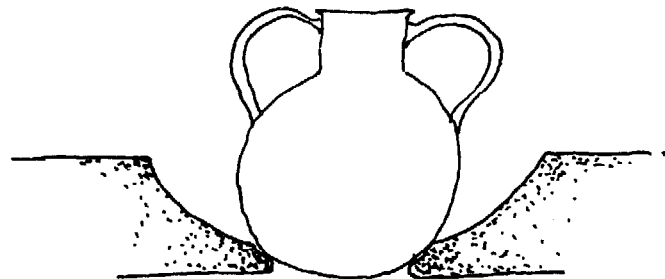

9. Potholes can be made to fit a variety of pots. This is most important for the pothole over the firebox. Different potholes can also be made to fit the same pot. This makes it possible to switch a pot from hole to hole in order to adjust the amount of heat it receives.

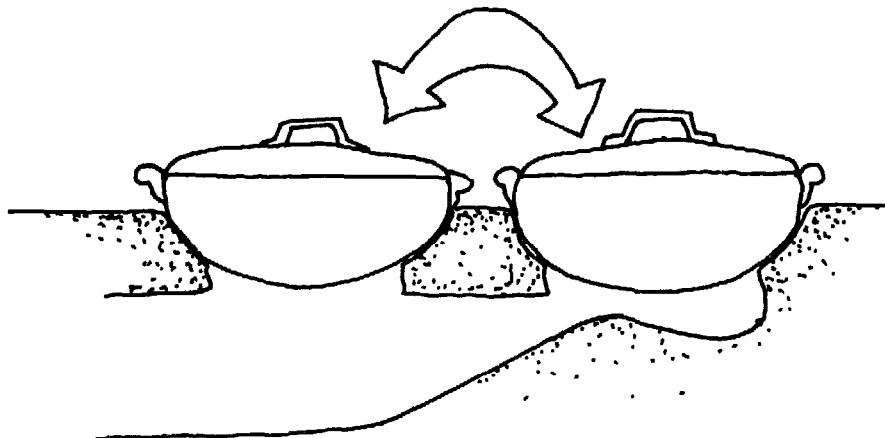

DIFFERENT POTHoles  
CAN FIT THE SAME POT

10. It is often convenient to provide a working surface for food preparation. This is especially desired in homes lacking kitchen furniture. A large stove top will have more usable working surface if the potholes are clustered tightly together.

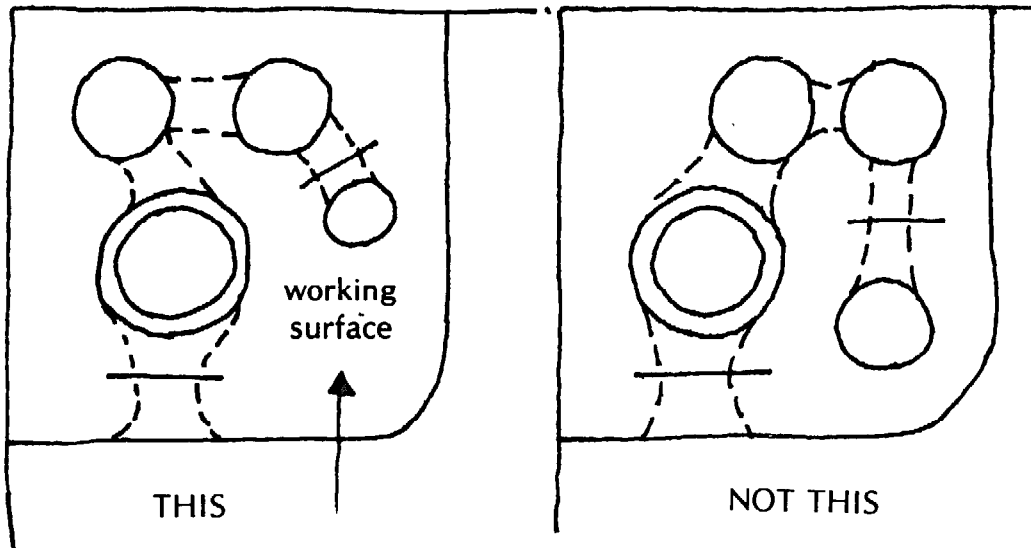

11. Make sure the chimney is out of the way and all pots can be reached easily by the cook. Be aware that left and right handed people have different access requirements.

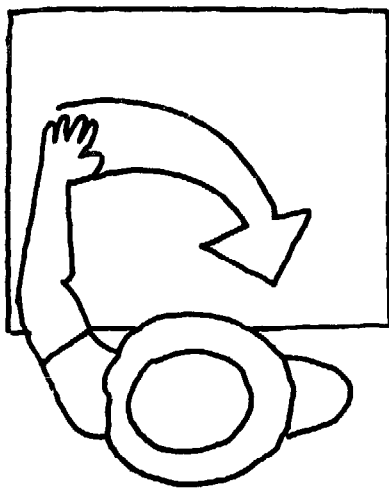

LEFT HANDED

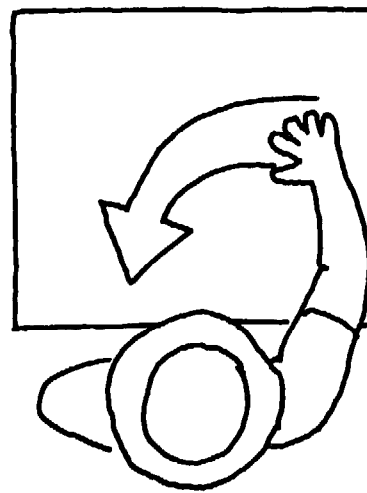

RIGHT HANDED

12. A water heater can be included in the stove design. A pot with a lid can be sunk deeply into the stove right after the last cooking pothole. It will absorb otherwise wasted heat before this heat escapes up the chimney pipe. A good enamelled or ceramic container is the best choice. The major problems with such water containers come from high creosote condensation from gases, which results in tunnel blockage and/or pots sticking to the stove body. Pots need to be removed occasionally to clean out the tunnel beneath them.

## DESIGN MODIFICATIONS

We believe that the following features of Lorena stoves **can** be modified:

1. Stove size, shape and height.
2. Number and size of potholes.
3. Chimney diameter, length and material.
4. Materials for the base.

There are, however, also features of Lorena stoves which we believe **cannot** easily be modified. Pay careful attention to planning and construction of these features:

1. There should be baffles to direct hot air against the bottom of each pot.
2. The firebox damper slot, if used, should be the proper distance from the front of the firebox opening.
3. The distance from the bottom of the firebox to the bottom of the pot over the firebox is critical.
4. The stove will always need a chimney if a long tunnel system is used.

At this point you should be able to work out a basic design for your stove. One of the best ways to design a particular stove is to sit down where it is to be built and draw the plan directly on the floor. The stove should be located where it will be easy to use and, in the case of chimneyless stoves, where smoke will not cause problems (i.e., on the downwind side of the house). Bring out the pots that are to be used on the stove; note which pots need the most heat and in what sequence they are used. The pots should then be arranged using the guidelines listed earlier.

On the following pages you will find sample stoves from several countries, and a case study illustrating how designs developed in one area can be tested and modified to better suit practices and conditions in another area. Use them to think about the stove you want to build, and to give you other ideas.

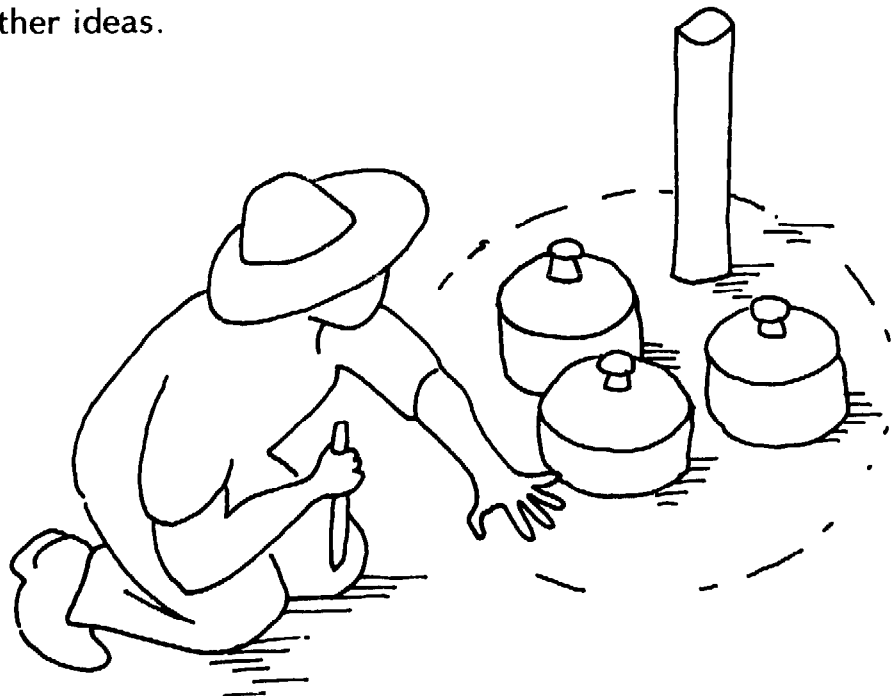



STOVE EXAMPLES

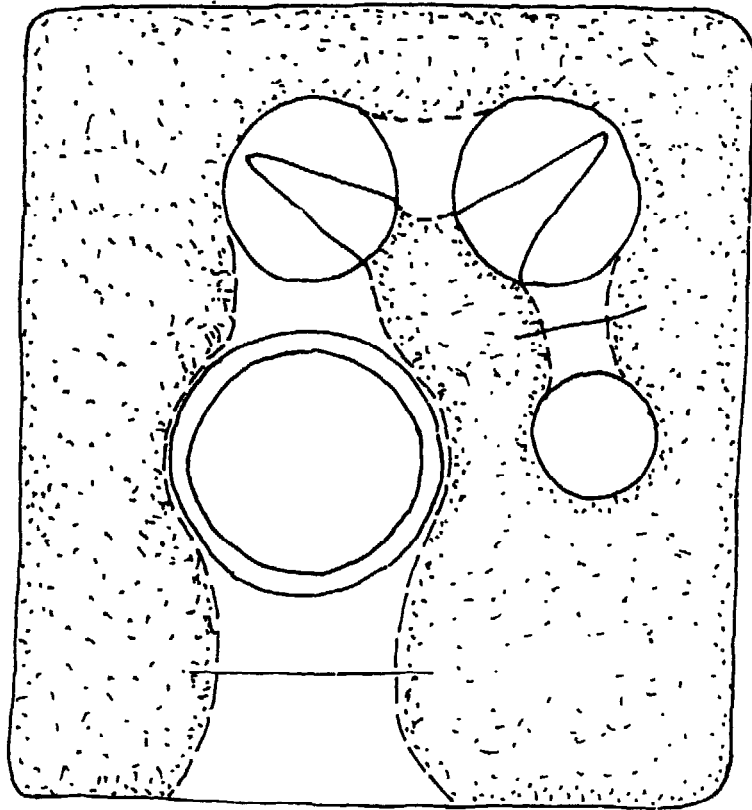

Guatemala

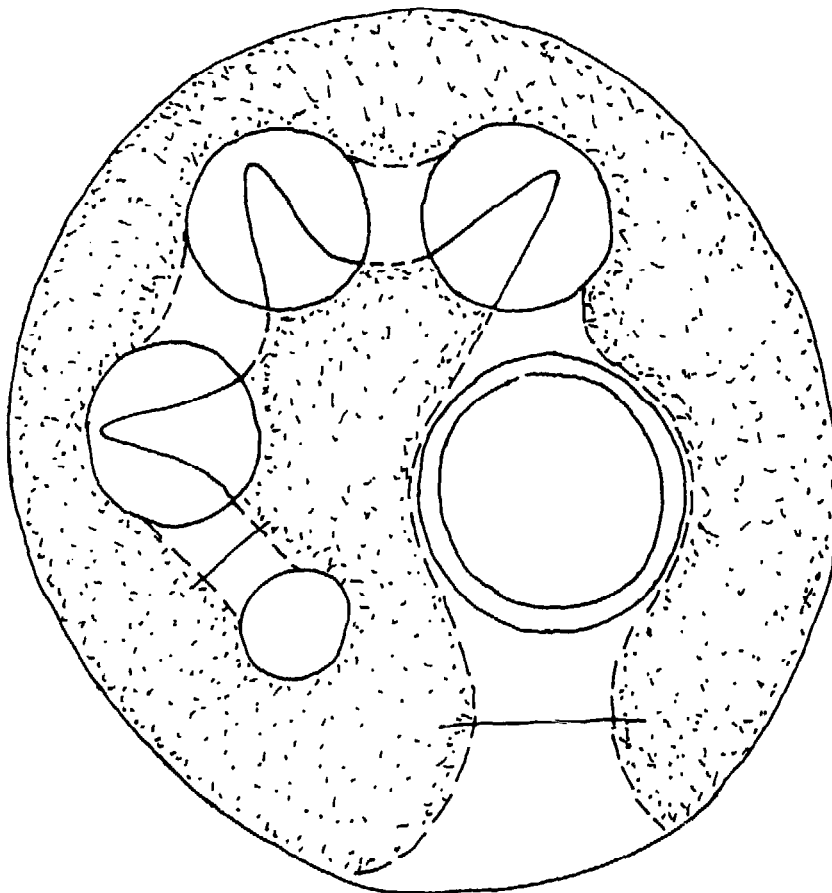
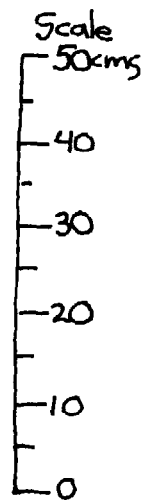

Guatemala

1. **Guatemala:** Slow cooking in several pots requires a stove with 2 or more pot holes, an effective damper system, and a chimney. Note the sharp bends in the tunnel to create turbulence under the pots. The large size of this stove allows food preparation on the stove top surface.

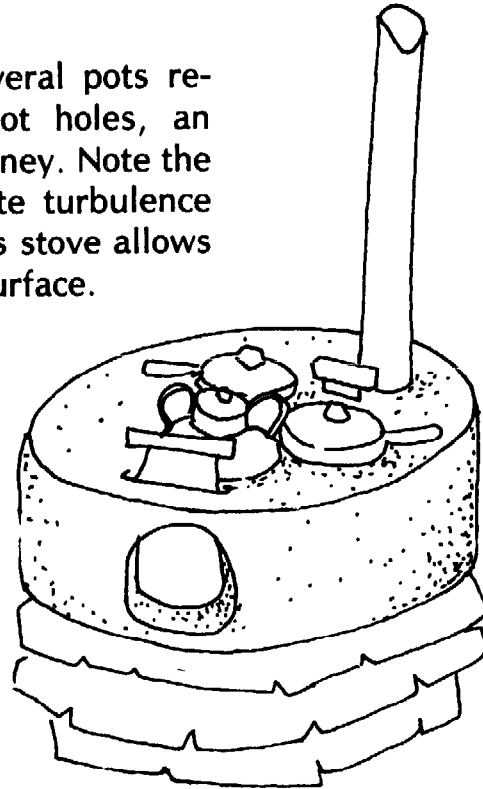

Guatemala

2. **Nepali:** A variation of a Guatemalan lorena showing the influence of the Indian Hurl Chula. It has a tiny firebox and appears to be well-adapted to the small pieces of wood commonly used as fuel in Nepal.

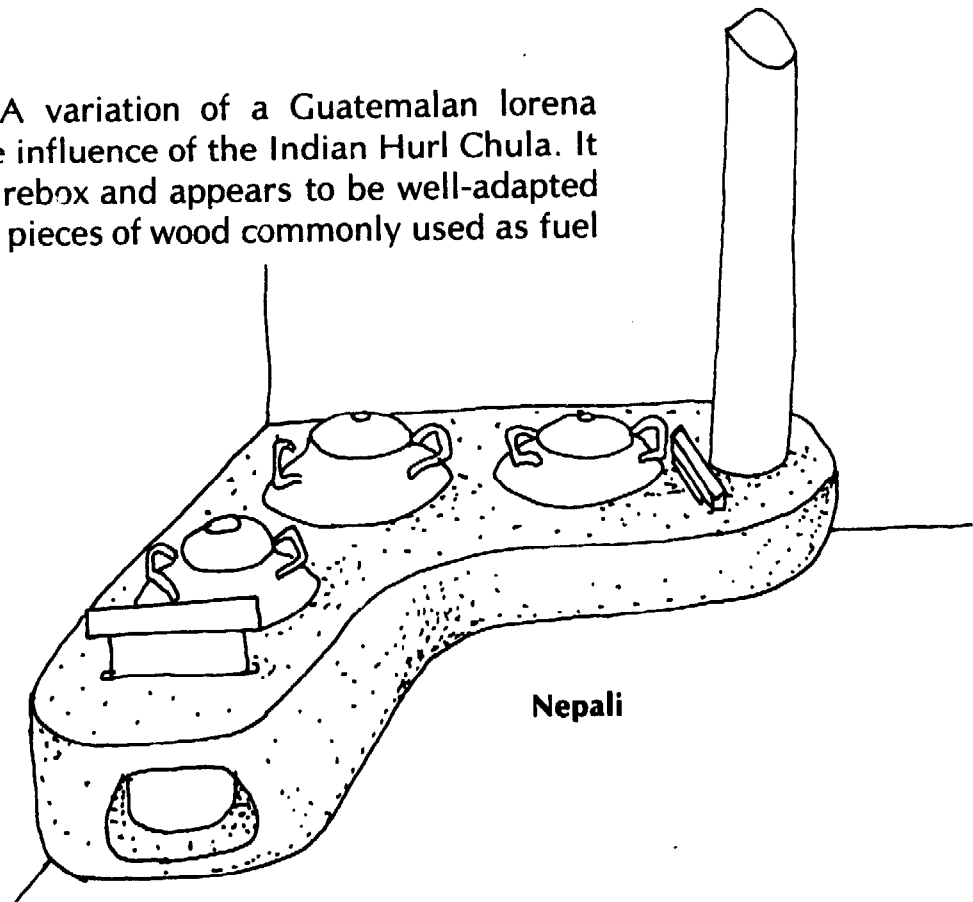

Nepali

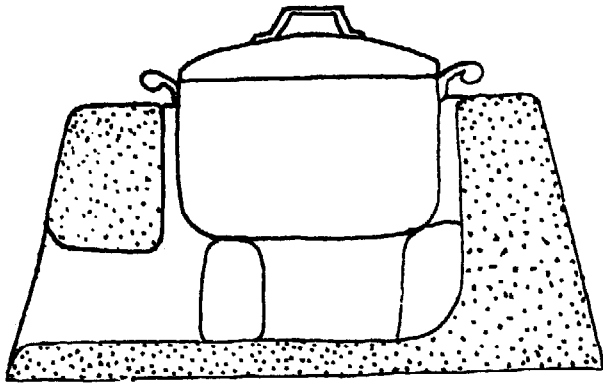

Louga (cross section)

3. **Louga (Senegal):** The single pothole of this outdoor stove also acts as a chimney. Smoke escapes through a narrow gap all around the pot, heating its sides. The small firebox entrance prevents too much air from reaching the fire. The stove is built using the pot itself as a form. The lorena material is packed around it, then carved out a little more to make the smoke passage. The pot rests on supports, which may be rocks or small cans.

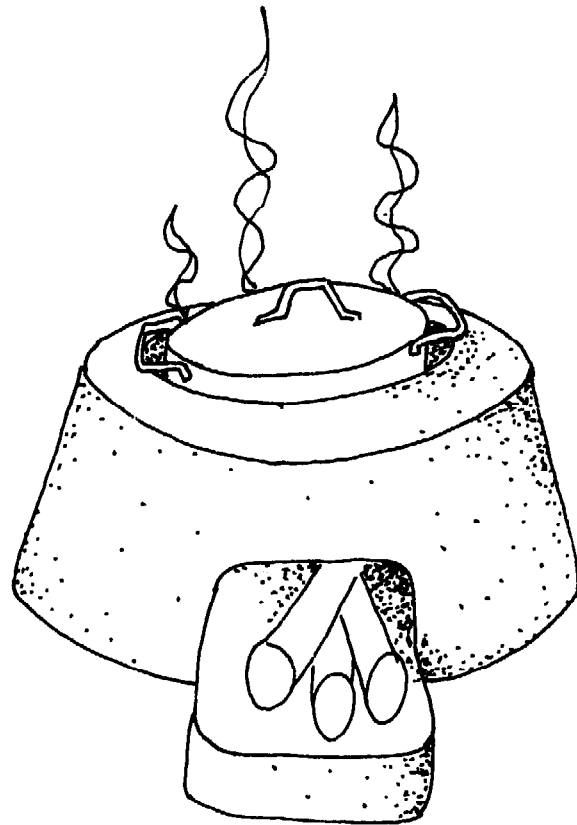

Louga

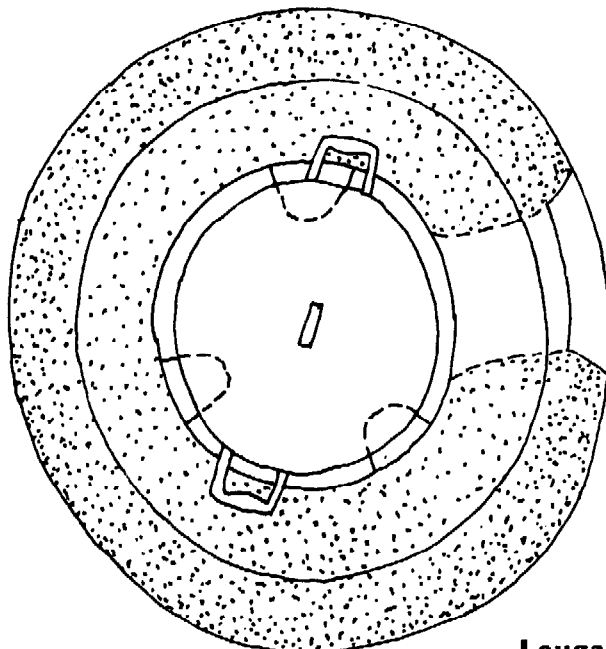

Louga (top view)

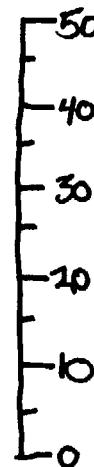

4. **Twin Fireboxes (Senegal):** This simple stove without dampers allows cooking over one or two fires. It might be a good design to introduce in an area without traditional stoves. After people have become accustomed to cooking on a simple stove, a more sophisticated design with dampers might be introduced.

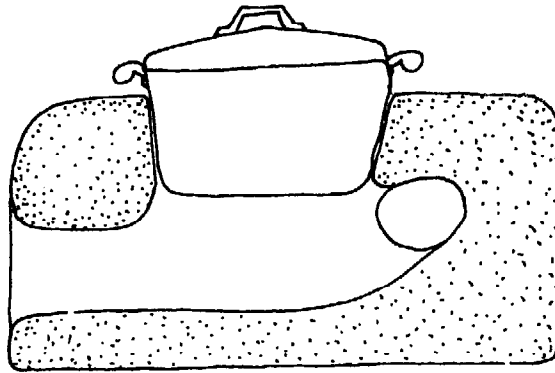

**Twin Fireboxes (cross section)**

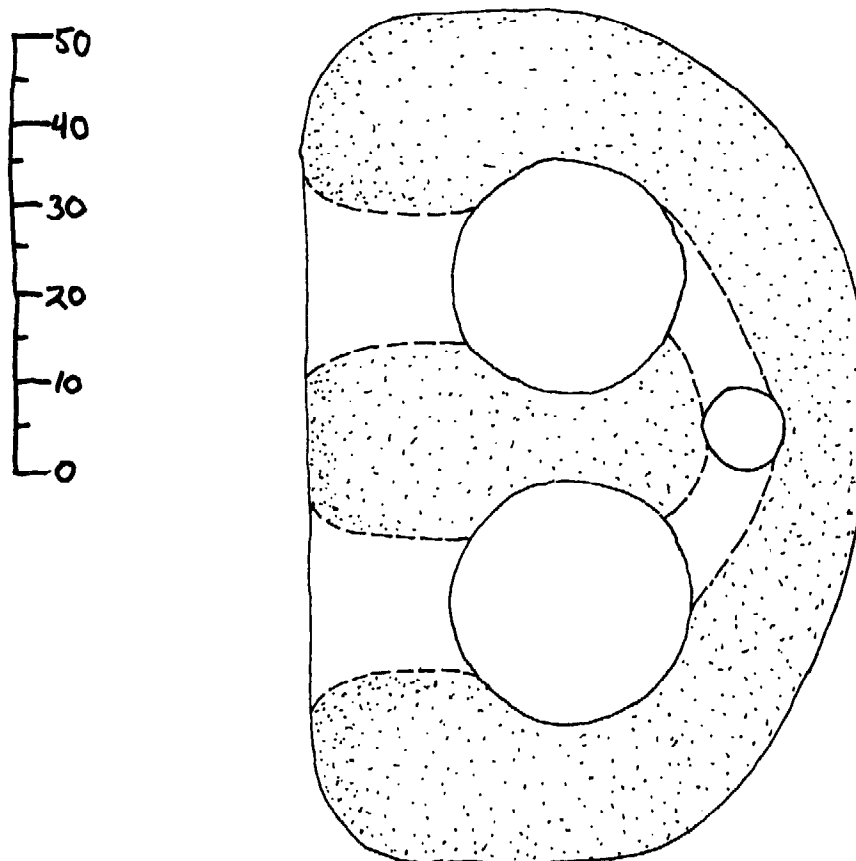

**Twin Fireboxes (top view)**

5. **Upper Volta Guitar Stove:** Another lorena adaptation for cooking out of doors in an area with scant rainfall. Smoke escapes around the elevated second pot, which acts as the chimney.

Upper Volta Guitar (top view)

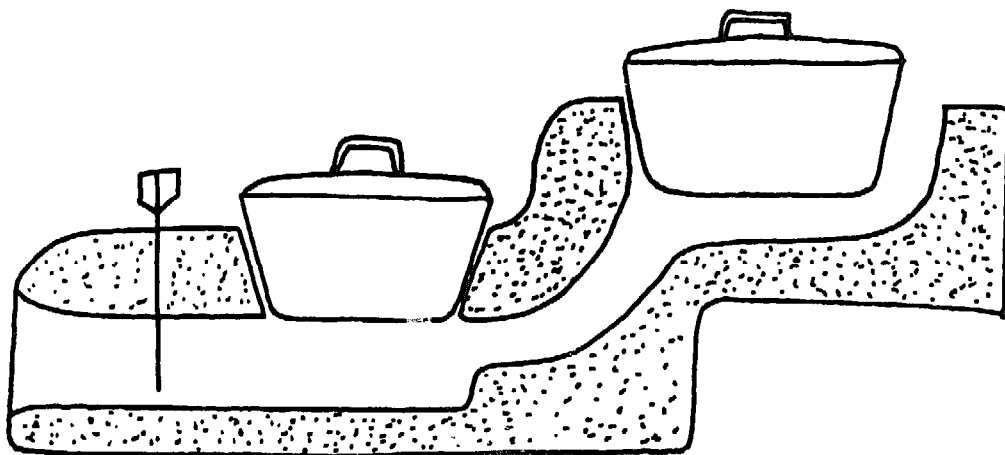
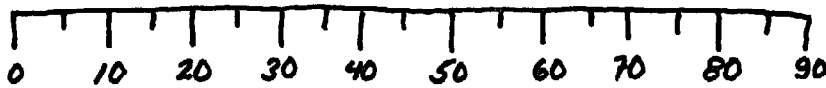
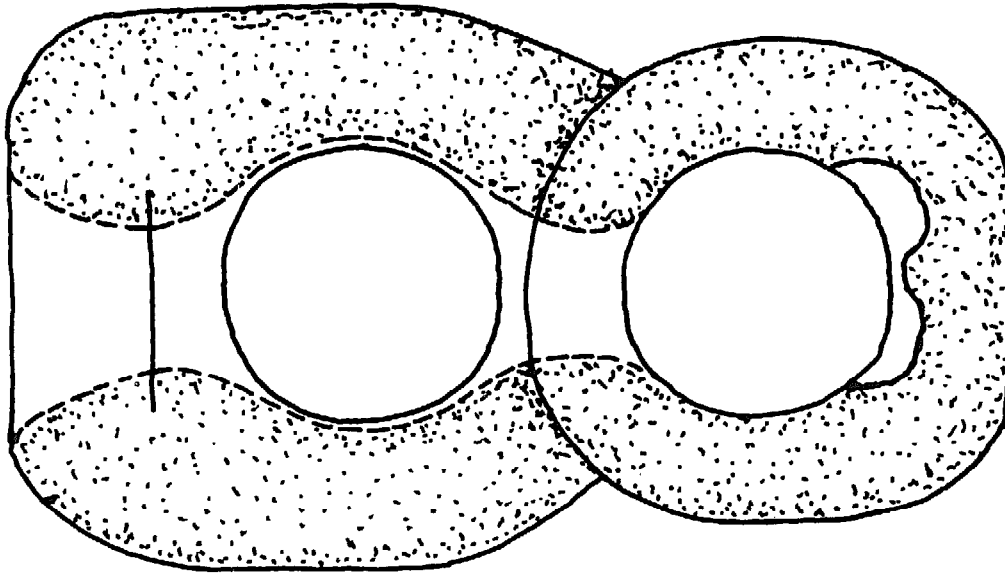

Upper Volta Guitar (cross section)

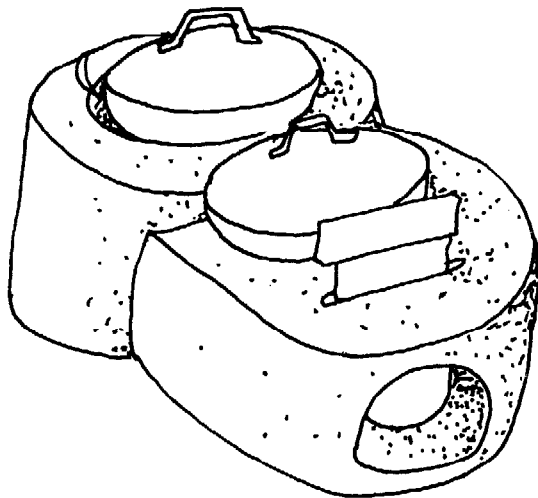
**Upper Volta Guitar**

6. **North American Heating Stove:** This stove has a large firebox which takes more wood in bigger pieces. This means that the stove requires less frequent stoking. Heat is released from the long tunnel into the bench. Because it heats so slowly, this design would not provide very much warmth except in a well-insulated house. The two cookholes shown are optional.

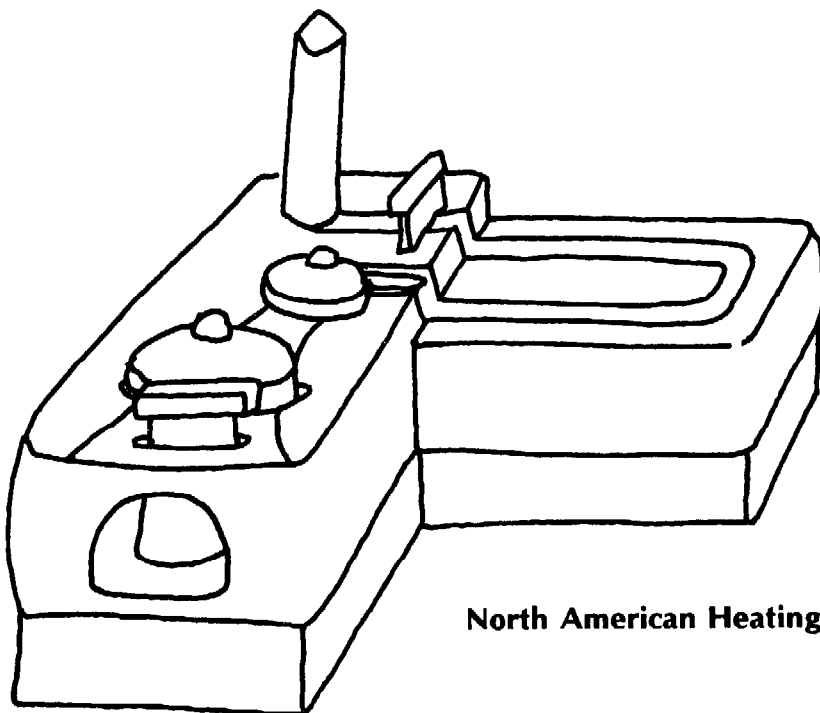
**North American Heating**

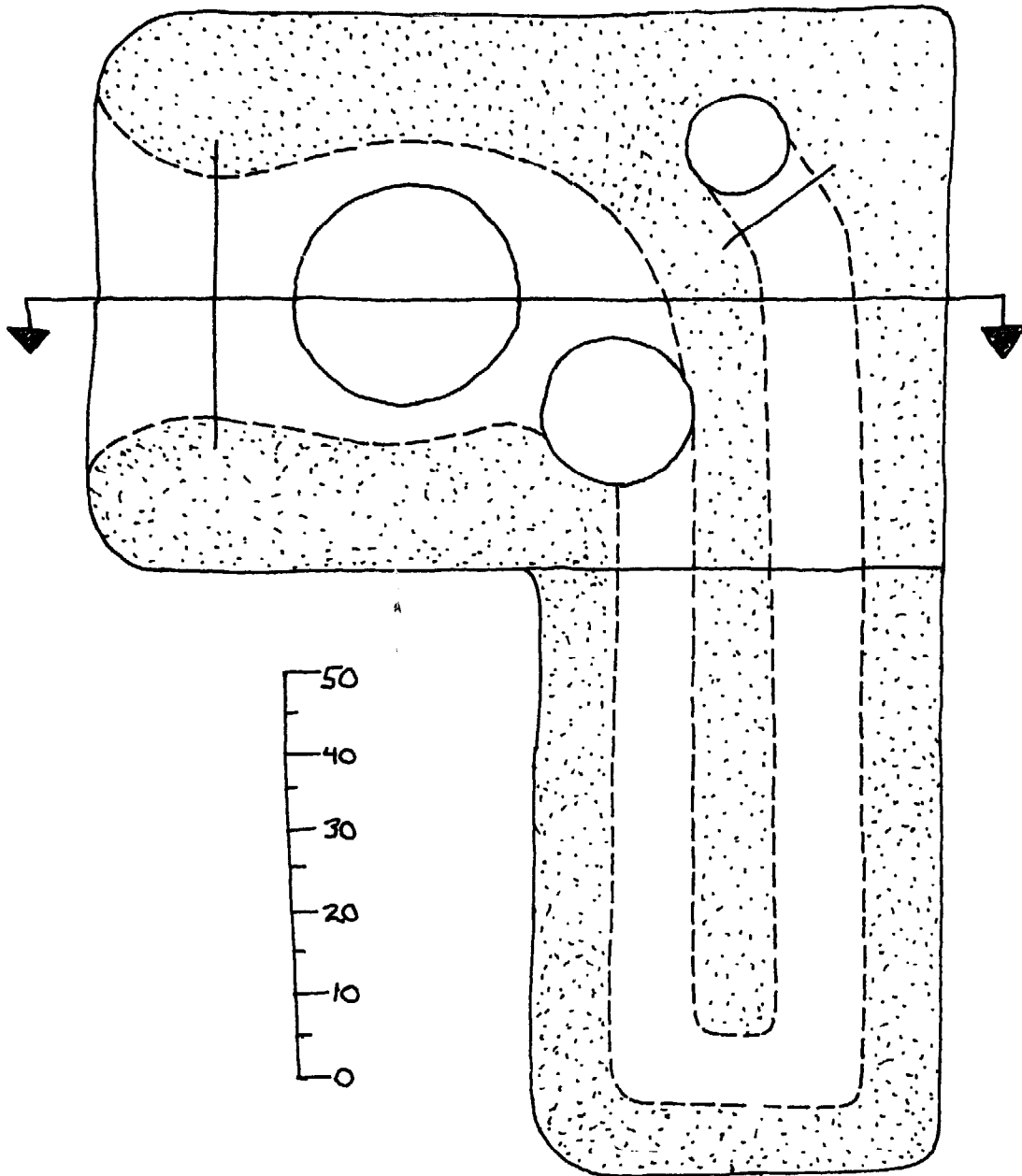

North American Heating (top view)

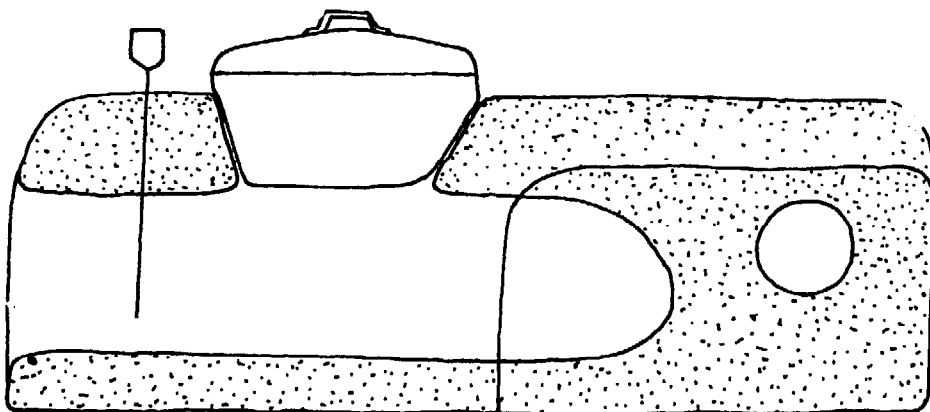

North American Heating (cross section)

## 7. A Case of Design Modification in Java:

Workers at Dian Desa, an appropriate technology group in Central Java, Indonesia, began building large Guatemala-type Lorena stoves (see picture on page 116) in villages near the city of Yogyakarta in late 1978. Many of these stoves were soon abandoned, and cooks returned to using their traditional stoves made of mud and slabs of local rock. Among the reasons for failure of the Lorena stoves, the most important seemed to be:

- Careless stove construction. Fuel consumption and efficiency tests (like the tests in this book—see appendix) confirmed that incorrectly-placed potholes, chimneys and tunnels, and damper systems that did not work, all contributed to poor performance in many of the new Lorena stoves built by local cadres. In fact, these new stoves sometimes performed less well than the traditional stoves.

- Reducing wood consumption did not seem to be an important goal for families. Wood gathering was an established habit; stove workers felt that local people did not relate their own level of wood consumption to advancing deforestation.

- Local people seemed far more interested, instead, in whether the stove was suited to their food preparation practices. People needed fast, hot fires for the quick frying and boiling of soybean cake, rice, and vegetables (typical of the afternoon meal). The Guatemala-type Lorena stove, however, was developed for slow cooking over long periods; it seemed suitable only in wealthy homes or kitchens where cooking was done for many people, many hours at a time.

These experiences with Guatemala-type Lorenas caused Dian Desa stove workers to question the usefulness of the new technology in that form. They tried to identify useful features of the traditional stoves and other locally-made stoves, and began to

experiment with small Lorenas combining the advantages of lorena material and reduced size for fast cooking and quicker heat-up time.

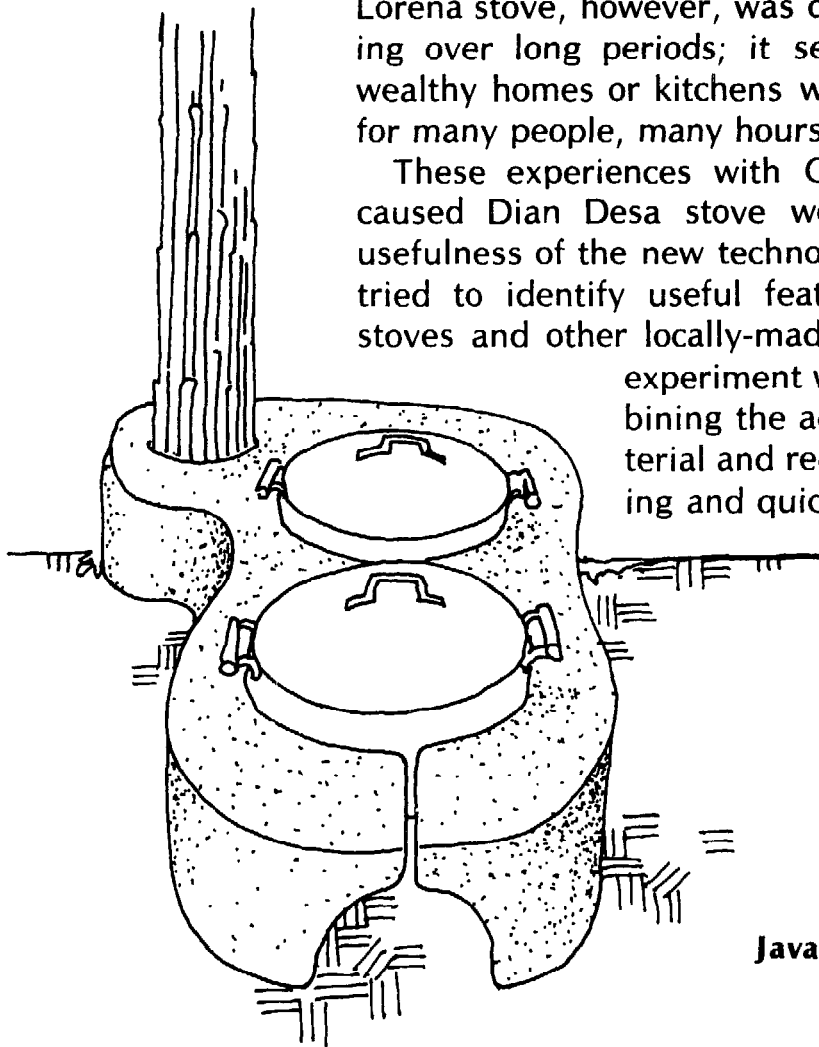

Java Stove with chimney



The resulting designs are for cooking in two pots, although sometimes these Java stoves are built with a third warming pothole. The walls of these stoves are thinner than the Guatemalan stoves, so that the stove block heats up to efficient temperatures faster. No dampers are used; to ensure the correct amount of draft, the firebox door is carefully carved to a height of 15 cm and a width of 10 cm, and tunnels are carved to 11 cm diameter (from the firebox to the second pothole) and 8 cm diameter (from the pothole to the chimney). For models without chimneys, airholes about 3 cm in diameter enter the firebox from each side of the stove block to provide increased draft.

These stoves are usually built directly on the kitchen floor, in keeping with the squatting posture in which most cooking is done. The kitchen floor is often dug out slightly below where the firebox will be, leaving room for 3-5 cm of lorena material between the firebox and the floor.

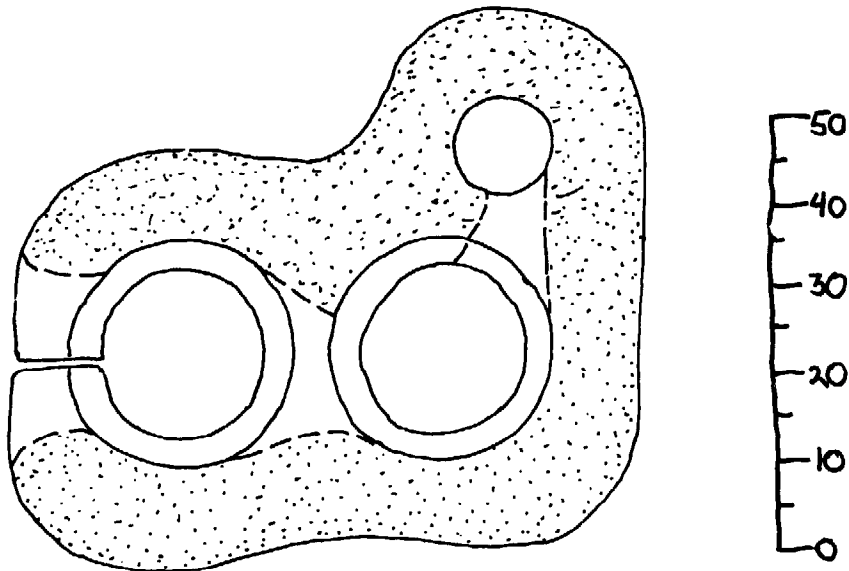

Java Stove with chimney (top view)

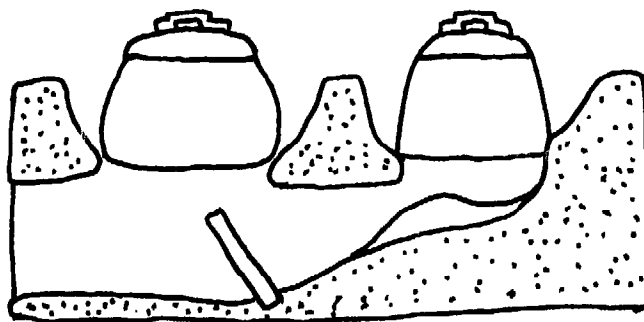

Java Stove with chimney (cross section)

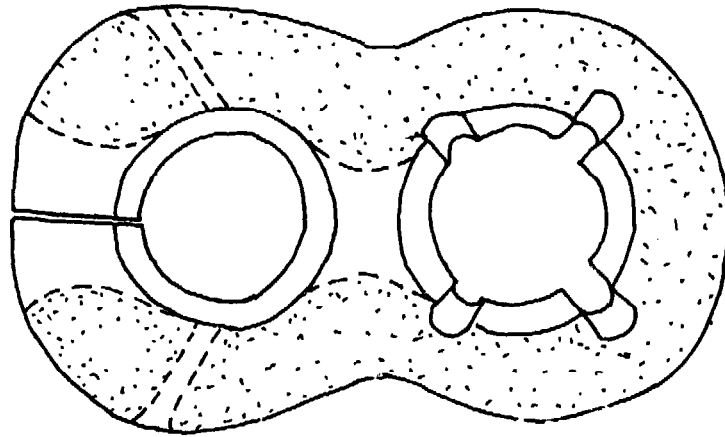

**Java Stove without chimney (top view)**

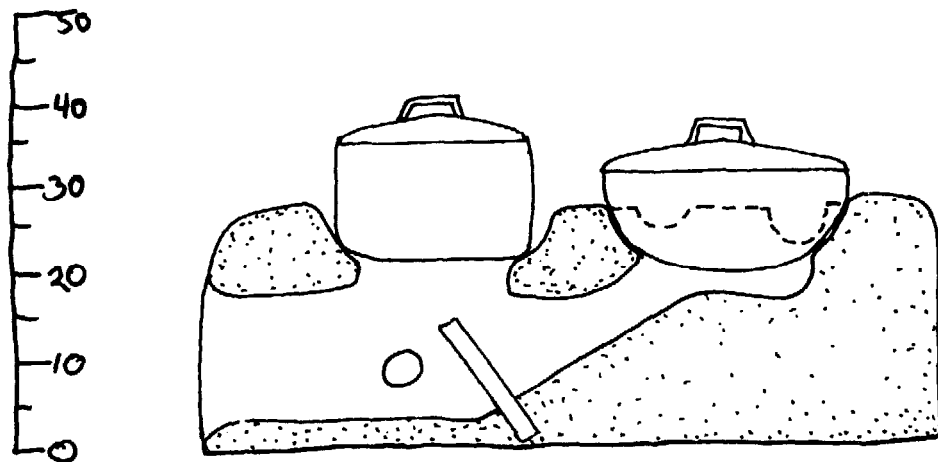

**Java Stove without chimney (cross section)**

The drawings show a piece of material which will not burn (a roof tile or other piece of fired clay material is suitable) set in the floor of the firebox. The function of this "deflector" is to confine the fire to the area of the firebox directly under the pot, and direct the flames upward so that they lick the pot bottom. This means that more heat is delivered to the first pot than would be the case if the deflector were not used.\*

Most Javanese Lorena stoves have been made without this deflector in the firebox. If it is to be used, it should be fitted into the firebox floor while the lorena material is still wet. If pieces of scrap metal are fitted into the wet lorena to support each side of the deflector, it can be removed and

---

\* The movement of flames in fireboxes with and without these deflectors can be studied through a heat-resistant glass dish. See page 73.

replaced as needed, and will not be loosened when bumped with large wood pieces. It should be placed at an angle of about 45 degrees to the floor of the firebox, and its upper edge should reach about 1/3 of the way across the pothole.

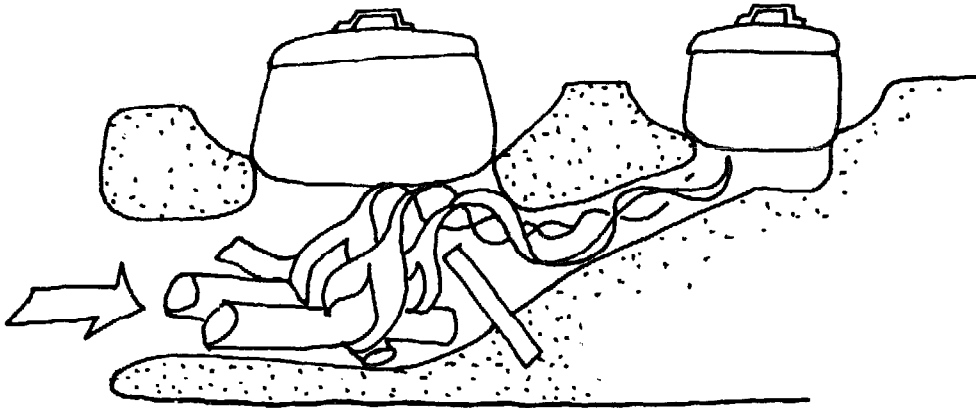

DEFLECTOR DIRECTS FLAMES  
AGAINST POT BOTTOM

## **Construction and Use**

## HOW TO BUILD A LORENA STOVE

This book describes in detail the following steps for building a Lorena stove:

- 1) Choosing the right soil, making sure it has enough clay (a clay that hardens when burned);
- 2) Making the lorena mix;
- 3) Making test blocks;
- 4) Building a solid stove base of rock, adobe, or other material;
- 5) Building up layers of lorena;
- 6) Trimming the lorena mass and smoothing the top, repairing cracks;
- 7) Marking potholes, damper slots, and chimney on the stove top;
- 8) Cutting damper slots, digging potholes and tunnels;
- 9) Completing tunnels, potholes and firebox; fitting pots, finishing sides and top, making repairs;
- 10) Making baffles;
- 11) Making and installing dampers and chimney;
- 12) Finishing the stove and choosing protective coatings;
- 13) Starting the first fire;
- 14) Learning to cook on the stove.

### Tools Needed

Shovel or big hoe for mixing  
Large metal spoon for carving tunnels  
Machete or big knife  
Masonry trowel (optional)  
Screen for sifting soil (optional)

### Materials Needed

Clay soil  
Sand  
Water  
Scrap sheet metal or metal cans for dampers (if used)  
Bricks, blocks, rocks, or adobes for base

## CHOOSING THE RIGHT SOIL

The lorena mix needs only two ingredients (plus water):

1. a lot of sand to form the mass of the stove; and,
2. a little clay to glue the sand mass together.

The secret of the lorena mix is that it is **mostly sand**. Sand doesn't shrink when it dries because the individual grains of sand are rigid and hold each other apart. The clay is the glue needed to hold the sand grains together.

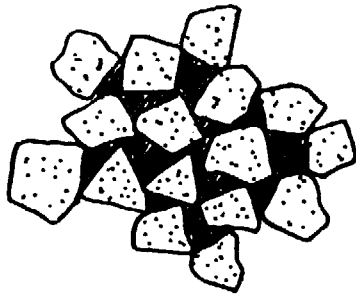

SAND GRAINS BIND TOGETHER. CLAY SHRINKING CAN'T SHRINK THE WHOLE MASS.

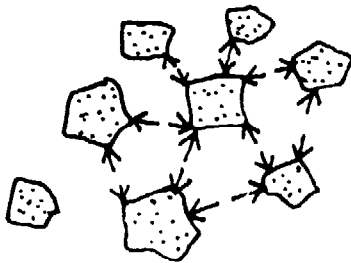

SAND GRAINS APART LEAVE ROOM FOR CLAY TO SHRINK ALONG ARROWS.

### Sand

Almost any sand will work, but sand composed of rough, angular grains is preferable to round, smooth sand. This gives the clay a better surface to stick to. It helps to run the sand through a 5 mm (3/16") screen, if available. (Larger pebbles may cause problems in carving.) Beach sands should be washed with fresh water to remove salt.

### Clay

The soil used should be of a high clay content. 60% or more clay is ideal. Pure clays have been found to work quite well. Avoid silty soils whenever possible. Silt may prevent the mix from binding together. Remove sticks, roots, and rocks bigger than 5 mm as they may cause problems during carving.

Good clays are sometimes harder to find than sand. The best way to find them is to ask local people who work with soil. Brick or adobe makers, well diggers, and especially potters are invaluable resources in locating clay soils. In many areas clay can be found just under the topsoil (which may

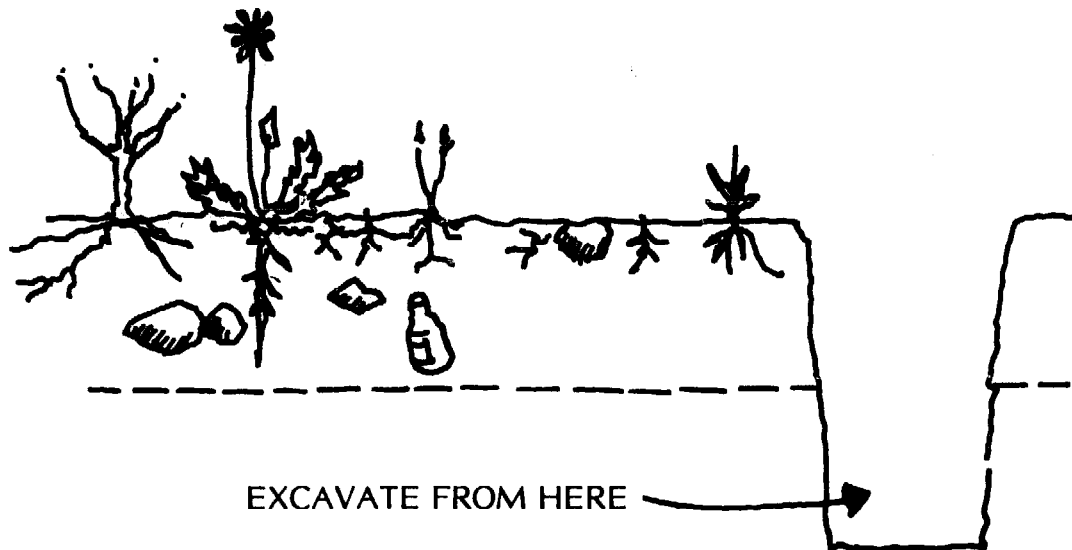

vary from several feet in the tropics to a few inches in dry regions). Road cuts and freshly dug wells can sometimes provide easy access to clay.

### Identification of Clay Soils

Because it is important to find a good clay soil, the following tests are recommended. Before testing, all soils should be free of organic matter, rocks and pebbles. Care should be taken to crumble apart any lumps of soil to obtain a homogeneous mixture.

**A. Feel Test.** The way the soil feels in your hands can give a rough indication of its composition. Clay soils feel sticky and greasy when slightly wetted. Sandy soil feels gritty. Silty soil leaves a talc-like, powdery residue on your hand when dry. When wet it will not stick to your fingers.

**B. Bite Test.** This is a quick and useful way of identifying sand, silt or clay. Take a small pinch of the soil and grind it **lightly** between your teeth. Identify the soil by the way it feels:

- 1) Sandy Soils—The sharp, hard particles of sand will grate between the teeth and will create an unpleasant feeling. Even very fine sands will do this.
- 2) Silty soils—Silt grains are much smaller than sand particles and although they will still grate between the teeth, they are not particularly unpleasant. They feel much smoother than sand.
- 3) Clayey Soils—Clay grains are not gritty at all. Instead, they feel smooth and powdery like flour between the teeth. You will find that a **dry** cake of soil with a lot of clay in it will tend to stick when lightly touched to your tongue.

**C. Shine Test.** Take a cake of either dry or moist soil and rub it with your fingernail or the flat side of a knife blade. If the soil contains silt or sand—even if the remainder is clay—the surface will remain dull. A soil that has a lot of clay in it will become quite shiny.

**D. Thread Test.** Mix just enough water with a lump of soil (10-15 mm. diameter or about  $\frac{1}{2}$ "') so that the lump can be easily molded in your hands, but is not sticky. On a flat clean surface, roll out the soil into a thread. With the palm of your hand or fingers, use just enough pressure to make the soil thread get continuously smaller. If it breaks before you roll it out to a 3 mm ( $\frac{1}{8}$ "') diameter thread, it is too dry and you need to add some more water to it. When the soil is at the right moisture content, the thread will begin to crumble into several small pieces just when you get it to a diameter of 3 mm ( $\frac{1}{8}$ "'). If the thread does not crumble and break at 3 mm, lump it together again, knead it into one lump, and repeat the rolling process until it crumbles at 3 mm. (The thread will eventually crumble because it dries as you keep rolling it out.)

As soon as the thread crumbles, re-mold the sample into a ball and see how much pressure it takes to squeeze the ball between your thumb and forefinger. This test gives an idea of how much clay is in a soil and also what type of clay it is. Here are some typical results when you squeeze the ball:

- 1) Tough thread—If the remolded ball can be deformed only with a lot of effort and it does not crack or crumble when you do it, your soil has a lot of clay in it.
- 2) Medium strength thread—This kind of soil can be remolded into a ball, but when the ball is squeezed between the fingers, it will crack and easily crumble. This soil has less clay.
- 3) Weak thread—When the soil has a lot of silt or sand and very little clay, you will find that the threads cannot be lumped together in a ball without completely breaking up or crumbling.

ROLLING SOIL INTO A THREAD

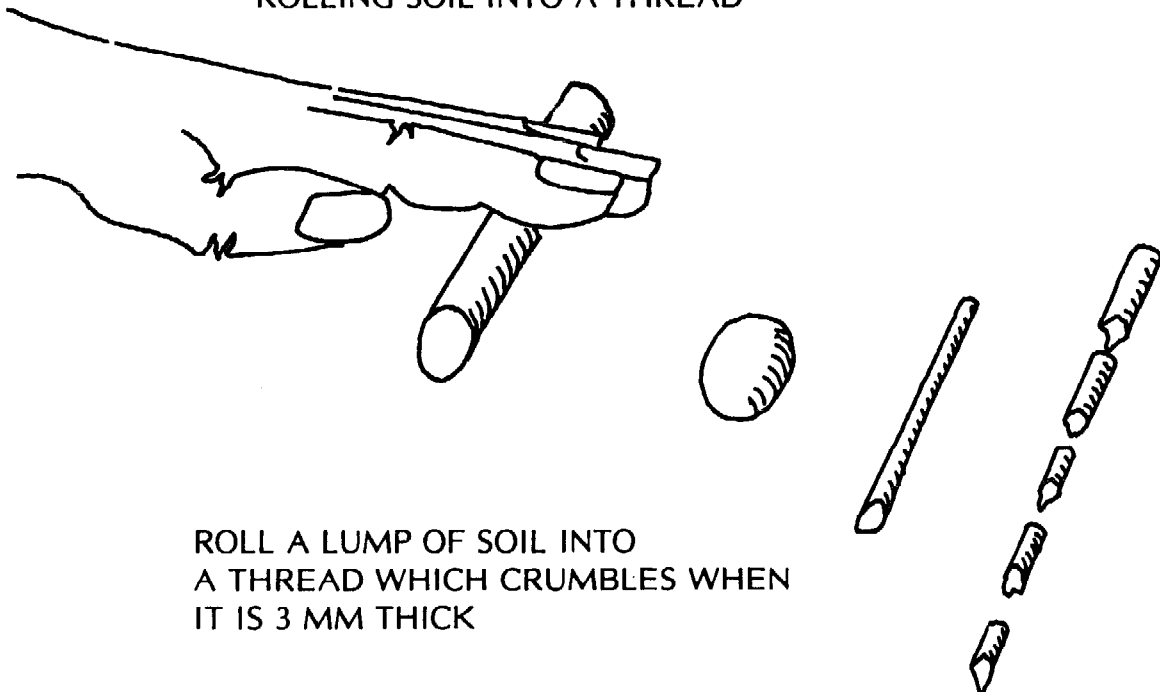



**E. Ribbon Test.** This test gives about the same kind of information that the thread test gives. It is a good practice to do both tests. One confirms the results of the other.

Take enough soil to form a roll about 1½ cm (½") in diameter and 10 cm (4") long. The roll should not be sticky, but wet enough to be rolled into a 3 mm (1/8") diameter thread without crumbling, as in the thread test. Put the roll in the palm of your hand and, starting at one end, flatten the roll by squeezing it between the thumb and forefinger to form a ribbon between 3 mm (1/8") and 6 mm (1/4") thick. Handle the soil very

RIBBON TEST

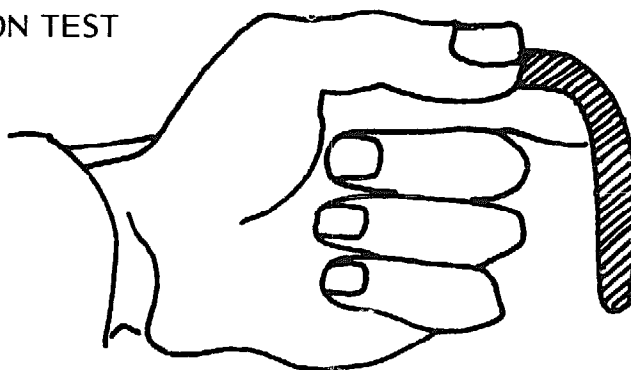

carefully to form the maximum length ribbon that the soil will support. See how long the ribbon will hold together without breaking. The results you can expect are:

- 1) Long ribbons. With some soils the ribbon will hold together for a length of 20 to 25 centimeters (8 to 10 inches) without breaking. This means that the soil has a lot of clay in it.
- 2) Short ribbons. If you can—with some difficulty—make ribbons in short lengths of about 5 to 10 centimeters (2 to 4 inches), the soil has a medium to small amount of clay in it. It will be about the same as the soils that give a medium or weak thread in the thread test.
- 3) Will not make a ribbon. Some soils cannot be formed into ribbons at all. This means either that they contain a very small amount of clay or none at all.

**F. Dry Strength Test.** This is another simple test that will help you determine how much clay you have in the soil. Prepare two or three wet cakes of the soil about 12 mm (½") thick and 25 to 50 mm (1" to 2") wide. Use enough water to make the soil quite soft but still strong enough to hold its shape when you form it into cakes. Then allow the cakes to dry in the sun or in an oven until they are dry all the way through. Break the soil cake and try to crush it into powder between your thumb and forefinger. Here is what you are looking for:

- 1) High dry strength. Samples with high clay contents will be very difficult to break. When they do break they will snap sharply, like a

crisp cookie. You will not be able to powder the soil between your thumb and forefinger. You may be able to crumble it a bit with your fingers.

- 2) Medium dry strength. When a soil has a medium dry strength, it will not be difficult to break the soil cake. With a little effort you will be able to powder the soil between your thumb and forefinger. This soil has moderate clay content.
- 3) Low dry strength. A cake with very little clay will break and powder easily. Cakes of very sandy soils will crumble in your hand.

### The Final Test: Firing

After the above tests have been used to identify a good clay soil, a firing test is very important. If you use a clay that does not fire, the inside surface of the firebox will flake apart.

To do the firing test, make a ball of soil approximately 5 cm (2") in diameter. Add water if necessary to make the soil workable. Let it dry thoroughly in the sun and then place the ball in hot coals for one hour. Remove the ball and let it cool. Rub the ball with your thumb; if the surface crumbles, the soil should not be used. The sample may crack when fired; however, this does not mean it will not work when mixed with sand.

### LORENA MIX

There are two basic methods of lorena construction, **wet method** and **dry method**. Each has advantages and disadvantages which you should consider before choosing your method.

The **wet method** should be easier for people familiar with mud mortar or adobe work. This method can use soils which are quite wet. The disadvantage is that each layer must dry before the next is applied, which may slow construction.

The **dry method** is similar to the technique used in building rammed earth structures. Its advantages are quick construction (due to reduced drying time) and that it can be used in cold, damp conditions. The problem with this method is that it requires relatively dry clay and sand, which can be hard to find in wet weather.

The two methods are similar in that the same ratio of sand to clay is used. The mixes differ in how they are handled during mixing, construction, and how they are carved.

### MAKING LORENA MIX

For a large stove with a top surface of one square meter you will need about ½ cubic meter of lorena mix. Smaller stoves require much less material, of course. The amount of soil or sand will depend upon the proportions you have determined. It is best to test the mix before getting all the material so as to avoid needless digging and hauling. For a large stove you will need up to 200 liters of water for the wet method and

approximately 30 liters for the dry method. A standard steel drum holds about 200 liters (55 U.S. gallons, 44 Imperial gallons). The water can be dirty, but it might cause problems if it is too salty or mineralized. (This needs additional research.)

**Dry Soil:** If the soil is thoroughly dry and lumpy (as clay often is), you should break up the lumps and then pass the crushed soil through a screen with a 6 mm (¼ inch) mesh to remove remaining lumps.

Soil lumps can be crushed using a two-handed post mallet (see drawing), grinding between two hard flat surfaces, using a mortar and pestle, or by moving an animal or vehicle over the pile of soil.

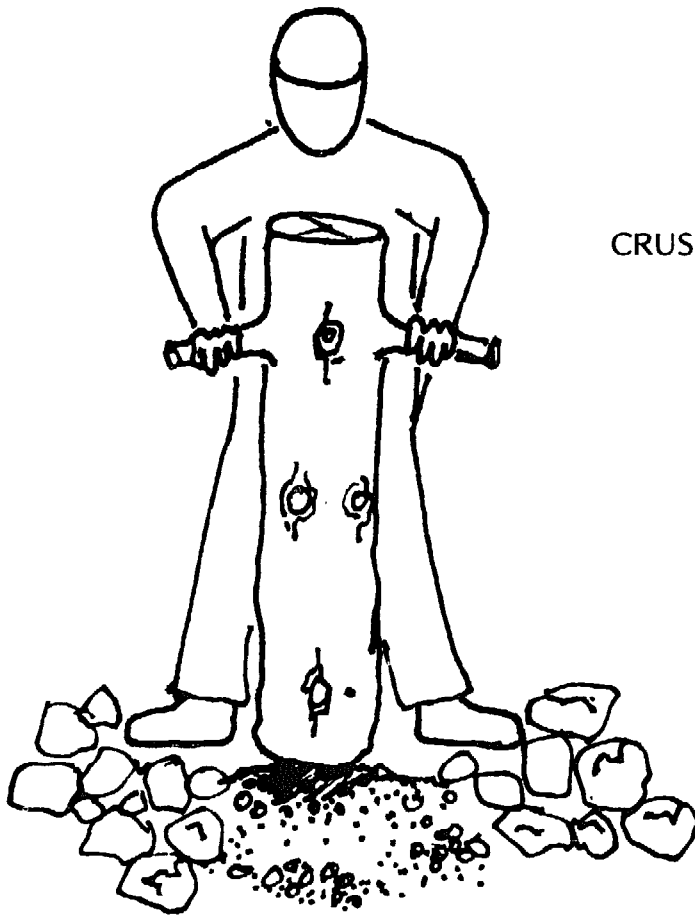

CRUSHING SOIL LUMPS

SCREEN REMOVES GRAVEL,  
ROCKS, ROOTS, AND TWIGS

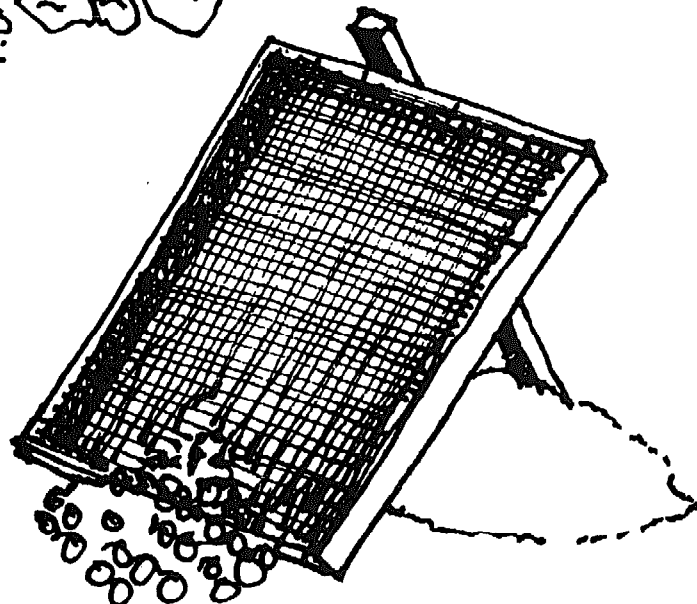

**Wet Soil:** If the soil is wet and not easily dried, you should wet it enough to make a stiff mud and use a "slurry" method. This means you should thoroughly break up the soil and then soak it the day before it is to be used. Make sure you remove hard objects such as rocks, sticks or roots. A damp soil containing a lot of clay will have to be broken up very thoroughly and then soaked for perhaps three days to soften all remaining clay lumps.

If a minimum of water is used or excess water is poured away before adding the slurry to dry sand, this method can be used to make "dry" mix.

**Dry or Wet Sand:** Pass your sand through the same screen used for the dry soil. Remove gravel, rocks and organic matter such as roots or twigs.

### **Making the correct lorena mix is very important!**

- a) With too much clay the lorena mass, as it dries, shrinks unevenly and cracks the stove;
- b) With too much sand the lorena is too soft and the mass will fall apart;
- c) With too much silt the sand-clay mix is diluted, causing interior surfaces to flake away in the heat of a cooking fire.

Remember that although a 1:4 lorena mix (one portion soil mixed with four portions sand) may be necessary in one place, a short distance away a 1:2 lorena mix may be necessary. Even two layers of soil directly on top of each other may have different clay contents.

If you use a pure clay soil you will need to make a lorena mix that is up to 75-85% sand. When you use soils with less clay you should also use less sand; especially if there is already sand in the soil. If you have a clay-silt soil you will find that the silt does not help much, so your sand percentage should remain high.

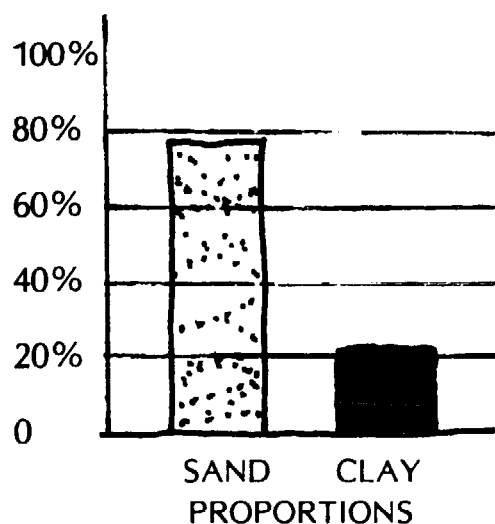

### Mixing lorena

Use the same proportions of sand, soil and water for each batch of lorena so the consistency of each layer is the same. (A very wet layer between drier ones will shrink differently and might cause cracks in the stove.)

If the soil and sand are dry, mix them thoroughly **before** adding water. Dry ingredients are lighter and easier to mix. If the soil and sand are already wet, be sure to mix them completely. Thorough mixing makes the lorena stick together well and helps prevent cracking when the lorena dries. We usually mix on a hard, flat surface (like a flat concrete or earth floor) but some people prefer to use a trough or wheelbarrow. When mixing lorena you can use a shovel, large hoe or the traditional foot-stomp method of adobe. Lorena is easy and satisfying to mix with hand tools. Turn the pile and chop it repeatedly with hoe or shovel, as you would any concrete. If a cement mixer is available, you can use it. A boulder placed in the cement mixer may help the mixing.

Check the mix carefully for lumps of clay. You want a smooth, even mixture.

**Water Content (Wet Method):** When ready to use, a wet lorena mix should be wet enough to shine brightly when you slide a shovel across it, yet dry enough to stand in a pile without slumping very much. Add water a little at a time and mix thoroughly before adding more water. With a little practice you will find the correct amount of water for a good mix.

#### WATER CONTENT (WET METHOD)

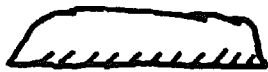

JUST RIGHT



TOO DRY



TOO WET

**Water Content (Dry Method):** Take a handful of well-mixed dry lorena and make a hard packed ball about 5 cm (2 inches) in diameter. Throw the ball up in the air 1 meter and catch it with a flat palm—don't cushion it. If it cracks apart it's too dry; if it deforms it's too wet.

### Quick Tests for the Right Mix

The Ball Test: When using the dry mix method, the feel of the ball (thrown up in the air in testing for water content) can tell you a lot about your mix. The ball should not deform when pressure is applied with your fingers. If the mix will not form a hard ball, even when more water is added, then more clay is needed.

The Palm Test: Take a handful of the wet method mix and slap it between your hands to make a flat cake. (If you are using the dry method, add water to make a small wet batch for testing.) Turn your hand palm down, and gradually open it. The cake should fall cleanly off your hand. If it sticks much, or leaves a lot of material in your hand, your mix has too much clay and needs more sand. Add sand and repeat the test until your mix is correct.



Practice will help you to confidently use both of these mix testing methods. Over time you will develop a feel for the proper mix. Small sample stoves can also be constructed. However, this requires a lot of work. An intermediate step for determining good mixes is the construction of test blocks.

### TEST BLOCKS

When you build a stove with a soil you haven't used before, you should mix some test blocks of lorena. These test blocks should contain different proportions of soil and sand (for example, 3:1, 2:1, and 1:1). Use a wooden mold at least 80 cm (30 inches) long, 25 cm (10 inches) wide, and 10 cm (4 inches) thick. Be sure to make a block long enough to imitate a stove in the way it shrinks. Blocks less than 80 cm tell you little about cracking.

Sprinkle sand on a flat surface. Lay the mold down and carefully pack it with wet lorena mix. Slip off the mold. Repeat this until you have at least three blocks of different sand-clay proportions to test.

Dry the blocks in the sun. When one side is dry, turn the blocks carefully on edge and look for cracks. Then let the blocks dry completely.

When the blocks are thoroughly dry, inspect them for cracking. Note

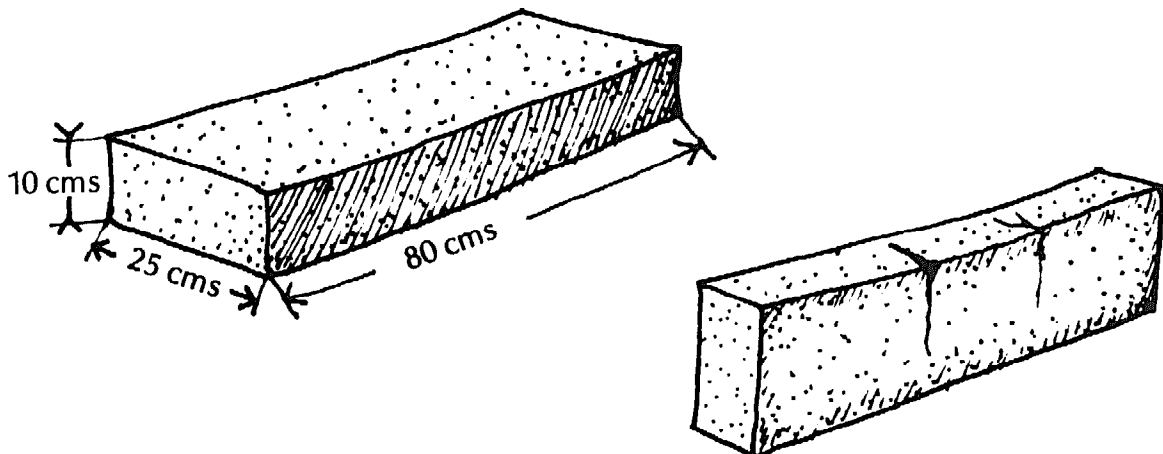

whether there are surface cracks (not a big problem) or deep cracks that extend through the block. Test the hardness of the blocks with a sharp object. Note whether the block is easy or hard to scratch. What you want is a block with a hard surface and no deep cracking.

### STOVE BASES

Lorena stoves can be built on a base of any height. The stove's height is important, and should reflect what people want and need. In many areas—Senegal and much of Java, for example—most cooks prefer low stoves. These stoves are built directly on the ground, requiring no base. In Guatemala, although floor level cooking is often the custom, most people seem to prefer a waist level stove that can also serve as a kitchen workspace. There the stove's finished height is usually 75-90 cm. The top half of the stove is made of layers of lorena that are a total of 30 cm thick. This sits on a base that is 45-60 cm thick. The base can be a solid mass of lorena, though it is usually easier to quickly construct a base out of materials such as brick, adobe blocks, concrete or soil-cement blocks, or mortared rock. A base can also be made of a box filled with rubble, soil, gravel or other available solid materials. Make sure the fill material is **thoroughly** compacted, or it may later settle under the weight of the stove, cracking and possibly ruining the stove.

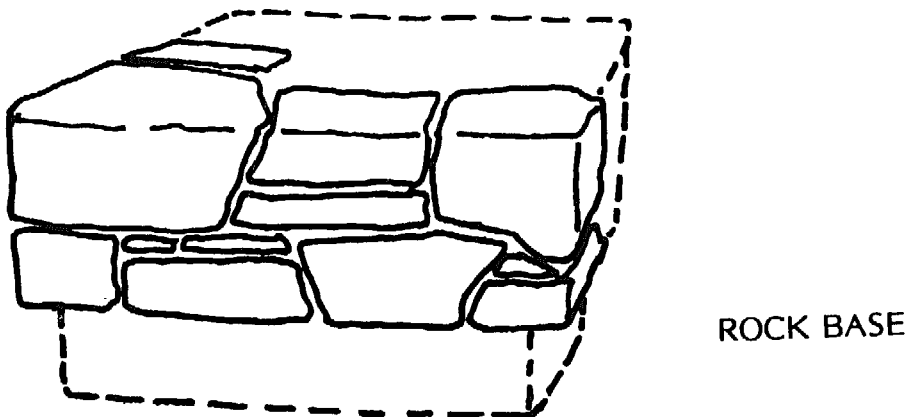
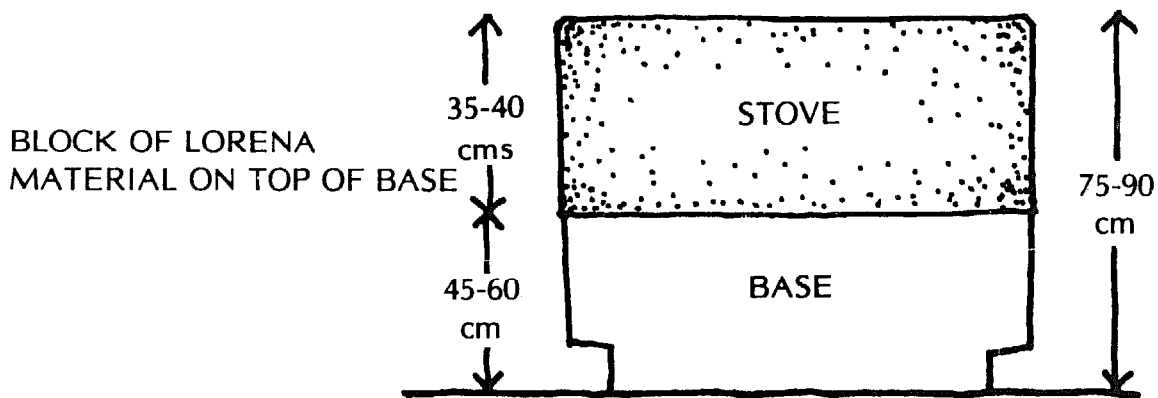

Level the surface upon which the base will be built. If you are building on an earth floor, carefully level it with a shovel, by digging, **not** by filling in low spots (which may cause cracking). If a stone or concrete floor slopes badly it should be leveled with a little extra concrete.

Bricks for the base are generally stacked with a "toe space" of 10 cm (4 inches) at the bottom. The toe space allows the cook to stand closer to the stove and be more comfortable when leaning over to stir or lift pots.

TOE SPACE ON A  
BRICK STOVE BASE

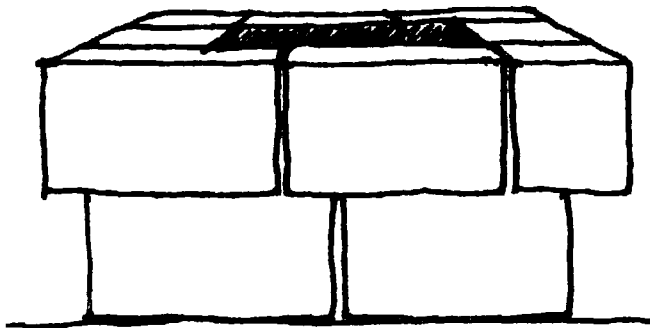
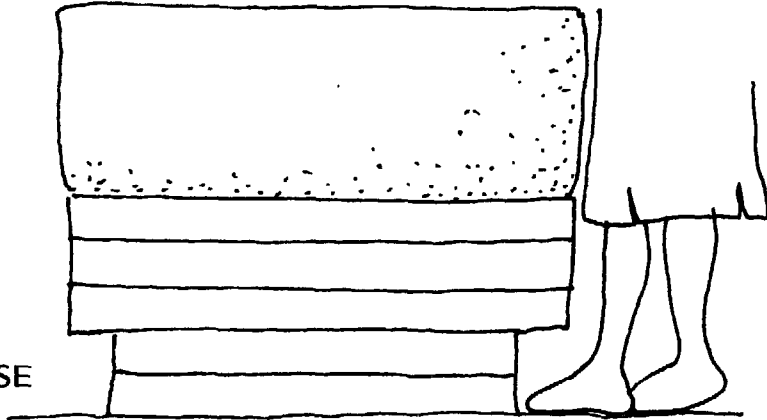

TOE SPACE  
ON A CONCRETE  
BLOCK STOVE BASE

When stacking bricks for the base, use 2.5 cm (1 inch) of mud mortar between the sides of the bricks. Be careful not to get the earth bricks wet from a mortar that is too wet. Earth bricks (such as adobes) weaken if they get wet, and may crumble under the weight of the stove. If your earth bricks do get wet, let them dry before continuing to build the stove.

When building a round or oval stove you should trim the earth brick base so that it is the same shape. If you use concrete blocks small pieces of wood or metal can cover the gaps between blocks. Cut them to be flush with the outer edge. Fill the hole in the center of the base with dry soil, and compact the soil lightly but firmly. Be careful not to disturb the blocks.

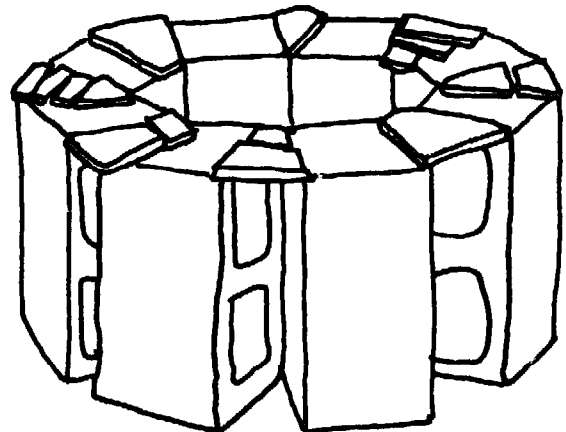



## BUILDING THE BLOCK

Early Lorena blocks were built with a wet paste applied in layers. This method took a long time and brought with it the danger of cracking and slumping during construction. Artisans working in Guatemala quickly worked out an alternative, tamping down a dryer mix rather like rammed earth. In most circumstances we now recommend this dry method, except when the materials are already too wet due to rain, or in cases where the stove can be poured into a mold.

Both methods are explained here.

**Dry Method.** Using a piece of wood the size of a hammer handle or the side of your hand, tamp the mix onto the base. Compact the mix until a finger pressed into the surface goes in less than 5 mm (use only the strength in your finger, not your whole hand). Apply layers 5 to 10 cm (2 to 4 inches) thick. When working near the edge use a support board pressed tightly against the block. This method provides equal pressure to both the top and side. If there is uneven pressure, cracking will result.

USING SUPPORT  
BOARD AT EDGE

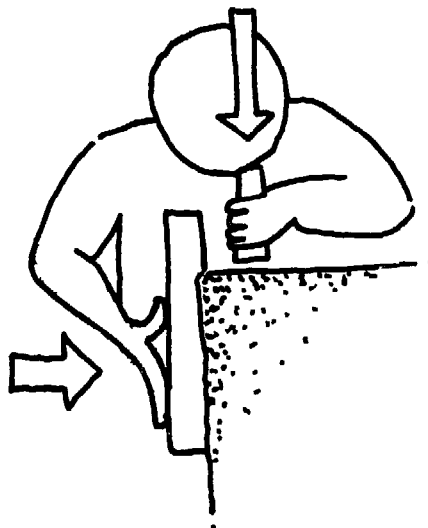

Take care to make the walls even with the base. Overhangs may fall off during drying. Make sure the edges are well compressed, as this is the area most likely to cause problems later.

Check each layer for hardness before applying the next. No drying is required between layers. If a layer has dried, dampen the surface carefully before continuing work.

OVERHANG CRACKING

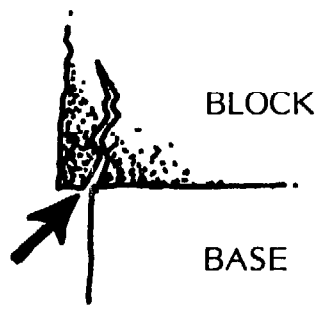

**Wet Method.** Wet method stoves are best built in warm, dry, breezy conditions. This allows for good air circulation so that layers will dry quickly and evenly. In cool, damp weather the layers of wet method lorena dry slowly. To allow for proper drying, you may be forced to add only one layer a day to the block.

In extremely hot and dry places the lorena may dry too fast. The block can be kept moist with wet newspaper, plastic or damp burlap. If work on the stove layers has to be stopped for a long time, cover the whole stove with a plastic sheet and tie it securely. The stove will remain moist for several days.

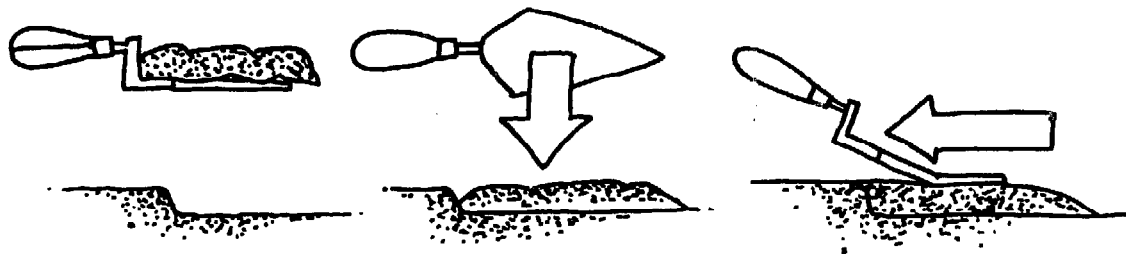
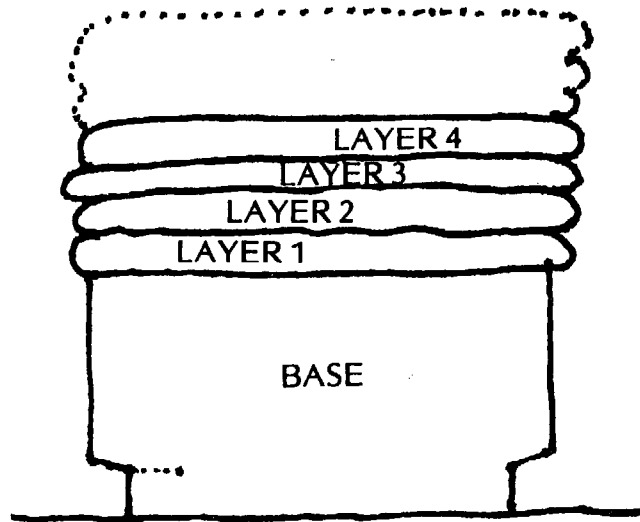

SMOOTH LORENA INTO  
THE REST OF THE LAYER

Use a mason's trowel, a machete or a spade to apply the layers of lorena. Lay the lorena on carefully, a shovelfull at a time, **smoothing** each lump into the rest of the layer with **only one or two strokes**. **Don't play with it!** You can press down but don't push sideways. If you push or shape the lorena a lot it will lose its stiffness and might slump or fall off at the edges. If a layer slumps, cut off the slumping portion with a straight cutting motion using a wet tool. **Don't** try to press the slump back into shape. At this stage it is better to leave the surface of each layer lumpy. The layer will dry better and provide a better anchor for the next one.

Each layer should dry evenly, without a dry crust on the surface, so apply 5 to 10 cm (2 to 4 inches) at a time. Allow each layer to dry until it no longer shines. If it is so dry that a crust has formed, you should lightly wet the surface and wait until it softens. Then continue to add layers. If there is cracking in the layers as they dry you should increase the proportion of sand in your mix for the later layers.

Disturb the block as little as possible, or the material can slump. Be sure that the previous layer doesn't move as you apply the next one.

The outer edges of the layers of lorena can be very rough at this time. Don't worry if there are some holes and overhanging chunks. These will be easily fixed when the lorena mass is drier.

There is a tendency to build the layers so that they slant inward. However, we've found it much easier to cut away extra material than to add material to the sides. This may mean you will have to mix more lorena material, but you are less likely to have cracks on the edges too.

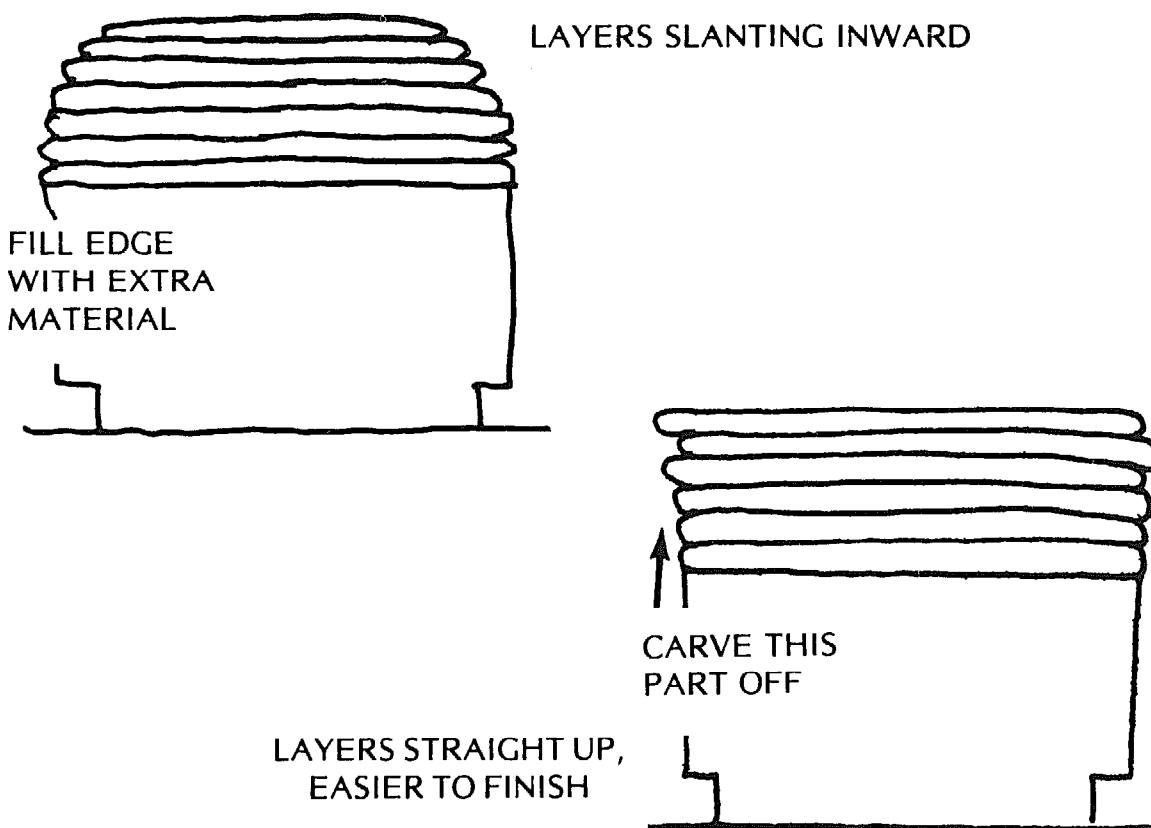

In dry or hot conditions you should apply the final lorena layer within a few hours after the previous one. If most of the stove is allowed to dry and shrink overnight, before the final layer is added, very bad surface cracking may result. This can usually be repaired, but such cracks do weaken the surface. Later, when you're digging the tunnels and the firebox, the cracks may cause stress that leads to more serious structural cracks. To help prevent cracks always add at least 10 cm (4 inches) of material on the last day. Very fine sand used for the last layer will provide a better finish.

When you have about 30 cm (12 inches) of lorena built up in layers, your block should look like this:

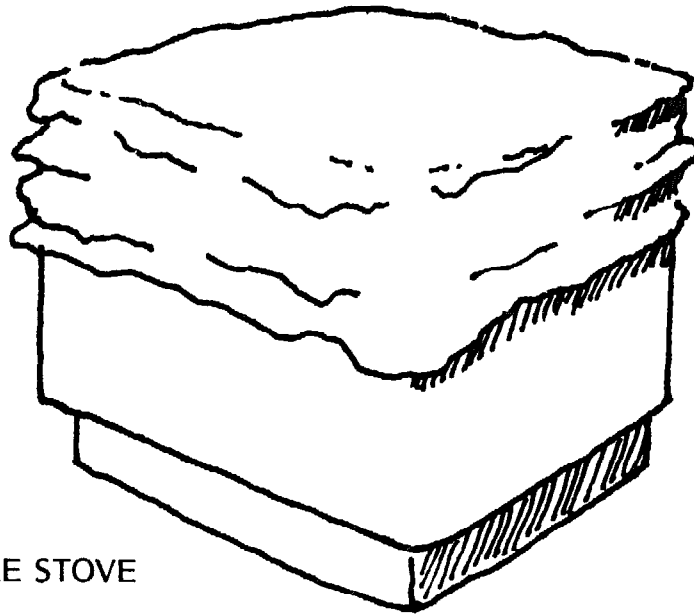

SQUARE STOVE

#### Trimming the Layers:

When the lorena has dried so that you can't easily push your finger in more than 1 cm (almost ½ inch), you should trim the lorena mass, fill holes and level the surface. Using a wet trowel, machete or knife, cut off the worst overhanging lumps. You can fill holes with this lorena material if you add water to make the proper consistency before using it. Trimming and filling the sides is easier to do now that the layers are drier.

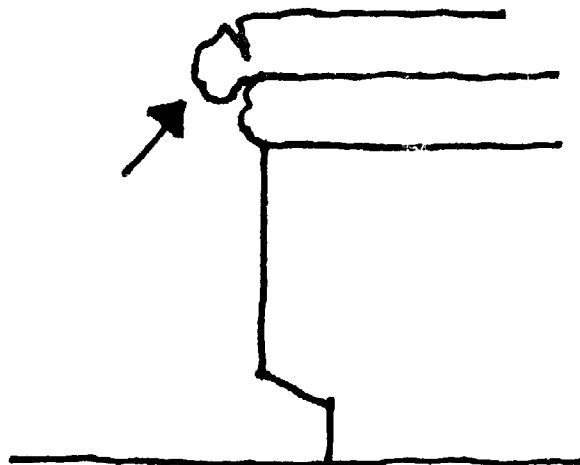

CUT OFF OVERHANGING  
LUMPS OF LORENA MATERIAL

**FORMS**

The stove may be built within a rigid wood or sheet metal form. This allows quicker construction time and eliminates cracking or slumping edges as the block is built up. The disadvantage is that a form will lock you into one shape for all the stoves you build. The materials to make the forms may also be hard to get and may cost more than the stove itself. Forms seem most useful to professional stove builders when standardization and quick construction are important. The cost of a form, spread out over many stoves, would not be very much.

A form should be rigid, because any movement of the form while building the block may cause cracking. Both wet and dry methods can be used with forms.

WOOD FORM

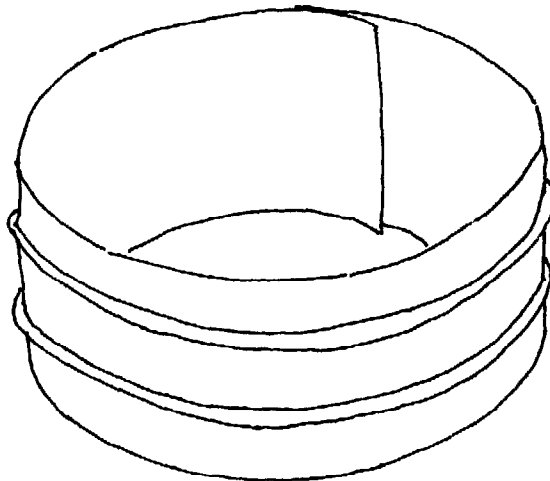
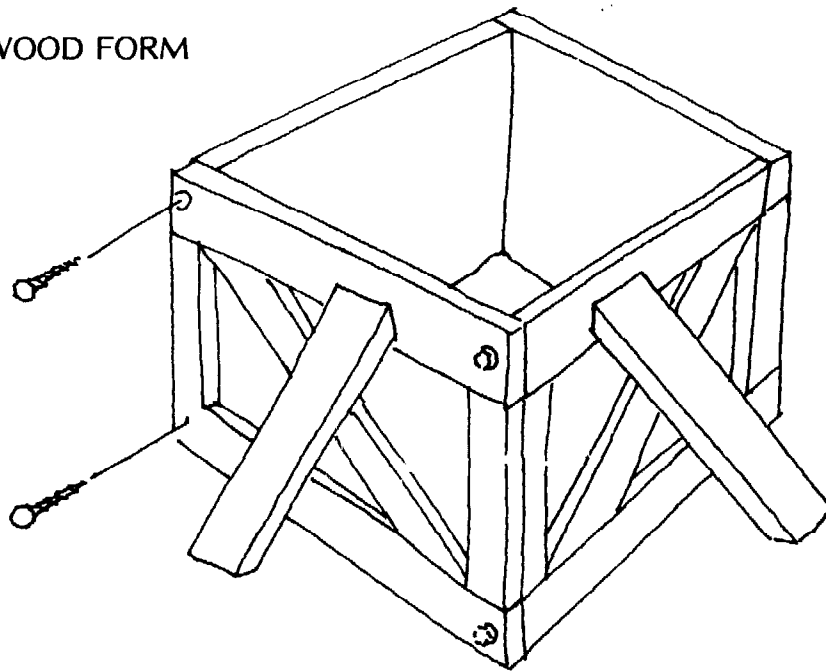

SHEET METAL FORM

**Leveling the Stove Surface (Wet and Dry Methods)**

To level the stove top, fill in the worst holes with lorena mix and carefully slice off the worst lumps. Then a wet board placed on edge can be gently pulled back and forth like a wood saw, lightly grinding down the high spots. Be careful or you may crack the block (especially along the edge). Move loosened material into the low spots as you continue the sawing motion over the whole surface of the stove. Pull the board North to South, then East to West, changing the direction until the stove top appears flat. Be careful to keep the edge of the board wet so it will grind smoothly and not tug and crack the stove surface. You should be able to make a flat and smooth surface.

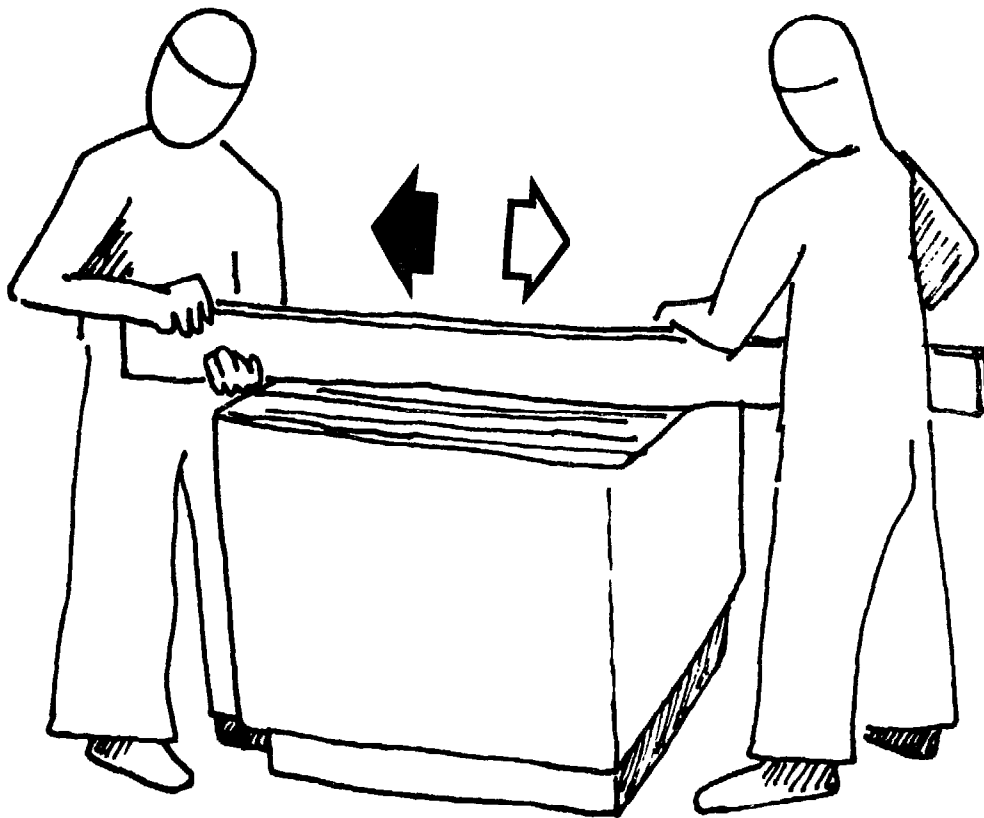

## CARVING THE STOVE

First make sure your stove block is dry enough. Can you push your finger in more than 1 cm? If so, let it dry more. As you carve the stove, periodically repeat this test before carving in a particular area.

**Very carefully** mark the outline of each pothole, damper slot, water heater container, and chimney hole (if used). Use the tip of your finger or something else very blunt to mark outlines; **don't** use anything sharp! A sharp or deep line creates a line of weakness and can lead to bad cracks as the stove top continues to dry. Make sure the outline is slightly smaller than the object to be put in the hole. Later, when finishing the potholes, you'll find it's **much** easier to make a small hole bigger than it is to make a big hole smaller.

**Keep your cutting tools wet!** This prevents tools from tugging or tearing at the lorena and causing cracks or slumping.

### Cutting the Damper Slots

Most stoves with chimneys will probably need dampers to control the draft. If your stove is going to have dampers, this is the time to cut the damper slots.

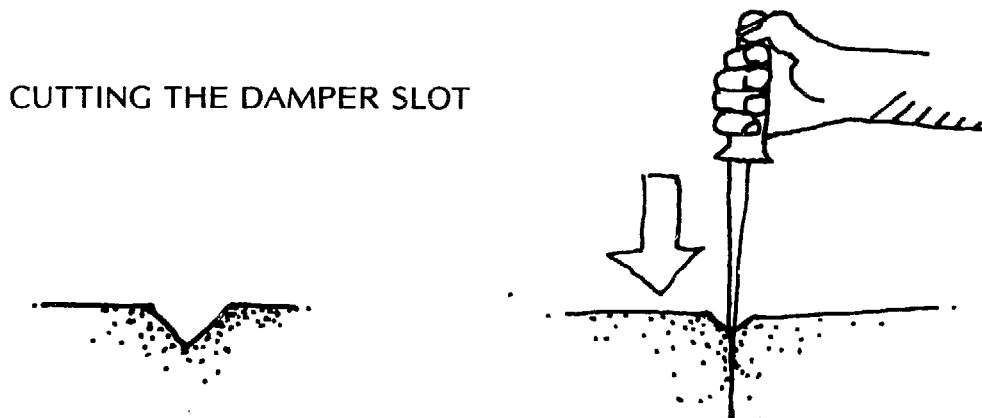

Use a machete or a big knife. First, slice a V-shaped furrow 3 cm (1 inch) wide in the stove top where the damper slot is to be. This protects the stove surface from damage when the knife is worked back and forth.

To deepen the slot in a **wet mix stove**, slowly slide the wetted blade into the block. The depth of the cut should be even with the bottom of the firebox. Be careful to keep the blade vertical at all times. Repeat the process along the damper slot, drawing the blade straight up out of the stove with even strokes; **don't saw it**. The slot will close as the stove dries and will have to be reopened after carving is completed.

In a **dry mix stove** the block will be somewhat harder and more brittle so more care should be taken. So that there will be less stress on the block, let the water on the blade loosen the lorena before you cut. Keeping the blade vertical, slice down into the stove 2 cm ( $\frac{3}{4}$  inch) and then draw the blade straight out. Repeat the process across the length of the damper

slot. Each pass across the slot should deepen the slit 2 cm ( $\frac{3}{4}$  inch). Continue this process until the damper slot is at the desired depth. Remember to always keep the blade wet.

### Carving Out the Interior of the Stove

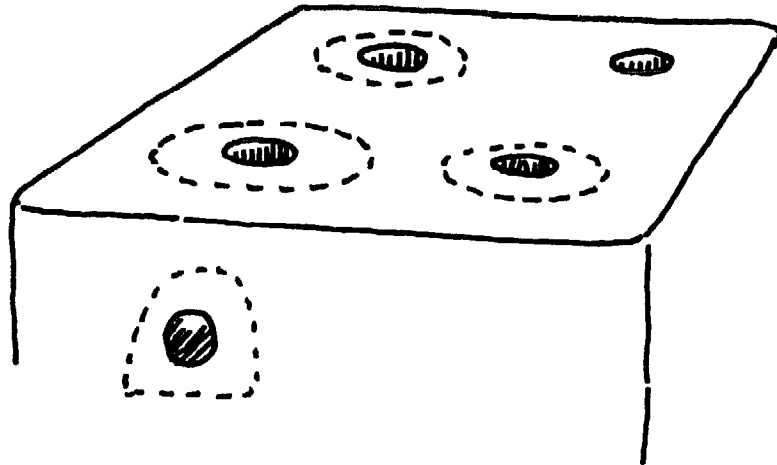

Begin to carve out the potholes by using a spoon, starting in the center of each marked circle and digging down vertically. Then, using a spoon, cut a tunnel horizontally into the planned center of the firebox. This will be the firewood feed entrance. When you start carving horizontally into the block it is important that you arch your tunnel and make it taller than it is wide. This will help prevent slumping. As the stove dries the tunnels may be widened. Be careful so the damper slot does not crumble. Make this horizontal tunnel meet the vertical hole you dug out earlier. Remember, if you can stick your finger into the lorena inside the tunnel, you must let it dry more before further cutting, or the stove may sag, slump, or crack very badly.

When this tunnel is finished, cut the damper slot through again.

### Final Excavations

When the interior lorena is dry enough, slowly enlarge the potholes, firebox and chimney hole. Then carefully cut tunnels to connect all the holes. Scrape and slice the holes and tunnels using a large metal spoon or small garden trowel. (**Don't** push or drag heavily while doing this!) When you finish, there should still be 10 cm (4 inches) of lorena material above the firebox and tunnels. Leave 5-10 cm of material below the firebox if a base is used that might burn. If the base could not burn, leave 0-5 cm below the firebox.



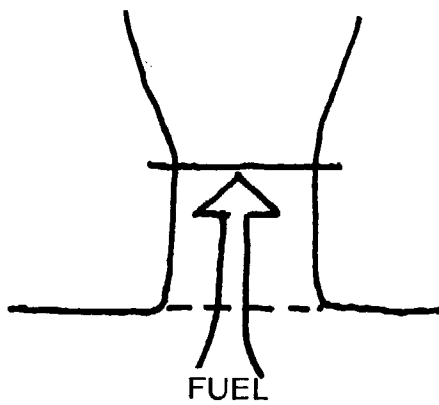

FIRST CUT FIREBOX  
MOUTH STRAIGHT

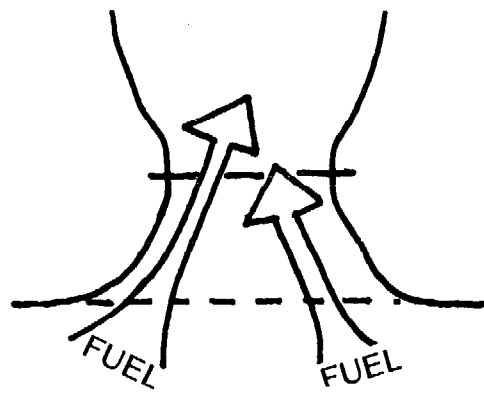

THEN ROUND OUT THE OPENING  
TO MAKE FIRE BUILDING EASIER

The firebox mouth should be shaped as shown, with the damper at its narrow throat. The wider mouth makes it easier to feed wood and inspect the fire.

When a stove is built without dampers, take care not to make the firebox mouth too big (for examples, see drawings on pages 35-38). Its size is important because it controls the amount of air entering the stove. Too much air can lower the temperature in the firebox, resulting in lower efficiency.

The inside of the firebox should be smoothed with the back of a spoon. This reduces the chance of the firebox flaking later on. Smoothing the entire stove inside and out is also helpful if the soil in your mixture contains a lot of silt.

### Connecting Tunnels

You should be able to hold two eggs in your hand and pass them through the tunnels easily. The first tunnel, connecting the firebox with pothole #2, should be larger and start at the rear of the firebox. If the tunnels rise slightly as they move through the stove, it may be easier to start your fires without having smoke enter the room. But once the stove is drawing air properly, tunnels that are flat or descending in places will still function well.

**Coming into each pothole**, the tunnel should rise. This forces the hot gases to hit the bottom of the pots instead of blowing past underneath.

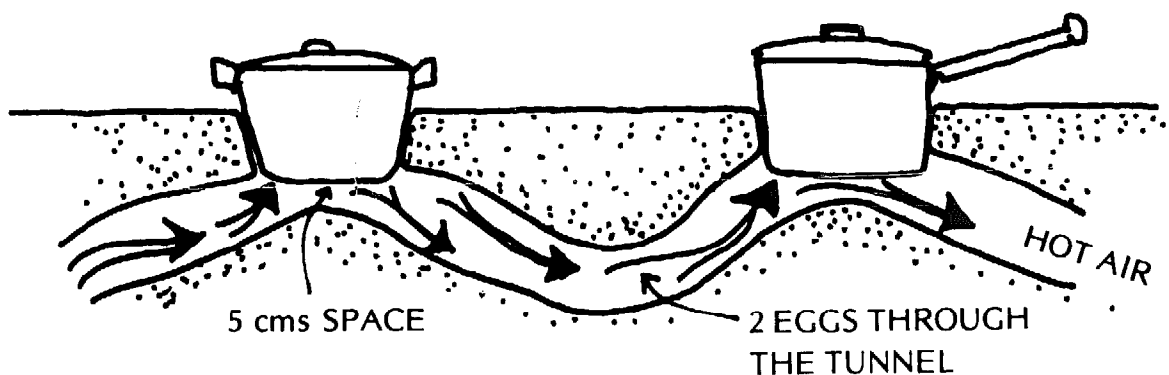

### LEAVE SPACE BENEATH WATER HEATER

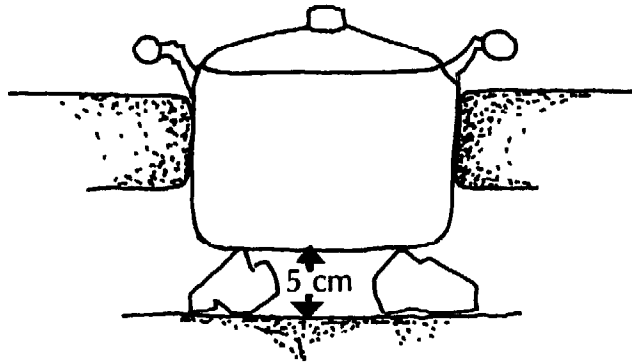

If you are using a water heater in a special hole just after the last pothole, you should leave 5 cm (2 inches) of space beneath it. A small rock can be placed underneath to support the container and allow the hot gases to reach the bottom. Steel cans corrode quickly when used for such water heaters; clay pots seem to last longer.

Sink the **chimney hole** 10 cm (4 inches) lower than the chimney inlet tunnel. This will allow chimney liquids and debris to collect at the bottom of the chimney hole without blocking the chimney inlet tunnel. You can support your chimney by pushing 3 nails into the sides of the hole.

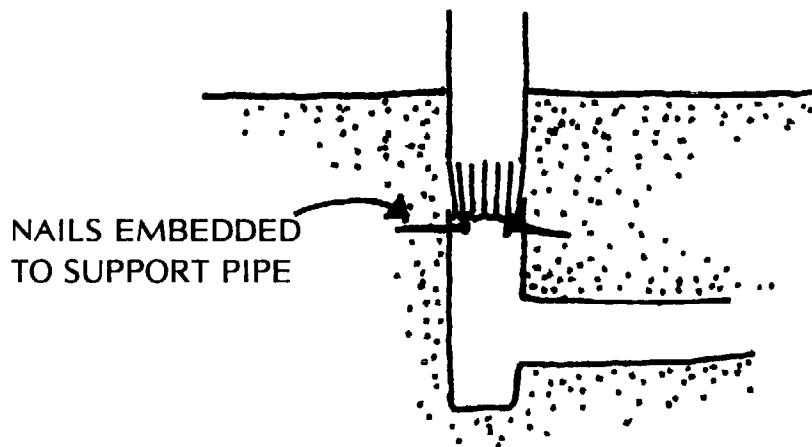

### Finishing the Potholes:

You should carefully enlarge each pothole until it is circular and slightly smaller than the pot. Then wet the outside of the pot and **without placing any weight on it** turn the pot in the pothole. Take it out and look for any places on the stove where it is too tight—where the surface is shiny and slick. Carefully scrape out a **little bit** of the wet lorena, then replace the pot and turn it again. If the pothole surface is too dry, wet the edge and wait until it has softened. Gradually you will cut down into the pothole until the pot fits deep and tightly. There should be no gaps around the edge of the pot where smoke or heat could escape. The inside surface of the pothole should harden well if you make it smooth and shiny.

For efficiency, the **pots** should be sunk as low into the stove potholes as

possible. They will be kept warm by the snug fit to the hot lorena mass, they will be exposed to as much of the tunnel heat as possible, and they will be protected from the cool air above the stove.

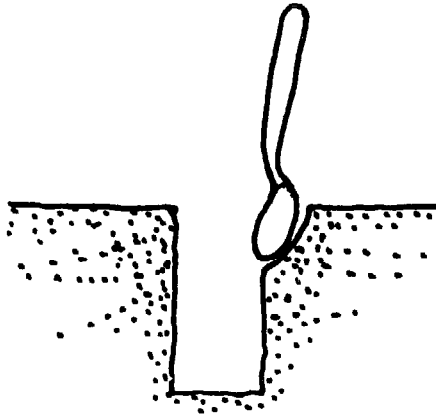

(A) USE SPOON AND POT  
TO SHAPE HOLES

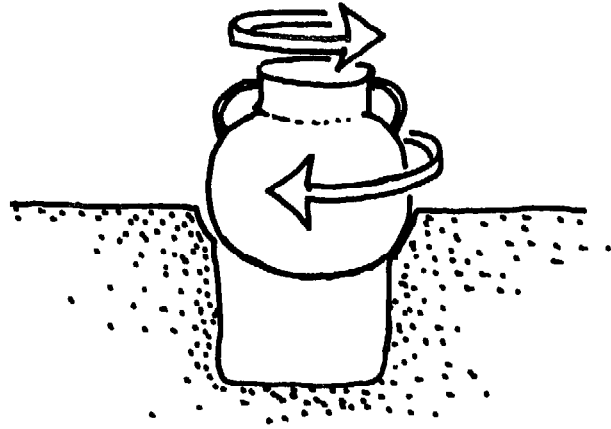

(B) WET SIDES OF POT AND  
REVOLVE BOTH WAYS WITHOUT  
DOWNWARD PRESSURE

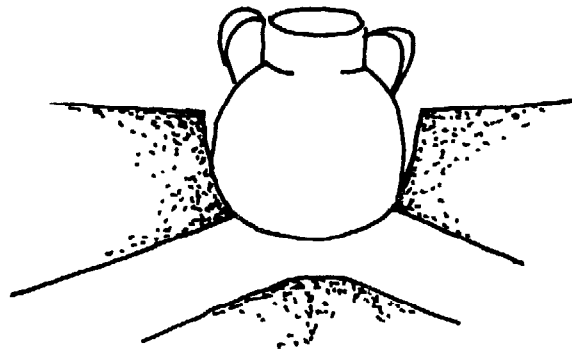

(C) BEST IF POT SITS  
AS DEEP AS POSSIBLE

### Making the Baffles

Baffles should be made to force the hot gases up against the bottom of the pot. Potholes can be made deep at first, and then baffles made of lorena mix can be built up after the rest of the stove is finished. This makes it easier to carve and smooth the tunnels.

Be sure that baffles are solidly attached to the rest of the stove. If they are not, they may crumble away due to the heat of the flue gases.

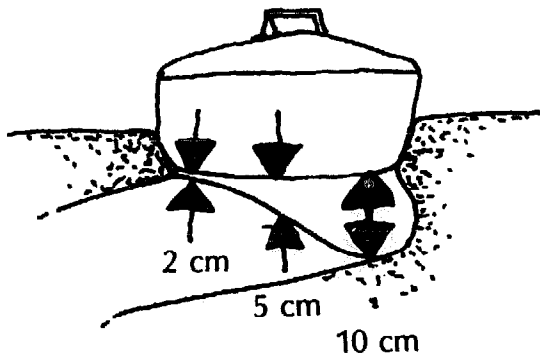

CROSS SECTION OF BAFFLE IN ANGLED TUNNEL

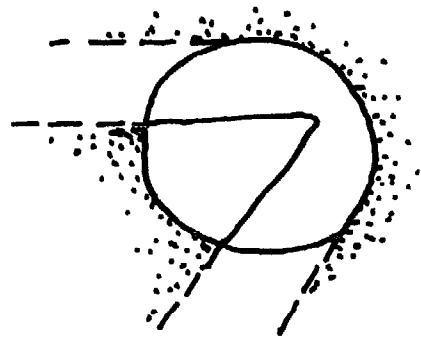

TOP VIEW OF BAFFLE IN ANGLED TUNNEL

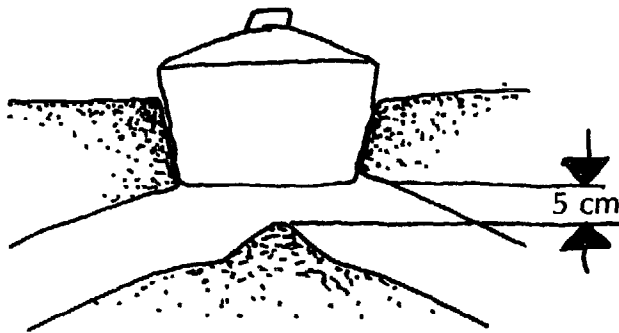

CROSS SECTION OF BAFFLE IN STRAIGHT TUNNEL

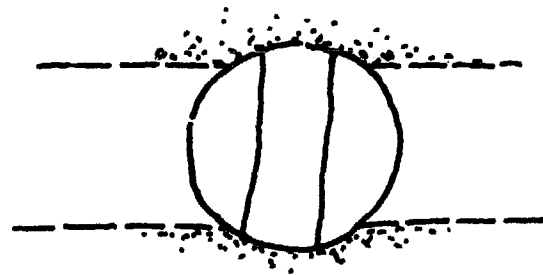

TOP VIEW OF BAFFLE IN STRAIGHT TUNNEL

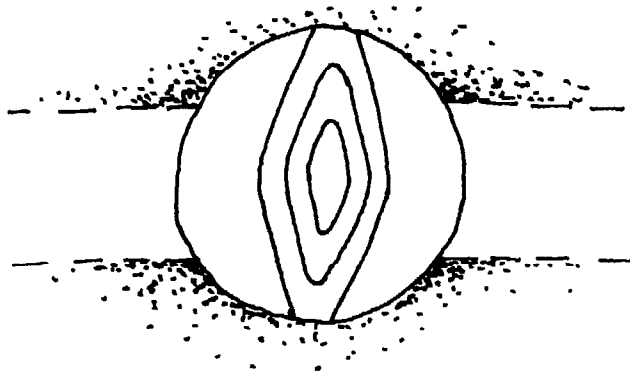

TOP VIEW OF BAFFLE IN STRAIGHT TUNNEL (LARGE POTHOLE)

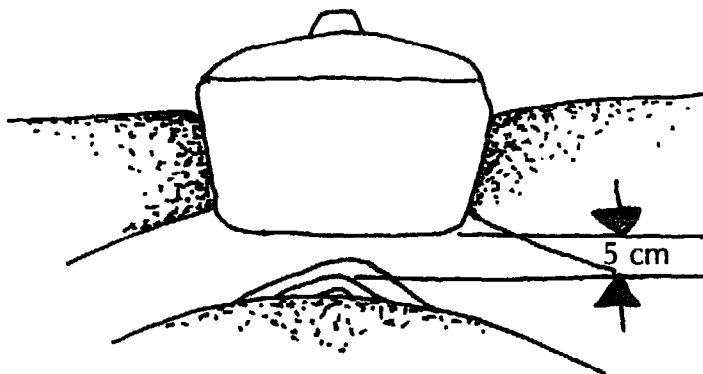

CROSS SECTION OF BAFFLE IN STRAIGHT TUNNEL (LARGE POTHOLE)

## Dampers

Dampers can be made of scrap sheet steel thin enough to be cut to the proper size and shape. Dampers should be a little wider (2 cm on each side) than the tunnels.

Dampers slide more easily if the corners are rounded a little. They crowd the stove top less if they don't stick out very far, and have no sharp edges. To make a damper handle, fold over or roll the top end of the metal damper. You can also nail two pieces of wood together, clamping the top of the damper.

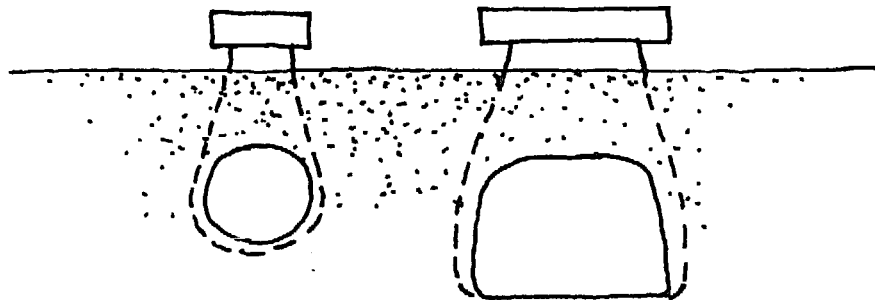

DAMPERS SHOULD BE  
WIDER THAN TUNNELS

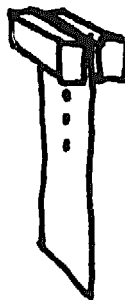

DAMPER HANDLE MADE FROM  
TWO PIECES OF WOOD

To prevent people from taking out the dampers and losing them, you can bend a flap at the bottom of the damper.

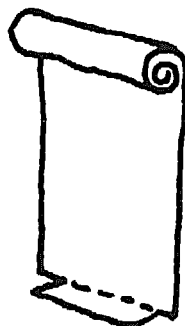

Make a row of small holes in the damper. A nail placed through one of these holes will allow you to adjust the depth of the damper in the stove tunnel.

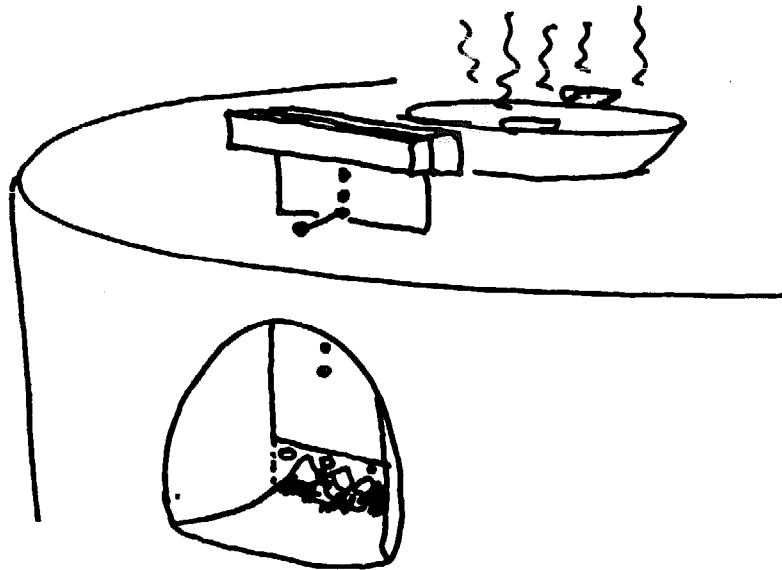

### Repairs

**Dry method** stoves are easy to repair. If a side collapses or a pot hole caves in, cut away the affected area. Fill in the area with new mix in the same manner as when building the block. The section can then be carved if necessary.

While tunneling or slicing the wet lorena of a **wet method** stove, watch for slumping or deep cracking. If such damage happens, you should immediately carefully slice off the affected portions. This will prevent the damage from spreading. Let the area dry more, and then firmly apply new lorena mix, a thin layer at a time. You can repair very bad slumps this way.

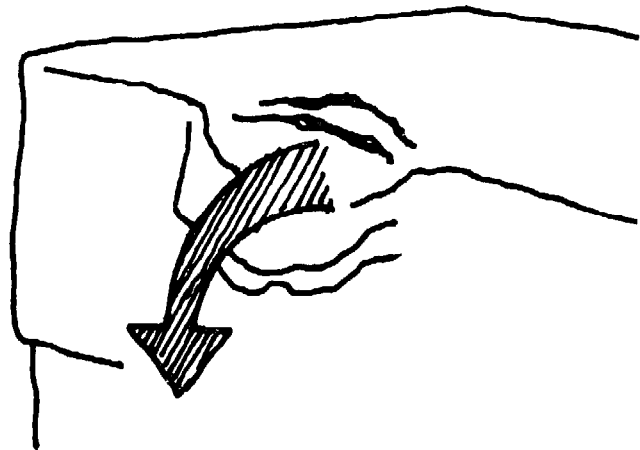

Small cracks can be firmly pressed in with your fingers. Later you can fill and level the area.

If you find cracks that extend down through the block, it's best to break up the stove and start over. You can wet the lorena from the broken up stove and use it for the new stove.

Serious cracks are usually caused by (1) overworking the lorena when building the layers, (2) cutting tunnels when the lorena layers are still too wet, or (3) excessive shrinkage of the lorena layers when drying, due to too much clay in the mix.

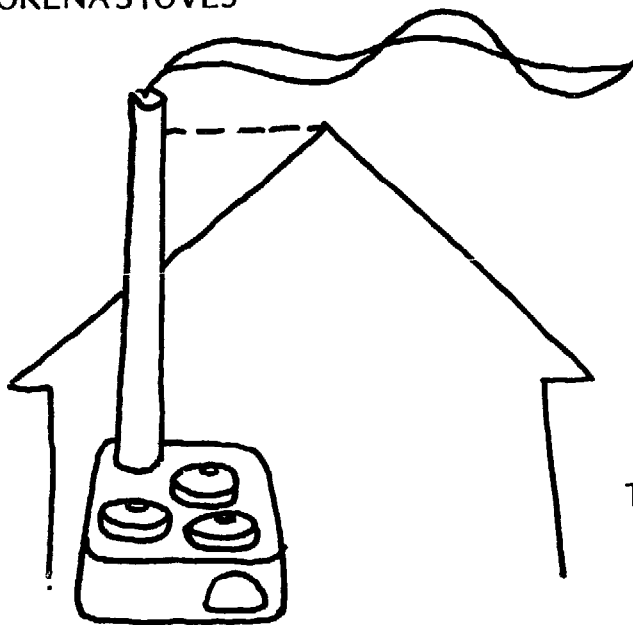

TALL CHIMNEY CARRIES  
SMOKE ABOVE ROOF

## CHIMNEYS

Chimneys have two functions: they create a draft by pulling air through the tunnels and firebox, and they can carry smoke out of the cooking area. The removal of this smoke can greatly reduce respiration and eye problems for the cook (see page 122). Some small Lorena stoves do not need the draft provided by a chimney; others require only a short chimney. In general, the larger the stove and the longer its tunnel system, the more important it is to use a chimney.

In many areas smoke from cooking fires is used to dry crops stored over the cooking area, and protect crops and thatched roofs from insects. Short chimneys can be used to maintain these functions yet reduce health problems caused by smoke. These can be made to reach above head level, allowing the smoke to continue to filter out through the roof. If this is to be done effectively and safely, there must be good venting in the roof, a safe distance between the chimney and nearby walls, and a spark arresting screen over the top of the chimney pipe (if there is any danger of sparks coming out of it).

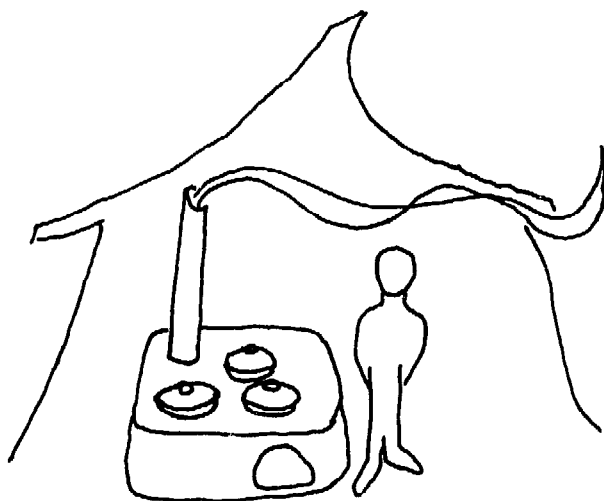

SHORT CHIMNEY CARRIES  
SMOKE ABOVE HEAD LEVEL

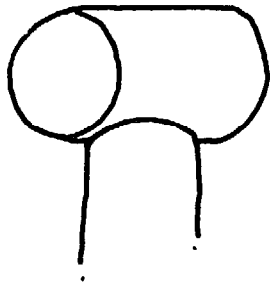

RAINCAP

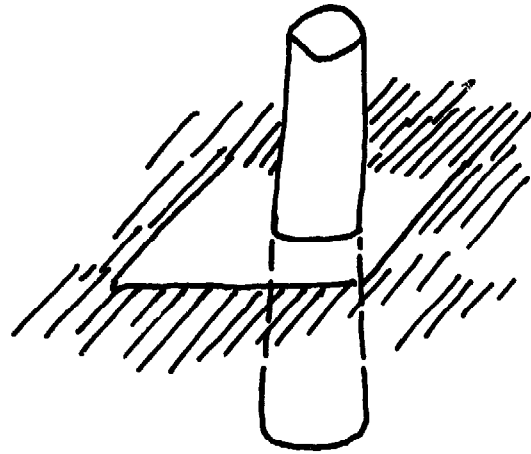
SHIELD SURROUNDS CHIMNEY  
TO PREVENT ROOF FIRE

Where a stovepipe (especially a metal stovepipe) passes through a flammable roof, make sure that the pipe is surrounded by a shield to prevent a roof fire. This shielding can be made of sheet metal or clay.

Interconnecting stove pipe should be joined with the tapered ends pointing down. Chimney residues, such as creosote, will then run down inside the pipe rather than leaking out through the joints.

The chimney should be cleaned with a brush or by knocking it whenever necessary (as often as every 2 weeks) to remove creosote condensation. Creosote will corrode metal pipe. Bamboo lined chimneys, lorena block chimneys, and clay pipe chimneys have less creosote condensation, because they do not lose heat to the outside air as quickly.

To complete the chimney, you can make a simple raincap out of a paint can with both ends removed, set horizontally over the top of the chimney. Without such a cap, rainwater entering the stove pipe may severely damage the stove.

### Lorena Mix Chimney

A lorena mix chimney can be constructed in two ways.

**1. Molded blocks.** In the first method, lorena blocks are made by tamping dry mix or placing wet mix into a metal form with a can or bottle in the center. The form is lifted off and the blocks left to dry. These blocks are then mud mortared into place.

LORENA CHIMNEY MOLD

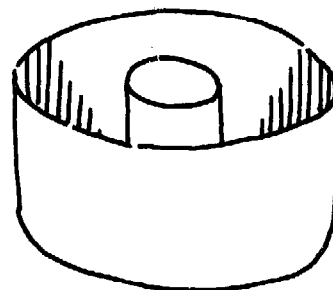



2. **Bamboo chimney.** In Indonesia, lorena chimneys are made by packing lorena mix around the outside of a large diameter piece of bamboo. The lorena is held in place by pieces of split bamboo bound around the mix with any kind of twine or cord. These chimneys, in use in Java, are made about 1½ to 2 meters tall. This gets much of the smoke above eye level, and provides about the right amount of draft for a small two-hole stove, yet the smoke is still discharged under the roof, where it dries grain. Over time the lorena mix hardens, and when the bamboo interior chars and burns away, a strong lorena chimney remains.

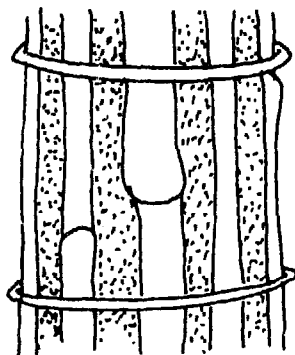

BAMBOO CHIMNEY

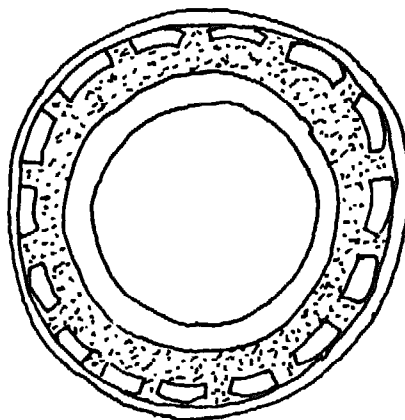
SPLIT BAMBOO HOLDS LORENA  
AROUND BAMBOO CORE

Experimental lorena chimneys have also been made by ramming a fairly dry mix into a form which is moved up continuously as the mix dries. It is difficult to build higher than 1.5 meters using this method unless the chimney is supported, but it can be built against a wall or in a corner.

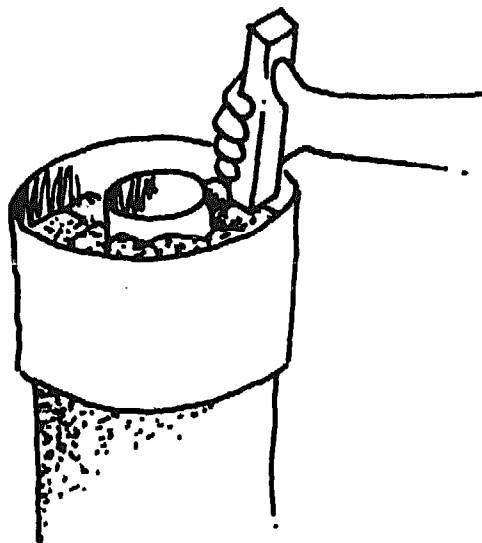

## FINISHING THE STOVE

This is the time for final coats of lorena to fill remaining holes or cracks and smooth the surfaces. Excavated lorena can be wetted and used to plaster sides and top of the stove. (Moisten the surface before adding lorena—this will make it stick.) With a mason trowel, or machete, you can smooth the wet lorena to a glossy surface that dries quite hard.

You can now make refinements. Perhaps you will want to cut a little more lorena out of the firebox so it will hold more wood. Or you may carefully slice the potholes to fit the pots more snugly.

You can fill holes or cracks in the base of the stove, and plaster the whole base with 3 cm (about an inch) of wet lorena mix.

The edges of the stove should be rounded. Sharp edges might break off if struck with a pot or log.

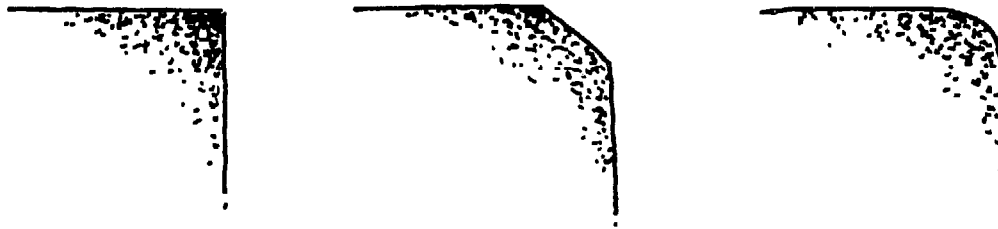

ROUNDED EDGES ARE BEST

## RAIN AND WATER DAMAGE

Lorena stoves must be kept out of the rain. Even after the stove is dry, water will soften the clay and weaken the stove. Common kitchen spills are not a big problem, but some kind of coating on the top is helpful.

### Protective Coatings:

When the stove body is completely dry it can be painted with lime, old motor oil, paint, varnish, or other suitable material. Painting the surface of the stove will help (1) prevent dust and grit from forming, (2) make the stove look more permanent, and (3) make a smooth surface that can easily be wiped clean. A 5-10 cm coat of cement-clay plaster is used in parts of Guatemala, particularly along those edges which are the most subject to wear. Stove builders in Java have begun to paint the top and insides of the stove with a mixture of 5 parts fire brick dust and one part cement.

## THE FIRST FIRE

We advise waiting 2 weeks or until the stove surface is quite dry before lighting the first fire. With some clays, this waiting time has made the difference between a solid stove and a badly cracked stove. If a water container is used, do not put any water in it until after the first fire, because steam from the wet lorena will condense under it, possibly causing a major crack.

After the chimney is installed, (1) put all pots in their holes, (2) open all the dampers, and (3) place kindling just inside the firebox and light it. Don't be disappointed if the firebox doesn't draw well at first. This will improve as the stove dries.

New stoves often produce a lot of steam and smoke from the wet lorena and unburned gases. This produces much condensation inside the stove and in the chimney. If you are using metal stove pipe, use only one piece for the first fire or two. This warm and short pipe section will allow most of the smoke to escape without condensing in the chimney. As soon as possible after the first fire, use a cloth to remove all liquid that has condensed within the stove.

After 3 or 4 hours of small fires your stove should be operating much better. Continue to use small fires for the first week.

If your lorena mix had too little clay or too much silt, the inside of the firebox may begin to come off. If this happens, you can try covering the firebox with a thin coat of sand-cement plaster.

## COOKING

It takes a little time to learn how to use a new stove most efficiently, so you should experiment with different ways of cooking on it. Then be sure to teach these cooking techniques to anyone who learns to build the stoves. The following are some basic rules which simplify stove operation.

It is most economical to use the firebox pothole for pots that need the greatest heat (for frying, for example). The farther a pothole is from the firebox, the cooler it will be. Use cooler potholes to pre-heat, slow-cook, or warm food. Slow-cooking, using stored heat in the thermal mass of the stove, can be done overnight or during times when the stove is closed down.

The dampers help to control burning rate. To slow down a fire, or conserve heat, close the front damper completely.

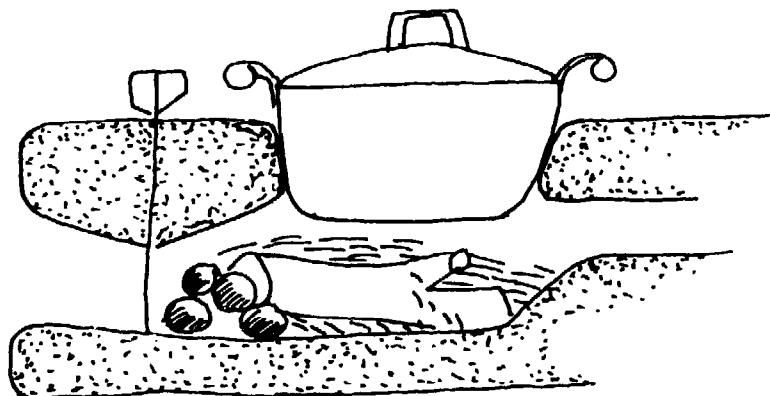

FIREBOX DAMPER CLOSED  
TO SLOW DOWN FIRE  
AND RETAIN HEAT

To keep the fire burning overnight or throughout a day or evening:

- 1) Rake the hot coals until they are right behind the firebox damper.
- 2) Add a large piece of firewood.
- 3) Close the firebox damper tightly.
- 4) Pour a bucketful of damp sawdust (sawdust works very well), wood chips, kitchen garbage, damp newspaper or other such material, into the firebox through the firebox pothole.
- 5) Close all dampers tightly.

Later, when you want the fire to begin burning strongly again:

- 6) Open the back damper completely.
- 7) Rake the coals up close to the firebox damper and add some small kindling.
- 8) Close the firebox damper but leave a 1 cm (3/8 inch) opening at the bottom. As the chimney begins to suck air into the firebox the hot coals will heat up greatly and your fire will be burning within a minute.

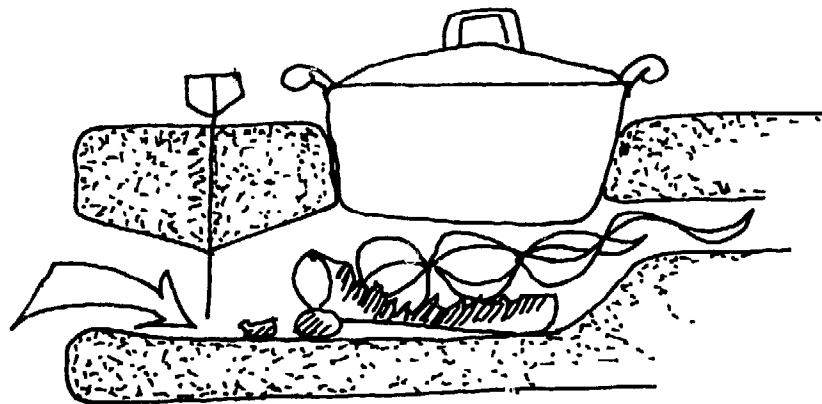

NEARLY CLOSED DAMPER CHANNELS  
AIR TO THE COALS

### Baking:

After a lengthy hot fire, rake out the coals and save them. Slide your bread into the firebox and close all the dampers and potholes. The heat remaining in the firebox will bake the bread.

Here is a summary of ways to conserve fuel.

1. **Use only wood that is dry.** Some of the energy in wet wood is wasted evaporating moisture. Dry wood produces more heat while causing lower creosote buildup on pots, in the tunnel, and in the chimney.
2. **Keep the dampers closed as much as possible.** This will help stop too much air from entering the stove.
3. **Use thin firewood.** This allows greater control of the fire.
4. **Make fires as small as possible.**
5. **Keep pots in all holes at all times.**

6. **Keep lids on the pots.** Lids reduce evaporative and convective heat losses.
7. **Cook out of the wind.** This reduces convective heat losses.
8. **Use pressure cookers and metal pots.** These pots use the heat more efficiently than ceramic pots.
9. **Boil liquids slowly (simmer) when possible.** Simmering cooks almost as fast as rapid boiling, while using considerably less fuel. This is because boiling always occurs at the same temperature.
10. **Use residual heat stored in the stove body for slow cooking and precooking of the next meal.**
11. **If more than one kind of fuel is to be prepared for a meal, cook them all at the same time.**
12. **Attend the fire regularly to make sure it is doing what you want and is not wasting fuel.**
13. **Pull out and extinguish unburned wood.** Save the charcoal.

#### **MAINTENANCE AND SAFETY: CLEANING THE CHIMNEY PIPE**

Every stove and fireplace has some formation of creosote (a liquid brown or tar-like substance) in the chimney. This material is condensation from unburned gases. It will corrode steel and galvanized iron. Creosote in the chimney will catch fire under certain circumstances. This happens only during a very hot fire, but then the creosote will burn at a very high temperature and can set the roof and house on fire.

Creosote formation also causes other problems. By narrowing the chimney or tunnel, it can restrict the flow of hot air and gases, reducing stove efficiency.

The major causes of creosote formation are use of green or wet wood and incomplete combustion in the firebox. Related factors are not enough air to fire, poor draft, cold chimney pipe, and long periods of burning with dampers nearly closed. The accumulation of creosote is worst in wood-burning stoves used as house heaters, in which a load of wood is added to burn slowly at night.

Bamboo, lorena mix, and clay or tile pipe are better insulators than metal pipe. This means that less creosote will form on the insides of chimneys made with these materials.

The best way to prevent creosote formation is to have complete combustion in a hot firebox. Dry wood should be used. (Dry wood will also produce more usable heat than wet wood, because no energy is lost in evaporating the moisture in the wood.)

**The chimney should be cleaned regularly with a stiff brush, or by banging it hard if it is made of metal. Resinous firewood can clog the chimney in as little as 2 weeks, though in most cases cleaning may only be required every month.**

If a chimney fire does occur, you should shut off all air entering the chimney from the stove, by closing all dampers and potholes.

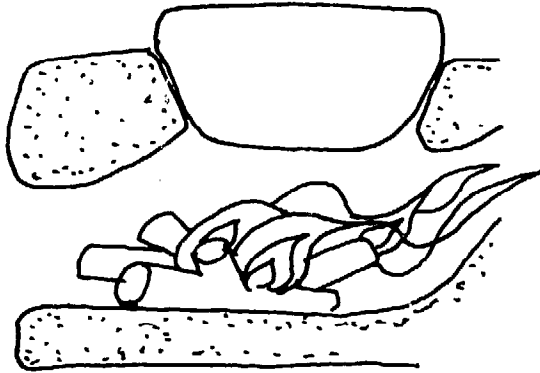

DRAFT OR FIREBOX  
TOO HIGH

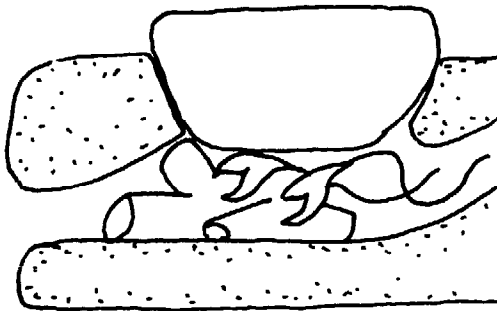

DRAFT OR FIREBOX  
TOO LOW

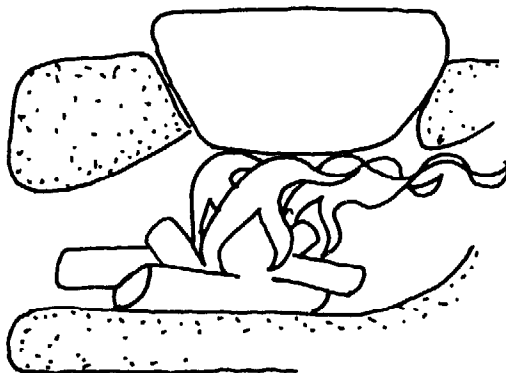

GOOD DRAFT  
AND FIREBOX HEIGHT

## USEFUL IDEAS FOR "TUNING" A STOVE

Here are some ideas to help indicate how well a stove is working. They also help in understanding stove design and how to improve cooking performance. (It is important to realize that these procedures do **not** show that a stove performs better than a traditional cooking arrangement. See the appendix "Evaluating Fuel Savings and Testing at the Village Level.")

1. Thick dark smoke or foggy white smoke indicates poor combustion. The reason may be that the firebox is too low, or that there is not enough draft. It is worth remembering, though, that most stoves produce thick smoke until they are totally dry.

2. By replacing a pot with a glass "pyrex" plate, flame and smoke paths can be watched in the firebox. Using this method you can adjust firebox heights and draft so that the flame licks the bottom of the pan to give maximum heat transfer.

3. If you place a small amount of mud in the bottom of a pan on an operating stove, bubbling in the mud will show which parts of the pan are being heated. Adjust the size and shape of the baffles until the bubbling pattern is evenly distributed.

## **TROUBLESHOOTING**

Here are some of the most common problems with Lorena stoves, their causes, and some possible solutions.

### **Smoking**

Causes:

- damper slots too wide
- improper operation of dampers
- creosote clogging a tunnel or chimney
- pots not properly seated
- chimney too short
- chimney too narrow
- improper chimney installation
- wet wood

### **Cracking**

Causes:

- too much clay in the mix
- clay and sand not mixed well enough
- settling of the base
- early fires too hot, causing rapid expansion
- dimension recommendations were not followed

Solution:

Cut out cracked area, moisten edges and pack in new lorena tightly.

### **Crumbling**

Causes:

- improper sand/clay mix (too much sand)
- silt in the mix
- mix improperly applied
- not enough compaction (dry method)

### **Flaking of the firebox**

Causes:

- failure to smooth the firebox interior
- clay of poor firing quality used

### **Fire hard to start in the morning**

Causes:

- wet wood
- tunnels clogged
- cold air settling in stove pipe

Solution:

To drive out cold air, place a candle or burning paper under the chimney.

**Damper slot enlarges**

Solution:

wet it, fill it in and carve a new one  
nail on an external damper

**Third pot won't boil**

It's not supposed to. If the third pot boils, too much heat is being lost up the chimney.

**Uneven or little heating of pots**

Causes:

baffles improperly made  
tunnel clogged or too small  
firebox too deep  
firebox not properly designed

**Pots stuck in stove**

Wait for the stove to cool, remove pots, splash on some water, refit pot

**New pots**

Make rings of metal as "collars" for new pots that are too small. If pots are larger, wet the pothole edge and recarve it (if the stove is already fired, you'll cause crumbling doing this).

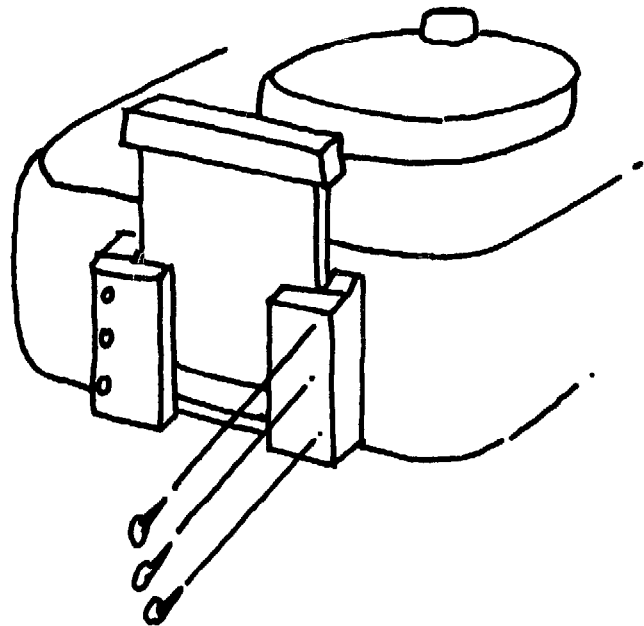

EXTERNAL DAMPER

**NEW IDEAS WORTH TRYING****External Damper**

You can mount the damper on the front of the stove, covering the firebox entrance. This eliminates the front damper slot, which frequently causes cracking problems. Other advantages include easier access to the



fire, more space for longer pieces of wood, and a reduction in the amount of lorena material required.

Pieces of wood should be used to make a housing slot for the damper, so that it fits tightly against the stove block. This will help stop uncontrolled air from entering the firebox. Nail the housing slot onto the stove when the block is almost dry. Nails should be placed at least 10 cm (4 inches) from the firebox entrance to avoid cracking the block.

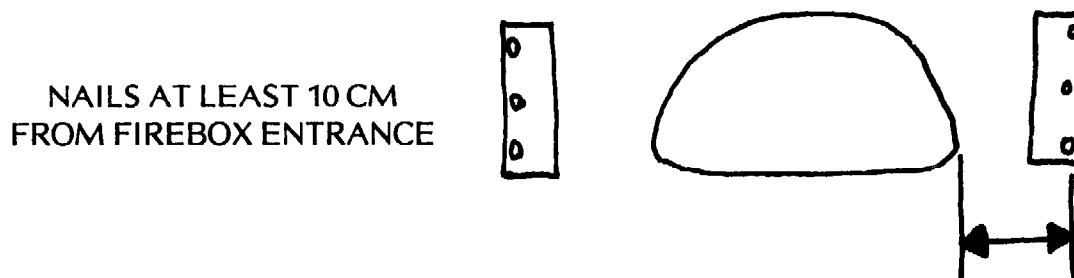

### Replacing Sand-Clay Mix with Rocks or Bricks

In places where clay is scarce you can substitute rocks or bricks for lorena material in some parts of the stove. This method can be applied to the walls of the firebox or any other area of the stove that will not be carved.

### Stress Release

The bridge over the firebox mouth is the main area of cracking in a lorena stove. At Correr in Senegal a piece of cardboard has been molded into the bridge. As the stove dries a crack will form where the cardboard has been inserted. This procedure allows the stove builder to locate the crack where it will cause the least problem.

### POSSIBLE MODIFICATIONS FOR HEATING INDOOR AREAS

The chief use of stoves made of lorena material is for cooking.

In North America and cool highland regions of poor countries, lorena stoves may have potential for space heating. The basic disadvantage is that sand-clay stoves fail to give the quick radiant heat of metal stoves and open fires. Listed below are a few modifications that may improve the space heating capabilities of lorena stoves.

1) The tunnel system on a cooking stove can pass through a built-in bench. This provides a warm place to sit on cold mornings. The long tunnel system allows more heat to be absorbed into the block, making it available for slow space heating.

2) A metal space heating stove could be connected directly into a tunnel system running through a block of lorena material. The metal stove would provide quick radiant heat while the lorena material would absorb the heat normally lost up the flue. This heat would then pass into the room long after the fire went out.

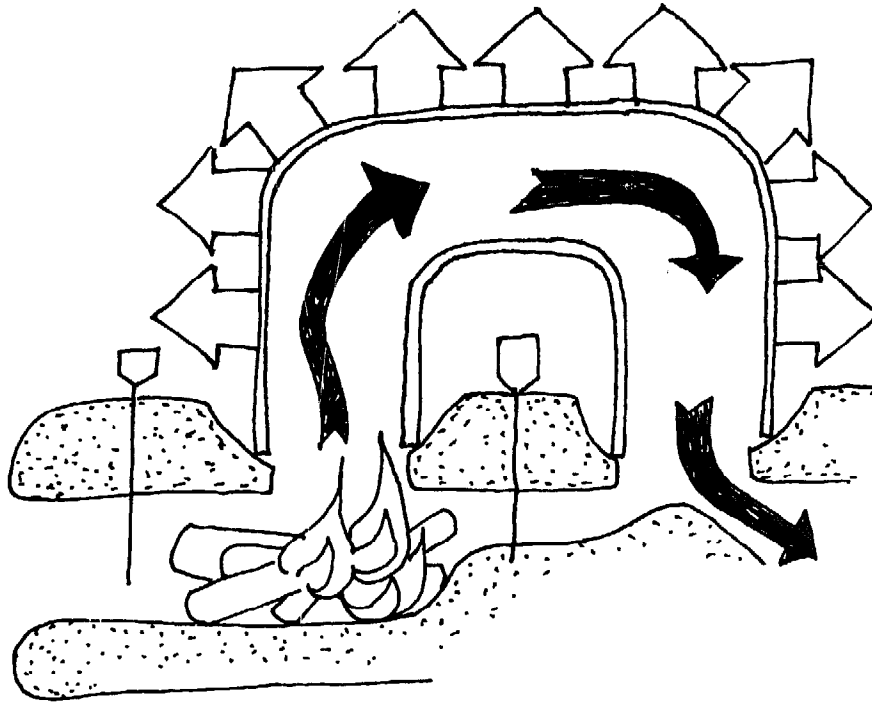

3) Hot gases from the firebox can be directed through a pipe connecting two potholes. In this way the hot gases are brought out of the insulating stove body. The pipe acts as a radiant heater. It is best to block the existing tunnel with a damper or rock to force the gases to flow through the pipe.

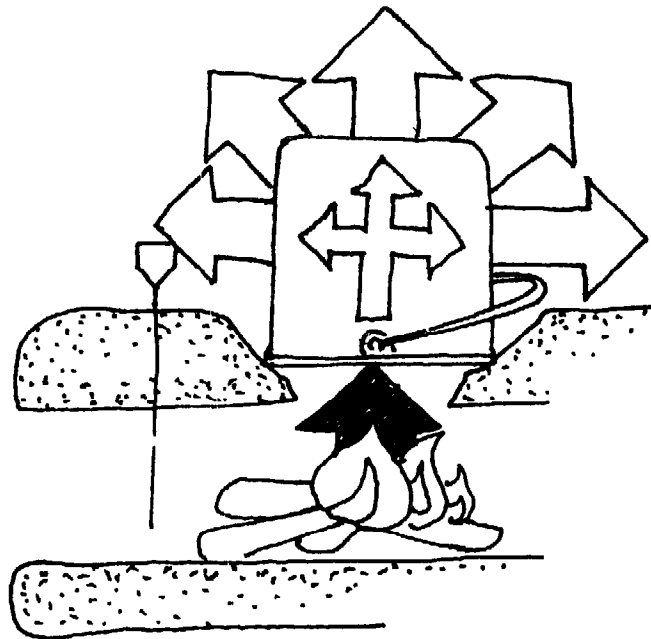

4) An overturned can could replace the first pot. The heat from the fire heats the can, which then radiates heat into the room.

Lorena stoves have potential (not yet tested) as backup heating systems for solar greenhouses. They could be used to deliver heat some hours after being fired up. The mass of the stove would leak the stored heat into the greenhouses to prevent damage in the early morning hours when temperatures are lowest.

**TOPICS FOR FURTHER STOVE RESEARCH**

1. **Alternatives to clay in the lorena mix where clay is scarce or unavailable.** Experiment with such things as brown sugar, cement and lime as substitutes for clay in lorena mix. Try materials that are not fire hazards and which have glue or binder properties, such as dung, straw and rice hulls.
2. **Fuel tests:** Use locally available organic materials such as rice hulls, dogwood bark, sawdust, bark chips, paper, bagasse, straw, walnut shells, peach pits, coal, charcoal or corn cobs. Work on simple ways to process these materials to make them burn and handle better.
3. **Space heaters:** Develop radiant metal panels with hot air tunnels going to them; better control of the time lag between firebox stoking and the moment when the lorena thermal mass begins to release heat to the area around the stove.
4. **Toxic gases:** Test for the presence of unhealthy gases inside enclosed rooms. Experiment with the stove dampers and other fuels to see how best to further eliminate any such smoke or gases.
5. **Dampers:** How can widening of damper slots due to friction be prevented? We've considered using metal sleeves at the ends of the slots to prevent this. Other ideas?
6. **Baking:** Adaptations could make baking possible while the potholes are being used for cooking. Potholes could be designed to hold racks for baking food inside cans or tins. Fireboxes could be designed to hold racks for more baked goods when baking with stored heat.
7. **Firebox lining:** Stoves in daily use for several years now show gradual crumbling of the firebox interior surfaces. Trials of fire clay and other reinforcing materials would be welcome.
8. **Grain dryers:** Adapt the lorena stove concept to make wood or crop residue fired grain dryers. These could take advantage of the relatively efficient combustion and the heat storage properties of the sand in the lorena mix.
9. **Ideas for stove users in relatively affluent countries like the United States:**
  - a) Construct a solar greenhouse, for house heating, with a lorena stove designed to function as a backup system.
  - b) Make an indoor/outdoor kitchen where your climate permits.
  - c) Build an outdoor barbeque or baking oven.

## A BRIEF HISTORY OF THE LORENA STOVE

Lorena stoves were developed at Estacion Experimental Choqui (where the author worked) in the highlands of Guatemala. After the February 1976 earthquake, enormous amounts of wood were cut for reconstruction. The rapid depletion of forest timber was itself becoming a disastrous problem. Fuelwood supplies were becoming increasingly scarce and expensive, soil erosion was greatly accelerated, and the population continued to grow rapidly.

A small team, led by Ianto Evans and Donald Wharton, worked on the stoves from November 1976 to April 1977. We designed and tested several dozen sand-clay stoves and then taught the construction methods to small groups of stove promoters. Our major concerns were:

- Fuelwood conservation;
- Smoke control;
- Protection from fire for cook and children;
- Use of a broader range of fuels than those burned in open fires.

Throughout the period of stove development local people were involved in testing and evaluating the stoves, often with surprising results. Our first stove designs were built with the cooking surface near floor level, in an attempt to adapt the stoves to the tradition of open fire cooking. We had supposed, with no good evidence and without consulting local people, that people would prefer to use floor level stoves. Demonstrations of these stoves were met with polite attention but without enthusiasm. Finally one woman scolded us: "What kind of fools do you take us for? We know perfectly well how high a real cook stove is. Why are you building these insulting, floor-level, undignified cook stoves?" Feeling rather foolish, we immediately began building stoves 75-90 cm (30-36 inches) high. They were instantly recognized by the women to be stoves worthy of the name and attracted great interest.

Cultural preconceptions of the functions of a stove were hard for us to shake off. Our next blunder came as we tried to keep stoves as small as possible, following our own 'modern' notions of economical use of kitchen space. The local women visited us, smiled, nodded politely and went away. It was some time before one of them asked outright, "Why are they so small?" We discovered that she wanted a working surface on the stove top for preparing food; many poor people like her have no kitchen table to work upon. We increased the size of the stoves from 60 X 75 cm to a full square meter, and then developed a whole series of sizes and shapes, from 90 cm on a side (square) to 1.60 meters in diameter (circular). As the stoves became bigger, new functions were added, including those of kitchen table, work surface, dining table, and social center. We also began to promote larger stoves because we discovered that with the long slow cooking procedures of highland Guatemala, up to a point the fuel efficiency increases when stove size increases. Since the materials for building Lorena stoves are sand and clay, there is little additional expense

involved in building larger stoves, although it does mean a lot more hauling and mixing of materials.

In Guatemala, the smoke produced by open indoor fires escapes only randomly through the tiled roofs and other openings. This smoke has a terrible effect on the cook, causing severe eye and lung problems which can lead to blindness, emphysema, bronchitis and lung cancer. Yet smoke is a good preservative for roof beams, keeping away most tropical wood-eating insects. The Lorena stove has neatly confined the smoke to a chimney, protecting the cook but no longer protecting the wooden roofs. Like **any** technology, an improved stove must be adapted to a cultural and geographical situation in a way which is sensitive to the effects of the technology on people and their environment. This may require new low-cost wood preservation techniques.

Much recent work on Lorena stoves has been done in West Africa and Java. Working with local people several special applications of the lorena system have been developed. In other parts of the world—Sri Lanka, the Philippines and Nepal in particular—lorena stoves are being modified to suit local conditions and needs.

Testing of efficiency and materials continues at Estacion Experimental ICADA-Choqui and at the Aprovecho Institute in Eugene, Oregon. Aprovecho emphasizes that specific stove designs, however, should only be generated among the people who will be using them. Usually the best ideas come from the people themselves; anything designed in another country far away is far less likely to be appropriate to specific local conditions and cooking practices.

## **PROMOTION AND EXTENSION WORK**

In Guatemala, the techniques of Lorena stove building have been taught in three-day workshops, with a dozen students (both men and women). We first held workshops for community leaders, people with adobe or masonry skills, and representatives of extension agencies such as national farming, forestry and health programs. Church groups, missionaries, and foreigners with direct influence in local communities were also involved. It is clearly valuable to work with established organizations that are prepared to help promote and monitor this new stove technology.

Workshop participants have worked in pairs to build a large stove, usually in 2 days. By the second afternoon the stoves were completed and cooking techniques were then learned (using dry, previously built stoves). Initially we held workshops only at Estacion Choqui, but this meant participants were traveling long distances and working in unfamiliar surroundings. Workshops are now usually held in local communities, training mostly local people.

### **Suggestions Concerning Workshops:**

1. Photographs, drawings, and slide shows can be a great help in communicating ideas.

2. Try contacting trainees through existing organizations such as co-ops, churches, etc.
3. Be sure each participant has a thorough understanding of each step of stove construction before the work begins.
4. Be aware of and respect local customs.
5. Remember to teach not only stove construction but stove theory, testing, and operation as well. In this way future innovations are more likely to be genuine improvements in the fuel efficiency of the stoves.
6. Make the workshop a festive occasion. Music and food are usually welcomed.
7. Be open to new ideas. Let people experiment; learn while teaching.

### **A FEW WORDS ABOUT THE NAME 'LORENA'**

To people who spend their lives battling with mud (living in mud houses with mud floors, growing crops in it and meeting it at every turn), the prospect of a "mud" stove holds little appeal. Since the sand-clay mixture used to construct the stoves is a different material, we thought that it should have a name of its own—one which would seem somewhat modern. We created the name 'Lorena' by combining two Spanish words: **lodo** (mud) and **arena** (sand). The word describes the intimate mix of the two materials used in building the stoves. Similarly, in Senegal, "lorena" is called "Ban ak Suuf Walof" for "sand and clay."

**APPENDIX:  
Evaluating Fuel Savings and  
Testing at the Village Level**

## APPENDIX

In this appendix we will discuss a number of different methods for ongoing evaluation of stove performance at the village level. In some areas wood shortages are very serious and almost any cookstove would be an improvement over existing cooking fires. If **both** of these conditions are true for your area, rapid dissemination of proven designs without continuous village-level evaluation and experimentation may be justifiable, though it is never preferable. We are, however, convinced that **no** dissemination program should be launched before a careful evaluation process has indicated that the new stoves actually save fuel when compared to the traditional stoves or cooking fires.

The first part of this appendix is about evaluating, without the use of tests, the fuel savings of stoves built in an extension program. Stoves used in daily cooking often operate under conditions that cannot easily be controlled for standard tests. In addition, the details of cooking practices vary a great deal from meal to meal and from family to family. For this reason, we recommend the following activities for evaluating fuel savings in new stoves being disseminated:

- A. Talking with users, and
- B. "Woodstack measurements".

The second part of the appendix will discuss stove testing. Tests are useful in experimenting with new designs and getting preliminary information on how the performance of new stoves might compare with that of traditional stoves. Three kinds of tests are covered:

- C. Food cooking tests
- D. Cooking simulation tests, and
- E. "Efficiency" calculations.



## ESTIMATING FUEL SAVINGS WITHOUT TESTS (Aprovecho Institute)

### TALKING WITH USERS

Our experiences in West Africa and Guatemala suggest that the people who use stoves will know quite accurately how much fuel a stove saves. They, after all, stand to gain directly from fuel savings. And if a stove actually uses more fuel than their traditional cooking method, they will know that and will probably abandon the stove, unless there are other advantages to it. For these reasons, great weight should be given to what stove users and fuel suppliers say.

In gathering this kind of information, it is important not to draw conclusions too quickly. Sometimes people will, out of politeness, tell an outsider what they think the outsider wants to hear. A question like "Is the stove saving half your fuel?" is likely to be answered "yes". Try, instead, several different connected questions such as "How long does it take to collect your wood now?", then later, "How long did it previously take to collect your wood?". Ask how much wood a neighbor without a new stove uses, how much wood was already burned today, and whether this person uses more than other family members. Local units, such as "a bundle every four days" or "six pieces a day" are as useful as standard units.

### WOODSTACK MEASUREMENTS

Woodstack measurements can complement a program of talking with users of new stoves. To be useful, these measurements should be done over several weeks, at a time of year when cooking patterns are typical (not, for example, during a fast or festival). Such measurements are easiest to do in places where there is a stock of wood collected seasonally or bought in large quantities. Then, if the wood remains at the same moisture content, the woodstack can actually be weighed before and after the test period. If fuel is collected every day, the stack must be weighed every time a fire is built. In some areas a portion of the daily fuel supply comes from the woodstack and another portion (e.g., kindling) is collected off the ground nearby and placed directly in the fire. Much fuel never passes through a storage pile (if there is one at all), and the pile itself may be continually growing and shrinking. Irregular guests and special meals can also add confusion for the investigator. All of these normal daily practices tend to make woodstack measurements inaccurate. You must compensate for these factors in your evaluation, if you are going to use this technique. In some situations accurate woodstack measurements are impossible to obtain.

Fuel savings comparisons like these are **not** experiments or tests; the use of the stove is uncontrolled, so that the habits of the people cooking and the needs of the family will have a great effect on how much fuel is used. For this reason, reliable comparisons can be made only between two

stoves (or a stove and an open fire) used by one family.

Still, these simple ways of assessing a stove's fuel savings are some of the most important. They are the only effective ways we have yet found to measure whether or not a stove saves fuel **in use**. They are accurate enough to tell a stove developer whether to proceed with one particular design, and they involve local people in the assessment. The discussion of fuel savings comparisons sometimes evokes inventive ideas from both the users and the stove workers recording the information.

### STOVE TESTS AT THE VILLAGE LEVEL

(By the Appropriate Technology Project of Volunteers in Asia)

As stove designs are adapted and refined, it is important to be able to measure the effect of changing a feature of a design—for example, widening the firebox, making the chimney taller, or adding dampers. Simple tests of stove performance under controlled conditions can be used to measure the effect of a design change.

Most testing of cookstoves has been done in laboratories. While laboratories provide highly controlled conditions, there are also problems with laboratory tests. One of these problems is that the equipment used in laboratory tests is usually so expensive and delicate that it cannot be taken anywhere else. All the tests must be performed in one place, which only a few people can use. Most importantly, laboratories are usually far from the villages, and therefore tests do not necessarily reflect real local conditions. Laboratory testing also excludes local ideas about desired design changes.

The tests described here, however, have been used by stove building teams in villages, and require a minimum of equipment: a spring scale

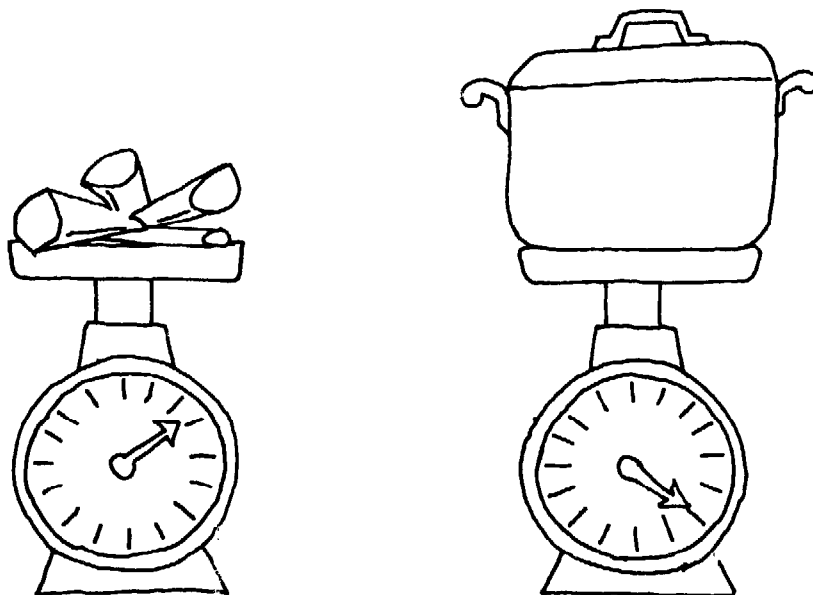

SCALE WEIGHS WOOD AND POTS CONTAINING WATER

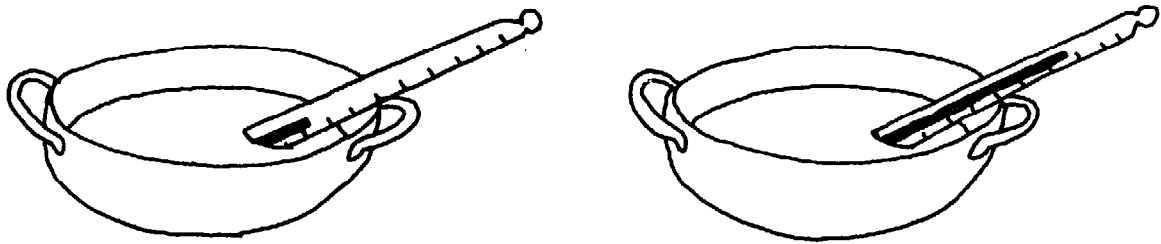

**THERMOMETER MEASURES TEMPERATURE CHANGE**

commonly available in cities for about US\$5-10, and a glass-mercury thermometer, which measures degrees Centigrade (°C) from 0-100 degrees. The scale is for measuring how much fuel is needed to heat how much water or food. (Volumetric flasks—special jars with markings for measuring liquids—can also be used for measuring the water.\* A scale must still be used, however, for measuring wood.) The thermometer is for measuring the temperature change of the water or food while it is heated on a stove.

**FOOD COOKING TESTS**

The simplest test measures the fuel consumed by cooking a typical local meal. The same person (a local person who cooks in the customary manner) should do all the cooking. The water and food to be cooked are carefully measured; exactly the same amount is used in each test. Wood is also weighed carefully before each test, and any wood left over after the food is cooked must be weighed and subtracted from that figure. The difference calculated is the amount of wood that was used for cooking and this amount is written down. The test should be repeated several times on each stove. Then the results of all the tests can be compared.

Stove A			Stove B		
Test 1	Test 2	Test 3	Test 1	Test 2	Test 3
Weight of wood at start	_____	_____	Weight of wood at start	_____	_____
Weight of wood at end	_____	_____	Weight of wood at end	_____	_____
Wood burned:	_____	_____	Wood burned:	_____	_____
Total wood burned in 3 trials:	○		Total wood burned in 3 trials:	○	

\* All measurements of water are in grams in this book. Water can also be measured by volume; one gram of water equals one milliliter (1/1000 liter).

A big problem with this kind of test is that it is difficult to decide precisely when the food is fully cooked, even when the same person does the cooking for all the tests. Also, using much wood for a large fire may not cook the food any faster than using less wood and simmering (boiling slowly). In addition, this kind of test requires a regular supply of the same kind of food, which may be difficult in many rural areas where food supplies vary greatly with the seasons. Cooking different kinds of food requires different amounts of heat from the fire. Remember that the test results and conclusions have little meaning in other places where people eat different foods or cook in a different way.

While wood consumption tests using food measure performance under very real cooking conditions, they do not measure this very accurately. They are therefore only a general indicator of performance, reliably reflecting only very great differences.

The stove designer would ideally like to have a very sensitive test that will reveal the small but significant effects of various design modifications.

### COOKING SIMULATION TESTS

One way to overcome some of the problems noted above is to use water in the pots instead of food. The advantage of "simulating" cooking by using water is that the amount of heat energy required to heat and vaporize (boil away) a certain amount of water is always the same. The disadvantage is that this simplification makes the test less like real cooking.

Instead of preparing a typical meal, water can be "cooked" the same way a meal would be, using water weighing the same as the amount of food normally cooked. In this test a carefully measured amount of water (for example, 4 liters or 4000 grams) is heated on a stove. The size of the fire and rate of feeding wood are adjusted in trial runs so that a certain amount of the water (for example, about 1500 grams) is boiled away within a certain amount of time (for example, 60 minutes) to imitate cooking. Quantities and times should be as much like local cooking as possible. For example, if beans weighing 1 kg (1000 grams) are normally cooked for 60 minutes, the test should run 60 minutes and involve the heating and boiling away of the same amount of water that would be done in the real process of cooking beans. At the end of this task we know that the stove has transferred a certain amount of heat from the fire to the water in the pot. The stove using the least wood to do this is the one with the best performance for this task.

In a boiling water test like this, it is not easy to boil away the same amount of water every time. You should make several trials (5 or more is good) in each stove test of this type, and throw out the trials in which the amount of water boiled away is more than 10% too much or too little. Then add together the **amounts of water boiled away** and the **amounts of wood used** for each of the remaining trials, and divide each total by the number

of trials to get an average. Here is an example for a test starting with a pot containing 4000 gm of water:

	<b>wood used</b>	<b>water boiled away</b>
Trial A	1200 gm	1400 gm
Trial B	1050 gm	1600 gm
Trial C	900 gm	1550 gm
Totals	<u>3150 gm</u>	<u>4550 gm</u>
 Averages:	 <u>1050 gm</u> 3   3150 gm	 <u>1517 gm</u> 3   4550 gm

When we divide each total by 3 (the number of trials), we see that on the average, this stove requires about 1050 gm of wood (3150 gm/3) to heat 4000 gm of water and boil away 1517 gm of water (4550 gm/3).<sup>1</sup> If all the other factors in the test are also carefully controlled—the moisture content and type of wood are the same, the type of pot and lid are the same, the starting temperatures in each test of the stove are the same, and so on<sup>2</sup>—a test like this can give a direct comparison of the amount of wood used in two different stoves for this task. If hot fires for frying or long slow fires for simmering are needed, different cooking simulation tests to approximate these activities should be used.<sup>3</sup>

---

1. It might seem tempting to say "this stove requires about 1050 gm of wood to boil away 1517 gm of water." **But it would be misleading to say this.** The amount of wood used also depends on how much cold water was in the pot at the beginning. For example, if we began the test with 6000 gm of water in the pot instead of 4000 gm, more wood would be needed just to heat the water to boiling. See "calculating efficiency" on pages 90-92 for an explanation of the different amounts of heat energy required to **heat water** and **boil water away**. Also, remember that in this test you are trying to simulate cooking, and therefore the time period of simmering is an essential piece of information.

2. See the section entitled "Control and Measurement in Testing" on pages 97-100.

3. See the discussion of burning rate and fire management on page 99.

## EFFICIENCY TESTS

Another way to compare the performance of stoves is to calculate each stove's "efficiency" in completing a similar cooking task. "Efficiency" in this case means measuring how much heat actually reaches the water in relation to the amount of heat energy produced by the burning fuel. In an absolutely perfect stove, all the heat energy from the fuel would be transferred to the water; but a perfect stove is an impossibility. Some heat energy is lost to the air, some is lost to the walls of the stove, some is lost to the pot holding the water, and some is lost in the form of unburned gases that escape up the chimney. A stove which best minimizes these losses under real cooking conditions is the most "efficient".

"Efficiency" figures are useful because they take both water heated and wood burned into account. But while "efficiency" figures are helpful, it is very important to remember that no stove has an exact "efficiency", and that "efficiency" figures can be directly misleading if not interpreted carefully. Efficiency calculations will be different for different cooking tasks performed on the same stove, and will be affected (like the wood consumption tests) by wood moisture content and other factors that must be controlled.\* This means that your efficiency calculations will never be exactly the same as those done by someone else in a different place, and that **the main value of your results is in helping you to compare stoves locally**. If you read about a stove in another country that is claimed to have a certain efficiency, you should be interested in knowing how and for what task that efficiency is determined. If such a stove has a better efficiency (calculated in the same way) than yours and is used for similar cooking tasks, it may be an improvement. You should confirm this by getting one or making one and comparing it to your new stoves and traditional stoves, using your own tests.

### Calculating "Efficiency"

To calculate efficiency, we need to figure out the amount of heat energy used to heat and boil water away in pots.

#### a) Heat energy used to heat water

The amount of heat energy required to raise the temperature of one gram of water one degree Centigrade is **one calorie** (the calorie is a small unit of heat). This is called the "specific heat constant" of water. (If this is beginning to sound complicated, don't be discouraged—it is not difficult to apply this. Read on, paying attention to the examples given.)

---

\* See the section on "Control and Measurement in Testing on pages 97-100.

Specific heat constant of water =

$$1 \text{ calorie per gm of water per } ^\circ\text{C of increased temperature} = \frac{1 \text{ calorie}}{\text{gram}^\circ\text{C}}$$

Multiplying this number times the amount of water in grams, times the temperature increase of the water, gives the number of calories of heat energy used to heat the water:

Heat energy used  
to heat water (calories) =

$$\frac{1 \text{ calorie}}{\text{gram } ^\circ\text{C}} \times \text{weight of water (grams)} \times \text{temp. increase of water (} ^\circ\text{C)}$$

**Here is an example** of how to do this calculation.

To raise the temp. of 1 liter (1000 gm) of water from 25°C to 100°C requires:

$$\frac{1 \text{ calorie}}{\text{gram } ^\circ\text{C}} \times \text{weight of water (1000 gm)} \times \text{temp. increase of water (100}^\circ\text{-25}^\circ\text{C)}$$

$$\frac{1 \text{ cal}}{\text{g } ^\circ\text{C}} \times 1000 \text{ g} \times 75^\circ\text{C} = 75,000 \text{ calories of heat energy}$$

### b) Heat energy used to vaporize water

Part of the heat energy reaching the water in the pots "vaporizes" it, or changes it from boiling water to steam. The amount of heat energy required to vaporize one gram of water is 536 calories. This is called the "heat of vaporization constant" of water:

$$\text{Heat of vaporization constant of water} = 536 \frac{\text{calories}}{\text{gram}}$$

Multiplying this number, times the amount of water vaporized in grams, gives the number of calories of heat energy used to vaporize water:

$$\text{Heat energy used to vaporize water} = \frac{536 \text{ calories}}{\text{gram}} \times \text{weight of water (grams).}$$

**Here is an example** of how to do this second calculation.

To vaporize 1 liter (1000 gm) of water, converting boiling water to steam, requires:

$$\frac{536 \text{ calories}}{\text{gram}} \times \text{weight of water (1000 gm)} = 536,000 \text{ calories}$$

**Efficiency**

Adding the heat energy used to heat water and the heat energy used to vaporize water gives the total amount of heat energy that has reached the water in a pot on a stove:

$$\text{Heat energy reaching water in pot} = \text{Heat energy used to heat water} + \text{Heat energy used to vaporize water}$$

If we add together the heat energy reaching all the pots in which cooking would normally be done (usually the first two pots), we get the total energy that has reached the water in those pots. If we divide this total by the amount of heat energy produced by the burning fuel, we have the "efficiency" of the stove for that particular task. This number is a percentage which tells how many usable calories of heat energy are transferred to water in pots, for every calorie produced by the fuel\*:

$$\text{Efficiency} = \frac{\text{Heat energy reaching water in pots}}{\text{Heat energy produced by burning fuel}}$$

Don't be discouraged if these formulas seem confusing to you. Reading over this section several times should be helpful. Remember that with these few formulas we are trying to carefully determine how well a stove works when compared to other stoves. We are simply combining numbers representing **wood used** and **heat reaching water in cooking pots** into one number.

---

\* Although the amount of energy in wood varies with plant species, most woods contain about 4800 calories per gram when dry. See discussion of the importance of controlling wood type and moisture content on page 98.



**Example of Calculating Efficiency**

Here is an example of a very simple efficiency test, for a clay pot on three bricks over a fire. **This is the procedure of the test:**

- |  |  |            |
|--|--|------------|
| 1. Weigh the pot.  | weight of pot.....                             | 1560 grams |
| 2. Weigh the pot with water in it  | weight of water and pot before test.....       | 3560 grams |
| 3. Weigh the wood to be burned   | weight of wood before test.....                | 1080 grams |
| 4. Measure the temperature of the water in the pot   | temperature of water at beginning of test..... | 25°C       |
| 5. Start the fire and heat the water in the pot until the temperature of the water stops rising (as the water boils). Write down this final temperature. | temperature of water at end of test.....       | 100°C      |
| 6. Boil for 30 minutes and move the pieces of wood apart to put out the fire. Then weigh the pot and remaining water.                                    | weight of water and pot after test.....        | 3000 grams |
| 7. Weigh remaining wood (if there is any) that was not needed in the fire.   | weight of wood remaining after test.....       | 120 grams  |
| 8. Weigh charcoal remaining  | weight of charcoal remaining after test.....   | 20 grams   |

calculation continues on next page.....

Here are the calculations we need to figure out the efficiency. First, we use the weight of water heated, the temperature increase of the water, and the specific heat constant of water, to calculate the **heat energy used to heat water**:

weight of water and pot	3560 grams
weight of pot	- 1560 grams
<hr/>	
weight of water heated	2000 grams

temperature of water at end of test	100°C
--	-------

temperature of water at beginning of test	- 25°C
<hr/>	
temperature increase of water	75°C

$$\text{heat energy used to heat water} = \frac{1 \text{ calorie}}{\text{gram}^\circ\text{C}} \times 2000 \text{ grams} \times 75^\circ\text{C}$$

$$\text{HEAT ENERGY USED TO HEAT WATER} = 150,000 \text{ calories.}$$

Now, we use the weight of water evaporated and the heat of vaporization constant of water to calculate the **heat energy used to vaporize water**:

weight of water and pot before test	3560 grams
weight of water and pot after test	- 3000 grams
<hr/>	
weight of water vaporized	560 grams

$$\text{heat energy used to vaporize water} = \frac{536 \text{ calories}}{\text{gram}} \times 560 \text{ grams}$$

$$\text{HEAT ENERGY USED TO VAPORIZE WATER} = 300,160 \text{ calories}$$

So the amount of heat energy that reaches the water in the pot is the total of the heat energy used to heat water plus the heat energy used to vaporize water:

$$\begin{array}{rcl} \text{heat energy reaching} & = & \text{heat energy used} + \text{heat energy used} \\ \text{water in pot} & & \text{to heat water} \quad \text{to vaporize water} \end{array}$$

$$\begin{array}{rcl} \text{heat energy reaching} & = & 150,000 \text{ calories} + 300,160 \text{ calories} \\ \text{water in pot} & & \end{array}$$

$$\begin{array}{rcl} \text{HEAT ENERGY REACHING} & & \\ \text{WATER IN POT} & = & 450,160 \text{ calories} \end{array}$$

Now we use the weight of wood burned and weight of charcoal remaining to calculate the heat energy produced by the fuel. If all the wood in the fire is not completely burned, some of it will probably be changed to charcoal. This charcoal should be knocked off the pieces of wood and weighed separately.

weight of wood at beginning of test	1080 grams
weight of wood remaining after test	120 grams
<hr/>	<hr/>
weight of wood burned	960 grams

weight of charcoal remaining	20 grams
------------------------------	----------

Most wood contains about 4800 calories of heat energy per gram. Charcoal is very light in weight but it contains about 7000 calories of heat energy per gram. We can now calculate the energy content of each.

$$\begin{array}{rcl} \text{HEAT ENERGY IN} & = & \frac{4800 \text{ calories}}{\text{gram}} \times 960 \text{ gm} = 4,608,000 \text{ calories} \\ \text{WOOD BURNED} & & \end{array}$$

$$\begin{array}{rcl} \text{HEAT ENERGY IN} & = & \frac{7000 \text{ calories}}{\text{gram}} \times 20 \text{ gm} = 140,000 \text{ calories} \\ \text{CHARCOAL REMAINING} & & \end{array}$$

Because the heat energy in the charcoal has not been used, it should be subtracted from the heat energy in wood burned.

$$\text{heat energy produced by the fuel} = \text{heat energy in wood burned} - \text{heat energy in charcoal remaining}$$

$$\text{heat energy produced by the fuel} = 4,608,000 \text{ calories} - 140,000 \text{ calories}$$

$$\text{HEAT ENERGY PRODUCED BY THE FUEL} = 4,568,000 \text{ calories}$$

We can use the two amounts in the boxes to calculate the efficiency.

$$\text{EFFICIENCY} = \frac{\text{HEAT ENERGY REACHING WATER IN POT}}{\text{HEAT ENERGY PRODUCED BY THE FUEL}}$$

$$\text{EFFICIENCY} = \frac{450,160 \text{ calories}}{4,568,000 \text{ calories}} = .098, \text{ or about } 10\%$$

To do this kind of test on your own stoves, refer to page 101 and the worksheet on pages 102-103.

## CONTROL AND MEASUREMENT IN TESTING

Performing a comparative test is a simple scientific experiment: a procedure for determining how a change in one factor changes the final results. To do this we change only one factor in each test, keeping all the others the same. (If we change both the size of the firebox and the diameter of the chimney, and then discover through testing that the stove performs better or worse than before, we won't know which change affected the final result, or by how much. By changing only one factor, we can be sure that this is the factor affecting the result.)

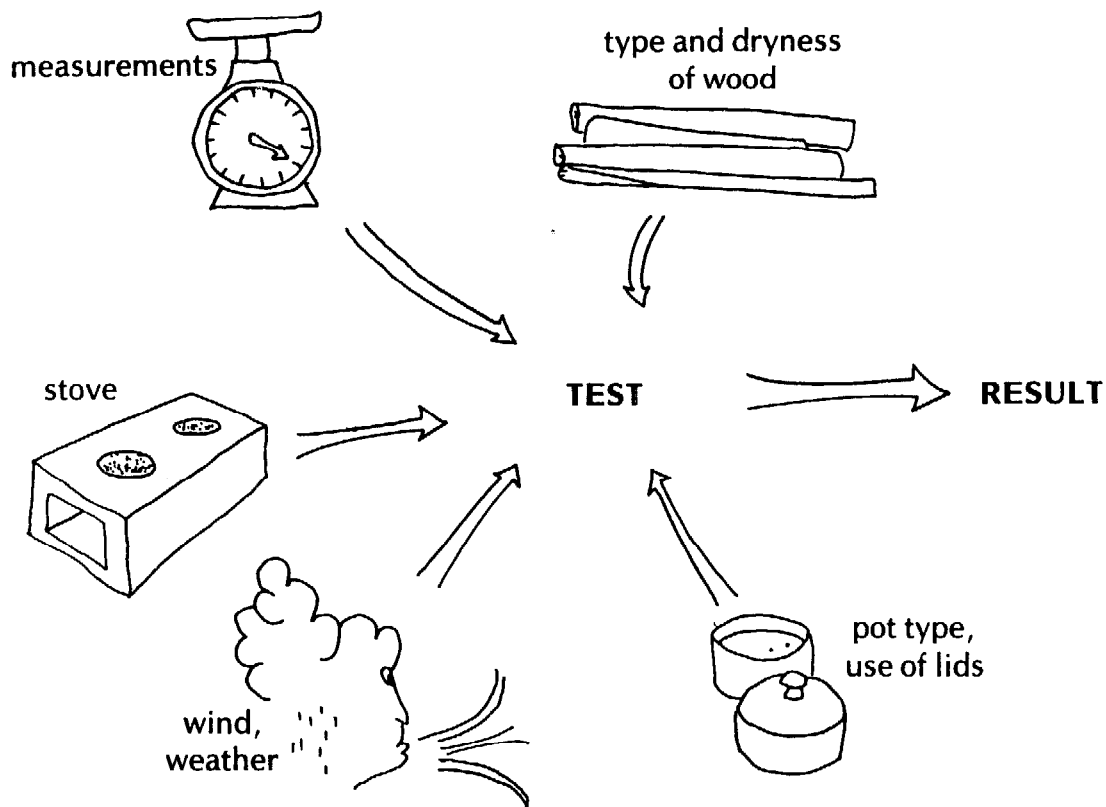

## IMPORTANT FACTORS AFFECTING RESULTS OF TESTS

When we comparatively test different stoves, either by simulating cooking or by measuring efficiency, how can we be sure that other factors are not changing and affecting the results too? We can check this by performing the same test several times, keeping everything the same. If the results of these identical tests are very close to each other, we know that we are successfully keeping all the factors the same, and we say that we have good **control**. Then when we test different stoves and get different results, we can be more confident that the differences are caused by the stoves, and not by the other factors in the test.

People who test stoves have found that because good control is crucial to getting useful results, it is a good idea to be aware of the factors which threaten to cause poor control. Some of the most important of these factors are:

1. **Dryness of fuel.** This is extremely important. When we weigh 1000 grams of wet wood, we are actually weighing partly water, so there is not as much energy in the wood as in 1000 grams of dry wood. Wet wood also gives less heat energy because some of the energy in the wood is used to vaporize the water in the wood. It is important to have enough wood of the same dryness for all tests. Using wet wood for some tests and dry wood for others will mean loss of control—we cannot be sure whether differences in results reflect differences in stoves or differences in wood moisture content. When doing tests, the easiest way to be sure that the wood has the same moisture content is to make sure that it all comes from the same place. Therefore, you should **use the driest wood available, from only one source.**

2. **Accuracy of measurements.** Your measurements of wood, water, and water temperatures can easily be inaccurate. Let's assume, for example, that the scale used to measure wood and water in the test procedure on page 86 is for weighing large objects, up to 10 kilograms. Each mark on the dial is 20 grams apart. This means that we cannot weight any more precisely than 20 grams; if the scale says the water and pot weigh 3560 grams (refer back to the test procedure on page 93), the scale might say 3580 grams if you took the pot of water off and weighed it again. If the scale is old, or sticks a little, the inaccuracy might be even greater. This might not seem to be a big problem, but when we remember that each measurement in a test contains this kind of inaccuracy and that **the inaccuracies are added together in calculations**, we realize that results can be affected greatly. For example, a scale like this might be used in the test on pages 89-91 where the final calculated efficiency was 10%. If we repeat the same test on the same stove with the same scale and exactly the same conditions, amounts, and procedures, we will get final calculated efficiency numbers ranging from 9 to 11%. An 11% stove uses approximately 1/5 less fuel than a 9% efficient stove. But in fact these numbers are for the same stove—they are so different because the scale does not always give the same reading for the same weight.

Obviously then, a scale which is not very accurate will reduce control in testing. Some stove testers believe that a scale accurate to 1 gram is needed to keep good control over the measurement of weights. We think that a scale accurate to 5 or 10 grams can be used to perform the tests in this book. (To compare results of tests on different stoves in different places, the **same** scale must be used, unless scales are accurate to 1 gram. This means that a program conducting widespread tests needs more accurate scales than a program that can do all of its tests with one scale.)

Temperature readings from thermometers also have limited accuracy. This can affect efficiency calculations in the same way.

3. **Pots.** Different pots will give different results on the same stove. Aluminum pots transfer heat from the fire to the water inside more effectively than clay pots, so up to 1/3 less wood is required to bring water to a boil in aluminum pots than in clay pots. Some clay pots retain heat better than aluminum pots, so that a smaller fire is required to **keep** the contents of these clay pots boiling. Therefore, you must **use the same kind of pots for all tests.**

4. **Lids.** Using lids can significantly reduce the amount of wood needed to cook food. They can also change the amount of wood required to heat and boil away water in tests. Therefore you should do all tests with lids or all tests without lids, depending on how people tend to cook in your area.

5. **Burning rate.** This can be a very important factor in controlling tests. Experience in both cooking and testing shows that large, rapidly burning fires may waste heat energy by sending much of it up the chimney instead of into the pots.

The rate at which pieces of wood are added to the fire and the size of the wood pieces both affect the burning rate. An effective way to check and control the burning rate during tests is to time each test with a watch. Then the weight of wood burned can be divided by the length of the test in minutes, to give a burning rate in grams of wood/minute. Analysis of tests of Lorena stoves in Java and Sri Lanka seems to show that both large and small stoves reach their highest efficiencies when their burning rates are approximately 17 grams per minute.\* (See page 106 at the end of this appendix for important notes on interpreting burning rate figures.)

6. **Use of dampers.** Whether or not dampers are used, and how they are used, can greatly affect the results of tests.

7. **Starting temperature of stove.** Energy from burning fuel is required to heat a cold stove, so tests begun with a cold stove will require more fuel than tests done in a stove which is already hot. Combustion is also more complete in a hot stove. Therefore you should compare tests using hot stoves only with other tests using hot stoves, and tests using cold stoves with other tests using cold stoves.

8. **Weather.** Weather conditions can greatly affect test results. Breezes can cause wood to burn faster and blow hot gases away from cooking pots. Therefore, you should **do all tests under the same weather conditions.**

**Here is a short summary of factors which can greatly affect the results of stove tests, and therefore must be controlled:**

1. **Dryness of fuel.**
2. **Accuracy of weighing wood, water and charcoal before and after tests,**

---

\* See "Laboratory and Field Testing of Monolithic Mud Stoves", ITDG Stove Project Interim Technical Report No. 3.2, by Steven Joseph and Yvonne J. Shanahan, January 1981.

and accuracy of measuring water temperatures.

3. Type of pots used.
4. Whether or not pots are used with lids.
5. Burning rate (how fast the fire is stoked; size of wood pieces).
6. Use of dampers.
7. Temperature of stove at beginning of test.
8. Weather conditions.

The importance of controlling these factors in any kind of test cannot be ignored. For example, a test of a cold two-hole stove (like the one on page 36) boiling water in two clay pots without lids and using damp wood might give an efficiency of 8 or 9%, similar to results on an open fire. If the same stove were already hot, and used to boil water in a test with aluminum pots and lids, and dry wood, the efficiency result might be double—in other words, wood consumption would be 1/2.

We can see then that the measured “efficiency” or wood consumption of a stove depends on both measurement accuracy and on how the stove is used. **The test procedures for comparing the performance of stoves in a particular village or district should, as closely as possible, reflect the way local people cook;** in this way, fuel consumption results will better predict how well stoves perform in actual use.

### DESIGNING A VILLAGE LEVEL “EFFICIENCY” TEST

Here is how a test might be designed in a community in which the main food is rice.

Let us assume that villagers cook rice and boil vegetables in the afternoon; this is the biggest cooking task of the day. Traditionally, rice is cooked in one pot with about 1 liter (1000 grams) of water, and vegetables are cooked in a second pot with 2 liters (2000 grams) of water. Both pots are placed on rocks surrounding an open fire. Lids are used; they are removed only to check once or twice whether the food is done.

Let’s imagine that we want to test a two-hole Lorena stove like the one on page 36. With this stove, people find that they can boil 1 liter (1000 grams) of water for rice on the first pothole while 2 liters (2000 grams) of water and vegetables are heating on the second pothole (fig. 1). Then, when the rice is boiling, it is moved to the second pothole to simmer and the vegetable pot is moved to the first pothole (fig. 2). When the vegetables boil, the fire is reduced and the vegetables simmer while the rice steams, about 30 minutes until the rice is done.

How can we test the Lorena stove and compare it to the traditional open fire? Here is a procedure:

1. Weigh the rice pot and the vegetable pot.
2. Weigh the rice pot containing about 1 liter (1000 grams) of water (but no rice!). Weigh the vegetable pot containing 2 liters (2000 grams) of



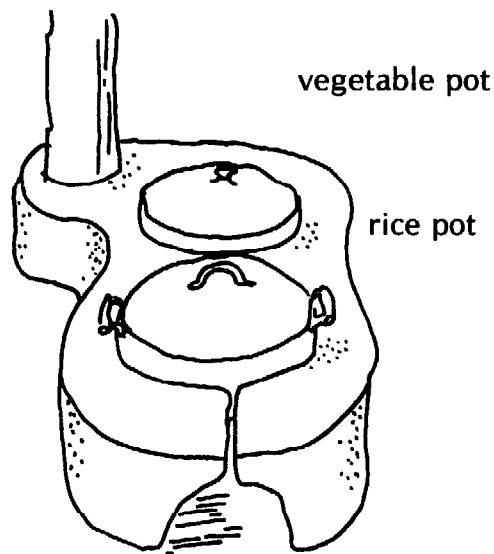

FIGURE 1.

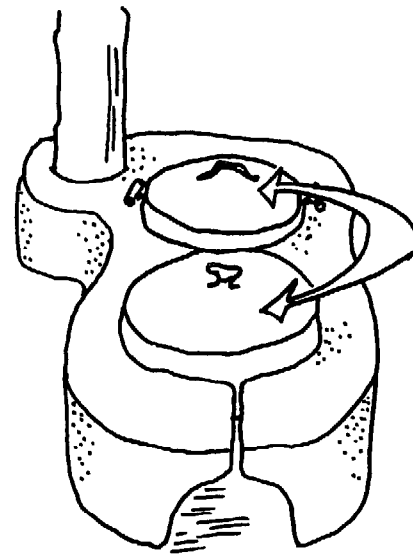

FIGURE 2: POTS SWITCHED

water (but no vegetables!). Place the rice pot on the front and the vegetable pot on the back pothole.

3. Weigh the wood to be burned.
4. Measure the temperature of the water in the pots.
5. Put the lids on the pots and start the fire. When the water in the rice pot boils, measure its temperature and move it to the back burner and move the vegetable pot to the front. When the water in the vegetable pot boils, measure its temperature and reduce the fire so that the vegetable pot just simmers. Simmer the vegetable pot like this for 30 minutes. Take off the lids only a few times, as if you were cooking a meal. At the end of 30 minutes, pull the pieces of wood out of the firebox to put out the fire.
6. Weigh the rice pot with the water remaining in it, and the vegetable pot with the water remaining in it.
7. Weigh **wood** and **charcoal** remaining from the fire.

We could perform the same procedure for the traditional open fire cooking method. We would calculate the efficiencies of the Lorena stove and the traditional open fire in the same way that efficiency was calculated for the single pot on the open fire on pages 93-96, adding the heat energy reaching each of the two pots before making the final calculation.

The next pages contain a worksheet which you can use to calculate efficiency for a test with two pots. Follow the numbers in circles on the left side of the page. They indicate the sequence for making and writing down measurements, so step 1 is to weigh each of the pots, step 2 is to weigh each of the pots with water in it, and so on.

# Worksheet

## First Pot

## Second Pot

**step 2** Weight of water and first pot before test \_\_\_\_\_ grams

Weight of water and second pot before test \_\_\_\_\_ grams

**step 1** Weight of first pot - \_\_\_\_\_ grams

Weight of second pot - \_\_\_\_\_ grams

WEIGHT OF WATER HEATED IN FIRST POT \_\_\_\_\_ grams

WEIGHT OF WATER HEATED IN SECOND POT \_\_\_\_\_ grams

**step 5** Temperature of water at end of test \_\_\_\_\_ °C

Temperature of water at end of test \_\_\_\_\_ °C

**step 4** Temperature of water at beginning of test - \_\_\_\_\_ °C

Temperature of water at beginning of test - \_\_\_\_\_ °C

TEMPERATURE RISE OF WATER IN FIRST POT \_\_\_\_\_ °C

TEMPERATURE RISE OF WATER IN SECOND POT \_\_\_\_\_ °C

Energy used to heat water in first pot =  $\frac{1 \text{ calorie}}{\text{gram } ^\circ\text{C}} \times \text{_____ grams} \times \text{_____ } ^\circ\text{C}$   
= \_\_\_\_\_ calories

Energy used to heat water in second pot =  $\frac{1 \text{ calorie}}{\text{gram } ^\circ\text{C}} \times \text{_____ grams} \times \text{_____ } ^\circ\text{C}$   
= \_\_\_\_\_ calories

Energy used to heat water in both pots = \_\_\_\_\_ calories .....

**step 2** Weight of water and first pot before test \_\_\_\_\_ grams

Weight of water and second pot before test \_\_\_\_\_ grams

**step 6** Weight of water and first pot after test - \_\_\_\_\_ grams

Weight of water and second pot after test - \_\_\_\_\_ grams

WEIGHT OF WATER VAPORIZED IN FIRST POT \_\_\_\_\_ grams

WEIGHT OF WATER VAPORIZED IN SECOND POT \_\_\_\_\_ grams

Weight of water vaporized  
in both pots

= \_\_\_ grams

Energy used to vaporize  
water in both pots

= 560 calories X \_\_\_ grams

= \_\_\_ calories

Energy reaching water  
in both pots

= energy used to heat water in both pots + energy used to vaporize water in both pots

= \_\_\_ calories + \_\_\_ calories

= \_\_\_ calories

step 3 Weight of wood before test

\_\_\_ grams

step 7 Weight of wood remaining after test

- \_\_\_ grams

WEIGHT OF WOOD BURNED

\_\_\_ grams

WEIGHT OF CHARCOAL REMAINING = \_\_\_ grams

Energy in wood burned

=  $\left(\frac{4800 \text{ calories}}{\text{gram}} \times \text{___ grams}\right) - \left(\frac{7000 \text{ calories}}{\text{gram}} \times \text{___ grams}\right)$

= \_\_\_ calories - \_\_\_ calories

= \_\_\_ calories

Efficiency

=  $\frac{\text{energy reaching water in both pots}}{\text{energy in wood burned}}$

=  $\frac{\text{calories}}{\text{calories}}$

=

## STOVE EVALUATION PROGRAMS

Great progress is currently being made in methods of evaluation of stoves and their impact on fuel use in villages; stove developers and promoters are producing new insights and information daily. Therefore, we do not want to say that one method or approach is valuable above all others. We hope, instead, that in this appendix we have raised concerns which will help readers think about designing their own evaluation strategies.

We do believe that it is important to combine different kinds of evaluation, and not to concentrate on a single type of survey or test. In other words, woodstack measurements to determine fuel consumption should not be done without also spending considerable time finding out from villagers how much fuel they think they are saving. In the same way, different kinds of tests—actual cooking tests, simulated cooking tests, and others—should be performed on each new and modified stove design.

There are several advantages to performing different kinds of tests on each type of new stove. The first advantage is that we can see which tests are best—which tests show how differences in stove construction affect performance, while still reflecting local cooking practices. Another advantage is that taken together, the results of several different kinds of tests can indicate a stove's versatility—how well it performs a variety of normal cooking tasks. A third important advantage is that we can learn from the different results how stove use and cooking practices might be adapted to improve efficiency and fuel savings.

Figure 3 is a chart showing how two stoves perform in four different efficiency tests. Stove A is a traditional box stove made of clay tiles with a hole in the front for the fire and a hole in the top for a pot. Stove B is a small Lorena stove. The chart shows that the clay tile stove may be just slightly more efficient for short cooking tasks like bringing water to a boil, but the small Lorena stove is more efficient and uses less wood for longer tasks like boiling for a half hour or more. Also, both stoves perform better bringing water to a boil when lids are used on the pots.

What can this chart tell us? First, it suggests that a test that ends after water is brought to a boil is not likely to show much difference between the traditional technology and the small Lorena stove. For short cooking tasks, the clay stove may perform as well as the small Lorena stove. On the other hand, the test with the one hour boiling period shows a definite difference in performance. Apparently the heavier Lorena stove takes longer to reach its most efficient operating temperature, but does transfer more heat to the pot after it has warmed up. For areas where cooking times are long, the small Lorena stove may perform better than light clay stoves, and this test may be a good indicator of the difference.

What about cooking tasks longer than bringing water to a boil but shorter than 30 minutes of cooking? We cannot tell from our chart which of these two stoves would perform such a task better. A stove which is

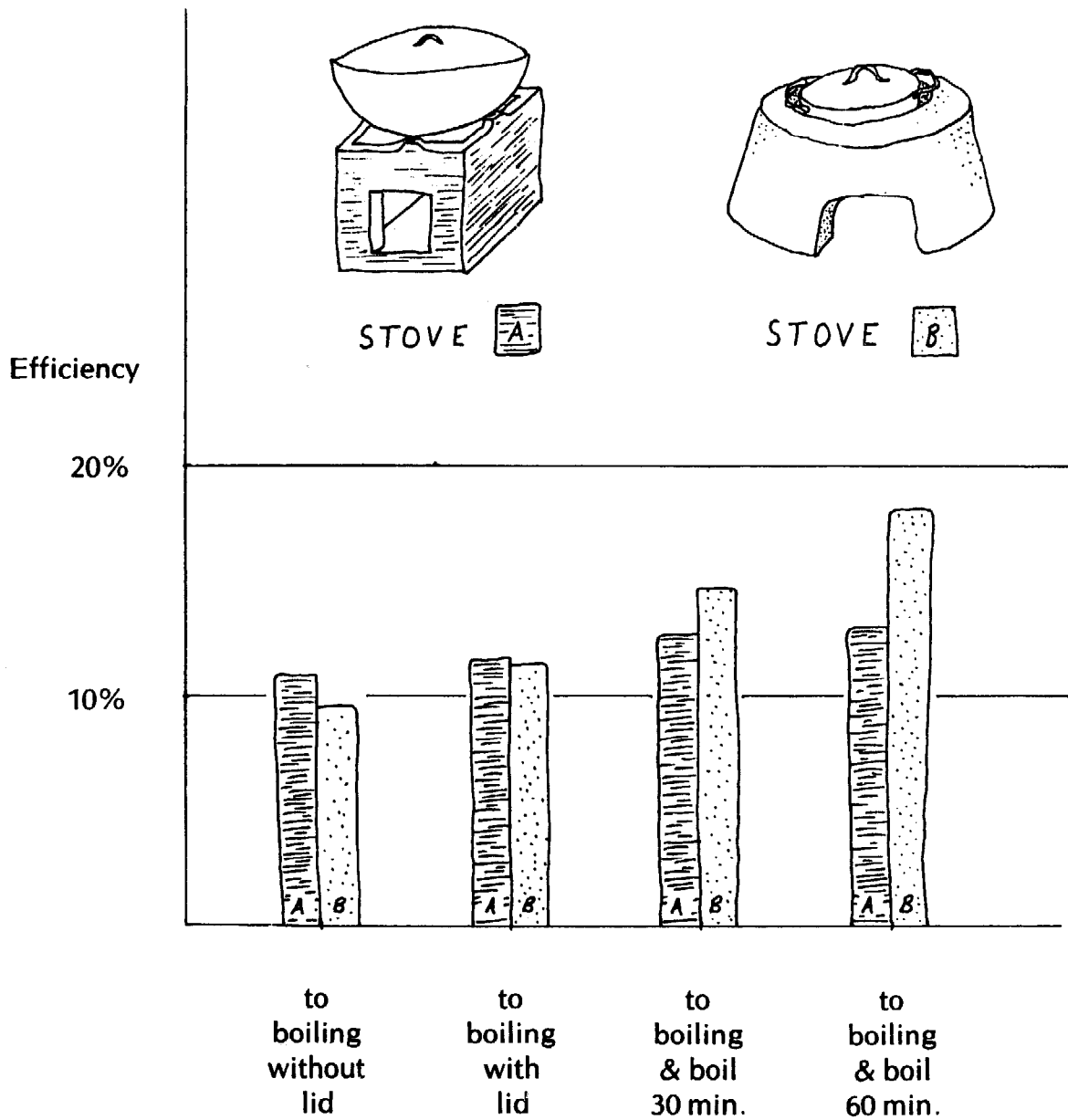
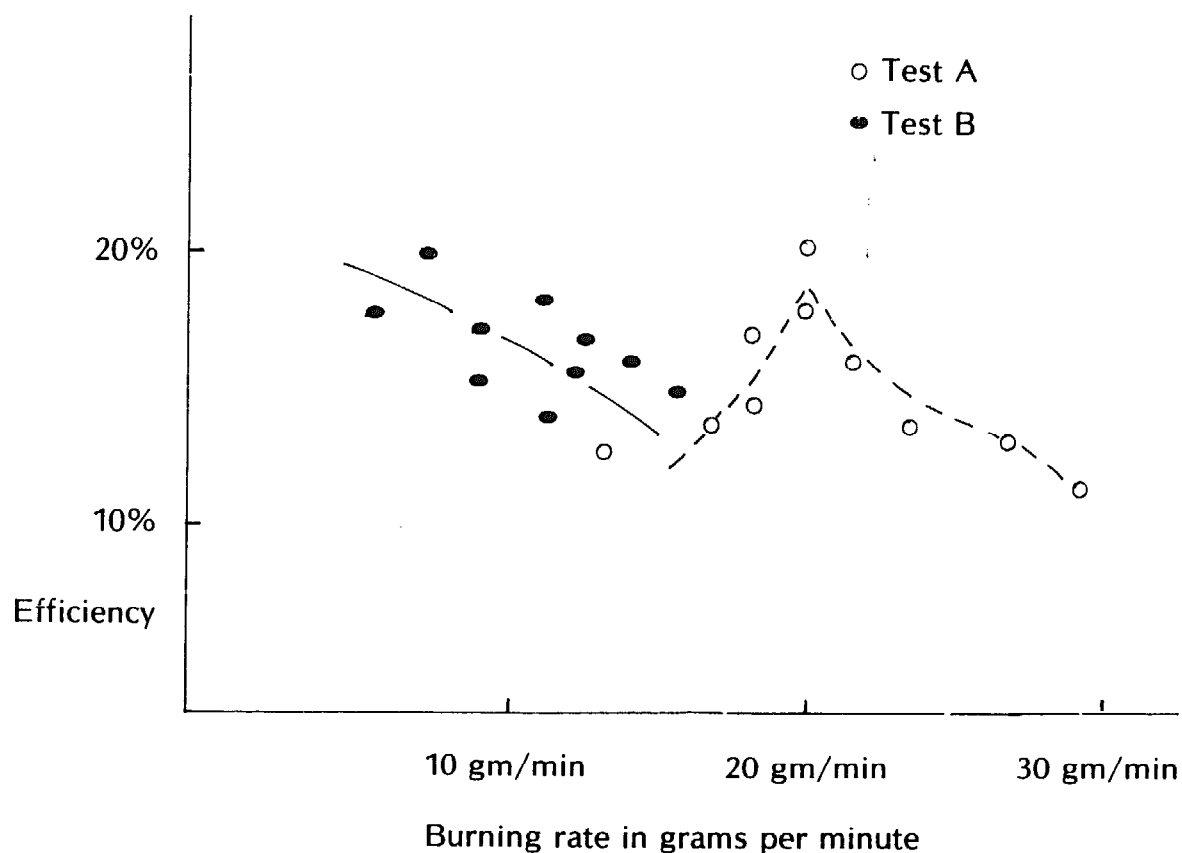

FIGURE 3

heavier than the clay stove but lighter than the Lorena stove might perform this task better than either stove on the chart. To investigate this, it would be useful to find or design and test such stoves.



(Graph from "Laboratory and Field Testing of Monolithic Mud Stoves", ITDG Stove Project Interim Technical Report No. 3.2, by Steven Joseph and Yvonne J. Shanahan, January 1981.)

FIGURE 4

Recent stove testing in Sri Lanka and Java indicates that burning rates (see page 99) are such an important part of stove performance that they should be measured and stated along with efficiency figures. When the burning rate for each efficiency result is shown on a simple graph, we can see how size and management of the fire are related to efficiency for a given task. Figure 4 shows efficiency vs. burning rate for 10 trials of each of two different boiling water tests done on the same stove. In test A, bringing a pot of water to a boil, burning rates of about 20 grams per minute seem to give the highest efficiencies. In test B, bringing water to a boil and boiling it for 30 minutes longer, efficiencies seem to be highest with a burning rate of less than 10 grams per minute.

These tests show dramatically that efficiency figures depend on how rapidly the fire burns. Clearly test results like these will not predict a stove's performance in use\*, unless the test fires are managed the way people manage fires when they cook.

\* Tests like these might indicate a different burning rate would be more efficient than the current burning rate used by people in the community. In this case, such information can be used in the extension program.

**GLOSSARY**

The following words are defined as they are used in the text:

**abandon**—leave alone or unused

**absorb**—draw in, take in

**adaptation**—a change to fit with new or different conditions

**adobe**—sun-dried mud

**applicable**—usable, relevant

**assess**—evaluate; figure out

**average**—sum of all results divided by the number of results

**backup**—secondary, supplementary

**baffle**—a mound of lorena material at the bottom of a pothole, used to direct the flow of hot gases against the bottom of a pot

**bagasse**—the burnable fiber remaining after sugar has been extracted from sugar cane.

**binders**—materials which hold things together (such as glue or cement)

**brittle**—easily cracked or broken

**burlap**—heavy cloth material made of jute

**burning rate**—how much wood a fire uses in a period of time, measured in grams/minute.

**calculate**—compute, work out with numbers

**calorie**—a unit of heat energy. Defined as the amount of heat energy needed to raise the temperature of 1 gm of water 1 degree C.

**Centigrade (°C)**—the temperature scale in most common use throughout the world. Zero degrees Centigrade is the temperature at which water freezes; 100 degrees Centigrade is the temperature at which water boils and vaporizes (this varies a little with altitude). One calorie raises the temperature of 1 gm of water 1 degree Centigrade.

**ceramic**—made of fired clay

**clockwise**—in the direction in which a clock's hands move

**clog**—stop up, restrict

**combustion**—burning

**compacted**—packed until solid

**compensate**—take into account, make adjustments

**complement**—add to; go with

**composition**—what something is made of

**conclusions**—knowledge gained from an investigation such as a test or experiment

**condensation**—a liquid that forms when a gas cools

**conduction**—heat moving through solid objects; different from 'convection' and 'radiation'

**confirm**—check, make sure

**conserve**—to use in such a way as to protect future supplies

**considerations**—things to remember

**consumption**—how much fuel a stove uses

**control**—carefully maintaining desired conditions

**convection**—heat carried by moving gases; different from 'conduction' and 'radiation'

**cord**—thin rope

**corrode**—rust, oxidize

**counterclockwise**—opposite to the direction in which a clock's hands move

**creosote**—a burnable liquid or tar-like substance that is formed when unburned firebox gases are cooled; often forms in metal chimneys and can be the cause of dangerous chimney fires.

**crumbly**—falling apart easily

**damper**—a sliding door which controls the entry or exit of gases

**debris**—unwanted materials

**deforestation**—the destruction of trees and shrubs that cover the land

**deform**—change shape

**depletion**—consumption of a resource at a rate which threatens future supplies

**diameter**—the distance across something with a circular shape; the thickness of a cord or thread

**dissemination**—spreading around

**down-draft**—a flow of air down through the chimney and into the room

**draft**—a current of air

**eddies**—circular currents

**effective**—making good use of available material or fuel; performing well

**efficient**—without waste; giving a good cooking result with relatively little fuel used

**elaborate**—complicated, complex

**enlarge**—make larger

**essential**—necessary

**evaluate**—to determine the value or usefulness of something

**evaporate**—to dry; lose moisture

**evoke**—bring out; draw out

**excavate**—to dig out



- excess**—extra, too much
- exclude**—keep out; rule out
- experiment**—set of steps for determining or measuring something, carried out under certain conditions
- factor**—something which affects performance or results
- faucet**—a valve which controls the flow of water in a pipe
- firebox**—the chamber in which the fuel is burned
- flammable**—could burn or catch fire
- flue**—tunnel or passageway for gases
- formula**—a sentence, written with numbers, which expresses a rule or relationship
- free-standing**—standing without supports
- grate**—1) a frame for holding burning fuel; 2) to make a rough scratching noise
- grit**—pieces of small hard material (such as sand)
- gunnysack**—a large bag made of jute
- heat of vaporization**—the amount of heat energy needed to change a boiling material to vapor or steam
- hopper**—a container holding material to be gradually fed into the firebox
- inaccuracy**—lack of precision or exactness; unreliability; amount of error
- incorporate**—include in, build in
- indigenous**—that which is local, native, traditional
- inlet**—opening that allows gases to enter
- innertube**—a tube holding air, that is inside of a bicycle tire
- innovation**—an idea for a new way to do something
- install**—attach, put on
- insulate**—prevent contact or flow. Materials that insulate do not allow heat to flow through them easily.
- investigate**—to find out, using carefully thought out procedures
- kindling**—small pieces of wood used to start a fire
- layout**—arrangement of different objects
- lorena**—a sand and clay mixture; the word comes from the Spanish 'lodo' (meaning 'mud') and 'arena' (meaning 'sand')
- machete**—a large heavy knife, used especially in South America
- mason trowel**—see 'trowel'
- masonry**—something constructed of stone, brick, or other hard material
- modification**—change
- modify**—to change or alter
- moisture content**—the amount of water in something; how damp something is
- monitor**—carefully observe

**mound**—hump, bump

**natural draft**—a flow of air caused by natural forces

**offset**—placed to one side; not centered

**outlet**—opening that allows air or gases to leave

**overheated**—heated too much

**perforated**—full of holes

**pipe elbow**—a short piece of curved pipe

**pipe-nut**—a nut which screws onto a threaded pipe

**plug**—a solid column of material formed inside a pipe

**potholes**—holes in the top of a stove into which pots are placed

**radiant heat transfer**—flow of heat from a hot object to a cooler object at a distance from it

**radiate**—to send out heat

**radiation**—heat given off by a hot object, which can be felt at a distance; different from 'convection' and 'conduction'

**rake**—to move around

**rammed earth**—a method for building walls in which soil is pounded inside forms

**residual**—remaining, left over

**rigid**—stiff and unmoving

**rubble**—solid pieces of hard materials such as concrete

**screed**—a technique for smoothing concrete using a flat board

**seasonal**—changing with the time of year or season

**sequence**—order

**shrink**—reduce in volume

**silt**—small particles of earth, of a size between clay and sand

**simmer**—boil gently

**simulation**—close imitation

**sketch**—to draw (a picture)

**slumping**—sagging, collapsing

**smoulder**—to burn, giving off smoke but little heat

**snug**—surrounded closely by something

**soil-cement**—a mixture of soil and cement

**soil composition**—the percentages of the different materials in a soil

**spacious**—having lots of open space

**specific heat**—the amount of heat energy needed to increase the temperature of a material (in this book, the material is always water)

**squatting**—a way of sitting on one's heels close to the ground

**stoking**—adding more fuel

**stress**—force on a material which might cause it to weaken or break

**structural**—affecting the main part of something

**subsoil**—soil that has little or no organic material in it, below the topsoil

**suck**—see 'suction'

**suction**—pulling air through

**tamp**—pound lightly and carefully

**taper**—a gradual change in the thickness or width of an object

**test**—a set of steps to 'try out', measure, or check something

**thermal mass**—the measure of the ability of a material to store heat

**toe space**—space for the feet at the bottom of a stove, which allows the user to stand close to the stove

**toxic**—poisonous

**transfer (heat)**—cause heat to move or flow

**trim**—to cut so as to make even

**trowel**—a hand tool used for spreading and smoothing

**turbulence**—roughness in the flow of air or gases, caused by the shape of its tunnel or passage

**typical**—usual, normal

**utilized**—made use of

**vaporize**—boil away, change to steam

**vault**—arch

**waterproof**—not letting water through



Cooking over an open fire in Guatemala



Building a Lorena stove: applying the first layer of lorena



Applying the fourth layer of lorena

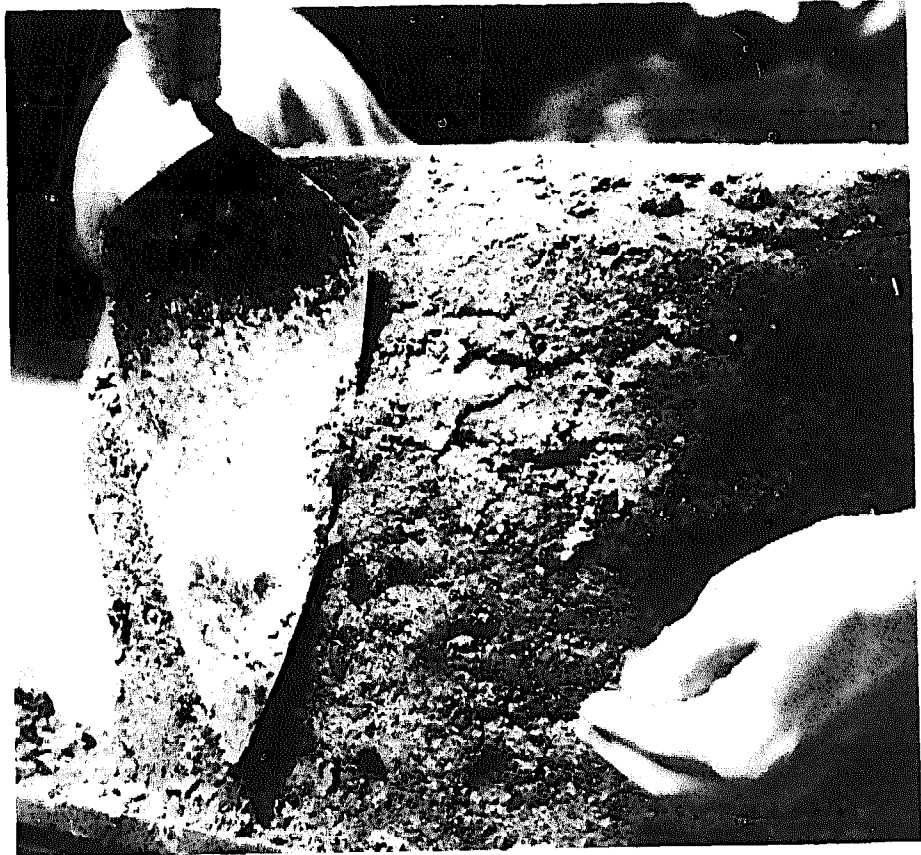

Smoothing the side of the stove

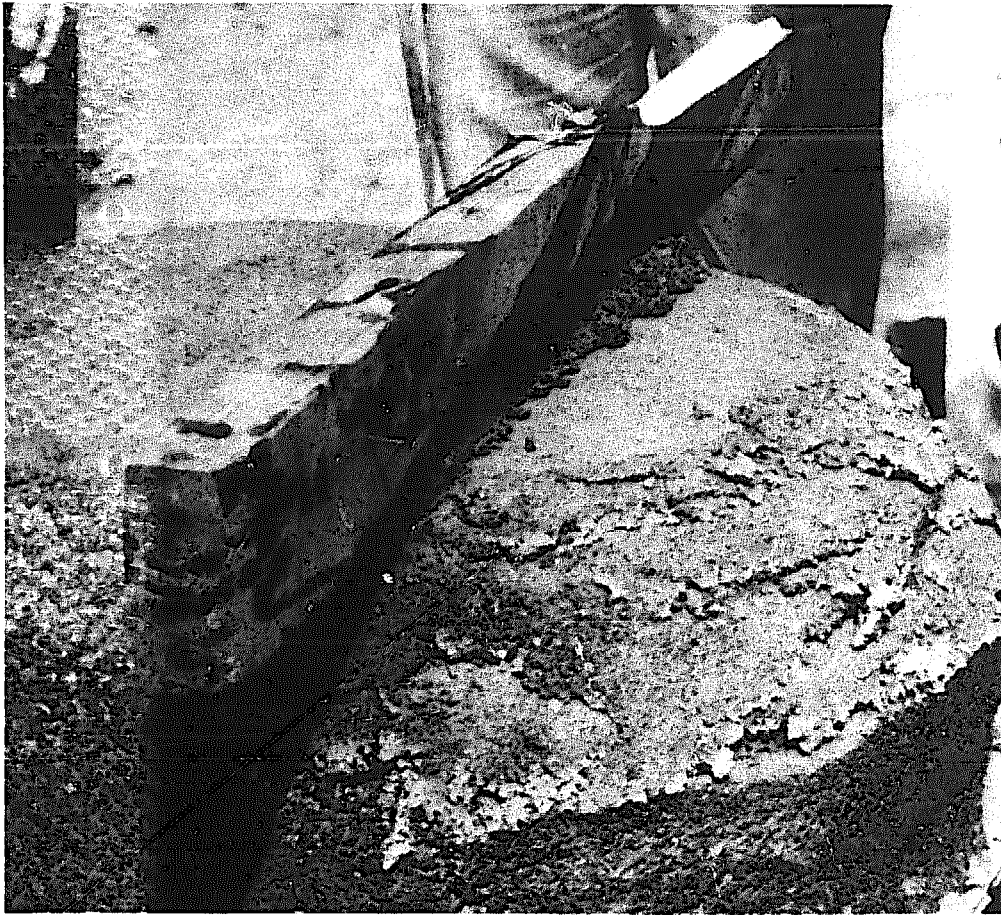

Wet board  
used to  
flatten  
the top of  
the stove

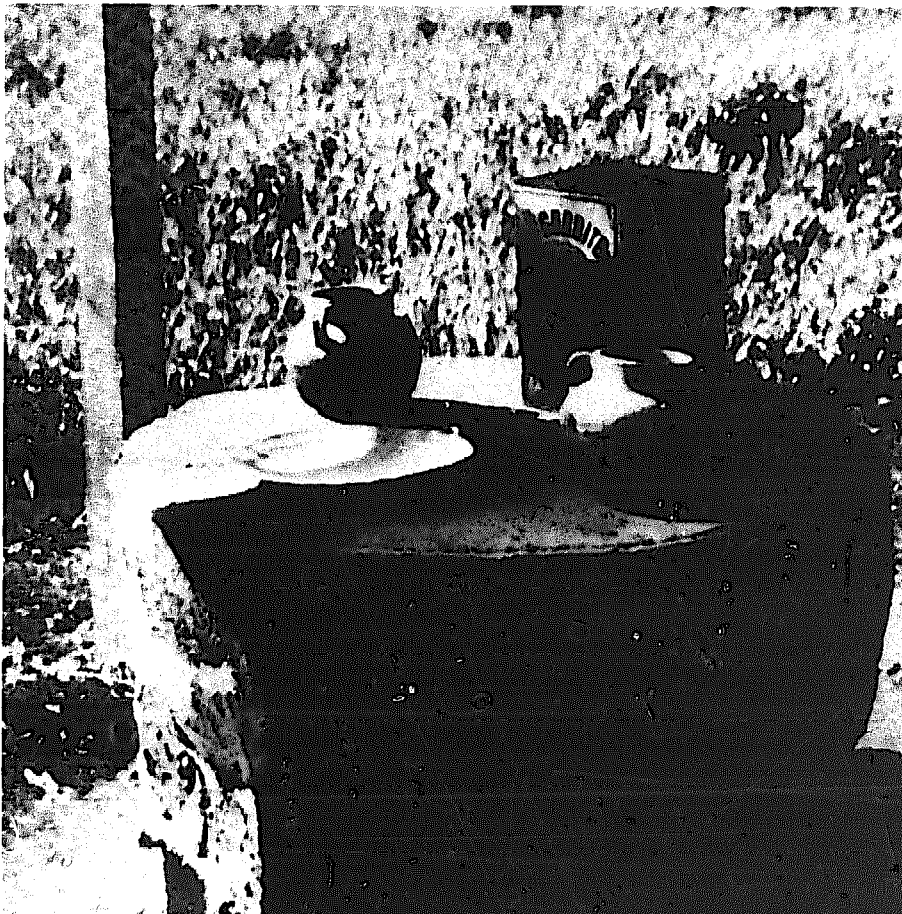

Pots, griddle  
and water can  
be placed on  
stove top while  
deciding position  
of each



TOP:  
Using the  
chimney pipe  
to carve out  
a pot hole



BOTTOM:  
Cooking on a  
large whitewashed  
Lorena stove  
in Guatemala

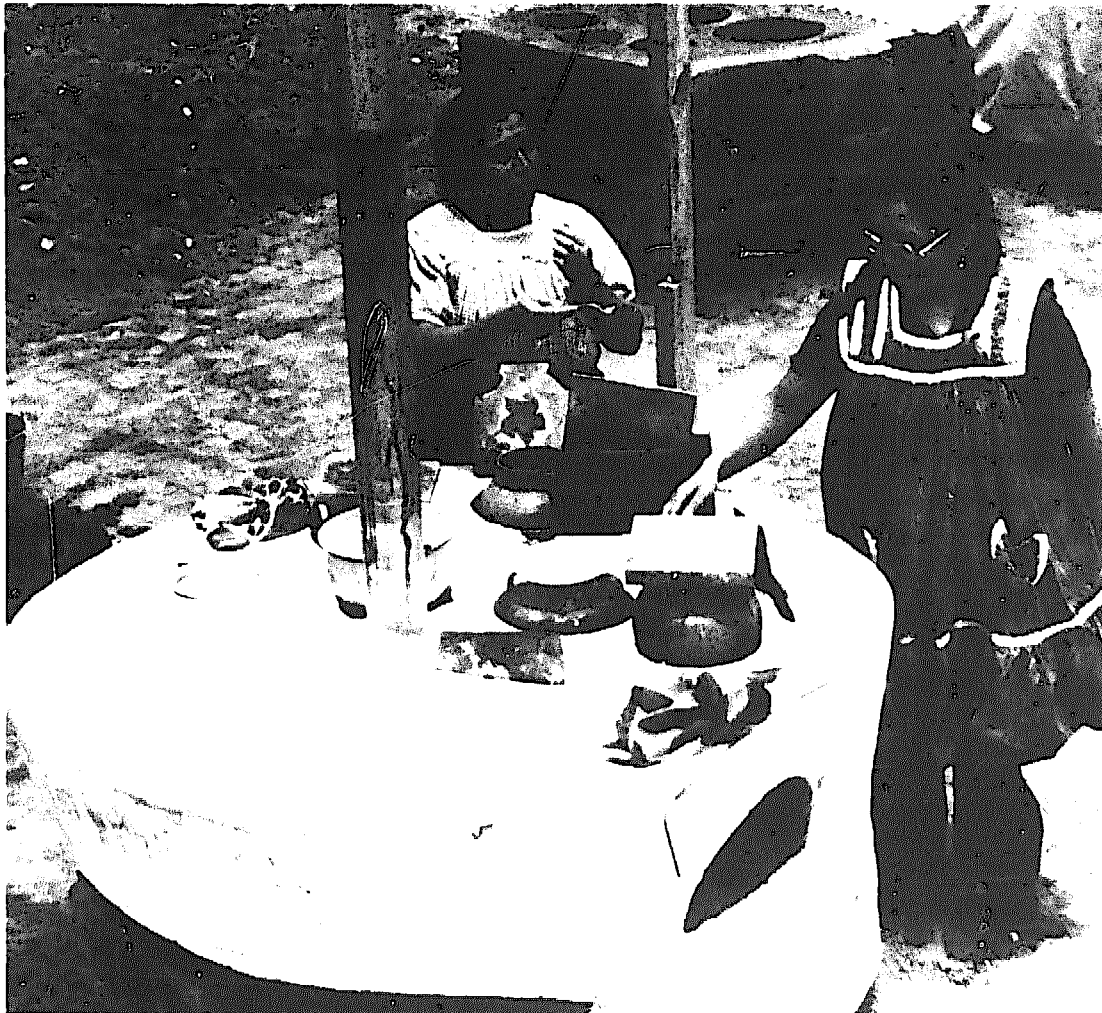



TOP:  
An early Lorena  
stove in Java

BOTTOM:  
Cooking on a  
large Lorena stove  
in Guatemala

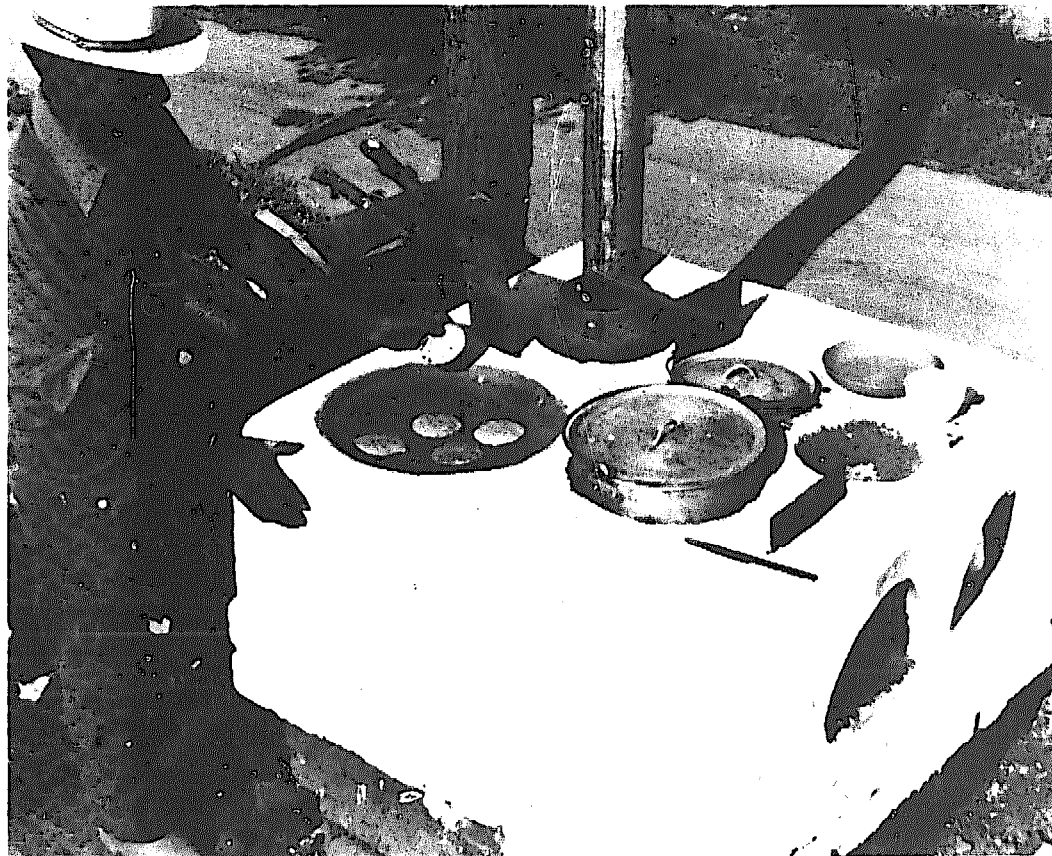



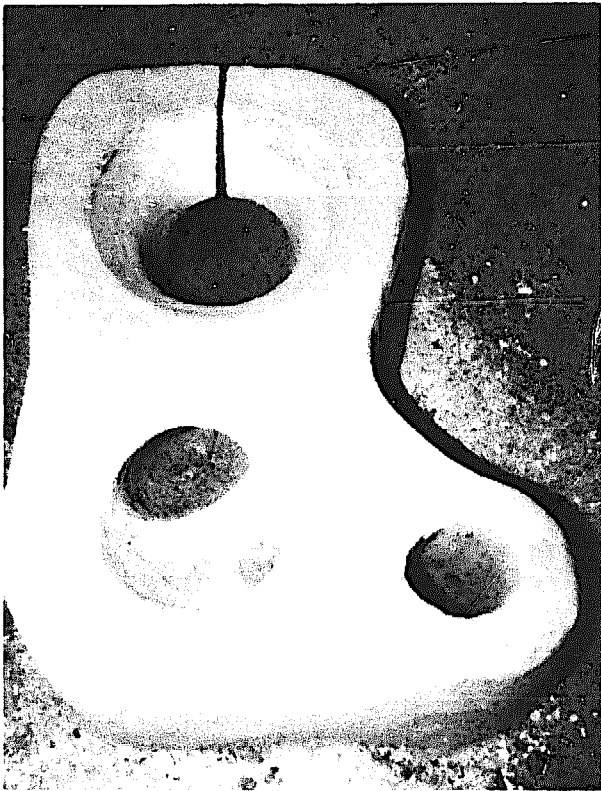

Java stove  
(chimney removed)

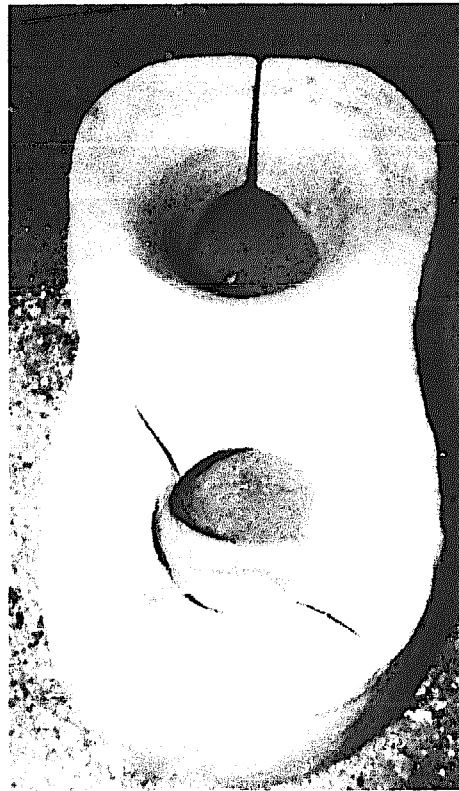

Java stove  
(chimneyless)



Efficiency testing on Java stoves

**POSTSCRIPT I:  
A Sociocultural Assessment of the Lorena Stove  
and its Diffusion in Highland Guatemala**

**Dale V. Shaller  
March 1979**

## **A SOCIOCULTURAL ASSESSMENT OF THE LORENA STOVE AND ITS DIFFUSION IN HIGHLAND GUATEMALA**

By Dale V. Shaller

### **INTRODUCTION**

The Lorena stove is a cooking technology designed to conserve scarce wood resources in the severely deforested highlands of western Guatemala. Since its conception in 1976, the stove has been introduced primarily among the indigenous people of the region in an attempt to encourage a more prudent use of wood for cooking and to alleviate health hazards associated with the smoke of the traditional open fire. The present work describes the study my wife and I undertook to evaluate the diffusion and acceptance of the stove in highland Guatemala, and to determine the ways in which those who use the stove are adapting it to better suit their needs. Our findings reveal several important problems with the stove design and promotion process, yet the overall responsiveness of the stove to the felt needs of the rural people shows it to be a technology highly appropriate to the area.

### **BACKGROUND INFORMATION**

Nearly four-fifths of the densely settled population in western Guatemala is indigenous. These descendants of ancient Mayan culture are largely subsistence farmers who continue to follow many of the same practices carried out by their forebears. Most Indian families still cook over an open fire, placing their clay pots over a hearth of three rocks arranged in a triangle on the ground. In recent years, however, it has become increasingly difficult for the highland Indians to obtain wood for their fires. A massive deforestation problem in the region has caused serious wood shortages, thus raising the cost of firewood as well as hastening the erosion of precious topsoil from the farmlands.

At the Estacion Experimental Choqui-ICADA, a small appropriate technology center near Quezaltenango, a solution was sought to help curb both the economic and ecological problems created by deforestation. In 1976, the Lorena stove was developed as an alternative to open-fire cooking. Formed out of a large monolithic block of sand and clay, the stove is designed to contain the heat of the fire and channel it through a system of internal flues, thus conserving the amount of firewood required for cooking and eliminating smoke build-up in the kitchen. The stove is relatively easy and inexpensive to construct, and uses materials which are locally available. In addition, the stove is designed to accommodate as much as possible the traditional cooking practices of the Indian people.

The Lorena stove is now being promoted in the highland region by

several private and governmental organizations. Diffusion of the new technology takes place by means of stove-building courses, exhibits at local fairs, dissemination of instruction booklets, and individual entrepreneurs who build the stove on a profit-making basis. Although no accurate estimate exists for the number of people using the stove, interest is extending rapidly throughout Guatemala and to other Latin American countries, including Honduras and Mexico.

## **STUDY METHODOLOGY**

The findings which follow are based on three months of research carried out in the Quezaltenango area during the fall of 1978. After a month of orienting ourselves to Indian culture and to the construction and function of the Lorena stove, we conducted a series of thirty-six in-depth interviews with stove owners in the communities of San Juan Ostuncalco and the Llano de Pinal. These interviews were supplemented by intensive observations of the cooking practices of six Indian families in San Juan Ostuncalco, where we lived. Three of the families observed used the Lorena stove exclusively, two used an open fire, and one family used both the stove and an open fire for cooking. Additionally, we held numerous discussions with local leaders who we judged to have a good understanding of the unique problems and circumstances confronting their community.

## **FINDINGS**

The results of our study indicate an overall high level of acceptance of the Lorena stove. Of the forty stove-owning families we interviewed and observed, thirty-four families are generally satisfied with the new cooking technology. Thirty-seven families use their stoves on a daily basis, and only eight families continue to use an open fire along with the stove. Of the six families which had completely abandoned their stoves after several weeks of use, three later built new ones and are now using them regularly.

The following sections describe our findings in detail. Because every indigenous community in highland Guatemala is culturally distinct, we do not know how widely representative our findings are; nor do we expect them to be statistically conclusive. We do believe, however, that our assessment of the Lorena stove offers some valuable insights into the nature of the stove's present use and diffusion in the highland area.

### **Perceived Advantages and Disadvantages of the Stove**

#### **Advantages**

When compared to the open fire, the primary advantage of the Lorena stove cited by the majority of families interviewed and observed is the reduction of smoke in the kitchen. Virtually all the stove owners in the study recognize unventilated smoke as a significant health hazard which

can cause serious eye and lung damage (1). Although the stove does not in fact remove all the smoke from the cooking area, it does eliminate most of the dangerous and unpleasant fumes produced in combustion.

The second most important advantage of the stove, as perceived by those who use it, is wood savings (2). Although it is difficult for most people to quantify precisely how much wood they use in a given time period, nearly two-thirds of all stove owners interviewed estimate that they burn less wood with the stove than with the open fire. Only a small number of families (about six percent) claimed that the stove uses half the amount of wood used previously (3), and twelve percent believe that they continue to burn the same amount of wood as before. (Several possible explanations why most stoves do not conserve as much fuel as expected will be discussed in a later section.)

The third most frequently mentioned advantage of the stove is the ability to cook in a standing position on an elevated surface. Several women even identified this difference from open-fire cooking as the primary advantage of the stove. The preference for elevated cooking actually refers collectively to a number of more specific benefits. These include: the increased comfort of standing as opposed to constant sitting or bending by an open fire; the greater degree of cleanliness afforded by removing pots and pans from dirt floors and away from wandering domestic animals; and greater safety for small children resulting from their limited access to burning embers and hot pots. Although many of these same advantages might be achieved by using an open fire on an elevated surface ("poyo"), they are principally recognized in association with the Lorena stove.

Another identified advantage of the stove is the reduction in effort required for cooking. Even though the overall time spent cooking does not vary significantly between the two technologies, the total amount of work exerted in the process of cooking with the stove is less. This is true because little effort is needed to tend the stove when cooking traditional foods (such as corn and beans) which must simmer for several hours. Both the fire and the pots are in fixed, stable positions in the stove, whereas in open-fire cooking, the pots are often supported by a precarious arrangement of burning wood. Thus many women generally state that cooking with the Lorena stove is "easier" because their many daily chores need not be constantly interrupted to, for example, save a bean pot from tipping over (4).

Two final advantages of the stove which were frequently mentioned are constant availability of hot water (provided by the water can depressed into the stove body) and the aesthetic qualities of the stove. Hot water is important to the Indians not only because it makes washing easier and drinking water safer, but also because of a belief that rinsing one's hands or bathing in cold water is harmful. Many families expressed considerable pride in the physical appearance of their stoves. In fact, a few stove owners claimed great satisfaction with their decoratively finished stoves

even though the internal structure was poor. This tendency to strongly value the outward appearance of the stove indicates that considerable prestige might be attached to the stove's mere presence in the kitchen.

### **Disadvantages**

The most important disadvantage of the Lorena stove is its inability to provide space-heat in the cold highland evenings and early mornings. By contrast, the open fire has traditionally been a source of warmth, especially for smaller children and the elderly. Because the stove is built precisely to contain heat rather than emit it, its fuel-saving properties conflict with values not related to efficiency. When given the choice, many of the more conservative Indians decide that they would rather enjoy the heat of the open fire than economize on firewood.

Another perceived drawback of the stove is the inflexible nature of its cooking surface. Several women interviewed find that the pot holes excavated in the stove body limit the size and number of pots which can be used. This limitation is particularly significant at harvest time and on fiesta days, when the stove cannot accommodate the special large pots used to cook food in quantity. Almost invariably, women will return to using an open fire when they cannot cook the necessary amount of food fast enough with the stove.

Other minor disadvantages not frequently mentioned include the initial difficulties encountered when making the transition from open-fire cooking to the stove, the cost of the stove (5), and the amount of maintenance required to keep the stove clean and functioning well.

## **Adaptations in Stove Design and Use**

### **Adaptations in Design**

Few stove owners have made major modifications in the basic design of the Lorena stove. All the stoves we observed are rectangular in shape, with the firebox in front, two pot holes at the sides, and the water can in the rear next to the chimney. About half of the stoves had been finished either with whitewash or with a thin layer of cement.

Almost all of the design adaptations we observed have been made in or around the firebox. One innovative stove owner improved the draft in his stove by inclining the floor of the firebox slightly upward from the front to the rear. Because of the cracking problems often encountered in the arch of the firebox opening, several people constructed their stoves with a steel rod inserted on either side of the slot for the firebox door, to help reinforce this structurally weak area. In a very few cases, the firebox door itself was modified to open from the front rather than the top, thus eliminating the need for a slot in the arch of the firebox opening; this was accomplished by attaching the door to the stove with hinges or by hanging it with nails.

Although few in number, these adaptations reveal at least a potential on the part of some stove owners to master a given design and make meaningful changes in it.

### **Adaptations in Use**

Several interesting adaptations were noted in the way people use the Lorena stove. Contrary to the cooking technique originally intended for it, most families observed follow a method of cooking very similar to that commonly used when cooking over an open fire. Women seldom use all the pot holes for slow, simultaneous cooking of different foods. Instead, almost exclusive use is made of the firebox to cook individual foods as rapidly as possible.

To begin cooking, most women place their pots directly inside the firebox and then transfer them to the pot holes once the food is partly cooked. As in open-fire cooking, some families build fires right around the pots to be heated. Or, they may support the pots in the firebox with a criss-cross arrangement of firewood, or place them on a metal stand often used with open fires. In some instances, a metal wash basin with a circular opening in the bottom is suspended over the firebox, and a small pot is rested in the hole to take advantage of the intense heat of the firebox without being placed directly inside. Regardless of the particular technique, the general trend is to cook over the fire in the firebox, using the pot holes primarily to keep cooked food warm.

Another major departure from intended cooking procedures is the misuse or abandonment of the firebox door and flue dampers. Very few of the families observed use the firebox door in a systematic or effective way, and virtually none displayed an understanding of damper function in controlling and directing the flow of heat inside the stove. In some cases, the firebox door and flue dampers were altogether absent from the stove, and some families had even filled the slot for the door with clay. Significantly, owners frequently stated that they had removed the door to take advantage of what little space-heat is emitted through the firebox opening.

Other notable adaptations in stove use include: removal of the water can and its replacement with a clay container which will not quickly oxidize and rupture; use of tin plates as temporary or permanent covers on which to warm foods over the pot holes; use of pots in holes where they fit improperly; placement of hot coals in the flues to increase heat intensity in the pot holes; kindling of separate fires in each of the pot holes; and use of the firebox as an oven to bake bread and pastries.

The adaptations in stove use have both negative and positive implications. With respect to modifications in cooking method, the overall efficiency of the Lorena stove is reduced when the firebox and pot holes are not properly sealed because heat, as well as some smoke, is allowed to escape. Likewise, misuse of the firebox door and flue dampers undermines efficiency by creating an improper draft. Moreover, the almost exclusive use of the firebox for cooking necessitates the kindling of more fires than would the use of all pot holes together according to design. In general, many of the adaptations in stove use partially negate the main intended benefits of the stove, namely, fuel conservation and smoke elimination.

In a positive sense, these independent adaptations may indicate that the people who use the stove are able to control and manipulate the new technology to better fit their needs. The modifications made in cooking technique show that the stove can be assimilated into traditional patterns of cooking without losing all of the benefits which it was originally designed to provide. More important, perhaps, than optimum efficiency is that people feel comfortable with the stove and can easily incorporate it into their daily rituals. For example, removing the firebox door in order to feel the warmth of the fire may detract from fuel savings, yet it may be just this adaptation which preserves the cooking place as the central gathering place in the Indian household.

Many families may follow modified cooking methods because their stoves are imperfectly constructed and do not function properly. One might argue, therefore, that greater emphasis be placed on improving stove-making skills and the corresponding ability to use the stove correctly, according to its present design. Yet many modifications in stove use represent real attempts to adapt the stove to traditional, more familiar cooking patterns; perhaps greatest attention should be given to developing ways in which the present stove design can be altered to conform more fully to established cooking procedures.

### **Problems Encountered**

The problem we most often observed during the course of our study is cracking or crumbling of the stove body. Nearly every stove had cracked in at least one area and, even though the cracks seldom affect stove function, they are considered very unattractive by most families. Cracking and crumbling often result from an improper mixture of sand and clay, or from the use of an inferior clay. Cracking is a much less frequent problem in stoves finished with a thin layer of cement; whitewashing, however, is of little value in preventing this problem.

Related to the problem of cracking is the difficulty of obtaining materials of good quality. Sand and clay can almost always be found locally, but the particular kind of clay needed to prevent cracking may be harder to come by. Consequently, stove building often requires first locating and then transporting the desired material, a process which can be costly both in terms of time and money (6).

In a few kitchens with Lorena stoves, smoke is still an annoying problem. The persistence of smoke is due to numerous factors, some of which have already been mentioned, such as uncovered pot holes and improper draft created by door misuse and inadequate chimney diameter or height. An important cause of smoke release not directly related to the stove itself is the use of green firewood (firewood with a high moisture content). Because many Indians obtain their firewood on an irregular basis, securing it as needed by felling it or buying it in small quantities, little attention is given to drying. As a result, stove efficiency is reduced and smoke continues to be a problem in some kitchens.



Another frequently encountered problem is the build-up of ash and creosote deposits in the stove flues. Excessive deposits of sooty residue are partly due to inadequate maintenance of the stove and partly to the use of green wood. The residue becomes a problem when it interferes with the normal draft of the stove and when it presents a fire hazard. Creosote build-up on the water can hastens oxidation, and the residue can also create problems when it collects on the outer surfaces of clay pots. (One family was forced to break their pots in order to free them from the soot which had glued them tightly inside the stove's pot holes.)

Faulty stove construction has, of course, inevitably led to problems in stove function. Improper excavation of the firebox and flues has resulted in poor heating performance in almost half of the stoves we observed.

### **Sociocultural Changes Engendered by the Stove**

The introduction of the Lorena stove has brought about few changes in the traditional lifestyle of the highland Indians. As suggested earlier, most families have been able to adopt the new cooking technology without significantly altering established cooking procedures. There are, however, some areas of traditional behavior which have been affected by the use of the stove.

Although the types of food prepared using the stove do not differ from those cooked over the open fire, the manner in which the food is eaten has changed slightly. Whereas in open-fire cooking the women eat kneeling on the ground next to the fire, they stand to eat when using the stove. The elevated surface of the stove has thus become a kind of table on which to eat as well as cook.

Interestingly, adoption of the Lorena stove has not adversely affected the nature of those social rituals which have traditionally revolved around the open fire. Despite its poor space-heating capacity, many Indian families gather around the stove for fellowship during the early morning and evening hours in much the same way they did before with the open fire. As already mentioned, though, the firebox door is usually removed to take advantage of as much heat as possible. Moreover, if the stove is unable to provide enough warmth, some families kindle a separate fire on the ground (often in the hearth previously used for open-fire cooking) to provide the necessary space-heat (7).

The traditional division of labor within the Indian family remains virtually unaffected by the stove, yet employment patterns at the community level have shifted somewhat. Although still on a very small scale, the promotion of the stove has created new sources of work for a few people. By building the stove for a small fee, an enterprising individual is able to earn some extra income while working in his free time.

### **Methods of Stove Promotion**

A key factor in the success or failure of the Lorena stove is the way in which the new technology is promoted. In general, the promotional methods used by the Estacion Experimental Choqui-ICADA and other

organizations have been successful in diffusing the innovation throughout the highland region, yet several important problems exist in communicating stove use concepts, controlling stove quality, and ensuring user participation in the on-going design process.

Stove-building courses, the principal method used to promote the technology, are relatively effective in teaching basic construction skills, yet they focus little instruction on how to use and maintain the stove once it is built (8). Stove courses introduce the new technology primarily as an **artifact**, a block of semi-hardened mud to be carved according to a specified design. Understanding the stove as a new **process** of cooking, however, is seldom emphasized. As a result, participants often complete two days of practical stove-building experience without learning about heat transfer, for example, or how the dampers and the chimney function to regulate air flow in the stove. The failure of stove-building courses to communicate the simple theory underlying the Lorena stove cooking process may be a major obstacle to the ultimate acceptance of the new technology.

Another important failing of stove-building courses is that male participants tend to dominate them. Women, the primary users of the stove, are seldom involved in the courses and almost never participate in the actual construction of the stove in their home. Consequently, women are forced to learn about stove use and function on their own or from their husbands, who, as already noted, often have a poor understanding of the new cooking process themselves.

By disseminating pamphlets and holding stove courses and exhibits in numerous scattered communities, promotional groups diffuse the stove widely throughout the highlands without providing for an effective control over stove quality. Individual stove owners are often unable to solve technical problems when they arise and, because the stoves are so extensively dispersed, expert advice is usually too far away to be of any practical assistance. Although the Estacion Experimental keeps a record of all stove course participants, its attempts to make follow-up visits in the homes of those who have built stoves are not adequate, and there are not yet enough competent local promoters who can assume responsibility for this kind of extension work (9). In short, the widely dispersed nature of stove promotion has resulted in a large number of stoves in diverse areas, but the quality of stove construction has degenerated owing to the lack of a systematic extension service. The Estacion Experimental undertakes research in the design and use of the Lorena stove, but little effort is made to bring local people who use the stove into this crucial innovation process. Although most of the personnel at the center have stoves of their own which they use regularly, their fundamental knowledge of the stove's problems and potentials is seldom supplemented by the insights of indigenous families who may have different cooking needs and priorities. Because they take no direct part in the stove development and testing process, most stove owners passively adapt to a technology designed for

them, rather than actively collaborating to improve a technology which can best meet those needs defined by them.

## SUMMARY AND RECOMMENDATIONS

The Lorena stove has achieved a high level of acceptance among the Indians of western Guatemala largely because it is responsive to local conditions and needs. In reducing firewood consumption and helping to eliminate smoke in the kitchen, the stove addresses at least two important problems identified by the people for whom the technology was designed to serve, without significantly affecting traditional lifestyles. Independent adaptations in the use of the stove may partially negate its main intended benefits, yet these modifications also suggest that some stove owners are able to manipulate and refine the new technology to better suit their needs. Although some adaptations leading to decreased efficiency may be due to a poor understanding of proper stove construction and use, modifications in stove use for space-heating purposes indicate that the present stove design could be altered to conform more fully to certain valued traditions.

One important way in which the Lorena stove can be made more appropriate to the highland region is by increasing local participation in the stove development and testing process. Problems in design, construction, and use can best be identified and solved when those who use the stove, particularly women, are able to contribute their ideas and suggestions as to possible improvements. By increasing local input in the decision-making process, not only will the Lorena stove become more relevant to locally perceived needs and problems, but the general innovative capabilities of the indigenous people will be enhanced.

A community-based approach, in which the stove is promoted intensively in a small area rather than extensively throughout a large region, might help to increase local participation as well as provide for a more effective control over stove quality. By concentrating promotional efforts in one community at a time, new and potential stove owners would have better access to technical assistance, and local promoters could be carefully supervised and trained to assume responsibility for extension work once the promotional group moves to another community.

Regardless of what geographical approach is taken, stove-building courses will likely remain the principal method of stove promotion. Courses can be improved by focusing more instruction on the basic theory underlying stove use and maintenance. By more effectively learning how the stove **should** be used according to its present design, people will have a better idea of how the stove **could** be used or altered to more appropriately meet their needs. Again, the important point is that indigenous input be maximized in both the stove innovation and

promotion process. In this way, the Lorena stove can become a more flexible and dynamic technology, capable of adapting to the diverse and changing needs of the highland people.

—Dale V. Shaller  
March, 1979

#### NOTES

1. Despite the overwhelming conviction that smoke is undesirable, some positive attributes of smoke were mentioned by a few of the families. An ancient practice of the Mayan people is to use the thick smoke from the open fire to help seal their roofs of straw; the sooty residue of the smoke causes the straw to stick tightly together, thus preventing water leaks and adding strength to the roof. Another traditional use of smoke is in the preservation of corn. Ears of corn are hung from the rafters above the open fire and the smoke serves to eliminate parasites, preserving the corn for as many as six or seven years. Finally, one person identified certain curative properties of smoke, but this belief does not seem to be widely shared.
2. Most people related wood savings directly to economic benefits, and not to its role in curbing deforestation problems in Guatemala.
3. Those who promote the stove estimate an average wood savings of fifty percent.
4. Even though the stove requires less tending than the open fire, women who use the stove remain in the kitchen and follow much the same daily routine as before.
5. The Estacion Experimental Choqui-ICADA estimates the building cost of the stove at \$4, yet the average cost of the stoves we observed was about \$14. This difference in cost is largely due to the price of the chimney pipe, which we found to average about \$7. (Interestingly, four families in the Llano de Pinal had not yet purchased chimneys even though two of the families had been using the stove on a daily basis for several weeks.) Another factor which may inflate the real price of the stove is the cost of transporting the construction materials. (Editor's note: chimney materials need not cost so much. In Indonesia, preliminary results indicate a bamboo chimney is practical, costing no more than \$1.25. In Nepal, four meters of clay pipe suitable for chimneys can be purchased for less than \$1.00.)
6. In the Llano de Pinal, one group of neighbors easily overcame the problem by collectively renting a truck to transport material for several stoves, and then splitting the cost.
7. At the time of writing, no data were available on how the stove might affect traditional practices associated with the sweat bath. In their "Ethnography" of the highland Mam-speaking people (in **Languages of Guatemala**, edited by Marvin K. Mayers, The Hague, Netherlands: Mouton & Co., 1965), H. Dudley and Dorothy M. Peck describe how, after bathing, the Indian dries himself in front of the open fire before going to bed. Given the importance of the sweat bath in highland culture, further study should be done on how the Lorena stove might disrupt this tradition by eliminating the space-heat of the open fire.
8. Instruction takes place during a two-day course in which participants build a stove, learning the procedure by working directly with their hands. Courses given by the Estacion Experimental are held either at the center or in the home of a participant, and are usually taught in Spanish by a skilled promoter, although sometimes a local Indian dialect is used. Upon completing a course, participants are expected to be able to build a stove by themselves, and perhaps go on to become local promoters, who can teach the procedure to others in their community.
9. In fact, poor stove quality can often be directly attributed to local promoters who, after attending only one stove course, are not proficient in teaching stove construction, use, and maintenance.

**POSTSCRIPT II:  
Use of Rice Hulls as a Fuel in Natural Draft Stoves**

*The following is a description of rice hull burning stoves in Java. This text is from a report by the Development Technology Center of the Institute of Technology, Bandung, for the ASEAN Food-Handling Sub-Committee. The drawings are originally by Craig Thorburn.*

*The stoves shown here probably could be made significantly more efficient. They have been included because the systems for continuously feeding rice hulls to the fire may be adaptable to fit Lorena stoves.*

*These stoves represent a refined indigenous technology for burning an otherwise hard-to-use fuel. The reader should note that these stoves use no dampers, and are kept going at full burning rate for many hours at a time in commercial activities. For domestic use, smaller stoves with some kind of damper system to control burning rate would be required for highest efficiency.*

Unless otherwise stated, all stoves described in the following section are made of fired bricks with regular cement mortar and plaster.

Smoke and hot gases rising through a flue create a strong suction in this type of stove. This draws air through a slanted grate located at the front. Rice hulls burn rapidly this way, with a clean hot flame and almost no smoke. The ashes are raked out from below the grate. The hopper above the grate is kept full so that no air leaks in there. The cooking pots are sealed into the top of the stove for the same reason. All air drawn into the stove passes through the burning rice hulls on the grate.

Figures A and B show a stove commonly used in Yogyakarta and Central and East Java to cook soy milk for the manufacture of "tahu" soy curd. The grate is made of 5 cm wide strap iron spaced 4½ cm apart and descending at an angle of about 60 degrees.

During cooking, rice hulls are stirred and pushed down onto the grate about every 10 minutes. The 4-meter tall chimney on this stove creates a strong draft. The flame produced is powerful and yellow.

This stove is used daily to boil between 800 and 1400 liters of soy milk in 150 liter batches. This requires about 10 gunny sacks or 125 kg of rice hulls per day. The stove has been in use for 15 years and the only maintenance has been replacement of the iron grate after 3 to 5 years of constant use.

FIGURE B

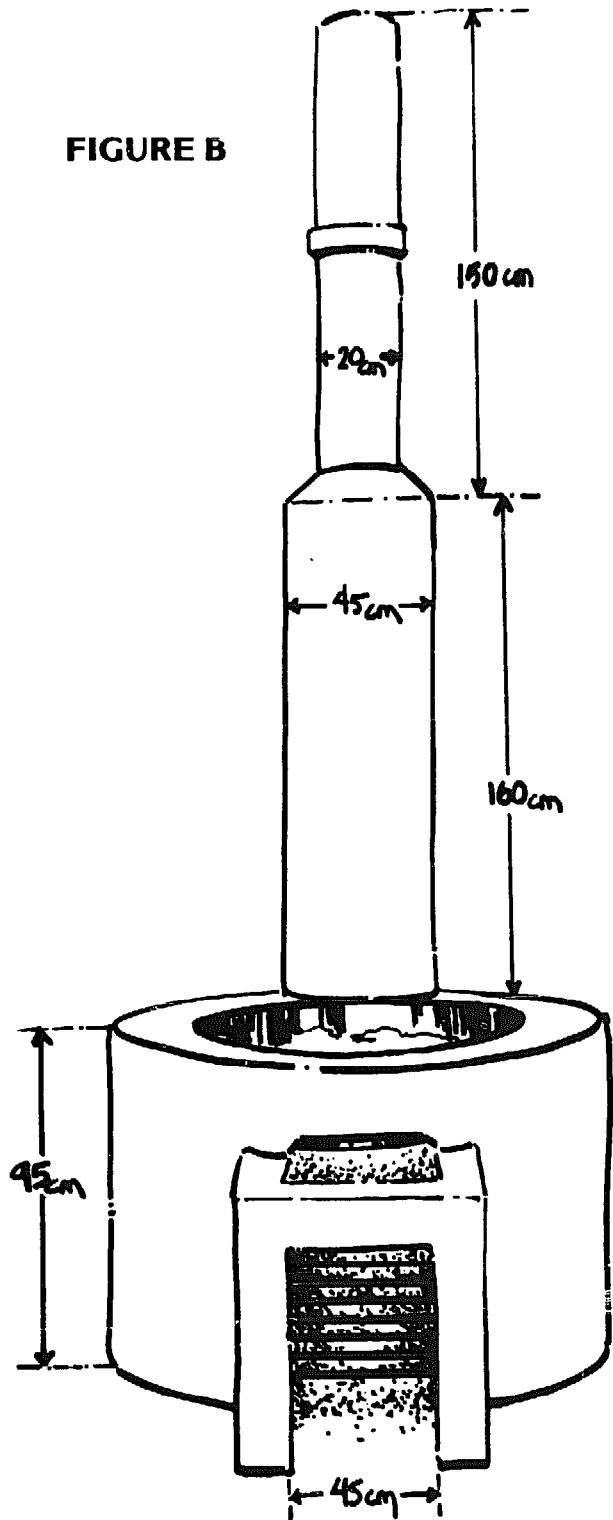
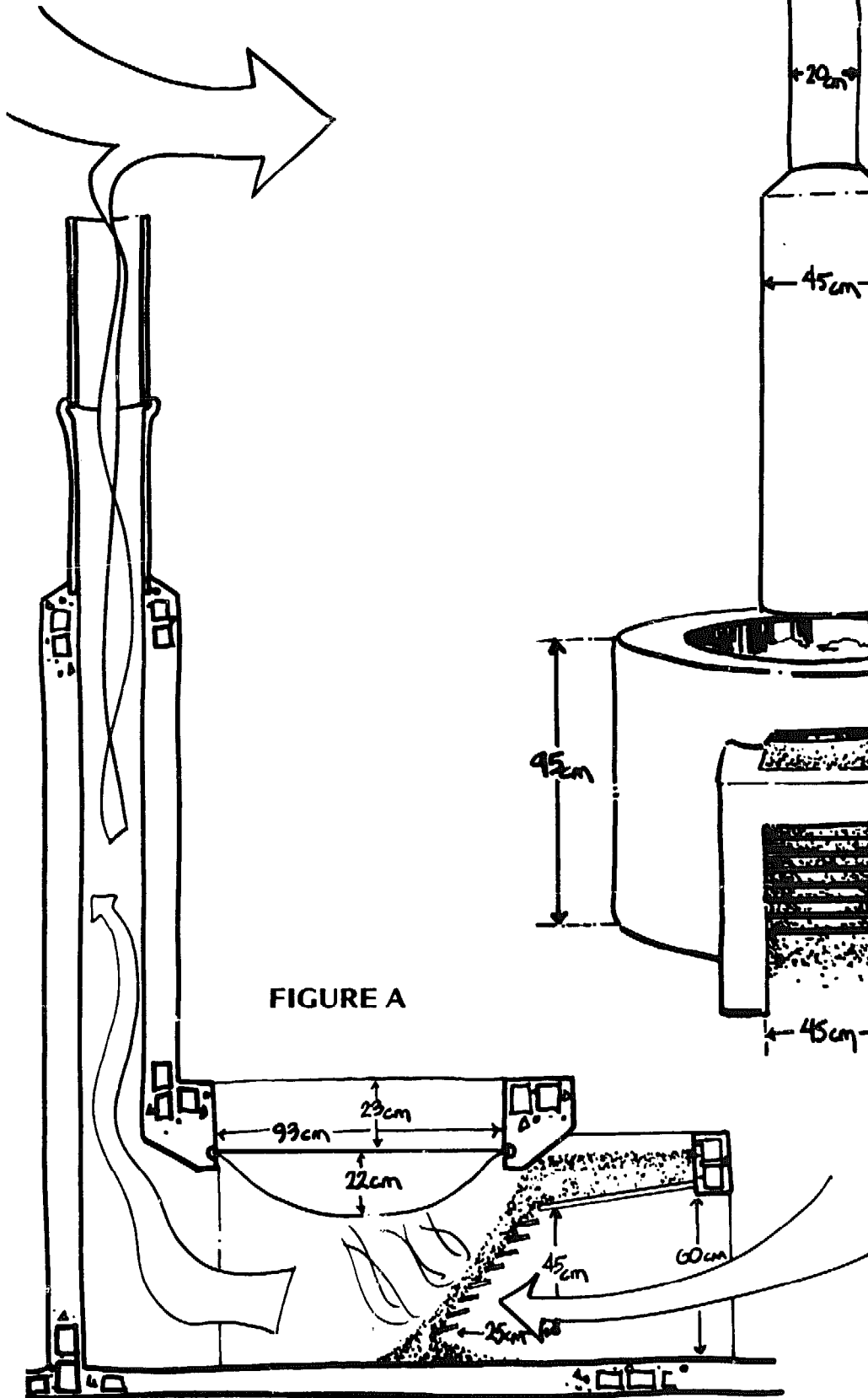

FIGURE A



Figures C and D show a stove used by "gula Jawa" coconut sugar producers in Blitar, East Java. At Rp. 3,500 (about US\$8.00), this is the cheapest natural draft stove that we saw. Clay mortar is used rather than cement. The 1½-meter chimney draws flames back to the last pot, 1¼ meters from the burning hulls in the grate. The floor slants slightly upward towards the back of the stove to increase the draft. The grate is a piece of perforated iron sheet placed almost vertically in the mouth of the stove. Unlike the other natural draft stoves we found, the pots could be lifted out of this one. The stove will not operate with the pots removed. When the pots are replaced, air leaks around the edges are simply patched with a mixture of mud and rice hull ash.

The pot nearest the fire is the hottest, and the one nearest the chimney is the coolest. This is especially well suited to the process of cooking gula Jawa, as different temperatures are required at different stages of the process. The temperatures of the pots range from a fast to a slow boil.

This stove is used daily to boil down 50 liters of coconut sap to 7 kg of light brown sugar cake. This requires half a gunny sack (about 6 kg) of rice hulls daily, burned over a period of 4 hours.

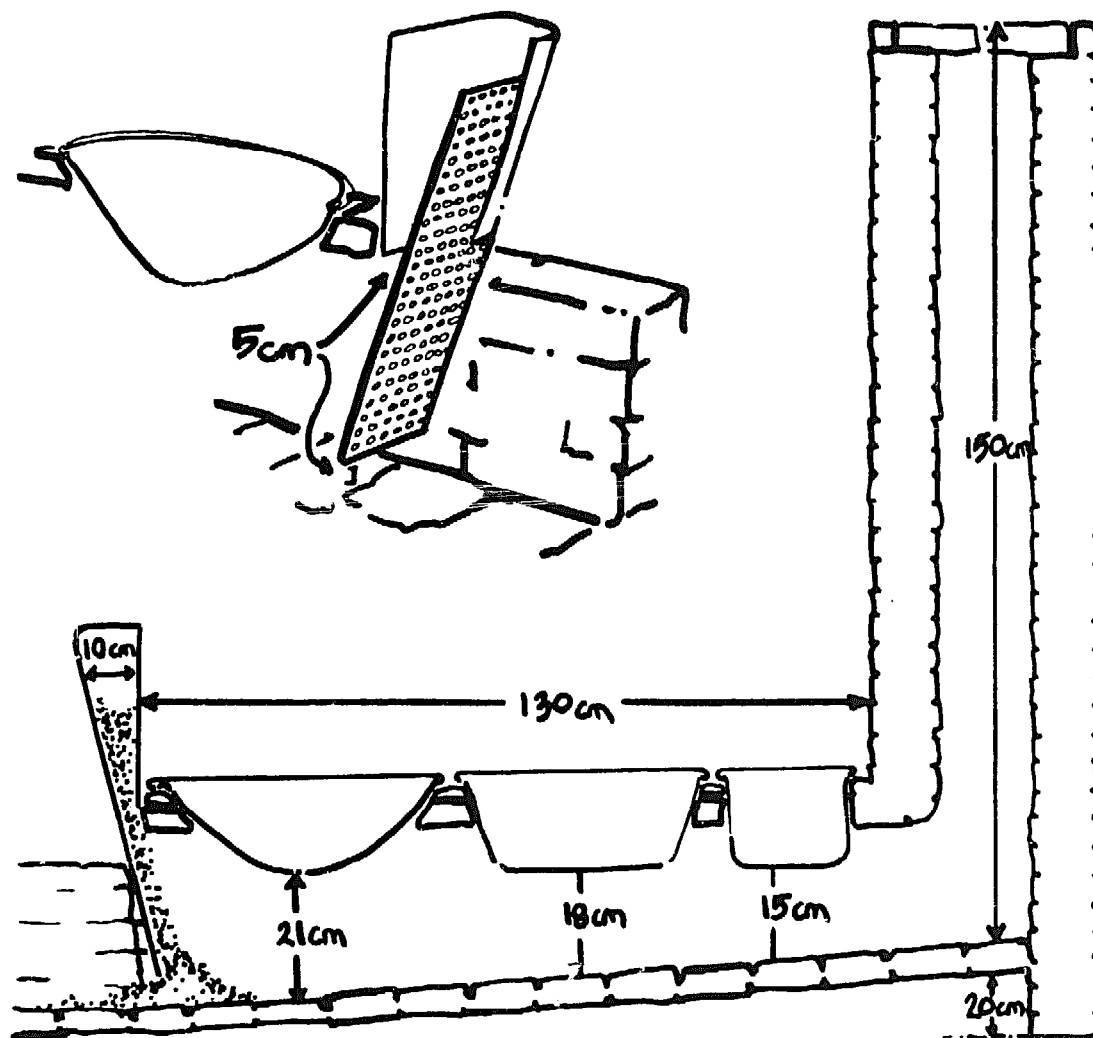

FIGURE C

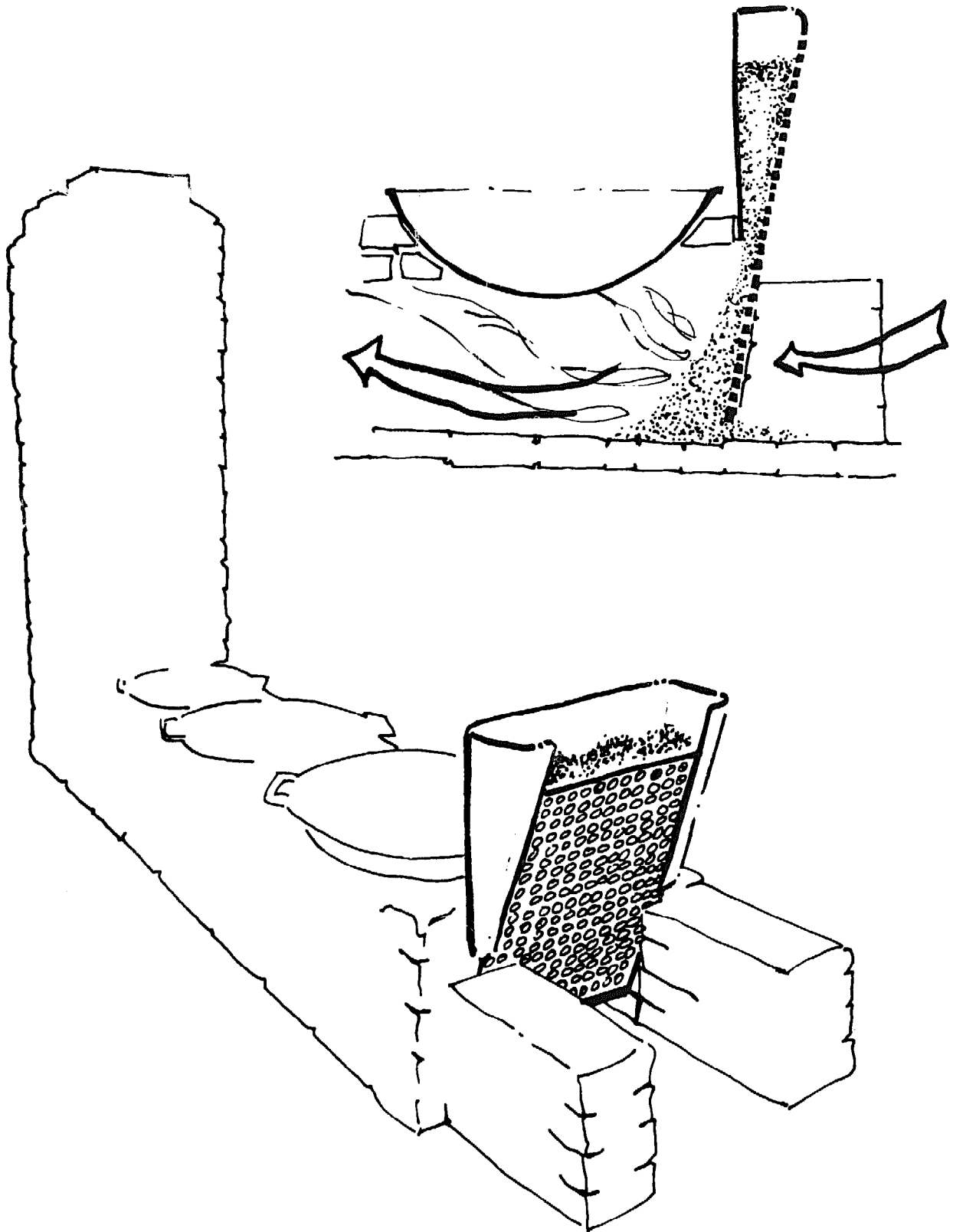

FIGURE D





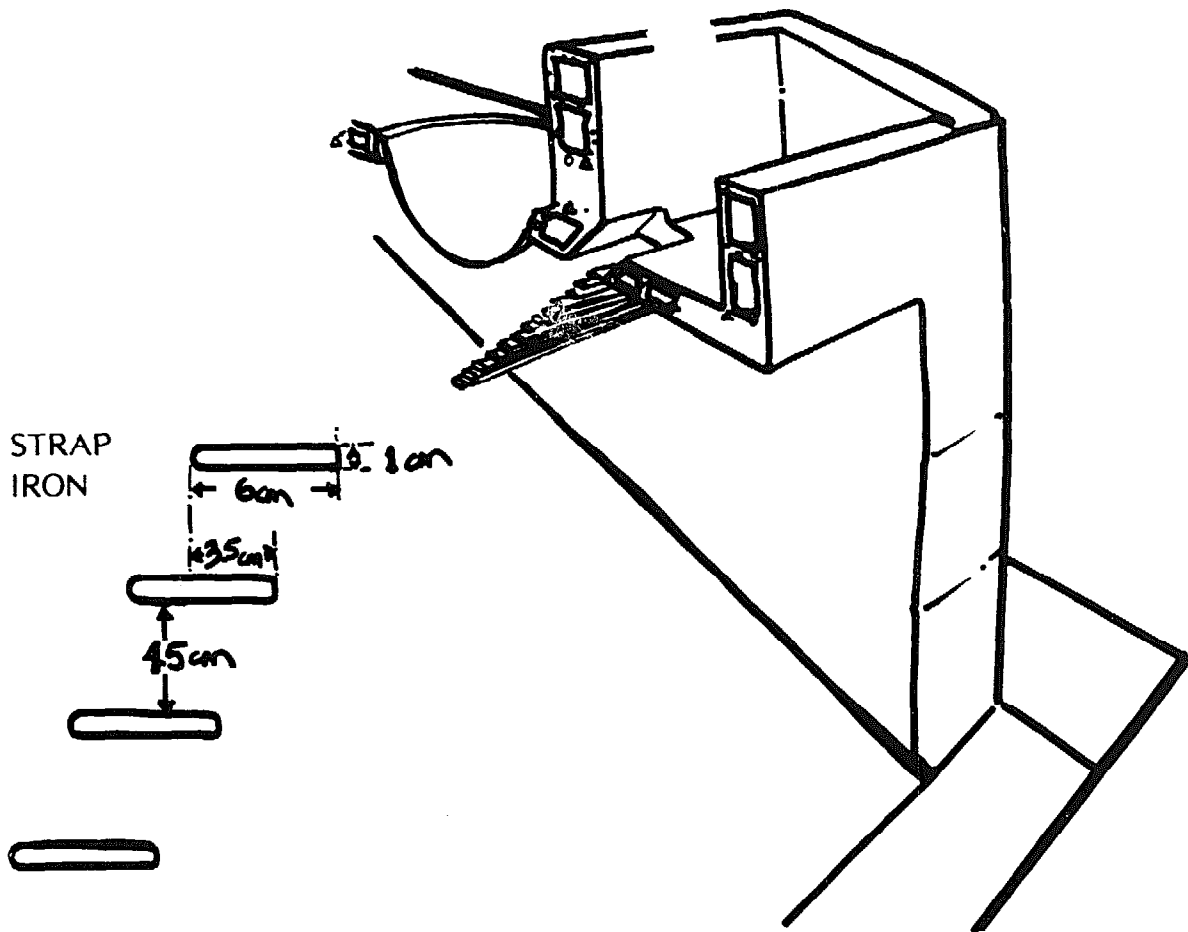

FIGURE F

The chimney is 7 meters tall. The inside diameter of the chimney decreases as it rises. This creates eddies which prevent ash from flying out of the chimney and covering the product being sun-dried in the yard and on the roof.

To keep approximately 350 liters of water at a rolling boil for seven hours a day, approximately 25 gunny sacks (300 kg) of rice hulls are required.

The owners of this stove claim that the dimensions are quite critical—that a variation of just a few centimeters will result in decreased efficiency. All krupuk producers in the area hire the same mason to build their stoves. When questioned, this mason was willing to share most of his secrets.

The grate is made of 1 X 6 cm strap iron spaced as shown at the top of Figure F. The grate is 55 cm wide. A narrower grate would not produce sufficient heat, while a wider grate wastes fuel. The floor slants upward towards the chimney end, rising 50 cm over a distance of 4½ meters. The pots are staggered also, the base of each being 2 cm **lower** than the one before it (see drawing). This is said to distribute the heat more evenly.

If fired at night, a red glow is evident at the top of the chimney. This glow is from flames drawn into the base of the chimney, reflected on the escaping smoke and steam.

Nearly everyone we interviewed agreed upon the following criteria for the design of natural draft rice hull stoves:

1. The wider the grate, the hotter the fire.
2. The grate should be steeper than 45 degrees.
3. A stove with a tall chimney will have a stronger draft, a longer flame, and a higher fuel consumption than a stove with a shorter chimney.
4. Stoves with more than one cookpot should have a floor that slopes slightly upwards towards the chimney end.

Natural draft rice hull burning stoves like these have been in use in some parts of Java for more than 20 years. The designs shown in Figures A, B, C, D, E, and F seem very well adapted to their respective uses.

The ash is raked from all of these stoves before combustion is complete, to make room for fresh fuel. The ashes are black in color (completely burned hulls produce a powdery white ash). We were told that this black ash can be mixed with sand and burnt lime to produce a strong cement mortar.

### POSTSCRIPT III: Additional References on Cookstove Design and Construction

Here are reviews of publications on wood energy and cook stove design, selected from the "Woodstoves" and "Improved Cookstoves and Charcoal Production" chapters of **Appropriate Technology Sourcebook, Volumes I and II** (by Ken Darrow, Kent Keller and Rick Pam, Appropriate Technology Project of Volunteers in Asia, 1981.)

**Helping People in Poor Countries Develop Fuel Saving Cookstoves**, book, 148 pages, by Aprovecho Institute, 1980, free to serious groups, from German Agency for Technical Cooperation (GTZ), P.O. Box 5180, 6236 Eschborn 1, Federal Republic of Germany; or, from Aprovecho Institute, 359 Polk Street, Eugene, Oregon 97402, USA.

Aprovecho carries out research on how low-cost stoves might be improved, and provides assistance to cookstove popularization efforts in poor countries.

This book is about such efforts, written for field workers (such as volunteers and extension agents), administrators and planners (especially those responsible for forestry and soil conservation programs), and researchers. The purpose of the manual is not to present construction methods in detail for specific stoves. Instead, the emphasis is on how to encourage poor people to develop solutions to their problems, with the focus on cooking technologies. Topics covered include important background information on how deforestation, declining agricultural production, and stagnating rural economies are related; working with villagers to design stoves; and systems for spreading information and training stove builders. "If improved stoves are to make a major impact on fuel demand, work will need to be immediate and broadscale. At current deforestation rates, it may be too late to merely seed a good idea, then go away, leaving it to grow naturally in its own time. Stove projects must be extensive, well-organized and adequately funded. Yet if heavy-handed methods are used for distributing or developing this technology, it may never be accepted. Involvement of the people is essential to effective dissemination.

"There are as many ways of going about dissemination as there are cultures, but (several points covered here are) raising public awareness; setting up an approach for dissemination; where to go for help in distributing information; promotion: ideas to try; where and how to start dissemination; setting up stove centers; training; involving women; evaluation and follow-up; use training; sponsoring and advising small businesses."

Three final chapters discuss how woodstoves work; how to design simple comparative stove testing procedures; and brief illustrated instructions for building a variety of Lorena, clay, metal, and other stoves.

Historically, efforts to introduce "appropriate technology" have relied on convincing people that they need a manufactured product. This valuable book is a down-to-earth discussion of how development workers can help people make use of their own ideas about what they need, to develop an improved technology for themselves.

**Wood Conserving Cook Stoves: A Design Guide**, book, 111 pages, 1980, \$8.95 (English), \$12.95 (French, Spanish, Arabic) from VITA.

About half of this rather expensive book gives construction and cooking procedures for four fuel-conserving cookstoves: a Lorena stove, a smokeless chula, a Singer stove, and a sawdust stove made from a rectangular 5-gallon can and sheet metal. Construction information is not detailed, but includes

good drawings that can be followed by someone with good manual skills.

More detailed information on each of these stoves can be found in other publications (see other entries in this section and on pages 582-589 of volume two). This book is valuable because it explains in non-technical English how fuel provides heat as it burns, and how traditional and improved stove designs contain this process and direct the transfer of heat for maximum cooking advantage. The chapter "How to make stoves efficient" explains how stoves lose heat energy and how these losses can be reduced by modifications in combustion chamber, chimney, damper, wall, and pothole design.

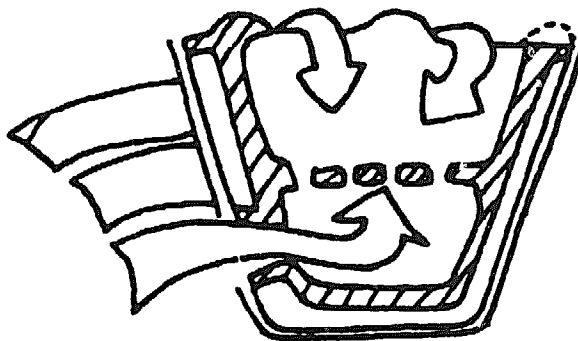

air flow pattern in insulated single burner Thai "bucket" stove

Clear and well-illustrated. The bibliography lists other interesting publications on traditional stoves and improved stove designs, but unfortunately gives no information on how to obtain them.

**Wood Stoves: How to Make and Use Them**, book, 194 pages, by Ole Wik, 1977, \$5.95 from Alaska Northwest Publishing Company, Box 4-EEE, Anchorage, Alaska 99509, USA.

Unlike most North American books on woodstoves, this one is concerned with making stoves. It also contains many ideas on design and construction of cooking stoves, which tend to be ignored in the literature. Those people experimenting with the design of improved-efficiency cookstoves will certainly want to read this book.

Only metal stoves, requiring purchased metal stovepipe and made primarily from discarded oil drums, are discussed. In the Third World, these stoves are

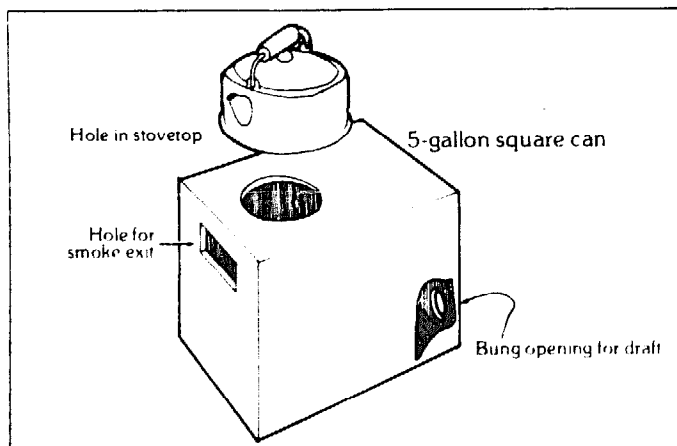

*Cooking stove made from a can*

expensive to build and corrode quickly. In addition, this book is based on years of experience in a very cold climate where wood is abundant and efficiency of combustion is not as important as in most semi-deforested regions. Also, protecting the cook and kitchen from excess heat is of little concern to the author. Designers using this book in the Third World will want to keep these differences in mind.

**Solid Fuel Cooking Stoves**, book, 116 pages, 1980, available on request from Tata Energy Research Institute Documentation Centre, Bombay House, 24 Homi Mody Street, Bombay 400023, India.

A review of literature from around the world on a broad range of cooking stoves, featuring a short discussion and simple drawings of each type. Sources of information are listed, but neither prices nor publishers' addresses are given. The 21 stoves presented include one- and multi-burner clay, metal, and mud designs; some have chimneys and some do not. Fuels include wood, charcoal, rice hulls, and other crop residues. A short section reviews stove and cookpot efficiency testing techniques developed at technical institutes and universities.

**Wood Burner's Encyclopedia**, book, 155 pages, by Jay Shelton and Andrew Shapiro, 1976, Vermont Crossroads Press, \$8.00 from META.

Here is an excellent reference book on 'wood as energy.' The chapter on energy, temperature and heat nicely provides an understanding of the basic physics involved in burning wood—in an open fire, a heater, or a cookstove. Although this book is primarily intended for use by North Americans wanting to use wood to heat their homes, the considerable amount of background discussion is often relevant to cook stove design. There are valuable sections on fuelwood, combustion, energy efficiency (wood heating), safety considerations,

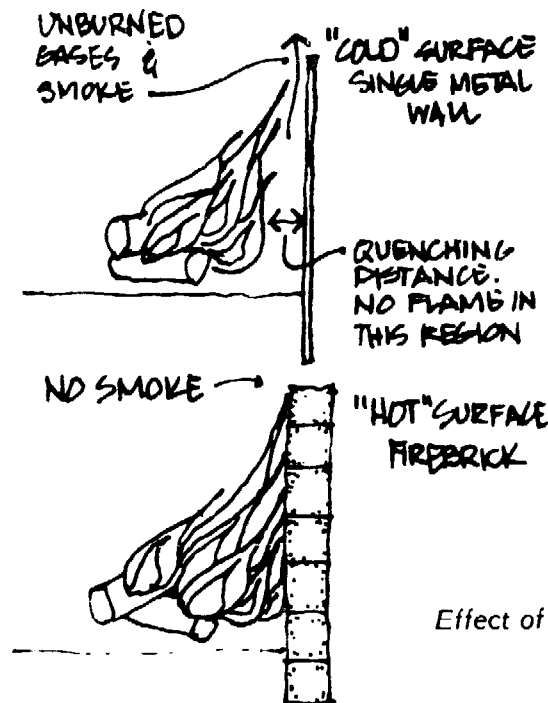

and creosote and chimney fires.

There is a list of manufacturers and some product information (though no designs detail or efficiency claims) for 33 different cook stoves made by 12 different companies. While these stoves cost so much (\$400-500) that they are not realistic models for developing countries, some lessons about the design of efficient cook stoves might be learned through careful analysis and testing.

Recommended for cook stove experimenters as a reference.

**Cookers**, in **Food Preparation, Series 1, Rural Home Techniques, Volume 3**, United Nations Food and Agriculture Organization (FAO), \$7.00 from UNIPUB or from local FAO offices, or from Chief, Home Economics and Social

Programmes Service, Human Resources, Institutions and Agrarian Reform Division, FAO, Via delle Terme di Caracalla, 00100-Rome, Italy.

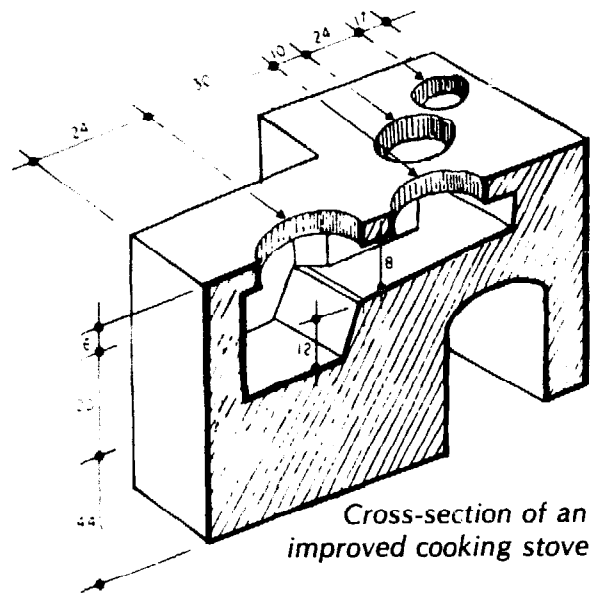

This is a complete set of drawings for construction of several cooking stoves with improved fuel efficiency. This material has been taken from a 1961 report to FAO written by Hans Singer, working in Indonesia, in which he did a detailed analysis of the fuel efficiency of existing Indonesian stoves and charcoal cookers. Unfortunately, only the construction details for his proposed improved stoves are reprinted here; the rest of the report (which we believe is out of print) would be valuable for people working on stove improvement programs.

"Cookers" is one of three sections in the FAO publication **Food Preparation: Series 1, Rural Home Techniques, Volume 3**. The other two sections contain brief instructions and drawings for making cleaning brushes and storage cupboards. Text for all three is in English, Spanish, and French.

**Cooking with Wood**, booklet, 23 pages, SKAT, 1980, SwFr 7 from Swiss Center for Appropriate Technology (SKAT), Varnbuelstrasse 14, CH-9000 St. Gall, Switzerland.

Here are photos of stove designs (many of them experimental) from all over the world, assembled for an exhibition in 1980 in Geneva. A short text is in German, English, and Spanish.

The photos of stove exteriors do not reveal important internal design features. No price or efficiency information is provided, and some of the other information given is inaccurate. Most of the stoves are made of sheet metal or bricks, and thus possibly too expensive for many rural people who most need them.

The collection, while not exhaustive, is worth looking at for adaptable ideas.

**Improving Solid-Fuel Cooking-Stoves with Special Reference to the Family Cooker**, book, 89 pages, by P.R. Attwood, 1980, available on request from the Industrial Engineering Faculty, Appropriate Technology Group, Eindhoven University of Technology, 5600 MB Eindhoven, The Netherlands.

"The purpose of this report is to present the results of an investigation for improving the effectiveness of solid-fuel cooking-stoves with the objective of making the Family Cooker as efficient as possible before putting it into

production." Includes descriptions and drawings of the Family Cooker (a small, one-burner sheet metal stove with a chimney) and procedures for conducting efficiency tests with varying air inlet areas, chimney heights, and chimney diameters. Good explanations of how cooking effectiveness is related to fuel economy and heat transfer efficiency, and the importance of types of cooking pans used and their fit to the stove. These testing procedures could be adapted for use with stoves other than the one shown.

**Rice Husk Conversion to Energy**, FAO Agricultural Services Bulletin No. 31, book, 175 pages, by E. Beagle, 1978, \$10.00 from UNIPUB.

This is an extensive reference book on the enormous variety of energy applications for rice husks around the world. About half of the world's 60 million tons of rice husks produced annually are currently used; another 20% (12 million tons) apparently could be used as well.

The author discusses the general processes for converting rice husks into energy along with existing technologies for doing this. Steam engines, producer-gas engines, paddy dryers, and domestic cooking stoves are among the topics considered. Where parboiling is done, small steam engines can effectively be used to power the mills and provide heat for parboiling. Where parboiling is not done, the best power choice for small (less than 5 tons per hour) mills would be "an engine fueled by gas produced from rice husk... This system of 'producer gas' is of proven technology, having been in continuous use for over 75 years." The great range of technologies discussed is unfortunately not supported by enough drawings.

The format allows the reader to go on to find more detailed information when relevant. For example, it is noted that the standard rice mill in Thailand is driven by a rice hull fired steam engine. A 224-entry list of contacts includes makers of such equipment in Thailand, and the 264-entry bibliography leads to further information on a wide variety of other topics.

The author concludes that rice husks are used far more extensively as an energy source than is generally recognized, that manufacturing capabilities for the related equipment are greater than realized, and that difficulties in information exchange prevent wider progress in applications. This book is a major step in overcoming the information exchange problem.

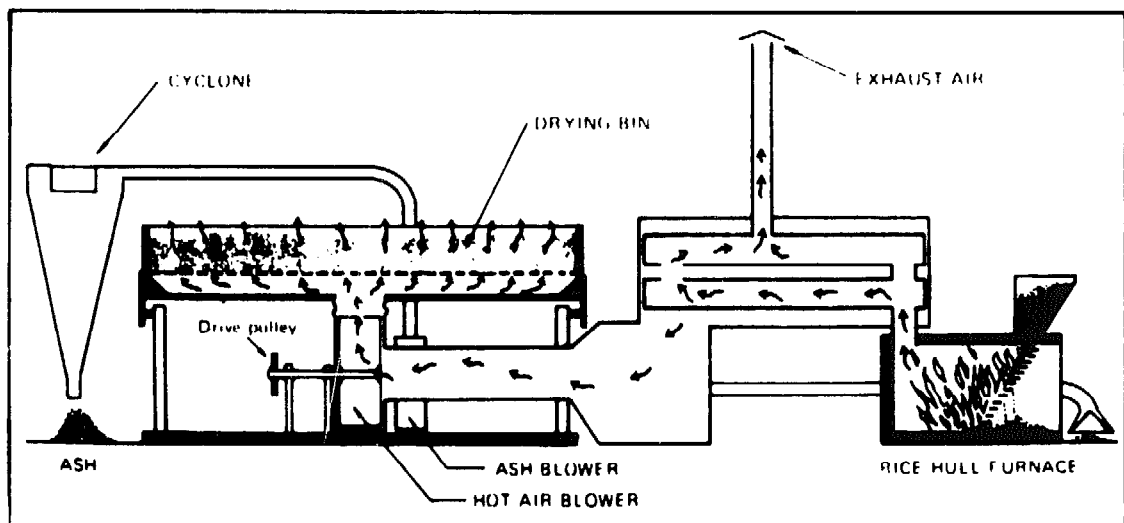

*Grain dryer using rice husks as fuel*



## THE APPROPRIATE TECHNOLOGY PROJECT OF VOLUNTEERS IN ASIA

Volunteers in Asia (VIA) has been sending volunteers to live and work in Asia since 1963. We attempt to learn by living and working side by side with our hosts. An independent, non-profit organization, VIA has chosen not to seek U.S. government funds in its effort to work directly and cooperatively with organizations in Asia.

VIA's Appropriate Technology Project was started by two returned volunteers in January of 1975. The project attempts to find basic technical information on tools and techniques that can be used in village circumstances. This includes practical books and plans on renewable sources of energy, farm implements, shop tools, agriculture, low cost housing, health care, water supply and many other subjects. These are mostly small-scale systems that use local skills and resources. Our goal is to make this information more accessible to people working in developing countries. The first major activity of the project was the gathering and selection of 400 books and plans relevant to appropriate village technology from all over the world. These materials were reviewed in the first Appropriate Technology Sourcebook, which is now being used in more than 100 countries, with some 30,000 copies in print. Volume II, containing 500 all new reviews and several new topic areas, was published in January 1981.

Through other publications the project seeks to widely promote a dialogue on issues related to technology and development, and document certain specific technologies of broad interest in the villages of the developing countries as well as our own country. We place volunteers in resource-person roles with small rural development groups in Asia. These volunteers take part in hands-on technology development and adaptation, and contribute to the project publications. Staff and many returned volunteers have found low consumption lifestyles to be fitting in a world in which so few waste so much, while so many are without basic necessities.

## THE APROVECHO INSTITUTE

"Aprovecho" is a Spanish word meaning "I make the best use of".

The Aprovecho Institute is a small group of people from several countries who develop and promote high quality alternatives to gross consumerism. Our purpose is to demonstrate the dignity of simpler, less consumptive lifestyles to ordinary people both in the "developed" countries and in the poorer countries where people emulate Western patterns. We work at two levels: 1) close day-to-day work in the communities in which we live, and 2) international exchanges of information and techniques for simple and cooperative living.

The wasteful affluence now enjoyed in the richest countries must decline as resources diminish. In poorer countries most of the people can never expect to live as we do now. Yet the "modern" world offers this one powerful image, to which (for want of alternatives) many of the world's poor aspire as a route out of their poverty. We believe that for most people this image is unattainable if not undesirable.

In many parts of the non-Western world, self-reliance in both technology and government have long been practiced. People there have developed simple but adequate technologies from local resources. Aprovecho Institute, drawing on these experiences, is working in the U.S. to rekindle pride in local techniques, forms of organization, and means of livelihood.

Institute members have a wide range of skills, both sociological and technical. We develop small-scale technologies and natural energy tools, and consult locally on energy-related matters. We will investigate and catalog simple techniques from countries where they are a part of daily life, and make them available in the "developed" countries. We plan exchanges of people interested in understanding daily living in poorer countries. We will bring people from poor countries to the

U.S. and Europe to show them clear working alternatives to the consumerist model and to make available their expertise in simple living.

Also by Aprovecho Institute: **Helping People in Poor Countries Develop Fuel Saving Cookstoves**, 148 pages, 1980. For a copy, write to us at the address at the front of the book.

### **PUBLICATIONS AVAILABLE FROM THE APPROPRIATE TECHNOLOGY PROJECT OF VOLUNTEERS IN ASIA**

1) **Appropriate Technology Sourcebook, Volume I**, by Ken Darrow and Rick Pam, revised edition February 1981, 320 pages, \$5.50 (plus \$1.00 postage). Special rate of \$2.75 (plus \$1.00 postage) for local groups in developing countries. Clothbound Smyth-sewn library edition \$10.50. Bulk Discounts.

The original illustrated guide to the best practical books and plans covering village and small community technology. Contains critical reviews of selected publications on renewable sources of energy, farm implements, workshop tools and techniques, agriculture, low-cost housing, health care, water supply, and related subjects. Small-scale systems using local skills and resources are emphasized. Reviews 385 publications from U.S. and international sources, with 250 illustrations. Price and ordering address are given for each publication. Extensive index. With 30,000 copies in print, this book is being used in more than 100 countries as the basic guide to the literature on appropriate technology.

2) **Appropriate Technology Sourcebook, Volume II**, by Ken Darrow, Kent Keller, and Rick Pam, January 1981, 496 pages, \$6.50 (plus \$1.50 postage). Special rate of \$3.25 (plus \$1.50 postage) for local groups in developing countries. Clothbound, Smyth-sewn library edition \$11.50. Bulk discounts.

The second, enlarged volume in the set covers all new material on the same topics found in the first volume, along with a number of additional topic areas of interest to the appropriate technology practitioner: fish farming, forestry, transportation, science teaching, local communications, non-formal education, and strategies for local self-reliance. Reviews 500 of the best recent publications in this field, along with 300 illustrations. Extensive index.

3) **Appropriate Technology: Problems and Promises, Part One: The Major Policy Issues**, by Nicolas Jequier, OECD Development Centre, 1976. Reprinted with permission, September 1977. 88 pages. Distribution restricted by agreement to the United States and the Third World only. \$2.50 (plus \$1.00 postage) in the U.S. Special rate of \$1.00 (plus \$1.00 postage) for local groups in developing countries.

This is the most important conceptual book on appropriate technology since E.F. Schumacher's **Small is Beautiful**. The author examines the roles of craftsmen, aid agencies, governments, research and development centers, universities, and domestic development agencies in the promotion of appropriate technology. He suggests that the appropriate technology movement reflects a cultural revolution in development efforts. A thorough treatment of the policy issues facing appropriate technology practitioners.

4) **Where There Is No Doctor**, by David Werner, 1977, 464 pages, \$6.00 (plus \$1.50 postage). Special rate of \$4.00 (plus \$1.50 postage) for local groups in developing countries.

This is a revised, updated translation of a highly successful book first written in Spanish— **Donde No Hay Doctor**. The Spanish version is now used in 15 Latin

American countries as a training and reference manual for village health workers, and has been widely praised for its simplicity, clarity, and practical value. Using simple words and over 1000 line drawings, the author explains what the reader can do to prevent, recognize, and treat many common illnesses. The book helps individuals to realize what they can do for themselves, as well as which problems need the attention of a more experienced health worker. Included are a wide range of subjects relevant to the health of the villager—from diarrhea to tuberculosis, from helpful and harmful home remedies to dosage and precautions for each medicine mentioned in the main text. The introductory section stresses the importance of using local resources whenever possible, and of building on the people's local traditions and ways of healing by adding to (rather than replacing) them with helpful aspects of modern medicine. (Published by the Hesperian Foundation, Palo Alto, California.)

5) **Trans-Cultural Study Guide**, edited by Darrow, Palmquist, Bryan and Morrow, 1975, 156 pages, \$3.00 (plus \$1.00 postage). Bulk Discounts.

Written for use by students, travelers, development workers, and others who want to systematically learn about other countries and cultures. The Study Guide suggests hundreds of questions within the topic areas of economics, politics, education, art, music, food, social structure and other subjects.

6) **Lorena Stoves**—additional copies of this construction manual can be obtained for \$4.00 (plus \$1.00 postage). Bulk discounts.

**All of the books above are available from the Appropriate Technology Project, Volunteers in Asia, P.O. Box 4543, Stanford, California 94305, USA.**