

# **AT** MICROFICHE REFERENCE LIBRARY

A project of Volunteers in Asia

Alternative Sources of Energy

No. 60, March/April 1983 (sample issue)

Published by:

Alternative Sources of Energy, Inc.  
107 South Central Avenue  
Milaca, MN 56353 USA

This periodical is printed six times each year. One-year subscriptions in the USA are \$19.50 for individuals and \$25 for institutions; in Canada and Mexico, \$25; foreign air mail subscriptions are \$38 for one year.

Available from:

Alternative Sources of Energy, Inc.  
107 South Central Avenue  
Milaca, MN 56353 USA

Reproduced by permission of Alternative Sources of Energy, Inc.

Reproduction of this microfiche document in any form is subject to the same restrictions as those of the original document.

# alternative sources of energy



March/April, 1983

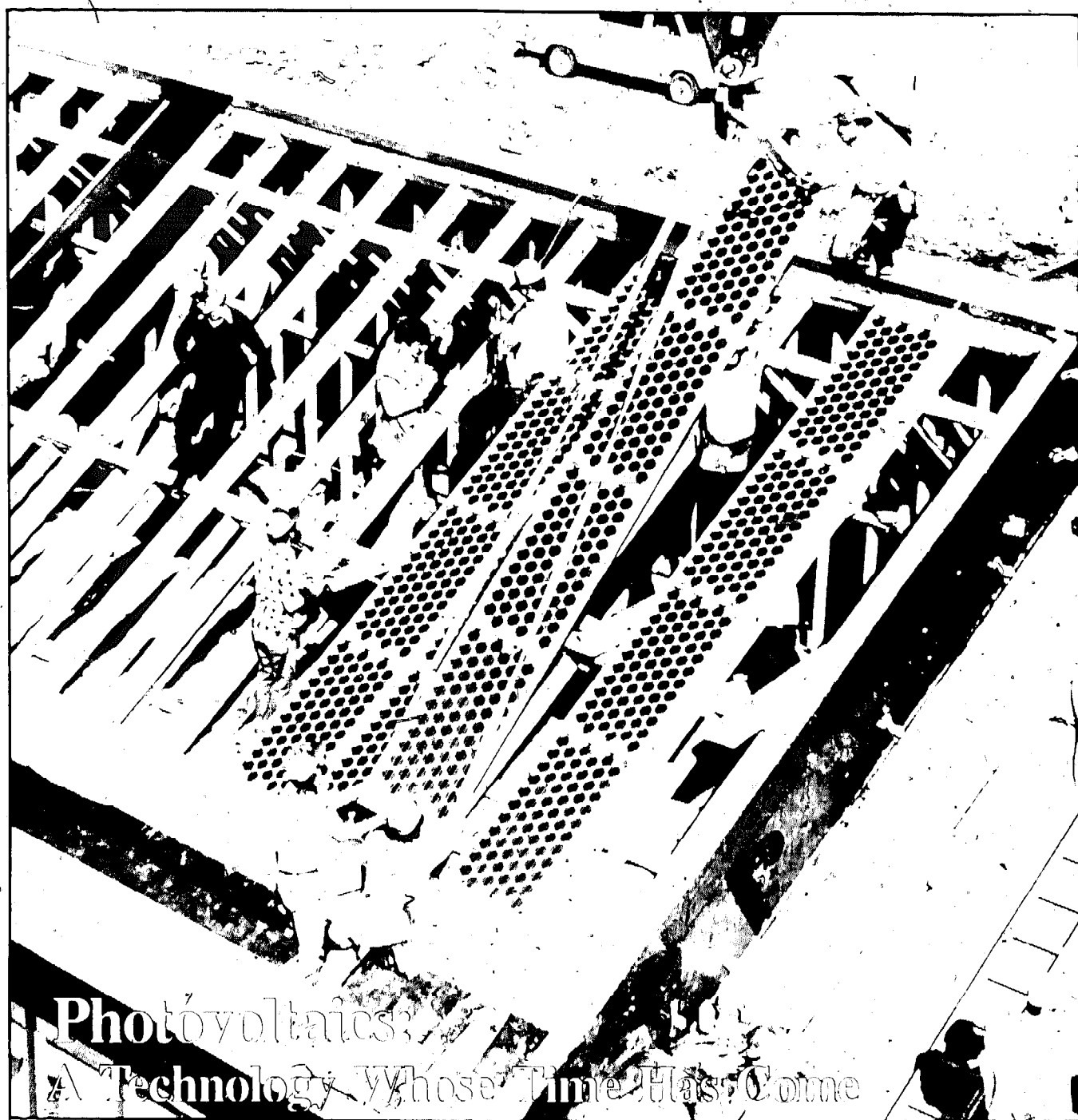

Photovoltaics:

A Technology Whose Time Has Come



# Out Here **Dependable Electricity** Comes from the Sun!

For the past 10 years, PHOTOWATT has been one of the country's leading manufacturers of photovoltaic panels and systems with over 12,000 applications worldwide.

If you are interested in being qualified as a dealer to supply photovoltaic systems for remote homes, please contact:

**DEALERSHIP SERVICES**  
2414 West 14th Street, Tempe, Arizona 85281

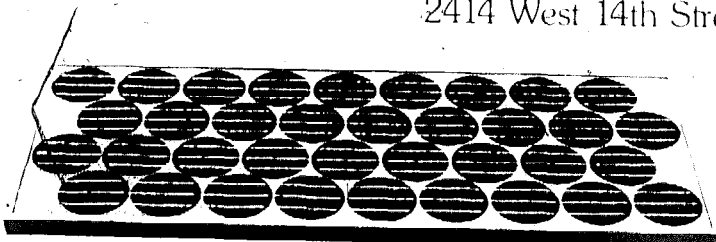

*Photowatt International's exclusive Model MI 7010, 55 watt, laminated panel features the world's largest silicon cell (5" diameter) in a solar panel*



## **PHOTOWATT**

INTERNATIONAL, INC.

2414 West 14th Street, Tempe, Arizona 85281  
(602) 894-9564

# staff

Number 60

Director of ASE, Inc./Executive

Editor: Donald Marier

Editor: Larry Stoiaken

Director of Advertising & Marketing:

Abby Marier

Technical Art: Anthony Rau

Special Projects Coordinator/Public

Relations: Abby Marier

Circulation & Wholesale Accounts:

Linda Day, Nancy Eggert

*Alternative Sources of Energy* is published bi-monthly by Alternative Sources of Energy, Inc., 107 S. Central Ave., Milaca, MN 56353 (612) 983-6892. Second class postage paid at Milaca, MN 56353 and additional mailing offices. POSTMASTER: Please send Form 3579 to Alternative Sources of Energy, Inc., 107 S. Central Ave., Milaca, MN 56353.

Copyright 1983 by Alternative Sources of Energy, Inc. All rights reserved.  
ISSN-0146-1001

ISBN: 0-917328-50-7

This publication is available on Microfilm. For information, write Dept. FA, University Microfilms International, 300 N. Zeeb Rd., Ann Arbor, MI 48106.

**Purpose.** *Alternative Sources of Energy, Inc.* is a nonprofit, tax-exempt, scientific and educational organization for those persons concerned with the development and use of renewable resources. Particular emphasis is on alternative environmental technologies which are energy-related. The major thrust of the organization is to publicize and share practical applications of such technologies as a means of attaining some degree of energy independence. *Alternative Sources of Energy, Inc.* serves as a focus for a variety of resource people. It is a vehicle by which ideas and experiences are shared. See last page of this issue for a complete listing of services.

*Alternative Sources of Energy* is published each January/February, March/April, May/June, July/August, September/October, November/December. The publisher is not responsible for product claims and representations. Statements of opinion and fact appearing in *Alternative Sources of Energy* are those of the authors. Designs and plans presented in articles in *Alternative Sources of Energy* are presented for informational purposes only. The publisher makes no guarantee of the workability or safety factor of such information.

**Editorial Offices:** Alternative Sources of Energy, Inc., 107 S. Central Ave., Milaca, MN 56353.  
**Subscription Rates:** \$19.50 for 6 issues, \$35.00 for 12 issues. Businesses, Libraries, Government Agencies and Organizations, \$25.00 for 6 issues, \$45.00 for 12 issues. Canada and Mexico, \$25.00 for 6 issues, \$45.00 for 12 issues. Foreign Air Mail, \$38.00 for 6 issues, \$68.00 for 12 issues. Single issues \$3.50 each. **Subscriptions, Renewals, and Change of Address,** c/o Circulation Dept. Allow 5 weeks for change of address or delivery of magazine. Correspondence relating to subscription problems should include the computer/subscription code from address label. The month and year of expiration appears on your label. **All editorial correspondence,** c/o Editor Stylesheet sent upon request. Unsolicited manuscripts and materials should contain a self-addressed, stamped envelope. Unless otherwise indicated, permission is assumed to include the name and address of persons submitting letters and feedback to be printed in *Alternative Sources of Energy*. **Advertisers:** Contact us for media kit and rate information.

# alternative sources of energy

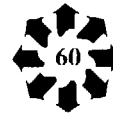

March/April, 1983

## Photovoltaics

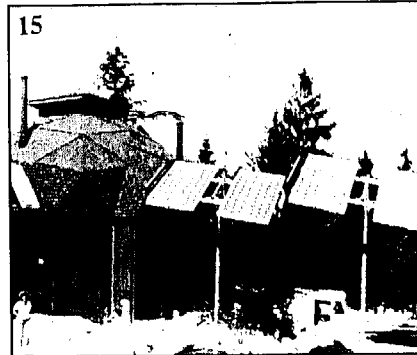

## features

### 6/The Future of Photovoltaics: An Interview with Paul Maycock

By Larry Stoiaken & Sam  
Vanderhoof

### 8/The Photovoltaic Specialists Conference

By Sam Vanderhoof & David  
Copperfield

### 10/A Sourcelist For the PV Shopper

### 12/Getting the Best of Both Worlds... The Photogenset Laurence Jennings

### 15/A Photogenset Hybrid Jim Cullen

### 17/Reader's PV Report Ernie Davidson

### 19/The Solar Breeder: A Bold Step By Solarex Marcus J. Smith

### 20/Mixing Renewables: Combining Wind and Solar Electricity Stephen P. Cook

### 24/Recycling Old Houses: The Super-Insulated Triple-Decker Steven Kropper

## departments

2/Letters

3/Editorial: Donald Marier

39/Book Reviews

41/Spectrum

44/Calendar

## energy focus

27/Wind

32/Photovoltaics

35/Solar

37/Conservation

38/Biomass

## services

43/Classified Ads

44/Directory of Advertisers

44/Order Form

About the Cover:

Workers install four of the 64 PV panels which will form the south roof of "Future I", Georgia Power's privately funded experimental home in Roswell, Georgia. The photovoltaic system for Future I consists of sixty-four 62 watt panels, each 25 1/2 in. by 4 ft., produced by SOLLEC International Inc. of Haythorne, California. The peak power rating of the 544 sq. ft. array is 4.1 kw. The PV panels are mounted directly on rafters, 28 inches on center, and perform double duty as the south roof. This photo is courtesy of Sibly + Seedorf, the architectural firm which designed the home.



# letters

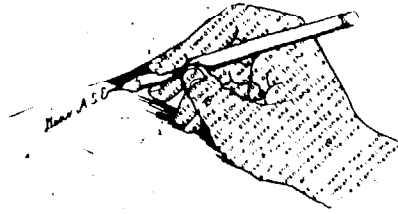

## Rubbed Wrong Way Over MPG Ad

Your issue (#58) is great in many ways. I learned a lot.

But... the page 46 ad, re Oldsmobile with 78 mpg, certainly rubs me the wrong way. This is such a classic field for swindles. Did you look into the matter carefully and really satisfy yourself that a typical 1977 Oldsmobile could be converted, by a typical fellow with hand tools, to getting 78 mpg by installing \$20.00 worth of new parts? The quality of ads in your periodical has been high and I am sure you yourself want it to stay that way!

Car makers are competing terrifically, these days, to provide good mileage. They go to great expense to eek out 1 more mpg. Yet this fellow in

*the product did have a 30 day money back guarantee, which we require of mail order advertisers. JLC agreed to forward the names of some customers, as requested. However, as the final deadline for the issue approached, the names had not arrived. A phone call to JLC was made and verbal assurance was given that the names would be forthcoming. They have still not arrived and we will not run this ad again until the names have been received.*

*Generally, we have more subtle judgements to make concerning ads. For example, the wind industry has yet to adopt standards, and so some companies can claim outputs that are optimistic, but still below theoretical levels. Clearly, the industry must adopt*

## Don't Miss An Issue

I've received my missed issue and the latest issue arrived at our new address yesterday. Your quick, personal response is refreshing.

Missing an issue made me realize how great the void would be if ya'll weren't around. There's simply no periodical around that covers the entire renewable energy field as well as ya'll do. Hope ya'll can keep the owner/builder experiences and how-to articles in every issue. I enjoy them immensely, not to mention the practical help I've got from them. Keep up the good work.

Micheal Gibbs  
Ranbourne, Alabama

**"You really are to be complimented on your work in the alternate energy field. Dissemination of the latest up-to-date information and news of the latest innovations are the key elements of our future energy picture."**

Noel E. Kirkby  
Cave Creek, AZ

Manchester, NH would have us believe that, for a mere \$20.00, the companies could up their mileage by 20 or 40 mpg or so! Who can believe this?

Bill Shureliff  
Cambridge, Mass

*Ed's Note: Bill's letter is representative of several which we received from readers with serious misgivings concerning the JLC carburetor ad which appeared on page 46 of ASE #58.*

*When we agreed to run the ad in question, it was based on two conditions. Editor Larry Stoiaken requested the names of at least 10 customers of the product so that he could contact them directly and receive more information on the system. Also, Advertising Director Abby Marier noted that*

*some standards.*

*As for the fuel economy of automobiles, one should keep an open mind as to what is attainable. Granted, it is unlikely that a single device will achieve incredible results, but there is no theoretical roadblock to building automobiles which get fuel economies of 75 to 100 mpg. Indeed, author Michael Ver Meulen, writing in the January, 1983 issue of The Atlantic, quotes General Motors and Ford executives who state just that. The problem, however, as Detroit sees it, is the prohibitive cost of retooling for the radically different designs in light of the fact that consumers are currently buying less fuel efficient automobiles.*

Donald Marier

## PV Siting

I've been working with photovoltaics for some time and would like to share some insights on the subject. A solar panel is a very special source: the output voltage rides up to almost the rated voltage with no appreciable decrease in current. This means that with a 16.5-volt panel and a 12-volt battery (13.7 volts maximum), you can afford to drop over 2 volts in line loss with virtually no decrease in performance. You can, for example, send 4 amps through 200 feet of #12 wire. The normal criteria for wire size calculation simply do not apply. True, if the cells get hot, the rated voltage drops, but in hot weather you usually have more power than you use anyway.

As for the diode, the night leakage current without a diode in the panels I've measured has never been more than a few milliamps. More important is the fact that a .7-volt diode drop is equivalent to 60 feet of #12 wire (again at 4 amps). If you need the distance and do leave the diode out, measure the night leakage on your panel just to be sure.

Why put the panel so far from the battery? Truly good sites can be hard to find. Remember that a shadow on

one cell reduces the output current almost as much as if the whole panel were shaded. If the shadow of so much as a flagpole reaches your panel, you should be looking for a new site.

Ed Colaianni  
Ukiah, CA

### PV Controversy

Many of us in the day-to-day business of selling and servicing photovoltaic panels were disturbed by a recent article you published, "A Comparison of Residential Photovoltaics" (ASE #56), that presented a biased and speculative view of today's products. It has done us and your readers a grave disservice.

The essay, by David Katz and Pam Wellish, purported to review pros and cons of three brands of photovoltaic modules. The reader was led to believe he or she could weigh the features and benefits of each module type to make a more-enlightened purchasing decision.

Dually, good and bad features of the

ARCO and Solarex panels were presented. Then the Photowatt panel was described in glowing terms with, lo and behold, no negative qualities.

An advertisement appeared in front of the article, indicating that Mr. Katz was introducing Photowatt modules. He is, in fact, a *Photowatt distributor* who no longer actively promotes competitor's products. That he has a vested interest in his own product line succeeding is quite clear.

Mr. Katz further claims that he and his associates have, in three years, sold over 2,000 modules and found Photowatt's to be the most reliable, panel available.

Isn't he perhaps being a little over-enthusiastic about the product he now distributes? He's gained most of his field-experience using ARCO and Solarex products. The Photowatt panels haven't been around long enough to invite fair comparisons. Indeed Mr. Katz states just that by letting us know

towards the end of the article, that his experience with them is *limited*. How then can he claim that they are "the most reliable panel available". (A clear contradiction)

The article also insinuates that Photowatt has a full 5 year warranty which is completely untrue. Check their literature. I have personally queried Photowatt on their warranty provisions and had this confirmed by them. Their warranty is 2 years to Arco's 5, *except under special individual competitive circumstances* where they must increase it in order to guarantee a sale.

Finally, Mr. Katz attributes certain opinions to the Jet Propulsion Laboratory. He should quote such sources directly, if he can. I have personally been unable to find any published results of the preliminary findings showing a "5 to 30% loss of power" related to module discoloration. (In any event, it is scientifically irresponsible to quote and use preliminary

## editorial

# Photovoltaics: Will They Be "Too Cheap To Meter?"

Donald Marier

*"Where can I buy those photovoltaic panels for 50 cents a watt?"*

I received just such an inquiry a few days ago and I had to sit back and think, "Where have I heard all this before?" Ah yes, it was back in the fifth grade when my teacher told me and my classmates that electricity from nuclear power plants was going to be so cheap that it would be difficult to even meter its use.

It is time to back off from overly optimistic PV price predictions. Anyone can sell the future. Fortunately, as David Copperfield, Sam Vanderhoof, Laurence Jennings and Paul Mayoock—all very involved in the PV field—point out in this issue of ASE Magazine, predictions of the dramatic price reductions "just around the corner" are being toned down. The word is getting out that there will be steady price declines as the technology improves—not the sudden breakthroughs which consumers were being built up for.

Then there is the question of total system costs. Even if module prices drop to the more realistic range of 2 to 4 dollars per peak watt by 1990, a lim-

iting factor will be the cost of batteries, inverters, controls, and other hardware. These are already relatively mature technologies which are not likely to undergo dramatic decrease in price. If anything, they will increase in cost with inflation. Furthermore, retail costs will not necessarily fall as fast as production costs, since as the market expands, distribution costs will probably increase. The uncertainty of the future of tax credits is also to be considered. As Laurence Jennings points out in his article in this issue: *"By purchasing all of the hybrid system components with a small quantity of photovoltaics, you will be able to lock in today's lower prices and be eligible for the extremely attractive federal tax credits before they go the way of the two dollar bill. As the price per peak watt of photovoltaics drops, you can slowly add to your energy portfolio . . ."*

A good approach to cost reduction then is through efficient system design and, where possible, minimizing energy demands to start with. Conservation is still, and will continue to be, the best policy! Larry Jennings and Jim

Cullen discuss one aspect of system design in this issue. There is still much room for development in this area, a good example being the inverter, which is constantly being redesigned for improvements, as more and more companies enter the field. Load demand controllers using computers, such as in Georgia Power's Future I home, or computer-like circuits are just beginning to be explored. New energy efficient water pumps, refrigerators, and other appliances are now being introduced on a regular basis. All these developments taken together—steady PV price reductions, improved system designs, and the development of more efficient appliances—are helping to make photovoltaics a growing and increasingly attractive industry.

### Upcoming Issues

*If you have material to contribute or would like to advertise in future issues, the tentative 1983 schedule appears below. Author manuscripts and advertising space reservations are due the 10th of the month, 3 months preceding the cover date:*

- #61/ Wind Power (May/June)
- #62/ Passive Cooling (July/August)
- #63/ Wood/Biofuels (Sept/Oct)
- #64/ Wind/Photovoltaics (Nov/Dec)

findings before they are comprehensive and finalized. JPL doesn't do it.) Mr. Katz also fails to tell the reader that Arco has changed its laminate design to mitigate this cosmetic effect. Since that time, I have not seen or heard of any module discoloration occurring. Nor have I ever been able to measure ANY power loss in the older style modules that have experienced discoloration. It is also instructive to note that Photowatt uses almost identical materials in the construction of their modules.

Now make no mistake about it, the firm for which I work is Solar Electric Specialties Co., a fully factory authorized distributor for Arco Solar Inc. Mr. Katz, as a Photowatt distributor, is clearly our competitor. I don't quarrel the ostensible goal of his article: to help people compare today's solar electric products. But, the Katz article fails to do this. He tells the reader what's bad about competitor's products, and leaves Photowatt smelling like a rose.

My own opinion, as a product researcher and engineer, is that both Photowatt and Arco manufacture excellent products. I say let them compete on their own merits—out in the

field—not in the pages of a carefully written piece of sales literature which claims to be an objective article.

My main complaint however, lies with this magazine. That merchants will tend to unobjectively evaluate competitor products while endorsing their own is not unusual. However, it is your special responsibility as an educational magazine to guarantee the *objectivity* and factual content of the material you print. Otherwise why print it?

Most of the time I think you do more than an excellent job. But the Katz article is a damaging exception. Expecting the cat to watch the canary usually is. That's why we have agencies like JPL. Why not submit such articles to industry peer review before printing them. I would urge you to do the same with this letter.

Laurence Jennings  
Product Research and Development  
Solar Electric Specialties Co.  
Willits, CA

#### Katz and Wellish Respond

We would like to thank Mr. Jennings for extending us the opportunity to respond to his letter.

We do not believe Mr. Jennings read

our article with an open mind. He thinks our article concludes that Photowatt panels are the best available panels and that the Arco and Solarex panels are no good. This is entirely incorrect. In the very beginning of the article we state, "All of these companies make excellent products. . . ." As a matter of fact, some people have read our article and then selected Solarex panels. Nowhere in the article is the Photowatt described as "the most reliable panel available".

Mr. Jennings claims the Photowatt panel was described in "glowing terms" and with no negative qualities. Rereading the article will prove our description of the Photowatt panel to be objective and certainly not glowing. That our experience with the Photowatt panel was limited (at the time the article was written) by the relatively short amount of time we had been selling it, was most definitely intended to be a negative quality. If we had known of any other negative qualities, we would have included them, and if Mr. Jennings knows of any, we would be most interested in hearing about them.

We believe we gave Arco credit for many positive qualities (for example: exceeding power output rating, five year warranty, pioneering home market). In fact, we were thanked by Charles Parker, Sales Manager of Arco Solar, Inc. It would not be responsible, however, to leave out the problems we've repeatedly encountered, specifically the easily broken output terminals and the encapsulant discoloration. When a customer comes in to ask why his panel is "rusting" (and this happens fairly often), is it enough to answer that Arco doesn't believe this will cause any problem? Of course, there are no published results of JPL's preliminary findings, and we stated in the article that the final results won't be known until mid 1983. Because the studies are being paid for by the manufacturers, it was difficult to get information from JPL. We did finally talk to a representative who furnished us with the information we used in the article and who did not want to be quoted by name. We are happy to hear that Arco has changed its lamination design and sincerely hope this will solve the discoloration problem.

A possible reason Mr. Jennings has not been able to measure power loss in modules with discoloration is because these panels have been in use less than three years, compared to the acceler-

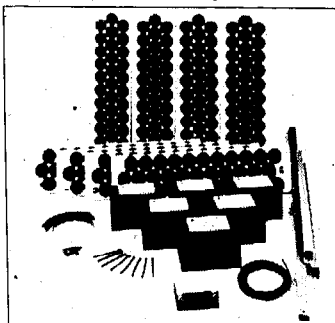

## A lot of value for your money. ARCO Solar Remote Home Power Systems. ARCO Solar ♦ Photovoltaic Products

Today, it is possible to provide even the most isolated homes with a reliable source of electrical power.

ARCO Solar photovoltaic systems can power most 12-volt appliances, such as radios, T.V.s, two-way radios, water pumps, small refrigerators or many other items. With a simple AC inverter, they can also be used to run numerous small electric tools and equipment.

The heart of any photovoltaic power system is the module. ARCO Solar modules are lightweight, rugged and specially engineered to give you maximum power using minimum space.

ALBAN OFFERS A FULL LINE OF ACCESSORIES FOR SOLAR POWER SYSTEMS.

For More Information &  
Name of Nearest Dealer  
**CALL COLLECT**  
**(301) 355-6700**

# ALBAN

1401 Cherry Hill Rd.  
Baltimore, MD. 21225

ated 10 to 20 year equivalent modules used in the JPL testing. The materials used in the construction of Photowatt and Arco panels may appear to be identical, but there is a difference between nickel and silver metalization and the way it reacts with the PVB encapsulant.

As we stated in the article, Arco's 5 year warranty has forced Photowatt, as well as Solarex, to extend their 2 year warranties. Consequently, every Photowatt ML5010 and ML7010 panel we sell carries a 5 year warranty.

We sell photovoltaic panels. We do not own stock in Photowatt and do not have a vested interest in their company. We do have a vested interest in selling high quality solar panels at reasonable prices. We now carry photovoltaics produced by three companies: ARCO Solar Inc., Photowatt International Inc., and Solarex Corp. Mr. Jennings sells only Arco panels. If anything, we are far less tied to Photowatt than he is to Arco.

We strongly object to our article being described as a "carefully written piece of sales literature". We never claimed the article to be completely "objective". It was written based on our experience with selling solar pan-

"Missing an issue made me realize how great the void would be if you weren't around. There's simply no periodical around that covers the entire renewable energy field as well as ya'll do."

Micheal Gibbs  
Ranbourne, Alabama

els over the last three years and was clearly labeled as such. Mr. Jennings calls for letting the various solar panels compete on their own merits, out in the field. We couldn't agree more, and that is exactly what we stated in the last sentence of our article.

David Katz  
Pam Wellish  
Alternative Energy Engineering  
Redway, CA

### Painting Our Future Energy Picture

We recently received ASE #56—another excellent issue! Our firm works entirely with photovoltaic energy systems, so we especially enjoyed the article by David Katz on comparisons of PV equipment. A very

objective and concise summary of available products.

Our 16 page Planning Booklet and Catalog is available for \$1 and includes far more information than product literature. It features a resource list that we feel is genuinely helpful and that, by the way, includes ASE as one of only three magazines we recommend.

You really are to be complimented on your work in the alternate energy field. Dissemination of the latest up-to-date information and news of the latest innovations are the key elements of our future energy picture.

Noel E. Kirkby, President  
Solar Electric Systems  
Box 1562  
Cave Creek, AZ 85331

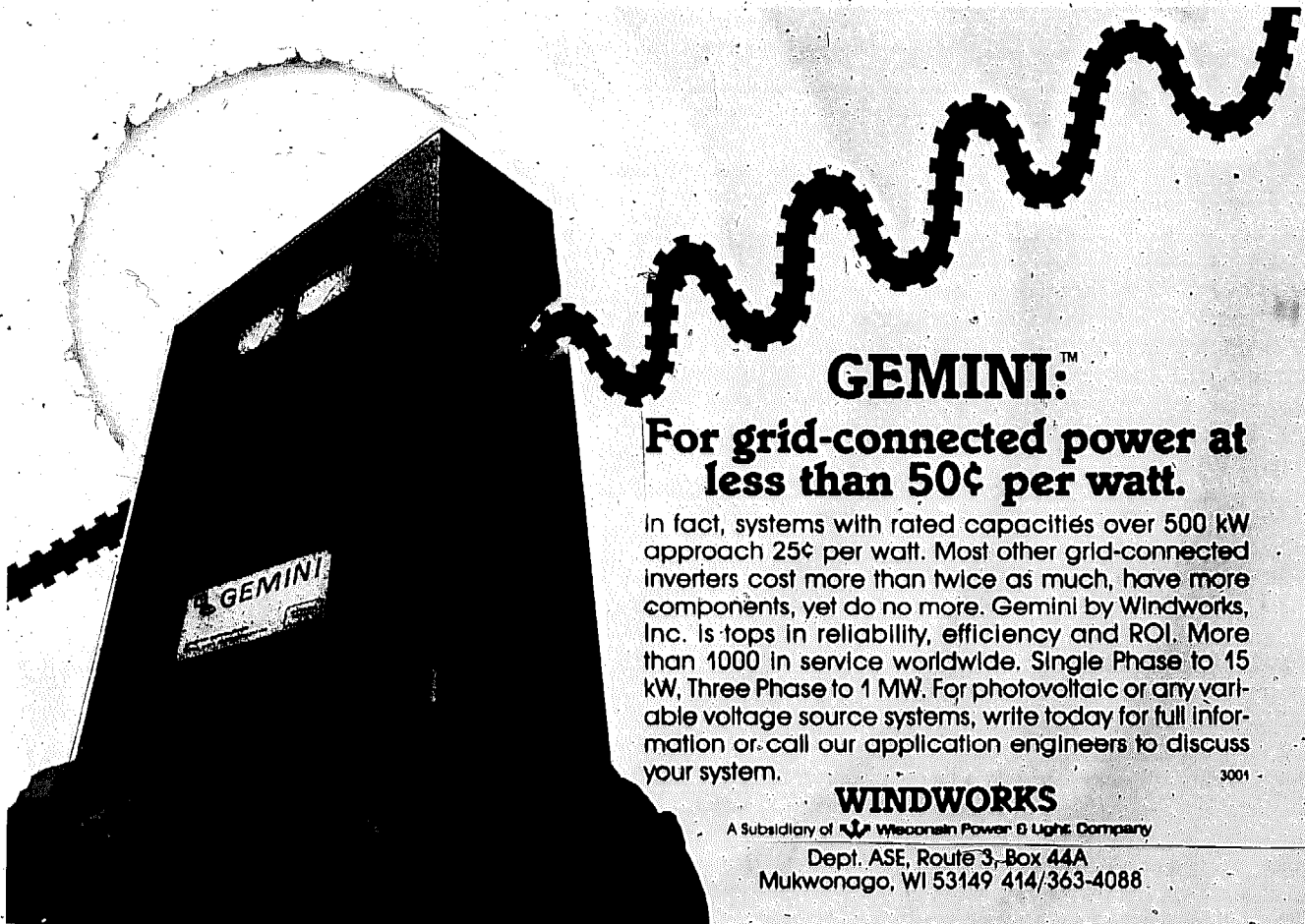

**GEMINI™**

**For grid-connected power at less than 50¢ per watt.**

In fact, systems with rated capacities over 500 kW approach 25¢ per watt. Most other grid-connected inverters cost more than twice as much, have more components, yet do no more. Gemini by Windworks, Inc. is tops in reliability, efficiency and ROI. More than 1000 in service worldwide. Single Phase to 15 kW, Three Phase to 1 MW. For photovoltaic or any variable voltage source systems, write today for full information or call our application engineers to discuss your system.

**WINDWORKS**  
A Subsidiary of Wisconsin Power & Light Company  
Dept. ASE, Route 3, Box 44A  
Mukwonago, WI 53149 414/363-4088

3001

# The Future of Photovoltaics:

By Larry Stoiaken & Sam Vanderhoof

## Alternative Sources of Energy

In your book *Photovoltaics: Sunlight to Electricity in One Step*, (Brickhouse Publishing Co.), you stated that photovoltaics will be fully economic for massive private use before a major utility can design, purchase, and install its next nuclear reactor. Are you still comfortable with that prediction?

**Paul Maycock**

I think this is absolutely true with the Sunbelt utilities, especially in California, where the intervenor cycle takes maybe an extra two years. I assume, and most people indicate, that it takes twelve years from start to finish to build a nuclear reactor. That means, if we start with 1982, at least 1994 before one could come on line. I think there's absolutely no doubt that PV systems will be installed at about two dollars a watt, or two thousand dollars a kilowatt, with about a 22% capacity factor by then, and that comes out to be economic with peaking power from coal or nuclear in that kind of climate. So I think the statement still holds.

## Alternative Sources of Energy

The catch-22 on photovoltaics seems to be that those people who are doing their research and seriously considering a purchase, invariably come across the information that within two to five years the price of photovoltaics will drop dramatically. Will it drop dramatically if those same people then decide to wait? In other words, will the largest price reductions result from an accelerated rate of purchase or from R&D that is unrelated to sales volume?

**Paul Maycock**

A very interesting market related technical question. There has always been, whenever there is a possibility of a future reduced price, a certain group of people who will wait. This was true when the calculators were coming down... people bought calculators at \$500, a few of them, and then a bunch of them bought them at \$10.00. All of us who have been in the business of doing market research know that this is called price elasticity. And price elasticity is precisely what relates to photovoltaics. When photovoltaics are ten dollars a watt, the market is somewhere between 10 and 20 megawatts.

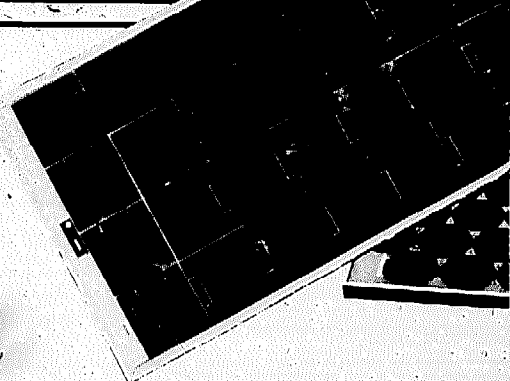
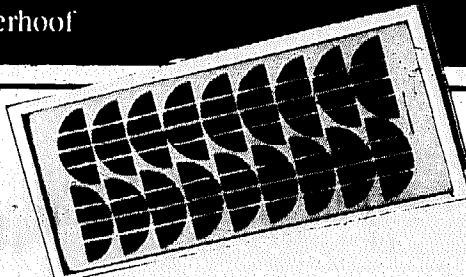

And people will buy 10-20 megawatts. When PV is down to five dollars a watt, the market will be on the order of 100 megawatts a year and at that time, a 100 megawatts will be sold. So this idea that people are waiting is correct, but there are enough of them at the present prices to pull in some cost reduction. Now your second point, the mix of market pull versus technology development; I would say it's about 50/50 right now. As we grow larger size factories to serve the larger market, the cost reduction in economies of scale and automation and so on are about half of the cost reduction that occurs and the other half comes from intrinsically new processes. So it's not an 'either or', it's some kind of combination of both forces. Now the third point in the market is when we get to roughly two dollars a watt. Then the market will easily be a thousand megawatts a year or more, on a worldwide basis. I think those numbers, 10 megawatts at 10 dollars, 100 megawatts at five dollars and a 1000 megawatts at 2 dollars plot a curve. I think that curve has been relatively well studied by those who do market research, like myself. Obviously, it's a crystal ball forecast, but so far it's come in pretty close to what we expected.

## Alternative Sources of Energy

Do you see a new timetable for the reduction of PV prices?

**Paul Maycock**

Certainly. I'm now forecasting roughly two dollars (1982 dollars) a watt in 1990 as opposed to the levels of seventy cents a watt in 1986. The good news is that the market is much larger at two dollars a watt than was ever anticipated. People are accepting photovoltaics much better than we ever anticipated and so, at two dollars a watt in 1990 I am forecasting about a billion and a half dollar industry. So the news isn't all that depressing. I think the DOE goals served their purpose. They caused people to work hard toward

something that was of value to the nation. I think when we get to our next oil crisis those goals could quickly come back.

## Alternative Sources of Energy

It appears that ARCO is currently in the lead as far as PV sales goes. Do you share this perception? Do you see any of the new entrants making a dramatic move to take over the lead?

**Paul Maycock**

At the moment Solarex and Arco are the leaders, and they are likely to remain so through 1990. I think the thing we want to watch for is a new entrant, that's very well capitalized, coming in with 50 million dollars worth of capitalization. That new entrant could then take over the pack. That, however, probably won't start to occur for another five years. We're still too small of a market for that kind of risk.

## Alternative Sources of Energy

In that five year framework, what do you see happening? How many companies will get in the act?

**Paul Maycock**

Within that time frame, you could envision a Texas Instruments making a bold move, or you could envision a General Electric making a bold move, but it will be after we're up around five hundred million dollars a year worth of sales. At that point, one of these larger outfits could say, "hey, we ought to invest a hundred million dollars" and they'll be right in the middle of it. That's what happens in big industry. We're going to have a proliferation of 50 or so U.S. PV companies and at the big shakeout drop back to 15 or so and we'll end up, as we become a commodity, with the top four, like the automobile industry. At the turn of the



# An Interview With Paul Maycock



century, near 2000, we'll have four or five major producers, as with any other commodity and we'll settle in. I would suspect that there's a good probability that Arco and Solarex could be one of those four, or five.

## Alternative Sources of Energy

Which PV technology do you see winning out economically in the short run and the long run?

### Paul Maycock

Well, if you're referring to module technology, clearly its single crystal silicon in the next two to three years. The Semix is coming up very quickly and will be number two in year three, clearly. And it will be silicon and semix in the next five years as the dominant market technology. Ribbon will stay at ten to fifteen percent, concentrators will also be at about ten to fifteen percent five years off, and then, the thing that will come right through the pack, gaining roughly twenty five to thirty percent of the world market in 1990 will be amorphous silicon. I can see no other material gaining much more than 10 percent of the world market by 1990. The new product is always at a disadvantage. You don't have proven long term data, you don't have proven liability data, and you get some people who are doing it better than others. You always have a reluctance on the part of the market to shift from something they really believe in and understand, especially if it's continually decreasing in price. So it just takes time. Not that a wholly new non-silicon cell is not going to become a reality, it's just going to take a lot more time than some people think. The headlines that say 60 cents a watt for amorphous silicon is just poppycock. It's just not going to happen on an instantaneous basis; maybe in 1990.

## Alternative Sources of Energy

In ASE #58, ARCO representative Arthur Rudin was quoted as saying that the American PV manufacturers are at least one year, and in some cases two years, ahead of the Japanese in amorphous silicon technology. Rudin admitted that the Japanese will "give us a run for our money", but he was confident that we'll maintain our leadership role. Do you agree with this scenario? Do you share Rudin's confidence, especially in light of your recent trip to Japan?

### Paul Maycock

If you divide technology into research in the laboratory, then I think his statement is nearly correct, in that there are some research teams in the U.S. that are ahead of the Japanese... whether its six months, a year or two years, its hard to know. So I think if you said that technology identically equals research in his statement, then he's correct. If you said that technology equals process technology, that is, the ability to produce areas with efficiency, longevity and some of the cost reductions in the physics of amorphous silicon, I think the Japanese are at least 18 months ahead of the U.S. There are no U.S. firms in production whatsoever, although there are some very high quality U.S. research teams. The only difference I see between the Japanese research and the U.S. research is that the Japanese research is using preproduction multi-chamber vacuum equipment and the U.S. research is still in bell jars. So the Japanese transfer their research results into production much quicker than the U.S. does. The Japanese are able to take the research results at the University of Usaka, in Dr. Hamakawa's lab, and then transfer that to the industry, I believe, much quicker than any other academic program in the U.S.

## Alternative Sources of Energy

What do you think of the government cutbacks?

### Paul Maycock

Well, we can't do much about it. Mr. Reagan has made his mark. The industry has responded and moved ahead with their own risk capital. Although I think that a larger Federal program is in order, I just want to keep it from going any smaller. As long as we have a 60 million dollar federal PV budget, I think we can go ahead and keep the American industry strong.

When I think about it, I guess the thing that bothers me more than anything else is that while we are cutting the renewables to hell, we are still increasing the fission, fusion, and the breeder. I just think that's an unbelievably difficult policy to swallow.

## Alternative Sources of Energy

I understand that you've got another book in the wings on photovoltaics. Can you give us an update on that?

### Paul Maycock

I have two, well actually three. We have updated *Photovoltaics: Sunlight to Electricity in One Step* and the new version should be available this March. We have just published a monograph called *America Challenged: Photovoltaics in Japan*. That book is now available from my company, Photovoltaic Energy Systems, Inc., and costs \$200 because of the very limited market and the cost of the research—we've sold quite a few copies already. The third book, and we haven't picked with the publisher the exact title, I'm calling it *PV Homes Directory* will cover some 200 photovoltaic powered houses, mainly off the grid, with pictures and descriptions of what the owners like and dislike about PV systems. There will be at least one system described in every state in the US.

*Paul Maycock is currently the president of Photovoltaic Energy Systems, Inc. (2401 Childs Lane, Alexandria, VA 22308). He is a director of both the Solar Energy Industries Association and the American Solar Energy Society. Paul was the director of the Department of Energy's Photovoltaics Division and before that spent 13 years with Texas Instruments in a series of positions involving high technology product planning.*



Tedeland Signal Corp.'s glass-encapsulated panel is a 6V unit with no frame, just very heavy glass on both sides. It is designed to run a light beacon with an amplifying lens.

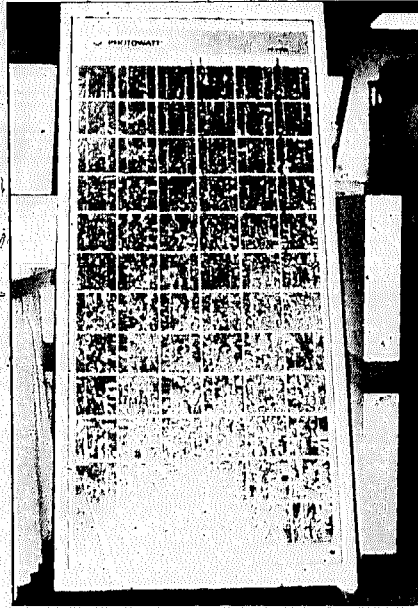

The new French-made semicrystalline Photo wall panel, not yet available in the US (photos by Sam Vanderhoof).

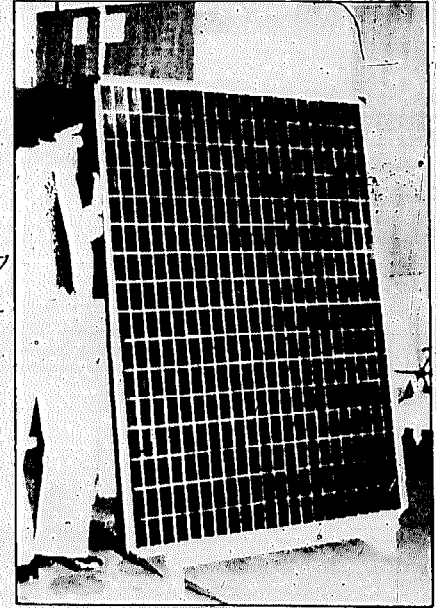

The Mobil ribbon technology panel. A smaller version is now commercially available.

# PV Conference Report

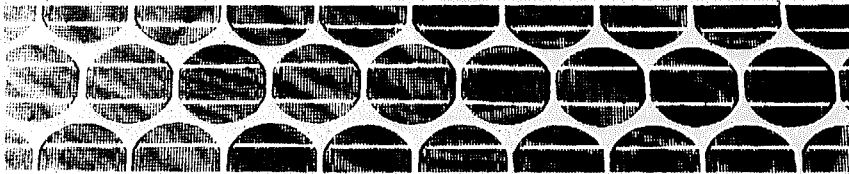

## Notes on the Sixteenth Annual IEEE

### (Institute of Electrical and Electronics Engineers) Photovoltaics Specialists Conference

By David Copperfield and  
Sam Vanderhoof

This past September, electrical and electronic engineers got together in San Diego, California for their annual PV Specialists Conference. We attended the conference with the goal of seeing what was in store for PV users. In general, one of the most frequent comments that we heard at this conference was that no big price drops are projected for at least two years, but gradual drops will continue. The big savings projected on polycrystal and ribbon technology have not yet materialized but the first of these two methods is now about equal in price to mono-crystal modules (ribbon is still about four dollars a watt more expensive). The next big step in the PV field, according to many conference

participants, should be the introduction of amorphous cells to the general public, but that is still several years down the line. Charlie Gay, Chief of Arco research engineering, along with Bill Yerkes, did discuss Arco's experiments with semicrystalline and ribbon technology.

Japan was, as expected, well represented at the conference, with a three person delegation from their Central Research Institute of Electrical Power Industry and a group from Sanyo. The Central Research Institute contingent reported on their experiments using PVs on apartments and utility interactive PV systems, and the Sanyo representatives reported on Amorphous silicon cell developments. For more on that, see the interview with Paul May-

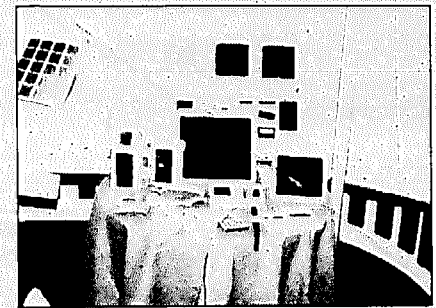

The Sanyo booth featured PV products such as Walkman-type radios, NiCad battery chargers and other electronics with built-in PVs.

cock in this issue.

Also giving interesting reports were J.F. Schaefer from the Solar Energy Institute of Las Cruces, New Mexico—using trackers for increased production; and W.A. Brainard of NASA-Lewis Research Center in Woburn, Massachusetts, who reported on the worldwide rural PV market.

Although Arco, Solarex and Photowatt are still the apparent leaders in PV sales, many more companies are starting to offer panels priced competitively with the frontrunners, and others are getting closer. Solar Power Corp. of Woburn, MA, Mobil of Waltham, MA and Solar Generators of Singapore were among those showing their new panels at the conference.

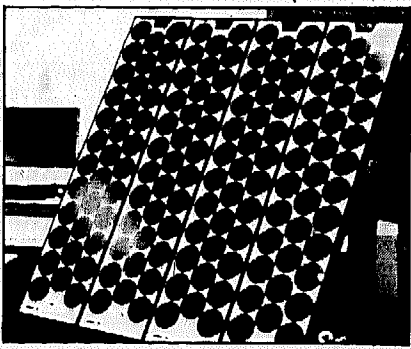

Solar Power Corp. had a four panel display of its competitively priced PV panel.

### Information Shared Freely

Much of the information at this conference was "high-tech", and we found that we learned as much from talking to people in their booths as in the larger meetings. The engineers were very open and research reports that had taken as much as three years and hundreds of thousands of dollars were shared freely, thus enabling peers to save the duplication of research. The more formal meetings covered subjects like crystal defect problems, silicon sheet technology, surface effects of high voltage silicon cells, and high efficiency approaches to PV technology. The format of these sessions made it all but impossible to ask ques-



SOLEC was displaying its new lightweight, flexible panels, which are offered in sizes from 30 to 66 watts. Independent Power Co. should have these panels available in the near future. The one drawback, at this point, is that the warranty for the panels is only one year.

tions, unless you knew almost as much as the speakers. There were, however, plenty of opportunities to ask simpler questions of the same people when they were at their booths or during mini-sessions. In this less formal environment, these same people would happily discuss their projects for hours on end.

The next big PV conference we know of will be at M.I.T., in Cambridge, Massachusetts, from March 24-26, 1983. Called "Photovoltaics: From Research to Reality", the conference promises to be oriented to the practical aspects of PV.

**Finally . . . A 12-volt panel that will charge ALL your batteries for under \$60.00**

**4.37 Watt Photovoltaic Battery Charger \$59.95**

Maximum output Amperage Size 17.5 v. 250 mA 5 1/4" x 10"

- Space quality silicon cells
- Anodized aluminum frame
- Silicone encapsulation
- One plug, universal cord
- Blocking diode

**Charges NiCad and Gel Cell batteries in combinations up to 12 volts.**

**Cradles for AA, C and D cells (4-8 at one time) available separately.**

*Order direct from:*

**INTERNATIONAL SOLAR PRODUCTS CORPORATION**  
1105 W. Chapel Hill St.  
Durham, N.C. 27701 USA  
(919) 489-6224

# BE ENERGY FREE IN 83

## PHOTOCOMM INC.

YOUR PHOTOVOLTAIC SYSTEMS SPECIALIST

AN ARCO  FACTORY AUTHORIZED DISTRIBUTOR PROVIDING:

- SOLAR POWERED WATER PUMPING SYSTEMS  
1-100 gal/min FOR LIVESTOCK WATERING, CROP IRRIGATION, ETC.
- REVOLUTIONARY SOLAR POWERED ADIABATIC AIR CONDITIONER
- COMPLETE REMOTE HOME POWER SYSTEMS
- FULL BALANCE OF PV SYSTEMS AND COMPONENTS
- CUSTOM DESIGNS FOR STAND ALONE AND COGENERATION SYSTEMS

CALL ABOUT OUR EDUCATIONAL SCHOOLS AND SEMINARS OR SEND FOR OUR COMPLETE CATALOG (\$5.00)

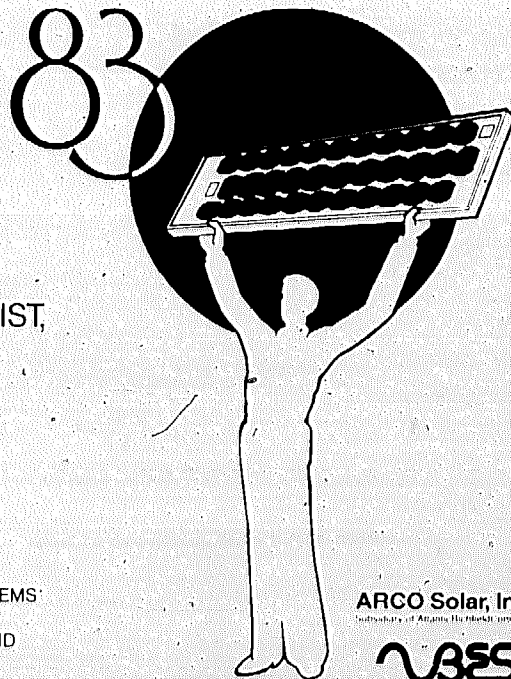

ARCO Solar, Inc. 

Member of Arco International Company

**BEST**  
BEST ENERGY SYSTEMS, INC. INCORPORATED

  
**PHOTOCOMM**  
INCORPORATED

745 East Broadway Blvd.  
Scottsdale, Arizona 85260  
602 948-8003



# A Sourcelist for the PV Shopper

SOLAR ELECTRICITY  
Making the Sun Work for You

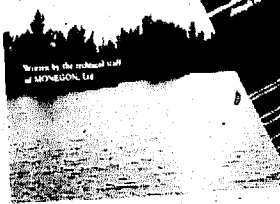

Starting Out:  
Do Your Research First

*Practical Photovoltaics:  
Electricity from Solar Cells*

Richard Komp  
Aatec Publications  
PO Box 7119  
Ann Arbor, MI 48107  
\$14.95 200 pp

*Photovoltaics: Sunlight to  
Electricity in One Step*

Paul D. Maycock  
Edward N. Stirewalt  
Brick House Publishing Co.  
34 Essex Street  
Andover, MA 01810  
\$9.95 222pp



*The Solar Electric Home: A  
Photovoltaics*

*How-To-Handbook*  
Joel Davidson and Richard Komp  
Aatec Publications  
PO Box 7119  
Ann Arbor, MI 48107  
\$10.00 150 pp

*Designing Small Photovoltaic  
Power Systems*

(2nd Revised Printing)  
Monegon, Ltd  
4 Professional Dr., Suite 130  
Gaithersburg, MD 20879  
\$10.00 29 pp

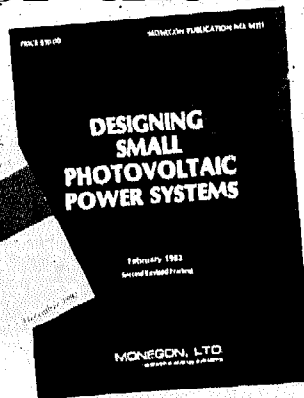

*Solar Electricity: Making the  
Sun Work for You*  
Technical Staff of Monegon, LTD  
Monegon, LTD  
4 Professional Drive, Suite 130  
Gaithersburg, MD 20760  
\$12.95 229pp

*Electricity from Sunlight: The  
Future of Photovoltaics*

Christopher Flavin  
Worldwatch Paper 52  
Worldwatch Institute  
1776 Massachusetts Ave. NW  
Washington, DC 20036  
\$2.00 63 pp

Also available from ASE

*Sunlight to Electricity:  
Photovoltaic Technology and  
Business Prospects*

(2nd Edition)  
Joseph A. Merrigan  
The MIT Press  
28 Carleton St.  
Cambridge, MA 02142  
\$19.95 215 pp

## FREE ELECTRICITY FROM SUNLIGHT!

Now there's a brand new, expanded catalog full of practical photo-voltaic equipment and supplies, from Energy Sciences, the retail subsidiary of Solarex Corporation, who pioneered solar electricity. In the new SOLAR WONDER—BOOK, you'll find cells and panels of all sizes, for all uses, along with systems, batteries, related apparatus, and lots of scientific devices both practical and fun.

To get your SOLAR WONDERBOOK, send \$3 (refunded on first \$15+ order) to:

**ENERGY SCIENCES**  
832 Rockville Pike, Dept. 531  
Rockville, MD 20852

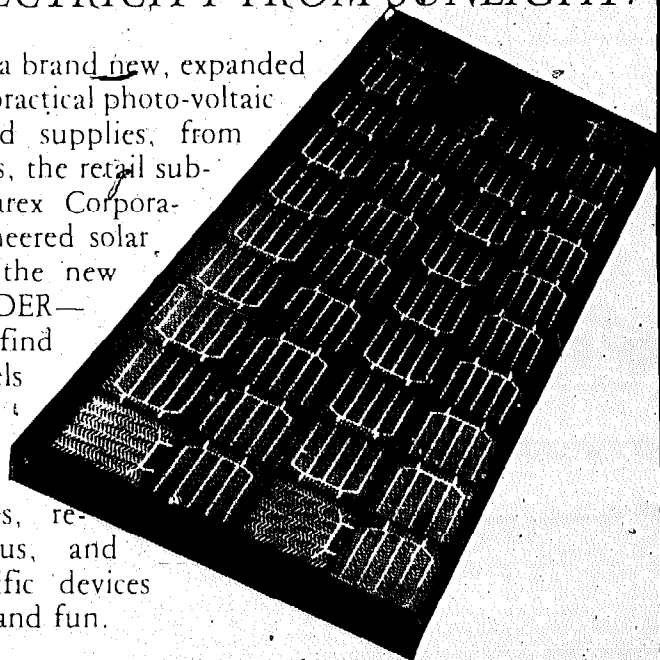

### Manufacturers

- ARCO Solar Inc., 20554 Plummer St., Chatsworth, CA 91311
- Chromar Corp., P.O. Box 177, Princeton, NJ 08540
- Electrolab, Inc., 2103 Mannix, San Antonio, TX 75222
- Free Energy Systems, Inc., Pine and Price Streets, Holmes, PA, 19043
- Mobil Solar Energy Corp., 16 Hickory Dr., Waltham, MA 02254
- Photon Power, Inc., 120 W. 13 Founders Blvd., El Paso, TX 79906
- Photowatt International, Inc., 2414 W. 14th St., Tempe, AZ 85281
- Sharp-ECD Solar, Inc., 1675 West Maple Rd., Troy, MI 48064
- Siemens AG, Postfach 103, D-8000, Munich 1, West Germany
- Silonex, Inc., 331 Cornelia St., Plattsburgh, NY 12901
- Solarex Corp., 1301 Piccard Dr., Rockville, MD 20850
- Solar Generators Singapore Pty Ltd., 151 Lorong Chuan, Singapore 1955
- Solar Power Corp., 20 Cabot Rd., Woburn, MA 01801
- Solartherm, Inc., 1315 Apple, Silver Spring, MD 20910
- Solvolt International, P.O. Box 2934, Phoenix, AZ 85062
- SOLEC International, 12533 Chadron Ave., Hawthorne, CA 90250
- Solenergy Corp., 171 Merrimac St., Woburn, MA 01801
- SunWatt Corp., P.O. Box 1396, Carbondale, CO 81623
- Tideland Energy Pty. Ltd., 100 Old Pittwater Rd., Brookside, N.S.W. 2100, Australia

## Distributors and Dealers

The following companies offer a variety of panels, PV components, and 12 volt appliances. Most of them offer a catalogue as well.

**Alternative Energy Engineering, P.O. Box 339D, Dept. ASE, Redway, CA 95560.**

**Earth Store, P.O. Box 679, Dept. ASE, North San Juan, CA 95960.**

**Solarwest Electric, 232 Anacapa Street, Dept. ASE, Santa Barbara, CA 93101.**

**Energy Sciences, 832 Rockville Pike, Dept. ASE, Rockville, MD 20852.**

**Northeast Solar Electric, P.O. Box 184, Dept. ASE, Endicott, NY 13760.**

**Real Goods Trading Co., 308C East Perkins, Dept. ASE, Ukiah, CA 95482**

**Solar Electric Specialties, P.O. Box 573, Dept. ASE, Willits, CA 95490.**

**Monegon, Ltd., 4 Professional Drive, Dept. ASE, Suite 130, Gaithersburg, MD, 20879.**

**William Lamb Co., P.O. Box 4185, Dept. ASE, N. Hollywood, CA 91607.**

**Independent Power Company, 12340 Tyler Foote Rd., Dept. ASE, Nevada City, CA 95959.**

**Western New England Solar, 118 Maple Street, Dept. ASE, Holyoke, MA 01040.**

**Communications Associates, 305 N. Republic Ave., P.O. Box 2399, Dept. ASE, Joliet, IL 60434.**

**Solar Electric Systems, Box 1562, Dept. ASE, Cave Creek, AZ 85331.**

**Solar Engineering Services, 111 N. Washington, Dept. ASE, Olympia, WA 98501.**

**Encon Corporation, 27584 Schoolcraft Rd., Dept. ASE, Livonia, MI 48150.**

**International Solar Products Corp., 1105 W. Chapel Hill St., Durham, NC 27701.**

**Solar Electric Systems, 3661 63rd Ave. N., Dept. ASE, Pinellas Park, FL 33565.**

**Photocomm, Inc., 7745 E. Redfield Rd., Dept. ASE, Scottsdale, AZ 85260.**

**E.J. Sales, P.O. Box 3084, Dept. ASE, Center Line, MI 48015.**

**WSR Solar Electric Systems, 715 J. St., Dept. ASE, San Diego, CA 92101.**

**Energy Alternatives, 979-A East Ave., Dept. ASE, Chico, CA 95926.**

**Alban Engine Power, Inc., 6455 Washington Blvd., Dept. ASE, Baltimore, MD 21227.**

**Solar Works, Rt. 2, Box 274, Dept. ASE, Santa Fe, NM 87501.**

**Solar Usage Now, Box 306, Dept. ASE, Bascom, OH 44809.**

**Solar Electronics, 156 Drake Ln., Dept. ASE, Summertown, TN 38483.**

## Mounts or Trackers

**Kee Klamps, P.O. Box 207, Dept. ASE, Buffalo, NY 14225.**

**The Energy Shop, Inc., 16422 D St., Dept. ASE, Victorville, CA 92392.**

**Motorola Solar Systems, Box 20912, Dept. ASE, Phoenix, AZ 85036.**

**Solar Electric Specialties, P.O. Box 537, Dept. ASE, Willits, CA 95490.**

**Solarwest Electric, 232 Anacapa St., Dept. ASE, Santa Barbara, CA 93101.**

**Zomeworks, P.O. Box 25805, Dept. ASE, Albuquerque, NM 87125.**

**AMP, Inc., P.O. Box 3608, Dept. ASE, Harrisburg, PA 17105.**

## Inverters

**Advanced Energy Corporation, 14933 Calvert St., Dept. ASE Van Nuys, CA 91411.**

**Alpha Energy, 7038 Convoy Ct., Dept. ASE, San Diego, CA 92111.**

**American Power Conversion Corp., 89 Cambridge St., Dept. ASE, Burlington, MA 01803.**

**Best Energy Systems, Rt. 1, Box 106, Dept. ASE, Necedah, WI 54646.**

**Creative Electronics, 221 N. LaSalle St., Dept. ASE, Suite 1038, Chicago, IL 60601.**

**Dyna Technology, Inc., 7850 Metro Parkway, Dept. ASE, Minneapolis, MN 55420.**

**Dytek Laboratories, Inc., Airport International Plaza, Dept. ASE, Bohemia, NY 11716.**

**Helionetics, Inc., DECC Division, Dept. ASE, 17312 Eastman St., Irvine, CA 92714.**

**Topaz Electronics, Dept. ASE, 5577 Kearny Villa Rd., San Diego, CA 92123.**

**Tripp-Lite, 500 N. Orleans, Dept. ASE, Chicago, IL 60610.**

**Windworks, Rt. 3, Box 329, Dept. ASE, Mukwonago, WI 53149.**

## Water Pumping Systems

**HOLEC (USA) Inc., 11c Esquire Rd., Dept. ASE, North Billerica, MA 01862.**

**A.Y. McDonald Mfg., Co., P.O. Box 508, Dept. ASE, Dubuque, IA 52001.**

**The Energy Shop, Inc., 16422 D St., Dept. ASE, Victorville, CA 92392.**

**GPI Industries, P.O. box 306, Dept. ASE, La Canada, CA 91011.**

**Grundfos Pumps Corp., 2555 Clovis, Dept. ASE, Clovis, CA 93612.**

*Did we miss your company, or a company that you know of? If so, please send us your literature—direct it to the attention of "Sourcelist"—and we'll be sure and get you in next time around.*



# PHOTOWATT

## PHOTOVOLTAICS NOW UNDER \$10 PER WATT

ML 7010 55 WATT PANEL \$495  
3.3 AMPS - 16.5 VOLTS

ML 5010 35 WATT PANEL \$349  
2.12 AMPS - 16.5 VOLTS

ALSO

ARCO 16-2000	35 WATT \$365
ARCO M-61	30 WATT \$295
SOLAREX SX110	36 WATT \$395
4" 2 AMP CELLS	FIRST QUALITY \$6 <sup>00</sup>

We pay shipping on pre-paid orders in the continental U.S. California residents add 6% sales tax.

For informative catalog of photovoltaics, wind, hydro power, batteries, inverters, lights, stereos, appliances, send \$2.00.

ALTERNATIVE ENERGY ENGINEERING  
P.O. BOX 339 DEPT. ASE 60  
REDWAY, CA 95560  
PHONE (707) 923-2277

# Getting The Best of Both Worlds . . . The Photogen-set

By Laurence Jennings

The characteristics of a photovoltaic utility-remote home power system read like an alternative energy friends' "wish list." Photovoltaic generated electricity is simple, clean and quiet. It is a "non-violent" energy source with virtually no moving parts and is therefore long lived. It's ridiculously easy to install and maintain, relative to other alternative sources of electrical power. Equipment availability and warranties are the best to be found. Finally, the modularity of a photovoltaic power system makes future expansion (or contraction) an absolute breeze. Figure 1 shows a typical photovoltaic utility-remote home power system. A photovoltaic array which produces d.c. electricity charges a battery bank through the PV charge controller. The batteries provide input power to an inverter which in turn makes a.c. electricity available to the desired loads. In addition, d.c. power directly from the batteries is available for any d.c. loads present. The PV charge controller serves as the "brain" of the system, making sure that the batteries are not overcharged or over discharged.

As everyone knows, the major disadvantage of stand alone photovoltaic power systems is their high initial cost. "It's neat stuff but it's expensive." The price per peak watt is "supposed" to drop radically, though just when, or at what rate, is anyone's guess.

On the other hand there is an abundant source of electrical energy that's been around for quite awhile and requires the lowest initial capital outlay of any "alternative" energy option. This is the "Gen-set plus" system. One form, as illustrated in Figure 2, utilizes an engine generator that produces a.c. power to drive a large industrial grade battery charger which produces d.c. electricity to charge a group of storage batteries. As with the photovoltaic system, an inverter then changes the d.c. power stored in the batteries back to a.c. electricity for use in the home. Naturally, for d.c. loads, d.c. electricity from the batteries can be used as well. Again, a modified

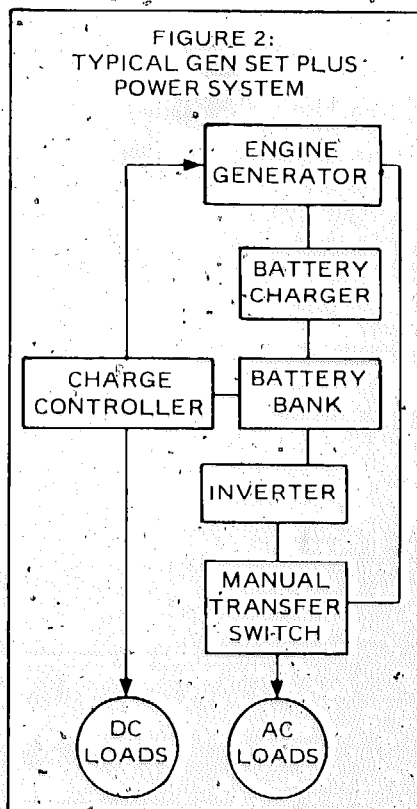
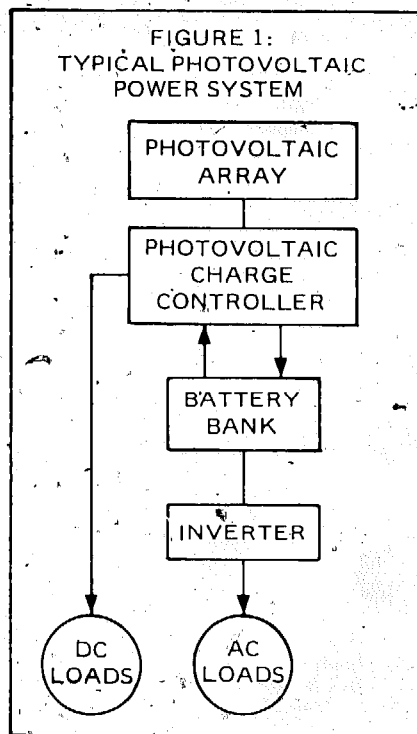

version of the PV charge controller acts as the system "brain", coordinating the various components into a complete, automatic system.

The Gen set plus system's chief advantage is low initial cost for an almost limitless quantity of electricity. The drawbacks however are numerous and read like a list of 'photovoltaic opposites'. Engine generators are noisy and polluting. The large quantity of moving parts they contain requires them to have frequent maintenance performed and virtually guarantee equipment failures. They are also absolutely dependent on a source of fuel. No fuel, no power-period.

## The Beauty Meets the Beast

Photovoltaic and Gen set plus systems certainly don't have much in common. It is for precisely this reason that they can be mated together to produce a hybrid system which goes a long way towards solving the original problems of each. Such a system is illustrated in Figure III. Let us take a moment to examine some of the synergistic effects created when the photovoltaic subsystem is interfaced with the gen set plus subsystem to produce the "Photogen-set" hybrid.

By virtue of the variable nature of the energy source, one of the most expensive aspects of a photovoltaic power system is the necessity for its designer to build in system autonomy. Autonomy is built into the stand-alone PV system in order to provide reliable power during "worst case" situations, which are usually periods of adverse weather or increased demand for power. This is accomplished by oversizing the PV array and greatly enlarging the battery storage components of a given system—the two most costly system components. Batteries, in particular, deserve special mention here, in that they wear out and require periodic replacement throughout the life of the system. The battery bank can therefore easily end up becoming the single most costly system component over the long run. Less obvious, but

equally as insidious, is the larger fraction of the array output required to offset battery self-discharge losses and more important; to provide the necessary periodic "equalizing charges" which usually take the form of a measured overcharge. The latter point is not well documented and often overlooked by photovoltaic system designers, (especially when lead antimony deep cycle batteries are utilized).

the necessary repairs are made. The value of this 'check and balance' design approach should not be underestimated, as reliability is the watchword when it comes to alternative power generation.

In exchange for solving the autonomy related expense problem, the PV subsystem mitigates the chronic engine generator shortcomings by regulat-

ing the Gen set to 'backup' status. The reasons for this are simple, and a little backtracking will show why.

### Reducing Inefficiency

Generally, photovoltaics as a function of the battery storage subsystem, are a 'low rate' charging source. A suitably sized Gen set plus system on the other hand, is a very 'high rate' charging

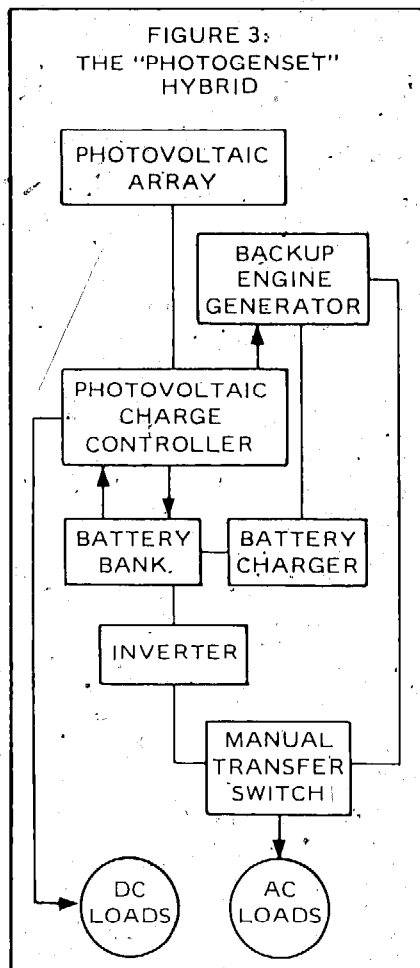

The incorporation of the Gen set plus subsystem into the photovoltaic system design, as shown in Figure III, totally eliminates the need to build in system autonomy, as it eliminates the "worst case" scenario. When the PV leg of the system provides insufficient power for any reason, be it adverse weather or increased power demand, the gen set is automatically brought on line to provide the required backup power. The resultant savings are substantial as we'll soon see. A fringe benefit of this approach to cost reduction is the added system reliability that the incorporation of a backup energy source provides. Should the PV subsystem go off line for any reason, the engine generator is standing by, ready to provide power and vice versa, until

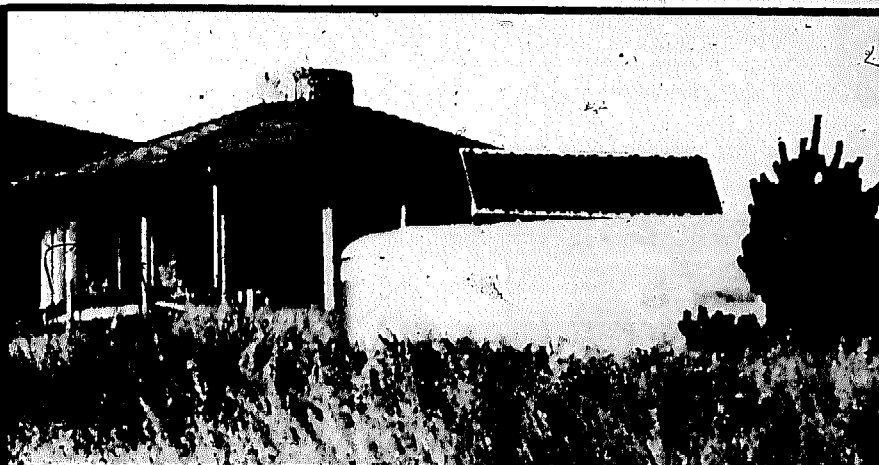

The McKuen household, with the 420pW photovoltaic array in the foreground.

## A PV Retrofit

By Laurence Jennings

In the golden hills above Fremont, California, Earl and Beverly McKuen built their own dreamhouse. Earl, an electrical contractor by trade, wired the sprawling 4200 sq. ft. house for the latest in electrical conveniences, and nothing was

spared. When the local utility, Pacific Gas and Electric Co., quoted a sum in excess of \$43,000 just to bring in their lines, Earl quickly turned to diesel fired engine generators for electrical power.

After purchasing two gen sets, one a 7½ and the other a 15 kw. unit (which he rotated in service to power his home directly), Earl ended up doing quite a bit of fueling and fixing. In time, he discovered the PhotogenSet concept. Earl retrofitted his existing system with a 420pW. photovoltaic array, 33 kwh. deep cycle battery bank, 5 kw. static inverter, and 3 kw. battery charger. The effect was dramatic. "Our diesel fuel consumption went from 220 gallons per month to 20. You might say I'm very happy with my new system!"

The retrofit cost about \$11,000 and garnered a full \$6,050 worth of state and federal tax credits. The resultant \$4,950 expenditure will be amortized by fuel savings alone in only 20 months of system operation, assuming an average cost of \$1.25 per gallon for diesel fuel over that 20 month period. As an added bonus, the McKuens now have 24 hour a.c./d.c. power, at the mere flick of a noiseless switch.

Freed from the weight of constant maintenance requirements, Earl manages to do a lot more fishing than fixing these days.

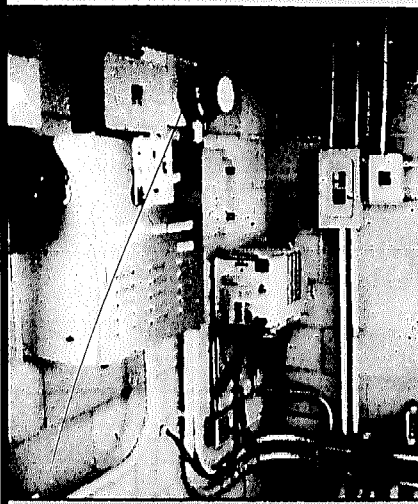

Inside the McKuen's generator room, showing the d.c. to a.c. inverter (5 k.w.), and 3 k.w. battery charger, along with the other interface circuitry.

source and is most efficient when operated at peak output. Now to complicate matters, deep cycle batteries of the type commonly used in these power systems, like both high and low charging rates. High when they are in a low state of charge, and low when they are in a high state of charge. This situation results in the gen set being run very inefficiently for a large portion of its duty cycle (the last 25-35% or so) because its large output capability is wasted to a degree as the battery charger automatically tapers its output downward, providing the lower charging rates the batteries require in order to prevent the deleterious effects of severe overcharging. The problem is solved in the Photogenset hybrid system by using the backup Gen set plus subsystem only for the initial high rate charging. This is accomplished by the brain of the hybrid system, the photovoltaic charge controller, which is designed to automatically bring the engine generator on line when the batteries reach a maximum allowable state of discharge (typically about 70%). The Gen set plus subsystem then runs full bore at peak efficiency until the batteries are at an approximate 60% state of charge at which point the charge controller shuts the engine generator off. The gentler low rate charging characteristic of the photovoltaic subsystem is then available to perform the "upper leg" of the charge cycle and to finally "top the batteries off" in a trickle mode. In this way the hybrid system capitalizes on the strengths of each of its power generating subsystems and minimizes their weaknesses. Overall system efficiency is kept high; as needless wear and tear on individual system components is kept low. This in turn guarantees longer component life and hence reduced eventual equipment costs, while insuring a more reliable and flexible power system. Indeed, with proper system sizing and design, demand is hard pressed to exceed supply. (Good news to most PV system owners!)

#### Why Buy Today?

Photovoltaics is a price declining market. Few people want to drop a sizable chunk of cash down on a large photovoltaic array, only to see the price per peak watt they paid for their PV modules drop by 50% in the space of a few years. On the other hand, the cost of photovoltaic balance of system components needed to complete a remote home power system are spiraling up-

wards as are most things these days. At the same time the currently available tax credits relevant to alternative energy generating equipment are here today, but may very well be gone tomorrow.

The Photogenset hybrid provides a simple solution to this dilemma. By purchasing all of the hybrid system components with a small quantity of photovoltaics, you will be able to lock in today's lower prices and be eligible for the extremely attractive federal tax credits before they go the way of the two dollar bill. Then, as the price per peak watt of photovoltaics drops, you can slowly add to your energy portfolio much the same way a commodities trader cautiously adds to his holdings in a bottoming futures market.

#### Cost Comparison

Now let's take a look at two different 24Vd.c./115Va.c. remote home power systems to illustrate the above purchasing strategy. Both systems power identical loads, utilize the same inverter, system "brain" or charge controller and battery type. The main difference lies in the alternative energy source themselves, and therefore the size of the battery storage bank. Table I details a stand alone system that derives 100% of its power requirements from photovoltaics. Table II depicts a Photogenset hybrid that employs a much smaller PV array with a Gen set plus backup subsystem.

As the tables show, the stand alone PV system costs roughly three times

<b>TABLE I</b>	
<b>DESIGN PARAMETERS</b>	
LOCATION: Davis, California	
AVERAGE DAILY LOAD DEMAND: 5 KWH	
AVERAGE DAILY HOURS OF "PEAK" SUN IN WINTER: 3.3 HR/DAY	
MINIMUM DAYS OF AUTONOMY REQUIRED: 10 DAYS	
<b>REQUIRED SYSTEM COMPONENTS FOR STAND ALONE PV SYSTEM</b>	
PHOTOVOLTAIC ARRAY: 1520 pW @ \$12/pW	\$18,240
BATTERY STORAGE BANK: 72 KWH @ \$190/KWH	13,680
PHOTOVOLTAIC CHARGE CONTROLLER: 60A @ 24V	1,000
INVERTER: 2500W @ 24V	2,300
<b>TOTAL:</b>	<b>35,220</b>
<b>LESS 40% FEDERAL TAX CREDIT (\$4,000 max.)</b>	<b>31,220</b>

<b>TABLE II</b>	
<b>DESIGN PARAMETER</b>	
LOCATION: same	
AVERAGE DAILY LOAD DEMAND: same	
AVERAGE DAILY HOURS OF "PEAK" SUN IN WINTER: same	
MINIMUM DAYS OF AUTONOMY REQUIRED: 2 days	
<b>REQUIRED SYSTEM COMPONENTS FOR "PHOTOGENSET" HYBRID</b>	
PHOTOVOLTAIC ARRAY: 500pW @ \$12/pW	\$ 6,000
BATTERY STORAGE BANK: 15KWH @ \$190/KWH	2,850
PHOTOVOLTAIC CHARGE CONTROLLER:	700
INVERTER: same	2,300
ENGINE GENERATOR: 1800 RPM, 4KWH	2,400
BATTERY CHARGER: 115A @ 24V	760
MANUAL TRANSFER SWITCH	225
<b>TOTAL</b>	<b>15,235</b>
<b>LESS 40% FEDERAL TAX CREDIT (\$4,000 MAXIMUM)</b>	<b>11,235</b>



what the Photogenet totals, for a net initial savings of approximately \$20,000! When one considers the replacement of the nearly \$14,000 battery bank in ten years or so, the point is driven home. Also note that in winter, our 'worst case' situation, the stand alone PV system is capable of producing a maximum average of 5 KWH per day and is without a backup power source. The Photogenet, on the

other hand, has the ability to elasticize to meet almost any demand this remote home is likely to drum up, and has built-in backup potential as well.

There is a catch of course. The Photogenet, unlike its rival, does make noise and part of the system relies on fossil fuel. However, for the illustrated system, the average generator running time will be in the neighborhood of only nine hours per week. Not bad for

the initial savings involved. Also, keep in mind that as you expand your system in the future (when PV \$/pW costs decline) the generator will run less and less and...

*Laurence Jennings is the product research specialist with Solar Electric Specialties, Co. (P.O. Box 537, Dept. ASE, Willits, CA 95490), one of the largest ARCO distributors in the U.S.*

## A Photogenet Hybrid

By Jim Cullen

Walter and Edvige (Eddy for short) Ross decided to build their beautiful home above Healdsburg in the coastal mountains overlooking a scenic wine growing area of California. Their three story dome home is a spacious 3200 square feet, complete with solarium, Jacuzzi, clothes washer, dryer and a myriad number of household appliances. 12 volts d.c. is used for lights and five circulating pumps for hot water. One pump each circulates water through two wood stove heat exchangers. Three more pumps circulate water through a solar drain-back domestic hot water system. All the pumps are monitored by a 12 volt temperature differential control. A converted Maytag wringer washer works on 12 volts too. A vacuum and numerous other light household appliances are run through a BEST M12-1000 inverter that delivers 600 watts of continuous 120 volt a.c. power on demand and up to a 4.0 kwh. surge for starting induction and capacitor motors. Propane gas is used for refrigeration and cooking. The BEST inverter satisfies most of the Ross's requirements, but when high powered water pumping or a shop tool is needed, they switch on the a.c. generator. It is a Lister 3.5 kwh diesel.

A 12-volt-d.c. battery charger uses 1.5 kwh. while charging, leaving 2.0 kwh. of a.c. electricity available for chores.

Eight ARCO 35 watt ASI-16-2000 photovoltaic modules are arrayed on two Zomeworks passive trackers. They provide close to 1.8 kwh. daily, feeding six 300 amp-hour 12 volt d.c. batteries connected in parallel. This amounts to 21.6 kwh. of storage enough for up to seven sunless days. Even if the generator should develop mechanical trouble during a

prolonged sunless period, there is plenty of time for repairs, even in the most remote area.

Eddy runs the diesel generator for just two days a week, eight hours, while doing other chores needing electricity, which provides another 1.4 kwh. daily (based on an average 40 amp regulated charger output at 16V/d.c.). Add this to the photovoltaic array output and you have an impressive daily electrical output totaling some 3.2 kwh. or about 96.0 kwh a month.

The Photogenet Hybrid system cost the Rosses about \$9,600.00 (excluding the generator they already owned) and 55% of that will be returned to them as tax credits for 1982, since they qualify for a 40% federal and 15% California state tax credit on the cost of all equipment and installation except the fossil fueled generator).

### Why Not Stand Alone

A stand-alone PV system designed to produce 3.2 Kwh daily is a modest system but would have required a total of fifteen photovoltaic modules plus two larger and more costly passive trackers. At about \$400.00 each for the seven additional modules and about \$300 more for trackers, the

cost to Walter and Eddy would have exceeded \$12,700.00. Because the tax credits are limited by the government to a maximum expenditure of ten thousand dollars in any one year, \$2,700.00 of the cost of a stand-alone system would not have qualified.

The paradox is the more kwh. one needs, the more economical the Photogenet Hybrid becomes.

Walter Ross is a Ships Master and is away from home for up to two months at a time. He needed a reliable, simple power system. One he felt confident Eddy could deal with when he's away from home.

I asked Walter why he didn't hook up to public utilities, being just two miles away from their power pole. "I checked the telephone company first, since they are about the same distance away." He said, "They wanted \$13,585.67 to install a telephone. I wasn't about to spend more than that for utilities, so I didn't even call for an estimate."

*Jim Cullen is the author of How To Be Your Own Power Company (Van Nostrand Reinhold Co. NY, \$10.95) and currently the energy consultant for Real Goods Trading Company, 308 East Perkins St, Dept. ASE, Ukiah, CA 95482.*



Eight ARCO panels follow the sun with the help of two Zomeworks passive trackers, providing enough power for up to seven sunless days for Walter and Eddy Ross.

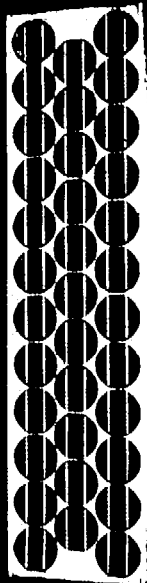
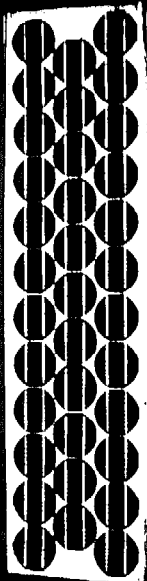

PHOTOVOLTAICS  
 REFRIGERATION  
 WATER PUMPING  
 REGULATORS  
 INVERTERS  
 BATTERIES  
 LIGHTING  
 MOTORS

\*

For 12, 24, & 48  
 Volt DC Systems

\*

\*

**ARCO Solar**™   
 Photovoltaic Products

\*

\*

\*

\*

\*

\*

\*

\*

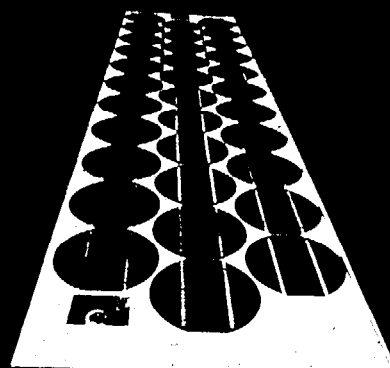

ARCO makes the finest photovoltaic products available. It's honest people at ARCO like Arthur Rudin who contribute to the high quality of service that you receive before and after you purchase your PV system.

I have always maintained the philosophy that I would never sell anything that I would not buy myself. Therefore, I believe that all the items in the catalog are the best choice of Photovoltaic products and accessories available.

I hope that you'll consider my company when assembling or adding to your Solar Electric System. Your order will be checked and packaged carefully so that you receive exactly what you paid for.

*Tom Pippk*

**WESTERN NEW ENGLAND SOLAR**

Send \$2.00 for catalog

118 MAPLE ST.  
 HOLYOKE \* MASS.  
 01040  
 413-533-7750 

Name: \_\_\_\_\_  
 Address: \_\_\_\_\_  
 City: \_\_\_\_\_  
 State: \_\_\_\_\_ Zip: \_\_\_\_\_

# Reader's PV Report: "We Never Considered Hooking Up"

by Ernie Davidson

*Without a large enough creek on our property in southwest Washington for hydropower and not enough wind for a wind generator, photovoltaics was our only practical possibility for a renewable energy source. We never considered hooking up to the power grid.*

I had been looking into photovoltaics for a year when I heard about the Department of Energy's Appropriate Technology Small Energy Grants Program. After wading through the paperwork, I sent in my proposal for a small, 12 volt photovoltaic system. We were pleasantly surprised when we found out we had received a grant for \$3900.00.

Our system currently consists of eight Arco 33 watt panels and six 105 amp deep cycle 12 volt batteries, with a 20 amp regulator and amp gauges to measure both charging rate and rate of use. There is a built in volt meter on the regulator.

After shopping around considerably, we purchased all of the above components for our system, except the batteries, from Alternative Energy Engineering (PO Box 339, Dept. ASE, Redway, CA 95560) whom we found out about through, guess who, ASE. I found the folks at Alternative Energy Engineering to be friendly and very helpful. Their prices were the best I could find at that time and delivery was fast.

When buying panels, I suggest you try to find another interested party and get together an order of at least 10 or 12. This can sometimes save you as much as \$50.00 per panel.

## In the House

When wiring and installing our panels I was on my own. I hadn't heard of any of David Copperfield's booklets and all the books I had come across on photovoltaics were skimpy on wiring the panels. I ended up routing my wires between panels through P.V.C. pipe and connecting these to #3 wire running into the house. I think a great improvement in the manufacturing of

panels would be to make it possible to plug them into each other.

The regulator, meters and batteries are centrally located on the second floor of the house to keep wire runs to a minimum. I use an older 100 amp fuse box with the screw in fuses. This is an easy way to run different circuits.

After weighing the pros and cons, we decided on fluorescent lights. The first thing I did was replace the cool white tubes with warm white tubes. These tubes produce a more natural color of light. One good thing about 12 volt fluorescents is that they don't buzz like 110 volt fluorescents.

Another thing in the lighting department. The newer, silent type switches quit working after about a month. They aren't made to handle direct cur-

---

At the present time we are running all our lights and stereo and have more than enough power.

---

You can get fuses for these panels all the way down to 4½ amps. With just the lights and stereo hooked up I am using 6½ amp fuses on all four circuits. All the wiring runs of any length are with #10 wire to keep the 12 volt line loss to a minimum. I'm also building a box for the batteries that will be vented to the outside.

rent and the contacts become corroded. We now have all older "click" type switches. We turn most of our lights on at the source, however, to cut down on the length of wire runs.

Instead of using the cigarette lighter type plugs, we opted for conventional outlets with 3 prong plugs to prevent any possible reverse connections.



Ernie and Jeri Davidson's new PV powered home in Randle, Washington.



# SAVE 30% ENERGY CONSUMPTION

## SNAP ON NO-WATT

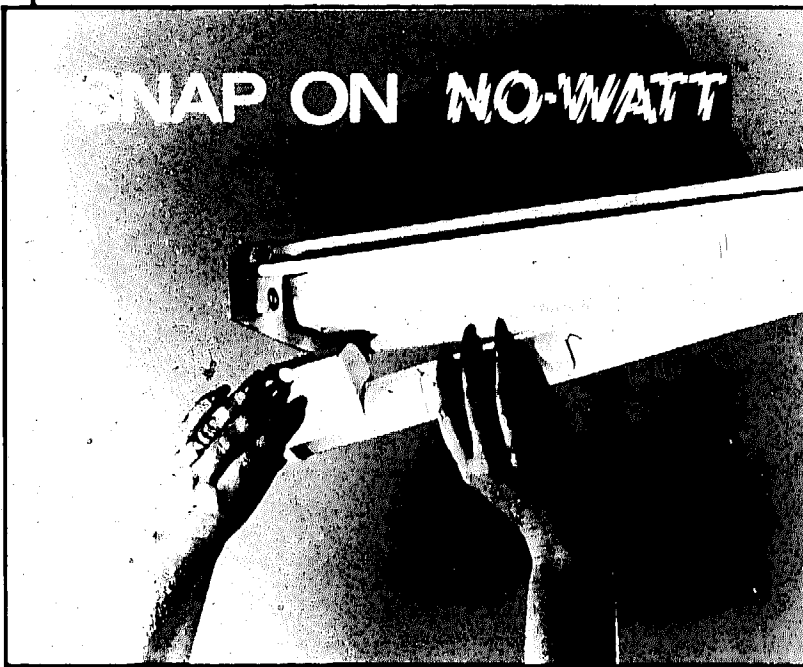

The NO-WATT energy saver is a compact electrical device made from Mylar\*. It is guaranteed to reduce power consumption in each fluorescent lighting fixture by 30%, or your money back.

At \$14.95, the unit pays for itself within a year, in most areas.

NO-WATT fits most 4' and 8' fluorescent lights, requires no wiring and comes with simple, easy-to-follow directions. It is UL listed, with a 5-year warranty.

Snap on NO-WATT today and save.

**\$14.95**

tax  
(plus \$1.50 postage & handling)  
Visa and MasterCard accepted

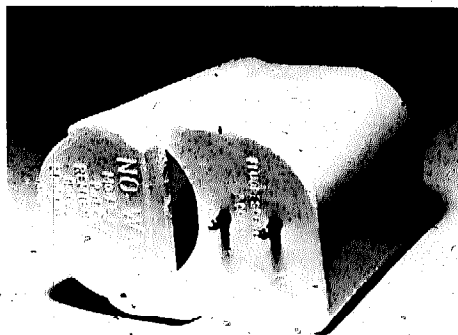

To order call or write:



# CPE

Correct Phase Electronics, Inc.  
1340 Hill Street  
El Cajon, CA 92020. Tel. 1 800 227 8321  
In California, call collect 619 579 7190

NO-WATT is a trademark of H.M.E.C. Systems.

Mylar is a trademark of DuPont.

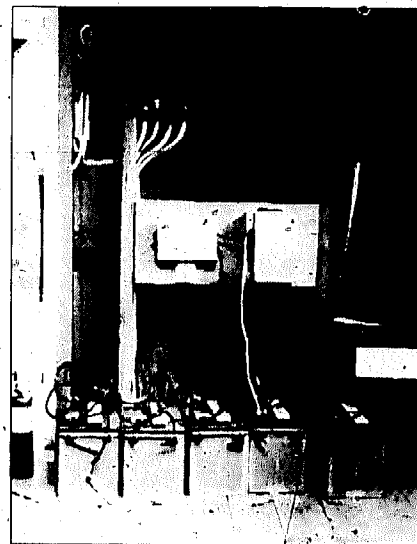

The author's batteries, fuse box, regulator, amp gauge and volt meter are all centrally located on the second floor to keep wire runs to a minimum.

At the present time we are running all our lights and stereo and have more than enough power. Soon we'll be adding a 12 volt charger for Ni-Cad flashlight batteries and other 12 volt items. We're in the process of feeling out the system this winter to see exactly how much power we'll have in periods of little sun.

### Good and Bad Points

We found it interesting that the panels were charging their highest not in mid-summer, as we expected, but last October, when the charging rate reached 17.5 amps right at the rated maximum. I think this was due to the fact that the cooler weather kept the panel temperature down, which helps their performance.

As with any form of energy, there are good and bad points to photovoltaics. You do have limited power (unless you have unlimited wealth) and you have to make some compromises. We have an older Servel refrigerator and use a wood cookstove for cooking and heating our water.

The advantages of the system include no maintenance, except for a once a month cleaning. At that time I check the panel angle and adjust it if necessary. The panels are usually charging every day, though on cloudy days it might be only at the rate of 1 or 1/2 amp.

My wife Jeri and I are very happy with our photovoltaic system and would highly recommend photovoltaics to any ASE reader needing a small power system.

# The Solar Breeder: A Bold Step by Solarex

by Marcus J. Smith

**On** October 30th, 1982, the world's first solar breeder was dedicated. The Breeder, brainchild of Dr. Lindermayer, Solarex's visionary leader, is designed to use solar energy to power a plant entirely for the manufacturing of more photovoltaic panels.

Statistically it is impressive; 25,000 square feet of Powerline™ photovoltaic panels produce up to 200 kw. of electric power at 300 volts d.c. Most of that power, stored in a 2800+ amp hour storage bank of Exide batteries, (enough for four sunless days), is used directly for powering machinery or resistance heaters, without converting it to a.c. (thus saving power). The completed plant cost in the neighborhood of six million dollars, giving cause to some to call it a "gimick", since the cost of commercially available power is still less (using a very narrow economic definition) than that produced by the panels, a short sighted view at best.

## The Real Breakthrough

The Breeder represents the first light industrial plant anywhere in the world to be totally solar powered. It is intended to be a prototype of other plants, which could be built practically anywhere in the world, for the manufacturing of basic consumer goods, from medicines to furniture to parts fabrication, almost anything which is not overly energy intensive. This is the real breakthrough. While other photovoltaic companies have concentrated on finding ways of making photovoltaics competitive with conventional power by the mid to late eighties, Solarex has striven to find areas where solar power can serve and compete right now.

The experience Solarex has gained in being its own prime contractor has taught the company about the application of solar power on an industrial scale. As a result, the

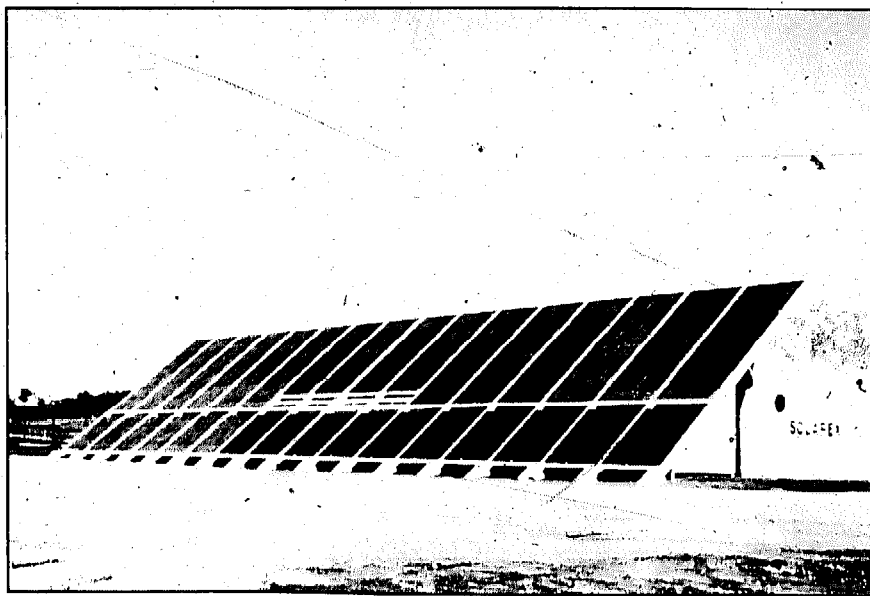

Solarex's new "Solar Breeder."

company may now have more knowledge about how to custom tailor such plants to match the site and purpose than any other solar firm. At present, Solarex is no longer just marketing its solar panels, but also its expertise in building to maximize the

sive hydropower projects or nuclear installations. Consider; for the price of one nuclear power plant (roughly \$2 billion) a country could build well over 300 solar breeders capable of operating 30 years without major maintenance (or major catastrophe).

---

**Consider; for the price of one nuclear power plant (roughly \$2 billion) a country could build well over 300 solar breeders capable of operating 30 years without major maintenance (or major catastrophe).**

---

efficiency and longevity of the entire system. According to the Solarex people, they are negotiating with foreign countries to construct similar plants.

Naturally, they would be viable only under special circumstances, such as the high cost of petroleum based generated power, plus remoteness from any power grid. Photovoltaics are uniquely suited to this purpose because while they are high tech to build, they are very low tech to operate, which makes such a plant even more attractive to a developing country. Imagine it; a solar powered manufacturing plant which makes more solar panels to run irrigation equipment, remote radios and television sets, plus refrigeration. A solar breeder for many of the world's fossil fuel poor countries would mean having a source of energy independent of the world market for the first time. It would have far less ecological impact and economic cost than mas-

Similarly, in North America, there are many isolated areas which could benefit from photovoltaic based generating plants, but even more, would benefit from the fact that the system is silent and nonpolluting. From an economic standpoint, if one amortized a photovoltaic powerplant over 30 years it would actually save money, based on reduced environmental impact.

What does this mean to the average homeowner? If Solarex can find a niche for its "breeders" in the world market, and thus reduce its prices through economies of scale, one would have to assume that the price for all its products would come down. And that means that in the not too distant future, more and more homeowner will find PV panels harder and harder to resist.

For more information on the Solarex line of PV panels, contact: Solarex Corporation, Dept. ASE, 1335 Piccard Drive, Rockville, MD 20850.

# Mixing Renewables:

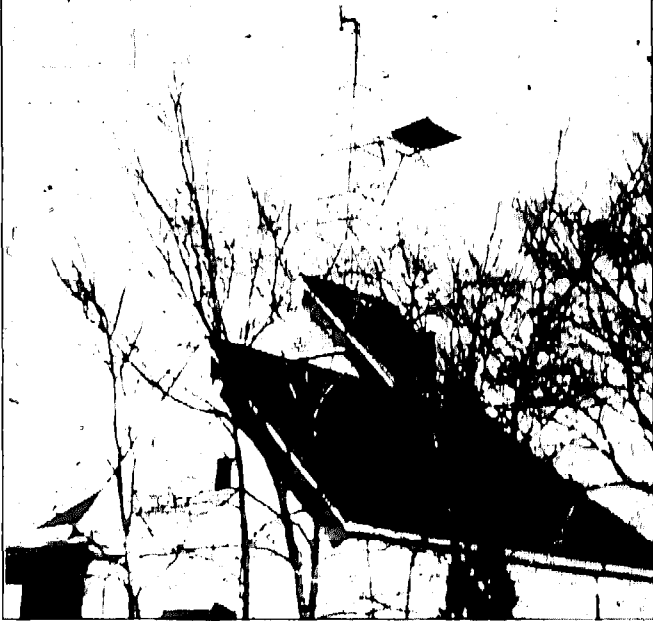

The solar panel array atop the Little Rock home of Dick Brown, a member of the Arkansas Energy Office. Note the horizontal orientation for best output.

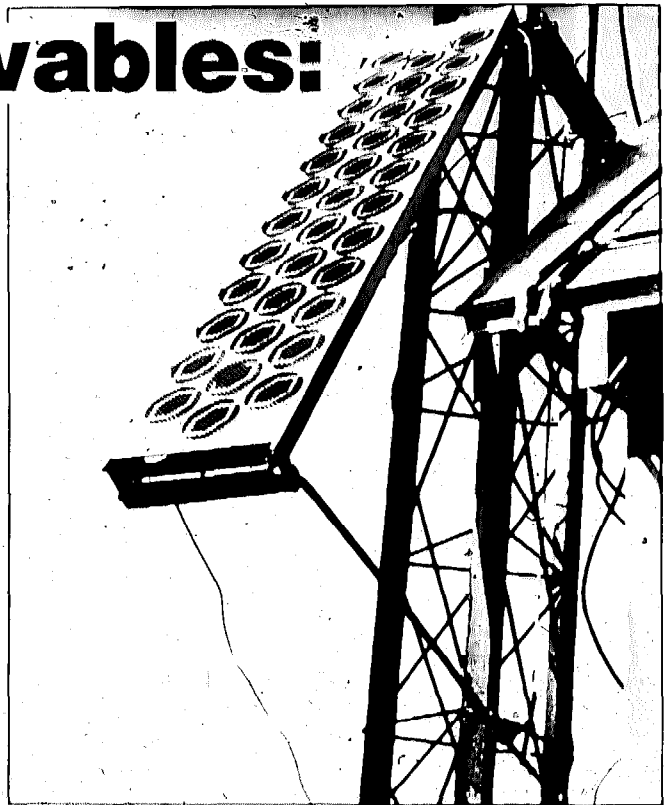

This photovoltaic panel's tilt angle can be changed in just seconds by loosening the wind-activated support bar. This system was designed by Richard B. Johnson of Columbia, Missouri, Arkansas. (A technical description of this system is given in this article and is on page 20 of the *Wind & Sun*, throughout Arkansas, including one courtesy from B&W with a PV system.)

## Combining Wind And Solar Electricity

By Stephen P. Cook

*When planning a 12 volt home electric system, a question which seems to be coming up more and more frequently these days is: Should I build it around a wind generator or a photovoltaic array?*

Since July of 1980 our Ozark home has been powered by *both* and for many locations I feel this combination will be more practical than either solar or wind alone. Why? Let's look at the disadvantages of the individual systems first.

### Disadvantages

#### ■ Wind Only

In many locations there's not much wind in the summer, and in general there's great seasonal output variation. This can lead to deep discharges or overcharging, thus shortening battery life.

To prevent deep discharges, battery capacity must be very large or fossil fuel backup generators employed.

To prevent overcharging, power wasting voltage regulators must be employed.

With their moving parts, wind machines need occasional maintenance and may be shut down for repairs once in a while.

#### ■ Photovoltaics Only

In some locations there will be marked seasonal solar electrical output variations, though usually not as dramatic as in wind systems. Although

"average" winter monthly sunshine records may seem adequate, I suspect they may be deceiving in some locations. I've seen two or three week January spells of little or no sun here in north Arkansas and other exceptionally sunny Januaries. The point is, some PV owners may find themselves turning off everything but the lights, filling up the kerosene lamps just in case, and praying for sun!

Photovoltaic systems are, in most locations, more expensive than wind systems.

### Planning A Combined System

Combination systems can overcome these problems in locations where, when solar outputs fall (winter) the

**TABLE 1 — WIND ONLY**

Location	Generator*	Annual Average Wind	Kwh./Month Output			
			Ave.	Max.	Min.	Max. Var. from Ave.
Denver, Co	200w.	10.4 mph	28.6	Apr. 40	Aug. 20.95	41%
Little Rock, AR	200w.	8.2 mph	14.9	Mar. 26	Aug. 7.1	81%
Portland, OR	200w.	7.8 mph	13.8	Jan. 26.9	Sept. 6.11	107%
Springfield, MO	200w.	10.5 mph	29.1	Apr. 39	July 16.65	43%

\*Winco 1222 H on small tower

**TABLE 2 — SOLAR ONLY**

Location	Generator*	Annual Average Solar	Kwh./Month Output			
			Ave.	Max.	Min.	Max. Var. from Ave.
Denver, CO	200w.	1568Btu./sq.ft. day	26.50	Aug. 29.08	Dec. 21.66	18.3%*
Little Rock, AR	132w.	1404Btu./sq.ft. day	14.37	Aug. 17.13	Dec. 10.22	28.9%
Portland, OR	165w.	1067Btu./sq.ft. day	13.78	July 24.35	Dec. 6.04	54.9%
Springfield, MO	264w.	1362Btu./sq.ft. day	28.52	Aug. 34.76	Dec. 19.86	30.4%

\*Fixed tilt latitude

wind is blowing, and when winds fail (summer?) there's plenty of sun. My family is sure thankful for the 100 watts of solar power when our 200 watt wind generator is temporarily down.

OK, enough generalization, let's imagine a family needs an average 25 kwh. of electricity per month. Not much energy, but does everyone realize how far that can go with the right 12 volt appliances? With about that, we power a small refrigerator, pretty good (mostly quartz-iodine) lighting for our 1000 square foot home, black and white TV, AM/FM stereo cassette, summer ventilating fan, vacuum cleaner, kitchen blender, microcomputer, etc. Basically everything we need, once we sat down and really considered "what we need." Now, lets consider how different the situation looks in four locations.

These outputs have been computer-derived from SOL ELECT and WIND ELECT (see box). Note that while the same wind generator has been employed at all locations, photovoltaic capacity has been sized to roughly

match the average Kwh./Mo. output from the wind unit. Balancing average electrical outputs from wind and sun is the first step in striving for that "ideal" system. From Table 1, we can see that wind alone would be impractical at Little Rock and Portland. Such a system would work much better in Denver or Springfield—but still suffer from outputs varying by over 40% from average values. Solar alone, according to Table 2, would work fine in Denver, with only 18% maximum variation (beware average weather rec-

ords?), perhaps in Little Rock and Springfield, but would be impractical in Portland with its lack of winter sun. When we combine systems, the situation in Portland improves dramatically. A family, desiring 25 Kwh./Mo. there might get by with a 200 watt Winco and 165 watts of solar cells. In Springfield, the seasonal variation in individual systems are smoothed out with the combined system and only small monthly output variations, ranging from a July low of 51 kwh. to an April high of 69 kwh., result. At Little

**TABLE 3 — COMBINED WIND AND SOLAR**

(generators as in Tables 1 and 2)

Location	—kwh./Mo.—			
	Ave.	Max.	Min.	Max. Var. from Ave.
Denver, CO	55.10	Apr. 67.59	Nov. 46.74	22.7%
Little Rock, AR	29.27	Mar. 41.45	Sept. 24.15	41.6%
Portland, OR	26.78	Jan. 33.65	Oct. 19.16	28.0%
Springfield, MO	57.62	Apr. 69.03	July 51.27	19.8%

## WHAT IS A PHOTOGENSET?

The PHOTOGENSET is a special hybrid photovoltaic-engine generator power system.

### CONSIDER THESE FEATURES:



- ARCO SOLAR INC. ◊ photovoltaics
- Most reliable power system available
- Costs up to 1/2 what other systems do
- Easy to install
- Eligible for solar energy tax credits
- Complete system packages available in any size range required.

If you need a remote power system, we are a complete one stop supplier. Our corporation has been in business at our present location for over 35 years.

— GET IN TOUCH —



Authorized Distributors for ARCO Solar ◊  
Dept. M1, Box 537 Willits CA 95490  
(707) 459-9496  
— DEALERS INQUIRIES WELCOMED —

## THE EARTH STORE

Specializing in  
SOLAR ELECTRIC  
and 12 VOLT applications  
for the home

### Spring Specials on ARCO Photovoltaic Modules

- 18-2000, 35 watt ..... \$370
- M51, 40 watt ..... \$410
- M61, 30 watt, self-regulating ..... \$290

#### OTHER SPECIALS:

- 12 volt Soldering Iron, 30 watt ..... \$9.95
- 5 amp Voltage Regulator ..... \$29.95
- 6volt, 220 amp Solar Battery \$70 or 2/\$135\*
- 12 volt, 104 amp Bond RV Battery ..... \$65\*
- SCI Battery Saver, adjustable low-voltage alarm or low-voltage disconnect (specify which) ..... \$69
- Tenaon 12 volt Chainsaw ..... \$140
- 30 watt 18" Fluorescent with bulbs ..... \$23.92
- 12 volt Blender ..... \$69
- ARCO 18-2000, Class B PV Module (2nd no-warranty) limited to stock on hand ..... \$269

We pay shipping on prepaid orders in continental U.S. Personal checks will take 3 weeks to clear. C.O.D.'s must include 25% deposit and will be shipped freight collect. Personal checks not accepted for C.O.D. balance.

\*Batteries shipped freight collect.

VISA and Mastercard honored. Send \$2.00 for catalogue, refundable on first order.

### THE EARTH STORE

Dept. B — P.O. Box 679  
N. San Juan, California 95960  
Phone Orders: (916) 292-3395

DEALER INQUIRIES  
INVITED

## COMBINATION WIND/PV SYSTEM SCHEMATIC

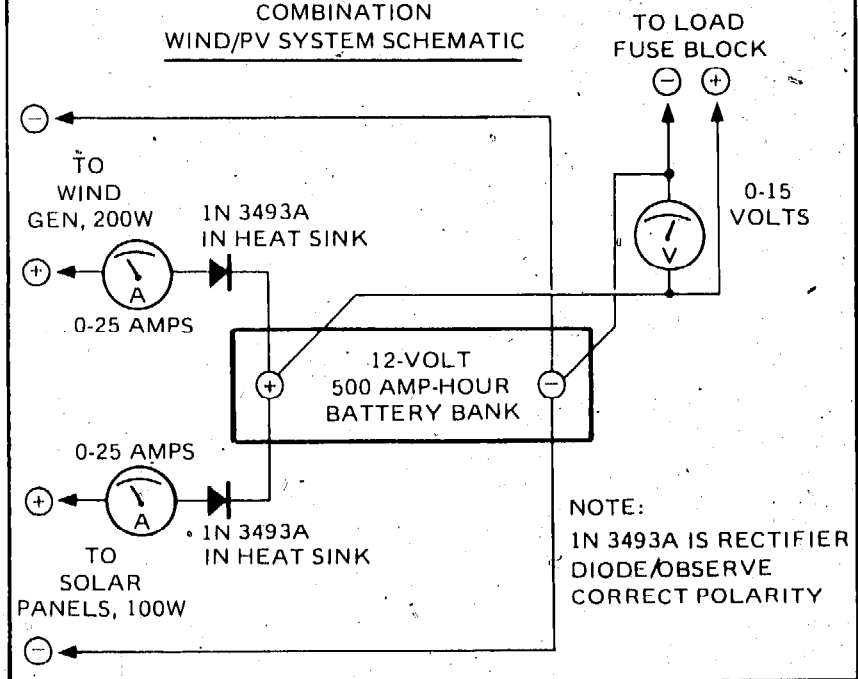

Rock, the situation is different: the combined system output undergoes much less variation than wind only, but still more than solar only. At Denver the combined system's maximum departure from average is nearly as good as solar. However, in that location, either individual system could probably supply the required 25 KWH/Mo. If 50 KWH/Mo was desired, the combined system, in Denver, as in Springfield, would serve nicely.

In practice, 12 volt homes will not have constant year round loads, although some may roughly approach it. Where refrigeration is employed there may be summer peak loads, while smaller systems (for lights, mostly) might show winter peaks. If one has a proper understanding of seasonal output variations of photovoltaic arrays or wind generators, appliance use can be custom tailored to more closely match production. Admittedly, this overview of designing combined systems lacks economic analysis. Hopefully, as small wind machine prices and photovoltaic prices continue to get closer to each other, this will not be a critical point.

*Stephen P. Cook is the director of the North Arkansas Community College Energy Center, which itself is powered by a 700 watt PV system, and president of compuSOLAR.*

**References:** *Solar Heating Design*; by Beckman, Klein, and Duffie; "An Analytical Expression for the Average Output Power for a Wind Machine"; by W. Richard Powell, *Solar Energy*, Vol. 26, pp 77-80.

## Combination System Hookup Remarks

Stephen P. Cook

Blocking diodes on both positive (+) wind and solar legs are needed, not only to prevent battery discharge, but to make sure the photovoltaics don't motor the wind generator and vice-versa. (see schematic)

I pulled the voltage regulator off my Winco because it was sensing the solar voltage, maybe 14 volts, instead of the "true" battery voltage, maybe 12.5 volts, and cutting the wind output to zero! Voltage regulators or charge controllers are not required if battery capacity is adequate and strict attention is paid to energy production versus energy use.

The most practical way to do that is to install a battery voltage gauge and regulate appliance use if necessary. A hot water tank or vacuuming job are much better places to dump excess electricity than the heat sink of a voltage regulator.

Separate battery banks for wind and solar could be used to overcome voltage regulation difficulties, but then you'll have a switching problem to overcome in powering the load. One battery bank works fine for us.

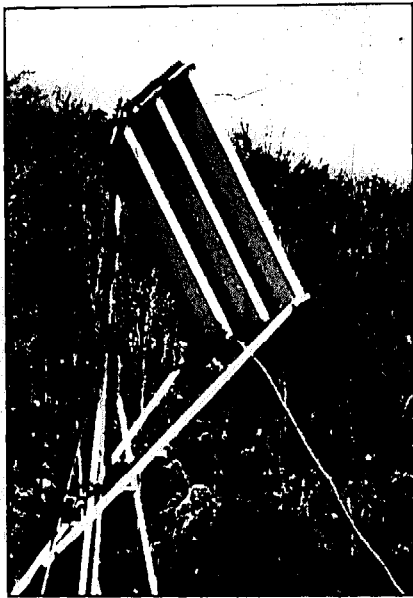

The author's 100 watt PV array and the barely visible 200 watt Winco in the background.

## Computer Assist

SOL ELECT and WIND ELECT are programs written in BASIC for a microcomputer with at least 16K RAM. Each provides expected Kwh./Mo. before losses due to transmission, voltage regulation, battery inefficiencies, and inverters. The values in Tables 1 through 3 are likewise uncorrected for these losses and don't include losses from obstructions which block sunlight or hinder free wind flow. SOL ELECT can readily assess how outputs change with location, photovoltaic array size, tilt angle and ground reflectance. For example, according to SOL ELECT, owners of small PV arrays at Denver and Portland can increase annual output by 11% (over Table 2) by 1) adjusting the tilt angle once monthly and 2) mounting the array on a surface of high ground reflectance (say a shiny metal or light-colored roof). The program is based on the simplified relationship:

$$E = \frac{\text{days in month} \times \text{HT} \times \text{watts of PV Capacity}}{425,700}$$

where E is the kwh./mo. output and HT is average solar radiation in BTU/sq. ft. day. More detailed assessments need to take photovoltaic efficiency variations with temperature into account. The program inputs average historical values of sunshine hitting a horizontal surface and the cloudiness factor for a location in cal-

culating HT for specified tilt angles.

WIND ELECT inputs various wind machine specifications, the average monthly wind speed at a reference height, tower height, and site terrain index. Its outputs are based on a simplified relationship which assumes a Rayleigh wind speed distribution. It can help assess how outputs will change with different wind machines and tower heights.

If you're interested in these computer tools, compuSOLAR can help. SOL ELECT, WIND ELECT, and many other solar related microcomputer programs are available at very reasonable prices. Input data (solar radiation, etc.) is provided for specified locations when available. A SASE will bring you more information.

If you don't have a microcomputer, but are interested in having a better understanding of how a photovoltaic array or a wind generator might perform at your location, you can send for information on compuSOLAR's low cost individualized computer services. Enclose a legal size SASE. The address is *compuSOLAR, Route 1, Dept. ASE, Jasper, AR 72641*

Introducing the new...

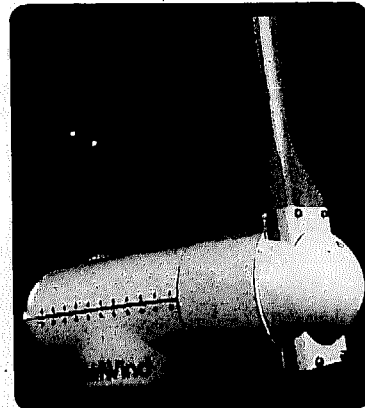

### WhirlWind Series 4000

Four Kilowatt Wind Generator

Heating

Battery Charging

Utility Interface

Send \$2.00 for complete catalog.  
Dealer and Foreign Inquiries Invited

## WhirlWind

Power Company

207 1/2 East Superior St.

Duluth, MN 55802

(218) 722-1492

## SOLAR ELECTRICITY

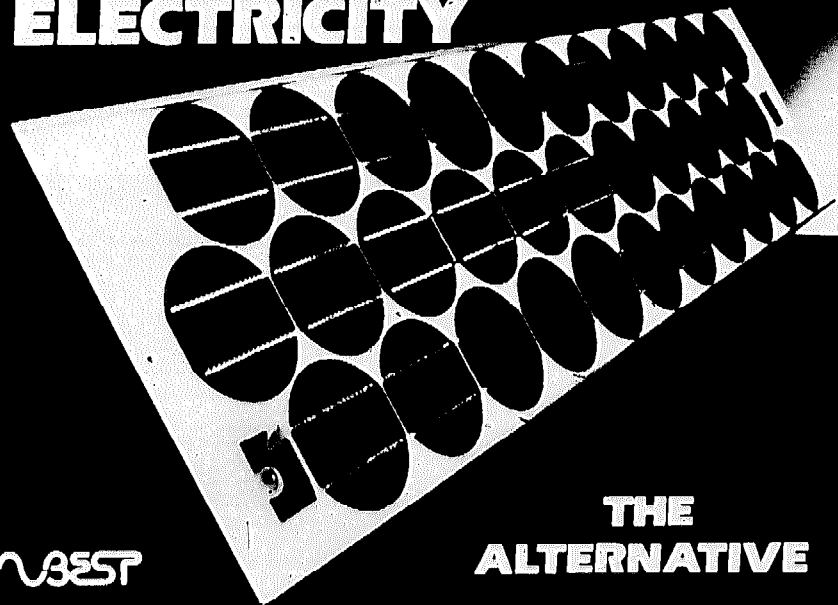

Affordable electricity for homeowners without utility power. Send \$3.00 for Catalog to Dept. ASE

Name \_\_\_\_\_  
Street \_\_\_\_\_  
City/State/Zip \_\_\_\_\_

### SOLARWEST ELECTRIC

A full line authorized distributor for ARCO Solar, Inc.

232 ANACAPA STREET, SANTA BARBARA, CA 93101 805 963 9667



# Recycling Old Houses: The Super-Insulated Triple-Decker

By Steven Kropper

**Two** years ago, I presented plans for a super-insulated triple decker. With one complete heating season past, I can now report on the project's success.

In 1980, six experts met to study how their technical specialties in conservation and energy production could yield the least cost energy future for the residents of Rowell Street in Dorchester, MA. We studied community scale district heating systems and individual options which would use waste heat heat pumps, ACES, solar or cogeneration. We examined conservation options from low and no cost to radical super-insulation.

We concluded that the costs and savings of district heat (by cogeneration) and super-insulation were equivalent. However, for the later to succeed, we had only to convince myself, my wife and the bank. With the district heating system, we would need cost sharing agreements from twenty homeowners. This would be an immense task, requiring more time and money than construction of the system itself. We chose super-insulation.

Solar heating was dismissed because our audit revealed that it would not be cost effective until we had invested \$30,000 in conservation. Further, you can not solar heat a three family energy sieve in a shaded urban neighborhood when its roof covers only 1,000 square feet.

Our triple-decker is one of 15,000 in Boston. It was built in 1911, has a flat roof, is made of wood frame construction and has porches on the front and back of each of the three apartments—hence "triple-decker."

## Construction

After reducing infiltration with "miles" of weatherstripping, we blew cellulose into the roof and walls. Cellulose is fire-treated, shredded newsprint. It is a locally produced, low technology, low energy material which has the least cost per "R" of any insu-



The triple decker before superinsulation consumed up to 1100 gallons of oil per floor each year.

lation.

We blew it into the roof to a depth of 16", and filled the wall cavity for a four inch depth. Blown insulation (and retrofit super-insulation) is usually installed from the exterior of the house. However, the interior of this house was in poor condition, and in need of repair. It would soon be covered with a second "super" layer of insulation. Thus, leaving the plaster and lath in place, we blew insulation through holes into the wall cavity. This raised the insulating value of the wall to R-15, and the roof to R-53. After adding six inches of insulation (fiberglass batts) under the floor, it was insulated to R-26.

Next, the windows. We had planned to replace them all with new operable casement units. However, forty-five windows at \$200 each was more expensive than OPEC oil, so we sought alternatives. We were advised to try a diversity of windows. As a result, we ended up with eight window styles including: awnings, casements, double-hung, fixed panes and "window eliminated." The cost dropped to an average of \$160 each. In choosing windows, we considered many factors, including ventilation, heat loss, solar gain, artificial and natural light, crime and cost. Our window to floor area is 13%—no styrofoam igloo here.

We were pleased recently by a visit-

## Source reduction of pollutants is cheaper than, and may eliminate the need for, an air to air heat exchanger.

ing Defense contractor who closed one of our new, tight windows and exclaimed, "Sounds like a submarine."

### Super-Insulation

By replacing the windows and blowing in the cellulose, we drove the heat loss even lower. Next, on the inside of the perimeter walls, we built a frame of 2x3s (24" o.c.) set three inches away from the wall and installed six inches of fiberglass in the resulting cavity. With great care, we caulked, taped and stapled a six mil polyethylene air/vapor barrier over the insulation to keep moisture in the house and infiltration out.

Finally, we screwed 1/2 inch gypsum board to the frame. With a skim coat and paint, a new home was created. The result is a super-insulated wall of R-38, eight times the original wall value.

Since we super-insulated from the inside, the floor joists and ends of the partition walls are untouched. Although heat is wasted here, insulation is not justified. The goal is to invest wisely in conservation, not merely to save energy. To insulate those spots would have been difficult and expensive, resulting in conservation at—\$4.00 per gallon of oil.

### Chasing BTUs

In a typical old New England sieve, the air change rate is modelled at two per hour. This means that all the warm air in the house is replaced by cold air twice every hour. In 1911, when the house was built, a high level of infiltration was a blessing. Drafts carried away pollution from stove pilots, space heaters, gas lamps, the stove and from sweaty unwashed bodies.

Our super-insulated home is modelled at 0.25 air changes per hour, or one air change every four hours. A new super-insulated home can be so tight that the air changes only once every twenty hours. With a retrofit, it is difficult to achieve such a tight house.

To minimize pollution, we prohibit smoking and use an electric stove. We were also cautious to select building materials which emit few pollutants. Source reduction of pollutants is cheaper than, and may eliminate the need for, an air to air heat exchanger.

### Freebies

Before we started, the heat provided by occupants, appliances, and the sun (called miscellaneous or intrinsic gains or "free" heat) was insignificant. This "free" heat provided, at most, five percent of the required heat.

In our newly retrofitted super-insulated home however, the miscellaneous gains dominate, and provide up to half of the required heat.

Our refrigerator, two warm bodies, a reasonable level of lighting and appliances can keep the house at 70° when it is 50° outside. Further, a super-insulated home is so tight that it remains comfortable at five degrees below a "normal" house. Thus, the miscellaneous gains can keep the house cozy to 45°. Close off two rooms to heat and we have free heat to 40°. Only below this temperature, called the balance point, do we need auxiliary heat.

### Staying Hot

Each apartment in the triple-decker was originally heated by its own 75,000 btu. per hour (btu./h) forced-hot-air furnace. Each furnace satisfied a peak load of 55,000 btu./h (at 65° dT). Now, super-insulated, the apartment peak load is 11,300 btu./h—almost a five-fold reduction in heat loss.

Heat is now provided by the conventional 30 gallon gas fired domestic water heaters which were in place prior to the retrofit. Each heater has a gross output of 30,000 btu./h and supplies both space and domestic water heat. Confronted with a possible choice between a hot shower or a warm home on a winter morning, we quickly invested in shower flow restrictors.

The smallest circulating pump available moves hot water through a conventional reverse-return system of fin-tube radiation (copper tube/aluminum fins). The radiation is oversized to be compatible with a future low temperature solar heating system. When tourists visit the house, they search in disbelief for the furnace, but find only three water heaters.

Using a water heater for space heat does levy an efficiency penalty, but it is very cheap (\$150) and of low output. Neither feature could be found in a high efficiency boiler.

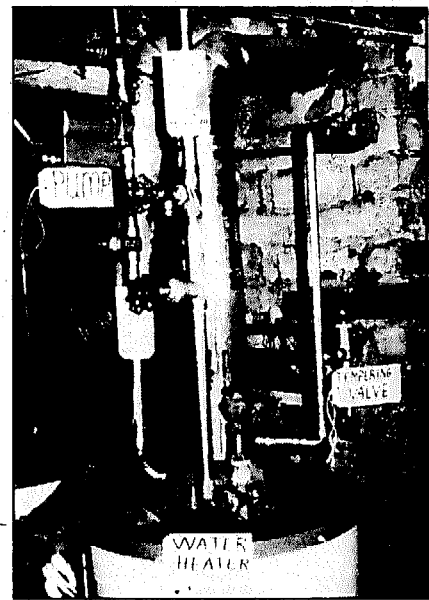

The existing, conventional 30 gallon gas fired water heater now provides both peak space and water heating requirements. The pump, supply and return lines and tempering valve were added to the water heater once it was decided to use it for space heating as well as water heating.

One unforeseen problem arose. Warm water from the heater, located in the basement, thermosyphons past the circulating pump and up into the radiators. The result is overheating and some fuel waste. I wonder whether a properly located heater would enable thermosyphoning to drive the system thus eliminating the pump.

### Chasing Dollars

NOTE: figures are for one floor only!

The project cost \$8120 per floor. All work was performed by contractors, with no subsidies. Before super-insulation, each apartment was in decrepit condition, and in need of rehabilitation. They suffered from high heating costs and commanded low rents.

In accounting for the projects, we consider that in addition to low heating bills, the quality of living space is improved too. The total budget is thus divided into cosmetic improvements (1/3), and actual conservation (2/3), or \$5415.

The pre-retrofit fuel bill was \$1250, and during 1981-82 (post retrofit) it was less than \$200. Thus a savings of \$1040 per unit, and a conservation expense of \$5415 yields a 19% return on investment and a five year payback.

The project cost is further reduced because we originally faced a bill of \$2200 to replace the furnace. With super-insulation, the furnace is not necessary. That sum can be invested in super-insulation, thus saving money instead of burning it. In addition, an



A unique opportunity...

## WIND/HYDRO/PV Alternatives for the

Midwest  
June 4, 1983

immediately following  
ASES Conf. &  
Wind Workshop VI

Minneapolis, Minnesota

A practical workshop, designed to answer your questions and provide information. Conducted by experts in each field. Coordinated by Donald Marier, Executive Editor, ALTERNATIVE SOURCES OF ENERGY magazine.

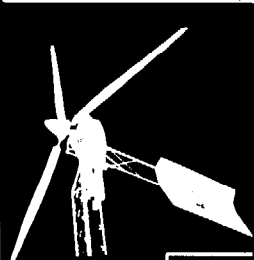

WIND  
POWER

PHOTO-  
VOLTAICS

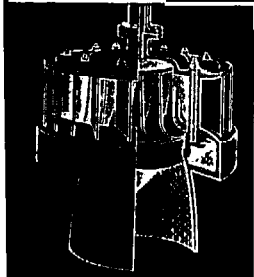
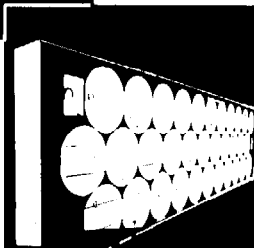

HYDRO  
POWER

This workshop is designed for the potential consumer or investor interested in learning about the practical aspects of generating electricity using renewable energy sources. Participants attend sessions which pertain to their field of interest. Subjects include: connecting to utilities; figuring payback; siting and output estimates; and types of equipment.

**Speakers:**

DONALD MARIER, author, WIND POWER FOR THE HOMEOWNER

JOHN GULLIVER, HYDROPOWER SPECIALIST, U of Minn.

RICHARD KOMP, author, PRACTICAL PHOTOVOLTAICS

PAUL HELGESON, WIND SPECIALIST, State of Minn.

Registration Fee, \$55 until April 25, \$65 late fee.

Please send more

**WORKSHOP INFORMATION:**

also send info. on American Energy Society Conference & Wind Workshop VI

Name

Address

City

State

Zip

Send to: **ENERGY DESIGNS**  
Milaca, MN 56353  
(612) 983-6892 or 983-2363



A drafty window (left) faced an adjacent home, and north. It was replaced (right) with a small awning window which provides light, ventilation and less heat loss.

annual furnace depreciation expense of \$150 is saved.

### How Much Is Too Much

I am often asked, "How much is too much?" and "With so much insulation, how can the house breathe?" I imagine piggy fiberglass lungs straining for air.

In most homes, the level of insulation in the walls is defined by the depth of the wood required to support the roof. In the roof, the "right" amount should be able to melt the snow, but still make you itch on a hot summer day. Sounds fishy.

The proper or "optimal" amount of insulation for a home depends upon the cost of energy and the cost of conservation. In the 1960s, R-15 may have been optimal. In the 1970s, R-20. For the 1980s and beyond, R-40 is the minimum. The higher the fuel price, the more insulation required. The optimal amount of insulation depends upon the interest rate, climate, the costs and savings of insulation, and the current and future price of fuel.

We kept adding insulation until the return on our investment in conservation equalled the rate of interest charged by the bank. In other words, we invested more and more money in conservation until the last dollar spent cost us more in financing charges than it saved in fuel bills.

For Boston today, R-40 at the walls, R-50 in the roof, R-25 in the floor and R-3 at the windows are optimal. These are only simple guide lines. It would,



of course, be possible to drive the auxiliary heating requirements to zero. However, the cost of this extreme step would far exceed the fuel savings (in a super-insulated home).

### Partners With The Bank

To finance the super-insulated, triple-decker, we borrowed funds from a bank. The loan enabled us to make a greater investment than we would have been able to on our own. Investing in conservation with financing from a bank assures a stable fixed price of super-insulation, for the term of the loan. It is similar to securing a long term fixed price contract to receive oil. When the term of our loan is over, Super-insulation will cost nothing.

In addition to insulating us from fuel price inflation, bank financing stabilizes expenses throughout the year. Since our fuel bill is so low, the monthly payment to the bank comprises our "heating" bill. While other people's energy expenses leap every winter, our expense is constant, predictable and lower!

Lastly, the bank is our partner. It has capital for loan, we have a great investment opportunity. We borrowed at 12% and re-invested the funds in super-insulation at 19%. Everyone wins.

*Steven Kropper is an energy economist based in Boston. He advises large commercial energy users on conservation investment opportunities in their facilities. Steven Kropper, 19 Rowell Street, Dorchester, MA 02125. (ph) 617-825-6904.*

# energy focus

an information update  
on all aspects of renewable energy

## WIND



A new concept in wind towers, the Captive Column, is designed to support the main load carrying elements along their entire length. The tower above, which is being tested by Jacobs Energy Research, Inc. is 45 feet high and hinged at the base for tilt up operation.

### A Light Weight Approach to Wind Towers

A "Captive Column" is being tested by Jacobs Energy Research Inc. (JERICO) near Moorhead, Minnesota. The structure, which was designed by Larry Bosch of Bosch Laboratories in Fargo, North Dakota, is designed to support the main load carrying elements along their entire length. This is done by wrapping the tower in a stainless steel wire "skin." According to Bosch, the column

weighs just 3.25 pounds per foot and is equivalent in strength to a steel tower weighing about 14 pounds per foot.

Apparently, Brigham Young University is testing the Captive Column (U.S. patent No. 3,501,880) concept to evaluate its strength characteristics and mass production capabilities for applications such as bridges and towers.

The tower being tested by JERICO is 45 feet high and hinged at the base for tilt-up operation. JERICO has mounted its Model S-S turbine, which has a 20.5 foot rotor diameter, on the tower. According to Dennis Jacobs of JERICO, during the first month of testing, the tower withstood winds in excess of 50 mph and the wind system generated 1200 kwh. of electricity for

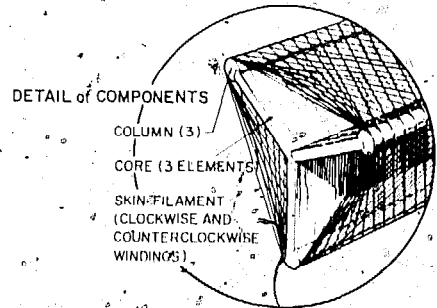

the Village Golf Course in Moorhead, Minnesota where it is installed. For further information on the test project, contact: JERICO, Rt. 1, Box 171D, Dept. ASE, Audobon, MN 56511. For further information on the Captive Column concept, contact: Bosch Laboratories, 1717 17th St. So., Dept. ASE, Fargo, ND 58103.

**AEROLITE**  
550 RUSSELLS MILLS RD. P.O. BOX 576 SO. DARTMOUTH MASS 02748  
PHONE (617) 993-9999

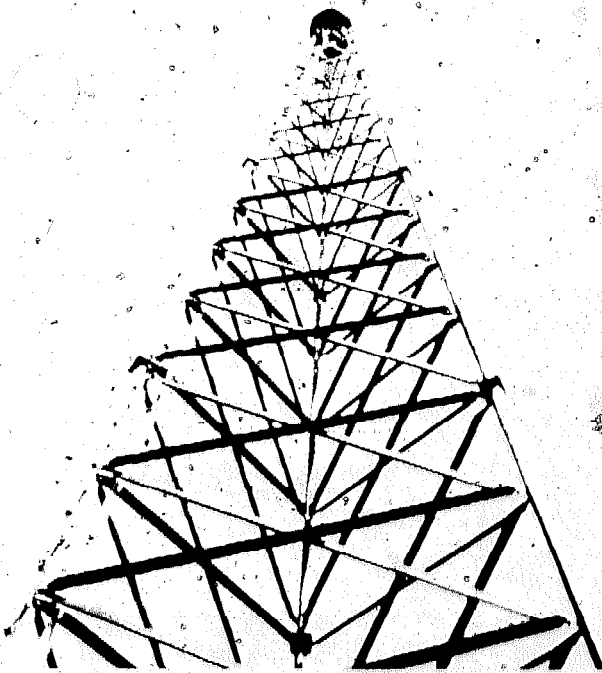

Welcome to the World of AEROLITE ENERGY  
The 1 METER SYSTEM

ENGINEERING EXCELLENCE IN A 10KW INDUCTION MACHINE  
Send \$3.00 for information Dealer Inquiries Invited  
Aerolite towers also available for most other machines

**PV + WIND POWER  
NEW PRODUCT**

**Sequencing Charger Control.**  
Upgrade your 12 volt system.  
Charge any multiple: 24 volt  
-36 volt - 48 volt - 120 volt, etc.,  
from 12 V-Source

Prices start at \$139.00  
**PLUS**

2 and 3 KW Whirlwind  
wind generators in stock.



979-A East Avenue  
Chico, CA 95926  
Phone 916-345-1722

FOR

**D.C. WIND  
GENERATORS**

- control panels
- line voltage monitors
- regulated power diverters

**PERPETUAL POWER CO.**

4203 Idaho St. #5  
San Diego, CA 92104  
(714)583-1414

(dealer inquiries invited)

**ARCO PV PANELS  
BEST PRICES EVER**

ALSO  
RV POWERPAC - Complete  
35 & 70-watt installation hard-  
ware & regulator package.

AND  
BATTERY GUARD & TEST  
MODULE - 100% solid state  
regulation device with com-  
plete metering & controls. 12  
volt models, 5 amp. & 10 amp.

**CONTACT US  
BEFORE YOU BUY**

SEND \$1.00: For Planning Booklet &  
Catalog with sizing worksheet.

**THE SILENT RV  
GENERATOR SPECIALIST**

SOLAR ELECTRIC SYSTEMS  
BOX 1562, Dept. ASE  
Cave Creek, AZ 85331  
Phone: (602) 488-3708

**wind**

**Livingston Montana—Hotbed of  
Wind Activity**

A number of wind projects are being proposed for the Livingston, Montana area. Randall Tinkerman of Windcraft Industries and American Energy Project (AEP) in San Francisco, California indicated to the Livingston City Council in mid-December that his company wants to lease land for a wind project. Tinkerman indicated that Windcraft Industries would install a 340 kw. "Windane" system, built by Danish Wind Technology of Viborg, Denmark, at the site. The proposed \$1.1 million project would also involve the installation of five wind monitoring stations.

Hamilton Standard is also reportedly looking into the possibility of a project in Livingston. Meetings between the company and the Montana Public Service Commission and the Livingston City Council have already been held. The concept behind the project would be to supply part of the load of an \$800 million aluminum smelting plant, which Alumax Corporation is proposing to locate in Montana. The plant's electrical load would be upwards of 400 mw. A Hamilton Standard WTS-

4, 4.8 mw. wind system with a 256 foot diameter rotor began operating in Medicine Bow, Wyoming on September 4, 1982.

Windpowered Machines, Ltd. has opened up a 3,700 sq. ft. facility in Livingston for the development of its 70 foot diameter sail turbine. Greg Cook, president of the Chicago-based company, reports that the company has installed the footings for the turbine and installation is now proceeding.

The City of Livingston itself is considering the installation of four more wind systems, most likely Jay Carter units, at its municipal wind farm this summer. This despite additional design problems experienced by the City's present four Carter units in December, 1982, when blade failures occurred on both the Montana Power Company units and on one of the City of Livingston's machines during 70 mph winds.

The blade failures occurred just 11 months after blade problems at the Livingston site in January, 1982. In the most recent cases, the blades were damaged when the rotor, which normally operates downwind, ended up

Electric Power From The Wind

**NITE & DAY  
WIND SYSTEMS  
is Overstocked!!**

We must clear out our stock of new

**Wind Powered Generators  
Photovoltaic Panels  
Towers X Inverters X Batteries**

Everything for the complete energy system.

We are slashing our prices **30%-50%**. All systems are fully warranted with technical assistance available. Write or call for price list.

**NITE & DAY WIND SYSTEMS**

634 Swanton Rd., Davenport, CA 95017

• Installation - service -  
site analysis (408) 425-7636



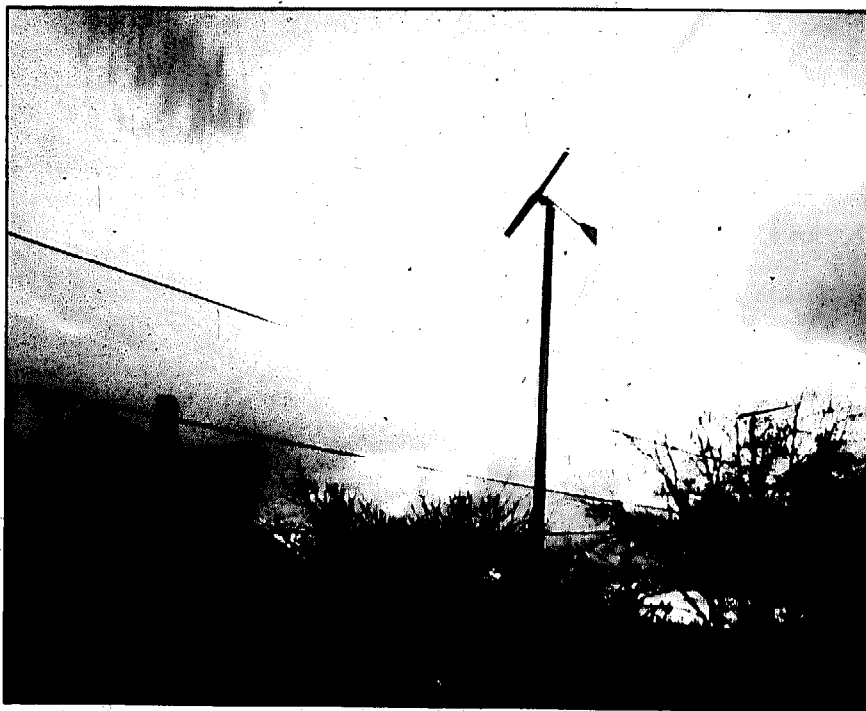

Reader Pete Gardiner of Laramie, Wyoming sent this picture of his 125 watt wind unit which he assembled from a Kucharik Kit (Kucharik Wind Electric, P.O. Box 786, Dept. ASE, Toms River, NJ 08753). Gardiner notes that he is experimenting with the unit in an urban setting. The wind unit is mounted on a guyed pole with a pivot at the bottom for ease of working on the whole assembly.

electrolyzer from a wind system, the electrolyzer takes 10 amperes of current and will produce about  $\frac{1}{8}$  cubic feet of hydrogen per hour. For more information, contact: *Hydrogen Wind Inc., L.E. Spicer, R.R. #2, Box 262, Dept. ASE, Lineville, IA 50147.*

#### Unique Wind Project

Unique Investments of San Francisco, California is seeking to install up to five Bendix Wind Systems in Livingston, Montana. Bob Conrich, general manager of Unique Investments, stated that the project is still in the planning stages. "The project is looking for a site and Livingston seems like a good place to locate it," Conrich noted. "We are some distance from making the decision where to locate—much depends on the utility contract." He indicated that locating the project in the Gorgonio Pass was also a possibility.

"No deal has been signed with the Bendix Corporation yet," Conrich said. "But we are in very serious conversation with them." According to Conrich, investment money for the project would come from a "large New York investment firm." At

facing the wind upwind and started up in strong winds. This condition occurred after the brake had been applied during gusty winds to prevent yaw instability and then restarted. Carter has now re-designed the hub to prevent the yaw instability and will be upgrading the machines. The machine that failed in December has already been repaired by Carter. Ed Stern, director of community development for Livingston, stated that the new design recently survived winds in excess of 100 mph, during which the out-of-balance mechanism was not even activated.

#### Hydrogen from the Wind

You can generate your own hydrogen gas with an electrolyzer unit manufactured by *Hydrogen Wind, Inc.* of Lineville, Iowa. L.E. Spicer, president of the firm, notes that the company previously sold plans for the units but has now set up for manufacturing. One electrolytic cell retails for \$135 with the electrolyte (potassium hydroxide) costing an extra \$15. The plates are sintered nickel, such as those used in nickel cadmium batteries. According to Spicer, under typical operating conditions, with 6 volts applied to the

## SITKA SPRUCE BLADES

For Larger Diameter Rotors

by

**Santa Rosa Machined Props**

**(707)545-8634**

*We can now produce blades  
up to 84 foot diameters*

present, negotiations are in progress with the Montana Power Company and the Montana Public Service Commission to set the stage for a power purchase contract. To make the project viable, Conrich indicated that a long term contract with a leveled buy-back rate of 10 cents per kwh. is desired by the company.

If the project materializes as planned, from one to five 4.5 mw. wind turbines, supplied by Bendix Corporation, would be installed by 1985. Bendix has been testing drive train components of its design on its Schachle machine near Palm Springs, California.

### MOD-2's Shut Down

All Boeing MOD-2's at Goodnoe Hills and Medicine Bow have been shut down pending a review of the design of the low speed shafts on the machines. According to Jim Couch, manager of field operations at NASA-Lewis Research Center in Cleveland, Ohio, a crack in the drive shaft of Unit #1 at Goodnoe Hills near Goldendale, Washington extends to about two-thirds of the circumference of the

shaft. "The crack is fatigue-related and caused by the weight of the rotor on the shaft," Couch stated. "A technician discovered the crack while he was in the process of resetting breakers in the nacelle due to an automatic shut-down of the machine on November 12, 1982." Since then, the three MOD-2 machines at Goodnoe Hills and the unit at Medicine Bow, Wyoming have been shut down. Similar, but very small cracks were found in Unit #2 at Goodnoe Hills. No cracks have been found in the other machines' shafts. Unit #1 at Goodnoe Hills had earlier been repaired due to the failure of an improperly lubricated bearing in June, 1981.

The crack in the drive shaft of Unit #1—each shaft is about four feet in diameter and is made of three-quarter inch thick steel—started in the region of a series of small holes that were drilled into the shaft skin to support brackets. The brackets are used to hold various pieces of equipment which are mounted on the outside diameter of the shaft. The bracket holes were not in the original design for the MOD-2, although it was known that various com-

ponents were going to be mounted on the shaft. According to Couch, during the whole design and construction phase of the MOD-2, the effects of drilling the holes in the shaft was somehow overlooked.

Couch states that the consensus of the Boeing-NASA review committee, established to evaluate the causes and what corrective measures to take, was that all machines would have developed the cracks in time. The corrective measure will be to install new drive shafts on all five machines in the field. Although the solution is simple, it is nonetheless expensive and presents a political problem. Four of the machines are owned by the Government and an additional request for funds will have to be made. Costs to redesign, build, and install the new shafts are estimated to be around a half million dollars per machine, which could amount to a significant percentage of the DOE wind budget. Congressional supporters are apparently willing to vote for the funds, but there is no guarantee that it will be done, given the present economic condition of the country.

Despite the shutdown of the Goodnoe Hills and Medicine Bow ma-

**ESI**  
delivers...

## Performance not promises

- Renewable fully tested systems
- Total project engineering
- Established international capability
- Simplicity of design and construction

**ESI**

ENERGY  
SCIENCES  
INCORPORATED

P.O. Box 3168  
Boulder, CO 80307  
(303) 449-3559

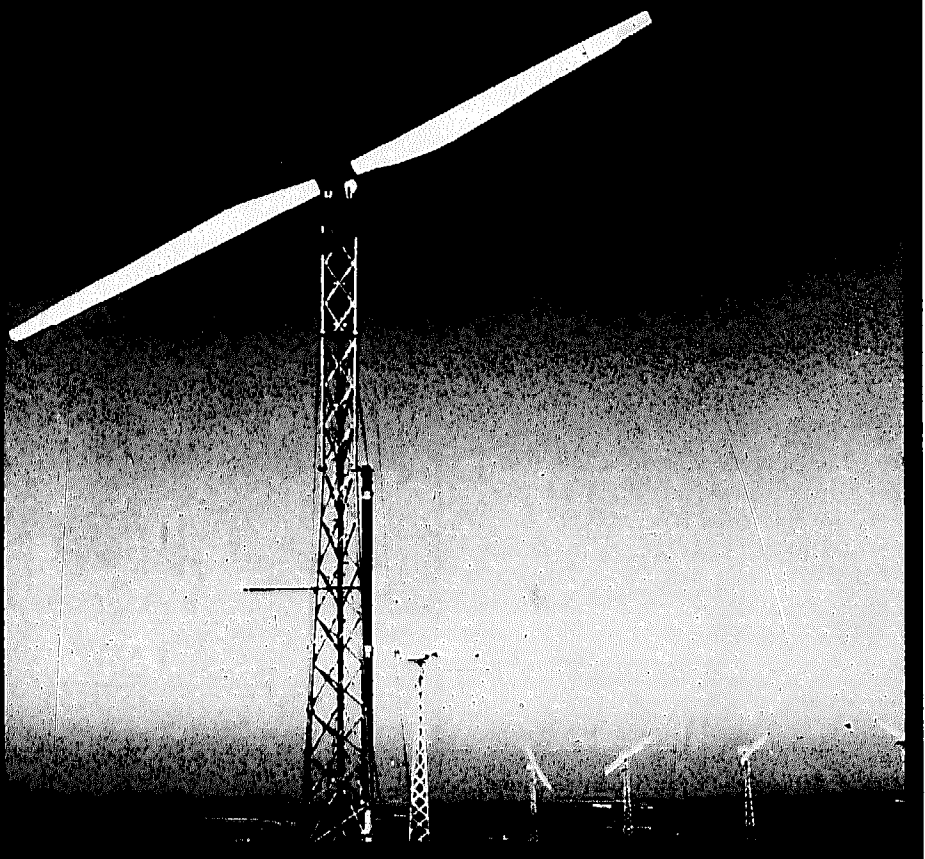

chines, PG&E has apparently decided to continue operating its MOD-2 while making frequent inspections. Company engineers performed dye-penetration, magnetic particle, and ultrasonic tests on the shaft and this led to the decision to continue operation. Officials plan to continue the dye-penetration tests as well as visual inspection for every ten hours of operation time until the shaft can be replaced, which will probably be about six months, at the earliest.

#### Wind in Puerto Rico

The City of San Sebastian, Puerto Rico will receive a 25 kw. wind system from *Future Energy R&D Corp.* under a grant from the Department of Energy. According to Gaylon Hinton, vice president of engineering with Future Energy, the grant called for the installation of a 10 kw. system but the company bid to install a 25 kw. machine for \$32,000, including tower and installation. The machine will be connected to the Puerto Rico Electrical Power Authority grid and excess electricity will be sold for 7 cents per kwh.

Hinton also reports that Future Energy has improved the efficiencies of

its blades and generators and that the coefficient of performance of the company's blades has tested out at 46 percent. This after redesigning the blades through computer analysis and wind tunnel testing of 80 different models. Hinton also states that the specially wound induction generators which the company uses are 81.5 percent efficient at 1/4 load for the 3 kw. model. Contact: *Future Energy R&D Corp., Carretera Estatal No. 113, Dept. ASE, Zona Industrial, Quebradillas, Puerto Rico, 00742.*

#### Electromatic Sensor

Electromatic has introduced an optoelectronic wind direction sensor. Electromatic Components Ltd. (1531 Burgundy Parkway, Dept. ASE, Streamwood, IL 60103), a manufacturer of modular control circuits for industry, has designed the model SO 115 wind direction relay which works in conjunction with their model OD 02 optoelectronic wind vane. The wind vane registers each change in wind direction of 7 deg. and sends its signals to the SO 115 for controlling yaw motors. A time delay is adjustable, from 0.8 to 18 seconds.

#### Coming Events

**WIND WORKSHOP VI**, June 1-3, 1983.

*Minneapolis, Minnesota*

Sponsored by the Wind Division of the American Solar Energy Society (ASES). Contact: *Dr. Irwin Vas, c/o FloWind Corp., 21212 68th Av. So., Kent, WA 98031.*

**ALTERNATIVES FOR THE MIDWEST: WIND, HYDRO AND PHOTOVOLTAICS**, June 4, 1983.

*Minneapolis, Minnesota*

Workshop sponsored by Energy Designs and Minnesota Solar Energy Association. Presentors include Donald Marier of Alternative Sources of Energy, Richard Komp of Skyheat Associates, and John Gulliver of St. Anthony Falls Hydraulic Laboratory. For more information, contact: *Alternatives Workshop, 1421 Park Av. #201, Minneapolis, MN 55404.*

**RENEWABLE ENERGY TECHNOLOGIES SYMPOSIUM & INTERNATIONAL EXPOSITON**, August 29-September 1, 1983.

*Anaheim, California*

Contact: *TMAC, 680 Beach St., Suite 428, San Francisco, CA 94109.*

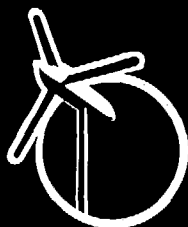

## Sixth Biennial Wind Energy Conference and Workshop

June 1-3, 1983 Minneapolis/St. Paul, Minnesota

In Conjunction With ASES 83—The 1983 ASES Annual Meeting, Solar Technologies Conference And Product Exhibition

Chairman

Dr. Irwin E. Vas, FloWind Industries

Sponsor

American Solar Energy Society, Wind Energy Division

Co-sponsors

U.S. Department of Energy, Wind Energy Technology Division

American Institute of Aeronautics and Astronautics

Terrestrial Energy Systems

American Society of Mechanical Engineers

Solar Energy Division

American Wind Energy Association

Alternative Sources of Energy Magazine

Host: Minnesota Solar Energy Association

### Attend the latest in this series of exceptional wind energy programs.

Results of studies in the public and private sectors will be featured in technical presentations, plenaries and working group discussions. Several topics of interest to the wind energy community will be covered, including:

- U.S. Wind Energy Program
- International Wind Energy Programs
- Large Wind Systems
- Small Wind Systems
- Vertical Axis Systems
- Community and Wind Farm Applications
- Aerodynamics/Wakes
- Performance and Testing
- Wind Characteristics
- Performance and Testing
- Safety and Environment
- Stand-alone Systems
- Dynamic Analysis
- Utility Interconnection.

Plus

- Attend a major renewable energy product exhibition with a special Wind Pavillion displaying the latest hardware in the marketplace.
- Interact with other disciplines and professions engaged in renewable energy development at the 1983 ASES Annual Meeting

### For Further Information

- Please send me program and registration information on Wind Workshop VI at ASES 83
- I cannot attend the meeting, but please send me ordering information on Wind Workshop VI Proceedings.

Name \_\_\_\_\_

Address \_\_\_\_\_

City \_\_\_\_\_

State \_\_\_\_\_

Zip \_\_\_\_\_

Day Telephone ( ) \_\_\_\_\_



Return this to:

American Solar Energy Society  
1230 Grandview Avenue  
Boulder, Colorado 80302  
303-492-6017



# PHOTOVOLTAICS

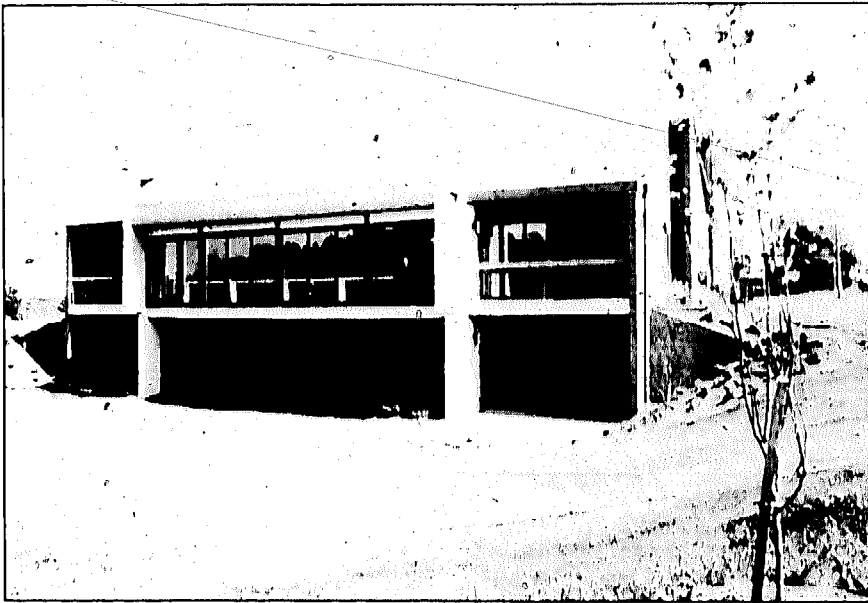

Future I, with its roof integrated SOLEC International PV panels, viewed from the outside, and from inside the attic, where the backs of the panels are left exposed to help keep them cooler.

## Future I

Georgia Power's privately funded Future I home in Roswell, Georgia uses a combination of energy technologies: passive solar; computerized load management; eutectic salt storage rods and, most notably, photovoltaic panels. Actually, the home is not futuristic in the sense that all of the component technologies are available in the marketplace now. According to the architect, Richard Sibly, president of Sibly + Seedorf and Associates in Atlanta, Georgia, the process of designing Future I and producing the architectural drawings took only 5½ weeks.

The photovoltaic system for Future I consists of sixty-four 62 watt panels, each 25½ in. by 4 ft., produced by SOLEC International Inc. of Hawthorne, California. The peak power rating of the 544 sq. ft. array is 4.1 kw. The array output of 200 d.c. volts and a nominal 20 amps is fed to a "Dece" synchronous inverter built by Delta Electronics. The inverter operates from an input range of 160 v. to 230 v. d.c. and has an output of 240 v., single phase, a.c. The PV system cost \$45,425, not including development and design costs. The total system was designed by Westinghouse Electric Corp. of Pittsburgh, Pennsyl-

vania under the direction of project manager P. F. Pittman.

The PV panels are mounted directly on rafters on 28 inch centers. There is no insulation directly behind them to help keep the panels as cool as possible and the roof/panel system is made watertight with Tremco mono caulking applied to special rafter risers before the panels are installed.

Sibly reports that in the period of August through November, 1982, the PV system supplied an average of 438 kwh. per month or an average of 18.8 percent of the total electrical consumption in the home.

A unique feature of Future I is the computerized load management system, designed by Heery Energy Consultants of Atlanta, which can control appliance usage and provides fire and burglar alarm protection. In addition, the computer, a Commodore MIME 2A, is used to divert excess electrical production from the PV array into storage loads such as the hot water heater in the house. If there is no load to divert the excess electricity to, it is sent back to Georgia Power via its utility lines. In the August-November, 1982 period, less than 13 percent of the PV array's output had to be diverted back to the power company.

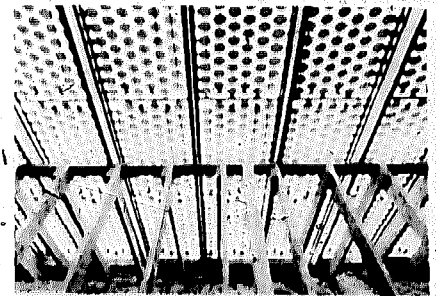

Other design features of Future I include a passive solar system with 421 sq. ft. of direct gain glazing in the family room, a 200 sq. ft. trombe wall in two bedrooms and a bath, and 24 Thermol-81 eutectic salt thermal storage rods in the living and dining rooms. The house is well insulated, with R-38 ceiling insulation, R-27 wall insulation, double glazed windows, and Roll-A-Way outside shutters. An air-to-air heat pump is used for additional heating or cooling.

## 12 Volt Blender

Independent Power Company has now added a 12 volt kitchen blender to its listing of appliances and devices for d.c. powered systems. The blender has a capacity of 40 oz. and consumes about 2.5 amps. Independent Power also has 12 volt Honda gasoline powered battery chargers and 12 volt soldering irons. For a copy of their catalog, contact: *Independent Power Company, 12340 Tyler Foote Rd., Dept. ASE, Nevada City, CA 95959.*

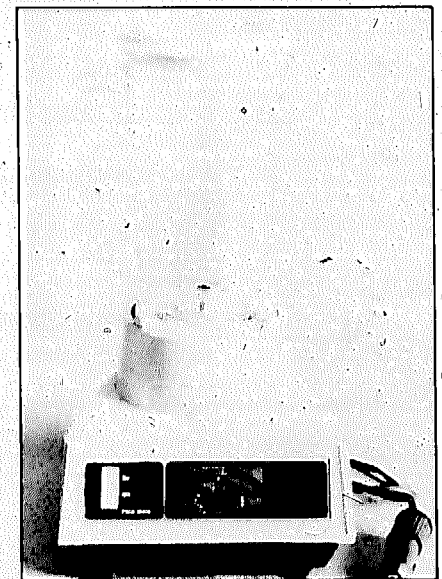

## photovoltaics

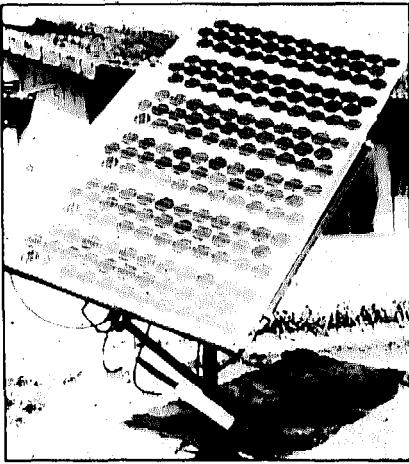

### Increasing PV Output

Photovoltaic module outputs can be increased from 25 percent in winter to up to 55 in summer when using a solar tracker, according to the *Energy Shop* of Victorville, California which manufactures the *SunSeeker Solar Powered Sun Tracker*.

According to the *Energy Shop*, one *SunSeeker* can track up to 12 PV panels. By adding a second tracking mechanism, the unit can track both azimuth and elevation if necessary. Prices for the tracker start at \$360. For more information, contact: *The Energy Shop Inc.*, P.O. Box 1512, Dept. ASE, Victorville, CA 92392.

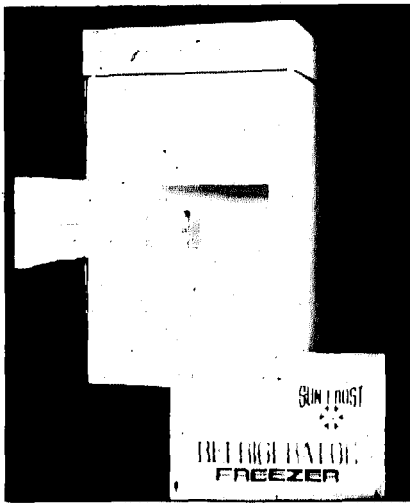

### Solar Powered Refrigerator

A refrigerator that runs on just 1/2 kwh. per day (41 a-h.), or about one-fifth the consumption of a standard refrigerator of comparable size, is now being made by *Sun Frost* of Arcata, California. The 17 cubic foot refrigerator achieves its high efficiency through the use of insulation; by compartmentalizing the sections; by placing the freezer between the upper and lower

refrigerator sections; and by placing the compressor on top of the refrigerator. According to Larry Schlusser of *Sun Frost*, the top mounted compressor runs cooler and does not heat the refrigerator compartments. The company also makes a four cubic foot chest-type refrigerator which consumes about 17.5 a-h. per day. For more information, contact: *Larry Schlusser, Sun Frost, Dept. ASE, 725 Bayside, Arcata, CA 95521*.

### PV Catalog

*Solarwest Electric* has just published its new 1983 PV catalog. The 32 page booklet costs \$5.00 and includes information on PV history, how they work, and on system sizing and siting. The catalog price is applicable to any purchase of over \$50. For more information, contact: *Solarwest Electric, 232 Anacapa St., Dept. ASE, Santa Barbara, CA 93101*.

### Photocomm Regulators

*Photocomm Inc.*, the authorized Southwest distributor for *Arco Solar* PV panels now offers regulators for PV systems. Its SR-series regulators are designed for small 12 volt (up to 80 watts) or 24 volt (up to 160 watts) systems. The regulator has internal circuitry for battery voltage temperature compensation.

For large arrays, *Photocomm* offers its SRM master controller regulator and SRS slave regulator. They are switching-shunt type regulators which prevent overcharging of the batteries by short circuiting the PV module with a solid state switch. When short circuited, the voltage of the modules reduces to almost zero volts and the current rises to a nominal 6 amps. so that the power dissipation (volts x amps.) in the modules is low compared to using shunting resistors. The master regulator turns off all the PV modules in the array. When the battery bank needs charging, the master regulator and each slave regulator limit the charge to the batteries while sensing the battery temperature. By sensing the battery temperature, the maximum charging voltage can be decreased as the battery temperature increases, thus preventing overcharging.

*Photocomm* also has plans to introduce a PV powered water pumping system in 1983. For further information, contact: *Photocomm Inc.*, 7745 East Redfield Road, Dept. ASE, Scottsdale, AZ 85260.

## ARCO Solar

Photovoltaic Products

- Full line of ARCO Solar photovoltaic modules, support structures & system accessories
- Static power inverters & line-tied inverters
- Photovoltaic storage batteries
- DC appliances & lighting systems
- Water delivery system components
- Ultra violet water purifiers
- Full line of mobile and marine radio systems and accessories
- Remote location power systems

### communications associates

305 N. Republic Avenue  
Joliet, Illinois 60434  
(815) 744-6444  
Toll free inquiry telephones  
U.S. Wats 800-435-9313  
Illinois 800-892-1611

**Authorized Distributor**  
**ARCO Solar™ Products**  
DEALER INQUIRIES INVITED

**WHAT OUR  
INVERTER  
CAN DO FOR YOU IS  
CHANGE A PART-TIME  
ENERGY SOURCE  
INTO A FULL-TIME  
ALTERNATING  
CURRENT  
ELECTRICITY  
SOURCE.**

**INTERESTED?**



**OF COURSE YOU ARE.  
SO GET IN TOUCH.**

Send \$2.00 for our informative brochure, "An Introduction to Independent Power Systems".

**BEST**

BEST ENERGY SYSTEMS, INCORPORATED  
P.O. Box 280 - Necedah, Wisconsin 54646 - 608-565-7200



## Solar Electric Panels

- 28 Watt complete panel kit \$216\*
- 35 Watt Arco seconds \$276\*  
—no warranty
- 35 Watt Arco \$366\*  
—5 year warranty \*Delivered

### Professional Energy Storage Batteries

- Constructed *only* for alternative energy applications
- Outstanding warranty/nationwide servicing
- 6 and 12 Volt, 95-300 AMPS
- As low as \$81.00 delivered

Your best energy storage value.

CATALOG \$3.00

(916)  
292-3754

Dealer  
Inquiry  
Invited



## photovoltaics

# Truckers Rely on PVs for Warning System

By Brian Shovers

Some PV installations do not require fancy amortization footwork to make sense to the hardnose economist. Such an account follows.

There is a winding, hilly stretch of Highway 70 that cuts through the canyonlands of Utah which has been plagued by serious truck accidents due to a lack of proper warning systems. The obvious solution to this problem was a flashing sign to alert truckers to the upcoming danger. This seems a simple enough solution, but in this case, the nearest available power source was 17 1/2 miles away. Seventeen miles of power line would have cost the Utah Department of Transportation over \$125,000.

There was, however, an alternative to this dilemma: photovoltaics. In 1980 the Utah Department of Transportation applied for and received a \$12,000 grant from the Department



Workers put the finishing touches on a unique PV installation in Utah which controls highway warning signals. To bring in the power lines would have cost the state 125,000 dollars.

of Energy to demonstrate the cost effectiveness of using photovoltaics to light the road sign. The solar powered sign, developed by Applied Research and Technology of Salt Lake, is powered by eight 1 x 4 foot solar panels, each containing 33 photovoltaic cells. Storage batteries, placed in an insulated box, can keep the signs operating through three sunless days.

During its first year of operation, the only significant problem has been vandalism. The PV cells, located on a butte above the sign itself, are 1,000 feet from the roadway, eliminating most tampering. According to John McEwan, an employee of the Utah Department of Transportation and an author of the proposal to DOE, this is the first system of its type in Utah, but it won't be the last. The success of this remote site application has inspired other applications by the department. McEwan said they are considering using photovoltaics to drive pumps at remote rest areas where the only source of energy to pump water would be gasoline generators. He also mentioned that the Utah Department of Fish and Game is looking into the use of photovoltaics for pumping water for livestock in remote locations. For more information about the Utah project, contact: John McEwan, Utah Dept. of Transportation, Room 408, State Office building, Salt Lake City, UT 84114.



## AT LAST A REPLACEMENT FOR STRIP CHARTS

With Direct Computer Data Retrieval.  
Use Battery Powered DATAPODS for \$650.  
Records — • Precipitation • Temperature  
• Dwell Time • Vehicle Counts • Wind

- Solar Radiation • Soil Moisture
- Leaf Wetness • Stream Stage
- Solid State Data Storage Module
- Waterproof • -35°C — + 50°C Operation

OMNIDATA Dept. T P.O. Box 3489  
Logan, UT 84321 (801) 753-7760

Write Today For a Free Brochure

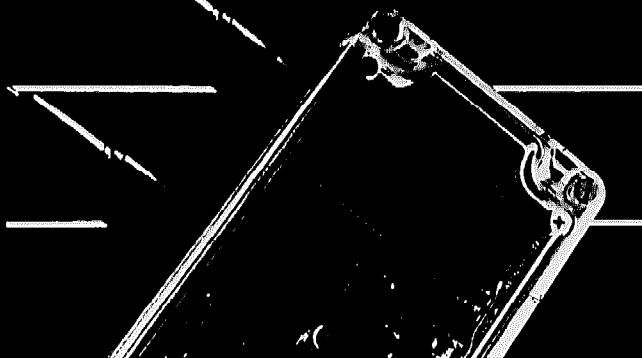

# SOLAR

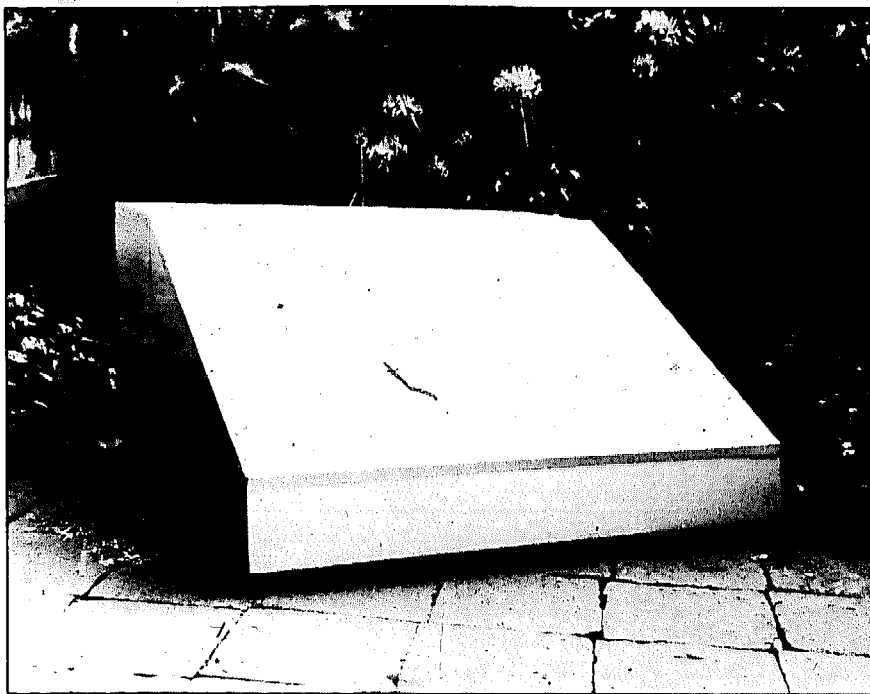

The new TEF SunRunner has an automatic, interior shutter which is controlled by a simple limit thermostat. TEF offers a unique guarantee. If the unit freezes within 5 years, they simply replace it.

## The "No Freeze" Guarantee

TEF Manufacturing has recently announced the availability of the *SunRunner*. The unit is a breadbox type solar water heater with an interesting twist. The insulated shutter, which is generally manually operated, is controlled by a limit thermostat. According to company president, Thomas Kristy, "This type of non-electronic limit thermostat has been in use for over forty years in the gas furnace industry. The preset temperature limits differ by approximately 10 degrees, which keeps the unit from continually opening and closing on a partly cloudy day." The insulating shutter is the only moving part on the unit.

TEF is apparently quite confident about the design. Kenneth H. Russell, director of research and development, says "The sheer simplicity of our solar water heater is the key to its high efficiency and what allows us to offer what we consider the most unique guarantee in the industry." Their guarantee is simple. Providing the unit is properly installed, if the SunRunner freezes within the first five years of operation, TEF will replace it at no charge. The guarantee applies anywhere in the continental United States.

The \$899 unit is shipped as a completely assembled package with its own mounting flanges and two plumbing connections which run to your existing water heater. There are no electronic controllers, sensors or valves to be connected.

For more information on the TEF SunRunner, contact: *TEF Manufacturing, 1550 North Clark, Dept. ASE, Fresno, CA 93703.*

## Invest in an SSA Account

Wondering where to invest your hard earned money? How about a "Solar Savings Account" (SSA). *Grumman Energy Systems* has an interesting angle to consider in their sales literature. The Grumman Sunstream<sup>®</sup> system is used as an example, but the economics should apply to other well designed and durable solar hot water systems.

You start with the assumption that a representative Grumman Sunstream system will cost about \$3,800 and that annual operating and maintenance will average about 1 percent of that cost, or \$38 a year. Assuming the system will save its owner about 13 million BTUs of energy annually and assuming the homeowner is presently heating water at a cost of seven cents per kilowatt hour, savings in the first year of use would be \$266 minus the \$38 annual

maintenance cost, or \$228.

Allowing for the effects of conventional energy inflation at an assumed 10 percent a year, savings could grow to \$334 annually by the fifth year, \$538 by the tenth year and to \$1,394 by year 20. If the price of the system is \$3,800, and the federal tax credit is 40 percent or \$1,520, the actual cost of the system is \$2,280. The system has an assumed service life of 20 years so the average cost per year of owning the system is \$2,280 divided by 20, or \$114 per year. Thus, if all the assumptions hold up, it will cost the homeowner \$114 to save \$228 in the first year. Each year thereafter the savings increase because of the effect of inflation on the cost of conventional fuel. According to Grumman, the savings represent an average tax free yield over just the first ten years of ownership of 14.6 percent on the \$2,280 investment. Someone in the 40 percent tax bracket would have to earn about 24 percent on a taxable investment to do as well.

Save up to 2/3 the cost of  
a photo-voltaics only  
system with a

## Photogen Hybrid System

Complete systems include: PV array w/passive tracking system, AC generator, battery charger, solar micro-processor/controller, Best inverter, auto-transfer switch and deep-cycle batteries.

Each system is custom designed according to individual requirements. For more information contact:

Jim Cullen

**Real Goods Trading Co.**  
308 E. Perkins  
Ukiah CA 95482  
(707)-468-9214

Send \$3.50 ppd. for 144-page  
*Alternative Energy Catalog.*

The most complete Alternative Energy  
Catalog in the world.

## Delta-T® Solar Products

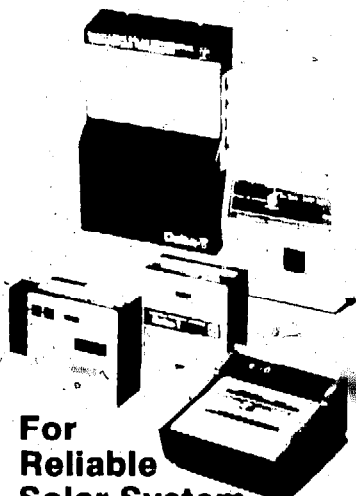

### For Reliable Solar System Control

A Complete Line of Solar Heating and Solar Hot Water Controls.

- **Delta-T® Differential Temperature Thermostats** available with the Temp-Trak® digital temperature display.
- **Delta-T® Multi-Logic™ (DML)** provides for multiple differential control in a single unit.
- **DER-300W Remote System Temperature Monitor** with six station digital display.

Also available is the **Hello-Logic®** multi-mode solar controller for completely custom residential or commercial solar applications and **Motorized Damper** for space heating with air systems.

For complete information on all Heliotrope General products write or call

### HELIOTROPE GENERAL

3733 Kenora Drive  
Spring Valley, CA 92077  
(619) 460-3930

Northeast: (203) 453-0476

CALL TOLL FREE:

In California (800) 552-8838

Outside California (800) 854-2674

Delta-T: the leading name in solar control circuitry



## solar

According to Leonard Rothenberg, vice president of the Grumman Energy Systems Company, "The amount of money that your solar system can save depends on how much hot water you use, the size of the system and the cost of conventional fuel. But solar definitely merits consideration as a solid investment, right up there along with CDs and IRAs."

For more information on Grumman's solar systems, contact: *Grumman Energy Systems, 445 Broad Hollow Road, Dept. ASE, Melville, NY 11747.*

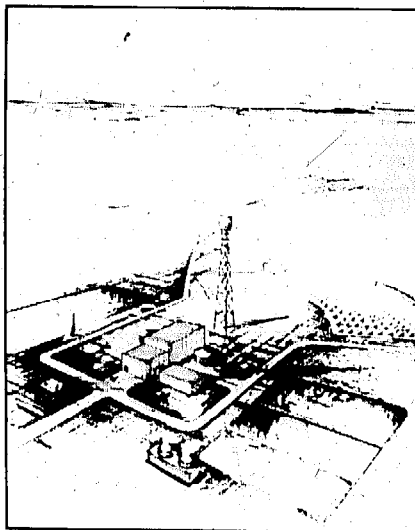

The Carrizo Plain, in eastern San Luis Obispo County, California, could well be the site of a new solar power tower three times larger than any now operating in the world.

### World's Largest Solar Power Tower in Planning Stages

The Carrizo Plain in eastern San Luis Obispo County is the planned site for design of a solar energy project proposed to be three times larger than any now operating in the world. Pacific Gas and Electric Company, Rockwell International Corporation's Energy Systems Group and ARCO Solar Industries will share the cost of developing the design with the U.S. Department of Energy. A contract for preliminary design of the plant has been awarded by the DOE to Rockwell International.

The Carrizo Plain, about midway between San Luis Obispo and Bakersfield, is now devoted to agricultural uses. The plant's design, when completed, could include a field of approximately 2,000 heliostats covering about 250 acres and a power tower over 400 feet high. The heliostats, each with more than 1,000 square feet

of reflecting area, would reflect sunlight to a central receiver atop the tower. Liquid sodium circulating through the receiver would be heated to more than 1,000 degrees (F). The sodium transfers the heat from the receiver to a steam generator which turns water into steam to power a turbine generator capable of generating 30,000 kilowatts.

When operational, the plant could produce 75 million kilowatt-hours of electricity a year, equivalent to the electrical consumption of more than 12,000 typical households and replacing more than 160,000 barrels of oil use per year.

After the Diablo Canyon Nuclear Power Plant starts operation, PG&E's plans call for 100 percent reliance on alternative resources—cogeneration, hydro, geothermal, solid waste and renewable resources like wind and solar energy—for the remainder of the 1980s.

### U.S. Solar Resource Data Base Now Available

A comprehensive collection of solar radiation and meteorological data for the United States has been published in a three volume series by the Department of Energy's Solar Energy Research Institute (SERI).

The *Solar Radiation Energy Resource Atlas of the United States*, (Stock No. 061-000-00570-6, \$18.00) the *Insolation Data Manual*, (Stock No. 061-000-00489-1, \$7.50) and its addendum, the *Direct Normal Solar Radiation Data Manual*, (Stock No. 061-000-00593-5, \$4.75) represent data accumulated and synthesized over a 23 year period from 248 National Weather Stations across the nation.

"The reference works are the result of an extensive cooperative effort among a number of organizations," says Roland Hulstrom, Chief of SERI's Renewable Resources Assessment and Instrumentation Branch. "Collectively, these volumes should prove extremely valuable not only to solar engineers, designers, and manufacturers, but to meteorologist and agricultural engineers as well."

All three publications are available from the *Superintendent of Documents, U.S. Government Printing Office, Washington, DC, 20402*. Orders must be prepaid and the stock numbers should be referenced when ordering.

# CONSERVATION

## The Larsen Truss

When it comes to superinsulation, one of the most common techniques currently in use is the double-wall system. This is, however, a specialized piece of framing requiring a meticulous and patient framing crew, something which is often hard to come by. Long time ASE reader John R. Hughes has come up with an interesting alternative. His group, *Passive Solar Designs Ltd.*, has developed a simplified framing system called the Larsen Truss, which can be used by an owner builder in conjunction with a normal framing crew.

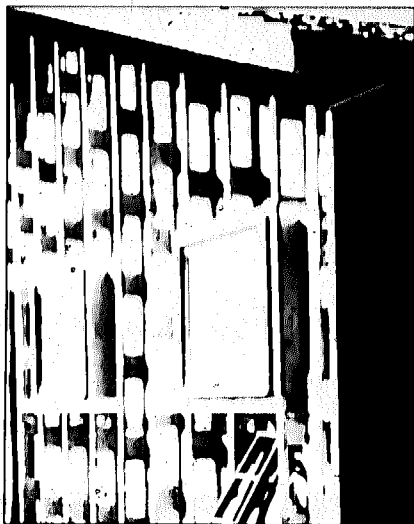

Basically, the Larsen Truss is a non structural truss made of 2x2 chords and intermittent plywood webs, somewhat similar to commercially available structural trusses used for floors and roofs. It is applied vertically on the outside of a conventional 2x4 frame wall. To ensure energy efficiency, the vapor barrier is placed on the outside of the structural wall before the trusses are put in place. Thus the inner wall can be built by any framing crew.

*Passive Solar Designs* provides consulting services on design, layout and siting, as well as full design and drafting of plans. They also have several detail sheets available for the owner builder, covering the Larsen Truss, conventional double wall construction and energy conservation in general. For more information, contact: *John Hughes, #204-10830-107 Avenue, Dept. ASE, Edmonton, Alberta, Canada, T5H 0X3.*



## Simplifying the Geodesic Dome

Gene Hopster, author of *How to Design and Build Your Dome Home* has found a way to simplify the geodesic dome. His innovative Hexadome design employs only 24 triangles. According to Gene, "I could see that the geodesic was too complicated for the kind of construction most people would want to tackle. I studied the

older-style geodesics and saw that I could reduce the number of shapes and make the task of building much less expensive and a very easy task. This simplification brought forth a design which has only 24 triangles instead of the 45, 60, 90, or even 120 commonly found with other designs."

Along with the 24 triangles the builder must construct 3 trapezoids, all assembled with their 'skins' before the dome is erected. According to Gene, this modular construction allows you to build without professional help. The parts for a Hexadome can be built at one place, a shop, for example, and moved by truck to the site for final assembly. The Hexadome design allows the builder to use standard doors and windows, which saves money, time and labor. The flat trapezoids are ideal for second floor windows, dormers or for attached solar panels.

For more information, contact: *Gene Hopster, Hexadome of America, P.O. Box 2351, Dept. ASE, La Mesa, CA 92041.*

## ELECTRICITY FROM SUNLIGHT

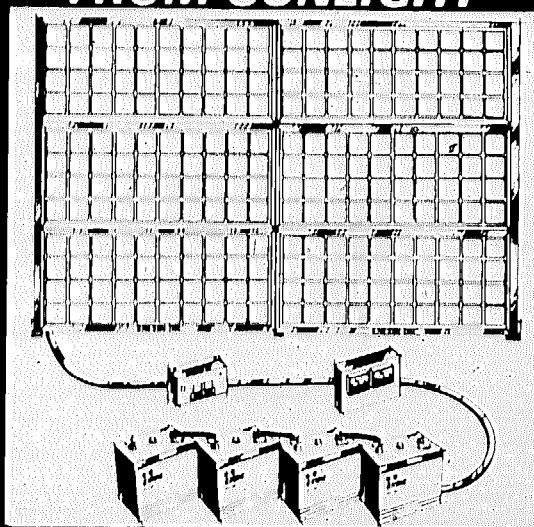

**We Make Photovoltaic Systems,  
Components, Hardware & Accessories  
A REALITY TODAY**

Send \$3.50 for Catalog to Dept. ASE.  
**ENCON PHOTOVOLTAICS**  
*Authorized Distributors of Solarex Photovoltaics*  
27584 Schoolcraft  
Livonia, MI 48150  
(313) 261-4130

# BIOMASS

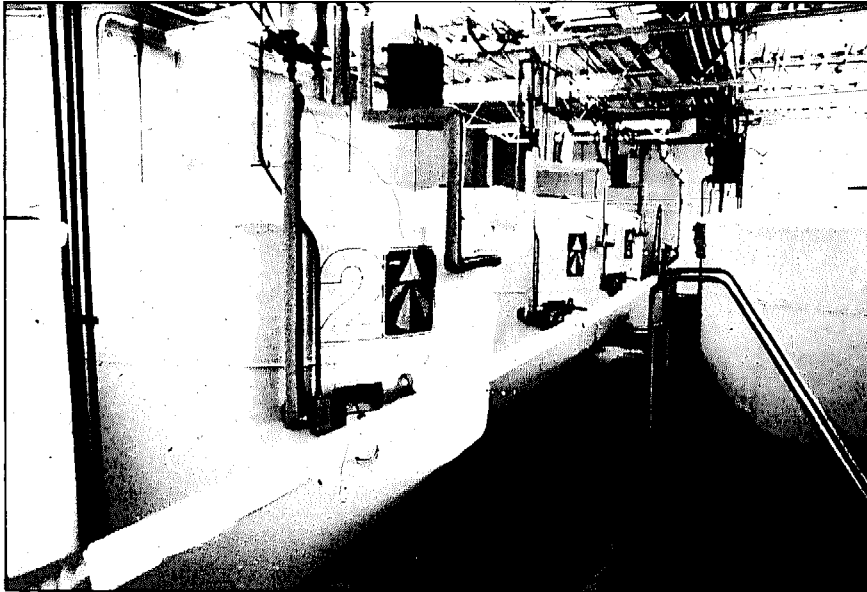

The Harvest Fuel 451™ is a 41,000 gallon capacity fuel alcohol plant designed by the Conklin Company for on farm use. It yields 2.3 gallons of 190 proof alcohol per bushel and produces 1,200 lbs. of high-protein distillers grains using 50 bushels of feedstocks daily. The on-farm system features six stainless-steel fermentation tanks (pictured above), distillation column, boiler, solids separator, plus plant training and site inspection.

## Converting Manure to Alcohol

Waste-a-hol, Inc., a corporation chartered in Tennessee, has announced the development of a process to make ethyl alcohol out of manure. According to the inventors, the process is less expensive and requires less capital and labor than present methods of obtaining ethyl alcohol.

A commercial prototype, built on the farm of one of the inventors, is reported to be producing 10 gallons of alcohol an hour. Besides ethyl alcohol (ethanol), the process also produces two other alcohols in lesser quantities, butanol and methanol. The residue left from the process contains many of the fertilizing nutrients of manure and,

since the pathogenic parts of the manure are removed, it could be sold as a soil conditioner or fertilizer. As an alternative, the manure residue could be used to produce methane gas to power the distillation unit or provide fuel for general farm use.

Inventors Roy Patterson and David Morgan state that the process has been tested on numerous animal manures and thus far has worked on all of them. Preliminary tests indicate that a 1,000 lb. cow will produce enough manure daily to make anywhere from 1.8 to 2.2 gallons of alcohol, and it appears theoretically possible to obtain 4.4 gallons daily.

The development is a fermentation process using the *Saccharomyces cerevisiae* and *Saccharomyces ellipsoideus* strains of yeast. These are the same yeasts commonly used to produce ethyl alcohol. The exact mechanism by which alcohol is produced is not known. It is theorized that the cellulose decomposing bacteria break down undigested cellulose to simple sugars, which the yeast converts to alcohol. Although the process is a very simple one, the best results are ob-

tained when pH, solids content and yeast concentration are maintained at recommended levels. Under favorable conditions, commercially feasible quantities of alcohol are obtained in three days. For more information, contact: *Waste-a-hol, Inc., Bay 16A, Dept. ASE, 153 Warehouse Mart, Chattanooga, TN 37421.*

## Conklin Company Branches Out

The Conklin Company, which manufactures and markets roofing and coating products, cleaner, agricultural and energy related products is now offering the "Harvest Fuel 451™." The Harvest Fuel 451 is a 41,000 gallon capacity fuel alcohol plant designed for on farm use. It yields 2.3 gallons of 190 proof alcohol per bushel and produces 1,200 lbs. of high-protein distillers grains (60% moisture) using 50 bushels of feedstocks (corn, wheat, milo, or wheat-barley) daily. The on-farm system features six stainless-steel fermentation tanks, distillation column, boiler, solids separator, plus plant training and site inspection. For more information, contact: *Conklin Company, Dept. ASE, 4660 W. 77th St., Minneapolis, MN 55435.*

## Biogas Bibliography Now Available

A bibliography on biogas, "Biogas from Agriculture and Other Wastes" has been compiled by researcher and writer Gregg Shaddock. This is a comprehensive subject bibliography that will interest people involved with energy production and waste management. It covers four decades' publications on fuel gas production by anaerobic digestion of such materials as livestock wastes, crop residues, food processing wastes, municipal solid waste, and others. The factors involved in anaerobic digester design and operation are covered, as are many digester types.

Copies of this publication are available from the National Technical Information Service, 5285 Port Royal Road, Springfield, VA 22161. Microfiche copies cost \$4.00 and paper copies cost \$24.00. Both have the order number DE82 011534.

## GREENHOUSES-BUILD YOUR OWN

SAVE THOUSANDS! Use our low-cost Factory Direct Double Insulated Glass. 40% TAX CREDIT! QUANTITY DISCOUNTS

20' x 36'	= \$7.95
20' x 64'	= \$13.95

28' x 76'	= \$31.95
34' x 76'	= \$36.95

ACT TODAY! (404) 691-1960  
Southeastern Energy Control, Dept. I  
P.O. Box 44066 Atlanta, GA 30336





The First Report and Directory  
**NETWORKING**

People Connecting with People,  
Linking Ideas and Resources

• Discover the latest in  
technology and cooperation  
books and through  
• Talk with the authors  
• Take an energy course with an  
• Personal and Spiritual growth  
• Community Services

Edited by Jessica Lipnack and Jeffrey Stamps

## book reviews

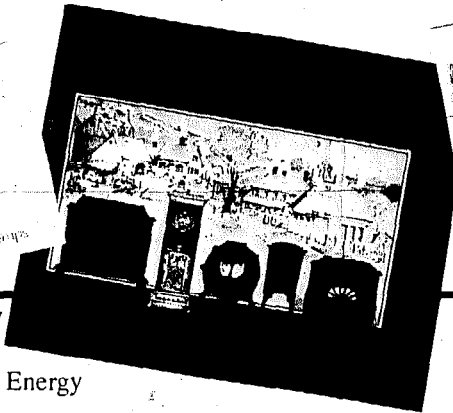

**CORDWOOD  
MASONRY HOUSES:**  
Practical Guide for the Owner-Builder

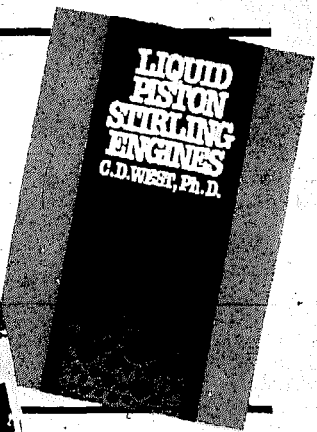

### Appropriate Technology

#### *Tools for the Soft Path*

International Project for Soft Energy Paths

Friends of the Earth Books  
1045 Sansome St., Dept. ASE  
San Francisco, CA 94111  
\$11.95 288 pp.

This highly recommended book is actually a collection of articles which contain a gold mine of useful information supporting a pragmatic, worldwide energy strategy—the soft energy path—for industrial and developing countries. The strategy is based on energy efficiency improvements and appropriate renewable energy technologies. Summaries of soft energy path studies are provided for the United States (the solar and conservation study by the DOE's Solar Energy Research Institute that the Reagan Administration tried to suppress), Great Britain, India, China, Malaysia, and Brazil.

Other subjects that are covered include superinsulated homes, air-to-air heat exchangers, earth sheltering, an Alaskan double-envelope house, solar industrial process heat, the Small Farm Energy Project, alcohol fuels, the food vrs. fuel controversy, organic farming and much more. *Reviewed by reader Dennis Nelson, an energy analyst from Wheaton, IL.*

### *Cordwood Masonry Houses; A Practical Guide for the Owner-Builder*

Robert L. Roy  
Sterling Publishing Co., Inc.  
Two Park Ave., Dept. ASE  
New York, NY 10016  
\$7.95 160 pp.

Roy takes the reader on a tour of cordwood houses, with a new selection of color photos. The homes are beautiful, energy efficient (both in use and in terms of material selection), and extremely affordable... if you have the time and inclination. Roy also presents

much practical information on the art of cordwood construction, both from himself and the many cordwood builders he has made it his business to meet over the course of the last several years. If you are interested in cordwood, this is the only place to start. Roy offers many additional resources in this book and during the building season he even offers seminars on construction. His new address is; Earthwood, RRI, Box 105, Dept. ASE, West Chazy, NY 12992.

### *The Book Of Heat: A Four Season Guide to Wood and Coal Heating*

Staff of Vermont Castings, Inc.  
William Busha, Stephen Morris, editors  
Stephen Green Press  
Fessenden Road at Indian Flat  
Brattleboro VT 05301

\$10.95 181 pages

An interesting approach for a wood heat book—splitting the sections into seasons. Woodburners around the country know that the work of heating with wood starts well before November 1st, and never really ends. The staff of Vermont Castings, drawing from their own experience and that of their customers has produced a thorough and often humorous account that might have been titled "A Year in the Life of a Woodburner."

### *Networking: The First Report and Directory*

Jessica Lipnack and Jeffrey Stamps  
Doubleday & Co.  
245 Park Ave.  
New York NY 10167  
\$15.95 416 pages

Of main interest to ASE readers will be the fact that this publication is a directory to over 1,500 "key social change networks." Networks, like "appropriate technology" and "soft energy paths", is one of those terms that ev-

eryone seems to have a different definition for. Be that as it may, this book purports to "not only examine what a network is, why it works, and how to use it; but also to provide the most reliable, up to date research findings about the new age in which we live." I don't know about that first part, but after reading some large chunks of this book, I would agree with the second part. If you're looking for information on an organization that is part of the "new age" (ASE is in there, so you're all part of it), this is the one stop place to find it.

### Solar

#### *Handbook of Conservation and Solar Energy: Trends and Perspectives*

V. Daniel Hunt  
Van Nostrand Reinhold Co., Inc.  
135 West 50th St.  
New York, NY 10020  
\$39.50 464 pp.

This new title from V. Daniel Hunt zeroes in on practical and economical methods of solving the problems we will have to face in our energy future. He presents an overview of the major thrusts and strategies of current conservation and solar energy programs and discusses the key roles played by government and the private sector. He also details the gamut of new and recently developed technologies that are involved in conservation and the use of alternate energy sources. The Handbook, among other things, is a well rounded primer on solar energy.

#### *Solar Remodeling: Passive Heating and Cooling*

Lane Publishing Co., (Sunset Books)  
Dept. ASE  
Menlo Park, CA 94025  
\$4.95 100 pp.

This book is a winner! As high in qual-



# MAKE MONEY New/Old Industry

2 EASY TO READ  
FUN TO DO BOOKS

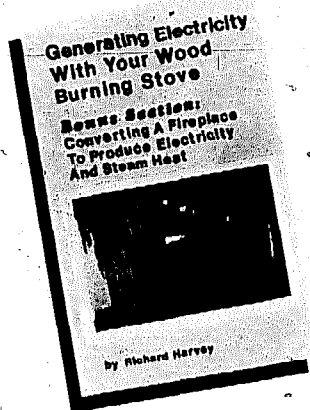

Price \$6.50

### Contents:

83 illus.

- Adding a high pressure steam coil to your stove.
- Safety and operating controls.
- Converting an air compressor to a steam engine.
- Alternators, generators and deep cycling battery banks.
- Firing with wood and coal.

### Bonus Section:

- The fireplace that used to be inefficient
- Low pressure steam for circulating heat
- High pressure steam to run a steam engine and generator
- Storing heat and electricity.

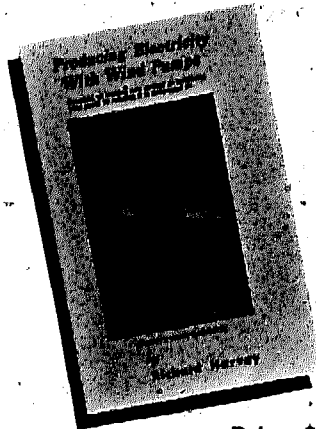

Price \$5.50

### Contents:

49 illus.

- All kinds of wind turbines and how they work.
- Home heating with wind power.
- Producing electricity with your own backyard built wind machine.

Both books for \$10.00. All orders mailed in one day—postage paid

Write — Harvey's, 1407 28th Ave.,  
Greeley, Colorado 80631

ity as it is low in price! The writing is beautifully smooth and clear. The selection of topics and the specific advice given reflects much wisdom, perhaps because of the large number of experts consulted—20! Starting methodically with discussions of goals and strategies, including the famous strategy "insulate, then insolate", the authors then present brief but crystal clear accounts of the main passive-remodeling and retrofit methods, including direct gain systems, solar sunspaces, Trombe walls, drum walls, window boxes, TAPs, and also the principal DHW passive systems and summertime passive cooling methods. All main points are illustrated by small but superb two color drawings. This is followed by a dazzling tour-de-force; 45 pages of color photographs of passive solar remodelings of houses in all parts of the U.S. These are big, clear photographs, accompanied by explanatory text and cross-section diagrams, exemplifying the varied solutions found by leading solar designers. The book concludes with several "how-to" sections, a good bibliography, a glossary and a fine index. All this for a mere \$4.95! *Reviewed by reader William Shurcliff, a solar advocate and author from Cambridge, MA*

### *The Solar Energy Directory*

Sandra Oddo & Martin McPhillips (ed.)

Grey House Publishing, Inc.  
360 Park Ave., South  
Dept. ASE

New York, NY 10010

\$50.00 350 pp.

This title is due to hit the book stores this March. We haven't seen a copy yet, but understand that Dick Munson of the Solar Lobby has called it the "Who's Who of the solar energy movement and industry." According to Grey House, the Directory will be a comprehensive and up-to-date guide to the rapidly expanding field of solar energy. Included will be professional, private, regional and government organizations, manufacturers and utilities, educational, training and research institutions, and sources of information pertaining to the solar energy field.

### *Thermal Applications of Solar Energy: A Professional Guide*

K.W. Heinemann  
Garland STPM Press  
136 Madison Ave., Dept. ASE  
New York, NY 10016  
\$32.50 280 pp.

In this book, one finds excellent professional level coverage of active, water-type solar heating systems. Most of the major aspects of collection, storage, distribution, and performance calculations are covered. The writing is first class and the editing is near perfect. Eleven valuable appendixes are included. On the negative side, most of the references cited are dated 1978 or before; few recent developments are described. The large and exciting subject of passive solar heating is scarcely mentioned. *(reviewed by William Shurcliff)*

### *Super Insulated Houses: a Builder's Perspective*

Bruce Sklare  
Bay Development Corp.  
7858 Bay Shore Drive, Dept. ASE  
Indianapolis, IN 46240  
\$12.00 90 pp.

This book is designed to tell the layman what a superinsulated house is, how well it performs, and how little it costs. Emphasis is on a 2400 sq. ft. "luxury" superinsulated house in Indianapolis which the author designed. Large photographs and clear drawings give the reader a close-up view of double stud walls, vapor barriers, etc. Too small and simple to interest experts, this attractive and well written book is just right for explaining to John Q. Public why superinsulation is creating so much excitement among architects, builders, and home owners. *(reviewed by William Shurcliff)*

### *Stirling Engines*

#### *Liquid Piston Stirling Engines*

C.D. West  
Van Nostrand Reinhold Co., Inc.  
135 West 50th St.  
New York, NY 10020  
\$18.95 144 pp.

Judging from the response that Bill Martini received on his Stirling Engines article (ASE #57), there is a lot of interest on the part of ASE readers on the topic. There is however, not that much data available. Here is a new title which provides a complete description of the liquid-piston Stirling engine, how it works, how to design one, how to build one and the theory of operation. The versatility of the engine is emphasized, and possible applications are discussed.

*Liquid Piston Stirling Engines* should be of special interest to high school and college laboratories, science fair participants and alternative energy enthusiasts.

# spectrum

Spectrum provides access to information, tools, and hardware that contribute to individual and community energy self-sufficiency. Send correspondence to Spectrum Editor, ASE Magazine, Milaca MN 56353.

## Conservation

Correct Phase Electronics, Inc.  
1340 Hill Street, Dept. ASE  
El Cajon, CA 92020

Correct Phase Electronics, Inc. (CPE) now manufactures the *NO-WATT* energy saver. The compact electrical unit which sells for \$14.95 plus \$1.50 postage and handling, snaps onto the end of either four foot or eight foot fluorescent lights. *NO WATT* limits the current going through the light, so that the fixture uses 30% less power. The design provides capacitive/reactive elements in series with the ballast and discharge tube to limit current flow and reduce wattage dissipation, while maintaining a high power factor. There is no reduction in lumen efficiency, according to CPE, whose five year warranty states that if the user does not realize a 30% electrical savings, the entire purchase price, including all postage and handling charges, will be refunded in full.



CAE, Inc.  
P.O. Box 430, Dept. ASE  
10087 Industrial Drive  
Hamburg, MI 48139

*Littlites* by CAE, Inc., are now available for illumination of control panels and work spaces in dimly lit areas. These slim gooseneck lamps are available in black finish in 6, 12, and 18 inch lengths. *Littlites* feature a built in dimmer and a quartz halogen bulb which produces a crisp, white light.

An extruded aluminum hood dissipates heat. *Littlites* use a 12 volt power supply.

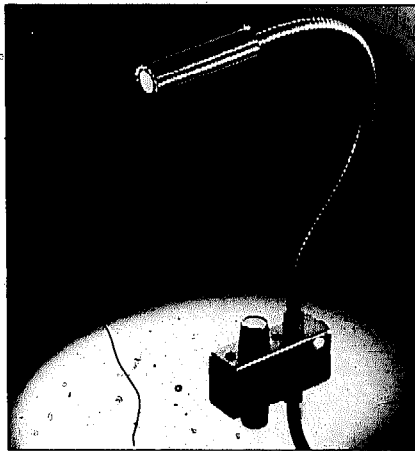

Star Technology Corp.  
417 Main St.  
P.O. Box 7, Dept. ASE  
Carbondale, CO 81623

*The Window Plug™* kit comes complete with panel edge trim with compression edge seal, spray adhesive for laminating fabric or graphic to the foam board, a window decorating idea guide, and detailed easy to follow instructions. No special tools are needed and the R value will be about 6.25. Star Technology suggests taking a picture of the view out the window and then sending it to one of those photo houses which specialize in big blow ups. The finished enlarged photo is then glued to the Window Plug with the spray adhesive. That way you never lose your view out the window, even when it's plugged.



Anderson Pulley Seals, Inc.  
920 West 53rd Street  
Dept. ASE  
Minneapolis, MN 55419

According to *Anderson Pulley Seals*, a recent Princeton University study revealed that double hung windows have an energy robbing flaw—pulley holes for sash weight rope. Thirty five percent of air lost through each window escapes through pulley holes. *Anderson Pulley seals*, in white or brown, with closed cell adhesive gaskets and screws, permanently seal these air leaks. The *Pulley Seals* sell for \$1.50 a pair.

## Solar

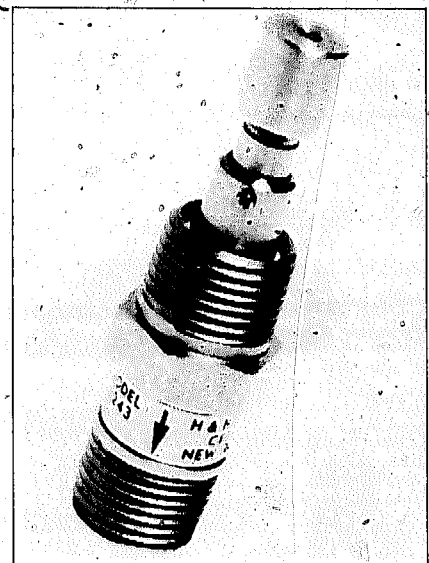

H&H Precision Products  
25 Canfield Road, Dept. ASE  
Cedar Grove, NJ 07009

H&H's newest product is the *Thermally Operated Two Way Valve*. This valve is designed to commence opening at a specific temperature and will continue to open as the temperature drops lower. When the temperature again rises, the valve will close itself. It does not require manual resetting. The valve is available with half inch NPT threads on both ends and can be



The National Center For Appropriate Technology

PRESENTS

# NEW PLANS FOR LOW COST SUPERINSULATED HOUSES

HEAT YOUR NEW HOME FOR UNDER \$100 A YEAR!

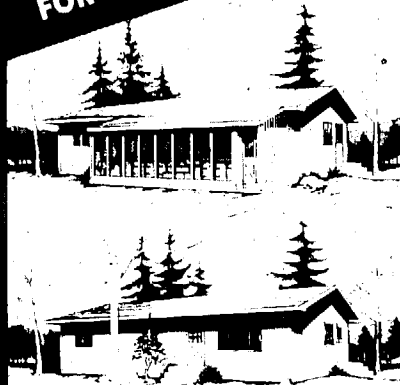

THESE PLANS ARE SUPER-DETAILED FOR THE OWNER/BUILDER OR CONTRACTOR BUILDING SUPERINSULATED HOMES FOR THE FIRST TIME. THE PLANS INCLUDE UNIQUE STEP-BY-STEP CONSTRUCTION SEQUENCE AND EVEN AN UP-TO-DATE RESOURCE LIST.

## \*\*\*\*\* DESIGN FEATURES:

- R-40 DOUBLE STUD WALLS,
- R-50 CEILINGS
- AIR-TIGHT VAPOR BARRIERS
- INTEGRATED AIR-TO-AIR HEAT EXCHANGER SYSTEM
- OPTIONAL SUNSPACE
- TWO BEDROOM/ONE BATH VERSION WITH CRAWL SPACE (MODULAR VERSION ALSO AVAILABLE)
- THREE BEDROOM/TWO BATH VERSION WITH FULL BASEMENT

For FREE brochure with detailed information on the plans, and a FREE NCAT publications catalog, simply write:

NCAT, Dept. ASE  
P.O. Box 3838  
Butte, MT 59702

factory preset to temperatures within the range of 40 to 90 degrees F. This particular valve can be used to drain a solar panel array when the outdoor temperature reaches a given preset temperature. It allows the array to drain until such time as it senses warmer fluid available. In this type of application, it should be isolated from the lowest point of the array and at the point that would most probably reach the coolest temperature.

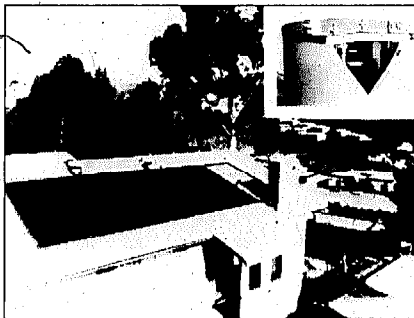

Sealed Air Corporation  
3433 Arden Rd., Dept. ASE  
Hayward, CA 94545

The "Sealed Air System 150" uses patented collectors with absorbers made of a special plastic, guaranteed for five years. The heated water is kept in a large container (150 gallons). The Sealed Air method uses the 150 gallons as a basic heat storing source, and is then plumbed to your existing hot water system, which the manufacturer claims will rarely be "on", due to the extra large storage tank with R-14 insulation.



### Solar

Enerspan, Inc.  
14168 Poway Rd., Dept. ASE  
Poway, CA 92064

Enerspan has recently introduced their SunCharger™ digital solar module. The solar modules include pump, controls, flow meter, heat traps, isolation valves, and drain valves in compact modules that simply bolt on any standard top fitted solar tank. Modules are available for both mild and hard freeze climates, and can be installed by the novice in just minutes, according to Enerspan. The module carries a five year limited warranty.



Research Products Corporation  
PO Box 1467, Dept. ASE  
Madison, WI 53701

The Suncell System is a completely equipped air-to-air solar heating system consisting of pre-assembled solar collectors, mounting accessories, an air handling unit, and the necessary controls. In addition, a heat storage area, ducts, manifolds, and auxiliary heating are required. The collector incorporates the use of doublepaned, tempered, insulated glass to allow high solar penetration. The glass is double-sealed and is totally enclosed in a rugged, weather-resistant, custom-molded rubber gasket that seals the glass into the frame. The absorber is constructed of six layers of slit and expanded aluminum, painted with special coating and fabricated with over 100,000 baffles in each cell. This unusual baffle arrangement causes turbulence as the air flows through the collector and provides three times the heat transfer area of a single plate absorber, according to the manufacturer.

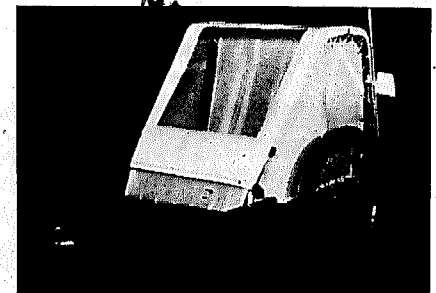

### Transportation

Burley Design Cooperative  
78300 Pacific Highway South, Dept. ASE  
Cottage Grove, OR 97424

The Burley Lite Bicycle Trailer is designed for those seeking a fun, healthful and inexpensive alternative to the automobile. Weighing in at 18 pounds, the trailer is well suited for round town errands, transporting children or groceries, or for the cycle tourist carrying gear which may not fit into bags or panniers. For a complete catalog of Burley Bicycle Products, send one dollar to the above address.

# reader-to-reader classified ads

To place an ad, send us \$32.50 for the first 25 words, \$1.30 per word thereafter. Words in all CAPS are \$1.45 each. Prepayment is required; name and address must be included in the word count. Zip Code is free. Display ad (1/18 page) in Classified Section: \$55 per issue. Interested in other display advertising? Write us for a rate card.

## Films About Alternatives

**Upbeat** documentaries about AT, WATER CONSERVATION, and RESOURCE RECOVERY. Award-winning films used all over the country. The recovery of energy from trash is the subject of our newest release, ENERGY WHERE YOU LEAST EXPECT IT. Third Eye Films, 12 Arrow St., Cambridge, MA 02138. (617)354-1500.

## Hydro

**PELTON** turbine wheels, 5" diameter, high strength urethane \$40 each (state shaft hole size required), includes information booklet (\$3.00 separately). PowerHouse Paul's Peltons, Box 1557/Station A, Sussex N.B. Canada E0E 1P0.

## Photovoltaics

Everything you need to build a complete solar-electric panel. 30 watts (plus or minus), \$229.00 delivered. Independent Power Co. 12340 Tyler

Foot Rd., Nevada City, CA 95959. (916)292-3754.

"**Passive Trackers** increase efficiency of photovoltaic arrays while using no motors which rob power from the system. Write Zomeworks, P.O. Box 25805-AS, Albuquerque, NM 87125 (505)242-3552."

**PHOTOVOLTAICS** — 35 watt ARCO panels \$375 ea. includes UPS delivery. Dealer prices on request. Informative catalog \$1.00; Solar Electric Systems, Box 1562, Cave Creek, AZ 85331.

## Stirling Engines

**STIRLING ENGINES ARE COMING.** Stirling engines are efficient, safe, silent, and can be inexpensive. Information is available to developers who want to build a biomass or solar heated Stirling engine to make electricity or pump water. Send \$2. to Martini Engineering, 2303 Harris, Richland, WA 99352, USA for information on how to get started.

## Solar

**SOLAR ENERGY DIGEST:** Keep updated on latest worldwide solar innovations. We've specialized in reporting them monthly since 1973. \$35.00/yr; overseas, \$43.00; sample copy, \$1.00. SED, P.O. Box 88-AE, Ocotillo, California 92259.

## Wind Power

**For sale:** Enertech 1800 Wind Generator. Asking \$3,000. Tom Peterson, Route 1, Box 362A, Prairie du Chien, Wis. 53821. 608-326-4228.

**Used lead-acid cells for sale.** Various sizes. Ideal for your low voltage power system. 10c per pound. Kilian Harrington, Salvatorians, St. Nazianz, Wisconsin 54232.

**Aero-Power Wind Generator:** SL-1000, 12 VDC, includes voltage regulation and control panel (tower not included). List \$3300, SALE \$1500 FOB Ukiah CA. Call Real Goods Trading Co. (707)468-9214, Jim or Sheila.

**Gemini 8KW Synchronous Inverter**—still in factory container - \$1800 Energy Options, Inc. Box 558 Beverly Shores, IN 46301. (219)879-9463.

Warm up in winter and  
Cool off in summer with a  
**THRU-THE-FLOOR FAN**

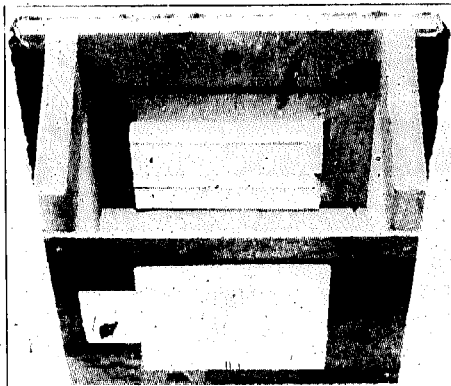

In summer,  
move cool air  
up from your  
basement to  
help cool your  
home.

In winter,  
circulate warm  
air up into  
hard-to-heat  
rooms.

Ideal with wood stove and fireplace heating!

**THRU-THE-WALL kit includes:**

- 6" x 10" open-close register
- 8" x 8" fan mounted inlet register
- Adjustable speed control
- Electrical outlet box
- 5 ft cord with plug

An easy do-it-yourself project!

Model F8-150-38 (150cfm/minute) \$64.50

Model F8-250-12 (250cfm/minute) \$66.50

Shipped prepaid. Write:

**THRU-THE-FLOOR**  
Dale and Associates  
2870 Bartells Drive  
Beloit, WI 53511

The Finest  
PV Panel Made

**SOLAREX  
SOLAR  
ELECTRIC  
PANELS**

Model #4330 EG

2.1 amps @ 16.5 volts

Special  
Offer **\$349**

**SOLAR  
ENGINEERING  
SERVICES**

111 N. Washington St. A

P.O. Box 7122

Olympia, WA 98507

(206) 357-4812

price FOB Olympia, WA • Offer ends 6/83

NOW AVAILABLE  
for  
Owner Installation

**SUNBOX**

**Solar Systems**

- You can install this system which includes fan & thermostat
- Complete Installation Kit includes ducts, dampers & mounting clips
- Installation time: 1 hour

**\$434.00 List + Tax**  
CONTACT:

**Northern Solar Power**  
311 Elm St. South  
Moorhead, Minnesota 56560  
(218)233-2515

# ORDER FORM

## alternative sources of energy\*

### HOW TO ORDER

To order a **SUBSCRIPTION** or our **FREE CATALOGUE** describing Back Issues, Technical Papers and literature currently available from Alternative Sources of Energy, simply indicate your selection below. Send this order form with your name, address and prepayment of your order. Your order will be shipped promptly upon receipt of payment.

My Name \_\_\_\_\_  
 Address \_\_\_\_\_  
 City \_\_\_\_\_ State \_\_\_\_\_ Zip \_\_\_\_\_

Send me a **FREE CATALOGUE OF ALTERNATIVE ENERGY INFORMATION**, describing Back Issues, Technical Papers, books, pamphlets and literature on the following topics: *Solar Energy, Wind Power, Photovoltaics, Biomass, Hydro, Agriculture, and Cooling Techniques.*

### MY SUBSCRIPTION

- new  
 renew  
 **Individual**  
 \$19.50-1 yr/6 issues  
 \$35.00-2 yrs/12 issues  
 **Institution**  
 \$25.00-1 yr/6 issues  
 \$45.00-2 yrs/12 issues  
 **Canada and Mexico** (surface mail only)  
 \$25.00-1 yr/6 issues  
 \$45.00-2 yrs/12 issues  
 **Foreign** (air mail only)  
 \$38.00-1 yr/6 issues  
 \$68.00-2 yrs/12 issues

### SEND A FREE CATALOGUE TO MY FRIENDS TOO!

Name \_\_\_\_\_  
 Address \_\_\_\_\_  
 City \_\_\_\_\_ State \_\_\_\_\_ Zip \_\_\_\_\_

### AND

Name \_\_\_\_\_  
 Address \_\_\_\_\_  
 City \_\_\_\_\_ State \_\_\_\_\_ Zip \_\_\_\_\_

**SUBSCRIPTION TOTAL \$** \_\_\_\_\_  
(U.S. Currency only. Allow 5-6 weeks delivery)

ALTERNATIVE SOURCES OF ENERGY, INC.  
 Milaca, MN 56353 USA

## ADVERTISER'S INDEX AND READER SERVICE

To receive information on any of the products advertised in this issue of **ALTERNATIVE SOURCES OF ENERGY**, simply check the appropriate box below and forward this form, complete with your name and address (*there is no charge for this service*).

- |  |  |
|--|--|
| <input type="checkbox"/> Aerolite/27                         | <input type="checkbox"/> International Solar Products/ 9     |
| <input type="checkbox"/> Alban Engine Power, Inc./ 4         | <input type="checkbox"/> NCAT/ 42                            |
| <input type="checkbox"/> Alternative Energy Engineering/ 11  | <input type="checkbox"/> Nite & Day Wind Systems/ 28         |
| <input type="checkbox"/> Alternative Sources of Energy/ IBC  | <input type="checkbox"/> Northern Solar Power Co./ 43        |
| <input type="checkbox"/> American Solar Energy Society/ 31   | <input type="checkbox"/> Onnidata International/ 34          |
| <input type="checkbox"/> Best Energy Systems/ 33             | <input type="checkbox"/> Perpetual Power/ 28                 |
| <input type="checkbox"/> Communications Associates/ 33       | <input type="checkbox"/> Photocomm, Inc./ 9                  |
| <input type="checkbox"/> Correct Phase Electronics, Inc./ 18 | <input type="checkbox"/> Photowatt International/ IFC        |
| <input type="checkbox"/> Dale and Associates/ 43             | <input type="checkbox"/> Real Goods Trading Co./ 35          |
| <input type="checkbox"/> The Earth Store/ 22                 | <input type="checkbox"/> Rohn/ BC                            |
| <input type="checkbox"/> Energy Alternatives/ 28             | <input type="checkbox"/> Santa Rosa Machined Props, Inc./ 29 |
| <input type="checkbox"/> Energy Designs/ 26                  | <input type="checkbox"/> Solar Electric Systems/ 28          |
| <input type="checkbox"/> Energy Sciences/ 10                 | <input type="checkbox"/> Solar Engineering Services/ 43      |
| <input type="checkbox"/> Energy Sciences, Inc./ 30           | <input type="checkbox"/> Solar Electric Specialties/ 22      |
| <input type="checkbox"/> Encon Corp./ 37                     | <input type="checkbox"/> Solarwest Electric/ 23              |
| <input type="checkbox"/> Harvey's/ 40                        | <input type="checkbox"/> Southeastern Energy Control/ 38     |
| <input type="checkbox"/> Heliolope General/ 36               | <input type="checkbox"/> Western New England Solar/ 16       |
| <input type="checkbox"/> Independent Power Co./ 34           | <input type="checkbox"/> Whirlwind Power Co./ 23             |
|  | <input type="checkbox"/> Windworks/ 5                        |

An Important Reminder  
 To Our Readers . . .

**PATRONIZE OUR  
 ADVERTISERS.**

## calendar

**Solar Technology Conference**  
 March 15-17, 1983; *Four Seasons Motor Inn in Albuquerque, New Mexico*

*Sponsored by Sandia National Laboratories, the Department of Energy and the Solar Energy Research Institute.*

**Contact:** Carlota Klimas, Solar Systems Applications Division 9727, Sandia National Laboratories, Albuquerque, New Mexico 87185. (505)846-0215.

**Critical Mass '83: National Conference for Energy Job Security**  
 March 25-27, 1983, *Howard University, Washington, D.C.*

*Sponsored by Public Citizens' Critical Mass Energy Project*

**Contact:** Public Citizens' Critical Mass Energy Project, 215 Pennsylvania Ave., S.E., Washington, D.C., 20003, (202) 546-4793

**Energy '83; First International Trade Fair and Congress**

April 19-23, 1983, *Hamburg Exhibition and Congress Center*  
*Sponsored by The Hamburg Messe and Congress GmbH, Jungiusstrasse 13, Postfach 30 23 60 2000 Hamburg 36, Federal Republic of Germany.*

**Contact:** Hans J. Rathje/Inter-View Communications, Inc., 545 Madison Ave., New York, N.Y. 10022. (212)758-4651.

**American Solar Energy Society Annual Meeting, Technologies Conference and Solar Products Exposition**  
 June 1-3, 1983 *Minneapolis/St. Paul, Minnesota; Minneapolis Convention Hall*

*Sponsored by American Solar Energy Society.*

**Contact:** ASES, 1230 Grandview Ave., Dept. ASE, Boulder, CO 80302. (303)429-6017.

**5th Annual International Energy Trade Show/Conference**

June 7-9, 1983, *The Ohio Center, Columbus, Ohio*

*Sponsored by Ohio Hardware Association and The National Energy Journal.*

**Contact:** The National Energy Journal, 411 Cedar Road, P.O. Box 15035, Chesapeake, Virginia 23320. (800)446-8303.



Free!

# A CATALOGUE OF SPECIALIZED INFORMATION

from **alternative sources of energy** 

Open the doors to an amazing array of energy information:  
*Our staff is constantly reviewing literature in the field - looking for that "diamond in the rough" - and when we find it, we make it available to our readers.*

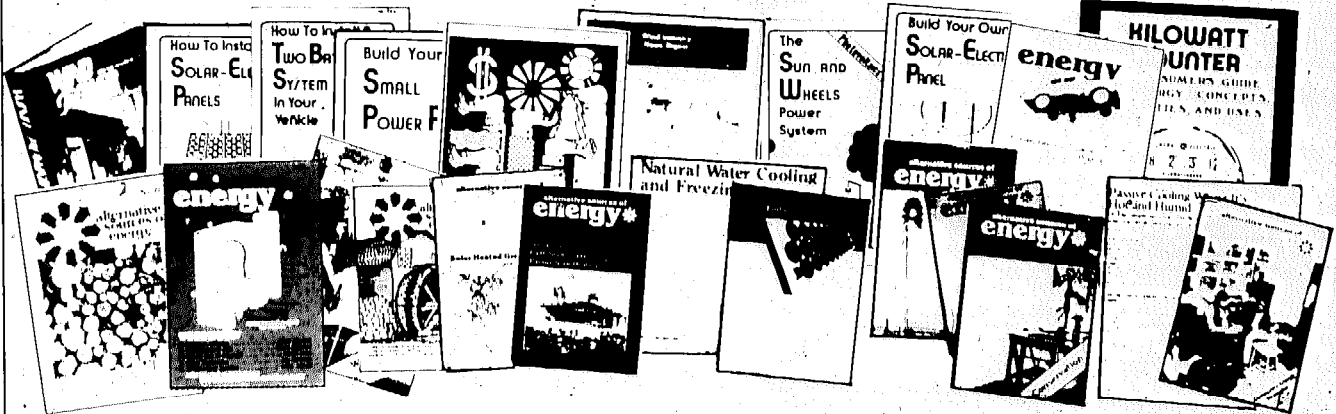

This CATALOGUE contains unique information on every conceivable topic in the field of renewable energy, including:

**ALCOHOL FUELS**  
**AGRICULTURE**  
**BIOMASS**  
**COOLING TECHNIQUES**  
**CONSERVATION METHODS**  
**ELECTRICAL GENERATION**  
**PHOTOVOLTAICS**

**SHELTER DESIGN**  
**SOLAR ENERGY**  
**SOLAR HOT WATER HEATING**  
**TRANSPORTATION**  
**WATER POWER**  
**WIND ENERGY**  
**WOOD/SOLID FUELS**

This information will be invaluable in assisting readers in making energy-related decisions. *It is unique information and generally is unavailable elsewhere. We invite you to look over the selections carefully.*

IF YOU'RE INTERESTED IN ENERGY... if you're a person who is interested in exploring new ideas and innovative solutions to the rising cost of energy...

**YOU NEED THIS  
INFORMATION.**

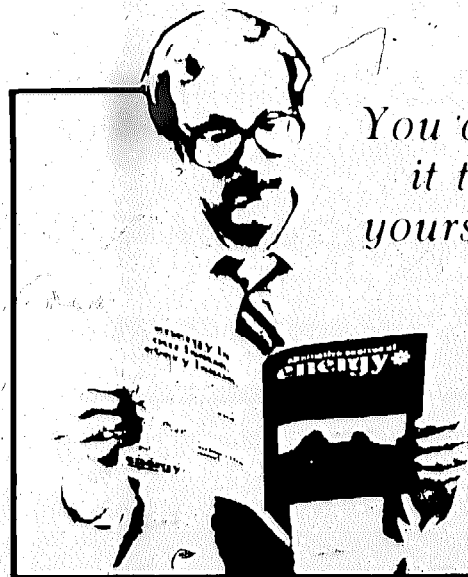

*You owe  
it to  
yourself.*

**TO ORDER YOUR FREE ALTERNATIVE ENERGY INFORMATION  
CATALOGUE, simply complete and send us the Order Form on Page 44.**



# Rohn Towers

**QUALITY WIND POWER SYSTEMS  
DESERVE QUALITY WIND TOWERS.**

ROHN has been designing and manufacturing quality towers for over 30 years. We started 'Hot-Dip' galvanizing our towers in 1954. Today, we employ high technology, Computer Assisted Design engineering and electronic inspection of raw materials to assure that only high quality towers carry the ROHN name.

It must be working. Our customers continue to order ROHN Quality Towers at record setting levels.

For more information on ROHN Quality Towers, contact your ROHN representative, or write:

**Rohn**  
6718 West Plank Road  
P.O. Box 2000  
Peoria, Illinois 61656

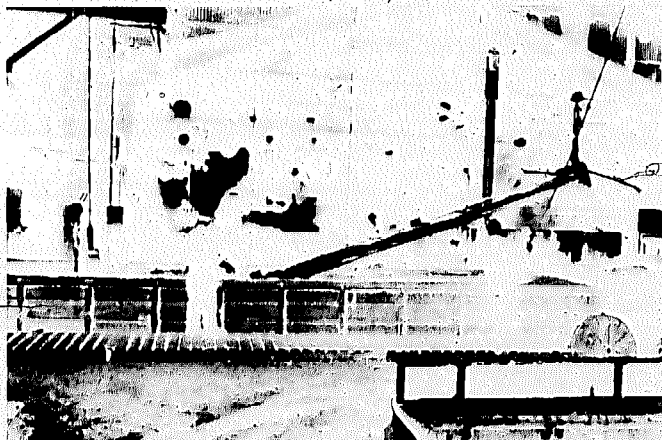

Our in-house 'Hot-Dip' process - as seen here - extends the life and durability of your tower.